

Effects of Various Radiant Sources on Plant Growth (Part 1)

Shinji TAZAWA

Light Source Division, Iwasaki Electric Co., Ltd.
(Gyoda, Saitama, 361-0021 Japan)

---Abstract-----

In Part 1 of this report, we introduced fundamental aspects of the use of artificial light in horticulture, giving an outline of a number of different artificial light sources and discussing recent research trends (such as the use of microwave-powered lamps, light-emitting diode and laser diode devices) in Japan.

Discipline: Agricultural facilities/Crop production/Horticulture

Additional key words: artificial light source, supplemental lighting, plant factory

● [1...32](#)): [References](#)

(Received for publication, December 18, 1998)

---Introduction-----

Most terrestrial plants grow by selective absorption of natural light from the sun. In plant factories and indoor living spaces, artificial light is necessary as a source of light energy. Therefore, it is necessary to develop technologies to control the light environment and provide effective and economical irradiation for plants. Part 1 of this report covers basic issues related to plant growth and light.

---Wavelengths for effective plant growth-----

Solar radiation is subject to extensive scattering and absorption by the atmosphere before it reaches the surface of the earth. Direct solar radiation has wavelengths ranging from 300 to 3,000 nm, and is divided into 3 bands: ultraviolet radiation, visible radiation and infrared radiation. The wavelengths of visible radiation for humans are in the range from 380 to 780 nm, and the peak of the visibility curve (photopic vision) is at 555 nm. Similarly, plants have a range of wavelengths that are physiologically effective. There are 2 types of effective radiation for plants: physiologically active radiation and photosynthetically active radiation (PAR). These 2 types of radiation, ranging from 300 to 800 nm, are physiologically effective in photosynthesis, pigment biosynthesis, photoperiodism, phototropism and photomorphogenesis⁸).

Physiologically active radiation is divided into 5 wavebands: near ultraviolet light (UV) 300-400 nm, blue light (B) 400-500 nm, green light (G) 500-600 nm, red light (R) 600-700 nm, and far-red light (FR) 700-800 nm ([Fig. 1\(20KB\)](#)). Photosynthesis, which uses PAR (waveband 400 to 700 nm), requires an energy source with high intensity. The units of PAR radiation are expressed as total photon fluxes in this waveband, since this radiation induces chemical reactions. The total energy emitted from the light source is designated as photosynthetic photon flux (PPF). On the other hand, the energy actually received by plants is designated as photosynthetic photon flux density (PPFD), and its S. I. units are expressed as $\frac{1}{4}\text{mole}\cdot\text{m}^{-2}\cdot\text{sec}^{-1}$. Although quantum sensors are preferable for measuring the photon flux, because of their high cost, radiation is often measured by PPFD with conversion factors for illuminance.

---Light intensity suitable for photosynthesis-----

Light intensity suitable for photosynthesis depends on the light adaptation and acclimation properties of the plants, which in turn depend on the environment of their place of origin. The effect of the light intensity can be estimated to some extent by changes in morphology. Generally, plants which grow in the shade or at low light intensities (shade plants) have large, and thin leaves. Inside their leaves, parenchymatous cells do not adequately develop, resulting in an increase of the development of the grana structure and of the chlorophyll content in chloroplasts. The same morphological changes also occur with exposure to red light. On the other hand, plants which grow at high light intensities (sun plants) have thick leaves. Inside their leaves, parenchymatous cells are remarkably developed, resulting in a lower development of the grana structure. However, many enzymes important for photosynthesis can be observed. The same morphological changes occur with exposure to blue light. These differences in the morphology can also be observed in a single plant. Leaves that grow at low light intensities are referred to as shade leaves, and leaves that grow at high light intensities are referred to as sun leaves. Accordingly, leaves in the upper and lower parts of trees have different photosynthetic capabilities⁹⁾. Morphological adaptation through changes of the light environment is related to the speed of photosynthesis. Plants growing at high light intensities (for example, watermelons, tomatoes, cucumbers, melons and C₄ plants) have high saturation points, and they show a maximum photosynthetic rate at the light saturation point. Therefore, a large amount of light energy is required to cultivate plants that grow better at high light intensities. [Fig.2\(21KB\)](#) was obtained by measuring the absorption and release of carbon dioxide during photosynthesis, and indicates the light adaption capability for photosynthesis. When the light intensity is low, the amount of carbon dioxide released by plant respiration is higher than the amount of that absorbed for photosynthesis, resulting in a net release of carbon dioxide. As the light intensity increases, absorbed and released amounts of carbon dioxide change and reach an equilibrium at point A where a net release of carbon dioxide is no longer observed. This point is referred to as the compensation point. If the light intensity increases further, the amount absorbed reaches point B. This point is the saturation point. A suitable light intensity can be determined somewhere between these points A and B according to the particular requirements. On the other hand, since plants that grow under a low light energy (for example, lettuce, *Cryptotaenia japonica*, herbage crops, and most of the indoor ornamental plants) have low saturation and compensation points, it is relatively easy to cultivate them, to provide them with supplemental lighting and to maintain growth with artificial lighting. [Table 1\(77KB\)](#) shows the saturation and compensation points of major crops, and [Table 2\(109KB\)](#) shows the saturation and compensation points of ornamental plants. Indoor ornamental plants, most of which are derived from jungle undergrowth, can maintain growth at a relatively low light intensity.

In cultivation facilities for plants utilized for salad, and lettuce in closed-system type plant factories in Japan, a light intensity of about 300 to 400 $\frac{1}{4}\text{molem}^{-2}\text{esec}^{-1}$ is used. Factories where a higher light intensity is needed are hybrid type plant factories where supplemental lighting of 100 to 150 $\frac{1}{4}\text{molem}^{-2}\text{esec}^{-1}$ is provided. For indoor ornamental plants, supplemental lighting of 10 to 50 $\frac{1}{4}\text{molem}^{-2}\text{esec}^{-1}$, depending on the variety, has been gradually employed.

---Photosynthesis action spectrum-----

The efficiency of plant photosynthesis is not the same throughout the 400 to 700 nm waveband. Just as human eyes have visual curves, plants have sensitivity curves over a wide range. Plants select effective wavelengths from white light and utilize them. [Fig. 3\(21KB\)](#) shows the photosynthesis action spectra described by Inada(1976)⁷⁾. Curve 1 shows the average values for 26 species of herbaceous plants, and curve 2 shows the average values for arboreous plants. [Fig. 4\(21KB\)](#) shows the photosynthesis action spectra described by McCree(1972)¹⁴⁾. Curve 1 shows the average values for 20 species of plants in chambers, and curve 2 shows the average values for 8 species of plants in fields. The sample plants used are listed in [Table 3](#). Each of these 4 photosynthesis action spectra has a large peak composed of 2 peaks at about 675 and 625 nm in the red light region, and a small peak between 440 and 450 nm. All 4 photosynthesis action spectra show that red light has a strong action and blue light a weak action. [Fig. 5\(18KB\)](#) shows the average values for the 4 photosynthesis action spectra, and is used to evaluate light sources for plant growth.

Table 3. Plant materials used for the determination of photosynthesis action spectra

Plants Species

Inada 1. (26 species of herbaceous plants, 1976)	rice, maize, wheat, barley, oat, soybean, peanut, kidney, bean, pea, cabbage, turnip, radish, tomato, eggplant, cucumber, squash, lettuce, garland, chrysanthemum, spinach, onion, sugar beet, sweet potato, perilla, buckwheat, strawberry
India 2. (7 species of arboreous plants, 1976)	peach, Japanese pear, grape, satsuma mandarin, tea, Japanese black pine, ginkgo
McCree 1. (20 species tested in chamber, 1972)	Maize, sorghum, wheat, oat, barley, secalotricum, sunflower, soybean, tampala, peanut, lettuce, tomato, radish, cabbage, cucumber, oriental melon, squash, clover, sugar beet, castor-oil plant
McCree 2. (8 species tested in field, 1972)	Maize, wheat, oat, secalotricum, rice, sunflower, squash, cotton

----Photomorphogenesis-----

Light acts on plant morphogenesis, including germination, flowering, stem growth, and leaf opening. Light is also a source of stimuli or information in different ways depending on the plant species and the stage of growth. In general, light with blue, red, and far-red components acts on plants. [Table 4\(57KB\)](#) shows the action of each range of wavelengths³¹).

Among these actions, the red and far-red reversible reaction of phytochrome (a photoreceptor involved in seed germination) is particularly well known. In the reaction, the promotive effect of germination by red light(660 nm) irradiation is cancelled out by far-red light(730 nm) irradiation. That is, the effect of the previously irradiated light appears when red and far-red light is irradiated alternately. High intensity blue light and low intensity red light induce strong control of internodal growth. It is well known that with combined irradiation, far-red light is necessary, and that the ratio of red to far-red light controls internodal growth^{12,15,17}). In addition, blue or high energy light promotes the growth of sun leaves, and red or low energy light promotes the growth of shade leaves. Daylength controls flowerbud formation (photoperiod). Plants are generally divided by daylength into 3 groups in which flowerbud formation is differentiated by specific daytime length: short-day plants, long-day plants, and intermediate-day plants. In flowerbud formation, light acts as a stimulus, with red light, far-red light or blue light being particularly effective, depending on the plant species. Besides photomorphogenesis, blue light with a wavelength of 500 nm or less acts phototropically, and blue light also acts on stomatal movement.

---Artificial light sources for plant growth-----

The artificial light sources shown in [Fig. 6\(40KB\)](#) can be divided into 2 systems: thermal radiation and luminescence. Among these light sources, 6 light sources which are actually used for plant growth are incandescent lamps, high pressure mercury fluorescent lamps, self-ballasted mercury lamps, metal halide lamps, high pressure sodium lamps and fluorescent lamps. Also, xenon lamps and low pressure sodium lamps are used for research. [Fig.7\(56KB\)](#) shows the energy spectrum of each lamp, and [Table 5\(73KB\)](#) shows the radiant energy balance and reduced values of PPF per 1,000 lx in the 400 to 700 nm waveband.

1) Incandescent lamps (IL)

Incandescent lamps radiate visible light by thermal radiation generated from tungsten filaments heated to a high temperature by an electric current. The energy distribution is continuous, but the intensity of red light is higher than that of blue light, which possibly leads to intercalary plant growth. Therefore, these lamps are not suitable for photosynthesis. Furthermore, since they have a low light conversion efficiency of around 10 lm/W, as well as high thermal radiation, they are not used for the cultivation of plants. These lamps are used mainly to control photomorphogenesis, and for example, in some factories they are used to control

the flowering of chrysanthemums under low light intensities, to prevent dormancy of strawberries and to promote germination.

2) *Fluorescent lamps (FL)*

Fluorescent lamps are low-pressure mercury vapor discharge lamps with a hot cathode. Ultraviolet light generated by the discharge is transduced to visible light by phosphor coating on the inside of a glass tube. These lamps easily provide the required radiant energy by use of an appropriately selected phosphor, but cannot provide sufficiently high energy light on their own for cultivation. These lamps are often used to grow seedlings in plant factories. Fluorescent lamps for plants are used not only as supplemental lighting for ornamental plants in flower shops but also for tissue culture, especially for plant growth. In addition, a plant factory system has recently been developed, in which an average value of $650 \frac{1}{4} \text{mole m}^{-2} \text{e sec}^{-1}$ can be achieved by employing a total lamp system where a 110 W 3-band fluorescent lamp irradiates cultivated plants at a distance of 30 cm (6). Furthermore, the compact fluorescent lamp has become popular, and is able to provide local supplemental lighting to indoor ornamental plants by recessed lights.

3) *High pressure mercury fluorescent lamps (HPMVL, phosphor-coated type)*

HPMVLs are based on the principle that the luminous efficiency of sources is enhanced when the vapor pressure of mercury is increased. These lamps are the most stable lamps, and have been used for many years to grow plants. They provide light composed mainly of the radiation line spectrum of mercury, that is, the light lacks the red light component. These lamps therefore enable to control plant growth. To compensate for the lack of red light, a phosphor lamp which provides red light was developed. The efficiency of this lamp is around 60 lm/W. It has been used for many years in foreign countries to provide supplemental lighting and lengthening of daytime. Two types of lamps are available: a clear bulb type and a phosphor-coated type. The phosphor-coated type is a type of fluorescent lamp. The phosphor-coated type is further classified into 2 types: the X type for general use, and the XW type, which compensates for the missing red light component. The range of this lamp is from 50 to 2,000 W. Regarding the outer bulb shape of this lamp, a BT type and an R type are available.

4) *Self-ballasted mercury lamps (SBML)*

In SBMLs, the arc tube is connected in series to the tungsten filament as a ballast. These lamps compensate for the red light component, which high pressure mercury vapor lamps lack. They provide a good spectral distribution, but since the efficiency is as low as 20 to 27 lm/W, they are used as supplemental lighting for ornamental plants. For plants, lamps where the input ratio of the arc tube of mercury lamps to that of the tungsten filament is adjusted are also available. Two types of outer bulbs are available: a clear bulb type and a fluorescent type. A BT type and an R type for the outer bulb form of this lamp are available. The lamps can be selected in the range from 100 to 750 W.

5) *Metal halide lamps (MHL)*

The structure of metal halide lamps is based on that of mercury lamps, but they contain various halide additives. There is a wide selection available, including lamps mainly with line spectra and lamps mainly with continuous spectra. The efficiency of MHLs is around 100 lm/W, and they provide light with a reduced red light component above 600 nm. Therefore they are used in plant factories in combination with high pressure sodium lamps. MHLs on their own are used for supplemental lighting in greenhouses, and high color rendition type MHLs which provide light with a spectrum distribution similar to that of natural daylight are used in hybrid type plants factories and growth chambers. Recently, high color rendering index types (70 to 150 W) have gradually been used for supplemental lighting and display lighting for indoor ornamental plants (20). Murakami et al. (18) carried out research on high color rendering MHLs containing Dy, Nd, Cs, In, Tl, and Na for use in horticulture. Two types of these lamps are available: a high efficiency lamp with a built-in starter and a high color rendition type. BT, T and R types (only for high color rendition lamps) for outer bulb shapes are available. The lamps can be selected in the range from 70 W and 2,000 W. Typical additives are as follows: indium (blue light), thallium (green light), sodium (yellow light), and lithium (red light).

6) *High pressure sodium lamps (HPSL)*

HPSLs use alumina ceramic for the arc tube, and in the arc tube, sodium and mercury from an amalgam acting as a buffer gas are enclosed. Neon-argon penning gas is also sealed in the arc tube to help starting. The efficiency of some of these lamps exceeds 150 lm/W. Since they have a large red light component which can cause intercalary growth, they are used with metal halide lamps which provide compensating blue light. These lamps are used on their own to cultivate herbage crops with green leaves. These lamps are used solely in hybrid type plants factories. Three types are available: a high efficiency type with a built-in starter, an improved color type with a built-in starter, and a high color rendition type. BT type, T type and R type for outer bulb shapes are available. The lamps can be selected in the range from 50 to 940 W. A lamp in which the lack of blue light component is compensated by the addition of sealed mercury has recently

been developed for plants. Inagaki et al.¹⁰⁾ developed a high pressure sodium lamp with an output of 1.2 kW and an efficiency of 180 lm/W. Xenon, an inert gas for starter assistance, was sealed in the double-end type lamp at nearly three times the normal pressure.

7) Research trends

(a) Electrodeless discharge lamps(Microwave-powered lamps)

There are several designs of electrodeless discharge lamps depending on the method of illumination, with the microwave-powered lamp being the most promising future development for use in horticulture. Until now, microwave-powered lamps have solely been used for ultraviolet curing in photoengraving processes. Research is currently being conducted on the application of high intensities(130 lm/W , $1,000 \frac{1}{4} \text{ mol} \cdot \text{m}^{-2} \cdot \text{sec}^{-1}$) which could be achieved by the variation of the sealed gas¹³⁾. The next challenge facing microwave-powered lamps would concern the production cost and the life-span of magnetrons. [Fig. 8\(31KB\)](#) shows the structure of a microwave-powered lamp and emission spectrum.

(b) Light-emitting diode devices(LED)

LEDs are light-emitting semiconductors with uses ranging from simple indicator lamps to more complicated bar and numeric displays, where the development of the blue LED leads to the practical use of full color displays. The LED is a remarkable evolving technical invention. When current flows through the p-n junction of compound semiconductors consisting of GaP(gallium phosphide) or GaAsP(gallium arsenide phosphide), light is emitted as a result of electrons recombining with holes near the p-n junction. The characteristics of LEDs are as follows: low voltage operation, low heat emission, a compact and lightweight design, lack of noise(electron discharge tubes produce noise) and easy control. Horticultural applications are being considered for plant cultivation in space³²⁾. In this application, an irradiation source(surface) consisting of a bundle of LED devices irradiates the plant at a close proximity, moving with the plant as it grows. At a distance of 1 cm, a 5,000 mcd, 660 nm LED is able to produce an intensity of almost 50,000 lx. In addition, a combination of red, green and blue devices together with lighting control can produce a balance that is compatible with photosynthesis. The next challenge facing LEDs concerns the production cost and the heating effects resulting from the concentrated use of LED devices. [Fig. 9\(13KB\)](#) shows the structure of a LED device²³⁾ and Fig. 10((shows the spectral distribution in composite lighting. Table 6 shows the characteristics of red, green and blue LED devices²¹⁾.

Table 6. Characteristics of red, green and blue LED devices (modification of Nakamura, 1995)

Color	Material	Peak wavelength (nm)	Luminous intensity (mcd)	Output power ($\frac{1}{4}w$)	External quantum efficiency(%)
Red	GaAlAs	660	5,000	4,500	12.0
Green	AlInGaP	570	1,000	400	1.0
	GaP	555	100	40	0.1
	ZnTeSe*	512	4,000	1,300	5.3
	InGaN	520	12,000	3,000	6.3
Blue	SiC	470	20	20	0.04
	ZnCdSe*	489	700	327	1.3
	InGaN	450	2,500	5,000	9.1

Under a forward current of 20 mA. . *Under a forward current of 10 mA.

(c) Laser diode devices(LD)

LDs are light-emitting semiconductors like LEDs. LDs are mainly used in bar-code readers, writeable compact disks(CD), mini disks(MD), compact disk read only memory(CDROM), optical communication transmission, and photocopiers or optical printers. The operation principle of an LD is equivalent to that of laser

oscillation. Light emitted from an LED is reflected by a mirror and amplified by stimulated emission. The light is finally emitted through the mirror surface. [Fig. 11\(24KB\)](#) shows a simple LD structure²²⁾. [Table 7](#) shows the wavelengths produced by several kinds of LDs²²⁾. Takatsuji & Yamanaka²⁴⁾ investigated the possibility of using LDs as light sources in greenhouses since the photo-electronic transducer efficiency of LDs is very high. Results showed that irradiation combined with red and blue LD light pulses was a promising future development in view of the production cost. In addition, Takatsuji & Mori²⁵⁾ confirmed the growth of lettuce using mixed light irradiation(PPFD: 50¼molem⁻²esec⁻¹)of red LD(660 nm)and blue LED(450 nm).

Table 7. Wavelengths of various LDs (Shimoda, 1997)

Material	Wavelength (nm)
GaN	440
Zn _x Cd _{1-x} Se	490-530
Ga _{1-x} Al _x As	650-840
In _x Ga _{1-x} Al _y P _{1-y}	660-690
GaAs	840
Inp	910
In _x Ga _{1-x} As _y P _{1-y}	1,350-1,560
In _x Ga _{1-x} As	840-3,100
InAs	3,100
InSb	5,200
Pb _x Sn _{1-x} Te	6,500-32,000

Tsuchiya et al.²⁸⁾ developed an LD6500 with a wavelength of 680 nm and output of 200 nW. A 35% photoelectric transducer efficiency was achieved (theoretical maximum 60%). Results of tests carried out on lettuce at 200¼molem⁻²esec⁻¹ PPFD showed that growth was slow. The leaves were thin, presumably due to the use of monochromatic and coherent light. In the mixed irradiation test using red LDs and blue fluorescent lamps(about 6%), plants showed an increased weight and a normal leaf shape, confirming the effect of blue light²⁹⁾. Mori & Takatsuji.¹⁶⁾ cultivated lettuce by irradiating light from different kinds of LEDs and red LDs(650 nm) alone or in combination(PPFD: 50¼molem⁻²esec⁻¹) and found that the growth was poor in cases where only red LD irradiation was used. This effect was considered to be due to the monochromatic characteristic of red LD light. The following problems in the application of LDs are as follows: sensitivity to electrostatic and current surges, wavelength increase of about 10 nm as the temperature rises, and need for development of a blue light LD.

---Conclusion-----

Two main requirements dominate the utilization of artificial light sources in horticulture in both gardens and commercial greenhouses, the first being efficiency. High pressure sodium lamps are generally adopted to offer the highest efficiency in terms of plant growth rate and economy. However, to remain within current standards of farm products(such as leaf greenness and coloration, internode length, stem diameter, and leaf thickness), combination with metal halide lamps is recommended. The second requirement is related to the esthetic improvement of store or house environments, where the primary concern is not growth but maintenance of a plant's natural appearance. High efficiency is not a prerequisite, but the light quality balance becomes important in order to bring out the essential color characteristics of plants and flowers as well as maintaining plant health. To meet these requirements, high color rendering index type MHLs are recommended. Current horticultural research trends lead to the development of 1.2 kW HPSL, 180 lm/W, LED and LD devices for use in commercial greenhouses and the application of microwave and 400 W MHL lamps in growth chambers.



[Forward to:-Effects of Various Radiant Sources on Plants Growth \(Part 2\)-](#)



[Contents](#)



[JIRCAS Home Page](#)

---References-----



[Back](#)

- 1) Abe, N. et al.(1967): Characteristics of photosynthesis for various flowers. Abstr. Jpn. Hort. Sci. Spring Meet. 336-337 [In Japanese].
- 2) Böhning, R. H. & Burnside, C. A. (1956): The effect of light intensity on rate of apparent photosynthesis in leaves of sun and shade plants. *Amer. J. Bot.*, **43**, 557-561.
- 3) Chapman, H. W. & Loomis, W. E. (1953): Photosynthesis in the potato under field conditions. *Plant Physiol.*, **28**, 703-716.
- 4) Hesketh, J. D. & Moss, D. N. (1963): Variation in the response of photosynthesis to light. *Crop Sci.*, **3**, 107-110.
- 5) Hesketh, J. D. (1963): Limitations to photosynthesis responsible for differences among species. *Crop Sci.*, **3**, 493-496.
- 6) Ikeda, A. et al. (1992): Development of plant factory using fluorescent lamps and its lighting design. *J. Jpn. Illum. Eng.*, **76** (10), 523-529 [In Japanese].
- 7) Inada, K. (1976): Action spectra for photosynthesis in higher plants. *Plant & Cell Physiol.*, **17**, 355-365.
- 8) Inada, K. (ed.) (1984): Light and plant growth, Yohkendo, Tokyo, 8-9 [In Japanese].
- 9) Inada, K. (ed.) (1984): Light and plant growth, Yohkendo, Tokyo, 72[In Japanese].
- 10) Inagaki, T. et al. (1998): Development of high pressure sodium lamps for high efficacy and high wattage. Abstr. Jpn. SHITA. Annual Conf. Meet., 28-29 [In Japanese].
- 11) Ito, K. (1965): Studies on photosynthesis in sugar beet plant. *J. Jpn. Crop Sci.*, **38**, 487-491 [In Japanese with English summary].
- 12) Klein, W. H. et al. (1969): Spectral distribution and its control of plant growth and development. Progress report on AEC Research Project-Contract AT (30-1) 2373, Radiation Biology Laboratory, Smithsonian Institution.
- 13) Kozai, T. & Kitaya, Y. (1993): Microwave-powered lamps and its application for growing plants. *J. Jpn. Agric. & Hortic.*, **68** (9), 44-52 [In Japanese].
- 14) McCree, K. J. (1972): The action spectrum, absorbance and quantum yield of photosynthesis in crop plants., *Agric. Meteorol.*, **9**, 191-216.
- 15) Morgan, D. C. & Smith, H. (1976): Linear relationship between phytochrome photoequilibrium and growth. *Nature*, **262**, 210-212.
- 16) Mori, Y. & Takatsuji, M. (1998): Effects of LED and LD radiation on the growth of lettuce. Abstr. Jpn. SHITA. Annual Conf. Meet., 26-27 [In Japanese].
- 17) Murakami, K. et al. (1991): Effect and estimations of additional far-red irradiation on plant growth. Abstr. Jpn. Illum. Eng. Inst. Annual Conf. Meet., 217 [In Japanese].
- 18) Murakami, K. et al. (1998): Development of metal halide lamps for plant growth. Abstr. Jpn. SHITA. Annual Conf. Meet., 32-33 [In Japanese].
- 19) Murata, Y. (1961): Studies on the photosynthesis of rice plants and its culture significance. *Natl. Inst. Agric. Sci.*, **D9**,

1-169 [In Japanese with English summary].

20) Nagai, E. et al. (1992): Artificial lighting for some indoor horticultural plants. Abst. Jpn. Illum. Eng. Inst. Annual Conf. Meet., 174 [In Japanese].

21) Nakamura, N. et al. (1995): High brightness InGaN blue, green and yellow light-emitting diodes with quantum well structures. *J. Jpn. Appl. Phys.*, **34**, Pt. 2, (10B), 1332-1335.

22) Shimoda, K. (1997): Actual situation of laser. *J. Jpn. Optronics.*, **1**, 238-240 [In Japanese].

23) Suehiro, N. et al. (1995): High brightness LED lamp with wide visibility angle. Tech. rep. Elect. & Commun. Eng. Inst. Jpn., EID94-114, 43-48 [In Japanese with English summary].

24) Takatsuji, M. & Yamanaka, M. 1994): Possibility of laser plant factory. *J. Jpn. SHITA.*, **6** (3), 184-190 [In Japanese].

25) Takatsuji, M. & Mori, Y. (1997): Laser plant factory. In Handbook of plant factory. ed. Takatsuji, M. Tokai Univ. Press, Tokyo, 80-85 [In Japanese].

26) Takeda, G. (1978): Photosynthesis and dry-matter reproduction system in winter cereals. *Natl. Inst. Agric. Sci.*, **D29**, 1-65 [In Japanese with English summary].

27) Tatsumi, M. & Hori, Y. (1969): Studies on photosynthesis of vegetable crops. *Hort. Res. Stn., Jpn.*, **A8**, 127-140 [In Japanese with English summary].

28) Tsuchiya, H. et al. (1997): Application of laser diode as a light source of plant factory. *SHITA Rep. Jpn.*, **13**, 17-19 [In Japanese].

29) Tsuchiya, H. et al. (1997): Application of red laser diode as a light source of plant production. *Rev. Jpn. Laser Eng. Laser Sci.*, **25** (12), 841-844 [In Japanese].

30) Tsuno, Y. & Fujise, K. (1965): Studies on the dry-matter production of sweet potato. *Natl. Inst. Agric. Sci.*, **D13**, 1-131 [In Japanese with English summary].

31) Van der Veen, R. & Meijer, G. (1962): Light and plant growth. The MacMillan Co. New York, 5-6.

32) Yokouchi, H. (1991): Meeting report, CIE Division 6. 22nd Session, Melbourne, *J. Jpn. JCIE.*, **8** (3-4), 28 [In Japanese].



[Back](#)

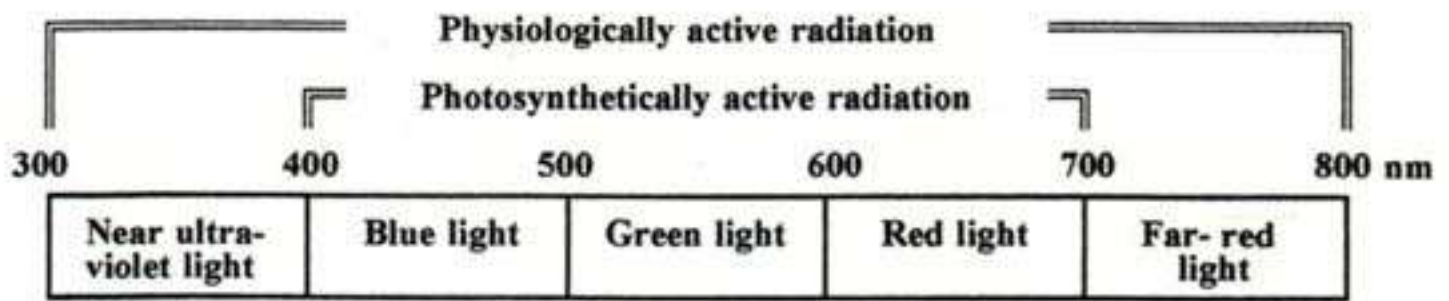


Fig. 1. Classification of effective wavebands for plant growth



[Back](#)

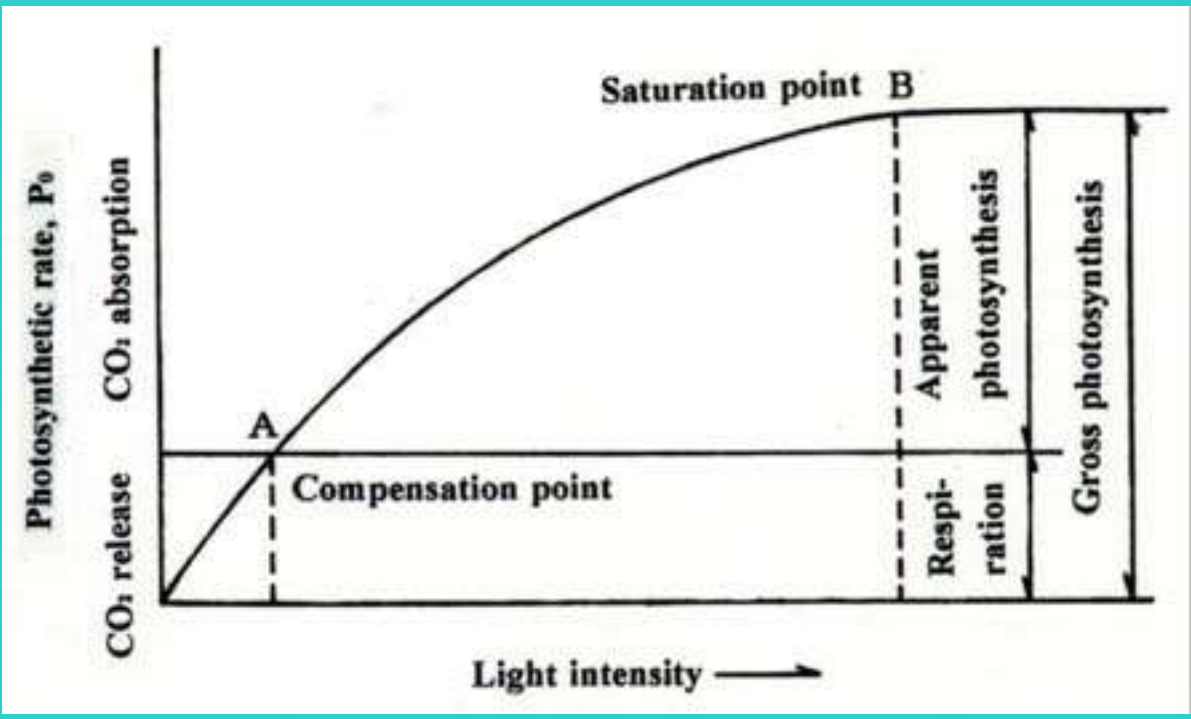


Fig.2. Relationship between intensity and photosynthetic rate

 [Back](#)

Table 1. Light saturation and compensation points of major crops

Species	Saturation point (klx)	Compensation point (klx)	Remarks
Rice	40-50 (672-840)	0.5-1.0 (8-17)	Murata, 1961 ^{2,1)}
Barley	50 (840)	-----	Takeda, 1978 ^{2,2)}
Maize	80-100 (1344-1680)	1.8 (30)	Hesketh & Moss, 1963 ⁴⁾
Sugar beet	80 (1344)	-----	Hesketh, 1963 ⁵⁾
Soybean	20-25 (336-420)	1.0-1.5 (17-25)	Bohning & Burnside, 1956 ²⁾
Kidney bean	20-25 (336-420)	1.0-1.5 (17-25)	
Sweet potato	30 (504)	-----	Tsuno & Fuzise, 1965 ^{3,3)}
Potato	30 (504)	-----	Chapman & Loomis, 1953 ³⁾
Sugar beet	30 (504)	0.8-1.0 (13-17)	Ito, 1965 ^{1,3)}
Castor bean	20-25 (336-420)	2.4 (40)	Bohning & Burnside, 1956 ²⁾ Hesketh, 1963 ⁵⁾
Tobacco	20-25 (336-420)	1.0-1.5 (17-25)	Bohning & Burnside, 1956 ²⁾
Cotton	20-25 (336-420)	1.0-1.5 (17-25)	
Tomato	70 (1176)	-----	Tatsumi & Hori, 1969 ^{3,4)}
Eggplant	40 (672)	2.0 (34)	
Red pepper	30 (504)	1.5 (25)	
Cucumber	55 (924)	-----	
Squash	45 (756)	1.5 (25)	
Melon	55 (924)	0.4 (7)	
Watermelon	80 (1344)	4.0 (67)	
Cabbage	40 (672)	2.0 (34)	
Chinese cabbage	40 (672)	1.5-2.0 (25-34)	
Turnip	55 (924)	4.0 (67)	
Taro	80 (1344)	4.0 (67)	
Pea	40 (672)	2.0 (34)	
Celery	45 (756)	2.0 (34)	
Lettuce	25 (420)	1.5-2.0 (25-34)	
<i>Cryptotaenia</i>	20 (336)	1.0 (17)	
<i>Zingiber mioga</i>	20 (336)	1.5 (25)	

* Figures in parentheses indicate the quantum flux.

The quantum flux densities in parentheses indicate the values for each illuminance multiplied by the conversion factor for natural daylight ($16.8 \mu \text{mol} \cdot \text{m}^{-2} \cdot \text{s}^{-1} / 1 \text{klx}$).



[Back](#)

•@

•@

Table 2. Light saturation and compensation points for some indoor ornamentals plants 1,2)

Plant species	Saturation point (klx)	Compensation point (klx)
<i>Hedera helix</i> 'English ivy'	18.5 ~ 19.0 (311 ~ 319)	0.2 ~ 0.3 (3.4 ~ 5)
<i>Cypripedium insigne</i>	18.0 ~ 18.5 (302 ~ 311)	max. 0.1 (1.7)
<i>Dracaena concine</i>	18.0 ~ 18.5 (302 ~ 311)	0.2 ~ 0.3 (3.4 ~ 5)
<i>Streptocarpus rexii</i>	18.0 ~ 18.5 (302 ~ 311)	0.2 ~ 0.3 (3.4 ~ 5)
<i>Fuchsia hybrida</i>	17.5 ~ 18.0 (294 ~ 302)	0.4 ~ 0.5 (6.7 ~ 8.4)
<i>Pelargonium zonale</i>	17.0 ~ 18.0 (286 ~ 302)	0.2 ~ 0.3 (3.4 ~ 5)
<i>Nephrolepis exaltata</i>	17.0 ~ 17.5 (286 ~ 294)	0.5 ~ 0.6 (8.4 ~ 10.1)
<i>Philodendron laciniatum</i>	16.0 ~ 16.5 (269 ~ 277)	0.2 ~ 0.3 (3.4 ~ 5)
<i>Cyclamen persicum</i>	14.5 ~ 15.0 (244 ~ 252)	0.2 ~ 0.3 (3.4 ~ 5)
<i>Begonia coccina</i>	14.0 ~ 15.0 (235 ~ 252)	0.2 ~ 0.3 (3.4 ~ 5)
<i>Cordyline terminalis</i>	14.0 ~ 14.5 (235 ~ 244)	0.3 ~ 0.4 (5 ~ 6.7)
<i>Oncidium flexuosum</i>	13.0 ~ 13.5 (218 ~ 227)	0.2 ~ 0.3 (3.4 ~ 5)
<i>Primula obconica</i>	12.0 ~ 13.0 (202 ~ 218)	0.2 ~ 0.3 (3.4 ~ 5)
<i>Chamaedorea elegans</i>	12.0 ~ 12.5 (202 ~ 210)	0.1 ~ 0.2 (1.7 ~ 3.4)
<i>Primula malacoides</i>	11.0 ~ 12.0 (185 ~ 202)	0.2 ~ 0.3 (3.4 ~ 5)
<i>Cymbidium ensifolium</i>	11.0 ~ 11.5 (185 ~ 193)	0.2 ~ 0.3 (3.4 ~ 5)
<i>Begonia rex</i>	9.5 ~ 12.5 (160 ~ 210)	0.2 ~ 0.3 (3.4 ~ 5)
<i>Rhoeo discolor</i>	9.0 ~ 9.5 (151 ~ 160)	0.5 ~ 0.6 (8.4 ~ 10.1)
<i>Nepenthes maxima</i>	8.0 ~ 8.5 (134 ~ 143)	0.2 ~ 0.3 (3.4 ~ 5)
<i>Adiantum pedatum</i>	8.0 ~ 8.5 (134 ~ 143)	0.2 ~ 0.3 (3.4 ~ 5)
<i>Begonia margaritae</i>	6.0 ~ 6.5 (101 ~ 109)	max. 0.1 (1.7)
<i>Begonia iron cross</i>	5.0 ~ 6.5 (84 ~ 109)	0.2 ~ 0.3 (3.4 ~ 5)
<i>Dendrobium merlin</i>	4.5 ~ 5.0 (76 ~ 84)	0.2 ~ 0.3 (3.4 ~ 5)
<i>Chlorophytum elatum</i>	4.5 ~ 5.0 (76 ~ 84)	max. 0.1 (1.7)
<i>Pilea cadierei</i>	3.5 ~ 4.0 (59 ~ 67)	0.2 ~ 0.3 (3.4 ~ 5)
<i>Anthurium andraeanum</i>	3.0 ~ 3.5 (50 ~ 59)	0.2 ~ 0.3 (3.4 ~ 5)
<i>Coleus</i>	20 ~ 25 (336 ~ 420)	1 ~ 1.5 (16.8 ~ 25.2)
<i>Philodendron</i>	5 ~ 10 (84 ~ 168)	0.5 (8.4)
<i>Saintpaulia</i>	5 ~ 10 (84 ~ 168)	0.5 (8.4)

The quantum flux densities in parentheses indicate the values for each illuminance multiplied by the conversion factor for natural daylight ($16.8 \text{ f}\hat{\text{E}}\text{mo}\cdot\text{m}^{-2}\cdot\text{sec}^{-1}/\text{klx}$).



[Back](#)

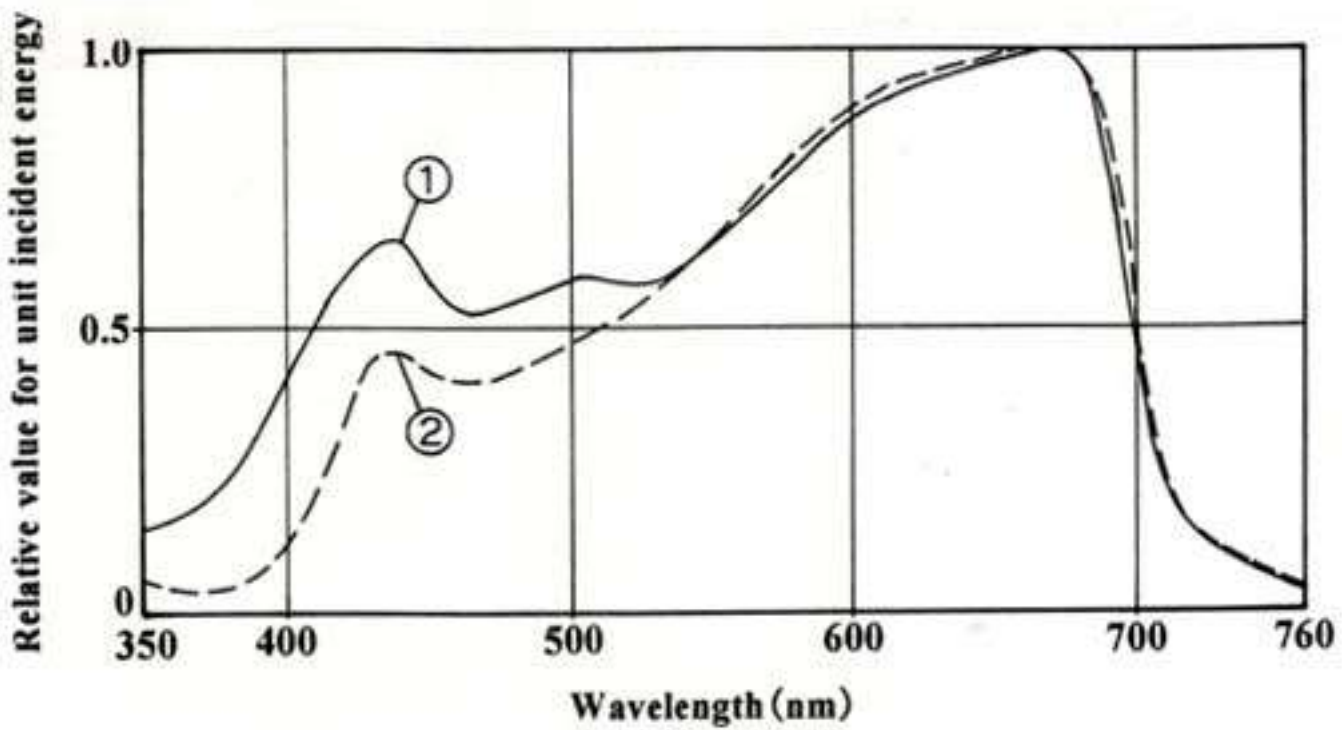


Fig.3. Average values for photosynthesis action spectra (Inada, 1976)

[1] Average of 26 species of herbaceous plants.

[2] Average of 7 species of arboreal plants.



[Back](#)

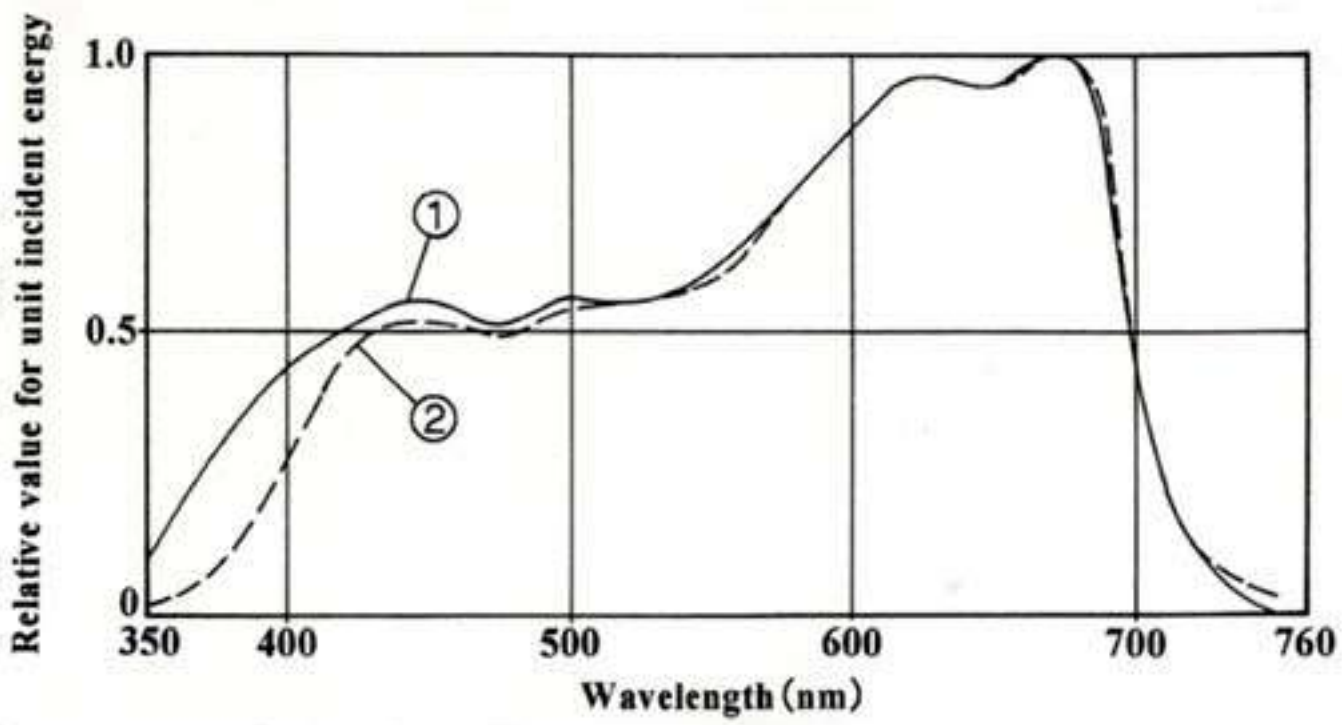


Fig.4. Average values for photosynthesis action spectra (McCree, 1972)

- [1] Average of 20 species grown in plant growth chambers.
- [2] Average of 8 species grown in the field.



[Back](#)

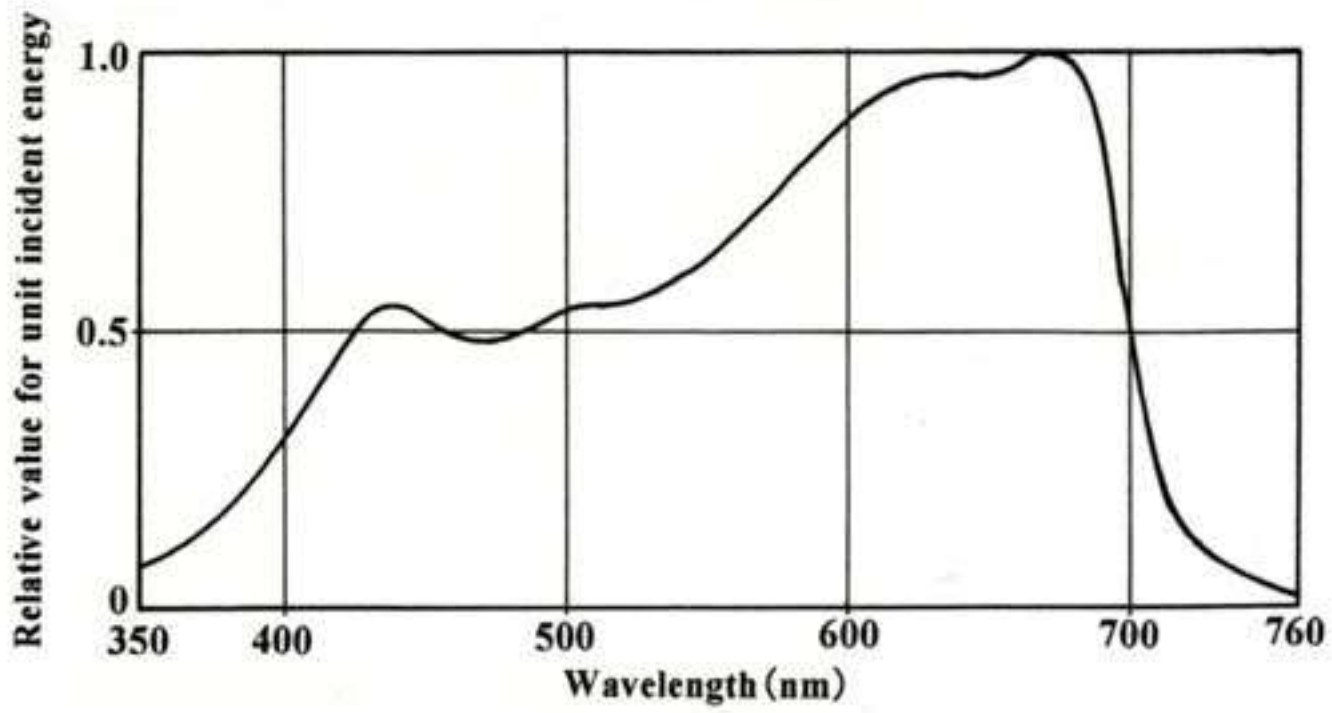


Fig.5. Average values for photosynthesis action spectra for 61 species

India; 33 species, McCree; 28 species.



[Back](#)

Table 4. Effect of various wavelengths on plants

Wavelength (nm)			Action	
Infrared radiation	IR-A	1400	No specific action, but thermal effects on plants.	
		800		
Visible radiation	Red	780	Specific elongation effect on plants. Germination control (730 nm)	
		760		
		700	Maximum absorption by chlorophyll. Maximum photosynthesis (675 nm). Promotion of germination (660 nm), opening of leaves and flowerbud formation.	
		640		
		610		
		590		Significant contribution to photosynthesis
		570		
510	Absorbed by yellow pigments, resulting in a peak of chlorophyll absorption. Phototropism (blue light)			
500				
450				
Ultraviolet radiation	UV-A	380	Generally controls plant height, makes leaves thick. Promotes coloring pigments.	
		315		
	UV-B	280	Excessive intensity exerts adverse effects; pronounced effects on many synthetic processes.	
		100		
UV-C		Plants wither rapidly.		


[Back](#)

Fig.6. Classification of artificial light sources

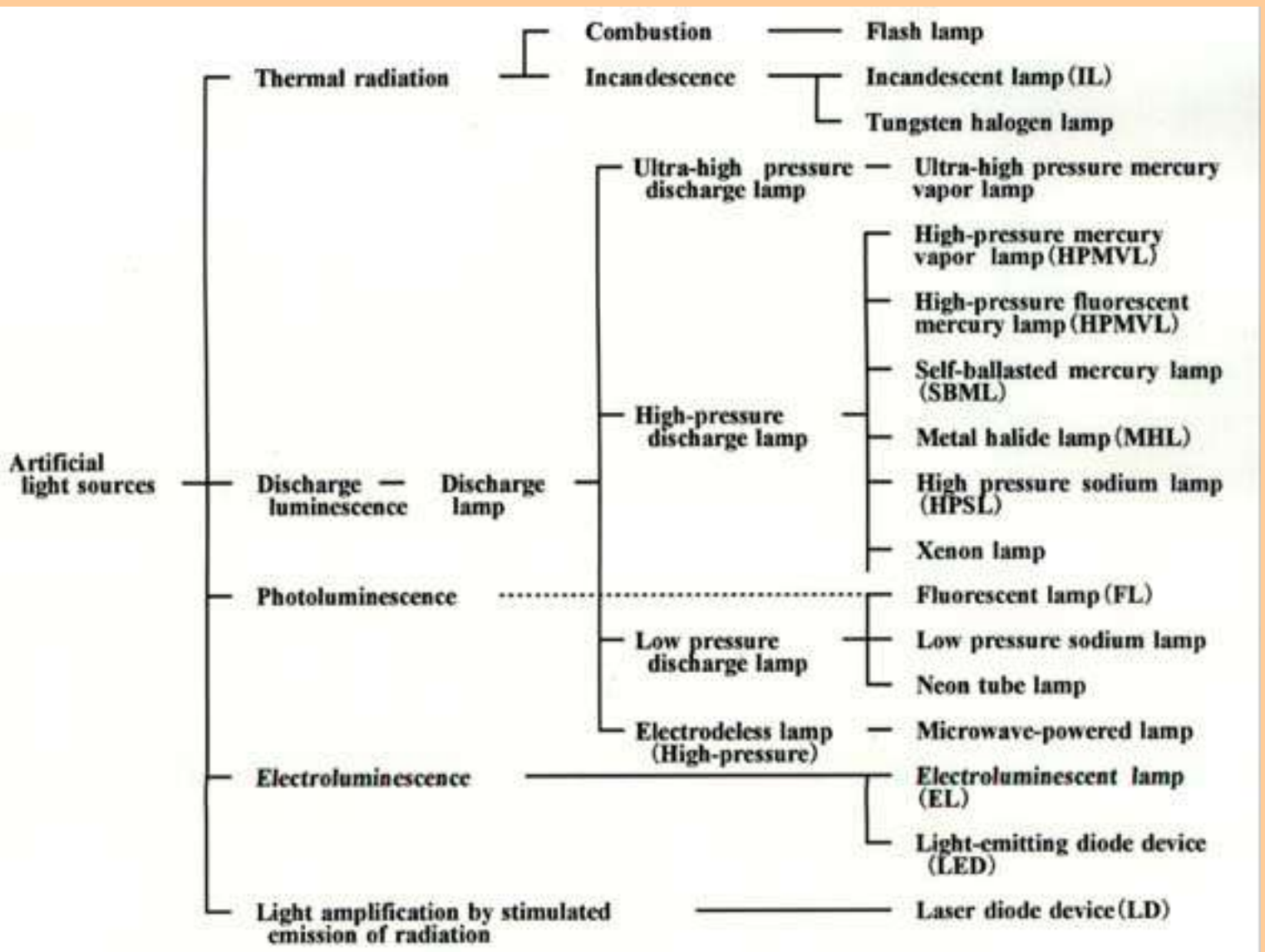
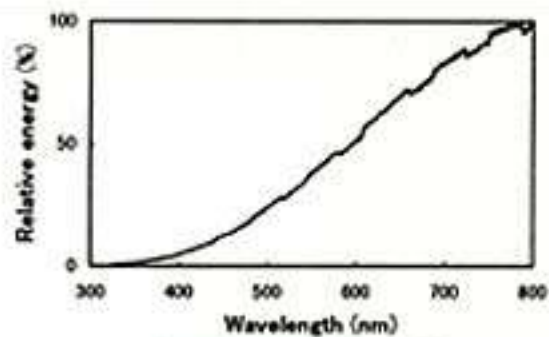
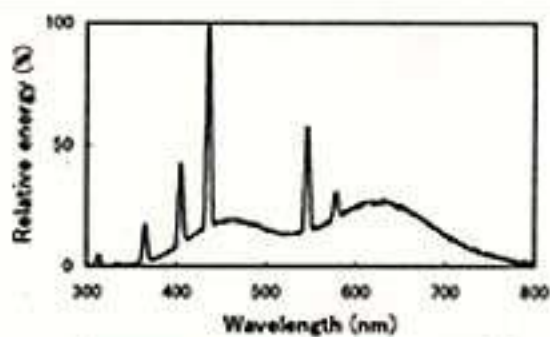

[Back](#)

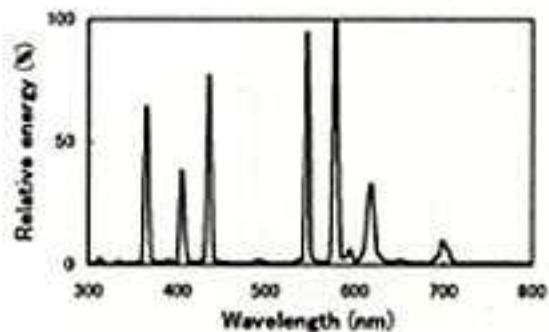
Fig.7. Spectral distribution of various artificial light sources



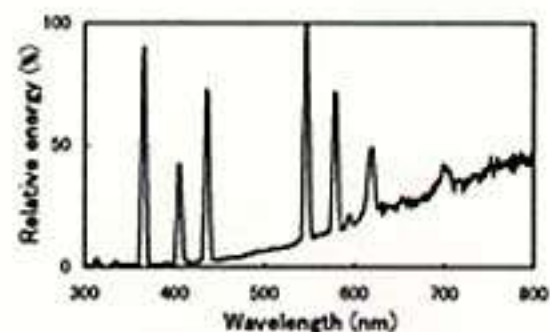
Incandescent lamp (IL)



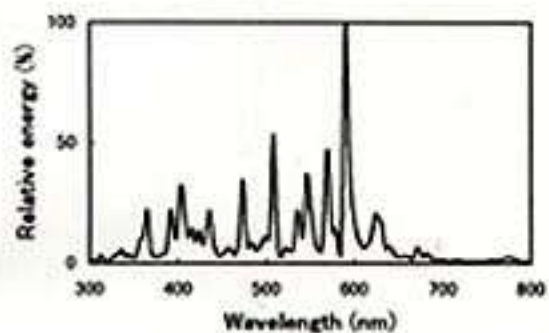
Fluorescent lamp (for plant growth)



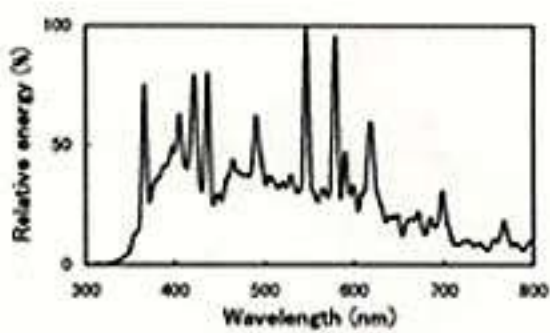
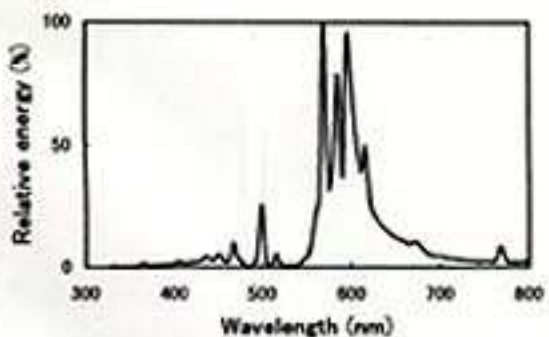
Fluorescent mercury lamp (HPMVL)



Self-ballasted mercury lamp (SBML)



Metal halide lamp (MHL)

High color rendition type
metal halide lamp (MHL)

High pressure sodium lamp (HPSL)

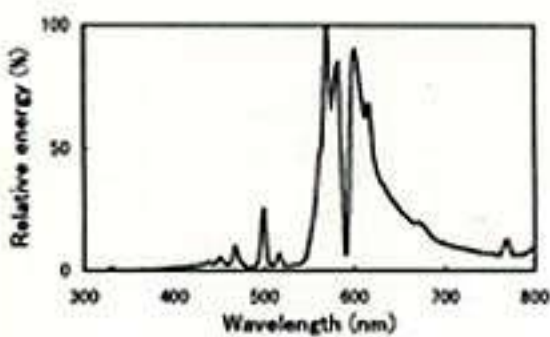
High color rendition type
high pressure sodium lamp (HPSL)
[Back](#)

Table 5. Radiant energy balance and PPF transformed value of various sources

	Blue light (400-500 nm) (%)	Green light (500-600 nm) (%)	Red light (600-700 nm) (%)	PPFD trans- formation factor a)
Quantum sensitivity spectrum	27.3	33.3	39.4	---
Photosynthesis action spectrum	23.5	32.0	44.5	---
Incandescent lamp (IL)	12.3	33.3	54.4	21.0
Self-ballasted mercury lamp (SBML)	22.3	43.3	34.4	16.8
Fluorescent mercury lamp (HPMVL)	31.1	51.2	17.7	12.3
Metal halide lamp (MHL)	29.2	51.4	19.4	13.6
High color rendering index type MHL	37.7	39.1	23.2	16.7
High pressure sodium lamp (HPSL)	8.9	51.4	39.7	13.3
Color improved type HPSL	5.8	38.2	56.0	15.4
High color rendering index type HPSL	9.1	28.1	62.8	22.1
Fluorescent lamp for plant growth	29.9	26.8	43.3	22.4
Fluorescent lamp for color evaluation	29.0	39.8	31.2	17.6
White color type fluorescent lamp	26.4	50.3	23.3	12.4
Daylight type fluorescent lamp	37.8	45.9	16.3	14.0
Three wave type fluorescent lamp	32.7	44.9	22.4	13.7
Day white type fluorescent lamp	31.6	42.9	25.5	13.3

Figures in the table indicate the ratio (wattage) of various light sources within PAR radiation energy (400 to 700 nm).

a): Unit of PPF transformation factor; $\mu \text{ mol} \cdot \text{m}^{-2} \cdot \text{sec}^{-1} / 1 \text{ klx}$



[Back](#)

Fig.8. Structure of microwave-powered lamp and its emission spectrum (Kozai and Kitaya, 1993)

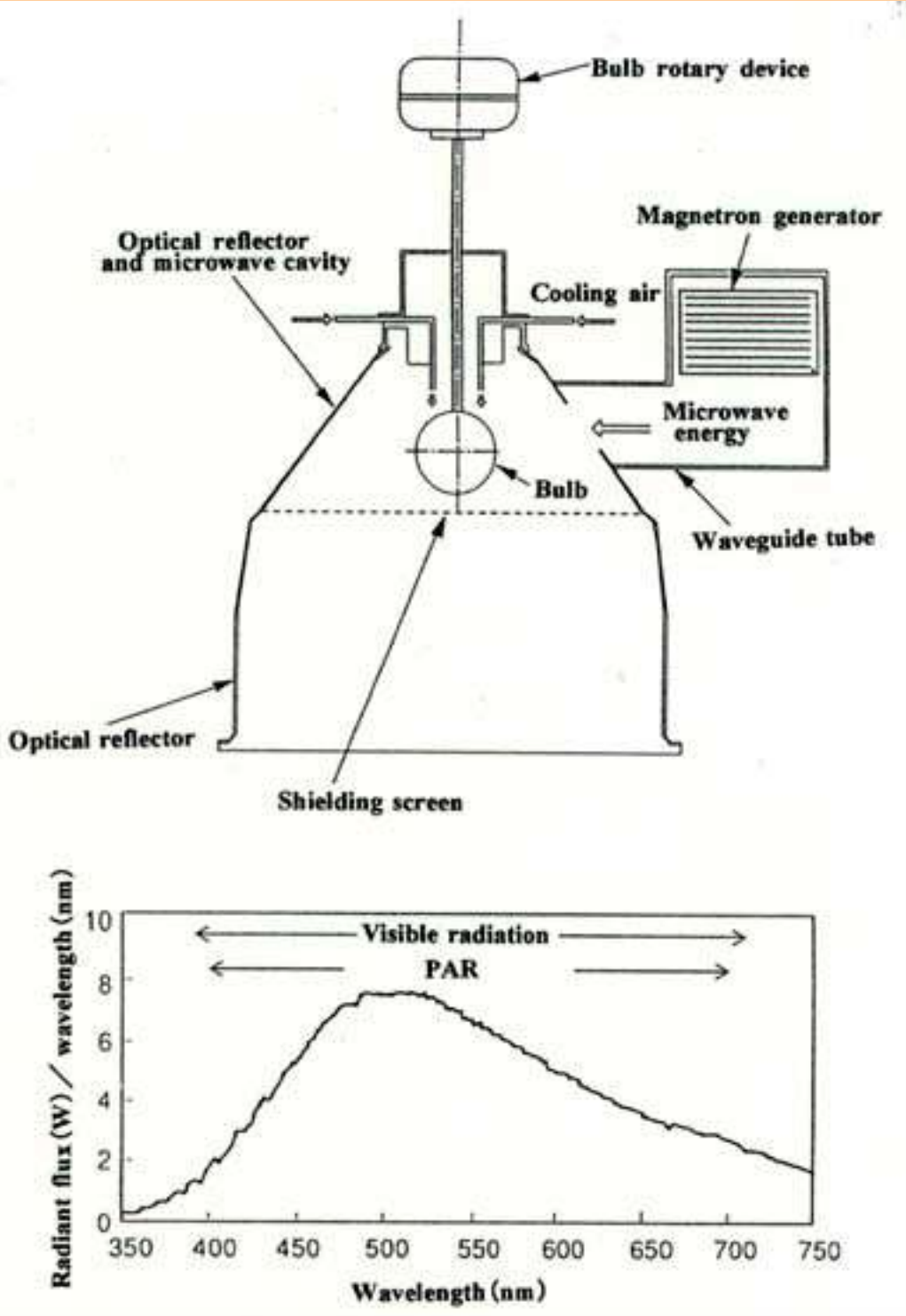
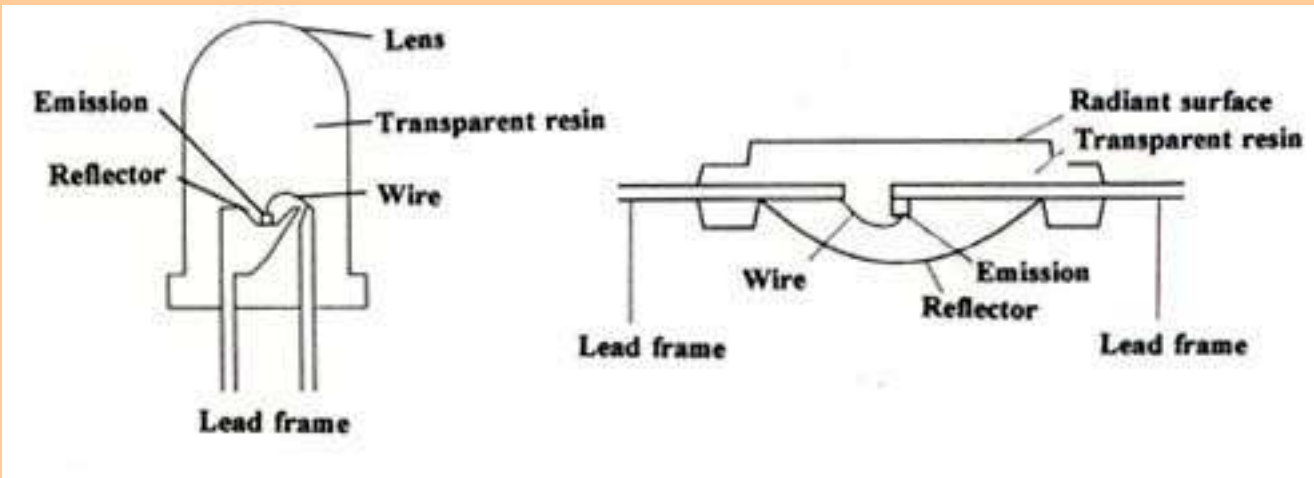

[Back](#)

Fig.9. Structure of LED device (Suehiro et al., 1995)



[Back](#)

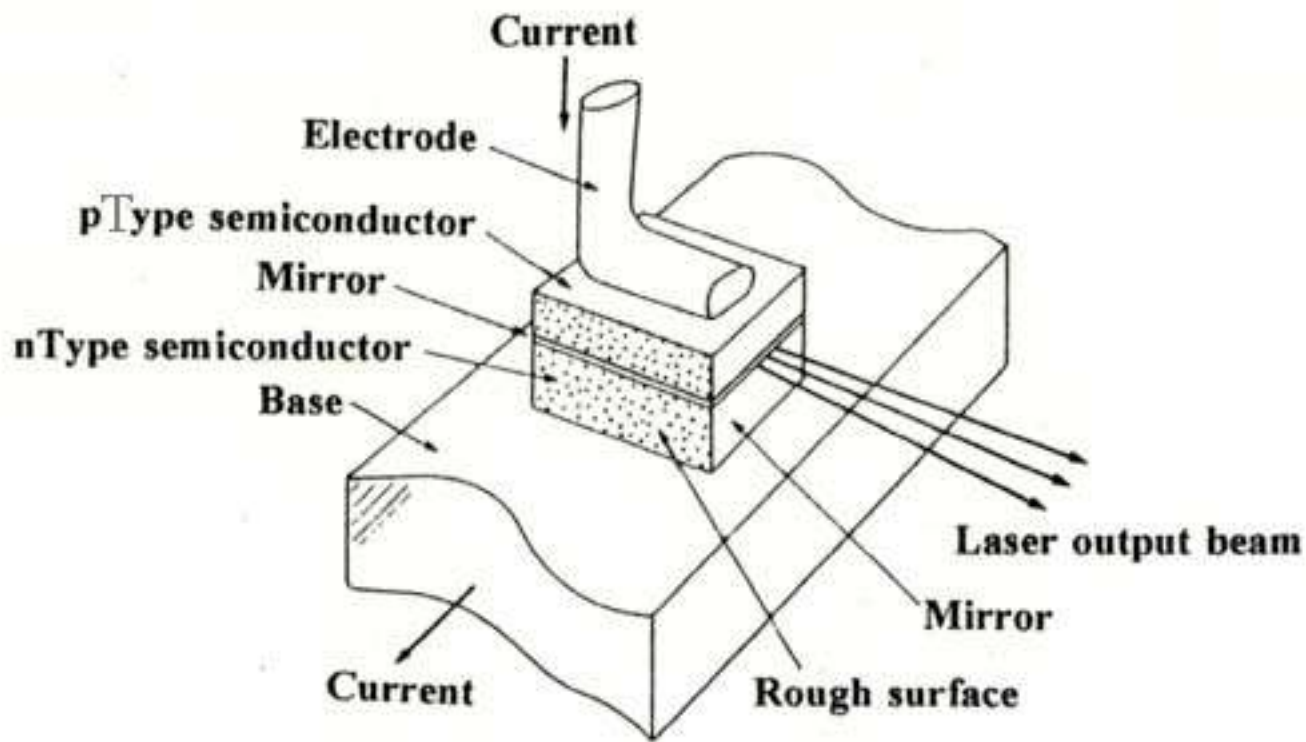


Fig.11. Simple LD structure (Shimoda, 1997)



[Back](#)

Effects of Various Radiant Sources on Plant Growth(Part 2)

Shinji TAZAWA

Light Source Division, Iwasaki Electric Co., Ltd.
(Gyoda, Saitama, 361-0021 Japan)

---Abstract-----

In Part 2 of this report, we analyzed the spectrum distribution of several high intensity discharge lamps, in which the spectrum values were multiplied by the average values for 4 different photosynthesis curves developed by McCree(1972) and Inada(1976), and we calculated the photoelectric conversion efficiency expressed as the plant growth radiant efficiency. As a result, we confirmed the high effectiveness of high pressure sodium lamps for plant growth within the PAR range of wavelengths, and concluded that a metal halide lamp 3,500 K(150 W high color rendering index type) was a suitable light source for indoor maintenance of ornamental plants. We also analyzed the light quality balance within the PAR range of different artificial light sources, by using the R/B and R/FR ratios as a reference to photomorphogenesis.

Discipline: Agricultural facilities/Crop production/Horticulture

Additional key words: artificial light source, supplemental lighting, plant factory

[1....5\):References](#)

(Received for publication, December 18, 1998)

---Introduction-----

Part 2 of this report deals with an evaluation of various radiant sources for plant growth and the quality of the light balance.

---Evaluation of various radiant sources for plant growth-----

Broadly speaking, 2 aspects must be considered in the evaluation of radiant sources for plant growth. The first is the efficiency of light energy transformation which is expressed by the ratio of the radiant energy of a lamp to the effective light energy for photosynthesis. This efficiency is a measure of how close the spectral distribution of a light source is to the photosynthesis action spectrum of the plants. To obtain this efficiency, the value for spectral distribution of a light source is multiplied by the sensitivity of the photosynthesis action spectrum of the plants, and then divided by the input power of the light source used. However, it is virtually impossible to analyze the photosynthesis action spectra of hundreds of thousands of plants on the earth. Therefore only the main typical species are used to calculate the efficiency. The quantum sensor, in which the sensitivity is close to the photosynthesis action spectrum, is considered to be a suitable device for measuring the efficiency. [Fig. 1\(23KB\)](#) shows the curve of luminous efficiency and quantum sensitivity. The second aspect to be considered is the quality of the light balance. In general, it is recognized that light with a large red light component promotes intercalary growth, and that light with a large blue light component controls plant growth. The ratio of blue, green

and red light components controls plant growth. The ratio of blue, green and red light components in PAR radiation is the key factor determining plant growth. In addition, the ratio of red light and far-red light is an important factor in the elongation of plants.

1) Evaluation of light energy transformation efficiency

To obtain the light energy transformation efficiency, the radiant energy of the light source is multiplied by either the quantum sensitivity or the operational sensitivity of photosynthesis, then divided by the input power of the lamp. Equations used to calculate the light energy transformation efficiency of the light sources are shown below (Eqns. 1 to 3).

Radiant energy of artificial light source;

$$\int_{380}^{780} P(\lambda) d\lambda / P_{in} \dots\dots\dots (1)$$

Radiant energy x quantum sensitivity;

$$\int_{400}^{700} P(\lambda) Q(\lambda) d\lambda / P_{in} \dots\dots\dots (2)$$

Radiant energy x average sensitivity of photosynthesis spectra ;

$$\int_{400}^{700} P(\lambda) S(\lambda) d\lambda / P_{in} \dots\dots\dots (3)$$

0(»): spectrum distribution,

1(»): quantum sensitivity,

3(»): average sensitivity of photosynthesis action spectra,

P_{in} : input power of lamp.

[Table 1\(52KB\)](#) shows the radiant energy and light energy transformation efficiency of various 660 to 1,000 W high intensity discharge lamps (HID lamps) used in closed system plant factories. Line (1) in Table 1 shows the transformation efficiency to visible light from electric energy supplied by actual light sources as radiant energy. Line (2) shows the light transformation efficiency multiplied by the quantum sensitivity for evaluating measurements. Line (3) shows the efficiency of light energy transformation actually used, which is calculated from the efficiency of light energy transformation multiplied by the average sensitivity of the photosynthesis action spectra of 33 plant species examined by Inada(1976)²⁾ and 28 by McCree(1972)⁴⁾. As shown in Table 1, from the standpoint of photosynthesis sensitivity and quantum sensitivity, the most effective lamp for plant growth is the HPSL, in which the red light component is large and the efficiency of light energy transformation is high. However, normal growth cannot be expected with a light with a large red light component only. That is, an adequate balance with blue and green light is also necessary.

[Table 2\(61KB\)](#) shows the efficiency of light energy transformation of 400 W HIDLs used in hybrid type plant factories and in greenhouses for supplemental lighting. Compared with HPMVL, MHL and HPSL show a higher efficiency. In addition, comparison of Tables 1 and 2, shows that high-wattage type HPSLs have a higher efficiency than 400 W HPLSs, and 400 W MHLs have a higher efficiency than high-wattage type MHLs.

[Table 3\(46KB\)](#) shows the efficiency of light energy transformation of compact type HID lamps installed for indoor ornamental plants. All MHLs have a high efficiency of light energy transformation, as shown

in Table 3. In particular, the 150 W 4,500 K lamp shows the highest efficiency, based on the multiplication with the average photosynthesis sensitivity.

2) Evaluation of quality of light balance

Evaluation of the quality of the light balance involves the determination of the relative balance of blue light, green light, and red light in the effective radiation range of photosynthesis. Among these, the balance of red light and blue light (R/B ratio) is a typical factor for consideration. High R/B ratio, depending on the light quantity, is associated with intercalary growth of the internodes, and a low R/B ratio is associated with growth control, i.e. suppression of elongation, and production of thick, strong leaves. [Table 4\(41KB\)](#) shows the quality of the light balance of various kinds of photosynthesis action spectra and quantum sensitivities. Considering quantum sensitivity as an indicator, an effective light balance is represented by an R/B ratio of 1.44, obtained with 27.3% blue light, 33.3% green light and 39.4% red light. The average quality of the light balance of 4 photosynthesis action spectra includes 23.5% blue light, 32.0% green light and 44.5% red light. From these values, the R/B ratio is calculated to be 2.71, indicating that light with a large red light component is effective. However, studies carried out by Inada & Yabumoto³⁾ using lettuce and radish, showed that an R/B ratio of 10 or higher was effective for cultivation. Takatsuji et al.⁵⁾ irradiated lettuce with red LED(660 nm, half wavelength about 30 nm) and blue LED(450 nm, half wavelength about 70 nm) and showed that an R/B ratio of 10 was effective.

Another factor for the evaluation is the photomorphogenesis reaction discussed in Section 5(Part 1). Based on the red light to far-red light ratio (R/FR ratio) it can be determined whether plants will have elongated or controlled growth. High R/FR values indicate controlled growth, and low values indicate elongated growth. The R/FR ratio is calculated by multiplying the light spectrum distribution by the quantum sensitivity. Inada & Yabumoto³⁾ using lettuce and radish, showed that an R/FR ratio between 1.00 to 2.00 was effective for cultivation. Horaguchi et al.¹⁾, who cultivated lettuce and sunflower using irradiation from several 4-band fluorescent lamps where an FR light was added to 3-band fluorescent lamps, showed that an R/FR ratio of 0.78 was effective. In general, the wavelength ranges are broadly defined as 600 to 700 nm for red light and 700 to 800 nm for far-red light. Equation (4) is used for the calculation of the R/FR ratio as follows;

R/FR ratio :

$$\int_{600}^{700} P(\lambda) Q(\lambda) d\lambda / \int_{700}^{800} P(\lambda) Q(\lambda) d\lambda \dots (4)$$

[Table 5\(42KB\)](#) shows the quality of the light balance, R/B ratio and R/FR ratio of various HID lamps(660 to 1,000 W). The light balance is adjusted on the basis of the visibility curve for human eyes, and therefore tends to contain a large green light component(500 to 600 nm). There is no lamp with an R/B ratio in the range of the quantum sensitivity and the average photosynthesis sensitivity(1.44 to 2.71), except for SBML that shows a low efficiency of light energy transformation. HPSLs, which have a large red light component, induce elongated growth, and are therefore used for cultivating herbage crops in plant factories of the closed system type because of their high efficiency. HPMVLs, and MHLs have a large blue light component, and therefore induce growth suppression. However, MHLs are currently the only high wattage lamps that can be used on their own to induce relatively good quality growth.

Table 6(58KB) shows the quality of the light balance of radiant energy, R/B ratio and R/FR ratio of various HID lamps(400 W). SBMLs show the optimum R/B ratio, but their R/FR ratio is associated with elongated growth because of the large FR component. The R/B ratios of HPMVL and MHL are associated with growth control, and that of HPSL with growth elongation. The R/FR ratio of the XW type of HPMVL, the MHL and the high color type of HPSL are all associated with growth elongation.

Table 7(39KB) shows the quality of the light balance, R/B ratio and R/FR ratio of compact type HID lamps for indoor ornamental plants. To achieve adequate growth in indoor shops, MHL 3,500 K may be recommended because of the high R/B ratio, R/FR ratio and light quality balance. For maintenance growth and esthetic displays, MHL 6,500 K can be recommended because it enhances the green color of leaves of ornamental plants. MHL 4,500 K or 6,500 K can be recommended because their R/B ratios are associated with growth control. If HPSL 2,500 K is used, ornamental plants may become overgrown indoors because both the R/B ratio and R/FR ratio lead to the optimum conditions for growth.

---Conclusion-----

To compare different artificial light sources, we determined the spectrum distribution of different light sources and multiplied the values by the average values for the photosynthesis curves derived from 4 sets of data to give an efficiency which we designated as the PGRE(plant growth radiant efficiency). As a result, the PGRE of high pressure mercury fluorescent lamps amounted to 8 to 12%, metal halide lamps(MHL) to 17 to 19% and high pressure sodium lamps to about 18 to 32%, respectively. Metal halide lamps were found to be the most efficient. High color rendition type HPSL and SBML gave excellent light quality balance and high R/B and R/FR ratios, but both exhibited a low basic photoelectric conversion efficiency. For the maintenance of ornamental plants, high color rendition type 4,500 K and 6,500 K lamps show a high PGRE and are effective, but we recommend the 3,500 K lamps due to the high light quality balance and R/B and R/FR ratios. However, if the esthetic effects of a certain store atmosphere are required, we may recommend MHL 4,500 K or 6,500 K in terms of color warmth as well as other factors. The HPSL 2,500 K lamps provide the highest combination of light quality balance, R/B and R/FR ratios, and lead to superior plant growth characteristics. Since many factors relating to plant growth and light irradiation remain unclear, we hope that this report will be a useful point of reference for the research and development of artificial light sources for horticultural applications.

---References-----



[Back](#)

- 1) Horaguchi, K. et al. (1992): Optical radiant environment for indoor plants. *Jpn. Matsushita Electr. Ind. Tech. Rep.*, 38(6), 627-634 [In Japanese].
- 2) Inada, K. (1976): Action spectra for photosynthesis in higher plants. *Plant & Cell Physiol.*, 17, 355-365.
- 3) Inada, K. & Yabumoto, Y. (1989): Effect of light quality, daylength and periodic temperature variation on the growth of lettuce and radish plants. *J. Jpn. Crop Sci.*, 58 (4), 689-694.
- 4) McCree, K. J. (1972): The action spectrum, absorbance and quantum yield of photosynthesis in crop plants. *Agric. Meteorol.*, 9, 191-216.

5) Takatsuji, M. et al. (1995): Plant growth experiment using visible light-emitting diodes. *J. Jpn. SHITA*, 7 (3), 163-165 [In Japanese].



[Forward to:-Respiration Models for Modified Atmosphere Packaging-](#)



[Contents](#)



[JIRCAS Home Page](#)

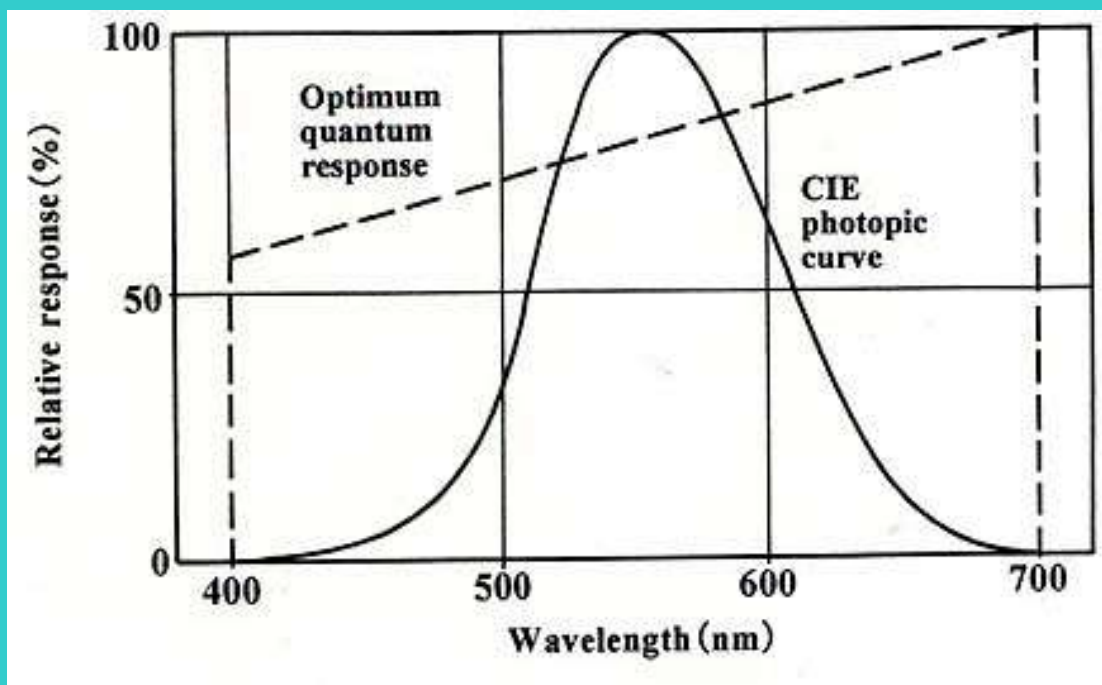


Fig.1. Curve of luminous efficiency and quantum sensitivity



[Back](#)

Table 1. Relation energy of various HID lamps (660 to 1,000 W)

Lamp name	H P M V L		M H L		H P S L		
Lamp type	HF1000-X	HF1000-XW	M1000	MF1000	NH660L	NH660-DL	NH940L
Luminous efficiency (lm/W)	59.5	63.0	90.0	87.0	152.0	111.0	157.4
Radiation energy of visible light (W) (380-780 nm)	171.5	188.7	293.4	291.9	280.6	245.7	415.3
① Efficiency of light energy transformation (%)	17.2	18.9	29.3	29.2	42.5	37.2	44.2
Radiation energy × quantum sensitivity (W) (400-700 nm)	125.2	136.8	203.2	202.8	215.0	182.3	318.2
② Efficiency × quantum sensitivity (%)	12.5	13.7	20.3	20.3	32.6	27.6	33.9
Radiation energy × photosynthesis sensitivity (W) (400-700nm)	109.3	119.7	177.5	178.4	207.0	175.6	306.4
③ Plant growth radiant efficiency (PGRE) (%)	10.9	12.0	17.8	17.8	31.4	26.6	32.6


[Back](#)

Table 2. Radiation energy of various HID lamps (400 W)

Lamp name	HPMVL				MHL			HPSL		
Lamp type	Clear bulb type	Fluo-rescent type X	Fluo-rescent type XW	Self-ballasted	Clear bulb type	Fluo-rescent type	High color type	Clear bulb type	Color improved	Hig' color type
Wattage (W)	400	400	400	500	400	400	400	360	360	400
Luminous efficiency (lm/W)	51	55	60	28	100	95	80	139	106	60
Radiation energy of visible light (380-780 nm) (W)	55.5	63.5	71.9	59.0	130.4	127.5	136.5	140.3	127.9	119.6
① Efficiency of light energy transformation (%)	13.9	15.9	18.0	11.8	32.6	31.9	34.1	39.0	35.5	29.9
Radiation energy × quantum sensitivity (400-700 nm) (W)	39.5	46.3	52.1	35.1	90.4	88.6	89.3	107.5	94.9	77.6
② Efficiency × quantum sensitivity (%)	9.9	11.6	13.0	7.0	22.6	22.2	22.3	29.9	26.4	19.4
Radiation energy × photosynthesis sensitivity (400-700 nm) (W)	33.3	40.6	45.6	31.4	78.9	77.8	76.5	103.4	91.4	76.6
③ Plant growth radiant efficiency (PGRE)(%)	8.3	10.2	11.4	6.3	19.7	19.5	19.1	28.7	25.4	19.2


[Back](#)

Table 3. Light transformation efficiency of compact HID lamps

Lamp type	HPSL2500K	MH3500K	MH4500K	MH6500K
Wattage (W)	1 5 0	1 5 0	1 5 0	1 5 0
Luminous efficiency (lm/W)	5 2 .0	6 6 .7	7 3 .3	7 3 .3
Radiation energy of visible light (380-780 nm) (W)	3 8 .6	4 4 .2	4 8 .5	5 1 .2
① Efficiency of light energy transformation (%)	2 5 .7	2 9 .5	3 2 .3	3 4 .1
Radiation energy × quantum sensitivity (400-700 nm) (W)	2 5 .2	3 0 .5	3 3 .2	3 3 .5
② Efficiency × quantum sensitivity (%)	1 6 .8	2 0 .3	2 2 .1	2 2 .3
Radiation energy × photosynthesis sensitivity (400-700 nm) (W)	2 4 .0	2 7 .7	2 9 .6	2 8 .8
③ Plant growth radiant efficiency (PGRE) (%)	1 6 .0	1 8 .5	1 9 .7	1 9 .2


[Back](#)

Table 4. Quality of light balance of photosynthesis action spectra

		Blue light (%) (400-500 nm)	Green light (%) (500-600 nm)	Red light (%) (600-700 nm)	R/B ratio	Remarks
Quantum sensitivity		27.3	33.3	39.4	1.44	
Photosynthesis action spectra	I n a d a ①	26.1	31.5	42.4	2.33	Average of 26 species of her- baceous plants
	I n a d a ②	19.3	33.5	47.2	3.49	Average of 7 species of arbo- reous plants
	M c C r e e ①	25.0	31.2	43.8	2.52	Average of 20 species (chamber)
	M c C r e e ②	23.5	31.5	45.0	2.74	Average of 8 species (field)
Photosynthesis action spectra (Average)		23.5	32.0	44.5	2.71	


[Back](#)

Table 5. Quality of light balance, R/B ratio and R/FR ratio of HID lamps

Lamp name		HPMVL		MHL		HPSL		
Lamp type		HF1000-X	HF1000-XW	M1000	MF1000	NH660L	NH660DL	NH940L
Quality of light balance (%)	Blue light (400-500 nm)	31 (51.1)	31 (54.4)	29 (76.1)	29 (75.0)	9 (22.9)	6 (12.8)	9 (33.8)
	Green light (500-600 nm)	51 (84.1)	49 (87.9)	54 (144.9)	51 (136.5)	51 (131.8)	38 (80.7)	51 (195.1)
	Red light (600-700 nm)	18 (29.1)	20 (36.0)	17 (44.3)	20 (51.6)	40 (101.8)	56 (119.0)	40 (150.7)
Red light / Blue light ratio a)		0.83	0.98	0.80	0.95	6.06	13.21	6.06
Red light / Far-red light ratio		4.61	3.96	5.88	4.34	3.85	3.23	3.85


[Back](#)

Table 6. Quality of light balance, R/B ratio and R/FR ratio of lamps

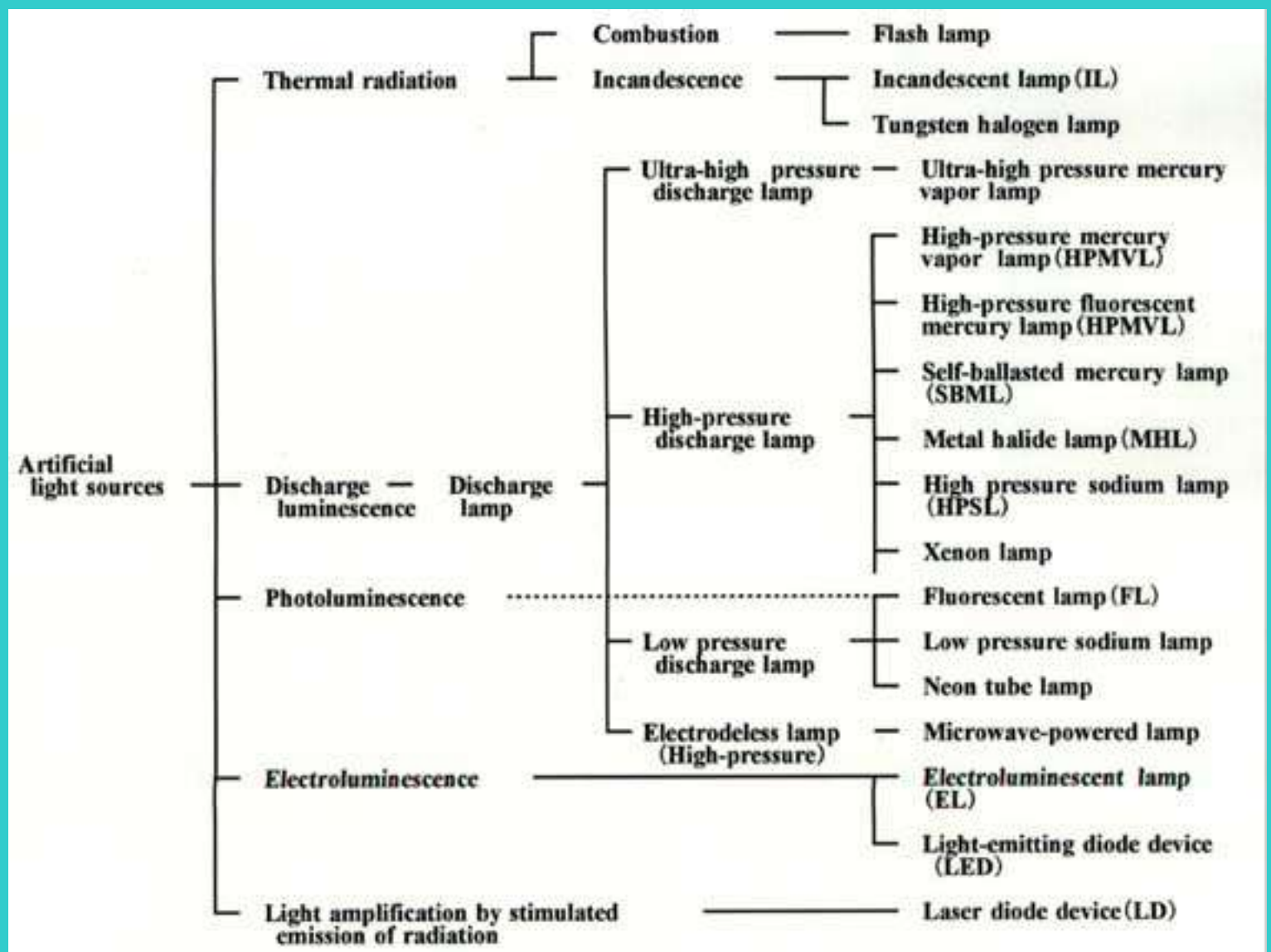

[Back](#)

Table 7. Quality of light balance, R/B ratio and R/FR ratio of compact HID lamps with good color rendition

Lamp type		HPSL2500K	MH3500K	MH4500K	MH6500K
General color rendering index (R _a)		85	96	96	96
Wattage (W)		150	150	150	150
Luminous efficiency (lm/W)		52.0	66.7	73.3	73.3
Quality of light balance (%)	Blue light (400-500 nm)	9 2.7	20 7.4	28 11.6	40 17.3
	Green light (500-600 nm)	28 8.2	36 13.2	36 14.9	35 15.4
	Red light (600-700 nm)	63 18.4	44 16.5	36 15.2	25 11.1
R/B light ratio		9.73	3.22	1.89	0.92
R/FR light ratio		1.74	2.18	2.29	2.09


[Back](#)

Development of Respiration Models for Modified Atmosphere Packaging of Horticultural Commodities

Yoshio MAKINO*

Department of Postharvest Technology, Kagawa Prefectural Food Research Institute

(587-1, Goto, Takamatsu, Kagawa, 761-8031 Japan)

Present address:

*Kagawa Prefectural Fermentation and Food Experimental Station
(Nohma, Uchinomi, Shohzu, Kagawa, 761-4421 Japan)

---Abstract-----

Oxygen uptake models for horticultural commodities were constructed based on the Langmuir adsorption theory, mechanism of depression of respiration caused by CO₂ and transition state theory in order to design modified atmosphere packaging (MAP) systems. To examine the usefulness of the models, O₂ uptake rate data for the commodities were applied to the models. The models were found to be suitable for describing the respiration of several kinds of commodities. Mathematical analysis of MAP systems for shredded lettuce and shredded cabbage was conducted using the proposed rate equations and mass balance equations. The simulated results were in agreement with the experimental data. The O₂ uptake models were found to be suitable for the design of the MAP systems.

Discipline: Postharvest technology

Additional key words: lettuce, cabbage, mathematical model, MAP

[1....26](#):[References](#)

(Received for publication, December 8, 1998)

---Introduction-----

In the storage and/or the transportation process of horticultural commodities, respiration control plays an important role in prolonging the postharvest life of the commodities. Decrease of O₂ and increase of CO₂ concentrations in the environment surrounding the commodities are effective for the depression of respiration¹¹). A modified atmosphere packaging (MAP) system is generally adopted for controlling the gas environment²⁶). The system creates an optimum composition of O₂ and CO₂ suitable for the storage of the commodities by controlling the respiration and film permeability.

Investigations on the prediction of the dynamics of atmosphere in various MAP systems have been undertaken since the 1960s¹⁰). Respiration models of the commodities used for the prediction were constructed by empirical approaches except for a model by Lee et al.¹⁵). It is thus necessary to develop a respiration model on a theoretical basis.

In the present study, theoretical models were constructed for representing the relationship between O₂ uptake rate in the commodities and O₂, CO₂ and temperature. Suitability of the derived models was

evaluated using respiration data for various kinds of commodities. Mathematical analysis of the MAP systems for shredded lettuce and shredded cabbage was conducted to analyze the suitability of the models.

---Mathematical models-----

1) *Respiration models*

Respiration is controlled by an elaborate interlocking system of feedback control that coordinates the rates of glycolysis, fatty acid breakdown, the citric cycle and electron transport¹). In the biochemical reaction of O₂ uptake in a unit cell, it is assumed that one molecule of O₂ is adsorbed on an active site of the cytochrome oxidase complex buried in the inner membrane of mitochondria, and that the O₂ molecule is desorbed from the site when it accepts 4 electrons, which react with the O₂ molecule, and is transformed to 2 molecules of H₂O²⁵). The cytochrome oxidase reaction is estimated to account for 90% of the total O₂ uptake in most cells¹). To analyze these biochemical reactions mathematically, a very complicated model is required. From a practical point of view, a simplified expression is desirable for predicting the atmospheric conditions within the package. An organism, for example a horticultural commodity, takes up an O₂ molecule by a chemical adsorptive reaction on an active enzyme site²⁵). Cytochrome oxidase complex adsorbs one molecule of O₂ per active site¹). I therefore attempted to construct a practical model for O₂ uptake in horticultural commodities based on the adsorption theory proposed by Langmuir¹⁴).

$$J_o = \frac{abp_o}{1 + ap_o} \dots\dots\dots(1)$$

It is generally assumed that in the respiratory depression by CO₂, the CO₂ molecule induces the metabolic inhibition of organic acids in the TCA cycle which is one of the most important steps in the respiratory process^{4,8,19}). The inhibition decreases the formation of NADH and FADH₂ which are produced from NAD⁺ and FAD. As a result, the desorption of the O₂ molecule in the final step of the electron transport chain is indirectly reduced²). Eq. 1 is modified to rate Eq. 2 for O₂ uptake¹⁷) as follows:

$$J_o = \frac{abp_o}{1 + ap_o + aip_o p_c} \dots\dots\dots(2)$$

On the basis of the transition state theory^{7, 18}), the maximum O₂ uptake rate *b* in Eq. 1 or 2 is expressed as follows:

$$b = \frac{NkT}{Lh} e^{-\frac{\Delta G}{RT}} \dots\dots\dots(3)$$

When the temperature dependence of the rate parameters a and i is assumed to be much lower than the dependence of b , the O_2 uptake rate of a horticultural commodity for storage is calculated using Eqs. 1 (or 2) and 3.

2) Respiration rate parameters

Eq. 1 is modified to a linear form given as follows:

$$\frac{p_o}{J_o} = \frac{1}{ab} + \frac{1}{b} p_o \dots\dots\dots(4)$$

The values of a and b are obtained from the slope b^{-1} and the intercept $(ab)^{-1}$ of $p_o \cdot J_o^{-1}$ vs p_o plots. Eq. 2 can be modified to a linear form as given below:

$$\frac{1}{J_o} = \frac{1}{b} + \frac{1}{abp_o} + \frac{i}{b} p_o \dots\dots\dots(5)$$

Equations for the calculation of the parameters a , b and i are derived from Eq. 5 as follows¹⁷:

$$a = \frac{C_1 p_1 - C_2 p_2}{p_1 p_2 (C_2 - C_1)} \dots\dots\dots(6)$$

$$b = \frac{p_1 - p_2}{C_1 p_1 - C_2 p_2} \dots\dots\dots(7)$$

$$i = \frac{B(p_1 - p_2)}{C_1 p_1 - C_2 p_2} \dots\dots\dots(8)$$

A linear form of Eq. 3 is given as follows:

$$\ln\left(\frac{b}{T}\right) = -\frac{\Delta G}{RT} + \ln\left(\frac{Nk}{Lh}\right) \dots\dots\dots(9)$$

3) Changes in atmosphere in a MAP system

Mass balance equations of O₂, CO₂ and N₂ gases in a MAP system are expressed by the following equations (10):

$$\frac{dv_o}{dt} = \frac{P_o A}{X} (q_o - p_o) - J_o W \quad \dots\dots\dots (10)$$

$$\frac{dv_c}{dt} = \frac{P_c A}{X} (q_c - p_c) + J_c W \quad \dots\dots\dots (11)$$

$$\frac{dv_N}{dt} = \frac{P_N A}{X} (q_N - p_N) \quad \dots\dots\dots (12)$$

Temperature dependence of a gas permeability coefficient of a polymeric film is expressed by the Arrhenius equation as follows (22):

$$P_i = F_i e^{-\frac{E_i}{RT}} \quad \dots\dots\dots (13)$$

Respiratory quotient (*RQ*) is defined as follows:

$$Q = \frac{J_c}{J_o} \quad \dots\dots\dots (14)$$

Atmospheric change with time in a MAP system included in a practical temperature range for storage of horticultural commodities is simulated by solving Eqs. 1 (or 2), 3 and 10-14 simultaneously by the Runge-Kutta method using a microcomputer.



[Materials and methods](#)



[Contents](#)

---References-----

[Back to the first page](#)

1. Alberts, B. et al. (1994): Molecular biology of the cell (3rd ed.). Garland Publishing, Inc., New York, 672-683.
2. Baldwin, J. E. & Krebs, H. (1981): The evolution of metabolic cycles. *Nature*, **291**, 381-382.
3. Beaudry, R. et al. (1992): Modified-atmosphere packaging of blueberry fruit; Effect of temperature on package O₂ and CO₂. *J. Amer. Soc. Hort. Sci.*, **117**, 436-441.
4. Bendall, D. S., Ranson, S. L. & Walker, D. A. (1958): Some effects of carbon dioxide-bicarbonate mixtures on the oxidation and reduction of cytochrome c by Ricinus mitochondria. *Nature*, **181**, 133-134.
5. Dilley, D. (1978): Approaches to maintenance of postharvest integrity. *J. Food Biochem.*, **2**, 235-242.
6. Fidler, J. C. & North, C. J. (1967): The effect of storage on the respiration of apples. 1. The effects of temperature and concentrations of carbon dioxide and oxygen on the production of carbon dioxide and uptake of oxygen. *J. Hort. Sci.*, **42**, 189-206.
7. Glasstone, S., Laidler, K. J. & Eyring, H. (1941): The theory of rate processes. McGraw-Hill Book Co. Inc., New York, 195-197.
8. Hulme, A. C. (1956): Carbon dioxide injury and the presence of succinic acid in apples. *Nature*, **178**, 218-219.
9. Joles, D. W. et al. (1994): Modified-atmosphere packaging of 'Heritage' red raspberry fruit: respiratory response to reduced oxygen, enhanced carbon dioxide, and temperature. *J. Amer. Soc. Hort. Sci.*, **119**, 540-545.
10. Jurin, V. & Karel, M. (1963): Studies on control of respiration of Macintosh apples by packaging methods. *Food Technol.*, **17**, 782-786.
11. Kader, A. A. (1986): Biochemical and physiological basis for effects of controlled and modified atmospheres on fruits and vegetables. *Food Technol.*, **40**, 99-104.
12. Kader, A. A., Zagory, D. & Kerbel, E. L. (1989): Modified atmosphere packaging of fruits and vegetables. *Critical Rev. Food Sci. Nutr.*, **28**, 1-30.
13. Karel, M. & Go, J. (1964): Control of respiratory gases. *Modern Packaging*, **37**, 123-127, 190-192.
14. Langmuir, I. (1918): The adsorption of gases on plane surface of glass, mica and platinum. *J. Amer. Chem. Soc.*, **40**, 1361-1403.
15. Lee, D. S. et al. (1991): Model for fresh produce respiration in modified atmospheres based on principles of enzyme kinetics. *J. Food Sci.*, **56**, 1580-1585.
16. Makino, Y. & Hirata, T. (1995): Gas permeability measurement of polymeric films for MA packaging of fresh produce by gas chromatography. *J. Packaging Sci. Technol. Jpn.*, **4**, 10-16 [In Japanese with English summary].
17. Makino, Y., Iwasaki, K. & Hirata, T. (1996): A theoretical model for oxygen consumption in fresh produce under an atmosphere with carbon dioxide. *J. Agric. Eng. Res.*, **65**, 193-203.
18. Makino, Y., Iwasaki, K. & Hirata, T. (1997): Application of transition state theory in model development for temperature dependence of respiration of fresh produce. *J. Agric. Eng. Res.*, **67**, 47-59.
19. Miller, G. W. & Hsu, W. J. (1965): Effects of carbon dioxide-bicarbonate mixtures on oxidative phosphorylation by cauliflower mitochondria. *Biochem. J.*, **97**, 615-619.
20. Morales-Castro, J. et al. (1994): Modified atmosphere packaging of sweet corn on cob. *J. Food Process. Preserv.*, **18**, 279-293.
21. Morales-Castro, J. et al. (1994): Modified atmosphere packaging of head lettuce. *J. Food Process. Preserv.*, **18**, 295-304.
22. Roberts, R. W. & Kammermeyer, K. (1963): Polymer structure and gas permeation. 1. Thermodynamic interpretation of permeation. *J. Applied Polymer Sci.*, **7**, 2175-2182.
23. Song, Y., Kim, H. K. & Yam, K. L. (1992): Respiration rate of blueberry in modified atmosphere at various temperatures. *J. Amer. Soc. Hort. Sci.*, **117**, 925-929

References

24. Stenesh, J. (1989): Dictionary of biochemistry and molecular biology (2nd ed.). John Wiley & Sons, New York, 501.
25. Tzagoloff, A. (1982): Mechanism of catalysis. *In* Cellular organelles, mitochondria. ed. Siekevitz, P., Plenum Press, New York, 126-129.
26. Zagory, D. & Kader, A. A. (1988): Modified atmosphere packaging of fresh produce. *Food Technol.*, **42**, 70-77.



[Back to the first page](#)

---Materials and methods-----

1) Horticultural commodities

Head cabbage (variety YR-Aoba), head lettuce (variety Cisco), tomatoes (variety Momotaro) and broccoli (variety Naomidori) were purchased from a wholesale market in Takamatsu (Kagawa Prefecture, Japan).

Head cabbage was shredded into 1 mm wide slices with a cooking cutter (CQ-34R, Toshiba, Inc., Tokyo, Japan). The shredded cabbage was washed twice in a stainless-steel pan and rinsed for 1 min using a water sprinkler. The water adhering to the surface of the cabbage was removed by centrifugation (64.1 m s^{-2} for 30 s). Head lettuce was shredded into $30 \times 30 \text{ mm}$ (900 mm^2) fragments with a kitchen knife. The shredded lettuce was treated by the same method as the shredded cabbage after shredding.

2) Measurement of O_2 uptake and CO_2 production rates

Oxygen uptake and CO_2 production rates of horticultural commodities were measured by the method of Jurin & Karel¹⁰ under gaseous environments including the combination of 5 levels of O_2 [2, 5, 10, 15 and 21% (partial pressures of 2.03, 5.07, 10.1, 15.2 and 21.3 kPa under 101.325 kPa)] and 3 levels of CO_2 [0, 3, and 9% (partial pressures of 0, 3.04 and 9.12 kPa under 101.325 kPa)] balanced with N_2 .

3) Measurement of O_2 and CO_2 concentrations in a MAP system

A low density polyethylene (LDPE) pouch (thickness 0.025 mm, effective area 0.072 m^2) was used for the MAP test with shredded cabbage or shredded lettuce. Oxygen, CO_2 and N_2 permeability coefficients of LDPE were determined by the method of Makino & Hirata¹⁶ at 5, 15, 20 or 30. The data of the permeability coefficients were analyzed by linear regression using the linear form of Eq. 13 [$\ln(P_i) = -E_i \cdot (RT)^{-1} + \ln(F_i)$].

The prepared shredded cabbage (0.06 kg) and shredded lettuce (0.08 kg) were enclosed in LDPE pouches. When shredded lettuce was enclosed, a small package of CO_2 scrubber (Ageless C[®], Mitsubishi Gas Kagaku, Inc., Tokyo, Japan) was also enclosed in the pouch because it is desirable that lettuce be stored under 0% CO_2 ⁵. The pouch was stored for 3 d (shredded cabbage) or 6 d (shredded lettuce) at 10. The void volume of the pouch was determined based on water displacement. Oxygen and CO_2 concentrations within the pouch were periodically measured during storage by gas chromatography.

Data for the changes in the gas concentrations in the LDPE pouch over time were compared with the simulated values to estimate the practical effectiveness of the model equations proposed in the present study.

---Results and discussion-----

1) Suitability of the O_2 uptake model for respiration in horticultural commodities

Fig. 1(26KB) shows the relationship between $p_O \cdot J_O^{-1}$ and p_O of the experimental data of O_2 uptake for shredded lettuce, tomatoes and broccoli, and of the published data for apples⁶, broccoli¹⁵, bananas¹³, and blueberries³ with linear regression lines. The correlation coefficients were found to be in the range of 0.94 to 1.00, which were significant at 99.9% level of Fisher's z-transformation method, suggesting that Eq. 1 may be applied for the prediction of the O_2 uptake rate of many kinds of commodities. Eq. 1 is a simplified mathematical form of the enzyme kinetic model proposed by Lee et al.¹⁵. The validity of this mathematical form has already been demonstrated by Lee et al.¹⁵. In this study, I observed that the same mathematical equation form can be derived using either the enzyme kinetic theory or the adsorption theory, as the control mechanism.

Fig. 2(29KB) shows the relationship between J_O^{-1} and p_C in the experimental data of O_2 uptake for shredded cabbage, tomatoes, and broccoli in this study, and those in the published data for broccoli¹⁵. The value of J_O^{-1} for broccoli obtained in this study was larger than that obtained in the literature¹⁵, presumably due to the difference in the experimental temperature: 16°C in this experiment, and 24°C in the literature. Kader et al.¹¹ reported that temperature and/or cutting treatment affect(s) the respiration rate of horticultural commodities. The correlation coefficients between the experimental data and the straight fit lines were found to be in the range of 0.587 to 0.902, values significant at 95% level of the Fisher's z-transformation except for one coefficient. These findings suggest that Eq. 2 may be applied for the prediction of the O_2 uptake rates of the 3 kinds of horticultural commodities. The O_2 uptake data from the literature¹⁵ for broccoli at 12.7 kPa of O_2 partial pressure resulted in a correlation coefficient which was not significant at the 95% level. However, the experimental data substituted in Eq. 5 were obviously linear as shown in Fig. 2.

The validity of Eq. 2 as a rate equation was demonstrated in the present study as shown in Fig. 2. Eq. 2 is a simplified mathematical form of the enzyme kinetic model with uncompetitive inhibition. The validity of this mathematical form has already been demonstrated by Lee et al.¹⁵ for the aerobic respiration of horticultural commodities. In this study, I observed that the same mathematical form equation describing the control mechanism can be derived using either the enzyme kinetic theory or the adsorption theory. The uncompetitive inhibition is

defined as the direct inhibition of the enzymic activity where an inhibitor binds to the enzyme-substrate complex but does not bind to the free enzyme²⁴). Lee et al.¹⁵) approximated the respiration rate of horticultural commodities with an uncompetitive inhibition model. However, many authors concluded that the mechanism for CO₂ inhibition of O₂ uptake in some way interferes with organic acid metabolism, which is an indirect effect¹⁹). Such indirect effects are not compatible with mathematical modeling of respiration rate equations at a mechanistic level. The macroscopic approach, such as adsorption theory, which was applied to derive Eq. 2 may be more suitable for expressing complex biochemical reactions.

The O₂ uptake rate data for shredded cabbage and shredded lettuce obtained in this study and for blueberries and raspberries obtained from the literature^{3,9}) are shown in [Figs. 3 and 4\(68KB\)](#) with calculated linear regression lines. The uptake rate rose with the increase of O₂ partial pressure, decrease of CO₂ partial pressure, and rise of temperature in the environment surrounding the commodities. The trend was in agreement with that described in the previous report¹²), supporting the assumption that the O₂ uptake rate data obtained in this study are suitable for the analysis of the temperature dependence of the O₂ uptake rate of the commodities.

Values of $\ln(b \cdot T^{-1})$ calculated from the values of the maximum O₂ uptake rate parameter b for various products are shown in [Fig. 5\(18KB\)](#). The results indicate that the values of $\ln(b \cdot T^{-1})$ were linearly correlated with the reciprocal of absolute temperature. These observations suggest that Eqs. 3 and 9 can be used for the analysis of the temperature dependence of the O₂ uptake rate of horticultural commodities. In the previous reports, Karel and Go¹³) and Song et al.²³), applied the Arrhenius equation to express the respiration rates of pre-climacteric hard green bananas, cut broccoli and blueberries, respectively. I applied Eq. 3 derived from the transition state theory. The correlation coefficients in Fig. 5 indicate that the proposed Eq. 3 is suitable for the O₂ uptake rate. The proposed Eq. 3 is composed of Boltzmann's constant k , Planck's constant h , Avogadro's constant L and gas constant R which are generally adopted in the physicochemical field except for the symbol N . These findings suggest that Eq. 3 is more suitable than the Arrhenius equation for describing the temperature dependence of the O₂ uptake rate from a theoretical viewpoint.

2) Simulation of dynamic changes in atmosphere in MAP systems for horticultural commodities

Experimental data and simulation results for the changes in the O₂ and CO₂ concentrations over time in the MAP systems for shredded cabbage and shredded lettuce are shown in [Fig. 6\(21KB\)](#). The simulation results obtained by using the parameters presented in Tables 1 and 2, indicated by the full lines, were in good agreement with the experimental data. These facts suggest that the model derived from the Langmuir adsorption theory, mechanism of the depression of respiration caused by CO₂ and the transition state theory is suitable for expressing the O₂ uptake rate of horticultural commodities as well as for the evaluation of the parameters, gas permeability coefficients and RQ .

Table 1. Oxygen uptake rate parameters for horticultural commodities

Commodity	βG	N	$a^a)$	$i^a)$	$Q^a)$
Shredded cabbage	8.81x10 ⁸	7.74x10 ¹⁸	3.09	0.0691	0.853
Shredded lettuce	7.28x10 ⁸	3.50x10 ¹⁶	0.0532	0.0838	0.962

a): Average in the range of 5 to 30.

Table 2. Gas permeability parameters for a low density polyethylene film

Gas	E_i	F_i
O ₂	4.74 x 10 ⁸	5.42
CO ₂	4.81 x 10 ⁸	44.8
N ₂	3.74 x 10 ⁸	0.126

Morales-Castro et al.^{20,21}) calculated the changes in the O₂ and CO₂ concentrations over time in the MAP systems for sweet corn and head lettuce using respiration models suitable for changes in temperature. The respiration models were constructed by the non-linear regression analysis which is an empirical approach. Deviation of the experimental results from the simulated results was larger than that in this study. It is suggested that the simplified model proposed in this study is more effective for the design of the MAP systems than the model(s) reported in the literature.

---Conclusions-----

An O₂ uptake model based on Langmuir adsorption theory was found to be suitable for the analysis of the actual data of O₂ uptake of shredded lettuce, tomatoes and broccoli obtained in this study and of apples, broccoli, bananas and blueberries obtained in the literature. An O₂ uptake model under an atmosphere with CO₂ based on the assumption that CO₂ gas inhibits the oxidation of the organic acids in the TCA cycle predicted well the actual rates for shredded cabbage, tomatoes and broccoli. The validity of the transition state theory for explaining the temperature dependence of the O₂ uptake rate of shredded cabbage, shredded lettuce, blueberries and raspberries was demonstrated in this study. Simulation of changes in O₂ and CO₂ concentrations over time in a MAP system for shredded cabbage or shredded lettuce was in good agreement with the experimental data. The model equations proposed in this study can thus be used for the design of MAP systems.

Notations

- a*: O₂ uptake rate parameter (kPa⁻¹)
A: effective area of a packaging film (m²)
b: maximum O₂ uptake rate (mmol kg⁻¹ h⁻¹)
B: constant (kg h mmol⁻¹ kPa⁻¹)
C: constant (kg h mmol⁻¹)
E: energy of activation for gas permeation (m² kg h⁻² mmol⁻¹)
F: frequency constant (mmol m⁻¹ h⁻¹ kPa⁻¹)
h: Planck's constant 3.976 x 10⁻³² m² kg h⁻¹
i: O₂ uptake rate parameter (kPa⁻¹)
J: uptake or production rate of a gas in a horticultural commodity (mmol kg⁻¹ h⁻¹)
k: Boltzmann's constant 4.97 x 10⁻²⁰ m² kg h⁻² K⁻¹
L: Avogadro's constant 6.022 x 10²⁰ molecules mmol⁻¹
N: total number of active sites for O₂ uptake in a horticultural commodity (molecules kg⁻¹)
p: partial pressure of a gas in the environment surrounding a horticultural commodity (kPa)
P: permeability coefficient of a gas through a plastic film (mmol m⁻¹ h⁻¹ kPa⁻¹)
q: partial pressure of a gas outside of a MAP system (kPa)
Q: respiratory quotient (RQ)
R: universal gas constant 1.08 x 10⁵ m² kg h⁻² mmol⁻¹ K⁻¹
t: storage time (h)
T: absolute temperature (K)
v: amount of a gas in a MAP system (mmol)
W: mass of fresh produce (kg)
X: thickness of a packaging film (m)
³*G*: Gibbs energy of activation for O₂ uptake (m² kg h⁻² mmol⁻¹)

Subscripts

- C, N, O*: CO₂, N₂, O₂
i: symbol expressing *C, N* or *O*
 1, 2: level of O₂ pressure



[Forward to:-Helminths of Pigs in Mekong Delta-](#)



[Contents](#)



[JIRCAS Home Page](#)

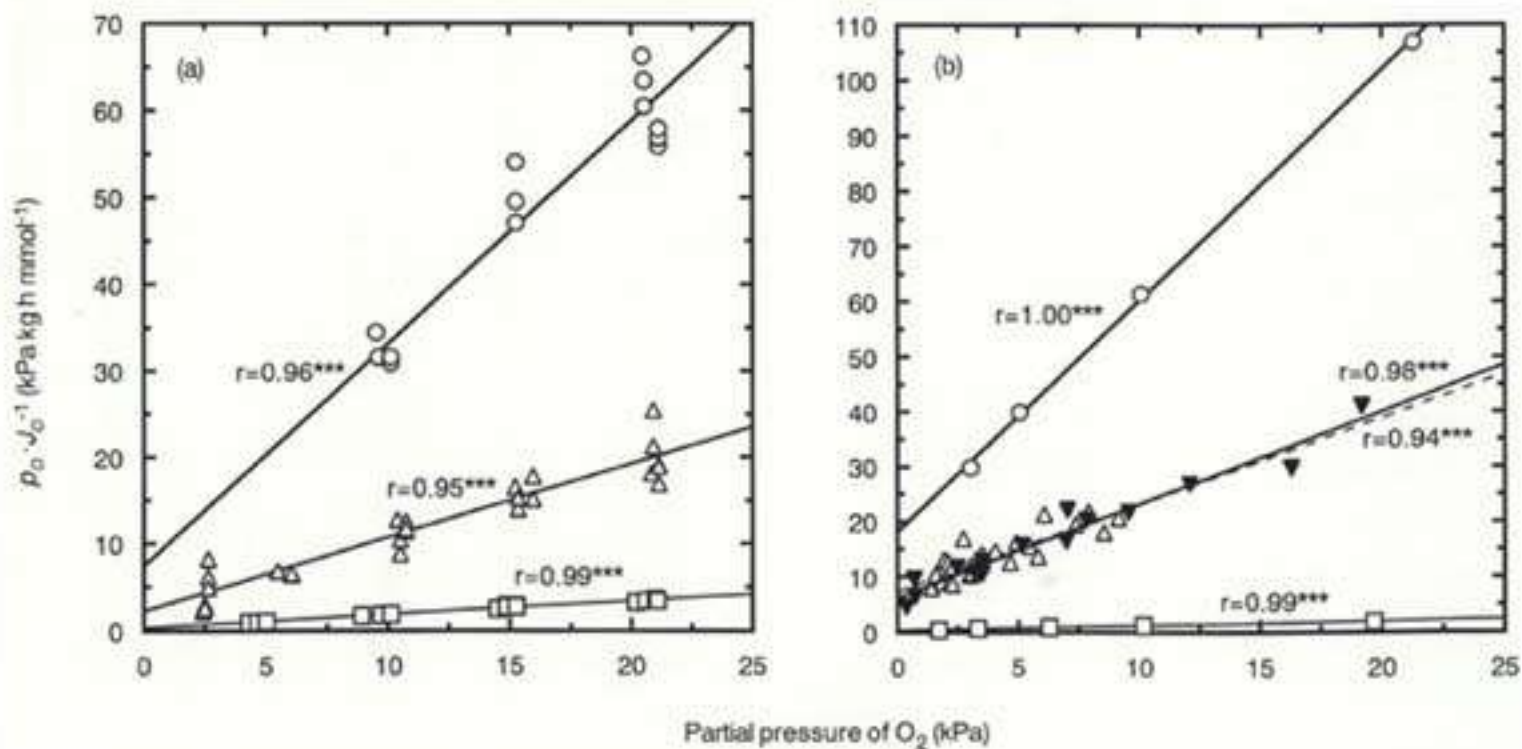


Fig. 1. Relationship between $p_{O_2} \cdot J_{O_2}^{-1}$ and partial pressure of O_2 for shredded lettuce (Δ), tomatoes (\circ) and broccoli (\square) based on the experimental data obtained in this study (a) and for apples (\circ), broccoli (\square), bananas (\blacktriangledown) and blueberries (Δ) based on the published data (b)

Solid lines denote the linear regression lines. A dashed line denotes the linear regression line for blueberries.



[Back](#)

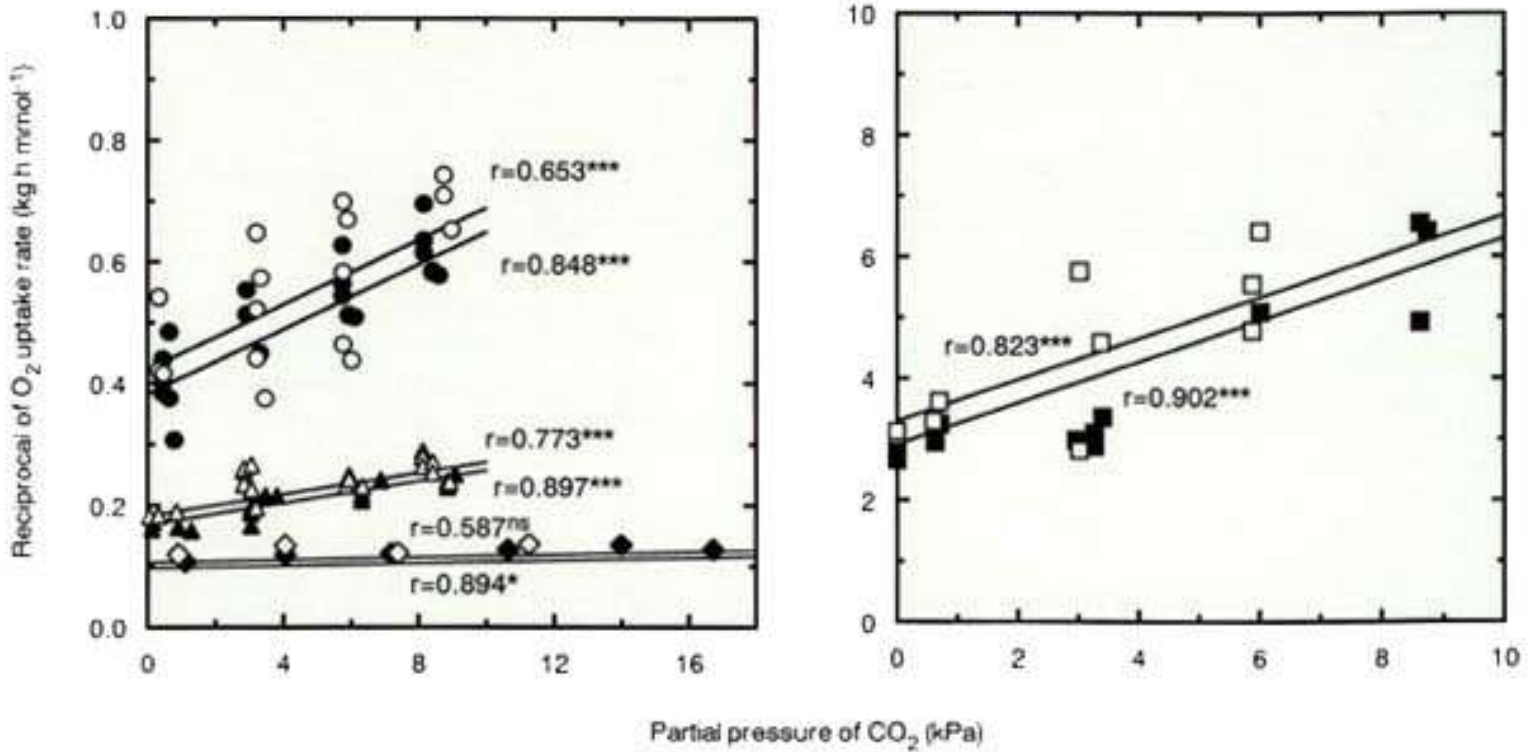


Fig. 2. Relationship between reciprocal of O₂ uptake rate and partial pressure of CO₂ for shredded cabbage (○), broccoli (△) and tomatoes (□) based on the experimental data obtained in this study and for broccoli (◇) in the literature¹⁵⁾

Open and closed symbols denote the data at 2.03 and 21.3 kPa O₂, respectively.



[Back](#)

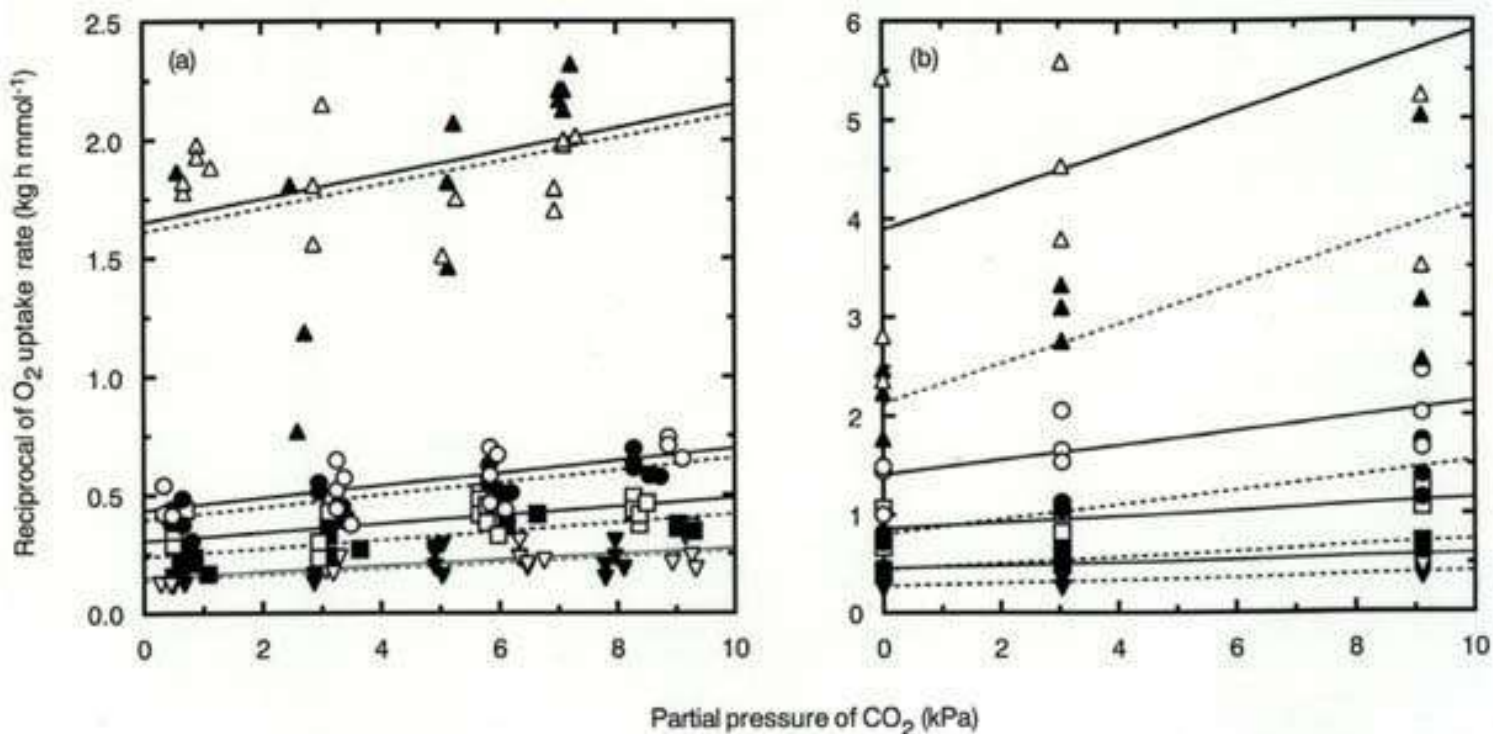


Fig. 3. Relationship between reciprocal of O₂ uptake rate and partial pressure of CO₂ for shredded cabbage (a) and shredded lettuce (b) at 5 (△), 15 (○), 20 (○) and 30°C (▽)

Open and closed symbols denote the data at 2.03 and 21.3 kPa O₂, respectively, on the basis of the experimental data obtained in this study. Solid and dashed lines denote the linear lines generated by the method of Makino et al.¹⁷⁾ in reference to the O₂ partial pressures of 2.03 and 21.3 kPa, respectively.

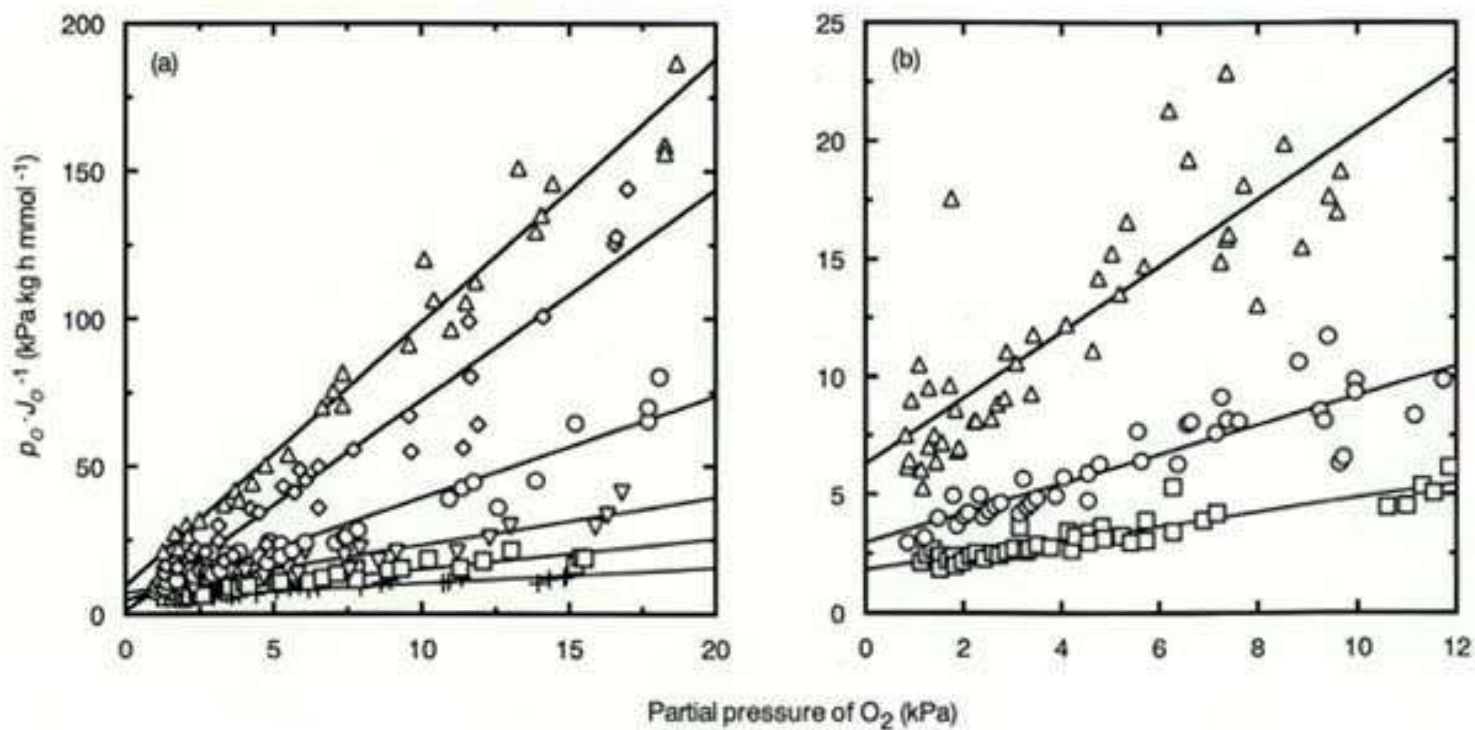


Fig.4. Relationship between $p_{O_2} \cdot J_{O_2}^{-1}$ and partial pressure of O₂ for blueberries (a) and raspberries (b) at 0 (△), 5

(◇), 10 (○), 15 (▽), 20 (□) and 25°C(+) on the basis of the data obtained in the literature^{3,9)}

Solid lines denote the linear regression lines.



[Back](#)

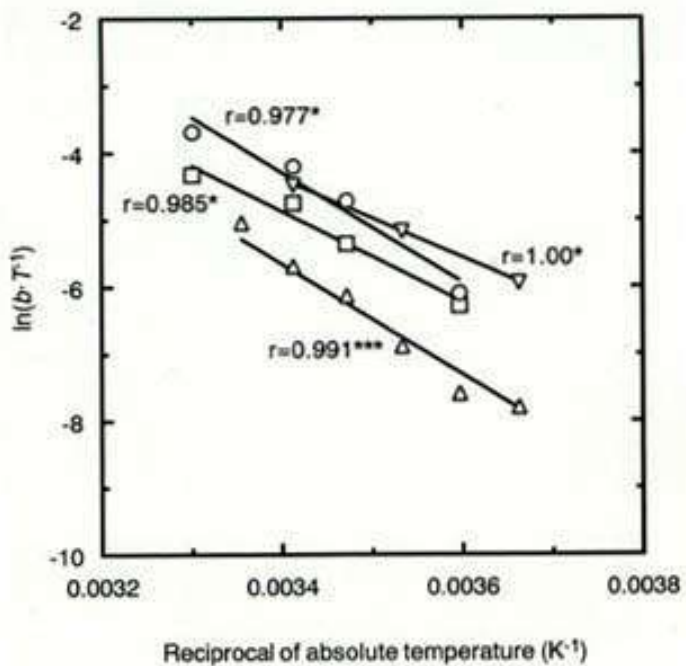


Fig. 5. Relationship between $\ln(b \cdot T^{-1})$ and reciprocal of absolute temperature for shredded cabbage (\circ), shredded lettuce (\square), blueberries (\triangle) and raspberries (∇) Solid lines denote the linear regression lines.



[Back](#)

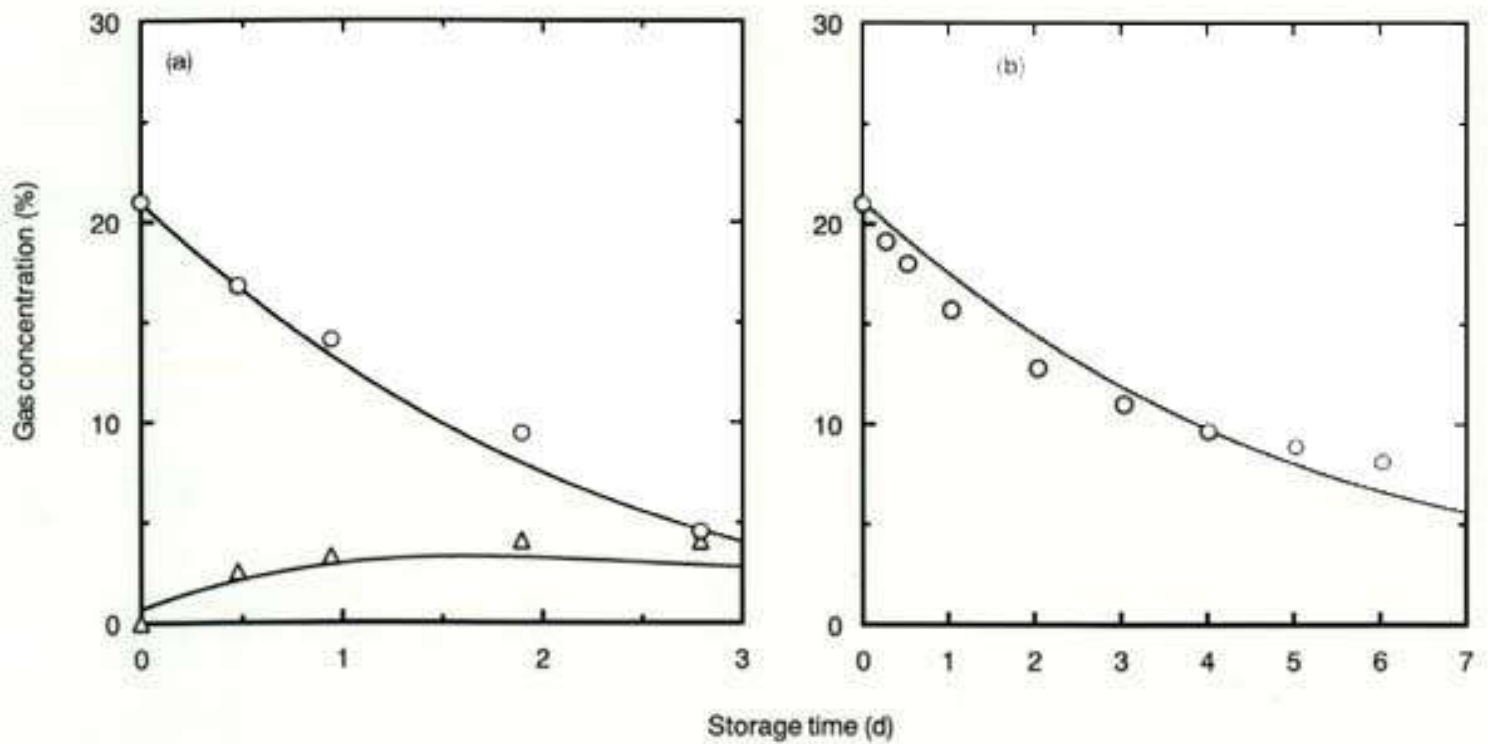


Fig. 6. Measured changes in concentrations of O₂ (○) and CO₂ (△) in modified atmosphere packaging (MAP) systems for shredded cabbage (a) and shredded lettuce (b)

Simulated results are indicated by the full lines. Initial amount of O₂, CO₂ and N₂ molecules in the systems are 3.16, 0 and 11.7 mmol (a) and 7.37, 0 and 27.4 mmol (b), respectively. Partial pressures of O₂, CO₂ and N₂ outside of the systems are 21.3, 0 and 79.0 kPa, respectively.



[Back](#)

Helminths and Helminthiosis of Pigs in the Mekong Delta Vietnam with Special Reference to *Ascariosis* and *Fasciolopsis buski* Infection

Shinobu YOSHIHARA*¹, Nguyen Phuoc Hung*², Nguyen Huu Hung*³ and Chau Ba Loc*³

*¹ Animal Production and Grassland Division, Japan International Research Center for Agricultural Sciences (Tsukuba, Ibaraki, 305-8686 Japan)

*^{2,3} Department of Veterinary Medicine, College of Agriculture, Can Tho University (3/2 street, Campus II, Can Tho, Vietnam)

This paper reports the results obtained in the joint project on "Integrated Research on Farming Systems Combining Agriculture, Animal Husbandry and Fisheries in the Mekong Delta" among the Japan International Research Center for Agricultural Sciences, Japan, Can Tho University and Cuu Long Delta Rice Research Institute, Vietnam, during the period of October 1995 to September 1997.

Present address:

*¹Research Development of Bacteriology and Parasitology, National Institute of Animal Health (Tsukuba, Ibaraki, 305-0856 Japan)

*²Graduate Course of Veterinary Medicine, University of Agriculture and Forestry (Thu Duc, Ho-Chi-Minh City, Vietnam)

---Abstract-----

To demonstrate the infection of pigs with helminths in the Mekong Delta, an investigation into the actual conditions was carried out in the area. A total of 87 pigs from 38 farms were examined for the presence of the helminths. Eggs of common nematodes, (*Ascaris suum*, *Metastrongylus* spp., *Oesophagostomum* spp., *Trichuris suis* and *Strongyloides ransomi*) present in Japan, were detected. Especially, since the morbidity rate of *A. suum* infection was very high, the effect of the *Ascaris* infection on pig growth was investigated. As a result, economic loss was estimated at US\$2.0/head. In addition, infection with *Fasciolopsis buski*, which does not occur in Japan, was detected in 4 pigs from 4 small farms. These 4 pigs were give water spinach as a supplemental feed. It was suggested that this vegetable played an important role in *F. buski* infection and that the fluke infection was one of the zoonoses. Infection with this fluke in human can be anticipated, because most of the inhabitants ate this vegetable in the Mekong Delta.

Discipline: Animal health

Additional key words: *Ascaris suum*, zoonosis, anthelmintic, economic loss

[1.....22\):References](#)

(Received for publication, December 22, 1998)

---Introduction-----

The Mekong Delta is an important region for the pig production industry in Vietnam¹¹). The pig production is conducted in small farms in integrated farming systems or in the *Vuon-Ao-Chung* (VAC) system combining agriculture, animal husbandry and fisheries for feed from agricultural by-products. The economic efficiency of these farms is very low and the income of the farmers is also low⁶). To increase the productivity of pigs and farmers' income, it is important to prevent the occurrence of various problems relating to feeds and diseases¹⁸). It is considered that helminthic diseases are associated with the low productivity and cause economic loss in the VAC system⁸).

On the other hand, helminthiasis may be an important zoonosis in the VAC system, because many intermediate hosts of helminths, such as snails, crabs or small fishes, occur in this area in which marshlands, small rivers, ponds and rice fields are located.

The objective of the present studies was to identify the swine helminthiasis including zoonotic trematodes in the VAC system. Therefore, we investigated *Ascaris suum* infection and *Fasciolopsis buski* infection in the Mekong Delta.

---Materials and methods-----

1) Surveys of helminths

Sampling sites: Eighty seven fecal samples were collected from pigs in 38 farms in the VAC systems ([Fig. 1\(29KB\)](#)) in the Mekong Delta area. Feces (50-100g each) were packed in plastic bags and stored in a refrigerator until the examination. We also determined which feeds were given as supplement in the farms.

Detection of eggs: The Watanabe sedimentation method¹⁹) was applied to detect eggs. Counts of eggs per gram (EPG) were carried out to estimate the degree of parasitism by using Dennis method⁵) for *F. buski*. The effect of anthelmintics on *A. suum* was estimated using McMaster EPG counting plate, if necessary.

2) Use of scanning electronmicroscope (SEM) for morphological studies of *F. buski*

Several flukes collected from slaughterhouses were fixed in 10% phosphate-buffered formalin and washed 3 times in 0.1 M phosphate buffer. After dehydration in ethanol, the fluke materials were subjected to isoamyl acetate immersion, critical point drying and coating with gold. The fluke specimens were observed with a scanning electronmicroscope (SEM, JEOL, JSM-5300).

3) Experiment on effect of *Ascaris* infection on pig growth

Pigs: Six pigs weighing approximately 40 kg were used. They were littermates and crossbreds of *Ba Xuyen* and Yorkshire from the Experimental Animal Farm of Can Tho University. They were positive for the *A. suum* eggs.

Experimental design: Group 1 consisted of 3 pigs treated with 1 mL per 15 kg of Polystrongle (injectable

form Tetramizole hydrochloride, France). Group 2 consisted of 3 untreated pigs. Their body weight was checked biweekly for 12 weeks. EPG count was carried out every day using McMaster egg counting plate for 10 days after treatment. *A. suum* eggs were also checked by the sedimentation method every week. All the animals were raised under the standard management applied in the animal farm of the university.

Pathological examination: Pigs from the 2 groups were necropsied 12 weeks after the onset of the experiment. At necropsy, middle parts of the small intestine were fixed in 10% formalin. For histological examination the tissue samples were embedded in paraffin wax, sectioned and stained with hematoxylin and eosin (HE).

4) Ovicidal effect of biodigester

Samples containing *F. buski* eggs were collected from the inlet and outlet of the biodigester (Fig. 1). Each sample of the fluke eggs was washed in tap water and vibrated to remove the debris around the eggs. Then, the egg samples were transferred into Petri dishes with water and incubated at 29 for 15 days. After the incubation, the eggs which did not develop to the next stage (or miracidium) were considered to be dead eggs. The eggs of *A. suum* were also incubated by the same method to examine their activity.



[Result](#)



[Contents](#)

---Reference-----



[Back to the first page](#)

- 1) Abu-Erreich, G. M. & Peanasky, R. J. (1974): Pepsin inhibitors from *Ascaris lumbricoides*. *J. Biol. Chem.*, **249**, 1558-1565.
- 2) An, B. X. (1996): The impact of low-cost polyethylene tube biodigester on small farms in Vietnam (MSc. thesis), Swedish University of Agricultural Sciences, Uppsala, Sweden, 1-14.
- 3) Anderson, S. (1976): The influence of *Ascaris suum* infection upon growth rate in pigs. *Nordic Vet. Med.*, **28**, 322-330.
- 4) Bossaler, W., Duedel, W. & Kirsch, D. (1983): Deworming of weaner pigs with Panacur. *In* Composition and meat quality in worm-free and worm-infected animals. The Blue Book 32, Hoechst AG, 79.
- 5) Dennis, W. R., Stone, W. M. & Swanson, L. E. (1954): A new laboratory and field diagnostic test for fluke ova in feces. *J. Am. Vet. Med. Assoc.*, **124**, 47-50.
- 6) Devendra, C. (1993): Sustainable animal production from small farming systems in Southeast Asia. *In* FAO animal production and health paper 106, FAO, Rome, 143.
- 7) Gibson, T. E. (1963): The influence of nutrition on the relationships of gastro-intestinal parasites and their hosts. *Proc. Nutr. Soc.*, **22**, 15-20.
- 8) Hung, N. H. (1990): Situation of infection and treatment of helminth on pigs in Haugian Province. *In* Result of veterinary research in the Mekong Delta. ed. Loc, C. B., 41-53 [In Vietnamese with English summary].
- 9) Hung, N. H. (1997): Study on metastrongylosis in pigs in some provinces in the Mekong Delta (MSc. thesis). Can Tho University, Can Tho, 35.
- 10) Le, N. T. (1978): Study on the biology of trematode *Fasciolopsis buski* (Lankaster, 1857) in Vietnam. *Med. Parasitol. (Mosk.)*, **47**, 81-84 [In Russian with English summary].
- 11) Loc, C. B., Son, V. V. & Son, T. C. (1995): Research priorities for improving animal production in the Mekong Delta. *In* Exploring approaches to research in the animal science in Vietnam. ed. Pryor, W. J., 213-216.
- 12) Pietsch, W. & Buchwalder, R. (1971): Experimentelle Untersuchung _ber den Einflub von Rinderg•le auf die Eier von *Fasciola hepatica*. *Mh. Vet. Med.*, **26**, 737-739 [In German with English summary].
- 13) Soulsby, E. J. L. (1965): Textbook of veterinary parasitology. Blackwell Scientific Publication, Oxford, 1220.
- 14) Stephenson, L. S. et al. (1980): *Ascaris suum* Nutrient absorption, growth, and intestinal pathology in young pigs experimentally infected with 15-day-old larvae. *Expl. Parasitol.*, **49**, 15-25.
- 15) Stewart, T. B. & Hale, O. M. (1988): Losses to intestinal parasites in swine production. *J. Anim. Sci.*, **66**, 1548-1554.
- 16) Taira, N. & Tasanee, C. (1989): Survey of the distribution of intermediate hosts of *Fasciola* and *Paramphistomum* in certain regions of Thailand. *Jpn. J. Vet. Med. Assoc.*, **42**, 429-434 [In Japanese].
- 17) Thong, T. T., Hai, L. T. & Quac, V. A. (1995): Research work on pig production in Mekong Delta. *In* Exploring approaches to research in animal science in Vietnam. ed. Pryor, W. J., 52-56.
- 18) Thong, T. T. (1996): Research and investment in agriculture. *Vietnam Southeast Asia Today*, June, 28-29.
- 19) Watanabe, S., Nagayama, F. & Iwata, S. (1953): A simple fecal sedimentation test for detection of *Fasciola* eggs. *Jpn.*

J. Vet. Med. Assoc., **6**, 176-177 [In Japanese].

20) Watanabe, S. (1960): Parasitic diseases of domestic animals and their problems (1). *Chikusan no kenkyu*, **14**, 98-102 [In Japanese].

21) Weng, Y. L. et al. (1989): Studies on ecology of *Fasciolopsis buski* and control of fascioliosis. *Chung Kuo Chi Sheng Chung Hsu Chi Sheng Ping Tsa Chih*, **7**, 108-111 [In Chinese with English summary].

22) Yoshihara, S. (1979): Ovicidal effect of cattle urine against *Fasciola* eggs in cattle manure. *J. Tokyo Vet. Med. Anim. Sci.*, **27**, 57-60 [In Japanese with English summary].



[Back to the first page](#)



Fig.1.
A tube type biodigester in a farming system combining pigpen, pond and orchard



[Back](#)

---Result-----

1) Surveys of helminths in the Mekong Delta

Eggs of *A. summ* were detected in 51% (44) of 87 pigs, *Metastrongylus* spp. in 14% (12), *Trichuris suis* in 26% (23), *Oesophagostomum* spp. in 14% (12), *Strongyloides ransomi* in 5% (4) and *F. buski* in 5% (4). There were distinct differences between the regions surveyed in the infective rate of *A. summ*. The rate of this nematode in the pigs from 12 farms near Can Tho University was 100%, whereas about 30% in other regions.

Eggs of *F. buski* (Fig. 2(23KB)) were detected in the feces of 4 pigs from 4 farms. All the pigs infected with this fluke had eaten water spinach (*Ipomoea aquatica*) as supplemental feed (Fig. 3(21KB)). In 3 pigs, the EPG count was 10 or less. However, a sow with severe constipation had an EPG count of more than 1,000 in the feces. The snails which were intermediate hosts of the flukes (*Gyraula* sp. and *Indoplanorbis* sp.) were detected in marshlands, ponds, small rivers and rice fields near the pig pens in the VAC systems. Furthermore, other snails (*Lymnaea* sp. and *Pila* sp.) also occurred in the same areas (Fig. 4(20KB)).

2) Morphology of F. buski

The eggs of *F. buski* were yellowish ellipsoidal and 130-140 x 80-85 μm in size. They were very similar to the eggs of *Fasciola gigantica* (Japanese type). The *F. buski* flukes in pigs from slaughterhouses were 2.0-4.4 x 0.5-2.0 cm in size. Several adult flukes were detected in the intestine (Fig. 5(30KB)). Under the scanning electronmicroscope an oral sucker, genital atrium and ventral sucker were observed (Fig. 6(43KB)). The middle part of the of the ventral surface of the body showed a crocodile skin appearance (Fig. 7(68KB)). In the tail of the fluke, the excretory bladder opened near the posterior extremity of the body (Fig. 8(68KB)).

3) Effect of A. summ infection on pig growth

In 6 pigs of the 2 groups, only *A. summ* eggs were detected in the feces. In 3 pigs of the treated group, adults of *A. summ* were eliminated within a few days after treatment with Tetramizole, and the EPG of this nematode reached a zero value (Table 1). However, since *A. summ* eggs were found again 6 weeks later, treatment was resumed. While the growth rate of the untreated pigs was low, the growth rate of the treated pigs improved (Fig. 9(22KB)). In the untreated group, the small intestine of an emaciated animal contained 12 *Ascaris* (Fig. 10(25KB)). The pig infected with *A. summ* showed a low weight gain (Table 2). The growth of the untreated pigs which reached a weight of 80 kg was delayed by 2 weeks compared with the treated pigs. Anorexia and diarrhea were not observed in pigs of both groups during the examination.

Table 1. Change in egg counts in feces of pigs after Tetramizole treatment

Group	Pig No.	Days after treatment									
		1	2	3	4	5	6	7	8	9	10
Treatment	1	800a)	0	0	0	0	0	0	0	0	0
	2	900	0	0	0	0	0	0	0	0	0
	3	300	100	0	0	0	0	0	0	0	0
-----	----	----	----	----	----	----	----	----	----	----	----
Control	4	700	800	900	800	800	1,000	900	1,100	900	1,100
No treatment	5	800	900	800	800	800	800	800	900	1,000	1,000
	6	400	400	400	400	400	400	400	400	400	600

a): Number of eggs per g in feces.

Table 2. Body weight of treated and untreated pigs (Unit: Kg)

Group	Pig No.	Weeks after treatment						
		0	2	4	6	8	10	12
Treatment	1	37	44	51	60	79	81	89
	2	40	45	52	60	70	82	89
	3	39	44	51	58	68	80	90
-----	----	----	----	----	----	----	----	----
Control	4	41	46	52	59	66	74	82
No treatment	5	39	44	50	57	64	72	81
	6	42	46	51	58	66	69	72

Macroscopically, there were a few petechial hemorrhage on the pulmonary pleura and white spots on the liver's capsule in the untreated pigs. These changes were less conspicuous in pigs of the treated group. One (No. 4), two (No. 5) and four (No. 6) adult worms were found in the middle part of the duodenum from untreated pigs and the lumen of the intestine become enlarged due to the presence of *A. summ* (Fig. 11(14KB)). Microscopically, the intestinal villi were depressed by *A. summ* infection and epithelial cells desquamated in the duodenum where the worms occurred. Eosinophils infiltrated the lamina propria (Fig. 12(37KB)).

4) Ovicidal effect of biodigester

After processing by the biodigester, eggs of *A. summ* which were collected from the outlet of the biodigester survived in the incubator. On the other hand, all the eggs of *F. buski* were inactivated by biodigester processing and they were not hatched.

---Discussion-----

Survey of the helminths disclosed that various eggs of helminths were detected in the Mekong Delta. Results of the investigation showed that the infection rate of lung worms (*Metastrongylus* spp.) was low. However, swine metastrongylosis is an important cause of swine pneumonia and disturbs their growth⁹). Therefore, it is very important to control this disease in order to increase the productivity of pigs and farmers' income in this area.

Although there are many studies on the biology of *F. buski* in Asian countries, the actual condition of this trematode in Vietnam has not been determined¹⁰). We observed this fluke under SEM and the morphological characteristics of *F. buski* were demonstrated. It is interesting to note that 4 pigs which ate water spinach given as a supplemental feed were infected with *F. buski*. This vegetable may thus play an important role in *F. buski* infection. Since many people eat water spinach in the Mekong Delta, human may possibly become infected with the fluke. In the small VAC system, a snail of *Pila* sp. which is the intermediate host of *Angiostrongylus cantonensis* and a snail of *Lymnaea* sp. which is the intermediate host of *Fasciola* sp. were detected¹⁶). Judging from the disappearance of fluke eggs in the outlet of a biodigester in VAC systems, it is likely that the biodigester contributes to the control of zoonoses, such as fasciolopsiosis, paragonimiosis or fascioliosis. It was considered that the inactivation of *F. buski* eggs may be due to the temperature and also to the effect of ammonia in the biodigester, since fluke eggs were susceptible to a low concentration of ammonia^{12,22}). The highest temperature in the tube type of biodigester was approximately 45²) and *F. buski* eggs were killed at 50 after 4 hours in an experiment²¹).

As *A. summ* eggs were detected again at 6 weeks after Tetramizole treatment, the treatment was resumed. After ingestion of *A. summ* eggs, about 9 weeks were required for the development of the adult stage¹³). Therefore, it is considered that this anthelmintic was effective in the adult stage of the nematode in the intestine, but not in the immature stage. Comparison of treated and untreated pigs showed that the growth rate of the untreated pigs was very low and this nematode infection might be a cause of heavy economic losses for the farmers. Anderson et al.³) reported that the growth rate decreased to 20% after *Ascaris* infection in Denmark. Calculations showed that the economic loss was about 25,000 Don Vietnam (about US\$2.0) per head in an experimental farm¹⁷). Low nutrition level including deficiency in protein and vitamin A may exert more deleterious effects on the infected hosts⁷). If farmers use anthelmintic therapy for their pigs, the growth period of the pigs may be shortened at least by 2 weeks. Total cost for the treatment was about 5,000 Don Vietnam. It may be necessary that the farmers use anthelmintics in order to increase productivity. Bossaler et al.⁴) pointed out that the treatment of parasites contributed to the production of good quality meat.

One untreated pig which was clinically thin and infected with 12 *A. summ* showed moderate pathological changes. The main pathogenetic mechanism of ascariasis may involve physical stimuli²⁰) and the effects of inhibitors of host pepsin, trypsin, chymotrypsin, and carboxypeptidases which are contained in the extract of *A. summ*¹). Intestinal ascariasis directly interferes with the absorption of protein, fat, and carbohydrates¹⁴). Larval migration caused "white spots in the liver" and "thumps in the lungs." In the primary phase of severe infection, the growth rate of the pigs decreased¹⁵).

Further examinations should be carried out to identify the presence of other zoonotic parasitoses and to determine the relation between the presence of parasites and the economic losses in the VAC system.

 [Forward to:-Impact of Fruit Tree Incorporation into Farming systems in Nepal-](#)

 [Contents](#)

 [JRCAS Home Page](#)

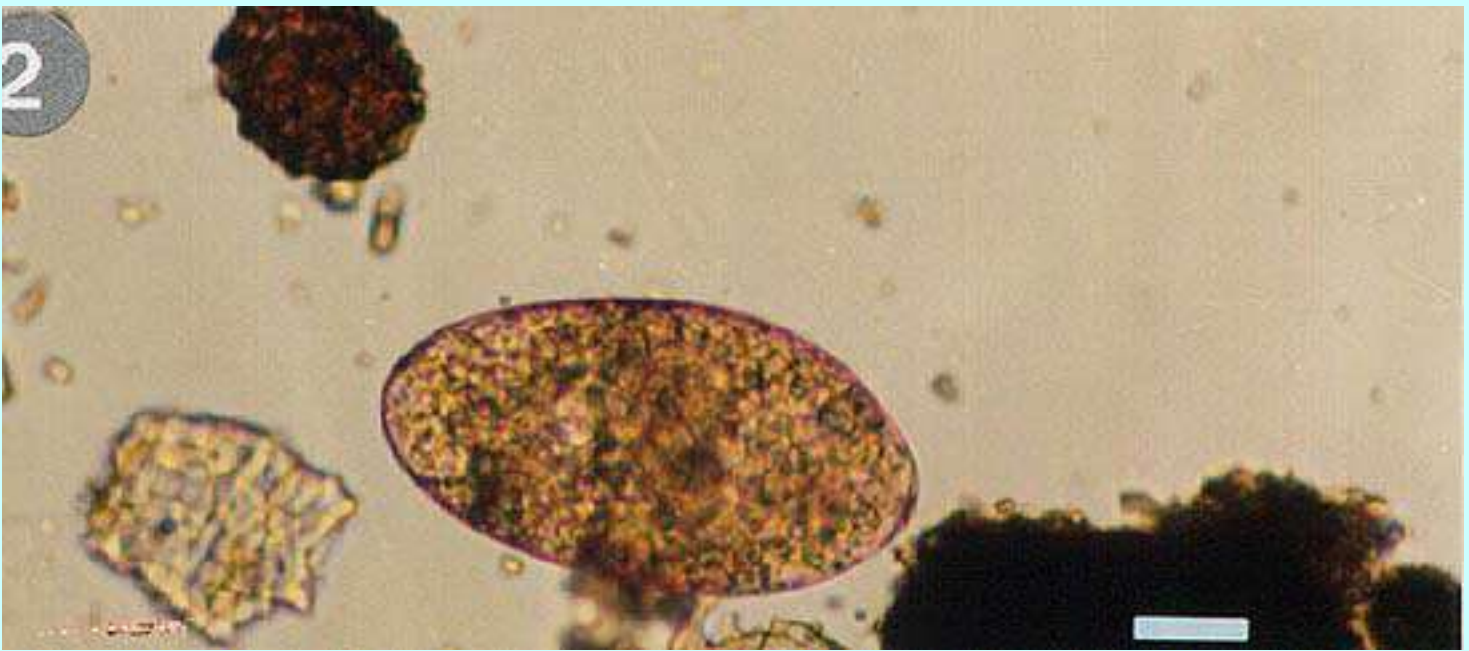


Fig.2. *F. buski* (right) and *A. suum* (left) eggs Bar shows 35 $\frac{1}{4}$ m.

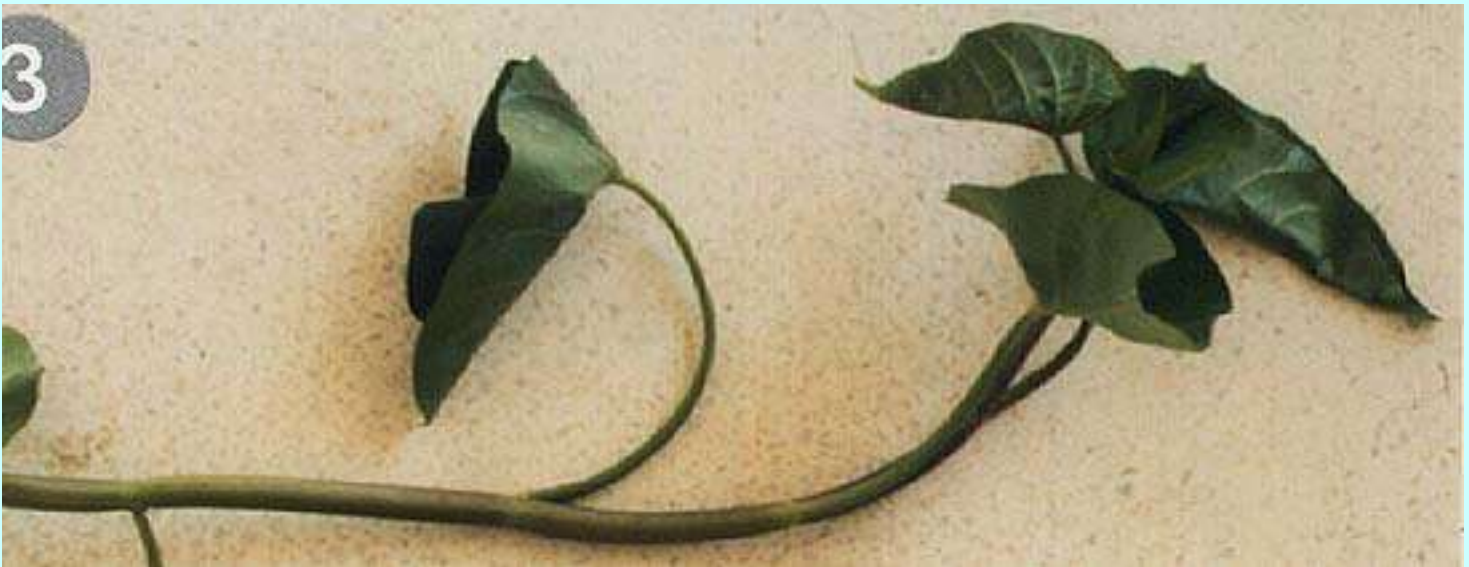


Fig.3. Water spinach used as supplement for feed in a farm

 [Back](#)

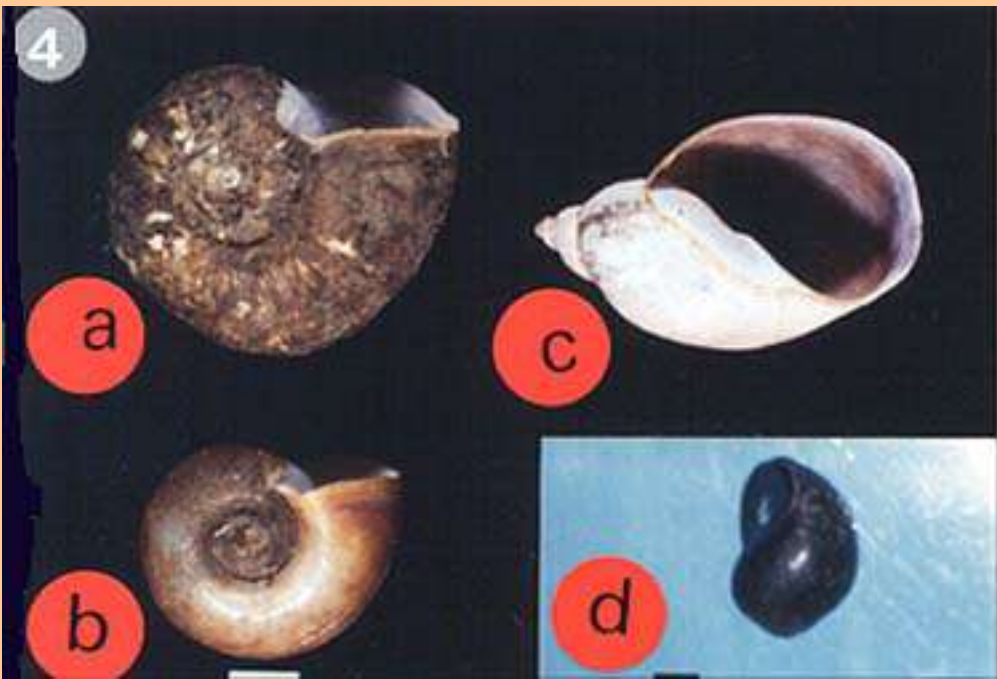


Fig.4. Intermediate hosts detected in VAC system

a; *Indoplanorbis* sp.,

b; *Gyraulus* sp.,

c; *Lymnaea* sp.,

d; *Pila* sp

Left bar indicates 3 mm and right one 15 mm.



[Back](#)

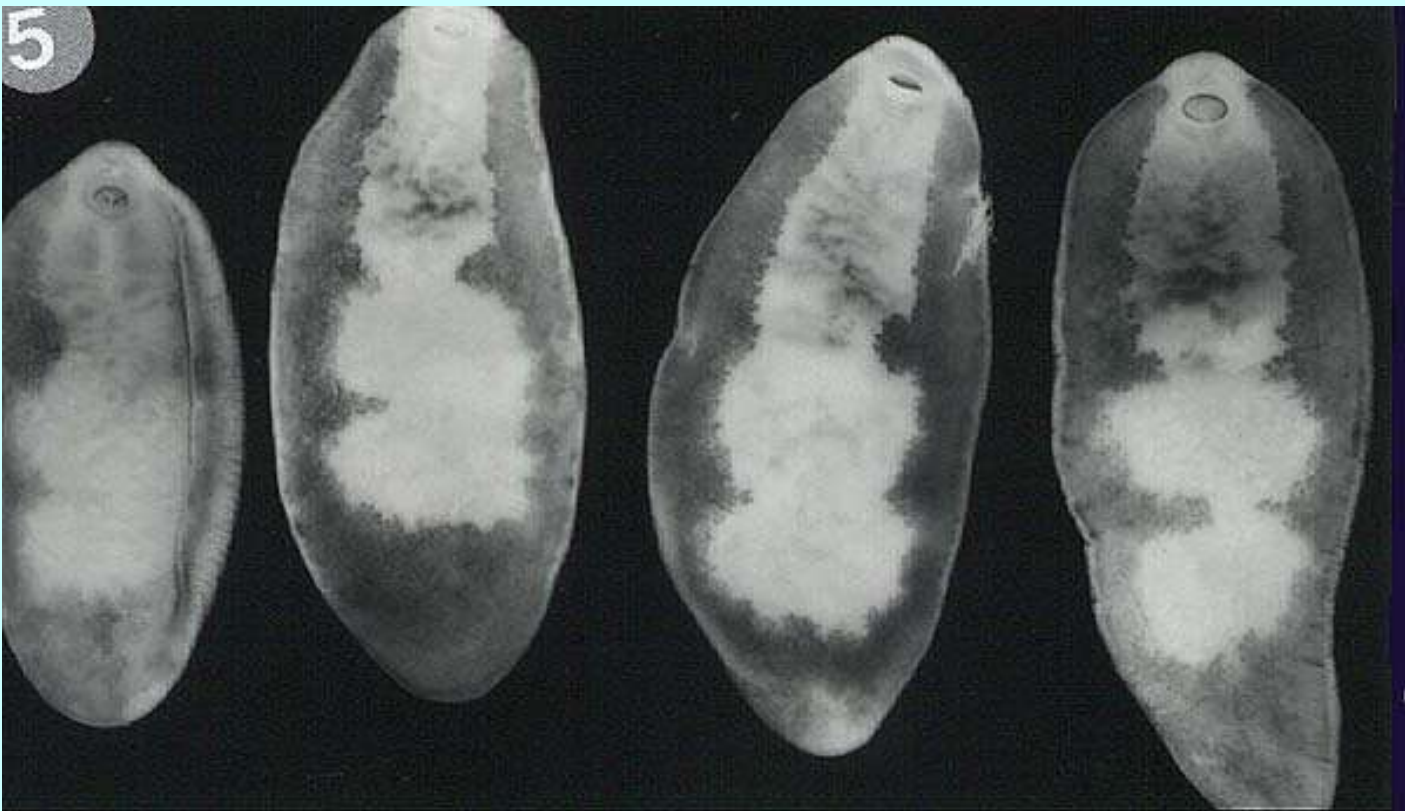


Fig.5. Adult of *F. buski* worms collected from a slaughterhouse



[Back](#)

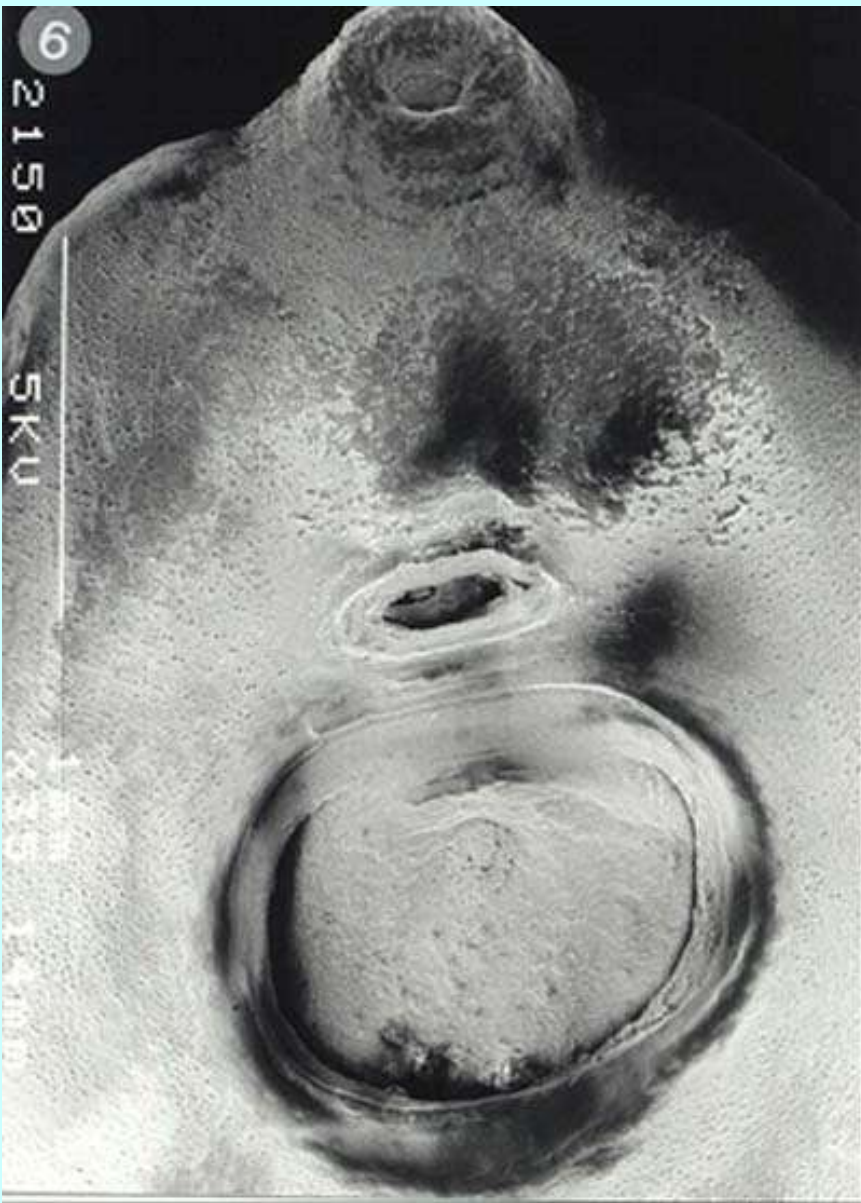


Fig.6. Posterior extremity of the mature *F. busuki* worm (SEM x 20)



[Back](#)

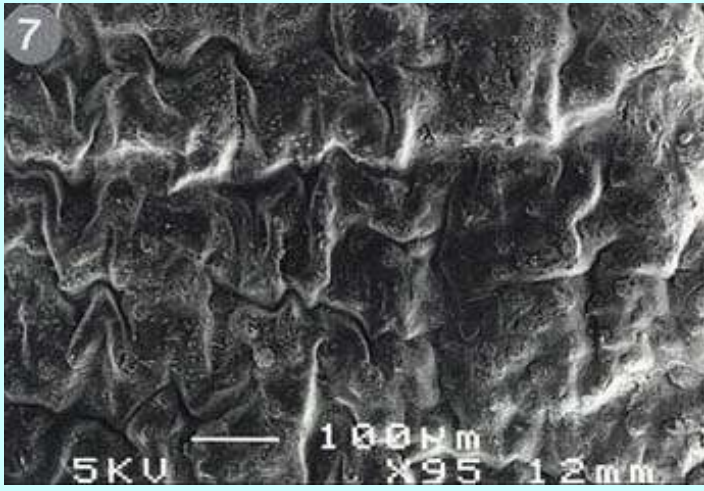


Fig.7.
Middle part of the ventral surface of mature *F. buski* worm
(SEM x 100)

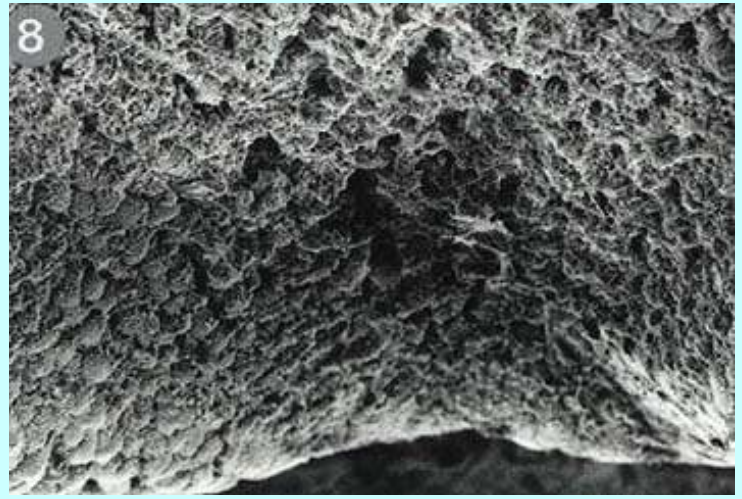


Fig.8.
Posterior extremity of mature *F. buski* worm (SEM x 100)



[Back](#)

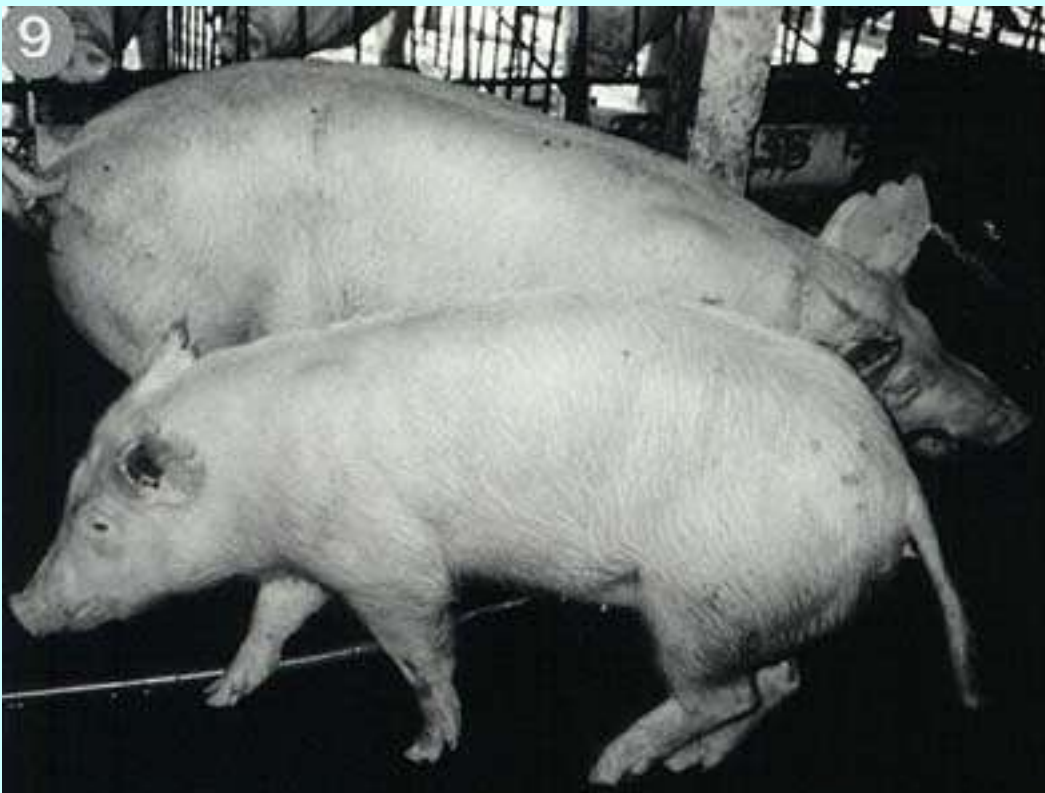


Fig.9. Treated (back) and untreated (front) pig in the experimental farm

 [Back](#)



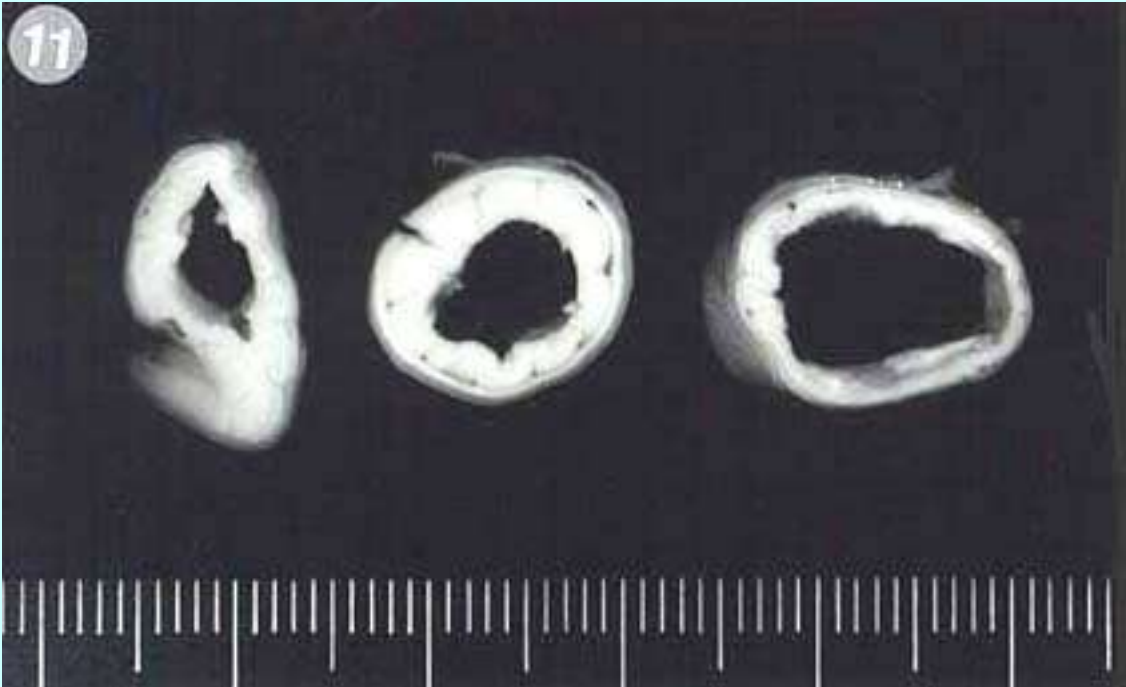
Fig.10. Small intestine and *Ascaris* worms from No.6 pig (untreated group)



[Back](#)

Fig.11. Transverse section of the middle part of the duodenum of 3 infected pigs

Left; intestine containing with 1 worm, middle; 2 worms, right; 4 worms



 [Back](#)

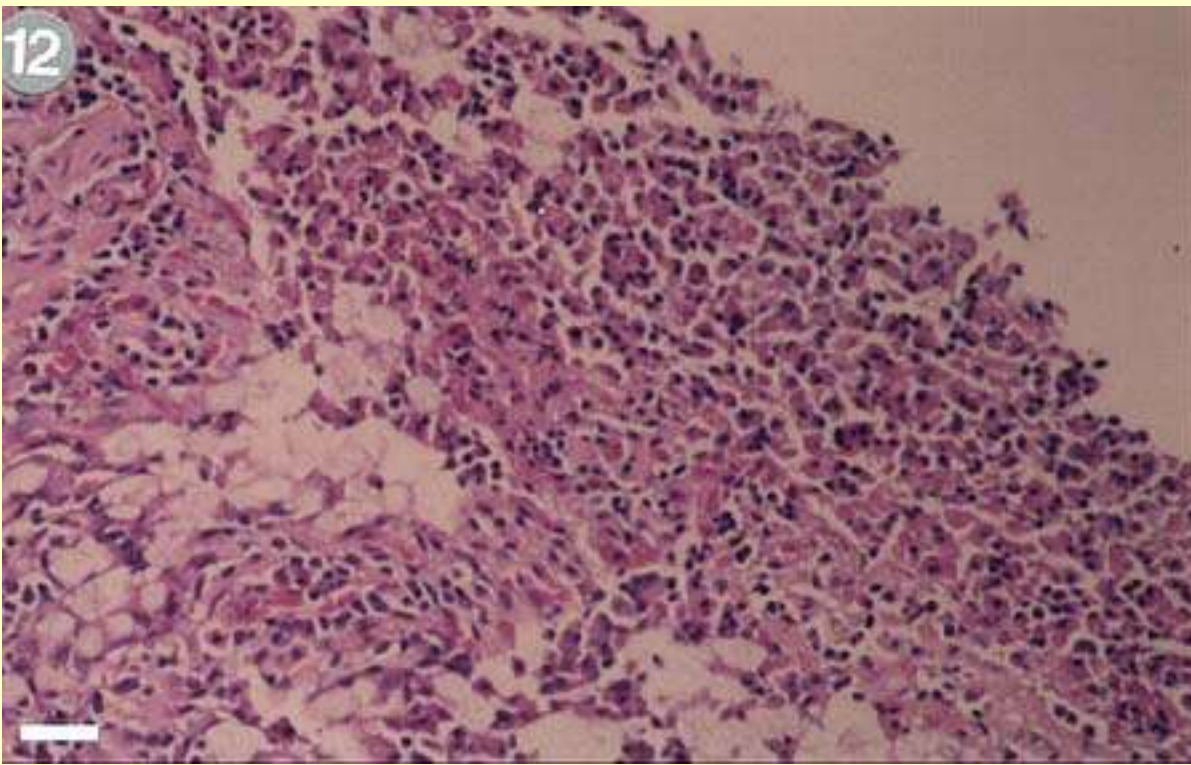


Fig.12. Histological specimen of middle part of duodenum in a pig infected with 4 worms

Severe desquamation of epithelium and cellular infiltration of lamina propria.
HE staining x 150, bar indicates 35 1/4m.



[Back](#)

Impact of Fruit Tree Incorporation into Farming Systems on Employment and Income in the Hill Region of Nepal

Shigeki YOKOYAMA*¹ and Devendra GAUCHAN*²

*¹Department of Foreign Agriculture, National Research Institute of Agricultural Economics
(Nishigahara 2-2-1, Kita-ku, Tokyo, 114-0024 Japan)

*² Outreach Research Division, National Agricultural Research Council
(P.O. Box 1440, Kathmandu, Nepal)

This paper is a part of the results of the STA (Science and Technology) fellowship program for the second author sponsored by Japan Science and Technology Corporation held at National Research Institute of Agricultural Economics from August to October 1998.

* E-mail: syokoyam@affrc.go.jp

---Abstract-----

Impact of fruit tree incorporation into farming systems on employment and income in the hill region of Nepal was analyzed, by applying the Gini decomposition analysis as a case study. In the study village, the introduction of orange production reduced employment opportunities in farming by 10% as a whole. The effect was most conspicuous for female labor (both family and hired) which decreased by 20%, while the use of hired male labor increased by 10%. It appears that the farm size was the major factor for the introduction of orange cultivation. Neither human resources (both quantity and quality) nor direct access to cash affected the dissemination of orange cultivation. Income from orange farming accounted for 44% of the total household income and for 56% of the total income inequality. Replacement of traditional upland crops by commercial orange may have worsened the income distribution, though absolute income increase might be significant. No villagers participated in marketing activities of orange, which has a large potential of employment and income generation. To further promote rural development focusing on the poor, use of labor for postharvest activities such as marketing and processing is recommended.

Discipline: Agricultural economics/Crop production/Horticulture

Additional key words: Gini decomposition analysis, mandarin orange, less-favored area

[1...7:References](#)

(Received for publication, January 13, 1999)

---Introduction-----

The hill region of Nepal, which supports nearly half of the nation population, has been facing environmental degradation due to increasing population pressure as well as expanding cultivation and overgrazing. In this context, incorporation of high value fruit trees such as citrus into the farming systems could be an alternative to improve the welfare of small farmers without impairing the resource base. As the access to urban market improved, commercial production of mandarin orange has increased in some of the hill regions since the mid-1970s. This paper aims to clarify the impact of the incorporation of commercial orange production into the existing farming systems.

First, we describe the agrarian conditions of the study village, then compare the labor use between traditional and new cropping systems. In the third section, impact of income distribution of orange is examined. We conclude with policy implications for rural development in less-favored areas.

---Data and methods-----

An in-depth household survey was conducted in 2 villages in Kavre district, central mid-hill region, in 1993. Farmers from randomly sampled 125 farm households were interviewed with a prepared questionnaire assisted by local resource persons. The field visits and group discussions with local key informants and some of the sample farmers were combined to verify the data collected.

The data of 1 village where orange is well disseminated were analyzed in this study. The sample size was reduced to 51 from originally surveyed 60 due to incompleteness and low reliability of some data.

---Agrarian conditions and cropping systems in the study village-----

The study village is located 50 km east of Kathmandu, the nation capital. This site has a moderate slope with a south-facing aspect at 1,300 to 1,600 m above sea level. The climate is warm temperate, ranging from 7°C in December-January to 30°C in April to September. The annual precipitation is about 1,300 mm. Within the village there is a great deal of microclimate variation due to the topography, altitude and the slope orientation.

Rough description of land use is presented in Table 1. The data from group discussions with key informants revealed that one-third of the village land is classified as lowland (*Khet* in Nepalese) for rice cultivation. Upland (*Bari*) accounts for about 40% in which annual crops grow in 16% and orange trees are planted in the remaining 24%. Privately owned forests or bushes account for only 4%, while community forests and grazing lands occupy one-third of the village area.

Table 1. Farmland use in the study village, Nepal, 1994

Land type	%
Lowland (<i>Khet</i>)	26
Upland (<i>Bari</i>)	
Annual crops	16
Orchard (orange)	24
Private forests /bushes	4
Community forests and grazing lands	30
-----	----
Total	100

Source: Informal survey, 1994.

Table 2 shows the size distribution of farmland holdings of the sample households. All of them were owner farmers. Tenant farming is seldom observed in the village, while at the national level 16% of the total farms are under tenancy¹⁾. Average farm size of 1.2 ha is equivalent to 0.96 ha of the national average¹⁾. In terms of number, the middle-sized farms ranging from 0.51 to 2.00 ha accounted for 73% in number and 62% in area. However, only 12% of farms with more than 2 ha accounted for 34% of the total area. This distributional structure resulted in highly skewed land holdings with a Gini coefficient of 0.70 compared with the national figure of 0.52¹⁾.

Table 2. Size distribution of farmland holdings of sample farms in the study village, Nepal, 1993

Area (ha)	Number of farms	Share (%)	
		In number	In area
- 0.50	8	16	4
0.51 - 0.75	10	20	11
0.76 - 1.00	10	20	14
1.01 - 2.00	17	33	37
2.01 -	6	12	34
Total	51	100a)	100
-----	----	-----	----
Total area (ha)	61.35		
Average (ha)	1.20		
Gini coefficient	0.70		

a): Round error.

Source: Household survey, 1993.

Under rainfed conditions, seasonal distribution of rainfall is the major determinant of cropping systems. The wet season in this area extends from May to October with a rainfall peak in July-August as shown in [Fig. 1\(31KB\)](#). In the lowland, rice is transplanted in July and harvested in November. Immediately after rice harvest, wheat is planted then harvested in April-May. In the upland, maize is planted in April and harvested in September. After maize harvest, farmers plant wheat or mustard or both. Orange is planted in July only once in its life cycle and starts bearing fruits after 6-7 years. In August-September, weeding is performed in

the orchard. Harvest season of orange falls in December-January.

Though the initial introduction of a few orange trees in the village dates back to nearly 100 years ago by a government official working at the Royal Palace in Kathmandu, commercial cultivation started only after 1974 when the government organized a mass campaign for the dissemination of new agricultural technologies. The government provided seedlings, input materials with subsidies and credit for fruit production in the hill regions. Some innovative resource-rich farmers quickly adopted orange cultivation at that time. However, the majority of the small farmers could not adopt immediately the cultivation of this crop, due to risks of long-term investment and low technical confidence. After observing the success of orange production by neighbor farmers, the followers gradually introduced this new commercial crop as a substitute for subsistence crops such as maize, wheat, mustard and millet in the upland. Mutual exchange of planting materials and technical know-how among farmers played a crucial role in wider dissemination. Initial capital mainly originated from informal sources such as relatives and middlemen³).

---Impact of orange production on employment-----

To determine how the introduction of orange cultivation affected the employment of the village farmers, we compared the cases of farmers who cultivated or did not cultivate orange. Labor input per ha by cropping system is presented in Table 3. The rice-wheat system was found to be the most labor-absorptive system followed by the maize-wheat/mustard system, while perennial orange required the least labor input. In terms of employment status (family vs. hired), rice-wheat system has a neutral feature in which family and hired labor is almost evenly distributed, while it is slightly male-biased, as male labor accounted for 60% of the total. Comparison between the maize-wheat/mustard system and orange, shows that total labor used in the latter system was only 66% of that in the former, while the latter slightly relied on more hired labor (42 vs. 53%) and consisted mainly of male labor (44 vs. 71%).

Table 3. Labor input of major cropping systems in the study village, Nepal, 1993

	Lowland		Upland	
	Rice-Wheat		Maize-Wheat/Mustard ^{b)}	Orange ^{c)}
	----- man-days/ha (%) -----			
Family labor ^{a)}	173 (53)		141 (58)	76 (47)
Male	9 (28)		63 (26)	51 (32)
Female	83 (25)		78 (32)	25 (16)
Hired labor	153 (47)		103 (42)	85 (53)
Male	68 (21)		44 (18)	62 (39)
Female	85 (26)		59 (24)	23 (14)
Total	326 (100)		244 (100)	161 (100)

a): Including unpaid exchanged labor.

b): Assuming that wheat and mustard are planted in 0.5 ha each.

c): Case of maturing trees 7 years after planting.

Source: Household survey, 1993.

Then to estimate the change in labor use at an absolute level, we calculated the labor input based on actual land use vs. the counterfactual one without orange (Table 4). In 1993, the sample farms actually cultivated a total of 56.2 ha in which 21.9 ha consisted of rice-wheat, 16.9 ha of maize-wheat/mustard and 17.4 ha of orange. Total labor input was estimated at 14,064 man-days for this pattern of land use. We assumed that there was no technical change in farming practices, especially in terms of labor use, during the process of orange dissemination. Assuming that the maize-wheat/mustard system is practiced also in the actual orange area of 17.4 ha, labor input can be estimated at 15,509 man-days. From this simulation, introduction of orange cultivation might reduce employment opportunities in farming by 10% for the sample farms. However, the impact varied with the gender and employment status due to the difference in the labor use pattern among the cropping systems. Orange production might have reduced female labor by 20% (both family and hired), while increased hired male labor by 10% and not changed the family male labor.

Table 4. Comparison of labor use in the study village, Nepal

	Actual in 1993 with orange cultivation ^{a)}	Counterfactual without orange cultivation ^{b)}	With/ without orange cultivation
	----- man-days -----		
Family labor ^{c)}	7,494	8,625	0.9
Male	3,923	4,132	1.0
Female	3,571	4,493	0.8
Hired labor	6,570 ^{d)}	6,884 ^{d)}	1.0
Male	3,312	2,998	1.1
Female	3,259	3,885	0.8
Total	14,064	15,509	0.9

a): Rice-Wheat; 21.9 ha, Maize-Wheat/Mustard; 16.9 ha, Orange; 17.4 ha, Total; 56.2 ha.

b): Rice-Wheat; 21.9 ha, Maize-Wheat/Mustard; 34.3 ha, Total; 56.2 ha.

c): Including unpaid exchanged labor.

d): Round error.

To analyze the economics of orange production, unique features of the tree crop must be considered. A typical economic life of orange tree is as follows³⁾. The gross margin (gross products * cash expenditure) is negative until 6 years after planting of seedlings as the tree does not bear fruit. After 7 years, the gross margin becomes positive with increasing rate until the 14th year, then it starts to decrease gradually. Simple comparison of the gross margin between maturing orange trees (Rs. 71,000/ha) and that of maize-mustard system (Rs. 9,000/ha) is misleading considering the conditions mentioned above. However it may be safe to state that orange production is much more profitable than traditional upland crop production.



[Continue to:-Effect on income distribution-](#)



[Contents](#)

---Effect on income distribution-----

We shall determine how highly profitable commercial orange farming affected the income distribution among the village farmers. Before analyzing the effect on income distribution, the factors that may promote orange adoption will be outlined. Table 5 shows the Pearson's correlation coefficient between the area planted with orange and various characteristics of sample households. Human dimensions of the farm such as age and educational level of household head, endowment of family labor (both farm and non-farm) were not related to the orange area. Neither rice yield, proxy of farming skill level, nor the non-farm income, indicator of cash access, affected the adoption of orange cultivation. It is obvious that the larger the farm size, the larger the orange area. The upland area in which orange can be planted as well as the lowland area, where trees can not grow, may affect the diffusion of orange. This fact suggests that households with secure supply of staple food such as rice could expand commercial production.

Table 5.
Correlation coefficient between orange-planted area and household characteristics in the study village, Nepal, 1993

	<u>Correlation</u>	<u>Probability</u>
Age of household head	0.025	0.859
Schooling years of household head	-0.002	0.990
Family farm-labor	0.255	0.068
Family non-farm labor	0.001	0.995
Upland area	0.395	0.004
Lowland area	0.765	0.000
Rice production	0.612	0.000
Yield of rice	-0.157	0.286
Non-farm income	0.128	0.367

* Significant at 1% level.

The high correlation between the farm size and orange production suggests that the diffusion of orange might have worsened the income distribution among the village farmers. To answer this question, we applied the Gini decomposition analysis (2,6,5) that enables to quantify the contribution of each income component to the overall income inequality. Gini decomposition is formulated as follows:

$$G(y) = S_i R(y, x_i) G(x_i),$$

where

y = Total household income

$G(y)$ = Gini ratio of total income,

x_i = Income from i th source,

S_i = Average income share of i th source,

$R(y, x_i)$ = Rank correlation ratio,

$G(x_i)$ = Gini ratio of i th income.

The rank correlation ratio is defined as:

$$R(y, x_i) = Cov[x_i, r(y)] / Cov[x_i, r(x_i)],$$

where $r(y)$ and $r(x_i)$ denote the ranking of the household in terms of total income and income from i th source, respectively. $R(y, x_i) = 1$ if $r(y) = r(x_i)$. Otherwise $R(y, x_i)$ is less than 1. In general, the larger the rank correlation ratio is, the larger the correlation between the ranking of total income and the ranking of component income.

Thus the formula decomposes the total Gini ratio into 3 factors, namely, income share, correlation effect of total and component income and the Gini ratio of component income. As in the case of the study village, farm households in developing countries generally earn income from various sources. We can not determine to what extent a certain income component contributes to the overall income inequality by simply comparing the Gini ratio of each income. The component with a large Gini ratio may not contribute substantially to the overall income inequality if its share is quite small. Or even it may equalize the overall income distribution if its ranking is negatively correlated with that of total income.

The results of Gini decomposition are presented in Table 6. Total income Gini ratio of 0.43 was significantly smaller than that of land holding (0.70 in Table 2). This finding suggests that various non-farm job opportunities which accounted for 26% of the total household income, including hired farm jobs, contributed to the leveling off of the economic status of the villagers.

Table 6. Decomposition of income Gini ratio in the study village, Nepal, 1993

	Income share	Rank correlation ratio $R(y, x_j)$	Component Gini ratio $G(x_j)$	Component Gini contribution $S_j R(y, x_j) G(x_j)$
Rice	0.24 (0.24) b)	0.76 (0.72)	0.40 (0.38)	0.08 (0.07)
Upland crops a)	0.06 (0.07)	0.50 (0.46)	0.35 (0.37)	0.01 (0.01)
Orange	0.44 (0.44)	0.90 (0.88)	0.61 (0.59)	0.24 (0.23)
Farm Wage	0.02 (0.03)	-0.16 (0.18)	0.89 (0.89)	-0.00 (0.00)
Non-farm wage	0.06 (0.06)	0.25 (0.37)	0.86 (0.87)	0.01 (0.02)
Small business	0.12 (0.10)	0.67 (0.54)	0.85 (0.84)	0.07 (0.04)
Formal job	0.06 (0.06)	0.66 (0.70)	0.88 (0.89)	0.03 (0.04)
Total	1.00 (1.00)	–	–	0.43c) (0.41)

a): Wheat, maize and mustard.

b): Number in parenthesis is based on per capita income.

c): Round error.


The major income source contributing to total income inequality was the income derived from orange cultivation. The highest income share (0.44) and rank correlation ratio (0.90) resulted in the highest component Gini contribution (0.24), which accounted for 56% of the total income inequality (0.24/0.43). This finding is consistent with the fact that the orange-planted area was highly correlated with the farm size (Table 5). The contribution of rice income was the second largest, though its figure (0.08 or 19% of total Gini) was much lower than that of orange income. A previous study also revealed that even in a typical rice-dependent village, rice income does not play a major role in the overall income inequality⁷). Contribution of traditional upland crops (wheat, maize and mustard) was negligible (0.01 or 2%) since its share in the total income (0.06), rank correlation ratio (0.50) and component Gini (0.35) was significantly smaller than that of orange and rice. These facts suggest that replacement of upland crops by orange may have worsened the income distribution.

In contrast to the relatively lower component Gini ratio of farm income (0.35 to 0.61), that of non-farm income was much larger ranging from 0.85 to 0.89. However non-farm income, including farm wage income, as a whole accounted for only 25% of the total income inequality, while the remaining 75% was attributed to farm income. Farm wage income showed a highly skewed distribution with a component Gini ratio of 0.89 and a negative rank correlation ratio (-0.16), indicating that the poorer the households, the more they engaged in hired farm jobs. Though this absolute figure was very small (less than 0.005), farm wage income contributed to equalizing the total household income distribution. The common non-farm wage jobs in the village include employment at local building construction sites, brick factory and portering of milk and daily necessities to and from local markets. Small businesses include miscellaneous self-employed jobs such as carpenter, tailor and small trade. Opportunities to work in the formal sector in the village are limited to the jobs of government officials, teachers, trekking company, police and army both in Nepal and India. Income share of small businesses and formal jobs (0.18) was smaller than that of rice (0.24), though the component Gini contribution (0.10) was larger than that of rice (0.08), due to the larger component Gini ratio than that of rice (0.85, 0.88 vs. 0.41).

---Conclusion-----

Introduction of profitable commercial orange production reduced employment opportunities in farming in the surveyed village by 10% as a whole. The effect was most conspicuous for female labor (both family and hired) which decreased by 20%, while the use of hired male labor increased by 10%. It appears that the area of both lowland and upland was the major factor for orange cultivation, though orange was planted only in the upland. Neither human resources (both quantity and quality) nor direct access to cash affected the dissemination of orange cultivation. Income from orange farming accounted for 44% of the total household income and for 56% of the total income inequality. Replacement of traditional upland crops by commercial orange may have worsened the income distribution, though absolute income increase might be significant. No villagers participated in marketing activities of orange, which has a large potential of employment and income generation. To further promote rural development focusing on the poor, use of labor for postharvest activities such as marketing and processing is recommended⁴).

---References-----

 [Back to the first page](#)

1) Central Bureau of Statistics (1992): Sample census of agriculture, 1991/92.

2) Fei, J. C. H., Ranis, G., & Kuo S. W. Y. (1978): Growth and the family distribution of income by factor components. *Q. J. Econ.*, **92** (1), 17-53.

3) Gauchan, D. (1994): An optimum planning for integrating citrus in Nepalese hill farming systems. Unpublished master thesis.

- 4) Hayami, Y. & Kawagoe, T. (1993): Agrarian origins of commerce and industry; A study of peasant marketing in Indonesia. St. Martin's Press, NY.
- 5) Otsuka, K., Cordova, V., & David, C. (1992): Green revolution, land reform and household income distribution in the Philippines. *Econ. Dev. & Cult. Change*, **40** (4), 719-741.
- 6) Pyatt, G., Chen, C., & Fei, J. (1980): The distribution of income by factor components. *Q. J. Econ.*, **95** (3), 451-473.
- 7) Upadhyaya, H. K. & Thapa, G. B. (1994): Modern variety adoption, wage differentials and income distribution in Nepal. *In* Modern rice technology and income distribution in Asia. eds. David, C. and Otsuka, K., IRRI, Manila. Lynne Rienner Publishers, Boulder and London.



[Forward to:-Impact of Depreciated Currency on Agriculture in Thailand-](#)



[Contents](#)



[JIRCAS Home Page](#)

	Jan	Feb	Mar	Apr	May	Jun	Jul	Aug	Sep	Oct	Nov	Dec
Rainfall (mm)	20	20	40	80	160	220	320	310	280	140	10	10
Lowland (<i>Khet</i>)	++ Wheat xxx			--- /// ++ Rice xxx ///								
Upland (<i>Bar</i>)	++ Wheat xxx ///			+++ Maize xxx			///					
	-ard xxx		/// +++ Maize xxx ///			+++ Must-						
	xxx				Orange			+++ +++			xxx	

---; Land preparation, ///; (Trans) Planting, +++; Weeding, xxx; Harvest.

Fig.1. Major cropping pattern in the study village, Nepal, 1993



[Back](#)

Contents

Distribution of Antimutagenic Components in Colored Sweetpotatoes	Makoto YOSHIMOTO et al.
Discrimination of Basidiomycete Species and Strains by Random Amplified Polymorphic DNA(RAPD) Analysis	Yasuhiro ITO, and Sonoe O.YANAGI
Determination of Optimal Spraying Tome for Chemical Control of Mulberry Scale, <i>Pseudaulacaspis pentagona</i> (Targioni) (Hemiptera:Diaspididae) in Tea Fields	Akio TATARA
Effects of Various Radiant Sources on Plant Growth (Part 1)	Shinji TAZAWA
Effects of Various Radiant Sources on Plant Growth (Part 2)	Shinji TAZAWA
Development of Respiration Models for Modified Atmosphere Packaging of Horticultural Commodities	Yoshio MAKINO
Helminths and Helminthosis of Pigs in the Mekong Delta, Vietnam with Special Reference to Ascariasis and <i>Faciolopsis buski</i> Infection	Shinobu YOSHIHARA et al.
Impact of Fruit Tree Incorporation into Farming Systems on Employment and Income in the Hill Region of Nepal	Shigeki YOKOYAMA and Devendra GAUCHAN
Impact of Deperciated Currency on Agriculture in Thailand	Minoru TADA
Preliminary Report on Stable Isotope Ratio Analysis for Samples from Matang Mangrove Brackish Water Ecosystems	Shigeo HAYASE et al.

Distribution of Antimutagenic Components in Colored Sweetpotatoes

Makoto YOSHIMOTO, Shigenori OKUNO, Tooru KUMAGAI, Masaru YOSHINAGA and Osamu YAMAKAWA

Department of Upland Farming, Kyushu National Agricultural Experiment Station
(Miyakonojo, Miyazaki, 885-0091 Japan)

---Abstract-----

Antimutagenicity of the water extracts prepared from the outer or inner portion of storage roots (hereafter referred to as 'outer and/or inner portion') of 4 varieties of sweetpotato differing in the flesh color was investigated using *Salmonella typhimurium* TA 98 to determine the distribution of the antimutagenic components. Analysis of anthocyanin pigments in both portions revealed a large distribution of anthocyanin pigments in the outer portion and showed that the content of cyanidin in the outer portion was higher than in the inner one. The strong antimutagenicity of Ayamurasaki outer portion was attributed chiefly to the high concentration of cyanidin. The extracts from the outer portions of Koganesengan, Sunny Red, and Joy White varieties showed an antimutagenic activity unlike the inner ones, suggesting that the antimutagenic component in the outer portions of these varieties was mainly associated with phenolics

Discipline: Food

Additional key words: antimutagenicity, anthocyanin, phenolics

1.13:References

(Received for publication, January 6, 1999)

---Introduction-----

Recently, new varieties of sweetpotato (*Ipomoea batatas*) differing in the flesh color have been released for new uses by the Kyushu National Agricultural Experiment Station. Several investigators have reported the presence of an antioxidative activity²⁾, reduction of liver injury induced by carbon tetrachloride in rats⁷⁾ and in man⁸⁾ which consumed purple-colored sweetpotato juice. Our recent study indicated that the anthocyanin pigments purified from purple-colored sweetpotato effectively decreased the reverse mutations induced by purified mutagens such as Trp-P-1, Trp-P-2, IQ, B[a]P, and 4-NQO, and also by dimethyl sulfoxide (DMSO) extracts of grilled beef¹³⁾. The anthocyanin pigment from purple-colored sweetpotato is more stable than other anthocyanins from red cabbage, elderberry and purple corn⁶⁾. At present, the flour from Ayamurasaki variety has been developed as a material for noodles, bread, a new type of alcohol drink, and a food colorant. However the distribution of functional components in sweetpotato is not clear. The functional components are not necessarily distributed uniformly in the sweetpotato storage roots. For instance, calcium⁴⁾ and phenolics¹⁰⁾ are abundant in the cortex of sweetpotato. Therefore it is important for effective application of sweetpotato to analyze the distribution of functional components such as nutritional or physiologically functional ones.

In this paper, we describe the distribution of the antimutagenic components of the storage roots of sweetpotato differing in the flesh color.

---Materials and methods-----

1) Sweetpotato materials

Four varieties of sweetpotato differing in the flesh color, Koganesengan, Sunny Red, Joy White, and Ayamurasaki ([Table 1](#)) were cultivated in 1996 under the same conditions in an experimental field at Miyakonojo (Japan). Harvested roots were cut into 2 portions and one half was used as the whole root. In the remaining half, the peeled outer layer (about 0.5 cm thick) as the outer tissue containing the skin and the cortex was separated from the inner portion without outer layer as the inner tissue, respectively. The peeled outer layer comprised all of the cortical region, which included the periderm, laticiferous ducts, and cambium. All the sections in each case were diced, lyophilized, and ground to flour. The flour samples were kept at -20 until use.

Table 1.
Effect of sweetpotato water extracts on the mutagenicity of Trp-P-1 against *Salmonella typhimurium* TA 98^{a)}

Variety	Flesh color	Amount of extract (mg/plate)	Inhibition (%) ^{b)}
---------	-------------	------------------------------	------------------------------

Distribution of Antimutagenic Components in Colored Sweetpotatoes

Ayamurasaki	Purple	1.0	41
		5.0	55
		10.0	62
Koganesengan	Yellow	1.0	0
		5.0	0
		10.0	5
Joy White	White	1.0	0
		5.0	0
		10.0	4
Sunny Red	Orange	1.0	5
		5.0	9
		10.0	8

a):Trp-P-1 was added at a dose of 0.075 $\frac{1}{4}$ g/plate. Mutagenicity was tested with S-9 mix.

b):Each value represents mean \pm SD of triplicate plates. In the values shown, the spontaneous mutation frequency was subtracted. The His⁺ revertant value of the control was 625 \pm 12.

2) Chemicals and bacteria

Trp-P-1 was obtained from Wako Pure Chemical Industries Ltd. Chlorogenic acid (ChA) was purchased from Sigma Chemical Co. S-9 Fraction prepared from rat liver treated with phenobarbital and 5,6-benzoflavone and cofactors were purchased from Oriental Yeast Co., Ltd. Folin-Ciocalteu phenol reagent was purchased from Nacalai tesque, Inc. (Kyoto, Japan). Other chemicals used were of special grade. Strain TA 98 of Salmonella typhimurium was supplied by the Institute for Fermentation, Osaka, Japan (IFO). The bacteria were cultured in nutrient broth for 16 h at 37 before the mutagenicity assay was conducted.

3) Preparation of sweetpotato water extract

The extract was made from lyophilized flour (1 g), using 20 mL of ice-cold water for 1 h. The suspension was centrifuged at 18,000 x g for 20 min, and the resultant precipitate was re-extracted under the same conditions. The collected supernatant was lyophilized.

4) Assay of antimutagenicity

The mutagenicity assay was performed by a modification of the method of Yahagi et al.¹¹⁾ The antimutagenic activity was evaluated for TA 98 using the purified mutagen, Trp-P-1. These mutagens require metabolic activation to induce mutation in TA 98. S-9 Mix contained 50 $\frac{1}{4}$ mol of sodium phosphate buffer (pH 7.4), 4 $\frac{1}{4}$ mol of MgCl₂, 16.5 $\frac{1}{4}$ mol of KCl, 2.5 $\frac{1}{4}$ mol of glucose-6-phosphate, 2 $\frac{1}{4}$ mol of NADH, 2 $\frac{1}{4}$ mol of NADPH, and 50 $\frac{1}{4}$ L of S-9 fraction in a total volume of 0.5 mL. For the inhibition test, 0.1 mL of each mutagen, 0.1 mL of sweetpotato water extract or DMSO-dissolved pigment solution, and 0.5 mL of S-9 mix or phosphate buffer were simultaneously incubated with 0.1 mL of bacterial suspension at 37 for 20 min, and then poured on minimal glucose agar plates with 2 mL of soft agar.

5) Measurement of color value and HPLC analysis of anthocyanin pigments from extracts of Ayamurasaki inner or outer portion

The color value was measured by absorbance at 530 nm after the 0.5% sulfuric acid extract from each portion was diluted 4 times with McIlvaine's buffer (pH 3.0).

Individual anthocyanin pigments were analyzed using a HPLC (Model LC-9A, Shimadzu, Kyoto, Japan) equipped with a variable wavelength spectrum flow monitor. The samples for HPLC analysis of the anthocyanin pigments were prepared by extraction with 0.5 % sulfuric acid. Separation of the pigments was carried out on a 4.6 mm x 10 cm Luna C18(2) column (Phenomenex) and detected at 530 nm. The column was conditioned with Solvent A (1.5% phosphoric acid), and the pigments were eluted using a linear solvent gradient of 0-100% Solvent B (1.5% phosphoric acid, 20% acetic acid, 25% acetonitrile) for 40 min at a flow rate of 1 mL/min.

6) Extraction and determination of phenolics

The lyophilized sweetpotato flour was vigorously mixed with 10 times its equivalent volume of 80% ethanol. The mixture was boiled for 5 min under a hood and centrifuged at 5,000 x g for 10 min. The residue was mixed with additional 80% ethanol and boiled for 10 min to re-extract the phenolics and centrifuged under the same conditions. The extracts were combined and made up to 10 mL. These extracts were used for the determination of total phenolics. Total phenolics were determined by the procedure described by Coseteng and Lee¹⁾. The alcohol extract was diluted to obtain an absorbance reading within the range of the standards (800-40 $\frac{1}{4}$ g ChA/mL). The absorbance in the microplate wells was measured at 600 nm with a dual wavelength flying spot scanning densitometer (Shimadzu, Kyoto), with a microplate system. The results were expressed as mg ChA/100 g flour.



[Results and Discussion](#)



[Contents](#)

---Results-----

1) Effects of water extracts from whole storage roots on the mutagenicity of Trp-P-1

The antimutagenic effect of the water extracts from whole storage roots of 4 varieties differing in the flesh color was examined using Trp-P-1 at a dose of 0.075 µg/plate (Table 1). The extract was used at doses of 1, 5, and 10 mg/plate. The Ayamurasaki extract inhibited the Trp-P-1-induced mutation by 41 to 62% and showed a dose-dependent antimutagenicity. The extracts from Koganesengan, Joy White, and Sunny Red varieties showed inhibitory activities of 5, 4, and 8% at a dose of 10 mg/plate, respectively. The antimutagenic effect of the extracts from whole storage roots of Koganesengan, Joy White, and Sunny Red on Trp-P-1 was negligible compared with that from Ayamurasaki.

2) Antimutagenic activity of the extracts from the inner or outer portion of sweetpotatoes

Table 2 shows the antimutagenic activity of the extracts from the inner or outer portion of Ayamurasaki, Joy White, Koganesengan, and Sunny Red. The extract in the Ayamurasaki variety was used at doses of 1, 5, and 10 mg/plate. The extract of Ayamurasaki inner portion inhibited the Trp-P-1-induced mutation by 14 to 74%, while that of the outer one by 53 to 80%. The extracts from both portions of Ayamurasaki showed a dose-dependent antimutagenicity. The extract of the outer portion showed an antimutagenic activity about 4 times stronger than that of the inner one at a dose of 1 mg/plate. The extracts from the portions in 3 varieties other than Ayamurasaki were used only at a dose of 10 mg/plate since the extracts from the whole root of these varieties did not display the antimutagenic activity at doses of below 5 mg/plate as shown in Table 1. The extracts from the outer portion of Joy White, Sunny Red, and Koganesengan inhibited the mutation by 24, 25, and 18%, unlike those of the inner one.

Table 2. Effect of extracts from sweetpotato inner or outer portion on the mutagenicity for Trp-P-1 against *Salmonella typhimurium* TA 98^{a)}

Variety	Portion	Amount of extract (mg/plate)	Inhibition (%) ^{b)}
Ayamurasaki	Inner	1.0	14
		5.0	69
		10.0	74
	Outer	1.0	53
		5.0	77
		10.0	80
Joy White	Inner	10.0	0
	Outer	10.0	24
Sunny Red	Inner	10.0	0
	Outer	10.0	25
Koganesengan	Inner	10.0	0
	Outer	10.0	18

a): Trp-P-1 was added at a dose of 0.075 µg/plate. Mutagenicity was tested with S-9 mix.

b): Each value represents mean ± SD of triplicate plates. In the value shown, the spontaneous mutation frequency was subtracted. The His⁺ revertant value of the control was 609±16/plate.

3) Color value and HPLC analysis of anthocyanins of extracts from Ayamurasaki inner or outer portion

The color value of the extracts from both portions of Ayamurasaki was measured at an absorbance of 530 nm ([Table 3\(28KB\)](#)). The color value of the extract from the outer portion was 15.8 and that from the inner portion 10.9. Anthocyanin content in the outer portion was 1.4 times higher than that in the inner

portion. These results indicate that anthocyanin pigments are abundant in the outer portion.

The difference in both color values was reflected in the HPLC pattern in that the peaks of the extract from the outer portion were generally higher than those of the inner one ([Fig. 1\(19KB\)](#)). Sweetpotatoes with purple-colored flesh contain at least 12 anthocyanins⁶ and their contents vary with the sweetpotato varieties²). The main anthocyanin pigments were respectively designated as YGM1 to YGM6. Ratios of each pigment in the extracts from both portions indicated in Fig. 1 are shown in Table 3. YGM5 in the extract from the outer portion was clearly separated into 2 components, YGM5a and YGM5b unlike the extract from the inner portion. The total content of YGM5 in the extracts from both portions was practically similar but the contents of HMG5a in the extracts from the outer portion were clearly higher than those in the inner portion. YGM1a, YGM1b, YGM2, YGM3, and YGM5a were more abundant in the outer portion, while the pigments with a ratio below that of YGM1 and above that of YGM6 showed a high concentration in the inner portion. Especially the contents of YGM1, YGM3, and YGM5a in the extract from the outer portion were about twice as high as those in the inner portion.

4) Phenolic contents in the extracts from the inner or outer portion of 4 varieties of sweetpotato

Phenolics are known to inhibit the reverse mutation induced by various mutations. We determined the phenolic distribution of sweetpotato roots to analyze the relationship between the phenolic contents and the antimutagenicity. The contents of total phenolics in the extracts from both portions of the varieties tested were expressed as mg/100 g flour ([Fig. 2\(15KB\)](#)). The phenolic contents in the extracts from the outer and inner portions in Ayamurasaki roots were 1,900 mg and 1,650 mg/100 g flour, respectively. In the extract from the inner portion of Koganesengan, Joy White, and Sunny Red the contents were about 100, 110, and 150 mg/100 g flour, while in the outer one 400, 240, and 360 mg/100 g flour. The high phenolic content of Ayamurasaki probably enhanced the reaction of anthocyanin pigments with Folin-Ciocalteu phenol reagent. Odake et al.⁵) and Goda et al.³) reported that anthocyanins of the purple-colored sweetpotato have a caffeoyl or feruloyl group in their structural formula.

---Discussion-----

The antimutagenic activity of the extracts from the inner or outer portion of the storage roots was investigated to analyze the distribution of the antimutagenic components in sweetpotatoes differing in the color of the flesh. In 4 varieties tested, only the extract of the whole root of Ayamurasaki inhibited effectively the Trp-P-1-induced mutation (Table 1). As anticipated, the extracts from both portions also decreased the reverse mutation, and the antimutagenic activity was stronger in the extract from the outer portion than in that from the inner portion (Table 2). The determination of the color value in both portions indicated that the content of anthocyanins in the outer portion was about 1.5 times higher than that in the inner portion (Table 3). These results appear to reflect the strong antimutagenicity detected in the outer portion of Ayamurasaki. However the antimutagenic activity of the extract from the outer portion was about 4 times stronger than that from the inner portion at a dose of 1 mg/plate. These results did not always reflect the difference in the anthocyanin contents in both portions.

HPLC analysis revealed the compositional difference of anthocyanin pigments in both portions. Namely, anthocyanin pigments corresponding to YGM1a, YGM1b, YGM2, YGM3, and YGM5a were more abundant in the outer portion. Anthocyanin pigments corresponding to YGM1 to YGM3 consist of cyanidin and those to YGM4 to YGM6 of peonidin^{3,5,6}). Total percentage of YGM1 to YGM3 in the outer portion was 18.6%, while 12.2% in the inner portion. Furthermore, the total percentage of YGM4 to YGM6 in the outer portion was 66.9%, while 65.7% in the inner portion. The cyanidin content in the outer portion was 1.5 times higher than that in the inner portion. These values were in agreement with the increase of the color value in the outer portion, suggesting that cyanidin was abundant in the outer portion. Our previous data also indicated that cyanidin showed a relatively stronger antimutagenic activity than peonidin¹³). These results suggest that the high concentration of cyanidin in the outer portion partially contributes to the strong antimutagenicity.

The extracts of the outer portion of Joy White, Sunny Red, and Koganesengan without anthocyanin in the flesh also effectively inhibited the reverse mutation (Table 2). The phenolic contents in the extracts of the outer portion were several times higher than those in the inner portion (Fig. 2). Yamada and Tomita¹²) reported that many kinds of extracts containing compounds analogous to caffeic acid or ChA effectively decreased the mutagenic activity of the

mutagens as heterocyclic amines. We also confirmed that chlorogenic acid showed a dose-dependent antimutagenicity against Trp-P-1- or Trp-P-2-induced reverse mutation (data not shown). Walter and Schadel¹⁰) indicated that phenolics including ChA are abundant in the outer tissues of the sweetpotato roots. Their results suggest that phenolics in the outer portion mainly suppress the reverse mutation.

In conclusion, the outer portion of Ayamurasaki contained a large amount of cyanidin reflecting the strong antimutagenicity of the outer portion. These results suggest that this new variety of sweetpotato with higher physiological functions should be selected. Furthermore our data showed that the functional components were more abundant in the outer portion of sweetpotatoes. Suzuki et al.⁹) reported that the calcium content was high in the cortex of sweetpotatoes. These results suggest that the utilization of the whole root including the skin is important for maximizing the beneficial physiological functions of sweetpotato. Such an utilization may contribute to the effective use of biological resources, and result in the reduction of the negative environmental impact of wastes from sweetpotato processing.

---References-----



[Back to the first page](#)

- 1) Coseteng, M. Y. & Lee, C. Y. (1987): Changes in apple polyphenoloxidase and polyphenol concentrations in relation to degree of browning. *J. Food Sci.*, **52**, 985-989.
- 2) Furuta, S. et al. (1998): High tert-butylperoxyl radical scavenging activities of sweet potato cultivars with purple flesh. *Food Sci. Technol. Int. Tokyo*, **29**, 33-35.
- 3) Goda, Y. et al. (1996): Two acylated anthocyanins from purple sweet potato. *Phytochemistry*, **44**, 183-186.
- 4) Murata, M., Noda, I. & Homma, S. (1995): Enzymatic browning of apples on the market; relationship between browning, polyphenol content, and polyphenol oxidase. *Nippon Shokuhin Kogyo Gakkaishi*, **42**, 820-826 [In Japanese with English summary].
- 5) Odake, K. et al. (1992): Chemical structures of two anthocyanins from purple sweet potato, *Ipomoea batatas*. *Phytochemistry*, **31**, 2127-2130.
- 6) Odake, K. et al. (1994): Evaluation method and breeding of purple sweetpotato "Yamagawamurasaki" (*Ipomoea batatas* Poir.) for raw material of food colorants. *Nippon Shokuhin Kogyo Gakkaishi*, **41**, 287-293 [In Japanese with English summary].
- 7) Suda, I. et al. (1997): Reduction of liver injury induced by carbon tetrachloride in rats administered purple-colored sweetpotato juice. *Nippon Shokuhin Kagaku Kogaku Kaishi*, **44**, 315-318 [In Japanese with English summary].
- 8) Suda, I. et al. (1998): Changes of serum ³-GTP, GOT, and GPT levels in hepatic function-weakling subjects by ingestion of high anthocyanin sweetpotato juice. *Nippon Shokuhin Kagaku Kogaku Kaishi*, **45**, 611-617 [In Japanese with English summary].
- 9) Suzuki, M., Nagata, T. & Komaki, K. (1998): Distribution of potassium and calcium in sweet potato by X-ray analytical microscope. *Nippon Shokuhin Kogyo Gakkaishi*, **45**, 735-739 [In Japanese with English summary].
- 10) Walter, W. M. Jr., Purcell, A. E. & McCollum, G. K. (1979): Use of high-pressure liquid chromatography for analysis of sweet potato phenolics. *J. Agric. Food Chem.*, **27**, 938-941.
- 11) Yahagi, T. et al. (1977): Mutagenicities of N-nitrosoamines on *Salmonella*. *Mutat. Res.*, **48**, 121-129.
- 12) Yamada, J. & Tomita, Y. (1996): Antimutagenic activity of caffeic acid and related compounds. *Biosci. Biotechnol. Biochem.*, **60**, 328-329.
- 13) Yoshimoto, M. et al. (1999): Antimutagenicity of sweetpotato (*Ipomoea batatas*) roots. *Biosci. Biotechnol. Biochem.*, **63**, 537-541.



[Forward to:-Discrimination of Basidiomycete Species and Strains by RAPD Analysis-](#)



[Contents](#)



[JIRCAS Home Page](#)

Table 3.
Color value and ratio of anthocyanin pigments in extracts from Ayamurasaki outer or inner portion

Portion	Color value	YGM composition ratio (percentage of area in HPLC)									Total	
		<YGM1	YGM1		YGM2	YGM3	YGM4	YGM5		YGM6		YGM6>
			YGM1a	YGM1b				YGM5a	YGM5b			
Outer	15.8	9.4	6.1		6.8	5.7	11.1	38.0		17.9	4.0	99.0
Inner	10.9	12.7	3.0	3.1	5.7	3.4	11.0	15.0	23.0	17.7	7.1	97.7
			3.1					37.0				
			2.1	1.0				—*	—*			

* The percentage was not calculated when the separation of both peaks was not distinct.



[Back](#)

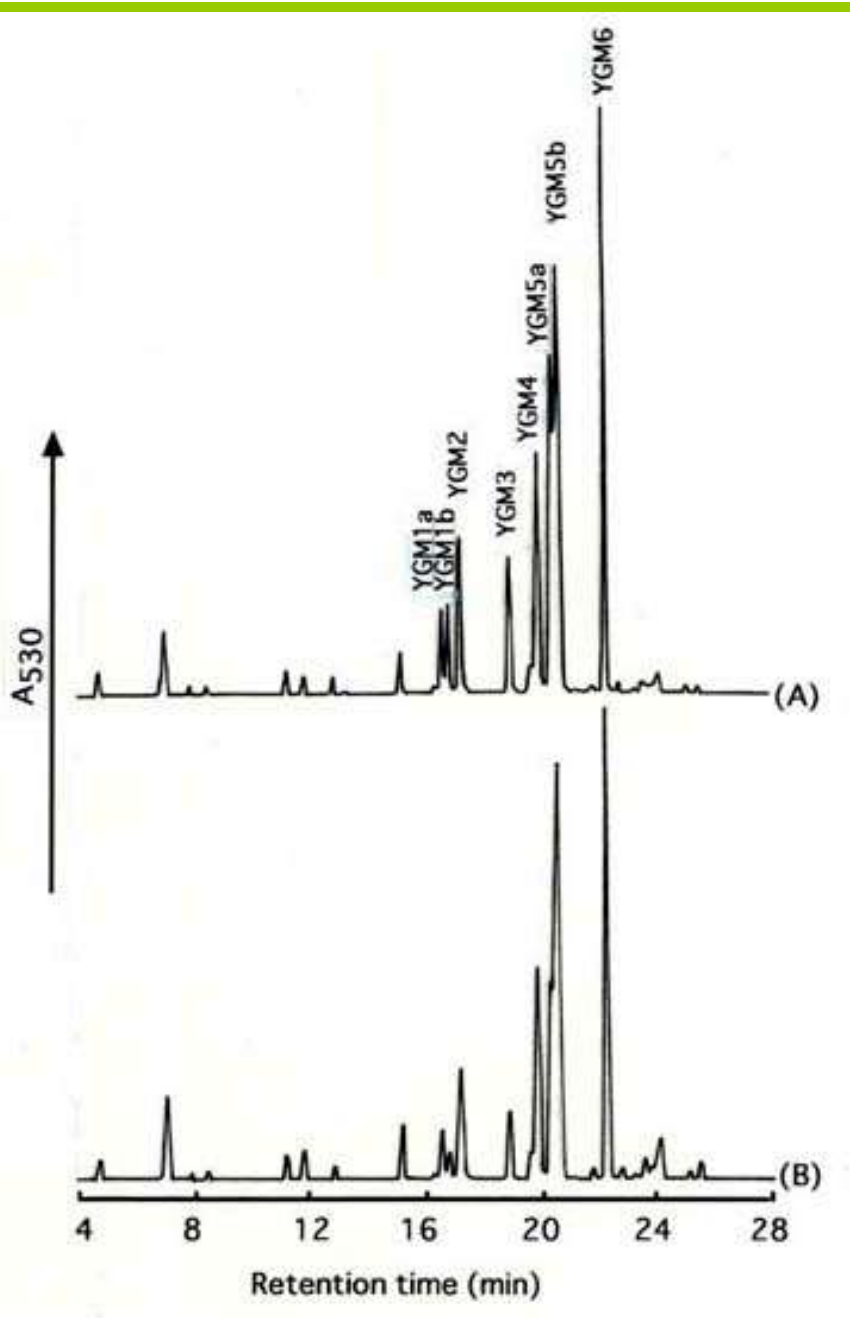


Fig.1. HPLC pattern of pigments in extracts from Ayamurasaki outer or inner portion (A): Outer portion, (B): Inner portion.



[Back](#)

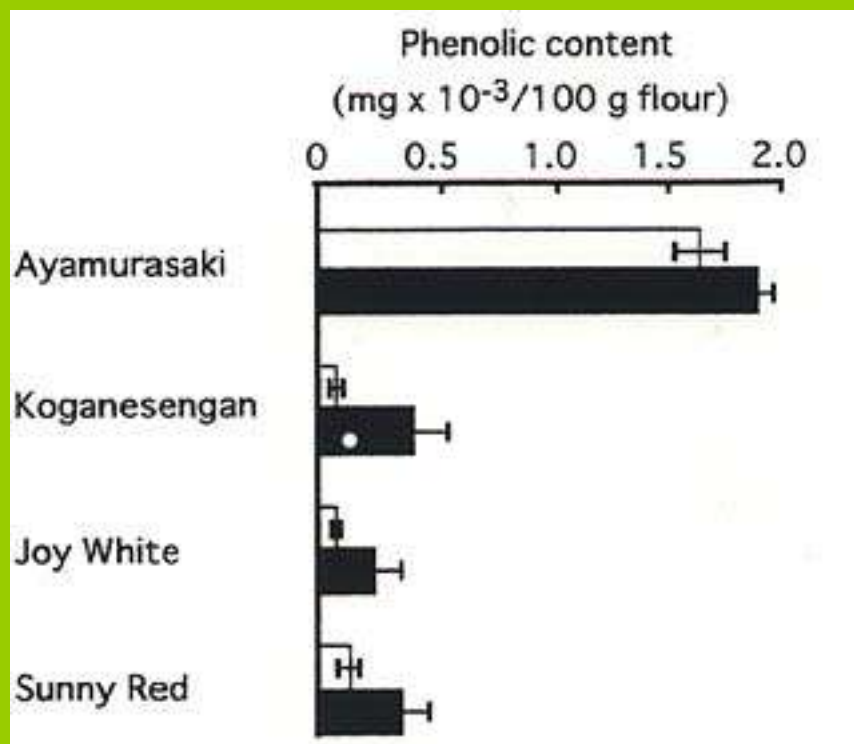


Fig. 2. Phenolic contents of extracts from the outer or inner portion from 4 varieties of sweetpotato
 □ : Inner portion, ■ : Outer portion.
 Each value represents mean ±SD of 5 samples.

 [Back](#)

Discrimination of Basidiomycete Species and Strains by Random Amplified Polymorphic DNA (RAPD) Analysis

Yasuhiro ITO and Sonoe O. YANAGI

Biological Function Division, National Food Research Institute
(Tsukuba, Ibaraki, 305-8642 Japan)

---Abstract-----

To develop a method for the discrimination of basidiomycete species and strains with vegetative mycelia, DNAs isolated from the mycelia of *Coprinus* and *Tricholoma* strains, were subjected to random amplified polymorphic DNA (RAPD) analysis. Seven *Coprinus* species could be distinguished, clearly showing species-specific DNA patterns in the RAPD analysis. One specimen of unknown *Coprinus* strain was identified as *C.cinereus* by this method. Six strains of *C.cinereus* and 4 of *C.angulatus* could also be distinguished by the presence of strain-specific RAPD fragments. Five members of the *Tricholoma* family, *T.matsutake* and related 4 species, also showed species-specific DNA patterns in the RAPD analysis. The discrimination of *Tricholoma* species was confirmed by cluster analysis based on 192 RAPD fragments. The 5 species could be clearly divided into 5 groups in complete agreement with the taxonomic classification. RAPD analysis of mycelial DNA, as shown in these studies, is a suitable method for distinguishing basidiomycete species and strains.

Discipline: Genetic resources

Additional key words: *Coprinus*, *Tricholoma*

1.....13):[References](#)

(Received for publication, January 11, 1999)

---Introduction-----

Basidiomycetes are mainly classified based on the morphology of fruit bodies. However many strains of basidiomycete species do not form fruit bodies readily, if not at all, under experimental conditions. The development of a simple method for distinguishing species or strains with vegetative mycelia, therefore, is important.

Recently, molecular markers, such as isozymes, restriction fragment length polymorphisms (RFLP) and random amplified polymorphic DNA (RAPD) have been used to detect genetic differences in species and strains of basidiomycetes. Among these molecular markers, RAPD, which was introduced by the use of polymerase chain reaction (PCR) with arbitrary 10-mer primers¹), can express DNA variations for distinguishing basidiomycetes species and strains with less labor and high reliability⁴).

We used RAPD analysis for 2 basidiomycete groups, *Coprinus* species and *Tricholoma* species. *Coprinus* species, mainly *C.cinereus*, have been used as a model material for basic studies on basidiomycetes since they grow rapidly with a short life cycle span. We used *Coprinus* species to develop the RAPD method for the discrimination of basidiomycete species. Although *T.matsutake* (S. Ito and Imai) Singer is the most valuable edible mushroom in Japan, fruit body formation of *T.matsutake* under artificial conditions has not been achieved yet. Discrimination of *T.matsutake* based on the morphology of mycelia is almost impossible too because these are no clamps. This paper describes the successful application of the RAPD method.

---Materials and methods-----

1) *Strains and culture conditions*

Coprinus and *Tricholoma* strains examined are listed in Table 1. To maintain the strains, MYG medium [1.0% (w/v) of malt extract (Difco, USA), 0.4% (w/v) of yeast extract (Difco, USA) and 0.4% (w/v) of glucose] with 1.5% (w/v) agar was used. For DNA extraction, mycelia of each strain were inoculated into 20 mL of liquid MYG medium each in 100 mL flasks, and cultured statically at 30 for 2-3 days for the *Tricholoma* strains, or at 20 for 1-2 months for the *Tricholoma* strains. Harvested mycelia were stored at -20 for DNA extraction.

Table 1. Strains of *Coprinus* and *Tricholoma* species examined

Species	Strain	Source (collection sites)

<i>Coprinus angulatus</i> Peck	225 516 624 711	Okayama Univ.a) Okayama Univ.a) Okayama Univ.a) Okayama Univ.a)
<i>C. atramentarius</i> (Bull. : Fr.) Fr. <i>C. cinereus</i> (Schaeff. : Fr.) S. F. Gray	MAFF430151 Wild 5005 5309 5312 5338 5348	G.B. b) NFRI c) Okayaman Univ.a) Okayaman Univ.a) Okayaman Univ.a) Okayaman Univ.a)
<i>C. comatus</i> (Muller : Fr.)	FRI 7T	Protoplast regenerant of Fis c d) NFRI
<i>C. disseminatus</i> (Pers. : Fr.)	11T E022	NFRI Forestry and Forest Products Research Institute
<i>C. micaceus</i> (Bull. : Fr.) Fr.	A342S	Forestry and Forest Products Research Institute
<i>C. sp</i> (species unknown)	MAFF425079	G.B
<i>Tricholoma matsutake</i> (S. Ito & Imai) Sing.	MAFF460031 MAFF460037 MAFF460051 MAFF460052 MAFF460057 MAFF460070 MAFF460101	G.B(Hyogo, Japan) G.B(Aomori, Japan) G.B(Yamanashi, Japan) G.B(Hokkaido, Japan) G.B (China) G.B(Kumamoto, Japan) G.B(Korea)
<i>T. caligatum</i> (Viv.) Ricken	MAFF460044 MAFF460064 MAFF460081	G.B(Algeria) G.B(Algeria) G.B(U.S.A)
<i>T. magnivelare</i> (Peck) Readhead comb. Nov	MAFF460025 MAFF460087	G.B(Aomori, Japan) G.B(Hokkaido, Japan)
<i>T. bakamatsutake</i> Hongo	MAFF460028 MAFF460029 MAFF460030	G.B(Kochi, Japan) G.B(Kyoto, Japan) G.B(Kyoto, Japan)

a): Maintained at National Food Research Institute for more than 10 years.

b): Genebank of Ministry of Agriculture, Forestry and Fisheries, Japan.

c): National Food Research Institute.

d): Fis^c was supplied from the University of Tokyo, maintained at NFRI for more than 10 years.

2) DNA extraction and PCR reaction

Mycelial DNA of each *Coprinus* strain was extracted by the method of Doyle and Doyle (1987) (1). DNA amplification was performed following a modification of the protocol of Williams et al. (1990) (11). The reaction mixtures contained 10 mM Tris-HCl, pH 8.3, 50 mM KCl, 1.5 mM MgCl₂, 0.2 mM of dATP, dCTP, dTTP, and dGTP, 1 μM of primer, 0.4 U of recombinant *Taq* DNA polymerase (Takara, Japan), and 10 ng of genomic DNA in a total volume of 10 μL. Ten decamer oligonucleotides were used as RAPD primers (Table 2). Amplification was carried out in a Program Temp Control System PC-800 (ASTECC, Japan) by the following procedure: initial denaturation at 94 for 2 min; 45 cycles of 94 for 30 s, 36 for 1 min and 72 °C for 2 min; and final extension at 72 for 2 min.

Table 2. RAPD primers used for discrimination of *Coprinus* strains and *Tricholoma* strains

Sequence (5' to 3')		Sequence (5' to 3')	
For <i>Coprinus</i> strains	GACTAGCCTC GTATCGCGGT TGGCACTGA TGGTCACCGA TGCGTGCTTG TTCGAGCCAG AGTGGAAGGT ATGCCTACAG AGCGCCATTG CTCACCGTCC CACCGTATCC CACCTAGTCC	For <i>Tricholoma</i> strains	GGCTCATGTG GGCACTGAGG AGGGCCGTCT ACGACCGACA GTCAGGGCAA GACCGCTTGT GTGATCGCAG TGCCGAGCTG GTTGCGATCC GGTGACTGTG

(Summary)

For the *Tricholoma* strains, total DNA was extracted from mycelia as described by Draper et al. (1988)²⁾. RAPD analysis was performed following a modification of the protocol of Williams et al. (1990)¹¹⁾. The reaction mixtures contained 10 mM Tris-HCl (pH 8.3), 50 mM KCl, 2 mM MgCl₂, 0.1 mM each of dATP, dCTP, dTTP and dGTP, 0.2 μM of RAPD primer (Table 2), 0.2 U of recombinant *Taq* DNA polymerase (Takara, Japan) and 1.0 ng of genomic DNA in a total volume of 10 μL. Amplification reactions were performed as follows: initial denaturation at 94 for 2 min; 30 cycles of 94 for 1 min, 36 for 1 min and 72 for 2 min; and final extension at 72 for 2 min.

Amplified DNA was electrophoresed in 1.6%(w/v) agarose gels, stained with 0.5 μg/L ethidium bromide, and photographed under UV light.

3) *RAPD data analysis for Tricholoma species*

Each polymorphic fragment was treated as a unit character, and compared between each pair of strains. The percentage of different fragments in each pair of strains was obtained by the following calculation: 100×number of different fragments/number of total detected fragments between the 2 strains. Cluster analysis was performed, based on the percentage of similarity of RAPD fragments, using the unweighted-pair-group method¹⁰⁾.



[Results and discussion](#)



[Contents](#)

---Results and discussion-----

1) *DiscriminaTion of Coprinus species*

Several DNA fragments from the genomic DNA of each *Coprinus* strain were successfully amplified with 12 primers. Two typical results of RAPD analysis are shown in [Fig. 1-A and B. \(13KB\)](#)

Strains of the same species gave similar RAPD patterns which included several DNA fragments of equivalent length (sample lanes 3-7, 8-11, and 12-13, respectively), making it possible to distinguish the species. Strains of different species, however, did not yield common fragments. RAPD patterns with other 10 primers gave similar results.

We attempted to identify the species to which a *Coprinus* strain stored as No. 425079 in the gene bank of MAFF belonged (Table 1). The RAPD patterns are presented in lanes No. 2 in [Fig. 1-A and B](#). With all the primers used, the RAPD patterns of strain 425079 clearly showed fragments common to *C.cinereus* strains, and the absence of homology with strains of other species. Therefore, this strain was identified as *C.cinereus*. Compatibility tests of mating between strain 425079 and monokaryotic strains of *C.cinereus* also gave the same results in RAPD analysis.

Hopple Jr. and Vilgalys (1994)³⁾ detected differences in the restriction sites of rDNA between *Coprinus* and related species, and estimated their phylogenetic relationship. However in the RAPD patterns in this study, since different *Coprinus* species showed few similarities to each other, the RAPD patterns were not suitable for use for phylogenetic analyses. On the other hand, the low similarity of the patterns between species makes this technique suitable for the discrimination of *Coprinus* species, as demonstrated by the identification of the species to which an unknown *Coprinus* strain belonged.

2) *DiscriminaTion of sTrains of C.cinereus and C. angulatus*

RAPD patterns of the *Coprinus* strains showed the presence of polymorphic DNA fragments among the strains in the same species. As shown in [Fig. 2-A\(15KB\)](#), 5 of such polymorphic fragments (indicated by arrows) were found simultaneously with 4 common fragments in the RAPD patterns of 7 *C.cinereus* strains using the primer TTCGAGCCAG. These polymorphic fragments were strain-specific, and the 7 strains could be distinguished by the presence or absence of these 5 polymorphic fragments which were generated with one primer only.

The RAPD patterns for 4 strains of *C. angulaTus* are depicted in [Fig. 2-B\(15KB\)](#). One primer, TGCGTGCTTG, gave 2 polymorphic fragments shown in lanes 1-4. These 2 markers allowed the discrimination of strains 225 and 711, while strains 516 and 624 could not be distinguished. Another primer, GACTAGCCTC, amplified another polymorphic fragment, as shown in lanes 5-8. By the presence or absence of this fragment, strain 516 was clearly distinguished from strain 624. Thus, the combination of 2 primers, in this case, allowed a clear discrimination of the strains.

The clarity and simplicity of these examples in the discrimination of the strains of *C.cinereus* and *C. angulaTus* indicated that the RAPD method is very efficient for strain discrimination. RAPD markers specific for strains could be obtained easily, and seemed to be useful as genetic markers.

Several papers on the identification of strains of *Coprinus* by DNA analysis have been published. Wu et al. (1983)¹² reported the presence of DNA polymorphisms caused by the insertion/deletion of DNA fragments or base pair substitutions by RFLP analysis of *C.cinereus*, and Laroche et al. (1995)⁷ attempted to group and identify *C. psychromorbidus* by RAPD and RFLP analyses.

The method used to identify a strain is important for the protection of commercial mushroom species, like *Agaricus bisporus*, *LenTinus edodes*, *PleuroTus osTreaTus*, and so on. It is easy to isolate the mycelia of commercially superior cultivars and to culture them without permission. To identify the cultivar, morphological characters of the fruit body can not be used, because they display wide variations with the environmental conditions. DNA fingerprinting techniques, such as RAPD, RFLP and AFLP, can describe specific DNA variations of the cultivar, and are useful to identify the cultivar.

3) RAPD analysis for discriminaTion of Tricholoma species

Several amplified DNA fragments were obtained from each of the 15 MAFF strains of the 5 *Tricholoma* species examined using 10 RAPD primers. Most of the RAPD primers gave several common fragments among the strains in the same species, while RAPD patterns of 5 *Tricholoma* species were species-specific ([Fig. 3-A\(11KB\)](#)). However, *T. maTsuTake* showed similar RAPD patterns to those of *T. caligaTum* or *T. magnivelare* in some cases ([Fig. 3-B\(11KB\)](#)). To determine whether the RAPD analysis is suitable for the discrimination of *T. maTsuTake* from other *Tricholoma* species, 192 distinct RAPD fragments obtained by 10 primers were classified. Ten fragments were found only in *T. maTsuTake* strains to be species-specific, 4 were found in all the 7 *T. maTsuTake* strains and all the 2 *T. caligaTum* strains, 7 in all the strains of *T. maTsuTake*, *T. caligaTum*, and *T. magnivelare*, and 1 in all the strains of *T. maTsuTake* and *T. magnivelare*.

Based on the 192 RAPD fragments, cluster analysis was performed to determine the relationship between the five *Tricholoma* species. The 5 species were clearly divided into 5 groups in complete agreement with the taxonomic classification ([Fig. 4\(26KB\)](#)). Intraspecific similarity between each strain was obviously higher than interspecific similarities among all the 5 species in *Tricholoma*. The highest similarity of 52.0% to *T. maTsuTake* was given by *T. caligaTum*. *T. magnivelare*, *T. fluvocasTaneum* and *T. bakamaTsuTake* gave 41.8, 38.7 and 24.6% similarities to *T. maTsuTake*, respectively. Since the intraspecific similarities among *T. maTsuTake* strains exceeded 85.0%, it appears that the RAPD patterns of the *T. maTsuTake* strains can be distinguished from those of the related species. Thus, RAPD analysis is a suitable method for distinguishing the 5 *Tricholoma* species as well as *T. maTsuTake* from the related species.

Six closely related species of *T. maTsuTake* have been reported, that is, the 4 species mentioned above and *T. robustum* and *T. zelleri*⁸). Among the 6 species, *T. maTsuTake*, *T. caligaTum* and *T. magnivelare* have been considered to be closely related in terms of the morphology and fragrant aroma of the fruit body, the characters of cultured mycelia, the morphology of fungal colonies in soil called *shiro*, and mycotrophy with coniferous trees^{8,9,13}). As described above, our RAPD data corresponded to the morphological classification, confirming the close relationship of these 3 species at the genetic level.

The classification of *Tricholoma* species has not yet been completed, although *T. maTsuTake* and related species are widely distributed in the Northern hemisphere. Several species were included in *T. caligaTum* which is distributed in North and Central America, Europe and North Africa^{5,6}). Some

researchers consider that *T. maTsuTake* is an indigenous species in East Asia, but Kytövuori (1988)⁶ stated that it was the synonym of *T. nauseosum* which is one of the species in the *T. caligaTum* group distributed in Europe and North Africa. To define the species and elucidate the phylogenetic relationships of closely related *Tricholoma* species in more detail, it is suggested that DNA analyses, especially RAPD method as indicated in this study, may provide accurate genetic information.

---References-----

- 1) Doyle, J. J. & Doyle, J. L. (1987): A rapid DNA isolation procedure for small quantities of fresh leaf tissue. *Phytochem. Bull.*, 19, 11-15.
- 2) Draper, J. et al. (1988): Plant genetic transformation and gene expression. A laboratory manual. Blackwell Scientific Publication, London, 212-214.
- 3) Hopple, Jr. J. S. & Vilgalys, R. (1994): Phylogenetic relationships among coprinoid taxa and allies based on data from restriction site mapping of nuclear rDNA. *Mycologia*, 86, 96-107.
- 4) Ito, Y., Fushimi, T. & Yanagi, S. O. (1998): Discrimination of species and strains of basidiomycete genus *Coprinus* by random amplified polymorphic DNA (RAPD) analysis. *Mycoscience*, 39, 361-365.
- 5) Iwase, K. (1996): Distribution of the Ectomycorrhizal fungus *Tricholoma maTsuTake* and the related species and some characteristics of their isolates. Soil microorganisms. Res. Counc. Secr. of MAFF and NIAR, 179-188.
- 6) Kytövuori, I. (1988): The *Tricholoma caligaTum* group in Europe and North Africa. *KarsTenia*, 28, 65-77.
- 7) Laroche, A. et al. (1995): Grouping and identification of low temperature basidiomycetes using mating, RAPD and RFLP analyses. *Mycol. Res.*, 99, 297-310.
- 8) Ogawa, M. (1978): Biology of *maTsuTake* mushroom. Tsukiji Shokan, Tokyo [In Japanese].
- 9) Ohara, H. & Ogawa, M. (1982): Microbial ecology of “shiro” in *Tricholoma maTsuTake* and its allied species XI. *Tricholoma caligaTum* in *Cedrus libanoTica* forest. *Trans. Mycol. Soc. Jpn.*, 23, 365-377 [In Japanese with English summary].
- 10) Sneath, P. H. A. & Sokal, R. R. (1973): Numerical taxonomy. W. H. Freeman and Company, San Francisco.
- 11) Williams, J. G. K. et al. (1990): DNA polymorphisms amplified by arbitrary primers are useful as genetic markers. *Nucleic Acids Res.*, 18, 6531-6535.
- 12) Wu, M. M. J., Cassidy, J. R. & Pukkila, P. J. (1983): Polymorphisms in DNA of *Coprinus cinereus*. *Curr. GeneT.*, 7, 385-392.
- 13) Zeller, S. M. & Togashi, K. (1934): The American and Japanese *maTsuTakes*. *Mycologia*, 26, 544-558.



[Forward to:-Optimum Spray Time for P.pentagona-](#)



[Contents](#)



[JIRCAS Home Page](#)

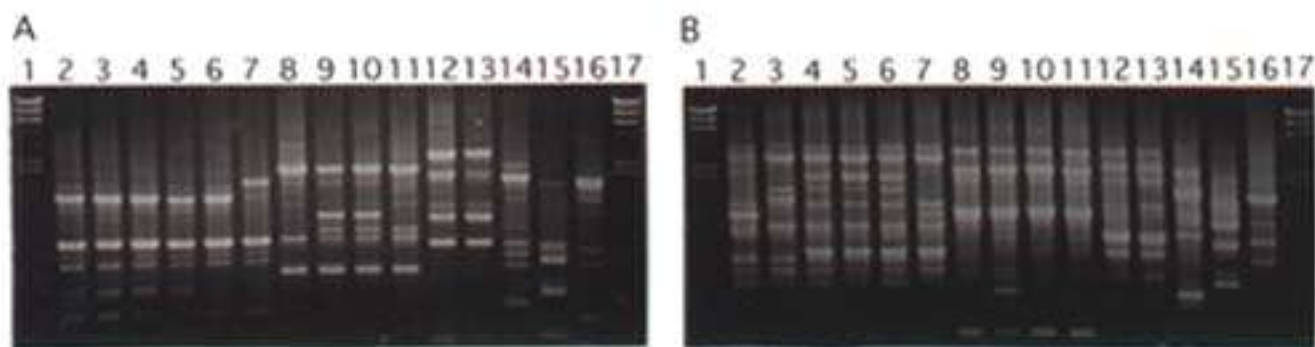


Fig.1.
RAPD patterns of 15 *Coprinus* strains in 6 species

A shows the RAPD patterns produced with the primer TGGTCACCGA, and B with AGCGCCATTG. Lanes 1 and 17, molecular size markers (»DNA digested with Hind III); lane 2, unknown species of *C. sp.*425079; lanes 3-7, *C.angulatus* 225, 516,624 and 711, respectively; lanes 12,13, *C. comatus* 7T and 11T, respectively; lane 14, *C. micaceus* A342S; lane 15, *C. disseminatus* Eo22; lane 16, *C. atramentarius* 430151.



[Back](#)

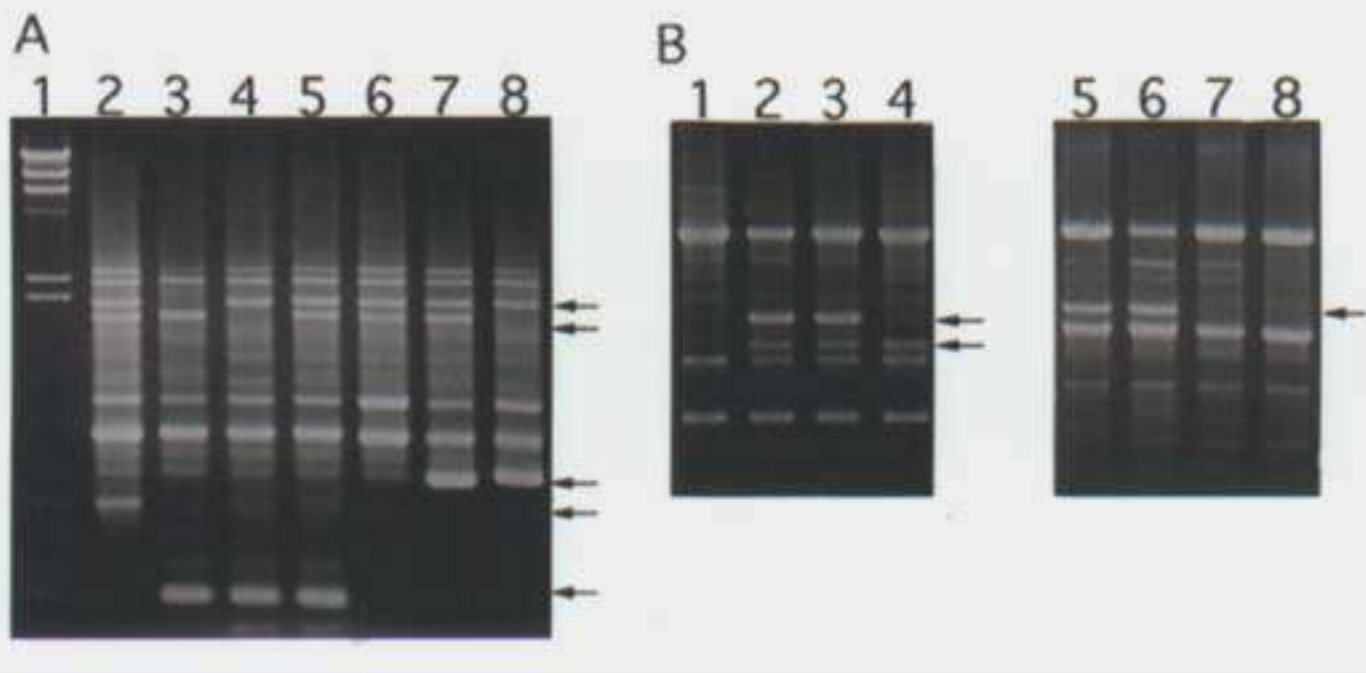


Fig. 2. Identification of basidiomycete strains by RAPD markers

A shows the RAPD patterns of 7 strains of *Coprinus cinereus* produced with the primer TTCGAGCCAG. Lane 1, molecular size marker(λ DNA digested with Hind III); lanes 2-8, *C. cinereus* wild, 5005, 5309, 5312, 5348, FR1, and *C. sp.* 425079 identified as *C. cinereus* in Fig. 1, respectively.

B shows the RAPD patterns of 4 strains of *C. angulatus*. Lanes 1-4, *C. angulatus* 225, 516, 624, and 711, respectively, generated with the primer TGCGTGCTTG; and lanes 5-8, the same strains, respectively, generated with the primer GACTAGCCTC. Arrows indicate polymorphic fragments.



[Back](#)

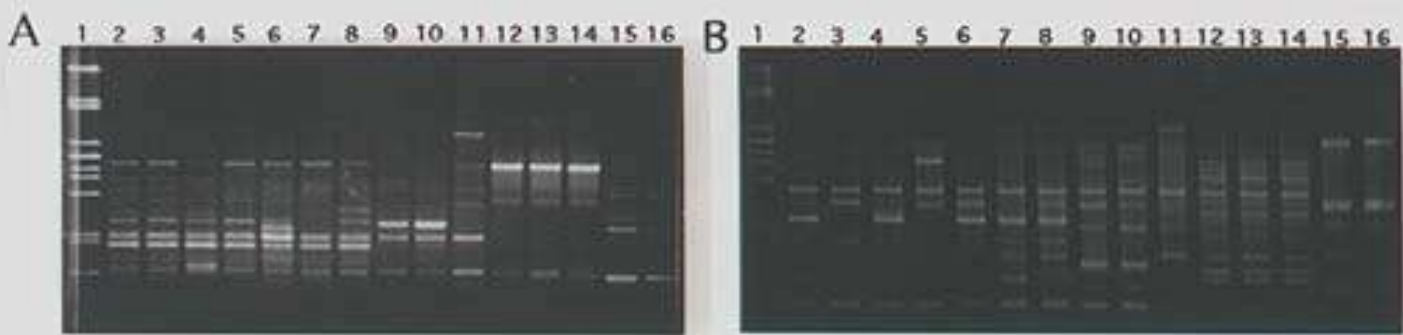


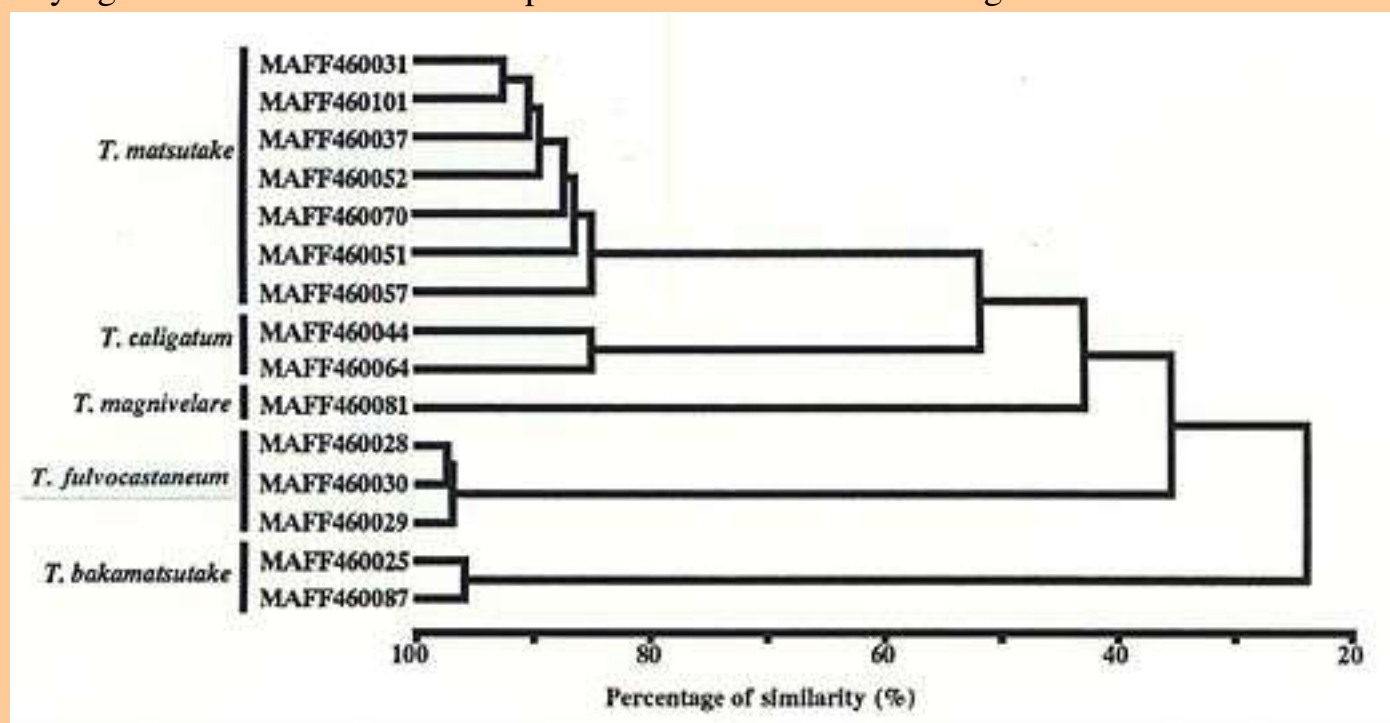
Fig. 3. RAPD patterns of strains of *T. maTsuTake* and related 4 species

A shows the RAPD patterns amplified with the primer of GACCGCTTGT, and B with TGCCGAGCTG. Lane 1, molecular size marker(λ DNA digested with *PsT* I); lanes 2-8, *T. maTsuTake* MAFF 460031, MAFF 460037, MAFF 460051, MAFF 460052, MAFF 460057, MAFF 460070 and MAFF 460101; lanes 9 and 10, *T. caligaTum* MAFF 460064 and MAFF 460044; lane 11, *T. magnivelare* MAFF 460081; lanes 12-14, *T. fluvocasTaneum* MAFF 460028, MAFF 460029 and MAFF 460030, lanes 15 and 16, *T. bakamaTsuTake* MAFF 460025 and MAFF 460087.



[Back](#)

Fig. 4.

Phylogenetic tree of *Tricholoma* species based on 192 RAPD fragments[Back](#)

Determination of Optimum Spraying Time for Chemical Control of Mulberry Scale, *Pseudaulacapis pentagona* (Targioni) (Hemiptera: Diaspididae) in Tea Fields

Akio TATARA

Shizuoka Agricultural Experiment Station
(Toyoda, Shizuoka, 438-0803 Japan)

---Abstract-----

Monitoring methods of mulberry scale larvae, *Pseudaulacapis pentagona*, were evaluated for determining the spraying time for effective chemical control. Among them, the ratio of "more than half hatched egg batches" which was found to be suitable due to its accuracy, is, however, time-consuming. Optimum spraying time is defined as the duration of the period required to achieve a ratio of more than half hatched eggs in egg batches (60 to 90%), which is referred to as "more than half hatched egg batches." The use of sticky traps set inside a tea bush to capture crawlers of the mulberry scale is a simple and accurate monitoring method. The optimum spraying time occurs 2 to 5 days after the peak capture of the crawlers by the traps. The traps should be set up from the beginning of the egg hatching period, and should be examined daily or every other day to determine the peak capture of the crawlers. The use of sticky traps for monitoring is suitable for only the first generation of mulberry scale. Thus observations of "more than half hatched egg batches" are needed to determine the optimum spraying time for the second and third generations of the mulberry scale.

Discipline: Insect pest / Tea industry

Additional key words: sticky trap, crawler, egg batch

● [1....15:References](#)

(Received for publication, December 4, 1998)

---Introduction-----

The mulberry scale, *Pseudaulacapis pentagona* (Targioni), has been a serious pest of tea in Japan. Outbreaks have been reported sporadically since 1955 in Shizuoka Prefecture³). Recently an outbreak was reported in 1994-1996 and the scales occurred in 40% of the tea-cultivated area in Japan²). The scale population frequently breaks out and occasionally even kills tea hosts. Three generations can occur per year in central Japan. The female lays eggs under her shell. The crawlers, i.e. walking first instar larvae, just after hatching walk out from under the shell. After 30 m to 11 h, the crawlers settle on tea branches and molt to the succeeding developmental stage within 15 days³).

It is difficult to find the crawler scale in the tea fields because the mulberry scale lives only on branches inside the tea bushes and the body size of the crawler is very small (0.2 mm). However, in the case of the mulberry scale, the effective period for pesticide application is very short⁹). Even if farmers detect the occurrence of this scale, it is difficult to determine the time of optimum control. Three monitoring methods were suggested to determine the spraying time for mulberry scale. These methods were evaluated in terms of accuracy and simplicity.

---Effect of insecticide application to mulberry scale-----

Generally, chemical control for scale insects is applied to larvae and adults. In the case of the larvae, it is effective only for young ones. Therefore chemical control methods for adult scales which do not involve a selection of the spraying time were examined. Spraying of petroleum oil during winter enabled to control effectively the arrow-head scale, *Unapsis yanonensis* (Kuwana), which is a kind of armored scale, that injures citrus⁷). However, the control by the use

of some pesticides including petroleum oil in the case of the adult female of mulberry scale in winter is less effective than in the case of the larvae¹²). Though fumigation with hydrocyanic acid gas applied to the adult of the mulberry scale and the arrow-head scale is effective^{4,6}), this method is very dangerous to man and its application is not realistic presently.

Some of the insect growth regulators and organophosphates are known to be effective insecticides against the larval stage of armored scales. The optimum period of pesticide application lasts for more than 4 weeks for the California red scale, *Aonidiella aurantii* (Maskell)¹⁴). Organophosphates are effective for the control of the first and the second instar larvae and also for that of the immature adults of the arrow-head scale¹¹). Many insecticides have been tested for the control of the mulberry scale. Some insecticides (e.g. buprofezin and methidathion) are effective against the larvae of the mulberry scale. However, the optimum period of application of these insecticides is very short and the effectiveness markedly decreases when spraying is performed 6 days after the optimum time⁹). Therefore, since pesticide control of the mulberry scale is more difficult than that of the California red scale or arrow-head scale, it is important to determine the spraying time for the control. Consequently, accurate and efficient monitoring methods are required for determining the optimum spraying time.

---Monitoring methods for insecticide application-----

1) *Observation of the number of crawlers*

Pesticides should be applied during the period of egg hatching³). A farmer goes to his tea fields and observes the walking crawlers on the tea branches. Pesticides should be applied when the farmer finds many crawlers on the branches. This is the easiest method. Alternatively, a farmer brings the branches with mulberry scale females to his house from his tea fields. Spraying of pesticides should be performed when the farmer observes the crawlers on the branches in water¹).

2) *"More than half hatched egg batch ratio"*

It is time-consuming to count the number of hatched eggs that would be statistically significant for calculating the hatchability. This is a simple method in which the ratio of "more than half hatched egg batch" is measured⁸). The female scales are observed under a microscope after their shells are peeled off using pointed tweezers. A group of eggs laid by one female is defined as one egg batch. If one or more eggs in one egg batch have hatched, the term "hatched egg batch" is used. If more than 50% of the eggs in one egg batch have hatched, the term "more than half hatched egg batch" is used. More than 100 live females in a tea field are required for this survey¹³).

Table 1 shows the effect of applications of two kinds of pesticides (buprofezin 25W and methidathion 40E) on different days at short intervals and the ratio of "more than half hatched egg batches" on the day of pesticide application. The most effective date for pesticide application was May 26 for both insecticides based on the colony number of male cocoons. The numbers in the plots sprayed with Buprofezin were small on May 23 and June 1. The colony numbers in the methidathion plots were small when spraying took place on May 26 and 30. Many colonies were observed in both sprayed plots on June 1. Therefore, the effective duration of safe application of these insecticides for the control corresponded to the period around May 26 to 30 in this test. The ratio of "hatched egg batches" reached a value of 100% before the optimum spraying time, while the ratio of "more than half hatched egg batches" increased slightly from May 23 to 26. Therefore it is assumed that the ratio of "more than half hatched batches" is a useful index for determining the duration of the optimum control time. And the effective period of pesticide application coincides with a ratio of "more than half hatched batches" ranging between 60 to 90%.

Table 1. Optimum spraying time for *P. pentagona* control¹³

Pesticide ^{a)}	Spraying date	Ratio of "more than half date hatched egg batches" on spraying day(%)	Mean number of colonies of male cocoons on June 20 ^{b)}

Buprofezin 2.5 ppm	May 23	25.0	2.75
Buprofezin	May 26	59.0	0.25
Buprofezin	May 30	94.9	2.40
Buprofezin	June 1	95.2	0.95
Buprofezin	June 5	100.0	14.35
-----	-----	-----	-----
Methidathion 4 ppm	May 23	25.0	10.6
Methidathion	May 26	59.0	6.65
Methidathion	May 30	94.9	6.80
Methidathion	June 1	95.2	22.95
Methidathion	June 5	100.0	30.30
-----	-----	-----	-----
Unsprayed	—		30.90

a): 1,000 L per 10 a were sprayed to each plot.
b): When male cocoons covered a large part of the tea branch, male cocoons 2 cm long were counted and defined as one colony.

3) Capture of crawlers by sticky traps

The crawlers of scale insects have been shown previously to disperse passively by the wind^{5,10,15}. They can be caught by sticky traps. Ozawa (1994a)⁸ who used a small sticky card trap (10×10 cm) placed inside the tea bush to monitor the crawlers and the male adults, tried to predict the optimum spraying time for chemical control by trap catches and the ratio of hatched eggs ([Fig. 1\(33KB\)](#)). Since both the number of captured crawlers by the traps and the hatchability increased rapidly during a period of about 10 days, more detailed data are necessary to determine the optimum spraying time.

[Fig. 2\(44KB\)](#) shows the changes in the numbers of captured crawlers using the Ozawa trap and hatching ratio of egg batches for the first generation at short intervals¹³. The results of the survey conducted in 1995 are shown in Table 1. The optimum spraying duration in 1995 during the period between May 26 and 30 corresponded to the period of 1 to 5 days after the peak of crawler captures. In 1996, the duration of period when the ratio of "more than half hatched egg batches" reached values of 60 and 90% corresponded to the period of June 5 to 10. This period corresponded to 2 to 7 days after the peak of the trap catches. Though the dates of the optimum spraying period and the peak of trap catches were different in 1995 and 1996, the optimum spraying time can be estimated from the peak of trap catches of the crawlers.

[Fig. 3\(50KB\)](#) shows the changes in the numbers of catches and hatching ratio of the egg batches for the second generation. The optimum spraying time was estimated to occur around August 1 based on the ratio of "more than half hatched egg batches." While the traps captured the crawlers on July 24 initially, the peak occurred on July 28. Since the difference in the number of catches between July 24 and 28 was not appreciable, it is difficult to detect the peak of trap catches in this case. In 1996, the optimum spraying time was estimated to occur from August 5 to 8 based on the 60 to 90% ratio of "more than half hatched egg batches." It is difficult to detect the peak because the number of trap catches markedly fluctuated from the trap setting. Based on the results obtained in both years for the second generation, it is difficult to detect the peak date from the changes in trap catches. The peak date of trap catches could be detected in the third generation in 1995, while crawlers were not caught in the traps in 1996. Therefore it is difficult to determine whether the sticky traps are useful to estimate the optimum spraying time for the third generation based on the results of both years ([Fig. 4\(26KB\)](#)).

The hatching duration of crawlers is longer in the second and third generations than in the first generation. It is very difficult to control the mulberry scale in the second and third generations with insecticides because the hatching of eggs continues for a long period. Even though monitoring by using sticky traps is possible only for the first generation, this method is suitable because the control of the first generation of the mulberry scale is very important to achieve further control.

Ozawa⁸) indicated that the optimum spraying time of the mulberry scale by sticky traps under the plucking surface of the tea tree corresponded to 5 days after the first catch by the trap. However, it is preferable to determine the pesticide application date based on the peak number of crawlers caught in the sticky traps. The optimum spraying time was 1 to 5 days after the peak of the trap captures in 1995 and 2 to 7 days in 1996 (Fig. 2). Considering the safety of the effect of chemical control, the period of optimum spraying time should corresponded to 2 to 5 days after the peak.

[Fig. 5\(27KB\)](#) shows simulations of different intervals of trap changes using an actual data set¹³). The actual peak of the number of captured crawlers occurred on May 25. In the case of two-day intervals, if the traps are set on May 19 or 20, the peak occurred on May 25 or 26 and the optimum duration of spraying corresponded to May 27 to 30 or May 28 to 31, respectively. In the latter case, since the peak was detected on May 28, preparations for the control can be made. In case of three-day intervals, if the traps are set on May 19, 20 or 21, the peak may occur on May 25, 26 or 27, respectively. When the peak occurred on May 27, the optimum spraying time should take place during the period from May 29 to June 1. But, in this case, the peak day can not be determined until May 30 when the next traps are set up. Since the actual period for optimum spraying to control the mulberry scale corresponded to May 27 to 30, preparations for the control cannot be made at that time. Therefore, traps should be changed daily or every other day.

---Evaluation of monitoring methods for optimum spraying time-----

The method involving only observations is the easiest and required little time. However, this method is not accurate since the results depend on the farmers' individual perception. For example, when a few percents of crawlers come out from the female shell under a high density of females, a farmer may make a mistake in deciding to spray due to the observation of a large number of crawlers. Though the observations of "more than half hatched egg batches" are accurate to determine the optimum spraying time for the control of the mulberry scale, this procedure is time-consuming.

Monitoring using sticky traps placed under the plucking surface of the tea tree requires less time than monitoring of the egg hatching ratio. The adhesive sheet (8 x 10 cm) is stuck on both sides of an acrylic card (10 x 10 cm) which is used as a sticky trap. The traps are placed vertically at 10 cm under the plucking surface of the tea canopy ([Fig. 6\(31KB\)](#)). The traps face the same direction as the tea hedge. The new traps were set in the same position after trap change. Captured crawlers are counted under a microscope. The sticky traps may enable to capture the crawlers over a wide area of tea fields. Since this monitoring method is not suitable for the second and the third generations, it is useful for the purpose of decision making for pesticide application only for the first generation of the mulberry scale. It is considered that the observation of egg hatching is necessary for the second and the third generations to identify the optimum spraying time.

---References-----

- 1) Ando, T. (1960): Early control of mulberry scale. *The Tea*, 13 (7), 28-31 [In Japanese].
- 2) Kawai, A., Tatara, A. & Kozaki, Y. (1997): The outbreak of mulberry scale, *Pseudaulacaspis pentagona* (Targioni), at tea fields in Japan in 1994 & 1995. *Tea Res. J.*, 85, 13-25 [In Japanese with English summary].
- 3) Minamikawa, J. & Osakabe, M. (1979): Pest of tea tree. Japan Plant Protection Association, Tokyo, 83-94 [In Japanese].
- 4) Minamikawa, J., Saito, T. & Osakabe, M. (1955): The controlling experiments on the mulberry scale (*Pseudaulacaspis pentagona* (Targioni)). Part 1. Spraying and fumigation trials. *Tea Res. J.*, 13, 15-21 [In Japanese with English summary].
- 5) Moran, V. C., Gunn, B. H. & Walter, G. H. (1982): Wind dispersal & setting of first-instar crawlers of the cochineal insect *Dactylopius austrinus* (Homoptera: Coccoidea: Dactylopiidae). *Ecol. Entomol.*, 7, 409-419.
- 6) Noguchi, T. (1928): A report of arrow-head scale (part 1). *Spec. Bull. Shizuoka Agric. Exp. Stn.*, 2, 1-57 [In Japanese].
- 7) Noguchi, T. (1932): A report of arrow-head scale (part 4). *Spec. Bull. Shizuoka Agric. Exp. Stn.*, 23, 1-80 [In Japanese].

Optimal spray timing for control of *Pseudaulacaspis pentagona* (Targioni) (HEMIPTERA:COCCIDAE) by sticky trap catching the crawler

- 8) Ozawa, A. (1994a): The occurrence of white peach scale, *Pseudaulacaspis pentagona* (Targioni), in tea fields and its chemical control. Monitoring the seasonal prevalence of the occurrence using sticky traps. *Proc. Kanto Plant Prot. Soc.*, 41, 251-252 [In Japanese with English summary].
- 9) Ozawa, A. (1994b): The occurrence of white peach scale, *Pseudaulacaspis pentagona* (Targioni), in tea fields and its chemical control. b. Effect of various pesticides in the control of the scale. *Proc. Kanto Plant Prot. Soc.*, 41, 257-259 [In Japanese with English summary].
- 10) Quayle, H. J. (1916): Dispersion of scale insects by the wind. *J. Econ. Entomol.*, 9, 486-493.
- 11) Seki, M. & Matsuo, Y. (1963): Studies on the monitoring of arrow-head scale (part 5). Predicting of optimal spray time of the first generation larvae. *Proc. Assoc. Plant Prot. Kyusyu*, 9, 77-79 [In Japanese].
- 12) Tataru, A. (1998a): Effect of pesticides application in winter for control of *Pseudaulacaspis pentagona* (Targioni) in tea field. *Proc. Kansai Plant Prot.*, 41, 155-156 [In Japanese].
- 13) Tataru, A. (1998b): Monitoring of mulberry scale by sticky trap. *The Tea*, 51(5), 20-26 [In Japanese].
- 14) Walker, G. P. et al. (1990): Using phenology to time insecticide applications for control of California red scale (Homoptera: Diaspididae) on citrus. *J. Econ. Entomol.*, 83, 189-196.
- 15) Washburn, J. O. & Frankie, G. W. (1981): Dispersal of a scale insect, *Pulvinariella mesembryanthemi* (Homoptera: Coccoidea) on iceplant in California. *Environ. Entomol.*, 10, 724-727.



[Forward to :-Effects of Various Radiant Sources on Plant Growth-](#)



[Contents](#)



[JIRCAS Home Page](#)

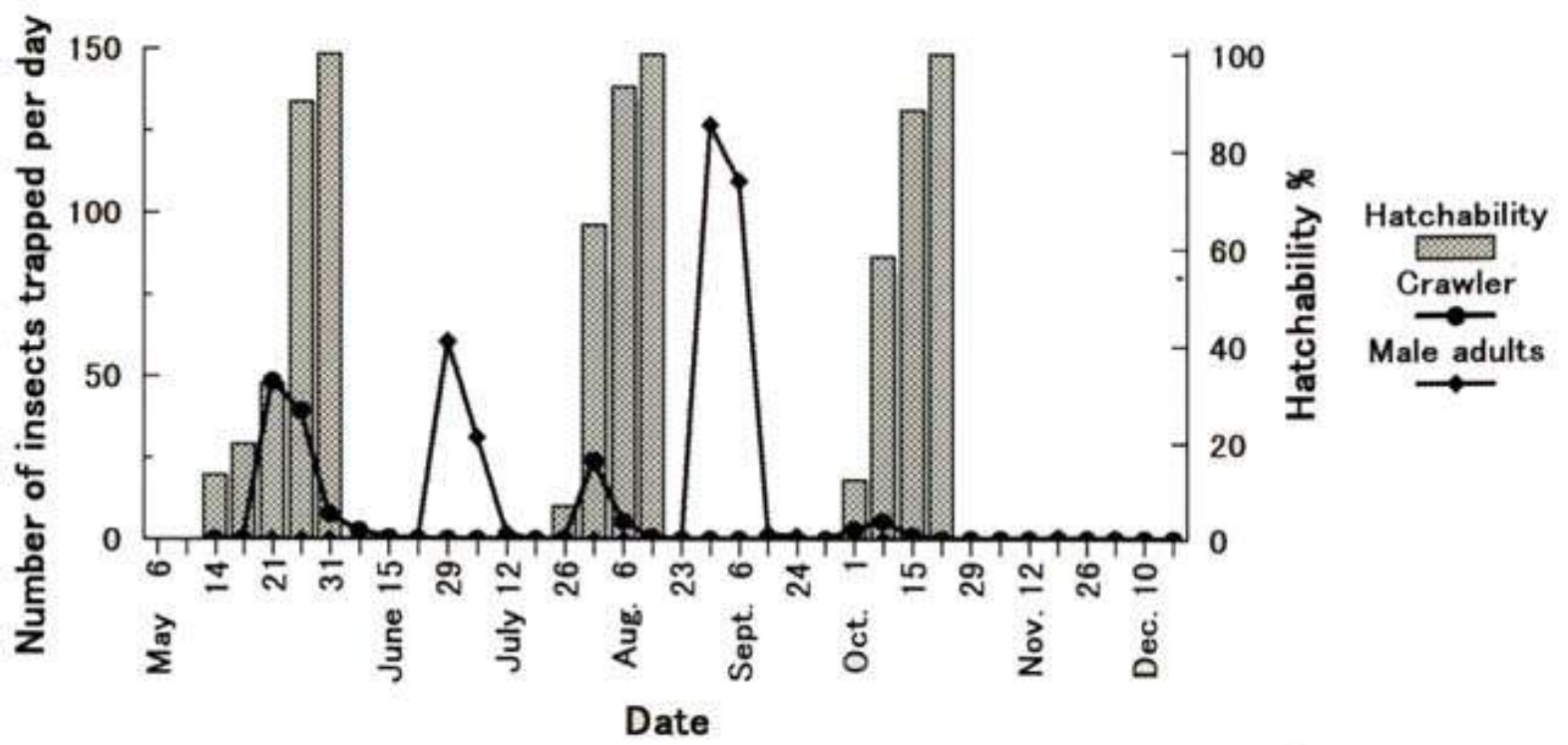
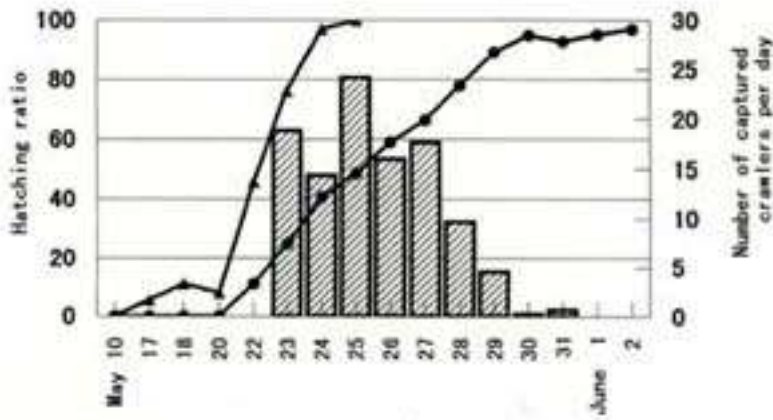


Fig.1. Hatching ratio of egg batches and number of trap catches of crawlers⁸⁾



[Back](#)

1995



1996

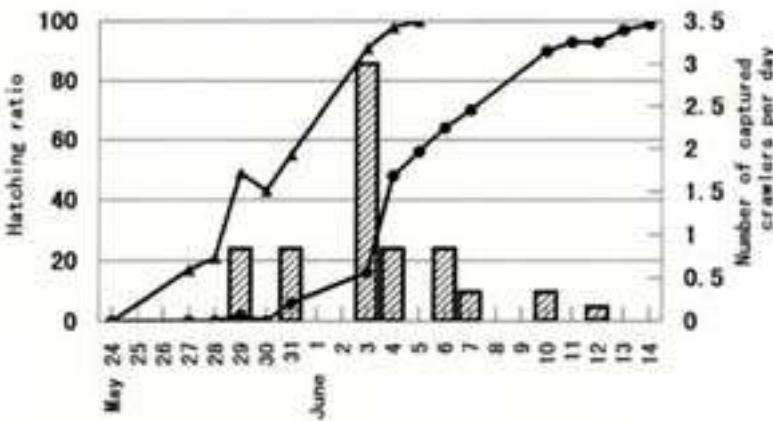


Fig.2. Hatching ratio of egg batches and number of trap catches of crawlers in the first generation

- Ratio of "more than half hatched egg batches"
- Ratio of "hatched egg batches"
- ▨ Number of captured crawlers by trap



[Back](#)

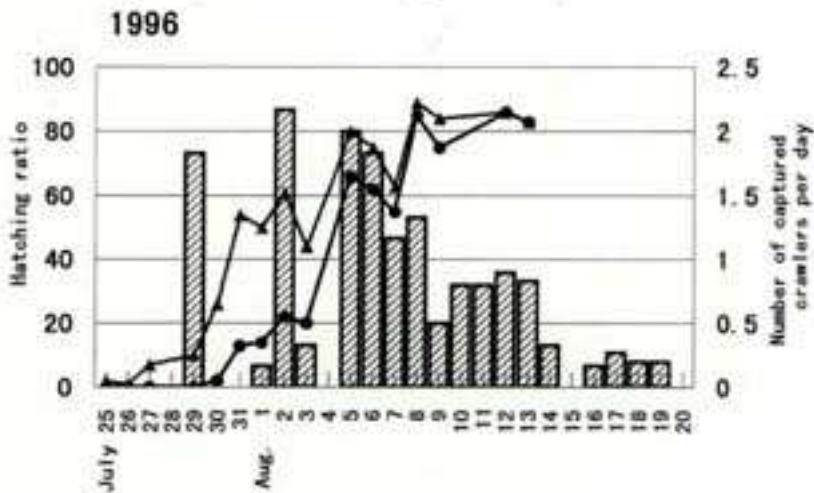
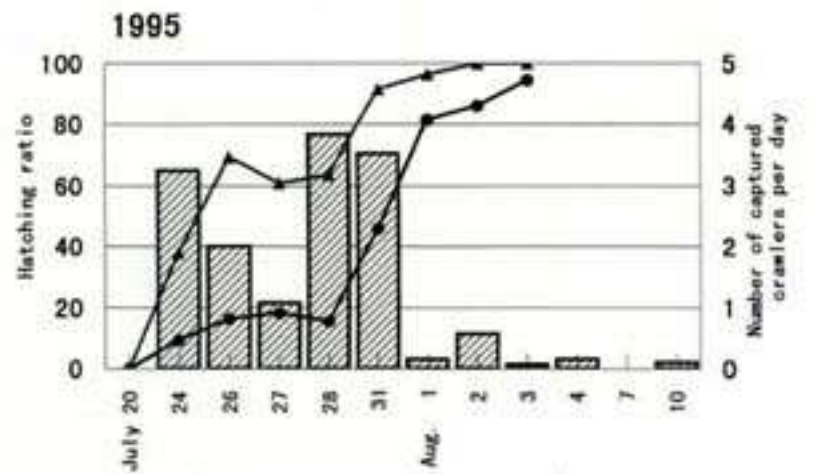


Fig. 3. Hatching ratio of egg batches and number of trap catches of crawlers in the second generation

- Ratio of "more than half hatched egg batches"
- ▲ Ratio of "hatched egg batches"
- ▨ Number of captured crawlers by trap



[Back](#)

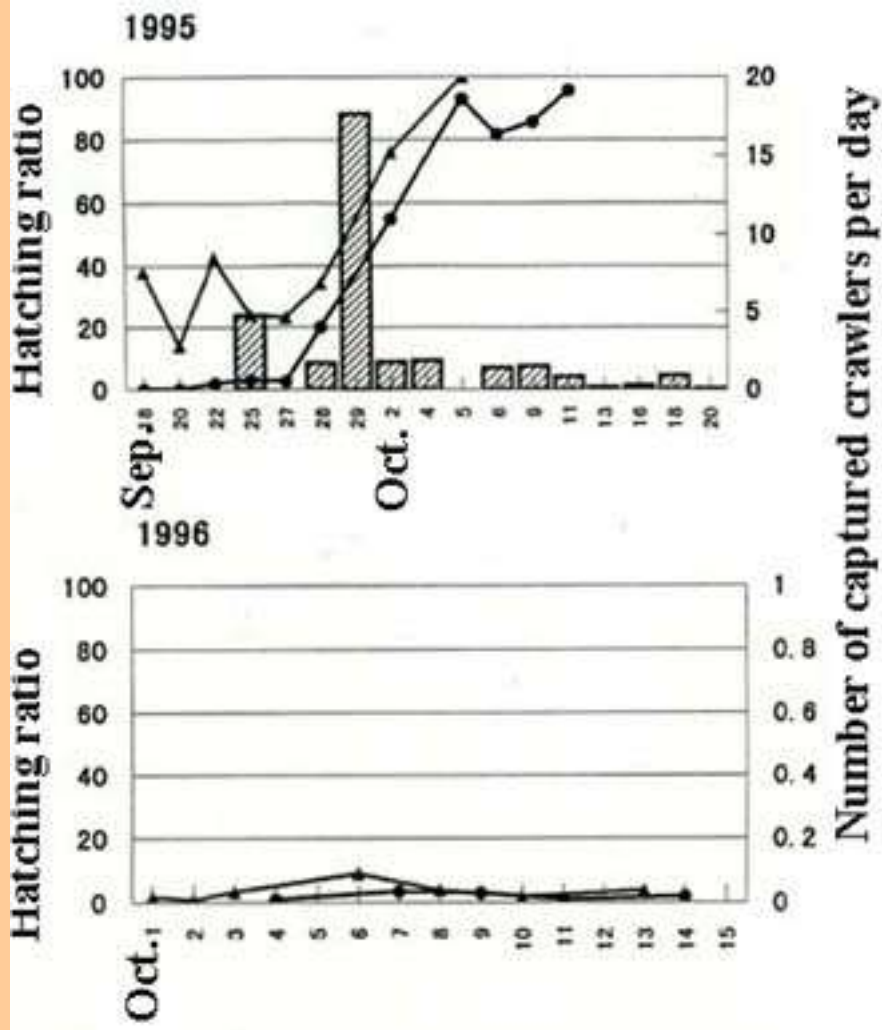


Fig.4. Hatching ratio of egg batches and number of trap catches of crawlers in the third generation

- Ratio of "more than half hatched egg batches"
- ▲ Ratio of "hatched egg batches"
- ▨ Number of captured crawlers by trap

 [Back](#)

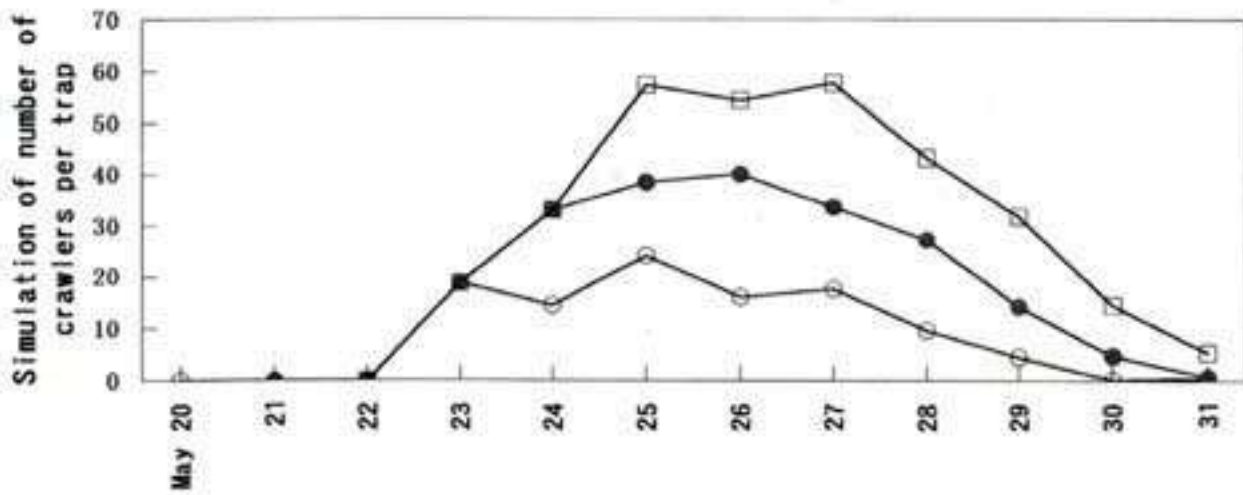


Fig. 5. Simulation of different intervals of trap change based on 1995 data

○ Daily, ● 2-day intervals, □ 3-day intervals.



[Back](#)

fig6

Fig.6. Setting of sticky trap under the plucking surface of tea tree



[Back](#)



Welcome to JIRCAS home page!

Japan International Research Center for Agricultural Sciences

➔ [JIRCAS HOME PAGE in Japanese \(SJIS\)](#)

JIRCAS Information

■ [What's JIRCAS?](#)

■ [Fellowship Program at Tsukuba 2002](#)

■ [Fellowship Program at Okinawa 2002](#)

■ [What's New?](#)

■ [JIRCAS International Symposium 2002](#)

■ [JIRCAS International WorkShop](#)

■ [Research Highlights](#)

■ [JIRCAS English language publications](#)



■ [Annual Report \(2000\)](#)

■ [JIRCAS Newsletter](#)

■ [JARQ \(Japan Agricultural Research Quarterly\)](#)

■ [JIRCAS Journal](#)

■ [JIRCAS Working ReportI](#)

■ [Map to JIRCAS & Transportation](#)

➔ [AFFRC HOME PAGE](#)

Related English Language Sites



● [MAFF \(Ministry of Agriculture, Forestry and Fisheries\)](#)

● [FAO \(Food and Agricultural Organization\)](#)

● [CGIAR \(Consultative Group on International Agricultural Research\)](#)

● [JICA \(Japan International Cooperative Agency\)](#)

● [National Research Institutes](#)

(Web Pages last updated 04/Oct./2002)

www@jircas.affrc.go.jp

Japan International Research Center for Agricultural Sciences

1-1, Ohwashi, Tsukuba, Ibaraki 305-8686 JAPAN

Telephone 0298-38-6313

Facsimile 0298-38-6316

f•fCf“%œ—Ê.Ö•@

fZf“f^•[.İŠT—v

fVf•fWfFfNfgÆœ†

Æœ†•→%œÊ•îñ

JIRCASS§•s•”

•îñ(ÈöŠJ

••Ūœ“—Æœ†•|•P^ç•—Ž—œ

Æœ†%œŪ“èff•[f^fx•[fX

œ“—~—p<@Ší

ŠCSŌ•o’£.İŽè’±,«

fŠf“fN•W

••Ū<@ŠÖ“™

” —Ń...ŽY•ÈŠÖœW

MAFFIN—~—pŽŌœÿ•ō•i•E’ō,İ,YfAfNfZfX%œ^”•j

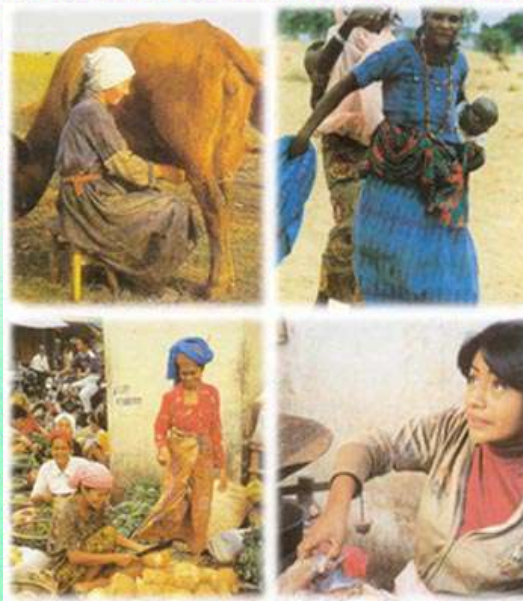
<Z•p’Š`k’<œû

メール

“Æ—§•s•—@•l

国際農林水産業研究センター

Japan International Research Center for Agricultural Sciences



^Ä“ä•] fofXŽž••\ fzfef<^Ä“ä •}•Ž°

•@

•V’...•îñ•F“—fz•[f fy•[fW,İ•Å•V•îñ,ÍÈ%°,İ,Æ,“,è,Å,••B

- 2002.10.07 [JIRCAS International Symposium Series](#) ,đ•X•V,μ,Ū,μ,½•B
- 2002.10.01 [’2”B•îñ](#),đ•X•V,μ,Ū,μ,½•B
- 2002.10.01 [•îñ\(ÈöŠJ](#),İfy•[fW,đœf•Ū,μ,Ū,μ,½•B
- 2002.09.18 [JIRCAS Newsletter No.32 \(PDF\)](#) ,đœf•Ū,μ,Ū,μ,½•B
- 2002.09.11 [JIRCAS Journal](#) ,İ•Å•V•îñ (No.10) ,đœf•Ū,μ,Ū,μ,½•B
- 2002.08.23 [JARQNo.36-3\(PDF\)](#) ,đœf•Ū,μ,Ū,μ,½•B
- 2002.08.15 [JIRCAS,fjf...•\[fX•Å•V•†iNo.30-31•‡•1•†j](#),đœf•Ū,μ,Ū,μ,½•B
- 2002.08.08 [Æœ†•E’ō•qŽáŽè^ç•—œ^”CSú•t\(Æœ†•^ō•j•â•W—v—İ](#),đœf•Ū,μ,Ū,μ,½•B
- 2002.07.29 [JIRCASS§•s•”•@••Ū” <Æœœ†•p•’fvfŠ•\[fY,İ](#)
•Å•V•îñ•iNo.12),đœf•Ū,μ,Ū,μ,½•B
- 2002.07.23 [•½•¬,P,R”N“x%œ^%œœ•\]œœi%œœiç’ã\Ÿ’ō,É,æ,é’••‡•\]œœi’Šœœ](#),đœf•Ū,μ,Ū,μ,½•B
- 2002.06.25 [‘æ9%œñJIRCAS••Ūfvf“flfwfEf_İ,2”Ä“ä](#),đœf•Ū,μ,Ū,μ,½•B
- 2002.05.27 [fOfŠ•\[f“•w“ü](#),İfy•[fW,đ•X•V,μ,Ū,μ,½•B
- 2002.05.14 [•Ūœ“—Æœœ†•|•P^ç•—œ,•iŽ—œ•iJIREC\)](#),İfy•[fW,đœf•Ū,μ,Ū,μ,½•B
- 2002.04.08 [•½•¬13”N“x••Ū” <Æœœœ†••%œÊ•îñ](#),đœf•Ū,μ,Ū,μ,½•B
- 2002.04.04 [•½•¬14”N“x”N“x\(œv%œœœ](#),đœf•Ū,μ,Ū,μ,½•B
- 2002.04.01 [—@’èœöŠJ•îñ,İ—đ’ō’P•EŽè“—K’ō](#),đ•X•V,μ,Ū,μ,½•B
- 2002.03.18 [f••\[fL’f“fOfœf•\[fg•iNo.23\)](#),İ“ä—e,đœf•Ū,μ,Ū,μ,½•B

•@

•@,,”m,ç,†

• [fOfŠ•\[f“•w“ü—@,É,Å,ç,Ä](#)

• [’2”B•îñ](#)

食料・環境問題の解決にむけて

世界に貢献する

国際社会の調和と安定のために

"2002"Ń10CEŽ07“ú•iCEŽ•j•X•V" **053552** (2001.11.22, ©, ç)

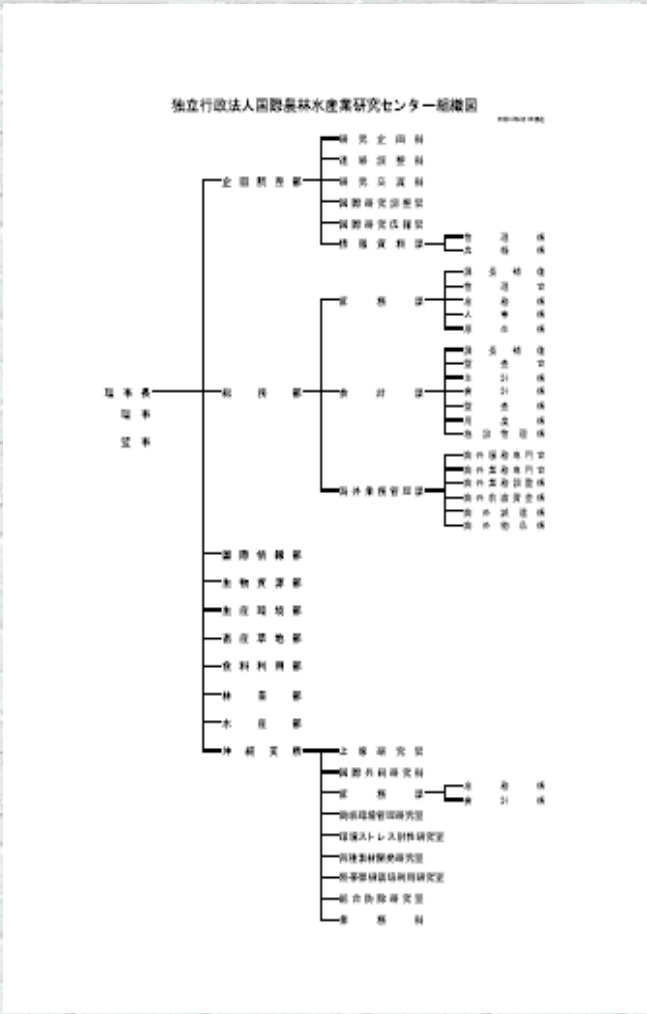


1ñ°ÝÇÀÎÓ;ã»°¶È,¡µæ¥»¥ó¥;¡¼;ÊJIRCAS;ËæÎ³µÍ×

● ¡¡ JIRCASæÍ¼ÇÍ×¶¶È³

- ¡µæ¼ÔæÍÇÈ, ¢ðÀæ; ¢Èææ; ÁÓ¼ã¡ñæÈÍñ°Ý¶¶È± ¡µæ
- ¢³º ¡µææð»ÙææèñÆâ ¡µæ
- ¢³ºæ«æé ¡µæ¼Ôæð¼æææÆ¹Ôæ¼æææ¶¶È± ¡µæ
- ¡µææÈìðÍæææ¼ðÈææ¼¼¼½; ¡Ê-ÀïæÈ¹-Èó¾æ°
- ¡ñ°Ý¥¥¥ó¥Ü¥ ¥¥ã; ¥¥; ¡¼¥¥¥ç¥Ã¥×Áùæ³«°Á
- ÁÓ¼ã¡ñµ»¼N±ç¼ðÁùæææ¼¼ð, Á;ç·x²è»U±ç
- çÇÁÁ; ¡¶-ÌæÆêÁùææ¥¥ó¥¥; ¥ó¥µ; Ç¼

● ¡¡ JIRCASæÍÁÈ;¥



ホームへ



••Ū—Ñ•...ZYÆE•+fZf“f^•(JIRCAS)Zā—vÆ—±

- 1. [JIRCASの概要](#)
- 2. [JIRCASの業務](#)
- 3. [JIRCASの施設](#)
- 4. [JIRCASの職員](#)
- 5. [JIRCASの活動](#)
- 6. [JIRCASの出版物](#)
- 7. [JIRCASのお問い合わせ](#)

JIRCASの概要

JIRCASの業務

JIRCASの施設

JIRCASの職員

JIRCASの活動

JIRCASの出版物

JIRCASのお問い合わせ

JIRCASの概要

JIRCASの業務

JIRCASの施設

JIRCASの職員

JIRCASの活動

JIRCASの出版物

JIRCASのお問い合わせ

JIRCASの概要

JIRCASの業務

JIRCASの施設

JIRCASの職員

JIRCASの活動

JIRCASの出版物

JIRCASのお問い合わせ

JIRCASの概要

JIRCASの業務

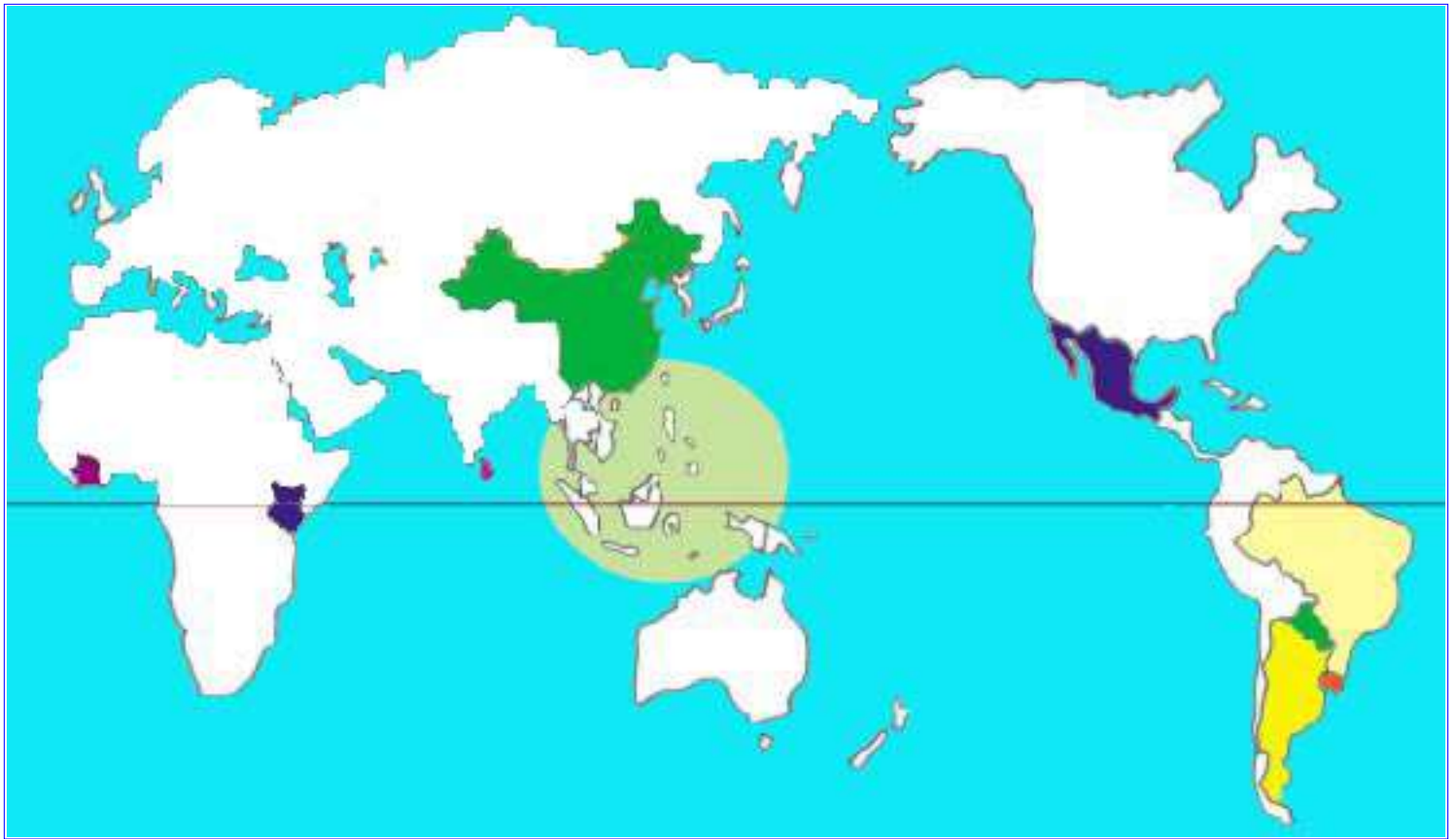
JIRCASの施設

JIRCASの職員

JIRCASの活動

fvf•fWfFfNfg

JIRCAS, aŽæ, è'g, ñ, Å, ç, é•••Û<æ““Ææ<†



•F, Ì•t, ç, Ä, ç, é••, ðfNfŠfbfN, ;, é, Æfvf•fWfFfNfg, Ì“à—e, a, 2——, É, È, ê, Ü, ••B



•@

•@fPffjA,É,;,̄,éfvf•fWfFfNfgŒα<†

1.-k,y,Ñ“ŒfAftfŠfJ'n^æ,É,;,̄,éfofbf^—P,ì•¶•†—•“İŠQ'ŽŠÇ—•-@,İŠJ”-

•iŒĀ•Éfvf•fWfFfNfg•j

•@

2.fgfŠfpfmf^[f]•Ç,É,;,̄,éTNFf¿,Ì-ðŠ,,%ð-¾

•iŒo•iŒα<†•j

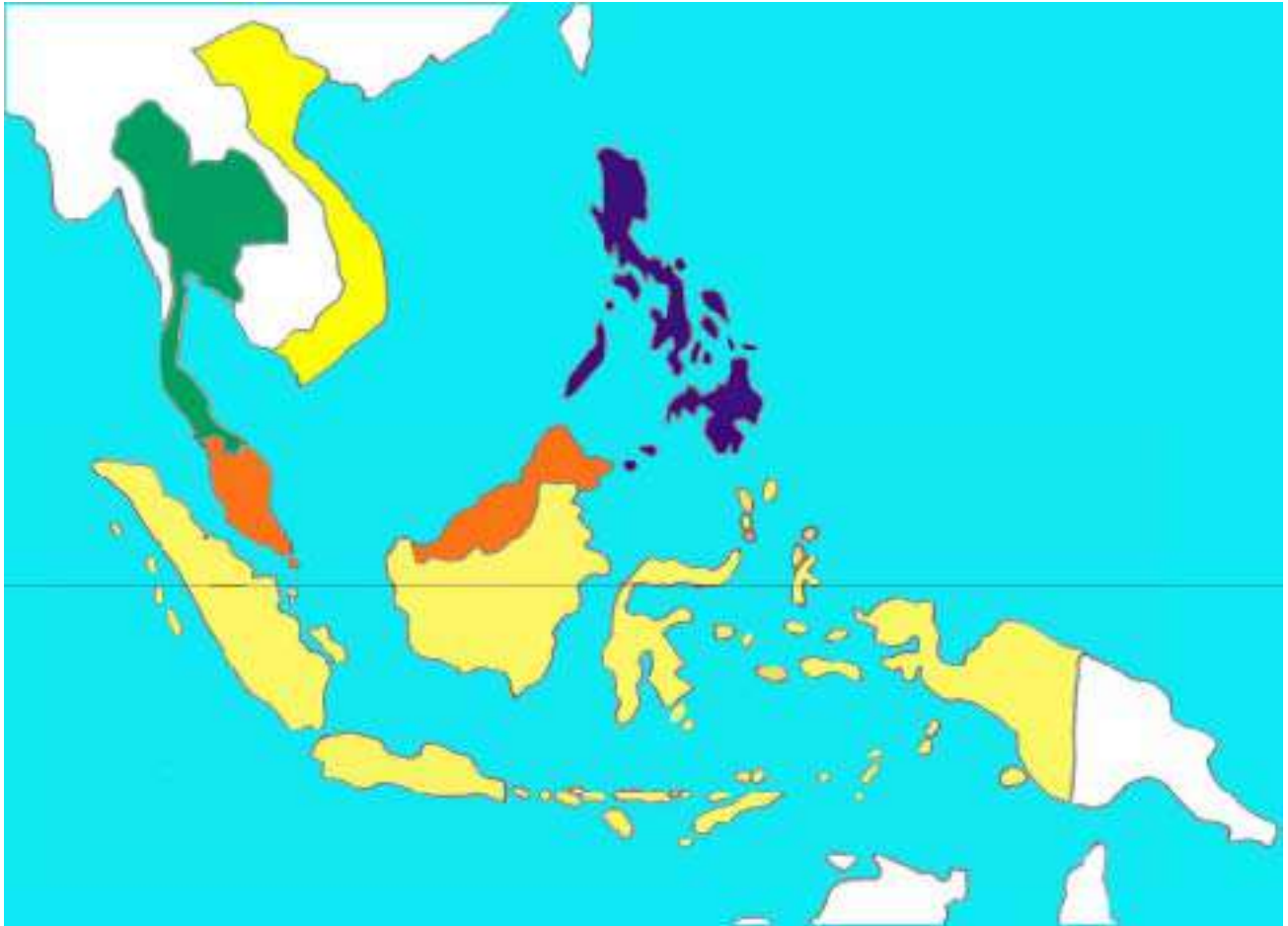
•@

もどる

ホームへ

“œ”ifAfWfA’n^æ,lfvf•fWfFfNfg

JIRCAS, aŽæ, è‘g, ñ, Å, ç, é•••Û<α“œα<†



•F, Ìt, ç, Ä, ç, é••, ðfNfŠfbfN, •, é, Æfvf•fWfFfNfg, Ì“à—e, a, 2——, É, È, ê, Ü, ••B

もどる

ホームへ

f•fRf“ff<f^,É,;, -, éftf@•[f~f“fO fVfXfef€,İŠJ”-

•yŒœ<‡,İ”wŒei•E,Ě,ç,ç•z

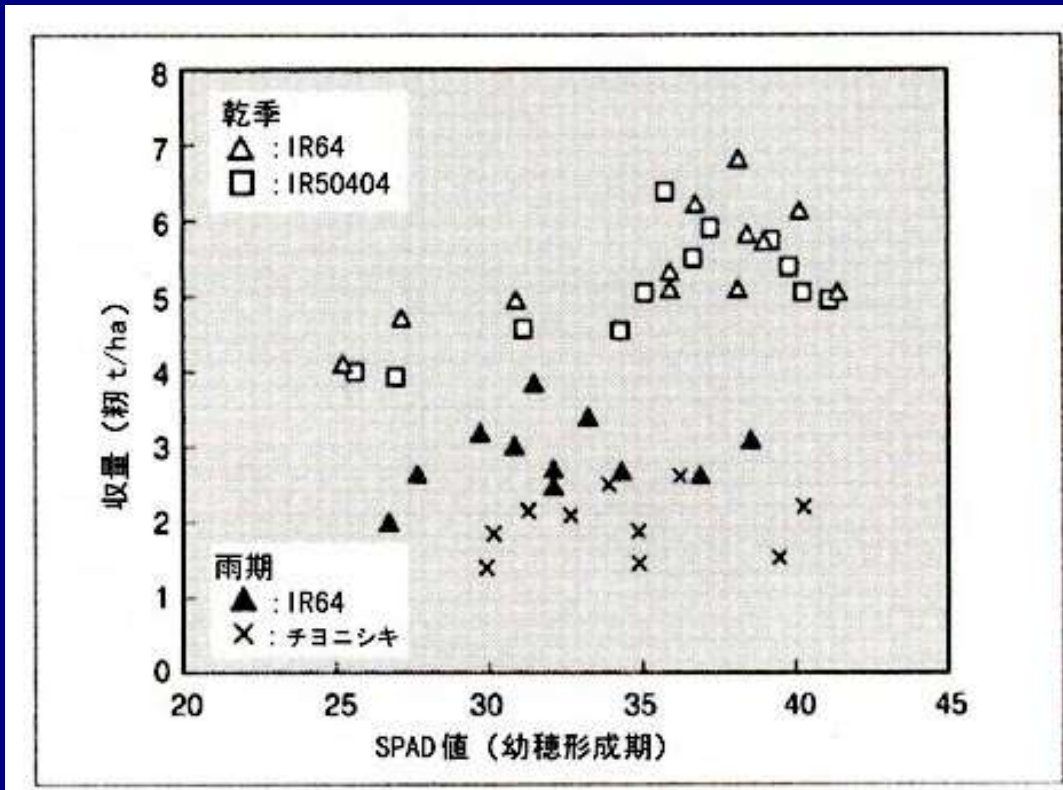
1. f•fRf“ff<f^,Í•Afxfgfif ,İfhfCf,fC•i•ü•V•j•••ôÊ•~•A”_<Œ,ª~ ,µ,-”-“W,µ•A•çŠE‘æ2,İ•Ä—A•o•‘,É,È,Á,½•B
2. ,µ,©,µ•A”_—,İ•ŒŠ^,Í,Ü,¾•n,µ,-•AfxCf“ftf%o,İ•®”õ,à’x,ê,Ä,ç,é•B
3. ”_’{•...•ŒŽYfVfXfef ,ð•I,Ý,É—~—p,•,é•j•‡Œo%oc,Í•AŽû“ü,ð’•,â,µŒo•İ”-“W,ÉŠñ—^,•,é•B



•@

•y•¬%oÊ,İ“à—e•E“Á’Ÿ•z

- j•‡Œo%oc,É,Í•Aîi•“Ø•|>•Aîi|fGfr•Aîi•“Ø•|i•Ø,È,Ç—I•X,Èf^fCfv,ª ,è•A•^•... ,İ•[,³•AŠC•... ,İ•k•ã’õ“x•A“y•ë,İŽç,È,Ç,É,æ,Á,Ä‘T’ð,³,ê,é•B
- î,Í•Á,à•d—v,È•i—Ú,Á•A•V•iŽí,âflf“fv”r•... ,È,Ç,É,æ,è•A”N2-3%oñŽûŠn,Á,« ,é,æ,œ,É,È,Á,½•B
- î,İ•... ŠÇ—,Í—t•F,É,æ,é•ŒçŠÇ—,æ,Á,Ä‘Žû,ª%oÄ’\,Œ,È,Á,½•B
- —{“Ø,Í•i’Ž,É,æ,è%oç•ŒŠÇ—,ª%oÄ’\,Œ,È,è•A‘•İ—Ê,ªŒü•ã,µ,½•B
- fhfCf,fC•-•ô,ÍŒo•İ”-“W,É‘â,«,-•vŒ£,µ,½,ª•A”_—,İŠK‘wª%o»,ð,à,½,ç,µ,Á,Ä ,é•B
- ‘â<K—Í”_%oŒ‘w,Í•î•ê<Œ,É,È,éŒEXŒü,ª ,é,ª•A‘†•¬”_%oŒ,Í•j•‡Œo%oc,ÁŽû“ü,ð’ÛŽ•,µ,æ,œ,Œ,µ,Ä,ç,é•B



—t•F(SPAD'l),ÆŽû—Ê,Æ,ÌŠÖEW

'f,â½,.,-,é,Æ—t•F,âZ,-,È,é,â½,š,µ,ÄŽû—Ê,â½,â,é

各階層の平均経営面積の変遷 (ha/ 戸)

農家階層	1974	1980	1988	1996
土地無し	0.2	0.2	0.2	0.0
1ha以下	0.4	0.5	0.6	0.7
1-2ha	1.8	0.8	1.2	1.4
2ha以上	1.4	1.1	1.2	3.3

'2, Žž(96"N),É•Ý'°,.,é" %oÆ,©,ç•,«Žæ,Á,½,à,Ì,Å•A

•@

•y•;CEã,Ì<α“~CEα<†•z

- V<Z•p,ìŽÀ•Ø,Æ” _-,ì‘g•D%o»•A’n^æ’P^Ê,Å,Ì•;•‡CEo%oc,đ-ÚŽw,μ•ACEø%oÊ“I,È,ftf@•[f~f“fOfVfXfef ,ì\’z,đ-ÚŽw,••B

もどる

ホームへ



••Ū”_—Ñ•...ŽY<Efvf•fWfFfNfg
EEx<†,İST—v

•@

•@••†E^fvf•fWfFfNfg

•@•@f•fRf”ffj•f^,É,””e”_—Ñ”[•...†:Z•p”i(EEn,İ”]‰ĵ,Æ%ü”P

(fxjgffjE-A”g-6”10”N”s)

•@

@fjgffj”i”Jf”Rf”ffj”n”N.Ä,İ”A”i”đ”†s.É...ŽY(••Afgf)•A”[ŽY(fuf”A/Afgf)•A%Q(‰ÉŽ•A-İ•O•A‰•Ó),É,Ç,đ”g”†,1/2,†:†E^”_•E,†s,İ,É,Ä,ē,Ü,•B,±,ē,ç,İ”A/fj”n”n”e”Ä—L,İ”bE,đS—p,μ,Ä•A‰=āŽü”u,İ”ā”A”n”e,É,””,ēšZ”H—ĵ,İ”à”e”MŽY,đ-Ü”L,E,μ,½,ä,İ,Ä, ,đ”A”G”B”İ”A”•šÖ”L,É”İ”Ü,đ”K””z”u...ē,±,Æ,É,æ,đ”A”y”n”A”...•A”ŽY”•,É,Ç”E,İ”E”—”İ—p,É,æ,ēŽ”•±‰Ä”É”...E,İ”‰Ä””s,đŽ,μ,Ä,ē,Ü,•B

•Šu(E”+ŽÖ	2-¼
•ZŠu(E”+ŽÖ	10-¼
•μü(E”+ŽÖ	5-¼

•@

戻る



“•Ū”_—Ñ•...ŽY<Efvf•fWfFfNfg
CEꣳ<†,İŠT—v

•@

●@CEÂ•Êfvf•fWfFfNfg

©_@”MˆÑŽY•Ý—^—L—pŽˆ,É,æ,éˆnˆæ•¶“ÓEñ,İ•Ā•¶,ÉŠÖ,ˆ,éŠˆb“İCEꣳ<†ŠJ”-

(ftfBfŠfsf“•A•½ˆ-8“Nˆ12“N“x)

•@

@“MˆÑ—Ñ,İ•A< }ˆ-,É—ð%œ„µ,½,è•A•ÁŽ,µ,½,è,µ,Ā,é,Ū,ˆ•B,•E,-,É•AƒAƒWfAˆnˆæ,İ“MˆÑ—Ñ,İ—DèŽˆŽi,Ā, ,éftf^foƒKfL%èŽˆ-Ø,İˆ,µ,-CE,+,µ,Ā,é,Ū,ˆ•Bftf^foƒKfL%èŽˆ-Ø,È,Ç,İ•Ý—ˆd—vŽˆŽi,İˆ½,-,İ•AˆVˆR,İ•Ā•¶ŽY“ˆ,á,ˆ•ACEˆ•Ý“ˆu,ˆ,è,Ā,é,éˆ8““VˆR•X•V-@,Ā,İ•A•X—Ñ,İ—ð%œ„ˆ,†(Eā,àˆ±,-,ÆŽv,ı,è,Ū,ˆ•B
,„±,Ā•AftfBfSfsf“,Ā,İftf^foƒKfL%èŽˆŽi,İfzƒfCƒfgf%œƒfˆ—p,ÉŠÖ,ˆ,éCEꣳ<†,δs,é•A,±,è,ç,İŽˆŽi,İˆ¶“Ō“TˆĀ•«,δ%œð-¼,µ•A•Ý—ŽY—L—pŽˆŽi,İˆé—ÑˆZp,δŠm—§,µ,Ū,ˆ•B

•@

もどる

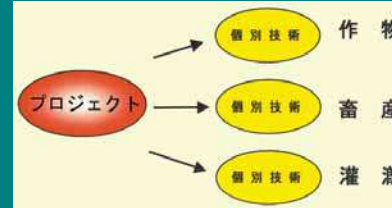
ホームへ

f^fC“CE-k”,É,;,-,éŽ•±“T”_<Æ<Z•p,İŠm—§,İ,½,β,İŠJ”-CEα<†(1995-2001) [i••†CE^fvf•fWfFfNfgj](#)

•yCEα<†,İ”wCEi•z



•@f^fC•,Á,Í•“à,İn^æŠi•,Šg^á,μ,Ä,é,é•B•@•@
•@•s^Á^è,È•~%J,â^,çŠE<G•A%—P•W•İ“y•ë“TM,É,æ,è“ŽY•α,“á,-•A•Š“%„Í•S••½,İ-ñ40%,ð•è,β,Ä,é,é•B



•@,±,é,ð%ø0CE^,•,é,½,β•A•f^fC••{,ð^†•S,É—İ•X,ÈCEα<†fvf•fWfFfNfg,“ŽÄŽ{,³,é,Ä,é,é•B
•@,μ,©,μ•ACEÄ•Ê“İ,È<Z•pŠJ”-,É,Æ,Ç,Ü,è•A”_%øÆCEø%øc,“½,ç•s,-,æ,β,È“••†“İ<Z•pŠJ”-,ÉŽŠ,Á,Ä,é,è,é•B



f^fC“CE-k”,É,İ,±,İ,æ,β,È%—P“y•ë,“L,“Á,Ä,é,é•B

•@

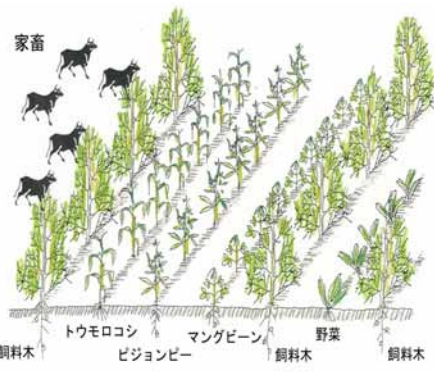
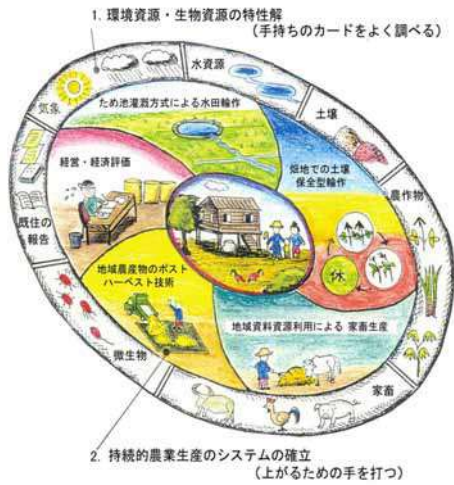
•@

•@

•@

•yCEα<†,İ“à—e•z

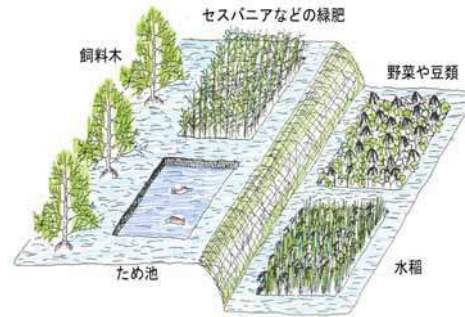
‘z’è,³,é,é“y’n—p,İ—á



1. fAfCfCfNf•fbfsf“fO-@,É,æ,é””n
 •@.iZ•±•¶ZY,íEü•ä

•<<

•yŠú•Ö,³,é,é-‰oÊ•z



2. •→•K-Í,½,B'r,ð—~—p,.,é•W-ñ“I
 •@,É•...“c—Ö•ì

•Ef^fc“CE-k”,”Í”_n“Ū•S,E”_<E•U◊•A^æ“à”_‰oE,ì•Š“%4CEü•ã
 •@
 •E“¼,İŠJ”-“r•ã”n^æ,Ö,ì‰ž—p

2. •Â•½•«•...^æ,É,,”,éŽ•±“I•¶ZY<Z•p,İŠJ”-•iCEo•iCE□<•j

もどる

ホームへ



“・” —Ñ...ŽY<Æfvf•fWfFfNfg
CE<†,İŠT—v

•@

●@••†CE^fvf•fWfFfNfg

©@f^fC(CE-k•",É,,"éŽ•±•T"_{E-Zp,İŠm—š,İ,½,B,İŠJ"_{E<†

(f^fC•A^½—7•13"N^x)

@f^fC.Ä,İA•)~.ÈEoİ~.İ†.ĂŽY<EŠO•A'n•eŠOŠi•.Šg'ã,µA,Æ,-.Éf^fC(CE-k•",İEİ—→o,É,æ,é"_{ZD%ã,İ,}İE,È-İ-e,ã•k'n,İ•r"p,•i+s,µ,Ä,ç,Ü,•B,½,ç,É•Ä•B,Ä,İEo-İŠe@,É"™,E•~.İŽ,"→AZD%ã•s'À,İŠg'ã,½,Y,ç,é,Ü,•B

@(CE-kf^fC,İ"_{Æ•qŽY,İAš@%N'È•ã,İŠEŠü,Æ•s'À'è,È•-%ã•z•AšA•s—Ç"y•ë(•Ö"~y,Š%—P"y•ë),İ•z•AšB"_{Æ•qŽY,Ö,İ•ŠŽ,İ•s'•A"™,É,æ,Ä,Ä'ã,«,→šEÄ,½,é,Ä,ç,Ü,•B

@,±,õ,µ,½•s—Ç•qŽY•øE%•,Ä•A'TÈŠO,É•X—Ñ,δ"™,İ,µ,ÄfLffbfTJfo•A,½,Æ,õ,«,Ñ"™,š•ã•i•",Æ,µ,Ä•f"l,½,é,Ä,ç,Ü,•,•A'İŽY•A•kÈŽ±•E-i•Q•qŽY,Æ,Ä,É,»,İŽü%•••"ã,•A"_{Æ,È,,"~•V,µ,ç,ZpŠJ"_{É,æ,é'n'æ•U•»,Šü'Ö,½,é,é'n'æ,Ä,•B

@f^fC(CE-k•",É,İA,•,Ä,É,İ,•,İ,Zp~—İ,É,æ,Ä,Ä••Ü"_{ÆŠJ"_{Eo•CfZf•f•(ITCAD),•@"ö,½,é•A'½,İEo†@ŠÖ,Æ,ã•—İ,µ,Ä"_{Æ,ZpŠJ"_{•i,½,ç,é,Ä,ç,Ä,"è•A••†•İ,ÈŽ•±•E"_{E-Zp,İŠJ"_{δ'É,½••ÜEo†~—İ,δŽÄŽ|,•,é,ã,ÄEo%•É"l,Ä,•B

@,±,İ,æ,õ,È"™Eİ,©,ç•A—{••†fvf•fWfFfNfgEo†,İAITCAD,İŽ|•Ÿ,ãŠ—p,µ,É,½,ç•AŠÄ••E•†•Ž'CE'A'n'æ•i•n•A'İŽY•E'•n•AflfXfgfn•fXfXfg•AEo%•E•Eoİ,É,Ç,İ•L,İ,È•i,É,,"e,Ä•AŠü%•,İ•~%•é,İ,ã,É•V,½,È,ZpŠJ"_{δ•s,ç•A•qŽY•,İ,•,çŽ•±•E"_{ÆfVfXfef,δŠJ"_{•,é,±,Æ,É,æ,Ä,Ä•A'n'æ,İ"_{E•U•»,ÉŽ',•,é,±,Æ,δ-Ü"l,Æ,µ,Ä,ç,Ü,•B

•ŠüEo†ŽÖ	5—½
•ZŠüEo†ŽÖ	9—½

•@

もどる

•@



•@ f}fœfCfVfA,É,¨,-,éfvf•fWfFfNfgœæ<†

- 1. œæ<†“â—e •@ fvf•fWfFfNfg,ìœ`´ô
f}f“fOf••[fu<D•...^æ,É,¨,-,é•¶|••¶ŽY<@”\,ì%ð-¾,ÆŽ•±“I—~—p •@ “•†œ^fvf•fWfFfNfg
- 2. ”MˆÑŽY•Ý—^—L—pŽ÷,É,æ,éˆn^æ•¶|“Ôœn,ì•Ă•¶|,ÉŠÖ,•,éŠÏˆb““Iœæ<†ŠJ”- •@ œÂ•Êfvf•fWfFfNfg
- 3. ŠČŠO—{•B◊%oi—p,ìŽ¾•a”-•¶|“œü •@ œÂ•Êfvf•fWfFfNfg
- 4. fZf“f_f“%èŽ÷ŽiŠQ’Ž,ì•¶|‘ì,Æ—h•œ •@ œo•íœæ<†
- 5. ”MˆÑŽY—ç—~—p—ØŽ¿Ž‘œ¹,ì—Lœø—~—p,ì,½,B,ì<Z•pŠJ”- •@ œo•íœæ<†
- 6. ”MˆÑf,f“fX•[f““n^æ,É,¨,-,é•L^æ•...“c—p•...ŠÇ—•Žè—@,ìŠJ”- •@ œo•íœæ<†

•@

もどる

f}fœ•[fvfa

f}f“fOf••[fu<D•...^æ,É,“, -, é•¶••¶ŽY<@’^
,İ%œđ-¾,ÆŽ•‘±“I—~—p*•i••¶œ^fvf•fWfFfNfgj*

•yœœœ†,İ’wœi•E,Ë,ç,ç•E—Ú“I•z

1. %đ•İ•...,ÆŠC•...,^a•-,¶,è•‡,œ•ê•Š,đ<D•...^æ,Æœ¾,œ•B”M•Ñ•E^ÿ”M•Ñ,İ<D•...^æ,Á,Íf}f“fOf••[fu—Ñ,^a”-’B,µ•A-Ø•P,đ<ÿ<<,é,Æ,Æ,à,É•Aœã”w’n,İ•Û•S,É,à-đ—§,Á,Ä,ç,é•B,Û,½•A•D•...^æ,Í•A’½—İ,ÈŠC—m•¶••,İ•¶’š^æ,Æ,µ,Ä,à-d—v,Á, ,é•B
2. ,µ,©,µ•A’½,-,İŠJ”-“r•ã’n^æ,Á,Í•A“sŽs%œ»•Afgfr,İ—{•B•A•k’n-Ê•İ,İŠg’â,È,Ç,É,æ,è•A•D•...^æ,İŠJ”-,^a•i,ñ,Ä,ç,é•B-³••~,ÈŠJ”-İ•Aœã”w’n,İ“y•ë•Z•H,âŠC—m•¶••,İ•-ı̂ç•ê,đœ,•-,³•A%œ^Šÿæ,İ•¶’Ôœn,É,à^«%œœ<ı̂,đ<y,Ú,µ,Ä,ç,é•B
3. ,±,İ,½,β•A”M•Ñ•E^ÿ”M•Ñ<D•...^æ,İ•¶••¶ŽY,đŽ©’R%œÈŠw,ÆŽĐ%œı̂%œÈŠw,İ—¼-Ê,©,ç%œđ•Í,µ•Af}f“fOf••[fu,âŠC—m•¶••,đŽ•‘±“I,É—~—p,µ,Ä,ç,-,½,β,É•K—v,È—~—p,İŠİ• ,đ•ô`è,•,é•B



<D•...^æ,É•L,^aé}f“fOf••[fu—Ñ



f}f“fOf••[fu—Ñ,©,ç•Ø,è•o,³é,½-Ø•P,Æ’Y•Ä,«

•@

•yœœœ†,İ’â—e•E“Á’ÿ•z

•@•çŠE—L”.,İf}f“fOf••[fu—Ñ,^a¶•ÿ,•,é}fœ[”¼“‡•¼Šÿ,đ’²•,’n,Æ,µ•A,»İ<D•...^æ,đŠJ”-İ’ö“x”™,É%œž,¶,Ä—Pœ^%œ»,•,é•BŽÿ,É•A—Pœ^Ê,É•Af}f“fOf••[fu—Ñ,Á,İ•¶••¶ŽY•E%œđ•A•D•...^æ,É—~“ü,•,é“y•ë,â%œh—{%œ—A’ê±“®••,âfvf%œof“fnfgf“•A,»µ,Ä<,âfgfr“™,İ•...ŽÿŽ’œ¹,ÉŽŠ,é^ê~A,İ•¶••¶ŽY,đ%œđ•Í,µ•A•D•...^æ,İŠÄ<<Žû—e—Í,đ-¾,ç,©,É,•,é•B



f}f“fOf••[fu—Ñ,đŠJ”-µ,½fgfr—{•B•ê



<D•...^æ,Á,İ’²•,

•@

•y•-%œÊ,İŠ^—p-Ê•E;œã,İ%œÛ`è,È,Ç•z

<D...^æ,É,;,~,é^ê~A,Ì•¶•¶ŽY,ð%ccð-¾,µ•AŽĐ%cci%ccÈŠw“IZ<“_,àŠÜ,B,Ä—~—p,ÌŠî•,ð•ô`è,.,é•B

もどる

ホームへ

”M‘Ñ‘••¶Ž÷ŽifAfJfVfA•Ef}f“fMfEf€
,ì‘½Ž¼•S•P,ì•«Žç%oođ-¾,Æ,»ì—~—p
[•iEÁ•Êfvf•fwFfNfgj](#)

•yœœç,ì”wœi•z

1. fAfJfVfA•Ef}f“fLfEf,ì•A•r”p’n,Ö,ì•A—Ñ,%œÁ”\,Á, ,é•B“œ”ifAfWfA,É1980”N”ã,©,ç•L,••A—Ñ,¾,é,½•B
2. •jEã•A,»é,ç,ì•A•A—Ñ,ð•s,ð,½,B,É,ì•A”¾,ç,é,é-Ø•P,ì—Lœø—~—p,¾•s%œÁEç,Á, ,é•B
3. ,»,ì,½,B•AfAfJfVfA•Ef}f“fMfEf,ìŠi-{"I,È•PŽç,ð”m,é•K—v,¾, ,é•B

•yœœç•%œÊ•z

1. -Ø•P,ì”ç%œ•”,É”ãd,ì’á,ç-ç•n,È•”•(-ç•n•P),¾¶Y,¾,é•B
2. -ç•n•P,ðŠÜ,ð•S•P,ì•A’È•i•AZü•Ö”,æ,è,...,ð½,-ŠÜ,ð”i’½Ž¼•S•P•A, ,é,ç,ì...ð,ç•P•j•B
3. “½Ž¼•S•P,ì”è”I,È”Á”Y,Æ,µ,Ä•A-¾@••W•i•AfofNfefŠfA,ì”É•B•A•ŠQ,Æ,ìŠÖ•A,ì”F,B,ç,é,È,ç•B”½Ž¼•S•P,ìE”•,ì•A-¾@fCf}f”W•i,É,æ,é•Z”š”¾,ìã•,•AfofNfefŠfA,¾¶ZY,µ,½fXf%œfCf, ,É,æ,é...ìczû”™,É,æ,é,à,ì,Á,í,È,ç,Á, ,è,ð,Æ•,¾,é,é•B
4. “½Ž¼•S•P,ì•AfAfJfVfA•Ef}f“fMfEf,ÉEÁ—L,ì•Žç,ì%œÁ”\œ,¾,é•B•S•P,È•¶Y,¾,é½—È,ì...ì•AfAfJfVfA•Ef}f“fMfEf,ì”İŠÉ•«ÉŠñ—¾,¾%œÁ”\œ,¾,é,à, ,é•B



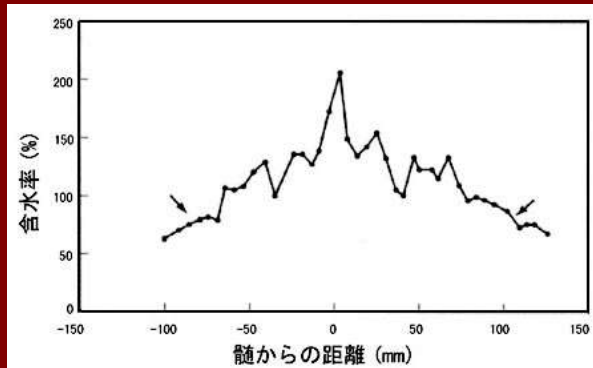
ŠÖ”ø,«ì,½,B,ÉŽñŠn,¾,é,½
fAfJfVfA•Ef}f“fMfEf

•@



ŽR%œŽ—Ö”n,È”V”R•X•V,µ,½
fAfJfVfA•Ef}f“fMfEf
(7”N•¶A•,¾15m•j

•@



“½Ž¼•S•P,ðŽ,ÁfAfJfVfA•Ef}f“fMfEf,ìŽ÷Š%œç”f—È”½Ž¼•S•P,ì”_F%œœ,¾œf,µ,ç

“½Ž¼•S•P,ð,à,ÁŽ,ÁfAfJfVfA•Ef}f“fMfEf,ìŽ÷Š%œç”f—È,ìŠÜ...—f”z—f”ó,ì•Ó•S•P«ŠE,ðŽ,.

•@

•y•%œÊ,ìŠ~—p•E•jEã,ì—ã”è•z

1. •S•P,È•¶Y,¾,é½—È,ì...ì•AŠÉ”çfRfXfg,ìã•,•AŠÉ”ç¶¶,ç,é,Ç,ì—ã”è,Æ,È,é•B”K”Ø,ÈŠÉ”ç@,ìŠm—š,¾•K—v,Á, ,é•Bf”fbfv,Æ,µ,Ä,ì—~—p,È,ì—ã”è,¾,ç,Æ•1,¾,ç,é,é•B
2. •A—Ñ”n,ìŠÁ«ã•A—Ñ”ü—@,È,æ,è•A”½Ž¼•S•P,ì”-¶”ð”,é,±,Æ,¾•o—^,é,©,Ç,ç,©,ð”m,é•K—v,¾, ,é•B
3. “½Ž¼•S•P,ì...ì•NCE”,Æ,»ì•¶—“I,È—ðŠ,,ð—¾,ç,©,È,¾,é•K—v,¾, ,é•B



••Ū”_—Ñ•...ŽY<Æfvf•fWfFfNfg
CEα<†,İŠT—v

•@

•@CEÂ•Êfvf•fWfFfNfg

@<@”M•ÑŽY•Ý—^—L—pŽz,É,e,é”n”æ”Ų”ÔCEn,İ•Ă”Ų,ÉŠÖ,,-éŠ”b”İCEα<†ŠJ”-

(f)j(CEfCjVfA•A+½-8”N•12”N“x)

•@

•@”M•Ñ—Ñ,İ}”-,É—ð%œ»,μ,½,è•A•ĂŽ,μ,½,è,μ,Ă,ç,Ū,•B,Æ,-,É•A f A f W f A ” n ” e, İ ” M • Ñ — Ñ, İ — D • è Ž z Ž İ, Ä, , é f t f ^ f o f K f L % e È Ž z - Ø, İ ” , μ, - CE, • -, μ, Ä, ç, Ū, • B f t f ^ f o f K f L % e È Ž z - Ø, È, Ç, İ • Ý — ^ d — v Ž z Ž İ, İ ½, -, İ • A “ V ” R, İ • Ä “ Ž Y ” “ a, • A C E » • Ý “ ± “ ü, ³, è, Ä, ç, é “ ð ” “ V ” R • X • V — @, Ä, İ • A • X — Ñ, İ — ð % œ », ³ ; (E ä, à “ ±, -, Æ Ž v, f, è, Ū, • B

•@, » , ±, Ä • A f } j (E f C j V f A, Ä, İ f (E f b f h f % c f • f “ — p, É Š Ö, -, é C E α < †, δ • s, ç • A, ±, è, ç, İ Ž z Ž İ, İ “ Ų “ T “ Ä “ «, δ % d - ¾, μ • A • Ý — “ Ž Y — L — p Ž z Ž İ, İ “ é — Ñ “ Z p, δ Š m — §, μ, Ū, • B

•@

もどる



••Ū”_—Ñ•...ŽY<Efvf•fWfFNfg
EBr<†,İŠT—v

•@

•@EĀ•Ēfvf•fWfFNfg

@ @ ŠCSO—†B•%ā—D,İŽ%a”•“@EĒ

(f)EJCfVJA•A“g—9”N”11”N)

•@

•@“E”fA/WfA.E.”.s-%ā—D—†B.İŠg“Ē.E.E.Ē.E.E.Ē.AZ%a.1”•“p”v.”%Ā.ĵ•A”ā—ĒEŽ . .s+†ā% . .E.Ā.Ā.c.Ū→B.ĵ.©ā•AZ%ā→bse.Ē→Ū.ŌŽg—p . .s.%B•A“ŽY.3,3,1%ā→D.1.H.Ē.ĵ.Ā“S•.”B%“pŠĀ•.”%ā→†p.Š•u.Ē.Ā.c.Ū→B•İŠŌ.Ē—LŠQ.E→Ū.İŽg—p—Ē.Ē.©.q.”•”Ē•A•→”“E”fA/WfA.©.q.1%ā→D.1”ŵ.(Ō.1—A”ŵ.ÖŽ-†[u.E.C”.E.q.s.s.s.E.Ē→vz.Ē•A.s.1.c.p.E.Ē.E.†•AE→zZY.E.1”ā.E”ŠQ.”†.s.Z-Ō.E.E.s.s.E.”→vz.3.Ū→B

•@



fXfŠf%of“fJ•iŒo•íŒα<†•j

•...“c,İšššú”•i,É,“,éŒø—†“I,È•...—~—p<Z•p,İšJ”-

もどる

ホームへ

f.f<fRfX•[f<•”••ifuf%ofWf<•Afpf%ofOfAfC•AfAf<f[f“f`f“•AfEf<fOfAfC•j
••‡Œ^fvf•fWfFfNfg

‘ŷ•Ä‘å“œ•L^æŒ^fvf•fWfFfNfg

- ‘ŷ•Ä•’•‘,É,;,~,é‘å“œ,Ì•,^Ê•¶ŽY•E—~—p<Z•p,ÌŠJ”-
- %oÁŠQ•ü’Ž,Ì—\—h‘Î•ôŒœ<†•@

もどる

ホームへ



••Ū”_—Ñ•...ŽY<E.fvf•fWfFfNfg
Eε<†,İŠT—v

•@

•@••†(E^fvf•fWfFfNfg

@•†•Ā••,É,;,éâ“u,İ,É•†ŽY•E—p•Zp,İ••†“İŠJ•Eε†

(fu)%fWf•Afp)%fOfAfc•AFAfJfL“f“f“A“/g—9•18“N)

•@

•@“â“u,İ•A“““Ž,•AZ%Ž,δ½,•SÜ,Y•A“•A—“Z,•E,É,ç,Ô•çSE,İ•d—v•†,Ā,•B“â“u,İ•†ŽY—É••â,İ•çSE,İ•H—EŽü•,İ•à“%•,É•s%•ĀE†,É%•Ū“•,Ā,•B“•Ā•••,İ•A•çSE,İ•â“•†ŽY,İ,İ/3,δ•é,ß•A,ç,É“•d,İ•%•Ā,•,é,•E•E•ç,é,Ā,ç,Ū,•B,μ,•©,μ•A“•Ā•••,İ•â“u,İ,Ū,¼—δŽ],•6,••A•s—ÇŠĀ•%•é,É,;,é†,İ,âfVfXfJfZf“f“f...fE,É,Ç,İ•âŽŠQ,İ—%•,É,Ç•A%•E†,•x,ç½,•,İ—â“è,δ•â,İ,Ā,ç,Ū,•B
•@—[“•†fvf•fWfFfNfg,İ•AZ•±%•Ā“\È“â“•†ŽY,ÉŠÖ,•,é%•Ū“•,É%•Ā•H•••,İ•EŽD%•(E••••,İ•E•†,δ%•Ā,İ•A“•Ā,É,;,éâ“u,İ••†“•†ŽY•E—p•Zp,İŠJ“,δ—ŪZw,μ,Ā,ç,Ū,•B•E•†,İ•,é,•,½,Ā,Ā,İ•A“½•ŠŌ—İ,é,•,é•E•†,İŽĀŽ(,Ā••Ū—İZ—E“c,É,İ•A•Eg•E—İ,δ•dZ,μ,Ā,ç,Ū,•B
•@

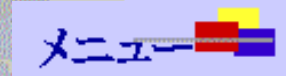
もどる

f•f•fRfX•[f••”••ifuf%°fWf••Afpf%°fOfAfC•AfAf•f[f“f`f“•AfEf•fOfAfC•j

•@



•@



+ fz • [f€

+ -Ú “I

+ ŽŽCE±CE<%oÊ

+ ŽŽCE±“à—e

+ •ü ’Ž

Español



Paraguay , Ì JIRCAS Web , Ö, æ, œ, ±, » • I

•@

, ; -â, ç, ð, í, ï, Í



, Ü, Ä, Ç, œ, ¼

, ; -â, ç, ð, í, ï, ñ

•Z•Š •FRuta Internacional No 7 Km 45, Distrito Yguazu, Alto-Parana, PARAGUAY

“d”b”Ô•† •F 595-972-520-610

Fax”Ô•† •F 595-632-20-608

E-Mail: jircas@foznet.com.br

•@



Centro Internacional del Japón para las Investigaciones de las Ciencias Agrícolas

Menu

- [Objetivo](#)
- [Estudio](#)
- [Resultado](#)
- [Nematodo](#)



•@

コンタクト **Contacto** JIRCAS en Paraguay

Ruta Internacional No 7, Distrito Yguazú Km 45, Alto Paraná, PARAGUAY

Teléfono: 595-632-20-608 **Fax:** 595-632-20-244



: jircas@foznet.com.br

目的 Objetivo

El proyecto de "Estudios Comprensivos sobre el Mejoramiento, Producción y Utilización de la soja en América del Sur" tiene designado expertos de diferentes especialidades en la Argentina, Brasil y Paraguay, siendo asignado al Paraguay los estudios referentes a medidas de control de nematodos.

El nematodo del quiste, es una plaga muy severa para la soja, está apareciendo en los países vecinos, Argentina y Brasil, no registrándose aún en el Paraguay; en el Ministerio de Agricultura y Ganadería(M.A.G.) se está llevando a cabo actividades para informar y advertir, de modo a prevenir cualquier ingreso casual.

Además de nematodo del quiste, se están realizando estudios de otras especies de nematodos de la soja, observándose sus distribuciones, hábitos y respectivos medios de control.

•@

•[Home](#)•[Objetivo](#)•[Estudio](#)•[Resultado](#)•[Nematodo](#)•

Preguntas o comentarios con respecto a este sitio esperamos su E-Mail : jircas@foznet.com.br

線虫 Nematodo

Que es un nemátodo?

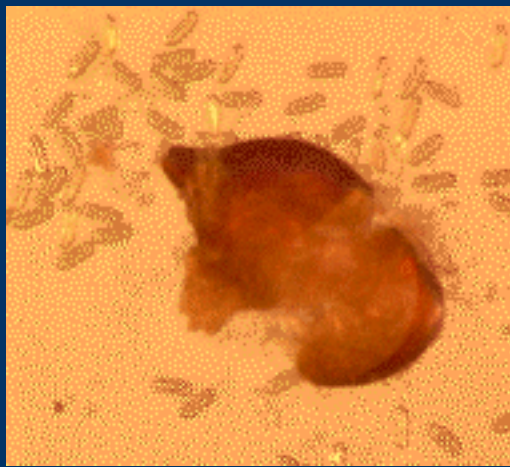
El nemátodo pertenece a la clase de los gusanos no metaméricos, con cuerpo redondo y alargado correspondiendo al grupo menor de las lombrices, cuyas estructuras se encuentran en una bolsa tubular donde se incluyen los órganos de reproducción y digestión.

Desde el punto de vista agronómico, los que causan daños son aquellas especies que parasitan las plantas, siendo estas imperceptibles; en todo el mundo son conocidas más de 2000 especies de estos parásitos, siendo 15 géneros, 45 especies las que perjudican a la soja. Según estudios realizados en el año 1998, se han encontrado 8 géneros, 9 especies en 7 departamentos del Paraguay.



Con el microscopio se observan los nemátodos, como en la imagen de arriba.

Como es el nemátodo del quiste?



La hembra en estado joven, su piel se vuelve liso y fuerte, formando una bolsa dentro de la cual oviposita para posteriormente perecer; esta situación se lo conoce como quiste.

El nemátodo del quiste, igual que el de las agallas queda dentro de la planta; con el avance del estado larval, su cuerpo sale mas de la mitad quedando la cabeza dentro de la raíz, en estos instantes si se extrae la raíz, se puede observar el cuerpo en forma de granos blancos. Estas adultas a medida que maduran, el color de la piel se convierte del blanco al color crema, luego al marrón, momento en el cual el, quiste se desprende separándose de la raíz de la soja.

Al quiste parásito de la soja se lo denomina nemátodo del quiste de la soja (*Heterodera glycines*) conociéndose en total 16 razas.

La soja una vez germinada, exuda una substancia denominada Glycinoeclepin A, el cual estimula la rápida eclosión del huevo del nemátodo. La larva recién eclodida, penetra en la raíz de la soja repitiendo su ciclo igual que el nemátodo de las agallas (*Meloidogyne spp.*), a diferencia que no forman agallas.

El área de ataque del nemátodo del quiste de la soja es estrecho, atacando solamente cuatro especies de leguminosas. Cuando no existen estas 4 especies, entran en estado de dormencia por tiempo prolongado, en cuyas situaciones llegan a sobrevivir por más de diez años, la soja que fue atacada con esta especie, no consigue desarrollar nódulos del rhyzobium impidiendo el suministro de Nitrógeno, cuya consecuencia se observa en el bajo rendimiento.

Los daños son relacionados con la densidad del nemátodo en el momento de la siembra; si existe mas o menos 7 huevos en un gramo de suelo, disminuye el rendimiento en 5%.

•@

•[Home](#)•[Objetivo](#)•[Estudio](#)•[Resultado](#)•[Nematodo](#)•

Preguntas o comentarios con respecto a este sitio esperamos su E-Mail : jircas@foznet.com.br

試験内容 Estudio

En el año 1998, se hizo un estudio de suelo en los departamentos más cercanos a Brasil y Argentina que son: Amambay, San Pedro, Canindeyu, Alto Paraná e Itapúa, el nemátodo del quiste no se a detectado en ninguno de las muestras. Pero si aparecieron otras especies, que actualmente estamos realizando el estudio de control.



De esta forma se realizan los estudios de control, con los suelos extraídos de diferentes departamentos.



En esta sala se realiza la separación del nematodo del suelo, por método de berman, para luego examinar con el microscopio.

•@

•[Home](#)•[Objetivo](#)•[Estudio](#)•[Resultado](#)•[Nematodo](#)•

Preguntas o comentarios con respecto a este sitio esperamos su E-Mail : jircas@foznet.com.br

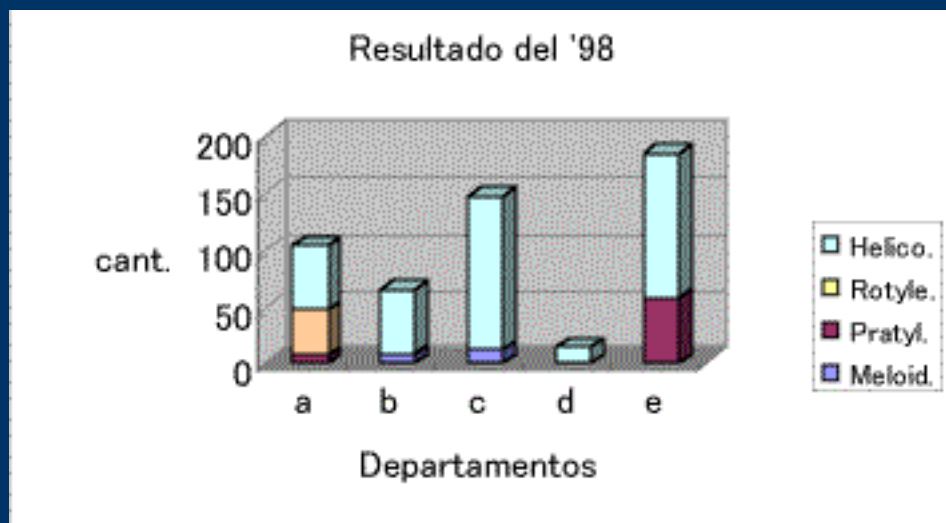
試験結果 Resultado

Según estudios realizados en el año 1998, se han encontrado 8 géneros, 9 especies en 7 departamentos del Paraguay. De estos 7 departamentos les vamos a presentar el resultado de 4 géneros en 5 departamentos.

Los lugares que están en color rojo, son los 5 departamentos que recorrimos.



a=Amambay, b=Canindeyú, c= San Pedro, d=Alto Paraná, e=Itapúa



Meloid.: *Meloidogyne*,
 Pratyf.: *Pratylenchus*,
 Rotyle.: *Rotylenchulus*,
 Helico.: *Helicotilenchus*

Como se ve en el resultado no se a detectado el nemátodo del quiste en Paraguay. Pero, en el transcurso del tiempo existen posibilidades de que ingresen por medio de máquinas contaminadas.

Para el control del cultivo cuando se observen la aparición de este nemátodo, se debe evitar el monocultivo, introduciendo aquellas que no sean hospederos (como maíz) y la introducción de plantas trampas tales como abonos verdes (tagetes o botón de oro, crotalaria, sorgo, avena, etc.) y mínimo dejar dos zafras para nuevamente cultivar la soja.

Si se dispone de variedades resistentes al quiste, se recomienda averiguar primeramente las razas de nemátodos existentes para proceder a la elección de los cultivares resistentes.



a=Amambay, b=Canindeyu, d=Alto Parana, e=Itapua, f=Misiones

El resultado de arriba es del año 1999, no se a encontrado el nemátodo del quiste.

En comparación al grafico de anterior aparece nuevo departamento que es Misiones.

•@

•[Home](#)•[Objetivo](#)•[Estudio](#)•[Resultado](#)•[Nematodo](#)•

Preguntas o comentarios con respecto a este sitio esperamos su E-Mail : jircas@foznet.com.br

研究目的

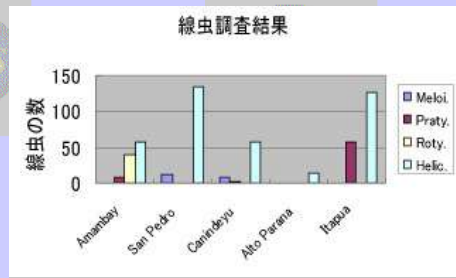
•u“q•Ä“ä“fvf•fwJfFfNfgv„ÍfAfçlf“f f“•Afuf%fwf•Afpf%fofAfc„É“á“n„ÍSeZíé-á%„E„ð“hCE„••Afpf%fofAfc„Ä„í“á“n„ð%„ÁSQ„:„é“ü“Z„í-h•e“í“ó„íCE•ç“„ð““S„µ„Ä„e„Ü„•B“á“n„ð%„ÁSQ„µ•A•Ä„à“°„é„ç„é„Ä„e„é„f_fcFyFvFxfgzf“f f...fE„fAfçlf“f f“•Afuf%fwfç„É“••¶„µ„Ä„e„Ü„:„•A—x“:„lfpf%fofAfc„É„Í“•¶„µ„Ä„e„Ü„!„ñ•B—{“ü“Z„í“N“ü„ðCEx“ü„µ„Ä“AMAG(Mi-nisterio de agricultura y Ganaderia)„Ä„í“é“•L„ñS“•@„:„s„í„é„A—e„í„N“ü„É““ó„!„Ä„e„Ü„•B„±„!„U„©„ÉSeZí—p„í“á“n„ð%„ÁSQ“ü“Z„É„í„µ„Ä“•z“A“¶“Ó•A—h•e“í“ó„ÍSeZí“:„•AÇE•ç“„:„s„í„é„Ä„e„Ü„•B

試験結果

•@•Ô,~"h,è,À,Ô,µ,½•"ª,ª¹²•,δ•s,Á,½CE§,Á,•B

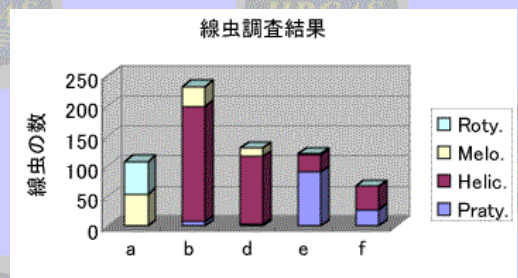


a = fAf}f"fofC•Ab = fJfjf"ff/Wf...•Ac = fTf"•@fy/fhf••A
 d = fAf<fg•@fpf%ofi•Ac = fCf^fvfAÇ§•B



Meloi.: *Meloidogyne*, Praty.: *Pratylenchus*, Roty.: *Rotylenchulus*, Helic.: *Helicotilenchus*

fAf}f"fofC•AFTf"•@fy/fhf••AJfjf"ff/Wf...•AfAf<fg•@fpf%ofi,ÆfCf^fvfAÇ§,ì²•,δ98"N,É•s,Á,½CE%èÈ,ªã,ìfOf%oft,É•o,À,Û,•B,„ìCE%èÈ,W•@,XZí—D,Ì•ü'Ž,•CE,Á,©,è•A,»Ì'†,Á'½,©,Á,½,SZí—D,Ì•ü'Ž,δfOf%oft,É•µ,Ä,c,Û,•B



a = fAf}f"fofC•Ab = fJfjf"ff/Wf...•Ad = fAf<fg•@fpf%ofi•A e = fCf^fvfA•Af = f~fVfIfXÇ§•B

99"N,É,Ì•AJTf"•@fy/fhf•,Ì,ì,è,Éf~fVfIfXÇ§,Ö•s,Á,Ä—^,Û,µ,½•Bª,ìfOf%oft,ª,»Ì²•,ìCE%èÈ,Á,•B

試験内容

fuf%efWf...EJAfJfJfF...ÁI+AVfXfgfZf"ff...fE...m.Á.é.l.Á1998"N.É.A.±.l2*.E.l*«.É.é.fAfJf"fofC+ATf"~@fyfbf**AJfJf"ffWf...AJAfJfg@fJf%efi.ÉfCf"fvfACES.É"...És.Á.½E%ÉA-(fZf"ff...fE.l.Ü.¾"~f.µ.é.Ü.1.ñ.Á.µ.¼.±.A.¼.JZf—p.l.ñ.Z.KE@.Á.©.Á.¼.¼.½.8%é.lZÉ*~ÁE@.é.a.o.É~p.é.Á.lZÉE±.δ.s.Á.Á.Ü.~B



CETAPAR~ifpff%fofAfc"~.E~*~:ZZ(E±~é~j.l
Ing.Agr.Fabio CenturiónZ~.E.l.σ~ZZ(E±.Á.A~dZi~.E.l.~IZq~B



~.És.Á.ÁZ~.Á.Á.A.Á.w~y.δZA(E±Z~.ÁfxffJf"~.É.©.~wZ~—É.δ.s.Á.Á.é.é—IZq~BfxffJf"~@.É.fKf%ofX.é.é.o.É.É....δ.l.é.é'è—É.l'y~é.δ.fefBfVf...fJfJf[l.Éñ.n.Á....É.Á.~.é.É.A*y.J~ü.Z~...É~éj.~.¾.µ.Á.é.é.É.l%é.É™.Ü.é.±.E.δ~—p.µ.¼~ü.Z~—É~ü.~@~B



”_—q—ÖŠ•fVfXfef€„İŠJ”-

•[fuf%ofWf<?†“i”„É„;„,éŽ•±CE^”_—q—ÖŠ•fVfXfef€„İŠJ”-^è

•yCEç†,İ”wCEi•z

1. fuf%ofWf<†“i”„İ•Afpf%ofi•i—~æ.ÉCE•~„3,é,½•½CE”n”N,Á•A”ú—{,İS-Êİ.É•C”G„.éL„3,đŽ•,Á•B”„çŠE.G„3, è•A”y•é,İ•Ó•F,İ”~—,È•ufef%of•fbfVfVf•v,©„ç’á”~—“x,İŽ•«“y,â»Žç”y•é,©„ç,È,é•B
2. „±,İ”n”N,İ•A”á”ç”TM,İ”ç—p•A•~”ž•AFTfğfEFLfr,È,Ç,İ•i•”„İ•Í”l,Æ•A•ú—q,đŽá”İ,Æ„µ,½—q”{„3s„í,é,Ä,ç,é•B
3. i•~„İ•Í”l,Á,İ•A”A•i•áŠQ•A•a”ŽŠQ,İ”½”•A”y•è•N•H,È,Ç„”~„µ,Ä,„è•A””±”I,È”e•ú•ú—q,É„æ,é’á,ç•¶ŽY•«„3-á”è„Æ,È,Ä,Ä,ç,é•B



•@

fZf%e•[fh,É„;„,éú—q

•@



fZf%e•[fh,É„;„,é”á”ç”i

•@

•yCEç†,İ-Ú”I•E”à—e•z

1. —{fvf•fWfFNfg„Á,İ•A•i••Í”l”n,Æ-q’•n,đ”ŠCEÝ,É—ÖŠ„µ,½•V„µ„ç•u”_—q—ÖŠ•fVfXfef•v„İŠJ”-„đ-ÚŽw„µ„Ä,ç,é•B„±,İfvfXfef„É„æ„Á„Ä•A•i•”„İ”A•i•áŠQ„đ-hŽ~„,é„Æ„Æ„à„È•A-q’•n„İ¶ŽY•«„đCEü•ã„3„•AŽ•±”I„Á„©„Á•„ç•¶ŽY—Í„đ-ÚŽw„µ„Ä,ç,é•B
2. JIRCAS„İ•Afu%ofWf<„Æ:ç”~„Á”È%ç”„İCEç†„đŽĂŽ{„µ„Ä,ç,é(1996-2002)•B

- Y—~CE^“y”n—~—pfVfXfef„İ”•„E%çđ•Í
- ”_—q—ÖŠ•fVfXfef„đ”~”~„éCE•Ê•Zp„İŠJ”-
- CE•Ê•Zp„đ”±”ü„µ„½•V„µ„çfvfXfef„İŽD%ç(CE•İ”I,È•¶%çç„ÆCE»”nŽĂ•Ø

•@

•@



”_—q—ÖŠ•fVfXfef

•y•~%oÊ„İŠ~—p•E”Óç•z

1. i•~”Í”l”_ççÆ„İ”A•i•áŠQ-hŽ~„Æ-q’{”_ççÆ„İ¶ŽY—Í(CEü•ã„ÉŠñ—^„,é•B
2. •„ç•è•Y•¶ŽY—Í„đŽ•„Áfu%ofWf<”_—qçÆ„İŽ•±”I”~”W„ÉŠñ—^„,é„ç„±„Æ„É„æ„Á„Ä•A•çŠE”I•K—Í„İ•H—Æ:Y<<—Í„İ(CEü•ã„É•vCEŁ„,é•B



••Ū”_—Ñ•...ŽY<Efvf•fWfFfNfg
CEπ<†,İST—v

•@

•@••†CE^fvf•fWfFfNfg

•@ fvf%WfJf%““““É,”“ēZ•±CE“”_q—AŠ-fVfXfef€,İŠf”

(fvf%WfJf•A^ŵ-Š*14”N”x)

•@ fvf%WfJf%JfL’š,É%Ák’n,đ—L...ē”+Á-Á’š,ł-%E.Á-•Bfvf%WfJf%Jf”_q.E.f’%š,É”-W.f%Á”•,đ”ñ,Ā,”ē•A21+ç.L)qŠE.l}H—;Žü•.É.á’%š,É•vCE.đ.É.,±.E.Šü’Ó,ē.Á.ç.Ú.~B.μ.©.μ•A.±.l.π.©.ÉŠü’Ó.É%đ.ł.ç.½.B.É.f-AGE→s.lZ’(E’Zü’DGE’ÁŠÁ••”f%đ’l.É’O’B’f’KE’Ó.l”_q.E.©.ç•A•.É’À’SE’ÁZ’±’l.É’Á••,đ”ñ,ł,½’(En.l”_q.E.É.İŠv.,.ç.±.E.†•%Á(É),E+ł,ç.ē.Ú.~B

•@ ±.l.±.E.©.ç•A-fvf•fWfFfNfg.É,”.ç.Ā.ł•A-Z•p(ED+•EZDE•(ED+đ”+μ.Ā.Ā•A-q”•n.E”_k’n.đ ŠEY.É—OS...ē’fVfXfef_đŠm—š...ç.±.E.É.π.Ā.Ā•A-q”•n.l}n—f+•,đ•k’n.l}y•ē—đ%••hZ’_đZÁGE...ç.E.É.á.É•A-q”•n.Ó.l}ZÁ•E%GE+“l}±”ñ.É.π.Ā.Ā•A+ı-Ú.l}½—f%••_đZÁGE+μAZs•ē’š’fXfN%đ”đ.É.š,½”“KE”_%E”““l}”+“”_lKE%ç”À”ē.á•vCE.,.ç.±.E.É.Ç.đZá—v.É-Ú’l.E.,.ç”•KE•†.đ•“.,.ç.±.E.É.μ.Ú.μ,½•B

戻る @



1. [i'†•,É,,-,éŽâ—v•H—ÆŽ'Ĉ¹,İŽ•±“I•¶ŽY<y,Ñ•,“x—~—p<Z•p,İŠJ”-](#)
[i'••‡Ĉ^fvf•fWfFfNfg:j](#)

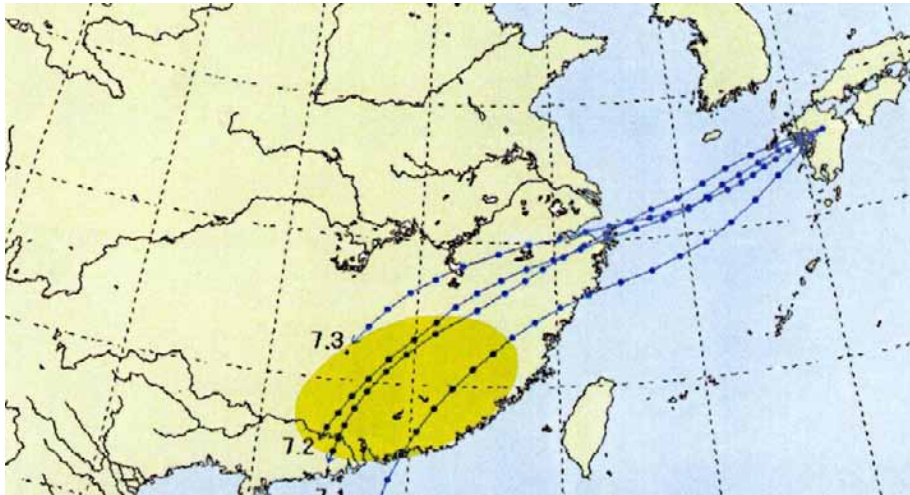
•@

['W...◊•i”~@•A•~@•A'◊“™•j,İ,“x—~—p<Z•p,İŠJ”-](#)



•@

2. [fEf“fJ“™,İ•L^æ•EÚ“®•«ŠQ'Ž,İŽ©'R,Æ'²~a,μ,½-h•æ-Z•p,İŠJ”-](#)



•@

[もどる](#)

[ホームへ](#)



中国の概要

中国の概要

中国の概要

(中国の概要)

中国の概要

中国の概要

もどる

†•W...◊,ª,;è•g,Æ,μ,ÄŽg,¡,é

†•“W...◊,ª,;è•g,Æ,μ,ÄŽg,¡,é

Development of SURIMI Made from Freshwater Fish Meat in China

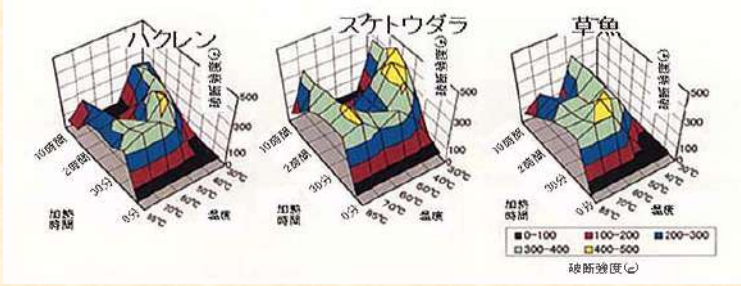
•@•%Ê,İŠT—v

†•••f v f W f F N f g • 1996 • 2003 j, İ Ž a — v • i, É • A • W • ... ◊, İ — p % c A • H, •, • é • B

È • Y • A • † •, • Á, İ • Ç • S • c e f g •, İ • W • ... ◊, İ • T M Š İ, •, • è, É, • Ç • A Š • o — A • — E — L, è Ž p — p, É — Ü, è • A Š C Ž Y ◊, İ, æ, ρ, È • ½ — İ, È — p, Ö, İ •, † j, Ü, è, Á, ç, é • B

Ž a — v • W • ... ◊, Á, • é f n f N f C E f • A • ◊, È, Ç, É, Á, ç, Ä • A, •, è g, É, μ, ½, •, È, •, İ ◊ •, İ f Q f • C E • † • • i • e — İ • • A Ž • c ž, İ • T M, İ C E • † • † j, •, ç, ©, È, É, è • A, •, è • g • T M, İ • H • † % c A • H • † • P, • E, μ, Ä • A Ž g — p, Á, •, • é •, • Š İ, ½ • B

±, İ • % c È, İ ž @ — Ž, μ, g, İ • Ä • † • ä C E f u f • f b f N % c ◊, Ö, İ C E • † • P, È, Ç • A — İ X, È — p C E • Ö, δ Š İ •, •, é, à, İ, E, μ, Ä • Ü, •, è, é, È, Ü, © • A † • A • † •, İ Ž s • è C E • † • Ü • s, È •, • H • † Š •, İ C E • ä • A • † • † • H • i • Ž w C E •, È % c ž, İ, ç, è, é • P, İ • ä — È • Y • c • A ž B • ½, İ • † • Ž • C E •, È • ä, x, Ä • W • ... ◊, İ Ž • —; C E • — İ, •, ç, ±, È, ©, ç • A Ž • —; Ž u ◊, İ •, Á, à • ä, •, È • Ö •, δ Ž •, Ä • % c È, Á, • é • B



f ^ f % ◊, İ — ä • C, •, è • g, • E • a Š r, μ, ½ • W • ... ◊, İ, •, è • g, İ f Q f • C E • † • † j, •, ç, ©, È, É, è • A • † • % c ◊, Á, •, • é • † •, İ, •, è, ±, • E, • Ž, •, è, ½

•@



f n f N f C E f • i • † • 0.5 • 1 m • j



W • ... ◊, İ • T M Š İ — C E i



† •, Á, İ ◊ — L, è Ž p j • T • † • S



• ◊ • † • 0.5 • 1 m • j

•@•@

Š Ö • A Ž • —; İ, ±, •, ç, θ, • —; •, ¾, •, ç • B

•@

• y • W C E i, È, È, ç • z • A • y • % c È, İ • ä — e • A • † • y • z • A • y • C E ä, İ % c Ü • è • z

† • A • T M • C E • † • Ž Y, İ • ó • μ	† • A • T M Š İ •, İ Ž İ — P • È • † • Ž Y • ó • μ	† • B • ... Ž Y — (• B — È • İ, İ • ó • μ
▲ 1 • T M • C E • † • Ž Y, İ •, Ü	▲ 1 • Ž İ — P • È • T M • C E • † • Ž Y — È, İ •, Ü	▲ 1 • ... Ž Y — (• B — È • İ, İ •, Ü
▲ 2 — (• B • † • Ž Y, È • Š İ • † • Ž Y, İ •, Ü	•@	▲ 2 — (• B • ä • @ • È — (• B — È • İ, İ •, Ü

•@

‡@◁™◁Æ•¶ŽY,ì•ó◁μ

•@

•\,P•@◁™◁Æ•¶ŽY—Ê,Ì•,ˆÚ•iˆPˆÊ•F—œt•j

•@

”N ŽŸ	•‡œv•¶ŽY—Ê	ŠC•...•‡œv	ŠC•...•BŠI	ŠC•...—{•B	’W•...•‡œv	’W•...•BŠI	’W•...—{•B
1980	449.7	325.7	281.3	44.4	124.0	34.0	90.0
1981	460.5	323.2	277.4	45.8	137.3	35.9	101.4
1982	515.5	359.3	309.8	49.5	156.2	35.5	120.7
1983	545.9	361.7	307.2	54.5	184.2	41.3	142.8
1984	619.3	394.4	330.5	63.9	225.0	43.9	181.1
1985	705.2	419.7	348.5	71.2	285.4	47.5	237.9
1986	823.5	475.4	389.6	85.8	348.2	53.0	295.1
1987	955.3	548.2	438.1	110.1	407.2	58.7	348.4
1988	1061.0	605.8	463.3	142.5	455.2	65.4	389.7
1989	1151.7	661.2	503.6	157.6	490.5	73.4	417.0
1990	1237.1	713.3	550.9	162.4	523.8	77.9	445.9
1991	1350.8	800.1	609.6	190.5	550.7	91.5	459.2
1992	1557.1	933.7	691.3	242.4	623.4	90.1	533.4
1993	1823.0	1076.0	767.3	308.7	747.0	102.9	644.1
1994	2143.1	1241.5	895.8	345.7	901.6	116.6	785.0
1995	2517.2	1439.1	1026.8	412.3	1078.1	137.3	940.8
(95/80)	5.60	4.42	3.65	9.29	8.69	4.04	10.45

•o•Š•F•uˆ†•““•œv”NŠÓ•vŠe”N”Å•B

•@

•@ †@•@ <™ <Æ•¶ŽY, Ì•ó <µ

•@

•\2 —{•B•¶ŽY, Æ•BŠl•¶ŽY, Ì•, ^Ú•i’P^Ê•F—æ•j

•@

”N ŽŸ	•‡(Ev•¶ŽY—Ê	•BŠl•‡(Ev	—{•B•‡(Ev	‘S’Ì—{•B—l(%)	’W•...—{•B—l(%)	ŠC•...—{•B—l(%)
1980	•@449.7	•@315.3	•@134.4	•@29.9	•@72.6	•@13.6
1981	•@460.5	•@313.3	147.2	•@32.0	•@73.9	•@14.2
1982	•@515.5	•@345.3	170.2	•@33.0	77.3	•@13.8
1983	•@545.9	•@348.6	197.3	•@36.1	•@77.6	•@15.1
1984	•@619.3	•@374.4	245.0	•@39.6	•@80.5	•@16.2
1985	•@705.2	•@396.0	309.1	•@43.8	•@83.4	•@17.0
1986	•@82305	•@442.6	380.9	•@46.3	•@84.8	•@18.0
1987	•@955.3	•@496.9	•@458.5	•@48.0	•@85.6	•@20.1
1988	•@1061.0	•@528.8	•@532.2	•@50.2	•@85.6	•@23.5
1989	•@1151.7	•@577.1	•@574.6	•@49.9	•@85.0	•@23.8
1990	•@1237.1	•@628.7	•@608.3	•@49.2	•@85.1	•@22.8
1991	•@1350.8	•@701.1	•@649.7	•@48.1	•@83.4	•@23.8
1992	•@1557.1	•@781.4	•@775.8	•@49.8	•@85.6	•@26.0
1993	•@1823.0	•@870.2	•@952.8	•@52.3	•@86.2	•@28.7
1994	•@2143.1	•@1012.4	•@1130.7	•@52.8	•@87.1	•@27.8
1995	•@2517.2	•@1164.1	•@1353.1	•@53.8	•@87.3	•@28.6
(95/80)	•@5.60	•@3.69	•@10.07	•@	•@	•@

•@•o•Š•F•\,P,©,ç(EvŽZ•B

•@†A•@<™Šl•,İŽí—P•Ê•¶ŽY•óμ

•@

•\,P•@Ží—P•Ê<™<Æ•¶ŽY—Ê,İ•,^Ú•i'P^Ê•F—æ•j

•@

”N ŽŸ	1980”N	1985”N	80”NfVfFA (%)	95”NfVfFA (%)	95/80 (%)
•¶ŽY—Ê	449.7	2517.2	100.0	100.0	5.60
ŠC•...◊—P	234.1	758.1	52.1	30.1	3.24
’W•...◊—P	116.4	1020.9	25.9	40.6	8.77
•i◊—PCEv•j	350.5	1779.0	77.9	70.7	12.01
ŠC•...%ŰŠI—P	42.1	184.8	9.4	7.3	4.39
’W•...%ŰŠI—P	5.1	27.1	1.1	1.1	5.30
•i%ŰŠI—PCEv•j	47.2	211.85	10.5	8.4	9.69
ŠC•...ŠL—P	23.4	392.7	5.2	15.6	16.78
’W•...ŠL—P	2.5	20.8	0.6	0.8	8.30
•iŠL—PCEv•j	25.9	413.46	5.8	16.4	25.08
ŠC•...’”—P	26.2	74.9	5.8	3.0	2.86
’W•...’”—P			0.0	0.0	
•i’”—PCEv•j	•@	74.9	5.8	3.0	2.86
ŠC•...‘‘¼	•@	28.6	•@	1.1	-
’W•...‘‘¼		9.3		0.4	-
•i‘‘¼CEv•j	•@	37.9	•@	1.5	-

•@•o•Š•F•w’†•‘‘•CEv”NŠÓ•xŠe”N”Á•B

•@‡B•@•...ŽY—{•B-Ê•İ,İ•ó<μ

•@

•\,P•@•...ŽY—{•B-Ê•İ,İ•,^Ú•i’P^Ê•F1000ha•j

•@

”N ŽY(”N)	—{•B-Ê•İEv	,μ,¿’W•...	fVfFfA(%)	,μ,¿ŠC-Ê	fVfFfA(%)
80	2993.5	2860.6	95.6	132.9	4.4
81	3014.6	2876.1	95.4	138.5	4.6
82	3210.6	3047.4	94.9	163.2	5.1
83	3278.5	3094.9	94.4	183.5	5.6
84	3508.5	3262.3	93.0	246.2	7.0
85	3902.5	3625.4	92.9	277.1	7.1
86	4111.9	3786.8	92.1	325.1	7.9
87	4225.8	3856.5	91.3	369.3	8.7
88	4308.2	3894.9	90.4	413.3	9.6
89	4235.3	3812.3	90.0	423.1	10.0
90	4258.7	3829.8	89.9	428.9	10.1
91	4277.2	3827.8	89.5	449.4	10.5
92	4475.0	3975.9	88.8	499.1	11.2
93	4718.9	4132.6	87.6	586.3	12.4
94	5083.3	4429.8	87.1	653.5	12.9
95	5385.1	4669.3	86.7	715.8	13.3
(95/80)	1.80	1.63	•@	5.38	•@

•@•o•Š•F•w’†•“•(Ev”NŠÓ•xŠe”N”Á•B

•@‡B•@•...ŽY—{•B-Ê•İ,İ•ó<μ

•@

•\2•@—{•B•û-@•Ê—{•B-Ê•İ,İ•,,^Ú•i’P^Ê•F1000ha•j

•@

”N ŽŸ	91”N	92”N	93”N	94”N	95”N
’W•...-Ê•İ A	3827.8	3975.9	4132.6	4429.8	4669.3
•i“â-ó•j	•@	•@	•@	•@	•@
’r“,,—{•B	1414.1	1475.8	1594.4	1738.0	1857.8
Ěİ”“—{•B	624.6	702.7	709.6	761.1	824.3
%oÍ•a—{•B	323.8	323.2	332.4	335.7	347.3
f_f€—{•B	1426.0	1425.7	1416.6	1477.1	1515.7
,»„İ¼	39.3	48.5	79.6	118.0	124.3
ŠC•...-Ê•İ B	449.4	499.1	586.3	653.5	715.8
•i“â-ó•j	•@	•@	•@	•@	•@
•óŠC—{•B	39.3	77.9	87.2	133.3	131.7
•~p—{•B	130.7	127.9	153.8	169.5	159.4
“â“h—{•B	279.4	293.3	345.3	350.6	424.6
Ÿ“c—{•B C	710.4	742.1	796.0	832.8	1029.3
A+B	4277.2	4475	4718.9	5083.3	5385.1
A+B+C	4987.6	5217.1	5514.9	5916.1	6414.4

•@•o•Š•F•w’†•”_‘“•Ěv”NŠÓ•xŠe”N”Â•B

mongol

$f, f' f S f <$

f•fL fV fR•iEo•íEα<†•j

f of C f I f e f N f m f • f W • [— ~ — p, É, æ, é • ¬ ” ž ‘ İ • a • «, Ì ^ ç Ž í < Z • p

もどる

ホームへ



••Ū”_—Ñ•...ŽY<Efvf•fWfFfNfg
CE=ç,İŠT—v

•@

●@•••;CE^fvf•fWfFfNfg

@•@•fAfJfŠJf,É,“,çÄ•ŽY,İ,½,B,ΓZŠÓEòŽGŽi,İŠ—p,ÉŠÖ,çCE=ç

(fR•[fgfWf{fA•[f•A•½-10•14”N)

@•½fAfJfŠJf,Ä,İ•A•šZs,Ö,İ•KEB,İ•W”•,â•Š”CE”Ö,İ•E%•,É”•,Ä,Ä•H—E•Ä”CE”Ö,â•İ,ç•A•Ä,İ•Ä”•,“•,É”%Ä,µ,Ä,ç,Ä,ç,Ü,•B,µ,©,µ•A”n•e”•Ä,İ•Ä,İ•ŽY—É,İCEÀ,ç,É,Ä,“,ç•A•Ä”•—É,İ•â”¼”•,δ—A”u,É,½,æ,Ä,Ä,ç,ÉCE=ç,©,ç•A•H—EŽÖç,İ•X,É,ç”%ç”,CE”O”,ç,É,Ü,•B,±,İ,½,B•AfJfŠJf,İ•CE•E”y•EŽD%çCE”Ö,É,Ç,İŽÀ•ç,É,µ,½,Ä,İ”ŽY•Z•p,İŠJ”•E••y,“•)±,Ä,•B

@••Ū”_•EKE=ç•ç•fOf•[fv•CGIAR•žP%ç,İ••Ū”_•EKE=çfZf”•[,İ•É,Ä,Ä,“,ç•½fAfJfŠJf”İŠJ”•%ç(WARDA),İ•A1971”N,İ•Y—š—É—•A•½fAfJfŠJf,İ%ç-ç17f”•,E•ç,ç”ACEg,δ•Ü,ç,ç•A”n•e,İ”•U•»,B•Ū”•İ•EKE=ç•E••yŠ”•@,δ•s,Ä,Ä,ç,Ü,µ,½•B”Ä,É•A•s—ÇŠÄ,ç,â•šQŽ,É”•,çŽ•,ÄfAfJfŠJf,İ•E½Zü•çfAfWfA”İ,İŽŠÓŽGŽi,δ—p,µ,½•½fAfJfŠJf”•EŽÖ,Γ”•İŽi,İŠJ”•É—İ,δ”u,ç,Ä,ç,Ü,•B

@WARDA,É,“,çfAfJfŠJf”n•e,İ,½,B,Γ•ZŠÓEò—Çfvf•fOf%ç,İ•ç—s•ç”,æ,Ñ”KEB=ç,É,“,ç%ç,“•,İ”•İ•EŽÀ•Ñ,©,ç•A—[ççÜ”è,É,“,ç,Ä,ç”CE=ç,δ•,ç,İ,ç±,æ,Æ,µ,Ü,µ,½•B

•ŠiCE=ç”ç	2-¼
”ZŠiCE=ç”ç	5-¼

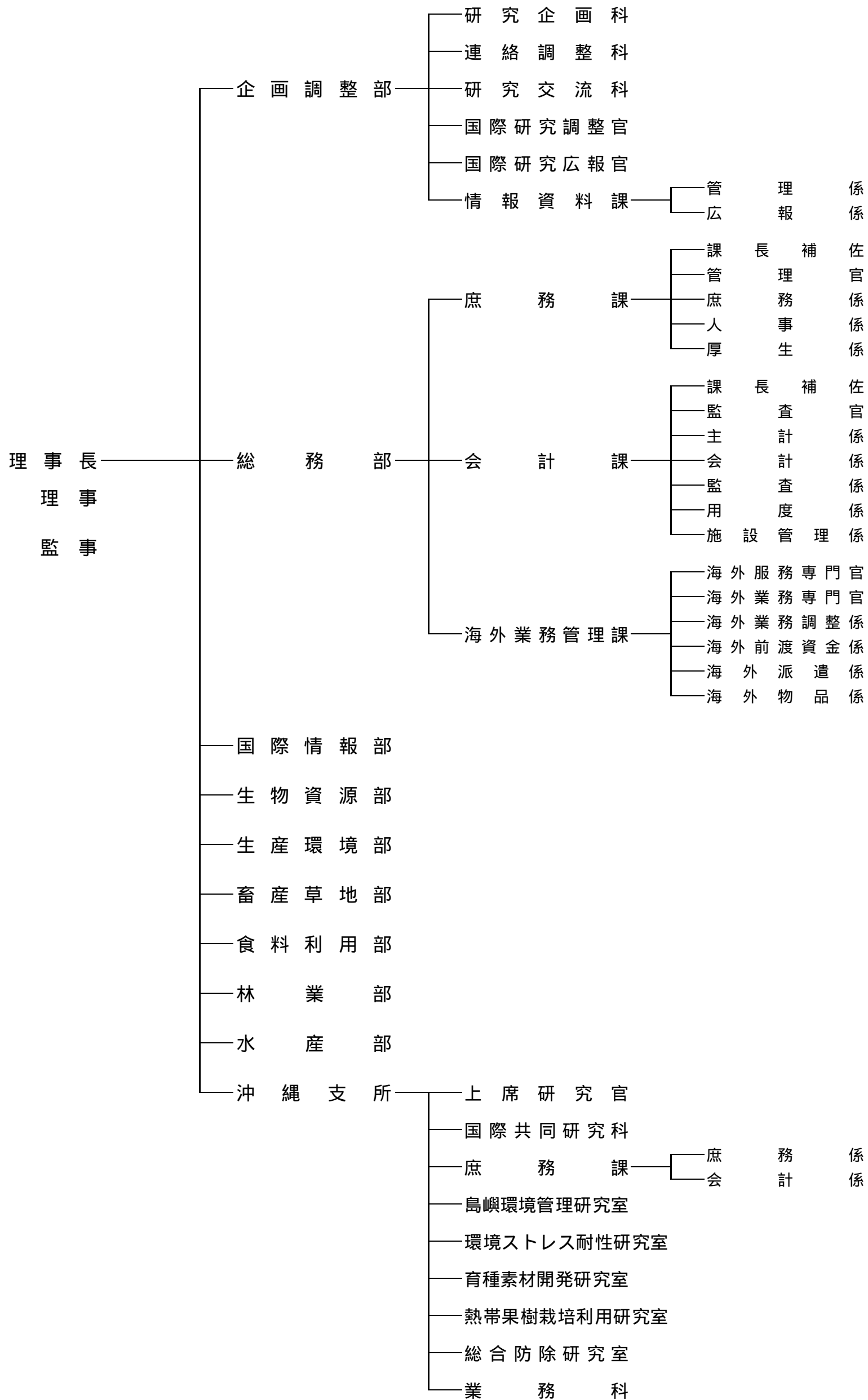
•@



fAfJfŠJf,İ•EfAfWfA”İ,KEòŽGŽi,É,æ,ç••”•ŽYfvfXfej

独立行政法人国際農林水産業研究センター組織図

平成13年8月1日現在



“Ū”_<ÆCEα<†•¬%oÊ•î•ñ•@

f•“Ū”_—Ñ•...ŽY<ÆCEα<†fZf“f^•[•,,

q•“Ū”_<ÆCEα<†•¬%oÊ•î•ñ•r (English here)

•@



•@

[•½•¬13”N“x](#)

•i‘æ9•†•j

[•½•¬12”N“x](#)

•i‘æ8•†•j

[•½•¬11”N“x](#)

•i‘æ7•†•j

[•½•¬10”N“x](#)

•i‘æ6•†•j

[•½•¬9”N“x](#)

(‘æ5•†)

[•½•¬8”N“x](#)

(‘æ4•†)

[•½•¬7”N“x](#)

(‘æ3•†)

[•½•¬6”N“x](#)

(‘æ2•†)

[•½•¬5”N“x](#)

(‘æ1•†)

•@

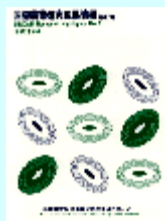
[JIRCAS WWW fz•\[f fy•\[fW,Ö](#)

[www@jircas.affrc.go.jp](#)

<JIRCAS Research Highlights>

<Japan International Research Center for Agricultural Sciences>

Cover image



[JIRCAS Research Highlights in 2000](#)

[JIRCAS Research Highlights in 1999](#)

[JIRCAS Research Highlights in 1998](#)

[JIRCAS Research Highlights in 1997](#)

[JIRCAS Research Highlights in 1996](#)

[JIRCAS Research Highlights in 1995](#)

[JIRCAS Research Highlights in 1994](#)

[JIRCAS Research Highlights in 1993](#)

Library, Japan International Research Center for Agricultural Sciences

Tel.: 0298-38-6340

Fax.: 0298-38-6656 e-mail: ref.@jircas.affrc.go.jp

1-1, Ohwashi, Tsukuba-shi Ibaraki-ken, 305-8686 JAPAN

BACK

HOME

[前へ](#)

[最初に戻る](#)

[目次](#)

[次へ](#)

•@

Research Highlights No.8•@(2000)

Contents

[1. China's WTO accession and its impact on domestic agriculture](#)

Research Information Division

[2. Genetic difference of resistance to Fusarium head blight in Japanese and Chinese wheat cultivars, Nobeokabouzu-komugi and Sumai 3](#)

Biological Resources Division

[3. Antisense suppression of proline degradation improves environmental stress tolerance in *Arabidopsis*](#)

Biological Resources Division

[4. The Nitrogen cycle for agricultural production in Khon Kaen province in Northeast Thailand](#)

Environmental Resources Division

[5. N balance in the grassland and in the soybean field, Brazil](#)

Environmental Resources Division

[6. Stimulated methane emission from a rice paddy under elevated atmospheric CO₂](#)

Environmental Resources Division

7. A method to retrieve snow depth and its melting condition

Environmental Resources Division

8. Varietal resistance to the whitebacked planthopper in Chinese japonica rice

Crop Production and Postharvest Technology Division

9. Evaluation of Indonesian soybean varieties for tofu and Tempe processing

Crop Production and Postharvest Technology Division

10. Isolation of white-spored mutants from the koji molds for the production of Kecap, an Indonesian soy sauce

Crop Production and Postharvest Technology Division

11. Alley cropping on the sloping upland field in Northeast Thailand

Crop Production and Postharvest Technology Division

12. Subsoiling treatment on the sloping upland field

Crop Production and Postharvest Technology Division

13. No-tillage cultivation of crops on the sandy upland field in Northeast Thailand

Crop Production and Postharvest Technology Division

14. Effects of mechanical weeding on the dominant upland weeds in Northeast Thailand

Crop Production and Postharvest Technology Division

15. Optimum seed rates in wet seeded rice culture in the Mekong Delta of Vietnam

Crop production and Postharvest Technology Division

16. Selection of soybean varieties, non-host crop and antagonistic plant for nematode control in Paraguay

Crops Production and Postharvest Technology Division

17. Inhibition of the adipocyte differentiation of 3T3-L1 by an amino acid derivative in fermented foods

Crop production and postharvest technology division

18. The roles of tumor necrosis factor alpha (TNF α) in genetic resistance of mice to *Trypanosoma congolense* infection

Animal Production and Grassland Division

19. Seeds of forage legume esparcet of Kazakhstan have a local seed size and high allelopathic activity

Animal Production and Grassland Division

20. Dry matter productivity and forage quality of *Panicum maximum* pastures established in agropastoral systems

Animal Production and Grassland Division

21. Nutritional diagnosis of sulfur in soybean plants

Research Information Division

22. Low impact harvesting method for tropical natural forests

Forestry Division

23. Decrease of organic waste by the polyculture of giant tiger prawn and green mussel

Fisheries Division

24. Purification of the wastewater from aquaculture ponds using the mangrove ecosystem

Fisheries Division

25. Alleviation of the incidence of internal tipburn in Chinese cabbage by subsurface drip fertigation

Okinawa Subtropical Station

26. Complete nucleotide sequence and genetic organization of papaya leaf distortion mosaic virus RNA

Okinawa Subtropical Station

27. Molecular cloning of Na⁺-ATPase cDNA from a marine alga, *Heterosigma akashiwo* (Sodium-pump in plant cell)

Okinawa Subtropical Station

28. Simple crossing method of snap bean using physiological pollen sterility caused by high temperature treatment

Okinawa Subtropical Station

29. Occurrence of male sterile cytoplasm in 'Kurodane Kinugasa' snap bean

Okinawa Subtropical Station

30. Distinction of sucrose phosphate synthase loci in sugarcane

Okinawa Subtropical Station

Title : China's WTO accession and its impact on domestic agriculture

Division : Research Information Division

Author : Akihide IKEGAMI

Key Words : China, WTO, Agriculture

Synopsis : The day is not far distant when China joins WTO. So we need to evaluate the impact of WTO accession to Chinese agriculture. In this research, we try to investigate the impact of assumption that (1) Chinese government observes "Agreement on Agriculture" of WTO, (2) adoption of tariff-rate quotas in major crops and tariff reductions of other agricultural products depend on U.S.-China WTO Accession Agreement.

[前へ](#)

[最初に戻る](#)

[目次](#)

[次へ](#)





•@

••Ū”_ <ÆCEæ<†•-%•Ê•îñ‘æ,W•†•k2000•i•½•¬12”N“x•j•l

-Ú•@•@•@ ÿ

1. WTO%Á-¿,ì†•”_ <Æ,Ö,ì%œ<¿ •k•s•-•l

••Ū”_—Ñ•... Y<ÆCEæ<†fZf“f^•[•EŠČŠO•îñ•”

2. “ú-•Ÿ—^•-” ,Æ†•^ç•-•-” ,ì•Ö,©,Ñ•a”i•R•«^â“ q,ì”äŠr,Æ•W•î •kCEæ<†•l

••Ū”_—Ñ•... Y<ÆCEæ<†fZf“f^•[•E•ŋ]•” ‘CE’•”

3. fvf•fŠf“ä ÓCeny†fâ“ q†•,É,æ,éŠÂ<<fXfgfCEfX†i•«•A•,ìŠJ”- •kCEæ<†•l

••Ū”_—Ñ•... Y<ÆCEæ<†fZf“f^•[•E•ŋ]•” ‘CE’•”•A—%•»ŠwCEæ<†•Š

4. f^fC•fRf“fPf“CE§,É,“,“é”_ <Æ•ŋ Y,ÉŠÖ,í,é’,f•zŠÂ •k•s•-•l

••Ū”_—Ñ•... Y<ÆCEæ<†fZf“f^•[•EŠÂ<< ‘CE’•”

5. fuf%fWf<,ì•n,“,æ,Ñf_fCfY”“,É,“,“é’,f ú x •kCEæ<†•l

••Ū”_—Ñ•... Y<ÆCEæ<†fZf“f^•[•EŠÂ<< ‘CE’•”

6. CO 2 ”Z“x’%•Á,É,Æ,à,È,æ... “c,©,ç,ìf•f^f”“-•ŋ—Ê’%•Á •kCEæ<†•l

••Ū”_—Ñ•... Y<ÆCEæ<†fZf“f^•[•EŠÂ<< ‘CE’•”

7. •í•á•[,]•°•z,Æ—Z%•ð•ó•µ,ðfŠf,•[fgfZf“fVf“fO,Á”m,é è-@ •kCEæ<†•l

••Ū”_—Ñ•... Y<ÆCEæ<†fZf“f^•[•EŠÂ<< ‘CE’•”

8. fzfWf•fEf“fJ,É,í,“é†•fWfff|fjfJ•... î•e•t•]-06f,ì•i î”i•R•« •kCEæ<†•l

••Ū”_—Ñ•... Y<ÆCEæ<†fZf“f^•[•E•ŋ] Y—~—p”•A’†••... îCEæ<†•Š

9. fCf“fhflfVfA Y’â“æ,ì”æ...•Efef“fy,Ö,ì%Á•H“K•« •kCEæ<†•l

••Ū”_—Ñ•... Y<ÆCEæ<†fZf“f^•[•E•ŋ] Y—~—p” •A fCf“fhflfVfA“æ—P fCf,—P•i”CEæ<†•Š

10. fCf“fhflfVfA,É,“,“éâ“æ”-y”²-ì%t fP f f f b f v•» ‘ç—p••Ū,ì%ü—Ç •kCEæ<†•l

••Ū”_—Ñ•... Y<ÆCEæ<†fZf“f^•[•E•ŋ] Y—~—p”•A•H•i••†CEæ<†•Š•E•H•i•@”•”•ECE”S•«•]•%•¿CEæ<†•°•A fCf“fhflfVfA“æ—P fCf,—P•i”CEæ<†•Š

11. “CE-kf^fCŠÉ î-Ê””n,É,“,“é fA fC fC fN f•f b f s f “fO<Z•p •k••Ū•l

••Ū”_—Ñ•... Y<ÆCEκ<†fZf“f^•[•E•η] Y—~—p•”

12. %°‘w“y”j•Ó^—,É,æ,é””n“y•ë...•a,ì—LCEø—~—p<Z•p •k••Ū•l

••Ū”_—Ñ•... Y<ÆCEκ<†fZf“f^•[•E•η] Y—~—p•”

13. “CE—kf^fC•» ζ””n“Ñ,É,;—,é•s•k•N•í”],ì“K—p•« •k••Ū•l

••Ū”_—Ñ•... Y<ÆCEκ<†fZf“f^•[•E•η] Y—~—p•”

14. “CE—kf^fC””n—D•è G•,É•í,•,é<@ŠB•œ•,ìCEø%•Ê •k••Ū•l

••Ū”_—Ñ•... Y<ÆCEκ<†fZf“f^•[•E•η] Y—~—p•”

15. f•fRf“ff<f^,ì... ã•“y”¼“d•í”],É,;—,é ũ—Ê•«,©,ç,Ý,½•Å“K”d í—Ê •k••Ū•l

••Ū”_—Ñ•... Y<ÆCEκ<†fZf“f^•[•E•η] Y—~—p•”

16. fpf%•fOfAfC,ì—LŠQ•ü’ —)•\$É—LCEø,Èf_fCfY•i í•A—Ö•i•i••y,Ñ’í•R•A•” •k••Ū•l

••Ū”_—Ñ•... Y<ÆCEκ<†fZf“f^•[•E•η] Y—~—p•”•A”_<ÆCEκ<†fZf“f^•[•A—kŠC“””_<Æ CE±•ê•A fpf%•fOfAfC”_—q•É•A••Ū•l—ì—<Æ’c fpf%•fOfAfC”_<Æ’••‡ CE±•ê

17. %•—b•x—E,Ö,ì•°%•»—)•\$CEø%•Ê,ð |,•‘á“x”••y•H•i’†,]•η—•. @”\•«•—•••kCEκ<†•l

••Ū”_—Ñ•... Y<ÆCEκ<†fZf“f^•[•E•η] Y—~—p•”•A•H•i•••‡CEκ<†•Š

18. íá‡%•ó ã• q•iTNFfζ,]f}fEfX,]f g fŠ f p f m f • f }Š •õ”•R•«„ÉŠñ—^,μ,Ä,ç,é •kCEκ<†•l

••Ū”_—Ñ•... Y<ÆCEκ<†fZf“f^•[•E’{ Y’•n•”•A••Ū’{ YCEκ<†•Š•iLRl•j

19. fJfUftfXf^f“ Yf}f%•È—q•fGfXfpf•f c f Ffg,ì í q,í•A’•n^æ“l•ĩ•Ū,^, .è•A•-,çfAfCEf•f p f V•,ð |,•kCEκ<†•l

••Ū”_—Ñ•... Y<ÆCEκ<†fZf“f^•[•E’{ Y’•n•”

20. ,Q í,]fAfOf•f p f X f g f %•f c f V f X f e f ,É,;—,é Panicum maximum ‘•n,]ŠŁ••η] Y•«,Æ ”—ζ%•ç’],ì”ãŠr•kCEκ<†•l

••Ū”_—Ñ•... Y<ÆCEκ<†fZf“f^•[•E’{ Y’•n•”•A f u f %•f W f c”_—qCEκ<†CEö Đ“÷•CEκ<†fZf“f^•[

21. fuf%•fWf<“CE—kfZf%•[fh,]f_fCfY•í”],É,;—,é fCfIfE,]h—{•f’Ši• •kCEκ<†•l

••Ū”_—Ñ•... Y<ÆCEκ<†fZf“f^•[•EŠČŠÖ•î•ñ•”•A f u f %•f W f c”_—qCEκ<†CEö Đ“á“xCEκ<†•Š

22. ŠÄ<<fCf“f p f N f g,ì•-,ç”M’Ñ“V’R—Ñ,]”•ì<Z•p •kCEκ<†•l

••Ū”_—Ñ•... Y<ÆCEκ<†fZf“f^•[•E—Ñ•Æ•”•A f } f C e f C f V f A • X—ÑCEκ<†•Š•iFRIM•r

23. fGfr,Æ“ñ—‡SL,ì•—‡—{•B,É,æ,é—L<@%•~’÷” ζ,]CEyCE, •k••Ū•l

••Ū”_—Ñ•... Y<ÆCEκ<†fZf“f^•[•E•... Y•”

24. f}f“fOf•[fu,ð—~—p,μ,½—{•B”r•...,]ò%•» •k••Ū•l

••Ū”_—Ñ•... Y<ÆCEκ<†fZf“f^•[•E•... Y•”

25. ‘n’†_—“H’•u,ð—p,ç,½,©,ñ... {”],É,æ,é f n f N f T f C • S •... ,ê•Ç,]CEyCE, •kCEκ<†•l

••Ū”_—Ñ•... Y<ÆCEα<†fZf“f^•[‰◀◀“ê x•Š•E’n—îŪ •CEα<† °

26. fpfpfCfAŠiCE—tf,fUfCfNfEfCf,fX•iPLDMV,j,l’S‰-Š”z—ñ •kCEα<†•l

••Ū”_—Ñ•... Y<ÆCEα<†fZf“f^•[‰◀◀“ê x•Š•E’i”•ŪCEiCEα<† °

27. •A”É,à“ŋ•Ý,μ,½fifgfŠfEf •i”r•o•jlf“fv•iNa + -ATPase•j •kCEα<†•l

••Ū”_—Ñ•... Y<ÆCEα<†fZf“f^•[‰◀◀“ê x•Š•E’•Ū◀◀“CEα<†‰È

28. •,‰•^—•,É,æ,é•ŋ—•“l‰Ō•s—◀,đ—~—p,μ,½fTf,,fCf“fQf“ŠÈŌCEđ”z—@ •kCEα<†•l

••Ū”_—Ñ•... Y<ÆCEα<†fZf“f^•[‰◀◀“ê x•Š•E’i”“±“ü•í”|CEα<† °

29. fTf,,fCf“fQf“i (e•• ŋBŠ)•f,ÅCE©,Á,©,Á,½•x—E ĵ—Y•◀◀s—◀ •kCEα<†•l

••Ū”_—Ñ•... Y<ÆCEα<†fZf“f^•[‰◀◀“ê x•Š•E’i”“±“ü•í”|CEα<† °

30. fTf•gfEfLfr,É,“,“,éfxfnf•[fxfŠf“_fvf“f^•[f[•iSPS•jâ“ q,l]•Ê—@ •kCEα<†•l

••Ū”_—Ñ•... Y<ÆCEα<†fZf“f^•[‰◀◀“ê x•Š•E’i”“ç í•φ•ā•ξ•iCEα<† °

•@



•@

[前へ](#) [最初に戻る](#) [目次](#) [次へ](#)

•@

—} —á

••Ú :<Z•p,]••Ú“]•É•L,ª•A“K%••«

,» ,ì• ,ì” _—Ñ•...ŽY<Æ%œü—Ç,É‘Í,μ,ĂŠJ”- ,μ,½<Z•p,ì“K%œž••« ,ª• ,••A,» ,ì<Z•p,ì“K%œž,ì”ÍÍ ,ª• n^æ“I•A••‘Ū“I•L,ª ,è,ì ,é•-%œĚ

œα† :fV•[fY,Æ,μ,Ā,ìd—v••AŠw•p“l”-“W,ì,½,β,ìŠñ—^

••‘Ū“I,É•L,çŽ<-ì,ðŽ•,Ā•V,μ,ç<Z•p,ìŽŽ,Ý,Ā•AŽŽœ±œα†,ìi“W,É,æ,Ā,Ā<Z•p,Æ,μ,Ā”-“W,·,é%œĀ^••« ,ì• ,ç,à,ì•B,Ū,½•AŠw•p“I,ÉŠ®•-“x,ª• ,••AŠi“b“l’mœ©•Aœα†žè-@“™,ìŠJ”- ,ÉŽ‘ , ,é•-%œĚ

•s• :•s•-y,Ñ Y<ÆŠE,ìfj•[fY,ÉÍ,·,é•vœœ

<œ“œα†• ,ìs•-“I—v••ç,ð-ž,½,·,à,ì,Ā•A,» ,ì• ,ì” _<Æ,ì•U<»,É’¼•Ū•EŠŌ•Ū,É%œœ<ç,ðŽ•,Ā%œž—p“lœα†<Z•p,ì•-%œĚ

ŽQ •l

•@‘¼’²•®<æ•ª,ìœα†•-%œĚ•i•ñ,ìª—P

•@••<y:••<y,É^Ū,μ“¾,é•-%œĚ

•@Žw“±:<Z•pŽw“±,ÉŽQ•l,Æ,È,é•-%œĚ

•@œα†:œα†<y,Ñ<Z•pŠJ”- ,É—Lœø,È•-%œĚ

•@•s•-:•s•-Ž{•δ“™,É”½%œf,μ,œ,é•-%œĚ

[前へ](#) [最初に戻る](#) [目次](#) [次へ](#)

•@

目次

次へ

@

1. はじめに

1.1 国際食料政策研究センターの設立と役割

1.2 国際食料政策研究センターの組織と運営

1.3 国際食料政策研究センターの活動と成果

1.4 国際食料政策研究センターの将来展望

1.5 謝辞

2. おわりに

3. 参考文献

4. 問い合わせ

目次

次へ

@

@

2. “ú-{-Y-~” ,Æ†-“ç-~” ,l-Ö,©,Ña†R«“ä“ q,l”äŠr,Æ•W†

“ú-{-Y-~”	Æ†-“ç-~”	l-Ö	©	Ña†R«“ä“	q,l”äŠr	Æ•W†
“ú-{-Y-~”	Æ†-“ç-~”	l-Ö	©	Ña†R«“ä“	q,l”äŠr	Æ•W†
“ú-{-Y-~”	Æ†-“ç-~”	l-Ö	©	Ña†R«“ä“	q,l”äŠr	Æ•W†

“ú-{-Y-~”

“ú-{-Y-~”

Æ†-“ç-~”

1. “ú-{-Y-~”
2. “ú-{-Y-~”
3. “ú-{-Y-~”

Æ†-“ç-~”

1. “ú-{-Y-~”
2. “ú-{-Y-~”
3. “ú-{-Y-~”

“ú-{-Y-~”

“ú-{-Y-~”

	“ú-{-Y-~”	Æ†-“ç-~”	l-Ö	©	Ña†R«“ä“	q,l”äŠr	Æ•W†
“ú-{-Y-~”	MR	S	(Ev)	Q	R	Q	R
Æ†-“ç-~”	55	8	0	63	5.08	0.002	0.002
l-Ö	45	12	0	57	0.47	3.81	0.002
©	100	20	0	120	4.44	1.92	0.002

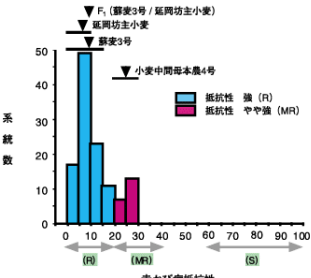


図1 (延岡坊主小麦 x 蘇麦3号) F1 由来の半数体倍加系統における赤かび病抵抗性の頻度分布。*両端矢印の線は抵抗性強(R)、やや強(MR)および罹病性(S)の標準品種のレンジを示す。

“ú-{-Y-~”

Æ†-“ç-~”

l-Ö

©

Ña†R«“ä“

q,l”äŠr

Æ•W†

“ú-{-Y-~”

“ú-{-Y-~”

Æ†-“ç-~”

@

@

k v n "E k f f C l j R f f p f e s . e . , , e " _ e a q y e s o . i . e . , f z s a			
k v n "E k f f C l j R f f p f e s . e . , , e " _ e a q y e s o . i . e . , f z s a	140 kg/ha, EE@1.3, e, eB " n. ES@E', e, e', f - E. 34 kg/ha. e. AS@E', e, E, e', f - E. 58 kg/ha. A. eA. e. e. l - eSOE' - L. @ * Z' CE' . n. OCE@ - t. ES@E' . e. e. E. e. e. A. ' fZuZx. l' K * % e . S@' O. A. , eB	EA - * e	0298(38)6355
*U " - N ... ZY. EE@ f Z' f' f' + ES@ z CE "	*U " . AE	é - á	Z' CE' - - p
*% e - %	*U " . AE	[- U	(E - U% e - l - Z' p
[* - P			[* - P

- k w CE. E. e. e. e
- "E k f f C l j R f f p f e s . e . , , e " _ e a q y e s o . i . e . , f z s a l j a . e B . a . l E " o . E . u . A . A " i " - E " y e a " . q . e . A . e . e . B . e . l . e . p . E " n . e . A . z * E " o . E . s m - s . e . % . B . E . f . A " _ e f " O E n . e . , , e - | * z S A . l j a " o . s " v . u . n . e . l - (* Z ' CE' . A - L E @ - - - p . u . A " y e " - - " X E u . i . l . % . B . l . e - @ . s m - s . e . e . A . e . K - v . A . e B . u . e . A . A " CE - k f f C l j R f f p f e s . o l j . U . E . A " n . e / CE / x / e . E . , , e . ' f z S A . s - % . e . e . u . A - (* Z ' CE' . E . u . A . l - - - p z A . O . l ' c " . s . o . B
- k * - % E . l j a - e - E " A " y
- 1. "E k f f C l j R f f p f e s . e s o . i . e 1990 " 1992 " N " i - e v z - . . A . * f f f / A E @ + n * A E u " n " . A " f C E @ + Z O . l j m E @ . s l . E . A " _ n . A " Z Y . e . l . % " i - * H (S " @ e e " l j Z " - (* A) * % A - H + e . s E o . A . A " p s u " . E . E . e . A " - . . a . u . - l " _ n . E " S " u . l . e . e ' . f - E . o . B . A / R f f p f e s . E . , , e " N S O . l j . f z S A . o . B . l j a) l j + B
- 2. * z Y O . l j Z Y - E . l s 2 kg/ha. E % . e . A " % * E a . * + e S O . O z . e . o . l . e . A . e . e . @ * A . p . l . e . e . e . B % e E " * A . f a " % . " . E Z l - p . l . e . A . e . e . A " Z Y - E . 34 kg/ha. E . U . e . % . - E . e . B . l . l . * A . A " f S / - . l S . " _ n . E - - - p . l . e . A . e . E . e . B % e S w " - Z l - p - E . l 18 kg/ha. E . a . e B
- 3. " _ n . E . , , e " : f Z u Z x . l - 40 kg/ha. EE@1.3, e, eB " n. ES@E', e, e', f - E. 34 kg/ha. A. e. l. E. l. u. AS@E', e, E, e', f - E. 58 kg/ha. A. e. A. e. e. l - L. @ * Z' CE' . s " n. O - L E @ . ES@E' . e . e . A . e . A " . f Z u Z x . l ' K * % e . E . d - v . A . e B
- k * % E . l S - p - E - E - " O " . i
- 1. - [Z e - A " % . e . e CE % E . f . A " n . e " . A - - - p % A " \ E - L . @ * Z ' CE' l - L E @ - - - p . l . % . E . l u - " l f % e z l j o " e . E S - - - p . A . e . e B
- 2. " y e " - " x . s . s . e . e . o . E - L . @ * Z ' CE' . s - - - p . e . e . A . e . d - v . A . e . A . . l . % . B . E . f . A " _ n . E Z l - p . l . e . l - L . @ . " l " @ " O % o - % . K - v . A . e B
- 3. - L . @ * Z ' CE' l - - - p z A . O . s . e - % . e . e . e . l . % . B . A " _ % e . O . l . e . z e . e " . s . o . K - v . l . e B

k s l j f f j a

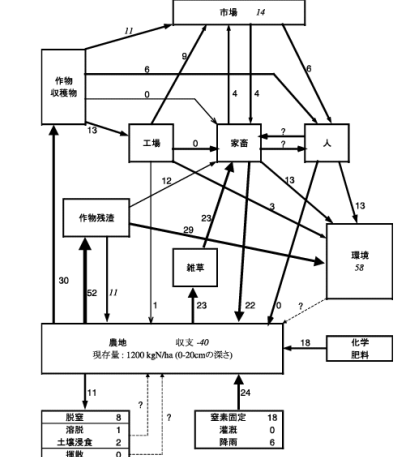


図1 タイ国コンケン郡における農業生産に伴う窒素循環 (1990-1992, kgN/ha/y) (イタリツはインプットからアウトプットを引いた値)

k , , l j a

(E@+eU)'s-% *F "E k f f C l j R f f p f e s . e . , , e " _ e a q y e s o . i . e . , f z s a . e s . (E@+
 - Z Z . e e + * F * * U (E@+m "E k f f C m
 (E@+S@sO * F +/s-12"N"x+i8*12"N"x+j
 (E@+S'-ZO * F +/s-1+s+v

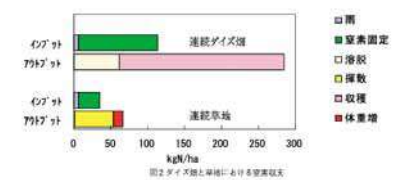
"A_ * TM * F +/s-[s+vEKobbiet PaisanchaenE Vidhaya Trelo-ges (1999) "E k f f C l j R f f p f e s . e . , , e " _ e s " @ . e s O . e . , f z S A . d j v j x e f " _ s w l 5 - E 1 : 45-46.

@

5. **fuf%Wf<|'n'',æNf_fCfY''É,"-é',f ù x**

0298(38)6353	0298(38)6353
0298(38)6353	0298(38)6353

1. JIRCASへようこそ! (2001) Nitrogen cycling in agropastoral system in the Cerrados, JIRCAS Newsletter No. 24
2. Kanda, K., Takahashi, M., C.H.B. Miranda (2001) Nitrogen flow in agropastoral system, Brazil. JIRCAS Journal, 9: 23-31



1) Kanda, K. (2000) Nitrogen cycling in agropastoral system in the Cerrados, JIRCAS Newsletter No. 24

2) Kanda, K., Takahashi, M., C.H.B. Miranda (2001) Nitrogen flow in agropastoral system, Brazil. JIRCAS Journal, 9: 23-31

•@

6.CO 2 ”Z“x’‰Á,É,Æ,à,È,α...“c,©,ç,Ìf•f^f”-•¶—Ê‘‰Á									
•k —v—ñ • CO2”Z“x’‰Á ,Í... ãìf of Cf If } fX ,đ‘‰Á, ^{3,1,é,Æ} “Žž,É•A...“c,©,ç,Ì f•f^f”-•¶—Ê ,đ‘‰Á, ^{3,1,é} •B									
•‘Û”_—Ñ...ŽY<Æœ<†fZf“f^•[•EŠĂ«Ž‘œ‘”					~A—•æ		0298(38)6306		
•’œi-¼		•‘Û”_<Æ		•ê-â	ŠĂ«•Û’S	‘Û	^ÛŽ•EŠÇ—•Z•p	• ^a —P	œœ<†

•k ”wœi•E,È,ç,ç •l

•çŠE“I,È...“c•k•i—Ê•İ,İšg‘â,É,Æ,à,È,α...“c,©,ç,Ìf•f^f”-•¶—Ê,Ì‘‰Á,Í•A’n<...‰œ’g‰œ»,Ìœ’^ö,Ì,Đ,Æ,Â,Â, ,é,Æ•l,l,ç,ê,Ä,ç,é•B^ê•û•A<ß”N,Ì‘â<C’†“ñŽ_‰œ»’Y‘f•iCO 2 •j”Z“x,Ì‘‰Á,Í•A...“c,É,“, ,é’Y‘f•zŠĂ—Ê,đ‘‰Á,^{3,1,é,½,ß}•A,^{3,ç,É}f•f^f”-•¶—Ê,đ‘‰Á,^{3,1,é,±,Æ}•A,l,ç,ê,é•B—{œœ<†,Â,Í•A6Šî,Ìf^fff“fo•[Ž{•Y•i“à—e•İ•F20.0 m 3 •j,đ—p,ç,Ä•Aœ»•Y,İCO 2 ”Z“x•đœ‰œ°•i350 ppm•j,Æ•CO 2 ”Z“x•đœ‰œ°•i650 ppm•j,Â...‘î,đ•Í’l,µ•A‘â<CCO 2 ”Z“x’‰Á,^a...“c,©,ç,Ìf•f^f”-•¶,Éy,Û,‰œç,đ-¾,ç,©,É, ,é,±,Æ,đ—Û“I,Æ, ,é•B

•k •-‰œÊ,Ì“à—e•E“Á’¥ •l

1. ... ‘î•Í’lŠúŠÔ,É,“, ,é f•f^f”-•¶—Ê,Í•A350,“,æ,Ñ650 ppm CO 2 ”Z“x,É,“,ç,Ä•A,»,ê,¼,ê18.4,“,æ,Ñ21.8 g/m 2 •i1998”N•j•A5.6,“,æ,Ñ13.7 g/m 2 •i1999”N•j,Â, ,è•A•,CO 2 •^—•,É,æ,è...“c,©,ç,Ìf•f^f”-•¶—Ê,Í—L’Ó•iP<0.05•j,É‘‰Á, ,é•i •} 1,“,æ,Ñ2•j•B
2. f•f^f”-•¶,É‘Û, ,éCO 2 ”Z“xœ‰œÊ,Í—¼”N,Æ,à•Í’lœĂšú,É,“,ç,Äœ°” ,Â, ,é•i •} 1,“,æ,Ñ2•j•B
3. •,CO 2 ”Z“x•đœ•,Â,Í•A... ‘î,Ì’n•â”f of Cf If } fX—Ê,Í—L’Ó•iP<0.05•j,É‘‰Á, ,é•B,Û,½•Aœs” ,“,æ,Ñ,à,ÝŽû—Ê,à‘‰ÁœXœü•iP=0.05,Â—L’Ó•,È,µ•j,đŽl,•i•l•j•B
4. ‘½—Ê,Ì‘î,í,ç,đŽ{—p,µ,½1998”N,Â,Í•A•Í’l‘OŠú,©,ç‘î,í,ç•Nœ’l,Ìf•f^f”-•¶,œ°” ,Éœ©,ç,ê•A,»,Ìœ‰œÊ•A•Í’lŠúŠÔ’S‘Ì,Â,Ìf•f^f”-•¶,É‘Û, ,éCO 2 ”Z“xœ‰œÊ,Í•,ç,ç•i •} 1,“,æ,Ñ2•j•B
5. ^ê-â,Ìœ‰œÊ,Í•A‘â<C’†,İCO 2 ”Z“x’‰Á,^a... ‘î,Ìf of Cf If } fX—Ê,đ‘‰Á,^{3,1,é,Æ}“Žž,É•A...“c,©,ç,Ìf•f^f”-•¶—Ê,đ‘‰Á,^{3,1,é,±,Æ}đŽl•’, ,é•B

•k •-‰œÊ,İš^—p—Ê•E—^Ó“_ •l

’n<...ŠĂ«•İ‘©,İ³,ÌftfB•[fhf of bf Nœ‰œÊ,Æ,µ,Ä•A«—^,É,“, ,é...“c,©,ç,Ìf•f^f”-•¶—Ê,Ì•, ,é,Éš^—p,^{3,é}•é•B

•k <î‘İ“İff•[f^ •l

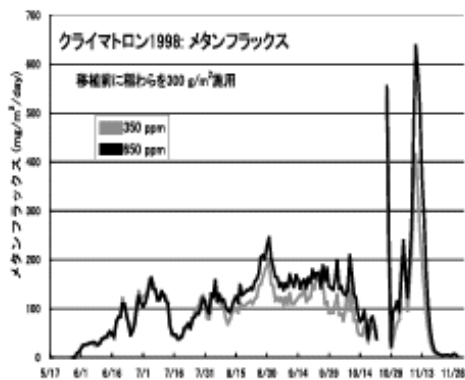


図1 現在のCO₂濃度条件下と高CO₂濃度条件下でのメタンフラックスの季節変化(1998年)(5/15 湛水・移植、10/15 収穫、移植時より、10月下旬の最終落水まで常時湛水状態)

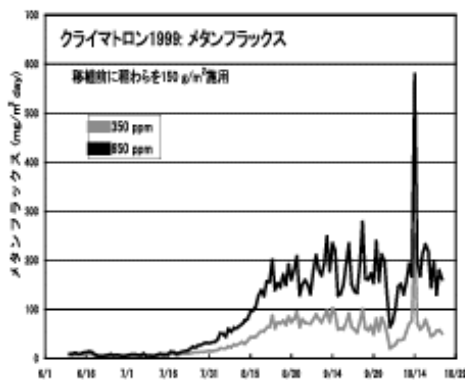


図2 現在のCO₂濃度条件下と高CO₂濃度条件下でのメタンフラックスの季節変化(1999年)(5/15 湛水・移植、10/6 収穫、移植時より、10月下旬の最終落水まで常時湛水状態)

表1 高CO₂濃度処理が水田からのメタン発生と水稲収量に及ぼす影響

	メタン発生量 [*] (g/m ²)	地上部バイオマス量 (g/m ²)	地下部バイオマス量 (g/m ²)	茎数 (/m ²)	もみ収量 (g/m ²)
1998					
現在のCO ₂ 濃度 (350 ppm)	18.4 a	1634 a	151 a	475 a	650 a
将来のCO ₂ 濃度 (650 ppm)	21.8 b	1783 b	158 a	498 a	795 a
増加割合 (%)	18.5	9.1	5.0	4.7	22.4
1999					
現在のCO ₂ 濃度 (350 ppm)	5.6 a	1657 a	140 a	478 a	774 a
将来のCO ₂ 濃度 (650 ppm)	13.7 b	1802 b	138 a	511 a	839 a
増加割合 (%)	144.6	8.8	-1.5	7.0	8.4

数値の右側の異なる記号は、高CO₂濃度処理にて有意差(自由度2の2処理間の差に関するt検定、P<0.05)のあることを示す

*5/15から10月下旬までの湛水期間の総発生量

•k ,»,İ¼ •l

œœ†%œÛ'è •F •...“c,©,ç,Ïf•f^f“”-•¶—Ê,Ï•]œœi,Æ,»,-}•§<Z•p,ÉŠÖ,•,éœœœ†

—ŹZœœ•ª •F œœœ•í•A%œÈ•E•í—ªŠî•b•kFACE•l

環境省 農林水産省 国際協力事業団

環境省 農林水産省 国際協力事業団

Yagi, K., Li, Z., Sakai, H., and Kobayashi, K. (2000): Effect of elevated CO₂ on methane emission from a Japanese rice paddy, Proceedings of the FACE 2000 Conference, p. 40.

[前へ](#) [最初に戻る](#) [目次](#) [次へ](#)

•@

8. fzfWf+feJf'fJ.E1. e'f'fWfffffJfJ... fce'f]-06f. H f'fR'e			
4. ... 4. ... f'fWfffffJfJ... fce'f]-06f. H f'fR'e			
f'fWfffffJfJ... fce'f]-06f. H f'fR'e			
f'fWfffffJfJ... fce'f]-06f. H f'fR'e			
f'fWfffffJfJ... fce'f]-06f. H f'fR'e			

- 1. ... 1. ... f'fWfffffJfJ... fce'f]-06f. H f'fR'e
- 2. fzfWf+feJf'fJ.E1. e'f'fWfffffJfJ... fce'f]-06f. H f'fR'e
- 3. ... 3. ... f'fWfffffJfJ... fce'f]-06f. H f'fR'e
- 4. ... 4. ... f'fWfffffJfJ... fce'f]-06f. H f'fR'e

4. ... 4. ... f'fWfffffJfJ... fce'f]-06f. H f'fR'e

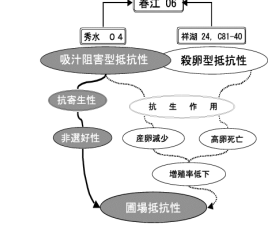


図1 春江 06 のセロワンの抵抗性機序

表1 春江 06 (TN) 変異 F2 のセロワンの抵抗性表現型の分離

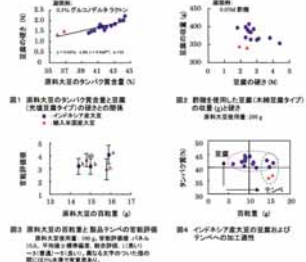
F2 集団	菌数 (阻害/殺菌)				P
	有/無	有/有	無/有	無/無	
春江 06 (TN)	42	14	4	0	1.44 (0.30)
TN1 (野生)	36	9	4	2	3.65 (0.30)

TN1: セロワンの感受性品群
 4. ... 4. ... f'fWfffffJfJ... fce'f]-06f. H f'fR'e
 春江 06 (TN) 変異 F2 のセロワンの抵抗性表現型の分離
 ... 22e + 4e + 0e ... 4e + 4e + 0e ...
 ... fzfWf+feJf'fJ.E1. e'f'fWfffffJfJ... fce'f]-06f. H f'fR'e ...
 ... fzfWf+feJf'fJ.E1. e'f'fWfffffJfJ... fce'f]-06f. H f'fR'e ...

9.fCf"jhffVfJA Y'a'x"l"we...Efef"fy.O]%.A#H"K«
4.→4.fCf"jhffVfJA Y'a'x"l"we...Efef"fy.O]%.A#H"K«
4.→4.fCf"jhffVfJA Y'a'x"l"we...Efef"fy.O]%.A#H"K«

4.→4.fCf"jhffVfJA Y'a'x"l"we...Efef"fy.O]%.A#H"K«
4.→4.fCf"jhffVfJA Y'a'x"l"we...Efef"fy.O]%.A#H"K«
4.→4.fCf"jhffVfJA Y'a'x"l"we...Efef"fy.O]%.A#H"K«

4.→4.fCf"jhffVfJA Y'a'x"l"we...Efef"fy.O]%.A#H"K«



4.→4.fCf"jhffVfJA Y'a'x"l"we...Efef"fy.O]%.A#H"K«
4.→4.fCf"jhffVfJA Y'a'x"l"we...Efef"fy.O]%.A#H"K«
4.→4.fCf"jhffVfJA Y'a'x"l"we...Efef"fy.O]%.A#H"K«

@

10.fCf fhflfVfA,É,,-,é,â,“x”-o,y’2-i%otfPpf fffbfv»‘ç—p••Ü,l%ü—Ç

*k—v-n-i fCf fhflfVfA, î-Y-ü-l'ä"-y’2-i%otfPpf fffbfv, î••»'ç—p,É•A Aspergillus ‘@, î-L-pŠ”,@,çŽšSOü•EŽÉ,É,æ,è ”•F•fUS” ,đ•i•-,µ,½B”••i•Y, î fAftf%ofgfLfVfVf”•ŲZY,Ų ,Æ,îŽ-É,æ—e-Ö,È,½, B•A fXf^i/f^ižžÛj ,Æ,µ,ÄŽg—p,Ä,«,é•B							
••Ü” —N...ŽY,Æ(Èç†fZf”f^fE•ŲZY—p••)•A							
•H•i’••ž(Èç†šE•H•i•@~\”•E(È”S•«%Ų(Èç†Ž”•A	~A—••æ	0298(38)6307					
fCf fhflfVfA“ç—p•fCf,—P•i”•(Èç†š							
•%çï-¼	••Ü”_Æ	•è-â	—p•E%çÄ•H	•î-Ų	”_ZY•	••—P	(Èç†

*k “wEi•E,È,ç,ç •l

“â“@,ç,Ä, -,ç,è,é,“••H•i, î,è,Ä, îfPpf fffbfv, î•A fCf fhflfVfA, î-Y-ü-l, î’2-’%çt, Ä, , é•B, „î•»'ç, î•A, Ų, •AŽî•n, µ, ½’â“o, ÉŽ... •ó•Ü, đ•Ųç, ³, î•A’â“o•, đ”•», , é, ±, Æ, çŽn, Ų, é•B, „, î•Ü’½, -, î•H•é, Ä, î•AŽîÛ, đ•ÜŽi, î, , •A’•u, µ, ½Žî”ç, ÉŽç, Æ, µ, Ä, -, é Aspergillus
 @”TM, îŽ... •ó•Ü, È, æ, è, ä“ç••, đ•»'ç, , é•B, µ, ç, Æ, ç†fCf fhflfVfA, î, Ų, ½•AŠî”YfKf” , đ”•, «N, ±, %çÄ”•«, î••, ç fJf”•Ä fAftf%ofgfLfVfVf” , đ•ŲZY, , é Aspergillus
 ‘Ž... •ó•Ü, î•Ų’ n, Ä, à, , é•B, ±, î, ½, B•A’A’S•«, îŠî”_ç, ç•A fPpf fffbfv••, î••ç—@, đ%çü—Ç, , , é, ±, Æ, đ—Ü”î, Æ, , é•B

*k •-%çÈ, î”à—E”Á”Y •l

- fCf fhflfVfA, îŽš•é, Ä•w•ü•A“üŽè, µ, ½%fçf bJfJzC•AfgfEf, f•fRjV, @, ç, î•A•, p”x, Ä fAftf%ofgfLfVfVf” , æEY•o, ³, é•A•ŲZY, Ų, à•”-£, ³, é, é•B
- îŽæ, µ, ½fCf fhflfVfA, î”â“ç•ŽŽ—i, @, ç fAftf%ofgfLfVfVf”•ŲZY•«Ü, à•”-£, ³, é, ½, ±, Æ, ç, ç•A”S•«, îŠî”_ç, ç•â“ç••»ç—@, đ%çü—Ç, , é•K—v•«ç, , é, çj•\i•j•B
- Aspergillus oryzae-flavus (Èç, îfPpf fffbfv—p, î—D—Ç, ŲŠ”, đ”î”đ, µ•AŽššO•ü•ÆŽÉ, È, æ, è””•F•î”ÜŠ”, đ”i•-, µ, ½•B
- , ±, é, ç, î”ÜŠ”, î•A•••”†, È∧-È, È•o(È, µ, ½””•F, î-Ežq, È, æ, è•A fAftf%ofgfLfVfVf”•ŲZY, Ų, Æ, îŠōŠî, @, ç—e-Ö, ÉŽ-È, ³, é, ç, î•j•A, Ų, ½•A’î”ÜŠ”, Ä”²», µ, ½Ppf fffbfv•”-i, î•A•... -n•«, ‘f•AftfHfç, i[fç’, f, Æ, àèŠ” , Æ, Ų, Æ, ñ, Ç, î, i, ç, è, ç, ±, Æ, ç, ç•AŽg—p, đ, •, š, Ä, «, é•B

*k •-%çÈ, îŠ—p-ÈE—”Ų_ •l

fCf fhflfVfA, î, æ, ç, Æ, ç†fAftf%ofgfLfVfVf”•ŲZY, Ų, î, ç•Y’n, Ä, î”•F•î”ÜŠ”Žg—p, î—L—p•«A•K—v•«, ”F, B, ç, è•A•(Eã•A’A’S•«, î•, ç””•F•î”ÜŠ”, î—p, æŠü”ö, ³, é, é•B

*k ç”î”fçf f”•l

表1 インドネシアの農産物および雑草から分離したAspergillus属菌株のアフラトキシン生産性

菌株	分離源	アフラトキシン(ppm) ¹⁾	
		B ₁	B ₂
GN1-2	ラッカセイ	N.D. ²⁾	N.D.
GN2-2	ラッカセイ	2	Trace
GN2-3	ラッカセイ	14	0.8
Corn	トウモロコシ	0.2	Trace
PD3	籼	21	0.5
R2	精白米	0.9	Trace
M2	土壌	8	0.2
K-1	雑穀 ³⁾	N.D.	N.D.
1-1	麹, No.1	N.D.	N.D.
1-2	麹, No.1	N.D.	N.D.
1-3	麹, No.1	1	Trace
2-1	麹, No.2	N.D.	N.D.
2-2	麹, No.2	N.D.	N.D.
2-3	麹, No.2	N.D.	N.D.
2-4	麹, No.2	N.D.	N.D.
2-5	麹, No.2	13	0.3
4-1	麹, No.4	N.D.	N.D.
4-2	麹, No.4	N.D.	N.D.
4-3	麹, No.4	N.D.	N.D.
4-4	麹, No.4	N.D.	N.D.
4-5	麹, No.4	N.D.	N.D.
5-1	麹, No.5	N.D.	N.D.
5-2	麹, No.5	N.D.	N.D.
5-3	麹, No.5	N.D.	N.D.
5-4	麹, No.5	N.D.	N.D.
5-5	麹, No.5	N.D.	N.D.
5-6	麹, No.5	N.D.	N.D.
6-1	麹, No.6	N.D.	N.D.
6-2	麹, No.6	N.D.	N.D.
6-3	麹, No.6	N.D.	N.D.
6-4	麹, No.6	N.D.	N.D.
6-5	麹, No.6	N.D.	N.D.

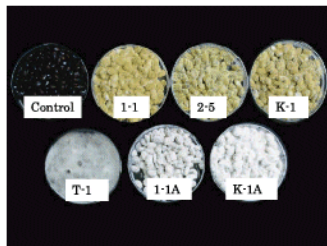


図1 白色変異株等を用いたケチャップ麹の調製

接種後3日間28℃での培養後の麹
 Control : 菌は接種せず(原料:黒大豆)
 1-1 : ケチャップ麹No.1からの分離菌株
 2-5 : ケチャップ麹No.2から分離されたアフラトキシン生産菌
 K-1 : 日本製麹造りからの分離菌
 T-1 : テンペ用の種菌
 1-1 A : 1-1 からの白色変異株
 K-1 A : K-1 からの白色変異株

¹⁾7日間培養したGY培地中のアフラトキシン濃度
²⁾検出せず,検出限界,アフラトキシンB₂で10 ppb
³⁾日本製麹用種麹

*k ,», î”¼ •l

(Èç†%çÜ”è-¼ •fCf fhflfVfA,É,,-,é,n”æ”_ZY•”, îžž•%çç, , æ, N—LÈç—p

—(ŽZ,æ æ •F••Ü(Èç†k’n”æ”_Æ•l

(Èç†šü Šō •F •½•-12”N“x•i10”12”N“x•j

(Èç†”S“•Žō •F•V•••K•ACEã”“Nçv•i•H•(Èç•E•H•i•@~\”•j•AGinting, E., Antarlina, S. S., Utomo, J. S. i fCf fhflfVfA•E”ç—p•fCf,—P•i”•(Èç†š•j

”-∨_ç”™ •F

1. Goto, T., Ginting, E., Antarlina, S. S., Utomo, J. S., Ito, Y., and Nikkuni, S., 1999. Aflatoxin contamination of agricultural commodities and fungi isolated from those in Indonesia. Proceedings of the International Symposium of Mycotoxicology, September 1999, Chiba, Japan, pp. 211-215.
2. Goto, T., Ginting, E., Antarlina, S. S., Utomo, J. S., and Nikkuni, S., 1999. Aflatoxin contamination of agricultural commodities on market and mycotoxin productivity of fungal isolates from Java, Indonesia. Final Program of the 113th AOAC International Annual Meeting, September 1999, Houston, USA, P. 74.
3. Nikkuni, S., Ginting, E., Antarlina, S. S., and Utomo, J. S., 2000. Improvement of Kecap koji making process using a white-spored mutant of koji mold. RILET-JIRCAS Workshop on Soybean Research, Malang, Indonesia, September 28.
4. Nikkuni, S., Ginting, E., Antarlina, S. S., and Utomo, J. S., 2000. Isolation of white-spored mutants from the koji molds for the production of Kecap, an Indonesian soy sauce. Proceedings of the 3rd International Soybean Processing and Utilization Conference, October 2000, Tsukuba, Japan, pp. 345-346.

[前へ](#) [最初に戻る](#) [目次](#) [次へ](#)

•@

12. 水稲と大豆の混作による持続可能な農業			
12. 水稲と大豆の混作による持続可能な農業	12. 水稲と大豆の混作による持続可能な農業	12. 水稲と大豆の混作による持続可能な農業	12. 水稲と大豆の混作による持続可能な農業
12. 水稲と大豆の混作による持続可能な農業	12. 水稲と大豆の混作による持続可能な農業	12. 水稲と大豆の混作による持続可能な農業	12. 水稲と大豆の混作による持続可能な農業

1. SEZL-E... (混作による持続可能な農業)
2. ... (混作による持続可能な農業)
3. ... (混作による持続可能な農業)
4. ... (混作による持続可能な農業)
5. ... (混作による持続可能な農業)



図1 水稲と大豆の混作による持続可能な農業

表1 水稲と大豆の混作による持続可能な農業 (10年間の平均)

項目	混作		単作	
	平均	標準偏差	平均	標準偏差
水稲の収穫量 (t/ha)	10.2	1.5	9.8	1.2
大豆の収穫量 (t/ha)	3.5	0.8	3.2	0.7

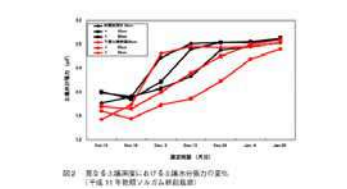


図2 水稲と大豆の混作による持続可能な農業 (10年間の平均)

12. 水稲と大豆の混作による持続可能な農業

12. 水稲と大豆の混作による持続可能な農業

12. 水稲と大豆の混作による持続可能な農業

12. 水稲と大豆の混作による持続可能な農業

@

Table with 5 columns: 年次, 品種, 播種期, 播種量, 収量. Rows include data for 2000, 2001, and 2002 across various rice varieties and planting dates.

- Table caption: 表4 異なる播種期における播種量と収穫量の関係
Table with 10 columns: 播種期, 播種量, 収量, 播種期, 播種量, 収量, 播種期, 播種量, 収量, 播種期.
Caption: 表5 異なる播種期における播種量と収穫量の関係
Table with 10 columns: 播種期, 播種量, 収量, 播種期, 播種量, 収量, 播種期, 播種量, 収量, 播種期.
Caption: 表6 異なる播種期における播種量と収穫量の関係
Table with 10 columns: 播種期, 播種量, 収量, 播種期, 播種量, 収量, 播種期, 播種量, 収量, 播種期.



表7 異なる播種期における播種量と収穫量の関係

Table with 6 columns: 年次, 播種期, 播種量, 収量, 播種期, 播種量. Rows show data for 2000, 2001, and 2002.

Table with 6 columns: 年次, 播種期, 播種量, 収量, 播種期, 播種量. Rows show data for 2000, 2001, and 2002.

表8 異なる播種期における播種量と収穫量の関係

Table with 6 columns: 年次, 播種期, 播種量, 収量, 播種期, 播種量. Rows show data for 2000, 2001, and 2002.

@

@

16.fpf%<i>fOfAfC</i>,l—LŠQ•ü” —}•š,É—LCEø,Èf_fCfY<i>i íA—Öi•i•“y,NÍ•R•A•”</i>			
*k—v—ñ•1fWfff•flfRfuZf“f...fE,lü”Z—š“x”š%ø,É_f_cFY5•iZi•A f~fif~flfOfTf(ÉfZf“f...fE,Ä,l_f_cFY1•iZi•A —Öi•i•”1•iZi•A ’l•R•A•”1•iZi•A fjjZfifNf•fZf“f...fE,Ä,l_f_cFY3•iZi•A—Öi•i•”1•iZi•A,—p,Ä,«é•B			
*Ü” —N•...ZY•Æ(Éø•†Zf“f•[•A—kŠC“”_ÆZZÉ±•é•A		A—••æ	
”_Æ(Éø•†Zf“f•[•A—kŠC“”_ÆZZÉ±•é•A		0298(38)6362	
fpf% <i>fOfAfC</i> ”_q•É•A••Ü•l—lZ—Æ’c’fpf% <i>fOfAfC</i> ”_Æ’••žžÉ±•é			
*%ä—¼	*•Ü”_Æ	*é—ã	*i•”žšQ
			*l•Ü
			f_cfY
			*l—D
			*•Ü

- *k ”w(Éi•E,È,ç,ø•l
- É••Y•Afpf%*fOfAfC*,l“i(Én”_cl,ð“†•S,É:ã•K—l,Èf_f_cFY,l“s•k•N•l“l,Ä•q•ŠE’è,l’Pžü,ð•ã,°,Ä,ç,é•B•i(Éä,Æ,ä•,•†žžY•«,ø”žž•,µ”Ä`è%ø,³,¹,é,½,B,É,l“l“l“E”y•é•E•AšQ”žž“TM,l—ã`è,ð%ø(É”,µ,È,`,é,l,È,ç,È,ø•B,»l”è,Ä,É•ü”žž—ã`è,°,é•A—Öi•i(Én,ð’È,µ,Ä`áfRfXfg•E’Ä`è”l,È•kžž—h•æ—@,ðšm—š,,é•K—v,°,é•B
- *k —%ø,È,l“ã—é•E”Ä”Y•l
 1. fpf%*fOfAfC*,l_f_cFY•l“l“n,Ä,l“fWfff•flfRfuZf“f...fE•A f~fif~flfOfTf(ÉfZf“f...fE•y,NífjZfifNf•fZf“f...fE,l3žž,l—LŠQ•ü”žž,“”F,B,ç,é,é•B
 2. f_cfY•iZi•i•uBR-6•v•A•uSANTA ROSA•v•A•uFT-COMETA•v•A•uBRAGG•v•A•uFORREST•v•j,l5f—(ÉžšÖ•l“l“i”E%ø“”•†j,É,æ,èfWfff•flfRfuZf“f...fE,l—š“x,Í(É“”_É`á%ø°,.,é•B
 3. —Öi•i•”i•fGf“fofNufwJcFlf(ç•v•j•A’l•R•A•”i•jNf•f“%øšfA•j•A_f_cfY•iZi•uPEKING•v,ð•l“l,.,é,±,Æ,Ä•A f~fif~flfOfTf(ÉfZf“f...fE,l—š“x,ð”ãžžž,l90%•20%,É`á%ø°,Ä,«é•B
 4. f_cfY•iZi•i•uSHARKY•v•A•uPICKETT•v•A•uFORREST•v•j•A—Öi•i•”i•fj•fKf•j,ð•l“l,.,é,±,Æ,Ä•A fjZfifNf•fZf“f...fE,l—š“x,l80%•30%,É`á%ø°,Ä,«é•B
- *k —%ø,È,lŠ—p—È•E—”Ó”_•l
 1. f_cfY•p•é,l“”•†žž”žž,lžž,ðšm”è(Éä•A—LCEø,È•kžž—h•æ,l,½,B,l“i•”,ð”l`è,.,é•K—v,°,é•B
 2. f_f•fKf,l_f~fif~flfOfTf(ÉfZf“f...fE,É,Í(Éø%è,è,³,—”½”l,È•ü”žž,ð•,ã,µ•A”išQ,ð••”,.,é,l,Ä•l“l,È“—,½,Ä,Ä”•Ó,.,é•K—v,°,é•B

表1 ジャワネコブセンチュウ

線虫	作物(品種)	線虫密度		
		初期	終期	減少率
ジャワネコブセンチュウ	ダイズ BR-6	8.0	0	100.0%
	SANTA ROSA	39.0	0	100.0
	FT-COMEITA	39.0	0.1	99.7
	BRAGG	16.3	0.1	99.4
	FORREST	16.3	0.4	97.5
ミナミネグサレセンチュウ	ダイズ AURORA	3.2	16.0	****
	エンバダ「ハイオーツ」	21.1	1.6	92.4
	クロタラリア「ネロボキラー」	6.9	3.4	50.7
	ダイズ PEKING	31.2	24.5	21.5
	AURORA	47.2	79.6	****
ニセフクロセンチュウ	ソルガム「ラッキーソルゴ」	0.2	182.8	****
	ダイズ SHARKY	132.4	25.1	81.0
	PICKETT	46.0	21.1	54.1
	FORREST	60.1	36.6	39.1
	ソルガム「ラッキーソルゴ」	8.0	5.5	31.2
ダイズ AURORA	115.2	204.8	****	

ジャワネコブセンチュウは鉢試験結果。他の2種は圃場試験結果。
 初期：栽培前線虫密度 (A)、終期：栽培後線虫密度 (B)、減少率：[1 - (B/A)] × 100%
 線虫密度：線虫数/土壌 20g、線虫分離法：バerman法 72時間、25℃。
 ****：増加のため、数値表示せず

*k ,»l”¼•l

Éø•†Zf“f•[•A—kŠC“”_ÆZZÉ±•é•A

—žž:æ•†F••Ü(Éø•†Zf“f•[•A—kŠC“”_ÆZZÉ±•é•A

Éø•†šššÖ•F•½•—12”N”x•i10”13”N”x•j

Éø•†S”—žž•F••...•@(Éi•i•žžY—”p”•j”•Efabio Centurion•i••Ü•l—lZ—Æ’c’fpf%*fOfAfC*”_Æ’••žžÉ±•é•j•E”P—Ç•”•F•i”_(ÉøfZf“f”•[•j•E•A(É’i•i•k”_žž:ž

”_Ä”_†žž”•F Shimizu,K.,F. Narabu and N. Minagawa(2000) Plant parasitic nematodes in a soybean field in Paraguay. †j†j†UCongresso Brasileiro de Nematologia 140pp.,102.

@

18. **いんげん豆の遺伝子解析と品種改良に関する研究**

種別	研究種別	研究内容	研究機関	研究員	発表年
大豆	遺伝子解析	いんげん豆の遺伝子解析と品種改良に関する研究	農研機構 大豆・豆蔻類総合研究所	佐藤 浩一	2001

いんげん豆の遺伝子解析と品種改良に関する研究は、大豆の遺伝子解析と品種改良に関する研究の一環として行われた。本研究は、いんげん豆の遺伝子解析と品種改良に関する研究の進捗状況を報告する。本研究は、いんげん豆の遺伝子解析と品種改良に関する研究の進捗状況を報告する。本研究は、いんげん豆の遺伝子解析と品種改良に関する研究の進捗状況を報告する。

1. Koyama et al. (2001) Genetic analysis of the *Ure2* gene in *Trichostema album*. *Genetics* 158: 101-108.
2. Koyama et al. (2001) Genetic analysis of the *Ure2* gene in *Trichostema album*. *Genetics* 158: 101-108.
3. Koyama et al. (2001) Genetic analysis of the *Ure2* gene in *Trichostema album*. *Genetics* 158: 101-108.

いんげん豆の遺伝子解析と品種改良に関する研究は、大豆の遺伝子解析と品種改良に関する研究の一環として行われた。本研究は、いんげん豆の遺伝子解析と品種改良に関する研究の進捗状況を報告する。本研究は、いんげん豆の遺伝子解析と品種改良に関する研究の進捗状況を報告する。本研究は、いんげん豆の遺伝子解析と品種改良に関する研究の進捗状況を報告する。



いんげん豆の遺伝子解析と品種改良に関する研究は、大豆の遺伝子解析と品種改良に関する研究の一環として行われた。本研究は、いんげん豆の遺伝子解析と品種改良に関する研究の進捗状況を報告する。本研究は、いんげん豆の遺伝子解析と品種改良に関する研究の進捗状況を報告する。本研究は、いんげん豆の遺伝子解析と品種改良に関する研究の進捗状況を報告する。

1) Koyama et al. (1999) *Asian phase response to TNF α deficiency mice during Trypanosoma congolense infection*. *Proceedings of 25th Meeting of the International Scientific Council for Trypanosomiasis Research and Control (ISCTRC)* p.79.

2) Koyama et al. (2000) *The roles of TNF α in genetic resistance of mice to Trypanosoma congolense infection*. *Proceedings of International Veterinary Cytology and Vaccine Conference* p.119-121.

Table with 2 rows and 10 columns. Row 1: 19.fJfUfYfXf^f^ Yff^eE-q^fGfXfPf.fcfFfg.l (q.l.A'n^æ^l^U^, .e.A^..cfAfCEf^pfV^ [δ] ;. Row 2: f^dU^=N...ZY^dEe=1fZ^f^p^e^ZY^e^

- *k → 1. 月日付の... 2. fGfXfPf.fcfFfg.lZzq.l... 3. Zzq.l...
*k → 1. fGfXfPf.fcfFfg.l... 2. fGfXfPf.fcfFfg.l...

表1 カザフスタンの稲穀高級ミスリフト種子の平均値の比較

Table with 4 columns: 産地地, 収量(kg), 収量(kg), 収量(%)

KIA: カザフスタン農林研究局; KIP: カザフスタン稲穀高級研究所; Kazakhstan: カザフスタン共和国の地図

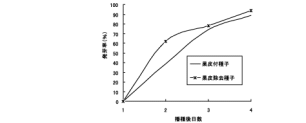


図1 ミスリフトの稲穀発芽に及ぼす収量の増加の影響

表2 サンドウィッチ法¹⁾によるミスリフトのアレロパシーの検定

Table with 4 columns: 検定距離, 1株での検定 (根長), 5株での検定 (根長)

1) 藤井・池野 (1993): 稲作研究 6, (9), 130-134
2) 有限区画に対する完全区画; 検定植物: レタス

*k → 1944

EB {SaD^e=14^f^%fAJfWfA.E^; .eZ^z^T^uS^C^→Zp.lS^}
→ZZe^e^f^e^U^...Em^%fAJfWfAm
EB {SaD^e^e^12^N^x^8^11^12^N^x^j
EB {S^ZD^e^e^E^ZY^C^; .e^e^2^_SAEB^p^C^A^p^N^→Y^CEBk^U^azale^v^fJfUfXf^f^...EBEB^1^δ^j
^..e^T^M^e^e^E^ZY^C^; .e^e^2000^p^fGfXfPf.fcfFfg.l^S^e^A^e^y^NfAJEJfP^V^ZG^EB^1^C45^e^E^p^C94^95.

<

23.fGfr,Æ"ñ-†SL,|→+†{•B,É,æ,é-L,@%•±•” ¿,|CEyCE,
kx→b4 JEJVGfr,afjfhjNjFCJk|†|•B,É,æ,é-L@%•±•” ¿,|CEyCE,
p%k→k N...ZYÆB†ZfjfhjNjFCJk|†|•B,É,æ,é-L@%•±•” ¿,|CEyCE,
p%k→k p%k→k p%k→k

“w(BE)E,É,æ,é
“EYJAWJA,É...JEJVGfr-p|→|B,É,æ,é-L@%•±•” ¿,|CEyCE,
|W-w†→|B,É,æ,é-L@%•±•” ¿,|CEyCE,
†|→|B,É,æ,é-L@%•±•” ¿,|CEyCE,
k→æ,é-L@%•±•” ¿,|CEyCE,
fjC%“...|fjfhjNjFCJk|†|•B,É,æ,é-L@%•±•” ¿,|CEyCE,
1. JRfjfhjNjFCJk|†|•B,É,æ,é-L@%•±•” ¿,|CEyCE,
2. JRfjfhjNjFCJk|†|•B,É,æ,é-L@%•±•” ¿,|CEyCE,
3. É0h7ç08ha†fçx†ZÆE,Ä†JEJVGfr,“P”→|B,É,æ,é-L@%•±•” ¿,|CEyCE,
k→æ,é-L@%•±•” ¿,|CEyCE,
1. “0@†ZÆE,Ä†SL,|→+†{•B,É,æ,é-L@%•±•” ¿,|CEyCE,
2. Z†p†LÉ→†|B,É,æ,é-L@%•±•” ¿,|CEyCE,
k→†fjfhjNjFCJk|†|•B,É,æ,é-L@%•±•” ¿,|CEyCE,

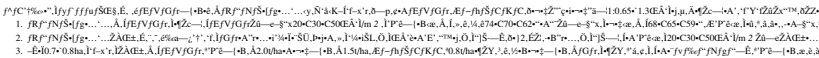


図1 2001年・2002年の各検査場所での検出状況 (コンナット本場)
図2 各検査場所での検出状況 (コンナット本場)
図3 各検査場所での検出状況 (コンナット本場)

<

<

<

<

<

<

<

<

<

<

<

<

<

<

<

<

<

<

<

<

<

<

<

<

<

<

<

<

<

<

<

<

<

<

<

<

<

<

<

<

@

27. A, E, a, Y, μ, 1/2 f f g f S f E f i r o j f f v i Na + -ATPase j

k v n i SCZY, l p Heterosigma akashimo, l f i f g f S f E f i r o j f f v i, d f R [f h . . e a " Z q i HANA v j, l 1330 f A f - f m Z . . c, e, e, a, " e Z q - E 146 k D a A 10, l - C E S N " E - l a, d Z, A - C E f f f p f N, d f R [f h, μ, A, e, e B HANA, l A A A, . c, l, % e, B, A f N f [f f f f O, i, e, 1/2 f i f g f S f E f f l f v, l a " Z q, A, . e B		A - a e		09808(8)6202	
k a - 1/4	• U _ c E	e - a	¶ - A f o f C f e f N	i - U	" - p

k " w e i E, E, e, e + l

e S E s e n, A E c, e, e A " y e, l % e - p W i, a S C . . . i " i u, E, C, E, a, e % S Q S g a, E, e, e A " e o - a i + . l i o, . a, . B, e, e, A, e, e B A A . E, l A f i f g f S f E f i r o j f f v i, d f R [f h . . e a " Z q i HANA v j, l 1330 f A f - f m Z . . c, e, e, e, a, " e Z q - E 146 k D a A 10, l - C E S N " E - l a, d Z, A - C E f f f p f N, d f R [f h, μ, A, e, e B HANA, l A A A, . c, l, % e, B, A f N f [f f f f O, i, e, 1/2 f i f g f S f E f f l f v, l a " Z q, A, . e B

k a - % e, l i a - e E " A Y + l

- H. akashimo cDNA f o f C f u f e f S [. c, e, e A A A . . c, e, e, l, % e, B, A, E, E, e f i f g f S f E f f l f v i + l A A + 2 j, l a " Z q i HANA, 4467 b p j, l f N f [f f f f O, d s, A, 1/2 + B
- HANA f f f p f N, l A 1330 f A f - f m Z . . c, e, e, e, a, " e Z q - E, l 146 k D a, l - C E f f f p f N, A A 10, l - C E S N " E - l a, d Z, A, A, e, l, c, e, e i + 3 + B
- HANA f f f p f N, l A f A f - f m Z . . S i, l A A " @ . l Na + / K + -ATPase i f i f g f S f E f f l f v i, A 40 % E a, l S " a, d Z, + B, μ, μ, " @ . . A, e, A, V " O - U, A, W " O - U, l - C E S N " E - l a, d Z, A, e, e B A A . E, l A f i f g f S f E f i r o j f f v i, d f R [f h . . e a " Z q i HANA v j, l 1330 f A f - f m Z . . c, e, e, e, a, " e Z q - E, l 146 k D a, l - C E f f f p f N, A A 10, l - C E S N " E - l a, d Z, A, A, e, l, c, e, e i + 3 + B
- " n, l % e - Z " x, d i % e, s, l A, a " Z q A f f p f N Z i, l - C E - E, l c, e, U, A, e, n, C, l % e, l C E c, e, e, e i d a t a n o t s h o w n + B x - E S O, l f i f g f S f E f i r o j f f v i, d f R [f h . . e a " Z q i HANA v j, l 1330 f A f - f m Z . . c, e, e, e, a, " e Z q - E, l 146 k D a, l - C E f f f p f N, A A 10, l - C E S N " E - l a, d Z, A, A, e, l, c, e, e i + 3 + B
- f A f - f m Z . . z - n, E S i, A, e, 1/2 P - t y p e A T P a s e f f f p f N Z i, l C e n + z + i + 4 j, l i t, A HANA f f f p f N, l A A - O " A " @ . l Na + / K + -ATPase f i T f u f i f j f b f g C Q, A, A, a, b, e " Z q, A, . e A N a + / K + -ATPase, l f N f o f X f f [E a - p, i, e, e B f C [f X f g, l Na + -ATPase i f i f g f S f E f f l f v i, l Ca 2 + -ATPase i f j f v f E f f l f v i, l f N f o f X f f [E a - p, i, e, e, 1/2, B A N a + - A - E S O, μ, A, E, l C e n + " @ . l s, i, e, 1/2, A, e, l, c, e, e B

k a - % e, l i S - p - E - E - " O _ l

H. akashimo, l f i f g f S f E f f l f v i, l a " Z q i HANA v j, l a " Z q i u, E, e, e, l % e - a i + i o, l 1/2, B, l C e a, A, μ, A - l - , A, . e B

k a i l f i f f A + l



図1 Heterosigma akashimo 細胞膜の持つナトリウムポンプの模式図 図2 Heterosigma akashimo 細胞膜の持つナトリウムポンプの活性

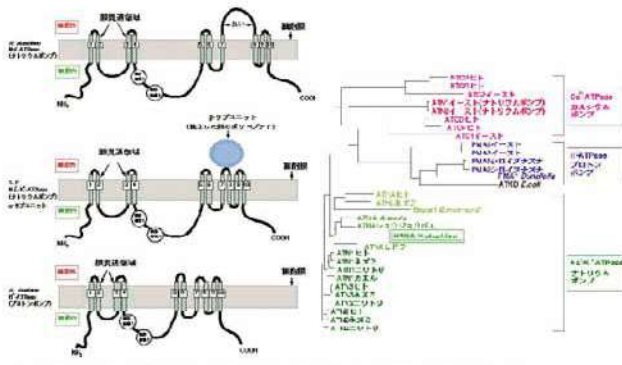


図3 ANA と Na⁺/K⁺-ATPase, H⁺-ATPase 間の 2 次構造の比較 図4 様々な P-type ATPase の系統樹

k a, l 1/4 + l

C e n + z + i + 4 j f i f g f S f E f i r o j f f v i, d f R [f h . . e a " Z q i HANA v j, l 1330 f A f - f m Z . . c, e, e, e, a, " e Z q - E 146 k D a A 10, l - C E S N " E - l a, d Z, A - C E f f f p f N, d f R [f h, μ, A, e, e B HANA, l A A A, . c, l, % e, B, A f N f [f f f f O, i, e, 1/2 f i f g f S f E f f l f v, l a " Z q, A, . e B

→ Z z a e + + • A " U _ c E k " l % e - a i + . l i o, . a, . B, e, e, A, e, e B A A . E, l A f i f g f S f E f i r o j f f v i, d f R [f h . . e a " Z q i HANA v j, l 1330 f A f - f m Z . . c, e, e, e, a, " e Z q - E 146 k D a A 10, l - C E S N " E - l a, d Z, A - C E f f f p f N, d f R [f h, μ, A, e, e B HANA, l A A A, . c, l, % e, B, A f N f [f f f f O, i, e, 1/2 f i f g f S f E f f l f v, l a " Z q, A, . e B

E a, e f S i S O + 1/2 - 12 " N " x i 4 + 13 " N " x j

C e n + z + i - Z O + F - i - a - Z q A " a " C e a - l i + % e Z z • E f S f f S Z x + e j A E - @ . g + " C e z a e e Z % e e " a " e S w + + j

" a _ ¶ " T M + F

1 j a " Z q i n f i f f A f x [f X D D B J, E " o " a + i c c e s s i o n n u m b e r A B 0 1 7 4 8 1 + j

2 j M. Shono, M. Wada, Y. Hara and T. Fujii (2001), Molecular cloning of Na⁺-ATPase cDNA from a marine alga, Heterosigma akashimo, Biochim. Biophys. Acta 1511,193-199

•@

@

29. fTf, fCf “fQf” i e o r̄BŠ } f, ACE, A, C, A, 1/2 x - E j - Y o s -

k -v-n i fTf, fCf “fQf” iZi e o r̄BŠ } f, dZiZqeA efnfCfufVf, %O e, A, μ, A 3/4, c, e, eZGZi, d l, , e, A' ... a, a, e, B, A s - C, A, E, e, a A tCE d” z, IF1, I o i, E' ... a, μ % O 2 - « a, , c B, ±, I s - «, I e o r̄BŠ } f, I x - E Z i - Y o s - «, E, a, e, a, I, A, e A fTf, fCf “fQf”, I F I Z G Z i, d S I 3/4, , e, p, I, A - L E o, A, , e B

U - N ... ZY ACE α † fZf “f” % « “ē Z x S E i” ± “ū I” I CE α † Z°		A - e		09808(8)6108	
% ai - 1/4	U - A - i O E f A E A ā B ” - A - i O E % O, «	e - ā	ç Ž i	I U	, c, n, °, n, U, B
				a - p	CE α †

k ”wEiE, E, c, e

F I Z G Z i, Z i, f w f e f f V f X, I i e o r̄BŠ } f, E L, - - - p, e, A, , e A J I R C A S % « “ē Z x S, a c o, μ, 1/2 i o r̄BŠ } f, f C f “f Q f” i Z i e f n f C f u f V f, A 1/4 i Z i, A, I F I , E, , c, A, a, % o % o, A 1/2 Z u, d Z i, C E % O E, a, c, e, A, e, e B f T f, f C f “f Q f”, I f w f e f f V f X, d Z A U, I ç Ž i, E, , c, A - - - p, e, E, I - Y o s - « x - E Z i, I - - - p, a - L E o, A, , e B

k o % O E, I a - e A “Y”

1. e o r̄BŠ } f e f n f C f u f V f, I E d ” z, E, a, e 3/4, c, e, e F I A o, , d 2 5 2 8 Z, I o 2 f K f % c f X Z, A l, , e, A % O 2 - « a i f A f Z f g f j [f ~ f o F, E, a, e j, I 3 6 . 8 4 1 . 0 “ j, A ” 1/4 s - «, d Z i, B e u A t C E d ” z, I F I , I % O 2 - «, a 8 3 . 8 “, A, , i l j A ” ... a, I o i, A, , e B, μ, 1/2, A, A A Š I Z @, e, e 1/4 s - «, I e o r̄BŠ } f, I - Y o s - « x - E Z i, E, a, e B e o r̄BŠ } f, I - L, , e - « % o a e a “ Z q, I z o I i, E “, - B
2. e o r̄BŠ } f e f n f C f u f V f F I A o, , I u “ C Z o 2, E, a, e ” ... a - I, d 1 2 8 % O, E, A, e, A 2, , μ, 1/2, A, ±, e 0 . 8 “, A A 2 5 2 8 Z, I l I “ d E % o, A, I, U, A, n, C ” ... a, μ, E, c B e u A a Q Z o 2 i o } j, E, a, e F I e f n f C f u f V f, I - B E d ” z, I ” ... a - I, I 3 0 . 0 “, A, , e i l j B
3. Š J % O “ - u, E a - Y, d, μ, E, c, A e f n f C f u f V f % O 2, d - B E d ” z, , e, A e i j } 2 j A ” ... a - I, I 9 0 . 0 “, A, , e B “ - I, E F I o - e o r̄BŠ } f A F I o i e f n f C f u f V f o - e o r̄BŠ } f j, I E d ” z, E, , , e ” ... a - I, I, , e, 1/4, e 7 5 . 0 “ A 5 3 . 6 “, A, , e A Z “ o s - «, I ” F, B, c, e, E, e, i l j B
4. i e o r̄BŠ } f e f n f C f u f V f j e o r̄BŠ } f, E, a, e - B E d ” z e a, A, I A ” 1/4 s - «, A % A - «, a 1 : 1, E a - E, , e i o 2 j B

k o % O E, I Š - p - E - “O” _

efnfCfufVf, A, IF I

i Z i, I ç o, E, I A, U, , e e f n f C f u f V f, I - Y o s - « E n “, d Š J ” , , e A Z Ÿ, E e A e o r̄BŠ } f, I - Y o s - « x - E Z i, E l, μ, A - E Z q I i, E “, - « % o a e a “ Z q, d T o, μ A † B Z G Z i (o, , a - C, - C E », e, e E n “ i i Z i j, E “ ± “ u, E, , e, I, E, c, e, c B

k a i I f f [f A

表 1 ‘ハイブシ’ と ‘黒種衣笠’ との F₁ 雑種の花粉稔性と戻交配の結果

交配組合せ*	交配花数	着実数 (%)	獲得種子数 (一実当たり)	花粉稔性 (%)
(KK × HB) の自殖	128	1 (0.8)	1 (1.0)	36.8
(HB × KK)	-	-	-	83.8
{ (KK × HB) × HB } ¹⁾	20	6 (30.0)	31 (5.2)	
{ (KK × HB) × HB } ²⁾	10	9 (90.0)	49 (5.4)	
{ (KK × HB) × KK } ²⁾	12	9 (75.0)	49 (5.4)	
{ (KK × HB) × (HB × KK) } ²⁾	28	15 (53.6)	72 (4.8)	

*KK: ‘黒種衣笠’, HB: ‘ハイブシ’
 1) 開花 1 ~ 2 日前に除雄し、直ちに授粉 (蕾授粉)
 2) 開花当日に、除雄せず授粉

表 2 ‘黒種衣笠’ × ‘ハイブシ’ × ‘黒種衣笠’ B₁F₁ 個体における半不稔と可稔の分離

	半不稔	可稔
花粉稔性	12.8-26.5%	87.0-95.4%
個体数	4	5
想定される遺伝子型	R ₁ r ₁	R ₂ R ₂
X ² for 1 R ₁ /r ₁ : R ₂ /R ₂ = 0.111	(0.80 > P > 0.70)	

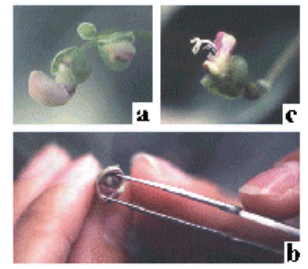


図 1 蕾授粉。開花 1 ~ 2 日前の蕾 (a) の旗弁を開き (b)、竜骨弁を割り裂いて除雄し、柱頭を露出させ (c)、交配する。

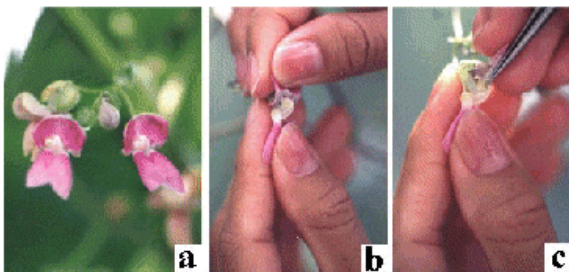


図2 雌性不稔細胞質利用による交配。開花当日の花 (a) の旗弁と翼弁をつかみ柱頭を露出させ (b)、授粉 (c) する。

•k ,»,İ'¼ •l

CEα†%oÛ'è¼ •F fTf,,fCf" fQf"•iŽi•ufnfCfuV•v,İ'İ•««,İ'¼•iŽi,Ö,İ'±"ü

—\ŽZ:æ •³ •F CEo•í•GŠî`bCEα†•,•iŽ—<Æ

CEα†Šú ŠÖ •F •½•-12"N"x•i10`13"N"x•j

CEα†'S"—ŽÖ •F •]•i<X•L•E'ËCEû'¼Žj•i•¶(CEα@•\•j•E'İ"ç"Ž"V•E—é-Ø•ŽCEÈ

"-λ`_•¶"™ •F fCf" fQf" f}f•,İ'İ•««,ÉŠÖ,•,é(CEα†•@9,•@fTf,,fCf" fQf"•iŽi•ufnfCfuV•v,Æ•u••Ži'BS}•v,İ•iŽiŠÖŽGŽi,ÉCE©,ç,ê,½•s-«,É,Â,ç,Ä•@"M'Ñ" _<Æ44•i•Ê2•j•F81-82•@•i2000•j

[前へ](#)
[最初に戻る](#)
[目次](#)
[次へ](#)

•@

1. Title : China's WTO accession and its impact on domestic agriculture

Division : Research Information Division

Author : Akihide IKEGAMI

Key Words : China, WTO, Agriculture

Synopsis : The day is not far distant when China joins WTO. So we need to evaluate the impact of WTO accession to Chinese agriculture. In this research, we try to investigate the impact of assumption that (1) Chinese government observes "Agreement on Agriculture" of WTO, (2) adoption of tariff-rate quotas in major crops and tariff reductions of other agricultural products depend on U.S.-China WTO Accession Agreement.

2. Title : Genetic difference of resistance to Fusarium head blight in Japanese and Chinese wheat cultivars, Nobeokabouzu-komugi and Sumai 3

Division : Biological Resources Division

Author : Tomohiro BAN

Key Words : disease resistance, doubled haploid, Fusarium head blight (Scab), integration of resistance genes

Synopsis : Fusarium head blight (FHB, scab) caused by *Fusarium graminearum* is one of the most destructive diseases of wheat in areas where the weather is warm and humid after the heading of wheat. It reduces grain yield and quality due to grain shriveling. FHB also produces mycotoxins harmful to animals and human health, such as deoxynivalenol (DON), nivalenol (NIV), T-2 toxin, zearalenone (ZEA) and their derivatives. For controlling this disease, host resistance should be considered. Repeated screening of the genetic resources led to the identification of several resistant cultivars of spring wheat, such as Shinchunaga, Nobeokabouzu-komugi and Nyubai from the Japanese gene pool. Sumai 3, Ning 7840 and CIt 11028 were also identified as resistant cultivars to FHB from the Chinese gene pool. The genetic constitutions of sources of resistance to FHB originating from different gene pools, however, have not yet been elucidated. It is essential to study the genetics of the resistance to FHB, including the identification of the genes responsible for resistance to FHB in several gene pools, so that different genes can be combined to improve the overall resistance of wheat. The objectives of the present study were to examine the difference in genetic constitution of resistance to FHB between Nobeokabouzu-komugi and Sumai 3 using doubled haploid lines (DHLs) derived from F1 cross.

From the cross combination of both highly resistant cultivars, transgressive segregants with the reaction of moderately resistant to FHB were found. Both parents seem to have at least one common gene for the resistance, because no DHL with the susceptible class was segregated. Chi-square test indicated that the segregation for the reaction to FHB fitted a three-gene model (7 R : 1 MR) in the population (Table 1 and Fig. 1). It is suggested that Nobeokabouzu-komugi have three dominant genes for the resistance, of

which two are unique and the another gene is identical to that of Sumai 3. This finding presents an important promise for pyramiding resistance genes from different genetic background. Furthermore, many lines with very high level of resistance combining genes from the both parents have been selected for possible use as parental lines.

3. Title : Antisense suppression of proline degradation improves environmental stress tolerance in *Arabidopsis*

Division : Biological Resources Division

Author : Kazuko YAMAGUCHI-SHINOZAKI

Key Words : Proline, Transgenic plant, Antisense, Freezing tolerance, Salinity tolerance

Synopsis : Many plants accumulate free proline (Pro) in response to environmental stresses such as drought, high salinity, and low temperature. P5CS is a rate-limiting enzyme in Pro biosynthesis and ProDH is an enzyme responsible for the first step of Pro degradation. To elucidate essential roles of Pro, we generated antisense transgenic *Arabidopsis* plants with P5CS or ProDH cDNAs. The P5CS antisense transgenic plants accumulated Pro at a significantly lower level than wild-type plants, and were susceptible to osmotic stress. In contrast, the ProDH antisense transgenic plants showed enhanced accumulation of Pro and tolerance to freezing and high salinity. These results will help us to improve crop tolerance to abiotic stresses. The constitutive accumulation of Pro due to inhibition of its degradation may be a promising approach to creating environmental stress tolerant crops.

4. Title : The Nitrogen cycle for agricultural production in Khon Kaen province in Northeast Thailand

Division : Environmental Resources Division

Author : Naruo MATSUMOTO

Key Words : Nitrogen Cycle, Nitrogen Flow, Nitrogen Balance, Crop Residues, Animal Feces

Synopsis : Soils in Northeast Thailand are characterized by a sandy texture and being low in capacity for nutrient supplying. These inherited characteristics typical of a poor fertile soil are the major limiting factors for crop productivity. One possible way to improve soil fertility may be to use locally available nutrient resources such as crop residues and animal feces more efficiently. In order to identify the available resources, it is necessary to quantify nutrient cycle through agricultural activities such as crop and livestock production in the region, and clarify limiting factor for effective utilization of the nutrient resources. In this report emphasis is placed on nitrogen as it is a major nutrient element.

A complete picture of the nitrogen cycle for agricultural production in Khon Kaen province was developed based on data from crop yields, chemical fertilizer application rate, animal feed supply, human food supply, production and usage of crop residues, animal and human feces and garbage, etc. These data were collected from agricultural statistics (1990-92), research reports, study reports, field observation, interview with farmers, and information from Thai researchers.

The nitrogen left as crop residues amounted to 52 kg ha⁻¹ yr⁻¹, out of which 12 kg was fed to animals, 29 kg emitted to the environment by burning, and 11 kg returned to farmland. It is speculated that although crop residues were the main nitrogen resource in the area, the rate of recycling back to the farmland was limited. Animals received 23 kg ha⁻¹ yr⁻¹ of nitrogen from the weeds as feeds besides the crop residues and provided 22 kg ha⁻¹ yr⁻¹ of nitrogen to the farmland as feces, which was 80 % of nitrogen produced as animal feces. The nitrogen withdrawal as crop harvests (30 kg ha⁻¹ yr⁻¹) was more than the nitrogen amendment as animal feces, suggesting that it was not feasible to fulfill the crop N demand only through application of the animal feces because of limited animal husbandry activities in the area. Chemical fertilizer application was limited only to 18 kg ha⁻¹ yr⁻¹ of nitrogen, clearly indicating that local farmers have applied no or low rate of chemical fertilizer to most of the crops even in the recent years. The nitrogen losses through denitrification, leaching, erosion and emission, and nitrogen gains through atmospheric N₂ fixation, irrigation and rainfall were also roughly estimated to draw a nitrogen balance sheet that consequently showed a negative value of 40 kg ha⁻¹ yr⁻¹. Considering that there is still 58 kg ha⁻¹ yr⁻¹ of nitrogen deficit to the farmland, more efficient utilization of available organic resources should be necessary in order to reduce negative value in the nitrogen balance.

5. Title : N balance in the grassland and in the soybean field, Brazil

Division : Environmental Resources Division

Authors : Kenichi KANDA

Key Words : Brazil, Cerrado, N balance

Synopsis : N balance was measured in a continuous grassland and a continuous soybean field, Cerrado in Brazil. Large amount of nitrate was observed to be accumulated in the subsoil of the continuous soybean field. Although N fertilizer was not applied, N balance showed negative values for the continuous grassland as well as the continuous soybean field. The negative values were greater in the continuous soybean field than those in the continuous grassland.

6. Title : Stimulated methane emission from a rice paddy under elevated atmospheric CO₂

Division : Environmental Resources Division

Author : Kazuyuki YAGI

Key Words :

Synopsis : Flooded rice cultivation is considered to be one of the major sources of atmospheric methane. It is pointed out that recent increase in the rice production has contributed to the global warming by increasing methane emissions. Elevated CO₂ in the atmosphere may have a positive effect on the emission increase through accelerating the rate of carbon turnover in rice-soil system. We examined the effect of elevated CO₂ on methane emission from a rice paddy using six

computer-controlled growth chambers. The experiments were conducted for two entire growing seasons of rice in 1998 and 1999. The CO₂ concentration was kept at 350 ppm (ambient) in three of the chambers, and at 650 ppm (elevated) in the other three chambers. Methane emission rates in the chambers were determined by an automated monitoring system.

Seasonal methane emission rates in ambient and elevated conditions were 18.4 and 21.8 g/m², respectively, in 1998. The rates in 1999 were 5.6 and 13.7 g/m², respectively, which were significantly lower than those in 1998, possibly caused by lower application rate of rice straw prior to transplanting rice plants. The results showed that elevated CO₂ increased seasonal methane emission significantly ($P < 0.05$). The increase in the emission rates was mainly observed after the middle growth stage. Elevated CO₂ also increased aboveground biomass of the rice plant.

7. Title : A method to retrieve snow depth and its melting condition

Division : Environmental Resources Division

Authors : Hiroyuki OHNO

Key Words : microwave, SSM/I, snow depth, snow melt

Synopsis : Synopsis: In this study, authors improved the accuracy of snow depth estimation and established an index which represented melting situation of deposited snow from microwave brightness temperature, observed by a space born passive microwave radiometer (SSM/I). A daily dataset consisting of ground measured snow depth and microwave brightness temperature for 339 points over North East Asia, from October 1993 to April 1998 was produced. Data archives produced by NCDC, NSIDC and IMH in Mongolia were used as the data sources.

At most of the points, the difference of brightness temperatures between 19GHz and 37GHz (T) indicated almost linear relationship with snow depth. Its slope and offset did not change much on a year to year basis although they changed markedly from place to place. Based on this fact, a multi-linear formula that determined the parameters from five geographic information (climatic maximum snow depth, vegetation index, polarization index of 37GHz in February, brightness temperature of 19GHz in February, and altitude) was established. Using the pair of raster map of the slope and offset generated with the equation, one can estimate snow depth from satellite image more accurately.

It was found that difference of T in the morning and that in the preceding evening, was able to detect the melting snow pack.

8. Title : Varietal resistance to the whitebacked planthopper in Chinese *japonica* rice

Division : Crop Production and Postharvest Technology Division

Authors : Kazushige SOGAWA

Key Words : Varietal resistance, Whitebacked planthopper, Chinese *japonica* rice

Symopsis : Despite its significant contribution to the rice production increase in 1980's in China, Chinese hybrid rice has caused great changes in insect pest status in the paddy fields, because of its high vulnerability to insect infestations. Among the insect pests, the whitebacked planthopper, *Sogatella furcifera*, has dramatically emerged as a key pest of the hybrid rice. *S. furcifera* infests not only the hybrid rice, but also the japonica rice in Middle China by massive immigrations from the hybrid rice-prone area in South China. There is a growing fear of deterioration of sustainable rice production ecosystem under the increasing insecticide treatments. Insect resistance in rice varieties is an alternative tool to cope with the pest threats, which is compatible with biological and ecological approaches of pest management.

A Chinese japonica rice, Chenjiang 06 (CJ-06), expressed a strong field resistance to *S. furcifera* infestations. The immigrants of *S. furcifera* did not prefer to settle on CJ-06, and failed to establish populations on the variety. Significantly less honeydew excretion by female adults of *S. furcifera* indicated their reluctant sucking on CJ-06 sap. Adult fecundity was reduced to about one third on CJ-06 as compared with susceptible varieties, because of suppressed sap ingestion on CJ-06. Besides, *S. furcifera* eggs suffered from a high mortality in the watery lesions induced at oviposition sites of CJ-06. From these results, field resistance in CJ-06 to *S. furcifera* was explained by two distinct mechanisms, namely the sucking suppression and the ovicidal function. The sucking suppression was the primary cause of the antixenosis of CJ-06 against *S. furcifera* immigrants as well as the antibiosis to reduce fecundity of the inhabitants. The ovicidal function is another antibiotic resistance induced by a specific interaction between CJ-06 and *S. furcifera* eggs.

The sucking suppression and ovicidal function were inherited independently. The F₂ populations from the crosses between CJ-06 and the susceptible TN1 variety were segregated into 4 phenotypes with different combinations of sucking suppression and ovicidal function. The segregation ratios fitted statistically to the theoretically expected ratio of 45:15:3:1, where 2 dominant and 1 recessive genes presumably controlled sucking suppression and ovicidal function, respectively.

Preliminary genealogical analysis indicated that the both resistance traits to *S. furcifera* in CJ-06 were derived conjointly from a single parental line, Xiushui 620. The other parental line, C81-40, had only the ovicidal activity. Sucking suppression and ovicidal resistance in Xiushui 620 were independently inherited from Xiushui 04 and Xianghu 24, respectively.

9. Title : Evaluation of Indonesian soybean varieties for tofu and Tempe processing

Division : Crop Production and Postharvest Technology Division

Author : Sayuki NIKKUNI

Key Words : characteristics of soybean, Indonesian soybean, tofu, Tempe

Synopsis : In the collaborative research project with Research Institute for Legume and Tuber Crops (RILET) of Indonesia, physical, chemical and processing characteristics of 14 Indonesian soybean varieties were investigated. Indonesian soybeans contained much more proteins and less lipids than the soybean samples imported from USA did. One hundred grain-weights of Indonesian soybeans except Argomulyo, Bromo, and Burangrang varieties were lower than those of imported ones. Tofu was

prepared using either glucono- δ -lactone (GDL) or acetic acid as a coagulant. Acetic acid is commonly used as a coagulant in Indonesia. The results obtained in this work showed that protein content of soybean is the most important factor for the hardness and yield of tofu prepared using either GDL or acetic acid. It is clarified that Indonesian soybeans are superior for preparing tofu using either GDL or acetic acid as a coagulant compared to the soybean imported from USA due to their protein contents and whitish color of tofu product. In Tempe making, the 100-grain weight of raw soybeans was found to be the most important factor for both yield and sensory evaluation of Tempe. An Indonesian soybean variety that has a 100-grain weight of around 15 grams as imported soybeans do was found to be suitable for Tempe processing.

10. Title : Isolation of white-spored mutants from the koji molds for the production of Kecap, an Indonesian soy sauce

Division : Crop Production and Postharvest Technology Division

Authors : Sayuki NIKKUNI

Key Words : Kecap, Tauco, koji, aflatoxin, *Aspergillus* , white-spored mutant, inoculum

Synopsis : A collaborative joint research work between JIRCAS and Research Institute for Legume and Tuber Crops (RILET) on improvement of fermented soybean food, Kecap, was conducted at RILET in Indonesia. Koji samples were collected from Kecap and Tauco factories in Java Island. Aspergillus was the dominant mold genus in five out of six koji samples, while one sample contained Mucorales as dominant fungi. Aspergillus contributed to hydrolysis of soybean proteins much more than the Mucoraceous fungus isolated from Tempe starter did. Although no aflatoxin was detected in these koji samples, two isolates out of 24 isolates from the Kecap and Tauco koji samples produced aflatoxins. In order to develop a pure culture starter for Kecap koji making, white-spored mutants were isolated by UV-irradiation from the selected Aspergillus strains. All white-spored mutants were proved to be aflatoxin-negative. The Kecap koji prepared by inoculating the mutant could be distinguished from that prepared by inoculating the original koji mold strain or the aflatoxin producer by developing a typical white color spores during koji making. The formol nitrogen contents of the Kecap mashes prepared by using white-spored mutants were almost same as those of prepared using original strains. Therefore, it is expected that a white-spored mutant can be applied as a starter for Kecap koji making from the standpoint of food safety.

11. Title : Alley cropping on the sloping upland field in Northeast Thailand

Division : Crop Production and Postharvest Technology Division

Authors : Nobuyuki KABAKI

Key Words : Alley cropping, *Leucaena leucocephala*, Pruning

Synopsis : A model field for alley cropping (0.5ha:50x100m) was set up with a leguminous tree species, *Leucaena leucocephala*, on the contour lines in the 5% sloping field in Northeast Thailand to prevent erosion and to supply organic materials into upland fields. Growth of crops (sweet corn, mungbean etc.) was evaluated at various distances from trees. Shading by tree canopy in rainy season and depletion of water by roots of trees in dry season were the main obstacles to crop growth when the trees and crops were planted closely. Width of tree rows was recommended to be 20m in view of crop production, mechanized crop management and prevention of soil erosion. Pruning of alley trees and subsequent supply of organic materials were effective to improve soil properties. Regeneration of twigs after pruning followed a similar pattern as that of the annual rainfall, and the appropriate frequency of pruning was three times in a year to save the labor under the sequential crop cultivation through rainy and dry season.

12. Title : Subsoiling treatment on the sloping upland field

Division : Crop Production and Postharvest Technology Division

Authors : Nobuyuki KABAKI

Key Words : Subsoiling, Soil moisture, Soil hardness

Synopsis : Subsoiling treatment was conducted at the beginning of rainy season by cracking soil layer (50~60cm depth) in the direction of contour lines in the sloping upland field. It was effective to accumulate running rain water leading to a higher moisture content in the deep layer of soil in dry season. Soil hardness was also reduced by subsoiling treatment reflecting higher soil moisture. Growth of crops was accelerated owing to the availability of water, which was more distinctive in dry season cultivation. In addition, enhanced physiological activities in the leaves as indicated by leaf color index and transpiration were also noticed. Combination with no-tillage cultivation was recommended in order to withdraw maximum advantage from the treatment.

13. Title : No-tillage cultivation of crops on the sandy upland field in Northeast Thailand

Division : Crop Production and Postharvest Technology Division

Authors : Nobuyuki KABAKI

Key Words : No-tillage, Erosion, Soil moisture

Synopsis : No-tillage cultivation of seed crops (maize, legumes, etc.) is a promising technique to develop a large scale production on the sandy soil in Northeast Thailand. No-tillage seeding alleviated busy and laborious odd jobs for land preparation at the beginning of rainy season, and prevented soil erosion which was commonly observed after the tillage of fields. It was also effective to preserve soil moisture in dry season due to the undisturbed soil condition. The growth of crops in no-tillage was generally superior to that in tillage seeding. In rainy season, crust formation on the soil surface inhibited the growth in tillage seeding. The higher soil moisture in no-tillage contributed to a vigorous growth in dry season. A no-tillage seeder with rotary disk and drill seeder was manufactured and tested for applicability, which

worked Satisfactorily on the sandy soil performing accurate grooving and seeding.

14. Title : Effects of mechanical weeding on the dominant upland weeds in Northeast Thailand

Division : Crop Production and Postharvest Technology Division

Author : Nobuyuki KABAKI

Key Words : Mechanical weeding, *Richardia scabra*

Synopsis : Mechanical weeding with the use of small rotary tiller attached to soil manipulator was effective to control a dominant upland weed, *Richardia scabra* L in Northeast Thailand. Inter-tillage between the row of crops could be conducted at a walking speed (1.6 m/min) alleviating the hard labor for hand weeding. Weeds lost the water content after uprooting and eventually withered to death. In the field condition, 2~3 hours was enough to reach this critical water deficit, which could be used as a criterion of operation under variable weather conditions. We also observed the difference in the effects of mechanical weeding on the growth of crops and weeds. The fast growing crops such as sorghum and pearl millet were more tolerant to weeds, and the frequency of weeding could be reduced compared to that for relatively slow growing crops such as sweet corn and mungbean. Proliferation of weeds was also suppressed by the former crops.

15. Title : Optimum seed rates in wet seeded rice culture in the Mekong Delta of Vietnam

Division : Crop production and Postharvest Technology Division

Author : Hiroyuki HIRAOKA

Key Words : Wet seeded rice culture, Double cropping, Triple cropping, Seed rate, , Mekong Delta, Vietnam

Synopsis : Double and triple cropping in wet seeded rice culture(WSC), which is broadcasting the pre-germinated seeds on the wet soil after the land preparation and draining out the standing water on the paddy fields, is predominant in the Mekong Delta area. The rice yields per hectare in the WSC have been stagnated since 1995. A feature in the WSC is to use seed rates as high as 200 to 300kg ha⁻¹ . So, we tried to identify the optimum seed rates in order to increase the yields per hectare and decrease the seed rates. The field trials on the seed rates were carried out in the fields at Cuu Long Delta Rice Research Institute and two other sites in Can Tho Province. Number of panicles per m² significantly decreased as the seed rates decreased from the conventional one (200kg ha⁻¹) in both dry and wet seasons. In contrast, the filled grains per panicle significantly increased as seed rates decreased from the conventional one in both seasons. As the 1000 filled grains weight at different seed rates were almost same, the grain yields at different seed rates were decided by the number of filled grains per m² . The

highest yields were obtained at the seed rates from 50 to 100 kg ha⁻¹ in both seasons. However, taking the establishment of sufficient number of seedlings into consideration, 80 to 100 kg ha⁻¹ were recommended as the practical seed rates. The recommended seed rates also have another advantage of saving 1/2 to 1/3 of the conventional seed rates. It is important that the seed rates should be applied to the paddy fields with smooth land level, and good irrigation and drainage facilities, and to the renovated farmers.

16. Title : Selection of soybean varieties, non-host crop and antagonistic plant for nematode control in Paraguay.

Division : Crops Production and Postharvest Technology Division.

Author : Kei SHIMIZU

Key Words : *Meloidogyne javanica*, *Pratylenchus coffeae*, *Rotylenchulus reniformis*, soybean, control, Paraguay.

Synopsis : Five soybean varieties for *Meloidogyne javanica* control, one soybean variety, one non-host crop and one antagonistic plant for *Pratylenchus coffeae* control, three soybean varieties and one non-host crop for *Rotylenchulus reniformis* control were selected.

17. Title : Inhibition of the adipocyte differentiation of 3T3-L1 by an amino acid derivative in fermented foods

Division : Crop production and Postharvest Technology Division

Author : Kazuhiko NAKAHARA

Key Words : 3T3-L1, adipocyte, differentiation, fermented food, soybean, MTCA

Synopsis : The inhibitory activity toward the adipose differentiation of 3T3-L1 preadipocyte was determined for ten kinds of fermented foods. A promising activity was detected in the methanolic extracts of miso (fermented soybean paste), soy sauce, tau-jaw (fermented soybean in Thailand, semi-liquid) and su-fu (fermented tofu). Two compounds were isolated from miso as the active principle. They were identified as (-)-(1*S*, 3*S*)- and (-)-(1*R*, 3*S*)-1-methyl-1, 2, 3, 4-tetrahydro- β -carboline-3-carboxylic acid. The morphological change in 3T3-L1 adipose differentiation was suppressed in the presence of these compounds. The induction of glycerol-3-phosphate dehydrogenase was suppressed to 55.9 \pm 3.1% and 44.9 \pm 2.7% by (1*S*, 3*S*)-MTCA and (1*R*, 3*S*)-MTCA, respectively, at a concentration of 20 μ g/ml.

18. Title : The roles of tumor necrosis factor alpha (TNF α) in genetic resistance of mice to *Trypanosoma congolense* infection

Division : Animal Production and Grassland Division

Author : Hiroshi KITANI

Key Words : trypanosomiasis, genetic resistance, tumor necrosis factor alpha, mice

Synopsis : To extend observations on the roles of tumor necrosis factor alpha (TNF α) in murine genetic resistance to trypanosomiasis, TNF α -gene knockout mice (on a C57BL/6 background) and C57BL/6 wild-type mice were infected with *Trypanosoma congolense* IL 1180. As reported previously, TNF α -deficient mice are highly susceptible to *T. congolense* infection with a mean survival time of 35 days in this study, while the wild-type mice had a mean survival time of 91 days. TNF α -deficient mice showed significantly higher parasitaemia levels than the wild-type mice and they also failed to develop germinal centers in the peripheral lymphoid organs. However, production of *T. congolense*-specific immunoglobulin M (IgM) and IgG was similar in the two mouse strains. Hepatic acute phase proteins, including ceruloplasmin, α 1-acid glycoprotein and serum amyloid P were induced similarly in knockout and wild-type mice. These findings indicate that TNF α contributes to control of parasitaemia during experimental *T. congolense* infection in mice. Further studies will be needed to determine whether TNF α controls *T. congolense* parasitaemia in mice directly or indirectly.

19. Title : Seeds of forage legume esparcet of Kazakhstan have a local seed size and high allelopathic activity

Division : Animal Production and Grassland Division

Author : Kenzi SATO

Key Words : Allelopathy, Esparcet, Germination, Kazakhstan, Legume, Locality, Seed size

Synopsis : Esparcet (*Onobrychis* spp.) is cultivated in Central Asia and is an important legume for soil fertilization and for feeding. We evaluated the germination and allelopathic activity of the esparcet seed produced in Kazakhstan. An individual plant of esparcet has many seeds, but one seed is in one pod. These seeds have a local morphology including seed size. The germination of esparcet seed without pod was faster than that of seed within the pod. In checking allelopathic effect using the sandwich method (Fujii and Shibuya, 1991), allelopathic activity of seed without pod was much higher than those of seed with pod and only pod. These results will help us in establishing a technology of esparcet in connection with weed control using the allelopathy.

20. Title : Dry matter productivity and forage quality of *Panicum maximum* pastures established in agropastoral systems

Division : Animal Production and Grassland Division

Author : Tsutomu KANNO

Key Words : Crude protein, Digestibility, Dry matter productivity, *Panicum maximum*

Synopsis : Dry matter productivity and forage quality were evaluated for *Panicum maximum* pastures established after 4 years of consecutive soybean cultivation in the summer (PM-SO), and 4 years of rotation of soybeans in the summer and millet for winter grazing (PM-MI). In the PM-SO pasture, dry matter production was much higher than that in the PM-MI pasture, and the content of crude protein and digestibility of the aboveground plant parts of PM-SO were also higher than those of PM-MI counterparts. It was considered that the cropping sequence before the pasture establishment affected the soil nitrogen fertility, which resulted the differences in the forage productivity and quality of the two *P. maximum* pastures.

21. Title : Nutritional diagnosis of sulfur in soybean plants

Division : Research Information Division

Author : Kiyoko HITSUDA

Key Words : Soybean, Criterion of sulfur concentration, Protein composition, Sulfur concentration in soybean plants

Synopsis : Soybean cultivation is expanding rapidly into the northeastern areas of Brazil and a study on soil fertilization in the region is necessary to serve as a basis for soil management. The criteria to maintain appropriate contents of nutrient elements in the plants should be studied. The supply of sulfur (S), manganese (Mn), zinc (Zn), boron (B) and copper (Cu) in two cerrado soils of the region was studied. The first limiting factor for soybean growth was S-deficiency in both the soils. The S concentration in the 3rd leaf at the flowering and in the grains at harvesting varied in a 1:1 ratio. Both concentrations were categorized from a point of grain production and of its protein composition. The classification was as follows: Severly lacking in case less than 1.0 g/kg; lacking at the range from 1.0 g/kg to 2.0 g/kg; low from 2.0 g/kg to 2.3 g/kg; and the normal at more than 2.3 g/kg. To obtain a satisfactory yield, the sulfuric material should be applied until the S concentration in 3rd leaf and/or grains becomes as high as 2.3 g/kg.

22. Title : Low impact harvesting method for tropical natural forests

Division : Forestry Division

Author : Shozo SASAKI

Key Words : Reduce impact logging, harvesting method, tropical forests

Synopsis : To reduce harvesting impacts of selective cutting operations in tropical natural forests, we are conducting the following studies; 1. Examination of soil compaction caused by bulldozer logging operations, and the effect of controlled felling direction, 2. Development of new cable yarding system using mobile tower yarder, which has an advantage in harvesting impacts over conventional system.

23. Title : Decrease of organic waste by the polyculture of giant tiger prawn and green mussel

Division : Fisheries Division

Author : Junya HIGANO

Key Words : Giant tiger prawn, green mussel, organic matter polyculture

Synopsis : Intensive prawn culture discharges a large amount of organic waste to the environment. We carried out studies on the monoculture of giant tiger prawn and the polyculture of giant tiger prawn and green mussel in concrete tanks and the earthen ponds in Thailand in relation to nutrient budget and water quality. In concrete tanks, the survival rates of shrimp at densities of 20, 30, 50 ind/m² were 75, 70, 62% in monoculture and 68, 65, 59% in polyculture, and the survival rates of green mussel were 43, 24 and 0.3%, respectively. Conversion ratio of feed's nitrogen to prawn was 21% in polyculture and 16% in monoculture, and ratios for the discharge were 56 and 71%, respectively. In earthen ponds, the production of prawn in polyculture and monoculture was 1.5 and 2.05 tons/ha, respectively. Green mussel only assimilated 2.7% and 4.4% of feed's nitrogen and carbon, respectively. However, the amount of the organic sediment was 368 and 793 m³/ha, in polyculture and monoculture, respectively. Consequently the polyculture contributed to reduction of the organic sediment, presumably due to the assimilation by green mussel and the other effects.

24. Title : Purification of the wastewater from aquaculture ponds using the mangrove ecosystem

Division : Fisheries Division

Author : Toru SHIMODA

Key Words : mangrove, nutrients, chlorophyll, nitrogen removal rate

Synopsis : An experiment was carried out using a semi-closed system, in which the wastewater from the prawn aquaculture ponds was passed through a mangrove afforested area with the aim of improving its quality before its return to the aquaculture ponds. The effect on the decrease in environmental load was examined. Watercourse 1, leading from the aquaculture ponds to the mangrove ponds, appeared to be the main site of decomposition for uneaten feed and generation of nutrients. Furthermore, a balance between decomposition and generation was observed in the mangrove pond; and nutrients were taken up by the phytoplankton in the prawn aquaculture ponds. During the experimental period, 22.37 kg of nitrogen was removed by the mangrove ecosystem. The nitrogen removal rate was calculated to be 62 - 232 mgN/m³/day.

25. Title : Alleviation of the incidence of internal tipburn in Chinese cabbage by subsurface drip fertigation

Division : Okinawa Subtropical Station

Author : Kazuo SUGAHARA

Key Words : Chinese cabbage (*Brassica pekinensis* Rupr), fertigation, internal tipburn, subsurface drip system

Synopsis : The potential of subsurface drip fertigation in reducing the incidence of internal tipburn in Chinese cabbage (*Brassica pekinensis* Rupr) was evaluated against conventional fertilization. In fertigation plots, nutrient solutions were applied weekly at a rate of 5 g N m⁻² through subsurface drip system for eight consecutive weeks. In the control plots, a compound fertilizer containing crotonylidene diurea was applied at a rate of 25 g N m⁻² before transplanting. Fertigation significantly reduced the tipburn incidence in all the five cultivars tested without any adverse effect on the yield. Among the five cultivars, Yuki in the fertigation plots expressed almost the complete tolerance to the tipburn incidence. Alleviation of the tipburn incidence was closely related to the level of total N and Ca/TN ratio in the inner leaves.

26. Title : Complete nucleotide sequence and genetic organization of papaya leaf distortion mosaic virus RNA

Division : Okinawa Subtropical Station

Author : Tetsuo MAOKA

Key Words : Papaya, Plant virus, Papaya leaf distortion mosaic virus, Complete nucleotide sequence

Synopsis : Papaya leaf distortion mosaic virus (PLDMV) and *Papaya ringspot virus* P type (PRSV-P) have been reported as the causal viruses of papaya disease in Japan. Both of them belong to the genus *Potyvirus*. The complete nucleotide sequence of the RNA genome of PLDMV was determined by overlapping cDNA clones and primer extension. The genomic RNA is 10,153 nucleotides in length,

excluding the poly(A) tract, and contains one large open reading frame encoding a polyprotein of 3,269 amino acids. Cleavage sites were predicted by analogy with the other potyviruses. The genetic organization of PLDMV RNA is proposed to be P1, the first proteinase; Hc-Pro, helper component proteinase; P3, the third protein; 6K1 and 6K2, 6kDa protein 1 and 2; CI, cytoplasmic inclusion protein; NIa, nuclear inclusion protein "a" including the VPg (NIa-Vpg) and NIa proteinase (NIa-Pro); NIB, nuclear inclusion protein "b"; CP, coat protein. The genetic organization of PLDMV is similar to that of the other potyviruses. The P1 protein of potyviruses is the most variable and may be considered important for identification of individual potyviruses. It might be useful for distinguishing between PLDMV and PRSV-P by RT-PCR. The sequence will be used for achieving transformation into papaya to make a PLDMV resistant papaya.

27. Title : Molecular cloning of Na⁺-ATPase cDNA from a marine alga, *Heterosigma akashiwo* (Sodium-pump in plant cell)

Division : Okinawa Subtropical Station

Author : Mariko SHONO

Key Words : Salt tolerance, Na⁺-pump, Na⁺-ATPase, Alga

Synopsis : Soil salinity is a major abiotic stress in agricultural production worldwide. Breeding of salt tolerant crops through genetic engineering is considered as one of the effective methods to solve that problem. Novel Na⁺-ATPase (HANA) cDNA from *H. akashiwo* was cloned as a target gene for the transformation. The full-length HANA cDNA was 4467-bp long and coded for a 1330-amino acid protein with a molecular weight of 146 and 306. HANA showed around 40% homology with animal Na⁺/K⁺-ATPase α -subunits in regards to identity of amino acids. A hydrophilic sequence of 285 amino acid residues that showed no homology with any sequence listed in databases existed in the M7-M8 junction of HANA. A phylogenetic tree of a P-type ATPase family comprised of three major clusters, mainly correlating with cation specificity, as follows: Ca²⁺-ATPases, H⁺-ATPases, and Na⁺/K⁺-ATPases. HANA is included in the cluster of Na⁺/K⁺-ATPases, being especially close to the Na⁺/K⁺-ATPases in invertebrates such as *Artemia*, *Drosophila*, or *Hydra*. However, yeast Na⁺-ATPases are classified into the cluster of Ca²⁺-ATPases. This is the first report on the primary structure of putative Na⁺ transporting ATPase from the plant cells.

28. Title : Simple crossing method of snap bean using physiological pollen sterility caused by high temperature treatment

Division : Okinawa Subtropical Station

Author : Yoshinobu EGAWA

Key Words : Crossing method, Snap bean, *Phaseolus vulgaris* , Heat treatment, Pollen sterility, Pod setting

Synopsis : High temperature causes pollen sterility in snap bean (*Phaseolus vulgaris* L.) rather easily. When 'Light Green' snap bean was exposed to a high temperature (35 °C) for 72 hours, the flowers that opened 8 to 12 days after the onset of heat treatment did not set pods by selfing. However, pod setting was 75% and 100 % 10 days and 11 days after the treatment, respectively, when the heat-treated 'Light Green' was crossed with fertile pollen of 'Haibushi' snap bean following the procedures described below. Crossing was carried out on the day of flowering without castration. Stigma easily protruded from the open mouth of keel petal by pressing down wing petals with fingers, which was pollinated with fertile pollen of 'Haibushi'. Hybridity of the plants obtained from the crossing were examined after 8 to 12 days of the heat treatment based on the coloration of hypocotyl. It was concluded that crossing method proposed by us did not require skilful castration technique and enabled us to produce F₁ hybrids for practical and experimental uses efficiently and highly successfully.

29. Title : Occurrence of male sterile cytoplasm in 'Kurodane Kinugasa' snap bean

Division : Okinawa Subtropical Station

Author : Yoshinobu EGAWA

Key Words : Cytoplasmic male sterility, Snap bean, *Phaseolus vulgaris* , 'Kurodane Kinugasa'

Synopsis : 'Kurodane Kinugasa' Snap bean produced semi-sterile hybrids when crossed as a seed parent with 'Haibushi'. Pollen stainability of the hybrid plants by aceto-carmin staining was 36.8 %. Since the reciprocal cross, 'Haibushi' × 'Kurodane Kinugasa' exhibited a high pollen stainability (83.8 %), the occurrence of male sterility in this cross combination is concluded to be cytoplasmic. B₁F₁ progeny derived from ('Kurodane Kinugasa' × 'Haibushi') × 'Kurodane Kinugasa' segregated into semi-sterile (12.8 to 26.5 % pollen stainability) and fertile (87.0 to 95.4 % pollen stainability) plants in a 1:1 ratio. 'Kurodane Kinugasa' is considered to have a single major restorer gene whose action is gametophytic. We have developed a cytoplasmic male sterile line of 'Haibushi' by recurrent backcrossing. 'Haibushi' is a heat-tolerant variety and exhibits high yielding ability in summer cultivation. To establish F₁ varieties of snap bean using male-sterile 'Haibushi' line as one parent, we are now exploring snap bean lines with sporophytic restorer gene(s) against this cytoplasmic male sterility.

30. Title : Distinction of sucrose phosphate synthase loci in sugarcane

Division : Okinawa Subtropical Station

Author : Takayoshi TERAUCHI

Key Words : Locus, Sucrose phosphate synthase, Sugarcane, Southern blot

Synopsis : Sucrose phosphate synthase (SPS) is considered to be an important enzyme in sucrose accumulation in sugarcane stems, as well as in sucrose transportation in photosynthesis of higher plants. Sugarcane genomic DNA was analyzed by southern blot analysis using combination of three restriction enzymes and four DNA fragments constructed from maize SPS cDNA as probes. Two recognition sites of each *Hin* d III and *Sac* I enzyme commonly existed in detected sugarcane SPS gene. Southern blot analysis using combination of *Sac* I enzyme and the 3'-end-side fragment of maize SPS cDNA as probe is considered to indicate SPS loci variation in sugarcane. Polymorphic band patterns were observed in sugarcane genetic resources by this method. The method enables SPS loci screening on genetic resources.

< JIRCAS Research Highlights in 1999 >

1. [Simulation analysis of food security using a food supply-demand model](#) Research Information Division
2. [Local rice varieties indigenous to the Mekong Delta, Vietnam, for screening of salinity tolerance.](#) Biological Resources Division
3. [Improving drought, salt, and freezing stress tolerance in transgenic plants](#) Biological Resources Division
4. [Groundwater quality and nitrogen cycling in agro-ecosystems of Lingxian county, Shandong province, China](#) Environmental Resources Division
5. [Root distribution in soil and sensitivity to water stress of upland rice in the tropics](#) Environmental Resources Division
6. [Quantitative analysis of 2-acetyl-1-pyrroline in aromatic rice](#) Crop production and postharvest technology division
7. [Cultivar identification of milled rice.](#) Crop production and postharvest technology division
8. [Digestion characteristic and energy requirement of native ruminants in Northeast Thailand](#) Department of Research Planning and Coordination, National
9. [Tropical grasses available for agropastoral systems, with high function in supplying organic matter into soil](#) Animal Production and Grassland Division
10. [Regeneration technique of Seraya on the logging roads in Peninsular Malaysias](#) Forestry Division
11. [Simplified pre-germination treatments for indigenous legume trees in the Philippines](#) Forestry Division
12. [Determination of amino acid sequence and site of mRNA expression of four vitellins in the giant freshwater prawn, Macrobrachium rosenbergii](#) Fisheries Division
13. [Productivity and diversity of fish in brackish water mangrove ecosystems](#) Fisheries Division
14. [Evaluation of heat tolerance in snap bean based on pollen stainability.](#) Okinawa Subtropical Station
15. [Characteristics of rainfall kinetic energy and raindrop size distribution in subtropical zone area](#) Okinawa Subtropical Station

Library, Japan International Research Center for Agricultural Sciences

Tel.: 0298-38-6340, Fax: 0298-38-6656, e-mail: ref@jircas.affrc.go.jp

1-2, Ohwashi, Tsukuba-shi Ibaraki-ken, 305-8686 JAPAN

[BACK](#)

1.

Title	Simulation analysis of food security using a food supply-demand model
Division	Research Information Division
Author	Osamu Koyama
Key words	Food supply-demand model, trade liberalization, food security
Synopsis	A simulation analysis was conducted using an econometric model, which was partially modified from a food supply-demand model built in OECD. The results shows that introduction of trade liberalization policy in the low-income food deficit countries in Asia would undermine the food security situation in the region, if external shocks such as crop failure in food exporting countries or currency depreciation in food importing countries occurred.



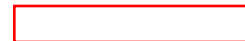
2.

Title	Local rice varieties indigenous to the Mekong Delta, Vietnam, for screening of salinity tolerance.
Division	Biological Resources Division
Author	Tomohiro Ban, Vuong Dinh Tuan
Key words	DNA marker, Genetic diversity, Local rice, Microsatellite, Salinity tolerance
Synopsis	<p>JIRCAS' Comprehensive Project on the "Development of new technologies and their practice for sustainable farming systems in the Mekong Delta" has an important component addressing the genetic diversity angle in Mekong Delta agriculture. Due to the introduction of high-yielding rice varieties, traditional varieties with stress tolerance might disappear rapidly. Dr. V. D. Tuan, JIRCAS Research Fellow, worked with JIRCAS staff in the analysis of genetic diversity of traditional varieties in the region.</p> <p>A total of 43 microsatellite primers were used for the genetic diversity analysis of 60 traditional rice varieties, five upland rice varieties from the region and 10 other lines as reference. Those 75 lines were grouped into four major groups (Figure 1). All japonica type varieties were clustered into Group I and indica type into Groups II to IV. Traditional varieties are grouped into Group II and IV, expressing a great deal of genetic diversity. Moreover, salinity tolerance was assessed. A total of 14 traditional varieties had shown levels of tolerance similar to or more than that of the standard tolerant varieties such as Pokkali and NipponBare.</p> <p>A high level of genetic diversity among traditional rice varieties in the Mekong Delta was confirmed. This indicated that conservation of those traditional varieties is important and further progress in breeding using those rice cultivars are feasible due to high level of variation observed. The discovery of salinity-tolerant rice varieties is highly encouraging. Tolerance was observed in all groups, indicating a wide spread of salinity tolerance and, consequently, a wide genetic base for the trait. Pyramiding genes of salinity tolerance with different genetic background seems possible based on the results.</p>



3.

Title	Improving drought, salt, and freezing stress tolerance in transgenic plants
Division	Biological Resources Division
Author	Kazuko Yamaguchi-Shinozaki, Mie Kasuga, Qiang Liu, Kazuo Nakashima, Zabta K. Shinwari and Kazuo Shinozaki
Key words	drought tolerance, freezing tolerance, transgenic plants, multigene expression, stress-inducible promoter
Synopsis	<p>Plant productivity is greatly affected by environmental stresses such as drought, salt loading, and freezing. We reported that a <i>cis</i>-acting promoter element, the dehydration response element (DRE), plays an important role in regulating gene expression in response to these stresses in <i>Arabidopsis</i>. The transcription factor DREB1A specifically interacts with the DRE and induces expression of stress tolerance genes. We show here that overexpression of the cDNA encoding DREB1A in transgenic <i>Arabidopsis</i> plants activated the expression of many of these stress tolerance genes under normal growing conditions and resulted in improved tolerance to drought, salt loading, and freezing. However, use of the strong constitutive 35S cauliflower mosaic virus (CaMV) promoter to drive expression of DREB1A also resulted in severe growth retardation under normal growing conditions. In contrast, expression of DREB1A from the stress inducible rd29A promoter gave rise to minimal effects on plant growth while providing an even greater tolerance to stress conditions than did expression of the gene from the CaMV promoter. As the DRE-related regulatory element is not limited to <i>Arabidopsis</i> the DREB1A cDNA and the rd29A promoter may be useful to improve the stress tolerance of agriculturally important crops by gene transfer.</p>



4.

Title	Groundwater quality and nitrogen cycling in agro-ecosystems of Lingxian county, Shandong province, China
Division	Environmental Resources Division
Author	Kazuyuki Yagi and Yasukazu Hosen
Key words	Environment, Fertilizer, Nitrate, Nitrogen flows, Nitrogen pollution
Synopsis	<p>A regional analysis of nitrogen cycling in the agro-ecosystems of Lingxian County, Shandong Province, China was carried out. Total input of nitrogen to arable land, derived from chemical and organic fertilizer, sewage, precipitation, irrigation, and nitrogen fixation, was estimated to be, on the average, 584 kgN ha⁻¹ year⁻¹. The nitrogen output, including plant uptake and denitrification, was 296 kgN ha⁻¹ year⁻¹. These results indicate that arable land in this area should receive a balance of 288 kgN ha⁻¹, annually. A survey of the ground water quality in the area shows that nitrate pollution of ground water has not been widely noticeable at present. However, the analysis of nitrogen cycling in agro-ecosystems predicts the large potential risk of nitrogen pollution in the environment in the near future.</p>



5.

Title	Root distribution in soil and sensitivity to water stress of upland rice in the tropics.
Division	Environmental Resources Division
Author	Motohiko KONDO
Key words	Phosphorus, Roots, Upland rice, Water uptake
Synopsis	<p>Response of upland rice to water stress in terms of root growth and water uptake from soil layers was characterized. Water uptake is more sensitive to soil drying as compared with nitrogen uptake, which signifies that water uptake is a major limiting factor for the plant growth under stressed conditions. Low water uptake under severe stress in rice can be attributed to shallower root distribution and poorer water capture from deep soil layer, deeper than 40 cm depth as compared with maize. Maize increased root growth in deep soil layers in responding to severe stress. In contrast, rice showed few stimulated root growth and limited water extraction rate per unit length of root under severe stress. Field investigation in acidic soils indicated that phosphorus application led to the formation of deeper root system. Amendment of phosphorus is considered to improve water capture from deep layers to sustain plant growth under stress in acidic soils with low available phosphorus.</p>



6.

Title	Quantitative analysis of 2-acetyl-1-pyrroline in aromatic rice.
Division	Crop production and postharvest technology division
Author	Tadashi YOSHIHASHI
Key words	Aromatic rice, Flavor components, 2-acetyl-1-pyrroline, Isotope dilution method
Synopsis	<p>A “popcorn*-like flavor compound, 2-acetyl-1-pyrroline, has been reported as an important flavor component of aromatic rice because of its lower odor threshold, i.e. 0.1 ppb (in H₂O), than the other volatile compounds in rice. In conventional method, 2-acetyl-1-pyrroline and other volatile components were extracted from 500g of rice sample by using simultaneous steam distillation / solvent extraction apparatus.</p> <p>In conventional method, the extracts were analyzed by gas chromatography / mass spectrometry in full scan mode or gas chromatography / flame ionization detection with internal standard method using 2,4,6-trimethyl pyridine as standard.</p> <p>Isotope dilution method, isotope labeled compounds is used as internal standard, is an ideal method for quantification using gas chromatography / mass spectrometry /selective ion monitoring which has higher sensitivity than full scan mode.</p> <p>An improved method, Gas chromatography / mass spectrometry / selected ion monitoring with isotope dilution method, can enhance the sensitivity for quantification of 2-acetyl-1-pyrroline in aromatic rice samples using small quantities (0.5g) with high specificity.</p>



7.

Title	Cultivar identification of milled rice.
Division	Crop production and postharvest technology division
Author	Tadashi YOSHIHASHI
Key words	Milled rice, DNA extraction, Microsatellite analysis, cultivar identification
Synopsis	<p>In our laboratory, we developed DNA extraction method based on a freeze-and-thaw cycle for extracting purified, high molecular weight DNA from grains. The developed technique does not require expensive equipment and materials, and is not a time-consuming procedure. By applying this method, we were able to obtain DNA for microsatellite analysis within 2h and the whole process of identification required 6h. Time saving and unemployment of expensive instruments or toxic chemicals of the present method is an attractive alternative to existing methods of identification. Obtained results showed that DNA extracted from tested samples was of high quality and hence could be used in PCR-based techniques for cultivar identification even in laboratories with a moderate level of technology. Another feature of this developed technique was saving in time and cost as well as the safety of this procedure.</p>



8.

Title	Digestion characteristic and energy requirement of native ruminants in Northeast Thailand
Division	Department of Research Planning and Coordination, National Institute of Animal Industry
Author	Tomoyuki Kawashima, W. Sumamal, P. Pholsen and R. Narmsrilee
Key words	Native cattle, Swamp buffalo, Energy requirement, Digestibility
Synopsis	Native ruminants, such as Thai native cattle and swamp buffalo, are able to efficiently digest low quality roughage without protein supplement. And these animals require less energy to maintain basal metabolism. Therefore, these animals can be effectively raised with low quality feed.



Title	Tropical grasses available for agropastoral systems, with high function in supplying organic matter into soil
Division	Animal Production and Grassland Division
Author	Tsutomu KANNO, Manuel C. MACEDO, and Valeria P.B. EUCLIDES
Key words	root biomass, soil organic matter, tropical grass
Synopsis	<p>Root biomass of five tropical grasses was compared as the function in supplying organic matter into soil of Brazilian savanna (Oxisol). Pastures of the five grasses, <i>Brachiaria decumbens</i> (BD), <i>B. brizantha</i> (BB), <i>Panicum maximum</i> cv. Tanzania (TA), <i>P. maximum</i> cv. Tobiata (TO), and <i>Andropogon gayanus</i> (AN), were established, and grazed for three years. Then the root biomass was measured in 0-10, 10-20, and 20-40cm of soil layers. Measured root biomass represented 53-76% of total biomass of the five grasses. Among the five grasses, root biomass level per square meter was in the order of BB>BD>TA>TO>AN, with the root biomass of BB significantly higher than those of the other grasses. Root biomass decreased quickly with the increase of soil depth, whereas the percentage of root biomass to dry soil of BB was highest among the five grasses in all of the soil layers. It is concluded that BB is the best option to introduce in crop-pasture rotation for soil quality improvement.</p>



10.

Title	Regeneration technique of Seraya on the logging roads in Peninsular Malaysias.
Division	Forestry Division
Author	OCHIAI(JIRCAS) and AZMAN Hassan(FRIM)
Key words	Hill forest, Seraya, Dipterocarp, Logging road, Regeneration
Synopsis	<p>The regeneration of Seraya, one of the most valuable tree species in hill forests where most logging operations are being carried out in Peninsular Malaysia, is investigated on a logging road with 500 m length in compartment 28, Semangkok forest reserve. About 400 seedlings of Seraya are found on the road. Their distribution is not uniform yet. All the seedlings are found on ridges while no seedlings are found on the lower slopes. This result is caused by the fact that most mother trees are distributed on the ridges and only a small number are on the lower slopes. On the ridges, the level ridges have more developed Seraya seedlings while the sloping ridges have less developed Seraya. This results from the seeds from mother trees being easily washed out by rainfall immediately after logging on the sloping ridges. Thus, germination there can only take place after sufficient litter has accumulated again. It is clear from the results that it is necessary to prevent the rainfall from washing away the seeds on the road in order to recover the logged-over forest quickly. Seraya's regeneration after logging is not difficult if microtopography is considered.</p>



11.

Title	Simplified pre-germination treatments for indigenous legume trees in the Philippines
Division	Forestry Division
Author	Kazunori TAKAHASHI, Wilfredo M., CARANDANG and Antonio F. GASCON
Key words	Germination, Hot Water Treatment, <i>Laucaena leucocephala</i> , Philippines
Synopsis	Simplified pretreatment to improve seed germination was investigated for reforestation tree species of Leguminosae and Mimosaceae which were indigenous to the Philippines. Seeds of these species are treated with hot water time-courses on several temperatures for 0.5-5 min, seed scarification and fire-heating by burning grass, and then sowed to nursery. Three varieties of <i>Laucaena leucocephala</i> , which were the most common reforestation planting species there, were all highly improved the germination rates in their most appropriate time-courses of hot water treatment. The fire-heating, which was usual pretreatment for the legume direct sowing, was also effective, but less than hot water treatment. Thus, the appropriate hot water treatment for seeds found should be given before the direct seed sowing to ensure the establishment of rehabilitated legume forest on the degraded grassland.



12.

Title	Determination of amino acid sequence and site of mRNA expression of four vitellins in the giant freshwater prawn, <i>Macrobrachium rosenbergii</i>
Division	Fisheries Division
Author	Marcy N. Wilder and Wei-Jun Yang
Key words	amino acid sequence, cloning, mRNA expression, vitellin
Synopsis	Four major yolk proteins, designated as vitellins (Vns) Macr-VnA, B, C and D, were extracted from mature ovary of <i>Macrobrachium rosenbergii</i> . These were purified to homogeneity by reversed-phase HPLC employing a unique separation system based on the hydrophobic properties of the Vn molecule. More than 33 N-terminal and 57 internal amino acid residues were determined for each of the four Vns. The cDNA fragments encoding the four Vns were amplified by PCR using degenerate oligonucleotide primers derived from the N-terminal and internal amino acid sequences. These cDNA fragments were cloned, sequenced and used as probes to examine the transcription of mRNAs encoding the four Vns. Significant accumulation of these mRNAs was observed in female hepatopancreas only, while mRNA expression was not detected in male hepatopancreas or any other female tissue including ovary, subepidermal adipose tissue, gill and muscle.



13.

Title	Productivity and diversity of fish in brackish water mangrove ecosystems
Division	Fisheries Division
Author	Masachika MAEDA
Key words	mangrove, fish, diversity, diatoms, nutrients
Synopsis	<p>Japan International Research Center for Agricultural Sciences (JIRCAS) and Malaysia (Fisheries Department, Forestry Department and Malaya University) organized the new project on "Brackish Water Mangrove Ecosystems* from April, 1995 * March, 2000. In three research areas of the mangrove estuary in Malaysia adopted as a project site, the characteristic differences between these are the ratios of the mangrove forests area/river area, in which the values for Matan (4.7), Merbok (2.1) and Lumut (1.1) are calculated, respectively. In the Matang mangrove estuary area (ratio: 4.7), the quantity of fish catch is larger than that in Merbok (ratio: 2.1) and Lumut (ratio: 1.1). In case of the diversity index of fish, however, shows a higher value in Merbok than in the other two mangrove areas. In Lumut, the volume of fish catch and diversity index are the lowest of the three areas. Based on these results, we conclude that the value of the ratio of mangrove forest area/river area is a useful index, with a value of between 4.7 and 2.1 being a precondition for sustainable fish production in mangrove estuary areas.</p> <p>The dominant macrobenthic animal group in Matang was the bivalves, accounting for 46 % of the total abundance, but in Lumut, polychaetes were the clearly dominant group, making up about 46 % of the total benthos population. In addition it was found in this project that wet land retains silicates where phytoalgal diatoms are present at high concentrations, which provide not only oxygen to benthic animals inside the wet land but also flow into the sea, resulting in high concentrations of biomass in seawater. These diatoms repress the growth of dinoflagellates due to the competition among the phytoalgae communities.</p>



14.

Title	Evaluation of heat tolerance in snap bean based on pollen stainability.
Division	Okinawa Subtropical Station
Author	Katsumi SUZUKI, Hiroyuki TAKEDA, Yoshinobu EGAWA and Tadashi TSUKAGUCHI
Key words	Heat stress, High temperature, Snap bean(<i>Phaseolus vulgaris</i>), Pollen stainability
Synopsis	Pollen stainability of snap bean decreases by being subjected to heat stress 8 to 11 days before flowering in a greenhouse. When mean air temperature about 10 days before flowering is over 28 , pollen stainability of snap bean decreases in the field at Okinawa Subtropical Station. Heat tolerant varieties show higher pollen stainability than heat sensitive varieties under high temperatures. Based on pollen stainability, tolerance to high temperature about 10 days before flowering can be evaluated.



Title	Characteristics of rainfall kinetic energy and raindrop size distribution in subtropical zone area
Division	Okinawa Sub-tropical Station
Author	Kenji BANZAI, Tamon FUMOTO, Yoshinari OHWAKI, Kazuo SUGAHARA
Key words	Rainfall intensity, Rainfall energy, Soil erosion, Raindrop size
Synopsis	<p>Characteristics of rainfall energy and raindrop size distribution were examined in a subtropical zone area using a disdrometer. Rainfall energy values were calculated from the observations obtained from the device which measures raindrop size distributions continuously and automatically. The device however can not measure raindrops below 0.3 mm, hence rainfall energy values may give an error of about 2.48 %. Measured kinetic energy vs. rainfall intensity data showed wide distribution between the upper limit equation by Wischmeier and the lower equation by Mihara. Kinetic energy over and above the Wischmeier equation was also observed below 30 mm/h rainfall. In Ishigaki, there were large size raindrops at rainfall intensities below 30 mm/h. The distribution of raindrop size was wide from 1 mm to 5 mm in diameter compared with those measured in Tsukuba where raindrop size was concentrated between 1-2 mm.</p>

CONTENTS

< JIRCAS Research Highlights in 1998 >

1. [Farming Systems Combining Agriculture, Animal Husbandry, and Fisheries in the Mekong Delta](#)
 2. [Coordinating a Multidisciplinary Research on the Agriculture in the Mekong Delta](#)
 3. [Research needs for improvement of no-tillage cultivation of soybean in South America](#)
 4. [Input-output analysis on soybean-related industries in Brazil](#)
 5. [Technical development and evaluation of doubled haploid breeding scheme in wheat improvement](#)
 6. [Suppression of nitrification in soil by a tropical grass](#)
 7. [Effect of the depth of NO and N₂O production in upland soil on their emission rates to the atmosphere](#)
 8. [Furrow bottom seeding to accelerate crop growth under the arid regions](#)
 9. [Pathogenicity of *Pyricularia grisea* and *Xanthomonas oryzae* pv. *oryzae* strains in Vietnam](#)
 10. [Determination of antimutagenic constituents from edible Zingiberaceae plants produced in Thailand](#)
 11. [Analysis of chitinolytic enzyme genes of a mycoparasitic bacterium *Flexibacter* sp. FL824A](#)
 12. [Effect of application of anthelmintic on the growth of pig with *Ascaris suum*](#)
 13. [Social Impact of Transmigration in Sumatra, Indonesia](#)
 14. [Chlorine-free bleaching of kraft pulp from oil palm empty fruit bunches](#)
 15. [Litterfall in a Matang mangrove forest](#)
 16. [Development of SURIMI made from freshwater fish meat in China](#)
 17. [Seed sterility of Japanese rice varieties under short-day condition](#)
 18. [Detection of bruchid-resistant strains in wild adzuki bean germplasm](#)
 19. [A fungal epiphyte \(*Ephelis* sp.\) of grasses on Ishigaki island and its effect on the feeding of two insect pests](#)
-

Library , Japan International Research Center for Agricultural Sciences

Tel.: 0298-38-6340, Fax.: 0298-38-6656, e-mail: ref@jircas.affrc.go.jp

1-2, Ohwashi, Tsukuba-shi Ibaraki-ken, 305-8686 JAPAN

BACK

< JIRCAS Research Highlights in 1997 >

1. [Long-range migration of rice planthoppers in monsoonal East Asia](#)
2. [Serological diagnosis of citrus greening disease](#)
3. [Comparative studies of fish production in brackish waters between intact \(Matang\) and exploited \(Merbok\) mangrove areas](#)
4. [Improvement of rice cropping for farming systems in the Mekong Delta, Vietnam](#)
5. [Changes in the agricultural structure under the Doi Moi policy in the Mekong Delta, Vietnam](#)
6. [Isolation of genes essential for molecular breeding of drought tolerant plants](#)
7. [Development of assessment method for vegetation stability using Neural Network](#)
8. [Development of a method to estimate the distribution of agricultural land use based on satellite data in the central part of the Deccan plateau in India](#)
9. [Measurement of nitrous oxide emissions from upland fields in Thailand](#)
10. [Edible insects in Kenya](#)
11. [Analysis of mechanical properties of collapsible soils and development of a quantitative method](#)
12. [Immunohistological analysis of the tick attachment site of *Rhipicephalus appendiculatus* infected with *Theileria parva*](#)
13. [In situ hybridization to detect bovine cytokine mRNAs in protozoan disease](#)
14. [Age determination of tropical fishes and squids in Indonesia](#)
15. [Enzyme activity of early maturing sugarcane stalks with high sugar content](#)
16. [Evaluation of mungbean cultivars for resistance to iron deficiency](#)
17. [Stimulation of ethylene synthesis from husks of rice seeds by ferrous iron](#)
18. [Contribution of caoutchouc to durability of teak \(*Tectona grandis* L. f.\) wood](#)
19. [Development and utilization of hybrid rice in Malaysia](#)
20. [Performance assessment for water resources management at watershed level using existing management data](#)

Library , Japan International Research Center for Agricultural Sciences

Tel.: 0298-38-6340 Fax.: 0298-38-6656 e-mail: ref@jircas.affrc.go.jp

1-2, Ohwashi, Tsukuba-shi Ibaraki-ken, 305-8686 JAPAN

[BACK](#)

1.

Title	Long-range migration of rice planthoppers in monsoonal East Asia
Division	Crop Production and Postharvest Technology Division
Authors	Kazushige SOGAWA and Akihiko TAKAHASHI
Key Words	Brown planthopper, Whitebacked planthopper, Southwest monsoon, East Asia, Winter-spring rice, Early rice , Two-staged migration, Immigration
Synopsis	<p>The brown planthopper, <i>Nilaparvata lugens</i>, and whitebacked planthopper, <i>Sogatella frucifera</i>, are international insect pests of rice, which undertake long-range migrations from tropical to temperate rice areas in East Asia every year. The rice planthoppers are transported downwind by a synoptic scale of wind systems associated with the southwest monsoon and Baiu climate. We demonstrated that the migratory planthoppers emigrating from North Indochina migrate to Japan <i>via</i> South China by means of trajectory analyses of airflow at 850hPa.</p> <p>The migration process involved two major stages of habitat displacements; from winter-spring rice in North Vietnam to early rice in South China in April to May, and from early rice to single rice in Japan in June to July. These two stages of migrations were achieved by seasonal advance of monsoon climate and geographical shifting of the rice cropping period in the migration zone in East Asia.</p>

[CONTENTS](#)[NEXT](#)

Title	Serological diagnosis of citrus greening disease
Division	Crop Production and Postharvest Technology Division
Authors	Yoshihiro OHTSU, Maitree PROMMINTARA, Koji KAWASHIMA, Seiichi OKUDA, Kazuo NAKASHIMA and Takeshi KANNO
Key Words	Citrus greening, Midrib, Phloem tissue, Microprecipitin test.
Synopsis	Accurate serological diagnosis with microprecipitin test was developed for greening disease. Phloem tissues were separated after digestion of diseased midribs in enzyme solution. Partially purified greening organisms GO concentrated up to 40 times of the midrib weight were obtained from final pellets after one cycle of centrifugation of homogenate of phloem tissue. Microprecipitin test was conducted by adding one drop 5% of the partially purified GO to one drop of the GO antiserum.

[BACK](#)[CONTENTS](#)[NEXT](#)

3.

Title	Comparative studies of fish production in brackish waters between intact (Matang) and exploited (Merbok) mangrove areas
Division	Fisheries Division
Authors	Shigeo HAYASE, Ahmad HUSIN (FRI), Yoh YAMASHITA (TNFRI), Katsuhisa TANAKA (NRIFS), A. SASEKUMAR and Chong Ving CHING (UM)
Key Words	Brackish water, Mangrove ecosystems, Matang mangrove area, Merbok mangrove area, Fish juvenile, Density, Biomass, Growth rate, Production, Food-chain
Synopsis	<p>The brackish waters in which sea water and fresh water are mixed occur mainly in tropical and subtropical coastlines, and many mangrove trees spread out along the brackish water coastlines. Mangrove trees are not only utilized for charcoal production but also serve as nursery grounds for fish and prawns. In the comprehensive studies conducted to evaluate the productivity of brackish water mangrove ecosystems and identify criteria for sustainable utilization of the areas, comparative studies have been carried out on fish biomass between intact (Matang) and exploited (Merbok) brackish water mangrove ecosystems in Peninsular Malaysia. The distinct C-N isotopic ratio gradient in the Matang brackish water mangrove ecosystems suggests that the food pathway start from the mangrove leaf-based detritus to carnivorous fish and squids through herbivorous shrimps and crabs. The Matang Mangrove Forest Reserve in Perak consisting of 40,711 hectares and situated on the northwestern coast of Peninsular Malaysia has been under sustainable yield management since the early part of the century. On the other hand, in the case of the Merbok Mangrove area in Kedah, situated in a further northwestern direction from Matang and covering 8,000 ha which has been exploited, the mangrove area during the past ten years has been reduced by about 11% from 9,037ha in 1980 to 8,034ha in 1990 and the loss of mangroves is still continuing. Biomass of juvenile anchovy, <i>Stolephorus</i> spp., in Matang was 4.3 times higher than in Merbok. The information obtained here will be useful to scientists in many fields to improve the technology for sustainable utilization of brackish water mangrove ecosystems, which will bring about benefits especially to dwellers in the areas and also to policy-makers.</p>

[BACK](#)
[CONTENTS](#)
[NEXT](#)

Title	Improvement of rice cropping for farming systems in the Mekong Delta, Vietnam
Division	Crop Production and Postharvest Technology Division
Authors	Tadao KON, Pham Sy TAN, Tran Ngoc HUAN, Trinh Quang KHUONG and Hoang Dinh DINH.
Key Words	Diagnosis, Fertilizer application, Leaf color, Water management, Yield component
Synopsis	<p>Under <i>Doi Moi</i> policy which started in 1986, farming systems combining agriculture, animal husbandry and fisheries developed widely in the Mekong Delta, Vietnam. Rice production, an important component of farming systems in the Delta, rapidly increased owing to field reclamation, canal excavation and dike construction, and introduction of double or triple cropping of rice together with newly bred high-yielding varieties.</p> <p>In the collaborative research project with Cuu Long Delta Rice Research Institute, we carried out studies for the improvement of rice cropping. Some useful results were obtained to achieve higher yields of rice. Firstly, leaf color was found to be a good indicator of the leaf nitrogen content which markedly affects the growth, yield components and lodging of rice plants. Fertilizer application can be improved by the diagnosis of nutrient conditions through leaf color measurement. Secondly, top dressing of nitrogen at an early stage of rice development was found to be rather hazardous because of easier and earlier lodging especially in the wet season. Thirdly, drainage of flooding water in rice fields during growth period of rice was effective for the prevention of lodging and for achieving higher yields, as observed in farmers' fields where a rice-fish farming system was adopted.</p> <p>The results will contribute to the development of low input sustainable rice production in farming systems in the Mekong Delta.</p>

[BACK](#)
[CONTENTS](#)
[NEXT](#)

5.

Title	Changes in the agricultural structure under the <i>Doi Moi</i> policy in the Mekong Delta, Vietnam
Division	Crop Production and Postharvest Technology Division
Authors	Ryoichi Yamazaki
Key Words	Market-oriented economy, Differentiation of farmers, Diversified farming
Synopsis	After 1988, in the Mekong Delta of Vietnam, the differentiation of farmers made rapid progress under the market-oriented economy, introduced by the <i>Doi Moi</i> policy. Some farmers have expanded their farm size rapidly. Others have reduced their farm size and finally became landless. However, medium or small-scale landowner's have attempted to stabilize their household economy by introducing diversified farming. In future diversified farming will be reorganized on a community basis.

[BACK](#)

[CONTENTS](#)

[NEXT](#)

6.

Title	Isolation of genes essential for molecular breeding of drought tolerant plants
Division	Biological Resources Division
Authors	Kazuko Yamaguchi-Shinozaki <i>et al.</i>
Key Words	Transcription factors, Drought-inducible genes, Promoters, Drought-tolerant plants
Synopsis	Plant genes for transcription factors were isolated that control expression of genes involved in drought tolerance. Regulatory elements in promoters were also identified that control drought-responsive gene expression. These transcription factors and promoters are expected to be useful for molecular breeding of drought-tolerant plants by regulating the number of genes involved in drought tolerance.

[BACK](#)[CONTENTS](#)[NEXT](#)

7.

Title	Development of assessment method for vegetation stability using Neural Network
Division	Environmental Resources Division
Author	Yukiyo YAMAMOTO
Key Words	Australia, Neural Network, Vegetation stability
Synopsis	In the test site located in central Australia, two Neural Network models to estimate vegetation abundance and changes were developed based on 7 factors including slope, geomorphic systems, hydrological units, soil units, vegetation units, distance from water points and distance from ridges. Furthermore, an assessment map for vegetation stability was constructed by the integration of two results of estimation using the Neural Network models mentioned above.

[BACK](#)

[CONTENTS](#)

[NEXT](#)

8.

Title	Development of a method to estimate the distribution of agricultural land use based on satellite data in the central part of the Deccan plateau in India
Division	Environmental Resources Division
Author	Satoshi UCHIDA
Key Words	Satellite data, Vegetation index, Semi-arid area of India, Rabi season, Agricultural land use, Spatial distribution
Synopsis	Vegetation index calculated from satellite remote sensing data reveals specific patterns of seasonal changes depending on land use types. In the semi-arid area of India, the value of the vegetation index of agricultural land use could be differentiated from that of other land uses during the latter half of the post-rainy cropping season called Rabi. In this study a method to estimate the spatial distribution of agricultural land use by adapting the temporally variable threshold value of vegetation index was developed. This method has enabled to collect quantitative information on Rabi cropped area for several years with available satellite data. Investigations of temporal changes showed that the location of the cropped area was correlated with the amount of rainfall during the sowing period and with the suitability of land conditions.

[BACK](#)[CONTENTS](#)[NEXT](#)

Title	Measurement of nitrous oxide emissions from upland fields in Thailand
Division	Environmental Resources Division
Authors	Takeshi WATANABE, Katsuyuki MINAMI and Prapai Chairroj (DOA)
Key Words	Nitrous Oxide, Nitrogen fertilizer, Upland soils, Tropics
Synopsis	Nitrous oxide emissions from upland soils were measured during a period of one year by the closed chamber method at four experimental sites in Thailand. Two treatments consisting of the application and absence of application of nitrogen fertilizer were set in triplicate at each experimental site. The total amount of nitrous oxide emitted throughout the maize cultivation period ranged from 0.08 to 0.48% of applied nitrogen fertilizer and these rates not significantly different from those recorded in the temperate zone.

[BACK](#)[CONTENTS](#)[NEXT](#)

10.

Title	Edible insects in Kenya
Division	Crop Production and Postharvest Technology Division
Authors	Shigemi Yagi, E. Kokwaro, Kesa Kishida and Mitsuo Yazawa
Key Words	Edible Insects, Western Kenya, Termites
Synopsis	<p>New uses of edible insects such as locusts, grasshoppers, termites, flies and wild silkmths were investigated in rural areas of Kenya. Field surveys conducted in the Maragoli area in western Kenya showed that villagers easily distinguish species and the emergence patterns of termites which are the most common edible insects in Kenya. Cooked termites are sold not only in the local markets but also in some open markets in Kisumu or Nairobi because they can be stored up to at least several days without spoilage. These results suggest that termites play an important role in the daily food consumption in this area in the rainy season, during periods of maize shortage, and that they may be especially valuable for children and pregnant women who require a high calorie and nutritious diet.</p>

[BACK](#)[CONTENTS](#)[NEXT](#)

11.

Title	Analysis of mechanical properties of collapsible soils and development of a quantitative method
Division	Crop Production and Postharvest Technology Division
Authors	Yuji Kohgo, S. B. Tamrakar and H. B. Tang
Key Words	Collapsible soil, Unsaturated soil, Suction, Elastoplastic model
Synopsis	The mechanical properties of the collapsible soils distributed in Northeast Thailand were investigated by using a triaxial compression test apparatus, oedometer and pressure plate test apparatus. A method for estimating the amount of collapse by using the elastoplastic model for unsaturated soils was also developed. Comparison of the experimental and estimated data of volume change due to the collapse showed that both agreed well. This method is suitable for the estimation of volume change due to collapse.

[BACK](#)

[CONTENTS](#)

[NEXT](#)

Title	Immunohistological analysis of the tick attachment site of <i>Rhipicephalus appendiculatus</i> infected with <i>Theileria parva</i>
Division	Animal Production and Grassland Division
Author	Yutaka MATSUBARA
Key Words	East Coast fever, <i>Theileria parva</i> , Tick, Skin, Immunohistochemistry
Synopsis	The brown ear tick, <i>Rhipicephalus appendiculatus</i> , transmits <i>Theileria parva</i> protozoan which causes theileriosis, commonly known as East Coast fever (ECF) in Africa. To enhance our understanding of the early events of <i>T. parva</i> infection <i>in vivo</i> for vaccine development against ECF, we have identified cell populations present at the site of tick attachment in cattle. Skin biopsies were immunohistochemically investigated by the biotin-streptavidin method using monoclonal antibodies against bovine leukocyte surface antigens.

[BACK](#)[CONTENTS](#)[NEXT](#)

Title	<i>In situ</i> hybridization to detect bovine cytokine mRNAs in protozoan disease
Division	Animal Production and Grassland Division
Author	Yutaka MATSUBARA
Key Words	Cytokines, <i>In situ</i> hybridization, Bovine cytokine mRNAs
Synopsis	Cytokines are a family of low molecular weight protein regulatory molecules involved in inflammation and immunity. They play an important role in the immune system to control cell growth and differentiation of immunocompetent cells. An <i>in situ</i> hybridization protocol using nonradioactively labeled RNA probes was established to detect bovine cytokine mRNAs TNF- α , IFN- γ , IL-2IL-4IL-6IL-10and IL-12p35 on cytospin preparations.

[BACK](#)[CONTENTS](#)[NEXT](#)

14.

Title	Age determination of tropical fishes and squids in Indonesia
Division	Fisheries Division
Authors	Satoshi SUYAMA, Syarifuddin Tonnek and Shinji UEHARA
Key Words	Age, growth, daily growth increments, otolith
Synopsis	Age and growth of fishes and squids distributed in Indonesia were estimated by analyzing daily growth increments in otolith. Ground otoliths were observed by light and scanning electron microscopy. Three of eight species, <i>Atherinomorus lacunosus</i> , <i>Sphaeramia ordicularis</i> and <i>Sepioteuthis lessoniana</i> , had clear increments which enabled the estimation of age in days. We additionally verified the daily periodicity of increment formation of <i>Sphaeramia ordicularis</i> under rearing experiments.

[BACK](#)[CONTENTS](#)[NEXT](#)

15.

Title	Enzyme activity of early maturing sugarcane stalks with high sugar content
Division	Okinawa Subtropical Station
Authors	Takatyoshi TERAUCHI, Makoto MATSUOKA, Makoto KOBAYASHI, Hiroshi NAKANO, Shunsuke ODA and Masahiro OKAMOTO
Key Words	Sugarcane, Early maturing, Acid invertase, Sucrose phosphate synthase
Synopsis	NiF4, an early maturing variety with a high sugar content, shows a high Brix-value even in the growing season compared to F172. Acid invertase activity, a negative factor for sugar accumulation, of NiF4 is relatively higher than in F172. Sucrose phosphate synthase activity, a positive factor for sugar accumulation, of NiF4 is higher than in F172. This enzyme activity increases in both the maturing season and under low temperature conditions with Brix increment.

[BACK](#)[CONTENTS](#)[NEXT](#)

Title	Evaluation of mungbean cultivars for resistance to iron deficiency
Division	Okinawa Subtropical Station
Authors	Yoshinari OHWAKI, Yoshinobu EGAWA, Kazuo SUGAHARA, Sanayh KROKAW (DOA) and Somsong CHOTECHUEN (DOA)
Key Words	Acidification, Chlorosis resistance, Iron deficiency, Mungbean (<i>Vigna radiata</i> (L.) Wilczek).
Synopsis	Ten mungbean cultivars were evaluated for their resistance to iron deficiency based on the developed of chlorosis symptoms, plant growth and seed yield under field conditions on a calcareous soil in Thailand. KPS2 cultivar was highly susceptible ; KPS1, PSU1 and Pag-asa1 cultivars were somewhat susceptible ; VC1163B cultivar was moderately tolerant ; CN36, CN60, UT1 and CNM-I cultivars were tolerant and ; CNM8509B cultivar was highly tolerant to iron deficiency. Compared with the susceptible cultivar KPS2, the tolerant cultivar UT1 had a greater ability to lower the pH of the nutrient solution in response to iron deficiency. Acidification of the medium in response to iron deficiency may contribute to the efficient solubilization of iron from calcareous soils, and it is closely related to the tolerance of iron deficiency in mungbean cultivars.

[BACK](#)
[CONTENTS](#)
[NEXT](#)

Title	Stimulation of ethylene synthesis from husks of rice seeds by ferrous iron
Division	Laboratory of Soil Management, Department of Agro-environmental Management, Chugoku National Agricultural Experiment Station
Author	Minoru YAMAUCHI
Key Words	Coleoptile, Ethylene, Ferrous iron, Husk, Oxygen concentration, Rice.
Synopsis	<p>Rice farmers in Asia are adopting direct seeding because this practice requires less labor than transplanting. The main constraint of the adoption is the inconsistent seedling establishment, because O_2 is deficient in flooded soil. It has been found recently that ferrous iron (Fe), which is commonly present in flooded soil, stimulates coleoptile elongation. This study was conducted to analyse the mechanism of Fe - stimulation of coleoptile elongation. Germinated rice seeds were placed and sealed in Erlenmeyer flasks or vials and then 2 mM Fe or water (as a control) was administered. We found that Fe application increased ethylene production as well as the elongation of coleoptile. When ethylene was applied exogenously to the germinating seeds, the effect of Fe on coleoptile elongation was eliminated. When Fe was applied to the germinated intact seeds, germinated caryopsis, or husks, ethylene production was stimulated by Fe in intact seeds and husks and not in caryopsis, suggesting that ethylene was produced in the reaction between husks and Fe. Trichloroacetic acid did not inhibit the reaction. Ethylene production was as low as at 0.02 mM Fe and maximum at between 2 and 200 mM. Ethylene production increased linearly up to 3hr after the application of Fe, even in the absence of O_2. The results suggest that Fe in flooded soil reacts with husks of germinating seeds, produces ethylene, and elongates the coleoptile to the soil surface where O_2 is present.</p>

[BACK](#)
[CONTENTS](#)
[NEXT](#)

Title	Contribution of caoutchouc to durability of teak (<i>Tectona grandis</i> L. f.) wood
Division	Forestry Division
Authors	Koichi Yamamoto, Maruli Simatupang (USM) and Rokiah Hashim (USM)
Key Words	Teak, Caoutchouc, Durability, Decay resistance, XPS, Water repellency,
Synopsis	Caoutchouc is present in very small amounts in sapwood, starting from it the central part. It occurs in heartwood parenchyma, especially in ray parenchyma, and in small amounts in fibers and vessel elements. Untreated teak heartwood cuttings showed a high contact angle with water, indicating hydrophobic properties. Extraction with acetone increased the contact angle slightly, due to the removal of polar compounds and redistribution and enrichment of apolar caoutchouc on the surface. X-ray photoelectron spectroscopy confirmed these findings. Reconstituted panels made from ethanol extracted teak heartwood meal were prone to decay. Specimens made from wood meal successively extracted with ethanol and chloroform showed a slightly lower resistance than specimens made from ethanol-extracted one. It is suggested that the high resistance to decay of untreated teak heartwood is due to the synergetic effect of decay active ethanol extracts and non-active caoutchouc.

[BACK](#)[CONTENTS](#)[NEXT](#)

Title	Development and utilization of hybrid rice in Malaysia
Division	Biological Resources Division
Author	Hiroshi Kato
Key Words	Malaysia, Hybrid rice, High yielding variety
Synopsis	<p>The instability of CMS in rice can only be attributed to a mixture of volunteer or contaminated plants mistakenly classified as revertants. We can use CMS lines for practical hybrid rice breeding without encountering instability problems. IRRI hybrids IR69690H and IR69694H always showed heterosis levels as high as 120 on the average, which were associated with 20 % higher yield over MR 84. IR69692H and IR67693H also occasionally showed a high heterosis level. In addition, these four hybrids headed about two to three weeks earlier compared with MR 84. In Malaysia, direct seeding is very popular. Based on the results of direct seeding yield trials of hybrids, it is not recommended to cultivate hybrid rice by reducing the seeding rate of hybrids in direct seeding. For the practical utilization of hybrids, the use of machine transplanters for reducing the amount of hybrid rice seed per unit area is recommended.</p>

[BACK](#)[CONTENTS](#)[NEXT](#)

Title	Performance assessment for water resources management at watershed level using existing management data
Division	Okinawa Subtropical Station
Author	Shigeo Yashima
Key Words	Water resources management, Performance assessment, Management data
Synopsis	Competition for water is increasing even in developing countries. In order to conserve irrigation water resources, the author developed a new method to assess water resources management at watershed level using management data left in stores after the use of data for regulating irrigation systems. The method will lead to the improvement of water resources utilization with minimum financial and personnel investment through detailed identification of constraints on proper performance.

[BACK](#)[CONTENTS](#)

< JIRCAS Research Highlights in 1996 >

1. [Rice market situation in Vietnam](#)
2. [New rice cultivars 'Hexi 34' and 'Hexi35' in Yunnan Province of China](#)
3. [Development of new disease-resistant varieties of cucumber and strawberry in Shanghai](#)
4. [Mechanism of salinization of shallow groundwater in Phra Yune area, Northeast Thailand](#)
5. [Influence of physical properties of rocks on rockdissolution process](#)
6. [Response of 2,4-D -resistant biotype of *Fimbristylis miliacea* \(L.\) Vahl. to several herbicides and its distriburuin in the Muda area, Malaysia](#)
7. [Increase in agricultural damage associated with the invasion of leaf-cutting ants in southern Brazil and Paraguay](#)
8. [Identification of a new species of root-knot nematode \(*Meloidogyne*\) based on enzyme phenotypes through electrophoresis](#)
9. [Function of group farming project in the Muda area, Malaysia](#)
10. [Nutritive value of sugarcane stalks for feeding of dairy cows](#)
11. [Quantitative estimation of edible feed resources in a large barley /rangeland zone in northeastern Syria](#)
12. [Wetwood and its formation in *Acacia mangium*](#)
13. [Elucidation of molting and reproductive mechanisms in the giant freshwater prawn, *Macrobrachium rosenbergii*](#)
14. [Manual for analyzing the genetic variability of fishers of economic importance in Southeast Asia](#)
15. [Large-scale production of lateral shoot seedlings of sugarcane using hydroponics systems](#)
16. [Cryopreservation of shoot tips of taro\(*Colocasia esculenta*\(L.\)shott\)by vitrification](#)
17. [Detection of capsid proteins of viruses in papaya plant using protease inhibitor:antipain](#)

BACK

1.

Title	Rice market situation in Vietnam
Division	Research Information Division
Authors	Mitsuhiro NAKAGAWA, Dang K. SON and Naguyen X.LAI
Key Words	Export quota system, Over-supply, Rice price
Synopsis	The Vietnamese government has imposed on export quota system on its rice exports to maintain the domestic rice at the targeted level. However, this export quota system exerts a negative impact on the income of the rice producers, because the expanding rice production causes a market situation characterized by over-supply. Based on an econometric model, a simulation study projected a further decline in the rice price when the export quota system is fixed at the current level. The relaxation of export control was found to be effective in raising the rice farmers' income in Vietnam.

[Click here to continue Highlights](#)

2.

Title	New rice cultivars 'Hexi 34' and 'Hexi 35' in Yunnan Province of china
Division	Biological Resources Division
Authors	Kazuo ISE <i>et al.</i>
Key Words	China, Yunnan, Rice, New cultivar, High yield, Good quality
Synopsis	We developed new rice cultivar, 'Hexi 34' and 'Hexi 35' in Yunnan Province of China; they will be officially registered by the Yunnan Provincial Government. The pedigree of these new cultivars can be traced to some Japanese rice genetic resources: a high-yielding cultivar 'Todorokiwase', a cool weather-tolerant cultivar 'Narukaze', blast-resistant germplasm accessions 'BL 1' and 'BL6', and others. 'Hexi 34' and 'Hexi35' performed very well in the uniform trails conducted at twelve sites representative of the japonica rice-growing areas in 1993 and 1994. They showed a higher yielding ability and better grain quality than the standard cultivar 'Yunkeng 9'. They were also tolerant to cool weather conditions during the growing season. They could become adapted to cool areas with an elevation of 1800-2000m in Yunnan and neighboring provinces.

[Click here to continue Highlights](#)

3.

Title	Development of new disease-resistant varieties of cucumber and strawberry in Shanghai
Division	Biological Resources Division
Authors	Keita SUGIYAMA, <i>et al.</i>
Key Words	Cucumber, Strawberry, Disease resistance
Synopsis	Two new F ₁ cucumber varieties and two new strawberry varieties were developed within the framework of the collaborative research program between JIRCAS and Shanghai Academy of Agricultural Sciences. The new cucumber varieties exhibit a high yield potential and a high resistance to Fusarium wilt and Downy mildew. The new strawberry varieties are characterized by a high yield potential, good quality and high resistance to Anthracnose.

[Click here to continue Highlights](#)

4.

Title	Mechanism of salinization of shallow groundwater in Phra Yune area, Northeast Thailand
Division	Environmental Resources Division
Authors	Masayuki IMAIZUMI, Pichai WICHADIT, Somasak SUKCHAN and Kriengask SRISUK
Key Words	Salinegroundwater, Rock salt, Fault, Groundwater potential head
Synopsis	Studies on hydrogeological structure and groundwater monitoring data from 16 investigation well stations in Phra Yuen area, Northeast Thailand showed that salinegroundwater from rock salt strata is supplied from G1 and F1 faults that the conductivity value of groundwater at A5 increased rapidly when the groundwater level decreased below 187.4 meters above sea level (Dead Level). When the groundwater level decrease below based on the groundwater potential head distribution figure. Salinegroundwater may rise from the underground through the fault cracks.

[Click here to continue Highlights](#)

5.

Title	Influence of physical properties of rocks on rockdissolution process
Division	Environmental Resources Division
Author	Tamao H _{ATTA}
Key words	Chemical weathering, Dissolution, Porosity
Synopsis	To elucidate the characteristics of dissolution of rocks and to examine the effect of physical properties on their dissolution characteristics, closed-system experiments were carried out thirteen rock types. The experiments using small block samples showed that the rocks with a higher porosity display higher rates of dissolution, particularly in the initial stage of the water-rock interaction. This evidence indicates that the concentration of dissolved materials is controlled by the porosity of the rocks.

[Click here to continue Highlights](#)

6.

Title	Response of 2,4-D resistant biotype of <i>Fimbristylis miliacea</i> (L.) Vahl. to several herbicides and its distribution in the Muda area , Malaysia
Division	Crop Production and Postharvest Technology Division
Authors	Hiroaki WATANABE, Md. Zuki ISMAIL (MADA) and Nai-Kin Ho (MADA)
Key Words	Malaysia, 2,4-D resistance, <i>Fimbristylis miliacea</i> (L.) Vahl.
Synopsis	Biotype of <i>Fimbristylis miliacea</i> (L.) Vahl. resistant to 2,4-D was found in the Muda area, Malaysia, which was 29 times more resistant to 2,4-D dimethylamine than the susceptible biotype. The 2,4-D resistant biotype was also resistant to other phenoxy compounds including MCPA, but no difference was observed in the reaction toward propanil, paraquat and glufosinate ammonium between the biotypes. Other types of herbicides with different modes of action could be useful to control the 2,4-D resistant biotype.

[Click here to continue Highlights](#)

Title	Increase in agricultural damage associated with the invasion of leaf-cutting ants in southern Brazil and Paraguay
Division	Crop Production and Postharvest Technology Division
Authors	Lui Carlos FORTI and Katsuya ICHNOSE
Key words	Leaf-cutting ant, Distribution, Damage, Brazil, Paraguay
Synopsis	Surveys on the geographical distribution and density of leaf-cutting ants were performed in southern Brazil and Paraguay from 1992 to 1996. The results showed that they were most abundantly distributed in the northern and southern regions of the area surveyed while much less or practically not in central Parana to Santa Catarina. Compared with the data obtained until 10 years ago, it appears that the ants have been expanding into and increasing their distribution in the surveyed areas, and that the ants can be distributed in all the regions. Studies should be carried out in order to control the expansion of the ants.

[Click here to continue Highlights](#)

8.

Title	Identificantion of a new species of root-knot nematode(<i>meloidogyne</i>) based on enzyme phenotypes through electrophoresis
Division	Crop Production and Postharvest Technology Division
Authors	Yukio TOIDA, Somkuan KEEREEWAN, Nuchanart TANGCHITSOMKID(DOA) and Takashi Y AEGASHI(Meiji Univ.)
Key words	New species, <i>Meloidogyne</i> , Isozyme pattern, Cultural control
Synopsis	Accurate identification of nematode species is necessary to develop methods of cultural control of nematodes. Therefore, cnzyme phenotypes in root- knot nematodes obtained through electrophoresis were analyzed in Thailand. The population of the root-knot nematode severely attacking mulberry in Udon Thani was indentified as a new species based on the specific pattern of phenotypes of esterase and malate dehydrogenase obtained through electrophoresis.

[Click here to continue Highlights](#)

Title	Function of group farming project in the Muda area, Malaysia
Division	Crop production and Postharvest Technology Division
Authors	Kumi YASUNOBU, Husna SULAIMAN(UPM) and Wong Foong YEE(UPM)
Key words	Malaysia, Group farming, Farm management
Synopsis	Group farming project which is promoted by the government is successful in terms of providing credit scheme with farming information. However, the result of the study showed that some problems must be overcome for sustainable development of the group farming project: there is a general feeling of unease among the farmers in the group due to excessive control by the government ; and the farmers tend to depend on the government support and easily accept the decision made by the authorities without critical evaluation.

[Click here to continue Highlights](#)

10.

Title	Nutritive value of sugarcane stalks as a roughage for dairy cows
Division	Animal Production and Grassland Division
Authors	Tomoyuki KAWASHIMA, W.SUMAMAL and P.PHOLSEN
Key words	Sugarcane stalk, Nutritive value,Cattle
Synopsis	<p>The use of sugarcane as a roughage for cattle was examined in Northeast Thailand. Metabolizable energy (ME) content in sugarcane stalk amounted to 9.05 MJ/kg based on a metabolic trial. It was estimated that sugarcane can produce nearly 3times more ME per area than ruzi grass which is the major grass grown in the region. Sugarcane can remain until the end of the dry season without withering, which allows farmers to cut it when they need it without having to preserve it. The use of sugarcane stalks can be a key feeding strategy in the dry season, especially in dairy production.</p>

[Click here to continue Highlights](#)

11.

Title	Quantitative estimation of edible feed resources in a large barley/ rangeland zone in northeastern Syria
Division	Animal Production and Grassland Division
Authors	Masahiro HIRATA (ICARDA), Haruhiro FUJITA and Gustav GINTZBURGER(ICARDA)
Key words	Yearly edible feed resources, Feed classification, Barley/ rangeland zone, Arid marginal lands
Synopsis	Feed resources in an arid barley/ rangeland zone of northeastern Syria were classified into eight classes and mapped by a series of field surveys and satellite data analyses. Amount of edible feed resources of each class was calculated based on the covering area and edible biomass in the fields, and the amount of yearly edible feed resources was estimated in the whole test zone.

[Click here to continue Highlights](#)

12.

Title	Wetwood and its formation in <i>Acacia mangium</i>
Division	Forestry Division
Authors	Koichi YAMAMOTO, SULAIMAN and O. R. HASHIM
Key Words	<i>Acacia mangium</i> , Wetwood, Tropical plantation species
Synopsis	<p>The report on the existence of wetwood, in <i>Acacia mangium</i> Willd. is the first one among tropical plantation species. Trees at two of the three different sites examined showed higher moisture contents in the inner heartwood than in the adjacent outer heartwood or sapwood. An increase in the moisture content in the heartwood region is normally referred to as wetwood which has been defined as an abnormal type of heartwood caused by decay or wound. As close relationship between inorganic element concentrations and moisture contents in wetwood have been described in the literature, the distribution of inorganic elements in this species was investigated. Radial distribution of 4 major elements from alkali metals and alkaline earth metals from sapwood to heartwood in the stem was analyzed in view of their relationship with wetwood using inductively coupled plasma spectroscopy. Wood from three plantation sites showed a similar pattern of K and Mg distribution. The concentration of K and Mg decreased gradually from the sapwood toward the outer heartwood, and did not show any significant variations within the heartwood. Radial distribution of Na and Ca failed to display any obvious trend. In all the analyzed samples that displayed wetwood or even without wetwood, generally the content of inorganic elements in heartwood was lower than in sapwood. Close relationship between the concentration of inorganic elements and moisture content which is found in the wetwood of temperate species, was not recognized in <i>A. mangium</i>. The characteristic and origin of wetwood may be different between temperate species and tropical ones. The origin of water in wetwood of <i>A. mangium</i> is an important problem to be clarified.</p>

[Click here to continue Highlights](#)

13.

Title	Elucidation of molting and reproductive mechanisms in the giant freshwater prawn, <i>Macrobrachium rosenbergii</i>
Division	Fisheries Division
Authors	Marcy N. WILDER, Nguyen Anh TUAN, Thanh PHUONG, Tran Thi Thanh Hien, Dang Thi Hoang OANH and Truong Quoc PHU
Key Words	Southeast Asia, Giant freshwater prawn, Reproduction, Molting, Endocrinological factors, Ecdysteroids, Juvenile hormone
Synopsis	<p>The giant freshwater prawn, <i>Macrobrachium rosenbergii</i>, is a commercially important crustacean species cultured extensively throughout Southeast Asia. In order to promote a more stable, efficient form of aquaculture, the development of improved technology for the production of seed (larvae) is highly necessitated. Artificial production techniques are based on the ability to induce reproduction and spawning in captivity, but knowledge concerning the basic mechanisms of these physiological processes is insufficient. In this research, the involvement of various endocrinological factors in the control of molting and reproduction were investigated in <i>M. rosenbergii</i>. Ecdysteroids which control molting, were additionally found to accumulate in maturing ovaries and to be present in newly-laid eggs, indicating a potential role in ovarian development and embryogenesis in this species. In addition, juvenile hormone (JH)-related substances were investigated, revealing the presence of the JH precursor, methyl farnesoate (MF) in the hemolymph. (MF) was seen to fluctuate during the molting cycle, suggesting that this hormone has a role in molting in addition to reproduction. This research also examined the synthesis of yolk protein, vitellogenin and its hormonal control. These results will form a basis for the promotion of cooperative research between JIRCAS and Cantho University, College of Agriculture, Vietnam within the framework of a cooperative project on combined farming systems in the Mekong Delta.</p>

[Click here to continue Highlights](#)

14.

Title	Manual for analyzing the genetic variability of fishes of economic importance in Southeast Asia
Division	Fisheries Division
Authors	Motoyuki HARA and Uthairat NA-NAKORN
Key words	Genetic variability, Isozyme, Breeding, Southeast Asia, Fisheries
Synopsis	A manual on isozymic, analysis was prepared in order to analyze the genetic variability of important fishes in Southeast Asia. By using this manual, the genetic differentiation among local populations of catfish was analyzed. The results showed that the local populations of catfish display genetic differences and are important genetic resources. It was also observed that the analysis of genetic variability enables the efficient selection of breeding methods.

[Click here to continue Highlights](#)

15.

Title	Large-scale production of lateral shoot seedlings of sugarcane using hydroponics systems
Division	Okinawa Subtropical Station
Authors	Yoshimitsu KATUTA, Shigenari SAKUMA and Eiichi KUROSHIMA
Key words	Low-input hydroponics, Sugarcane, Mother palnt cultivation, Lateral shoot seedlings, Large-scale production
Synopsis	The JIRCAS Okinawa Subtropical Station developed a low input hydroponics system allowing the cultivation of sugarcane by large-scale production of lateral shoot seedlings.

[Click here to continue Highlights](#)

16.

Title	Cryopreservation of shoot tips of taro (<i>Colocasia esculenta</i> (L.) shott) by vitrification
Division	Okinawa Subtropical Station
Authors	Hiroko TAKAGI, Nguyen Tien THNH, Toshihiro SENEBOKU and Shigeo YASHIMA
Key words	Cryopreservation, shoot tips, Vitrification Taro (<i>Colocasia esculenta</i> (L.) shott) , Long-term preservation
Synopsis	<i>In vitro</i> -grown shoot tips of taro (<i>Colocasia esculenta</i> (L.) shott) were successfully cryopreserved by vitrification. By the protocol developed in this study, the average rate of shoot recovery amounted to 100% for the triploid taro cultivars and 80% for the diploid taro cultivars. The protocol appeared to be very promising for the long term preservation of taro germplasm.

[Click here to continue Highlights](#)

17.

Title	Detection of capsid proteins of viruses in papaya plant using protease inhibitor : antipain
Division	Okinawa Subtropical Station
Authors	Tetsuo MAOKA and Chiyoichi NODA
Key words	Plant viruses, Detecting method, Protease inhibitor, Papaya
Synopsis	Modified western blotting for detecting capsid proteins of papaya's viruses directly from papaya plants was developed. This method is expected to accelerate the production of transgenic papaya plants.

< JIRCAS Research Highlights in 1995 >

1. [Development of a statistical information system relating to world agriculture, forestry and fisheries](#)
 2. [Haploid production in wheat crossed with stored pearl millet pollen](#)
 3. [Screening cowpea for drought tolerance](#)
 4. [Distribution patterns and characteristics of the lowland soils in the Philippines](#)
 5. [Physiological mechanisms for acid-soil tolerance of upland rice in the savanna of South America](#)
 6. [Mitigation technologies of methane emission from tropical rice fields](#)
 7. [Mechanism of desertification relating to micrometeorology caused by over-grazing](#)
 8. [Ecological traits of weedy rice \(padi angin \)in direct seeded rice fields in Malaysia and control strategy](#)
 9. [Reproductive strategy of the parasitoid fly, Exorista japonica \(Diptera: Tachinidae\)-clutch size regulation in response to host density -](#)
 10. [Formulae and processing methodology of urea molasses blacks for ruminant animals in Malaysia](#)
 11. [Utilization of oil palm frond silage in the tropics](#)
 12. [Statistical procedure for the assessment of the association between multiple DNA markers and phenotypic records](#)
 13. [LA-PCR method for mitochondrial DNA RFLP analysis in pigs and wild pigs](#)
 14. [Evaluation of land degradation for resource management](#)
 15. [Studies on low regeneration capacity after selective logging in tropical rain forests](#)
 16. [Ecophysiological performance of Dipterocarps in response to environmental stress -Special emphasis on water relations-](#)
 17. [Soil erosion in pineapple fields and its control](#)
 18. [Low-input hydroponics systems under field conditions](#)
-

BACK

1.

Title	Development of a statistical information system relating to world agriculture, forestry and fisheries
Division	Research Information Division
Authors	Osame KOYAMA
Key Words	Food demand and supply analyses, Software, Socio-economic statistics
Synopsis	In order to promote studies on food demand and supply world wide and to enhance the strategic planning of international joint research projects, a software for integrated accumulation and handling of socio-economic statistics relating to world agriculture forestry and fisheries was designed and developed.

2.

Title	Haploid production in wheat crossed with stored pearl millet pollen
Division	Biological Resources Division
Authors	Masanori INAGAKI, Abdul MUJEEB-KAZI(CIMMYT)
Key Words	Wheat, Pearl millet, Haploid, Wide cross, Pollen storage
Synopsis	Pearl millet pollen germinated at frequencies in the range of 40-50% when pollen water contents were reduced from 50-60%(fresh)to 5-7%.Dried pollen showed similar germination frequencies after the freezing process. In crosses of wheat with pearl millet pollen stored for 3months, haploid wheat embryos were obtained at frequencies of 14-29% which were comparable to those in case of crosses with fresh pollen. These results suggest that stored pearl millet pollen can be used for wheat haploid production when and where fresh pollen is not available.

3.

Title	Screening cowpea for drought tolerance
Division	Biological Resources Division
Authors	Tomio TERA0, Iwao WATANABE, B.B. SINGH (IITA)
Key Words	Africa, Cowpea, Adaptation to drought conditions
Synopsis	Drought-tolerant lines of cowpea were screened for adaptation to the semiarid tropics of West Africa. These lines were able to grow vigorously in the dry season using residual soil moisture and they yielded an adequate amount of fodder and grains (about 1 ton per ha) without any precipitation and irrigation.

4.

Title	Distribution patterns and characteristics of the lowland soils in the Philippines
Division	Environmental Resources Division
Authors	Kenzo MIURA
Key Words	Philippines, Luzon Island, Lowland, Soils, Characteristics, Parent materials, Climate, Topography, Distribution patterns
Synopsis	Distribution patterns and characteristics of the soils in the major lowland rice areas in Luzon Island, the Philippines were analyzed in relation to factors such as parent material s, climate, and topography. The characteristics of the Philippine lowland soils were essentially controlled by the basic nature of the parent materials. However, differences in the soil characters among regions and within a region were induce d by factors such as rainfall and topography, which may control the local soil moisture conditions.

5.

Title	Physiological mechanisms for acid-soil tolerance of upland rice in the savanna of South America
Division	Environmental Resources Division
Authors	Kensuke OKADA, Albert FISCHER (CIAT), Elcio GUMARAES
Key Words	Acid-soil tolerance, Upland rice, Al, Savanna, South America, Rhizosphere, Soil solution, Physiological mechanism, pH
Synopsis	The Physiological mechanisms controlling genotypic differences of upland rice in tolerance to acid-soils were investigated in the savanna of South America. It was found that the soil pH decreased to 4.3 during crop growth, and the Al concentration in the soil solution increased to the level which brought about direct toxic effect on root growth. The tolerant genotypes the rhizosphere showed a slightly higher pH were able to avoid Al toxicity.

1

2

3

4

5

6

10/7/2002 8:42:15 PM

10/7/2002 8:42:15 PM

10/7/2002 8:42:15 PM

10/7/2002 8:42:15 PM

7.

Title	Mechanism on desertification relating to micrometeorology caused by over grazing
Division	Environmental Resources Division in collaboration with National Institute of Agro-Environmental Sciences
Authors	Yoshinobu HARAZONO
Key Words	Grazing intensity, Grassland, Penetration of rain Evaporation
Synopsis	Experiments involving different grazing intensities (change in sheep numbers grazing in the plots) were carried out in the semi-arid grassland in eastern part of Inner Mongolia, China. Changes in biomass and micrometeorology in each plot were examined. Biomass in the grassland decreased and the number of sheep footprints increased with the increase of the grazing intensity, leading to soil hardening. Penetration of rain water into the ground was prevented in plots with higher grazing in intensity resulting in increased evaporation just after rainfall and suppression of grass development.

8.

Title	Ecological traits of weedy rice (padi angin) in direct seeded rice fields in Malaysia and control strategy.
Division	Crop Production and Postharvest Technology Division
Authors	Hiroaki WATANABE, Azmi MAN (MARDI), Md. ZUKI Ismail (MADA), Duncan A. VAUGHAN (NIAR)
Key words	Malaysia, Direct-seeded rice, Weedy rice, Weedy control
Synopsis	In Malaysia, weedy rice (<i>Oryza sativa</i> L., locally designate d as •padi angin•h) induces crop losses by reducing the yield and quality of commercial rice. Weedy rice plants showed a wide variation in their morphology and in some ecological weedy traits such as easy grain shattering and seed dormancy, indicating that integrated control measures based on ecological methods should be applied to overcome the problems.

9.

Title	Reproductive strategy of the parasitoid fly, <i>Exorista japonica</i> (Diptera: Tachinidae) -clutch size regulation in response to host density-
Division	Crop Production and Postharvest Technology Division
Authors	Satoshi NAKAMURA
Key words	<i>Exorista japonica</i> , Tachinidae, Oviposition behaviour, Noctuidae, Biological control
Synopsis	Effect of host encounter rate and host density per patch on the oviposition decision of <i>Exorista japonica</i> females, natural enemies of many noctuid larvae, was studied in the laboratory. The number of eggs laid per bout increased as the rate of host encounter decreased and as the host density per patch increased. The results indicated that <i>E. japonica</i> females were able to regulate the clutch size with the host density (the rate of host encounter).

10.

Title	Formulae and processing methodology of urea molasses•@blocks for ruminant animals in Malaysia
Division	Animal Production and Grassland Division
Authors	A. OSHIBE, M. WAN ZAHARI(MARDI)
Key Words	Supplement, Molasses, Ruminant, Malaysia
Synopsis	Urea molasses block (UMB) is a promising feed supplement for ruminant animals in Malaysia. We developed formulae and a processing methodology that can be utilized on a semi-commercial scale through the collaborative research program with the Malaysian Agricultural Research and Development Institute (MARDI)

11.

Title	Utilization of oil palm frond silage in the tropics
Division	Animal Production and Grassland Division
Authors	Motohiko ISHIDA and Abu Hassan OSMAN (MARDI)
Key Words	Oil palm frond, Feed, Tropical cattle
Synopsis	Digestion and feeding trials were conducted to determine the feeding value of oil palm frond (OPF) silage in the tropics. It was found that beef and milk could be produced by utilizing OPF silage as one of the feed ingredients in the diet of fattening bulls and lactating dairy cows.

12.

Title	Statistical procedure for the assessment of the association between multiple DNA markers and phenotypic records
Division	Animal Production and Grassland Division
Authors	Kenji TOGASHI and J.E.O. REGE(ILRI)
Key Words	Breeding value, Genetic markers, Accuracy of selection
Synopsis	A procedure for the assessment of the associations between DNA markers and phenotypic records was developed. Remarkable increase of selection accuracy was found by restricting the number of DNA markers to the top 30 in the order of magnitude. These findings that DNA markers for small effects tend to add noise to the estimation and that the procedure using selected DNA markers for large effects enhances the accuracy of selection.

13.

Title	LA-PCR method for mitochondrial DNA RFLP analysis in pigs and wild pigs
Division	Animal Production and Grassland Division in collaboration with National Institute of Animal Industry
Authors	Masanori KOMATSU, Job. M. MATIAS, Kumiko TAKEDA and Akira ONISHI
Key Words	Mitochondrial DNA, RFLP analysis, Pig, Wild pig, LA-PCR, Philippines
Synopsis	We developed a simple method for amplification of pig and wild pig mitochondrial DNA (mtDNA), 2kb, and for mtDNA RFLP analysis using the long-Accurate (LA) PCR method. The usefulness of the present method for mtDNA amplification and mtDNA RFLP analysis was confirmed in Luzon native pigs and Luzon wild pigs.

14.

Title	Evaluation of land degradation for resource management
Division	Animal Production and Grassland Division
Authors	Yukiyo YAMAMOTO, Haruhiro FUJITA, Gustav GINTZBURGER (ICARDA)
Key Words	Evaluation of land degradation, Neural network Resource map database, GIS, Marginal system
Synopsis	Neural network modelling was applied to evaluate land degradation hazard of a marginal agricultural system using a resource map database. Degradation degree and extent as supervisors, elevation, slope, direction, soil and vegetation as explanatory factors, were selected for the neural network modelling. Precisions of the modelling for the evaluation of the degree and extent of degradation were 86% and 79%, respectively. The evaluation of the degradation hazard was found valid in the northern foothills and plain during the field verification, where hazardously evaluated areas corresponded to sites with frequent gully erosion.

15.

Title	Studies on low regeneration capacity after selective logging in tropical rain forests
Division	Forestry Division in collaboration with Forestry and Forest Products Research Institute (FFPRI)
Authors	Hiroyuki TANOUCHI, Azman HASSAN(FRIM), Nazarudin RAMLI (FRIM), Yosuke KOMINAMI•@•@•@•@•@•@ (FRPRI), Toshio KATSUKI (FFPRI), Keizo HIRAI, Shozo SASAKI (FFPRI), Md. Farid Abd. Rashid (FRIM)
Key Words	Selective logging, Natural regeneration, Logging methods, Soil disturbance
Synopsis	It was suggested that hill forests after selective logging should be maintained for the regeneration of Dipterocarp species. Although there were many saplings after selective logging, they could not become established around logging roads and grow under shaded canopy. Removal of stemless palms was effective in improving the light condition for shaded saplings.

16.

Title	Ecophysiological performance of dipterocarps in response to environmental stress•@-special emphasis on water relations-
Division	Forestry Division
Authors	Yutaka MARUYAMA, S.K.YAP (FRIM)
Key Words	Water relation, Stomatal response, Dipterocarp
Synopsis	Slow growth of dipterocarps appeared to be caused by stomatal closure during daytime, which strongly reduced photosynthetic CO ₂ uptake. Low soil-to-leaf hydraulic conductance in dipterocarps limited water availability and thus caused a decrease in the leaf water potential especially in mature tall trees. Seedlings of dipterocarps grown in the nursery were susceptible to water stress due to the low ability of maintaining turgor. On the other hand, leaves of exposed trees had adapted to water deficiency stress morphologically and turgor was maintained, through osmotic adjustment.

17.

Title	Soil erosion in pineapple fields and its control
Division	Okinawa Subtropical Station
Authors	KAZUO SUGAHARA
Key Words	Pineapple field, Erosion, Weeping lovegrass, Pigeonpea, Non tillage planting
Synopsis	Results indicate that soil erosion occurred downward along roads in a pineapple field. For the alleviation of erosion hazards, we grew pigeonpea in a field and weeping lovegrass on the lower edge before the initiation of nontillage planting of pineapple with residues of pigeonpea.

18.

Title	Low-input hydroponics systems under field conditions
Division	Okinawa Subtropical Station
Authors	Harushige SAKUMA, Katsmi SUZUKI
Key Words	Field conditions, Hydroponics, Low-input, Lack of electricity, Nutrient control, Problem soils
Synopsis	It is difficult to cultivate crops in areas with problem soils such as saline, acid sulphate soils, etc.. For crop Production in such regions we developed new hydroponics systems that could be used field conditions without requiring electricity and control of nutrients.

< JIRCAS Research Highlights in 1994 >

1. [Agricultural Characteristics and Recent Research Activities in Central Asia](#)
 2. [Phylogenetic differentiation of tetraploid *Vigna* species, *V. glabrescens* detected by isozyme analysis](#)
 3. [Molecular Cloning and Characterization of cDNAs for Genes That Are Responsive to Dehydration Stress in Higher Plant](#)
 4. [Land degradation analysis of rainfed agricultural area in Pakistan using remote sensing data](#)
 5. [Effect of windbreak rows made of a combination of several tree species on crop growth and improvement of micro-climatic conditions](#)
 6. [Effects of timing of N fertilizer application on grain production and N use efficiency in pigeonpea/sorghum intercropping \(Timing of N fertilizer application in intercropping systems of the semi-arid tropics\)](#)
 7. [Rice direct Seeding- Development of anaerobic Seeding technology in the tropics](#)
 8. [In vitro rearing of the tachinid parasitoid, *Exorista japonica*](#)
 9. [Population dynamics of the diamondback moth in Thailand](#)
 10. [Analysis and Modeling of Water Balance in the Inter-Connected Tank Irrigation System in Sri Lanka](#)
 11. [Procedure for the construction of a model for simultaneous analysis of a combination of productivity and adaptability traits in African cattle](#)
 12. [Map database construction for regional resources management and its applicability](#)
 13. [Ecology and protection of the albizzia borer, *Xystrocera festiva*](#)
 14. [Registration of a Heat Tolerant Snap Bean Variety in Japan](#)
-

BACK

1

Title	Agricultural Characteristics and Recent Research Activities in Central Asia
Division	Research Information Division
Authors	Mitsunori Oka, Masaaki Suzuki
Key Words	Agriculture, Livestock, Fisheries, Environment, Soil Conservation, Water Resources, Genetic Research Activities, Central Asia
Synopsis	JIRCAS expanded its research activities to the Central Asia region. To identify the major research topics to be implemented jointly with research institutes in the region, we investigated the characteristics of agriculture and current research topics.

Title	Phylogenetic differentiation of tetraploid <i>Vigna</i> species, <i>V.glabrescens</i> detected by isozyme analysis
Division	Biologica Resources Division
Authors	Yosinobu Egawa, Ithnin Bujang, Somsong Chotechuem, Charaspon Thavarasook, Kitbamroong Charas
Key Words	Phylogenetic differentiation, isozyme, <i>Vigna</i> , <i>Ceratatropis</i> , <i>V. glabrescens</i> , <i>V. reflexo-pilosa</i> , <i>V. minima</i> , <i>V. trinervia</i>
Synopsis	Based on Isozyme analysis, it is suggested that wild tetraploid <i>Vigna</i> species, <i>V. reflexo-pilosa</i> originated from interspecific hybridization between <i>V. minima</i> and <i>V. trinevia</i> followed by netural chromosome doubling <i>V. glabrescens</i> is considered to be derived from <i>V. reflexo-pilosa</i> as cultivated type with erect growth habit.

Title	Molecular Cloning and Characterization of cDNAs for Genes That Are Responsive to Dehydration Stress in Higher Plants
Division	Biological Resources Division
Authors	Kazuo Yamaguti-Sinozaki, Tomio Terao
Key Words	cDNA, dehydration stress, differential hybridization, <i>Arabidopsis thaliana</i> , <i>Vigna unguiculata</i>
Synopsis	We isolated 16 independent cDNAs (ERDs) for genes that are early-responsive to dehydration in <i>Arabidopsis thaliana</i> by using the technique of differential hybridization. We also isolated 10 independent cDNAs (CPRDs) for genes that are responsive to dehydration stress in <i>Vigna unguiculata</i> . Sequence analyses of these genes indicate that their products may play a role in the protection of cells from dehydration

Title	Land degradation analysis of rainfed agricultural area in Pakistan using remote sensing data
Division	Environmental Resources Division
Authors	Satoshi Uchida
Key words	Remote sensing, Land degradation, Vegetation conditions, Soil erosion
Synopsis	To extract a markedly eroded area, spot Panchromatic data were used. Multi-spectral information supplied by landsat tm data was used to calculate several kinds of indices related to vegetation, coverage and soil conditions. The characteristics of the distribution of these indices inside and out side of a markedly eroded area could not be clearly separated from each other, although from the statistical point of view some differences which are reflected in the regional characteristics could be recognized. The results obtained may contributed to a more precise analysis of land degradation and associated environmental deterioration in the study area.

Title	Effect of windbreak rows made of a combination of several tree species on crop growth and improvement of micro-climatic conditions
Division	Environmental Resources Division
Authors	Taichi Maki *, Borong Pan **, Ryoji Sameshima***, Mingyuan Du***
Key words	Climatic improvement , Multiple windbreaks , Arid land, Desert
Synopsis	It is important to improve the climatic conditions in the marginal area extending from barren land (•gdesert•h) to farm land (•goasis•h) to prevent desertification in arid lands. It was shown that the micro-climatic conditions of farm land were improved and alleviated by the construction of windbreak rows made of a combination of several tree species and also that the growth and development of crops were promoted and crop yields increased by windbreaks under the adverse climatic conditions including high temperature ,low humidity and strong wind that prevail at Turpan in Northwest China.

*Meteorological Disaster Laboratory, Department of Farmland Utilization, National Agriculture Research Center

** Xinjiang Institute of Biology, Pedology and Desert Research, China

***JIRCAS

Title	Effects of timing of N fertilizer application on grain production and N use efficiency in pigeonpea/sorghum intercropping (Timing of N fertilizer application in intercropping systems of the semi-arid tropics)
Division	Environmental Resources Division
Authors	Osamu Ito*, Katsuyuki Katayama**, C. Johannsen***, J.J.Adu-Gyamfi***
Key Words	Intercropping, Pigeonpea, Sorghum, Nitrogen fertilizer, Nitrogen use efficiency
Synopsis	Nitrogen fertilizer application at about a month after sowing brought about a higher grain yield, area-time equivalent ratio and nitrogen use efficiency compared with the application before sowing. It is speculated that inorganic nitrogen which accumulated in the soil solution during dry the season contributed significantly to the initial growth of fast-growing component crops (sorghum) in the intercropping system.

*JIRCAS

**Project Research Team2, National Agriculture Research Center

***ICRISAT

Title	Rice direct Seeding-Development of anaerobic Seeding technique in the tropics-
Division	Environmental Resources Division (Department of Agro-Environmental Management, Chugoku National Agricultural Experiment Station)
Authors	Minoru Yamauchi, K. Moody, T. P. Tuong
Key Words	Soil, Crop establishment, Direct seeding, Grain yield, Rice, Weed competition
Synopsis	Anaerobic seeding technique in which pregerminated seeds are sown under the puddled soil surface has been developed to alleviate the constraints direct (erratic crop establishment, increased weed infestation, and lodging) in direct seeding culture of rice in the tropics. Germplasm accessions tolerant to flooded anaerobic soil were identified. The seeds were sown anaerobically by broadcasting or drilling. The technique was tested successfully in fields located in the Philipplines, Vietnam, and Myanmar and was production was as high as in the case of transplanted rice.

Title	In vitro rearing of the tachinid parasitoid, <i>Exorista japonica</i>
Division	Crop Production and Postharvest Technology Division
Authors	Shigemi Yagi, Satoshi Nakamura
Key Words	in vitro rearing, Tachinidae, parasitoid, biological control
Synopsis	A tachinid parasitoid fly, <i>Exorista japonica</i> , a natural enemy of many lepidopterous larvae, was aseptically reared throughout the larval stages from the egg stage in vitro by using various artificial diets based on insect tissue culture media and heat-treated silkworm haemolymph (BMH). When diets containing BMH were used, most of the larvae formed respiratory funnels at the 1 st instar stage and developed to the 3 rd instar. When BMH was used as a diet, 13% of the larvae developed into adult flies. On the other hand the addition of 20-hydroxy ecdysone in the diets did not affect the larval development of the fly in vitro.

11

Title	Procedure for the construction of a model for simultaneous analysis of a combination of productivity and adaptability traits in African cattle
Division	Animal Production and Grassland Division
Authors	Kenji Togashi
Key Words	Genetic covariance, Simultaneous analysis, Productivity, Adaptability, African cattle
Synopsis	A model the for simultaneous analysis of genetic (co) variances for productivity and adaptability was developed by based in a Bayesian procedure. Herd life and milk yield were selected as adaptability and productivity traits, respectively. This procedure was applied to the data set of Friesian cattle in Kenya. Heritability values for milk yield and herd life were 0.172 and 0.4, 24, respectively. Genetic correlation was -0.452. These data indicate that simultaneous analysis must be carried out to a void losing genetic diversity in each trait.

12

Title	Map database construction for regional resources management and its applicability
Division	Animal Production and Grassland Division
Authors	Haruhiro Fujita, Gustav Gintzburger
Key Words	Map database, Resources management, Land degradation, Thematic maps, GIS, Human influences
Synopsis	Map database of land resources (topgraphy, soil, landform, landunit, vegetation, land degradation) and their utilization (grazing and shrub cutting areas and their intensities) in a local barley/rangeland/livestock agricultural system was constructed within GIS. The map database was found to be useful for the evaluation and integration of human influences on natural resources in such marginal agricultural systems where land degradation prevails.

Title	Registration of a Heat Tolerant Snap Bean Variety in Japan
Division	Okinawa Subtropical Station
Authors	Hiroshi Nakano, Tokuhiko Momonoki et al.
Key Words	Breeding, Heat tolerance, High temperature, Phaseolus vulgaris, Pod setting,
Synopsis	Ishigaki 1 was bred and registered as a new variety by the Ministry of Agriculture, Forestry and Fisheries. It is a heat tolerant variety during pod setting. Critical temperature for pod setting of Isihigaki 1 ranges from 28.0 to 29.5°C (mean day air temperature). The variety is adapted to the climatic conditions prevailing in the subtropical island of Japan called Nansei-shoto.

< JIRCAS Research Highlights in 1993 >

1. [Tropical Agriculture Research Reference Information System\(TROPIS\)](#)
2. [Structure and Function of Genes Responsive to Dehydration in Higher Plants](#)
3. [DNA Probes for Detecting Pathogenic Mycoplasma-like Organisms in Plant Diseases in Southeast Asia](#)
4. [New Rice Varieties Registered in Yunnan Province, China](#)
5. [New Cucumber Varieties for Summer Season in Sub- tropical China](#)
6. [Genetic diversity of bradyrhizobia in Thailand](#)
7. [Soil properties in the desert region](#)
8. [Pepper and cucurbit virus incidence and control in Thailand](#)
9. [Laboratory breeding of the smallest ruminant, lesser mousedeer\(Tragulus javanicus\), as a new laboratory animal](#)
10. [Studies on cellulolytic bacteria in the rumen of tropical domestic ruminants and its characterization](#)
11. [Variants of wheat partially lacking Wx proteins for breeding waxy wheat](#)

[BACK](#)



JIRCAS Šš•s••



•@[JIRCAS Šš•s••, Ì•Ī•J](mailto:JIRCAS.S.S.S.I@affrc.go.jp)



•@[Šš•K'è \(JARQ\)](mailto:Šš•K'è@affrc.go.jp)

Šš•@•s•@••@-1/4		“à•@•@—e	Šš•s•p“x
<p>•@JIRCAS Journal</p>	•@%opCEê •@“ú—{CEê	<p>•Á•O•ü,ÁŠ^-ô,•,éCEĚ<žŽÖ,ÌfIfŠfwfif<_•¶,ðCEf•Ú,•,éCEĚ<ž•ñ•••• %opCEê•B-M•¶—vŽ </p>	<p>”N2%ñ 9CEŽ 3CEŽ</p>
<p>•@JIRCAS Newsletter</p>		<p>fZf“f^•[,Ī“@,«EŽ-\llcornerÆ•ECEĚ<žŠ“@,ð%op•¶,É,Ä•Đ%oi %opCEê•B•S•¶(CEöŠJ</p>	<p>”N4%ñ 6CEŽ 9CEŽ 12CEŽ 3CEŽ</p>
<p>•@JIRCAS International Symposium Series (JISS)</p>		<p>JIRCASŽä•Ä,Ī••Ûfvf“f fwfEfe€,Ī,Û,Æ,B %opCEê•B-M•¶—vŽ •t,«</p>	<p>”N1•2%ñ</p>
<p>•@ Annual Report</p>		<p>JIRCAS,Ī,P”NŠÖ,İCEĚ<žŠ“@,ð•Đ%oi %opCEê•B•S•¶(CEöŠJ</p>	<p>”N1%ñ 9CEŽ</p>
<p>•@ JIRCAS Working Report</p>		<p>Še•,É,“,”,é”_\llcornerÆCEĚ<ž,â<Z•p•Afe•[f]•ÊCEĚ<ž,ð,Æ,è,Û,Æ,B,½CEĚ<žŽQ•ĪŽ“—;• %opCEê•A“ú—{CEê•B-M•¶—vŽ •t,«</p>	<p>”N•”%ñ</p>
<p>•@ JIRCAS International Agriculture Series</p>	•@%opCEê •@“ú—{CEê	<p>^ê•û,Ī-[,Æ,μ,Ä,Û,Æ,B,ç,ê,½,i,©,è,â,•,ç”_\llcornerÆCEĚ<ž••AŽs”Ī,à, è “ú—{CEê•A%opCEê•B</p>	<p>”N1•2%ñ</p>
<p>•@••Û”_\llcornerÆCEĚ<ž•-1%oÊ•î•ñ</p>	•@“ú—{CEê •@%opCEê	<p>JIRCAS,İŠe”N“x-^,İCEĚ<ž•-1%oÊ “ú—{CEê•B%op•¶—vŽ •t,«@‘S•¶(CEöŠJ</p>	<p>”N1%ñ 7CEŽ</p>

<p>JIRCAS http://www.jircas.affrc.go.jp</p>	<p>“fZf“f^•[,İ“@,«•EŽ-Ā•EĒα<†Š““@,ð•D%oi “ú-[(Eê•B‘S•¶(EöŠJ</p>	<p>”N4%oiñ 6EŽ 9EŽ 12EŽ 3EŽ</p>
<p>JARQ (Japan Agricultural Research Quarterly) http://www.jarq.affrc.go.jp</p>	<p>“ú-[(P”_—Ñ•...ŽYĒα<†,İ•-%oÊ,ðŠČŠO,É•D%oi %opĒEê•B‘S•¶(EöŠJ</p>	<p>”N4%oiñ 6EŽ 9EŽ 12EŽ 3EŽ</p>

www.jircas.affrc.go.jp

JIRCAS Šš•s•,İ•İ‘J



JIRCAS ©
 •@
 (••Ū”_—Ñ•...ŽYĒα<†fZf“f^•D
 [1993.10.1•Ē»•Ý]



TARC
 •i”M‘Ñ”_ĀĒα<†fZf“f^•[•j
 [1970-1993.9.30]

JIRCAS Journal •@•@•@•@•@•@•@
 1/Y
 V.1(1), N.2-8+1994-1999+

•@

JARQ
 4/Y
 V.27(2)-V.34(4)+1993-2000+

•@

JARQ•@•@•@•@•@•@•@•@•@•@
 V.1(1)-27(1)+1966-1993+

JIRCAS International Symposium Series(JISS)
 1/Y
 N.1-8+1994-2000+

•@

•@

Tropical Agriculture Research Series(TARS)

N.1-25. •IŠ§ 1968-1992.

Annual Report

1/Y •@•@•@•@•@•@•@•@•@•@•@•@•@

1995-2000+

•@

JIRCAS Newsletter

4/Y

V.1(1)-2(2), N.4-25+1993-2000+

•@

•@

Newsletter

V.1(1)-4(3).•IŠ§ •@1990-1993.

•@

Technical Bulletin

N.1-28. •IŠ§ 1971-1991.

JIRCAS Working Report

•••Ū”_<ÆCEα<†•î•ñ •@•@•@

4/Y •@•@•@•@•@ •@

N.1-18 1996-2000+

•@

CEα<†%oi•ñ•••W•@
N.1-4. •IŠ§ 1994-1995.

CEα<†Ž’—;•@
N1-9. •IŠ§ 1994-1995.

•@

”M’Ŋ”_CEα•W•ñ
N.1-74. •IŠ§ 1966-1993.

•@

Ž’—;•@
N.1-34. •IŠ§
1967-1975.

•@

”MCEαŽ’—;•@
N.35-96. •IŠ§
1976-1993.

•••Ū”_<ÆCEα<†‘p’•

2/Y•@•@

N.1-10+1995-2000+

•@

•@

”M’Ŋ”_<Æ<Z•p’p’•

N.1-23. •IŠ§ 1966-1992

••Ū”_<ÆCEꣳ<†•→%ŌÊ•î•ñ
1/Y•@•@•@•@•@•@•@•@•@ •@
•½•→5”N“x,N.2-7+1994-2000+

•@

•@

”M•Ñ”_<ÆCEꣳ<†•→%ŌÊ•î•ñ
•½•→,Q”N“x-•½•→,S”N“x.
•IŠ§ 1991-1993.

Žâ—vCEꣳ<†•→%ŌÊ
•°~a59”N“x

”M•Ñ”_<ÆŽâ—vCEꣳ<†•→%ŌÊ
•°~a60”N“x-•°~a63”N“x•A•½•→CE³”N“x

JIRCAS fjj...•[fX •@•@•@•@•@•@•@•@•@
4/Y
N.6-24+1996-2000+

•@

••Ū”_CEꣳfjj...•[fX

V1(1)-3(1),N.5. 1993-1995

•@

”MCEꣳfjj...•[fX

V.1(1)-V.4(2) •IŠ§ 1990-1993.

•Å•%,É-B,é

;-â,ç•†,í,•æ: •§305-8686
~r•éCE§,Å,-,îŽs‘â,í,µ1-2
••Ū”_—Ñ•...ŽY<ÆCEꣳ<†fZf“f^•[
•î•ñŽ‘—;‰ŪTEL: 0298-38-6341,FAX:0298-38-6656

[www@jircas.affrc.go.jp](http://www.jircas.affrc.go.jp)

もどる

1 趣 旨

我が国の農林水産業に関する試験研究の動きや成果等を、主に開発途上地域を中心に海外に紹介することを目的とする。我が国の研究者が海外で行った研究も含むこととし、内容は必要に応じ要約する。

2 記事の区分

次の区分により、原稿を編集掲載する。

1) 原著論文 (original articles)

著者が行った研究に基づく成果をとりまとめたもので、内容などで他に前例のない論文

2) 個人研究レビュー (personal research reviews)

著者が行った一連の研究について、既発表報文も含め、研究のねらい、成果及び意義等についてレビューし、あわせて今後の展望をとりまとめたもの

3) 一般研究レビュー (general research reviews)

近年関心の高い事項について、関連をもって実施されているいくつかの研究全体について、研究のねらいや成果、意義等についてレビューし、あわせて今後の展望をとりまとめたもの

3 投稿及び査読

1) 編集幹事は、我が国の農林水産業に関わる試験研究の成果等(我が国の研究者が海外において行ったものも含む。)の投稿を受付ける。受付は、国内の研究者が関与した研究成果などに限る。

2) 編集幹事は、投稿論文の分野に応じて編集委員に査読を依頼する。

3) 編集委員は査読の責任を負い、その結果を編集委員長(担当:編集幹事長)に報告する。また、必要に応じ別途査読者を依頼し意見提出を求めることができる。その場合は、当該査読者名もあわせ編集委員長に報告する。

4) 編集委員長は、上記 3) の報告に基づき、投稿論文の再考または不採用を決定することができる。

4 記事の取り扱い

JARQ に掲載された論文に関する著作権は、国際農林水産業研究センターに帰属する。JARQ の全文は JIRCAS ホームページを通じ、インターネット上で公表する。

5 刊 行

JARQ は、原則として年に 4 号発行する。

以 上

(注) 編集委員及び編集幹事は、編集委員長(国際農林水産業研究センター理事長)が、国内の研究機関、大学などの関係者の中から別途任命します。

JARQ 執筆要領

1 原稿の作成

1) 原稿は英文で作成する。

(1)初回は、原稿、フロッピー、JARQ 原稿送り状を JIRCAS 編集室 JARQ 係に送付する。

原稿：本文、表、図（含む写真）を各 2 部（図、写真はコピー可）。

フロッピー：本文は Windows 版 Word、Mac の場合は Windows で読める Word、
又は一太郎で、Table は、Excel 又は花子で作成することが望ましい。

(2)査読、英文校閲を経た後、最終原稿、フロッピーディスク、原図を同上宛送付する。

2) 学術用語は、文部省編学術用語集による。

それに無い学術用語は各学会の慣例に従う。

3) 原稿は、A 4 判用紙を用い、マージンを上下左右各 3 cm とし、

文字フォント：Times New Roman

文字サイズ：11 又は 12 ポイント、25 行で作成する。

4) 原稿の枚数は原則として次のとおりとする。

原稿 8 頁（表、図（含む写真）は別）

刷上り（A 4 判） 6 頁（表、図（含む写真）を含む）

表及び図は別紙に作成し、本文原稿用紙の右欄外に Table 1, Fig. 1 のように
挿入位置を示す。

5) 執筆者は、原則として日本人 1 名以上を含むものとする。

論文が共著の場合には、内外を問わず、執筆者が共著者及び相手機関等に
JARQ 掲載についての了解を得ることとする。

6) タイトルページについて（見本参照）

(1) タイトル：内容を的確かつ簡潔に表わすものとする。

(2) 著者名：フルネーム、名は小文字で前、姓は大文字で後に記す。

(3) 部名、所属機関、所在地：研究が実施された時のものを記す。

(4) Abstract：約 200 words

(5) Discipline：執筆要領 3 に指定する当該論文の関連専門分野名から選ぶ。

(6) Additional key words：タイトルに含まれていないもの、5 words 以内

(7) 研究が海外における共同研究などによって実施された場合、
その背景（プロジェクト名、相手機関名、実施場所、実施期間）を記す。

(8) Present address：研究実施後著者が他に異動した場合には記す。

(9) *Corresponding author：連絡先著者として Fax No. e-mail アドレスを記す。

(10) Received, accepted(受理日) : 最終原稿を作成する時に JARQ 係から指示する。

(11) Running title : 10 語以内で記す。タイトルが 10 語以下の場合そのまま使用する。

7) 見出しの順位は、以下のようにする。

第 1 順位 : 番号なしで 11Point 太字	Introduction
第 2 順位 : 番号なしで 10Point 太字	Analysis
第 3 順位 : 番号.	1. Effect
第 4 順位 : 番号で両括弧	(1)Yield

8) 本文は、ピリオドの後は半角 2 文字空け、コンマの後は半角一文字空けとする。
段落の書き出しは、Space key で空けずに、Tab key で空ける。

9) 学名はイタリックで書く。

10) 単位表示は原則として SI 単位を用いる。

[例] 長さ :	km, m, cm, mm, μm , nm
面積 :	km^2 , m^2 , cm^2 , mm^2 , ha, a
容積 :	kL, L, mL,
体積 :	km^3 , m^3 , cm^3 , mm^3
質量・重量 :	t, kg, g, mg,
時間 :	y, day, h, min, s (hours, hr, hrs など使わない)
質量濃度 :	kg/m^3 , g/L (又は $\text{kg}\cdot\text{m}^{-3}$, $\text{kg}\cdot\text{m}^{-3}$, $\text{g}\cdot\text{L}^{-1}$, $\text{g}\cdot\text{L}^{-1}$)
モル濃度 :	mol/m^3 , mol/L (又は $\text{mol}\cdot\text{m}^{-3}$, $\text{mol}\cdot\text{m}^{-3}$, $\text{mol}\cdot\text{L}^{-1}$, $\text{mol}\cdot\text{L}^{-1}$)
その他 :	, 同位元素 ^{32}P , 酸化還元電位 Eh, 水素イオン濃度 pH

省略のピリオドはつけない(例えば、mg L など)。

複数形を使用しない。

%, の単位は space を空けずに書くこと。(25%, 25)

11) 謝辞は原則として省く。

12) 引用文献はそれを引用してある箇所(本文中、あるいは図表)の右肩上に
文献番号で表示する。

13) 引用文献について

(1) 引用文献は本文のあとに References と表示し、著者名(機関名の場合も含む)のアルファベット順に記載する(通し番号をつける)。

同一著者のものが二つ以上ある場合は発表年次順とする。

著者名が不明の場合は Anonymous とする。

(2) 記載の方法

文献番号： 通し番号

著者名： 姓前、名後（イニシャルのみ）とする。

複数の場合も同様とし、&(and にしない)を使用する。

4人以上の場合は、第1著者名のみ記載し、et al. を付ける。

年号： 西暦で示し、括弧書きとする。

タイトル名：

誌名： 雑誌名の略称は、原則として公表された基準によることとし、イタリックとする。

巻(号)： 巻は太字とする。

発行所： 論文集・単行本の場合には、記載する。

発行地： 論文集・単行本の場合には、都市名・国名を記載する。

頁数： 引用論文の始めと終わりのページをハイフンで分けて記す。
単行本など全体を引用した場合は、pp. で示す。(pp. 251)

注意事項： 日本語の文献の場合は文献の末尾には [In Japanese] とし、
英文サマリーのある場合は [In Japanese with English summary] と記載する。

(3) 記載例

雑誌記事の場合：

文献番号. 著者名(年号): タイトル. 誌名, 巻号, 頁数.

[例] 8. Kondo, T. et al. (1997): Structural changes of forage grass lignin by rumen digestion. *JARQ*, **31**, 49-54.

論文集の場合：

文献番号. 著者名(年号): タイトル. *In* 書名. ed. 編者名, 発行者(所), 発行地, 頁数.

[例] 8. Chern, S. & Pallardy, S. (1998): Food security in Asia. *In* Sustainable agricultural development. JIRCAS Int. Symp. Ser. No. 6. eds. Horiuchi, H. & Tsubota, K., JIRCAS, Tsukuba, Japan, 1-11.

単行本の場合：

文献番号. 著者名(年号): 書名. 発行所, 発行地, 頁数.

[例] 8. Atherton, J. G. (1987): Manipulation of flowering. Butterworths, Kent, UK, pp.425.

2 別刷

著者には別刷50部を贈呈する。50部以上の別刷を必要とする場合は実費を著者の負担とする。その場合、実費印刷希望部数のみを「JARQ原稿送り状」に明記する。

3 専門分野 (Disciplines) 名リスト

- Agricultural chemicals
- Agricultural economics
- Agricultural engineering
- Agricultural environment
- Agricultural facilities
- Agricultural machinery
- Agro-meteorology
reclamation
- Animal health
- Animal industry
- Animal pest
- Aquaculture
- Biotechnology
- Crop production
- Fisheries
- Food
- Forestry and forest products
- Genetic resources
- Grassland
- Horticulture
- Information technology
- Insect pest
- Irrigation, drainage and
 - Plant breeding
- Plant disease
- Post harvest technology
- Sericulture
- Soils, fertilizers and plant nutrition
 - Tea industry
- Weed control

見本

タイトルページについて、この見本の順にタイプして下さい。

Corresponding author の印

タイトル

Cultural Control Systems of Naturalized Weeds in Forage Crop Fields

著者名

Seturo SATO*, **Koji TATENO**, **Ryoji KOBAYASHI¹** and **Kuniaki SAKAMOTO**

所属

(部名 機関名 住所)

Grassland Division, Kyushu National Agricultural Experiment Station

(Nishigoshi, Kumamoto 861-1192, Japan)

Abstract

Experiments were conducted to control spiny amaranth (*Amaranthus spinosus* L.) and velvetleaf (*Abutilon theophrasti* Medic.) in a field of forage corn sown in early, mid- and late

Discipline: Weed control

Additional key words: dense sowing, living mulch, spiny amaranth, swinecress

共同研究の場合

→ This paper reports the results obtained in the joint project on "Integrated..." sponsored by...

異動した場合

Present address:

¹Department of Animal Production, Chugoku National Agricultural Experiment Station

(Oda, Shimane 694-0013, Japan).

連絡先 (fax, e-mail)

* Corresponding author: fax +81-8548-2-2280, e-mail ssato@anim.affrc.go.jp

日付

Received 13 January 2000; accepted 5 February 2000.

ランニングタイトル

Running title: Cultural Control Systems of Naturalized Weeds in Forage Crop Fields

Introduction

In recent decades, various alien weeds have been detected in forage crop fields throughout

JARQ 原稿送り状

1. タイトル

英文： _____

和文： _____

2. 著者名

英文： _____

和文： _____

3. 各著者の所属機関・部名など

英文： _____

和文： _____

4. 記事の区分 原著論文 (article)
個人研究レビュー (personal research review)
一般研究レビュー (general research review)

5. Running Title (表題が 10 Words 以内はそのまま、以上の場合は 10 Words 以内に)

英文： _____

6. Corresponding Author (連絡対応著者)

氏名： _____

所属機関・部など： _____

住所： 〒 _____

Tel： _____ Fax： _____ E-mail： _____

7. 原稿・図表枚数

本文 (A4)： _____ 枚 表： _____ 枚 図 (写真を含む)： _____ 枚

使用パソコン _____ ワードプロソフト _____

8. 別刷り希望部数：50部（無償） + _____部（有償、1部150円 + Tax）

9. その他

JIRCAS Journal -for Scientific Papers- Full List of Contents

Issue No. 10 marks the end of JIRCAS Journal. From now on, this journal will be integrated with JARQ (Japan Agricultural Research Quarterly) [For details click here](#)

In English



No.10	(2002.3)
No.9	(2001.3)
No.8	(2000.3)
No.7	(1999.3)
No.6	(1998.11)
No.5	(1997.11)
No.4	(1997.3)
No.3	(1996.3)
No.2	(1995.9)
No.1	(1994.11)

HOME

JIRCAS Journal was established to provide a medium, not only for JIRCAS staff but also for other researchers working on JIRCAS research projects, to publish and share their research findings with the rest of the research community in Japan as well as in other countries. Its first issue was released in November, 1994. Since then, it has been published almost annually, with its 10th issue coming up this year.

On the other hand, the Japan Agricultural Research Quarterly (JARQ) started being published in 1966 with the aim of disseminating overseas, up-to-date information on achievements and trends of research activities pertaining to agriculture, forestry and fisheries that are carried out in Japan that may also be relevant to the needs of other countries, particularly in the developing regions.

As both publications have been pursuing similar objectives, it has been decided to integrate the two journals. Issue No.10 marks the end of JIRCAS Journal. From now on, papers which deserve publication in this journal will be published in JARQ .

We would like to extend our deep appreciation and gratitude for all the support and contribution you have given to JIRCAS Journal. We hope you will find great pleasure in reading JARQ as well.

JIRCAS Journal
— for Scientific Papers —
No. 10, March 2002

CONTENTS

Kazuma MATSUMOTO, James Rubinsin KOTULAI Field Tests on the Effectiveness of <i>Azadirachta</i> Companion Planting as a Shoot Borer Repellent to Protect Mahogany.....	1
Kiyoshi NAKAMUTA, Kazuma MATSUMOTO and James R. KOTULAI Field Trapping of the Mahogany Shoot Borer, <i>Hypsipyla robusta</i> (Lepidoptera: Pyralidae), with Synthetic Sex Pheromones in Sabah, Malaysia.....	9
Zhaohui ZHAO, Masayoshi SAITO, Tadashi YOSHIHASHI, Kazuhiko NAKAHARA and Eizo TATSUMI Microorganism Control in Packed Tofu Manufacture with Electrolyzed Water	13
Nobuyuki KABAKI, Haruo TAMURA, Takashi KOMATSU, Kenzo MIURA, Hirohiko MORITA, Ryuichi TABUCHI, Kenji KATAOKA, Tawilkal WUNGAHART, Paiwit WATANAVITAWAS Development of a Comprehensive Series of Technologies for Upland Cropping Systems in Northeast Thailand	21
John S. CALDWELL, Somsak SUKCHAN, Wimonrat ON-OK, Chumporn SATRAVAHA, Chikara OGURA, Yukiyo YAMAMOTO, and Prapatsorm PRAPIN Farmer Perceptions of Water Availability, Soil Erosion, and Yield Relationships in Rainfed Paddy and Upland Fields on Two Transects in a Watershed in Nong Saeng Village, Khon Kaen Province, Thailand	31
Ryoji SAMESHIMA and Lisong TANG Meteorological Conditions and Agricultural Water Use in Oasis in Fukang.....	43

Full List of -for Scientific Papers-Contents

No. 8, March (2000)

	Title	Authors	Additional key words	page
1.	Maturation Cycle of Short Mackerel, <i>Rastrelliger brachysoma</i> , in South Sulawesi, Indonesia	Satoshi SUYAMA, Syarifuddin TONNEK, and Taufik AHMAD	short mackerel, gonad development, oocyte, spawning season, rainy season	1-12
2.	Nutrient Levels in Ponds during the Grow-out and Harvest Phase of <i>Penaeus monodon</i> under Semi-intensive or Intensive Culture	Poh-Sze CHOO and Katsuhisa TANAKA	penaeid prawn, intensive culture, nutrient, pollution, mangrove, coastal water, ammonia environmental impact	13-20
3.	Recent Development of Agricultural Policy in Vietnam	Ryoichi YAMAZAKI	Agricultural collectivization, <i>Doi moi</i> policy, Contract system, Land law reform	21-31
4.	Rapid Anaerobic Incubation Method for Measuring N Mineralization Potential in Soil	Kenichi KANDA	N fertility, tropical soil	33-40
5.	Simple and Rapid DNA Extraction from Milled Rice and Its Application to Thai Aromatic Rice (<i>Oryza sativa</i> L.) variety, Khao Dawk Mali 105	Tadashi YOSHIHASHI	cultivar identification, PCR, rapid extraction, genomic DNA	41-47
6.	Occurrence of an <i>Ephelis</i> Fungus on Ishigaki Island and Observations on its Epiphytic Association with Host Grasses	Michael J. CHRISTENSEN, Keiichi TAKAHASHI, Katsuyuki KOHNO, Takao TSUKIBOSHI and Makoto KOBAYASHI	Clavicipitaceae, <i>Ephelis</i> , epiphyte, grasses	49-60
7.	Agricultural Zoning Based on an Economic Viewpoint in the Mekong Delta of Vietnam	Ryoichi YAMAZAKI	soil fertility, agricultural land size, urbanization	61-74

8.	Saturated and Unsaturated Mechanical Properties of Typical Soils Distributed in Northeast Thailand	Yuji KOHGO	collapsible soil, sandy soil, suction, unsaturated soil.	75-91
----	--	------------	--	-------

[BACK](#)

Full List of -for Scientific Papers-Contents

No. 7, March (1999)

	Title	Authors	Additional key words	page
1.	Molecular Detection and Characterization of Phytoplasmas That Cause Sugarcane White Leaf Disease	KAZUO NAKASHIMA, Pornpip WONGKAEW, wicha CHALEEPROM, Pisan SIRJTHORN and Takaharu HAYASHI	mycoplasma-like organism (MLO) , detection, hybridization, PCR, ribosomal DNA, extrachromosomal DNA	1-17
2.	Analysis of Phyllody Disease Caused by Phytoplasmas in Sesame and Richardia Plants	KAZUO NAKASHIMA, Wicha CHALEEPROM, Pornpip WONGKAEW, Pisan SIRITHORN and Takaharu HAYASHI	phytoplasma, mycoplasma-like organism, distribution, udo dwarf	19-27
3.	Prediction of Future Situation of Rice Farming in the Muda Area, Malaysia	Kumi YASUNOBU, Wong Foong YEE and Toshiyuki MONMA	farmer's opinion, simulation of agricultural population, simulation of farmland	29-43
4.	Current Situation of Water Resources and Proposal for Construction of Subsurface Dam in Northeast Thailand	Masayuki IMAIZUMI, Somsaku SUKUCHAN and Krisanee PALOPKERN	rainfed paddy field, small-scale pond, saline groundwater, excess rain water	45-67
5.	Diel and Seasonal Variations of Methane Flux from Bang Khen Paddy Field in Thailand	Kunihiko KATO, Prapai CHAIROJ, Kazuyuki YAGI, Haruo TSURUTA, Katsuyuki MINAMI and Wisit CHOLITKUL	global warming, methane flux, irrigation, paddy soil	69-75
6.	Methane Emission from Paddy Field in Northern Thailand	Kunihiko KATO, Prapai CHAIROJ, Kazuyuki YAGI, Haruo TSURUTA, Katsuyuki MINAMI and Wisit CHOLITKUL	fresh organic material, global warming, methane flux, paddy soil	77-85

7.	Methane Emission from Paddy Fields in Northeast Thailand	Kunihiko KATOH, Prapai CHAIROJ, Kazuyuki YAGI, Haruo TSURUTA, Katsuyuki MINAMI and Wisit CHOLITKUL	fresh organic matter, global warming, methane flux, paddy soil, sandy loam soil	87-96
8.	A method of construction of small ponds in Northeast Thailand	Yuji KOHGO, Surendra Bahadur TAMRAKAR and Hui Gong TANG	collapse due to wetting, erosion, small pond unsaturated soil	97-104
9.	Identification of Antimutagenic Substances (Ames test) from <i>Boesenbergia pandurata</i> Schl. (Fingerroot) and <i>Languas galanga</i> (Galanga)	Gassinee TRAKOONTIVAKORN, Kazuhiko NAKAHARA, Hiroshi SHINMOTO and Tojiro TSUSHIDA	antimutagenicity, <i>Boesenbergia pandurata</i> Schl., <i>Languas galanga</i> , Thai spices, Ames test	105-116
10.	Modification of Farmers' Differentiation Process and Role of Farmers' Organizations : A case study in Hoa An village, Mekong delta of Vietnam	Ryoichi YAMAZAKI, and Duong Van NI	agricultural structure, farming systems, diversification, medium-sized class, poverty alleviation	117-132

BACK

Full List of -for Scientific Papers-Contents

No. 6, November (1998)

	Title	Authors	Additional key words	page
1.	Geographical Distribution of Leaf-cutting Ants and Possible Increase of Damage due to Their Expansion in Southern Brazil and Paraguay (Hymenoptera : Formicidae)	Katsuya ICHINOSE, Luiz Carlos FORTI, and Denis Rogerio PRETTO	Leaf-cutting ant, geographical distribution, pest, agricultural damage, South America	1-10
2.	Production of Urea Molasses Blocks for Ruminant Animals in Malaysia	Akinori OSHIBE and Mohamed Wan ZAHARI	processing technology, supplemental feed	11-20
3.	Drought Tolerance of Cowpea (<i>Vigna unguiculata</i> (L.)Walp.) I. Method for the Evaluation of Drought Tolerance	IWAO WATANABE	breeding method, Sudan Savanna	21-28
4.	Drought Tolerance of Cowpea (<i>Vigna unguiculata</i> (L.)Walp.) II. Field Trial in the Dry Season of Sudan Savanna and Dry Matter Production of Potted Plants under Water-stress	IWAO WATANABE and Tomio TERAO	cowpea breeding, deep-rooting character, dry matter ditribution	29-37
5.	Extraction of Soil Characteristics and Monitoring of Agricultural Land Use in the Semi-Arid Tropics of India Using Remote Sensing	Satoshi UCHIDA	land suitability, normalized vegetation index temporal profile, IRS data	39-52
6.	Detection of Trematode of Swine, <i>Fasciolopsis buski</i> , in Small Scale Farms in The Mekong Delta	Shinobu YOSHIHARA, Nguyen Huu HUNG, Nguyen Phuc HUNG and Masaru KOBAYASHI	zoonotic trematode, public health, water spinach, biodigester	53-58

7.	Breeding of New Cultivars of Cucumber and Strawberry with Multiple Disease Resistance under Japan and China Collaborative Program	Keita SUGIYAMA, Yuji NOGUCHI, Yoshiteru SAKATA, Masami MORISHITA, Xu QIXIN, Tong YAOMING, Ye ZHENGWEN, Chen YOUYUAN, Zheng HONGQING, Lu SHIJUN, Chen HAIRONG and Yu JIZHU	Cucumis sativus L, Fragaria x ananassa Duch, breeding	59-69
8.	Improvement of Rice Cropping Technique in the Mekong Delta Farming Systems	Tadao KON, Pham Sy TAN and Tran Ngoc HUAN, Trinh Quang KHUONG and Hoang Dinh DINH	diagnosis, fertilizer application, leaf color, seeding rate, water management, yield component	71-82
9.	Introduction of Agroforestry in the Philippines	Katsuyuki KATAYAMA and Amelita C.LUNA	Agrisilviculture, soil erosion, multistoried cropping system, sloping agriculture land technology	83-88
10.	Current Status of Freshwater prawn culture in the Mekong River Delta of Vietnam	Tran Thi Thanh HIEN, Truong Hoang MINH, Nguyen Thanh PHUONG and Marcy N.WILDER	giant freshwater prawn, aquaculture, faming system, seed production	89-100

CONTENTS

Full List of -for Scientific Papers-Contents

No. 5, November (1997)

	Title	Authors	Additional key words	page
1.	"Haibushi", a New Variety of Snap Bean Tolerant to Heat Stress	Hiroshi NAKANO, Tokuhiro MOMONOKI, Toshikazu MIYASHIGE, Hiroo OTSUKA, Toshio HANADA, Akira SUGIMOTO, Hitoshi NAKAGAWA, Makoto MASUOKA, Takayoshi TERAUCHI, Makoto KOBAYASHI, Masaichi OSHIRO, Keiji YASUDA, Nirat VANICHWATTANARUMRUK, Somsong CHOTECHUEN and Decha BOONMALISON	evaluation, germplasm, high temperature, <i>Phaseolous unlgaris</i>	1-12
2.	Vegetational Interpretation of Remotely Sensed Images in Syria	Shigeru TAKAHATA and Afmed Ei Tayeb OSMAN	rangland, conservation, saltbush, grazing, balloon, aerial photography, LANDSAT	13-22
3.	A Promising Method to Protect Mahogany Plantations from Attack by the Shoot Borer, <i>Hypsipyla robusta</i> Moore (Lepidoptera: Pyralidae)	Kazuma MATSUMOTO, Kusdi MULYADI and Ragil S.B. IRIANTO	Meliaceae, Swietenia macrophylla, Acacia mangium, topical forest, pest control	23-29
4.	Characteristics of Soils of Lowland Areas in the Philippines with Special Reference to Parent Materials and Climatic Conditions	Kenzo MIURA, Rodrigo B. BADAYOS and Angelina M. BRIONES	Chemical and physical properties, primary and clay mineral composition, rainfall conditions, regional differences, total chemical composition	31-42

5.	Establishment of <i>Stylosanthes capitata</i> and <i>Arachis pintoi</i> by Paper Bag Method in Native Pastures of Llanos Orientales of Colombia	Norihisa KITAHARA	establishment method, paper bag, macro-pellet, broadcasting, <i>Stylosanthes capitata</i> , <i>Arachis pintoi</i>	43-49
6.	An Iterative Procedure for Analyzing a Combination of Censored and Uncensored Traits in Mixed Models: Estimation of Location Parameters	Kenji TOGASHI and J.E.O. REGO	sire model, censored data, herd -life , milk -yield	51-63
7.	Maximum Likelihood and an Approximate Expectation and Maximization Procedures to Estimate Dispersion Parameters in a Data Set of Combination of Censored and Uncensored Traits	Kenji TOGASHI and J.E.O. REGO	censored data, (co) variance estimation, herd-life	65-78
8.	Selective Isolation and Characterization of Cellulolytic Bacteria by Cellulose Enrichment Method from the Rumen of Ruminants	F.C.F. FOONG, Kuo Joan CHENG, Norhani ABDULLAH, Yin Wan Ho, Syed JALALUDIN, Mutsumi SUGIURA, Takafumi NAGAMINE, Cristina ARAKAKI and Hiroshi KUDO	Fibrobacter succinogenses, Ruminococcus flavefaciens, Butyrivibrio fibrisolvens, Treponema, cattle, water buffalo.	79-89
9.	Resource Evaluation of Marginal Lands in Dry Areas 1. Geomorphological Analysis	Haruhiro FUJITA and Saleh NASRI	geomorphological analysis, landform classification, marginal lands land use	91-103

CONTENTS

Full List of -for Scientific Papers-Contents

No. 4 March (1997)

	Title	Authors	Additional key words	page
1.	Method of Analysis of Saturation Collapse Behavior	Yuji KOHGO	effective stress, consolidation analysis, constitutive equation of soil, plasticity, unsaturated soil	1-28
2.	Nematode Parasites on Agricultural Crops and Their Distribution in Sri Lanka	H. M. Rohini EKANAYAKE and Yukio TOIDA	nematode pests, detection frequency, crop damage, distribution types	29-39
3.	The Yellow Butterfly Species of the Genus <i>Eurema</i> Huner Causing Severe Defoliation in the Forestry Plantations of Albizzia, <i>Paraserianthes falcataria</i> (L.) Nielsen, in the Western Part of Indonesia	Ragil S.B. IRIANTO, Kazuma MAATSUMOTO and Kusdi MULYADI	Pieridae, tropical forest pest, population outbreak	41-49
4.	Technical Advances in Wheat Haploid Production Using Ultra-wide Crosses	Masanori INAGAKI	<i>Triticum aestivum</i> , chromosome elimination, embryo rescue	51-62
5.	Effects of pH Amendment and Fertilizer Application on Root Growth of Maize (<i>Zea mays</i> L.) in Tropical Peat Soil	Katsuyuki KATAYAMA, Shigetoshi MURAYAMA and ZAHARI Abu BAKAR	acid soil, liming, root growth, tropical agriculture	63-72
6.	Development of Energy-Saving Hydroponics Systems without Requiring Electricity	Harushige SAKUMA and Katsumi SUZUKI	Chinese mustard, melon, sweet potato, tomato	73-77
7.	Establishment of Lesser Mouse Deer (<i>Tragulus javanicus</i>) Colony for Use as a New Laboratory Animal and/or Companion Animal: 1.Behavior; 2.Hematological Characteristics; 3.Reproductive Physiology; 4.Rumen Microbiology in Relation to Feed Digestibility; and 5.Metabolic Activities	Hiroshi KUDO, Katsuhiro FUKUTA, Soichi IMAI, Ismail DAHALAN, Norhani ABDULLAH, Yin Wan Ho and Syed JALALUDIN	Ruminants, rumen, living fossil	79-88
8.	Observation of Water Use in an Irrigated Cotton Field in Xinjiang, China	Ryoji SAMESHIMA and Lisong TANG	Xinjiang, evaporation, transpiration, evapotranspiration, furrow irrigation, cotton	89-97

Full List of -for Scientific Papers-Contents

No. 3 March (1996)

	Title	Authors	Additional key words	page
1.	Detection of 16S rDNA of Thai Isolates of Bacterium-Like Organisms Associated with Greening Disease of Citrus	Kazuo NAKASHIMA, Maitree PROMMINTARA, Yoshihiro OHOTSU, Takeshi KANO, Jun IMADA and Meisaku KOIZUMI	citrus greening, liberobacter, 16SrDNA, PCR, repid diagnosis	1-8
2.	Pathogenic Races of <i>Xanthomonas oryzae</i> pv. <i>oryzae</i> in South and East Asia	Takahito NODA, Tsuyoshi YAMAMOTO, Tsugufumi OGAWA and Hisatoshi KAKU	<i>Xanthomonas oryzae</i> pv. <i>oryzae</i> , race, bacterial leaf blight, rice	9-15
3.	Monitoring Field Populations with Pheromone Trap and Seasonal Trend of Adult Body Size of the Diamondback Moth, <i>Plutella xylostella</i> (L.) (Lepidoptera: Yponomeutidae), in Central Thailand	Masahiko KUWAHARA, Piyaratt KEINMEESUKE and Yoichi SHIRAI	population fluctuation, immigration, forewing length, tropics, biological characteristics	17-22
4.	Effects of Bruchid-Resistant Mungbean Meal on Growth and Blood-Biochemical Values in Mice	Katsuhiko MIURA, Masao ISHIMOTO, Noriko YAMANAKA, Shigeru MIYAZAKI, Miyako HIRAMATSU, Yasuyuki NAKAJIMA, Koichi HIRANO, Keisuke KITAMURA and Shoji MIYAZAKI	<i>Vigna radiata</i> , <i>Callosobruchus chinensis</i> , insect-resistance gene, histopathological changes, feed safety test	23-31
5.	Dynamics of Roots and Nitrogen in Cropping Systems of the Semi-Arid Tropics	Osamu ITO, Ryoichi MATSUNAGA, Katsuyuki KATAYAMA, Satoshi TOBITA, Joseph J. Adu-G YAMFI, Junichi KASHIWAGI, Theertham P. RAO and Gayatri DEVI	semi-arid tropics, intercropping, pigeonpea, root system, nitrogen balance	33-48
6.	Phylogenetic Differentiation of Tetraploid Vigna Species, <i>V. glabrescens</i> and <i>V. reflexo-pilosa</i>	Yoshinobu EGAWA, Ithnin Bin BUJANG, Somsong CHOTECHUEN, Norihiko TOMOOKA and Yoichi TATEISHI	<i>Ceratotoropsis</i> species. <i>V. trinervia</i> , <i>V. minima</i> var. <i>minima</i> , isozyme analysis, interspecific hybridization	49-58
7.	Nematode Species Attacking Crops in Thailand with Measurements of Second-Stage Juveniles of <i>Meloidogyne</i> spp	Yukio TOIDA, Nuchanart TANGCHITSOMKID, Somkuan KEEREewan and Takayuki MIZUKUBO	plant parasitic nematodes, field crops, fruit trees	59-68

8.	Effect of Intensity of Weed Infestation on the Occurrence of <i>Leptocorisa oratorius</i> Fabricius (Heteroptera: Alydidae) in Paddy Fields of Sri Lanka	Atsushi SUGIMOTO and Lionel NUGALIYADDE	Rice bug, alternate host plants, ovarian development	69-74
9.	Salt Tolerance of Cultivated Rice Varieties from Vietnam	Bui Ba BONG, Satoshi TOBITA, Nurliani BERMAWIE and Toshihiro SENBOKU	<i>Oryza sativa</i> L., seed germination, seedling growth, varietal screening	75 -83
10.	Heading Performance of Rice Varieties under Double Cropping on Ishigaki Island	Tsukasa NAGAMINE, Makoto YAMAMORI, Masumi KATSUTA and Makoto KAWASE	rapid generation advancement, Indica, Japonica	85-95

Full List of -for Scientific Papers-Contents

No. 2 September (1995)

	Title	Authors	Additional key words	page
1.	Supply and Demand Analysis for Rice in Peninsular Malaysia -With special reference to direct seeding in the Muda Area-	Minoru TADA and Yoshinori MOROOKA	rice, self-sufficiency rate, supply, demand, direct seeding, econometric model, simulation, Muda Area	1-11
2.	Damage of Rice Grains caused by the Rice Bug, <i>Leptocorisa oratorius</i> Fabricius (Heteroptera : Alydidae)	Atsushi SUGIMOTO and Lionel NUGALIYADDE	Sri Lanka, Stylet sheath	13 -17
3.	Improved Method of Determination of Membrane Thermostability for Screening Heat-Tolerant and Sensitive Varieties in <i>Brassica</i>	Mohammad Mofazzal HOSSAIN, Hiroyuki TAKEDA and Toshihiro SENBOKU	Temperature stress, EC, heat Killing time	19-27
4.	Fauna of Plant Parasitic Nematodes in the Temperate Region of Japan 1. Surveys in Shizuoka and Kagawa Prefectures	Emiko YAMAMOTO and Yukio TOIDA	plant parasitic nematodes, Shizuoka Pref., Kagawa Pref., vegetables, flowers, bonsai pine	29-36
5.	Fauna of Plant Parasitic Nematodes in Temperate Region of Japan 2. Survey in Chiba Prefecture	Emiko YAMAMOTO and Yukio TOIDA	plant parasitic nematodes, Chiba Pref., temperate region, vegetables, flowers	37-42
6.	Fauna of Plant Parasitic Nematodes in Temperate Region of Japan 3. Survey in Wakayama Prefecture	Emiko YAMAMOTO and Yukio TOIDA	plant parasitic nematodes, Wakayama Pref., temperate region, vegetables, flowers	43-48
7.	Screening of Bacteria Producing Vitamin B ₁₂ from Tua-Nao in Thailand	Noriyuki OKADA, Charan CHETTANACHITARA and Wiwut DAENFSUBHA	fermented soybeans, Natto, cell fusion	49-57
8.	Relation between Population Density of the Rice Bug, <i>Leptocorisa oratorius</i> Fabricius (Heteroptera: Alydidae), and Damage of Rice Grains	Atsushi SUGIMOTO and Lionel NUGALIYADE	<i>Echinochloa crus-galli</i> , weeds, Sri Lanka	59-64

9.	Anaerobic Direct Seeding of Rice in the Tropics	Minoru YAMAUCHI	coleptile, crop establishment, cultivar, lodging, seed aging, weeds	65-78
10.	Land Levelling under Direct Seeding Rice Culture in Malaysia	Hideto FUJII and Meng Chang CHO	Malaysia, Vacant spot, Motor grader, Tractor, Seedling establishment	79-86
11.	Proline Content in <i>Brassica</i> under High Temperature Stress	Mohammad Mofazzal HOSSAIN, Hiroyuki TAKEDA and Toshihiro SENBOKU	<i>Brassica oleracea</i> , <i>B. campestris</i> , heat tolerance, hybrids, proline, reproductive stage	87-93

Full List of -for Scientific Papers-Contents

No.1 November (1994)

	Title	Authors	Additional key words	page
1.	Role of Natural Enemies in the Regulation of Stored-Product Insect Populations in Rice Storages in Thailand	Porn-tip VISARATHANONTH, Hiroshi NAKAKITA, and Prasoot SITTISUANG	predators, parasites, ants, spiders, pseudoscorpion	1-7
2.	Prevention of Aflatoxin Contamination in Thai Maize 2. Distribution of maize with high moisture content and methods of control of <i>Aspergillus flavus</i> infection.	Shoichi KAWASUGI, Koji KAWASHIMA, and Prisan SIRIACHA	<i>Aspergillus flavus</i> , maize, hermetic storage	9-17
3.	Changes of Communal Ties among Rice Farmers in Group Farming -A case of <i>kelompok tani</i> in the Muda Area, Malaysia -	Kumi YASUNOBU, Yoshinori MOROOKA, and Hin Soon WONG	guess-who test, double-cropping, sociogram, direct seeding	19-27
4.	Effects of Forest Windbreaks deployed in Arid Lands, Turpan, Northwest China 1.Effect on climatic improvement	Taichi MAKI, Borong PAN, Mingyuan DU, Makoto NAKAI, and Kenji UEMURA	tamarisk, wind speed, air temperature, surface soil temperature, relative humidity	29-38
5.	Effects of Forest Windbreaks deployed in Arid Lands, Turpan, Northwest China 2.Effects on prevention of wind erosion and on crop growth	Taichi MAKI, Borong PAN, Mingyuan DU, Makoto NAKAI, and Kenji UEMURA	tamarisk, wind direction sand accumulation, plant growth	39-45
6.	Climatic Differences between an Oasis and its Peripheral Area in Turpan Basin, Xinjiang, China	Mingyuan DU, and Taichi MAKI	climate improvement, evaporation, heat balance, windbreak	47-55
7.	Detection of Mycoplasma-like Organisms Associated with White Leaf Disease of Sugarcane in Thailand using DNA Probes	Kazuo NAKASHIMA, Mitcha CHALEEPROM, Porn-tip WONGKAEW, and Pisan SIRITHORN	MLO, dot hybridization	57-67
8.	Function and Regulation of Genes that are Induced by Dehydration Stress in <i>Arabidopsis thaliana</i>	Kazuo YAMAGUCHI-SHINOZAKI, Takeshi URAO, Toshisuke IWASAKI, Tomohiro KIYOSUE, and Kazuo SHINOZAKI	signal transduction, abscisic acid, <i>cis</i> -acting element, transcription factor, transgenic plant	69-79

JIRCAS Journal

‘•–ÚŽŸ

<u>No.10</u>	(2002.3)
No.9	(2001.3)
No.8	(2000.3)
<u>No.7</u>	(1999.3)
<u>No.6</u>	(1998.11)
<u>No.5</u>	(1997.11)
<u>No.4</u>	(1997.3)
<u>No.3</u>	(1996.3)
<u>No.2</u>	(1995.9)
<u>No.1</u>	(1994.11)



JIRCAS Journal
— for Scientific Papers —

No. 10, 2002. 3

目 次

- 松本和馬, ジェームス・R・コトゥライ
*Azadirachta*属樹種とマホガニーの混合植栽による
マホガニーマダラメイガの被害防除試験…………… 1
- 中牟田潔, 松本和馬, ジェームス・R・コトゥライ
合成性フェロモンによるマホガニーマダラメイガ
*Hypsipyla robusta*の野外における誘引…………… 9
- 趙朝輝, 斎藤昌義, 吉橋忠, 中原和彦, 辰巳英三
電解水を用いた充填豆腐製造の微生物制御…………… 13
- 椛木信幸, 田村治男, 小松 隆, 三浦憲蔵, 森田弘彦, 田淵隆一,
片岡健治, タウインカン ワンカート, パイウイット ワタナビタワス
タイ東北部における土壌保全型畑作システムの開発…………… 21
- ジョン・S・コールドウェル, ソムサク・スクチャン,
ウィモンラト・オンオク, チュンポルン・サトラヴァハ, 小倉力,
山本由紀代, プラバトソム・プラピン
水状況、浸蝕、および収量の関係に対する農家の捉え方…………… 31
- 鮫島良次, 唐立松
新疆のオアシス内外の気象条件とワタ圃場における水の利用…………… 43

–Ú•@ Žÿ

No.7, (1999.3)

•@	'è•@-¼	'•@ŽĐ	fL•[f•[fh	fy•[fW
1.	•Žq•Šw•Žè-@,Đ-p,è,½fTfgfEflfr''•Ø•afTf@fCfGfvf%cfYf),.İCEÿ•o,Æ•«ø%cd•İ	'•ž•è-Y•Afl•[f•f fbfvfEfHf•fJfD•AfeBfBf f.,[f f.,fŠ•[f]f•fTfTf•fvfŠfg•[f••A-N -Ži	fTfgfEflfr''-t••Aftf@fCfGfvf%cfYf)•ADNA•A•v'•f•A•â''Šw''İ•«ø	1-17
2.	fSf y,ÑRichardia•A•.É,,"e,Äftf@fCfGfvf%cfYf),.É,æ,è•ø,«cN,±,³,è,è-¼%co•a,İ%cd•İ	'•ž•è-Y•AfeBfBf ff•[f fffŠ•[fzf•f•Afl•[f•f fbfvfEfHf•fJfDfsTfTf•fvfŠfg•[f••A%coÄ''i•ø•ä	ftf@fCfGfvf%cfYf)•Afl)fcfRfvf%cfYf)-l''÷•¶••A•øz•AfeHf•P•k•a	19-27
3.	f)jE•[fvfA•Ef f_n•æ,É,,"é•i•i,İ•«-~•\³	^Ä%co,cv''ü•AfeHf• ftfHf•fC•[•A-âŠÖ•q•K	fvf-f•f•E -fvfž•f•A ''_•%coÄ,İ%coÄ''İŠİ	29-43
4.	"CE-kf^fC,É,,"é...Ž•E),İE»•ó,Æ'n%eßf_ f (Eš•Ý,İ%coÄ''«•)%coÄ	•j•ðáÄ''V•Afv fTfbfN fXfNf fff••AfnfŠfbfTfj•[fpf•fvfPp''	"V...''c•A•~•K-İ,½,B'r•A%co-ø'n%co•...•E%cd•è•~%coJ	45-67
5.	f^fC%cd•fof•fPp''...c,É,,"é•f•f^f•ftf%cfbfnfX,İ•ú•İ''•,Æ•G•B•İ''•	%coÄ''j-M•F•AP.Chairoj•A''•Ø'è•s•A'B'cŽj-Y•A-z ••s•AW.Cholitkul	'n...%co'g%co•Afvf^f•ftf%cfbfnfX•AŠŠT•A...''c''y•è	69-75
6.	-k•''f^fC,É,,"é...c,©,ç,İf•f^f''''•¶	%coÄ''j-M•F•AP.Chairoj•A''•Ø'è•s•A'B'cŽj-Y•A-z ••s•AW.Cholitkul	•V'N-L@•''•A'n...%co'g%co•Afvf^f•ftf%cfbfnfX•A...''c''y•è	77-85
7.	"CE-kf^fC,É,,"é...c,©,ç,İf•f^f''''•¶	%coÄ''j-M•F•AP.Chairoj•A''•Ø'è•s•A'B'cŽj-Y•A-z ••s•AW.Cholitkul	•V'N-L@•''•A'n...%co'g%co•Afvf^f•ftf%cfbfnfX•A...''c''y•è•A•»•è''y	87-96
8.	"CE-kf^fC,É,,"é...K-İ,½,B'r,İ'z'è•ú-@	(Eü(Eä-Y''ñ•AfXfE'f'fhf%cfofnff...f< f^f f%cfJf•AftfB fKf•f^f''	-O'afrf%cfcfvfx fGf•[fWfž•f•A,½,B'r•A•s-O'a''y	97-104
9.	•R•İ''ÜE'•«(fG•[f fXfefXfg),Đ-L,,éftfBf''fK•[f•[fg(Boesenbergia pandrata Schl.)y,ÑfKf%cf''fK(Langas galanga)••³,É,Ä,ç,Ä	fQfbfvfj•[•@fGf%cfN•[f''fefBf•fR•[f''•A'+CE~a•F•A•V-[-mŽm•A'ÄŽu''c''i''ñ''Y	•R•İ''ÜE'•«•A•@Boesenbergia pandrata Schl, Langas galanga f^fCZYfn•[fu•Afg•[f fXŽZE±	105-116
10.	"_•E•N'è•İ''•İE'•Ö•İ%co,É,,"é''_•g•D,İ-ðŠ,, fxfgfif •AfvRf''ff•f^,İfzfAFAf''ø,É,,"éŽ-á•ø•İ	ŽR•è-ø'è•Afvf...f'' fof''fj•[ftf@•[f-f'fOfvfxfef''_'[•...•j•žEo%co•A'+ŠÖ•K-İ'w•A•n•è-à'è	117-132

•@

•@•	•@•—¼	••@ŽÒ	fL•f•f/h	f•y•f/W
1.	fuf%efWf%,Efpff%ofOfAfC.I"•.É.,,éfnLfŠfAJS.Ìn→"l•xZ,ÆxA.,,Ì•xŠg.á,É,æ,é",E.Ö.Ì"ŠQ.Ì"•%Ä,Ì%Ä"•x	Ž•x•L•Ž—q•Af•fCfX•Efbf,f•fX•EfbfHf•f•AfjfjX•E•f•fWfFŠfEfbfCfbf	fñfLŠfAfŠA'n→•l•x•x•A"_.EŠQŽ•A"•Á	6-10
2.	fJfEfCfVfA.É.,,•é"š•š•E'l—p"•A"P"œ—fuf•fbfN.Ì"ŸZY	%cŸ•"š•c"•Awān ZAHARI Mohamed	••'q•B-@•A•d•Ž"—i	11-20
3.	fTfTfQ•iVigna unguiculata (L.)Walp. •j.ÌŠE•x	"ñq"•@Eµ	čŽi•B-@•AfJfEfs[•AfTfTJQ•AfX•f_f"•AfTf"•f@f"fi•A'İŠE••x•A'İŠE••x"Ÿec,—@	21-28
4.	fTfTfQ•iVigna unguiculata (L.)Walp. •j.ÌŠE•x	"ñq"•@Eµ•AŽ"•ü•x•v	fJfEfs•l•AŠE•G•AŠE••xŽY•AfTfTJQ•AŽE—•y•x•...•A•l••x•AfX•f_f"•Efbf"•f@f"fi•A'İŠE••x•A...fXfGfEfx	29-37
5.	fŠf•fJGfZf"•fV"•fJÖ.Đ—p,e.½fC"•fb"•šŠE"•M•N"•æ.É.,,•e"y•e"•Ä•x.Ì"Š•o.Æ"_n.İf.fj•f"•Šf"•fJÖ	"š"•c•@—@	"y•e"•K"••x•A••x•K%œ•x•A•qŽw••x•AŽŠÖ"•f•E•AIRSf•f•f•	39-52
6.	f•fRf"•f•f•f•,İfuf@f•f"•fJfVfXfef.É.,,•e"Ö.Ì"•k•ozŽ"•fasciolopsis buskij,É.Ä,e.Ä	•gE"•@"E•AfOJGf"•EfbfE•fuf"•AfOJGf"•EfbfN•Efbf"•A•••—N•@•Ÿ	ŠB•qŽ•A"•l'•dÉŠ"•B•Ç•AfEfbfH[f"•fXfSfbfBf•AfofCfWfEfx"•f•	53-58
7.	"ü"••œ"•Eœ•š•É,æ,fL...fEšEfbf fS.Ì"•œ•••x•ž•i.Ì"ç••	•"šžREc"•A•-KEB—TŽ•A•d•c•D•P•A•X%œ"•ŽÖ•A•-@E[•V•A"•q"•eY—½•A—t@•"•p"•A'•Ä•@—cE[•A"•A•@•G"•A—D"•@•qç"•A'•Ä•@ŠC•d•A—j]•@•l'E	fL...fEš•AfCfJfS•A'•čŽi	59-69
8.	f•fRf"•f•f•f•,İfuf@f•f"•fJfVfXfef.É.,,•e"i•i•Zp.İ%di"•P	d•@"•œ"•j•Afuf@f"•EjV•Efbf"•A•@f•f•f"•EjSfbfN•Efbf@f"•AfeB"•Efbf"•Nf"•AfbfH"•EfbfB"•EfbfB"	•q"•ç"•f•AŽ[•"•@•A—t•F•A•...ŠC—•x•AŽB—É•x•—v•f	71-82
9.	fYBfŠfS"•É.,,éfAfOj•f•fHfEfx"•fS"•f.Ì"•D%ā	•DŽR•Ÿ"•V•AfAf•fŠf"•Efbf	"—š•E•A"•y•e•N•H•A'½"•w••"—š•i•i•kE"•A•E•XŽ"•n"•_•E.Zp	83-88
10.	fXfGfj"•EfbfR"•fj"•f"•É.,,•éW•...fGf•—l•B.İE••ó	fG%œ"•f"•Efbf"•Efbf"•EfbfG"•Af f...fJ"•fO•EfbfAf"•Efbf"•AfOJFf"•Efbf"•Efbf"•Afj[•fV"•Efbf"•Cf•f...l	fj[f•efJkfgf•A•...ZY—{•B•Afj@f•f"•f"•fJfVfXfef•AŽfœ•qŽY	89-100

•@-Ú•@ ŽŸ

No.4•@(1997.3)

•@	'è•@-¼	'~@ŽŸ	fL•fj•fjh	fj•fjW
1.	-OafRf%efbfvfx"'''@_f%dbÍŽ2-@_È_Ä_e_Ä	€Bt€Bt@—Y"ñ	—LEt0%ž—ÍrA"—§%dB†A"y_Ír~Ž@•A"Y••A•s—O"a"y	1-28
2.	fXfŠf%ef"jI_È_,"_è•A•Šñ•+•ù Ž_ÍŽi—p„E•+•z	f•f•qfj•EjGjffjf„jP•A"0"•K•v	•r•%e_ÁŠQ•ù Ž•A•EÛ•o•p"••A•L"•e•+•z•A•Ç"•n•+•z	29-39
3.	fCf"•fhfjfvA•f•+•"„lJfA•f•rjWfA'è—Š"n_È_,"_e_Ä+H—SQ_0"••N_±_p_Ä_e_é•fL•f•fj•E'@+iEurem•+•j	f%efMf•_S.B._fCfŠfA•f"fg•A•f•+•l—"u"n•A•NfXffjfb•+•E•f•fŠ„fjfb	fV•f•f•fj•fE%è•A"•M"•Š—N_•EŠQ"Ž•A"•ù"••¶	41-49
4.	'"•%e"•e•€EŽG_ð—"•—p„_•éRf•fM"•f•+•"„l_í+•o_ÈŠŸ„_•é•ZpŠj"•	íŠ_•+•T	fRf•fM•A•fgfE•f•f•jRfV•A•j•fgfE•fW•f"•fjG•A"•%•"„l_•A"e"•%e•€EŽG•A_Í0"„l—{•A•+•F"l"[%e•A•%e_Ö•+•T"„l_•A•0_è•ù"—[•A"•çŽi-@	51-62
5.	"M"•N"•D"•Y"•y•é_È_,"_•éŽ_•••+•j_Ÿj"•+••r„NŽ{•+•"„l_•fj•g•f•f•j•r•j•v_•l_•l_¶f"•ç_È_•y_Û_•%e•e_•j_	•DŽR•Y"•V•A"•ŽR•d•r••A•f•u•f•h•Š•E•f•A•f•u•E•f•o•+•fj•+•	Ž_••"•y_è•A_•ÍŠDŽ{—p•A_••¶f"•ç•A"•M"•Š"„l_•E	63-72
6.	•EjGfj•f•M•(E#—[%d•+•T"•u_ÈŠŸ„_•éŽjÈ±	±_v_ŠŸŸ_Ä_•+•A—é_0_+ŽEÈ	f•f"•fQ"•fTjC•A•f•f•f"•A•fTj•e•f•}•C•f•A•f•g•f•}•f•g	73-77
7.	•V_•p_•éŽÄE±"•@•+•"•fj•fb•f•g_•E_•p_•Ä_•l•f•j•f•W•fj•+•Tragus javanicus•+•jR•f•f•j_•ÍŠm—§_•P•D•s"•@•G_•Q•D•E•E%è•+••0•G_•R•D"•È_•B_¶•+•+•G_•S•DŽ"—_•í_•Á%e•_ÈŠŸ„_•é_•f_•f•f•+•"•+•G_•T•D"•íŽŸŸ••e	•H"•+•@"Ž•A•Y"•c•Y—m•A_•+•"„l_•+•A•f•C•X•f•}•C•f•+•E•f_•+•l•f%e•+•A•f•m•f•+•j•u•f•j•E•f•A•f•u•f•h"•e•+•A•f•C"•+•E•f•f"•+•E•f•z•+•A•f•T•j•C•f•h_•E•j•f•f%e•f•_•f•j"•	"½_•_•@•+•A•f_•+•f•f"•+•è"•Y_•+•A_¶_••_•%e•e•+•Í	79-88
8.	'r•+•ŠE"•ç"•n_•e_•ÍŠÁY0"„n_È_,"_•è•+•"—p_ÍŽÄ_Ö	ŽL"•ç—ÇŽY•A"•_•@—§+¼	•V•á•+•A•+•0"•+•A_•+•ù•L•A_•+•0"•_Ž•U	89-97

•@	'è•@-¼	'•@ŽÒ	fL•[f•[fh	fy•[fw
1.	fJf~fLfcfOfŠ•[fj~fO•a,Ī•aE'fojNfefŠfA—Ī••••if^fCS'•j,Ī 16SrDNA,ĪEŸ•o	"Ī••••è—Y•Af)fCfGfE•[Efvf~f~f^f%•A'ā'Ā'P•O•A%•eĀ'"[•@E'•A•j•c@••A••→•ò-Ā™e	fJf~fLfcfNfŠ•[fj~fO•a•Aliberobacter•A 16SrDNA•A PCR•A •v'~•f'f	1-8
2.	"E'ifAfWfA,É,," ,éfcfl" —(EĪ•a•ŪfE•[fX,Ī••z	-Ī"•F•Ī•AŽRE'•@••,•A•••i•D•••A%•eĀ—^•v•q	<i>Xanthomonas oryzae</i> pv. <i>oryzae</i> •AfE•[fX•A'" —(EĪ•a•Ū•AfCfl	9-15
3.	f^fC'••,É,," ,éRfifK,Ī"••—§"x,Æ—Y••—Ž,Ī'•,Ī•G•B•Ī'•Ū	(EKE'•e•F•Afsf,•f%•efbg•EjJfCf"•f~•[fXfN•A'"••ā—m"è	fRfifK•Af^fC•A—§"x•i%•e•A'Ī'•A•••Šw"•T"•Ā••	17-22
4.	fAfYfLffJfEf fV"•R•«fŠf~fNfGfE•%•e•a,•f}fEjX,Ī••••,ÆE%•e•t••%•e•Šw'Ī,É,," ,e,Ū,•%•e•ç	ŽO%•Y•Ž—m•A•Ī—{•••}•AŽR'••TŽq•A•[•è•@-Ī•A•½•½•@•"s•A'Ī•••-ò"V•A•½•-Ī•F•è•AŠ'•½••E%•e•Ā•A•[•è•@ŽŽ	<i>Vigna radiata</i> , <i>Callosobruchus chinensis</i> , Ī'Ž•«'ā"Žq•A•a—•g•DŠw"•Ī•%•e•a•AŽ"—ç'Ā'•S•«ŽŽE±	23-31
5.	"¼ŠE'••"M•N,É,," ,é•i•t,•ĪE"•ā,Ī••,Æ',•f,Ī"•Ū	"É"•@Ž,Ī•A•%•e•ā—•è•A•DŽR•Ÿ"V•A"•ò"•c@•"N•AfWf~fZfJ. fAfhfDfMfff"•fufB•A'•-Ø•f"è•AfV•[fTf P.f%•e•fĪ•AfKfCf.,fgfŠ•Eflf	"¼ŠE'••"M•N•AŠŌ•Ī•AfLff}••A••E"•A',•fžžx	33-48
6.	fTfTfQ'•S"Ī'Ži•AVigna glabrescens,ÆVigna reflexo-pilosa,ĪE"••%•e•	•]•i•X•L•AfCfXfj"•EfuWfff"•AfN fN"•Ef f~f•ef f...fGf"•A—F%•e•E•F•A—§Ī—f"è	fAfYfL'Ÿ'•-AV. <i>trinervia</i> , <i>V. minima</i> var. <i>minima</i> •A fAfCfNfUfCf •Ī•AŽŠŌŽGŽi•i•o	49-58
7.	f^fC'•,É,," ,é•i•%•e•ĀŠQ•ü'Ž,ĪŽi—D	"ò"•K•v•AfKf fffi•[fg•Ej^f"•fOf fGfNf fLfbfh•AfN fNf"••EjLfŠ•[f"•A•...•v•Ū—"V	•A•Šn••ü'Ž•AfJfRfufZf"•f...fE2Šü—c'Ž•A'"•i••A%•e•Žž	59-68
8.	fXfŠf%•e•fJ,Ī•...•c,É,," ,é^fCf•f"•fNf,fwšfJf•fV,Ī"•••,É•y,Ū,ŽG•,Ī%•e•ç	•™—{•@••-Af%•e•Cflfj•EfkKfŠf,•lff	"šQ'Ž•Af^fCf•f"•fNf,fwšfJf•fV•A—•"•f"•ç•A—Ī•••ŠnŽā•A•••AŽG•	69-74
9.	fxfgfif ,Ī'Ī'fCfl•Ži,Ī'Ī'•e•,É,Ā,•e,Ā	fufC•Efo•Ef{f"•A"•ò"•c@•"N•AfKf,šfAfj•Efo•[f]f•[•A•ā-k•r•O	fCfl•A'Ī'•e•«•AŽiŽq"•%•e•A•c,Ī••••A•iŽifXfNfŠ•[fj~fO	75-83
10.	ĪŠ"••,Ī"nŠū•i•Ī'Ī,É,," ,éfcfl•Ži,Ī•o•ā,Ī'ĀŸ	••ò•@Ži•AŽRŽç•@•½•A•Ÿ"•cāĀ•Ÿ•A%•e•ĪPāĀ,Ō	fCfl•AfCf"•fhE"•A•o•ā"Ā•«•A•e'•ā'•E•i•A"•nŠū•i•A"•ū—{E"•A•iŽiEQ	85-95

•@-Ú •@ ŽŸ

No.2•@ (1995.9)

•@	•@-¼	•@ŽÒ	fL•[f•[fh	fy•[fW
1.	f}fCEfCfVfA,É,," ,é'¼"d'i,]••y,AE•Ā,ĪŽù<<©Eü •(Eo•Ī•~' ,•E•(Eü•%eĀ,Ī%eœ<ç•	'½"•c•@-«•A•"•%eĀCE•,	•Ā•AŽ©<<-!•A•Ÿ<<•AŽù-v•A'¼"d•AEv-Ê(Eo•Īf,ff••AfVf~f...fE•[fVfžf'•Af f_ 'nœ	1-11
2.	f^fCf•f^fNf,fwfšfJf•fV,É,•,é•Ā-±,Ī'išQ	•TM-{ •@^••Af%eCfCfĪfĪf•EfkfKfšf.,•[ff	ŸšQ'Ž•Af^fCf•f^fNf,fwfšfJf•fV•AEü•j•â•AfXfšf%eç'•fJ	13-17
3.	fAfu%eçf%eĒ-t•Ø-D•,%œ•Ī•«•iŽifXfNfš•[fj'f•fO,Ī,½,B,Ī×-E-(E%œ•"x'Ī•«'•ž-@,Ī%eü-Ç	Mohammad Mafazzal Hossain•A' "c"Ž"V•A•â-k•r•O	Ž¼"xXfçfCEfX•A"d'±-!•Afq•[fç•Eflfšf'fO•Efl^fCf	19-27
4.	-{M%œ'g'n,Ī"n,É,," ,é•A•Šñ•¶•ü'Ž'Š 1. •Ā%eœ,," ,æ,Ń••i-¼E§,É,," ,é'²•,	ŽR-{(Eb"üŽq•A"ó"•c•K•v	•A•Šñ•¶•ü'Ž•A•ç-t(E§•A%œ'g'n•A%œÔ,«•A-i•Ø	29-36
5.	-{M%œ'g'n,Ī"n,É,," ,é•A•Šñ•¶•ü'Ž'Š 2. •ç-t(E§,É,," ,é'²•,	ŽR-{(Eb"üŽq•A"ó"•c•K•v	•A•Šñ•¶•ü'Ž•A•ç-t(E§•A%œ'g'n•A%œÔ,«•A-i•Ø	37-42
6.	-{M%œ'g'n,Ī"n,É,," ,é•A•Šñ•¶•ü'Ž'Š 3. •a%çŽRE§,É,," ,é'²•,	ŽR-{(Eb"üŽq•A"ó"•c•K•v	•A•Šñ•¶•ü'Ž•A•a%çŽRE§•A%œ'g'n•A-i•Ø•A%œÔ,«	43-48
7.	f^fC,ĪfgfDfAfifĪ,æ,èftrf^f~f",a12¶ŽY,Ū,Ī•-£	%œ"•cE)•K•Af fff%eç'•Ef fFfbf^fif f^f%œ•AfeBf•fbfg•E fi{f"fofXfo	'â"œ".•y•H•i•A"["œ•A•x-E-Z•ž	49-57
8.	f^fCf•f^fNf,fwfšfJf•fV,Ī•¶-§-x,AE•Ā-±,Ī'išQ,E,ĪšÖEW	•TM-{ •@^••Af%eCfCfĪfĪf•fkfKfšf.,•[ff	ŸšQ'Ž•Af^fCf•f^fNf,fwfšfJf•fV•AfqfG•AŽG'••AfXfšf%eç'•fJ	59-64
9.	"M'Ń,É,," ,é•...Ī,Ī'X•... "y•e'±'¼"d•Z•p	ŽR"â•@-«	ŽG'••AŽižqfGfCfWf'fO•A•â-t•A"l'š•A•c-§,ç•A•iŽi	65-78
10.	f}fCEfCfVfA,Ī...Ÿ'¼"d'Ī,É,," ,é•D•é,Ī•½	"i"ü•G•l•A CHO Meng Chang	f}fCEfCfVfA•AEž•c-Ê•Ī•Af,•[f^•[fOfE•[f_•Afçf%eçNf^•A•c-§	79-86
11.	•,%œfXfçfCEfX%eœ,É,," ,éfAfu%eçf%eĒ•i•,Īfv•fšf'šŪ-Ê,É,Ā,ç,Ā	Mohammad Mafazzal Hossain•A' "c"Ž"V•A•â-k•r•O	fLfffxç•AfnfNfTfC•A•,%œ•Ī•«•AŽGŽi•Afvf•fšf'•A•¶•B•¶'•šŪ	87-93

JIRCAS Journal

•@-Ú•@ ŽŸ

No.1•@(1994.11)

•@	•@-/A	•@ŽÒ	fL•f•[fh	fy•[fW
1.	f^fC•,ĭ•Ä™™••ē•Š,É,„,é™™•ŠQŽĚÄĭĚQ•§ĚÄ,É,y,Ů,„V™G—P,ĭ•δŠ,,	f™fBfTf%of^fmf™fX•Ejf™f fbfv•A™†k•@•G•Afvf fXfA™fO•Efvf%ofX•[fg	™™•ŠQŽ•A™™G•A•B•HŽÖ•A•Ä™™••ē•Š	1-7
2.	f^fCf•fCfY,ĭfAftf%ofgLfVf™%o•ō-hŽ-,ÉŠÖ,„ēĚD•† 2•D•,„•f•fCfY,ĭ—†É,„EAspergillus flavus%o•ō,ĭ-hŽ~—@	•i™™•™•ē•A•i™™•„ñ•AfvfŠfA™ff•EfvfŠfXfi•[fAftf%ofgLfVf™•AAspergillus flavus•AfgJfE•f•fRfV•A—Š™™•	9-17
3.	f fĚfCfVfA•Efvf_“i”™,É,™,„é•ŹY•g•D,„E”_‰E,ĭĭ‰ēž •fNf•f™fifb•Efvfj,ĭž—á••ĭ	“Ä‰‰,v”ü•A•™‰‰‰‰•,•AHS.fE/fH™	fQfX•Efvf•[EfvfXfg•A“ñŠü•i•AfvfVfifO%ofX•A•...™™•d“f”	19-27
4.	“i••-k•%•”,ĭŠÉ“†nfgf•fjf@f™,É,™,„é-h•—ñ,ĭĚ‰‰ē 1.‰CE‰‰ē—Č‰‰ē	•A~Ø“%‰‰AàN@“‰ĚÄ•A“m•@~‰‰‰‰•A“†ü•@•M•A•ä“‰‰ēŽ _i	f^f fŠfXfN•A•—™™•A.C‰‰•A`n‰‰‰•A`Š`ĭŽ¼“x	29-38
5.	“i••-k•%•”,ĭŠÉ“†nfgf•fjf@f™,É,™,„é-h•—ñ,ĭĚ‰‰ē 2.™—H-hŽ-,„E•i•Žü—É,Ö,ĭĚ‰‰ē	•A~Ø“%‰‰AàN@“‰ĚÄ•A“m•@~‰‰‰‰•A“†ü•@•M•A•ä“‰‰ēŽ _i	f^f fŠfXfN•A•—‰‰‰•A`ĭ•••A•A••“‰‰ē	39-45
6.	“i••Vádfgf•fjf@f™,É,™,„éfifAVfX,„E,„,ĭžü•Ó,ĭCEó•“Ů	“m•@~‰‰‰‰•A•A~Ø“%‰‰	‰CE‰‰ē—Č•A•ö”•A”MŽüŽx•A-h•—ñ	47-55
7.	DNAfvf•[fu,É,„ēf^fC,ĭfTfgfE/Lf™™—†•a•a(“f fCfRfVf%ofYf)—†•†•,„ĭĚŸ•o	“i™™•‰‰—Y•AfvfBfbf f f•Efvf f f f Š•[fvvf•Afvf™f fbfv•EfvfHf™fJfE•AfvfTf™•EfvfŠfg•[f™	MLO•AfhfbfgfnfCfušfš_fCf[fVfžf™	57-67
8.	f,ff•ŽÄĚ±•A™fVf•fCfkiFYfi,ĭŠÉ“†—U“±••“á“Žq,ĭ@“\,E”•E»§ĚÄ	ŽÄ•ē“aŽq•A‰‰Y”ö•@•,„AŠâ•ē•‰‰‰•A•“—m•G•AŽÄ•ē“ē—Y	ŠÉ“†fXfgfEfvX•AfvfVfWf™Ž_•A“â“Žq”•E»•A“â“Žq@“\•A“]ŽÉ•§ĚÄ•AfvfOfif“™™•B•Afgf%of“fXfWfEfvfN•A•”	69-79

JIRCAS Newsletter

Year/Month of Publication	March	June	September	December
2002	No.30 /(PDF)	No.31 /(PDF)	No.32 /(PDF)	
2001	No.26	No.27 /(PDF)	No.28	No.29 /(PDF)
2000	No.22	No.23	No.24	No.25
1999	No.18 /(PDF)	No.19	No.20	No.21
1998	No.14	No.15	No.16 October	No.17
1997	No.10	No.11	No.12	No.13
1996	No.6	No.7	No.8	No.9
1995	No.4	No.5		

Comments? Questions? Suggestions?

Please send them via e-mail to : letter@ml.affrc.go.jp

Japan International Research Center for Agricultural Sciences



A typical local market in Ghana, West Africa (Photo by J. Furuya)

NEWSLETTER

JIRCAS

Japan International Research Center for Agricultural Sciences

For International Collaboration

March 2002

30

Contents

[Distribution Systems and Rural Development](#)

[Project on Prevention of Shrimp Viral Diseases in Malaysia](#)

[Flavor Compound Analysis of Aromatic Rice](#)

[Rainfall Station Network in Tropical Monsoon Area](#)
[Welcoming New JIRCAS Fellows](#)

[**JIRCAS Home Page**](#)

Distribution Systems and Rural Development



Kazuyuki Tsurumi
Director, Development Research Division, JIRCAS

In West Africa

A few years ago, I had the opportunity to visit several countries in West Africa. As generally known, West Africa is an area where the income level is very low and where essential food products are in short supply, especially, compared to other developing areas. In addition, these countries are facing many problems such as limited water resources, degradation of soil, difficulty in increasing the production of foods, etc.

During my visit there, I was able to observe a farming village where farmers were actively tackling the production of farm products, especially, the production of vegetables under such difficult conditions. Actually, only part of the farmers were working actively in the village. However, they not only dug wells for themselves to ensure the water supply for their own use but also installed a fence neatly around the village to protect themselves from wild animals. Furthermore, their farmland was well-managed and they appeared to be full of life. According to them, very recently, an open market had been set up near the village and they began to deliver their products to the market. It is obvious that when cash income is readily available, farmers are strongly motivated to produce farm commodities. Although I heard that there was only one TV set in the village, it seemed that the TV supplied a great deal of information as well as a means of entertainment in the village. It is no exaggeration to say that the example of the village in West Africa described above suggests that the presence of markets strongly affects the regional economy and this is common throughout the world. Still, I would like to emphasize that the vitality I observed in the village I visited was remarkable, compared with other villages in the vicinity.

Agricultural promotion measures

Not only in Africa but also in many other regions, agricultural promotion measures are being implemented based on some development programs managed by each country or each region. Besides, international agencies and institutes in advanced and developing countries also have long been carrying out on a large scale studies on the development of new varieties of crops, pest control measures, effective policy and systems, etc. as well as conducting surveys on social and cultural trends. Moreover, these countries and institutes have been making utmost efforts to disseminate the newly developed technology by dispatching specialists or advisors. However, I must admit that the results of these efforts are not satisfactory when I see the actual situation of farmers working on their farmland. Although there must be many reasons for the poor results, one of the major reasons is that it is difficult to give an incentive to farmers only by introducing new technology and/or constructing facilities. Actually, even though the activities seem to be successful at the beginning while they are supported with subsidies and by advisors, these activities are likely to revert to the original state upon termination of the said support. From a short-range view, there must be, at least, a tangible output for the benefit of producers to some extent in order for producers to maintain the incentive. In other words, cash income from markets and purchase of assets must be greatly attractive for them. Of course, only the existence of markets will not solve all of the problems. Needless to say, the production activities are indispensable. At the same time, it is important to ensure means of distribution of crops for sale. In order to improve the income level of all of the farmers, in this case, monetary distribution in a wide area which involves as many regions as possible is necessary, because the transfer or return of wealth in a limited region will not enable to improve the standard of living of all.

Distribution systems

The existing distribution systems in developing regions have their own background based on traditions and social and economic conditions, respectively. In fact, the activities of official agencies and private distributors are closely related to support these distribution systems, and many actors operate between producers and retailers. What is important for agricultural promotion and the development of farming villages is not to totally remove the existing systems but to carefully review their advantages and disadvantages and to make full use of the existing advantages for necessary reforms. By maintaining fairness as a whole, it is more important in particular to orient private distributors toward a direction to let them play their role to their full capacity. In some countries and regions, due to the migration of populations to large cities, changes in food habits, etc., changes have already taken place in the distribution network and in the process of price formation.

Together with the reform of systems, it is important to construct well-organized infrastructures for the distribution systems since basic infrastructures are often rudimentary in many developing regions. Because of the lack of adequate infrastructures, transportation of the crops produced takes a long time, resulting in losses of large quantities of crops and deterioration in quality during the transportation, which are serious problems. To address these problems, development of wholesale markets, transportation networks, storage facilities, etc. are urgently required in addition to technological development for processing the crops and preservation of the crops in the distribution system. Obviously, technological development varies with the environment, economic conditions, etc. of each country, starting from the development of techniques to prevent losses of the harvested crops and drying, and extending to the development of techniques to process crops to products with value added, provided that these commodities can be purchased at a low price and are acceptable to most of the people in the country or the region.

For the development of efficient distribution systems

Since the distribution systems play an important role in the improvement of the income of farmers and the enhancement of the regional economy, development of distribution systems is required along with technological development and its dissemination. Therefore, approaches from both aspects are suggested for the development of an efficient distribution system: one from the view point of system or institution, and the other from the technology perspective. As for the former, it is necessary to identify the existing constraints in the current system, taking into account the social background, and for the latter, to determine the current technological level and the objectives. Then, it is essential to implement a policy related to the reform and improvement of the distribution system as well as to determine the need for the introduction of newly developed technologies and to consider the possible impact on farmers' economy and regional economy. Since a considerably large amount of investment, however, is required for the development of infrastructures for the distribution systems, plans for the promotion of distribution systems in the respective regions should be drafted carefully by setting up clearly priorities for the implementation of the programs.

The example in West Africa introduced at the beginning of this article shows only one aspect of the distribution systems in that region. However, such a trend certainly offers a good opportunity for more efficient rural development, even though in some cases, how to maintain a market in itself is a problem. Furthermore, I would like to underline the fact that due to the changes in the technologies and systems for the distribution of products, the structure of producing areas for many kinds of foods has changed a great deal even in Japan. Now, I do hope that studies on technologies and structure for the development of more efficient distribution systems will be promoted to accelerate rural development in the developing regions, which requires a close collaboration among related researchers in many fields.



Rice from Thailand, China, Vietnam, Bangladesh, and the U.S. for sale in Ghana, West Africa

Development of Technology for the Diagnosis and Prevention of Shrimp Viral Diseases in Malaysia

The collaborative project titled: • gDevelopment of technology for the diagnosis and prevention of shrimp viral diseases• h was conducted for five years from 1996 until 2002 in Malaysia. This JIRCAS project was planned to target Southeast Asia which is a major area for prawn production. The fisheries industry is extremely important for many Southeast Asian countries surrounded by the sea. Especially, the prawn industry is the key of all fisheries, because of the high value to obtain foreign exchange. Recently, prawn culture has expanded rapidly in these areas because of the development of culture technology (Fig. 1). At the beginning of the 1990s, prawn production in the world amounted to about 700,000 MT, with Southeast Asia accounting for the major part. However, the production of cultured prawns markedly decreased as a result of serious viral disease outbreaks in the first part of the 1990s. Yellow Head Virus (YHV) and White Spot Syndrome Virus (WSSV) were the main viral pathogens. At present, WSSV is the most serious problem for the prawn industry in Southeast Asia. This viral disease has occurred in most of the prawn farms in Malaysia since 1996. The increased severity of widespread viral infection is the most significant threat to stable aquacultural production. Therefore, in order to ensure stable production of cultured products, it is essential to adopt preventive measures against viral diseases. The aim of this project is the development of serological diagnosis, disinfection, and other control methods for the prevention of prawn viral diseases.



Fig. 1. Harvest of black tiger prawns from culture ponds.

Research was executed according to a four-phase plan. In the first phase, investigations of the present conditions and problems associated with shrimp viral diseases were carried out. In these studies, field work was conducted based on the collection of accurate epidemiological data. In the second phase, the pathogens were identified by polymerase chain reaction (PCR) and other methods, and concentrated and purified in the next step. In the third phase, methods for rapid diagnosis were designed, including the production of monoclonal antibodies to develop serological diagnostic methods (Fig. 2). In the last phase, disinfection methods for disease control were developed. Sterilization of facilities using disinfectants was used, and attempts will be made to prevent the occurrence of prawn viral diseases. For this project, JIRCAS collaborated with the Fisheries Research Institute (FRI), Department of Fisheries, Ministry of Agriculture of Malaysia. The institute consists of four research divisions, namely Aquaculture, Fish resources, Marine

ecology, and Food processing. Fish health section belonging to the Aquaculture division was selected as the counterpart of the project. This laboratory had just initiated fish virological research because of the increase in the incidence of many fish viral diseases during the development of marine fish aquaculture. As a result, the required equipment had been already provided for virological studies. The Pathology division, National Research Institute of Aquaculture (NRIA), Ministry of Agriculture Forestry and Fisheries of Japan, supported this project by sending experts in 1998 and in 2000. As a result of this project, a few clones of virus-specific monoclonal antibodies were obtained. Hereafter, these monoclonal antibodies will be used for the diagnosis of WSSV. On the other hand, the WSSV inactivation test indicated that halogenous disinfectants induced effective inactivation even at lower concentrations. In future, the application of effective methods of diagnosis and disinfection of WSSV should enable to achieve sustainable aquaculture in Southeast Asia.

Norihisa Oseko

Fisheries Division, JIRCAS

Present, National Research Institute of Aquaculture, Fisheries Research Agency

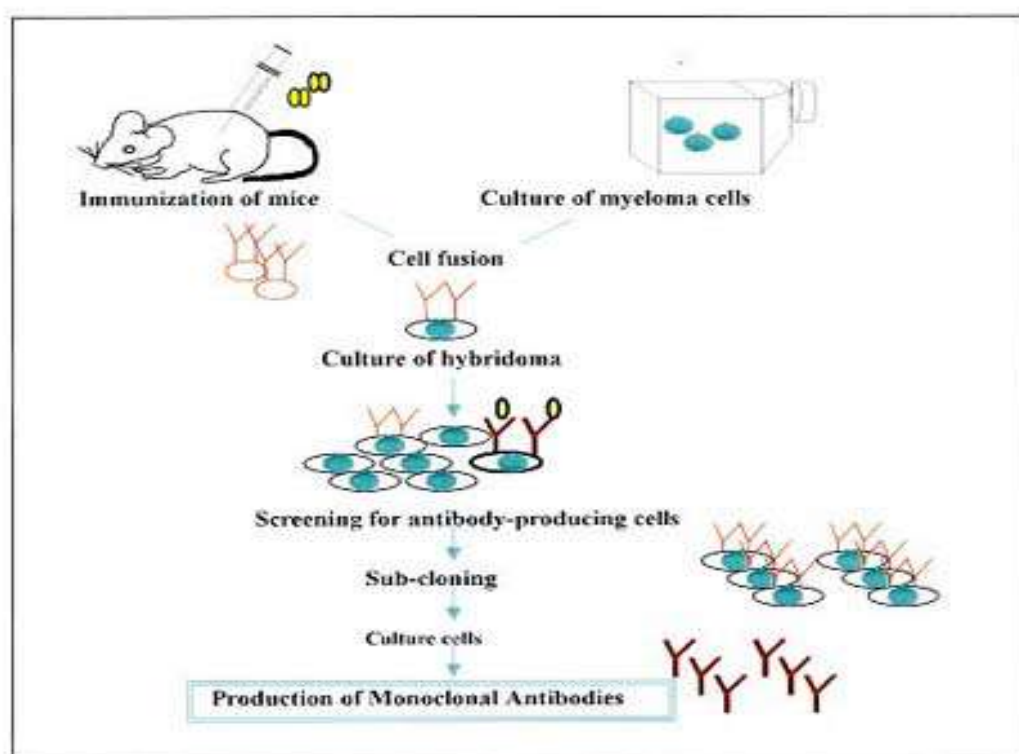


Fig. 2. Process of monoclonal antibody production.

[JIRCAS Newsletter No.30 March 2002](http://www.jircas.affrc.go.jp/kanko/newsletter/nl2002/No.30/03.htm)

Quantitative Analysis of 2-Acetyl-1-Pyrroline, a Strong Flavor Compound of an Aromatic Rice Variety, Khao Dawk Mali 105

A large quantity of rice is produced in many areas worldwide to meet the demand of consumers. In fact, aromatic rice varieties are very popular in Southeast Asia. Recently, they have gained a wide acceptance in Europe and the U.S.A. One of the major aromatic varieties, Khao Dawk Mali 105, is mainly produced in Northeast Thailand. The demand for this variety is increasing in both domestic and international markets due to the recognition of its good quality, i.e. pleasant aroma. Although an increase in production is urgently needed, cultivation is limited due to infertile and drought-stricken sandy soils. Erratic rainfall at the beginning of the rainy season and labor shortage for transplanting are other constraints on the production of this variety in Northeast Thailand. Since rice production is the most important activity in Northeast Thailand, where Khao Dawk Mali 105 is the main variety, it is essential to maintain the quality of this variety. It is assumed that the aroma quality depends on cultivation conditions and postharvest practices. However, there is no agreement with regard to factors controlling the aroma, and this could probably be related to the lack of objective methods for aroma evaluation of rice. Empirical methods include biting kernels, smelling tissue after warming, soaking in potassium hydroxide solution and organoleptic evaluations of cooked rice.

A • gpopcorn• h-like flavor compound, 2-acetyl-1-pyrroline (AcPy) (Fig. 1), has been reported to be an important flavor component of aromatic rice, which has a lower odor threshold than other volatile compounds in aromatic rice varieties. This compound also has been isolated and identified from pandan (*Pandanus amaryllifolius* Roxb.) leaves and popcorn. Moreover, this compound contributed to the aroma of roasted beef and crusts of wheat and rye breads. Quantification of this flavor compound in rice has been performed using a simultaneous steam distillation and solvent extraction. However, it is known that distillation leads to the loss of components during volatilization and also requires large amounts of samples. Consequently, quantification of AcPy in rice varied among the reports. Therefore, it is necessary to develop a method for quantification of AcPy in aromatic rice varieties using smaller samples and not employing steam distillation for extraction.

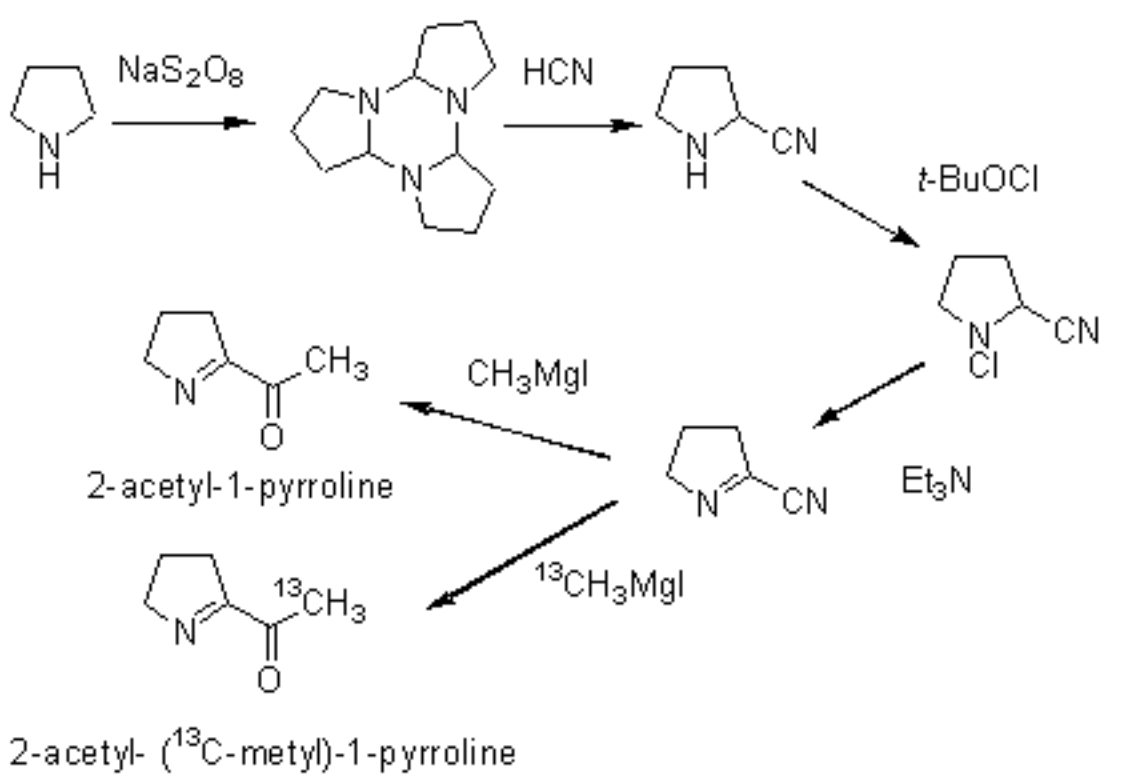


Fig. 1. Synthetic route leading to 2-acetyl-1-pyrroline and its labeled analog.

Isotope dilution method, the method using isotope-labeled compounds as an internal standard, is an ideal method for quantification of AcPy using gas chromatography-mass spectrometry-selective ion monitoring (GC-MS-SIM). In our laboratory, we synthesized its Carbon 13 analog, 2-acetyl- $(^{13}\text{C}\text{-methyl})$ -1-pyrroline, for an internal standard following a straightforward synthetic route (Fig. 1). AcPy in rice was extracted with hot ethanol containing the standard compound, and analyzed by GC-MS-SIM. This improved method can enhance the sensitivity for quantification of AcPy in aromatic rice samples using small quantities (0.5 g) with a high specificity, linearity and reproducibility.

Market samples, including KDML 105 (known as • gJasmine• h) were analyzed to demonstrate the applicability of this method. In milled rice of Khao Dawk Mali 105, the concentration of AcPy was 286 ± 4.2 ppb (Fig. 2). Concentration of AcPy in brown rice, rice bran, husk and seedlings samples was relatively higher than in milled rice.

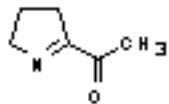
We hope that the quantitative analysis method for AcPy we have developed will facilitate the studies on the elucidation of the AcPy formation pathway, and will eventually lead to the identification of the factors controlling the flavor of aromatic rice.

Tadashi Yoshihashi
Food Science & Technology Division, JIRCAS

2-acetyl-1-pyrroline

Molecular Weight

m/z 111



m/z 112

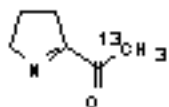
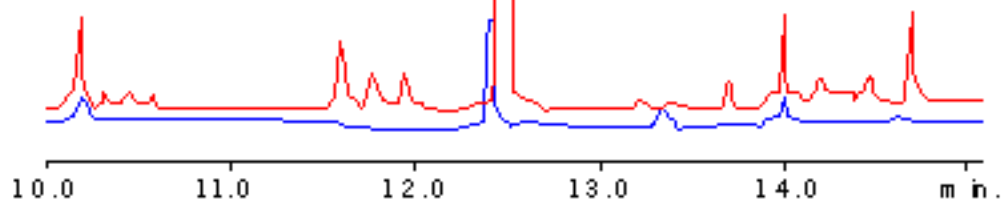
2-acetyl-1-pyrroline
conc. 286 ppb

Fig. 2. GC-MS-SIM chromatogram of the Khao Dawk Mali 105 milled rice extract.

Evaluation of Rainfall Station Network in Tropical Monsoon Area

When a field plot receives rainfall during the irrigation season, rainfall becomes effective for crop production if the water requirement can be properly estimated and water storage in reservoirs can be properly managed. For this purpose, it is necessary to monitor the average amount of rainfall over an irrigation system using a rainfall station network. The spatial variability of precipitation and accuracy of rainfall observation for water management should determine the rainfall station density. This study aims at proposing a method to evaluate the rainfall station density.

The study was carried out in the Muda Irrigation Scheme that is located in the northwestern part of peninsular Malaysia. It covers an area of 126,000 ha, of which 96,000 ha consist of rice fields.

First, the spatial variability of rainfall should be investigated. It is expected that in a large area the depth of rainfall tends to decrease. Depth Area (DA) analysis deals with the relationship between the rainfall amount and area. The Depth Area relationship can be described by many empirical equations. In this study the simplified Horton method was used.

$$P_l = P_0 \cdot \exp(-k \cdot l)$$

P_0 : Maximum rainfall in one rainfall area

P_l : Rainfall at the point l km apart from a rainfall center

k : Coefficient (km^{-1})

l : Distance (km)



Rainfall station with VHF radio

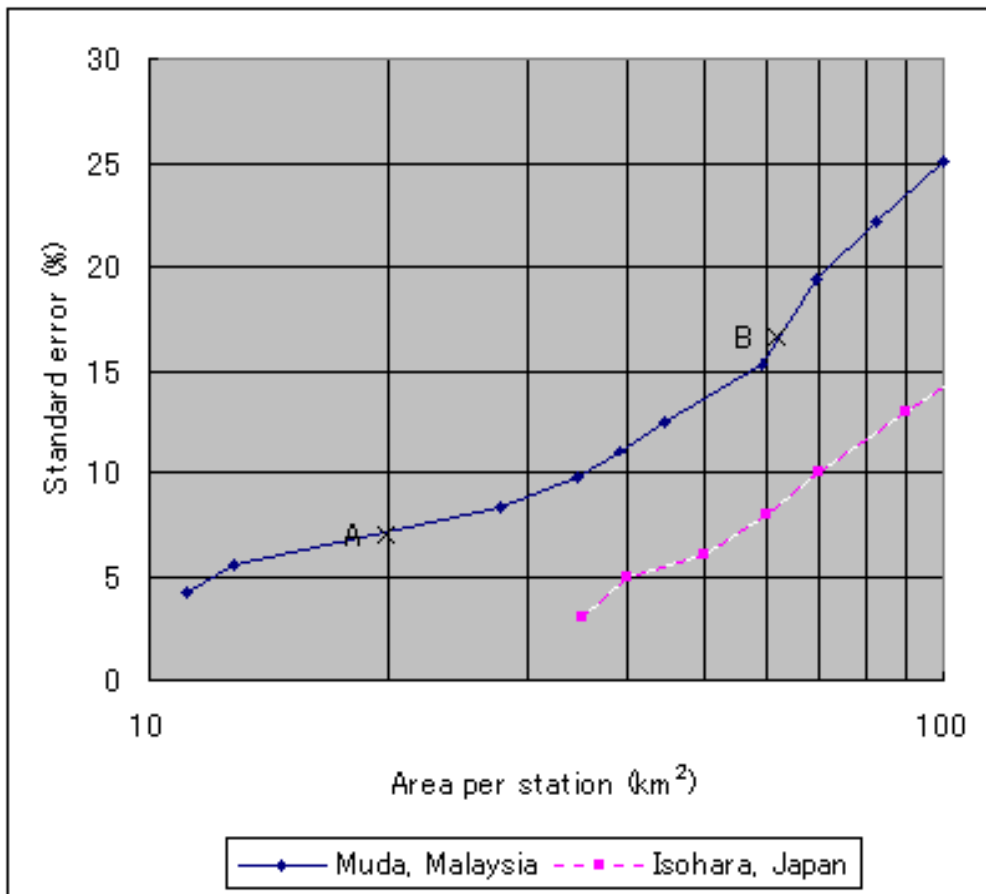
Values of coefficients k were obtained using 385 one-day rainfall events in a part of the target area with 10 rainfall stations. The location of the center for each rainfall event should be estimated at the same time. The coefficient of correlation between observed and estimated rainfall for each rainfall event was calculated. The average value of the correlation coefficients was 0.78. Although the equation is very simple, it describes the spatial variability of rainfall well because rainfall caused by convective lifting

predominates in the tropical monsoon area. Application of the equation to rainfall caused by frontal lifting or orographic lifting remains to be tested.

Values of coefficient k for 95% of the rainfall events ranged from 0 to 0.6, while in 5% of the rainfall events extreme values of coefficient k exceeding 2.0 were recorded. DA analysis results showed that the average amount of rainfall decreased rapidly when the area increased.

Next, rainfall events with specified coefficient k over an area in which rainfall stations were evenly scattered were simulated. Accuracy of observation for simulated rainfall events under the given station density was calculated. Relationship between the accuracy of observed rainfall and rainfall station density was obtained for the coefficient k of rainfall after appropriate simulations.

Finally, the rainfall station network was evaluated by combining the distribution of the coefficient k with the results of simulations. Standard error of rainfall events as a function of the station density in the Muda Irrigation Scheme is shown in Fig. 1. The evaluation of the rainfall station network implemented in Isohara by the Meteorological Agency of Japan is shown in the same Figure. It was considered that the rainfall station density in the Muda area should be higher because of the larger spatial variability of rainfall.



A: Present station density

B: Initial station density

Fig. 1. Standard error of rainfall events as a function of station density.

Rainfall data acquisition system began with 20 stations and has expanded to 61 stations in the Muda area.

The effect of this improvement and further investment was not apparent. The Figure shows that the expansion of the rainfall station network improved the accuracy of rainfall observations. However, a large number of rainfall stations are necessary for further improvements.

Traditional evaluation methods require many rainfall stations. In this study attempts were made to combine the evaluation of the rainfall station network with Depth Area analysis to reduce the number of rainfall stations for evaluation. The evaluation method proposed could be applied to irrigation systems in the flat plains of the tropical monsoon area.

Naoki Horikawa

Crop Production & Environment Division, JIRCAS

[JIRCAS Newsletter No.30 March 2002](#)

JIRCAS Fellowship Program: Welcoming New Visiting Researchers

Nineteen Visiting Researchers are participating in the 2001-2002 JIRCAS Visiting Research Fellowship Program to carry out collaborative research at Tsukuba and Okinawa.

Tsukuba (1 year at JIRCAS HQ.)

Ketut Wikantika	Bandung Institute of Technology, Indonesia	Diversification of vegetable type mapping in mountainous area using remote sensing and GIS data
Lam-Son Phan Tran	Nara Institute of Science and Technology, Japan (from Vietnam)	Functional analysis of drought-inducible genes for transcription factors containing a NAC DNA binding domain
Pang Xin	Chinese Academy of Sciences, China	Physiological mechanisms of nutrient acquisition by crops from low-fertility tropical soils
Rowena H. Oane	International Rice Research Institute, Philippines	Studies on the ecology and physiology of endophytic micro-organisms (nitrogen-fixing bacteria, chitinase-producing bacteria, etc.) in plants
Molay Kumar Roy	Ehime University, Japan (from Bangladesh)	Studies on the mechanism of apoptotic cell death induced by some dietary components in human cancer cell lines

Tsukuba (5 months at National Institute of Agrobiological Resources)

Muhammad Ayub Khan	National Agricultural Research Center, Pakistan	Analysis of relationship between bruchid resistance and mungbean seed protein
Zong Xuxiao	Institute of Crop Germplasm Resources, China	Analysis of genetic diversity in the <i>Vigna angularis</i> complex and related species in East Asia
Nguyen Van Hau	National Institute of Animal Husbandry, Vietnam	Study on the methods for evaluation and characterization of Vietnamese pig genetic resources by using DNA markers
Enda Y. Ardales	University of the Philippines, Los Banos, Philippines	Characterization of the <i>aur Bs2</i> gene homolog in <i>Xanthomonas oryzae</i> pv. <i>oryzae</i>

Okinawa (1 year at JIRCAS Subtropical Station)

Nur Ahamed Khondaker	Bangladesh Agricultural Research Council, Bangladesh	Maximizing water use efficiency by micro-irrigation at different irrigation depths and with different amounts of water
Wan Abdullah Wan Yusoff	Malaysia Agricultural Research and Development Institute, Malaysia	Evaluation of soil erosion and nutrient flux in Ishigaki Island
Tarlan Mamedov	Azerbaijan Academy of Sciences, Azerbaijan	Characterization of heat tolerance in transgenic tobacco (ER-sHSP)
Sabaruddin Zakaria	Syiah Kuala University, Indonesia	Pollen tube growth and accumulation of reserve substances under high temperature stress in snap bean
Mohamed Koronfel	Cairo University, Egypt	Genetic engineering of salt tolerance in rice plants
Arifin Noor Sugiharto	Brawijaya University, Indonesia	Development of transformation methods and suitable tissue culture procedures for generating a high survival rate of sugarcane regenerants
Yunxia Liu	Chinese Academy of Agricultural Sciences, China	Differential screening of anthocyanin transcriptional activator genes of sweet potato
Muchdar Soedarjo	Research Institute for Legume and Tuber Crops, Indonesia	Cloning of anthocyanin transcriptional activator genes from cDNA library of sweet potato
Jiang Ling	Huazhong Agriculture University, China	Development of genetic transformation technique in papaya plant

Bui Thi Ngan	Cotton Research Center, Vietnam	Evaluation and utilization of natural predator, <i>Antilochus coqueberti</i> against the cotton stainer
--------------	---------------------------------	---

[JIRCAS Newsletter No.30 March 2002](#)



A typical local market in Ghana, West Africa (Photo by J. Furuya)

NEWSLETTER

JIRCAS

Japan International Research Center for Agricultural Sciences

For International Collaboration

March 2002

30

Contents

Distribution Systems and Rural Development	2
Project on Prevention of Shrimp Viral Diseases in Malaysia	3
Flavor Compound Analysis of Aromatic Rice	4
Rainfall Station Network in Tropical Monsoon Area	5
Welcoming New JIRCAS Fellows	6



A freshwater fish shop in Guangzhou, China. Sliced fish, covered in blood to demonstrate its freshness, is on sale, although freshwater fish is usually sold live in China. (Photo by Y. Fukuda)

NEWSLETTER

JIRCAS

Japan International Research Center for Agricultural Sciences

For International Collaboration

June 2002

31

Contents

[World Aquatic Foods and JIRCAS Activity](#)

[Collaborative Research in Vietnam](#)

[Agropastoral Systems in the Brazilian Savannas](#)

[Tagging of Wheat Leaf Resistance Genes](#)
[Forthcoming JIRCAS International Symposium](#)
[People](#)

[JIRCAS Home Page](#)

World Aquatic Foods and Activities of JIRCAS



Yutaka Fukuda
Director, Fisheries Division, JIRCAS

Food production capacity of the hydrosphere

When seen from a spacecraft, the hydrosphere of the earth's surface appears as a beautiful blue region. It occupies 70% of the earth's surface and its deepest point is deeper than 10,000 meters. Therefore, the hydrosphere by far surpasses land in its capacity as a potential space where creatures could live. The world's oceanic region, however, despite its huge volumetric capacity, has a lower biological productive capacity than land due to its low nutrient content. As a potential place for food production, land provides cereal and other primary products that form the staple human diet. Unfortunately, it is difficult to utilize the hydrosphere's primary product, phytoplankton, as food. Instead, humans exclusively utilize fish, shellfish, and other higher-order products of the hydrosphere.

Trends in catch quantity

In 1999, the total catch of the world's fisheries reached 137 million tons. This amount was 1.3 times larger than that in 1990, with the increase being greater than the increase in production of cereal grains, which remained at the same level between 1990 and 1999. However, it is generally believed that the ocean's capacity to provide foods will probably run out in the near future. With respect to country-wise distribution of catch quantity in 1999, Japan landed 6.61 million tons, the third highest in the world. Japan's catch at one point was higher than any other country in the world, but it was ousted from its position by China in 1989. China, which landed 47.5 million tons, equivalent to about 35% of the world's entire catch in 1999, harvests more from the hydrosphere, by far, than any other country. Although some economists doubt China's catch statistics, the catch quantities, especially of the freshwater fisheries resources, are dramatically increasing, pushing up the world's total catch. Therefore, the inland water regions of the world are expected to become potential places for development of fisheries. Peru and Chile, South American countries where sardine is a major fisheries resource, landed 8.44 and 5.59 million tons, respectively, becoming the world's second and fifth highest ocean harvesters.

Predicted consumption of fishery products in year 2010 (FAO)

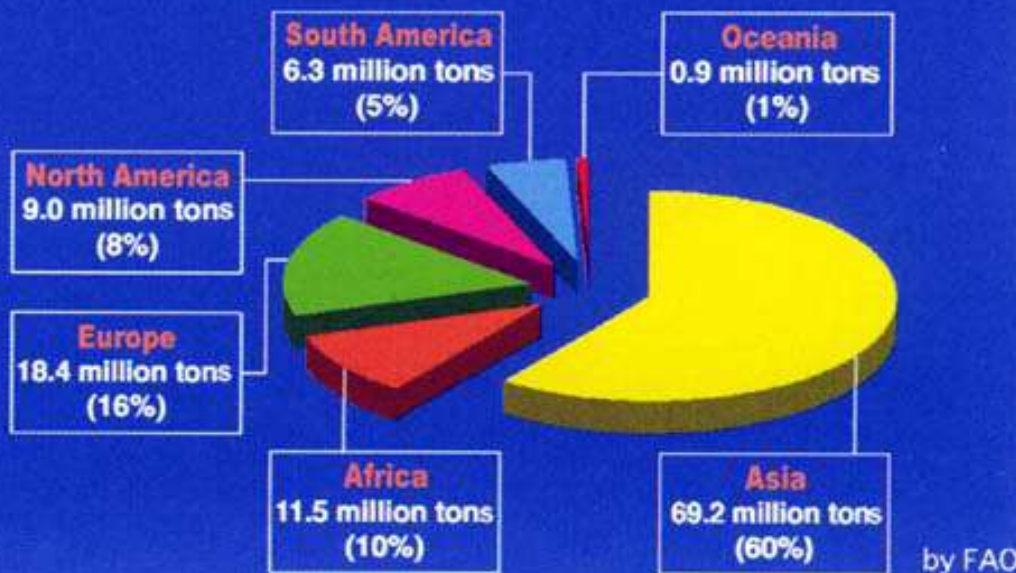
In year 2010, the world's population is expected to reach 7.03 billion. Accordingly, 100 to 120 million tons of aquatic food will be needed. Assuming that about 30% of the total catch is inedible, it is expected that there will be a shortfall of 10 to 40 million tons in aquatic foods. Japan and other Asian countries including China, India, Indonesia, the Philippines, and Thailand consume a particularly large amount of fish products. Various ichthyophagous cultures are now being practised in monsoon regions around Asia where the staple food is rice, while in European countries diets are mainly based on various meat products. Considering the significant increase in personal incomes of people in Asia in recent years, it is estimated that 69 million tons of aquatic foods will be needed around this region by year 2010. In other words, more than half of the world's fisheries products will be consumed in Asian countries (see figure).

Activities of JIRCAS Fisheries Division

In this context, the JIRCAS Fisheries Division is engaged in three international collaborative studies to secure fisheries products in Asia. The first is a study on sustainable production systems of aquatic animals in brackish mangrove areas, conducted in cooperation with the Philippines, Malaysia, and Thailand. This study aims to restore fisheries resources and develop the technology of environment-friendly aquaculture using natural nutrients and the environmental protection ability

of brackish-water mangrove forests. The second study is • gElucidation of reproductive mechanisms in the giant freshwater prawn, and research aiming to improve prawn-rice farming systems in the Mekong Delta. • h This study is being conducted in cooperation with Vietnam, and is aiming at the establishment of freshwater prawn aquaculture systems combined with rice growing as part of the conventional complex agriculture in the Mekong Delta of Vietnam. The third study is entitled, • gDevelopment of technology for utilization of freshwater fisheries resources. • h This study is being carried out in cooperation with China, and is aiming at the development of techniques to manufacture frozen minced fish meat (SURIMI) and fishmeal from freshwater fish.

Predicted pattern of consumption of aquatic foods in year 2010 ***(Total world consumption-115.3 million tons)***



Collaborative Research in Vietnam: Development of Farming Systems in the Mekong Delta Area

The Mekong Delta was formed about 10 thousand years ago at the mouth of the Mekong River. Covering roughly four million hectares, the region, except for small hills near the Cambodian border, is less than one m above sea level (Fig. 1). Large-scale flooding follows the rainy season and washes away damaging salt and acid sulfate, providing fresh fertile soil and fish. Depending on the topography, the Delta's soils range from alluvial to acid sulfate to saline. Houses line the banks of the well-developed canal network due to the high elevation and the convenience of waterway transportation (Fig. 2). In addition, ponds are also dug for stocking fish and as a source of soil with which to expand the farm area (Fig. 3).

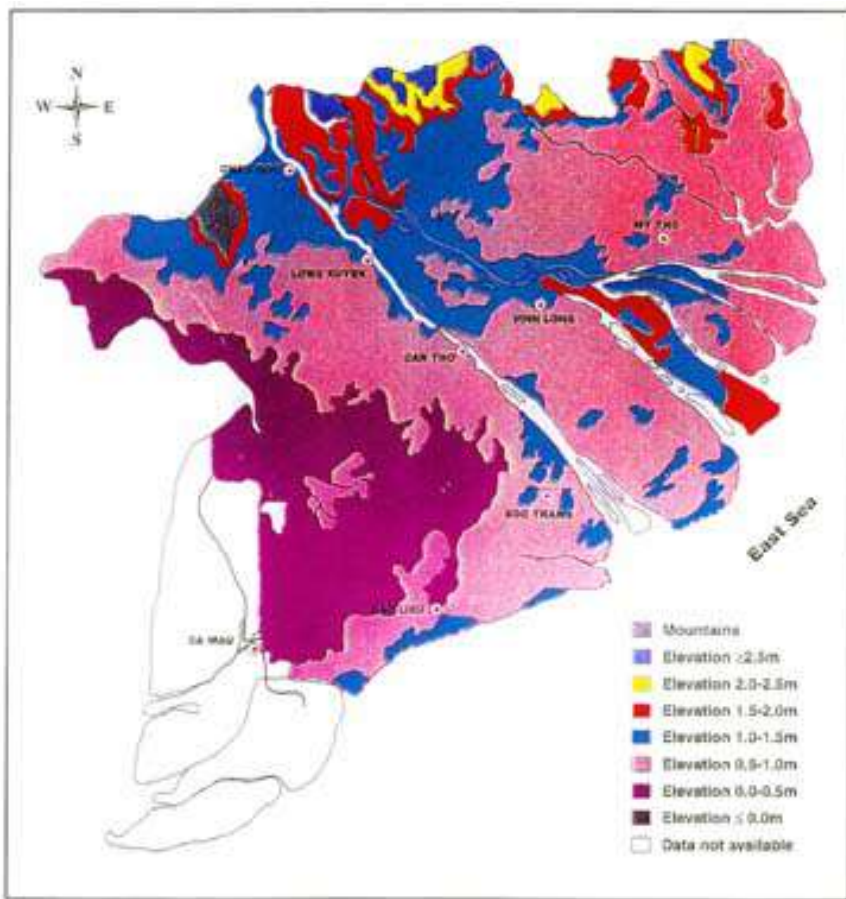


Fig. 1. Topology map of the Mekong Delta (Ministry of Irrigation, 1987).



Fig. 2. A typical farmer's house in the Mekong Delta with a pigsty and a fish pond.



Fig. 3. Farmer's fruit garden with a pond.

In the region, the *doi moi* economic renovation program, initiated in the late 1980s, has contributed to rapid economic growth through further development of the traditional and unique agricultural VACR systems (a Vietnamese acronym standing for fruits and vegetables, aquaculture, livestock and rice). They combine fruit and vegetable cultivation, animal husbandry and aquaculture and contribute to sustainable agricultural management by cycling products through several stages of production in order to minimize waste while maximizing benefits.

The major objective of the five-year research project (1999-2003), titled "Development of new technologies and their practice for sustainable farming systems in the Mekong Delta," is to promote agricultural practices that are not only economically profitable but also ecologically sustainable as farming systems. Research subjects included in

the project comprise the development of technology for components of farming systems in the areas of rice, livestock, fruit and aquaculture production. The project also aims to develop and evaluate sustainable farming systems that employ technology for environmental conservation and VACR farming systems and put these technologies into practice through the establishment of model VACR farming and extension systems. For this purpose, the studies have been carried out in collaboration with Cantho University (CTU), Cuu Long Delta Rice Research Institute (CLRRI) and the Southern Fruit Research Institute (SOFRI). So far, in the project, studies for the development of techniques for the breeding of salt-tolerant varieties and development of integrated pest management in rice and rice-based farming systems have been carried out. In the livestock area, techniques for feeding management for pig production and pathological diagnosis of porcine diseases have been improved. A model orchard was established for the improvement of fruit production at the on-farm trial site and basic technology for prawn seed production has also been developed (Fig. 4). Development of methods for the assessment of nitrogen cycling is currently being promoted. In the socio-economic area, farming systems at the research site were classified and the cause-effect relationship of the technical and economic factors in farming systems was analyzed.

The annual Workshop of 2001 was held at CLRRI, Cantho, Vietnam, during the period of November 27 - 29, 2001, to review the results already obtained and to examine the future research direction of the project (Fig. 5). The next annual Workshop of 2002 will be held at the College of Agriculture, Cantho University in November 2002.



Fig. 4. Giant freshwater prawns being cultured at the Institute for Marine Aquaculture, Cantho University.



Fig. 5. The 2001 annual Workshop held at CLRRI, Cantho, Vietnam.

Tetsushi Hidaka
Development Research Division, JIRCAS
(Present, Research Center for the Pacific Islands Kagoshima University)

[JIRCAS Newsletter No.31 June 2002](http://www.jircas.affrc.go.jp/kanko/newsletter/nl2002/No.31/HTML/03.htm)

On-Farm Trial to Develop Agropastoral Systems in the Brazilian Savannas

Since 1996, JIRCAS has been implementing an international collaborative project with Brazilian Agricultural Research Corporation (EMBRAPA), for developing agropastoral systems (sustainable crop-pasture rotation systems) in the Brazilian savannas. As a part of the project, an on-farm trial to transfer the technologies and knowledge of the experimental stations to private farms has been conducted. Here, the process and results of the trial are introduced.

The Agricultural Training Center of National Federation of Japanese Immigrant Agricultural Cooperation (JATAK-ATC) was selected as the experimental site of the on-farm trial. JATAK-ATC is located in the Guatapara district of the San Paulo State, which is approximately 300 km northwest from Sao Paulo City. It consists of 570 ha of upland fields and 450 ha of wetland, and is playing an important role to demonstrate and diffuse the advanced agricultural technologies to the small or middle holders in the district. The aims of this study are (1) selection of forage species suitable for intensive grazing on the upland fields, (2) selection of forage species suitable for the wetland pasture, and (3) establishment of key technologies to develop sustainable agropastoral systems in JATAK-ATC.



Grazing cattle on the wetland pasture during dry season.

When the on-farm trial was begun in 1997, most of the upland field area was utilized as sugar cane fields (Fig. 1). However, to avoid soil deterioration by mono-crop cultivation of sugar cane, JATAK increased the cultivated area of corn in 1998. The soil of the upland fields was an Oxisol, which had a very high sand content (80%), and low organic matter content (1.8%). Thus, an agropastoral system combining forage crops with sugar cane and corn seemed to be a good alternative to enhance soil fertility of the upland fields. Until 1997, *Brachiaria decumbens* was the only grass species planted in JATAK-ATC. It is known that *B. decumbens* has tolerance to low soil fertility, but its nutritive value is relatively low. Thus, a grazing experiment was conducted for two years, comparing *B. brizantha*, *B. dictyoneura*, and *Panicum maximum* with *B. decumbens*. Results of the experiment indicated that *B. brizantha* was most suitable for intensive grazing, from the points of view of dry matter productivity, forage quality and persistency of the pastures.

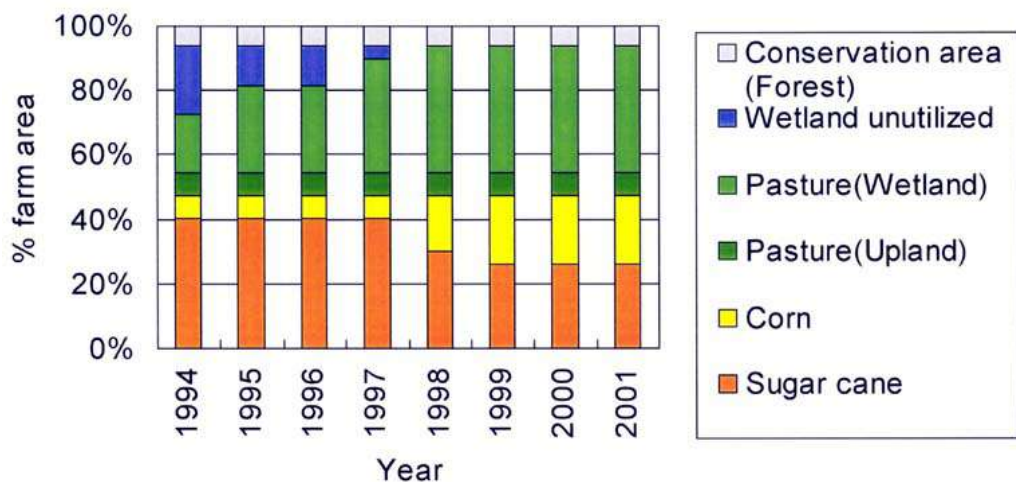


Fig. 1. Change of land use with time in the Agricultural Training Center of JATAK, the Guatapara district, San Paulo State.

On the other hand, in the wetland, a drainage system was constructed between 1994 and 1997, and the drained areas have been utilized as native pastures. The number of animals of JATAK-ATC also increased from 197 heads in 1994 to approximately 1,000 heads in 2001. Since 1998, several field experiments have been conducted to select grass species to improve pasture productivity of the wetland. Flooding tolerance was compared between *Brachiaria decumbens*, *B. brizantha*, *B. humidicola*, *Andropogon gayanus*, *Paspalum atratum*, and *Cynodon dactylon*. Only *B. humidicola* and *P. atratum* could survive the flooding during the rainy seasons. In Central Brazil, the producer can buy seeds of *B. humidicola* more easily than *P. atratum*. Thus, *B. humidicola* was considered to be the most suitable forage species for the wetland of JATAK-ATC. Moreover, results of the seeding experiments indicated that the suitable seeding period of the wetland was the beginning of the dry season when it became possible for a tractor to enter the wetland.

In the Guatapara district, 750 ha of the wetland owned by the small and middle holders remain unutilized. The pasture establishment technologies for *B. humidicola* tested in JATAK-ATC can be adopted by them. Results of this study also suggest that JATAK-ATC can develop sustainable agropastoral systems combining sugar cane and grain production and livestock production in future. Further research will be continued to improve the agricultural sustainability and to enhance the feeding resources of JATAK-ATC.

Tsutomu Kanno
Animal Production & Grassland Division, JIRCAS
(Present, National Agricultural Research Organization
National Agricultural Research Center for Tohoku Region)

Tagging of Leaf Rust Resistance Genes, *Lr34* and *Lr46*, Using Microsatellite Markers in Wheat

Leaf rust, caused by *Puccinia recondita* Roberge ex Desmaz f. sp. tritici Eriks. & E. Henn. is the most serious disease in wheat. Resistant cultivars are very important for sustainable wheat production in developing countries for economic and environmental reasons. Most of the leaf rust resistance genes identified are race-specific, and since they may be overcome by genetic shifts or new virulence in the pathogen population, durable resistance, that is, race-nonspecific and/or slow rusting genes, may be of primary interest to wheat breeders. This resistance may be expressed best at the adult plant stage as a quantitative trait.

Slow rusting genes have small effects, and hence are easily affected by environmental conditions and are difficult to identify due to their race-nonspecificity. Tagging these genes with molecular markers increases the efficiency of selecting leaf rust resistance and facilitates marker-assisted selection.

A doubled haploid (DH) population was produced from cv. Fukuho-komugi × cv. Oligoculm by means of wheat × maize crosses. A full genetic linkage map was constructed using various kinds of molecular markers, such as microsatellite, RFLP, RAPD etc. A framework map with 343 markers was used to perform QTL (quantitative trait loci) analysis for leaf rust resistance in this population. Leaf rust severity was scored at adult plant stage in the field for two seasons, 2000 and 2001, at Cd. Obregon, Sonora State, Mexico (Fig. 1).



Fig. 1. Symptoms of leaf rust-infected leaves.

From left to right (two leaves each): Fukuho-komugi (*Lr34*), Oligoculm (*Lr46*), resistant and susceptible DH lines.

Two chromosome regions, 7DS and 1BL, for the putative QTLs were detected by composite interval mapping (CIM) (Fig. 2). These QTLs were considered to be due to the effects of the known slow rusting genes, *Lr34* and *Lr46*, according to their positions. The QTL analysis also indicated that *Lr34* was derived from the Japanese cv. Fukuho-komugi, while *Lr46*, from the Israeli cv. Oligoculm. These QTLs explained about 40% and 26% of the total variation.

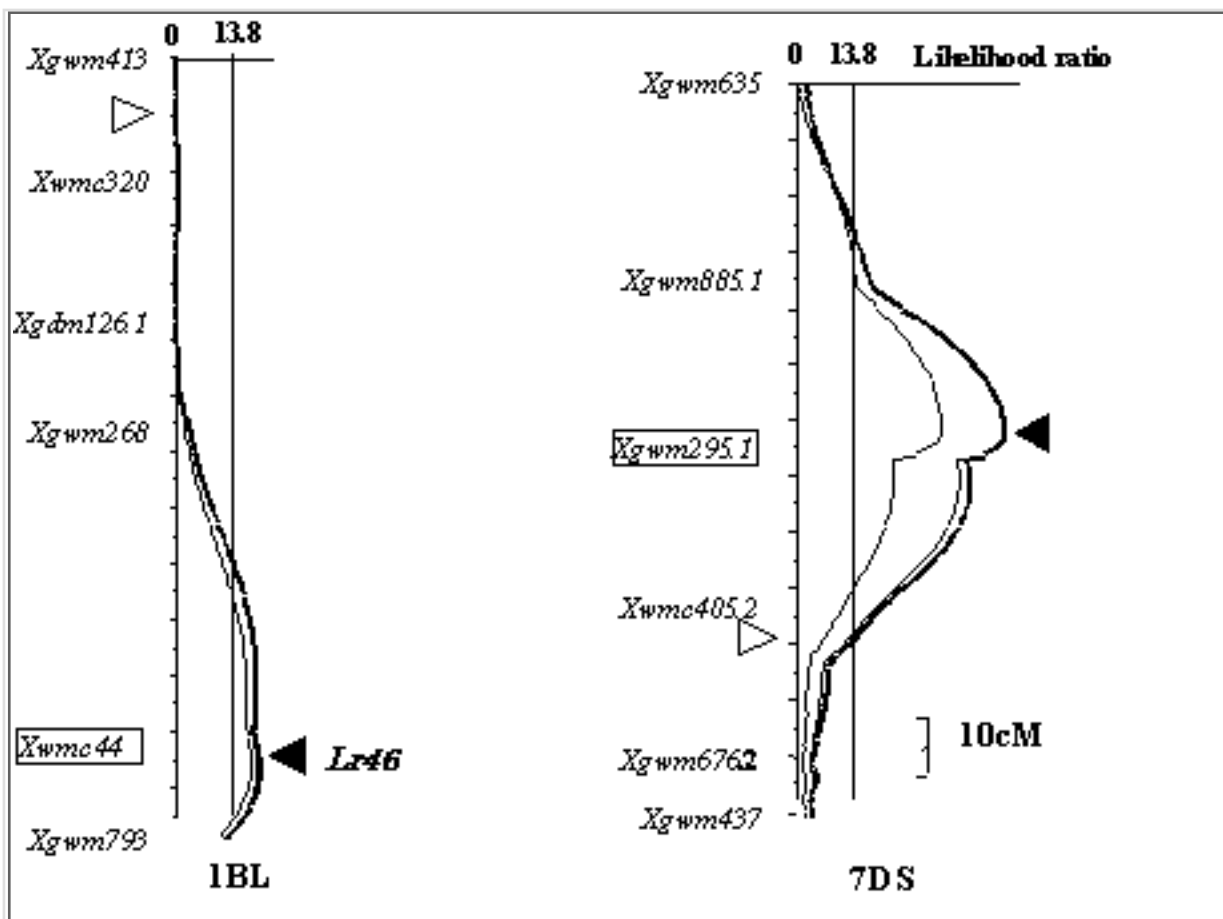


Fig. 2. Likelihood ratio (LR) contour by composite interval mapping for QTL detection of leaf rust severity on chromosome 1B long arm and 7D short arm. Bold contour indicates LR by joint analysis of data for the years 2000 and 2001. LR thresholds, equivalent to LOD=2.5, are 11.5 for a single year and 13.8 for joint analysis. Short arms are toward the top. • ♦ @ indicates centromere.

Microsatellite markers, *Xgwm295.1* and *Xwmc44*, were linked to these QTLs on 7DS and 1BL, respectively. When the population was classified according to the genotypes of these markers, the mean differences in leaf rust severity for *Xgwm295.1* and *Xwmc44* were 40.1% and 25.5%, respectively. The mean severity of the lines, whose genotype was resistant for both *Xgwm295.1* and *Xwmc44*, was 11.3%; this was 61.6% more resistant than the mean of susceptible lines (Table 1), and 19.9% more resistant than the overall mean. Moreover, genotyping using these molecular markers aids in discriminating the lines with *Lr34* and *Lr46* from those with only *Lr34*.

Lr34 and *Lr46* classified as slow rusting genes are widely used in CIMMYT (International Maize and Wheat Improvement Center) breeding program. The results indicated that the molecular markers used in this study facilitate the identification of *Lr34* and *Lr46*, and contribute to pyramiding of the leaf rust resistance genes in the breeding program.

This study was conducted as part of a collaborative program between Biological Resources Division, JIRCAS and Applied Biotechnology Center, CIMMYT from Jan. 1998 to Jan. 2002.

Table 1 Genotypic effects of flanking loci on leaf rust severity (%)

Locus	Genotype ^a	2000	2001	Mean	
<i>Xgwm295.1</i> (7DS)	F	12.6	10.9	11.9	
	O	57.1	46.6	52.1	
	dif.	-44.5	-35.7	-40.1	
<i>Xwmc44</i> (IBL)	F	47.6	41.4	44.9	
	O	23.2	16.8	19.5	
	dif.	24.4	24.6	25.5	
<i>Xgwm295.1</i> / <i>Xwmc44</i>	F / O	12.6	10.1	11.3	a ^b
	F / F	11.6	12.5	12.5	a
	O / O	32.8	25.6	30.2	b
	O / F	80.4	66.4	73.0	c
	dif. (FO vs. OF)	-67.8	-56.3	-61.6	

a F, O and dif. indicate Fukuho-komugi, Oligoculm and genotypic difference between F and O genotypes. F and O are resistant and susceptible for *Xgwm295.1*, and susceptible and resistant for *Xwmc44*, respectively.

b Mean values with different letters are significantly different (P<0.05).

Kazuhiro Suenaga
Biological Resources Division, JIRCAS

[JIRCAS Newsletter No.31 June 2002](#)

• gValue-Addition to Agricultural Produce and Products• h

- Towards increase of farmers• f income and vitalization of rural economy -

The 9th JIRCAS International Symposium on • gValue-Addition to Agricultural Produce and Products• h will be held October 16-17, 2002, in Tsukuba, Japan.

Background and Objectives

The current world population is about 6 billion and it is anticipated that the population will reach 7.5 billion and 8.0 billion by years 2020 and 2030, respectively, according to United Nations• f World Population Prospects. Global food production should be increased so as to meet the demands of the rapidly increasing population, with the limited water resources and arable land. Therefore, the roles of rural areas where agriculture and food industry greatly contribute to the production of agricultural produce and products will become more important, from the point of food security. Agriculture is still the largest sector of rural economies, and a majority of the rural population is engaged in agriculture, in developing countries. The incomes of rural people are much lower than the urban ones, and the population has been shifting from the rural to the urban areas seeking better incomes and convenient daily-life. These trends will lead to the reduction of rural potential as a base for food supply and the increase of the poorest in slums in big cities. On the other hand, it is difficult for small-scale rural food companies to compete with big companies of the urban and developed countries. In considering these facts, we have to make efforts to give rural people and enterprises tools to increase their income by adding value to the commodities, in order that they may stay in the rural areas and continue to be engaged in agriculture and food production.

Changes in urban life-style as a result of the increased income and the increasing number of working women have resulted in increased consumers• f demand for a more diversified diet, for processed and convenience foods and for animal products. When people overcome hunger, they become concerned about the quality and safety of what they eat. For example, they will avoid foods with contaminants such as pathogens, mycotoxins and pesticides, and prefer foods with physiological functions such as anti-carcinogenicity and anti-hypertension. It is important for rural farmers and enterprises to market products that meet the demands of urban consumers. We dealt with postharvest losses of grains in the 5th JIRCAS Symposium in 1998, and then started a research project to reduce postharvest losses of grains in Southeast Asia. It is worthwhile to review the demands of urban consumers, the role of rural food industry and the related research activities in developing countries. For this purpose, we will invite distinguished experts from Japan and overseas, to discuss problems associated with ensuring high quality/safety of, and adding value to agricultural produce and products, and explore directions for research on these topics in developing countries.

For further information, please visit the website <http://www.jircas.affrc.go.jp/sympo/>, or contact:

Dr. Yutaka Mori

Secretariat of the Organizing Committee for the 9th JIRCAS International Symposium

Japan International Research Center for Agricultural Sciences (JIRCAS)

1-1 Ohwashi, Tsukuba, Ibaraki 305-8686, Japan

Fax: +81-298-38-6342 E-mail: sympo9@ml.affrc.go.jp

[JIRCAS Newsletter No.31 June 2002](#)

Dr. Yutaka Fukuda, was appointed Director of the Fisheries Division on March 1, succeeding Dr. Masachika Maeda who has joined Miyazaki University as Professor in the Department of Environmental Sciences. Dr. Fukuda is a fisheries scientist and, prior to joining JIRCAS, was Director of Food Processing and Preservation Division at the National Research Institute of Fisheries Science (NRIFS). From 1996 to 2000, as senior scientist of JIRCAS, Dr. Fukuda conducted research on efficient utilization of freshwater resources at Shanghai Fisheries University, as part of a JIRCAS collaborative research project with China. (See page 2 for his Feature Article and photo)

Dr. Masa Iwanaga, Director of the Biological Resources Division at JIRCAS, has been appointed new Director General of the International Maize and Wheat Improvement Center (CIMMYT) and will join CIMMYT in July 2002. Dr. Iwanaga is the first Japanese scientist to become director of a CGIAR Center. He has said that he will • gbuild on CIMMYT• fs strong mission to end hunger and poverty in the developing world through clearly focused research on maize and wheat. • h He added, • gCIMMYT has an impressive record in improving the livelihoods of hundreds of millions of poor people, in rural as well as urban areas. My task is to ensure that CIMMYT continues to play a critical role in developing new knowledge and science-based technologies that will help farmers and consumers overcome malnutrition, improve their incomes, and move from subsistence into an economy marked by globalization and interdependence. • h

Dr. Iwanaga holds a MS degree from Kyoto University and Ph. D. in Plant Breeding and Plant Genetics from the University of Wisconsin, USA. He has more than two decades of research and management experience in international development. He had worked for IPGRI, CIAT, and CIP for about seven, three, and ten years, respectively, before he joined JIRCAS in April 2000.

[JIRCAS Newsletter No.31 June 2002](#)



NEWSLETTER

JIRCAS

Japan International Research Center for Agricultural Sciences

For International Collaboration

June 2002

31

Contents

World Aquatic Foods and JIRCAS Activity 2

Collaborative Research in Vietnam 3

Agropastoral Systems in the Brazilian Savannas 4

Tagging of Wheat Leaf Resistance Genes 5

Forthcoming JIRCAS International Symposium 6

People 6

2002
September

No.32

JIRCAS Newsletter

for
INTERNATIONAL COLLABORATION



CONTENTS

[*Okinawa Subtropical Station: Present and Future*](#)

[*Physiological Mechanism of Crop Heat Tolerance and Development of Heat-Tolerant Crops*](#)

[*The First Report of a Sodium-Pump \(Na⁺-ATPase\) Gene in Plant Cells*](#)

[*Control of Microbial Contamination by Electrolyzed Water in Tofu Manufacturing*](#)

[*A Differential System for Rice Blast Disease*](#)

[*9th JIRCAS International Symposium*](#)



[**JIRCS Home Page**](#)

Okinawa Subtropical Station: Present and Future

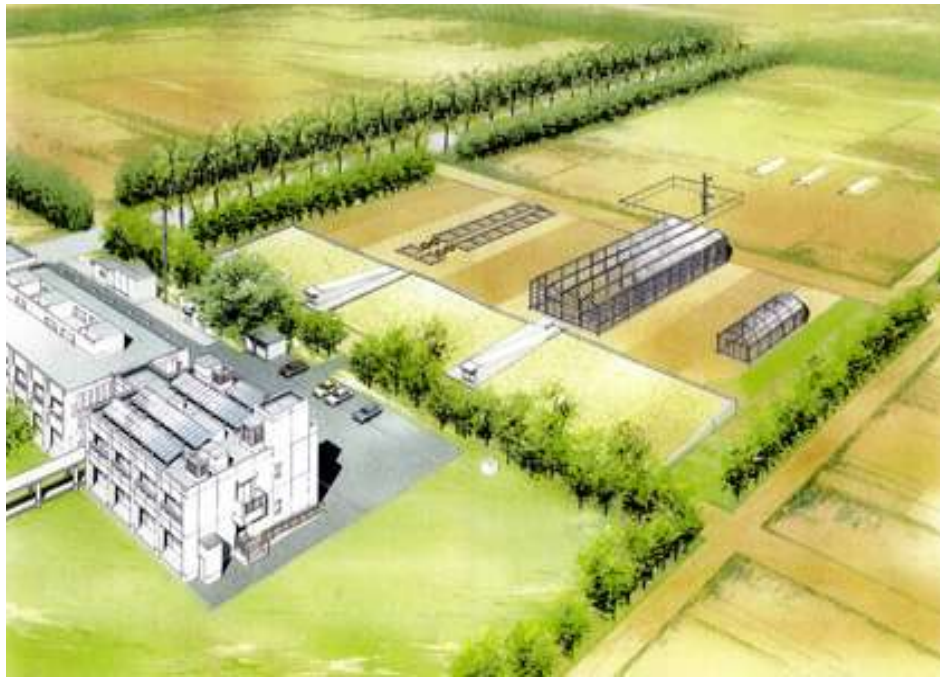


Masaaki Suzuki
Director, Okinawa Subtropical Station, JIRCAS

Unique features

The JIRCAS Okinawa Subtropical Station has two unique features. First, it is the only national research institution located in the subtropical climate zone of Japan. This makes it possible to conduct experiments with many tropical and subtropical crops either in open fields or in slightly heated greenhouses of the Station. Similar climatic conditions can be simulated only in heavily heated greenhouses or climate chambers in other Japanese research institutions. The Station has, therefore, served as a center for conducting research on tropical and subtropical crops as well as the gateway for introducing and acclimatizing tropical crops. Second, the Station is located in Ishigakijima Island, a small coral island of which the environment typifies the subtropical and tropical insular regions of the world. Special socioeconomic and technological considerations are indispensable for the development of agriculture in these regions, and the Station has served as a key research station to develop agricultural technologies adaptable to these regions.

The Station, at present, consists of five laboratories as well as the International Collaborative Research Section. The Island Environment Management Laboratory is the leading laboratory and is expected to develop technologies for attaining sustainable agricultural production in insular environments. The Environmental Stresses Laboratory is studying mainly the mechanisms of heat tolerance in vegetable crops and evaluating useful genetic resources that could be utilized for domestic and foreign breeding programs. The Crop Breeding Laboratory is developing useful breeding materials for sugarcane and tuber crops using biotechnology and is producing breeding materials for rice and wheat crops by rapid generation advancement techniques using advantageous climatic conditions. The Tropical Fruit Crops Laboratory is developing technologies for culturing tropical fruit crops in subtropical conditions and evaluating the eating quality of fruits. This laboratory is also developing new technologies for the mass production of fruit tree seedlings. The Plant Protection Laboratory is developing technologies for controlling important tropical pests and diseases such as citrus greening disease by introducing an integrated pest management method. Finally, the International Collaborative Research Section serves as a receiving office for research fellows from tropical and subtropical countries. At present, 10 post-doctoral fellows have been invited from Indonesia, China, Egypt, etc. and are conducting pioneer research in the above-mentioned laboratories.



An air view of insular environment and technology development facilities.

Future prospects

More collaborative work within the Station is essential to contribute more effectively to the development of technologies for small islands in developing regions. We are now constructing a new building with a large-scale lysimeter, where the transpiration of crops, evaporation and infiltration of soil water, and the water movement in a soil-crop continuum can be measured accurately. Furthermore, by using the runoff plots, the mechanism of erosion can be studied more precisely and countermeasures can be proposed. The addition of these new facilities is expected to give a boost to the research in the Station and would hopefully lead to a better understanding of the tropical and subtropical island environments. One of the major problems facing such islands is the sustainable production of food. The JIRCAS Okinawa Subtropical Station hopes to contribute toward alleviating and solving this problem.



Farm land in Ishigakijima Island.

Contents

Physiological Mechanism of Crop Heat Tolerance and Development of Heat-Tolerant Crops

Heat stress is one of the most important constraints of crop production in tropical and subtropical regions, and the severity of the situation is growing worse each year due to increasing global warming. The JIRCAS Okinawa Subtropical Station has conducted research on physiological responses to high temperature conditions in various crops such as snap bean, adzuki bean, and tomato. Our research is financed in part by Japanese Bio-oriented Technology Research Advancement Institution (BRAIN).

Physiological characteristics of heat-tolerant snap bean • eHaibushi• f

Flower and pod abscission occur easily under high temperature conditions in snap bean. The Station has successfully developed a heat-tolerant cultivar • eHaibushi• f by screening more than 350 accessions of germplasm. • eHaibushi• f was able to produce more fertile pollen and higher yield under high temperatures than other existing cultivars. The cultivar keeps withdrawing and transpiring water under high temperature and intense light conditions, and this seems to be a main reason why it is able to exhibit an excellent performance. The cultivar also lowered water potential in floral organs under high temperature conditions more gradually than a heat-sensitive cultivar. The cultivar was registered in the National Catalogue of Agricultural Crops in 1998.

Utilization of heat-tolerant germplasm for breeding programs

Wild plant germplasm generally exhibits a wide range of genetic diversity including responses to various environmental stresses. We found that Southeast Asian wild adzuki bean *Vigna minima* could set pods and produce viable seeds under high temperature conditions and can hybridize with adzuki bean. We are now developing isogenic lines of heat-tolerant adzuki bean cultivar by recurrent backcrossing and selection, and plan to conduct comparative research on these isogenic lines.



**Heat-tolerant snap bean • eHaibushi• f
developed by the JIRCAS Okinawa
Subtropical Station.**

Function of small heat shock protein

Plants usually produce small heat shock proteins (sHSPs) in response to heat stress. Mitochondrial (MT)- and endoplasmic reticulum (ER)-located sHSP genes have been successfully cloned from tomato, and it was observed that both genes worked specifically in stigmas under heat stress at the flowering period. In tomato flowers, MT-sHSP was produced more quickly at 40°C treatment as compared with ER-sHSP. These sHSPs have a molecular chaperon function which can enhance the renaturation of chemically denatured citrate synthase *in vitro*. We have also successfully produced transgenic tobacco and tomato plants by introducing MT- and ER-sHSP genes, and found that the MT-sHSP transgenic tobacco plants enhanced heat tolerance during vegetative growth stage. We are now evaluating how MT-sHSP gene works during reproductive growth stage.



Transgenic tobacco lines introduced with MT-sHSP gene.

*Yoshinobu Egawa, Mariko Shono, Katsumi Suzuki, Tadashi Tsukaguchi, Kazutuka Sanmiya
Okinawa Subtropical Station, JIRCAS*

[Contents](#)

The First Report of a Sodium-Pump (Na^+ -ATPase) Gene in Plant Cells

Salinity is a major abiotic stress in agriculture worldwide and more than 40% of irrigated lands are affected by salinity. Breeding of salt tolerant crops through genetic engineering is considered as one of the effective methods of solving salinity problems especially when land reclamation is very difficult.

Recently, several genes have been proved to be crucial for salt tolerance in plants. We have conducted research to develop a salt tolerant plant by introducing a gene related to Na^+ -pump which can prevent the accumulation of sodium ions in the cytoplasm. However, Na^+ -pump has been identified only in animal cells so far, and it used to be considered that higher plant cells would not have Na^+ -pump. The marine algae *Heterosigma akashiwo*, which we have studied, usually live in brackish water and have a function of expelling sodium ions. Recently, we detected Na^+ -ATPase activity in the plasma membranes of algae (Figs. 1, 2).

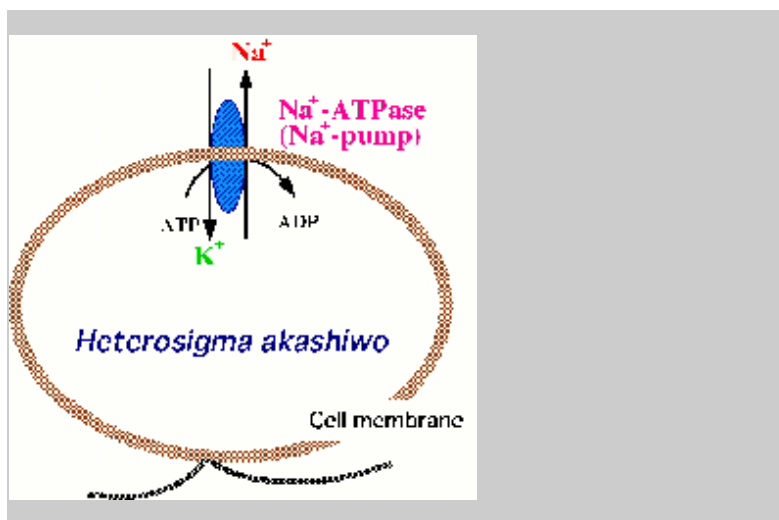


Fig. 1. Na^+ -transporter model in the plasma membrane of *Heterosigma akashiwo*.

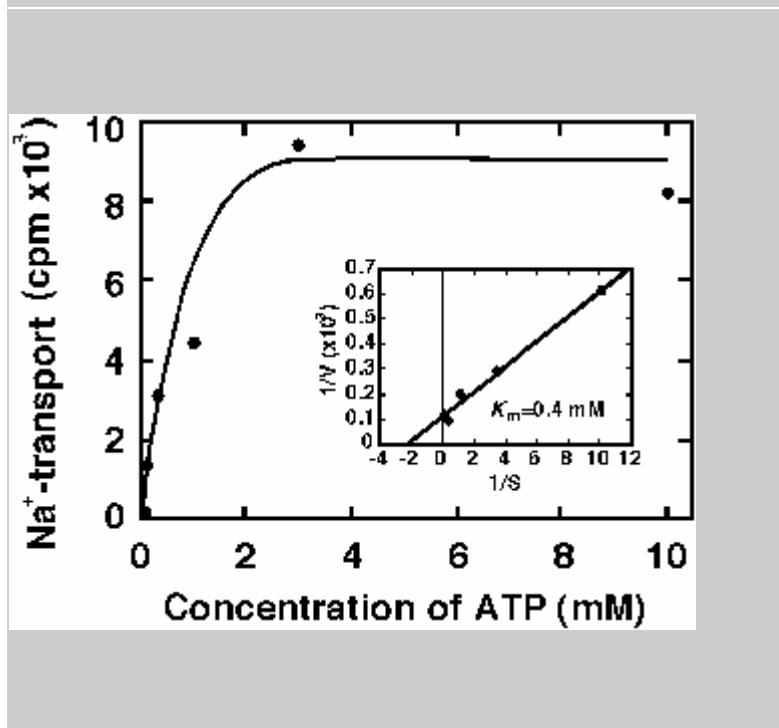


Fig. 2. Na^+ -transporting activity in the plasma membrane of *Heterosigma akashiwo*.

Moreover, we succeeded in the world's first cloning of cDNA of membrane-bound enzyme Na^+ -ATPase (HANA) from these algae. The full-length HANA cDNA was 4,467-bp long and coded for a 1,330-amino acid protein with a molecular

weight of 146,306. HANA is a member of P-type ATPases; it has 10 deduced transmembrane domains and conserved domains including phosphorylation sites and ATP binding sites. It showed 40% identity in amino acids with animal Na⁺/K⁺-ATPase α -subunits. A hydrophilic sequence with 285 amino acid residues existed between the 7th and 8th transmembrane domains. This sequence has not been found in animal cells. Studies on the sequence indicate that HANA has monomeric composition and does not have a β -subunit which animal Na⁺/K⁺-ATPases usually have. The amounts of cDNA and HANA did not vary when *H. akashiwo* cells were cultured for one week at various concentrations of NaCl solutions ranging from 0.3 to 0.5 M.

The phylogenetic tree of a P-type ATPase family was established by using the neighbor-joining method in GrowTree Phylogram of Wisconsin GCG DNA sequence analysis software. Sequences of ATPases were obtained through the GenBank, EMBL, and SWISS-PROT databases. The tree consists of three major clusters, Ca²⁺-ATPases, H⁺-ATPases, and Na⁺/K⁺-ATPases, HANA is included in the 3rd cluster (Fig. 3). Therefore, HANA is similar to Na⁺/K⁺-ATPases of invertebrates such as *Artemia*, *Drosophila*, and *Hydra*. It can be indicated that both HANA and yeast Na⁺-ATPases are Na⁺-pumps, but that the latter is classified in the cluster of Ca²⁺-ATPases. This difference indicates that the origin of Na⁺-transport system in alga is different from that in yeast. We are now trying to incorporate HANA cDNA into higher plants such as tobacco, and study how Na⁺-transporting activity works in these transgenic plants.

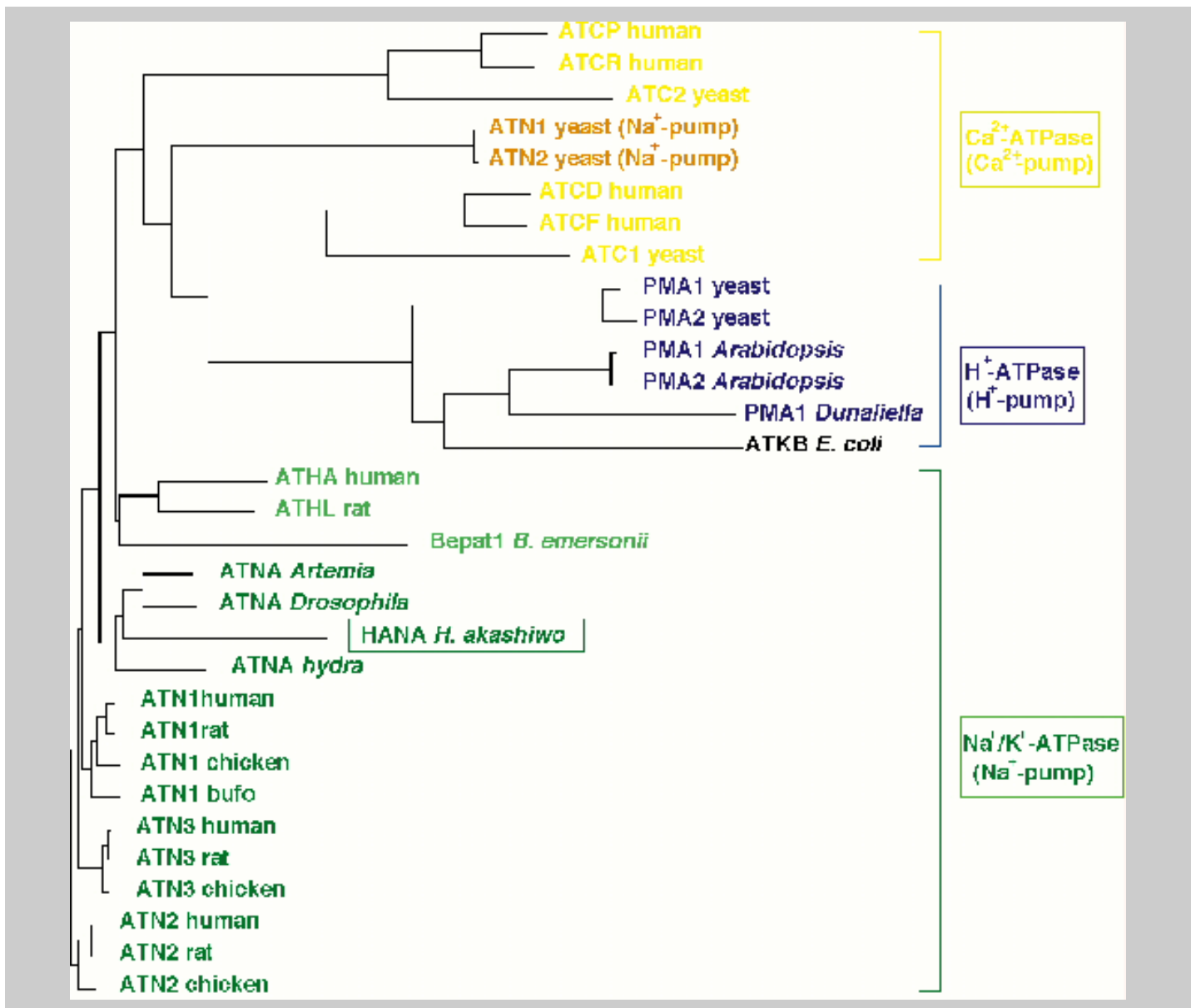


Fig. 3. Phylogenetic tree of P-type ATPases family.

Mariko Shono
Okinawa Subtropical Station, JIRCAS

[Contents](#)

Control of Microbial Contamination by Electrolyzed Water in Tofu Manufacturing

Tofu is a popular processed food in Asia, and recently, it has become popular worldwide as a health food containing high contents of essential amino acids and isoflavone. Since the consumption of tofu is gradually increasing, it becomes very important to maintain hygienic conditions during its manufacture. Especially, the control of heat-resistant spore-forming bacteria, which are predominant on the surface of soybean, is an essential part of tofu manufacturing. This report describes the potential of electrolyzed water to control microbial contamination in tofu manufacturing.

Electrolyzed water

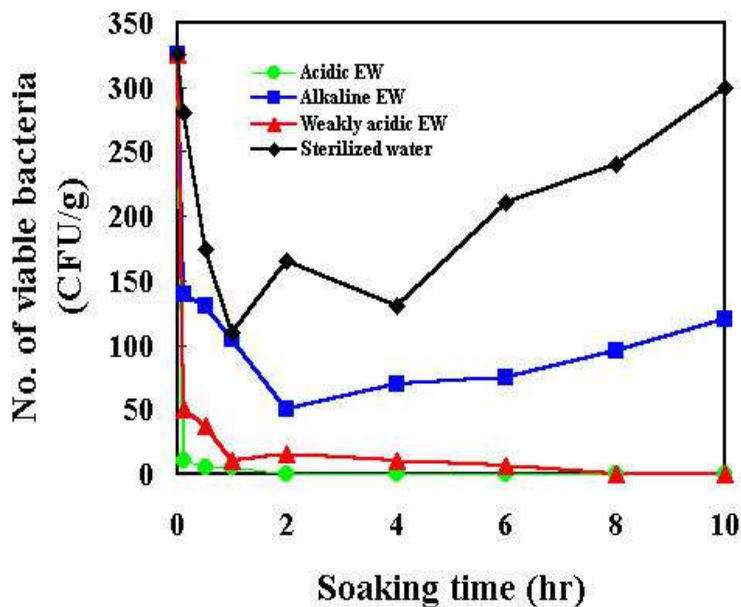
Electrolyzed water can be produced by electrolyzing sodium chloride solution or dilute hydrochloric acid. Electrolyzed water is classified into 3 types: acidic electrolyzed water (germicidal, used for hygienic purposes), alkaline ionized water (having medical effects; drinking water), and alkaline electrolyzed water (lipid-detergent). Scientific evidences concerning electrolyzed water increased in the 1990s and some industrial applications were also developed. Nowadays, acidic electrolyzed water is used to sanitize food-processing equipment and fresh-cut vegetables in food industries.



The electrolyzed water generator introduced in China Agricultural University.

Utilization of electrolyzed water for soaking soybeans

Microbial contamination could be effectively eliminated by using acidic electrolyzed water. We soaked soybean in 3 types of electrolyzed water: acidic electrolyzed water at pH 2.1, 1185 mV oxidation-reduction potential (ORP) and 100 ppm chloride, alkaline electrolyzed water at pH 11.7, -120 mV ORP, and a mixture (weak acidic electrolyzed water) of both waters at pH 6.5, 891 mV ORP, and 50 ppm chloride. Microbial population of the water became negligible after only 30 min. of treatment in acidic electrolyzed water and 1 hour in the mixture, while physico-chemical characteristics of tofu and milk made from soybean thus treated were not changed at all. Electrolyzed water is however very unstable and should be prepared only at the time of use. Moreover, acidic and weak acidic electrolyzed water are easily inactivated when polluted by organic matter; therefore, it is necessary to always protect them from pollution and to preliminarily wash the manufacturing lines with electrolyzed water before use. In order to apply electrolyzed water in processing of other foods, similar analyses of the efficiency, stability, and reactivity (safety) of electrolyzed water in the presence of other organic materials are needed.



Changes in viable bacteria populations in soybeans soaked in electrolyzed water.

Effects of electrolyzed water on soybean, soybean milk, and tofu

	Alkaline EW*	Acidic EW	Weak acidic EW	Sterilized water
Water absorbency of soybeans (%)	120.6	112.6	114.0	116.1
Solid content in soaked water (%)	0.51	0.47	0.37	0.32
Yield of soybean milk (ml**)	232.9	230.6	229.1	227.4
Solid content in soybean milk (%)	10.85	11.04	10.60	10.64
Tofu gel strength (kPa)	15.14	15.90	17.68	17.78

EW*: Electrolyzed water

**ml: Yield of soybean milk extracted from 50 g of dry seed.

Eizo Tatsumi
Food Science & Technology Division, JIRCAS

[Contents](#)

A Differential System for Rice Blast Disease

IRRI-Japan Collaborative Research Project has been implemented with financial assistance from the Japanese Ministry of Agriculture, Forestry and Fisheries (MAFF), and researchers from Japan International Research Center for Agricultural Sciences (JIRCAS) have continued joining the project since 1984. Phase IV of the project •Physio-genetic studies on yield determination and ecological adaptability for sustainable rice culture•f was initiated in October 1999 and will continue until September 2004.

Among our activities, I describe our major progresses in the genetic studies of rice blast resistance.

Blast research now

Blast caused by *Pyricularia grisea* Sacc. is one of the most serious diseases of rice (*Oryza sativa* L.) all over the world. In the lowland areas of tropical Asia, tungro virus and bacterial leaf blight are the most important, and blast used to be considered as the 3rd most important. However, the introduction of new cultivars without blast resistance genes has caused an increased occurrence of this disease. Moreover, as rice production in upland and rainfed areas has become more important, blast has become a more serious problem.

Japan has accumulated a lot of knowledge and technology on rice blast. However, the blast pathogen has a wider genetic variability in pathogenicity in tropical areas, and that requires more comprehensive research. Especially, a differential system of blast, which was developed in Japan, was not adaptable to blast isolated in the tropics, indicating that additional genes are associated with blast resistance.

Since the prevention of pests and diseases using resistance genes is the most important method in developing countries where pesticides are not sufficiently available, the differential system of blast is a very important research area to accelerate the use of resistance genes in rice breeding programs and pest control.

Approach of IRRI-Japan Project

We have developed differential lines, which are useful tools in understanding the pathogenicity of blast isolates. The lines were developed as a result of continuous backcrosses between Japanese differential varieties as donors of resistance genes and three recipient cultivars Lijiangxintuanheigu (LTH), CO 39, and US 2 as recurrent parents as shown in the Table. Since Japonica type cultivars LTH and US 2 have no resistance gene and Indica type cultivar CO 39 has only one gene *Pia*, the pathogenicity of blast isolates can be easily determined using near isogenic lines (NILs) developed from these lines.

Target resistance gene	Genetic background •including resistance gene•j			
	Monogenic lines (-)	LTH NILs(Lijiangxintuanheigu) (-)	CO 39 NILs (<i>Pia</i>)	US 2 NILs(Non)
<i>Pia</i>	BC1F15	BC6F8, BC6F9	-	BC6F2
<i>Pib</i>	BC1F13	BC6F8	BC6F9	BC6F2
<i>Pii</i>	BC1F15	-	-	BC4F1
<i>Pik</i>	BC1F14	BC6F8	BC6F9	BC6F2
<i>Pik-h</i>	BC1F13	BC6F8	BC6F9	BC6F2

<i>Pik-m</i>	BC1F11	-	BC6F9	-
<i>Pik-p</i>	BC1F13	-	BC6F9	BC6F2
<i>Pik-s</i>	BC1F15	BC6F8, BC6F9, BC6F5	BC6F9	BC6F2
<i>Pish</i>	BC1F13, BC1F15	-	BC6F9	BC4F1
<i>Pita</i>	BC2F13, BC3F13, BC5F11	BC6F8, BC6F10	BC6F9	BC6F2
<i>Pita-2</i>	BC1F9, BC1F11	BC6F6	BC7F7, BC6F9	-
<i>Pit</i>	BC2F13	-	-	-
<i>Piz</i>	BC1F15	BC6F8	BC6F9	-
<i>Piz-5</i>	BC3F13, BC5F11	BC6F10	BC6F9	-
<i>Piz-t</i>	BC1F15	BC6F8, BC6F9	BC7F7	BC6F2
<i>Pi1</i>	BC3F13	-	BC6F9	BC6F2
<i>Pi3</i>	BC2F13	BC6F10	-	-
<i>Pi5</i>	BC3F13	BC6F10	BC6F9	BC6F2
<i>Pi7</i>	BC3F13	BC6F10	BC6F9	BC6F2
<i>Pi8(t)</i>	-	BC6F6	-	-
<i>Pi9</i>	BC3F13	BC6F10	-	BC6F1
<i>Pi11</i>	BC2F13	BC5F7, BC6F10	BC6F9	BC6F2
<i>Pi12</i>	BC2F13	-	BC6F9	BC5F1
<i>Pi19</i>	BC1F15	-	-	-
<i>Pi20</i>	BC1F11	BC6F6	BC7F7	-

Four kinds of differential variety series, namely, monogenic lines, LTH NILs, CO 39 NILs, and US 2 NILs have been developed. A total of 24 monogenic lines were derived from backcrossing one to three times with LTH, and self-pollinating at F₁₁ to F₁₅ generations. Morphological traits of LTH, LTH NIL, and a donor line are shown in Fig. 1. A total of 17 LTH NILs were developed at generations BC₆F₈ to BC₆F₁₀. LTH NILs still segregate in some morphological characteristics and will need further fixation processes. A total of 18 Indica-type CO 39 NILs were developed and attained relatively uniform traits. Although there still exist some morphological variations, these monogenic lines, LTH NILs, and CO 39 NILs could be used as differential varieties. Unfortunately, seed production using these lines is limited under tropical conditions, and a high yielding line such as US 2 is being developed.



Fig. 1. Monogenic lines and donor variety parents.

- A: LTH (long day condition: LDC),
 B: LTH (natural [short] day condition: SDC),
 C: Monogenic line, IRBL19-A (LDC),
 D: IRBL19-A (SDC),
 E: Donor variety, Aichiasahi (SDC)

The differential varieties we developed have already been distributed to national institutes and colleges in China, India, Japan, Korea, the Philippines, Thailand, and Vietnam, and pathologists and plant breeders are working with them for blast isolate determination and breeding of resistant cultivars.

Our research provides the possibility of a future global research network for a better understanding of blast disease and resistance genes and enhancing the development of a more concrete differential system and blast-resistance breeding program in related countries.

Yoshimichi Fukuta
International Rice Research Institute (IRRI)

[Contents](#)

9th JIRCAS International Symposium

• gValue-Addition to Agricultural Products• h --Towards increase of farmers• f income and vitalization of rural economy--

Date: October 16 and 17, 2002

Venue: Epochal Tsukuba

Organized by: JIRCAS

Incooperation with: National Agricultural Research Organization

National Food Research Institute

Fisheries Research Agency

PhAction

Food Forum Tsukuba

PROGRAM

Day 1 (Wednesday, October 16)

Opening Session (9:30-10:00)

Opening address and welcome remarks

Keynote addresses (10:00-11:00)

1. Status of postharvest development and the potential future contribution of value addition to rural economy (Geoffrey Mrema, FAO)
2. Linking farmers to markets - PhAction Initiative (Guy Poulter, Chair of PhAction, NRI, UK)

Session 1 (11:15-15:20)

Current status of rural economy and measures for increasing farmers• f income and vitalization of rural economy

1. China (Li Suoping, CAAS, China)
2. The Philippines (Nerlita M. Manalili, SEARCA, The Philippines)
3. Vietnam (Le Van To, Post-Harvest Technology Center, Vietnam)
4. Indonesia (Made S. Mahendra, UNUD, Indonesia)
5. South Asia (Andy Hall, CPHP, India)
6. Latin America (Bernard Ospina, CLAYUCA, Colombia)
7. Africa (Shaun Ferris, IITA, Uganda)

Session 2 (15:35-17:55)

System forensuring high quality and safety

1. Codex standards and food safety (Yukiko Yamada, NFRI, Japan)
2. Systems for ensuring production quality and safety for small rural agro-enterprises - the way forward (Linda Nicolaidis, NRI, UK)
3. Grain Quality-storage to market (Joseph Rickman, IRRI, The Philippines)
4. Safety of feed and animal products (Andrew Speedy, FAO, Italy)
5. Extension of fish pre-rigor state by enhancing mitochondrial ATP synthesis (Shugo Watabe, Univ.Tokyo, Japan)

Day 2 (Thursday, October 17)**Session 3 (9:00-12:30)**

Research on value-addition and novel utilization

1. Application of value adding technologies in Thailand (Gassinee Trakoontivakorn, IFRPD-KU, Thailand)
2. Present status and problems of traditional fish products in Southeast Asia (Tan Sen Min, SEAFDEC, Singapore)
3. Development of intermediate foodstuff from freshwater fish in China (Wang Xi Chang, SFU, China)
4. Inventory of indigenous plants and minor crops in Thailand based on bioactivities (Kazuhiko Nakahara, JIRCAS, Japan)
5. Functionalities of traditional foods in China (Li Lite, CAU, China)
6. Functionalities of foods and their utilization in Japan (Makoto Shimidzu, Univ.Tokyo, Japan)

Poster Session (12:30-14:30)**Session 4 (15:00-16:30)**

General Discussion

1. What needs to be done to make postharvest research and development serve the needs of the poor farmers in their efforts to find markets for their products? (Chair: Geoffrey Mrema, FAO)
2. Changing focus of postharvest research - from postharvest losses towards value- addition - re-evaluation of indigenous products and traditional foods (Chair: Toru Hayashi, JIRCAS)

Closing Address (16:30-16:45)**Secretariat:**

Yutaka Mori

Development Research Coordinator
Japan International Research Center
for Agricultural Sciences (JIRCAS)
1-1 Ohwashi, Tsukuba, Ibaraki 305-8686, Japan
Tel: +81-298-38-6343 Fax:+81-298-38-6342
E-mail: sympo9@ml.affrc.go.jp

<http://www.jircas.affrc.go.jp/sympo/sympo9.html>

Contents

The 21st Annual Group Meeting on Agricultural Science and Technology Exchange between China and Japan at Kunshan, China

The 21st Annual Meeting on Agricultural Science and Technology Exchange between China and Japan was held at Kunshan, China, from June 3 to 5, 2002. Nine Japanese delegates led by Mr. Akihiko Ohmori, Senior Councilor for Technical Affairs from Ministry of Agriculture, Forestry and Fisheries, and 12 Chinese delegates led by Ms. Jin Sisheng, Deputy Director-General from Department of International Cooperation (DIC), Ministry of Agriculture discussed the results of the previous year's activities, future strategy and direction of agricultural research and technology development, and extension work in both countries. Dr. Y. Morooka, Vice-President of JIRCAS joined the Meeting and also attended the 7th research coordinating meeting, which was held in order to discuss substantial issues on the ongoing comprehensive research project entitled "Development of Sustainable Production and Utilization of Major Food Resources." The coordinating meeting was chaired by Mr. Liu Zhangwei, Acting Director of the Asia and Africa Division of DIC, and members from both countries agreed that the project has achieved satisfactory results. Moreover, they exchanged views on suitable topics and schedules for the next project to be prepared, and subjects such as an early prediction and warning system of weather hazards and dietary functions of Chinese traditional foods were suggested. Special emphasis was placed on strengthening the coordinating functions of institutions which were likely to join the upcoming project. The next annual meeting will be held in Tokyo next May.



Masanori Inagaki
Research Planning & Coordination Division, JIRCAS

Visitors

JIRCAS welcomed Dr. Joachim Voss, Director General of Centro Internacional de Agricultura Tropical (CIAT) on April 25, Dr. Peter Hartmann, Director General of International Institute of Tropical Agriculture (IITA) on June 17, and Dr. Marc Cohen, Special Assistant to the Director General of International Food Policy Research Institute (IFPRI) on July 17. Our staff members have had very fruitful discussions with them.

PEOPLE



Dr. Ryoichi Ikeda joined JIRCAS on June 1, 2002, as Director of Biological Resources Division, succeeding Dr. Masa Iwanaga who left JIRCAS and now is Director-General of El Centro Internacional de Mejoramiento de Maiz y Trigo (CIMMYT). Dr. Ikeda has been serving as a rice breeder and research director for 21 years in National Agriculture Research Center, Tohoku National Agricultural Experiment Station and Central Agricultural Experiment Station, all of which now belong in the competence of the newly established independent administrative institute of the government, National Agricultural Research Organization. He was also engaged in international research work as International Research Coordinator in JIRCAS from 2000 to 2001 and a plant breeder in International Rice Research Institute from 1988 to 1993. His new assignment in JIRCAS covers various crops and regions, and he wishes to make every effort to attain the goal of JIRCAS by amalgamating activities of fellow researchers within the division and accelerating collaborative research work with various national and international agricultural research centers.

[Contents](#)

[JIRCAS Home Page](#)

2002
September

ISSN 0919-8822

No.32

JIRCAS Newsletter

for
INTERNATIONAL COLLABORATION



CONTENTS

- 2 *Okinawa Subtropical Station: Present and Future*
- 3 *Physiological Mechanism of Crop Heat Tolerance and Development of Heat-Tolerant Crops*
- 4 *The First Report of a Sodium-Pump (Na^+ -ATPase) Gene in Plant Cells*
- 5 *Control of Microbial Contamination by Electrolyzed Water in Tofu Manufacturing*
- 6 *A Differential System for Rice Blast Disease*
- 7 *9th JIRCAS International Symposium*
- 8 *Topics*

JIRCAS

JAPAN INTERNATIONAL RESEARCH CENTER FOR AGRICULTURAL SCIENCES

JIRCAS

Newsletter

No. 26

March 2001



Street vendor selling "Kao Lam," traditional sticky rice cooked using fragments of bamboo stem in Khon Kaen, Thailand
(Photo by M. Suzuki)

CONTENTS




<Feature Article>

- [Research Activities at JIRCAS Okinawa Subtropical Station](#)

<Collaborative Research Project>

- [Technology Development for Reducing Postharvest Losses](#)

<JIRCAS Research Highlight>

-  [Cable Logging System for Timber Harvest](#)
-  [Vegetation Status in the Sub-Saharan Region using Remote Sensing](#)
-  [Characteristics of Rainfall Kinetic Energy](#)

<Workshop>

<People>

<JIRCAS Fellowship>

-  [**JIRCAS Home Page**](#)

Message from the JIRCAS Okinawa Subtropical Station

Steps towards a new era



Masaaki Suzuki
Director, Okinawa Subtropical Station, JIRCAS

The G-8 meeting was held in Okinawa at the dawn of the 21st century. For a brief moment, the world's eyes, and the nation's eyes were turned to this group of islands in the southwestern part of the Japanese archipelago that is known as the Ryukyu Islands. In the southernmost end of the Ryukyu Islands is a group known as Yaeyama Islands. One of these islands is Ishigaki, and this is where, 30 years ago, the Okinawa Subtropical Station of JIRCAS (formerly Tropical Agriculture Research Center (TARC)) was established.

Ishigaki Island is only 230 km² in area, but it is a beautiful island surrounded by coral reefs and lying in the path of the Black Stream that brings warm water from the south to mainland Japan. The climate is humid subtropical with an average temperature of 24 and an annual precipitation of 2,100 mm.

The organization of the Station consists of the International Collaboration Research Section, and the Laboratories of Crop Introduction and Cultivation, Crop Breeding and Rapid Generation Advance, Tropical Fruit Tree, Plant Protection, and Soil Fertility. The staff consists of 24 researchers and 14 members in the administration and field management sections. In addition, ten outstanding scientists are invited each year from developing countries under the "JIRCAS Visiting Research Fellowship Program at Okinawa." They work closely with each other to develop technology on optimum utilization of bio-resources and the promotion of sustainable agricultural production in the tropics and subtropics.

JIRCAS will be reorganized as an agency in April, 2001. Our Station is fortunately blessed at present with several important factors for conducting research. First is the high ability of the young staff including the highly qualified researchers from abroad. Second is the ideal environmental factors that come naturally with the location of this island. The third one is the existence of good facilities such as buildings and fields and modern laboratory equipment as well. Last, but the most important factor, is the

availability of sufficient funds. I do hope that these conditions will prevail even after the reorganization.

We successfully implemented many important projects in the past 30 years and contributed to the development of agricultural technologies in the tropics and subtropics. For example, the low input hydroponics system, a new device for crop cultivation was developed at this Station. The system was applied to the efficient production of sugarcane seedlings, and has contributed to a large extent to the development of mechanization in sugarcane production in Okinawa. A procedure was developed here for successful cryopreservation of shoot meristems of taro cultured *in vitro*. A heat-tolerant variety of winged bean "Urizun" and a heat-tolerant variety of snap bean "Haibushi" were released in 1986 and in 1995, respectively from this Station. In another research project conducted here, it was revealed that soil loss from pineapple fields could be prevented by planting weeping lovegrass at the lower edge of the slope.

Next year, our projects will be much more oriented to sustainable agricultural production in small tropical and subtropical islands in order to contribute to the agricultural development of these islands. One of our major projects will be a study on the evaluation of the factors causing unstable crop production under tropical and subtropical conditions in connection with meteorological and soil conditions, and studies on the methods of control. How to minimize the use of water and fertilizers will be important issues in the project from the viewpoint of stable production and environmental protection.

The development of crops resistant to environmental stresses such as heat and salt will be another important field of study. The demand for crop production under unfavorable conditions seems to increase due to the increase in the population of the developing countries. The project is implemented not only by the use of traditional breeding methods, but also by using biotechnology in combination with physiological analyses.

Citrus greening disease occurs widely in Thailand, Vietnam, Taiwan and also in Okinawa. The disease brings serious damage to citrus production and is very difficult to control. The Asian citrus *Psylla* is known as the vector insect and a kind of wasp is known to be its natural enemy. However, the wasp can not be utilized to control the Asian citrus *Psylla*, because the wasp is also known to have another wasp as its natural enemy. These complex ecosystems must be clarified one by one to develop the technology for controlling citrus greening disease.

Tropical fruits such as papaya and mango will be studied to enhance the quality, in terms of color, flavor and taste, etc., because fruit trees are very important in tropical countries for improving farmer's livelihood and for soil conservation.

Last, but not the least, the rapid generation advance of hybrid populations of rice and wheat, and the breeding of sugarcane using biotechnological methods, taking advantage of the subtropical conditions of Ishigaki Island, are also important projects to be continued further.

Close cooperation among the researchers, the effective utilization of the facilities of the Station in the unique environment provided by Ishigaki Island will hopefully lead to the solution of many of these problems.



JIRCAS Okinawa Fellow carrying out studies on heat tolerance of tomatoes

[NEXT](#)

[CONTENTS](#)

Development of Low-Input Technology for Reducing Postharvest Losses of Staples in Southeast Asia

Akinori Noguchi

Director, Crop Production and Postharvest Technology Division, JIRCAS

The first collaborative research project for the reduction of postharvest losses was launched on September 18, 2000 by the signature of a Memorandum of Understanding (MOU) among the Department of Agriculture (DOA), Institute of Food Research and Product Development (IFRPD) at Kasetsart University, School of Energy and Materials (SEM) at King Mongkut's University of Technology Thonburi (KMUTT), the Royal Thai Government and JIRCAS. This project is titled: "Development of low-input technology for reducing postharvest losses of staples in Southeast Asia" and will be continued for five years from 2000.

The increase in the world population and limited cultivated area emphasize the issue of food security as one of the global problems facing humans worldwide. While the production of food resources should increase, special attention must be paid to the reduction of postharvest losses in developing regions through the development of low-input and appropriate technologies.

Due to the fact that the climate in the Southeast Asian countries is typically hot and humid, postharvest losses have been estimated at about 30%, caused mainly by improper drying techniques and insect infestation during crop storage.

It was recognized that the widely used fumigant in the world, methyl bromide, is characterized by ecocidal and environmental disruption and contributes to the depletion of the ozone layer. Therefore, it will be strictly banned from use by 2015. On the other hand, an alternative pesticide, phosphine, induces tolerance and shows a marginal insecticide activity. As a result, developing countries have attempted to develop proper technologies for reducing postharvest losses.

Far too often the problem of feeding the world hungry is conceived in terms of producing a sufficient amount of food. Equally pressing problems related to preservation and distribution issues that affect food products between harvest and consumption, are frequently neglected.

While agriculture is obviously affected by the surrounding environmental conditions, there are many constraints on the rapid increase of food production. Therefore, it is very important to develop techniques for reducing postharvest losses as well as improving the quality and nutritional value of agricultural produce, prior to consumption.

The following technologies can be selected as appropriate solutions for common issues of postharvest losses in developing regions; drying and maintenance of freshness of products from harvest through transportation to storage. Safety assessment, product selection prior to processing and improvement and development of processing to meet the cultural food traditions should also be considered. The former two fields correspond to preventive technology for postharvest losses and the latter corresponds to technology for quality evaluation.

While harmonized development of these technologies is required to achieve a stable food supply and

improve farmer's income, the infrastructure and laws relevant to food and other agricultural products have not been updated to meet new challenges in developing regions. Therefore, we must adapt selected technologies to the conditions in developing regions, keeping in mind how agricultural productivity can be enhanced through incentives to the farmers.

In this project, the objectives are to develop low-input drying technology using natural energy sources such as sunlight, husks and straw. Preservation technology will employ natural enemies and products such as neem and pheromones. Achievement of effectiveness and development of lower-cost technology systems for the reduction of postharvest losses at the farmer level or in small-scale farming, are other objectives of the present project.

The scope of the studies can be summarized as follows; 1) Survey of postharvest losses of staple crops such as rice and maize and identification of causes of quality deterioration, 2) Analysis of the dynamic status of major stored products insects and the mechanisms of damage and possible alleviation, 3) Development of low-input drying technology and biological control of stored products insects using natural enemies and products, 4) Development of environment-safe technologies for reducing postharvest losses of staples.



Signature of Memorandum of Understanding at the DOA office

NEXT

CONTENTS

Development of a Cable Logging System for Low-Impact Timber Harvest in Tropical Natural Forests

Shozo Sasaki
Forestry Division, JIRCAS

Because of its high productivity and versatility, the ground skidding system has been commonly used for timber harvest in tropical natural forests. However, since the heavy crawler tractors used in the operations can easily damage residual trees and the forest floor, it is difficult to achieve sustainable forest management with this harvesting system. This is especially true in the operations in hilly areas, where current logging activities are increasing. It is necessary for tropical forest management to develop low-impact, socially and economically acceptable logging techniques that can be used in the steep, rugged and fragile forest environment.

Cable logging system has an advantage over the ground skidding system in that it is not necessary to bring heavy machinery into forest stands. However, because a few heavy logs are scattered in a broad forest area, the cable system may not be suitable in terms of cost and benefit. Therefore, we are developing a new cable logging system that is suitable for selective cutting in tropical natural forests in many aspects.

The cable system is a combination of standing skyline system and running skyline system. For quick installation, operations and dismantling, we selected a wire rope 20-mm in diameter for the skyline, which is rather smaller for heavy logs in tropical natural forests. To ensure safety with the smaller skyline, the cable is installed very loosely, with a maximum mid-span deflection (sag) value of 0.1. The cable tension and sag values can be controlled according to the log weight. Fig. 1 shows the results of some examinations in trial operations. For light logs less than 2 t in weight, with a sag value of 0.04, we observed that the cable system could totally lift up the logs all the way in the span. With the 0.08 sag setting, heavy logs up to 5 t could be totally lifted in the middle of the skyline over a stream buffer zone. On a slope, logs could be extracted by dragging with one side lifted up. The calculated and measured maximum cable tension values were 7,500 and 7,000 kgf, respectively, which is compatible with the skyline safety factor. Based on logging impact data, the ratio of disturbed area in the cable system is much smaller (1/10) than that of the ground system.

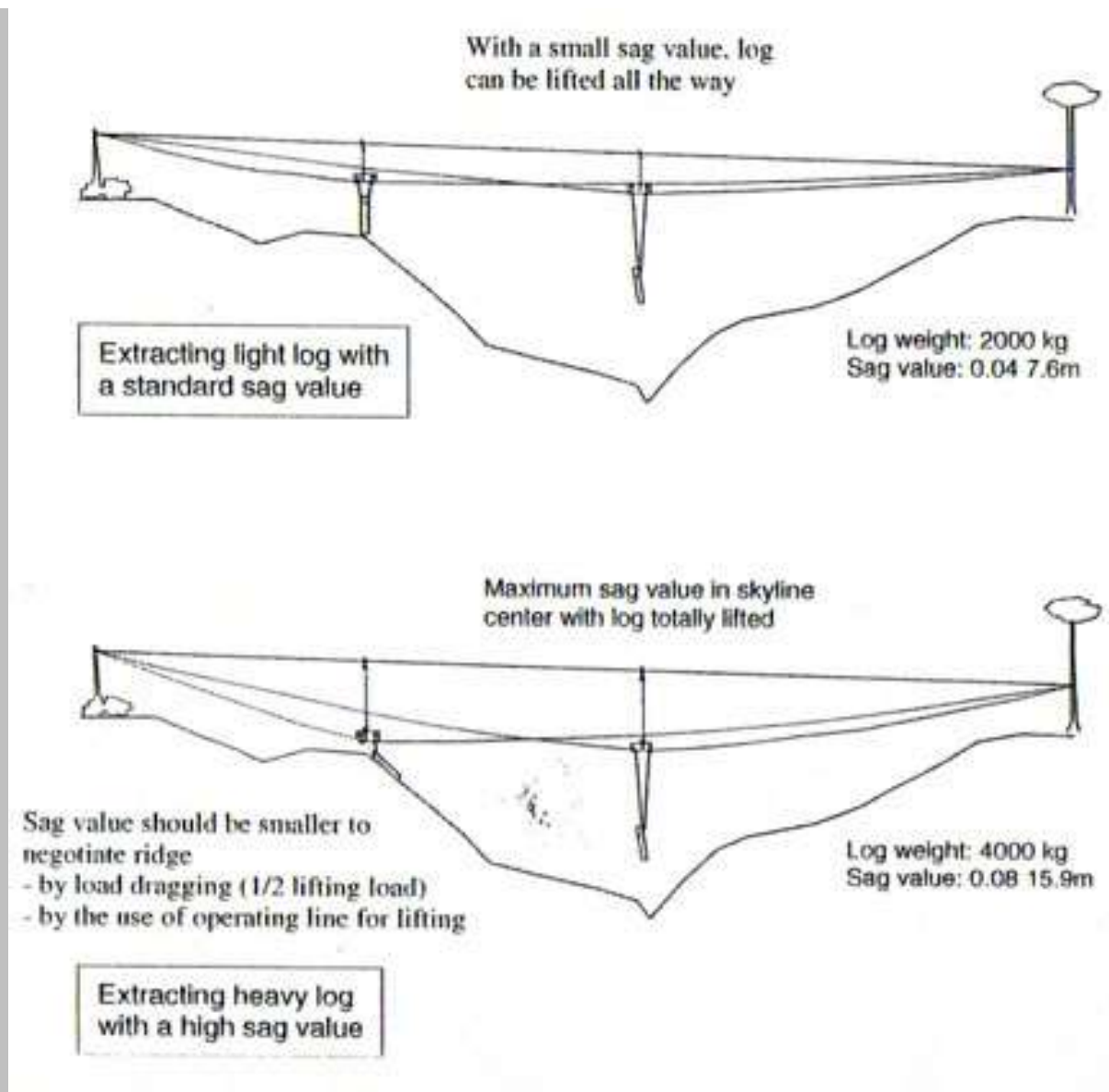


Fig. 1. Comparison of carrying load and cable sag values in trial operation.

Our target specification of the system is as follows: 6 t carrying load, 500 m working span, and 50 m lateral working range. We are currently conducting several trials in a 30 ha research plot in a hill forest in Peninsular Malaysia. Eight cable corridors are selected based on cable installation conditions, maximum accessibility to cutting trees, and minimal road construction. We plan to further improve the system, techniques, ground preparation work and operational procedures for efficient and lower-impact harvest.



A trial operation of the cable logging system

[NEXT](#)

[CONTENTS](#)

Characterization of Vegetation Status in the Sub-Saharan Region Using Remote Sensing

Satoshi Uchida

Environmental Resources Division, JIRCAS

In the southern part of the Sahara desert, there are vast areas under semi-arid climatic conditions that form a belt zone. These areas are prone to a decline of the soil productivity and to desertification. Although monitoring of nutrient conditions over a long period of time would be required to estimate the soil productivity, this method can not cover areas out of experimental stations. Alternative method to estimate the soil productivity within a spatially wide range is to examine the vegetation status in relation to the soil productivity. Remote sensing is a suitable method for identifying the vegetation density at every pixel within the coverage of an observed scene and for monitoring the temporal changes. In this study, low spatial resolution (1 km) satellite data were used to characterize the vegetation status in association with physical environmental factors and high spatial resolution (20 m) satellite data were used to discriminate agricultural land use around the study site.

Normalized Difference Vegetation Index (NDVI) calculated by the combination of near infrared spectral band data and visible red spectral band data can be used to estimate the vegetation status. Fig. 1 shows the changes in the 1 km mesh 10-day composite NDVI derived from NOAA/AVHRR data during the period from October 1992 to September 1993, where 10-day composite denotes the maximum value recorded during 10 days in order to remove the effects associated with cloud cover. Each item in this figure represents averaged NDVI over land unit, which was defined by overlying soil (Regosols) and annual rainfall maps in Burkina Faso.

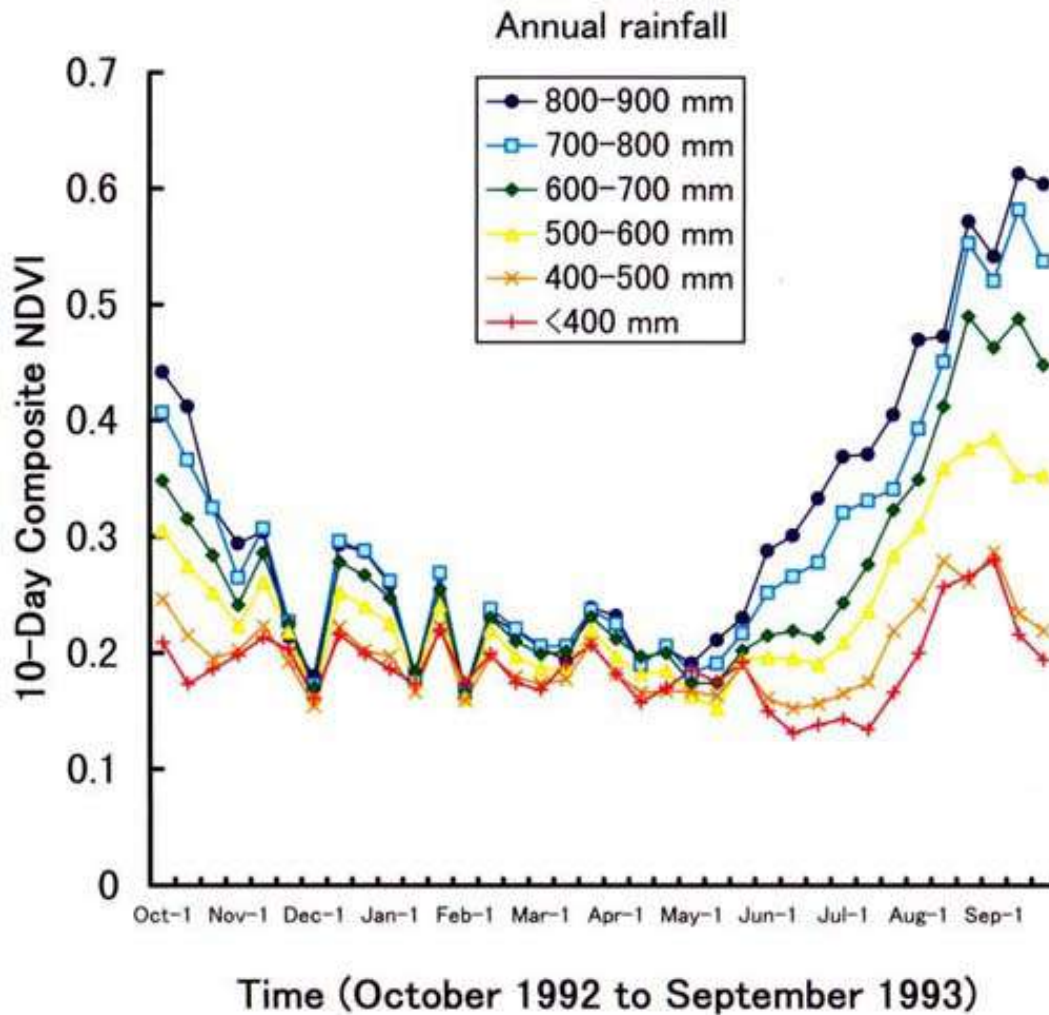


Fig. 1. Temporal changes of 10-day composite NDVI for unit areas depending on annual rainfall ranges. Areas are located on the same soil type, Regosols, in Burkina Faso.

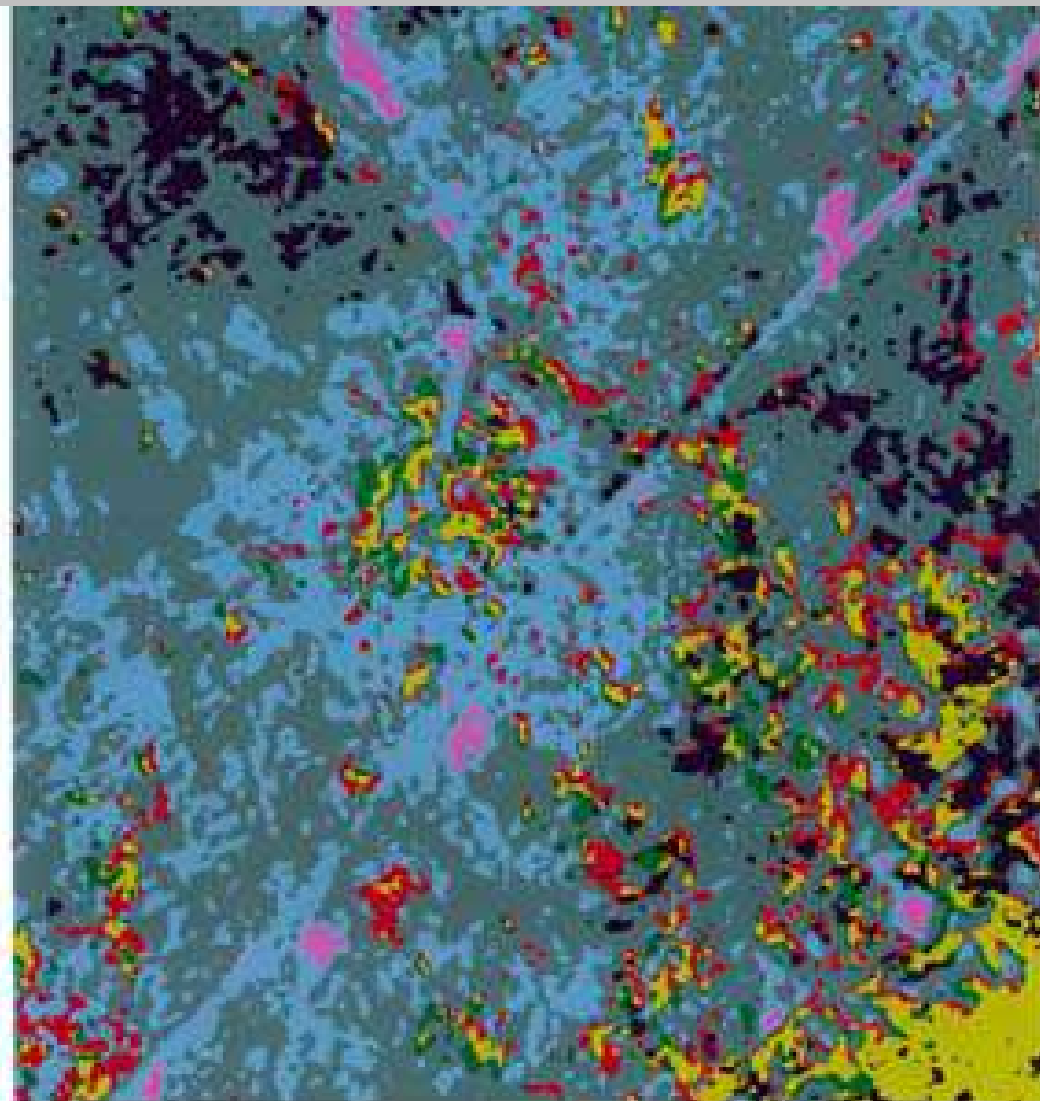
As the rainy season started in June, NDVI began to increase from the unit with the largest amount of annual rainfall to the unit with a smaller amount. The difference in the level of maximum NDVI was mainly caused by the proportional existence of vegetation components and not by the difference in the status of the vegetation. The Figure indicates that the landscape in the rainy season in the area with more than 700 mm annual rainfall was distinctively different from that in the area with less than 500 mm. In other words, annual rainfall in the range from 500 to 700 mm was identified as the critical level to maintain the vegetation reproductivity.

Spatially detailed information on actual land use was analyzed by using SPOT/HRV data with a spatial resolution of 20 m. Annual rainfall at the study site, Kolbila village, is about 700 mm. In terms of land use, millet was generally cultivated in the surroundings of house clusters while wide fallow areas could also be observed. In this study, the author attempted to discriminate cropped area and fallow from other land use types by applying the decision tree method for multi-temporal NDVI obtained from SPOT/HRV data. This method is based on the difference in the characteristics of the vegetation coverage depending

on the land use types; i.e., both cropped area and fallow showed relatively low NDVI values compared with forest or bush during the post-rainy season and the cropped area showed a distinctively high NDVI value during the crop growing period.

Fig. 2 displays the estimated land use in 1992 and 1993 over the Kolbila village, in the center of the image, and its surroundings. Cropped area in the southeastern part was located around the river course, where the conditions of cultivation were considered to be more suitable in terms of soil moisture level than in the Kolbila village. This figure characterizes the variation of the cropped area in the Kolbila village as follows; 1) about half of the cropped area in 1992 was cropped subsequently in 1993, 2) continuously cropped area occurred mostly in the range within a distance of about 500 m from the center of the village.

Fallow shown in Fig. 2 could include the deforested area. According to the estimated land use for the extensive area around the Kolbila village, fallow appeared widely mixed with bare land. These land use features should be examined in relation to the location conditions, e.g., topography, accessibility to road or river, for the purpose of analyzing the changes in the soil productivity.



 Cropped in 1992&1993  Center of Kolbila village
 Cropped in 1992

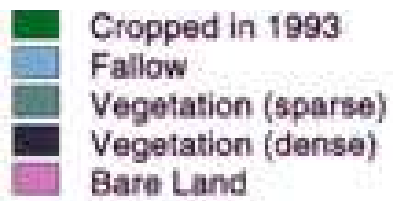


Fig. 2. Distribution of cropped area in Kolbila village and its surroundings in 1992 and 1993 estimated by using multi-temporal NDVI of SPOT/HRV data.

[NEXT](#)

[CONTENTS](#)

Characteristics of Rainfall Kinetic Energy and Raindrop Size Distribution on Ishigaki in the Subtropical Zone of Japan

Kenji Banzai
Okinawa Subtropical Station, JIRCAS

It has been recently observed that a large amount of red soils flows out from the rivers to the seacoast in the southwestern islands of Japan, particularly Okinawa. This phenomenon exerts a considerable effect on the natural ecosystems and endangers the coral reefs and seaweed habitat in this subtropical area. High rainfall intensity and large raindrop size have been known to contribute to this severe soil erosion. Using current rainfall energy equations, energy values can be calculated to predict soil loss which in turn can be very useful in formulating remedial measures. However, the distribution of the actual rainfall energy values is often wide and the characteristics of the rainfall energy in each zone have not been elucidated.

The filter paper method in which a filter paper with eosin powder is exposed to rain for several seconds to measure the raindrop diameter is not practical and prevents rapid and accurate determinations.

To gain a basic understanding of rainfall energy values, we examined the characteristics of the rainfall energy and raindrop size distribution in the subtropical area using a disdrometer. The device transforms the vertical momentum of the raindrop impact into an electric pulse, whose amplitude is a factor in the function of the drop diameter. Rainfall energy values were calculated from the observations obtained with the device, which enables to measure the raindrop size distribution continuously and automatically. The device however can not measure raindrops below 0.3 mm, hence rainfall energy values may show an error of about 2.48%.

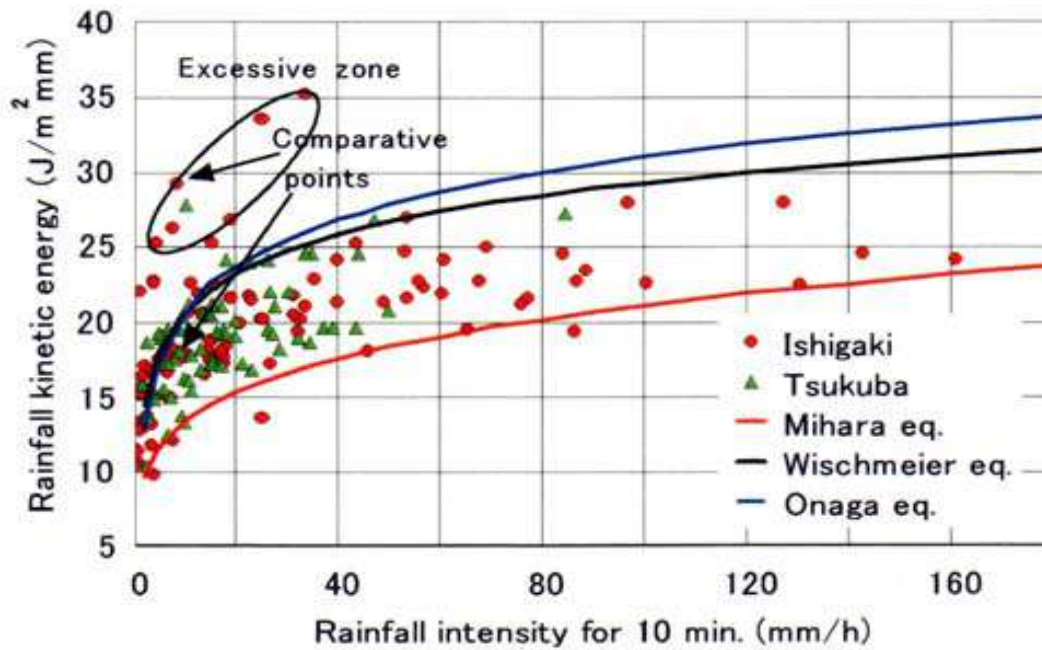


Fig. 1. Relationship between rainfall intensity and energy.

Measured kinetic energy vs. rainfall intensity data revealed a wide distribution between the upper limit equation of Wischmeier and the lower limit equation of Mihara (Fig. 1). Kinetic energy above the Wischmeier equation which was also observed below 30 mm/h rainfall corresponded to the excess zone. On Ishigaki, there were large-sized raindrops at a rainfall intensity below 30 mm/h. The distribution of the raindrop size on the points shown in Fig. 1, was wide, ranging from 1-5 mm in diameter compared with the data recorded in Tsukuba where the raindrop size was mainly in the range of 1-2 mm (Fig. 2).

This study highlights the higher rainfall kinetic energy and larger raindrop size observed in the subtropical area compared with the temperate area. Rainfall energy values derived from disdrometer measurements can also be used effectively for the calculation of the rain coefficient in the USLE equation, estimation of the amount of splash erosion and elucidation of the processes involved in soil crust formation.

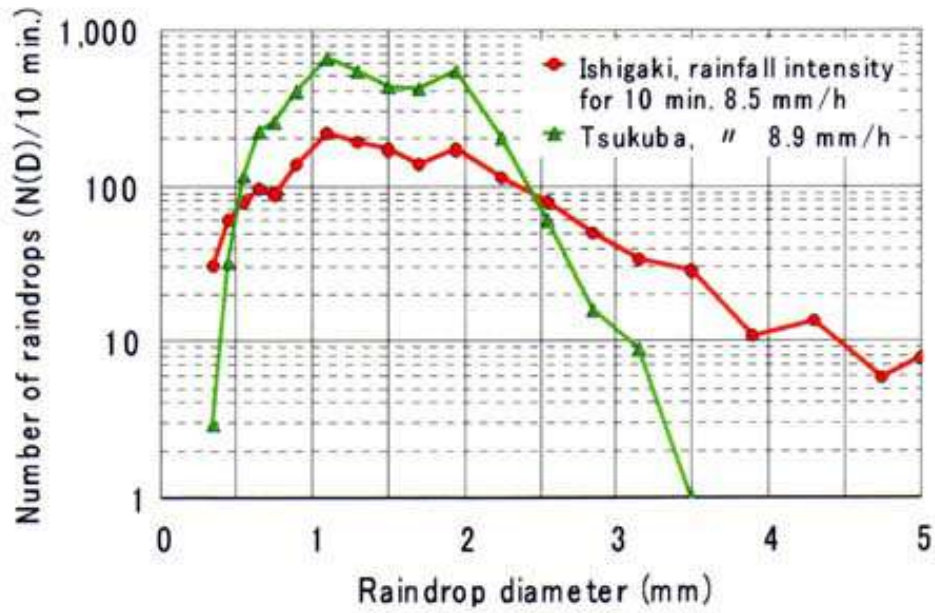


Fig. 2. Properties of raindrop diameter distribution.

[NEXT](#)

[CONTENTS](#)

Annual Workshop on 'Mekong II Project' Held in Cantho, Vietnam

The comprehensive project entitled "Development of new technologies and their practice for sustainable farming systems in the Mekong Delta (Mekong II)" has been implemented since last year, 1999, after a high degree of success was achieved in the phase I project entitled "Evaluation and improvement of farming systems combining agriculture, animal husbandry and fisheries in the Mekong Delta." The Mekong II project focuses on the production of commodities through the material circulation of by-products and/or wastes generated in the VACR farming systems. VACR is a Vietnamese acronym standing for fruits and vegetables, aquaculture, livestock and rice. For this purpose, the studies have been carried out in collaboration with Cantho University (CTU) and Cuu Long Delta Rice Research Institute (CLRRI) since 1999, respectively, and with the Southern Fruit Research Institute (SOFRI) since 2000.

The annual workshop on the comprehensive 'Mekong II' project was held at the Mekong Delta Farming Systems Research and Development Institute (MDFSRDI), CTU, Cantho, Vietnam during the period of November 14-17, 2000. The main purpose of the workshop was to review the results and to examine the future research direction of the project.

There were more than 80 participants from Vietnamese organizations, including local authorities such as agricultural extension departments and Tan Phu Thanh village representatives (the research site for the on-farm trial of the project), as well as CTU and CLRRI, in addition to 12 Japanese participants.

After the greeting address delivered by Prof. Dr. Le Quang Minh, Vice Rector of CTU, followed by the opening addresses given by Prof. Dr. Vo-Tong Xuan, Director of MDFSRDI, and by Dr. Osamu Ito, Director of Environmental Resources Division, JIRCAS, 52 reports were presented in 9 sessions during the first three days. In Session A, an outline of the on-farm trial site of the project was introduced. Technical report on rice cultivation was presented in Session B. In Session C, integrated pest management in rice cultivation was reported, and topics on upland crops such as soybean with rice cultivation and on drying technologies were discussed in Sessions D and E, respectively. After the discussion on fruit production in Session F, the results of pig production were presented in Session G. In Session H, 12 reports were presented on aquaculture production including fish and freshwater prawn. After Session I which covered the development and evaluation of farming systems, future direction and development for closer collaboration for the studies were discussed comprehensively in Session J. On the last day, November 17, a field trip to Tan Phu Thanh village was organized for all the participants. The workshop was successful due to the strong commitment of the experienced staff of the MDFSRDI, CTU. The Proceedings of the Workshop were published by JIRCAS.

Participants exchanged views on the progress of the project and confirmed the importance of such studies. During the workshop, it was eventually concluded that the development of sustainable farming systems which combine rice cultivation, fruit production, animal husbandry and aquaculture is definitely important, and may enable the organizations involved in the project to devise new strategies for developing techniques for the improvement of farming systems in the Mekong Delta. The next annual workshop for the project will be held at CLRRI in late October, 2001. (*Testushi Hidaka*)



Farmer house (left) and a farming system with the use of soil mounds for fruit tree cultivation in paddy fields (right) in the Mekong Delta

[NEXT](#)

[CONTENTS](#)

People



Dr. Takahiro Inoue, a soil scientist, was appointed Director General of JIRCAS on January 6, 2001 after the retirement of Dr. Nobuyoshi Maeno. Dr. Maeno who had been assigned to CIAT from 1977 to 1981 as a TARC (predecessor of JIRCAS) member, eventually joined JIRCAS in August 1994 as Director of the Research Planning and Coordination Division and became Director General of JIRCAS in August 1996. Dr. Inoue had briefly assumed the position of Director of JIRCAS* Research Planning and Coordination Division from April 1, 1998 until August 31, 1998. He then joined Tohoku National Agricultural Experiment Station where he became Director General on April 1, 1999. As a TARC member, he had the opportunity to carry out "Studies on the Increase of Productivity of Upland Soils in Thailand" in collaboration with the researchers of the Department of Agriculture of Thailand from 1980 to 1984.

[NEXT](#)[CONTENTS](#)

JIRCAS Fellowship

JIRCAS Fellowship Program: Welcoming New Visiting Researchers

Eighteen Visiting Researchers are participating in the JIRCAS 2001 Visiting Research Fellowship Program to carry out collaborative research at Tsukuba and Okinawa.

Tsukuba: Long-term (2 years at JIRCAS HQ.)

Donghe Xu	Tianjin Agricultural Academy of Sciences, P. R. China	Mapping of resistance genes to fusarium head blight (FBH) in wheat
Nguyen Van Dong	Agricultural Genetics Institute, Vietnam	Fine-mapping of tms-4(t) and marker-aided selection for thermosensitive genetic male sterility in rice
Nguyen Thi Thu Huong	Institute of Chemical Technology, Vietnam	Quality analysis and evaluation of food resources for better use
Subbarao V. Guntur	International Crops Research Institute for the Semi-Arid Tropics (ICRISAT), India	Physiological studies on nitrification inhibition and nitrogen absorption in <i>Brachiaria humidicola</i>

Tsukuba: Short-term (5 months at National Institute of Agrobiological Resources)

Zhenbo Tan	Beijing Academy of Agricultural and Forestry Sciences, P. R. China	Isolation of cDNAs clones encoding proteins that regulate freezing of cold-hardy plant tissues
Shahid Masood	Plant Genetic Resources Institute, Pakistan	Molecular evaluation of rice varieties collected from Pakistan
Chongjian Hong	China Agricultural University, P. R. China	Induction of high quality mutants and analysis of the mutation mechanism in sweet potato
Wong Boonsuebsakul	Kasetsart University, Thailand	Establishment of rapid and reliable method for the diagnosis of bacterial wilt disease of curma, ginger and other economic crops in Solanaceae plants by immunological and molecular techniques

Okinawa: Long-term (1 year at JIRCAS Subtropical Station)

MD. Khalilur Rahman	University of Dhaka, Bangladesh	Subsurface drip irrigation of some vegetable crops
Le Van Hoa	Can Tho University, Vietnam	Physiological and biochemical studies on aluminum-resistant pineapple
Md Abudul Awal Howlader	Bangladesh Agricultural Research Institute, Bangladesh	Molecular mechanism of biosynthesis and metabolism of metabolites related to heat tolerance of crops
Jalal Ud din	Land Resources Research Institute, Pakistan	Physiological, biochemical and molecular basis of heat tolerance in transgenic tomato (MT-sHSP) at the reproductive growth stage
Vijay K. Yadav	Rajasthan Agricultural University, India	Cloning of salinity gene(s) in <i>E. coli</i> and characterization
Arifin N. Sugiharto	University of Brawijaya, Indonesia	Cloning of useful genes and transformation in sugarcane
Lawrence M. Aboagy	Plant Genetic Resources Center, Ghana	Characterization and evaluation of factors for early growth in sugarcane

Xiaochuan Liu	China National Rice Research Institute, P. R. China	Comparison of salt-tolerance QTLs in different RI populations of rice (<i>Oryza sativa</i> L.)
Yunxia Liu	Institute of Biological Control, P. R. China	Development of regeneration system of sweet potato for utilizing anthocyanin transcriptional activator genes
Jiang Ling	Huazhong Agricultural Institute, P. R. China	Development of genetic transformation technique in papaya plant

 [Contents](#)

 [JIRCAS Home Page](#)



City market at Vientiane, Laos (Photo by T. HIDAKA)

NEWSLETTER

JIRCAS

Japan International Research Center for Agricultural Sciences

For International Collaboration

June, 2001

27

Contents

[Message from the President of JIRCAS](#)

[Biological Function of Proline in Osmotolerance](#)

[Utilization of New Forage Species in Agropastoral Systems](#)

[Technology Selection in Mekong Delta Project](#)
[Symposium](#)
[Workshop](#)
[New Structure of JIRCAS](#)

JIRCAS Newsletter No.27 June 2001

Message from the President of JIRCAS

"New JIRCAS" - Structural Reorganization -

Within the framework of the administrative reform enacted by the Japanese Government for the reorganization of government-affiliated research organizations, on April 1, 2001, Japan International Research Center for Agricultural Sciences (JIRCAS) became an Independent Administrative Institution (a semi-autonomous agency) under the supervision of the Ministry of Agriculture, Forestry and Fisheries of Japan (MAFF).



President : Takahiro Inoue

The introduction of the new system of Independent Administrative Institutions (IAI) is at the core of the administrative reform. This system has been introduced to enhance the effectiveness, quality and transparency of technological development by separating the administration functions into an implementing function and a planning and drafting function, by transferring the implementing function of the national research institutions to the IAI, each of which has its own independent judicial status. Therefore, under the new system, JIRCAS should implement not only autonomous and flexible programs, but also commit itself to a strict *ex post facto* evaluation and review of its performance, and disclosure of various issues.

In many developing countries, although the demand for food is increasing due to population increase and the improvement of the dietary habits, agricultural production remains at a low and unstable level. As a result, hunger and poverty are still important problems. Moreover, concern about the deterioration of the global environment has generated the need for sustainable development of agriculture, forestry, and fisheries, in harmony with the natural ecosystems. The mandate given to JIRCAS by the Japanese Government does not change fundamentally from the previous one in which JIRCAS was entrusted with the mission of promoting sustainable development of agriculture, forestry and fisheries compatible with the preservation of the environment in developing regions of the world through the implementation of integrated collaborative research programs.

The most distinctive feature of the new IAI is the semi-autonomy with limited prior control from outside and the *ex post facto* evaluation by which the IAI itself strictly evaluates its own performance to apply the results of the evaluation for subsequent activities. In the new system, MAFF defines JIRCAS mid-term objectives, which "New JIRCAS" should achieve during a five-year period. The mid-term objectives include issues related to the enhancement of the efficiency of the research activities, improvement of the quality of the research programs and of financial performance. Based on the mid-term objectives, the IAI drafts a mid-term plan to achieve these objectives autonomously.

The performance of the research activities evaluated by the IAI itself will be periodically evaluated additionally by the IAI Evaluation Committee established in MAFF which is composed of experts who do not belong to the public sector. Each fiscal year, the IAI Evaluation Committee will investigate and

analyze the achievements of the mid-term objectives during the given fiscal year. The results of the evaluation will be subjected to structural modifications in terms of operational and financing systems for the next fiscal year.

Since the research activities need to be fully executed, the Government will allocate, within budgetary limitation, most or all of the financial resources required to carry out the defined objectives. Moreover, JIRCAS should make utmost efforts to receive financial support from either any other governmental offices or the private sector, etc. to fulfill the mid-term objectives.

Role and Research Strategy

Since the role of JIRCAS is to promote the development of agriculture, forestry and fisheries in developing regions of the world through integrated collaborative research programs, the priorities identified by "New JIRCAS" for the research strategies are as follows: 1) Development of production and utilization systems for sustainable agriculture, forestry and fisheries in harmony with the environment by carrying out research on the development of stress-tolerant crops, technologies for preserving arable land environments, new farming systems for ensuring profitability for the producers and technologies for efficient postharvest management and utilization, and 2) Rehabilitation, maintenance, improvement and utilization of the natural environmental resources, with emphasis placed on tropical forest and coastal ecosystems.

In order to complete the mid-term objectives within the above research strategy, "New JIRCAS" carries out its main activities through the implementation of 1) International collaborative research programs in developing regions by sending researchers on a long-and short-term basis, 2) Collaborative research with researchers invited from developing regions, 3) Research in Japan to further enhance international collaboration, 4) Accumulation and analysis of research information for supporting the collaborative work, 5) Organization of international symposia, workshops and seminars, 6) Technical assistance for food and environmental issues, 7) Advice to national organizations involved in overseas development assistance as a think tank function.

In conclusion, the reorganization of JIRCAS into an IAI should enable JIRCAS to gain more flexibility in the implementation of its research programs, in the hiring procedures since it will be possible to recruit researchers from universities or institutes which do not belong exclusively to the public sector and in financial aspects since funds could be obtained from both the public and private sectors. At the same time, the strict evaluation of the performance of the Center may contribute to the enhancement of the quality of the research programs and to a more efficient utilization of the financial resources to further promote collaborative activities compatible with the needs of the developing regions.

Biological Functions of Proline in Osmotolerance Revealed in Antisense Transgenic Plants

Proline (Pro) is a major organic molecule that accumulates in many plants exposed to environmental stresses such as drought, high salinity, high temperature, freezing, UV radiation, and heavy metals. Under stressed conditions, Pro has been considered to play an adaptive role in mediating osmotic adjustment and protecting the subcellular structure. In particular, many studies in plants have focused on the roles of Pro in defense mechanisms against impairments caused by osmotic stress. Some reports have indicated a positive correlation between the accumulation of Pro and stress tolerance in plants. However, in other reports, it was suggested that the increase in the free Pro level merely resulted from stress. Thus the roles of Pro in osmotolerance in plants still remain controversial, and there have been few practical demonstrations of the function and the mechanism of action of Pro throughout plant growth. In higher plants, Pro is synthesized via both the glutamic acid (Glu) and ornithine (Orn) pathways. The former is considered to be a major pathway, especially under osmotic stress. In the Glu pathway (Fig. 1), Pro is synthesized from Glu via 2 intermediates, glutamic- δ^1 -semialdehyde (GSA) and δ^1 -pyrroline-5-carboxylate (P5C). Two enzymes catalyze this pathway, P5C synthetase (P5CS) in the first step and P5C reductase (P5CR) in the final step. Genes encoding P5CS and P5CR have been isolated from various plants, and their expression and the functions of their products have been characterized. As a result, it has been shown that P5CS is the rate-limiting enzyme in Pro biosynthesis in higher plants. On the other hand, Pro is metabolized to Glu via P5C and GSA. Two enzymes catalyze this pathway, proline dehydrogenase (ProDH) in the first step and P5C dehydrogenase (P5CDH) in the final step.

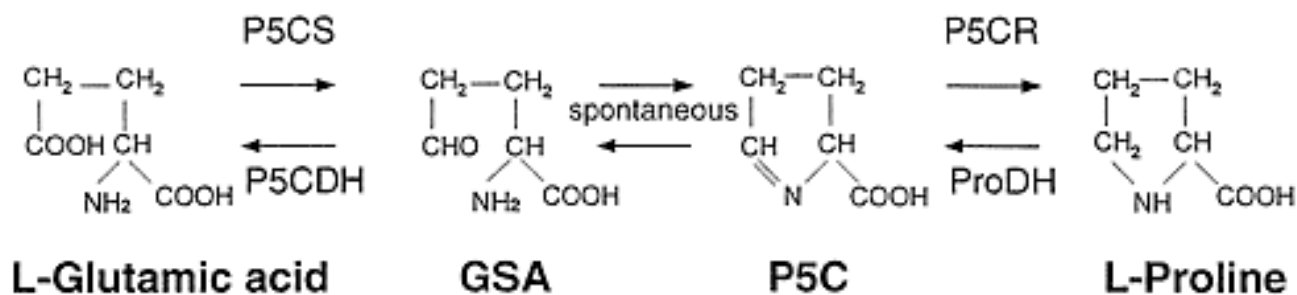


Fig. 1. Metabolic pathway of Pro in plants (the Glu pathway). GSA, glutamic- δ^1 -semialdehyde; P5C, δ^1 -pyrroline-5-carboxylate; P5CS, P5C synthetase; P5CR, P5C reductase; ProDH, proline dehydrogenase; P5CDH, P5C dehydrogenase.

Arabidopsis accumulates Pro in response to osmotic stresses due to drought, high salinity, and chilling. Stress-induced Pro accumulation in *Arabidopsis* is caused by the activation of Pro biosynthesis, and by the inactivation of Pro degradation. The elevated expression of an *AtP5CS* gene encoding the P5CS protein in *Arabidopsis* precedes the accumulation of Pro in response to these stresses. In contrast, the expression of the *AtProDH* gene is repressed during the stress conditions. Gene expression of *AtP5CS* and *AtProDH* corresponds well to Pro accumulation, suggesting that metabolic regulation is essential for the control of endogenous Pro level.

To investigate the function of Pro biosynthesis and degradation in the accumulation of Pro and to further elucidate the roles of Pro in growth and stress tolerance in plants, we generated antisense transgenic *Arabidopsis* plants with an *AtP5CS* and an *AtProDH* cDNA, respectively. The *AtP5CS* antisense transgenic plants exhibited morphological changes and were susceptible to osmotic stress. Mutated phenotypes in both morphology and osmotolerance were suppressed by the application of exogenous L-Pro but not by that of D-Pro, suggesting that Pro plays other roles in addition to being a compatible osmolyte in terms of osmotolerance in plants. We further investigated the specific effect of Pro deficiency on protein biosynthesis in the *AtP5CS* antisense transgenic plants. We observed a significant reduction in the Pro and hydroxyproline (Hyp) contents in hydrolysates of a purified cell wall fraction but not in the Pro content of hydrolysates of soluble proteins in transgenic leaves. These results show that Pro deficiency specifically leads to a defect in biosynthesis of the cell wall structural proteins in the transgenic plants. That is, Pro may act as a major constituent of structural proteins of cell walls in osmotolerance as well as morphogenesis of plants.

On the other hand, the *AtProDH* antisense transgenic plants showed an enhanced accumulation of Pro, providing evidence for a pivotal role of ProDH in Pro degradation. These transgenic plants were tolerant to freezing and high salinity, indicating the efficiency of suppressing Pro degradation in Pro accumulation, and the contribution of Pro to stress tolerance in higher plants (Fig. 2).

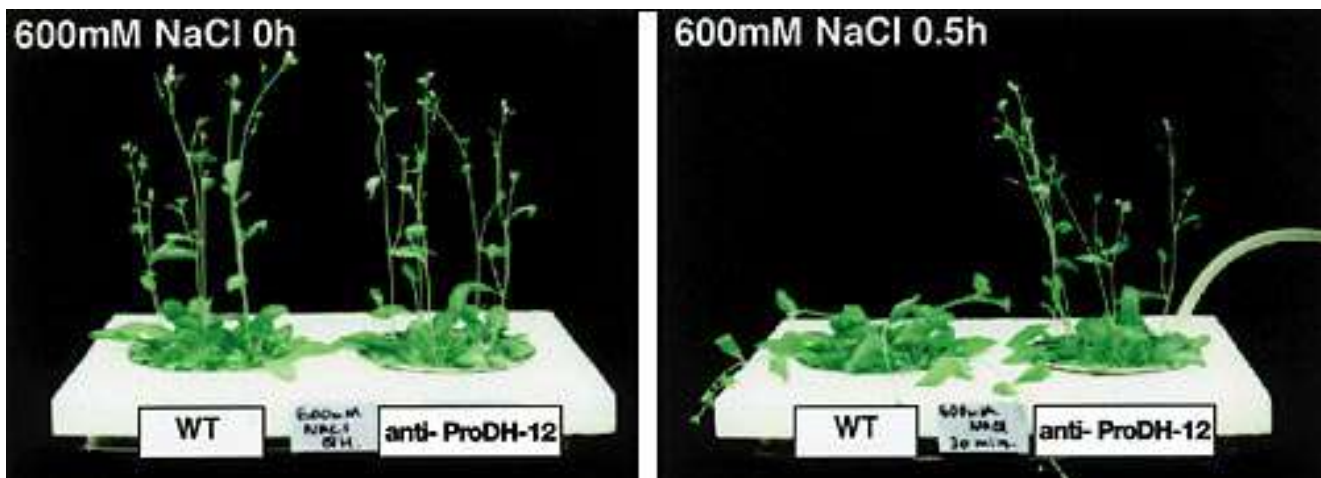


Fig. 2. Salinity tolerance of the *AtProDH* antisense transgenic plants. Phenotype of plants exposed to salinity stress for 0.5 h. Plants used for the analysis were wild-type (WT) and anti-*AtProDH*-12 transgenic plants.

In our study, we not only confirmed the key roles of two enzymes, P5CS and ProDH, in the regulation of Pro accumulation, but also revealed a positive correlation between Pro and osmotolerance in higher plants using transgenic technologies. Moreover, we identified a new function of Pro in growth and osmotolerance in plants.

Kazuko Yamaguchi-Shinozaki

Biological Resources Division, JIRCAS

Utilization of *Panicum maximum* in Agropastoral Systems in the Brazilian Savannas

Since the 1970s, *Brachiaria* spp. of African origin, such as *B. decumbens* and *B. brizantha* have been rapidly introduced into the Brazilian savannas. However, extensive pasture utilization without fertilizer application has led to the degradation of more than 50% of the pastures into which the grasses had been introduced. Recently, the adoption of agropastoral systems (sustainable crop-pasture rotation systems) has been considered to be an alternative for pasture renovation in the savanna regions. The major improvement in agropastoral systems for forage production is the residual effect of fertilizer applied to the preceding crops. Moreover, it is also expected that the residual effect of fertilizer applied to annual crops will enable to utilize high quality forage species even in the savanna soils with a low fertility. *Panicum maximum* is a promising forage species with a high productivity and high nutritive value. Therefore, in this study, the suitability of the use of *P. maximum* in agropastoral systems was examined in the Brazilian savannas.



Photo: Grazing experiment on the *Panicum maximum* pastures established after 4-year cultivation of soybean (front) and 4-year rotation of summer soybean with winter millet (back)

At first, a greenhouse experiment was conducted to compare the growth response of *B. decumbens*, *B. brizantha*, and *P. maximum* to different P (0, 25 and 50 kgP/ha) and N (25, 150 and 300 kgN/ha) application rates. P application increased the dry matter yield of the 3 species, and their response to the P application was very similar. On the other hand, an increase of N application up to 300 kg/ha resulted in the increase of the dry matter yield of *P. maximum* linearly, while the dry matter yield of *B. decumbens* and *B. brizantha* reached a plateau at 150 kgN/ha. Their external N requirement was in the following order: *P. maximum* > *B. brizantha* > *B. decumbens*. It appears that the high N external requirement of *P. maximum* may be associated with its high soil fertility requirement.

Furthermore, a grazing experiment was conducted at the National Beef Cattle Research Center of the Brazilian Agricultural Research Corporation in Campo Grande, Brazil. *P. maximum* pastures were established after 2 different cropping sequences: in one previous cropping sequence, soybean had been cultivated for 4 years in summer (SO-PM), and in the other, a 4-year rotation of summer soybean with winter millet for grazing (SO/MI-PM) had been adopted. The average soybean yield in the previous 4 years was 2,559 kg/ha. During a period of 253 days, herbage samples were harvested at 6-week intervals, and the dry matter productivity was evaluated. Table 1 shows the average value of total biomass (plant top + existing litter) during the experimental period. The average biomass in the SO-PM system was significantly higher than that in the SO/MI-PM system. Total dry matter production in the SO-PM system was much higher than that of the SO/MI-PM system. During the investigation period, leaf samples were taken 2 times to evaluate the nutritive value. Significant differences were observed in the contents of

crude protein and nitrogen. *In vitro* digestibility of SO-PM was also higher than that of SO/MI-PM. These data indicated that dry matter productivity and forage quality of SO-PM were much higher than those of SO/MI-PM. Based on the soil analysis, it is considered that, in the rotation of summer soybean with winter millet, soil nitrogen was immobilized into the plant residues of millet, and that *P. maximum* after the rotation could not utilize the soil nitrogen. Thus, the growth and forage quality of *P. maximum* were limited after the rotation of soybean and millet, because of its high nitrogen requirement.

However, in farming practices, rotation of summer soybean with winter millet is more rational than continuous soybean cultivation from the point of view of economic profit, weed management, and sustainability of the soil nitrogen content. Therefore, to achieve a high productivity and enhance the nutritive value of *P. maximum* even after the rotation of soybean with millet, application of a small amount of nitrogen fertilizer could be effective. It is also considered that the use of species other than *P. maximum* (such as *Brachiaria* spp. with a lower external N requirement) could be an alternative for the development of a sustainable agropastoral system.

Table 1. Average biomass, dry matter production and nutritive value of *Panicum maximum* pastures established after 4-year cultivation of soybean and 4-year rotation of summer soybean with winter millet

•@	Average biomass	Dry matter production	Crude protein	In vitro digestibility	Nitrogen
•@	(DM t/ha)	(DM t/ha/253 days)	(%)	(%)	(%)
After soybean	12.7	16.6	12.7	56.0	1.92
After soybean+millet	9.0	10.3	8.6	51.8	1.31

Tsutomu Kanno**, *M. C. M. Macedo**

****Animal Production & Grassland Division, JIRCAS,***

*****National Beef Cattle Research Center,***

CNPq Researcher (Fellow of the Brazilian National Council of Research and Development), Brazil

Technology Selection in Mekong Delta Project

For the implementation of research projects dealing with technology development, attention should be paid to the kind of technology required for meeting farmers, needs. In particular, in the case of comprehensive research projects, component technology should be integrated. In our project, in order to meet farmers, needs for technology development and to integrate component technology within the whole farming systems, we applied a farming systems research and extension approach for selecting the technologies to be developed in the project. The study site is representative of the irrigated alluvial soil area in the Mekong Delta, Vietnam. In the above approach, the first step is the diagnosis stage and the second step, the design stage. In the first step, problems and requirements were identified and compiled. In the second step, we applied the AHP-Method for evaluating the technology. In the AHP-Method (Analytic Hierarchy Process), the decision-making process is applied when there are options with some of the criteria conflicting with each other.

The results were as follows. As shown in Table 1, among the problems, those related to the farming systems were as follows: 1) "Difficulty in adoption of VAC systems," "Difficulty in crop selection and combination," 2) Optimum waste disposal," 3) Waste pollution," and 4) " Optimum way of selecting chemicals." Besides these problems, there are various kinds of individual problems in each component such as rice-fish, livestock, fruit trees and fisheries.

Based on the above data, we listed up the technology required to address these problems. We compared each technique with the criteria. The criteria suitable for technology assessment (evaluation) included "effects," "technology level" ("possibilities"), "ease of adoption for farmers (to learn technology),"and " research cost." For each criterion, the respective techniques were scored. Fig. 1 shows the results of the analysis.

In this figure, IPNM technology was evaluated. IPNM stands for integrated pest and nutrient management. IPNM technology includes: "Comparison of sustainability of double and triple rice cropping," "Development of measures to maintain or improve soil fertility," "Development of fertilizer application methods," "Utilization of resistant varieties," "Renewal of varieties," "Utilization of natural enemies," "Protective methods associated with labor-intensive management," "Development of rice-duck system," "Development of rice-fish system." IPNM technology is one of the important technologies for farming systems and one of the possible solutions to address problems such as "Optimum waste disposal" and "Optimum way of using chemicals." Among the IPNM techniques, "Development of measures to maintain or improve soil fertility (fruit tree gardens and paddy fields)" includes manure production and composting technology, evaluation of fish pond and canal deposits as fertilizer, and evaluation of fermented liquid from bio-digester as fertilizer. "Protective methods associated with labor-intensive management" refer to the development of water control methods which include land leveling and deep water management for weed control. "Development of rice-fish system" aims at weed control and reduced use of chemicals. "Development of rice-duck system" aims at the control of the golden apple snail. Among these, "Development of measures to maintain or improve soil fertility" had the highest total score. Especially the scores of effects and technology level were much higher compared with others. On the other hand, we obtained the results of evaluation from farmers. As it is too difficult for farmers to answer in the form of AHP-Method, we decided to ask them to score each research topic. As a result, "Development of measures to maintain or improve soil fertility" had a higher score. Therefore, we

selected this technology for development in the project. Likewise, we also selected technologies in other research fields.

In the above process, we identified the technologies to be applied in the Phase 2 of the Mekong Delta project. The objective of the project is to develop sustainable farming systems by technology development for environmental conservation, including bio-digester technology, technology for soil fertility preservation, and water control technology. At the same time, component technology will be developed as follows: 1) In the rice component, direct seeding technology, IPM technology, rotation technology, and drying technology, 2) In the pig component, feeding technology by using local resources and disease control technology, 3) In the fruit tree component, IPM technology, 4) In the aquaculture component, farming technology and seed production technology. These technologies were selected based on farmers, requirements identified at the diagnosis stage. At the design stage, we considered four important criteria such as "effects," "technology level" ("possibilities"), "ease of application for farmers (to learn technology)," and "research cost." The procedure described above may enable to minimize the risks of failure of technology development and to increase the possibility of integrating each technology for the implementation of the comprehensive research project.

Table 1. Main problems relating to farming systems

1 <Difficulty in VAC systems adoption / Difficulty in crop selection and combination>

It is difficult to adopt VAC systems due to the lack of resources / capital. I do not know how to select and combine components. It is difficult to invest due to the difficulty in borrowing money.

2 <Optimum waste disposal>

I do not know what is the optimum amount of wastes in ponds and ditches. There are problems about the decrease in soil fertility. But, there is neither enough knowledge nor enough materials to make manure.

3 <Waste pollution>

Livestock wastes cause environmental problems such as decrease of water quality and bad smell. On the other hand, it is difficult to use the bio-digester.

4 <Optimum way of using chemicals>

I do not know the optimum way of applying fertilizers and of spraying pesticides and herbicides.

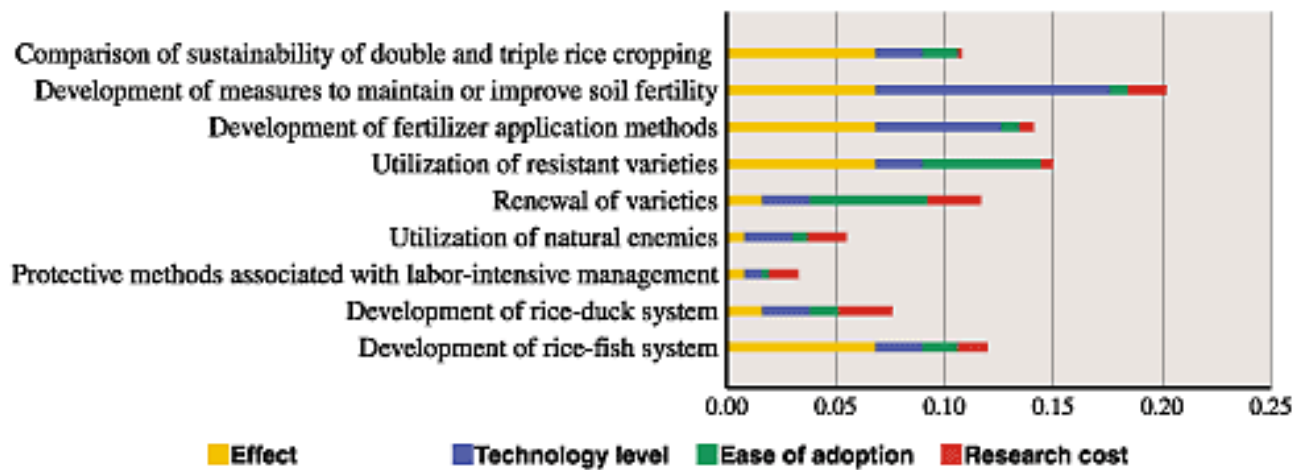


Fig. 1. Technology evaluation by AHP (IPNM).

Ryuichi Yamada
Development Research Division, JIRCAS

International Symposium on "Lignocellulose - Material of the Millennium: Technology and Application"

A joint international symposium between JIRCAS and Universiti Sains Malaysia (University Science Malaysia, USM) was held at Penang, Malaysia, during the period of March 20 ~ 22, 2001. The symposium was titled: "Lignocellulose - Material of the Millennium: Technology and Application." The purpose of the symposium was to exchange information on the latest achievements in research works on lignocellulose and related materials through paper presentations and discussions.

More than 100 participants attended the symposium, including 20 from Japan, 60 from Malaysia, and others from Europe, North America and Asian countries. There were 39 oral presentations, including 5 lectures and 40 posters.

Professor Mohd. Azemi Mohd Noor (Chairman of the Symposium, USM) and Dr. Terunobu Suzuki (Director of Forestry Division, JIRCAS) delivered the opening addresses, followed by the declaration of official opening of the symposium by Y. Bhg. Dato, Professor Dzulkifli Abdul Razak (Vice Chancellor, USM). Session I included 5 presentations on pulp, paper and cellulose derivatives. Session II was held in the afternoon with 7 papers relating to food, feed and medical applications of lignocellulosic materials (Session II-A) and 7 presentations on lignocellulose-based composites (Session II-B). On the morning of the second day, Session III-A dealt with the properties and characterization of lignocellulose materials and products (6 papers), while Session III-B with lignocellulose composites (8 papers). Sessions II-B and III-B differed in terms of processing and utilization of lignocellulosic fibers, namely fiber-reinforced composites (II-B) and chemical reaction on fibers (III-B). After Session III, a poster session with 40 papers was held. Session IV included 6 presentations on new technological developments in lignocellulose research, followed by the closing ceremony with a speech by Professor Azemi and closing remarks by Dr. Suzuki. On the last day, March 22, a visit to a wood-based board factory, including briefing of Penang Island, was organized for all the participants. The symposium was very successful due to the strong commitment of the experienced staff of USM.

During the symposium, participants exchanged views and opinions on a wide range of research works related to wood and non-wood lignocellulosic materials. A large number of papers presented during the symposium involved studies on the extraction of lignocellulose materials from plant by-products such as oil palm wastes, rubber wood and banana fibers, which are often discarded after collection of the main products. The current project between JIRCAS and USM, indeed, dealt with such materials, especially by-products from oil palm. The presentations indicated that there is a great potential for the utilization of these wastes as raw materials for the production of pulp, paper, composites and plastics in addition to food and feed resources. It was also noted that the relationship between JIRCAS and USM had been strengthened through this joint symposium.



Opening ceremony



Audience during an oral presentation

Ryohei Tanaka
Forestry Division, JIRCAS

[JIRCAS Newsletter No.27 June 2001](http://ss.jircas.affrc.go.jp/kanko/newsletter/nl2001/No.27/06.html)

Workshop

International Workshop on Nitrogen Fertilization and the Environment in East Asian Countries

The use of nitrogen fertilizers has significantly contributed to the remarkable increase of the production and yield of various staple crops since the Green Revolution. However, in recent years, the beneficial effect of nitrogen fertilization on crop production has been somehow offset by the occurrence of adverse effects on the environment. Excessive use of nitrogen fertilizers often induces pollution of soils, water and the atmosphere by the emission of nitrogen compounds. Such environmental problems have recently become serious in the countries of East Asia, namely China, Korea and Japan, which are characterized by intensive agriculture with high input due to recent economic development and high population density.



The international workshop on "Nitrogen Fertilization and the Environment in East Asian Countries" held on February 5-9, 2001 addressed the issues related to nitrogen fertilization and the environment in East Asian countries and aimed (1) to exchange views on the issues, (2) to identify gaps in knowledge, and (3) to discuss future research needs and possible forms of cooperation. The workshop hosted by the Environmental Resources Division of JIRCAS included an international symposium, a planning meeting for the environmental component of the JIRCAS China project, and a field excursion tour.

A total of 100 scientists from 15 countries participated in the 2-day, s international symposium. After the opening address delivered by Dr. T. Inoue, Director General of JIRCAS, Dr. A. Mosier of USDA-ARS and three other leading scientists from China and Japan presented keynote lectures to outline the issues in East Asian countries and the world. Then followed 6 general sessions with 25 reports by researchers from Japan, China, Korea, UK, Germany and USA. The symposium was closed by discussion sessions both in the break-out groups and synthesis and closing remarks by Dr. Minami, Director General of the National Institute for Agro-Environmental Sciences.

During the 4th planning meeting for the environmental component of the JIRCAS China project titled: "Evaluation and development of methods for sustainable agriculture and environmental conservation," discussions were held on the results and future plans of the project with participants outside of the project in addition to the counterparts. During the excursion tour, the participants visited JIRCAS experimental fields, Shizuoka Prefecture Tea Experiment Station, and Shizuoka Prefecture Agricultural Experiment Station and exchanged views on recent studies conducted in Japan and technologies applied for minimizing the impact of nitrogen fertilization on the environment.

This was the first international workshop focused on nitrogen fertilization and environment in East Asia. We consider that this workshop gave a good opportunity to promote the development of technologies or policies that maximize the use of land, water, soil, and biota resources without exerting an adverse impact on the environment, by the development of research networks in East Asian countries and the world.

For further details, please visit our web site (<http://www.jircas.affrc.go.jp/EANWS/EANWStop.html>)

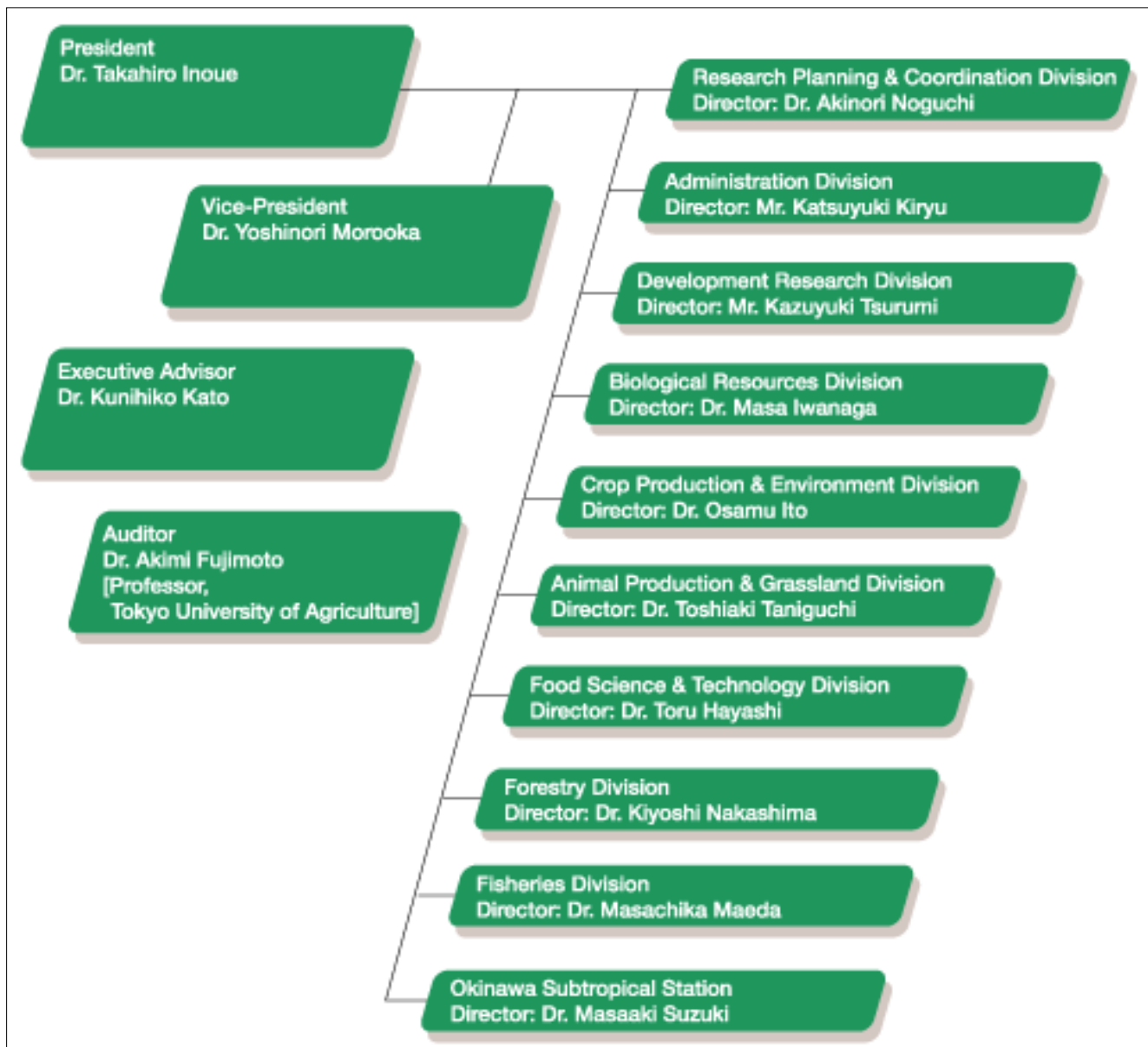


Participants in the workshop

Kazuyuki Yagi
Environmental Resource Division, JIRCAS
(Present, National Institute for Agro- Environmental Resource)

[JIRCAS Newsletter No.27 June 2001](#)

Japan International Research Center for Agricultural Sciences (JIRCAS)



The 8th JIRCAS International Symposium

The 8th JIRCAS International Symposium with the tentative title of "Water for Sustainable Agriculture in Developing Regions" will be held at Epochal Tsukuba, Tsukuba, Japan during the period of November 27-28, 2001.

For further information, please contact: **Dr. Masaharu Yajima**
Secretary of the Organizing Committee for the 8th JIRCAS International Symposium

Japan International Research Center for Agricultural Sciences (JIRCAS)
1-1 Ohwashi, Tsukuba, Ibaraki 305-8686 JAPAN
Fax: +81-298-38-6342
E-mail: symp8@ml.affrc.go.jp

NEWSLETTER
JIRCAS

Japan International Research Center for Agricultural Sciences (JIRCAS)



June 2001-No.27
Editor : Tetsushi HIDAKA

1-1 Ohwashi, Tsukuba, Ibaraki, 305-8686 JAPAN
Phone. +81-298-38-6304 Fax. +81-298-38-6342
letter@ml.affrc.go.jp
<http://www.jircas.affrc.go.jp/>

[JIRCAS Newsletter No.27 June 2001](#)



City market at Vientiane, Laos (Photo by T. HIDAKA)

NEWS LETTER

JIRCAS

Japan International Research Center for Agricultural Sciences

For International Collaboration

June, 2001

27

Contents

Message from the President of JIRCAS	2
Biological Function of Proline in Osmotolerance	3
Utilization of New Forage Species in Agropastoral Systems	4
Technology Selection in Mekong Delta Project	5
Symposium	6
Workshop	7
New Structure of JIRCAS	8



Pineapple fields on hilly land near Luang-Prabang, Laos (Photo by T. HIDAKA)

NEWSLETTER

JIRCAS

Japan International Research Center for Agricultural Sciences

For International Collaboration

September, 2001

28

Contents

[Shift in Environmental Research at JIRCAS](#)

[Soybean Project in South America](#)

[Diagnosis and Prevention of Shrimp Viral Diseases](#)

[Agro-Environment and Land Use in West Java](#)

[Workshop on Rice Farming Research in West Africa -Economic Analyses-](#)

[China - Japan Annual Meeting](#)

[Forthcoming JIRCAS Symposium](#)

[People](#)

JIRCAS Newsletter No.28 September 2001

Feature Article

Shift in Environmental Research at JIRCAS Following Restructuring



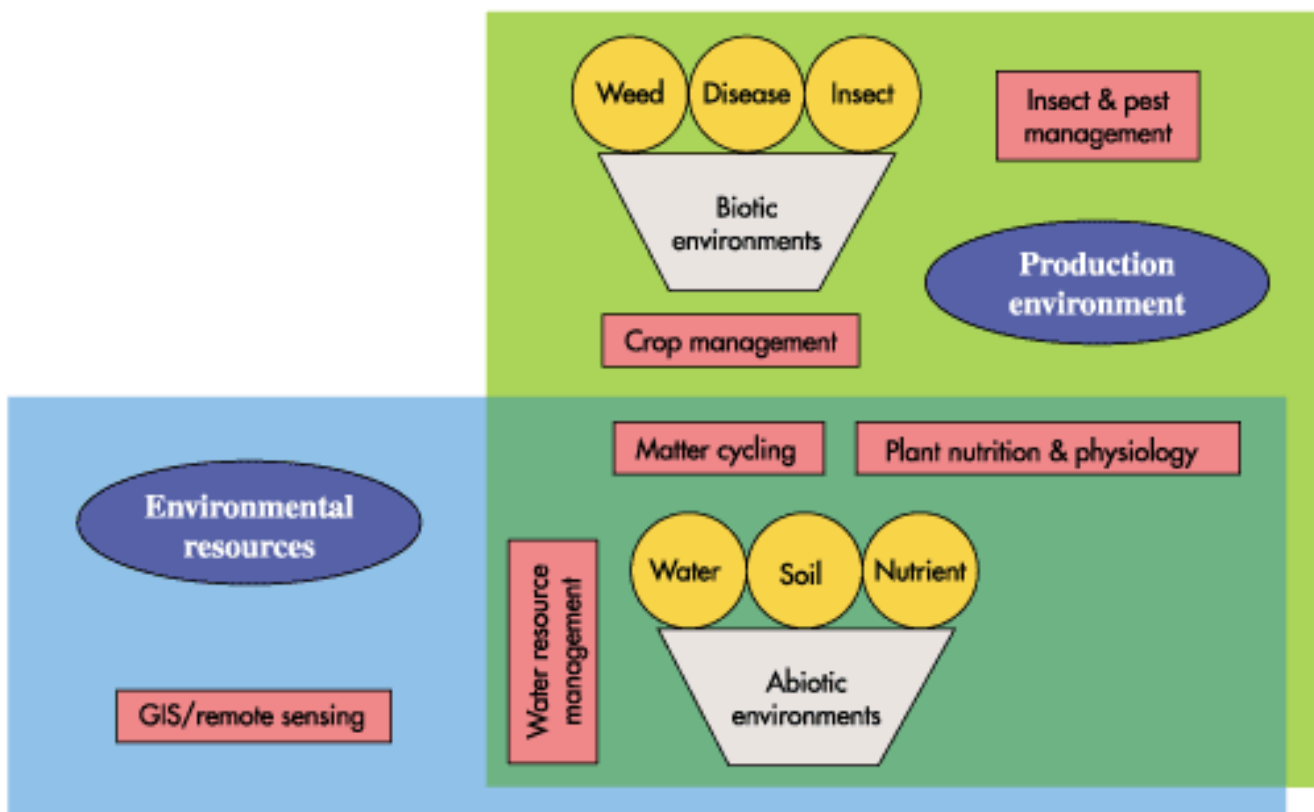
•@Characterization of environmental resources has been one of the key research activities of JIRCAS and has been carried out mainly on a large scale by applying remote sensing techniques within the framework of geographic information systems (GIS). These activities are closely associated with the major comprehensive projects that JIRCAS is implementing in different parts of world. The outcome is utilized by other scientists in the projects for their own research as basic information about their study area. These activities are expected to contribute to prioritization of research needs and integrated analysis of individual results in the projects. Due to the high expectation of stronger linkages with socio-economic analysis, it was eventually decided to transfer this part of activities to the Development Research Division at the time of the reorganization of JIRCAS. This functioned as a trigger for major changes in the divisional concept of the former Environmental Resources Division from macro-analysis of environmental resources to micro-analysis of production environments including not only abiotic but also biotic components. Beside the analyses using GIS/remote sensing, the Division had been dealing with the nutrient flow in agro-ecosystems and abiotic stress management under unfavorable conditions, indicating that the main focus of the Division had been placed on abiotic components among various environmental resources relating to agricultural production. Incorporating research groups specialized in the management of crops, water resources, and pests and diseases, the new Division (Crop Production & Environment Division) is now ready to start research, focusing more on the development of integrated technologies required for the improvement of productivity and sustainability in a cropping environment.

•@The majority of the research themes documented in the mid-term plan of JIRCAS for the next five years will be conducted through so-called comprehensive projects as driving vehicles. The projects have been merged into five groups based on the type of activity and/or target region. The projects will be managed by the JIRCAS scientists under long-term assignments as core researchers, assisted by scientists not only from JIRCAS but also from other research organizations who will be sent under short-term assignments. More than half of the scientists in the Division are stationed at a project site and conduct their activities under the management of a two-way matrix with one axis for the Division and one for the project. The other half of the scientists in the Division carry out research mainly at the Headquarters. As long as they participate in a comprehensive project, however, they operate within the matrix frame as in the case of the scientists in secondment. In most of the cases, these scientists are under the supervision of the Division Director and the project coordinator. Although the matrix system tends to increase the complexity of the operations within the organization, it certainly contributes to enhancing the transparency of the management and the interaction among staff scientists with different backgrounds,

which is necessary for multidisciplinary projects. Especially for research aiming at technology development for cropping systems in different agro-ecosystems, which should be the major task for the new Division, tighter linkage among the scientists is most important to achieve the objectives since any technologies applicable to the field conditions should result from the integration of various scientific disciplines. Through the grouping of scientists with similar disciplines and active interaction among the groups, we hope to generate more in-depth discussions on the subjects and more systematic integration of the research plan and results from different groups.

Osamu Ito

Director, Crop Production & Environment Division, JIRCAS



Shift in the divisional thrust from environmental resources to production environments

Collaborative Research Project

Comprehensive Studies on Soybean Improvement, Production and Utilization in South America and Mid-Term Evaluation Meeting

•@In 1997, the comprehensive collaborative project titled: "Comprehensive studies on soybean improvement, production and utilization in South America" was initiated in the MERCOSUR countries. The project is focusing on the development of sustainable and more efficient systems of soybean production in the MERCOSUR countries such as Brazil, Argentina and Paraguay, because soybean production in this area accounts for approximately one-third of the total world production, and unstable production of soybean in these countries may hamper the supply of soybean worldwide. However, soybean production in South America has often been carried out under environmentally vulnerable conditions in arid and acid soils characterized by a low fertility. On the other hand, since the history of soybean cultivation in this area is relatively short, there is a growing concern that continuous cropping, pest and disease outbreaks, and soil erosion may adversely affect future soybean production.

•@This comprehensive project focuses on research in five areas: genetics and breeding, soil management and pest control, crop management and production, postharvest technology, and socio-economic analysis. The project is executed in collaboration with several South American research organizations, such as National Center for Soybean Research (CNPSO) and National Center for Beef Cattle Research (CNPGC), Brazilian Agricultural Research Corporation (EMBRAPA), Center for Agricultural Technology in Paraguay (CETAPAR), Japan International Cooperation Agency (JICA) and Ministry of Agriculture and Livestock, Paraguay (MAG), and Marcos Juarez Agricultural Experiment Station (EEA-MJ), National Institute of Agricultural Technology, Argentina (INTA). Presently, in 2001, three researchers on a long-term basis are carrying out studies on genetics and breeding, soil management, and drought tolerance of soybean cultivars, respectively at CNPSO, Brazil. One researcher on a long-term basis is conducting studies on soybean diseases at EEA-MJ, Argentina. Studies on plant parasitic nematodes are being carried out at CETAPAR/JICA, Paraguay. In addition, one scientist currently stationed at CNPSO is in charge of the coordination of the project.

•@The seminar on soybean research conducted between CNPSO and JIRCAS was held at CNPSO on December 11, 2000 for the preparation of the mid-term evaluation meeting. Some of the reviews and results obtained in this project were presented and discussed during the seminar.



JIRCAS researcher collecting soil samples for isolation of plant parasitic nematodes in a no-tillage soybean field in Paraguay.

Greenhouse experiments for the evaluation of the micronutrient status in soybean plants at CNPSo, EMBRAPA.

•@A mid-term evaluation meeting for this project was organized on March 22, 2001 at Tsukuba by JIRCAS. The main purpose of the meeting was to evaluate the results and to examine the future research orientation of the project. Dr. Peter Kerridge, Coordinator, International Center for Tropical Agriculture (CIAT)-Asia, CIAT, Prof. Dr. Kazuo Kawano, Kobe University, and Dr. Shinji Sakai, Director of Department of Crop Breeding, Tohoku National Agricultural Experiment Station were invited as commentators for the meeting.

•@After the opening address given by Dr. Takahiro Inoue, Director General of JIRCAS, the researchers of JIRCAS and related institutes presented the results and future research plans for each subject as follows: 1) Genetic improvement of chemical constituents in soybean seeds, 2) Production of DNA markers, Breeding methods for insect-resistant soybean plants in South America, 3) Identification of soybean genes for resistance to *Phytophthora sojae* using molecular markers, 4) Improvement of soil management practices, 5) Improvement of methods of control of diseases and insects in Paraguay, 6) Ecology and control of major diseases of soybean in Argentina, 7) Morphological and physiological characterization of drought-tolerant soybean cultivars and identification of selection criteria for drought tolerance, 8) Analysis of soybean supply and demand, and 9) Socio-economic evaluation of new technologies.

•@After the presentations, several critical comments on the studies were presented and the participants discussed solution strategies and future plans for the studies. They also exchanged views on the progress of the project during the meeting. Finally, the framework, future plans and orientation of the project were approved in general. Particular issues raised by one reviewer were as follows: 1) To define more clearly how this project could contribute to overall research on soybean improvement in South America, 2) To give a high priority to the development of soybean for consumption as food as well as to carry out research common to all soybean production, 3) To continue to promote a close collaboration with national scientists.

•@A workshop on soybean will be held in November 2001 in Brazil during which feedback of the current studies and the future orientation of the program will be discussed.

Toshiaki Taniguchi
Director, Animal Production & Grassland Division, JIRCAS

JIRCAS Research Highlight

Diagnosis and Prevention of Shrimp Viral Diseases in Southeast Asia

•@Southeast Asia including Thailand, Malaysia, Indonesia, and so on, is a significant area for world shrimp culture. However, in recent years, the production of cultured shrimps has markedly decreased as a result of serious viral disease outbreaks. The increased severity of widespread viral infection is the major constraint on stable aquaculture. Therefore, in order to ensure sustainable production of cultured products, it is essential to adopt preventive countermeasures against viral diseases. Therefore, the development of rapid diagnosis and inactivation methods for White Spot Syndrome Virus (WSSV), which is the most serious problem in Southeast Asia, was promoted.

•@Serological diagnosis using monoclonal antibodies is one of the most rapid and accurate methods, in addition to the low cost and simplicity. The use of monoclonal antibodies resulted in a higher sensitivity to the virus than the use of polyclonal antibodies, because monoclonal antibodies give a very specific reaction against a particular part of the virus. The methods of monoclonal antibody production involve four steps. First, the virus antigen to mice was prepared by artificial injection of the wild pathogen virus to healthy prawns. The hemolymph containing a large amount of virus was collected from diseased prawns, and then the virus was concentrated and purified by high speed centrifugation and ultracentrifugation. In the next step, mice were immunized. The virus antigen prepared in the previous step was injected intraperitoneally into the mice, and then a few more viral injections were performed as a booster after three weeks. In the third step, cell fusion took place. After the final immunization, the spleens of immunized mice were removed and the spleen cells were fused with myeloma cells, because the spleen cells can not survive over a long period of time, while the hybridomas (fused spleen and myeloma cells) can grow and produce antibodies. In the final step, screening and culture were performed. The cells, which produced the specific antibodies against WSSV were selected by screening from many hybridomas using the immuno-fluorescence technique (Fig. 1).

•@After screening, they were cultured and they produced antibodies used as monoclonal antibodies. A few strains producing virus-specific antibodies were obtained from more than 100 strains of hybridomas, which were selected by antibody production tests. Hereafter, virus-specific strains will be further selected and used for the diagnosis of the disease caused by WSSV.

•@Viral inactivation was tested using chemicals, such as formalin and halogenous disinfectants, including sodium hypochlorite and IsodineR (povidone-iodine was an effective ingredient). The concentrations of formalin were 0, 0.1, 0.25, 0.5 and 1% (V/V), while 0, 0.5, 1.0, 2.5 and 5.0 ppm of effective chloride in sodium hypochlorite, and 0, 2.5, 5.0 and 10.0 ppm of effective povidone-iodine in IsodineR were used for the inactivation test. These chemicals were mixed with equal volumes of the virus and then made to react together at 25°C for 10 minutes. After the reaction, the resultant products were injected intramuscularly to 10 healthy prawns at the dose of 0.1 ml/prawn. The mortality was monitored for 2 weeks after the injection. The experiments showed that mortality was not recorded at concentrations above 0.25%, 0.5 ppm, and 2.5 ppm for formalin, effective chloride in sodium hypochlorite, and effective povidone-iodine in IsodineR, respectively (Fig. 2). These data indicated that halogenous disinfectants induced an effective

inactivation even at lower concentrations. It was suggested that these disinfectants were extremely useful for the inactivation of WSSV.

•@The studies on the diagnosis and disinfection of WSSV should enable to prevent pathogen intrusion into aquaculture farms, and, therefore, should contribute to sustainable aquaculture in Southeast Asia.

Norihisa Oseko

Fisheries Division, JIRCAS

(WSSV antigen was stained by FITC-labeled virus-specific monoclonal antibody).

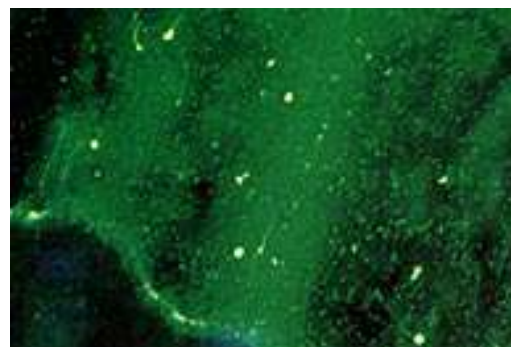


Fig. 1. Positive sample for the screening test using monoclonal antibody. (WSSV antigen stained by FITC-labeled virus-specific monoclonal antibody)

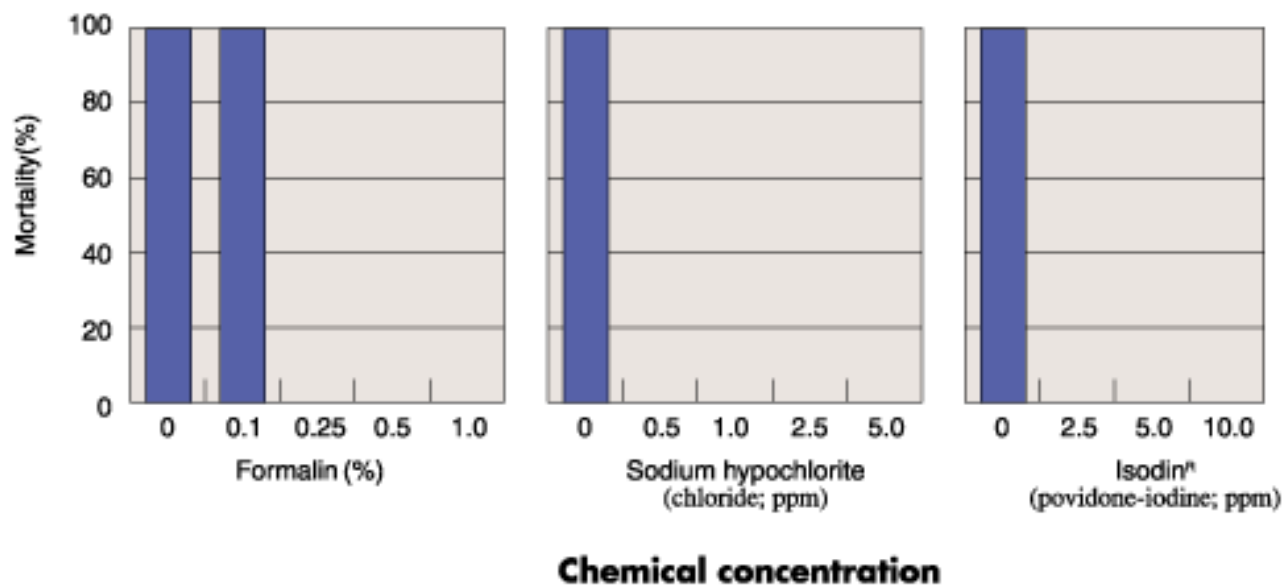


Fig. 2. •@Virus inactivation effects at several concentrations of chemicals: formalin, chloride, and Isodin^R.

JIRCAS Research Highlight

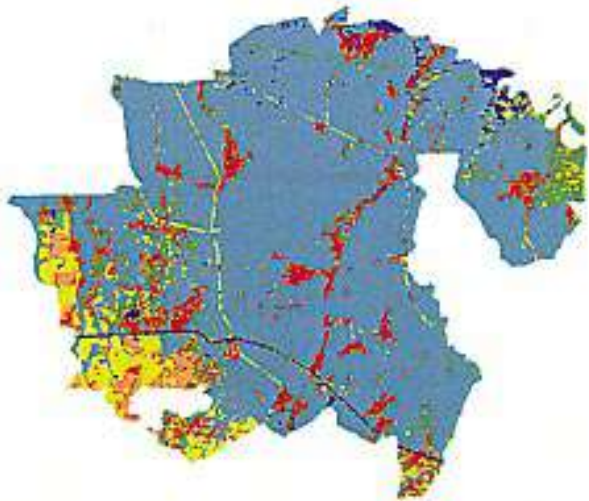
Agro-Environment and Land Use in Different Farming Systems in West Java, Indonesia

- @Farming Systems (FS) in Indonesia have been implemented and developed in harmony with physical and socio-economic conditions through a long history of human activities. In this country, FS comprise a variety of types associated with the great diversity in the geographic and cultural environment of more than 17,000 islands. This study focused on the spatial analysis of agro-environmental factors for typical FS in West Java in association with land use changes, by using satellite data, thematic maps and statistical data.
- @Two specific FS implemented in a flat area and mountainous area, Kecamatan (Sub-district) Binong in Kabupaten (Regency) Subang and Kecamatan Cibinong in Kabupaten Cianjur, respectively, were characterized in this study. In order to describe the characteristics of FS clearly, methods to quantify the distribution pattern of land use and to identify the planting time and cultivation pattern of rice fields were developed.
- @Land use maps in Binong and Cibinong were obtained by supervised classification of LANDSAT/TM data acquired on June 26, 1997. The map showed that most areas in Binong were occupied by paddy fields, while in Cibinong two dominant land use types characterized by upland fields and forests were observed. Entropy, which is the index of randomness of distribution, indicated that the land use in Cibinong was more dispersive than that in Binong. The value of entropy calculated for Cibinong was 1.921, whereas 1.291 for Binong. Entropy value depending on land use categories was the lowest, 0.333 for paddy fields in Binong, suggesting that the distribution of paddy fields in Binong was very concentrated. In contrast, in Cibinong, paddy fields showed the highest degree of dispersion with the highest entropy value of 2.598 (Fig. 1).
- @Topographic factor analysis using Digital Elevation Model indicated that Binong was very flat with a low elevation and topographically homogeneous. On the other hand, the Cibinong location showed a wide range of elevations and consisted of a steep sloping area. These topographic features affected the distribution pattern of agricultural land use at each site. Analysis of the location of land use in Cibinong showed that upland fields were mainly distributed in the area where the elevation ranged between 200 and 600 m and the soil type consisted of Yellowish Red Podsollic soil, while forests were located in areas around 1,000 m in elevation with two soil types; 1) a combination of *Yellowish Red Podsollic*, *Yellow Podsollic* and *Regosol*, and 2) an association of *Brown Andosol* and *Brown Regosol*.
- @In the irrigation area located in the northern plain in West Java, the cropping pattern of rice was analyzed using the Normalized Difference Vegetation Index (NDVI) data, which were provided as 10 day-composite maximum values with 1 km mesh. The analysis of the temporally sequential NDVI data set showed that the time of planting of rice, which started from the upper part to the lower part of the irrigation network, could be spatially represented. These findings suggest that the progression of planting can be estimated by the multi-temporal data obtained at appropriate times, although the planting time of rice changed year by year. The pattern of planting and growing of rice in Binong was analyzed in greater








detail by using NDVI of LANDSAT/TM data, which showed a higher spatial resolution (30 m) and could be compared with the data from the irrigation planning map issued by the Provincial Office. The results indicated that the TM data enabled to detect the variation in cropping time in smaller land units than the units shown in the irrigation planning map (Fig. 2).

•@From 2001 onward, studies on vegetable-based FS will be initiated in addition to those on contrasting FS of Cibinong and Binong, to identify the constraints on sustainable and efficient production of vegetables in West Java.

Yukiyo Yamamoto and Satoshi Uchida
Development Research Division, JIRCAS



[Binong]

	Km2	%	Entropy
 Paddy fields	110.5	72.0	0.333
 Plantations	10.9	7.1	2.052
 Mixed gardens	11.0	7.2	2.657
 Bare soil	3.2	2.1	1.285
 Settlement	13.7	8.9	2.210
 Infrastructure	0.3	0.2	1.999
 Water	3.8	2.5	1.902
Total	153.4	100.0	1.291



[Cibinong]






	km2	%	Entropy
 Paddy fields	21.7	4.9	2.598
 Upland fields	219.4	49.5	1.112
 Tea gardens	1.7	0.4	1.864
 Forests	161.5	36.4	1.588
 Bare soil	39.2	8.8	2.039
Total	443.4	100.0	1.921

Fig. 1. Land use maps produced by satellite data classification.

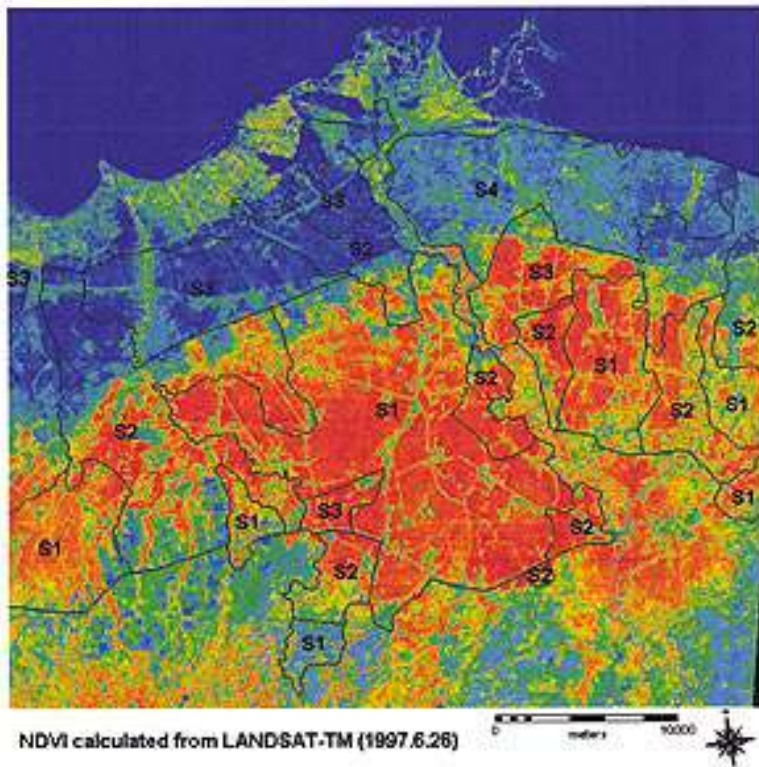


Fig. 2.Spatial distribution of NDVI calculated from LANDSAT/TM data (colored parts) compared with land units derived from the irrigation planning map (boundaries are indicated by black solid lines) in the northern coastal area of West Java.

Note:Reddish part shows higher values of NDVI of LANDSAT/TM. Based on the irrigation planning map, the time schedule of irrigation was divided into 4 periods, S1 to S4, and the area with identical symbols should be irrigated during the same period.

Workshop & Meeting

Economic Analyses of Agricultural Technologies and Rural Institutions in West Africa: Achievements, Challenges and Application to Rice Farming Research

- @The international workshop titled:"Economic Analyses of Agricultural Technologies and Rural Institutions in West Africa," with emphasis placed on rice farming research in the region, was held at JIRCAS on July 12-13, 2001.
- @In 1998, JIRCAS initiated a collaborative research project with the West Africa Rice Development Association (WARDA). Rapid demographic expansion and urbanization in Africa have shifted food preferences from traditional foodstuffs to rice and bread, and the demand for rice in sub-Saharan Africa is growing faster than that for any other major food staples. These patterns are especially evident in West Africa. In collaboration with WARDA, JIRCAS is conducting an economic study, focusing mainly on rice farming in lowland regions of Cote d'Ivoire and Ghana. Factors such as land tenure management through local organizations, market access and access to capital through informal financial systems are recognized to play important roles in farmers, capacity to adopt and use improved technology, including such developments as land improvement through investment in water control mechanisms, utilization of improved varieties, chemical inputs, and related cultural practices. Furthermore, it has been observed that the systems by which individuals gain access to land and capital may be discriminatory toward an individual,s social origin and gender. Therefore, the objective of this project is to assess how the institutional and economic environment affects the farmers, capacity to effectively adopt new technology.
- @The value of economic analysis has already gained clear recognition in the field of agricultural research in developing countries. Its potential value is expected to be even greater for the assessment of the impact of technology systems as well as policy/institutions on the welfare of agricultural households and the regional economy. Session I reviewed socio-economics research activities in CGIAR Centers (i.e. ICRISAT, IITA and WARDA) and JIRCAS in West Africa and the roles of economic analyses in the field of agricultural research were discussed. Session II was focused on the rice farming-related research of the JIRCAS-WARDA project and details of the schemes and methodology of economic analysis were discussed. The workshop, with 53 participants, provided an excellent opportunity to discuss the role of economic studies in addressing the problems related to agriculture and rural livelihood in West Africa. It was also pointed out that the effective interaction between economic studies and technological studies based on a multi-disciplinary approach was essential to facilitate agricultural research and development in the region.

Hiroko Takagi
Development Research Division, JIRCAS



Discussion at the workshop

Workshop & Meeting

Sixth China -Japan Annual Research Coordination Meeting

•@Following the 20th Annual Group Meeting on Exchange of Agricultural Science and Technology between China and Japan held in Tokyo, the Chinese delegation led by Mr. Tang Zhengping, Director-General, Department of International Cooperation, Ministry of Agriculture, PRC, visited JIRCAS on May 31, 2001 in order to attend a research coordination meeting for discussing substantial issues relating to the ongoing comprehensive research project "Development of sustainable production and utilization of major food resources in China." This coordination meeting has been organized alternatively in China and Japan and this year, the sixth annual meeting was held. Both parties appreciated the favorable evaluation of the project conducted during the mid-term research review meeting held in February 2001. JIRCAS expressed its gratitude for the appropriate procedures implemented for duty-free import of research materials sent to China and the granting of visas to the Japanese scientists. This year, the main discussions focused on the orientation of international research collaboration after the reorganization of JIRCAS into an independent administrative institution (semi-autonomous agency) and the appropriate allocation of the budget for supporting the collaborative research project. Next annual meeting will be held in Beijing in May 2002.

Masanori Inagaki
Research Planning & Coordination Division, JIRCAS



Participants in the meeting

8th JIRCAS International Symposium

Water for Sustainable Agriculture in Developing Regions -More crop for every scarce drop-

Date: 27 - 28 November 2001

Venue: Epochal Tsukuba, Tsukuba Science City, Japan

Background and Objectives

- @Many observers have pointed out the dangers of future food shortages and famine due to impending global water shortages. Already, one-third of the world's population faces water shortages, and this proportion is expected to rise to two-thirds by the year 2025 (report by U.N. Secretary-General Kofi Annan, March 2000). Competition for water between urban and rural areas, increased demand for water due to rising living standards, and changes in annual precipitation and rainfall patterns as a result of environmental change all indicate that water demand and supply are in the process of major change.
- @In the past, when water was insufficient for agricultural production, irrigation systems based on the construction of dams and canals had been put in place. However, the number of areas where new irrigation infrastructure is economically viable is becoming limited. Concerns have also increased about the negative impacts on the environment. New approaches are especially needed for water-limited semi-arid and arid environments, as well as in other environments with unreliable rainfall and uncertain water availability for agriculture.
- @For these reasons, development of drought-resistant and stress-tolerant crops coupled with small-scale but effective technologies to make efficient use of limited water resources on a regional basis are needed. Ecological approaches, breeding, and transgenic genetic improvement can provide crop resources to help make resource-efficient technologies go further. These technologies include farm and watershed-based water collection and storage, improved agronomic practices that use soil water more efficiently, and water-saving crop production techniques. Such technologies are adapted to both the environmental conditions and the production practices of farmers in the area for which they are developed. Development of such technologies and establishment of stable and sustainable agricultural production systems, and ultimately living environments, are essential to maintain a world environment in balance.
- @For this purpose, we have invited distinguished experts from within Japan and other countries, to discuss problems associated with water availability and use in developing regions, with a focus on water-limited semi-arid and arid environments, as well as other environments with unreliable rainfall and uncertain water availability, and to explore directions for research on water for sustainable agricultural production.

PROGRAM

Day 1 (Tuesday, November 27)

KEYNOTE ADDRESSES

- @
 - œ Global Water Resources Assessment and Future Projections
Prof. Katumi Musiake, *Institute of Industrial Science, University of Tokyo*
- @
 - œ Meeting the Water Needs for Food and Environmental Security
Dr. David Molden, *IWMI*
- @
 - œ Global Evolution and Future Directions of Water Use in Agriculture
Prof. Yoshihiro Kaida, *SCEAS, Kyoto University*

SESSION I - Increasing Drought Resistance and Water Stress Tolerance through Ecological and Genetic Approaches

- @
 - œ Reducing Water Stress through Ecology and Crop Characteristics
Prof. Shinobu Inanaga, *Tottori University*
- @
 - œ Development of Drought-Resistant and Water Stress-Tolerant Crops through Traditional Breeding
Dr. Rodomiro Ortiz, *IITA*
- @
 - œ Development of Drought-Resistant and Water Stress-Tolerant Crops through Biotechnology
Dr. Kazuko Shinozaki, *JIRCAS*

SESSION II - Agronomic Approaches for Improved Crop Water Use

- @
 - œ Soil Water Balance and Crop Water Use Efficiency
Dr. Rony Wallach, *The Hebrew University of Jerusalem*

Day 2 (Wednesday, November 28)

SESSION III - Transforming Agricultural Production in Water-Stressed Areas of Developing Regions

- @
 - œ Improving Water Availability and Use in Rainfed Systems
Dr. Osamu Ito, *JIRCAS*
- Commentators:
 - Dr. John S. Caldwell, *JIRCAS*
 - Dr. Yoshiyuki Shinogi, *NIRE*
 - Dr. Chayasit Aneksamphant, *Land Development Dept., Thailand*
- @
 - œ Water Management and Crop Production in Semi-Arid and Arid Environments - Successes from technical cooperation projects -
Mr. Ryuzo Nishimaki, *Managing Director, JICA*
- Commentators:
 - Prof. Ali A. Al-Jaloud, *KACST*
 - Mr. Yoshiaki Kano, *Managing Director, TBIC, JICA*

POSTER SESSION

- @
 - œ Summary of major themes and issues from each session
 - œ JIRCAS's goals and areas of contributions
 - œ Examples of research from Thailand and Laos
 - œ Needs and contributions of partners
 - œ Developing collaborative partnerships with public institutions, international research institutions, non-governmental organizations, and users of research results

For further information, please contact:

- @
•œ Technologies for Improved Soil Water Use
Prof. Shuichi Hasegawa, *Graduate School
of Agriculture, Hokkaido University*
- @
•œ New Water-Saving Production
Technologies
Dr. Peter Thorburn, *CSIRO Sustainable
Ecosystems*

Dr. Masaharu Yajima
Secretary of the Organizing Committee for the
8th JIRCAS International Symposium

Japan International Research Center for
Agricultural Sciences (JIRCAS)

1-1 Ohwashi, Tsukuba, Ibaraki 305-8686,
JAPAN

Fax :+81-298-38-6342 E-mail :

symp8@ml.affrc.go.jp

PEOPLE

Dr. Nobuyoshi Maeno, former Director General of JIRCAS, became Director of UN/ESCAP CGPTR Center located in Bogor, Indonesia on July 1, 2001.

NEWSLETTER
JIRCAS

Japan International Research Center for Agricultural Sciences (JIRCAS)



June 2001-No.27

Editor : Tetsushi HIDAKA

1-1 Ohwashi, Tsukuba, Ibaraki, 305-8686 JAPAN

Phone. +81-298-38-6304 Fax. +81-298-38-6342

letter@ml.affrc.go.jp

<http://www.jircas.affrc.go.jp/>



Tofu and deep-fried tofu seller in Malang, Java, Indonesia (Photo by S. Nikkuni)

NEWSLETTER

JIRCAS

Japan International Research Center for Agricultural Sciences

For International Collaboration

December, 2001

Contents

29

[Role of Food Science and Technology Division](#)

[Development of New Rice Varieties for Africa](#)

[Forest Conversion and Road Construction in Sumatra](#)

[Nucleotide Sequence and Genetic Organization of Papaya Leaf Distortion Mosaic Virus RNA](#)

[APEC/JIRCAS Joint Symposium and Workshop on Agricultural Biotechnology](#)

[Seminar on Multifunctionality of Agriculture](#)

[8th JIRCAS International Symposium](#)

[**JIRCAS Home Page**](#)

Role of New Division --- Food Science and Technology Division



Toru Hayashi

Director, Food Science & Technology Division, JIRCAS

Establishment of new Division

The Food Science and Technology Division was established on April 1, 2001, when JIRCAS was reorganized from a governmental institution into an Independent Administrative Institution (IAI, semi-autonomous agency), under the supervision of the Ministry of Agriculture, Forestry and Fisheries of Japan. The Division is to be engaged in research activities in the field of postharvest technology to contribute to food security, poverty alleviation and sustainable development on a global scale through research collaboration with scientists in developing countries, while another IAI, National Food Research Institute, is mainly engaged in research for and development of food science and technology relevant to the interests of the Japanese consumers and the Japanese food industry. Postharvest research covers a wide range of fields in the harvest-consumption chain: harvesting, handling, drying, storage, grading, packaging, processing, transport, disease and insect control, quality/safety evaluation and inspection, and marketing.

Food security

Food security is one of the major global problems facing humans today. The world population reached about 6 billion in 2000 and it is anticipated that the population will exceed 7.5 billion in 2020, according to United Nations' World Population Prospects. Because agriculture is influenced by the environmental conditions and global arable land is limited, global food production may not increase sufficiently to meet the demand of the rapidly increasing population. On the other hand, postharvest losses of grains have been estimated at 20-30%, caused mainly by insect infestations and microbial infection in developing countries. Therefore, the products once harvested should be consumed with minimum loss during handling, transportation and storage. Developing techniques to reduce postharvest losses of agricultural products and to maintain their quality will contribute to global food security.

Poverty alleviation

Agriculture is still the largest sector of rural economies, and a majority of the rural population is engaged in agriculture, in developing countries. The income of urban people is much higher than that of the rural ones, and population has moved from the rural to the urban areas, seeking higher income and more convenient living conditions. Against this background, we must make utmost efforts to give rural people the means to increase their income, so that they may stay in the rural areas and continue to cultivate their land and rear their livestock. The prices of agricultural commodities are declining and their percentage in the final consumer price is decreasing, which indicates the necessity of value addition to the commodities. Consumers are concerned about the quality and safety of what they eat. Changes in the urban life-style associated with increased income and women's work have resulted in increased consumers' demand for a more diversified diet, for processed and convenience foods and for animal products.

It is important for rural farmers to market products that meet the demand of urban consumers. Therefore, studies to ensure high quality/safety of agricultural commodities and to enhance their value will contribute to the improvement of rural income.

Sustainable development

Postharvest technologies to be developed should be environment-friendly in order to promote environmental sustainability. Since technologies less dependent upon chemicals are preferable from the viewpoint of not only food safety but also environmental preservation, the development of alternative methods to chemical treatment is highly required. For example, the world's most widely used fumigant, methyl bromide, is to be phased out by 2015 due to its ozone-depleting potential, and worldwide scientists have been making efforts to develop alternative methods for disinfesting agricultural products such as grains and fruits and vegetables.

Research activities

We are currently conducting a research project titled: "Development of low-input technology for reducing postharvest losses of staples in Southeast Asia" in collaboration with Thai organizations, to develop low-input drying technology using natural energy sources such as sunlight, husks and straw and to develop insect-controlling technology employing natural enemies and bioactive botanicals. The technologies will result in effective and lower-cost systems that are also environment-friendly to reduce postharvest losses of rice. We investigate the bioactivity of indigenous plants in Southeast Asia such as ginger as well as the characteristics of Thai aromatic rice in order to promote value-adding utilization of these commodities.

We are also involved in other research projects, including the improvement of the process for the production of Chinese traditional foods such as soybean milk curd (tofu) and rice noodles (miefun) in China and the development of technology for the utilization of soybeans for non-feed purposes in Brazil. In Indonesia, we have successfully isolated white-spored mutants from the koji molds for the production of Kecap, an Indonesian soy sauce, to discriminate the koji molds from mycotoxin producers.

All these research activities are expected to contribute to global food security, rural poverty alleviation and environment sustainability.



Rice noodles in China



Fingerroot (*Boesenbergia pandurata*), produced in Nakhon Pathom, Thailand



Koji-making process of kecap, an Indonesian soy sauce



Contribution of JIRCAS to the Development of New Rice Varieties for Africa

In the middle of the 1990s, West Africa Rice Development Association (WARDA, based in Bouake, Cote d'Ivoire) had succeeded in producing fertile progeny lines from the interspecific cross of *Oryza sativa* (Asian rice) and *O. glaberrima* (African indigenous rice). These hybrid lines have attracted considerable attention because they are expected to be better adapted to crop management with limited resource input, compared with Asian varieties that cover almost 100% of the rice area in this region. WARDA has been the major organization involved in the Africa/Asia Joint Research Project (Interspecific Hybridization between African and Asian Rice Species), a South-South Cooperation Project funded by UNDP/TCDC since 1997. In early 1998, JIRCAS joined the project with an independent budget and started a 5-year collaborative research program with WARDA to analyze the genetic and eco-physiological characteristics of the interspecific hybrids. For the project, JIRCAS had been assigned to conduct research on drought and soil acidity, which are the major constraints on rice production in the resource-limited rainfed ecosystems in West Africa.

During the first half of the project (1998-2000), JIRCAS dispatched a crop physiologist to WARDA. He was assigned to the Molecular Biology Laboratory of the Breeding Unit, headed by Dr. Monty Jones, who had successfully conducted studies on interspecific hybridization. The laboratory aims at tagging genes responsible for important traits of the interspecific progenies through QTL analysis, on the basis of which superior marker-aided selection systems could be developed. With substantial assistance from Dr. Cadalen, a molecular biologist, and the technical assistance extended by Cornell University, a molecular analysis scheme for polymorphism among rice varieties/lines was effectively developed in the laboratory. The main activity of the crop physiologist sent by JIRCAS was centered on the development of screening methods and quantitative criteria applicable to QTL analysis of drought and soil acidity tolerance.

For drought tolerance, field experiments were conducted during a dry spell at Mbe, in an upland field near Bouake, using several African and Asian lowland and upland rice varieties. Growth analysis showed that upland rice varieties displayed a much higher tolerance to drought than lowland varieties. It was interesting to note that the growth of the African rice varieties was significantly reduced by drought stress at the early vegetative stage. Another finding on the physiological response of *glaberrima* rice to drought was that CG20, an African rice variety originating from Casamance (Senegal), showed a much higher reduction rate in transpiration than in photosynthesis. Though it is not necessarily true for all African rice, the drought-tolerance mechanism of CG20 was associated with a rapid closure of the stomata leading to a reduction in the amount of transpired water. This was confirmed by the larger increase in the $\delta^{13}\text{C}$ value (carbon isotope discrimination rate) in CG20, compared with other *glaberrima* varieties. Therefore, it was assumed that there would be a wide range of variation among African rice varieties in the response to drought stress.

The ability of water uptake by roots is another determinant for drought tolerance at the vegetative growth stage of rice plants. With the technical assistance of Dr. Ookawa, Associate Professor, Tokyo University of Agriculture and Technology, during a short-term visit to WARDA, several parameters of water relations were examined. Among them, the rate of xylem exudation from the cut section of stem was well correlated with drought tolerance. Due to the simplicity of this measurement, the xylem exudation rate could be adopted as a quantitative criterion for QTL analysis of drought tolerance at the vegetative growth stage.

Emphasis was also placed on the genotypic variation in soil acidity tolerance among *O. glaberrima* varieties. We conducted an experiment in an upland field at Man, an acidity-prone area in the western part of Cote d'Ivoire, using several Asian and African rice varieties. As phosphorus deficiency is the main limiting factor in acidic soils in this area, the studies were focused on the response to P-application. The responsiveness to P-application in *glaberrima* rice was as high as that of *sativa* rice. IG10, an African rice variety from Cote d'Ivoire gave the highest yield under P-deficiency. After confirmation of the reproducibility of the results, it was suggested that new interspecific crosses could be made for breeding a variety with outstanding tolerance to soil acidity and P-deficiency.

Satoshi Tobita

Crop Production & Environment Division, JIRCAS



First observation of the drought trial at Mbe by the team of WARDA's Molecular Biology Laboratory, Mr. Gabriel Aluko, Mme Hortense Sehi, Dr. Monty Jones, Mr. Dobo Macaire, Dr. Thierry Cadalen and Mr. Pierre-Louis Amoussou (from left).

[JIRCAS Newsletter No.29 December 2001](#)

Forest Conversion and Road Construction - A Case Study in a Rubber Village in Sumatra, Indonesia -

Indonesia has the third largest area of tropical forests in the world. According to FAO, about one million ha of forests are being lost each year in this country. Historically, shifting cultivation had been considered to be the primary cause of deforestation. However, subsequent studies have paid more attention to profitable tree crops and found that smallholder tree crop production, rubber in particular, contributes to the deforestation rather than shifting cultivation. Rubber earns the highest agricultural income in Indonesia. Rubber is the dominant smallholder crop in much of Sumatra and Kalimantan.

The construction of roads is well known to accelerate forest conversion to agricultural land. Previous studies on road and deforestation revealed that closer distance from roads and higher density of roads likely lead to a higher rate of deforestation. However, little is known about how road construction affects farmers' behavior in forest clearing.

Collaboration work between JIRCAS and International Centre for Research in Agroforestry (ICRAF) focused on the impact of road construction on forest conversion to agricultural land in a village of rubber smallholders in Sumatra. The village named Talang Sungai Bungo was chosen for the farmer survey. Swidden-based rubber cultivation is the dominant economic activity in the village. The farming system is a combination of shifting cultivation and traditional rubber planting. Our fieldwork was conducted in 1999-2000. A survey was conducted for 40 randomly selected households in the study village through two interviews. The first interview was made in May-June 1999, to obtain information about land acquisition and land tenure and the second was performed in February-March 2000, to analyze the household economy.

The economic development policy of President Suharto (period: 1967-1998) had accelerated the improvement of the infrastructure in Indonesia. The road related to the transport of rubber from the village to the market had been substantially improved and paved by the government in 1974 and 1978. The road construction enabled to lower the cost and shorten the time of transport of rubber remarkably. As the market price of rubber remained constant, the villagers were able to sell rubber at a higher price and the profitability of rubber increased.

To identify changes in farmers' behavior in terms of forest clearing after road construction, the following data were analyzed: data-1) Land ownership of the households, data-2) Acquisition methods of the land owned by the households, data-3) Forest clearing implemented by the households, (1) distance from the village center to the plots of forest clearing, (2) year when the plots were cleared, (3) size (ha) of the plots, data-4) Number of total households in the village, based on statistical data of the district.

Results of analysis of data-1) showed that a household owned an average of 16 ha of land, including rubber gardens (9.7 ha) and bush fallows (5.8 ha). Analysis of data-2) indicated that the main method of land acquisition involved the clearing of primary forests (73% of the plots of land). According to the custom law, the person who clears a primary forest can acquire the land. Other methods of land acquisition included inheritance and purchase. Results of data-3) analysis showed that forest conversion to agricultural land in the village had been sharply accelerated in the late 1970s and has been stable since then. Analysis of data-4) showed that population growth had been stable and ranged between 1 and 3% during the period of 1970-2000. Analysis of data-3) (2)-(3) indicated that the area of forest cleared per household had doubled in the late 1970s and has been stable since 1980. As a result of the analyses of data-3) and -4), it was found that the expansion of agricultural land in the 1970s was mainly associated with the increase in forest clearing per household and that the contribution of population growth was not significant.

Based on this study, we observed that expansion of agricultural land occurred not because of local population growth, but because smallholders cleared a larger forest area, reflecting farmers' behavior in response to road construction. Road construction which had improved the transport of rubber and raised the profitability of rubber in the village, enhanced farmers' incentive to expand the farm size.

This study indicates that road construction is effective for local people to improve their living standard in the short term. However, excessive clearing of forests may result in inequality of the land area among local people in addition to all the adverse effects associated with deforestation, including the loss of biodiversity. It is thus important to strike a balance between forest conservation and the welfare of the local people in this area.

Motoe Miyamoto
Forestry Division, JIRCAS



Forest cleared for planting rubber in the study village in Sumatra



Mature rubber garden in the study village

[JIRCAS Newsletter No.29 December 2001](http://ss.jircas.affrc.go.jp/kanko/newsletter/nl2001/No.29/04.html)

Complete Nucleotide Sequence and Genetic Organization of Papaya Leaf Distortion Mosaic Virus* RNA

Papaya (*Carica papaya* L.) is one of the most important fruit trees in tropical and subtropical areas. Papaya leaf distortion mosaic virus (PLDMV) and *Papaya ringspot virus* type P (PRSV-P) have been reported to cause papaya diseases in Japan. Out of them, PLDMV is the most destructive factor in papaya production in Japan (Fig. 1). The viruses belong to the genus *Potyvirus*. They are similar to each other in several properties including characteristic symptoms that appear on papaya plants, host range, transmission mode of aphid and physical properties.



Fig. 1. Ringspot and distortion symptoms on a papaya fruit caused by PLDMV.

Information on the nucleotide sequence of PLDMV-RNA is necessary to identify similar viruses, as mentioned above, and to develop methods for their control. The complete nucleotide sequence of the RNA genome of the PRSV-P Hawaii isolate was reported in 1992. On the other hand, only the 3' terminus of that of PLDMV was reported in 1996.

In this study, the complete nucleotide sequence of the RNA genome of PLDMV was analyzed to determine the genomic organization of PLDMV and to classify PLDMV based on molecular taxonomy.

The sequence was determined from 6 overlapping cDNA clones and by primer extension. The genomic RNA was 10 153 nucleotides (nt) in length, excluding the poly(A) tract, and contained one large open reading frame that started at nucleotide positions 135 to 137 and ended at positions 9942 to 9944, encoding a polyprotein of 3269 amino acids. The 5' untranslated region (5'UTR) of PLDMV preceding the ORF was 134 nt and contained box a-like (ACAAAACCTT) and box b-like (TCAATACA) sequences which were highly conserved sequences in the other reported potyviruses. The 209 nt of the 3' untranslated region (3'UTR) was present downstream of the ORF.

The polyprotein was cleaved by viral proteinases into smaller proteins. Cleavage sites were predicted by analogy with the other potyviruses. The genetic organization of PLDMV RNA was defined as follows: P1, the first proteinase, a protein with a proteolytic activity; Hc-Pro, helper component proteinase, a protein with aphid transmission helper component activity and proteolytic activity; P3, the third protein, function unknown; 6K1, 6kDa protein 1, function unknown; CI, cytoplasmic inclusion protein, a protein with RNA helicase activity; 6K2, 6kDa protein 2, function unknown; NIa, nuclear inclusion protein "a" including the VPg (NIa-VPg), genome-linked viral protein covalently attached to the 5' terminal nucleotide and NIa proteinase (NIa-Pro); NIB, nuclear inclusion protein "b", the RNA polymerase and CP, coat protein (Fig. 2). The proteins were not assembled into virus particles, but they were nonstructural virus-encoded host-alien proteins except for CP.

The genetic organization of PLDMV was similar to that of the other potyviruses. Predicted amino acid sequences of PLDMV proteins were compared with those of PRSV-P and other 23 distinct potyviruses. The overall percentages of amino acid sequence identity ranged from 46.4% with *Potato virus V* (PVV) to 50.5% with *Plum pox virus* (PPV). PLDMV exhibited the highest percentage of amino acid identity (65.6%) in its NIB with PPV. The region with the lowest identity among the potyviruses was the P1 protein, with identity ranging from 18.4% with *Bean yellow mosaic virus* (BYMV) to 29.2% with *Bean common mosaic virus* (BCMV). CP amino acid sequence identities, which are the criteria used for the taxonomy of potyviruses, ranged from 61.9% with *Potato virus Y* (PVY) to 52.1% with *Tobacco vein mottling virus* (TVMV). These molecular characterizations confirmed that PLDMV is a distinct member of the genus *Potyvirus*.

The PLDMV and PRSV-P also shared the highest sequence identity value (63.0%) in their NIb, and the lowest (22.8%) in their P1 protein. Since the P1 protein of the potyviruses is the most variable, it is considered to be a very important protein for the identification of individual potyviruses. It might be useful for the distinction between PLDMV and PRSV-P by RT-PCR. The information on the complete sequence will be used for the development of technology for the transformation of PLDMV-resistant papaya in the near future.

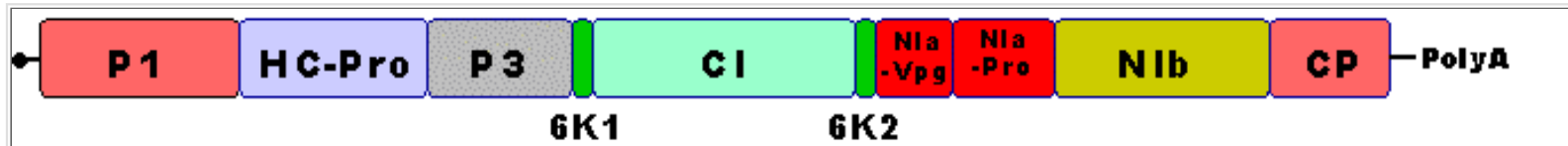


Fig. 2. Proposed genomic map for PLDMV RNA.

P1, the first proteinase; Hc-Pro, helper component proteinase; P3, the third protein; 6K1, 6kDa protein 1; CI, cytoplasmic inclusion protein; 6K2, 6kDa protein 2; NIa, nuclear inclusion protein "a" including the VPg (NIa-Vpg), genome-linked viral protein and NIa proteinase (NIa-Pro); NIb, nuclear inclusion protein "b"; CP, coat protein.

**Since Papaya leaf distortion mosaic virus has not yet been officially recognized by the International Committee of Taxonomy of Viruses, italics were not used.*

Tetsuo Maoka
Okinawa Subtropical Station, JIRCAS
(Present, National Agricultural Research Center for Hokkaido)

[JIRCAS Newsletter No.29 December 2001](http://ss.jircas.affrc.go.jp/kanko/newsletter/nl2001/No.29/05.html)

APEC/JIRCAS Joint Symposium and Workshop on Agricultural Biotechnology

The Asia-Pacific Economic Cooperation (APEC) Agricultural Technical Cooperation Working Group and JIRCAS joined hands to organize the "Joint Symposium and Workshop on Agricultural Biotechnology" in Bangkok during September 3-7, 2001. The first day was open to the public, attracting more than 300 participants. Discussion was focused on "The Future of Biotechnology in World Agriculture." Several internationally known experts gave keynote speeches followed by a panel discussion. It became clear that agricultural biotechnology would have a significant impact on future agriculture and world trade, especially through the safe and prudent application of transgenics (genetically modified organisms, GMOs) in both developing and developed countries. Public acceptance of biotechnology applications was considered to be the key for current and future society to benefit from biotechnology applications.

Subsequently, APEC organized a workshop focused on "Policy and Regulations on Biotechnology Applications." Special attention was directed towards food safety and environmental safety in relation to GMOs. APEC member economies are sharing information and experience in this very sensitive area in order to achieve a more regionally coherent approach. Many developing economies requested further support for their capacity building in policy, regulatory and technical areas for the active and safe implementation of biotechnology to address their agricultural production and use problems.

JIRCAS' workshop, which was organized from 5 to 7 September, was titled: "Genetic Engineering of Crop Plants for Abiotic Stress." The reasons why abiotic stress was chosen as theme are threefold. First of all, poor farmers in marginal areas are more vulnerable to the impact of abiotic constraints (e.g. drought) on the production of food crops. Second, most of the transgenics that are already present in farmers' fields or in the pipeline for future release are related to herbicide resistance, disease/pest resistance, postharvest or nutritional quality. These are important traits for high-income countries and high-input agriculture. Unfortunately, no transgenics with abiotic stress tolerance are anticipated for commercial use. This is probably because poor farmers in marginal areas are not the prime targets of biotechnology research by the private sector. Poor farmers of developing countries are deprived of the benefits from transgenics adapted to their growing conditions. Thirdly, JIRCAS believes that recent developments in basic biological science (genomics in particular) can lead to a much better understanding of the biological mechanisms of abiotic stress response and tolerance. Moreover, knowledge and DNA obtained through research in one crop can be used for other crops since the biological mechanisms for abiotic stress response are considered to have common features (functional synteny) among higher plants.

More than 10 prominent scientists gave lectures on the basic biological mechanisms for tolerance to drought, high temperatures, low temperatures and high salinity, as well as on recent progress in the development of transgenics in cereals, legumes, tropical fruits and root and tuber crops. Dr. J. M. Ribaut of CIMMYT and Prof. K. Watanabe of Tsukuba University reported on successful transformation with abiotic stress tolerance in wheat and potatoes, respectively, presenting the promise of future production of crops with abiotic stress (such as drought, low temperature) for use by poor farmers in marginal areas. They used DREB (drought responsive element binding protein) genes provided by Dr. Shinozaki of JIRCAS, demonstrating that the genetic mechanisms controlling the biological response to drought, low temperature and high salinity that were originally found in *Arabidopsis* can also be used for those important economic plants.

Participants benefited from the joint symposium and workshop organized by APEC and JIRCAS since they could attend sessions dealing with policy aspects (APEC's main interest) as well as scientific progress (JIRCAS' main interest). Policy and science should go hand-in-hand, but there had not previously been any opportunity for policy authorities and science experts to get together. Proceedings of the JIRCAS workshop will be published as a JIRCAS Working Report in early 2002.

Masa Iwanaga
Director, Biological Resources Division, JIRCAS

[JIRCAS Newsletter No.29 December 2001](http://ss.jircas.affrc.go.jp/kanko/newsletter/nl2001/No.29/06.html)

Seminar on "Multifunctionality of Agriculture"

On October 17-19, 2001, an international seminar on the multifunctionality of agriculture was held at JIRCAS. The seminar was organized by the Food and Fertilizer Technology Center for the Asian and Pacific Region, a Taiwan-based international organization, and co-sponsored by four Japanese research institutes, including JIRCAS.

The purpose of the seminar was to gain a better understanding of the multiple functions of agriculture through the exchange of information and to determine whether information gaps exist and how these can be filled, for the benefit of those involved in agricultural research and policy formulation. The participants came from eight Asian countries, and 17 papers were presented. The keynote speech on "Agriculture and the Environment" was delivered by Dr. K. Minami, President of the National Institute for Agro-Environmental Sciences, Japan, followed by four sessions: Food security, Environmental protection, Other externalities, Evaluation of multifunctionality.

During the discussion, the multifunctionality of agriculture, one of the key topics being currently debated at forums, especially in developed countries, was found to be an important issue for developing countries' agriculture, of which roles need to be recognized from a broader viewpoint in order to obtain stronger support. There was a wide consensus among the participants that paddy rice production, which is a common agricultural activity in the region, has positive externalities in several aspects. However it was also concluded that the definition of multifunctionality needed additional clarification, and that the methodologies used for evaluating externalities, in general, should be improved by further promoting the research network and research collaboration among the Asian countries.

On the third day of the seminar, the participants made a field trip to "Kasama Kleingarten" located north of Tsukuba, a small community where city dwellers are able to rent simple cabins with vegetable and flower gardens.

Osamu Koyama
Research Planning & Coordination Division, JIRCAS



Participants in the FFTC International Seminar on Multifunctionality of Agriculture

[JIRCAS Newsletter No.29 December 2001](#)

Water for Sustainable Agriculture in Developing Regions

- More crop for every scarce drop -



Opening address by Dr. T. Inoue,
President of JIRCAS

For its 8th International Symposium, JIRCAS chose the theme, "Water for Sustainable Agriculture in Developing Regions - *More crop for every scarce drop* -." This theme was chosen because of impending conflicts among agriculture, human livelihood, and the environment for scarce water, and the real danger of future food shortages and famine. Over 200 participants exchanged research results and ideas on ways to address this pressing problem during the two days of the Symposium, November 27-28, 2001.

The symposium presented current knowledge and state-of-the-art research in three sessions, moving from the global to the user-based level. In the opening session, three keynote speakers presented key elements of the problem and directions towards solution. Prof. A. Musiaka, University of Tokyo, presented results of global modeling of water supply and demand until 2050, using a 0.5°x 0.5° grid and specific river basins, showing projected water scarcities driven by population increase. Dr. D. Molden, International Water Management Institute, explained that to meet environmental water needs, reduction in irrigation use will require productivity increases of 60% in irrigated agriculture and 35% in rainfed agriculture. Prof. Y. Kaida, Kyoto University, presented a framework for solution and numerous real-world examples based on individualized, communalized, and regionalized ecotechnologies. This framework proposed moving from engineering approaches that characterized the Green Revolution era to environmentally formative and adaptive approaches, with the goal of "more welfare for every drop." The following three sessions examined concrete ways to achieve the goals of productivity increase and environmentally formative water management. *Session 1* presented new genetic and ecological approaches to increasing drought resistance and water stress tolerance. Prof. S. Inanaga, Tottori University, presented examples of crop ecological adaptation using mechanisms of escape, avoidance, tolerance, and recovery, and approaches to enable crops to better use these mechanisms, including conservation tillage, deep tillage, fallow, mulching, and intercropping. Dr. R. Ortiz, International Institute of Tropical Agriculture, presented a model for decentralized plant breeding based on expansion of the phenotype concept adding management, farmers, institutions, and policy to genotype-environment interaction. He supported this with concrete examples of maize, cowpea, groundnut, and soybean breeding, including recent advances using genetic markers. Finally, Dr. K. Yamaguchi-Shinozaki, JIRCAS, described recent progress in transferring drought stress genes and promoter proteins in model plants, and explained plans being developed with other public institutions and the private sector to extend these new methods to economic crops.

Session 2 presented new agronomic approaches for improved crop water use. In terms of Dr. Ortiz model, this moved from the genotype side to the environment side of the phenotype model. Prof. R. Wallach, Hebrew University of Jerusalem, explained results of detailed studies of water movement demonstrating how water flux from the soil to the plant, measured by unsaturated hydraulic conductivity, is the real determinant of soil water depletion, rather than tension or water content alone. Dr. S. Hasegawa, Hokkaido University, showed the importance of macropores for crop deep water exploitation, and presented techniques for reducing soil impedance of root penetration developed in Northeast Thailand, including hardpan fracture and organic amendments in trenches. Finally, Dr. P. Thornburn, CSIRO, explained how soil wetting patterns using trickle irrigation depend on structure and hydraulic properties of specific soils, and not simply on soil structure, and illustrated this with a new decision-support tool.

Session 3 examined concrete examples of approaches to transforming agricultural production in water-stressed areas, through two series of presentations and comments. In the first series, Dr. O. Ito, JIRCAS, presented two models of comprehensive

research in rainfed agriculture in Northeast Thailand, the first focused on crop-livestock integration, and second which will develop small-scale watersheds through toposequence management and small-scale irrigation, starting in 2002. Three commentators provided additional perspectives relevant to the new project. Dr. W. Pichai, Department of Land Development, Thailand, explained the national policy background which the new project will support. Dr. Y. Shinogi, NIRE, presented an example of small-scale watershed management, the cascade system of Sri Lanka. Dr. J. Caldwell, JIRCAS, through comparisons between small-scale watershed research in Northeast Thailand and Mali, West Africa, showed the potential for cross-regional research interaction. These included participatory methods, future adaptation of small-scale ponds for long *bas-fonds* in West Africa, and strategic weather prediction for crop management decision-making being developed in Mali. In the second series, Mr. R. Nishimaki, JICA, using an example from Kenya, explained how JICA has integrated participatory approaches into its development programs, combining water management with support to other needs of users. Paralleling the concept of "more welfare for every scarce drop," evaluation of its programs examines relevance, sustainability, and impact, as well as efficiency and effectiveness. Two commentators provided additional perspectives. Dr. A. Al-Jaloud, King Abdulaziz City for Science and Technology, Saudi Arabia, showed how well-integrated management practices have enabled that country to achieve remarkable increases in food production in an arid environment. Mr. Y. Kano, JICA, presented a case study of how community forestry in Senegal, led by beneficiaries themselves, has increased sustainable reforestation. The Symposium concluded in *Session 4* with an introduction to the World Water Forum, a summary of JIRCAS' achievements in water-focused research over the past 10 years, and general discussion of research needs, contributions, and potential partnerships for achieving more crop and more welfare from every scarce drop.

John S. Caldwell
Development Research Division



Poster session



Tofu and deep-fried tofu seller in Malang, Java, Indonesia (Photo by S. Nikkuni)

NEWSLETTER

JIRCAS

Japan International Research Center for Agricultural Sciences

For International Collaboration

December, 2001

29

Contents

Role of Food Science and Technology Division 2

Development of New Rice Varieties for Africa 3

Forest Conversion and Road Construction in Sumatra 4

Nucleotide Sequence and Genetic Organization of Papaya Leaf
Distortion Mosaic Virus RNA 5

APEC/JIRCAS Joint Symposium and Workshop on
Agricultural Biotechnology 6

Seminar on Multifunctionality of Agriculture 6

8th JIRCAS International Symposium 7

JIRCAS

Newsletter

NO. 22

March 2000



City market at Asuncion, Paraguay
(Photo by M. Kokubun)

CONTENTS

<Feature Article>






[Socio-Economic Studies in Developing Regions](#)

<Collaborative Research Project>



[Collaborative Research Project with CIMMYT](#)

<JIRCAS Research Highlights>

-  [Prediction of Pork Production and Consumption in China](#)
-  [Water Quality in Prawn Farms in Thailand](#)
-  [Mitigating NO Emission from Soils](#)

[<Workshop>](#)

[<PEOPLE>](#)

[<JIRCAS Fellowship>](#)

 [**JIRCAS Home Page**](#)

Socio-Economic Studies Related to Agricultural Development in Developing Regions



Kazuyuki Tsurumi
Director, Research Information Division, JIRCAS

The Research Information Division conducts research projects on socio-economic development and promotes the implementation of comprehensive multidisciplinary research projects including studies on socio-economic aspects and natural sciences in developing regions. The comprehensive projects have been implemented by JIRCAS as a whole in order to address complex issues like poverty alleviation. Scientists belonging to several Divisions at JIRCAS join the project to carry out research related to their respective fields and develop new technologies. Up to now, eight comprehensive research projects have been implemented (Table 1). On the other hand, socio-economic studies have been mainly carried out by scientists from the Research Information Division itself (Photo). Research subjects cover the situation of the supply and demand of food worldwide and in specific developing regions, as well as the impact of agricultural policies and systems, including extension systems, on agriculture and rural development, and the relation between agricultural development and changes in the natural environment.

Table 1. International comprehensive projects at JIRCAS

Title of the project	Target area
Comprehensive studies on soybean improvement, production and utilization	Brazil, Argentina, Paraguay
Comprehensive studies on the development of sustainable agro-pastoral systems in the subtropical area of Brazil	Brazil
Evaluation and improvement of regional farming systems	Indonesia
Improving food security through increased productivity in rainfed rice systems	West Africa
Comprehensive studies on sustainable agricultural systems in Northeast Thailand	Thailand
Development of new technologies and their practice for sustainable farming systems in the Mekong Delta	Vietnam
Development of sustainable production and utilization of major food resources	China
Productivity and sustainable utilization of brackish water mangrove ecosystems	Malaysia

In the comprehensive research projects, socio-economic studies play two major roles. One is to identify issues to be addressed and the another is to evaluate the results of research activities. Prior to the implementation of the research projects, usually a kind of baseline survey mainly related to socio-economic aspects has been conducted, including agricultural production, consumption, distribution systems, foreign trade, and even social customs. From these results, several issues to be tackled for achieving sustainable agricultural development can be identified along with the technologies and systems to be newly developed. In general, the most serious problem in developing regions has been the low production of food, especially of grain. In this case, major factors should be considered, such as soil conditions, water management, cultivation technologies, farming systems, and even farmers' association structure. Once the most important technologies

required have been identified, scientists can initiate research. The purpose of the baseline survey should be very clear and indicate some direction. The second role of the socio-economic studies is to evaluate the technologies newly developed. Even if some technologies and systems may contribute to the increase of agricultural production or the reduction of production costs, they must be adapted to the farmers' management level. When farmers have to invest a large amount of money in order to introduce the new technologies, the outcome may not be successful.

Apart from the role in the comprehensive research projects, socio-economic studies are closely related to policy and administration aspects. For decision-makers, it is important to evaluate the impact of the new policies and systems they plan to introduce. Econometric simulation models may enable to forecast the supply and demand situation of food, agricultural trade development and farm household economy when, for example, trade liberalization and price support policies are introduced. Moreover, through economic studies, to a certain extent, the impact of agricultural activities on the natural environment can be evaluated. Usually, since the relations between these two aspects are discussed in qualitative terms, there is a need to add a quantitative dimension. From the socio-economist viewpoint, in these simulations, for the development of methodology for estimation of impacts in more realistic terms, research results will be important.

It is important to emphasize that the socio-economists should carefully consider the scope of their studies and clearly indicate the objectives since the results are more closely linked with policies developed by decision-makers than in the case of research covering natural science disciplines. In other words, the results of socio-economic studies themselves might contribute to changes in policy direction. However, at the same time, to preserve the objectivity of the studies, the socio-economists should avoid to be too strongly influenced by the decision-makers.



Interview of farmers in a village in Kalimantan, Indonesia
(Photo by J. Gotoh)

[NEXT](#)

[CONTENTS](#)

Collaborative Research Project with CIMMYT for the Development of an Effective Selection System for Disease Resistance in Wheat by Using DNA Markers

Kazuhiro Suenaga

Biological Resources Division, JIRCAS

The Headquarters of the International Maize and Wheat Improvement Center (CIMMYT) are located at El Batan, a suburb of Mexico City. CIMMYT focuses its activities on increasing the productivity and sustainability of maize and wheat production in developing countries in the world. Major activities include the development and worldwide distribution of improved varieties, the conservation of genetic resources, and the production of documentation related to new knowledge about these crops.

There has been a long collaboration between CIMMYT and JIRCAS (formerly Tropical Agriculture Research Center (TARC)). In 1993, a JIRCAS researcher was sent to CIMMYT on a long-term basis to carry out collaborative studies on the development of wheat x maize crosses for producing and utilizing wheat haploids for breeding purposes and genetical analyses.

Since January 1998, a JIRCAS researcher has been involved in collaborative studies on the development of an effective selection system for wheat varieties harboring resistance genes to Fusarium head blight (FHB) and yellow rust using DNA markers.

Indeed, biotic and abiotic stresses to plant production are major issues in developing countries. Although important diseases may differ depending on the region/country, Fusarium head blight (FHB) and yellow rust are among the most serious diseases in wheat production areas. In Japan, due to the high rainfall during the maturation season of wheat, wheat production often experiences serious damage by FHB, especially the southern and northern parts of Japan (Kyushu and Hokkaido). Moreover, since recent abnormal weather has caused an epidemic of FHB worldwide, it is important to develop efficient breeding systems for wheat cultivars resistant to FHB.

In order to breed disease-resistant cultivars efficiently, an appropriate system for the selection for the disease is essential. Accuracy of evaluation of the disease or the resistance genes may vary depending on the year or other environmental conditions. A considerable amount of labor may be required to evaluate certain kinds of diseases. Recently, we have developed a method in which molecular markers are used for the selection, instead of selecting resistant lines in breeding fields. That is, differences in the DNA level between resistant and susceptible lines are used for the selection. Once molecular markers for resistance genes are identified, it is possible to perform a very reliable selection, because molecular markers themselves are never affected by environmental conditions.

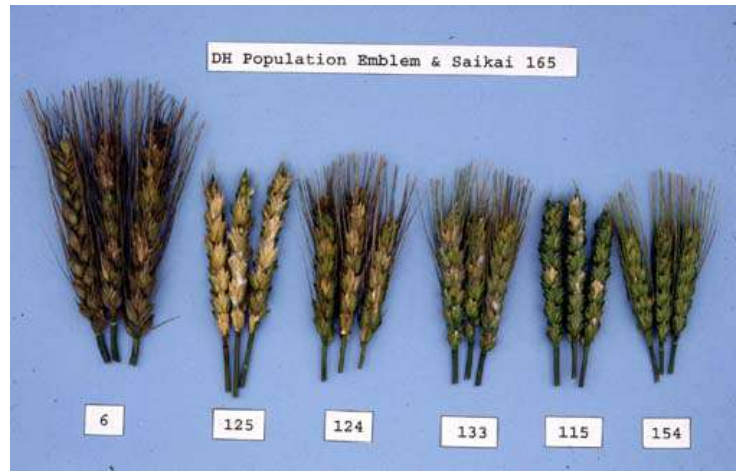
Emphasis is currently placed on the development of molecular markers for FHB and yellow rust diseases in wheat. There are various types of resistance genes for yellow rust. The most important genes in the breeding program at CIMMYT are those which exert relatively small effects and confer a resistance at the adult plant stage. Most of these genes are considered to confer a durable resistance and they are race-non-specific. Therefore, the use of molecular markers is considered to be more effective than for major genes.

Evaluation for FHB is often affected considerably by the environmental conditions. Resistance to FHB is classified into at least three types, as follows: 1) resistance to fungal penetration into wheat tissues, 2) resistance to fungal spread within spikes and 3) ability to degrade the toxin produced by the fungi. Each type of resistance requires different and laborious evaluation systems.

Since FHB damage has been a major problem in Japan for many years, Japanese wheats are one of the several resistance sources to FHB in the world. Many highly resistant cultivars have been identified among Japanese cultivars, and we are using such resistant cultivars to tag the resistance genes in the collaborative studies at CIMMYT. As one Japanese wheat played an important role in the Green Revolution, another Japanese wheat germplasm may again contribute to the breeding of FHB-resistant wheat cultivars for developing countries.



CIMMYT Headquarters (front)



Variation of resistance to FHB in the recombinant inbred lines derived from Emblem x Saikai 165. From left to right: susceptible to resistant.

[NEXT](#)

[CONTENTS](#)

Water Quality and Carbon and Nitrogen Budgets in Intensive Prawn Farms in Freshwater Areas of Thailand

Junya Higano* and Phongchate Pichitkul*²

*Fisheries Division, JIRCAS and *²Faculty of Fisheries, Kasetsart University, Thailand

The Giant Tiger Prawn (*Penaeus monodon* Fabricius 1798) is Thailand's major export commodity: annual production exceeded 280,000 tons in 1995. However, extensive discharge of organic substances from prawn farms is causing environmental damage to surrounding areas, resulting in decreased production and increased frequency of disease outbreaks. Uneaten feed and feces are key problems since they are the major sources of organic effluent and sediments. It is necessary to evaluate the carbon and nitrogen cycles in conventional prawn farming practices to promote the development of sustainable aquaculture techniques. The purpose of this study was to analyze the changes in water quality and their correlation with the carbon and nitrogen budgets in a closed pond system.

The field survey was conducted in two earthen ponds in a private prawn farm in Bang Len District, Nakhon Pathom Province, Thailand. Pond 1 was 6,400 m² in area and square-shaped, and Pond 2 was 3,200 m² in area, with an irregular shape. The initial stocking densities for Pond 1 and Pond 2 were 52 and 69 individuals/m², respectively. Prawn culture period extended from mid-January to the end of May 1998. Pond water consisted of concentrated salt water transported from salt fields, diluted with fresh water from irrigation canals. The pond water was not replaced or discharged until prawn harvest.

Throughout the culture period, the water temperature, salinity, pH, amount of dissolved oxygen and turbidity were measured weekly at the center and the edge of the pond and the contents of inorganic nitrogen, phosphorus, etc. were also analyzed. Feed, prawn and sediment samples were dried and pulverized prior to chemical analysis. The carbon and nitrogen contents were measured using an NC analyzer.

The water temperature gradually increased from January - February (the cool season) to March - May (the hot season). The temperature in the afternoon was 1 - 3 °C higher than in the morning. This difference tended to decrease in the last two months. During the culture period, the highest temperature exceeded 35 °C. The initial salinity of the water was 7 - 10 (psu), which decreased upon the addition of fresh water until the intended salinity level of 2 was reached. At the start, the pH value was stable at 7.5 - 7.6 in both ponds throughout the day. After two weeks, the pH in the afternoon was higher than in the morning and this trend became more pronounced after March. In the center of the ponds, fluctuation of pH was greater than at the edge, occasionally exceeding a value of 9. The changes in the dissolved oxygen level followed the same pattern as those of the pH: close to saturation in the morning and showing supersaturation in the afternoon under a working paddle wheel. Chlorophyll concentration rapidly increased after two months, ultimately exceeding 500 µg/l. The type of phytoplankton bloom observed was strongly associated with the changes of the pH and amount of dissolved oxygen. Total ammonia concentration exceeded 1 mg-N/l at the start. After the second week, the concentration decreased except for abrupt increases caused by phytoplankton mortality.

The survival rates of prawn in Pond 1 and Pond 2 were 80% and 43% and production rates were 0.75 kg/m² and 0.53 kg/m², respectively. Whereas the commonly used Feed Conversion Ratios (FCRs) expressed as wet weight were 1.58 and 1.71, the FCRs expressed as dry weight were 5.49 and 6.62 (Fig. 1). The results of the element analysis indicated that 16 - 19% of the carbon composition of feed was converted into prawn, 60 - 72% was converted into sediments, and the loss to water and air was 12 - 21%. The rate of nitrogen composition of feed was 25 - 30% converted into prawn, 46 - 54% into sediments, with a loss to water and air of 21 - 24%.

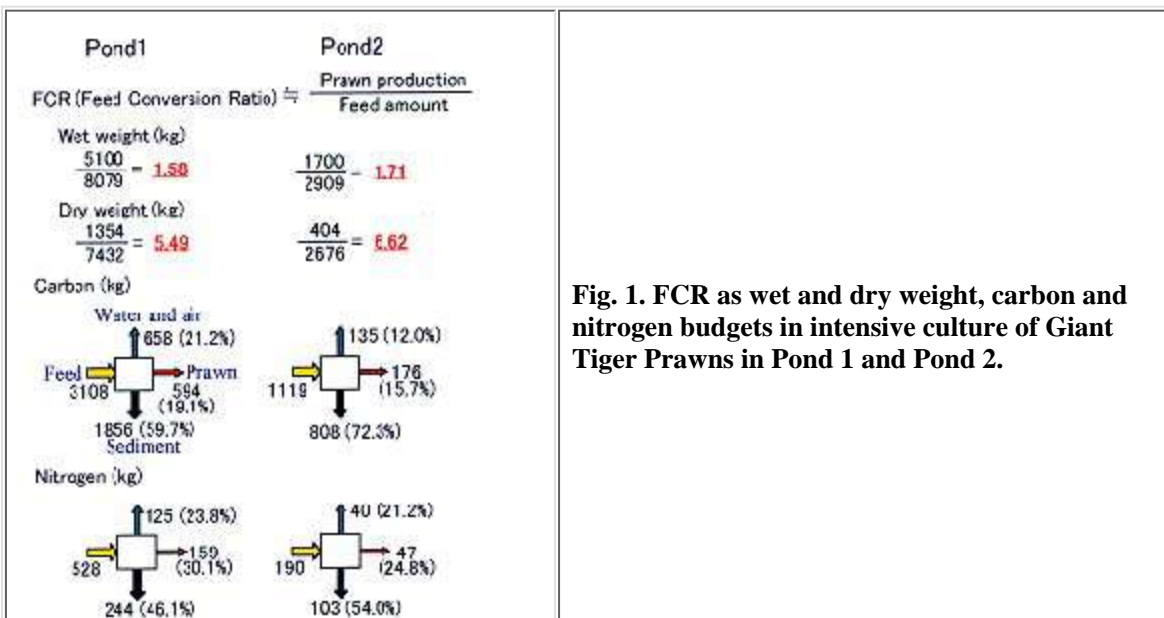


Fig. 1. FCR as wet and dry weight, carbon and nitrogen budgets in intensive culture of Giant Tiger Prawns in Pond 1 and Pond 2.

These results indicated that the production of 280,000 tons of *P. monodon* also led to the production of 138 - 156,000 tons of carbon and 20 - 23,000 tons of nitrogen that were discharged into the environment as wastewater and contaminated soil. We need therefore to consider the fate of these wastes and develop effective ways of reducing them. We have started a polyculture experiment between *P. monodon* and bivalves which are assumed to act as biofilters.

Note: prawn culture in freshwater areas was banned at the end of December 1998 as a result of its damaging effects on agricultural land, specifically damage caused by salinity.



**Discharge of water by pumping
water when *P. monodon* was
harvested**

NEXT

CONTENTS

Mitigating NO Emission from Soils by Deep Application of Fertilizers

Yasukazu Hosen and Kazuyuki Yagi
Environmental Resources Division, JIRCAS

To increase food production, the rate of chemical fertilizer application to arable land has been rising rapidly in developing regions, which could lead to harmful effects on the environment. For example, China has been the largest consumer of chemical fertilizer in the world since 1989 and many environmental problems have resulted due to the excessive load of nutrients on agricultural land, in particular nitrogen. To address such problems in China, JIRCAS launched a 7-year collaborative research project entitled "Evaluation and Development of Methods for Sustainable Agriculture and Environmental Conservation" since 1997. This project covers four major agricultural regions in China and both field experiments and local analyses are conducted at representative sites of each study area.

To support this project, experiments have also been carried out at JIRCAS in Japan. The objectives of these experiments are (1) to develop methods for quantifying total nitrogen cycling in arable land, including gas exchange between the pedosphere and the atmosphere, and soluble nutrient exchange between the pedosphere and the hydrosphere, and (2) to develop key technology for minimizing the impact of agricultural activities on the environment. As for (2), the possibility of mitigating nitric oxide (NO) emission from soil was suggested.

NO is known to be a cause of photochemical atmospheric pollution, acid rain, and is linked to increased tropospheric ozone, one of the major greenhouse gases. Arable land should not be overlooked as a source of NO, because global annual NO emissions from soil are in the order of 10 Tg NO-N, about half the amount contributed by fossil fuel combustion processes to the annual global NO-x budget. We focused our studies on the effect of depth of fertilizer placement in an attempt to develop a method for mitigating NO emission from upland fields.

Firstly, a numerical model was designed based on pre-existing survey data of soil NO concentration profiles in Andisol upland fields. Based on this model analysis, the possibility of deep application of fertilizer to mitigate NO emission was pointed out. Secondly, the estimated results were verified in a laboratory experiment with soil columns. Topsoil from an Andisol whose moisture weight percentage was 49 (± 0.9)% was put in cylindrical PVC tubes, 1.03 m in height and 0.194 m in internal diameter, at the bulk densities of 0.60 and 0.75 Mg m⁻³ and at the depths of 0-20 and 20-100 cm, respectively. As nitrogen fertilizer, ammonium sulfate (200 kgN ha⁻¹) was applied at the depths of 0-10, 5-15 or 10-20 cm in soil columns in duplicate. No water had been supplied to the soil columns for 15 days after fertilizer application. Then, the groundwater level was set at the depth of 100 cm. Soil gas was collected from sampling tubes installed in each soil column at intervals of 5 cm. Gas emission rate from the soil surface was determined by the closed-chamber method. This experiment was carried out in a thermostatic chamber (22.2 \pm 0.6°C). The results obtained from this experiment supported well our findings from model analysis. All the NO concentration profiles in soil showed a sharp peak at each fertilized site within 29 days after fertilizer application. Fig. 1 shows that the NO concentration in soil decreased abruptly as the distance from the fertilized site increased at 15 days after fertilizer application. These findings imply that NO is produced mainly at the fertilized site, but does not diffuse widely in the soil columns, because of the high NO-uptake by soil. As a result, the NO concentration gradient near the soil surface decreased when the depth of the fertilized site increased (Fig. 1). Consequently, the NO emission rate from soil columns fertilized at 10-20 cm depth during a period of 29 days after fertilization was reduced to almost the same rate as that of the unfertilized one, which was equivalent to 0.9-20% of the value from the fertilized columns at the depth of 0-10 cm (Fig. 2). These results indicated that a lower amount of NO was emitted from soil when the distance between the fertilized site and the soil surface increased.

Our findings demonstrate that NO emission from arable land could be mitigated by applying fertilizer deeper into the soil, in other words, by designing an unfertilized soil layer near the soil surface. We carried out field experiments to verify our findings from the laboratory experiment and to examine the possibility of application to field management as a mitigating technology, by using a system to monitor nutrient leaching in soil as well as gas emissions. The system enables to evaluate the effects of fertilizer treatment on the impact on the environment and to develop new technologies for mitigating the impact while sustaining crop yield. The environment-friendly technologies developed in this study will be applied to agriculture in developing regions.

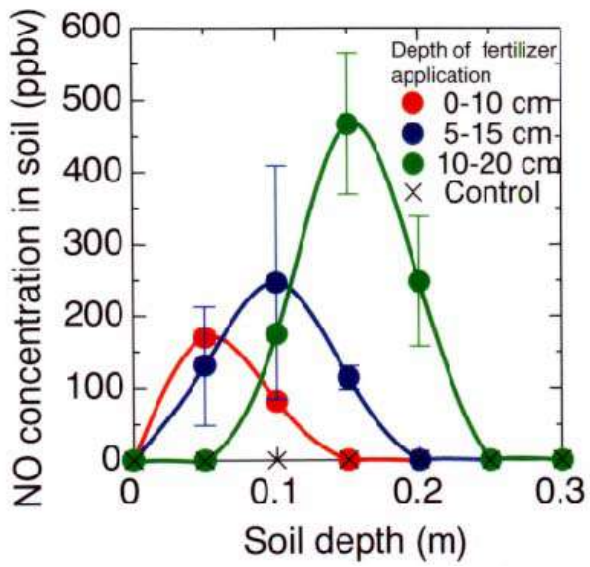


Fig. 1. Concentration profiles of soil NO at 15 days after fertilizer application at different depths.

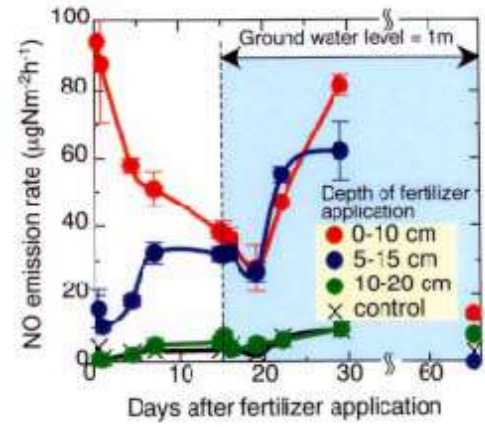


Fig. 2. Time course of NO emission rates after fertilizer application at different depths.

NEXT

CONTENTS

EMBRAPA/JIRCAS Joint Workshop on Agro-Pastoral Systems in South America

The research project entitled "Comprehensive Studies on the Development of Sustainable Agro-Pastoral Systems in the Subtropical Area of Brazil" has been implemented since 1996. This research project is focused on the development of sustainable farming systems with high productivity in environmentally degraded areas in the subtropical zone of Brazil, with emphasis placed on land utilization through the adoption of crop-pasture rotation systems. For this purpose, the studies are being carried out in collaboration with the National Center for Beef Cattle Research (EMBRAPA-CNPGC) and Japan International Research Center for Agricultural Sciences (JIRCAS).

The workshop titled: "EMBRAPA-CNPGC/JIRCAS Joint Workshop on Agro-Pastoral Systems in South America" was held in Campo Grande, Brazil on December 7 and 8, 1999. After Dr. A. Boock, Director General of CNPGC, delivered the opening address, 10 papers were presented in research areas covering crop and pasture management, maintenance of soil fertility and economic evaluation of the systems. In a field tour which was organized during the meeting, the participants observed the experimental fields of CNPGC for the "Agro-Pastoral" project. From 5 countries, 35 scientists participated and reviewed the results obtained until now during the implementation of the project as well as other related studies, and discussed the future strategy and orientation of the project. In the closing remarks, Dr. N. Maeno, Director General of JIRCAS, reminded the participants of the potential of agro-pastoral systems to alleviate the food problem and environmental concern on a global scale and emphasized the importance of the multidisciplinary approach to achieve the objectives of this project. The proceedings of this workshop will be published this year.

(Makie Kokubun)



Experimental fields of CNPGC for the "Agro-Pastoral" project

NEXT

CONTENTS

PEOPLE



Dr. Masaaki SUZUKI, a soil scientist, became Director of JIRCAS's Okinawa Subtropical Station on March 1, succeeding Dr. Shigeo Yashima who was appointed Professor of Faculty of Bioresources, Mie University. Dr. Suzuki was in charge of JIRCAS's Thai Office (at the Department of Agriculture of Thailand (DOA) from June 1, 1996.

[NEXT](#)

[CONTENTS](#)

JIRCAS Fellowship

JIRCAS Fellowship Program: Welcoming New Visiting Researchers

Eighteen Visiting Researchers are participating in the JIRCAS 2000 Visiting Research Fellowship Program to carry out collaborative research at Tsukuba and Okinawa.

Tsukuba: Short-term (5months at National Institute for Agrobiological Resources)

Yoon Mun Sup	National Seed Management Office, Rural Development Administration, Republic of Korea	Genetic diversity in the <i>Vigna angularis</i> complex
Badraddin Ebrahim Sayed-Tabatabaei	University of Tehran, Iran	Genetic variation of wild (<i>H. vulgare</i> ssp. <i>spontaneum</i>) and cultivated (<i>H. vulgare</i> ssp. <i>vulgare</i>) barley from Iran based on a DNA region linked to the <i>vrs1</i> locus
Liu Qingchang	China Agricultural University, P. R. China	Production of cell-induced sweet potato mutants for table and vegetable uses
Natalya v. Alpatyeva	N. I. Vavilov Research Institute of Plant Industry, Russia	Genetic diversity of cereal crops revealed by DNA polymorphism

Tsukuba: Long-term (2 years at JIRCAS HQ.)

Malik Ashiq Rabbani	National Agricultural Research Centre, Pakistan	Analysis of plant responses to environmental stresses and gene expression
Yin Changbin	Institute of Natural Resources and Regional Planning, P. R. China	Studies on regional food production, marketing and consumption in China
Najeeb S. Alzoreky	Sanaa University, Yemen	Analysis and evaluation of biological activity of indigenous edible plants
Thanawan Boonpunt	Kasetsart University, Thailand	Studies on changes in the physicochemical properties of rice grain during post-harvest processing

Okinawa: Long-term (1 year at JIRCAS Subtropical Station)

MD. Khalilur Rahman	University of Dhaka, Bangladesh	Subsurface drip irrigation of some vegetable crops
Lauro Gumasing Hernandez	Soils Research and Development Center, Philippines	Effect of subsurface "drip fertigation" on Chinese cabbage tipburn
Sayed Fathey El-Sayed	Cairo University, Egypt	Genetic studies on heat tolerance in snap bean (<i>Phaseolus vulgaris</i>) plants
Nguyen Thi Lang	Cuulong Delta Rice Research Institute, Vietnam	QTL mapping for rice salt tolerance genes and their evaluation
Werapon Ponragdee	Field Crops Research Institute, Thailand	Intergeneric crossing in sugarcane for higher environmental tolerance
Lin Tong-Xiang	Institute of Subtropical Pomology Fujian Agricultural University, P. R. China	Analysis of DNA markers in <i>Dimocarpus longan</i> and development of test kit
Liu Xiaochuan	China National Rice Research Institute, P. R. China	Tagging heterosis traits with molecular markers in rice

Ishwar Singh	Indian Institute of Sugarcane Research, India	Physiological and molecular characterization of heat tolerance in tomato and tobacco (transgenic of sHSP)
Maribel Regla Quintana Sanz	Institute of Pastures and Forages Research, Cuba	Sucrose phosphate synthase gene expression in sugarcane
Fan Shuguo	South China Institute of Botany, P. R. China	Molecular analysis of NaCl-tolerant and LiCl-tolerant suspensions of rice (<i>Oryza sativa</i> L. cv. Taipei 309)

 [Contents](#)

 [JIRCAS Home Page](#)

Overview of JIRCAS

■ Objectives and Past Accomplishments

Global problems are increasingly impacting world food security. These include continued world population growth, deterioration of environments, and destruction of cultivated lands. Even more intensive efforts than ever before are essential to solve these problems. The promotion of sustainable agriculture, forestry and fisheries in harmony with natural ecologies is a critical need.

The demand for food is increasing in a large number of developing countries due to both population increase and improved diets. At the same time, where agricultural and fisheries productivity has remained low, food supplies remain unstable and serious problems of hunger and poverty continue to persist. To address these critical needs, the Japan International Research Center for Agricultural Sciences (JIRCAS) promotes research aimed at achieving a stable global food supply and ensuring sustainable agriculture, forestry and fisheries in harmony with the environment. It carries out interdisciplinary research on biological and social aspects of agriculture, forestry and fisheries, and undertakes collaborative projects with institutions of developing countries as well as international organizations.

JIRCAS was established on October 1, 1993, through the reorganization of the former Tropical Agriculture Research Center founded on June 1, 1970. From this year, on April 2001, it has become an independent administrative institution. JIRCAS is making many active contributions internationally to address the agricultural, forestry, fisheries, food and environmental problems of the world, with a focus on developing regions.

■ Main Activities of JIRCAS

1. Conducts collaborative research with developing countries, primarily through sending JIRCAS researchers.
2. Conducts experimental research in Japan to support research topics of international relevance.
3. Creates opportunities for scientists in developing countries to do collaborative research in Japan, by inviting research fellows from countries collaborating with JIRCAS.
4. Collects, analyzes and publishes information of relevance for research in developing regions.
5. Organizes international symposia and workshops.
6. Participates in research planning and offers technical support, counseling and aid to developing countries.
7. Serves as a think-tank for technology research focused on food supply, environmental problems, and related issues.

■ Organization

 [President](#) Takahiro Inoue

 [Vice President](#) Yoshinori Morooka

 [Executive Advisor & Auditor](#) Kunihiko Kato, Akimi Fujimoto

 [Research Planning and Coordination Division](#)

Research Planning Section, Research Coordination Section, International Relations Section, International Research Coordinator, Public Information Officer, Publication and Documentation Section, Field Management Section

 [Administration Division](#)

General Affairs Section, Accounting Section, Overseas Staff Support Section

 [Development Research Division](#)

Development Research Coordinators Regional Trend, Supply and Demand Situation on Food, Farming System, Information System

 [Biological Resources Division](#)

Genetic resources Utilization, Biological Functions Development, Breeding Methodologies

 [Crop Production and Environment Division](#)

Crop Management, Plant Protection, Plant Physiology and Nutrition, Material Cycling, Water Resources Management

 [Animal Production and Grassland Division](#)

Animal Production, Feed Resources, Tropical Diseases of Animals

 [Food Science and Technology Division](#)

Quality Assesment, Distribution and Processing

 [Forestry Division](#)

Rehabilitation of Degraded Forestlands, Utilization of Forest Resources

 [Fisheries Division](#)

Aquaculture, Fisheries Resources Development, Coastal Environment

 [Okinawa Subtropical Station](#)

Associate Director for Research, International Collaboration Section, Administration Office, Island Environment Management Laboratory, Environmental Stresses Laboratory, Crop Breeding Laboratory, Tropical Fruit Crops Laboratory, Plant Protection Laboratory, Field Management Section

➡ [What's New](#)

➡ [Back to JIRCAS home page](#)

Message from the President



President
Takahiro Inoue

A new JIRCAS-structural reorganization

Implications of the new organization

On April 1, 2001, under the Japanese Government's administrative reform calling for the reorganization of government-affiliated research organizations, the Japan International Research Center for Agricultural Sciences (JIRCAS) became an Independent Administrative Institution (a semi-autonomous agency) under the supervision of the Ministry of Agriculture, Forestry, and Fisheries of Japan (MAFF).

The introduction of the new system of Independent Administrative Institutions (IAI) is at the core of the administrative reform. This system has been introduced to enhance the effectiveness, quality, and transparency of technological development by splitting the administration into its implementation functions and its planning and drafting functions. By converting the implementation functions of the national research institutions to the IAI system, each institution has gained its own independent judicial status. Therefore, under the new system, JIRCAS will conduct not only autonomous and flexible programs, but also commit itself to a strict ex post facto evaluation and review of its performance, as well as disclosure of various institutional issues.

The new mandate given to JIRCAS by the Japanese Government does not fundamentally change the previous mandate, in which JIRCAS was entrusted with the mission of promoting the development of sustainable agriculture, forestry, and fisheries compatible with environmental preservation in developing regions of the world. Although the demand for food is increasing due to population increases and improvements in dietary habits, agricultural production remains at a low and unstable level in many developing countries. As a result, hunger and poverty remain prominent issues. Moreover, concern for the deterioration of the global environment has generated the need for the development of sustainable systems of agriculture, forestry, and fisheries that are non-destructive to natural ecosystems.

The most distinctive features of the new IAI system are, first, semi-autonomy with limited control from outside institutions, and second, ex post facto performance evaluations, the results of which each IAI uses to plan subsequent activities. Under the new system, MAFF presents to JIRCAS mid-term objectives, a list of goals that the "New JIRCAS" is expected to achieve during a five-year period. The mid-term objectives include issues related to the enhancement of the efficiency of research activities, improvement of the quality of research programs, and financial performance. Based on the mid-term objectives, the IAI drafts a mid-term plan to achieve these objectives autonomously.

The IAI Evaluation Committees, established under MAFF and composed of experts not belonging to the public sector, will also periodically review the performance of IAI research activities. Each fiscal year, an IAI Evaluation Committee will investigate and analyze the progress made on the previous year's mid-term objectives. The results of evaluation will be subjected to operational and financial modification the following fiscal year.

Since the research activities need to be fully executed, the government will allocate, within budgetary limitations, most or all of the financial resources required to carry out the defined objectives. In addition, JIRCAS will make utmost efforts to gain supplementary financial support from such sources as other governmental offices or the private sector to fulfill the mid-term objectives.

Roles and research strategy

Given that the role of JIRCAS is to promote the advancement of agriculture, forestry, and fisheries in developing regions of the world through integrated collaborative research programs, the "New JIRCAS" has established the following priorities for research strategy. The first is to develop production and utilization systems in sustainable agriculture, forestry and fisheries in harmony with the environment by conducting research on such topics as stress-tolerant crops, technologies for preserving arable land environments, new farming systems for ensuring profitability of producers, and technologies for efficient postharvest management and utilization. The second priority is to rehabilitate, maintain, and improve the utilization of natural resources, with emphasis placed on tropical forest and coastal ecosystems.

In order to complete the mid-term objectives adhering to the above research strategies, the "New JIRCAS" plans to conduct and take full advantage of (1) international collaborative research programs in developing regions, dispatching researchers on long- and short-term bases, (2) collaborative research with researchers from developing regions, (3) domestic research that will further enhance international collaboration, (4) accumulation and analysis of research information for supporting collaborative work, (5) international symposia, workshops and seminars, (6) technical assistance relating to food and environmental issues, and (7) functioning as a think tank for advisory committees of national organizations involved in overseas development.

In conclusion, the reorganization of JIRCAS into an IAI makes it possible for JIRCAS to gain more flexibility in the implementation of its research programs. The reorganization will also transform hiring procedures, enabling JIRCAS to recruit researchers from universities or institutes that do not belong exclusively to the public sector, and the financial aspects of the institution, since funds can now be obtained from both the public and private sectors. At the same time, the strict evaluations by the Evaluation Committee may enhance the quality of the research programs and lead to a more efficient utilization of financial resources, ultimately furthering collaborative activities compatible with the needs of developing regions.

[HOME](#)

[BACK](#)

Research Planning and Coordination Division

■ Director Akinori Noguchi

The Research Planning and Coordination Division in itself does not act as a research division but rather serves to oversee and support the activities of the Research Divisions and Okinawa Subtropical Station. The Division consists of four sections which are the Research Planning Section, the Research Coordination Section, the International Relations Section, and the Publication and Documentation Section. In addition, a International Research Coordinator and a Public Information Officer are assigned to the Division.

In order to promote the implementation of research programs both overseas and in Japan, the first 3 sections are responsible for the overall planning of JIRCAS research projects, dispatching of researchers on long-term or short term bases, implementing programs for the invitation of researchers and administrators, and coordinating with international and domestic institutions and agencies. The Publication and Documentation section is responsible for the collection, classification, and supply of bibliographic materials from both overseas and domestic sources, as well as the release of public relation materials. The International Research Coordinator manages the comprehensive projects. The Public Information Officer is responsible for the publications of JIRCAS.

▶ [Continue to Administration Division](#)

Administration Division

■ Director Katsuyuki Kiryu

The Administration Division consists of three sections: the General Affairs Section, the Accounting Section, and the Overseas Support Section. The General Affairs Section is responsible for the management of official documents, personnel-related matters, and social affairs pertaining to JIRCAS staff. The Accounting Section handles overall accounting, all budgeting, settlements, and wage distribution. Lastly, the Overseas Support Section is in charge of all matters pertaining to JIRCAS overseas operations, which includes general international affairs, overseas expenditures, and overseas shipments of equipment and materials.

▶ [Continue to Development Research Division](#)

Development Research Division

■ Director Kazuyuki Tsurumi

This division gathers and analyses information and data on the natural and social environments, the macro economies, and the agriculture, forestry and fisheries sectors of developing regions throughout the world. Using these data, it carries out research aimed at developing a global food security data collection system and a world food supply forecasting model.

Another activity of this division is the assessment of current farming systems and development of improved systems in representative priority regions.

The division also carries out research to identify the directions of technology development most likely to meet future needs, and contributes to the establishment of a comprehensive research strategy for JIRCAS.

▶ [Continue to Biological Resources Division](#)

Biological Resources Division

Director Masaru Iwanaga

The division masters the latest research techniques of the biotechnology and develops breeding materials and breeding methodology in order to ensure the effective utilization of genetic resources of the plants that play important roles in food production and environmental problems in the developing regions.

 [Continue to Crop Production and Environment Division](#)

Crop Production and Environment Division

Director Osamu Ito

The division carries out research to develop the sustainable agricultural technologies in consideration of harmony with the natural ecosystem and environmental conservation on global scale through effective utilization of diversified functions of crops and microbes, and appropriate utilization of natural resources.

 [Continue to Animal Production and Grasslands Division](#)

Animal Production and Grasslands Division

Director Toshiaki Taniguchi

The division aims to develop sustainable animal husbandry technologies in harmony with the natural, social and economical conditions of the developing regions. In order to achieve these, the division is carrying out researches for the development of feed resources, improvement of pasture management and livestock feeding, and control of important diseases of animals.

 [Continue to Food Science and Technology Divison](#)

Food Production and Technology Division

■ Director Toru Hayashi

The division evaluates the safety and nutritional characteristics of food resources, and acts to minimize the qualitative and quantitative losses through development of techniques in the conformity to the actual circumstances of developing countries.

In addition it develops techniques to evaluate food qualities and technologies concerning with the distribution and processing for the purpose of improving the incomes of the farmers.

▶ [Continue to Forestry Divison](#)

Forestry Division

■ Director Kiyoshi Nakashima

The division carries out research on the technologies for the sustainable forest management, proper utilization and processing of the forest resources in the developing regions.

▶ [Continue to Fishery Division](#)

Fisheries Division

Director Masachika Maeda

The division carries out research to develop the techniques for the management and sustainable utilization of marine fisheries resources, and to promote the aquaculture utilizing the new varieties of fishes.

In addition, it conducts experiments on the utilization, processing and transportation of marine and fresh water fishes, and the preservation and restoration of the coastal environment.

 [Continue to Okinawa Subtropical Station](#)

Okinawa Subtropical Station

Director Masaaki Suzuki

The substation carries out researches on the heat tolerance and breeding of tropical and subtropical crops, farming, utilization and diseases resistance of tropical fruits, and environmental management techniques for intensive agriculture by taking advantage of the special subtropical climatic conditions due to its geographical location.

➡ [Back to the contents \(Overview of JIRCAS\)](#)

➡ [Back to JIRCAS home page](#)



/ 18 / 2002

 [Research Topics](#) (Japanese)

 [Studies on the control of the injurious nematode to soybean in Paraguay.](#)

 [9th JIRCAS International Symposium](#)

Value-Addition to Agricultural Products - Towards increase of farmers' income and vitalization of rural economy -

 **Newly Released Publications**

 [JIRCASNewsletter](#) (No.32)

 [JARQ](#) (Japan Agricultural Research Quarterly) (Vol.36-3)

 [JIRCAS Journal](#) (No.10) (Contents)

 [JIRCAS Working Report](#) (No.23)

 **Visiting Research Fellow Program**

 [Tsukuba Fellows Program](#)

 [Okinawa Fellows Program](#)

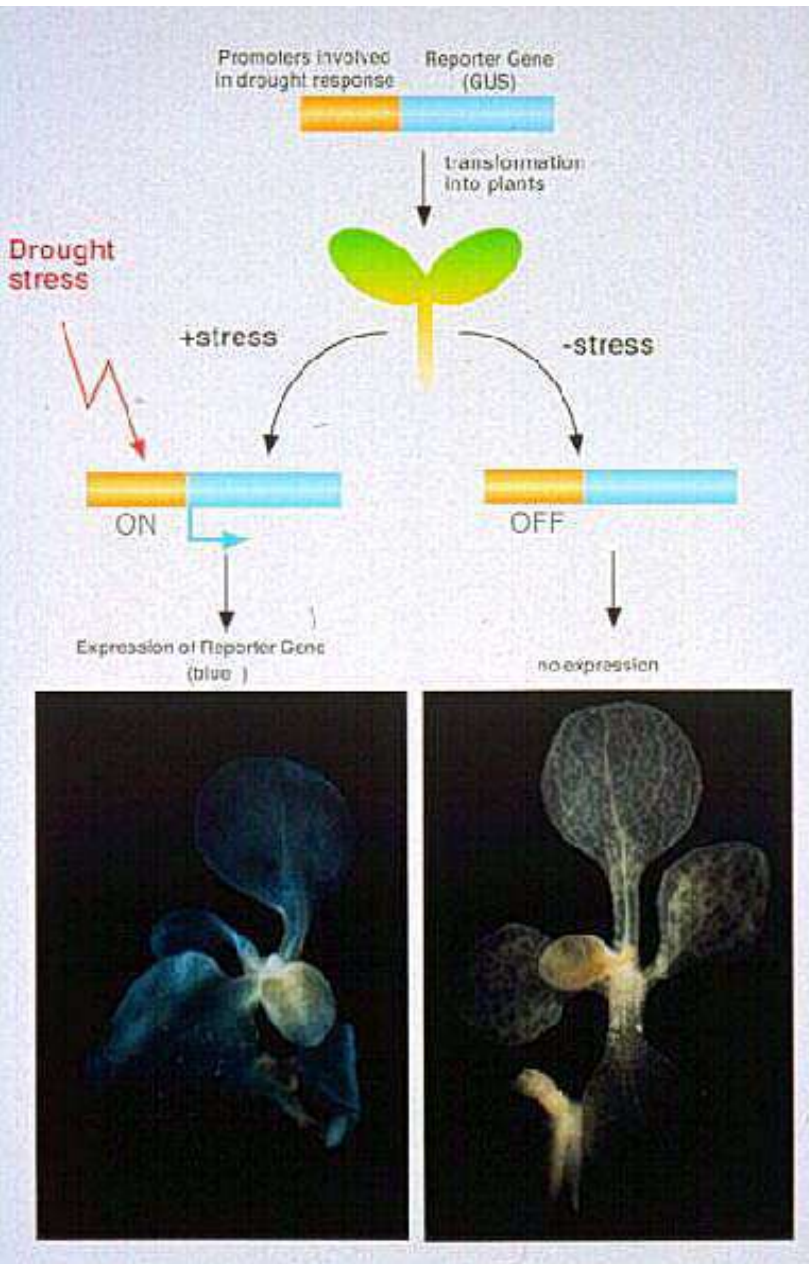
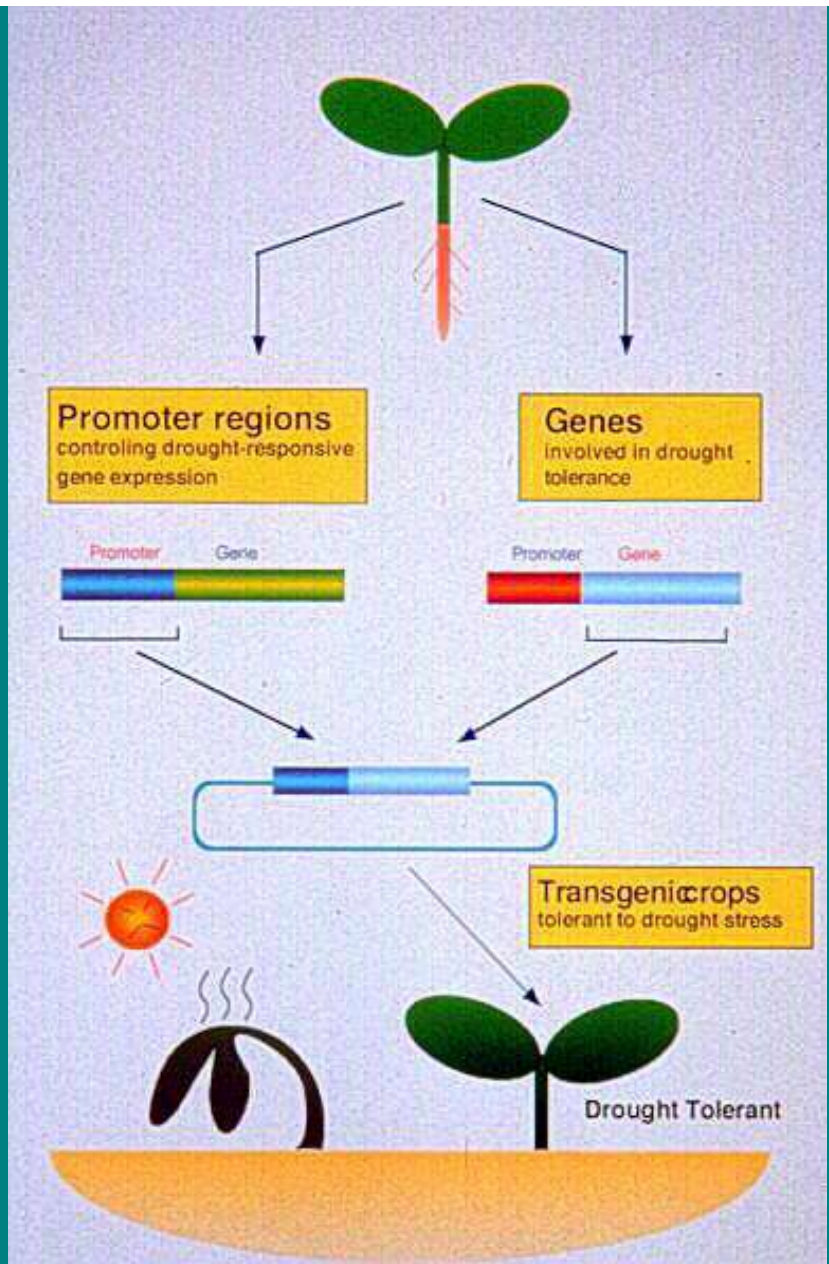
 [What's JIRCAS](#)

GENES ESSENTIAL FOR MOLECULAR BREEDING OF DROUGHT TOLERANT PLANTS WERE ISOLATED.

Plant genes for transcription factors were isolated that control expression of genes involved in drought tolerance. Regulatory elements in promoters were also identified that control drought responsive gene expression. These transcription factors and promoters are expected to be useful for molecular breeding of drought tolerant plants by regulating number of genes involved in drought tolerance.

Strategies to develop crops that are tolerant to drought stress

Novel promoters control drought-responsive expression of GUS reporter gene



JIRCAS



•@

•@•É%»—}•š•ì—p,đ,à,Â”M‘ÑfCfI%È-q‘•,Ì”-©

•@

•@•@f^fCŽYfVf‡fEfK,É<@”\•«•@-”-fKf“—}•š,ÉCEø%È-

•@

•@•@•@“]ŽÊ•šCEäâ“Žq,đ—p,ç,Ä—ò^«ŠÂ«‘İ•«•A•”,Ì•^aŽq^çŽí,É
•çŠE,Å•%,ß,Ä•-CE÷

•@

•@•@’†•’W•...<>,a,;è•g,Æ,μ,ÄŽg,!,é

•@

•@•Šš‘‡fXfgfCEfX‘İ•«•A•”,Ì•^aŽq^çŽí,Ö,Ì“^a,đ‘ñ,-

•@

•@fX•[f_f“•EfTf”f@f“fi,Ìšš<G,Å,à•Í’],Å,«,é‘İ••«,ÌfTfTfQ,đ”-©
•i•k•ìCEÀŠE’n,Ì•H•¶Š^,đŽx,!,éTfTfQ•j

•@

•@—{•t•Í’],É,æ,éTfTfgfEfLfr‘ž}•c,Ì‘â—Ê‘••B

•@

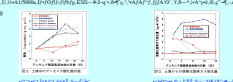


Brookside, New South Wales, Australia

•É%»—}•§i—p,ð,à,Â”M’ÑfCfj%È—q’•,}”•œ©

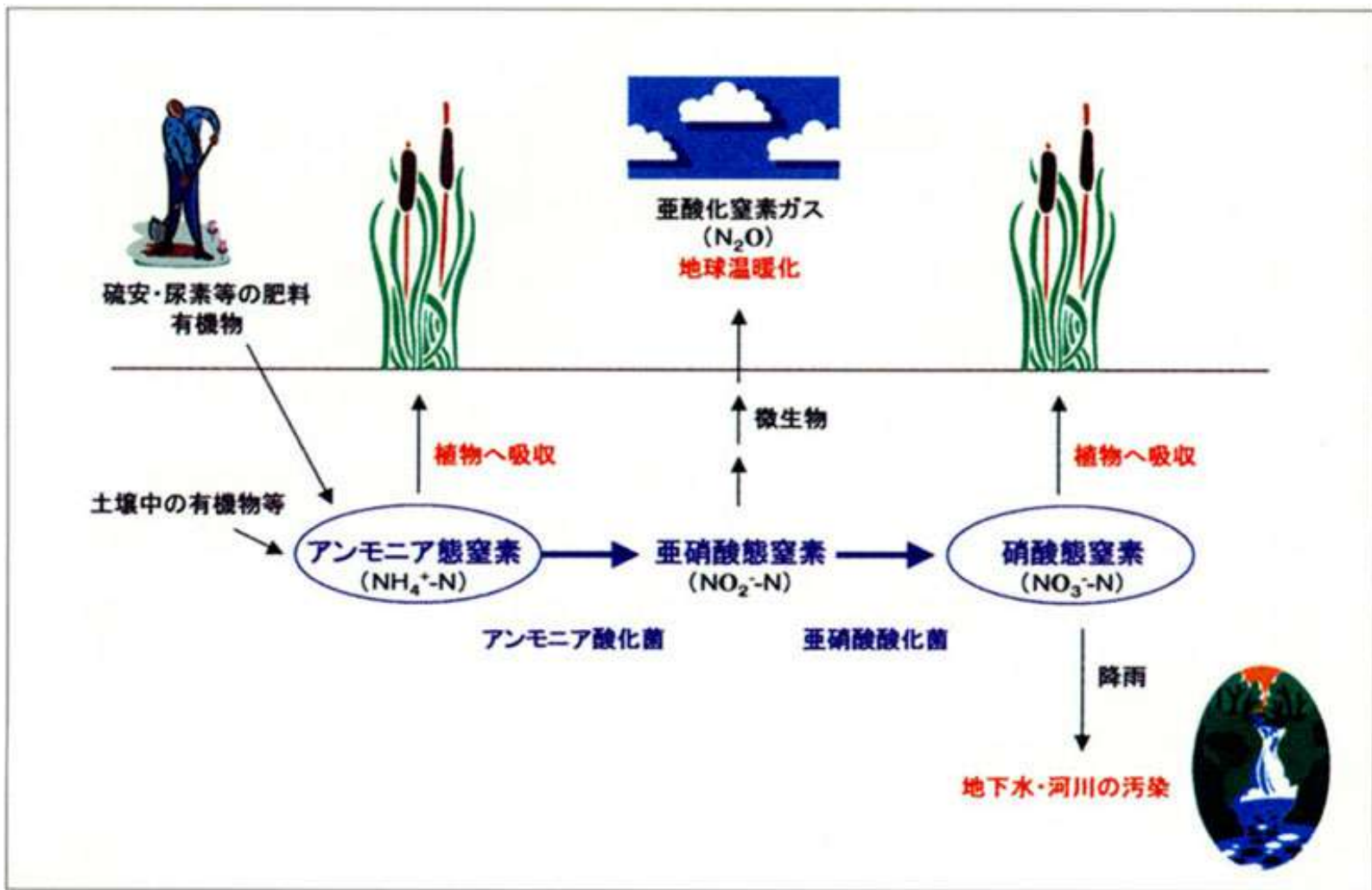


•É%»—}•§i—p,ð,à,Â”M’ÑfCfj%È—q’•,}”•œ©



•É%»—}•§i—p,ð,à,Â”M’ÑfCfj%È—q’•,}”•œ©

•É%»—}•§i—p,ð,à,Â”M’ÑfCfj%È—q’•,}”•œ©



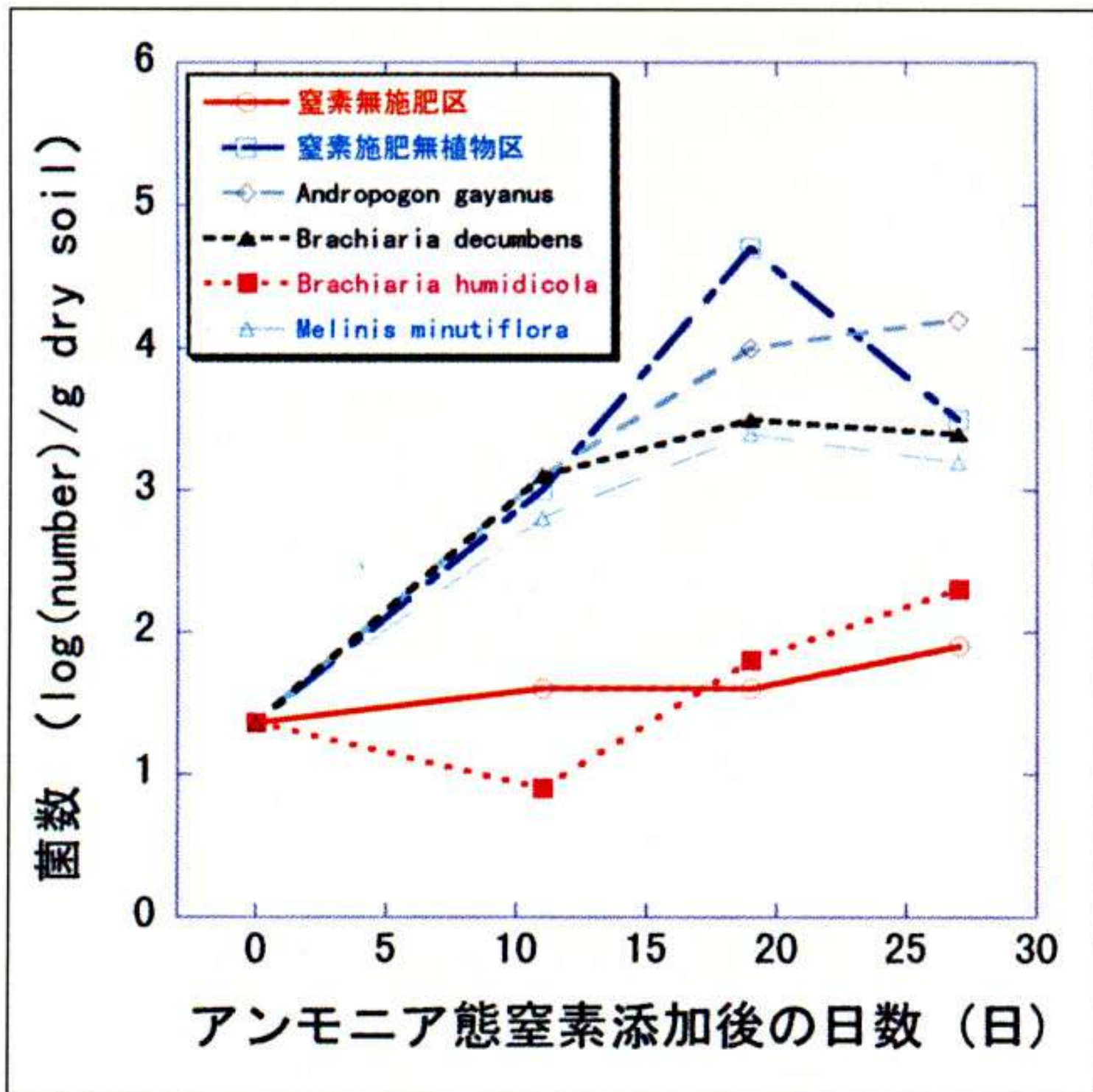


図 2. 土壤中のアンモニア酸化菌の数

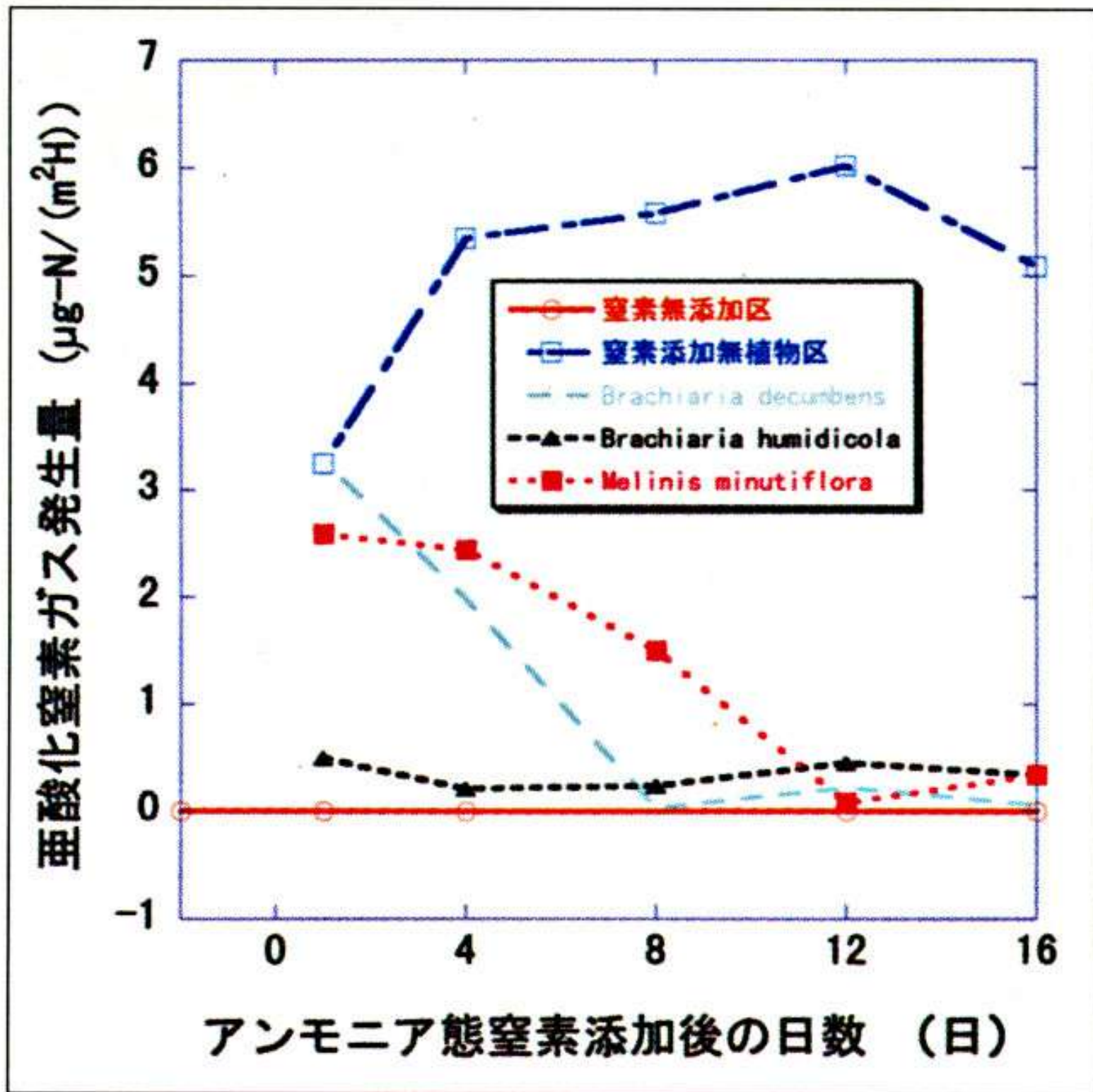


図 3. 土壌からの亜酸化窒素ガス発生量

f^fCZYfVf;fE.fK%È•H—p•A*,ÉSÜ,Û,è,é
•R•ÏÛE'←→*,ÏP—É•E←→è

nm~DEE.E.g.n

1.Nf/E/K%bA~1%...A/KF,KE~%.E.E.É3"ZqPERFÜ,Δ→H,ç9→p.ΔZ,~B
2.P(CA)→BKEVf/EK→B~p,ÉA,~bA~,çB4'UE'9→p.ΔZ,~k1f%,çB
3.P(CZYVf/EK→B)peLE,AE,çA'VE'UE'9→p.ΔZ,~çB~ç,çB

nm~%È,É,É~çE'A~n



1.NG.ΔZ→B)P(CZYVf/EK%bA~1%...A/KF,KE~%.E.E.É3"ZqPERFÜ,Δ→H,ç9→p.ΔZ,~B

f^fCZYVf/EK%bA~1%...A/KF,KE~%.E.E.É3"ZqPERFÜ,Δ→H,ç9→p.ΔZ,~B



nm~%È,É,É~çE'A~n

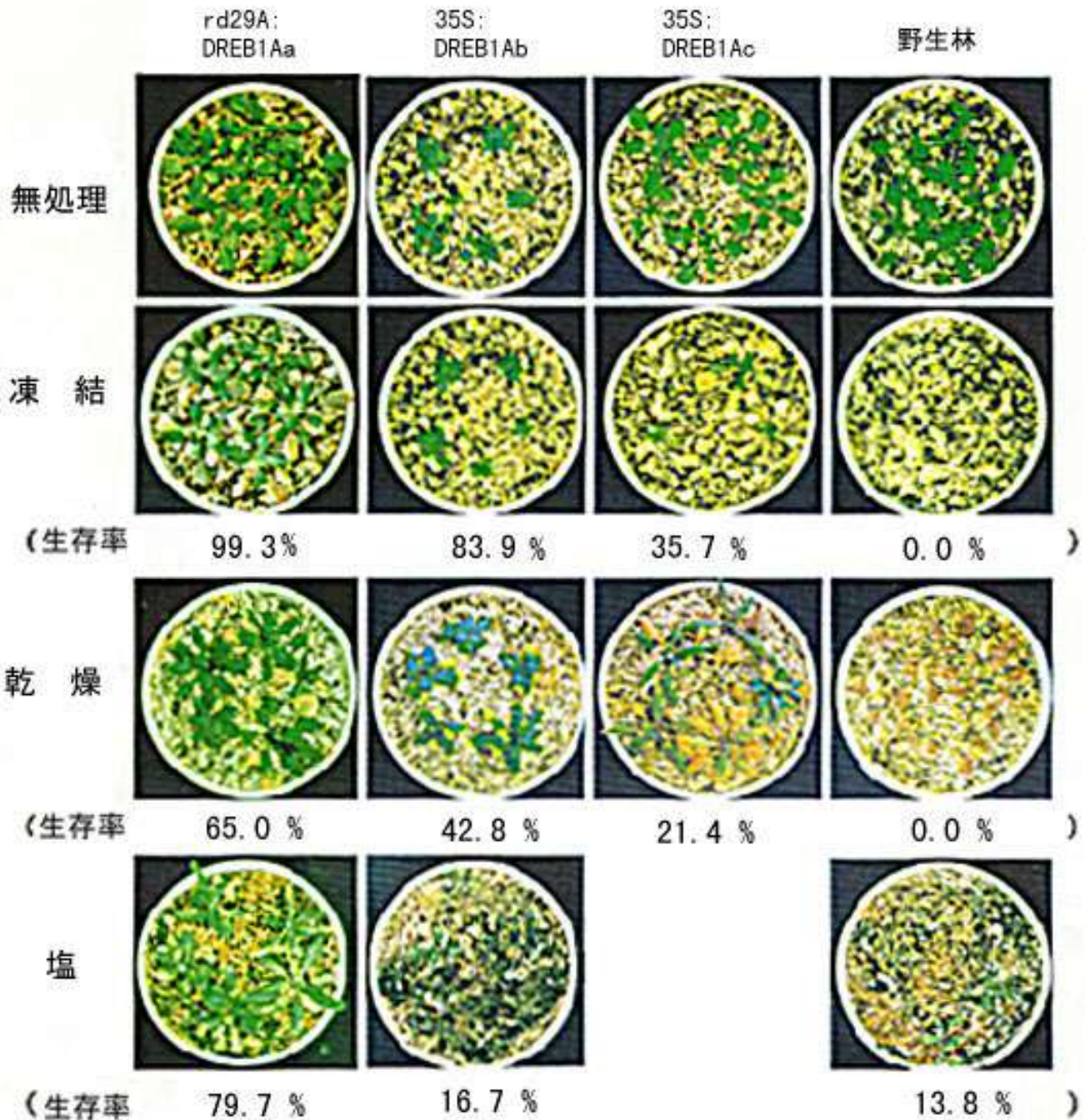
①1.Nf/E/K%bA~1%...A/KF,KE~%.E.E.É3"ZqPERFÜ,Δ→H,ç9→p.ΔZ,~B
②2→p,ÉA,~bA~,çB4'UE'9→p.ΔZ,~k1f%,çB

2002年7月10日 10時48分27秒

2002年7月10日 10時48分27秒

2002年7月10日 10時48分27秒

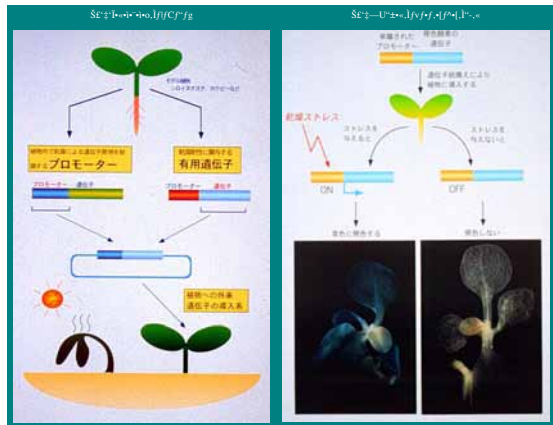
2002年7月10日	10時48分27秒	2002年7月10日	10時48分27秒	2002年7月10日	10時48分27秒
2002年7月10日	10時48分27秒	2002年7月10日	10時48分27秒	2002年7月10日	10時48分27秒
2002年7月10日	10時48分27秒	2002年7月10日	10時48分27秒	2002年7月10日	10時48分27秒
2002年7月10日	10時48分27秒	2002年7月10日	10時48分27秒	2002年7月10日	10時48分27秒
2002年7月10日	10時48分27秒	2002年7月10日	10時48分27秒	2002年7月10日	10時48分27秒
2002年7月10日	10時48分27秒	2002年7月10日	10時48分27秒	2002年7月10日	10時48分27秒



Genes essential for molecular breeding of drought tolerant plants were isolated.

GENES ESSENTIAL FOR MOLECULAR BREEDING OF DROUGHT TOLERANT PLANTS WERE ISOLATED.

[http://www.affrc.go.jp/topics/kansou.html](#)
[http://www.affrc.go.jp/topics/kansou.html](#)
[http://www.affrc.go.jp/topics/kansou.html](#)
[http://www.affrc.go.jp/topics/kansou.html](#)
[http://www.affrc.go.jp/topics/kansou.html](#)
[http://www.affrc.go.jp/topics/kansou.html](#)
[http://www.affrc.go.jp/topics/kansou.html](#)
[http://www.affrc.go.jp/topics/kansou.html](#)
[http://www.affrc.go.jp/topics/kansou.html](#)
[http://www.affrc.go.jp/topics/kansou.html](#)



••Ū—Ñ•...ŽYÆCE▪•†fZf“f^•[

••Ū—Ñ•...ŽYÆCE▪•†fZf“f^•[

••Ū—Ñ•...ŽYÆCE▪•†fZf“f^•[

••Ū—Ñ•...ŽYÆCE▪•†fZf“f^•[

••Ū—Ñ•...ŽYÆCE▪•†fZf“f^•[

••Ū—Ñ•...ŽYÆCE▪•†fZf“f^•[

••Ū—Ñ•...ŽYÆCE▪•†fZf“f^•[

••Ū—Ñ•...ŽYÆCE▪•†fZf“f^•[

••Ū—Ñ•...ŽYÆCE▪•†fZf“f^•[

••Ū—Ñ•...ŽYÆCE▪•†fZf“f^•[

••Ū—Ñ•...ŽYÆCE▪•†fZf“f^•[

••Ū—Ñ•...ŽYÆCE▪•†fZf“f^•[

••Ū—Ñ•...ŽYÆCE▪•†fZf“f^•[

••Ū—Ñ•...ŽYÆCE▪•†fZf“f^•[

••Ū—Ñ•...ŽYÆCE▪•†fZf“f^•[

••Ū—Ñ•...ŽYÆCE▪•†fZf“f^•[

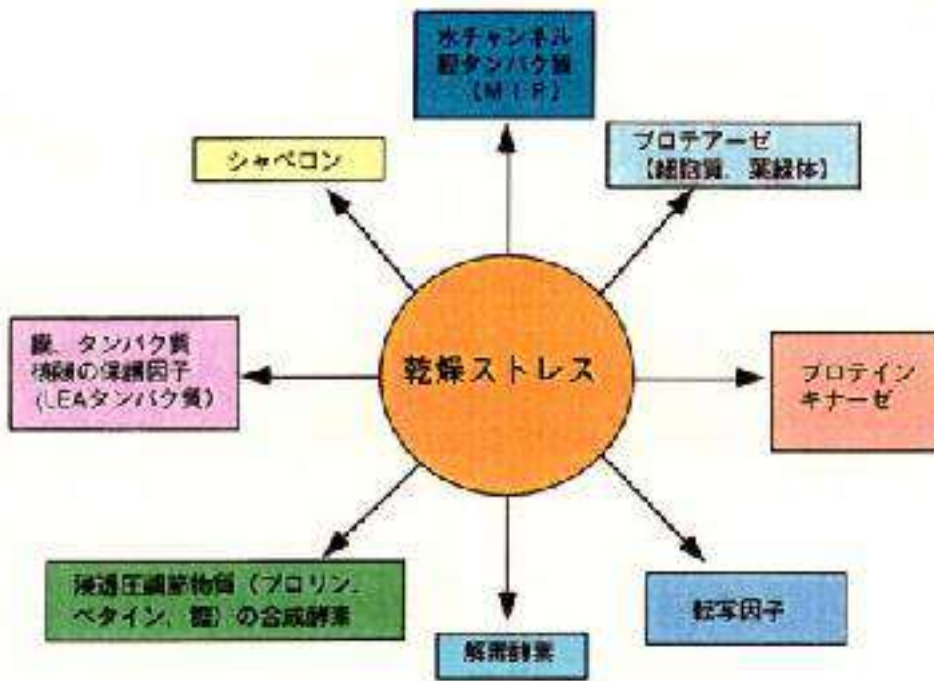
••Ū—Ñ•...ŽYÆCE▪•†fZf“f^•[

••Ū—Ñ•...ŽYÆCE▪•†fZf“f^•[

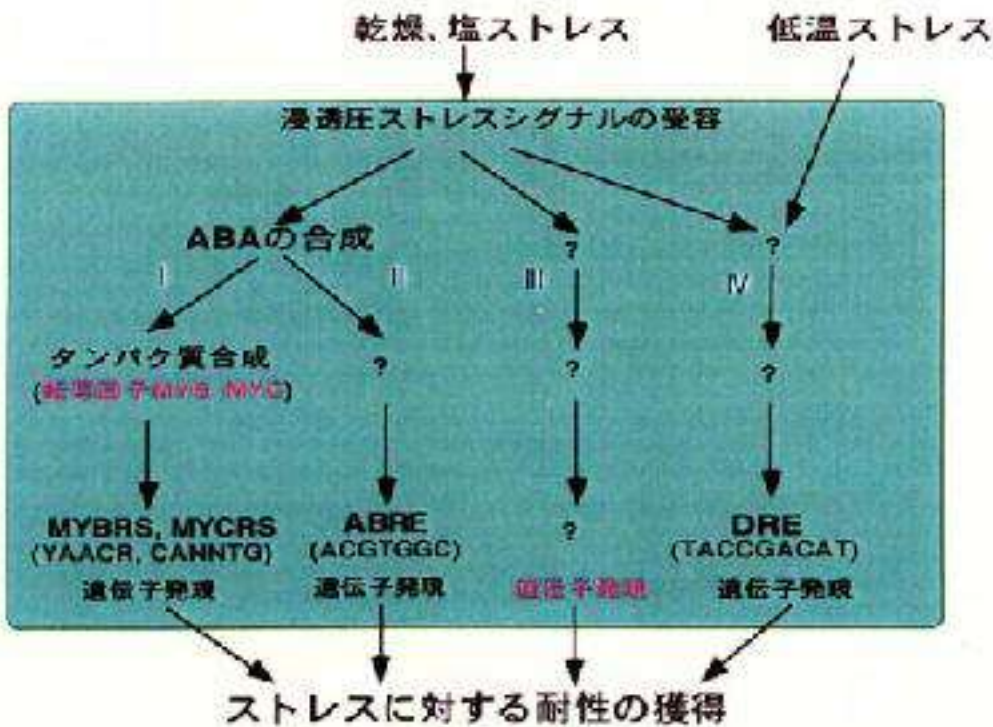
••Ū—Ñ•...ŽYÆCE▪•†fZf“f^•[

••Ū—Ñ•...ŽYÆCE▪•†fZf“f^•[

••Ū—Ñ•...ŽYÆCE▪•†fZf“f^•[



乾燥ストレス耐性の獲得に働く遺伝子群の機能

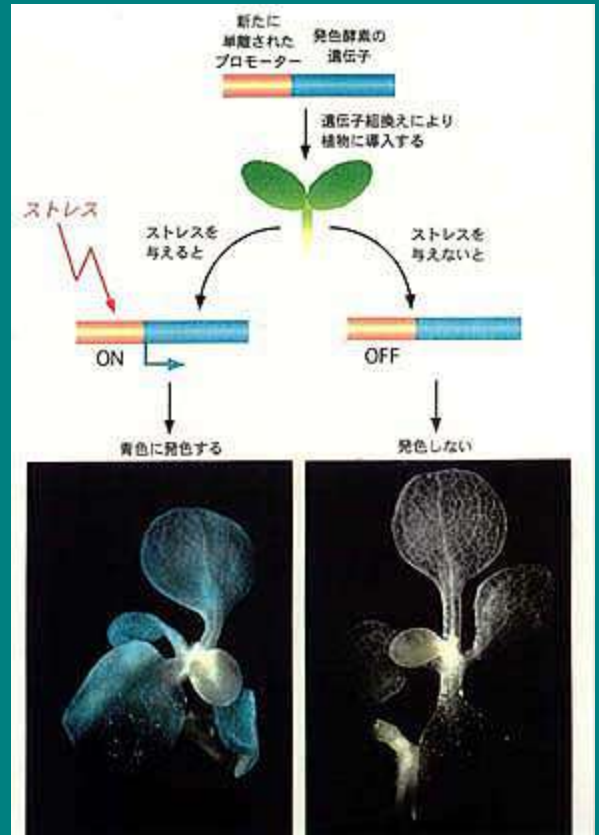


環境ストレスを受けてから植物がストレスに対する耐性を獲得するまでの分子レベルの道筋

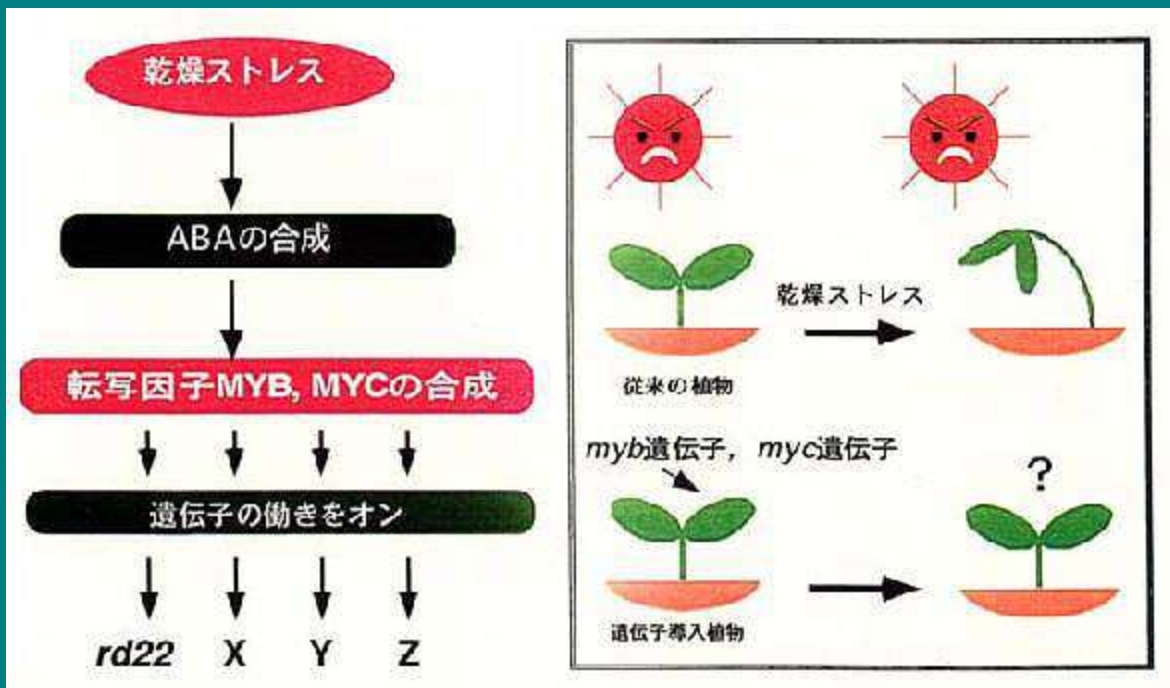
•@



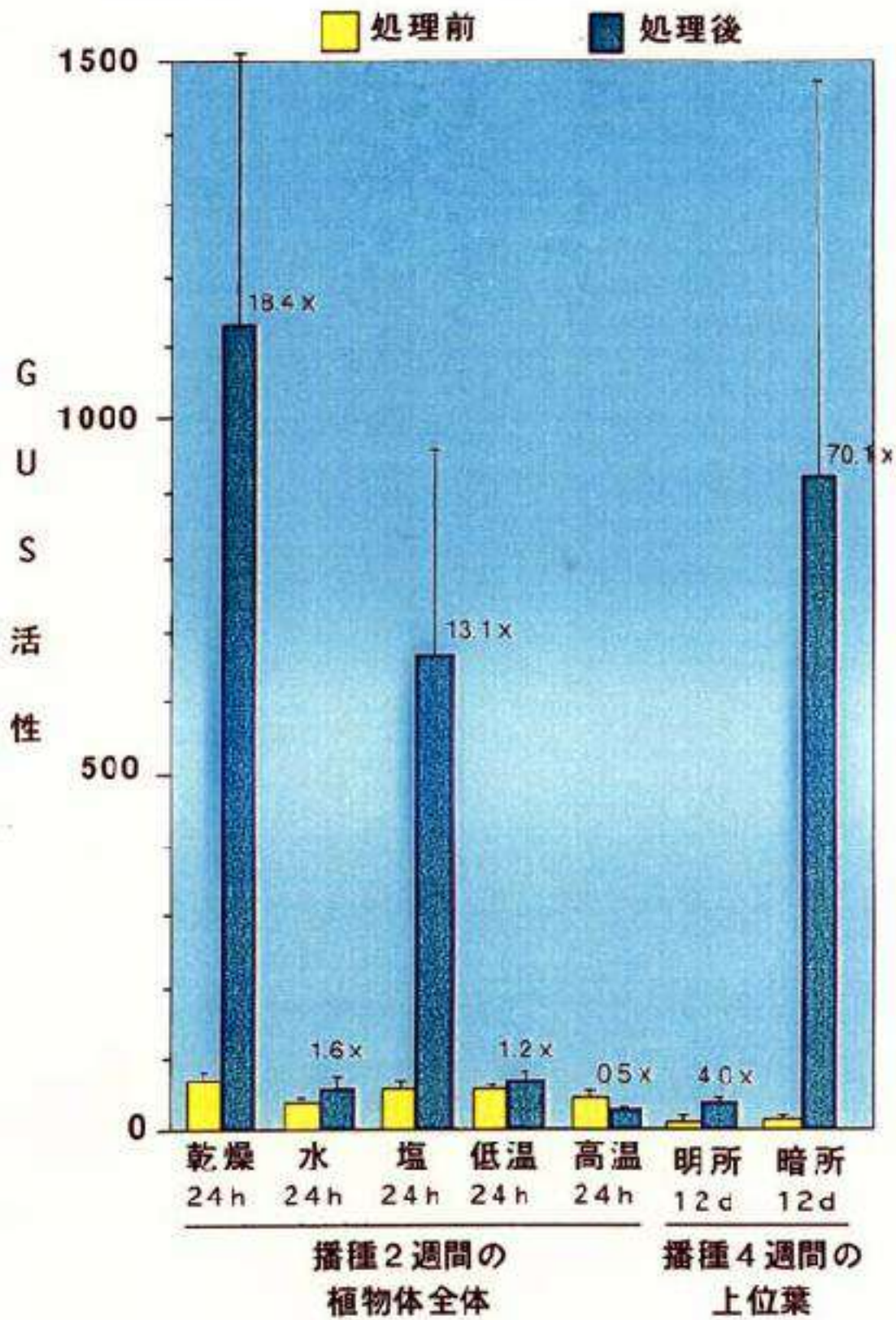
•@



•@



•@



erd1プロモーターは乾燥・塩ストレス時または暗所で遺伝子の働きをコントロールする

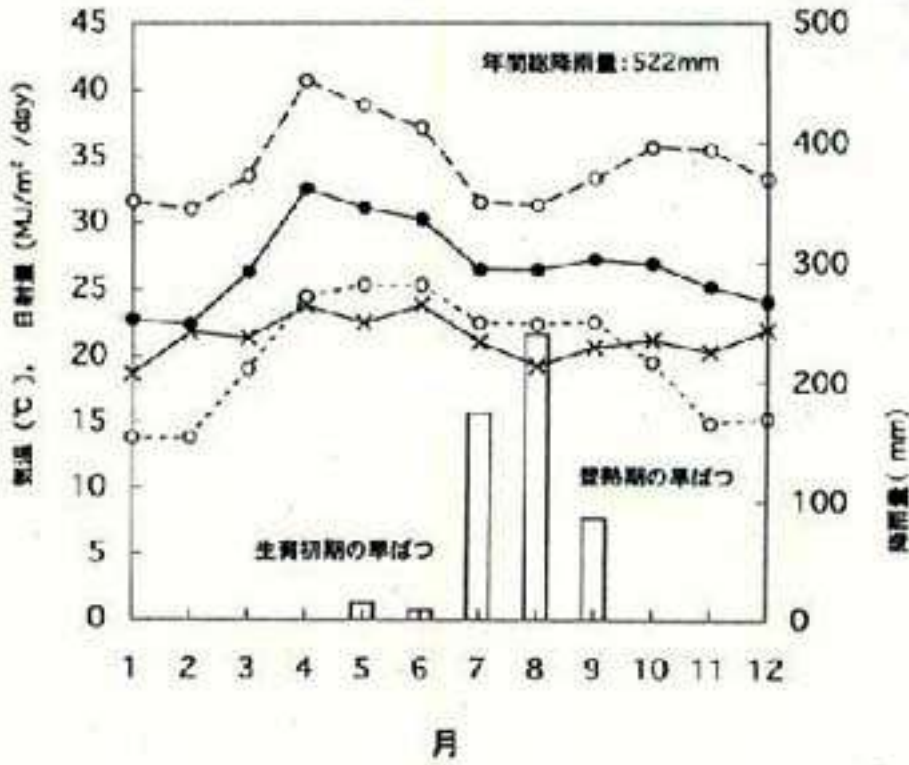


図1 ナイジェリア、カノーにおける気象資源の年間の推移 (1990年)

降雨量 最高気温月間平均値 -○- 最低気温月間平均値 -○-
 平均気温月間平均値 -●- 日射量の月間平均値 -X-

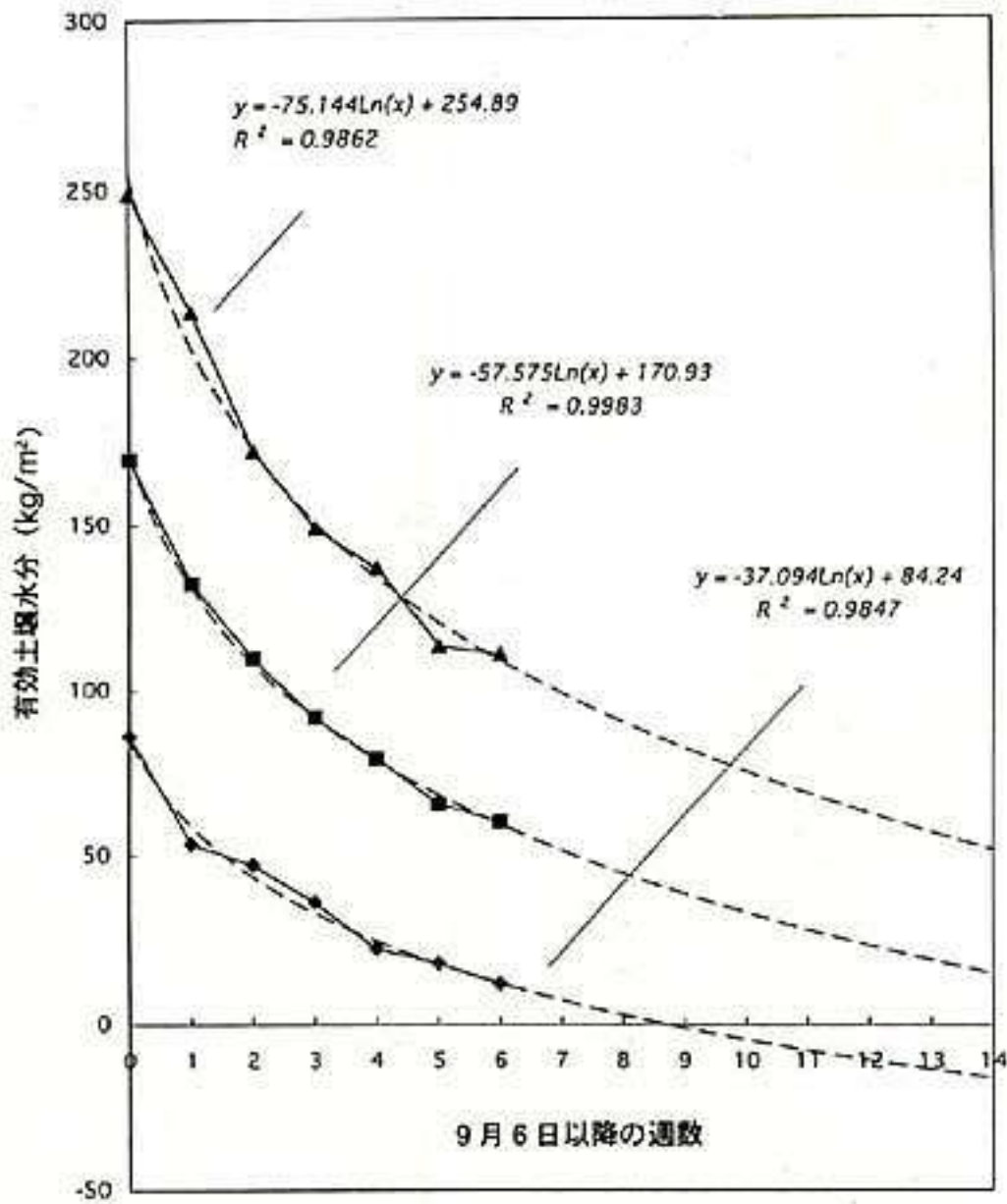


図2 雨期末期の播種（9月6日）を想定した場合の
その後の有効土壌水分の推移

根圏が0-60cmの場合—●— 0-120cmの場合—■— 0-180cmの場合—▲—

表 1. カノーの乾季圃場におけるササゲ遺伝資源の子実収量
(1994/95)

遺伝資源 系統(Tvu No.)	収集地	耐旱性 スコア	子実収量 (t/ha)			
			1区	2区	3区	平均±SE
11979	スーダン	4.9	1.37	0.67	0.98	1.01±0.35
11986	インド	4.9	0.57	0.74	1.46	0.92±0.47
12348	モザンビーク	4.7	0.87	0.99	0.87	0.91±0.07

7778	アイボリーコースト	1.5	0.24	0.34	0.23	0.27±0.06
8256	アイボリーコースト	1.4	0.16	0.24	0.07	0.15±0.09
9357	アイボリーコースト	1.3	0.52	0.15	0.15	0.27±0.21

註1) 播種 9月28日, 畦間 75cm, 株間 40cm, 1株2本立

註2) 耐旱性スコア: 極強≥4.0, 極弱<2.0

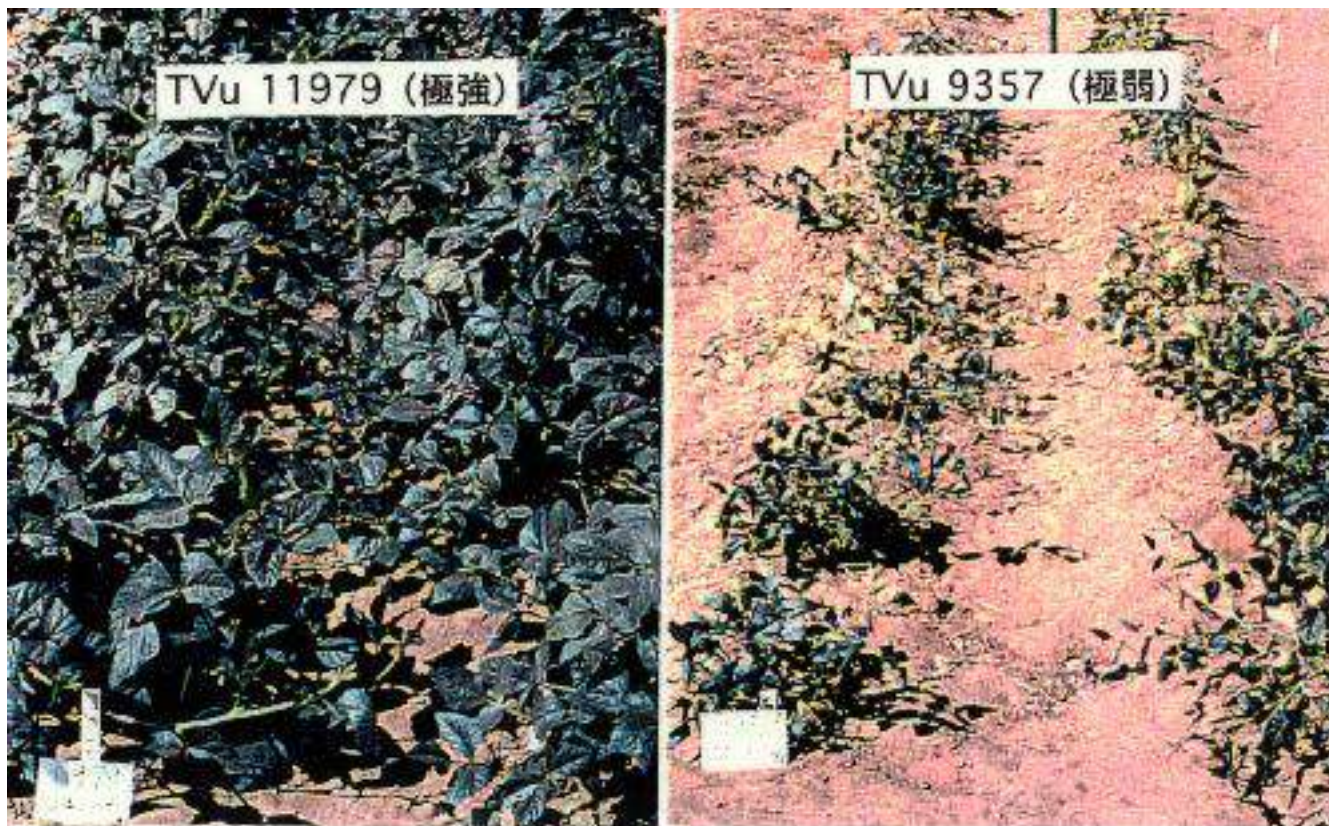


図 3、カノーの乾季圃場におけるササゲ遺伝資源系統の生育状況
(1994年12月上旬)

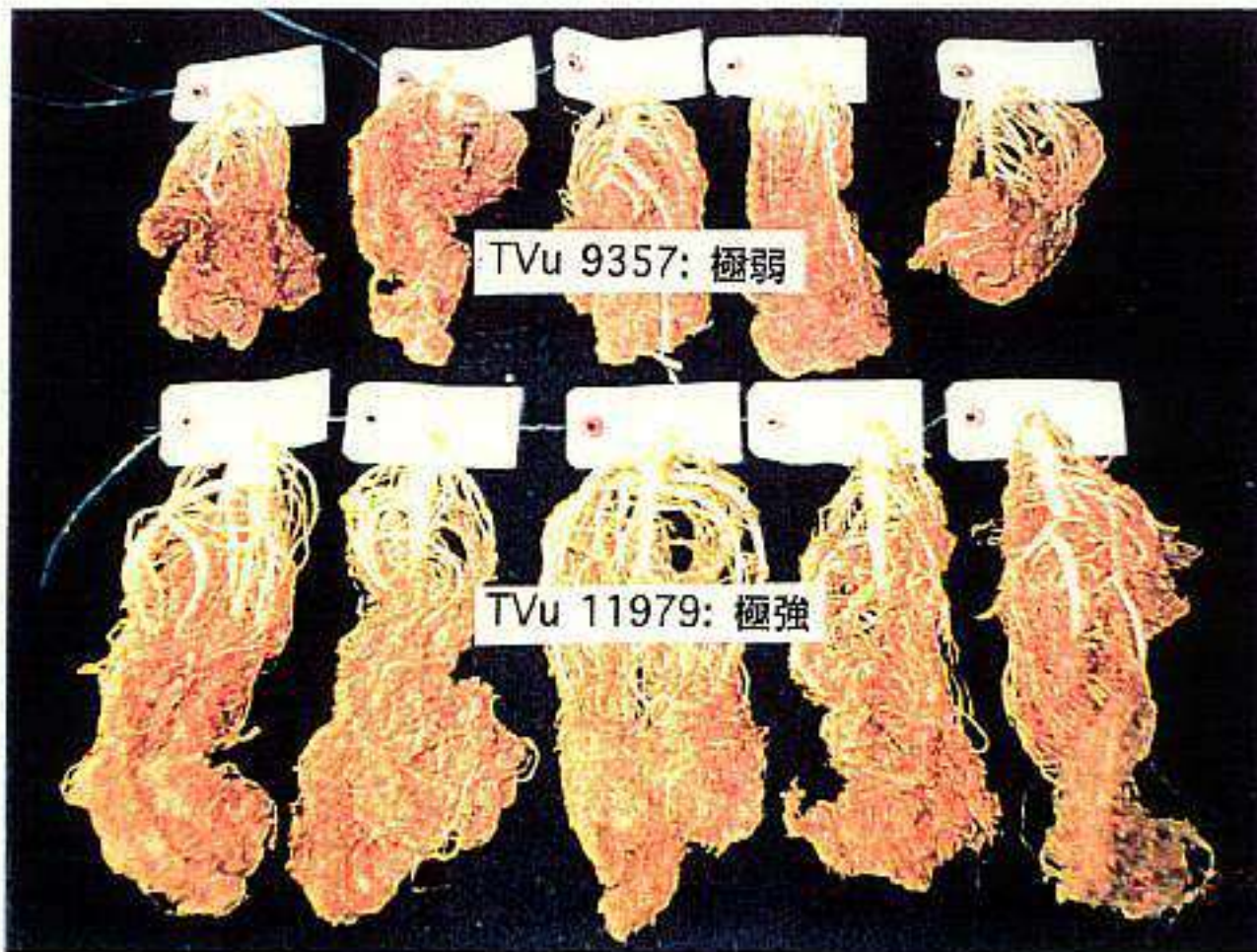


図4、ポット栽培したササゲの根量（播種後67日）

根への乾物分配率 TVu 11979 : 17.9% TVu 9357 : 9.8%

•k•iĀĚÅŠE'n,İ•H•ŕŠ^,đŽx,!,éƒTƒTƒQ

•k•iĀĚÅŠE'n,İ•H•ŕŠ^,đŽx,!,éƒTƒTƒQ

•@

Ē'ŽY'n •¼ƒAƒƒŕŠƒJ•à,^a—L—Í

•ĉŠE,İ•ŕŽY—Ê ,Q,O,O•` ,R,O,O—œƒƒƒ“

ŽšŽY'n ƒAƒƒŕŠƒJ,İƒTƒ”ƒ@ƒ“ƒi'n'Ñ•iŽqŽŽÀ—p•j

•@ ƒuf%œƒWƒ<•iŽqŽŽÀ—p•A—i•Ø—p•j

•@ ƒCƒ“ƒh•iŽqŽŽÀ—p•A—i•Ø—p•j

•@ “Ē“iƒAƒWƒA•i—i•Ø—p•j

“ñ,Â,İ,iŽiĒEQ •@

•EŽqŽŽÀ—p ~a-¼•FƒTƒTƒQ•@•@%œp-¼•FCowpea

•@ Šw-¼•FVigna unguiculata spp. Unguiculata cultivar-group unguiculata

•E—i•Ø—p ~a-¼•FƒWƒ...ƒEƒ•ƒNƒTƒTƒQ•AƒiƒKƒTƒTƒQ

•@ %œp-¼•FYard-long bean

•@ Šw-¼•FVigna unguiculata spp. Unguiculata cultivar-group seaquipedalis

Ē»'n,Â,İ'²—•@ •@

•EƒiƒCƒWƒFƒŕŠƒƒA •F'E”ĉ••»•2•%œÁ•...•“—û,Â—g,°,é•“akara
•F•Q•Q•Q•V•Q•Q•Q•Q•“,Ó,©,•“moin-moin

•EƒCƒ“ƒh •Fƒ_ƒ<i,Đ,«,í,è•j•“ƒX•[ƒv,È,Ç

•@ •@

“Á•F

—đ^«ŠÁ««,É<,ĉ••k•iĀĚÅŠE'n,Â,İƒ^ƒ“ƒƒƒNŽi,•i•“,Æ,µ,Ä•d—v
ŽqŽŽÀ•¬^a•Fƒ^ƒ“ƒƒƒNŽi,•@,Q,R•`,Q,T•“•AŽ%œ—b•@,Q•“•@•¬“œ,É—ƒŽ—
‘İŠ±•«,É,Í—D,ê,é,^a•ÛŽ¼•«,^a—đ,é
ƒƒ<ƒKƒ•Aƒ~ƒĒƒƒƒg,ÉŠÔ•i,³ê,é•ê•‡,^a½,ĉ
••Û”M“Ñ”_<ÆĒœ<‡•Š(IITA),İ^a•S•i•“

JIRCAS

Newsletter

No. 23

June 2000



Rehabilitation of mangrove forest in the Philippines
(Photo by M. Maeda)

CONTENTS




<Feature Article>

- [Offshore Environmental Research](#)

<Collaborative Research Project>

- [Collaborative Research Projects with ICIPE](#)

<JIRCAS Research Highlight>

-  [Oil Palm Residues for Pulp and Paper](#)
-  [Simple and Rapid Identification Technique for Aromatic Rice](#)
-  [Genetic Variation of Rice in Yunnan, China](#)

[<Workshop>](#)

[<JIRCAS International Symposium>](#)

[<People>](#)

-  [JIRCAS Home Page](#)

Offshore Environmental Research



Masachika Maeda
Director, Fisheries Division, JIRCAS

The argument for protecting the environment is based on the fear that the biotopes will be unable to withstand the disturbances caused by human activities, along with a deep concern for the future generations, in particular the under-privileged groups in the society.

Despite the development and use of modern measurements and technologies, far too little is actually being done for the promotion of sustainable development. There is not even a clear agreement as to what sustainable development is. Under these conditions, to enable the development of common standards for sustainable production in the field of agriculture, forestry and fisheries, scientific research will play a crucial role.

Coastal zones sharply illustrate the problems and policy challenges faced locally as well as on a global scale. These zones are under increasing environmental pressure and are showing an unacceptable level of environmental degradation as a result of population growth, urbanization, reckless adoption of aquaculture and other multiple and often conflicting changes in resource utilization. The alleviation of these problems and the adoption of practical and sustainable economic development policy objectives will require innovative policy responses. Integrated coastal zone management (ICZM) is one of such comprehensive policy/management options. ICZM requires the formulation of a wide range of general principles, as well as the combination of economically efficient and sustainable resource utilization with prevention strategies.

In many coastal areas, maintenance or expansion of the regional economy is a major, often the primary, objective. However, the benefits associated with the development in coastal economies, such as tax revenues, tourist expenditures, and employment may be reduced as a result of the deterioration of water quality.

In the context of regional and area economic development, the objectives of ICZM can be expressed in two forms: the negative and positive aspects. On the negative side, people will have to bear the costs of normal production, net coastal management, discharge reduction, mangrove or beach restoration, coastal protection, cost for repair of existing damage and the administrative cost of management. The positive factors include improved income from increased gross regional product combined with benefits from improved environmental quality processes which are an international focus of interest. For example, by using natural microbial foods and taking advantage of the capacity of highly productive mangrove ecosystems to absorb effluents, aquaculture can become an eco-friendly process (Fig. 1), that will provide the fishermen with a higher income in the long term.

In addition, we should remember the words of the famous novelist Ryotaro Shiba: "People of the late 20th century, having gained the knowledge that they are merely one part of Nature, have again begun to fear Nature in the way people feared the gods in ancient times. The period in which man regards himself as master of Nature will come to an end as we draw increasingly close to the 21st century. Human beings do not live on their own, but are kept alive by a great presence."

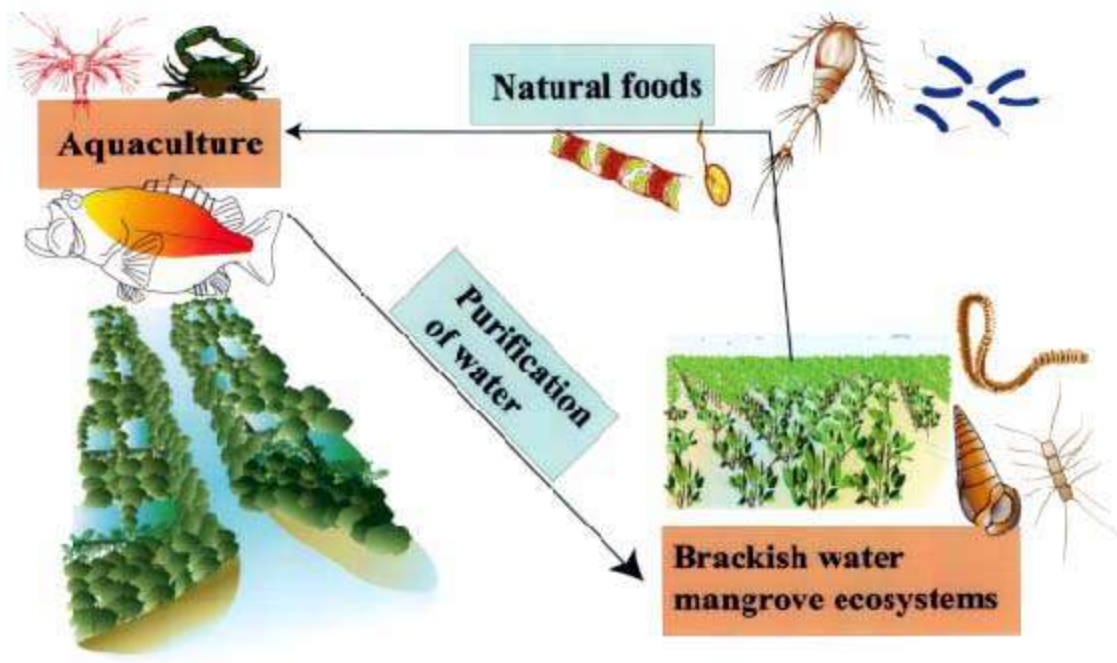


Fig. 1. Use of natural food chain and coastal purification procedures for aquaculture.

[NEXT](#) [CONTENTS](#)

Collaborative Research Projects between ICIPE and JIRCAS

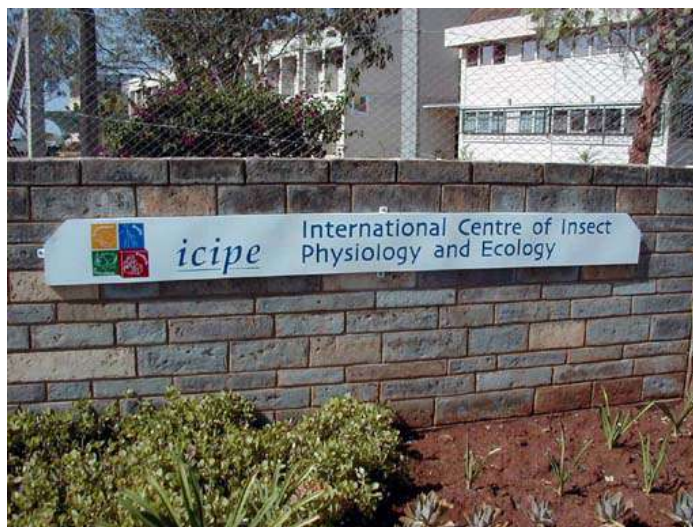
Satoshi Nakamura

Crop Production and Postharvest Technology Division, JIRCAS

The International Centre of Insect Physiology and Ecology (ICIPE), based in Nairobi, Kenya, was established in 1970 as an advanced research institute amidst growing global concern about the misuse and overuse of synthetic pesticides. ICIPE was registered as an intergovernmental organization in 1986, with governance through a 16-member international Governing Council. Due to its broader mandate encompassing health and environment as well as agriculture, ICIPE has remained outside the CGIAR system, whose work is primarily commodity-oriented. Interested donors judiciously established a Sponsoring Group (SGI) in 1980 to help guarantee scientific excellence and funding.



Building of ICIPE



Sign at the entrance of ICIPE

Today, ICIPE continues to follow its original mandate of developing technologies to alleviate world poverty and to ensure food security and good health for the peoples of the tropics through management and control of both harmful and useful arthropods. The Centre's current objectives aim at improving and promoting the activities of the "4H's" (human, animal, plant and environmental health) interdisciplinary teams of scientists engaged in research related to ecosystems science, behavioral biology and chemical ecology, molecular biology and biotechnology and social sciences. Research support is provided by biomathematics, animal breeding and quarantine and biosystematics units, and computer and information services. The 360-strong staff members originate from 19 countries, primarily in developing regions. Programs are mainly focused on plant pest management, disease vector management, insect biodiversity conservation and utilization, and capacity building from post-doctoral to farmer level.

Collaboration is a by-word at ICIPE, with partners from 45 universities throughout the world, including 30 African universities in ARPPIS (The African Regional Postgraduate Programme in Insect Science), other IARCs and CGIAR centres, more than 20 advanced research institutions, NARS in Africa and beyond, and NGOs.

JIRCAS is one of these partners and JIRCAS-ICIPE collaborative research started from 1994 and then the project: "Biorational Approaches to Long-term and Sustainable Management of Desert Locusts in East and North Africa" was conducted during the period 1995-1999, which produced fruitful results on the mechanism of change from the "solitary" to harmful "gregarious" phase of desert locusts, based mainly on physiological and endocrinological studies. Presently these studies are being taken over to the new five-year project: "Physiological and Ecological Studies for the Development of IPM for Economically Important Pests in Africa" funded by the Ministry of Agriculture, Forestry and Fisheries of Japan.

Besides locusts, another objective of the new project is to focus on the biological control of stemborers of staple cereals in East Africa. The spotted stemborer, *Chilo partellus*, an exotic cereal pest that was accidentally introduced into Africa from Asia in the 1930s, has been responsible for crop losses of up to 80%. A natural enemy of the stemborer, a parasitic wasp *Cotesia flavipes*, was imported by ICIPE from Pakistan in 1991 and has been found to be one of the most effective biological control agents for this destructive pest. However, for further suppression of stemborer densities, other promising natural enemies will be studied and introduced in the near future.



Nymphs of *Schistocerca gregaria*
(Photo by S. Tanaka, Natl. Inst. Sericult. Entomol. Sci.)

[NEXT](#)

[CONTENTS](#)

Utilization of Oil Palm Residues as a Raw Material for Pulp and Paper

Ryohei Tanaka
Forestry Division, JIRCAS

African oil palm, *Elaeis guineensis*, is one of the most important plants in Malaysia. It produces palm oil and palm kernel oil, which are widely used in food and other industries such as detergents and cosmetics. Malaysia is the world's largest producer and exporter of the oil, accounting for approximately 10% of the world's oil and fat production (1998). The total area of oil palm plantations is close to 3.2 million hectares, which account for almost 50% of the land under cultivation in Malaysia.

Although oil from the palm tree is an excellent product for the country, residues from oil palm have not been used sufficiently. One of the abundant lignocellulosic residues consists of empty fruit bunches (EFB), which are left behind after removal of oil palm fruits for the oil refining process at palm oil refineries. Tons of EFB are discharged from each refinery regularly, amounting to 16 million tons per annum in the year 2000. Some of them are used as fuel at the factories, but most of them are left unused.

Converting this lignocellulosic waste to paper-making pulp is a promising way of utilization, as the consumption of paper is increasing dramatically in the Southeast Asian countries including Malaysia. Several investigations have been carried out on EFB pulping, whereas studies on bleaching of EFB pulp have been very limited so far. Collaboration work between JIRCAS and Universiti Sains Malaysia (USM) has, therefore, focused on the bleaching of chemical pulp from EFB, especially using total chlorine-free (TCF) methods.

TCF bleaching was examined for EFB chemical pulps such as kraft, soda and soda-anthraquinone pulps. TCF processes include oxygen (O_2) delignification, ozone (O_3) bleaching, acid treatment, hydrogen peroxide (H_2O_2) bleaching and alkali extraction. It was found that a pulp brightness of 75% can be obtained for EFB kraft pulp by a bleaching sequence of O_2 -acid- O_3 - H_2O_2 . The brightness is required to be above 80% for commercial bleached kraft pulp based on JIS Standard. Mechanical properties such as tensile and tear strength of handsheets produced from this pulp were found to be comparable to those of hardwood pulps. Furthermore, since the TCF bleaching method removes most of the coloring compounds, that is lignin, in EFB, the bleaching ability is assumed to be similar to that of bleaching methods using chlorine. Soda pulp and soda-anthraquinone pulp of EFB, which contain less lignin than EFB kraft pulp, have also reached a brightness level of 70-75% with a single bleaching stage using O_2 or O_3 . This also indicates that the coloring materials in EFB can be easily removed without using any chlorine compounds.

Based on this study, we observed that the total chlorine-free bleaching method can be applied to EFB chemical pulps and that EFB is suitable as a raw material of chemical pulp. Although the bleaching and even pulping methods for producing EFB pulp for paper-making have not been optimized yet, there is a great potential for the utilization of this oil palm lignocellulosic residue in pulp and paper industries. Currently, the world trend in pulp bleaching is toward the application of non-chlorine processes because of environmental concern. Once the oil palm by-product becomes a raw material for pulp production, it will be essential to develop TCF bleaching processes in future.



Oil palm is one of important plant in Malaysia and some other tropical countries in South-East Asia

Oil palm tree

Empty fruit bunch (left), fibrous strands of EFB (right top) and paper sheets made of TCF-bleached EFB pulp (right bottom)

[NEXT](#)

[CONTENTS](#)

Simple and Rapid Technique for the Identification of an Aromatic Thai Rice Variety (Khao Dawk Mali 105)

Tadashi Yoshihashi

Crop Production and Postharvest Technology Division, JIRCAS

In order to meet consumers' demand for food, a large quantity of rice (*Oryza sativa* L.) is produced in many parts of the world. Aromatic rice types, i.e. rice varieties having a stronger aroma than ordinary rice, have become increasingly popular in Southeast Asian countries, Europe and the U.S.A.

An aromatic variety, Khao Dawk Mali 105 (KDML105), is mainly produced in Northeast Thailand. Being recognized for its better quality, market demand for this variety has increased both in Thailand and overseas. Although increase of production is urgently needed, the cultivation is limited due to infertile and drought-stricken sandy soils. Moreover, erratic rainfall at the beginning of the rainy season and labor shortage for transplanting are other constraints on the production of KDML 105. As a matter of fact, no objective method for the identification of such an aromatic variety has been developed. As a result, varieties different from KDML 105 are often marketed under the name of KDML 105.

In Japan, since rice is distributed as brown rice which can germinate, information about varieties can be obtained. In contrast, in Southeast Asia, rice is mainly marketed as milled rice unable to germinate. To identify varieties of milled rice in a mixture with varieties of similar appearance, conventional methods such as determination of the length-width ratio are not suitable.

Molecular marker techniques based on the polymerase chain reaction (PCR), have provided more objective methods for the identification of grain varieties. These techniques (i.e., microsatellite analysis, randomly amplified polymorphic DNA (RAPD) and amplified fragment length polymorphism (AFLP)) could be very useful for plant-based identification; microsatellite analysis is particularly useful for simple and rapid analysis. To apply this technique to milled rice, however, high quality DNA must be extracted from a single grain of milled rice. It is difficult to extract DNA, because the main components (starch and proteins) of milled rice show the same solubility as that of DNA. It should be emphasized that enzyme-inhibiting polysaccharides often contaminate the "purified" DNA.

Extracting procedures for simple and rapid identification of grain varieties require breakage of the cell wall, disruption of the cell membrane, protection of DNA from endogenous nucleases and finally removal of polysaccharides.

In our laboratory, we developed a DNA extraction method based on a freeze-and-thaw cycle for extracting purified, high molecular weight DNA from grains. The developed technique does not require expensive equipment and materials, and is not a time-consuming procedure.

Microsatellite analytical method for cultivar identification was used for extracting DNA. We analyzed rice samples obtained from Bangkok, Suwannaphum (Northeast Thailand) and Kuala Lumpur markets as well as selected varieties different from KDML 105 (Bangkok and Kuala Lumpur market rice samples). Fig. 1 shows the results of microsatellite analysis of market samples on agarose gel. Some of the rice samples originating from Kuala Lumpur and Bangkok markets did not match the KDML 105 variety.

[Fig. 1. Agarose gel electrophoresis of DNA fragments amplified from rice market samples by PCR using primer set RM17. Arrowheads indicate the position of the amplified fragments of authentic KDML105.](#)

A simple and rapid method for cultivar identification of milled rice is illustrated in Fig. 2. By applying the improved method, we were able to obtain DNA for microsatellite analysis within 2 h and the whole process of identification required 6 h. Time saving and the possibility to avoid the use of expensive instruments or toxic chemicals in the present method are an attractive alternative to existing methods of identification. The results obtained showed that DNA extracted from tested samples was of high quality and hence could be used in PCR-based techniques for cultivar identification even in laboratories with a moderate level of technology. Another feature of this developed technique was the saving in time and cost as well as the safety of the procedure.

[Fig. 2. Scheme of rapid DNA extraction and cultivar identification of milled rice.](#)



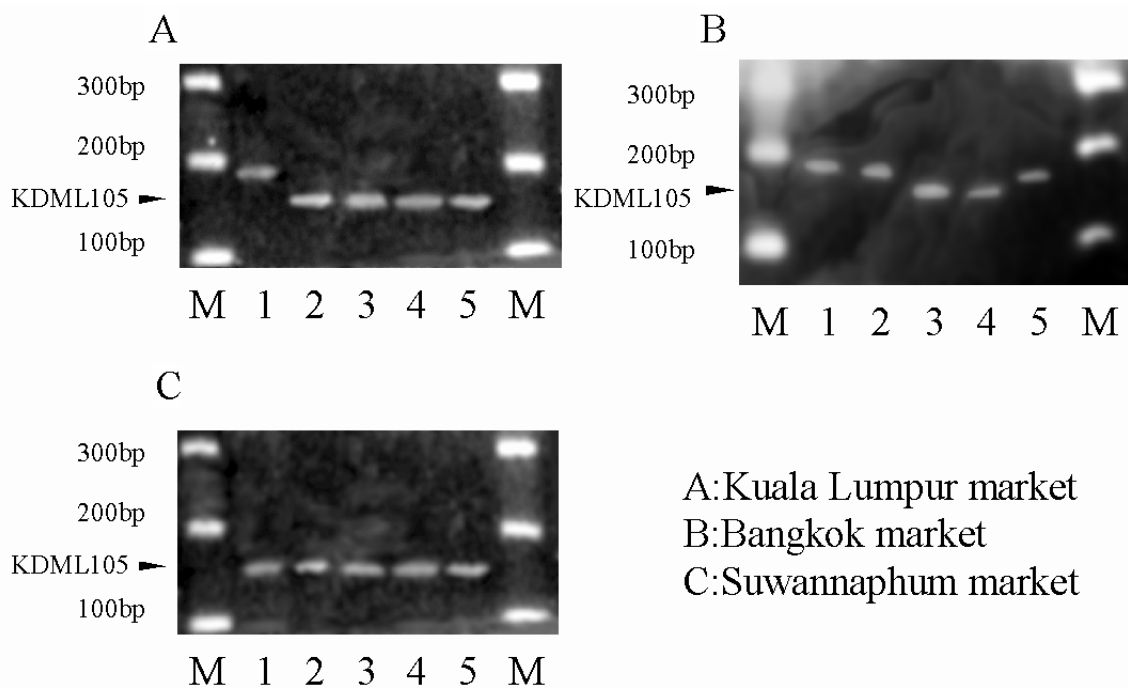


Fig. 1. Agarose gel electrophoresis of DNA fragments amplified from rice market samples by PCR using primer set RM17. Arrowheads indicate the position of the amplified fragments of authentic KDML105.

BACK

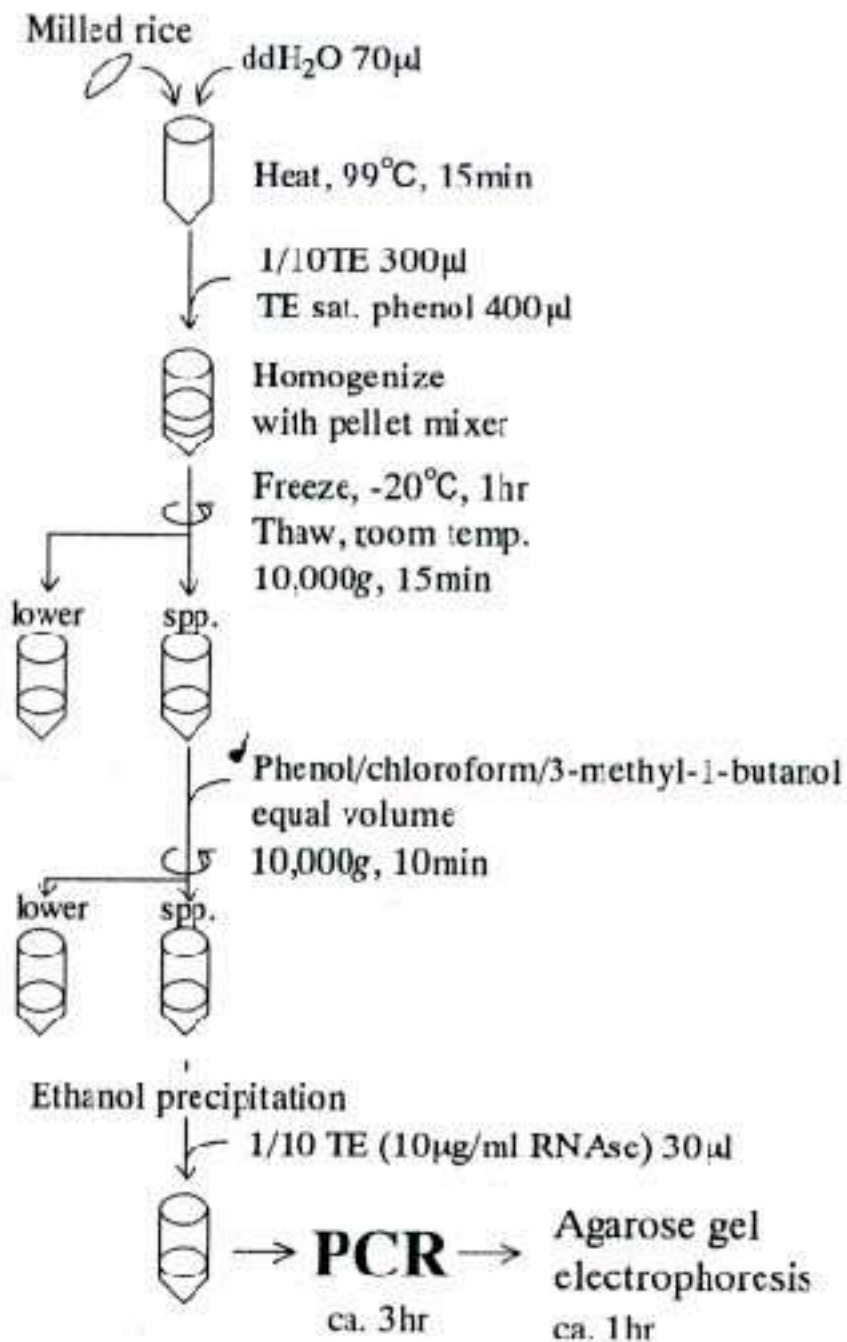


Fig. 2. Scheme of rapid DNA extraction and cultivar identification of milled rice.

BACK

Genetic Variation in Amylose Content and Lipoxygenase-3 Activity of Seeds from Rice Genetic Resources in Yunnan, China

Kazuo Ise*, Sun Youquan*² and Dai Luyuan*²

*Biological Resources Division, JIRCAS, *²Yunnan Academy of Agricultural Sciences (YAAS), China

Yunnan province in China is a center for genetic diversity in Asian cultivated rice (*Oryza sativa* L.). We studied the biochemical properties of rice grains using a wide variety of genetic resources from Yunnan and Japan.

The amylose content in endosperm starch is a major determinant of eating, cooking, and processing of rice grains. Starch in nonglutinous endosperm contains both amylose and amylopectin, whereas starch in glutinous endosperm contains only amylopectin and lacks amylose, or contains a small amount of amylose. The eating quality of cooked rice is negatively correlated with the amylose content in nonglutinous rice. Cooler temperature during grain filling considerably affects the increase of the amylose content of rice plants cultivated in paddy fields at an altitude of 1500 - 2100 m above sea level in Yunnan province. To improve the eating quality, YAAS breeders are implementing a breeding program to develop new rice varieties with a low content of amylose.

We screened 581 varieties from Yunnan (n=376) and Japan (n=205) for the endosperm amylose content (Fig. 1). Yunnan rice showed a 1.7 times larger variation than Japanese rice based on the Shannon-Wiener index (H'). Upland rice exhibited the largest variation in the amylose content among the varietal groups from Yunnan: Indica paddy rice ($H'=0.734$), Japonica paddy rice ($H'=0.844$), and upland rice ($H'=0.909$). Upland rice varieties with a low amylose content (5-11%) are expected to be useful for the breeding of new varieties with improved eating quality in highland areas.

Rice grain deterioration and the development of staleness during storage are serious problems that reduce quality. It is difficult for developing countries to construct temperature-controlled warehouses that would help ensure proper treatment of harvested rice. Lipid degradation is considered to be responsible for the deterioration during rice storage. Lipoxygenase enzyme catalyzes the oxidation of polyunsaturated fatty acids containing a 1,4-pentadiene moiety into conjugated hydroperoxy fatty acids. The lack of lipoxygenase in rice grains may contribute to the reduction of oxidative deterioration during storage.

We screened the germplasm collection from Yunnan for the lipoxygenase-3 (LOX-3) content in embryos, by using monoclonal antibodies against LOX-3, in collaboration with Dr. Y. Suzuki, National Agriculture Research Center, Japan. We detected 22 varieties that lacked LOX-3, the major component among isozymes in rice seeds, after screening 108 varieties from Yunnan rice genetic resources. Most of the varieties that lacked LOX-3 belonged to upland rice, and to Groups 4 and 6 based on the esterase isozyme genotype of *Est1*, *Est2*, and *Est3* (Fig. 2).

Major agronomic features of the varieties lacking LOX-3 include early heading, red and round grains, long culms, and glabrous leaves and hulls. These varieties showed a poor agronomic performance in the paddy fields because of severe lodging before harvest. The lack of LOX-3 was inherited as a single recessive trait in a cross between CI-115 lacking LOX-3 and Norin 20 having LOX-3. CI-115 is a pure line selected from the indigenous upland variety Chongtui. No tight linkage was observed between the lack of LOX-3 and the red pericarp derived from CI-115.

Varieties lacking LOX-3 could help reduce off-flavor formation in rice stored in warehouses that are not temperature-controlled. We are currently developing breeding lines lacking LOX-3 by crossing CI-115 with improved varieties that are agronomically superior.

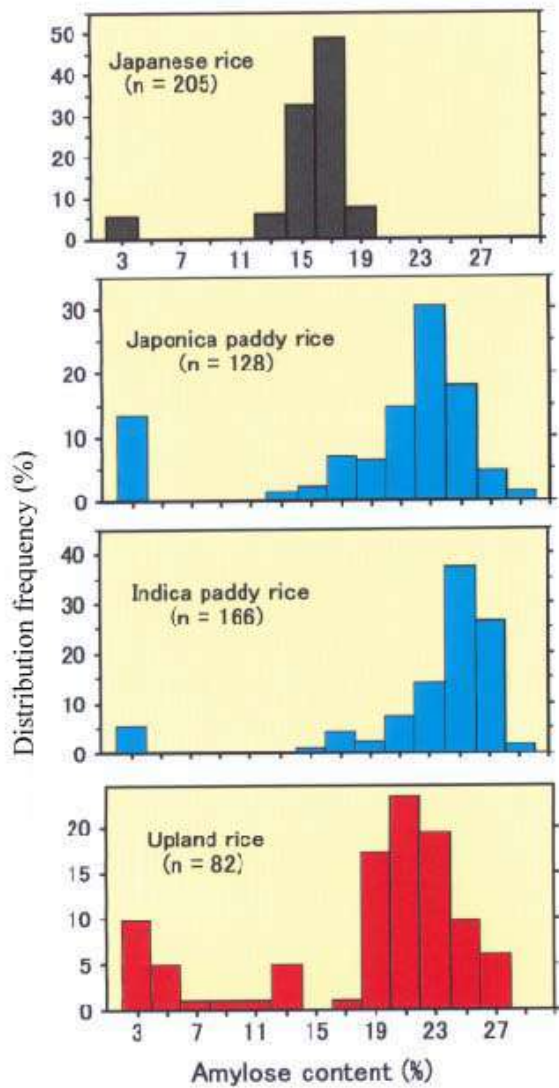


Fig. 1. Frequency distribution of varieties differing in the endosperm amylose content in Japanese rice and three groups of Yunnan indigenous rice. Varieties with less than 3% belong to glutinous rice.

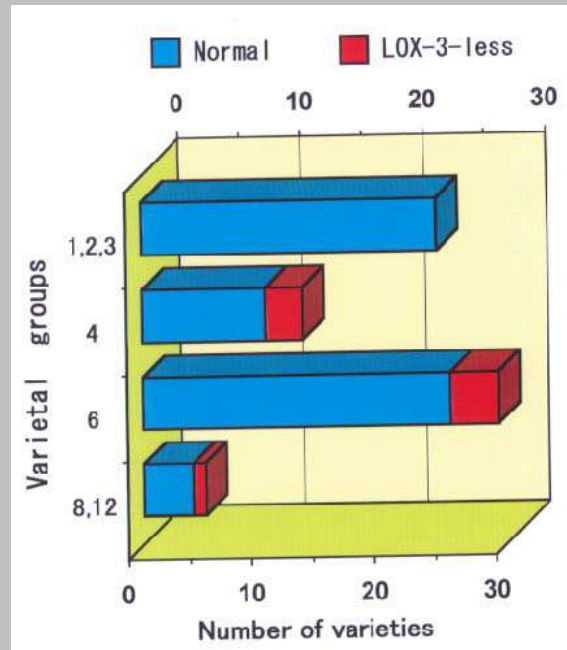


Fig. 2. Relationship between lipoxygenase-3 (LOX-3) activity in seeds and rice varietal groups based on genotypes of esterase isozymes (*Est1*, *Est2*, and *Est3*) in leaves.

NEXT CONTENTS

JIRCAS International Workshop:

"Brackish Water Mangrove Ecosystems - Productivity and Sustainable Utilization"

February 29 - March 1, 2000, Tsukuba, Japan

Twenty-one technical papers and 3 panel papers were presented at this workshop, which was attended by 114 participants. The workshop focused on the socio-ecological conditions in the Matang, Merbok and Lumut mangrove ecosystems in Malaysia, the main sites of the collaborative study entitled "Productivity and Sustainable Utilization of Brackish Water Mangrove Ecosystems," which was carried out in Malaysia from April 1995 to March 2000 by JIRCAS, Fisheries and Forestry Agencies in Japan, and the Fisheries Research Institute (FRI), the University of Malaya (UM) and the Forest Research Institute (FRIM) in Malaysia. The workshop consisted of 5 sessions: (1) Structure, management and reforestation of mangrove areas; (2) Nutrients, plankton and fish species in brackish water mangrove areas; (3) The ecological significance of benthic animals in the mangrove forest biotope; (4) Aquaculture in mangrove estuary areas; and (5) General Discussion on collaborative work on ecosystem research in brackish water mangrove areas.

This international workshop was held in the final year of the JIRCAS comprehensive project mentioned above, for which two rivers in Matang (the Selinsing and Sangga), one river each in Merbok (the Merbok) and in Lumut (the Dinding) were selected as the research sites in Malaysia. The characteristic differences between the three mangrove areas are that the ratios of mangrove forest area to river area are 4.7 in Matang, 2.1 in Merbok and 1.1 in Lumut. During this workshop, a wide range of results were reported, including the following: (1) the brackish water area of the River Selinsing in Matang was found to be important as a breeding ground for penaeid shrimp, (2) the freshwater areas of the River Sangga in Matang act as a feeding site for *Arridae* spp., (3) areas of the River Merbok are feeding sites for *Scianidae* spp. and (4) the freshwater areas of the River Dinding in Lumut act as a migration site for marine fish species, including *Leiognathidae* spp. The range of species and the ecological features of prawns and benthic animals were also elucidated in the three mangrove areas. Concerning the diversity of fish, in the Matang mangrove estuary area, the volume of fish catches was greater than that in the Merbok and Lumut ones. The diversity index of fish, however, showed a higher value in the Merbok than in the other two mangrove areas. In the Lumut area, the volume of fish catches and diversity index were the lowest of the three areas.

Socio-economic studies in these mangrove areas have additionally revealed that in well-managed areas, such as the Matang Mangrove Forest Reserve, mangrove forests generate significant social and economic advantages. On the other hand, inappropriate management of mangrove areas causes socio-economic losses due to the exhaustion of available resources.

(Masachika Maeda)

JIRCAS International Workshop

Brackish Water Mangrove Ecosystems -Productivity and Sustainable Utilization-

Feb. 29 ~ Mar. 1, 2000
International Congress Center
"Epochal Tsukuba"

Organized by

Japan International Research Center for Agricultural Sciences

Supported by

Agriculture, Forestry and Fisheries Research Council
Fisheries Agency, Forestry Agency, Japan
Fisheries Research Institute, Forest Research Institute
University of Malaya, Malaysia
Research Institute for Coastal Fisheries, Indonesia
Kasetsart University, Thailand
Kantho University, Vietnam
Southeast Asian Fisheries Development Center





JIRCAS International Symposium

The 7th JIRCAS International Symposium on "Agricultural Technology Research for Sustainable Development in Developing Regions" will be held on November 1-2 at Epochal-Tsukuba in conjunction with the 30th anniversary of TARC-JIRCAS. This is an opportune time to re-assess the progress of agricultural development in developing countries and to re-examine the roles and contributions of the different actors involved in development, from farmers to national research and extension organizations, non-governmental organizations, the private sector, as well as government and international research institutes including JIRCAS.

For further information, please contact:

Dr. M. Yajima

Secretariat of the Organizing Committee for the 7th JIRCAS Symposium:

Fax: +81-298-38-6348

E-mail: sympo7@jircas.affrc.go.jp

[NEXT](#)

[CONTENTS](#)

People



Dr. Masa IWANAGA, a plant geneticist, became Director of JIRCAS's Biological Resources Division on April 1, succeeding Dr. Tsuguhiro Hoshino who was appointed Director of the Department of Crop Physiology and Quality, National Agriculture Research Center. Dr. Iwanaga worked as Deputy Director General (Programmes) at the International Plant Genetic Resources Institute (IPGRI), Rome, Italy, for more than seven years. Before IPGRI, he worked for CIAT and CIP for three and ten years, respectively. Dr. Iwanaga holds a MS degree from Kyoto University and Ph. D. from the University of Wisconsin-Madison.



Dr. Osamu ITO, a plant physiologist, became Director of JIRCAS's Environmental Resources Division on April 1, succeeding Dr. Tadao Hamasaki who became Director of the Department of Natural Resources, National Institute of Agro-Environmental Sciences. Dr. Ito worked as International Research Coordinator for Thailand at JIRCAS's Research Information Division for six months after spending three years at the International Rice Research Institute as Director of the Agronomy, Plant Physiology and Agro-Ecology Division.

Dr. Makie KOKUBUN left JIRCAS on April 1, to take up his appointment as Professor of the Graduate School of Agriculture, Tohoku University. Dr. Kokubun served as International Research Coordinator for South America at JIRCAS's Research Information Division for four years.

Organization of the Japan International Research Center for Agricultural Sciences (JIRCAS)

<i>Director General</i>	<i>Research planning and Coordination Division</i>
	<i>Administration Division</i>
	<i>Research information Division</i>
	<i>Biological Resources Division</i>
	<i>Environmental Resources Division</i>
	<i>Crop Production and Postharvest Technology Division</i>
	<i>Animal Production and Grassland Division</i>
	<i>Forestry Division</i>
	<i>Fisheries</i>
	<i>Okinawa Subtropical Station</i>

[Contents](#)

[JIRCAS Home Page](#)

JIRCAS

Newsletter

No. 24

September 2000



Secondary forest of *Acacia mangium* five years after
the occurrence of a forest fire, Sabah, Malaysia
(Photo by T. Suzuki)

CONTENTS

<Feature Article>

- [Technology Development for the Rehabilitation of Tropical Forests](#)

<JIRCAS Research Highlight>

- [Nitrogen Cycling in Agro-Pastoral Systems in the Cerrados](#)

 [Evaluation of Heat Tolerance of Snap Bean](#)

 [Digestion Characteristics and Energy Requirements of Ruminants in Northeast Thailand](#)

<Collaborative Research Project>

 [Development of Sustainable Agricultural Systems in Northeast Thailand](#)

<Workshop>

<7th JIRCAS International Symposium>

 [JIRCAS Home Page](#)

Development of Agroforestry Technology for the Rehabilitation of Tropical Forests

- JIRCAS New Agroforestry Project -



Terunobu Suzuki
Director, Forestry Division, JIRCAS

With excessive logging and indiscriminate cutting of trees for fuel as well as with the increasing exploitation of arable land associated with the high demand for food, the deterioration and clearing of natural forest areas have been rapidly progressing, particularly in developing regions. This is bringing about serious economic and environmental problems not only at the local level but also on a global scale. Therefore, the rehabilitation and sustainable management of these forests are urgent issues. Development of forest production systems and postharvest technologies for local communities can be considered to be essential means for the reduction of forest degradation.

Forest rehabilitation and enrichment of denuded and degraded areas are the first steps in developing sustainable management of forest areas. JIRCAS has played a significant role in alleviating forest degradation by focusing its efforts on methods of reforestation and ways to motivate local inhabitants to participate in reforestation activities.

Research on methods for the establishment of fast-growing species as shelter wood for the promotion of growth of valuable indigenous trees such as Dipterocarps in logged-over tropical forests is being conducted in collaboration with the researchers of the College of Forestry, University of the Philippines at Los Banos (Philippines). Studies on the regeneration and growth of *Shorea* species seedlings on logging roads in Malaysia are conducted in collaboration with the researchers of the Forest Institute of Malaysia (FRIM), where joint investigations on the improvement of logging techniques for the selective management system applied in Malaysia, including the improvement of harvesting methods using a mobile tower yarder, are also in progress.

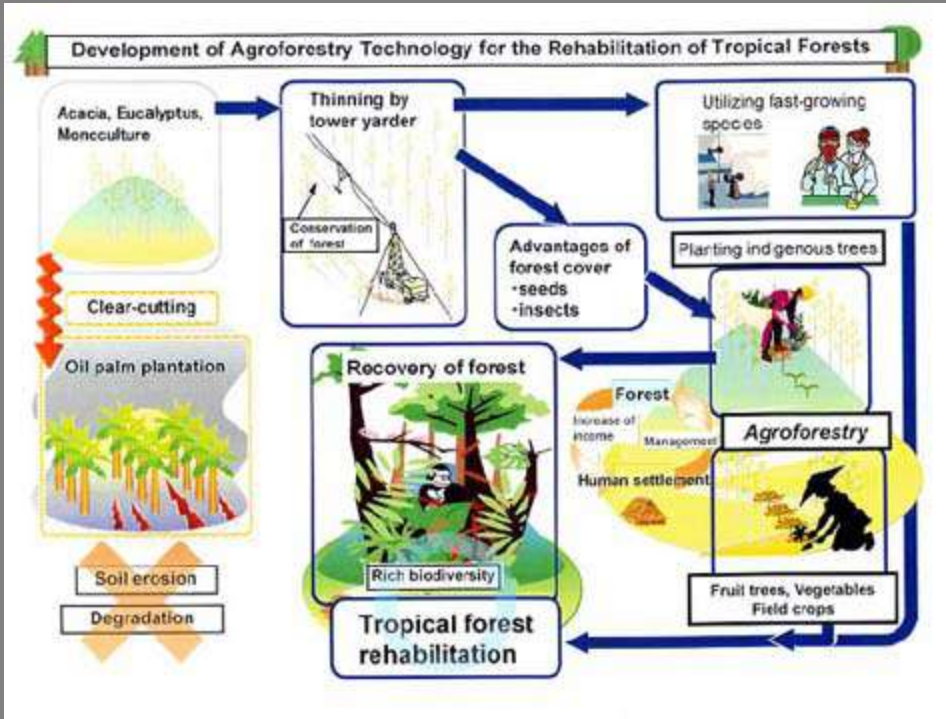
Malaysia is one example of several countries with which JIRCAS has been working closely on deforestation issues. In Malaysia, forests are logged on a large scale and the enrichment of remaining secondary forests is a major task for the government. Compared to other Southeast Asian nations, Malaysia's standard of living is higher and its forest management programs have been more effectively carried out, particularly in the state of Sabah. Nevertheless, in Sabah alone, several hundred thousand local inhabitants, over 10% of the state's population, still practice shifting cultivation. Their activities, which include unsustainable forest harvesting, slash and burn agriculture, repeated cultivation and wildfires have had a considerable impact on the forest ecosystems and resulted in losses of flora and fauna, erosion, flooding, decrease of forest resources and general soil degradation.

However, this situation may be improved by introducing agroforestry systems which encourage people to settle in a certain residential area, cultivate cash crops and participate in intercropping, afforestation and reforestation activities. Along with initiating the development of cultivation and farming technology, local authorities and scientists have been engaged in the assessment and analysis of social and economic factors in order to develop sustainable management systems for forest resources. In the 1970s, for example, agroforestry was first introduced to Sabah with a certain amount of success through the intercropping of cacao. On the whole, however, agroforestry techniques are essentially site-specific and for any given program to be successful, acceptance by the local community is indispensable. Given these conditions, we therefore proposed a more flexible research project titled: "Development of agroforestry technology for the rehabilitation of tropical forests." This program which will be implemented mainly in collaboration with the Forest Research Centre, Forestry Department, Sabah, Malaysia, aims at balancing out the effects of secondary forests, burnt forests, monoculture plantations and grasslands by introducing a cropping system consisting of cash crops including vegetables, fruit trees as well as indigenous trees. Our final objective is to establish a technological base for the ongoing development of biodiversity-rich forests, high-value timber forests, forests that perform critical environmental functions and fruit tree orchards where soil fertility has been improved or is well maintained. These studies will contribute to the mitigation of agriculture-forestry conflicts while promoting environmental conservation and sustainable forest resource management.

Over the seven-year (2000-2006) duration of the project, specific objectives will include a socio-economic evaluation of agroforestry, the re-establishment of a productive environment for agroforestry and the development of agroforestry techniques with the utilization of shade trees. Individual targets for the program include the development of technology for the re-establishment of a productive environment for agroforestry and development of techniques for growing non-arboreal crops under shade trees.

Finally, it is indispensable to promote close relations between forestry researchers and agriculture researchers in order to promote the project

and obtain good results.



NEXT **CONTENTS**

Nitrogen Cycling in Agro-Pastoral Systems in the Cerrados

Kenichi Kanda

Environmental Resources Division, JIRCAS

In Brazil, grasslands have been developed over large areas originally covered by savannas (Cerrados). However, problems of declining productivity have arisen in recent years because of the low soil fertility. Agro-pastoral systems that combine soybeans and grasses in rotation have been proposed for sustaining grassland productivity. One of the primary advantages of these systems is that lime and P fertilizer are used for crop cultivation and that the succeeding grasses can benefit from the remaining P. Since N is added to the system through the N₂ fixation of soybeans, the grasses grow well. On the other hand, the organic matter content of the soil decreases steadily under soybean cultivation. To evaluate the agro-pastoral systems in terms of N budget, N flow into the systems, N₂ fixation by soybean, input from rain, removal associated with harvest of soybean grains, gaseous losses from animal excreta and denitrification* as well as leaching were studied.

A long-term field experiment has been carried out at the National Beef Cattle Research Center (CNPGC), National Corporation of Agricultural Research (EMBRAPA), Campo Grande, MS, Brazil. The soil is classified as Purple Red Latosol. In a grassland with grazing beef cattle, NPK fertilizer (14 kg N/ha, 70 kg P₂O₅/ha and 70 kg K₂O/ha) was applied and *Brachiaria decumbens* cv. Basilisk was sown in November 1993. Soybeans were sown in November and harvested in April of the next year. PK fertilizer (80 kg P₂O₅/ha and 80 kg K₂O/ha) was applied at the time of seeding.

The rate of N₂ fixation of soybeans was determined using a non-nodulating isolate, T201, as a control. The rate ranged from 23 to 51% of the total plant N. Most of the plant N was removed after harvest of the grains, resulting in a negative N balance in the field. It was shown that the amount of N entering the system through rainwater was small. Nitrate accumulation from the surface to a depth of 100 cm in soil under soybeans indicated the potential leaching of nitrate (Fig. 1). The estimated amount of leaching from the soybean field was large compared with that from the grassland. A large negative N balance was observed in the soybean field, whereas there was a small negative N balance in the grassland (Fig. 2).

The nitrate that accumulated in the subsoil can be absorbed by grasses grown subsequently. Thus, rotational grassland may be more sustainable. On the other hand, both soybean field and grassland showed a negative N balance. It is concluded that in order to sustain N fertility in agro-pastoral systems, some application of N fertilizer may be necessary over time.

*Data relating to gaseous losses from animal excreta (ammonia volatilization and denitrification) were cited from Cadisch, G. *et al.*, Tropical Grasslands (1994), 28, 43-52.

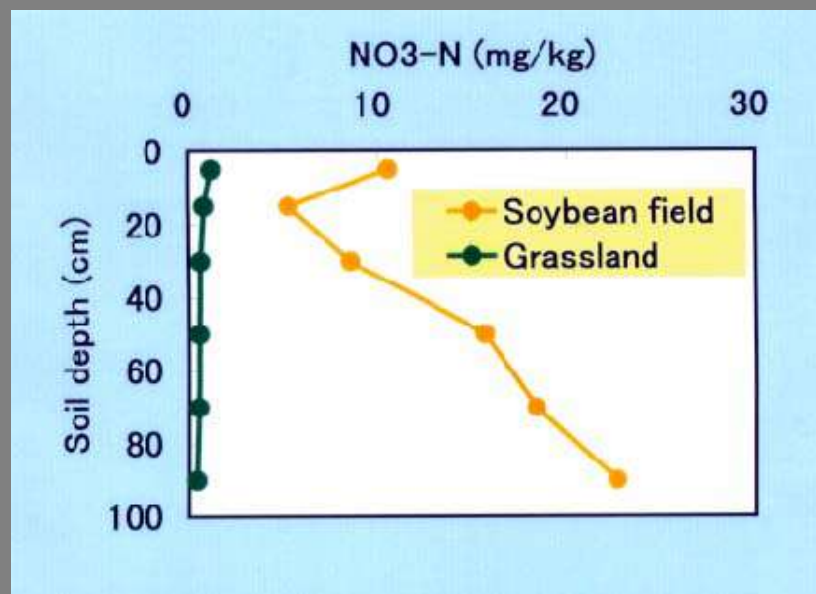


Fig. 1. Concentration of NO₃ - N (mg/kg) in soil.

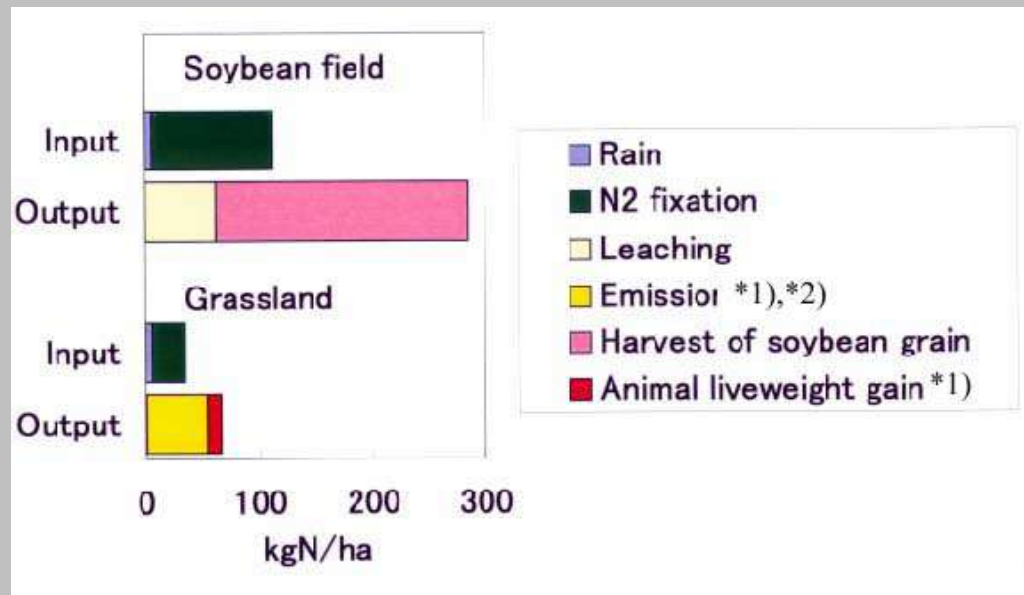


Fig. 2. N balance for soybean field and grassland.

*1) Cadisch, G. *et al.*, 1994

*2) Gaseous losses from animal excreta (ammonia volatilization and denitrification)

[NEXT](#)

[CONTENTS](#)

Evaluation of Heat Tolerance of Snap Bean Based on Pollen Stainability

Katsumi Suzuki, Tadashi Tsukaguchi, Hiroyuki Takeda and Yoshinobu Egawa
Okinawa Subtropical Station, JIRCAS

Yield of temperate vegetables decreases at high temperatures in tropical and subtropical areas. Heat tolerance is one of the most important characters for the promotion and increase of vegetable production in these areas. It remained to be determined why heat-tolerant varieties show a superior yield under high temperature conditions. Simple methods of evaluation of heat tolerance are necessary for developing heat-tolerant varieties efficiently and introducing new crops suitable for high temperature conditions. JIRCAS Okinawa Subtropical Station is located on Ishigaki Island (lat. 24-20°N) under subtropical conditions in Japan. At this station, a heat-tolerant variety of snap bean (*Phaseolus vulgaris*), 'Haibushi', was developed from an accession collected in Southeast Asia by screening about 350 breeding lines and varieties. However, the mechanism controlling heat tolerance in 'Haibushi' compared with other varieties has not been elucidated. We investigated the pollen stainability of 'Haibushi' during cultivation in summer and compared it with that of other varieties under high temperature conditions.

The young pod yield, mean temperature and pollen stainability changed during the cultivation of snap bean as shown in Table 1. Mean air temperature during the harvest period of the first, second and third croppings was 25.7, 27.9 and 29.8, respectively. Young pod yield of all the varieties decreased when the mean temperature rose. As the mean air temperature during the flowering period in each cropping rose, pollen stainability decreased. In the first cropping, each variety showed a pollen stainability above 80%. While the pollen stainability of 'Okinawa Local' and 'Kentucky Wonder' decreased to 55 and to 65% in the second cropping, respectively, that of 'Haibushi' was still higher than 75%. In the third cropping, though the pollen stainability of the three cultivars decreased to less than 20%, that of 'Haibushi' was higher than 60%.



Fig. 1. Sterile pollen grains (a) of heat-sensitive variety 'Kentucky Wonder' (A) and normal pollen grains (b) of heat-tolerant variety 'Haibushi' (B) cultivated under high temperature conditions.

When the plants were exposed to a high temperature (32/28, day/night) for 24 hours and then returned back to optimum conditions (25/25) in a greenhouse, the pollen stainability of the flowers which opened 8 to 11 days after the treatment decreased. Pollen stainability thus decreased by exposure to high air temperature 8 to 11 days before flowering. Pollen stainability also decreased when the mean air temperature during this period exceeded 28 under field conditions. The heat-tolerant variety 'Haibushi', however, showed a higher pollen stainability than the heat-sensitive variety 'Kentucky Wonder' under high temperature conditions.

Reduction of young pod yield was ascribed to the decrease in pollen stainability, since a high correlation was observed between the pollen stainability and pod set. We concluded that the decrease of pollen stainability by high temperature led to a failure of fertilization and abscission of flowers, resulting in yield reduction in snap bean.

As mentioned above, yield reduction was accompanied by a lower pollen stainability. A heat-tolerant variety 'Haibushi' showed a high young pod yield and high pollen stainability under high temperature conditions. We suggest that examination of pollen stainability is one of the effective methods for evaluating heat tolerance.

Table 1. Yield of young pods and average pollen stainability (PS) of snap bean during each period of cultivation

Seeding date	27 Feb.		10 Apr.		13 May	
Harvest period	14 Apr. - 12 May		26 May - 25 June		25 June - Aug.	
Mean air temperature during harvest period (°C)	25.7		27.9		29.8	
	Yield	PS	Yield	PS	Yield	PS
Cultivar	(t/ha ⁻¹)	(%)	(t/ha ⁻¹)	(%)	(t/ha ⁻¹)	(%)
Haibushi	11.4	90.7	6.6	75.2	2.8	61.3

Evaluation of Heat Tolerance of Snap Bean Based on Pollen Stainability

Okinawa Local	-	-	5.5	55.8	0	8.0
Oregon	8.0	96.0	5.1	73.0	0	19.5
Kentucky Wonder	10.5	83.0	1.4	65.1	0	14.3
-: no data						

[NEXT](#) [CONTENTS](#)

Digestion Characteristics and Energy Requirements for Maintenance of Native Ruminants in Northeast Thailand

Tomoyuki Kawashima
National Institute of Animal Industry

Animal production in Northeast Thailand plays an important role in nutrient cycling for the development of sustainable agricultural systems. While exotic breeds have been introduced in the region to increase the production of meat and milk, the number of native ruminants, such as swamp buffalo and Thai native cattle, has been decreasing. Consequently, low quality roughages such as rice straw are not well utilized and some are burnt in the fields while the consumption of concentrate feed has been increasing. Although it is generally recognized that native ruminants have an inherent ability to digest low quality diet better than exotic breeds, the mode of digestion and nutrient requirements of native breeds developed in the tropics have not yet been fully elucidated.

Metabolism trials were conducted in sheep, Brahman cattle, swamp buffalo and Thai native cattle given Ruzi grass hay with different levels of soybean meal in order to examine the effect of protein levels on fiber digestion. The quality of hay used in each trial was slightly different and the crude protein (CP) contents in four dietary treatments ranged from about 3, 6.5, 10 and 13.5%. The outline of the results is shown in Fig. 1. In sheep, fiber digestibility was improved by the supplementation of soybean meal until the dietary CP content reached 10%. Beyond this level, the positive effect of supplements was not observed. In Brahman cattle, the fiber digestibility without protein supplements was lower than that with supplements (CP 6.5%). But there was no improvement by additional protein supplements to a level above 6.5%. On the other hand, in swamp buffalo and Thai native cattle, fiber digestibility without supplements was not different from that with supplements. And the fiber digestibility in Thai native cattle was generally higher than in the other animals. It was considered, therefore, that these native ruminants, especially Thai native cattle, have a superior ability to digest fiber without protein supplements.

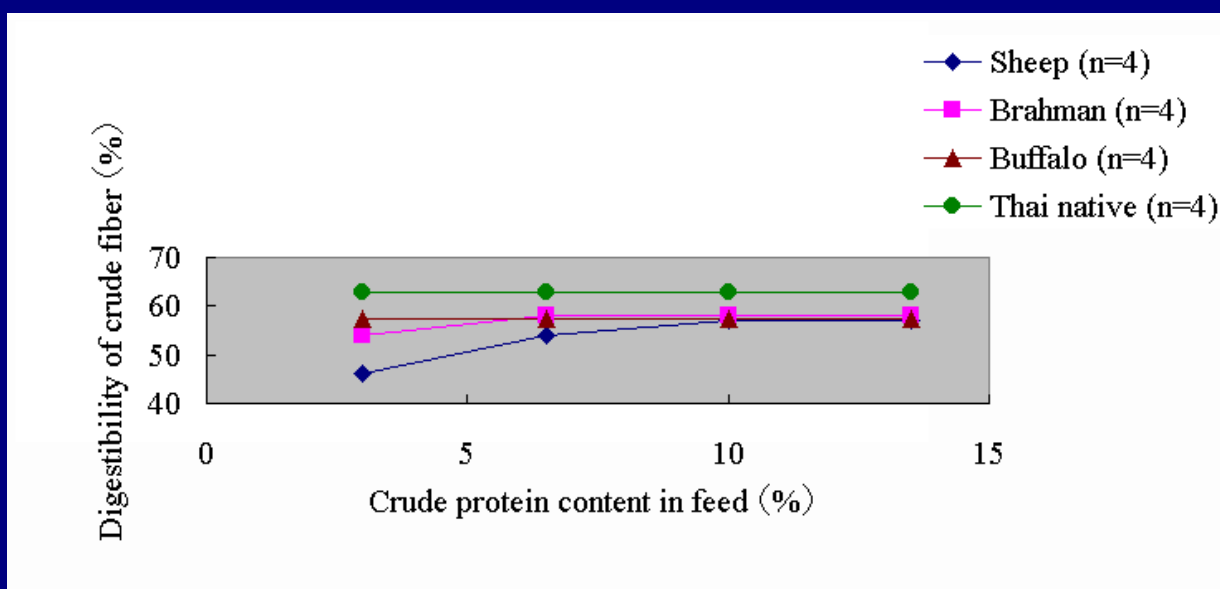


Fig. 1. Changes in crude fiber digestibility depending on the supplementation of soybean meal.

A total of 44, 27 and 20 metabolism-trial data, in Brahman cattle, swamp buffalo and Thai native cattle, respectively, were examined in order to compare metabolizable energy (ME) requirements for maintenance. The ME requirements for maintenance were obtained by regression analysis of energy retention against ME intake based on the metabolic body size. The values were 377, 334 and 245 KJ/BWkg^{0.75} in Brahman cattle, swamp buffalo and Thai native cattle, respectively, which corresponded to 86, 76 and 56% of the value of Japanese Black Cattle. These findings clearly showed that native ruminants, such as Thai native cattle and swamp buffalo, require less energy to maintain their body weight compared with high performance breeds.

The ability to efficiently utilize low quality roughage and the lower energy requirements in native ruminants enable them to survive under a severe feeding environment. It was considered that such animals have been selected for their characteristics by farmers, which led to the development of a breed or a group adapted to the local conditions. The soil in Northeast Thailand, where the largest population of these native ruminants can be found, is characterized by low organic matter and nutrient contents. Re-construction of a system utilizing native ruminants in order to exploit available low quality feed may contribute to the sustainable development of agriculture and animal production in Thailand.



Thai native cattle (Northeastern group)

[NEXT](#)

[CONTENTS](#)

Development of Sustainable Agricultural Systems in Northeast Thailand

- Toward the end of the project -

Osamu Ito

Director, Environmental Resources Division, JIRCAS

The northeastern part of Thailand is a region with an unfavorable production environment characterized by infertile sandy soils and a long dry season. About half of the total land area in the region used to be covered with tropical rainforest which drastically decreased to 14% by deforestation. Intensive upland farming that reduces soil fertility and expansion of the arid land area have further accelerated the deterioration of croplands. Under such unfavorable conditions, rice, cassava, sugarcane and legumes are cultivated as cash crops, but they bring an insufficient income to the farmers (family income being only 40% of the national average). Regional development through agricultural technology improvement has become the highest priority in the Northeast.

In order to further develop agriculture in the region, it is necessary to shift the agricultural systems from those that depend heavily on a few cash crops to more sustainable systems in which diverse cropping options are combined with more efficient utilization of local resources. The project titled: "Comprehensive studies on sustainable agricultural systems in Northeast Thailand" was initiated in 1995 for a seven-year period in order to promote the technological development of rice, upland crops, vegetables, livestock and the sericulture industry, as well as to develop sustainable agricultural systems combining various types of farming and animal husbandry. The project has been implemented in close collaboration with Thai partners, including researchers from the Department of Agriculture (DOA), Department of Livestock Development (DLD), Land Development Department (LDD), International Training Center for Agricultural Development (ITCAD) and Khon Kaen University (KKU).

The project is composed of five main themes (Table 1). Until half of the project period, much focus had been placed on rather fundamental aspects within each research theme. Some of the outputs from fundamental research (Table 1) are now being integrated to develop sustainable agricultural systems suitable for the biophysical and socio-economic environment in the region. Main targets in the latter half of the project are as follows: (1) development of a rainfed lowland rice production system with more profitable farming operations and (2) crop-livestock integration in upland cropping systems with year-round feed supply and more efficient nutrient cycling. Farm mechanization for rice production in the transition from transplanting to direct seeding and utilization of locally available organic materials to sustain the soil fertility in upland fields are the central issues toward the end of the project.

In future, it may become important to maximize the use of water resources through the establishment of irrigation facilities compatible with the local hydrogeological characteristics, in order to further enhance the sustainability of agriculture in the region along with improving the socio-economic conditions of the rural communities.

Table 1. Main research themes and activities/outputs of the project

Research themes	Activities/outputs
I. Evaluation and effective utilization of environmental and biological resources in the region	<ul style="list-style-type: none"> ûEffective recycling systems of organic materials were proposed through the analysis of nutrient cycling of organic and inorganic components in present farmlands. ûThe salt-affected area was characterized using GIS and remote sensing. ûFor the development of water resources, the construction of sub-surface dams was proposed based on hydrogeological studies. ûSugarcane and pineapple were found to fix atmospheric nitrogen, indicating future possibility to cultivate these crops by reduced N application.
II. Development of sustainable crop production systems	<ul style="list-style-type: none"> ûThe proper planting interval of leguminous trees for alley cropping was determined in order to develop an integrated system of trees and crops. ûThe agronomical factors for the introduction of direct seeding on dried paddy fields were thoroughly examined, particularly in relation to non-tillage operations and farm mechanization.
III. Improvement of feeding management using local feed resources	<ul style="list-style-type: none"> ûFor feed supply during the dry season, leguminous pasture, fodder trees and sugarcane were examined for their growth under limited moisture conditions. ûFor the nutritional characterization of grass pastures, their nutritive value and digestion physiology were analyzed. ûMetabolizable energy and protein requirements for the maintenance of local ruminants were clarified.

IV. Development of postharvest technologies for local agricultural products	ûThe main flavor component of Khao Dawk Mali 105 was identified as 2-acetyl-1-pyrroline. The analytical method for its quantification was established. A technique to identify the rice variety using DNA was developed, which makes it possible to detect mixing of non-Khao Dawk Mali 105 varieties. ûHigh-quality silk could be obtained through the use of cocoons after crossbreeding of polyvoltine and bivoltine silkworm strains.
V. Economic evaluation of multiple cropping and livestock farming systems	ûThe economic and managerial evaluation of the current agricultural systems shows that (1) mechanization of rice production could improve farmer's income under certain conditions and (2) profitability of dairy farming is relatively high, but further technological improvement is still required.



Workshop on Weather-Based Information Systems for Risk Reduction in West African Cropping Systems

On July 18, 2000, JIRCAS held an introductory workshop to start a new three-year project titled: "Development of Risk-Reducing Technologies for West African Cereal-Based Cropping Systems Based on Advanced Weather Modeling." This project seeks to respond to the global call made recently by the CGIAR to apply advanced technology to address the need to reduce poverty among those parts of the developing world that have benefited least from previous agricultural research. The objective of this project is to provide farmers with information that will enable them to make better choices among crops, production practices, and land use based on the analysis of farmer behavior and crop performance in response to weather variability. By combining results of advanced weather analysis, crop response, and understanding of farmer behavior, the project seeks to establish the criteria for more accurate and productive production choices in the face of rainfall variability. Information technology will enable to gather information on land use and farmer behavior at precise locations in small areas, as well as to develop a system in which it can be shared visually with farmers in a participatory way.

Twenty scientists from seven institutes and organizations representing a diversity of disciplines participated in the workshop. The workshop was organized around six topic areas: West African agriculture; soil and crop conditions; weather analysis and water use; information processing; risk management; and linkages to research in related on-going projects. After opening remarks by T. Ishitani and K. Tsurumi, Division Directors, JIRCAS, the workshop started with the first topic area, with two presentations on West African agriculture. J. Caldwell, JIRCAS, presented slides and data on rainfed cereal production in Mali, and T. Sakurai, JIRCAS, presented slides and data on rice production in several West African countries. The second topic area included presentations by K. Okada, JIRCAS, on soil fertility and its improvement in West Africa, and H. Hasegawa, Tohoku National Agricultural Experiment Station, on quantitative modeling of crop growth parameters. In the third topic area, H. Kanno, Tohoku National Agricultural Experiment Station, provided an introduction to weather analysis used in the Tohoku region of Japan, and possibilities for application of analysis methods in West Africa. K. Ozawa, JIRCAS Okinawa Subtropical Station, followed with a presentation on water use-efficient technologies for semi-arid regions. This was followed by two presentations in the fourth topic area. K. Takezawa, Hokuriku National Agricultural Experiment Station, presented information on decision support systems using pattern recognition. T. Hayashi, JIRCAS, described new portable information loggers appropriate for land use surveys. Next, in the fifth topic area, T. Nanseki, National Agriculture Research Center, provided an introduction to risk modeling. T. Sakurai presented results of research on household budgets and risk in semi-arid West Africa. In the last topic area, S. Asanuma, JIRCAS, described the studies carried out within the framework of the anti-desertification project, and H. Takagi, JIRCAS, explained the research being conducted within the framework of the West Africa rice improvement project. The workshop closed with a general discussion on how to implement the project plan, with a focus on the linkages among the project components of farmer production decision-making criteria, weather modeling, and risk management.

(John S. Caldwell)

NEXT

CONTENTS

7th JIRCAS International Symposium

"Agricultural Technology Research for Sustainable Development in Developing Regions"



Date: 1 and 2 November 2000

Venue: Epochal Tsukuba

At the dawn of the new millennium, the Japan International Research Center for Agricultural Sciences (JIRCAS, formerly TARC, Tropical Agriculture Research Center), celebrates its 30th anniversary. TARC was established in 1970, just as the Green Revolution was reaching its peak. The major impetus to the Green Revolution at that time was the need to address the chronic food shortages in developing countries, especially Southeast and South Asia. These efforts enabled most countries to become self-sufficient in basic foods.

Today, at the start of a new century, agricultural research faces many more challenges. Increased food production continues to be a high priority in the face of continued world population increase. This needs to be achieved through the development of production systems in better harmony with the environment. Technology development targeted towards environments with marginal soil and water resources, where still over half of the farmers of developing countries make a living from agriculture characterized by unstable production, is a critical need. Advances in research and application of biotechnology, information technology, and other new technologies are needed to help solve these problems. In addition to such discipline-based research, strengthening farmer participation and linkages with other stakeholders in research and extension is essential to achieve new production and resource management systems with high sustainability.

This symposium will address four themes, with the objective of assessing future directions for sustainable agricultural development in developing regions, drawing from the experience of all symposium participants, including public institutions, non-governmental organizations and the private sector in each country, and international research institutions, with a focus on JIRCAS:

1. Accomplishments, needs, and potential for technology development for increased production
2. Concepts and approaches for agro-ecological sustainability
3. Farmer-researcher-extension-private sector partnerships for technology development and dissemination
4. Past achievements and future orientation of JIRCAS and partners in the development of sustainable agriculture, forestry and fisheries

Program

Day 1

Keynote addresses

- (1) An assessment of technology development from the Green Revolution to today

Dr. William D. Dar, Director General, ICRISAT

- (2) Key characteristics of agricultural sustainability

Dr. Pedro A. Sanchez, Director General, ICRAF

- (3) Evolution and new directions using information systems for enhanced farmer partnership in NARS agricultural research

Dr. Stein W. Bie, Director General, ISNAR

Session 1 Technology development for increased production: accomplishments, needs, and potential

(1) Developing new crop varieties for stress and low-input conditions

Prof. Kazuyoshi Takeda, Okayama University

(2) Contribution of molecular biology to breeding and issues associated with its application in developing countries

Dr. Ronald P. Cantrell, Director General, IRRI

(3) Distribution and processing systems for stable supply of products from agriculture, forestry and fisheries

Dr. Greg Johnson, Program Manager, Postharvest Technology, ACIAR

Session 2 Concepts, needs, and approaches for agro-ecological sustainability

(1) Sustainable land management for crop production

Dr. Eric T. Craswell, Director General, IBSRAM

(2) Sustainable water management for crop production

Dr. S. A. Prathapar, Director, IWMI Pakistan

(3) Sustainable aquaculture production and fisheries management

Dr. Meryl J. Williams, Director General, ICLARM

Day 2

Session 3 Evolution of farmer-researcher-extension-private sector partnerships for technology development and dissemination

(1) Evolution of concepts and approaches of systems-oriented, farmer participatory agricultural research

Dr. John S. Caldwell, International Research Coordinator, JIRCAS

(2) Contributions of farmer knowledge to agricultural technology development

Prof. Harold J. McArthur, University of Hawaii

(3) Institutionalization of technology development

Prof. David W. Norman, Kansas State University

(4) Developing sustainable agricultural systems: case study examples, determinants, future approaches, and roles of different partners, as viewed from the cooperation agency

Mr. Nobuyuki Samejima, Managing Director, JICA

(5) Developing sustainable agricultural systems: case study examples, determinants, future approaches, and roles of different partners, as viewed from the national agricultural research system

Dr. Ananta Dalodom, Director General, DOA, Thailand

Poster session

Session 4 Discussion and Synthesis of Symposium Themes: Past achievements and future orientation of JIRCAS and partners in the development of sustainable agriculture, forestry and fisheries

(1) Research output and future direction of JIRCAS

Dr. Takasuke Ishitani, Director, Research Planning and Coordination Division, JIRCAS

(2) Questions, comments, and discussion

(3) Synthesis and conclusions

For further information, please contact:

Secretary of the Organizing Committee for the 7th JIRCAS International Symposium

Japan International Research Center for Agricultural Sciences (JIRCAS)

1-2 Ohwashi, Tsukuba, Ibaraki 305-8686, JAPAN

Fax: +81-298-38-6342

E-mail: sympo7@jircas.affrc.go.jp

 [Contents](#)

 [JIRCAS Home Page](#)

JIRCAS

Newsletter

No. 25

December 2000



Cattle raising using maize stalks and leaves in a small farm in Jilin, China
(Photo by T. Taniguchi)

CONTENTS




<Feature Article>

- Sustainable Livestock Production in Farming Systems

<Collaborative Research Project>

- Comprehensive Project in China

<JIRCAS Research Highlight>

-  [Genetic Improvement of Drought-Tolerant Crops](#)
-  [Changes in Soymilk Properties after Heating](#)
-  [Treatment System for Wastewater from Prawn Aquaculture](#)

[< JIRCAS 7th International Symposium >](#)

[<Topic>](#)

-  [Mr. Motai, Chairman of AFFRC, Visited China](#)

[<People>](#)

-  [**JIRCAS Home Page**](#)

For Sustainable Livestock Production in Farming Systems



Toshiaki Taniguchi

Director, Animal Production and Grassland Division, JIRCAS

The Animal Production and Grassland Division is currently implementing research projects on 1) Improvement of livestock production using locally available feed resources in Northeast Thailand in collaboration with Khon Kaen Animal Nutrition Center, Thailand, 2) Improvement of swine production in farming systems in the Mekong Delta in collaboration with Cantho University, Vietnam, and 3) Development of grassland management technologies for sustainable agro-pastoral systems in the subtropical zone of Brazil in collaboration with Empresa Brasileira de Pesquisa Agropecuaria (EMBRAPA), Brazil.

Two of the three projects mentioned above are focused on sustainable development of small-scale farming systems in Southeast Asia. The latter is focused on a sustainable crop and forage rotation system in large-scale livestock and crop production systems in South America. Livestock production remains at low levels throughout the developing world due to constraints such as low genetic potential, poor quality feeds, disease prevalence, harsh climatic conditions, and low management level. In Southeast Asia, the number of native animals, such as swamp buffalo, native cattle and swine (Photo) has been decreasing along with the introduction of exotic breeds for increasing the production of meat and/or milk. However, the introduction of exotic breeds may be frequently faced with low productivity due to malnutrition in the dry season, inadequate feeding management and endemic diseases. On the other hand, livestock play an important role in matter cycling in farming systems, namely the wastes from cattle and swine are used as fertilizer for the cultivation of crops, fruits and vegetables and as fuel in Northeast Thailand and the Mekong Delta. Therefore, removal of constraints in developing areas and maximization of the advantages of livestock are important for increasing the sustainability of livestock production in farming systems and animal industry in these areas.

Another aspect is to consider the efficient utilization of available native animals raised in various areas, because the native ruminants have a superior ability to digest fiber without protein supplements and require less energy to maintain their body weight compared with high performance breeds, as mentioned by Dr. T. Kawashima in a previous Newsletter (No. 24, Sept. 2000). Therefore, the development of a system utilizing native ruminants in order to exploit available low quality feed should contribute to

sustainable development of animal husbandry in these areas.

The next problem is how to obtain feed quality all the year round. Production of natural grasses and pastures decreases remarkably in the dry season in tropical areas. This is a key constraint on further development of livestock production. In the Mekong Delta, local by-products such as rice bran and meal leavings are used as swine feed. Local by-products such as rice straw and sugarcane stalks are used as good roughages for cattle feeding in the dry season in Northeast Thailand. Especially, wild relatives of sugarcane, such as *Saccharum spontaneum* and *Erianthus* spp. and inter-specific crosses between sugarcane varieties could be used as forage crops due to the high biomass production with a lower sugar content and attenuated leafy character in the near future under the collaborative research project between Khon Kaen Field Crops Research Center and JIRCAS. Use of available local feed resources is needed for developing a feeding system which is compatible with the local socio-economic and environmental conditions.

In the Brazilian savannas, decreasing grain yields have recently been observed in the region, as a result of continuous mono-cropping. In conventional mono-cropping systems, the intensive use of disk plows has resulted in the rapid loss of organic matter in most soils. Therefore, agro-pastoral systems (sustainable crop-pasture rotation) are considered to be an effective method of ensuring adequate physical, chemical, and biological soil conditions. It was demonstrated that the introduction of *B. brizantha* into agro-pastoral systems was the optimum solution to improve the quantity and depth distribution of soil organic matter due to the high biomass production of roots. Development of agro-pastoral systems compatible with individual farming systems may contribute to sustainable production of crops and livestock.

Maize stalks and leaves after harvest of maize cobs are also used as roughage for beef and dairy cattle. However, the nutrient level of maize stover is not always sufficient for animal feeding. Therefore, attempts were made to utilize agricultural commodities based mainly on maize and its residues for animal feed as silage in collaboration with the China Agricultural University and Jilin Academy of Agricultural Sciences.

It is also necessary to pay attention to the quality of the feed, including feed safety as roughage for livestock feeding, because, roughage contaminated with pathogens could become a source of infectious diseases and toxicosis in domestic animals.

The value of local feed resources and native animals should be more emphasized for future development of animal husbandry compatible with environmental and socio-economic characteristics in the respective regions.



Photo: A F1 native sow in the Mekong Delta in Vietnam

NEXT

CONTENTS

Comprehensive Project in China Faces Mid-Term Evaluation

Osamu Koyama

Research Planning and Coordination Division, JIRCAS

Three years have already passed, since the new comprehensive collaborative research project conducted in China and titled "Development of sustainable production and utilization of major food resources" started in 1997. In the project, attempts were made to integrate several research activities, which had been separately carried out with Chinese research institutes engaged in different scientific fields, and aimed at solving the food problems in China from comprehensive viewpoints. The research project which was undertaken after the signature of a Memorandum of Understanding by both parties consists of the following five components.

1. Socio-economic research component, including research on food policies, impact of new technologies and regional food balance.
2. Environmental research component, including studies on material cycling and farming systems aimed at environmental conservation.
3. Rice research component, including studies on indigenous genetic resources, new breeding materials and insect pest management.
4. Soybean and maize research component, including studies on genetic resources in Northeast China and utilization of maize residues.
5. Food processing and distribution research component, including studies on starch and protein food from plants and freshwater fish meat.



Meeting at Beijing, China

For each component, detailed research subjects were drafted, and counterpart institutes were assigned, including ten institutes such as five research institutes under the Chinese Academy of Agricultural Sciences, China Agricultural University, and Shanghai Fishery University. From the Japanese side too, many research institutes affiliated to the Ministry of Agriculture, Forestry and Fisheries participated in the project in addition to JIRCAS. The project places emphasis on activities in Japan through the invitation of Chinese researchers, in addition to the conventional collaborative work conducted in China by the Japanese researchers dispatched. During FY 1999 (ended in March 2000), 35 researchers including 6 researchers on long-term assignments were sent to China, and 20 Chinese researchers including 11 research managers were invited to Japan.

The results of the studies have been reported gradually and increasingly, particularly in areas where the research activities had started without any constraint. For example, the socio-economic analysis based on field surveys, the study on soil nutrition balance focused on nitrogen dynamics, and the studies on processing technologies using materials from fresh-water fish, rice and soybeans for such food products as fish meat surimi, rice noodles, tofu, etc. are highly appreciated also in China. Many workshops have been held both in China and Japan for the dissemination of the results and exchanges of views among the wide range of researchers. General audience was also invited to some workshops.

However, the priorities of the project are changing rapidly. Recently China has enjoyed continuous high yields and excess stock has been reported for some commodities such as low-quality cereals. National research institutes are trying to define the future orientation of their activities within the context of economic and organizational reforms. The gap appears between what we expected at the planning stage of the project and what we are currently facing regarding the research organization and the recognition of the problems. On the other hand, however, various attempts are being made to develop sustainable production technologies based on the increasing awareness about environmental degradation, and the need for practical research such as food processing and distribution technologies is rapidly increasing in China. At the end of the fiscal year 2000, halfway in the course of the whole project, mid-term evaluation will be made and the above issues will be discussed.

In addition, cooperation between the project and a new program of technology transfer sponsored by Japan International Cooperation Agency (JICA) is being pursued. It is essential that both projects be effectively conducted through joint ownership of the results, joint utilization of the facilities and exchanges of views among researchers, when grant-aid is allocated and technical cooperation programs in agricultural research are implemented. JIRCAS is participating in the planning of these programs through the exchange of experience and expertise.



Introduction of water-saving irrigation in Shandong province

[NEXT](#)

[CONTENTS](#)

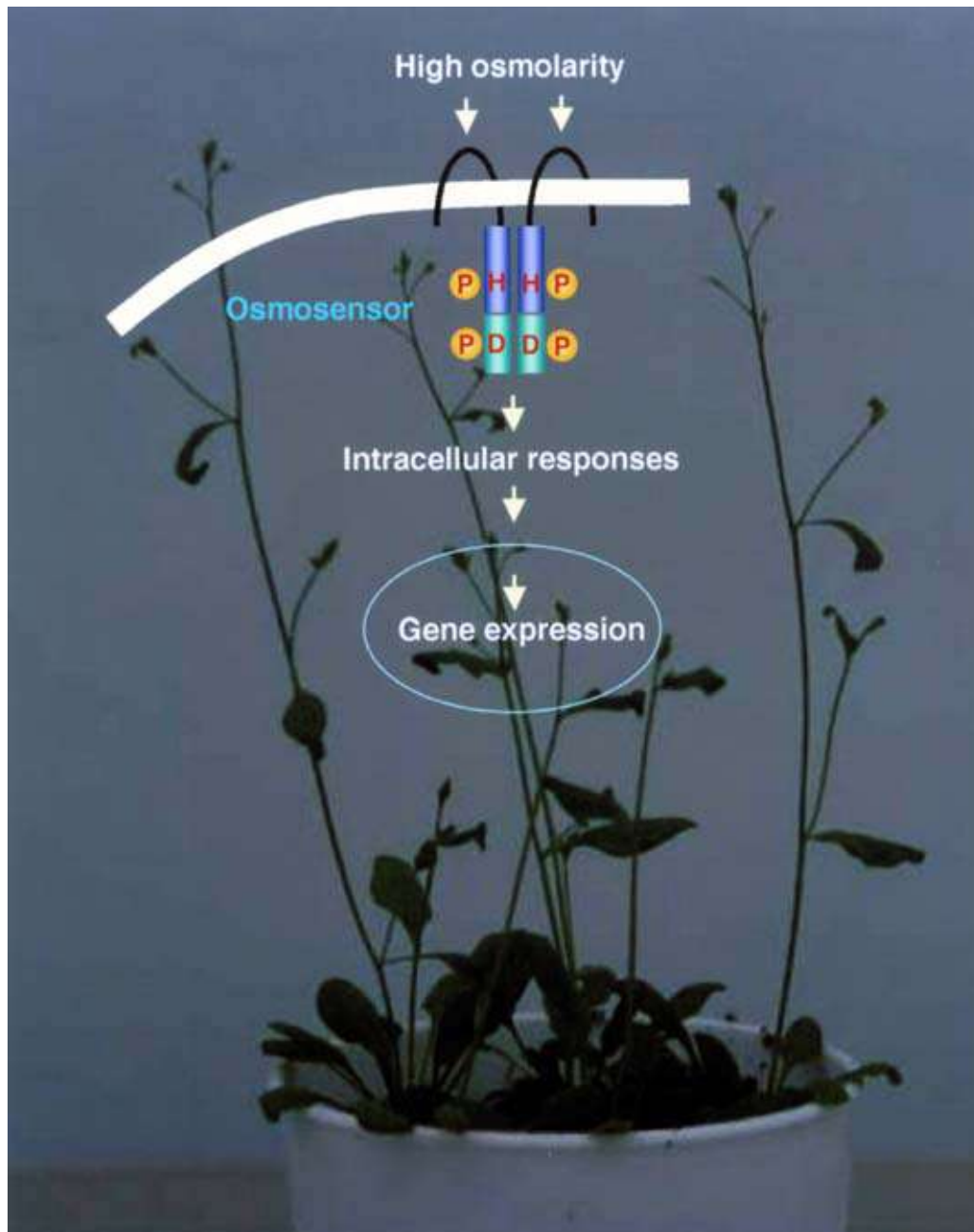
An Osmosensor as a Molecular Tool for the Genetic Improvement of Drought-Tolerant Crops

Takeshi Urao and Kazuko Yamaguchi-Shinozaki
Biological Resources Division, JIRCAS

As the world population rapidly increases, we are now faced with the need to increase and stabilize food production. In marginal or arid lands in developing countries, environmental factors such as drought, high salinity, high temperature, and flooding are serious problems that lead to instability of crop production. To address these problems, development of stress-tolerant plants had so far been conducted by transfer of a gene encoding protective proteins or enzymes involved in stress tolerance from various organisms. However, past efforts yielded limited success due to the genetic complexity of stress responses and adaptation. This indicated that the introduction of a large number of genes into a plant is necessary to confer fully improved stress tolerance. To overcome this limitation, our approach currently being studied is to manipulate a regulatory gene that controls the amounts and timing of numerous effector molecules described above. Under drought conditions, a change in cellular osmotic pressure caused by water loss triggers various intracellular responses, including activation of signal transduction pathways followed by gene expression of osmoprotectants. The first step in this event is the perception of osmotic changes by a sensor or receptor protein(s) at the plasma membrane. Therefore, we aimed at developing an osmosensor as a regulatory gene.

Based on an analogy in bacteria and yeast, histidine kinase(s) was expected to function as an osmosensor in plants, leading us to clone a cDNA encoding a histidine kinase ATHK1 from *Arabidopsis*. RFLP mapping showed that the ATHK1 gene is located on chromosome 2. The ATHK1 mRNA was more abundant in roots than in other tissues and accumulated under high salinity and low temperature conditions. Histochemical analysis of GUS activities driven by the ATHK1 promoter further indicated that the ATHK1 gene is transcriptionally up-regulated in response to changes in external osmolarity. These results suggest that ATHK1 is necessary for efficient sensing of environmental signals such as high salinity and drought stresses. ATHK1 contains two hydrophobic transmembrane regions adjacent to a putative extracellular domain in the N-terminal half, suggesting the presence of a functional similarity to the yeast osmosensor SLN1. Overexpression of the ATHK1 cDNA suppressed the lethality of a yeast *sln1* mutant. By contrast, the substitution of either putative phosphorylation site, His or Asp, failed to complement the *sln1* mutant, indicating that ATHK1 acts as a histidine kinase and that ATHK1 is in an active form in the absence of external signals (e.g. high osmolarity). Moreover, the introduction of the ATHK1 cDNA into a yeast mutant lacking both osmosensors, SLN1 and SHO1, allowed normal growth and activation of the HOG1 MAPK cascade under the high osmolarity conditions, suggesting that the ATHK1 activity changed from the active state to the inactive state in response to increases in external osmolarity. Thus, we demonstrated, by analyzing both sensing (input) and catalytic (output) activities of ATHK1 *in vivo* using the yeast osmosensing-defective mutants, that ATHK1 is able to sense and transduce a signal of external osmolarity to the downstream targets. This is the first evidence that a plant histidine kinase acts as an osmosensor. The ATHK1 gene could be one of useful molecular tools or biological resources for the genetic improvement of drought-tolerant crops. We are currently generating

transgenic *Arabidopsis* and rice plants to examine the ability to improve stress tolerance.



Possible function of an osmosensor in intracellular signaling under drought conditions

NEXT

CONTENTS

Changes in Soymilk Properties after Two-Stage Ohmic Heating

Eizo Tatsumi and Liu Zhishong*²*

**Crop Production and Postharvest Technology Division, JIRCAS, *²China Agricultural University, China*

Thermal processing is a traditional method in the food processing industry. Currently, most of the thermal processing techniques employ indirect heating by thermal conduction and thermal convection. However, these techniques limit the processing of the food material by several-stage heating because of the difficulty in controlling the temperature in a short time. For instance, the external part of a food material needs to be held at a processing temperature for several minutes before the center of the material reaches the required temperature; at that time the rest of the food will have been significantly overprocessed. An alternative technique is direct heating, in which heat is generated within the food material itself. Ohmic heating, which uses the inherent electrical resistance of a material to generate heat, is a relatively new process in food engineering, and has already attracted the attention of some companies. It is important to mention that both the outer and inner parts of a food material can reach a required temperature in a short time.

Soymilk is used to make tofu, which is one of the most popular foods in the world. Usually, soymilk is heated at more than 95°C for several minutes before the addition of a coagulant to make tofu. Almost all the tofu factories and researchers have paid attention to the temperature and time by using one-stage heating because of the technical limitation in the traditional heating procedure. Soymilk was heated under several conditions using a simple ohmic heating system. The rate of increase of the temperature was 40°C/min. Fig. 1 shows that heated soymilk by the standard method (at 95°C for 5 min) had essentially the same viscosity as raw soymilk. However, the viscosity of soymilk heated by the two-stage procedure (at 75°C for 15 min, and then at 95°C for 5 min) was 6 times higher.

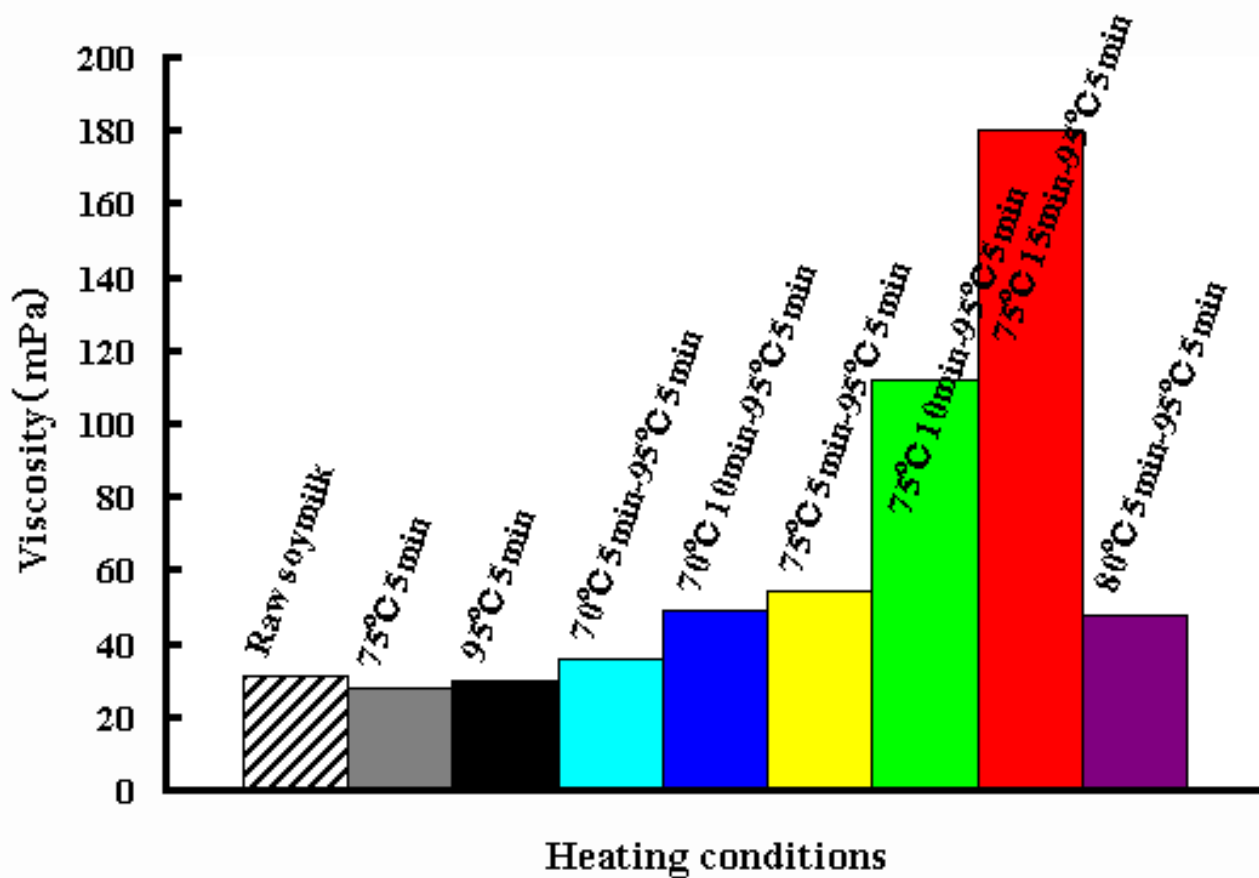


Fig. 1. Viscosity of soymilk after ohmic heating under different conditions.

During the heat treatment, proteins in soymilk are transformed into a partially denatured conformation. Under the denatured state, some non-covalent bonds of protein molecules are destroyed and hydrophobicity in the surface area of the molecules increases. In consequence, protein molecules are dissociated and/or associated. We found that many small particles were produced in soymilk after two-stage heating. These observations suggest that the degree of aggregation in protein molecules was quite different between different heating conditions. The denaturation temperatures for 7S and 11S globulin, which are major protein components in soybean milk, are around 75°C and around 85°C, respectively. The dissociation/association of 7S and 11S globulin occurred at the same time under one-stage heating. In the case of two-stage heating, 7S globulin sub-units were dissociated/associated selectively at the first heating stage. During the second stage, 7S sub-units and/or newly dissociated 11S sub-units were associated cooperatively. Consequently, large aggregated molecules, which affected the increase in the viscosity, were produced in heated soymilk.

Partially denatured states of several food proteins are closely related to their functionality, including gelling and emulsifying properties. The tofu gel properties under the different heating conditions were evaluated in terms of consistency, elasticity, and water loss (Fig. 2). We found that the tofu prepared from two-stage heated soymilk was firmer and more elastic although the first step temperature and

heating time were slightly lower than those obtained from viscosity analysis. The tofu displayed a lower water loss. That is, moderately associated protein molecules enabled tofu to form a tight gel after the addition of a coagulant.

Ohmic heating in high temperature short time processing has been developed to produce high quality sterile food. From the above observations, we concluded that, unlike traditional thermal processing techniques, several-stage ohmic heating enables us to obtain a more suitable texture for a food material, which contains multiple lipids, carbohydrates, and proteins.

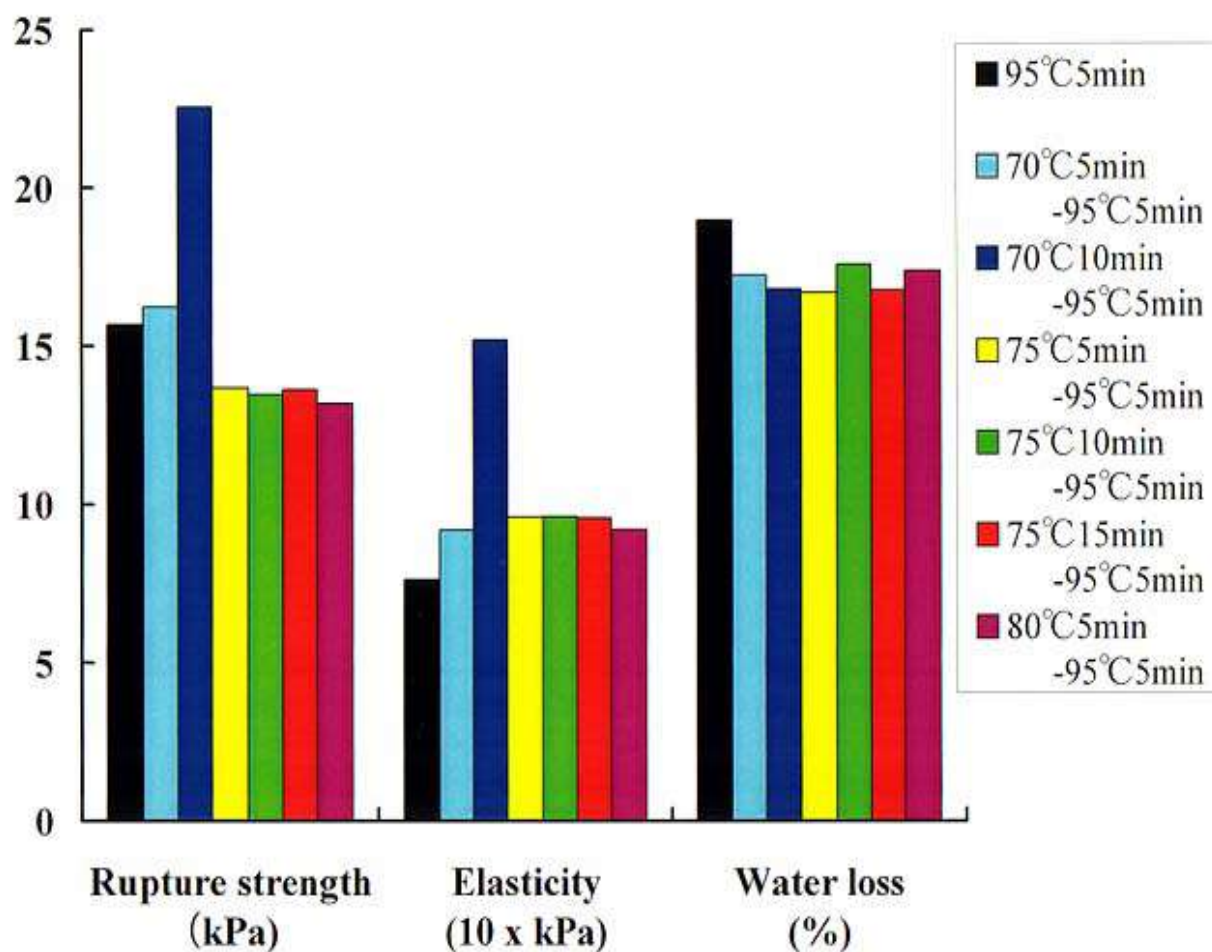


Fig. 2. The quality of tofu gel prepared from soymilk after two-stage ohmic heating.

NEXT

CONTENTS

Studies on Treatment System for Wastewater from Prawn Aquaculture Pond Using Natural Purification Ability of Mangrove Stand

Toru Shimoda and Taufic Ahmad*²*

**Fisheries Division, JIRCAS, *²Research Institute for Coastal Fisheries, Indonesia*

In the Southeast Asian countries including Indonesia, prawn aquaculture is actively carried out to acquire foreign currency. Coastal areas, including areas of mangrove forest, have been destroyed to develop aquaculture ponds for this purpose. Moreover, wastewater containing large quantities of nutrient materials is discharged from the aquaculture ponds, causing environmental deterioration in coastal waters.

The present studies were conducted to analyze the effectiveness of improving the water quality of wastewater using mangrove stands and the mangrove ecological system prior to the discharge of wastewater into the environment.

The investigation site is shown in Fig. 1. Wastewater from the prawn aquaculture pond was introduced into a mangrove reforestation area. The mangrove stand consisted of saplings aged 0 to 2 years planted in a pond at intervals of 40 cm. Water that had passed through the mangrove pond was recirculated to the prawn aquaculture pond via an oyster pond and an seaweed pond. Thirty percent of the water in the prawn pond was exchanged once every 3 days. Water evaporation and seepage into the soil were compensated for by supplying river or well water depending on the degree of salinity. Investigations were conducted at the site once every 15 days. Water temperature, salinity, dissolved oxygen, pH, turbidity, and the concentrations of nutrients (ammonia, nitrate, nitrite, phosphate, and silicate) and chlorophyll *a* were measured.

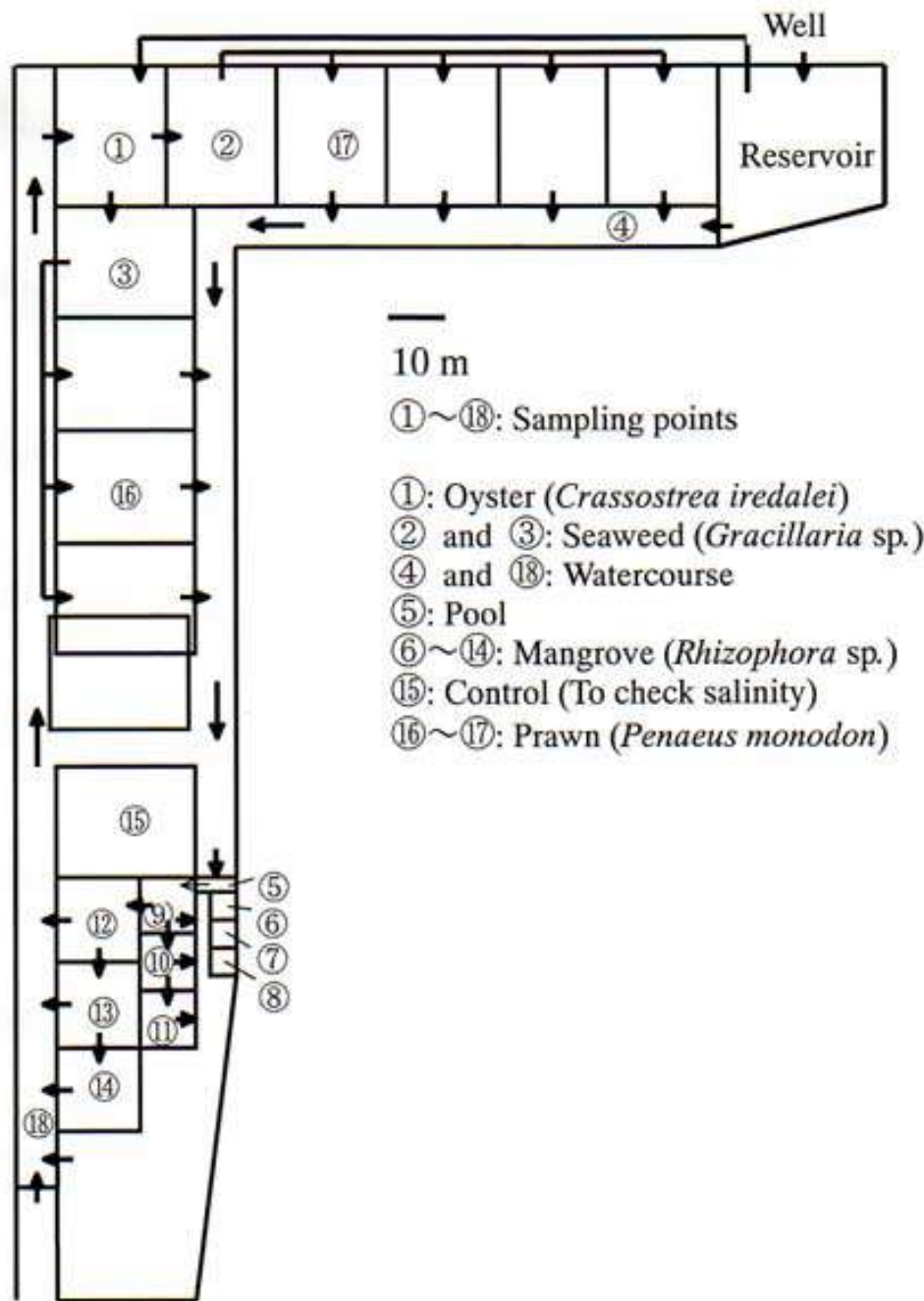


Fig. 1. Investigation site in Maranak, South Sulawesi, Indonesia.

The water temperature ranged from 25 to 30. Salinity exceeded 40(psu) in the dry season and fell below 30(psu) in the rainy season. From the beginning of the experiment, ammonia (NH_3) (Fig. 2) and nitrate (NO_3) concentrations were always high and increased in the oyster pond and the algae pond. The phosphate (PO_4) concentration was initially high because that of the supplied river water was high. Subsequently, it decreased once, then slightly increased in all the ponds. The silicate (SiO_2) concentration increased in the oyster pond, the seaweed pond, and the mangrove pond due to the well water supplied. In the prawn pond, on the other hand,

after increasing once, it decreased due to the increase in the population of diatoms, which have a silicious skeleton. Chlorophyll *a* (Fig. 2) concentration increased gradually in the prawn pond, and exceeded 160 μ g/l at the end of the experiment.

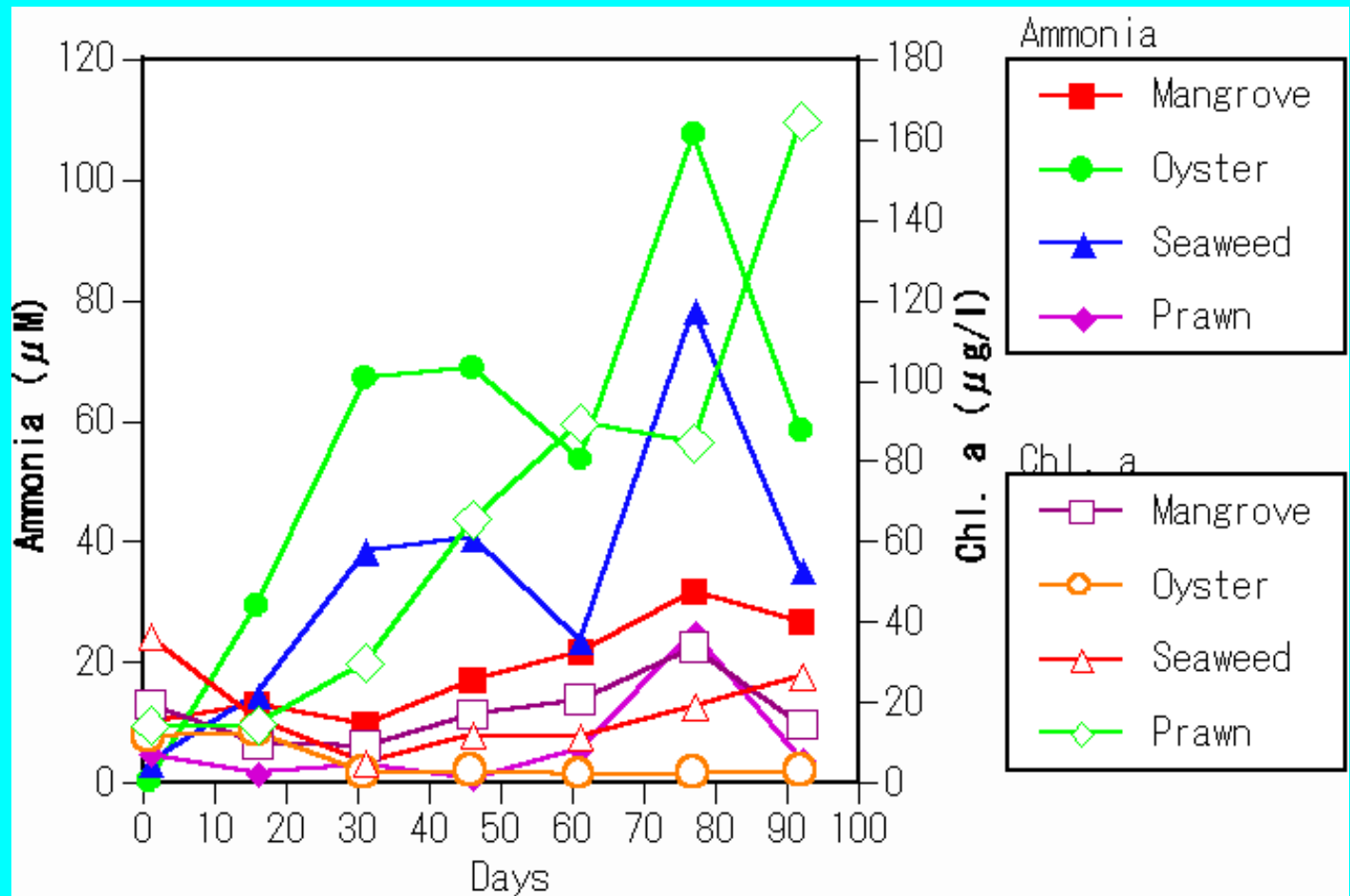


Fig. 2. Changes in ammonia and Chl. *a* concentration in mangrove, oyster seaweed and shrimp aquaculture ponds.

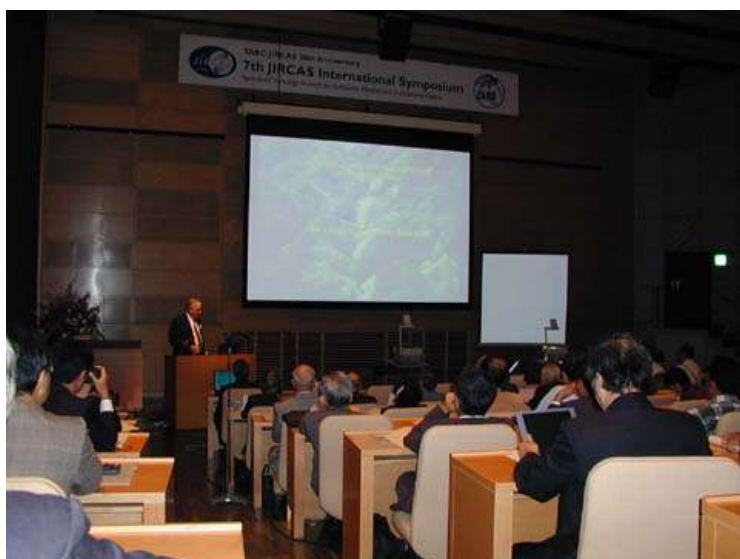
In this experiment, the pond in which wastewater was most effectively disposed of was the oyster pond. Since the oysters fed on phytoplankton while excreting ammonia, the phytoplankton concentration was very low after 30 days while the ammonia concentration was high. Therefore, the amount of phytoplankton, an organic material, markedly decreased. The ammonia and phosphate concentrations in the seaweed pond adjacent to the oyster pond were lower than those in the oyster pond, indicating that the algae took up nutrients. The ammonia concentration in the mangrove pond was always higher than that in the prawn pond and continued to gradually increase. It is considered that the amounts of nutrients generated from the feed and excreta were greater than those taken up by the mangrove stand, presumably because the area of the mangrove pond was too small compared with that of the aquaculture pond. We will attempt to obtain an afforestation area that corresponds to the area of the aquaculture pond by analyzing the material balance in the mangrove stand and the amount of nutrients taken up per unit area of the mangrove stand.

NEXT

CONTENTS

JIRCAS 7th International Symposium

On November 1-2, 2000, JIRCAS held its 7th International Symposium, with 300 participants. To mark the 30th anniversary of JIRCAS and its predecessor, the Tropical Agriculture Research Center (TARC), and to define the future direction of the activities of JIRCAS and its partners in the new century, a broad theme was selected, "*Agricultural Technology Research for Sustainable Development in Developing Regions.*"



Session 2: Nov. 1

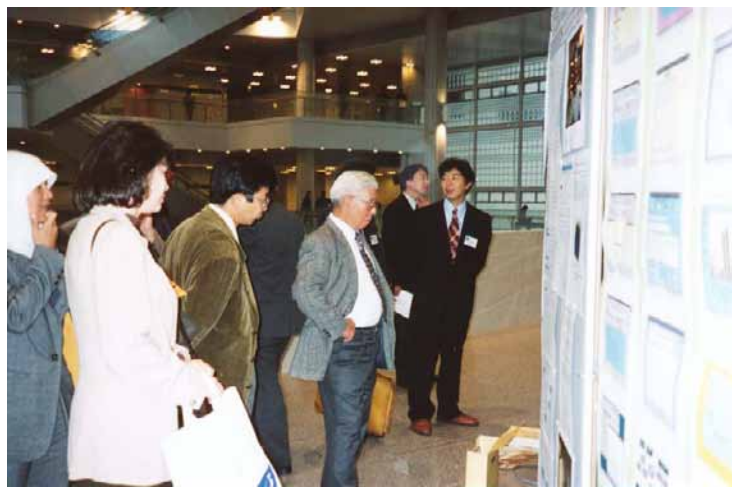


**Opening address:
Dr. Maeno, Director General, JIRCAS**

The symposium addressed this overall theme in five parts. There were three keynote addresses. Dr. Dar, ICRISAT, reviewed the accomplishments of agricultural technology research from the Green Revolution until today, and presented needs and directions for the future including applications of biotechnology and information technology. Dr. Sanchez, ICRAF, centered his presentation on the key characteristics of agricultural sustainability in the tropics, emphasizing the need to adopt a new approach to find solutions to low productivity and poverty in marginal areas. Dr. Bie, ISNAR, suggested that information technology could contribute to the design of agricultural programs more directly relevant to the needs of farmers. This was followed by three sessions focused on specific areas of research. Session I assessed the development of crop varieties with tolerance to stress and low-input conditions (Prof. Takeda, Okayama Univ.), contributions of molecular biology (Dr. Cantrell, IRRI) and the importance of postharvest technology, with emphasis placed on distribution and processing systems (Dr. Johnson, ACIAR). Session II examined agro-ecological sustainability, considering land (Dr. Craswell, IBSRAM) and water management (Dr. Prathapar, IWMI) for crop production, as well as fisheries management and aquaculture production (Dr. Williams, ICLARM). Session III considered partnerships for technology development, including farmer participatory research (Dr. Caldwell, JIRCAS), contributions of farmer knowledge (Prof. McArthur, Univ. of Hawaii) and changes in institutional structures (Prof. Norman, Kansas State Univ.). The strategy adopted by the Japan International Cooperation Agency (JICA) for the transfer of technology (Mr. Samejima) and the policies of national agricultural research systems (Dr. Fagi, Indonesia; Dr. Carrao-Panizzi, Brazil) were also presented. In the closing session, Dr. Maeno, Director General of JIRCAS, reviewed JIRCAS' contributions to date and offered four research strategies for the coming years: strategic basic research, comprehensive research, postharvest technology research, and strengthening of the collaborative approach. A large part of the general discussion that followed was devoted to the potential contributions and limitations of farmer participation in research. Comments on other topics included the importance of 1) developing human resources, 2) emphasizing the content of information in the field of information technology, 3) emphasizing value-adding in postharvest technology and 4) the importance of animals in agriculture. As for the future orientation of JIRCAS activities, several suggestions were made including: the need to 1) strike a balance between strategic basic research and adaptive research and 2) control of preharvest losses in addition to postharvest losses. It was also suggested that since farmer participation in research is being promoted in many international research centers, JIRCAS could benefit from the experience gained by these organizations for the implementation of some of its programs, while building on its strength in basic strategic and comprehensive research. (*John S. Caldwell*)



Poster session



Poster session

NEXT

CONTENTS

Topic

Mr. Motai, Chairman of AFFRC and Mr. Tsuchiya, Director of International Research Division of AFFRC Visited China

Mr. Shigeru Motai, Chairman of the Agriculture, Forestry and Fisheries Research Council, AFFRC, Ministry of Agriculture, Forestry and Fisheries, MAFF, Mr. Tadashi Tsuchiya, Director of the International Research Division, AFFRC/MAFF and Mr. Kazuyuki Tsurumi, Director of the Research Information Division of JIRCAS visited China in September 2000. Their main purpose was to hold discussions with key persons who are concerned with the collaborative research project titled: "Development of sustainable production and utilization of major food resources," on the research direction in the second half of the project, and to visit the research laboratories and fields.

In Beijing, they had the opportunity of meeting with Mr. Liu Jian, Vice-Minister, Ministry of Agriculture, People's Republic of China and Mr. Tang Zhengping, Director General, Department of International Cooperation, Ministry of Agriculture. They also met with Dr. Wang Hongyi, Vice-President of the Chinese Academy of Agricultural Sciences and they exchanged views on the research results so far obtained and future activities relating to the collaborative research project. At the China Agricultural University, they attended the opening ceremony of the Japan-China Food Research Center. Mr. Motai gave an address for the celebration and cut the ribbon to open the center together with Dr. Li Lite, Vice President of China Agricultural University, Dr. Liu Xing Xin, Vice-President of the China Food Oil Society, and Mr. Tsuchiya. About hundred people, including members of the Ministry of Agriculture, Ministry of Education, food oil societies and oil industry associations in Beijing, attended the ceremony. Dr. Li Lite is convinced that this new center will enable to promote research activities in food processing, one of the key sectors in agriculture in China presently.



Cutting the ribbon during the opening ceremony for Japan-China Food Research Center

(from left, Dr. Liu, Dr. Li, Mr. Motai and Mr. Tsuchiya)

In Jilin, they visited the Jilin Academy of Agricultural Sciences (JAAS) and discussed with Dr. Feng Wei, President of JAAS and Dr. Liu Kai, Director of Soybean Institute of JAAS, various aspects relating to the soybean research activities. The JAAS members explained that they had developed a soybean variety with high fat and protein contents which is now being disseminated in Jilin.

In ZheJiang, they visited the China National Rice Research Institute (CNRRI) and held discussions with Dr. Cai Hong-Fa, Director General of CNRRI and Dr. Zhang Zhi Tao, Vice-Director General of CNRRI on the rice situation in China. CNRRI explained that rice double-cropping cultivation has been decreasing mainly due to the low quality of the first crop and that hybrid varieties account for half of the planted area in China. In Shanghai, they visited Shanghai Fisheries University (SFU) and discussed with Dr. Zhou Ying Qi, President of SFU, and Dr. Hung Shuolin, Vice-President of SFU various aspects relating to fish research activities, particularly the processing sector.

On these occasions, they visited farmers in Jilin and ZheJiang, and noticed that agricultural activities had changed during the last decade. In Jilin, cultivated commodities have been diversified from maize to vegetables and fruits, such as strawberry, watermelon and grape, which are more profitable. In ZheJiang, some farmers have entrusted other farmers with tilling and harvesting activities, particularly in the rural areas where employment opportunities are available in other industries than agriculture. *(Kazuyuki Tsurumi)*



People



Mr. Akira Mizushima became Director of JIRCAS's Administration Division on September 1, 2000. He was until recently Director of Computer Division of Tsukuba Office, Agriculture, Forestry and Fisheries Research Council Secretariat of MAFF.

[● Contents](#)

[● JIRCAS Home Page](#)

JIRCAS

Newsletter

No.18 March 1999



Soil salinity due to inadequate water management with waterlogging
(Photo by Y. Shinogi)

CONTENTS

<Feature Article>

- [Animal Production in Developing Regions](#)

<JIRCAS Research Highlights>

- [Suppression of Nitrification by a Grass](#)

 [Resistance Mechanisms to Planthopper in Rice](#)

 [Chitinolytic Enzyme Genes in Bacteria](#)

<Seminars>

 [Seminar on High Value Timber Species for
Plantation Establishment](#)

 [4th Seminar on "Brackish Water Project" Held in
Malaysia](#)

<Topics>

 [Collaboration with IWMI](#)

[<JIRCAS Symposium>](#)

[<Visitor>](#)

[<People>](#)

 [JIRCAS Home Page](#)

Animal Production in Developing Regions: Importance of the Conservation of Genetic Resources

Mitsugu Shimizu

Director, Animal Production and Grassland Division, JIRCAS

Farm animals contribute to more than 30% of agricultural products and supply food rich in protein, hide, fiber, fertilizer for crops, and draught power. In the developing regions, animal production may enable smallholders to upgrade their living conditions through the improvement of their diet and health conditions and the increase of farm household income, alleviation of poverty, and diversification of resources to reduce risks. In addition, animal production is an important component of sustainable agricultural systems in these areas, because animals can use agricultural by-products and residues as feed resources, animal excreta and wastes can be utilized as a source of household energy and fertilizer for crops, while draught power is used for plowing land and for transportation. However, animal productivity is reduced by many constraints in developing regions. The major factors involved in the low animal productivity are the deficiency in feed in terms of quantity and quality and low nutrition level, inappropriate management practices, and the depletion of grassland resources, which result in poor growth of the animals. The other serious problem is related to animal health. Farm animals in developing regions, especially in tropical and subtropical countries are often reared in unsanitary and stressful environments, and are frequently exposed to various pathogens, including viruses, bacteria, and parasites and to harsh climatic conditions that cause considerable damage to the animals. Economic losses of animal production due to sanitary problems in the developing regions have been estimated at more than 40% of total production.

Therefore, the Animal Production and Grassland Division (APGD), Japan International Research Center for Agricultural Sciences (JIRCAS), has promoted collaborative research with various countries, placing emphasis on securing feed resources by either identifying new feedstuffs or utilizing agricultural by-products and residues along with the improvement of grassland and animal management, and implementation of measures for disease control. For instance, oil-palm fronds and sugarcane stalks have been successfully used as ruminant feeds through collaborative research with Malaysian and Thai scientists, respectively, and the project entitled "Development of Agro-pastoral Systems in the Subtropical Area of Brazil" is being carried out to develop a sustainable technology for grass production in Brazil. APGD, JIRCAS intends to continue these research activities in order to achieve a sustainable increase of animal production compatible with the preservation of natural resources and environmental conditions in the respective regions.

To increase livestock production in developing regions, research on genetic characterization and conservation of indigenous breeds of farm animals, and their effective utilization for animal raising is important. In the past 12,000 years, human beings developed about 4,500 breeds of domestic animals from approximately 40 animal species, and most countries, depending on the geographic and climatic conditions, have their own unique animal breeds with various traits. Only a few breeds of important domestic animals have been successfully developed to improve some traits in relation to production in developed regions, mostly in northern countries. These breeds consume nutritious feeds and live in favorable environments. As a result, they produce more meat, milk, eggs, etc, when they are fed with sufficient quantities of high quality feeds, and reared under well controlled environments. However, they may not be adapted to the conditions prevailing in the developing regions where animals are usually reared with poor quality feeds, and always exposed to harsh climatic conditions, various pathogens, diseases, insect bites, and other environmental stresses. On the other hand, many indigenous breeds that are well adapted to the harsh conditions of the respective regions are distributed in the developing regions. Although these locally adapted breeds harbor valuable traits for adaptation to harsh climatic conditions, low quality feeds and various diseases, many of them are now becoming endangered species. These indigenous breeds appear to be valuable, and essential for further enhancement of sustainable animal production that does not depend upon high inputs and skillful management in the developing regions. The genetic characterization of indigenous breeds, and the conservation and utilization of useful genetic resources, particularly genes controlling heat and drought tolerance, adaptability to low quality feeds, disease resistance, and so on, should be promoted to improve animal production in the developing regions.

Although JIRCAS is not currently involved in such activities, in future, research along these lines should be considered.



Photo 1: Native pig in the Philippines



Photo 2: Nelore cattle in Brazil



Photo 3: Sustainable agro-pastoral systems in Brazil

[NEXT](#)

[CONTENTS](#)

Suppression of Nitrification in Soil by a Tropical Grass

Takayuki Ishikawa

Environmental Resources Division, JIRCAS

Nitrogen in fertilizers and organic components is transformed into ammonium-N in soil by microorganisms. In the nitrification process, ammonium-N is converted into nitrite-N by ammonium-oxidizing bacteria and nitrite-N is converted into nitrate-N by nitrite-oxidizing bacteria. Since plants can absorb only ammonium-N and nitrate-N, nitrification markedly influences the nitrogen absorption efficiency by plants. Nitrate-N that is not absorbed by plants easily leaches down from the rhizosphere to the deeper layers of soil and pollutes the underground water. During the process of nitrification, nitrous oxide, one of the greenhouse gases, is emitted from the soil to the atmosphere. By controlling nitrification, it is possible not only to increase the nitrogen absorption efficiency by plants but also to minimize the nitrogen loss by leaching and volatilization. In order to decrease the nitrogen loss, chemical fertilizers with nitrification inhibitors have been developed but their application is very limited in developing countries because of their high cost. If plants could inhibit the nitrification process, their nitrogen absorption efficiency would be considerably enhanced. It was reported that the amount of nitrate-N accumulated in the soil where a tropical grass grew seemed to be smaller than that in the soil where other tropical grasses grew. The objective of this study was to demonstrate the ability of this tropical grass to suppress nitrification and to identify the relation between nitrification suppression and nitrous oxide emission to the atmosphere.

Three tropical grasses (*Brachiaria decumbens* (Bd), *B. humidicola* (Bh), *Melinis minutiflora* (Mm)) supplied by CIAT were grown for 6 weeks in Wagner pots and soils were sampled. Ammonium-N was applied to the sampled soils and the nitrification process was observed. In soils with Bd and Mm, the content of ammonium-N decreased 4 days after ammonium-N application and nitrification started rapidly (Fig. 1). However, the content of ammonium-N in the soil with Bh did not change until the 8th day and there was a lag period before the onset of nitrification. The results indicate that only *B. humidicola* suppressed nitrification in soil.

[Fig. 1. Content of ammonium-N in soil](#)

In order to study the effect of nitrification suppression on nitrous oxide emission, Bd, Bh and Mm were grown for 4 weeks in Wagner pots and ammonium-N was applied to the soil. From soils without plants (No Plants), and with Bd and Mm treatments, nitrous oxide was emitted at a rate of $3 \frac{1}{4}$ g-N/m²hr one day after ammonium application (Fig. 2). From the No Plants soil, nitrous oxide emission increased from the twelfth day. In the case of the Bd and Mm treatments, nitrous oxide emission continued for more than 4 days and then began to decrease because nitrogen in soils was absorbed by the plants. However, nitrous oxide emission from the soil with the Bh treatment was low throughout the experimental period. The amount of nitrous oxide emitted from the soil with the Bh treatment was 1/4 smaller than that from the Bd and Mm treatments.

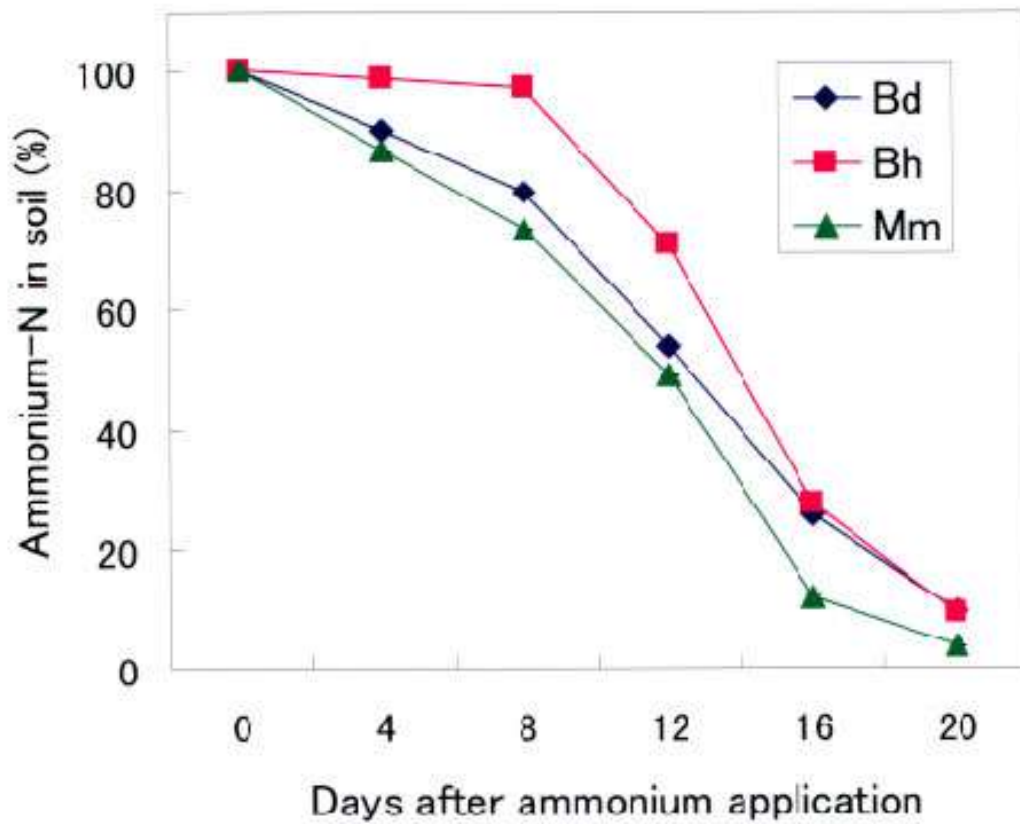
[Fig. 2. Nitrous oxide emission from soil](#)

In another experiment, it appeared that *Brachiaria humidicola* suppressed the multiplication of ammonium-oxidizing bacteria specifically but had no effect on the nitrite-oxidizing bacteria. Of the two nitrification processes, it is assumed that the process in which ammonium-N is changed into nitrite-N is a rate-determining process. By the suppression of multiplication of ammonium-oxidizing bacteria, *Brachiaria humidicola* suppresses nitrification in soil and nitrous oxide emission to the atmosphere. Generally it is considered that tropical grasses preferentially use nitrate-N compared to ammonium-N. Among the *Brachiaria* species, it is assumed that only *B. humidicola* can utilize both forms of nitrate-N and ammonium-N and that this function of *B. humidicola* may lead to an efficient use of nitrogen in soil.

Native pastures are widely distributed in various countries of the tropical zone but their productivity is very low. In order to increase livestock production, if *Brachiaria humidicola* could be introduced, it would be possible to decrease the nitrogen input for agriculture in addition to preserving the environment and ecosystems.

[NEXT](#)

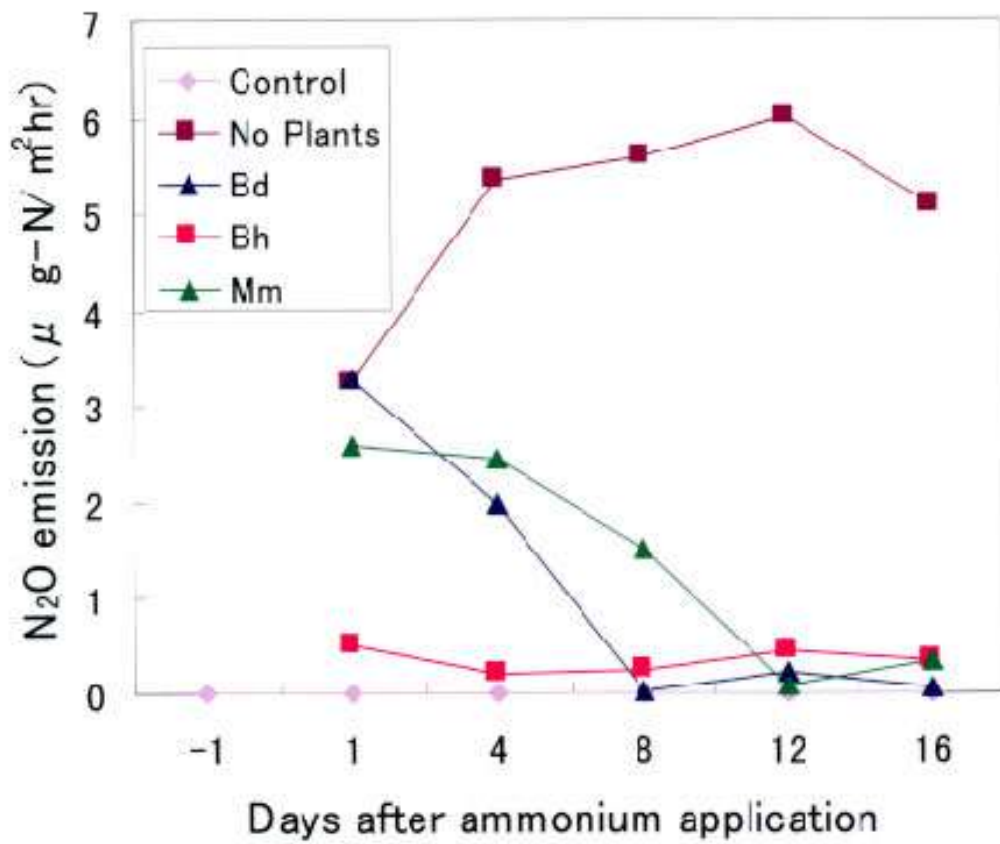
[CONTENTS](#)



Ammonium-N in soil was taken as 100% at 0 days.

Fig. 1. Content of ammonium-N in soil

BACK



Control : soil to which ammonium-N was not applied
 No Plants : soil to which ammonium-N was applied

Fig. 2. Nitrous oxide emission from soil

BACK

Compound Resistance Mechanisms to the Whitebacked Planthopper in Chinese Japonica Rice Variety "Chenjiang 06"

Kazushige Sogawa

Crop Production and Postharvest Technology Division, JIRCAS

Rice agriculture in China is characterized by the wide adoption of high-yielding F1 hybrid rice. Since its introduction in 1976, the cultivation of hybrid rice has expanded rapidly and hybrid rice was planted to about half of the total rice area in China in the 1990s. The remarkable increase in rice production in the 1980s was largely dependent on hybrid rice. However, Chinese hybrid rice has caused a new pest problem, namely outbreaks of the whitebacked planthopper, *Sogatella furcifera*, because of its high susceptibility to the pest. Subsequent increase of insecticide applications has resulted in the development of resistance of insect pests to pesticides in paddy fields, and increased the risk of pest resurgence due to the destruction of natural enemies in the paddy ecosystem. Growing pest and pesticide problems in rice agriculture in China drew our attention to varietal resistance to insect pests in Chinese rice as an effective component of the ecologically based pest management (EBPM) system. In the course of the JIRCAS-CNRRRI Collaborative Research Project on EBPM for rice planthoppers in China, we demonstrated the mechanism of varietal resistance to *S. furcifera* in Chinese japonica rice "Chenjiang 06 (CJ-06)".

S. furcifera resistance of CJ-06 was investigated in comparison with that of a susceptible indica hybrid rice cultivar "Shanyou 63 (SY-63)." Field experiments revealed the high field resistance of CJ-06 to *S. furcifera*. The *S. furcifera* immigrants did not land and failed to establish populations on CJ-06. They preferred to settle on SY-63 on which they could well reproduce. Under a free choice condition, significantly fewer *S. furcifera* individuals alighted on CJ-06 than on SY-63. The significantly smaller amount of honeydew excreted by *S. furcifera* females on CJ-06 than on SY-63 indicated a low sucking activity on CJ-06. Both fecundity and egg hatchability were markedly reduced on CJ-06, when newly emerged *S. furcifera* females continuously fed and were allowed to oviposit on it. Consequently, the number of nymphs hatched on CJ-06 amounted to only about one-tenth of that on SY-63. *S. furcifera* eggs showed a high mortality in watery lesions at oviposition sites of CJ-06. The watery lesions rapidly led to the formation of conspicuous necrotic symptoms before the eggs hatched. The egg mortality in the watery lesions occurred within 1-2 days after oviposition (Fig. 1). Such watery lesions seldom occurred in SY-63, where the eggs hatched normally.

[Fig. 1. Embryonic development of *S. furcifera* eggs in resistant CJ-06 and susceptible SY-63.](#)

Based on the above findings, we concluded that sucking suppression and ovicidal reaction were critical factors for the *S. furcifera* resistance in CJ-06. These functions are associated with the antixenosis mechanism against *S. furcifera* immigrants, as well as the antibiosis mechanism whereby fecundity and egg hatchability of inhabitants are reduced, respectively. Such dual mechanisms of varietal resistance may result in a stable and durable field resistance to *S. furcifera* in Chinese japonica rice CJ-06 (Fig. 2). It would be important to identify the chemical components responsible for the sucking inhibition and ovicidal reaction associated with the resistance of CJ-06 to *S. furcifera*, compared to the susceptibility of SY-63 and to analyse the genetic basis of the resistance for subsequent breeding work.

[Fig. 2. Antixenotic and antibiotics resistance to *S. furcifera* in Chinese japonica rice, CJ-06.](#)

[NEXT](#)

[CONTENTS](#)

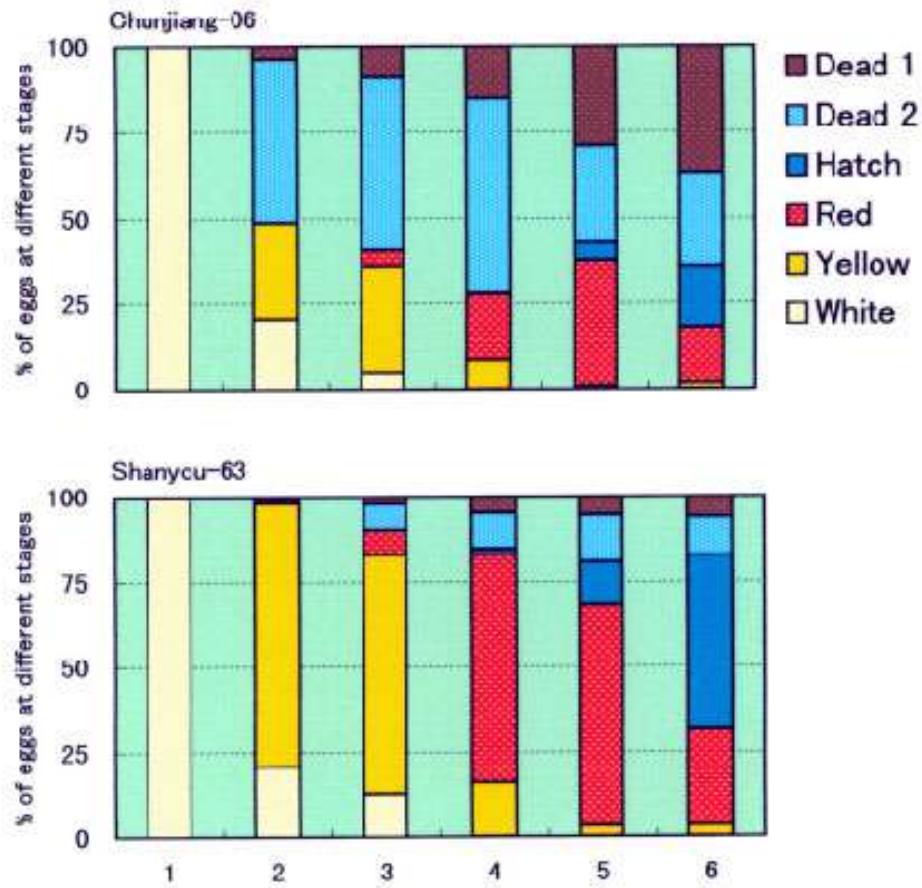


Fig. 1. Embryonic development of *S. furcifera* eggs in resistant CJ-06 and susceptible SY-63.

White = newly deposited eggs, Yellow = eggs at yellow spot stage,
 Red = eggs at eye-spot stage, Hatch = hatched eggs,
 Dead 2 = opaque dead eggs, Dead 1 = discolored dead eggs

BACK

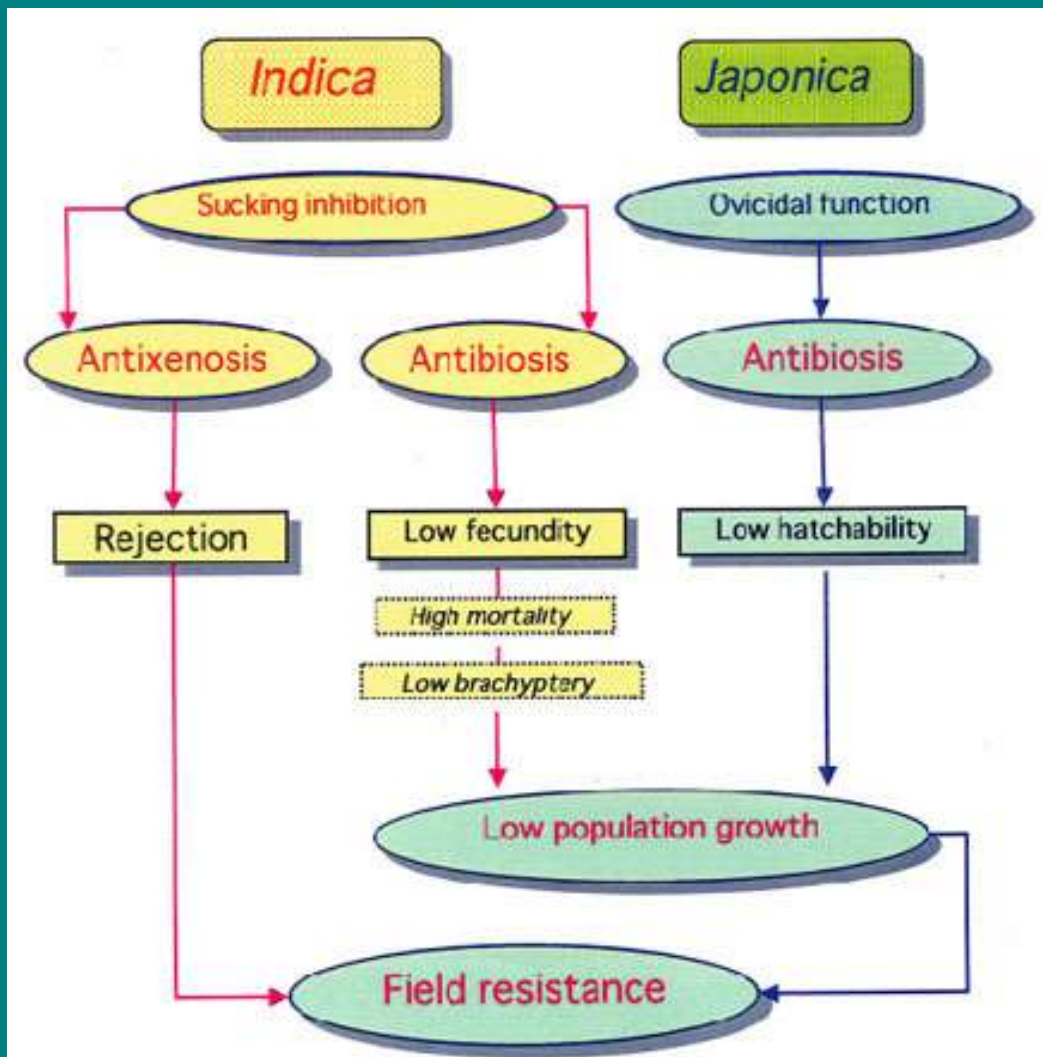


Fig. 2. Antixenotic and antibiotics resistance to *S. furcifera* in Chinese japonica rice, CJ-06.

BACK

Analysis of Chitinolytic Enzyme Genes of a Mycoparasitic Bacterium *Flexibacter* sp. FL824A

Yasuo Ando

Animal Production and Grassland Division, JIRCAS

The purpose of this study is to develop disease control utilizing lytic microorganisms. We detected a lytic activity in a mycoparasite *Flexibacter* sp. FL824A toward several plant pathogenic fungi, consisting of the secretion of lytic enzymes, chitinolytic enzymes (chitinases and *N*-acetylglucosaminidases), β -1,3-glucanases and proteases. Chitinolytic enzymes are considered to play an important role in the mycoparasitic process, because chitin, poly- β -1,4-*N*-acetylglucosamine [(GlcNAc)_n], is a major structural component of cell walls of fungi. In the first step of our study, we analyzed the genes of chitinolytic enzymes from *Flexibacter* sp. FL824A.

A genomic library of *Flexibacter* sp. FL824A using pUC19 and *Escherichia coli* was constructed. Hydrolysis activity of the crude protein of the transformants was determined by using analogs of chitin derivatives, 4-methylumbelliferyl- β -D-*N*, *N'*-diacetylchitobioside [4-MU-(GlcNAc)₂] or 4-methylumbelliferyl- β -D-*N*,*N'*,*N''*-triacetylchitotriose [4-MU-(GlcNAc)₃] as substrates. Among 6,000 transformants tested, four clones showed a positive activity. They fell into two groups according to their specificity to the substrates (Table 1). We selected two clones CHF1149 and CHF1351, based on the activity level, specificity to the substrates, size of DNA-inserted fragment, and digestion pattern of the insert with restriction endonucleases.

Table 1. Enzymatic activity of positive clone using 4-MU-*N*-acetylchitoooligose as substrate

Clone	Enzymatic activity $\frac{1}{4}$ Unit/ml ¹⁾		Ratio of activity (dimer/trimer)
	dimer ²⁾	trimer	
Group A			
CHF2778	7.63	10.36	0.74
CHF2601	15.81	26.16	0.60
CHF1149	232.19	446.39	0.52
Group B			
CHF1351	768.50	40.33	19.06

1) 1Unit of enzymatic activity was defined as 1mmol of 4-MU/min at 37°C.
2) dimer, 4-MU-(GlcNAc)₂; trimer, 4-MU-(GlcNAc)₃.

An open reading frame (ORF) of 4236 bp was found to code for a chitinase with 1412 amino acids based on the nucleotide sequence and deduced amino acid sequencing of an 8.7-kbp insert of pCHF1149. Homology analysis of the deduced amino acid sequence of this protein revealed that the enzyme has a multiple domain structure consisting of at least seven domains (Fig. 1). The most interesting property is that the enzyme has two catalytic domains, one homologous to the catalytic domain of chitinase A1 of *Bacillus circulans* WL-12 on the N-terminal side of the protein and the other homologous to that of chitinase D of the same bacterium on the C-terminal side.

Fig. 1. Schematic representation of the domain structures of chitinases from several bacteria

The DNA sequence of 5.0 kbp of the DNA-inserted fragment of pCHF1351 was determined after subcloning. An open reading frame (ORF)

of 1962 bp was found to code for a putative protein with 654 amino acids. The protein shared a 25% homology with endo- β -*N*-acetylglucosaminidase of *Clostridium perfringens*.

Strong lytic activity of *Flexibacter* sp. FL824A may be due to the presence of a unique chitinase with two catalytic domains. Further studies on the chitinase should be carried out to analyse the chitin degradation of this mycoparasitic bacterium.

[NEXT](#)

[CONTENTS](#)

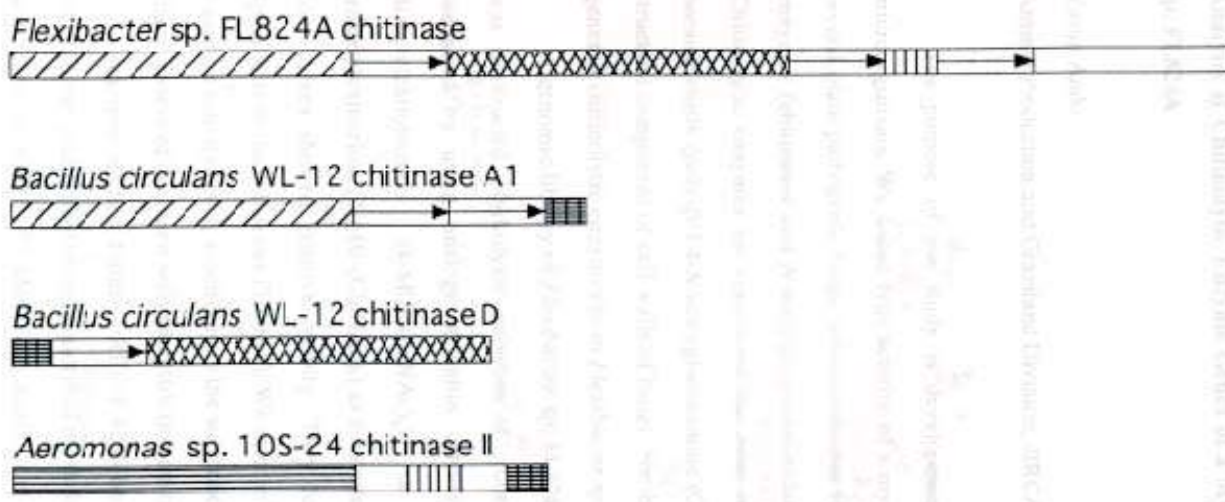









Fig. 1. Schematic representation of the domain structures of chitinases from several bacteria

 ,  ,  , catalytic domain ;  , chitin-binding domain ;
 , fibronectin type III repeating unit ;
 ,  , unknown domain.

BACK

Seminar on "High Value Timber Species for Plantation Establishment - Teak and Mahogany Species -"

Disappearance of the natural forests has prompted the Southeast Asian nations to establish and develop artificial forest plantations. The trees selected for this purpose have been mostly fast-growing species for pulp and/or light use timber. Recently, however, in Malaysia, including Sabah State, there has been a growing interest in planting high value timber species with longer rotation periods. Not only the foresters, from either governmental organizations or the private sector, but also estate plantation holders and farmers are interested in planting teak (*Tectona grandis*) in their plantation or farm areas, and more recently some of them have also started to plant mahogany species (American mahogany, *Swietenia macrophylla*, and African mahogany, *Khaya ivorensis*). Malaysian experience with these species is, however, rather limited.

To fill this gap, JIRCAS, INNOPRISE (Sabah Foundation) and Sabah Forestry Department decided to jointly organize a "Seminar on High Value Timber Species for Plantation Establishment" with emphasis placed on teak and mahogany species. The seminar was held at the Auditorium of Sabah State Library, Tawau, Sabah on December 1, 1998. Following the opening addresses by Datuk Musa Haji Aman (Chief Executive of INNOPRISE), Dr. Kiyoshi Tanaka (Director of Forestry Division, JIRCAS) and Mr. Herman Anjin (Deputy Forestry Director of Sabah Forestry Department), Dato' Dr. Salleh Mohd. Nor (Executive Director of TROPBIO Research) gave a keynote address and 14 experts from five countries presented nine papers related to silviculture, propagation, protection, wood utilization and marketing in three sessions. More than 130 participants, including forestry scientists, foresters and many plantation holders from Sabah, Sarawak and Peninsular Malaysia, held animated discussions and exchanged information. More than 50 participants also joined a field trip to the Luasong Forestry Centre, about 100 km from Tawau to observe demonstration/experimental stands of teak and mahogany on the next day. This seminar was very timely and successfully promoted the establishment of plantations of teak and mahogany species in Malaysia, especially in Sabah.



Photo: Participants leaving for field trip

(Kazuma Matsumoto)

NEXT

CONTENTS

4th Seminar on "Brackish Water Project" Held in Malaysia

On December 8-9, 1998, the 4th "Brackish Water Project" seminar was held in the Conference Room of the Hotel Equatorial Penang, in Penang Island, Malaysia. This project on "Productivity and Sustainable Utilization of Tropical and Subtropical Brackish Water Mangrove Ecosystems" aims to evaluate the productivity of the above areas and identify the criteria for sustainable utilization of resources. The West coast of peninsular Malaysia has been selected as the study area due to the presence of various types of mangrove forests differing in the level of management and exploitation. The counterpart organizations include the Fisheries Research Institute (FRI), the University of Malaya (UM) and the Forest Research Institute of Malaysia (FRIM).

Subjects addressed in the seminar were as follows:

1) Forest and litter fall, 2) Benthic communities, 3) Aquatic organisms, 4) Socio-economic aspects, 5) Environmental aspects. About 40 scientists and government officials from Japan, Malaysia, and Australia participated in the seminar, and fourteen papers were presented.

During the 4th seminar, Mr. Hashim Ahmad, Deputy Director General of the Department of Fisheries Malaysia gave an opening address, and Dr. Shiro Uno of JIRCAS presented closing remarks.

During the two days' seminar, it was concluded that the surveys conducted in 1997-1998 in the mangrove forest and waters had been completed. At that stage, it is necessary to analyse the structure of the mangrove ecosystems and to ensure that economic activities in these areas are sustainable.



Photo : Survey in the Merbok Mangrove Estuary

(Katsuhiko Kiso)

[NEXT](#)

[CONTENTS](#)

Current Status of Collaborative Research Activities between IWMI and JIRCAS

The International Irrigation Management Institute (IIMI), one of the sixteen organizations supported by the CGIAR, was established by an Act of Parliament in Sri Lanka. The Act is currently under amendment to rename the Institute as International Water Management Institute (IWMI).

IWMI implements four global research programs to improve water resources and irrigation management as follows: 1) Performance and Impact Assessment, 2) Design and Operation of Irrigation Systems, 3) Policy, Institutions and Management, and 4) Health and Environment. Collaborative research activities between IWMI and JIRCAS cover the Design and Operation of Irrigation Systems Program.

Two studies are being carried out as follows: "Optimal Water Management under Water Deficit Conditions" and "Soil Salinity Problems."

The site for the "Optimal Water Management" study is located in the North-Central province of Sri Lanka. Irrigation water is used not only for agriculture but also for bathing, washing, as drinking water, etc. Although rainfall is usually abundant in this area, due to the lack of effective water management, the amount of water available for agriculture and daily life is sometimes insufficient. Many small tanks (ponds) are connected to one another (tank cascade system) in the area and they comprise the main water reservoirs. At first, it is necessary to analyse the water balance in these systems for identifying optimum cropping patterns based on traditional systems and more advanced technology in order to improve water management. As a result, crop productivity could be enhanced and maintained during the dry season, also. These practices could be adopted in other areas in Sri Lanka and in other countries.

Soil salinity is one of the most severe problems in arid and semiarid environments. Sometimes, it is caused by inadequate water management practices such as waterlogging, which is associated with excessive irrigation and which induces soil salinity. Soil salinity is a complex phenomenon which is region-specific. Productivity can be improved in the affected areas and it is important to determine the main causes of salinity so as to reduce it. The main factors can be determined by statistical methods, and one prediction model could be constructed with these parameters to predict the areas that may experience soil salinity.

"Soil slotting" is considered to be a useful technique to improve salinized (sodic) land. In this technique, some slots are cut and filled with soil and chemical substances or organic matter. It is important to analyse the soil-water and solute movement in this technique to identify suitable specifications (slot width, depth, space, etc.). These parameters can be simulated using a solute movement model under different water management conditions. Such a technology may enable to promote sustainable agriculture and raise the productivity of crops. The results could be applied to other salinized areas.



*Photo: In rural areas irrigation water is used for many purposes
(Sri Lanka)*

(Yoshiyuki Shinogi)

[NEXT](#)

[CONTENTS](#)

<The 6th JIRCAS International Symposium>

GIS Applications for Agro-environmental Issues in Developing Regions

The symposium on "GIS Applications for Agro-environmental Issues in Developing Regions" will be held in Tsukuba, Japan during the period of September 7 – 9, 1999.

The greatest challenge for mankind today is to develop agricultural systems that would enable to utilize biological and natural resources adequately to feed the global human population and preserve the resources simultaneously. To meet this objective, quantitative and temporal evaluation of the resources in a given environment is required. However, geographic information to be used for this purpose has been lacking in many developing regions, which has hindered the precise evaluation. Geographic Information Systems (GIS) are now expected to become an effective tool to produce various kinds of evaluation maps on the environment by overlaying multiple geographic data. These data include not only drawn map sheets and written statistics but also digital remote sensing data, which have been accumulated for a quarter of a century and should be effective for quantitative and temporal analyses of various agro-environmental issues, including deforestation, desertification, soil erosion and salinity, etc.

JIRCAS is actively implementing GIS-related research in collaboration with various countries in different geographic environments. This symposium offers a unique opportunity to review the studies carried out in this field by JIRCAS and other institutes, evaluate the current status of research and plan for the future. About 200 participants will attend the symposium and JIRCAS welcomes their active participation.

The symposium consists of two keynote speeches and three sessions as follows:

Keynote Speech: Application of GIS and remote sensing technology for agro-environmental issues in developing regions

Dr. Andrew K. Skidmore, ITC, Netherlands

Dr. Tsuyoshi Akiyama, Gifu University, Japan

Session 1	Development of global dataset and models for agro-environmental sciences Six presentations from representative institutes of USA and Japan
Session 2	Applications of GIS for agro-environmental issues in various developing regions Nine presentations covering different geographic environments (Nepal, Indonesia, China, Pakistan, Colombia, Thailand and Japan)
Session 3	Education and training in the field of GIS Presentations from AIT (Thailand), PUSDATA (Indonesia) and JIRCAS (Japan)

For further information, please contact:

Dr. Makie Kokubun

Research Information Division, JIRCAS

1-2 Ohwashi, Tsukuba, Ibaraki, 305-8686 Japan

Tel: +81-298-38-6345

Fax: +81-298-38-6342

E-mail: sympo@jircas.affrc.go.jp

(Makie Kokubun)

[NEXT](#)

[CONTENTS](#)

President of Tanzania Visited JIRCAS



The President of the United Republic of Tanzania, Benjamin William Mkapa visited Japan in December, 1998. It was the first visit by an African head of state since the Second Tokyo International Conference on African Development (ITCADA) held in Tokyo in October. Since gaining its independence, Tanzania has maintained close ties with Japan and Japan continues to extend technical and economic assistance for development in many areas such as agriculture, health, telecommunications and human resources development.

During his stay in Japan, President Mkapa visited JIRCAS on December 15. After the welcome-ceremony and the briefing of the center's activities by Dr. Nobuyoshi Maeno, Director General of JIRCAS, (Photo, left) President Mkapa (Photo, center) and his group observed the Biotechnology Laboratory where research on "Improving Plant Tolerance to Environmental Stress by Gene Transfer" is being carried out.

[NEXT](#)[CONTENTS](#)

PEOPLE



Masachika MAEDA, a microbiologist (and protozoologist), became Director of the Fisheries Division on January 1, succeeding Dr. Shiro Uno who was transferred to the National Research Institute of Fisheries Sciences (NRIFS). Before joining JIRCAS, Dr. Maeda was Director, Physiology and Molecular Biology Section, NRIFS. Dr. Maeda was a visiting research fellow at the Royal Society and British Museum, England from 1980 to 1983.

[● Contents](#)

[● JIRCAS Home Page](#)

JIRCAS

Newsletter

FOR INTERNATIONAL COLLABORATION

NO.18

March 1999



Soil salinity due to inadequate water management with waterlogging
(Photo by Y. Shinogi)

CONTENTS

Animal Production in Developing Regions	2
Suppression of Nitrification by a Grass	3
Resistance Mechanisms to Planthopper in Rice	4
Chitinolytic Enzyme Genes in Bacteria	5
Seminars	6
Collaboration with IWMI	7
JIRCAS Symposium	7-8
Visitor	8
People	8

JIRCAS

JAPAN INTERNATIONAL RESEARCH CENTER FOR AGRICULTURAL SCIENCES

Animal Production in Developing Regions: Importance of the Conservation of Genetic Resources

Mitsugu Shimizu

Director, Animal Production and Grassland Division, JIRCAS

Farm animals contribute to more than 30% of agricultural products and supply food rich in protein, hide, fiber, fertilizer for crops, and draught power. In the developing regions, animal production may enable smallholders to upgrade their living conditions through the improvement of their diet and health conditions and the increase of farm household income, alleviation of poverty, and diversification of resources to reduce risks. In addition, animal production is an important component of sustainable agricultural systems in these areas, because animals can use agricultural by-products and residues as feed resources, animal excreta and wastes can be utilized as a source of household energy and fertilizer for crops, while draught power is used for plowing land and for transportation. However, animal productivity is reduced by many constraints in developing regions. The major factors involved in the low animal productivity are the deficiency in feed in terms of quantity and quality and low nutrition level, inappropriate management practices, and the depletion of grassland resources, which result in poor growth of the animals. The other serious problem is related to animal health. Farm animals in developing regions, especially in tropical and subtropical countries are often reared in unsanitary and stressful environments, and are frequently exposed to various pathogens, including viruses, bacteria, and parasites and to harsh climatic conditions that cause considerable damage to the animals. Economic losses of animal production due to sanitary problems in the developing regions have been estimated at more than 40% of total production.

Therefore, the Animal Production and Grassland Division (APGD), Japan International Research Center for Agricultural Sciences (JIRCAS), has promoted collaborative research with various countries, placing emphasis on securing feed resources by either identifying new feedstuffs or utilizing agricultural by-products and residues along with the improvement of grassland and animal management, and implementation of measures for disease control. For instance, oil-palm fronds and sugarcane stalks have been successfully used as ruminant feeds through collaborative research with Malaysian and Thai scientists, respectively, and the project entitled “Development of Agro-pastoral Systems in the Subtropical Area of Brazil” is being carried out to develop a sustainable technology for grass production in Brazil. APGD, JIRCAS intends to con-

tinue these research activities in order to achieve a sustainable increase of animal production compatible with the preservation of natural resources and environmental conditions in the respective regions.

To increase livestock production in developing regions, research on genetic characterization and conservation of indigenous breeds of farm animals, and their effective utilization for animal raising is important. In the past 12,000 years, human beings developed about 4,500 breeds of domestic animals from approximately 40 animal species, and most countries, depending on the geographic and climatic conditions, have their own unique animal breeds with various traits. Only a few breeds of important domestic animals have been successfully developed to improve some traits in relation to production in developed regions, mostly in northern countries. These breeds consume nutritious feeds and live in favorable environments. As a result, they produce more meat, milk, eggs, etc, when they are fed with sufficient quantities of high quality feeds, and reared under well controlled environments. However, they may not be adapted to the conditions prevailing in the developing regions where animals are usually reared with poor quality feeds, and always exposed to harsh climatic conditions, various pathogens, diseases, insect bites, and other environmental stresses. On the other hand, many indigenous breeds that are well adapted to the harsh conditions of the respective regions are distributed in the developing regions. Although these locally adapted breeds harbor valuable traits for adaptation to harsh climatic conditions, low quality feeds and various diseases, many of them are now becoming endangered species. These indigenous breeds appear to be valuable, and essential for further enhancement of sustainable animal production that does not depend upon high inputs and skillful management in the developing regions. The genetic characterization of indigenous breeds, and the conservation and utilization of useful genetic resources, particularly genes controlling heat and drought tolerance, adaptability to low quality feeds, disease resistance, and so on, should be promoted to improve animal production in the developing regions.

Although JIRCAS is not currently involved in such activities, in future, research along these lines should be considered.



Photo 1: Native pig in the Philippines



Photo 2: Nelore cattle in Brazil



Photo 3: Sustainable agro-pastoral systems in Brazil

Suppression of Nitrification in Soil by a Tropical Grass

Takayuki Ishikawa
Environmental Resources Division, JIRCAS

Nitrogen in fertilizers and organic components is transformed into ammonium-N in soil by microorganisms. In the nitrification process, ammonium-N is converted into nitrite-N by ammonium-oxidizing bacteria and nitrite-N is converted into nitrate-N by nitrite-oxidizing bacteria. Since plants can absorb only ammonium-N and nitrate-N, nitrification markedly influences the nitrogen absorption efficiency by plants. Nitrate-N that is not absorbed by plants easily leaches down from the rhizosphere to the deeper layers of soil and pollutes the underground water. During the process of nitrification, nitrous oxide, one of the greenhouse gases, is emitted from the soil to the atmosphere. By controlling nitrification, it is possible not only to increase the nitrogen absorption efficiency by plants but also to minimize the nitrogen loss by leaching and volatilization. In order to decrease the nitrogen loss, chemical fertilizers with nitrification inhibitors have been developed but their application is very limited in developing countries because of their high cost. If plants could inhibit the nitrification process, their nitrogen absorption efficiency would be considerably enhanced. It was reported that the amount of nitrate-N accumulated in the soil where a tropical grass grew seemed to be smaller than that in the soil where other tropical grasses grew. The objective of this study was to demonstrate the ability of this tropical grass to suppress nitrification and to identify the relation between nitrification suppression and nitrous oxide emission to the atmosphere.

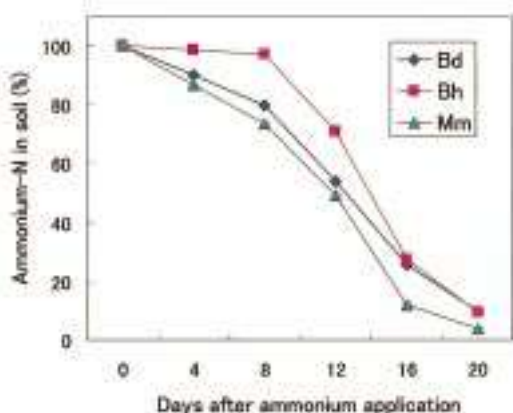
Three tropical grasses (*Brachiaria decumbens* (Bd), *B. humidicola* (Bh), *Melinis minutiflora* (Mm)) supplied by CIAT were grown for 6 weeks in Wagner pots and soils were sampled. Ammonium-N was applied to the sampled soils and the nitrification process was observed. In soils with Bd and Mm, the content of ammonium-N decreased 4 days after ammonium-N application and nitrification started rapidly (Fig. 1). However, the content of ammonium-N in the soil with Bh did not change until the 8th day and there was a lag period before the onset of nitrification. The results indicate that only *B. humidicola* suppressed nitrifi-

cation in soil.

In order to study the effect of nitrification suppression on nitrous oxide emission, Bd, Bh and Mm were grown for 4 weeks in Wagner pots and ammonium-N was applied to the soil. From soils without plants (No Plants), and with Bd and Mm treatments, nitrous oxide was emitted at a rate of 3 μ g-N/m²hr one day after ammonium application (Fig. 2). From the No Plants soil, nitrous oxide emission increased from the twelfth day. In the case of the Bd and Mm treatments, nitrous oxide emission continued for more than 4 days and then began to decrease because nitrogen in soils was absorbed by the plants. However, nitrous oxide emission from the soil with the Bh treatment was low throughout the experimental period. The amount of nitrous oxide emitted from the soil with the Bh treatment was 1/4 smaller than that from the Bd and Mm treatments.

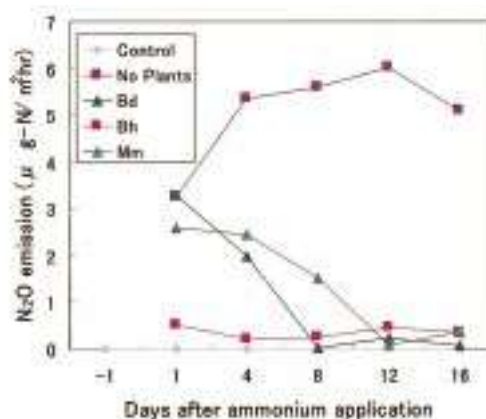
In another experiment, it appeared that *Brachiaria humidicola* suppressed the multiplication of ammonium-oxidizing bacteria specifically but had no effect on the nitrite-oxidizing bacteria. Of the two nitrification processes, it is assumed that the process in which ammonium-N is changed into nitrite-N is a rate-determining process. By the suppression of multiplication of ammonium-oxidizing bacteria, *Brachiaria humidicola* suppresses nitrification in soil and nitrous oxide emission to the atmosphere. Generally it is considered that tropical grasses preferentially use nitrate-N compared to ammonium-N. Among the *Brachiaria* species, it is assumed that only *B. humidicola* can utilize both forms of nitrate-N and ammonium-N and that this function of *B. humidicola* may lead to an efficient use of nitrogen in soil.

Native pastures are widely distributed in various countries of the tropical zone but their productivity is very low. In order to increase livestock production, if *Brachiaria humidicola* could be introduced, it would be possible to decrease the nitrogen input for agriculture in addition to preserving the environment and ecosystems.



Ammonium-N in soil was taken as 100% at 0 days.

Fig. 1. Content of ammonium-N in soil



Control : soil to which ammonium-N was not applied
No Plants : soil to which ammonium-N was applied

Fig. 2. Nitrous oxide emission from soil

Compound Resistance Mechanisms to the Whitebacked Planthopper in Chinese Japonica Rice Variety “Chenjiang 06”

Kazushige Sogawa
Crop Production and Postharvest Technology Division, JIRCAS

Rice agriculture in China is characterized by the wide adoption of high-yielding F1 hybrid rice. Since its introduction in 1976, the cultivation of hybrid rice has expanded rapidly and hybrid rice was planted to about half of the total rice area in China in the 1990s. The remarkable increase in rice production in the 1980s was largely dependent on hybrid rice. However, Chinese hybrid rice has caused a new pest problem, namely outbreaks of the whitebacked planthopper, *Sogatella furcifera*, because of its high susceptibility to the pest. Subsequent increase of insecticide applications has resulted in the development of resistance of insect pests to pesticides in paddy fields, and increased the risk of pest resurgence due to the destruction of natural enemies in the paddy ecosystem. Growing pest and pesticide problems in rice agriculture in China drew our attention to varietal resistance to insect pests in Chinese rice as an effective component of the ecologically based pest management (EBPM) system. In the course of the JIRCAS-CNRI Collaborative Research Project on EBPM for rice planthoppers in China, we demonstrated the mechanism of varietal resistance to *S. furcifera* in Chinese japonica rice “Chenjiang 06 (CJ-06)”.

S. furcifera resistance of CJ-06 was investigated in comparison with that of a susceptible indica hybrid rice cultivar “Shanyou 63 (SY-63.” Field experiments revealed the high field resistance of CJ-06 to *S. furcifera*. The *S. furcifera*

immigrants did not land and failed to establish populations on CJ-06. They preferred to settle on SY-63 on which they could well reproduce. Under a free choice condition, significantly fewer *S. furcifera* individuals alighted on CJ-06 than on SY-63. The significantly smaller amount of honeydew excreted by *S. furcifera* females on CJ-06 than on SY-63 indicated a low sucking activity on CJ-06. Both fecundity and egg hatchability were markedly reduced on CJ-06, when newly emerged *S. furcifera* females continuously fed and were allowed to oviposit on it. Consequently, the number of nymphs hatched on CJ-06 amounted to only about one-tenth of that on SY-63. *S. furcifera* eggs showed a high mortality in watery lesions at oviposition sites of CJ-06. The watery lesions rapidly led to the formation of conspicuous necrotic symptoms before the eggs hatched. The egg mortality in the watery lesions occurred within 1-2 days after oviposition (Fig. 1). Such watery lesions seldom occurred in SY-63, where the eggs hatched normally.

Based on the above findings, we concluded that sucking suppression and ovicidal reaction were critical factors for the *S. furcifera* resistance in CJ-06. These functions are associated with the antixenosis mechanism against *S. furcifera* immigrants, as well as the antibiotics mechanism whereby fecundity and egg hatchability of inhabitants are reduced, respectively. Such dual mechanisms of varietal resistance may result in a stable and durable field resistance to *S. furcifera* in Chinese japonica rice CJ-06 (Fig. 2). It would be important to identify the chemical components responsible for the sucking inhibition and ovicidal reaction associated with the resistance of CJ-06 to *S. furcifera*, compared to the susceptibility of SY-63 and to analyse the genetic basis of the resistance for subsequent breeding work.

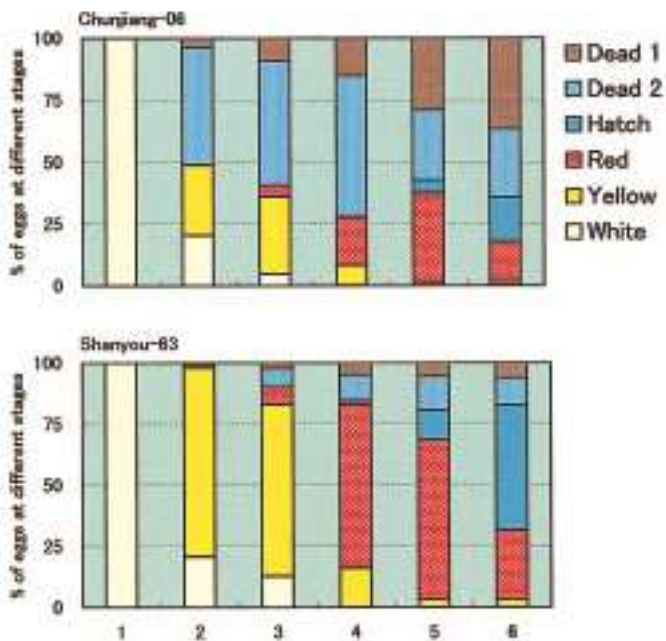


Fig. 1. Embryonic development of *S. furcifera* eggs in resistant CJ-06 and susceptible SY-63.
White = newly deposited eggs
Yellow = eggs at yellow spot stage
Red = eggs at eye-spot stage
Hatch = hatched eggs
Dead 2 = opaque dead eggs
Dead 1 = discolored dead eggs

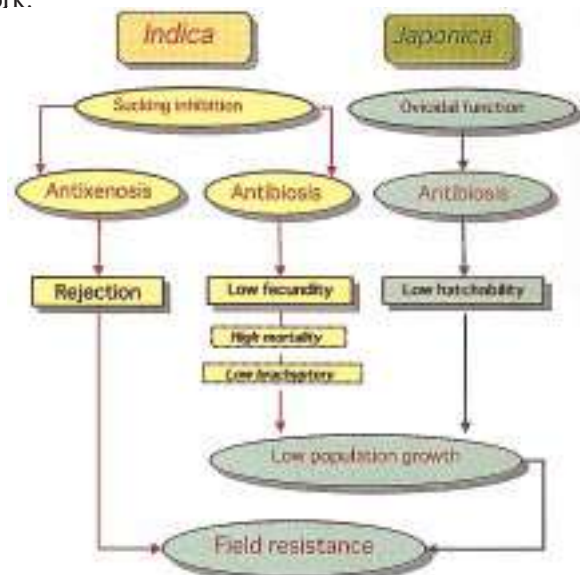


Fig. 2. Antixenotic and antibiotics resistance to *S. furcifera* in Chinese japonica rice, CJ-06.

Analysis of Chitinolytic Enzyme Genes of a Mycoparasitic Bacterium *Flexibacter* sp. FL824A

Yasuo Ando

Animal Production and Grassland Division, JIRCAS

The purpose of this study is to develop disease control utilizing lytic microorganisms. We detected a lytic activity in a mycoparasite *Flexibacter* sp. FL824A toward several plant pathogenic fungi, consisting of the secretion of lytic enzymes, chitinolytic enzymes (chitinases and *N*-acetylglucosaminidases), α -1,3-glucanases and proteases. Chitinolytic enzymes are considered to play an important role in the mycoparasitic process, because chitin, poly- α -1,4-*N*-acetylglucosamine [(GlcNAc)_n] is a major structural component of cell walls of fungi. In the first step of our study, we analyzed the genes of chitinolytic enzymes from *Flexibacter* sp. FL824A.

A genomic library of *Flexibacter* sp. FL824A using pUC19 and *Escherichia coli* was constructed. Hydrolysis activity of the crude protein of the transformants was determined by using analogs of chitin derivatives, 4-methylumbelliferyl- α -D-*N*, *N'*-diacetylchitobioside [4-MU-(GlcNAc)₂] or 4-methylumbelliferyl- α -D-*N*,*N'*,*N''*-tri-

acetylchitotriose [4-MU-(GlcNAc)₃] as substrates. Among 6,000 transformants tested, four clones showed a positive activity. They fell into two groups according to their specificity to the substrates (Table 1). We selected two clones CHF1149 and CHF1351, based on the activity level, specificity to the substrates, size of DNA-inserted fragment, and digestion pattern of the insert with restriction endonucleases.

An open reading frame (ORF) of 4236 bp was found to code for a chitinase with 1412 amino acids based on the nucleotide sequence and deduced amino acid sequencing of an 8.7-kbp insert of pCHF1149. Homology analysis of the deduced amino acid sequence of this protein revealed that the enzyme has a multiple domain structure consisting of at least seven domains (Fig. 1). The most interesting property is that the enzyme has two catalytic domains, one homologous to the catalytic domain of chitinase A1 of *Bacillus circulans* WL-12 on the N-terminal side of the protein and the other homologous to that of chitinase D of the same bacterium on the C-terminal side.

The DNA sequence of 5.0 kbp of the DNA-inserted fragment of pCHF1351 was determined after subcloning. An open reading frame (ORF) of 1962 bp was found to code for a putative protein with 654 amino acids. The protein shared a 25% homology with endo- α -*N*-acetylglucosaminidase of *Clostridium perfringens*.

Strong lytic activity of *Flexibacter* sp. FL824A may be due to the presence of a unique chitinase with two catalytic domains. Further studies on the chitinase should be carried out to analyse the chitin degradation of this mycoparasitic bacterium.

Table 1. Enzymatic activity of positive clone using 4-MU-*N*-acetylchitooligoside as substrate

Clone	Enzymatic activity (μUnit/ml) ¹⁾		Ratio of activity (dimer/trimer)
	dimer ²⁾	trimer	
Group A			
CHF2778	7.63	10.36	0.74
CHF2601	15.81	26.16	0.60
CHF1149	232.19	446.39	0.52
Group B			
CHF1351	768.50	40.33	19.06

1) 1 Unit of enzymatic activity was defined as 1μmol of 4-MU/min at 37°C.

2) dimer, 4-MU-(GlcNAc)₂; trimer, 4-MU-(GlcNAc)₃.



Fig. 1. Schematic representation of the domain structures of chitinases from several bacteria

Seminar on “High Value Timber Species for Plantation Establishment – Teak and Mahogany Species –”

Disappearance of the natural forests has prompted the Southeast Asian nations to establish and develop artificial forest plantations. The trees selected for this purpose have been mostly fast-growing species for pulp and/or light use timber. Recently, however, in Malaysia, including Sabah State, there has been a growing interest in planting high value timber species with longer rotation periods. Not only the foresters, from either governmental organizations or the private sector, but also estate plantation holders and farmers are interested in planting teak (*Tectona grandis*) in their plantation or farm areas, and more recently some of them have also started to plant mahogany species (American mahogany, *Swietenia macrophylla*, and African mahogany, *Khaya ivorensis*). Malaysian experience with these species is, however, rather limited.

To fill this gap, JIRCAS, INNOPRISE (Sabah Foundation) and Sabah Forestry Department decided to jointly organize a Seminar on “High Value Timber Species for Plantation Establishment” with emphasis placed on teak and mahogany species. The seminar was held at the Auditorium of Sabah State Library, Tawau, Sabah on December 1, 1998. Following the opening addresses by Datuk Musa Haji Aman (Chief Executive of INNOPRISE), Dr. Kiyoshi Tanaka (Director of Forestry Division, JIRCAS) and Mr. Herman Anjin (Deputy Forestry Director of Sabah Forestry Department), Dato’ Dr. Salleh Mohd. Nor (Executive Director of TROPBIO Research) gave a keynote address and 14 experts from five countries presented nine papers



Photo: Participants leaving for field trip

related to silviculture, propagation, protection, wood utilization and marketing in three sessions. More than 130 participants, including forestry scientists, foresters and many plantation holders from Sabah, Sarawak and Peninsular Malaysia, held animated discussions and exchanged information. More than 50 participants also joined a field trip to the Luasong Forestry Centre, about 100 km from Tawau to observe demonstration/experimental stands of teak and mahogany on the next day. This seminar was very timely and successfully promoted the establishment of plantations of teak and mahogany species in Malaysia, especially in Sabah.

(Kazuma Matsumoto)

4th Seminar on “Brackish Water Project” Held in Malaysia

On December 8-9, 1998, the 4th “Brackish Water Project” seminar was held in the Conference Room of the Hotel Equatorial Penang, in Penang Island, Malaysia. This project on “Productivity and Sustainable Utilization of Tropical and Subtropical Brackish Water Mangrove Ecosystems” aims to evaluate the productivity of the above areas and identify the criteria for sustainable utilization of resources. The West coast of Peninsular Malaysia has been selected as the study area due to the presence of various types of mangrove forests differing in the level of management and exploitation. The counterpart organizations include the Fisheries Research Institute (FRI), the University of Malaya (UM) and the Forest Research Institute of Malaysia (FRIM).

Subjects addressed in the seminar were as follows:

1) Forest and litter fall, 2) Benthic communities, 3) Aquatic organisms, 4) Socio-economic aspects, 5) Environmental aspects. About 40 scientists and government officials from Japan, Malaysia, and Australia participated in the seminar, and fourteen papers were presented.

During the 4th seminar, Mr. Hashim Ahmad, Deputy Director General of the Department of Fisheries Malaysia gave an opening address, and Dr. Shiro Uno of JIRCAS presented closing remarks.

During the two days’ seminar, it was concluded that the surveys conducted in 1997-1998 in the mangrove forest and waters had been completed. At that stage, it is necessary to analyse the structure of the mangrove ecosystems and to ensure that economic activities in these areas are sustainable.

(Katsuhiro Kiso)



Photo: Survey in the Merbok Mangrove Estuary

Current Status of Collaborative Research Activities between IWMI and JIRCAS

The International Irrigation Management Institute (IIMI), one of the sixteen organizations supported by the CGIAR, was established by an Act of Parliament in Sri Lanka. The Act is currently under amendment to rename the Institute as International Water Management Institute (IWMI).

IWMI implements four global research programs to improve water resources and irrigation management as follows: 1) Performance and Impact Assessment, 2) Design and Operation of Irrigation Systems, 3) Policy, Institutions and Management, and 4) Health and Environment. Collaborative research activities between IWMI and JIRCAS cover the Design and Operation of Irrigation Systems Program.

Two studies are being carried out as follows: "Optimal Water Management under Water Deficit Conditions" and "Soil Salinity Problems."

The site for the "Optimal Water Management" study is located in the North-Central province of Sri Lanka. Irrigation water is used not only for agriculture but also for bathing, washing, as drinking water, etc. Although rainfall is usually abundant in this area, due to the lack of effective water management, the amount of water available for agriculture and daily life is sometimes insufficient. Many small tanks (ponds) are connected to one another (tank cascade system) in the area and they comprise the main water reservoirs. At first, it is necessary to analyse the water balance in these systems for identifying optimum cropping patterns based on traditional systems and more advanced technology in order to improve water management. As a result, crop productivity could be enhanced and maintained during the dry season, also. These practices could be adopted in other areas in Sri Lanka and in other countries.

Soil salinity is one of the most severe problems in arid and semiarid environments. Sometimes, it is caused by inadequate water management practices such as waterlogging, which is associated with excessive irrigation and



Photo: In rural areas, irrigation water is used for many purposes (Sri Lanka)

which induces soil salinity. Soil salinity is a complex phenomenon which is region-specific. Productivity can be improved in the affected areas and it is important to determine the main causes of salinity so as to reduce it. The main factors can be determined by statistical methods, and one prediction model could be constructed with these parameters to predict the areas that may experience soil salinity.

"Soil slotting" is considered to be a useful technique to improve salinized (sodic) land. In this technique, some slots are cut and filled with soil and chemical substances or organic matter. It is important to analyse the soil-water and solute movement in this technique to identify suitable specifications (slot width, depth, space, etc.). These parameters can be simulated using a solute movement model under different water management conditions. Such a technology may enable to promote sustainable agriculture and raise the productivity of crops. The results could be applied to other salinized areas.

(Yoshiyuki Shinogi)

JIRCAS Symposium

The 6th JIRCAS International Symposium GIS Applications for Agro-environmental Issues in Developing Regions

The symposium on "GIS Applications for Agro-environmental Issues in Developing Regions" will be held in Tsukuba, Japan during the period of September 7 – 9, 1999.

The greatest challenge for mankind today is to develop agricultural systems that would enable to utilize biological and natural resources adequately to feed the global human population and preserve the resources simultaneously. To meet this objective, quantitative and temporal evaluation of the resources in a given environment is required. However, geographic information to be used for this purpose has been

lacking in many developing regions, which has hindered the precise evaluation. Geographic Information Systems (GIS) are now expected to become an effective tool to produce various kinds of evaluation maps on the environment by overlaying multiple geographic data. These data include not only drawn map sheets and written statistics but also digital remote sensing data, which have been accumulated for a quarter of a century and should be effective for quantitative and temporal analyses of various agro-environmental issues, including deforestation, desertification, soil

erosion and salinity, etc.

JIRCAS is actively implementing GIS-related research in collaboration with various countries in different geographic environments. This symposium offers a unique opportunity to review the studies carried out in this field by JIRCAS and other institutes, evaluate the current status of research and plan for the future. About 200 participants will attend the symposium and JIRCAS welcomes their active participation.

The symposium consists of two keynote speeches and three sessions as follows:

Keynote Speech: Application of GIS and remote sensing technology for agro-environmental issues in developing regions

Dr. Andrew K. Skidmore, ITC, Netherlands

Dr. Tsuyoshi Akiyama, Gifu University, Japan

Session 1: Development of global dataset and models for agro-environmental sciences

Six presentations from representative institutes of USA and Japan

Session 2: Applications of GIS for agro-environmental issues in various developing regions

Nine presentations covering different geographic environments (Nepal, Indonesia, China, Pakistan, Colombia, Thailand and Japan)

Session 3: Education and training in the field of GIS

Presentations from AIT (Thailand), PUSDATA (Indonesia) and JIRCAS (Japan)

For further information, please contact:

Dr. Makie Kokubun,

Research Information Division, JIRCAS

1-2 Ohwashi, Tsukuba, Ibaraki, 305-8686 Japan

Tel: +81-298-38-6345

Fax: +81-298-38-6342

E-mail: sympo@jircas.affrc.go.jp

(Makie Kokubun)

Visitor

President of Tanzania Visited JIRCAS

The President of the United Republic of Tanzania, Benjamin William Mkapa visited Japan in December, 1998. It was the first visit by an African head of state since the Second Tokyo International Conference on African Development (ITCAD II) held in Tokyo in October. Since gaining its independence, Tanzania has maintained close ties with Japan and Japan continues to extend technical and economic assistance for development in many areas such as agriculture, health, telecommunications and human resources development.

During his stay in Japan, President Mkapa visited JIRCAS on December 15. After the welcome-ceremony and the briefing of the center's activities by Dr. Nobuyoshi Maeno, Director General of JIRCAS, (Photo, left) President Mkapa (Photo, center) and his group observed the Biotechnology Laboratory where research on "Improving Plant Tolerance to Environmental Stress by Gene Transfer" is being carried out.



PEOPLE



Masachika MAEDA, a microbiologist (and protozoologist), became Director of the Fisheries Division on January 1, succeeding Dr. Shiro Uno who was transferred to the National Research Institute of Fisheries Sciences (NRIFS). Before joining JIRCAS, Dr. Maeda was Director, Physiology and Molecular Biology Section, NRIFS. Dr. Maeda was a visiting research fellow at the Royal Society and British Museum, England from 1980 to 1983.

*Japan International Research Center
for Agricultural Sciences (JIRCAS)*

Ministry of Agriculture, Forestry and
Fisheries

Editor: *Kunio Tsubota*

Assistant Editor: *Hiroko Takagi*

Address: 1-2, Ohwashi, Tsukuba,
Ibaraki, 305-8686 JAPAN



Tel.: +81-298-38-6304

Fax.: +81-298-38-6342

E-mail: letter@jircas.affrc.go.jp

JIRCAS

Newsletter

No. 19 June 1999



Ploughing upland rice field in Togo
(Photo by S. Asanuma)

CONTENTS

<Feature Article>



[Biological Resources Research at JIRCAS](#)

<JIRCAS Research Highlights>



[Bruchid Resistance in Wild Adzuki Bean](#)

 [Surface Analysis of Starch Granules](#)

 [Nitrogen Pollution in China](#)

<Workshops>

 [Workshop in Indonesia](#)

 [JIRCAS Seminar in Bangkok](#)

<Collaborative Research Project>

 [Collaborative Project at IRRI](#)

<International Workshop>

 [Workshop on Nutrient-Stressed Environments](#)

<People>

 [JIRCAS Home Page](#)

Contribution of Biological Resources Research to the Stabilization and Increase of Production of Main Crops



Tsuguhiro Hoshino

Director, Biological Resources Division, JIRCAS

1. Background and importance of biological resources research

Human beings had succeeded in producing enough food by using natural resources hitherto. However, due to the rapid growth of the population, many developing regions in the world are now faced with the need to utilize land with major constraints on crop cultivation as well as to increase and stabilize agricultural production through methods compatible with the preservation of the environment. Agricultural technologies that optimize the use of biological resources will play an important role in determining whether these objectives can be achieved. In response to these concerns, the Biological Resources Division is placing considerable emphasis on collaborative on-site breeding research in foreign countries and on biotechnology in Tsukuba.

2. Current activities

JIRCAS is currently engaged in collaborative projects with 3 international centers supported by the CGIAR. At the International Maize and Wheat Improvement Center (CIMMYT) in Mexico, doubled haploid breeding method has been applied for enhancing breeding efficiency. This is because the artificial production of haploid plants followed by chromosome doubling is the quickest method for developing homozygous breeding lines from heterozygous parental genotypes in a single generation. Different sources of resistance genes to fusarium head blight are being mapped using RFLP and SSR markers. In cooperation with the International Rice Research Institute (IRRI) in the Philippines, studies on rice blast resistance have enabled to identify rice blast resistance genes in IR varieties (see related article on page 7). The collaborative research on interspecific hybridization between the African and Asian rice species (*Oryza glaberrima* and *O. sativa*) has been initiated at the West Africa Rice Development Association (WARDA). Studies on the genetic and eco-physiological characterization of the interspecific progenies are being carried out with emphasis placed on tolerance to drought and acid soil conditions in West Africa.

In China, breeding research projects have started for the evaluation of genetic resources and development of novel breeding materials of rice and soybean. Through the projects, elite germplasm will be selected from the abundant indigenous germplasm for the development of disease and insect pest resistance. In soybean production in tropical and subtropical areas, one of the major problems is the damage caused by insects, especially *Spodoptera litura* Fabricius. Since highly resistant germplasm to *S. litura* has not been identified yet, soybean lines with a higher resistance will be obtained through back-crossing by pyramiding of moderate resistance genes. Moreover, breeding research for improving nutrient quality and disease resistance was initiated in Brazil. New rice and soybean cultivars with superior characteristics will be developed by the utilization of indigenous genetic resources.

Basic research for the application of advanced technology is being promoted in Tsukuba to support overseas research activities and to develop new technologies for the future. Molecular biotechnological methods have been recently utilized to study the tolerance to environmental stresses such as drought, salinity and freezing in higher plants. In particular, the researchers are determining how to use genes and regulatory factors for the production of transgenic crops tolerant to environmental stresses. A number of genes involved in stress tolerance were isolated using *Arabidopsis thaliana* and cowpea plants, and regulatory factors for the expression of these genes were analyzed for stress response. Many genes for transcription factors, controlling the expression of the stress tolerance genes, have been also isolated. Regulatory elements in promoters were identified that control stress-responsive gene expression. Using the genes for transcription factors and the stress-responsive promoters, multi-stress tolerance to freezing, drought and salinity was improved in transgenic *Arabidopsis* as a model. The existence of similar regulatory systems has been reported in other crop plants such as rice, tobacco and cowpea.

Such studies may lead to the development of commercial crops capable of withstanding potentially damaging environmental stresses, thereby contributing to mitigating problems relating to the food crisis and environmental degradation in developing countries.

3. Orientation of activities in the future

In developing countries, cooperation for biological resources research should be further promoted through consortia and networks with advanced research units worldwide. Therefore, JIRCAS plans to strengthen its activities in close collaboration with CGIAR centers for the evaluation of genetic resources and breeding methodologies. Through the use of genetic resources and application of biotechnological procedures, collaborative breeding projects should be implemented in various countries in order to develop new varieties of rice, soybean and wheat characterized by high yield potential and resistance to various diseases and environmental stresses. These new varieties should contribute to the increase and stabilization of agricultural production with lower inputs in the developing countries.



Wheat and corn in CIMMYT field

NEXT

CONTENTS

Detection of Bruchid-Resistant Strains in Wild Adzuki Bean Germplasm

Yoshinobu Egawa, Katsuyuki Kohno, Keiichi Takahashi, Norihiko Tomooka*,
Somsong Chotechuen*², Ithnin Bujang*³ and Yoichi Tateishi*⁴

Okinawa Subtropical Station, JIRCAS, *National Institute of Agrobiological Resources, *²Chai Nat Field Crops Research Center, Thailand,
*³Universiti Malaysia Sabah, Malaysia, *⁴University of the Ryukyus

Adzuki bean, *Vigna angularis* var. *angularis* (2n=22, 2x) considered to have originated in East Asia is one of the most familiar legumes for Japanese people. This bean is cultivated for the preparation of various forms of foods including "anko" (sweet bean jelly), "seki-han" (steamed rice with red adzuki bean), etc. Adzuki bean belongs to the subgenus *Ceratotropis* of the genus *Vigna*. This subgenus is divided into two groups morphologically and phylogenetically, adzuki bean group and mungbean group. It is known that several wild relatives (germplasm) belonging to the adzuki bean group occur in Asia. Wild germplasm should be considered to be primary and secondary gene pools for the breeding of cultigens. Wild germplasm, however, is now confronted with gradual extinction due to the disturbance of the natural habitat by recent widespread land clearance for the construction of roads and buildings. Against this background, we collected wild adzuki bean germplasm in Southeast Asian countries (**Photo 1**).



Photo: 1 Collection of wild adzuki bean germplasm in Peninsular Malaysia

Adzuki bean weevil (*Callosobruchus chinensis*) causes serious damage to adzuki bean, mungbean and cowpea seeds during storage (**Photo 2**). One accession of wild progenitor species of mungbean (*V. radiata* var. *sublobata*), TC1966, is known to exhibit a complete resistance against *C. chinensis*. However, since there is a reproductive isolation between adzuki bean and mungbean, it was impossible to incorporate the resistance from TC1966 to adzuki bean through conventional crossing procedures. Therefore, we examined the accessions of wild adzuki bean germplasm including *V. angularis* var. *nipponensis* (wild progenitor of adzuki bean), *V. nakashimae*, *V. nepalensis*, *V. minima* var. *minor*, *V. hirtella*, *V. umbellata* and *V. trinervia*, etc. to detect the occurrence of bruchid-resistant strains within them.



Photo 2: Infestation with adzuki bean weevil (*Callosobruchus chinensis*)

Based on feeding tests by adzuki bean weevil, *V. hirtella*, *V. umbellata* and *V. trinervia* exhibited a resistance against the infestation with *C. chinensis* although other species were highly susceptible. It was reported that the resistance exhibited by TC1966 was controlled by a single dominant gene. We plan to examine this aspect for these three wild species. *V. hirtella* is distributed in India (Assam, Bengal), Myanmar, Thailand, Indo-China, South China and Malaysia and the strains examined by us were collected in the northern part of Thailand under a JIRCAS project. Cross-compatibility of *V. hirtella* with adzuki bean was high and we have successfully obtained fertile F₁ hybrids between them (**Photo 3**). We are now backcrossing the F₁ hybrids with adzuki bean to develop bruchid-resistant lines with a combination of feeding test by adzuki bean weevil. Wild form of *V. umbellata* is distributed widely in northern Thailand and several accessions have been collected under the JIRCAS project. Hybridization between adzuki bean and *V. umbellata* was impossible. *V. minima* var. *minor* was, however, cross-compatible with both adzuki bean and *V. umbellata*, and could be used as a bridging species for gene flow between them. To develop

resistant lines of adzuki bean, we plan to transfer the resistance gene(s) of *V. umbellata* first to *V. minima* var. *minor* by backcrossing this species recurrently to the hybrid between *V. minima* var. *minor* x *V. umbellata*, and then incorporate the resistance to adzuki bean by crossing with *V. minima* var. *minor* (which has become resistant). Geographical distribution of *V. trinervia* ranges from Madagascar, through South India, Sri Lanka, Myanmar and Indonesia, to Papua New Guinea and we have successfully collected a large number of accessions from Peninsular Malaysia. Cross-compatibility of *V. trinervia* with adzuki bean has not yet been analyzed.



Photo 3: Hybrid plant between *V. hirtella* and adzuki bean, showing that the F₁ fertility is high

Generally, exploration and collection of wild germplasm are a time-consuming and difficult task, and there is little or no information available about potentially useful characteristics which it harbors. Considering the genetic erosion that occurs rapidly on a worldwide scale, it is important to collect wild *Ceratotropis* species from the areas covering their wide range of geographical distribution and evaluate and preserve them as genetic resources.

[NEXT](#)

[CONTENTS](#)

Surface Analysis of Starch Granules

*Tamao Hatta, Seiko Nemoto and Keiji Kainuma**

Environmental Resources Division, JIRCAS

**Bio-oriented Technology Research Advancement Institution (BRAIN)*

Surface-sensitive analytical techniques, AFM (Atomic Force Microscopy) and XPS (referred to as either X-ray Photoelectron Spectroscopy or ESCA: Electron Spectroscopy for Chemical Analysis) have been developed in many fields. With AFM, imaging of nearly any surface can be achieved by atomic force under vacuum, air and solution conditions and surfaces can be observed during reactions. XPS is used for the characterization of electron structure, chemical binding state, and alteration process of the area near surface (less than 5 nm in thickness) of solid. A large number of recent studies on the mechanisms of rock weathering, mineral dissolution, soil genesis and desertification have been reported using AFM (SPI3800+SPA300, Seiko Instruments Inc.) and High-Resolution XPS (ESCA300, Gammadata-Scienta AB) in our laboratory. Recently, AFM and XPS have been applied to a wide variety of materials.

The results of application of AFM and XPS for the characterization of the surface structure of starch granules is presented in this paper. Data on AFM imaging and detailed XPS spectra of starch had not been reported hitherto. The detailed structure of the starch surface observed by AFM is shown in **Fig.1a**. This is the first time that the rough surface structure of a potato starch granule was studied by AFM. We observed a cavity, presumably hilum, less than $1\ \mu\text{m}$ in diameter. After embedding potato starch in paraffin, sample specimens were prepared by cutting with a microtome and the linear structure of the inner part of the granule was observed at the molecular level(**Fig.1b**).

[•@Fig. 1. AFM images of a potato starch.](#)

[\(a\) A granule of potato starch. \$10\ \mu\text{m}\$.](#)

[\(b\) Inner part of potato starch granule. \$80\ \text{nm}\$.](#)

Considering the electron shell in relation to the molecular structure, we analysed the electronic state of the starch granule using XPS as chemical structural probe. The narrow spectra of C1s orbital of potato starch and waxy corn starch were measured compared with those of several saccharides (**Fig. 2**). The C1s photopeak of starch is characterized by the presence of a chemical shift with a small peak at the low binding energy site. To examine this peak, the amorphous precipitate was prepared by gelatinization of native crystalline starch. The peak at the low energy site disappeared in the C1s spectrum of the amorphous product as anticipated. Consequently, it was revealed that the specific photopeak of starch corresponds to the three-dimensional structure of the crystal in reference to the double helix structure of starch. Investigations of the atomic structure and binding state of crystals of starch and saccharides using AFM and XPS have just been initiated.

[Fig. 2. \$\text{C1s}\$ narrow spectra of two kinds of starch and related saccharides.](#)

[NEXT](#)

[CONTENTS](#)

•@

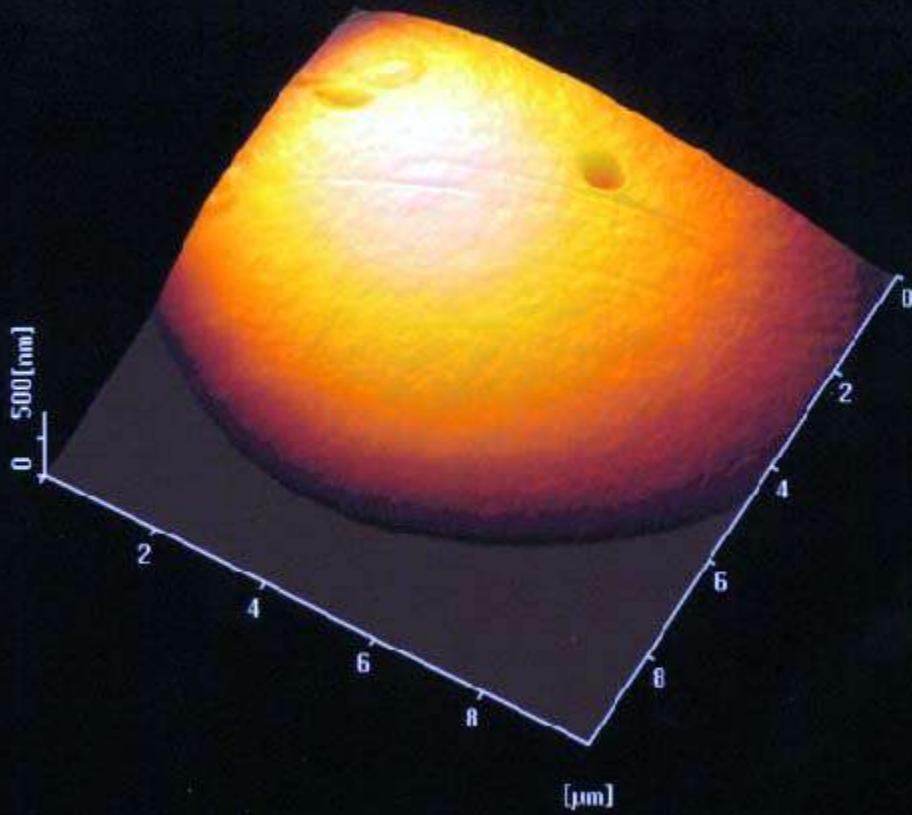
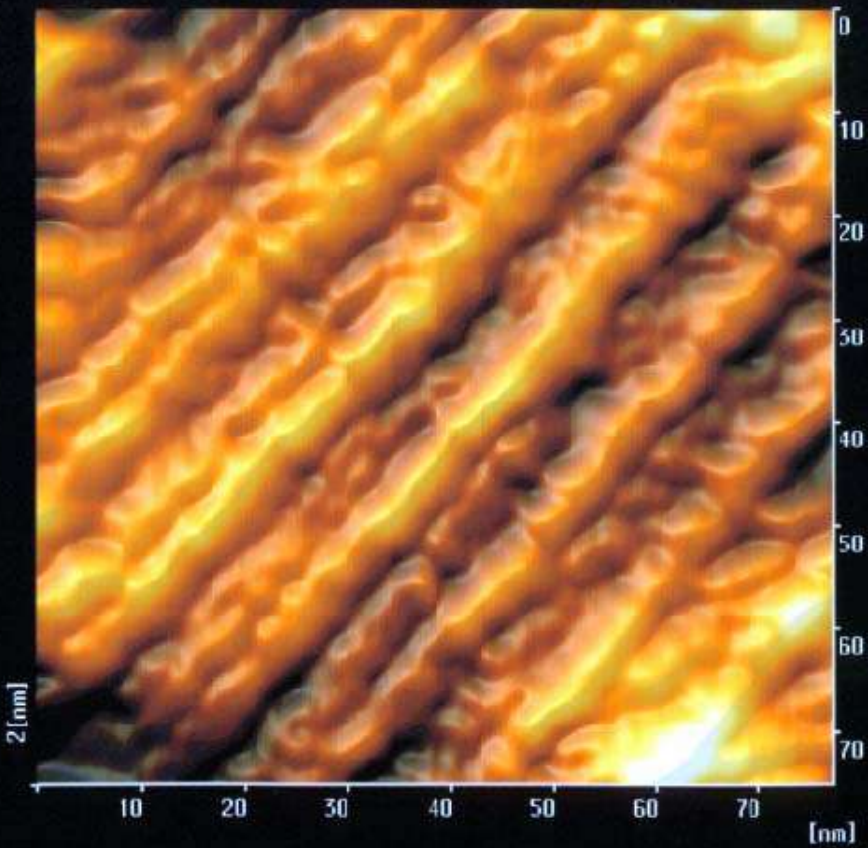


Fig. 1. AFM images of a potato starch.

(a) A granule of potato starch. $10 \mu\text{m}$.

•@



(b) Inner part of potato starch granule. 80 nm• .

BACK

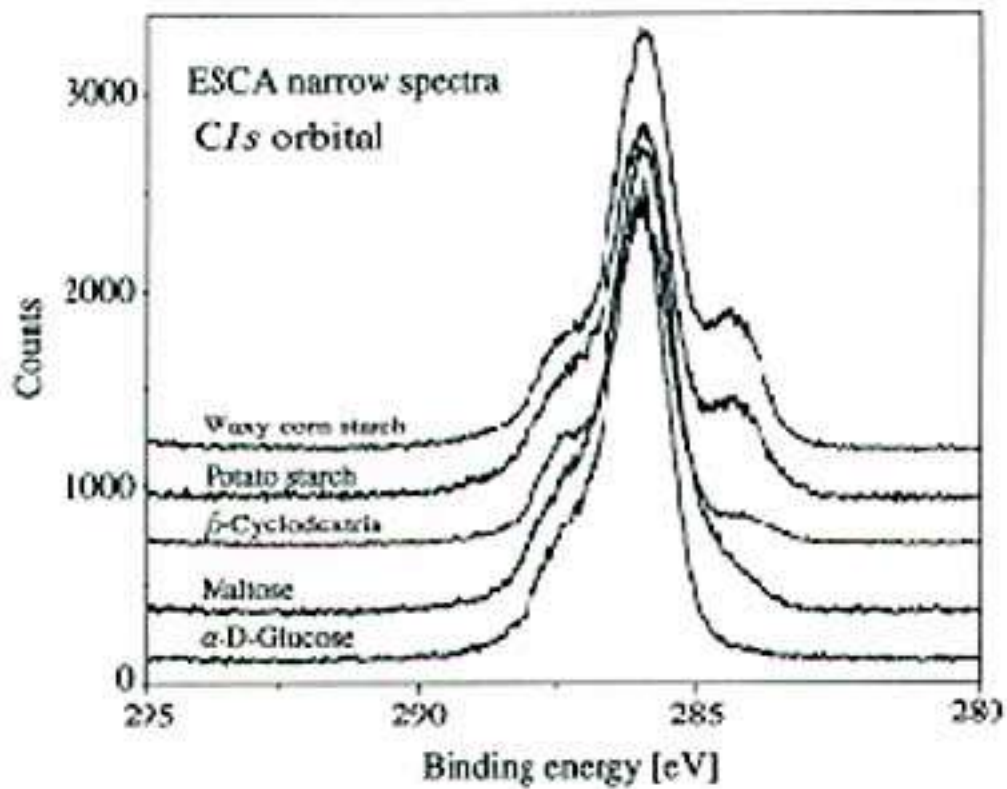


Fig. 2. C1s narrow spectra of two kinds of starch and related saccharides.

BACK

Assessing Nitrogen Pollution in Chinese Agriculture

Kazuyuki Yagi

Environmental Resources Division, JIRCAS

China is the largest producer, as well as the largest consumer, of food in the world. The introduction of new technologies and reform policies has substantially improved food supply conditions to meet the large demand for grain in this country. On the other hand, adverse effects of modern intensive agriculture on the environment have recently become apparent and the sustainability of land resources and environment has become a cause for concern. Environmental problems due to intensive agriculture, such as land degradation, shortage of irrigation water, and pollution of air and water, have become serious in various parts of China. Many of these problems have resulted from the use of agricultural land in a manner that overloads nutrients, in particular nitrogen. Indeed, consumption of nitrogen fertilizer in China has increased by about 60% during the last decade and accounted for 23.6 M ton nitrogen in 1995. Chinese agriculture must now address serious issues: How large is the environmental impact of intensive cropping systems? How is the impact changing? What will happen in future? How can we mitigate the impact?

To answer these questions, JIRCAS launched a 7-years' collaborative research project entitled "Evaluation and Development of Methods for Sustainable Agriculture and Environmental Conservation" with two Chinese research institutes: the Institute of Soils and Fertilizers, Chinese Academy of Agricultural Sciences and the Institute of Soil Sciences, Chinese Academy of Sciences since 1997. The project is conducted as one of the components under the comprehensive collaborative research project between JIRCAS and research institutes and universities in China and aims to develop technologies that minimize the adverse impact associated with nitrogen fertilization and, at the same time, secure sustainable food production.

The project covers four major and remarkable agricultural regions in China (**Fig. 1**): 1) Huang-Huai-Hai plain which is one of the main maize-wheat production areas distributed in alluvial lands of three large rivers. 2) Jing-Jin-Tang region where highly intensive farming of upland crops and vegetables is performed in the suburbs of big cities. 3) Tai-hu region where highly intensive rice-wheat cropping is performed in the lower reaches of Changjiang River. 4) Red soil region where double cropping of rice is widely adopted in hilly lands located in the subtropical zone. Both field experiments and regional analyses are conducted at typical sites of each study area. The field experiments determine the plant uptake efficiency and environmental impact of different types and management practices of nitrogen fertilizers. The regional analyses evaluate the nitrogen balance and its losses to the environment in the region by the application of a nitrogen flow model. Combining the results of the field experiments and the regional survey, the status of nitrogen pollution in each region will be evaluated and alternative management strategies to minimize the impact on the environment will be proposed.

[Fig. 1. Map showing the study area of the project.](#)

The project is proceeding and is entering the third year as planned. Field experiments at Lingxian, Xishan, and Qiyang are currently being conducted. Attempts to analyse regional nitrogen flows are also being made at the corresponding sites. For instance, based on a preliminary analysis of the nitrogen flow in Lingxian County, Shandong Province, it was estimated that the input of nitrogen to cultivated land was, on the average, 594 kgN ha⁻¹ year⁻¹, while the output was 265 kgN ha⁻¹ year⁻¹ (**Fig. 2**). These findings indicate that cultivated land in this region receives a balance of 329 kgN ha⁻¹, annually. A part of the excess nitrogen flows out to groundwater through leaching, to surface water through runoff, and to the atmosphere through volatilization in various forms of gaseous nitrogen. The remaining part accumulates in the soil layers. The results for Lingxian in this analysis suggested the potential risk of substantial pollution in the near future.

[Fig. 2. Estimated nitrogen flow in agro-ecosystems of Lingxian, 1997. The value for the flow from accumulation in cultivated land to the environment will be determined from the results of ongoing field experiments.](#)

Although increased use of nutrients is essential for meeting the growing demand of food, it is a double-edged sword. Unless nutrient supply is managed properly, the contribution to agricultural productivity could be offset by the adverse impact on the environment. This collaborative project may enable to develop environmental conservative agricultural technologies in order to contribute to sustainable development of agriculture in China.

[NEXT](#)

[CONTENTS](#)

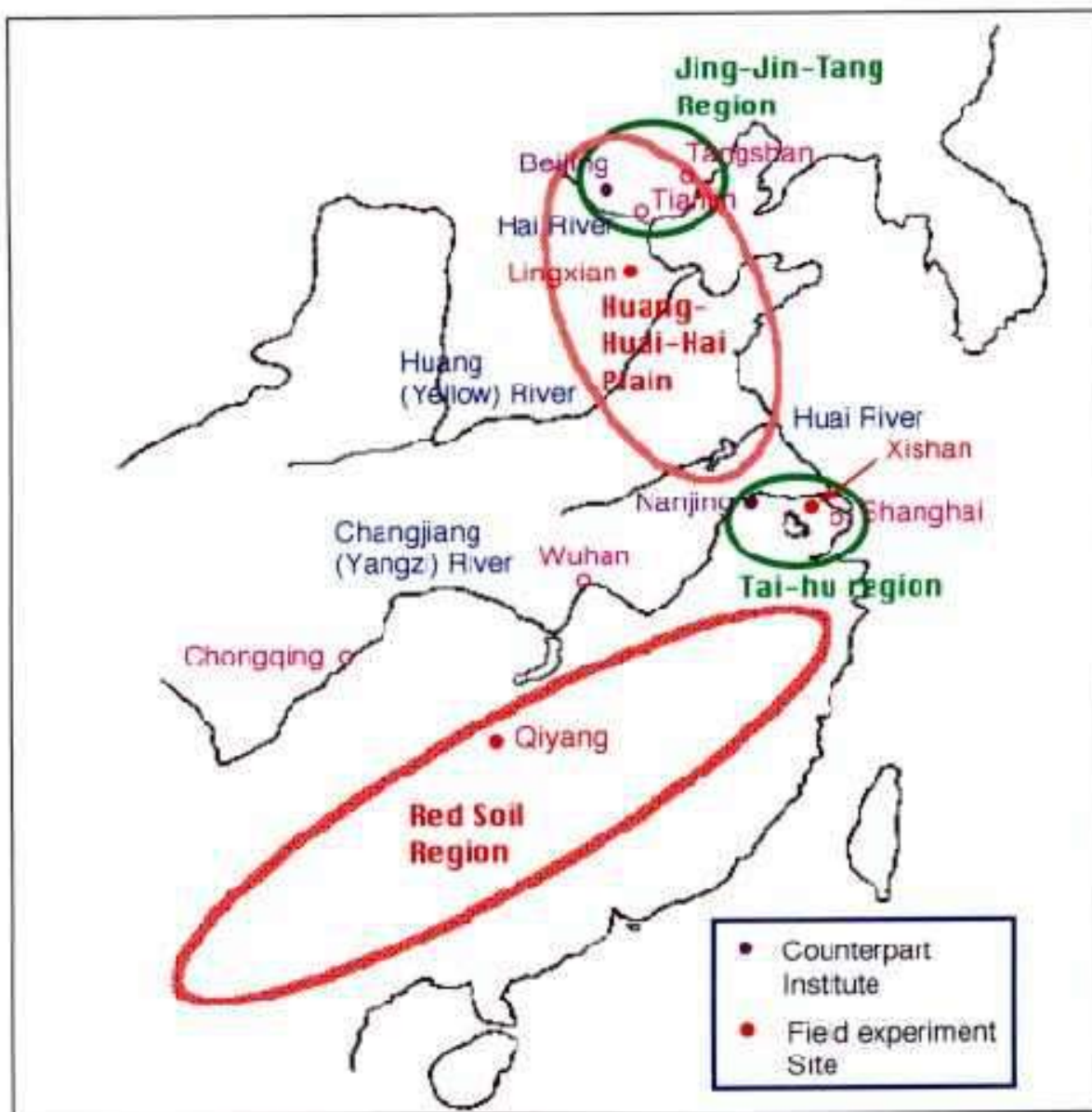


Fig. 1. Map showing the study area of the project.

BACK

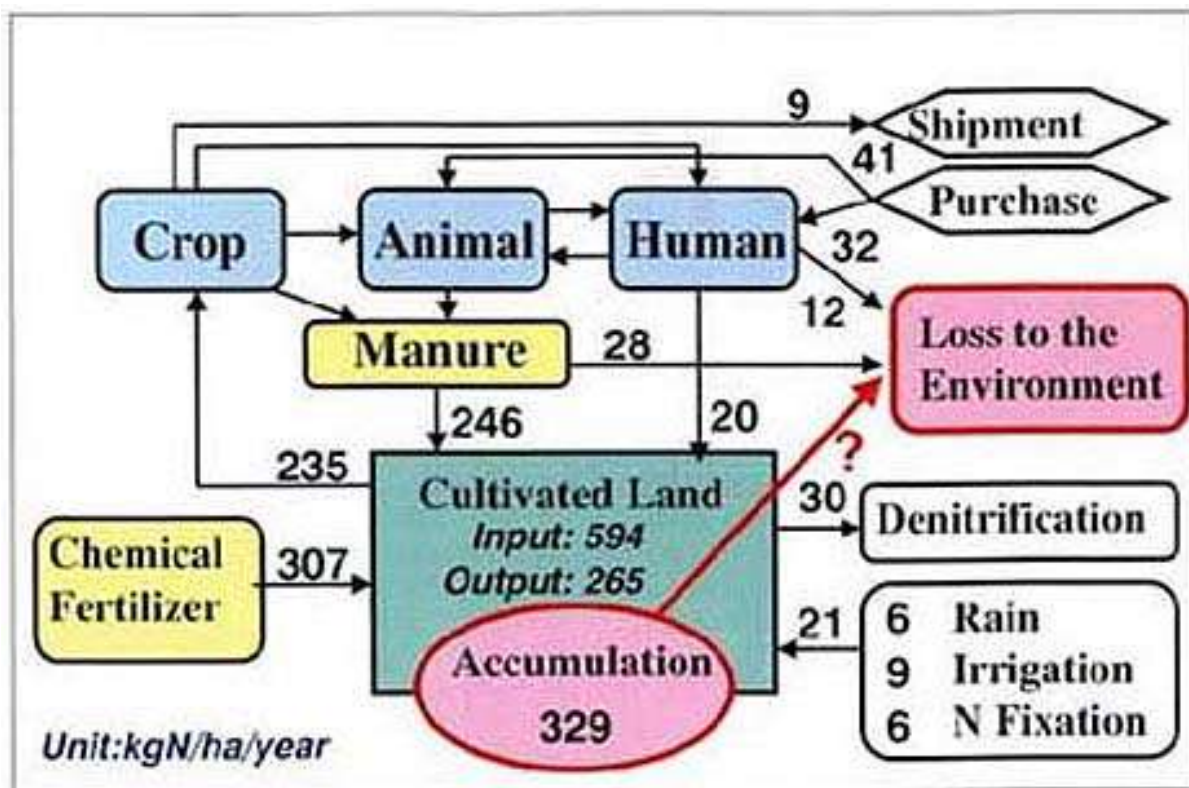


Fig. 2. Estimated nitrogen flow in agro-ecosystems of Lingxian, 1997. The value for the flow from accumulation in cultivated land to the environment will be determined from the results of ongoing field experiments.

BACK

International workshop on "Learning from the Farming Systems Research Experiences in Indonesia"

The International Workshop on "Learning from the Farming Systems Research Experiences in Indonesia" jointly organized by JIRCAS and the Center for Agro-Socioeconomic Research (CASER), the Agency for Agricultural Research and Development (AARD), Ministry of Agriculture, Republic of Indonesia, was held in Bogor, Indonesia during the period 3-4 March, 1999.

Farming Systems Research (FSR) is a highly controversial subject. Some critics pretend that it has been proved to be ineffective, while some others tend to criticize the excess expectation from donors and policy-makers and lack of consensus among the different actors involved in the FSR activities during the boom period of the 1970s and early 1980s. Indonesia was not an exception and hosted a myriad of internationally funded farming systems projects. Compared to these, FSR activities in Indonesia in recent years did not attract the attention of international observers. However, with the establishment of the Assessment Institutes for Agricultural Technology throughout the country in 1995, it appears that Indonesia has entered another stage of FSR.

By combining both historical and up-to-date information regarding FSR experiences within the AARD organizations, this workshop contributed to the reconciliation of views between the two extremes, negative or positive, regarding the benefit of FSR. The participants in the workshop tried to address the following key issues from various angles and with diverse personal experiences.

- How can we interpret the past 25-year history of FSR in Indonesia?
- What are the roles and relationships of researchers and extension specialists in FSR?
- What are the roles of the social and natural sciences in the FS approach?
- How adequate or inadequate is the institutional framework?
- Foreign assistance in and commitment to FSR: How can Indonesia use these most effectively?
- Technology in FS approach: assessment of technology vs. technology for assessment

Approximately fifty people from Indonesia, Japan, Australia, and the U.S.A. participated in the workshop. The workshop was successful due to the strong commitment of the experienced staff of CASER. All the participants realized that the system of FSR still needs improvement and stressed the importance of mutual exchange of information. The Proceedings of the Workshop will be published by JIRCAS in 1999/2000.



Participants in the workshop

(Junko Goto)

NEXT

CONTENTS

"JIRCAS Seminar in Bangkok"

JIRCAS Thailand Office held a seminar entitled "JIRCAS Seminar in Bangkok 1999" on March 3, 1999 at Maruay Garden Hotel in Bangkok. The main purpose of the seminar was to introduce our collaborative research activities to the people who had been concerned about or interested in the activities of JIRCAS in Thailand. This type of seminar was held in 1994 at the time of the 25th anniversary of the collaboration between the research organizations in Thailand and TARC (Tropical Agriculture Research Center)/JIRCAS. Therefore, this seminar covered JIRCAS activities in Thailand during the past 4 years.

To better understand and overcome agricultural problems in Northeast Thailand, JIRCAS initiated a research project entitled "Comprehensive Studies on Sustainable Agricultural Systems in Northeast Thailand." Therefore, most of the scientists who have been dispatched to Thailand by JIRCAS at present are more or less related to the Northeast Thailand project except for the collaborative project in the field of fisheries entitled "Studies on the Development of Sustainable Aquaculture Technology in Southeast Asia."

There were 150 participants from the Department of Agriculture (DOA), Department of Livestock Development (DLD), Land Development Department (LDD), Kasetsart University (KU), Khon Kaen University (KKU), Asian Institute of Technology (AIT), National Research Council of Thailand (NRCT) and International Board for Soil Science Research and Management (IBSRAM).

After the Inaugural Address delivered by Dr. Ananta Dalodom, Director General of DOA, 19 reports were presented during 6 sessions. In Session 1, an outline of the project on "Sustainable Agricultural Systems in Northeast Thailand" was given by the project leader Dr. S. Matsui and 3 reports were presented. Technical reports on animal production and grassland were presented in Session 2. In Sessions 3 and 4, nine reports were presented on soils and plant nutrition. Three reports were presented in the field of fisheries in Session 5. In Session 6, 2 reports were presented on plant pathology and postharvest technology.

At the end of the seminar, special comments related to the activities of JIRCAS in Thailand were made by Prof. Karl E. Weber, Vice President of AIT, Mr. Chaiyasit Anecksamphant, Deputy Director-General of LDD, Associate Prof. Supot Faungfupong, Vice President of KU, Associate Prof. Anake Topakngam, Dean of KKU and Ms. Tuenchai Niyamangkoon, Chief of NRCT.

The proceedings entitled "Highlights of Collaborative Research Activities between Thai Research Organizations and JIRCAS" with 58 reports were published by JIRCAS Bangkok Office.

(Masaaki Suzuki)

[NEXT](#)

[CONTENTS](#)

IRRI-JIRCAS Collaboration within the Framework of the Special Project Funded by the Japanese Government

Hiroshi Kato and Motohiko Kondo

IRRI, Los Banos, Laguna, Philippines

Background of the project

Japan International Research Center for Agricultural Sciences (JIRCAS) and International Rice Research Institute (IRRI) have been collaborating by assigning Japanese breeders, agronomists and physiologists to IRRI in the Philippines under a special project funded by the Japanese Government since 1984. The first phase of the project covering the period 1984 to 1989 dealt with the development of low nitrogen input technology and the identification of genes that conferred a resistance to various races of the pathogen of bacterial leaf blight disease. The second phase covering the period 1989 to 1994 dealt with the development of direct seeding technology and study of genetic aspects of rice tungro disease. The third phase of the project initiated since December 1994 will be terminated in November 1999. Studies on the genetic control of rice blast and nutrient-water interaction in upland rice are being currently carried out.

Rice blast

Rice blast is a major disease of rice worldwide. For improving the varietal resistance against rice blast, pyramiding of major genes, accumulation of minor genes, combination of major and minor genes, and development of multilines of major genes are considered to be effective methods. Information about the genetic constitution of major genes in rice cultivars and the pathogenicity of blast isolates is a prerequisite for all these strategies.

Resistance genes of various varieties were estimated based on their reactions to Philippine blast isolates whose pathotypes were confirmed by the use of Japanese differential varieties. Inheritance of blast resistance and allelism tests were also conducted by inoculating BC₁F₂ lines of crosses of IR varieties with CO39. Blast resistance genes, *Pi b*, *Pi k-s*, *Pi a*, and *Pi 20* were identified in IR24. *Pi 20* has been recently identified. The blast resistance gene constitution of IR34, IR36, IR46, IR56, IR60, IR64, and IR74 was determined and the resistance genes of other IR varieties were also estimated based on the reaction to Philippine blast isolates.

We are developing lines with a single additional resistance gene from crosses with four recurrent parents and over 40 donor parents with blast resistance genes. The lines possess the genetic background of Lijiangsintuanheigy (LTH), CO39, IR24, and IR49830-7-1-2-2. LTH is a *japonica* variety which does not harbor any known rice blast resistance genes. CO39 is an *indica* variety which is expected to harbor a *Pi a* gene for rice blast. These lines will be used as rice blast differential systems for the identification of the pathogenicity of blast isolates in each country. By using such isolates, the resistance genes of different varieties in the world will be identified. IR24 is a variety suitable for irrigated rice ecosystems and IR49830-7-1-2-2 is an elite line for rainfed lowland areas in Thailand. These lines will be used as rice blast-resistant multilines for the first time in tropical areas.

Nutrient-water interaction in upland rice

In the last few decades, a remarkable increase in rice yield was achieved in irrigated ecosystems in Asia. In contrast, the average yield in the upland areas remains at 1.2 t ha⁻¹, a value much lower than the average yield of 3.5 t ha⁻¹ in the irrigated systems. Major factors that limit the productivity of upland rice include unstable water-availability and low nutrient supply. The IRRI-JIRCAS Project seeks to analyse the role of the interaction of water and nutrients in determining yield and develop management options for overcoming these two constraints.

The study focuses on the effect of soil and crop management on the water-capturing capacity of rice roots and the improvement of N use efficiency under fluctuating water regime in upland areas. High sensitivity of rice to water stress can be primarily attributed to the low capacity of shallow roots to capture water. After water stress, corn could extract water from lower layers deeper than 60 cm, while rice could extract it only at a low rate below 40 cm so that the total water uptake declined rapidly (**Fig. 1**). It is important to improve the effective rooting zone for water capture by genotypic and environmental manipulation. Field experiments in major upland rice areas in the Philippines, Thailand, and India, revealed that the nutrient supply environment for N and P in the surface soil may have a significant effect on the water-capturing capacity from layers below the surface through its effect on root development and, consequently, on the performance of the rice plant under stress. This finding implies that the deficiency in nutrients is likely to enhance water stress. In the course of the project, a quantitative analysis of the compensating effect of nutrient input on yield loss due to drought in tropical Asia is being conducted presently.

[Fig. 1. Water extraction from soil profile by rice and maize under water stress.](#)

To alleviate the scarcity of water which is becoming a serious constraint on agriculture in the tropics with increasing population, efforts for the improvement of rice production under water-limited conditions are considered to be crucial for maintaining the food security.

The fourth phase

The fourth phase is under preparation, and it will start in October 1999 until September 2004. In that phase Japanese scientists will conduct "Physiological and genetic studies on yield determination and ecological adaptability for sustainable agriculture." The Japanese scientists are

expected to breed varieties that are resistant to multiple diseases and pests and are environment-friendly and to develop suitable agronomic practices for the new varieties by using DNA marker selection technology.

[NEXT](#)

[CONTENTS](#)

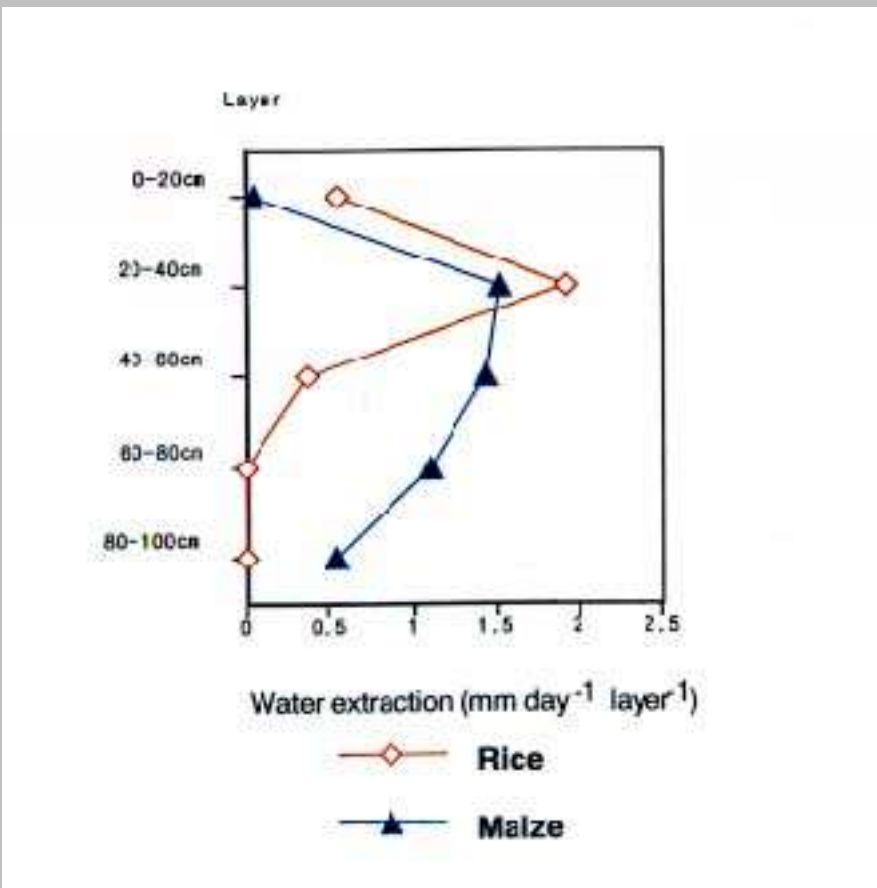


Fig. 1. Water extraction from soil profile by rice and maize under water stress.

BACK

ICRISAT/JIRCAS International Workshop

The International Workshop:

Food Security in Nutrient-Stressed Environments: Exploiting Plant Genetic Capabilities

The workshop on "Food Security in Nutrient-Stressed Environments: Exploiting Plant Genetic Capabilities" will be held at ICRISAT-Patancheru, India during the period of September 27-30, 1999, organized by the International Crops Research Institute for the Semi Arid Tropics (ICRISAT) and Japan International Research Center for Agricultural Sciences (JIRCAS).

ICRISAT has been hosting a Special Project funded by the Government of Japan on "Sustainable Cultivation of Upland Crops in the Semi-Arid Tropics" since December 1984. During the first phase (1984-89), scientists found that pigeonpea can increase the available phosphorus (P) pool of cropping systems in which it is grown by accessing Fe-P via its unique root exudates. In the second phase (1989-94), root distribution in cropping systems was examined as a prerequisite to understanding N acquisition from the soil. The current phase III (1994-1999) is examining the physiological and genetic adaptation of crop plants to low-nutrient environments. This workshop is being organized to round off the activities of phase III of the project.

The objectives of the workshop are:

- To explore the scope for genetic manipulation of the ability of crop plants to gain access to and utilize nutrients (N, P)
- To prioritize candidate mechanisms for enhancing nutrient uptake and use in terms of suitability for genetic manipulation
- To examine appropriate methodologies for genetic enhancement of crop plant ability to absorb nutrients and use them efficiently
- To suggest how genetic options can best be combined with management options to improve nutrient uptake and use

The workshop consists of four sessions as follows:

Session 1: Breeding for low nutrient environments: is it sustainable?

Session 2: Candidate mechanisms

Session 3: Methodology for genetic manipulation of nutrient availability

Session 4: Combining genetic improvement with natural resource management

For further information, please contact:

Dr. J. J. Adu-Gyamfi

ICRISAT, Patancheru, 502 324 AP, India

Tel +1 650 833 6640, Fax +1 650 833 6641

E-mail: j. j. adugyamfi@cgiar.org

[NEXT](#)

[CONTENTS](#)

PEOPLE



Kazuyuki TSURUMI, an agricultural economist, became Director of JIRCAS's International Research Information Division, succeeding Mr. Kunio TSUBOTA who moved to Agricultural and Economic Development Analysis Division, Economic and Social Department, FAO. Mr. Tsurumi, until recently, was Managing Director, Agriculture Forestry and Fisheries Development Study Department, Japan International Cooperation Agency (JICA). He joined the Headquarters of the Ministry of Agriculture, Forestry and Fisheries (MAFF) in 1974 and mainly worked in the field of international affairs. During 1986-1991, he served as an agricultural economist at OECD, Paris.



Toshiaki TANIGUCHI, a veterinary pathologist, succeeded Dr. Mitsugu SHIMIZU as Director of JIRCAS's Animal Production and Grassland Division. Before joining JIRCAS, he was Associate Director for Research, Department of Pathology and Physiology, National Institute of Animal Health. Dr. Taniguchi was involved in several JICA's animal health projects in Indonesia, Malaysia and Thailand as a short-term expert.

[Contents](#)

[JIRCAS Home Page](#)

JIRCAS

Newsletter

No. 20 September 1999



Qingping Lu Market, Guangzhou, China
(Photo by T. Hidaka)

CONTENTS

<Feature Article>

- Research Issues Relating to Environmental Resources

<Research Topic>

- Biological Control of Fish Diseases

<JIRCAS Research Highlights>

- Soybean Virus Diseases in Northeast China
- Experimental Plantation of Dipterocarps in the Philippines

<Collaborative Research Project>

- Farming systems Research in Indonesia

<Topics>

 [Visit of National Center for Beef Cattle Research, EMBRAPA, Brazil](#)

 [JIRCAS Home Page](#)

Collaborative Research on Issues Relating to Environmental Resources



Tadao Hamazaki

Director, Environmental Resources Division, JIRCAS

In developing regions, increasing the supply of agricultural products and stabilizing agricultural productivity are matters of great urgency due to the rapid increase in human population and the improvement in the standard of living. In these regions, the greatest challenge for agriculture today is to sustain agricultural production under adverse soil and climatic conditions, because most of these regions are located in unfavorable agricultural environments such as low soil fertility and/or arid and semi-arid climate, and many farmers can not afford to use enough fertilizers and agricultural chemicals due to economic constraints. Therefore, it is necessary to develop agricultural technologies, which may enable to use more efficiently the local organic resources or to maximize useful functions of plants and microorganisms, based on the characteristics of soils, climate, and socioeconomic conditions.

Recently many attempts have been made to increase food production in these regions. However, these efforts have led to a deterioration of agricultural environments and global environmental problems such as pollution of rivers, lakes and inshore waters, soil degradation, and deforestation. These environmental problems have been caused by excessive application of fertilizers and agricultural chemicals, large-scale feeding of livestock, overgrazing, inappropriate irrigation, overcropping, and expansion of agricultural lands. Accordingly, sustainable agricultural technologies compatible with environmental preservation should be developed based on the analysis of the mechanisms of material cycling in the agro-ecosystems.

On the other hand, agriculture is practiced under various natural and social environments in these regions. Therefore, it is necessary to analyze the actual conditions and characteristics of the environmental resources to develop agriculture compatible with environmental conservation. However, geographic information on land and environmental resources is lacking in many of these regions. Geographic information systems (GIS), are now expected to become an effective tool for developing methods for the analysis and evaluation of the spatial and temporal changes of environmental resources and for producing various kinds of evaluation maps on environment by overlaying multiple geographic data including remote sensing data.

To address these problems, the Environmental Resources Division (ERD) is conducting research to develop technologies for the promotion of sustainable agriculture and environmental conservation. In the comprehensive research projects on sustainable agricultural technologies in Northeast Thailand and on agro-pastoral rotation systems in Brazil, EDR researchers are carrying out studies on the evaluation of sustainability of the agricultural systems from the viewpoint of material cycling and utilization of local organic resources and nitrogen-fixing plants. At the same time, in the comprehensive research projects on sustainable production and processing of major food resources in China and on the evaluation and improvement of farming systems in the Mekong Delta of Vietnam, other EDR researchers are performing studies on the evaluation and development of methods for the improvement of agricultural activities compatible with the preservation of the environment and the ecosystems.

The Division is also promoting research on GIS. Within the framework of the Northeast Thailand project and the comprehensive research project on the evaluation and improvement of regional farming systems in Indonesia, EDR researchers are analyzing the mechanisms of land use changes and physical factors for regional farming systems. Additionally, in the China project, GIS researchers are studying the spatial and temporal characteristics of environmental conditions of agricultural lands.

Furthermore, one researcher is developing monitoring systems of evapo-transpiration, depth of snow and soil moisture under the harsh climatic conditions in the Mongolian plateau.

The Division is also conducting two special projects in collaboration with the international agricultural centers. With the International Crops Research Institute for the Semi-Arid Tropics (ICRISAT) in India, the Division has been involved in studies on the physiological and genetic adaptation of sorghum and pigeonpea to low nutrient availability in the semi-arid tropical environment. Researchers dispatched by the Division to the International Rice Research Institute (IRRI) in the Philippines have been conducting studies on the stabilization of rice culture under water stress in the tropics utilizing a broader spectrum of genetic resources. These two projects will end in 1999, and the Division is planning to dispatch a researcher to initiate a new research project entitled "Physio-genetic studies on yield determination and ecological adaptability for sustainable rice culture" at IRRI scheduled to begin by the end of this fiscal year.

On the other hand, at WARDA (West Africa Rice Development Association), one researcher is carrying out studies on the genetic and eco-physiological characterization of indigenous rice varieties and interspecific progenies, with emphasis placed on tolerance to drought and

acid soil conditions in the West African region.

In addition, the EDR is actively engaged in research activities within the framework of the JIRCAS Fellowship Program in the field of material cycling, GIS, photoelectron spectroscopy, etc. and frequently invites to Tsukuba counterpart researchers from the organizations with which JIRCAS carries out collaborative studies.



Sugarcane field in Northeast Thailand: sugarcane residues are used to improve soil fertility



Experimental field for rational fertilizer application to prevent excess application in China

NEXT

CONTENTS

Biological Control of Fish Diseases in Aquaculture

Masachika Maeda

Director, Fisheries Division, JIRCAS

The health of fish in aquaculture, as well as in nature, depends primarily upon their inherent resistance to microbial invasion, and the biological equilibrium between competing beneficial and detrimental microorganisms at the fish/water environment interface. In fact, useful and harmful microbes in the water environment directly affect the growth of fish (Maeda, 1999).

More than one million of microorganisms per milliliter inhabit the aquatic environment and affect each other, both through the substances they produce and emit, as well as through the various ways they come into contact with one another. Fertilization of aquaculture seawater, through the addition of low concentrations of organic materials, leads to an increase in the number of microorganisms which utilize the organic materials as nutrients to construct microbial assemblages which enhance the survival rates of fish larvae (Maeda, 1999). In aquaculture, where phytoalgae are used as the main live food, the survival rates of prawns, crabs and finfish are not considered to be sufficiently high. However, if certain species of bacteria are present with the algae, the survival rate increases significantly. It is therefore preferable to feed microbes to fish along with algae (Maeda, 1999), although the control of these microbial assemblages is essential to prevent the pathogens from dominating the microbial communities. Thus microorganisms play several useful roles which help to maintain suitable environmental conditions in aquaculture and promote fish growth, as well as functioning as live food.



The bacterial strain cultured in the ZoBell 2216E medium in seawater at 25°C for 4 days was added into seawater where the larvae of striped jack were reared

The methods of determining how to keep pathogenic microorganisms, mainly bacteria and viruses, away from fish rearing environments are one of the main concerns of the people engaged in aquaculture. To this end, the filtration of water, the addition of sodium chloride, ozonation, the use of ultraviolet light, and even the use of artificial compound food containing antibiotics for sterilization, are all commonly adopted techniques in aquaculture. People in aquaculture tend to consider that these procedures can eventually eliminate all the microbes in seawater, and produce and maintain a nearly pure water quality. However, with these treatments, pathogenic microorganisms which cause fish diseases cannot be permanently removed from the water. For example, if the antibiotic kanamycin is added to seawater, the bacterial numbers decrease for about two days, but eventually the numbers will recover to their original level. The same phenomena can be seen when seawater is sterilized by filtration, ozonation or ultraviolet light treatment. After such treatments, bacteria grow very quickly because antagonism among the bacterial populations is reduced. Furthermore, no one can anticipate what kind of bacterial species may grow in the vacant space generated by the above treatments. *Penaeus* prawn aquaculture in Asia and South America in part has not yet recovered from its collapse in the 1980s. In addition, many fish diseases are spreading through aquaculture facilities worldwide.

Although people who are engaged in aquaculture have started to realize that antibiotics are less effective, almost no alternative method of controlling diseases has been developed. It is therefore essential that new methods should be adopted wherein the antagonism of certain microorganisms is used to repress other pathogenic microbes, bacteria and viruses, in seawater.

The antagonism among microbes is a naturally occurring phenomenon through which pathogens can be killed or reduced in number in the aquaculture environment. This method, which is called biological control or biocontrol, has already been recognized in the field of agriculture. For example, the famous bacterium, *Bacillus thuringiensis*, which infects pathogenic insects orally and eventually kills them is now commercially available in Europe and North America where several thousands of tons are used. These positive results have led to further studies using viruses, fungi and protozoa as biocontrol agents to eliminate pathogenic organisms. This approach in aquaculture is described in detail herein.

Several viral diseases have seriously affected the fish rearing industry. *Penaeus* prawn, *P. monodon* and *P. japonicus*, have almost all been infected with Baculo-like viruses. In Taiwan, the production of *P. monodon* decreased from about 90,000 metric tons in 1987, to 30,000 in 1988, to 20,000 in 1989, and has still not recovered. In Japan since 1993, the prawn rearing industry of *P. japonicus* has been seriously

damaged by a virus infection, and many prawn nursery ponds in the western part of Japan stopped production because all the prawns died. There are also other viruses: Infectious Hematopoietic Necrosis Virus (IHNV) and Infectious Pancreatic Necrosis Virus (IPNV) which infect salmon, HIRRV which infects a flounder, the Yellowtail Ascites Virus (YAV) which infects yellowtail, Striped Jack (Sima-Aji) Nervous Necrosis Virus (SJNNV) which mainly infects striped jack, the Irido Virus which infects sea-bream, and many more, all of which cause serious damage in aquaculture.

Using the direct counting method combined with electron microscopy, virus counts were reported to range from 10^4 - 10^8 virus particles /ml, i.e. numbers which were 10^3 - 10^7 times higher than previous reports of virus particle numbers in natural aquatic environments, that in turn were based on counts of plaque-forming units using various host bacteria. Thus viral concentrations changed from 10^4 to 10^8 virus particles/ml, which indicates the possible effect of anti-viral microorganisms on the presence of virus particles in seawater. This phenomenon helps to explain why the concentration of viruses fluctuates so markedly in sea and fresh-water. In addition, viruses have the ability to be transferred from one infected organism to another through the water environment. If anti-virus bacteria dominate the water environment, virus transfer among fish communities may be repressed to a large extent. Based on this concept, anti-virus bacteria are used in rearing procedures of larvae in practical aquaculture applications.

According to one hypothesis, bacteria which are able to inhibit the growth of other bacteria, may also inhibit the growth of viruses. From this point of view, for the detection of anti-virus bacteria in seawater, the first step should be to determine the anti-bacterial activity. This procedure is easier than determining the anti-viral activity directly. The bacterial strain VKM-124, *Pseudoalteromonas undina*, which has a vibrio-static activity and is used in practical aquaculture, inhibited the appearance of the cytopathic effect (CPE) on the epithelioma papillosum cyprini (EPC) cells in which about a 2-day delay was observed in the *P. undina* experimental fraction, compared to the control fraction. Thus this strain, which shows a strong antibacterial activity, can inhibit the growth of the virus.

The bacterial strain VKM-124, *Pseudoalteromonas undina*, used in aquaculture processes, is able to prevent fish larvae from being infected with SJNNV, Baculo-like viruses and Irido virus. When this useful strain was added to water at a concentration of about 10^6 cells/ml in rearing containers of *Penaeus* prawn, Sima-aji and Sea-bream larvae, the survival rates of these larvae were much higher in the presence of the bacterium than without the bacterium. All the fish larvae died due to viral disease without the addition of the bacterium (**Fig. 1**) (Maeda, 1999).

Fig. 1. Survival of Sima-aji (Striped jack, *Caranx delicatissimus*) larvae with and without the bacterium VKM-124, *Pseudoalteromonas undina*. Larvae died due to infection with the virus, SJNNV, in the container without the addition of the bacterial strain.

Viruses in seawater spread from infected fish to others which are not yet suffering from disease. However, probiotic bacteria may inhibit the migration of viruses among fishes. In addition, if fish feed on such probiotic bacteria, the immune system of the fish may become stronger, as shown in the enhancement of immune activities of vertebrates with bacteria in many reports. With such useful effects and features, probiotic bacteria could certainly be extremely effective in protecting fish from the spread of viral diseases in aquaculture.

Note: Detailed information and references are available in the book of Maeda (1999); Microbial Processes in Aquaculture. Natl. Res. Inst. Aquaculture, 102 pp. The scientists who would like to read this book can obtain it by writing to JIRCAS.

NEXT

CONTENTS

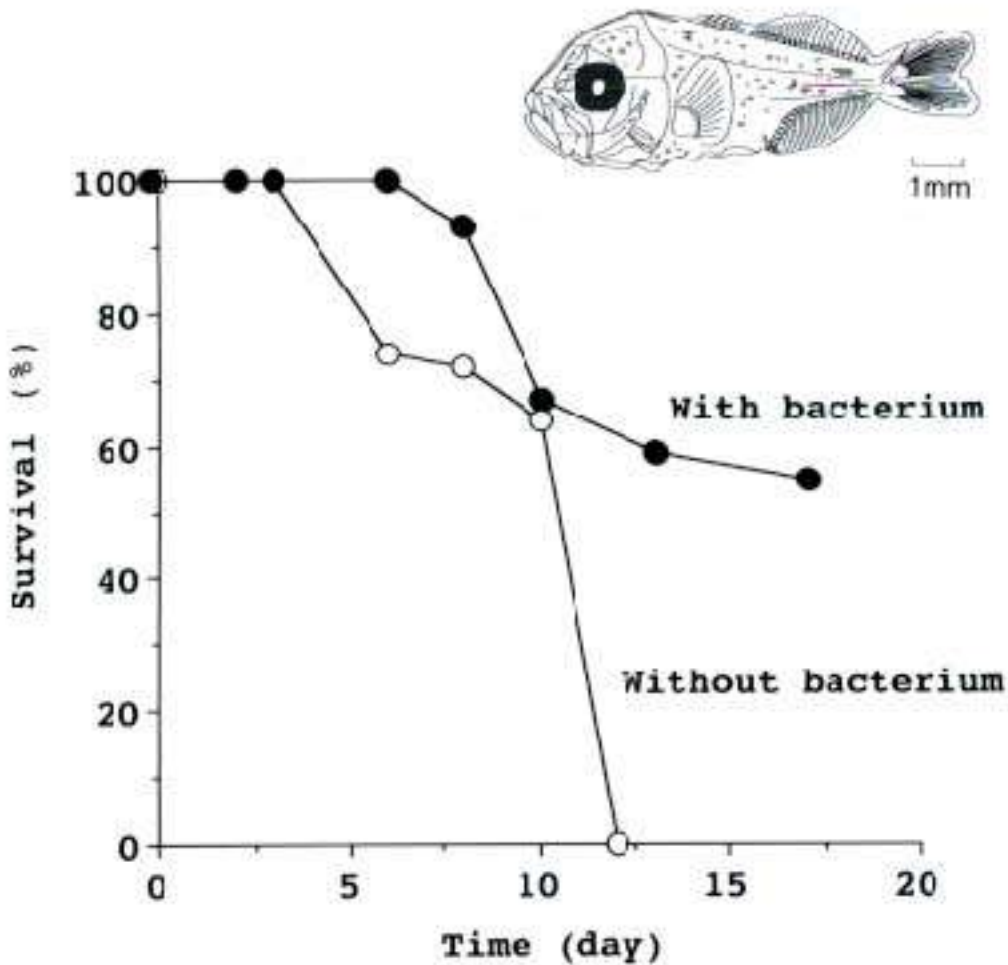


Fig. 1. Survival of Sima-aji (Striped jack, *Caranx delicatissimus*) larvae with and without the bacterium VKM-124, *Pseudoalteromonas undina*. Larvae died due to infection with the virus, SJNNV, in the container without the addition of the bacterial strain.

Numbers of larvae used: 254, 000 Ind.

Water volume: 20 metric tonnages.

Bacterial numbers added every day for 17 days: about 1 million cells/ml.

BACK

Soybean Virus Diseases in Northeast China

Masaaki Nakano
Biological Resources Division, JIRCAS

Northeast China is the major soybean production area in China. More than 40% of soybean grains in China are produced in three provinces in the Northeast, i.e., Heilongjiang, Jilin, and Liaoning. JIRCAS has initiated a program of collaborative research on soybean breeding with The Soybean Institute of Jilin Academy of Agricultural Sciences. At first, we focused on soybean virus diseases that cause severe damage to soybean production.

In a soybean field, sometimes plants display symptoms such as curling of leaves, deep leaf color and pale green or yellow mosaic, brownish necrosis along the leaf veins, or dwarfing. These are the typical symptoms of soybean virus diseases and sometimes they lead to a severe yield reduction. Many viruses infect soybean in China. Since each virus shows a different mode of transmission, the kinds of viruses should be identified and characterized in Jilin province for control including breeding of resistant varieties.

We investigated soybean virus diseases all over the Jilin province by applying the Dot-ELISA method using virus-specific antisera and by electron microscopy. We could detect the soybean mosaic virus (SMV), cucumber mosaic virus-soybean stunt strain (CMV-SS), alfalfa mosaic virus (AMV), and bean common mosaic virus (BCMV) during the period 1996-1998 (**Table 1**).

Table 1. Detection of soybean viruses by Dot-ELISA in Jilin province (1996-1998)

Region	No. of tested materials	SMV	BCMV	CMV-SS	AMV
Baicheng	35	3	2	0	0
Qianguo	22	0	2	0	0
Siping	279	128	10	9	6
Changchun	21	5	0	0	0
Jilin	52	22	0	2	2
Yanbian	174	5	0	1	5
Tonghua	10	1	0	4	0
Baishan	11	0	0	2	0
Total	604	164	14	18	13

BCMV causes severe vein necrosis on some cultivars (Fig. 1). This virus infects other legume crops such as bean, mungbean, and adzuki bean and some of the plants may become a source of inoculum. Although severe yield reduction in individual soybean plants can be observed, the incidence is very low.

AMV causes distinct yellow mosaic symptoms on leaves (Fig. 2). Since alfalfa and some legume grasses for animal feeds are a source of inoculum, AMV could be detected on soybean plants cultivated next to alfalfa fields.

Mosaic disease caused by SMV was the major virus disease in this area (Fig. 3). As SMV can be detected in soybean seeds, SMV is disseminated by seeds over a soybean-growing area and the germinated plants become inoculum sources. Then SMV is rapidly transmitted to neighboring soybean plants by aphids.

Although CMV-SS is also a seed-transmissible virus, its incidence was lower than that of SMV.

The most effective method of control of SMV is the utilization of resistant cultivars. However, many SMV strains infect various resistant cultivars. Therefore, although resistant cultivars enable to control certain SMV strains, if another SMV strain infects the resistant cultivar, a severe epidemic may occur. We investigated the SMV strains in Jilin province to select cultivars suitable for the control of SMV. Our work revealed that almost all the isolates of SMV in this area belonged to the SMV-B strain in Japan. Besides, we observed that almost all the cultivars developed at Jilin Academy of Agricultural Sciences for the past years were resistant to SMV-B. If farmers replace the old cultivars with new cultivars, SMV could be eliminated in their fields. After the introduction of resistant cultivars, the occurrence of other virulent SMV strains should be carefully monitored and the agricultural institutes are responsible for providing pathogen-free seeds.

Recently, we have isolated an unidentified virus from SMV-resistant soybean plants. This virus is different from SMV and other known

viruses in this area, because it does not react with the antisera used and was not transmitted by aphids. This virus must show other ecological characters. Therefore another strategy for control should be developed. We will soon identify it and will show how we can control it in the near future.



1. BCMV



2. AMV



3. SMV

Figs. 1, 2, 3. Symptoms of soybean virus diseases

[NEXT](#)

[CONTENTS](#)

Experimental Plantation of Dipterocarp Species in Luzon Island, Philippines

Shiro Okuda* and Antonio F. Gascon*²

*Forestry and Forest Products Research Institute,

²College of Forestry, University of the Philippines at Los Banos

Dipterocarp species are one of the main component trees of the tropical forest. Due to the high commercial value, Dipterocarp stands have been logged on a large scale, leading in some areas to a serious decline of forest resources. In the Philippines, lowland forests had been dominated by Dipterocarp species in the past, and recently logging has spread all over the country, resulting in a remarkable reduction of useful timber resources.

Reproduction of the forest generally has been achieved by natural regeneration which is too slow in some hardly disturbed cases. Planting of seedlings is more efficient to establish a targeted forest in a short period of time. In the case of Dipterocarp species, planting had been commonly carried out under canopy trees, to obtain a higher survival rate of planted seedlings. However, stagnation of growth was often observed. Light is efficient for the growth of seedlings and it is important to explore the possibility of plantation in an open environment with Dipterocarp species.

A joint experimental plantation site had been established at the campus of UPLB (University of the Philippines at Los Banos) in cooperation with the SFI Department. Seedlings of eight species belonging to the Dipterocarp family were planted. All the species were indigenous to the Philippines and seedlings from seeds collected from Mt. Makiling Forest Reserve and the surrounding area were maintained in a nursery for 6 months prior to planting. To analyze the growth response under different light conditions, the site was divided into two parts, one in a fully opened area and the other under the canopy of an *Acacia* stand (RLI about 30%).

The initial growth for two years after plantation differed depending on the species. In the fully opened part, *Anisoptera thurifera* ssp. *thurifera* (Palosapis) and *Shorea contorta* (White Lauan) grew better than the other species both in terms of height and diameter. On the other hand, in the case of *Dipterocarpus grandiflorus* (Apiton) the values for these parameters were the lowest. The other species showed an intermediate growth between the two groups. There was no appreciable difference in growth between seedlings in the fully opened part and the part under the canopy for *D. grandiflorus*. However, the species that became big in the fully opened part showed only less than half growth in the part under the canopy. The survival rate showed the same trend as that of *A. thurifera* ssp. *thurifera* and *S. contorta* i.e., around 90%. The rate was not significantly different between the two parts of the site. The other species showed a lower rate, and particularly *D. grandiflorus* reached a rate of about 50% after planting.

Weed and vine growth was luxuriant in the fully opened part. This vegetation competed with the planted seedlings. To maintain higher growth and survival rates, weeding was an efficient treatment when practiced at intervals of 2, 3 months. In the non-weeded site, the survival rate decreased for all the species that had been planted.

Thus the growth and survival varied with the species and site conditions in the opened area; microclimatic factors may vary not only in terms of light intensity compared to the area under canopy, but temperature and humidity of air and soil may also be different. Therefore, light is not the only factor that accelerates growth. Further studies focused on the response of growth to other factors should be carried out to analyze the species characteristics.



A. thurifera ssp. *thurifera* in fully opened part



A. thurifera ssp. *thurifera* under the canopy of

NEXT

CONTENTS

Farming Systems Research in Indonesia - Toward the Improvement of Household Economy in Rural Areas in West Java

Shuichi Asanuma
Research Information Division, JIRCAS

Natural and socio-economic conditions surrounding agriculture

Agricultural land area accounts for about 23% of the total land territory of Indonesia, while for 67% in Java Island. Agricultural production varies markedly from location to location, depending upon the natural environmental and socio-economic conditions in each region. For instance, rapid economic growth, industrialization, and urbanization on Java have widened the gap between cities and villages and altered fundamentally the social and economic conditions in rural areas. On the outer Islands, on the contrary, generally the low standard of living reflects the slow pace of economic development including agricultural production and the delay in the development of appropriate technologies to overcome the difficulties in resources exploitation.



Cabbage field in mixed cropping system on steep slope of Mt. Bromo, East Java



Beans planted in paddy fields in Pasuruan, East Java

Agricultural production and research

Most of the agricultural research in Indonesia has been focused on lowland farming systems based on the cultivation of rice. This focus, when combined with the effects of other governmental programs to help rice farmers, allowed Indonesia to achieve its national goal of self-sufficiency in rice by 1984. On the other hand, upland crop areas have not much benefited from the modern agricultural technologies although numerous research projects have targeted upland or rainfed lands. Consequently, upland agriculture remains much less developed than lowland agriculture throughout the country. Under these conditions, in addition to the shortage of rice production experienced during the past few years, increase of food crop production, particularly of rice, maize and soybean, both in the lowland and the upland, has become the most urgent target in agricultural research and development in Indonesia (Table 1).

Table 1. Production and import of main grain crop commodities in Indonesia

(x 1,000 ton)						
Commodities	Production			Import		
	'85	'90	'95	'85	'90	'95
Rice	38,660	44,490	49,860	40	50	3,158
Wheat	0	0	0	1,333	1,767	4,274*
Maize	5,300	6,741	8,223	50	9	969
Soybean	825	1,427	1,689	302	541	607

Bean cake	-	-	-	175	5	682
* Including wheat flour						
Source: FAO Production Yearbook; FAO Trade Yearbook						

Implementation of farming systems research in Indonesia

The comprehensive research project entitled "Evaluation and Improvement of Regional Farming Systems in Indonesia" aims at examining, from farmers' standpoint, the socio-economic and technical achievements of the past and on-going practices relating to farming systems research and extension in Indonesia and at suggesting ways for improvement. A "farming systems research approach" is characterized by a bottom-up participatory process and an emphasis on a multi-disciplinary approach to problems in agriculture. The project started in April, 1998 based on the Memorandum of Understanding (MOU) between the Agency for Agricultural Research and Development (AARD) of Indonesia and the Japan International Research Center for Agricultural Sciences (JIRCAS), and is scheduled to last for five years. The research institutes of Indonesia with which JIRCAS is currently collaborating include the Center for Agro-Socio-Economic Research (CASER), the Research Institute for Legume and Tuber Crops (RILET) of the Central Research Institute for Food Crops (CRIFC), and the Center for Soil and Agroclimate Research (CSAR) and Lembang Assessment Institute for Agricultural Technology (AIAT-Lembang).

Research activities under progress and planning

The following research activities are in progress, 1) studies on the farmer-state linkages in upland farm development in Indonesia, 2) analysis of physical environmental resources using remotely sensed data and GIS for evaluation and improvement of regional farming systems in Indonesia, and 3) evaluation of Indonesian soybean varieties for the processing and improvement of traditional fermented foods. An additional activity consisting of the evaluation of vegetable-based farming systems and improvement of vegetable and fruit cultivation in highland regions in West Java is now under planning, the objectives of which are 1) to analyze geographic, climatic and socio-economic conditions, of temperate vegetable-producing areas in West Java, 2) to analyze the demand for temperate vegetable production in Indonesia, 3) to analyze and evaluate the distribution systems of temperate vegetables and fruits in West Java, 4) to analyze and evaluate the present cultivation and protection technology of temperate vegetables in West Java, and 5) to analyze and evaluate the characteristics of upland crops and fruit trees utilized in the mixed cropping systems of temperate vegetable cultivation in West Java and to suggest the incorporation of alternative varieties of upland crops and/or fruit trees into the systems.

We expect that the collaborative research between AARD and JIRCAS will contribute to the improvement of vegetable farmers' life in West Java through the increase of household income in the near future.

[NEXT](#)

[CONTENTS](#)

Mr. Matsumoto, Chairman of AFFRC, Mr. Tsuchiya, Director of International Research Division of AFFRC and Dr. Maeno, DG of JIRCAS Visited Brazil

Kiyomi Kosaka
Animal Production and Grassland Division, JIRCAS



Visit of a laboratory at CNPGC. From left: Dr. Maeno, Dr. Boock, Mr. Matsumoto and Dr. Miranda

Mr. Sakue Matsumoto, Chairman of the Agriculture, Forestry and Fisheries Research Council, AFFRC, Ministry of Agriculture, Forestry and Fisheries, MAFF, Mr. Tadashi Tsuchiya, Director, International Research Division, AFFRC/MAFF and Dr. Nobuyoshi Maeno, Director General of JIRCAS visited Brazil in August 1999. In Sao Paulo, they had the opportunity of meeting with Dr. Sugai, economist of the Brazilian Agricultural Research Corporation, EMBRAPA, and they discussed various aspects relating to the orientation of future collaborative research activities between Brazil and Japan, especially in the field of socio-economic studies.

Mr. Matsumoto, Mr. Tsuchiya and Dr. Maeno visited the National Center for Beef Cattle Research (CNPGC), EMBRAPA in Campo Grande and discussed with Dr. Arae Boock, Director General of CNPGC, and his staff, in greater detail various aspects relating to the on-going collaborative research project entitled "Comprehensive Studies on the Development of Sustainable Agro-Pastoral Systems in the Subtropical Area of Brazil." In Campo Grande, they also had the opportunity of meeting with Mr. Moacir Kohl, Director General of the State Department of Agriculture and Vice President of Mato Grosso do Sul and Mr. Paulo Shiguenori Kanazawa, Deputy Director of State Finance and Science Department, and learned more about recent agricultural developments in the Cerrados Area.

On these occasions, Mr. Matsumoto, Mr. Tsuchiya and Dr. Maeno also had the opportunity of meeting with many immigrant farmers who became the leaders of the Japanese communities of Brazil in Sao Paulo, Campo Grande, Mariria and Gutapara, in particular with Mr. Shunji Nishimura, owner of Pompeia Agriculture and Industry High School, who contributed significantly to forging close links between the Brazilian and Japanese agricultural organizations for many years.

[Contents](#)

[JIRCAS Home Page](#)

JIRCAS

Newsletter

No. 21 December 1999



Sowing pigeon pea in an alfisol field at ICRISAT
(Photo by O. Ito)

CONTENTS

<Feature Article>

● Postharvest Technology for Developing Countries

<Research Topic>

● Natural Food Chain in Aquaculture

<JIRCAS Research Highlights>

 [A Fungus Infecting Grasses in Okinawa](#)

 [Helminthic Diseases of Pig in the Mekong Delta](#)

 [Antimutagenic Effect of Thai Ginger](#)

[<JIRCAS Symposium>](#)

[<Workshops>](#)

[<People>](#)

 [JIRCAS Home Page](#)

Future Orientation of International Collaborative Research on Postharvest Technology for Developing Countries



Akinori Noguchi

Director, Crop Production and Postharvest Technology Division, JIRCAS

The Crop Production and Postharvest Technology Division implements research projects on topics ranging from production and storage to the processing and marketing of agricultural products. Our research activities encompass a variety of disciplines including agronomy, plant protection (pest, disease, and weed control), agricultural mechanization, irrigation, drainage, cropping systems, food storage, postharvest technology, farm management and agricultural economics.

Far too often the problem of feeding the world's hungry is conceived in terms of producing a sufficient amount of food. Equally pressing problems related to preservation and distribution issues that affect food products between harvest and consumption are frequently neglected. Postproduction operations in agriculture and horticulture include a wide range of functions necessary for supplying good quality food, reducing transaction costs, and raising domestic welfare. It is necessary to place emphasis on postharvest studies of agricultural products, such as quality improvement, safety, extension of shelf life, and control of insects and microorganisms in foodstuffs. These constitute important objectives of this Division.

Finally, sustainable production of agricultural commodities can only be supported by the development of sustainable markets. Technology for enhancing the value of agricultural products is being developed with a view to increasing incentives for farmers to promote sustainable production. Economic studies are essential for furthering the development of target countries.

It is only natural that food production covers wide fields as a chain from the cultivation to the final food market. Postharvest technology including selection, preservation, packaging and processing has contributed to the promotion of agricultural production through the improvement of farmer's income by raising the value of agricultural produce. Agriculture is very sensitive to the natural environment and there are many constraints on the rapid increase of production. Therefore, it is very important to develop techniques to reduce postharvest losses as well as to preserve or improve the quality, freshness and nutritional value of agricultural produce until the products reach the consumers.

The Division will concentrate its research activities on the prevention of postharvest losses, with emphasis placed on the improvement of methods of drying, transportation and storage of the products, quality preservation and evaluation and food processing. The constraints on the infrastructure and relevant technologies in developing regions, result in quality deterioration of agricultural produce and in compelling the farmers to sell their products at a low price in the market. Low-input preservation technology will be developed by identifying the factors controlling quality deterioration during collection, storage and distribution. On the other hand, since the price of agricultural products is determined based on their quality such as freshness, shape, size, color, flavor, texture, components, nutritional value, safety, damage caused by pests and functional properties for processing, technology for quality preservation and evaluation will play a very important role in the pricing of agricultural products. However, since most of these technologies have been designed in developed countries, they must be adapted to the needs of developing regions and more simple and low-cost technology for quality preservation and evaluation should be developed. As for processing, in general, traditional methods of food processing aim at meeting the requirements of the domestic market sometimes under unpredictable supply of raw materials and limited level of technology. The Division will attempt to analyze and improve the various steps involved in the traditional methods of food processing to meet the increasing demand of consumers for diversified foods, along with developing new technologies for food processing through technology transfer.

This approach was also emphasized during the 19th ASEAN and 1st APEC Seminar on Postharvest Technology (Ho Chi Minh City, Vietnam, 9-12 November 1999). This seminar covered a wide range of durable and perishable agricultural commodities and focused on issues relating to quality assurance, evaluation of quality, quality maintenance and contaminant reduction, cost efficiencies and systems approaches to postharvest research and development.



Sun-drying of paddy rice on the road (Cantho, Vietnam)



Cabbage damaged during transportation is unloaded from a truck (Beijing, China)

NEXT

CONTENTS

Natural Food Chain in Aquaculture

Masachika Maeda

Director, Fisheries Division, JIRCAS

For years the food chain in seawater has been misunderstood, and consequently aquaculturists have often followed the wrong direction. Until recently, scientists had considered that the food chain's primary producers (microalgae, which fix light energy and yield organic materials), were consumed by the zooplankton as soon as they were produced. However, recent studies have shown that several other food transfer pathways exist as well. For example, it was reported that the dominant species in zooplankton communities, which have been considered to be typical herbivores, feed on detritus and bacteria. Maeda (1999) also outlined the significant role of bacterial aggregates as food for the zooplankton.

In terrestrial ecosystems, few of the primary producers are directly utilized by predators as food. In the forest ecosystem, for example, only a small proportion of the leaves is eaten by animals, whereas a major proportion of the nutrients from fallen leaves is transferred through bacteria, fungi and protozoa, as well as through small plants and small to middle-sized animals.

Although this energy transfer is considered to represent the detritus food chain, a large number of microorganisms attached to the detritus are in fact the main nutrient source for the predators (**Fig. 1**).

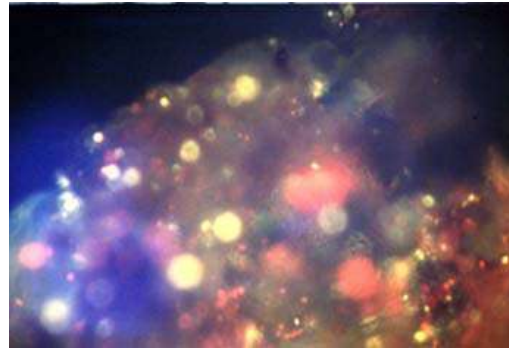
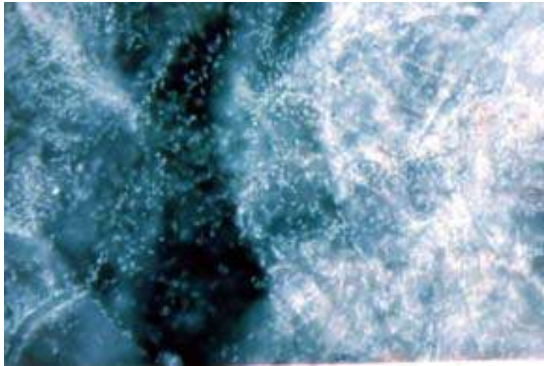


Fig. 1. Microbial cell assemblages in detrital materials in seawater.

This food pathway could thus be designated as microbial food chain instead of detritus food chain (Maeda 1999). It is therefore more appropriate to define primary producers as builders of a dissolved organic matter (DOM) pool. Based on this DOM pool, which originates from exudates of microalgae, etc., "microbial food assemblages" are formed. These assemblages are the starting point of the energy flow in the lower trophic levels of the food chain in the aquatic environment as shown in **Fig. 2**, although the effect of viruses on these microorganisms has not been considered.

Fig. 2. Food chain in the lower trophic level of larval rearing water in aquaculture.

Since many protozoa feed on bacteria, the bacteria contribute to higher trophic levels. In fact, protozoa are considered to be a significant food source for fish and zooplankton. Furthermore, Robertson (1983) increased the feeding rate of *Acartia* by using tintinnids as food at a concentration of 10^3 cells/L. It is interesting to note that the copepod *Scottolana canadensis* was capable of producing eggs more frequently when ciliated protozoa were given as food than when only microalgae were available. Gall *et al.* (1997) also reported the significant role of protozoa as live feeds to oyster, *Crassostrea gigas*.

In aquaculture, the concept of the microbial food chain can be adopted. In fact, the addition of low concentrations of organic matter promotes the growth of fish. For example, in cases where the phytoplankton is used as the main live food, certain species of bacteria may be added with the algae. Under such treatment, survival rates of fish increase significantly. It is therefore considered preferable to feed microbes to fish along with algae. In conclusion, microbial food assemblages formed by the addition of microalgae and organic matter play a significant role as live food in aquaculture waters.

Note: Detailed information and references are available in the book of Maeda (1999). The scientists who would like to read this book can obtain it by writing to JIRCAS.

References

- Gall, S. L., Hassen, M. B. and Gall, P. L. (1997): Mar. Ecol. Prog. Ser., 152, 301-306.
 Maeda, M. (1999): Microbial Processes in Aquaculture. Biocreate Press, London, 102 pp.
 Robertson, J. R. (1983): Estuar. Coast. Shelf Sci., 16, 27-36.

JIRCAS International Workshop

JIRCAS plans to organize an International Workshop on "Brackish Water Mangrove Ecosystems _ Productivity and Sustainable Utilization -" to be held in Tsukuba, Japan during the period February 29 _ March 1, 2000.

Four themes will be covered in four sessions as follows:

- 1) Production and decomposition processes in mangrove areas
- 2) Nutrient flux from rivers to coastal areas
- 3) Energy flow in brackish water of mangrove areas
- 4) Socio-economic evaluation of mangrove coastal areas.

For further information, please contact:

Dr. Masachika Maeda, Fisheries Division, JIRCAS

FAX: +81-298-38-6655

E-mail: mamaeda@jircas.affrc.go.jp

URL: <http://www.jircas.affrc.go.jp/mangrove>

NEXT

CONTENTS

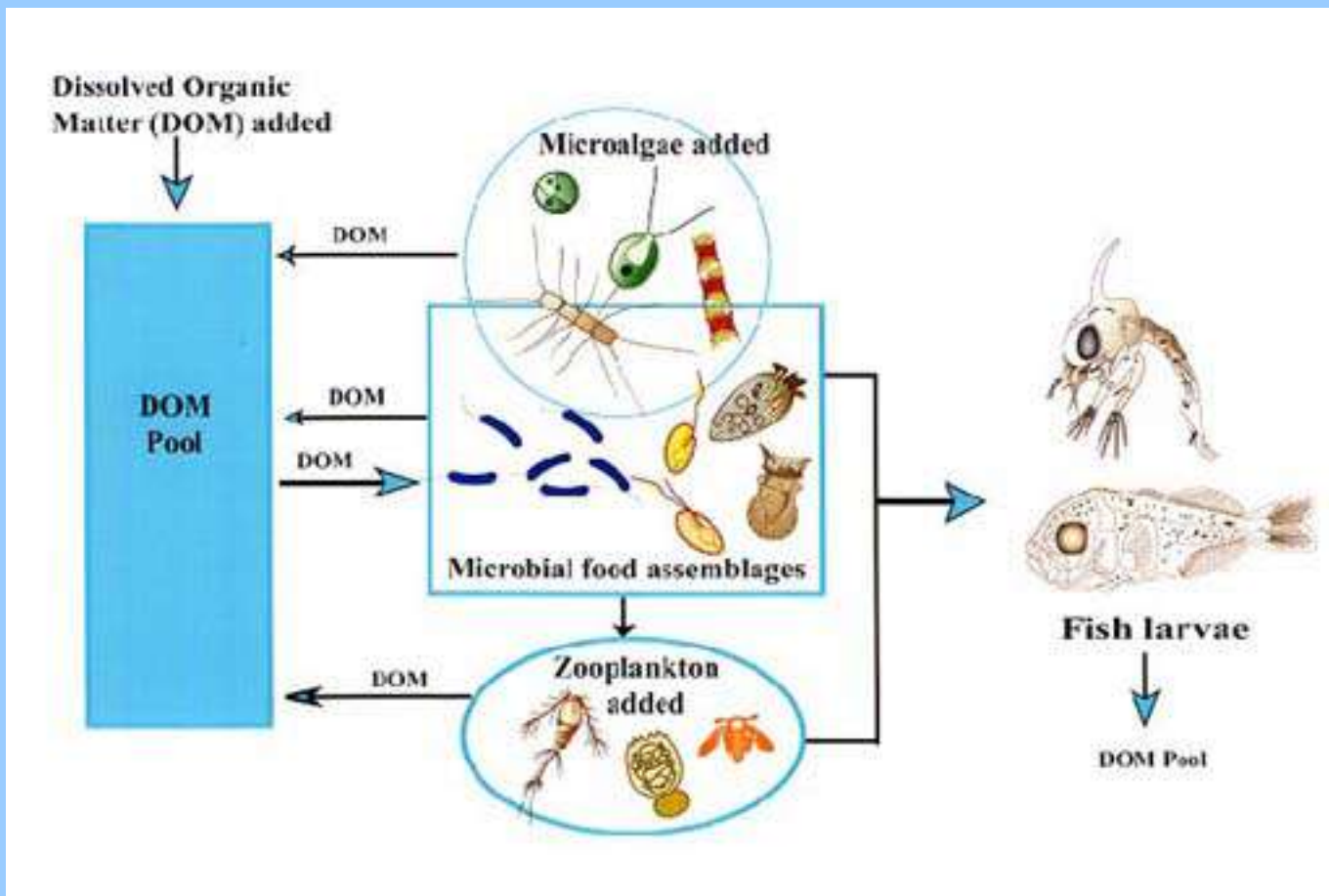


Fig. 2. Food chain in the lower trophic level of larval rearing water in aquaculture.

BACK

A Fungus (*Ephelis* sp.) of Grasses on Ishigaki Island and Its Effect on the Feeding of Two Insect Pests

Keiichi Takahashi*, Michael J. Christensen*², Katsuyuki Kohno*³, Takao Tsukiboshi*⁴ and Makoto Kobayashi*⁵

National Food Research Institute, *²AgResearch, New Zealand, *³Okinawa Subtropical Station, JIRCAS, *⁴National Institute of Agro-Environmental Sciences and *⁵National Grassland Research Institute

A number of alkaloids with insect deterrence or toxicity are present in grasses infected with fungi belonging to the tribe Balansiae, especially *Neotyphodium* species. However, no information is available for *Ephelis* species. We, therefore, studied *Ephelis*-infected grasses and their effect on the feeding of insect pests in Okinawa.

Ephelis sp., a fungus belonging to the family Clavicipitaceae (tribe Balansiae), was detected in fifteen species of grasses on Ishigaki island, Okinawa; *Brachiaria mutica* (Forsk.) Stapf, *Chloris barbata* Swartz, *C. divaricata* R. Br., *Chrysopogon aciculatus* (Retz.) Trin., *Cynodon dactylon* (L.) Pres., *C. pletostachyus* (K. Schem.) Pilger, *Digitaria decumbens* Stent., *D. violascens* Link, *Imperata cylindrica* (L.) Beauv. var. *koenigii* (Retz.) Durand et Schinz, *Leptochloa panicea* (Retz.) Ohwi, *Panicum crus-galli* Beauv. var. *praticola* Ohwi, *P. repens* L., *Paspalum scrobiculatum* L., *P. urvillei* Steud. and *Eriochloa procera* C. H. Hubb.

Sites with *Ephelis* infection were most commonly wet areas that had remained undisturbed for many years. The frequency of infection varied widely between grass species. In three of the fifteen grasses, *C. aciculatus*, *D. violascens* and *P. scrobiculatum*, infected plants were observed at many sites, while in other species, infected plants were present at only one or two sites. *Ephelis* infection of *C. dactylon*, *E. procera* and *P. urvillei* was found only in a single plant. The number of infected tillers at each site was typically low, and apparently showed a random distribution, with no evidence of spread from sites of infection. Infected plants were characterized by stromata that covered the inflorescence with dense mycelial growth (**Photo 1**). Numerous narrow, elongated conidia were present on the stromata (**Photo 2**). In most grasses, hyphae were observed on the surface of the leaf blades. Infected plants of 10 species revealed that the *Ephelis* fungus was essentially an epiphyte, with hyphae in vegetative tillers being located on the surface of the stem apex, including primordial leaves. Hyphae on leaf blades were also apparently confined to epiphytic growth.



Photo 1:
Inflorescence of *Digitaria decumbens* covered with stroma of the *Ephelis* fungus

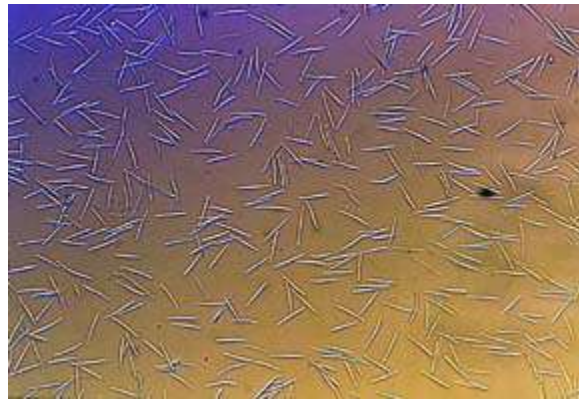


Photo 2:
Elongated conidia of *Ephelis* on stroma in *Brachiaria mutica*

Insect feeding deterrence associated with the presence of the *Ephelis* sp. was detected in choice tests involving infected and uninfected leaves. Larvae of the armyworm, *Mythimna (Pseudaletia) separata*, preferred *Ephelis*-free grass to *Ephelis*-infected leaves of *D. decumbens* (**Fig. 1**), but feeding was unaffected on *Ephelis*-infected leaves of *C. pletostachyus*. Adults of the grasshopper, *Aiolopus thalassinus tamulus*, preferred *Ephelis*-free to *Ephelis*-infected leaves of *D. decumbens* and *C. pletostachyus* (**Fig. 1**). Adults of *A. thalassinus tamulus* fed on *Ephelis*-free *D. decumbens* leaves survived over a significantly longer period than those fed on *Ephelis*-infected leaves (**Table 1**). These studies indicate that the *Ephelis* fungus occurring on Ishigaki island produces at least one feeding deterrent in the host grasses examined.

Fig. 1. [Comparison between *Ephelis*-infected \(E+\) and *Ephelis*-free \(E-\) *Digitaria decumbens* leaves in relation to eating preference of the 6th instar larvae of *Mythimna \(Pseudaletia\) separata* and the adults of *Aiolopus thalassinus tamulus*. The numbers indicate the number of individuals.](#)

Table 1. Comparison between *Ephelis*-infected (E+) and *Ephelis*-free (E-) *Digitaria decumbens* leaves in relation to survival (days) of the adults of *Aiolopus thalassinus tamulus*

(Date of start)	1st trial	2nd trial	3rd trial
	Sep. 10	Oct. 6	Nov. 30
Survival E+	13.0±4.0**	7.5±3.5**	8.5±2.8*
(days) E-	21.0±7.0**	15.8±8.1**	12.7±5.0*

** : Significantly different based on Mann-Whitney test. $P < 0.01$

* : Significantly different based on Mann-Whitney test. $P < 0.05$

A number of alkaloids with insect deterrence or toxicity are present in grasses infected with fungi belonging to the tribe Balansiae. These have been extensively studied in grasses infected with *Neotyphodium* species, in particular those which form seed-borne endophytic associations with perennial ryegrass, *Lolium perenne* L. and tall fescue, *Festuca arundinacea* Scrb. The main alkaloids known to confer resistance are peramine, lolines and ergovaline. Peramine is a feeding deterrent that affects oviposition. Lolines are toxins that occur at high concentrations, up to 10,000 ppm. Ergovaline, found throughout the Balansiae, is mainly considered to be a mammalian toxin but is known to enhance protection against insect pests. The presence of ergovaline and other alkaloids in *Ephelis*-infected grasses in Japan, and the spectrum of alkaloids in different host species, remain to be determined.

[NEXT](#)
[CONTENTS](#)

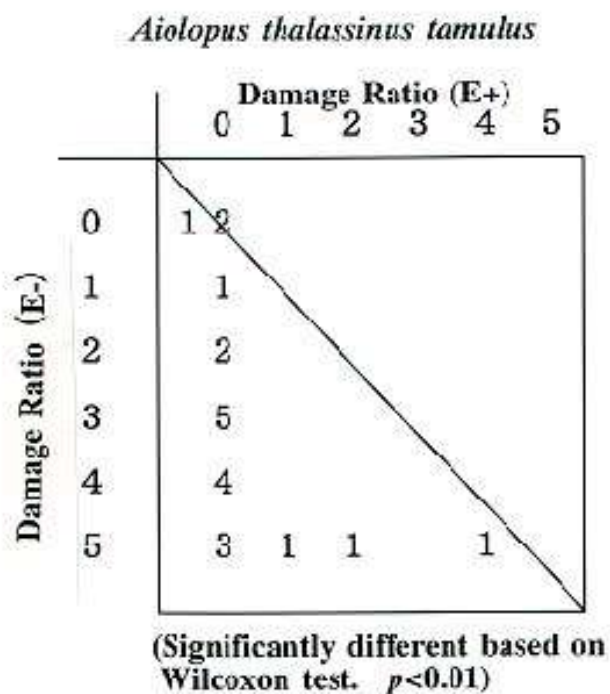
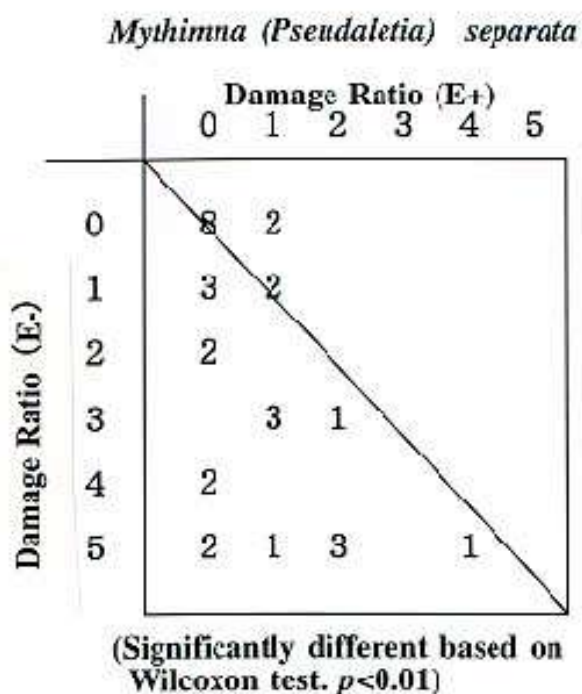


Fig. 1. Comparison between *Ephelis*-infected (E+) and *Ephelis*-free (E-) *Digitaria decumbens* leaves in relation to eating preference of the 6th instar larvae of *Mythimna (Pseudaletia) separata* and the adults of *Aiolopus thalassinus tamulus*. The numbers indicate the number of individuals.
 Damage ratio of grass leaves; 0 : 0%, 1 : 1-20%, 2 : 21-40%, 3 : 41-60%, 4 : 61-80%, 5 : 81-100%

BACK

Ascaris suum Infection in the Mekong Delta, Vietnam and Application of Anthelmintics

Shinobu Yoshihara
National Institute of Animal Health

It is well known that helminthic diseases are associated with the low productivity of pigs and cause economic losses in small-scale farms in the Mekong Delta. Therefore, an attempt was made to estimate the economic losses due to *A. suum* infection.

Six littermate pigs weighing approximately 40 kg from the Experimental Animal Farm of Can Tho University were used. *A. suum* eggs were detected. Group 1 consisted of 3 pigs treated with 1 mL per 15 kg of polystrongyle (injectable form of tetramizole hydrochloride, France). Group 2 consisted of 3 untreated control pigs. Their body weight was checked biweekly for 12 weeks. In 3 pigs of the treated group, adults of *A. suum* were eliminated within a few days after treatment. However, since *A. suum* eggs were found again 6 weeks later, the treatment was resumed. The growth period of the treated pigs which reached a weight of 80 kg was shortened at least by 2 weeks compared with the untreated pigs (Table 1). Fig. 1 shows an emaciated pig in the untreated group. Based on data collected in Vietnam, it was estimated that the economic loss due to the infection amounted to about 25,000 Don Vietnam (about US\$ 2.0) per head in an experimental farm. Low nutrition level including deficiency in protein and vitamin A may exert more deleterious effects on the growth of infected pigs. Therefore, it is considered that the growth rate of untreated pigs in small-scale farms may be even lower.

As a result, it may be necessary that the farmers use anthelmintics to increase productivity.

Table 1. Body weight of treated and untreated pigs

		(Unit: kg)						
Group	Pig No.	Weeks after treatment						
		0	2	4	6	8	10	12
Treatment	1	37	44	51	60	79	81	89
	2	40	45	52	60	70	82	89
	3	39	44	51	58	68	80	90
Control	4	41	46	52	59	66	74	82
	5	39	44	50	57	64	72	81
	6	42	46	51	58	66	69	72



Fig. 1. Treated (back) and untreated (front) pigs in experimental farm. Untreated pig was emaciated.

NEXT

CONTENTS

Remarkable Antimutagenic Effect of a Thai Ginger, Fingerroot

Gassinee Trakoontivakorn^{*}, *Kazuhiko Nakahara*^{*2}, *Makiko Takenaka*^{*3}, *Mayumi Kameyama*^{*3},
Hiroshi Shinmoto^{*4}, *Tadahiro Nagata*^{*5} and *Tojiro Tsushida*^{*3}

**Institute of Food Research and Product Development Kasetsart University, Thailand, *2Crop Production and Postharvest Technology Division, JIRCAS, *3National Food Research Institute, *4Tohoku National Agricultural Experimental Station and *5National Institute of Animal Industry*

It has been suggested that antimutagenic phytochemicals, such as polyphenols, in some fruits or vegetables may play a role in the prevention of cancer based on epidemiological investigations as well as animal model experiments. Several edible plants, such as common ginger (*Zingiber officinale*) and turmeric (*Curcuma longa*), in the family of Zingiberaceae are reported to contain some phenolic compounds that exhibit strong antimutagenic effects. In Thailand, several members of the Zingiberaceae family besides common ginger and turmeric are available in food markets. One of them, fingerroot (*Boesenbergia pandurata* Schl. syn. *Kaempferia pandurata* Roxb.), known as "krachai" in Thailand, has a characteristic appearance with several slender, long tubers sprouting in the same direction from the central part of the rhizome (**Fig. 1**). Fingerroot is generally utilized as a folk medicine in Southeast Asia. Interestingly, fingerroot is used as an ingredient in some dishes in Thailand. Since it had been already reported that fingerroot contains a large amount of some polyphenols as major constituents, it was expected that the plant would display an antimutagenic effect. In the current studies, we examined the antimutagenic properties of fingerroot and determined the chemical structure of active constituents under the JIRCAS Visiting Research Fellowship Program at Tsukuba.

One kilogram of fresh fingerroot rhizomes, purchased in a local market in Bangkok, were homogenized and extracted in 80% methanol. Then, the filtrate was collected, concentrated under reduced pressure and used for an antimutagenic assay (Ames Test). In this study, the antimutagenic effect was manifested by the suppressive activity of the extract toward the mutagenicity of 3-amino-1,4-dimethyl-5H-pyrido[4,3-b]indole (Trp-P-1) with *Salmonella typhimurium* TA98 in the presence of S-9 enzyme, that activates Trp-P-1, prepared from rat liver. The fingerroot extract showed a highly potent antimutagenic activity (**Fig. 2**). Only 0.15 mg of the fingerroot extract almost completely suppressed the mutagenesis, while a Thai spice galanga (*Languas galanga* syn. *Alpinia galanga*) showed about 80% of suppression at the same dose. The antimutagenic effect of both fingerroot and galanga was much more pronounced than that of lemon grass, another common spice in Thailand. It was reported that 10 mg of lemon grass extract suppressed 84% of mutagenesis.

Subsequently, active compounds in the extract were isolated to analyze the antimutagenic properties and chemical structure. Six antimutagenic compounds FR1, FR2, FR3, FR4, FR5 and FR6 were obtained. And, all six isolated compounds exhibited a potent antimutagenic activity in a suppressive range of 90% to 95% at a concentration of 25 μ g/plate. Effective dose of these compounds that can suppress 50% of mutation (ED_{50}) was estimated at 1.1, 0.9, 0.5, 1.0 μ g, for FR1, FR2, FR3 and FR4, respectively. Preparations of FR5 and FR6 could not be used for the experiments and structural determination due to the very small amount obtained. The chemical structure of FR1, FR2, FR3 and FR4 was determined by liquid chromatography mass spectrometry, UV-absorption spectrometry and nuclear magnetic resonance spectrometry. FR1 and FR3 were identified as two chalcone derivatives, 2', 4', 6'-trihydroxy chalcone and cardamonin. FR2 and FR4 were identified as two flavanone derivatives, pinocembrin and pinostrobin, respectively. All of these four identified compounds are not new ones. However, the antimutagenic activity of these compounds had not been reported except for pinocembrin. Edenharder reported that pinocembrin acted as an effective antimutagen against another mutagen, 2-amino-3-methylimidazo[4,5-f]-quinoline (IQ). This was not surprising because Trp-P-1 and IQ are metabolized by almost the same molecular species of cytochrome P450 in S-9.

When rhizomes of fingerroot are utilized as ingredient in Thai dishes, heating is involved in the preparation process. It was reported that antimutagens found in vegetables could be either heat-stable or heat-sensitive. Therefore, heat stability of antimutagens (FR1, FR2, FR3 and FR4) in fingerroot was determined by heating at 105° C for 15 min. No deterioration of the antimutagenic activity of any of the compounds was observed, which is an important information for food ingredients. The results suggested that fingerroot may play an important role in cancer chemoprevention, and, may have a potential as an effective functional food.



Fig. 1. Fingerroot (Chinese key).

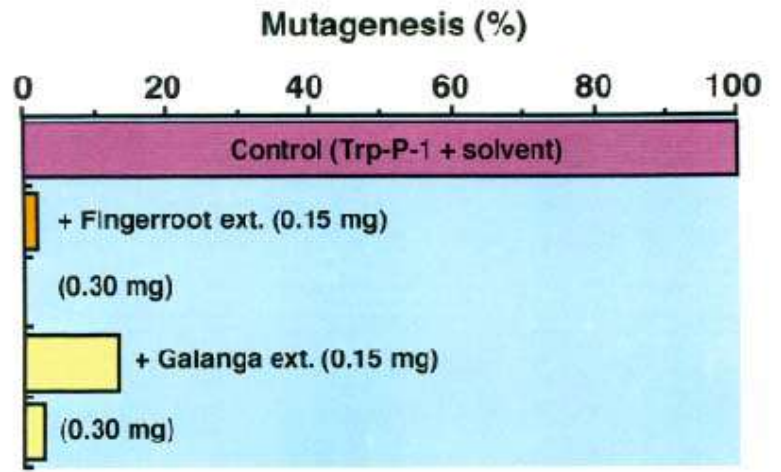


Fig. 2. The antimutagenic effect of fingerroot and galanga.

[NEXT](#)

[CONTENTS](#)

<SYMPOSIUM>

The 6th JIRCAS International Symposium: "GIS Applications for Agro-Environmental Issues in Developing Regions" Was Held in Tsukuba

The 6th JIRCAS International Symposium on "GIS Applications for Agro-Environmental Issues in Developing Regions" organized by Japan International Research Center for Agricultural Sciences (JIRCAS) in cooperation with International Center for Tropical Agriculture (CIAT), National Institute of Agro-Environmental Sciences (NIAES), Forestry and Forest Products Research Institute (FFPRI) and National Research Institute of Fisheries Science (NRIFS), was held in Tsukuba, Japan during the period of September 7 – 9, 1999.

GIS technology which involves complex computer-based processing of georeferenced and attribute data obtained from various sources, including remote sensing, provides integrated and updated spatial and temporal information for the inventory and monitoring of environmental resources which are closely related to agriculture, forestry and fisheries activities. JIRCAS is actively implementing GIS-related research in collaboration with various countries in different geographic environments. This symposium offered a unique opportunity to review the studies carried out in this field by JIRCAS and other institutes, evaluate the current status of research and plan for the future.

A total of 155 scientists and administrators including 26 participants from abroad representing 13 countries gathered and exchanged views on the main issues, major constraints of GIS applications in developing regions, as well as the future orientation of the GIS applications in the regions. At the beginning of the symposium, Mr. Sakue Matsumoto, Chairman, Agriculture, Forestry and Fisheries Research Council, Ministry of Agriculture, Forestry and Fisheries gave the welcome address, following the opening address delivered by Dr. Nobuyoshi Maeno, Director General of JIRCAS.

The symposium consisted of two keynote speeches and three sessions as follows. As keynote speakers, Andrew K. Skidmore, ITC, Netherlands and Tsuyoshi Akiyama, Gifu University, Japan, gave lectures on the application of GIS and remote sensing technology for agro-environmental issues in developing regions.

Session 1 reviewed the current status of the development of global data sets and models for agro-environmental sciences. Session 2 dealt with the applications of GIS for agro-environmental issues in various developing regions. During the session, eight presentations covering different geographic environments (Nepal, Indonesia, P. R. China, Mongolia, Colombia, Thailand and Japan) were given. In Session 3, the current status of education and training in the field of GIS was considered. Following the general discussion, Dr. Grant Scobie, Director General of CIAT, delivered the closing address.

The proceedings of the symposium will be published by JIRCAS in early 2000.



Participants in the symposium

(Makie Kokubun)

NEXT

CONTENTS

<WORKSHOP>

The ICRISAT/JIRCAS International Workshop on "Food Security in Nutrient-Stressed Environments: Exploiting Plant Genetic Capabilities"

The ICRISAT/JIRCAS international workshop on "Food Security in Nutrient-Stressed Environments: Exploiting Plant Genetic Capabilities" organized by the International Crops Research Institute for the Semi-Arid Tropics (ICRISAT) and Japan International Research Center for Agricultural Sciences (JIRCAS), was held at ICRISAT-Patancheru, India during the period of September 27-30, 1999.

This workshop marked the culmination of the activities of the Government of Japan Special Project Phase III (1994-1999) on "Sustainable Cultivation of Upland Crops in the Semi-Arid Tropics." The Project funded by the Economic Affairs Bureau, Ministry of Agriculture, Forestry and Fisheries of Japan had been implemented for 15 years since its initiation in 1984 at ICRISAT. During the 15-year period, scientists conducted research aimed at improving crop nutrient and water uptake and utilization efficiency through field management practices and/or by exploiting morphological, physiological and genetic systems to improve the adaptation of ICRISAT mandate crops to the low-nutrient and low-moisture environments of the semi-arid tropics. During the Project, research fellows, visiting scientists and scholars were trained and the technical skill of the supporting staff was eventually upgraded. In conclusion, the Project helped to increase the productivity of upland crops in the semi-arid tropics through research, and enhanced the knowledge base of the mechanisms of phosphorus and nitrogen acquisition by crops. The Project also helped to strengthen interdisciplinary efforts among scientists from Japan and their counterparts at ICRISAT.

From 23 international and national institutes, and universities of 16 countries, more than 50 scientists including 10 scientists from Japan participated in the workshop. Dr. L. D. Swindale, Interim Director General of ICRISAT, who helped initiate the Project in 1984, delivered the welcome address and Dr. T. Hamazaki gave closing remarks. After the Government of Japan Special Project activities were reviewed by the Project leader Dr. J. J. Adu-Gyamfi *et al.*, 31 papers were presented during 4 sessions. Session 1 dealt with the theme "Breeding for low-nutrient environments: is it sustainable?" covering crop physiology, breeding and socio-economic aspects. During Session 2, genotypic variability and mechanisms of nutrient uptake and use efficiency of crop plants in low-nutrient environments were outlined. The research achievements of the Project were presented in this session. During Session 3, the methodology for genetic manipulation of nutrient availability in low-nutrient environments was reviewed while the theme "Combining genetic improvement with natural resources management in low-nutrient environments" was considered during Session 4.

The workshop was successful due to the effort of the organizing committee of ICRISAT to ensure a high standard of paper presentation and discussions. I would like to thank the ICRISAT staff and all the participants in the workshop for their contributions.

The proceedings of the workshop will be published by ICRISAT/JIRCAS within this fiscal year.



Participants in the workshop and the Project staff at ICRISAT

(Tadao Hamazaki)

Workshop and Mid-Term Evaluation Meeting on Northeast Thailand Project

The Workshop and Mid-Term Evaluation Meeting on the Northeast Thailand Project titled: "Comprehensive Studies on Sustainable Agricultural Systems in Northeast Thailand" were held at the International Training Center for Agricultural Development (ITCAD), Department of Agriculture (DOA) in Khon Kaen on September 23 and 24, 1999.

This collaborative project is focused on the area of rainfed paddy fields in Northeast Thailand and aims at the development of technology for

the promotion of sustainable agricultural systems that combine farming with animal husbandry. The project was launched in April 1995 and it will last until the end of March 2002.

The workshop was held on the first day. There were 67 participants including 13 persons from Japan. Thai participants were mainly from Bangkok and from Khon Kaen Province. There were 9 research organizations from Thailand and 5 from Japan. The researchers who had been engaged in the project described the research activities and research highlights. Major topics were as follows: 1. Evaluation and effective utilization of environmental and biological resources in the region. 2. Development of sustainable crop production systems. 3. Improvement of livestock feeding management with locally available feed resources. 4. Development of postharvest technologies for local agricultural products. 5. Economic evaluation of multiple cropping and livestock farming.

On the second day, a field trip and the mid-term evaluation meeting took place at the Khao Suan Kwang Demonstration Farm in the morning and at ITCAD in the afternoon, respectively. About 30 participants joined the morning session in the field and they listened to the outline of the field trials conducted by the researchers. Participants showed a keen interest in the field trials and also in the small-sized agricultural machines and attachments such as soil manipulator, binder, drill seeder and subsoiler, etc. which were displayed at the farm.

The mid-term evaluation meeting was held after the field visit with committee members engaged in various research fields. The outline of the overall project and five research themes was given by concerned scientists prior to the discussion. It was generally agreed by the committee members that satisfactory progress had been made so far, and that for further development of the project, much closer linkage among the project scientists and more active input from socio-economic aspects would be required.

(Masaaki Suzuki)



PEOPLE



Dr. Terunobu SUZUKI, a forestry scientist, became Director of JIRCAS's Forestry Division on October 1, succeeding Dr. Kiyoshi Tanaka who was appointed Director of the Research Coordination Division, Forestry and Forest Products Research Institute. Dr. Suzuki worked as a Senior Research Scientist in the Research Coordination Division, Forestry and Forest Products Research Institute (1997 - 1999) after carrying out studies at the National Amazon Research Institute in Brazil as a team-leader of the Brazilian Amazon Forest Research Project of JICA.



Dr. Osamu ITO who spent three years at the International Rice Research Institute as Director of the Agronomy, Plant Physiology and Agroecology Division returned to JIRCAS on October 1, 1999. He joined the Research Information Division and will be mainly in charge of coordinating the research collaboration between JIRCAS and several research organizations in Thailand, which has been actively promoted for many years.

<AWARD>

Dr. Noguchi Received the 1999 Friendship Award of P. R. China

Dr. A. Noguchi, Director of Crop Production and Postharvest Technology Division, received the 1999 Friendship Award from the State Administration of Foreign Experts Affairs, P. R. China, on account of his major contribution to the implementation of the JIRCAS-China Project titled: "Development of Sustainable Production and Utilization of Major Food Resources in China."

[Contents](#)

[JIRCAS Home Page](#)

JIRCAS Newsletter 1998 (No.14)



Fruit market in Vietnam (Photo : by KOSUGI Sho)

CONTENTS

< Research Project >

[" Farming Systems in Mekong Delta " -Workshop at JIRCAS-](#)

<JIRCAS Research Highlights>

- [Edible insects in East Africa \(collaborative Research with ICIPE:\)](#)
- [Traits for Drought Tolerance in Cowpeas \(collaborative Research with IITA:\)](#)
- [Rice varieties tolerant to acid soils \(collaborative Research with CIAT:\)](#)

<China-Japan Joint Workshop on Insect Pests >

[" Migration and Management of Insect Pests of Rice in Monsoon Asia"](#)

[<3rd Seminar on " Brackish Water Project " Held in Malaysia>](#)

<The 5th JIRCAS International Symposium >

[" Postharvest Technology in Asia - A Step Forward to Stable Supply of Food Products-"](#)

[<People>](#)

Research Project "Farming Systems in Mekong Delta"

- a Workshop at JIRCAS -

Shigeo Matsui

Under the research project on "Evaluation and Improvement of Farming Systems Combining Agriculture, Animal Husbandry, and Fisheries in the Mekong Delta" a workshop was held on December 8-9, 1997 in JIRCAS International Conference Room to review the project and to develop a closer cooperation with Vietnam organizations. Six researchers from Vietnam headed by Dr. Vo-Tong Xuan, Director, Farming Systems R&D Institute, Cantho University were invited. The meeting started with opening remarks by Dr. Maeno, Director General, JIRCAS and the keynote address of Dr. Vo-Tong Xuan titled "History and future farming systems in the Mekong Delta". Then 4 sessions followed:

In session 1, the farming systems were described with 3 case study reports presented by Mr. Nguyen Xuan Lai, Dr. D. N. Thanh and Mr. Duong Van Ni. Rapid increase in rice production and constraints were outlined. Mr. Ni, Farming Systems R&D Institute reported that in the case of Hoa An village, the introduction of *Melaleuca* trees into farming systems had enabled to plant two crops of rice a year in an area with strongly acidic soils. In session 2 which dealt with technology development, Mr. T. Kon, Tohoku National Agricultural Experiment Station, Dr. S. Yoshihara, National Institute of Animal Health and Dr. M. Wilder from JIRCAS reported on current achievements and constraints in rice production, swine husbandry, and aquaculture, respectively. In session 3, reports by Dr. Yamazaki, Rakuno Gakuen University and Mr. Kosugi, JIRCAS stressed the need for organizing farmers into farmers' cooperatives because credit and/or collective commodity marketing are indispensable for the future development of farming systems. In session 4, Mr. Le Thanh Duong, Farming Systems R&D Institute discussed the problems on the promotion of sustainable agriculture. Mr. N. Vromant, VVOB, Belgium working at the same institute, reported about rice-fish farming systems with emphasis placed on proper water management. Mr. R. Yamada, JIRCAS outlined his plan of research on farm management.

Although rice production has markedly increased in the Mekong Delta, farmers' incomes and living standards have remained low. The workshop concluded that the development of sustainable farming systems which combine rice cultivation, animal husbandry and aquaculture is definitely important. It was also stressed that the creation of viable credit and marketing channels as well as the promotion of technology transfer, etc. is the key to further development of agriculture in the Mekong Delta.

Among the participants, Dr. Matsuno, Tokyo University of Agriculture, Dr. Cho, Kyushu University, Dr. Furukawa, Kyoto University and Dr. Oe, Tokyo University of Agriculture and Technology, old friends of Dr. Vo-Tong Xuan enjoyed their reunion.

Prior to the Workshop, Dr. Maeno, Director General of JIRCAS had attended the ceremony marking the 20th anniversary of CLRRI held at O Mon, Cantho, Vietnam on December 2. He expressed his deep gratitude for the cooperation in the project.

[Photo : Discussion at the Workshop in Tsukuba \(center\) and Farming Systems in Mekong Delta.](#)

Photo: Discussions at the Workshop in Tsukuba (center) and Farming Systems in Mekong Delta.



JIRCAS RESERACH HIGHLIGHTS

Collaborative Research with ICIPE:

Edible Insects in East Africa

Shigemi Yagi

More than 500 insect species are used for human consumption in the tropical and subtropical regions of the world. In Africa, many species of insects have been used as traditional foods among indigenous people and have played an important role in the history of human nutrition. Many insects usually considered as crop pests such as locusts, grasshoppers, weevils and some termite species have been used as important food sources. Interviews with 9 main Kenyan ethnic groups and field surveys in western Kenya revealed that at least 8 insect families representing 6 orders are eaten. The major orders of edible insects include *Isoptera* (termites), *Orthoptera* (locusts, grasshoppers, crickets), *Coleoptera* (beetles), *Hymenoptera* (honey bees), *Lepidoptera* (moths) and *Diptera* (lakeflies). The most common edible insects are the termites which are highly appreciated by practically every ethnic group in Kenya. The sexual winged forms (reproductive forms) of termites are frequently caught for food.

Our research in the Maragoli area in western Kenya has shown that villagers can easily distinguish species and the emergence patterns of termites. They apply various methods for catching termites. In one method, they build a tent-like structure consisting of branches and leaves to cover some of the emergence holes (*Photo 1*). By closing the other holes, the termites have to emerge from the holes in the tent structure which has an opening on one side to which the flying termites are attracted by sunlight, artificial light or moonlight. Near this opening, a receptacle is placed to collect the termites. In another method they introduce a light source inside a bucket lined with wet slippery banana leaves, and then the bucket is placed near an active mound. Attracted by the light, termites drop in the bucket. In the dry season, termites can be induced to come out when stimulated by fumes of smoke from burnt dried leaves of specific wild plants or the slow rhythmic vibrations created by striking stones or by beating a large piece of wood with two sticks. A similar drumming technique for collecting termites has been reported in Uganda.

[Photo1 : A termite trap along the road in Maragoli area in western Kenya.](#)

Termites are prepared in various ways for eating. In Enzaro village, Maragoli, it is popular to lightly fry the termites in their own fat over a low heat, add a little salt and sometimes remove the wings. Fried winged termites are tasty after being dried in the sun and they can be consumed for a rather long period of time. In some areas, termites are used as gifts for marriage. Raw termites are also frequently eaten. In some areas of western Kenya, sun-dried termites are packed in various containers and sold during the rainy season in the local food markets. They are sometimes transported over long distances to urban markets of East African large cities such as Kisumu, Kampala or even Nairobi (*Photo 2*).

[Photo2 : Termites sold in an open market in Kampala, Uganda.](#)

Our field surveys, suggest that termites play an important role in daily food consumption in the Maragoli

area in the rainy season, when there is a shortage of maize supply. We concluded that the termites are especially valuable for children and pregnant women which require a high calory diet and nutritious food. Research should be further promoted to create an awareness about the importance of insects as a good and cheap source of lipids and animal protein.





Collaborative Research with IITA:

Traits for Drought Tolerance in Cowpeas

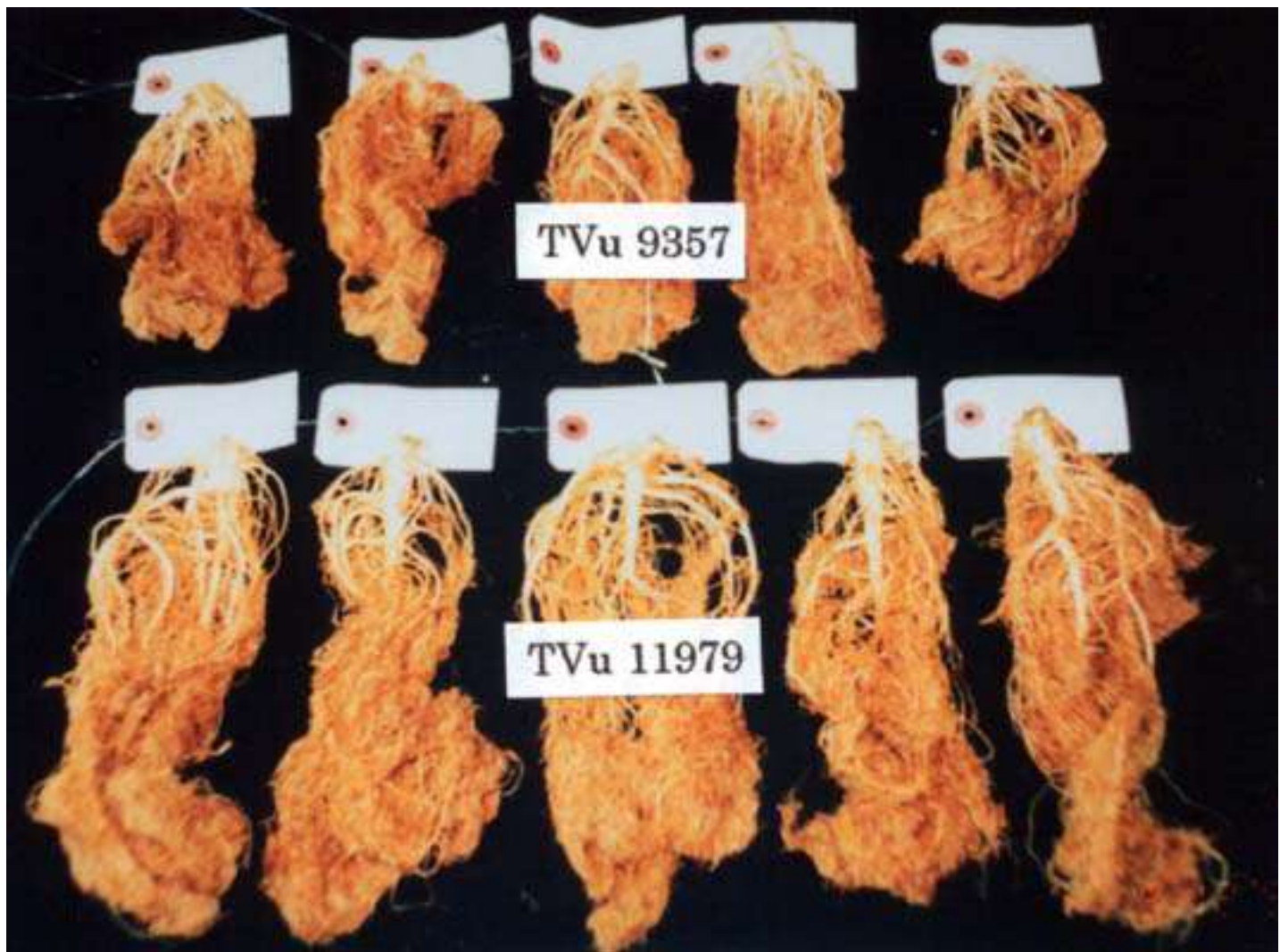
Iwao Watanabe

Three cowpea accessions (TVu 11979, 11986, 12348), which were identified as highly drought-tolerant, yielded about one ton of grain per ha in the dry season at Kano in Sudan Savanna. This trial encouraged farmers to cultivate drought-tolerant cowpea varieties to alleviate food shortage in the dry season and their acreage under cultivation has been increasing in drought-prone areas of Sudan Savanna. However, some of the agronomic traits of these accessions should be further improved. In the breeding programs for tolerance to drought, information on causative traits for the tolerance is important for the selection of progenies after crossing. Therefore, physiological studies were conducted to compare tolerant and susceptible lines.

1. Distribution percentage of dry matter to roots was higher in the tolerant lines. Root weight of these lines increased steadily even at maturity in contrast with the considerable decline in the susceptible ones after flowering. This deep-rooting trait enables plants to collect residual soil moisture receding downwards day by day and to grow vigorously in the dry season. This trait adversely affects the production of grains under well-watered conditions, due to the lower distribution percentage of dry matter to pods. These tolerant lines, therefore, should be recommended as specific cultivars for drought-prone areas or for the introduction of a new cropping system in the dry season.
2. Transpiration rate of tolerant lines under lethal water stress was lower than that of susceptible ones. This trait for economical use of water allows tolerant lines to survive for a longer period of time under lethal water stress.
3. No difference was observed among cowpea lines in the water use efficiency, measured by the increase in the dry matter per unit amount of water lost through transpiration. Photosynthesis/transpiration ratio was also almost the same among the cowpea lines tested. These results suggest that the vigorous growth of tolerant lines in the dry season described earlier must have been due to the active absorption of water and not to the efficient use of water.
4. There are two types of drought in Sudan Savanna. One is the initial drought at the seedling stage. At this stage, roots are short yet and no available moisture remains in the root zone except for the moisture supplied by current precipitation. In this type of drought, therefore, seedlings are faced with lethal water stress. The only strategy for survival until the next rain is the economical use of water. The other type is the terminal drought at the ripening stage due to delayed planting caused by late arrival of the rainy season. At the ripening stage, a fairly large amount of available water remains in deep soil layers. In this type of drought, therefore, the strategy for completing the life cycle and getting seeds for the next generation is the continued absorption of water associated with the deep-rooting traits. In the long history of adaptation of cowpeas to drought-prone areas, they must have acquired the two traits simultaneously, that is the trait for economical use of water under lethal water stress and that for deep-rooting.

Photo : Roots of potted cowpeas at 67 days after sowing . Root weight of highly tolerant line, Tvu 11979, exceed that of highly susceptible line, Tvu 9357, by fifty percent.

Fig. 1 Time course of dry matter distribution among plant organs.



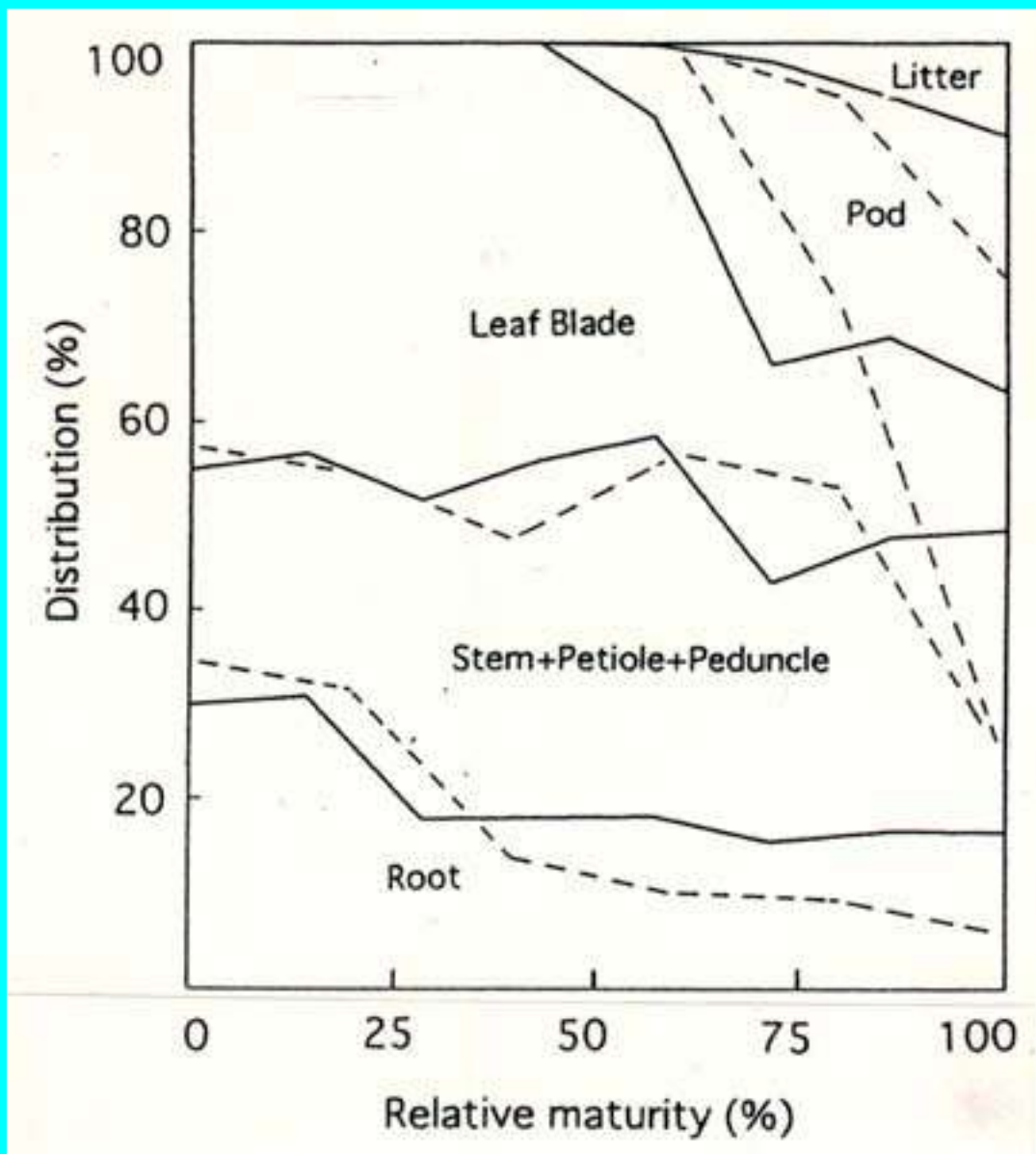


Fig.1. Time course of dry matter distribution among plant organs

Relative maturity

0: 25 days after sowing 100: last sampling

—— Highly tolerant line, TV_U 11979

----- Highly susceptible line, TV_U 9357

Collaborative Research with CIAT:

Mechanism of Adaptation of Upland Rice Genotypes to Highly Weathered Acid Soils of Savannas in South America

*Kensuke Okada and Albert J. Fischer**

Tropical humid savannas which extend over 240 million hectares in South America are covered with highly weathered acid soils (Oxisols and Ultisols). A crop-pasture rotation has been introduced to these under-exploited ecosystems as a sustainable cropping system, in which upland rice is an important component due to its relative tolerance to acidity and infertility of soils. Since upland rice displays a wide range of genotypic differences in tolerance to soil acidity, the lack of suitable screening techniques had hampered rapid development of breeding. Aluminum has been considered to be the major limiting factor for plant growth in acid soils in general, but in the case of savanna soils, deficiency of other nutrients complicates the situation. Therefore, JIRCAS-CIAT collaborative project initiated since 1992, attempted first to identify the major limiting factors for the growth of upland rice on acid savanna soils, then to analyse the mechanism controlling the genotypic differences in the tolerance, in order to contribute to the promotion of efficient methods of breeding of upland rice for tropical savannas.

Field experiments on the response to liming were conducted using both tolerant and susceptible genotypes over a period of 4 years at two sites in the Eastern Plains of Colombia (Llanos Orientales). The acidity of the top soil was found to increase during crop growth due to the accumulation of KCl and urea which were applied sequentially according to farmers' practice. The yield of the tolerant varieties did not respond to lime application, while that of the susceptible ones declined at a very low rate of liming ($< 300 \text{ kg ha}^{-1}$), at which the relative yield (the ratio of yield at low lime rate to the yield at high lime rate (3 t ha^{-1})) of the susceptible varieties correlated significantly ($p < 0.05$) only with the amount of exchangeable Ca of soil (Fig. 1-C).

Other indicators of soil acidity such as soil pH and amount of exchangeable Al did not show any significant correlation with yield decline in the susceptible varieties, and further, the tendency was opposite in terms of indication of soil acidity (Fig. 1-A, B). Al saturation which is the indicator most widely used for soil acidity, was not correlated significantly, either (Fig. 1-D). These results suggested that the amount of exchangeable Ca should be used as indicator of soil acidity for upland rice, rather than Al-related parameters. This finding has a practical implication for the selection of stressful sites for on-site field screening.

Then pot experiments for lime response were conducted using top and subsoils of savanna. In addition to other soil chemical characteristics, aluminum concentration in the soil solution was measured. First, it was found that soil acidity increased gradually as in the case of field experiments, and that where the growth was more suppressed, the soil acidity was more pronounced because the salts were not absorbed

by plant roots but accumulated. Therefore, although the growth of plants was apparently negatively correlated with the concentration of Al in the soil solution, it was found that the high aluminum concentration was not the cause but rather the result of the growth retardation. Also, no varietal differences were detected in the response to Al concentration in the soil solution. Second, total Ca supply (exchangeable Ca of original soil plus applied Ca as lime) determined the total growth even when the results of both top and subsoils were combined. The adaptation of the tolerant variety to low Ca conditions was attributed to the low requirement of Ca when Ca in soil started to be deficient.

Since it was concluded that Ca absorption rather than direct Al toxicity is the key factor which differentiates the degree of tolerance, the relative affinity of Ca and Al to the root cell wall (at the level of which these two elements compete) was investigated by measuring the ion exchange and chelating characteristics of the root tip surface. It was found that the lower interference of Al in the Ca retention by the root cell wall was the main reason for the high efficiency of uptake and utilization of Ca for tolerant varieties.

These results indicate that the better growth of the tolerant varieties at the low lime rate was due to their tolerance to a low Ca supply rather than to tolerance to high Al in acid soils, which has a direct implication in determining the target of both field and laboratory screening tests. It was suggested that the ion exchange and chelating characteristics of the root cell wall should be used as criteria for acid soil tolerance.

*Formerly: CIAT Rice Program, presently: University of California, Davis, USA.

Fig. 1. Response of susceptible varieties of upland rice to indices of soil acidity in the topsoil of savanna (0-20 cm).

Photo : Root sampling in upland rice experimental field in Llanos, Colombia.

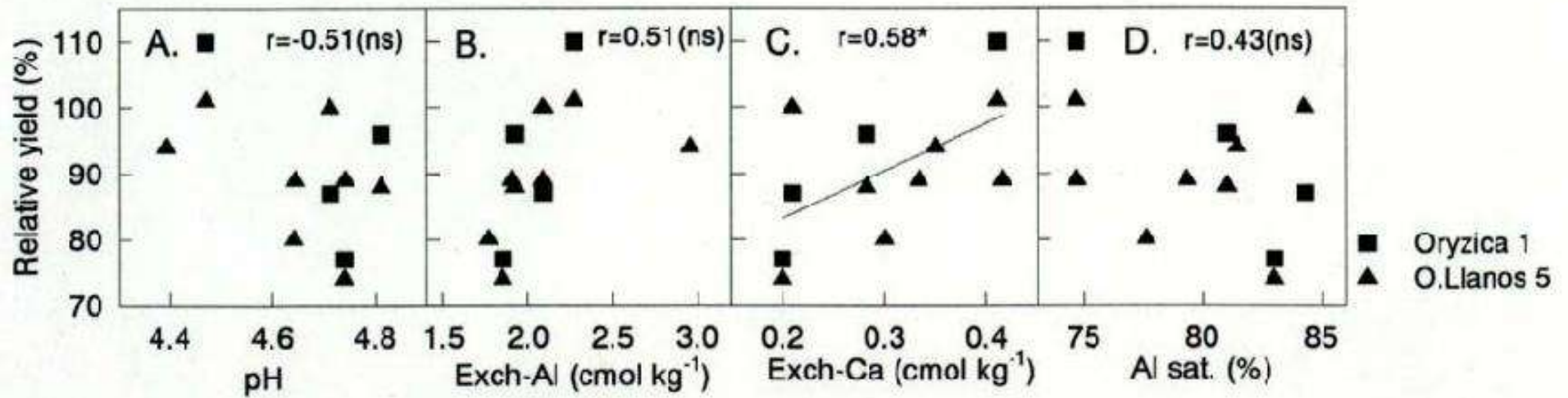


Fig. 1 The response of susceptible varieties of upland rice to soil pH (A), exchangeable Al (B), exchangeable Ca (C) and Al saturation (D) in the top soil of savanna (0-20 cm).

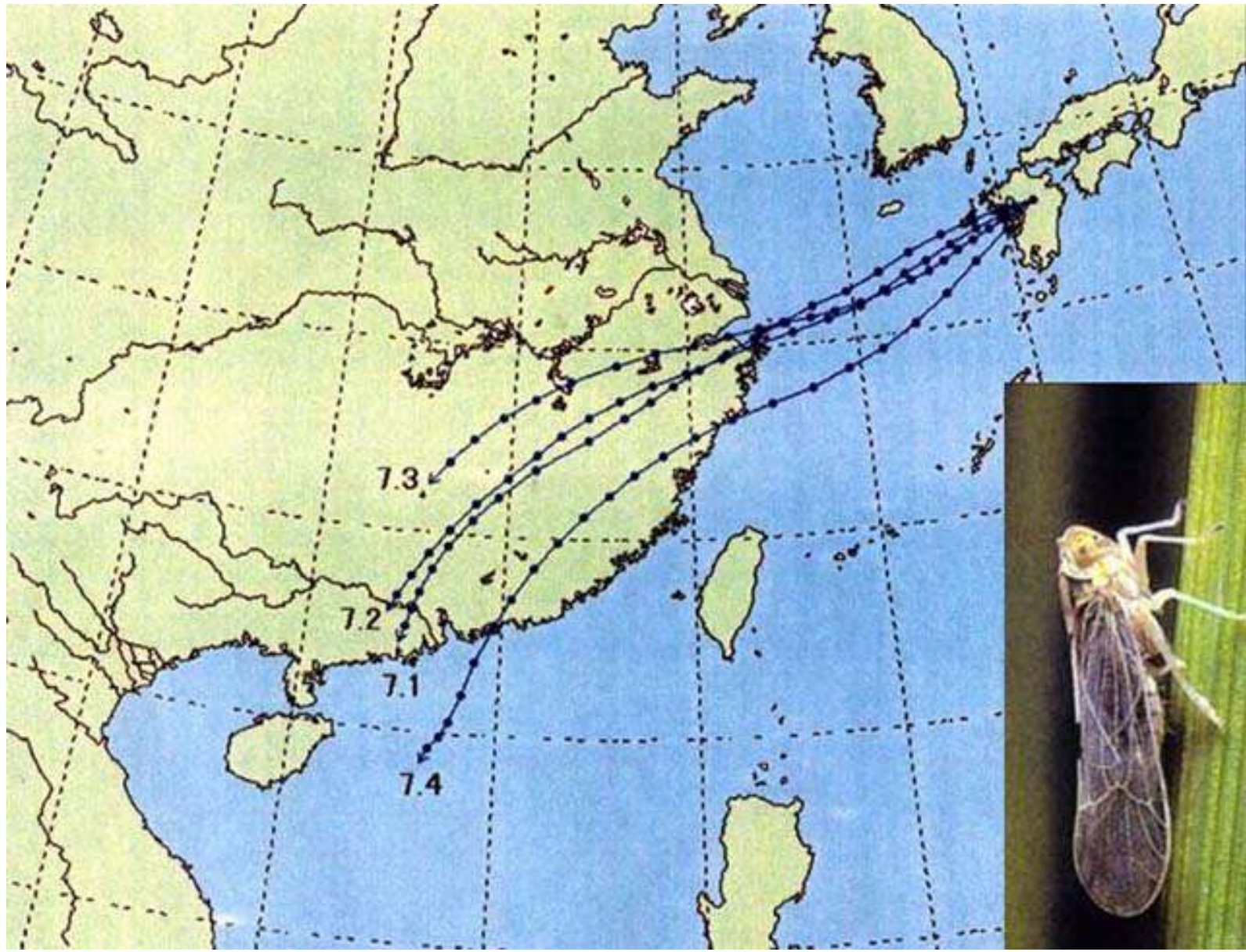


China-Japan Joint Workshop Held on "Migration and Management of Insect Pests of Rice in Monsoon Asia"

The rice planthoppers are international insect pests of rice, which undertake long-range migrations from tropical to temperate rice areas in Asia. The collaborative research project on "Long-range migration of rice insect pests in monsoonal East Asia" between JIRCAS and National Agro-Technical Extension and Service Center (NATESC), P. R. China was initiated at China National Rice Research Institute (CNRRI) in 1992. The project which enabled to clarify the dynamic process of the rice planthopper migrations from Indochina to Japan *via* South China, was successfully terminated in January, 1997. In the same year, JIRCAS and CNRRI agreed to continue the research collaboration on rice planthoppers, shifting the research focus from migration to management for the subsequent 5-year period.

Taking this opportunity, JIRCAS organized the China-Japan Joint Workshop on "Migration and Management of Insect Pests of Rice in Monsoon Asia" in collaboration with CNRRI and NATESC to review the collaborative research project and to promote the new JIRCAS-CNRRI project on "GEU-based IPM (Integrated Pest Management) for migratory insect pests of rice in China". The Workshop was held during the period 27-29, November, 1997 at CNRRI. Eighteen speakers were invited, including 7 overseas participants from Korea, Laos, Myanmar, Philippines, Taiwan and Vietnam. The Workshop started with introductory remarks on the management of insect pests of rice in China by NATESC, and reviews of planthopper migration studies in Japan and China by JIRCAS and CNRRI, respectively. The Workshop program was divided into the migration and IPM sessions. A study report on computer simulations of windborne migrations developed by JIRCAS, and 6 case studies on migrations to South and Central China, Taiwan, Ishigaki Island, and Korea were presented in the "Migration Session". The "IPM Session" consisted of 4 country reports on the ecology and management of rice planthoppers and other insect pests in Vietnam, Laos, and Myanmar, and 2 papers on theoretical approaches for sustainable pest management in rice ecosystems. In the "Closing Session", monsoon-linked long-range migrations of rice planthoppers, practical significance of insect resistance in rice in IPM, and new paradigms for rice pest management were highlighted and subjected to discussions. (*Kazushige Sogawa*)

[Fig.1 An example of trajectory analysis of windborne migrations by the rice planthoppers\(photo\) from China to Japan on the computer program developed by JIRCAS.](#)



3rd Seminar on *Brackish Water Project* Held in Malaysia

On December 8-9, 1997, the 3rd "Brackish Water Project" seminar was held in the Conference Room of the Institute of Postgraduate Studies and Research, University of Malaya in Kuala Lumpur, Malaysia. This seminar is held annually as a part of the comprehensive project on "Productivity and Sustainable Utilization of Tropical and Subtropical Brackish Water Mangrove Ecosystems." The project aims to evaluate the productivity of such areas and identify the criteria for sustainable utilization. The west coast of Peninsular Malaysia was selected as the study area due to the presence of various types of mangrove forests. Counterpart organizations include the Fisheries Research Institute (FRI), the University of Malaya (UM) and the Forest Research Institute of Malaysia (FRIM).

Subjects addressed in the seminar were as follows: 1) Water quality, 2) Forest and litter fall, 3) Food web, 4) Meio and macro-fauna, 5) Socio-economic aspects and policy, and 6) Fish and prawns. About 40 scientists from Japan, England, and Malaysia participated in the seminar, and fourteen papers were presented.

During the 3rd seminar, Professor T. K. Mukherjee, Dean, Institute of Postgraduate Studies and Research, University of Malaya gave a welcome address, Dato' Mohd. Mazlan b. Jusoh, Director General, Department of Fisheries gave an opening address, and Dr. Shiro Uno of JIRCAS made closing remarks.

During the two days' seminar, it was concluded that the research surveys conducted in 1996-1997 in the unexploited mangrove brackish water area had been completed and that in future the surveys should be concentrated in areas subjected to deforestation such as the Lumut mangrove area (Dinding river) in Perak State. (*Shigeo Hayase*)

[Photo : Discussions at the 3rd "Brackish Water Project" Seminar.](#)



The 5th JIRCAS International Symposium:

Postharvest Technology in Asia – A Step Forward to Stable Supply of Food Products –

The symposium on “Postharvest Technology in Asia” organized by JIRCAS will be held in Tsukuba, Japan during the period of September 9-11, 1998.

In Asia, agricultural research so far has been mainly centered on the improvement of crop production itself to achieve self-sufficiency in food in order to support the growing population of the respective countries. It is anticipated that, in the near future, the food supply problems will become more complex as patterns of food consumption have improved in the region along with the increase of income and social development.

Postharvest technology, which encompasses issues ranging from harvesting methods in farmers’ fields to food processing, should be more emphasized to prevent crop losses and for utilizing agricultural products efficiently to meet the changes in the food demand, especially the demand for processed foods. Food industries are closely related to crop production in the region but due to the lack of proper technology, sound progress of the food industry can not be fully achieved. In this Symposium, the development of the food industry in Asia will be reviewed and the basic technical problems involved for future progress will be outlined.

The Japan International Research Center for Agricultural Sciences (JIRCAS) is implementing collaborative projects in Asian countries and “postharvest technology” should receive more attention in future research collaboration. Development of “postharvest technology” could contribute to securing a stable supply of food products in addition to the increase of agricultural income and improvement of the diet in the developing regions of Asia.

The symposium program consists of a keynote speech and three sessions as follows:

Keynote Speech

Keiji Kainuma (BRAIN, Japan)

Session 1: Main Priorities and constraints in postharvest technology in Asia

Priorities and constraints of postharvest technology:

- | | |
|---------------------|--|
| <i>-Vietnam</i> | <i>Le Van To</i> (Post-harvest Technology Institute) |
| <i>-Philippines</i> | <i>Silvesta C. Andales</i> (BPRE) |
| <i>-Thailand</i> | <i>Jingtair Siriphanich</i> (Kasetsart Univ.) |
| <i>-China</i> | <i>Feng Shuangqing</i> (China Agric. Univ.) |
| <i>-India</i> | <i>Ananthaswamyrao Ramesh</i> (CFTRI) |

Session 2: Current development and future orientation of technology of grain storage and preservation in the tropics

In Asia, agricultural research so far has been mainly centered on the improvement of crop production itself to achieve self-su

- | | |
|--|--|
| <i>-Alternative chemicals for Methyl Bromide.</i> | <i>ruce R. Champ</i> (Australia) |
| <i>-Hermetic storages of grains in the tropics.</i> | <i>Filipinas Caliboso</i> (BPRE, Philippines) |
| <i>-Role of biological control of grain storage in the tropics</i> | <i>Hiroshi Nakakita</i> (NFRI, Japan) |
| <i>-Minimizing aflatoxin production in grains in the tropics.</i> | <i>Prisnar Siriacha</i> (Kasetsart Univ., Thailand) |
| <i>-Strategies to maintain grain quality in the humid tropics.</i> | <i>Mulyo Sidik</i> (Ministry of Food Affairs, Indonesia) |
| <i>-General comments</i> | <i>Greg Johnson</i> (ACIAR, Australia) |

Session 3: Current situation and future orientation of technology of food industries in Asia

Development and constraints in the food industries:

- | | |
|---------------------|--|
| <i>-Thailand</i> | <i>Saipin Maneepun</i> (Kasetsart Univ.) |
| <i>-Philippines</i> | <i>Josue S. Falla</i> (BPRE) |
| <i>-China</i> | <i>Deng Yong</i> (China Agric. Univ.) |
| <i>-Indonesia</i> | <i>Aman Wirakarta Kusumah</i> (Bogor Agric. Univ.) |
| <i>-Taiwan</i> | <i>Liu Tin-Yin</i> (FIRDI) |
| <i>-Korea</i> | <i>Cherl-Ho Lee</i> (Korea Univ.) |
| <i>-Japan</i> | <i>Hideki Uehara</i> (Nihon Univ.) |

For detailed information, please contact:

Dr. Yoshihiko Nawa
Research Information Division
Japan International Research Center for Agricultural Sciences (JIRCAS)
1-2 Ohwashi, Tsukuba, Ibaraki, 305-8686 JAPAN
FAX:+81-298-38-6342
E-mail: sympo@jircas.affrc.go.jp

(Hiroko Takagi)

PEOPLE

New Visiting Researchers in Okinawa

Nine visiting researchers will participate in JIRCAS Visiting Research Fellowship Program in Okinawa to carry out collaborative research focused on important topics related to tropical agriculture until September, 1998.

- Development of techniques for environmental control by using plants and microorganisms specific to the tropics and subtropics

El Khawas Hussein (Egypt) **Wang Bujun** (China)

- Studies on the mechanism of heat tolerance of tropical and subtropical and microorganisms specific to the tropical and subtropical crops

Liu Jian (China) **Yakubov Bakhtiyor** (Uzbekistan)

- Identification and evaluation of self-tolerant crops

Safdar Hussain Shah (Pakistan) **Li Chengyun** (China)

Sumanasinghe Vithanaarachchige Ariyawanse(Sri Lanka) **Masood M. Shahid** (Pakistan)

- Evaluation and development of long-term conservation techniques of genetic resources of vegetatively propagated crops in the tropics and subtropics

Narinder Pal Singh Dhillon (India)

[Photo: JIRCAS visiting research fellows outside the Okinawa Subtropical Station.](#)

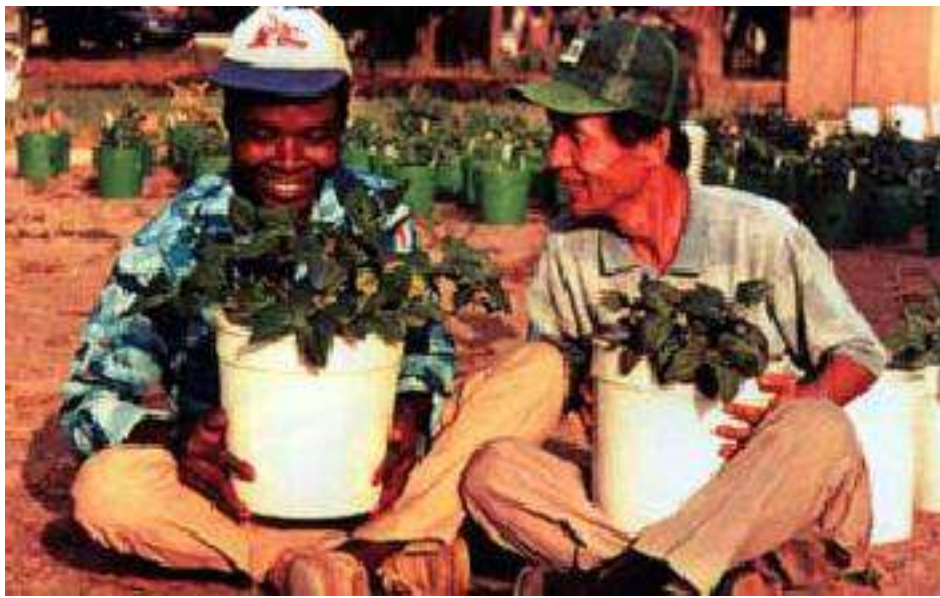
Dr. Iwao Watanabe Biological Research Division was appointed as Deputy Director General of the Food and Fertilizer Technology Center in Taipei. He is going to assume the post from April 7, 1998. Dr. Watanabe has worked as senior researcher in the field of plant physiology and cultivation management for the Tropical Agriculture Research Center and JIRCAS since 1990. During this time, he was based at the International Institute for Tropical Agriculture for the collaborative research on drought tolerance in cowpea from 1990 to 1992. Dr. Watanabe received an award from the Japanese Society of Tropical Agriculture on March 27, 1998 for his research at IITA (related article in Research Highlights). The award is given to a researcher in recognition of his contribution to agricultural research for the tropics.

[Photo : Dr. I. Watanabe with Mr. Akin at IITA Kano station, Nigeria.](#)

Dr. Akinori Noguchi, a food scientist, became Director of JIRCAS's Crop Production and Postharvest Technology Division on March 1, succeeding Dr. Koji Kawashima who became Professor at Seitoku University. Dr. Noguchi worked as a Research Coordinator for China in JIRCAS's Research Information Division (1996-1998) after carrying out studies at the National Food Research Institute as the Head of Food Engineering Laboratory.

[Photo : Dr. A. Noguchi New Director of Crop Production and Postharvest Technology Division, JIRCAS.](#)







JIRCAS Newsletter 1998 (No.15)



*Hornless (poll) Boran cattle in ILRI's pasture field
(Photo by Eitaro Imaizumi)*

CONTENTS

● [Social Sciences at JIRCAS](#)

< JIRCAS Research Highlights >

- [Economic Models for Brazilian Farm Management](#)
- [Projecting the Future World Food Situation](#)
- [Research Collaboration with CASER Focusing on the Farming Systems Research Experiences in Indonesia](#)
- [Demand for Livestock Products and Feed in Southeast Asia Countries: Preliminary Projections](#)

< International Meetings Organized by JIRCAS >

- [International Contribution of Japan and ILRI to World Animal Production Research](#)
- [Seminar on "No-tillage Cultivation and Future Research Needs" for the New Soybean Project](#)
- [USM-JIRCAS Joint International Conference on "Acacia Species-Wood Properties and Utilization" in Malaysia](#)

< **Forthcoming Workshop** >

 [JIRCAS/IPGRI Joint International Workshop: Cryopreservation of tropical plant germplasm](#)

 < [People](#) >

Social Sciences at JIRCAS



Kunio Tsubota

Director, Research Information Division

One basic feature that differentiates JIRCAS from its predecessor, the Tropical Agriculture Research Center (TARC) is the increased role of social sciences in the research activities. This reflects the fact that food and agriculture problems are becoming more global, complex and inter-linked. Even for research and development projects, many developing countries often express their concern about the socio-economic implications, sustainability, and environmental aspects of the developed technologies. It is widely recognized that these issues can be better addressed through a close collaboration between natural and social scientists.

The recent trend of JIRCAS to place more emphasis on multidisciplinary and comprehensive projects follows the same line. JIRCAS is convinced that project goals are better achieved if social scientists work together with natural scientists before and during the project. Social scientists are often expected to play a bridging role in a multidisciplinary project by considering individual technologies within a broader context of the socio-economy of the countries concerned. Nowadays agro-economists and rural sociologists are expected to play an important role in the JIRCAS comprehensive projects.

In the Mekong delta project, agro-economists are evaluating the sustainability and expansion capacity of the specific crop-livestock-fish farming system. This would assist, in particular, the natural scientists who are dealing with technological problems relating to pig raising and aquaculture. In the northeastern Thailand project, economists are projecting the demand for livestock products and analysing the comparative advantage of various farm and non-farm sectors, while other researchers carry out studies on the improvement of cropping systems as well as feed supply capacity including the use of sugarcane by-products as cattle feed. A rural sociologist and economists are carrying out preliminary studies to assess the validity of the farming systems research approach in Indonesia which may result in a more efficient dissemination of improved technologies.

Apart from the social scientists engaged in the collaborative projects overseas, some JIRCAS economists are conducting more general studies at the headquarters, including world demand-supply projections and policy simulations based on econometric models. The models can illustrate possible changes in world commodity markets under different scenarios. As an example, by linking these models with national models, we expect that more precise predictions will be made for specific commodities such as soybean in Brazil. Attempts are also made to modify the models so that environmental factors can be incorporated

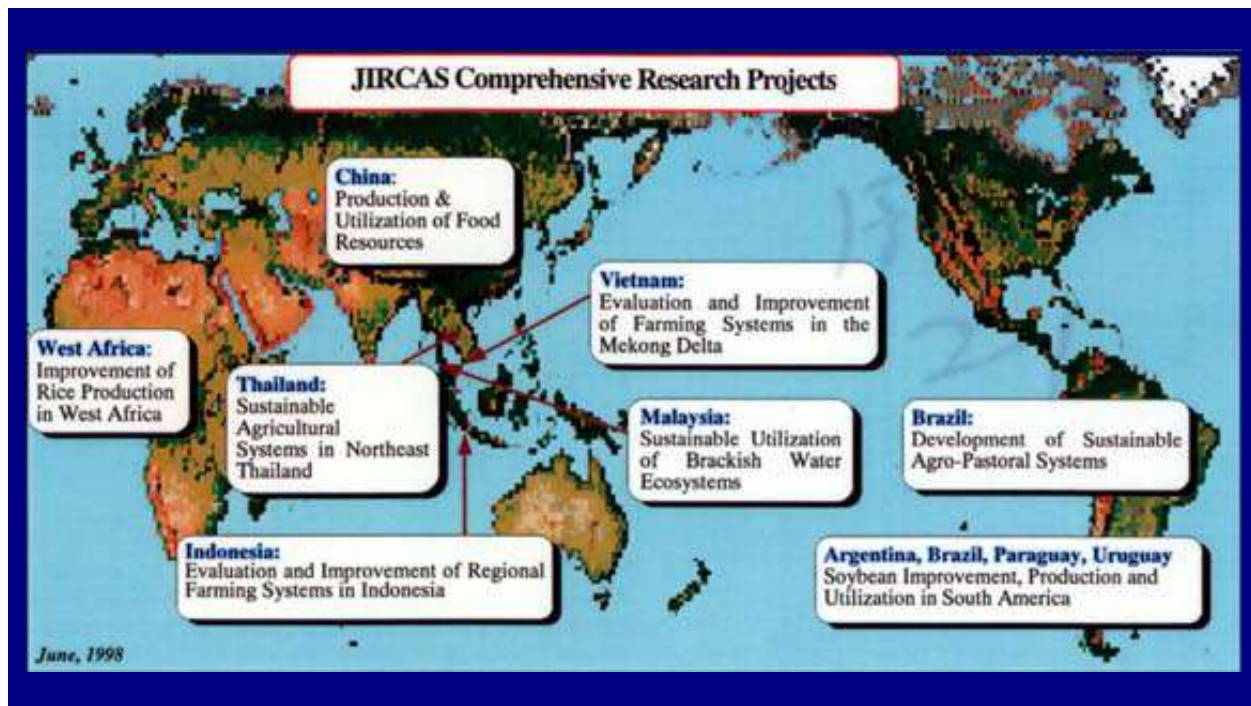
The methodologies used by JIRCAS social scientists vary. Many rely on econometric methods while some use farm budget or cost-benefit analysis. Others adopt more qualitative or institutional approaches including farming systems research.

In spite of the growing demand, currently JIRCAS has only a few social scientists in its staff. To fill the gap, two institutes affiliated to MAFF, the National Research Institute of Agricultural Economics and the National Agriculture Research Center, assign their economists and sociologists to work as short-term visiting researchers in JIRCAS projects abroad. Some visiting foreign researchers who stay at JIRCAS also assist JIRCAS social scientists in such fields as econometric analysis or country economic studies.

[Fig. 1. JIRCAS Comprehensive Research Projects. \(49KB\)](#)

Next

Back



Back

Economic Models for Brazilian Farm Management

Hideki Ozeki

JIRCAS has been implementing the collaborative research project titled "Development of Agro-Pastoral Systems in the Subtropical Area of Brazil" with EMBRAPA in Brazil since 1996. As part of this project, Dr. Yoshihiko Sugai and myself have been constructing economic models in collaboration with several economists of EMBRAPA for evaluating the Brazilian agro-pastoral sector from both micro and macroeconomic viewpoints. The selection of appropriate models is an important issue. In this study, three models were used for evaluating the sector at different levels. The models consist of 1) evaluation model for agro-pastoral systems at farm level, 2) spatial equilibrium model at regional and national levels (EMBRAPA) and 3) input-output model for agro-industries at national level. Each model can work independently, but will be linked by using simulation results from the other models as exogenous variables. In addition, 4) assistant external systems for the three economic models supply exogenous factors.

The first evaluation model for agro-pastoral systems, based on revised linear programming method, aims at evaluating the financial superiority of improved agro-pastoral farming systems i.e. the mixed, multiple-cropping systems with crop-pasture rotation. It examines the optimum resource allocation to the farm of the new technology.

The second spatial equilibrium model has been developed by EMBRAPA to evaluate the new agricultural technology and policies at the national level. It takes account of the geographic conditions as well as economic conditions and thus calculates the optimum allocations of production units including agro-pastoral ones. A trial calculation (SEA/EMBRAPA, 1998) shows that optimization of present resource allocation raises the quantity of grain production by 20% over the actual level of the 1993~95 period. If 70% of the farmers were to adopt the improved technology, grain output would increase by 53%. Though the farmers in the grain production area are willing to introduce the improved technology, poor transportation network discourages their activities and leaves the potential unexploited.

The model is built mainly for the grain sector presently, but in the near future, plans are made to include the livestock sector too. Moreover, geographic information system (GIS) will be introduced into this model to visualize the large output produced by the simulation.

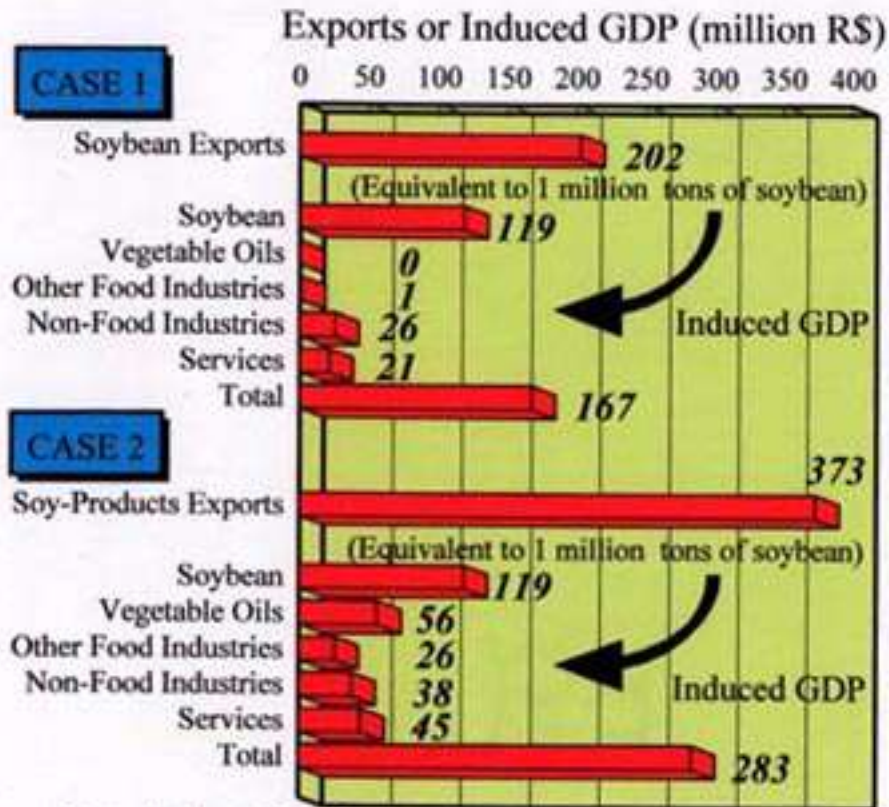
The third input-output model for agro-industries evaluates the impact of the changes in the macroeconomic conditions, for instance, the changes in total agricultural output, grain import prices, etc. Especially it enables to analyse quantitatively the nation-wide relationships among agriculture, food processing industries and other related industries. As the categorization of input-output tables published by IBGE (Instituto Brasileiro de Geografia e Estatística) is too simple, the tables were rearranged based on a definite mathematical model. Fig. 1 depicts a part of the estimation results. It assumes first that the soybean exports could increase by 1 million tons as a result of changes in the agricultural policy or trade policy. In the first scenario, 1 million tons of soybean are assumed to be exported as grains (CASE 1). In this scenario, 167 million R\$ of GDP (Gross Domestic Product) could be induced mainly in the soybean production sector, while the impact on the other industries and services is likely to be negligible. The second alternative assumes that 1 million tons of soybean are exported in the form of soybean products (oils, card, etc.) (CASE 2). In this scenario, 283 million R\$ of GDP will be induced in the soybean

production sector, the vegetable oils industry and other industries. This trial calculation suggests that the economic impact of exports as "processed and value-added products" will be larger and broader than in the case of "primary or raw materials".

The fourth assistant external systems include the 1995 Agricultural Census published by IBGE and the world food model developed by JIRCAS. We plan to incorporate the results of former large statistics and the latter into the economic models and to develop a data bank of census results to enable researchers to retrieve these data easily.

[Fig1. Induced GDP by exports of soybean or soybean products.
\(equivalent to 1 million tons soybean\) \(45KB\)](#)

Next



Note : Estimated by using input-output model (base year, 1995).

Fig. 1. Induced GDP by exports of soybean or soybean products. (equivalent to 1 million tons of soybean)

Back

Projecting the Future World Food Situation

Osamu Koyama

The situation of food supply and demand in the future is a matter of serious concern. The issues currently addressed are whether agriculture in the world will be able to continue to supply adequately food to the increasing population, and whether the present regional imbalances in food supply will be solved in the future. If these issues are solved, what will be the price level and the technological level? To answer these questions, many research organizations are conducting analyses on the future food supply and demand situation. JIRCAS also examines the future orientation of agricultural technology development, analyses domestic and overseas policies for agriculture and conducts projection studies.

For the past 35 years, mankind has succeeded in achieving a food production level above population increase. The relative price of grains has declined almost consistently. Thus, many projections relying on long-term past trends all reach optimistic conclusions. However, the recent trends, mainly those of grains, have led to some discrepancies about the future situation. In the late 1980s, the world food output per capita began to decrease, along with issues related to the degradation of the global environment, stagnation in technical development and lower investment in agriculture. Consequently discussions about the world production potential have been rekindled.

Econometric models are widely used in many projections. In the models, the relationship among various factors to the food supply and demand is translated into formulae in an econometric way using past and present data. The International Food Policy Simulation Model (IFPSIM) used at JIRCAS is such a model (Fig. 1). It consists of a combination of 14 main food commodities models. It covers the entire world divided into 31 countries and regions.

[Fig. 1. Data flow chart of IFPSIM \(example of cereals for a region/country\). \(36KB\)](#)

The external conditions given to the model and the parameters in the model determine the outcome of the projections. Especially important are the rates of population growth, income rise, technological changes related to yield per unit acreage, etc. Income elasticity, the factor indicating the impact of income on demand for food, plays a decisive role, too. According to the tentative baseline projection to the year 2020, the rate of increase of grain production will amount to about 2% per year, a higher value than the estimated population growth. The demand for soybeans and livestock products is estimated to be much higher than the population increase. The key to a higher food supply in the future is a higher yield per unit area. The yield level is markedly affected by, among others, the ratio of irrigated areas and that of areas planted with high-yielding varieties. In addition, the input of fertilizers and agricultural chemicals will be an important factor in the future. Further econometric analyses of these elements are required.

Fig. 2 shows the outcome of several scenarios studies, one of the advantages of model analysis. In the scenario where the rate of increase of the yield of crops will gradually decline to half of the recent trend owing to the environmental issues and limited supply of resources, it is anticipated that world grain prices continue to rise. In the second scenario a wide crop failure of grains and soybeans is predicted leading to high prices of agricultural commodities. It is feared that such high price levels will adversely affect low-income countries relying on inexpensive imported food. In the third scenario where it is predicted that prices will decrease, it is assumed that economic growth will slow down. However, it

should be noted that lower food prices do not always result in a higher nutrition level.

[Fig. 2. Simulation of grain price \(index: 1992=100\). \(36 KB\)](#)

In a quarter of century from now, the need for increasing food production may become less acute than presently. However, it may not be possible to continuously increase production or to keep the current production level in future without sacrificing resources and the global environment. On the other hand, even an optimistic forecast warns that the 800 million undernourished population in the world may not decrease appreciably. Through the modeling studies attempts are made to examine the overall direction of problems facing world agriculture. The outcome of these studies should provide a clearer view of the issues which may become beyond control unless serious attention is being paid now.

Next

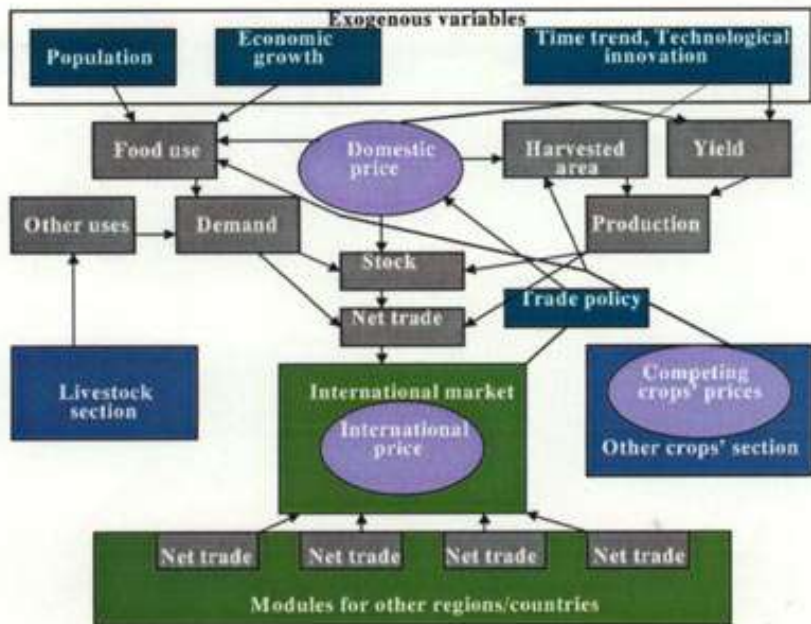


Fig. 1. Data flow chart of IFPSIM (example of cereals for a region/country).

Back

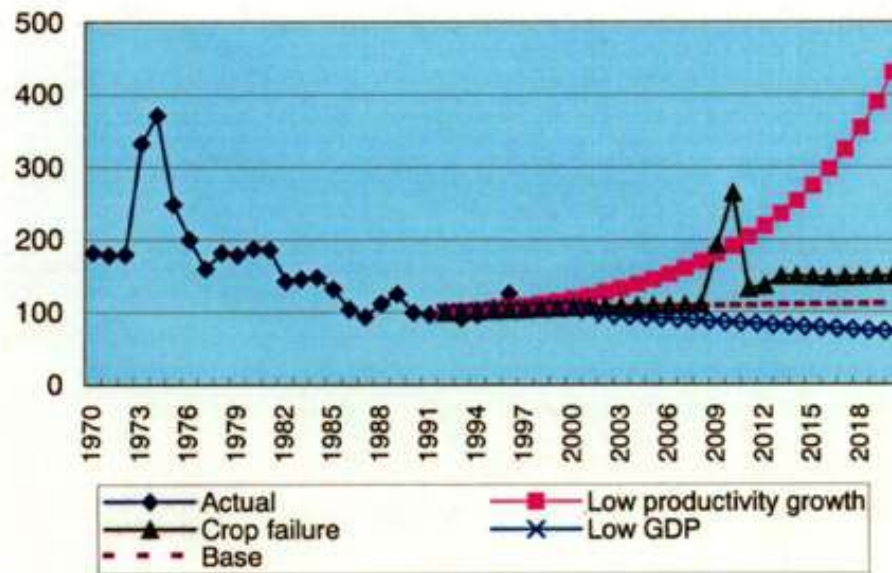


Fig. 2. Simulation of grain price (index:1992=100).

Back

Research Collaboration with CASER Focusing on the Farming Systems Research Experiences in Indonesia

*Junko Goto and Henny Mayrowani**

CASER, the Center for Agro-Socio-Economic Research, and JIRCAS have started a new collaborative research project. This new study currently titled "A study on the farmer-state linkages in upland farm development in Indonesia" aims to trace the history of FSR development in Indonesia and to conduct an in-depth case investigation of the extent of farmers' participation in the on-going FSR activities. Here, we would like to introduce briefly the background and key questions of our proposed research.

Since the heyday of the Green Revolution in the 1970s, a farming systems approach has become a popular exercise among researchers, extension workers, and agricultural officials working in and for the developing countries throughout the world. Though diverse in methods and applications, it emphasizes a farmer-first attitude and bottom-up participatory procedure as well as a multi-disciplinary team play. Indonesia is no exception. The history of farming systems-oriented research in Indonesia can be dated back to the period of cropping systems research in the early 1970s under the strong influence of IRRI. Agricultural research in those days focused mainly on lowland, i.e., rice production, so that the large growing population would not go hungry. FSR gradually expanded to rainfed areas and, to some extent, to less-favored agricultural areas such as swamp areas and upland areas.

The diversity of agroecosystems and the complexity of traditional agricultural practices prevailing in Indonesia offered an ideal ground for field investigations. Over the years, FSR incorporated various new challenges for the agricultural research community by exploring crop-livestock integration, agroforestry practices, rice-fish production combination, and so forth. Some latest studies also emphasize social and economic issues such as gender perspectives, credit institutions, and marketing strategies for farming households and communities. What can we extract from this rich, yet, rather unexplored history of research efforts? How was the English term "farming systems research" interpreted and adopted? How can we find the interaction between the foreign influence and the indigenous elements? And how can we identify the current position of farming systems research in Indonesia? These are our basic questions.

We would like to elaborate a little on the "who" question--the main actors in the implementation of FSR in Indonesia. In the 1970s and early 1980s, the technical and financial assistance from outside the country played an important role in disseminating the concept of farming systems approach, training the researchers and extension workers, and formulating various on-farm research projects. The degree of foreign commitment may vary from one project to the other. Nevertheless, the Indonesian research institutes under the Agency for Agricultural Research and Development (AARD) of the Ministry of Agriculture became the core organizations for FSR activities.

AARD organizations have undergone several changes during the past quarter of century reflecting the changing needs and priorities for agricultural research of the people and the government. Historically, the current Central Research Institute for Food Crops (CRIFC) has been the leading institute in organizing FSR, while other institutes such as Animal Sciences Institute, Horticulture Research Institute, and CASER also took part in the FSR activities as supporting institutes. In spring 1995, as part of the effort to decentralize the AARD system and to promote locally adaptive research, Assessment Institutes for

Agricultural Technology (AIATs) were established throughout the country to carry out region-specific research and extension. CASER was assigned to supervise the activities of AIATs in conjunction with CRIFC and other AARD institutes. Thus, AIATs have become the leading agents for the promotion of farming systems approach. At present, SUTPA (*Sistem Usahatani Berbasis Padi dengan Orientasi Agribisnis*) program, rice-based market-oriented farming systems research program, is the best known operation for most AIATs. Yet, AIAT activities are not limited to lowland, rice-based areas. In spite of the abundant evidence of high expectation for their work, there seems to be a lack of information regarding their day-to-day operation, coordination with local governments and other agents, and linkage and interaction with local farmers. Who will work with AIATs in specific localities? How do local farmers perceive their efforts? We would like to adopt a case analysis approach in answering these questions.

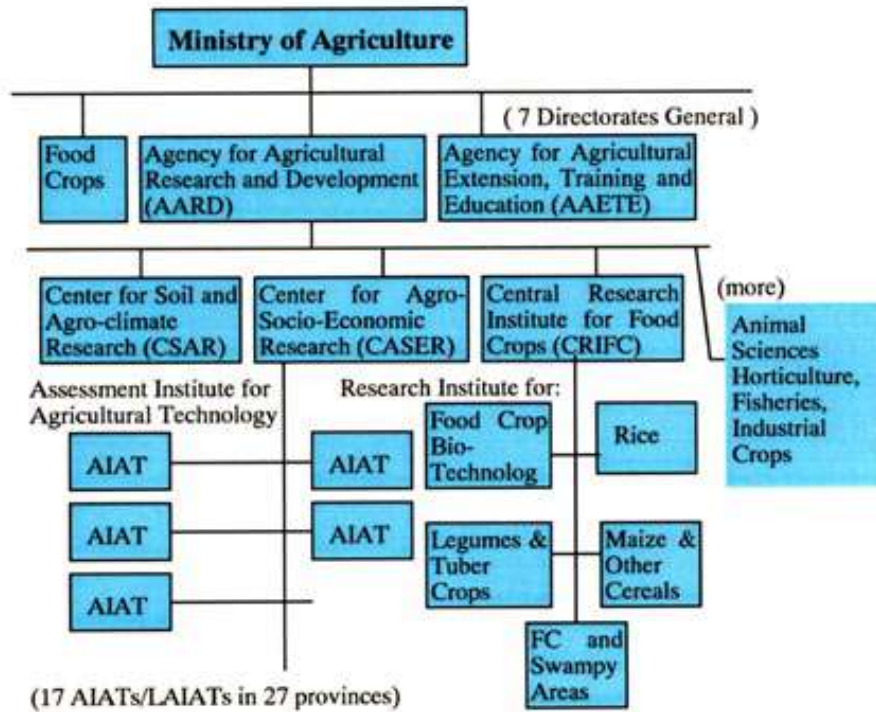
Since 1995, CASER has organized several research projects on various aspects of AIATs activities with some assistance provided by ISNAR and IBRD. Compared to this rather large-scale, top-down examination, the proposed study should adopt a low-key, bottom-up approach in clarifying the role of AIATs, the challenges and limitations they face, and possible innovations and improvements in the existing system. We will use the case of an on-going farming systems research project for upland areas conducted in West Java as a window and the broader historical review as background. We expect that this study will generate a dialogue across disciplines and enhance communication and coordination between researchers and extension workers.

**Center for Agro-Socio-Economic Research, Bogor, Indonesia*

[Fig. 1. Organizational structure for farming systems research operation. \(49KB\)](#)

A rectangular button with a red-to-orange gradient background and the word "Next" written in bold, yellow, sans-serif font.

Organizational Structure for Farming Systems Research Operation



Back

Demand for Livestock Products and Feed in Southeast Asian Countries: Preliminary Projections

Hiroaki Kobayashi

The trend of feed demand in so-called "Dynamic Asia" will play an important role in this field. The current study aimed at estimating the potential demand for livestock products and feed in the near future in some Southeast Asian countries, i.e., Thailand, Indonesia, the Philippines and Malaysia.

We attempted to estimate the demand for livestock products and subsequent feed demand, maize in particular by a simple model. Detailed analyses of feed grains production will be conducted in future studies. Although the model in this study is still incomplete, we estimated the potential demand for maize for feed use in the above four countries up to the year 2004. The ongoing model comprises 43 equations. Feed production in these countries seems to have peaked in recent years, and the potential demand in the future may affect the world grain market directly (Fig. 1).

[Fig. 1. Balance of feed grains: Thailand. \(37KB\)](#)

Table 1 shows the estimated results of demand functions of livestock products. While income elasticities of demand for meat and eggs in Thailand are 0.22 and 0.21, respectively, the elasticities of other livestock products are relatively high, indicating that a larger increase in demand associated with economic growth can be expected. Price elasticities of demand for meat and eggs are estimated to be very low, i.e., in the range from -0.01 to -0.12 , because we used maize prices in the world market as proxies of those of the final products. Price elasticities for dairy products were estimated to be much higher.

[Table 1. Results of estimation of elasticities of demand \(4KB\)](#)

Using the estimation results of demand functions, we projected the potential demand for livestock products under the following three scenarios:

Scenario I: Economic growth rates follow the past trend during the period from 1983/84 to 1993/94, except for 0% for the Philippines. Exchange rates are fixed at the 1994 levels.

Scenario II: Economic growth rates are halved, with 0% for the Philippines. Exchange rates are fixed at the 1994 levels.

Scenario III: Economic growth rates are the same as those in Scenario II. Exchange rates are fixed at the March 1998 levels after 1998.

Then we linked estimation results of domestic production of livestock products to a potential demand for feed, i.e., maize. The amount of products was converted to an equivalent of protein contents in this linkage. We handled only maize, because it is the dominant element of feed grains, and the share of maize was in the range of 82-88% in the four countries. The next main component is rice bran or wheat bran which hardly responds to changes in the demand for feed.

Some of the preliminary results are summarized in Table 2 and the potential demand for maize forecast

for each scenario is as follows:

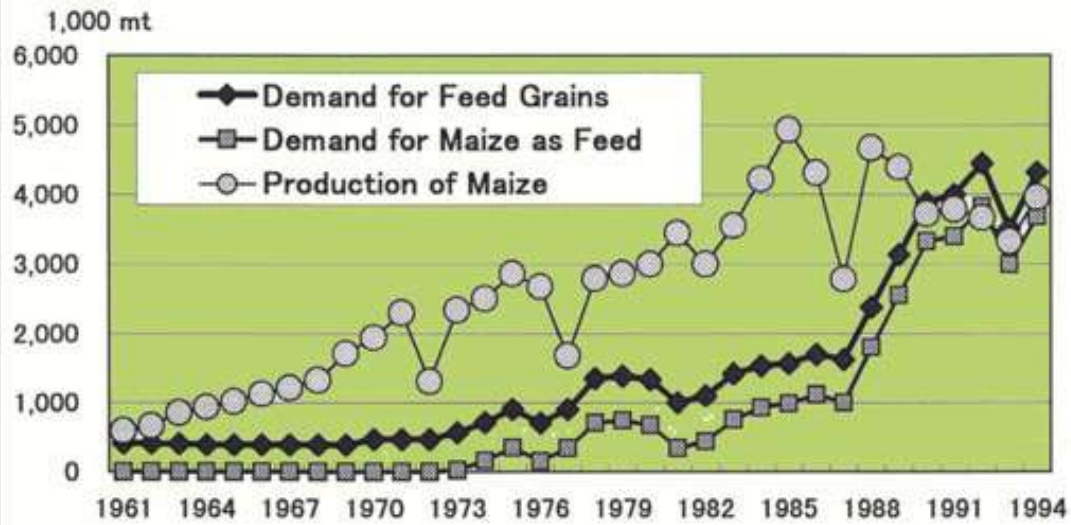
Scenario I: Malaysia continues to lead in terms of per capita consumption of livestock products. Per capita consumption of meat and eggs in Thailand does not increase appreciably, reflecting the relatively low income elasticities estimated. Sharp increases in meat consumption in the Philippines are generated only by the trend variable, which may lead to an overestimation to some extent. The consumption of maize in these four countries, which is deduced from livestock production, is predicted to increase roughly by 6 million metric tons (mt) from 11.9 million mt in 1994 to 17.9 million mt in 2004.

Scenarios II & III: It is obvious that the increase in consumption of the various livestock products will be lower than that predicted in Scenario I. The difference between the results of Scenario II and those of Scenario III is deduced from the difference in the prices of the products according to the lower exchange rates. We observe that economic growth is the main factor in promoting consumption of livestock products, except in the case of the Philippines where 0% economic growth is assumed. The devaluation of currencies affects more seriously the consumption of dairy products. The total maize consumption is forecast to increase by roughly 4.5 million mt to 17.5 million mt in the year 2004 in Scenario II and by roughly 4.1 million mt to 16.1 million mt in Scenario III.

[Table 2. Projections of potential demand for livestock products \(8KB\)](#)

A rectangular button with a dark red background and a yellow border. The word "Next" is written in a bold, yellow, sans-serif font in the center of the button.

Demand for Feed Grains: Thailand



[Back](#)

Table 1. Results of estimation of elasticities of demand

	Thailand	Indonesia	the Philippines	Malaysia
Income elasticities				
Eggs	0.21	0.58**	1.20**	1.35**
Dairy	0.88**	0.93	1.29	0.75
Own price elasticities				
Meat	-0.01	-0.08	-0.12	-0.13
Eggs	-0.03		-0.01**	-0.15
Dairy	-0.28	-0.38	-0.32	

Note: ** denotes statistical significance at 1% level.

Back

Table 2. Projections of potential demand for livestock products

	1994		Year 2004	
	Actual	Scenario I	Scenario II	Scenario III
Countries	Per capita consumption of meat (kg)			
Thailand	21.2	24.8	23.1	23.0
Indonesia	9.7	16.7	12.8	11.2
The Philippines	24.8	36.8	36.8	35.1
Malaysia	49.1	69.2	59.4	58.5
	Per capita consumption of eggs (kg)			
Thailand	8.8	11.4	10.6	10.5
Indonesia	3.1	4.0	3.6	3.6
The Philippines	5.3	5.9	5.9	5.9
Malaysia	17.6	26.3	22.3	21.9
	Per capita consumption of dairy products (kg)			
Thailand	21.6	33.8	25.2	21.5
Indonesia	6.6	8.7	7.2	4.0
The Philippines	20.7	33.0	33.0	28.9
Malaysia	59.1	74.3	68.2	68.2


 A rectangular button with a dark red background and a yellow border. The word "Back" is written in a bold, yellow, sans-serif font in the center of the button.
 Back

International Meetings Organized by JIRCAS

International Contribution of Japan and ILRI to World Animal Production Research

Joint workshop of JIRCAS with International Livestock Research Institute (ILRI) was held on February 13, 1998 in the International Conference Room of JIRCAS.

The main purpose of this workshop was to discuss matters related to the future strategy and orientation of livestock research, as well as to enhance the relations in collaborative research not only between ILRI and JIRCAS but also between ILRI and other Japanese institutes in charge of animal sciences.

Collaborative research between the Tropical Agriculture Research Center (TARC) and former International Laboratory for Research on Animal Diseases (ILRAD) and International Livestock Center for Africa (ILCA) and subsequently between JIRCAS and ILRI covers a history of 18 years. In 1980, TARC initiated a joint study on theileriosis with ILRAD in Kenya. During these 18 years, JIRCAS sent 8 researchers on long-term assignments and 7 short-term visiting scientists.

Japanese researchers dispatched to ILRAD and ILRI had conducted basic research for developing a new vaccine to prevent theileriosis. They obtained excellent results in investigations on the transmission of theileriosis. JIRCAS also sent a researcher to develop statistical methods for evaluating the productivity of milk and meat, and the adaptability of African cattle to their environment.

ILRI is a new institute established in 1995 after the fusion of ILRAD and ILCA among the CGIAR Centers. It has attempted to extend its scope of research activities to Asian developing countries under a new mandate.

This workshop was organized by the Agriculture, Forestry and Fisheries Research Council Secretariat of MAFF, Japan, JIRCAS and ILRI in collaboration with the National Institute of Animal Industry, National Grassland Research Institute and National Institute of Animal Health under the sponsorship of Japan Livestock Technology Association.

The workshop emphasized the importance and significance of the future strategy and orientation of livestock production research in Asian developing countries. Also valuable information was exchanged throughout the discussions, which enabled to deepen mutual understanding and collaborative relations between the Japanese and ILRI scientists toward the 21st century. (*Eitaro Imaizumi*)

Seminar on "No-tillage Cultivation and Future Research Needs" for the New Soybean Project

JIRCAS has initiated a research collaboration with MERCOSUR countries for a 10-yr (1997-2006) project titled: "Comprehensive Studies on Soybean Improvement, Production and Utilization in South America". For the implementation of the collaboration, Dr. Nobuyoshi Maeno, Director General of JIRCAS visited Brazil, Paraguay and Argentina in March 1998 and signed the Record of Discussions Relating to Research Collaboration with the Ministry of Agriculture and Livestock, Paraguay (MAG) and the National Institute of Agricultural Technology, Argentina (INTA). With the Brazilian Agricultural

Corporation (EMBRAPA), this project is the second comprehensive project following the "Agro-Pastoral Project" which has been carried out since 1996.

To commemorate the initiation of the project, the seminar titled "No-tillage Cultivation and Future Research Needs" was held on March 5-6 in Foz do Iguassu, Brazil under the joint organization of JIRCAS and the Centro Tecnológico Agropecuario en Paraguay (CETAPAR-JICA). It was the 1st JIRCAS seminar on soybean research in South America. From 6 countries, 60 scientists participated and exchanged views on the current situation of and future prospects for no-tillage cultivation system as well as on the potential demand and uses of soybean. The proceedings of the seminar will be published by JIRCAS. (*Makie Kokubun*)

USM-JIRCAS Joint International Conference on "Acacia Species-Wood Properties and Utilization" in Malaysia

The International Conference on "Acacia Species-Wood Properties and Utilization" organized by Universiti Sains Malaysia (USM) and JIRCAS was held in Penang, Malaysia during the period March 16-19, 1998.

Fifty scientists from 7 countries, participated in the conference and discussed the current situation of *Acacia mangium* utilization. During the meeting, the need for carrying out further research on the wood properties of *Acacia mangium* and promoting a better utilization of the species was emphasized. Twenty five papers and 6 posters were presented in the 4 sessions. In a post-conference tour, most of the Japanese participants observed a movable sawmill set up in the thinning area of a 11 years *Acacia mangium* plantation in Selangor, Malaysia. (*Koichi Yamamoto*)



JIRCAS also organized a workshop on "Water Management and Agriculture in Malaysia" to which representative from relevant organizations in Malaysia were invited during the period March 25-27, 1998.

In addition, delegates from Indonesia, Malaysia, the Philippines and Thailand participated in a workshop on "Aquaculture and Environmental Problems in Southeast Asian Countries" organized by JIRCAS during the period March 26-30, 1998.

During these two workshops' discussions were held to further promote collaborative research activities between some of these organizations and JIRCAS.

Next

Forthcoming Workshop

JIRCAS/IPGRI Joint International Workshop:

Cryopreservation of tropical plant germplasm

JIRCAS and International Plant Genetic Resources Institute (IPGRI) are jointly organizing an International Workshop entitled: "Cryopreservation of tropical plant germplasm: Current research progress and applications". This workshop will take place at JIRCAS in Tsukuba, Japan from the 20 to 23 October, 1998.

In the traditional method of conserving the genetic resources of recalcitrant seed species and vegetatively propagated crops, whole plants are maintained in the field. There are, however, several serious problems with field genebanks, including exposure to natural disasters, attacks by pests and pathogens, and high maintenance costs. The Global Plan of Action for the Conservation and Sustainable Utilization of Plant Genetic Resources for Food and Agriculture has identified the development of safe and cost-effective techniques for the long-term conservation of these problem species as a priority research area.

For long-term conservation of problem species, cryopreservation is the only method currently available. Dramatic progress has been made over recent years in the development of new cryopreservation techniques and cryopreservation protocols have been established for over 100 different plant species. However, cryopreservation of tropical and sub-tropical species has been less extensively investigated than that of temperate species.

An increasing number of National Programmes in the tropics are initiating research activities in this area. The workshop will provide a unique opportunity for cryopreservation researchers to gather and meet leading scientists in this field, and to discuss numerous aspects of cryopreservation of tropical plant species. The objectives of the Workshop are:

- To assess the current state of the art, present application of and existing problems with cryopreservation of plant germplasm, with emphasis placed on tropical species
- To identify priority areas for collaborative research, technology development, transfer and application

The tentative program of the workshop which will include oral and poster presentations is as follows:

- 1 - fundamental aspects of cryopreservation
- 2 - case studies (cells, embryos, pollen and apices)
- 3 - applications of cryopreservation in the genebank context
- 4 - country reports
- 5 - general discussion

For additional information please contact:

Hiroko Takagi

JIRCAS

1-2, Ohwashi, Tsukuba, Ibaraki, 305-8686 JAPAN

Tel: +81-298-38-6384

Fax: +81-298-38-6342

E-mail: takagiw@jircas.affrc.go.jp

Florent Engelmann

IPGRI

Via delle Sette Chiese 142

00145 Rome, Italy

Tel: +39-6-51892224

Fax: +39-6-5750309

E-mail: f.engelmann@cgnet.com

Next

PEOPLE



Takahiro INOUE, a soil scientist, became Director of JIRCAS's Research Planning and Coordination Division on April 1, 1998, succeeding Dr. Keiji Ohga who became Professor of Tokyo University. Before joining JIRCAS, Dr. Inoue was Director of the Department of Research Planning and Coordination at Kyushu National Agricultural Experiment Station. As a TARC (predecessor of JIRCAS) member, he carried out "Studies on the Increase of Productivity of Upland Soils in Thailand" in collaboration with the researchers of the Department of Agriculture of Thailand from 1980 to 1984.



Kenji MURAKAMI became Director of JIRCAS's Administration Division on April 1, 1998. He was until recently Deputy Director of the Policy Planning Division, Fisheries Agency, Ministry of Agriculture, Forestry and Fisheries (MAFF). He also worked at the Economic Affairs Bureau and Agricultural Structure Improvement Bureau previously.



Tsuguhiko HOSHINO, a wheat and barley breeder, became Director of JIRCAS's Biological Resources Division on April 1, 1998, succeeding Dr. Teruo Ishige who was transferred to MAFF's Research Council Secretariat. During his former assignment at Chugoku National Agricultural Experiment Station, he was head of the Research Planning Section. In 1986 and 1987, he spent two and three months, respectively, at ICARDA as visiting scientist.

 [Contents](#)

 [JIRCAS Home Page](#)

JIRCAS Newsletter 1998 (No.16)



**Matang mangrove forest along Sangga Besar River
Inset: Homogeneous stand of *Rhizophora* mangroves
(Photo by K. Tanaka)**

CONTENTS

<Feature article>

- [New Structures for Collaboration](#)

<JIRCAS Research Highlights>

- [Japan Government Project at ICRISAT](#)
- [Mangrove forests in Malaysia](#)
- [Technology for utilization of fish meat in China](#)

<News>

- [Introduction of small machinery into Thailand](#)
- [Opening of JIRCAS Beijing Office](#)

CONTENTS

 [International Symposium on "Plant Signaling"](#)

 [People](#)

Building New Structures for Collaborative Research



Nobuyoshi Maeno
Director General

During the time of the Tropical Agricultural Research Center (TARC), the predecessor of JIRCAS, collaborative research was conducted primarily in individual fields of research with particular research organizations in specific countries. There is no doubt that, based on unidisciplinary collaborative research efforts under such institute-to-institute relationships, we have obtained numerous valuable research results.

However, when TARC was reorganized into the present Japan International Research Center for Agricultural Sciences (JIRCAS) in 1993, the scope of our research objectives and, concomitantly, the number of partner countries and regions in our cooperative research program widened considerably. In order to respond to this newly expanded mandate within the constraints of limited resources, an emphasis on collaborative research and research structures differing from those previously utilized became necessary. As a result, a variety of new initiatives have been undertaken since the start of JIRCAS. One such initiative involves efforts to strengthen comprehensive research programs aimed at systematic multidisciplinary research in complement to the unidisciplinary approach characteristic of the past. At present, comprehensive research projects are underway in Thailand, Vietnam, Malaysia, the People's Republic of China, Brazil, Indonesia, etc.

As the scope of our research has broadened from unidisciplinary to multidisciplinary, the number of research organizations in partner countries with whom we maintain relationships has also quite naturally expanded. Consequently, institution-to-institution relationships of the past have become what might be called government-to-government relationships. As a result, relationships with partner countries have become more formalized and systematized.

These changes have allowed JIRCAS to pursue a broad range of additional international initiatives, some of which are described below.

Multinational Initiatives

In one new initiative, we have developed structures allowing us to implement research in collaboration with multiple countries regarding research problems spanning broad areas. Our collaborative soybean research project with the MERCOSUR countries (Brazil, Paraguay, and Argentina) provides one example. It marks our attempts since the days of TARC to move from cooperative relationships with individual countries toward cooperative multilateral relations within which we can work together with several countries simultaneously. Through these efforts, we have become better able with limited research resources to implement efficient and effective collaborative research for addressing problems common to several countries.

Furthermore, in the South American soybean project, we have created new research systems amenable to the participation of experts outside those organizations formally affiliated with the Ministry of Agriculture, Forestry and Fisheries. These arrangements might be described as the practical application of the power of post-doctoral research, as they allow JIRCAS to complement the abilities of its own staff by adopting, for relatively long periods of time, outside experts to assist with multinational research projects. Many of these researchers have previously accumulated invaluable experience in conducting collaborative research in targeted areas of the developing world.

Additionally, in our comprehensive project on the "Sustainable Production and Utilization of Major Food Resources in China," we have made possible the participation of researchers from Japanese prefectural agricultural research organizations, which often conduct research highly relevant to the developing areas with which JIRCAS is most concerned. Now, in cooperation with JIRCAS, these organizations can take advantage of opportunities to dispatch personnel overseas and develop links with foreign countries.

Through these initiatives, the Center hopes to be able to plan for further expansion in the ranks of researchers interested in international agricultural research collaboration, particularly with developing countries.

New Cooperative Relationships with CGIAR Centers

Since the beginning of Fiscal Year 1997, we have been promoting a project on "New technologies for agricultural research" in cooperation with the International Service for National Agricultural Research (ISNAR). The project will be funded with a special allotment to ISNAR from the Japanese Ministry of Foreign Affairs, but JIRCAS has been selected to cooperate in the implementation of technical matters. This marks for us a new cooperative relationship with one of the international research organizations under the umbrella of the Consultative Group on International Agricultural Research (CGIAR). Up to this point, we have had relationships in which JIRCAS researchers are dispatched to CGIAR research organizations and utilize available research infrastructure to implement particular research projects. Hereafter, however, it will be necessary to expand these types of new cooperative relationships.

With the restructuring of TARC into JIRCAS, our mandate has grown. Because it would prove difficult to respond to this new mandate using only established methods, new structures for research cooperation are becoming increasingly necessary. Therefore, in the future, by commissioning research to organizations in developing countries and by devising a variety of other new structures, we hope to realize more efficient, effective cooperative research.

[Next](#)

[Contents](#)

Government of Japan Special Project at ICRISAT

Hiroshi Nakano

JIRCAS scientists have been involved in the Government of Japan (GOJ) Special Project carried out at the International Crops Research Institute for the Semi-Arid Tropics (ICRISAT) in India. In the research project, since 1994, the collaborative studies with ICRISAT scientists have dealt with the "Physiological and Genetic Adaptation of Sorghum and Pigeonpea to Low Nutrient Availability in the Semi-arid Tropical Environment". Mandate crops of ICRISAT are pigeonpea, sorghum, pearl millet, etc. which are cultivated in areas where the soil and climatic conditions are very severe in Asia and Africa. Drought stress in rainfed agriculture and low level of soil nutrients are the main constraints for the production of the crops in these areas. Many new varieties and hybrids of sorghum and pigeonpea have been released by ICRISAT and national institutes of tropical countries but these modern varieties require good cultivation conditions to perform well. However, many farmers can not use inputs for the production of such low income crops. Sorghum and pigeonpea are cultivated mainly under rainfed conditions and without fertilizer application. Recently many studies have been conducted to develop technologies for increasing the yield in low fertile land without irrigation and with limited application of fertilizer, that is, technologies for low input and sustainable agriculture. Scientists of the previous GOJ special project teams at ICRISAT also directed their attention to such research and they investigated the mechanisms whereby sorghum, pigeonpea, etc. take up low available soil nitrogen and phosphorus. We intended to expand the soil and plant nutrition studies by introducing genetic aspects.

Sorghum and pigeonpea were investigated through two main approaches; 1) screening of genotypes which are highly adapted to low nitrogen and low phosphorus contents in soil and 2) plant nutrition studies on nitrogen and phosphorus uptake and translocation and assimilation in the crop organs. Varieties of both crops show a wide genetic diversity in terms of plant morphological and physiological characteristics. For example, plant height which widely ranged from 50 cm to 300 cm reflected the high genetic diversity of the sorghum germplasm (**Photo 1**).

[Photo 1: Local sorghum variety with a long stem \(50KB\)](#)

ICRISAT preserves many germplasm accessions of both crops. We anticipate that some germplasm useful for the enhancement of adaptability to low available nitrogen and phosphorus will be identified in the large gene bank. Field screening tests of varieties of both crops have been carried out in experimental fields with low nitrogen and phosphorus fertility at the ICRISAT campus (**Photo 2**).

[Photo 2: Screening test of sorghum varieties at ICRISAT campus \(30KB\)](#)

The results indicated that genetic diversity could be detected in the adaptability of sorghum and pigeonpea to low soil phosphorus and in the adaptability of sorghum to low soil nitrogen availability. On the other hand, physiological studies on phosphorus uptake and assimilation in sorghum showed that there were genotypic differences in the "production efficiency of phosphorus" that is expressed by the plant biomass production per unit amount of phosphorus absorbed by roots. On the other hand, nitrogen studies in sorghum showed that the roots of some of the varieties display a high activity in soil nitrogen uptake, especially after the heading stage. We expect that these findings will contribute to further development of the studies carried out within the framework of the GOJ Special Project at ICRISAT.

[Next](#)

[Contents](#)



Photo 1: Local sorghum variety with a long stem

Next

Back

Research on Mangrove Forests in Matang Forest Reserve, Malaysia

Ochiai Yukihito

About 200 km north of Kuala Lumpur, the capital city of Malaysia, the Matang Mangrove Forest Reserve near Taiping city extends over 40,711 ha. This forest reserve is famous for its sustainable management. With a 30-year rotation, *Rhizophora apiculata* (one of the major species of mangrove there) can be harvested for charcoal and also planted at the same time as harvest.

JIRCAS comprehensive research project entitled: "Productivity and Sustainable Utilization of Brackish Water Mangrove Ecosystems" is being carried out in this area. This project is implemented jointly by the Fisheries and Forestry Divisions of JIRCAS, University of Malaya, Fishery Research Institute of Malaysia and Forest Research Institute Malaysia. The participants in the project carry out investigations on mangroves, crabs, plankton, fish, human activities, etc. to evaluate the concept of sustainable management of mangrove forests.

The term "mangrove" refers to the plant community in an intertidal area. Mangroves capture and intercept any objects and organisms flowing from the upper stream, hence their importance for the production of fishery resources as well as their role in the protection of the environment.

Every organism in a mangrove forest depends on the mangroves and productivity depends on that of the trees. As a part of this project, the Forestry Division of JIRCAS has analysed the litter fall in three different types of mangrove forests. Litter fall refers to anything that falls from mangrove trees. Three types of forests including a) mixture of *Avicennia* spp. and *Sonneratia* spp., b) *Rhizophora* spp. and c) *Bruguiera* spp. are common mangrove forests in this area. The distance separating type a) from the sea is shortest, followed by b) and c). According to the measurement of the water level, the maximum water level of type a) is about 90 cm above the land surface and that of type b) is 70 cm during the spring tide (**Fig. 1**).

[Fig. 1. Water level of forest type a\) mixture of *Avicennia* spp. and *Sonneratia* spp. and forest type b\) *Rhizophora* spp., measured from November 11 to 20, 1996. \(24KB\)](#)

Type a) is under water 16 hours a day during the spring tide and 10 hours a day during neap tide, type b) 11 hours and 8 hours, while even during the spring tide, type c) is slightly above the water level most of the time. The difference in the type of vegetation is considered to be resulted from the water level.

Total weight of litter fall in types b) and c) is very similar (**Fig. 2**), while that of type a) is half that of b) and c). Despite the difference in total weight, the rate of leaf weight is similar in all the forest types. The leaves account for 56-58% of the total weight, which implies that leaves are the major components of litter fall in all the forest types, followed by branches.

[Fig. 2. Litter fall of three different forest types from January 1996 to January 1997. \(25KB\)](#)

The mangrove tree is unique not only by its shape but also by the movement of the fallen leaves. In lowland and hill forests which occur in Peninsular Malaysia, most of the fallen leaves are decomposed on the forest floor. On the other hand, in a mangrove forest, many fallen leaves are flown to the sea by water during both spring and neap tides in type a). In type b), the fallen leaves are flown by water during the spring tide although most of the leaves remain during the neap tide. Most of the leaves remain during both spring and neap tides in type c). The movement of the leaves determines the fertility of the soil and food chain of the mangrove ecosystem.

Although the flora of mangrove forests is relatively simple compared to that of the other forest types in Malaysia, it prevents the land from sinking in water and protects the sea from pollution with trash. Unfortunately, mangroves are disappearing rapidly due to the development of fish or prawn ponds and other human activities. Matang can be an outstanding example of sustainable forest management.

[Next](#)

[Contents](#)

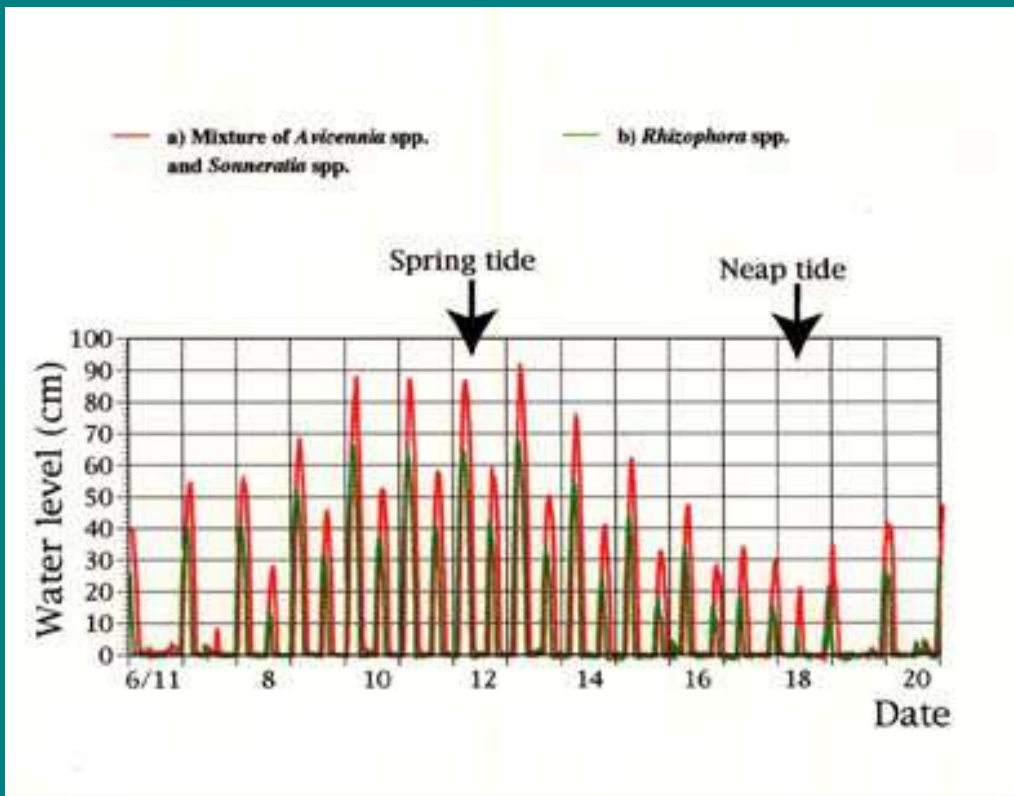


Fig. 1. Water level of forest type a) mixture of *Avicennia* spp. and *Sonneratia* spp. and forest type b) *Rhizophora* spp., measured from November 11 to 20, 1996.

Next

Back

Development of SURIMI Made from Freshwater Fish Meat in China

Yutaka Fukuda

It is no exaggeration to say that a new source of animal protein appeared in the latter half of the 20th century, namely freshwater fisheries resources produced mainly by aquaculture technology in inland water regions of China. The freshwater fisheries catches have increased rapidly after the economic reform movement, and reached 10,780,000 tons in 1995. This amount corresponds to about 10% of the world total catches and about 43% of the Chinese total catches. Freshwater fisheries play a significant role in the diversification of the food production structure in the world. Therefore, the developing countries which face a lack of animal protein are being encouraged by this success in China.

On the other hand, regardless of the rapid increase of the catches of freshwater fisheries resources, the infrastructure relating to the distribution, storage and processing is not well developed in China. Since most of the freshwater fishes are transported as live fishes without any treatments, their distribution sphere and storage period are very limited. Recently, postharvest loss of freshwater fishes has become significant. If this problem is not addressed, the plan for increasing the production of food resources in China might be jeopardized.

To improve the postharvest problems, JIRCAS launched a collaborative research project entitled "Development of Technology for Utilization of Freshwater Fisheries Resources" with the Shanghai Fishery University in 1996. We are promoting the development of processing technology for frozen "surimi" from freshwater fish meat. Surimi is originally a Japanese term and an intermediate foodstuff with high potential for long frozen shelf-life and for the production of a variety of texturized products such as crab analog. Surimi is generally manufactured by applying a simple technology through the washing of the minced meat by water, dehydration, and mixing with cryoprotectants.

We carried out studies on the gel-forming ability of the surimis made from Silver carp, Bighead carp and Grass carp, which are the main freshwater fish species in China, compared with Alaska pollack surimi, a typical commercial marine fish surimi which accounts for more than 60% of the production in the world.

The three-dimensional configuration of the gel strength which depended on the heating temperature and time was classified into two types (**Fig. 1**). That is, the surimi of Silver carp and Bighead carp showed the shape of a U character as in the case of Alaska pollack, while that of Grass carp showed the shape of a plateau.

[Fig. 1. Gel-forming properties of surimis of freshwater fishes in China and Alaska pollack depending on the heating temperature and time. \(26KB\)](#)

The surimis of Silver carp and Bighead carp form a gel by heating at low temperature (around 30°C) and high temperature (around 85 °C), though the gel tends to collapse by heating at an intermediate temperature (around 60 °C). The formation of a gel of fish surimi by heating at a low temperature is called "setting". The strength of setting gels of both surimis was further enhanced by subsequent heating at 85 °C for 30 min (two-step heating), though being slightly inferior to that of Alaska pollack. Consequently, it was demonstrated that Silver carp and Bighead carp surimis display a high gel-forming ability, though it is necessary to select a narrow range of heating temperatures.

Next, Grass carp surimi displays a wide range of optimum heating temperatures and time zones, though it does not show the setting phenomenon and the enhancing efficiency by two-step heating. Consequently, it was concluded that Grass carp surimi which forms a gel in a wide range of heating temperatures, is more advantageous although the gel-forming ability is lower than that of the former two.

We were able to determine that the main freshwater fish species of China can be utilized as raw materials of surimi.

[Next](#)

[Contents](#)

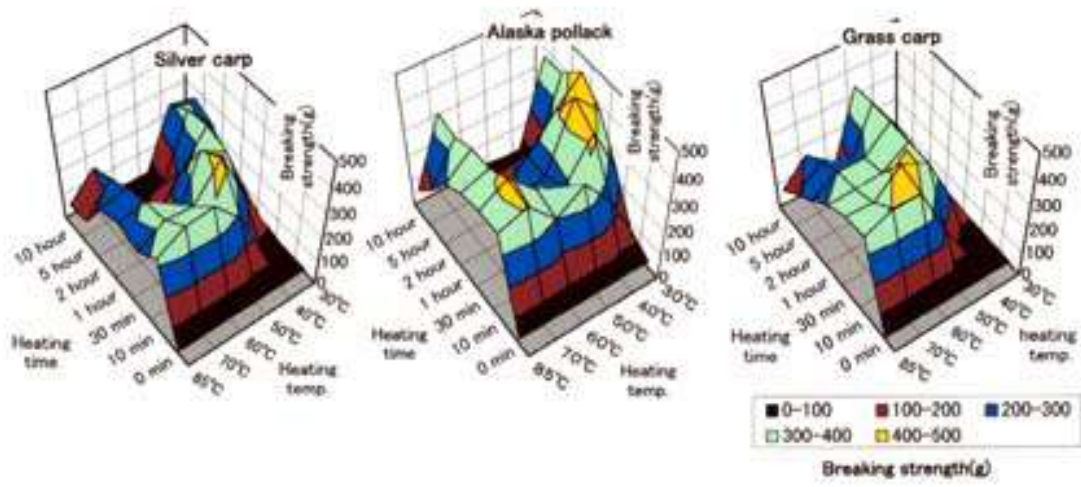


Fig. 1. Gel-forming properties of surimis of freshwater fishes in China and Alaska pollack depending on the heating temperature and time.

Next

Back

Introduction of Small Machinery into Upland Cropping Systems in Northeast Thailand

Photos: (121KB)

a): Seeding of corn with rotary drill seeder

b): Cutting of green manure with flail mower

c): Weeding with soil manipulator

d): Herbicide application with shoulder broadcaster

Improvement of field operations is indispensable for the development of sustainable agriculture since crop production largely depends on human labor. Therefore, it is necessary to reduce heavy work and to develop efficient production systems to increase the income of farmers.

Recently, within the framework of the collaborative research project entitled: "Comprehensive Studies on Sustainable Agricultural Systems in Northeast Thailand", JIRCAS has introduced several agricultural machines consisting of a tractor and attachments, and some small items of equipment to facilitate field operations. The tractor (25ps) was purchased in Thailand and four attachments, i.e., rotary tiller, drill seeder, flail mower and boom sprayer were sent from Japan. Soil manipulator or small hand tractor and shoulder broadcaster for crop tending between rows of crops were also introduced.

For the setting-up of machinery and guidance for operation, an expert in agricultural machinery Mr. Haruo Tamura, Head of Field Management Section, Crop Production and Postharvest Technology Division, JIRCAS was dispatched to Thailand. To complete the technology transfer, a demonstration entitled "Use of small machinery in farming" was held on June 17, 1998 at Khao Suan Kwang Demonstration Farm, International Training Center for Agricultural Development (ITCAD) to illustrate the use of this machinery for field operations. Some 60 people from agricultural administration, extension offices, research institutes and Khon Kaen University participated in the demonstration and exchanged views on farm mechanization. Highlights of the demonstration are as follows.

Land preparation with rotary tiller drew a great deal of attention. Although mechanized disk plough is commonly used for tillage to plant cassava or sugarcane, soil is not fine enough for seed bed preparation for legumes, vegetables or corn. It was shown that the use of a rotary tiller enabled to improve labor by fine harrowing of the field. Drill seeder, attached to the back of a rotary tiller, can perform the following operations: grooving, fertilizer application, seed laying and soil compaction in a single operation. This system is useful to save labor and also to secure good germination of crop seeds through elaborate land preparation and constant depth of seeding. Flail mower is used for cutting weeds or green manure into small fragments. Many questions were raised on the suitability of the machinery for green manure application or mulching since management of organic matter is laborious under tropical conditions. Boom sprayer is used for the application of pesticides or herbicides by tractor drive. Application is uniform and accurate with the use of a boom which extends horizontally over a distance of 5 m.

Soil manipulator for weeding and ridging and shoulder broadcaster for the application of granular pesticides and fertilizer are used for crop tending. Small and light body is suitable for transportation to the field and for the operation without requiring much experience. Price and means of introduction were the main interest of the participants in terms of availability of the machinery.

Although the purpose of machinery introduction in this project was mainly for the convenience and promotion of field research, the demonstration may have attracted the attention of the participants to the possibility of developing agricultural mechanization in Northeast Thailand. However, prior to the introduction of such machines, it is necessary to conduct a detailed economic analysis on the advantages of agricultural mechanization along with studies on soil erodibility in this region and on the design of machines most adapted to the conditions prevailing in Northeast Thailand.

(Nobuyuki Kabaki)

[Next](#)

[Contents](#)



a): Seeding of corn with rotary drill seeder



c): Weeding with soil manipulator



b): Cutting of green manure with flail mower



d): Herbicide application with shoulder broadcaster

Next

Back

Opening Ceremony of JIRCAS Beijing Office

On June 10, 1998, Japan International Research Center for Agricultural Sciences (JIRCAS) held the official opening ceremony of the JIRCAS Beijing Office. Actually, in November 1997, JIRCAS had opened the office in a room of Beijing Friendship Hotel near the Chinese Academy of Agricultural Sciences (CAAS) after consultation with the bureau concerned of the People's Republic of China (P. R. C.).

[Photo 1: Dr. N. Maeno, DG of JIRCAS, giving his address at the opening ceremony of the JIRCAS Beijing Office \(25KB\)](#)

From Japan, 15 persons including Mr. Sakue Matsumoto, Chairman, Agriculture, Forestry and Fisheries Research Council (AFFRC), Ministry of Agriculture, Forestry, and Fisheries (MAFF), Mr. Toshiaki Namba, Director, International Research Division, AFFRC, Dr. Nobuyoshi Maeno, Director General, JIRCAS, and the members of the Embassy of Japan at Beijing, attended the ceremony.

From P. R. C., 31 persons were on hand to celebrate the occasion. Main guests were Mr. Lu Ming, Vice Minister, Ministry of Agriculture, Mr. Gan Zuofu, Minister-Counselor, the Embassy of P. R. C. at Tokyo (former Deputy Director General, Department of International Cooperation, Ministry of Agriculture), Mr. Du Ying, Director, Department of Policy, Reform & Law, Mr. Wang Youtian, Assistant Counselor, Department of Science and Technology, Ms. Chen Fengrong, Deputy Director, Department of Agricultural Resources Management and Regional Planning, Ms. Ye Zhen Qin, Deputy Director General, Department of Agriculture, Mr. Liu Guangming, Research Center for Rural Economy, Professor Lu Fei Jie, President, CAAS, the staffs of the Institutes of CAAS, the members of Jilin Academy of Agricultural Sciences, the members of institutes affiliated to the Chinese Academy of Sciences, and Mr. Wang Wenzhe, President, China National Food Industry Association. Representatives of the Chinese press such as the Hsinhua News Agency, Renmin Ribao (the People's Daily News) and the Farmers' Daily News were also invited.

The ceremony started with opening remarks by Mr. Matsumoto followed by addresses by Vice Minister Lu, and then by Dr. Maeno. Dr. Maeno emphasized, in his address, that JIRCAS planned to collaborate actively in solving "problems in agricultural fields" which are a major issue in P. R. C. Dr. Maeno mentioned that such an objective could be achieved based on the results obtained during the studies carried out formerly by the Tropical Agriculture Research Center (the predecessor of JIRCAS) or JIRCAS in collaboration with various research institutes of P. R. C., including the development of rice varieties with cold or disease tolerance, and of high-yielding varieties through the utilization of genetic resources at Yunnan Academy of Agricultural Sciences, as well as the first comprehensive research project with P. R.C. (from 1997 to 2003) on the "Development of Sustainable Production and Utilization of Major Food Resources in China" by integrating the existing collaborative research projects.

Returning the compliment, CAAS President Professor Lu delivered a congratulatory address in which he stated that he expects that the new Japan-China comprehensive research project will be successful and contribute to further development of Japan-China collaboration in research in the field of agriculture.

The new comprehensive research project is composed of wide-ranging research fields from social sciences to natural sciences, involving 10 research institutes of P. R. C., 8 research institutes of MAFF including JIRCAS, and several prefectural research institutes. Exchange of information and researchers between P. R. C. and Japan along with the opening of the Beijing office should contribute to further promoting the Japan-China research collaboration.

[Photo 2: Japanese delegates for the opening ceremony standing in front of the JIRCAS office in the Friendship Hotel, Beijing \(From right to left \): Dr. Maeno, Mr. Matsumoto, Mr. Sakamoto, Mr. Kawahara, Mr. Namba, Dr. Ikegami \(32KB\)](#)

(Yoshihiko Nawa)

JIRCAS Beijing Office

*3 Bai Shi Qiao Road Beijing, China 100873
Beijing Friendship Hotel, Ya Yuan,
Room No.63723+63724
Tel: +86-10-6849-8563
Fax: +86-10-6849-8564*

[Next](#)

[Contents](#)



Photo 1: Dr. N. Maeno, DG of JIRCAS, giving his address at the opening ceremony of the JIRCAS Beijing Office

Next

Back

International Symposium on "Plant Signaling"

The International Symposium on "Plant Signaling: Molecular Responses to Environmental Stimuli and Stress" organized by Japan International Research Center for Agricultural Sciences (JIRCAS), in conjunction with the RIKEN Institute and BRAIN (Basic Research Activities for Innovative Biosciences) was held at JIRCAS, Tsukuba, on August 12, 1998. This symposium was organized to gather scientists who are focusing their research on plant signal transduction and responses to the biotic and abiotic environmental stresses and exchange information and ideas for the future.

[Photo: Discussions at the International Symposium on "Plant Signaling" \(23KB\)](#)

In recent years, food supply and environmental deterioration problems on a global scale have become increasingly critical, especially in the developing regions. Biotechnology could be a useful method to increase food production through the development of crops with improved tolerance to biotic and abiotic environmental stresses. To develop stress-tolerant crops, basic research on plant molecular biology is important. Recently, considerable progress has been made in understanding how plants sense and respond to various stimuli in their environment.

Molecular and genetic approaches have led to considerable progress in elucidating how environmental stimuli and stress elicit the production of second messengers, how plant cells perceive the messengers, as well as in the induction of specific responses and the physiological consequences. The most active scientists in the area of research on molecular responses to environmental stimuli and stress were invited to present papers at the symposium. From 10 countries, 191 scientists participated in the symposium. Dr. Nobuyoshi Maeno, Director General of JIRCAS and Dr. Keiji Kainuma, Vice President of BRAIN gave the welcome address. A keynote lecture was delivered by Prof. Nam-Hai Chua, Rockefeller University, USA and 10 foreign scientists from USA, France, Germany, England, Austria and 4 Japanese scientists presented papers during the three sessions as follows: Ethylene signaling and biotic stress response, ABA signaling and water stress response and Short talks. The symposium was successful and valuable information was exchanged throughout the discussions.

[Next](#)

[Contents](#)

(Kazuko Yamaguchi-Shinozaki)



Photo: Discussions at the International Symposium on "Plant Signaling"

Next

Back

PEOPLE



Takasuke ISHITANI, an agricultural chemist and expert in postharvest technology, became Director of JIRCAS's Research Planning and Coordination Division on September 1, 1998, succeeding Dr. Takahiro INOUE who was appointed Deputy Director General, Tohoku National Agricultural Experiment Station (TNAES). Before joining JIRCAS, Dr. Ishitani was Head of the Department of Research Planning and Coordination at TNAES. He has gained an extensive experience in the field international collaboration in agriculture and fisheries, as a lecturer for various training courses on postharvest technology in China, Peru, India and ASEAN countries and as a guest speaker at international meetings.



Mitsugu SHIMIZU, veterinarian (animal virology), succeeded Dr. Eitaro IMAIZUMI as Director of JIRCAS's Animal Production and Grassland Division on September 1. He carried out research at the National Institute of Animal Health (NIAH) (1968-1995). During his assignment at NIAH, Dr. Shimizu was posted as a visiting scientist at USDA, Plum Island, USA for two years (1973-1975) and was involved in the JICA's animal health projects in Mexico (1981-1982, 1985-1986 and 1992). Before joining JIRCAS, he was Head of the Planning Section, Department of Planning and Coordination, NIAH.

[Contents](#)

[JIRCAS Home Page](#)



*Photo 2: Japanese delegates for the opening ceremony standing in front of the JIRCAS office in the Friendship Hotel, Beijing
(From right to left): Dr. Maeno, Mr. Matsumoto, Mr. Sakamoto, Mr. Kawahara, Mr. Namba, Dr. Ikegami*

Next

Back

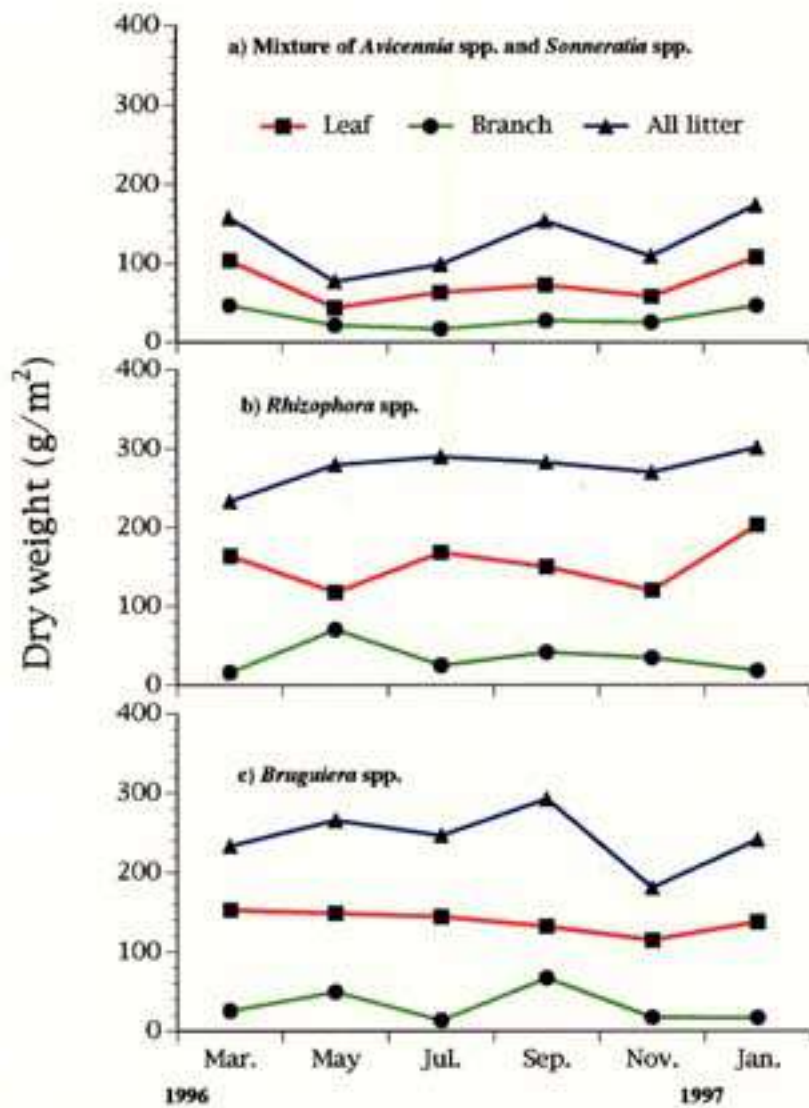


Fig. 2. Litter fall of three different forest types from January 1996 to January 1997.

Next

Back



Photo 2: Screening test of sorghum at ICRISAT campus

Next

Back

JIRCAS

Newsletter

No. 17 December 1998



Threshing rice in Cote d'Ivoire
(Photo by S. Tobita)

CONTENTS

<Feature Article>

- [Improving Heat Tolerance of Crops](#)

<Symposium>

- [JIRCAS Symposium on Postharvest Technology](#)

< JIRCAS Research Highlights >

- [Photosynthesis of Longan and Mango](#)
- [Antioxidant Properties of Thai Plants](#)

<News>

 [Collaborative Project at WARDA](#)

 [Workshop on Cryopreservation](#)

 [Welcoming New Fellows](#)

 [**JIRCAS Home Page**](#)

Improving Heat Tolerance of Crops

Masaharu Yajima

Associate Director for Research, Okinawa Subtropical Station, JIRCAS

The Okinawa Subtropical Station of Japan International Research Center for Agricultural Sciences (JIRCAS Okinawa) is located in Japan's southernmost city, Ishigaki. By taking advantage of the subtropical climate, research is being carried out to develop techniques which will contribute to the promotion of agriculture in the tropical and subtropical areas.

Heat tolerance is one of the major themes taken up at the Station to promote and increase crop production in those areas. For example, vegetables are mainly cultivated during winter and spring in Okinawa and it is very difficult to grow temperate vegetables during the summer season.

Therefore, attempts were made to overcome this shortcoming at the Station through the evaluation of the germplasm collected from Southeast Asian countries and foreign research institutions including CIAT, USDA, etc. By screening the germplasm for heat tolerance, a heat-tolerant snap bean variety "Haibushi" was eventually developed (Haibushi means "southern star" in Okinawa dialect). We anticipate that "Southern Star, Haibushi" will pave the way for the development of crop varieties with higher heat tolerance by conducting further research on the mode of inheritance of heat tolerance and physiological mechanisms.

Therefore, the five-year research project entitled: "Inheritance and Physiological Mechanism of Crop Heat Tolerance and Development of Heat-tolerant Crops" has been initiated in collaboration with research teams from several universities since the end of September, 1998. This project is financed by Bio-oriented Technology Research Advancement Institution (BRAIN). Dr. Yoshinobu Egawa, Head of Crop Introduction and Cultivation Laboratory, JIRCAS-Okinawa is assuming the leadership of the project. This project consists of four research teams with the following themes and research contents.

(1) Genetic and physiological mechanisms of crop heat tolerance during the reproductive process(JIRCAS-Okinawa)

By comparing the heat-tolerant genotype of a crop with heat-sensitive genotypes, the following aspects will be studied: 1) the stage at which plants are most sensitive to high temperature during the reproductive process, 2) the organs or tissues which are damaged by high temperature, 3) growth response of heat-tolerant genotypes under high temperature conditions, 4) QTL mapping and genetic regulation of heat tolerance of crops.

Under heat stress conditions, small-heat-shock-proteins (sHSP) are sometimes observed in plant. Role of sHSP and their function under heat stress are also studied by this team.

(2) Improvement of heat tolerance by functional modification of mitochondria (Ryukyu University)

Active oxygen sometimes injures organic substances inside the cell. Injury is mainly generated at the level of mitochondria and its generation is accelerated under high temperature conditions through the process of respiratory electron transport chain in mitochondria. In this research, the physiological and genetic role of mitochondria will be specified with reference to heat tolerance of crop at the mitochondria-DNA level and attempts will be made to develop heat-tolerant crops by functional modification of mitochondria.

(3) Gene transfer for heat tolerance and functional analysis of its recombinant (Nagoya University)

Under stress conditions such as cold or salinity, some of the tolerant plants show an accumulation of glycine betaine inside the cells. It is considered that this accumulation is related to some protection mechanisms from environmental stresses. Transgenic rice plants which harbor the pathway of glycine betaine synthesis are expected to be heat-tolerant due to a similar mechanism. This team will examine the transgenic plants to clarify further mechanisms of plant response to heat.

Since it is assumed that crop productivity decreases under high light intensity, gene expression of heat tolerance will also be examined by transferring related genes for controlling photo-respiration and elimination of active oxygen. Through collaboration with other teams, heat tolerance-related genes will be transferred into tomato and other plants.

(4) Functional characterization of acetylcholine-esterase for heat tolerance of plants (Tokyo University of Agriculture)

Acetylcholine (Ach) is a well-studied chemical transmitter in the synaptic junction for the opening of cation-selective channels in nerve synapses of animals. In plants, it is known that Ach is induced by environmental stimuli, such as heat stress, salinity stress and gravity, affecting calcium ion concentration and safranin transport. Especially, heat stress induces an elevation of calcium ion concentration and activity of acetylcholine-esterase (AChE) in plant cells. Further research on the function of Ach and AChE will be studied and transgenic

plants will be produced by isolating the AchE gene to develop heat-tolerant plants.

Through this research project, we hope to elucidate physiological aspects of "Heat Tolerance of Crops" and to contribute to crop breeding in order to develop heat-tolerant crops.

[Fig. 1. Outline of the Project on "Improving Heat Tolerance of Crops" at the Okinawa Subtropical Station.](#) (42KB)

[Next](#)

[Contents](#)

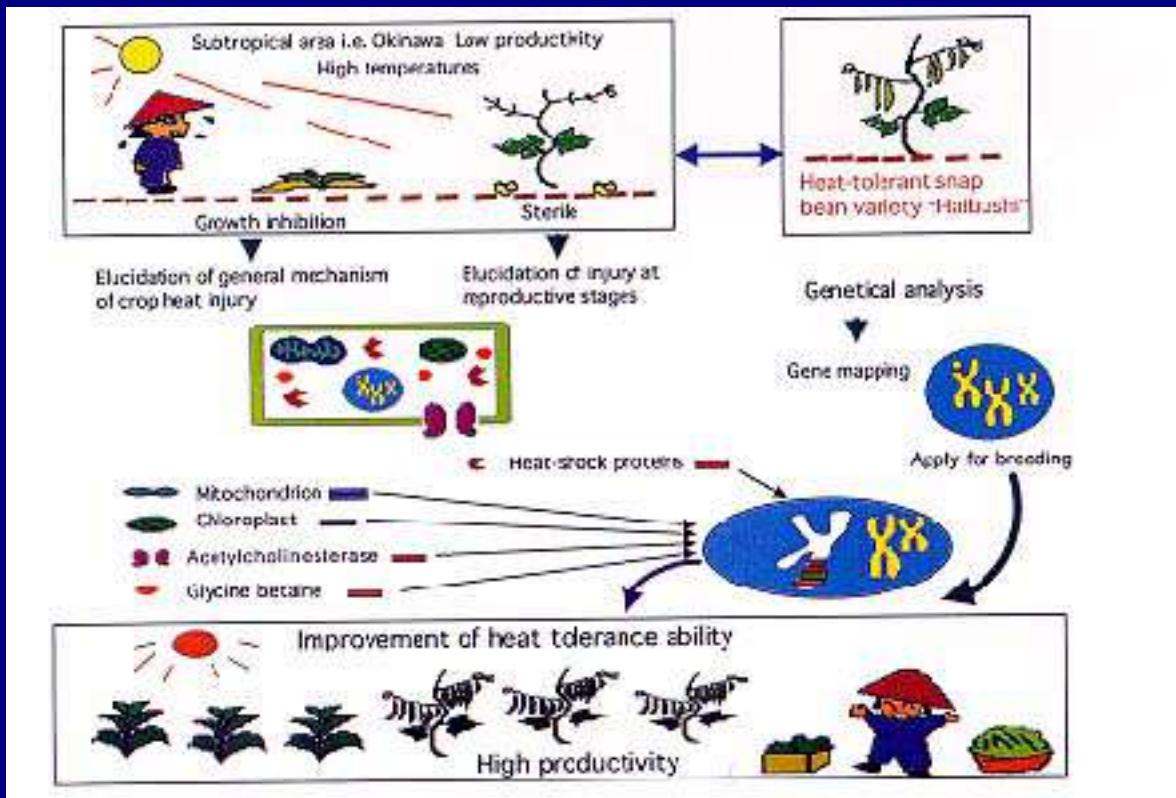


Fig. 1.

Next

Back

5th JIRCAS International Symposium on Postharvest Technology in Asia Was Held in Tsukuba

The 5th JIRCAS International Symposium on "Postharvest Technology in AsiaA step forward to stable supply of food products" orga nized by Japan International Research Center for Agricultural Sciences (JIRCAS) in cooperation with the National Food Research Institute (NFRI), National Agriculture Research Center (NARC), Food Forum Tsukuba and Nestle Science Promotion Committee was held in Tsukuba during the period 9-10 September, 1998.

[Photo 1: Speakers with other participants \(from right to left, the sixth person in the front line: Mr. Sakue Matsumoto, the fifth person in the next line: Dr. Keiji Kainuma, the fourth person in the same line: Dr. Nobuyoshi Maeno\) \(27KB\)](#)

Although the development of technology for increasing crop production, remains essential, "postharvest technology" was selected as theme for the symposium by JIRCAS for the first time, since the development of postharvest technology is becoming increasingly important.

Indeed in Asia, it is anticipated that, in the near future, the food supply problems will become more complex as patterns of food consumption have improved in the region along with the increase of income and social development. Postharvest technology should be more emphasized to prevent crop losses and for utilizing agricultural products efficiently to meet the changes in the food demand, especially the demand for processed foods. Food industry is closely related to crop production in the region but due to the lack of proper technology, sound progress of the food industry can not be fully achieved. In this Symposium, the development of the food industry in Asia was reviewed and the basic technical problems involved in future progress were outlined.

From 21 countries including African countries, nearly 230 scientists and administrators, (59 from abroad) gathered and exchanged views on the main priorities and constraints of postharvest technology in Asia, and on the current situation and future orientation of technology for grain storage/preservation and food industries in Asia.

Mr. Sakue Matsumoto, Chairman, Agriculture, Forestry and Fisheries Research Council gave the welcome address. A keynote speech was delivered by Dr. Keiji Kainuma (former Director General of JIRCAS), Vice President, Bio-oriented Technology Research Advancement Institute (BRAIN), Japan, and 18 papers were presented during the three sessions.

JIRCAS is implementing collaborative projects in Asian countries and "postharvest technology" should receive more attention in future research collaboration. Development of "postharvest technology" could contribute to securing a stable supply of food products in addition to the increase of agricultural income and improvement of the diet in the developing regions of Asia.

The Proceedings of the Symposium will be published by JIRCAS.

(Yoshihiko Nawa)

[Next](#)

[Contents](#)



Photo 1: Speakers with other participants (from right to left, the sixth person in the front line: Mr. Sakue Matsumoto, the fifth person in the next line: Dr. Keiji Kainuma, the fourth person in the same line: Dr. Nobuyoshi Maeno)

Next

Back

Photosynthesis in Longan and Mango as Influenced by High Temperatures under High Irradiance

*H. Fukamachi**, *M. Yamada***, *S. Komori**, and *T. Hidaka**

**Okinawa Subtropical Station, JIRCAS*

***Persimmon and Grape Research Station, National Institute of Fruit Tree Science*

The combination of high temperature and irradiance is a common characteristic in the tropical and subtropical regions. Fruit species originating in those regions may be adapted to these climatic conditions, but the differences in adaptability to these conditions are not well-known. The objectives of our studies were 1) to compare gas exchange characteristics of longan and mango leaves upon exposure to high temperature and irradiance and 2) to examine the mechanisms contributing to the variation in the response of the net photosynthetic rate to high temperature and irradiance.

Leaves of 2-year-old longan and mango seedlings were exposed to high irradiance ($2000\frac{1}{4}\text{molem}^{-2}\text{esec}^{-1}$) provided by metal halide lamps at $70\pm 5\%$ RH. Temperature was raised by increments of 3°C every 1.5 h, from 30 to 36°C . Net assimilation rates decreased for both species as temperature increased, but the decline was greater in longans than in mangoes (**Table 1**). As temperature increased, stomatal conductance decreased and intercellular CO_2 concentration increased for both species, especially longans. A significant positive correlation was found in longan between stomatal conductance and net assimilation rate at 30 and 33°C , but not at 36°C . In mangoes, the correlation coefficient was significant at all 3 temperatures. Intercellular CO_2 concentration and net assimilation rate were not closely related at 30 and 33°C , but showed a strong negative correlation at 36°C in both species. These results indicate that the decline in net assimilation rate was caused by non-stomatal limitations at high temperatures. In further experiments, the extent of decline in the chlorophyll fluorescence ratio (variable (Fv) to maximum fluorescence (Fm)) caused by high temperature treatment (up to 45°C) was greater in longans than in mangoes (**Table 2**), suggesting that mango leaves are more tolerant of high temperatures than are longan leaves.

Table 1. Gas exchange characteristics in longan and mango leaves exposed to $2000\frac{1}{4}\text{molem}^{-2}\text{es}^{-1}$ of irradiance with stepwise increase of temperature

Species	A ($\frac{1}{4}\text{molem}^{-2}\text{es}^{-1}$)			gs ($\text{molem}^{-2}\text{es}^{-1}$)		
	30°C	33°C	36°C	30°C	33°C	36°C
Longan (L)	6.72 ± 0.34^z (100) ^Y	4.18 ± 0.43 (62)	1.30 ± 0.30 (19)	0.204 ± 0.019 (100)	0.157 ± 0.018 (77)	0.127 ± 0.008 (62)
Mango (M)	9.64 ± 0.33 (100)	7.71 ± 0.50 (80)	5.87 ± 0.51 (60)	0.241 ± 0.016 (100)	0.203 ± 0.015 (84)	0.180 ± 0.013 (75)
Ratio (L/M)	0.7	0.54	0.22	0.85	0.77	0.71

Species	Ci (ppm)			E ($\text{mmolem}^{-2}\text{es}^{-1}$)		
	30°C	33°C	36°C	30°C	33°C	36°C
Longan (L)	100 ± 10 (100)	100 ± 10 (100)	100 ± 10 (100)	100 ± 10 (100)	100 ± 10 (100)	100 ± 10 (100)
Mango (M)	100 ± 10 (100)	100 ± 10 (100)	100 ± 10 (100)	100 ± 10 (100)	100 ± 10 (100)	100 ± 10 (100)

Leaves of 2-year-old longan and mango seedlings were exposed to high irradiance ($2000\frac{1}{4}\text{molem}^{-2}\text{sec}^{-1}$) provided by metal halid

Longan (L)	262 \pm 3 (100) ^Y	278 \pm 3 (106)	308 \pm 4 (118)	5.68 \pm 0.31 (100)	5.37 \pm 0.37 (95)	5.83 \pm 0.32 (103)
Mango (M)	246 \pm 2 (100)	254 \pm 2 (103)	265 \pm 4 (108)	6.33 \pm 0.24 (100)	6.44 \pm 0.29 (102)	7.16 \pm 0.32 (113)
Ratio (L/M)	1.07	1.09	1.16	0.9	0.83	0.81

Z Mean \pm SE (n=26)

Y Numbers in parenthesis indicate percentage to the value at 30°C

Table 2. Chlorophyll fluorescence ratio (Fv/Fm) in leaves of longan and mango exposed to high temperature

Species	Duration	25°C (Control)	40°C	42.5°C	45°C
Longan	20 min.	0.827 \pm 0.004 ^Z	0.808 \pm 0.013	0.797 \pm 0.007	0.592 \pm 0.030
		(100%) ^Y	(98%)	(96%)	(64%)
	40 min.	0.820 \pm 0.005	0.810 \pm 0.005	0.599 \pm 0.028	0.481 \pm 0.029
		(100%)	(99%)	(73%)	(59%)
Mango	20 min.	0.819 \pm 0.007	0.823 \pm 0.009	0.808 \pm 0.009	0.743 \pm 0.011
		(100%)	(100%)	(99%)	(91%)
	40 min.	0.827 \pm 0.005	0.807 \pm 0.013	0.756 \pm 0.017	0.642 \pm 0.007
		(100%)	(98%)	(91%)	(78%)

Z Mean \pm SE (n=4)

Y The percentage to the value at 25°C

[Next](#)

[Contents](#)

Antioxidant and Antimutagenic Properties of Some Edible Thai Plants

Kazuhiko Nakahara* and Gassinee Trakoontivakorn**

*Crop Production and Postharvest Technology Division, JIRCAS

**Institute of Food Research and Product Development, Kasetsart University, Bangkok, Thailand

Several hundreds of native plant species are used for daily diet in Thailand as vegetables, fruits, spices and condiments. Many of them are also employed for traditional medicine. Edible plants in Thailand are rich in phytochemicals such as vitamins, terpenoids, flavonoids, alkaloids, organosulfur compounds, pigments and other phenolics. Since such phytochemicals exhibit various biological activities, it has been suggested that edible plants in Thailand may play a role in the prevention of human chronic diseases as well as cancer. In this regard, the "functionality" of such edible plants is being emphasized. However, since this aspect has been investigated in only a few Thai plants, under the JIRCAS Visiting Research Fellowship Program at Tsukuba, a total of 47 species (48 samples) of edible plants from Thailand were collected and their methanolic extracts were analyzed in relation to two important functions, antioxidant activity and antimutagenicity. The results are summarized as follows.

1. Antioxidant activity

Molecular oxygen is easily converted to reactive free radicals called "oxygen free radicals" (ORF) *in vivo*. ORFs are formed by the transfer of one electron to the oxygen molecule during various physiological processes such as respiration chain, oxygenase reactions and cellular immunization reaction. ORFs damage the cell membrane, cytosolic molecules and genes, and they are associated with the incidence of various chronic diseases, *i.e.* heart diseases, thrombosis, hypertension and cancer. It has been suggested that the ingestion of dietary antioxidants that suppress the ORF production or scavenge ORFs may prevent harmful effect of ORFs. Some phytochemicals, *i.e.* flavonoids, pigments and antioxidative vitamins, are known to be potent antioxidants. We determined the antioxidant activity of methanolic extracts from edible Thai plants by the β -carotene bleaching method. The data obtained are summarized in **Fig. 1**. We found that more than 70% of Thai plant species showed a very high (+++) and high (++) antioxidant activity, while only one-third of common edible plants in Japan exhibited a high activity. Especially, three plant species (4 samples) showed a significantly potent activity. "Pak kra doon" (**Photo 1**; *Careya sphaerica* Roxb.), a leafy vegetable, exhibited the highest activity (121.0 mg BHA equivalent /g dry weight). The leaf of "Pak sa meg" (*Syzygium gratum* Wall.), and the fruit and the leaf of "Kra thin" (*Acacia farnesiana* Willd.) also showed a high activity (40.2, 38.8 and 44.7 mg BHA equivalent /g, respectively).

[Fig. 1. Antioxidant activity \(upper\) and antimutagenicity \(lower\) of edible plants in Thailand and Japan. \(22KB\)](#)

2. Antimutagenicity

Heterocyclic amines and polyaromatic hydrocarbons are considered to be the major cause of cancer due to their potent carcinogenicity. They are formed during the daily cooking process and commonly occur in food. Burnt grilled fish or smoked foods contain a mutagenic heterocyclic amine, 3-amino-1,4-dimethyl-5H-pyrido[4,3-b]indole (Trp-P-1). Trp-P-1 acquires genotoxicity after being converted to N-hydroxy Trp-P-1 by hepatic enzyme cytochrome P450 monooxygenases (P450). N-hydroxy Trp-P-1 is easily transformed to its radical, which reacts with DNA to induce frame-shift mutation. In the present study, we examined the suppressive activity of Thai vegetables towards the mutagenicity of Trp-P-1 with *Salmonella typhimurium* TA98 in the presence of S9 mix. *S. typhimurium* TA98 is a mutant of *Salmonella* bacteria that requires histidine to grow (*his*⁻), owing to mutation in a gene for histidine biosynthesis, and S9 mix is a mutagen-activating metabolic enzyme system from rat liver homogenate containing P450. The activated mutagen induces reverse mutation, and resulting wild-type revertants (*his*⁺) can grow in the histidine-deficient medium. If a plant extract inhibits the reverse mutation, the number of wild-type revertants must decrease. By this method, we observed that several plant extracts have a potent inhibitory effect on the mutagenicity of Trp-P-1 (**Fig. 1**). The methanolic extracts from 1.25 mg of freeze-dried "Pak pai" (**Photo 2**; fragrant knotweed; *Polygonum odoratum* Lour.), that is a common condiment in Thailand and Vietnam, suppressed 96% of the mutagenicity of 50 ng Trp-P-1, followed by "Pak chee" (coriander; *Coriandrum sativum*; 94%), "Hoom yae" (*Trachyspermum roxburghianum* Craib; 92%) and "Pegah" (Indian trumpet flower; *Oroxylum indicum* Vent.; 90%).



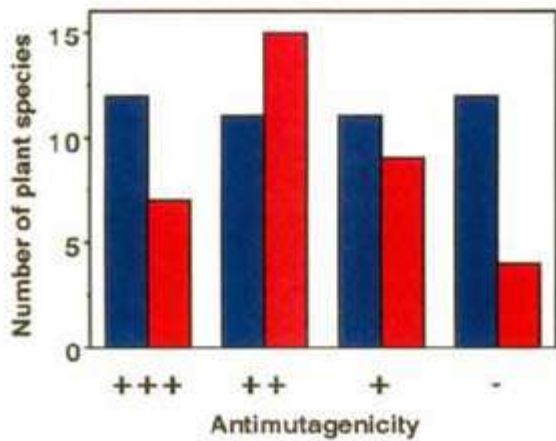
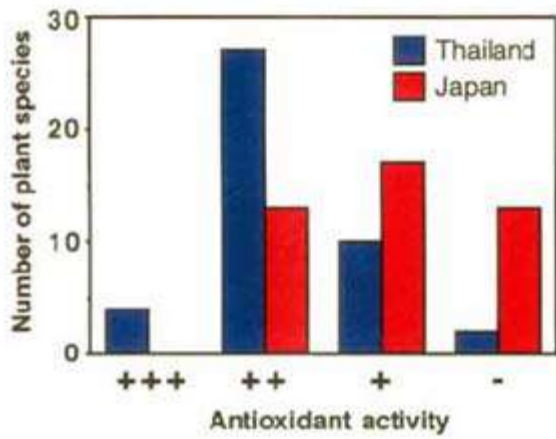
Photo 1: "Pak kra doon,"
(*Careya sphaerica* Roxb.)



Photo 2: "Pak pai,"
(*Polygonum odoratum* Lour.)

Next

Contents



The antioxidant activity (AA) was classified into four ranks by the inhibitory activity: +++, very high (≥ 20 mg BHA equivalent /g); ++, high (20 - 3.6 mg BHA eq./g); +, low (3.6 - 0.75 mg BHA eq./g); -, negative (≤ 0.75 mg BHA eq./g). The antimutagenicity; +++, very high ($\geq 80\%$); ++, high (80 - 60%); +, low (60 - 40%); -, negative ($\leq 40\%$).

Fig. 1. Antioxidant activity (upper) and antimutagenicity (lower) of edible plants in Thailand and Japan.

Next

Back

Collaborative Research on Interspecific Hybrids of Rice at WARDA



Fig. 1. WARDA and its member countries

Rapid demographic expansion and urbanization in Africa led to changes in food preference toward rice and bread which can be more easily prepared than traditional food-stuffs. These patterns are especially evident in West Africa where the substitution of rice for coarse grains and traditional root and tuber crops has fueled growth in demand at an annual rate of 5.6% between 1961 and 1992.

The demand for rice in sub-Saharan Africa is growing faster than for any other major food staple, with consumption increasing across all the socioeconomic classes. Rice is no longer a luxury food and the poorest urban households in West Africa derive larger shares of their cereal-based calories from rice than do higher income households, and rice purchases account for a greater part of their total cash expenditure. Rice availability and rice prices impact directly on the welfare of the poorest West African consumers who experience the lowest rate of food security.

The increase of rice production in Africa is hampered by a number of constraints, including diseases and pests, weed infestation, inadequate water management, soils with a low fertility, and lack of suitable varieties. In sub-Saharan Africa, farmers cultivate two species of rice, African rice (*Oryza glaberrima*) and Asian rice (*Oryza sativa*). Although *O. sativa* is preferred by African farmers due to its higher yield potential, *O. glaberrima*, the indigenous domesticated species, has several advantages over *O. sativa*, such as high weed competitiveness, resistance to drought, soil acidity, rice yellow mottle virus, African rice gall midge. Most of the improved varieties currently available to farmers have been developed from Asian *O. sativa* germplasm recently introduced that has yet acquired little resistance to the stresses prevailing under the environmental conditions of West Africa.

Following the initial breakthrough at WARDA in producing fertile progenies of interspecific hybrids, an Africa/Asia joint research project on interspecific hybridization of rice was initiated in January 1997, under the aegis of the Japan/United States Common Agenda for Cooperation. Funding and technical assistance were provided by the Government of Japan, the United Nations Development Program (UNDP), and the Rockefeller Foundation. The main objective of the project is to improve the welfare of rice producers and consumers by developing rice varieties adapted to low input-management through interspecific hybridization, that are well suited to resource-poor farmers in West Africa.

The new interspecific progenies include a significant percentage of intermediate types combining the seedling vigor, high tillering and weed suppression traits of *O. glaberrima* with the panicle and grain type characteristics of *O. sativa* and are considered to be promising as new breeding materials. Further efforts for combining a high-yielding ability and stress tolerance are now being emphasized at WARDA.

Within the framework of the WARDA's mid-term strategies, JIRCAS initiated a collaborative research project at WARDA from April this year to implement the hybridization project by sending senior researchers to WARDA to take up the following research topics:

- 1) Genetic and eco-physiological characterization of indigenous rice varieties and interspecific progenies, with emphasis placed on tolerance to drought and acid soil conditions.
- 2) Studies on socio-economic aspects in relation to the sustainability of lowland rice cultivation in West Africa.

[Photos : \(82KB\)](#)

[Photo 1: Rice fields in Cote d'Ivoire \(left: irrigated field, right: rainfed upland field\)](#)

[Photo 2: Field for breeding of interspecific hybrids at WARDA](#)

[Photo 3: A farmer and his family growing a WARDA breeding line along with maize and cassava](#)

Next

Contents



Photo 1: Rice fields in Cote d'Ivoire (left: irrigated field, right: rainfed upland field)



Photo 2: Field for breeding of interspecific hybrids at WARDA



Fig. 1. WARDA and its member countries



Photo 3: A farmer and his family growing a WARDA breeding line along with maize and cassava

Next

Back

International Workshop on "Cryopreservation of Tropical Plant Germplasm"

The intensive exploration and collection activities in recent years have resulted in the rapid increase of plant germplasm collections throughout the world. The development of safe and cost-effective techniques for the long-term conservation of the collections, especially recalcitrant seed- and vegetatively propagated species is considered as a priority research area.

For long-term conservation of the problem species, cryopreservation is the only method currently available. Dramatic progress has been made in recent years in the development of new cryopreservation techniques, and cryopreservation protocols have been established for over 100 different plant species. However, cryopreservation of tropical and sub-tropical species has been less extensively investigated than that of temperate species.

Against this background, Japan International Research Center for Agricultural Sciences (JIRCAS) and International Plant Genetic Resources Institute (IPGRI) jointly organized the International Workshop on "Cryopreservation of Tropical Plant Germplasm - Current research progress and application-" held at JIRCAS, Tsukuba during the period 20-23 October, 1998.

In an increasing number of National Programmes in the tropics there has been a growing awareness of the importance of cryopreservation and research activities in this field have been initiated recently. Thus the workshop was timely in providing a unique opportunity for cryopreservation researchers to get together to exchange information and to discuss numerous aspects of cryopreservation of tropical plant species. From 29 countries, 93 scientists including scientists from the International Agricultural Research Centers i.e. IPGRI, CIAT, CIP, IITA, INIBAP participated in the workshop. Dr. Nobuyoshi Maeno, Director General of JIRCAS gave the welcome address and key note addresses by Prof. Akira Sakai (Professor of Emeritus, Hokkaido University) and Dr. Florent Engelmann (IPGRI) were delivered, followed by 41 oral presentations and 51 posters.

Session I dealt with "fundamental aspects of cryopreservation," including ultra-structural studies on cell adaptation to freezing and studies on molecular mechanisms of plant freezing tolerance. During Session II, cryopreservation techniques involving cells, pollen, embryos, meristems were outlined. During Session III, application of cryopreservation protocols to germplasm conservation was reviewed while during Session IV, the "current status of cryopreservation research and future perspectives of its application in natural programs" were considered.

The workshop was successful with active discussions to assess the current status of research, present application of and existing problems with cryopreservation of plant germplasm with a strong focus on tropical species, and to identify priority areas for collaborative research, technology development, transfer and application. It was also pointed out that the workshop could be a good start for setting up a network, even informal, in the field of germplasm conservation to facilitate international research collaboration. The proceedings of this workshop will be published early next year.

[Photo: Participants in the workshop \(25KB\)](#)

(Hiroko Takagi)

[Next](#)

[Contents](#)



Photo: Participants in the workshop

Next

Back

JIRCAS Fellowship Program: Welcoming New Visiting Researchers

Seventeen Visiting Researchers are participating in the JIRCAS 1998 Visiting Research Fellowship Program to carry out collaborative research at Tsukuba and Okinawa.

Tsukuba: Short-term (5 months at National Institute for Agrobiological Resources)

Dr. Dea de Lima Vidal	Univ. of Zaragoza, Brazil	Economic and breeding evaluation of animal genetic resources in developing countries
Dr. Lawrence Misa Aboagye	Plant Genetic Resources Center, Ghana	Evaluation of diversity for a starch synthetic gene in wheat
Dr. Irina Olegovna Vvedenskaya	N. I. Vavilov, All Russian Inst. of Plant Industry, Russia	Molecular basis of protein markers in wild relatives of crops
Dr. Dennis Yeo	National Inst. of Agrobiological Resources, Singapore	Development of strategy to generate male-sterile plants using transcription

Tsukuba: Long-term (2 years at JIRCAS, Tsukuba)

Dr. Joseph Gogo Dubouzet	Former Post Doctoral Fellow at Hokkaido National Agric. Exp. Station, Philippines	Molecular analysis of drought stress responses in rice
Dr. Vipaporn Na Thalang	Kasetsart Univ., Thailand	Chemical and biological evaluation of Thai Vegetables (Family <i>Leguminosae</i>)
Ms. Do Thi Thanh Huong	Cantho Univ., Vietnam	Physiological studies on reproduction and osmoregulation in the giant freshwater prawn, <i>Macrobrachium rosenbergii</i>
Mr. Jianjun Guo	Research Center for Rural Economy, Ministry of Agric., China	Economic analysis on food consumption of Chinese farm households

Okinawa: Long-term (1 year at JIRCAS Okinawa Subtropical Station)

Dr. Bujun Wang	Inst. of Crop Breeding and Cultivation, China	Methane emission and carbon cycling in rice fields as affected by elevated atmospheric CO ₂ concentration and environmental factors
Dr. Md. Abdul Karim	Inst. of Postgraduate Studies in Agric., Bangladesh	Interactive effect of thermal and irradiance stresses on some physiological and biochemical parameters of grain legumes and mango
Dr. Narinder Pal Singh Dhillon	Punjab Agric. Univ., India	Genetic variation and relationships in sweet potato populations detected with RAPD and AFLP markers
Dr. Liu Jian	Shandong Teacher's University, China	Cloning the heat tolerance-related genes from tomato reproductive tissues
Dr. Armando Rubio Calderon	Instituto Nacional Autonomo de Investigaciones Agropecuarias Iniap, Ecuador	Evaluation and characterization of oligofructan content in yacon germplasm
Dr. Xinwen Hu	Chinese Academy of Trop. Agric. Sci., China	Development of microsatellite markers in snap beans
Dr. Charuwan Bangwaek	Prachinburi Rice Res. Center, Thailand	Enzymes activities related to sugar accumulation in sugarcane
Dr. M. Arumugam Pillai	Tamilnadu Agric. Univ., India	Screening of cDNA library for salt tolerance gene in rice
Ms. Maribel Regla Quintana Sanz	Inst. of Pastures and Forages Research, Cuba	Evaluation of genomic diversity of sugar-related enzyme genes in sugarcane genetic resources

[*Photo 1: Welcome party at JIRCAS headquarters upon the arrival of the new research fellows \(40KB\)*](#)

[*Photo 2: JIRCAS visiting research fellows at Okinawa Subtropical Station \(24KB\)*](#)

The new application form for the JIRCAS fellowship program is now available.

For the details, please contact :

International Relation Section, JIRCAS

FAX: +81-298-38-6337

[Contents](#)

[JIRCAS Home Page](#)



Photo 1: Welcome party at JIRCAS headquarters upon the arrival of the new research fellows

Back



Photo 2: JIRCAS visiting research fellows at Okinawa Subtropical Station

Back

JIRCAS Newsletter 1997•@(No.10)



CONTENTS

- [International Collaborative Studies Undertaken by JIRCAS Fisheries Division](#)
-Promotion of Sustainable Fisheries Industry Together with Agriculture, Animal Production, and Forestry-
- [Current Research at Okinawa Subtropical Station](#)

•@•áJIRCAS Research Highlights•â

- [Estimation of DNA Marker Effects in Marker-Quantitative Trait Loci \(QTL\)- Association Analysis](#)
- [Development of Sustainable Aquaculture Technology in Southeast Asia](#)
- [Ecophysiological Characteristics of Tropical Tree Species](#)
- [Determination of Site Factors that Promote the Regeneration of Tree Species](#)

•@•áTopics•â

- [2nd Seminar on•gBrackish Water Project•hHeld in Malaysia](#)

•@•áVisiting Scientist•â

- [Plants Respond to Environmental Conditions](#)

International Collaborative Studies Undertaken by JIRCAS Fisheries Division

-Promotion of Sustainable Fisheries Industry Together with Agriculture, Animal Production, and Forestry-



Kunihiko Fukusho

Director, Fisheries Division

•@

The Fisheries Division is in charge of research on marine and freshwater fisheries resources management, aquaculture, fisheries products processing, which are major themes for international collaboration. The researchers of the Division are engaged in the following research fields:

Dr. Yutaka Fukuda (fisheries products processing), Dr. Shigeo Hayase (squid ecology), Dr. Motoyuki Hara (fish genetics), Dr. Marcy N. Wilder (crustacean endocrinology), Dr. Satoshi Suyama (marine fish ecology), and Mr. Masashi Sekino (freshwater fish culture).

Several seminars and workshops on fisheries resources management and aquaculture were held prior to the initiation of the international collaborative studies in the field of fisheries sciences to identify priorities. The main orientation of effective collaborative studies was eventually defined as follows:

- 1) Development and improvement of technology for sustainable fisheries industry compatible with environmental protection
- 2) Japan's contribution to Asian countries as one of the Asian countries (First step; subsequently researchers will be sent to other regions such as South America, Africa, etc.)
- 3) Promotion of integrated and comprehensive multidisciplinary studies involving agriculture, animal production, and forestry fields
- 4) Collaboration with the organizations belonging to the Consultative Group on International Agricultural Research (CGIAR) such as ICLARM (International Center for Living Aquatic Resources Management) and Regional International Organizations like the SEAFDEC (Southeast Asian Fisheries Development Center)
- 5) Attempts to address urgent issues in the field of aquaculture

The Fisheries Division has started to implement collaborative research projects in five Asian developing countries in order to develop a technology for sustainable production of fish, methods of fish culture compatible with the preservation of the environment, and methods for efficient utilization of fisheries products. Title, duration, and counterpart organization of these collaborative studies are as follows:

- 1) Development of sustainable aquaculture technology in Southeast Asia (1994-1999). Faculty of Fisheries, Kasetsart University, Thailand
- 2) Evaluation and improvement of farming systems combining agriculture, animal husbandry, and aquaculture in the Mekong Delta (1994-1999). College of Agriculture, Cantho University, Vietnam
- 3) Production and sustainable utilization of tropical and subtropical brackish water ecosystems (1995-2000). Fisheries Research Institute, Forestry Research Institute, and Faculty of Science, University of Malaya, Malaysia
- 4) Study on the utilization and processing of freshwater fishes in China (1995-2000). College of Food, Shanghai Fisheries University, China
- 5) Study on the ecology and life history of coastal fishes (1995-2000). Central Research Institute for Fisheries, Indonesia

The 4th collaborative study will be incorporated into a new comprehensive project entitled •gDevelopment of sustainable production and utilization of major food resources in China•h 1997. Furthermore, a new collaborative study •gDevelopment of methods for the diagnosis and prevention of penaid viral diseases•h is scheduled to start in Asian countries in 1997.

The Division also is actively participating in the JIRCAS Visiting Research Fellowship Program at Tsukuba, and has invited distinguished researchers from developing countries in the field of prevention of fish diseases. The researchers who participate in the Program are expected to be key scientists for collaborative studies in the future.

Although the Division has a small number of researchers, it is supported by nearly 430 scientists affiliated to the Fisheries Institutes of the Fisheries Agency, and will also implement joint research programs with other Divisions of JIRCAS.



Photo 1: Prawn culture, Bali

Island

Current Research at Okinawa Subtropical Station



Tadaaki Yamashita

Director, Okinawa Subtropical Station

The Okinawa Subtropical Station is the only national research organization that carries out agricultural research under subtropical conditions in Japan. The Station is located in Japan's southernmost city, Ishigaki (2100 Km southwest from Tokyo). By taking advantage of the subtropical environment, research is carried out in order to develop techniques which should contribute to the promotion of agriculture in the tropical and subtropical areas. Research at the Station covers various fields relating to the production of tropical crops, including breeding and cultivation methods, plant nutrition, soil management, plant physiology and pathology, biotechnology, etc. At the Station, researchers from developing countries are engaged in collaborative studies for optimum utilization of bioresources for conservation of the environment and sustainable agricultural production in the tropics. Since the establishment of the Station in 1970, significant results have been obtained and emphasis has been placed on the enhancement of research activities to develop a new technology aimed at securing food production and preserving the tropical environment.

•@

Explore, Conserve and Utilize Biodiversity

To alleviate the constraints associated with the expansion of areas with salinity problems, salt-tolerant crops are identified using rapid and simple methods. A large variation in salinity tolerance was observed among cultivated varieties of rice originating from all over the world. Salinity-tolerant varieties were geographically distributed mainly in Bangladesh, Malaysia and West African countries at higher frequencies. Isozyme analysis showed that the esterase allele *Est-2* is one of the genetic markers of salinity tolerance in rice.

For long term storage of vegetatively propagated plant germplasm, cryopreservation is a useful method. Protocols for the stable cryopreservation of germplasm of tropical crops, especially root crops such as taro, yams and sweet potato were developed. By successful cryopreservation of shoot meristems of taro (*Colocasia esculenta* (L.) Shott.), on average, 80 percent of the shoot tips could be stored in liquid nitrogen after dehydration treatment using vitrification solution. Most of the surviving shoot meristems developed shoots and roots normally.

Palatability of flour-derived food is considered to be influenced by amylose in wheat. For amylose

synthesis, waxy protein is responsible and three waxy proteins (Wx-A1, Wx-B1, Wx-D1) are present in wheat. Analysis of 1,960 accessions of wheat germplasm enabled to detect a Chinese wheat variety which lacked the Wx-D1 protein. From a cross between the Chinese wheat variety and a Japanese wheat variety which was deficient in both Wx-A1 and Wx-B1 proteins, a wheat variety lacking waxy proteins was produced. This variety does not contain amylose and may become a novel material for food use.

Aiming at Sustainable Agricultural Production

In the global atmosphere, concentration of methane is increasing and methanogenic bacteria are biological producers of the gas. Application of rice straw and cellulose has resulted in a considerable increase in methane emission from subtropical paddy fields as well as an increase in the populations of methanogenic bacteria. Methanogenic colonies in cultures of the bacteria showed a blue auto-fluorescence. Currently the populations of methane-oxidizing bacteria in the soil and rice rhizosphere are being investigated and attempts are made to isolate them in order to utilize them as methane-oxidizers for biological control of methane emission.

Soil loading due to erosion in coastal marine environments is a serious problem. For the alleviation of erosion hazards in pineapple fields, the effects of organic mulch, cover crops, and nontillage planting were investigated. Results indicated that a cover crop, weeping lovegrass (*Eragrostis curvula*), on the lower edge of the slope reduced soil loss to a negligible level.

New cultivar of snap bean, •gHaibushi•h (*Phaseolus vulgaris* L.), was released in 1995. •gHaibushi•h was bred through pure line selection from Malaysian germplasm. It shows a superior heat tolerance compared with the local cultivars and gives a high pod yield in the subtropical area of Japan where vegetable production in summer is difficult. The plant type is indeterminate and young pods are light green.

Papaya leaf distortion mosaic potyvirus (PLDMV) damages papaya plants in the subtropical zone of Japan. The DNA complementary to the 3•f-terminal region of PLDMV RNA was cloned and sequenced. Papaya ringspot potyvirus (PRSV) is an other potyvirus which was isolated from papaya in Japan. Results of sequencing of cDNA of PLDMV supported the classification of PLDMV as a distinct member of the genus Potyvirus.

Physiological Studies To Overcome Environmental Constraints

Heat tolerance in tropical fruit crops was determined by chlorophyll fluorescence. This method has been widely used to examine the variation in tolerance of photosystem II to high temperature. Chlorophyll fluorescence test revealed that pineapple, cherimoya, sugar apple, and coconut palm were tolerant to heat whereas Java apple, rose apple, and longan were sensitive among 25 tropical fruit crops.

Some plants experience iron deficiency chlorosis when grown on alkaline calcareous soils. This problem can be overcome by using resistant cultivars. In chickpea (*Cicer arietinum*) and mungbean (*Vigna radiata*), some cultivars developed iron deficiency chlorosis when grown on alkaline soil while others did not exhibit visible symptoms. It was revealed that the resistant cultivars were able to lower the pH around the root in response to iron deficiency, resulting in the solubilization of insoluble iron.

Areas with problem soils such as saline, acid sulfate, sandy soils, etc. are continually increasing in the tropics and subtropics. Hydroponics may be a suitable alternative for crop production in such regions. We developed a new apparatus for crop production, which does not require the use of electricity. In this

system, supply of nutrients is achieved through capillary action, and the amount of nutrient solution can be reduced by using a floating valve system.

-JIRCAS RESERCH HIGHLIGHT-

Estimation of DNA Marker Effects in Marker-Quantitative Trait Loci (QTL)-Association Analysis

*Kenji Togashi**

•@

African indigenous cattle display a high degree of resistance to many diseases including trypanosomiasis. In particular, tsetse-transmitted trypanosomiasis is the major constraint on livestock and agricultural production in Africa. Currently, tsetse infestation covers an area of 11 million km² in Africa, accounting for about 37% of the surface of the continent. It is considered that 7 million km² of the area would otherwise be suitable for livestock and mixed agriculture without detrimental effect on the environment, if trypanosomiasis could be controlled. Over a period of several thousand years, certain breeds of cattle such as N'Dama and West African Shorthorn have developed the ability to thrive in tsetse-infested areas where there is a high risk of trypanosome infection. Consideration is now being given to the use of trypanotolerant breeds of domestic animals as an approach to sustainable livestock development in tsetse-infested areas.

The gene responsible for the resistance to trypanosomiasis is currently being identified at ILRI (International Livestock Research Institute) by using crosses between the trypanotolerant N'Dama and zebu cattle breeds, e.g. the Boran. The procedure to estimate the effect of DNA markers linked to the gene responsible for trypanosomiasis was developed as a joint study between JIRCAS and ILRI. Based on the procedure, the degree of effects of DNA markers was found to be highly correlated with the degree of relationship of the true and estimated marker effects. For example, the relationship was even more significant by limiting the number of markers depending on the degree of effects of DNA markers to the top 30 markers than by using all the markers (Table 1). This finding indicated that selection should be based on the use of DNA markers with more pronounced effects, since the markers with poor estimation and negligible effects only create noise for selection.

•! Present address : Hokkaido National Agricultural Experiment Station, Animal Production Division

Table 1. Correlation coefficients between the true and estimated DNA marker effects when the number of progenies per sire is 500

	Number of DNA markers per chromosome	
	3	4
Heritability		
0.2	0.7221 (0.5928)	0.6741 (0.5131)
0.4	0.7823 (0.6649)	0.7316 (0.5763)

The figures represent the correlation when the number of DNA markers was limited to the top 30 markers
The figures in the parenthesis indicate the correlation when all the DNA markers were used

•@

•@

•@

-JIRCAS RESEARCH HIGHLIGHT-**Development of Sustainable Aquaculture Technology in Southeast Asia***Motoyuki Hara*

Recently, in the Southeast Asian countries, especially in Thailand, an intensive form of aquaculture has been promoted in order to increase product volume in accordance with economic growth, and such an intensive form of aquaculture has rapidly spread. As a result, production from aquaculture, especially in relation to prawns, has markedly increased in a short period of time ([Fig. 1](#)). However, in some countries and regions, this intensive form of aquaculture had to be reduced or discontinued because of the occurrence of diseases affecting cultured species. It was eventually recognized that it is difficult to maintain a high productivity using intensive aquaculture. In order to achieve sustainable production for aquaculture in Southeast Asia, it is necessary to promote basic studies relating to aquaculture sciences, such as genetics, physiology, pathology and dietetics of fish and prawns. JIRCAS considers that technologies for the promotion of sustainable aquaculture can be developed through basic studies relating to aquaculture sciences.

The collaborative studies covering a five-year period were initiated in 1994 between the Japan International Research Center for Agricultural Sciences (JIRCAS) and the Faculty of Fisheries, Kasetsart University, Thailand. In the first half period of the research program, genetic studies were emphasized as one of the approaches to promote basic studies relating to aquaculture sciences.

At first, in order to develop methods for the detection of genetic variability for breeding, a manual for isozymic analysis for 20 aquatic animal species of economic importance in Thailand fisheries was prepared. The genetic variability of wild populations of catfish (*Clarias macrocephalus*) was analysed using this manual.

The wild population of catfish collected from five localities indicated in [Fig. 2](#) was analysed by using as markers the genes at eleven loci controlling nine enzymes. As a result of isozymic analysis, it was found that the populations examined were genetically independent of each other, because most of the pairs of five populations showed significant differences in all the allele frequencies at more than one locus. Furthermore, based on the genetic distances among the six local populations of catfish, the dendrogram showed that genetic relationships of the populations could be determined ([Fig. 3](#)). The relationships between the populations of Prachin Buri and Chachoeng Sao, or Pattani and Yala were very close genetically, whereas the relationship between the Chiang Rai and Pattani (or Yala) populations was genetically distant. A vertical dotted line was drawn across the dendrogram to delineate a group with a distance of 0.01. The genetic distance of 0.01 was considered to correspond to a local race level based on the results of analysis of many kinds of animals. Using this vertical dotted line, the five local populations were divided into two groups, which indicated the differentiation of local races into north/central and south groups.

This species was strongly related to the geographical distance or geographical regions in Thailand. Thailand consists of three regions i.e. central plain, northeastern plain and southern plain, and the three wide regions could be differentiated as a whole, which suggests the possibility of genetic segregation of wild populations.

It is important to identify a local race for breeding, since hybridization among local races can lead to

heterosis, and the productivity could be increased. Thus the productivity could be increased by using breeding technologies for two species of economic importance for aquaculture.

The steady increase in the world population requires that sustainable and higher productivity be promoted. The increase of productivity through breeding may lead to sustainable production. However, to promote sustainable aquaculture, it is necessary to develop technologies adapted to the regions.

•@

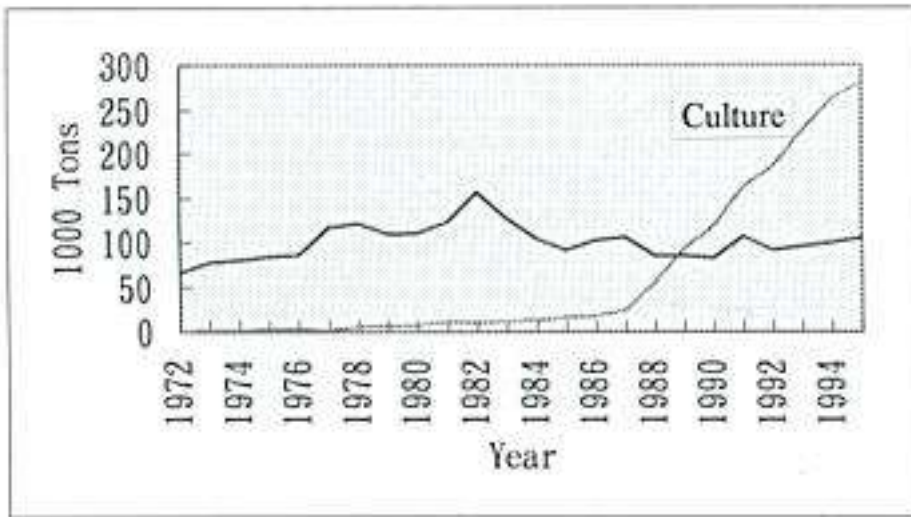


Fig. 1 . Production of prawns, catches and culture in Thailand

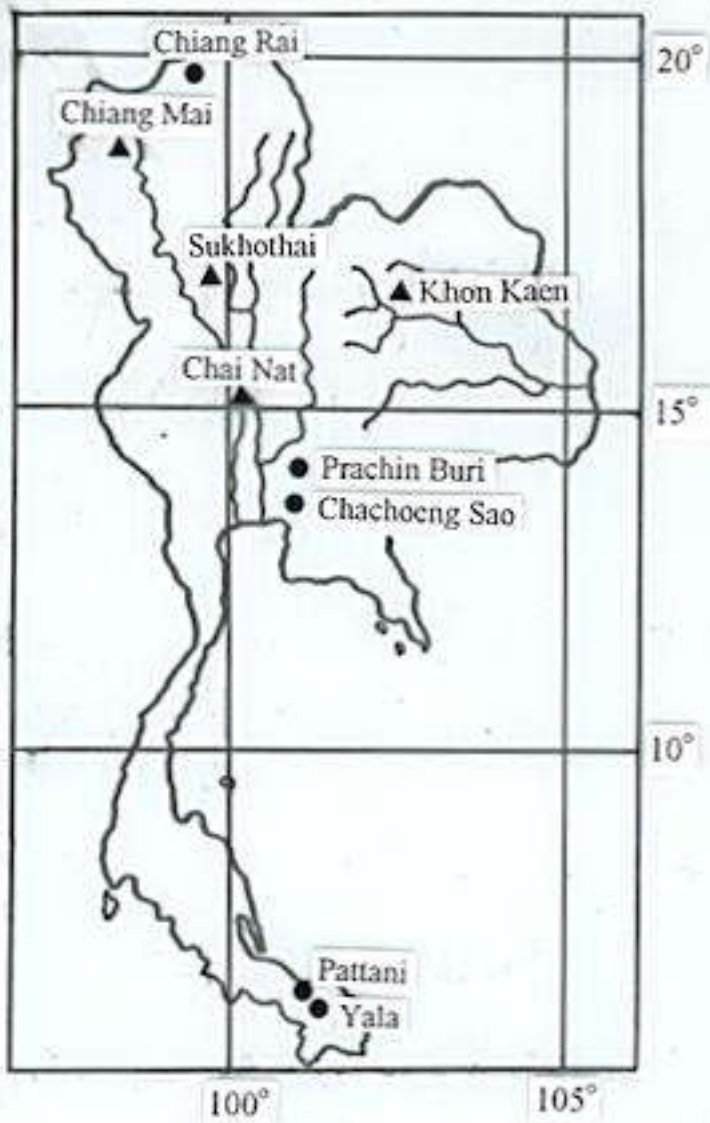


Fig. 2. Sampling sites of catfish (●) and snake-head fish (▲)

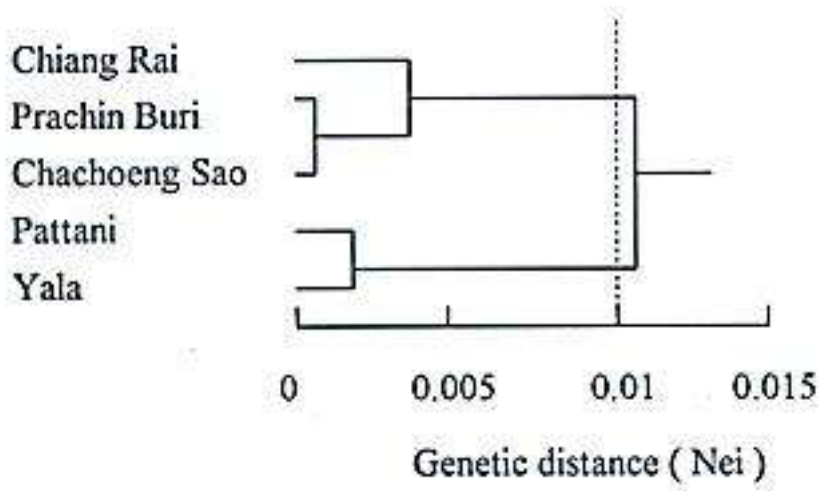


Fig. 3. Dendrogram depicting the relationship among local populations of catfish in Thailand

-JIRCAS RESERCH HIGHLIGHT-**Ecophysiological Characteristics of Tropical Tree Species***Yutaka Maruyama*

•@

Dipterocarps are the main timber-producing trees in Malaysia. Most of the dipterocarps are slow-growing, late successional species, and require moderate shade for optimum growth at the early stage. It is generally considered that dipterocarp seedlings are not suitable for open planting because of their low adaptability to environmental stresses associated with exposed sites. On the other hand, fast-growing pioneer species require strong sunlight for their establishment. In this study, ecophysiological characteristics of these tree species were examined to compare their drought resistance and adaptability to environmental stresses such as heat and light.

The leaf water relation parameters showed that the capacity for maintaining a positive turgor was low in shaded and well-watered nursery seedlings of dipterocarps. On the other hand, leaves of exposed trees were well adapted to water stress morphologically, being smaller and thicker, as well as by their ability to maintain a positive turgor through osmotic adjustment. The rate of net photosynthesis (P_n) was lower in dipterocarps than in the fast-growing species such as acacia and teak. However, in a dipterocarp, *Hopea odorata*, P_n was similar to that of fast-growing species and the trees exhibited a very high water use efficiency (WUE). Decrease in P_n in response to non-optimum temperatures was relatively moderate in *H. odorata* and *Shorea platyclados*, suggesting that gas exchanges of these species were stable under variable temperatures. Among the dipterocarps, *H. odorata* and *S. platyclados* could be recommended as suitable species for open planting. Midday depression of stomatal conductance (G_w) was observed in most of the species examined. G_w started to decrease when the leaves were exposed to full sunlight and when the vapour pressure difference between the leaf and the ambient air (VPD) was above 0.01 Pa/Pa. Since photosynthetic CO_2 uptake is strongly controlled by stomatal opening, P_n of dipterocarps was limited by the reduction of G_w . However, the reduction of the transpiration rate (T_r) was relatively small because of the increase of VPD, which stimulates evapotranspiration, with increasing temperature and decreasing air humidity. In contrast, G_w of *Acacia mangium*, a well known fast-growing and drought-tolerant species, remained relatively constant even under full sunlight and when the VPD was above 0.01 Pa/Pa, resulting in a high T_r at midday. Leaf water potential ($f_{\mu w}$) was low, or more negative, at noon when T_r was high. In tall mature trees, the difference in the gravitational potential ($f_{\mu g}$) could also cause a lowering of $f_{\mu w}$ in the upper canopy. In addition, low soil-to-leaf hydraulic conductance (L) in tall trees limited the water uptake from soil. The resulting lower minimum $f_{\mu w}$ in tall trees can lead to enhanced water stress, and lower G_w and P_n than in smaller trees. In *A. mangium*, L was remarkably high. High L enabled this species to maintain a less negative $f_{\mu w}$ for the same transpiration rate compared to dipterocarps. By keeping the water deficit low through high L , *A. mangium* maintained a high G_w during the day when the transpiration rate was high.

These results indicate that the slow growth of dipterocarps may be attributed to the relatively low rates of net photosynthesis and midday stomatal closure. Low L of dipterocarps can limit water availability and lower leaf water potential, especially in the mature tall trees. Nursery-grown seedlings of dipterocarps were more susceptible to water stress because of their relative inability to maintain a positive turgor. To enhance their ability to cope with water stress, it is recommended that nursery-grown dipterocarps be

preconditioned to drought and direct sunlight prior to transplanting. Partial shading after transplanting is also recommended in order to avoid excessive water loss and to stabilize stomatal conductance and rates of gas exchange in the daytime.

[Photo 1: Nursery](#)

[Photo 2: Drooping of leaves of a planted dipterocarp seedling](#)





-JIRCAS RESEARCH HIGHLIGHT-

Determination of Site Factors that Promote the Regeneration of Tree Species

Hiroyuki Tanouchi

•@

Although there is an abundance of commercial species in the hill forests of Peninsular Malaysia, the regeneration of tree species does not necessarily succeed in the forests left alone after selective logging. The more valuable of these species is *Shorea curtisii*, which is distributed on the ridges and upper slopes. To develop and further improve techniques for the regeneration of *S. curtisii*, the relationship between the regeneration dynamics and environmental factors needs first to be analysed. We set up a 4 ha (400m•~100m) plot in 1994. The plot which was logged selectively five years ago was located on a west-facing slope of Semangkok area (500 m asl; 3•<37'N, 101•<44"E). Dataset of an old-growth forest next to the plot was used for comparison. The density and size distribution of the saplings in both forests were not significantly different. Most saplings in the logged-over forest were established before logging, indicating that logging had not affected appreciably the mortality. However, there were few saplings along the logging roads. Though the canopy in the tree layer was not closed yet, stemless palms (*Eugeissona tristis*) formed a dense canopy in the shrub layer in the logged-over forest. Under the deep shaded conditions (relative canopy openness < 2%), most of the saplings had not developed a main shoot and they extended lateral branches (left, Photo 1). The saplings around the gap of the old-growth forest and at the site without palms showed an adequate upper growth (right, Photo 1).

The palms in a 1 ha plot were removed for improving the light conditions of the saplings (Photo 2). The relative canopy openness was 1.7% and 4.3% before and after removal, respectively. There were no morphological changes in the saplings until six months after removal, then many saplings initiated upper growth. Some saplings which lacked a main shoot elongated new shoots. Removal was estimated to be an effective method at a low cost. Moreover effects of soil compaction and erosion on the regeneration were analysed.

The techniques employed to examine the factors influencing the regeneration of the species will be adopted for studies on some of the more commercial species in the hill forests. Results from these studies will be used to develop silvicultural tending techniques for improving regeneration in logged-over hill forests. This study was carried out as part of a collaborative project between Forest Research Institute, Malaysia and JIRCAS.

[Photo 1: Saplings of *Shorea curtisii* in forest](#)

[Left: the sapling does not develop a main shoot and extends lateral branches under deep shaded conditions Right: the sapling grows upward with a main shoot in a site where more light is available](#)

•@

[Photo 2: Removal of stemless palms forming a closed canopy in the shrub layer](#)





•áTopics•â

2nd Seminar on •gBrackish Water Project•h Held in Malaysia

Shigeyuki Kawahara

•@

The seminar is held annually as a part of the comprehensive project •gProductivity and Sustainable Utilization of Tropical and Subtropical Brackish Water Mangrove Ecosystems•h. Tropical and subtropical brackish water areas, usually with developed mangrove forests, are an important habitat for fisheries resources. The project aims to evaluate the productivity of such areas and identify the criteria for sustainable utilization. The West coast of the Malay Peninsula was selected as the study area due to the presence of different types of mangrove forests. Counterpart organizations include Fisheries Research Institute (FRI), Forest Research Institute Malaysia (FRIM) and University of Malaya (UM).

The 2nd seminar was held in a meeting room of FRI's aquarium in Penang on December 5, 1996. Four subjects were taken up during the seminar as follows: ‡@Mangrove forest, meiofauna and macrobenthos, ‡APrawn and fish, ‡BRunoff of soil into the brackish waters, and ‡CSocio-economic aspects in the mangrove areas. About 30 scientists from Japan and Malaysia participated in the seminar, and nine papers were presented. Also, Dr. Kato, Director General of the Seikai National Fisheries Research Institute, introduced the Ishigaki Branch, which is the only site for studies on subtropical fisheries in Japan.

During the 1st seminar, which was held in Kuala Lumpur just one year ago, almost all the presentations dealt with reviews of previous studies (JIRCAS Working Report No. 4), because the project had just started at that time and it was considered that such reviews would contribute significantly to the execution of the project. During the 2nd seminar, the papers from the two JIRCAS researchers on long-term assignments (Dr. Hayase at FRI and Mr. Ochiai at FRIM) and seven JIRCAS researchers on short-term assignments dealt with the collaborative studies carried out with their Malaysian counterparts.

However, the comprehensive project is expected to produce integrated results in addition to the results obtained in each respective field. For integration, material/energy flow should cover the sequence from leaves in mangrove forests to crab/seashells along rivers and phyto/zooplankton and fish/shrimps in water. For such interdisciplinary studies, close collaboration between researchers in different fields is essential and it is obvious that the seminar held annually may enable to achieve this objective.

•@

[Photo 1: Mr. Ibrahim Saleh \(left\), Director General of FRI, Drs. Kato \(middle\) and Hayase \(right\)](#)

[Photo 2: Mangrove forest and fishing vessels at Matang](#)

•@





Plants Respond to Environmental Conditions

•@~



Zhu Weiming

Institute of Agrobiological Genetics and Physiology, Jiangsu Academy of Agricultural Sciences, Nanjing, China

Drought, low temperature, high salt level, insects and pathogens are some common environmental stresses to which plants are often exposed. Plants are different from animals, and since they are immobile, they have developed unique mechanisms to avoid these environmental stresses.

Plant molecular biologists have been interested in studying the mechanism(s) of plant defense systems and improving their resistance to these environmental stresses by using molecular biological techniques and plant engineering. During the past several years, I studied the resistance of transgenic plants to insects in cotton and vegetables. Now I am carrying out studies on plant response to dehydration with my Japanese colleagues. Main object of our studies is to determine how plants respond to environmental stresses, such as drought, cold and high salt at the molecular level. We have isolated several genes that respond to drought, cold and high salt stresses at the transcriptional level, and analysed their function. Now, we are trying to identify new genes that encode regulatory factors for the response to drought, cold, high salt level using yeast one-hybrid system. We are also analysing their function using transgenic tobacco and *Arabidopsis* plant system.

JIRCAS Newsletter 1997 (No.11)



Sugarcane field with extensive damage caused by leaf-cutting ants
Inset: a forager of the species carrying grass leaf (Photo by K. Ichinose)

CONTENTS•@

- [1996 Annual Meeting for Review and Promotion of Research for International Collaboration](#)
- •áJIRCAS Research Highlights•â
- [Yellow Butterfly Species \(Genus Eurema Hubner\) Causing Serious Defoliation in Forest Plantations of Albizzia, Paraserianthes falcataria \(L.\)Nielsen, in the Western Part of Indonesia](#)
- [Soil Loss from Pineapple Fields and Control](#)
- [Studies on Geographical Distribution of leaf-Cutting ants and Damage to Agriculture Caused by the Ants in Brazil](#)
- [Wide Adaptability of New Rice Cultivars in Yunnan Province of China](#)
- [Identification of Meloidogyne Species Including a New Species Based on Enzyme Phenotypes in Thailand](#)
- •áTopics•â

- [JIRCAS Symposium on Status and Requirement of Minerals in Ruminants in Thailand](#)
-Current Knowledge and Future Research-
 - [People](#)•
 - [Obituary](#)•
 - [Symposium](#)•
- [The 4th JIRCAS International Symposium Sustainable Agricultural Development Compatible with Environmental Conservation in Asia](#)

•@

[ISNAR-JIRCAS Meeting was held at JIRCAS](#)

1996 Annual Meeting for Review and Promotion of Research for International Collaboration



Keiji Ohga

•@~

- @The 1996 Annual Meeting for the Review and Promotion of Research for International Collaboration was held on February 26, 1997 in the International Conference Room of JIRCAS Headquarters.
- @A total of 54 participants attended the meeting, including representatives from various institutes affiliated to the Ministry of Agriculture, Forestry and Fisheries (MAFF) and from MAFF's Headquarters along with delegates from JICA (Japan International Cooperation Agency) as well as the Director General, Directors of Research Divisions, International Research Coordinators and several staff members of JIRCAS.
- @Following the introduction of the general situation relating to international research collaboration as well as the orientation of JICA activities, the overall research activities implemented by JIRCAS during the fiscal year 1996 were reviewed and discussed, including collaborative research projects, international symposium, seminars, workshops, various meetings, and JIRCAS Visiting Research Fellowship Program at Okinawa Subtropical Station and Tsukuba Headquarters.

[Table 1. On-going comprehensive/multidisciplinary projects including new projects starting in 1997](#)

[Photo1: Discussion at 1997 Annual Meeting](#)

- @During the present meeting, emphasis was placed on 1) JIRCAS Visiting Research Fellowship Programs, 2) comprehensive/multidisciplinary research projects, 3) research activities of Fisheries Division and at Okinawa Subtropical Station. Particularly discussions were focused on the research direction of the comprehensive/multidisciplinary research projects and how to cooperate with national institutes in the pursuit of the projects.
- @In the session on specific topics, discussions were centered on the strategies for promoting collaborative activities in South America which is considered to have a high potential for food production. The current status of food supply and demand, evaluation of natural environment and present technologies adopted in crop production and animal production in the region were reported and discussed.

by the participants. These reports and discussions should provide useful information for the promotion of a new project entitled •gComprehensive studies on soybean improvement, production and utilization in South America•h. JIRCAS plans to initiate the project from 1997 fiscal year in collaboration with MERCOSUR countries such as Brazil, Argentina, Paraguay, etc. The project places emphasis on the following aspects, 1) consolidation of the collaboration with JICA, and utilization of CETAPAR (Centro Tecnológico Agropecuario en Paraguay) as the main research site of the project, 2) multidisciplinary studies on soybean improvement and utilization in the MERCOSUR countries through collaboration with researchers from Japan and South American countries.

Table 1. On-going comprehensive/multidisciplinary projects including new projects starting in 1997

Title	Site	Year
1. Evaluation and improvement of farming systems combining agriculture, animal husbandry, and fisheries in the Mekong Delta	Vietnam	1994-1999
2. Productivity and sustainable utilization of tropical and sub-tropical brackish water mangrove ecosystems	Malaysia	1995-2000
3. Development of sustainable agricultural technology in Northeast Thailand	Thailand	1995-2002
4. Comprehensive studies on the development of a sustainable agro-pastoral system in the sub-tropical zone of Brazil	Brazil	1996-2003
5. Development of sustainable production and utilization of major food resources in China	China	1997-2004
6. Comprehensive studies on soybean improvement, production and utilization in South America	MERCOSUR countries	1997-2007



-JIRCAS Research Highlight-

Yellow Butterfly Species (Genus *Eurema* Hubner) Causing Serious Defoliation in Forest Plantations of Albizzia, *Paraserianthes falcataria* (L.) Nielsen, in the Western Part of Indonesia

Ragil S. B. Irianto^{*}, *Kazuma Matsumoto* and *Kusdi Mulyadi*^{**}

•@ Albizzia, *Paraserianthes falcataria*, is a fast-growing multi-purpose tree widely planted in Southeast Asia. Outbreaks of a pierid butterfly species of the genus *Eurema* occasionally occur in albizzia plantations, leading to severe defoliation. The butterfly species had so far been identified either as *E. blanda* or *E. hecabe*, and some authors assigned it to both species. We investigated *Eurema* species occurring in forest plantations of albizzia in five localities in Sumatra, Java, and Kalimantan, and identified four species, *E. blanda*, *E. hecabe*, *E. alitha* and *E. sari*. When the yellow butterflies were abundant, *E. blanda* predominated. The population of *E. blanda* fluctuated widely, decreasing in the dry season and increasing in the rainy season, sometimes resulting in a population outbreak and total destruction of the foliage in the plantation. On the other hand, the population levels of *E. hecabe* and *E. alitha* were more stable, and *E. sari* seldom occurred. These species are therefore considered to be of minor importance as a pest of albizzia. *E. hecabe* which has been frequently reported to be a serious defoliator of albizzia could have been mistaken for *E. blanda*. *E. hecabe* and *E. alitha*, which had been mistaken for *E. hecabe* did not occur together in our samples.

* Forest and Nature Conservation Research and Development Centre

** Palembang Reforestation Technology Centre

•@

[Photo 1: Outbreak of *Eurema blanda* \(Benakat, South Sumatra Prov., May 1994\)](#)

•@

[Photo 2: Total defoliation of an albizzia plantation by *E. blanda* \(Benakat, South Sumatra Prov., May 1994\)](#)





-JIRCAS Research Highlight-

Soil Loss from Pineapple Fields and Control

Kazuo Sugahara

•@For the last three decades, soil loading due to erosion in coastal marine environments has been serious in the Ryukyu Islands resulting in damage to the coral reefs surrounding these islands. The above soil loss can be ascribed to large-scale pineapple cultivation. Pineapple fields are located mainly on acidic red and yellow soils and receive an annual average rainfall of 2,100 mm with a slope ranging from 20 to 150 m in length and from 0 to 8•K in gradient. Since the growth of pineapple plant is very slow, fields are not covered for a long time, so that soil erosion in pineapple fields becomes a serious problem. Rill erosion occurs frequently along roadsides because of agricultural practices, such as spraying of chemicals and shipping of products.

[Photo 1 : Effect of cover crops on the prevention of soil erosion in pineapple fields](#)

•@A set of four plots was used for the investigation of the effect of cover crops on the prevention of soil erosion from October 1993 to September 1994. Ground nut (*Arachis pintoï*) and weeping lovegrass (*Eragrostis curvula*) were selected as cover crops. Each of them was planted on the lower edge of a slope. After the grasses grew well, soil erosion was effectively reduced. The alleviation of soil loss in the plots with ground nut and weeping lovegrass was 1/680 and 1/110 of the control plot, for 12 months after planting of pineapple. Another set of four plots was used for the investigation of the effect of nontillage planting on the prevention of soil erosion from October 1994 to September 1995. In the plot of nontillage planting, pigeonpea (*Cajanus cajan*) was cut down at about four months after the seedling stage, and then pineapple was planted without plowing. Nontillage planting reduced soil erosion effectively from October 1994 to May 1995. However, the effect disappeared after June 1995, because the residues of pigeonpea decomposed during this period. The alleviation of soil loss in the plot of nontillage planting was 1/14 of the control plot for 8 months after planting of pineapple. In conclusion, we recommend that farmers employ cover crops and practice nontillage planting for the protection of the soil surface. Organic mulch is less suitable because of the scarcity of labor and materials.



Studies on Geographical Distribution of Leaf-Cutting Ants and Damage to Agriculture Caused by the Ants in Brazil

•@

Katsuya Ichinose

•@Leaf-cutting ants cut parts, especially leaves, of plants for cultivation of fungi, on which their immature forms feed (Photo 1). Due to this harvesting behavior, the ants are recognized as one of the most important pests in Central to South America, though neither the geographical distribution of the ants nor their damage to agriculture is well-documented. We carried out surveys on the geographical distribution of leaf-cutting ants in Brazil from 1993 to 1996 and the distribution of the species in various regions, their density and the extent of the damage to agriculture caused by the respective species were eventually elucidated.(Fig 1) Along with the survey on the distribution and density of leaf-cutting ants in the regions, we asked farmers at some locations whether they encountered problems with leaf-cutting ants or not. The information enabled to determine the presence or absence of damage by the ants.

•@The leaf-cutting ants rated as serious pests for agriculture in Brazil are as follows: *Acromyrmex balzani*, *Ac. fracticornis*, *Ac. landolti*, *Ac. striatus*, *Atta bisphaerica*, *At. capiguara*, *At. cephalotes*, *At. goiana*, *At. laevigata*, *At. sexdens* (Photo 1). Comparison of the data with those obtained previously suggests that the distribution of the species listed in Table 1, especially *At. capiguara*, and *At. goiana*, had expanded in these decades to regions where few or none of them had been found or reported in the past. Scientists point out that incipient (less than one year old) nests of these ants (Photo 1) are very susceptible to and easily destroyed by tillage. Hence damage by the ants may increase with the adoption of nontillage cropping which is currently recommended by agricultural institutes in Brazil. Similarly the incidence of *At. cephalotes*, *At. laevigata*, and *At. sexdens* in the Amazon region may increase with the progression of logging or land development. Thus damage to agriculture by leaf-cutting ants in regions where there is at present little or no problem is likely to increase with time.

•@Hence, we have to pay attention to the expansion of the distribution of leaf-cutting ants for the control of the ants.

[Table 1. Distribution of leaf-cutting ants](#)

•@

[Photo 1 : The fungus garden\(white spherical form\), on top of which the queen stands ,of an incipient nest of *At. bisphaerica*. This nest was established in soil at a 20 cm depth.](#)

•@

[Photo 2 : Sugarcane field with extensive damage caused by leaf-cutting ants inset: a forager of the species carrying grass leaf](#)

•@

[Fig. 1. Estimation of damage to agriculture caused by leaf-cutting ants in Brazil. Regions are divided by broken lines and abbreviations for the regions are the same as in Table 1.](#)

Table 1. Distribution of leaf-cutting ants

Species	Distribution	Density (nests/ha)	Rating
<i>Ac. balzani</i>	SOE, CEW	2500	occasionally serious
<i>Ac. fracticornis</i>	SOU	700	occasionally serious
<i>Ac. landolti</i>	NOR, NOE	1500	occasionally serious
<i>Ac. striatus</i>	SOU	4	serious
<i>At. bisphaerica</i>	SOE, CEW	5	locally serious
<i>At. capiguara</i>	SOE, CEW	48	serious
<i>At. cephalotes</i>	NOR, NOE	2	locally serious
<i>At. goiana</i>	CEW	5	locally serious
<i>At. laevigata</i>	All	6	serious
<i>At. sexdens</i>	All	6	serious

Abbreviations: Northern region (NOR), Northeastern region (NOE), Central western region (CEW), Southeastern region (SOE), and Southern region (SOU)





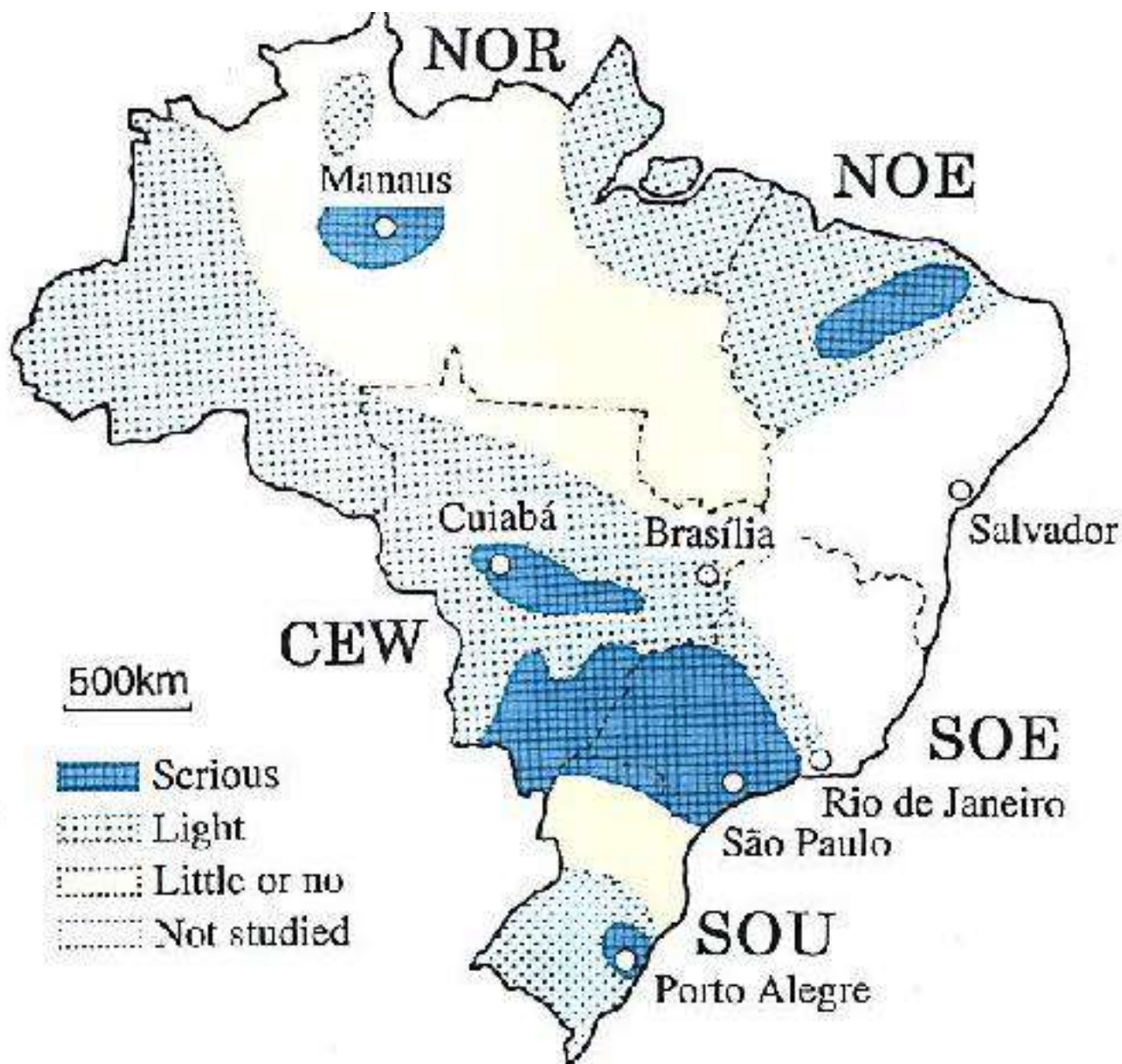


Fig. 1. Estimation of damage to agriculture caused by leaf-cutting ants in Brazil. Regions are divided by broken lines and abbreviations for the regions are the same as in Table 1.

Wide Adaptability of New Rice Cultivars in Yunnan Province of China

Kazuo Ise, Sun Youquan, Liu Jishin*, Zhou Tiande*, Satoru Kudo**,*

*Yoshihiro Sunohara***, and Jiang Zhinong**

•@

•@The collaborative research project for rice breeding using a wide diversity of genetic resources has been conducted in Yunnan Province of China since 1982. The new rice cultivars developed through the joint project have been widely grown in and around the province. In 1996, the total acreage of these cultivars covered more than 170,000 ha, accounting for nearly 20% of the total rice-growing area in Yunnan.

•@In 1996, two rice cultivars, •eHexi 34•f and •eHexi 35•f, were developed and newly released by the project; they will be officially registered by the Yunnan provincial government. Hexi 34 was developed from the cross •eYunxi 2•f/•eDianyu 1•f, and Hexi 35 from the cross •eHexi 15•f/•eHexi 4•f. The pedigree of these new cultivars, can be traced to some Japanese rice genetic resources: a high-yielding cultivar •eTodorokiwase•f, a cool weather-resistant cultivar •eNarukaze•f, blast-resistant germplasm accessions •eBL 1•f and •eBL 6•f, and others.

•@The principal reason for releasing these two cultivars is that they display a higher yielding ability than that of current japonica-rice cultivars grown in Yunnan, which is the most important factor in crop production in China. Hexi 34 and Hexi 35 performed very well in the uniform trials conducted at twelve sites representative of the japonica-rice growing areas in the central and northern parts of Yunnan. In twenty-four tests across twelve locations during a two-year period, the average yield of Hexi 34 and Hexi 35 was 8.55 and 8.80 t ha⁻¹, respectively, compared with 7.10 t ha⁻¹ for the standard cultivar •eYunkeng 9•f.

•@We conducted a statistical analysis of adaptation based on the data of the uniform trials using the linear regression method and principal component analysis. The regression coefficients on the mean yield of each environment of Hexi 34 and Hexi 35 were smaller than those for other tested cultivars. The findings indicate that these cultivars are well adapted to various kinds of environments in Yunnan. The results of principal component analysis also revealed the high-yielding characteristics and wide-adaptability of Hexi 34 and Hexi 35.

•@The cooking and processing qualities of Hexi 34 and Hexi 35 are superior to those of the standard cultivar •eYunkeng 9•f in Yunnan. Milled kernels of Hexi 34 and Hexi 35 are nonglutinous and nonaromatic; they are translucent in contrast to those of Yunkeng 9, which show a pronounced white belly. Taste panelists rated Hexi 34 and Hexi 35 as satisfactory in the sensory tests of steamed rice. Recently, the living standard in urban areas of China has been rapidly rising, resulting in a remarkable increase in the demand for rice with good taste. These two new cultivars should meet the demand for good quality rice.

•@Finally, we should pay careful attention to the shift in the frequency of the blast fungus races, because Hexi 34 and Hexi 35 exhibit a race-specific resistance to rice blast disease. These cultivars could be widely grown in and around the Yunnan Province, because of their high yielding ability and high grain quality as mentioned above. However, breakdown of the blast resistance is common in many rice-growing areas, often shortly after the release of cultivars with race-specific resistance. Rice blast is the most devastating disease in Yunnan japonica-rice growing areas. We should develop breeding strategies for durable resistance to reduce the impact of rice blast disease by using the abundant rice genetic resources of Yunnan and Japan.

•@

* Yunnan Academy of Agricultural Sciences, China

** Mountainous Region Agricultural Research Institute, Aichi-Ken Agricultural Research Center, Japan

*** Fujisaka Branch of Aomori Agricultural Experiment Station

[Table 1. Main agronomic characters of •eHexi 34•f and •eHexi 35•f](#)

[Photo 1: Rice cultivation in a basin near Kunming City, Yunnan Province. Rice plants \(right\) belong to a new cultivar •eHexi 35•f. Mountainous regions account for about 84% of the total area in the province. Cultivation of japonica-rice for high yield is conducted in a small number of basins at an elevation of 1,500 to 2,000m.](#)

•@

Table 1. Main agronomic characters of 'Hexi 34' and 'Hexi 35'

Character	Hexi 34	Hexi 35	Yunkeng 9 (Standard)
Maturity	Medium	Medium	Medium
Plant Height (cm)	88	93	115
Lodging Resistance	HR	HR	S
Cool Weather Resistance	MR	MR	R
Blast Resistance	HR	M	R
Grain Appearance	Good	Good	Poor
Eating Quality	Good	Good	Poor
Yielding Ability (%)	112	121	100

Notes: HR, high resistance; MR, moderate resistance; M, moderate; S, susceptible



-JIRCAS Research Highlight-

Identification of *Meloidogyne* Species Including a New Species Based on Enzyme Phenotypes in Thailand

Yukio Toida

- @Species of root-knot nematodes (*Meloidogyne* spp.), the most important pests of crops among nematodes in Thailand, were identified based on the phenotypes of esterase and malate dehydrogenase by electrophoresis, which are more reliable than those based on morphological characters of the female perineal pattern.
- @Two distinct bands of esterase (Est: A2) and one or three bands of malate dehydrogenase (Mdh: N1, N3) were observed in *M. arenaria*. One clear broad band of Est (VS1) in *M. graminicola*, one band each (N1, I1) of Est (I1) and Mdh (N1) in *M. incognita*, and three bands of Est (J3) and one band of Mdh (N1) in *M. javanica* were revealed respectively (Table 1). Two of the nematode populations examined did not show any band pattern of the enzyme.
- @The population collected from a weed in Bangkok displayed three bands of Est and two bands of Mdh, suggesting the presence of an unrecorded species in Thailand (Photo 1).
- @The population collected from mulberry plants in Udon Thani which exhibited one band of Est and two bands of Mdh (Photo 1) belonged to a new species based on the specific phenotypes of esterase and malate dehydrogenase and the unique morphological characters of the female perineal pattern (Photo 2). This is the second record of a new species of *Meloidogyne* in Thailand since the discovery of *M. microcephala* (Cliff *et al.*, 1984). The new species occurred in large numbers in mulberry fields at Udon Thani Sericulture Research Center and also on some ornamental plants around this area.
- @As mulberry plants in this area are seriously damaged by this species (Photo 3), methods of control against the nematode attacking mulberry should be developed.

[Table 1. Phenotypes of esterase and malate dehydrogenase of *Meloidogyne* species in Thailand](#)

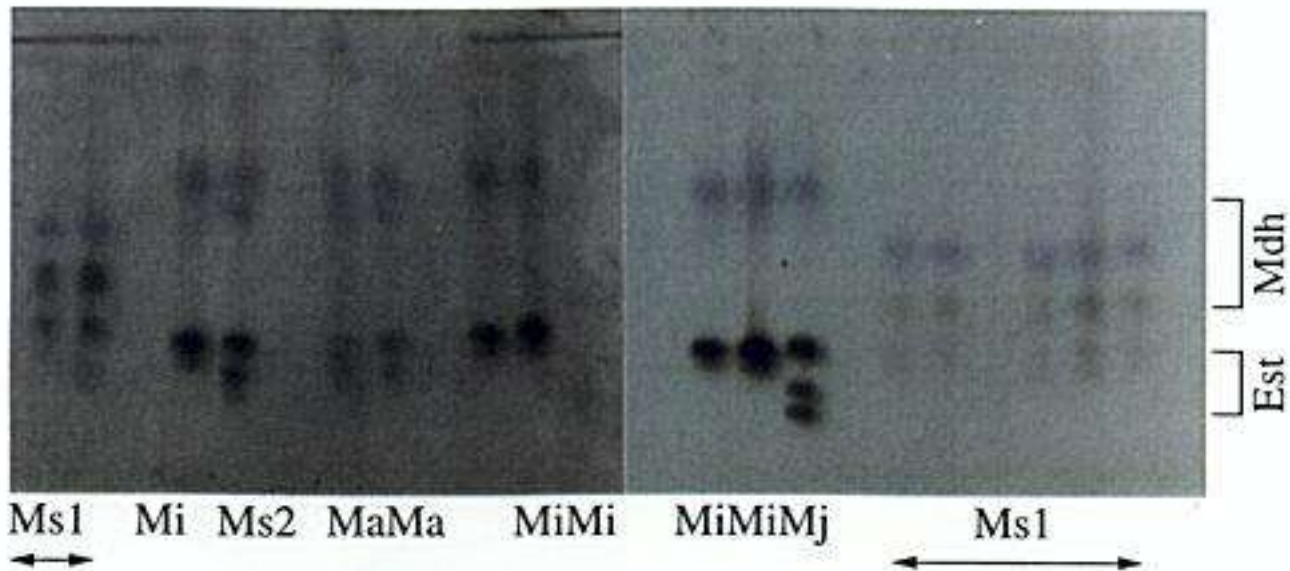
[Photo 1: Polyacrylamide gel \(phast system\) showing esterase and malate dehydrogenase phenotypes of females of *Meloidogyne*](#)

[Photo 2: Perineal pattern of a new species of *Meloidogyne* on mulberry in Udon Thani](#)

[Photo 3: Mulberry root damage caused by a new species of *Meloidogyne*](#)

Table 1. Phenotypes of esterase and malate dehydrogenase of *Meloidogyne* species in Thailand

<i>Meloidogyne</i>	Host plants	Phenotypes	
		Est	Mdh
<i>M. arenaria</i>	Cucumber	A2	N3
do	A weed	A2	N1
<i>M. incognita</i>	Tomato	I1	N1
<i>M. javanica</i>	Eggplant	J3	N1
<i>M. graminicola</i>	Upland rice	Vs1	?
<i>Meloidogyne</i> sp. 1	Mulberry	1	2
<i>Meloidogyne</i> sp. 2	A weed	3	2



*Photo 1: Polyacrylamide gel (Phast System) showing esterase and malate dehydrogenase phenotypes of females of Meloidogyne
Ma: M. arenaria, Mi: M. incognita, Mj: M. javanica, Ms1: new species, Ms2: unrecorded species in Thailand*





•áTopics•â

JIRCAS Symposium on Status and Requirement of Minerals in Ruminants in Thailand

-Current Knowledge and Future Research-

Tomoyuki Kawashima

•@The role of animal industry is becoming increasingly important in the agricultural sector due to the strong demand for protein in Thailand. The annual rate of increase of milk production in the country was the highest in Asia and the Pacific region in the past decade. The consumption of commercial concentrate feed as well as supplement feed has increased very rapidly.

•@JIRCAS had dispatched two researchers (K. Nishimura, T. Kawashima) to carry out collaborative studies in the field of animal nutrition with the Department of Livestock Development (DLD), Thai government. The field of mineral nutrition was one of the key subjects in their projects. It is still not clear, however, whether the formula applied for the commercial mineral supplements is the most suitable for the conditions in Thailand, as the information both on the mineral contents in the feed and on the requirement of minerals by animals in Thailand is very limited.

•@Therefore, the JIRCAS symposium entitled •gStatus and requirement of minerals in ruminants in Thailand -Current knowledge and future research-•hwas held on May 9, 1997 in Bangkok, Thailand, aiming at presenting research results on mineral nutrition in the country in order to determine the general characteristics of the mineral status of cattle and buffalo in the country and to identify the research themes required for the future. The symposium was divided into the following three sessions:

1. Identification of mineral status in animal production
2. Influence of minerals on ruminant physiology and productivity
3. General discussion on "Future research strategies on mineral nutrition in Thailand".

•@The proceedings will be published as JIRCAS Working Report Series.

[Photo 1: Participants in, and presentation, at the symposium](#)



People

•@

•@**Akihiko Nishiyama** became Director of JIRCAS's Administration Division on April 1. He was until recently Deputy Director of International Trade and Tariff Division, Ministry of Agriculture, Forestry and Fisheries (MAFF). He also served as Consul at the Consulate-General of Japan in Los Angeles, USA (1991-1994) as well as at MAFF's Research Council Secretariat.

•@**Teruo Ishige** became Director of JIRCAS's Biological Resources Division on April 1, succeeding Dr. Shoji Miyazaki who was transferred to the National Institute of Agrobiological Resources (NIAR). Dr. Ishige, a plant cell biologist, worked successively as Head, Plant Cell Breeding Laboratory of NIAR (1988-1995) and Senior Research Coordinator of MAFF's Research Council Secretariat (1995-1997).

•@**Eitaro Imaizumi**, an animal nutritionist, succeeded Dr. Hirofumi Hayakawa as Director of JIRCAS's Animal Production and Grassland Division on April 1. He initiated his research career at Hokkaido National Agricultural Experiment Station (1963-1981). During his former assignments at JIRCAS (formerly TARC), he served as Research Coordinator (1987-1990) and Head of Research Planning Section (1990-1993), after working on animal nutrition in Malaysia (1981-1983).

•@**Shiroh Uno**, a biological oceanographer, replaced Dr. Kunihiko Fukusho as Director of JIRCAS's Fisheries Division on April 1. Dr. Uno carried out most of his research work on coastal ecology at Nansei National Fisheries Research Institute (1974-1982) and Seikai National Fisheries Research Institute (1983-1994). Before joining JIRCAS, he was Director of Japan Marine Science and Technology Center (1994-1997).

OBITUARY

•@We were saddened to learn that Dr. **Noboru Yamada**, first Director General of the Tropical Agriculture Research Center (TARC, reorganized to JIRCAS in 1993), passed away on 18 May 1997 at the age of 85. Dr. Yamada, who graduated from The University of Tokyo (1938) and then spent most of his research career at the National Institute of Agricultural Sciences, was a distinguished crop physiologist and his work on the physiological mechanism of flooding tolerance of rice plants had been highly evaluated by the scientific community.

•@Dr. Yamada also served successively as an expert under the Colombo Plan, as Regional Officer of FAO in Bangkok and as a consultant to the Asian Development Bank. In 1970, he became the first Director General of TARC. Through his scientific achievements and strong commitment to the promotion of international collaboration in the field of agriculture, Dr. Yamada displayed the leadership required for laying a firm foundation for the activities of TARC and subsequently JIRCAS.

•áTopics•â

The 4th JIRCAS International Symposium

Sustainable Agricultural Development Compatible with Environmental Conservation in Asia

Hisataro Horiuchi

•@The 4th JIRCAS International Symposium on Sustainable Agricultural Development Compatible with Environmental Conservation in Asia•horganized by Japan International Research Center for Agricultural Sciences (JIRCAS) in cooperation with the National Agriculture Research Center (NARC), National Institute of Agro-Environmental Sciences (NIAES), National Research Institute of Agricultural Economics (NRIAE) will be held at Tsukuba Science City during the period August 26-28, 1997. The subject of the symposium covers the current situation of and future prospects for sustainable agricultural development in Asia.

•@This symposium attempts to highlight the swelling demand for food, the decline in food self-sufficiency and to discuss possible solutions that would enable to achieve sustainable food production and preserve the environment simultaneously. In many Asian countries, recently, rapid economic growth has been altering the balance between food supply and demand. On the demand side, the rising household incomes and population are causing an overall expansion of food demand and a shift in its composition. On the supply side, the •gGreen Revolution•h that had led to a remarkable increase in food production in Asia since the 1960s seems to be losing its momentum. Asian agriculture is also being confronted with many serious environmental constraints associated with the increased application of chemical inputs, urbanization, deforestation and desertification. One may wonder to what extent Asian green resources and technologies will be able to sustain the swelling demand for food. With the huge population in Asia, a decline in food self-sufficiency would make the world food market more volatile. This symposium attempts to highlight these issues and to discuss possible solutions.

•@The symposium consists of a keynote speech and three sessions (1, 2, 3). The keynote speech delivered by Dr. George H. L. Rothschild, Director General of IRRI, Philippines is entitled: •gMain Issues for Sustainable Agricultural Development in Asia•h. The theme of Session 1 covers •gFood Problems in Asia•hPapers to be presented include :

- Brief Introduction by Chairperson. Wen S. Chen (Taiwan)
- Asian Food Supply-Demand Situation from Global Perspective. Osamu Koyama (Japan)
- Food Problems and Outlook in China. Ke Bing Sheng (China)
- Food Problems and Outlook in Southeast Asia. Nipon Poapongsakorn (Thailand)

•@ The theme of Session 2 covers •gAgriculture and Environment in Asia•h. Papers to be presented include:

- Sustainable Agriculture and Environment. D. Keeney (USA)
- Global Warming and Sustainable Agriculture. Katsuyuki Minami (Japan)
- Technology for Conservation of Soil and Water Resources in China. Zhao Qi Guo (China)
- Technology for Conservation of Soil and Water Resources in Korea. Pil-Kyun Jung (Korea)

- Material Balance and Ecological Functions of Paddy Farming. Hidenori Iwama (Japan)
- External Economies of Agriculture. Eiichiro Nishizawa (Japan)

•@The theme of Session 3 covers •gTechnological Issues after the Green Revolution•h. Papers to be presented include:

- JIRCAS Projects for the Development of Technologies for Sustainable Agriculture in Asia. Makie Kokubun (Japan)
- Development of Rice Production Technology in Southeast Asia. Nobuyuki Kabaki (Japan)
- Development of Rice and Wheat Production Technology in India. I. P. Abrol (India)
- Rural Development through Farming Systems Research. Achmad Suryana (Indonesia)
- Rural Development through Integrated Farming Systems Combining Agriculture, Animal Husbandry and Fisheries. Dang Kim Son (Vietnam)
- Strategy for Rice Production Technologies at IRRI. Osamu Ito (Philippines)

[Photo1: JIRCAS's Main Building in May](#)



ISNAR-JIRCAS Meeting was held at JIRCAS

•@The Japan International Research Center for Agricultural Sciences (JIRCAS) and International Service for National Agricultural Research (ISNAR) jointly organized a •gProject Planning Meeting on Research Management•h which was held in Tsukuba during the period 24-27 March, 1997. The objective of the meeting was to discuss priority themes in the project on two subjects: the Management of Information and the Management of Biotechnology. During the meeting the strategies by which research managers and policy makers in Asia recognize the importance of information technology and biotechnology were discussed. During the meeting discussions were also held on the preparation of a series of seminars for the research managers who are responsible for the drafting of information and biotechnology programs. In addition to the participants from ISNAR, including Dr. Stein Bie, Director General, and JIRCAS, heads of the representative NARSs and several ASEAN (Association of Southeast Asian Nations) countries attended the meeting.

JIRCAS Newsletter 1997 (No.12)



Sheep grazing in the piedmont steppe (2,000m altitude) of Kazakhstan
(Photo by K. Sato)

CONTENTS

<Project Report>

- [Development of Sustainable Production and Utilization of Major Food Resources in China](#)
- [JIRCS Visiting Research Fellowship Program: Review of five years of operation](#)

<JIRCAS Research Highlights>

- [Mechanism of Uplifting of Saline Groundwater in Phra Yuen Area, Northeast Thailand](#)
- [Wetwood of *Acacia Mangium* in Malaysia](#)
- [The First Collaborative Research Project of JIRCAS in Central Asia](#)
- [New Varieties of Cucumber and Strawberry Resistant to Diseases China](#)

<People >

< Topics >

- [Dr. Maeno, DG of JIRCAS Attended CGIAR Mid-Term Meeting 1997](#)
- [JIRCAS International Symposium was Held in Tsukuba](#)

Development of Sustainable Production and Utilization of Major Food Resources in China

Akinori Noguchi



Photo 1: Signature of Comprehensive Agreement; Li Xia-fen(left), Deputy DG of Department of International Cooperation, MOA and Yoshihiko Kotaka(right), Research Councillor, AFFRC

The first comprehensive collaborative research project for China was launched on May 28, 1997 by the signature of a Comprehensive Agreement between JIRCAS, Agriculture, Forestry and Fisheries Research Council (AFFRC), Japan and Ministry of Agriculture (MOA), the people's Republic of China on the occasion of the 16th meeting of Japan-China Agricultural Science and Technology Exchange Group held in Tokyo. This project is entitled "Development of Sustainable Production and Utilization of Major Food Resources in China" and will be continued for seven years from 1997.

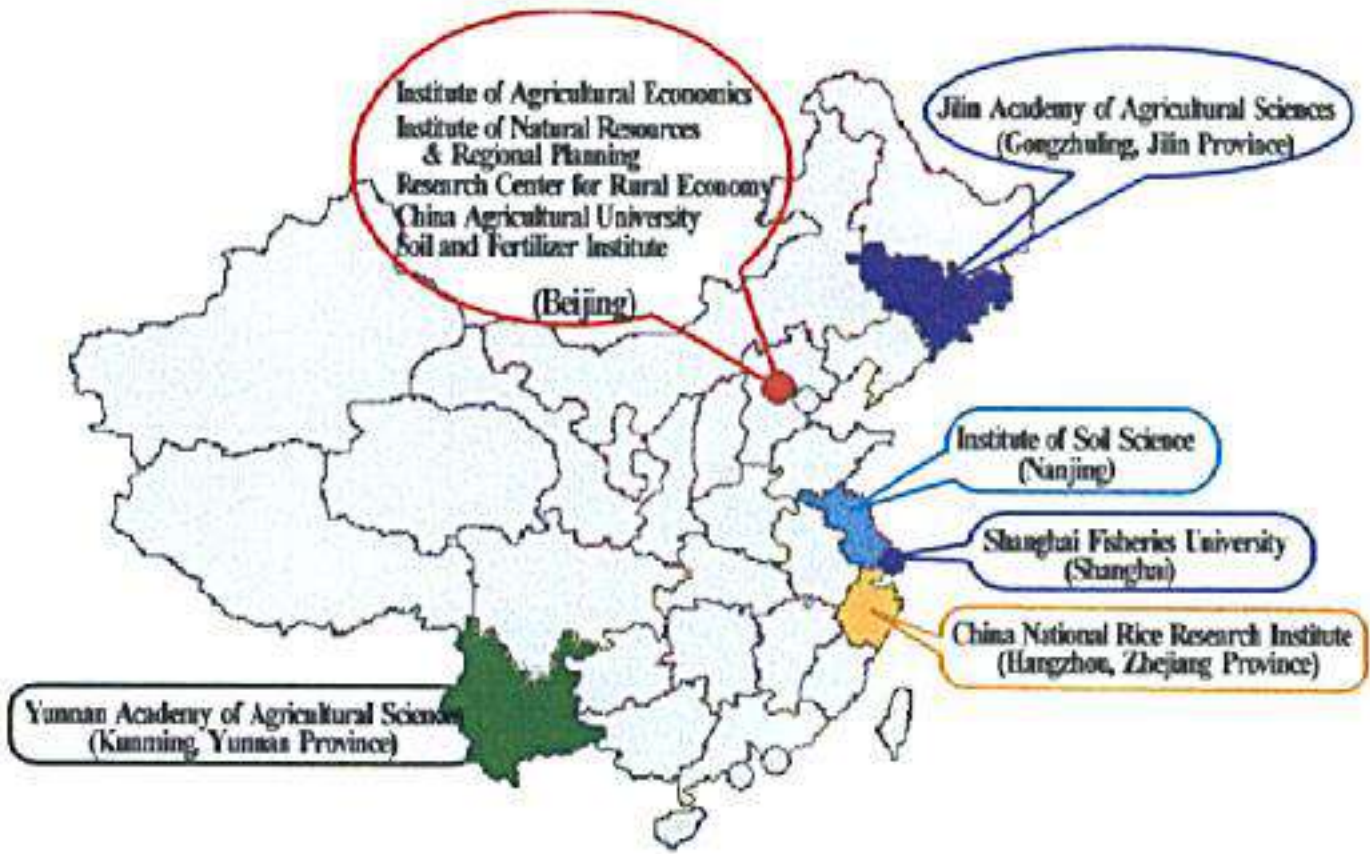
The report entitled "Who Will Feed China? Wake-up Call for a Small Planet" (L. Brown, 1995) triggered the increased concern about China's future food problems. Many Chinese and foreign researchers have carried out a large number of analyses and projections on China's food future, focusing most of their studies on the grain sector and they published reports. No consensus can be found in the reports on food production and demand, probably due to differences in assumption, date and estimation approaches. Nevertheless, the following consensus is that the demand will increase continuously over the next three decades and the supply can not meet the demand, and thus ever rising import will occur.

Major factors influencing food production in China, will include cultivated land, the yield of grains and some constraints such as poor quality of farmland, weak response to fertilizer and small-scale farm structure. It is inevitable that more farmland will be diverted to non-farm uses in the process of rapid economic development and newly reclaimed land and increased cropping index do not seem to alleviate the continued tendency of a decrease of the cultivated land area. The yield is significantly lower in China than in more advanced countries. On the other hand, major factors influencing the food demand will include population expansion, population structure change due to the rural-urban migration, income growth, price of agricultural products and poor infrastructure.

This project aims to develop technologies for sustainable production and utilization of major food resources in China such as rice, soybean, corn and freshwater fishes in order to respond the increasing expectations for high-quality dietary life caused by the development of the Chinese economy and the increase of people's purchasing power. More specific objectives of this project are; **1**: to develop an effective production and distribution system of agricultural produce to cope with the changing supply and demand structure of foods, which is based on the following studies; **1**) evaluation of the dissemination of new technologies in selected areas and their effects on the rural and individual farmer's economy, **2**) modeling for the supply and demand of foods in selected areas and analysis of the structure of the corresponding farming areas and agricultural production, **3**) more sustainable and effective control systems designed for better supply and demand of major food products among selected areas. **2**: to develop technologies for sustainable and stable production of major food resources, based on the following studies; **1**) evaluation on existing gene resources and development of new crop species, **2**) development and evaluation of environment-friendly agricultural technologies. **3**: to develop food technologies for improved utilization and distribution of major food resources, based on the following studies; **1**) quality evaluation of major food resources and development of new food ingredients from them, **2**) improved preservation and distribution technologies for major food resources.

The research subjects taken up in this project will require the collaboration of each component for the progress of the project.

[Fig. 1. The research institutes expected to participate in this project](#)



JIRCS Visiting Research Fellowship Program: Review of five years of operation

Shigeo Yashima

1 JIRCAS visiting Research Fellowship Program

The International Collaboration Research Section(ICS)was established in Okinawa Subtropical Station in 1991 with the special mission to promote the Visiting Research Fellowship Program. Five Japanese researchers were engaged in the following four research projects with ten visiting researchers from developing countries invited on a one to two-year tenure.

- 1.Environmental control by using plants and microorganisms
- 2.Mechanism of heat tolerance of crops with emphasis placed on vegetable crops
- 3.Indentification and evaluation of salt tolerance in rice varieties.
- 4.*In vitro* conservation of genetic resources for vegetatively propagated crops.

2 Visiting researchers

Up to date, a total of 50 visiting researches from 14 countries have participated in the program as indicated below. Development of a research network between ICS and these researchers should be ICS's priority to further promote the program.

India(8 researchers)

China(7 researchers)

Indonesia(5 researchers)

Thailand (5 researchers)

Nigeria(5 researchers)

Philippines(5 researchers)

Vietnam(4 researchers)

Bangladesh(3 researchers)

Burkina Faso (2 researchers)

Egypt(2 researchers)

Brazil(1 researchers)

Ghana(1 researchers)

Malaysia(1 researchers)

Pakistan(1 researchers)

[Photo 1: The visiting researchers hold meeting on their respective research fields](#)

3. Research activities during the five-year period

1) Environmental control by using plants and microorganisms

Methane emission from paddy fields treated with rice straw and cellulose was measured by a chamber method under the subtropical climatic conditions. Ecological studies included the enumeration of population and isolation of methanogenic bacteria (MGB) and methane-oxidizing bacteria (MOB) which produce and oxidize methane, respectively in paddy fields. The findings for the studies led to the development of a model ecosystem of methane production and oxidation which should enable to elucidate the interaction between the activities of MGB and MOB in the co-culture system. Final target is the development of techniques to regulate methane emission in the rice rhizosphere by using MOB.

2) Mechanism of heat tolerance of crops with emphasis placed on vegetable crops.

Physiological characteristics and genetic variability of heat tolerance were investigated. It was found that proline contents and membrane thermostability can be used as indices for the screening of heat tolerance in cabbage (*Brassica oleracea*). The effects of nitrogen and potassium concentrations under heat stress in cabbage were studied. Application of high nitrogen or potassium levels increased heat tolerance of cultivars.

Genotype variation in reproductive responses, including gamete development and function, to heat stress in chickpea (*Cicer arietinum*) and pigeonpea (*Cajans cajan*) was examined. The variation was limited among cultivated. The variation was limited among cultivated genotypes in both crops.

However, a congenial wild relative of pigeon pea, *Atylosia scarabaeoides*, sets many pods and seeds under heat stress conditions.

3) Identification and evaluation of salt tolerance in rice varieties

The Salinity Tolerance project aims finally to develop a breeding method to produce salinity-tolerant varieties of crops, using advanced technologies at the molecular level. Under this project, so far, genetic and geographical variations in salt tolerance in cultivated rice were investigated. Recent studies have been focused on the physiological characteristics of photosynthesis and anti-oxidative mechanisms of salt-tolerant indigenous varieties and wild relatives of cultivated rice. Molecular cloning and characterization of salt tolerance genes from rice were also investigated.

4) *In vitro* conservation of genetic resources for vegetatively propagated crops

Cryopreservation is considered to be a practical and efficient tool for long-term storage of plant germplasm. The project aims to develop techniques for the efficient and stable cryopreservation of vegetatively propagated tropical crops.

Vitrification method, a simple method using highly concentrated solution of cryoprotectants to dehydrate explants, was selected among different strategies for cryopreservation. Basic conditions of the vitrification method were investigated in detail and the cryopreservation protocols of *in vitro* grown shoot tips of taro, banana, yams and sweet potato were successfully developed with 60-100% of post-thaw survival. The shoot tips cryopreserved by these protocols resumed growth and developed shoot

directly without intermediate callus formation.



Mechanism Uplifting of Saline Groundwater in Phra Yuen Area, Northeast Thailand

*Masayuki Imaizumi**

In Northeast Thailand, salt accumulation in soil is considered to be derived principally from saline groundwater. Several theories have been proposed for salinization in Northeast Thailand. All of them indicate that salinization is related mainly to the presence of a few rock salt strata of the Mahasarakham formation which are widespread in Northeast Thailand. One of the problems to be solved is how salt of the rock salt strata can reach the ground surface. The understanding of the mechanism of uplifting of saline-groundwater in Northeast Thailand should contribute to the development of technologies for the utilization of ground water and the evaluation of water resources in Northeast Thailand.

Phra Yuen area which is a salt-affected area was selected for studying the relationship between the geological structure and groundwater flow. Piezometers were installed at every intersecting point of a regular 1km grid. Intersecting points were set up at 16 stations in total (A1-A16). At each intersecting point, 3 investigation wells 5, 10 and 15 meter in depth were set up for monitoring the groundwater level (potential head), electric conductivity (EC), and temperature of the groundwater.

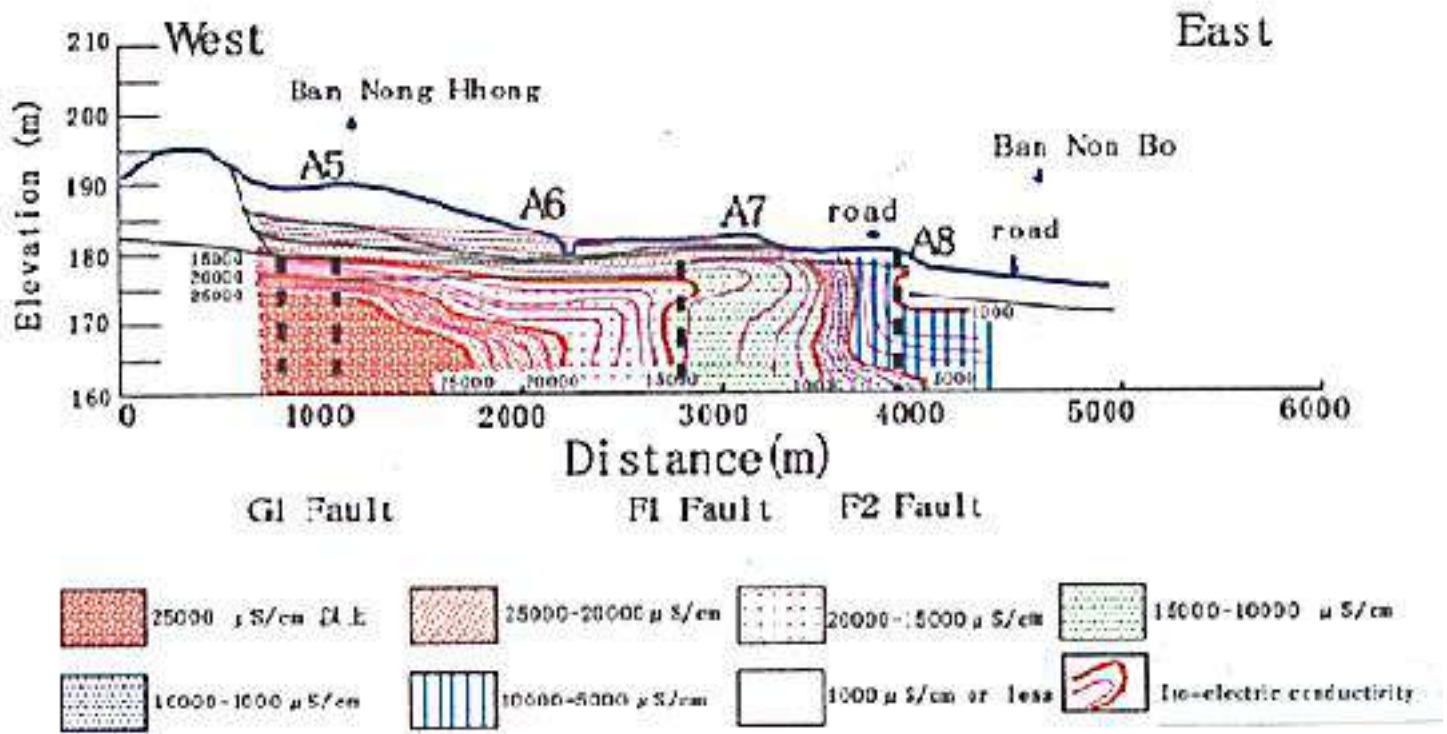
Lineament analysis, upper structure of the Mahasarakham formation, and distribution level of the gravel layer in the Quaternary laterite deposits revealed the presence of G1, F1, F2 and F3 faults. Saline groundwater at A1, A5, A9 and A13 station was supplied from the G1 faults (Fig.1) and that at A11 station from the F1 fault. However, all the faults were not involved in the passage of saline groundwater.

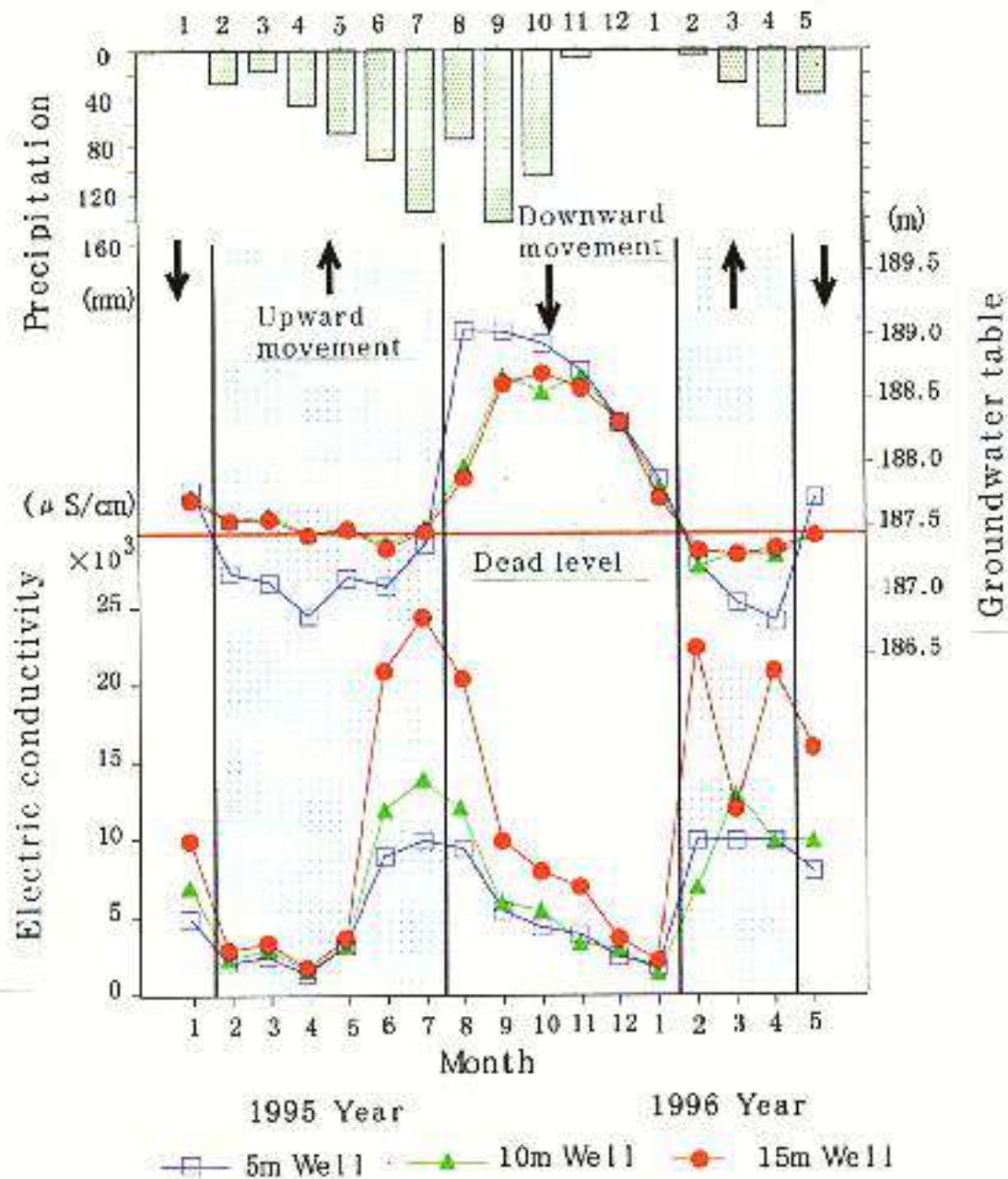
[Fig.1. Electric conductivity distribution geological sections in April, 1995](#)

[Fig.2. Fluctuation of monthly precipitation, groundwater level, and electric conductivity at A5 station](#)

EC value increased rapidly when the groundwater level decreased below 187.4 meter above sea level (Dead Level) at A5 (Fig.2) The iso-potential line of 187 meter in the vicinity of A5 showed an eastward direction in April, 1995 so that the flux of the groundwater moved up. On the other hand, the equi-potential line of 189 meters showed a westward direction in September, 1995. It is suggested that the flux of the groundwater there moves down and when the groundwater level decreases below the Dead Line, the flux of upward groundwater may reach the maximum volume. Saline groundwater may rise from the underground through the fault crack.

* Present Address: National Research Institute of Agricultural Engineering





Wetwood of *Acacia Mangium* in Malaysia

Koichi Yamamoto, Othaman Sulaiman and Rokiah Hashim**

Acacia mangium Willd. is native to North Queensland, Australia. Since it was introduced to Malaysia as an exotic species in 1996, it became one of the major plantation species for timber and pulp production. *A. mangium* is a fast-growing tree of good form that grows on degraded soils. Recently the occurrence of some defects such as heart-rot and wetwood, however, has been reported. In spite of its importance for sustainable timber resources in the future, comprehensive characteristics of *A. mangium* wood have not been fully documented. In this study, the occurrence and characteristics of wetwood were examined to analyse the basic wood properties of *A. mangium*. Forty one trees from 6 sites in Malaysia were surveyed.

Most of the trees except for those in the Byram Forest Reserve had higher moisture contents in the inner heartwood than in the adjacent middle or outer heartwood and sapwood (Table 1). Presence of wetwood in tropical plantation wood species has not been reported yet. In most of the tree species the moisture content is lower in heartwood than in sapwood. An increase in moisture in the heartwood region is usually referred to as wetwood, which corresponds to an abnormal type heartwood caused by decay or wound. In most cases in *A. mangium*, wetwood was free of decay, which was confirmed by light and scanning electron microscopy. Only one sample in Rawang displayed heart-rot in the inner heartwood.

The density of wood near the pith is lower than in the surrounding outer heartwood. These result suggest that in *A. mangium* juvenile wood occurs near the pith. The lower density in juvenile wood leads to a higher moisture content, as wood with a lower density can retain more water. Difficulty in drying *A. mangium* could be related to the high moisture content in heartwood.

[Fig.1. Radial distribution of potassium content of *A. mangium* stem from 4 different sites \(Bidor, Byram, Kota Kinabalu and Rawang\). Maximum values were always detected in the outermost sapwood and then decreased toward the sapwood-heartwood boundary. No obvious variations were observed in the heartwood. Arrows show the boundary between sapwood and heartwood.](#)

[Table 1. Average moisture contents\(%\) of *A. mangium* at various sites](#)

As a close relationship between inorganic element concentration and moisture content in wetwood has been described in the literature, the distribution of inorganic elements in this species was investigated. Radial distribution of 4 major elements alkali metals and alkaline earth metals from sapwood to heartwood in stem was analysed using inductively coupled plasma spectroscopy. Wood specimens from 4 plantation sites, showed a similar pattern of K and Mg distribution. The concentration of K and Mg decreased gradually from the outer sapwood toward the outer heartwood, and did not show significant variations within the heartwood (Fig.1). Radial distribution of Na and Ca did not show any obvious trend. All of the samples displaying wetwood (Rawang; March 96 and Bidor) or not displaying wetwood (Byram; Dec.95 and Kota Kinabalu; Jan 97) generally showed a lower content of total inorganic elements in heartwood than in sapwood. The close relationship between inorganic element concentration and moisture content was described in wetwood of temperate species, but had not been recognized in *A. mangium*. The characteristics and origin of wetwood may differ between temperate and tropical species.

Based on the results of decay and inorganic element concentration, wetwood occurring in *A. mangium* was considered not to be an abnormal type of heartwood, wetwood seems to be an intrinsic characteristic of *A. mangium*. The origin of water in wetwood of *A. mangium* should be clarified in the future.

* School of Industrial Technology, Universiti Sains Malaysia, 11800 Penang, Malaysia

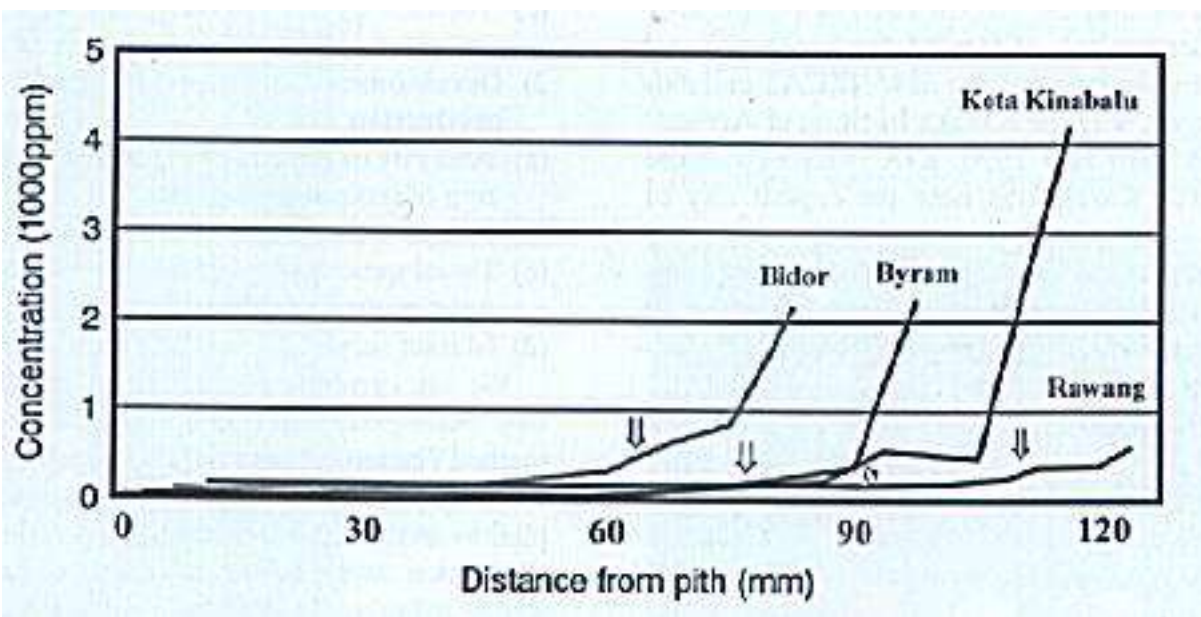


Table 1. Average moisture contents (%) of *A. mangium* at various sites

Site	Planting	Sampling time	No. of samples	Sapwood	Outer heartwood	Middle heartwood	Inner heartwood
Bidor, Perak	1990	Apr. 96	3	124	138	150	179
Byram Forest Reserve, Pulau Pinang	1996	Dec. 95	3	84	93	78	57
		Oct. 96	14	89	92	90	90
Kota Kinabalu, Sabah	1988	Oct. 96	1	113	128	127	160
		Jan. 97	1	71	77	82	87
Rawang, Selangor	1985	March 96	2	76	91	116	135
		Oct. 96	6	81	94	115	131
Sampadi Forest Reserve, Sarawak	1984	June 97	10	104	106	145	204
USM, Pulau Pinang	*	May 96	1	115	111	148	173

* unknown

The First Collaborative Research Project of JIRCAS in Central Asia

-Studies on Grassland Management in Kazakhstan-

Kenji sato

Central Asia is one of the new research areas targeted for collaboration with JIRCAS Kazakhstan which is a pasture (steppe) country and the largest country (about 2.71 million Km²) in Central Asia is famous for the steppe and Oasis Silk Road. In this country, the new JIRCAS collaborative research project with the Kazakh Institute of Agriculture (KIA) started from July 1996. KIA is located in the southeastern part of Kazakhstan near the capital city of Almaty.

Our project has two objectives: 1) development of technology for sustainable management of grassland and 2) development of technology for sustainable animal production. Research contents are as follows:

1) Development of technology for sustainable grassland management

- (a) Evaluation of grassland vegetation based on vegetation maps and field surveys
- (b) Monitoring of grassland production in relation to animal grazing
- (c) Identification of indigenous herbage tolerant of drought and cold stress
- (d) Analysis of soil characteristics related to grassland production
- (e) Technology for restoring degraded grasslands by the introduction of suitable forage crops



Photo 1: Resting after survey in the steppe near Kirghistan



Photo 2: Boys riding on a horse in the steppe of Kazakhstan

2) Development of technology for sustainable animal production

- (a) Analysis of genetic characteristics and biological function of indigenous animals
- (b) Effective utilization of supplemental feeds for animals
- (c) Development of methods for estimation of milk and meat quality and quantity
- (d) Market survey for animal products

We are currently attempting to improve degraded areas into ecologically sound pastures using the oversowing method (including seed pellets) which does not require cultivation for the establishment of forage crops. This year, we plan to analyse the relation between soil fertility and grass production on the steppe as well as to improve the degraded steppe using seed pellets and to investigate the changes in the socio-economic structure of agriculture within the framework of our project.

New Varieties of Cucumber and Strawberry Resistant to Diseases China

Keita Sugiyama*

Under the collaborative project on "Breeding of disease resistant vegetable in sub-tropical China, 1991-1995" between the Shanghai Academy of Agricultural Sciences, People's Republic of China and JIRCAS, new varieties of cucumber and strawberry resistant to diseases were eventually developed in China.

1) New cucumber varieties 'Hu 116' and 'Hu 119'

'Hu 116' (photo 1) was found to display a high level of resistance to *Fusarium oxysporum* sch. f. sp. *cucumerinum* and *Pseudoperonospora cubensis* Rostowzew both in laboratory tests and in the field. 'Hu 116' bears many female flowers and its yield is about 10 to 15% higher than that of 'Sinkofushianri 11'. The fruit length is about 21 to 24 cm.

The skin is deep green with few nodules and spines. 'Hu 119' exhibits a similar degree of resistance to *F. oxysporum* and *P. cubensis* to that of 'Hu 116'. Although 'Hu 119' shows a lower female flower bearing capacity than 'Hu 116', stable harvest can take place during the growing period. Like in the case of 'Hu 116', the fruit quality is good.

'Hu 116' and 'Hu 119' are adapted to semi-forcing culture all over the Shanghai area as well as in the Zhejiang, Jiangsu, Shandong, Sichuan areas, etc.



Photo 1 : 'Hu 116'

2) New strawberry varieties 'Shenxu No. 1' and 'Shenxu No. 2'

The total yield of 'Shenxu No. 1' until April was higher than that of 'Toyonoka' or 'Hokouwase'. The fruit is large, about 11-14g, conic in shape with a shiny scarlet skin. The Brix value of the soluble solids in the fruits ranged for 8 to 10. Since the flesh is firm and the skin is hard, this new variety is suitable for transportation. 'Shenxu No.2' (Photo 2) is a very early variety. The harvesting season of 'Shenxu No. 2' is earlier than that of 'Toyonoka'. The fruit is large, about 10-11 g in weight, conic in shape with a very shiny scarlet skin color. The fruit is very sweet, moderately sour and very juicy, with a good taste.

'Shenxu No.1' and 'Shenxu No.2' display a higher resistance to *Colletotrichum acutatum* Immonds and *C. fragariae* Brooks than 'Hokuwase'

'Shenxu No.1' and 'Shenxu No.2' are adapted to forcing culture all over the Shanghai area.

* Present Address : Kurume Branch, National Research Institute of Vegetables, Ornamental Plants and Tea



Photo 2 : 'Shenxu No. 2'

People

Shigeo Yashimma, irrigation engineer, replaced Dr. Tadaaki Yamashita as Director of JIRCAS's Okinawa Subtropical Station on July 3. He was until recently Head of International Collaboration Research Section at the Station. Dr. Yashima carried out research as international staff at the International Irrigation Management Institute (IIMI) during the period 1992-1996, after being engaged in a collaborative research project between Muda Agricultural Development Authority (MADA), Malaysia and the predecessor of JIRCAS, the Tropical Agriculture Research Center (TARC) during the periods 1971-1974 and 1979-1984.

Kozo Fujisaki, former International Research Coordinator of JIRCAS on August 1 and became professor at Obihiro University of Agriculture and Veterinary Medicine. He was in charge of the planning and coordination of the collaborative projects involving research on grassland, animal production and health, and was in launching the project for the "Development of Sustainable Agro-pastoral Systems in the Subtropical Area of Brazil".

Dr. Maeno, DG of JIRCAS Attended CGIAR Mid-Term Meeting 1997

Dr. Nobuyoshi Maeno, Director General, JIRCAS attended the CGIAR (Consultative Group on International Agricultural Research) Mid-Term Meeting which was held in Cairo, Egypt from 26 May to 30 May.

The meeting started with opening remarks by H. E. Youssuf Wally, Deputy Prime Minister of Egypt. In the remarks Professor Wally expressed his full support for the work of the CGIAR and its importance to developing countries.

The main theme of the meeting was the presentation of the Centers' Medium Term Research Plans (MTP) for 1998-2000. To deepen the discussion about the individual centers' MTP, each was considered in parallel session. In the sessions of IRRI (International Rice Research Institute) and WARDA (West Africa Rice Development Association), Dr. Maeno was designated as the chairperson and he emphasized the importance of rice production in the world and introduced the cooperation activities between both centers and JIRCAS.

During the meeting, Dr. Maeno and Dr. Pedro A. Sanchez, Director General, ICRAF (International Center for Research in Agroforestry) signed the MOU between ICRAF and JIRCAS. He also discussed future collaborative activities with the directors general of other centers.



Photo1: Parallel sessions of IRRI and WARDA (The third person from left: Maeno)

The meeting ended with the endorsement of MTPs and reached an agreement that the centers should further promote biotechnology research.

On his way back from Cairo, Dr. Maeno stopped in Rome and visited IPGRI (International Plant Genetic Resources Institute) and FAO to exchange opinions about the possibility of collaboration in the field of preservation of plant genetic resources and prevention of cattle diseases.

JIRCAS International Symposium was Held in Tsukuba

The 4th JIRCAS International Symposium on " Sustainable Development Compatible with Environmental Conservation in Asia" organized by Japan International Research Center for Agricultural Sciences (JIRCAS) in cooperation with the National Agriculture Research Center (NARC), National Institute of Agro-Environmental Sciences (NIAES) and National Research Institute of Agricultural Economics (NRIAS) was held in Tsukuba during the period 26-28 August, 1997. From 15 countries, 214 scientists and administrators, including 27 from abroad, met together and exchanged views on the current situation of and future prospects for sustainable agricultural development in Asia. Mr. Sakue Matsumoto, Chairman, Agriculture, Forestry and Fisheries Research Council gave the welcome address. A keynote speech was delivered by Dr. George Rothschild, Director General of IRRI and 16 papers were presented in the three sessions. The proceedings of the symposium will be published by JIRCAS.



Photo1: General discussion at the symposium.

From right to left : Wen S. Chern (Institute of Economics, Taiwan), chairman of session 1, Dennis Keeny (Iowa State University, USA) chairman of session 2, Osamu Ito (IRRI, The Philippines), chairman of session 3, Kunino Tsubota (JIRCAS, Japan), chairperson, William Coyle (Department of Agriculture, USA), general comments, Keiji Oga (JIRCAS Japan), general comments

JIRCAS Newsletter 1997 (No.13)



Woman Peladang Jaya in Selangor is operating a coffee shop for farm works near the fields(photo:by K.Yasunobu)

CONTENTS

<Project Report>

[Comprehensive Studies on Soybean Improvement, Production and Utilization in South America](#)

<JIRCAS RESEARCH HIGHLIGHTS>

[Cryopreservation of Germplasm of Tropical Crops](#)

[Entrepreneur Farmers in Peninsular Malaysia: Profile of Peladang Jaya](#)

[Sugarcane Stalk Can Be a Good Roughage for Daily Cattle in the Dry Season](#)

<JIRCAS Fellows in Okinawa>

[Response of Lowland Rice to Inoculation with Plant Growth-Promoting Rhizobacteria \(PGPR\) and Their Culture](#)

[Physiological, Biochemical and Genetic Characterization of Salinity Tolerance in Rice](#)

[Studies on the Relationship between Salinity Tolerance and Cold Tolerance at the Booting Stage of Rice \(Oryza sativa L.\)](#)

<Workshop on Heat Tolerance of Crops>

[October 7 & 8, 1997 JIRCAS Okinawa Subtropical Station](#)

<Preliminary Notice for The 5th JIRCAS International Symposium>

[“Postharvest Technology in Asia-For a Stable Supply of Food Products-”](#)

Comprehensive Studies on Soybean Improvement, Production and Utilization in South America

Makie Kokubun

Soybean, *Glycine max*, is considered to be one of the major crops for human life, especially as oil resource for human consumption and as protein resource for livestock feed. The increase of soybean production has been very rapid compared with that of other major crops for the last three decades (Table 1) and the continuous growth is considered to be very important for the stabilization of the world food supply.

Soybean production in South America, mainly in the MERCOSUR countries such as Brazil, Argentina and Paraguay, accounts for approximately one-third of the total world production (Table 2), and thus the MERCOSUR countries play a major role as leading soybean export countries. However, soybean production in South America has been mostly carried out under environmentally vulnerable conditions such as arid, acid soils with low fertility level. Also, the history of soybean production in these countries is relatively short since cultivation was initiated on a large scale only in the 1960s. It is anticipated that in future growth retardation due to continuous cropping, outbreaks of diseases and pests and soil erosion may adversely affect soybean production in this area. Therefore, research efforts focused on the development of sustainable and more efficient systems of soybean production in South America should be promoted to address these constraints.

[Photo 1: Soybean field in Paraguay \(January, 1997\)](#)

Japan has a long history of soybean cultivation and its use as material of traditional foods. Until now, soybean research in Japan had played an important role worldwide along with the results stemming from research applied in several collaborative research projects implemented by JIRCAS and JICA (Japan International Cooperation Agency). In Brazil, JIRCAS initiated in 1996 a research project entitled “Comprehensive Studies on the Development of Sustainable Agro-Pastoral Systems in the Subtropical Zone of Brazil” in which soybean will be the main crop for the development of mixed, multiple-cropping systems. Also, the Centro Tecnológico Agropecuario en Paraguay (JICA-CETAPAR), which was established in 1962 for extending technical assistance to the Japanese immigrant farmers in Paraguay, is now engaged in studies for the dissemination of no-tillage cultivation system of soybean in the fertile area covered with Terras Roxas soils in Paraguay and neighboring countries for sustainable production.

The JIRCAS’s new research project entitled “Soybean Improvement, Production and Utilization in South America” places emphasis on the following characteristics,

- (1) Multidisciplinary studies on soybean production and utilization in South America through the collaboration of researchers from Japan and South American countries.
- (2) Promotion of collaboration with JICA, and selection of CETAPAR as one of the research sites of the project.

Research areas for implementation include,

1. Genetics and breeding,
2. Soil management and pest control,
3. Crop management and production,

4. Postharvest technology,
5. Socioeconomic aspects.

Research organizations expected to participate in the project are institutes affiliated to EMBRAPA (Empresa Brasileira de Pesquisa Agropecuaria, Brazil) and to INTA (Instituto Nacional de Tecnologia Agropecuaria, Argentina), and CETAPAR. The project will be implemented during the period 1997-2006.

Table 1. Cultivated acreage, yield and production of major crops in the 1962-1992 period

Crop	Planted acreage (million ha)		Yield (tons/ha)		Production (million tons)		Ratio (‘92/’62)
	1962	1992	1962	1992	1962	1992	
Rice	119	147	2.0	3.6	242	525	217%
Wheat	203	220	1.2	2.6	237	564	238
Corn	103	132	2.1	4.0	214	526	246
Soybeans	27	55	1.2	2.1	31	114	368

Source: FAO Production Yearbook, 1963, 1993

Table 2. World soybean production (10,000 tons) by region

Year	World	Asia	North/Central America	South America	Africa	Europe
1979-81	8,607	1,034	5,620	1,801	33	62
1994	13,673	2,237	7,238	3,898	60	146

Source: FAO Production Yearbook, 1994



Cryopreservation of Germplasm of Tropical Crops

Hiroko Takagi, Nguyen Tien Thinh and Pius M. Kyesmu

Conservation of plant genetic resources has become an issue of common global concern. With increasing numbers of accessions requiring *ex situ* conservation through recent intensive collecting activities, it is important to develop reliable techniques for long-term conservation, especially for vegetatively propagated species that are mainly preserved in field gene banks.

Cryopreservation, storage in liquid nitrogen (LN₂) at a temperature of (-196°), is the only current method that could provide ideal conditions for base collection of vegetatively propagated plant germplasm. In recent years, remarkable progress was made in the field of cryopreservation techniques and different plant materials (cells, protoplasts, meristems, embryos, etc.) from more than 110 plant species were reported to be adequately stored in LN₂. Consequently, cryopreservation was recognized as a practical, efficient and economical tool for long-term storage of vegetatively propagated plant germplasm. There is a growing interest in cryopreservation of crop germplasm in the tropics where species that require clonal maintenance are prevalent. Since tropical species are known to be more sensitive to chilling, low temperature and desiccation than cold hardy or temperate species, cryopreservation of tropical species has not been studied extensively.

In view of the significance of cryopreservation for plant genetic resources activities, a project on the development of techniques for the long-term conservation of vegetatively propagated tropical crops was set up at the Japan International Research Center for Agricultural Sciences (JIRCAS). This project aims to develop simple techniques for the efficient and stable cryopreservation of shoot tips of several tropical crops i.e. taro, yams and banana.

Recent progress in cryopreservation has provided potentially valuable cryogenic procedures such as slow freezing, desiccation, encapsulation/dehydration, and vitrification. We focused on the vitrification method because the handling of explants by this method is relatively simple and the method has been reported to be successful with complex tissues such as meristems rather than cells. The principle of the vitrification method is as follows: dehydration of a specimen by exposure to a vitrification solution containing a high osmoticum and changes in the conditions of intracellular water as well as penetration of antifreeze substances (such as sucrose, ethylene glycol, dimethyl sulfoxide (DMSO), glycerol) in the vitrification solution to promote the vitrification of the specimen by rapid cooling in LN₂.

Through detailed investigations of the conditions of each procedure of the vitrification method, a protocol for shoot tips of taro (*Colocasia esculenta* (L.) Schott) was eventually optimized (Table 1). The keys for the success were as follows: 1) conditioning culture of shoot tip donor plants with high concentration of sucrose (120g/l), 2) selection of shoot tips with proper size and developmental stage, 3) preculture of dissected shoot tips with 0.3M sucrose prior to the cryogenic procedure, and 4) loading treatment by cryoprotectants at lower concentrations than vitrification solutions. Vitrified and warmed shoot tips obtained by this method resumed growth within 7 days, developed shoots directly without intermediate callus formation and almost all the shoot tips that survived were easily transferred to soil in pots. No morphological abnormalities were detected in the plants developed from the cryopreserved shoot tips (Photo 1). The protocol developed was applied to various triploid and diploid taro cultivars and post-thaw survival rates of 67-100% were obtained for the different genotypes.

The protocol for taro was also successfully applied to tannia (*Xanthosoma* spp.), banana (*Musa* spp.), yams (*Dioscorea rotundata* and *alata*), pineapple (*Ananas comosus*), orchid (*Cymbidium*) with some modifications depending on the level of sensitivity of each species to sucrose and vitrification solution.

Our study demonstrated that cryopreservation of shoot tips by vitrification can be useful for the long-term conservation of vegetatively propagated tropical crops.

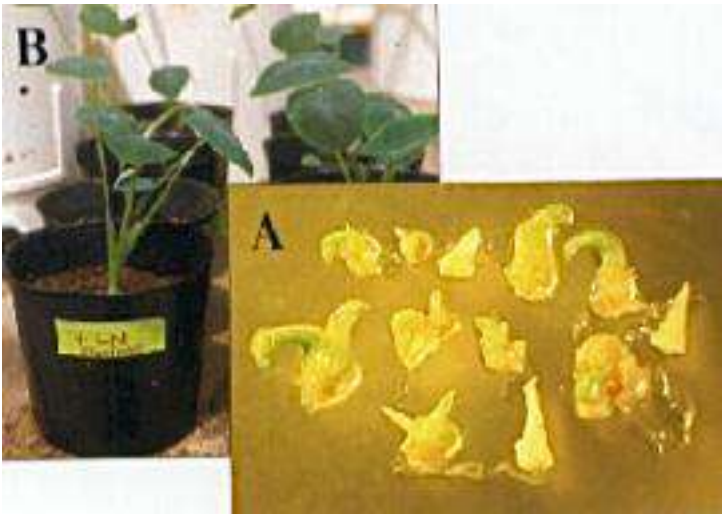
[Photo 1:](#)

[A\) Taro shoots formed from cryopreserved shoot tips by vitrification. Dead shoot tips turned white whereas those which survived showed a green color](#)

[B\) Taro plants developed from cryopreserved shoot tips by vitrification](#)

Table 1. Protocol developed for cryopreservation of shoot tips of taro by vitrification

- Step1:** Culture the shoot tip donor plants on Murashige and Skoog medium (MS) supplemented with 120g/l sucrose for three weeks (conditioning culture)
- Step2:** Dissect shoot tips (0.5-0.8mm in length, apical dome + 1-2 leaf primordia)
- Step3:** Preculture the shoot tips on MS containing 0.3M sucrose for 1 night at 25°C
- Step4:** Treat the precultured shoot tips with a loading solution [2M glycerol + 0.4M sucrose] for 20min at 25°C
- Step5:** Expose the loaded shoot tips to PVS2 [30%(w/v) glycerol + 15%(w/v) ethylene glycol +15%(w/v) DMSO + 0.4M sucrose] for 10min at 25°C
- Step6:** Directly immerse the shoot tips into LN₂ and store
- Step7:** Rapidly rewarm the cryopreserved shoot tips in a 40°C water bath
- Step8:** Soak the shoot tips into 1.2M sucrose for 10min at 25°C
- Step9:** Reculture the shoot tips on two layers of blotting paper over MS supplemented with 0.3M sucrose
- Step10:** Transfer the shoot tips to MS containing 0.1M sucrose for regrowth of plantlets



Entrepreneur Farmers in Peninsular Malaysia: Profile of *Peladang Jaya*

Kumi Yasunobu, Wong Foong Yee and Laily Paim

The new National Agricultural Policy (1992-2010) sealed a new era for the small-holder farmers in Malaysia. The emphasis of the new policy is on the commercialization of the small-holder and the small "unorganized farmers" sub-sector. To achieve the above objectives, the traditional farmers need to become entrepreneur farmers. In our study, we focus on a special exclusive group of farmers, who have won the annual title of "*Peladang Jaya*" or "Successful Farmers", awarded by the Ministry of Agriculture as respondents. They were chosen to become role model of modern, innovative, resourceful farmers, for others to emulate. They are outstanding individuals when compared to other farmers, nationwide. In our evaluation, they are one step nearer to the "entrepreneur farmer" types as envisioned by the policy makers, to transform the agricultural sector into a modern commercialized entity.

The main purpose of the study is to explore the characteristics of a group of leader farmers, who stood above the rest of their counterparts nationwide, for which they won the title of "*Peladang Jaya*" in annual competition. From the year 1987 to 1993, out of a total 88 farmers listed, 71 *peladang jaya* were selected; 40 male and 31 female farmers. They were purposely selected to represent all the states in Peninsular Malaysia. The respondents were personally interviewed by the researchers. The data collection lasted from November 1993 to July 1994.

In Malaysia, encouraged by the market demand, the enterprising farmers began to diversify their crops and farming activities, which include livestock raising and aquaculture. The survey found that the *peladang jaya* were mostly engaged in mixed cropping, except for 20% who were involved in mono-cropping paddy cultivation. In paddy cultivation, 14 people were mainly engaged in mono-cropping. Others combined the cultivation of paddy rice with other field crops-mostly a combination with industrial, and/or with short term cash crops, and fruit orchards.

The average income of the respondents in the sample was RM42,791 per year. The income was derived from earnings from farming and non-farming activities. The proportion earned from farming activities was high at 73%. Judging from the average annual income earned, this group of *peladang jaya* can be categorized as middle income group, and a few can be classified as upper middle income group.

As for the farm and household equipment, the standard of living of *peladang jaya* was higher than the Malaysian average in Agricultural Census. All the farmers owned houses, some of them being relatively large and comfortable, fully equipped with the basic necessities and utilities such as piped indoor water and toilets, when compared to the farmers in their respective villages. Almost all the respondents owned basic electric appliances such as fan (98.6%), refrigerator (97.1%), television set (100%) and radio (95.7%). All except 2 of the respondents used a LPG stove for cooking and 88.6% owned sewing machines. Seventy nine percent of the farmers•Ehouseholds owned washing machines while slightly more than two-thirds had telephones. It is noteworthy to observe that almost one-third (32.9%) owned Kubota/2 wheel tractors, while another 10% big tractors.

By applying principal component analysis, seven factors that represent the attitude of the *peladang jaya* were identified as follows:

Factor 1: "work eagerness"

The respondents were diligent in conducting farming job. Once they faced a problem, they attempted to solve it.

Factor 2: "good planning"

They recognized the importance of planning and realized that their effort leads to success. In other words, they attributed their success mainly to proper planning.

Factor 3: "challenging"

They realized the importance of recording and they showed challenging spirits. They knew what action should be taken to resolve a difficulty without other people's help. **Factor 4: "self-confidence"**

They considered that the ability to manage is much more important than physical involvement. They also carried out the project because they had a great deal of knowledge and experience.

Factor 5: "cautiousness"

The respondents were able to consider risk.

Factor 6: "resourcefulness"

The respondents knew where and how to seize the opportunities required to improve their farming.

Factor 7: "information seeker"

In summary, they were not only eager to collect information but also did not hesitate to ask people to get more information. These 7 factors accounted for approximately 75% of the variance.

Based on the analysis and interview observations, following three major characteristics can be pointed out for the leading farmers:

- 1) They made utmost efforts to increase their income. Besides farming they held various side-jobs in small industry or were engaged in large scale business.
- 2) They were interested in the new technologies including machinery, chemicals and new varieties. They planted the crops which other farmers in the area did not use. They easily adopted new projects.
- 3) They had acquired a knowledge and/or experience of farm management practices. Almost all the respondents participated in courses and seminars.

It is noteworthy that even though their educational background was not high, they were eager to gain useful information pertaining to farm management as much as possible. Their formal educational attainment varied from none to 6 years (elementary school level). Some of the respondents who did not have formal education attended "*pondok*" (religious school) in the village.

Besides being actively involved in farm and non-farm activities, the respondents were also engaged in social activities, such as group farming projects, agricultural associations, religious groups, village committees, etc. They joined not only as members, but held important positions like head, deputy and committee member, implying that they are playing an important role as leaders in their community.

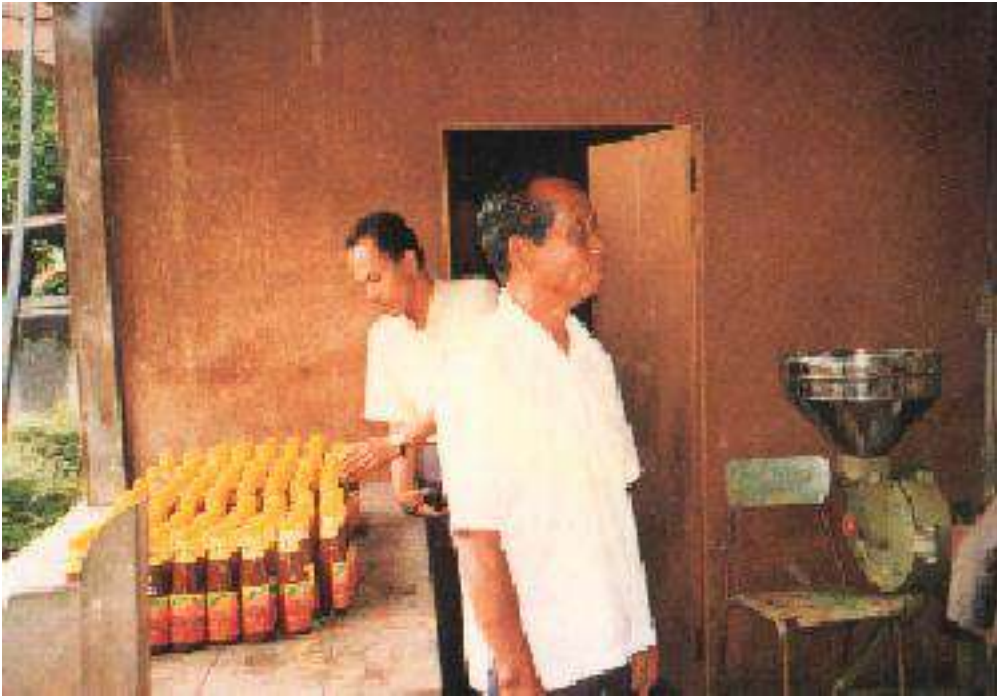
[Photo 1: Interview of Peladang Jaya in Pahang](#)

[Photo 2: A woman peladang jaya who has a retail lot in the market besides the production of vegetables \(Pahang\)](#)

[Photo 3: Peladang Jaya involved in food processing \(chilli sauce\) after working in the field \(Johor\)](#)

[Fig. 1. Map of Peninsular Malaysia and location of the respondents' house](#)







“Sugarcane Stalk* Can Be a Good Roughage for Dairy Cattle in the Dry Season

Tomoyuki Kawashima

Dairy production has been developed in the temperate and cool zone. The feeding system adopted in this area is generally based on preserved roughage such as hay and silage. This system requires large machinery with a large scale of operation. On the other hand, dairy production has been newly introduced into monsoon and savanna zones in the tropics. Generally speaking, dairy production in this region is characterized by a small scale of operation and manpower system. In this system, hay or silage making has not yet been practically implemented. Farmers are very much relying on rice straw as a roughage in the dry season (Photo 1). Low nutritive value of rice straw limits further improvement of production. And collection of rice straw is a labor/time-consuming work, which is another constraint. On the other hand, sugarcane has unique characteristics. It can produce a large amount of biomass and stand until the end of the dry season without withering, which allows farmers to cut it when necessary without the need for preservation. The use of sugarcane stalks (Photo 2 and 3) as a roughage for cattle has been examined in Northeast Thailand.

A metabolic trial by using Brahman cattle was carried out in order to determine the content of metabolizable energy in sugarcane stalks, which amounted to 9.05 MJ/kg. It was estimated that sugarcane can supply nearly 3 times the level of metabolizable energy per ha than that that by ruzi grass which is the major grass produced in the region.

Sugarcane stalk can be divided into an easily soluble fraction, i.e. sugar, and hardly degradable fraction, i.e. bagasses. The turnover rate of digesta from the rumen was compared between the cattle given either ruzi grass hay or sugarcane stalks. While the liquid phase outflow was faster in the cattle given sugarcane stalks than in those given ruzi grass hay, the solid phase outflow was slower in the cattle given sugarcane stalks (Table 1). It was considered that bagasses remained in the rumen for a long period of time without degradation, which would suppress feed intake. Although sugarcane stalks have a relatively high metabolizable energy content, cattle can not consume a sufficient amount of sugarcane stalks to satisfy their energy requirement. Therefore, cattle must be given concentrate feed to fulfill not only the protein but also the energy requirement.

Feeding trial was carried out using milking cows owned by a private dairy farmer in order to examine the use of sugarcane as a roughage for milking cows. Milking cows were given either only rice straw *ad libitum* or chopped sugarcane stalks plus rice straw *ad libitum*. Both groups were also given commercial concentrate feed whose amount was determined by the farmer based on the cow's body condition as well as milk yield. Milk production tended to be higher in the cows given sugarcane stalks than those given only rice straw in spite of the lower total DM consumption. Protein content in the milk of the cows which received sugarcane stalks was significantly higher than that in the milk of cows given rice straw. It was considered that the energy supply was increased by supplying sugarcane stalks, which affects the improvement of the protein content in the milk, while energy supply was not sufficient when only rice straw was given to cows.

Sugarcane stalks can be a good roughage for milking cows in the dry season provided that they are

Sugarcane as a roughage for cattle feeding

supplemented with proper protein and energy sources.

[Table 1. Turnover rate of liquid and solid phase in rumen, and liquid volume of cattle given ruzi grass hay and sugarcane stalks](#)

[Photo1: Popular feeding system characterized by the use of dry season rice straw.](#)

[Photo2: Cattle are found of chopped sugarcane stalks which should, however, be supplemented with energy and protein sources.](#)

[Photo3: Chopped sugarcane stalks.](#)

Table 1

Table 1. Turnover rate of liquid and solid phase in rumen, and liquid volume of cattle given ruzi grass hay and sugarcane stalks

Feed	Turnover rate of		Liquid volume
	Liquid	Solid	
	% hour	% hour	l/BW ^{0.75}
Ruzi grass hay	10.8	4.17	0.557
Sugarcane stalks	16.3*	2.61*	0.335
MSE	1.7	0.50	0.091

*: Significant difference (p<0.05)







JIRCAS Fellows in Okinawa

Response of Lowland Rice to Inoculation with Plant Growth-Promoting Rhizobacteria (PGPR) and Their Culture Supernatants



Dr. Hussein M. El-Khawas

*Department of Microbiology, Faculty
of Agriculture, Cairo University, Giza, Egypt*

Cereal crops are the most important sources of food. In particular, rice is the major food for more than one-third of the world population. Many plant growth-promoting rhizobacteria (PGPR) have been isolated from cereal crops and demonstrate the ability to promote plant growth under different growth conditions. Various free-living nitrogen-fixing bacteria are considered to be PGPR, including *Azospirillum* and *Klebsiella* species. These nitrogen-fixing microorganisms also produce growth regulators such as auxins, several gibberellins and cytokinins. Therefore, the aim of my study at the JIRCAS International Collaboration Research Section (ICRS) is to identify and quantify auxins, gibberellins, and cytokinins in culture medium of *Azospirillum* and *Klebsiella* strains and to determine their effect on the development of rice roots. In addition, the study will also focus on the response of rice seedlings to inoculation with different PGPR strains. The practical use of such PGPR bacteria may enable to save chemical fertilizers.

JIRCAS Fellows in Okinawa

Physiological, Biochemical and Genetic Characterization of Salinity Tolerance in Rice



*Dr. Safdar Hussain Shah
Agricultural Research Station
Dhodial Mansehra, NWFP, Pakistan*

Generally plants experience some kind of stress during the various stages of growth. Salinity is a widespread stress occurring worldwide which limits the yield on 30% of the total land. The ever-increasing salinity-affected area coupled with the decreasing soil resources, dwindling fresh water availability and increasing demand for food requires that plant scientists develop a biological strategy (breeding crops for saline areas) to complement the technological strategy (reclamation and drainage, etc.) for intensive and extensive agriculture. Salinity exerts diverse effects (osmotic, toxic and ionic imbalance) on plants/cells and tolerant genotypes are expected to have more than a single adaptation simultaneously.

My collaboration at JIRCAS Okinawa Subtropical Station aims to identify and characterize the salinity markers in rice that are associated with the osmotic component (cytosolute accumulation) and toxic component (modifications of membranes) of salt tolerance by studying the cation co-tolerance phenomenon through the selection of cell lines tolerant to LiCl (toxic effect), PEG (osmotic effect) and NaCl (osmotic+toxic effects). This may lead to the elucidation of the components of salinity tolerance in rice that could contribute to the characterization of salt tolerance and development of salt-resistant plants by biotechnological techniques in conjunction with classical breeding methodology.

JIRCAS Fellows in Okinawa

Studies on the Relationship between Salinity Tolerance and Cold Tolerance at the Booting Stage of Rice (*Oryza sativa* L.)



Li Chengyun

Yunnan Academy of Agricultural Sciences, People's Republic of China

Drought, cold, heat and salt stress all induce dehydration in plants and it is well known that the panicle initiation stage is a very sensitive stage both to cold and salt stress in rice. It has been reported in the literature that a number of genes respond to dehydration as well as to low temperature and high salt stress at the transcriptional level. These results indicate that there may be some common physiological characteristics between salinity and cold tolerance, especially at the booting stage. Although tolerance of rice varieties to salinity and cold has been studied by many researchers, salt tolerance was mainly studied at the seedling stage and cold tolerance at the booting stage. Therefore, 30 rice varieties showing a wider variation in cold tolerance will be utilized in this study for the development of salinity tolerance. The effect of salinity on the percentage of seed setting, mean grain weight, grain yield, protein and amylase content in brown rice, *in vitro* pollen germination, Na⁺ accumulation in roots, old leaves and flag leaves will be investigated. The results may enable to clarify the mechanism of cold and salt tolerance in rice plant.

Workshop on Heat Tolerance of Crops

- October 7&8, 1997 JIRCAS Okinawa Subtropical Station -

Takaharu Hayashi

JIRCAS is expected to contribute to the development of agricultural technology for developing countries. One of the divisions of JIRCAS, Okinawa Subtropical Station (OSS) was established to promote agricultural research under a subtropical environment. Thus, heat tolerance of crops is a major research activity at OSS. The Workshop on Heat Tolerance of Crops held at OSS aimed at two objectives. One was to review previous research output from OSS and the other was to devise new strategies for developing techniques for improving heat tolerance of crops including mitigation of heat stress and heat tolerance.

The workshop was held for two days from Oct. 7 to Oct. 8, 1997 at OSS under the sponsorship of JIRCAS. Prof. Anthony Hall from the Department of Botany & Plant Science, University of California and Dr. George Kuo from the Asian Vegetable Research and Development Center were invited as keynote speakers. Dr. Ishige from JIRCAS Headquarters was also invited as commentator and chairman of the general discussion. A total of 28 researchers including OSS staff members participated in the workshop.

On the day first, Dr. Kuo, Director of Crop Improvement Program, gave a presentation on “Vegetable improvement of heat tolerance under tropical conditions” and Prof. Hall gave a presentation on “Positive and potential negative effects on crop of Heat Tolerance Genes”. Following the keynote speeches, six researchers from OSS including three visiting scientists from JIRCAS Visiting Research Fellowship Program '97 presented their research outcome. On the second day, five researchers outlined future strategies for studies of heat tolerance of crops at OSS. Participants exchanged views on the progress of heat tolerance studies and confirmed the importance of such studies. In the last part of the workshop, Dr. Ishige, chaired the general discussion. During the workshop, questions, were raised and discussions and comments took place. The workshop may enable OSS to devise new strategies for developing techniques for improving heat tolerance of crops in the future.

[Photo : Participants in the workshop](#)



Preliminary Notice for The 5th JIRCAS International Symposium

“Postharvest Technology in Asia – For a Stable Supply of Food Products – ”

The symposium on “Postharvest technology in Asia – For a stable supply of food products –” organized by the Japan International Research Center for Agricultural Sciences (JIRCAS) will be held in Tsukuba, Japan during the period of September 9-11, 1998.

In Asia, agricultural research so far has been mainly centered on the improvement of crop production itself to achieve self-sufficiency in food in order to support the growing population of the respective countries. It is anticipated that, in the near future, the food supply problems will become more complex as patterns of food consumption become more diversified in the region along with the increase of income and societal development.

“Postharvest technology”, which encompasses issues ranging from harvesting methods in farmers’ fields to food processing, should be more emphasized to prevent crop losses, to utilize agricultural products efficiently and to meet the changes in the food demand.

Recognizing the importance of “Postharvest technology”, this symposium will attempt to highlight the main priorities, constraints and perspectives in the field of postharvest technology. Three sessions with invited speakers will cover the following themes:

Session 1: Main priorities and constraints relating to postharvest technology in Asia

Session 2: Perspective of technology for grain storage and preservation in the tropics

Session 3: Development and orientation of technology for food industries in Asia

For detailed information

Dr. Hiroko Takagi

Research Information Division Japan International Research Center for Agricultural Sciences (JIRCAS)

1-2, Ohwashi, Tsukuba, Ibaraki, 305 JAPAN

FAX: +81-298-38-6342

E-mail: sympo@jircas.affrc.go.jp (effective from January, 1998)

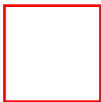
JIRCAS Newsletter 1996 (Vol.4 No.1)



Contents of No.1

- [Orientation of Research Activities](#)
 - [Current Studies at Forestry Division](#)
 - [JIRCAS Research Highlights Mycorrhizal Fungi Occurring in Indonesian Dipterocarp Forests](#)
 - [JIRCAS Research Highlights Population Dynamics in Fields with Cruciferous Vegetables and to Insecticides of the Diamondback Moth, *Plutella xylostella*](#)
 - [JIRCAS Research Highlights Construction of a Map Database for Resources Management and Application](#)
 - [JIRCAS Research Highlights Genetic Background of Tetraploid *Vigna* Species, *V.glabrescens*](#)
 - [Desert Locust in Africa](#)
 - [JIRCAS News](#)
 - [Research Project in the Mekong Delta JIRCAS News](#)
 - [Visit to Brazil by Chairman of AFFRC](#)
 - [Rural Development in Indonesia](#)
 - [New Research Area : Cote d'Ivoire and WARDA](#)
 - [Collaborative Research at CIP-Quito](#)
-

JIRCAS Newsletter 1996 (No.7)



CONTENTS

[Development of Sustainable Livestock Production](#)

[Annual Review of International Collaborative Research](#)

JIRCAS Research Highlights

- [@*Screening of Cowpea Lines for Drought Tolerance and Root Characteristics*](#)
- [@*Pedological Characterization of Lowland Areas in the Philippines*](#)
- [@*Reproductive Strategy of the Parasitoid Fly, *Exorista japonica* \(Diptera: Tachinidae\)*](#)
- [@*Low-Input Hydroponics*](#)

[Sustainable Agriculture and Control of Gas Emissions](#)

[JIRCAS News](#)

[Collaborative Research with ILRI](#)

JIRCAS Newsletter 1996 (No.,W)



CONTENTS

[Crop Production and Postharvest Technology](#)

JIRCAS Research Highlights

•@•@[Production of Urea Molasses Blocks for Ruminant Animals in Malaysia](#)

[Statistical Database System for World Agriculture, Forestry and Fisheries](#)

JIRCAS-STAT

Topics

[Research Collaboration in Kazakhstan has Started](#)

[International Symposium on the Biosafety Results of Field Tests](#)

of Genetically Modified Plants and Microorganisms

[Sustainable Agriculture in Northeast Thailand](#)

Visiting Researchers in Okinawa

[Dianou Dayeri](#)

[Dr. Lukman Gunarto](#)

[Harvinder Singh](#)

[Baiqing Lin](#)

[Padmanaban](#)

[Armenia B. Mendoza](#)

[Lin Hongxuan](#)

[Somsong Chotechuen](#)

[Nguyen Tien Thinh](#)

[P. M. Kyesmu](#)

[People](#)

Latest Research Topics in the Crop Production and Postharvest Technology Division

-With Emphasis Placed on Crop Protection-

Dr. Koji Kawashima

Director, Crop Production and Postharvest Technology Division

The Crop Production and Postharvest Technology Division is expected to cover various agricultural research fields such as the production of paddy rice, upland crops and fruit trees, plant protection, weed control, cultivation of cash crops, irrigation and drainage, agricultural engineering, postharvest technology, agricultural economics, etc.

At present there are 17 researchers in the Division including nine in the field of plant protection, two each in the fields of paddy production, irrigation, and postharvest technology, one each in the fields of upland crop production and agricultural economics. Out of 17 researchers, ten were dispatched abroad for collaborative research and seven are carrying out research in Japan.

Some of the collaborative research studies conducted abroad in this Division will be described, with emphasis placed on plant protection.

1. Study on the Biology and Control of Leaf Cutting Ants (collaborative research with Universidade Estadual Paulista, Campus de Botucatu, Brazil)

In the tropical and subtropical areas of the North and South American continent, leaf cutting ants attack almost every crop including pasture crops. Especially in Brazil, along with deforestation, the area of leaf cutting ants has expanded recently, including species that didn't used to be serious so far. Leaf cutting ants mow a large volume of plants that are stored in the nest underground to produce their food, a special kind of mushroom. In order to eradicate the ants, poisonous feeds are scattered or strong pesticides are applied into the underground nest. However, since these methods are not as effective as expected and furthermore they bring about environmental pollution, alternative methods of control are being studied.

A JIRCAS researcher has succeeded in raising ants for more than six months for the first time under artificial conditions in the laboratory. Then he selected the leaves which the insects prefer and sprayed them with pesticides so that the insects would take them into their nest. It was interesting to note that after the leaves were heated at 120°C and that some components were removed, the ants consumed such leaves, suggesting that preference for a kind of leaves depends on the presence or absence of a repellent.

2. Biorational Control of Desert Locust (collaborative research with ICIPE, Kenya)

Even since the prehistorical era until now in North Africa, mainly in Sudan and Ethiopia, large swarms of locusts have occurred with occasional migration to eastern and western areas, resulting in serious damage to agricultural products and pastures in these areas.

To eradicate the desert locust, large amounts of various chemicals have been sprayed by airplane but due to the adverse impact on the environment alternative ways that are environmentally friendly are being sought.

A JIRCAS researcher is studying the effects of insect hormones and pheromones on the behavior of the locusts. These substances disturb the insect physiological behavior-oviposition, aggregation, sexual

attraction, resulting in the decrease of locust survival. It was observed that when a hormone (NC-184) was applied to young (3rd to 4th instars) or adult locusts, the body color became darker and the duration of the 5th instar was prolonged. Induction of abnormal sexual behavior of young locusts by the hormone may enable to control the desert locust.

3. Ecological Studies on Long Distance Migrating Planthoppers

(collaborative research with Chinese Rice Research Institute, China)

Planthoppers are among the most serious insects for paddy rice in the monsoon area in East Asia. Since in Japan and in most of China planthoppers can not survive during the winter season, it is considered that outbreaks are due to the migration of a large number of insects from other areas. Ecological studies are essential to develop an accurate method for the forecasting and the control of planthoppers.

A JIRCAS researcher is staying in Hang Zhou, South China. He is investigating the immigration, multiplication and emigration of planthoppers in the paddy area of the southern Yangzi Jiang river and also the relation between the weather conditions and the behavior of the insect for migration. It has been reported recently that the population of the white-backed planthoppers has drastically increased. The reason for the increase is being investigated. Ecological studies on planthoppers during the winter season are also being carried out in the coastal area of South China. Genetic diversity of planthoppers is being traced geographically to clarify the center of origin of this insect.

4. Integrated Research on the Control of Biotic Agents in Rice Production (collaborative research with MADA and MARDI , Malaysia)

Alor Setar area in North Malaysia is the major rice granary in Malaysia. In the 1980s direct seeding of rice rapidly spread to this area due to labor shortage and it was gradually observed that direct seeding was associated with the growth of biotic agents, i.e. weeds especially during the first dry direct seeding season. Two JIRCAS researchers are carrying out studies on rice cultivation and weed control. In order to avoid weed hazard, it is recommended to sow an early variety of rice just before the onset of the rainy season. For this purpose some rice varieties have already been selected.

For some of the main weeds, seed production, survival rate of seeds in soil and chemical tolerance are investigated. Recently it has been observed that weedy rice was a serious weed. Morphological and ecological studies are being conducted to develop methods of control of this weed.

[Photo1:Leaf cutting ant](#)





Production of Urea Molasses Blocks for Ruminant Animals in Malaysia

Akinori Oshibe, M. Wan Zahari and M. S. Nor Ismail

Despite the abundance of various agricultural by-products, Malaysia is still a net importer of feed ingredients with an estimated value of more than M\$ 500 million annually. By using molasses, urea and other ingredients as supplements, these materials can be made into urea molasses block (UMB), a promising and practical feed supplement for ruminants. Recently, a suitable UMB formula using efficient processing technology has been developed at the Malaysian Agricultural Research and Development Institute (MARDI) for semi-commercial UMB production through the collaborative work between MARDI and JIRCAS. This paper reports on the method of UMB processing and its effects on the performance of ruminants.

We designed a UMB processing line that consists of an ingredient conveyance system, weighing system, a cutter mixer, a vertical twin shaft mixer and a single horizontal shaft mixer. A procedure that could be handled by a small number of operators and required a short time was developed. More than fifty formulae were examined based on the mixing efficiency, speed of solidification and palatability for animals. The composition of the formulae associated with a good palatability is shown in Fig. 1. Performance of the lambs was used as a criterion for the evaluation of the UMB. Fifteen lambs (mean live-weight 17.3 kg) were randomly divided into three groups. The first group which acted as a control was fed oil palm frond silage (containing 6% crude protein) *ad libitum*. The second and third groups received a similar type of diet supplementation with either imported UMB or locally made UMB (WZ42D), respectively. Changes in live weight and UMB intake were recorded weekly over the 6-week period of the experiment. At the end of the experiment, the total intake of WZ42D was approximately five times higher than that of imported UMB (Fig. 2), which may be due to the higher palatability. On the other hand, body weight of the control group decreased markedly during the trial (Fig. 3). It was evident that low UMB intake was a limiting factor in the use of imported UMB. Intake and live-weight gain of the animals supplemented with WZ42D were significantly higher ($P < 0.05$) than those in the other groups. Within the conditions of the trial, it can be concluded that the performance of the animals which received WZ42D was higher than that of the animals fed imported UMB.

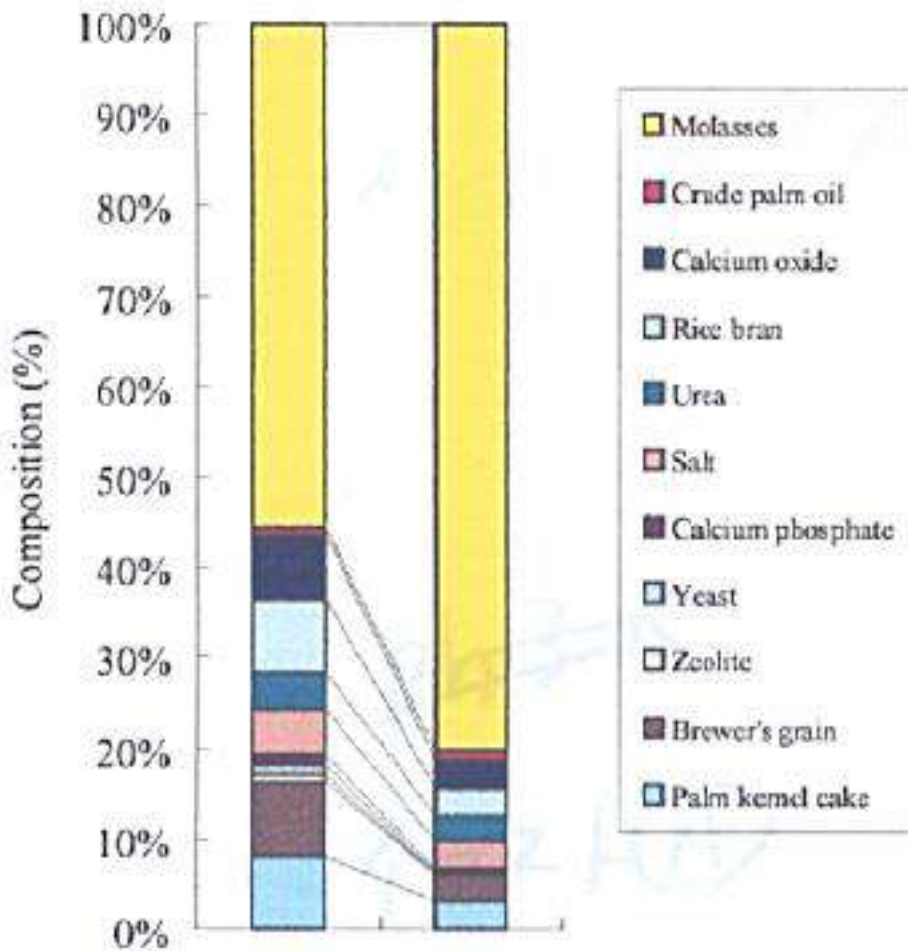


Fig. 1. Ingredients of formulae

[Fig.1.Ingredients of formulae](#)

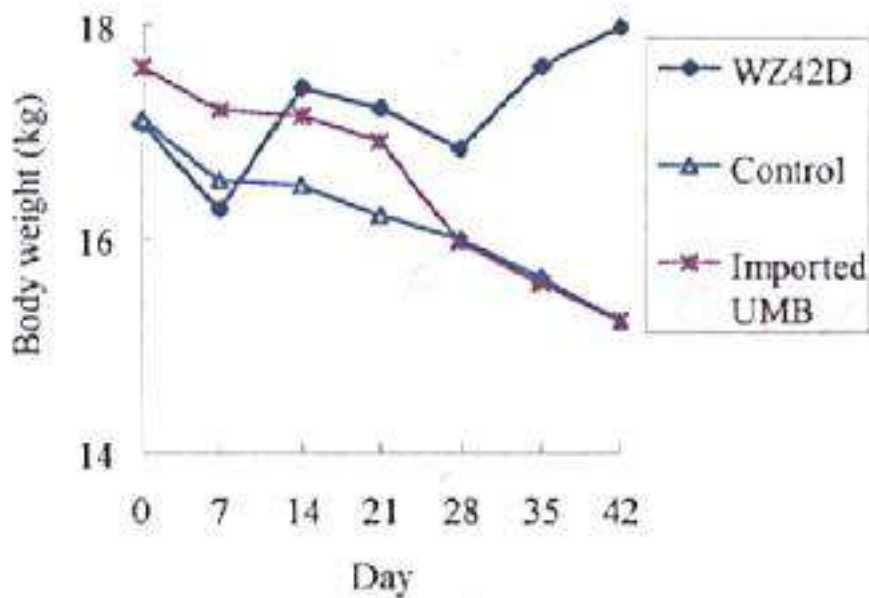


Fig. 3. Change in body weight

[Fig.2.Intake of UMB](#)

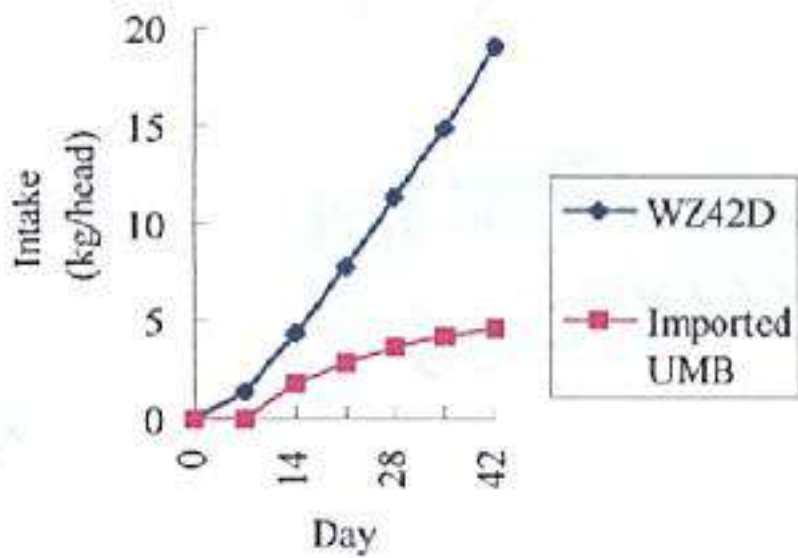


Fig. 2. Intake of UMB

[Fig.3.Change in body weight](#)

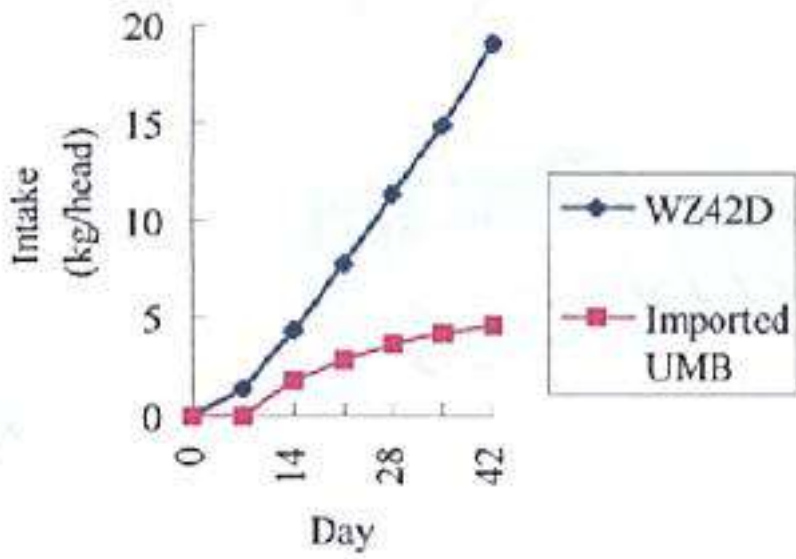


Fig. 2. Intake of UMB

Statistical Database System for World Agriculture, Forestry and Fisheries

JIRCAS-STAT

Osamu Koyama

In order to facilitate analytical work for the planning of research projects and to conduct research related to world food demand / supply projections, the Division has constructed a statistical database system which enables to handle a large variety of socio-economic time series data in an integrated manner.

With the database system, the user can look up the data needed by simply selecting the regions, items and years. The user can arrange the data in various types of tables. In addition, using the combined software, graphical display of the data and statistical / econometric analyses can also be easily carried out.

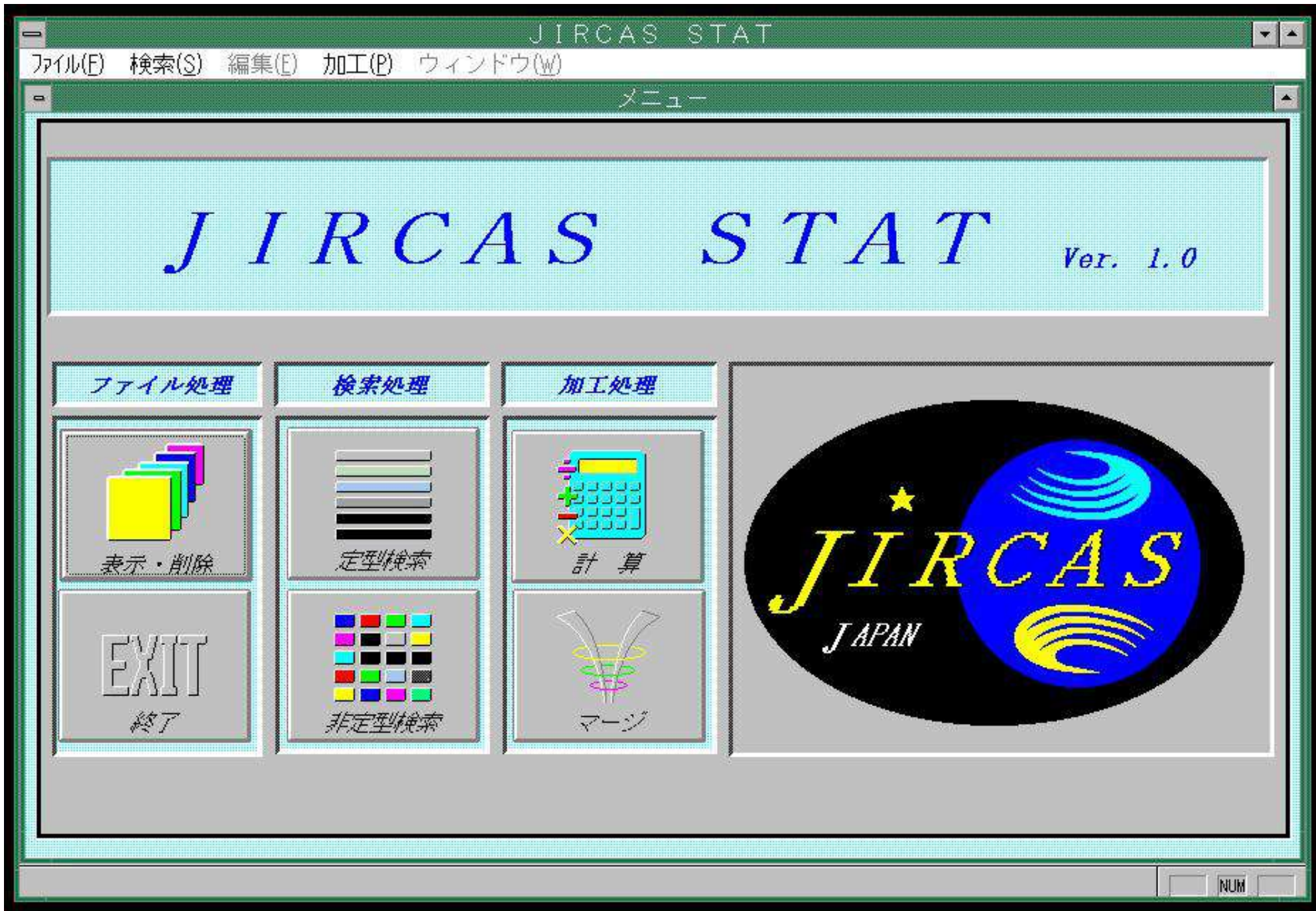
Until now, most of the relevant data published by the international organizations had been stored in a database with a common format. The database covers yearly statistics related to agriculture, forestry and fisheries fields. It also includes general indicators such as population, GDP, land use in addition to the data classified by products, e.g. production, trade, food balance sheets, food aid, etc.

The advantage of this system is that it is user-friendly. As it is based on the Windows operating system, the most popular system for personal computers, users do not need to learn any special commands. Due to the original approach of transforming a modern relational database structure into a structure suitable for the statistical time series data, the system affords a great efficiency in terms of both processing speed and data storage space.

The system is being used for the preparatory work of the econometric model analysis of the world food market carried out by the Division. It has been installed in several locations of the Headquarters of the Ministry. Within a year it will also be available through information networks to the remote users in the Ministry. In addition, a database system for documents and pictures is being constructed in the Division.

[Photo:JIRCAS-STAT](#)

[Data Stored in the JIRCAS-STAT](#)



Topics

Research Collaboration in Kazakhstan Has Started

JIRCAS initiated a collaboration with the Kazakh Institute of Agriculture (KIA) for a 5-yr (1996-2000) research project entitled: "Development of Sustainable Systems of Grassland Management and Animal Production in Central Asia". On this occasion, Dr. Keiji Kainuma, Director General of JIRCAS visited Kazakhstan at the beginning of July and signed the Memorandum of Understanding between the Kazakh Institute of Agriculture (KIA) and JIRCAS, as the last mission during his tenure at JIRCAS. Under the MOU, Dr. Kenji Sato, a pasture agronomist of JIRCAS, will be engaged in the new collaborative project at the Institute. The research project is the first to be implemented by JIRCAS in Central Asia.

[Photo 1: Ceremony marking the signature of MOU; Dr. R.•@A. Urazaliev \(left\), DG of KIA and Dr. Keiji Kainuma \(right\), DG of JIRCAS \(photo by Dr. M. Oka\).](#)



International Symposium on the Biosafety Results of Field Tests of Genetically Modified Plants and Microorganisms

Shigeo Matsui

From 29 countries all over the world, 220 scientists and administrators, including 90 from abroad, in the field of biotechnology met together on July 14-17 at Tsukuba Dai-ichi Hotel. It was the "4th International Symposium on the Biosafety Results of the Field Tests of Genetically Modified Plants and Microorganisms" which was held as the 3rd JIRCAS International Symposium at the same time. The participants were molecular biologists, plant breeders, food engineers, medical scientists, bacteriologists, virologists, geneticists, etc. Some of them are in charge of public acceptance or safety assessment in their governments or companies.

Recently, progress in biotechnology, especially in recombinant DNA technologies, has made the use of artificially gene-modified plants or microorganisms common and familiar to us. First gene-modified and commercially produced commodity "Flavr Savr" tomato which was released only two years ago is now followed for example, by cotton and potato plants with *B.t.* genes which produce insect-killing proteins, herbicide-resistant rapeseed, soybean and corn plants, virus coat protein-transferred tobacco and sugar beet plants which are tolerant to virus diseases, low ethylene-emitting carnations with long vase life, etc., as introduced by researchers from Monsanto, AgrEvo, PGS and Florigene, private companies. Moreover, gene-modified bacteria and viruses are being tested for use for bioremediation or to substitute chemicals conventionally applied to protect and stimulate crops. The papers presented at the symposium indicated that we are reaching a historical point in the era of new agriculture, indeed.

The effects of these transformed organisms on the eco-systems or on human health require that exhaustive field tests be performed. To discuss the results from such tests, the Symposium has brought together scientists with a wide range of expertise every other year since 1990, and this year, the conference coincided with the rapid increase of releases of genetically modified organisms (GMOs).

This Symposium was also significant in that it was held in Asia for the first time and leading scientists from developing countries were invited to introduce the present situation of the biosafety issues in each country. Developing countries really need to develop those new crops to feed rapidly growing populations and to minimize environmental stresses and actually they are very eager to use transgenic crops, as typically reported by Dr. Chen from China.

In order to evaluate biosafety, the development of new methods was presented. Allergen proteins from MGOs could be detected using IgE antibody-binding assay and immortalized cells, as reported by Dr. Lehrer from USA and Dr. Shinmoto from Japan, respectively. Dr. Ramos from Spain showed that the containment of recombinant microbes to the site of application was possible by using "suicide genes". Environmentally applied microorganisms can be detected by CCD camera if they are bioluminescent, as reported by Dr. Dane from USA. Regarding the risk assessment, commercial use of genetically modified virus insecticides was discussed by Dr. Wood from USA, and the possibility of natural gene transfer from transgenic plants to wild viruses aggravating the disease in crops was discussed by Dr. Tepfer from France.

Most of the speakers admitted that there is little possibility that the genetically modified plants or microorganisms will be dangerous to us and our environment. However, it is still essential that proper

guidelines should be established and relevant field tests should be performed to confirm the biosafety before such organisms are released to the environment.

At the end of the Symposium, Dr. K. Kainuma, Director General of JIRCAS emphasized in his closing remarks that international collaboration is essential to promote the harmonization of biosafety guidelines for the development of transformed crops, in particular in the developing regions. He also indicated that he was much pleased to transfer his duties to Dr. Willy De Greef, who is accepting the responsibility to host the 5th Symposium in 1998 in Belgium.

Participants obviously enjoyed the opportunity to see each other after an interval of two years and to obtain up-to-date information. They also enjoyed the nice foods and beautiful sounds of the *koto* strings during the dinner held on the third evening of the Symposium.

[Photo1:At the moderator round table of the Symopsium,](#)

[Photo2:Prof.Dr.S.Jia,](#)





<<Project Report>>

Sustainable Agricultural Systems in Northeast Thailand

Makie Kokubun

1. Constraints on agricultural development in Northeast Thailand

As a result of the rapid economic growth in the past decade, the relative economic importance of agriculture has remarkably decreased in Thailand. In Northeast Thailand, where the economy largely depends on agriculture, income per capita is only one ninth compared to that of Bangkok. Due to the low profitability of agriculture in the region, a large outflow of labor force from the region to urban areas has occurred, which has led to the shortage of workforce in agriculture, particularly young people.

Since the 1960s, a large acreage of forest has been cleared to make room for upland fields in Northeast Thailand, leading to a reduction of the water-holding capacity and to salt accumulation due to the elevation of the groundwater table. In addition, the deforestation of sloping land has made the land highly vulnerable to soil erosion by wind and rainfall. Soil fertility of the reclaimed fields, which was originally low, has further deteriorated after several years of cultivation, because of the inadequate application of fertilizers and organic materials. Moreover, precipitation is erratic and the dry season lasts for more than half a year in the region. These environmental constraints as well as the social problems facing Northeast Thailand have restricted agricultural development in the region.

2. Comprehensive project based on past JIRCAS (formerly TARC) and JICA achievements

To address these constraints and problems, JIRCAS initiated in 1995 a 7-year research project, "Comprehensive studies on sustainable agricultural systems in Northeast Thailand". This multidisciplinary research project includes soil, crop and livestock sciences as well as economic and social studies. The contents of the project are based on the knowledge and experience gained in previous collaborative research activities undertaken by JIRCAS (formerly TARC) and JICA in Northeast Thailand for the past few decades. Research activities are currently being carried out at the Agricultural Development Research Center in Northeast Thailand (ADRC) and other Thai research institutes affiliated to the Department of Agriculture (DOA), Department of Land Development (LDD), Department of Livestock Development (DLD), Khon Kaen University (KKU) and Asian Institute of Technology (AIT).

Biological regulation of methane emission in paddy fields

Methane is an important greenhouse gas which contributes to global warming. As an important source of CH₄, rice fields account for approximately 10 % of the global anthropogenic methane emission and it is considered that 80 % is derived through the methane-generating bacteria (MGB).

CH₄ emission from rice fields is the net effect of CH₄ production and CH₄ oxidation. CH₄ oxidation by methane-oxidizing bacteria (MOB) consumes 1 to 10 % of the total global emission and MOB are considered to be important biological regulators of methane fluxes in nature.

My collaboration with Dr. Adachi aims to characterize the dominant MOB in Ishigaki paddy fields and to establish a model ecosystem *in vitro* to elucidate the mechanism of methane production and oxidation in paddy fields. I do hope that these studies will result in technological development for environmental control of methane emission and sustainable crop production in rice-growing countries.



[Dr. Lukman Gunarto,](#)

Central Research Institute for Food Crops, Bogor,

Indonesia

***Azospirillum* study in lowland rice**

It is well known that soil microorganisms are the driving force behind nutrient transformation in soils and thus contribute significantly to soil fertility. Especially for the availability of nitrogen, the involvement of soil microorganisms is indispensable.

Azospirillum are associative N₂-fixing bacteria. Inoculation of these bacteria to lowland rice may enable to increase the efficiency of N fertilization at a low cost. They also produce growth hormone for plant root growth and promote nutrient absorption by plant. Indigenous strains of *Azospirillum* have been successfully isolated from Ishigaki Island, Japan and two indigenous strains (V.S.2.2. and VIII.P1.2) and one type culture (AZ 92-2) were selected as promising strains for the promotion of growth of lowland rice. Present study focuses on the mechanisms of enhancement of the growth of lowland rice by *Azospirillum* .



Heat tolerance in grain legumes

Groundnut and chickpea are the two major grains in the semi-arid tropics (SAT) as an important source of dietary protein and fat. The average yield is around 0.8 t ha^{-1} which is far below their yield potential. High temperature is one of the major abiotic constraints on the adaptation of these two crops in tropical and subtropical areas.

High temperature affects primarily membrane-related processes and heat tolerance appears to be determined by the thermal sensitivity of primary photochemical reactions occurring in the thylakoid membrane system. Tolerance limits vary among genotypes but are also subjected to acclimation. These legumes are more sensitive during their reproductive stages than vegetative ones. Therefore, the objectives of the current research work are as follows:

1. To analyse the effects of high temperature on photosynthesis, flowering and pod setting processes.
2. To examine the genotypic variations in heat acclimation potential.
3. To determine the biochemical changes in leaf and floral parts of these crops.



Physiological and biochemical mechanisms of heat tolerance in Brassicaceae and Legumes

Cabbage and Chinese cabbage form heads in a temperature range of 15-22C. Therefore their production in the tropical region is largely restricted to the cool highland areas. My research under the JIRCAS Visiting Research Fellowship Program 1995 aimed at elucidating the physiological and biochemical mechanisms of heat tolerance in the Brassicaceae.

Our results showed that the period of plant growth most sensitive to the temperature changes in cabbage and Chinese cabbage generally corresponds to 40-56 DAS (Days After Sowing) and 32-45 DAS, respectively in terms of heading failure. We then concentrated our attention on protein regulation during the heading process. At present we are interested in the purification and characterization of low molecular weight heat shock proteins (smHSP) in terms of identification of a 19.2 KD protein, confirmation of the inducible nature of the protein, investigations on cell water potential and component of solutes from various treated plants, etc.



[Padmanaban Annamalai](#),

University of Madras,

India

Cloning and characterization of heat tolerance genes in *Brassica* (Cabbage)

The productivity of plants is markedly affected by abiotic stresses and the genetic improvement of stress tolerance is an urgent need for sustainable agriculture. The effects of an increased incidence of heat shock, as a result of global warming for example, would be quite considerable, particularly with the occurrence of high temperatures on a number of consecutive days. Investigations into the molecular mechanisms of survival under high temperature stress could provide valuable information both on how plants survive and what genes are involved.

The Brassicas are subjected to a variety of stresses such as cold, heat and others. Stress is often associated with complex physiological changes and is mediated by alterations in the messenger RNAs (mRNAs) and proteins. My study aims to elucidate the regulatory mechanisms through cloning and characterization of heat tolerance genes in *Brassica oleracea* var. *capitata* by constructing cDNA libraries using mRNA and further to identify the heat-regulated transcripts by differential screening. The isolation and characterization of heat-regulated transcripts would lead to the identification of the molecular regulatory elements responsible for gene expression in response to heat tolerance.



[Armenia B. Mendoza](#),

University of the Philippines,

Diliman, Quezon City,

Philippines

Physiological and biochemical mechanisms of genotypic variability in response to salinity in rice

Soil salinity restricts rice production in arid and semi-arid regions of the world. In irrigated agricultural lands without adequate drainage system, soil salinity will also pose a major threat to rice cultivation. Breeding of high-yielding salt-tolerant cultivars that can adapt to a saline environment is more practical than costly adjustments of stressed environments through engineering and chemical treatment. However, information regarding the mechanisms that affect rice growth and adaptation to salinity is scanty.

In my research, physiological and biochemical mechanisms of genotypic variability in response to salt stress in cultures of rice cells and tissues *in vitro* are studied based on the notion that metabolites that maintain homeostasis and growth are important criteria in the selection of salt-tolerant rice varieties. In addition, spontaneous genetic mutations that can be induced in tissue culture are exploited for introgression of salinity tolerance in rice. Changes in the activities of the enzyme system that minimize tissue and seedling damage under saline environment are also investigated.



LIN Hongxuan

[Lin Hongxuan](#),

China National Rice Research Institute,

Hangzhou 310006,

People's Republic of China

**Mapping of QTLs for salt tolerance of rice (*Oryza sativa* L.) using
molecular markers**

Accumulation of salt in soil causes deleterious effects and leads to a reduction in rice production.

•@Saline soils cover about 950 million hectares of the earth surface. Improving the salt tolerance in rice is one of the major objectives of rice breeding programs.

Since 1985, rice germplasm for salinity tolerance has been evaluated and utilized from a large number of rice germplasm accessions in China. Significant progress has been made.

At the JIRCAS Okinawa Subtropical Station, I am identifying QTLs (quantitative trait loci) for salt tolerance in rice by using molecular markers. I hope that we will be able to identify marker loci linked to salt tolerance, evaluate the contribution of those genes to genetic variation, determine gene interaction, and understand the genetics and inheritance of salt tolerance as a basis for investigating the possible mechanisms involved in salt tolerance of rice in this program. I believe, that our research may be useful in improving salt tolerance in rice.



[Somsong Chotechuen,](#)

Chai Nat Field Crops Research Center,

Field Crops Research Institute, Department of Agriculture,

Thailand

Physiological and biochemical studies on genotypic variability in rice (*Oryza sativa* L.) in response to salt stress

Salinity is one of the substantial stress factors affecting crop production in many countries. In Thailand, saline soils are widely distributed along the coastal areas and cover approximately 5.9 million hectares in the Northeast region. Basic principles of stress injury and resistance in plants should be elucidated in order to breed salt-tolerant genotypes and to ensure better agricultural development in these areas.

My study at JIRCAS focuses on the responses of rice seedlings to salinization and induced mutation for salt tolerance in rice. The research outcome of this study will be relevant to my responsibility in Thailand for breeding plants resistant to various environmental stresses, such as mungbean and some other crops suitable for rice-based cropping systems, in order to achieve sustainable agricultural production in the country.



[Nguyen Tien Think,](#)

Nuclear Research Institute,

Viet Nam

Cryopreservation of germplasm of vegetatively propagated tropical monocotyledonous plant species

A large number of plant genetic resources in the tropics consist of vegetatively propagated monocotyledonous species. •@These genetic resources are non-renewable and are among the most essential among the world's natural resources. •@For the use of present and future generations, it is necessary to preserve them.

Recently, **cryopreservation** has become an ideal tool for the long-term preservation of plant germplasm since it is a safe, economical and compact way of storage in comparison with *ex situ* conservation through field genebanks and *in vitro* tissue culture conservation. At JIRCAS Okinawa Subtropical Station, I am studying the development of cryopreservation techniques for the germplasm of several tropical monocotyledonous species. The research has successfully proceeded and several efficient cryoprotocols have been developed for the preservation of shoot meristems of taro, tannia, banana, rice and orchid.



[P. M. Kyesmu](#),

University of Jos,

Faculty of Natural Sciences,

Department of Botany,

Nigeria

Developing protocols for the cryoconservation of the West African tuber crop 'Rizga' (*Plectranthus esculentus* N. E. Br. syn. *Coleus dazo* A. Chev. and Perrot.).

P. esculentus, a minor tuber crop that belongs to the mint family-Lamiaceae, is cultivated vegetatively within the semi-arid regions of Sub-Saharan Africa. Its germplasm is continually being eroded as a result of the decline in its cultivation and preference for exotic tuber crops. Hence the need to develop conservation protocols in order to conserve its genetic base since it provides the raw materials for development either through traditional plant breeding or the use of biotechnological tools.

Cryoconservation is one of such protocols which is being developed at the JIRCAS International Collaboration Research Section (ICRS). This technological development which is currently rudimentary in developing countries such as Nigeria should contribute to the conservation and storage of genetic resources of economically and biologically important crop plants leading to the improvement of agricultural activities in these countries.



People

Nobuyoshi Maeno became Director General of JIRCAS on August 1, 1996, succeeding Dr. Keiji Kainuma who retired after serving as the first DG of JIRCAS since 1993. Dr. Maeno, a pasture agronomist with extensive experience in collaborative research on tropical pastures, was until recently Director of JIRCAS's Research Planning and Coordination Division. As for the profile of Dr. N. Maeno, please see pg 3 of the JIRCAS Newsletter Vol. 2, No. 2, December 1994.

Keiji Ohga, an agricultural economist and former Director of JIRCAS's Research Information Division, succeeded Dr. Maeno as Director of JIRCAS's Research Planning and Coordination Division. As for the profile of Mr. K. Ohga, please see pg 8 of the JIRCAS Newsletter Vol.2, No.1, June 1994.

Kunio Tsubota, an agricultural economist, succeeded Mr. Ohga as Director of JIRCAS's Research Information Division. Mr. Tsubota was until recently Deputy Director of Asian and African Division, National Research Institute of Agricultural Economics. He served as an agricultural economist at OECD in Paris (1982-1986) and project economist at the Asian Development Bank in Manila (1990-1993) along with working at the Headquarters of the Ministry of Agriculture, Forestry and Fisheries (MAFF).

Message from Dr. Kainuma, former DG, to the Editor of the Newsletter: "At the time of leaving JIRCAS, I would like to express my deep gratitude to the members of the organizations with which JIRCAS collaborated, for their continuing support and friendship during my tenure."

JIRCAS Newsletter•@1996(No.9)•@



•@CONTENTS

[Toward Global partnership in Agricultural Research](#)

-JIRCAS Research Highlights-

[Use of Stored Pearl Millet Pollen in Wheat Haploid Production](#)

[Options for Mitigating Methane Emissions from Tropical Rice Fields](#)

[Biotype of *Fimbristylis miliacea* \(L.\) Vahl. Resistant to 2,4-D in the Muda Area](#)

[People](#)

Project Report

[Comprehensive Studies on the Development of Sustainable Agro-pastoral Systems in the Subtropical Area of Brazil](#)

Topics

[Mr.Matsumoto, Chairman of AFFRC, and Dr. Maeno, DG of JIRCAS, Visited Indonesia](#)

[Recent Advances in Nutrition and Feeding Standard of Farm Animals in Asian-Australasian Countries :](#)
Satellite Symposium of the 8th Animal Science Congress of Asian-Australasian Association of Animal
Production Societies (AAAP)

Visiting Scientists

[Artificial Propagation of Giant Freshwater Prawn](#)

[Evaporation and Formation of Secondary Salts](#)

- challenge to Desertification -

Toward Global Partnership in Agriculture Research

Nobuyoshi Maeno

Director general



•@On August 1, 1996, I became the second Director General of Japan International Research Center for Agricultural Sciences (JIRCAS) after succeeding Dr. Keiji Kainuma who retired from the Ministry .

Under the dynamic leadership of Dr. Kainuma, the former Tropical Agriculture Research Center was reorganized into JIRCAS and the difficult task of setting up a new structure was eventually accomplished.

•@During the three-year tenure of Dr. Kainuma, the new orientation of the JIRCAS activities was defined, for example new research facilities were constructed, comprehensive research projects were implemented, research activities in various countries that hitherto had not been targeted for research collaboration, such as Kazakhstan in Central Asia were initiated, the JIRCAS Visiting Research Fellowship Program at Tsukuba was inaugurated, research activities in Japan were further promoted while the relations between JIRCAS and the Japan International Cooperation Agency (JICA) became much closer.

•@Therefore, presently, the research activities of JIRCAS are being expanded and promoted along the basic strategy built-up during the past three years as follows:

1. Expansion of the areas targeted for research collaboration

•@When TARC was reorganized into JIRCAS, the areas targeted for research collaboration expanded to cover all the developing regions, in addition to the tropical and subtropical regions. However, due to the constraints on the budget earmarked and on the research capability, it became necessary to set up priorities. Presently, research collaboration with the countries located in the Asian region accounts for 80% of the total, mainly due to geographical considerations and a certain similarity in culture. Although in the case of Africa and Latin America, research is implemented mainly in collaboration with the CGIAR centers, etc., in future, the relations with the countries located in these regions may gradually expand. In addition, since the research themes taken up vary mainly with the countries and regions, the strategy adopted must be adjusted accordingly.

2. Importance of research dealing with information systems and socio-economic aspects

•@For the selection of research themes relevant to the needs of the countries and for the effective implementation of the projects, it is necessary to collect, process and analyse in a comprehensive manner, information pertaining to agriculture, forestry and fisheries fields in various regions. In addition, it is essential to develop appropriate technology compatible with the socio-economic conditions of the respective regions. To achieve these objectives, it is important to promote information activities aimed at integrating social and natural sciences.

3. Multidisciplinary versus unidisciplinary approach

•@Due to the complexity of the agricultural ecosystems and of the social systems, in order to develop techniques for the promotion of sustainable development of agriculture, forestry and fisheries activities in harmony with the environment, it is more than ever necessary to adopt a systematic and integrated strategy instead of an isolated and fragmentary approach. Therefore efforts should be made to promote the implementation of comprehensive projects on a multidisciplinary basis in addition to specific studies. Research covering information sciences and socio-economic aspects, as mentioned previously (2), should place emphasis on the drafting and implementation of integrated projects.

4. Development of collaboration on a multinational basis

•@Hitherto, research collaboration with the NARS had been implemented on a bilateral basis with the respective countries and organizations. However, for large scale problems common to several countries or regions, the implementation of research collaboration on a multilateral basis would be more effective and efficient. Therefore, in future, in order to promote collaboration on a multinational basis, it will be necessary to gain the understanding and cooperation of the related NARS.

5. Link between research carried out overseas and in Japan

•@The research strategy adopted since the establishment of TARC consisted of dispatching researchers to various countries to carry out collaborative research in the respective regions. In future, this system will be essentially maintained. However, in the case of basic advanced research fields requiring the use of sophisticated equipment and instruments, it is preferable to use the facilities available in Japan. Therefore, JIRCAS has set up its own research facilities in addition to utilizing the equipment and facilities available in other research institutes located in the Tsukuba Research Complex. As a result, in future, since the links between research carried out overseas and in Japan may become closer, a system whereby research carried out in Japan could alleviate the difficulties in the execution of research projects overseas could eventually evolve.

6. Development of human resources (training programs and fellowships)

•@To contribute to the development of sustainable agriculture, forestry and fisheries activities, it is essential to promote research as a resource base, hence the need to train researchers who can fulfill such requirements. To achieve this objective, JIRCAS currently sponsors two types of fellowships in making the best use of advanced facilities and of an environment conducive to research. These activities aim at enhancing the capability of the invited researchers while promoting research collaboration with the JIRCAS researchers. In addition, it is anticipated that when the recipients of the fellowship return to their respective countries, they will become the core partners for

research collaboration with JIRCAS.

- @**For the past three years, the activities of JIRCAS have become widely recognized within the agricultural research community worldwide and JIRCAS has received requests from a large number of countries for the initiation of research collaboration.**
- @**Therefore, the collaboration on a partnership basis between JIRCAS, NARS, CGIAR centers, etc. should pave the way for a global partnership for the development of techniques aimed at the preservation of the global environment and the promotion of sustainable agriculture, forestry and fisheries activities.**
- @**However, due to the limitation in the number of researchers and research funds, it will be essential for JIRCAS to fully utilize its comparative advantage and to identify research priorities best suited to its capability and to the needs of the respective countries and regions.**



Photo 1: Embryo formation in wheat, self-pollinated (left), and crossed with stored pollen of pearl millet (right).

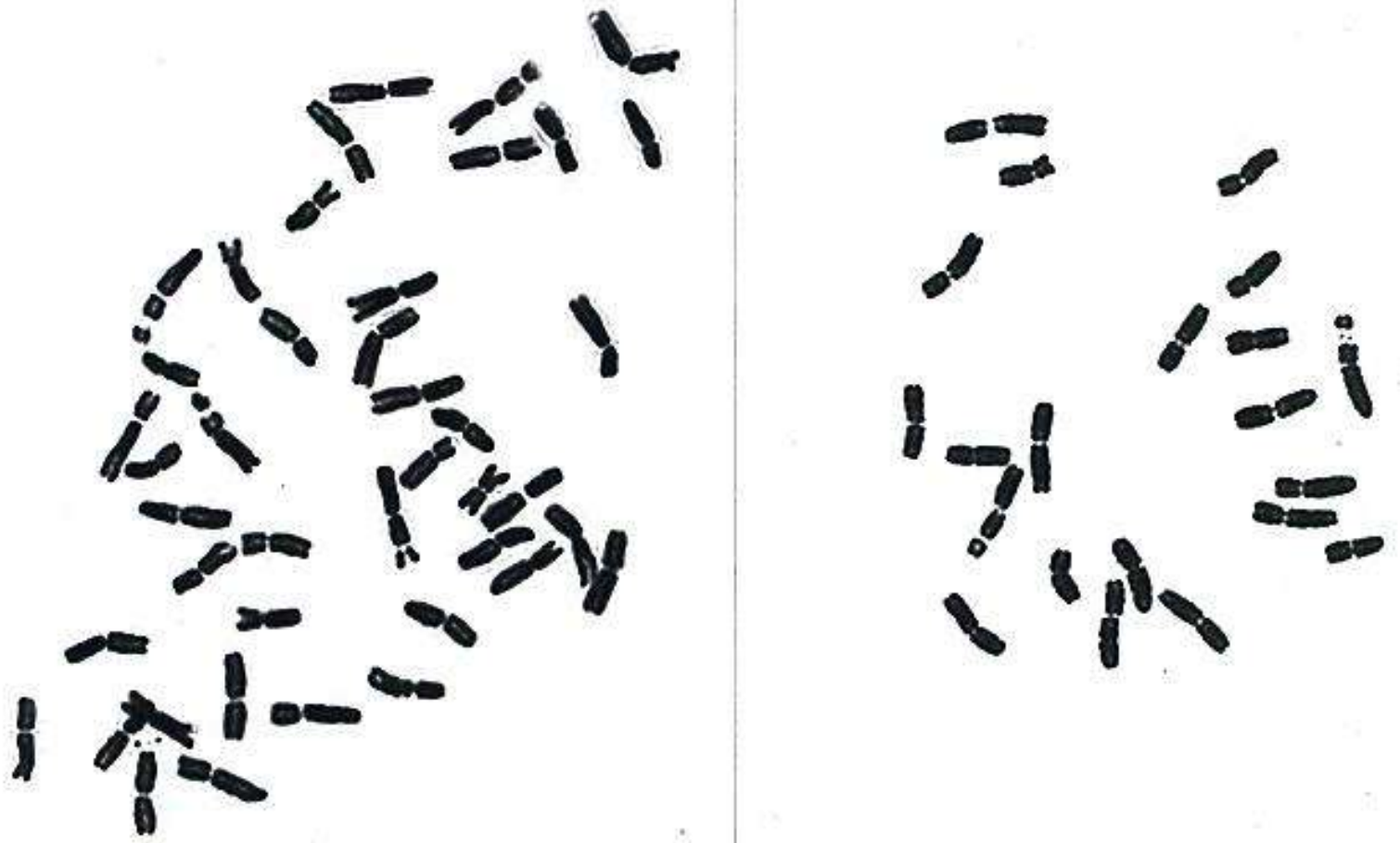


Photo 2: Somatic chromosomes of plants obtained from wheat, self-pollinated (left, $2n=6x=42$), and crossed with stored pollen of pearl millet (right, $2n=3x=21$)

Options for Mitigating Methane Emissions from Tropical Rice Fields

•@~@Kazuyuki Yagi

•@Atmospheric concentration of methane (CH_4) has been increasing rapidly in recent years. Because CH_4 is a radiative trace gas (greenhouse gas) and takes part in atmospheric chemistry, the rapid increase could be of significant environmental consequence. The scientific report of the Intergovernmental Panel on Climate Change (IPCC) concluded that a 10 to 15% reduction in the CH_4 emissions from individual sources would stabilize the concentration in the atmosphere. Of the wide variety of sources, wetland rice fields are considered to be an important source of atmospheric CH_4 , because the harvested area of rice increased by about 70% during the last 50 years, and it is likely that CH_4 emissions increased proportionally. Recent estimates suggest that global emission rates of CH_4 from rice fields account for about 4-19% of the emission from all sources.

•@Due to the large amount of global emission, the reduction in CH_4 emission from rice cultivation is very important to stabilize the atmospheric concentration. In addition, since it is possible to control the emissions by agronomic practices, rice cultivation must be one of the most hopeful sources for mitigating CH_4 emission. In particular, tropical rice fields are important because more than 70% of the world rice acreage is located in this region. The current studies which aimed at measuring the CH_4 flux from rice fields and at developing options for mitigating CH_4 emissions from tropical rice fields were carried out within the framework of a collaborative project among the National Institute of Agro-Environmental Sciences (NIAES), Japan International Research Center for Agricultural Sciences (JIRCAS) (formerly Tropical Agriculture Research Center), Department of Agriculture, Thailand (DOA), and Malaysian Agricultural Research and Development Institute (MARDI) from 1991 to 1996.

•@Field measurements of CH_4 flux were conducted at 9 sites in Thailand (5 sites in the central plain and 2 sites each in North and Northeast Thailand). The CH_4 flux from rice paddy fields to the atmosphere was measured by using the closed chamber method (Photo 1). The measurements were performed during the rice cultivation periods. The results showed a large variation in CH_4 emission rates among the sites. The average emission rates during the rice cultivation periods ranged from 1.1 to 23.0 mg m⁻² hr⁻¹. A relatively large flux was observed in the northern and northeastern sites, whereas a small flux was observed in rice fields with acid sulfate soils and soils with a low content of labile organic matter and high content of free oxides. The results indicated that the soil properties and agronomic practices including water and organic matter management affected the CH_4 emission rates from rice fields.

•@Effect of organic matter application on the CH_4 flux was also investigated. Application of rice straw to paddy soils prior to flooding increased the total CH_4 emission 3.8- to 10.4-fold. The largest CH_4 flux was observed in the early stage of cultivation in the plot with rice straw application plot, whereas in the latter stage in the plot without rice straw application (Fig. 1). Green manure application also increased CH_4 emission significantly. On the other hand, some organic amendments such as palm oil wrung residues and complehumus did not affect the CH_4 emission rates significantly. These results indicate that fresh organic matter containing a large amount of labile fractions significantly enhances CH_4 emission from rice fields. For mitigating CH_4 emission from tropical rice fields, aerobic degradation of organic matter by composting or incorporation into soil during the off-season drainage period could also be proposed.



Photo 1: Closed chamber method for CH₄ flux measurements

[Fig. 1. Effect of rice straw application on CH₄ emission from rice fields](#)

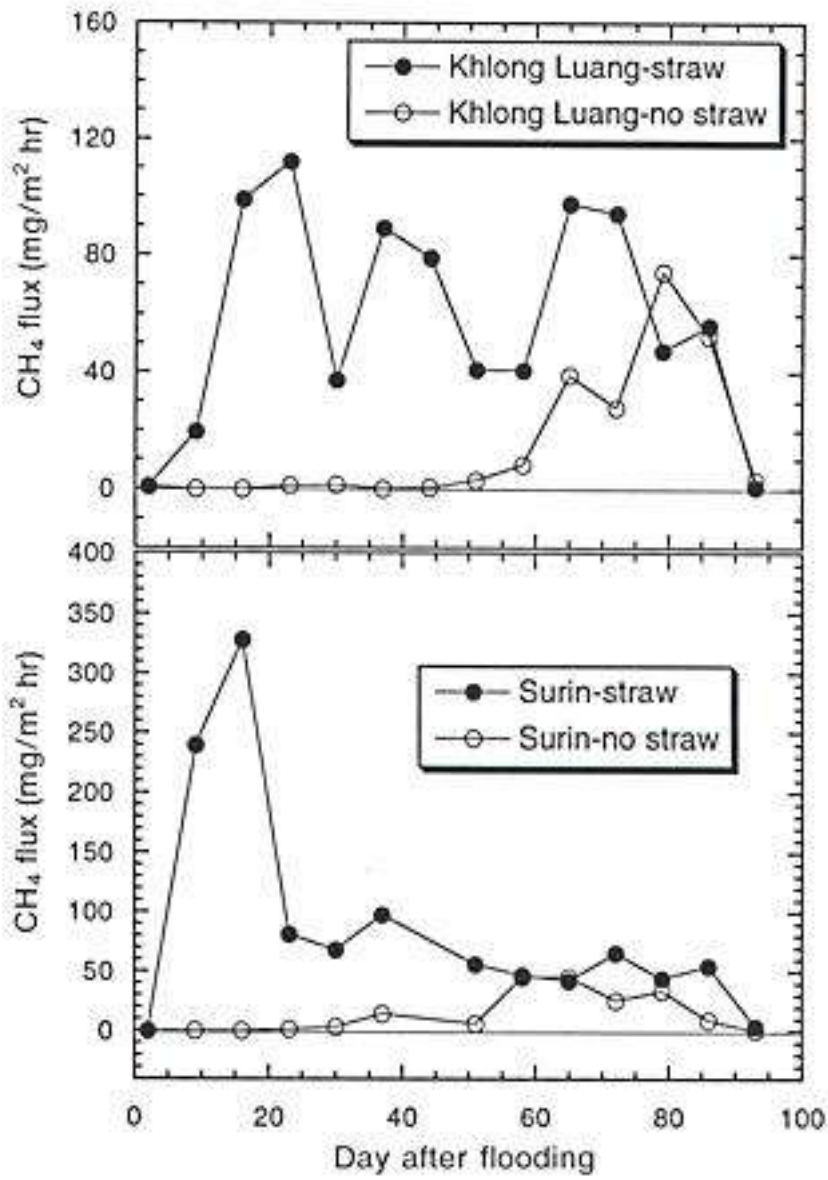


Fig. 1. Effect of rice straw application on CH₄ emission from rice fields

Biotype of *Fimbristylis miliacea* (L.) Vahl. to 2,4-D in the Muda Area

•@*Hiroaki Watanabe, Md. Zuki Ismail and Nai-Kin Ho**

•@In the Muda area, chemical weed control began with the use of 2,4-D dimethylamine in the early 1960s and wettable powder formulation of 2,4-D iso-butylester became popular among farmers from the early 1970s because of its superior effectiveness for the control of broadleaved weeds and sedges. *Fimbristylis miliacea* (L.) Vahl. is the most common annual sedge in direct-seeded rice fields in Malaysia. The weed could be controlled easily by the application of 2,4-D at the rate of 0.8 to 1.0 kg a.i./ha. However, a 2,4-D-resistant biotype of *F. miliacea* was observed in the off-season of 1989 in a farmer's field in Kampung (Kpg.=village) Gulau, locality D-III in the Muda Irrigation Area, where 2,4-D had been seasonally applied since 1975.

Differences in the susceptibility to 2,4-D dimethylamine between biotypes were investigated in a pot experiment. R-type recovered after the application of 2,4-D dimethylamine at doses up to 1.39 g a.i./m² (equivalent to 16 times the recommended dose), whereas the susceptible biotype (S-type) from Kpg. Titi Batu, locality G-IV, MADA, was strongly affected at all rates higher than 0.022 g a.i./m² (equivalent to one-quarter of the recommended dose). The R-type was not distinguishable from the S-type based on taxonomic characters such as panicle form, shape of spikelets, glume and nut (seed). There were no statistical differences in the size of panicles and spikelets between the biotypes.

R-type showed a cross-resistance to other phenoxy-compounds such as 2,4-D iso-butylester, 2,4-D ethylester, 2,4-D sodium salt and MCPA. However, no distinct differences were observed between the biotypes in the reaction toward propanil, paraquat and glufosinate ammonium.

Distribution of the R-type was investigated using soil samples from 100 rice fields in the Muda area in 1993. R-type plants were detected in five rice fields at different locations including Kpg. Gulau, while only S-type plants were found in the other 95 rice fields, indicating that most of the rice fields in the Muda area were infested with the S-type. Infestation with *F. miliacea* and percentage of R-type plants were investigated in Kpg. Gulau. No relationship was observed between the degree of *F. miliacea* infestation and R-type percentages. R-type percentage decreased from 1993 to 1995 in the rice fields where 2,4-D compound herbicides had not been applied since 1992.

In Malaysia, the use of sulfonylurea compounds such as bensulfuron-methyl and metsulfuron-methyl is increasing steadily and tends to replace 2,4-D herbicides. Herbicide-resistant biotype often evolved by repeated use of the same herbicide. Continuous monitoring of the herbicide-resistant weeds is imperative in the Muda area.

* *Muda Agricultural Development Authority (MADA)*

[Photo 1: Rice field infested with *Fimbristylis miliacea* \(L.\) Vahl.](#)

[Photo 2: R-type treated with 2,4-D dimethylamine](#)

Photo 3: S-type treated with 2,4-D dimethylamine



Photo 1: Rice field infested with Fimbristylis miliacea (L.) Vahl.



Photo 2: R-type treated with 2,4-D dimethylamine



Photo 3: S-type treated with 2,4-D dimethylamine

PEOPLE

Katsuyuki Minami, Director of the Environmental Resources Division, JIRCAS, was selected by the International Union of Air Pollution Prevention and Environmental Protection Associations (IUAPPA) in cooperation with the International Academy of Sciences (IAS) as the first recipient of the award "Hopes for the Future for a Sustainable World" for his work on "The Effect of Agricultural Practices on Methane Emissions from Rice Fields".

Kiyoshi Tanaka, a forest pathologist, became Director of JIRCAS's Forestry Division on October 1, succeeding Dr. Yasuo Osumi. Dr. Tanaka was until recently Research Coordinator at the Forestry Agency, Ministry of Agriculture, Forestry and Fisheries (MAFF). He carried out most of his research work at Hokkaido Research Center and Kansai Research Center, Forestry and Forest Products Research Institute, MAFF. He also spent one year as Visiting Scientist at the Pacific Southwest Forest Experiment Station (USDA) in California, USA from 1978 to 1979.

•âProject Report•â

Comprehensive Studies on the Development of Sustainable Agro-pastoral Systems in the Subtropical Area of Brazil

Kozo Fujisaki

•@JIRCAS is committed to contributing to a more effective implementation of collaborative research programs to promote sustainable development of agriculture, forestry and fisheries in harmony with the local conditions and environment in the developing regions through the establishment of closer relations with both overseas and Japanese research organizations. Based on the strategy of JIRCAS, the research project entitled "Comprehensive Studies on the Development of Sustainable Agro-pastoral Systems in the Subtropical Area of Brazil" will be implemented during the period 1996-2002.

The subtropical area of Brazil

•@The subtropical area of Brazil has been considered to be one of the areas where modern agriculture originated in South America. This area, where continuous cultivation of field crops has been carried out on a large scale as the major agriculture system with extensive cattle grazing, is extremely important to the food supply and economy of Brazil at present. This area which covers about 400 thousands km² (approximately equal to the Japan land area) has a triangular shape, straddling the cities of Londrina, Botucatu, Ribeirao Preto and Campo Grande. Also, the area is characterized by the settlement of hundreds of thousands of Japanese-Brazilian farmers who are mainly providing essential food commodities for the Sao Paulo and Rio de Janeiro megalopolises.

•@In the subtropical area of Brazil, the increase of agricultural production has been achieved by continuous expansion of arable land and high dependence on the net primary productivity of fertile land with minimum input. As a result, in most of this area the land has become environmentally vulnerable and the efficiency of production has remained low without improvement of agricultural technologies. Plant growth retardation associated with continuous cropping, the occurrence of diseases, outbreaks of pests, and soil erosion threaten agriculture in this area and are the main constraints on sustainability and productivity.

New project on agro-pastoral systems in the subtropical area of Brazil

•@This research project is focused on the development of sustainable farming systems with high productivity in environmentally degraded areas in the subtropical zone of Brazil, with emphasis placed on land utilization through the adoption of crop-pasture rotation systems. For this purpose, the following research themes will be taken up:

- 1) Analysis and evaluation of indigenous and traditional land utilization systems for agriculture
- 2) Multidisciplinary studies for the adoption as sustainable crop-pasture rotation systems

‡@ Mixed and multiple cropping agricultural systems employing soybean as a main crop for field crop diversification

‡@ Introduction and management of forage crops in mixed, multiple-cropping systems for soil improvement and erosion control

‡B Dynamics of soil fertility and plant nutrition in crop-pasture rotation

‡C Control of biotic agents, e.g., pathogens, pests and weeds

‡D Management of grazing cattle in crop-pasture rotation

3) Socio-economic evaluation of crop-pasture rotation from the standpoint of farming systems

4) On-farm participatory research on newly developed "agro-pastoral systems"

Project sites

The studies will be mainly carried out in collaboration with research centers affiliated to EMBRAPA, namely National Research Center for Beef Cattle (CNPGC) and National Research Center for Soybean (CNPSo). The expertise of CIAT in crop-pasture system development in South American countries will be sought. Also, collaboration with the JATAK International Center of Agriculture Technology, which is one of the Japanese nongovernmental organizations for Japanese-Brazilian farmers, will be promoted.

[Photo 1: Two traditional herdsmen, "Gaucho", at Campo Grande.](#)

[Photo 2: Soybean farm contiguous to a pasture at Campo Grande, as a prototype of agro-pastoral systems to be implemented in this study.](#)



Photo 1: Two traditional herdsmen, "Gaucho", at Campo Grande



Photo 2: Soybean farm contiguous to a pasture at Campo Grande, as a prototype of agro-pastoral systems to be implemented in this study

•áTopics•â

Mr. Matsumoto, Chairman of AFFRC, and Dr. Maeno, DG of JIRCAS, Visited Indonesia

Masahito Sato

•@Mr. Sakuei Matsumoto, Chairman of the Agriculture, Forestry and Fisheries Research Council (AFFRC), Ministry of Agriculture, Forestry and Fisheries (MAFF), and Dr. Nobuyoshi Maeno, Director General of JIRCAS visited Indonesia in August 1996. They had the opportunity of meeting with his Excellency Sjarifudin Baharsjah, Minister of Agriculture of Indonesia, Dr. Faisal Kasryno, Director General of the Agency for Agricultural Research and Development (AARD), Ministry of Agriculture (MOA) and the Directors of the Institutes affiliated to AARD.

•@They exchanged views about the future orientation of research collaboration between the Institutes affiliated to Indonesian organizations, namely AARD and the Institutes affiliated to MAFF, namely JIRCAS.

•@It was eventually agreed: 1) that research collaboration implemented by JIRCAS for the development of technology in the field of agricultural production should also include socio-economic aspects to promote rural development in taking account of the conditions prevailing in the respective regions of Indonesia, 2) that it is essential that research collaboration deal with the expansion of agricultural production compatible with the preservation of the natural environment on a global scale in order to achieve sustainable development of agriculture and 3) that for the effective implementation of the research projects it is desirable that JIRCAS promotes research collaboration with the Indonesian organizations in paying a close attention to the technical cooperation activities sponsored by JICA.

•@Mr. Matsumoto and Dr. Maeno visited several research institutes affiliated to AARD, such as the Central Research Institute for Food Crops and Research Institute for Food Crop Biotechnology in Bogor, as well as The Research Institute for Coastal Fisheries in Ujungpandang. They also met with JICA administrators and experts in Jakarta and visited the ESCAP/CGPRT Center in Bogor and JICA Mangrove Forest Conservation Project in Bali.

[Photo 1: Meeting with the Minister of Agriculture of Indonesia \(From left to right\): Dr. Effendi, Dr. Maeno, Honorable Sjarifudin Baharsjah, Mr. Matsumoto, Mr. Kadowaki, Mr. Kawamoto, Mr. Sato](#)



Photo 1: Meeting with the Minister of Agriculture of Indonesia (From left to right): Dr. Effendi, Dr. Maeno, Honorable Sjarifudin Baharsjah, Mr. Matsumoto, Mr. Kadowaki, Mr. Kawamoto, Mr. Sato

Recent Advances in Nutrition and Feeding Standard of Farm Animals in Asian-Australasian Countries:

Satellite Symposium of the 8th Animal Science Congress of Asian-Australasian Association of Animal Production Societies (AAAP)

Hirofumi Hayakawa

•@International symposium on the above theme was held in Tsukuba Science City during the period October 20-21, 1996 under the joint auspices of the National Institute of Animal Industry (NIAI), Japan International Research Center for Agricultural Sciences (JIRCAS) and Japan Livestock Technology Association (JLTA). From 12 countries, 105 scientists, including 34 from abroad, in the field of animal nutrition and animal production participated in the symposium.

•@Livestock play a vital role in the rural economies of the Asian-Australasian region. Recent advances in animal nutrition are making great strides in many countries. However, there are still many problems to address technically to achieve an optimum level of animal production under practical conditions. Development of feeding standard for farm animals together with feed information on nutritive values, both being the outcome of research activities in the field of animal nutrition, is originally expected to require the collaboration of both researchers and animal farmers.

•@Keynote addresses, were as follows: "Nutrient requirements for ruminants in the tropics" by Dr. B.A. Young from the University of Queensland, Australia, "Development of feeding technologies and contribution of nutrition research to dairy farming in Japan" by Dr. S. Oshio from National Grassland Research Institute (NGRI), and "Concept of the Asia-Pacific regional feed composition information network" by Mr. K. Kosaka from JIRCAS. In the country reports, scientists from Malaysia, Thailand, Indonesia, Vietnam, Nepal, Korea, China and Japan made presentations on related topics.

•@The symposium provided a new opportunity to discuss these important issues and search for the solutions through the promotion of collaborative networks in this region.

[Photo 1: Participants in and presentation at the symposium](#)

Photo 1: Participants in and presentation at the symposium



Photo 1: Participants in and presentation at the symposium

•ávisiting Scientists•â

Artificial Propagation of Giant Freshwater Prawn

Muharijadi Atmomarsono

Research Institute for Coastal Fisheries, South Sulawesi, Indonesia 90511

•@The giant freshwater prawn, *Macrobrachium rosenbergii*, is one of the important crustaceans mainly cultured in the countries of the Asia-Pacific region, and North and South America. However, the production of prawn larvae in the hatchery is still insufficient due to the dependence on the use of natural spawners, and therefore, the prawn larvae must be partly supplied by using wild forms. Many methods have been applied to increase the production rates, but information about reproductive mechanisms and means of controlling larval diseases in the early stages is still lacking.

•@It is well known that eyestalk ablation in prawns can stimulate the molting cycle and vitellogenesis based on species, age, and stage of the ovary. Part of my current work involves the examination of the structure and processing of vitellogenin (yolk protein) in female *Macrobrachium rosenbergii* by sampling the hemolymph of eyestalk-ablated prawns and analysing samples using sodium dodecyl sulfate-polyacrylamide gel electrophoresis (SDS-PAGE) followed by western blotting. In subsequent experiments the role of the ovary will be examined to determine whether the ovary itself functions as an endocrine organ to promote yolk protein production and/or serves as a source of endogenous vitellogenin.

•@*Macrobrachium rosenbergii* prawns migrate naturally to brackish water areas during the time of spawning, when the female broods an egg mass attached to the abdominally located setae. Prawns may be prone to diseases at any stage of their life cycle. Since diseased breeders which are infected with pathogenic fungi can contaminate their larvae, it is necessary to separate the eggs from the breeders for disease prevention. If eggs are put into freshwater, the larvae die soon after hatching. In order to determine the optimal conditions of salinity or osmolarity of the water media for hatching and survival of giant freshwater prawn embryos, I am analysing osmoregulatory mechanisms and testing the use of sea water at various percentages. Results thus far suggest that water media with an osmolarity between 500-600 mOsm (about 50% sea water) are most satisfactory. Identification and evaluation of fungi isolated from giant freshwater prawns will also be carried out in the near future.

[Photo 1: M. Atmomarsono \(right\) and M. N. Wildew are monitoring the conditions of culture of the giant freshwater prawn](#)



Photo 1: M. Atmomarsono (right) and M. N. Wildew are monitoring the conditions of culture of the giant freshwater prawn

Evaporation and Formation of Secondary Salts

-Challenge to Desertification-

[Chang Qing](#)

Xinjiang Institute of Biology, Soil and Desert Research, Chinese Academy of Sciences, People's Republic of China

•@It is estimated that about 10% of the land on our planet is being affected by salinization which is now recognized as an increasing cause of land and stream degradation in arid and semi-arid lands. Arid and semiarid areas account for almost half of the land area of China. Salinization and resulting desertification are the most serious challenges to agriculture and the environment in these regions.

•@Relevant studies in the field of agriculture, geochemistry and environmental sciences have been carried out. During the past 5 years, I studied the occurrence and mineralogy of salt-affected soils in the desert area of northwestern China. The soil salts are derived from weathering products of rocks, while the redistribution of salts mainly depends on the water movement and evaporation rate. We were able to elucidate the mechanism of salt accumulation and identify mineralogical species on a relatively large geographic scale.

•@Now, my research theme is focused on the mechanism of formation of evaporative secondary salt minerals under simulated arid conditions. Under climatic conditions characterized by high temperature and scarce precipitation, evaporation is the dominant link between rock weathering and salinization from weathering products. Our recent experiments suggest that surface properties and porosity of solid phase (soil matrix) and, density and adhesion of liquid phase (soil solution) are important factors determining the processes of evaporation-precipitation.



JIRCAS Newsletter 1995(Vol.3 No.1)•@



•@

CONTENTS

- [Information Activities at JIRCAS and Role of Research Information Division](#)
- [1994 Annual Meeting for Review and Promotion of Research for International Collaboration](#)
- [Review of Thai-JIRCAS Collaborative Research for 25 years](#)
- [New Buildings for JIRCAS](#)
- [•sJIRCAS Research Highlights•t](#)
- [Analysis of land degradation phenomena using remote sensing techniques](#)
[-Extraction of geomorphological characteristics and land coverage in eroded areas-](#)
- [Structure and function of dehydration-inducible in higher plants](#)
- [Micro-climatic improvement associated with the use of windbreaks made of a combination of various tree species](#)

- [Development of water balance model for Tank Cascade Irrigation Systems in Sri Lanka](#)
- [Procedure for simultaneous analysis of productivity and adaptation traits in indigenous cattle in Africa](#)

•@•sLetters•t

- [Letters from JIRCAS Visiting Scientists](#)
 - [Dr. Abdul Baset](#)
 - [Ancha Srinivasan](#)
 - [Bayani M. Espiritu, Ph.D.](#)
 - [L. Gunarto](#)
 - [Dr. Mbangi Musoko](#)
 - [Mohamed Hassan Rashad](#)
 - [Nampiah Sukarno](#)
 - [Nguyen Tien Thinh](#)
 - [Dr. Tie Gang Lu](#)
 - [Xu Ningsheng](#)
- [Tsukuba Seminar on Japan-IRRI Day](#)

•@•sNew Research Area•t

- [Research Collaboration with Mongolia](#)

•@•sResearch Collaboration•t

- [Collaborative Research Project with CIMMYT on Wheat •~ Maize Crosses](#)

Information Activities at JIRCAS and Role of Research Information Division



•@Mr. Keiji Ohga

Director, Research Information Division

•@Obviously the word information has various connotations. Most of the people including myself who deal with information systems tend to use the word information in relation to computer technology. But here I will define information as the •gknowledge acquired or derived for decision-making or taking a specific action.•h In this sense everybody at JIRCAS is engaged in some kind of information activity. Researchers collect and process data in the course of their research work. Staff members of the Research Planning & Coordination Division and of the Administration Division use and coordinate collected information to formulate research plans and draft administrative regulations, respectively.

•@What is the role of the Research Information Division? the Research Information Division of JIRCAS fulfills three functions. The first function is to carry out surveys to analyse activities relating to agriculture, forestry and fisheries mainly in countries located in developing regions. The second is to formulate and coordinate international collaborative research projects. The third is to develop and maintain computer-based information systems at JIRCAS.

•@During the surveys conducted overseas on activities relating to agriculture, forestry and fisheries in developing regions, information on agricultural sciences and related socio-economic conditions in these regions is collected and subsequently analysed. Surveys are conducted by two groups of research coordinators with a wide expertise in related research fields and international cooperation. The first group adopts a region-oriented approach covering five zones; monsoon Asia, arid and semi-arid Asia, Africa, Latin America, developed countries. They place emphasis on countries for which JIRCAS had limited information hitherto, such as Central Asia or Africa. The second group of research coordinators adopts a problem-oriented approach by conducting surveys on three topics; environment, food problems and rural development. Both comprehensive regional surveys and problem-oriented surveys are conducted on an interdisciplinary basis combining natural sciences and socio-economic fields.

•@Research coordinators also formulate and coordinate collaborative research projects based on the surveys and analyses of regional agriculture or agriculture-related problems. JIRCAS is currently implementing three integrated research projects in Vietnam (Mekong Delta), Malaysia and Northeast Thailand. For the comprehensive or multidisciplinary projects the research coordinators work in close collaboration with the directors of the research divisions and researchers concerned.

•@The Research Information Division is responsible for developing and maintaining research information systems based on computer networks at JIRCAS. Information scientists combine research on information processing with the operation of the computer system at JIRCAS. As applied information science is now an essential component of agricultural sciences, the Division is developing comprehensive information systems, including statistical data, documents such as reports on surveys and image data based on PC windows and UNIX workstation since JIRCAS is involved in research related to socio-economic fields in connection with research on agricultural technology development in LDCs.

•@The Division is also in charge of a specific project dealing with projections of the supply and demand of major food commodities including cereals, animal products and oil seeds, based on econometric analyses in collaboration with organizations concerned in China, Indonesia, Malaysia and Thailand.

•@The three functions of the Research Information Division are all based on information activities and are closely interrelated. The Division plans to combine in future activities relating to interdisciplinary research with planning and supportive activities.

•@

Intl. Research Coordinators

Area, Research Fields and •gIntegrated Research Projects•h

•iRegion-oriented approach)

Asia I*, Plant breeding, •gDevelopment of agriculture in Mekong Delta (1994-1998)•h

Mr. Akira Kobayashi

Dr. Mitsunori Oka

Asia II**, Cropping systems, •gDevelopment of agriculture in Northeast Thailand (1995-2001)•h

Dr. Kozo Fujisaki

Central and South America, Animal production and health

Dr. Norihiko Kobayashi

Africa, Plant pathology

Mr. Shigeyuki Kawahara

Advanced countries, International agricultural research organizations, Fisheries biology

(Problem-oriented approach)

Conservation of global environmental resources, Soil science and plant nutrition, •gBrackish water mangrove ecosystems (1995-1999)•h

Dr. Masaaki Suzuki

Dr. Yoshinobu Kitamura

Rural planning and development, Irrigation and drainage engineering

Dr. Mitsuhiro Nakagawa

Food supply and demand, Agricultural economics

* : East & Southeast Asia

** : West & South Asia

(Yoshinobu Kitamura)

1994 Annual Meeting for Review and Promotion of Research for International Collaboration



Dr. Nobuyoshi Maeno

Director, Research Planning and Coordination Division

•@

1. Report on the meeting held at the new JIRCAS Headquarters

•@The 1994 Annual Meeting for the Review and Promotion of Research for International Collaboration was held on February 7, 1995 in the International Conference Room of the new JIRCAS Headquarters constructed in conjunction with the establishment of JIRCAS (the official inauguration of the facilities took place on April 18, 1995).

•@A total of 51 participants attended the meeting, including representatives from various institutes affiliated to the Ministry of Agriculture, Forestry and Fisheries along with delegates from the Ministry as well as the Director General, Directors of Research Divisions and several staff members of JIRCAS.

•@At first the collaborative activities pursued by JIRCAS during the fiscal year 1994 were reviewed and discussed, including information, research projects, international symposium, workshops, seminars, various meeting, Visiting Research Fellowship Program at the Okinawa Subtropical Station of JIRCAS, in addition to the orientation of JICA activities, etc.

•@During the present meeting, emphasis was placed on the Visiting Research Fellowship Program at Tsukuba which will be initiated on October 1, 1995. Under the program, a total of 6 researchers will be invited, of which 4 will undertake long-term projects for a period of 2 years at JIRCAS and 2 researchers will be engaged in short-term projects for a period of 5 months mainly at the National Institute of Agrobiological Resources. In addition, the report on the proceedings of the meeting organized on the previous day for reviewing TARC/JIRCAS collaborative research activities with Thai agricultural research organizations for the past 25 years and discussing the future orientation of research collaboration attracted a great deal of attention (see related article).

•@Thereafter discussions were held on an important topic, namely the possibility of undertaking research in the field of agriculture, forestry and fisheries in areas that hitherto had not been targetted by TARC, including cold areas located in Central Asia, South America as well as Mongolia, in addition to the programs currently implemented in the tropical and subtropical zones. The results of short-term surveys

conducted in this newly targetted region were analysed for further orientation of research. It was eventually concluded that although there is a definite potential for the development of agriculture, forestry and fisheries in these areas and there is a strong demand for research collaboration with JIRCAS to enhance this potential, it is still essential to collect more basic information about this region. In future, based on further information, it may be possible to promote collaborative research mainly centered on animal production and grassland management in such areas. Plans are currently being formulated for the implementation in the fiscal year 1996 of two research projects as follows: 1. Comprehensive studies on the development of sustainable agro-pastoral systems in the subtropical zone of Brazil and 2. Development of technology for grassland management and animal production systems. Short-term surveys will be conducted along with preliminary arrangements for the implementation of these projects.

•@The general discussion was centered on the strategy that should be adopted to promote integrated research as a challenge to the expansion of both research fields and areas targetted for research as well as on the Visiting Research Fellowship Program at Tsukuba.

•@

2. JIRCAS Visiting Research Fellowship Program at Tsukuba

•@On October 1,1993, the Tropical Agriculture Research Center (TARC) was reorganized into the Japan International Research Center for Agricultural Sciences (JIRCAS).

•@Since its establishment in 1970, TARC has been engaged in collaborative research activities consisting of the dispatching of researchers to various institutes located in the tropics and subtropics to promote the development of agriculture, animal husbandry and forestry in these regions and substantial results were obtained.

•@However, recently there has been a growing awareness of the importance of conducting collaborative research in making use of the high level of research opportunities available in Japan, including advanced research fields of biotechnology to alleviate various constraints such as environmental problems occurring on a global scale. To achieve this objective, in addition to the dispatching of researchers to conduct collaborative research , since 1992 the Visiting Research Fellowship Program has been implemented to enable 10 outstanding researchers holding a doctorate degree from institutes located in tropical and subtropical countries to carry out collaborative research for a period of one year at the Okinawa Subtropical Station of the Center (Okinawa was selected in view of the similarity of the research priorities and climatic conditions to those in the tropical and subtropical regions).

•@To respond more adequately to the rapid and recent changes in the situation of agriculture and food supply worldwide, JIRCAS added fisheries to the research fields already covered and included temperate and cold regions into the areas targetted for research to address in a comprehensive manner the problems of food production and conservation of natural and environmental resources confronting the developing regions. Therefore, starting from this year, JIRCAS will implement the Visiting Research Fellowship Program at Tsukuba in taking advantage of the research environment of Tsukuba Science City, namely the strong base for research and development in the field of advanced science and technology, by inviting young promising researchers from counterpart institutes in the developing regions to carry out collaborative research in order to address the problems facing these areas.

•@

The outline of the program is as follows:

•@Under the Fellowship Program, a total of 6 researchers will be invited, to carry out research pertaining to one of the themes listed below. Four researchers will undertake long-term projects for a period of 2 years and 2 researchers will be engaged in short-term projects for a period of 5 months. The former 4 will carry out collaborative research at JIRCAS, while the latter 2 will conduct research at the National Institute of Agrobiological Resources (NIAR) at Tsukuba.

Research Themes

I Long-term Projects

1. Methods for optimum utilization of biological resources

1) Analysis of plant responses to environmental stresses and gene expression

2) Development of DNA-based assay for indexing plant diseases

3) Development of practical methods for the evaluation of the quality of indigenous crops and for the analysis of components and functionality of foods

4) Methods for the development of livestock breeds with high productivity through crossing with indigenous species

5) Development of methods for the diagnosis and prevention of diseases affecting aquatic animals for fresh water and marine aquaculture

2 Analysis and evaluation of the impact of climatic and anthropogenic factors on environmental resources

1) Relation between climatic changes and biomass in agro-ecosystems

2) Investigations of the process of rock-weathering through the analysis of the rock surface by electron spectroscopy

II Short-term Projects

1) Methods for the analysis and preservation of biodiversity

2) Production of new biological resources through the application of biotechnological procedures

3) Methods for the analysis and control of biological functions

Fellowship Qualifications

(1) Applicants should be outstanding researchers who will play a major role in the activities of the counterpart institutes in future. After the completion of the Fellowship, they should continue to carry out research at the same institute.

(2) Hold a Master's degree in a field relating to natural sciences and technology or equivalent qualifications in related fields. Be preferably less than 35 years of age.

- (3) Carry out research related to one of the themes listed under •gResearch Themes•g.
- (4) Should enjoy good health.
- (5) Have an adequate command of English or Japanese language.

Tenure

In principle, the long-term projects will cover a period of 2 years and the short-term projects will cover a period of 5 months.

Fellowship Conditions

- (1) A round-trip airline ticket (economy class) will be available.
- (2) Living allowance: ¥260,000.- per month.
(including housing allowance)
- (3) Housing: International Guesthouse
1-2, Kannondai, Tsukuba
- (4) Fixed-rate insurance package (for injury, sickness and damage, etc.) will be covered under the JIRCAS Fellowship Program.

Application Procedure

Applicants are required to submit the following documents to the Director-General of JIRCAS.

- (1) Application form (Form I)
- (2) Two recommendation letters (Form II) from the official representative or appropriate authority of the research organization in the respective research field
- (3) Medical certificate (Form III)
- (4) Copy of University Diploma

Deadline for Application

June 30, 1995

Notification

The Director General of JIRCAS will examine the application documents and notify the results of the selection to the successful applicants and their recommending authorities about two months after the deadline date for application.

Further information about the Visiting Research Fellowship Program can be obtained from the International Relation Section, Japan International Research Center for Agricultural Sciences, 1-2, Ohwashi, Tsukuba, Ibaraki, 305 Japan.

Tel.: 81 - 298 - 38 - 6335

Fax.: 81 - 298 - 38 - 6337

Telex: 3652456 JIRCAS J

Review on Thai-JIRCAS Collaborative Research for 25 years

Koji Kawashima

•@The meeting organized for reviewing TARC/JIRCAS•fs collaborative research activities in Thailand during the past 25 years was held in Tsukuba, at JIRCAS Headquarters on February 6th, 1995. Two delegates from the Department of Agriculture (DOA), Thailand joined the discussions. It was the first meeting held at JIRCAS International Conference Room after the opening of the new building in December 1994. The review of JIRCAS-Thai collaborative research was particularly timely because in September 1994, a ceremony marking the 25th anniversary of the collaboration between the agricultural research organizations of Thailand and the research institutes affiliated to the Ministry of Agriculture, Forestry and Fisheries of Japan was held in Bangkok (JIRCAS Newsletter Vol. 2, No. 2).

[Photo : Thai-JIRCAS collaborative research](#)

•@The meeting chaired by Dr. K. Kawashima started with an opening address given by the Director General of JIRCAS, Dr. K. Kainuma, followed by an overview of the collaborative research activities (Dr. T. Murakami) and review of research in the field of soils and fertilizers (Dr. N. Nakaya) and plant protection (Dr. C. Noda), impact of research cooperation on the development of agricultural technology in Thailand (Dr. C. Wisit), review of research in the fields of postharvest technology (Dr. H. Nakakita), livestock and animal diseases (Dr. H. Hayakawa), future research priorities (Mr. C. Charus) with final comments from nine resource speakers covering various research fields including forestry and fisheries.

•@JIRCAS is currently sending abroad approximately 40 researchers on long-term•@assignment every year and Thailand remains one of the most important counterpart countries.

•@During the past 25 years, nearly one hundred researchers with long term assignments stayed in Thailand (26 for research in the fields of plant protection, 23 for soil and fertilizers, 14 for upland field crops , 13 for wetland rice , 12 for research on livestock and animal diseases, 5 for postharvest technology, etc. About 580 researchers with short term assignments visited Thailand and from Thailand 108 researchers and administrators were invited to Japan.

•@The counterpart-institutes of JIRCAS in Thailand include DOA, Department of Livestock Development (DLD), Kasetsart University (KU) and Khon Kaen University (KKU). In addition, research is scheduled to be carried out at the Agricultural Development Research Center for Northeast Thailand (ADRC), Asian Institute of Technology (AIT) and Department of Land Development (LDD) in future.

•@During the meeting, Dr. C. Wisit highly evaluated the past collaborative research and as an example of successful research in the soil science area, he indicated studies on soil productivity which demonstrated that a low phosphorus content in paddy soil was associated with a low rice yield. Although the DOA plans to pay more attention to the preservation of the environment , Dr. Wisit stated that the improvement of crop productivity still remained one of the major objectives. Mr. C. Charus mentioned that the DOA plans to further promote collaborative research in the fields of postharvest technology, integrated pest management and environmental protection in future.

•@During the past 25 years, a total of two to three hundred Thai researchers were engaged in

collaborative investigations with TARC/JIRCAS members on a long term basis. In addition, it was emphasized that more attention should be paid to postharvest problems. In this regard, the DOA will be reorganized and a new institute for research on postharvest technology will be established. The utilization and development of livestock resources will be one of the future research subjects. In the fields of fisheries research collaboration which was initiated in 1994 at KU will be further promoted.

- @ Also a comprehensive research project for the development of sustainable agricultural systems in Northeast Thailand for a duration of seven years will start in 1996, with the participation of seven Thai organizations.

- @

- @



New Buildings for JIRCAS

Taiichiro Maekawa

•@On April 18, 1995, a ceremony was held to mark the official inauguration of the new JIRCAS buildings (JIRCAS Main Building, Fisheries Science and Earth Science Laboratories and Biotechnology Unit). These buildings are located within a short walk from the Central Building where most of the research divisions remain. The new buildings with their simple and functional design and walls made of pale moss green ceramic tiles are well integrated within the surrounding landscape.

1. JIRCAS Main Building

•@This building where the headquarters of JIRCAS are located consists of three parts: Center, East Wing and West Wing.

1. Center: On the first floor there is a large entrance hall (567 m²),•gJIRCAS Hall•h with an area for informal meetings and an information corner for the public. The walls are decorated with photographs illustrating various aspects of agriculture, forestry and fisheries worldwide taken by JIRCAS researchers during surveys or long-term assignments. The International Conference Room with a booth for simultaneous interpretation and a sophisticated projector is on the second floor.
2. East Wing: The first floor houses the Research Information Division, including an information •@processing room containing various types of computers. On the second floor the facilities of the Research Planning and Coordination Division as well as a lecture room are located.
3. West Wing: The facilities of the Administration Division are located on the first floor. The second floor houses the office of the Director General in addition to several other offices and meeting rooms.

2. Fisheries Science and Earth Science Laboratories

These facilities that are housed in a separate building contain advanced equipment for various analyses and experiments. The ESCA (Electron Spectroscopy for Chemical Analysis) apparatus enables to analyse the surface of materials at the molecular level. With the Aquatron studies on the optimum conditions for aquaculture of freshwater, marine and brackish water fishes can be carried out. The Wind Tunnel enables to analyse the effects of climatic factors on crop cultivation, including changes in the atmospheric air stream, temperature and humidity levels. Among the apparatus, ESCA is of major interest as there are only five instruments of this kind in Japan. These facilities will be used to promote basic research related to fisheries science and earth science for application to various fields of agriculture, forestry and fisheries both in Japan and overseas.

•@

3. Biotechnology Unit

•@This two-storied unit is equipped with the most advanced facilities to carry out research on gene transformation and regulation of expression in plants to develop transgenic plants tolerant to various adverse environmental conditions, including drought tolerance. There are also three P2-level laboratories and greenhouses where gene engineering studies can be conducted with maximum safety.

•@It should be emphasized that the facilities described above which will be used by researchers from both JIRCAS and various countries were built to contribute to the development of sustainable production in the field of agriculture, forestry and fisheries worldwide.

[Photo : JIRCAS Main Building](#)

[Photo : JIRCAS Biotechnology building](#)





JIRCAS RESEARCH HIGHLIGHT

Analysis of Land Degradation Phenomena Using Remote Sensing Techniques - Extraction of Geomorphological Characteristics and Land Coverage in Eroded Areas -

Satoshi Uchida, Shahid Ahmad and Rakhshan Roohi**

- @Studies on the geomorphological patterns which describe the specific characteristics of gullies caused by severe soil erosion were carried out in the Pothwar plateau area located in the northern part of the Punjab province, Pakistan. Various types of sensors loaded on remote sensing platforms in the upper atmosphere enabled to observe these patterns.
- @Examination of the spatial characteristics of satellite imagery of SPOT data showed that the variation in brightness of pixels within a distance of about fifty meters was considerably larger in severely eroded areas compared with other areas. The two-dimensional distribution of gully areas assumed a shape corresponding to the dissection of the valleys. Based on these observations, a model was constructed for automatically identifying eroded areas by image processing of remote sensing data. In some cases, it was possible to distinguish eroded areas from others although additional geographic information, such as the topography or location of settlements, may be necessary to improve the performance of the method.
- @Another attempt was made to analyze the relation between erodibility and ground surface conditions which could be estimated by the calculation of multispectral band data of LANDSAT-TM. It was observed that the erodibility was negatively correlated with the coverage index deduced from band 2 (green) and band 3 (red) data at the time of Rabi cultivation .
- @Soil erosion shows a dynamic behavior with temporal changes depending on environmental conditions. One of the advantages of remote sensing is that the same area can be observed repeatedly within a certain interval of time. This thus suggested that a model describing the dynamic behavior of soil erosion based on the results of this study can be constructed by analysis of multi-temporal data. (*National Agricultural Research Center, Pakistan)

•@

•@*[Photo: Eroded area appearing as dissected Valleys by SPOT panchromatic imagery.](#)*



JIRCAS RESEARCH HIGHLIGHT

Structure and Function of Dehydration - Inducible Genes in Higher Plants

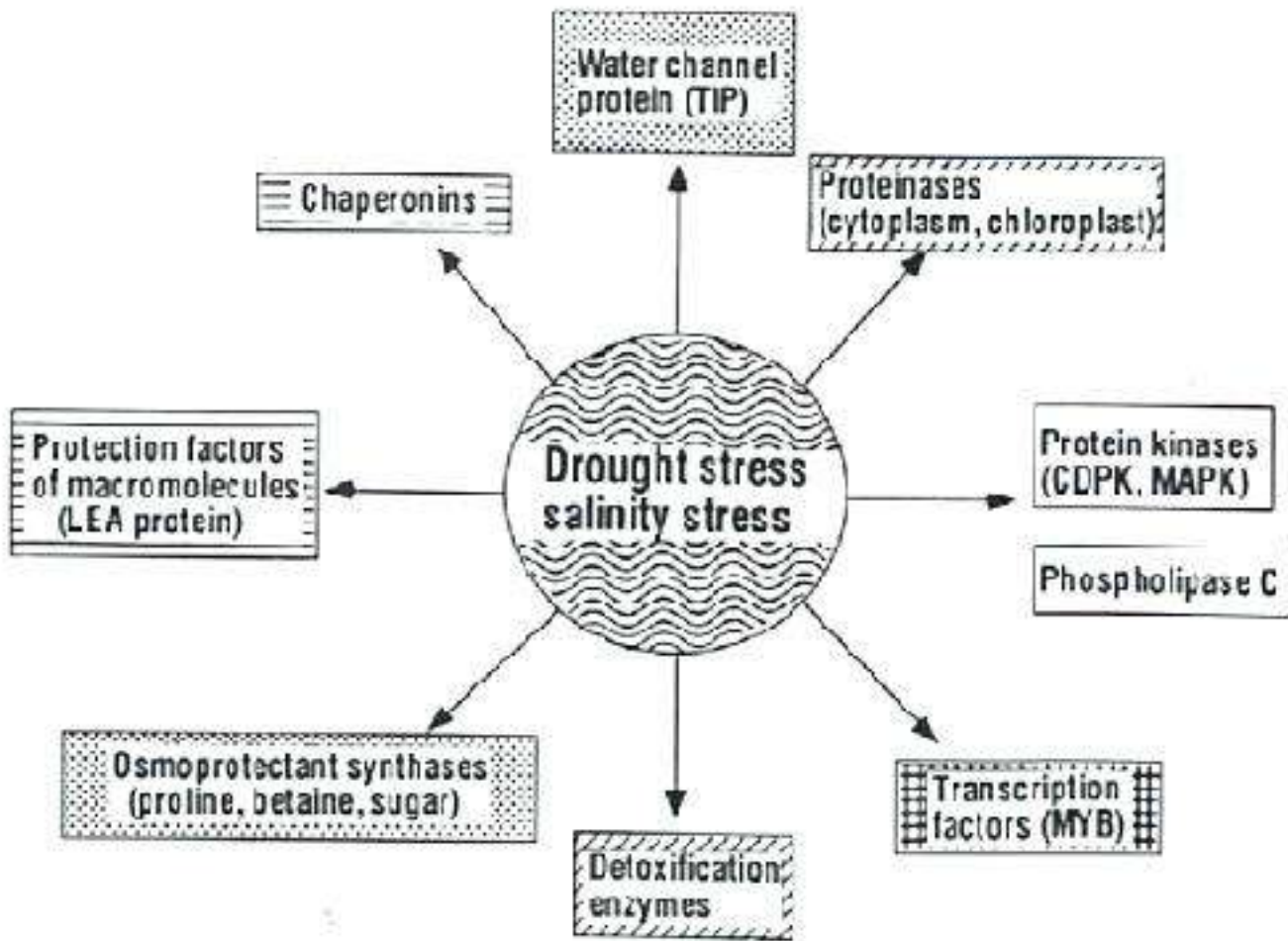
Kazuko Yamaguchi-Shinozaki and Tomio Terao

•@The genetic improvement of drought tolerance is an important problem for the future of agriculture in desert and savanna areas of developing countries. Biotechnology has the potential to improve the drought tolerance of crops using transgenic plant technology. The limiting factor for developing this technology are the isolation of genes that function in drought tolerance and the precise understanding of the molecular process of drought tolerance. As higher plants are immobile they must adapt to conditions of severe environmental changes in order to survive. Plants respond to these environmental changes with a number of physiological and developmental changes to tolerate these stresses. Drought, one of these stresses, severely affects plant growth. Plant hormone, abscisic acid (ABA) is produced under water deficit conditions and plays an important role in drought tolerance. A number of genes respond to dehydration as well as exogenous ABA treatment at the transcriptional level. However, there are few reports on the dehydration stress-induced expression of genes prior to the accumulation of endogenous ABA.

•@We used *Arabidopsis thaliana* as a plant material for the analysis of molecular processes of drought tolerance. In order to analyze the early response of plants to dehydration stress at the molecular level, we isolated cDNA clones for drought-inducible genes expressed prior to the accumulation of endogenous ABA. When *Arabidopsis* plants were subjected to dehydration stress, they lost water gradually, reaching a plateau of 90% water loss after 10 hr of dehydration stress. Accumulation of ABA began to increase after dehydration-stress for 2hr and reached a maximum level at 10 hr. We constructed a cDNA library from polyA RNA prepared from 1-hr dehydrated *Arabidopsis* plants. We isolated 26 cDNA clones from the cDNA library by applying the differential screening method. The cDNA clones were classified into 16 groups based on Southern blot hybridization, and named ERD (Early Responsive to Dehydration). All the genes, named *erd*, corresponding to ERD cDNAs were induced by 1hr-dehydration. Nucleotide sequences of the DNA inserts of the 16 ERDs have been determined and homologies to these 16 sequences were examined in a protein sequence data base. These analyses of the cDNAs revealed that genes induced by dehydration encode proteins that may play a role in the protection of cells from dehydration as shown in Figure 1. For instance, they encode putative proteinases that may degrade denatured or unnecessary proteins, chaperonins that probably renature proteins, water channel proteins that function in controlling the osmotic potential of stressed cells, LEA proteins that may protect plant cells against dehydration, and so on. These genes could be used as useful sources for the construction of transgenes to transform crop plants in order to produce drought tolerant transgenic crops in the near future.

•@[*Drought-or salinity stress-induced genes and their functions in stress tolerance in higher plants*](#)

•@



JIRCAS RESEARCH HIGHLIGHT

Micro-climatic improvement associated with the use of windbreaks made of a combination of various tree species

Taichi MAKI

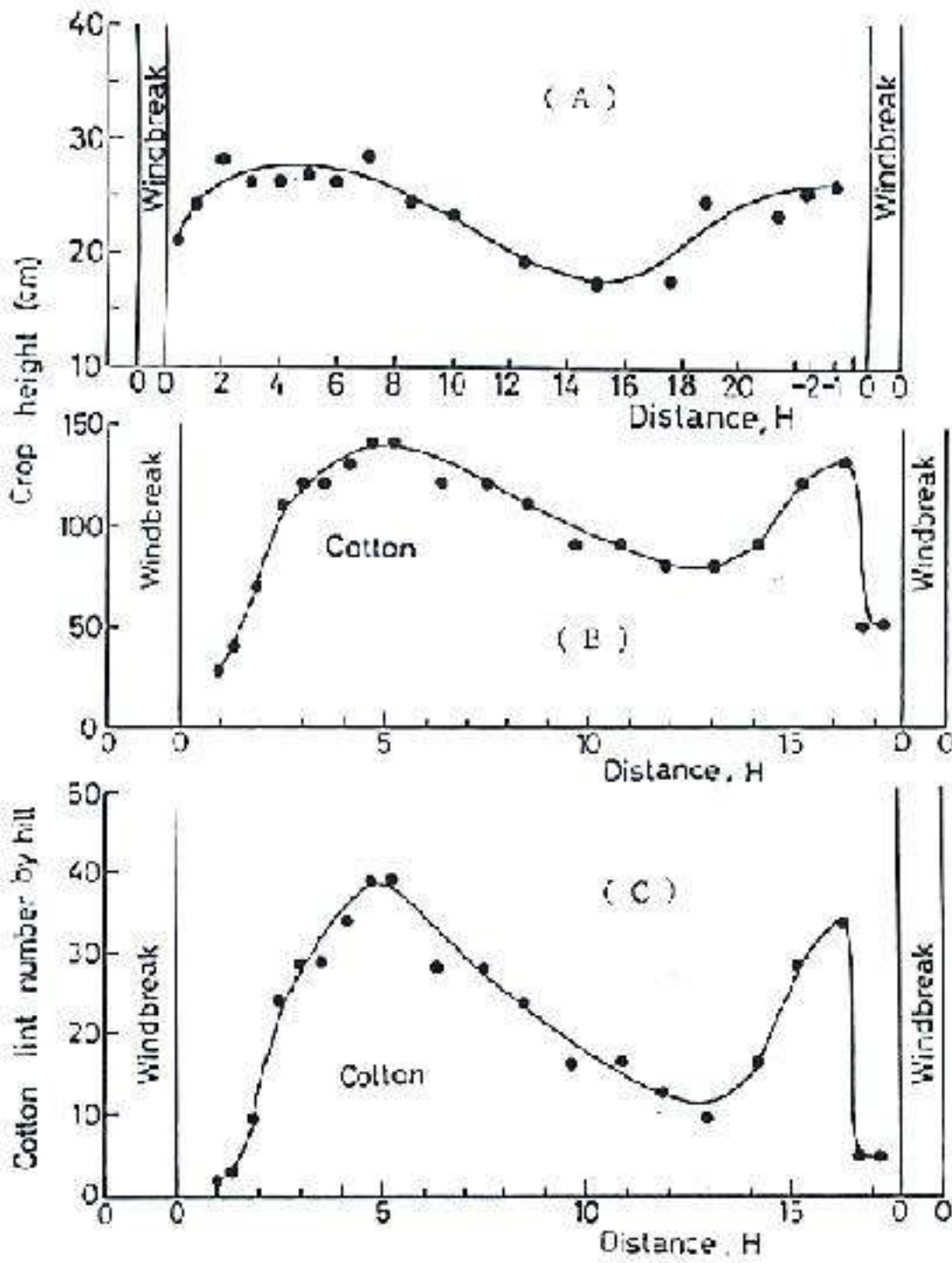
•@It is important to improve the micro-climate in marginal areas of arid lands where desertification is expanding. It was shown that the micro-climatic conditions improved or could be alleviated by the construction of multiple rows of windbreaks made of a combination of various tree species in an agricultural field, and that crop growth and development were promoted and the yield increased under high temperature conditions of dry and strong wind at Turpan, China. The height of the windbreaks made of *Ulmus pumila* L., *Elaeagnus angustifolia* L. and *Populus euphratica* Oliv. was 8.0 m and the tree density was 70%.

•@The wind speed decreased by 40% on the windward side of the first windbreak, then it increased by 80% gradually near the windward side of the second windbreak. However, the wind speed decreased with the increase of the number of windbreak rows. The negative effect of the decrease of the wind speed on the increase of the air-soil temperatures was considerable during the day. However the humidity which is important in arid lands increased and its effect became more pronounced with the increase of the number of windbreak rows.

•@The decreasing pattern of the wind speed during the night was similar to that during the day. The air and soil temperatures increased near the windbreaks, but decreased by radiation cooling between the 1st and 2nd windbreaks. The effect of humidity during the night was more pronounced than that during the day in particular when the number of windbreak rows increased.

The height of cotton plants at the early stage of growth and development was large from 1 to 10 H (distance from the windbreak expressed as multiples of windbreak height, H) for the 1st windbreak and for the 2nd windbreak from 5 H on the windward side. At the maturation stage, crop height was large from 3 to 8 H on the leeward side from the 1st windbreak and at around 2 H on the windward side for the 2nd windbreak. The effect of the windbreak on cotton yield was more pronounced than that on crop height.

[Fig.1.Variation of crop height of cotton at\(A\)young stage and \(B\)mature stage, and \(C\)cotton lint number per hill at mature stage cased by the windbreaks made of a combination of tree species.](#)•@



JIRCAS RESEARCH HIGHLIGHT

Development of water balance model for Tank Cascade Irrigation Systems in Sri Lanka

Jun Itakura

- @In the dry zone of Sri Lanka, the construction of inter-connected tank (reservoir) irrigation systems used to be a traditional method of irrigation to alleviate water shortage. A series of tanks had been linked in a small watershed to facilitate the re-use of return flow. Such irrigation systems referred to as •g Tank Cascade Irrigation Systems (TCIS) •h enabled farmers to use small watersheds and were extensively developed in ancient times.
- @However, the use of TCIS declined during the colonial period. The over-exploitation of tanks and poor management had disturbed the water use within watersheds. At present, the rehabilitation of TCIS is one of the major agricultural policies in Sri Lanka. To achieve this objective, JIRCAS and IIMI initiated a joint research project in 1991, to develop a water balance model of TCIS in order to rehabilitate the TCIS.
- @One typical TCIS was selected as a study site. Based on a two-year analysis of the water balance seepage & percolation loss rate of the system was estimated at 4.7 mm/day. It was found that wasteful consumption of water (including seepage & percolation loss, evaporation loss) accounted for over 50% of the total water consumption in the watershed. These figures underline the ineffective aspect of TCIS.
- @Water balance analyses indicated that the return-flow (inflow from the upstream tank to the last downstream tank) ratio accounted for 20 - 40% of the total outflow consisting of seepage & percolation loss and water discharge from the upstream tank. These findings confirm that the re-use of return-flow is a very important factor for water use in TCIS.
- @In the basic design of the water balance model, three coefficients (runoff percentage, seepage & percolation loss rate, return flow ratio) essential for the construction of a water balance model were determined. To incorporate these coefficients into the model, fluctuations of tank water storage volume were simulated and compared with actual fluctuations. Although this model was very simple, the similarity of the two fluctuation curves was very close and it was considered that the model may enable to develop techniques for improving long-term water management and rehabilitation of TCIS.

Due to the deleterious effect of overcrowding of tanks such as increase of water use and water pollution, the possibility of streamlining tanks in TCIS was studied with the model. It was considered that the tank in the most upper-stream position could be eliminated and combined with the second upper-stream tank at the expense of water use. For the management of TCIS in future, streamlining of tanks should be examined.

•@

[Photo : Tank Cascade Irrigation Systems in Sri Lanka](#)

•@



JIRCAS RESEARCH HIGHLIGHT

Procedure for simultaneous analysis of productivity and adaptation traits in indigenous cattle in Africa

•@Kenji Togashi

•@Indigenous cattle in Africa, through natural selection, have developed characteristics which make them well-adapted to adverse environmental conditions such as diseases, parasite infestations, climatic and nutritional stress. Thus, indigenous breeds are valuable genetic resources which need to be maintained and improved to implement livestock breeding programs. There is a great potential for improving livestock productivity by utilizing genetic adaptation of African indigenous livestock. However, unless the structure of genetic variation in a livestock population in Africa is analyzed, future livestock development may be difficult due to the loss of the genetic diversity which evolved over millennia. In low input and highly variable environments such as those prevailing in the tropics, especially in smallholder systems, selection pressure on females for production traits such as milk yield is nearly zero. Thus, how long a cow remains in a herd is closely linked to her overall adaptation. Under such circumstances herd-life can be considered to be a measure of adaptation. At any point in time, the period during which a particular animal remained in the herd can be considered to correspond to herd-life. However, such animals still may stay in the herd beyond the period of measurement. Thus, herd -life is right-censored. If censoring is ignored in the analyses, information may be lost and bias may be introduced. Several methods have been developed for analysing survival data in cattle. However, none of these took into account censoring. A procedure for simultaneous analysis of productivity traits for example (milk yield) and adaptation traits (herd-life) was developed in which location parameters (sire or animal breeding value) for herd-life (right-censored) and milk yield (uncensored) were estimated. A subset of the data on Kenyan Friesian was used to illustrate this procedure. The estimates for heritability for milk yield, heritability for herd-life, genetic correlation and residual correlation were 0.172, 0.424, -0.452 and 0.210, respectively. Particularly genetic correlation was negative, suggesting that selection for the increase of milk yield may adversely affect adaptation. That is, we may lose the genetic adaptation which evolved over millennia in indigenous cattle in Africa if we keep selecting only for productivity trait, for example the increase in milk yield. The productivity of indigenous cattle in Africa could be improved without a concomitant loss of adaptability by using the simultaneous procedure developed in the cooperative studies between ILRI (International Livestock Research Institute) and JIRCAS.

•@[*Photo: Cattle market in Addis Ababa*](#)



Letters to the Editor from JIRCAS Visiting Scientists



JIRCAS visiting in 1994, From left to right, Mohamad Hassan Rashad, Tie Gang Lu, Ancha Srinirasan Bayani Espiritu, L.Gunarto, Nampiah Sukarno, Abdul Baset, Xu Ningsheng, Nguyen Tien Thinh and Mbangu Musoko

***In vitro* selection and introduction of salt tolerance into cultivated rice varieties from their wild relatives.**

•@Salinity affects about 400 million hectares of land in the world. In Bangladesh approximately 1 million hectares of land are affected by salinity problems in the coastal regions, and not suitable for rice cultivation. This saline area is increasing day by day along with the expansion of shrimp culture. Over the past 25 years, with the active cooperation and financial support of the International Rice Research Institute (IRRI), the Bangladesh Rice Research Institute (BRRI) has so far developed more than 20 high-yielding rice varieties adapted to different agro-ecological regions of the country. However, none of the modern varieties developed by BRRI are salt -tolerant. Actually in the past, BRRI had attempted to develop or improve high-yielding rice varieties suitable for favourable environments only. Since the population of the country is increasing rapidly, the demand for an increase in rice production is also growing. It is therefore, essential to develop modern rice varieties adapted to stress environments along with favourable environments. Recently BRRI has undertaken research projects to develop modern rice varieties adapted to stress environments. Salinity is one of the problem areas that is targeted.

•@As a recipient of the JIRCAS-Visiting Research Fellowship Program 1994, I am carrying out some studies on *in vitro* selection of proline & hydroxyproline-resistant varieties of cultivated rice that could be utilized in the salt-tolerant rice variety development program. I am also trying to incorporate salinity tolerance gene(s) into cultivated rice varieties from their wild relatives using appropriate biotechnological procedures. I hope that the research experience and knowledge that I am acquiring through this fellowship will be useful for the development of salt-tolerant rice varieties in Bangladesh in future.

•@

Dr. Abdul Baset

Senior Scientific Officer

Bangladesh Rice Research Institute

Gazipur-1701, BANGLADESH

•@

Crop Production in Hot and Dry Environments -

A Growing Challenge to Agricultural Sustainability

•@Hot weather and moisture deficits cause substantial reductions in crop productivity. Breeding of stress-tolerant crops is of considerable significance for two reasons. First, there is a growing need to use more marginal land for food production due to increasing pressures of rising human population and degradation of favorable land and natural resources. Secondly, the predictions on climate change indicate that in future carbon dioxide concentrations will increase, periods of hot weather may be more frequent and extreme, and that water limitation may be more severe than now. Progress in breeding cultivars adapted to these climates is, however, slow due to the limited knowledge on genetic diversity for tolerance, and the lack of simple and reliable screening techniques.

•@Legumes are important sources of protein and fat in many developing countries but their cultivation is being increasingly relegated to marginal lands. Improvement of stress tolerance in legumes can ensure sustainability. I have been carrying out studies on heat tolerance of legumes since October 1993. The results suggest that groundnut and soybean are more tolerant than pigeonpea and chickpea, and that each legume shows a wide genetic diversity. Refinement of screening methods, and analysis of the mechanisms of tolerance during pod set are in progress.

•@

Ancha Srinivasan

JIRCAS Visiting Research Fellow (1993-1995)

Andhra Pradesh, INDIA

•@

•@

Knowing More About Bacteria Which

Filter out Methane in Rice Paddies

•@Methane is an important greenhouse gas that significantly contributes to global warming. It has been associated with past climatic changes in the world. Today, the concentration of methane in the atmosphere increases by about 1% every year. A significant proportion of methane global emissions is derived from rice paddies through the methane producing microorganisms. Much is known already about methane production but less on its regulation.

•@While there are bacteria which produce methane, there is another group that eats up methane. These are the methane-oxidizing bacteria (MOB) and they are considered to play a major role in regulating the fluxes of methane from important methane sources such as wetlands and rice paddies. The MOB are obligately aerobic bacteria that can utilize methane as the sole source of carbon and energy for growth. They are important biological regulators of methane in nature.

•@Very limited information is presently available on the levels of populations of MOB and their activities in different environments such as rice paddies. We are now conducting experiments on these aspects which may enable to improve management practices or to identify inputs to control methane emissions.

•@For this reason, I feel that we are really doing some pioneering studies here at JIRCAS. I am working on MOB with a Japanese co-researcher, Dr. K. Adachi, under the guidance of Dr. T. Senboku, our section head.

•@

Bayani M. Espiritu, Ph.D.

Researcher and Project Leader

BIOTECH, U.P. Los Banos

College, Laguna, PHILIPPINES

•@

***Azospirillum* Inoculation to Lowland Rice:**

Enhancement of Plant Growth and Increase of Nitrogen Fertilization Efficiency

•@

•@Fertilizers are considered to be very important inputs leading to increased yields : they were responsible for approximately 55% of the increase in yields in developing countries. The expansion of fertilizer use is expected to be rapid during the next two decades, averaging 8.5% a year. Since the foreign exchange cost of fertilizer to importing countries is high, accounting for more than half of the total cost, and as its cost to the producer in relation to total monetized inputs is also high, priority should be given to research aimed at increasing the efficiency with which inputs are used.

•@Nitrogen is the most common nutrient whose deficiency affects the production of crops. Studies on the increase of N fertilization efficiency have been carried out mostly through the manipulation of the form and application of N fertilizer. The inoculation of *Azospirillum* to lowland rice may enable to increase the efficiency of N fertilization at a lower cost and in turn increase the benefit of the farmers. *Azospirillum* which are associative N₂-fixer bacteria are able to produce a growth hormone leading to the improvement of the growth of plant roots and to the enhancement of the ability of the plants to absorb nutrients.

•@Presently, I am trying to isolate endogenous *Azospirillum* from Ishigaki island, Japan and screen them to select a promising isolate that may enable to promote the growth of lowland rice. I am also trying to determine to what extent *Azospirillum* can minimize the rate of N fertilizer applied to lowland rice. These studies may contribute to a better understanding of the means to improve the technology for increasing N fertilization efficiency compatible with the preservation of the environment .

•@

L. Gunarto

Soil Microbiology Laboratory

Central Research Institute for Food Crops (CRIFC)

Jl. Tentara Pelajar No. 3A, Bogor 16114, INDONESIA

•@

•@

Mycorrhizas: Colonists of Plants and Soil and Their Role in Sustainable Agriculture

•@World agriculture faces an unprecedented problem: that of achieving long term sustainability in the supply of food for domestic and international consumption. Sustainability of crop production depends on many factors including the maintenance of optimum soil physical structure and chemical and biological balances in the soils. Conventional agriculture has highlighted the problems of soil degradation arising from the excessive use of pesticides and chemical fertilizers, the removal of organic matter from the topsoil, erosion and compaction. This has led to a call for change from production-oriented agriculture to production and protection-oriented one. Such a call is very appropriate for many African countries where the cost of chemical fertilizers is prohibitive to a large number of small scale farmers, and where population pressure has led to markedly reduced fallow periods to enable adequate soil fertility recovery. There is increasing evidence showing that the integrity and resilience of the soil-plant system in the face of natural and cultural stresses depend on a myriad of microorganisms such as mycorrhizas.

•@Mycorrhizal fungi penetrate living cells of plant roots without harming them and their hyphae utilize bulk soils, thereby linking plants and soils and act as mineral transport agents. The potential of the vesicular-arbuscular type of mycorrhizas to increase plant productivity is well recognized though insufficiently exploited. My studies in Ishigaki are aimed at selecting efficient indigenous strains of mycorrhizal fungi, establishing a germplasm bank and selecting optimum fungi/host plant combinations to enhance crop production.

•@

Dr. Mbangu Musoko

International Institute of Tropical Agriculture

Ibadan, NIGERIA

•@

•@

Physiological Studies on the Mechanism of Heat Tolerance in Cabbage Varieties

•@

•@Cabbage is considered to be one of the most popular vegetables for human beings. Increase of productivity is essential to meet the demand of the population. In Egypt, cabbage plants are always grown in the winter season.

•@Investigations on the metabolic responses to temperature of different cabbage varieties have been carried out at different potassium and nitrogen levels, as well as plant hormonal concentrations (GA₃, IAA).

•@The process of acclimatization to high temperature involves the acceleration of the photosynthetic activity, sugar accumulation, increase in growth and cuticle layer accumulation rates and decrease in transpiration and evaporation rates.

•@I am thus analysing various physiological characteristics of cabbage varieties under high temperature conditions compared with the control temperature to develop positive correlations between heat stress, nutrient levels and plant hormonal concentrations to increase vegetable production.

•@

Mohamed Hassan Rashad

Lecturer of Plant Physiology

Faculty of Agriculture

Cairo University, EGYPT

•@

•@

Use of Vesicular-Arbuscular Mycorrhizas as Biofertilizer to Improve Crop Production

•@

•@ Vesicular-arbuscular mycorrhizas (VAM) induce mutualistic symbiosis between plant and fungus. This symbiosis is found in most (over 90%) of the major plant families including agriculturally important plants such as maize, soybean, onion, upland rice, citrus and cacao. Numerous experiments have shown that a wide range of plant species benefit from infection with VAM fungi, primarily through enhanced phosphorus (P) uptake, especially in P-deficient soils. The fungus benefits from this association by obtaining its carbohydrate requirements.

•@ P deficiency is one of the common nutrient problems which limit plant growth particularly in acidic soils. The role of VA mycorrhizal fungi is important under such conditions because external hyphae in the soil can compensate for poor root growth by taking up nutrients particularly P, after which the fungi in the roots transfer the nutrient to the plant, which in turn enhances plant growth.

•@ The aim of the project is to isolate and evaluate VAM fungi which are efficient in taking up P from the soil and subsequently promoting the growth of the plant primarily in acidic soils on Ishigaki island. The project may contribute to the isolation and screening of acid-tolerant fungi which are efficient for enhancing plant growth, able to function with low inputs of P fertilizer and responsive to a wide range of crops.

•@ The results from the research outlined above will be further applied at Bogor Agricultural University (IPB), Bogor, Indonesia after the completion of the fellowship, to promote basic research on the mechanism of acid tolerance of VA mycorrhizal fungi and utilization of VA mycorrhizal fungi particularly in acidic tropical soils to enhance crop production in the field. The studies may contribute to the development of sustainable agriculture compatible with the preservation of the environment on a global scale.

•@

Nampiah Sukarno

Laboratory of Mycology, Department of Biology, Faculty of Mathematics and Natural •@

•@•@•@•@•@•@ Sciences

Bogor Agricultural University, Bogor, INDONESIA

•@

•@

Preservation of Plant Genetic Resources in VIETNAM

•@

•@ Although VietNam is a small country in South East Asia, the specific geographical and climatic conditions make it rich in plant genetic resources. This natural receptacle for a long time, however, has been subjected to various types of erosion, of which the VietNam War and the post-war poverty could be the two major factors. As a result, some valuable species have already become extinct and many others are disappearing. Recently, international programs of assistance in the collection and preservation of plant germplasm have been implemented in VietNam.

•@ Along these lines, I am fortunate to have the opportunity to carry out studies on the cryopreservation of plant genetic resources of one of the important tuber crop plants in VietNam -Taro (*Colocasia esculenta* Schott.) under the JIRCAS Fellowship Program.

•@ Such studies which are among the first in this field in VietNam should contribute to the development of a firm base for further undertakings in the preservation of natureal resources through biotechnology.

•@

Nguyen Tien Thinh

Appllied Radiobiology Division

Nuclear Research Institute

Dalat, VIETNAM

•@

Collection, Evaluation and Conservation of Genetic Resources of

Vegetatively Propagated Crops

•@

•@Because of the large size and geological and climatic complexities, China is rich in plant genetic resources. A large number of germplasm accessions have not been collected, evaluated, conserved and used up to now. With the increase in the developmental activities of mankind, plant genetic resources especially those of vegetatively propagated crops, are being rapidly lost because they are mainly conserved in the field and are easily destroyed by human intervention and natural disasters.

•@Biodiversity has become one of the most important research topics in China since the signature of the World Treaty on Biodiversity in 1992. At the Institute of Botany, Academia Sinica in Beijing, more than 100 researchers are engaged in research on these subjects. Collection, evaluation and conservation of genetic resources are the main aspects of such research. I feel that the protection of plant genetic resources is essential for the survival of mankind.

•@At the JIRCAS Okinawa Subtropical Station, I am studying various aspects related to the conservation and evaluation of yam germplasm. I hope that I shall be able to apply the various new techniques learned in this program in my future studies on vegetatively propagated plants such as medicinal plants and fruit trees, which play an important role in China's agriculture, medicine and economy.

•@

Dr. Tie Gang LU

Assoc. Prof., Institute of Botany, Academia Sinica

Beijing 100044, CHINA

•@

•@

Evaluation of Rice Germplasm for Salinity Tolerance

•@

•@Salinity limits rice yields or prevents rice planting over large land areas around the world. Population pressure and loss of favorable land require research to develop varieties that can more effectively tolerate salinity. To achieve this objective, the evaluation and utilization of rice germplasm accessions are essential.

•@There are abundant rice germplasm resources in Yunnan province, China, which is considered to be one of the resources center of diversity of cultivated rice. Since 1982, Yunnan Academy of Agricultural Sciences has cooperated with TARC (Tropical Agricultural Research Center) and subsequently with JIRCAS, (Japan International Research Center for Agricultural Sciences) to evaluate and utilize rice germplasm and significant progress has been made.

•@As a researcher from the Yunnan Academy of Agricultural Sciences, I am evaluating the salt-tolerance of rice germplasm from Yunnan province. I have studied about 200 Yunnan varieties from the Gene Bank in Japan. I have detected salt-tolerant varieties, among which upland rice varieties. I plan to investigate various physiological characteristics. This information, I believe may enable us to analyse tolerance mechanisms that could contribute to the development of salt-tolerant varieties.

•@

Xu Ningsheng

Yunnan Academy of Agricultural Sciences

Kunming City, Yunnan Province, P. R. CHINA

[Photo : Screening of rice genotypes from Yunnan Province ,China for salt tolerance at seedling stage](#)

•@



Tsukuba seminar on the occasion of Japan-IRRI day

Shoji Miyazaki

•@The seminar entitled •gRecent progress in Rice Research and Challenges toward the 21st Century•h, sponsored by the Japan International Research Center for Agricultural Sciences (JIRCAS) was held in cooperation with the International Rice Research Institute (IRRI) in the auditorium of the Tsukuba Office of the Secretariat of the Agriculture, Forestry and Fisheries Research Council, Tsukuba City, on November 24, 1994.

•@The Tsukuba seminar, one of the two important meetings organized on the occasion of Japan-IRRI day, focused on scientific aspects and was followed by the Tokyo meeting for public awareness which was held on the next day in Tokyo. Approximately 400 participants including ten scientists from IRRI were gathered together to review recent progress in rice research and also discuss future prospects at the seminar.

•@•gMore than one thousand children die every hour because of hunger and hunger-related diseases•h said Dr. Klaus Lampe, Director General of IRRI in his keynote address. •gFrom soil preparation to harvesting, what have been the standard practices over thousand of years will in all likelihood change drastically before the middle of the next century. Our ultimate goal is harmony between the need for doubling food production and our obligation to protect the resources on which this production is based.•h

•@After another keynote address entitled •gGenetic Restructuring of Rice Plants•h presented by Dr. Hiroshi Fujimaki, Director General of the National Institute of Agrobiological Resources, seven papers were presented by rice researchers as follows : G.S. Khush, Challenges in Rice Breeding and Biotechnology; M. Yano, Genome Research and Breeding Strategies in Rice Plants; M. Yamauchi, Direct Seeding Technology; R. Ikeda, Rice Breeding in Japan; P.S. Teng, Sustainability in Rice Growing; K. Ohtsubo, Grain Quality and Utilization in Rice; T.W. Mew, IRRI-Japan Shuttle Program Strengthens Rice Research.

•@During the seminar, the auditorium was full of participants including numerous young scientists as well as students who are involved in rice research. We hope that many of these young people will join our effort to fill up billions of empty rice bowls with rice, with emphasis placed on the sustainability•@of agricultural production.

•@[Photo : Japan-IRRI Day in Tsukuba](#)

•@



•áNew Research Area•â

Research Collaboration with Mongolia

NAKANO H. and T. MIYASHIGE

•@Mongolia is a country of highlands surrounded by Russia and China. Although the land area of Mongolia is four times larger than that of Japan, its population is only about two millions which is equivalent to one fiftieth of Japan population. Recently Japanese mass media have given a wide coverage of the nature, people, culture and society of Mongolia after the opening of Mongolia to foreign countries. These programs reflect the deep interest of the Japanese people in Mongolia. Collaboration with the Japanese Government has also been initiated in many fields. However, it was the first mission of JIRCAS to determine whether a form of collaboration in the field of agriculture could be initiated with Mongolian organizations.

Country of grasslands

•@Mongolia is a country of grasslands and nomads. A Mongolian proverb says •gMongolians are born on the back of a horse and grown there•h. Sheep, goats, cattle and yaks, camels in addition to horses are also very important animals for nomadic people who account for about half of the population. Grasslands cover 80% of the land area. From on airplane, in summer Mongolia appears as a vast green grassland where many wheel tracks connect towns and camping sites of nomads. Ulan Bator was hidden in the grassland. In Mongolia, we were surprised to observe such a variety of traditional foods made of livestock products. Most of the nomads have lived only with these foods without consuming any cereals and vegetables.

•@After World War ‡U, mechanized farming for upland crops and large-scale livestock production were introduced in the country in order to increase the agricultural productivity and meet the demand of the consumers in newly built cities. Thereafter the production of cereals and vegetables was promoted. Currently people living in the cities consume a large amount of foods of plant origin as well as livestock products. However, along with the introduction of a market economy after the collapse of the socialist system, the productivity of modern agriculture in this country has experienced a decrease. The supply of agricultural chemicals such as fertilizers was discontinued and agricultural machines, irrigation facilities and plant equipment for food processing factories became obsolete.



nomad Family

Mongolian boy on a horse



Mongorian

•@

For future development in agriculture

•@Climatic conditions are very harsh in Mongolia. Since from October to April there is a long winter, the nomads must protect their animals from the intense cold. Heavy snow makes it difficult for the animals to graze on withered grass. In the cropping season from May to September, the productivity of cereals such as wheat and barley is low and very unstable due to cold stress and drought stress. Strong wind in spring and fall causes severe soil erosion of the cultivated fields. The soil fertility is gradually declining due to soil erosion and the insufficient application of organic materials. Scarce rainfall contributes to salt accumulation in soil, too.

•@Moreover, the changes in the eating habits of the Mongolian people mainly in cities are associated with an ever-increasing demand for vegetables, rice, sugar and vegetable oil as well as livestock products. The development of agricultural technology for producing the foods must be promoted to achieve self-sufficiency. In future, preservation of native grasslands will be an important subject for increasing livestock production. Mongolian researchers discussed prospects for the future and emphasized the role of agriculture in the economy of the new country. They hope that research collaboration with JIRCAS will be initiated to address these problems. •@Farewell and Meeting again

•@We remember with great pleasure a party held in the camp of nomadic families who invited us. We were served sheep meat cooked in the Mongolian style and kumiss, an alcoholic beverage made of mare's milk. After the party, we were taken to a small hill and drank together again. It is a ceremony whereby Mongolian nomads bid farewell, hoping to see their guests again.

•@The people in Mongolia, who lead a secluded life in vast grasslands, obviously enjoy meeting their friends. We do hope that it will be possible to initiate a form of collaboration between Mongolian and Japanese scientists .

•@

•áResearch Collaboration•â

Collaborative Research Project with CIMMYT on Wheat•~Maize Crosses

Masanori Inagaki

Biological Resources Division

•@The International Maize and Wheat Improvement Center (CIMMYT) was established in 1966 in Mexico, following the implementation of a special research program sponsored by the Mexican Government and the Rockefeller Foundation. CIMMYT, with headquarters at E1 Batan, 45 km northeast of Mexico City, and with 15 regional offices in the developing countries, implements research and training programs related to the production of maize and wheat. Major activities include the development and worldwide distribution of improved varieties, the conservation of genetic resources, and the production of documentation related to new knowledge about these crops.

•@New wheat varieties developed by CIMMYT in the 1960s are characterized by a stable stem rust resistance, photoperiod insensitivity and semi-dwarfness. These characters allow adaptation of the wheat varieties far beyond Mexico to other developing countries. The resulting rapid growth in wheat production led to the term of •gGreen Revolution•h. In the Post-Green Revolution phase, various agroecological regions or mega-environments of the developing countries have been defined in order to develop effective breeding strategies. The methodology for wide adaptation and high yielding potential involves shuttle of breeding materials between alternate sites in Mexico. Rapid development of the varieties is another aspect to meet the demand for increasing production.

•@Use of haploids is of great interest to wheat breeders, since the production of haploid plants followed by chromosome doubling enables to obtain genetically homozygous lines. The successful production of doubled haploids provides the most rapid method for developing homozygous breeding lines with favorable uniformity in selection procedures, and complements conventional breeding programs. The Japan International Research Center for Agricultural Sciences (JIRCAS, formerly Tropical Agriculture Research Center) has been promoting technical development of wheat haploid production through wide crosses in collaboration with the International Center for Agricultural Research in the Dry Areas (ICARDA). It is possible to obtain wheat haploids from wide crosses using wheat as female parent and a perennial species, *Hordeum bulbosum* L. as pollen parent. After fertilization, the chromosomes of the pollen parent are eliminated from the hybrid zygote resulting in the production of wheat haploids. This method is limited since the success of haploid production strongly depends on the wheat genotypes used for crosses.

•@Recent reports have indicated that crosses of wheat with maize pollen resulted in the production of wheat haploids across diverse wheat genotypes. In addition to maize, selected species from the Panicoides subfamily, such as pearl millet and sorghum, also provide an alternative pollen source for wheat haploid production. A collaborative research project between CIMMYT and JIRCAS has been carried out since 1993 and has focused on the development of wheat •~ maize crosses for producing and utilizing wheat haploids for breeding purposes and genetical analyses. The current cooperative studies

related to wheat haploids include the development of method for long-term storage of maize pollen, genetic analysis of drought tolerance, and evaluation of various breeding schemes. Technical development for efficient production of wheat haploids should contribute to the promotion of basic research projects as well as conventional breeding programs.

•@

[Photo 1. CIMMYT Headquarters at El Batan, with maize and wheat fields.](#)

[Photo 2. Embryos of wheat seed](#)

•@

•@





JIRCAS Newsletter 1995 (Vol.3 No.2)



Contents of No.2

- [Research Activities on Biological Resources](#)
- [Changes in Earth Environment and Agriculture](#)
- [JIRCAS Research Highlights](#) [Anaerobic Direct Seeding of Wetland Rice in the Tropics](#)
- [JIRCAS Research Highlights](#) [Survey on Characteristics of Agriculture in Central Asia and Priorities for Research Collaboration](#)
- [JIRCAS Research Highlights](#) [A New Variety of Heart-Tolerant Snap Bean](#)
- [JIRCAS Research Highlights](#) [Ecology and Control of the Albizzia Borer, Xystrocera festiva](#)
- [JIRCAS Research Highlights](#) [Nitrogen Management for Pigeonpea-Based Intercropping in the Semi-Arid Tropics](#)
- [Collapsible Soils](#)
- [Land Use Right in Vietnam](#)
- [The 2nd JIRCAS International Symposium on Weed Management](#)
- [Utilization of Freshwater Fishes in China](#)
- [Collaborative Study with World Bank](#)
- [Eastern European Countries](#)

- [Collaborative Project with CIAT](#)
-

www@jircas.affrc.go.jp



Updated
23/AUG/2002

[Vol.36 No.3](#)
July 2002

[Vol.36 No.2](#)
April 2002

[Vol.36 No.1](#)
January 2002

[Vol.35 No.4](#)
October 2001

[Vol.35 No.3](#)
July 2001

[Vol.35 No.2](#)
April 2001

[Vol.35 No.1](#)
January 2001

[Vol.34 No.4](#)
October 2000

[Vol.34 No.3](#)
July 2000

[Vol.34 No.2](#)
April 2000

[Vol.34 No.1](#)
January 2000

[Vol.33 No.4](#)

JARQ

---- Japan Agricultural Research Quarterly ----

Purpose: Dissemination to overseas countries of up-to-date information on achievements and trends of research activities pertaining to agriculture, forestry and fisheries that are carried out in Japan but would also be relevant to the needs of the respective countries, particularly in the developing regions.

History: *Japan Agricultural Research Quarterly (JARQ)* was established in 1966 by the Agriculture, Forestry and Fisheries Research Council, the Ministry of Agricultural and Forestry. Through the editorial services of the Tropical Agricultural Research Office also established in 1966, such a publication which aimed at introducing the achievement and trends of agricultural research activities in Japan to overseas readers was expected to contribute to the development of agriculture in the countries of the tropical and subtropical regions. In June 1970, the Tropical Agriculture, Forestry and Fisheries Research Council. The publication of *JARQ* was thereafter undertaken by TARC. In October 1993, TRAC was reorganized into the Japan International Research Center for Agricultural Sciences (JIRCAS) with the creation of the Fisheries Division. As a result, *JARQ* also covers the field of fisheries research.

Publication Information: *Japan Agricultural Research Quarterly (JARQ)* is published four times a year, by the Japan International Research Center for Agricultural Sciences, Ministry of Agriculture, Forestry and Fisheries, Tsukuba, Ibaraki, 305-8686 Japan. The present circulation of each issue numbers 2,100, of which nearly two thirds are sent to more than 90 countries mostly in developing regions. Subscription is limited to institutions only, free of charge, and subscription inquiry should be directed to the Editorial Secretary of *JARQ*.

Editorial Policy: The Editorial Board serves as a screening committee. The Board members nominate candidates for the submission of papers for the forthcoming issues, and the decision is finalized during the Board meeting. Contributed papers are divided into two categories: **research articles** which summarize the findings of recent research activities of the author which may have been published elsewhere (but include also original contributions), and **research reviews** which review the objectives, procedures, and achievements of research activities by Japanese researchers on a specified research topic.

Editorial Inquiries: Send questions on editorial policy and procedure to the Editorial Secretary. Advice and comments are also welcome.

October 1999

● [Vol. 33 No.3](#)
July 1999

● [Vol. 33 No.2](#)
April 1999

● [Vol. 33 No.1](#)
January 1999

● [Vol. 32 No.4](#)
October 1998

● [Vol. 32 No.3](#)
July 1998

Copyright: Copyright to all manuscripts published in *JARQ* belongs to the Japan International Research Center for Agricultural Sciences. An individual may make an single copy of an article for personal use. Multiple copying is authorized only with permission in writing from the publisher.



[JIRCAS Home Page](#)

*Published by :Japan International Research Center for Agricultural Sciences Ministry of Agriculture, Forestry and Fisheries Tsukuba, Ibaraki, 305-8686 Japan
www@jircas.affrc.go.jp*

ARTICLES

Biotechnology & Plant breeding

- 119 *Agrobacterium*-Mediated Transformation in Liliaceous Ornamental Plants Sakae SUZUKI & Masaru NAKANO

- 129 Preparation of Microprotoplasts for Partial Genome Transfer via Microprotoplast Fusion in Liliaceous Ornamental Plants Hiroyuki SAITO & Masaru NAKANO

□

Plant breeding & Grassland

- 137 Treading Resistance and Breeding of Guineagrass Suitable for Rollbale Hidemichi MATSUOKA, Yasuharu SANADA, Hiroyasu SATO & Ken KOBASHI

Plant breeding & Tea industry

- 143 Genetic Analysis of Tea Gray Blight Resistance in Tea Plants Yoshiyuki TAKEDA

Agricultural engineering

- 151 Water Pollution of Irrigation Ponds in Kagawa Prefecture and Possible Alleviation by Increasing the Amount of Water Haruo UCHIDA, Hisayoshi INOUE & Masatoshi HOSOKAWA

- 157 Soil Loss Estimation on a Local Scale for Soil Conservation Planning Takahiro SHIONO, Ken-ichiro KAMIMURA, Shuji OKUSHIMA & Masato FUKUMOTO

Agricultural machinery & Horticulture

- 163 Robotic Harvesting System for Eggplants Shigehiko HAYASHI, Katsunobu GANNO, Yukitsugu ISHII & Itsuo TANAKA

Food

- 169 Characterization of *Bacillus subtilis* Strains Isolated from Fermented Soybean Foods in Southeast Asia: Comparison with *B. subtilis* (*natto*) Starter Strains Yasuhiro INATSU, Keitarou KIMURA & Yoshifumi ITOH

Horticulture

- 177 New Method of Producing Diploid Seedless Watermelon Fruit Keita SUGIYAMA & Masami MORISHITA

Grassland

- 183 Effect of Tree Canopy on the Growth of *Zoysia japonica* Steud. under a Deciduous Forest with Different Tree Densities Ichirou OTANI, Naoyuki YAMAMOTO & Shigeki ENT^{late}SU



Contents

Volume 36 Number 2, 2002

□ **REVIEW****Animal Husbandry**59 Silage and Microbial Performance,
Old Story but New ProblemsSadahiro OHMOMO,
Osamu TANAKA,
Hiroko K. KITAMOTO &
Yimin CAI□ **ARTICLES**□ **Agricultural Environment**73 Comparison of the Three-Temperature Model
and Conventional Models for Estimating
T_r transpirationGuo Yu QIU,
Koichi MIYAMOTO,
Sadanori SASE,
Yong GAO,
Peijun SHI &
Tomohisa YANO83 Sequence Analysis and GTP-Binding Ability
of the Minor Core Protein P5 of
*Rice Gall Dwarf Virus*Kenzaburo ICHIMI,
Akira KIKUCHI,
Yusuke MORIYASU
Boxiong ZHONG,
Kyoji HAGIWARA
Hiroshi KAMIUNTEN &
Toshihiro OMURA89 Ecological Characteristics and Biological
Control of Mulberry AnthracnoseShigenobu YOSHIDA
Akira SHIRATA &
Syuntaro HIRADATE97 Specific Amplification of Microsporidian DNA
Fragments Using Multiprimer PCRYoshinori HATAKEYAMA &
Shoji HAYASAKA**Horticulture**103 Acoustic Emissions in Tomato Plants under
Water Stress ConditionsGuo Yu QIU,
Limi OKUSHIMA,
Sadanori SASE &
In-Bok LEE**Forestry**111 Plant Species Diversity in Tropical Planted
Forests and Implication for Restoration of
Forest Ecosystems in Sakaerat,
Northeastern ThailandKoichi KAMO,
Tosporn VACHARANGKURA,
Sirin TIYANON,
Chingchai VIRIYABUNCHA,
Suchat NIMPILA &
Bunnasart DOANGSRISEN

Contents

Animal Husbandry

- | | | |
|---|--|---|
| 1 | Improvement of Resistance to Sclerotinia Crown and Stem Rot of Alfalfa through Phenotypic Recurrent Selection | Michio KANBE,
Yuko MIZUKAMI and
Fumihiko FUJIMOTO |
| 7 | Fundamental Studies on Freezing Hardiness and Wet Tolerance in Italian Ryegrass (<i>Lolium multiflorum</i> Lam.) Breeding | Kazuhiro TASE |

Agricultural Environment

- | | | |
|----|--|--|
| 17 | Investigations on Some Meteorological Conditions and Evaluation of the Effects of Tree Windbreaks on the Improvement of Meteorological Conditions in Turpan Oasis, China | Yoshitaka KUROSE,
Lisong TANG,
Kazuhiko OHBA,
Atsushi MARUYAMA and
Taichi MAKI |
| 25 | Identification of Antifeedants in Bitter Gourd Leaves and their Effects on Feeding Behavior of Several Lepidopteran Species | Hiroe YASUI |

Agricultural Environment & Horticulture

- | | | |
|----|---|--|
| 31 | Potential of Predatory Natural Enemies for Biological Control of Sap-Sucking Insect Pests in Paraguay | Takashi NODA,
Yutaka KIMURA,
Maria B. R. de LÓPEZ,
Mirian T. de EVERT and
Carlos PALACIO |
|----|---|--|

Agricultural Engineering

- | | | |
|----|--|---|
| 37 | Effects of Hydrological Factors on the Estimation of Storm Runoff Loading in a Large River Watershed | Junji TAKAHASHI,
Ikuo YOSHINAGA,
Hitoshi HASEBE and
Eisaku SHIRATANI |
|----|--|---|

Food Technology

- | | | |
|----|--|--|
| 45 | Traditional Japanese Fermented Foods Free from Mycotoxin Contamination | Kenji TANAKA,
Tetsuhisa GOTO,
Masaru MANABE and
Shinji MATSUURA |
|----|--|--|

Fisheries

- | | | |
|----|--|--------------------|
| 51 | Method to Estimate the Population Density of the Snow Crab <i>Chionoecetes opilio</i> Using a Deep-Sea Video Monitoring System on a Towed Sledge | Toshihiro WATANABE |
|----|--|--------------------|

Contents

Biotechnology & Genetic Resources

- 217 Characterization of Duck Microsatellite Repeat Sequences Hideaki TAKAHASHI, Masahiro SATOH, Mitsuru MINEZAWA, Tresnawati PURWADARIA and Hardi PRASETYO

Agricultural Environment

- 221 *Claviceps sorghicola* and *C. africana*, the Ergot Pathogens of Sorghum, and their Cultural Control in Japan Takao TSUKIBOSHI, Tadayuki SHIMANUKI and Hironori KOGA
- 227 Eradication Programs of Two Sweetpotato Pests, *Cylas formicarius* and *Euscepes postfasciatus*, in Japan with Special Reference to their Dispersal Ability Seiichi MORIYA and Takahisa MIYATAKE

Agricultural Engineering

- 235 Development of a Current and Water Quality Observation System Using Drift Type DGPS Buoys Hideto FUJII, Hirohide KIRI and Tetsuo NAKAYA
- 245 Analysis of Soil Erosion and Sediment Transport along a Rill Channel using a Sediment Transport Model Azuma TAKAGI, Seiji NAKAO and Tatsumi TOMOSHO
- 255 Rotary Tilling and Ridge-Making Methods for Heavy Clay Soil Hisashi HOSOKAWA, Kazuhide ADACHI, Kouichi ITOH and Morio MATSUZAKI

Horticulture

- 263 Regulation of Flowering in Stock [*Matthiola incana* (L.) R. Br.] by Manipulation of Gibberellin Biosynthesis Tamotsu HISAMATSU and Masaji KOSHIOKA

Animal Husbandry

- 271 Concentrations and Crystallization of Phosphate, Ammonium and Minerals in the Effluents of Bio-Gas Digesters in the Mekong Delta, Vietnam Kazuyoshi SUZUKI, Takeshi WATANABE and Vo LAM

Forestry

- 277 Rehabilitating Eutrophic Lakes Using Tree Planting along the Shoreline Takashi YOSHITAKE, Kazunori SHIMADA and Michiaki OKANO

Fisheries

- 281 Production and Use of Marine Algae in Japan Masakazu MURATA and Jun-ichi NAKAZOE

- 291 Contents and Author Index for Vol. 35

Contents

Crop Science

- 149 Characteristics of HPLC Columns and Mass Spectra of LC-MS for Phytohormone Analysis Kiyohide KOJIMA

Agricultural Environment

- 155 Application of Parametrization Using the Richards Function to Nitrogen Release from Coated Urea and Growth of Rice Seeds Yoshitaka HARA
- 163 Relation between Resistance to Bacterial Wilt and Calcium Nutrition in Tomato Seedlings Hiromichi YAMAZAKI

Agricultural Engineering

- 171 Development of Hydrological Information System in the Chao Phraya River Basin Yoshio HAYASE, Kaichi KOSEKI, Kumjon LAPCHAROEN and Attaporn BUDDHAPALIT

Horticulture

- 177 Single-Truss Tomato System — A Labor-Saving Management System for Tomato Production Kunio OKANO, Yuka NAKANO and Shin-ichi WATANABE
- 185 Development of a Simple Preparation Method for Tea-Seed Saponins and Investigation on Their Antiyeast Activity Yuji YAMAUCHI, Keiko AZUMA, Minoru TOMITA, Hideki HORIE and Katsunori KOHATA

Animal Husbandry

- 189 Use of a Trial Probiotic Product in Calves Experimentally Infected with *Escherichia coli* O157 Tatsuo OHYA, Masato AKIBA and Hiroya ITO
- 195 Palatability, Digestibility and Voluntary Intake of Processed Oil Palm Fronds in Cattle Hidenori KAWAMOTO, Wan Zahari MOHAMED, Nor Ismail MOHD SHUKUR, Mohamed Sharudin MOHD ALI, Yunus ISMAIL and Shuichi OSHIO
- 201 Relationship between Voluntary Intake of Timothy Hay in Dairy Cattle and Chemical Composition, Retention Time in the Rumen, Digestibility and Digestion Rates Masahiro AMARI, Noboru MORI, Hiroyuki SHINGU, Shigehiko MASAKI and Akira ABE
- 209 Practical Study on Farming Development to Overcome Poverty in Livestock Farms in Keerqin Sand Land, Inner Mongolia, China Sukeo KAWANABE, Toshio OSHIDA, Yin hao NAN, Zenwu KOW, Deming JIANG and Naoko TAKADA-OIKAWA

Contents

Biotechnology & Genetic Resources

- 79 Polymorphism and Phylogeny of Soybean Based on Chloroplast and Mitochondrial DNA Analysis Yoshiya SHIMAMOTO

- 85 Nucleotide Sequence Variation and Use of Mitochondrial DNA for Phylogenetic Analyses in Anthocorid Bugs (Hemiptera: Anthocoridae) Masahiko MURAJI, Kenjiro KAWASAKI and Toru SHIMIZU

Agricultural Environment

- 91 Erosion Control in Pineapple Fields on the Island of Ishigaki Kazuo SUGAHARA, Yoshinari OHWAKI and Kenji BANZAI

- 97 Pathogenic Diversity of *Xanthomonas oryzae* pv. *oryzae* Strains from Yunnan Province, China Takahito NODA, Chengyun LI, Jiarui LI, Hirokazu OCHIAI, Kazuo ISE and Hisatoshi KAKU

Food Technology

- 105 Quality Preservation of Fruits and Vegetables by Simple Spotted Cooling System and/or by Packaging Using New Plastic Films Yoshihiko NAWA, Hiroshi HORITA, Kazunori SATO and Takasuke ISHITANI

Agricultural Economics

- 117 Forage Production and Feeding Management in Hungarian Large-Scale Dairy Farms Hiroki UKAWA

Horticulture

- 125 Non-Destructive Measurement of Watercore in Japanese Pear (*Pyrus pyrifolia* Nakai) 'Hosui' Yuji INOMATA and Kunihiko SUZUKI

Animal Husbandry

- 131 Development of Method for Early Diagnosis of Mastitis in Dairy Cows by Chemiluminescence Hideyuki TAKAHASHI, Masaharu ODAI, Kenji MITANI, Shozo ARAI, Nobuo KOIZUMI, Shigeki INUMARU and Yuichi YOKOMIZO

- 137 Effects of High Environmental Temperature and Exercise on Cardiorespiratory Function and Metabolic Responses in Steers Takashi UENO, Yuji TAKEMURA, Kichiro SHIJIMAYA, Fumihito OHTANI and Riohei FURUKAWA

Fisheries

- 145 Brief Assessment of Stock of Mud Crabs *Scylla* spp. in Matang Mangrove Forest, Malaysia and Proposal for Resources Management Takeharu KOSUGE

Contents

Biotechnology and Genetic Resources

- 1 Japanese Native *Vigna* Genetic Resources
Norihiko TOMOOKA, Duncan VAUGHAN, Ru-Qiang XU, Kouichi KASHIWABA and Akito KAGA

Agricultural Environment

- 11 Simultaneous Determination of Transformation Rates of Nitrate in Soil
Takashi NISHIO, Michio KOMADA, Tomohito ARAO and Tetsuo KANAMORI
- 19 Comparison of the Characteristics and Sex Pheromone of *Etiella behrii* (Zeller), a Newly Identified Pod Borer of Soybean in Indonesia, with *E. zinckenella* (Treit.)
Makoto HATTORI, Sadao WAKAMURA, Kazunori IGITA, Koji YASUDA and TRIDJAKA

Agricultural Engineering

- 25 Automated Rice Transplanting Operation Using GPS and FOG Sensors
Yoshisada NAGASAKA, Ken TANIWAKI, Ryuji OTANI and Kazuto SHIGETA

Food Technology

- 31 Dietary Fat-Dependent Changes of Gene Expression in Rat Adipose Tissue
Yoko TAKAHASHI and Takashi IDE

Horticulture

- 39 Methods of Control of Injury Associated with Continuous Vegetable Cropping in Japan — Crop Rotation and Several Cultural Practices —
Mitate YAMADA
- 47 Method of Forcing Carnations to Bloom to Meet Special Market Demand
Hitoshi IMAMURA and Kenichi SUTO
- 53 Effect of Salt and Water Stress on Fruit Quality, Physiological Responses, Macro- and Micro-Element Contents in Leaves of Satsuma Mandarin Trees under Greenhouse Conditions
Kunihisa MORINAGA and Steve R. SYKES
- 59 Screening of Mulberry Genotypes Suitable for Fruit Production and Development of High-Yielding Strains with Large Fruits
Akio KOYAMA, Hiroaki YAMANOUCHI and Hiroaki MACHII

Fisheries

- 67 Early Life Ecology of Skipjack Tuna, *Katsuwonus pelamis*, Based on Survey Cruises off Palau and Micronesia, 1992–1996
Toshiyuki TANABE, Miki OGURA and Mio TAKAHASHI

Contents

- [Rice Cell Culture](#)
- [Rice Varieties and Cropping Systems in Bangladesh Deepwater Areas](#)
- [Prospects and Strategies for Precision Farming in Japan](#)
- [Mechanized Production System for Orchards on Sloping Land](#)
- [Computer Simulation of Greenhouse Natural ventilation](#)
- [Freeze-Tolerant Baker's Yeast](#)
- [Effects of Light and Drought on Freezing Tolerance of Cabbage](#)
- [Genetic Relationships between CD-1 Stocks of Mice in Uruguay](#)
- [Measurement Apparatus for Eyelid and Eyeball Movements](#)
- [Physiology of Vitamin Kin Fish -Review-](#)

Taiichi OGAWA

Hong-Wei CAI & Hiroiko MORISHIMA

Akira SASATO & Sakae SHIBUSAWA

Masahiro MIYAZAKI

In-Bok LEE et al.

Jun SHIMA et al.

Hidekazu SASAKI et al

Tadahiro INOUE et al.

Tetsu NEMOTO et al.

Miho UDAGAWA

[First Page of JARQ](#)

[What's New](#)

[JIRCAS Home Page](#)

Improvement of Cell Culture Conditions for Rice

Taiichi OGAWA*

Department of Biotechnology, National Institute of Agrobiological Resources
(Tsukuba, Ibaraki, 305-8602 Japan)

*Corresponding author: fax +81-298-38-8397, e-mail togawa@abr.affrc.go.jp

Received 1 November 1999, accepted 31 January 2000.

Abstract

Cell culture techniques are necessary for the use of biotechnology including the production of transgenic rice plants. However, there are significant differences in *in vitro* culture responses among rice varieties. These differences limit the application of biotechnology to genetic improvement of rice. In this study, it was demonstrated that nitrite reductase activity is one of the physiological factors correlated with the differences among rice varieties in cell culture. It was indicated that the modification of the culture medium was effective in overcoming the differences in cell culture: the calluses of some Indica and Japonica type varieties showed a poor growth or did not grow under the initial conditions, whereas the calluses of all the varieties tested showed good growth when the nitrogen source, carbon source and medium pH were modified. As a result, in this study the culture conditions applicable to a wider range of varieties, including Indica type, Japonica type and Indica-Japonica crossed varieties as well as Japonica type were identified.

Discipline: Biotechnology

Additional key words: *Oryza sativa*, abscisic acid, amino acid, genotypic difference, nitrogen metabolism

References

Introduction

In rice, progress is being made in the application of biotechnology, including haploid method of breeding by anther culture, the use of somaclonal variation, the production of somatic hybrids by cell fusion, and the production of transformed plants. To use these techniques, plants must be regenerated from objective cells using cell culture techniques. However, significant differences in the efficiency of callus formation, somatic embryogenesis, and plant regeneration have been detected among the varieties of many plant species, including rice^{1,21}). These varietal differences limit the application of biotechnology to the genetic improvement of rice. For example, only a few Japonica varieties, such as Nipponbare and Taipei 309, can be readily cultured and maintained in the embryogenic state, and used to produce transformed rice plants^{9,19,23}). So far, no reports have dealt with the improvement of culture conditions that could be applied to a wide range of varieties and genotypes in rice.

In rice cell culture, immature and mature embryos are used as materials for callus induction, because the derived calluses have a high ability of plant regeneration^{19,23}). Embryogenic suspension culture can be established by continuously culturing the calluses in a liquid medium. A large amount of protoplasts, into

which foreign genes have been introduced by electroporation^{19,23)} and polyethylene glycol⁹⁾ methods, have been isolated from the suspension cultures. And also the cultures can be used as target materials for the transfer of foreign genes by biolistic⁴⁾ and *Agrobacterium* methods¹⁰⁾. Therefore, it is important to develop embryogenic suspension cultures for the application of biotechnological methods in rice.

In this study, the culture conditions for rice were improved in order to overcome the varietal differences in the culture response and to obtain embryogenic cultures from all types of rice varieties. Furthermore, the physiological factors related to varietal differences in rice cell culture using calluses cultured under the improved conditions were identified.

NEXT

References

- 1) Abe, T. & Futsuhara, Y. (1986): Genotypic variability for callus formation and plant regeneration in rice (*Oryza sativa* L.). *Theor. Appl. Genet.*, **72**, 3-10.
- 2) Aslam, M. & Huffaker, R. C. (1989): Role of nitrate and nitrite in the induction of nitrate reductase in leaves of barley seedlings. *Plant Physiol.*, **91**, 1152-1156.
- 3) Beevers, L. & Hageman, R. H. (1980): Nitrate and nitrite reduction. *In The Biochemistry of Plants* vol. 5. ed. Mifflin, B. J., 115-168.
- 4) Cao, J. et al. (1992): Regeneration of herbicide resistant transgenic rice plants following microprojectile-mediated transformation of suspension culture cells. *Plant Cell Rep.*, **11**, 586-591.
- 5) Chu, C. C., Wang, C. C. & Sun, C. S. (1975): Establishment of an efficient medium for anther culture of rice through comparative experiments on the nitrogen sources. *Scientia Sinica*, **18**, 659-668.
- 6) Daigen, M. & Abe, S. (1993): Callus formation from seed explant, growth in suspension culture and plant regeneration in rice (*Oryza sativa* L. cv. Koshihikari). *Plant Tissue Cult. Lett.*, **10**, 176-179 [In Japanese].
- 7) Filner, P. (1966): Regulation of nitrate reductase in cultured tobacco cells. *Biochim. Biophys. Acta*, **118**, 299-310.
- 8) Gamborg, O. L., Miller, R. A. & Ojima, K. (1968): Nutrient requirements of suspension cultures of soybean root cells. *Exp. Cell Res.*, **50**, 151-158.
- 9) Hayashimoto, A., Li, Z. & Murai, N. (1990): A polyethylene glycol-mediated protoplast transformation system for production of fertile transgenic rice plants. *Plant Physiol.*, **93**, 857-863.
- 10) Hiei, Y. et al. (1994): Efficient transformation of rice (*Oryza sativa* L.) mediated by *Agrobacterium* and sequence analysis of the boundaries of T-DNA. *Plant J.*, **6**, 271-282.
- 11) Ida, S., Mori, E. & Morita, Y. (1974): Purification, stabilization and characterization of nitrite reductase from barley roots. *Planta*, **121**, 213-224.
- 12) Joy, K. W. & Hageman, R. H. (1966): The purification and properties of nitrite reductase from higher plants, and its dependence on ferredoxin. *Biochem. J.*, **100**, 263-273.
- 13) Ogawa, T., Fukuoka, H. & Ohkawa, Y. (1996): Effects of reduced nitrogen source and sucrose concentration on varietal differences in rice cell culture. *Breeding Sci.*, **46**, 179-184.
- 14) Ogawa, T. et al. (1999): Relationships between nitrite reductase activity and genotype-dependent callus-growth in rice cell cultures. *Plant Cell Rep.*, **18**, 576-581.
- 15) Ohira, K., Ojima, K. & Fujiwara, A. (1973): Studies on the nutrition of rice cell culture I. A simple, defined medium for rapid growth in suspension culture. *Plant Cell Physiol.*, **14**, 1113-1121.
- 16) Ohira, K., Yamaya, T. & Ojima, K. (1976): Changes in the nitrate reductase activity during the growth of cultured rice cells. *J. Sci. Soil Manure Jpn.*, **47**, 79-84.
- 17) Scholl, R. L., Harper, J. E. & Hageman, R. H. (1974): Improvements of the nitrite color development

in assays of nitrate reductase by phenazine methosulfate and zinc acetate. *Plant Physiol.*, **53**, 825-828.

18) Shimamoto, K. et al. (1989): Fertile transgenic rice plants regenerated from transformed protoplasts. *Nature*, **338**, 274-276.

19) Sihag, R. K., Guha-Mukherjee, S. & Sopory, S. K. (1979): Effect of ammonium, sucrose and light on the regulation of nitrate reductase level in *Pisum sativum*. *Physiol. Plant.*, **45**, 281-287.

20) Torrizo, L. B. and F. J. Zapata (1986): Anther culture in rice; The effect of abscisic acid on plant regeneration. *Plant Cell Rep.*, **5**, 136-139.

21) Vasil, I. K. (1987): Developing cell and tissue culture systems for the improvement of cereal and grass crops. *J. Plant Physiol.*, **128**, 193-218.

22) Zeevaart, J. A. D. & Creelman, R. A. (1988): Metabolism and physiology of abscisic acid. *Annu. Rev. Plant Physiol. Plant Mol. Biol.*, **39**, 439-473.

23) Zhang, W. & Wu, R. (1988): Efficient regeneration of transgenic plants from rice protoplasts and correctly regulated expression of the foreign gene in the plants. *Theor. Appl. Genet.*, **76**, 835-840.

Materials and methods

1) Callus induction and culture

Fifty rice varieties used in this study are shown in [Figs. 2 and 3](#). Rice seeds were provided by the Genebank and the Rice Breeding Laboratory, Chugoku National Agricultural Experimental Station, Ministry of Agriculture, Forestry and Fisheries of Japan (MAFF). Seeds were sterilized in 70% ethanol for 30 s and in a sodium hypochlorite solution containing an available chlorine concentration of 1 % for 30 min, followed by rinsing with sterile water 3 times. After rinsing, the sterilized seeds were immersed in sterilized water for 6 to 7 h. Embryos were cut off from the imbibed seeds and were placed with the scutellum pointing upwards on induction media. The induction media contained constituents of Medium C (shown in [Table 1](#)) except for proline and were solidified by 0.8% agar. The pH of the medium was adjusted to 5.8. Seven-day-old calluses derived from the scutella were transferred to 20 mL of Medium A and Medium C in 100 mL-flasks on a gyratory shaker at 100 rpm by subculturing every 7 days. For subculturing, about 0.4 mL cell volume of calluses were transferred to 20 mL of a fresh medium with the same composition in 100 mL-flasks. The calluses were used as materials after subculture for more than 2 months. The following experiments were carried out with 3 replications.

For the measurement of the callus growth rate during the seven-day-culture period, about 250 mg fresh weight of the subcultured calluses were transferred to a fresh medium. Fresh weight of the calluses was measured after removing excess medium around calluses with pieces of sterile filter paper at 0 and 7 days after transfer, and growth rates were calculated.

2) Enzyme assays

Ten Japonica type varieties used for the enzyme assays are shown in [Fig. 4](#). The calluses were subcultured in Medium C for more than 2 months. About 250 mg of the subcultured calluses were transferred to Medium B or C. The 2 media contained potassium nitrate at the same concentration of 20 mM. The calluses were homogenized in three-fold volumes of the extraction buffer 3 days after transfer according to the method of Ida et al.¹¹). The extraction buffer contained 50 mM Tris-HCl (pH 7.9), 5 mM cysteine and 2 mM EDTA. The homogenate was centrifuged at 10,000 x g for 20 min and the supernatant (500 \hat{I} /₄L) was concentrated with Microcon 10 (Amicon Inc. , USA) for reducing the amounts of nitrate ions. The concentrated supernatant was diluted by the addition of 500 \hat{I} /₄L of the buffer containing 50 mM Tris-HCl (pH 7.5), 1 mM cysteine and 2 mM EDTA and was assayed for nitrate reductase (NR) and nitrite reductase (NiR) activities. The operations described above were carried out at 4 \hat{a} .,f Protein content of the extract was determined by a Bio-rad protein assay kit using bovine serum albumin as standard protein.

Enzyme activity was assayed by *in vitro* method. The assay mixture for NR contained 25 mM potassium phosphate buffer (pH 7.5), 10 mM KNO₃, 0.2 mM NADH, 5 mM NaHCO₃ and 5 \hat{I} /₄L of extract in a final volume of 0.5 mL. The assays were conducted at 30 \hat{a} .,f for 15 min. The reaction was terminated by the addition of 50 \hat{I} /₄L of 0.5 M Zn(CH₃COO)₂ and excess NADH was oxidized by the addition of 50 \hat{I} /₄L of 0.15 mM phenazine methosulfate¹⁷). The amount of NO₂ⁱ/₄ produced was determined colorimetrically²).

NiR activity was assayed following the reduction of $\text{NO}_2^{i/4\bullet}$ from the assay mixture¹²). The assay mixture contained 50 mM Tris-HCl (pH 7.5), 0.5 mM NaNO_2 , 1 mM methyl viologen and 50 $\hat{\text{I}}/4\text{L}$ of extract in a final volume of 0.9 mL. The reaction was started by the addition of 100 $\hat{\text{I}}/4\text{L}$ of 0.12 M $\text{Na}_2\text{S}_2\text{O}_4$ dissolved in 0.2 M NaHCO_3 and incubated at 30 $\hat{\text{a}},,f$ for 60 min. The reaction was terminated by vigorous mixing on a tube mixer until the color of methyl viologen fully disappeared. After the addition of 100 $\hat{\text{I}}/4\text{L}$ of 1 M $\text{Zn}(\text{CH}_3\text{COO})_2$, the mixture was centrifuged at 10,000 x g for 10 min. The amount of residual $\text{NO}_2^{i/4\bullet}$ in the supernatant was determined colorimetrically as in the NR activity assay.

For the measurement of the $\text{NO}_2^{i/4\bullet}$ content, the supernatant of the callus homogenate was prepared as described above 3 or 7 days after transfer. $\text{NO}_2^{i/4\bullet}$ content of the supernatant was colorimetrically determined by the method of Aslam and Huffaker²).

3) Measurement of abscisic acid content in calluses

The calluses of Nipponbare, Koshihikari and IR24 which were subcultured in Medium C were used for the measurement of abscisic acid. About 1 g of the calluses were collected at the end of the seven-day-culture period. The calluses were homogenized with 3 mL of the 100% methanol on ice. The homogenizer blade was washed with 16 mL of 80% methanol and the washed solution was added to the homogenate. The homogenate was kept overnight at 4 $\hat{\text{a}},,f$ in the dark. Polyvinylpyrrolidone (0.5 g) was added to the homogenate, mixed and kept for more than 10 min. The mixture was filtered and evaporated *in vacuo*. After evaporation, the residue was dissolved in 1.5 mL of 0.5 M potassium buffer (pH 8.3). The sample solution was partitioned against hexane 3 times and then against ethyl acetate 3 times. The pH of the aqueous phase was adjusted to around 2.5 and the solution was partitioned against ethyl acetate 3 times. The ethyl acetate phase was collected and evaporated *in vacuo*. The residue was dissolved in 100% methanol and loaded onto a Bondesil DEA column (Varian Associates. Inc., U.S.A.). After absorption, the column was washed with 100% methanol and eluted with methanol containing 0.5% acetic acid. The eluate was evaporated *in vacuo* and the residue was used for the determination of the ABA content by an immunoassay. The culture medium was also collected and evaporated *in vacuo* at the end of the seven-day-culture period and purified for the determination of the ABA content in the same way as for calluses except for hexan partitioning and first ethyl acetate partitioning. Butylated hydroxytoluene, an antioxidant, was added to all the solvents for homogenization and purification at the concentration of 20 mg/L. ABA content in the purified sample was determined using an abscisic acid immunoassay detection kit (Sigma-Aldrich Japan K. K., Japan).

NEXT

Variety / Line

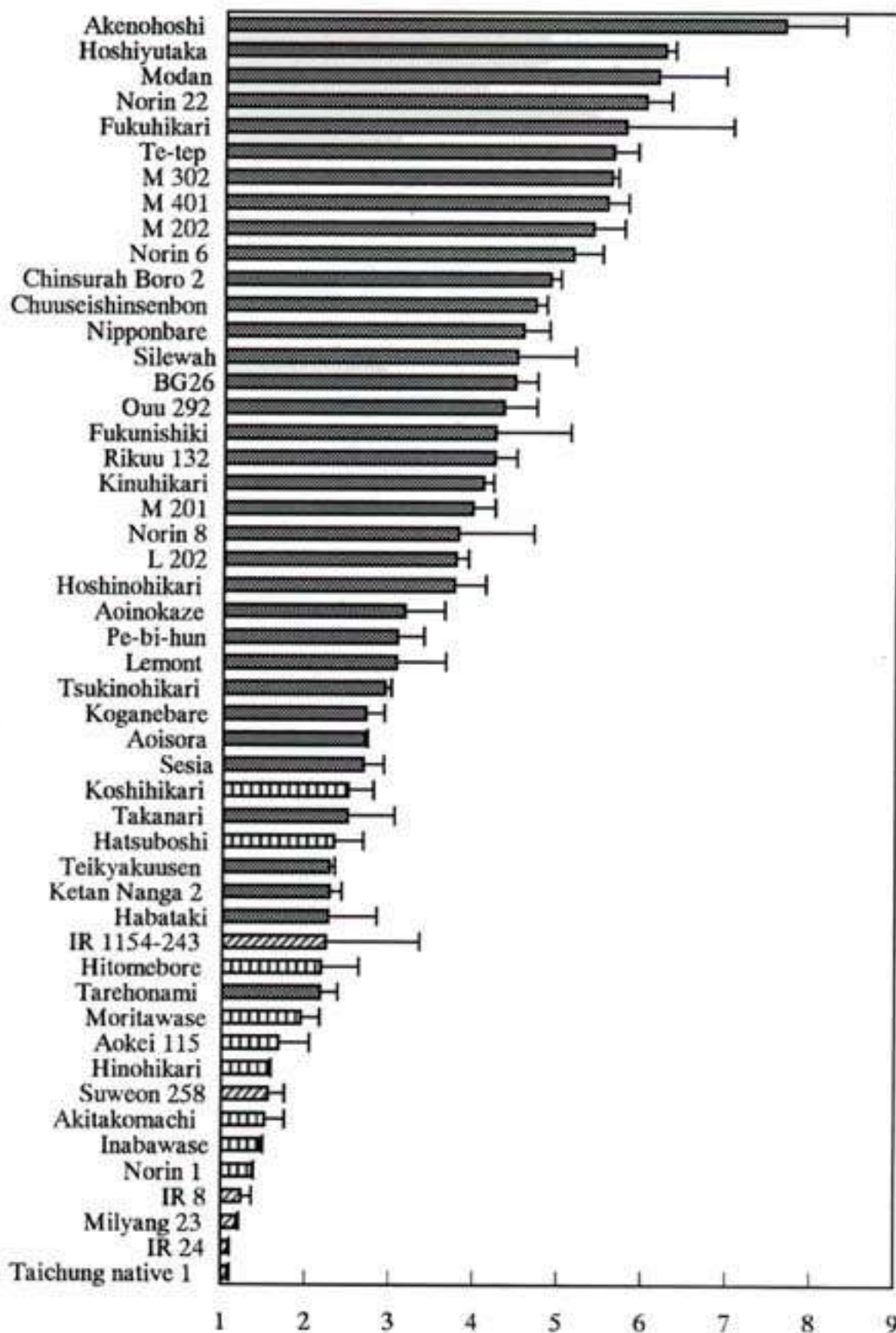





Fig. 2. Varietal differences in callus growth rate under the initial conditions(Medium A) in liquid cell culture in rice

■ Nipponbare type varieties or lines

-  Nipponbare type varieties or lines
-  Koshihikari type varieties or lines
-  IR24 type varieties or lines

BACK

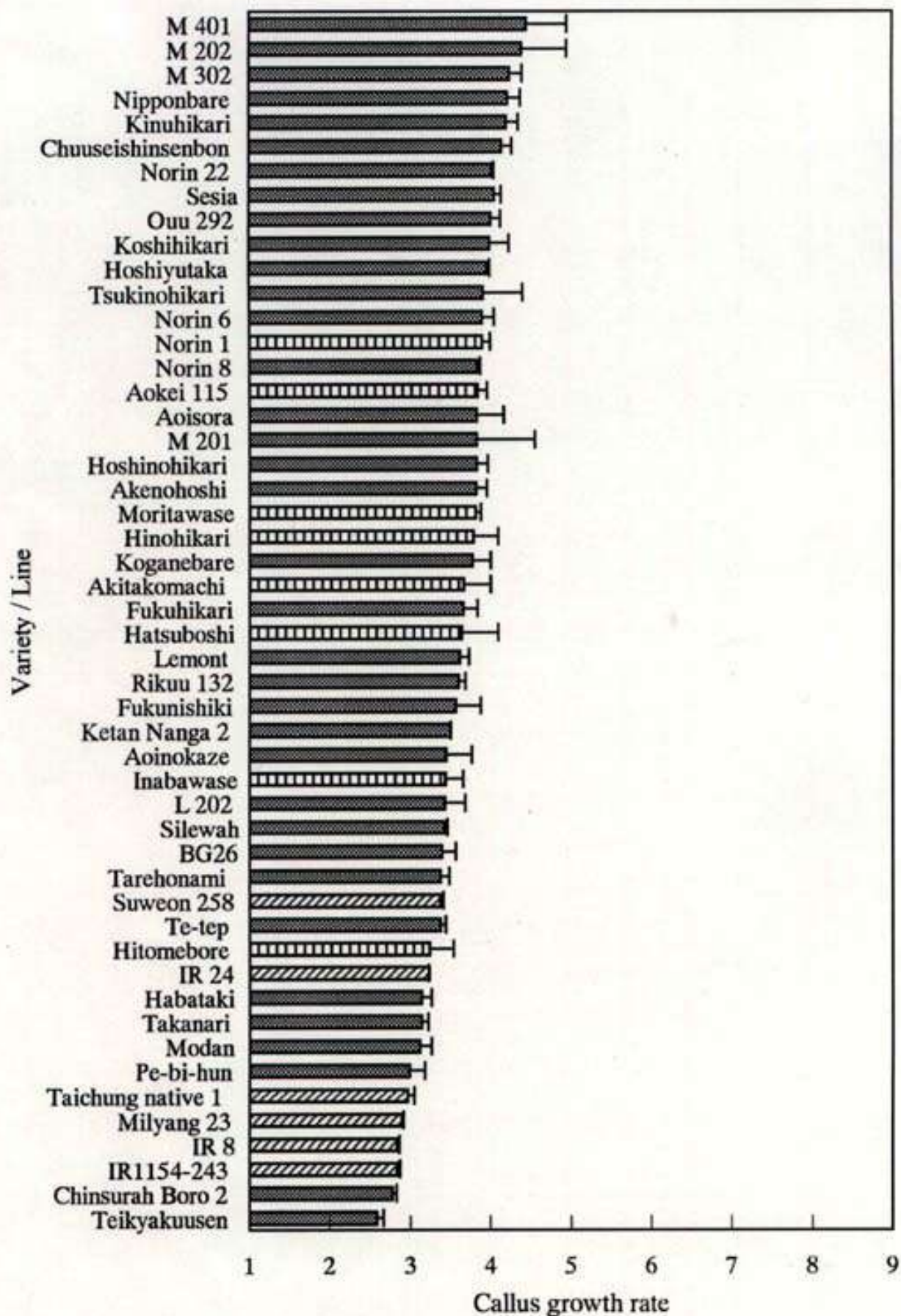





Fig. 3. Varietal differences in callus growth rate under the modified conditions (Medium C) in liquid cell culture in rice

-  Nipponbare type varieties or lines
-  Koshihikari type varieties or lines
-  IR24 type varieties or lines

BACK

Table 1. Medium composition

Constituents	Medium A (Initial medium)	Medium B	(mg/L)
			Medium C (Modified medium)
Inorganic salts			
Macro-elements			
KNO ₃	4,040	2,020	2,020
(NH ₄) ₂ SO ₄	330	330	-
CaCl ₂ e2H ₂ O	147	147	147
MgSO ₄ e7H ₂ O	245	245	245
KH ₂ PO ₄	-	272	272
NaH ₂ PO ₄ e2H ₂ O	312	-	-
Micro-elements			
Fe-EDTA	19	19	19
MnSO ₄ e4H ₂ O	1.6	1.6	1.6
ZnSO ₄ e7H ₂ O	2.2	2.2	2.2
CuSO ₄ e5H ₂ O	0.20	0.20	0.20
Na ₂ MoO ₄ e2H ₂ O	0.13	0.13	0.13
H ₃ BO ₃	2.8	2.8	2.8
Vitamins			
Nicotinic acid	1.0	1.0	1.0
Thiamine-HCl	10.0	10.0	10.0
Pyridoxine-HCl	1.0	1.0	1.0
myo-Inositol	100.0	100.0	100.0
Amino acids			
Alanine	-	-	445
Proline	-	-	1,151
Carbon sources			
Sucrose	30,000	30,000	-
Maltose	-	-	3,750
pH	5.8	5.8	4.5

BACK

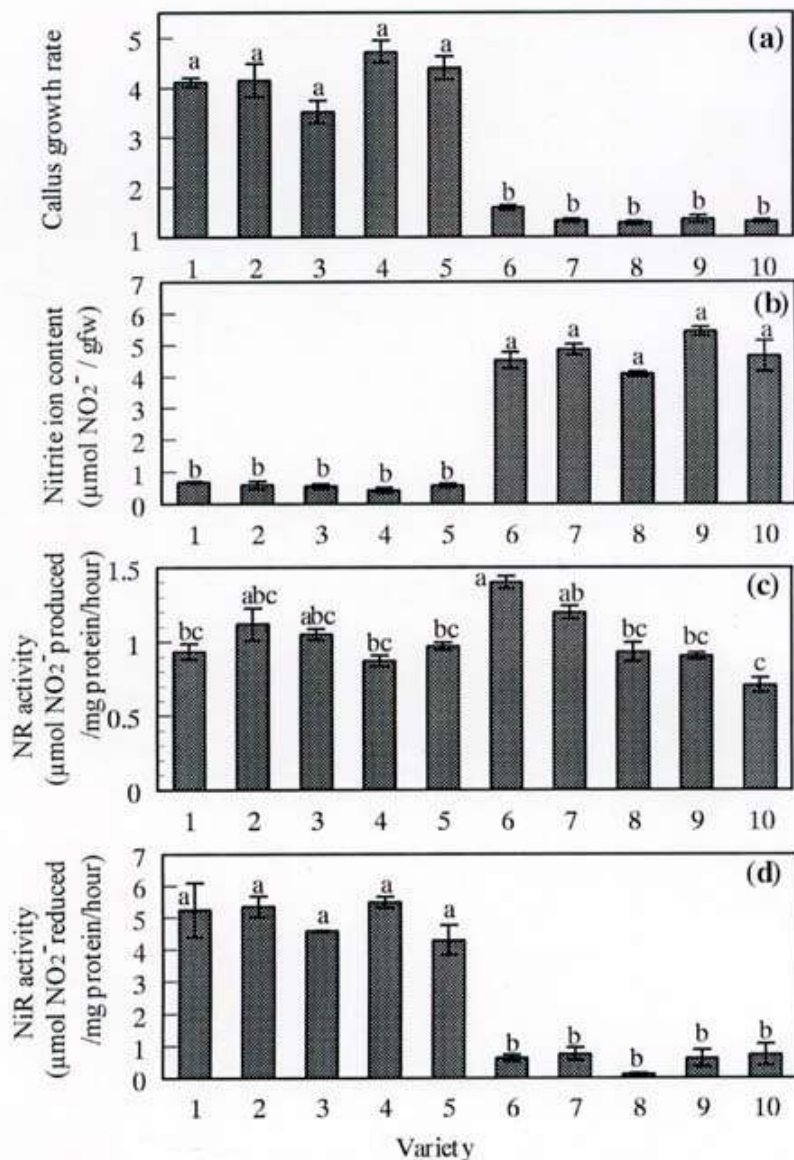


Fig. 4. Comparison of growth rate, nitrite ion content, NR activity and NiR activity of scutellum-derived calluses cultured in Medium B among 10 varieties

(a) Callus growth rate, (b) Nitrite ion content, (c) NR activity, (d) NiR activity.

Variety: (1) Nipponbare, (2) Norin 6, (3) Norin 22, (4) Norin 8, (5) Chuuseishinsenbon, (6) Norin 1, (7) Akitakomachi, (8) Moritawase, (9) Hitomebore, (10) Koshihikari.

Error bars indicate standard errors of the means in 3 replications. Differences between bars having the same letters are not significant at 1% probability level by Scheffé's multiple comparison test.

BACK

Physiological factors related to differences between Nipponbare and Koshihikari in culture response

Ammonium sulfate is most commonly used as a reduced nitrogen source for preparing a basal medium in tissue and cell culture, because the addition of ammonium ion in combination with nitrate generally enhances the growth rate of cultured cells^{8,15}). However, as described above, this compound was considered to be the factor that inhibited the growth of the calluses of Koshihikari type varieties. Attempts were made to investigate the metabolism of nitrogen sources in order to determine the physiological basis of the differences in callus growth between Koshihikari and Nipponbare type varieties¹⁴). The calluses cultured in the modified medium were considered to be suitable materials in this analysis, because no differences were observed in the growth rates and appearance of the calluses between Koshihikari and Nipponbare type varieties.

The nitrite ion content and activity of nitrate reductase and nitrite reductase were examined in the calluses of 10 varieties using the liquid medium (Medium B) with the same composition as that of the initial medium (Medium A), except that the concentration of potassium nitrate was 20 mM ([Fig. 4](#)). The calluses of the Koshihikari type varieties (No. 6-10) accumulated significantly more nitrite ions during the culture period than those of the Nipponbare type varieties (No. 1-5). The callus growth rate was negatively correlated with the nitrite ion content ($r=-0.9525$, $p < 0.001$), indicating that the calluses of the Koshihikari type varieties were injured by toxic nitrite ions, which led to browning and poor growth of the calluses.

The reduction of nitrate to ammonia is catalyzed by 2 enzymes, nitrate reductase (NR) and nitrite reductase (NiR), and nitrite ion is considered to be an intermediate in the pathway. The accumulation of nitrite ions may be attributed to either excessive production of nitrite ion by NR or slow reduction of nitrite by NiR reductase. In this study the second assumption was verified. The calluses of the Koshihikari type varieties showed significantly lower levels of NiR activity than those of the Nipponbare type varieties. On the other hand, no differences were observed in the NR activity in either group. The results suggested that the higher ion levels observed in the Koshihikari type varieties were due to a lower ability to reduce nitrite ions and that NiR activity is one of the physiological factors correlated with the differences between varieties in rice cell culture.

As shown in [Fig. 5](#), the calluses of the Koshihikari type varieties displayed the same growth rate as those of the Nipponbare type varieties in the modified medium (Medium C), but also contained significantly lower levels of NiR. NR activity was inhibited in the calluses of both varieties in the improved medium compared to Medium B. The results suggested that the inhibition of the NR activity resulted in the accumulation of trace amounts of nitrite ions in the calluses of the Koshihikari type varieties in spite of the lower NiR activity and, as a result, callus growth improved in the modified medium.

NR activity is known to be regulated by $\text{NO}_3^{i/4}$, light, reduced nitrogen sources, sugar, etc.^{3,19}). It was reported that ammonium ions and casein hydrolysates decreased the NR activity of rice cultured cells when the nitrogen sources were added in combination with $\text{NO}_3^{i/4}$ ¹⁶). However, it remained to be determined whether the effect on the inhibition of the NR activity was different among the amino acids added in rice cultured cells. Filner⁷) reported that the effect on the NR activity depended on the amino

acids added in cultured tobacco cells: NR activity was inhibited by one group of amino acids, i. e. alanine, arginine, etc. and depressed by a second group of amino acids, i. e. asparagine, lysine. In a further study, differences in the effect of reduced nitrogen sources including alanine and proline in rice calluses will be examined. The calluses of Nipponbare type varieties showed a slightly lower growth rate in Medium C (Fig. 5) than in Medium B (Fig. 4). This decrease may be associated with the decrease in both NR and NiR activities observed in the Nipponbare type varieties. Although we replaced 30 g/L sucrose in Medium B with 3.75 g/L maltose in Medium C, differences in sugar types and concentrations may also be responsible for the decrease in the growth rate of Nipponbare type varieties in Medium C. However, it was reported that when the sucrose concentration increased, the NR activity was enhanced at least in pea seedlings¹⁹). Further improvement of the sugar composition for rice cell culture should be examined by monitoring the balance between NR and NiR activities to avoid the toxicity of NO₂^{i/4}•.

Differences in endogenous abscisic acid content among varieties

IR24 type varieties could be cultured in the modified medium (Medium C). However, the calluses of this type showed a lower growth rate than those of Nipponbare and Koshihikari type varieties even in the modified medium: 6 varieties of IR24 type were found in the lower rank as shown in Fig. 3. In the following experiment, the regeneration ability of the calluses which were cultured in the modified medium was examined. The results showed that the calluses of IR24 type varieties exhibited a higher ability of plant regeneration than those of other types of varieties (data not shown). Based on these results, it was assumed that the IR24 varieties were characterized by both a lower ability of callus growth and high ability of plant regeneration from calluses. Although abscisic acid is a phytohormone which exerts various effects on plant growth²²), one of the effects consists of the inhibition of plant growth. In studies on plant tissue culture, the addition of abscisic acid to the medium enhanced the frequency of plant regeneration from cells²⁰). The content of abscisic acid in the calluses cultured in the modified media was compared among 3 varieties, Nipponbare, Koshihikari and IR24. As shown in [Table 2](#), in the calluses of IR24 the level of abscisic acid was 12.0 and 8.6 times higher than that in Nipponbare and Koshihikari, respectively. Similar results were obtained when the ABA content in the culture medium was compared among the three varieties. These results suggested that the higher content of endogenous ABA was responsible for the lower growth rate and higher regeneration ability of the IR24 calluses cultured in the modified medium.

It is assumed that the IR24 type varieties can naturally accumulate a higher level of ABA in the cells than other types of varieties. Because the initial medium contained unsuitable factors for callus growth, such as amounts of sucrose, ammonium sulfate and pH values, a high level of ABA could inhibit more strongly callus growth of the IR24 type varieties in the initial medium than in the modified medium. As a result, the calluses of IR24 type varieties may not be able to grow or display limited growth. To confirm this hypothesis, the relationships between the endogenous ABA content and differences in the culture response are being currently analyzed.

Discussion

Although varietal differences are widely observed in rice cell culture, there are few reports on the culture conditions required to overcome the differences. Daigen and Abe⁶) modified a culture medium by

one-fifth dilution of all of inorganic salts and obtained the conditions suitable for the culture of calluses of the Japonica type variety Koshihikari. In this study the range of tested varieties was expanded and the conditions applicable to a wider range of varieties including Indica type, Javanica type and Indica-Japonica crossed varieties as well as Japonica type were defined. For further improvement, such as enhancing the growth rate, the modified conditions developed in this study could be used as basal conditions.

For the application of biotechnology in rice, varieties and genotypes are selected based on the ability of their response to culture. The selected varieties may not necessarily belong to elite ones in rice. It is possible to transfer the traits which are genetically modified through biotechnological procedures from the manipulated plant to an elite variety by the backcrossing method. On the other hand, the backcrossing process to fix the genetic traits is time-consuming and an undesirable trait might be introduced into the derived plants if genes are closely linked to the gene for the trait. The modified culture conditions developed in this study should facilitate the application of biotechnology to rice breeding, so that elite varieties can be used directly.

There are few reports on the physiological processes related to the differences in the culture response. In most cases, no detailed analysis has been conducted to clarify the physiological aspects of varietal differences in cell culture. In this study, the nitrite ion content was found to be one of the physiological factors related to the differences in rice cell culture. It was also observed that when there is a high concentration of these ions in cells with poor growth, inhibition of the NR activity may enable to improve the growth. Physiological information related to the varietal differences in the culture response should be useful to simplify the process of improving the culture conditions as described above in rice and in other plants.

[NEXT](#)

[TOP](#)

[HOME](#)

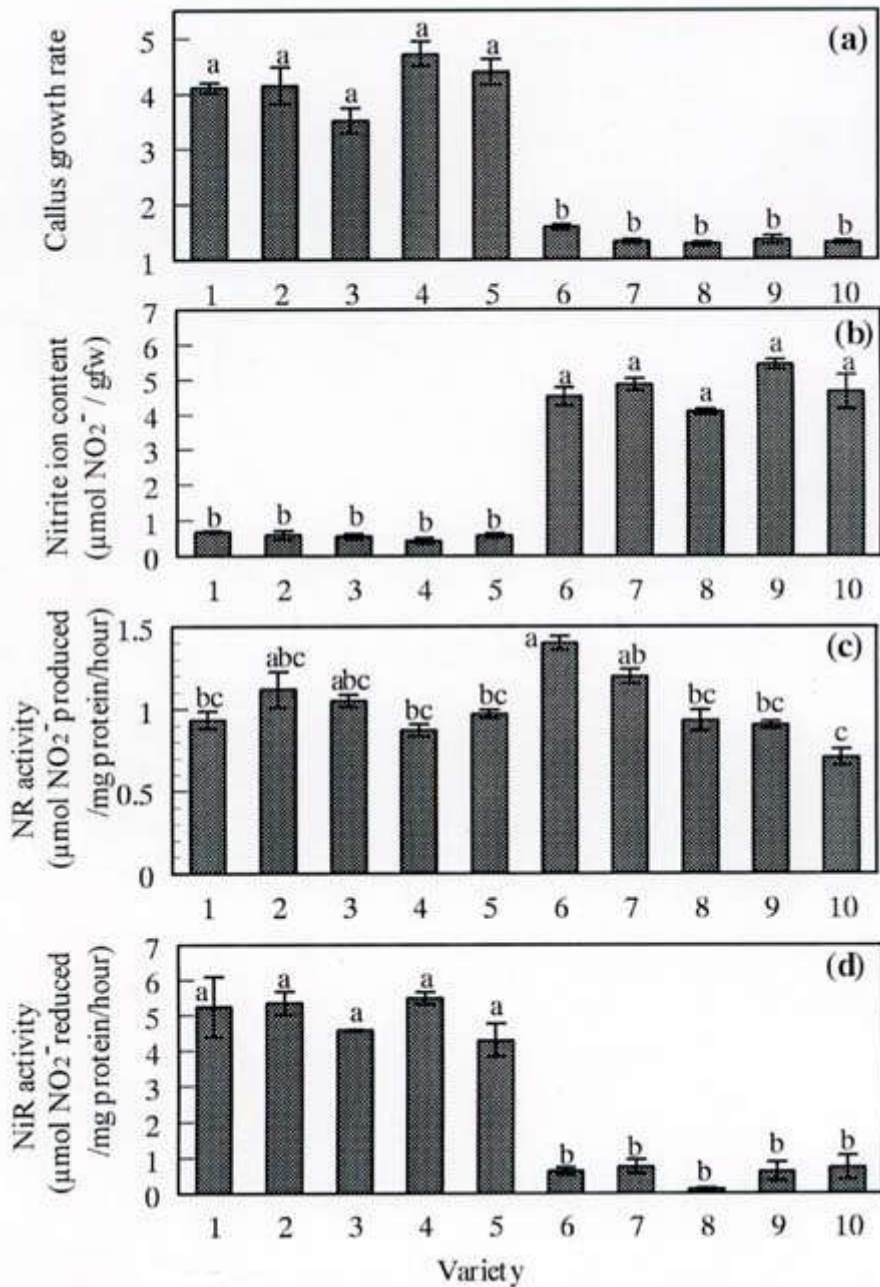


Fig. 4. Comparison of growth rate, nitrite ion content, NR activity and NiR activity of scutellum-derived calluses cultured in Medium B among 10 varieties

(a) Callus growth rate, (b) Nitrite ion content, (c) NR activity, (d) NiR activity.

Variety: (1) Nipponbare, (2) Norin 6, (3) Norin 22, (4) Norin 8, (5) Chuuseishinsenbon, (6) Norin 1, (7) Akitakomachi, (8) Moritawase, (9) Hitomebore, (10) Koshihikari.

Error bars indicate standard errors of the means in 3 replications. Differences between bars having the same letters are not significant at 1% probability level by Scheffé's multiple comparison test.

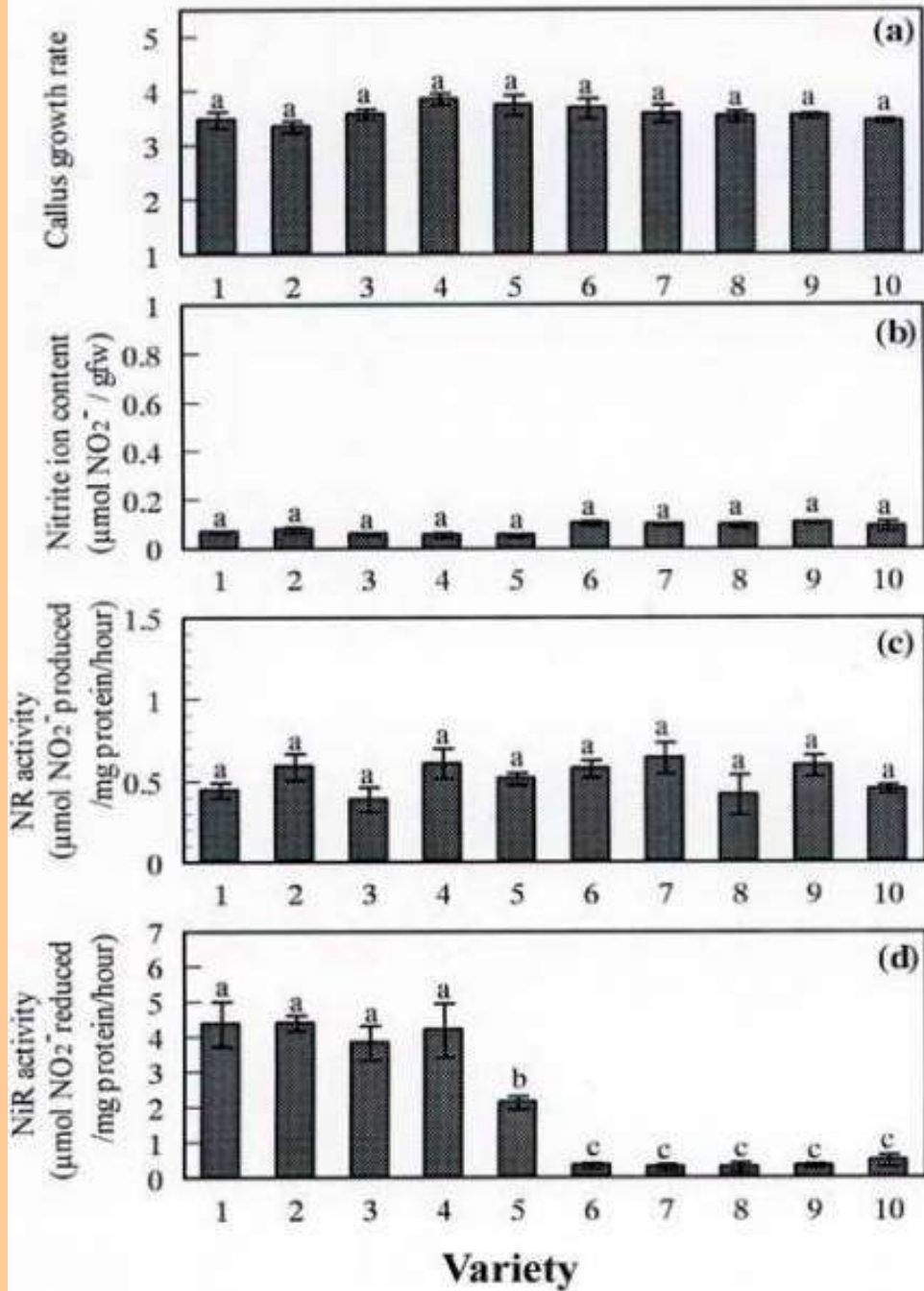
BACK

Fig.5. Comparison of growth rate, nitrite ion content, NR activity and NiR activity of scutellum-derived calluses cultured in Medium C among 10 varieties

(a) Callus growth rate,
(b) Nitrite ion content,
(c) NR activity, (d) NiR activity.

Variety: the same as in Fig. 4.

Error bars indicate standard errors of the means in 3 replications. Differences between bars having the same letters are not significant at 1% probability level by Scheffé's multiple comparison test.



BACK

Table 2. Content of endogenous abscisic acid (ABA) in the calluses and concentration of abscisic acid in the media in 3 varieties

Variety	Endogenous ABA content in the calluses (ng / gfw)	Concentration of ABA in the medium (ng / mL)
Nipponbare	0.48 b	0.10 b
Koshihikari	0.67 b	0.07 b
IR24	5.78 a	0.34 a

Values within a column having different letters are significantly different at 5% level by Duncan's new multiple range test. Values show the mean of 2 replications.

BACK

Diversity of Rice Varieties and Cropping Systems in Bangladesh Deepwater Areas

Hong-Wei CAI¹ and Hiroko MORISHIMA^{2*}

National Institute of Genetics (Mishima, Shizuoka, 411-8540 Japan)

Present address:

¹Japan Forage Seed Association, Nishinasuno Branch
(Higashiakada, Nishinasuno, Tochigi, 329-2742 Japan).

² Saiwai-cho, Hiratsuka, Kanagawa, 254-0804 Japan.

*Corresponding author: Fax +81-0463-22-2111, e-mail: hmorishi@msb.biglobe.ne.jp

Received 21 December 1999, accepted 19 January 2000.

Abstract

Sixty-eight indigenous rice cultivars collected in deepwater areas in Bangladesh were examined in terms of heading behavior and allozyme variation. Seasonal ecotypes differed in the heading behavior for adaptation to their respective cropping seasons. Isozyme analysis revealed that cultivars grown in deepwater areas in Bangladesh consisted of a Japonica-like group and an unclassified unique group in addition to a major Indica group. Classification by isozyme variation was not necessarily consistent with the differentiation into seasonal ecotypes. Cultivars collected in a restricted area in Khulna District consisting of various seasonal ecotypes showed a genetic similarity to each other, suggesting that geographical differentiation preceded seasonal differentiation. Based on a case study conducted in 2 villages in Khulna, it was pointed out that diverse landraces which are adapted to different local and seasonal conditions have evolved by interacting with traditional planting systems.

Discipline: Genetic resources

Additional key words: heading behavior, isozyme, varietal differentiation

1...19): [References](#)

Introduction

Bangladesh is situated in the wide delta of the Ganges, Brahmaputra and Meghna rivers. Average annual rainfall is about 2,000 mm, with 95% being concentrated from May to September. In addition to rainfall, melting of snow in the Himalayas leads to the rise of the river water level during the monsoon period and more than half of the total land of the country is flooded. In the flood-prone low-lying areas, rice is the major or sometimes the only crop that can be cultivated.

Three cropping seasons of rice have been identified in Bengal (Bangladesh and West Bengal State of India), namely, Boro (winter), Aus (summer) and Aman (autumn)^{10,12}. Varietal groups which are used for different seasons, are designated by the name of the respective cropping seasons. In the dry winter season, Boro is grown mainly in the irrigated fields. In the rainy summer season, short duration Aus is grown in lowland as well as in upland areas. From summer to autumn, long-duration Aman is grown by

transplanting (T. Aman) or by broadcasting (B. Aman). B. Aman rice is almost synonymous to deepwater rice that can elongate the internodes markedly in response to the rising water level. Furthermore, 2 minor groups of deepwater rice, Rayada and Ashina, occur in Bangladesh. Rayada shows a very long growth duration, and is cultivated in a restricted area along the river Madhumaty, a tributary of the Ganges. Ashina belongs to a small varietal group characterized by early heading.

Nearly 10,000 landraces are considered to exist in Bangladesh. These varieties have been generally considered to belong to the Indica type in the same way as those grown in other low-lying areas in tropical Asia. Isozyme studies, however, revealed that Bangladesh deepwater rice contains some varieties that did not fall under either the Indica or Japonica type^{5,13}). The objective of the present study was to analyze the pattern of genetic variation among rice cultivars distributed in flood-prone areas in Bangladesh with special reference to varietal differentiation corresponding to the cropping seasons. A case study in Rayada-growing villages was conducted to analyze the diversity of rice cultivars in relation to the traditional cropping systems.

Materials and methods

The present study was mainly based on the samples and information obtained during a study-trip to deepwater areas in Bangladesh in which the second author participated. The trip was organized in December 1989 through the financial support of a grant from Monbuscho International Scientific Research (No. 0104110) and with the cooperation of the Bangladesh Rice Research Institute (BRRI). The details of the field observations were described in the trip report¹⁵). Sixty-eight rice cultivars dealt with in the present paper consisted mostly of landraces collected from farmers' fields or their seed stocks in the Districts of Dhaka, Habiganj, Sylhet, Mymensingh, Tangail and Khulna. Twenty landraces provided by BRRI were also analyzed.

Collected seed samples were sown in mid-April in 1990 and grown in the automatic short-day (12.5 h) apparatus at the National Institute of Genetics, Mishima. The same set of samples was planted in paddy fields under natural daylength (not all the accessions were examined because of the shortage of plants). Heading date of each variety was recorded under short and long (natural) day conditions. Isozyme assay was conducted using plumules or germinated seeds derived from multiplied seeds. Eight loci (*Est2*, *Est5*, *Est10*, *Est11*, *Est12*, *Mal1*, *Mal2* and *Amp5*) were assayed by polyacrylamide gel electrophoresis (PAGE) and 12 loci (*Acp1*, *Amp1*, *Amp2*, *Amp3*, *Cat1*, *Est2*, *Est9*, *Pgd1*, *Pgd2*, *Pgi1*, *Pgi2* and *Sdh1*) by starch gel system. In PAGE, 22 landraces from Asian countries other than Bangladesh were analyzed together as check varieties. The details of the methods of isozyme analysis were described in the reports of Ishikawa et al.¹⁴) and Cai et al.⁴). In the 2 villages of Surigati and Katadula (Khulna District), we tried to collect not only seed samples but also information about each variety through interviews with local people.

NEXT

Prospects and Strategies for Precision Farming in Japan

Akira SASAO* and Sakae SHIBUSAWA

Faculty of Agriculture, Tokyo University of Agriculture and Technology
(3-8-5 Saiwai, Fuchu, Tokyo, 183-8509 Japan)

*Corresponding author: fax +81-42-367-5761, e-mail sasao@cc.tuat.ac.jp

Received 7 January 2000, accepted 8 February 2000.

Abstract

Precision farming is bringing about a new revolution in agricultural farming systems with its high potential of reducing the environmental impact and increasing the productivity, based on the high efficiency of advanced technology. Variability management is the key approach in precision farming, using field maps and real-time sensing for temporal and spatial variation in soils, plant growth and yield, and other parameters related to cultivation. Site specific field management can be implemented based on accurate information. Scale-free precision farming approaches are suitable for small-scale Japanese agriculture. Prospects and strategies for Japanese precision farming are introduced, followed by the results derived from investigations on soil mapping and the use of soil sensors.

Discipline: Agricultural engineering

Additional key words: small-sized farm, variability soil map, soil sensor

1...10): [References](#)

Introduction

Precision farming, which aims at reducing the environmental impact and increasing the productivity, has been rapidly developed in the world during the current decade. In the United States, for example, the National Research Council⁶⁾ suggested that the federal government should encourage research and development related to precision farming as a national strategy. European countries have also promoted the development of precision farming. In Japan, the Ministry of Agriculture, Forestry and Fisheries started an R&D project on Japanese precision farming in 1998, while several universities and companies have already studied specific issues.

Promotion of precision farming should affect related industries as well as agriculture due to technology innovation.

In this paper, the concept of precision farming is outlined and studies related to Japanese precision farming (soil mapping and soil sensors) are introduced.

Concept of precision farming

Precision farming is characterized by a systems approach to orient the total system of agriculture toward sustainability, as shown in [Fig. 1](#)⁷⁾. Regulations for environmental conservation have become increasingly stricter worldwide. Specific problems such as pollution by chemicals, organic agriculture or agriculture without the use of pesticides have attracted a wide interest. However, such an agricultural system had focused on the improvement of only one or several aspects of agriculture, which sometimes resulted in reduced productivity, and did not enable to modify the whole system of agriculture supported by farmers. Precision farming aims at solving such trade-off problems on environmental conservation and productivity, using variability management and a systems approach²⁾.

Three fundamental techniques must be considered for integrating the components of precision farming systems.

1) Analysis of variability is the key concept of precision farming, in particular to analyze within-field variability, in order to adjust agricultural inputs to site-specific requirements. Variability should involve at least 3 aspects: spatial variability, temporal variability and predictive variability^{2,8)}.

2) Variable-rate technology (VRT) is used for adjusting the agricultural inputs to site-specific requirements at each location in the field, which requires variable-rate working machinery while manual application can be used in a small-scale farm. Variable-rate application allows: (1) accurate position in the field, (2) accurate information at the position, and (3) precise operations at the position.

3) Decision support system (DSS) offers some choices to a farmer in terms of trade-off problems such as productivity and environment. This component is characterized by a systems approach to optimize a complex system.

How to integrate the technology components to meet the conditions peculiar to Japan agriculture, is a major issue for researchers, engineers and politicians as well as farmers.

NEXT

References

- 1) Birrell, S. J., Sudduth, K. A. & Kitchen, N. R. (1996): Nutrient mapping implications of short-range variability. Proc. 3rd Inter. Conf. Precision Agriculture, ASA-CSSA- SSSA, Madison, WI, USA, 207-216.
- 2) Blackmore, S. (1994): Precision farming; An introduction. *Outlook Agric.*, **23**(4), 275-280.
- 3) Everett, M. W. & Pierce, F. J. (1996): Variability of corn yield and soil profile nitrates in relation to site-specific N management. Proc. 3rd Inter. Conf. Precision Agriculture, ASA-CSSA-SSSA, Madison, WI, USA, 43-53.
- 4) Ferguson, R. B. et al. (1996): Soil sampling for site-specific nitrogen management. Proc. 3rd Inter. Conf. Precision Agriculture, ASA-CSSA-SSSA, Madison, WI, USA, 13-22.
- 5) Li, M. et al. (1999): Local variability of soil nutrient parameters in a Japanese small size field. *J. JSAM*, **61**(1), 141-147 [In Japanese].
- 6) National Research Council (NRC) (1997): Precision Agriculture in the 21st Century. (Committee on Assessing Crop Yield: Site-Specific Farming, Information Systems, and Research Opportunities), National Academy Press, Washington DC., pp. 149.
- 7) Shibusawa, S. (1998): Precision farming requests further advancement in terrain-vehicle dynamics. *Terramechanics (Japan)*, **18**, 107-112 [In Japanese].
- 8) Shibusawa, S. (1998): Precision farming and terramechanics. Proc. 5th Asia-Pacific Regional Conference ISTVS at Seoul, 251-261.
- 9) Shibusawa, S., Sasao, A. & Sakai, K. (1999): Local variability of nitrate nitrogen in a small field. Precision Agriculture '99 Proc. 2nd European Conference on Precision Agriculture/Denmark, July, 377-386.
- 10) Shibusawa, S. et al. (1999): On-line real-time soil spectrophotometer. Precision Agriculture '99 Proc. 2nd European Conference on Precision Agriculture/Denmark, July, Poster 43.

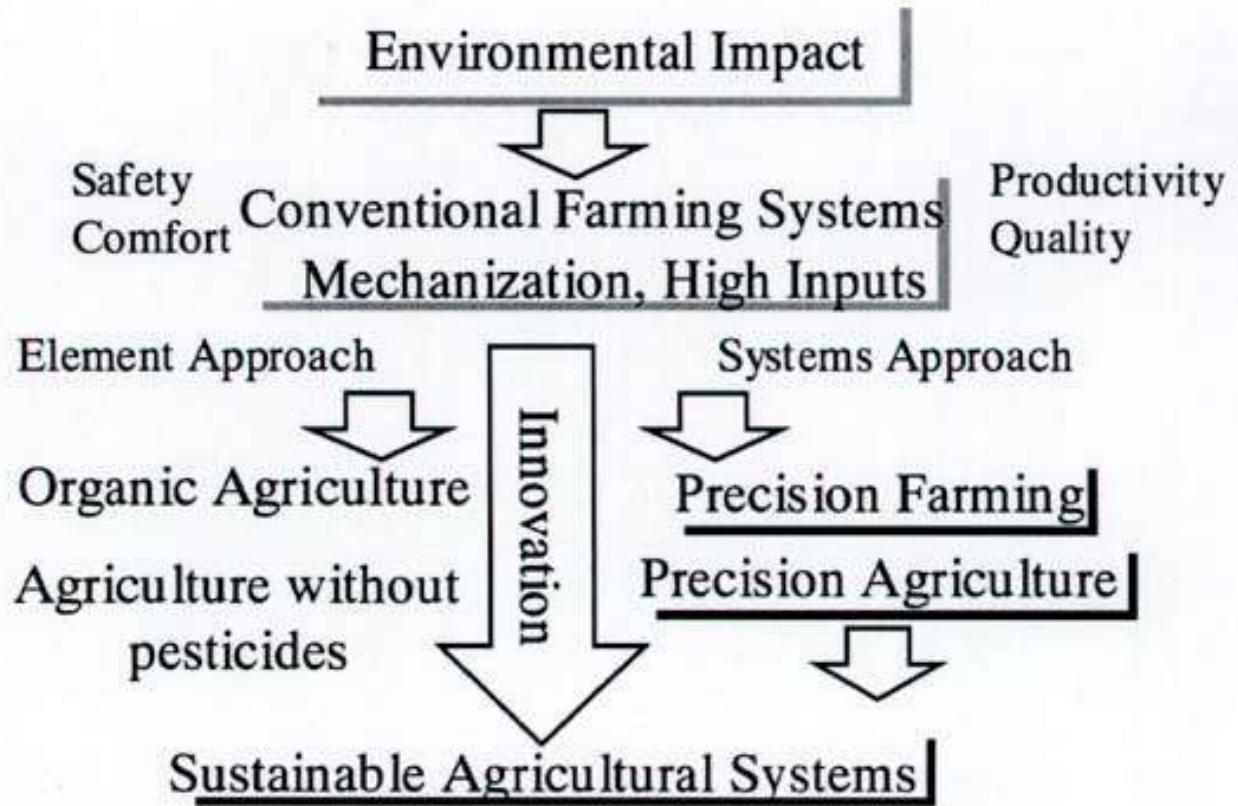


Fig.1. Trends of agriculture and implications for precision farming

BACK

Scale-free precision farming

Japanese agriculture is characterized by a small-scale and labor-intensive operations based on individual plant management involving variability. Considering the variability of management in precision farming, the precision farming approaches can be adopted for any scale of farming as shown in [Table 1](#).

In the case of small farms, farmers should concentrate their activities on fields based on empirical knowledge. Information on each field on an average and use of simple monitoring techniques for mechanical applications, enable to conduct variable-rate controls for site-specific management based on farmers' skills. The variability management system deals with only averaged data per field. For the management of a farm of several hectares, it becomes difficult for the farmers to evaluate the variability within each cultivation field. This is more evident for farming on a much larger scale. Positioning by using GPS techniques, automatically sensing systems, etc. may enable to generate field maps to analyze the spatial and temporal variability. Sensor-based variable-rate control machines can be used for managing such large-scale farms because of the requirement of high-speed operations.

Consequently precision farming approach can be designed and re-arranged to fit any scale of farms, which is an important aspect for Japanese agriculture due to the diversity in field size, crop variety, field elevation, water management for paddy fields, climatic and soil conditions, etc.

Prospects and strategies

1) *Paddy field precision farming*

The concept of paddy field precision farming will be outlined here ([Fig. 2](#)). In general, a paddy field is a small-sized and flattened field with a well-organized irrigation and drainage system. The paddy fields located in a region are interdependent at least due to water management. In Japan, intensive farm works are implemented to achieve uniformity in the soil conditions, transplanting, crop management, etc. within a field with full mechanization. It was generally considered that there was less variability within such a paddy field, although variability within the field had been reported⁵⁾.

Regarding between-field variability, many variations can be found in terms of crop varieties cultivated, productivity and yield, water permeability of soil and working time. Large facilities for grain drying and processing have already been operated as "rice centers" throughout the rice production areas in Japan, in addition to the compact grain dryers owned by individual farmers. Moreover there are well-organized farmers' associations and cooperatives everywhere. If a yield monitor could be attached to a combine harvester and use of the cooperative facilities could be recorded accurately, it would be easy to observe the variability between fields. This could be the first step of paddy field precision farming, putting one field as a unit for observing the variability, followed by determinations on how to manage the variability. Global monitoring system can be used for observing and managing such regional variability.

On the other hand, environmental pollution associated with paddy farming has become a cause for concern. How to reduce the environmental impact requires the development of a monitoring system and

measures for environmental conservation in the respective fields or locations in the field. As a result, management of within-field variability, aiming at reducing the environmental impact and at maintaining the productivity should be promoted. Sensor-based precision farming in paddy fields is thus required.

Sensing for within/between-variability, VRT machines and DSS algorithms that are the main technology components for precision farming should be developed as early as possible. These tools can also be used for evaluating the variability and for identifying the distinctive characteristics of precision farming in the respective countries.

2) Variability within a field

Temporal and spatial variability of $\text{NO}_3\text{-N}$ in a corn field in a 30.5 m grid sampling was reported by Everett et al. ³⁾, and soil nutrient mapping for short-range variability was also reported by Birrell et al. ¹⁾, but the minimum grid spacing was still 25 m. Grids with a narrower spacing with cells 6.1 m wide and 15.2 m long were used for investigating the temporal and spatial variability of soil parameters, and N recommendation maps were generated ⁴⁾. These grid spacings are still too wide for the small Japanese fields. Sampling using 1 m grids for $\text{NO}_3\text{-N}$ mapping was conducted over a 10 m² area in a small Japanese field and temporal and spatial variability was confirmed ⁵⁾, although the whole field was not observed. Japanese farming is sometimes characterized by crop-stubble management with intensive farm works in a small field, and it is generally considered that there is less variability within a field.

Analysis of the variability is the first step for precision farming. Our studies have focused on within-field variability of nitrate nitrogen ($\text{NO}_3\text{-N}$) in a 0.3 ha field, a typical size in Japan, because $\text{NO}_3\text{-N}$ is water-soluble and infiltrates groundwater easily, and it is also an important parameter of soil fertility.

Figs. 3 to 5 show $\text{NO}_3\text{-N}$ contour maps for 3 study areas within the field⁹⁾. Value levels were classified for every 2 mg/100 g. The whole field at the top 5-15 cm depth, as shown in [Fig. 3](#), showed 4 levels of $\text{NO}_3\text{-N}$ with the predominance of the middle 2 levels. The 1 $\tilde{\text{A}}$ —1 m² area at the top 5-15 cm depth, located in the southern part of the field, exhibited a fairly uniform distribution, as shown in [Fig. 4](#). The 8 $\tilde{\text{A}}$ —8 m² area at the 25-35 cm depth showed 7 levels of the $\text{NO}_3\text{-N}$ and a complicated pattern, as shown in [Fig. 5](#). It was therefore confirmed that the $\text{NO}_3\text{-N}$ distribution varied with the observation scale as well as depth. Implications of the variability for agricultural practices should be further investigated.

NEXT

Management scale (ha)	Positioning for operations	Soil mapping in a field	Yield mapping within a field	Variable-rate control
-1	Empirical determination & intuition	Average for each field	Average for each field	Manual control with a monitor
1- 10	Automatic field-based survey or machine positioning	Variability within a field determined by soil sensors	Variability within a field determined by yield monitor	Operator's skill with monitoring and automated machinery
10 - 50	GPS-oriented + field-based machine positioning	Variability within a field determined by GPS-based sensors + remote sensing	Variability within a field determined by GPS-based monitor + remote sensing	Sensor-based variable-rate control with GPS/GIS
50-	GPS-oriented + field- based machine positioning	Within/regional field variability determined by GPS-oriented sensors + remote sensing	Within/regional field variability determined by GPS-oriented monitor + remote sensing	Sensor-based variable-rate control with GPS/GIS

BACK

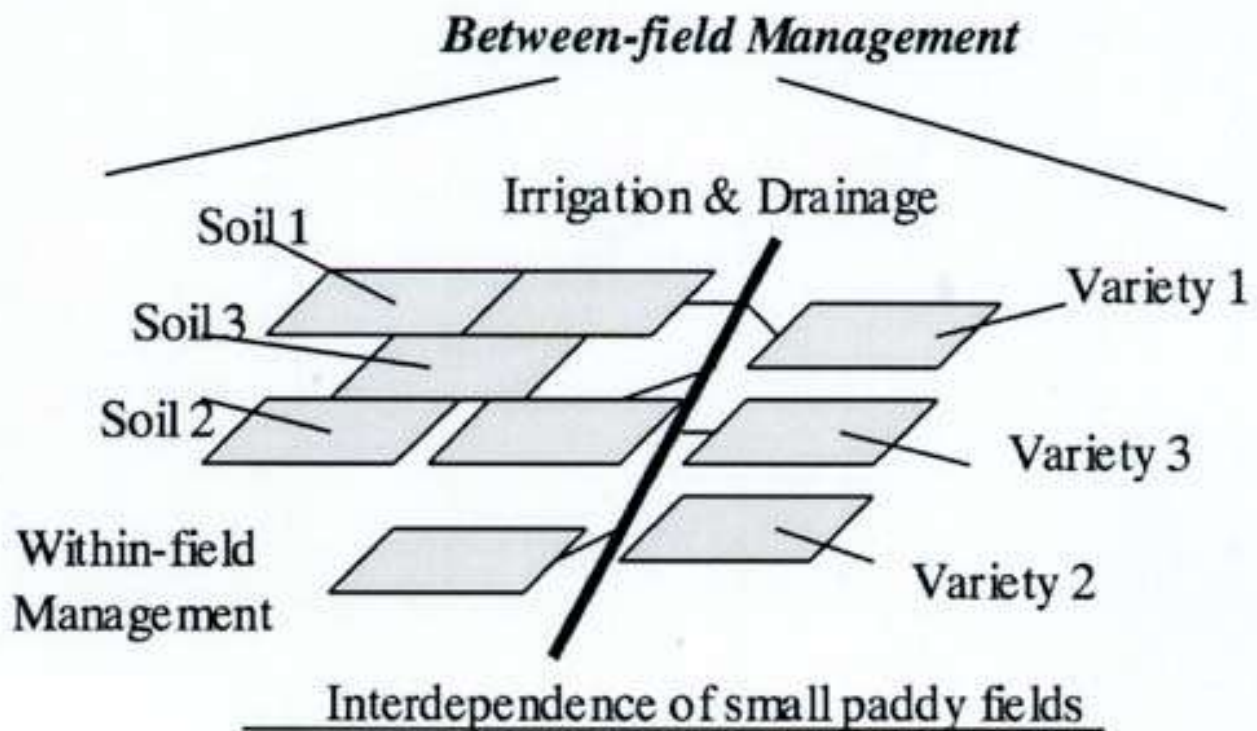


Fig. 2. Paddy farming in relation to variability management

BACK

0.3 ha Field ('96.10.29)

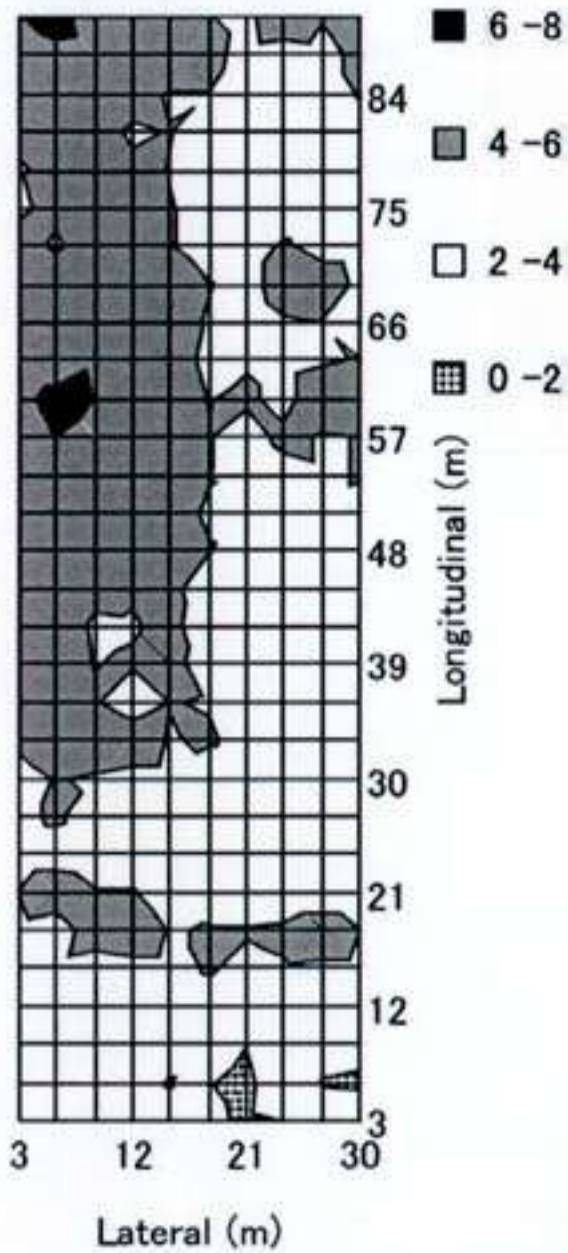


Fig. 3. Map of nitrate nitrogen content at 5-15 cm depth in a 0.3 ha dry land field (3 m grid spacing)

BACK

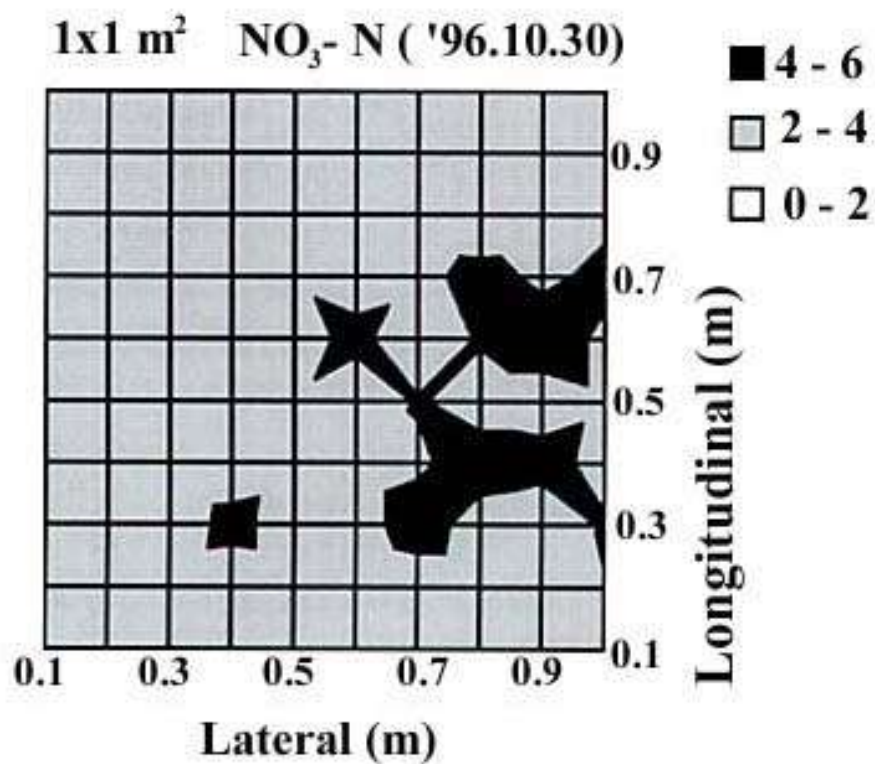


Fig. 4. Map of nitrate nitrogen content at 5-15 cm depth within a 1x1 m² area (0.1 m grid spacing)

BACK

8 x 8m² 25-35 cm depth ('96.10.18)

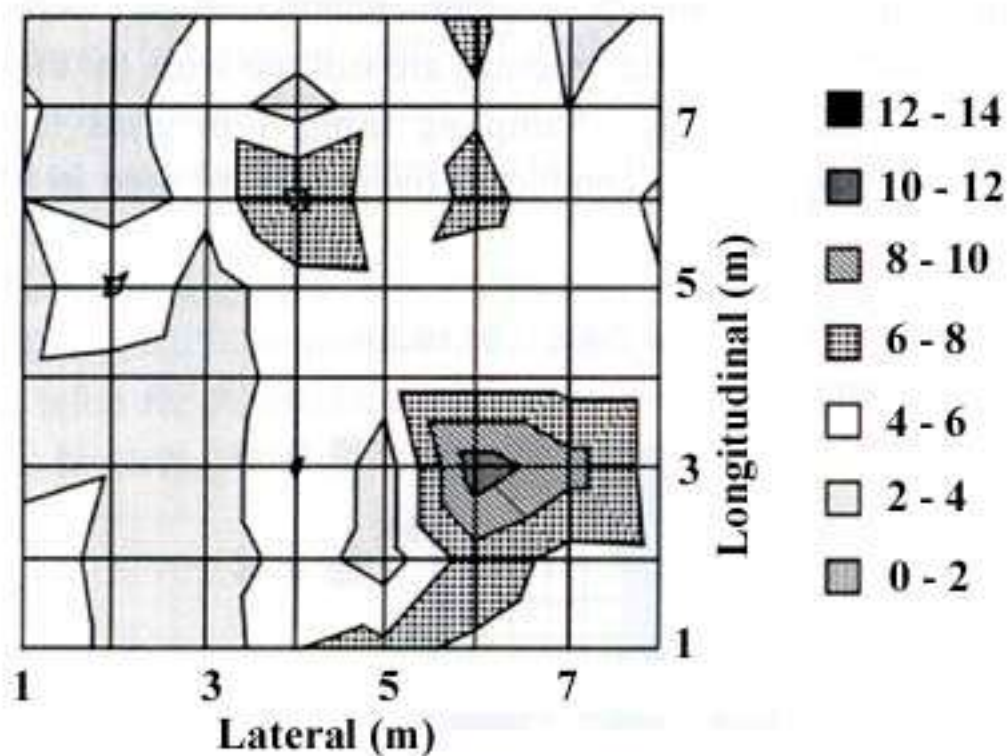


Fig.5. Map of mitrate nitrogen content at 25-35 cm depth with in a 8 x 8² m area (1 m grid spacing)

BACK

3) Spectrophotometer¹⁰⁾

On-line real-time sensing of soil parameters *in situ* has been an important issue for scientists and engineers engaged in precision farming research. Spectroscopic approach is one of the issues for real-time soil sensing because multiple parameters could be evaluated at the same time, since the photometric properties of many soil parameters can be included in a wide range of spectral absorption/reflectance records.

(1) Prototype spectrophotometer

A diagrammatic representation of the spectrophotometer is presented in [Fig. 6](#). It was composed of 3 main parts as follows.

A soil penetration chisel equipped with micro-optical devices operated as a tunnel for continuous space measurement in soil and to collect the light reflected at the same time, as shown in [Fig. 7](#). The optical units consisted of 2 optical fiber probes from a 150 W illumination halogen lamp, visible and NIR optical fiber probes, and CCD camera. The case for the sensor probes, about 600 mm long, 200 mm high and 50 mm thick, was equipped with a shank 700 mm deep, 100 mm wide and 25 mm thick. A micro-NIR thermometer was also installed for the calibration of temperature variations.

A spectrometer with linearly arrayed photo-diodes to detect the spectra of reflected light was used. It can simultaneously measure 256 channel spectra in a range of 400 to 900 nm by using the visible device and 128 channels in 900 to 1,700 nm by using the NIR device.

A control and data logging device of personal computer (233MHz, RAM 128 MB), liquid crystal display and a pulse generator with a free rotating wheel and rotary encoder to trigger timing signals were used. The soil penetrator was attached to a 4WD 18kW tractor with a three-point hitch. All the components were also placed on the tractor.

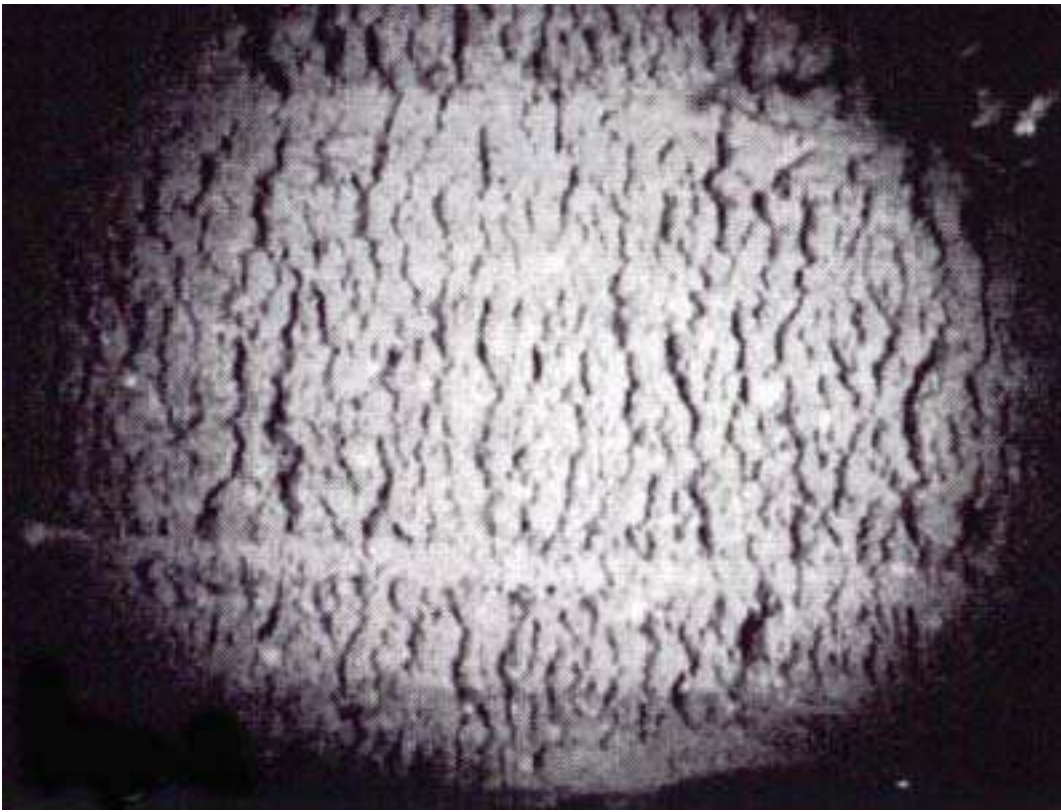


Fig.8. Soil surface image

through the CCD camera

(2) Field test

Test runs were conducted in a clay paddy field after harvesting and in an upland loam field. The paddy field test is briefly introduced below. The instrument for measuring the soil surface was flattened by the blade, as shown in [Fig. 8](#).

A distinct photo-spectrum reflectance was obtained from the underground soil at a 28 cm depth and at a spacing of about 1 m, as shown in [Fig. 9](#). It was confirmed that the correlation coefficients between soil parameters and spectrum reflectance were 0.83 (1,462 nm) for the soil moisture level, 0.78 (1,488 nm) for the pH, 0.80 (1,462 nm) for the electric conductivity (EC), 0.93 (1,538 nm) for the content of soil organic matter (SOM), and 0.44 (1,462 nm) for the content of nitrate nitrogen. Other information can be obtained from the soil spectrum reflectance collected.

Conclusion

In this paper, the concept of precision farming was outlined and studies related to Japanese precision farming (soil mapping and soil sensors) were introduced as follows.

1. Precision farming is characterized by a systems approach and variability management for farming on any scale, aiming at the maintenance of both productivity and environmental conservation. Analysis of the variability is the first step for promoting precision farming.

2. Paddy field precision farming could be initiated for between-field variable management, while technology components should be developed as early as possible.

3. The variability of the soil parameters was demonstrated in a small field in Japan.

4. A real-time on-line portable spectrophotometer was developed for collecting data on underground soil reflectance, which enabled to determine the moisture level, pH, EC and SOM content.

[NEXT](#)[TOP](#)[HOME](#)

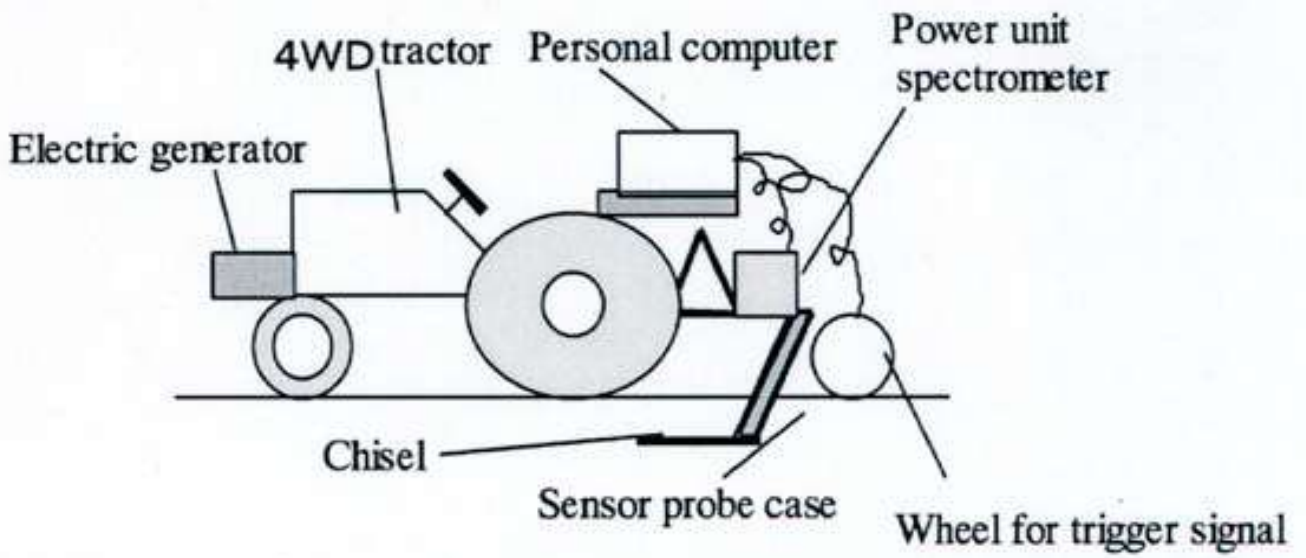


Fig. 6. Portable spectrophotometer system developed for *in-situ* soil sensing

BACK

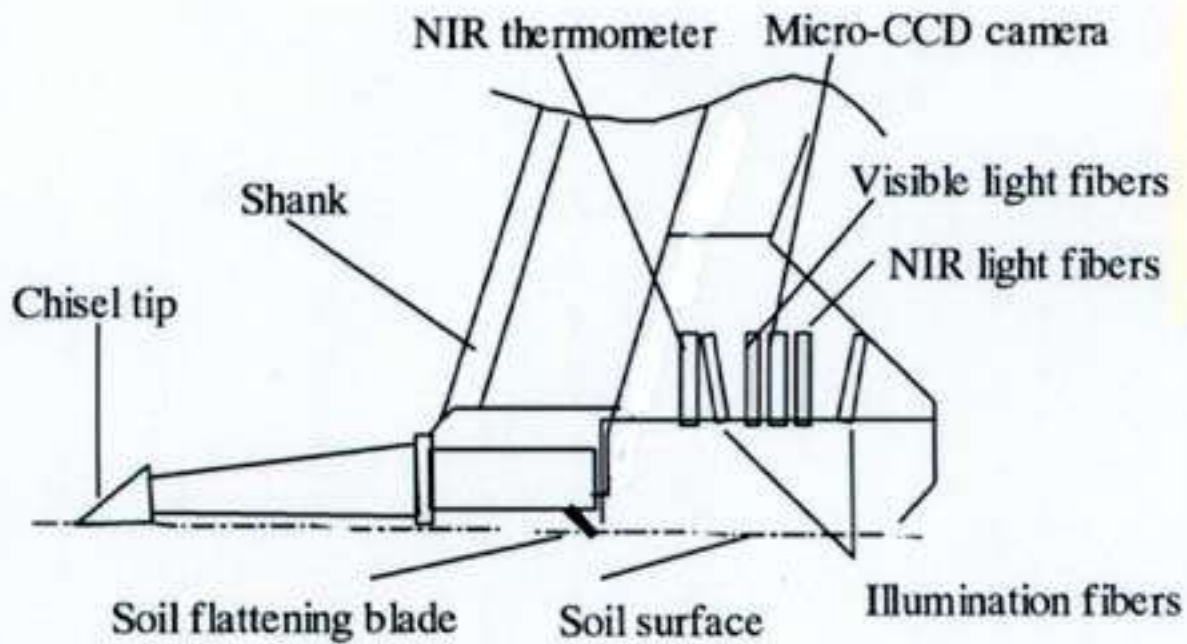


Fig.7. Soil penetrator and optical fiber probes

BACK

IR 1525

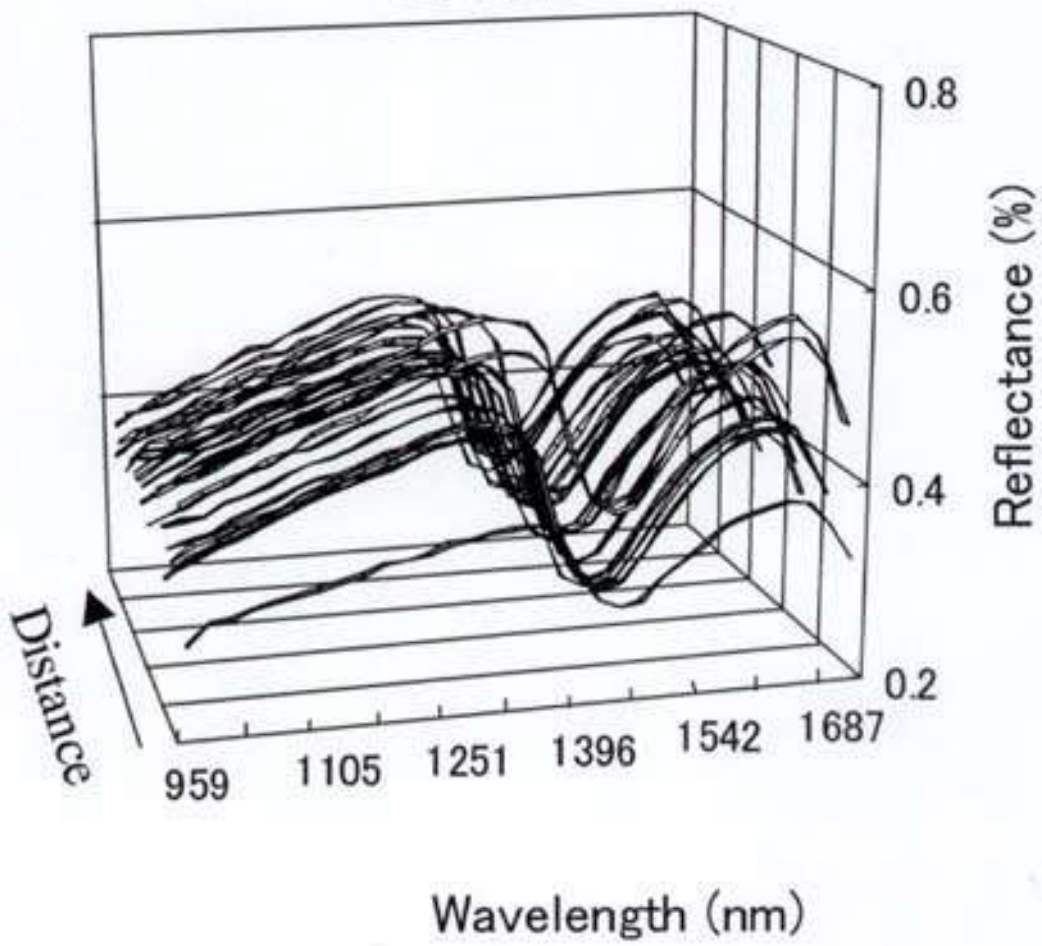


Fig.9. NIR spectral reflectance

BACK

Mechanized Production System for Orchards on Sloping Land in Japan

Masahiro MIYAZAKI*

Department of Hilly Land Agriculture, Shikoku National Agricultural Experiment Station
(Zentsuji, Kagawa, 765-0053 Japan)

Present address:

Department of Tea Agronomy, National Research Institute of Vegetables, Ornamental Plants and Tea
(2769 Kanaya, Haibara, Shizuoka, 428-8501 Japan).

Corresponding author: fax +81-547-46-2169, e-mail miyamasa@tea.affrc.go.jp

Received 15 November 1999, accepted 19 January 2000.

Abstract

In Japan, most of the farm operations in orchards on sloping land in the past had been carried out manually, since no suitable machinery was available. However presently, the problem of aging farmers and shortage of young successors, especially for citrus orchards on steep hillsides must be solved. Therefore, a mechanized production system (MPS) for orchards on sloping land was developed involving the construction of farm paths and the use of machines behind which the operator walks, such as air-blast sprayer, raised bed transporter, and fertilizer spreader. The benefits of MPS were confirmed by comparison with a conventional production system (CPS) in an actual farmer's orchard at Yoshida town, Ehime prefecture, which is one of the leading citrus-production districts in Japan. The use of this system enabled to reduce the total working hours by 35% as well as improve the working conditions without yield decrease and decline of the quality of fruits.

Discipline: Agricultural machinery

Additional key words: Farm path, pest control, transportation, fertilizer application

1...5): [References](#)

Introduction

As in most Asian countries, the area of arable land in Japan is very small. Therefore, hilly areas have been cultivated since ancient times. After World War II, many orchards on sloping land in Southwest Japan were brought under cultivation for satsuma mandarin, the most popular citrus variety with the highest fruit production. Since orchards on sloping land are well-drained, exposed to sunshine and well ventilated, farmers can grow sweet citrus fruits that fetch a high price.

However, the mechanization of such orchards has been lagging behind that of lowlands in Japan because the use of machinery is difficult, and sometimes even dangerous due to the steep gradients and high-density planting. As a result, farmers have tended their orchards by hand, spending long hours stooped over their trees. Statistics showed that the yearly labor requirement for citrus crops per unit area was 4 times higher than that for rice production using a tractor, a rice transplanter, and a head-feeding combine. Moreover, farming in Japan is facing growing problems due to the shortage of efficient farmers associated with the increase of the average age of the farmers and decrease of the number of young

people. Therefore the number of abandoned orchards is increasing.

To address these problems, a mechanized production system (MPS) was developed to reduce hours as well as improve the working conditions in citrus orchards on steep slope. This system involves the construction of farm paths and the use of small walking-type machinery behind which the operator walks.

Construction of farm paths⁵⁾

The mechanization of orchards on sloping land with steep gradients depends on the construction of paths for agricultural machinery. The construction of wide farm roads or paths to allow the passage of large machines is not suitable on steep slopes because the construction costs are high and there is a risk of landslide. Furthermore, the total yield from the orchard decreases because many trees must be cut to make room for the machinery. Instead, a new farm path system was developed for MPS.

The layout of the farm path system is shown in Fig. 1. It includes 2 kinds of paths, a working path which is 1.0 m wide, and a connecting road more than 1.3 m wide. The connecting road acts as a backbone, while working paths are located laterally to the road. To ensure that the machines can travel safely along the paths, the gradient of the connecting road should be less than 15°. The path should have a turning circle where the machines can turn around, with a diameter of 2 m.

The working paths also function as hillside ditches, intercepting run-off water. It is important to pave them, to prevent erosion and to allow machines to travel smoothly. We have developed a low-cost cement aggregate pavement, using soil from the orchards rather than gravel and sand brought in from outside. The cement is mixed with a coagulant powder and water, and hardens into smooth, durable pavement. Such a pavement is easy to construct, and the total cost is comparatively low.



Paved farm path

Construction process of farm paths is carried out as follows (*Fig. 2*):*(1) The path is dug out using a small back hoe. (2) Cement is mixed together with the coagulant and spread over the soil surface. (3) It is mixed together with soil, using a rotary-tiller. (4) Water is sprinkled onto the mixture, using a power sprayer. (5) A rotary-tiller is used to mix all the ingredients thoroughly together, and level out the surface.*

The ratio of soil, cement, and coagulant in the in the pavement materials is 100:13:0.3, respectively. The water is sprinkled at a rate of 20

L/m². Pavement depth is 7 - 10 cm. The farm path is constructed at a rate of 100 m²/h with a team of 5 workers.

It is also important to install a water supply system. Usually a water storage tank is constructed at the lower end of the connecting road, for collecting the water running down the farm paths. The water is used for irrigation, or for mixing pesticide sprays.

NEXT

References

- 1)Miyazaki, M. (1998): Mechanized farming for slopeland orchards â... Japan. *Food Fert. Technol. Center (FFTC), Ext. Bull.*, **452**, 1-8.
- 2)Miyazaki, M. et al. (1999): Improvement of pesticide and fertilizer application works on steep sloping citrus orchards. *Jpn. J. Farm Work Res.*, **34** (2), 85-94 [In Japanese with English summary].
- 3)Miyazaki, M. & Ishizuka, N. (1999): Analyzing the process of selecting an operation system for citrus production by the developed decision support system. *Jpn. J. Farm Work Res.*, **34**(3), 191-201 [In Japanese with English summary].
- 4)Miyazaki, M. et al. (1999): Reducing hours and hardness of works in steep sloping citrus orchards by construction of farm path and a small machinery system. *Jpn. J. Farm Work Res.*, **34**(3), 203-210 [In Japanese with English summary].
- 5)Okazaki, K. et al. (1998): Simple construction technique of orchards path in slope land. *Jpn. J. Farm Work Res.*, **33**(4), 213-219 [In Japanese with English summary].

Fig.2. Construction process of farm path



(1) Digging out using a small back hoe

BACK

Fig.2. Construction process of farm path



(2) Spreading cement and coagulant over the soil surface

BACK

Fig.2. Construction process of farm path



**(3) Mixing together with soil
using a rotary-tiller**

BACK

Fig.2. Construction process of farm path



**(4) Sprinkling water onto the mixture
using a power sprayer**

BACK

Fig.2. Construction process of farm path



(5) Mixing all the ingredients and leveling out the surface

BACK

Development of small machines^{1,2)}

Because the farm paths in orchards on sloping land are steep and narrow, large farm machinery cannot be used. Instead, we designed specialized small machines with the following basic specifications; (1) Use of crawler treads, rather than wheels. (2) The operator does not ride on the machine, but walks behind it. (3) The machine has a very small turning circle.

1) Mechanization of pest control

In fruit culture, chemical sprays are necessary for pest control. In Japan, they need to be applied about 10 times per year. At present, power sprayers with long hoses are widely used, but they require a long amount of labor. Farmers need a kind of sprayer with a lower labor requirement and higher efficiency.

Therefore, we designed an air-blast sprayer ([Fig. 3](#)). The operator walks behind the sprayer along a farm path. The sprayer is equipped with an axial fan, and emits a fine and dense chemical mist. The operator can direct the spray precisely onto the target by controlling the direction of a fan drum, that can be adjusted freely between 35° upward and 20° downward. Air turbulence associated with the fan drum swinging automatically shakes the leaves of trees, so that chemical spray adheres to both sides of the leaves.

This sprayer is equipped with a liquid chemical tank with a capacity of 300 L. It can apply pesticides at a rate of 3,000 to 5,000 L/ha with a working efficiency of 0.15 ha/h. Since the machine is operated by only one operator without any co-workers, the application can be conducted at suitable times for fruit trees.

2) Mechanized transportation

At present, the transportation of loads involving a container for harvested fruits and a bag of fertilizer weighing 20 kg has been conducted manually with a high labor intensity. However, a transporter with crawler treads could be used to carry heavy loads. With a good network of farm paths, the use of such a transporter may lead to a significant improvement in efficiency and comfort of farm work.

The transporter we developed has an adjustable elevated bed measuring 45 to 118 cm, with outriggers to give stability ([Fig. 4](#)). Its loading capacity is suitable for 10 containers (a 20kg load). By raising the bed, it is possible to reduce the labor required for loading harvested fruits from the transporter to a truck. In addition, the raised bed can be used as a platform for the farmer who carries out operations in the tree canopy, such as pruning, thinning and harvesting.

3) Mechanized fertilizer application

The application of fertilizer 3 times each year (in spring, summer, autumn) does not require many working hours for fruit production in Japan, but the work of spreading fertilizer over an orchard is rather hard.

We developed a fertilizer unit mounted on the bed of the transporter ([Fig. 5](#)). The capacity of the hopper of the fertilizer is about 100 L. Granular or pellet type fertilizer metered through an auger attached to the bottom of the hopper is led to a discharge pipe, and blown out with air from a centrifugal fan. Mounting and unmounting the unit on the bed of the transporter are easy operations, because of the transporter's hydraulic lift system.

Fertilizer can be applied in a band up to 4.6 m wide, at a rate of 14 - 25 kg/min. Fertilizer can be applied at a rate of 1.0 to 1.5 t/ha with a working efficiency of 0.45 ha/h.

[NEXT](#)

[TOP](#)

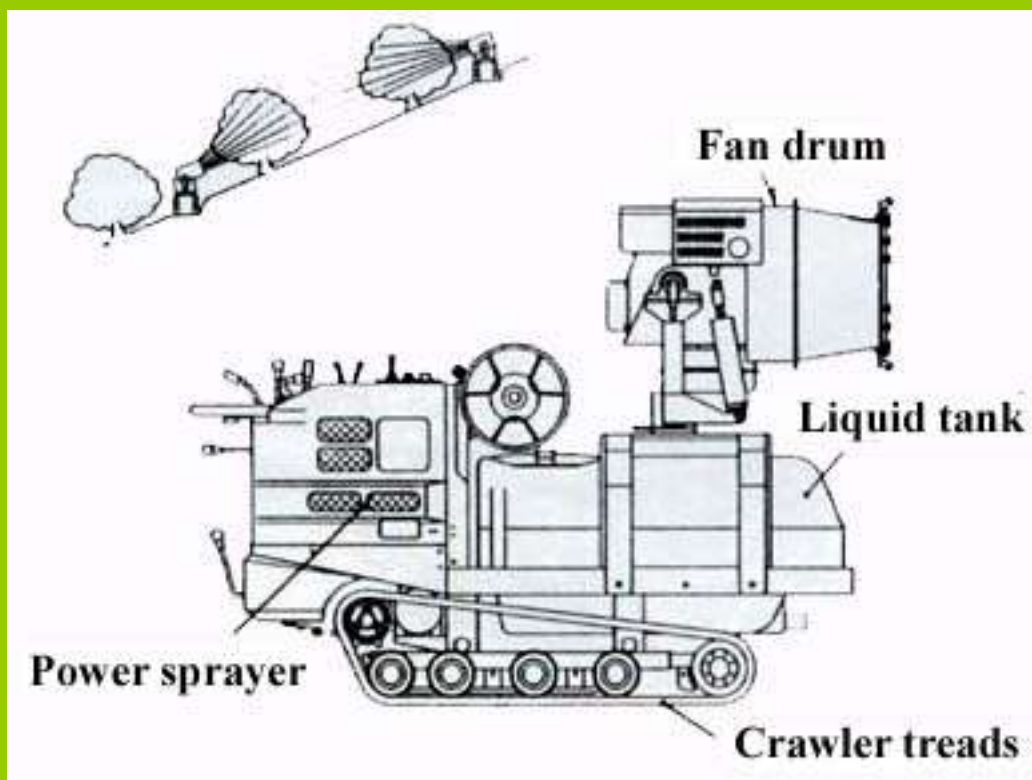
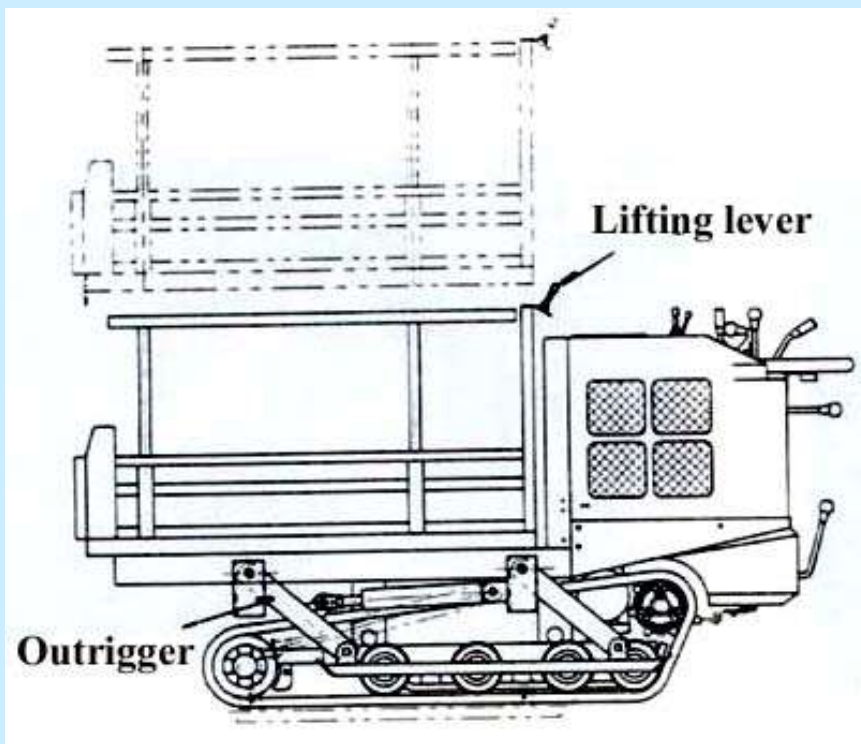


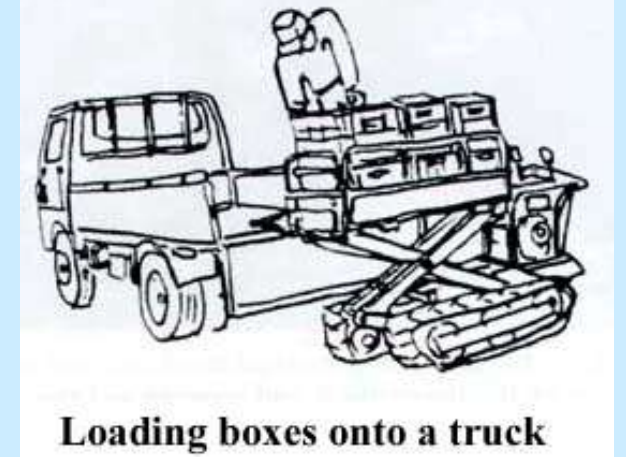
Fig. 3. Walking-type air-blast sprayer

**Length: 2,600 mm, Height: 1,410 mm,
Width: 960 mm, Weight: 510kg,
Spray capacity: 13-27 L/min,
Air flow rate: 180 m³/min.**

BACK



Oprations in the tree canopy



Loading boxes onto a truck

Fig. 4. Walking-type raised bed transporter

Length: 2,090 mm, Height: 1,080 mm,
 Width: 1,110 mm, Weight: 530 kg,
 Lifting height: 1,180 mm, Loading capacity: 500 kg.

BACK

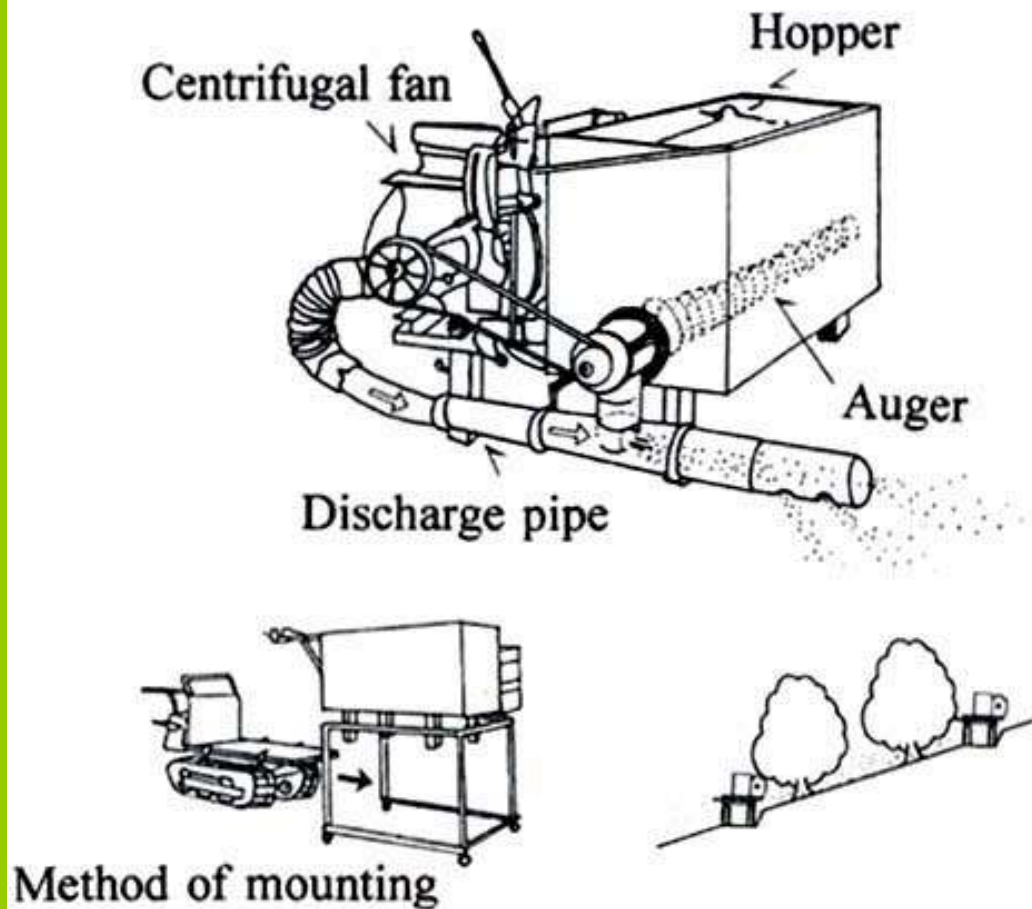


Fig.5. Fertilizer unit mounted on transporter

Length: 1,930 mm, Height: 1,350 mm,

Width: 900 mm, Weight: 355 kg,

Discharge capacity: 14-25 kg/min,

Air flow rate: 11m³/min.

BACK

Advantages of mechanized production system^{3,4)}

1) Methods

To confirm the advantages of MPS, we set up a model orchard in an actual farmer's orchard with a mean slope gradient of 25°, at Yoshida town, Ehime Prefecture. The model orchard was improved by adopting the developed farm path system from 1994 to 1995. The working path was placed at an interval of every 2 tree rows, with a path density of 1.2 km/ha. The rate of removed trees for the construction of the farm path was only 8%.

Field experiments were conducted to determine the labor intensity of each operation and the yearly working hours by comparison with a conventional production system (CPS) for 2 years. The labor intensity level of each operation was classified based on the increase of worker's heart rate. [Fig. 6](#) shows the difference between MPS and CPS for pest control, transportation of harvested fruits, and methods of fertilizer application. The other operations such as pruning, thinning, and mowing were also improved. Investigations of yield and selling price for the model orchard were performed to evaluate the productivity compared with the area average.

2) Labor intensity and working hours

[Table 1](#) shows the labor intensity and yearly working hours for MPS and CPS. The labor intensity required for pest control, fertilizer application, harvesting in the case of MPS was obviously reduced by the use of small machines. In addition, the labor intensity for mowing weeds using a bush cutter was also reduced because the worker could perform the operation on the working path and not on a slope. As a result, the labor intensity of the operations was reduced to less than the average level.

The working hours of each operation in the case of MPS were also reduced, and the application of fertilizer using the fertilizer spreader was more uniform than that with the hand-spreader. Especially the transporter in the case of MPS led to a significant reduction of the labor required for the transport of fruits during harvest so that the output of harvested fruits per worker could be increased. Tests showed a 38% reduction in the working hours required for harvesting. As a result, the yearly working hours were reduced by 35%.

3) Effect of introduction of MPS on citrus production

[Table 2](#) shows the yield and selling price of fruits in the model orchard where farm paths were constructed from 1994 to 1995. The yield and selling price of citrus fruits varied with the years because fruit-bearing occurred in alternate years. Compared to the area average, the yield in 1994 and 1995 was slightly higher than in case of thinning of citrus trees. The yield after the introduction of MPS was more than 150% higher, indicating that the improvement of orchards by this system did not cause a yield reduction in spite of some thinning of citrus trees.

The selling price also was higher than that of the area average. Considering that this district is one of the leading citrus production centers in Japan, MPS enabled to produce high-quality citrus fruits. In addition, the owner who introduced MPS stated that this system enabled to reduce the labor intensity and working hours and also to enhance the quality of fruits due to the improvement of the light conditions in lower and inner portions of the tree canopy.

Conclusion

In citrus orchards on sloping land, the shortage of labor has become a serious problem in Japan. Therefore, we developed a mechanized production system (MPS) involving the construction of farm paths, and the use of small machines behind which the operator walks, including an air-blast sprayer, raised bed transporter, and fertilizer spreader.

The advantages of MPS were tested in an actual farmer's orchard by comparing it with the conventional production system (CPS). The tests showed that the MPS enabled to reduce yearly working hours by 35% as well as improve the working conditions without a decline of the quality of fruits and yield. These results indicate that the introduction of this system enabled farmers to avoid hard manual labor required for the maintenance of orchards on sloping land and extended the scale of farm operations. Consequently, the MPS for orchards on sloping land should contribute to the development of stable orchard management.

[NEXT](#)

[TOP](#)

[HOME](#)

Fig. 6. Pest control, transportation, and fertilizer application in MPS and CPS

Pest control



Transportation of harvest fruits



Spreading fertilizer



Mechanized production system (MPS)

Conventional production system (CPS)

BACK

Table 1

Table 1. Labor intensity and working hours in MPS and CPS

Work	Mechanized production system (MPS)			Conventional production system (CPS)			Rate of working hours MPS/CPS (%)
	Method	Labor intensity ^{a)}	Working hours (h/ha)	Method	Labor intensity ^{a)}	Working hours (h/ha)	
Pruning	Manualwork	Moderate	81 ^{b)}	Manualwork	Moderate	140	58
Fertilizer application	Fertilizer unit	Moderate ^{b)}	22	Hand-spread	Hard	20	110
Mowing	Bush cutter	Moderate ^{b)}	83 ^{b)}	Bush cutter	Hard	115	72
Pest control	Air-blast sprayer	Moderate ^{b)}	84 ^{b)}	Power-sprayer	Hard	159	53
Tinning	Manualwork	Light	313 ^{b)}	Manualwork	Light	442	71
Harvesting	Transporter	Light ^{b)}	258 ^{b)}	Hand-carry	Moderate	414	62
Total			841 ^{b)}			1,290	65

a): Labor intensity level is classified based on the increase of worker's heart rate. Light: 0-30%, Moderate: 30-50%, Hard: 50-90%.

b): Effects of MPS.

BACK

Table 2

Table 2. Yield and selling price of citrus fruits in model orchard compared with area average

Year	Yield			Price ^{c)}		
	Model orchard (M t/ha)	Area average ^{a)} (A t/ha)	Rate of yield (M/A %)	Model orchard (M yen/kg)	Area average ^{a)} (A yen/kg)	Rate of price (M/A %)
1994 ^{b)}	20.6	19.5	105	233	207	113
1995 ^{b)}	30.1	22.3	135	153	152	101
1996	26.3	17.3	152	272	241	113
1997	45.7	28.9	158	70	50	140

a): Area around model orchard at Yoshida town site.

b): Model orchard was improved by the construction of farm paths for MPS from 1994 to 1995.

c): Yen rate, about 0.01 US\$.

BACK

Evaluation of Structural Characteristics of Naturally Ventilated Multi-Span Greenhouses Using Computer Simulation

In-Bok LEE^{1*}, H. SHORT², Sadanori SASE¹, Limi OKUSHIMA¹, and Guo Yu QIU¹

¹ Department of Land Improvement, National Research Institute of Agricultural Engineering (Tsukuba, Ibaraki, 305-8609 Japan)

² Department of Food, Agricultural, and Biological Engineering, The Ohio State University/Ohio Agricultural Research and Development Center (Wooster, OH44691, U.S.A.)

*Corresponding author: fax +81-298-38-7609, e-mail ilee@nkk.affrc.go.jp

Received 27 October 1999, accepted 2 March 2000

Abstract

Natural ventilation system modifications were evaluated using a computational fluid dynamics (CFD) numerical model (code: Fluent Version 4.5). Wind speed and direction, side vent opening size and location, roof vent opening type, and number of spans were examined in terms of ventilation rates and airflow distribution. For the side vent located at 2.5 m above the floor with a west wind of 2.5 m/s, 59 % of the incoming air through the side vent was predicted to move out through the first roof vent opening without reaching distant areas in the greenhouse, resulting in high inside air temperatures. The air mainly moved in through the side vent and fourth roof vent openings for an east wind of 0.5 m/s while the third and fourth roof openings were the only predicted inlets of airflow for an east wind of 2.5 m/s. The hinged open roof multi-span greenhouses were predicted to have significantly higher natural ventilation rates than the double polyethylene-covered multi-span greenhouses for all the spans in the absence of side vent.

Discipline: Agricultural facilities

Additional key words: computational fluid dynamics

1...10): [References](#)

Introduction

While mechanical ventilation systems are still widely used throughout the industry presently, high energy costs associated with market-driven production methods have forced growers to consider alternative means of ventilating their greenhouses in order to remain competitive. While natural ventilation systems can be very difficult to design properly, increased emphasis is being placed on such systems for greenhouses as they generally require less electrical energy, less equipment operation and maintenance, and are much quieter than fan ventilation systems.

A common goal of ventilation system designs for greenhouses during hot summer weather is to keep the inside air temperature as close as possible to the outside air temperature. For natural ventilation, this objective is generally achieved by using high air exchange rates, evaporative cooling systems such as

fogging, evaporative cooling from plants, and some forms of shading systems. Natural ventilation is achieved by air exchanges through multiple openings due to natural pressure variations inside and outside the greenhouse. Wind is the primary driving force making natural ventilation systems very difficult to design properly because of variations in the wind velocity and direction. The optimization of these systems for suitable climate control requires a thorough knowledge of the airflow rates and patterns in relation to weather conditions and greenhouse structural characteristics⁶⁾.

A successful numerical model was assumed to be an ideal tool to analyze the complex phenomena of natural airflow and help designers choose optimum designs. There was a particular interest in computational fluid dynamics (CFD) numerical techniques to analyze the air distribution in agricultural structures as well as air quality and thermal conditions⁶⁾.

The objective of this study was to evaluate the consequences of various modifications of natural ventilation systems by using a computational fluid dynamics (CFD) numerical model (code: Fluent Version 4.5)²⁾. The studies focused on the effects of wind speed and direction, side vent opening size and location, roof vent opening type, and number of spans on ventilation rates and airflow distribution inside and outside multi-span greenhouses.

Woodruff¹⁰⁾, Kacira et al.⁴⁾, and Lee⁶⁾ studied various naturally and mechanically ventilated greenhouse types by using a CFD numerical model. They mainly investigated the effects of weather conditions, greenhouse structural specifications, internal and external shading screens, number of greenhouse spans, and presence of plants and benches on the air exchange rates in greenhouses.

Lee⁶⁾ simulated the natural ventilation of a 2-dimensional four and one-half-span greenhouse in a CFD numerical model and compared it to a control volume energy balance model. Assuming the results of the control volume energy balance model as the standard, the results of the steady state CFD model during a sunny day showed errors (negative values) as high as 15 % in the morning and comparable errors (positive values) in the afternoon. Such errors were assumed to be due to heat storage in the floor, benches, and greenhouse structure and the CFD model was found to be the most reliable.

Lee⁷⁾ numerically analyzed the temperature distribution in a naturally ventilated multi-span greenhouse with plants by a CFD simulation program using the standard k- ϵ turbulence model. The computed CFD results of air temperature distribution showed a maximum error of $\hat{A}\pm 3.2$ % for west and east winds compared to air temperatures measured in the greenhouse for the same boundary conditions. The measured air temperature distribution showed that the air came into the greenhouse through the leeward side vent opening for low wind speed.

NEXT

References

1. Bennet, C. O. & Myers, J. E. (1995): Momentum, heat, and mass transfer. McGraw-Hill Inc., New York, U.S.A.
2. Fluent Inc. (1998): The manual of Computational Fluid Dynamics (CFD), Version 4.5, Lebanon, NH 03766, U.S.A.
3. Hinze, J. O. (1975): Turbulence, Second edition. McGraw-Hill Inc., New York, U.S.A.
4. Kacira, M. et al. (1998): A CFD evaluation of naturally ventilated, multi-span, sawtooth greenhouses. *Trans. of the ASAE*, **41**,833-836.
5. Launder, B. E. & Spalding, D. B. (1974): The numerical computation of turbulent flows. *Comput. Methods in Appl. Mech. and Eng.*, **3**, 269-289.
6. Lee, In-Bok (1998): Fluid dynamic simulation and validation of a naturally ventilated multispan greenhouse. Ph.D. Thesis. Department of Food, Agricultural, and Biological Engineering, The Ohio State University, Ohio, U.S.A.
7. Lee, In-Bok & Short, T. H. (2000): Verification of computational fluid dynamic temperature simulations in a full scale naturally ventilated greenhouse. *Trans. of the ASAE*, in press.
8. Monteith, J. L. & Unsworth, M. H. (1990): Principles of environmental physics. Routledge, Chapman and Hall, Inc., New York, U.S.A.
9. Oke, T. R. (1991): Boundary layer climates, 2nd ed. Routledge, Chapman and Hall, Inc., New York, U.S.A.
10. Woodruff, V. I. (1997): Analysis of vent designs for naturally ventilated gutter connected greenhouses. M. S. thesis. Department of Food, Agricultural and Biological Engineering, The Ohio State University, Ohio, U.S.A.

Materials and methods

1) CFD numerical model

The CFD technique numerically solved the Reynolds-averaged form of the Navier-Stokes equations^{2,5)} within each cell in the domain. The equations were discretized on a curvilinear grid to enable computations in complex and irregular geometries. The Reynolds-averaged process considered the instantaneous fluid velocity to be the sum of a mean and a fluctuating component of turbulence^{1,3)}. Since the high-frequency and small-scale fluctuations of turbulent flow could not be directly quantified, turbulence numerical modeling related some or all of the turbulent velocity fluctuations to the mean flow quantities and their gradients.

The standard k- ϵ turbulence model was used in this study because the results were found to be most typical to known ventilation flows^{2,4,5,10)}. The k- ϵ turbulence model was an eddy-viscosity model in which the Reynolds stresses were assumed to be proportional to the mean velocity gradients, with the constant of proportionality being the turbulent eddy viscosity. The turbulent viscosity was obtained by assuming that it was proportional to the product of a turbulent velocity scale and length scale. In the k- ϵ model, these velocity and length scales were obtained from 2 parameters ; the turbulent kinetic energy (k) and the dissipation rate of k (ϵ).

Close to solid walls, there were boundary layer regions where the local Reynolds number was so small that viscous effects predominated over turbulent effects²⁾. To account for this effect and for the large gradients of variables near the wall, the wall function method of Launder and Spalding⁵⁾ was used in the CFD model. Wall functions, when used in conjunction with the standard k- ϵ equations, were intended to reproduce the logarithmic velocity profile of a turbulent boundary layer near the wall.

Fluent V4.5 was a two-part package consisting of a preprocessor, Geomesh, and a main module, Fluent/UNS2). Geomesh was used to create geometry and generate structural grids, and the triangular grids were developed to efficiently model the complex geometries of greenhouse structures. Fluent/UNS was used to specify physical models, boundary conditions, and fluid properties in the computational domain. The inlet air flow was assumed to be incompressible, vertically uniform in speed, and all the computations were performed assuming steady-state conditions.

The Boussinesq model^{2, 5)} was activated for the buoyancy effect in the computational domain. Thermal boundary conditions were defined at all the fluid inlets and at all the wall/fluid interfaces in the CFD computational domain. At the fluid inlet, the air temperature, air velocity, air velocity direction, atmospheric pressure, gravitational acceleration, turbulence intensity, and characteristic length were specified. The thermal conditions of density, specific heat, viscosity, and thermal conductivity were also specified for the fluid inlets. For the walls, several thermal boundary conditions were specified such as surface temperature, emissivity of the wall, and conductive heat transfer coefficient.

2) Experimental procedures

A simulated four-span, double polyethylene greenhouse (a) and a hinged open roof single-layered glass greenhouse (b) were designed with a side vent and roof vents ([Fig. 1](#)). The four-span greenhouse was

slightly modified from a four and one-half-span, double polyethylene greenhouse at Quailcrest farm located near Wooster, Ohio⁶). The glass greenhouse was assumed to have a similar gutter configuration to that of the double polyethylene greenhouse. It was assumed to be a peaked-roof house with hinged roof panels that opened and closed via rack-and-pinion drives. For convenience, the spans between gutters were called the first, second, third, and fourth spans from west to east.

Weather data were collected on hot summer (35th,f) days for westerly and easterly winds from June 1 to August 30, 1997 near Wooster, Ohio (40th47'N, 81th55'W, elevation 310 m), and generalized for the CFD model inputs shown in [Table 1](#). The input data sets were based on 4 averaged values for 4 min when the weather conditions such as wind speed, wind direction, and solar radiation were stable⁶). Air density, viscosity, specific heat, thermal conductivity, and emissivity of various materials were calculated from the table of thermophysical properties^{8, 9}). In the 2-dimensional CFD models, no end wall effects were assumed because the input data used in this study were collected when the wind direction was generally perpendicular to the vent openings.

In this study, the 2-dimensional CFD models were developed to investigate the effects of side vent location, side vent opening size, roof vent opening type, number of spans, wind speed, and wind direction on the natural ventilation of multi-span greenhouses without plants and benches. The CFD-computed results of volumetric air change rate per minute (A.C./min), vent opening efficiency, and airflow distribution were compared according to greenhouse structural specifications and weather boundary conditions. The visual representation of the airflow distribution in the greenhouse was obtained via vectors with the CFD model.

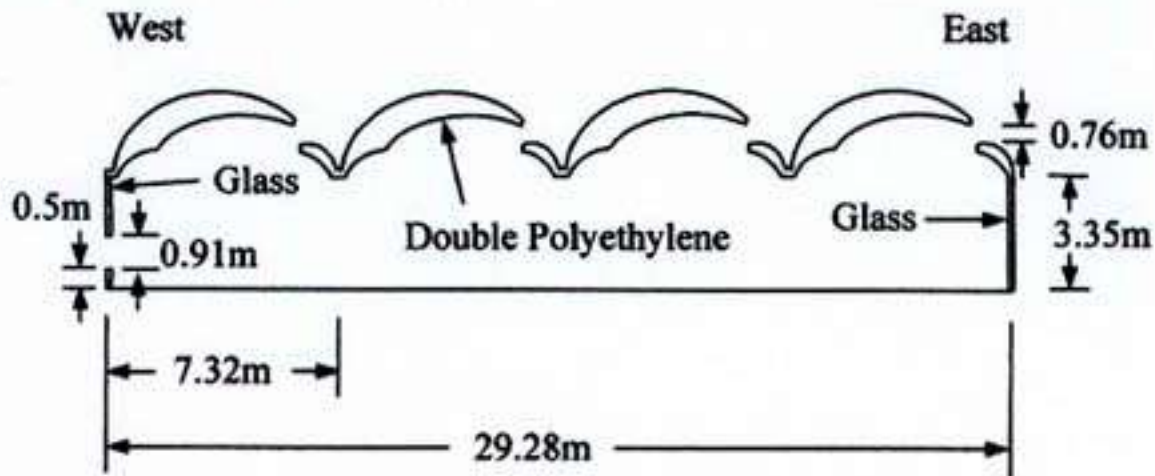
Side vent placement was very important to prevent plant damage and yet avoid short-circuiting of airflow out through an adjacent roof vent. The effect of the west side vent location on the natural ventilation of a four-span double polyethylene-covered greenhouse was investigated for west and east winds of 0.5, 1.0, and 2.5 m/s when the vertical roof and side vent opening sizes were 0.76 and 0.9 m in height, respectively. The distance between the bottom of the west side vent opening and floor varied from 0.5 to 2.5 m.

The 2-dimensional CFD models were developed to investigate the effect of the vertical opening size of the west side vent on the natural ventilation of the greenhouse with west and east winds. All the vertical roof vent openings were 0.76 m wide and the distance between the bottom of the west side vent and floor was 0.5 m. The vertical opening size of the west side vent varied from 0.9 to 2.7 m.

The effects of the roof vent opening type and number of greenhouse spans on natural ventilation rates of multi-span greenhouses were investigated. The predicted natural ventilation rates of the double polyethylene greenhouse ([Fig. 1\(a\)](#)) and hinged open roof greenhouse ([Fig. 1\(b\)](#)) were compared to each other. The average wind speed of 2.5 m/s was assumed based on a statistical analysis of the weather data conducted in Ohio from 1991 to 1995¹⁰). The distance between the bottom of the west side vent and floor was 0.5 m for all cases. The vertical roof vent opening sizes of the double polyethylene greenhouse were 0.76 m in height while the horizontal roof vent opening sizes of the glass greenhouse were 6.2 m.

NEXT

(a) Double polyethylene-covered greenhouse



(b) Hinged open roof glass greenhouse

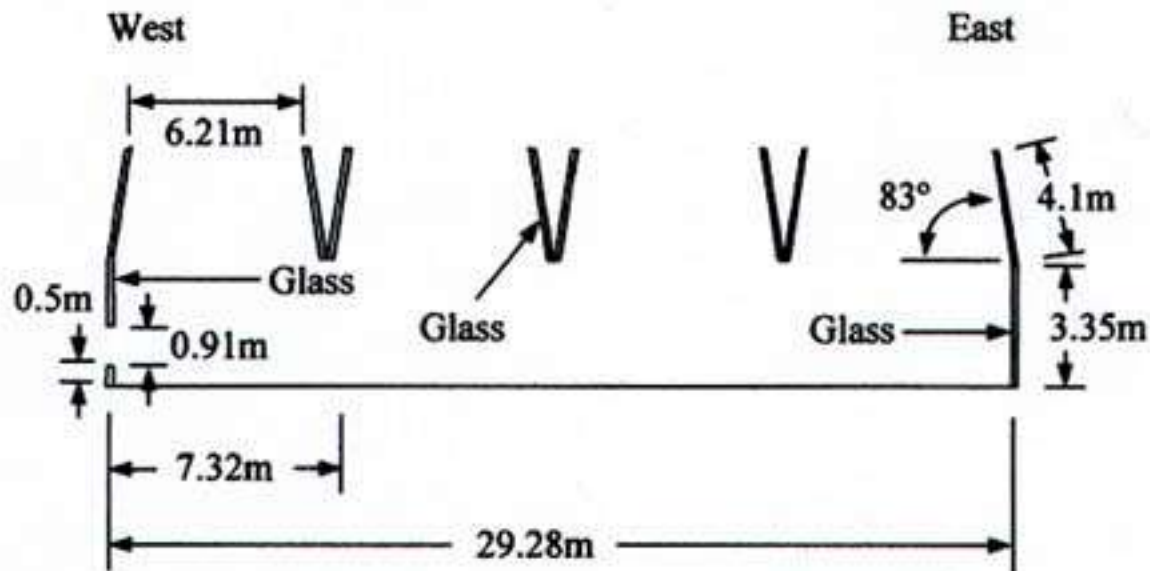


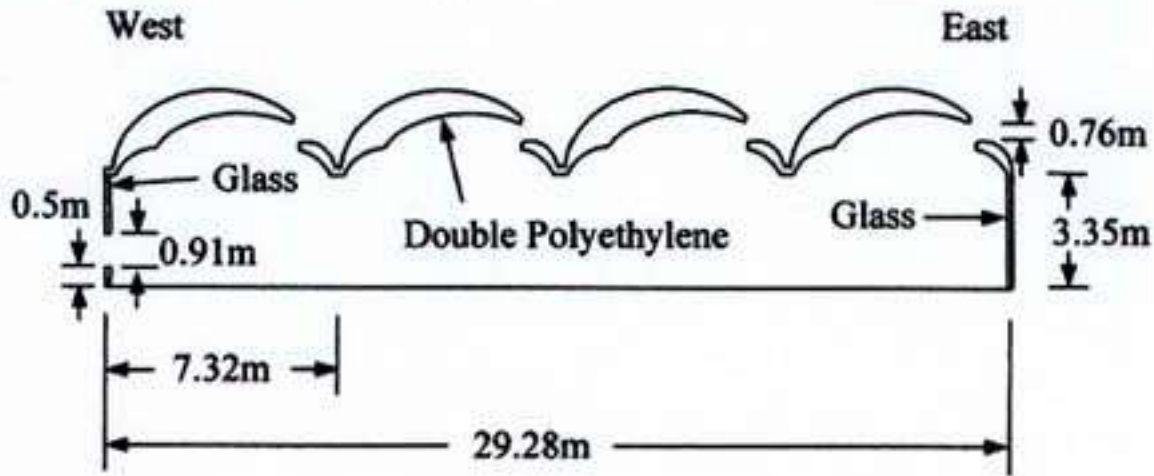
Fig. 1. Sketches of the four-span double polyethylene-covered greenhouse (a) and hinged open roof greenhouse (b) when the vertical west side vent opening size was 0.9 m in height

Table 1. Constant main input values for the 2-dimensional CFD model

Factor	Value
Wind direction	West (left to right) East (right to left)
Roof cover temperature	40°C
Side wall temperature	40°C
Inside ground temperature	43°C
Outside ground temperature	40°C
Sky temperature	32°C
Temperature of inlet (outside) air	32°C
Density of inlet air	1.1448 kg/m ³
Viscosity of inlet air	1.97E-05 kg/m·s
Thermal conductivity of inlet air	0.0267 W/m·°C
Specific heat of inlet air	1007.2 J/kg·°C
Thermal expansion coefficient	0.0033 L/°C
Thermal conductivity of double polyethylene	4.0 W/m·°C
Thermal conductivity of single glass	6.3 W/m·°C
Turbulence intensity	5%
Turbulence length of greenhouse	3.5 m
Gravitational acceleration of inlet air	9.81 m/s ²
Atmospheric pressure	101,324 Pa
Sky emissivity	0.90
Cover emissivity	0.93
Glass emissivity	0.90
Outside ground emissivity	0.95
Inside ground emissivity	0.90

BACK

(a) Double polyethylene-covered greenhouse



(b) Hinged open roof glass greenhouse

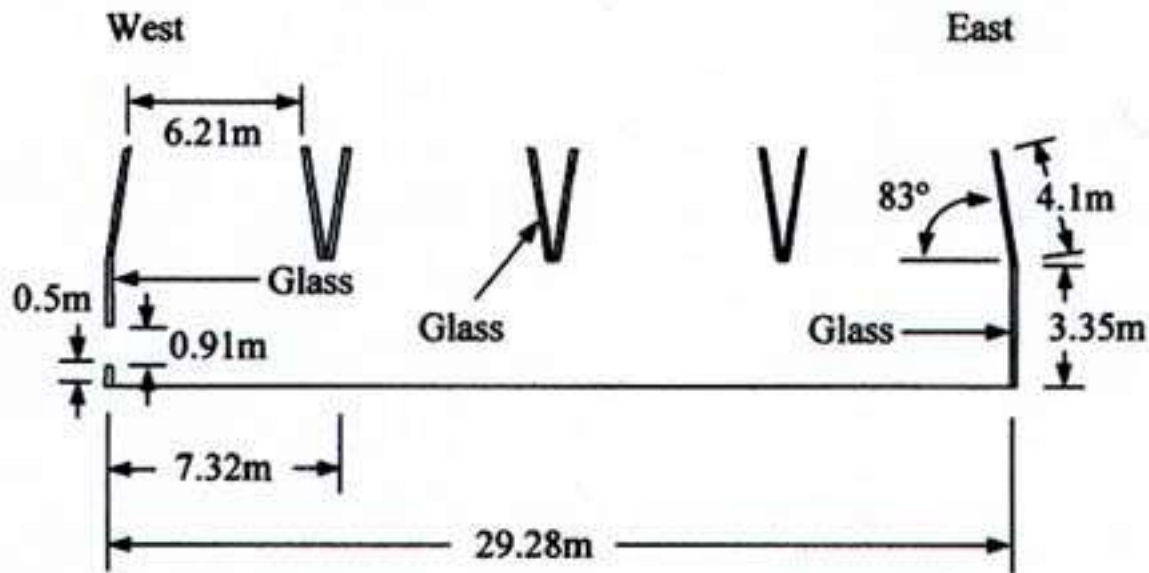


Fig. 1. Sketches of the four-span double polyethylene-covered greenhouse (a) and hinged open roof greenhouse (b) when the vertical west side vent opening size was 0.9 m in height

Results and discussion

1) Effect of side vent location on natural ventilation

[Fig.2](#) shows the predicted effects of side vent location, wind speed, and wind direction on the natural ventilation rates in a double polyethylene-covered four-span greenhouse when the vertical side vent and roof vent opening sizes were 0.9 and 0.76 m, respectively. The CFD-computed results showed that the west side vent location exerted the most pronounced effect on the total ventilation rate for a west wind where the rates were reduced by approximately 20, 16, and 14 % for winds of 2.5, 1.0, and 0.5 m/s, respectively when the west side vent was moved from the lowest to highest position. The results indicated that the lowest side vent location (0.5 m above floor) gave the highest natural ventilation rate for both wind directions and the west wind led to an average of 11 % higher natural ventilation rate than the east wind. An east wind of 0.5 m/s, however, showed a 17 % higher natural ventilation rate than a west wind of 0.5 m/s while a west wind of 2.5 m/s showed a 20 % higher natural ventilation rate than an east wind of 2.5 m/s. With low east wind speed, the combination of buoyancy and wind effects exerted a positive pressure on the fourth roof vent and the west side vent openings. This resulted in both vent openings being inlets and a greater natural ventilation rate than in the case of a west wind with the same speed.

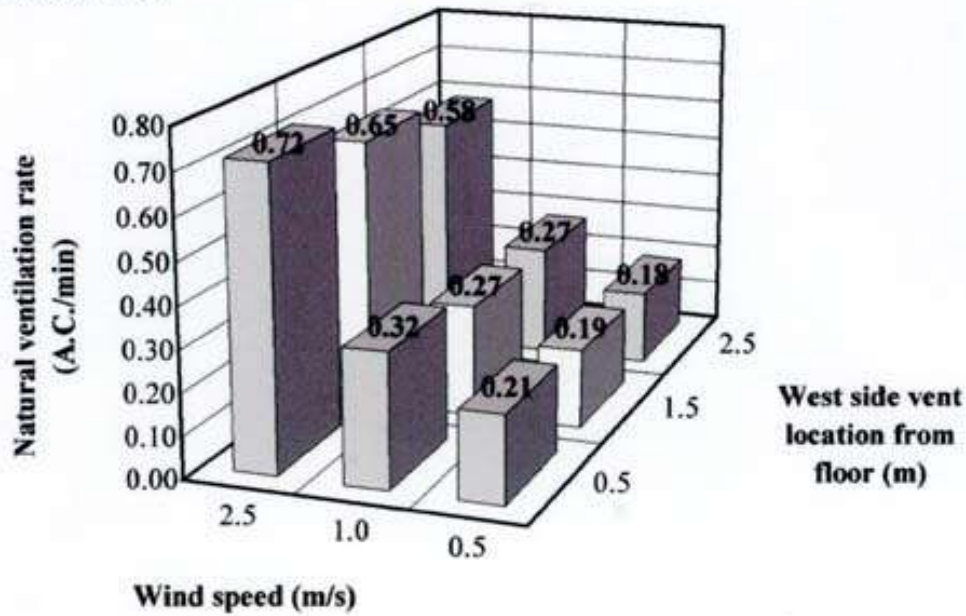
The CFD-computed results in [Table 2](#) showed that the side vent was a very active vent opening as either an inlet or outlet depending on both wind speed and direction. The air mainly moved in through the side vent and fourth roof vent openings for an east wind of 0.5 and 1.0 m/s while the third and fourth roof openings were the only predicted inlets of airflow for an east wind of 2.5 m/s. When the bottom of the side vent was located at 0.5, 1.5, and 2.5 m above the floor, the percentages of airflow through the side vent as an inlet were 70, 44, and 37 %, respectively for an east wind of 0.5 m/s while 57, 44, and 42 %, respectively as an outlet for an east wind of 2.5 m/s. It indicated that the side vent was likely to become a more active vent opening as the side vent location was lower.

For a west wind, as shown in Table 2, the incoming air was predicted to enter the side vent and the first roof vent openings and to move out at all the other roof vents when the bottom of the side vent was located at 0.5 and 1.5 m above the floor. The incoming air, however, was predicted to enter the side vent and the fourth roof vents for a low west wind speed when the bottom of the side vent was located at 2.5 m above the floor. For the same vent configuration and a west wind of 2.5 m/s, approximately 59 % of the incoming air through the side vent was predicted to "short-circuit" out through the first roof vent opening. This also resulted in a very low velocity prediction near the plant level in the third and fourth spans in spite of a favorable overall natural ventilation rate as shown in Fig.2.

[Fig.3](#) shows the CFD-computed vectors of airflow in a double polyethylene multi-span greenhouse for a west wind of 2.5 m/s when the bottom of the west side vent opening was located at 0.5 m (a) and 2.5 m (b) above the floor. Fig. 3(a) shows that the predicted inlet air moved along the floor from west to east in the greenhouse when the side vent was located at 0.5 m above the floor. A large portion of the inlet air through the side vent located at 2.5 m above the floor, however, was predicted to move out through the first roof vent opening and the air flow was very low at the second, third, and fourth vents of the greenhouse.

NEXT

(a) West wind



(b) East wind

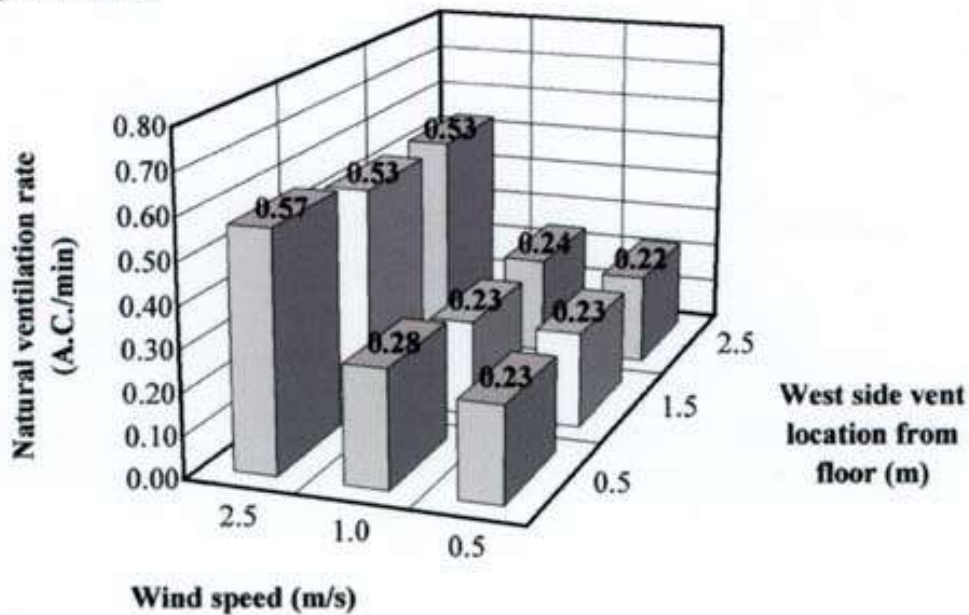


Fig.2.CFD-computed natural ventilation rates (A.C./min) in a double polyethylene-covered four-span greenhouse based on west side vent location, wind direction, and wind speed when the vertical side vent and roof vent opening sizes were 0.9 and 0.76 m, respectively

BACK

Table 2. CFD-computed percentages of volumetric inlet and outlet airflow at vent openings based on west side vent location (W.S.V.L.), wind speed, and wind direction when the vertical west side vent and roof vent opening sizes were 0.9 and 0.76 m, respectively

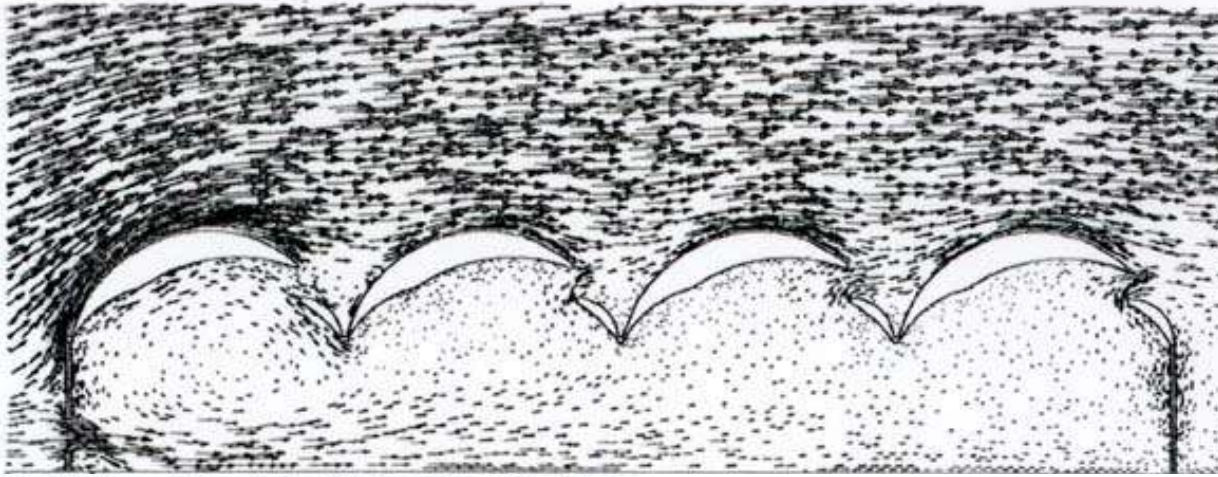
W.S.V.L. ^{b)} (m)	West wind (m/s)	Percentage of inlet/outlet airflow at vent opening ^{a)} (%)				
		Side	Roof1	Roof2	Roof3	Roof4
0.5	0.5	94/0	6/2	0/20	0/39	0/39
	1.0	98/0	2/7	0/24	0/32	0/37
	2.5	94/0	6/1	0/20	0/33	0/46
1.5	0.5	88/0	12/0	0/23	0/40	0/37
	1.0	95/0	5/4	0/26	0/32	0/38
	2.5	90/0	10/0	0/24	0/31	0/45
2.5	0.5	92/0	0/19	0/22	0/45	8/14
	1.0	98/0	0/39	0/11	0/33	2/17
	2.5	92/0	0/54	8/0	0/11	0/35
Vent location (m)	East wind (m/s)	Percentage of inlet/outlet airflow at vent opening ^{a)} (%)				
		Side	Roof1	Roof2	Roof3	Roof4
0.5	0.5	70/0	0/15	0/39	0/46	30/0
	1.0	29/0	0/28	0/52	0/20	71/0
	2.5	0/57	0/20	0/12	5/11	95/0
1.5	0.5	44/0	0/26	0/57	0/17	56/0
	1.0	11/0	0/55	0/36	0/9	89/0
	2.5	0/44	0/27	0/16	5/13	95/0
2.5	0.5	37/0	0/52	0/44	3/4	60/0
	1.0	22/0	0/65	0/23	0/12	78/0
	2.5	0/42	0/28	0/17	5/13	95/0

a): The roof (vent) number is counted from the west span to the east span.

b): W.S.V.L. indicates the distance between the bottom of the west side vent opening and floor.

BACK

(a) Side vent located at 0.5 m above the floor



(b) Side vent located at 2.5 m above the floor

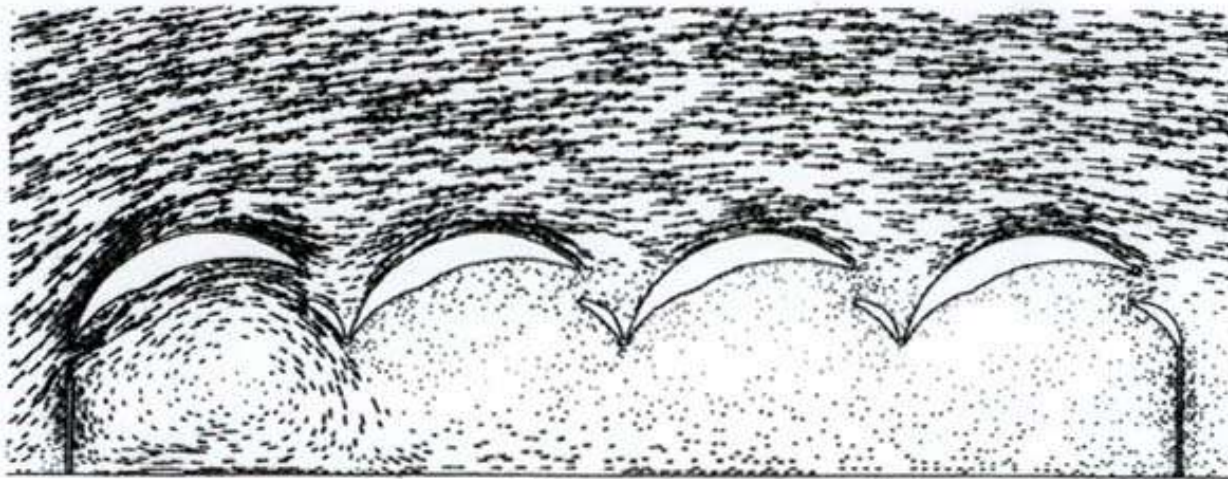


Fig. 3. CFD-computed vectors of airflow in a double polyethylene multi-span greenhouse for a west wind of 2.5 m/s when the bottom of the west side vent opening was located at 0.5 and 2.5 m above the floor

The vertical side vent opening size was 0.9 m in height. The minimum and maximum computed air velocities in the computational domain were (a) 0.004 and 4.48 m/s, respectively and (b) 0.002 and 4.49 m/s, respectively.

BACK

1...10): [References](#)

2) Effect of side vent opening size on natural ventilation

[Fig. 4](#) shows the effects of the vertical west side vent opening size, wind speed, and wind direction on the natural ventilation rate in a double polyethylene-covered four-span greenhouse when the bottom of the side vent opening was located at 0.5 m above the floor. [Fig. 4](#) shows that the averaged natural ventilation rates with the vertical side vent opening sizes of 0.9, 1.8, and 2.7 m in height, were 0.42, 0.71, and 0.95 A.C./min, respectively for a west wind and 0.36, 0.64, and 0.78 A.C./min, respectively for an east wind. The CFD-computed results indicated that the west side vent opening size could markedly affect the natural ventilation rate of the greenhouse, especially for the west wind and high east wind speed.

[Table 3](#) shows the CFD-computed percentages of volumetric airflow at each vent opening based in the vertical west side vent opening size, wind speed, and wind direction. For west winds, the side vent was the only inlet of airflow with vertical side vent opening sizes of 1.8 and 2.7 m in height while the side vent and the first roof vent openings were inlets with a vertical side vent opening size of 0.9 m in height. For east winds of 0.5 and 1.0 m/s, the side vent became a more active inlet of airflow as the vertical side vent opening size increased while the side vent was predicted to be a significant outlet for an east wind of 2.5 m/s.

3) Effect of number of spans and roof vent opening type on natural ventilation

The predicted effects of the number of spans and vertical west side vent opening size on the natural ventilation rate in double polyethylene multi-span greenhouses for a west wind of 2.5 m/s are shown in [Fig. 5\(a\)](#). The CFD-computed results indicated that the natural ventilation rate decreased as the number of greenhouse spans increased while the natural ventilation rate was directly proportional to the vertical west side vent opening size for all cases. Even an 8-span greenhouse (60 m wide) was predicted to have a high natural ventilation rate when a large side vent opening was used. The CFD-computed results also showed that the natural ventilation was very low without the windward side vent opening. As shown in [Table 4\(a\)](#), the air generally was predicted to come into the greenhouse through the windward side vent and the first roof vent with a 0.9 m side vent opening while the side vent was predicted to be the only inlet of airflow with a windward side vent opening of 2.7 m in height. It was also predicted that the flow rates of the roof vents as outlets increased from windward to leeward walls when the windward side vent was open. When the windward side vent was closed, however, the air was predicted to mainly move into the greenhouse through the middle roof vents and move out through both end side roof vents.

The predicted effects of the number of spans and vertical west side vent opening size on natural ventilation rate for a hinged open roof multi-span greenhouse with a west wind of 2.5 m/s are shown in [Fig. 5\(b\)](#). Significantly higher natural ventilation rates were predicted compared to the double polyethylene greenhouses for all the spans, especially when no side vent or a small side vent was used. It indicated the influence of the roof vent opening size and shape and the possibility of air moving over the windward wall and the creation of reverse flow in the greenhouse at plant level.

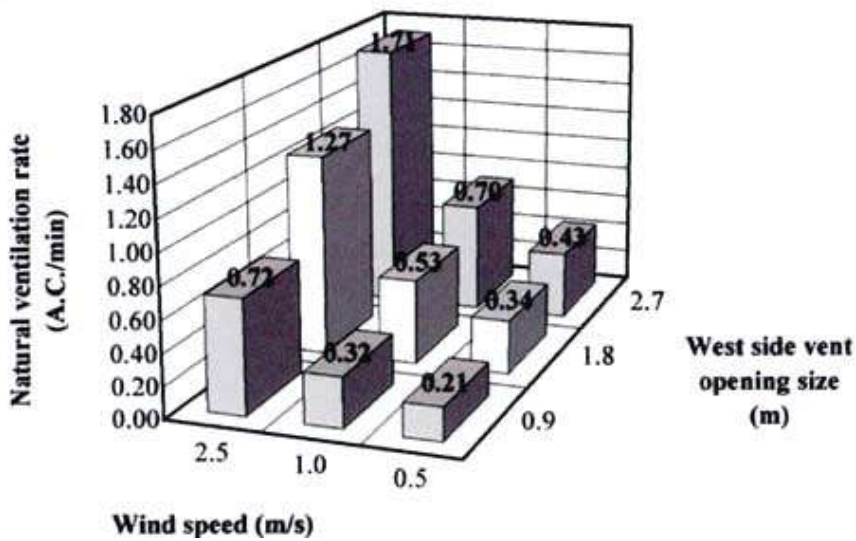
No consistent relationship was revealed between the natural ventilation rate in the hinged open roof greenhouse and the number of spans and side vent opening with vertical windward side vent opening sizes of 0.0 and 0.9 m. This was because the air flow was predicted to pass up and over the west,

windward wall and come down in reverse flow as shown in [Fig. 6](#). With a side vent opening size of 2.7 m, the natural ventilation rate was predicted to increase proportionally to the number of spans. When the open roof multi-span greenhouse had more than 6 spans, the larger side vent opening was predicted to provide the optimum natural ventilation rates. As shown in [Table 4\(b\)](#), the CFD-computed results indicated that the roof vents acted as inlet or outlet of airflow according to the number of spans and windward side vent opening size while the windward side vents always acted as an inlet to airflow.

Fig. 6 shows the CFD-computed vectors of airflow in a hinged open roof greenhouse for a west wind of 2.5 m/s when the vertical windward side vent opening sizes were 0.0 m (a) and 2.5 m (b) in height. The fourth and first roof vents were the main inlet and outlet openings, respectively without the side vent open while the side vent and the fourth roof vent were the main inlet and outlet openings, respectively while the side vent was open. The CFD results predicted that the same ventilation patterns would develop as in the double polyethylene greenhouse when the windward side vent was fully open. When the windward side vent was closed, however, the air went up and over the windward side wall and entered the greenhouse at the fourth roof vent opening, creating a reverse flow across the greenhouse.

[NEXT](#)

(a) West wind



(b) East wind

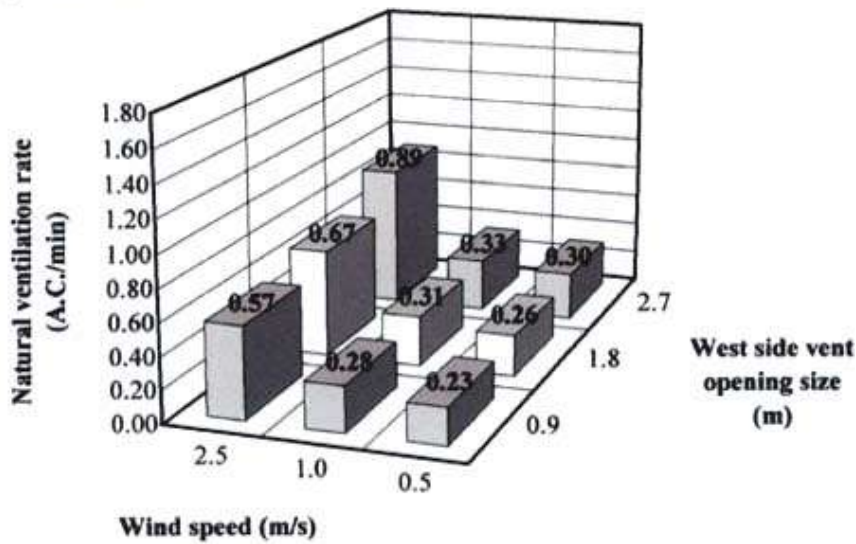


Fig. 4. CFD-computed natural ventilation rate (A.C./min) in a double polyethylene-covered four-span greenhouse based on west side vent opening size, wind direction, and wind speed when the bottom of the side vent was located at 0.5 m above the floor

BACK

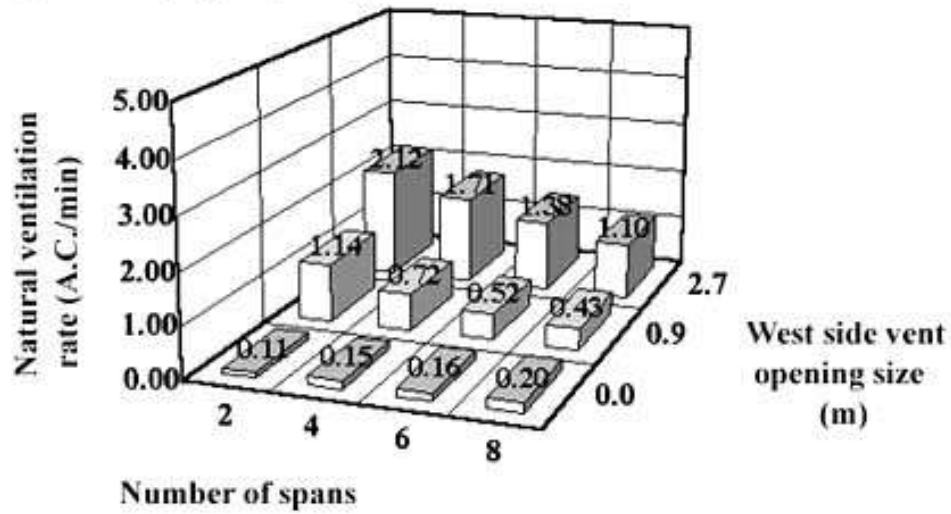
Table 3.
CFD-computed percentages of volumetric airflow at vent openings based on vertical west side vent opening size, wind speed, and wind direction when the bottom of the side vent was located at 0.5 m above the floor

Vent open size (m)	West wind (m/s)	Percentage of inlet/outlet airflow at vent opening ^{a)} (%)				
		Side	Roof1	Roof2	Roof3	Roof4
0.9	0.5	94/0	6/2	0/20	0/39	0/39
	1.0	98/0	2/7	0/24	0/32	0/37
	2.5	94/0	6/1	0/20	0/33	0/46
1.8	0.5	100/0	0/10	0/25	0/32	0/33
	1.0	100/0	0/12	0/27	0/30	0/31
	2.5	100/0	0/7	0/26	0/29	0/38
2.7	0.5	100/0	0/16	0/25	0/29	0/30
	1.0	100/0	0/19	0/26	0/27	0/28
	2.5	100/0	0/18	0/23	0/26	0/33
Vent open size (m)	East wind (m/s)	Percentage of inlet/outlet airflow at vent opening ^{a)} (%)				
		Side	Roof1	Roof2	Roof3	Roof4
0.9	0.5	70/0	0/15	0/39	0/46	30/0
	1.0	29/0	0/28	0/52	0/20	71/0
	2.5	0/57	0/20	0/12	5/11	95/0
1.8	0.5	83/0	0/15	0/34	0/51	17/0
	1.0	37/0	0/29	0/45	0/26	63/0
	2.5	0/85	4/2	17/0	0/13	79/0
2.7	0.5	92/0	0/16	0/31	0/45	8/8
	1.0	41/0	0/28	0/43	0/29	59/0
	2.5	0/92	16/0	17/0	4/8	63/0

a): The roof (vent) number is counted from the west span to the east span.

BACK

(a) Double polyethylene greenhouse



(b) Hinged open roof greenhouse

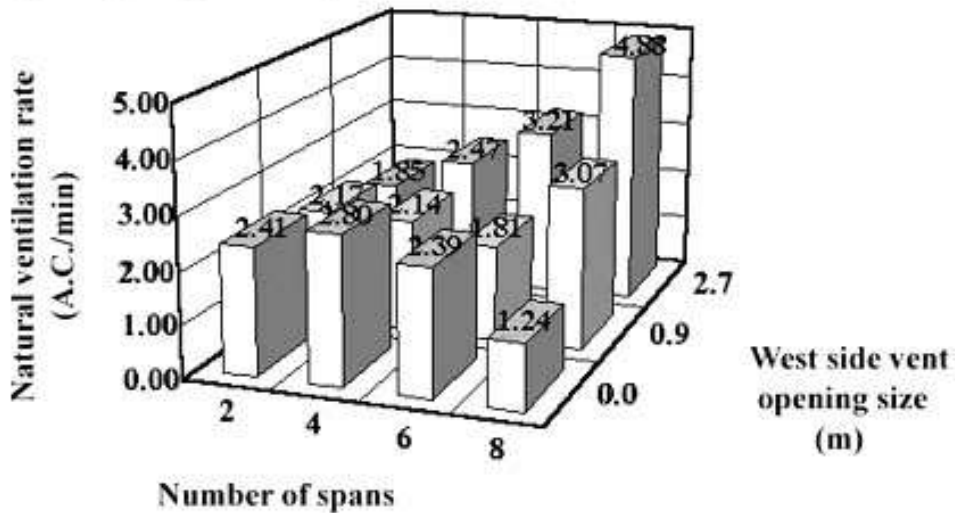


Fig. 5. Effects of number of spans and vertical windward side vent opening size on natural ventilation rate in a double polyethylene greenhouse (a) and a hinged open roof greenhouse (b) for a west wind of 2.5 m/s

BACK

Table 4.
CFD-computed percentages of volumetric airflow at vent openings based on roof vent opening type, number of spans, and vertical windward side vent size for a west wind of 2.5 m/s when the bottom of the side vent was located at 0.5 m above the floor

(a) Double polyethylene multi-span greenhouse

Side vent(m)	No. of spans	Percentages of inlet/outlet airflow at vent opening ^{a)} (%)								
		Side	Roof1	Roof2	Roof3	Roof4	Roof5	Roof6	Roof7	Roof8
0.0	2	0/0	100/0	0/100						
	4	0/0	0/36	33/0	67/0	0/64				
	6	0/0	0/15	25/0	34/0	41/0	0/56	0/29		
	8	0/0	0/21	0/18	0/20	0/9	26/0	34/0	40/0	0/32
0.9	2	100/0	0/25	0/75						
	4	94/0	6/1	0/20	0/33	0/46				
	6	89/0	9/0	2/2	0/13	0/18	0/28	0/39		
	8	89/0	11/0	0/6	0/11	0/9	0/8	0/12	0/19	0/35
2.7	2	100/0	0/43	0/57						
	4	100/0	0/18	0/23	0/26	0/33				
	6	100/0	0/5	0/15	0/16	0/16	0/22	0/26		
	8	97/0	3/0	0/8	0/9	0/11	0/14	0/16	0/18	0/24

a): The roof (vent) number is counted from the west span to the east span.

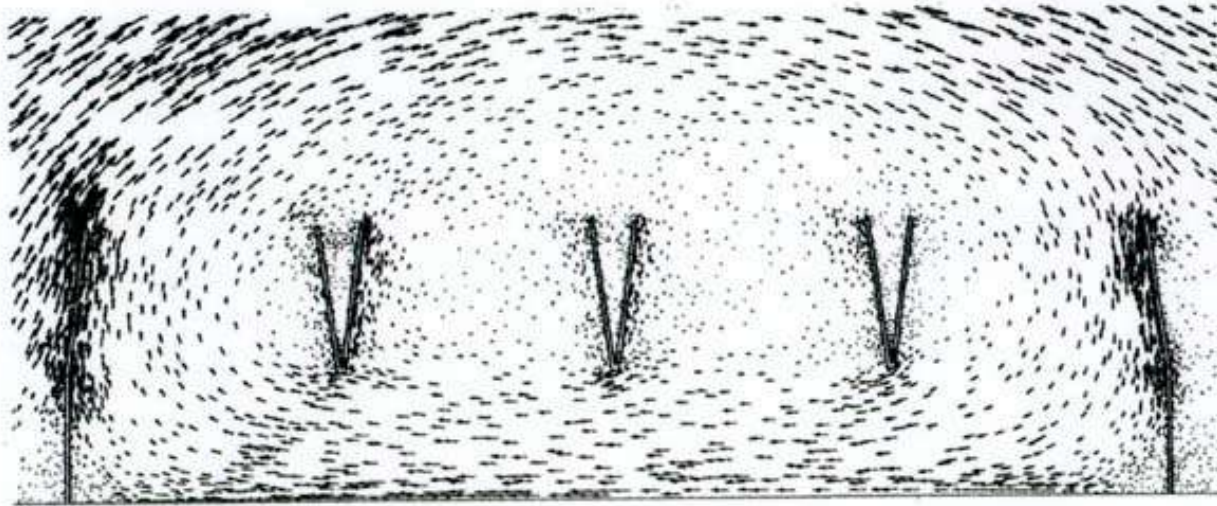
(b) Hinged open roof multi-span greenhouse

Side vent (m)	No. of spans	Percentages of inlet/outlet airflow at vent opening ^{a)} (%)								
		Side	Roof1	Roof2	Roof3	Roof4	Roof5	Roof6	Roof7	Roof8
0.0	2	0/0	43/53	57/47						
	4	0/0	0/69	12/20	15/11	73/0				
	6	0/0	0/53	8/11	16/8	32/0	44/0	0/28		
	8	0/0	0/57	8/12	7/6	8/7	21/0	31/0	25/3	0/15
0.9	2	36/0	51/17	13/83						
	4	36/0	41/19	19/28	0/47	4/6				
	6	23/0	17/14	9/16	2/21	2/38	7/11	40/0		
	8	14/0	10/13	5/10	0/32	3/30	5/11	12/4	27/0	24/0
2.7	2	66/0	29/13	5/87						
	4	50/0	23/9	12/16	13/14	2/61				
	6	63/0	19/10	5/15	5/7	4/18	0/5	4/45		
	8	58/0	20/9	4/12	3/9	0/6	9/8	0/20	3/2	3/34

a): The roof (vent) number is counted from the west span to the east span.

BACK

(a) Side vent opening size of 0.0 m



(b) Side vent opening size of 2.7 m

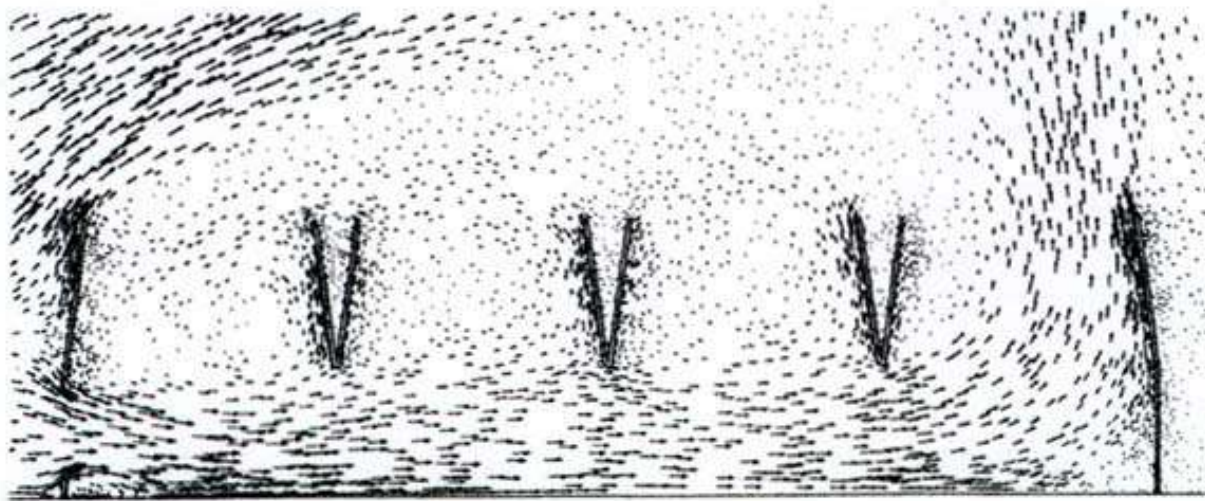


Fig. 6. CFD-computed vectors of airflow in a hinged open roof glass greenhouse for a west wind of 2.5 m/s when the vertical windward side vent opening size was 0.0 (a) and 2.7 m (b) in height and the bottom of the side vent was located at 0.5 m above the floor

The minimum and maximum computed air velocities in the computational domains were (a) 0.002 and 4.27 m/s, respectively and (b) 0.003 and 3.72 m/s, respectively.

BACK

Conclusions

The CFD-computed results predicted that the west side vent location did not strongly affect natural ventilation rates in a four-span double polyethylene-covered greenhouse for both wind directions as much as the wind speed.

It was predicted that the lowest side vent location at 0.5 m above the floor resulted in a higher natural ventilation rate in the double polyethylene multi-span greenhouse for both wind directions than the higher vent location. The west wind cases were predicted to show an average of 11 % higher natural ventilation rate than the east wind.

An east wind of 0.5 m/s showed an average of 17 % higher natural ventilation rate than a west wind of 0.5 m/s with a west side vent opening while a west wind of 2.5 m/s showed an average of 20 % higher natural ventilation rate than an east wind of the same velocity.

The CFD-computed results indicated that the west side vent was a very active vent opening as inlet and outlet of airflow, respectively for low and high east wind speeds. The air mainly moved in through the side vent and fourth roof vent openings for an east wind of 0.5 m/s while the third and fourth roof openings were the inlets of airflow for an east wind of 2.5 m/s. It was also predicted that the side vent would become a more active vent opening as the side vent location was lower.

For the bottom of the 0.9 m side vent located at 2.5 m above the floor for a west wind of 2.5 m/s, approximately 59 % of incoming air through the side vent was predicted to move directly out through the first roof vent opening without reaching the other areas of the greenhouse.

The CFD-computed results indicated that the west side vent opening sizes markedly affected the natural ventilation rate in the greenhouse, especially for the west wind. For west winds, the side vent was the only inlet of airflow with the vertical side vent opening sizes of 1.8 and 2.7 m in height while the side vent and the first roof vent openings were inlets with a vertical side vent opening size of 0.9 m in height.

The natural ventilation rate in the double polyethylene greenhouse was predicted to decrease as the number of greenhouse spans increased while the natural ventilation was very low without the windward side vent opening. It was also predicted that the windward side vent opening size was very important for good natural ventilation of the multi-span greenhouse.

The hinged open roof vent greenhouses generated significantly higher natural ventilation rates than the double polyethylene greenhouses for 2, 4, 6, and 8 spans. It indicated the importance of the roof vent opening size and shape and the possibility of achieving reverse airflow at plant level when no side vent was used with the hinged open roof greenhouse.

For the hinged open roof vent greenhouse, the highest natural ventilation rate for the widest span tested (8 spans) was obtained with a side vent opening size of 2.7 m. When the multi-span greenhouse had more than 6 spans, larger side vent openings were predicted to generate better natural ventilation.

[TOP](#)

[HOME](#)

Breeding of Freeze-Tolerant Baker's Yeast by the Regulation of Trehalose Metabolism

Jun SHIMA^{1*}, Yasuo SUZUKI², Ryouichi NAKAJIMA², Hajime WATANABE², Katsumi MORI¹ and Hiroyuki TAKANO¹

¹Applied Microbiology Division, National Food Research Institute
(Tsukuba, Ibaraki, 305-8642 Japan)

²Tokyo Laboratory of Fermentation and Food Technology, Oriental Yeast Co., Ltd.
(Azusawa, Itabashi, Tokyo, 174-8505 Japan)

*Corresponding author: fax +81-298-38-7996, e-mail shimaj@nfri.affrc.go.jp

Received 17 December 1999, accepted 13 January 2000.

Abstract

Accumulation of trehalose, which is a disaccharide composed of 2 molecules of glucose, is generally considered to be a critical determinant in improving the stress tolerance of the baker's yeast *Saccharomyces cerevisiae*. To retain this accumulation in yeast cells, we constructed diploid homozygous trehalase (trehalose-hydrolyzing enzyme)-deficient mutants by the gene disruption method from commercial baker's yeast. During fermentation, degradation of intracellular trehalose was inhibited in the trehalase-deficient mutants. Their freeze tolerance was maintained at a higher level than that of the parent strain. Due to the improved freeze tolerance exhibited by the trehalase-deficient mutants, these strains may be suitable for use in the baking process of frozen dough.

Discipline: Food microbiology

Additional key words: bread

1...25): [References](#)

Introduction

In the baking industry, frozen dough technology has recently been applied due to its advantages in supplying oven-fresh bakery products to consumers, as well as improving labor conditions for bakers¹⁰. Standard commercial baker's yeast is generally susceptible to damage during frozen storage and does not retain a sufficient leavening ability after frozen storage. Freeze tolerance is an important characteristic for yeast used in frozen doughs, because post-thaw leavening activity is essential prior to baking. The ability to tolerate freeze stress depends on many factors, including the growth phase and rate, nutritional status, rate of freezing, and the intracellular amount of cryoprotective compounds^{12,18,21}. Although freeze-tolerant yeast strains have also been obtained by conventional mutation procedures^{14,16,25}, bread baked with such strains has less taste and flavor compared with bread baked with parent strains. The objective of this study was to develop freeze-tolerant baker's yeast from commercial strains using DNA recombinant techniques, without loss of the yeast's other beneficial properties.

Because disaccharide trehalose is considered to be a critical determinant of stress tolerance in the yeast *Saccharomyces cerevisiae* (*S. cerevisiae*)^{5,7,9,21}, we constructed trehalase-deficient mutants and investigated their freeze-tolerance. Two enzymes are capable of hydrolyzing trehalose: a neutral cytosolic trehalase (designated as Nth1p) and an acidic trehalase (designated as Ath1p)¹³. Both Nth1p and Ath1p have been purified from *S. cerevisiae*, and the corresponding genes have been cloned and sequenced^{1,6,11}.

In order to determine the effect of trehalase gene disruption during the baking process, we constructed trehalase-deficient diploid strains from commercial baker's yeast. We showed that these mutants accumulated higher levels of trehalose than their parent strain under optimal culture conditions for high trehalose contents, and that trehalose accumulation was correlated with a higher freeze tolerance in frozen dough baking. We also showed that commercial application of the mutant strains could be obtained by gene disruption.

NEXT

Effects of Light during Low Temperature Treatment and Water Stress on Freezing Tolerance and Sugar Contents in Cabbage Seedlings

Hidekazu SASAKI^{1*}, Kazuo ICHIMURA², Masayuki ODA³ and Shigeo IMADA⁴

^{1,3,4} Department of Applied Plant Physiology, National Research Institute of Vegetables, Ornamental Plants and Tea

ã (Ano, Age, Mie, 514-2392 Japan)

² Department of Floriculture, National Research Institute of Vegetables, Ornamental Plants and Tea

ã (Ano, Age, Mie, 514-2392 Japan)

Present address:

¹ Department of Vegetable Breeding, National Research Institute of Vegetables, Ornamental Plants and Tea

ã (Shimokuriyagawa, Morioka, Iwate, 020-0123 Japan).

³ College of Agriculture, University of Osaka Prefecture

ã (Gakuen, Sakai, Osaka, 599-8531 Japan).

*Corresponding author: fax +81-19-641-6315, e-mail hsasaki@nivot-m.affrc.go.jp

Received 22 December 1999, accepted 16 February 2000.

Abstract

Cabbage seedlings exposed to non-freezing low temperature (5°C, f) under a 12 h photoperiod acquired the freezing tolerance, while the plants exposed to non-freezing low temperature in the dark did not acquire the freezing tolerance. On the contrary, in the case of reversal from cold acclimation, the freezing tolerance of the plants was reduced by exposure to normal growth temperature (20/15°C, f) regardless of light conditions. These changes in freezing tolerance coincided with the changes in the sugar contents of cabbage leaves. The plants subjected to water stress by withholding water displayed a higher degree of freezing tolerance and increase of sugar contents compared with the watered plants. Thus, it was assumed that cabbage seedlings required light to acquire the freezing tolerance after exposure to low temperature, while deacclimation was induced without light and it was confirmed that water stress increased to a certain extent the freezing tolerance in cabbage seedlings.

Discipline: Horticulture

Additional key words: cold acclimation, de-acclimation

1...15): [References](#)

Introduction

Cabbage is one of the most important vegetables in Japan and is often injured by cold or frost. Most of the overwintering plants acquire the freezing tolerance by exposure to non-freezing low temperature, and

this process is referred as cold acclimation. Freezing tolerance of plants is affected by various environmental factors¹⁾, besides temperature. Furthermore, cold acclimation is also influenced by several environmental factors. Drought and desiccation stress increased the freezing tolerance in rye²⁾, and winter wheat¹⁴⁾. On the other hand, it has been reported that cold acclimation is accompanied by biochemical changes affecting sugars^{9,11)}, proteins¹⁰⁾ and plasma membrane lipids¹⁵⁾. Sasaki et al. (1996)⁸⁾ showed that cabbage seedlings exposed to non-freezing low temperature (5°C) acquired a freezing tolerance. However, the role of light during cold acclimation and deacclimation and the relationship between the freezing tolerance and water stress in cabbage seedlings remained to be elucidated.

The analysis of the mechanism of acquisition and loss of freezing tolerance in cabbage could contribute to the stable production of cabbage and other vegetables. This study was conducted to investigate the effects of light during cold acclimation and deacclimation and water stress on freezing tolerance and sugar contents in cabbage seedlings.

Materials and methods

1) Plant materials and growth conditions

Seeds of cabbage (*Brassica oleracea* L. cv. Banchurisou) were sown in plastic pots filled with a soil mixture (Pretty Soil Gold N-140, Otsukasangyo, Nagano, Japan). Plants (one plant per pot) were grown in a growth chamber at 20/15°C (day/night) and under a 12 h photoperiod in which illumination was supplied by metal halid lamps (MLBOC400C-U, Mitsubishi Electric OSRAM, Yokohama, Japan) using a photosynthetic photon flux density (PPFD) of $230 \pm 10 \mu\text{mol} \cdot \text{m}^{-2} \cdot \text{s}^{-1}$.

2) Exp.1 Effects of light on cold acclimation and deacclimation

Three weeks after sowing, the seedlings were exposed to 5°C for 7 days under a 0 (dark) or 12 h (light) photoperiod as cold acclimation treatments. For deacclimation treatments, seedlings cold-acclimated by exposure to 5°C under a 12 h photoperiod for 7 days were transferred to a growth chamber at 20/15°C for 2 days under a 0 or 12 h photoperiod. In the plants subjected to the low temperature and deacclimation treatments, the freezing tolerance and sugar contents were determined.

3) Exp.2 Effects of water stress on freezing tolerance and sugar contents

The seedlings which unfolded 2 leaves and were watered daily, or not watered for 3 days, were grown in a growth chamber at 20/15°C under a 12 h photoperiod. The amount of water supplied to the plants exceeded $40 \text{ mL} \cdot \text{pot}^{-1} \cdot \text{day}^{-1}$. The soil water contents (mean \pm standard error) of the watered and non-watered treatments were $45.4 \pm 1.6\%$ and $22.3 \pm 0.9\%$, respectively. The plants that were watered and not watered were used for measuring the freezing tolerance and sugar contents.

4) Freezing tolerance test

The degree of freezing tolerance of the seedlings was expressed in terms of the electrolyte leakage determined by methods previously described⁸⁾. Leaf discs excised from the 2nd leaves of the seedlings were placed in a test tube. Test tubes were transferred to a chamber where the temperature was lowered to -8°C at a rate of 0.25°C/min. When the temperature in the chamber was -2°C, test tubes were

maintained at -2°C for 1 h and the leaf discs were sprayed with deionized water to initiate extracellular freezing. Test tubes were maintained at -2 , -4 , -6 or -8°C for 30 min and were allowed to thaw at room temperature for about 1 h. The warming rate was about $0.4^{\circ}\text{C}/\text{min}$. Test tubes in which deionized water (15 mL) was added were stored overnight at room temperature. Then the conductivity of the solution in the test tubes was measured. After heating in boiling water for 20 min, the conductivity was again measured. The degree of electrolyte leakage was calculated as a percentage of conductivity of the solution before heating to that after heating.

5) Determination of soluble sugars

Soluble sugar contents were measured by the method previously described¹²). The 2nd leaves were cut from the plants and their midribs were removed. The remainder of the leaf was extracted in 10 volumes of 80% (v/v) ethanol at approx. 75°C for 30 min. After cooling at room temperature, xylose (0.5% of the sample weight) was added as an internal standard, and the sample was homogenized. The homogenate was centrifuged at $1,500 \times g$ for 10 min. The pellet was re-extracted twice in 5 volumes of 80% (v/v) ethanol, the three supernatants were combined and dried in a vacuum centrifuge. The residue was dissolved in 1 mL of distilled water. The sample was passed through a SEP⁺ PAK C18 cartridge (Millipore Corporation, Massachusetts, USA) which had been equilibrated with water, after which 2 mL of distilled water was eluted. An aliquot (20 μL) of the eluate was analyzed by HPLC using an RI refractive index detector (JASCO, Tokyo, Japan) and a Shodex SUGAR SP0810 column (Showa Denko Co., Tokyo, Japan). The column temperature was 80°C , and the mobile phase consisted of distilled water at a flow rate of 0.8 mL min^{-1} .

Breeding of Freeze-Tolerant Baker's Yeast by the Regulation of Trehalose Metabolism

Jun SHIMA^{1*}, Yasuo SUZUKI², Ryouichi NAKAJIMA², Hajime WATANABE², Katsumi MORI¹ and Hiroyuki TAKANO¹

¹Applied Microbiology Division, National Food Research Institute
(Tsukuba, Ibaraki, 305-8642 Japan)

²Tokyo Laboratory of Fermentation and Food Technology, Oriental Yeast Co., Ltd.
(Azusawa, Itabashi, Tokyo, 174-8505 Japan)

*Corresponding author: fax +81-298-38-7996, e-mail shimaj@nfri.affrc.go.jp

Received 17 December 1999, accepted 13 January 2000.

Abstract

Accumulation of trehalose, which is a disaccharide composed of 2 molecules of glucose, is generally considered to be a critical determinant in improving the stress tolerance of the baker's yeast *Saccharomyces cerevisiae*. To retain this accumulation in yeast cells, we constructed diploid homozygous trehalase (trehalose-hydrolyzing enzyme)-deficient mutants by the gene disruption method from commercial baker's yeast. During fermentation, degradation of intracellular trehalose was inhibited in the trehalase-deficient mutants. Their freeze tolerance was maintained at a higher level than that of the parent strain. Due to the improved freeze tolerance exhibited by the trehalase-deficient mutants, these strains may be suitable for use in the baking process of frozen dough.

Discipline: Food microbiology

Additional key words: bread

1...25): [References](#)

Introduction

In the baking industry, frozen dough technology has recently been applied due to its advantages in supplying oven-fresh bakery products to consumers, as well as improving labor conditions for bakers¹⁰. Standard commercial baker's yeast is generally susceptible to damage during frozen storage and does not retain a sufficient leavening ability after frozen storage. Freeze tolerance is an important characteristic for yeast used in frozen doughs, because post-thaw leavening activity is essential prior to baking. The ability to tolerate freeze stress depends on many factors, including the growth phase and rate, nutritional status, rate of freezing, and the intracellular amount of cryoprotective compounds^{12,18,21}. Although freeze-tolerant yeast strains have also been obtained by conventional mutation procedures^{14,16,25}, bread baked with such strains has less taste and flavor compared with bread baked with parent strains. The objective of this study was to develop freeze-tolerant baker's yeast from commercial strains using DNA recombinant techniques, without loss of the yeast's other beneficial properties.

Because disaccharide trehalose is considered to be a critical determinant of stress tolerance in the yeast *Saccharomyces cerevisiae* (*S. cerevisiae*)^{5,7,9,21}), we constructed trehalase-deficient mutants and investigated their freeze-tolerance. Two enzymes are capable of hydrolyzing trehalose: a neutral cytosolic trehalase (designated as Nth1p) and an acidic trehalase (designated as Ath1p)¹³). Both Nth1p and Ath1p have been purified from *S. cerevisiae*, and the corresponding genes have been cloned and sequenced^{1,6,11}).

In order to determine the effect of trehalase gene disruption during the baking process, we constructed trehalase-deficient diploid strains from commercial baker's yeast. We showed that these mutants accumulated higher levels of trehalose than their parent strain under optimal culture conditions for high trehalose contents, and that trehalose accumulation was correlated with a higher freeze tolerance in frozen dough baking. We also showed that commercial application of the mutant strains could be obtained by gene disruption.



Genetic Relationships between CD-1 Stocks of Mice in Uruguay

Tadahiro INOUE^{1*}, Hugo COITINHO², Enrique POCHINTESTA², Jorge BALTAR² and Nobuo GOTO^{1, 3}

^{1,3}The Veterinary Laboratories Improvement Project in Uruguay, Japan International Cooperation Agency

Â (JICA) (Ruta 8 km. 17.500, P. O. Box 6577, Montevideo, Uruguay)

² Veterinary Laboratories Division (DI.LA.VE.) "Miguel C. Rubino", General Direction of Livestock Services, Ministry of Livestock, Agriculture and Fisheries (Ruta 8 km. 17.500, P. O. Box 6577, Montevideo, Uruguay)

Present address:

¹ Department of Pathology and Physiology, National Institute of Animal Health (Tsukuba, Ibaraki, 305-0856 Japan).

³ Imamichi Institute for Animal Reproduction (Kasumigaura, Niihari, Ibaraki, 300-2656 Japan).

*Corresponding author: fax +81-298-38-7907, e-mail chujo@niah.affrc.go.jp

Received 30 November 1999, accepted 24 December 1999.

Abstract

Multivariate analysis of mandible measurements was applied to identify and to investigate the genetic relationships between 5 outbred stocks of female mice, Dlv:CD-1, Hg:CD-1, Crj:CD-1, CF-1 and Slc:ddY. (1) Principal component analysis revealed that CF-1 had a relatively large mandible with an obtuse muscular process and a low anterior mandibular body, whereas Hg:CD-1 had a smaller mandible and exhibited intermediate values in terms of muscular process shape and anterior height. Crj:CD-1 showed a moderately large mandible and a higher anterior mandibular body. While the mandibles of Dlv:CD-1 and Slc:ddY were comparatively similar to each other in that they were both medium-sized, the former had an acute muscular process projecting posteriorly whereas the latter had a less prominent process. These morphological relationships between the 5 stocks determined by principal component analysis were generally in agreement with Mahalanobisâ™ distance between stocks based on the same mandible measurements. (2) According to the results of discriminant analysis, the frequency of misclassification was 11.4%, or 9/79 head when actual mandible measurements were used in categorization and 10.1%, or 8/79, when relative values, which exclude the size effect, were used. These data indicate that the genetic constitution of the 3 CD-1 stocks examined in this study differed from one another. (3) Based on dendrograms calculated from actual mandible measurements and relative values, Dlv:CD-1 was more closely related to CF-1 or Slc:ddY, which are derived from mice of other origins, than the CD-1 stocks examined in this study. Thus genetic monitoring seems to be essential for outbred stocks as well as for inbred strains.

Discipline: Animal health / Genetic resources

Additional key words: laboratory mice, outbred stock, mandible analysis, principal component analysis, discriminant analysis

1...8): [References](#)

Introduction

The CD-1 strain, one of the most useful outbred stocks (closed colonies) of laboratory mice, has been used for various testing conditions including those for drugs and biological products. In Uruguay, CD-1 mice have also been introduced to several research institutions by the Charles River Laboratories (USA) and have been maintained and used for the above-mentioned tests. Since the CD-1 mice were introduced separately into each institute and were maintained independently from generation to generation, it is possible that the genetic constitution of each stock may differ from one another. Therefore, investigations of the genetic relationships between the outbred stocks should be carried out.

For inbred strains of laboratory mice or rats, genetic monitoring such as strain identification and estimation of genetic relationships between strains has mainly been performed by the use of biochemical and immunological marker genes⁷⁾. These methods, however, are not as effective for outbred stocks such as CD-1.

Mandible analysis proposed by Festing¹⁾ is based on the assumption that the shape of the mandible is a heritable trait. This type of analysis is suitable not only for genetic monitoring of inbred strains but also for that of outbred stocks²⁻⁴⁾.

In light of the above-mentioned advantages of mandible analysis, the present study was undertaken to clarify the genetic relationships among several independently maintained CD-1 stocks.



Development of an Eye Camera for Measuring Eyelid and Eyeball Movements in Domestic Animals

Tetsu NEMOTO¹, Toshiyuki SAITO, Etsuko KASUYA, Yoshifumi HONDA², Masato NAKAMURA³, Toshiyo KOBAYASHI⁴, Wenxi CHEN⁴, Issey TAMADA⁴, Ryo KUSUNOSE⁵ and Makoto KAI⁵

^{1,2}Department of Physiology, National Institute of Animal Industry
(Tsukuba, Ibaraki, 305-09041 Japan)

³Department of Feeding and Environment, National Institute of Animal Industry
(Tsukuba, Ibaraki, 305-09041 Japan)

⁴Laboratory of Animal Management, Hokkaido National Agricultural Experiment
(Hitsujigaoka, Toyohira, Sapporo, Hokkaido, 062-8555 Japan)

⁵ Department of Bioengineering, Faculty of Engineering, Soka University
(Funakicho, Hachioji, Tokyo, 192-8577 Japan)

⁶ Equni Reserch Institute Japan Racing Association
(Tokamicho, Utsunomiya, Tochigi, 320-0856 Japan)

Present address:

¹ Department of Laboratory Sciences, School of Health Science, Faculty of Medicine, Kanazawa University
Â (Kanazawa, Ishikawa, 920-0942 Japan).

* Corresponding author: fax +81-76-234-4369, e-mail nemotot@mhs.mp.kanazawa-u.ac.jp

Received 2 November, accepted 24 December 1999.

Abstract

The analysis of the resting behavior of domestic animals must include the analysis of eyelid and eyeball movements and bodily motion. We developed an apparatus for measuring the movement of eyelids and eyeballs of domestic animals. The apparatus consists of a charge-coupled device (CCD) camera placed in the eyelid region of a head mask, and an infrared light-emitting diode as a light source. Two types of apparatus have been developed: one, using a wire system and the other, using a measurable telemetry system in an unrestricted state. The weight of the device with the wire system was about 50 g and that with the telemetry system was about 880 g. The operating time of the telemetry system was 24 h or more when nickel-hydrogen was used in the power supply. By using the wire system in calf, the movements of the eyelid and eyeball could be divided into four categories; fully open eyelid movement, half-closed eyelid movement, fully closed eyelid movement and eyeball movement. The results showed that the time of half-closed eyelids and fully closed eyelids while the animal was lying down was longest from

midnight to 7:00 a.m. and eyelids were half-closed or fully closed even during rumination. In the horse, the telemetry system device could be used continuously without discomfort for 24 h. Comparison of the eyelid movement and cortex brain waves, showed that the power spectrum of the cerebral cortex brain waves in an animal lying down with a half-open eyelid mainly consisted of d waves while when the animal was standing with a fully open eyelid, a waves also appeared.

Discipline: Animal industry

Key words: brain waves, behavior analysis

1...8): [References](#)

Introduction

Active movement and resting behavior, or the waking and sleeping behavior, of domestic animals can be distinguished according to changes in bodily motion⁴). However, the analysis of the resting behavior is insufficient when used by itself for the detection of changes in bodily motion. For the purpose of our study, the resting behavior of domestic animals may include any of the following conditions, fully closed eyelid, half-closed eyelid in a state of drowsiness, fully opened eyelid, and eyeball moving with fully opened eyelid in a state of quiescence, which might occur when an animal is lying down or stretched out on its stomach. In addition, resting behavior may also be identified by a half closed-eyelid or a fully closed eyelid while an animal is ruminating. Thus, resting animal's awareness occurs at several different levels. When rest is considered to reflect the actions of the parasympathetic nervous system, it was observed that the resting behavior was closely related to stress. It has also been reported that the difference in the frequency spectrum of brain waves indicates whether the eyes are open or closed because of the relationship between the activity of the eyelid and brain waves resulting from cerebral electrical activity^{7,8}). Therefore, the determination of a resting animal's awareness level is a necessary part of a more complete analysis of a domestic animal, which includes eyelid and eyeball movements and the determination of certain behaviors associated with specific bodily motions. It is possible to determine the level of a resting animal's awareness from its eyelid and eyeball movements. However, there are almost no reports on methods of measuring eyelid and eyeball movements in domestic animals.

Therefore, we developed an eye camera consisting of an ultra-compact CCD camera and infrared light-emitting diodes (LEDs). We installed the camera into the eyelid region of a head mask that was fitted onto domestic animals for measuring the eyeball and eyelid movements. Simultaneously, we developed a telemetry system for tracking the eyelid and eyeball movements. We used this equipment in experiments in which we tracked and measured the eyelid and eyeball movements of a calf. In addition, the experiment involved a comparison between cerebral cortex brain waves and eyelid movement. It is considered that such studies may eventually contribute to the improvement of feeding management in taking account of the welfare of the animal.



Physiological Role of Vitamin K in Fish -Review-

Miho UDAGAWA*

Physiology and Molecular Biology Division, National Research Institute of Fisheries Science

(Fukuura, Kanazawa, Yokohama, 236-8648 Japan)

*Correspondence author: fax +81-45-788-5001, e-mail udagawa@nrifs.affrc.go.jp

Received 27 December 19, accepted 27 January 2000.

Abstract

Basic information on the role of vitamin K in fish was described in relation to dietary intake. Vitamin K in the fish tissues was mainly concentrated in the liver and gonads, with a small amount in muscles. There was a difference in the concentration of vitamin K between demersal and pelagic fish depending on the habitat and between cultured fish and wild fish. The composition and content of vitamin K in the gastrointestinal tract which were very similar to those of the food consumed differed in the tissues, suggesting that all the vitamin K in food was not transferred to the tissues of fish. There was no clear indication that vitamin K deficiency affected the growth rate or mortality in fish, although it was reported that vitamin K deficiency caused anemia, prolonged prothrombin time, histopathological changes and bone abnormalities. Therefore, more studies are required to determine the role of vitamin K in fish.

Discipline: Fisheries

Additional key words: menaquinone, phylloquinone, fish nutrition

1...29): [References](#)

Introduction

Vitamin K was first discovered by Dam³⁾ as a substance playing an important role in the synthesis of blood-clotting factors. Vitamin K is a group name for a series of related compounds that act as cofactor for the microsomal enzyme $\hat{\Gamma}^3$ -glutamylcarboxylase. This enzyme is involved in the post-translational conversion of peptide-bound glutamate residues into $\hat{\Gamma}^3$ -carboxyglutamate (Gla), which occurs in a number of blood coagulation factors and bone proteins^{4,7,27}). Natural forms of vitamin K include phylloquinone (PK) and menaquinone (MK). PK designated as vitamin K₁ occurs abundantly in plant tissues while MK, vitamin K₂, is mainly produced by bacteria. Furthermore, a variety of diseases due to vitamin K deficiency has been reported in mammals. In particular, human infants, a few weeks old, are prone to hemorrhage due to vitamin K deficiency. In addition, the attention has since been increasingly focused on the importance of vitamin K for normal bone development. However, the role of vitamin K in fish has not been well-documented. In the following review, the distribution and absorption of vitamin K in relation to the intake of vitamin K in fish will be outlined.

Derivatives of vitamin K

There are several derivatives of vitamin K (**Fig. 1**) as follows: 1) PK called vitamin K₁, is produced by plants; 2) MK which is synthesized by microorganisms is called vitamin K₂ and has long side-chains arranged in MK-n series. MK-4 consists of short isoprene units and MK-9 is one of the typical long-chain MKs produced by bacteria; 3) Synthetic analogues of menadione (MD) designated as vitamin K₃ have no side-chains, and are utilized for animal and fish commercial diets.

Water-soluble salt of synthetic menadione, menadione sodium bisulfite (MSB) is generally supplemented in the commercial fish diets. Parts of PK, MK and MD are metabolized to MK-4 in the tissues¹³).

Fig.1. Chemical structure of vitamin K

Vitamin K in fish

Tissue distribution of vitamin K in fish varies with the feed habitat, for example, demersal and pelagic fish²²) as well as between cultured and wild fish^{21,23}).

Food habits differ markedly between pelagic fish and demersal fish. Pelagic fish feed on plankton and small fish, while demersal fish feed chiefly on benthos.

Benthos are the organisms which live in the benthic zone of the sea. The PK and MK contents in the pelagic and demersal fish tissues are illustrated in [Fig. 2](#)²²). None of the samples showed even a trace of MK-9. In mackerel, MK-6 was detected unlike other long-chain MKs. The content of PK was much higher than that of MKs, particularly in the liver where the PK content was as high as 3-4 times that in the heart and kidney. However, only a trace amount of vitamin K was detected in the ordinary and dark muscle tissues. In striking contrast to mackerel, MK-4 appeared to be the major vitamin K in the heart and gonads of saury with a very low level of PK. Furthermore, a negligible amount of vitamin K was present in the liver. The total vitamin K content was, however, much lower than that in mackerel.

In the case of marbled sole, significant amounts of long-chain MKs (MK-6 and 7) were detected together with MK-4 in the heart and kidney. Furthermore, MK-8 was also found in the kidney. On the other hand, in sillago, PK and MK-4 were commonly distributed in various organs, whereas MK-6, 7 and 8 were found only in the liver. In both marbled sole and sillago, the PK level was higher than that of saury on the whole but very much lower than that of mackerel.

In another report, it was stated that the PK contents in the serum, heart, kidney, gonads and liver of wild sardine were much higher than those of cultured sardine, especially in the liver²¹). MK-4 contents in cultured sardine were significantly higher than those of wild sardine in the serum, heart, kidney, gonads

and liver.

In the tissues of wild ayu, PK appeared to be the major form of vitamin K, and MKs were present at very low levels ([Fig. 3](#))²³). Long-chain MKs in different forms were present in the liver, but their quantity was lower than that of PK. Only MK-6 was detected in tissues other than the liver. On the other hand, in the tissues of cultured ayu, the major form of vitamin K was MK-4, while MK-6 was detected only in the heart and kidney. Unlike in the wild ayu, no long-chain MKs were observed in the liver.



JARQ
---- Japan Agricultural Research Quarterly ----

Purpose: Dissemination to overseas countries of up-to -date information on achievements and trends of research activities pertaining to agriculture, forestry and fisheries that are carried out in Japan but would also be relevant to the needs of the respective countries, particularly in the developing regions.

History: *Japan Agricultural Research Quarterly (JARQ)* was established in 1966 by the Agriculture, Forestry and Fisheries Research Council, the Ministry of Agricultural and Forestry. Through the editorial services of the Tropical Agricultural Research Office also established in 1966, such a publication which aimed at introducing the achievement and trends of agricultural research activities in Japan to overseas readers was expected to contribute to the development of agriculture in the countries of the tropical and subtropical regions. In June 1970, the Tropical Agriculture, Forestry and Fisheries Research Council. The publication of *JARQ* was thereafter undertaken by TARC. In October 1993, TRAC was reorganized into the Japan International Research Center for Agricultural Sciences (JIRCAS) with the creation of the Fisheries Division. As a result, *JARQ* also covers the field of fisheries research.

Publication Information: *Japan Agricultural Research Quarterly (JARQ)* is published four times a year, by the Japan International Research Center for Agricultural Sciences, Ministry of Agriculture, Forestry and Fisheries, Tsukuba, Ibaraki, 305-8686 Japan. The present circulation of each issue numbers 2,100, of which nearly two thirds are sent to more than 90 countries mostly in developing regions. Subscription is limited to institutions only, free of charge, and subscription inquiry should be directed to the Editorial Secretary of *JARQ* .

Editorial Policy: The Editorial Board serves as a screening committee. The Board members nominate candidates for the submission of papers for the forthcoming issues, and the decision is finalized during the Board meeting. Contributed papers are divided into two categories: **research articles** which summarize the findings of recent research activities of the author which may have been published elsewhere (but include also original contributions), and **research reviews** which review the objectives, procedures, and achievements of research activities by Japanese researchers on a specified research topic.

Editorial Inquiries: Send questions on editorial policy and procedure to the Editorial Secretary. Advice and comments are also welcome.

Updated
23/AUG/2002

[Vol.36 No.3](#)
July 2002

[Vol.36 No.2](#)
April 2002

[Vol.36 No.1](#)
January 2002

[Vol.35 No.4](#)
October 2001

[Vol.35 No.3](#)
July 2001

[Vol.35 No.2](#)
April 2001

[Vol.35 No.1](#)
January 2001

[Vol.34 No.4](#)
October 2000

[Vol.34 No.3](#)
July 2000

[Vol.34 No.2](#)
April 2000

[Vol.34 No.1](#)
January 2000

[Vol.33 No.4](#)

October 1999

[Vol. 33 No.3](#)
July 1999

[Vol. 33 No.2](#)
April 1999

[Vol. 33 No.1](#)
January 1999

[Vol. 32 No.4](#)
October 1998

[Vol. 32 No.3](#)
July 1998

Copyright: Copyright to all manuscripts published in *JARQ* belongs to the Japan International Research Center for Agricultural Sciences. An individual may make a single copy of an article for personal use. Multiple copying is authorized only with permission in writing from the publisher.

[JIRCAS Home Page](#)

*Published by :Japan International Research Center for Agricultural Sciences Ministry of Agriculture, Forestry and Fisheries Tsukuba, Ibaraki, 305-8686 Japan
www@jircas.affrc.go.jp*

Contents

- [Mapping of Useful Genes by FISH](#) Kiichi FUKUI and Nobuko OHMIDO
- [Transformation of Taro \(*Colocasia esculenta* Schott\) Using Particle Bombardment](#) Nobuko ITO-FUKINO et al.
- [Citrus Leafminer in Japan](#) Takeshi UJIYE
- [Relationship between Irrigation Pond Characteristics and Water Quality](#) Junji TAKAHASHI, Eisaku SHIRATANI and Ikuo YOSHINAGA
- [Stingless Bees as Crop Pollinators](#) Kazuhiro AMANO, Tetsu NEMOTO and Tim A. Heard
- [Determination of Tea Components by Enzymatic Flow Injection Analysis](#) Hideki HORIE
- [Bovine Thymic Lymphoma](#) Yoshikazu Yamazaki et al.
- [Bovine Hemangiopericytoma](#) Takashi TAKAHASHI et al.
- [Potential Risk of Transmission and Spread of FMD](#) Takashi OGAWA and Kenshi MATSUDA
- [Evaluating of Alternative Farming Systems by Multicriteria Analysis](#) Kiyotada HAYASHI

[!\[\]\(83f22ed94ec5517769dd76d702c6bfd8_img.jpg\) First Page of JARQ](#)[!\[\]\(8d0f0e0fe25b320c33272c52aec1fbca_img.jpg\) What's New](#)[!\[\]\(642aa997563f9a325b310230bb5078b7_img.jpg\) JIRCAS Home Page](#)

Visual Detection of Useful Genes on Plant Chromosomes

Kiichi FUKUI^{1*} and Nobuko OHMIDO²

¹Department of Biotechnology, Graduate School of Engineering, Osaka University
(Suita, Osaka, 565-0871 Japan)

²Laboratory of Rice Genetic Engineering, Hokuriku National Agricultural Experiment Station
(Joetsu, Niigata, 943-0193 Japan)

This work has been supported in a part by the Grant-in-Aid for IRRI/Japan Shuttle Research Project and Rice Genome Project, AFFRC, MAFF, Japan.

* Corresponding author: fax +81-6-6879-7441, e-mail kfukui@cell.bio.eng.osaka-u.ac.jp

Received 12 November 1999, accepted 6 January 2000.

Abstract

In this manuscript the current status of direct visualization of gene location on chromosomes was reviewed by considering 5 aspects as follows: principle of *in situ* hybridization (ISH) method, historical perspective of mapping genes by *in situ* hybridization, improvement in the sensitivity of fluorescence *in situ* hybridization (FISH), visualization of location of useful genes on chromosomes, and prospects for visualization of useful genes.

Discipline: Experimental apparatus and method/Biotechnology/Plant breeding

Additional key words: physical mapping, rice, FISH

1...21): [References](#)

Principle of *in situ* hybridization (ISH) method

ISH is a method for the visualization of the location of nucleotide sequences on chromosomes, nuclei, and even in the tissues. The principle of the method involves the hybridization of labeled nucleotide sequences, or probes, directly to DNAs or RNAs with the complementary sequences in chromosomes, nuclei or tissues. The location of the labeled probes hybridized to the complementary DNA sequences in chromosomes, for example, is detected by fluorochrome-labeled antibodies that recognize the label of the probes under a fluorescence microscope. The ISH in which fluorescence is used to detect probes is referred to as "fluorescence *in situ* hybridization (FISH)".

Historical perspective of mapping genes by ISH in rice²⁾

In 1910, the rice chromosome number was determined to be $2n=24$ by Kuwada¹⁴⁾. It took, however, more than 80 years until all the rice chromosomes were identified objectively and a rice chromosome map was developed by Fukui and Iijima³⁾ using imaging methods¹⁾. The long time interval from the determination of the rice chromosome number to the identification of individual chromosomes can be ascribed to the fact that rice has the smallest genome size of 430 Mb, thus the smallest chromosome size, among those of the main cereals.

Attempts to visualize specific DNA sequences directly on rice chromosomes have been pursued for years without the use of an objective method for identifying rice chromosomes nor a chromosome map at the beginning of the 1980s. Fukui et al.⁶⁾ succeeded in physically locating 18S-5.8S-25S ribosomal RNA genes (45S rDNA) loci at the end of a pair of chromosomes with ¹²⁵Iodine-labeled ribosomal RNA probes. This was the first reproducible result of *in situ* hybridization (ISH) using repetitive sequences in rice (Fig. 1a). The location of 45S rDNA loci in rice was detected by non-radioactive (biotin-labeled) probes by coloration using Japonica rice in 1991⁸⁾ (Fig. 1b). FISH was successfully achieved in 1992 for the first time and variability in the number of 45S rDNA loci was revealed among the rice species⁵⁾ (Fig. 1c). Multicolor FISH using different fluorescent colors simultaneously for detecting 5S rDNA and 45S rDNA was developed in 1994 soon after the successful development of FISH. Presently the multicolor FISH is a common method widely utilized to locate different nucleotide sequences simultaneously, such as telomere sequences (green fluorescence) and rice A genome specific tandem repeat sequence, TrsA (red fluorescence) (Fig. 1d)¹⁸⁾.

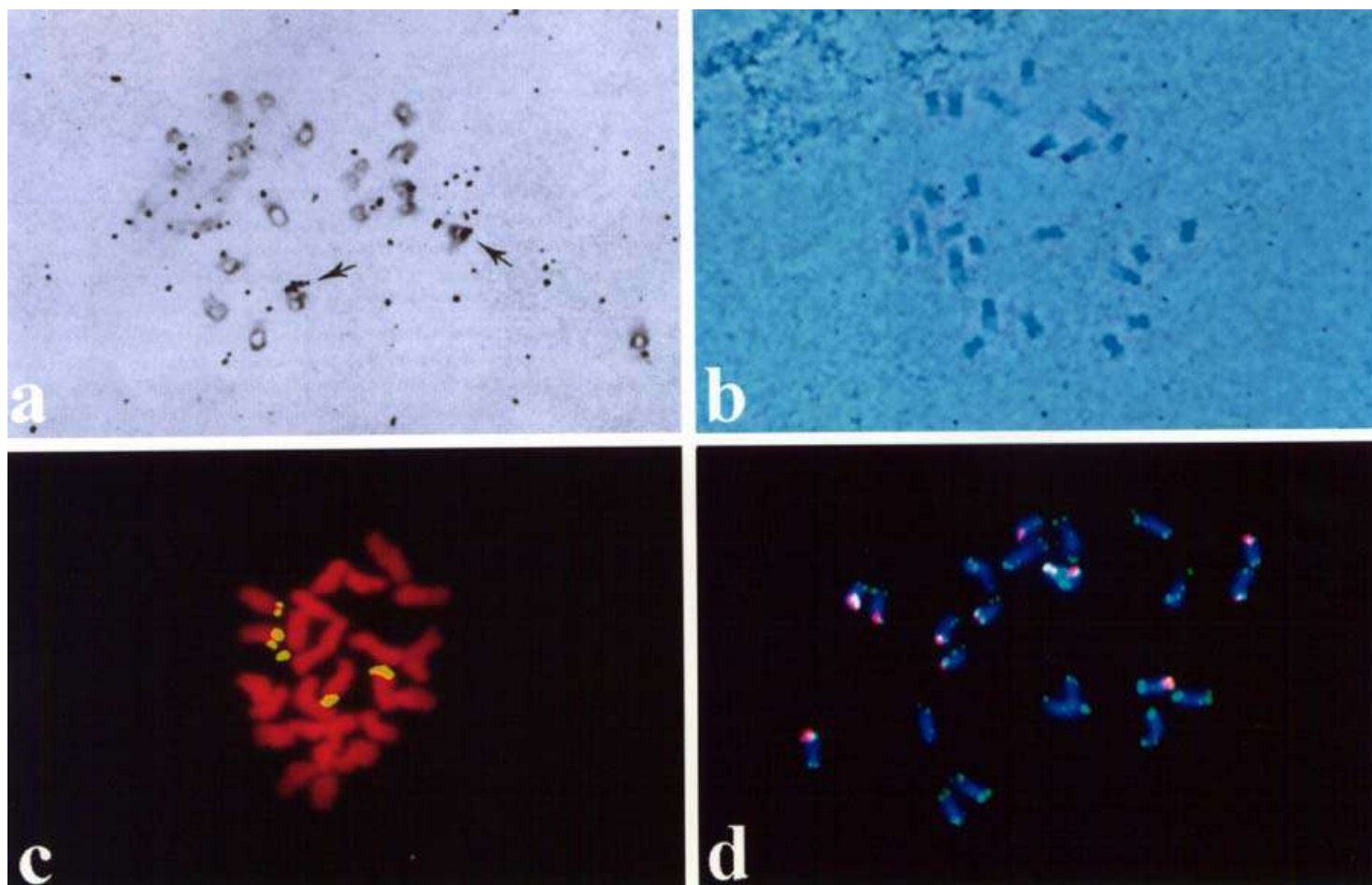


Fig. 1. Recent advances in *in situ* hybridization (ISH) for the past 15 years

a: Detection of ribosomal RNA gene (rDNA) locus with radioactive ribosomal RNA.

b: Detection of rDNA by a non-R1 labeling method.

c: Detection of rDNA loci in Indica rice by FISH.

d: Detection of multi-color fluorescence from different probes (telomere, green and TrsA, red) simultaneously.

All these efforts have enabled the detection of highly repetitive sequences on rice chromosomes reproducibly and efficiently. The development of both the chromosome map and the FISH method have contributed significantly to the physical mapping of DNA sequences in rice.

NEXT

TOP

References

1. Fukui, K. (1986): Standardization of karyotyping plant chromosomes by a newly developed chromosome image analyzing system (CHIAS). *Theor. Appl. Genet.*, **72**, 27 -32.
2. Fukui, K. (1996): Advances in rice chromosome research, 1990-1995. *In Rice Genetics III, Proc. 3rd Intl. Natl. Rice Genet. Symp.* ed. Khush G. S., International Rice Research Institute, Manila, Philippines, 117-130.
3. Fukui, K. & Iijima, K. (1991): Somatic chromosome map of rice by imaging methods. *Theor. Appl. Genet.*, **81**, 589-596.
4. Fukui, K. & Kakeda, K. (1990): Quantitative karyotyping of barley chromosomes by image analysis methods. *Genome*, **33**, 450-458.
5. Fukui, K., Ohmido, N. & Khush, G. S. (1994): Variability in rDNA loci in the genus *Oryza* detected through fluorescence *in situ* hybridization. *Theor. Appl. Genet.*, **87**, 893-899.
6. Fukui, K. et al. (1987): *In situ* hybridization of ¹²⁵I-labeled rRNA to rice chromosomes. *Rice Genet. Newslett.*, **4**, 114-116.
7. Fukui, K. et al. (1992): Microdissection of plant chromosomes by argon-ion laser beam. *Theor. Appl. Genet.*, **84**, 787-791.
8. Iijima, K., Kakeda, K. & Fukui, K. (1991): Identification and characterization of somatic rice chromosomes by imaging methods. *Theor. Appl. Genet.*, **81**, 606-612.
9. Iwano, M. et al. (1999): Visualization of a self-incompatibility related *SLG* gene in *Brassica campestris* L. by multi-color FISH. *Theor. Appl. Genet.*, **96**, 751-757.
10. Kamisugi, Y. et al. (1994): Physical mapping of the 5S ribosomal RNA genes on rice chromosome 11. *Mol. Gen. Genet.*, **245**, 133-138.
11. Kamisugi, Y. et al. (1998): Visualization of the *Brassica* self-incompatibility *S*-locus on identified oilseed rape chromosomes. *Plant Mol. Biol.*, **38**, 1081-1087.
12. Kunzel, G., Korzun, L. & Meister, A.: Cytologically integrated physical RFLP maps for the barley genome based on translocation breakpoints. *Genetics* (in press).
13. Kurata, N. et al. (1994): A 300 kilobase interval genetic map of rice including 883 expressed sequences. *Nature Genet.*, **8**, 365-372.
14. Kuwada, Y. (1910): A cytological study of *Oryza sativa* L. *Bot. Mag. (Tokyo)* **24**, 267-280.
15. Mitsunaga, S. et al.: Direct cloning of an α -amylase gene from barley chromosome 6 by a microdissection method (submitted).
16. Nakamura, M. & Fukui, K. (1997): A chromosome-oriented approach to genome analysis in a woody plant - *Sequoiadendron giganteum* (Lindl.) Buchholz. *In Cytogenetic studies of forest trees and shrub species.* eds., Borzen Z. & Schlarbaum S. E., Univ. Zagreb, Zagreb, 89-102.
17. Nakamura, S. et al. (1997): Constitution of an 800-kb contig in the near-centromeric region of the rice blast resistance gene *Pi-ta²* using a highly representative rice BAC library. *Mol. Gen. Genet.*, **254**, 611-620.
18. Ohmido, N. & Fukui, K. (1997): Visual verification of close disposition between a rice A genome-specific DNA sequence (TrsA) and the telomere sequence. *Plant Mol. Biol.*, **35**, 965-968.
19. Ohmido, N., Akiyama, Y. & Fukui, K. (1998): Physical mapping of unique nucleotide sequences on identified rice chromosomes. *Plant Mol. Biol.*, **38**, 1043-1052.

20. Ohmido, N. et al. (2000): Quantification of total genomic DNA and repetitive sequences reveals concurrent changes of different DNA families in *indica* and *japonica* rice. *Mol. Gen. Genet.* (in press).
21. Rajyashri, K. R. et al. (1998): Isolation and FISH mapping of yeast artificial chromosomes (YACs) encompassing an allele of the *Gm2* gene for gall midge resistance in rice. *Theor. Appl. Genet.*, **97**, 507-514.

Improvement in the sensitivity of FISH

Once reproducible detection of the repetitive sequences on rice chromosomes using the FISH method was obtained in the early 1990s, the main objective of FISH was to enhance the detection sensitivity of the fluorescent signals. Even though the visual detection of repetitive sequences on rice chromosomes had become routine work, detection of a unique sequence was considered to be difficult because of the smaller sizes of nucleotide sequences.

[Fig. 2a](#) shows clones differing in sizes, which were used as probes in the FISH experiments to evaluate the sensitivity of detection of fluorescent signals on rice chromosomes. In the clones with insert sizes ranging from 399 kb to around 1 kb, attempts were made to determine whether their fluorescence could be visualized on rice chromosomes after FISH¹⁹). The largest clones were those of yeast artificial chromosomes (YAC) with 399 and 340 kb of inserted rice genomic DNAs. A bacterial artificial chromosome (BAC) with a 180 kb insert, and a cosmid clone with a 35 kb insert were also tested using the FISH method. The smallest clones were molecular markers cloned into plasmid vectors with around 1 kb inserts.

To visualize these clones, both the experimental procedures and the detection equipment were improved. First, the detection sensitivity of faint fluorescent signals from the probe DNAs was enhanced by the introduction of a cooled CCD camera. The camera was directly mounted on top of a microscope. Second, in the FISH protocol, a longer hybridization period between the labeled probes and chromosomal DNAs was used. The longer hybridization period ensured hybridization between the probes and complementary DNA in the chromosomes. All the clones from nearly 400 to 1 kb were successfully visualized by the improved FISH method. As a result, the detection sensitivity of FISH was enhanced by 400 times throughout the experiments¹⁹) ([Fig. 2b](#)).

Visualization of location of useful genes on plant chromosomes

1) Mapping of a resistance gene to gall midge, *Gm2*

[Fig. 3](#) shows the results of the improved FISH method using different DNA clones as probes. All the clones contained useful genes such as disease-resistance genes. The result of FISH using a YAC clone (YAC5212) with a 340 kb rice genomic DNA was presented, because YAC5212 is flanking a gall midge (*Orseolia oryzae*) resistance gene, *Gm2*. Gall midge is a major dipteran insect pest of rice in India, China, Africa and Southeast Asia and its resistance genes are now being cloned. Fig. 3a shows the YAC signals on the pair of rice chromosome 4²¹). Fluorescent signals are detected in the interstitial region of long arms indicating the physical location of *Gm2*. The position of *Gm2* was also confirmed by the FISH using 2 RFLP markers genetically linked to *Gm2*.

2) Mapping of a resistance gene to leaf blast, *Pi-b*

The physical location of the resistance gene to rice leaf blast was then examined. Rice blast caused by *Pyricularia oryzae* (*Magnaporthe grisea* (Hebert) Barr) is the most important fungal disease of rice. The resistance gene, *Pi-b* was cloned into a BAC clone (BAC123) which has a 180 kb insert of rice genomic DNA. Because the location of the genomic DNA on rice chromosomes was unknown, the FISH method was employed to physically determine the actual location of the BAC clone or the position of the gene,

Pi-b.

Fig. 3b shows the signals from the BAC clone at the end of the long arm of rice chromosome 2¹⁷⁾. Haploid rice plant derived by anther culture was used for chromosome preparations. Thus one single-tagged chromosome shows clear doublet signals which are essential for the discrimination between genuine signals from noises. Thus the chromosomal location of the *Pi-b* gene was determined at 2p1.2 according to the rice chromosome map²⁾.

We further analyzed the BAC signals on the ten chromatids of rice chromosome 2 by the imaging method to determine the precise location of the gene on the chromosomes. As a result, the *Pi-b* gene was located at the position of 96.16 ± 0.91 from the end of the short arm when the total chromosome length of chromosome 2 was 100.00¹⁷⁾. This method was also employed to determine the 5S ribosomal RNA genes on rice chromosomes. The 5S rDNA locus was allocated to the position of 39.3 ± 2.6 on chromosome 11 (11p1.1) from the end of the short arm¹⁰⁾.

3) Mapping of a resistance gene to bacterial blight, *Xa-21*

The smaller rice genomic DNA of 35 kb nucleotide sequences cloned into a cosmid vector, was examined. The clone contained a resistance gene, *Xa-21* to the rice disease, bacterial leaf blight (*Xanthomonas oryzae*). Bacterial leaf blight is also a major rice disease widely distributed in Asian countries. The same improved FISH method was used to locate *Xa-21* on the rice chromosome. In this case, since we used the Indica rice variety IR36, a diploid plant material, the signals were observed in a pair of rice chromosomes.

Fig. 3c shows the fluorescent signals from a pair of rice chromosomes. By using the uneven condensation pattern, the rice chromosomes were identified as rice chromosome 11 and the doublet signals were clearly observed in the interstitial region on the long arm (11q1.3)¹⁹⁾.

4) Mapping of the molecular marker, *Xnp 247*

Molecular markers are very useful for the construction of linkage maps and more than 2,000 molecular markers were developed to construct the rice linkage map¹¹⁾. The size of the molecular markers varies and the size of molecular markers, such as RFLP markers is often less than a few kilo basepairs. The RFLP markers played an important role in the construction of many linkage maps at the beginning of genome mapping. We applied the FISH method to locate a RFLP marker (*Xnp 247*) with 1.29 kb of rice genomic DNA.

Fig. 3d shows the signal position from the RFLP marker. The doublet signals were clearly detected at the end of rice chromosome 4 (4q2.1)¹⁹⁾. The results indicate that even a nucleotide sequence with about 1 kb could be successfully detected by the improved FISH method. It also means that practically all the functional genes could be directly detected on the chromosomes by the improved FISH method¹⁷⁾. Self-incompatibility-related genes of *Brassica* spp. have already been mapped by using FISH^{9,11)}.

The physical mapping of the nucleotide sequences also reveals a discrepancy between the physical length of the chromosomes and the genetic distance calculated by the recombination values. [Fig. 4](#) shows 2 examples of the discrepancy detected in rice¹⁹⁾ and barley⁴⁾. Comparison of the chromosomal location of *Xa-21* determined by FISH and linkage analyses revealed a remarkable discrepancy between the total length in the two maps. The linkage map of chromosome 11 showed a much longer length when the chromosome map and the linkage map were aligned by the two landmarks i.e. the centromere and the

position of *Xa-21* now determined¹⁹⁾ (Fig. 4a). As demonstrated in the barley chromosome map that was developed by imaging methods⁴⁾ and linkage map, the length of the satellite part, that is the terminal region of the chromosome 6 was markedly over-estimated in the linkage map. The discrepancy was again confirmed by a detailed comparison between the chromosome and dense linkage maps in barley¹²⁾. The over-estimation of the terminal length in the linkage map compared to the actual length of barley chromosomes determined by FISH and/or imaging methods suggests that recombination occurs frequently only in the terminal region of the barley chromosomes.

Although the discrepancy between the overall length of the chromosome and linkage maps was demonstrated in rice chromosome 11 (Fig. 4a), it remains to be determined whether the frequent recombination observed only in the terminal chromosomal regions could also occur in rice and other plant species as a general tendency.

Prospects for visualization of useful genes

Visualization or mapping of useful genes is important in genetic analyses. Since, not all the plants have as dense linkage maps as rice¹³⁾ and it is usually time-consuming and laborious to construct a dense linkage map, FISH is a useful and efficient alternative method in many plant species. FISH could be applied for the mapping of genes and clones regardless of plant species.

When molecular markers that sandwich a certain character can be found, the distance between the markers could be obtained by using FISH on chromosomes and extended DNA fibers (EDFs)²⁰⁾. Moreover, it may be possible to clone the gene by a FISH-oriented method and not by an ordinary map-based cloning method. First, FISH using the linked marker(s) could enable to determine the chromosomal position of the target gene. Then the laser dissection⁷⁾ or the ordinary dissection method could be applied to collect the chromosomal fragments with the signals. Finally, clones in the chromosomal regions could be obtained by the use of degenerated oligo-primer (DOP)-PCR method using the dissected chromosomal fragments as the templates. Direct amplification of ribosomal RNA genes¹⁶⁾ and \pm -amylase genes¹⁵⁾ by using the laser-dissection method has been successful in some cases.

In conclusion, the visualization of useful genes is important not only to determine their actual location on the chromosomes, but also it may be possible to clone the genes in conjunction with the chromosome dissection method even in plants with limited genome information. It is anticipated that the visualization method represented by FISH will be more useful when it is combined with new methods to manipulate chromosomes and even DNA fibers.

[NEXT](#)[TOP](#)[HOME](#)

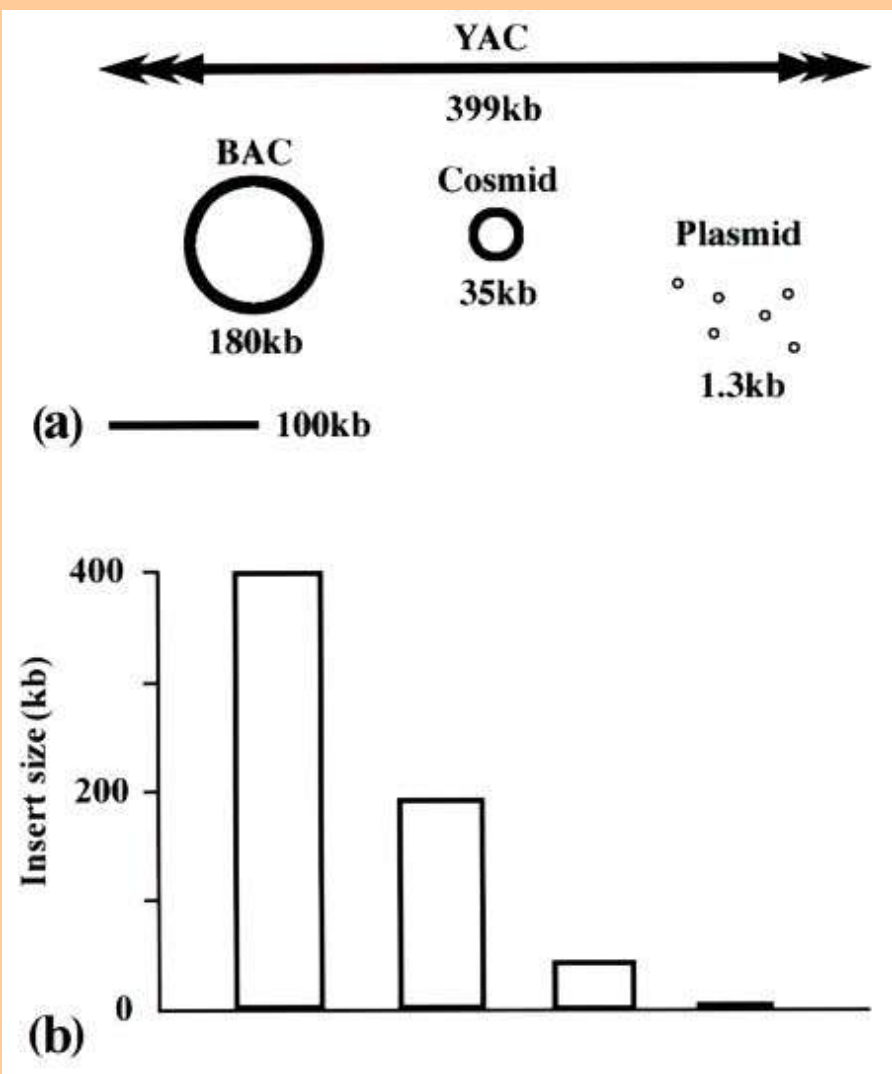


Fig.2. Various sizes of probe DNAs used in FISH (a) and improvement of the detection sensitivity of FISH (b)

BACK

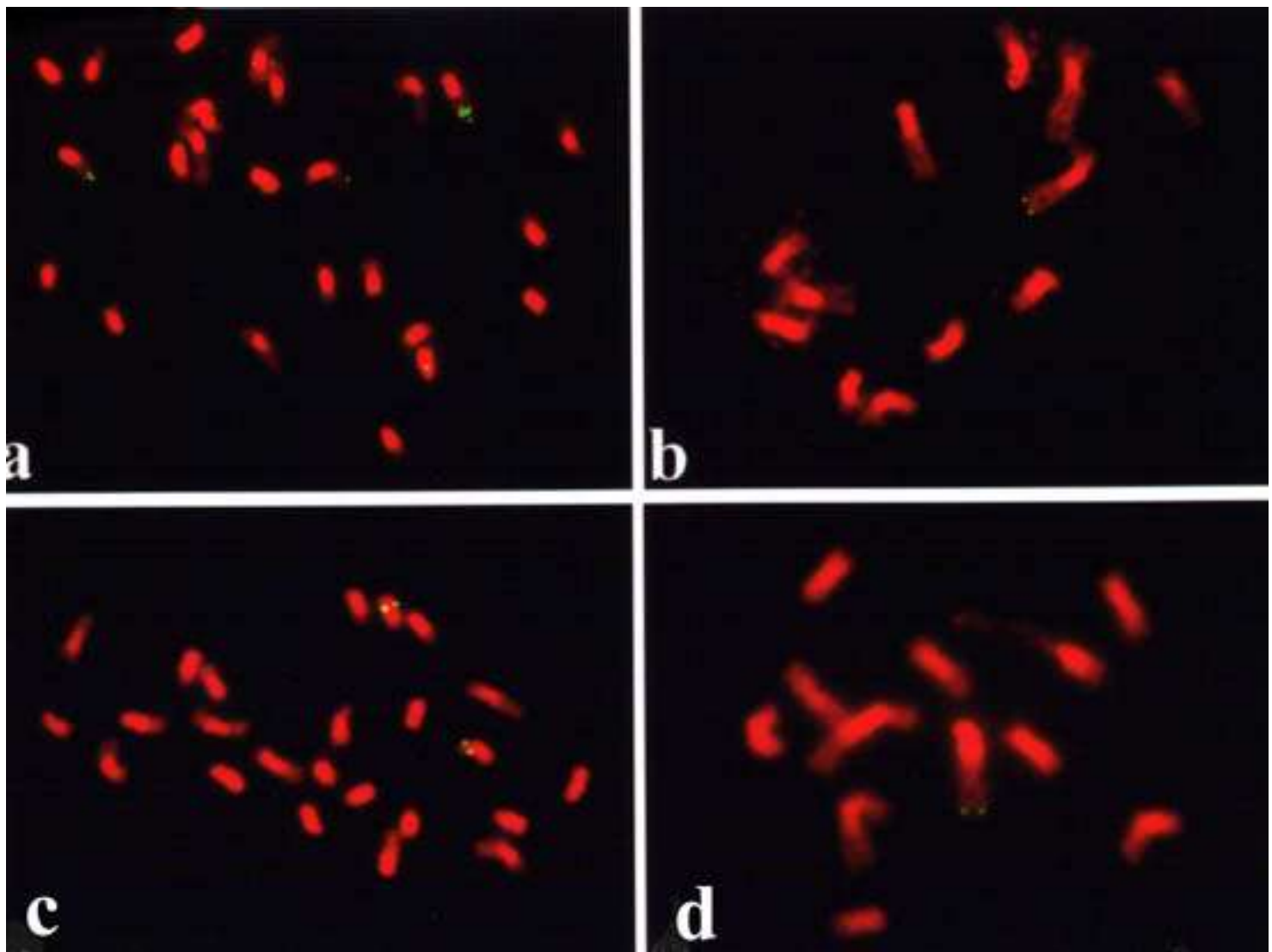


Fig.3. Visualization of the location of useful genes on rice chromosomes

- a: Gall midge resistance gene on chromosome 4.**
- b: Leaf blast resistance gene on chromosome 2.**
- c: Bacterial blight resistance gene on chromosome 11.**
- d: RFLP marker (*Xnp247*) on chromosome 4.**

BACK

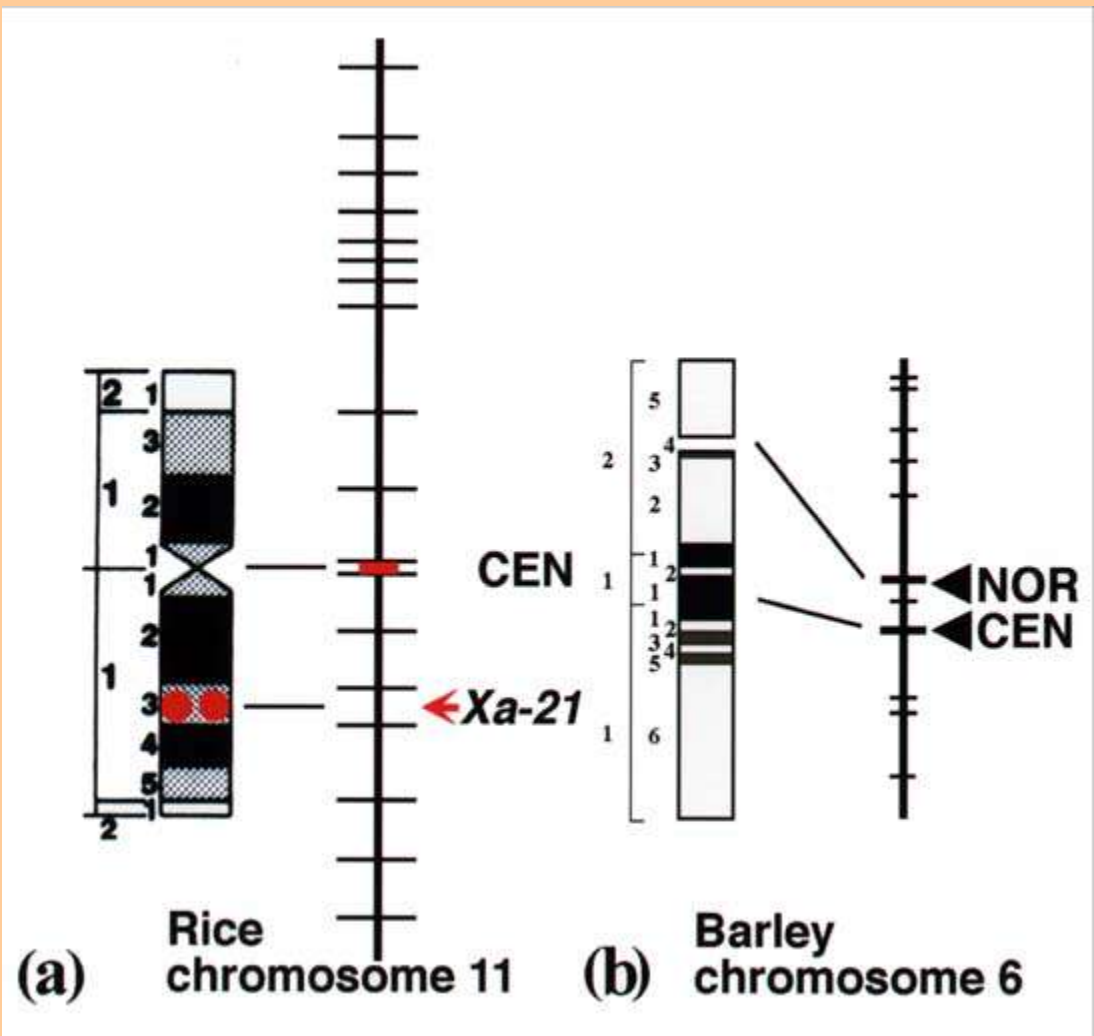


Fig.4. Discrepancy between the chromosome and genetic maps for rice chromosome 11 (a) and barley chromosome 6 (b)

BACK

Transformation of Taro (*Colocasia esculenta* Schott) Using Particle Bombardment

Nobuko FUKINO (ITO)^{1*}, Kaoru HANADA², Hidetoshi AJISAKA³, Junichi SAKAI², Hirohiko HIROCHIKA⁴, Masashi HIRAI¹, Takashi HAGIO⁵ and Sueo ENOMOTO⁶

1,3,6 Department of Vegetable Breeding, National Research Institute of Vegetables, Ornamental Plants and Tea
(Ano, Mie, 514-2392 Japan)

2 Department of Crop Breeding, Kyushu National Agricultural Experiment Station
(Nishigoshi, Kumamoto, 861-1192 Japan)

4 Department of Molecular Genetics, National Institute of Agrobiological Resources
(Tsukuba, Ibaraki, 305-8602 Japan)

5 Department of Biotechnology, National Institute of Agrobiological Resources
(Tsukuba, Ibaraki, 305-8602 Japan)

Present address:

3 Leaf Tobacco Research Laboratory, Japan Tobacco Inc.
(Oyama, Tochigi, 323-0808 Japan).

6 Department of Research Planning & Coordination, National Institute of Agrobiological Resources
(Tsukuba, Ibaraki, 305-8602 Japan).

* Corresponding author: fax +81-59-268-1339, e-mail nbk@nivot.affrc.go.jp

Received 10 November 1999, accepted 2 December 1999.

Abstract

Transgenic taro (*Colocasia esculenta* Schott) plants were obtained by high-velocity particle bombardment. The plasmid pREXHGUS, carrying the hygromycin resistance gene, was used as a selection marker. Highly regenerative taro callus was obtained from the apical meristem, and maintained in liquid culture. The callus was chopped into small fragments with a forceps, then transformed and selected on LS medium containing BA, NAA and hygromycin. Since the transformed calli obtained showed vigorous growth on LS-BN medium with 20 mg/L hygromycin, this concentration was considered to be suitable for the selection of transgenic taro. The transformants were confirmed by amplification of the GUS gene, and Southern hybridization. The expression of the foreign gene was demonstrated by the GUS activity.

Discipline: Plant breeding

Additional key words: callus, hygromycin-resistance gene, GUS gene

1...22): [References](#)

Introduction

Taro originated in India and adjacent areas of Southeast Asia, and is now widely cultivated in Asia and Oceania¹⁸). In some Oceanian countries, this crop is one of the main sources of starchy food. Since taro propagates mainly with tubers, the occurrence of virus diseases is one of the main problems affecting its cultivation, along with taro leaf blight in tropical countries¹²). Once a clone is infected with virus, its productivity may be reduced. It is difficult to remove the virus under natural conditions of cultivation. Although shoot tip culture *in vitro* has been used to remove virus particles, the problem of reinfection with virus still remains. Recent biotechnological research has revealed that transformation with the coat protein gene or some other viral genes, confers resistance to virus diseases^{1,4}). The objective of the present study was to breed a virus-resistant cultivar of taro. Since taro is a monocotyledon, *Agrobacterium*-mediated transformation is considered to be difficult. Although protoplast culture of taro has been reported¹³), this technique is very laborious and it is difficult to obtain regenerated plants, in addition somaclonal variation may occur more frequently. Therefore, protoplast culture is not suitable for direct transformation of taro, and instead particle bombardment is most appropriate for the transformation of taro. Few studies on the transformation of taro have been carried out. Here we report the transformation of taro using a particle bombardment system.

[NEXT](#)

[TOP](#)

References

- 1) Beachy, R. N., Loesch-Fries, S. & Tumer, N. E. (1990): Coat protein-mediated resistance against virus infection. *Annu. Rev. Phytopathol.*, **28**, 451-474.
- 2) Broglie, K. et al. (1991): Transgenic plants with enhanced resistance to the fungal pathogen *Rhizoctonia solani*. *Science*, **254**, 1194-1197.
- 3) Coates, D. J., Yen, D. E. & Gaffey, P. M. (1988): Chromosome variation in taro, *Colocasia esculenta*; Implications for origin in the Pacific. *Cytologia*, **53**, 551-560.
- 4) Hackland, A. F., Rybick, E. P. & Thompson, J. A. (1994): Coat protein-mediated resistance in transgenic plants. *Arch. Viol.*, **139**, 1-22.
- 5) Hirai, M., Sato, T. & Takayanagi, K. (1989): Classification of Japanese cultivars of Taro (*Colocasia esculenta* (L.) Schott) based on electrophoretic pattern of tuber proteins and morphological characters. *Jpn. J. Breed.*, **39**, 307-317.
- 6) Karube, M., Shimonishi, K. & Kukimura, H. (1992): Plant regeneration *in vitro* of Taro. *Jpn. J. Breed.*, **42** (1), 58-59.
- 7) Kemper, E. L., de Silva, M. J. & Arruda, P. (1996): Effect of microprojectile bombardment parameters and osmotic treatment on particle penetration and tissue damage in transiently transformed cultured immature maize (*Zea mays* L.) embryos. *Plant Sci.*, **121**, 85-93.
- 8) Kosugi, S. et al. (1990): An improved assay for b-glucuronidase in transformed cells; Methanol almost completely suppresses a putative endogenous b-glucuronidase activity. *Plant Sci.*, **70**, 133-140.
- 9) Linsmaier, E. M. & Skoog, F. (1965): Organic growth factor requirements of tobacco tissue cultures. *Physiol. Plant*, **18**, 100-127.
- 10) Liu, Y. G. et al. (1995): Efficient isolation and mapping of *Arabidopsis thaliana* T-DNA insert junctions by thermal asymmetric interlaced PCR. *Plant J.*, **8** (3), 457-463.
- 11) Mitsuhashi, I. et al. (1996): Efficient promoter cassettes for enhanced expression of foreign genes in dicotyledonous and monocotyledonous plants. *Plant Cell Physiol.*, **37** (1), 49-59.
- 12) Morishita, M. (1988): Taro (*Colocasia esculenta* Schott). In *Biotechnology in agriculture and forestry* 6. ed. Bajaj Y. P. S., 322-328.
- 13) Murakami, K., Kimura, M. & Matsubara, S. (1995): Plant regeneration from protoplasts isolated from callus of taro (*Colocasia esculenta* Schott). *J. Jpn. Soc. Hort. Sci.*, **63** (4), 773-778.
- 14) Murray, M. & Thompson, W. F. (1980): Rapid isolation of high molecular weight plant DNA. *Nucleic Acids Res.*, **8**, 4321-4325.
- 15) Nyman, L. P., Gonzales, C. J. & Arditti, J. (1981): Production of salt tolerant tissue and plantlets of taro, *Colocasia esculenta* var. *antiquorum*. *IFS Provisional Rep.*, **11**, 340-352.
- 16) Nyman, L. P., Gonzales, C. J. & Arditti, J. (1983): *In vitro* selection for salt tolerance of taro (*Colocasia esculenta* var. *antiquorum*). *Ann. Bot.*, **51**, 229-236.

- 17) Nyman, L. P. & Arditti, J. (1984): Effects of 2,3,5-triiodobenzoic acid on plantlet formation from cultured tissues of taro (*Colocasia esculenta* (L.) Schott (Araceae)). *Ann. Bot. (London)*, **54**, 459-466.
- 18) Purseglove, J. W. (1972): Tropical crops; Monocotyledons 1. Longman, London, 62-69.
- 19) Shimoyama, J. et al. (1992): Some physicochemical and serological properties of konjak mosaic virus and dasheen mosaic virus. *Ann. Phytopath. Soc. Jpn.*, **58**, 713-718.
- 20) Wilmink, A. & Dons, J. J. M. (1993): Selective agents and marker genes for use in transformation of monocotyledonous plants. *Plant Mol. Biol. Rep.*, **11**, 165-185.
- 21) Yam, T. W., Webb, E. L. & Arditti, J. (1990): Callus formation and plantlet development from axillary buds of taro. *Planta*, **180**, 458-460.
- 22) Yam, T. W., Ichihashi, S. & Arditti, J. (1991): Callus growth and plantlet regeneration in taro, *Colocasia esculenta* var. *esculenta* (L.) Schott (Araceae). *Ann. Bot.*, **67**, 317-323

Materials and methods

1) Plant material

A triploid cultivar of taro (*Colocasia esculenta* Schott), 'Eguimo', was used in the present study. Eguimo is one of the major cultivars used in Japan, and callus induction and shoot regeneration of this cultivar have been developed⁶).

2) Plasmid

A plasmid, pREXHGUS, was constructed based on the pUC18 plasmid ([Fig. 1](#)). A selection marker, the hygromycin phosphotransferase (hpt) gene, was driven by a 35S promoter harboring one copy of the enhancer, and a beta-glucuronidase (GUS) gene containing the phaseolin intron 1 gene was driven by the 35S promoter containing 7 copies of the cauliflower mosaic virus (CaMV) 35S enhancer region¹¹).

3) Induction and maintenance of callus

Linsmaier and Skoog⁹) medium (LS medium) supplemented with 2 mg/L benzyladenine, 1 mg/L naphthaleneacetic acid and 3% sucrose was used as a basic medium (LS-BN medium). The shoot tips (0.5 to 1 mm) were removed from surface-sterile tubers and planted on LS-BN medium solidified with 2% gellan gum, then cultured at 25°C (16 h photoperiod, 36 $\frac{1}{4}$ m² sec⁻¹) to induce callus. The induced calli were maintained on the solidified medium by subculturing every 2 or 3 weeks. As a target for particle bombardment, the calli were chopped into small pieces (2 to 3 mm in diameter) with a forceps, and cultured in liquid LS-BN medium with rotary shaking at 100 rpm at 25°C. These calli were maintained by weekly chopping and subculture.

4) Particle bombardment

The calli (ca. 2.0 g) were placed on a sterile filter paper (70 mm in diameter). Then, the filter paper was placed on a 9 cm petri dish filled with solid LS-BN medium and cultured at 25°C for 2~24 h.

Biolistic PDS-1000/He (Bio-Rad) was used. Before the bombardment, the pressure in the chamber was reduced to 660 mm Hg. Gold (1.6 μ m in diameter) or tungsten (1.1 $\frac{1}{4}$ μ m in diameter) particles were coated onto the plasmids as previously described⁷), then delivered from a distance of 9 cm to the taro calli on a filter paper at a pressure of 1,100 psi.

A total of 96 runs were conducted.

5) Optimization of culture duration and hygromycin concentration

The calli were bombarded at 0, 4, 6 and 8 days after chopping. The bombardment procedure was the same as that described above. After 48 h of bombardment, GUS activity was examined as described by Kosugi et al.⁸) by counting the number of blue spots. This experiment was repeated twice. The data points were subjected to logarithmic transformation, then analyzed statistically.

For optimization of the hygromycin concentration, the calli (120 to 195) were placed on hormone-free LS medium and LS-BN medium containing 0, 5, 10, 20 and 40 mg/L hygromycin. After 40 days of culture, callus survival was examined. Then, surviving calli were subcultured onto the same medium containing 10 mg/L hygromycin, and after 40 days of culture the number of surviving calli were counted.

6) Maintenance and selection of transformants

After the bombardment, the calli were cultured for 2 days on the same filter paper at 25°C. The treated

calli were then transferred to liquid LS-BN medium supplemented with 20 mg/L hygromycin (Hyg), then cultured for 5 days with rotary shaking at 100 rpm. After 5 days of shaking culture, the calli were transferred to solid LS-BN medium with 20 mg/L hygromycin, then cultured at 25°C under a 16-d photoperiod. Resulting green calli were transplanted onto solid LS-BN medium with 10 mg/L hygromycin for 30 days, then on hormone-free LS medium supplemented with 5, 10 and 20 mg/L hygromycin for induction of plantlets.

The flow chart of taro transformation is shown in [Fig. 2](#). Selected transformed plantlets and non-transformed control plants were used for GUS analysis.

7) PCR and Southern blot analysis

For PCR amplification, DNA was isolated from fresh leaf tissue according to the method of Liu et al.¹⁰. The presence of the transferred gene was assayed by PCR using oligonucleotides specific for the GUS genes. The upstream and downstream primers employed were (5'-ATGTTACGTCCTGTAGAAAC-3') and (5'-GTCCAGTTGCAACCACCTGT-3'), respectively. For Southern blot analysis, genomic DNA was isolated from fresh leaf tissue as previously described¹⁴, digested with *Bam*HI, *Eco*RI, *Hind*III, and *Pst*I, respectively, then blotted onto a nylon membrane. Plasmid DNA was labeled with digoxigenin using a DIG-DNA labeling kit (Boehringer Mannheim) then used as a probe. Hybridization and detection were performed according to the manufacturer's protocol.

[NEXT](#)[TOP](#)

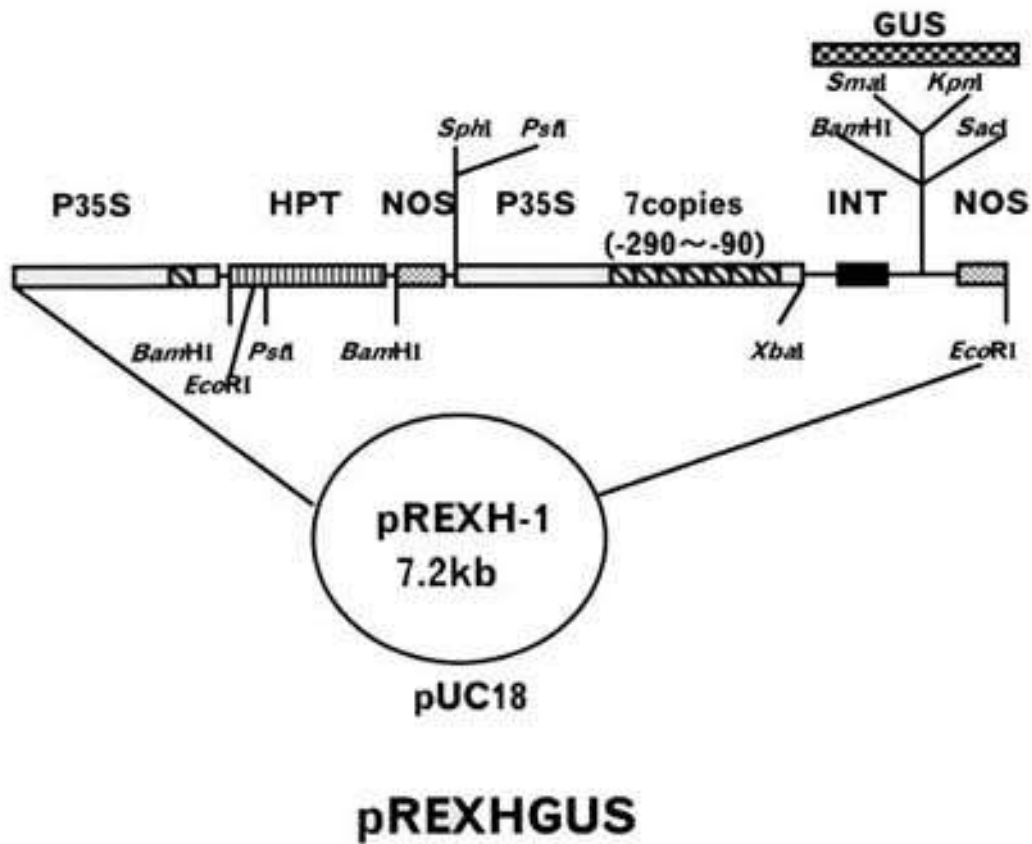


Fig. 1. Diagrammatic representation of the transformation plasmid pREXHGUS. A modified 35S promoter and an intron (intron 1 of the phaseolin gene) synergistically activate the gene expression.

BACK

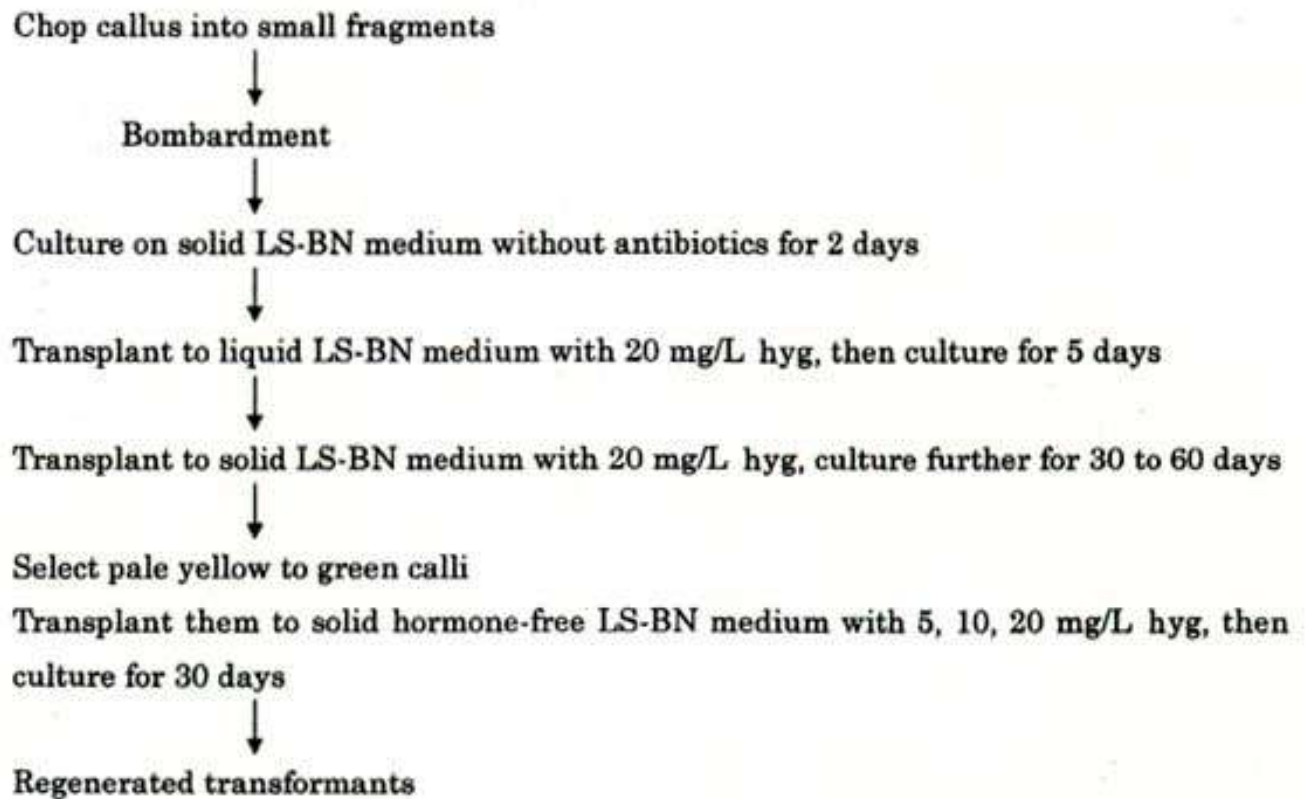


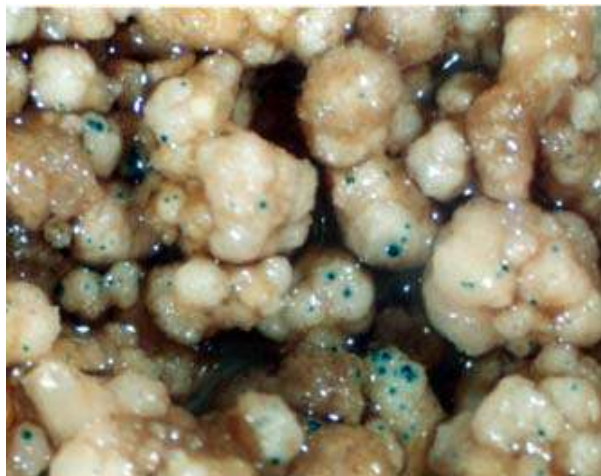
Fig. 2. Flow chart of taro transformation

BACK

Results

1. Effect of culture duration after callus chopping

Since taro calli grow as a mass, they need to be chopped into small pieces for efficient delivery of the particles. The effect of the culture duration after callus chopping was examined ([Table 1](#)). Bombardment just after chopping resulted in rather poor transient expression of the GUS gene. However, the expression ability recovered almost fully after 4 days of culture (Fig. 3a). Therefore, calli after 4~8 days of culture were used subsequently.



a



b



c



d-1



d-2



e-1



e-2

Fig.3. Transient expression of GUS gene, and selection of transformants

- a. Staining of calli for GUS activity 48 h after bombardment.
- b. Calli after 40 days of bombardment.
- c. Plant regeneration on LS-BN medium containing hygromycin.
- d. Plant growth on LS-BN medium with 20 mg/L hygromycin. 1:untransformed, 2:transformed.
- e. Expression of GUS gene in regenerated plant. 1:untransformed, 2:transformed.

2) Effect of antibiotic concentration on callus growth

Effects of various concentrations of hygromycin in LS medium on callus growth were examined ([Table 2](#)). The growth of untransformed callus was effectively suppressed by 20 mg/L hygromycin. After 40 days, surviving calli on the media containing 5 or 10 mg/L hygromycin were further cultured on a new medium containing 10 mg/L hygromycin, for an additional 40 days. None of the calli survived.

3) Callus growth after bombardment

Most of the calli on the solid LS-BN medium with 20 mg/L hygromycin turned dark brown 30 to 60 days after bombardment, then died. However, a small number of yellowish to greenish calli were observed among the dark brown calli (Fig. 3b). These calli were transplanted onto hormone-free LS medium with 10 mg/L hygromycin to induce plantlets (Fig. 3c). Antibiotic resistance of the regenerated plants was examined on LS medium supplemented with 5, 10 and 20 mg/L hygromycin. Some plants did not grow, or wilted, on the medium containing 10 mg/L hygromycin (Fig. 3d). Others showed normal and rapid growth on the same medium. Two of these plants were propagated vegetatively.

4) GUS and DNA analysis

The plantlets were stained with X-gluc solution, and the young leaves and tracheal tissue of roots showed a blue color (Fig. 3e). The genomic DNA was

Results

extracted from the plants showing normal growth on the medium containing hygromycin. The presence of the introduced gene was examined by PCR. A 650-bp band was observed in these plants after gel electrophoresis. A band of the same size was also observed when the original pREXHGUS plasmid was used as a template ([Fig. 4](#)). The presence of the foreign gene was further examined by Southern blot analysis. The DNA was digested with restriction enzymes, separated by gel electrophoresis, then blotted onto a nylon membrane, probed with the digoxigenin-labeled pREXHGUS. The hygromycin-resistant plants showed positive signals while the non-transformed controls did not show any bands ([Fig. 5](#)).

[NEXT](#)

[TOP](#)

Table 1. Effect of additional culture after chopping the callus

Culture duration after chopping (days)		Number of blue spots per dish ^{a)}
0		2.3(2.3)
4		5.3(0.9)
6		4.4(0.2)
8		5.1(0.0)

a): Mean value of 2 replications.

(): SD.

BACK

Table 2

Table 2. Effect of antibiotic concentration on the growth of untransformed taro callus

Plant hormone	Concentration of hygromycin(mg/L)	Surviving calli (%) ^{a)}	Surviving calli after subculture (%) ^{b)}
Present	0	100	-
	5	26.7	0
	10	19.5	0
	20	2.5	-
	40	0	-
Absent	0	100	-
	5	12.8	0
	10	3.6	0
	20	0	-
	40	0	-

A total of 120 to 195 calli were used for each experiment.

a): Callus survival was examined after 40 days of culture.

b): Surviving calli were subcultured onto LS-BN medium with 10 mg/L hygromycin. After an additional 40 days, the numbers of surviving calli were counted.

[BACK](#)

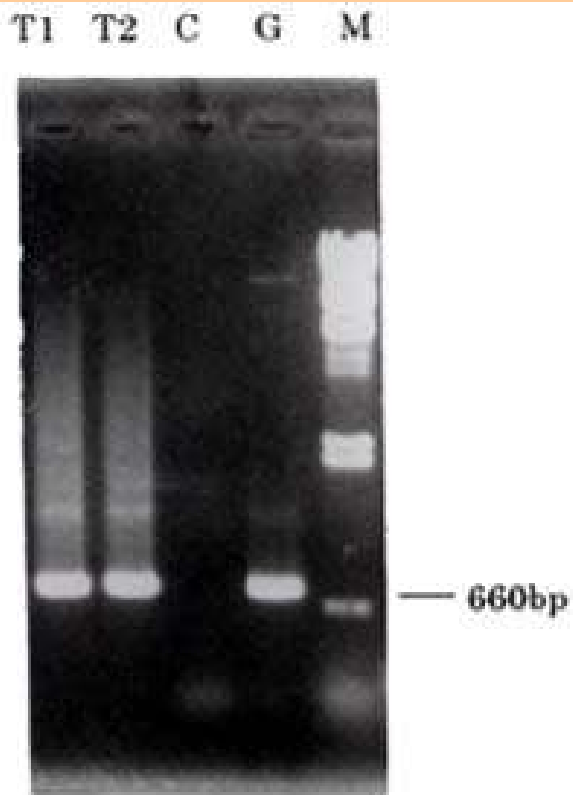


Fig.4. Amplification of the introduced gene by PCR

T1: transformed plant 1. T2: transformed plant 2.
C: untransformed plant. G: plasmid pREXHGUS.
M: molecular marker (»HindIII).

BACK

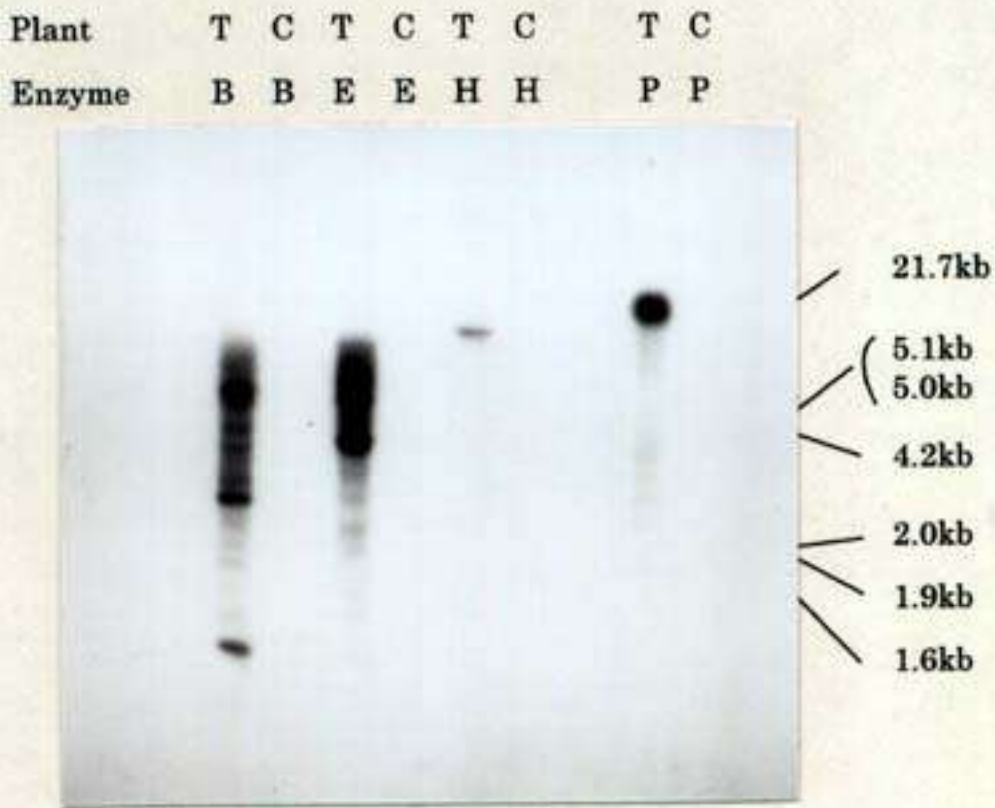


Fig.5. Southern blot analysis of the GUS gene

T: transformed plant, C: untransformed plant,
 B: *Bam*HI, E: *Eco*RI, P:*Pst*I.

BACK

Discussion

1) Regeneration system for taro

The system used in the present study was originally developed by Karube et al.⁶⁾ using a triploid cultivar, Eguimo. The calli of Eguimo showed a very high regeneration ability in this system. Moreover, the calli were easily maintained on solid or liquid LS-BN medium. They readily differentiated plantlets on the hormone-free medium, and were considered to be a suitable target for transformation. A similar regeneration system can be established in other triploid cultivars. However, taro shows a wide range of genetic diversity^{5,17)}, and cultivars are classified into 2 varieties: var. *antiquorum* and var. *esculenta*. Cultivars grown in tropical areas are diploid and classified into var. *esculenta*¹⁸⁾. Using a cultivar from the Solomon Islands, a regeneration system for taro has also been reported^{15,16,21,22)}. Although a detailed description of the cultivar was not given, cultivars from the Solomon Islands should be diploid and classified into var. *esculenta*³⁾. With minor modifications, the transformation system described here is considered to be suitable for other cultivars including diploid ones. To maintain a fine suspension of callus, the callus should be chopped when subcultured. However, the results of bombardment just after chopping were not satisfactory, and therefore the calli may have been under some stress, inducing a low transformation competence.

2) Selection of taro transformants

Choice of a selection marker gene and the concentration of selective agents are key factors for successful transformation. Kanamycin is widely used for the transformation of various plant species. However, Wilmlink and Dons²⁰⁾ have reported that hygromycin is more suitable for the selection of monocot transformants. In wheat, rice and barley, hygromycin is commonly used as a selection marker for transformants. Moreover, in our preliminary experiment, taro calli survived on a medium containing up to 200 mg/L kanamycin (data not shown). Therefore, in the present study, we tried to select taro transformants using hygromycin. This antibiotic induced a clear suppression of callus growth at a concentration of 20 mg/L (Table 2). Therefore, selection of transformed calli with 20 mg/L hygromycin is considered to be optimal.

Some of the untransformed calli survived during 40 days of culture, but finally died when transplanted onto new medium containing 10 mg/L hygromycin. To obtain transformants rapidly, regeneration medium containing 10 mg/L hygromycin was used. Since some of the untransformed plants may possibly survive under these conditions, regenerated taro plants showing rapid growth and budding from the base on medium containing 10 mg/L hygromycin should be selected as transformants.

Efficiency of transformation is still rather low: a total of 2 independent transformants were obtained from 96 runs. Each run involved one petri dish containing 2.0 g of calli. The number of blue spots also varied considerably in each experiment, and this may have been due to the physiological status of the calli used. More detailed studies are required to obtain more efficient and stable conditions for transformation.

3) Breeding of disease-resistant taro cultivars

Since taro is widely cultivated in Asia and Oceania, the present study has shown that this technique is applicable to the breeding of taro. The occurrence of virus diseases is one of the main problems for taro growers. For example, dasheen mosaic virus and cucumber mosaic virus have been detected in taro

cultivated in Japan^{12,19}). Both viruses have been well studied at the molecular biological level. Transformation of these viruses with coat protein (CP) genes may enable to confer virus resistance to taro. Another possibility is to breed taro varieties resistant to leaf blight, which is caused by a fungus, *Phytophthora colocasiae*, and is a serious problem in tropical areas^{12,18}). Transformation with chitinase genes has been reported to produce plants resistant to fungal diseases²). This technique may be useful for breeding disease- resistant taro varieties.

[NEXT](#)

[TOP](#)

[HOME](#)

Biology and Control of the Citrus Leafminer, *Phyllocnistis citrella* Stainton (Lepidoptera: Gracillariidae) in Japan

Takeshi UJIYE*

Department of Plant Protection, National Institute of Fruit Tree Science
(Tsukuba, Ibaraki, 305-8605 Japan)

Present address:

Ushiku, Ibaraki, 300-1216 Japan.

* Corresponding author: tel +81-298-71-1265.

Received 27 September 1999, accepted 28 October 1999.

Abstract

Recent advances in research on the life history, natural enemies, sex attractant, and practical control of the citrus leafminer (CLM) in Japan are described. Adult CLM overwinters within canopies of the citrus trees in the warmer districts of the citrus belt where the overwintering females begin to oviposit in mid-March. The moth passes 9 to 10 and 5 generations per year in the southwestern and northeastern parts of the citrus belt, respectively. Developmental zero and effective heat units for development from egg to adult emergence are 12.1°C and 206 degreedays, respectively. Eighty per cent or more larvae were killed by parasitoids and unknown factors before pupation during the summer-autumn seasons. Dominant parasitoids are *Sympiesis striatipes* in mainland-Japan and *Cirrospilus ingenuus* and *Citrostichus phyllocnistoides* in the Southwestern Islands. Biological control of CLM by native parasitoids is not sufficiently effective in Japan because *Ageniaspis citricola*, a most effective biological control agent in tropical Asia, has not been detected in Japan. A sex attractant, (Z,Z)-7,11-hexadecadienal showed a high activity for male moths in Japan, but was ineffective for those in foreign countries. The sex attractant appeared to be useful for the forecasting of seasonal occurrence, and control measures by using this substance should be initiated. Insecticides are commonly used for the control of CLM on young trees. Nicotine sulfate, IGRs, imidacloprid, alanycarb and pyrethroids are sprayed 4 to 5 times at 5- to 10-day intervals during the flush developing period. Recently, CLM has become resistant to pyrethroids in some districts of Kyushu. To avoid the spread of insecticide resistance of CLM, an attempt was made to use the effective parasitoid, *A. citricola*, through introduction from Taiwan and Thailand to Japan.

Discipline: Insect pest

Additional key words: parasitoid, sex attractant

1..25): [References](#)

Introduction

The citrus leafminer, *Phyllocnistis citrella* Stainton (CLM), is a serious pest in nurseries and on top-grafting trees of citrus, and also on citrus growing in plastic greenhouses in Japan.

CLM originated in tropical Asia from Afghanistan to China, and was introduced to Japan in the 1600s⁶⁾. CLM had been spreading slowly over adjacent areas, and became known also in the temperate zone of Asia, Australia, Pacific Islands, South Africa (miss-identification?) and eastern part of Africa by the beginning of the 1980s. Then its distribution spread rapidly: it was confirmed in southern Florida in late May of 1993^{6,7)}, in Florida, most of the Caribbean region, the southern part of the USA^{2,8)} and the northern part of South America by September in 1994, and lastly in Uruguay in January, 1997. It also first occurred simultaneously on the Mediterranean coast of Europe¹¹⁾, in the Middle East¹⁹⁾, North Africa¹¹⁾ and Reunion Island¹³⁾ in 1993 to 1995.

This paper describes recent contributions to studies on CLM biology and current status of control of CLM in Japan.

Outline of citriculture in Japan

The citrus cultivation belt of Japan stretches along the southwestern coast of Honshu, Shikoku and Kyushu, extending from 35° to 31°N ([Fig. 1](#)). It belongs to an area with relatively cool winter temperatures among the citrus cultivation zones of the world. Mean air temperature in a year and in January ranges from 14 to 17°C and 4 to 7°C, respectively, and the daily minimum air temperature sometimes falls below 0°C in mid-winter. Small-scale citrus orchards are also dispersed about all over the Southwestern Islands.

Among the citrus cultivars planted in Japan, about 65% consist of Satsuma mandarin, followed by Iyo (10%), Natsudaidai (5%) and Hassaku (4%).

About 77% of the citrus orchards are located on slopes with an inclination above 5° for the following reasons: plains are used for rice paddy fields, citrus trees on plains are often damaged owing to freezing night temperatures in winter, and high quality fruits are obtained usually from sloping orchards with good drainage.

The citrus trees have generally 3 flush seasons; the spring flush from early April to early May, the summer flush from June to August and the autumn flush from early to late September. Because of the low winter temperature, there are no young leaves during more than 5 months from October to early March. The spring shoots are very important as fruit-bearing branches of the next year, while the summer and autumn shoots are less important or often useless in mature trees. Therefore, the optimum method of tree management is to suppress the growth of the new shoots from summer to autumn; or, secondarily, to cut off the new shoots emerging during these seasons.

On the other hand, in young or top-grafting trees, the summer shoots are necessary to build up the tree shape. In addition, in plastic greenhouses, the summer shoots are also useful as fruit-bearing twigs of the next year. The summer and autumn shoots must be healthy for cultivation, and not damaged by pests

such as CLM.

[NEXT](#)

[TOP](#)

References

- 1) Ando, T. et al. (1985): (7Z,11Z)-7,11-hexadecadienal: sex attractant of the citrus leafminer moth, *Phyllocnistis citrella* Stainton (Lepidoptera, Phyllocnistidae). *Agric. Biol. Chem.*, **49**, 3633-3635.
- 2) French, J. V. & Legspi, J. C. (1996): Citrus leafminer in Texas; population dynamics, damage and control. *In* Managing the citrus leafminer, Proc. Int. Conf. Orlando/Florida, 80.
- 3) Gyoutoku, Y. (1995): The important insect pests of the mid and late season maturing citrus varieties. *Plant Prot.*, **49**, 67-69 [In Japanese].
- 4) Gyoutoku, Y. et al. (1996): The resistance of the citrus leafminer, *Phyllocnistis citrella* Stainton, to insecticides and laboratory bioassay method. *Jpn. J. Appl. Entmol. Zool.*, **40**, 238-241 [In Japanese with English summary].
- 5) Hamamura, T. (1980): Studies on the overwintering of the citrus leaf miner, *Phyllocnistis citrella* Stainton (Lepidoptera: Lyonetiidae) in Hiroshima. *Bull. Fruit Tree Res. Stn.*, **E3**, 99-122 [In Japanese with English summary].
- 6) Heppner, J. B. (1993): Citrus leafminer, *Phyllocnistis citrella* in Florida (Lepidoptera: Gracillariidae; Phyllocnistinae). *Trop. Lepid.*, **4**, 49-64.
- 7) Hoy, M. A. and Nguyen, R. (1994): Classical biological control of the citrus leafminer: a progress report in Florida. *Citrus Ind.*, **75 (6)**, 61-62.
- 8) Johnson, S. J., Vaugh, A. and Bougeois, W. J. (1996): Rearing and release methods for *Ageniaspis citricola* for a classical biological program of the citrus leafminer in Louisiana. *In* Managing the citrus leafminer, Proc. Int. Conf. Orlando/Florida, 63.
- 9) Kawamura, M. (1976): Studies on the life cycle of the citrus leaf miner, *Phyllocnistis citrella* Stainton, and its seasonal prevalence of eggs and pupae. *Bull. Kochi Inst. Agric. Forest Sci.*, **8**, 11-20 [In Japanese]
- 10) Kurisaki, M. (1920): On the life history of the citrus leafminer, *Phyllocnistis saligna* Zell. and the relation between the miner and citrus canker, *Pseudomonas citri* Hasse. *Insect World*, **24**, 39-44 [In Japanese].
- 11) Malausa, J. C., Quilici, S. & Brun, P. (1996): Status and first studies on the citrus leafminer in France; Azur Coast, Corsica and Reunion Island. *In* Managing the citrus leafminer, Proc. Int. Conf. Orlando/Florida, 88.
- 12) Ohkubo, N. (1993): Occurrence and control of Pyrethroid-resistant citrus leafminer, *Phyllocnistis citrella* Stainton in Nagasaki Prefecture. *Proc. Assoc. Plant Prot. Kyushu*, **39**, 131-133 [In Japanese with English summary].
- 13) Quilici, S. et al. (1995): Un nouveau ravageur des agrumes à la Réunion, la mineuse *Phyllocnistis citrella*. *Phytoma-La Défense des Végétaux*, **474**, 37-40.
- 14) Ujiye, T. (1988): The number of larval instars, their generalized terms and some problems on habits of the citrus leaf miner. *Plant Prot.*, **42**, 564-566 [In Japanese].
- 15) Ujiye, T. (1990): Studies on the utilization of a sex attractant of the citrus leafminer moth,

- Phyllocnistis citrella* Stainton (Lepidoptera: Phyllocnistidae). 1. Analysis of seasonal population trends and some behavioral characteristics of the male moths by use of synthetic sex attractant traps in the field. *Bull. Fruit Tree Res. Stn.*, **18**, 19-46 [In Japanese with English summary].
- 16) Ujiye, T. & Adachi, I. (1995): Parasitoids of the citrus leafminer, *Phyllocnistis citrella* Stainton (Lepidoptera: Phyllocnistidae) in Japan and Taiwan. *Bull. Fruit Tree Res. Stn.*, **27**, 79-102 [In Japanese with English summary].
- 17) Ujiye, T., Kamijo, K. & Morakote, R. (1996): Species composition of parasitoid and parasitism of the citrus leafminer (CLM), *Phyllocnistis citrella* Stainton (Lepidoptera, Gracillariidae) in central and northern Thailand, with key of parasitoids of CLM collected from Japan, Taiwan and Thailand. *Bull. Fruit Tree Res. Stn.*, **29**, 79-106 [In Japanese with English summary].
- 18) Ujiye, T. & Morakote, R. (1992): Parasitoid of the citrus leafminer, *Phyllocnistis citrella* Stainton (Lepidoptera: Phyllocnistidae) in Thailand. *Jpn. J. Appl. Entomol. Zool.*, **36**, 253-255 [In Japanese with English Summary].
- 19) Uygun, N. et al. (1996): Status of the citrus leafminer in Turkey. *In Managing the citrus leafminer*, Proc. Int. Conf. Orlando/Florida, 101.
- 20) Yamamoto, E. (1967): On the overwintering of the citrus leafminer. *Kyusyu Agric. Res.*, **29**, 122-123 [In Japanese].
- 21) Yamamoto, E. (1968): Studies on the biology and control of the citrus leaf miner, *Phyllocnistis citrella* Stainton. 1. On the biology. *Proc. Assoc. Plant Prot. Kyusyu*, **14**, 7-50 [In Japanese].
- 22) Yamamoto, E. (1969): Studies on the biology and control of the citrus leaf miner, *Phyllocnistis citrella* Stainton. 2. On the biology (2). *Proc. Assoc. Plant Prot. Kyusyu*, **5**, 158-160 [In Japanese].
- 23) Yamamoto, E. (1971): Studies on the biology and control of the citrus leaf miner, *Phyllocnistis citrella* Stainton. 3. On the development. *Proc. Assoc. Plant Prot. Kyusyu*, **17**, 64-65 [In Japanese].
- 24) Yamamoto, E. (1979): Studies on the biology and control of the citrus leaf miner, *Phyllocnistis citrella* Stainton. 7. Effectiveness of several insecticides. *Proc. Assoc. Plant Prot. Kyusyu*, **25**, 141-143 [In Japanese].
- 25) Yoshida, M. & Takei, Y. (1964). Seasonal history and bionomics on the citrus leaf miner, *Phyllocnistis citrella* Stainton at Shizuoka district. *Bull. Fac. Agric. Shizuoka Univ.*, **14**, 167-175 [In Japanese with English summary].

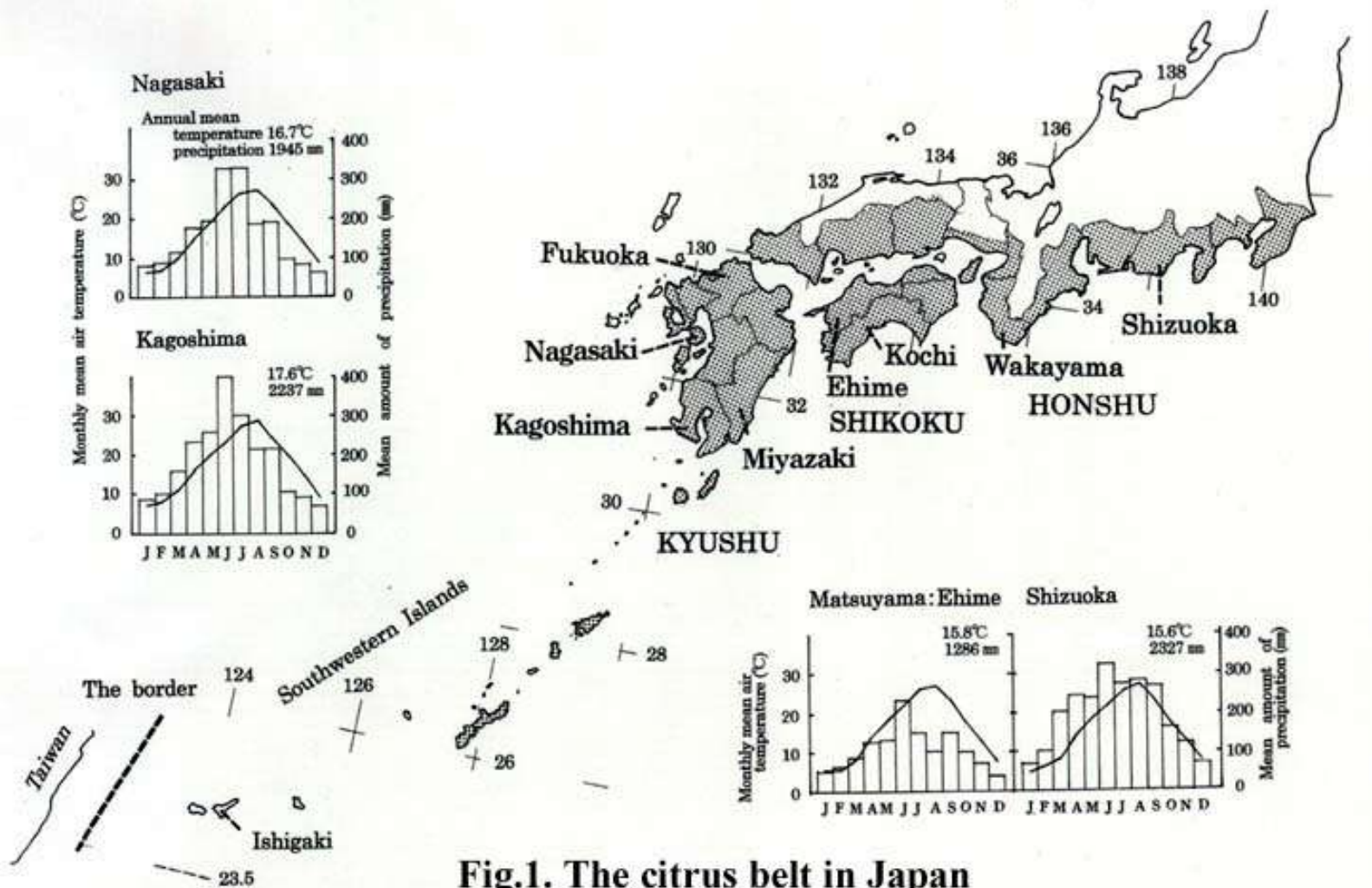


Fig.1. The citrus belt in Japan

BACK

Life history of CLM

Yamamoto^{20,21}) first observed that the adult of CLM overwintered within canopies of citrus trees in Miyazaki Prefecture in the southern part of Kyushu. Thereafter, overwintering adults were observed in several warmer districts of the citrus belt such as Kagoshima, Nagasaki (Kyushu), Kochi (Shikoku) and Wakayama (Honshu), though their presence has not been confirmed in some orchards located in rather cool districts of the belt. For example, based on observations made in 1992-1995 in Shimizu (Shizuoka Prefecture: near the northeastern end of the belt), mines formed by the 1st-generation larvae were found in 1992, 1994 and 1995, but not in 1993. These results suggest that the density of the 1st generation varies among years and that CLM probably does not always overwinter every year in Shimizu.

Key factors for the fluctuations in the density of overwintering CLM adults have not been clarified, but it is assumed that the population density before winter and temperatures during winter are important. A small amount of flushes and/or too early flushing in autumn tend to reduce the number of overwintering adults. Low temperatures during winter also appear to be harmful to CLM. Winter diapause of CLM has not been confirmed. Because the ovaries of female moths emerging in autumn are absorbed while exposed to low temperatures before winter⁵), CLM females seem to be in diapause. On the contrary, because male moths are sexually active during winter as described later, CLM males do not appear to have a winter diapause.

Most adults emerging in autumn seem to die during the winter, because their density in spring is very low even in the warmer districts of southern Kyushu where the moths constantly overwinter every year. In rather cool regions such as Fukuoka and Ehime, adults of CLM often occur from June corresponding to the 2nd-generation flight season in the overwintering districts. It is suggested that short distance migration or movement of adult moths occurs from the overwintering sites to northern and non-overwintering parts of the belt during the 1st flight season every year. It was confirmed that the overwintering female moths started to oviposit from mid-March on the sprouts of cultivars with early germination such as oranges²¹) and Ponkan.

Based on observations using traps baited with sex attractant in Kuchinotsu (Nagasaki Prefecture), the emergence of the 1st generation seemed to start from early to mid-May¹⁵). Developmental zero and effective heat units for the development of CLM were estimated at 12.1°C and 238 degree-days respectively, by Yamamoto²³). However, the latter value was rectified to 206 degree-days by Ujiye¹⁵) based on the results of further tests. Using these values, CLM was estimated to have 7 to 8 complete generations per year in Kuchinotsu¹⁵). It was also estimated based on field population trends that CLM passed 9 to 10 generations per year in Miyazaki²¹), 7 to 8 in Kochi⁹) and 7 in Wakayama¹⁰). In these districts, the presence of overwintering adults of CLM was confirmed. On the other hand, Yoshida and Takei²⁵) observed 5 generations in Shizuoka, where the winter conditions are sometimes too severe for adults to overwinter as mentioned above.

Sex ratio of CLM was about 1:1. A female moth mated on the early morning of the day after emergence²²), and laid 55 to 133 eggs during her life span²¹).

Eggs of CLM are laid singly on both the upper and lower surfaces of a citrus leaf, sometimes also on green shoots and seldom on young fruits. Oviposition occurs on leaves more than 5 mm in length. Eggs are seldom laid on hardened leaves; if eggs were deposited on such leaves, hatching larvae would die without mining within the leaves.

The larvae have 4 instars; the 1st to the 3rd instar larvae are sap-feeders, and the 4th is a spinning larva which can not feed on the leaf epidermis due to the degeneration of the mouth parts. The sap-feeder makes a serpentine mine in which it feeds within the epidermis leaving only the cuticular layer. It finally reaches the leaf margin where it molts to a spinning larva after enlarging the terminal part of the mine (Figs. 2, 3). The spinning larva makes a pupal cell by bending the leaf edge and pupates inside¹⁴).



Fig.2. Third instar larva feeding on sap from ruptured epidermal cells



Fig.3. Infestation of summer flushes of Satsuma mandarin tree with the citrus leafminer

[NEXT](#)

[TOP](#)

Natural enemies

As shown in Table 1, 24 species of parasitoids emerged from the mines of CLM collected from about 50 locations all over Japan¹⁷⁾. Among them, *Sympiesis striatipes* and *Quadrastichus* sp. were the dominant species in many citrus orchards. *Cirrospilus phyllocnistis*, *Chrysocharis pentheus* and *Zaommomentedon brevipetiolatus* were also major parasitoids in some orchards of the mainland. *Citrostichus phyllocnistoides* and *Cirrospilus ingenuus* were the dominant or major species in the Southwestern Islands in the subtropical region. During the larval stages of the summer generations, 80% or more miners were killed by parasitoids and unknown factors. Most of the parasitoids attacked mainly the late 3rd to the 4th instar larvae when the host mines were fully developed with a certain amount of injury¹⁶⁾. Heavily infested leaves curl and fall off the tree. Citrus canker, *Xanthomonas campestris* pv. *citri* (Hase) Dye, can easily invade from the cuticle-removed mine traces to internal tissues of the leaf. For these reasons, in spite of the high parasitism rates, biological control of CLM by the native parasitoid complex seems to be difficult in Japan.

In Taiwan and Thailand, the polyembryonic encyrtid, *Ageniaspis citricola* was recognized as the most effective biological control agent of CLM^{17,18)}. Because *A. citricola* does not occur in Japan, attempts were made to introduce it from Thailand and Taiwan in the summer of 1995. Although the attempt failed because of the death of the wasps during transport, further efforts should be made in future.

Although larvae and pupae were found to be killed by unknown predators, the predator species and their effects have not been identified.

Sex attractant

Ando et al.¹⁾ confirmed that (Z,Z)-7,11-hexadecadienal strongly attracted male CLM moths in the field. In a trap baited with a rubber septum containing 1 mg of the substance, the number of male moths caught per day was 30 to 90 times higher than that in a trap with a virgin female, and this level of attracting ability was maintained for more than 2 months. Male moths were caught not only in the traps placed in the citrus orchard, but also in those placed in a wood located at a distance of 200 m or more from the nearest citrus groves¹⁵⁾. Males were attracted to the sex attractant mainly from May to November, and a small number of males were also caught on warm and windless days even in the winter season. Based on these results, it was confirmed that the sex attractant was useful for forecasting the CLM seasonal occurrence.

The attracting ability of the substance to male moths was evaluated throughout Japan and in some areas in foreign countries in which CLM occurred. The male moths were caught in traps placed in the citrus-growing regions from Shizuoka to Ishigaki Island in Japan. A small number of CLM moths were also caught in traps set in Nepal. However, in other countries such as Thailand, Taiwan, Turkey, China, Egypt, Spain, Reunion Island and Uruguay, males were not attracted by this substance.

Control

As stated above, since the spring population density of CLM is very low, it is not necessary to control CLM before late June in most parts of the citrus belt in Japan.

On the other hand, it is so important to protect the new shoots of the young or top-grafting citrus trees from the infestation of the CLM summer generations, that insecticides such as nicotine sulfate, IGRs, imidacloprid, alanycarb and pyrethroids need to be sprayed. These were applied 4 to 6 times at several day intervals from the beginning of germination to the end of shoot growth. As a rule, nicotine sulfate, IGRs such as diflubenzuron and tflubenzuron, and pyrethroids and imidacloprid are sprayed at intervals of 5 days, 7 days, 7 to 10 days, respectively, in Japan.

Susceptibility of CLM to many pyrethroids has decreased recently in the western part of Kyushu^{3,4,12}) and populations resistant to pyrethroids are expanding gradually to the east, so that this group of insecticides is becoming ineffective in these areas. To control CLM, organo-phosphorous insecticides such as penthoate, phosmet, and isoxathion had been used until about 20 years ago, but they also can not be used presently because of resistance²⁴). Petroleum oils are commonly sprayed in summer to control CLM in Australia, Israel, etc., but oil sprays after late July should be avoided owing to the decrease of the Brix content of fruits in Japan.

In general, special insecticide sprays for CLM are not applied on the mature Satsuma mandarin trees. However, some insecticides are customarily applied to control other main pests such as yellow tea thrips (*Sciltothrips dorsalis*), white-spotted longicorn beetle (*Anoplophora malasiaca*), and arrowhead scale (*Unaspis yanonensis*) in the citrus orchards. Although these insecticides seemed to influence the incidence of mortality of CLM, under these conditions, about 100% of new leaves are likely to be heavily infested with CLM during the summer to autumn seasons every year. In order to suppress the population density of CLM, it is recommended to cut off all of the infested shoots as a cultural control method for CLM.

Conclusion (some problems for the future)

For nurseries, top-grafting trees, trees planted in plastic greenhouses, and susceptible cultivars to citrus canker, many insecticides are applied to control CLM at short-term intervals during the seasons of shoot development in Japan. These continuous sprays of insecticides can not only induce CLM resistance to insecticides but also eliminate natural enemies of many citrus pests from citrus orchards. An additional problem is the increased cost of operating pesticide sprays. Consequently, attempts should be made to use only natural enemies and sex attractants for the control of CLM in Japanese citrus orchards.

Natural enemies: As stated above, the native natural enemies were not sufficiently effective as biological control agents for CLM in Japan. An encyrtid parasitoid, *Ageniaspis citricola* appeared to be the most effective parasitoid for the natural control of CLM in Thailand and Taiwan. The wasp which has been recently introduced from these countries to Australia, United States and Israel, established successfully and was able to reduce the CLM population markedly under the new circumstances. An attempt to introduce *A. citricola* from Thailand and Taiwan to Japan was made in the summer of 1995, resulting in failure because of the death of the wasps during transport. Additional efforts should be made to introduce *A. citricola* from tropical Asia or secondarily colonized areas such as Florida and Australia

to Japan. Though it remains to be determined whether *A. citricola* is able to overwinter under the long, cold Japanese winter conditions, attempts should at least be made to introduce the encyrtid from Taiwan to Ishigaki Island which is located of the same latitude as the northern part of Taiwan.

Sex attractant: It was suggested that (Z,Z)-7,11-hexadecadienal could be utilized for forecasting the occurrence of CLM moth, but suppressive effects on CLM were obtained based on small-scale field tests using the sex attractant as a mating disruptant. It appears that many mated females flew into the sex-attractant-treated field from the surrounding untreated ones. Large-scale testing using large amounts of the sex attractant should be performed in large fields. In Japan, however, as most of the citrus orchards are located on slopes where a gassy sex attractant can not drift in the air for a long period of time, it may be difficult for the synthesized sex attractant to disturb the sensibility of the male moths occurring throughout the citrus orchards.

Kuroko and Kumata, Japanese experts in the taxonomy of Gracillariidae, identified the specimens collected from Thailand and Morocco as *Phyllocnistis citrella*, which is the same species as the citrus leafminer occurring in Japan. However, the synthesized substance strongly attracted Japanese CLM males, while it did not attract the moths occurring in other countries. This difference of sensibility to the synthesized sex attractant may indicate that *P. citrella* has differentiated into some biotypes. Consequently, (Z,Z)-7,11-hexadecadienal used in these studies was synthesized as an analogue from one component of the pink bollworm sex pheromone and confirmed to be a sex attractant of CLM based on random screening tests in the field¹⁾. The substance was assumed to be at least one component of the sex pheromone of CLM based on its strong attractiveness for male moths of CLM. It is necessary, however, to extract the true pheromone from the virgin female, to determine whether it is the same material as the synthetic one, and whether it contains other minor components, in order to utilize this substance for effective control or monitoring of the populations in various parts of the world.

[NEXT](#)[TOP](#)[HOME](#)

Relationship between the Characteristics and Water Quality of Irrigation Ponds in Japan

Junji TAKAHASHI^{1*}, Eisaku SHIRATANI and Ikuo YOSHINAGA

Department of Hydraulic Engineering, National Research Institute of Agricultural Engineering (Tsukuba, Ibaraki, 305-8609 Japan)

Present address:

¹ Hokuriku Regional Agricultural Administration Office

* Corresponding author: fax +81-25-231-6986.

Received 20 October 1999, accepted 17 December 1999.

Abstract

This study dealt with the relationship between the characteristics of irrigation ponds and water quality. We conducted a statistical analysis of 556 irrigation ponds located in urbanized rural areas and flat rural areas throughout the country, and examined a number of indicators of water quality such as pH, chemical oxygen demand (COD), contents of total phosphorus (T-P) and total nitrogen (T-N). There were no strong correlations between the characteristics of the irrigation ponds and water quality. We then conducted a similar analysis of the ponds after classifying them into 4 groups based on hydraulic and meteorological characteristics. In this analysis, a strong relationship was found for the water quality in each group of ponds. We also studied the nitrogen load in the effluent from the catchment basins and found that diffuse non-point-source nitrogen was the major constituent. Relative intensity of the factors affecting water quality was investigated by multiple regression analysis and box plot analysis.

Discipline: Irrigation, drainage and reclamation

Additional key words: basin characteristics, statistical analysis, diffuse non-point source, water quality preservation, load management

1...9): [References](#)

Introduction

In Japan, there are about 213,890 irrigation ponds. Of these, the irrigation area of 68,850 ponds is larger than 2 ha and together they cover a total area of 1,235 thousand ha and contain an effective volume of 4,769 million m³ of water⁶). This volume of water amounts to about 16% of the 30,470 million m³ of the effective volume of water contained in dams in Japan⁴) and about 8% of the 58,700 million m³ used yearly for agriculture³). The ponds are an important source of water for agriculture. They are also considered to be closed and are a valuable component of local open-spaces, fulfilling multiple purposes in many areas.

With increasing development and a tendency toward crowded living, the inflow of gray water to irrigation ponds may cause pollution and the resultant abnormal algal bloom may lead to environmental problems, for example the death of fish, stench, and destruction of scenery. This deterioration of water quality by factors such as water inflow and nitrogenous and phosphorus sediments is a result of socioeconomic activity in the catchment basins. It is essential to analyze the basin characteristics, including land utilization, agricultural practices, weather, and sources of pollutant loading for the preservation of the water quality in irrigation ponds. An understanding of how the characteristics of the basins and the hydraulic properties of the ponds influence the water quality may provide effective information to promote the preservation of the water quality in future.

[NEXT](#)[TOP](#)

References

1. Department of Statistical Information, Ministry of Agriculture, Forestry and Fisheries (1990): District Division for Statistics of Agriculture and Forestry, 7 [In Japanese].
2. Department of Water Resources, National Land Agency (1997a): Water Resources in Japan, 31 [In Japanese].
3. Department of Water Resources, National Land Agency (1997b): Water Resources in Japan, 22 [In Japanese].
4. Iwasa, Y. (1991): Engineering Limnology. Sankaido, 224 [In Japanese].
5. National Astronomical Observatory (1961-1990): Chronological Scientific Tables. Maruzen, Tokyo [In Japanese].
6. Resources Division, Planning Department, Agricultural Structure Improvement Bureau, Ministry of Agriculture, Forestry and Fisheries (1992): Report on the results of water quality conservation survey in the agricultural reservoirs, pp. 175 [In Japanese].
7. Resources Division, Planning Department, Agricultural Structure Improvement Bureau, Ministry of Agriculture, Forestry and Fisheries (1996): Summary of water quality of agricultural waterways and irrigation ponds, pp. 20 [In Japanese].
8. Watanabe, H. et al. (1985): Introduction to exploratory data analysis. Asakura Shoten, Tokyo, 35 [In Japanese]. Water Resources Association (1996): Handbook of Water Resources, 100 [In Japanese].
9. Water Resources Association (1996): Handbook of Water Resources, 100 [In Japanese].

Method of analysis

We examined the water quality of irrigation ponds from 1991 to 1993. Nationwide, approximately 25,000 irrigation ponds have an irrigation area of more than 5 ha in urbanized agricultural areas or agricultural areas⁵). From these, 852 were sampled from prefectures across the nation in proportion to the number of ponds in each prefecture.

In principle, sampling was carried out 5 times at sluice gates and from a depth of approximately 50 cm at each pond during the irrigation season (May through October).

Of the 852 irrigation ponds, in some river water was introduced except for basin use, others were used for other purposes, such as aquaculture, golf courses, industries and farming, and for some of them the information we collected could not be used. The data from these types of ponds were excluded in the analysis of water quality characteristics because the actual conditions were not clarified and it was difficult to estimate the occurrence of nutrient loading. Therefore in principle, we examined 556 irrigation ponds in the present study.

These 556 irrigation ponds were then classified into groups to analyze the influence of major environmental factors, such as water depth, retention time, and hours of sunlight on the fluctuation of water quality. Although it was possible to group the ponds by combining each factor, considering the shallow irrigation ponds studied in this report, the hours of sunlight were found to be the factor that influences primary productivity, such as growth of plant plankton. Retention time and water depth were also used as a measure to group the ponds. The uses of the irrigation ponds were other factors that influenced the water quality. Based on these factors, the following 4 groups were analyzed in this report.

For the water depth and retention time, median values were determined by statistical analysis of whole irrigation ponds.

Group I Long period of sunlight (≥ 1900 h/year) and shallow irrigation ponds (< 4.0 m).

Group II Short period of sunlight (< 1900 h/year) and shallow irrigation ponds (< 4.0 m).

Group III Long retention time (≥ 60 days) and deep irrigation ponds (≥ 4.0 m).

Group IV Short retention time (< 60 days) and shallow irrigation ponds (< 4.0 m).

General conditions of irrigation ponds

[Table 1-a](#) shows the statistical values of the characteristics of the irrigation ponds. The average values of the indicators of water quality of the irrigation ponds were as follows: COD, 9.02 mg/L; T-N, 1.36 mg/L; T-P, 0.10 mg/L; pH, 7.6; and EC, 143 μ S/cm. Of these values, pH, COD, and T-N exceeded the standards for water for agricultural use (paddy rice, [Table 1-b](#)). When the average nutrient concentrations in summer exceeded 0.5-1.5 mg/L for T-N and 0.02-0.10 mg/L¹) for T-P, eutrophic conditions were likely to prevail.

The average retention time ([effective storage capacity of the pond]/[volume of inflow water into the pond]) was 114.1 days, which is approximately equivalent to 1/4 of the general retention time of lakes and marshes in Japan (approximately 1.2 years).

Land use in the catchment basins of the irrigation ponds was as follows: 70% for forests, 8% for paddy fields, 6% for farms, 4% for orchard areas, and 2% for grasslands ([Fig. 1](#)). Non-agricultural land use accounted for the remaining 10%. Consequently, land use was characterized by a high ratio of forests.

NEXT

TOP

Table 1-a. Statistical values of characteristics of irrigated ponds and catchment basins

	Number of ponds	Mean	STD
Available storage capacity (10^3m^3)	555	94.5	260.2
Catchment area (ha)	556	66.0	179.4
Depth (m)	467	5.1	3.9
Retention time (day)	555	114.1	190.2
Available storage capacity/catchment area (m)	555	2.7	4.2
Available storage capacity/depth (ha)	467	19.4	43.0
Area rate of arable land (%)	556	25.6	29.9
Beef cattle density (head/ha)	39	1.0	1.6
Dairy cattle density (head/ha)	25	0.8	1.1
Pig density (head/ha)	20	3.0	6.4
Domestic fowl density (head/ha)	22	327.7	837.0
Application of N fertilizer to the field (kg/10a)	288	1.2	7.2
Application of P fertilizer to the field (kg/10a)	289	1.0	5.4
Application of K fertilizer to the field (kg/10a)	288	1.1	6.2
Population density (persons/ha)	271	18.1	71.0
Extension rate of sewerage (%)	271	22.4	38.0
Ratio of night soil treatment (%)	271	77.6	38.3
Mean precipitation (mm/year)	556	1,482	371
Mean temperature of air ($^{\circ}\text{C}$)	556	14.4	2.2
Yearly daylight hours (hour)	556	1,893	171
COD (mg/L)	553	9.02	10.19
T-N (mg/L)	552	1.36	1.78
T-P (mg/L)	528	0.10	0.19
pH	553	7.6	0.8
EC ($\mu\text{S}/\text{cm}$)	553	143	198

BACK

**Table 1-b. Standard values for water for agricultural use
(paddy rice)**

Item	Standard value
pH	6.0~7.5
Chemical oxygen demand (COD)	below 6 mg/L
Suspended solids (SS)	below 100 mg/L
Dissolved oxygen (DO)	below 5 mg/L
Total nitrogen (T-N)	below 1 mg/L
Electric conductivity (EC)	below 300 μ S/cm
As	below 0.05 mg/L
Zn	below 0.5 mg/L
Cu	below 0.01 mg/L

BACK

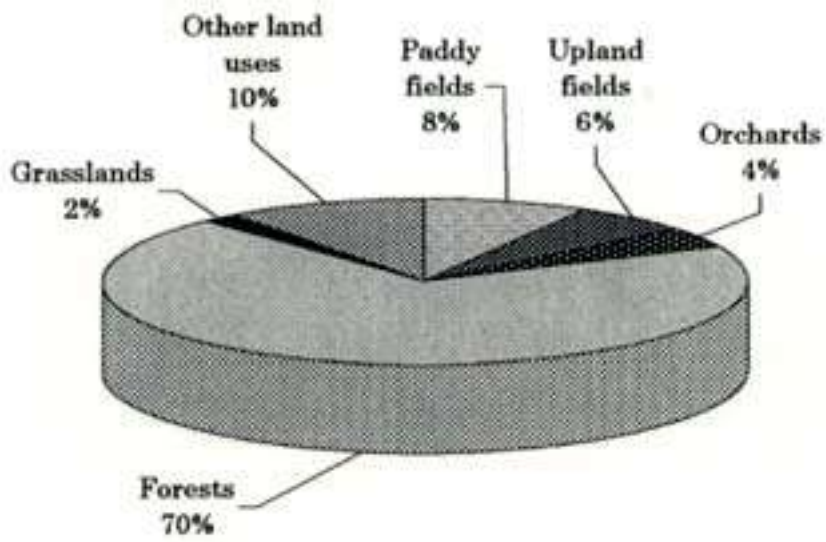


Fig. 1. Land utilization in the catchment basins of the irrigation ponds

BACK

Water quality in irrigation ponds and characteristics of catchment basins

1) Correlation between water quality in irrigation ponds and catchment basin characteristics

Our data failed to reveal a strong correlation between the hydraulic properties of the irrigation ponds or basin characteristics (such as agricultural practices, land use, and environmental conditions) and pond water quality. For example, there was no strong correlation between the retention time and T-N value ([Fig. 2 \(1\)](#)) or between the proportion of forests in the basins and the T-N value in the ponds ([Fig. 2 \(2\)](#)). We performed single correlation analyses between the indicators of water quality and each of these characteristics, but the results were identical.

When classified into 4 groups, however, the irrigation ponds showed a correlation between each pond property and water quality indicators ([Tables 2](#) and [3](#)). In Group I, average values of COD, T-N, and T-P exceeded the averages for all the irrigation ponds and also the averages for each of the other groups. In Group III, average COD and T-P values were lower than in the other groups.

In Group I, there was a low correlation between the retention time and COD compared with all the irrigation ponds and the other groups. In Group I there was a strong correlation between the COD and the T-P value compared with all the irrigation ponds and the other groups. Group II showed a strong correlation between the T-N and T-P values, suggesting that the N/P ratio was relatively stable. In Group III there was a strong correlation between the COD and the T-P value, indicating that phosphorus may be the limiting factor for eutrophication. In Group IV, no strong correlation was found between any of the indicators of water quality.

The correlations between the water quality indicators in each group suggest that they affect the variation of water quality in irrigation ponds.

2) Outflow characteristics of nitrogen load from the catchment basins

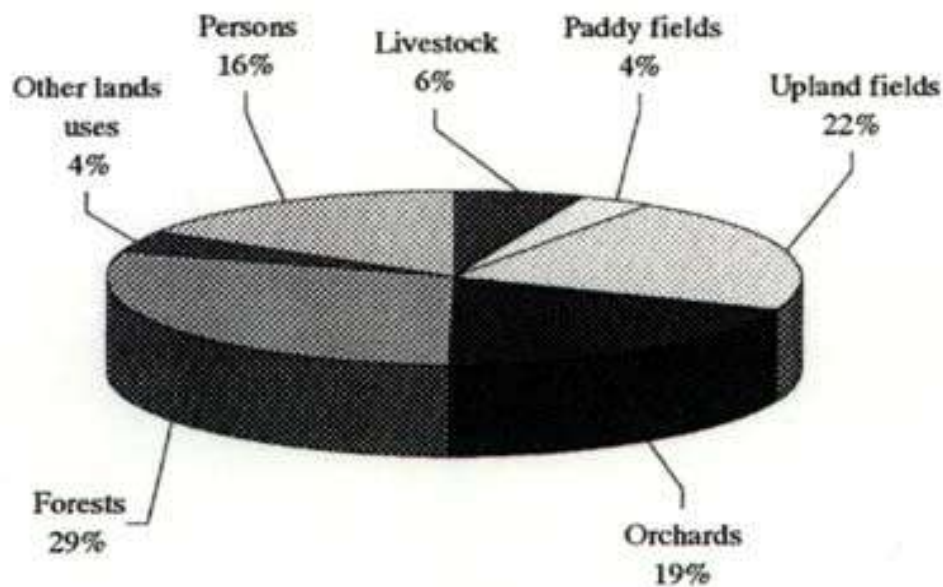


Fig. 3. Nitrogen load from effluent in the catchment basins

The proportion of nitrogen load in the catchment basins of irrigation ponds (Fig. 3) was determined by the unit method. The nitrogen load from paddy fields, forests, and areas with non-agricultural land use was calculated by multiplying the T-N concentration of rainfall by the amount of precipitation during the period of irrigation.

The nitrogen load from farms and orchards was calculated by multiplying the amount of fertilizer applied during the irrigation period by the discharge rate of 30%²⁾.

The nitrogen load from livestock was estimated by using the documented value for cattle/head/day and the documented value for pigs/head/day⁸⁾. The nitrogen load from the households in the basins was estimated from the documented⁷⁾ value of 6.0 g/person/day of treated household drainage from septic tank (mixed drainage and urine) and 1.45 g/person/day of untreated mixed household drainage.

Although land use in the basins of the irrigation ponds consisted of forests (70%), farmland (20%), and other land uses (10%) (from Fig. 1), agricultural land use accounted for about 51% of the nitrogen load, indicating that agriculture exerts a major influence on water quality in irrigation ponds. The nitrogen load per unit area in the basins was 90 g/ha/d (standard deviation 153 g/ha/d; median value 36 g/ha/d). Since 78% of the nitrogen load was derived from diffuse non-point sources, such as farmland and forests, it might be difficult to control or manage the load.

NEXT

TOP

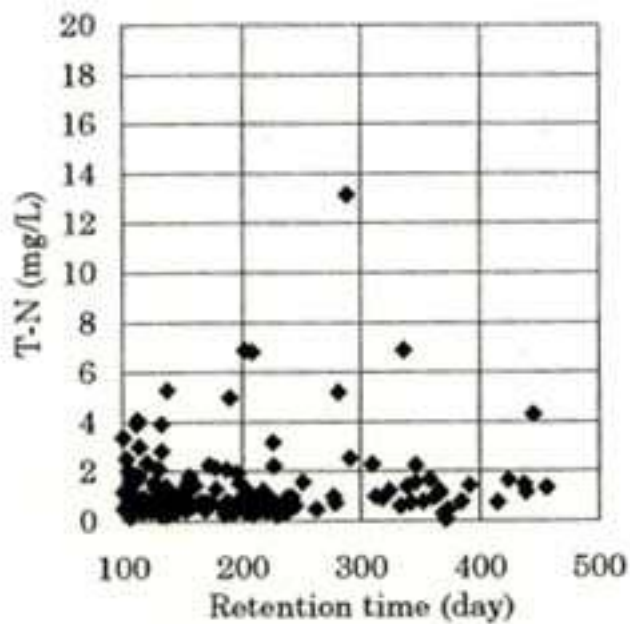


Fig. 2(1). Relationship between retention time and T-N in the irrigation ponds

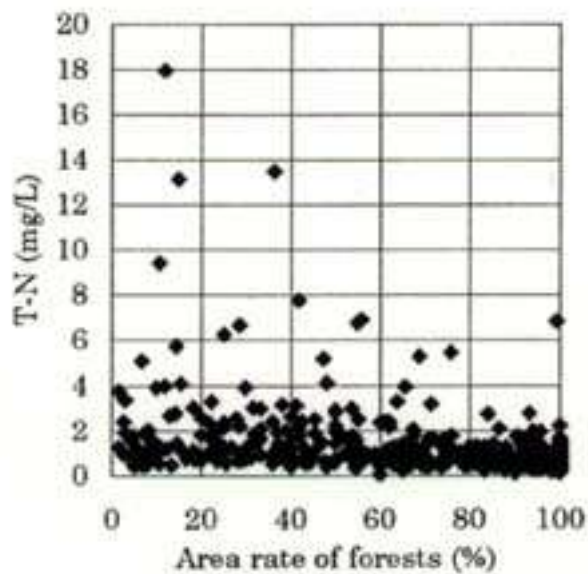


Fig. 2(2). Relationship between the proportion of forests in the catchment basins and T-N in the irrigation ponds

BACK

Table 2. Mean values of depth, daylight hours, retention time, and water quality indicators calculated for each group of irrigation ponds

	All irrigation ponds	Group I	Group II	Group III	Group IV
Number of ponds	556	99	85	153	115
Available storage capacity (10 ³ m ³)	94.5	40.1	64.0	199.0	23.6
Depth (m)	5.1	2.5	2.4	7.1	2.3
Retention time (day)	114.1	108.2	61.5	216.2	22.4
Yearly daylight hours (hour)	1,893	2,003	1,771	1,915	1,878
COD (mg/L)	9.02	11.36	10.51	8.20	8.98
T-N (mg/L)	1.36	1.96	1.28	1.28	1.42
T-P (mg/L)	0.10	0.13	0.11	0.08	0.09
pH	7.6	7.7	7.5	7.7	7.5
EC (μS/cm)	143	166	173	144	175

[BACK](#)

Table 3. Correlation coefficients between irrigation pond characteristics and water quality indicators classified into 4 groups

	COD				T-N				T-P			
	G. I	G. II	G. III	G. IV	G. I	G. II	G. III	G. IV	G. I	G. II	G. III	G. IV
Available storage capacity (10^3m^3)	0.212	-0.057	-0.218	-0.013	0.254	-0.065	-0.093	-0.029	0.131	-0.017	-0.160	0.003
Catchment area (ha)	0.028	0.099	-0.143	0.149	0.077	0.030	-0.058	0.009	0.092	0.051	-0.107	0.177
Depth (m)	-0.061	-0.117	-0.281	-0.129	-0.043	-0.237	-0.045	-0.129	-0.122	-0.142	-0.189	-0.203
Retention time (day)	0.411	0.035	-0.029	-0.020	0.077	0.117	-0.087	-0.005	0.282	0.172	-0.052	-0.001
Available storage capacity/depth (ha)	0.215	-0.049	-0.112	0.012	0.248	-0.045	-0.056	0.007	0.143	-0.009	-0.088	0.052
Mean precipitation (mm/year)	-0.210	-0.029	-0.222	-0.021	-0.007	-0.172	-0.122	-0.092	-0.157	-0.032	-0.095	-0.058
Mean temperature ($^{\circ}\text{C}$)	0.225	0.131	0.254	0.031	-0.084	0.061	0.092	-0.013	0.157	0.114	0.148	-0.048
Yearly daylight hours (hour)	-0.023	0.202	0.409	0.013	-0.021	0.141	0.189	0.110	-0.021	0.061	0.266	-0.024
COD (mg/L)	1.000	1.000	1.000	1.000	0.286	0.243	0.312	0.078	0.792	0.343	0.605	0.423
T-N (mg/L)	0.286	0.243	0.312	0.078	1.000	1.000	1.000	1.000	0.391	0.684	0.196	0.313
T-P (mg/L)	0.792	0.343	0.605	0.423	0.391	0.684	0.196	0.313	1.000	1.000	1.000	1.000
pH	0.595	0.234	0.515	0.230	0.228	0.386	0.318	0.134	0.638	0.355	0.343	0.404
EC ($\mu\text{S}/\text{cm}$)	0.271	-0.023	0.166	-0.001	0.643	-0.010	0.448	0.090	0.401	-0.033	0.003	-0.002

BACK

3) Multiple regression analysis of water quality and catchment basin characteristics

Variables were selected by multiple regression analysis taking the indicators of water quality as the objective variables and the characteristics of irrigation ponds and their catchment basins as explanatory variables. Because the number of cattle raised in the basins was relatively low, we excluded the density of farm animals from the variables before performing the analysis. The standard of variable selection was set up as $F_{in} = F_{out} = 2.0$ for the F value of the variance ratio, and was estimated by the methods of forward selection and backward elimination. [Table 4](#) shows the standardized partial regression coefficients between the indicators of water quality (objective variables) and the characteristics selected as a result of variable selection. The proportion and Variance Inflation Rate (VIF) were calculated by carrying out a multiple regression analysis taking the individual explanatory variables selected from [Table 4](#) as the objective variables and the other variables as the explanatory variables. The value of VIF was 1.0-2.7 and the explanatory variables were found to be independent. The absolute values from [Table 4](#) are considered to reflect the degree to which individual indicators of water quality were influenced.

Based on these considerations, the characteristics of irrigation ponds and their catchment basins that most affected water quality were as follows:

for COD, depth of water, annual average temperature, and annual precipitation;

for T-N, proportion of forests in basins, yearly hours of daylight, and proportion of farmland in basins;

for T-P, depth of water, yearly hours of daylight, and non-agricultural land uses.

Land use characteristics influence water quality, particularly the T-N. In comparison with the T-N, COD and T-P values are affected by a variety of characteristics other than land use. However the proportion of forests in basins affected all of the above indicators of water quality: i.e. the values of all the indicators of water quality tended to decrease in proportion to the increase of the forest areas in basins.

4) Analysis by box plot

When there are biases or outliers in the distribution of research data, the correlation coefficient is not always an appropriate index to describe the correlation among variables. We used parallel box diagrams⁹⁾ to analyze the relationships among variables in these cases.

In this analysis, all the data of the variables on the horizontal axis were arranged from minimum to maximum values and then divided into 5 sets, each containing an equal number of data. A box diagram of the variables on the vertical axis was made for each of the 5 data sets. The position of each box plot on the horizontal axis corresponded to the position of the central value in each horizontal data set. The central horizontal line in the box plot represented the 50% value (median), and the upper and lower hinge values were 75 and 25%, respectively; thus 50% of all the data were included within the height of the box. The maximum and minimum values in each set were represented by the upper and lower vertical lines ([Fig. 4](#)).

In the parallel box plots, the correlations are not indicated quantitatively with a coefficient, but the relative tendencies among the variables can be observed.

We analyzed the relationships between each water quality indicator (COD, T-N, and T-P) and irrigation pond characteristics by this method. The characteristics derived from this analysis coincided with the results of the multiple regression analysis as follows:

- (1) The pond depth and the proportion of forests in the catchment basins showed a negative correlation with all the water quality indicators ([Figs. 5 \(1\) and 5 \(2\)](#)).
- (2) A positive correlation was found between yearly daylight hours and COD. Although there was a positive correlation between the COD and retention time up to about 100 days, there was no correlation with the COD for longer retention times ([Figs. 5 \(3\) and 5 \(4\)](#)).
- (3) T-N showed a positive correlation with the area of upland fields. There was a positive correlation between T-N and nitrogen applied as fertilizer up to about 0.4 kg/ha. However, there was no clear correlation at levels of application beyond that value ([Figs. 5 \(5\) and 5 \(6\)](#)).
- (4) No significant correlation could be found between T-P and any irrigation pond characteristics except for the positive correlation with the pond depth and the proportion of forests in the catchment basins.
- (5) There were positive correlations among the water quality indicators, such as COD, T-N, and T-P ([Figs. 5 \(7\) and 5 \(8\)](#)).

Conclusion

Although the mechanisms responsible for the fluctuations of water quality cannot be clearly determined by statistical analysis alone, the following information is necessary to preserve the water quality in irrigation ponds.

Since current agricultural practices result in COD, nitrogen, and phosphorus load mostly occurring from diffuse non-point sources, it is difficult to control or manage the load. And we consider that the improvement of the methods of fertilizer application and water management in the fields may not drastically decrease the occurrence of pollutants in the short period.

Water quality in irrigation ponds can be improved by reducing the source materials, pollutant runoff into the irrigation ponds, and the amount of pollutants in the irrigation ponds. Although many engineering methods involving the construction of drainage treatment facilities, by-passing the waterways, compact oxidizing of the waterways, use of aquatic plants, and dredging of the ponds can be applied, it is difficult to achieve effective and long-term control by a single method at this time.

When a comprehensive evaluation of the situation is taken into consideration, on a long-term basis, it will be important that the basin characteristics of each irrigation pond be thoroughly analyzed and appropriate engineering steps be taken for water quality preservation. These steps should include the use of load management to structurally remove the sources of pollutants.

[TOP](#)

[HOME](#)

Table 4. Standard regression coefficients in multiple regression model for prediction of the water quality of irrigation ponds

		COD	T-N	T-P
Hydraulic characteristics	Available storage capacity			
	Catchment area			
	Depth	-0.175		-0.111
	Retention time			
	Available storage capacity/catchment area		-0.070	
	Available storage capacity/depth	0.071	0.054	
Agricultural characteristics	Area rate of arable land			
	Application of N fertilizer to the field			
	Application of P fertilizer to the field			
	Application of K fertilizer to the field			
Land use characteristics	Area rate of paddy fields	0.075	-0.095	
	Area rate of upland fields		0.109	
	Area rate of orchards		0.085	
	Area rate of forests	-0.044	-0.335	-0.095
	Area rate of grasslands			
	Area rate of other land uses			0.096
Social characteristics	Population density			
	Extension rate of sewerage		-0.085	
Meteorological characteristics	Mean precipitation	-0.116		
	Mean temperature	0.163		
	Yearly daylight hours		0.119	0.103

BACK

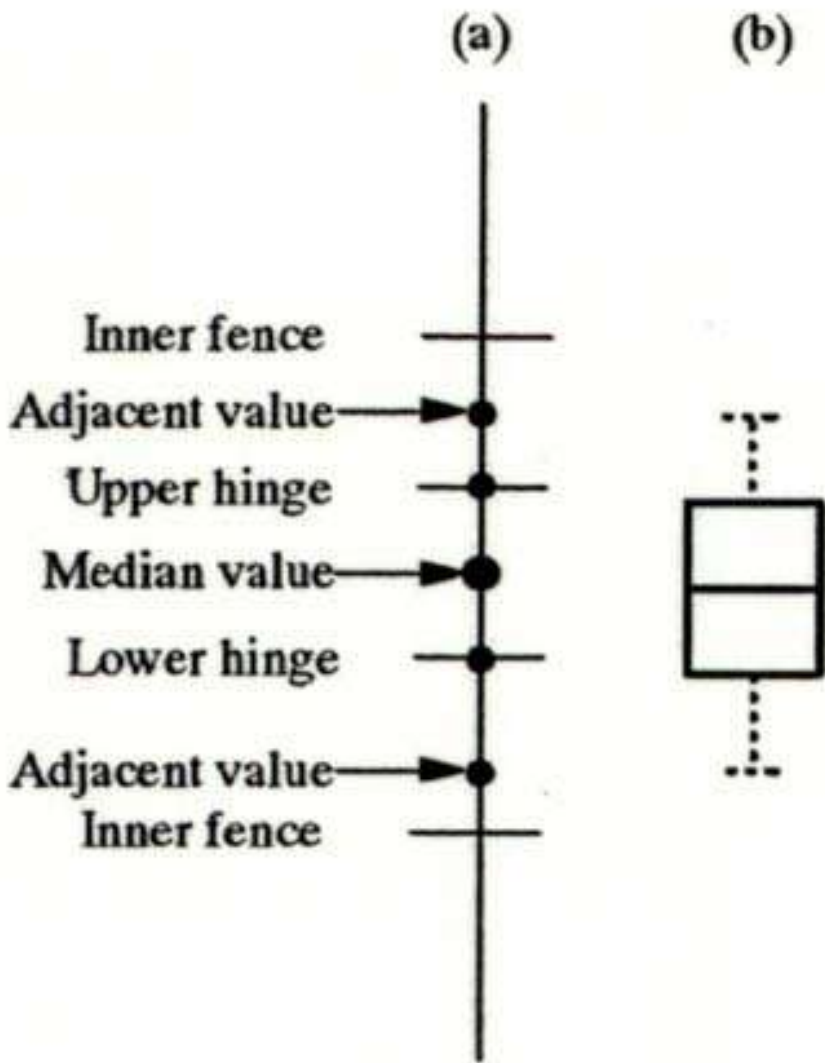


Fig. 4. Concept of box plot

BACK

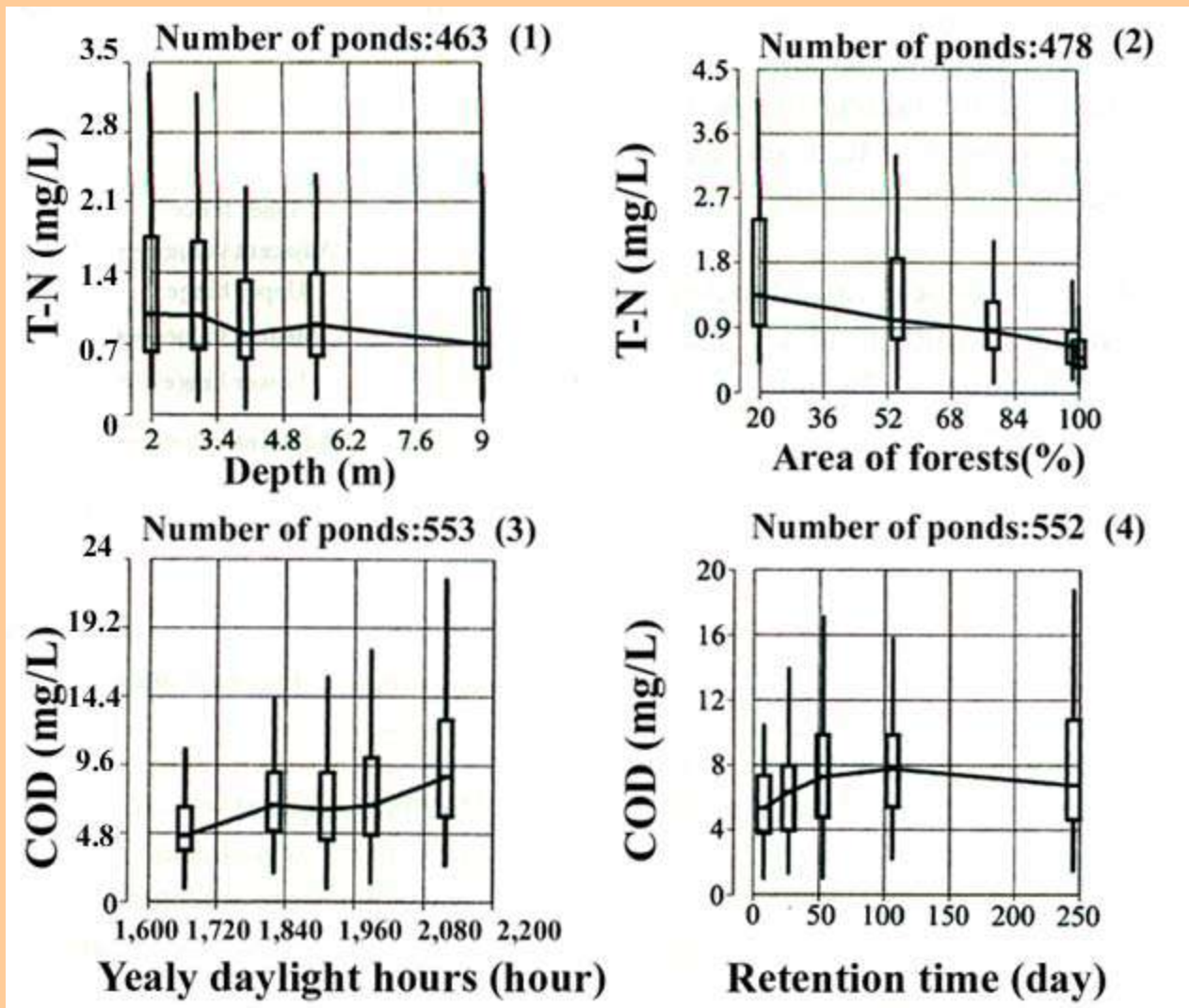


Fig.5. Parallel box plots

- (1). Depth and T-N
- (2). Proportion of forests in the catchment basins and T-N
- (3). Yearly daylight hours and COD
- (4). Retention time and COD

BACK

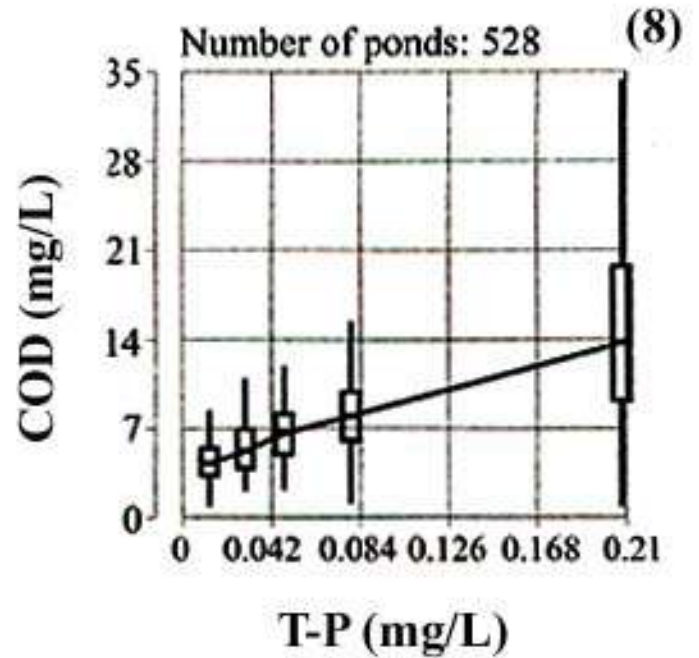
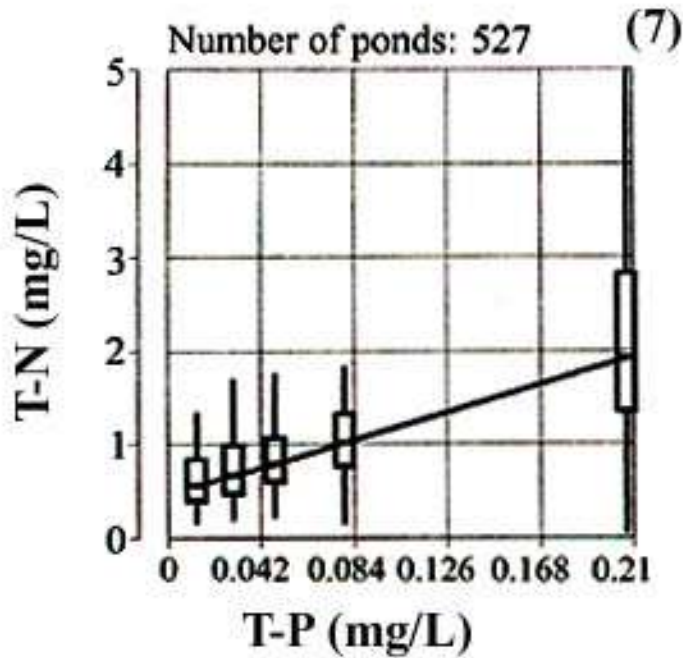
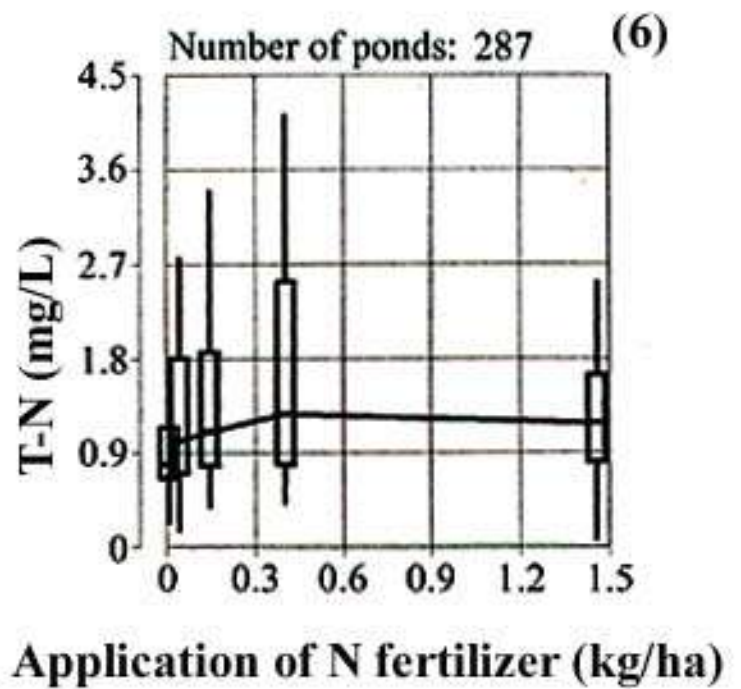
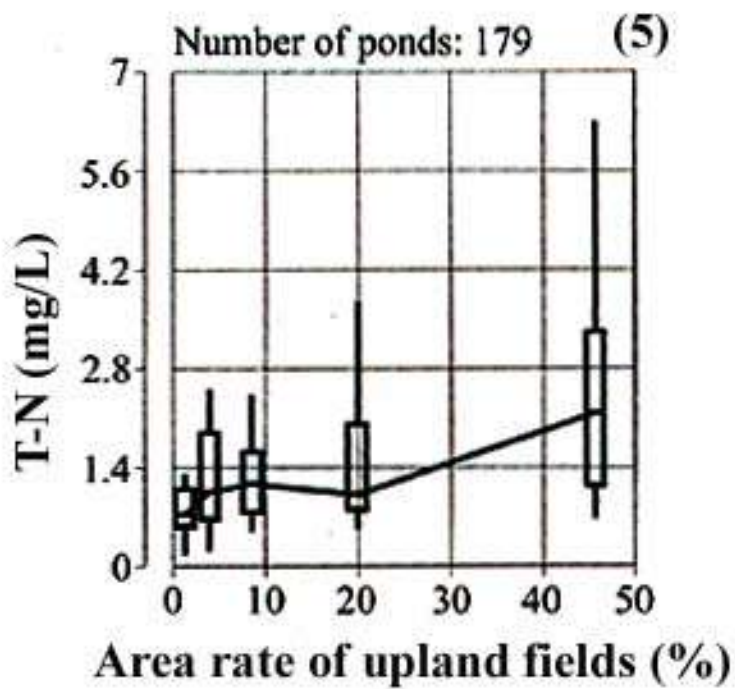


Fig.5. Parallel box plots

(5). Proportion of upland fields in the catchment basins and T-N.

(6). Nitrogen fertilizer application and T-N.

(7). T-P and T-N.

(8). T-P and COD.

BACK

What are Stingless Bees, and Why and How to Use Them as Crop Pollinators? --- a Review ---

Kazuhiro AMANO 1*, Tetsu NEMOTO2 and Tim A. HEARD3

1 Laboratory of Apiculture, National Institute of Animal Industry
(Tsukuba, Ibaraki, 305-0901 Japan)

2 Laboratory of Neurophysiology, National Institute of Animal Industry
(Tsukuba, Ibaraki, 305-0901 Japan)

3 Long Pocket Laboratories, CSIRO Entomology
(PMB 3 Indooroopilly 4068, Australia)

* Corresponding author: fax +81-298-38-8606, e-mail aamano@niai.affrc.go.jp

Received 5 November 1999, accepted 7 December 1999.

Abstract

The efficiency of insects as crop pollinators depends on their biological characteristics in relation to the crop and the environment in which they are needed. For glasshouse pollination in Japan, stingless bees are potentially promising pollinators for the following reasons: they are harmless to beekeepers and glasshouse workers, they visit a wide range of crops (polylecty), they are tolerant of high temperatures, they are active throughout the year, they can be transported easily, and they do not pose an environmental risk by escaping and invading natural habitats as they would not survive the Japanese winter. There are still, however, some limitations to using stingless bees in such areas, one of which lies in how to improve methods for propagating and maintaining the colonies throughout the year. To address this problem we suggest the development of a new type of hive box.

Discipline: Crop production/Horticulture

Additional key words: bee-keeping, meliponiculture

1...30): [References](#)

Introduction

Stingless bees are social bees which lack a functional sting. They store honey and pollen, and are sometimes called stingless honey bees¹⁷). Since they occur in perennial colonies in tropical and sub-tropical climates, it is impossible for them to survive naturally throughout the cold season in countries with a temperate climate such as Japan. Considering that these people-friendly and ecosystem-friendly bees could be used as crop pollinators, we introduced colonies of several species from Australia and other countries, and investigated methods for keeping and multiplying hives.

The general biology of stingless bees has been described by various authors^{17,23,28}), and pollination by

stingless bees in tropical areas has been reviewed recently⁹⁾. Most of the research, however, has been conducted in the areas where the bees live. Very little work on using stingless bees introduced from overseas has been performed in Japan, much less from the practical pollination point of view. Sakagami introduced the concept of domestication of stingless bees first into Japan²²⁾. Maeta et al. imported 7 species of stingless bees, *Trigona minangkabau*, *T.moorei*, *T. itama*, from Southeast Asia; *Nannotrigona testaceicornis*, *Plebeia droryana*, *T. angustula*, *T. barocoloradensis* from Brazil, with a view to testing them as pollinators of strawberries and published a note stating that *N. testaceicornis* was the most effective one and that economical fruit production could be maintained by the introduction of colonies into glasshouses¹⁵⁾.

In this paper we describe the use of insects as crop pollinators in Japan, and also the potential of the stingless bee, *T. carbonaria*, from Australia to be kept and utilized successfully as pollinators under glasshouse conditions.

[NEXT](#)

[TOP](#)

References

- 1) Amano, K. (1997): Successful breeding of non-stinging honeybees. *Farming Jpn.*, 31 (5), 36-42.
- 2) Amano, K & Boongird, S. (1997): Keeping of the stingless bee, *Trigona fuscobalteata* (Hymenoptera: Apidae) in an environmentally enclosed chamber. *Annu. Rept. Prot. North Jpn.*, 48, 210-212 [In Japanese with English summary].
- 3) Camargo, C. A. (1972): Mating of the social bee *Melipona quadrifasciata* under controlled conditions. *J. Kans. Entomol. Soc.*, 45, 520-523.
- 4) Crane, E. (1992): The past and present status of beekeeping with stingless bees. *Bee World*, 73, 29-42.
- 5) Cruz-Landim, C. et al. (1968): Mandibular gland development and communication in field bees of *Trigona* (*Scaptotrigona*) *postica*. *J. Kans. Entomol. Soc.*, 41, 474-481.
- 6) Dollin, A. & Heard, T. (1998): Keeping Australian stingless bees in a log or box. *In* Native Bees of Australia Series Booklet 5. Australian Native Bee Research Center, 1-14.
- 7) Esch, H. et al. (1965): Sound; an element common to communication of stingless bees and to dances of the honeybee. *Science*, 149, 320-321.
- 8) Heard, T. A. et al. (1993) Factors influencing flight activity of colonies of the stingless bee *Trigona carbonaria* (Hymenoptera: Apidae). *Aust. J. Zool.*, 41, 343-353.
- 9) Heard, T. A. (1999): The role of stingless bees (Meliponinae) in crop pollination. *Annu. Rev. Entomol.*, 44, 183-206.
- 10) Heard, T. A. & Dollin, A. (1998): Crop pollination with Australian stingless bees. *In* Native Bees of Australia Series Booklet 6. Australian Native Bee Research Centre, 2-17.
- 11) Imperatriz-Fonseca, V. L. (1975): On swarming activity in Meliponinae. *In* Proc. 25th Int. Apic. Congr., 298.
- 12) Kerr, W. E. (1959): Bionomy of Meliponids. VI. Aspects of food gathering and processing in some stingless bees. *In* Food gathering in Hymenoptera. Symp. Entomol. Soc. Am. Detroit, 24-31.
- 13) Kerr, W. E. (1974): Sex determination in bees. III. Caste determination and genetic control in *Melipona*. *Insectes Soc.*, 21, 357-367.
- 14) Kleinert-Giovannini, A. et al. (1987): Aspects of the trophic niche of *Melipona marginata marginata* Lapeletier (Apidae, Meliponinae). *Apidologie*, 18, 69-100.
- 15) Maeta, Y. et al. (1992): Utilization of the Brazilian stingless bee, *Nannotrigona testaceicornis* as a pollinator of strawberries. *Honeybee Sci.*, 13, 71-78 [In Japanese with English summary].
- 16) Michener, C. D. (1961): Observations on the nests and behavior of *Trigona* in Australia and New Guinea. *Am. Mus. Novit.* 2026, 1-46.
- 17) Michener, C. D. (1974): The social behavior of the bees; A comparative study. Cambridge, Mass, Harvard Univ. Press, pp. 404.
- 18) Moritz, R. F. A. (1986): Genetics of bees other than *Apis mellifera*. *In* Bee genetics and breeding. Academic press Inc., 121-154.
- 19) Nogueira-Neto, P. (1951): Stingless bees and their study. *Bee World*, 30 (10), 73-76.
- 20) O' Toole, C. & Raw, A. (1991): Bees of the world. Blandford (a Cassell imprint), London, pp. 192.
- 21) Roubik, D. W. (1990): Biogeographical ecology of *Melipona* (Apidae: Meliponinae). *In* Proc. 11th Int. Congr. IUSI, 379-380.

- 22) Sakagami, S. F. (1957, 58): Biology of the stingless bee and its domestication (1), (2). *Seitai-kontyu*, 6 (15), 101-116, 7(1), 28-46 [In Japanese].
- 23) Sakagami, S. F. (1982): Stingless bees. *In Social insects*. Vol 3. ed. Hermann, H. R., Academic Press, New York, USA, 362-376.
- 24) Tezuka, T. & Maeta, Y. (1993): Effect of UVA film on extranidal activities of three species of bees. *Jpn. J. Appl. Entomol. Zool.*, 37, 175-180.
- 25) Wallace, H. M., Vithanage, V. & Exley E. M. (1996): The effect of supplementary pollination on nut set of Macadamia (Proteaceae). *Annu. Bot.*, 78, 765-773.
- 26) Wille, A. & Michener, C. D. (1973): The nest architecture of the stingless bees with special reference to those of Costa Rica. *Rev. Biol. Trop.*, 21, Suppl. 1, pp. 278.
- 27) Wille, A. (1979): Phylogeny and relationships among the genera and subgenera of the stingless bees (Meliponinae) of the world. *Revista de Biologia Tropical*, 27 (2), 241-277.
- 28) Wille, A. (1983): Biology of the stingless bees. *Ann. Rev. Entomol.*, 28, 41-64.
- 29) Wilson, E. O. (1971): The insect societies. Belknap Press of Harvard University Press, Cambridge, Mass., pp. 548.
- 30) Young, A. M. (1983): Nectar and pollen robbing of *Thunbergia grandiflora* by *Trigona* bees in Costa Rica. *Biotropica*, 15 (1), 78-80.

Status of pollinator utilization in Japan

Where no pollinators are available, many crops need hand or mechanical pollination. Multiple use of insecticides and expansion of single cropping, both of which have been conducive to development of modern agriculture, have also led to the decrease of natural pollinator populations. In addition, cultivation under structures, such as glasshouses or greenhouses, where no rain, wind, or natural pollinators could be expected, has been disseminated in response to the rising demand for fruits and vegetables. These agricultural conditions have stimulated the demand for efficient manageable pollinators for crops.

Three species of insects have had a great impact on crop pollination recently in Japan.

The first is *Osmia cornifrons*, a solitary bee used since 1945 and now essential for the pollination of crops, especially of apples. The pollinating ability of *Osmia cornifrons* on apple is considered to be much higher than that of the honey bee. *Osmia cornifrons* is so efficient at pollinating crops that it was introduced into the USA in 1977 for small orchards on the East coast, and into Denmark for greenhouse crops. Its life cycle is very simple: the mated female makes a series of cells in the tubes it selects for nesting in spring; when foraging trips occur, each cell is filled with a honey pollen mixture on which it lays an egg; a new adult emerges within the nest in early autumn and overwinters therein; she appears out of the nest and mates and then makes foraging trips for a new nest in the following spring. The foraging period coincides with the flowering of apple. Since *Osmia cornifrons* bees nest in bamboo or reed and readily accept artificial nests, beekeeping is simple for the farmer to manage with minimal skill. Presently the bees are being used as apple pollinators in more than 18,000 ha of orchards in the northern part of Japan, and furthermore the bees will be applied to other crops by shifting the adult emerging time through the control of the hibernation temperature.

The second useful insect pollinator is the European bumblebee, *Bombus terrestris*, which is a social insect. Unlike honey bees or stingless bees, the colonies are annual and only queens fertilized the previous autumn survive the winter in hibernation alone and appear in spring to start up new colonies by themselves. The first adults produced by the queen are all workers. With the progression of the season, the colony becomes more populous. Males and new queens are produced at the climax of colony development around summer. The males of the colony, whether they mated or not, die before the onset of the winter season. So do the workers. In the case of artificial nests, the colony around the climax of its development can be used for crop pollination for about 2 months. The bumble bee is considered to be an efficient pollinator of some crops because buzz-pollination of crops that require it such as Solanaceae can be achieved. Buzzing bees cling to the ends of the anthers and vibrate their indirect flight muscles, leading to pollen release.

The colonies have been imported from Europe since 1991 for pollination of tomatoes alone in glasshouses, and now more than 30,000 colonies are imported per year. These bees are popular because farmers can manage them by themselves.

The third insect is the honey bee, or the European honey bee, *Apis mellifera*. This well-known social insect is an important pollinator of orchards, fields, and large-scale glasshouses partly because of its large colony population (over 10,000 individuals), long distance flights (more than 2 km), wide range of plants on which it forages (more than 80% of cultivated crops), and availability of established beekeeping

techniques. In fact, honey bees are used widely as pollinators overseas but not in Japan. Most of the Japanese farmers who need pollinators do not keep the honey bees by themselves, but, if necessary, have professional beekeepers manage the colonies. There are only 5,000 professional or semiprofessional beekeepers in Japan, the small number of which limits the use of honey bees as pollinators.

Both bumblebees and *Osmia cornifrons* bees have been commonly used mainly because the farmers can manage the bees by themselves unlike the case of honey bees. A study aimed at breeding a mutant strain of honey bees with non-stinging characteristics by using gamma radiation has been initiated so that the farmers can manage the colonies for pollination with ease¹⁾.

Only honey bees and stingless bees are highly eusocial species living in perennial colonies which are easy to keep in hives and to be moved to any place, when necessary. As a highly eusocial bee group, stingless bees also share various useful characteristics, and could be expected to be effective crop pollinators.

Stingless bees and honey bees

Social insects show some of the following characteristics: cooperation among adults in brood care and nest construction; overlapping of at least 2 generations; and reproductive division of labor²⁹⁾. Those which display all 3 of the above characteristics are called eusocial insects. Of over 10,000 different species of social insects existing today, honey bees of the subfamily Apinae and stingless bees of the subfamily Meliponinae, have attained the most advanced social levels and they are called highly eusocial insects. The colonies of other social insects die when the fertile individual dies. But honey bees and stingless bees live in perennial colonies by replacement of the queen when needed. European honey bees and Oriental honey bees (*A. cerana*) have been kept for a long time in Europe and Asia (beekeeping or apiculture), and stingless bees have been kept in Central and South America (stingless beekeeping or meliponiculture) due to their perennial colonies.

[NEXT](#)[TOP](#)

Biology of stingless bees

The characteristics of stingless bees including *T. carbonaria* are reviewed here.

1) Distribution

Stingless bees are considered to have their center of origin in Africa and have dispersed to other tropical and subtropical parts of the world, based on paleontological and biogeographic data. This hypothesis is also supported by the fact that their primitive species with a well-developed sting system live in Africa exclusively²⁷).

Stingless bees belong to the subfamily Meliponinae in the family Apidae. In general, stingless bees are easily distinguished from other bees by the following 3 characters: reduction and weakness of the wing venation; presence of the penicillum; and reduction of the sting²⁸). In contrast to Apinae which consist of only 4 main species and less than 10 species in total in the one genus *Apis*, Meliponinae are a fairly large group with diverse morphology and biology. The group contains more than 400 species. At least 250 species have been described in South and Central America where research has been most advanced. About 50 species live in South Asia and Malaysia, and 20 in Australia, Papua New Guinea, and the Philippines and as many as 40 are native to Africa. Since the forests in the tropical areas mostly consist of entomophilous plants, stingless bees are of great importance for the pollination of many wild plants in addition to tropical crops²¹).

2) Species used for stingless beekeeping

The important genera for stingless beekeeping are *Melipona* and *Torigona*. Crane listed 14 species of *Melipona* and 21 of *Torigona* that have been used in traditional beekeeping⁴). *Melipona* species are restricted to Central and South America, and are of historical significance because of their long-time culture for the production of honey and wax. *Torigona* species are present in all the tropical continental areas, and traditional hive beekeeping with them has occurred in tropical America and occasionally in Asia. Most *Torigona* species are relatively small, and long-winged. *Melipona* species are short-winged and tend to be larger, some being as large as honey bees⁴).

T. carbonaria is very common in coastal Queensland in Australia and extends as far south as Sydney, being the southernmost species of all stingless bees in the world¹⁶).

3) Defense mechanisms

The stingers are vestigial and non-functional but the bees have various and efficient means of defense for colonies. Some species adopt aggressive ways of defense, like biting (*T. cupia*, *T. fuscipennis*), emitting a caustic liquid from the mouth (all species of *OxyTorigona*), releasing unpleasant odors (*T. capitata*, *M. marginata*) and irritating by crawling into eyes ears, etc. However, the most common strategy of defense is to make their nests and the entrance invisible to intruders. Therefore, most species do not harm people or animals.

T. carbonaria is a gentle species and can be manipulated with ease. The insects defend the nest by sealing up all unnecessary nest openings, and sometimes crawl over persons, and give tiny nips with their mandibles when their nest is disturbed⁶).

4) Nest structure

A few species of stingless bees build their nests in underground cavities such as termite mounds, most of them belonging to primitive groups, e.g. genera of *Meliplebeia*, *Plebeia*, and *Nogueiraps*. Some other species build an exposed nest which is surrounded by hard and sometimes brittle layers hanging on tree branches in the air. Those species do not seem to have ever been considered for beekeeping.



Fig.1. Brood comb of the shinglee bee, *Trigona carbonaria* showing a spiral type.

The most common type of nest is found in a tree cavity. The nest is usually made of 5 parts; brood comb, involucrum, store pots, batumen, and an entrance. The comb consists of brood cells, in each of which a single young is reared, and surrounded by a sheath of cerumen, or involucrum (Fig. 1). Therefore, the cavity where the brood cells are present is called a brood chamber. Cerumen is made of a mixture of wax secreted from the glands on the abdomen of workers and propolis, which is derived from resins collected from plants. Honey and pollen are stored in pots quite different from the brood cells. These storage pots are usually placed above and below the involucrum, and made of cerumen. The extra space in the tree cavity is sealed by batumen plates, usually made of cerumen and mud. The entrance of the nest is a simple hole. It often extends from the nest as a tube, and also continues inside the nest cavity. There are pillars and connectives inside the nest to support all the other structures within the batumen plates. The brood cells of the combs are in contact with one another, and the combs are usually horizontal, but in some species like *Torigona carbonaria*, the combs form a spiral. In subgenera, such as *Plebeia*, *HypoTorigona*, *Trigonisca*, *Torigona*, and *Tetragona*, some species construct cluster-type nests. This type of nest contains a cluster of brood cells irregularly arranged instead of combs. Unlike the nests with combs, cluster-type nests can take advantage of small and irregular spaces¹⁷).

Only the African species *Dactylurina staudingeri* has vertical, double combs, each consisting of 2 layers of horizontal cells opening in opposite directions, as in the case of honey bees²⁸).

5) *Reproduction*

There are 2 ways of reproduction in social insects as follows: (1) development of a colony, or increase in the number of individuals, which depends mainly on the egg-laying ability of queens. The number of eggs laid per day varies among species and does not change appreciably with the season as in the case of European honey bee subspecies; (2) colony reproduction, or increase in the number of colonies. In stingless bees, like honey bees, all the new nest foundations result from a fission of the colony. New colonies are formed by reproductive swarming with a queen and workers, but the procedure is quite different from that of honey bees^{17,23}). In honey bees, an old queen leaves the mother nest when reproductive swarming occurs, but in stingless bees young virgin queens leave, and the connection between the mother and daughter nests can last for weeks and even months. Typical formation of new colonies in stingless bees proceeds as follows: a new nesting site is searched for and identified by workers; the workers transport the necessary materials both for construction and for food from the mother nest; the new nest except for brood cells is complete; a young virgin queen flies to the new site from the mother nest along with drones; mating flights are made; and the new nest is occupied by adult bees including the new queen¹⁷). It has been reported that *T. julianii* and *T. varia* carry out some construction work in the new nest before the young queen arrives¹⁸), and that stingless bees do not necessarily need to fly during mating³). Variations in the swarming process have been reported¹¹).

[NEXT](#)[TOP](#)

6) Population of nests

The number of workers comprising the colony ranges from a few hundreds to several thousands depending on the species and other factors. Wille & Michener²⁶⁾ presented a list of the populations: from *Torigona corvia* 7,200 to *T. buyssoni* 136, including the major meliponiculture species: *T. schrotkyii* 300, *T. mosquito* 1,175, *T. mirandula* 2,281-4,076, *T. cupira* 2,900, *T. clavipes* 5,000-8,000, *M. marginata* 243, *M. fasciata* 2,00. The color of the workers is black, brown, red yellow, and white depending on the species. A mature colony of *T. carbonaria* consists of about 10,000 individuals¹⁰⁾.

7) Division of labor

Two kinds of division of labor can be observed in the social life of the stingless bees as in that of honey bees: division of caste referring to the reproductive system, and division of labor among workers, productive system.

The females are divided into 2 castes, queens and workers. Caste dimorphism is strongly developed. Queens are much larger than workers, lack corbiculae (the pollen-carrying structures on the hind legs) and wax glands.

As workers age, their tasks change. Their sequence of activities can be divided into stages as follows²⁸⁾: self-grooming (just after emergence from the pupae); incubation and repairs in the brood chamber; construction and provisioning of cells, and feeding of young adults and the queen; reconstruction of the involucre and guard duty at the entrance; and collection of pollen, nectar, and propolis. Basically the sequence of the workers' activities is similar to that in honey bees.

8) Thermoregulation

Honeybees are able to maintain the temperature around the brood at 34-36°C. The temperature is raised with their own body heat, generated by shivering the wing muscles, and lowered, if necessary, by fanning their wings at the nest entrance to draw cooler air into the nest or gathering water into the nest to spread over the comb. Generally, stingless bees are not as efficient as honey bees in controlling the nest temperature, especially when the temperature is low, they are inefficient in raising it. This may be a factor that limits stingless bees to tropical and subtropical areas. When the temperature is high, they lower the temperature by fanning their wings at the nest entrance partly for ventilation as honey bees do. Only a few species, *Torigona spinipes* and *T. duckei*, however, are known to have the ability to regulate the nest temperature within certain limits¹⁷⁾. Our studies show that *T. carbonaria* can not easily control the temperature in the hive ([Fig. 2](#)).

9) Queen behavior and oviposition

The honey bee queen flies when swarming occurs, while the stingless bee queen flies only once in her life. Once she has mated and begun to lay eggs, her abdomen enlarges and she loses the ability to fly. As a result, she remains in the old nest. In contrast to honey bees, stingless bee queens are reared continuously, and tolerated in the nest for a time. Some of them establish new colonies through swarming or take over the old queen, but most are killed by workers¹⁷⁾.

Stingless bees provide the brood cells with the food all at once, and then close the cell just after the queen lays an egg. In the genus *Torigona*, the rearing method of queens and workers is similar to that of honey bees. Queens are reared in special large cells at the margins of the comb and filled with more larval food than workers' cells. The production of a queen depends on the amount of food during the larval stages, and any fertilized egg can become a queen or a worker, that is, growing into a queen is purely the result of a greater larval food supply, and the caste is determined trophically. In contrast, queens and workers are reared in cells with the same size and caste is determined genetically in *Melipona*. Kerr suggests that the caste genes regulate juvenile hormone production¹³).

10) Foraging

The last stage of the workers' activity is foraging. Like honey bees, stingless bees collect pollen, nectar, and propolis. Most of the stingless bee species are polylectic, foraging a wide range of crops for pollen.

In contrast to honey bees, since stingless bees can forage without the help of near ultraviolet light, they can easily forage in a greenhouse with a roof made of ultraviolet-absorbing film²⁴). The colonies of *T. fuscobalteata* were being kept without any problems in foraging in an environmentally controlled chamber (10 m², 26°C, 13L:11D with fluorescent lamps) provided properly with plant flowers²). *T. angustula*, *T. bipunctata*, and *T. carbonaria* can also be successfully kept in the same conditioned chamber.

11) Flight range

Stingless bees show a compact flight range compared with honey bees. The workers of honey bees can forage over 2-3 km, while those of the stingless bee can forage over 1 km at most. There are some correlations between flight range and the body size of the workers¹²). According to Kerr¹²), small bees like those of the subgenus *Plebeia* (3-4 mm) have a flight range of about 300 m, medium-sized bees, as in the case of the subgenus *Torigona* (5 mm), have a flight range of about 600 m, large bees (10 mm) have a flight range of about 800 m, and very large bees (13-15 mm), i.e. *Melipona fuliginosa*, have a flight range of about 2,000 m²⁸). Flight activity of stingless bees is constantly influenced by the weather conditions⁸). In *M. marginata*, the flight activity is correlated positively with the temperature and negatively with RH, but the behavior indicates a flexible response to prevailing weather conditions¹⁴). In *T. carbonaria*, foraging bees fly over a maximum distance of 500 m and usually prefer to fly over a distance of about 100 m from the nest¹⁰).

12) Communication

Like the honey bees, many species of stingless bees are able to communicate the location of a food source. They use a chemical secreted from the mandibular gland and sunlight for orienteering. Foraging workers stop at intervals of a certain distance and leave scented spots on the way from a good source of food to the colony. Other bees leave the nest and begin to follow the odor trail outward²⁸). In *Torigona postica*, the foraging workers seem to be able to act as guide bees by leading the others in a group back and forth for several trips⁵). Some species of stingless bees such as *T. angustula* communicate with sounds and zigzag running. In *M. quadrifasciata* and *M. merillae*, returning foragers produce sound impulses varying proportionally to the distance of the

food source⁷⁾. In *T. carbonaria*, a foraging bee that has located a good food source marks it with a chemical scent to help other workers find it.

13) Longevity of colonies

The colony of stingless bees could last permanently by replacing the queen successively as long as a lethal disaster does not occur. Generally, the longevity of the queens seems to be longer than that of the honey bees which is 3-5 years²⁸⁾. We obtained a colony of *T. fuscovariata* from Thailand in 1995, when the colony was 12 years old. We have kept it under environmentally closed conditions for more than 3 years since then. It is still in good condition and there has not been any exchange of queen. The workers of stingless bees also seem to live considerably longer than those of honey bees. For instance, *T. xanthotricha* workers spend about 6 weeks in the nest and then about the same length of time in the field, a lifespan about double of that of a honey bee²⁰⁾.

14) Pollination efficiency

Although few quantitative data are available on the influence of pollination by stingless bees on crop yield, many species are considered to be useful for pollination of plants⁹⁾, although some species can not be used. *T. silvestriana*, *T. fulviventrid* and *T. textacea* damage the corolla of *Thunbergia grandiflora*³⁰⁾.

T. carbonaria is polylectic and an effective potential pollinator of crops such as the nut-bearing tree, *Macadamia integrifolia*, and also quickly adapts to new plants previously unknown^{10,25)}. In fact the foraging bees thrive on a wide variety of Japanese flowering plants they have never seen before, which we provided in our experiment. Two hives per 10 a of crop fields would be recommended for sufficient pollination¹⁰⁾.

NEXT

TOP

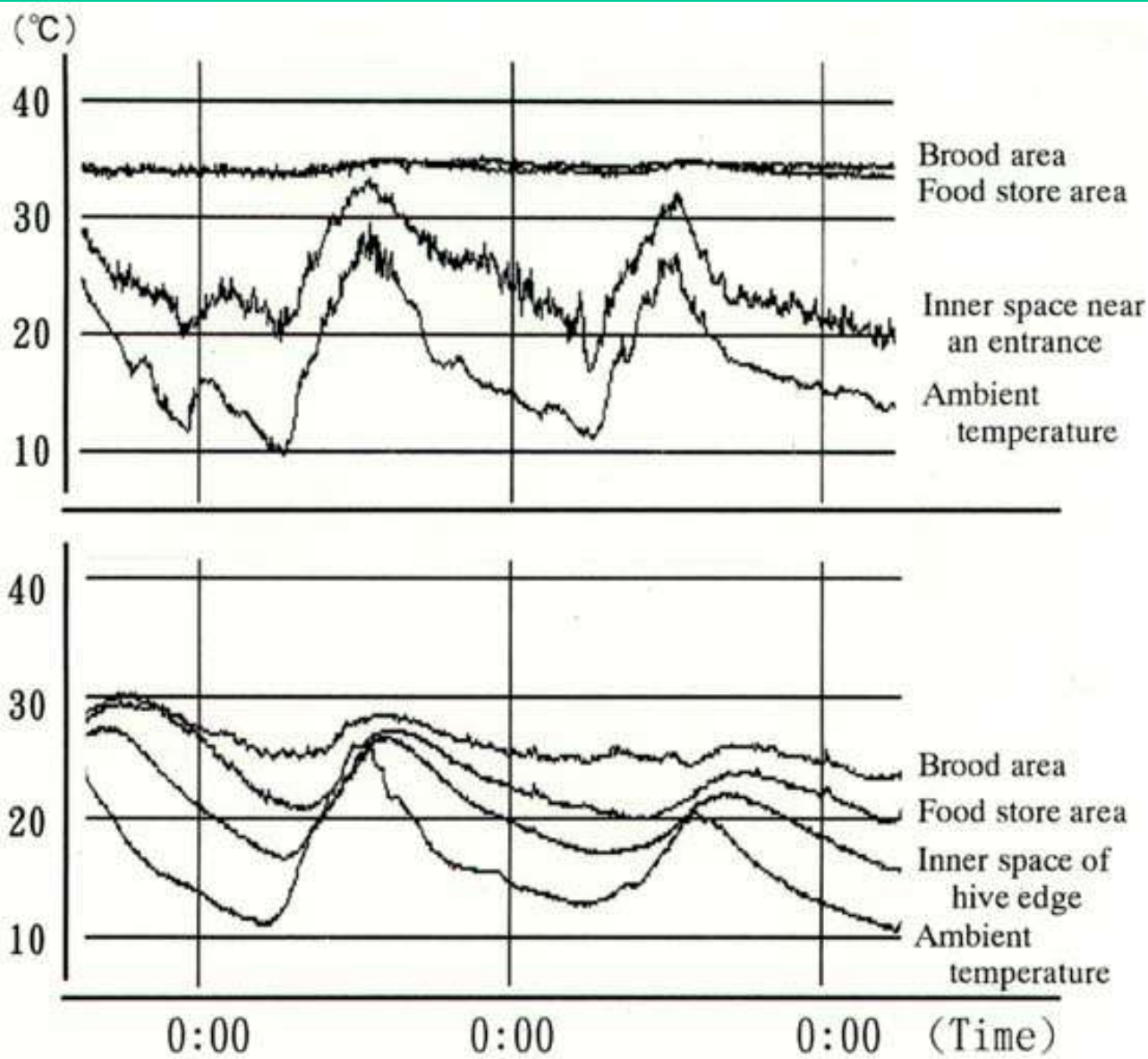


Fig. 2. Temperatures in and out of the nest of the honeybee, *Apis mellifera* (above), and the stingless bee, *Trigona carbonaria* (below)

BACK

Stingless beekeeping

Before honey bees were imported to South and Central America, stingless bees were the only honey producers in these areas. Even presently hives of stingless bees are kept for honey harvest, and some researchers have outlined in detail the management and domestication of several stingless bee species. Various kinds of hives have been designed according to the species to facilitate honey harvesting and avoid the destruction of the nest¹⁹).

1) Hives for *T.carbonaria*

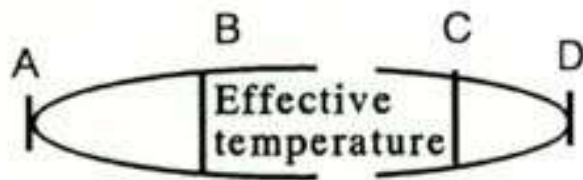
Researchers in Australia have developed various types of hives for *T.carbonaria*⁶). As shown in Fig. 2, *T.carbonaria* are not able to control the temperature in the hive, compared with honey bees. The tolerance of low temperature in *T.carbonaria* adult bees is not appreciably different from that in the honey bees ([Fig. 3](#)). The honey bees form a cluster when the ambient temperature is fairly low, as the temperature in the hive remains within the optimum range, unlike *T.carbonaria*. Therefore, the major problem for keeping them in Japan is how to maintain them safely under warm conditions. We have tried to design a hive in reference to Heard's works, so as to make the bees survive throughout the year and even enable them to multiply the colony in Japan. The hive consists of two boxes, an inner hive box and an outer box ([Fig. 4](#)). The inner box is designed with three stories to contain a brood space, food storage space, and feeding space. The brood space can be divided for propagating the colony. The outer box is equipped with a heater system which keeps the hive at a fixed temperature even in the winter season.

2) Splitting the colony

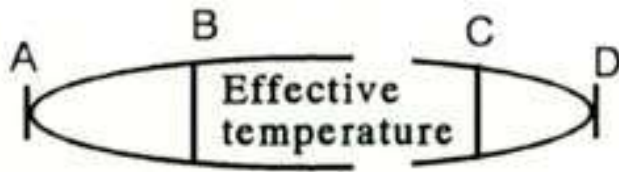
To multiply the colony, the nest, especially brood, should be split. The layers of *T.carbonaria*'s brood cells form a single spiral, that is, a single comb. The summit and the advancing edges of the spiral comb are a growing portion where new cells are constructed and added along them. When the summit reaches the ceiling of the brood chamber, the growing portion appears again at the bottom to repeat its rise¹⁶). To split a nest, the inner box is prized open while the brood in a brood space is cut in half. New empty inner boxes are then added to each half of the original inner box. Then 2 new nests are formed. There is no problem with the new nests which contain the original queen. Consequently the other one does not contain queens. However, in this species, usually several large cells contain developing queen bees, scattered throughout the brood comb. One of these cells will grow to become a queen⁶).

By using this type of hive boxes, we have succeeded in keeping the colonies of *T.carbonaria* in Japan with a view to using them as pollinators of crops in glasshouses.

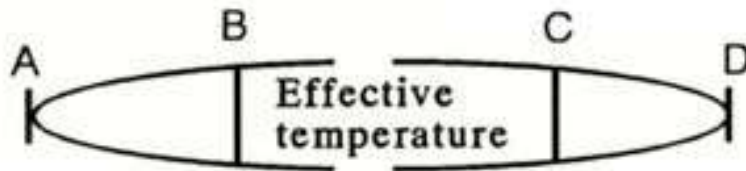
[NEXT](#)[TOP](#)[HOME](#)



A. mellifera



A. cerana japonica



T. carbonaria

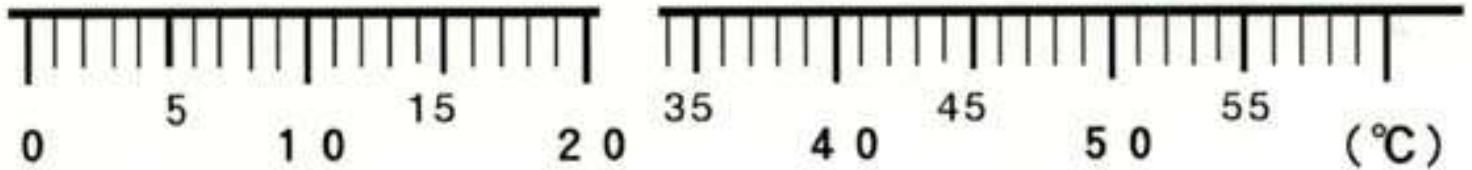


Fig. 3. Thermo-responses of adult workers in three species

A: Lethal low temperature, B: Effective low temperature, C: Effective high temperature, D: Lethal high temperature

BACK

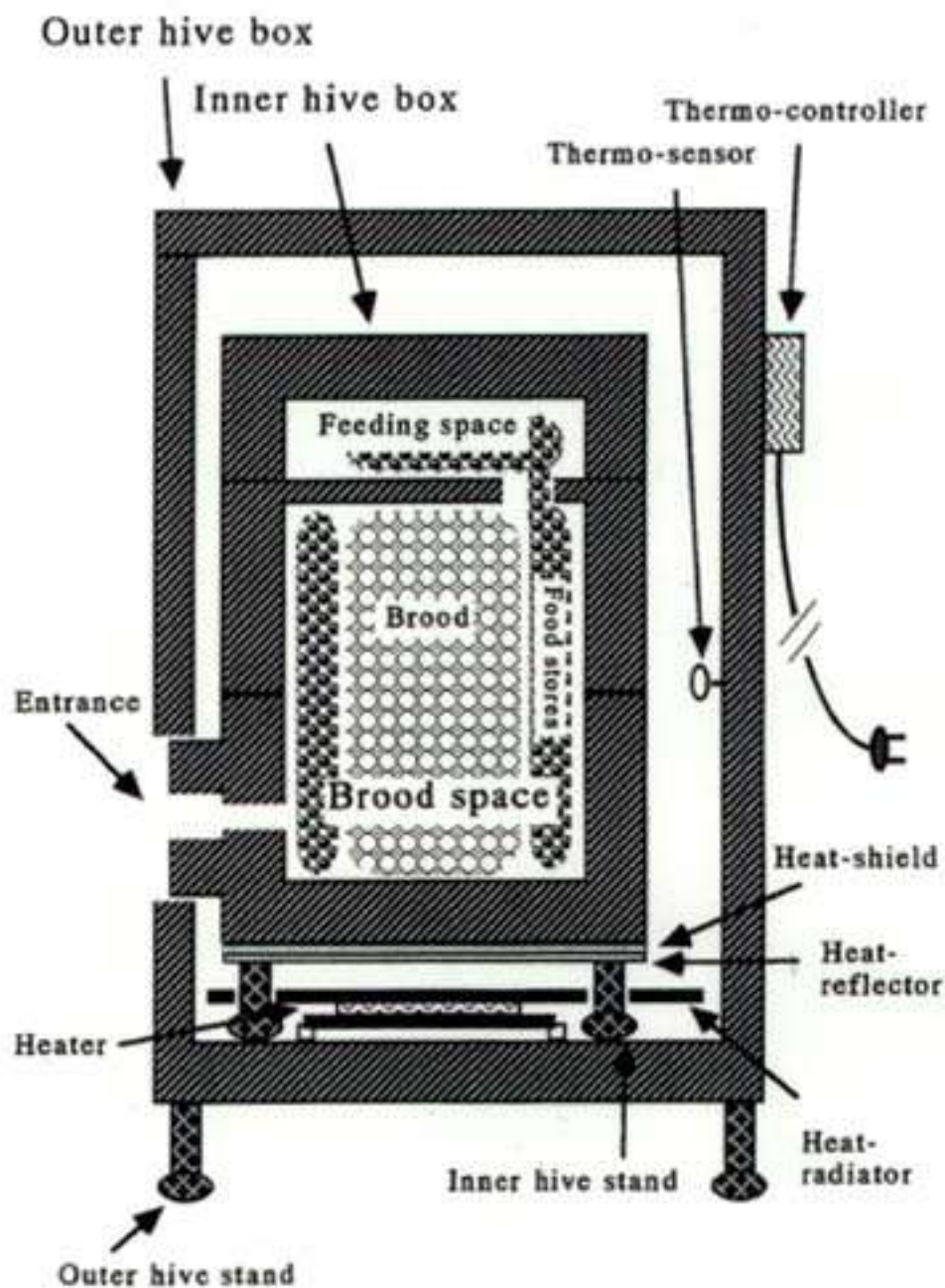


Fig. 4. Thermo-controlled hive box for the stingless bee, *Trigona carbonaria*

BACK

Determination of Tea Components by Enzymatic Flow Injection Analysis

Hideki HORIE*

Department of Tea Processing Technology, National Research Institute of Vegetables, Ornamental Plants and Tea (Kanaya, Shizuoka, 428-8501 Japan)

* Corresponding author: fax +81-547-46-2169, e-mail horie@tea.affrc.go.jp

Received 4 November 1999, accepted 1 December 1999.

Abstract

Rapid and easy analysis of qualitatively important components is required for the fair-trading of green teas. Flow injection analysis combined with immobilized enzymes was applied for that purpose, and the target compounds were amino acids (total amino acids, L-glutamic acid and ³-amino butyric acid) and ester-type catechins.

Discipline: Food / Tea industry

Additional key words: immobilized enzyme, biosensor, theanine, catechins, GABA

1...8): [References](#)

Introduction

Studies on green tea have revealed the relationship between the quality or taste and its chemical constituents³). Amino acids (such as theanine and glutamic acid) give the UMAMI taste and high-grade teas contain a large amount of them. Catechins are related to the astringency and bitterness. The balance between amino acids and catechins is important for the optimum taste of green tea. Although high-performance liquid chromatography (HPLC) or colorimetric methods can be applied to the determination of the concentrations of amino acids and catechins, these methods are time-consuming and laborious. Recently, near infrared spectroscopy has been applied for the rapid analysis of tea components¹). The spectrometer itself can be used even by untrained persons, while the determination of calibration curve parameters for each tea component is very laborious and the parameters determined can only be applied to the samples which show similar characteristics as those used for calibration. Moreover the instrument itself is expensive. Thus other methods for rapid measurement of the contents of chemical components of tea are required.

Flow injection analysis (FIA) may be an effective method for that purpose. The selectivity of the analysis can be provided using the enzyme reactions. This paper describes the simultaneous flow injection determination of the concentrations of total amino acids and glutamic acid by FIA using biosensors, combined with enzyme immobilized membranes and oxygen electrodes. The analysis of ester-type catechins ((-)-epigallocatechin gallate and (-)-epicatechin gallate) using enzyme reactors and

pH-sensitive transistors is outlined. Finally, γ -aminobutyric acid (GABA) determination using an enzyme reactor and a fluorometric detector is described.

[NEXT](#)

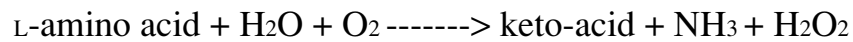
[TOP](#)

References

1. Goto, T. et al. (1991): Utilization of near infrared spectroscopy for the analysis of components in green tea. *In* Proceeding of the International Symposium on Tea Sciences, Shizuoka, 81-85.
2. Hakamata, K. (1990): Anaerobically treated tea and its hypertensive effects. *JARQ*, **24**, 105-110.
3. Nakagawa, M. (1970): Constituents in tea leaf and their contribution to the taste of green tea. *JARQ*, **5** (3), 43-47.
4. Horie, H. et al. (1993): An experiment on flow injection analysis of amino acids in tea infusions with enzyme sensors. *Tea Res. J.*, **78**, 53-60 [In Japanese with English summary].
5. Horie, H. et al. (1992): Measurement of total amino acids concentration by using an enzyme sensor. *Tea Res. J.*, **75**, 33-38 [In Japanese with English summary].
6. Horie, H. et al. (1992): Tea quality evaluation using sensors. 2. Measurement of glutamic acid and tannin. *Tea Res. J.*, **76** (Special issue), 86-87 [In Japanese].
7. Horie, H. et al. (1997): Flow injection analysis of (-)-epigallocatechin gallate in green tea infusions with an immobilized tannase reactor. *Food Sci. Technol. Int. Tokyo*, **3**, 27-30.
8. Horie, H., Sawai, Y. & Kohata, K. (1999): Flow injection analysis of γ -aminobutyric acid in GABA-enriched tea. *J. Jpn. Soc. Food Sci. Technol.*, **46**, 494-496 [In Japanese with English summary].

Simultaneous determination of total amino acids and glutamic acid⁴⁾

High-grade teas are rich in amino acids, and theanine is the dominant amino acid in tea leaves. We observed that the biosensor for amino acids (amino acid sensor), when combined with L-amino acid oxidase-immobilized membrane and an oxygen electrode, responded linearly to the concentration of theanine⁵⁾. The reaction is as follows.



The oxygen consumed by this enzyme reaction was monitored by the oxygen electrode. The sensor responded to theanine, asparagine, arginine, glutamine and serin but did not respond to glutamic acid or aspartic acid among the major amino acids found in tea leaves. The amino acid sensor was then calibrated with theanine, which gave the highest response among the major amino acids in tea leaves. The contents obtained by this method are referred to as "total amino acids". As the amino acids to which the sensor responded are abundant in high-grade green teas, the sensor is expected to show a higher response to the infusions of high-grade teas. The use of this amino acid sensor was a convenient method to analyze the concentrations of total amino acids in tea infusions and estimate the quality of teas, but still it took about 10 min for the analysis of one sample⁵⁾.

The amino acid sensor did not respond to glutamic acid, while glutamic acid gave the strongest UMAMI and is one of the major components for tea quality. Sometimes sham teas are produced by the addition of sodium glutamate to enhance the taste of tea in the manufacturing process. Determination of the content of glutamic acid in tea is also important, and we found that the glutamate sensor, which was composed of a glutamate oxidase-immobilized membrane and an oxygen electrode, was effective for the analysis of the concentration of glutamic acid in tea infusions⁶⁾.

For more rapid and simultaneous analysis of the concentrations of total amino acids and glutamic acid, a flow injection system was developed by setting the glutamate sensor upstream of the amino acid sensor ([Fig. 1](#))⁴⁾. The filtered tea infusions could be directly injected into the flow system. Glutamic acid and total amino acids in the infusions were then analyzed using the glutamate sensor and the amino acid sensor, respectively.

The results of determinations in tea samples by this method were compared with those obtained using the HPLC method (Fig. 2). Correlation coefficients were significant for the practical use of both sensors. Using this flow injection system, 30 tea infusions could be analyzed in one hour for both the concentrations of glutamic acid and total amino acids. High-grade green tea showed a higher response to the amino acid sensor as expected, while sham teas to which glutamate had been added showed a high response to the glutamate sensor. This system was therefore effective for the rapid and objective estimation of tea quality and could be used to detect glutamate addition to green teas.

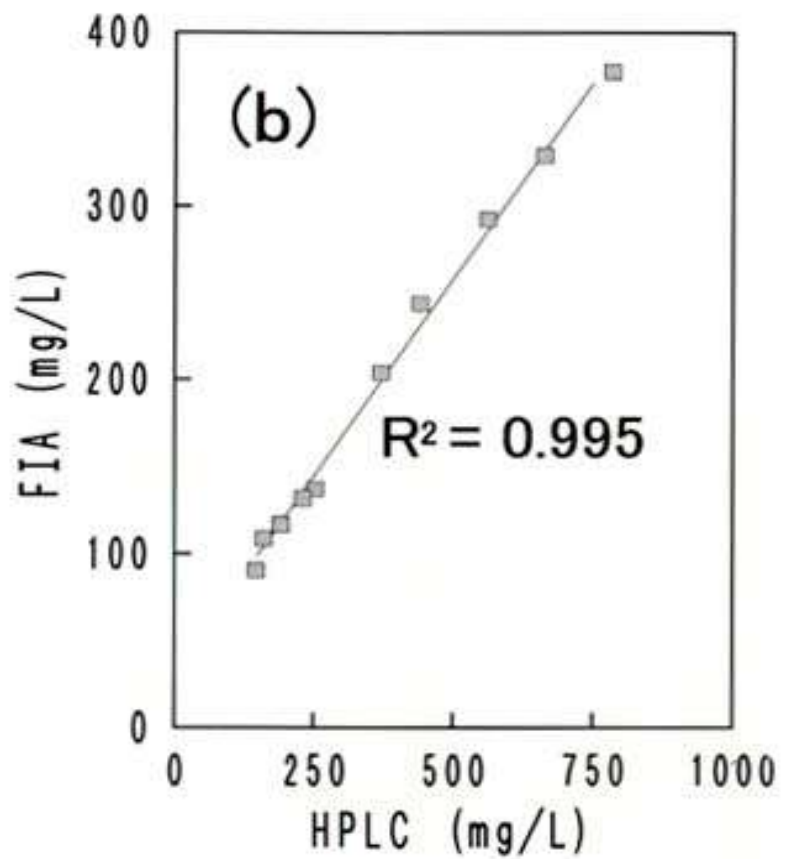
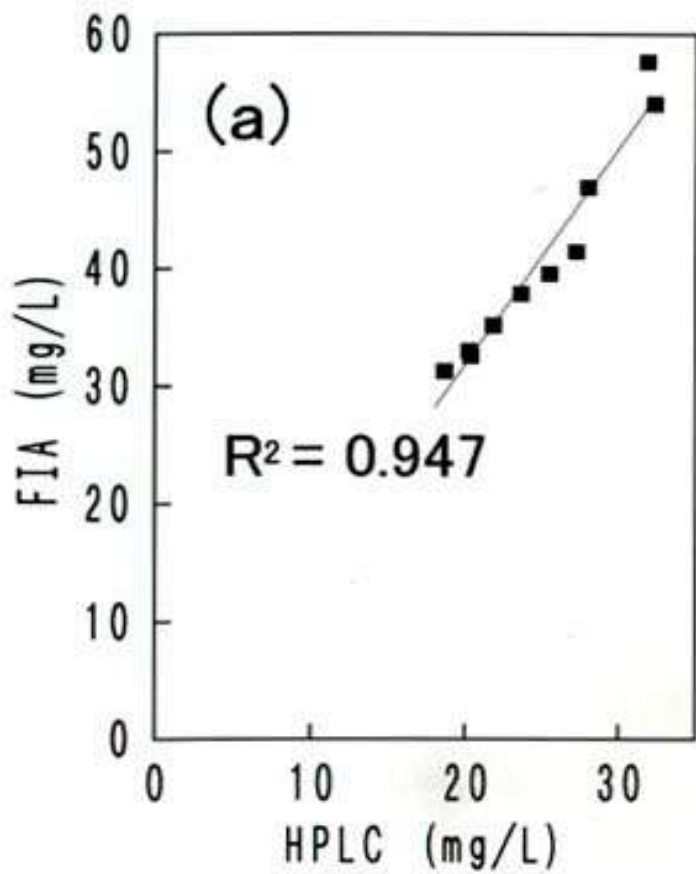


Fig.2. Comparison of the composition of tea infusions determined by FIA and HPLC methods

(a): glutamic acid, (b) :total amino acids.

To 3 g of tea, 180 mL of boiling water was added. The infusion was used as the sample for FIA analysis, after filtration with No.2 filter.

NEXT

TOP

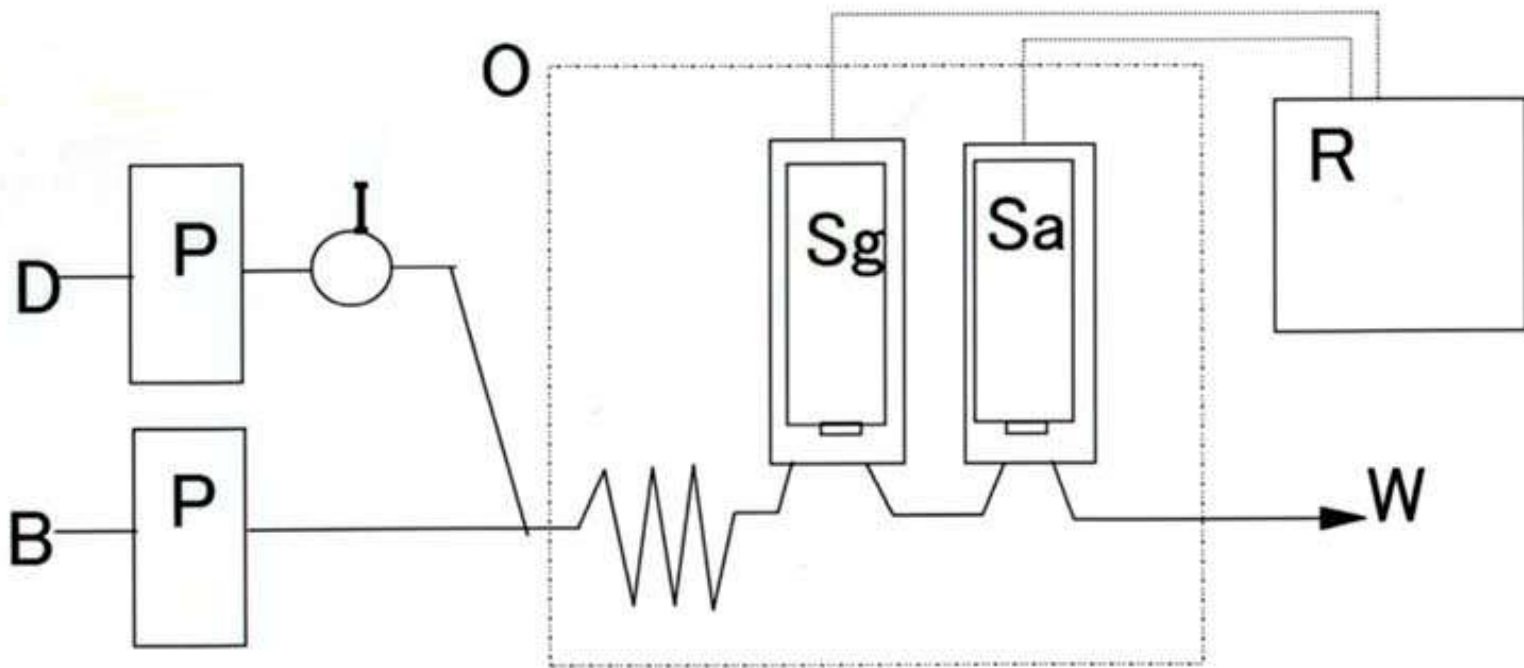


Fig.1. Flow injection system for the simultaneous determination of the concentrations of glutamic acid and total amino acids

D: distilled water (flow rate 0.7 mL/min),
B: phosphate buffer (1/15M, pH 6.4, flow rate 2.7 mL/min),
P: peristaltic pump, **I:** injection valve (loop 100 μ L),
O: column oven for HPLC (30° C),
S_g: glutamate sensor, **S_a:** amino acid sensor,
R: recorder, **W:** waste.

BACK

FIA determination of ester-type catechins⁷⁾

Catechins are associated with the astringent and bitter taste of tea. Tea catechins that have a gallate moiety through ester linkage show a stronger astringency³⁾ and such catechins are called ester-type catechins. Major ester-type catechins in tea are (-)-epigallocatechin gallate (EGCg) and (-)-epicatechin gallate (ECg), and usually the content of the former is several times higher than that of the latter.

The analysis of ester-type catechins is therefore important for the evaluation of the taste and quality of green teas. A rapid analytical system was developed for ester-type catechins (Fig. 3)⁷⁾. In this system the enzyme tannase was used to catalyze the following reaction.

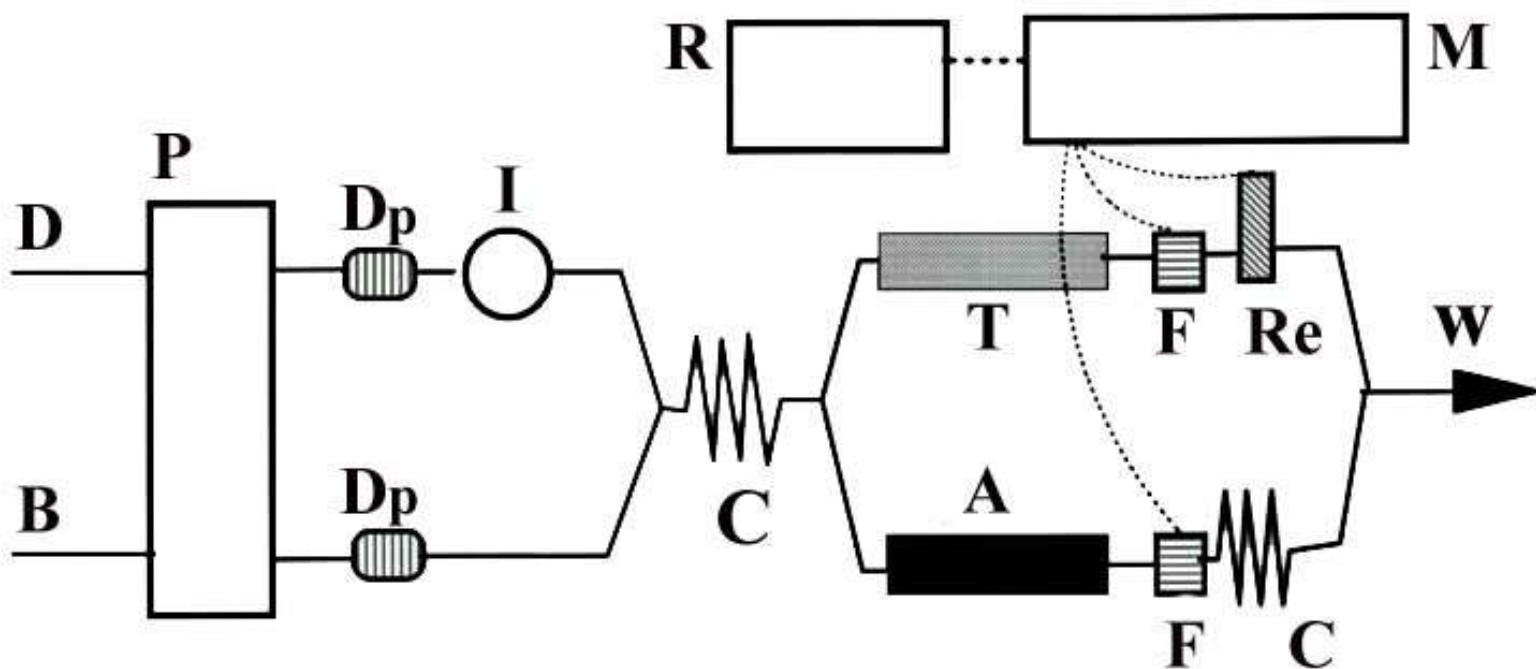
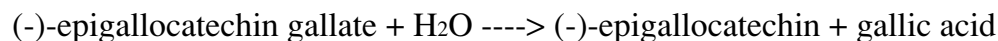


Fig. 3. Flow injection analysis system for ester-type catechins

D: distilled water, **B:** buffer (10 mM phthalate buffer, pH 5.5), **P:** peristaltic pump (total flow rate 0.7 mL/min), **Dp:** pulse-damper, **I:** injection valve (sampling loop 100 μ L), **C:** coil, **T:** tannase-immobilized reactor (1 mm i.d. \times 20 mm), **A:** bovine serum albumin-immobilized reactor, **F:** pH-ISFET electrode, **Re:** reference electrode, **W:** waste, **M:** ISFET pH/mV meter, **R:** recorder.



The gallic acid formed can be detected by the pH shift using a pH electrode. The transistor electrode (pH-ISFET) was used here as a pH electrode to reduce the size of the system, by setting it in the flow cell. The enzyme reactor, which was filled with tannase-immobilized glass beads, was connected upstream of the electrode. After a standard EGCg solution was injected, the gallic acid formed in the reactor was detected by the change of the electric potential of the pH-ISFET. However when the tea infusion was introduced, the pH shift due to the tea interfered with the analysis. A dummy reactor, which immobilized albumine instead of the enzyme, and a pH-ISFET electrode were prepared as control.

In this system a linear response to EGCg was observed with selected buffers. The gallate-releasing activity of the immobilized tannase from ECg was the same as that for EGCg. Filtered tea infusions could be introduced every 3 min, and the results were compared with the HPLC method ([Fig. 4](#)). The correlation was significant for practical and rapid evaluation of the astringency of the green tea infusions.

Determination of γ -aminobutyric acid in GABA-enriched tea⁸⁾

In the normal production of green tea, the content of γ -aminobutyric acid (GABA) is less than 0.1%, while anaerobic treatment of fresh leaves leads to a considerable increase of the content of GABA²⁾. Since the consumption of GABA-enriched tea decreases the blood pressure in humans with hypertension, such teas are sold as "GABARON CHA" in Japan. As the effective component is GABA, it is necessary to analyze GABA easily and rapidly at the site of tea manufacturing and trading.

The enzyme complex called GABAse has been identified and it catalyzes the following reaction.

GABA + 2-ketoglutaric acid + H₂O + NADP⁺ > succinic acid + glutamic acid + NADPH + H⁺

NADPH is a fluorescent compound, and the fluorescence due to the enzyme-catalyzed reaction can be measured with a fluorescence detector. In the FIA ([Fig. 5](#)), GABAse was immobilized on glass beads and the beads were set in a silicone tube, which was used as an enzyme reactor. The injection valve was connected upstream and the detector was located downstream of the reactor, respectively⁸⁾.

For tea samples, the fluorescence from tea components interfered with the precise analysis of the sample. A guard column for HPLC packed with C₁₈-silica was connected upstream of the detector to prevent the interference. The flow from the reactor was acidified by acetic acid before entering the C₁₈ column to improve the efficiency of the removal of the interfering substances and prevent the packed material in the column from deteriorating.

Using this system, the sample could be injected every 4 min. The results of determinations by this method were compared with those by the authentic HPLC method ([Fig. 6](#)). The correlation was significant for the rapid determination of the GABA content of GABA-enriched teas at the tea manufacturing factories.

Conclusion

We developed flow injection determination systems for the major components of green tea. These methods significantly reduced the time required for the analysis compared to the authentic methods. Moreover, since the buffer solutions and the wastes are harmless, they can be safely used by untrained workers at the tea factories. These newly developed methods are suitable for the estimation of the quality of teas by tea manufacturers and traders.

[NEXT](#)[TOP](#)[HOME](#)

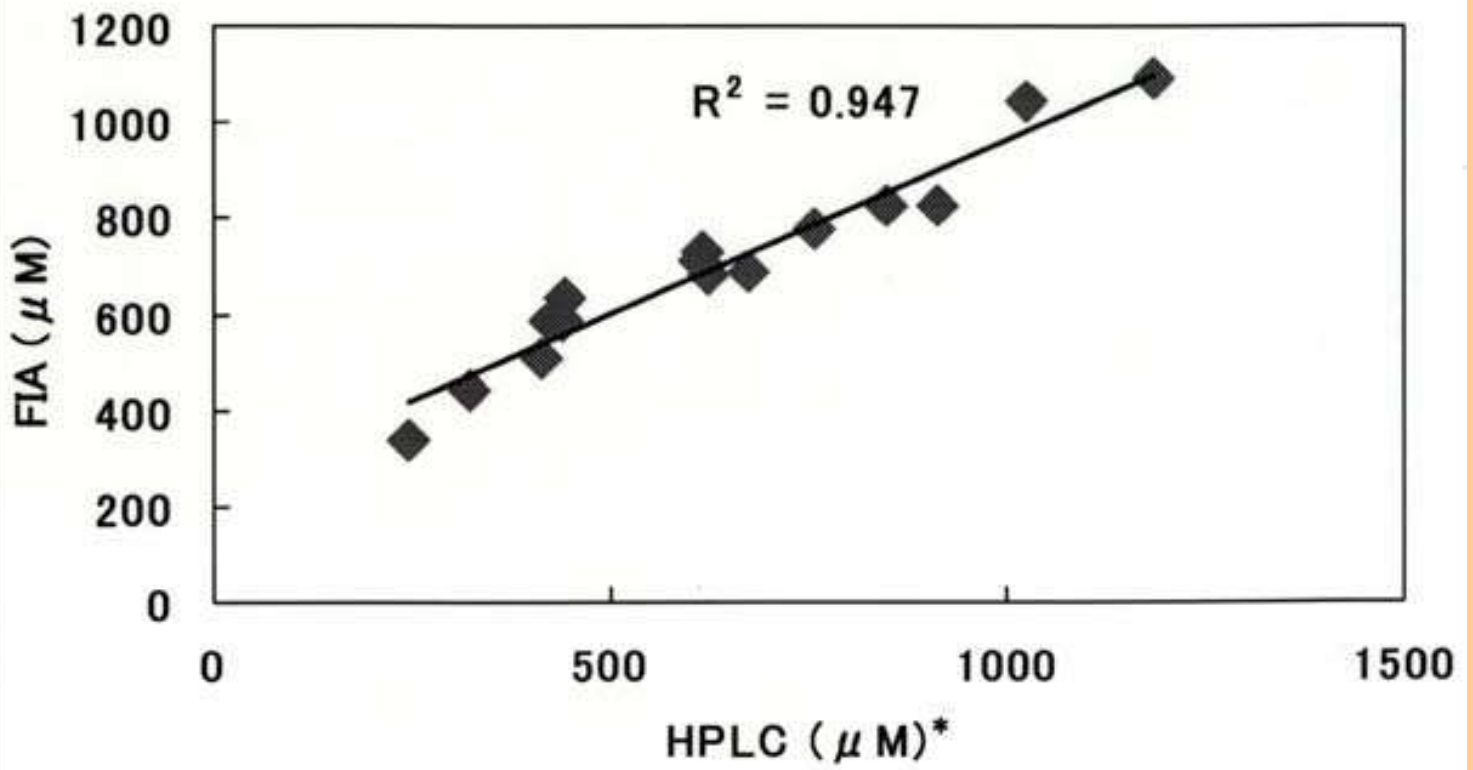


Fig. 4. Comparison of the concentrations of ester-type catechins in tea infusions determined by HPLC and FIA methods

*[EGCg] + [ECg]

BACK

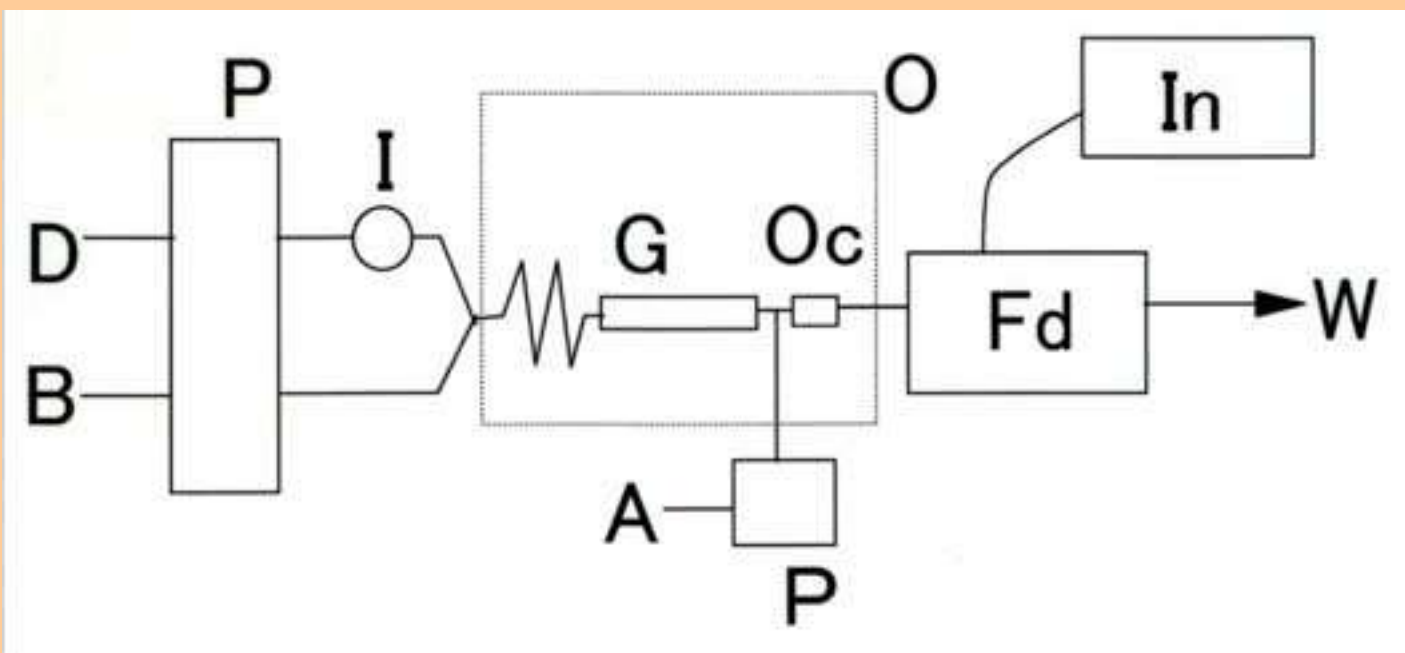


Fig. 5. Flow injection system for GABA analysis

D: distilled water, **B:** buffer (100 mM tris-HCl pH 8.0, 400 mM sodium sulfate, 1 mM NADP⁺, 5 mM 2-ketoglutaric acid, 2 mM mercaptethanol), **P:** pump (flow rate 0.2 mL/min), **I:** injection valve (sampling loop 20 μ L), **G:** GABAse-immobilized reactor (1 mm i.d. \times 100 mm), **Oc:** C₁₈ column (4.6 mm i.d. \times 10 mm), **A:** acetic acid (1%), **Fd:** fluorescent detector (EX. 360 nm, Em. 460 nm), **In:** integrator, **O:** column oven (30°C), **W:** waste.

BACK

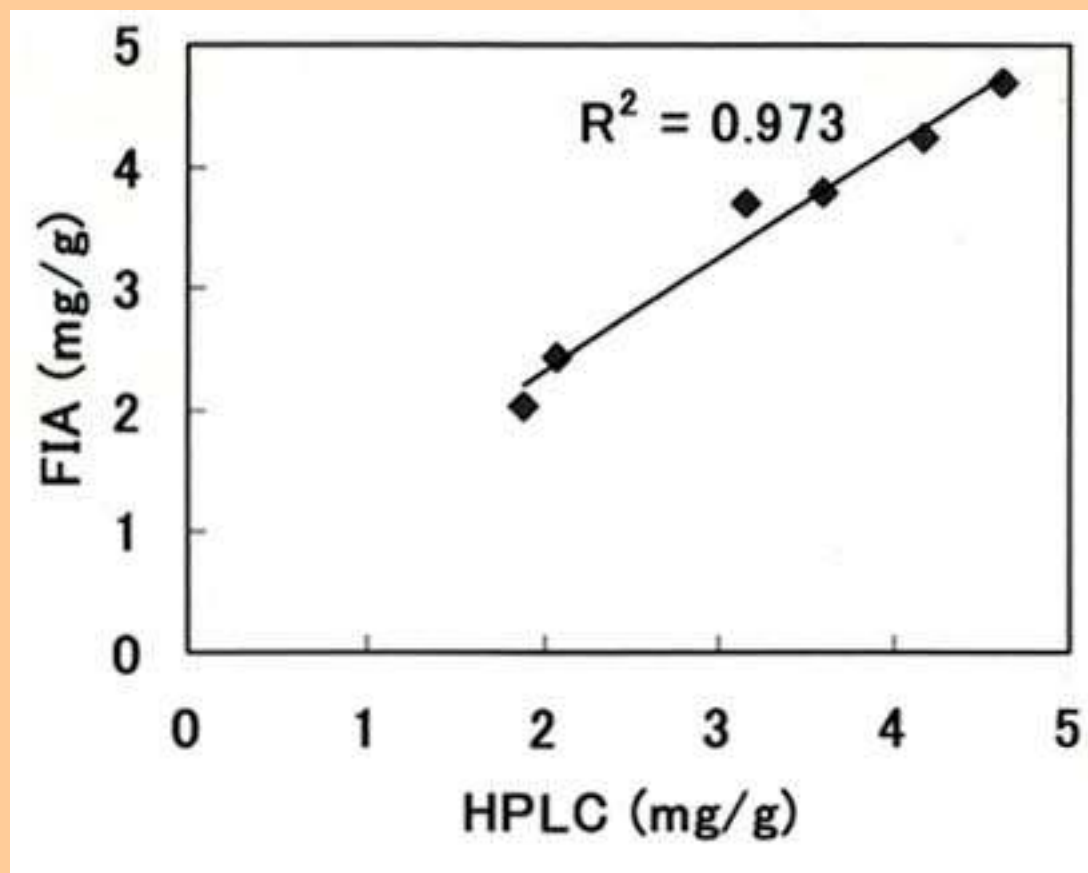


Fig. 6 Relationship of the GABA content in GABA-enriched teas between FIA and HPLC methods

GABA-enriched teas (1.0 g) were extracted with 100 mL of distilled water for 40 min. The concentrations of GABA in the filtrates were determined by FIA and HPLC methods.

BACK

An Immunohistochemical and Ultrastructural Study of Thymic Lymphoma in a Steer

Yoshikazu YAMAZAKI¹, Yoshiharu ISHIKAWA², Tomoyuki SHIBAHARA², Koichi KADOTA^{2*} and Seishi ISHINO³

¹Department of Livestock Industry, Ehime Prefecture
(Matsuyama, Ehime, 790-8570 Japan)

²Hokkaido Research Station, National Institute of Animal Health
(Hitsujigaoka, Sapporo, 062-0045 Japan)

³National Institute of Animal Health
(Tsukuba, Ibaraki, 305-0856 Japan)

* Corresponding author: fax + 81-11-853-0767, e-mail kkadota@affrc.go.jp

Received 6 September 1999, accepted 13 September 1999.

Abstract

A thymic lymphoma was found in a 14-month-old Holstein steer. Use of antisera applicable to paraffin-embedded sections showed that the tumor cells were of T-cell lineage. Although the cells were characterized histologically by the presence of irregular nuclei, electron microscopic examination disclosed that they were cleaved. Although nuclear convolution and cleavage are important in the subtyping of some human lymphomas, these characteristics may not be related to the immunophenotype of the tumor cells in bovine lymphomas.

Discipline: Animal health

Additional key words: bovine, T-cell

1...24): [References](#)

Introduction

Nuclear convolution which is a cytological marker for human T-cell malignancies may be present in human thymic lymphomas²⁴). Valli et al.²¹) divided canine, feline and bovine lymphoid tumors into cleaved and non-cleaved types, but complex indentations of tumor cell nuclei producing serpentine profiles were recognized ultrastructurally in a canine cutaneous lymphoma²⁰). In addition, the presence of nuclei showing a convoluted or cloverleaf-like conformation was verified by electron microscopy in canine⁹) and swine^{7,8}) thymic lymphomas. There is no convincing evidence that nuclear convolution occurs in bovine lymphomas including the thymic form. Here we describe a case of bovine thymic lymphoma, with emphasis placed on the ultrastructural observation of the shape of the nucleus in the tumor cells.

Materials and methods

Tissues were fixed in 10% neutral buffered formalin and processed according to standard methods for paraffin embedding. Sections were stained with hematoxylin and eosin (HE). Additionally, selected sections were stained by the avidin-biotin-peroxidase complex immunoperoxidase technique (ABC). The following monoclonal antibodies were used: anti-human CD79a (HM57) (Dako, Denmark) and anti-major histocompatibility complex class II (MHC II) (H42A) (VMRD, USA). Anti-human CD3 (Dako) was also utilized. An immunoperoxidase staining kit (BioGenex Laboratories, USA) was used in the subsequent processes. For electron microscopy, small pieces from formalin-fixed tissues were post-fixed in 1% osmium tetroxide, embedded in epoxy resin, stained with uranyl acetate and lead citrate, and examined by transmission electron microscopy (TEM).

[NEXT](#)[TOP](#)

References

- 1) Alexander, A. N. et al. (1996): Clinical and immunohistochemical characterization of thymic lymphosarcoma in a heifer. *J. Vet. Intern. Med.*, **10**, 275-278.
- 2) Asahina, M. et al. (1994): An immunohistochemical study of an equine B-cell lymphoma. *J. Comp. Pathol.*, **111**, 445-451.
- 3) Day, M. J. (1995): Immunophenotypic characterization of cutaneous lymphoid neoplasia in the dog and cat. *J. Comp. Pathol.*, **112**, 79-96.
- 4) Henderson, D. W., Papadimitriou, J. M. & Coleman, M. (1986): Lymphoid and plasmacytic tumours. *In Ultrastructural appearances of tumours* (2nd ed.). Churchill Livingstone, Edinburgh, 280-299.
- 5) Ishino, S. et al. (1988): Histopathological observations on regression of skin lymphosarcoma in five cows. *J. Vet. Med. A*, **35**, 578-585.
- 6) Kadota, K. (1987): A case of swine T-cell lymphoma with the Lennert's lesion. *Jpn. J. Vet. Sci.*, **49**, 913-916.
- 7) Kadota, K., Ishino, S. & Nakajima, H. (1986): Immunological and ultrastructural observations on swine thymic lymphoma. *J. Comp. Pathol.*, **96**, 371-378.
- 8) Kadota, K. et al. (1990): Malignant lymphomas of thymus origin in two sows. *J. Vet. Med. A*, **37**, 592-600.
- 9) Madewell, B. R. et al. (1988): Bizarre lymphoid cells in serous effusion of a dog with mediastinal lymphoma. *J. Comp. Pathol.*, **99**, 229-233.
- 10) Moulton, J. E. & Harvey, J. W. (1990): Tumors of the lymphoid and hematopoietic tissues. *In Tumors in domestic animals* (3rd ed.). ed. Moulton, J. E., University of California Press, Berkeley, 231-307.
- 11) Nakajima, H. et al. (1990): Ultrastructural characteristics of lymphomas in 16 pigs. *J. Jpn. Vet. Med. Assoc.*, **43**, 369-374 [In Japanese with English summary].
- 12) Okada, H. et al. (1987): Pathological studies on a case of bovine skin leukosis. *Jpn. J. Vet. Sci.*, **49**, 411-418.
- 13) Okada, K. et al. (1989): Spontaneous regression of bovine cutaneous leukosis. *Vet. Pathol.*, **26**, 136-143.
- 14) Parodi, A. L. et al. (1989): Preliminary report of familial thymic lymphosarcoma in Holstein calves. *Vet. Rec.*, **23**, 350-353.
- 15) Pearson, G. R. et al. (1999): B-cell (CD79a+) lymphoma affecting the tarsal joint synovia in a sheep. *J. Comp. Pathol.*, **120**, 295-299.
- 16) Sato, Y. et al. (1999): T-cell lymphoma in a savanna monkey (*Ceropithecus aethiops*) probably related to simian T-cell leukemia virus infection. *J. Vet. Med. Sci.*, **61**, 49-52.

- 17) Suchi, T. (1981): A newly proposed classification of non-Hodgkin's lymphomas. *In Color atlas of malignant lymphomas, based on a new classification.* eds. Kojima, M. et al., Bunkodo, Tokyo, 27-50 [In Japanese].
- 18) Tani, K. et al. (1997): Further analysis of the phenotype and distribution of tumor cells in sporadic B-cell and T-cell lymphomas in the lymph node and spleen of cattle. *Vet. Immunol. Immunopathol.*, **55**, 283-290.
- 19) Tanimoto, T. & Ohtsuki, Y. (1996): Evaluation of antibodies reactive with porcine lymphocytes and lymphoma cells in formalin-fixed, paraffin-embedded, antigen-retrieved tissue sections. *Am. J. Vet. Res.*, **57**, 853-859.
- 20) Thrall, M. A. et al. (1984): Cutaneous lymphosarcoma and leukemia in a dog resembling Sézary syndrome in man. *Vet. Pathol.*, **21**, 182-186.
- 21) Valli, V. E. et al. (1981): Histocytology of lymphoid tumors in the dog, cat and cow. *Vet. Pathol.*, **18**, 494-512.
- 22) Vernau, W. et al. (1997): The immunophenotypic characterization of bovine lymphomas. *Vet. Pathol.*, **34**, 222-225.
- 23) Vernau, W. et al. (1992): Classification of 1,198 cases of bovine lymphoma using the National Cancer Institute Working Formulation for human non-Hodgkin's lymphomas. *Vet. Pathol.*, **29**, 183-195.
- 24) Wakasa, H. et al. (1981): Non-Hodgkin's lymphomas. *In Color atlas of malignant lymphomas, based on a new classification.* eds. Kojima, M. et al., Bunkodo, Tokyo, 51-77 [In Japanese].

Results

1) Clinical and macroscopic observations

A 14-month-old Holstein steer was anorexic and emaciated, with a swollen brisket, enlarged lymph nodes in the neck region, severe jugular vein distention, and edema in the intermandibular space. The animal's temperature was 40.7°C rectally, the pulse was 104 per minute, and the respiration was 44 per minute. Hematological values were as follows: hematocrit, 34%; white blood cell count, 9,900 cells/ μ L; red blood cell count, 6,390,000 cells/ μ L. Atypical lymphoid cells were occasionally observed on smears of the peripheral blood. Antibodies to bovine leukemia virus were not detected by the agar gel immunodiffusion test. Since the animal was considered to have a poor prognosis, it was euthanatized. At necropsy, there was a massive enlargement of the thymus. The retropharyngeal, cervical, axillary and bronchomediastinal lymph nodes were markedly enlarged, and the largest measured more than 20 cm in the greatest dimension.

2) Light microscopy

The thymus and affected lymph nodes were almost entirely replaced by neoplastic tissue, and hemorrhages and necrotic foci were observed. There was a moderate infiltration of neoplastic cells in the heart, and a slight one in the liver and kidneys. The neoplastic cells were medium to large in size, and many cells showed irregular nuclear contours (Fig. 1). The nucleoli were medium-sized or inconspicuous, and the chromatin was finely clumped. Mitotic figures were abundant.

3) Immunohistochemistry

In the thymic tissue, the neoplastic cells gave a positive reaction for CD3 (Fig. 2), but not for CD79a and MHCII.

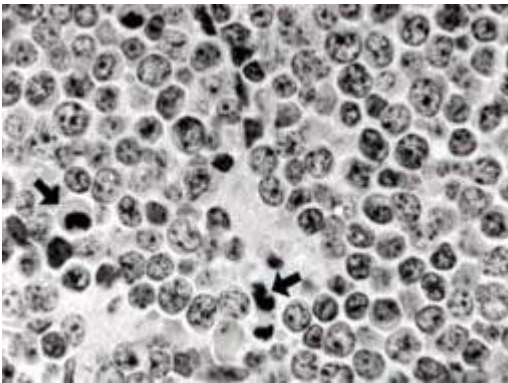


Fig. 1. Thymus: Light-microscopic feature

Neoplastic cells displaying irregular nuclei predominate in this field. Mitotic figures are visible (arrows) (HE \times 630).

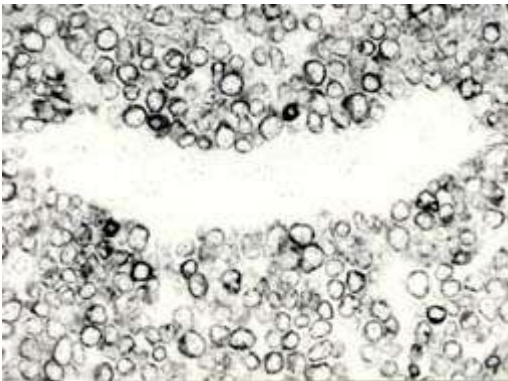


Fig. 2. Thymus: Immunohistochemical feature

Almost all the tumor cells stained intensely or weakly for CD3. There are no positive deposits in a blood vessel and surrounding connective tissue (center) (ABC \times 400).

4) Electron microscopy

Most of the tumor cells showed nuclear irregularity of varying degree. Some nuclei were slightly irregular and others were cleaved (Fig. 3), though a few cells contained more irregular nuclei (Figs. 4, 5). The cells had poorly to slightly developed organelles, which had a tendency to localize in one portion of the cytoplasm. Occasional cells contained several dense bodies near the Golgi complex (Fig. 6), but compact accumulation of the bodies was seldom observed.

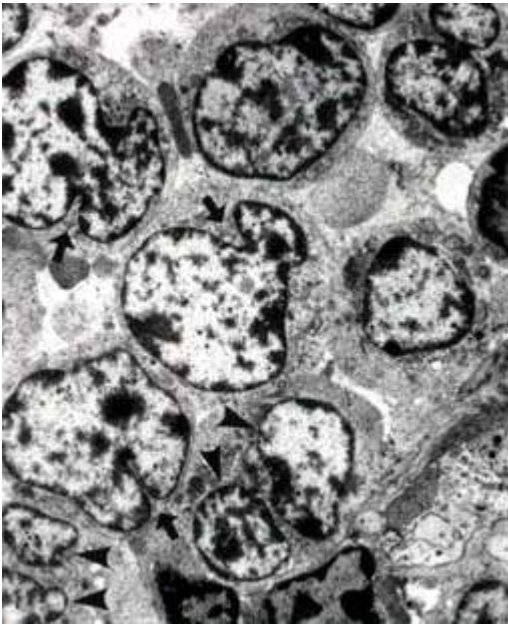


Fig. 3. Thymus: Nuclear shape

Arrows indicate nuclear cleavage. Binuclear profiles (arrowheads) presumably result from ultrathin sectioning of single cleaved nuclei (TEM \times 3,750).



Fig. 4. Thymus: Nuclear shape

Compared with the cloverleaf pattern, this nucleus shows shallow clefts (TEM \times 6,000).

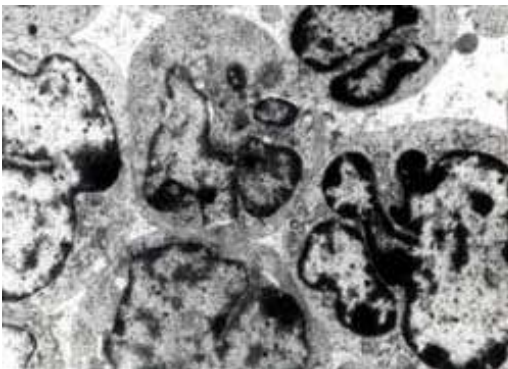


Fig. 5. Thymus: Nuclear shape

Tumor cell nuclei are irregular in contour, and one cell apparently shows a partially folded nucleus (lower right) (TEM \times 4,500).

Fig. 6. Thymus: Cytoplasmic organelle

Electron-dense bodies are located at one pole of the cell, but are not organized into a compact mass (TEM \times 12,000).



Discussion

In a bovine thymic lymphoma, the neoplastic lymphocytes were considered to be of thymic T-cell origin based on the immunostaining of formalin-fixed, paraffin-embedded tissue sections using a rabbit anti-human T-cell, CD3 polyclonal antibody¹⁾. This antibody has been used for the identification of T-cell lymphomas in other animals including dogs, cats³⁾, pigs¹⁹⁾ and a monkey¹⁶⁾. On the other hand, MHCII and CD79a were useful B-cell markers, respectively, in bovine and equine lymphomas^{2,18,22)} and in various animal species^{3,15,19)}. The present case where a reaction with CD3 alone was observed could be categorized as a T-cell lymphoma.

The presence of clustered dense bodies, which have been identified as lysosomes, was reported to be an ultrastructural characteristic of T-cell neoplasms in humans²⁴⁾, pigs⁶⁻⁸⁾ and a monkey¹⁶⁾. Similar bodies have been described in bovine cutaneous lymphomas derived from T-cells^{12,13)}, and were also observed in our case though the majority of them was not as compactly arranged.

In humans, follicular center cells sometimes display cleaved nuclei, which are considered to be the most important cytological finding in B-cell lymphomas, whereas nuclear convolution is characteristic of T-cell lymphomas¹⁷⁾. Thrall et al.²⁰⁾ demonstrated the presence of nuclear convolution in a canine cutaneous lymphoma resembling Sezary syndrome in man. In bovine cutaneous lymphomas, by contrast, the tumor cells contained round, oval or cleaved nuclei^{5,12,13)}. In a canine mediastinal lymphoma, the cells showed cloverleaf-like, convoluted nuclei⁹⁾. Likewise, convolution or multilobation was observed in swine thymic T-cell lymphomas^{7,8)}. Although Parodi et al.¹⁴⁾ reported that the convoluted form of tumor cells was confirmed by electron microscopy in bovine thymic lymphomas, the nuclei showed only a slight irregularity in the electron micrograph. In our case, slightly irregular or cleaved nuclei were detected. A few nuclei appeared to be more irregular, but were partially indented in contrast to convoluted nuclei with extensive folding²⁰⁾. Such an irregularity could be interpreted as a variation of cleavage^{11,17)}. Conversely, nuclear convolution was reported to be present in cases of bovine B-cell lymphoma^{18,23)}, although no ultrastructural examination was performed.

Lymphoproliferative diseases resembling mycosis fungoides (cutaneous T-cell lymphomas) are uncommon in dogs, and nuclear indentation or lobulation is generally less conspicuous than in humans and is not usually detected by light microscopy¹⁰⁾. Vernau et al.²³⁾ classified bovine lymphoid neoplasms observed by light microscopy based on the tumor cell size and nuclear shape, and presented high power photomicrographs depicting nuclear convolution or cleavage. The tissues, however, seemed inadequately preserved for cytological observation, because the tumor cells showed indistinct cell boundaries with or without pyknotic nuclei. In the subsequent study, Vernau et al.²²⁾ reported the absence of correlation between the immunophenotype and cell type or nuclear morphology in bovine B-cell lymphomas. The identification of nuclear profiles may be difficult in routine paraffin-embedded sections⁴⁾, and there is no convincing ultrastructural evidence of nuclear convolution in bovine T-cell lymphomas.

NEXT

TOP

HOME

Immunohistochemical and Ultrastructural Studies on Hemangiopericytomas in Two Calves

Takashi TAKAHASHI¹, Yukie TETSUKA², Yoshiro MITARAI³, Masumi SATO⁴, Mizue HIKITA⁵, Tomoyuki SHIBAHARA⁶ and Koichi KADOTA^{6*}

¹ Tochigi Prefectural Institute of Animal Health
(Hiraide Kogyodanchi, Utsunomiya, 321-0905 Japan)

² Ujiie Livestock Hygiene Service Center (Ujiie, Tochigi, 329-1311 Japan)

³ Oita Livestock Hygiene Service Center (Onotsuru, Oita, 870-1153 Japan)

⁴ Kyushu Research Station, National Institute of Animal Health
(Chuzan, Kagoshima, 891-0105 Japan)

⁵ Ishikari Livestock Hygiene Service Center (Hitsujigaoka, Sapporo, 062-0045 Japan)

⁶ Hokkaido Research Station, National Institute of Animal Health
(Hitsujigaoka, Sapporo, 062-0045 Japan)

* Corresponding author: fax + 81-11-853-0767, e-mail kkadota@affrc.go.jp

Received 6 September 1999, accepted 13 September 1999.

Abstract

After castration of 2 male Japanese Black calves, hemangiopericytomas developed in the subcutis near the scrotum. Their pericytic origin was demonstrated by the absence of focal densities, positive immunoreactivity for alpha smooth muscle actin, and absent staining for desmin. A similar neoplasm has been reported in a castrated male Japanese Black calf. It is considered that hemangiopericytomas in calves may be closely related to castration and certain bovine breeds.

Discipline: Animal health

Additional key words: castration

1...12): [References](#)

Introduction

Hemangiopericyoma is a relatively common subcutaneous neoplasm of dogs that is considered to originate from pericytes, but the tumor cells have never been unequivocally proven to be pericytes by histochemical and electron microscopic examination⁵). In contrast, a bovine hemangiopericyoma was

considered to be of pericytic origin based on immunohistochemical and ultrastructural findings⁷⁾. Here we describe 2 additional cases of hemangiopericytoma. It is assumed that such tumors may occur mainly in castrated male Japanese Black calves.

Materials and methods

Case 1 was an 8-month-old, castrated male Japanese Black calf exhibiting 2 tumor masses (4 x 3 cm) and 3 smaller ones (2 x 1.5 cm) near the scrotum. These subcutaneous tumors, protruding above the surface of the skin, could be surgically excised with minimal bleeding, because they were not connected to the underlying musculature. Case 2 was an 8-month-old, castrated male Japanese Black calf with a raised tumor nodule (4.5 x 2 x 1.5 cm) in the subcutis near the scrotum. The tumor, which was surgically removed, was not encapsulated and showed somewhat indistinct borders. All the tumors in cases 1 and 2 were similar macroscopically. The tumors were rubbery in consistency, and were grayish white to pink in color.

Tissues were fixed in 10% buffered formalin, embedded in paraffin wax, cut at 4 μ m, and stained with hematoxylin and eosin (HE). For immunohistochemistry (IH) and electron microscopy (TEM), formalin-fixed tissues were treated as described previously^{4,7)}.

[NEXT](#)[TOP](#)

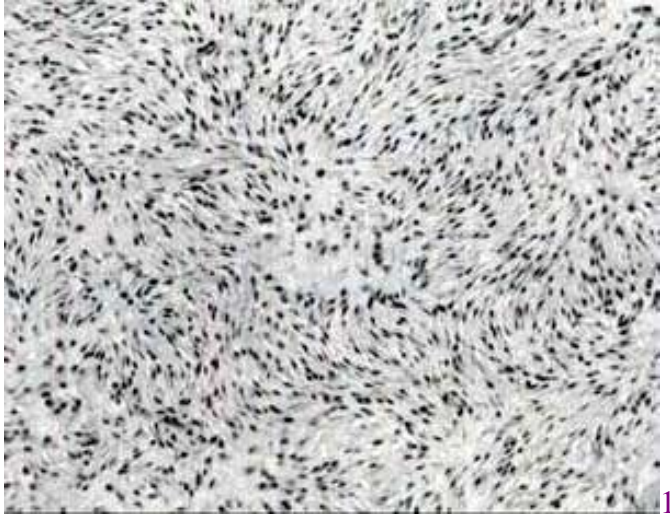
References

- 1) Anjiki, T. et al. (1991): An ultrastructural study of vulval myofibroblastoma in a cow. *J. Vet. Med. A*, **38**, 770-775.
- 2) Dass, L. L. et al. (1987): A rare case of Sertoli cell tumour in a bullock. *Indian Vet. J.*, **64**, 740-741.
- 3) Goldschmidt, M. H. & Shofer, F. S. (1992): Canine hemangiopericytoma. *In Skin tumors of the dog and cat*. Pergamon Press, Oxford, 168-174.
- 4) Hikita, M. et al. (1999): Myofibroblastoma of the neck in a heifer. *J. Vet. Med. Sci.*, **61**, 1157-1159.
- 5) Jones, T. C., Hunt, R. D. & King, N. W. (1997): The skin and its appendages. *In Veterinary pathology* (6th ed.). Williams & Wilkins, Baltimore, 817-871.
- 6) Madewell, B. R., Griffey, S. M. & Munn, R. J. (1992): Ultrastructure of canine vasoformative tumors. *J. Vasc. Res.*, **29**, 50-55.
- 7) Mitarai, Y., Ishikawa, Y. & Kadota K. (1998): Haemangiopericytoma in a calf. *Res. Vet. Sci.*, **65**, 265-267.
- 8) PÃ©rez, J. et al. (1996): Immunohistochemical characterization of hemangiopericytomas and other spindle cell tumors in the dog. *Vet. Pathol.*, **33**, 391-397.
- 9) Pulley, L. T. & Stannard, A. A. (1990): Tumors of the skin and soft tissues. *In Tumors in domestic animals* (3rd ed.). ed. Moulton, J. E., University of California Press, Berkeley, 23-87.
- 10) Sato, N. et al. (1998): Malignant mesenchymoma arising in an incisional scar of the abdominal wall. *Eur. J. Surg. Oncol.*, **24**, 449-450.
- 11) Une, Y., Shiota, K. & Nomura, Y. (1993): Immunohistochemical study on bovine myogenic tumors. *Vet. Pathol.*, **30**, 445.
- 12) Wheeler, J. E. & Rudy, F. R. (1990): The testis, paratesticular structures, and male external genitalia. *In Principles and practice of surgical pathology* (2nd ed.). ed. Silverberg, S. G., Churchill Livingstone, New York, 1531-1585.

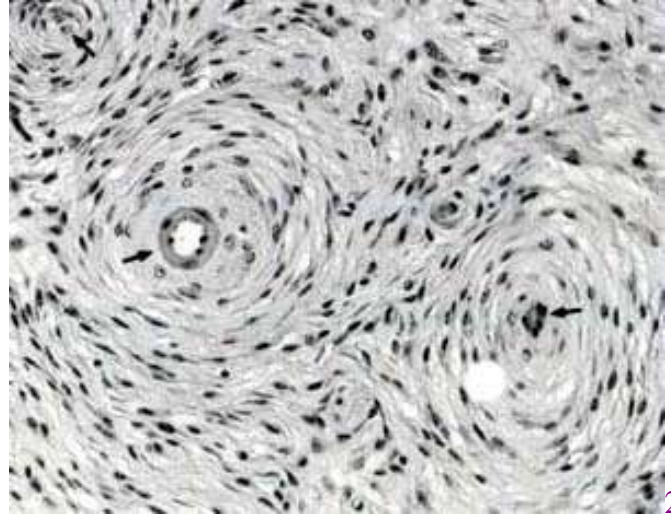
Results and discussion

The neoplasms in cases 1 and 2 showed very similar histological, immunohistochemical and ultrastructural features. The neoplastic tissues in cases 1 and 2 were present in the dermis and subcutis, and the borders with surrounding connective tissue were well defined. The tumor tissues were composed of diffusely distributed cells, and there was an edematous, mucinous or fine fibrillary stroma between the cells. In some areas, neoplastic cells grew in a storiform pattern (Fig. 1), and it was uncommon to find cells arranged in a concentric fashion around blood vessels with varying sizes (Figs. 2, 3) or hair follicles. The most predominant cells were slender spindle cells with fusiform nuclei. However, some cells were larger in size and varied from plump spindle cells to ovoid or stellate cells, with large oval nuclei. Mitotic figures were seldom observed.

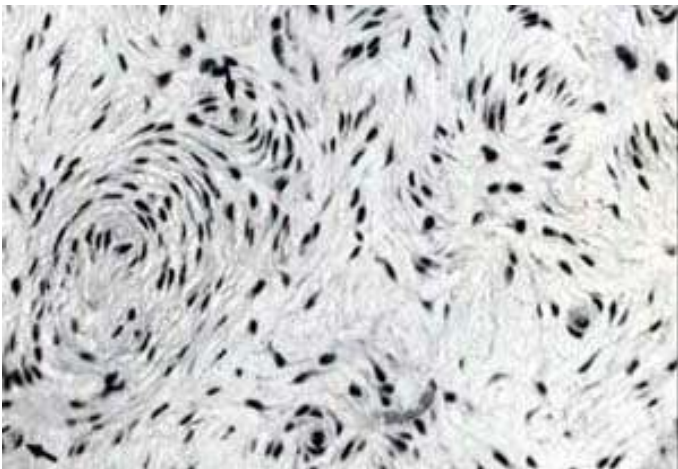
Immunohistochemically, the neoplastic cells in cases 1 and 2 were positive for vimentin, and the vast majority were also positive for alpha smooth muscle actin (SMA) (Fig. 4). Desmin-positive neoplastic cells were absent.



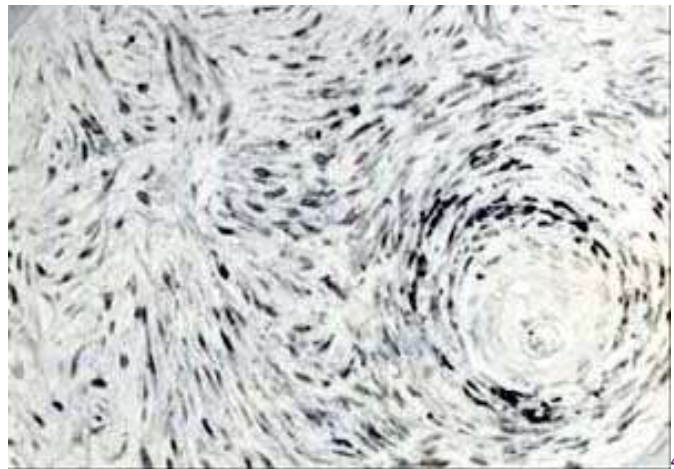
1



2



3



4

Fig. 1. Case 1: Intertwining bundles of slender spindle cells produce a typical storiform pattern (He x 100)

Fig. 2. Case 1: Blood vessels of various sizes (arrows) are present in the center of concentric whorls of tumor cells (HE x 200)

Fig. 3. Case 2: Tumor cells form whorls around capillaries that contain red blood cells (arrows) (He x 200)

Fig. 4. Case 2: Tumor cells showing SMA positivity are arranged in fascicles and encircle a hair follicle (right) (IH x 200)

In both cases the most outstanding ultrastructural feature of the neoplastic cells was the presence of extremely elongated cell processes, from which a large number of microvillous projections protruded in case 2 (Figs. 5, 6), while they were inconspicuous in case 1 (Fig. 7). The rough endoplasmic reticulum (RER) was moderately well developed. Subplasmalemmal densities could be observed, unlike focal densities. In case 2, a few cells showed highly irregular nuclear contours or contained glycogen particles (Fig. 8).

In a bovine hemangiopericytoma⁷⁾, the tumor cells, characterized by a perivascular whorl formation, SMA positivity and absence of focal densities, were considered to have arisen from a pericyte⁷⁾. Because the same features could be confirmed, the present neoplasms were diagnosed as hemangiopericytomas. The perivascular whorled pattern, however, was less conspicuous compared with that in the previous case, and in the neoplasms described here tumor cells were arranged distinctly in a storiform pattern in some areas. It is highly probable that such neoplasms have been mistakenly diagnosed as fibroblastic or fibrohistiocytic tumors showing a storiform pattern.

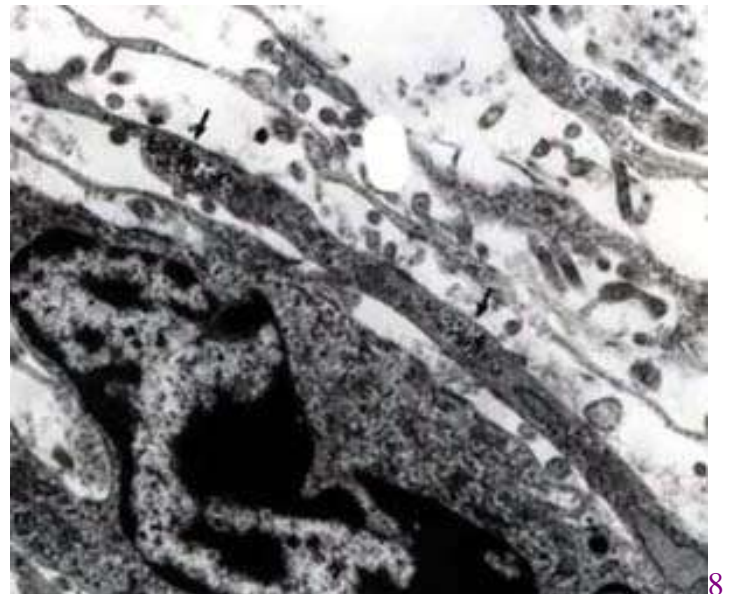
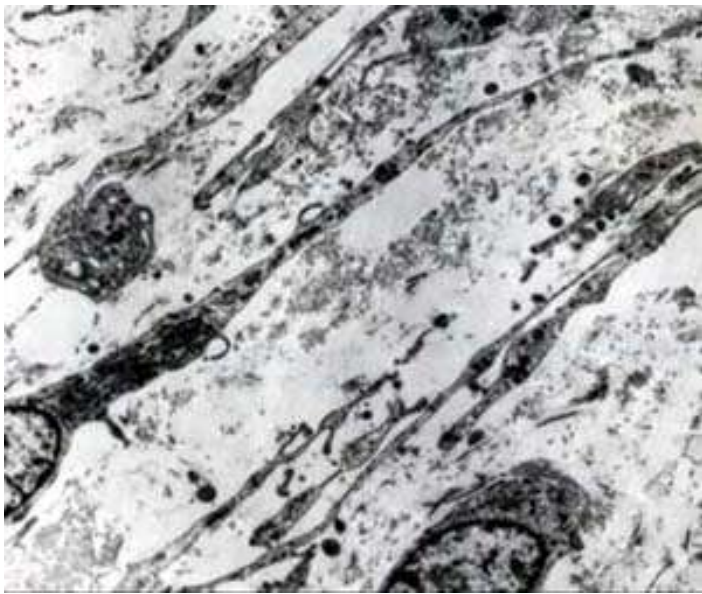
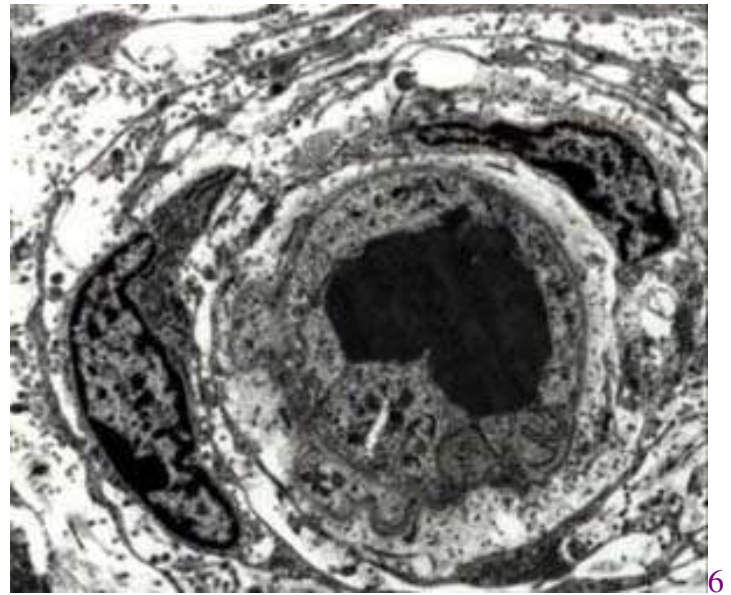
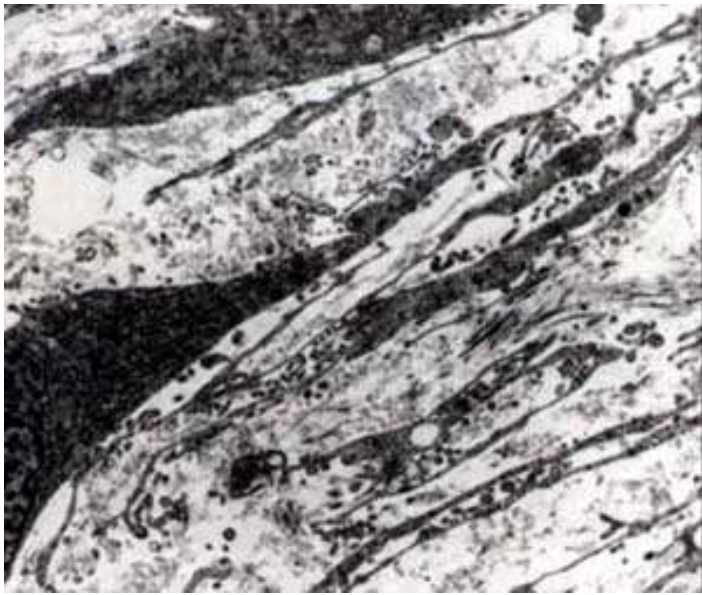


Fig. 5. Case 2: Many microvillous projections protrude from the surface of tumor cells (TEM x 3,750)

Fig. 6. Case 2: A capillary containing erythrocytes is surrounded by tumor cells with microvillous projections (TEM x 4,500)

Fig. 7. Case 1: As shown in Fig. 5, tumor cells display long slender cytoplasmic processes, with few microvillous projections (TEM x 3,750)

Fig. 8. Case 2: Aggregates of glycogen particles (arrows) are detected in a cytoplasmic process, and the nucleus of an adjoining tumor cell shows an irregular contour (TEM x 9,000)

As in the case of bovine hemangiopericytoma, the typical histological pattern in canine hemangiopericytomas is characterized by the presence of layers of tumor cells arranged in a concentric fashion around a small central lumen, but this pattern is often lacking and the lumen is mostly devoid of any erythrocytes^{3,9)}. Madewell et al.⁶⁾ showed that canine hemangiopericytomas were ultrastructurally similar to their human counterpart neoplasms, which apparently differed from canine and bovine hemangiopericytomas in the growth pattern⁷⁾. In contrast, Pérez et al.⁸⁾ considered that canine

hemangiopericytomas were pericytic in origin based on the following immunohistochemical results; muscle actin was expressed by some tumor cells in 22 out of 44 cases analyzed, but desmin was absent. It is, however, difficult to rule out the possibility that the actin-positive, desmin-negative cells were myofibroblasts, because myofibroblasts were indistinguishable from pericytes by immunohistochemistry alone^{4,11}). Thus, there is a considerable controversy regarding the histogenesis of canine hemangiopericytomas, and there has never been a conclusive evidence that they are derived from pericytes^{5,9}).

Trauma is related to human soft tissue sarcomas¹⁰) and testicular tumors¹²), but the etiological role has not been determined. A Sertoli cell tumor was detected in a bullock, but its exact etiology was unknown²). It was suggested that a vulval myofibroblastoma in a cow was affected by sex hormones¹). Because the present and previous neoplasms occurred at sites different from operation wounds⁷), a hormonal imbalance after castration may have contributed to the development of the neoplasms. In addition, since the tumors occurred in 3 young animals of the same breed, it is suggested that Japanese Black calves may be prone to the development of hemangiopericytomas.

[NEXT](#)

[TOP](#)

[HOME](#)

Potential Risk of Transmission and Spread of Foot-and-mouth Disease in Kagoshima Prefecture, Japan

Takashi OGAWA^{1*} and Kenshi MATSUDA²

¹ Kyushu Research Station, National Institute of Animal Health
(2702, Chuzan, Kagoshima, 891-0105 Japan)

² Aira Livestock Hygiene Service Center, Kagoshima Prefecture
(1641-1, Kida, Kajiki, Kagoshima, 899-5241 Japan)

* Corresponding author: fax +81-99-268-3088, e-mail epidemic@sat.affrc.go.jp

Received 21 October 1999, accepted 18 November 1999.

Abstract

In March 1997, outbreaks of foot-and-mouth disease (FMD) affected pigs in Taiwan. To assess the potential risk of transmission and spread of FMD, a survey on normal movement pattern in livestock farms was carried out in Kagoshima Prefecture, Japan. In a total of 20 farms (9 for pig farrow-to-finish operations, 6 beef cattle farms and 5 dairy cattle farms) participating in the survey, all the movements to or off the farms (e.g. animals, materials and people / number of contacts and destination) were recorded daily over a period of one-week using a questionnaire. The movements were classified into 4 grades: risk 4 (very high) to risk 1 (low), respectively, assigned to the types of contacts. The movements off the farm were more frequent than those to the farm in each livestock farm. In particular the movements off the pig farms were concentrated on animal shipping to slaughterhouse with grade risk 4. Mean distance of shipping also extended over a radius of more than 20 km of the control zone for FMD emergency in Japan. Should an outbreak of FMD be detected in a pig farm, FMDV might, therefore, have already spread prior to the diagnosis of the disease over the FMD control zone.

Discipline: Animal health

Additional key words: epidemiology, risk analysis

1...8): [References](#)

Introduction

Foot-and-mouth disease (FMD) which is a highly contagious viral disease that affects primarily cloven-hoofed animals, often with serious economic consequences, is classified into list A of animal diseases to be reported to the Office International des Epizooties (OIE)³. The outbreak of FMD can result in a dramatic decrease in livestock productivity and loss of foreign markets for livestock and animal products²).

Foot-and-mouth disease virus (FMDV) is present in all the physiological secretions of infected animals. High

concentration of FMDV can be detected in the saliva hours before clinical lesions appear and in feces and milk up to 4 days before clinical signs occur. Thus, infected animals not yet showing clinical signs of the disease may be efficient transmitters of the virus¹⁾.

Since March 1997, outbreaks of FMD caused by the porciphilic strain of the virus have affected pigs in Taiwan⁴⁾. The Japanese Government has strictly regulated the ban on importation of all animals and animal products from Taiwan.

If an outbreak of FMD occurs in Japan, all the movements of the animals and animal products would be restricted to limit the spread of FMD to the control zone within a radius of 20 km based on the Manual for Control of Overseas Animal Diseases⁵⁾. A model that predicts the direction and extent of all the livestock movements within the control zone prior to an outbreak of FMD is expected to be developed in Japan, because, in New Zealand, a decision support system (DSS) has already been developed to help control a FMD emergency: EpiMAN (NZ)⁷⁾. A similar DSS for use in the EU was also developed as EpiMAN (EU)⁶⁾.

In order to confirm FMD dissemination through normal movements relating to animals, materials and people from infected premises, a questionnaire survey was conducted on the movements during a period of one-week in Kagoshima Prefecture, Japan. In this paper the potential risk of transmission and spread of FMD was assessed based on the results of the survey.

[NEXT](#)

[TOP](#)

References

1. Callis, J. J. (1990): Foot-and-mouth disease. *In* Foreign animal disease reference. Revised 4th ed., USDA:APHIS:VS, National Veterinary Services Laboratories, Washington, DC, 124-136.
2. Centers for Epidemiology and Animal Health (1994): Foot-and-mouth disease; source of outbreaks and hazard categorization of modes of virus transmission. Centers for Epidemiology and Animal Health, Colorado.
3. Donaldson, A. I. et al (1996): Foot-and-mouth disease. *In* OIE manual of standards for diagnostic tests and vaccines. 3rd ed., OIE, Paris, 47 - 56.
4. Dunn, C. S. & Donaldson, A. I. (1997): Natural adaptation to pigs of a Taiwanese isolate of foot-and-mouth disease virus. *Vet. Rec.*, **141**, 174-175.
5. Japan Veterinary Medical Association (1965): Foot-and-mouth disease; manual of diagnosis. Japan Veterinary Medical Association, Tokyo [In Japanese].
6. Nielen, M. et al. (1996): Quantification of contacts between Dutch farms to assess the potential risk of foot-and-mouth disease. *Prev. Vet. Med.*, **28**, 143-158.
7. Sanson, R. L. et al. (1993): The potential extent of transmission of foot-and-mouth disease; a study of the movement of animals and materials in Southland, New Zealand. *N. Z. Vet. J.*, **41**, 21-28.
8. Statistic Analysis System Institute (1988): SAS/STAT user's guide. Release 6.03, Cary. NC.

Materials and methods

1. Selection of the pilot area

The pilot area was selected in close cooperation with the Aira Livestock Hygiene Service Center, Kagoshima Prefecture, and set up approximately in the same way as the FMD control zone, around infected premises, within a radius of 20 km in the Aira region. The area was located on the border of neighboring 2 Prefectures (Kumamoto and Miyazaki), as shown in Fig. 1.

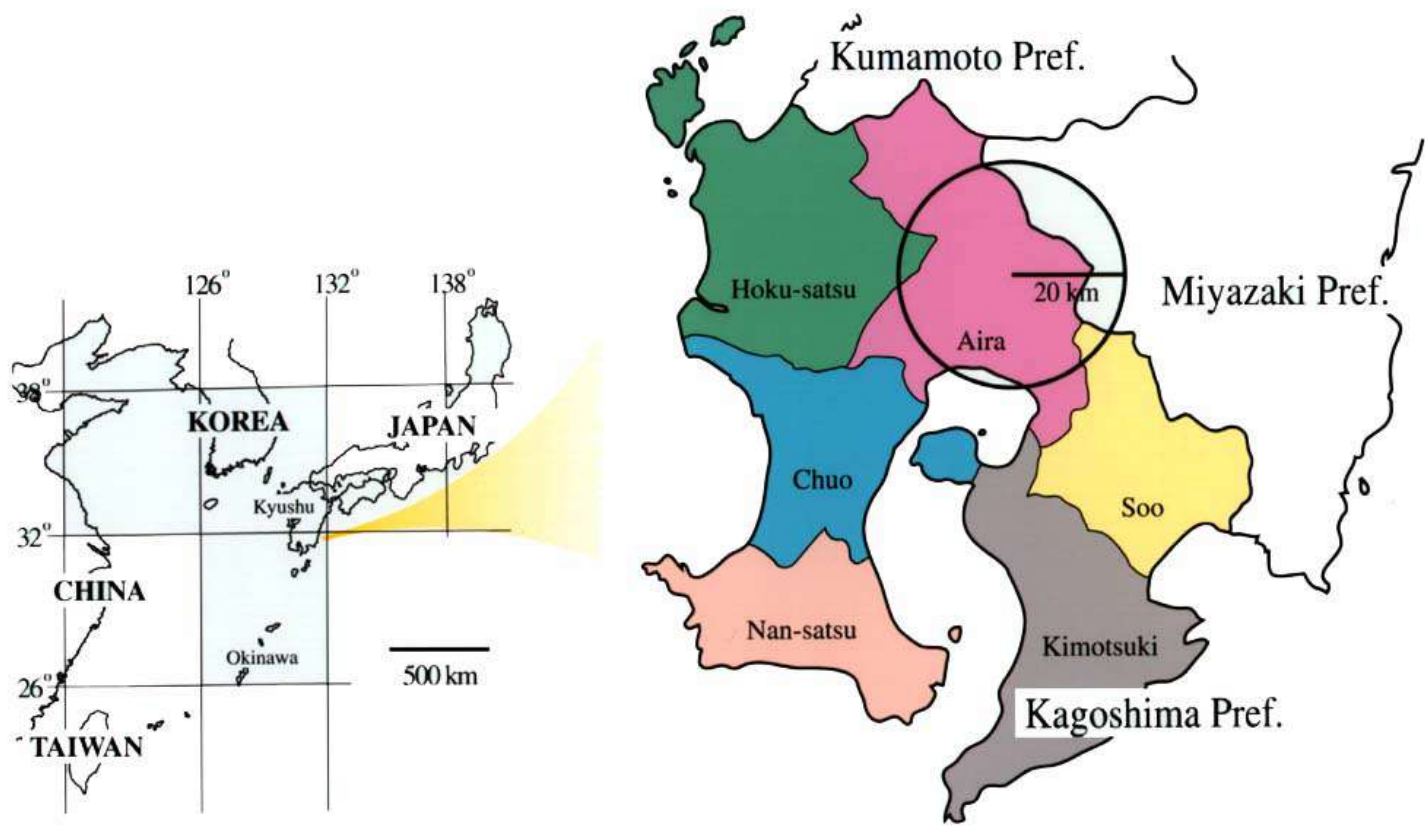


Fig.1. Location of the pilot area in the Aira region, Kagoshima Prefecture, Japan

2. Data collection

As shown in [Table 1](#), a total of 2,191 livestock farms with pigs or cattle were located within the pilot area. Also, the pilot area was characterized by a high density of pigs and a large number of small holders of beef cattle for breeding. Then, 20 farms within the pilot area were selected for the survey through the Aira Livestock Hygiene Service Center. The farms consisted of pig farrow-to-finish operations (9 farms), beef cattle for breeding (6 farms) and dairy cattle farming (5 farms).

A questionnaire survey was conducted during a period of one-week between August 26 and September 1, 1997. The participating farmers were visited and veterinary inspector officers of the Aira Livestock Hygiene Service Center asked questions about general issues and livestock management. The farmers were also asked to record all the movements to or off their farms (e.g. animals, materials and people / number of contacts and destination) everyday for a period of one-week using a questionnaire.

For animal movements to or off the farm the following data were recorded: date, species, number of animals in transport, own vehicle used for transport ("Yes" or "No"), origin and destination address and types (e.g. farms with pigs or cattle, agricultural cooperatives, live-animal market, animal traders, slaughterhouses or others).

3. Definition of potential risk of transmission and spread of FMD

Risk and types of contacts were designed assuming that the farm had been recently infected with FMD, but with the animals not showing any clinical signs. Classification of the potential risk of transmission and spread of FMD was based and modified according to the expert rules developed in New Zealand⁷⁾ or The Netherlands⁶⁾. The types of contacts were classified into 4 grades of risk, as shown in [Table 2](#). Also, the movements were divided into 2 types (to or off the farm). As a result, all the movements were classified into 9 categories of risk assigned to the types of contacts: 5 <to> and 4 <off> the farm, as shown in [Table 3](#). The distance (km) between the origin and destination of the movements was defined as the shortest way in a road map.

4. Data compilation and analyses

All the data were coded and entered into Excel (Microsoft) on a personal computer. For example, a cross-assortment of the types of contacts or their distance for each farm was carried out using spreadsheets of Excel (Microsoft) for a period of one-week. All the data analyses were carried out according to the procedures of the SAS program⁸⁾ with HP-9000 UNIX workstation on MAFFIN (Ministry of Agriculture, Forestry and Fisheries Information Network, Tsukuba). Continuous data such as number or distance of contacts were analyzed using UNIVARIATE and GLM procedures of the SAS program⁸⁾

[NEXT](#)

[TOP](#)

Table 1. Livestock conditions in the pilot area^{a)}

Animals	Number of farms	Population
Pigs	71	186,690
Beef cattle	2,061	21,200
Dairy cattle	59	2,910

a): The pilot area was set up in the Aira region (Kagoshima Prefecture) within a radius of 20 km.

BACK

Table 2. Classification of risks and types of contacts for foot-and-mouth disease

Grade	Risk	Type of contact
4	Very high	Susceptible animals
3	High	People or vehicles with animal contact Animal products (feces, manure or milk) Animal feed
2	Medium	Other (non-animal) materials (equipment or straw)
1	Low	People or vehicles without animal contact

BACK

Table 3. Assignment table of risk for all the movements (to or off the farm)

Grade	Categories of movements (to/off the farm)
4	to Animal introduction (e.g. other farms, live-animal market, etc.) off Animal shipping (e.g. slaughterhouse, etc.)
3	to Visitors related to livestock management (e.g. veterinarians, artificial insemination technicians, animal traders, etc.) off Farmers going out for livestock management to Purchase of animal feed off Transportation of feces or manure
2	to Purchase of livestock materials (e.g. equipment, straw, etc.)
1	to Visitors in general (e.g. family, friends, mailman, etc.) off Daily life activities (e.g. shopping, etc.)



Results

1. Number of contacts during a period of one-week in the livestock farms

The cross-assortment table for 9 categories of movements for each livestock farm is presented in [Table 4](#). As shown in the sum of movements to or off the farm, the movements off the farm were more frequent than those to the farm. Particularly, total movements off the farm classified into grade 3 (high-risk group), accounted for about 34% (143/423). For the grade risk 4 (very high-risk group), the movements were recorded 3 times for animal introduction and 14 times for animal shipping. Shipping from the pig farms to the slaughterhouse was recorded 13 times during a period of one-week.

2. Movement patterns during a period of one-week in the livestock farms

As shown in [Table 5](#), total movements including those to and off the farm during a period of one-week were not statistically significant among the livestock farms ($p=0.537$). However, comparison of means between the movements to and off the farm was significant ($p=0.003$). As a result, the movements off the farm were more frequent than those to the farm in each livestock farm.

3. Distance (km) of grade risk 4 and 3 movements in livestock farms

The cross-assortment table of the movement distance (km) is presented in [Table 6](#). The mean distance of the movements from the origin to the farm ranged from 15 to 58 km, and that off the farm to the destination from 3 to 153 km. In particular, the mean distance of animal shipping, for grade risk 4, from the pig farm to the slaughterhouse exceeded the radius of 20 km of the control zone for FMD emergency in Japan. Also the movements, namely "farmers going out", for grade risk 3, varied and covered a very long distance (e.g. maximum 900 km for pig or 116 km for beef cattle farms).

Discussion

Under the WTO system, increased trade of livestock, decreased transit time of animals and animal products, and changes in sanitary standards between exporting and importing countries may result in the exposure to FMD and accidental reintroduction of FMD into Japan. Also, because the last outbreak of FMD in Japan was recorded in 1933 and due to the limited number of cases under quarantine, most of the livestock farmers or persons related to animal health in Japan have not been familiar with the disease for a long period of time.

In March 1997, suddenly, outbreaks of FMD associated with smuggled pork from Mainland China affected pigs in Taiwan. Prior to the recognition of the outbreaks, Japan was importing large quantities of pork products (about 260,000 metric tons) from Taiwan. It was considered that the overall risk of transmission of FMD to Japan due to the outbreaks in Taiwan might be very high at that time. If an outbreak of FMD were to occur in Kagoshima Prefecture, since Kagoshima has the largest livestock number and quantity of animal products, particularly in the case of pigs in Japan, economic damage would markedly affect the animal industry in this area.

Thus, this was the first opportunity to survey FMD in Japan, in spite of the small scale of the investigations that covered only 20 livestock farms and a period of one-week in Kagoshima Prefecture compared with the experience of New Zealand⁷⁾ or The Netherlands⁶⁾.

On the other hand, through the survey, the transmission and spread of FMD from infected premises were determined. For instance, we observed that the pig farms, in particular, those for large-scale farrow-to-finish operations, were frequently shipping animals to slaughterhouses, as shown in Table 4. Furthermore, the mean distance of shipping exceeded the radius of 20 km of the FMD control zone (50.3 km in Table 6). Moreover, the movement of "farmers going out for livestock management" was recorded in 83 instances in the 20 farms and the distance covered by the movement ranged from 900 to 3 km (mean: 152.8 km).

Therefore, the survey was useful for FMD control as information on the potential risk of transmission and spread of FMD could be obtained. These data showed that, if an outbreak of FMD were to be detected in a pig farm, FMDV might, therefore, have already spread prior to diagnosis of the disease over the FMD control zone. Then, the introduction of animals and animal products affected with FMDV from countries with FMD into Japan should be strictly prohibited through a variety of regulations.

[NEXT](#)[TOP](#)[HOME](#)

Table 4

Table 4. Cross-assortment table of risk grades for all the movements and livestock farms during a period of one-week

Grade	Item	Livestock farm			Sum
		Pigs (9 farms)	beef cattle (6 farms)	dairy cattle (5 farms)	
4	Animal introduction	2	0	1	3
3	Visitors related to livestock management	17	16	20	53
	Purchase of animal feed	32	3	7	42
2	Purchase of livestock materials	1	3	3	7
1	Visitors in general	34	24	14	72
	Sum of movements to the farm	86	46	45	177
4	Animal shipping	13	0	1	14
3	Farmers going out for livestock management	23	38	22	83
	Transportation of feces or manure	27	16	17	60
1	Daily life activities	31	29	29	89
	Sum of movements off the farm	94	83	69	246
	Total	180	129	114	423

BACK

Table 5

Table 5. Comparison of the number of movements to or off the farm in each livestock farm during a period of one-week

Livestock farm	Number of farms	Frequency of all movements		Mean frequency ^{b)}	
		Mean ^{a)}	SD	off	to
Pigs	9	20.0	5.12	10.4	9.6
Beef cattle	6	21.5	4.85	13.5	8.0
Dairy cattle	5	22.8	2.17	13.8	9.0

a): Comparison among livestock farms was not significant ($p=0.537$).

b): Comparison between two means of to / off the farm was significant in each livestock farm ($p=0.003$)

BACK

Table 6. Cross-assortment table of risk grades (very high and high) for movement distance (km) and livestock farms

Grade	Item	Livestock farm		
		Pigs (9 farms)	beef cattle (6 farms)	dairy cattle (5 farms)
4	Animal introduction	32.5 ^{a)} 50 - 15 ^{b)}	- ^{c)} -	30 30 - 30
3	Visitors related to livestock management	57.5 75 - 2	- -	15 25 - 5
	Purchase of animal feed	54.9 130 - 2	21.7 60 - 1	24.4 45 - 17
4	Animal shipping	50.3 115 - 4	- -	60 60 - 60
3	Farmers going out for livestock management	152.8 900 - 3	7.2 116 - 1	5.7 20 - 1
	Transportation of feces or manure	3 3 - 3	3.5 7 - 1	10 20 - 3

a): Mean (km), b): Maximum - minimum (km), c): No data

BACK

Evaluation of Alternative Farming Systems by Multicriteria Analysis

Kiyotada Hayashi*

Department of Integrated Research for Agriculture, Tohoku National Agricultural Experiment Station (Morioka, Iwate, 020-0198 Japan)

Permission: Parts of this paper are reprinted from *Agricultural Systems*, 58(4), Kiyotada Hayashi, Multicriteria aid for agricultural decisions using preference relations: methodology and application, 483–503, ©(1998), with permission from Elsevier Science.

* Corresponding author: fax +81-19-641-7794, e-mail hayashi@affrc.go.jp

Received 1 December 1999, accepted 28 December 1999.

Abstract

A methodology was presented for selecting a farming system from multiattribute discrete alternatives by multicriteria analysis. An *ex ante* evaluation of vegetable production systems was performed in addition to a review of previous case studies to demonstrate the usefulness of this methodology and difficulties in applying it. The various methods used in the studies were classified into 3 groups: the compensatory, the non-compensatory, and the distance-based approaches, and were reviewed from a practical viewpoint. Since problems with weighting occurred in many case studies, special attention was paid to weights, especially to their meaning and the way to assess them. On the basis of this discussion, a method using multiattribute value functions was utilized for the evaluation. Labor-saving vegetable production systems under development, in which a self-propelled harvester was introduced and thinning was eliminated, were compared with the conventional system at the farm level based on criteria of profitability and farmwork characteristics. Determination of which labor-saving production system appears more desirable and a framework to effectively investigate “what-if” questions were provided.

Discipline: Agricultural economics

Additional key words: multiattribute value functions, vegetable production system

1...14): [References](#)

Introduction

Many alternative technologies have been proposed for improving farm management. For example, production systems using innovative farm machinery and management practices to mitigate environmental degradation have been studied; results related to profit and loss, working hours, ease of labor, soil erosion, chemical and nutrient contamination, etc., were analyzed or estimated using field experiments, survey methods and simulation techniques. These kinds of information are by themselves considered to be useful for farmers and extension services.

The attributes used for measuring the performance of the systems, however, are in general conflicting with each other. Costs increase when labor-saving machinery is introduced into farm management; margins may decrease when management aims at preserving the environment. Therefore, it is necessary to determine how to evaluate and select a farming system.

The purpose of this study was to develop an approach to select a multiattribute discrete alternative using multicriteria analysis. In Section 2 the methodology was outlined and difficulties were explained through a review of previous studies. In Section 3 the methodology was applied to the evaluation of labor-saving production systems for vegetables.

[NEXT](#)

[TOP](#)

References

1. Arondel, C. & Girardin, P. (1998): Sorting cropping systems on the basis of their impact on groundwater quality. Technical Report 158, LAMSADE, Université Paris-Dauphine, Paris.
2. Figueira, J. & Roy, B. (1999): Determining the weights of criteria in the ELECTRE type methods with a revised Simos' procedure. (Submitted to *European Journal of Operational Research*).
3. Foltz, J. C. et al. (1995): Multiattribute assessment of alternative cropping systems. *Am. J. Agric. Econ.*, **77** (2), 408-420.
4. Hayashi, K. (1998): Multicriteria aid for agricultural decisions using preference relations; methodology and application. *Agric. Syst.*, **58** (4), 483-503.
5. Hayashi, K. (1999): Rethinking weight elicitation for analytic hierarchies; practical implications of the modifications. Proceedings of the Fifth International Symposium on the Analytic Hierarchy Process, Kobe, 194-199.
6. Hayashi, K. (1999): Multicriteria analysis for natural resource management; coping with diversity of methods. *In Emerging technologies for sustainable land use and water management*, eds. Musy, A., Pereira, L. S. & Fritsch, M., Presses Polytechniques et Universitaires Romandes, Lausanne, Switzerland (in CD-ROM).
7. Hayashi, K. (2000): Multicriteria analysis for agricultural resource management; a critical survey and future perspectives. *Eur. J. Oper. Res.*, **122** (2), 486-500.
8. Heilman, P., Yakowitz, D. S. & Lane, L. J. (1997): Targeting farms to improve water quality. *Appl. Math. Comput.*, **83**, 173-194.
9. Lawrence, P. A. et al. (1997): Using measured data and expert opinion in a multiple objective decision support system for semiarid rangelands. *Trans. ASAE*, **40** (6), 1589-1597.
10. Mawapanga, M. N. & Debertin, D. L. (1996): Choosing between alternative farming systems; an application of the Analytic Hierarchy Process. *Rev. Agric. Econ.*, **18**, 385-401.
11. Olson, D. (1996): *Decision aids for selection problems*, Springer-Verlag, New York.
12. Tiwari, D. N., Loof, R. & Paudyal, G. N. (1999): Environmental-economic decision-making in lowland irrigated agriculture using multi-criteria analysis techniques. *Agric. Syst.*, **60** (1), 99-112.
13. Vincke, P. (1999): Outranking approach. *In Multicriteria decision making*, eds. Gal, T., Stewart, T. J. & Hanne, T., Kluwer Academic Publishers, Dordrecht, 11-1- 11-29.
14. Yakowitz, D. S., Lane, L. J. & Szidarovszky, F. (1993): Multi-attribute decision making; dominance with respect to an importance order of the attributes. *Appl. Math. Comput.*, **54**, 167-181.

Methodology and review of previous studies

In this study farming systems were evaluated through solving the following decision problem: to select a solution from a discrete set of alternatives using a set of criteria. These problems (selection problems¹¹) have been studied by discrete multicriteria analysis which attracts much attention because of its ability to deal with ill-structured problems as compared with multiobjective programming (continuous multicriteria analysis).

The methods were classified into 3 groups. First, in the compensatory approach, multiple attributes were aggregated into overall values by, for example, multiattribute value (utility) functions in which the concept of tradeoffs plays a crucial role. Second, in the non-compensatory or outranking approach, aggregation procedures based on concordance and discordance concepts were introduced; the concepts were derived from outranking relations, which indicate that an alternative is at least as good as another one. Third, in the distance-based approach such as compromise programming, the distance between an ideal point and the alternative was minimized.

In the following part, previous case studies will be reviewed and the difficulties in applying these methods will be outlined^{6,7}. After surveying compensatory approaches such as methods using multiattribute value functions, other methods including outranking approaches will be considered.

A method based on an additive multiattribute model has been widely applied for ranking alternatives using an importance order of attributes without specifying numerical values of attribute weights^{8,9,14}. Farming practices were evaluated from the viewpoint of profitability and environmental quality of soil and water. The method, however, was associated with the following problems. (1) The meaning of rank-ordered weights based on the relative importance of attributes was ambiguous. (2) The intervals of overall values were sometimes too wide to make decisions (to develop dominance relationships). (3) The fact that the structure of a value tree (a hierarchy of criteria) may affect the final results was not taken into account. Another method using ranking information on weights (pairwise ranking) has been applied for assessing alternative cropping systems from profitability and environmental quality perspectives³. The weighting procedure of the method, however, was also based on intuitive meaning, although weights based on importance judgments, not derived from attribute ranges, may distort rescaling of single-attribute value functions.

A common technique to alleviate the range problem is swing weighting. This technique has been applied to the evaluation of vegetable production systems from the viewpoint of profitability and farmwork⁴. Since the first step of the assessment is the development of a rank order, the ranked swing weights are also applicable to case studies instead of using intuitive ranked weights.

An outranking approach has been utilized for sorting cropping systems based on their impact on groundwater quality¹. The revised "weighting with cards" method² has been used, although the concept of weights is quite different from the case of additive multiattribute value functions. The concept of weights which does not involve tradeoffs has also been used in the Analytic Hierarchy Process (AHP), though the aggregation procedure is based on compensation. Although this method has been applied to the evaluation of alternative farming systems^{10,12}, there are numerous limitations related to the notion of weights⁵; the method has been criticized even by advocates of outranking approaches². The differences in the interpretation of weights suggest that using more than one type of methods may complicate the interpretation^{6,13}, although it seems to be a safe approach and some authors follow that procedure; for instance, the AHP and compromise programming are used for the same example¹².

An application: evaluation of labor-saving production systems

In this section an application of multiattribute value functions is presented. The decision problem this case study addressed is whether to introduce labor-saving production systems for daikon (*Raphanus sativus* L.) cultivation. The issue is the tradeoff relationship between profitability and working hours with reference to ease of labor. The decision maker was a representative farmer at Hiruzen Heights (440-520 m elevation) in the northern part of

Okayama Prefecture, Japan. Since this is an *ex ante* evaluation, interval representation was introduced into models to cope with imprecision and uncertainty in data as well as in preferences⁴).

1) Evaluation criteria

Farm profitability and farmwork characteristics were used as 2 main criteria that summarize the information contained in many indicators for the evaluation. [Fig. 1](#) illustrates the calculation process. Since the profitability is based on the profit before accounting for unpaid family labor, there is no overlap or redundancy between the 2 attributes. Farm profitability was based on the net profit, which is affected by the percentage of germination, the percentage of the number of openings with germination to the total number of openings in plastic mulch, and the percentage of a yield of high quality to a gross yield. Farmwork characteristics were derived from working hours for each task such as seeding or harvesting.

2) Alternatives

Farming systems, alternatives in decision analytic terminology, can be defined as combinations of components and were developed using the strategy-generation table shown in [Table 1](#). The following 3 production systems for daikon were generated:

1. The conventional system, in which 2 (or 3 in the case of seeding, thinning, harvesting, and carrying) family workers (plus a few hired workers for thinning) cultivate a farm of 5 ha by sowing 2 seeds per opening in a plastic mulch and harvesting by hand.
2. The first improved alternative (labor-saving alternative A, LS-A for short), in which 2 (or 3 in the case of seeding, harvesting, and carrying) family workers cultivate a farm of 5 ha by sowing 1 seed per opening to eliminate thinning work and harvesting with a self-propelled harvester to improve the ease of the work.
3. The second improved alternative (LS-B), which is the same as LS-A except that seeding and harvesting labor is entrusted to an agricultural cooperative.

3) Results

Overall values of each alternative were obtained through the aggregation of weights for each attribute and single-attribute values. The swing weight for profitability was 0.769 and the weight for farmwork characteristics was 0.231. Sensitivity to the weights will be analyzed later. The values are shown in [Table 2](#).

Using the overall values, the relationship among alternatives is represented graphically as (7) in [Fig. 2](#). The representation shows that the conventional system was weakly preferred to LS-A, the conventional system and LS-B were indifferent, and LS-B was weakly preferred to LS-A. Since this is a preliminary analysis of new production systems, sensitivity analysis is expected to provide significant results. Thus, the following discussion will focus on the effects of changes in value judgments and in technical improvements.

The stability of the current results can be represented by weight intervals within which the preference relations do not change. For example, the current relation (7) does not change within $W_1 = [0.718, 0.784]$ and $W_2 = [0.216, 0.282]$. The stability of the results can be expressed as intervals of data that preserve the preference relations in the same way. The current relation (7) does not change within the interval of yield per unit that fluctuates from 0.68 to 1.12 times of the current level provided that the ratio of the high quality price to the low quality price does not change.

As Fig. 1 shows, the percentage of germination and the percentage of a yield of high quality to a gross yield affected the net profits and consequently overall values. These effects can be examined in a two-way sensitivity analysis. Fig. 3 illustrates the results. A point on the graph was defined by a pair of parameters; the first number is the percentage of openings with germination; the second number is the ratio of the percentage of high quality in the labor-saving systems (LS-A or LS-B) to the percentage of high quality in the conventional system. The regions

surrounded by lines, which were numbered from (4) to (11), correspond to the preference relations shown in Fig. 2. The *status quo* was located at (0.9, 0.8). The figure shows that if improvements in the percentages were to be realized, LS-A and LS-B would be preferred to the conventional system, although neither of them would be strictly preferred to the conventional system due only to these technical improvements.

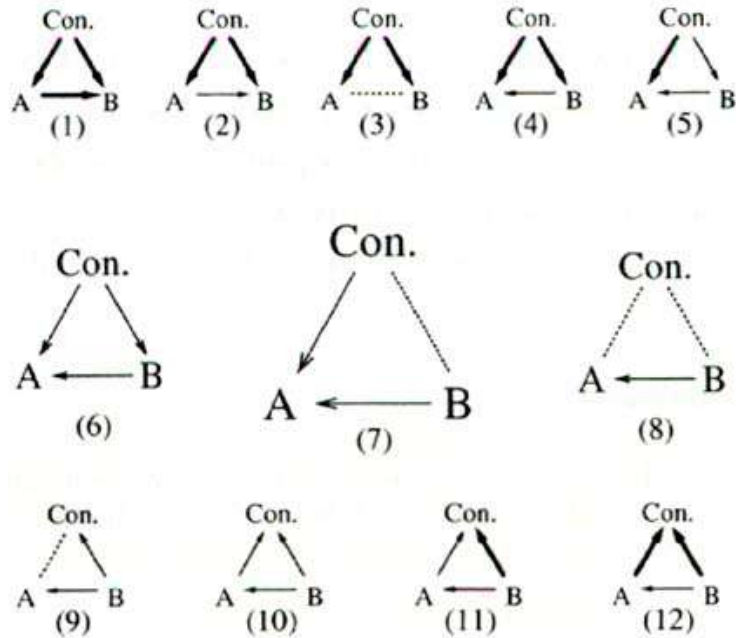


Fig.2. Preference relations
Con.: the conventional system.
A: the labor-saving alternative A.
B: the labor-saving alternative B.
a >b: aPb.
a >b: aQb.
ab: alb.

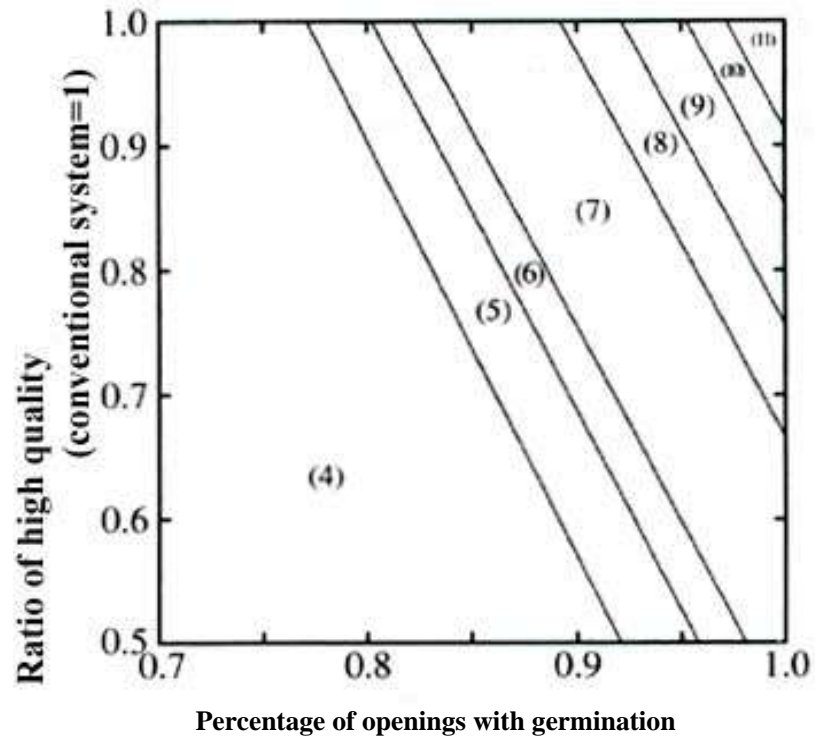


Fig.3. Effects of technical improvements

Concluding remarks

Research on the relationship between farm income and labor utilization is important for evaluating a farming system as illustrated already; it is a traditional theme and many case studies using multiobjective programming or goal programming have employed these criteria⁷⁾. However, the growing concern about the severity of environmental problems such as pollution of groundwater, which may account for the recent increase of case studies using multicriteria analysis, will require that more complex problems be dealt with. Since criteria and alternatives do not exist beforehand and decision makers and perspectives are plural in that case, attention should be paid to problem structuring.

TOP

[Contents](#)

TOP

[First page of JARQ](#)

HOME

[JIRCAS Home Page](#)



**Japan International Research Center for Agricultural Sciences
Ministry of Agriculture, Forestry, and Fisheries
1-2 Ohwashi, Tsukuba, Ibaraki, 305-8686 JAPAN**

www@jircas.affrc.go.jp

<http://ss.jircas.affrc.go.jp/engpage/jarq/firstpage1.html>

Telephone 0298-38-6304

published on July 14, 2000

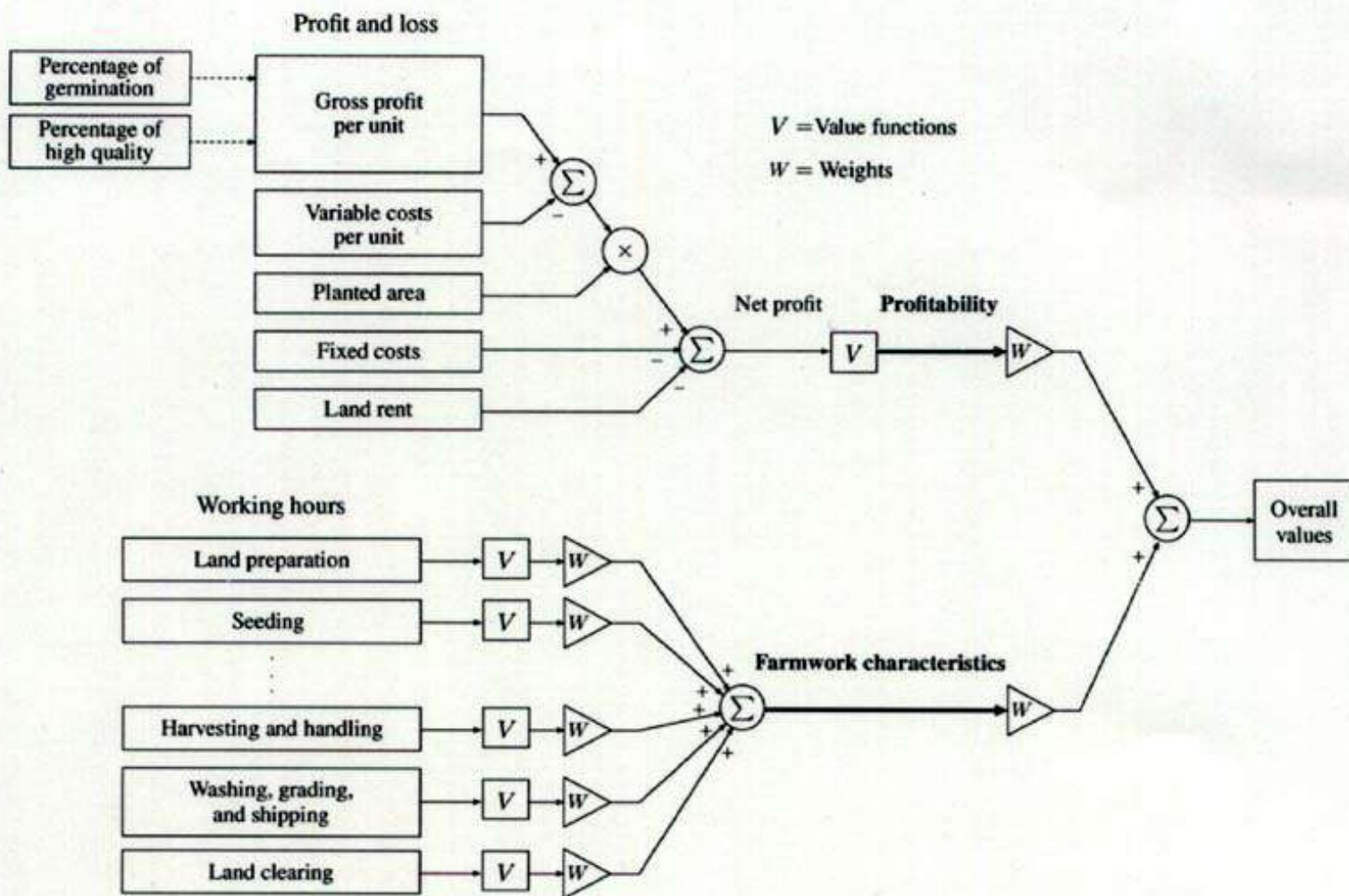
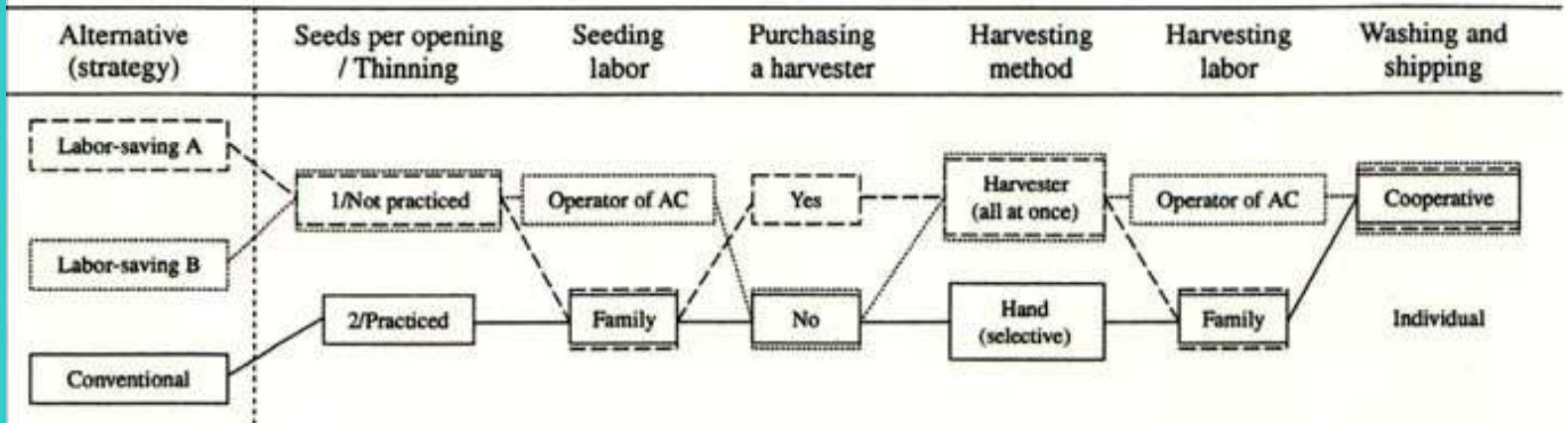


Fig. 1. Calculation process of overall values

BACK

Table 1. Generation of alternatives



BACK

Table 2. Values of the alternatives

Attribute	$V_i(\text{LS-A})$	$V_i(\text{LS-B})$	$V_i(\text{Con.})$
1. Profitability	[0.215, 0.215]	[0.212, 0.212]	[0.309, 0.309]
2. Farmwork characteristics	[0.698, 0.832]	[0.810, 0.886]	[0.457, 0.681]
21. Land preparation	[0.300, 0.593]	[0.300, 0.593]	[0.300, 0.593]
22. Seeding	[0.269, 0.671]	[1.000, 1.000]	[0.269, 0.671]
23. Thinning	[1.000, 1.000]	[1.000, 1.000]	[0.400, 0.733]
24. Weeding	[0.375, 0.375]	[0.375, 0.375]	[0.375, 0.375]
25. Chemicals application	[0.247, 0.592]	[0.247, 0.592]	[0.247, 0.592]
26a. Harvesting and handling (by hand)	[1.000, 1.000]	[1.000, 1.000]	[0.320, 0.500]
26b. Harvesting and handling (by machine)	[0.375, 0.479]	[0.583, 0.653]	[1.000, 1.000]
27. Washing, grading, and shipping	[1.000, 1.000]	[1.000, 1.000]	[1.000, 1.000]
28. Land clearing	[0.737, 0.737]	[0.737, 0.737]	[0.474, 0.474]

BACK

Contents

- [Relationship between Root Length Density and Water Uptake](#)
Katsuyuki KATAYAMA, Osamu ITO,
Joseph Jackson ADU-GYAMFI and
Theertham Pradyмна RAO
- [Nitrogen, Phosphorus and Potassium in Relation to Chemical Fertilizer Application in Japanese Orchard Fields](#)
Kiyoshi HIRAOKA and
Yoshiaki UMEMIYA
- [Variation in Southern Blight Fungus in Japan Detected by ITS-RFLP Analysis](#)
Ikuko OKABE, Chiharu MORIKAWA
and Naoyuki MATSUMOTO
- [Robotization of Agricultural Vehicles \(Part 1\)](#)
Osamu YUKUMOTO, Yosuke MATSUO
and Noboru NOGUCHI
- [Robotization of Agricultural Vehicles \(Part 2\)](#)
Osamu YUKUMOTO, Yosuke MATSUO
and Noboru NOGUCHI
- [Cultural Control Systems of Naturalized Weeds in Forage Crop Fields](#)
Seturo SATO, Koji TATENO,
Ryoji KOBAYASHI and
Kuniaki SAKAMOTO
- [Safe Ammonia Treatment System of Cereal Straws for Ruminant Feeding](#)
Tomiharu MANDA, Masaru MURAI
and Akio YAMAZAKI
- [Isolation of Bacteria Producing Bluish-Purple Pigment and Use for Dyeing](#)
Akira SHIRATA, Takanori TSUKAMOTO,
Hiroe YASUI, Tamako HATA, Shoji HAYASAKA, Atsushi
KOJIMA and Hiroshi KATO
- [TNF \$\alpha\$ and Nitric Oxide Production in Mice Treated with Sex Steroids](#)
Meraku TEFERA and
Eiichi MOMOTANI
- [Species Composition and Biomass of a Mangrove Forest in Malaysia](#)
Hiroyuki TANOUCHI, Shozo NAKAMURA, Yukihito OCHIAI
and AZMAN Hassan

● [First Page of JARQ](#)

● [What's New](#)

● [JIRCAS Home Page](#)

Analysis of Relationship between Root Length Density and Water Uptake by Roots of Five Crops Using Minirhizotron in the Semi-Arid Tropics

Katsuyuki KATAYAMA*¹, Osamu ITO*², Joseph Jackson ADU-GYAMFI
and Theertham Pradymna RAO*³

Agronomy Division, International Crops Research Institute for the Semi-Arid Tropics (ICRISAT)
(Patancheru, A. P., India)

Present address:

*¹ Project Research Team 2, National Agriculture Research Center
(Tsukuba, Ibaraki, 305-8666 Japan)

*² Agronomy, Plant Physiology and Agroecology Division,

*³ Crop Science Laboratory, School of Agricultural Sciences, Nagoya University
(Chikusa, Nagoya, 464-0814 Japan)

Corresponding author: K. Katayama (katuyuki@narc.affrc.go.jp, fax +81-298-38-8837)

Abstract

Experiments were carried out to analyze the root and water dynamics simultaneously using a minirhizotron on an Alfisol soil in the semi-arid tropics in 1993. Sorghum (CSH 5), pearl millet (ICMV 221), pigeonpea (ICP 1-6), groundnut (ICGS 11) and cowpea (EC 82-7) were used to describe the relationship between the root length density (RLD) and water uptake by roots per day (WU). During the periods from 37 to 46, from 51 to 59 and from 72 to 77 days after sowing, the average values of RLD of sorghum and pearl millet at the soil depth of 15-60 cm were consistently higher than those of pigeonpea, groundnut and cowpea, whereas the average values of WU of the cereals were not always higher than those of the grain legumes. Thus, there was no significant relationship between RLD and WU for the 5 crops due to the higher values of the specific root water uptake (SRWU) of grain legumes than those of cereals in each period. In this study, it was demonstrated that WU and SRWU as well as RLD for the 5 crops could be estimated by using the minirhizotron since dynamic values of the root length of the 5 crops and soil moisture content (SMC) in each soil layer could be quantified from data-sets by frequent observations and with limited sampling errors. Therefore the minirhizotron was found to be a suitable tool for simultaneous monitoring of the root and water dynamics in soil layers except for the soil surface.

Discipline: Crop production

Additional key words: cereals, grain legumes

1)....15):[References](#)

(Received August 30, 1999; accepted October 29, 1999)

Introduction

The minirhizotron method, which is a nondestructive, rapid and efficient root measurement technique, was applied to observe root development using a microvideo camera in the observation tube^{3,8}). In a similar manner, the soil moisture content (SMC) was estimated by a neutron probe method using an aluminum tube. The minirhizotron and the neutron probe methods are nondestructive and allow continuous observations from the same spot in different soil layers. Thus, these methods are suitable for monitoring time-course changes in root development and SMC. Since the tubes using the minirhizotron and the neutron probe methods are usually embedded in soil separately, it is difficult to estimate the relationship between the root and water dynamics due to soil heterogeneity, artifacts of tube installation and so on. As few studies have been carried out to minimize these factors, attempts were made to analyze the root and water dynamics *in situ* simultaneously. In our previous study⁹), since there was a close positive correlation of neutron counts between aluminum and acrylic tubes, we were able to estimate SMC even by using the acrylic tube based on the following regression equation: $y = 0.97x - 0.044$, $r^2 = 0.99$, where x represents the neutron count for the soil moisture measurement using an acrylic tube and y that using an aluminum tube. The objective of this study was to determine whether the minirhizotron was a suitable tool for simultaneous monitoring of the root and soil water dynamics in soil layers.

Materials and methods

The experiment was conducted during the 1993 rainy season on an Alfisol at ICRISAT Asia Center, near Hyderabad, India. The initial characteristics of the soil in the experimental area were as follows: pH, 6.78 (1:2 soil/water ratio); inorganic N content, 22.9 mg kg⁻¹ soil and NaHCO₃-extractable P, 3.34 mg kg⁻¹ soil. Medium duration pigeonpea (*Cajanus cajan* L. Millsp. cv. ICP 1-6), hybrid grain sorghum (*Sorghum bicolor* L. Moench cv. CSH 5), pearl millet (*Pennisetum glaucum* L.R.Br. cv. ICMV 221), groundnut (*Arachis hypogaea* L. ICGS 11) and cowpea (*Vigna sinensis* Endl. cv. EC 82-7), which are staple food crops in the semi-arid tropics, were sown on broad beds on 25 June 1993. Spacing for the sole crops was as follows: for pigeonpea, 75 x 20 cm; sorghum, 50 x 15 cm; pearl millet, 50 x 15 cm; groundnut, 37.5 x 10 cm and cowpea, 50 x 10 cm. All the plots received a uniform basal application of 25 kg N ha⁻¹ as urea and 20 kg P₂O₅ ha⁻¹ as single superphosphate prior to sowing, which were incorporated into the soil up to 20 cm by disc plowing before sowing. The experimental layout consisted of a randomized complete block design with 3 replications. The size of each plot was 6 x 12 m, consisting of 12 broad beds with a 90 cm width. Heading of pearl millet and sorghum occurred at 51 and 78 days after sowing (DAS) and flowering of groundnut, cowpea and pigeonpea occurred at 30, 51 and 142 DAS, respectively. The crops were harvested at maturity, 85 DAS for pearl millet and cowpea, 114 DAS for groundnut and sorghum and 209 DAS for pigeonpea.

Monitor, Video tape recorder,
Camera control unit, Batteries

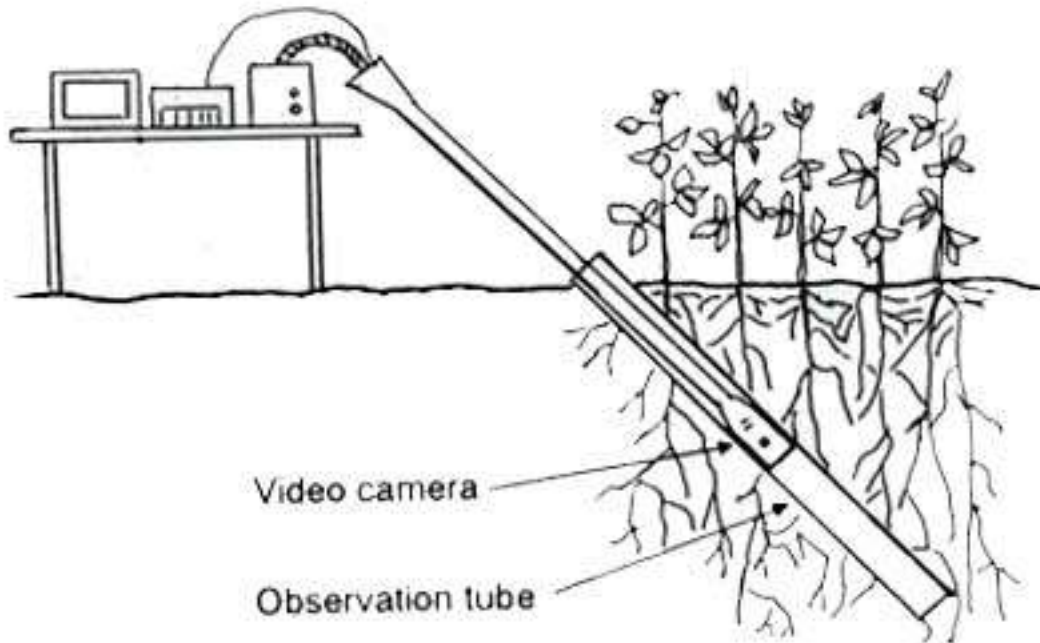


Fig.1. Diagrammatic representation of the minirhizotron

Root length of the crops was measured by the minirhizotron method (CIRCON MV9011 agriculture system with MV9390 color CCD microvideo camera) at 31, 46, 60, 74, 84, 105, 143 and 169 DAS. The transparent plastic minirhizotron tubes (58 mm in diameter and 100 cm in length) were installed at a 45° angle between rows of each crop before sowing (Fig. 1). This experiment was carried out in an Alfisol with a hardpan layer below 60 cm. Root length at 15 cm intervals up to 60 cm depth was calculated from the number of roots observed on a video display¹⁵⁾. Soil moisture was measured with a soil moisture meter (Model 3332, Troxler Electronic Laboratories Inc., N.C., USA) at 15 cm intervals up to 60 cm depth except at the soil surface using the same transparent acrylic tube as in the minirhizotron method at 7, 23, 37, 46, 51, 59, 72, 77, 93, 107, 119, 143, 157, 172 and 213 DAS. Usually, SMC at the soil surface was measured by the gravimetric method. Thus, we analyzed seasonal changes in SMC at the depths of 15-30, 30-45 and 45-60 cm, where consecutive data could be obtained in the same spot in this study. The values of SMC on a weight basis in each layer were converted to the values on a volume basis by multiplication by the bulk density for an estimation of water uptake by roots per day (WU). The values of the bulk density at the depths of 15-30, 30-45 and 45-60 cm were 1.69, 1.59 and 1.59 Mg m⁻³, respectively. The WU was estimated based on the volume of water extracted within the respective soil layers per day. The specific root water uptake (SRWU) referred to the volume of water extracted within a soil layer per unit root length per day⁶⁾.

During this study, rainfall which amounted to 695.2 mm was mainly distributed at the onset of the rainy season (June-November) ([Fig. 2](#)). Nine, 6 and 7 mm of water were used for irrigation at 79, 143 and 155 DAS, respectively.

References

- 1) Ball-Coelho, B. et al. (1992): Root dynamics in plant and ratoon crops of sugar cane. *Plant Soil*, 142, 297-305.
- 2) Benjamin, K. & Sinclair, T. R. (1994): Soil core and minirhizotron comparison for the determination of root length density. *Plant Soil*, 161, 225-232.
- 3) Beyrouthy, C. A. et al. (1990): Root development of bermudagrass and tall fescue as affected by cutting interval and growth regulators. *Plant Soil*, 127, 23-30.
- 4) Boyer, J. S. (1970): Differing sensitivity of photosynthesis to low leaf water potentials in corn and soybean. *Plant Physiol.*, 46, 236-239.
- 5) Bremner, P. M. et al. (1986): A field comparison of sunflower (*Helianthus annuus*) and sorghum (*Sorghum bicolor*) in a long drying cycle. *Aust. J. Agric. Res.*, 37, 483-493.
- 6) Hamblin, A. & Tennant, D. (1987): Root length density and water uptake in cereals and grain legumes; how well are they correlated? *Aust. J. Agric. Res.*, 38, 513-527.
- 7) Heeraman, D. A. & Juma, N. G. (1983): A comparison of minirhizotron, core, and monolith methods for quantifying barley (*Hordeum vulgare* L.) and fababean (*Vicia faba* L.) root distribution. *Plant Soil*, 148, 29-41.
- 8) Heeraman, D. A. et al. (1993): A color composite technique for detecting root dynamics of barley (*Hordeum vulgare* L.) from minirhizotron images. *Plant Soil*, 157, 275-287.
- 9) Katayama, K. et al. (1996): Relationship between root length density and soil moisture content simultaneously measured with minirhizotron. In *Crop research in Asia: Achievements and perspective*. eds. Ishii, R. & Horie, T., Proc. 2nd Asian Crop Sci. Con., 690-691.
- 10) Katayama, K. et al. (1996): Root system development of component crops in intercropping. In *Dynamics of roots and nitrogen in cropping systems of the semi-arid tropics*. eds. Ito, O. et al., JIRCAS, Tsukuba, Japan, 199-209.
- 11) Levan, M. A. et al. (1987): Light leak effects on near-surface soybean rooting observed with minirhizotrons. In *Minirhizotron observation tubes; methods and application for measuring rhizosphere dynamics*. ed. Taylor, H. M., ASA Spec. Publ. no. 50. Am. Soc. Agron., Crop Sci. Soc. Am., Soil Sci. Soc. Am., Madison, Wisconsin, USA, 89-98.
- 12) Majdi, H. et al. (1992): A comparison between minirhizotron and monolith sampling methods for measuring root growth of maize (*Zea mays* L.). *Plant Soil*, 147, 127-134.
- 13) Manson, W. K. et al. (1983): Water balance of three irrigated crops on fine-textured soils of the Riverine plain. *Aust. J. Agric. Res.* 34, 183-191.
- 14) Polley, H. W. et al. (1992): Determination of root biomasses of three species grown in a mixture using stable isotopes of carbon and nitrogen. *Plant Soil*, 142, 97-106.
- 15) Upchurch, D. R. & Ritchie, J. T. (1983): Root observations using a video recording system in mini-rhizotrons. *Crop Sci.*, 75, 1009-1015.

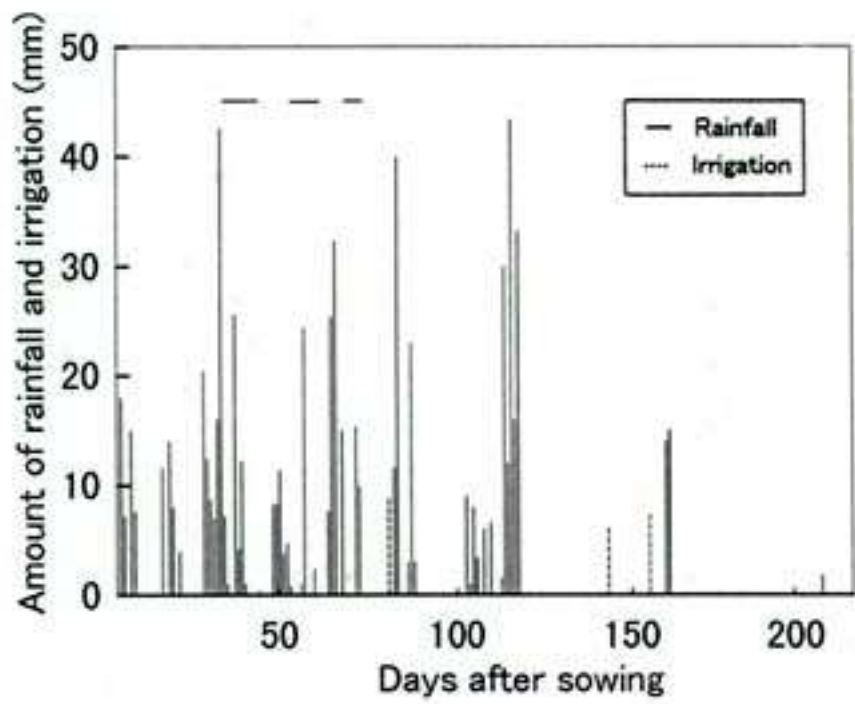


Fig.2. Distribution of rainfall and irrigation after sowing

Horizontal bars indicate periods when the water uptake by roots was measured.

BACK

Results

1) Seasonal changes in SMC

Seasonal changes in SMC at the soil depths of 15-30, 30-45 and 45-60 cm determined with a minirhizotron for 5 crops are depicted in [Fig. 3-a, b and c](#), respectively. Water flow was assumed to be one-dimensional with the increase in SMC on successive dates being attributed to rainfall and irrigation and the decrease attributed to the root uptake. Fluctuation range in SMC was lower at the soil depth of 15-30 cm, followed by the soil depth of 30-45 cm and the widest range in SMC was obtained at the soil depth of 45-60 cm during the sampling period, presumably due to the presence of a hard layer below 60 cm depth. Since a decrease in SMC on successive dates was obtained during 3 periods from 37 to 46, from 51 to 59 and from 72 to 77 DAS before the harvest of pearl millet and cowpea as shown in Fig. 3, these periods were selected to estimate the WU of the 5 crops.

2) Estimation of total root length (TRL), RLD, WU and specific root water uptake (SRWU) of 5 crops using the minirhizotron

The seasonal changes of TRL of the 5 crops are depicted in [Fig. 4](#). The values of TRL of pearl millet and sorghum were higher than those of cowpea, groundnut and pigeonpea except at 31 DAS. During the periods from 37 to 46, from 51 to 59 and from 72 to 77 DAS, the average values of RLD of sorghum and pearl millet at the soil depth of 15-60 cm were consistently higher than those of pigeonpea, groundnut and cowpea, whereas the average values of WU of cereals were not always higher than those of the grain legumes ([Table 1](#)). Thus, there was no significant difference between the RLD and WU of the 5 crops in each period ([Fig. 5-a, b and c](#)) due to the higher values of SRWU of grain legumes than those of cereals. The average values of SRWU for groundnut, cowpea and pigeonpea were higher than those for pearl millet and sorghum, namely 2.5 to 5.8 times higher during the period from 37 to 46 DAS, 2.4 to 8.0 times during the period from 51 to 59 DAS and 2.5 to 5.8 times during the period from 72 to 77 DAS.

Discussion

The main advantage of the minirhizotron method is the ability to monitor root growth and death throughout the growing period^{3,8}. On the other hand, one disadvantage is the quantitative discrepancy with the conventional destructive method in the soil surface layers^{1,2}. Katayama et al.¹⁰ showed that in the surface soil layers, the ratios of RLD observed using the minirhizotron compared with the monolith method were below unity, indicating that the RLD value obtained by the minirhizotron is likely to be underestimated. Underestimation at the soil surface may be due to the effects of light leaking through the top of the minirhizotron tubes above the soil surface¹¹ and to temperature differences at the glass-soil interface^{7,12,15}. Katayama et al.¹⁰ reported that the values of TRL of pearl millet and sorghum were significantly higher than those of cowpea, groundnut and pigeonpea when the monolith method was used due to the higher RLD values of cereals compared with grain legumes at the soil surface. Polley et al.¹⁴ reported that the root biomass of the C₄ monocots is concentrated in the upper 20 cm layer of soil. Thus, it is assumed that the values of TRL of the 5 crops shown in Fig. 4 were underestimated.

In this experiment, it was found that the WU of pearl millet and sorghum with higher RLD values was not always greater than that of groundnut, cowpea and pigeonpea with lower RLD values due to the higher values of SRWU of grain legumes than those of cereals. Difference in stomatal conductance

between C₃- and C₄-pathway species may be partially responsible for the variation in water use⁴⁾. However, the discrepancy between RLD and WU of cereals and legumes in this study was in agreement with the results obtained in cereals and legumes of C₃-pathway species by Hamblin and Tennant⁶⁾. They reported that cumulative uptake water by roots for wheat from the soil profile over the period from 70 to 110 DAS was very similar to that of lupin, although the value of the TRL per unit ground area of wheat was 9 times as high as that of lupin⁶⁾. They also showed that the apparent water uptake per RLD per day was greater for lupin than wheat since lupin had large and abundant metaxylem vessels in roots, which give a much lower axial resistance of roots, compared with wheat⁶⁾. Moreover, the discrepancy between RLD and WU in monocotyledonous and dicotyledonous species consisting of maize, sorghum and sunflower, was also reported elsewhere^{5,13)}.

In this study, it was demonstrated that WU and SRWU as well as RLD for 5 crops could be estimated using the minirhizotron since the dynamic values of the root length of the 5 crops and SMC in each soil layer could be quantified based on data-sets by frequent observations and with limited sampling errors. Therefore the minirhizotron was found to be a suitable tool for simultaneous monitoring of the root and water dynamics in soil layers except for the soil surface.

NEXT[:Nitrogen, Phosphorus and Potassium Balance in Fertilizer-Amended Japanese Orchard Fields](#)**TOP**[:Contents](#)**HOME**[:JIRCAS Home Page](#)

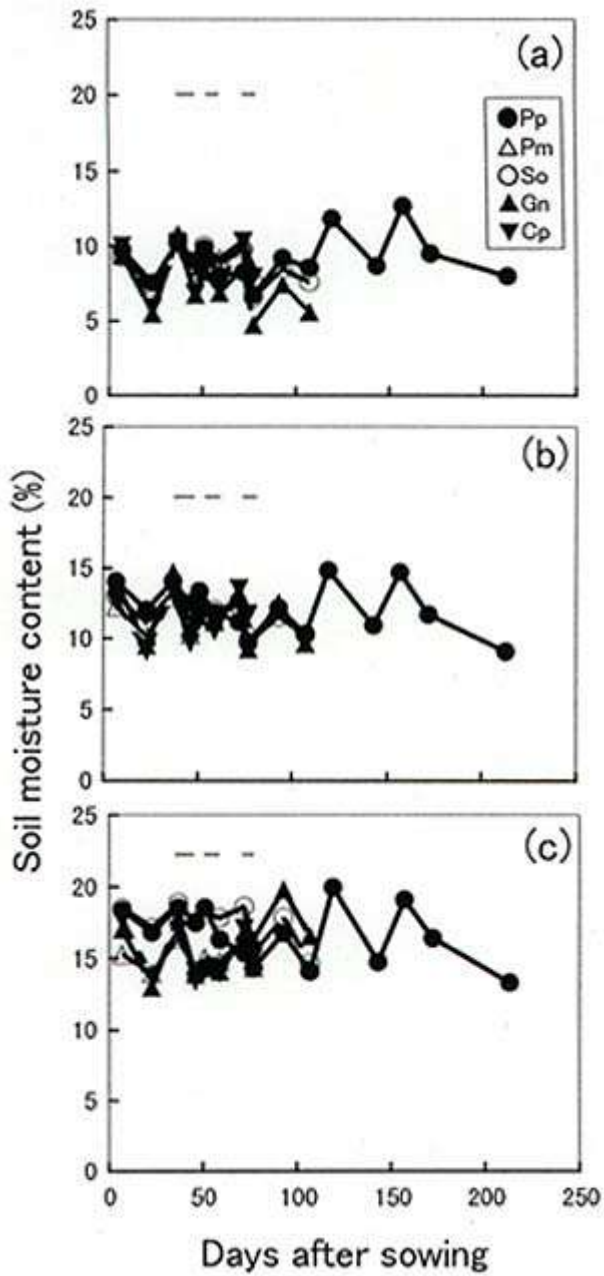


Fig.3. Seasonal changes in soil moisture content at the depths of 15-30 (a), 30-45 (b) and 45-60 (c) under the 5 crops after sowing

Horizontal bars indicate periods when water uptake by roots was measured.

BACK

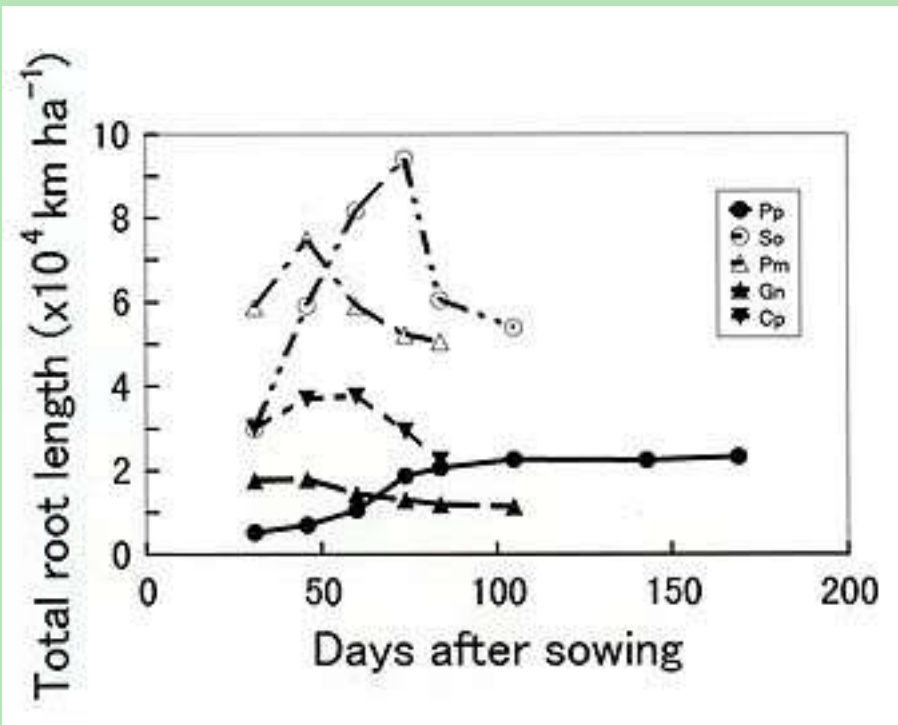


Fig.4. Seasonal changes in total root length (TRL) of 5 crops after sowing

BACK

Table 1. Root length density (RLD), water uptake by roots per day (WU) and specific root water uptake per RLD per day (SRWU) of pigeonpea(Pp), sorghum(So), pearl millet(Pm), groundnut(Gn) and cowpea (Cp) at the soil depths of 15–30, 30–45 and 45–60 cm during the periods from 37 to 46, from 51 to 59 and from 72 to 77 days after sowing (DAS)

Crop depth (cm)	37–46 DAS			51–59 DAS			72–77 DAS			
	RLD ^{a)}	WU ^{b)}	SRWU ^{c)}	RLD	WU	SRWU	RLD	WU	SRWU	
Pp	15–30	0.16	2.29	23.1	0.19	1.48	7.8	0.42	9.16	22.1
	30–45	0.16	2.79	27.6	0.19	0.54	2.8	0.38	6.95	18.3
	45–60	0.07	1.77	17.7	0.10	1.35	13.5	0.27	6.25	23.6
	AVG	0.13	2.28	22.8	0.16	1.12	8.0	0.36	7.45	21.3
So	15–30	0.80	3.90	4.9	1.48	2.61	1.8	2.67	10.88	4.1
	30–45	1.03	3.77	4.0	2.16	0.92	0.4	2.43	8.36	3.4
	45–60	0.54	2.47	5.3	0.81	0.58	0.8	0.75	7.95	10.6
	AVG	0.79	3.38	4.7	1.48	1.37	1.0	1.95	9.06	6.0
Pm	15–30	1.41	5.23	4.4	1.43	1.19	1.2	1.29	6.26	4.9
	30–45	1.62	4.62	3.2	1.39	1.19	1.5	0.97	5.73	6.0
	45–60	1.10	3.71	4.2	1.08	0.41	0.6	1.00	6.14	6.2
	AVG	1.37	4.52	3.9	1.30	0.93	1.1	1.09	6.04	5.7
Gn	15–30	0.47	7.07	15.3	0.40	2.92	7.5	0.30	12.80	44.1
	30–45	0.37	7.10	20.6	0.30	2.63	10.7	0.23	12.52	55.6
	45–60	0.28	7.07	26.4	0.27	0.70	2.7	0.26	0.08	0.3
	AVG	0.37	7.08	20.8	0.32	2.08	7.0	0.26	8.47	33.3
Cp	15–30	0.81	6.23	8.3	1.11	2.14	1.9	0.69	8.04	12.0
	30–45	0.80	6.53	8.9	0.79	1.34	2.4	0.64	5.73	9.9
	45–60	0.36	6.24	18.1	0.27	0.61	3.4	0.30	6.46	22.6
	AVG	0.66	6.33	11.8	0.72	1.36	2.6	0.54	6.74	14.8

a): $\times 10^4 \text{mm}^{-3}$. b): $\times 10^{-3} \text{m}^{-3} \text{m}^3 \text{day}^{-1}$ c): $\text{SRWU} = \text{WU}/\text{RLD}, \times 10^{-7} \text{m}^3 \text{day}^{-1}$

BACK

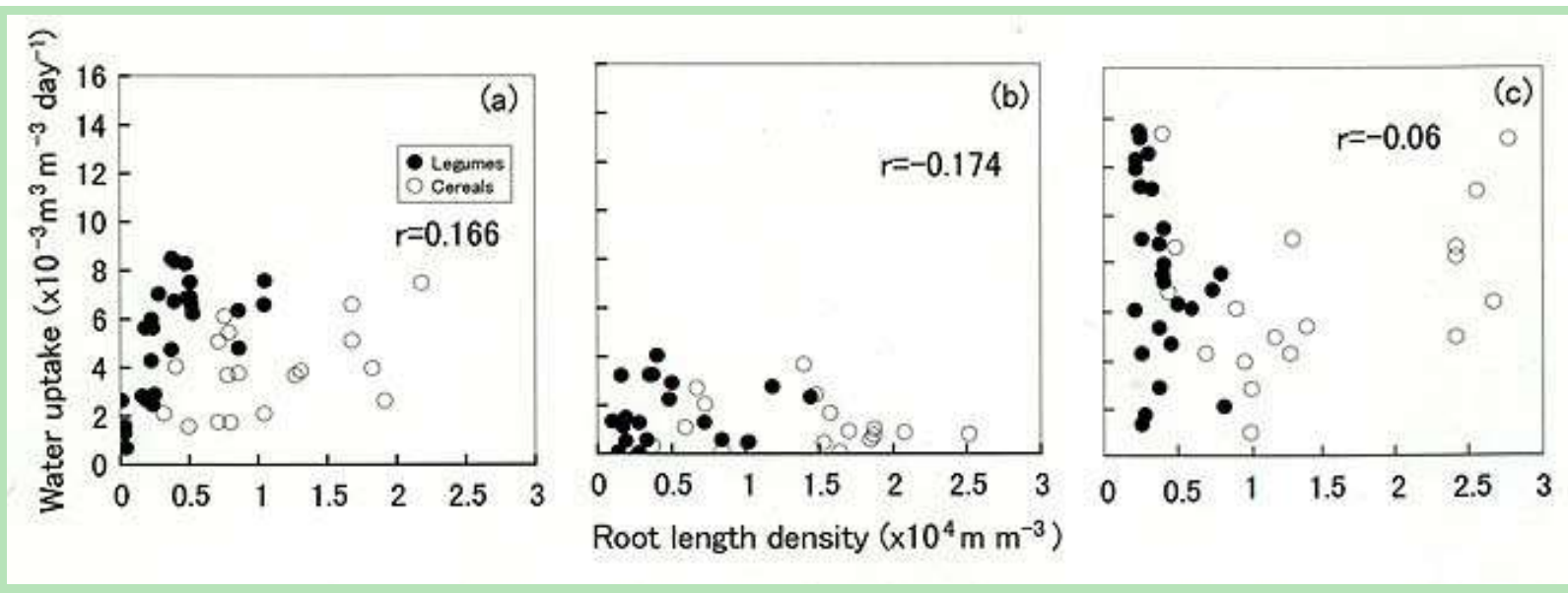


Fig.5. Relationship between root length density and water uptake of 5 crops during the periods from 37 to 46 (a), from 51 to 59 (b) and from 72 to 77 (c) days after sowing

BACK

Estimation of Balance of Nitrogen, Phosphorus and Potassium in Relation to Chemical Fertilizer Application in Japanese Orchard Fields

Kiyoshi HIRAOKA^{*1} and Yoshiaki UMEMIYA

Department of Pomology, National Institute of Fruit Tree Science

(Tsukuba, Ibaraki, 305-8605 Japan)

Present address:

^{*1} Division of Mume Apricot Tree, Horticultural Experiment Center, Wakayama Research Center of Agriculture, Forestry and Fisheries

(Shioya, Gobo, Wakayama, 644-0024 Japan)

Corresponding author: K. Hiraoka (kho@affrc.go.jp, fax +81-738-22-6903)

Abstract

The consumption of chemical fertilizers in 1996 amounted to 511,700 t for nitrogen (N), 610,100 t for phosphorus (P₂O₅), 441,200 t for potassium (K₂O). The area of orchard fields was 314,900 ha in 1995 and the ratio to the total cultivated area was 6.4%. If the same amount of chemical fertilizer is applied to each field, the total application to orchard fields should be 32,700 t for nitrogen, 39,000 t for phosphorus and 28,200 t for potassium, respectively. In this report, we estimated the input of chemical fertilizers to orchard fields based on the results of official surveys of orchard area and the standard application rate based on the cultivation guidelines adopted in 37 prefectures. In 1995, the input for main fruit tree species amounted to 50,600 t for nitrogen, 36,400 t for phosphorus and 40,700 t for potassium. The output of nutrients from the orchard fields was estimated based on the results of field experiments for the nutrient uptake of fruit trees as follows: 39,800 t for nitrogen, 9,100 t for phosphorus and 35,300 t for potassium for mature fruit-bearing trees. The ratio of estimated input to output was 1.3 for nitrogen, 4.5 for phosphorus and 1.2 for potassium, respectively. These results indicate that the amount of chemical fertilizer application to the orchard fields may be appropriate for nitrogen and potassium but is excessive for phosphorus. However the total nutrient balance was not calculated exactly in Japanese orchard fields because the total nutrient input could not be determined owing to the paucity of statistical data on organic matter application and also the total output could not be calculated due to the paucity of field experimental data.

Discipline: Soils, fertilizers and plant nutrition

Additional key words: fruit tree, nutrient uptake, nutrient balance, application rate of fertilizer, sustainable agriculture

1...14): [References](#)

(Received February 3, 1999; accepted September 10, 1999)

Introduction

Many temperate and some tropical fruit trees are planted in Japan because the country consists of many islands extending from the temperate to the subtropical zone. The total area of fruit trees decreased from 430,000 ha in 1975 to 308,000 ha in 1996. Especially the area of citrus fruits decreased remarkably and the area in 1995 was about half of that in the 1975s. This decrease of the area is due to the decrease in the fruit demand. The demand for citrus fruits per capita per year decreased from 25 kg in 1975 to 11 kg in 1995. This situation is attributed to the diversification of eating habits or food culture associated with the changes in the economic conditions. The increase of fruit importation is also likely to affect the decrease of area. Along with the changes in the marketing environment, the quality of fruits is becoming more important than the quantity for sales. These changes led to a decrease in the rate of fertilizer application to orchard fields because, based on many field experimental data, emphasis was placed on the production of high quality fruits under suitable low application rates. However, the surplus fertilizer that was applied previously may affect the environment around the orchard fields. As the sustainability of agriculture has become a social problem, it remains to be determined whether fertilizer or organic matter application results in a load to the surroundings of orchard fields. We attempted to estimate the nitrogen (N), phosphorus (P_2O_5) and potassium (K_2O) balance in relation to chemical fertilizer application by compiling the results of surveys and field experiments to determine the nutrient balance in Japanese orchard fields.

Input of nitrogen, phosphorus and potassium associated with chemical fertilizer application

The standard application rate of fertilizer to orchard fields was determined based on the results of field experiments in most of the prefectures. We compiled the rates from the cultivation guidelines adopted in 37 prefectures. The rates are generally determined depending on the species and age of the fruit trees. The yield of fruits and the soil type of orchard fields are also key factors to determine the rate in some prefectures.

1) Species of fruit trees

[Table 1](#) shows the mean of standard application rates of nitrogen, phosphorus and potassium for mature fruit-bearing trees. These results indicate that much more fertilizer is applied to orchard fields with evergreen and tropical fruit trees. The means of rates ranged from 204 to 350 kg per ha for nitrogen (N), 115 to 239 kg per ha for phosphorus (P_2O_5) and 160 to 310 kg per ha for potassium (K_2O). The rates for the late maturing citrus species, Navel orange, 'Iyo' tangor, 'Hassaku' pummelo mandarin and Natsudaidai, were higher than those for the early maturing species, 'Unshu' mandarin. But in the case of Unshu mandarin, the rates for the late maturing varieties were almost the same as those for the early maturing varieties although the late maturing varieties were harvested in the same season as the late maturing citrus species. For the deciduous fruit tree species, the rate for Japanese pears was the highest and about twice that of apple and grapevine trees for nitrogen. These differences may depend on the nutrient uptake and the characteristics of root distribution. The rates for the evergreen fruit trees that did not bear fruits were also higher than those for the deciduous fruit trees that did not bear fruits as well as mature fruit-bearing trees ([Table 2](#)).

2) Age of fruit trees

The standard application rates of fertilizer for the trees that did not bear fruits (from 3 to 5 years old) ranged from one-third to one-fifth of those of mature fruit-bearing trees (10 or more years old) (Tables 1, 2). The application rate of fertilizer to each mature fruit-bearing tree should range from 6 to 10 times that of trees that did not bear fruits because the planting density of the latter trees is about twice that of the mature fruit-bearing trees. This difference may be due to the size of the trees. The rates for bigger mature fruit-bearing trees should be higher than those for smaller trees that did not bear fruits because fertilizer is usually applied under the trees. The rates for mature fruit-bearing trees usually increase until the trees become about 15 years old. However, the rates are almost the same after 15 years in many fruit tree species, while the rate for Unshu mandarin increases until 50 years after planting.

3) Yield of fruits

As the yield increased, the application rates of fertilizer increased for each fruit tree species. The rates for the high-yielding species such as citrus fruit and pineapple trees were generally higher than those for the other fruit trees (Table 1). However the yield of apple trees was high although the application rate was low. And the yield in plastic greenhouses was about 1.5 times higher than that in orchard fields with the same fertilizer application rates in the case of Unshu mandarin. These differences may be due to the climatic conditions during the growth period of fruits. The ratio of application rate to yield was higher for chestnuts, loquats and cherry tree which gave a low yield ([Table 3](#)). But the ratio was significantly low in apple trees and half or one-third of that of the other trees.

4) Soil type

The application rates of chemical fertilizer were determined for certain soil types in some prefectures. The rate was generally higher in sand-dune regosols and lower in andosols. This difference between the soil types is usually not as conspicuous as that between fruit tree species. However this difference must affect the rates of each fruit tree species because the main area of citrus species consists of yellow soils whereas that of apple and grapevine trees consists of brown forest soils.

[NEXT](#)[TOP](#)

Output of nitrogen, phosphorus and potassium

The output of nutrients from the orchard fields is mainly estimated based on the nutrient uptake of fruit trees. However, there are few field experimental data because it is very difficult to determine the nutrient uptake of fruit trees in orchard fields. In one field experiment, 2 middle-sized trees were selected at first. One tree was cut in spring and the other tree in winter. The nutrient uptake was calculated by the difference in the dry weight between the 2 cut trees and the nutrient content of each section. [Table 4](#) shows the total nutrient uptake of 11 fruit tree species that was calculated based on the results of the field experiments^{1-12,14}. These results show that the nutrient uptake of evergreen fruit trees was higher than that of deciduous fruit trees, while the potassium uptake of chestnut trees was lower than that of the other trees compared to nitrogen and phosphorus¹. On the other hand, the phosphorus and potassium uptake of kiwifruit was higher than that of the other trees⁷. However, it is difficult to determine the nutrient uptake of each fruit tree species because the age of the sample trees and yield of fruits were different and the soil type was also different in each experimental field. A larger number of experimental data should be collected to determine whether these differences are associated with the nutrient requirement of each fruit tree species.

Nitrogen, phosphorus and potassium balance in relation to chemical fertilizer application

The input of chemical fertilizer to the orchard fields was calculated by the following formula based on the orchard area determined in the official surveys¹³ and the average value of the rates of chemical fertilizer application compiled from the cultivation guidelines adopted in 37 prefectures.

Input (t) = Orchard area (ha) x Chemical fertilizer application rate (kg/ha)/1000

The input of fruit-bearing trees and trees which did not bear fruits was 50,600 t for nitrogen, 36,400 t for phosphorus and 40,700 t for potassium, respectively in 1995. The output from fruit-bearing trees in the orchard fields was calculated by the following formula based on the orchard area determined in the official surveys and field experimental data of nutrient uptake.

Output (t) = Orchard area (ha) x Nutrient uptake based on field experiment (kg/ha)/1000

However, it was difficult to calculate the output because no field experimental data of nutrient uptake were available for pineapples, Navel orange, Iyo tangor, Hassaku pummelo mandarins, cherries, plums and pears. The data of other similar species were used for these species to calculate the output. The data of Natsudaidai were used for Navel orange, Iyo tangor and Hassaku pummelo mandarins. The data of peaches^{8,14} were used for cherries. The data of Mume apricot were used for plums. The data of Japanese pears⁹ were used for pears. However since there were no good data for pineapples, the output was estimated to be half of that of the chemical fertilizer application. The output from fruit-bearing trees in 1995 was 39,800 t for nitrogen, 9,100 t for phosphorus and 35,300 t for potassium, respectively.

The ratio of the input to output was 1.3 for nitrogen, 4.5 for phosphorus and 1.2 for potassium. The ratio of each fruit tree species ranged from 1 to 2 for nitrogen and potassium and from 2 to 6 for phosphorus, excluding Japanese pears ([Table 5](#)). These results indicate that the balance of nitrogen and potassium was adequate in 1995 while the phosphorus balance was excessive in the Japanese orchard fields. However about 30 years ago, the rates of nitrogen and potassium were also almost twice those of the present ones. The surplus chemical fertilizer may flow to groundwater. It was reported that the NO₃-N content of groundwater is presently above the environmental upper standard (10 mg/L) in some orchard fields. Results from the surveys in orchard fields show that phosphorus tends to accumulate in soil. In these areas, the available phosphorus content exceeds 100 (mg/100 g dry soil) although the adequate level of available phosphorus is 30 (mg/100 g dry soil) based on the official guidelines adopted for orchard fields.

In Japanese pears, the ratios were higher than in the other species. Especially the ratio of phosphorus was remarkably high with a value of 8. This difference may be due to the planting density. We used the mean of chemical fertilizer application rates and the nutrient uptake in order to estimate the nutrient balance. The planting density of mature Japanese pears is the lowest among all fruit tree species, 70 per ha ([Table 4](#)). Therefore, Japanese pear trees may not be able to absorb nutrients effectively because the root distribution is not very dense.

Organic matter application and nutrient balance

We must estimate the total input of organic matter to calculate the nutrient balance exactly in orchard fields. However, we could not estimate the input because statistical data were not available. The results of the official surveys covering 2,757 farmers show the tendency of organic matter consumption. The standard nutrient contents of 12 organic materials are also listed for nitrogen (0.6~3.6%), phosphorus (0.2~5.1%) and potassium (0.3~2.7%). If the consumption of these organic materials, nutrient contents and area data are used to estimate the input of organic matter, the input to the orchard fields should amount to 11,900 t for nitrogen, 15,600 t for phosphorus and 12,400 t for potassium. This input ranged from half to one-fourth of that from chemical fertilizer. However, organic matter application is common in only some orchard fields because it is difficult to obtain a sufficient amount of organic matter in other orchard fields. Therefore these data show that nutrient input from organic matter may be the same as or higher than that from chemical fertilizer in some orchard fields. The surplus organic matter may lead to eluviation of nutrients around the fields. The results of the soil surveys in orchard fields show that the potassium content

of soils is excessive in some orchard fields to which a large amount of manure had been applied for a long time because the manure has a high potassium content. In these areas, the rate of potassium fertilizer application decreased.

Conclusion

We estimated the input of chemical fertilizer to the orchard fields based on the results of official surveys of orchard areas and the standard application rate based on the cultivation guidelines adopted in 37 prefectures in 1995. The input was 50,600 t for nitrogen, 36,400 t for phosphorus and 40,700 t for potassium for the main fruit tree species. The output of nutrients from the orchard fields was estimated from the results of field experiments for the nutrient uptake of fruit trees. The output was 39,800 t for nitrogen, 9,100 t for phosphorus and 35,300 t for potassium for mature fruit-bearing trees. Because the ratio of the input of chemical fertilizers to the output from fruit trees was 1.3 for nitrogen and 1.2 for potassium, the application of nitrogen and potassium fertilizer to the orchard fields is not considered to affect the surrounding environment presently. But about 30 years ago, the application rates were almost twice those of the present ones. The NO₃-N content of groundwater exceeds the environmental upper standard (10 mg/L) in some orchard fields. And the available phosphorus content is above 100 (mg/100 g dry soil) in some orchard fields although the adequate level is 30 (mg/100 g dry soil) based on the guidelines for orchard fields because the ratio of input to output is still 4.5.

The total nutrient balance was not calculated exactly because the total nutrient input could not be determined due to the paucity of statistical data on organic matter applications. Moreover, the total output could not be calculated due to the paucity of field experimental data. However the results of the estimation of the nutrient balance in relation to chemical fertilizer application indicate that the total nutrient balance in some orchard fields may show an excess in nitrogen, phosphorus and potassium. The surplus nutrients must lead to the increase of the available nutrient content in soil and result in a load to the surrounding environment of the orchard fields if heavy application continues.

[NEXT](#)[:Variation in Southern Blight Fungus in Japan Detected by ITS-RELP Analysis](#)[TOP](#)[HOME](#)

Table 4. Total nutrient uptake of fruit trees

	Nitrogen	Phosphorus	Potassium	Age	Planting density	References
	(N)	(P ₂ O ₅)	(K ₂ O)	(yr)	(No./ha)	
	(kg/ha/yr)					
'Unshu' mandarins	235	38	178	16~50	750, 1500	3, 4, 5, 6
Natsudaikai	202	35	150	14	750	
Loquats	164	40	182	15, 20	300	
Mume apricot	142	34	154	14	300	
Kiwifruit	137	77	220	4~11	320	7
Chestnuts	123	30	56	7~13	160~330	1
Peaches	115	28	97	7~11	180~480	8, 14
Japanese persimmons	115	27	99	9~25	180~400	10, 11
Apples	79	31	113	10~23	120	12
Grapes	66	26	74	3~ 5	400	2
Japanese pears	64	19	98	8~36	70~200	9

BACK

References

- 1)Aoki, A. & Wakabayashi, S. (1967): The amount of the nutrient elements absorbed by chestnut tree on the volcanic ash soil. *Bull. Tochigi Agric. Exp. Stn.*, 12, 111-116 [In Japanese].
- 2)Aragaki, K. et al. (1983): Studies on diagnosis of growth and nitrogen application in Kyoho grape. *Bull. Yamagata Hortic. Exp. Stn.*, 2, 33-58 [In Japanese].
- 3)Harada, Y. & Inoue, H. (1982): Investigation on seasonal change of several nutritional components absorption in Satsuma Mandarin trees in plastic greenhouse. *Bull. Kagawa. Agric. Exp. Stn.*, 34, 16-22 [In Japanese with English summary].
- 4)Hirobe, M. & Ogaki, C. (1968): Experiment on the absorption of nutrient elements in Unshiu orange tree. 1. On the seasonal absorption of nutrient elements by non-bearing young tree. *Bull. Kanagawa Hortic. Exp. Stn.*, 16, 4-11 [In Japanese with English summary].
- 5)Hirobe, M. & Ogaki, C. (1969): Experiment on the absorption of nutrient elements in Unshiu orange tree. 2. On the seasonal absorption of nutrient elements by mature tree. *Bull. Kanagawa Hortic. Exp. Stn.*, 17, 18-26 [In Japanese with English summary].
- 6)Hirobe, M. & Ogaki, C. (1970): Experiment on the absorption of nutrient elements in Unshiu orange tree. 3. On the seasonal absorption of nutrient elements by bearing young tree. *Bull. Kanagawa Hortic. Exp. Stn.*, 18, 10-17 [In Japanese with English summary].
- 7)Hirobe, M. (1992): On the distribution of root systems and the amounts of nutrient elements absorbed by Kiwifruit trees grown on volcanic ash soil. *Bull. Kanagawa Hortic. Exp. Stn.*, 42, 1-10 [In Japanese with English summary].
- 8)Kimura, M., Sobajima, Y. & Osamura, Y. (1958): Studies on the amount of the nutrient elements absorbed by the peach trees. *J. Jpn. Soc. Hortic. Sci.*, 26, 59-68 [In Japanese with English summary].
- 9)Sakamoto, H. & Wakabayashi, S. (1968): Studies on fertilized phosphorus on pear in Volcanic ash soil 2. On the amount of absorbed nitrogen, phosphorus, potassium, calcium, magnesium for one year and accumulated nitrogen, phosphorus, potassium in tree trunk. *Bull. Tochigi Agric. Exp. Stn.*, 13, 104-110 [In Japanese].
- 10)Sato, K. & Ishihara, M. (1954): The amounts of the nutrient elements absorbed by Japanese persimmon trees. 1. *J. Jpn. Soc. Hortic. Sci.*, 22, 1-5 [In Japanese with English summary].
- 11)Sato, K. & Ishihara, M. (1956): The amounts of the nutrient elements absorbed by Japanese persimmon trees. 2. *J. Jpn. Soc. Hortic. Sci.*, 24, 217-221 [In Japanese with English summary].
- 12)Sato, Y., Suzuki, T. & Sasaki, I. (1976): Seasonal changes of the nutrients in newly produce top tissues of apple trees. *Bull. Fukushima Hortic. Exp. Stn.*, 6, 1-16 [In Japanese].
- 13)Statistics and Information Department (1997): Fruit and Nuts. *In The 72th statistical yearbook of Ministry of Agriculture Forestry and Fisheries.* ed. MAFF, 82-88.
- 14)Suzuki, A., Sato, Y. & Sasaki, I. (1986): The process of production of dry matter and nutrient absorption of peach trees in ten years. *J. Jpn. Soc. Hortic. Sci.*, 54, 431-437 [In Japanese with English summary].

Table 5. Ratio of application rates of fertilizer to nutrient uptake of fruit trees

	Nitrogen (N)	Phosphorus (P ₂ O ₅)	Potassium (K ₂ O)
Japanese pears	3.0	8.0	2.0
Japanese persimmons	1.6	4.8	1.5
Natsudaidai	1.5	6.5	1.5
Apples	1.5	2.1	0.8
Kiwi fruit	1.3	1.8	0.7
Peaches	1.2	3.5	1.3
Mume apricot	1.2	3.1	1.0
Loquats	1.2	4.2	0.9
'Unshu' mandarins	0.9	4.3	0.9
Chestnuts	1.0	3.0	1.8

BACK

Variation in Southern Blight Fungus in Japan Detected by ITS-RFLP Analysis

Ikuko OKABE*¹, Chiharu MORIKAWA*² and Naoyuki MATSUMOTO*¹

*¹ Department of Environmental Biology, National Institute of Agro-Environmental Sciences (Tsukuba, Ibaraki, 305-8604 Japan)

*² Department of Plant Protection, Ishikawa Agriculture Research Center (Kanazawa, Ishikawa, 920-3198 Japan)

Corresponding author: I. Okabe (besan@niaes.affrc.go.jp, fax +81-298-38-8199)

Abstract

PCR-RFLP analysis of the ITS region in the ribosomal RNA gene cluster revealed that Japanese isolates of the southern blight pathogen consisted of 5 groups. Groups 1, 2 and 3 corresponded to *Sclerotium rolfii*, whereas groups 4 and 5 were similar to *S. delphinii*, a related species of *S. rolfii*. Most of the isolates belonging to groups 1 and 2 were detected in the central to southwestern regions of Japan, while groups 3, 4 and 5 were distributed in the central to northern regions. Although the ITS-RFLP groups also differed in the size of the sclerotia, the sclerotial size varied with the incubation temperature and became indistinguishable at high temperatures. These groups showed hyphal anastomosis with one another, indicating their conspecificity.

Discipline: Plant disease

Additional key words: *Sclerotium rolfii*, *Sclerotium delphinii*

1...19): [References](#)

(Received September 6, 1999; accepted October 28, 1999)

Introduction

Sclerotium rolfii Saccardo (teleomorph; *Atheria rolfii* (Curzi) Tu & Kimbrough) is a soil-borne plant pathogenic fungus, which infects approximately 500 species belonging to 100 plant families⁶⁾ including soybean, peanut, and other leguminous crops. Infection occurs at the level of or just below the soil surface, causing basal stem rot and blighting of the leaves, referred to as southern blight. Southern blight is characterized by the presence of white mycelium and brown sclerotia, about the size of mustard seeds on diseased plants (Fig. 1a, b). Sclerotia act as the primary inoculum, since they are the sole organ capable of withstanding adverse conditions. Asexual spores are not produced, and the sexual stage is seldom observed^{14,15)}. Hot and humid weather is conducive to sclerotial germination and mycelial growth, and consequently the disease is more serious in subtropical and tropical regions than in temperate regions¹⁹⁾.

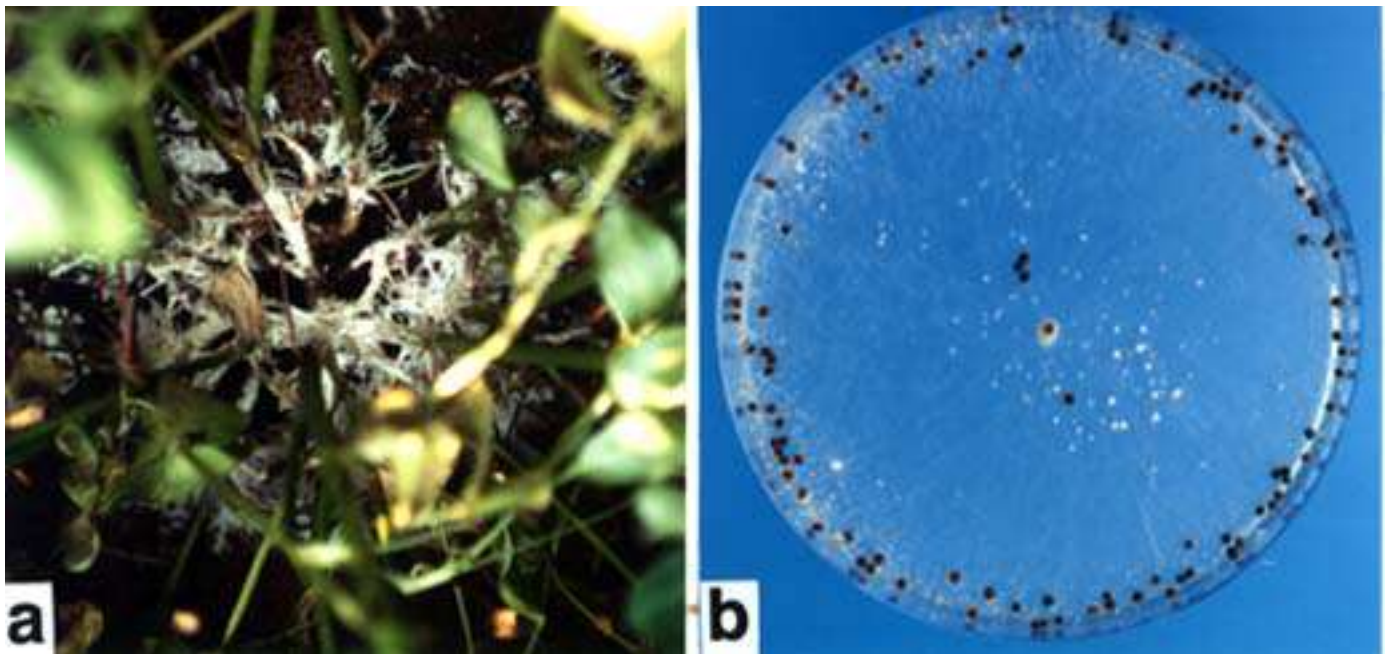


Fig.1. Mycelia and sclerotia formed on a peanut plant (a) and potato-dextrose agar (b)

Although *S.rolfsii* does not usually prevail in the cool temperate zone, southern blight has also been reported in the central to northern regions of Japan^{9,11,16}), suggesting the existence of subgroups of *S.rolfsii*, which may be adapted to relatively low temperatures. Another possibility is that the isolates reported from cool regions belong to *S.delphinii* Welch, a related species to *S.rolfsii*. *S.delphinii* is known to infect ornamental plants grown in temperate regions in North America, e.g. Delphinium sp.¹⁸), scilla¹⁰), lilies and iris¹⁷). Differentiation of these 2 species based on morphological criteria is difficult although they may be distinguished by the size of the sclerotia^{13, 17}).

Recent advances in molecular techniques have enabled inter- and intraspecific grouping of fungi³) with few morphological differences. The analysis of restriction fragment length polymorphisms (RFLPs) of the internal transcribed spacer (ITS) region of ribosomal RNA genes (rDNA) indicated the presence of genetic variation in *S.rolfsii*^{8,12}). In this paper, we reviewed the genetic variation of the Japanese isolates of the southern blight fungus and their geographic distribution. We also evaluated the species concept in *S.rolfsii*.

NEXT

TOP

References

- 1)Avisé, J. C. (1994): Molecular markers, natural history and evolution. Chapman & Hall, New York, 252-256.
- 2)Boerema, G. H. & Hamers, M. E. C. (1988): Check-list for scientific names of common parasitic fungi. Series 3a: Fungi on bulbs: Liliaceae. *Neth. J. Plant Pathol.*, 94, Suppl. 1, 1-32.
- 3)Bruns, T. D., White, T. J. & Taylor, J. W. (1991): Fungal molecular systematics. *Annu. Rev. Ecol. Syst.*, 22, 525-564.
- 4)Carling, D. E. (1996): Grouping in *Rhizoctonia solani* by hyphal anastomosis reaction. In *Rhizoctonia* species; Taxonomy, Molecular Biology, Ecology, Pathology and Disease Control. eds. Sneh, B., Jabaji-Hare, S. & Neate, S., Kluwer Academic Publishers, Netherlands, 37-47.
- 5)Chowdhury, N., Dey, T. K. & Khan, A. L. (1993): Effect of culture media, light, temperature and pH on the mycelial growth and sclerotia formation of *Sclerotium rolfsii* Sacc. *Bangladesh J. Bot.*, 22, 149-153.
- 6)Gazaway, W. S. & Hagan, A. K. (1989): Sclerotium blight. In *Compendium of soybean diseases*, Third edition. eds. Sinclair, J. B. & Backman, P. A., APS Press, St. Paul, 48-49.
- 7)Gregory, P. H. (1984): The fungal mycelium: an historical perspective. *Trans. Br. mycol. Soc.*, 82, 1-11.
- 8)Harlton, C. E., Levesque, C. A. & Punja, Z. K. (1995): Genetic diversity in *Sclerotium (Athelia) rolfsii* and related species. *Phytopathology*, 85, 1269-1281.
- 9)Hayama, K. et al. (1984): Morphology, pathogenicity and taxonomy of *Sclerotium* spp. isolated from several plants. *Ann. Phytopathol. Soc. Jpn.*, 50, 403 [In Japanese].
- 10)Huber, A. G. & Gould, C. J. (1948): *Sclerotium delphinii* Welch on scilla. *Phytopathology*, 38, 82-85.
- 11)Nishihara, N. (1961): Miscellaneous Publication of the Chiba-Ken Agricultural Experiment Station, 1, 6-8 [In Japanese].
- 12)Okabe, I. et al. (1998): Variation in *Sclerotium rolfsii* isolates in Japan. *Mycoscience*, 39, 399-407.
- 13)Punja, Z. K. & Damiani, A. (1996): Comparative growth, morphology, and physiology of three *Sclerotium* species. *Mycologia*, 88, 694-706.
- 14)Punja, Z. K. & Grogan, R. G. (1983): Basidiocarp induction, nuclear condition, viability, and heterokaryon incompatibility in *Athelia (Sclerotium) rolfsii*. *Phytopathology*, 73, 1273-1278.
- 15)Punja, Z. K., Grogan, R. G. & Adams, G. C. (1982): Influence of nutrition, environment, and the isolate, on basidiocarp formation, development, and structure in *Athelia (Sclerotium) rolfsii*. *Mycologia*, 74, 917-926.
- 16)Saito, T. & Yoshimura, S. (1962): Clover diseases in Hokuriku. *Proc. Assoc. Pl. Prot. Hokuriku*, 10, 51-54 [In Japanese].
- 17)Stevens, F. L. (1931): A comparative study of *Sclerotium rolfsii* and *Sclerotium delphinii*. *Mycologia*, 23, 204-222.
- 18)Welch, D. S. (1924): A sclerotial disease of cultivated Delphinium. *Phytopathology*, 14, 31.
- 19)Yorinori, J. T. (1994): Fungal diseases. In *Tropical soybean; improvement and production*. ed. Brazilian Agricultural Research Enterprise, FAO, Rome, 52-55.

ITS-RFLP analysis

ITS-RFLP analysis was first applied to *S.rolfsii* and related species by Harlton et al.⁸⁾. They tested 119 *S.rolfsii* isolates and 12 *S.delphinii* isolates from the U.S.A. and other countries, using restriction enzymes *Alu* I, *Hpa* II, *Rsa* I and *Mbo* I. *S.delphinii* was distinguished from *S.rolfsii* by the *Rsa* I pattern, and *S.rolfsii* isolates were classified into 12 groups (I to XII). They also suggested the existence of phylogenetic relationships ([Fig. 2](#)).

To determine the geographical variability in the *S.rolfsii* population, we examined 67 isolates from different hosts and various regions of Japan, and classified them into 5 ITS-RFLP groups ([Figs. 3 and 4](#))¹²⁾. Groups 1 and 2 were distributed in the southwestern region of Japan, which is located in the warm temperate zone, and groups 3, 4 and 5 were found in the central to northeastern regions of Japan, which are cool temperate regions. Groups 1 and 3 corresponded to groups II and XI, respectively, and group 4 showed the same pattern as that of *S.delphinii* from the U.S.A. Groups 2 and 5 were newly found, and group 2 was similar to group 1, whereas group 5 was close to group 4.

ITS-RFLP analysis indicated that isolates resembling *S.delphinii* were distributed in the central to northern regions in Japan, whereas *S.rolfsii* occurred in the central to southwestern regions. The boundary was not clear, and they overlapped in the Kanto and Hokuriku areas. All the groups except for group 3 were found in Tokyo, suggesting that trade of seedlings and bulbs had introduced various *Sclerotium* strains.

Growth temperature reaction of ITS-RFLP groups

The most evident morphological difference between *S.rolfsii* and *S.delphinii* lies in the sclerotial size: *S.delphinii* produces larger sclerotia than *S.rolfsii*¹⁷⁾. We observed sclerotial formation in several isolates of groups 1, 2 and 4 grown on potato dextrose agar (PDA) plates at various temperatures. Group 4 produced larger sclerotia than group 1 ([Fig. 5](#)). However, the size decreased with increasing temperature, and the difference between groups 1 and 4 became less distinct. Sclerotial size of group 2 was similar to that of group 1 (data not shown). Few sclerotia were formed by isolates of group 5, and group 3 failed to produce sclerotia.

S.delphinii and *S.rolfsii* also differed in the optimal temperature for mycelial growth. *S.rolfsii* grew better at high temperatures¹³⁾ than *S.delphinii*, which is in agreement with the fact that *S.rolfsii* is prevalent in tropical and warm temperate regions whereas *S.delphinii* occurs in cool temperate regions. In our observations of the Japanese isolates, the growth temperature response was different among the ITS-RFLP groups but did not vary as much as that between *S.delphinii* and *S.rolfsii* in foreign countries. Group 1 showed optimum growth on PDA at 30°C ([Fig. 6](#)), but the growth rate decreased at 33°C whereas *S.rolfsii* isolates from the U.S.A. and South Asia grew well even at 35°C^{5,13)}. The optimal growth temperature was 28°C for most of the isolates of group 5 and some of group 4, but other isolates of group 4 grew most rapidly at 30°C. Group 2 showed the same pattern as group 1 (data not shown), and one isolate of group 3 was not included in this test because it showed restricted growth.

Hyphal anastomosis between different RFLP groups

Conspicuity can be determined by hyphal interactions in basidiomycetous fungi. Hyphae of the same isolate often fuse (or anastomose) with one another, forming a hyphal network. Anastomosis may also occur between hyphae of different strains of the same species but usually results in the death of fused cells and in the subsequent formation of a boundary line between the mycelia. Hyphal anastomosis does not occur between different species⁷⁾ nor between genetically isolated populations within a species complex³⁾.

Hyphal anastomosis was observed between different RFLP groups, when they were paired on water agar plates ([Fig. 7](#)). Fused hyphal cells in the contact zone subsequently died in every combination except for the self-pairings, suggesting that all the groups should be considered as the same genetic entity. Some researchers proposed the term *S.rolfsii* var. *delphinii* to accommodate *S.delphinii* in the *S.rolfsii* complex²⁾.

Conclusion

ITS-RFLP analysis suggested the existence of population differentiation in the southern blight fungus in Japan. The groups from southern regions included *S.rolfsii*, and those distributed in the northern regions corresponded to *S.delphinii* in a broad sense. Before ITS-RFLP analysis was applied, *S.rolfsii* and *S.delphinii* had been distinguished by the sclerotial size and optimal growth temperature. However, sclerotial morphology was found to vary with the incubation temperature, and optimal growth temperature did not enable to distinguish ITS-RFLP groups in Japan. Lack of significant differences within the southern blight fungus may be due to the less distinct climatic differences between localities in Japan, and indicate the existence of intergrades between the 2 species. *S.rolfsii* and *S.delphinii* are considered to represent 2 extremes of continuous variation.

Information about the mating behavior of *S.rolfsii* and *S.delphinii* is limited, and the biological species concept¹⁾ is not easily applicable to these fungi. The phylogenetic tree based on ITS-RFLP analysis indicated a close relationship between these species (Fig. 2). Moreover, hyphal anastomosis also suggested their incomplete segregation as separate species. Further investigations are required to reveal the genetic background of the groups and to reassess the species concept of *S.rolfsii* and *S.delphinii*.

[NEXT](#)[:Robotization of Agricultural Vehicles \(Part 1\)](#)[TOP](#)[HOME](#)

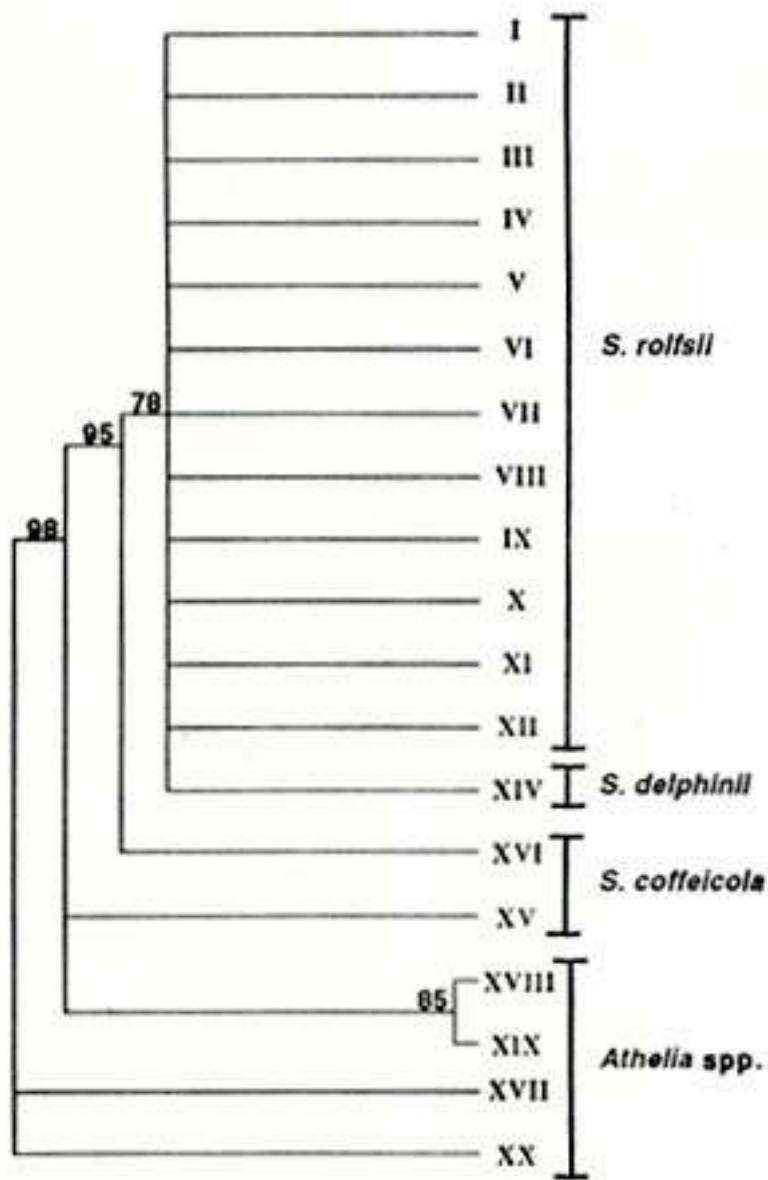
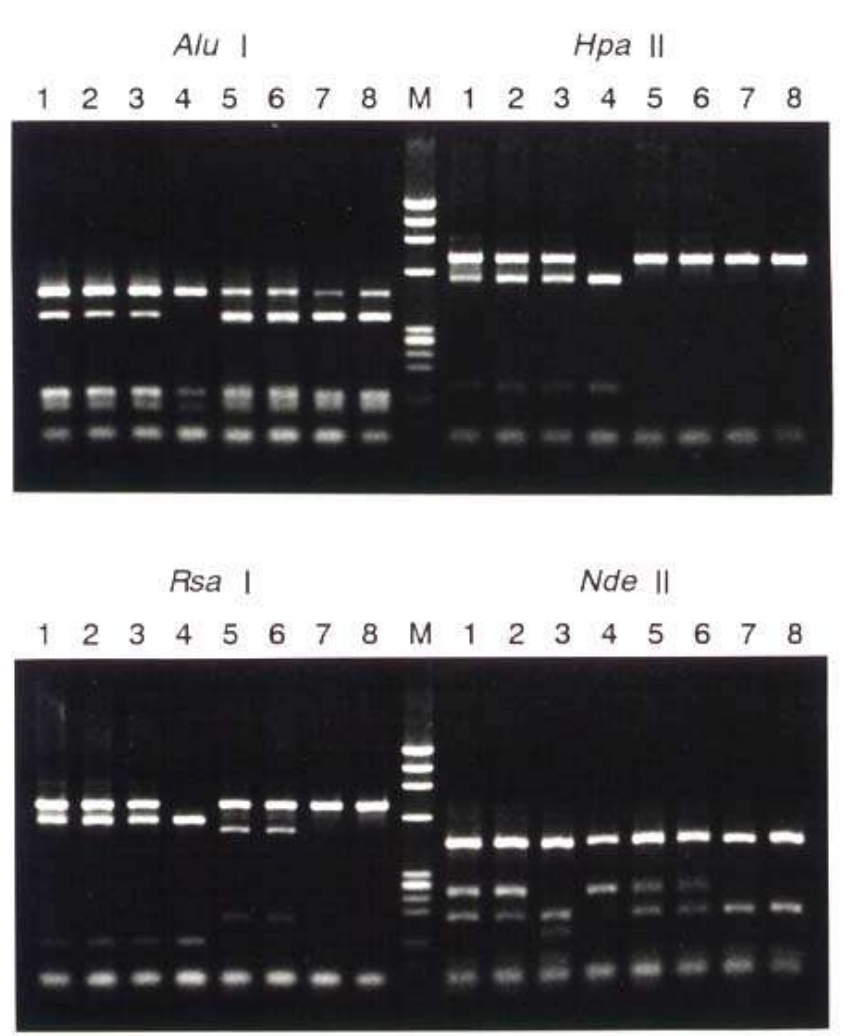


Fig.2. Putative phylogenetic relationships between three *Sclerotium* and three *Athelia* species based on *Alu* I, *Hpa* II, *Rsa*, and *Mbo* I restriction sites of internal transcribed spacer,(ITS) region⁸⁾

BACK

Fig.3. ITS-RELP patterns of Japanese isolates¹²⁾



Four restriction enzymes (*Alu I*, *Hpa II*, *Rsa I* and *Nde II*) were used.

- Lane1: isolate S-22(group 1).
- Lane2: isolate S-42(group 1).
- Lane3: isolate S-43(group 2).
- Lane4: isolate S-17(group 3).
- Lane5: isolate S-41(group 4).
- Lane6: isolate S-56(group 4).
- Lane7: isolate S-8 (group 5).
- Lane8: isolate S-12(group 5).

M: Φ C174 / *Hae III*(1353, 1078, 872, 603, 310, 281, 234, 194, 118bp).

BACK

Fig.4. Distribution of ITS-RFLP groups in Japan

Numbers of isolates of groups 1,2,3,4 and 5 from each location are shown in parentheses, respectively.



BACK

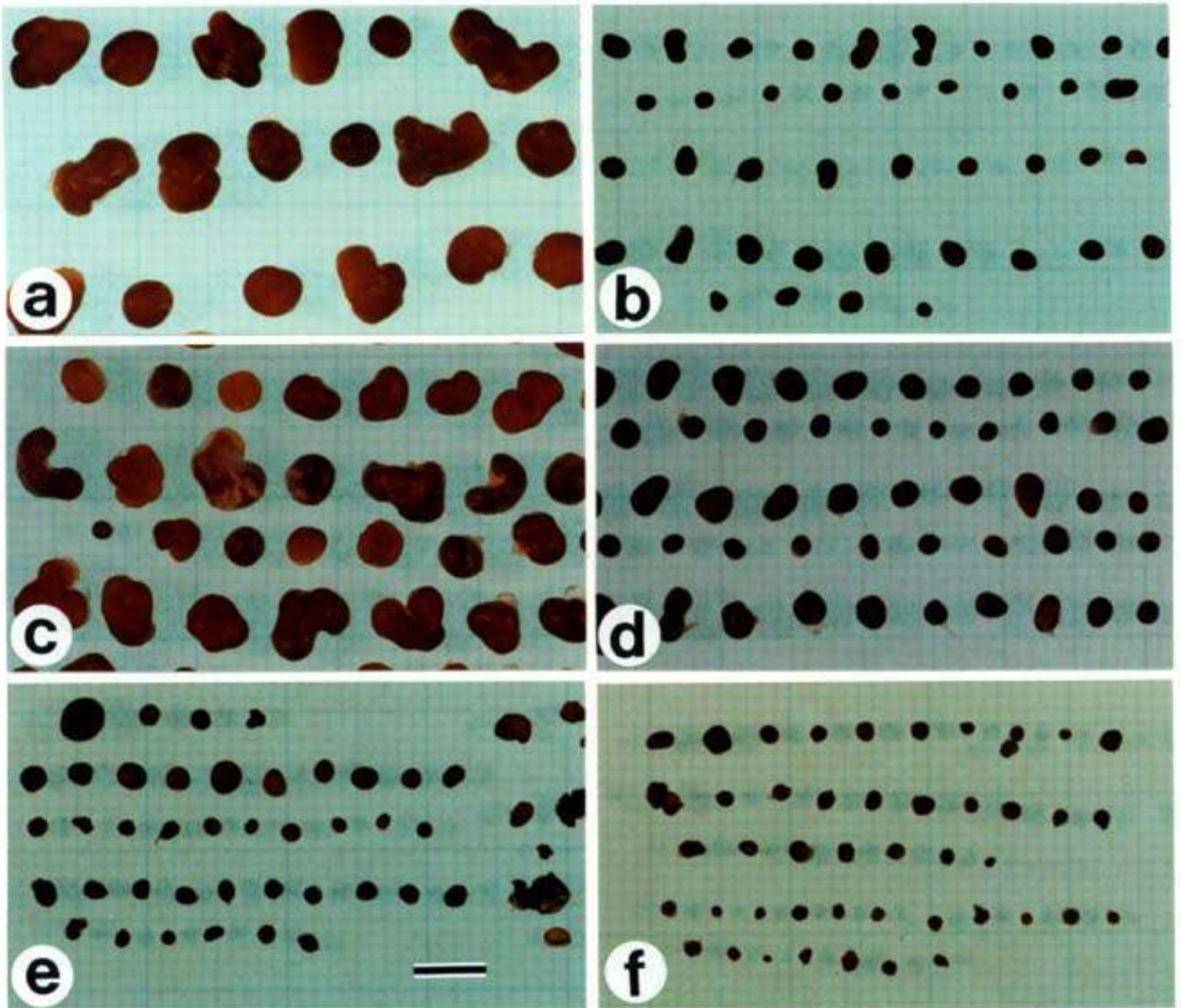


Fig.5. Sclerotia of isolates S-58(group 4) and S-46(group 1) produced at 23,28, and 33°C¹²⁾

a: Isolate S-58 at 23°C. b: S-46 at 23°C. c: S-58 at 28°C. d: S-46 at 28°C. e: S-58 at 33°C. f: S-46 at 33°C.
Scale bar = 5 mm.

BACK

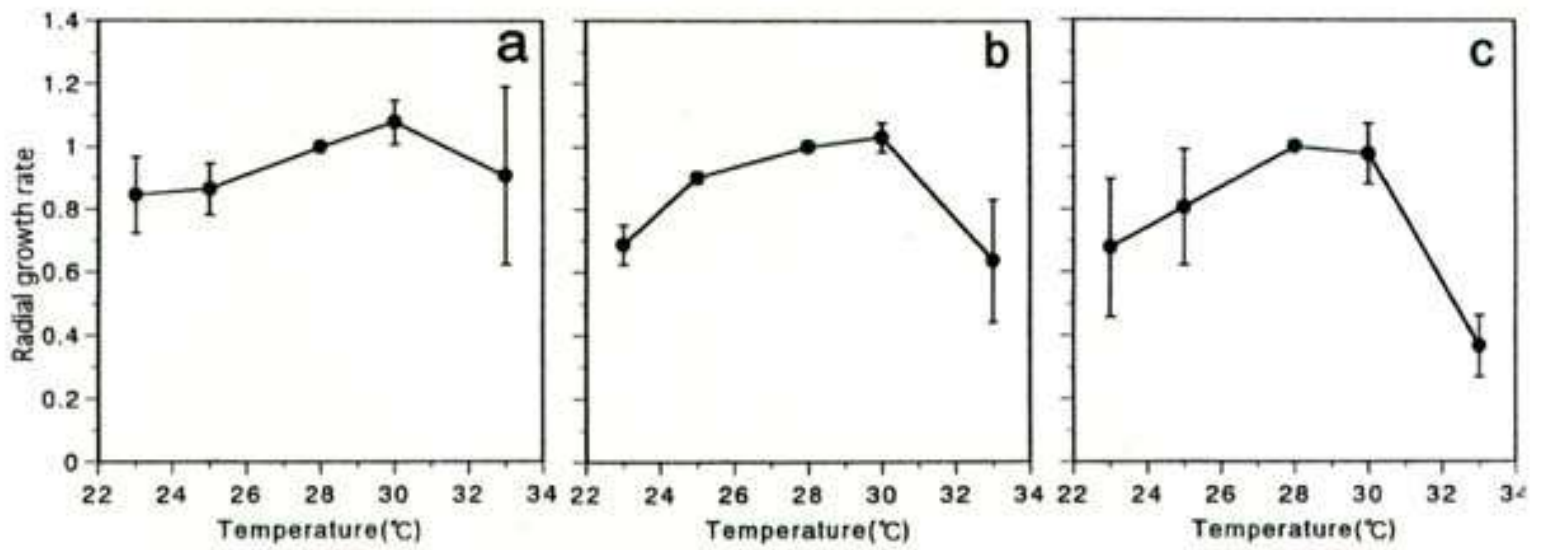


Fig.6. Mycelial growth of groups 1(a), 4(b), and 5(c)¹²⁾

Mycelia were incubated for 2 days at different temperatures. Data are expressed relative to the growth at 28°C. Vertical bars show the standard deviations.

BACK

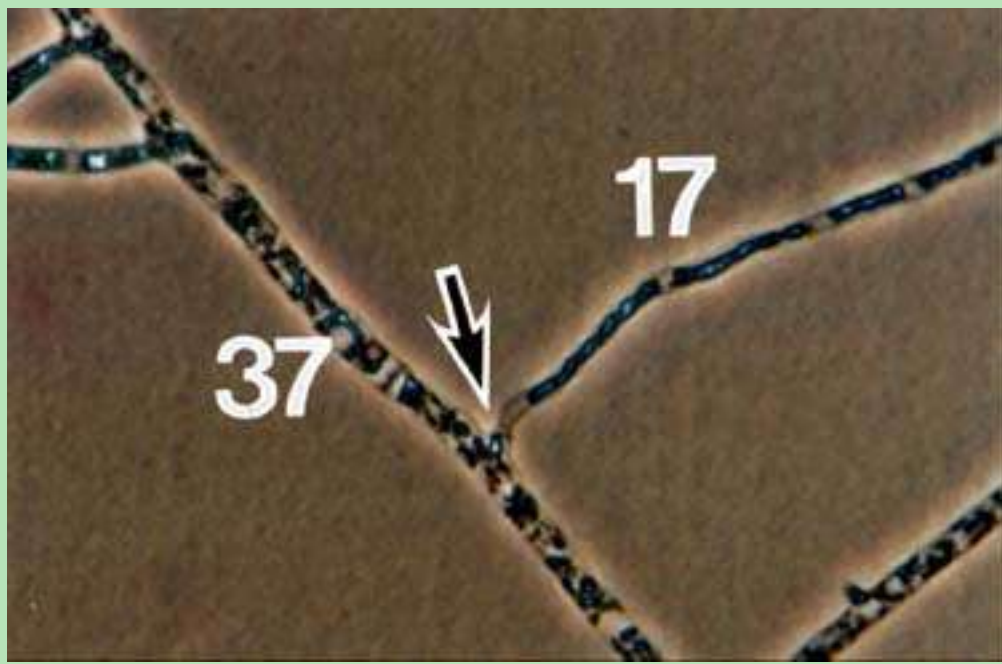


Fig.7. Hyphal anastomosis of isolates S-17(group 3) and S-37(group 5) observed under a phase-contrast microscope¹²⁾

BACK

Robotization of Agricultural Vehicles (Part 1) - Component Technologies and Navigation Systems -

Osamu YUKUMOTO*¹, Yosuke MATSUO*¹ and Noboru NOGUCHI*²

*¹ Fundamental Technology Department, Institute of Agricultural Machinery (BRAIN-IAM)
(Omiya, Saitama, 331-8537 Japan)

*² Faculty of Agriculture, Hokkaido University (Sapporo, Hokkaido, 060-8589 Japan)

Corresponding author: O. Yukumoto (oyukumot@iam.brain.go.jp, fax +81-48-654-7131)

Abstract

Studies on the robotization of agricultural vehicles have been conducted to perform labor-saving, high-precision operations, etc. Component technologies for the robotization were described in general, along with navigation systems. As an example of robotized vehicles, we planned to develop a tilling robot. To recognize the position with an error less than 5 cm and at intervals less than 1 s, we developed 3 types of navigation systems; an off-the-wire type, a kinematic global positioning system (GPS) with inertial navigation system (INS) type and an optical type.

Discipline: Agricultural machinery

Additional key words: mobile robot, unmanned operation, operation software, tractor

1...7): [References](#)

(Received for publication, July 14, 1999)

Introduction-Objectives of robotization of agricultural vehicles

Currently, whether the agricultural industry in Japan will be able to survive is a cause for concern due to the difficulty in finding successors and the rapidly expanding market for imported agricultural products. Efforts are being made to promote the industry through labor-saving, lower costs, and enhanced product quality. In addition, studies on the robotization of agricultural vehicles have been conducted in recent years²⁾ to achieve the following objectives³⁾:

- 1) Labor-saving through completely unmanned operations,
- 2) High-precision work superior to human work, and
- 3) Improvement of safety and amenity by eliminating operator intervention.

Subsequently, new working methods will be developed in response to the robotization of agricultural vehicles and the following additional benefits are anticipated³⁾:

- 1) Single operator can manage and operate many vehicles concurrently,

2)Through continuous day and night work, a small machine can cover a large area and solve problems such as soil compaction, and

3)The ability to detect vehicle positions will enable to obtain information on yield and soil conditions of each part of the field, and to execute precision farming.

This paper describes the navigation systems we studied, together with the control of vehicles with these systems and the performance of their prototypes.

[NEXT](#)

[TOP](#)

References

- 1) Matsuo, Y. et al. (1997): Research on tilling robot (Part 4) -Unmanned operation with the total station of automatic tracking type. Proc. Jpn. Soc. Agric. Mach. 56th Annu. Meet., 57-58 [In Japanese].
- 2) Tillet, N. D. (1991): Automatic guidance sensors for agricultural field machines; A Review. *J. Agric. Eng. Res.*, 50, 167-187.
- 3) Yukumoto, O. (1990): Autonomous traveling of farm vehicles (Part1, 2). *Agric. and Hortic.*, 65(1), 144-148, 65(2), 41-44 [In Japanese with English summary].
- 4) Yukumoto, O. (1995): Navigation technologies in agriculture - Review. Int. Hi-tech Forum Osaka '95 Proc., Osaka, 89-93 [In Japanese with English summary].
- 5) Yukumoto, O. (1996): Autonomous land vehicle. Handbook of Bioproduction Machinery, Jpn. Soc. Agric. Mach., CORONA Publishing CO., Ltd., Tokyo, 375-382 [In Japanese].
- 6) Yukumoto, O. & Matsuo, Y. (1997): Navigation technology for tilling robots - Robotization of agricultural vehicles and the outline of navigation systems for robots. Int. Symp. on Mobile Agric. Bus-System LBS and PA for the Large-Scale Farm Mech. Proc., Hokkaido Branch of Jpn. Soc. Agric. Mach., Sapporo, 59-78.
- 7) Yukumoto, O. & Matsuo, Y. (1998): Research on tilling robot. Annu. Rep. 1997, IAM- BRAIN, Omiya, 2-9 [In Japanese].

Technology and conditions required for robotization of agricultural vehicles

1) Component technologies³⁾

The component technologies that support the robotization of agricultural vehicles are similar to the 5 main components for common mechatronics systems, which are listed in Fig. 1. Each component is described below.

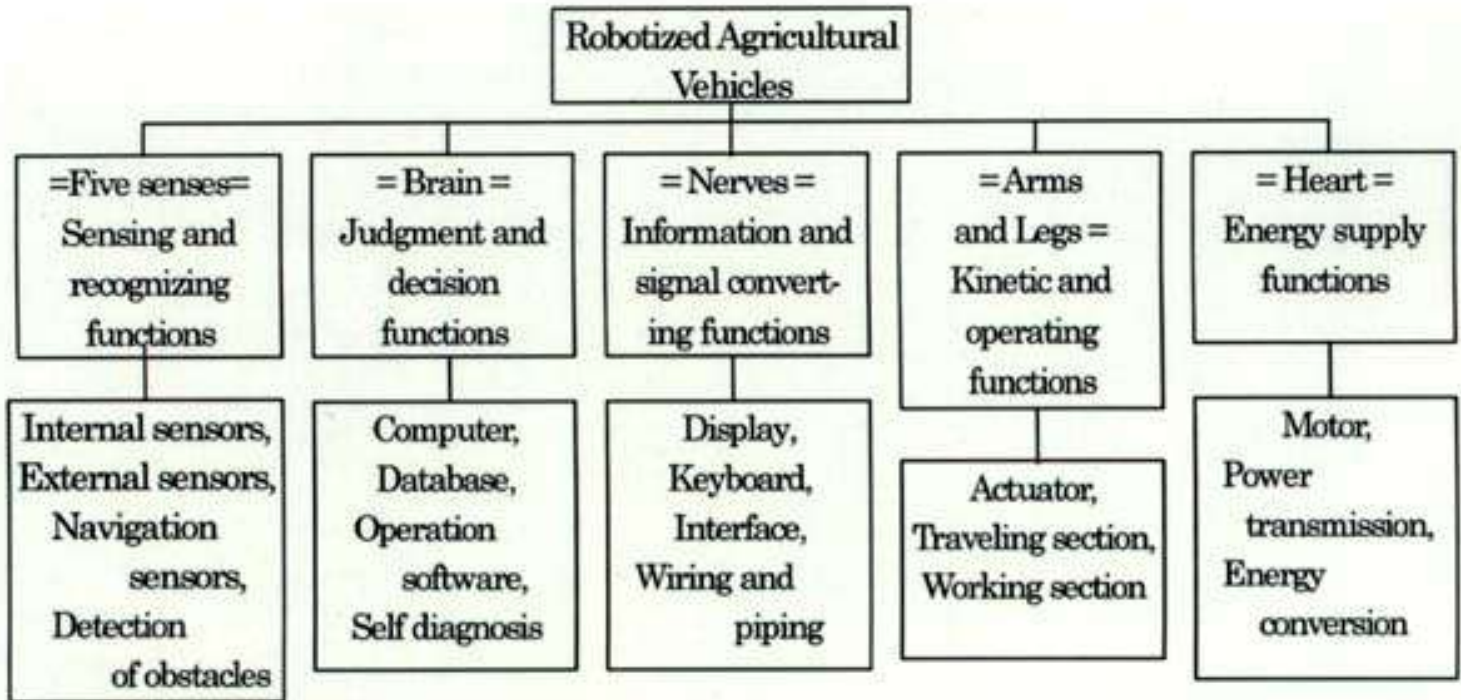


Fig. 1. Component technologies for the robotization of agricultural vehicles

(1) The energy supply and operating functions require technical developments, in addition to conventional technology, in the following areas:

- a. While an actuator mechanism which provides excellent control is required for the steering, throttle, transmission, and brake operations in place of an operator, conventional systems for manual operation are also required for traveling to and from the field and teaching the field area.
- b. Various adjustments of the implements must be automated to enable unmanned operation.
- c. Power sources corresponding to the sensor and actuator are required.
- d. Each part must be highly reliable since prompt detection of failures cannot be expected during unmanned operation.

(2) The information transfer and signal conversion functions require a keyboard and monitor for dialogues between the robotized vehicle and the operator. In addition, stable communication functions are required among the sensor, controller and actuator, depending on the navigation system used and also between the vehicle and an external device.

(3) Judgment and decision functions determine the vehicle behavior. These are the basis of the system, which is composed of a computer, hardware including peripheral devices and software.

The know-how necessary to perform unmanned operations is incorporated into the software. A slight error in judgment and control may lead to an accident. Therefore methods such as a division of tasks are required for avoiding such malfunctions, and sufficient field tests under various conditions are also required.

(4) For the sensing and recognition functions, the robot itself must detect internal information such as the fuel level and operating conditions of each part, as well as external information such as the vehicle position, heading, and the status of the soil and peripheral conditions. Although the information about navigation is particularly important for the robotization of vehicles, since no navigation system currently in use efficiently meets the requirements of cost, performance, and ease of use, new technology must be developed.

2) Conditions for development and introduction

Each component described before is required for robotization of vehicles to function under the conditions of use required by outdoor agriculture. [Table 1](#) shows the conditions of use as compared with those in other fields. The conditions of use for agricultural vehicles, such as the operator, annual operating hours, and the capital of the managing body, differ markedly from those in other fields. Therefore, considerations for lowering the cost, enhancing the reliability, and improving the operation should be included from the beginning of development.

[NEXT](#)

[TOP](#)

Table 1. Conditions for using mobile robots for various purposes

	AGV in factories	Construction	Agriculture
Range of use	<Several hundreds of meters	<Several hundreds of meters	<Several hundreds of meters
Traveling distance	<Several kilometers	<Several hundreds of meters	<Several kilometers
Traveling method	Along the track	Whole surface Along the track	Whole surface
Road surface	Hard and flat	Slightly soft and irregular	Soft and irregular
Inclination	Horizontal	Nearly horizontal	Slopes are included
Dust, etc.	Small amount	Large amount	Large amount
Velocity	Low	Low	Low
Continuous operating hours	Short	Long	Long
Place of use	Indoor	Indoor and outdoor	Outdoor
Intrusion of outsiders	Can be prevented	Can be prevented	Cannot be prevented
Operator	Semi-professional	Professional	Non-professional
Annual operating hours	Long	Long	Short

BACK

Navigation systems-classification and objectives

1) Classification and adaptability of navigation systems

Classification of navigation systems is shown in [Table 2^{5\)}](#). Because fields vary widely depending on the kind of crops and the stage of work, there is no universal navigation system that can adapt to every stage of agriculture. [Table 3](#) shows the general adaptability of the respective navigation systems in the case of agriculture⁶⁾. In the following, general conditions and the restricting factors are described.

- (1) In paddy fields or upland fields, since the whole field is tilled, it is almost impossible to use a fixed route with a mechanical system. Furthermore, because the running route is fixed, a fixed route may lead to the deterioration of soil penetrability due to the pressure on the soil.
- (2) When using the spot mark system, the other navigation systems must be applied between the marks.
- (3) The accuracy of the internal information system will decrease in a large field or during long continuous work. A field with a slippery surface may cause an error in the estimation of the traveling distance based on wheel rotation.
- (4) When visually observing external information from the vehicle, such as a known point, an error may occur due to the rolling and pitching of the vehicle, which requires a correction.
- (5) Since no stable map in the field, is available, it is difficult to apply the map matching method used in the case of car navigation.
- (6) The external information system may not be applied where the work boundary is unclear, such as during puddling, or in the absence of ridges or row edge.
- (7) When using the external mark system, the measurement may be hindered by obstacles, depending on the observation medium. For example, when light is used as the medium, shade from trees in an orchard may occur, or the measurement may not be correct due to reflected rays from a glasshouse.

2) Navigation systems for tilling robot

As an example of robotized agricultural vehicles, we planned to develop a tilling robot that can recognize its own position and heading, while performing unmanned tilling at almost the same work rate as manual work.

Based on the above factors, external information system and the external mark system of a free route type were considered to be suitable for the position detecting system for tilling robots. Furthermore, we estimated that the concurrent use of an internal information system with distance and heading system is adequate for detecting the vehicle heading in the turning and for temporarily continuing the unmanned operation during a malfunction of the positional detecting system.

Among the navigation systems described in this section, the systems that have been studied are outlined below.

[NEXT](#)
[TOP](#)

Table 2. Classification of navigation systems for agriculture

Route	System	Object of detection	Example of target, sensors, facilities, etc.
Fixed	Mechanical system	Mechanical guides	Ridges, furrows, pipes, rails
	Non-contact system	Non-contact guides	Leader cables, laser beams
Semi-fixed	Spot mark system	Spot marks	Magnetic signs
	Internal information system with inertial navigation	Acceleration	Gyro+accelerometer
	Internal information system with distance and heading	Distance(velocity) +heading	Wheel rotation+gyro, geo-magnetic sensor
Free	Internal information system with differential wheel rotation	Right and left wheel rotation	Wheels, crawlers
	External information system with object tracking	Crop rows, work boundaries, etc.	TV cameras+image processor
	External information system with relative distance	Hedges, ridges, crop rows, etc.	Ultrasonic sensor, off-the-wire leader cable
	External mark system with triangulation surveying	Multiple relative angles	TV cameras, optical sensors +optical reflection marks
	External mark system with traverse surveying	Relative angles +distance	Transit+ranging sensor (with tracking vehicles)
	External mark system with hyperbolic navigation	Multiple distances	Radio beacons, laser beacons, GPS

BACK

Table 3. Applicability of navigation systems for agriculture

Navigation system	Restriction on use	Applicability to agricultural systems*					
		Paddy field	Upland field	Green-house	Orchard	Grass-land	Interior of facilities
Fixed route with mechanical system non-contact system	Routes are limited	×	×	○	○	×	○
		△	△	◎	◎	×	◎
Spot mark system	Requires concurrent use of other navigation methods	△	△	○	△	△	○
Internal information system	Cumulative errors become a problem in case of long distance or long time operation	△	△	△	△	△	△
External information system	Crop rows, etc. to be tracked are indispensable	○	○	◎	○	○	○
External mark system	No obstacles such as trees in case of an optical system	◎	◎	△	△	◎	△

* Applicability was estimated based on common field area and form.

◎ : Applicable to almost all types of operation. ○ : Applicable to selected types of operation.

△ : Applicable to limited types of operation and sizes of field. × : Not applicable to almost all types of operation.

BACK

Navigation systems-positioning systems

1) Development of off-the wire type navigation system (LNAV) [6,7](#)

The LNAV developed by KUBOTA Co. is a navigation system characterized by a free route and external information with a relative distance. The cables for generating the magnetic fields for each modulation frequency are installed, as shown in [Fig. 2](#). Although the magnetic fields are generated in the field depending on the distance from each cable, the relation between the strength of the magnetic field and the distance is not linear, since each cable has a finite length. Therefore, as shown in [Fig. 3](#), a magnetic field sensor is mounted on the right and left front parts of the vehicle. The vehicle performs a teaching run along the field boundary by manual operation. The teaching data TD0 related to the boundary of the field are obtained from the left sensor, and the teaching data TD1 of the magnetic field distribution along the first returning path are obtained from the right sensor. Then, the magnetic field distribution data at the end of the path are also obtained. In the first returning path in an autonomous operation, while performing an autonomous straight run by referring to the TD1 from the left sensor, the vehicle automatically obtains the TD2 for the next path from the right sensor. After the 180° turn based on information on the end position, the vehicle performs the next straight run according to the TD2. In this way, the LNAV does not detect the absolute position in the field but guides the vehicle to repeat the magnetic field distribution initially obtained for performing the operation.

Based on the above description of the LNAV system, no test was performed to measure its positioning accuracy, but because it could accurately repeat the autonomous run on the taught path, it was estimated that with this system the error was 5 cm or less. Furthermore, the data sampling interval was 0.1 s or less. This system is not influenced by natural conditions like weather. However, the cost to construct the cable line and the fixed path for work are limiting factors.

2) Development of GPS type navigation system (SNAV) [6,7](#)

The SNAV developed by Japan Aviation Electronics Industries, Ltd., is a navigation system characterized by a free route and external marks with hyperbolic navigation. In the SNAV the differential GPS (DGPS), geomagnetic sensor (TMS) and the inertial measuring unit (IMU) are combined with the device configuration as shown in [Fig. 4](#). The GPS system has a data sampling interval of 1s basically. As the communication and processing times are added, the calculated DGPS position data involve a considerable delay. The SNAV supplements the positions during such delays using an IMU.

Presently, satisfactory positional detection has been achieved at intervals of 0.1 s. The positioning error amounted to several cm or less over several hours of measurement when the mobile station was fixed to a position. And the errors in autonomous operation were 10 cm or less due to the decrease of the turning velocity in taking account of the capacity of the IMU.

Several types of GPS positioning systems have been commercialized by several companies. The accuracy and the sampling rate are sufficient in the double frequency real time kinematic GPS type. However, the cost and information service of the reference station are still unsolved.

3) Development of optical type navigation system (XNAV) [4,6](#)

The XNAV is a navigation system characterized by a free route and external marks with traverse surveying. The XNAV was developed by BRAIN-IAM and the manufacture of its prototype was assigned to Sanyo Electric Co., Ltd.



(1) System configuration and principle

The principle of the XNAV measurement is shown in [Fig. 5](#). Target P, installed on the vehicle, was observed from the center O of the transit section of the reference station. The diagonal distance L between O and B, the horizontal angle H formed by the reference line and segment OP, and the vertical angle V are obtained. And then the coordinates of the target point P (x_i , y_i , z_i) are obtained through the principle of traverse surveying. Although segment OP can always be obtained by tracing and estimating the target from the reference station (Fig. 6), the steps to follow are shown in Fig. 5.

Fig.6. References station of the prototype XNAV system

a. Input image 1 when the strobe light on the target is lit and image 2 when it is not lit at the shortest possible interval,

b. Compute the differential image between image 1 and image 2, and binarize it,

c. Extract the strobe image from the differential image,

d. Repeat steps a to c to calculate the traveling speed of the target,

e. Move the transit section so that the strobe image appears in the center of the image sensor, and

f. Measure distance L and calculate the position.

(2) Performance, precision, and ease of use

In the test results of the XNAV, the positions were detected during continuous operation of approximately 15 min at the velocity of 0.4 m/s in a roughly flat field 45x15 m in size. The positioning accuracy was 5 cm or less with an average data sampling interval of 0.52 s. However, sometimes the target was missed during a steep turn. Manual coordination was required on 2 occasions, and at other positions the measurements could be continued by using the self- tracking restoration function.

(3) Characteristics and problems

Although this system does not require field equipment other than one reference station in the field, there are shortcomings, including adaptation to the changes in natural lighting conditions and reliability of the self-restoration function.

(4) Total station of automatic tracking type AP-L1¹⁾



Fig.7. References station of AP-L1

Total station AP-L1, with an automatic tracking function for moving objects, was put on the market by TOPCON, Co., while the XNAV was under development. The AP-L1 is able to track and range the target automatically by a single laser beam, and is also equipped with automatic searching and retracking functions when the target is missed. In the same way as the XNAV, the AP-L1 measures the diagonal distance L and the horizontal and vertical angles, H , V while tracking the optical reflection target from the reference station (Fig.7). It also calculates the 3-dimensional coordinate positions of the target point. As a result of field tests, we found that it fully reaches the target accuracy and tracks a moving object in a very stable manner. We confirmed that it can perform automatic tracking, position measurement, and data communication at a distance of 500 m in an area with good perspective. At that point, the modification and improvement of the XNAV were discontinued and the AP-L1 was used in place of the XNAV in subsequent tests. The main specifications of the AP-L1 are shown in [Table 4](#).

NEXT

[:Robotization of Agricultural Vehicles \(Part 2\)](#)

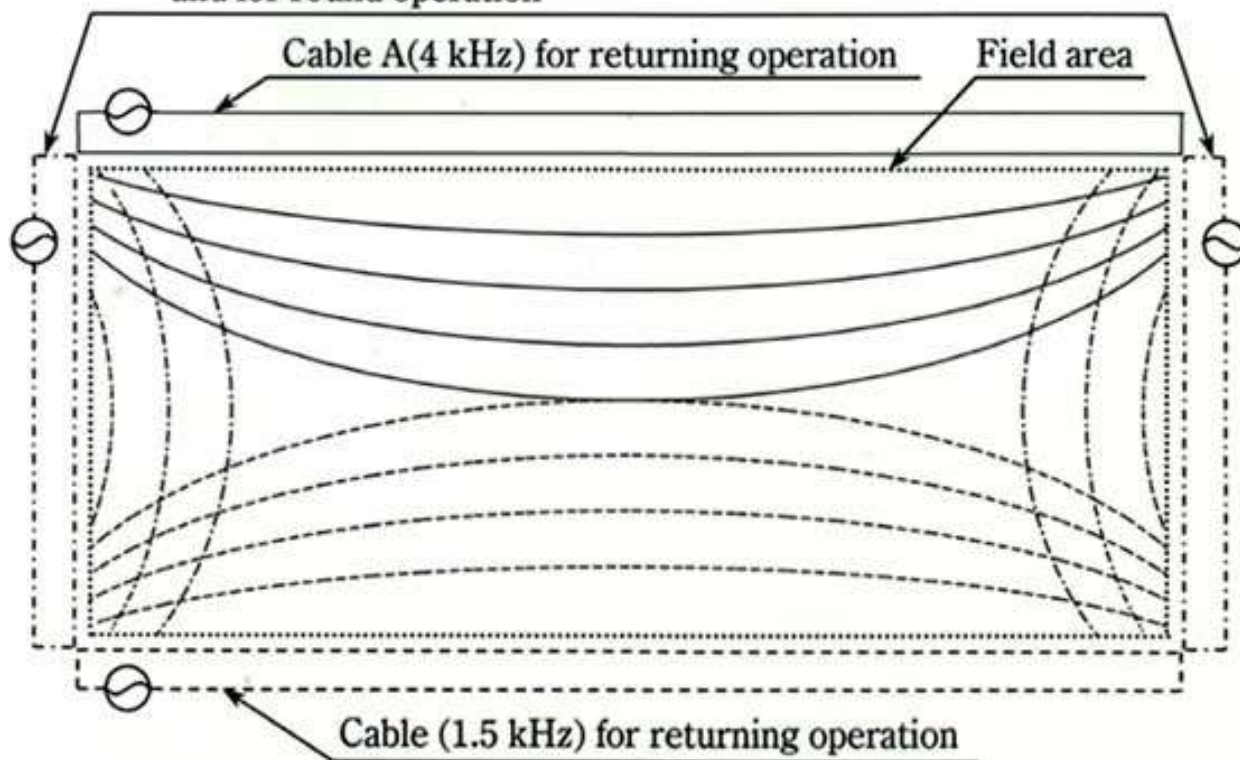
TOP

HOME

Cable C(10 kHz) for detecting the end position
and for round operation

Cable A(4 kHz) for returning operation

Field area



Cable (1.5 kHz) for returning operation

- Modeled diagram of isomagnetic lines from Cable A
- - - Modeled diagram of isomagnetic lines from Cable B
- · · Modeled diagram of isomagnetic lines from Cable C

Fig. 2. Cable installation for LNAV

BACK

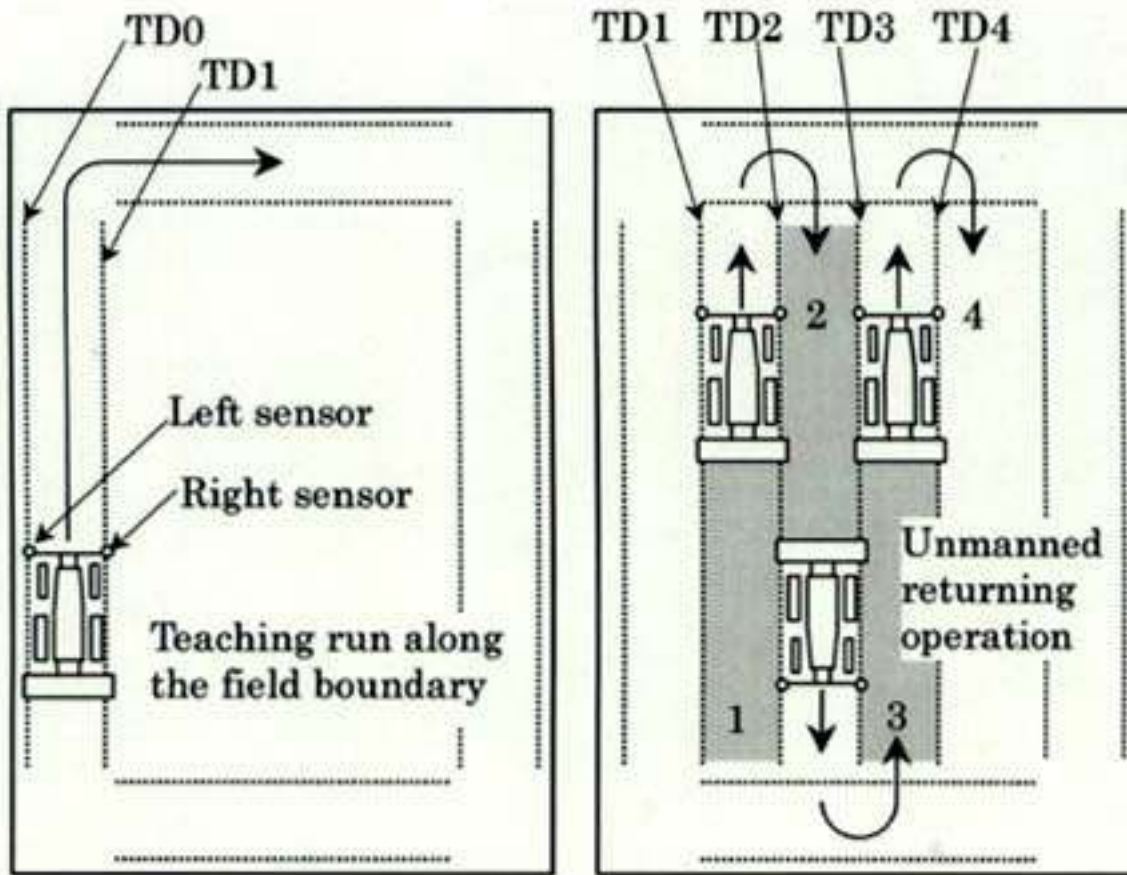


Fig. 3. Operation method of LNAV

BACK

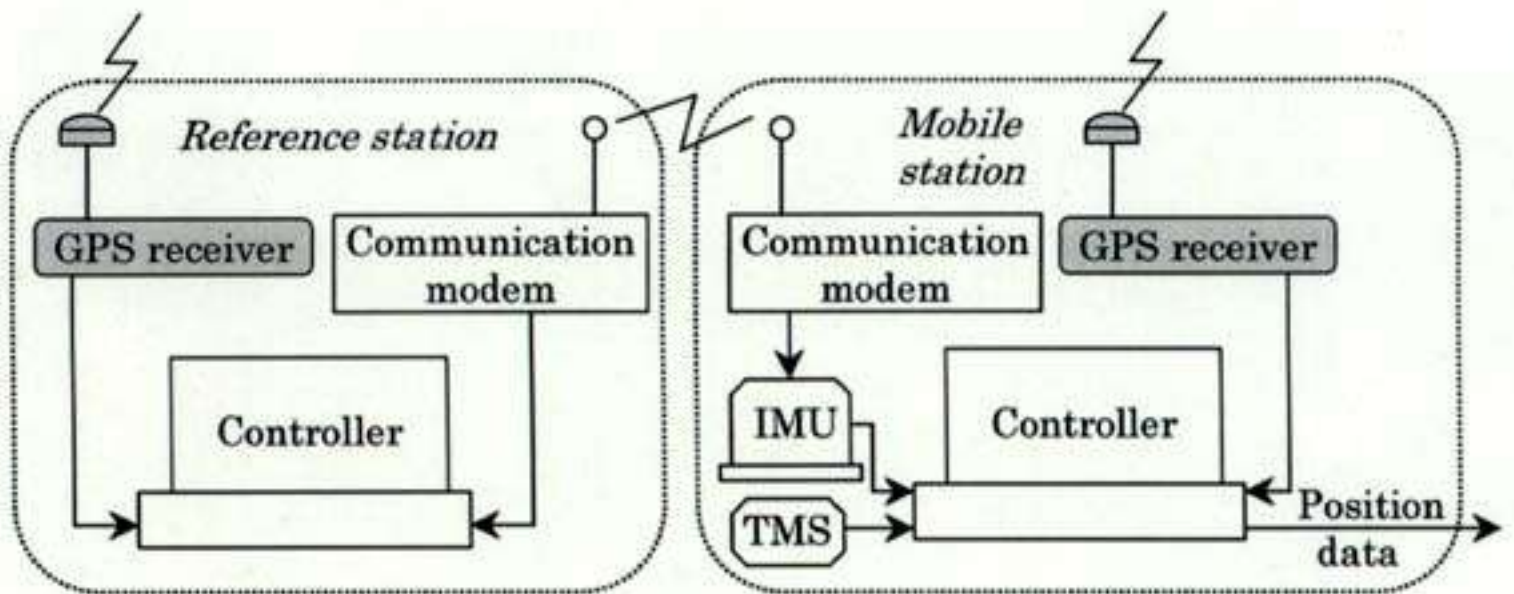


Fig. 4. Configuration of SNAV

BACK

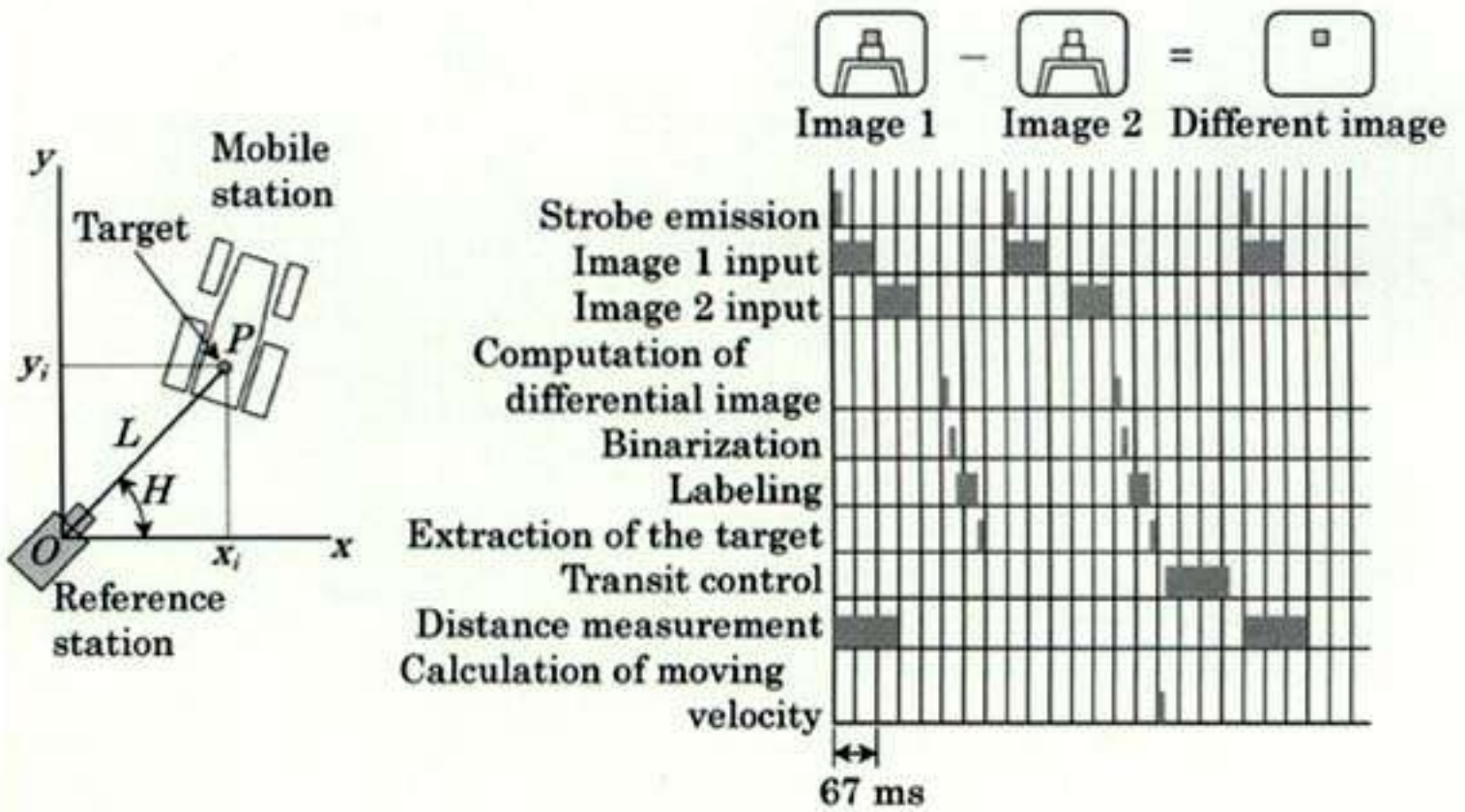


Fig. 5. Measurement principle and time chart of tracking in XNAV

BACK

Table 4. Specifications of the AP-L1

Automatic tracking section	Tracking angular velocity : $10^\circ/\text{s}$ Tracking accuracy : $\pm 2 \text{ min}$ (at $10^\circ/\text{s}$) Laser : LED Laser (Class 1)
Range finder section	Range : 7–700 m Accuracy : $\pm (10 \text{ mm} + 2 \text{ ppm})$ Intervals : $> 0.5 \text{ s}$
Transit	Accuracy : 3s
Function, etc.	Automatic target searching and retracking function, Data communication : RS232C, Radio modem

BACK

Robotization of Agricultural Vehicles (Part 2)

- Description of the Tilling Robot -

Osamu YUKUMOTO*1, Yosuke MATSUO*1 and Noboru NOGUCHI*2

*1 Fundamental Technology Department, Institute of Agricultural Machinery (BRAIN-IAM)
(Omiya, Saitama, 331-8537 Japan)

*2 Faculty of Agriculture, Hokkaido University
(Sapporo, Hokkaido, 060-8589 Japan)

Corresponding author: O. Yukumoto (oyukumot@iam.brain.go.jp, fax +81-48-654-7131)

Abstract

We have developed a tilling robot that can recognize its own position and heading, while performing unmanned tilling at almost the same work rate as manual work. The tilling robot is composed of navigation systems for positioning and heading, a robotized vehicle, a controller, and an operation software. A geomagnetic sensor (TMS) is utilized for the navigation system for heading. The operation software consists of teaching, path planning, vehicle controlling, self-diagnosis, and abnormality alarming sections. We found that the tilling robot can perform unmanned tilling operations over a whole field area of 50 a with almost the same efficiency and accuracy as manual work.

Discipline: Agricultural machinery

Additional key words: mobile robot, unmanned operation, operation software, tractor, navigation 1..11):[Reference](#)

(Received for publication, July 14, 1999)

Development of tilling robot

1) Tilling robot

The BRAIN-IAM has accumulated data related to technology for robotization of agricultural vehicles from several trials since 1988^{1,2,5}. The Ministry of Agriculture, Forestry and Fisheries launched an agricultural machine development project in the fiscal year 1993. A 5-year plan for the development of a tilling robot (1993 to 1997) was implemented under this project. This development was performed jointly with KUBOTA Co., Japan Aviation Electronics Industries, Ltd., Hokkaido Univ. and BRAIN-IAM.

The objective of the tilling robot is to develop a working vehicle that can recognize its own position and heading, while performing unmanned tilling, including headland treatment, at the same work rate as a manual operation. The target specifications are shown in Table 1. The fields are limited to paddy fields and upland fields that cover an almost flat and rectangular area. In our study, the robot works within sight of the operator, which enables the operator to stop the robot by remote control in case of emergency.

2) Target specifications for the navigation system

The performance required for the navigation system of tilling robots or robotized agricultural vehicles is

outlined in [Table 1](#). This table specifies the concurrent provision of positional information and the vehicle heading information. For position accuracy, we assume that the overlap width of the implement should be approx. 10 cm. The tolerance was set for half of that value to avoid untreated areas. The heading accuracy was set so that the overlap width of the implement would be maintained if the vehicle was operated autonomously, depending only on the heading information for a length of approx. 100 m of the assumed field and taking into consideration the capacity of the present heading sensor. Although the sampling interval for the position data was set at 1 s or less, it is assumed that the transitory changes of position during this interval, as required, are complemented by dead reckoning, etc.

Navigation systems

1) Navigation systems for positioning

We developed 3 types of navigation systems for positioning, namely an off-the-wire type, a kinematic GPS with inertial navigation system (INS) type, and an optical type.

The details of these navigation systems were described in "Robotization of Agricultural Vehicles (Part 1)".

2) Navigation system for heading⁶⁾

(1) System configuration and principle

Geomagnetic sensor (TMS) is a heading sensor used for the navigation system characterized by a free route and internal information with distance and heading type. A flux gate type TMS was adopted, which displays a relatively high reliability and is commonly used in the field of traffic. Principle of measurement is shown in [Fig. 1](#). Heading of the vehicle is represented by the relative angle from magnetic north by measuring the horizontal components x and y , which are detected by the intersected coils X and Y , and by calculating $\tan^{-1} (x / y)$. However, if the TMS mounted on the vehicle tilts together with the vehicle, it is impossible to detect the horizontal components of geomagnetism. Therefore, the geomagnetism must be detected as a 3-dimensional vector and the horizontal components must be calculated by measuring the pitching and rolling angles of the TMS using a clinometer. This operation is referred to as "calibration of inclination". In addition, because the vehicle itself is a magnetic substance, it is necessary to correct the error due to the influence of its magnetism. This correction is referred to as "calibration of magnetic environment". The influence of a magnetized substance is represented by the vector OO' in [Fig. 2](#). The vector OO' can be measured beforehand by running the vehicle in a loop in an area free of any magnetism from buildings, etc., and then the calibration of the magnetic environment is achieved using that value.

(2) Performance, precision, and ease of use

[Table 2](#) shows the main specifications of the TMS we used. After incorporation of the measured value into the computer and calibration of the inclination and the magnetic environment, a reproducibility of 0.3° was secured based on the trace of autonomous straight running with the TMS.

(3) Characteristics and problems

Although the cost of TMS is low and it has no driftage, TMS measures a very small magnetic field. This can cause a problem when the measured value is affected by surrounding structures, whose influences can not be corrected.

[NEXT](#)

[TOP](#)

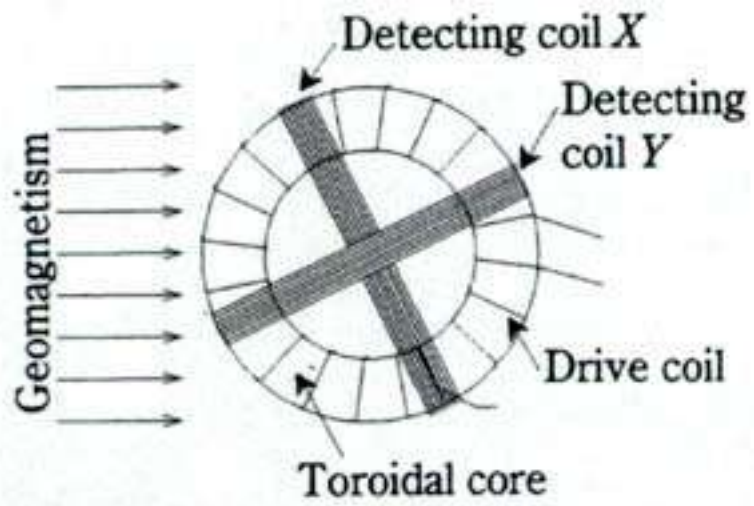
References

- 1) Matsuo, Y. & Yukumoto, O. (1994): Developments of autonomous operating system (Part 2). IAM-BRAIN, Omiya, 21-34 [In Japanese].
- 2) Matsuo, Y. & Yukumoto, O. (1995): Research on autonomous traveling with vision sensor and geo-magnetic sensor. IAM-BRAIN, Omiya, pp. 44 [In Japanese].
- 3) Matsuo, Y., Yukumoto, O. & Noguchi, N. (1998): Self-diagnosis and abnormality alarming of tilling robot and man-robot communication. *In 7th IEEE int. workshop on Robot and Human Communication Proc.*, IEEE, Takamatsu, 383-390.
- 4) Matsuo, Y., Yukumoto, O. & Noguchi, N. (1998): Navigation system and work performance of tillage robot. ASAE Paper No.983192, Orlando, pp. 12.
- 5) Yukumoto, O. et al. (1991): Developments of autonomous operating system (Part 1). IAM-BRAIN, Omiya, 1-27 [In Japanese].
- 6) Yukumoto, O. & Matsuo, Y. (1996): Measurement of magnetic field. *J. Jpn. Soc. Agric. Mach.*, 58(5), 93-96 [In Japanese with English summary].
- 7) Yukumoto, O. & Matsuo, Y. (1997): Navigation technology for tilling robots-Robotization of agricultural vehicles and the outline of navigation systems for robots. *In Int. Symp. on Mobile Agricultural Bus-System LBS and PA for the Large-Scale Farm Mech. Proc.*, Hokkaido Branch J. Jpn. Soc. Agric. Mach., Sapporo, 59-78.
- 8) Yukumoto, O. et al. (1998): Research on tilling robot. *Annu. Rep. 1997*, IAM-BRAIN, Omiya, 2-9 [In Japanese].
- 9) Yukumoto, O. et al. (1998): Development of tilling robot (part1) - Concept of control algorithm and task planning using position sensing system and geomagnetic direction sensor -. *J. Jpn. Soc. Agric. Mach.*, 60(3), 37-44 [In Japanese with English summary].
- 10) Yukumoto, O. et al. (1998): Development of Tilling Robot (part2) - Steering control on autonomous operation using position sensing system and geomagnetic direction sensor -. *J. Jpn. Soc. Agric. Mach.*, 60(4), 29-36 [In Japanese with English summary].
- 11) Yukumoto, O. et al. (1998): Development of tilling robot (part3) - Improvement in performance of 90° turn and sideways movement using position sensing system and geomagnetic direction sensor -. *J. Jpn. Soc. Agric. Mach.*, 60(5), 53-61 [In Japanese with English summary].

Table 1. Required specifications of tilling robot

Field	Re-adjusted, flat and rectangular field		
Operator	One man can supervise several robots, and perform other tasks at the same time		
Vehicle	Type	4WD, 20–25 kW Tractor	
	Implement	Rotary tiller	
	Controlled systems	Steering, shuttle system, brakes (right and left), throttle, hydraulic system and fuel cut system	
	Equipment	Automatic implement control system, bi-speed turning system	
Navigation systems	Position	Detecting error	: < 5 cm
		Detecting intervals	: < 1s
	Vehicle heading	Detecting error	: < 0.1°
Controller	Personal computer utilized in the trial model		
Operation software	Operations	Tillage, soil puddling, ridging, etc.	
	Operation method	Returning operation (including head-land operation)	
Safety systems	Emergency stopping system, system monitor, obstacle detecting system, radio-controlled system for vehicle stopping		

BACK



Heading direction $\theta = \tan^{-1}(x/y)$

Fig. 1. Principle of measurement of geomagnetic sensor

BACK

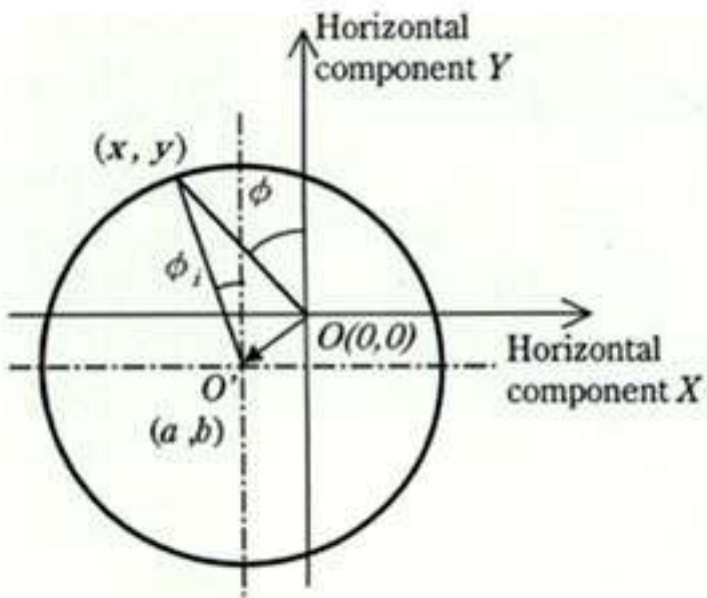


Fig. 2. Influence and calibration of magnetic environment

BACK

Table 2. Specifications of TMS
(Watson Industries Inc. Model FGM-200A)

Type	3-Axes fluxgate type
Axis alignment	$\pm 1^\circ$ to case
Range	$\pm 1,000$ mG
Zero field bias	0V $\pm 1\%$ full scale
Linearity error	Less than $\pm 0.5\%$
Frequency response	DC to 15 Hz
Input voltage	+6 to +15 VDC

BACK

Vehicle (ROBOTRA) and control systems^{7,8)}

1) Vehicle

To test the navigation systems and autonomous operation software, the ROBOTRA (Fig. 3) was developed by trial using a stock tractor as the base vehicle. Although the new original vehicles designed for a tilling robot could have been developed in this study, commercialized tractors were eventually used due to their versatility as well as the lower development cost. The respective specifications as listed in [Table 3](#), and presently the ROBOTRA is designed for rotary tilling work. Since this base vehicle has a shuttle gear, bi-speed turning system, and automatic depth and level control functions for rotary tiller, it is possible to simplify the control parts of the vehicle.

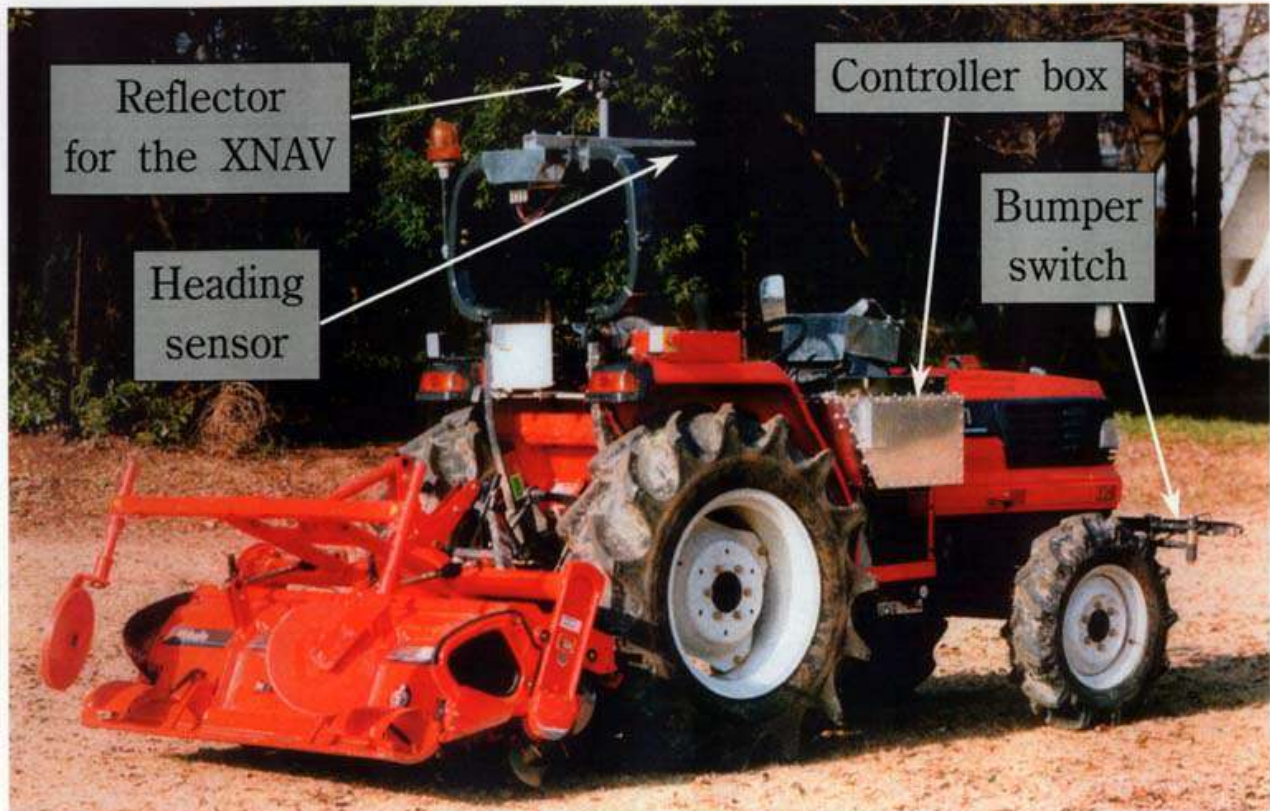


Fig.3. Robotized vehicle “ROBOTRA”

Control of each part is achieved through an exclusive vehicle controller, as shown in [Fig. 4](#). For steering control, the steering angle is detected by the potentiometer mounted on the output shaft of the steering gear box and fed back to the servomotor driver in the vehicle controller so that the specified steering angle can be obtained. To simplify the system, shift positions are manually set prior to the test so that the velocity is controlled by switching between the part throttle previously set and full throttle. To ensure safety, the ROBOTRA has an emergency stopping mechanism that is activated by either a bumper switch or through radio control.

2) Control system

The main controller inputs information items related to navigation as well as various internal information, determines the control value for each part of the vehicle according to a path plan, and outputs them to the vehicle controller. A personal computer is presently used for the main controller. Inputs and outputs are processed through various boards that are suitable for each type of signal. A

communication modem of spectrum spread type (developed by Cralion, Co.) was used for the data transfer between the reference station of the navigation system and the controller on the ROBOTRA.

[NEXT](#)

[TOP](#)

Table 3. Specifications of the base vehicle

Base vehicle		
Model	KUBOTA GL-320	
Type	4WD with front wheel steering	
Engine	23.5 kW / 2800 rpm	
Dimensions	L 3,180 × W 1,455 × H 1,985 mm, Weight 1,280 kg (excluding the implement)	
Additional equipment	Automatic implement control system (depth and level), bi-speed turning system, shuttle gear, power shift mechanism	
Control of each section		
Steering	DC servomotor	(position control)
Throttle	DC motor	(two-stage control)
Shuttle gear	Electric servo cylinder	(position control)
Brake system	Hydraulic cylinder	(two-stage control)
3P. linkage system	Electrical signal	(two-stage control)
Engine stopping system	Solenoid	
Others	Emergency stopping device by radio control and safety devices	

BACK

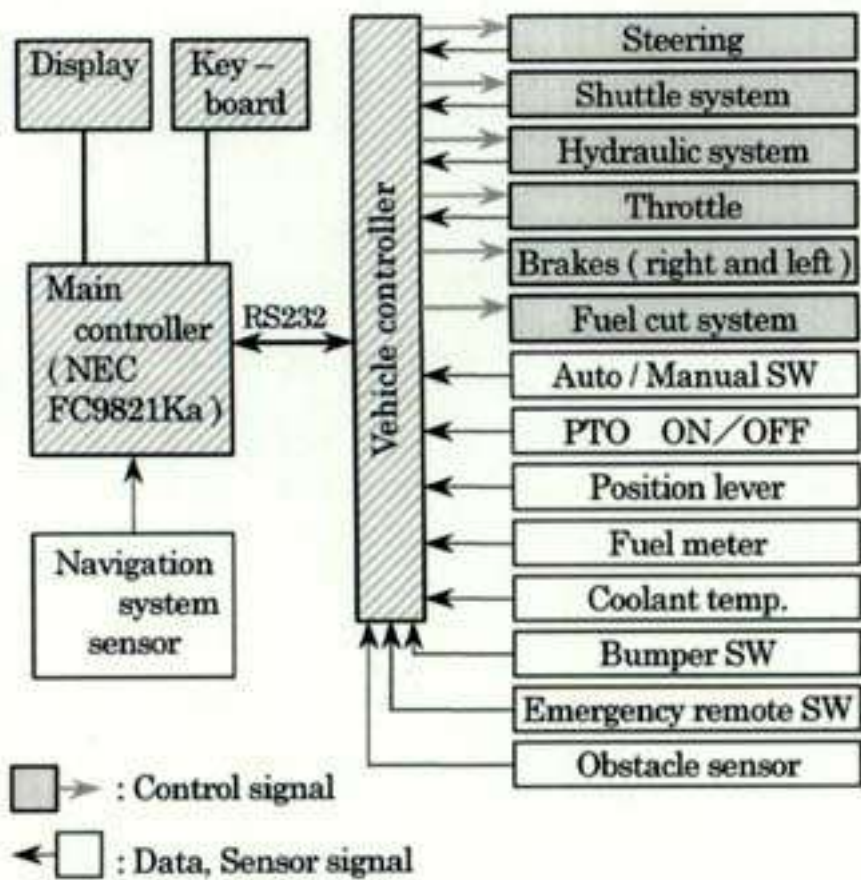


Fig. 4. Control systems of the ROBOTRA

BACK

Implementation of autonomous operation

1) Autonomous operation of tilling robots using the LNAV or SNAV [8\)](#)

The operation using the LNAV is executed by detecting the position of the vehicle through comparison of a signal with the magnetic reference. In the returning operation, an original method is applied to obtain the reference value of the next path, while performing the operation on the present path. Since the SNAV uses absolute latitude and longitude as its coordinate system, it differs from the XNAV. Therefore, the operation software applied to the SNAV uses a different method of managing the coordinate system from that for the XNAV, but the method is identical in other areas.

Presently, the performance of the autonomous operation using the LNAV or SNAV is almost equivalent to that of the autonomous operation using the XNAV described in the following section. Detailed explanation will be given separately.

2) Autonomous operation of tilling robots using the XNAV

(1) Concept and strategy [9\)](#)

In the autonomous operation with the XNAV, the TMS is also used concurrently for the navigation system with the AP-L1. Detecting intervals of positional data are slightly long and heading information for the vehicle is required for turning and sideways movement. The operation of the whole field is performed by first making returning operations around the center of the field, assuming that the field has a rectangular shape, and then making a round operation around the peripheral areas of the field, including the headlands. For the tilling operation using the ROBOTRA, triple round courses are needed to perform the operation in the peripheral area, because a headland length of nearly 5 m is required for a returning operation. To generate the operation paths, one manual teaching run was performed along the field boundary, as shown in [Fig. 5](#). Information on positions P_{0s} to P_{3e} and information on directions $\mathcal{A}E_0$ to $\mathcal{A}E_3$ were obtained during the teaching run. As shown in [Fig. 5](#), the operation paths consisted of,

- a. The transference path 1 from a corner of the field, the entrance to the field,
- b. Returning operation paths 1 to n, including the 180° turns in the headland,
- c. Transference path 2 from the end of the returning operation path to the starting point of round operation, and
- d. Round operation paths 11, 21, 31, ..., including the 90° turns in each corner of the field.

In path planning, it was assumed that the operation ended near the entrance to the field. By following the procedures of the actual operation reversely, the routes of 3 round operation paths were set so that the overlap between work areas was 10 cm, and the number of paths and routes of returning operation were set for the remaining area with proper overlap.

(2) Operation software [10,11\)](#)

Operation software to perform "teaching", path planning and autonomous operation consists of multiple software modules. [Fig. 6](#) shows the flow of general software. These software modules include "straight operation routine", " 180° turning routine", " 90° turning routine", "sideways movement routine", etc.

A returning operation consists of a straight run control and a 180° turn control. In the straight operation control routine ([Fig. 7](#)), an interval of 0.5 s was used to obtain position data and steering control. It was specified that heading data from the TMS would be applied to the straight run control for the period of time when normal position data could not be obtained. In addition, countermeasures were implemented, such as temporary retraction after an 180° turn to facilitate sideways movement for adjusting overlap at the starting point of tilling.

In the round operation module, highly precise positioning is required to avoid any extrusion beyond the border of the field area, to ascertain that there are no untreated areas and to minimize stamping of the treated area. Therefore, the following measures were incorporated:

- a. Small retraction or switchback before a 90° turn,
- b. Guidance to the target route after the turn, by sideways movements of forward and backward runs, and
- c. Providing learning function for the turning radius.

Options to change the operation method depending on the conditions of the field have been provided, such as performing round operations of the whole field or returning operations to diagonal directions of the rectangular field.

In addition, the positioning accuracy was improved at the end of the path by concurrently using dead reckoning at intervals of 0.1 s, based on the heading information and vehicle velocity.

(3) Self-diagnosis and abnormality alarming³⁾

To secure the reliability and safety of unmanned operations, this system is required with the following functions:

- a. A "self-diagnosis" function for confirming the normal operation of various sensors, actuators and control adjustment before starting the operation, and
- b. An "abnormality alarming" function for detecting the abnormalities of the system, and indicating any abnormalities to the operator (supervisor) during the operation, and/or temporarily discontinuing the operation until the abnormal state is eliminated.

These functions are incorporated into the operation software, as shown in [Tables 4 and 5](#).

(4) Work performance⁴⁾

To evaluate the performance of unmanned operation, we planned and executed 3 categories of evaluation tests as follows:

- a. Work performance tests to check the work efficiency and accuracy,
- b. Operation tests to check the ease of use and safety in the installation and setting of the robot, and
- c. Reliability tests to check the resistance to environments and the safety and reliability of work.

To evaluate the effect of labor-saving by unmanned operation, in the work performance tests, we introduced such indexes as operator efficiency which refers to the time during which the operator works in a unit area. And to evaluate the work accuracy, indexes on straight running performance were introduced, too.

Evaluation tests were executed in several fields. In some of the work performance tests, conventional manual operations were performed with the ROBOTRA by a skilled worker as well as under the conditions of unmanned operations. Examples of test results are shown in Table 6, and the trace of unmanned operation with the ROBOTRA and XNAV system in a paddy field 100 x 50 m in size is shown in [Fig. 8](#). The overlap between work areas was set at 10 cm for both returning and round operations with a 1.7 m width implement. We found that the work efficiency and the work accuracy were nearly equivalent to those of conventional manual operations. In the straight running performance, the robot was superior to a skilled operator. Throughout the evaluation tests, no trouble occurred and there was no problem in the resistance to environments and the durability of the robot.

Conclusion and prospects

The authors carried out studies on navigation systems such as LNAV, SNAV, XNAV and TMS for tilling robots. Using these navigation systems, the position of the moving vehicles can be recognized with an error less than 5 cm and at intervals less than 1 s. During these studies, we attempted to use them for field operations as far as possible and investigated the feasibility of robotizing agricultural vehicles.

The tilling robot was composed of these navigation systems, the prototype vehicle, the controller and the operation software. We observed that the tilling robot can perform unmanned tilling over a whole field area of more than 50 a with almost the same efficiency and accuracy as manual work. However, when an unmanned vehicle performs an operation such as tractor work, any abnormality or problem of hardware or software may lead to a serious accident. Therefore, the tilling robot was fitted with the self-diagnosis and abnormality alarming functions, which conferred a high reliability and provided a fail-safe system for any emergency.

Furthermore, when these technologies are introduced into actual fields, the following applications must also be studied.

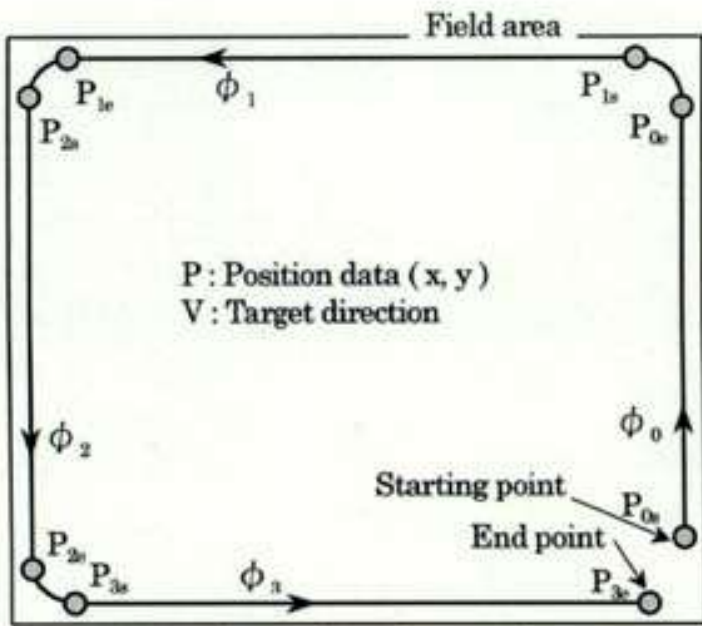
- 1) A single operator supervises several tilling robots that operate simultaneously.
- 2) The operator performs other tasks while supervising the operation of the tilling robot.
- 3) The tilling robot is also used for such operations as soil puddling, ridging, etc.
- 4) New working methods are developed to maximize the use of the robot's ability.

NEXT

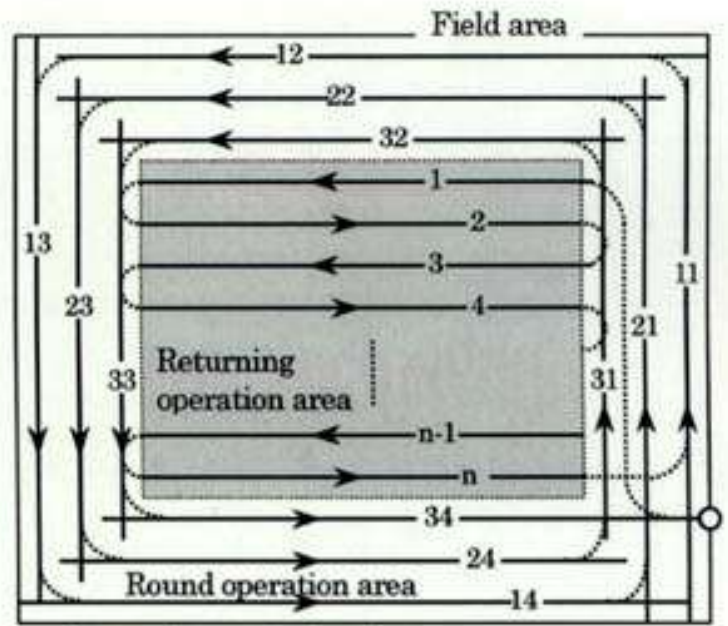
[:Cultural Control Systems of Naturalized Weeds in Forage Crop Fields](#)

TOP

HOME



Information obtained in teaching run



Operation path planning

← : Operation path

..... : Non - operation path

○ : Starting point (entrance of the field)

Fig. 5. Teaching and operation path

BACK

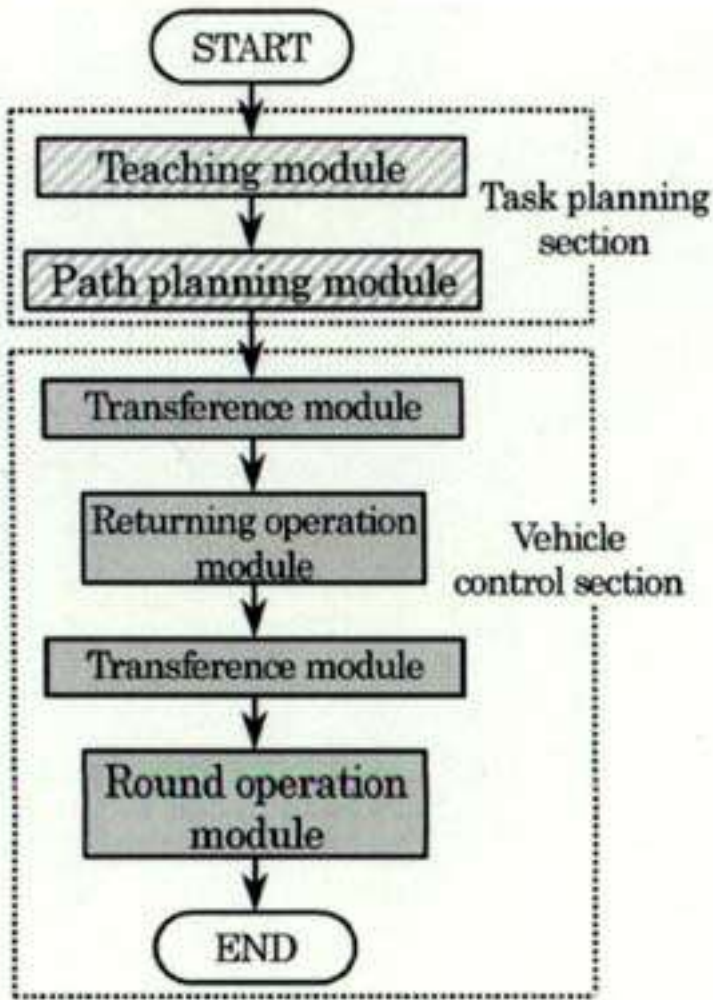


Fig. 6. Main flow chart of operation

BACK

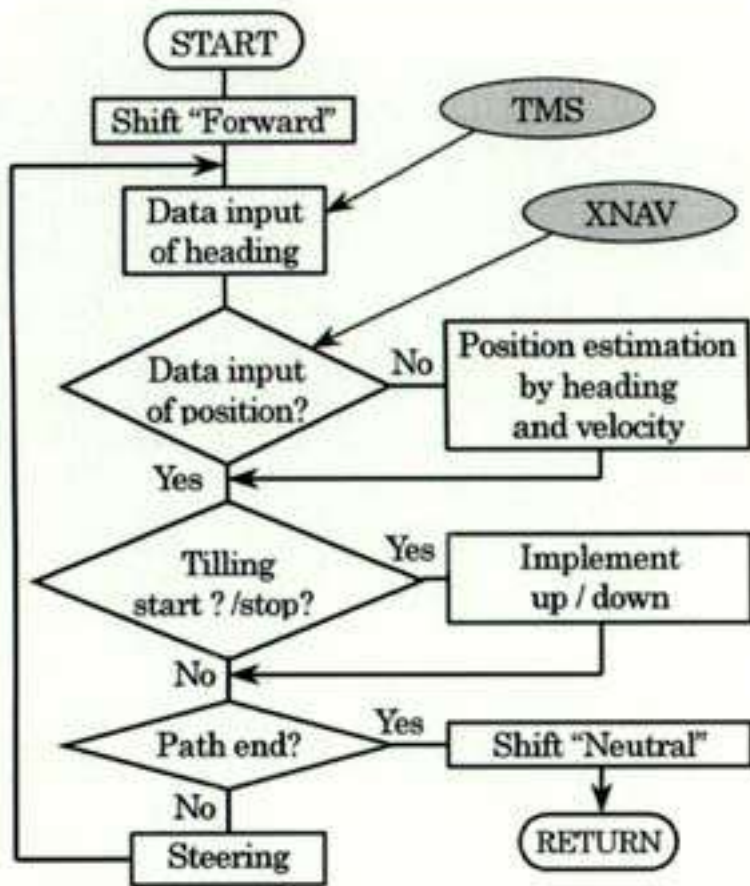


Fig. 7. Flow chart of straight operation routine

BACK

Table 4. Examples of self-diagnosing objects

No.	Item	Check criteria
1	Position data	1) normally acquired ? 2) in the field area ? 3) fluctuation is small ?
2	Heading data	1) normally acquired ? 2) in the direction along the longer side of field ? 3) fluctuation is small ?
3	Inclination data	1) normally acquired ? 2) almost level ?
4	Operation mode	automatic control mode ?
5	Gear position	set position ?
6	Position lever	in controllable position ?
7	PTO	turned on ?
8	Fuel	level > 1/2 ?
9	Steering	automatically actuated ?

Table 5. Checking of abnormalities

No.	Abnormal state
1	Position data abnormality-1 (data cannot be updated / data are abnormal)
2	Position data abnormality-2 (auto-recovery cannot be operated)
3	Position data abnormality-3 (data are outside of the field)
4	Excessive speed due to "dashing", etc.
5	Decrease in speed due to slippage, etc.
6	Excessive inclination
7	Overload to engine
8	Fuel shortage
9	Detection of obstacles

BACK

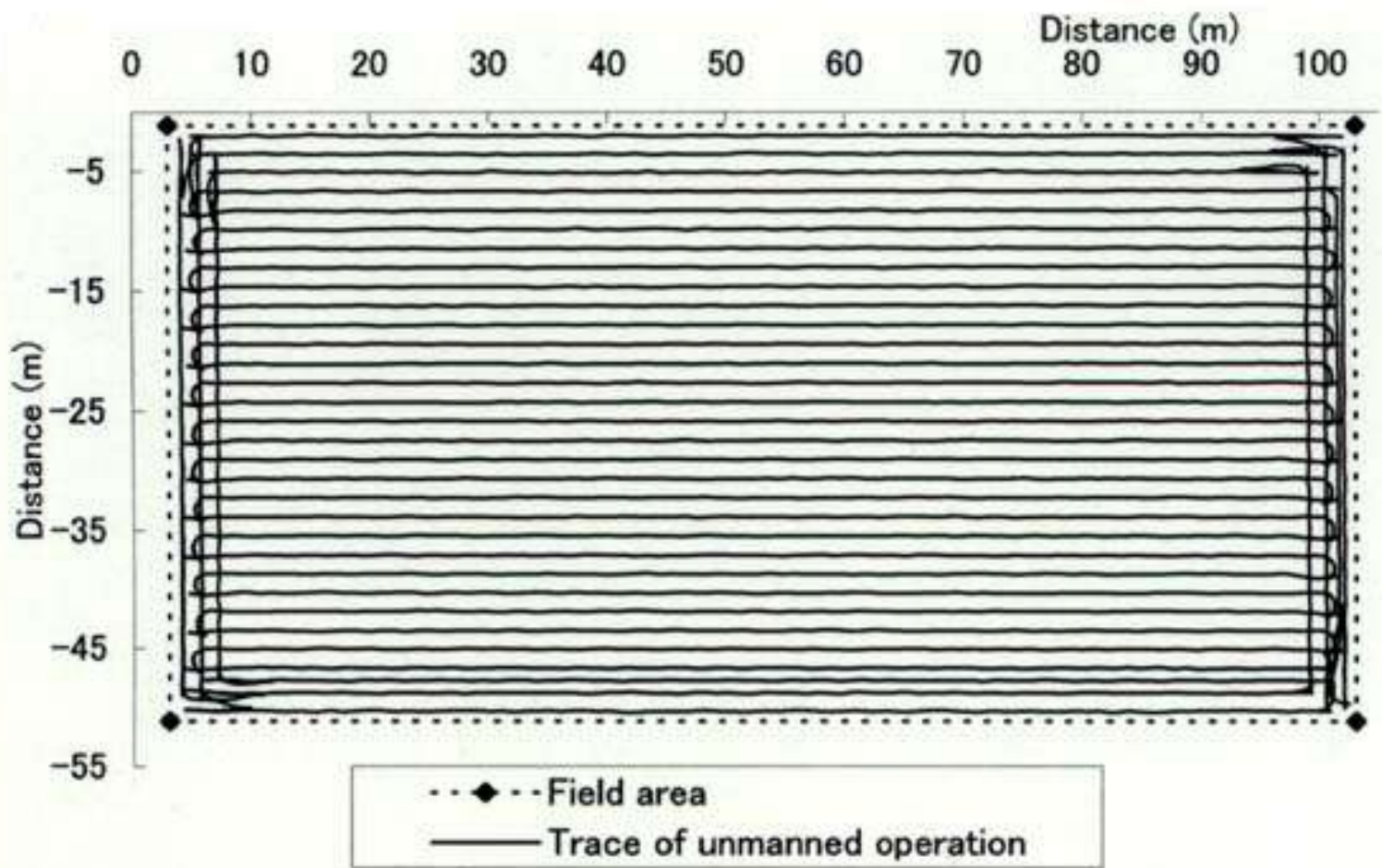


Fig. 8. Trace of unmanned operation with XNAV in a paddy field

BACK

Cultural Control Systems of Naturalized Weeds in Forage Crop Fields

Seturo SATO*1, Koji TATENO*2, Ryoji KOBAYASHI*3 and
Kuniaki SAKAMOTO*4

*1,2,3 Grassland Division, Kyushu National Agricultural Experiment Station
(Nishigoshi, Kumamoto, 861-1192 Japan)

*4 Department of Research Planning and Coordination, Kyushu National Agricultural Experiment Station
(Nishigoshi, Kumamoto, 861-1192 Japan)

Present address:

*1 Department of Animal Production, Chugoku National Agricultural Experiment Station
(Oda, Shimane, 694-0013 Japan)

*2 Department of Research, Planning and Coordination, National Grassland Research Institute
(Nishinasuno, Tochigi, 329-2793 Japan)

Corresponding author: S. Sato(uhyouhyo@anim.affrc.go.jp, fax +81-8548-2-2280)

Abstract

Experiments were conducted to control spiny amaranth (*Amaranthus spinosus* L.) and velvetleaf (*Abutilon theophrasti* Medic.) in a field of forage corn sown in early, mid-and late spring by using an Italian ryegrass (*Lolium multiflorum* Lam.) living mulch, and to control swinecress (*Coronopus didymus* (L.) J. E. Smith) in an Italian ryegrass sward by dense sowing at the Kyushu National Agricultural Experiment Station, Nishigoshi, Kumamoto. Growth of spiny amaranth in the corn field depended on weed control treatments. The living mulch adequately controlled the weed in the field of corn sown in early spring, but the weed-controlling effect was reduced with the delay in the sowing date, and the living mulch did not control the weed in the late spring sowing plot. Although the living mulch substantially reduced the fodder yield of corn in the early spring sowing plot, it only slightly reduced the corn yield in the mid-spring sowing plot. Pre-emergence application of atrazine + alachlor adequately controlled the weed irrespective of the sowing dates. Neither living mulch nor pre-emergence herbicide mixture adequately controlled velvetleaf, but the growth of velvetleaf in the field of forage corn depended on the sowing date of corn. At the time of corn harvest, growth in the late spring sowing plot was more reduced than that in the plot sown in mid-spring, which indicates that a shift of the corn sowing date to late spring could be effective for avoiding damage by velvetleaf. Sowing of Italian ryegrass at twice as much as the standard density adequately suppressed the growth of existing swinecress in the ryegrass sward, and dense sowing markedly reduced the amount of the weed both in the first and second croppings of ryegrass without reduction of the crop yield. Cropping systems of forage crops that could effectively avoid the damage caused by velvetleaf, spiny amaranth and swinecress were examined based on the experimental results.

Discipline: Weed control

Additional key words: dense sowing, living mulch, spiny amaranth, swinecress, velvetleaf

1...13): [References](#)

(Received for publication, June 16, 1999)

Introduction

In recent decades, various alien weeds have been detected in forage crop fields throughout Japan. It is considered that these species were introduced through imported concentrates¹⁰⁾, and some of them are recalcitrant. Our previous questionnaire revealed that the most serious naturalized weeds in the Kyushu district were spiny amaranth (*Amaranthus spinosus* L.) and velvetleaf (*Abutilon theophrasti* Medic.) in forage corn fields and swinecress (*Coronopus didymus* (L.) J. E. Smith) in Italian ryegrass swards³⁾.

Spiny amaranth and velvetleaf compete with corn during the growing season, and their mature lignified plants, which reach 2 m or more in height, mechanically disturb the harvest. Spiny amaranth often occurs in fields treated with the conventional pre-emergence herbicides, *i.e.*, atrazine, alachlor and their combination, and velvetleaf is considered to be resistant to the pre-emergence herbicides^{3,6,12)}. Although swinecress reaches a height of only 20 to 30 cm and has no adverse effect on Italian ryegrass growth, cows tend to produce milk with a strong odor of swinecress when the weed contaminated their feed⁹⁾. Swinecress plants are often overlooked because they slip into the ryegrass sward, and thus, chemical control of this weed is frequently unsuccessful.

For these reasons, it is important to develop cultural methods to replace chemical applications for the control of spiny amaranth, velvetleaf and swinecress.

Living mulch (cover crop) is considered to be a suitable cultural method to control weeds in row crops in the United States⁵⁾ and Sato et al.⁹⁾ reported that the growth of swinecress observed in Italian ryegrass swards was affected by the sowing density of ryegrass.

The objectives of this study were 1) to implement the cultural control of spiny amaranth and velvetleaf in forage corn fields by the use of an Italian ryegrass living mulch, 2) to control swinecress in Italian ryegrass swards by dense sowing, and 3) to analyze the cultural systems applied to control these weed species in forage crop fields.

[NEXT](#)[TOP](#)

References

- 1) Herr, E. D. & Stroube, E. W. (1970): Velvetleaf control as influenced by herbicide placement and seed depth. *Weed Sci.*, 18, 459-461.
- 2) Horowitz, M. & Taylorson, B. (1984): Hardseededness and germination of velvetleaf (*Abutilon theophrasti*) as affected by temperature and moistures. *Weed Sci.*, 32, 111-115.
- 3) Kobayashi, R., Tateno, K. & Sato, S. (1993): Occurrence of naturalized weeds in forage crop fields in Kyushu, and promotion methods for germination of velvetleaf, spiny amaranth and swinecress seeds. *Res. Bull. Kyushu Branch Jpn. Grassl. Sci. Soc.*, 23(2), 14-20 [In Japanese].
- 4) Oliver, L. R. (1979): Influence of soybean (*Glycine max*) planting date on velvetleaf (*Abutilon theophrasti*) competition. *Weed Sci.*, 27, 183-188.
- 5) Paine, L. K. & Harrison, H. (1993): The historical roots of living mulch and related practices. *HortTechnology*, 3, 137-143.
- 6) Ritter, R. L. (1986): Triazine resistant velvetleaf and giantfoxtail control in no-tillage corn. Proc. 40th Annu. Meet. Northeastern Weed Sci. Soc., 50-52.
- 7) Sato, S., Tateno, K. & Kobayashi, R. (1994): Influence of seeding date on flowering and seed production of velvetleaf (*Abutilon theophrasti*). *Weed Res. Jpn.*, 39, 243-248.
- 8) Sato, S., Tateno, K. & Kobayashi, R. (1994): Occurrence and control of naturalized weeds in forage crop fields in Kyushu. *Syokutyo*, 28, 53-63 [In Japanese].
- 9) Sato, S. et al. (1996): Cultural control of swinecress (*Coronopus didymus*) in Italian ryegrass (*Lolium multiflorum*) sward by dense sowing. *Weed Res. Jpn.*, 41, 107-110.
- 10) Shimizu, N. et al. (1994): Recent situation of emergence of alien weeds invading grasslands and forage crop fields. *Weed Res. Jpn.*, 39(suppl. I), 228-229 [In Japanese].
- 11) Tateno, K. & Kobayashi, R. (1993): Research on naturalized weed occurrence in forage crop fields in Kyushu district. *J. Jpn. Grassl. Sci. Soc.*, 39(suppl.), 65-66 [In Japanese].
- 12) Warwick, S. I. & Black, L. D. (1988): The biology of Canadian weeds. 90. *Abutilon theophrasti*. *Can. J. Plant Sci.*, 68, 1069-1085.
- 13) Yamamoto, I. & Fukami, J. (1979): Pesticide Design. Soft Science Inc., Tokyo, 1093-1098 [In Japanese].

Materials and methods

All the experiments were conducted at the Kyushu National Agricultural Experiment Station in Nishigoshi, Kumamoto. The soil type was a thick high humic Andosol (Melanudands). Plots were arranged in a randomized complete block design with 2 or 3 replications, and data were subject to an analysis of variance ($P < 0.05$).

1) Control of spiny amaranth and velvetleaf in forage corn field

Experiments were conducted to control spiny amaranth and velvetleaf in a forage corn yield using a cultural method in 1995 and 1996. The experimental design is shown in [Table 1](#). Corn (*Zea mays* L. cv. Pioneer 3352) was sown 20 cm apart in rows 0.75 m apart in 3 m long plots. Velvetleaf seeds were treated with water at 70°C for 15 min to promote their germination². After sowing of spiny amaranth or velvetleaf seeds, plots were treated with either a living mulch or a pre-emergence herbicide mixture to control the weeds. Italian ryegrass (*Lolium multiflorum* Lam. cv. Tachiwase) was sown at a density of 0.3 and/or 0.6 kg/a in the living mulch plots, and pre-emergence application of atrazine + alachlor at a rate of 10.0 + 10.8 g/a was performed in the herbicide-treated plots. For each weed, a single plot was left untreated as a check plot. In all the experiments, both the sowing of the weeds and the weed control treatments were carried out on the same day as the sowing of corn.

To monitor the growth of weeds and corn, vegetation from either a 0.4 x 0.75 or a 0.6 x 0.75 m area with 2 or 3 corn plants in the center was cut periodically, and leaf area and dry weight of weeds and corn were determined. At harvest time, 5 corn plants from a 1 m section of a central row in each plot, and vegetation in a 1 m section of interrow adjacent to the central row were cut to determine the dry weight.

2) Control of swinecress in Italian ryegrass sward

On October 18, 1995, Italian ryegrass was sown in three 3 x 6 m plots infested with swinecress seeds previously sown at a density of 50 g/a. In one of the plots, ryegrass was sown at a density of 250 g/a with post-emergence application of thifensulfuron-methyl (Harmony) at a rate of 0.375 g/a 6 weeks after sowing (herbicide-treated plot). In the 2 remaining plots, ryegrass was sown at the density of 250 g/a (check plot) and 500 g/a (dense-sowing plot) without herbicide application. Samples of crops from the first and second croppings (hereafter referred to as "first and second crops") from two 0.5 x 0.5 m quadrates in each plot were harvested on April 15 and May 2, 1996, respectively. All the samples were assorted into the ryegrass and swinecress (no other species were found), and the growth of the weed and yield of ryegrass were determined. Prior to the sowing, swinecress seeds were treated by the method of Kobayashi³ to promote their germination. Plots were fertilized at a rate of 0.5-0.5-0.5 kg/a with a 16-16-16 N-P₂O₅-K₂O compound fertilizer before sowing.

[NEXT](#)[TOP](#)

Table 1. Experimental design of spiny amaranth and velvetleaf control^{a)}

Cultural details	Corn sowing time		
	Early spring	Mid-spring	Late spring
Date of corn sowing	April 5, 1995	April 28, 1996	May 24, 1996
Amount of fertilizer applied (N-P ₂ O ₅ -K ₂ O)(kg/a)	3.0-3.0-3.0	2.5-2.5-2.5	2.5-2.5-2.5
Sowing rate (g/a) and sowing depth of spiny amaranth seeds (cm)	17.8 0	26.7 0-8	26.7 0-8
Sowing rate (g/a) and sowing depth of velvetleaf seeds (cm)	46.0 0	46.0 0-10	46.0 0-10
Plot size of one treatment (m) and no. of rows in a plot (rows/plot)	3.0 × 6.75 9	3.0 × 6.0 8	3.0 × 6.0 8
Weed control method ^{b)}	L3, L6, HB	L3, HB	L3, HB
Date of sampling to determine growth parameters in spiny amaranth control experiment (weeks after sowing)	7, 9, 11	5.5, 6.5, 7.5, 8.5	5.5, 6.5, 7.5
Date of sampling to determine growth parameters in velvetleaf control experiment (weeks after sowing)	6, 8, 10	5, 6, 7, 8	5, 6, 7
Harvest date	July 19, 1995	July 29, 1996	August 13, 1996

a): Each experiment was carried out in different fields.

b): L3 and L6: Italian ryegrass living mulch treatment sown at a density of 0.3 and 0.6 kg/a, respectively.

HB: Pre-emergence application of atrazine + alachlor at a rate of 10.0 + 10.8 a. i. g/a.

BACK

Results and discussion

1) Control of spiny amaranth and velvetleaf in forage corn field

(1) Spiny amaranth control

Changes in the weight of spiny amaranth during corn growth are shown in [Fig. 1](#). Italian ryegrass living mulch completely controlled spiny amaranth during the growing season of corn in the early spring sowing plot. Adequate weed control was achieved because Italian ryegrass grew vigorously enough to compete with the weed under cool temperatures during the growing season. The effect of the living mulch on weed control was less pronounced with the delay in corn sowing, and the mulch of the late spring sowing plot failed to control the weed because the ryegrass seedlings withered at high temperatures after emergence. The effect of the mulch on the control of spiny amaranth in the mid-spring sowing plot was intermediate between that of the early and late spring sowing plots.

Pre-emergence application of atrazine + alachlor adequately controlled spiny amaranth in every sowing. Weed seeds were present in the surface soil in the early spring sowing plot, and in soils at a depth of 0-8 cm in the mid- and late spring sowing plots. The herbicide mixture completely controlled the weed when the weed seeds were in and under the herbicide-treated layer. Since spiny amaranth is sensitive to atrazine + alachlor, these herbicides may be absorbed both through the roots and the hypocotyls exposed to the treated soil¹⁾.

Changes in the dry weight and leaf area of corn and spiny amaranth during corn growth are shown in [Table 2](#) and [Fig. 2](#), respectively. In the early spring sowing plot, the living mulch suppressed the growth of corn. The dry weight and LAI (leaf area index) of corn in the living mulch plots were found to be significantly smaller than those in the untreated and herbicide-treated plots during growth in the early spring sowing plot. In the mid-spring sowing plot, although the dry weight of corn in the living mulch plot was smaller than that in the untreated and herbicide-treated plots 6.5 weeks after sowing, and although the LAI of corn in the living mulch plot was smaller than that in the herbicide-treated plot 7.5 weeks after sowing, the living mulch suppressed the growth of corn less in the mid-spring sowing plot than in the early spring sowing plot. In the late spring sowing plot, the living mulch did not suppress the corn growth, and there was no difference in the growth parameters among the weed control treatments.

Dry weight of spiny amaranth at the corn harvest time and corn yield are shown in [Fig. 3](#). Spiny amaranth plants were not detected in the living mulch plots sown in early spring. In the mid-spring sowing plot, the dry weight of the weeds in the living mulch plots was smaller than that in the untreated plots, while in the late spring sowing plot, the dry weight of the weeds was similar. In the herbicide-treated plots, few spiny amaranth plants were observed, and the dry weight of the weeds was significantly smaller than that in the untreated plots in every sowing. In the early spring sowing plot, corn fodder yield in the living mulch plots was reduced to 60-66% of that in the untreated plot. In the mid-spring sowing plot, a slightly lower corn yield was observed in the living mulch plot. No significant difference was observed in the yield between the living mulch and the untreated plots in the late spring sowing plot. Corn fodder yield in the herbicide-treated plots was approximately similar to that in the untreated plots irrespective of the sowing dates. In the untreated and herbicide-treated plots, corn yield in the late spring sowing plot was lower than that in the early and mid-spring sowing plots, because harvest was earlier than the maturation time of corn to avoid damage by typhoons.

Meanwhile, pre-emergence application of atrazine + alachlor successfully controlled spiny amaranth irrespective of the sowing dates without any reduction in corn yield, although this herbicide mixture has often been reported to be ineffective in corn fields^{8, 11}). Failure to control the weed using pre-emergence herbicides is often observed in fields in which slurry and/or immature compost had been continuously applied. It is assumed that a change in soil adsorption resulting from continuous application of organic fertilizer might be responsible for the ineffectiveness of the pre-emergence herbicides¹³).

The results revealed that the Italian ryegrass living mulch 1) strongly suppressed corn growth in the early spring sowing although it could control the weed, 2) could not control the weed in the late spring sowing, and 3) could adequately control the weed in the mid-spring sowing without severe reduction of the corn yield. The use of the living mulch could be a suitable method of control of spiny amaranth in fields of forage corn sown in mid-spring if a slight reduction of corn yield and slight infestation with the weed were acceptable to the farmers. Moreover, it is definitely an effective method of control in the fields where application of slurry and/or immature compost as fertilizer had reduced the effectiveness of pre-emergence herbicides.

(2) Velvetleaf control

Changes in the dry weight of corn and leaf area of corn and velvetleaf during corn growth are shown in [Table 3](#) and [Figs. 4](#) and [5](#), respectively. Data on mid-and late spring sowings are presented and analyzed because velvetleaf seeds used in the early spring sowing were less vigorous and the percentage of emergence was too low to obtain the data.

Neither the Italian ryegrass living mulch nor pre-emergence herbicide mixture controlled velvetleaf during the growing season of corn irrespective of the sowing dates. There were no differences among the weed control treatments in terms of the growth of the weed for both sowing dates. Although the living mulch had no effect on weed growth because ryegrass seedlings withered at high temperatures, the dry weight of the weed in the late spring sowing plot was smaller than that in the mid-spring sowing plot for all of the investigation dates during corn growth.

In the mid-spring sowing plot, there were no significant differences in the change in the dry weight of corn between the plots treated with living mulch and untreated plots, and the dry weight of the herbicide-treated plots was largest among the weed control treatments. Although the LAI of corn in the mid-spring sowing plots was smaller in the living mulch and untreated plots than that in the herbicide-treated plots 5 and 6 weeks after sowing, no significant differences were observed among the weed control treatments subsequently.

In the late spring sowing plot, the living mulch did not suppress corn growth, and there were no differences in the growth parameters among the weed control treatments.

Dry weight of velvetleaf at corn harvest time and corn yield are shown in [Fig. 6](#). No significant differences were observed in the dry weight of velvetleaf among the weed control treatments in either the mid-or late spring sowing plot. However, the growth of the weed in the late spring sowing plot was much more reduced than that in the mid-spring sowing plot, and the difference corresponded to the weed growth during the corn growing season. The reduced growth of velvetleaf in the late spring sowing plot may have been caused, partly, by competition with vigorous corn growth during the growing season, and, partly, by the short photoperiodic response of the weed^{4,7}). There were no significant differences in the corn yield among the weed control treatments in either the mid- or late spring sowing plot.

In the current experiment, neither the Italian ryegrass living mulch nor the pre-emergence herbicide mixture could control velvetleaf in the forage corn field. However, shifting the sowing date to late spring should be recommended as a useful cultural method for avoiding damage by this weed.

[NEXT](#)

[TOP](#)

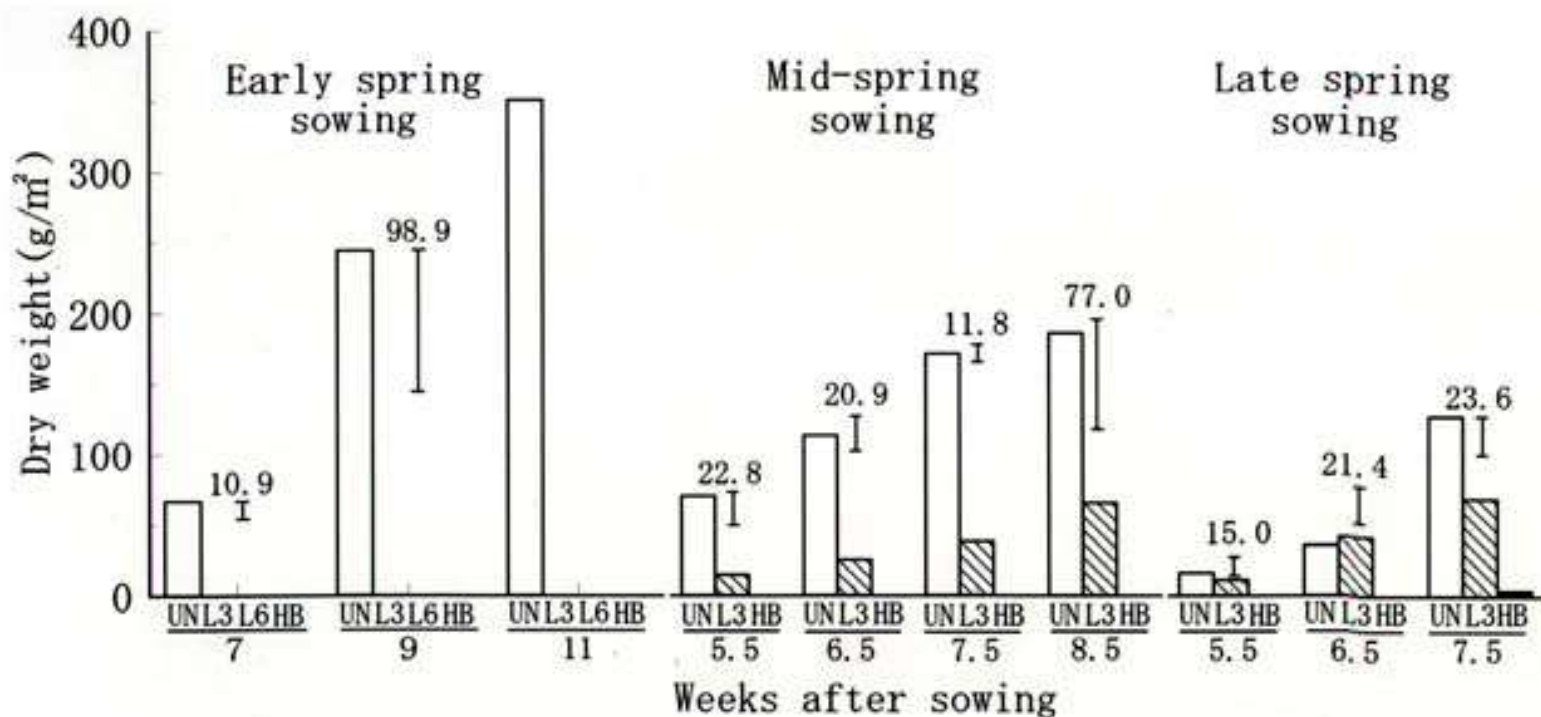


Fig. 1. Changes in dry weight of spiny amaranth during corn growth

UN(□):Untreated. L3(▨)and L6(▩):Italian ryegrass living mulch treatment sown at a density of 0.3 and 0.6 kg/a, respectively. HB (■):Pre-emergence application of atrazine + alachlor at a rate of 10.0+10.8 a. i. g/a.

Vertical lines indicate LSD($P < 0.05$).

BACK

Table 2. Changes in dry weight of corn during growth in the spiny amaranth control experiment ^{a)}
(g/m²)

Sowing time	Early spring			Mid-spring				Late spring		
	7	9	11	5.5	6.5	7.5	8.5	5.5	6.5	7.5
Untreated check	36.8A	191.6A	451.5A	53.0A	121.7A	182.5A	329.5A	75.5A	221.0A	498.2A
Living mulch plot (L3) ^{b)}	14.4B	47.7B	199.7B	56.9A	90.1B	201.5A	336.5A	79.6A	188.7A	560.9A
Living mulch plot (L6) ^{b)}	16.4B	69.7C	127.8C	-	-	-	-	-	-	-
Pre-emergence application ^{c)}	38.8A	158.0D	586.2D	62.1A	113.4A	253.4A	422.4A	73.8A	266.8A	574.5A

a): Values followed by the same letters within the same columns are not significantly different (P<0.05).

b): Living mulch plots were treated with Italian ryegrass sown at a density of 0.3 or 0.6 kg/a.

c): Mixture of atrazine+alachlor was applied at a rate of 10.0+10.8 a.i. g/a before corn seedling emergence.

BACK

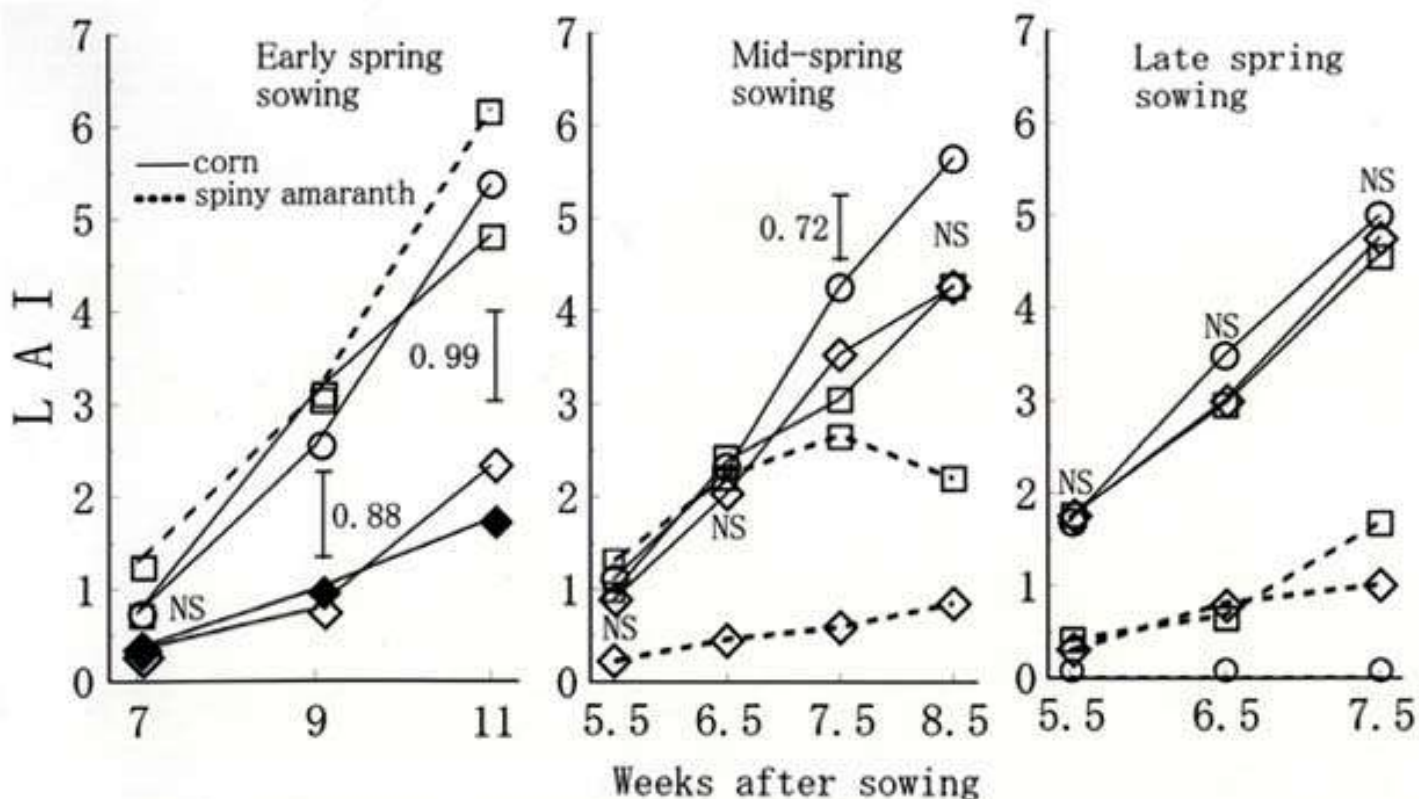


Fig. 2. Changes in leaf area of corn and spiny amaranth during corn growth

□: Untreated. ◇ and ◆: Italian ryegrass living mulch treatment sown at a density of 0.3 and 0.6 kg/a, respectively. ○: Pre-emergence application of atrazine + alachlor at a rate of 10.0+10.8 a. i. g/a.

Spiny amaranth plants were not observed in the living mulch plots nor in the herbicide-treated plots in the early spring sowing.

Vertical lines indicate LSD ($P < 0.05$) of corn. NS: Not significant ($P < 0.05$).

BACK

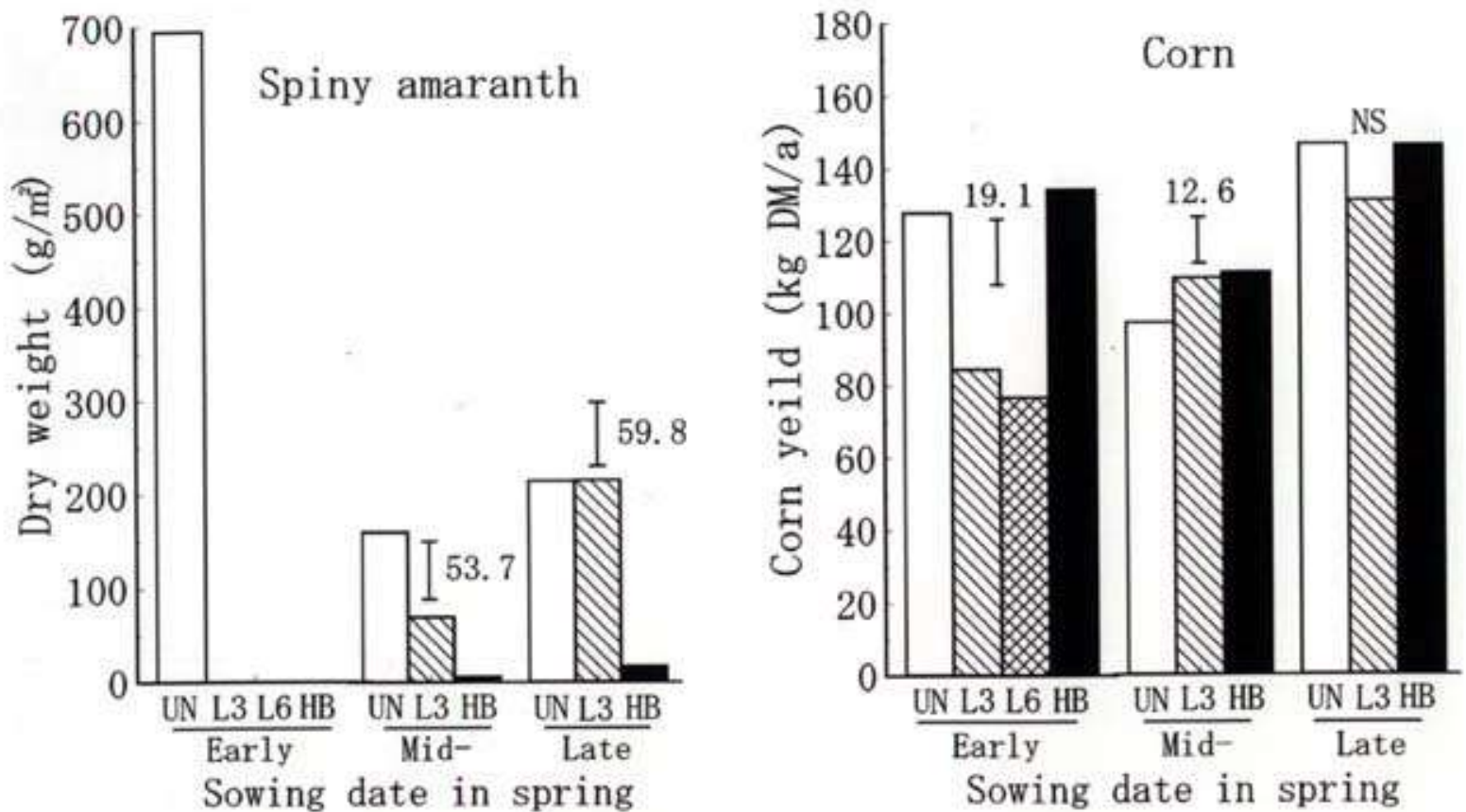


Fig. 3. Dry weight of spiny amaranth at corn harvest time and corn yield

UN(□):Untreated. L3(▨)and L6(▩):Italian ryegrass living mulch treatment sown at a density of 0.3 and 0.6kg/a, respectively. HB(■): Pre-emergence application of atrazine+alachlor at a rate of 10.0+10.8 a. i. g/a.

Vertical lines indicate LSD ($P < 0.05$). NS:Not significant ($P < 0.05$).

BACK

Table 3. Changes in dry weight of corn during growth in the velvetleaf control experiment^{a)}
(g/m²)

Sowing date	Mid-spring				Late spring		
	5	6	7	8	5	6	7
Untreated check	26.9A	71.4A	146.8A	212.2A	86.1A	137.2A	296.1A
Living mulch plot (L3) ^{b)}	25.4A	68.9A	145.6A	191.1A	83.9A	152.8A	328.0A
Pre-emergence application ^{c)}	36.3B	121.8B	195.8B	238.4A	82.4A	184.3A	332.6A

a): Values followed by the same letters within same columns are not significantly different ($P < 0.05$).

b): Living mulch plot was treated with Italian ryegrass sown at a density of 0.3 kg/a.

c): Mixture of atrazine+alachlor was applied at a rate of 10.0+10.8 a.i. g/a before corn seedling emergence.

BACK

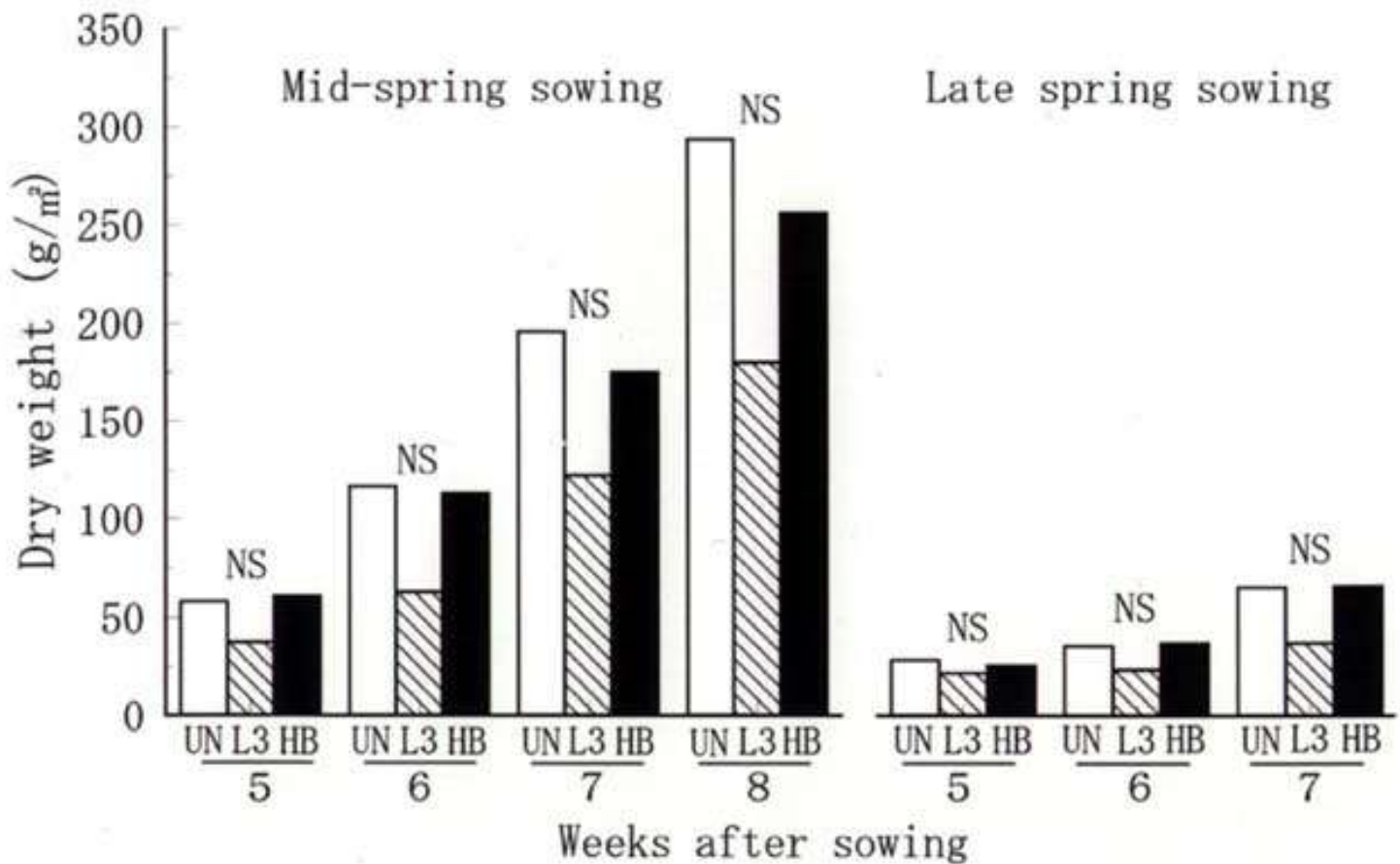


Fig. 4. Changes in dry weight of velvetleaf during corn growth

UN(□):Untreated. L3(▨):Italian ryegrass living mulch treatment sown at a density of 0.3kg/a. HB(■):pre-emergence application of atrazine+alachlor at a rate of 10.0+10.8 a. i. g/a.

NS:Not significant ($P < 0.05$).

BACK

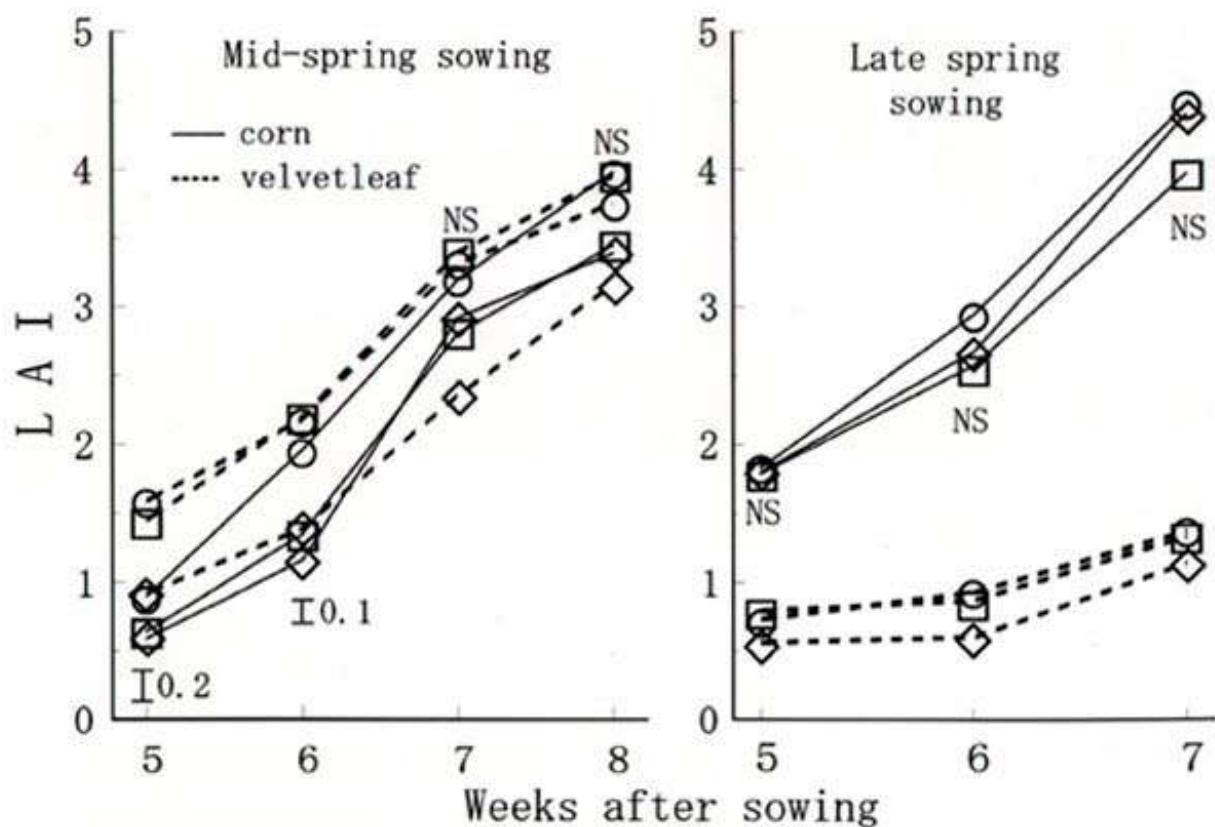


Fig.5. Changes in leaf area of corn and velvetleaf during corn growth

□:Untreated. ◇:Italian ryegrass living mulch treatment sown at a density of 0.3kg/a. ○:Pre-emergence application of atrazine+alachlor at a rate of 10.0+10.8 a. i. g/a.

Vertical lines indicate the magnitude of LSD (P<0.05) of corn. NS:Not significant (P<0.05).

BACK

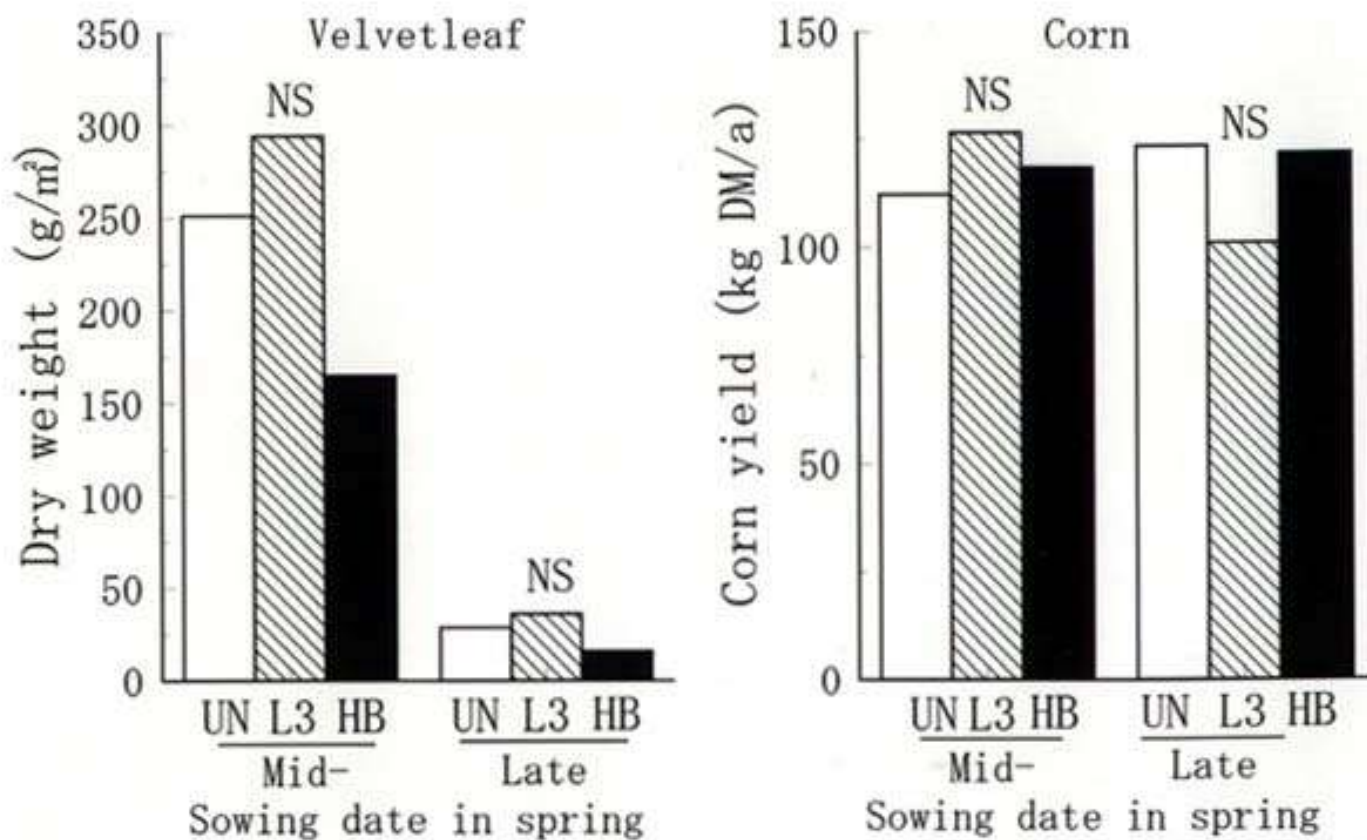


Fig. 6. Dry weight of velvetleaf at corn harvest time and corn yield

UN(□):Untreated. L3(▨):Italian ryegrass living mulch treatment sown at a rate of 0.3kg/a. HB(■): Pre-emergence application of atrazine +alachlor at a rate of 10+10.8 a. i. g/a.

NS:Not significant ($P < 0.05$).

BACK

2) *Control of swinecress in Italian ryegrass sward*

Growth of swinecress and yield of Italian ryegrass at harvest time are shown in [Table 4](#). At the first crop harvest, the plant density and weight of swinecress in both the dense sowing and herbicide-treated plots were smaller than those in the untreated plot. No flowering plants of the weed were observed in the first crop. At the second crop harvest, the plant density and weight of swinecress in both the dense sowing and herbicide-treated plots were much smaller than those in the untreated plot. After the first crop harvest, most of the swinecress plants in each plot resumed growth and flowered by the second crop harvest. The number of flowering plants in both the dense sowing and herbicide-treated plots was significantly smaller than that in the untreated plot.

Ryegrass yield in the dense-sowing plot was almost similar to that in the untreated plot, but was higher than that in the herbicide-treated plot at each harvest. The decrease of the ryegrass yield in the herbicide-treated plot was ascribed to injury by the herbicide during the growing season (Table 4).

It is concluded that dense sowing of Italian ryegrass should be a promising method not only for the suppression of the growth of swinecress plants present in the Italian ryegrass swards but also for the prevention of future infestation through the inhibition of seed production.

3) *Cropping systems of forage crops for weed control*

Forage corn production followed by the planting of Italian ryegrass is a major cropping system in the Kyushu district, where pre-emergence application of atrazine + alachlor is performed for weed control in forage corn field (System 1 in [Table 5](#)). Spiny amaranth and velvetleaf in the corn fields and swinecress in the ryegrass swards are the most serious weeds in this cropping system. The present study revealed that 1) ryegrass living mulch could be applied to control spiny amaranth in corn sown in mid-spring, 2) damage to corn caused by velvetleaf should be less serious in the late spring sowing than that in the mid-spring sowing, and 3) the growth of swinecress in the Italian ryegrass sward could be suppressed when the ryegrass is sown at a high density. Based on these results, Table 5 presents 5 modified cropping systems in the forage crop fields infested by these weed species.

Spiny amaranth could be controlled with the pre-emergence herbicide mixture irrespective of the sowing date. However, in the fields where fertilization with immature compost has reduced the effectiveness of the herbicide mixture owing to the changes in soil adsorption, Italian ryegrass living mulch should be applied for controlling the weed and corn must be sown in mid-spring in this case (System 2). Although neither the pre-emergence herbicides nor the living mulch could control velvetleaf, weed damage to corn was less appreciable in the late spring sowing. In the Kyushu district, when Italian ryegrass is harvested twice using a bale machine specialized for grass harvesting, the second crop is often harvested in mid-spring. Therefore, it is recommended to sow corn in late spring after the second harvest of Italian ryegrass to avoid the damage by velvetleaf and to use efficiently the bale machine (System 3).

As herbicide application is not useful to control swinecress in an Italian ryegrass sward, dense sowing may be the only effective method of weed control. In the case of the ryegrass sward already infested with swinecress, dense sowing might be combined with System 1, 2 or 3, depending on the weed species in corn, and Systems 4, 5 and 6 could be recommended.

NEXT

[:Safe Ammonia Treatment System of Cereal Straws for Ruminant Feeding](#)

TOP

HOME

Table 4. Growth of swinecress and Italian ryegrass yield harvest time^{a)}

Weed control treatment (sowing density of ryegrass)	First cropping ^{b)}				Second cropping ^{b)}			
	Swinecress ^{c)}			Italian ryegrass yield	Swinecress ^{c)}			Italian ryegrass yield
	No. of plants	Dry weight	No. of flowering plants		No. of plants	Dry weight	No. of flowering plants	
(kg/a)	(/m ²)	(g/m ²)	(/m ²)	(kg DM/a)	(/m ²)	(g/m ²)	(/m ²)	(kg DM/a)
Untreated (0.25)	28.3A	2.56A	0	113.6A	18.7A	1.74A	17.7A	38.8A
Dense sowing (0.50)	3.3B	0.05B	0	99.4A	2.7B	0.20B	2.3B	40.4A
Herbicide ^{d)} (0.25)	5.0B	0.03B	0	71.3B	1.0B	0.02C	1.0B	27.8B

a): Values followed by the same letters within same columns are not significantly different ($P < 0.05$).

b): First and second crops were harvested on April 15 and May 18, 1996, respectively.

c): Swinecress was sown at a density of 0.05 kg/a prior to the ryegrass sowing.

d): Post-emergence application of thifensulfuron-methyl (Harmony) was made at a rate of 0.375 g/a 42 days after ryegrass sowing.

BACK

Table 5. Cropping systems for the control of spiny amaranth, velvetleaf and swinecress in forage crop fields

Cropping System	Weed control treatment (▲)	Weed species	Pre-emergence herbicide effectiveness	Forage crops and their growing season												
				Jan.	Feb.	Mar.	Apr.	May	June	July	Aug.	Sep.	Oct.	Nov.	Dec.	
System 1	Pre-emergence application (▲ 1)	General	effective				○	~~~~~corn~~~~~	~~~~~	×			○	~~~~~	Italian ryegrass	~~~~~
				~~~~~	Italian ryegrass	~~~~~	×									
System 2	Living mulch (▲ 2)	Spiny amaranth	ineffective				○	~~~~~corn~~~~~	~~~~~	×			○	~~~~~	Italian ryegrass	~~~~~
				~~~~~	Italian ryegrass	~~~~~	×									
System 3	Shift of sowing date (▲ 3)	Velvetleaf	effective or ineffective				○	~~~~~corn~~~~~	~~~~~	×			○	~~~~~	Italian ryegrass	~~~~~
				~~~~~	Italian ryegrass	~~~~~	×									
System 4	Pre-emergence application (▲ 1)	General	effective				○	~~~~~corn~~~~~	~~~~~	×			○	~~~~~	Italian ryegrass	~~~~~
	Dense sowing (▲ 4)	Swinecress		~~~~~	Italian ryegrass	~~~~~	×						▲ 4			
System 5	Living mulch (▲ 2)	Spiny amaranth	ineffective				○	~~~~~corn~~~~~	~~~~~	×			○	~~~~~	Italian ryegrass	~~~~~
	Dense sowing (▲ 4)	Swinecress		~~~~~	Italian ryegrass	~~~~~	×						▲ 4			
System 6	Shift of sowing date (▲ 3)	Velvetleaf	effective				○	~~~~~corn~~~~~	~~~~~	×			○	~~~~~	Italian ryegrass	~~~~~
	Dense sowing (▲ 4)	Swinecress	ineffective	~~~~~	Italian ryegrass	~~~~~	×	~~~~~	×				▲ 4			

▲ 1-4: Weed control treatment. ○ : Sowing of forage crops. × : Harvest of forage crops.

BACK



# Safe Ammonia Treatment System of Cereal Straws for Ruminant Feeding

**Tomiharu MANDA*1, Masaru MURAI*2 and Akio YAMAZAKI**

Department of Research Planning and Coordination, Hokkaido National Agricultural Experiment Station (Hitsujigaoka, Sapporo, 062-8555 Japan)

Present address:

*1:Department of Research Planning and Coordination, National Institute Animal Industry (Kukisaki, Ibaraki, 305-0901 Japan)

*2:Department of Animal Production, Tohoku National Agricultural Experiment Station (Kuriyagawa, Morioka, Iwate 020-0123 Japan)

Corresponding author: T. Manda (manda@niai.affri.go.jp, fax +81-298-38-8573)

## Abstract

An ammonia treatment system for cereal straws has been recently developed in Japan. The new method is based on a contractor system and is referred to as the "HOKUNOU-S" system. Ammoniation can be used for all types of silos, including, stack, bag, tube and bunker silos as well as wrapped bales. In addition, this technique is suitable for use where a safe, economical, labor-saving treatment with ammonia can be applied. The injection system consists of a large-sized high-pressure vessel, a volume and pressure regulator, lead hose, an injection pipe and nozzle; the durability of this equipment and the safety of its handling comply with Japanese industrial standards. For one treatment, normally 8 kg of ammonia is injected into a round bale 1.2 m in diameter within 1-2 min. About 10 t or 40 round bales of cereal straw can be treated by a contractor within 1 h. By treating rice straw with ammonia, the TDN content of rice straw increased from 40 to 60%. As a result, treated rice straw was similar to good quality grass hay while treated barley and wheat straws were similar to grass hay harvested at a slightly later stage. An adequate level of breeding efficiency in yearly calving was obtained in the 3-year reproduction test using a total of 96 breeding cattle. The cost varied with the supply and demand of straw, the length of the actual working time of the wrapping machine, and field conditions (wet conditions cause an increase in time and therefore an increase in harvesting expenses).

Discipline: Animal industry

Additional key words: silage, animal nutrition, hyperexcitability in cattle

1...8):[References](#)

(Received for publication, July 23, 1999)

## Introduction

Feeding value, palatability, and digestibility of low-quality cereal straws can be remarkably improved by treatment of the straw with ammonia⁷⁾. Ammoniation of straw has thus contributed to a considerable increase in livestock production in many countries. A fully automated system of ammoniation is already being employed in some European countries. However, a method for ammoniating crop residues has only been partly adopted in Japan due to the difficulty in handling ammonia and farmers' collection of cereal straw. Furthermore, in Japan, the storage, transportation, handling and application of ammonia are more strictly regulated than in other countries. Use of ammonia is restricted by the following regulations: the Poisonous and Deleterious Substance Control Law, the High Pressure Gas Control Law, the Fire Service Law, the Industrial Safety and Health Law, and the Ordinance on the Prevention of Hazards due to Specified Chemical Substances. To promote widespread production and the use of cereal straw for feed, it is necessary to develop a safe, low-cost ammonia process as well as a system for supplying and using ammonia safely. Such a treatment system has been recently developed in Japan. The new method based on a contractor system is referred to as the "HOKUNOU-S" system³⁾.

[NEXT](#)[TOP](#)

## References

- 1) Kristensen, V. F. et al.(1991): Forgiftning forarsaget af ammoniakbehandlet grovfoder (Toxicity of ammoniated roughages). *Beretning fra Faellesudvalget for Statens Planteavlso Husdyrbrugsforsog*, 17, 1-41 [In Danish].
- 2) La Bore, D. E., Miksch, D. & Newman, L. E.(1984): Bovine Bonkers. *Herd Health Memo* 9, Univ. Kentucky, Lexington, 85-90.
- 3) Manda, T. et al.(1992): The "HOKUNOU-S" system, a new method of ammonia treatment for straw. *Misc. Publ. Hokkaido Natl. Agric. Exp. Stn.* 48, 1-196 ;In Japanese=.
- 4) Manda, T.(1993): Toxicity problems associated with ammoniated roughages. *Proc. Jpn. Soc. Anim. Nutr. Metab.*, 43(1), 23-46 [In Japanese].
- 5) Motoi, Y.(1994): Ammoniated forage poisoning of cattle. *Bull. Natl. Inst. Anim. Health*, 100, 21-28 [In Japanese with English summary].
- 6) Perdok, H. B. & Leng, R. A. (1987): Hyperexcitability in cattle fed ammoniated roughages. *Anim. Feed Sci. Tech.*, 17, 121-143.
- 7) Sundstol, F., Coxworth, E. & Mowat, D. N.(1978): Improving the nutritive value of straw and other low quality roughages by treatment with ammonia. *World Anim. Rev.*, 26, 13-21.
- 8) Ukawa, H. (1995): Crop-livestock integration in Hokkaido, Japan, based on ammonia-treated straw as livestock feed. *Food Fert. Technol. Cent.*, 407, 1-12.



## Description of the contractor system "HOKUNOU-S"

The operation of this new system consists of the following 3 functions: collection of cereal straw, wrapping of the straw with plastic stretch film, and ammonia injection. A specially trained and certified contractor injects liquid ammonia into wrapped round bales through a perforated stainless steel pipe. As illustrated in [Fig. 1](#), the contractors are responsible for dealing with the treatment while the farmers are required to bale, collect, and wrap the straw to be treated.

**Fig.2. Rapid and safe injection of ammonia**

Ammoniation can be used for all types of silos, including stack, bag, tube and bunker silos, as well as wrapped bales. In addition, this technique is suitable for use where a safe, economical, labor-saving treatment with ammonia can be applied and where the results of its effectiveness can be confirmed (Fig. 2). For outside storage, round bales wrapped with plastic stretch film allow for better treatment and preservation. There is a minimum risk of waste compared with that of stack and bunker silos. If the moisture content is high, the quality of straw ammoniated in stack or bunker silos is often reduced soon after opening.

### ***1) Rapid and efficient operation of ammonia injection***

The injection system consists of a large-sized high pressure vessel, a volume and pressure regulator, lead hose, an injection pipe and nozzle; the durability and safety of handling of this equipment comply with the Japanese industrial standards. Ammonia is injected through a perforated stainless steel pipe, the sharpened conical head of which is easily inserted into wrapped bales of straw. The pipe is perforated with a number of holes, 2-3 mm apart, along its length for efficient and faster injection of liquid ammonia, which results in the thorough volatilization of the remaining ammonia, as indicated by structural tests. A variable orifice meter controls the flow rate of liquid ammonia to the bale. However, other factors affect the flow rate of ammonia, such as the ambient temperature and the pressure of ammonia in the vessel. For one treatment, normally 8 kg of ammonia is injected to a round bale 1.2 m in diameter within 1-2 min. About 10 t or 40 round bales of cereal straw can be treated by a contractor within 1 h.



**Fig.3**  
**Wrapping of cereal straw with plastic stretch film**

**2) *New plastic stretch film and air-tightness***

Cereal straw, air-dried to less than 30% of its original moisture content, is collected and wrapped with a newly introduced plastic stretch film. This film was developed to improve various physical properties including the ability to stretch, plasticity, clinging ability and durability. All of these are combined to ensure a complete airtight seal for the prevention of mold growth and better preservation over longer periods of time, even when

ammoniation is delayed (Fig. 3). A rudimentary method of ammoniation was used to inhibit further mold growth in grass hay and cereal straw, particularly when they became wet due to rain. However, such wet materials must not be injected with ammonia, due to the possible formation of toxic substances. Due to the security issues relating to the safety of livestock feed and public food supply, there is a growing awareness of the potential problems associated with ammoniation of crop residues with excessively high moisture. These issues will be discussed later in this report.

**3) *Appropriate amount of ammonia injected***

Based on a number of experiments, the quality of treated straw can be improved when the amount of ammonia added increases. An amount of ammonia ranging from 2.5 to 3.5%, based on the dry matter of the straw, can be justified for the cost. Since in straw containing more than 30% moisture, a reduction in forage quality and the occurrence of toxic products are likely to occur, emphasis should be placed to determine the maximum amount of ammonia that can be safely administered. Four percent ammonia, based on the dry matter content, may be recommended as the upper limit. This amount will result in high performance in terms of cost and will also enable to avoid the risk of toxicity problems in livestock, e.g., hyperexcitability. As the concentration of ammonia is closely related to a satisfactory reaction with the straw, it is preferable to hire trained contractors than using farmers' more rudimentary methods to ensure that an accurate amount of ammonia is injected.

**4) *Distribution of ammonia injected into straw***

When ammonia is injected into the straw and absorbed, it binds to the fiber. Although the concentration of ammonia during dissipation remained at about 3.9% in a bag silo and 6.1% in a wrap silo just after injection, it drastically decreased to less than 1.0% after about 20 days and 0.78 and 0.82% remained approximately 103 days later, respectively. It was also observed that treatment with 1% ammonia always resulted in a lower level of permeation of ammonia than treatment with 3%, as evidenced by the average value of 0.02% about 103 days after injection. This type of ammonia became stable until 28 days after injection and did not change appreciably in the wrapped bales and bag silos ([Table 1](#)).

The amount of straw-bound ammonia can be estimated by air-drying a sample in an oven and measuring the increase in the nitrogen content of the treated materials. The amount of absorbed and straw-bound ammonia was calculated to be about 70 and 20% of the total amount, respectively, when an amount of 3% ammonia was used. The residual amount of ammonia injected vaporized and was released during storage. In straw with a high moisture content, a considerable amount of absorbed ammonia easily vaporizes and is released into the atmosphere, especially when combined with the moisture from ponds near the upper surface of the bale or stack when opened. Wastage of ammonia and air pollution can be prevented by avoiding treating straw with a high moisture content and by mixing ammonia in the treated materials with volatile fatty acids (VFAs). Ammonia binds well to the VFAs which are present in the silage. These aspects should be carefully considered as the treatment becomes more popular in Japan.

### ***5) Temperature for treatment***

A chemical reaction between ammonia and straw normally occurs faster at higher than at lower temperatures. When liquid ammonia is injected, the temperature increases rapidly, reaching a maximum value 2-6 h after injection. The increase ranges between 40 and 60°C, depending on the following factors: temperature at the onset, amount of ammonia injected, exposure time of the reaction, and moisture content of the treated materials. Due to the combination of internal temperature with radiant heat from sunlight, temperatures above 80°C can occur in the outer layer of round bales. The decrease in temperature also depends on a number of factors causing ambient temperatures to level off at about 15°C. This temperature is normally reached within 1-2 weeks after injection. Liquid anhydrous ammonia is gradually vaporized at the bottom of a stack, leading to a drastic cooling of the surroundings. The temperature at the bottom is below 0°C for 5 days after injection and reaches a value of 15°C (ambient temperature) after an additional 6-7 days ([Fig. 4](#)). The time necessary to treat cereal straw depends on the temperature; the lower the temperature, the lower the rate of treatment. Data on the temperature of the treatments revealed that optimum improvement in the feeding value can be achieved after 8 weeks of storage at temperatures below 5°C, between 4-8 weeks at temperatures around 5-15 °C, between 1-4 weeks at temperature from 15-30°C, and at 1 week at 30°C. These findings indicate that effective treatment requires more than 1 month at high temperatures and 3 months at low temperatures. Palatability is also improved when the duration of the period of treatment increases. Colorless and transparent films were initially used, which enhanced the increase of the ambient temperature. In the new injector system, white films were developed and were recommended for use in order to avoid the drastic increase of ambient temperature and toxicity of the treated materials to livestock.

[NEXT](#)

[TOP](#)

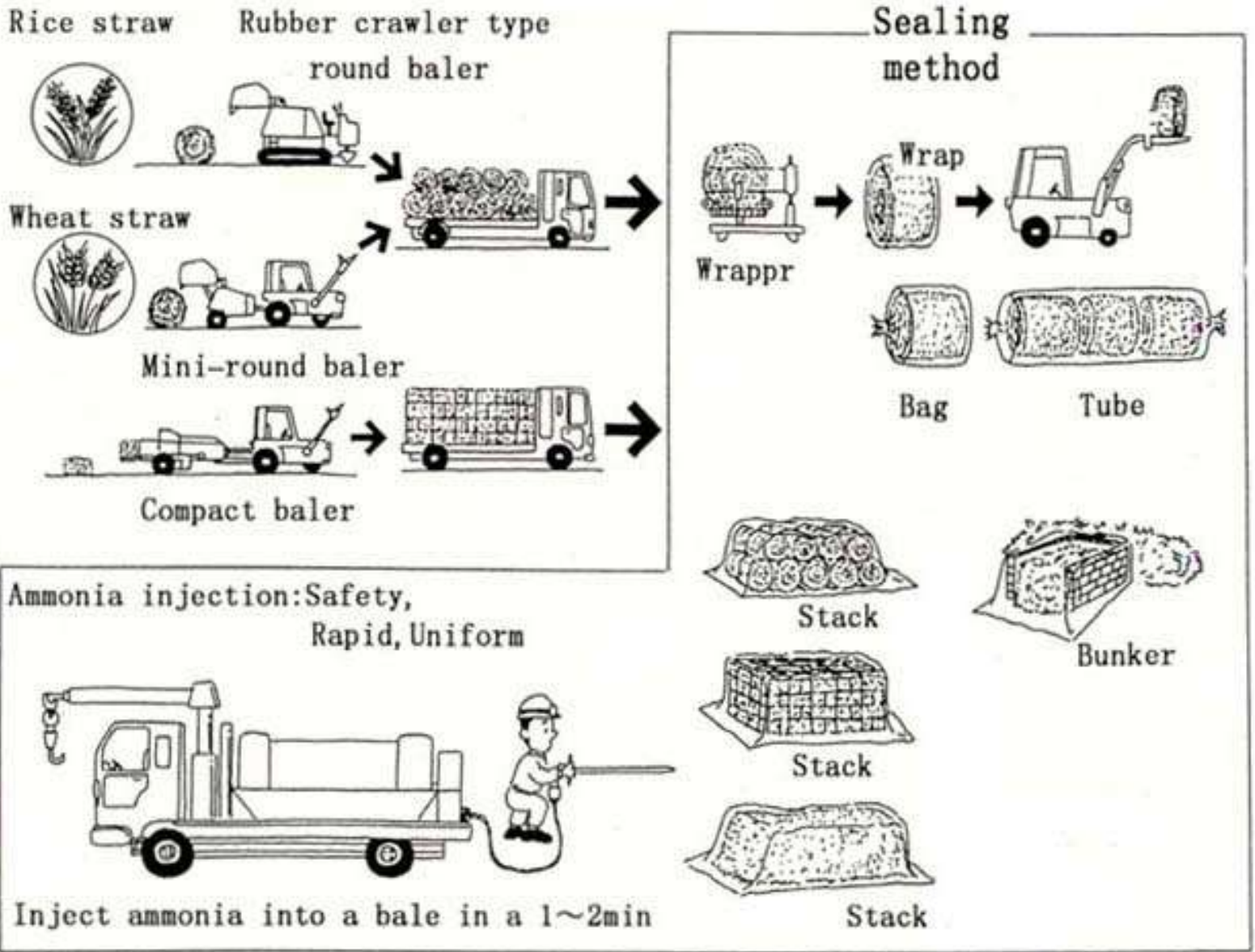


Fig.1. Illustrations of "HOKUNOU-S", a new contractor system

**BACK**

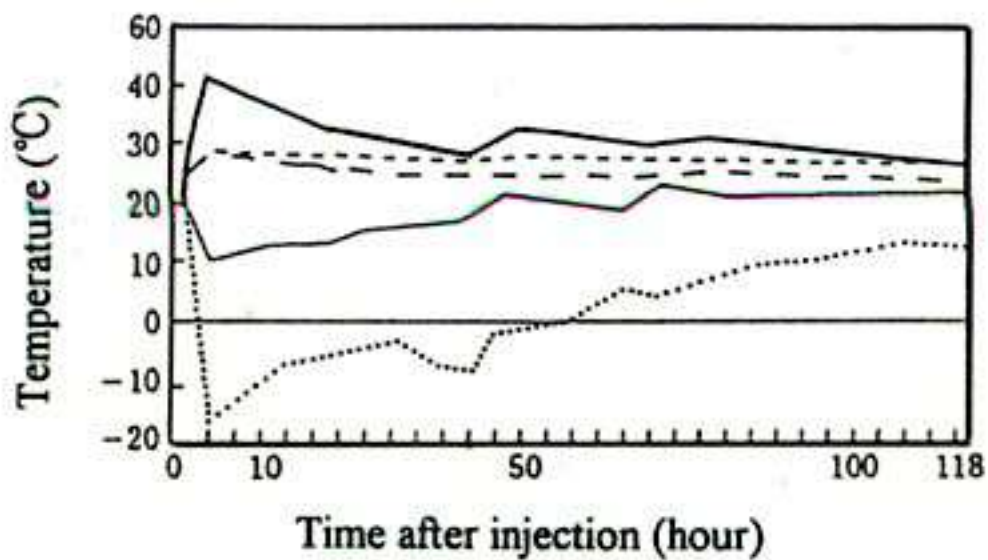
**Table 1. Distribution of ammonia injected into feedstuffs**

Type of silo	Bag silo			Wrap silo
Days after injection	14	28	56	56
	----- % -----			
Straw-absorbed NH ₃	70	89	84	109
Straw-bound NH ₃	20	34	35	40
Permeated NH ₃	0.2	0.3	0.4	0.8
Released NH ₃	30	10	16	-9

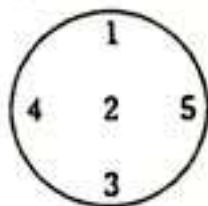
Cereal straw was treated with 3% ammonia based on dry matter weight.

**BACK**





— 1 — 2 - - - 3 - - - 4 - - - 5



Measuring points

Fig.4. Changes in temperature at various points in round bale, after the injection

BACK

# Feeding method of treated cereal straw for cattle and sheep

## *1) Intake of treated straw*

By treating rice straw with ammonia, the TDN (total digestible nutrients) content increased from 40 to 60%. Thus, treated rice straw was found to be similar to good-quality grass hay, while treated barley and wheat straws were similar to grass hay harvested at a slightly later stage. Ammoniated cereal straw offered to ruminants provides a larger source of supplementary nitrogen than grass hay. When fed to animals in higher amounts, supplements of minerals and vitamins are required. Cereal straw contains virtually no vitamins and fewer minerals than does grass hay. According to the practical guidelines for the feeding of ammoniated cereal straw in Japan, the recommended daily allowance of treated roughage was up to 2 kg per day per cow. These guidelines were set mainly because the concentration of ammonia in roughage (dry matter basis) was barely controlled under the conventional method, and was used only as a method of inhibiting mold in damp grass hay. The "HOKUNOU-S" system has been authorized for application to cereal straw, but not to grass hay. Furthermore, since it can only be applied under strict and safe conditions, it may enable to increase the intake of treated straw as ruminant feed, thus lowering the cost of production for beef and dairy cattle operations.

## *2) Feeding experiment with treated straw given to breeding beef cattle*

A 3-year reproduction test using a total of 96 breeding cattle was carried out at the Tokachi Farm of the National Animal Breeding Center and the Hokkaido National Agricultural Experiment Station in Japan. Cattle reared under the system of summer-grazing and winter-housing were fed treated straw during the winter. In these cattle, dry-matter intake of treated straw (6 kg per day), and palatability of treated straw as a basal ration were high ([Table 2](#)). The contents of vitamins and minerals of the treated straw are lower than those of grass hay. However, by supplementing the ration with vitamins A, D and E, phosphate, calcium, and other minerals, a satisfactory level of breeding efficiency in yearly calving was obtained ([Table 3](#)). The occurrence of white muscle disease in calves can be prevented by the addition of selenium in rations, since the selenium levels in the soils of field and cereal straw tend to be very low in Japan. If ammoniated straw is to be used as livestock feed, selenium should be added.

## Treatment costs for cereal straw

The treatment costs for cereal straw include the expenses for the purchase or baling of the straw, collection and transfer, and wrapping and ammonia injection. The cost is about 32 yen per kg of wheat or barley straw in Hokkaido and if the cereal straw could be home-delivered, the price may be reduced to 20 yen. The cost varies with the supply and demand of straw, the length of the actual working time of the wrapping machine, and field conditions-wet conditions cause an increase in time leading to the increase of harvesting expenses⁸⁾.

## Metabolic disorders in cattle fed treated roughages

Only in the last 2 decades has ammoniation of cereal straw and other agricultural by-products been subjected to research for use in animal feed rations. However, in 1984, the first cases of hyperexcitability in cattle and sheep fed on treated roughage were reported, due in large part to the increasing popularity of ammoniation as a method of enhancing the intake and digestion of low quality roughage in ruminants^{1,2,6)}. The hyperexcitability of ruminants, generally referred to as "Bovine bonkers", is associated with a neurological disorder. Thus, a number of leading factors have been extensively

examined, including the method of ammoniation, treatment temperature, level of intake of treated roughage, cereal species and variety, sugar and magnesium contents in the roughage. The possibility of transfer of substances to milk and other animal products should be more thoroughly investigated to ensure the safety of society's food supply.

### ***1) Feeding test for detection of possible toxicity of roughages in Japan***

Since the late the 1980s, feeding trials using treated rice, wheat, and barley straw have been extensively conducted on dairy cows and beef cattle in Japan. There have been no reports of the occurrence of metabolic disorders in ruminants fed cereal straw treated with 3% ammonia based on dry matter weight. It was also confirmed that straw treated with an amount of up to 6% ammonia did not show any adverse effect on the health and growth efficiency of steers; the feeding value was found to be as high as that of straw treated with a 3% concentration of ammonia. However, in rare cases where immature grass containing higher levels of soluble sugars was treated even with a 3% concentration of ammonia and was subsequently fed to cows, the suckling calves displayed signs of hyperexcitability⁵⁾, presumably due to the passage of toxins in cow's milk. A feeding trial using such toxic grass (treated with a 6% concentration of ammonia) showed a decrease in milk production in young dairy cows compared with previous calvings. Treatment of high-quality immature grass with high concentrations of ammonia was found to be toxic and to have an adverse effect on milk production⁴⁾.

### ***2) Practical guidelines for ensuring feed safety***

Several important factors must be considered for the ammoniation of crop residues. The feeding system, and type and age of animals are also equally important factors to be considered to determine whether treated roughage will have a toxic effect or cause hyperexcitability. By following a standardized procedure for ammoniation, the occurrence of "Bovine bonkers" can be prevented to achieve safety in animal production and in the supply of wholesome food to the public. It has been demonstrated that in the presence of moisture, ammonia and glucose react to form 4-methylimidazole. The 2- and 4-methylimidazole compounds are known to cause convulsions in mice and have been implicated in a clinical poisoning syndrome in cattle. The guidelines for ammoniation recommended in Japan are as follows:

(a) Roughage containing high levels of reduced sugars, including grass and whole crop feeds, should not be subjected to ammoniation. Moldy roughage should be excluded from treatment because it may produce toxic materials (Fig. 5).



**Fig.5. Moddy roughage that should not be ammoniated**

plastic stretch film and storing feed in a shaded area. It is also recommended to quickly wrap round bales to avoid heating due to respiration and aerobic fermentation.

The contractor must follow these guidelines completely, as required by the legislation concerning feeds and feed additives. The legislation has recently been amended in Japan to include the use of "HOKUNOU-S"-processed ammoniated straw as feed for ruminants.

(b) The concentration of ammonia administered is normally 3% or less, based on the dry matter of the straw; when the moisture content exceeds 30%, a concentration of up to 4% ammonia is permitted.

(c) Better diffusion of ammonia can be obtained by injecting ammonia into the lower part of round bales and turning the bales upside down.

(d) Treatment at high temperatures should be avoided by using white

[NEXT](#)

[:Isolation of Bacteria Producing Bluish-Purple Pigment and Use for Dyeing](#)

[TOP](#)

[HOME](#)

**Table 2. Dry matter intake of ammoniated wheat straw**

Year	Feeding period	Feeding days	Intake (DM kg d ⁻¹ )
1990	12/17 ~ 5/15	150	7.1
1991	12/ 5 ~ 5/20	167	6.3
1992	11/ 6 ~ 5/29	205	6.2

[BACK](#)

**Table 3. Breeding record of Japanese black beef cattle fed ammoniated cereal straw under a summer-grazing and winter-housing system**

Year	Insemination (No. of cattle)	Conception (No. of cattle)	Conception rate(%)	Stillbirth (No. of cattle)	Calving rate(%)	Delivery interval (days)
1990	30	29	96.6	1(1)	93.3	374
1991	33	33	100.0	2(1)	91.2	385
1992	33	33	100.0	2(0)	92.3	363

( ): summer grazing season.

**BACK**

# Isolation of Bacteria Producing Bluish-Purple Pigment and Use for Dyeing

**Akira SHIRATA*¹, Takanori TSUKAMOTO*², Hiroe YASUI*³, Tamako HATA*⁴, Shoji HAYASAKA*⁵, Atsushi KOJIMA*⁶ and Hiroshi KATO*⁴**

*^{1,2,5} Department of Sericulture, National Institute of Sericultural and Entomological Science (NISES) (Tsukuba, Ibaraki, 305-634 Japan)

*³ Department of Insect Physiology and Behavior, National Institute of Sericultural and Entomological Science (NISES) (Tsukuba, Ibaraki, 305-8634 Japan)

*⁴ Department of Insect Process Engineering, National Institute of Sericultural and Entomological Science (NISES) (Tsukuba, Ibaraki, 305-8634 Japan)

*⁶ Haya Science Firm (Tomioka, Gunma, 370-2451 Japan)

Present address:

*¹ Planning and Coordination Division, National Institute of Sericultural and Entomological Science (NISES) (Tsukuba, Ibaraki, 305-8634 Japan)

*² Yokohama Plant Protection Service (Kitanakadori 5-57, Naka-ku, Yokohama, 231-0003 Japan)

Corresponding author: A. Shirata (ashirata@affrc.go.jp, fax+81-298-38-6062)

## Abstract

*Janthinobacterium lividum* was isolated from wet silk thread whose color became bluish-purple^{7,8}. This bacterium produced large amounts of bluish-purple pigment on some media containing amino acids, such as Wakimoto medium. The pigment was extracted with methanol and was identified as a mixture of violacein and deoxyviolacein. This pigment could be used to dye not only natural fibers like silk, cotton and wool, but also synthetic fibers like nylon and vinylon, and generally gave a good color tone. The shade depended on the material. Silk, cotton and wool showed a bluish-purple color, nylon a dark blue color, and acetate a purple color. Dyeing could be performed by a simple procedure consisting of either dipping in the pigment extract or boiling with the bacterial cells. By changing the dipping time and the temperature of the dye bath, shades ranging from light purple to deep bluish-purple could be selected. The color fastness of the dyed material was about the same as that of materials dyed with vegetable dyes, but the color faded easily when the material was exposed to sunlight. However, since the pigment can be mass-produced by culturing, if these shortcomings could be overcome, the dye may become promising. The pigment displayed an antimicrobial activity against phytopathogenic fungi like *Rosellinia necatrix* which causes white root rot of mulberry⁷. It could also be used as a bio-fungicide.

Discipline: Sericulture

Additional key words: *Janthinobacterium lividum*, violacein, natural pigment, bluish-purple color.

1...9): [References](#)

(Received for publication, May 12, 1999)

## Introduction

At present, fabrics are dyed mainly with synthetic pigments. However, natural pigments are still valuable because of their natural color tones. People have had a strong liking for natural purple pigments since ancient times. Among the natural purple pigments, that obtained from shell fish belonging to the genus *Murex* is very famous. But it is very expensive because mass production is difficult. About 10 years ago, one of the present authors (Kojima) observed that parts of wet silk threads, that had been left unattended, had turned bluish-purple. Since then, this color change of silk thread waste was observed every year in winter⁷. In the course of studying this phenomenon, one of the present authors (Shirata) isolated *Janthinobacterium lividum* from such silk threads^{7,8}. The bluish-purple pigment produced by this bacterium dyes not only natural fibers like silk, wool and cotton, but also synthetic fibers like nylon and acetate fairly well. The main component of this pigment was found to be violacein, which could be obtained in large amounts by culturing the bacterium. Since the fabric dyed with this pigment has a mild feel, it can be successfully used as a fabric dye⁶.

[NEXT](#)

[TOP](#)



## References

- 1) Gillis, M. & De Ley, J. (1992): The genera *Chromobacterium* and *Janthinobacterium*. In *The prokaryotes* 2nd edition, 3, eds. Ballows et al., Springer-Verlag, Tokyo, 2591-2600.
- 2) Grace, T. D. C. (1962): Establishment of four strains of cells from insect tissues grown *in vitro*. *Nature*, 195, 788-789.
- 3) Hashimoto, T. et al. (1988): Blue pigments from a bacterium isolated from soil; structural determination, assignments of  $^{13}\text{C}$  NMR, and some structure-antibiotic activity relationship. *Bull. Fac. Agric. Niigata Univ.*, 40, 17-33.
- 4) Kato, H. et al. (1988): Interaction between a bluish-purple pigment (violacein) isolated from bacteria and thiourea. *Sen-i Gakkai Preprints*, 1998(G), G-132 [In Japanese].
- 5) Kato, H. et al. (1998): A method of improving light-fastness of blue bacterial pigment. *Jpn. Pat. Appl.*, Heisei No. 9-319906, November 20, 1998 [In Japanese].
- 6) Laatsch, H. & Thomson, R. H. (1984): Spectroscopic properties of violacein and related compounds; Crystal structure of tetramethylviolacein. *J. Chem. Soc. Perkin Trans.*, II, 1331-1339.
- 7) Shirata, A. (1997): Bluish-purple bacteria pigment. *BRAIN Tech. News*, 60, 14-15 [In Japanese].
- 8) Shirata, A. et al. (1997): Production of bluish-purple pigments by *Janthinobacterium lividum* isolated from the raw silk and dyeing with them. *J. Seric. Sci. Jpn.*, 66 (6), 377-385 [In Japanese].
- 9) Tabei, H. et al. (1991): Bacterial diseases of crops-diagnosis, prevention and control. Nihon Shokubutsu Boeki Kyokai, Tokyo, 308 [In Japanese].

# Materials and methods

## 1) Culture medium

The following 6 types of culture media were used.

(1) Semi-synthetic potato agar medium (Wakimoto medium): 1,000 mL of boiled extract of 300 g potato tubers, 0.5 g of  $\text{Ca}(\text{NO}_3)_2 \cdot 4\text{H}_2\text{O}$ , 2 g of  $\text{Na}_2\text{HPO}_4 \cdot 12\text{H}_2\text{O}$ , 5 g of peptone, 15 g of sucrose and 15 g of agar.

(2) Potato sucrose agar medium (PSA medium): 1,000 mL of boiled extract of 250 g potato tubers, 20 g of sucrose and 15 g of agar.

(3) King B medium: 20 g of proteose peptone No. 3, 1.5 g of  $\text{K}_2\text{HPO}_4$ , 1.5 g of  $\text{MgSO}_4 \cdot 7\text{H}_2\text{O}$ , 10 mL of glycerol, 15 g of agar and 1,000 mL of water.

(4) Modified King B medium: King B medium without  $\text{K}_2\text{HPO}_4$  and  $\text{MgSO}_4 \cdot 7\text{H}_2\text{O}$ .

(5) Peptone agar medium: 20 g of peptone, 1,000 mL of water and 15 g of agar.

(6) Silk extract agar medium: 1,000 mL of boiled extract of 20 g of silk thread waste and 15 g of agar.

Unless otherwise specified, the semi-synthetic potato agar medium(a) was used for all the experiments.

## 2) Isolation and identification of the bacterium

The bacterium was isolated using standard methods from the bluish-purple parts of silk thread waste. Fresh bacteria that had been cultured for one day at 25 were used for identification. The morphology of the bacterium and the colonies, the extent of multiplication at 37, motility, Gram reaction, and production of water-insoluble pigments and fluorescent pigments were examined by standard methods⁹. Other bacteriological properties were determined by identical sets of bacteria, API20E and API20NE, using *Janthinobacterium lividum* strain IAM13948 (=ATCC 12473 type) as the standard.

## 3) Bioassay of physiological activity

(1) Effect on cultured insect cells

A cultured cell line originating from the ovaries of *Antheraea eucalypti*, a silkworm of the family Saturniidae, has been established². We used *A. eucalypti* cells that had been successively cultured in the Silkworm Disease Laboratory of the National Institute of Sericultural and Entomological Science to study the effect of the pigment on cultured cells. These cultured cells are known to be highly sensitive to toxic components. In our experiments, the cells were cultured at 26 in a culture solution prepared by the addition of 5% each of silkworm serum and bovine embryo serum to the medium used by Grace². For examining the effects, 0.1 mL of the pigment suspension containing 0.3% of the dried methanol extract of the pigment was added to 3 mL of the culture solution and the culture was maintained for 48 h. The cells were then observed through an inverted microscope

to detect abnormalities.

### (2) Toxicity to silkworms

First instar larvae of the silkworm variety Habataki were fed with mulberry leaves that had been treated with 0.1 g of the dried methanol extract of the pigment per 1.4 g of leaf, and the growth during the first instar stage was observed.

### (3) Anti-microbial activity

Five bacteria and 8 fungi, all of which are plant pathogens, were used for testing the anti-microbial activity ([Table 3](#)).

In the case of bacteria, 15 mL of King B medium that had been first dissolved and then cooled to 55 and 2 mL of a bacterial suspension containing about  $10^9$  cells per mL were mixed and poured into a 9 cm diameter petri dish to prepare flats containing the bacteria. Separately, 1 g of dried methanol extract of the pigment was dissolved in 50 mL of acetone to prepare a stock solution. This stock solution was mixed with an equal amount of distilled water to prepare a diluted 1/2 strength solution, which was then diluted successively, to half strength each time, using 50% acetone. A 10 $\frac{1}{4}$ L of this diluted solution was dropped onto the medium containing the bacteria. After evaporation of the acetone and water in a clean bench, the bacteria were cultured for 1-2 days and the diameter of the growth inhibition zone of the bacteria, that appeared as a transparent circular area in the region where the diluted pigment solution had been added, was measured.

In the case of fungi, a small piece of fungal mass (about 0.5 x 0.5 x 0.5 mm) was inoculated onto PSA medium and 10 mL of the diluted pigment solution prepared above was dropped over the fungal mass. After culturing for 3-4 days, the diameter of the fungal colonies that had developed was measured.

### (4) Color fastness

Silk and cotton fabrics that had been dyed with the methanol extract of the bacteria, and those dyed by boiling with the bacterial cells, were used to examine the color fastness, according to the JIS method⁴. The color depth of the silk fabric used in the experiment corresponded to No. 3 of the standard color depth chart.

NEXT

TOP

**Table 3. Antimicrobial activity of the bluish-purple pigment against phytopathogens**

Phytopathogen	Dilution of pigment solution ^{a)}					
	2	4	8	16	22	64
(Bacterium)	Diameter of growth free zone (mm) ^{b)}					
<i>Bacillus subtilis</i>	13	13	10	8 ±	8 ±	8 ±
<i>Clavibacter michiganensis</i> pv. <i>michiganensis</i>	21	17	9	8	8 ±	0 ±
<i>Erwinia carotovora</i> subsp. <i>carotovora</i>	0	0	0	0	0	0
<i>Pseudomonas cichorii</i>	0	0	0	0	0	0
<i>Xanthomonas campestris</i> pv. <i>oryzae</i>	15	13	12	8	8 ±	0 ±
(Fungus)	Growth inhibition(%) ^{c)}					
<i>Bipolaris leersiae</i>	70	67	64	44	18	3
<i>Botrytis cinerea</i>	83	81	72	49	15	2
<i>Colletotrichum demantium</i>	100	100	100	100	100	100
<i>Diaporthe nomurai</i>	100	95	84	52	40	16
<i>Fusarium lateritium</i> f. sp. <i>mori</i>	63	56	33	11	4	0
<i>Fusarium solani</i> f. sp. <i>mori</i>	63	58	54	29	17	13
<i>Rosellinia necatrix</i>	100	100	100	100	100	58
<i>Sclerotinia sclerotiorum</i>	95	94	83	23	8	0

a): The pigment was extracted from bacterial cells with methanol and dried. 1 g of this dried extract was dissolved in 50 mL of acetone which was taken as the full strength solution. The solution prepared by the addition of an equal amount of distilled water to the full strength solution was taken as the 2 dilution solution. In the subsequent dilution steps, an equal amount of 50% acetone was used for the dilution. A 50% acetone solution was used as the control.

b): A 10 µL aliquot of the diluted solution was dropped onto King B medium that had been mixed with the bacterium. After 2 days of culture, the diameter of the area where there was no growth was measured. The ± symbol indicates that the antibacterial activity was very low.

c): Small pieces of fungal colonies were placed on PSA medium and 10 µL of the diluted solution was dropped onto them. The diameter of the fungal colonies was measured 3–5 days later and the inhibition rate of the growth of each fungal colony compared to the diameter of the fungal colonies in the control, was calculated.

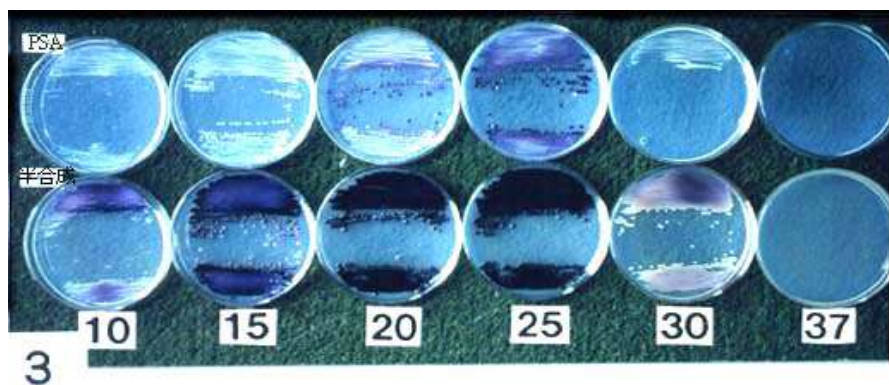
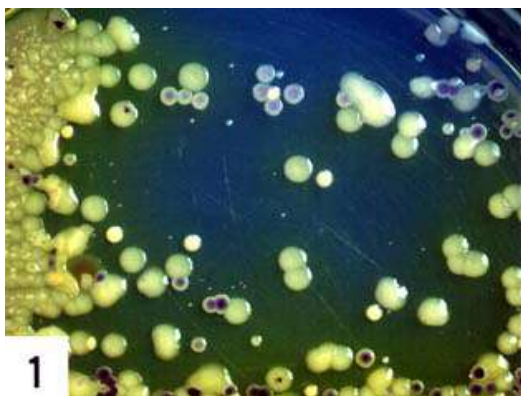
**BACK**

## Results and discussion

### 1) Characteristics of the bacterium and pigment

#### (1) Isolation of the bacterium

Considering that the blue color of the silk thread waste was due to a microbe, we attempted the isolation of the bacteria on various media⁸⁾. During the first 2 days of culture, a number of yellow and greyish white bacterial colonies appeared, but there were no bluish-purple colonies. After 4 days, however, small bluish-purple colonies appeared on the King B medium (Fig. 1-1). This culture was mixed with sterile water and subjected to pure culturing on the semi-synthetic potato agar medium. Dark bluish-purple colonies and light purple colonies developed within 3 days (Fig. 1-2). When silk thread waste was inoculated with the dark bluish-purple colonies, the thread developed a bluish-purple color within a few days.



**Fig.1. *Janthinobacterium lividum* which produces a bluish-purple pigment and samples dyed with the pigment**

**1:** Isolation of bacteria on King B medium. Bacteria that produced bluish-purple pigment could be seen in 4-days-old colonies.

**2:** Isolation of bacteria that produced bluish-purple pigment on semi-synthetic potato agar medium. The light and dark purple colonies all consist of *J.lividum*, the dark colored colonies being long to strains with high pigment production.

**3:** Multiplication of *J. lividum* and pigment production on potato sucrose agar medium (PSA, upper) and semi-synthetic potato agar medium (lower) at different temperatures (10-37). More pigment was produced on the semi-synthetic potato agar medium and the optimum temperature was 25.

**4:** Emergence of pigment-producing mutant bacteria. Reverse mutation from non-pigment-producing bacteria to pigment-producing bacteria could be seen.

#### (2) Pigment production by the isolated bacterium under different conditions

The production of the bluish-purple pigment differed considerably, depending on the medium used. The media, listed in decreasing order of pigment production, were 1. semi-synthetic potato agar medium, 2. silk extract agar medium, 3. King B medium and peptone agar medium, and 4. potato sucrose agar (PSA) medium. The bacteria multiplied fairly well in the PSA medium but pigment production was low (Fig. 1-3). The media listed under 1. to 2. above are rich in peptone or amino acids unlike medium 4.

When shake culture in a liquid semi-synthetic potato medium was compared with culture on the solid agar medium, for pigment production, culture on solid medium was found to be better. Extraction of the pigment was also easier from the bacterium on the solid medium. However, the bacterium cultured in the liquid medium also produced a fairly large amount of pigment.

As for the effect of the culture temperature, the bacterium grew well in the range of 5-30, with optimum growth at 25. No growth occurred at 37. Maximum pigment production occurred at 25, followed by 20. At temperatures lower than 10 and higher than 30, pigment production was very low (Fig. 1-3).

Bacterial cells cultured at different temperatures were extracted with methanol to determine the dyeing performance of the extracts for silk fabric. The darkest color was obtained with extracts of bacteria cultured at 25, followed by bacteria cultured at 20, 15, 10, 30 and 5°C. The order of the temperature for pigment production, was about the same as that of the growth and color of the bacteria on the medium.

When the isolated bacteria were cultured at temperatures higher than 20, particularly in the range of 27-30, a mutant of light purple or white color bacteria often appeared (Fig. 1-4).

On the basis of the above results, the semi-synthetic potato agar medium was selected as the optimum medium for pigment production. The optimum temperature for culture was 20-25. All the subsequent culture experiments were conducted using this medium and this temperature range. When the bacterium was cultured under these conditions for 5 days, 0.25 g of bacterial cells were produced per 9 cm diameter petri dish. By extracting these cells with methanol, 47 mg of dry extract was obtained which was dissolved in 16 mL of methanol to prepare a stock solution for dyeing. Thus the extract content of this stock solution was 0.3%.

### (3) Identification of the bacterium

The bacterial strain that showed the highest pigment production was selected and single colony separation was performed three times to obtain a pure strain. The selected strain S-9601 was used for the identification of the isolated bacterial cells. The colonies of this strain initially showed a greyish-white color when grown on the semi-synthetic potato agar medium. After several days of culture, the colonies showed a light bluish-purple and then a dark bluish-purple color. The colonies were flat with entire margins. The bacteria were Gram negative, aerobic, bacilli, having flagella and motility. The bacteriological characteristics are shown in [Table 1](#).

The bacteriological characteristics of strain S-9601 agreed with the reported properties of *Janthinobacterium lividum*¹. When the isolated strain and the standard *Janthinobacterium lividum* were tested together, the 2 were identical in terms of the production of the bluish-purple pigment and all bacteriological characteristics. Therefore, the bacterium was identified as *Janthinobacterium lividum*.

### (4) Extraction of pigment

The bacterium was inoculated onto the semi-synthetic potato agar medium and cultured for one week. The bacterial cells that had become dark bluish-purple were placed in a small beaker and extracted with various organic solvents. Tetrahydrofuran was found to be the most efficient solvent for extracting the pigment, followed by methanol. Acetone, ethyl acetate and ether did not extract the pigment well. Almost no pigment was extracted with water ([Table 2](#)).

### (5) Separation of the pigment components and their structure

The bacterial cells were extracted with tetrahydrofuran for one day and the extract was filtered. Then, after concentrating the extract under reduced pressure, it was fractionated by silica gel chromatography (hexane : tetrahydrofuran: acetone = 4 : 2 : 1) and reversed phase high performance liquid chromatography (70% methanol), recrystallized, and 2 bluish-purple pigment components were separated. Component 1 (which was the main component and had a higher polarity than the other component) and Component 2 were subjected to different types of instrumental analysis, to determine their chemical structure.

Component 1 had a molecular weight of 343 when estimated by FAB-MS:  $m/z344(M+H)^+$  and the presence of nitrogen was inferred. The IR spectrum suggested the presence of amide also. ¹H and ¹³C NMR spectra showed that Component 1 has a total of 4 NH or phenol OH, 11 quaternary carbons and 9 tertiary carbons, and no secondary or primary carbons. Based on these data and after detailed examination of the MS spectrum, etc., Component 1 was identified as violacein ([Fig. 2](#)).

Component 2 had a molecular weight of 327 when estimated by FAB-MS: $m/z344(M+H)^+$  and the presence of nitrogen was inferred. The IR spectrum was similar to that of Component 1. ¹H and ¹³C NMR spectra did not show any signal originating from phenol OH. The carbon signal that appeared at the base of the phenol OH was shifted to a considerably higher magnetic field. Based on these data and other changes in the spectral pattern, Component 2 was identified as deoxyviolacein (Fig. 2), the deoxy form of Component 1 without the phenol group. Various spectral data of these 2 components of the pigment agreed with reported data^{3,6}.

### (6) Safety and antimicrobial activity of the pigment

#### a: Safety

When the effect of the extracted pigment on cultured insect cells was studied, no adverse effect could be detected. It was thus concluded that the pigment was not toxic or exhibited a negligible toxicity to insect cells. The toxicity to silkworm cells was then examined. Twenty silkworms were made to ingest a total of about 2 g of mulberry leaves on which the pigment had been applied during their 1st instar stage. All 20 of them developed normally, without any signs of abnormality.

#### b: Antimicrobial activity

A study of the antimicrobial activity of the pigment toward plant pathogens revealed that it had such an activity against 11 of the plant pathogenic microorganisms tested, excluding *Erwinia carotovora* and *Pseudomonas cichorii* ([Table 3](#)). The inhibitory activity was particularly strong against *Colletotrichum dematium* and *Rosellinia necatrix* which cause anthracnose and white root rot diseases of mulberry, respectively ([Fig. 3](#)).

NEXT

TOP

**Table 1. Bacterial characteristics of the isolated strain S9601**

Shape of bacterial cells	Bacillus
Colony shape	Flat
Growth at 37°C	–
Motility	+
Gram reaction	–
Fluorescent pigment	–
Production of water-insoluble pigment	+
	(bluish-purple)
Aerobic / anaerobic	Aerobic
Nitrate-reducing activity	+
Gas production from nitrate	+
Oxidase activity	+
Hydrolysis of esculin	+
Hydrolysis of gelatin	–
Arginine dihydrolase activity	–
Urease activity	–
$\beta$ -Galactosidase activity	–
Lysine decarboxylase activity	–
Ornithine decarboxylase activity	–
Tryptophan deaminase activity	–
Indole production	–
Hydrogen sulfide production	–
Acetone production	–
Utilization of sugars and organic acids	
Glucose	+
L-Arabinose	+
D-Mannose	+
D-Mannitol	+
Maltose	+
N-Acetyl-D-glucosamine	–
Sodium citrate	+
Adipic acid	+
dl-Malic acid	+
Potassium gluconate	–
n-Capric acid	–
Phenyl acetate	–

Note: *J. lividum* IAM13948 gave the same results.

**BACK**

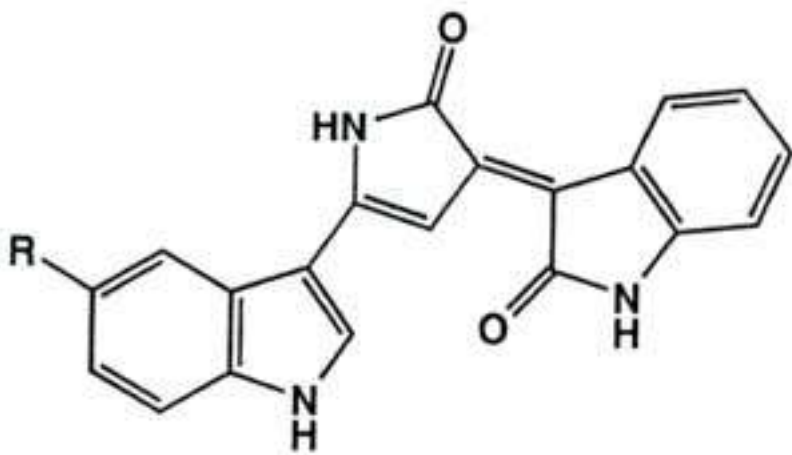
**Table 2. Extraction of the pigment by organic solvents**

Organic solvent	Concentration (%)	Pigment extraction ^{a)}
Tetrahydrofuran	100	++++
Methanol	100	+++
Methanol	50	+++
Ethanol	100	++
Acetone	100	++
Acetone	50	+
Ethyl acetate	100	++
Diethyl ether	100	+
-----		
Control (water)		±

a): The color depth of the extracted solution was classified into 5 grades, from colorless (-) to dark (++++).

**BACK**





- 1; R=OH, Violacein  
2; R=H, Deoxyviolacein

Fig.2. Chemical structure of the bluish-purple pigment  
The main component violacein is a kind of antibiotic.

BACK

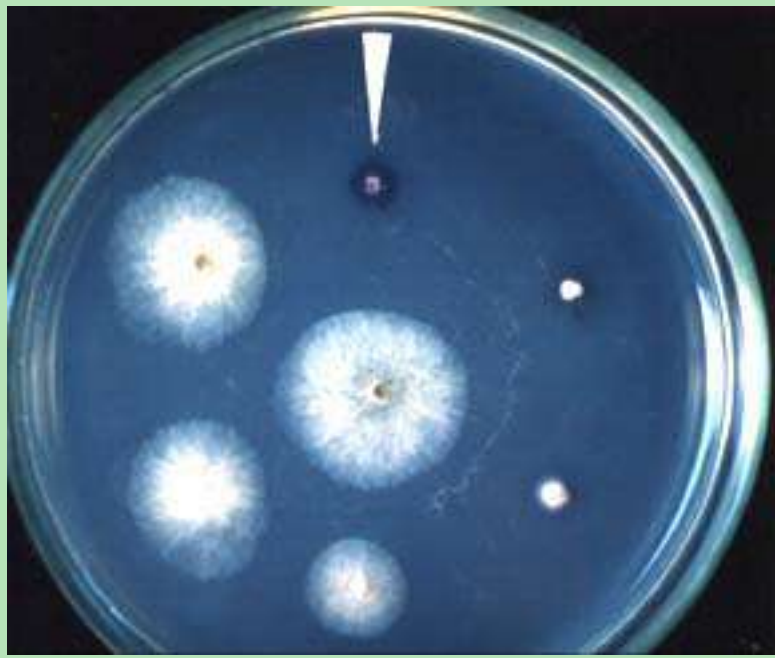


Fig.3. Anti-fungal activity of the bluish-purple pigment

Seven small pieces of a colony of *Diaporthenomurai*, which causes die- back of mulberry, were placed on PSA medium. Each 10  $\frac{1}{4}$ L of the diluted pigment solution with 50% acetone was dropped onto them. The twofold diluted solution was placed in a 12 o'clock position and the strength was 1/4, 1/8, 1/32, and 1/64 in the clock-wise direction. The control, 50% acetone alone, was located in the center of the dish. The photograph shows the growth after 7 days.

BACK

## 2) Dyeing and characteristics of the pigment

### (1) Method of dyeing

#### *a:* Dyeing with the extract solution

Dyeing was attempted using an organic solvent solution of the pigment. After extraction of the pigment with tetrahydrofuran and air-drying of the extract, a fixed amount of dry pigment was dissolved in a certain amount of various organic solvents. Silk and cotton fabrics were immersed in the various solutions for half a day and the extent of dyeing was compared. The cotton and silk fabrics were dyed very well both in the methanol and the ethanol solutions ([Table 4](#)).

In the next experiment, the bacterial colonies were extracted with methanol and the fabric was directly immersed in the extract. The fabric developed a bluish-purple color, indicating that methanol could extract the pigment well, and also enabled the pigment to become attached to the fabric.

The dyeing method used was very simple and consisted of 3 steps: **1.**immersion of the silk fabric in the methanol extract overnight; **2.**washing with water; and **3.**drying in the shade.

#### *b:* Boiling dye with bacterial cells

The bacterial cells were transferred to a vessel along with the medium and boiled after the addition several times of more than 10 times the amount of water. After bringing the solution to boiling, the fabric to be dyed was dipped in it and the bath was allowed to simmer for about 20 min. The fabric was then washed with water and dried in the shade. If a deep color was not required, immersion of the fabric for 3-5 min in the bath, after boiling and cooling to 80-90, was sufficient.

The characteristics of the 2 methods of dyeing used here were as follows: Athe procedure was very simple, Csatisfactory dyeing could be achieved without using mordants, and E dyeing occurred uniformly. Fabric made from the silk of the silkworm variety Akebono is considered to be generally prone to uneven dyeing and to require special procedures for dyeing. However, even Akebono silk could be uniformly dyed by an unskilled person using the dyeing methods described above when the liquor ratio of the bath was sufficiently high. The shade of the dyed fabric varied depending on the amount of dye present in the bath in the range of light blue, violet, bluish-purple and dark bluish-purple. Fig.1-5, 1-7 and 1-8, respectively show the silk fabric dyed to a deep color in the extract solution, a silk scarf dyed to a comparatively light color with the extract, and a kimono dyed to a very light color by boiling with the bacterial cells.



5: Silk fabric dyed and showing a bright bluish-purple color in a concentrated methanol extract of the pigment.



6: Dyeing performance of the pigment with 9 different materials (multifiber test cloth). A: polyester, B: raw silk, C: acrylic fiber, D: rayon, E: wool, F: acetate showed a purple color. Nylon and vinylon showed a deep bluish-color, whereas acetate showed a purple color.



7: Scarf showing a light bluish-purple color in a relatively dilute methanol extract solution of the pigment.



8: Kimono dyed by boiling with the bacterial cells.

**Fig.1. *Janthinobacterium lividum* which produces a bluish-purple pigment and samples dyed with the pigment**

## (2) Dyeing performance

### *$\alpha$* : Dyeability of different fibers

Since we had found that the pigment was capable of dyeing not only natural fibers but also synthetic fibers, we compared the dyeing performance of 9 different fibers, using a multi-fiber test cloth (Fig. 1-6). The dyeing performance differed depending on the type of fiber. Nylon was the easiest to dye, followed by vinylon, acetate, raw silk, cotton and wool. Rayon could be dyed only slightly and almost no dyeing occurred with acrylic fiber and polyester. Although Fig. 1-6 shows that polyester also had been dyed to a moderate extent, almost no dyeing occurred when the pigment concentration was low. Most of the fibers showed a color range from light purple to bluish-purple. However, the shade differed slightly depending on the fiber, for example, nylon showed a deep bluish-purple color and acetate a purple color.

NEXT

TOP

**Table 4. Dyeability in different organic solvents**

Organic solvent	Concentration used (%)	Extent of dyeing ^{a)}
Methanol	100	++++
Methanol	50	++
Ethanol	100	++++
Ethanol	50	++
Acetone	100	++
Acetone	50	+
Ethyl acetate	100	+
Ethyl acetate	50	+
-----		
Control (water)		+

a): The color depth of the silk fabric dyed at room temperature was classified into 5 grades, from colorless (–) to dark (++++).

**BACK**

## (2) Dyeing performance

### (2) Dyeability of difference

#### *b*: Duration of immersion and extent of dyeing

The extent of dyeing differed with the duration of immersion in the dye bath. At room temperature using the methanol extract, silk and cotton become dyed within 5-10 min of immersion. The color became deeper within 1-10 h and dye uptake continued even after, reaching a peak in about 2 days. On the contrary, nylon and acetate required only a very short time for dyeing. Dyeing occurred within several seconds after the start of immersion and within more than 10 h. Dyeing of acetate peaked after about 1 h. With nylon, the shade could be varied freely from pale lavender to dark bluish-purple by changing the dyeing time.

#### *c*: Temperature and dyeing rate

The dyeing rate was significantly affected by the temperature of the dye bath. For example, when silk was dyed in the methanol solution of the pigment, the immersion time required for the color depth achieved in 15 min of dyeing at 20, was 5 min at 40, 1 min at 60, and 30 s at 70. For achieving the color depth obtained after 6 h at 20, it took one day at 40 and 3 days at 60.

### (3) Color fastness

Silk samples dyed by the 2 methods were tested for their color fastness⁴. The method of dyeing did not affect appreciably the color fastness ([Table 5](#)). Although the fastness of the color against light was somewhat low (Grade 1), the fastness against washing was of Grade 2-3, and 3-5 in other tests. Overall, the color fastness was about the same as that of vegetable dyes. In other words, although the color fastness was not very high, it was in the practically tolerable range, except for the fastness against light⁴. About the same results were obtained with cotton fabric in all the tests. The color fastness against light of deeply dyed nylon and vinylon was slightly higher than that of silk or cotton(Grade 1-2).

### (4) Improvement of color fastness against light

In practice, when a bluish-purple dye is used to dye fabrics, the major problem is the photosensitivity of the color. The bluish-purple color fades very rapidly in the presence of sunlight, and such dyeing is therefore of limited practical use⁴. As a result, we examined various treatments for improving the resistance to light of textiles dyed with the bluish-purple pigment⁵. We had examined various treatments for improving the color fastness against light of fiber and textile products dyed with this bluish-purple pigment. It was found that if the dyed material was subjected to post-treatment with a thiourea solution, the fading of color due to light was considerably reduced⁵.

A piece of silk fabric (plain Habutae with Mezuke weight 14) was dyed in a methanol solution of the bluish-purple pigment extracted from the bacterium, at room temperature by dipping in the dye bath at a liquor ratio of about 1:100 for 2 days. The dyed material was then immersed in a 0% ~ saturated thiourea solution (liquor ratio about 1:300) for about 1 min at room temperature. It was then drained and air-dried. The color fastness of the dried material against light was determined by the direct sunlight method (JIS L 0841). The thiourea-treated fabric showed a slower rate of color fading, suggesting that the color fastness had improved ([Fig. 4](#)). The effect of suppression of fading under light became more pronounced with the increase of the thiourea concentration. When the dyed samples were treated with a 5% thiourea solution and a saturated thiourea solution, the former showed a color fastness of Grade 2 and the latter of Grade 3. The color fastness of the untreated material was lower than Grade 1. The bluish-purple dyed material which had been treated with the thiourea solution did not cause any change in shade, nor did it have any adverse effect on the feel of the material.

Next, we treated the bluish-purple dyed material once, 2 or 5 times with a saturated thiourea solution, through the steps described below.

1. Dipping in a saturated thiourea solution for 3 min at room temperature, draining and air-drying.
2. Washing with lukewarm water (deionized water at 40) for 2 min.
3. Dipping in a saturated thiourea solution for 1 min at room temperature, draining and air-drying.

Only the steps 2. and 3. were repeated when the treatment was applied several times. The fading of color under light was suppressed even more with repeated

(2) Dyeing performance  
thiourea treatment ([Table 6](#)).

## Conclusion

About 10 years ago, one of the present authors (Kojima) discovered that the color of some thread dust left in a bucket had become bluish-purple. We were able to isolate a bacterium which was identified as *Janthinobacterium lividum*.

The bacterial cells were extracted with tetrahydrofuran for one day and the extract was filtered. Then, after concentrating the extract under reduced pressure, it was fractionated by silica gel chromatography (hexane : tetrahydrofuran : acetone = 4 : 2 : 1) and reversed phase high performance liquid chromatography (70% methanol), recrystallized, and 2 bluish-purple pigment components were separated. The color was derived from a pigment called violacein stored by the bacteria. The bacteria are not pathogenic and violacein is not toxic.

The pigment from these bacteria can be used to dye natural fibers, providing good color tone and stability. The results of the color fastness tests against washing, hot-water, sweat and rubbing were about the same as those of vegetable dye and were in the practically tolerable range, except for the fastness against light (Grade 1). We examined various treatments for improving the resistance to light of textiles dyed with the bluish-purple pigment. It was found that when the dyed material was subjected to post-treatment with a thiourea solution, the fading of the bluish-purple color due to light was considerably reduced. When the dyed samples were treated with a 5% thiourea solution and a saturated thiourea solution, color fastness of Grade 2 and Grade 3 was obtained with the former or the latter, respectively. Also, the bluish-purple dyed material which had been treated with the thiourea solution did not show any change in shade, nor did it have any adverse effect on the feel of the material. Moreover, since mass-culture of the bacteria is possible, the pigment and dye can be produced cheaply.

NEXT

[:TNF± and NO Production in Mice Treated with Sex Steroids](#)

TOP

HOME

**Table 5. Color fastness of silk fabric showing a bluish-purple color^{a)}**

Color fastness test against	Staining ^{b)} Fading	Evaluation ^{c)}	JIS Standard
Light		1	L 0841 Day-night method
Washing	Staining Fading	2 2-3	L 0844 A No. 1 method
Hot water	Staining Fading	3-4 4	L 0845 (50°C×10 min)
Acidic sweat	Staining Fading	3-4 3-4	L 0848 A method
Alkaline sweat	Staining Fading	3 3	L 0848 A method
Rubbing	Staining (dry) (wet)	5 5	L 0848 II type
	Fading (dry)	3	
	(wet)	2-3	

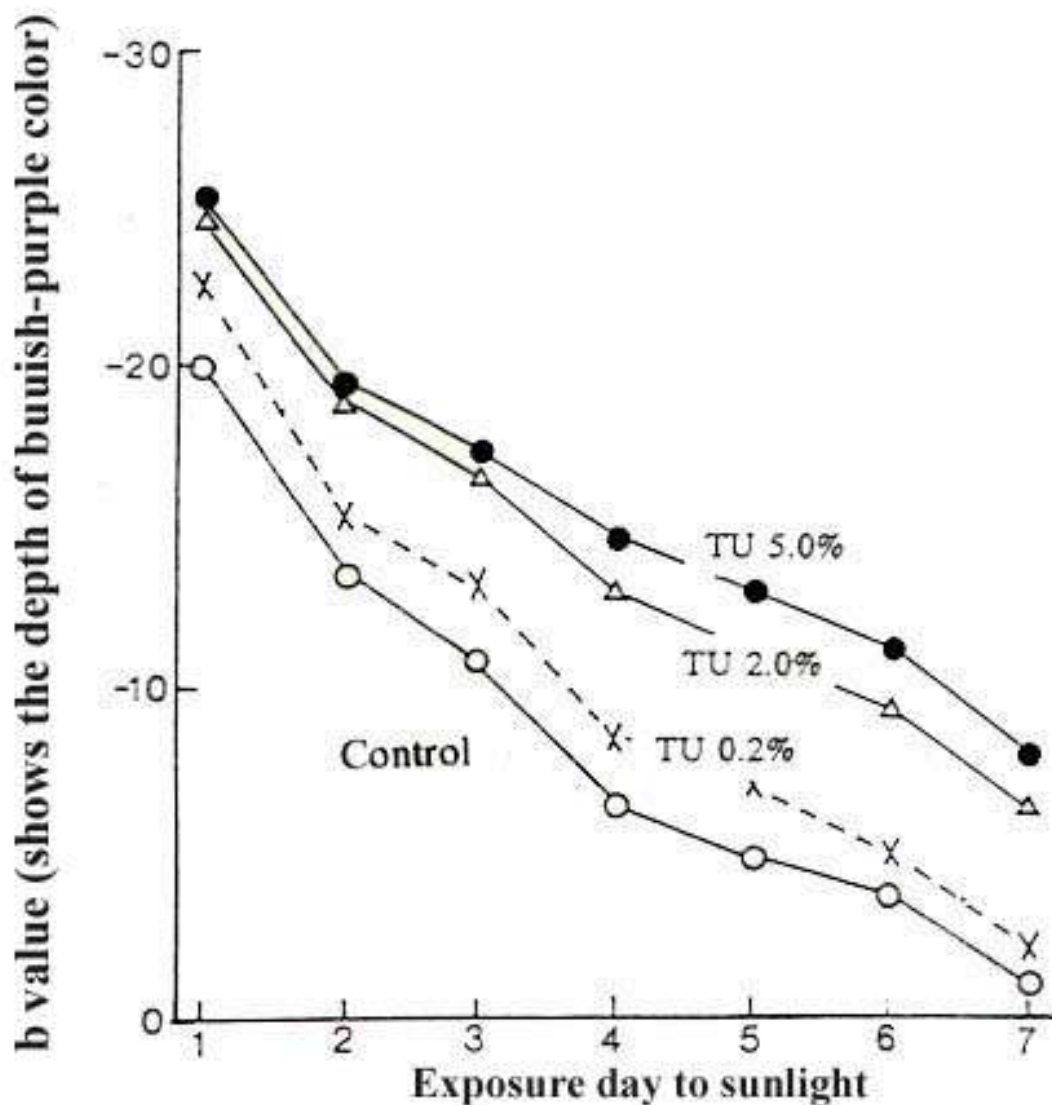
a): About the same results were obtained with different methods of dyeing.

b): The extent of staining was estimated by the amount of color transferred to colorless fabrics when the dyed piece of fabric was sandwiched between colorless pieces of silk and cotton fabric, and treated.

c): Color fastness was graded into 5 categories, 1-5, in the order of increasing fastness.

**BACK**





**Fig.4. Fading of the bluish-purple color after exposure to sunlight**

Samples of TU.0.2%, TU.2.0% and TU.5.0% were treated with 0.2%, 2.0% and 5.0% thiourea solution for about 1 min, respectively.

BACK

**Table 6. Effect of thiourea treatment on fading of bluish-purple dyed fabric after exposure to sunlight**

Frequency of treatment with thiourea	Color coefficient b value ^{a)} of fabric after exposure	Reduction rate after exposure (%) ^{b)}
0 (Control)	-13.65	45.2
1	-18.61	25.4
3	-19.00	23.8
5	-20.96	15.9

a): The more negative the b value, the deeper the bluish-purple color.  
B value of unexposed fabric as control was -24.93.

b): The reduction is obtained by comparing the b value of the original dyed fabric.

**BACK**

# Modulation of TNF $\alpha$ and Nitric Oxide Production by Macrophages and Uterine Protein Expression in Mice Chronically Treated with Sex Steroids

**Meraku TEFERA*¹ and Eiichi MOMOTANI**

Laboratory of Molecular Pathology, Department of Immunology, National Institute of Animal Health (NIAH) (Tsukuba, Ibaraki, 305-0856 Japan)

Present Address:

*¹ Faculty of Dryland Agriculture, Mekelle University (P.O. Box 231, Mekelle, Ethiopia)

Corresponding author: E. Momotani (momotani@niah.affrc.go.jp, fax+81-298-778)

## Abstract

The objective of the current studies was to analyze the relation of sex steroid treatment with the pattern of uterine secretory proteins and production of tumor necrosis factor  $\alpha$  (TNF $\alpha$ ) and nitric oxide (NO) by murine macrophages. Specific pathogen free (SPF) CD1 mice were ovariectomized and divided into 6 groups which were treated with different sex steroids: progesterone (group 2), estradiole (group 3), progesterone plus estradiole (group 4), estradiole plus progesterone (group 5), testosterone (group 6) and placebo (group 1). The treatments were continued by subcutaneous embedding of hormone pellets for 30 days. Total white blood cell counts in groups 4 and 5 showed a statistically higher total leukocyte count ( $p \leq 0.05$ ) than that in groups 2 and 6 ( $p \leq 0.05$ ). Lipopolysaccharide (LPS)-stimulated peritoneal macrophages from estrogen-treated mice produced a significantly higher level of NO than those in the other groups ( $p \leq 0.05$ ). TNF $\alpha$  production by the macrophages significantly increased by estrogen or testosterone treatment compared with the control ( $p \leq 0.05$ ). LPS induced a 2 fold production of both TNF $\alpha$  and NO by peritoneal macrophages. It was observed that steroid treatment induced a *de novo* synthesis of products with patterns specific to uterine proteins. Our results showed that sex steroids affect the macrophage function and modulate the pattern of secretory uterine proteins. The usefulness of the mouse model with subcutaneous embedding of hormone was also demonstrated.

Discipline: Animal health/ Animal industry

Additional key words: LPS, uterus, NO

1...³⁴): [References](#)

(Received for publication, June 8, 1999)

## Introduction

The sex steroids exert various actions on the reproductive tract and they modulate the immune system^{18,31}). It is known that estrogen stimulates, whereas progesterone and testosterone suppress systemic¹²) and local³³) production of immunoglobulins, respectively. The natural killer cell activity was inhibited by estradiole^{1,2}) and progesterone²). Both estrogen and progesterone show an enhancing effect

while Danzol, a synthetic testosterone, an inhibitory effect on interleukin-1*b* (IL-1*b*), serum proteins and TNF*α* production in cultured human monocytes¹⁹). Macrophages of the uterus show a change in number and functional ability in the production of cytokines, reactive oxygen intermediates and bioactive lipids depending on the reproductive cycle⁹). Although data on the influence of sex steroids on macrophages have accumulated, many aspects remain to be elucidated^{3,4,9,12,15}). Characteristic pattern of uterine secretory proteins which has been analyzed in relation to the host reproductive cycle and host defense mechanisms in some animals, has not been reported in mice^{14,20,24,25}). The purpose of this study was to develop a mouse model for chronic sex steroid treatment with estradiole, progesterone, testosterone and their combination and to determine the effects on the modulation of TNF*α* and NO production by macrophages, as well as the pattern of uterine secretory proteins.

[NEXT](#)

[TOP](#)

**References**

- 1) Baral, E., Nagy, E. & Berczi, I. (1995): Modulation of natural killer cell-mediated cytotoxicity by tamoxifen and estradiol. *Cancer*, 75, 591-599.
- 2) Bartho, J. S., Kinsky, R. & Chaouat, G. (1990): The effect of progesterone-induced immunologic blocking factor on NK-mediated resorption. *Am. J. Reprod. Immunol.*, 24, 105-107.
- 3) Chao, T. C. et al. (1995): Steroid sex hormones regulate the release of tumor necrosis factor by macrophages. *Cell. Immunol.*, 160, 43-49.
- 4) Chao, T. C. et al. (1996): Steroid sex hormones and macrophage function; Regulation of chemiluminescence and phagocytosis. *Am. J. Reprod. Immunol.*, 35, 106-113.
- 5) Ding, A. H., Nathan, C. F. & Stuehr, D. J. (1988): Release of reactive nitrogen intermediates and reactive oxygen intermediates from mouse peritoneal macrophages; Comparison of activating cytokines and evidence for independent production. *Immunology*, 141, 2407-2412.
- 6) Eguchi, K. et al. (1995): Effect of cabergoline, a dopamine agonist, on estrogen-induced rat pituitary tumors; *In vitro* culture studies. *Endocrinol. J.*, 3, 413-420.
- 7) Green, L. C. et al. (1982): Analysis of nitrate nitrite, and [15N] nitrate in biological fluids. *Anal. Biochem.*, 126, 131-138.
- 8) Hishikawa, K. et al. (1995): Up-regulation of nitric oxide synthase by estradiol in human aortic endothelial cells. *FEBS Lett.*, 360, 291-293.
- 9) Hunt, J. S., Miller, L. & Platt, J. S. (1998): Humoral regulation of uterine macrophages. *Dev. Immunol.*, 6, 105-110.
- 10) Hutchinson, S. J. et al. (1997): Sex hormones and vascular reactivity. *Hertz*, 22, 141-150.
- 11) Jain, N. C. (1986): Schalm's veterinary hematology. Lea and Febiger, Philadelphia 4th ed., 240-308.
- 12) Lahita, R. G. (1992) The effect of sex hormones on the immune system in pregnancy. *Am. J. Reprod. Immunol.*, 28, 136-137.
- 13) Lorsbach, R. B. & Russell, S. W. (1992): A specific sequence of stimulation is required to induce synthesis of the antimicrobial molecule nitric oxide by mouse macrophages. *Infect. Immun.*, 60, 2133-2135.
- 14) Lui, W. J. & Hansen, P. J. (1995): Pathways for inhibition of lymphocyte activation by uterine milk proteins. Sixth international congress of reproductive immunology. *Am. J. Reprod. Immunol.*, 33, 445.
- 15) Miller, L. & Hunt, J. S. (1996): Sex steroid hormones and macrophage function. *Life Sci.*, 59, 1-14.
- 16) Miller, L. & Hunt, J. S. (1998): Regulation of TNF-alpha production in activated mouse macrophages by progesterone. *J. Immunol.*, 160, 5098-5104.
- 17) Momotani, E. et al. (1998): The effect of oligosaccharides on the production of tumor necrosis factor-alpha by macrophage-like cell line J774/JA-4. *J. Vet. Med. Sci.*, 60, 519-522.

- 18) Morell, V. (1995): Zeroing in on how hormones affect the immune system. *Science*, 269, 773-774.
- 19) Mori, H. et al. (1990): Danzol suppresses the production of interleukin-1B and Tumor necrosis factor by human monocytes. *Am. J. Reprod. Immunol.*, 24, 45-50.
- 20) Pentecost, B. T. & Teng, C. T. (1987): Lactotransferrin is the major estrogen inducible protein of mouse uterine secretions. *J. Biol. Chem.*, 262, 10134-10139.
- 21) Robert, R. & Spitzer, J. A. (1997): Effects of female hormones (17 beta-estradiole and progesterone) on nitric oxide production by alveolar macrophages in rats. *Nitric Oxide*, 1, 453-462.
- 22) Schneemann, M. et al. (1993): Nitric oxide synthase is not a constituent of the antimicrobial armature of human mononuclear phagocytes. *J. Infect. Dis.*, 167, 1358-1363.
- 23) Schoedon, G. et al. (1993): Regulation of the L-arginine-dependent and tetrahydrobiopterin-dependent biosynthesis of nitric oxide in murine macrophages. *Eur. J. Biochem.*, 213, 833-839.
- 24) Stephenson, D. C. & Hansen, P. J. (1990): Induction by progesterone of immunosuppressive activity in uterine secretions of ovariectomised ewes. *Endocrinology*, 126, 3168-3178.
- 25) Sullivan, D. A. & Wira, C. R. (1984): Hormonal regulation of immunoglobulins in the rat uterus; Uterine response to multiple estradiole treatments. *Endocrinology*, 114, 650-658.
- 26) Takasuka, N., Tokunaga, T. & Akagawa, K. S. (1991): Preexposure of macrophages to low doses of lipopolysaccharide inhibits the expression of tumor necrosis factor-alpha mRNA but not of IL-1 beta mRNA. *J. Immunol.*, 146, 3824-3830.
- 27) Takeda, K., Takahashi, N. & Shimizu, S. (1988): Identification and characterization of an estrogen-inducible glycoprotein (uterine secretory protein-1) synthesized and secreted by rat uterine epithelial cells. *Endocrinology*, 122, 105-113.
- 28) Teng, C. T. et al. (1986): Purification and properties of an estrogen-stimulated mouse uterine glycoprotein (approx. 70 KDa). *Biochem. J.*, 240, 413-422.
- 29) Tracey, K. J. (1994): Tumour necrosis factor-alpha. In *The Cytokine Handbook*. ed. Thompson, A., Academic Press, London, 289-304.
- 30) Walmer, D. K. et al. (1992): Lactoferrin expression in the mouse reproductive tract during the natural estrous cycle; Correlation with circulating estradiole and progesterone. *Endocrinology*, 131, 1458-1466.
- 31) Weigent, D. A. & Blalock, J. E. (1995): Associations between the neuroendocrine and immune systems. *J. Leukocyte. Biol.*, 58, 137-150.
- 32) Weiner, C. P. et al. (1994): Induction of calcium-dependent nitric oxide synthases by sex hormones. *Proc. Natl. Acad. Sci. USA.*, 91, 5212-5216.
- 33) Wira, C. R. & Sarola, C. P. (1980): Hormonal regulation of immunoglobulins A and G in the rat uterus. *Endocrinology*, 106, 1020-1026.
- 34) Zhang, X. & Morrison, D. C. (1993): Lipopolysaccharide-induced selective priming effects on tumor necrosis factor alpha and nitric oxide production in mouse peritoneal macrophages. *J. Exp. Med.*, 177,

511-516.

# Materials and methods

## 1) *Animals*

Forty specific pathogen free (SPF) mice (strain CD1), nulliparous (CLEA Inc., Japan), 6-8 weeks of age and weighing 30-40 g were used. The mice were kept in micro-isolation units in a laminar flow rack housing system (ICM Inc., Tsukuba, Japan). All the mice underwent an ovariectomy operation under general anesthesia with intraperitoneal injection of 50 mg/mice of pentobarbital sodium (ABBOT Laboratories, USA). Mice were given proper postoperative care and were maintained under SPF housing system.

## 2) *Treatment with sex steroids*

Two weeks after the ovariectomy, the mice were divided into 6 groups and treated as shown in [Table 1](#). In the combined treatment, implants were applied at 2 different sites. The treatment continued for 30 days in the SC implants. Progesterone (C₂₁ H₃₀ O₂), estradiole (C₁₈ H₂₄ O₂) and testosterone (C₁₉ H₂₈ O₂) were purchased from NACALAI TESQUE Inc., Kyoto, Japan. The hormone pellets were prepared by mixing the sex steroid with 0.2 g cholesterol and 0.1 g sesame oil⁶). This mixture was injected subcutaneously in the hind back with a syringe with a wide gauge needle. The controls received only the vehicle.

## 3) *Hematology*

At the end of the treatment period, heparinized and non-heparinized blood was collected under general ether anesthesia. Serum was stored at -20°C until the assay. Differential leukocyte count was performed using May-Grunwald-Giemsa stained blood smears. White blood cell count (WBC) was performed using a Coulter counter (Coulter Electronics Inc., Florida), with LYES II (K-CN) reagent for the simultaneous quantitative determination of hemoglobin and leukocytes (Japan Scientific Instrument Co., Ltd.).

## 4) *Peritoneal macrophages*

Peritoneal macrophages were collected aseptically by injection with 5 mL of cold RPMI 1640 (Nissui Pharmaceutical Co., Ltd., Japan) and the back of the mice was agitated for 30 s. Thereafter, the fluid was aspirated. Peritoneal cells were harvested with 2 successive washings in RPMI 1640 medium by centrifugation at 300 xg for 5 min at 4°C. The number of macrophages was counted and the macrophages were seeded into the wells of 96 well plates (Becton Dickinson) at the rate of 10⁴ macrophages/ well. They were incubated for 2 h at 37°C in 5% CO₂ to allow them to adhere and those that did not adhere were removed by washing twice in RPMI 1640.

## 5) *Analysis of TNF $\alpha$ and NO*

The macrophages of each group were stimulated by lipopolysaccharide (LPS, *Escherichia coli* 0111: B4, Sigma, USA) for 4 h and 20 h. Supernatants were collected at 4 h for the TNF $\alpha$  assay and 20 h for the NO assay after the stimulation and stored at -20°C until the assay. Two sets of wells were prepared: LPS+ and 2 other sets as LPS- or controls during the assays.

The NO synthesis of the macrophages was determined by Griess assay⁷). Cell culture supernatants were assayed by the addition of 1:1 (v/v) 50 mL to each well of a 96-well plate (in triplicate), and 50 mL Griess reagent (N-1-naphthyl ethylene diamine dehydrochloride 0.1% in H₂O, sulphonil amide 1% in 5% H₃PO₄, Sigma), then immediately mixed and incubated at room temperature for 5 min. Absorbance at 550 nm was measured by using the plate reader Model 450 (Bio Rad, USA). The NO concentration was



calculated from the standard curve produced during each assay by using NaNO₂ (NACALAI TESQUE Inc., Kyoto, Japan) dissolved in 15 mM HEPES, pH 7.5 and expressed as nmol /mL as mean values  $\pm$ SD.

The level of TNF $\alpha$  in the supernatant of the macrophage culture was measured by the sandwich ELISA method. Rat anti-mouse TNF $\alpha$  monoclonal antibody (mAb) (generously provided by Dr. Nakane of Hirosaki University) was diluted to 2 mg/mL in 0.1 M NaHCO₃, pH 8.2. Wells of a 96 flat-bottomed probind assay plate (Becton Dickinson) were coated with 50 mg/well of the capture antibody and incubated overnight at 4°C. The plates were washed 2 times in 350 mL of PBS Tween-20 (Bio Rad) using an immuno-wash 450 (Bio Rad). Three hundred fifty mL of blocking agent (Snow Brand, Japan) was added per well and incubated for 2 h at room temperature and washed 2 times. Standard recombinant mouse TNF $\alpha$  (Genzyme) diluted serially in the blocking agent to generate a standard curve and samples were added at the rate of 100 mL/well in triplicate and incubated at 4°C overnight and washed 4 times. Biotinylated anti-mouse TNF $\alpha$  clone mp6-XT3 (Pharmingen, USA) diluted to 1 mL/mL in the blocking agent was added and washed 6 times. Then 4x10³/mL of the peroxidase-conjugated streptavidin (Biogenx Lab. USA) diluted 1:3 v/v in the blocking agent was added at 100 mL/well, incubated for 30 min at room temperature and washed 8 times. Finally 20 mg of a substrate, phenylene diamine (NACALAI TESQUE), in 25 mL of 0.1 M citric acid, 25 mL of 0.2 M NaHPO₄/2H₂O and 1 mL of 30% H₂O₂ was added at the rate of 100 mL/ well and the color was allowed to develop at room temperature for 90 min. The color reaction was stopped using 3N H₂SO₄ and read at OD 450 nm using a microplate reader 450 (Bio Rad). TNF $\alpha$  values were calculated from the standard curve as mean  $\pm$ SD. The sensitivity of the assay was 50 pg/mL.

#### **6) Examination of uterine fluid**

Uterine secretion was washed out aseptically in 200 mL of 0.9% NaCl solution. Individual and pooled samples from the same group were designated as uterine luminal proteins 1 to 6 (ULP1 to ULP6) and stored at -20°C until assay. Uterine fluid was cultured in DHL and B. H. I agar medium (Eiken Chemical Co., Ltd., Japan) for bacterial examination.

For electrophoresis, uterine fluid was adjusted to 200 mg/mL protein, and added to the 2X SDS sample buffer 2: 1 (v/v) and to 5% 2-mercaptoethanol. The sample cocktail was then denatured by incubation for 5 min at 100°C. The samples and molecular markers were loaded on Phast gel gradient 10-15 (Pharmacia Biotech, USA) using an 8/1 sample applicator and analyzed by Phast system SDS-PAGE (Pharmacia KLB). Electrophoresis was run for 65 Vh at 250 V, 10.0 mA, 3.0 W and 15°C. Gels were then stained using a silver staining kit (Pharmacia Biotech). The gels were analyzed using Phast image software (Pharmacia LKB); gels were scanned in transmittance mode. Lanes were examined slice by slice with calibration curves.

#### **7) Statistical analysis**

Data were analyzed by the Student T test ( $p \leq 0.05$  indicated statistical significance).

**NEXT**

**TOP**

**Table 1. Type of treatment and doses used**

Group	No. of animals	Treatment	mg/Implant
1	12	Placebo	20
2	7	Progesterone	20
3	6	Estradiole	20
4	7	Progesterone	20
		+	
		Estradiole	5
5	5	Estradiole	20
		+	
		Progesterone	5
6	7	Testosterone	20

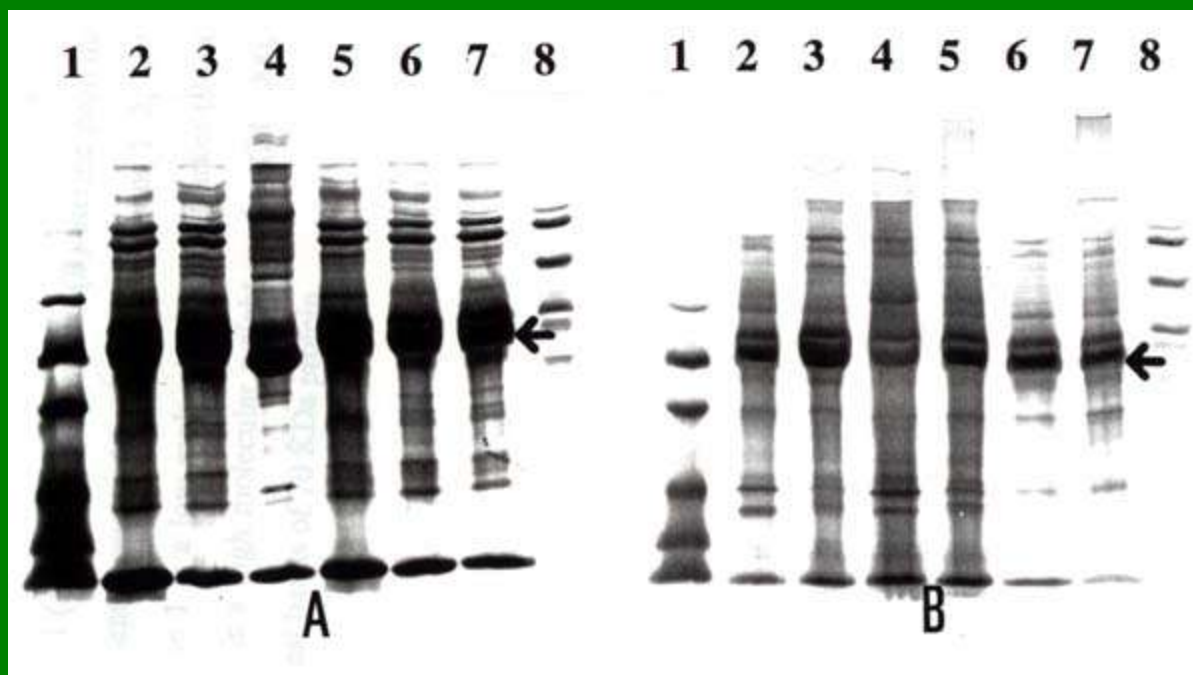
**BACK**

## Results

The concentration of NO was compared in the 20 h culture supernatant of resident peritoneal macrophage cell culture obtained from the *in vivo* sex steroid-treated mice and *in vitro* macrophages exposed to LPS ([Table 2](#)). The peritoneal macrophages from the group treated with estradiole alone showed a significantly higher concentration of NO than those in the other groups ( $p \leq 0.05$ ) ([Table 2](#)). No statistical difference was observed in the production by macrophages without LPS stimulation ([Table 2](#)). NO values were always higher in the LPS+ than LPS- macrophage culture supernatants.

TNF $\alpha$  production in the 4 h culture supernatants with or without LPS is shown in [Table 2](#). Peritoneal macrophages from the estradiole or testosterone-treated groups showed a higher level of TNF $\alpha$  production without LPS stimulation ( $p > 0.05$ ) than those in groups 1, 2 and 4. LPS treatment stimulated TNF $\alpha$  production by the macrophages in all the groups. However, the groups treated with estradiole or testosterone showed a significantly higher TNF $\alpha$  production than group 1 ( $p \leq 0.05$ ).

Mouse uterine fluid and serum samples were subjected to SDS-PAGE. There were many similar bands in both samples, but unique bands were also detected. After the samples were scanned, the bands common to serum and uterine proteins were deleted to determine whether the treatments with each of the sex steroids had induced specific uterine protein bands. The treatments induced several proteins as shown in [Fig. 1](#). After the samples were scanned, bands common to serum and uterine proteins, as well as specific bands in the uterine fluid or serum were obtained as shown in [Table 3](#).



**Fig.1.** SDS-PAGE analysis of total serum proteins (A) and (B) uterine proteins in response to sex steroid treatments

Lane 1: low molecular weight marker (94,000, 67,000, 43,000, 30,000, 20,100, 144,000).

Lane 2-7: samples from treatment groups 1,2,3,4 and 5, as described in the materials and methods.

Arrows indicate bands of 70 KDa protein.

The effect of the chronic sex steroid treatment on the total and absolute number of leukocytes is shown in [Table 4](#). The total number of white blood cells (WBC) and subsets of peripheral leukocytes in the groups 4 or 5 were higher compared to the groups 2 and 6. WBC numbers and their subsets were affected by the treatment ( $p \leq 0.05$ ) as shown in [Table 4](#). The total number of red blood cells (RBC) and mean corpuscular hemoglobin concentration (MCHC) were not different among the treated and control groups (data not presented here). Bacterial culture of uterine fluid for *E. coli* was negative.

## Discussion

In the present study, the effects of chronic subcutaneous treatment with embedded sex steroid pellets in mice on the modification of the macrophage activities, hematological characteristics, and pattern of uterine secretory protein were investigated. LPS is a well-known stimulator of macrophages^{17,23,29}). Priming effects for the up- and down-regulation of TNF $\alpha$  and NO production by different concentrations of LPS and other substances were reported^{22,26,34}). The present results showed that there were no significant differences in the background level of NO production by peritoneal macrophages obtained from mice treated with different sex steroids. However, LPS stimulation up-regulated NO synthesis by the peritoneal macrophages. Schneemann et al. (1993) reported a 2.5-30 fold increase of NO in the supernatants from murine peritoneal macrophages after stimulation with LPS²²). Furthermore, a single estrogen treatment led to the priming

of macrophages to produce higher levels of NO than those attained with other steroids²²). This observation suggests that estrogen plays an immuno-potentiating role. In contrast to the present results, rat alveolar macrophages treated *in vitro* with estradiol or progesterone showed a down-regulation of NO production²¹). In other cells than macrophages, it was reported that estradiol up-regulated NO production in cultured human aortic endothelial cells⁸). No significant calcium-independent NO activity was reported either during the pregnancy or after administration of sex hormones³²). These data suggest that the effect of female sex steroids varies depending on the tissues, or duration of the treatments, and under *in vivo* and *in vitro* conditions. Sex steroids affect the host antimicrobial function via NO production^{13,32}).

In the present study, the level of TNF $\alpha$  increased by treatment with both estradiol and testosterone. It was reported that female sex steroid hormones enhance the production of colony-stimulating factor-1 (CSF-1), transforming growth factor (TGF $\alpha$ ), granulocyte monocyte- colony stimulating factor (GM-CSF) and TNF $\alpha$ ⁹). Since the NO synthesis induced by LPS was mediated by IFN and not by TNF $\alpha$ , it is suggested that TNF $\alpha$  and NO had different regulatory pathways⁵). In the LPS stimulated mouse macrophage cell lines (RAW264, ANA cells) estrogen up-regulated the TNF $\alpha$  production and progesterone down-regulated it¹⁶). Chao et al. (1995) reported that estrogen treatment at a rate of 10⁻² and 10⁻³ g/mL significantly up-regulated TNF $\alpha$  expression in male rat peritoneal macrophages, but down-regulated it at a rate of 10⁻¹ or less than 10⁻⁴ mg/mL³). These results also indicate that the effects of sex steroids on the macrophage function are complex.

Characteristic pattern of uterine fluid depending on the reproduction cycle was reported and the role of the proteins in host defense mechanisms was examined^{18-20,24,25,28,30,33}). However, since no report on the pattern in mice had been reported previously, we observed the expression patterns of protein in the uterine fluid in the present study. Treatment of ovariectomized ewes with progesterone F2 $\alpha$  induced the production of an immuno-suppressive protein with a molecular weight of 55,000 in the uterus²⁴). Chronic estrogen exposure was reported to lead to the development of complex endometrial hyperplasia in women and was related to the over-expression of lactoferrin²⁰). Lactoferrin (LF) is a 70 KDa protein that is not induced by either progesterone or testosterone^{28,30}). However, in our study in all the treated groups, a 70 KDa protein was induced, presumably due to the longer treatment period. However, further determination using Western blotting should be carried out.

The uterus is a sex steroid-responsive organ²⁷). Treatment with steroids induced the formation of several proteins, which were identical with serum proteins, presumably due to the uterine edematous reaction, serum transudation by vasodilation^{10,27}), or secretion by uterine epithelial cells²⁷). The patterns specific to uterus protein, in the present study, corresponded to de novo synthesized products as a result of the steroid treatment.

Compared to previous reports¹¹), in our study, the number of WBC was lower, which may be due to the fact that we used SPF mice.

In conclusion, we demonstrated the modulation of macrophage function and the expression of uterine proteins by sex steroid treatment. Further studies are required to characterize fully the uterine proteins and analyze their relationship with the function of macrophages.

The authors thank Prof. P. S. Gwakisa of Sokoine University, Tanzania for his suggestions.

**NEXT**

[Species Composition and Biomass of a Mangrove Forest in Malaysia.](#)

**TOP**

**HOME**

**Table 2. Production of NO and TNF $\alpha$  by peritoneal macrophages (mean $\pm$ D)**

Group	NO production (nmol/well)		TNF $\alpha$ production (pg/well)	
	LPS-	LPS+	LPS-	LPS+
1	34.7+25.4	71.6+24.9 ^{a)}	43.0 $\pm$ 51.5 ^{a)}	92.5 $\pm$ 61.0 ^{a)}
2	37.3+31.0	64.2+17.0 ^{a)}	69.0 $\pm$ 50.0 ^{a)}	180.0 $\pm$ 91.5
3	41.3+38.6	89.5+37.5 ^{b)}	106.0 $\pm$ 102.0 ^{b)}	225.5 $\pm$ 171.5 ^{b)}
4	37.0+12.5	63.2+39.0 ^{a)}	97.0 $\pm$ 61.0	212.5 $\pm$ 188.5
5	38.2+ 8.7	68.5+10.2 ^{a)}	52.0 $\pm$ 33.5 ^{a)}	178.0 $\pm$ 162.0
6	39.8+23.3	61.6+ 2.0 ^{a)}	105.0 $\pm$ 118.5 ^{b)}	220.0 $\pm$ 152.5 ^{b)}

a) vs b) in each test was  $p \leq 0.05$ .

BACK

**Table 3. Protein identification in uterine fluid and serum**

Peak Mr Wt KDa	Source*											
	serum						uterus					
251-260	g1	g2	g3	g4	g5	g6	g1	g2	g3	g4	g5	g6
241-250												
231-240			g3	g4								
221-230	g1	g2			g5							
191-200	g1	g2										g6
181-190				g4	g5		g1		g3	g4	g5	g6
171-180	g1	g2	g3			g6		g2			g5	
161-170									g3	g4		
151-160	g1			g4	g5		g1	g2				g6
141-150		g2	g3			g6			g3	g4	g5	
131-140	g1		g3		g5		g1	g2				
121-130	g1	g2		g4		g6	g1					
111-120					g5							
91-100	g1	g2	g3	g4		g6			g3			
81-90	g1				g5				g3		g5	g6
71-80	g1	g2	g3	g4			g1	g2	g3	g4	g5	g6
61-70	g1	g2	g3	g4	g5	g6	g1	g2	g3	g4	g5	g6
51-60				g4	g5					g4		
41-50	g1	g2	g3	g4	g5		g1	g2	g3	g4	g5	g6
31-40	g1	g2	g3	g4	g5	g6		g2	g3			g6
21-30	g1	g2	g3	g4	g5	g6	g1	g2	g3	g4	g5	g6
11-20	g1	g2	g3	g4	g5	g6	g1	g2	g3	g4	g5	g6

*Bands in each group were represented as: g1 = Pc, g2= P₄,  
g3= E₂, g4= P₄E₂, g5= E₂P₄ and g6= Te.

BACK

**Table 4. Total and absolute leukocyte Nos/ $\mu$ L blood (mean $\pm$ SD)**

Group	WBC	Neutrophils	Lymphocytes	Monocytes	Eosinophils
1	4.3 $\pm$ 2.2	0.046 $\pm$ 0.064 ^{b)}	4.2 $\pm$ 2.2	0.023 $\pm$ 0.036 ^{b)}	0.003 $\pm$ 0.008 ^{b)}
2	3.3 $\pm$ 1.2 ^{b)}	0.092 $\pm$ 0.149	3.1 $\pm$ 1.2 ^{b)}	0.050 $\pm$ 0.080 ^{b)}	0.010 $\pm$ 0.017 ^{b)}
3	4.2 $\pm$ 1.7	0.047 $\pm$ 0.085 ^{b)}	4.0 $\pm$ 1.6	0.023 $\pm$ 0.042 ^{b)}	0.008 $\pm$ 0.021 ^{b)}
4	5.4 $\pm$ 3.1 ^{a)}	0.204 $\pm$ 0.223 ^{a)}	5.0 $\pm$ 2.6 ^{a)}	0.145 $\pm$ 0.310 ^{a)}	0.026 $\pm$ 0.046 ^{a)}
5	5.8 $\pm$ 2.5 ^{a)}	0.093 $\pm$ 0.075 ^{a)}	5.7 $\pm$ 2.6 ^{a)}	0.018 $\pm$ 0.025 ^{b)}	0.012 $\pm$ 0.026 ^{b)}
6	3.3 $\pm$ 1.6 ^{b)}	0.065 $\pm$ 0.082 ^{b)}	3.2 $\pm$ 1.6 ^{b)}	0.013 $\pm$ 0.023 ^{b)}	0.015 $\pm$ 0.027 ^{b)}

( $p \leq 0.05$ ) between groups for total WBC and absolute number of leukocytes.

a) vs b) in each test was  $p \leq 0.05$ .

**BACK**



# Profiles of Species Composition and Aboveground Biomass in a Mangrove Forest, Matang, Peninsular Malaysia

Hiroyuki TANOUCHI*¹, Shozo NAKAMURA*², Yukihiro OCHIAI*³ and AZMAN Hassan*⁴

- *1 Silviculture Division, Hokkaido Research Center, Forestry and Forest Products Research Institute (Sapporo, Hokkaido, 062-8516 Japan)
- *2 Research Coordination Division, Forestry and Forest Products Research Institute (Tsukuba, Ibaraki, 305-8687 Japan)
- *3 Forestry Division, Japan International Research Center for Agricultural Sciences (Tsukuba, Ibaraki, 305-8686 Japan)
- *4 Natural Forest Division, Forest Research Institute of Malaysia (Kepong, Kuala Lumpur, 52109 Malaysia)

This study was supported fully by a grant-in-aid for the Research Project on "Productivity and Sustainable Utilization of Brackish Water Mangrove Ecosystems" from Japan International Research Center for Agricultural Sciences.

Corresponding author; H. Tanouchi (tano@ffpri-hkd.affrc.go.jp, fax +81-11-851-4167)

## Abstract

To analyze the sustainability and carrying capacity of a mangrove forest, we studied the profiles of species composition and biomass from the riverside to inland. A belt transect (25?180 m) divided into 9 plots was established in compartment 46, in the Matang Mangrove Forest Reserve, Perak, Peninsular Malaysia. Five tree species were distributed in the transect. *Rhizophora apiculata* showed the highest density, followed by *Bruguiera parviflora*, *B. sexangula*, *R. mucronata* and *Avicenia alba*. From the riverside to inland, the structure changed from pure *R. apiculata* stands to mixed *Rhizophora-Bruguiera* stands. The mean aboveground biomass of all the plots was 316 Mg ha⁻¹. The largest and smallest volumes for biomass were 558 Mg ha⁻¹ on the riverside and 144 Mg ha⁻¹ inland, respectively. The values tended to be higher in *R. apiculata*-dominant stands. If a larger productive area could be set up where *R. apiculata* would predominate, i.e. an area at a lower ground level, a larger sustainable amount of biomass for firewood and charcoal use could be produced. The annual dead biomass, which is supplied to the forest floor as nutrients for aquatic life, was 5.1 Mg ha⁻¹. While stocked biomass is more valuable to a local economy than the dead biomass, the contribution of the fallen trees (dead biomass) to habitats and nutrients for aquatic life must be evaluated exactly in the future.

Discipline: Forestry and forest products

Additional key words: *Rhizophora*, *Bruguiera*, brackish water, sustainable management

1...11):[References](#)

(Received for publication, July 16, 1999)

## Introduction

The Matang mangrove forest in Perak, Peninsular Malaysia covers a land area of approximately 40,711 ha^{1,3)}. The productive forest accounts for 85% of the area and has been appropriately managed under a working plan since the beginning of the 19th century. Moderate harvesting of firewood and wood for charcoal has supported the livelihood of the local people working in forestry. Meanwhile, the floor of mangrove forests and surrounding brackish water areas have supplied habitats enabling aquatic animals, i.e. crabs, shrimps and fish, to grow and breed. In other words, the people engaged in fisheries harvest the benefits of the forest.

The brackish water mangrove project has been carried out jointly by Japan International Research Center for Agricultural Sciences, Fisheries Research Institute, University of Malaya and Forest Research Institute of Malaysia for 5 years (FY 1995-1999). It aimed at obtaining new findings and information to analyze the sustainability and carrying capacity of the mangrove ecosystems. Under the project, the forest biomass stocked as living trees (wood resources), and released as litter (nutrients for aquatic life) was analyzed. The aboveground biomass had been estimated for several forests of the same species^{4,5,9)}. However, the differences among micro-sites and the total amount of litter (biomass of dead trees) are still unknown. In this study, we report the changes in species composition and aboveground bio-mass from the riverside to inland and the dead biomass in a typical natural forest dominated by *Rhizophora* and *Bruguiera* species.

## Methods

The experimental site established in compartment 46, Matang, Perak, Peninsular Malaysia (4°47'52"N, 100°38'49"E), consists of a belt transect extending from the riverside to inland with a size of 25 x 180 m. The transect was divided into 9 plots (25 x 20 m each), Plots 1-9, starting from the riverside. The edge of Plot 1 was separated by a distance of about 10 m from the riverside. The arrangement of the plots was described in previous reports^{6,7)}.

For all the live trees more than 1.2 m in height, we measured the diameter of the stem at the 1.2 m height (D), as well as the height (H) and determined the location. When the position of the highest prop root was higher than 1.2 m, we measured D at 20 cm above the prop root. In this study, trees corresponded to a stem with D x 5 cm and saplings to a stem with  $H \geq 1.2$  m and  $D < 5$  cm. Gap was defined as the area under a canopy opening, which is equivalent to the canopy gap defined by Runkle¹⁰⁾. Location and area of the gap were also determined. The dead trees of 1 year were recorded in the following year.

The volume of each tree (D² x H) was used to calculate the biomass (dry matter weight of aboveground organs). To estimate the biomass, we used the coefficients of allometric equations of Kusmara et al.⁵⁾.

[NEXT](#)[TOP](#)

**References**

- 1) District Forest Officer, Larut and Matang, Taiping (Unknown): Briefing on the Management, Silviculture and Rehabilitation in the Matang Mangrove Reserve. Perak State Forestry Department.
- 2) Fujimoto, K. et al. (1992): Topographical condition and species composition in a mangrove forest, the mouth of Urauchi River, Iriomote Island. *Annu. Rep. Kyushu Res. Cent. For. Forest Prod. Res. Inst.*, 4, 3 [In Japanese].
- 3) Haron A. H. (1981): The Matang Mangrove Forest Reserve, Perak. Perak State Forestry Department.
- 4) Komiyama, A. (1988): Primary productivity of mangrove forest. *Biological System of Mangroves*. eds. Ogino, K. & Chihara, M., 97-106.
- 5) Kusmana, C. et al. (1992): An estimation of above ground biomass of a mangrove forest in East Sumatra, Indonesia. *TROPICS*, 1, 243-257.
- 6) Nakamura, S. et al. (In press): Stand structures of experimental plots established in Matang mangrove forest, Perak, Malaysia. *Proc. 3rd Seminar on Results for 1996/97 Res. Proj.*
- 7) Ochiai, Y. et al. (1997): Litterfall and stand structure of Mangrove forest in Matang, Perak. *Proc. 2nd Seminar on Results for 1995/96 Res. Proj.*, 1-4.
- 8) Ong, J., Gong, W. & Wong, C. (1982): Studies on nutrient levels in standing biomass, litter and slash in a mangrove forest. *BIOTROPICA*, 3557, 1-44.
- 9) Putz, F. E. & Chan, H. T. (1986): Tree growth, dynamics and productivity in a mature mangrove forest in Malaysia. *Forest Ecol. Manage.*, 17, 211-230.
- 10) Runkle, J. R. (1981): Gap regeneration in some old-growth forests of the eastern United States. *Ecology*, 62, 1041-1051.
- 11) Saenger, P. & Snedaker, S. C. (1993): Pantropical trends in mangrove above-ground biomass and annual litterfall. *Oecologia*, 96, 293-299.

## Results

Five species were recorded in the transect. *Rhizophora apiculata* showed the highest density, followed by *Bruguiera parviflora*, *B. sexangula*, *R. mucronata* and *Avicenia alba*. While the trees showed a random distribution in space, the saplings showed a contiguous distribution (Fig. 1). Gaps existed in all the plots except in Plot 1, but the larger ones were concentrated in Plots 4, 5 and 6.

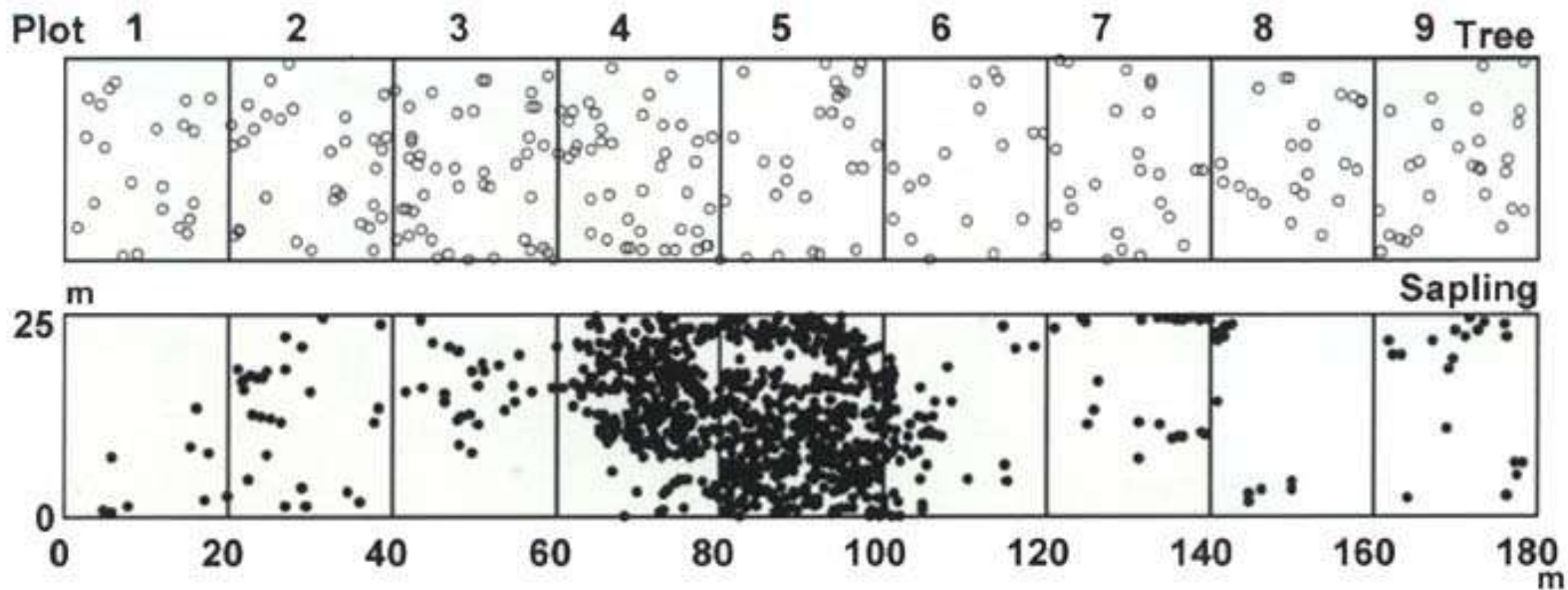


Fig.1. Spatial distribution of trees (upper) and sapling (lower) in a belt transect (Compartment 46, Matang mangrove forest)

Plots numbered 1 to 9 are located on a transect extending from the riverside to inland.

Some values among the plots showed distinct differences (Fig. 2). The maximum H of trees ranged from 33.2 m (Plot 1) to 23.4 m (Plot 5). Although the mean H of trees was similar among the 7 plots, the values in Plot 1 (26.0 m) and Plot 8 (15.3 m) were considerably higher and lower than those in the other plots, respectively. The mean D values in Plots 1 and 8 were largest (27.8 cm) and smallest (14.2 cm), respectively among the plots. The smaller the values of H and D, the higher the density. The canopy rate, which is defined as the plot area (100%) minus gap area (%), ranged from 100% in Plot 1 to 83% in Plot 5. The largest and smallest values for biomass were 558 Mg ha⁻¹ in Plot 1 and 144 Mg ha⁻¹ in Plot 8, respectively. The mean biomass of all the plots was 316 Mg ha⁻¹.

The tree species showed some features in their height distribution, i.e. the structural profile along the transect (Figs. 3 and 4). For trees, there were 4 species which differed in their distribution and density. *R. apiculata* formed a canopy in all the plots, and it was the most abundant species in each plot except in Plot 8; in particular, it occurred in the canopy layer contiguously in Plot 1. *B. parviflora* was distributed in most plots, except in Plots 1 and 6, and was mainly observed in the sub- or under-canopy layer. *B. sexangula* formed the canopy in Plots 5, 8 and 9. *R. mucronata* was found only in the canopy layer of Plot 9.

There were 4 species of saplings (Figs. 3 and 4). *B. parviflora* was the most abundant species and was distributed contiguously in Plots 4 and 5, followed by *B. sexangula* which was distributed from Plots 2 to 9. *R. apiculata* was observed in the lower layer at around 1.2 to 3.0 m and was concentrated in Plots 4 and 5. No *R. mucronata* saplings were detected in the transects, and in the case of *A. alba*, there were no trees but saplings in the lower height layer.

*R. apiculata* accounted for 83% of the total above-ground biomass, followed by *B. sexangula*, *B. parviflora* and *R. mucronata* with 8, 6 and 3% of the total, respectively. Percentages of tree density for *R. apiculata*, *B. sexangula*, *B. parviflora* and *R. mucronata* were 65, 14, 20, 1%, respectively. *R. apiculata* accounted for a larger biomass rate than the density rate in most plots, except in Plots 8 and 9 (Fig. 4). The profiles of densities of saplings showed different patterns compared with trees (Figs. 3 and 4). The densities were extremely high in Plots 4 and 5, and the composition rate of the species was different. For *R. apiculata* the density of saplings was lower than the density of trees, and the value was lower in plots where the species was predominant in terms of tree biomass and density, e.g. Plots 1, 2 and 6. Conversely in the case of *B. parviflora* the tree biomass and density were not the highest in all the plots, but the density of the saplings was predominant in most plots.

The mean value of aboveground biomass that produces debris (large litter) on the forest floor in a year was 5.1 Mg ha⁻¹ ([Table 1](#)). The biomass corresponded to the dry weight of the trees which had died in a year. The values ranged from 0 to 15.4 Mg ha⁻¹ among the plots and the rates to the living biomass were 0 to 6.3%.

## Discussion

The study plots in the transect appeared to reflect the structure of the Matang forest reserve. The forest is widely dominated by *R. apiculata* associated with *R. mucronata*, *B. parviflora* and *B. sexangula*³. *R. apiculata* was distributed and formed a canopy layer all over the transect (Figs. 3 and 4). *R. apiculata* trees were the only trees in some plots, and they tended to grow taller with a large biomass near the riverside. Nakamura et al.⁶ reported that *R. apiculata* showed a unimodal D distribution in Plot 1 in the area closest to the riverside. Moreover, the density of individuals in the understory and the sapling layer was low and the mortality of the seedlings (H < 1.2 m) was higher than in the other species. Therefore, they suggested that *B. sexangula* and *B. parviflora* that occurred as saplings and seedlings with a lower mortality might replace *R. apiculata*. Other plots also showed this tendency. The seedling density of *R. apiculata* was higher than that of *B. sexangula* and *B. parviflora* in Plot 1⁶. Moreover, the ratios of *R. apiculata* and 2 *Bruguiera* species showed an opposite trend for the values on the riverside (Plot 1) and inland (Plot 9). For *R. apiculata*, the riverside is a suitable site for seedling establishment, but not for growth and survival. In any case, in all tree species, the seedlings can not survive under closed canopy⁶. Therefore, in Plot 1 with a 100% canopy rate (see Fig. 3) light conditions are unfavorable for recruiting the seedlings to the sapling stage, suggesting that light rather than topographical factors affects the recruitment.

The profile of the species composition from the riverside to inland showed species-specific changes (Figs. 3 and 4). While the *R. apiculata* biomass largely predominated on the riverside, mixed stands with 3 to 4 species were observed inland. The fact that the density rates of *B. parviflora* and *B. sexangula* for trees, and especially for saplings, were higher inland suggests that forests change to a *Bruguiera* spp. forest with increasing distance from inland. Fujimoto et al.² also indicated a similar change in profile in Japan: *Rhizophora* species became predominant with decreasing ground level toward the seaside. A *Rhizophora-Bruguiera* mixed forest was established at higher ground level (inland). Haron Abu Hassan³ reported that *Rhizophora* and *Bruguiera* species were the major trees and shared the main habitat in the Matang mangrove forest. Therefore, it is important to analyze the dynamics and biomass of the 2 genera to determine the sustainability and carrying capacity of the forest.

The total biomass at the study site was 316 Mg ha⁻¹ ([Table 1](#)), a value lower than that in the protected stands with a mean of 409 Mg ha⁻¹ in Matang⁹ and showed comparable values to those of *R. apiculata* forests in Indonesia (356 Mg ha⁻¹)⁴. Kusmana et al.⁵ pointed out that a large biomass of more than

200 Mg ha⁻¹ is produced in an area where the annual temperature and precipitation exceed 25°C and 2,000 mm, respectively. The Malay Peninsula where the study area is located is under such climatic conditions. Moreover, the lack of wind disturbance mainly associated with typhoons contributes to the growth of taller trees⁹⁾, and consequently higher trees produce a large biomass¹¹⁾. In this study, pure stand of *R. apiculata* (Plot 1) had a large biomass with a value (dry matter, 558 Mg ha⁻¹) presumably higher than the biomass values reported in the literature. Sites with an extremely high or low biomass occur patchily in natural forests. Most of the pure stands of *R. apiculata* (Plots 1, 2 and 7, Figs. 2 and 3) display a larger biomass than the stands where *Rhizophora* and *Bruguiera* species grow together. Wood of *Rhizophora* species has a higher quality as fuel compared with that of *Bruguiera* species³⁾. For the production of larger amounts of sustainable biomass for firewood and charcoal, it is important to secure a larger productive area where *R. apiculata* can predominate easily, i.e. areas at a lower ground level.

The annual dead biomass, which is supplied to the forest floor as nutrients for aquatic life, amounted to 5.1 Mg ha⁻¹. However, since this value was only recorded for 1 year and there are no other reports on dead biomass, further studies should be carried out. The balance between dead and growth mass in a year is 0 in a well-matured forest. Based on the biomass in a stand whose age was recorded exactly in Malaysia, the annual growth was 7.9 Mg ha⁻¹⁸⁾. Although we can not simply compare the value⁸⁾ with the dead mass in our stands, the forest under study must be still growing and preserving organic matter as live biomass. Moreover, it remains to be determined when the respective organs (leaf, branch and stem) fall to the floor after dying. It will be necessary to clarify the process whereby dead standing trees produce debris to determine the effect of fallen trees (dead biomass) on habitats and nutrients for aquatic life.

**BACK** [Contents](#)

**TOP** [First page of JARQ](#)

**HOME** [JIRCAS Home Page](#)



**Japan International Research Center for Agricultural Sciences**  
**Ministry of Agriculture, Forestry, and Fisheries**  
**1-2 Ohwashi, Tsukuba, Ibaraki, 305-8686 JAPAN**  
**[www@jircas.affrc.go.jp](mailto:www@jircas.affrc.go.jp)**  
**<http://ss.jircas.affrc.go.jp/engpage/jarq/firstpage1.html>**  
**Telephone 0298-38-6304**  
**published on April 28, 2000**

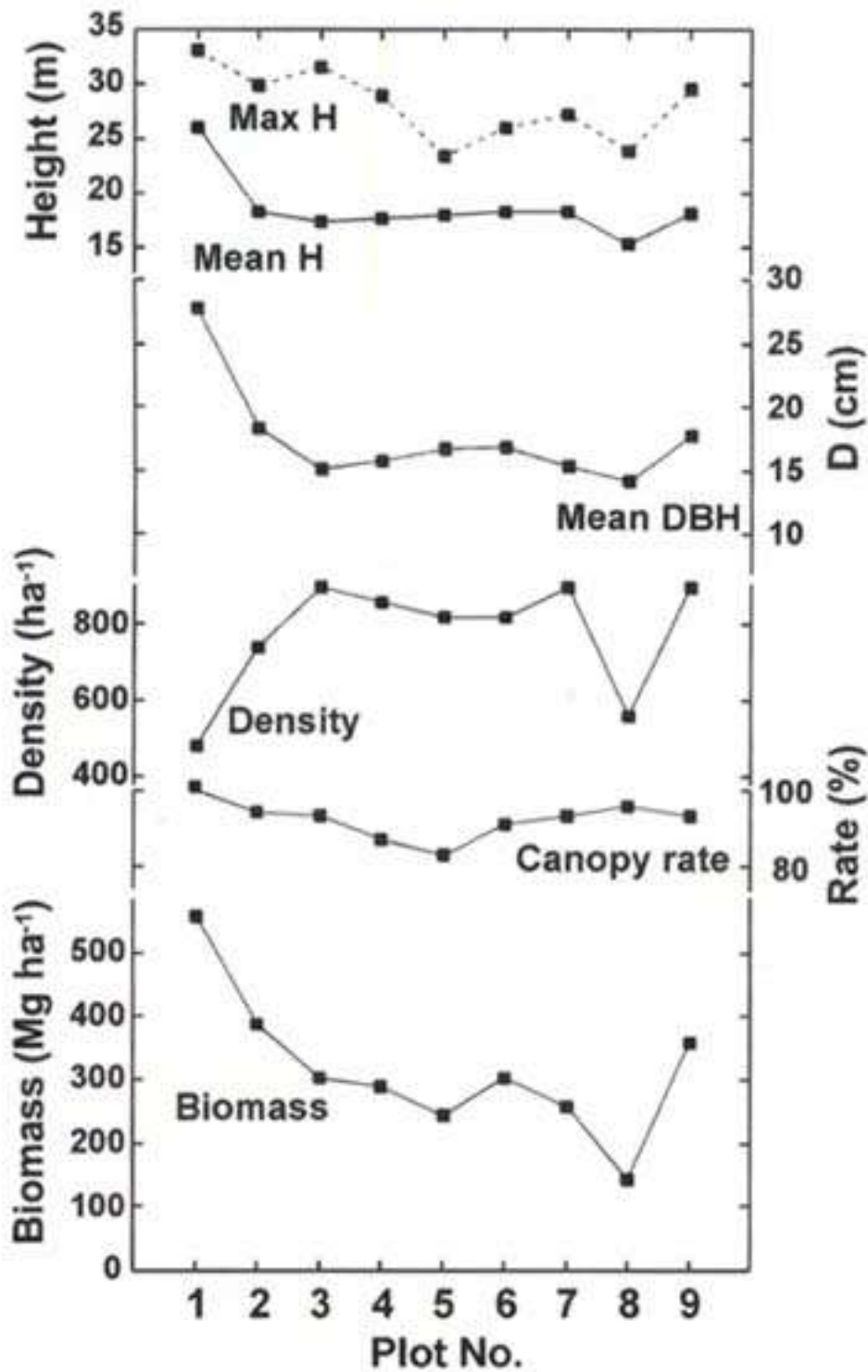


Fig.2. Changes in values of trees along a transect from Plot 1 (riverside) to Plot 9 (inland), Matang mangrove forest

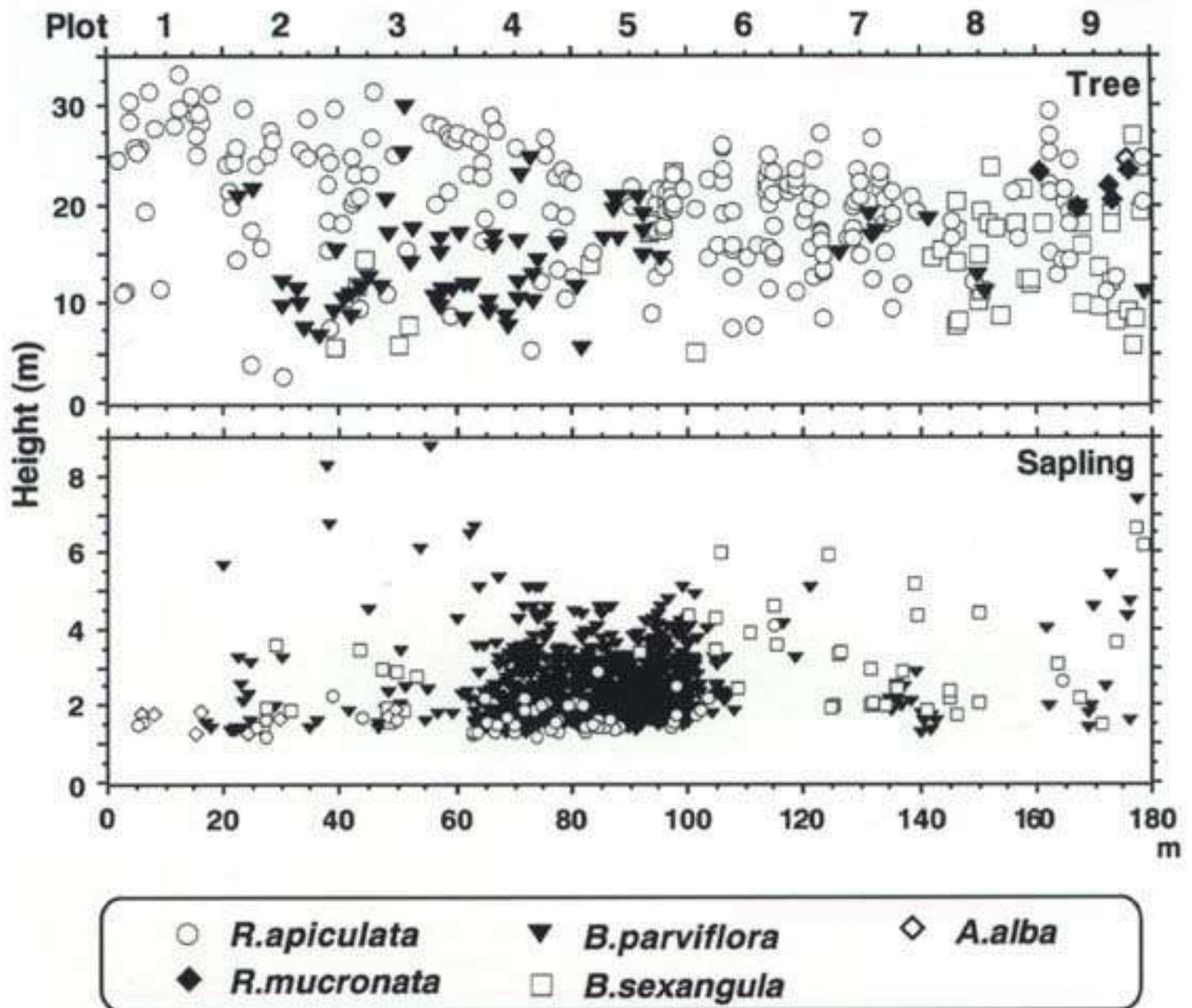
Each point shows the value calculated for trees

(DBH  $\geq$  5cm).

Canopy rate = 100 (plot area,%) - gap area (%)

[BACK](#)





**Fig. 3.** Height distribution of trees and saplings along a transect (20 x 180 m) from Plot 1 (riverside) to Plot 9 (inland), Matang mangrove forest

BACK

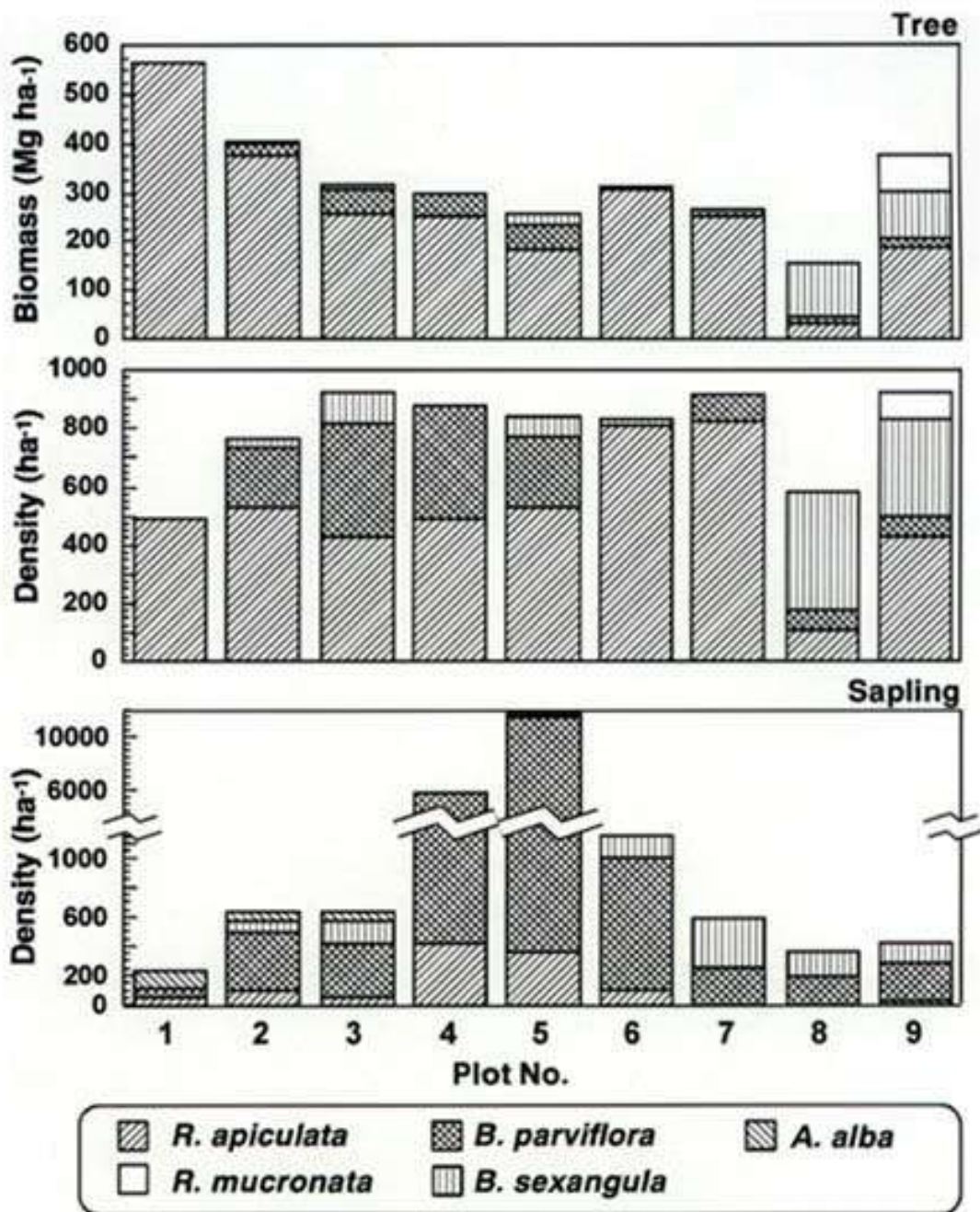


Fig.4. Profile of biomass and density along a transect from Plot 1 (riverside) to Plot 9 (inland), Matangmangrove forest

BACK

**Table 1. Aboveground biomass and biomass supplied as debris in each plot**

Plot	Aboveground biomass (Mg ha ⁻¹ )	Supplied biomass (Mg ha ⁻¹ yr ⁻¹ )*	Ratio (%)
1	557.8	0.0	0.0
2	387.8	1.2	0.3
3	302.4	15.2	5.0
4	289.0	4.2	1.5
5	244.4	15.4	6.3
6	301.8	0.0	0.0
7	257.4	4.8	1.9
8	143.9	5.0	3.5
9	359.1	0.0	0.0
Mean	315.9	5.1	1.6

* Value refers to dead aboveground biomass in a year.

**BACK**



# JIRCAS Working Report

No.	Language	Title / Author ,Editor	date
No.1	English	<b>INTERNATIONAL FOOD AND AGRICULTURAL POLICY SIMULATION MODEL (USER'S GUIDE)</b> by keiji Oga and Koji Yanagishima	1996/03
No.2	English	<b>Mungbean Germplasm:collection, Evaluation and Utilization for Breeding Program</b> Edited by P. Srinives , C Kitbamroong and S .Miyazaki	1996/03
No.3	Japanese	<b>Soils and Agriculture of Turpan, China</b> by Makoto Nakai, Guihai Zao, Zili Fffan and Leide Zhang	1996/10
No.4	English	<b>Sustainable Utilization of Coastal Ecosystems•@Proceedings of the Seminar on Sustainable Utilization of Coastal Ecosystems for Agriculture, Forestry and Fisheries•@in Developing Regions</b> Editd by M. Suzuki, S. Hayase and S. Kawahara	1996/10
No.5	Japanese	<b>Development of Sustainable Agricultural Systems in Northeast Thailand</b> Edited by Mitsunori Oka and Shotaro Ando	1997/02
No.6	Japanese	<b>Chinese Soil Taxonomy (Revised proposal )</b> by Chinese Soil Taxonomy Research Group, Institute of Soil Science, Academia Sinica & Cooperative Research Group on Chinese Soil Taxonomy	1997/03
No.7	Japanese	<b>Agriculture and Soybean in South America</b> Edited by Makie Kokubun and Kozo Fujisaki	1997/11
No.8	Japanese	<b>Changes in Food Supply and Demand in China&gt;under Economic Reform</b> by Chien Hsiaoping, Noriko IRIE, Mitsuhiro Nakagawa	1998/03
No.9	Japanese	<b>Review and Intercomparison of Land -Surface Models for Evaluating Large Scale Evapotranspiration</b> by Kumiko Takada and Hiroyuki Ohno	1998/03
No.10	English	<b>Status Requirement of Minerals in ruminatants in Thailand Current Know ledge and future research</b> Edited by T. Kawashima and P.Vijichulata	1998/03

No.11	English	<b>Comparative Studies on Phosphorus and Iron Nutrition of Tropical Legumes</b> by Yoshinori Ohwaki	1998/03
No.12	Japanese	<b>Current State and View of International Collaborative Research in Fisheries Postharvest technology</b> Edietedd by Yutaka Fukuda and Shiro Uno	1998/12
No.13	English	<b>No-Tillage cultivation of Soybean and Future Research Needs in South America</b> Edited by Makie Kokubun	1998/12
No.14	English	<b>Proceedings of Workshop on Heat -Tolerance of Crops</b> Edited by M. Yajima and T. Hayashi	1999/03
No.15	Japanese	<b>Studies on Papaya Virus Disease in Japan and Southeast Asia - Occurrence, Distribution, Isolation, Diagnosis and Taxonomy of Virus -</b> by Tetsuo MAOKA	1999/12
No.16	English	<b>Proceedings of the Seminar on High Value Timber Species for Plantation Establishment-Teak and Mahoganies,1-2 December 1998,Tawau, Sabahto</b> Edited by Chan Hing Hon and Kazuma Matsumoto	1999/03
No.17	Japanese	<b>Studies on the Development of a Plant Regeneration System from Protoplasts of Sugarcane (Saccharum spp.)</b> by Makoto MATSUOKA	2000/03
No.18	English	<b>Learning from the Farming Systems Research Experiences in Indonesia</b> Edited by J.Goto and M.Mayrowani	2000/03
No.19	English	<b>Jircas/EMBRAPA Gado de Corte International Joint Workshop on Agropastoral System in South America</b> Edited by Tsutomu Kanno and Manuel.C.Macedo	2001/01
No.20	English	<b>Development of Technology for Utilization and Processing of Freshwater Fisheries Resources</b> Edited by Y.Fukuda,X.Wang,M.Yokoyama and M.Maeda	2001/01
No.21	Japanese	<b>Trend in Farm Household Economy Under the Tanzania Kilimanjaro Agricultural Development Project</b> <b>- A Field Survey in Lower Moshi Area -</b> by Toshitaka KATSUKI	2001/07
No.22	Japanese	<b>Oryza Glaberrima Genetic Resources: Evaluation and Use</b> Edited by Hiroko TAKAGI, Osamu ITO and Masaru IWANAGA	2001/12
No.23	English	<b><u>Genetic Engineering of Crop Plants for Abiotic Stress</u></b> Compiled by M.Iwanaga	2002/02



# JIRCAS Working Report

No.23

Genetic Engineering of Crop Plants for Abiotic Stress

Compiled by M.Iwanaga

## Contents (Name of Presenters)

Title/Author	
CHAPTER 1	<a href="#"><u>Biological Mechanisms of Drought Stress Response</u></a> Kazuko Yamaguchi-Shinozaki
CHAPTER 2	<a href="#"><u>Biological Mechanisms of Low Temperature Stress Response: Cold Acclimation and Development of Freezing Tolerance in Plants</u></a> E. Tapio. Palva
CHAPTER 3	<a href="#"><u>Functional Analysis of Mitochondrial Small Heat Shock Protein</u></a> Mariko Shono
CHAPTER 4	<a href="#"><u>Salt Stress Tolerance of Plants</u></a> Shuji Yokoi
CHAPTER 5	<a href="#"><u>Development of Transformation Methods Toward Producing Transgenic Plants with Abiotic Stress Tolerance</u></a> Francisco J.L.Aragao
CHAPTER 6	<a href="#"><u>Recent Developments in Transgenics fo Abiotic Stress Tolerance in Rice</u></a> Swapen K. Datta
CHAPTER 7	<a href="#"><u>Progress in the Genetic Engineering of Wheat for Water-Limited Conditions</u></a> J.-M. Ribaut
CHAPTER 8	<a href="#"><u>Recent Developments in Transgenics for Abiotic Stress in Legumes of the Semi-arid Tropics</u></a> Kiran K. Sharma
CHAPTER 9	<a href="#"><u>Challenges in Biotechnology for Abiotic Stress Tolerance on Roots and Tubers</u></a> Kazuo N. Watanabe
CHAPTER 10	<a href="#"><u>Genetic Dissection and Plant Improvement Under Abiotic Stress Conditions: Drought Tolerance in Maize as an Example</u></a> J.-M.Ribaut

CHAPTER 11

[Rice functional Genomics via cDNA Microarray: Systems for the Microarray Analysis and the Expression Profiles of Stress Responsible Gene Expression](#)  
Shoshi Kikuchi



# Biological mechanisms of drought stress response

Kazuko Yamaguchi-Shinozaki¹, Mie Kasuga¹, Qiang Liu¹,  
Kazuo Nakashima¹, Yoh Sakuma¹, Hiroshi Abe¹,  
Zabta K. Shinwari¹, Motoaki Seki² and Kazuo Shinozaki²

¹Biological Resources Division, Japan International Research Center for Agricultural Sciences (JIRCAS), 1-1 Ohwashi, Tsukuba, Ibaraki 305-8686, Japan.

²Laboratory of Plant Molecular Biology, The Institute of Physical and Chemical Research (RIKEN), 3-1-1 Koyadai, Tsukuba, Ibaraki 305-0074, Japan

## Abstract

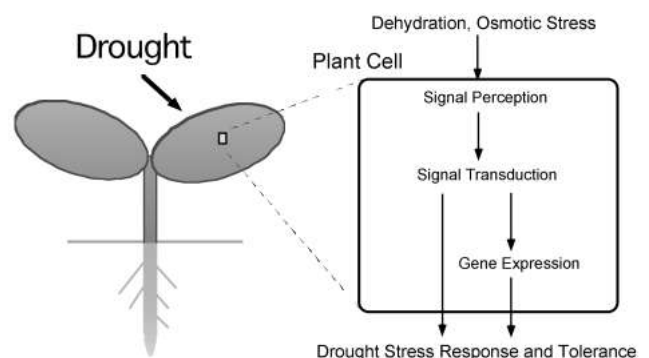
Plant productivity is greatly affected by drought stress. We reported that a *cis*-acting promoter element, the dehydration response element (DRE), plays an important role in regulating gene expression in response to drought stress in *Arabidopsis*. The DRE is also involved in low-temperature and salt responsive gene expression. The transcription factor DREB1A specifically interacts with the DRE and induces expression of stress tolerance genes. Overexpression of the cDNA encoding DREB1A in transgenic *Arabidopsis* plants activated the expression of many of these stress tolerance genes under normal growing conditions and resulted in improved tolerance to drought, salt loading, and freezing. We prepared a cDNA microarray using full-length *Arabidopsis* cDNAs to identify the target stress tolerance genes of DREB1A. Twelve stress-inducible genes were identified as the target genes of DREB1A, and six of them were novel. However, use of the strong constitutive 35S cauliflower mosaic virus (CaMV) promoter to drive expression of DREB1A also resulted in severe growth retardation under normal growing conditions. In contrast, expression of DREB1A from the stress inducible *rd29A* promoter gave rise to minimal effects on plant growth while providing an even greater tolerance to stress conditions than did expression of the gene from the 35S CaMV promoter. As the DRE-related regulatory element is not limited to *Arabidopsis*, the DREB1A cDNA and the *rd29A* promoter may be useful to improve the stress tolerance of agriculturally important crops by gene transfer.

*Keywords: abiotic stress, stress tolerance, gene expression, cis-element DRE, transcription factor DREB1A, transgenic plant*

## Introduction

Drought, salt loading, and freezing are environmental conditions that cause adverse effects on the growth of plants and the productivity of crops. Plants respond to these stresses at molecular and cellular levels as well as physiological level. Expression of a variety of genes has been demonstrated to be induced by these stresses.¹⁻⁴ The products of these genes are thought to function not only in stress tolerance but also in the regulation of gene expression and signal transduction in stress response (Fig.1).^{5,6}

Genetic engineering is thought to be useful for improving the stress tolerance of plants. Recently, several different approaches were attempted to improve the stress tolerance of plants by gene transfer.⁷ The genes selected for transformation were those involved in encoding enzymes required for the biosynthesis of



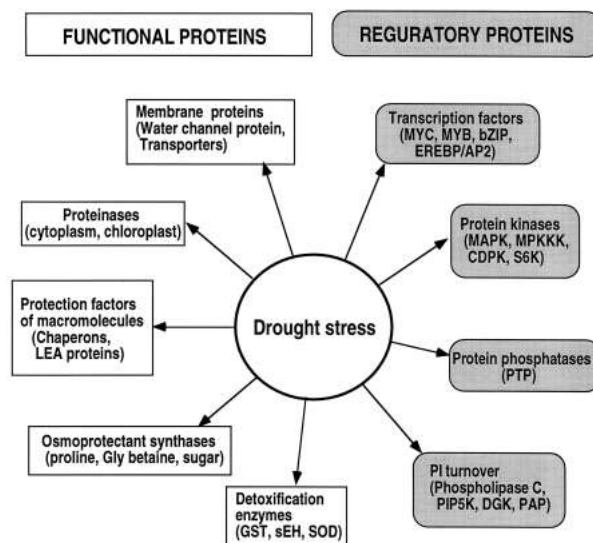
**Fig. 1.** Schematic representation of molecular responses to drought stress in plant cells. Molecular and cellular responses to drought stress include perception of dehydration signal, signal transduction to cytoplasm and nucleus, gene expression, and responses and tolerance to drought stress

various osmoprotectants.⁸⁻¹⁰ Other genes that have been selected for transformation include those that encoded enzymes for modifying membrane lipids, LEA protein, and detoxification enzyme.¹¹⁻¹⁴ In all these experiments, a single gene for a protective protein or an enzyme was overexpressed under the control of the 35S cauliflower mosaic virus (CaMV) constitutive promoter in transgenic plants, although a number of genes have been shown to function in environmental stress tolerance and response. The genes encoding protein factors that are involved in regulation of gene expression and signal transduction and function in stress response seem to be useful to improve the tolerance of plant to stresses by gene transfer as they can regulate many stress-inducible genes involved in stress tolerance.

Drought is one of the most severe environmental stresses and affects almost all the plant functions. Abscisic acid (ABA) is produced under water deficit conditions and plays important roles in tolerance against drought. Most of the drought inducible genes that have been studied to date are also induced by ABA.^{5,6} Several reports have described genes that are induced by dehydration but are not responsive to exogenous ABA treatments.^{5,6} These findings suggest the existence of ABA-independent as well as ABA-dependent signal-transduction cascades between the initial signal of drought stress and the expression of specific genes.^{5,6} To understand the molecular mechanisms of gene expression in response to drought stress, *cis*- and *trans*-acting elements that function in ABA-independent and ABA-responsive gene expression by drought stress have been precisely analyzed.^{5,6} In this article, we summarize recent progress of our research on *cis*- and *trans*-acting factors involved in ABA-independent gene expression in drought stress response. We also report stress tolerance of transgenic plants that overexpress a single gene for a stress-inducible transcription factor using *Arabidopsis* as a model.

### A variety of functions of drought-inducible genes

Various genes respond to drought-stress in various species, and functions of their gene products have been predicted from sequence homology with known proteins. Many drought-inducible genes are also induced by salt stress and low temperature, which suggests the existence of similar mechanisms of stress responses. Genes induced during drought-stress conditions are thought to function not only in protecting cells from water deficit by the production of important metabolic proteins but also in the regulation of genes for signal transduction in the drought stress response.¹⁻⁶ Thus, these gene products are classified into two groups (Fig. 2). The first group includes proteins that probably function in stress tolerance; such as chaperones, LEA



**Fig. 2.** Drought-stress inducible genes and their possible functions in stress tolerance and response. Gene products are classified into two groups. The first group includes proteins that probably function in stress tolerance (Functional proteins), and the second group contains protein factors involved in further regulation of signal transduction and gene expression that probably function in stress response (Regulatory proteins).

proteins, osmotin, antifreeze proteins, mRNA binding proteins, key enzymes for osmolytes biosynthesis, water channel proteins, sugar and proline transporters, detoxification enzymes and various proteases. LEA proteins, chaperones and mRNA binding proteins have been analyzed biochemically and shown to be involved in protecting macromolecules like enzymes, lipids and mRNAs from dehydration. Proline, glycine betaine and sugars function as osmolytes and protecting cells from dehydration. Key enzymes of several osmolytes have been cloned and analyzed biochemically. Water channel proteins, sugar transporters and proline transporters are thought to function in transport of water, sugars and proline through plasma membranes and tonoplast to adjust osmotic pressure under stress conditions. Detoxification enzymes, such as glutathione S-transferase, superoxide dismutase, and a soluble epoxide hydrolase are involved in protection of cells from active oxygens. Proteases including thiol proteases, Clp protease, and ubiquitin are thought to be required for protein turnover and recycle of amino acids.

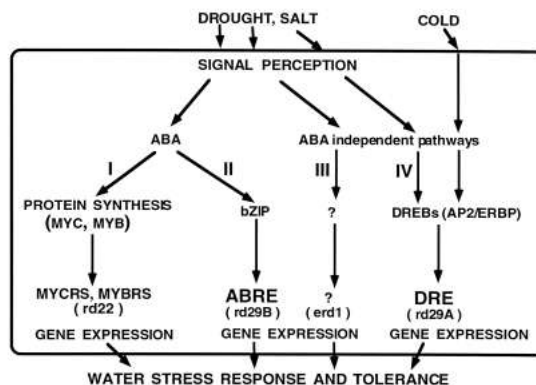
The second group contains protein factors involved in further regulation of signal transduction and gene expression that probably function in stress response: protein kinases, transcription factors and enzymes in phospholipids metabolism.¹⁻⁶ Genes for a variety of transcription factors that contain typical DNA binding motifs, such as bZIP, MYB, MYC, ERF/AP2 and Zinc fingers, have been demonstrated to be stress inducible.^{4,6}

These transcription factors function in further regulation of various functional genes under stress conditions. Various protein kinases, such as MAP kinases, calcium dependent protein kinases (CDPK), SNF1 related protein kinase and ribosomal S6 kinase were demonstrated to be induced or upregulated by dehydration.^{6,15} Stress-inducible genes for protein phosphatases are reported.¹⁶ These protein kinases and phosphatases may be involved in modification of functional proteins and regulatory proteins involved in stress signal transduction pathways. Phospholipids, such as inositol 1,4,5-triphosphate, diacylglycerol and phosphatidic acid are believed to be involved in stress signaling process in plants.⁶ Enzymes involved in phospholipids metabolism of which genes are stress-inducible may play important roles in stress signaling as well. Existence of variety of drought-inducible genes suggests complex responses of plants to drought stress. Their gene products are involved in drought stress tolerance and stress responses.

### Expression of dehydration-induced genes in response to environmental stresses and ABA

The expression patterns of genes induced by drought were analyzed by RNA gel-blot analysis. Results indicated broad variations in the timing of induction of these genes under drought conditions. All the drought-inducible genes are induced by high salinity stress. Most of the drought-inducible genes also respond to cold stress but some of them do not, and vice versa. Many genes respond to ABA whereas some others do not.¹⁻⁶ ABA-deficient mutants were used to analyze drought-inducible genes that respond to ABA. Several genes were induced by exogenous ABA treatment, but were also induced by cold or drought in ABA-deficient (*aba*) or ABA-insensitive (*abi*) *Arabidopsis* mutants. These observations indicate that these genes do not require an accumulation of endogenous ABA under cold or drought conditions, but do respond to ABA. There are ABA-independent as well as ABA-dependent regulatory systems of gene expression under drought stress. Analysis of the expression of ABA-inducible genes showed that several genes require protein biosynthesis for their induction by ABA, suggesting that at least two independent pathways exist between the production of endogenous ABA and gene expression under stress conditions.

As shown in Fig. 3, it is now hypothesized that at least four independent signal transduction pathways function in the activation of stress-inducible genes under dehydration conditions: two are ABA-dependent (pathways I and II) and two are ABA-independent (pathways III and IV).^{5,6} One of the ABA-dependent pathways requires protein biosynthesis (pathway I). *Cis-*



**Fig. 3.** Signal transduction pathways between initial dehydration stress signal and gene expression. There are at least four signal transduction pathways: two are ABA-dependent (I and II) and two are ABA-independent (III and IV). Protein synthesis is necessary for one of the ABA-dependent signal pathways (I). ABRE is involved in one of the ABA-dependent pathway (II). In one of the ABA-independent pathways, DRE is involved in the regulation of genes not only by drought and salt but also by cold stress (IV). Another ABA-independent pathway is controlled by drought and salt, but not by cold (III).

and *trans*-acting factors involved in ABA-induced gene expression have been extensively analyzed in one of the ABA-dependent pathway (pathway II). One of the ABA-independent pathways overlaps with that of the cold response (pathway IV). There are several drought-inducible genes that do not respond to either cold or ABA treatment, which suggests that there is a fourth pathway in the dehydration stress response (pathway III). Recently, based on genetic analysis of *Arabidopsis* mutants with the *rd29A* promoter::luciferase transgene, the existence of drought-, salt- and cold-specific signaling pathways in stress response was suggested, but crosstalks between these signaling pathways were also observed.

### Identification of a *cis*-acting element, DRE, involved in drought-responsive expression

Numbers of genes are induced by drought, salt and cold in *aba* (ABA-deficient) or *abi* (ABA-insensitive) *Arabidopsis* mutants. This suggests that these genes do not require ABA for their expression under cold or drought condition. Among these genes, the expression of a drought-inducible gene for *rd29A/lti78/cor78* was extensively analyzed.¹⁷ At least two separate regulatory systems function in gene expression during drought and cold stress; one is ABA-independent (Fig. 3, pathway IV) and the other is ABA-dependent (pathway II).

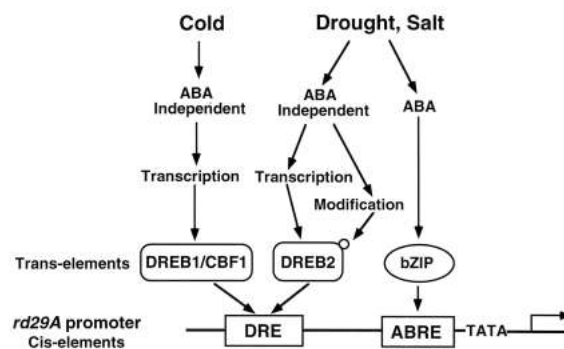
To analyze the *cis*-acting elements involved in the ABA-independent gene expression of *rd29A*, we

constructed chimeric genes with the *rd29A* promoter fused to the b-glucuronidase (*GUS*) reporter gene and transformed *Arabidopsis* and tobacco plants with these constructs. The *GUS* reporter gene driven by the *rd29A* promoter was induced at significant levels in transgenic plants by conditions of dehydration, low-temperature, or high-salt or by treatment with ABA.¹⁸ The deletion, the gain-of-function and the base substitution analysis of the promoter region of *rd29A* gene revealed that a 9-bp conserved sequence, TACCGACAT (DRE, Dehydration Responsive Element), is essential for the regulation of the expression of *rd29A* under drought conditions. Moreover, DRE has been demonstrated to function as a *cis*-acting element involved in the induction of *rd29A* by either low-temperature or high-salt stress.¹⁷ Therefore, DRE seems to be a *cis*-acting element involved in gene induction by dehydration, high-salt, or low temperature, but does not function as an ABA-responsive element in the induction of *rd29A*.

### Important roles of the DRE binding proteins during drought and cold stresses

Two cDNA clones that encode DRE binding proteins, DREB1A and DREB2A, were isolated by using the yeast one-hybrid screening technique.¹⁹ The deduced amino acid sequences of DREB1A and DREB2A showed significant sequence similarity with the conserved DNA binding domains found in the ERF and APETALA2 proteins that function in ethylene-responsive expression and floral morphogenesis, respectively.^{20, 21} Each DREB protein contained a basic region in its N-terminal region that might function as a nuclear localization signal and an acidic C-terminal region that might act as an activation domain for transcription. These data suggest that each DREB cDNA encodes a DNA binding protein that might function as a transcriptional activator in plants.

The ability of the DREB1A and DREB2A proteins expressed in *Escherichia coli* to bind the wild-type or mutated DRE sequences was examined using the gel retardation method.¹⁹ The results indicate that the binding of these two proteins to the DRE sequence is highly specific. To determine whether the DREB1A and DREB2A proteins are capable of transactivating DRE-dependent transcription in plant cells, we performed transactivation experiments using protoplasts prepared from *Arabidopsis* leaves. Coexpression of the DREB1A or DREB2A proteins transactivated the expression of the *GUS* reporter gene driven by the DRE sequence in *Arabidopsis* leaf protoplasts. These results suggest that the DREB1A and DREB2A proteins function as transcription activators involved in the cold- and dehydration-responsive expression, respectively, of the *rd29A* gene (Fig. 4).¹⁹



**Fig. 4.** A model of the induction of the *rd29A* gene and *cis*- and *trans*-acting elements involved in stress-responsive gene expression. Two *cis*-acting elements, DRE and ABRE, are involved in the ABA-independent and ABA-responsive induction of *rd29A*, respectively. Two types of different DRE binding proteins, DREB1 and DREB2, separate two different signal transduction pathways in response to cold and drought stresses, respectively. DREB1s/CBF1 are transcriptionally regulated whereas DREB2s are controlled post-translationally as well as transcriptionally. ABRE binding proteins encode bZIP transcription factors.

We isolated cDNA clones encoding two DREB1A homologs (named DREB1B and DREB1C).¹⁹ The DREB1B clone was identical to CBF1.²² We also isolated cDNA clones encoding a DREB2A homolog and named it DREB2B. Expression of the *DREB1A* gene and its two homologs was induced by low-temperature stress,²³ whereas expression of the *DREB2A* gene and its single homolog was induced by dehydration.²⁴ These results indicate that two independent families of DREB proteins, DREB1 and DREB2, function as *trans*-acting factors in two separate signal transduction pathways under low-temperature and dehydration conditions, respectively (Fig. 4).¹⁹

### Analysis of the roles of DREB1A and DREB2A by using transgenic plants

We generated transgenic plants in which the DREB1A or DREB2A cDNAs were introduced to overproduce the DREB proteins to analyze the effects of overproduction of the DREB1A and DREB2A proteins on the expression of the target *rd29A* gene. *Arabidopsis* plants were transformed with vectors carrying fusions of the enhanced CaMV 35S promoter and the DREB1A (35S:DREB1A) or DREB2A (35S:DREB2A) cDNAs in the sense orientation.^{19, 25} All of the transgenic plants

carrying the 35S:DREB1A transgene (the 35S:DREB1A plants) showed growth-retardation phenotypes under normal growth conditions. The 35S:DREB1A plants showed variations in phenotypic changes in growth retardation that may have been due to the different levels of expression of the DREB1A transgenes for the position effect.¹⁹

To analyze whether overproduction of the DREB1A protein caused the expression of the target gene in unstressed plants, we compared the expression of the *rd29A* gene in control plants carrying pBI121 vector. Transcription of the *rd29A* gene was low in the unstressed wild-type plants but high in the unstressed 35S:DREB1A plants.¹⁹ The level of the *rd29A* transcripts under the unstressed control condition was found to depend on the level of the DREB1A transcripts.¹⁹ To analyze whether overproduction of the DREB1A protein caused the expression of other target genes, we evaluated the expression of its target stress-inducible genes. In the 35S:DREB1A plants the *kin1*, *cor6.6/kin2*, *cor15a*, *cor47/rd17* and *erd10* genes were expressed strongly under unstressed control conditions, as was the *rd29A* gene.^{6, 26, 27}

Recently we prepared a cDNA microarray using 1300 full-length *Arabidopsis* cDNAs to identify further target stress-inducible genes of DREB1A.²⁸ mRNA prepared from the 35S:DREB1A plants and wild-type control plants were used for the preparation of Cy3-labeled and Cy5-labeled cDNA probes, respectively. These cDNA probes regarded genes with expression levels more than two times greater in the 35S:DREB1A transgenic plants than in wild-type control plants as DREB1A target genes. In total, 12 DREB1A target genes were identified by cDNA microarray analysis. Among them, six were shown to be DREB1A target genes: *rd29A*, *kin1*, *cor6.6/kin2*, *cor15a*, *cor47/rd17* and *erd10*. Also, among the six novel DREB1A target genes that have not been shown as DREB1A target genes previously, we found cDNAs showing sequence identity with putative cold acclimation protein, DC1.2 homolog, enolase and cysteine proteinase inhibitor, and *erd4* cDNA. All these gene products probably function in stress tolerance in plant cells.

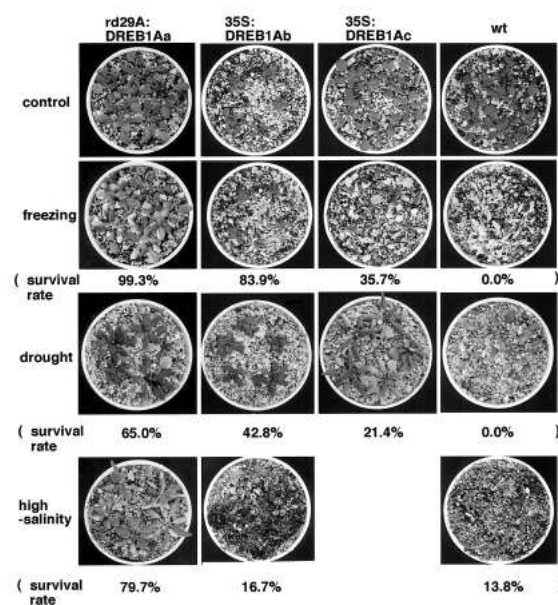
In contrast, the transgenic plants carrying the 35S:DREB2A transgene (the 35S:DREB2A plants) showed little phenotypic change. In the 35S:DREB2A transgenic plants, the *rd29A* mRNA did not accumulate significantly, although the *DREB2A* mRNA accumulated even under unstressed conditions.¹⁹ Expression of the DREB2A protein is not sufficient for the induction of the target stress-inducible gene. Modification, such as phosphorylation of the DREB2A protein, seems to be necessary for its function in response to dehydration (Fig. 4). However, DREB1 proteins can function without modification.

## Drought, salt and freezing stress tolerance in transgenic plants

The tolerance to freezing and dehydration of the transgenic plant was analyzed using the 35S:DREB1A plants grown in pots at 2°C for 3 weeks. When plants were exposed to a temperature of -6°C for 2 days, returned to 22°C, and grown for 5 days, all of the wild-type plants died, whereas the 35S:DREB1A plants survived at high frequency.^{19, 27} Freezing tolerance was correlated with the level of expression of the stress-inducible genes under unstressed control conditions (Fig. 5; between 80 and 30%, survival).^{19, 27}

To test whether the introduction of the DREB1A gene enhances tolerance to dehydration stress, we did not water the plants for 2 weeks. Although all of the wild-type plants died within 2 weeks, between 70 and 20% of the 35S:DREB1A plants survived and continued to grow after rewatering. Drought tolerance was also dependent on the level of expression of the target genes in the 35S:DREB1A plants under unstressed conditions (Fig. 4).^{19, 27}

Overexpression of the DREB1A cDNA, driven by the constitutive 35S CaMV promoter in transgenic



**Fig. 5.** Freezing, drought and salt stress tolerance of the 35S:DREB1Ab, 35S:DREB1Ac and *rd29A*:DREB1Aa transgenic plants. The stress treatments were conducted as described in the text. control = 3-week-old plants growing under normal conditions; freezing = plants exposed to a temperature of -6°C for 2 days and returned to 22°C for 5 days; drought = water withheld for 2 weeks; high-salinity = plants soaked in 600 mM NaCl solution for 2 h and transferred to pots under normal growing conditions for 3 weeks.

plants, activated strong expression of the target stress-inducible genes under unstressed conditions, which, in turn, increased tolerance of freezing, salt and drought stresses.^{19, 27} Jaglo-Ottosen et al. reported that CBF1 overexpression also enhances freezing tolerance.²⁹ However, the overexpression of stress-inducible genes controlled by the DREB1A protein caused severe growth retardation under normal growth conditions.^{19, 27}

To resolve the problem of growth retardation, we used the stress-inducible *rd29A* promoter to cause overexpression of DREB1A in transgenic plants (*rd29A*:DREB1A plants).²⁷ Because the *rd29A* promoter was stress-inducible and contained binding sites for the DREB1A protein, it did not cause expression of the DREB1A transgene at high levels under unstressed conditions; instead, it rapidly amplified expression of the DREB1A transgene only under dehydration, salt, and low-temperature stress. The *rd29A*:DREB1A plants revealed strong stress tolerance even though their growth retardation under normal growing conditions was not significant. Moreover, the growth and the productivity of these plants were almost the same as those of the wild-type plants under normal growing conditions.²⁷

On the contrary, the *rd29A*:DREB1A transgenic plants are more tolerant to the stresses than the 35S:DREB1A plants that exhibited growth retardation under normal growing conditions (Fig. 5).²⁷ As the *rd29A* gene is one of the target genes of the DREB1A protein, the *rd29A* promoter is more suitable for the tissue specific expression of the DREB1A gene in plants than the 35S CaMV promoter. In the *rd29A*:DREB1A plants, the target gene products seem to be strongly accumulated in the same tissues that express the products under stress conditions. These results indicate that combination of the DREB1A cDNA with the *rd29A* promoter would be quite useful for improving drought, salt and freezing-stress tolerance in transgenic plants.

In previous studies, we showed that DRE also functions in gene expression in response to stress in tobacco plants^{17, 18}, which suggests the existence of similar regulatory systems in tobacco and other crop plants. DRE-related motifs have been reported in the promoter region of cold-inducible *Brassica napus* and wheat genes.^{30, 31} These observations suggest that both the DREB1A cDNA and the *rd29A* promoter can be used to improve the dehydration, salt and freezing tolerance of crops by gene transfer.

## Conclusion

Molecular mechanisms of drought stress response and tolerance have been actively studied these ten years. Many genes that are regulated by drought stress have been reported in a variety of plants. Analyses of stress-inducible gene expression have revealed the presence of

multiple signal-transduction pathways between the perception of drought-stress signal and gene expression. At least four different transcription factors have been suggested to function in the regulation of dehydration-inducible genes; two are ABA-responsive and two are ABA-independent. This explains the complex stress response observed after exposure of plants to drought stress. Genetic analysis of *Arabidopsis* mutants with the *rd29A* promoter::Luciferase transgene also suggest complex signaling pathways in drought-, salt- and cold-stress responses.³² Some genes are rapidly induced by drought stress in 10 min whereas others are slowly induced in a few hours after the accumulation of endogenous ABA. Several genes for various transcription factors are induced by drought stress and ABA at transcriptional levels, which might be involved in the regulation of slowly expressed genes of which products functions in stress tolerance and adaptation. In addition, many genes for factors involved in the signal-transduction cascades, such as protein kinases and enzymes involved in PI turnover, are upregulated by drought stress signal.⁶ These signaling factors might be involved in the amplification of the stress signals and adaptation of plant cells to drought-stress conditions. Molecules that functions as osmosensors and ABA-receptors have not been identified. Based on the knowledge of osmosensors in yeast and bacteria, cloning of homologues of the two-component histidine kinase as an osmosensor is in progress in higher plants. Molecular analyses of these factors should provide a better understanding of the signal-transduction cascades during drought stress. Transgenic plants that modify the expression of these genes will give more information on the function of their gene products.

Sequence of *Arabidopsis* entire genome was completed by the end of 2000, which means that structures of all the 26,000 genes of *Arabidopsis* were determined.^{33, 34} All the stress-inducible genes will be identified by systematic analysis of gene expression. In the next decade, we think it important to develop novel methods to analyze complex networks of stress responses of higher plants. Reverse genetic approach as well as classical genetics will become more important to understand not only functions of stress-inducible genes but also complex signaling process in environmental stress responses. Efficient gene disruption methods as well as transgenic approaches using antisense or sense constructs also contribute for the precise understanding of molecular mechanisms of stress response.

## References

1. Shinozaki, K. and Yamaguchi-Shinozaki, K. Molecular responses to drought and cold stress. *Curr. Opin. Biotech.* 1996; 7: 161-167.

2. Thomashow, M.F. *Arabidopsis thaliana* as a model for studying mechanisms of plant cold tolerance. In Meyrowitz, E. and Somerville, C. (eds.), *Arabidopsis*. Cold Spring Harbor Laboratory Press, Cold Spring Harbor, New York, 1994: 807-834.
3. Ingram, J. and Bartels, D. The molecular basis of dehydration tolerance in plants. *Annu. Rev. Plant Physiol. Plant Mol. Biol.* 1996; 47: 377-403.
4. Bray, E.A. Plant responses to water deficit. *Trends Plant Sci.* 1997; 2: 48-54.
5. Shinozaki, K. and Yamaguchi-Shinozaki, K. Gene expression and signal transduction in water-stress response, *Plant Physiol.* 1997; 115: 327-334.
6. Shinozaki, K. and Yamaguchi-Shinozaki, K. Molecular responses to dehydration and low temperature: differences and cross-talk between two stress signaling pathways. *Curr. Opin. plant Biol.* 2000; 3: 217-223.
7. Holmberg, N. and Bulow, L. Improving stress tolerance in plants by gene transfer. *Trends Plant Sci.* 1998; 3: 61-66.
8. Tarczynski, M. and Bohnert, H. Stress protection of transgenic tobacco by production of the osmolyte mannitol. *Science*, 1993; 259: 508-510.
9. Kavi Kishor, P.B., Hong, Z., Miao, G.-U., Hu, C.A.H. and Verma, D.P.S. Overexpression of D¹-pyrroline-5-carboxylate synthetase increases proline production and confers osmotolerance in transgenic plants. *Plant Physiol.* 1995; 108: 1387-1394.
10. Hayashi, H., Alia, Mustardy, L., Deshniun, P., Ida, M. and Murata, N. Transformation of *Arabidopsis thaliana* with the codA gene for choline oxidase; accumulation of glycinebetaine and enhanced tolerance to salt and cold stress. *Plant J.* 1997; 12: 133-142.
11. Kodama, H., Hamada, T., Horiguchi, G. Nishimura, M. and Iba, K. Genetic enhancement of cold tolerance by expression of a gene for chloroplast w-3 fatty acid desaturase in transgenic tobacco. *Plant Physiol.* 1994; 105: 601-605.
12. Ishizaki-Nishizawa, O., Fujii, T., Azuma, M. Sekiguchi, K., Murata, N., Ohtani, T. and Toguri, T. Low-temperature resistance of higher plants is significantly enhanced by a nonspecific cyanobacterial desaturase. *Nature Biotech.* 1996; 14: 1003-1006.
13. Xu, D., Duan, X., Wang, B., Hong, B., Ho, T.H.D. and Wu, R. Expression of a late embryogenesis abundant protein gene, HVA1, from barley confers tolerance to water deficit and salt stress in transgenic rice. *Plant Physiol.* 1996; 110: 249-257.
14. McKersie, B.D., Bowley, S.R., Harjanto, E. and Leprince, O. Water-deficit tolerance and field performance of transgenic alfalfa overexpressing superoxide dismutase. *Plant Physiol.* 1996; 111: 1177-1181.
15. Mizoguchi, T., Ichimura, K. and Shinozaki, K. Environmental stress response in plants: the role of mitogen-activated protein kinases (MAPKs). *Trends Biotech.* 1997; 15: 15-19.
16. Xu, Q., Fu, H.-H., Gupta, R. and Luan, S. Molecular characterization of a tyrosine-specific protein phosphatase encoded by a stress-responsive gene in *Arabidopsis*. *Plant Cell* 1998; 10: 849-857.
17. Yamaguchi-Shinozaki, K. and Shinozaki, K. A novel *cis*-acting element in an *Arabidopsis* gene is involved in responsiveness to drought, low-temperature, or high-salt stress. *Plant Cell* 1994; 6: 251-264.
18. Yamaguchi-Shinozaki, K. and Shinozaki, K. Characterization of the expression of a desiccation-responsive *rd29* gene of *Arabidopsis thaliana* and analysis of its promoter in transgenic plants. *Mol. Gen. Genet.* 1993; 236: 331-340.
19. Liu, Q., Sakuma, Y., Abe, H., Kasuga, M., Miura, S., Yamaguchi-Shinozaki, K. and Shinozaki K. Two transcription factors, DREB1 and DREB2, with an EREBP/AP2 DNA binding domain, separate two cellular signal transduction pathways in drought- and low temperature-responsive gene expression, respectively, in *Arabidopsis*. *Plant Cell* 1998; 10: 1391-1406.
20. Okamoto, J.K., Caster, B., Villarroel, R. Van Montagu, M. and Jofuku, K.D. The AP2 domain of *APETALA2* defines a large new family of DNA binding proteins in *Arabidopsis*. *Proc. Natl. Acad. Sci. USA* 1997; 94: 7076-7081.
21. Ohme-Takagi, M. and Shinshi, H. Ethylene-inducible DNA binding proteins that interact with an ethylene-responsive element. *Plant Cell*, 1995; 7: 173-182.
22. Stockinger, E.J., Gilmour, S.J. and Thomashow, M.F. *Arabidopsis thaliana* CBF1 encodes an AP2 domain-containing transcriptional activator that binds to the C-repeat/DRE, a *cis*-acting DNA regulatory element that stimulates transcription in response to low temperature and water deficit. *Proc. Natl. Acad. Sci. USA*, 1997; 94: 1035-1040.
23. Shinwari, Z.K., Nakashima, K., Miura, S., Seki, M., Yamaguchi-Shinozaki, K. and Shinozaki, K. An *Arabidopsis* gene family encoding DRE/CRT binding proteins involved in low-temperature-responsive gene expression. *Biochem. Biophys. Res. Cmmu.* 1998; 250: 161-170.
24. Nakashima, K., Shinwari, Z.K., Sakuma, Y., Seki, M., Miura, S., Shinozaki, K. and Yamaguchi-Shinozaki, K. Organization and expression of two *Arabidopsis* DREB2 genes encoding DRE-binding proteins involved in dehydration- and high-salinity-responsive gene expression. *Plant Mol. Biol.* 2000; 42: 657-665.
25. Mitsuhara, I., Ugaki, M., Hirochika, H., Ohshima, M., Murakami, T., Gotoh, Y., Katayose, Y., Nakamura, S., Honkura, R., Nishimiya, S., Ueno, K., Mochizuki, A., Tanimoto, H., Tsugawa, H., Otsuki, Y. and Ohashi, Y. Efficient promoter cassettes for enhanced expression of foreign genes in dicotyledonous and monocotyledonous plants. *Plant Cell Physiol.* 1996; 37: 49-59.
26. Kiyosue, T., Yamaguchi-Shinozaki, K. and Shinozaki, K. Characterization of two cDNAs (ERD10 and ERD14) corresponding to genes that respond rapidly to dehydration stress in *Arabidopsis thaliana*. *Plant Cell Physiol.* 1994; 35: 225-231.
27. Kasuga, M., Liu, Q., Miura, S., Yamaguchi-Shinozaki, K. and

- Shinozaki, K. Improving drought, salt and freezing tolerance by gene transfer of a single stress-inducible transcription factor. *Nature Biotechnology* 1999; 17: 287-281.
28. Seki, M., Narusaka, M., Abe, H., Kasuga, M., Yamaguchi-Shinozaki, K., Carninci, P., Hayashizaki, Y. and Shinozaki, K. Monitoring the expression pattern of 1300 *Arabidopsis* genes under drought and cold stresses by using a full-length cDNA Microarray. *Plant Cell* 2001; 13: 61-72.
29. Jaglo-Ottosen, K.R., Gilmour, S.J., Zarka, D.G., Schabenberger, O. and Thomashow, M.F. *Arabidopsis* CBF1 overexpression induces *cor* genes and enhances freezing tolerance. *Science* 1998; 280: 104-106.
30. Jiang, C., Iu, B. and Singh, J. Requirement of a CCGAC *cis*-acting element for cold induction of the *BN115* gene from winter *Brassica napus*. *Plant Mol. Biol.* 1996; 30: 679-684.
31. Ouellet, F., Vazquez-Tello, A. and Sarhan, F. The wheat *wcs120* promoter is cold inducible in both monocotyledonous and dicotyledonous species. *FEBS Lett.* 1998; 423: 324-328.
32. Ishitani, M., Xiong, L., Stevenson, B. and Zhu, J.K. Genetic analysis of osmotic and cold stress signal transduction in *Arabidopsis*: Interactions and convergence of abscisic acid-dependent and abscisic acid-independent pathways. *Plant Cell* 1997; 9: 1-16.
33. Bevan, M., Ecker, J., Theologis, S., Federspiel, N., Davis, R., McCombie, D., Martienssen, R., Chen, E., Waterston, B., Wilson, R., Rounsley, S., Ventor, C., Tabata, S., Salanoubat, M., Quetier, F., Cherry, J.M. and Meinke, D. The complete sequence of a plant genome. *Plant Cell* 1997; 9: 476-478.
34. Arabidopsis Genome Initiative. Analysis of the genome sequence of the flowering plant *Arabidopsis thaliana*. *Nature* 2000; 408: 796-815.





# Biological mechanisms of low temperature stress response: Cold acclimation and development of freezing tolerance in plants

E. Tapio. Palva^{1,2}, Sari T. Htiharju¹, Ilkka Tamminen¹, Tuula Puhakainen^{1,2},  
Roosa Laitinen¹, Jan Svensson¹, Elina Helenius¹ and Pekka Heino^{1,2}

Viikki Biocenter

¹Department of Biosciences, Division of Genetics

²Institute of Biotechnology

University of Helsinki, FIN-00014, Helsinki, Finland

## Abstract

---

Plant growth, productivity and distribution are severely limited by environmental stresses including freezing, drought and salinity, all of which disturb the water balance of the cell. Plants have evolved different adaptive strategies to alleviate the adverse effects of these abiotic stresses. In plant cold acclimation exposure to moderate stress (such as low nonfreezing temperatures) or to other environmental cues (such as drought or changes in photoperiod) triggers stress acclimation pathways leading to an increase in freezing tolerance. We employ *Arabidopsis* as our model to explore the cold acclimation process that takes place during the growing season, typical to many temperate herbaceous species. This acclimation is associated with activation of several stress response regulons (including genes e.g. for dehydrins) and subsequent metabolic and physiological alterations required for the enhanced stress tolerance. Overexpression of some of the target genes of these regulons or metabolic engineering of biosynthesis of osmoprotectants, such as trehalose, has been shown to result in improved freezing and drought tolerance.

Elucidation of the signal pathways and components controlling the stress response regulons is one of the key areas plant stress research. A central theme in our research is to clarify how plants sense the environmental cues triggering cold acclimation and how these signals are transduced to the level of target gene expression. A number of interacting signal pathways appear to control the activation of the low temperature responsive genes, some of which are mediated through the action of the plant hormone ABA. Our recent work in *Arabidopsis* has been focused on characterization of selected candidate signal components including putative channel proteins and protein phosphatases. As one example antisense inhibition of *PP2CA* was shown to lead to accelerated cold acclimation indicating that this phosphatase is a negative regulator of the cold acclimation response. Such modulation of the key components of low temperature response pathways (regulon engineering) provides a way for improving plant stress tolerance. Another approach used for regulon engineering has been ectopic expression of the *ABI3* gene encoding a seed specific transcription factor, which also resulted in enhanced freezing tolerance. In conclusion understanding the molecular basis of plant cold acclimation response already provides several strategies to improve freezing tolerance in plants.

*Keywords: stress tolerance, cold hardiness, abscisic acid, signal transduction, gene expression, Arabidopsis*

## Introduction

Plants are constantly exposed to, and need to survive, a changing and often unfavorable environment. This has led to the evolution of adaptive strategies that permit plant cells to sense environmental stimuli and to

activate responses that allow avoidance or survival of the environmental stresses encountered. One of the major environmental challenges to plant growth, productivity and distribution are stresses leading to cellular water deficit such as freezing, drought and high salinity (Boyer, 1982). Freezing stress is commonly

experienced by plants growing in temperate and boreal climates. Resistance or sensitivity to the stress depends on the species, the genotype, and the developmental age of the plant (Bray et al., 2000). Suboptimal temperature can cause serious damage to a number of plants. However, different plant species vary widely in their ability to tolerate low temperature stress (Levitt, 1980; Sakai and Larcher, 1987). Chilling-sensitive tropical species can be irreparably damaged when temperatures drop below 10°C while chilling tolerant but freezing sensitive species are readily damaged by subzero temperatures. Injuries are caused by impairments in cellular processes including alterations in membrane properties, interactions between macromolecules and enzymatic reactions. Freezing-sensitive tissues are damaged at subzero temperatures as a result of ice formation. In contrast, freezing-tolerant temperate plants are able to survive considerable extracellular freezing, e. g. fully acclimated herbaceous species can readily tolerate temperatures of -10 to -20°C. Freezing stress is a composite stress caused by the low temperature as such and mechanical stress due to ice formation in the tissues. On cellular level freezing stress is mainly due to freeze-induced cellular dehydration resulting in injuries in membranes (Steponkus et al., 1993) and linking freezing with other stresses (drought and high salinity) leading to cellular water deficit (Palva, 1994). However, other factors may contribute also to cellular damage during freezing stress. At low temperatures, protein denaturation may occur (Guy et al., 1998). Moreover, there is evidence that freezing stress can trigger the production of reactive oxygen species that play a role in generation of membrane damage (McKersie and Bowley, 1997). Plants can be exposed to freezing temperatures both during active growth as well as during overwintering. Overwintering woody plants as well as dormant seeds of many plant species exhibit extremes of low temperature survival, e.g. fully acclimated birch tissue can tolerate liquid nitrogen temperature.

### **Cold acclimation**

Plants need to adjust to both daily and seasonal fluctuations in temperature. Seasonal acclimation is operational in overwintering herbs and in woody plants. In woody species, acclimation is a two-step process where the first phase of acclimation is triggered by shortening of the photoperiod and the second by low temperature. In both annual and in most overwintering herbaceous plants, freezing tolerance is not affected by the photoperiod but acclimation is mainly triggered by low nonfreezing temperatures. Cold acclimation is a rather rapid process in many herbaceous species. A substantial increase in freezing tolerance of e.g.

*Arabidopsis* can be achieved already after one-day exposure to low temperature although full acclimation requires more than a week. Upon return to normal growth temperatures, freezing tolerance is rapidly lost (Palva, 1994; Thomashow, 1999). In addition to low non-freezing temperatures, cold acclimation can be triggered by exposing the plants to moderate water stress or exogenously applied abscisic acid (ABA) (Lång et al., 1989; Guy et al., 1992; Mäntylä et al., 1995).

Cold acclimation is associated with several physiological and biochemical alterations in the plants. The best-characterized changes include alterations in gene expression, changes in hormone levels, increases in soluble sugars, amino acids and organic acids, accumulation of osmoprotectants and protective proteins as well as modification of membrane lipid composition (for reviews, see Palva, 1994; Hughes and Dunn, 1996; Palva and Heino, 1997; Thomashow, 1999). Although the causal relationship of many of these changes to increased freezing tolerance is still unclear, some of the genes and regulons involved in cold acclimation are being unraveled (Thomashow, 1999; Nuotio et al., 2001).

Already in 1985 it was demonstrated that cold acclimation is correlated with changes in translatable mRNA populations. Subsequently, a great number of cold-induced genes has been isolated and characterized from a variety of plant species, (for reviews see Palva, 1994; Hughes and Dunn 1996; Thomashow 1998). Some of these genes code for proteins whose biochemical function is known or at least can be predicted based on sequence homology. Among these are fatty acid desaturases, chaperones, lipid transfer proteins, proteins involved in osmoprotectant biosynthesis, antifreeze proteins and signal transduction components, such as transcription factors, kinases and phosphatases (Hughes and Dunn 1996; Thomashow 1998; Nuotio et al., 2001). However, for many of the low temperature induced/cold regulated (*LTI/COR*) gene products, there is no known function. In many cases, however, related genes have been found in different plant species, indicating that the proteins induced by low temperature are conserved.

One of the most common categories of genes induced by low temperature encode dehydrins (*dehydration induced*), also called LEA (*late embryogenesis abundant*) proteins in a wide range of higher plants. Indeed, there is evidence that they exist in all of photosynthetic organisms (Close 1997). Most dehydrin genes are induced in response to any environmental influence that has a dehydration component (such as drought, low temperature or salinity), by ABA or during the late stages of embryogenesis. The dehydrins are hydrophilic and remain soluble after boiling. They are characterised by one or more copies of a lysine rich repeat (the K

segment) EKKGIMDKIKEKLPG, which has been proposed to form an amphipathic (-helix (Dure 1993; Close 1997). Many dehydrins also contain other conserved motifs such as a run of serine residues (S-repeat) or the Y segment (Close 1997). Even though the exact function of these proteins has not been established, their biochemical properties and accumulation patterns suggest that the dehydrins could stabilize cellular structures during dehydration stress (Close 1997; Nylander et al., 2001b). There are about 10 dehydrin genes in the genome of *Arabidopsis* suggesting that dehydrins constitute a redundant family of proteins.

Although great progress has been achieved in understanding the molecular basis for plant cold acclimation during the last decade, the complexity of the systems hampers genetic engineering of plant freezing tolerance. As discussed above, little is known about the exact function of many of the proteins encoded by the low temperature induced genes. It is, therefore, essential to elucidate the function and contribution of these genes and gene products in tolerance before a general strategy for engineering plants with increased frost tolerance is available. Several transgenic plant lines overexpressing different low temperature responsive genes have been created, but only a marginal effect on freezing tolerance has been demonstrated (Artus et al., 1996; McKersie and Bowley, 1997; Puhakainen et al., unpublished). Similar results have been obtained in studies of water stress tolerance. Thus, this type of target gene engineering has not been very fruitful in engineering plant freezing tolerance. The approach is most likely hampered by the redundancy of the system, where an individual gene product has only a minor contribution to the overall tolerance. Thus this approach would require pyramiding a number of target genes providing additive effects on tolerance.

In contrast to the limited success achieved by target gene engineering, metabolic engineering of osmoprotectants appears to be of more promise in improving plant stress tolerance. Induction of osmoprotectants biosynthesis is part of the plant response to both drought and low temperature. There are now a number of examples in which increased drought tolerance was obtained by introducing simple metabolic traits from other organisms such as production of trehalose or glycine betaine (see e. g. Holmström et al., 1996; Holmström et al., 2000) to plants. In addition to their effect on drought tolerance osmoprotectants appear also to enhance freezing tolerance in plants. Recent data from our laboratory suggest that transgenic *Arabidopsis* lines producing trehalose exhibit increased tolerance to freezing temperatures both in cold acclimated and in nonacclimated plants (Tamminen et al., unpublished).

### **Signal transduction in cold acclimation**

In order to respond to low temperature, plants have to perceive the stress, transduce the signal to the nucleus, and activate specific gene expression. The exact mechanisms by which this occurs are not clear, even though different components involved in the process have been characterized. The emerging insight is that this mechanism is complex, consisting of several distinct signal pathways that may interact with each other (Thomashow, 1999; Shinozaki and Yamaguchi-Shinozaki, 2000; Nuotio et al., 2001; Zhu, 2001). Moreover, it is likely that the low temperature signal pathways are converging and interacting with other stress-induced pathways, such as those mediating dehydration and abscisic acid responses (Ishitani et al., 1997). Our earlier work established the presence of ABA-independent and ABA-mediated pathways in low temperature signaling (Nordin et al., 1991; 1993) and also underlined the requirement for ABA in cold acclimation. Several lines of evidence indicate the role of ABA-controlled processes in cold acclimation: (i) Exogenous application of ABA at normal growth temperature leads to increased freezing tolerance (Chen et al., 1983; Lång et al., 1989). (ii) There is a transient increase in endogenous ABA at the onset of acclimation (Lång et al., 1994). (iii) Several low temperature induced genes are also responsive to ABA (Palva 1994). (iv) Both ABA-deficient and ABA-insensitive *Arabidopsis* mutants are impaired in cold acclimation (Heino et al., 1990; Mäntylä et al., 1995).

The nature of the primary sensor of low temperature is still a puzzle. Murata and Los (1997) suggested that a primary signal might be the change in membrane fluidity, which is one of the most rapid effects of temperature on the plasma membrane. The mechanisms by which reduction in membrane fluidity would lead to gene activation are not understood. Murata and Los (1997) have proposed the relationship between membrane fluidity and calcium channel activity at low temperature, but so far no such mediator has been detected. However, a clear correlation between temperature and calcium influx to the cells has been demonstrated in *Arabidopsis* (Nordin-Henriksson, personal communication) suggesting that a temperature modulated  $Ca^{2+}$  channel could indeed be involved in the temperature sensing. Mechanosensitive calcium channels exhibiting temperature dependent modulation have been identified in plants and they might be involved in low temperature sensing (Ding and Pickard, 1993). Further evidence for the role of the plasma membrane fluidity in cold sensing has come from experiments in alfalfa and Brassica (Örvar et al., 2000; Sangwan et al., 2001), where chemical agents were used to modulate membrane fluidity. Membrane fluidization during cold treatment inhibited the induction of cold

inducible genes and the development of freezing tolerance, whereas membrane rigidification at 25°C activated these genes and led to an increased freezing tolerance. The effects on gene expression were apparently mediated by reorganization of cytoskeleton and a following calcium influx.

Another type of temperature sensor has been proposed in cyanobacteria. There is recent evidence for the involvement of two-component systems in low temperature perception in *Synechocystis*. Two membrane associated histidine sensor kinases were recently identified whose inactivation was shown to result in a reduction of transcription of several low temperature inducible genes (Suzuki et al., 2000). Whether this type of sensor is operational also in plants remains to be determined.

The transduction of the signal generated by calcium influx is apparently transmitted through phosphorylation and dephosphorylation of proteins by kinases and phosphatases, respectively. Inhibitors of protein kinases can block induction of some low temperature responsive genes and development of freezing tolerance both in alfalfa and Arabidopsis (Tähtiharju et al., 1997). Moreover, freezing tolerance is induced at 25°C by a protein phosphatase inhibitor (Monroy et al., 1993). The presence of low temperature induced calcium-dependent protein kinases (CDPKs) in Arabidopsis (Tähtiharju et al., 1997) and alfalfa (Monroy and Dhindsa 1995), and the fact that their inhibition prevents cold acclimation (Monroy et al., 1993) supports the connection between changes in cytosolic calcium levels and protein phosphorylation. Specific CDPKs have also been connected to the regulation of gene expression in response to ABA, drought, cold and salinity (Sheen 1996). In addition to CDPKs, several other protein kinases have been proposed to play a role in cold signal transduction. Evidence supports the involvement of a mitogen-activated protein (MAP) kinase cascade in low temperature signal transduction.

How do these signals lead to activation of the low temperature responsive genes? We originally suggested the identity of a low temperature responsive element (LTRE) in the *LTI78* promoter (Nordin et al., 1993). The presence of this element was subsequently demonstrated by deletion analysis and it was shown that the 9-bp element, TACCGACAT, confers responsiveness to low temperature, drought and high salinity, but not to ABA (Yamaguchi-Shinozaki and Shinozaki 1994). This low-temperature and dehydration-responsive element (LTRE/DRE) occurs also in several other promoters and has also been referred to as the C-repeat (CRT) (Baker et al., 1994). A small family of proteins called CBF1, CBF2 and CBF3 (CRT binding factor) or DREB1B, DREB1C and DREB1A (DRE-binding protein), respectively, activate the expression of genes carrying the DRE/CRT/LTRE element (Stockinger et al., 1997;

Liu et al., 1998; Gilmour et al., 1998; Shinwari et al., 1998). Overexpression of *CBF1/DREB1B* or *CBF3/DREB1A* leads to the constitutive expression of genes with promoters containing the DRE/CRT/LTRE element and to improved freezing, drought and salt tolerance of non-acclimated plants (Jaglo-Ottosen et al., 1998; Kasuga et al., 1999). In addition, the overexpression of CBF3 leads to elevated levels of proline and sugars that are normally associated with cold acclimation (Gilmour et al., 2000). In conclusion, the DRE-containing CBF/DREB controlled genes constitute a low temperature responsive regulon that is ABA independent.

However, low temperature responsive genes without this *cis*-acting DRE/CRT/LTRE element in their promoters do exist, e.g. the Arabidopsis *LTI6/RCI2A* gene (Nylander et al., 2001a), indicating that also other elements confer cold responsiveness. Furthermore, most of the low temperature responsive genes are also induced by exogenous ABA. Consequently, their promoters should contain *cis*-elements mediating this response. Indeed, sequences closely resembling ABA response elements (ABREs) exist in these promoters. The ABREs have been shown to confer ABA-regulated expression of many genes when present in more than one copy (Guiltinan et al., 1990; Leung and Giraudat 1998). The consensus sequence in ABREs is the motif (C/T)ACGTGGC.

Several proteins that can specifically bind to ABREs have been reported (e.g. Guiltinan et al., 1990). They contain the basic domain/leucine zipper (bZIP) motif found in many transcription factors. Two bZIP proteins that bind specifically to the ABRE elements required in the dehydration and ABA induction of the Arabidopsis *RD29B(LTI65)* gene were recently characterized (Uno et al., 2000). These genes, encoding AREB1 and AREB2 (ABA-responsive element binding protein) are drought, salt and ABA responsive. The AREB proteins can function as transcription factors, and they need ABA for their activation. In another study a small family of ABRE binding factors (ABFs) was characterized, also from Arabidopsis (Choi et al., 2000). One of these ABF proteins corresponds to AREB2 and the others are highly homologous to AREBs. *ABFs* respond differently to various environmental stresses including low temperature, suggesting that they act in different stress-responsive pathways. Further studies of the putative role of *ABF1* in activating low temperature induced genes whose promoters contain ABREs will bring interesting knowledge about the role of ABA in cold acclimation.

The ABA-mediated signal pathway leading to expression of low temperature induced genes appears to encompass similar second messengers and signal components as described above for the ABA-independent pathway. The initial steps of temperature

sensing might be shared by both pathways, although this needs to be demonstrated. Perception of the low temperature stimulus leads to a transient increase in ABA (Lång et al., 1994), which in turn triggers downstream events leading to target gene expression. Calcium is apparently used as a second messenger also downstream of ABA through cADPR controlled release from intracellular stores (Møller and Chua 1999). Both protein kinases and phosphatases have been implicated in these events by biochemical and molecular (Møller and Chua 1999; Sheen 1996) as well as genetic studies using ABA-insensitive mutants (Nordin et al., 1993; Lång and Palva, 1992). The latter studies showed that ABA induced expression of several cold responsive target genes was blocked in dominant negative *abi1* phosphatase 2C mutants (Nordin et al., 1993; Lång and Palva, 1992). Furthermore, these mutants were impaired in their freezing tolerance development (Mäntylä et al., 1995). Our recent studies have underlined the importance of protein phosphatases in cold acclimation. Antisense inhibition of the gene for protein phosphatase 2CA (PP2CA) was shown to accelerate the cold acclimation response and sensitize the cell to ABA (Tähtiharju and Palva, 2001). This suggests that PP2CA is a repressor of the ABA-mediated low temperature-signaling pathway.

### Regulon engineering of freezing tolerance

As discussed above some success in improving plant freezing tolerance has been achieved by overexpression of target genes and metabolic engineering of osmoprotectants biosynthesis. A completely different strategy to enhance plant stress tolerance involves manipulation of the signal transduction pathways leading to activation of stress responsive genes. Expression of a big cluster of genes controlled by the same regulatory pathway is expected to have greater effect on freezing tolerance than expression of an individual gene. Such regulon engineering was recently achieved (Jaglo-Ottosen et al., 1998; Kasuga et al., 1999) by overexpression of the CBF/DREB transcriptional activator. This overexpression activated several cold-responsive genes and, more importantly, increased the freezing tolerance of nonacclimated *Arabidopsis* plants. Thus, a low temperature response was obtained without low temperature stimulus. Although the approach was used to modulate freezing tolerance in a plant fully capable of cold acclimation, it might be also extended to plants normally sensitive to freezing.

Other signal components can be also used for this type of approach. As discussed above antisense inhibition of the gene for a repressor, PP2CA of the ABA-mediated low temperature-signal pathway leads to an accelerated cold acclimation response in

*Arabidopsis*. A similar strategy could be used to enhance cold acclimation in crop plants.

Many plants have the genetic potential for low temperature and desiccation tolerance, as indicated by the ability of seeds to survive these stresses. The genes responsible for this tolerance are normally under strict developmental control and expressed only during embryo maturation. However, ectopic expression of seed-specific genes may confer to vegetative tissues the ability to accumulate seed-specific transcripts and influence responses in vegetative tissues, as shown by ectopic expression of the *ABI3* gene in *Arabidopsis* (Parcy and Giraudat, 1997). We could recently demonstrate that such *ABI3* transgenic *Arabidopsis* plants exhibited enhanced freezing tolerance (Tamminen et al., 2001). Both the low temperature and ABA induced development of freezing tolerance was clearly improved in these plants.

### Conclusions

Recent years have evidenced tremendous progress in plant cold acclimation research. Although the biological processes leading to cold acclimation and the mechanisms of freezing tolerance are only partially understood, several key components of cold acclimation have been recently identified. In particular, elucidation of the signal transduction pathways and identification of the regulators required for expression of the cold responsive genes has progressed rapidly. These studies have already opened new avenues to improve freezing and drought stress tolerance in crop plants.

### Acknowledgements

The work in the authors' laboratory is supported by Academy of Finland, Biocentrum Helsinki, EU and Technology Development Centre (TEKES).

### References

- Artus, N.N., Uemura, M., Steponkus, P.L., Gilmour, S.J., Lin, C.T. and Thomashow, M.F. 1996. Constitutive expression of the cold-regulated *Arabidopsis thaliana* *COR15a* gene affects both chloroplast and protoplast freezing tolerance. Proc. Natl. Acad. Sci. USA 93:13404-13409.
- Baker, S.S., Wilhelm, K.S. and Thomashow, M.F. 1994. The 5'-region of *Arabidopsis thaliana* *cor15a* has cis-acting elements that confer cold-, drought- and ABA-regulated gene expression. Plant Mol. Biol. 24:701-713.
- Boyer, J.S. 1982. Plant productivity and environment. Science 281:443-448.
- Bray, E.A., Bailey-Serres, J. and Weretilnyk, E. 2000. Responses

- to abiotic stress. In *Biochemistry & Molecular Biology of Plants*. (Buchanan, B., Gruissem, W. and Jones, R. Eds.). The American Society of Plant Physiologists.
- Chen, H.H., Li, P.H. and Brenner, M.L. 1983. Involvement of abscisic acid in potato cold acclimation. *Plant Physiol.* 71:362-365.
- Choi, H., Hong, J., Ha, J., Kang, J. and Kim, S.Y. 2000. ABFs, a family of ABA-responsive element binding factors. *J. Biol. Chem.* 275:1723-1730.
- Close, T.J. 1997. Dehydrins: A commonality in the response of plants to dehydration and low temperature. *Physiol. Plant.* 100:291-296.
- Ding, J.P. and Pickard, B.G. 1993. Modulation of mechanosensitive calcium-selective channels by temperature. *Plant J.* 3:713-720.
- Dure, L.III. 1993. Structural motifs in LEA proteins of higher plants. In *Response of Plants to Cellular Dehydration during Environmental Stress* (Close, T.J and Bray, E.A. Eds.) The American Society of Plant Physiologists.
- Gilmour, S.J., Sebolt, A.M., Salazar, M.P., Everard, J.D. and Thomashow, M.F. 2000. Overexpression of the Arabidopsis CBF3 transcriptional activator mimics multiple biochemical changes associated with cold acclimation. *Plant Physiol.* 124:1854-1865.
- Gilmour, S.J., Zarka, D.G., Stockinger, E.J., Salazar, M.P., Houghton, J.M. and Thomashow, M.F. 1998. Low temperature regulation of the Arabidopsis CBF family of AP2 transcriptional activators as an early step in cold-induced COR gene expression. *Plant J.* 16:433-442.
- Gultinan, M.J., Marcotte, W.R. and Quatrano, R.S. 1990. A plant leucine zipper protein that recognizes an abscisic acid response element. *Science* 250:267-271.
- Guy, C.L., Haskell, D., Neven, L., Klein, P. and Smelser, C. 1992. Hydration-state-responsive proteins link cold and drought stress in spinach. *Planta* 188:265-270.
- Guy, C.L. and Li, Q.B. 1998. The organization and evolution of the spinach stress 70 molecular chaperone gene family. *Plant Cell* 10:539-556.
- Heino, P., Sandman, G., Lång, V., Nordin, K. and Palva, E.T. 1990. Abscisic acid deficiency prevents development of freezing tolerance in *Arabidopsis thaliana* (L.) Heynh. *Theor. Appl. Genet.* 79:801-809.
- Holmström, K.-O., Somersalo, S., Mandal, A., Palva, E.T.* & Welin, B (2000) Improved tolerance to salinity and low temperature in transgenic tobacco producing glycine betaine. *J. Exp. Bot.* 51: 177-185.
- Holmström, K.-O., Mäntylä, E., Welin, B., Mandal, A., Palva, E.T., Tunnela, O.E., Londesborough, J. (1996) Drought tolerance in tobacco. *Nature* 379: 683-684.
- Hughes, M.A. and Dunn, M.A. 1996. The molecular biology of plant acclimation to low temperature. *J. Exp. Bot.* 47:291-305.
- Ishitani, M., Xiong, L., Stevenson, B. and Zhu, J.-K. 1997. Genetic analysis of osmotic and cold stress signal transduction in Arabidopsis: Interactions and convergence of abscisic acid-dependent and abscisic acid-independent pathways. *Plant Cell* 9:1935-1949.
- Jaglo-Ottosen, K.R., Gilmour, S., Zarka, D.G., Schabenberger, O. and Thomashow, M.F. 1998. *Arabidopsis CBF1* overexpression induces *COR* genes and enhances freezing tolerance. *Science* 280:104-106.
- Kasuga, M., Liu, Q., Miura, S., Yamaguchi-Shinozaki, K. and Shinozaki, K. 1999. Improving plant drought, salt, and freezing tolerance by gene transfer of a single stress-inducible transcription factor. *Nature Biotechnol.* 19:287-291.
- Leung, J. and Giraudat, J. 1998. Abscisic acid signal transduction. *Annu. Rev. Plant. Physiol. Plant Mol. Biol.* 49:199-222.
- Levitt, J. 1980. Responses of Plants to Environmental Stresses: Chilling, Freezing and High Temperature Stresses. 2nd ed. Academic Press. New York.
- Liu, Q., Kasuga, M., Sakuma, Y., Abe, H., Miura, S., Yamaguchi-Shinozaki, K. and Shinozaki, K. 1998. Two transcription factors, DREB1 and DREB2, with an EREBP/AP2 DNA binding domain separate two cellular signal transduction pathways in drought- and low-temperature-responsive gene expression, respectively, in Arabidopsis. *Plant Cell* 10:1391-1406.
- Lång, V., Heino, P. and Palva, E.T. 1989. Low temperature acclimation and treatment with exogenous abscisic acid induce common polypeptides in *Arabidopsis thaliana* (L.) Heynh. *Theor. Appl. Genet.* 77:729-734.
- Lång, V. and Palva, E.T. 1992. The expression of a *rab*-related gene, *rab18*, is induced by abscisic acid during the cold acclimation process of *Arabidopsis thaliana* (L.) Heynh. *Plant Mol. Biol.* 20: 951-962.
- Lång, V., Mäntylä, E., Welin, B., Sundberg, B. and Palva, E.T. 1994. Alterations in water status, endogenous abscisic acid content and expression of *rab18* gene during the development of freezing tolerance in *Arabidopsis thaliana*. *Plant Physiol.* 104: 1341-1349.
- McKersie, B.D. and Bowley, S.R. 1997. Active oxygen and freezing tolerance in transgenic plants. In *Plant Cold Hardiness. Molecular Biology, Biochemistry and Physiology*. (Li, P.H. and Chen, T.H.H. Eds.) pp.203-214. Plenum. New York.
- Monroy, A.F. and Dhindsa, R.S. 1995. Low temperature signal transduction: Induction of cold-acclimation specific genes of alfalfa by calcium at 25°C. *Plant Cell* 7:321-331.
- Monroy, A.F., Sarhan, F. and Dhindsa, R.S. 1993. Cold induced changes in freezing tolerance, protein phosphorylation and gene expression: Evidence for a role of calcium. *Plant Physiol.* 102:1227-1235.
- Murata, N. and Los, D.A. 1997. Membrane fluidity and temperature perception. *Plant Physiol.* 115:875-879.
- Møller, S.G. and Chua, N.-H. 1999. Interactions and intersections of plant signaling pathways. *J. Mol. Biol.* 293: 219-234.
- Mäntylä, E., Lång, V. and Palva, E.T. 1995. Role of abscisic acid in drought-induced freezing tolerance, cold acclimation and accumulation of *LTI78* and *RAB18* proteins in *Arabidopsis thaliana*. *Plant Physiol.* 107:141-148.
- Nordin, K., Heino, P. and Palva, E.T. 1991. Separate signal pathways regulate the expression of a low-temperature-

- induced gene in *Arabidopsis thaliana* (L.) Heynh. *Plant Mol. Biol.* 16: 1061-1071.
- Nordin, K., Vahala, T. and Palva, E.T. 1993. Differential expression of two related, low-temperature-induced genes in *Arabidopsis thaliana* (L.) Heynh. *Plant Mol. Biol.* 21:641-653.
- Nuotio, S., Heino, P. and Palva, E.T. 2001. Signal transduction under low-temperature stress. In *Crop Responses and Adaptations to Temperature Stress*. (Basra, A.B. Ed.) pp.151-176. Food Products Press. Binghamton, New York.
- Nylander, M., Heino, P., Helenius, E., Palva, E.T., Ronne, H. and Welin, B.V. 2001a. The low temperature- and salt-induced *RC12A* gene of *Arabidopsis* complements the sodium sensitivity caused by a deletion of the homologous yeast gene *SNA1*. *Plant Mol. Biol.* 45:341-352.
- Nylander, M., Svensson, J., Palva, E.T. and Welin, B. 2001b. Stress-induced accumulation and tissue specific localization of dehydrins in *Arabidopsis thaliana*. *Plant Mol. Biol.* 45:263-279.
- Palva, E.T. 1994. Gene expression under low temperature stress. In *Stress Induced Gene Expression in Plants*. (Basra, A.S. Ed.) pp.103-130. Harwood Academic Publishers. New York.
- Palva, E.T. and Heino, P. 1998. Molecular mechanism of plant cold acclimation and freezing tolerance. In *Plant Cold Hardiness*. (Li, P.H. and Chen, T.H.H. Eds.) pp.3-14. Plenum. New York.
- Sakai, A and Larcher, W. 1987. *Frost Survival of Plants: Responses and Adaptation to Freezing Stress*. Springer-Verlag. Berlin.
- Sheen, J. 1996.  $Ca^{2+}$ -dependent protein kinases and stress signal transduction in plants. *Science* 274:1900-1902.
- Shinozaki, K. and Yamaguchi-Shinozaki, K. 2000. Molecular responses to dehydration and low temperature: differences and cross-talk between two stress signaling pathways. *Curr. Op. Plant Biol.* 3:217-223.
- Shinwari, Z.K., Nakashima, K., Miura, S., Kasuga, M., Seki, M., Yamaguchi-Shinozaki, K. and Shinozaki, K. 1998. An *Arabidopsis* gene family encoding DRE/CRT binding proteins involved in low-temperature-responsive gene expression. *Biochem. Biophys. Res. Commun.* 250: 161-170.
- Steponkus, P.L., Uemura, M. and Webb, M.S. 1993. Membrane destabilization during freeze-induced dehydration. *Curr. Topics Plant Physiol.* 10:37-47.
- Stockinger, E.J., Gilmour, S.J. and Thomashow, M.F. 1997. *Arabidopsis thaliana CBF1* encodes an AP2 domain-containing transcriptional activator that binds to the C-repeat/DRE, a cis-acting DNA regulatory element that stimulates transcription in response to low temperature and water deficit. *Proc. Natl. Acad. Sci. USA* 94:1035-1040.
- Suzuki, I., Los, D.A., Kanesaki, Y., Mikami, K. and Murata, N. 2000. The pathway for perception and transduction of low-temperature signals in *Synechocystis*. *EMBO J.* 19:1327-1334.
- Tamminen, I., Mäkelä, P., Heino, P., and Palva, E.T. (2001) Ectopic expression of *ABI3* gene enhances freezing tolerance in response to abscisic acid and low temperature in *Arabidopsis*. *Plant J.* 25: 1-8.
- Tähtiharju, S. and Palva, E. T. (2001) Antisense inhibition of protein phosphatase 2C accelerates cold acclimation in *Arabidopsis thaliana*. *Plant J.* 26: 461-470.
- Tähtiharju, S., Sangwan, V., Monroy, A.F., Dhindsa, R.S. and Borg, M. 1997. The induction of *kin* genes in cold-acclimating *Arabidopsis thaliana*. Evidence for a role of calcium. *Planta* 203: 442-447.
- Thomasow, M.F. 1998. Role of cold-responsive genes in plant freezing tolerance. *Plant Physiol.* 118:1-7
- Thomashow, M.F. 1999. Plant cold acclimation: freezing tolerance genes and regulatory mechanisms. *Annu. Rev. Plant. Physiol.* 50:571-599.
- Uno, Y., Furihata, T., Abe, H., Yoshida, R., Shinozaki, K. and Yamaguchi-Shinozaki, K. 2000. Arabidopsis basic leucine zipper transcription factors involved in an abscisic acid-dependent signal transduction pathway under drought and high-salinity conditions. *Proc. Natl. Acad. Sci. USA* 97:11632-11637.
- Yamaguchi-Shinozaki, K. and Shinozaki, K. 1994. A novel cis-acting element in an *Arabidopsis* gene is involved in responsiveness to drought, low-temperature, or high-salt stress. *Plant Cell* 6:251-264.
- Zhu, J.K. 2001. Cell signaling under salt, water and cold stresses. *Curr. Op. Plant Biol.* 4: 401-406.
- Örvar, B.L., Sangwan, V., Omann, F. and Dhindsa, R.S. 2000. Early steps in cold sensing by plant cells: the role of actin cytoskeleton and membrane fluidity. *Plant J.* 23:785-794.



# Functional analysis of mitochondrial small heat shock protein

Mariko Shono¹, Jian Liu², Kazutsuka Sanmiya^{1,3}, Ishwar Singh⁴,  
Jalal ud Din⁵, Katsumi Suzuki¹, Tadashi Tsukaguchi^{1,3} and Yoshinobu Egawa¹

¹Japan International Research Center for Agricultural Sciences, Okinawa Sub-tropical Station, Japan

²Shandong Teachers University, China

³Bio-oriented Technology Research Advancement Institution, Japan

⁴Indian Institute of Sugarcane Research, India

⁵Land Resources Research Institute, Pakistan

## Abstract

---

We successfully cloned and sequenced a full-length cDNA (LeHSP23.8: accession number AB017134) encoding the precursor of the mitochondria-located small heat shock protein (MT-sHSP) from tomato (*Lycopersicon esculentum* Mill.). The deduced protein precursor with a calculated molecular weight of 23.8 kDa was predicted to target mitochondria. A single copy of LeHSP23.8 was found in tomato genomic DNA by southern-blot analysis. Northern-blot analysis revealed the heat-inducible character of LeHSP23.8 mRNA. The LeHSP23.8 mRNA was hardly detectable at 36°C but accumulated abundantly at 40°C in tomato leaves. Among the MT-, ER-, Class I- and Class II-sHSP genes, MT-sHSP mRNA responded most quickly at 40°C in tomato flowers. In flowers on the flowering day, sHSP genes (MT- and ER-) were expressed specifically in the female organs when the plants were incubated under the heat stress.

The molecular chaperone function of LeHSP23.8 was confirmed *in vitro*. The recombinant LeHSP23.8 was able to enhance the renaturation of chemically denatured citrate synthase. Moreover, the recombinant LeHSP23.8 protected citrate synthase from thermal inactivation and also promoted the renaturation of thermally inactivated citrate synthase. Partially purified mitochondria fraction from MT-sHSP transgenic tobacco showed much higher Cytochrome C oxidase activity than the control under higher temperatures.

Protein analysis by western blotting showed that expression of MT-sHSP occurred in leaves, flowers and pollen of transgenic tobacco lines (MT-a, MT-d, MT-e) at 28°C but could not be detected in these organs in the control plant (pBI). However, MT-sHSP was induced under heat stress (37°C) in pBI leaves. Although we could not detect MT-sHSP in pollen of pBI at 37°C, it was overexpressed in pollen of MT-a. We observed *in vitro* pollen germination and comparatively low pollen bursting at 45°C in MT-sHSP transgenic lines, indicating a possible role of MT-sHSP in plant reproduction. We are also trying to analyze the *in vivo* function of MT-sHSP.

*Key words:* heat-stress; mitochondria; molecular chaperone; pollen germination; small HSP

## Introduction

Heat stress is one of the most important constraints on crop production. Plants respond to heat stress by changing their metabolic pathways so as to acclimatize to high temperature. Under heat stress, synthesis of most proteins is repressed and some proteins, which are called heat shock proteins (HSPs), start to be synthesized. In plant species adapted to temperate environments, 20 to 40 different HSPs, which are divided into several classes, are induced under heat

stress (Vierling 1991). Some low molecular weight (15-30 kDa) HSPs, so-called small heat shock proteins (sHSPs), are also expressed in plants. The sHSPs are classified into five classes in accordance with their molecular phylogeny and localization in the cell. Cytosolic I and cytosolic II sHSPs are found in the cytoplasm. The other three classes are found in the chloroplast, mitochondria and endoplasmic reticulum. Most of the sHSPs are believed to help the plants to adapt under stress conditions. During heat stress, some plants can acclimate to high temperature and



accumulate sHSPs up to 1% of total soluble proteins (Hsieh et al. 1992). Accumulation of sHSPs has been reported in endoplasmic reticulum under low temperature (Ukaji et al. 1999) and in chloroplast during oxidative stress (Harndahl et al. 1999). The sHSPs have also been detected in plant organs such as maturing pollen grains, developing embryos (Wehmeyer et al. 1996), growing fruits (Sabehat et al. 1996) and germinating seeds (Arranco et al. 1997).

Experimental results over a period of 20 years have shown that almost all the high molecular weight HSPs act as molecular chaperones *in vitro* and *in vivo* (Vierling 1991). Molecular chaperones are able to help the newly synthesized peptides to fold into a correct configuration, prevent protein from denaturation at high temperature, help denatured proteins to recover their original active configuration and facilitate the passage of signal peptide-processed proteins through cell compartment membranes. Recently, some important experiments also have proved the chaperone activities of sHSPs. Cytosolic I and II sHSPs were found to exhibit an ATP-independent molecular chaperone function *in vitro* (Lee et al. 1995, Yeh et al. 1995, Collade et al. 1997, Helm et al. 1997). In addition, the *Arabidopsis* cell, transformed by the rice cytosolic I sHSP gene, showed a more efficient ability to prevent luciferase from thermo-denaturation and to accelerate the renaturation of denatured luciferase *in vivo* (Forreiter et al. 1997). These results suggested that cytosolic I sHSPs also exhibit a molecular chaperone activity *in vivo* and can contribute to the heat tolerance of plants.

As an important organelle in plant cells, mitochondria perform many essential functions. The structural breakdown and any abnormality of the metabolic activities of the mitochondria at high temperature affect cell viability. Therefore, the capability of mitochondria to tolerate heat has a great impact on the whole cell activity and survival. Since heat-stressed plants accumulate much more MT-sHSPs than HSP60 and HSP70 (Vierling 1991, Lenne and Douce 1994, Lund et al. 1998) and the accumulation of MT-sHSPs is synchronized with the enhancement of the heat tolerance of plant mitochondria (Chou et al. 1989), it is suggested that MT-sHSPs play a major role in the heat tolerance of plant mitochondria. However, still little is known about the cellular functions of MT-sHSP in heat tolerance of plants.

We aimed to clone mitochondrial sHSP cDNA from tomato leaves, evaluate the transcription of the mitochondria-sHSP gene at various temperatures and assay the molecular chaperone activity of mitochondria-sHSPs *in vitro*. We are also analyzing the function of MT-sHSP *in vivo*, especially in reproductive organs.

## Results and Discussion

### Cloning and expression analysis of LeHSP23.8 gene

Poly (A)⁺ RNA was purified from tomato leaves treated at 40°C for 6 h. A cDNA library was constructed with ZAP-cDNA/Gigapack Cloning Kit (Stratagene). PCR-amplified fragment, which encoded the tomato MT-sHSP gene conserved region, was used as a probe. The longest clone, with an insert of about 0.8-kb, was sequenced and designated LeHSP23.8. Its DDBJ accession number is AB017134. The complete nucleotide sequence of LeHSP23.8 and the amino acid sequence translated for the open reading frame (ORF) are shown in Fig.1. The whole sequence of the LeHSP23.8 gene is 827 nucleotides. The ORF of LeHSP23.8 begins with ATG at the 50th base and ends

```

GAAGCTTTAC TCAATCGGCA AGTTATTCAG AATCTTTTGG TATCAGAAAT 50
                                     M
GGCAACTCTT GCTCTAAGGA GGGCCACCGC CTCATCACTA TTCAACAGGC 100
A T L A L R R A T A S S L F N R L
TCGTCAATCC TGTTCGTCT GCATCTGCTT TCCGTTCAIT CAATACTAAC 150
V N P V R S A S A F R S F N T N
ACTCAGATGA CAGCTTATGA CCAGGATGAT CGTGGCGTTG ATGTTGACCG 200
T Q M T A Y D Q D D R G V D V D R
CCGGTCCGAT CGATCCGTCT CTGCGCGTGA TGCTTTTCTT AGTTTATICT 250
R S D R S V S R R D A F P S L F S
CAGATGTATT TGATCCATT TCAACCACAA TTAGGAGCGT GAGCCAATTG 300
D V F D P F S P P I R S V S Q L
CTGAACATGA TGGATCAAAAT GATGGATTCT CCATTCGTAG CTGCACCCGG 350
L N M M D Q M M D S P F V A A P R
TGCAATGGGC GCCGGAGTTG GAGCAAGAAG AGGATGGGAT GTAAGGAGG 400
A M G A G V G A R R G W D V K E D
ACGATAACGC TCTGTATATA AAAATGGACA TGCCTGGACT CGATAAGGAG 450
D N A L Y I K M D M P G L D K E
AATGTGAAGG TGGCGGTGGA GGAGAACACG CTGATAATCA AAGGAGAAGG 500
N V K V A V E E N T L I I K G E G
CGAGAAAGAG TCGGAGAATG AAGAGTATAG AAGGAGGTAC TCTACCAGAC 550
E K E S E N E E Y R R R Y S T R L
TGGAAATTC TCAAAATATC TACAAATTGG ATGGAATCAA GGCGGAGATG 600
E I P Q N I Y K L D G I K A E M
AAGAATGGAG TGTGAAAGT AGCTGTTC AAGGTGAAGC AAGAAGAAAG 650
K N G V L K V A V P K V K Q E E R
GAAGGATGTT TTCGATGTTA AAATTGAGTG AGAGCTTTTA AGCTTTGCCA 700
K D V F D V K I E .
AGTTTGTGCA ACAATTGAGT GTTGATGTTA TTAACTTTTT CAACTTTTTA 750

GTTCTTAGAT AGGTTGTGTG GGAAAATAAA AGATTATGTG CTA AAAAATTG 800

GAATTCTGAT TGTAAGAGTT TGTT C 825

```

Fig. 1. Nucleotide sequence of LeHSP23.8 cDNA and deduced amino acid sequence of LeHSP23.8. A putative pre-sequence targeting of protein LeHSP23.8 into mitochondria is underlined. The nucleotide sequence reported here appeared in the Genbank, EMBL and DDBJ Nucleotide Sequence Databases under the accession number AB017134.

with TGA at the 680th base. Since the length of the LeHSP23.8 cDNA agreed well with the estimated size of the mRNA (see Fig. 3), the clone LeHSP23.8 cDNA was considered to be a complete sequence. The deduced molecular weight of the precursor protein was 23.8 kDa. By using on-line PSORT software, designed according to the method reported by Gavel and Heijine (1990), the probable subcellular compartmentation of LeHSP23.8 protein was predicted. A putative pre-sequence targeting of protein LeHSP23.8 into mitochondria was detected by PSORT. The pre-sequence consisted of 31 N-terminal amino acids of the LeHSP23.8 protein.

The amino acid sequence alignment between the LeHSP23.8 protein and other reported MT-sHSP proteins showed two consensus blocks, both of which were located at the C-terminus of proteins and represented the basic character of the MT-sHSP family (Fig. 2). Another amino acid sequence alignment between the LeHSP23.8 protein and the three sHSPs of tomato (Cytosolic-I, Cytosolic-II and chloroplast-sHSP) revealed that two typical motifs of sHSPs, P---GVL--- and PGL---E---, are present in the consensus blocks (data not shown). These two motifs widely occur in

<i>T. aestivum</i>	IKTRVVFQNR	I-PLVRAMEN	L LAAS----	GSALRPAAYA	GGVRYGAGA	45
<i>Z. mays</i>	MAITVAARRA	V-PLVRALEK	L LAAS SAPGT	GSALRPAAYA	GGLRGYNTGA	49
<i>L. esculentum</i>	MAFLA-LRRA	TAS SLFRLV	MPVRSASAF	-R SFNTNTQM	TAYDQDRGV	47
<i>C. rubra</i>	MAFMA-LRRL	ASRNLVY--G	GIFRP LSVS--	-R SFNTNAQM	GRVDH-DH EL	44
<i>P. glauca</i>	MAFVASAK SM	VNK SVTPAWK	KCLLP SGRIQ	-GDS SASAMC	RSLSSTAARY	48
<i>S. mar</i>	MAFSLTAKRF	LSSGL LRS-	-LLRP AASAS	HR SFDTNAMR	QYDNRADDHS	48
<i>P. sativum</i>	MAFSLTAKRF	LSSGL LRS-	-FLRP YASSA	SR SFDTNAMR	SR SFDTNAMR	48
<i>A. thaliana</i>	MAFSLTAKRF	LSSGL LRS-	-FLRP YASSA	SR SFDTNAMR	SR SFDTNAMR	48
Consensus	MAF.....R	.....RP.....	.....R.F.TNA.	.....	.....	50
<i>T. aestivum</i>	PLRSYDRDEA	VEDTRR--VA	RE--RDIGVP	SFSDYFRDP	FSAPQSLGR	91
<i>Z. mays</i>	PLRRYEGAES	EDD SYREYDG	RHGGRDYAVP	SLFSDFRDP	LSAPHSIGRL	99
<i>L. esculentum</i>	DVD--RRS--	-DR SYSRDA	FP--SLFSDFE	-D--PFSPPF	RSVYQLNMM	88
<i>C. rubra</i>	D-D--RSM--	-RAPSRRGD	FPASFSDYF	-D--PF-RAT	RSVYQLNMM	84
<i>P. glauca</i>	RP E-YD SA--	-IQDQDQMRQ	ASETRRGLD	-M--IFGDF	YPLRLSGFL	91
<i>S. mar</i>	-TDIDRHSER	SFP STARRDD	FILRCVGSIF	SD--SEFEPG	SEHMGPH--	93
<i>P. sativum</i>	-VDVYRHS--	-FPRTRDDI	LL----SDYF	-D--P-FSDP	RSLSQVLM--	84
<i>A. thaliana</i>	GVDLYRHS--	-WR--RR--	-----GDFE	SDVDFDFSP	RSVYQLNMM	85
Consensus	..D.YR...--	.....R...--	.....VF	..D...F.P.	..S..Q.....	100
<i>T. aestivum</i>	LSMLDD--VA	AASPDGAARA	AMRRGTHAR	EDADRIILRY	DMPTGKEHY	139
<i>Z. mays</i>	LMLYDD--LA	VAADPRA----	-VRRGMIAK	ED EELILRY	DMPTGKEHY	142
<i>L. esculentum</i>	DQMDSPFVA	APRANGAGY--	-GARRGMVYK	EDDMALYDYM	DMPTGKEHY	136
<i>C. rubra</i>	DQLMDFPFA	ASRSGRGMH--	-RRGMVYR	ED EELILRY	DMPTGKEHY	130
<i>P. glauca</i>	DQLMDFPFA	ASRSGRGMH--	-RRGMVYR	ED EELILRY	DMPTGKEHY	141
<i>S. mar</i>	GQSYD--LR	YARDRSDR	--SRGMVYR	ED EELILRY	DMPTGKEHY	137
<i>P. sativum</i>	--MVD--LL	TDMVPLSAA--	--SRGMVYR	ED EELILRY	DMPTGKEHY	126
<i>A. thaliana</i>	DQFMDFPFA	ASRSGRGMH--	-RRGMVYR	ED EELILRY	DMPTGKEHY	132
Consensus	.Q..D...LA	A.R..G...--	RRGMVYR	ED..ALILRY	DMPTGKEHY	150
<i>T. aestivum</i>	KYVAEINSY	IKGEEKEESE	QEGAD--AP	RYSGRIELAG	DYRMDIETRA	186
<i>Z. mays</i>	KYVAEINSY	IKGEEKEESE	EDEAA--PP	RYSGRIELAP	EYRMDIETRA	190
<i>L. esculentum</i>	KYVAEINTLI	IKGEEKEESE	NEEY----RR	RYSTRLEIDP	KLHKIDIEEA	182
<i>C. rubra</i>	KYSVEINTLI	IKGEEKEETE	EEEQ----RR	RYSSRIEILP	KLHKIDIEEA	176
<i>P. glauca</i>	KYVAEINMAY	IKGEEYSDAE	LDG S----AR	KYSSRIEILP	KYMKLDIEEA	187
<i>S. mar</i>	KYSVEINTLI	IKGEEGAKK	--GD EEE--SAR	RYSSRIEILP	KLHKIDIEEA	183
<i>P. sativum</i>	KYSVEINTLI	IKGEEGAKK	--SEK EKSGR	RFSSRIEILP	KLHKIDIEEA	174
<i>A. thaliana</i>	KLALFQDTLY	IKGEEGAKK	GGEEGESGM	RFSSRIEILP	KLHKIDIEEA	182
Consensus	KY...EINTL	IKGEE...E...	...E...R	RYSSRIEILP	...KLDIEEA	200
<i>T. aestivum</i>	EMKNGVLRV	VPRKEEERK	DVFVWVD			214
<i>Z. mays</i>	EMKNGVLRV	VPRKEEERK	DVFVWVE			218
<i>L. esculentum</i>	EMKNGVLRV	VPRKEEERK	DVFVWVE			210
<i>C. rubra</i>	EMKNGVLRV	VPRKEEERK	DVFVWVD			204
<i>P. glauca</i>	EMKNGVLRV	VPRKEEERK	DVFVWVE			215
<i>S. mar</i>	EMKNGVLRV	VPRKEEERK	DVFVWVE			211
<i>P. sativum</i>	EMKNGVLRV	VPRKEEERK	DVFVWVD			202
<i>A. thaliana</i>	EMKNGVLRV	VPRKEEERK	DVFVWVD			210
Consensus	EMKNGVLRV	VPRKEEERK	DVFV.V.			228

Fig. 2. Alignment of LeHSP23.8 with reported MT-sHSP amino acid sequences. The boxes indicate the consensus amino acid residues in the sequences.

sHSPs from various organisms (Waters et al. 1996).

Southern-blot analysis revealed the existence of a distinct LeHSP23.8 gene in the tomato genome. The genomic DNA blots probed with LeHSP23.8 showed that only one band was detected on each lane (data not shown). The signals of southern blots suggested that only a single copy of the LeHSP23.8 gene occurs in tomato genomic DNA.

Heat induction of MT-sHSP mRNA in leaves was confirmed by northern-blot analysis. The threshold temperature was around 36°C (Fig. 3). Expression of

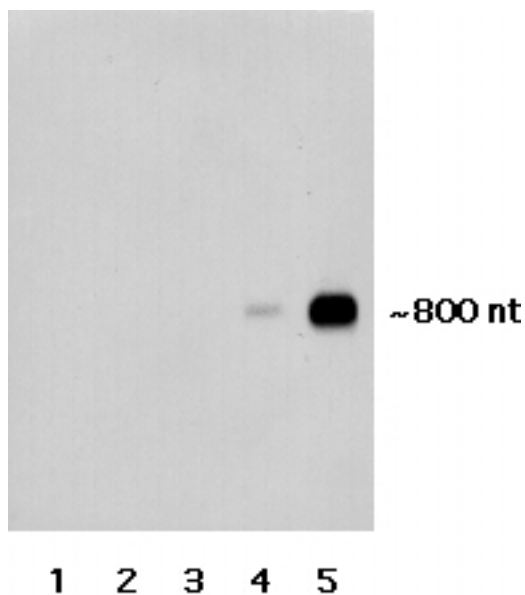
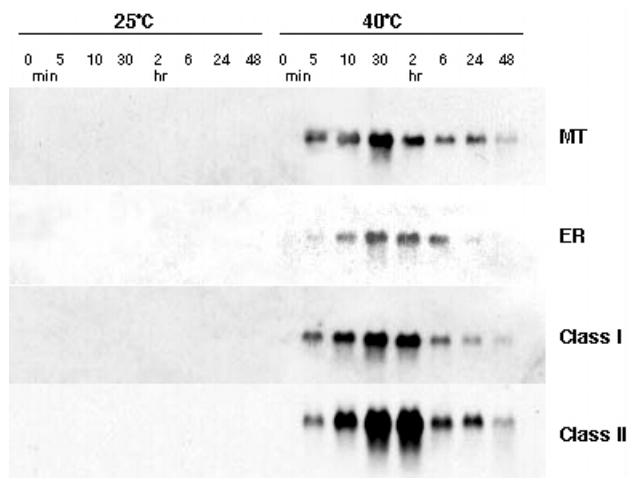


Fig. 3. Northern-blot analysis of temperature-dependent LeHSP23.8 mRNA accumulation. Lane 1: tomato plant grown at 25°C (control), lanes 2-5: tomato plants treated at 28°C, 32°C, 36°C and 40°C for 2 h, respectively.

MT-sHSP mRNA in flowers was compared with other sHSPs (Class I-, Class II-, ER-). Although all the investigated sHSPs' mRNA were expressed at 40°C, the peak of MT-sHSP gene expression was the earliest (Fig. 4). The MT-sHSP mRNA showed a very sensitive response to change of temperature. This fact suggests the presence of sensitive heat sensor(s) and systems of feedback regulation for MT-sHSP in the tomato cells.

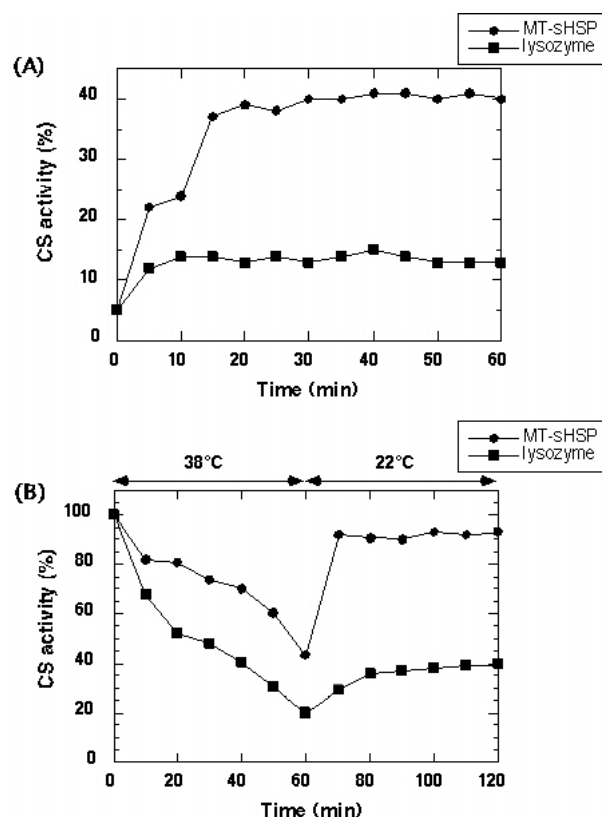
Flowers on the flowering day were subjected to the *in situ* hybridization analysis. The plants were incubated in the growth chamber at 32°C or 40°C, for the detection of MT- and ER-sHSP mRNA, respectively. On the day of flowering, sHSP genes were not expressed in pollen, but were expressed specifically in the female organs (type MT in stigma and ovule, and type ER in ovule, respectively) (data not shown). No expression of MT- and ER-sHSP genes in pollen suggested one of the reasons why the male organ is more sensitive to heat stress than female organs.



**Fig. 4.** Northern-blot analysis of heat-induced sHSP genes in tomato flower. Tomato plants grown in the greenhouse were transferred to the growth chamber on the day of flowering, then incubated at 25°C or 40°C. The flowers were collected 0 min to 48 hr after the incubation. Panel MT, ER, Class I, Class II shows the expression of the genes for MT-, ER-, Class I- and Class II-sHSP, respectively.

**Characterization of the molecular chaperone activity of tomato LeHSP23.8 *in vitro***

The recombinant LeHSP23.8 and citrate synthase (CS) were used for the *in vitro* assay of the molecular chaperone activity of LeHSP23.8 according to a standard experimental procedure (Lee, 1995). A very high level of activity of molecular chaperone was observed with LeHSP23.8. When the recombinant LeHSP23.8 was mixed with CS denatured by guanidine hydrochloride, the activity of CS was recovered gradually. After 60 min of incubation, 40% of the native CS activity was recovered. This value was two times higher than that of the control experiment in which LeHSP23.8 was replaced by lysozyme (Fig. 5A). In another experiment, recombinant LeHSP23.8 protected CS from thermal inactivation and also promoted the renaturation of thermally inactivated CS. The loss of CS activity was relatively slow when CS was incubated with recombinant LeHSP23.8 at 38°C. After 60 min incubation at 38°C, the remaining activity of CS was 39%, which was two times that for the control experiment with lysozyme. Furthermore, when the incubation temperature was shifted to 22°C, a rapid renaturation of thermal-denatured CS was observed within 10 min, and 90% of CS activity was recovered (Fig. 5B). The molecular chaperone efficiency of recombinant LeHSP23.8 protein in promoting the renaturation of thermally denatured CS was higher than that in promoting the renaturation of chemically denatured CS. These results were consistent with the



**Fig. 5.** (A) Effect of LeHSP23.8 protein on the renaturation of chemically denatured citrate synthase (CS). CS (15 μM) was denatured in 6 M guanidine hydrochloride for 120 min and then diluted 100-fold into a solution supplemented with 150 nM lysozyme (■) or with 1.8 mM recombinant LeHSP23.8 (●). (B) Effect of recombinant LeHSP23.8 on the thermal inactivation of CS. CS (150 nM) was incubated in the presence of 150 nM lysozyme (■) or 1.8 μM recombinant LeHSP23.8 (●) at 38°C for 60 min and then at 22°C.

observations made by Ehrnsperger et al. (1997). It is suggested that sHSPs can prevent the irreversible aggregation of CS units due to thermal treatment, but sHSP does not play an important role in the renaturation of the denatured protein because sHSPs only provide unspecific intermediate surfaces for substrate proteins (Ehrnsperger et al. 1997).

Partially purified mitochondria fraction from MT-sHSP transgenic tobacco and endogenous Cytochrome C oxidase were also used for another *in vitro* assay. The mitochondria fraction from MT-sHSP transgenic tobacco showed much higher Cytochrome C oxidase activity than mitochondria fraction from control tobacco under higher temperatures.

**Heat-stress response of MT-sHSP in transgenic tobacco**

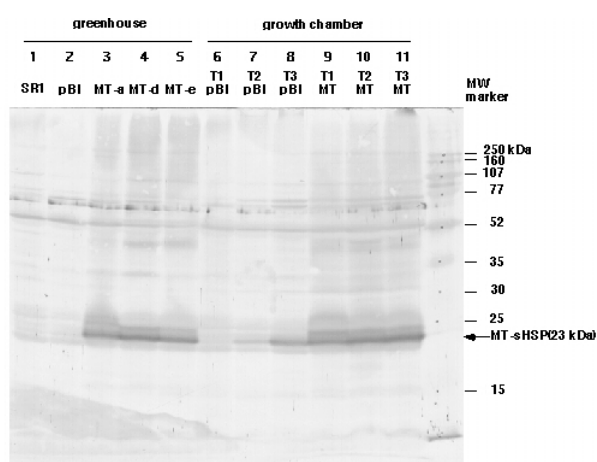
Successful pollination and fertilization are absolute requirements for sexual reproduction in higher plants

(Wolters-Arts et al. 1998). Heat stress affects plant reproduction by affecting pollen fertility (Weever et al. 1985, Suzuki et al. 1999) and viability (Weever and Timm 1989, Shivana and Cresti 1989, Shivana et al. 1991). The effect of high temperature on pollen response has been reported in connection with the synthesis of heat shock proteins (Xio and Mascarenhas 1985, Frova et al. 1987, Herpen et al. 1988, Frankis and Grayson 1990). However, there is no report about the role of Mt-sHSP in pollen germination.

Western blotting analysis of leaf proteins showed a distinct protein band of MT-sHSP of 23 kDa molecular size in LeHSP23.8 transgenic lines MT-a, MT-d and MT-e but the band could not be detected in non-transgenic cultivar SR1 and vector transgenic pBI grown under favorable growth conditions (28/22°C, day/night). However, exposure of pBI tobacco to 32°C and 37°C for 48 hr induced MT-sHSP production. Much more expression of MT-sHSP was observed at 37°C (Fig. 6).

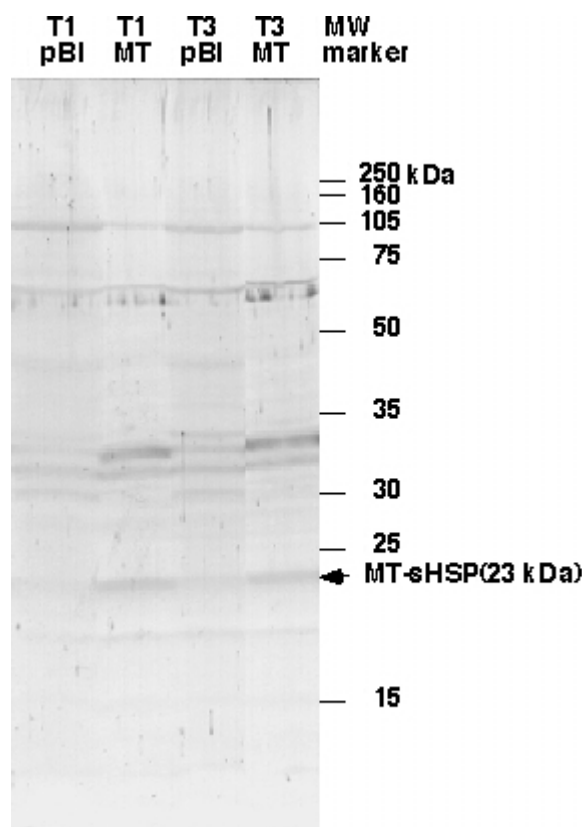
MT-sHSP was also expressed in both flowers and pollen of transgenic lines MT-a and MT-d at 28°C but could not be detected in pBI. The heat stress of 37°C for 48 hr was unable to induce MT-sHSP in pollen grains of pBI, which was overexpressed in the transgenic lines (Fig. 7), indicating a possible role of MT-sHSP in heat tolerance during plant reproduction. We confirmed this observation by testing pollen viability under *in vitro* and *in vivo* heat-stress conditions.

Tobacco flowers were collected from the plants cultivated in a greenhouse (28/22°C, day/night) and then treated to heat stress. Treatment of isolated flowers for one hour at 45°C did not affect *in vitro* pollen



**Fig. 6.** Heat induction of MT-sHSP in transgenic tobacco leaves was analyzed by western blotting. Lanes 1-5 were protein analysis in leaves collected from the greenhouse (28/22°C day/night temperature and natural sunlight). Plants of pBI and MT-a were treated at 25/25(T1), 32/25(T2) and 37/25(T3)C, day/night temperature with 14/10-hr day/night cycle for 48 hr.

germination both in MT-a and pBI at 25°C. Pollen germination was completely inhibited at 40°C and 45°C in pBI, although pollen from MT-a flowers showed some germinability (Table 1).



**Fig. 7.** Heat induction of MT-sHSP in transgenic tobacco pollen was analyzed by western blotting. Plants of pBI and MT-a were treated at 25/25(T1) or 37/25(T3)°C, day/night temperature with 14/10-hr day/night cycle for 48 hr.

**Table 1**

Effect of incubation temperature on pollen germination (PG, %), bursting (PB, %) and tube length (PTL, μm) in transgenic tobacco. The pollen samples were collected from heat-treated flowers for one hour at different temperatures. In the treatment column, the first figure indicates flower treatment temperature and the second figure denotes the incubation temperature

Plant type		Treatment (°C)			
		25-25	45-25	40-45	45-45
pBI	PG	83.2	83.5	0.0	0.0
	PB	3.4	7.3	39.7	89.9
	PTL	718.1	269.3	0.0	0.0
MT-a	PG	91.9	86.9	4.0	2.4
	PB	5.0	4.4	31.5	83.5
	PTL	652.8	338.6	18.5	30.6

We are also trying to analyze the *in vivo* function of MT-sHSP. Further studies exclusively on mitochondrial respiration and respiratory enzymes of transgenic tobacco flowers will be helpful for a better understanding of the role of MT-sHSP in plant sexual reproduction. The studies need to be extended to other commercial crops.

## Summary

1. Full-length cDNA of mitochondria-located small heat shock protein (LeHSP23.8: accession number AB017134) was cloned from tomato (*Lycopersicon esculentum* Mill.). The deduced protein precursor with a calculated molecular weight of 23.8 kDa was predicted to target mitochondria.
2. MT-sHSP gene was the quickest responding gene among the sHSPs in flower. This finding suggests that mitochondria should be the most sensitive organelle to heat stress.
3. MT-sHSP showed the molecular chaperone activity *in vitro*. The recombinant LeHSP23.8 was able to protect citrate synthase from thermal inactivation and promoted the renaturation of thermally or chemically denatured citrate synthase. Overexpression of MT-sHSP in mitochondria made some enzymes there heat tolerant.
4. Both MT- and ER-sHSP were not expressed in pollen but in female organs under the heat stressed conditions. *In vitro* pollen germination was completely inhibited at 40°C and 45°C in control tobacco, although pollen germination of MT-sHSP overexpressed flowers was observed. Expression of MT-sHSP in pollen made pollen more tolerant to heat stress.
5. We plan to confirm the contribution of MT-sHSP to heat tolerance by *in vivo* experiments.

## Acknowledgements

This research was supported in part by funds from the Bio-oriented Technology Research Advancement Institution.

## References

- Arranco, R., Almoguera, C. and Jordano, J. (1997) A plant small heat shock protein gene expressed during zygotic embryogenesis but non-inducible by heat stress. *J. Biol. Chem.* 272: 27470-27475.
- Chou, M., Chen, Y.M. and Lin, C.Y. (1989) Thermotolerance of isolated mitochondria associated with heat shock proteins. *Plant Physiol.* 98: 617-621.
- Collade, C., Gomez, R., Casado, R. and Aragoncillo, C. (1997) Purification and *in vitro* chaperone activity of a class I small heat-shock protein abundant in recalcitrant chestnut seeds. *Plant Physiol.* 115: 71-77.
- Ehrnsperger, M., Graber, S., Gaestel, M. and Buchner, J. (1997) Binding of non-native protein to Hsa25 during heat shock creates a reservoir of folding intermediates for reactivation. *EMBO J.* 16: 221-229.
- Forreiter, C., Kirschner, M. and Nover, L. (1997) Stable transformation of an *Arabidopsis* cell suspension culture with firefly luciferase providing a cellular system for analysis of chaperone activity *in vivo*. *Plant Cell* 9: 2171-2181.
- Frankis, R.C. Jr and Grayson, G.K. (1990) Heat-shock response in germinating pine pollen. *Sex. Plant Reprod.* 3: 195-199.
- Frova, C., Binelli, G. and Ottaviano, E. (1987) Isozyme and HSP gene expression during male gametophyte development in maize. *Isozymes: Curr. Top. Biol. Med. Res.* 15: 97-120.
- Gavel, Y. and Von Heijine, G. (1990) Cleavage-site motifs in mitochondrial targeting peptides. *Protein Eng.* 4: 33-37.
- Harndahl, U., Hall, R.B., Osteryoung, K.W., Vierling, E., Bornman, J.F. and Sundby, C. (1999) The chloroplast small heat shock protein undergoes oxidation-dependent conformational changes and may protect plant from oxidative stress. *Cell Stress Chaperones* 4: 129-138.
- Helm, K.W., Lee, G.W. and Vierling, E. (1997) Expression and native structure of cytosolic class II small heat-shock protein. *Plant Physiol.* 114: 1477-1485.
- Herpen, M.M.A. van, Reijnen, W.H., Schrauen, J.A.M., De Groot, R.P.M. and Wullems, G.L. (1988) Heat shock protein in germinating pollen of *Nicotiana tabacum* before and after heat shock. In: Cresti, M., Gori, P. and Pacini, E. (Eds.) *Sexual Plant Reproduction in Higher Plants*. Springer, pp. 277-281.
- Hsieh, M.H., Chen, J.T., Jin, T.L., Chen, Y.M. and Lin, C.Y. (1992) A class of soybean low molecular weight heat shock protein. *Plant Physiol.* 99: 1279-1284.
- Lee, G.J. (1995) Assaying proteins for molecular chaperone activity. *Methods Cell Biol.* 50: 325-334.
- Lee, G.J., Pokala, N. and Vierling, E. (1995) Structure and *in vitro* molecular chaperone activity of cytosolic small heat shock protein from pea. *J. Biol. Chem.* 270: 10432-10438.
- Lenne, C. and Douce, R. (1994) A low molecular mass heat-shock protein is localized to higher plant mitochondria. *Plant Physiol.* 105: 1255-1261.
- Lund, A.A., Blum, P.H., Bhatramakki, D. and Elthon, T.E. (1998) Heat-stress response of maize mitochondria. *Plant Physiol.* 116: 1097-1110.
- Sabehat, A., Weiss, D. and Lurie, S. (1996) The correlation between heat-shock protein accumulation and persistence and chilling tolerance in tomato fruit. *Plant Physiol.* 110: 531-537.
- Shivana, K.R. and Cresti, M. (1989) Effect of high humidity and temperature stress on pollen membrane integrity and pollen vigour in *Nicotiana tabacum*. *Sex. Plant Reprod.* 2: 137-141.
- Shivana, K.R., Linskens, H.F. and Cresti, M. (1991) Response of tobacco pollen to high humidity and heat stress: viability and

- germinability *in vitro* and *in vivo*. *Sex. Plant Reprod.* 4: 104-109.
- Suzuki, K., Takeda, H., Matsuura, S., Yuo, Y. and Egawa, Y. (1999) Morphological study on injury of pollen of snap bean by heat stress. *Proc. Int. Symp. "World Food Security"*, Kyoto: 203-206.
- Ukaji, N., Kuwabara, C., Takezawa, D., Arakawa, K., Yoshida, S. and Fujikawa, S. (1999) Accumulation of small heat shock protein homologs in the endoplasmic reticulum of cortical parenchyma cells in mulberry in association with seasonal cold acclimation. *Plant Physiol.* 120: 481-490.
- Vierling, E. (1991) The role of heat shock-proteins in plant. *Annu. Rev. Plant Physiol. Plant Mol. Biol.* 42: 579-620.
- Waters, E.R., Lee, G.J. and Vierling, E. (1996) Evolution, structure and function of small heat shock proteins in plant. *J. Exp. Bot.* 47: 325-338.
- Weever, M.L. and Timm, H. (1989) Screening tomato for high temperature tolerance through pollen viability tests. *Hort. Science* 24: 493-495.
- Weever, M.L., Timm, H., Silbernagel, M.J. and Burke, D.W. (1985) Pollen staining and high temperature tolerance of bean. *J. Amer. Hort. Sci.* 110: 797-799.
- Wehmeyer, N., Hernandez, L.D., Finkelstein, R.R. and Vierling, E. (1996) Synthesis of small heat shock protein in part of developmental program of late seed maturation. *Plant Physiol.* 112: 747-757.
- Wolters-Arts, M., Lush, W.M. and Mariani, C. (1998) Lipids are required for directional pollen tube growth. *Nature* 392: 818-21.
- Xio, C.M. and Mascarenhas, J.P. (1985) High temperature induced thermotolerance in pollen tubes of *Tradescantia* and heat shock proteins. *Plant Physiol.* 78: 887-890.
- Yeh, C., Yeh, K., Wu, S., Chang, P.L., Chen, Y. and Lin, C. (1995) A recombinant rice 16.9-KDa heat shock protein can provide thermoprotection *in vitro*. *Plant Cell Physiol.* 36: 1341-1348.



# Salt Stress Tolerance of Plants

**Shuji Yokoi, Ray A. Bressan and Paul Mike Hasegawa**

Center for Environmental Stress Physiology, Purdue University  
1165 Horticulture Building, Purdue University, West Lafayette, IN 47907-1165 USA

## Abstract

---

Salinity stress negatively impacts agricultural yield throughout the world affecting production whether it is for subsistence or economic gain. The plant response to salinity consists of numerous processes that must function in coordination to alleviate both cellular hyperosmolarity and ion disequilibrium. In addition, crop plants must be capable of satisfactory biomass production in a saline environment (yield stability). Tolerance and yield stability are complex genetic traits that are difficult to establish in crops since salt stress may occur as a catastrophic episode, be imposed continuously or intermittently, or become gradually more severe, and at any stage during development. However, cell biology and molecular genetics research is providing new insight into the plant response to salinity and is identifying genetic determinants that effect salt tolerance. Recent confirmation that many salt tolerance determinants are ubiquitous in plants has led to the use of genetic models, like *Arabidopsis thaliana*, to further dissect the plant salt stress response. Since many of the most fundamental salt tolerance determinants are those that mediate cellular ion homeostasis, this review will focus primarily on the functional essentiality of ion homeostasis mechanisms in plant salt tolerance. The transport systems that facilitate cellular capacity to utilize Na⁺ for osmotic adjustment and growth and the role of the Salt-Overly-Sensitive (SOS) signal transduction pathway in the regulation of ion homeostasis and salt tolerance will be particularly emphasized. A perspective will be presented that integrates cellular based stress signaling and ion homeostasis mechanisms into a functional paradigm for whole plants and defines biotechnology strategies for enhancing salt tolerance of crops.

*Keywords: Salt adaptation, ion homeostasis, transport determinants, stress signaling*

## Introduction

Soil salinity is a major constraint to food production because it limits crop yield and restricts use of land previously uncultivated. The United Nations Environment Program estimates that approximately 20% of agricultural land and 50% of cropland in the world is salt-stressed (Flowers and Yeo, 1995). Natural boundaries imposed by soil salinity also limit the caloric and the nutritional potential of agricultural production. These constraints are most acute in areas of the world where food distribution is problematic because of insufficient infrastructure or political instability. Water and soil management practices have facilitated agricultural production on soils marginalized by salinity but additional gain by these approaches seems problematic. On the horizon are crop improvement strategies that are based on the use of molecular marker techniques and biotechnology, and can be used in

conjunction with traditional breeding efforts (Ribaut and Hoisington, 1998). DNA markers should enhance the recovery rate of the isogenic recurrent genome after hybridisation and facilitate the introgression of quantitative trait loci necessary to increase stress tolerance. Molecular marker techniques were used successfully to transfer alleles of interest from wild relatives into commercial cultivars (Tanksley and McCouch, 1997).

The basic resources for biotechnology are genetic determinants of salt tolerance and yield stability. Implementation of biotechnology strategies to achieve this goal requires that substantial research effort be focused to on identify salt tolerance effectors and the regulatory components that control these during the stress episode (Hasegawa et al., 2000b). Further knowledge obtained about these stress tolerance determinants will be additional resource information for the dissection of the plant response to salinity, which

will reveal how plants sense salt stress, transduce signals to mediate a defensive response and define the signal pathway outputs or effectors that accomplish the processes required for stress survival and alleviation, and steady-state growth in the saline environment. Molecular genetic and plant transformation advances have made it feasible to assess biotechnological strategies based on activated signal cascades, engineered biosynthetic pathways, targeted gene or protein expression or alteration of the natural stress responsiveness of genes for development of salt tolerant crops (Hasegawa et al., 2000b; Zhu, 2001).

The molecular identities of key ion transport systems that are fundamental to plant salt tolerance are now known (Hasegawa et al., 2000b). More recently, the SOS salt stress signalling pathway was determined to have a pivotal regulatory function in salt tolerance, fundamental of which is the control of ion homeostasis (Hasegawa et al., 2000b; Sanders, 2000; Zhu, 2000). This review will summarize research on plant ion homeostasis in saline environments and present a model that integrates current understanding of salt stress sensing, which leads to the activation of the SOS pathway and the regulation of ion transport systems that facilitate ion homeostasis.

### **Genetic Diversity for Salt Tolerance in Plants**

The extensive genetic diversity for salt tolerance that exists in plant taxa is distributed over numerous genera (Flowers et al., 1986; Greenway and Munns, 1980). Most crops are salt sensitive or hypersensitive plants (glycophytes) in contrast to halophytes, which are native flora of saline environments. Some halophytes have the capacity to accommodate extreme salinity because of very special anatomical and morphological adaptations or avoidance mechanisms (Flowers et al., 1986). However, these are rather unique characteristics for which the genes are not likely to be introgressed easily into crop plants.

Research of recent decades has established that most halophytes and glycophytes tolerate salinity by rather similar strategies often using analogous tactical processes (Hasegawa et al., 2000b). The cytotoxic ions in saline environments, typically  $\text{Na}^+$  and  $\text{Cl}^-$ , are compartmentalized into the vacuole and used as osmotic solutes (Blumwald et al., 2000; Niu et al., 1995). It follows then that many of the molecular entities that mediate ion homeostasis and salt stress signaling are similar in all plants (Hasegawa et al., 2000b). In the fact, the paradigm for ion homeostasis that facilitates plant salt tolerance resembles that described for yeast (Bressan et al., 1998; Serrano et al., 1999). The fact that cellular ion homeostasis is controlled and effected by common molecular entities made it feasible to use of

model genetic organismal systems for the dissection of the plant salt stress response (Bressan et al., 1998; Serrano et al., 1999; Hasegawa et al., 2000a; Sanders, 2000; Zhu, 2000; 2001). Research on the plant genetic model *Arabidopsis* has increased greatly our understanding of how cellular salt tolerance mechanisms are integrated and coordinated in an organismal context, and are linked to essential phenological adaptations. Since *Arabidopsis* is a glycophyte, a salt tolerant genetic model will be required to delineate if salt tolerance is affected most by form or function of genes or more by differences in the expression of common genes due either to transcriptional or post-transcriptional control (Zhu, 2001).

### **Cellular Mechanisms of Salt Stress Survival, Recovery and Growth**

High salinity causes hyperosmotic stress and ion disequilibrium that produce secondary effects or pathologies (Hasegawa et al., 2000b; Zhu, 2001). Fundamentally, plants cope by either avoiding or tolerating salt stress. That is plants are either dormant during the salt episode or there must be cellular adjust to tolerate the saline environment. Tolerance mechanisms can be categorized as those that function to minimize osmotic stress or ion disequilibrium or alleviate the consequent secondary effects caused by these stresses. The chemical potential of the saline solution initially establishes a water potential imbalance between the apoplast and symplast that leads to turgor decrease, which if severe enough can cause growth reduction (Bohnert et al., 1995). Growth cessation occurs when turgor is reduced below the yield threshold of the cell wall. Cellular dehydration begins when the water potential difference is greater than can be compensated for by turgor loss (Taiz and Zeiger, 1998).

The cellular response to turgor reduction is osmotic adjustment. The cytosolic and organellar machinery of glycophytes and halophytes is equivalently  $\text{Na}^+$  and  $\text{Cl}^-$  sensitive; so osmotic adjustment is achieved in these compartments by accumulation of compatible osmolytes and osmoprotectants (Bohnert, 1995; Bohnert and Jensen, 1996). However,  $\text{Na}^+$  and  $\text{Cl}^-$  are energetically efficient osmolytes for osmotic adjustment and are compartmentalized into the vacuole to minimize cytotoxicity (Blumwald et al., 2000; Niu et al., 1995). Since plant cell growth occurs primarily because of directional expansion mediated by an increase in vacuolar volume, compartmentalization of  $\text{Na}^+$  and  $\text{Cl}^-$  facilitates osmotic adjustment that is essential for cellular development.

Movement of ions into the vacuole might occur directly from the apoplast into the vacuole through



membrane vesiculation or a cytological process that juxtaposes the plasma membrane to the tonoplast (Hasegawa et al. 2000b). Then compartmentalization could be achieved with minimal or no exposure of the cytosol to toxic ions. However, it is not clear presently the extent to which processes like these contribute to vacuolar ion compartmentalization. The bulk of  $\text{Na}^+$  and  $\text{Cl}^-$  movement from the apoplast to the vacuole likely is mediated through ion transport systems located in the plasma membrane and tonoplast. Presumably, tight coordinate regulation of these ion transport systems is required in order to control net influx across the plasma membrane and vacuolar compartmentalization. The SOS signal pathway is a pivotal regulator of, at least some, key transport systems required for ion homeostasis (Hasegawa et al., 2000a; Sanders, 2000; Zhu, 2000).

### Osmolytes and Osmoprotectants

As indicated previously, salt tolerance requires that compatible solutes accumulate in the cytosol and organelles where these function in osmotic adjustment and osmoprotection (Rhodes and Hanson, 1993). Some compatible osmolytes are essential elemental ions, such as  $\text{K}^+$ , but the majority are organic solutes. Compatible solute accumulation as a response to osmotic stress is an ubiquitous process in organisms as diverse as bacteria to plants and animals. However, the solutes that accumulate vary with the organism and even between plant species. A major category of organic osmotic solutes consists of simple sugars (mainly fructose and glucose), sugar alcohols (glycerol and methylated inositols) and complex sugars (trehalose, raffinose and fructans) (Bohnert and Jensen, 1996). Others include quaternary amino acid derivatives (proline, glycine betaine,  $\beta$ -alanine betaine, proline betaine), tertiary amines (1,4,5,6-tetrahydro-2-methyl-4-carboxyl pyrimidine), and sulfonium compounds (choline *o*-sulfate, dimethyl sulfonium propionate) (Nuccio et al., 1999). Many organic osmolytes are presumed to be osmoprotectants, as their levels of accumulation are insufficient to facilitate osmotic adjustment. Glycine betaine preserves thylakoid and plasma membrane integrity after exposure to saline solutions or to freezing or high temperatures (Rhodes and Hanson, 1993). Furthermore, many of the osmoprotectants enhance stress tolerance of plants when expressed as transgene products (Bohnert and Jensen, 1996; Zhu, 2001). An adaptive biochemical function of osmoprotectants is the scavenging of reactive oxygen species that are by-products of hyperosmotic and ionic stresses and cause membrane dysfunction and cell death (Bohnert and Jensen, 1996).

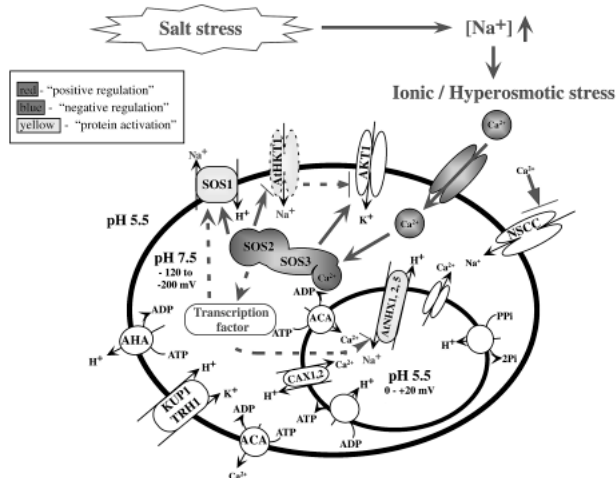
A common feature of compatible solutes is that these

compounds can accumulate to high levels without disturbing intracellular biochemistry (Bohnert and Jensen, 1996). Compatible solutes have the capacity to persevere the activity of enzymes that are in saline solutions. These compounds have minimal effect on pH or charge balance of the cytosol or lumenal compartments of organelles. The synthesis of compatible osmolytes is often achieved by diversion of basic intermediary metabolites into unique biochemical reactions. Often, stress triggers this metabolic diversion. For example, higher plants synthesize glycine betaine from choline by two reactions that are catalyzed in sequence by choline monooxygenase (CMO) and betaine aldehyde dehydrogenase (BADH) (Rhodes and Hanson, 1993). Pinitol is synthesized from myo-inositol by the sequential catalysis of inositol-*o*-methyltransferase and ononitol epimerase (Bohnert and Jensen, 1996).

### Ion Homeostasis - Transport Determinants and Their Regulation

Since NaCl is the principal soil salinity stress, a research focus has been the transport systems that are involved in utilization of  $\text{Na}^+$  as an osmotic solute (Blumwald et al., 2000; Hasegawa et al., 2000b; Niu et al., 1995). Research of more than 30 years previously, established that intracellular  $\text{Na}^+$  homeostasis and salt tolerance are modulated by  $\text{Ca}^{2+}$  and high  $[\text{Na}^+]_{\text{ext}}$  negatively affects  $\text{K}^+$  acquisition (Rains and Epstein, 1967).  $\text{Na}^+$  competes with  $\text{K}^+$  for uptake through common transport systems and does this effectively since the  $[\text{Na}^+]_{\text{ext}}$  in saline environments is usually considerably greater than  $[\text{K}^+]_{\text{ext}}$ .  $\text{Ca}^{2+}$  enhances  $\text{K}^+/\text{Na}^+$  selective intracellular accumulation (Maathuis et al., 1996; Rains and Epstein, 1967).

Research of the last decade has defined many of the molecular entities that mediate  $\text{Na}^+$  and  $\text{K}^+$  homeostasis and given insight into the function of  $\text{Ca}^{2+}$  in the regulation of these transport systems. Recently, the SOS stress-signaling pathway was identified to be a pivotal regulator of plant ion homeostasis and salt tolerance (Hasegawa et al., 2000b; Sanders, 2000). This signaling pathway functionally resembles the yeast calcineurin cascade that controls  $\text{Na}^+$  influx and efflux across the plasma membrane (Bressan et al., 1998). Expression of an activated form of calcineurin in yeast or plants enhances salt tolerance further implicating the functional similarity between the calcineurin and the SOS pathways (Mendoza et al., 1996; Pardo et al., 1998). A diagram of the relevant transporters and  $\text{Ca}^{2+}$ -dependent stress signaling pathway involved in  $\text{Na}^+$  homeostasis is shown in Figure 1. Little is known about the mechanistic entities that are responsible for  $\text{Cl}^-$  transport or the regulation of  $\text{Cl}^-$  homeostasis (Hedrich, 1994).

Salt Stress Signaling that Mediates Na⁺ Homeostasis

**Fig. 1. Salt stress-induced, Ca²⁺-dependent signalling that mediates Na⁺ homeostasis and salt tolerance.**

SOS1, plasma membrane Na⁺/H⁺ antiporter; SOS2, serine/threonine kinase; SOS3, Ca²⁺ binding protein; AHA, plasma membrane H⁺-ATPase; ACA, plasma/tonoplast membrane Ca²⁺-ATPase; KUP1/TRH1, high-affinity K⁺-H⁺ co-transporter; AKT1, K_{in} channel; NSCC, non selective cation channel; CAX1 or 2, Ca²⁺/H⁺ antiporter; NHX1, 2 or 5, endomembrane Na⁺/H⁺ antiporter; red - positive regulation, blue - negative regulation, yellow - protein activation

Ion Transport Systems that Mediate Na⁺ Homeostasis

**H⁺-Pumps.** H⁺ pumps in the plasma membrane and tonoplast energize solute transport necessary to compartmentalize cytotoxic ions away from the cytoplasm and to facilitate the function of ions as signal determinants (Maeshima, 2000; Maeshima, 2001; Morsomme and Boutry, 2000; Ratajczak, 2000). That is these pumps provide the driving force (H⁺ electrochemical potential) for secondary active transport and function to establish membrane potential gradients that facilitate electrophoretic ion flux (Figure 1). The plasma membrane localized H⁺ pump is a P-type ATPase and is primarily responsible for the large (pH and membrane potential gradient across this membrane (Morsomme and Boutry, 2000). A vacuolar type H⁺-ATPase and a vacuolar pyrophosphatase generate the ΔpH and membrane potential across the tonoplast (Drozdowicz and Rea, 2001; Maeshima, 2001). The activity of these H⁺ pumps is increased by salt treatment and induced gene expression may account for some of the upregulation (Hasegawa et al., 2000b; Maeshima, 2001).

Recently, the plasma membrane H⁺-ATPase was confirmed as a salt tolerance determinant based on analyses of phenotypes caused by the semi-dominant *aha4-1* mutation (Vitart et al., 2001). The mutation to *AHA4*, which is expressed predominantly in the roots,

causes a reduction in root and shoot growth (relative to wild type) of plants that are grown on medium supplemented with 75 mM NaCl. Decreased root length of salt treated *aha4-1* plants is due to reduce cell length. In NaCl supplemented medium, leaves of *aha4-1* plants accumulate substantially more Na⁺ and less K⁺ than those of wild type. It is postulated that *AHA4* functions in the control of Na⁺ flux across the endodermis (Vitart et al., 2001).

**Na⁺ Influx and Efflux Across the Plasma Membrane.**

Recently, much insight has been gained about Na⁺ transport systems that are involved in net flux of the cation across the plasma membrane (Amtmann and Sanders, 1999; Blumwald et al., 2000; Hasegawa et al., 2000b). Transport systems with greater selectivity for K⁺ are presumed to facilitate Na⁺ "leakage" into cells. Specifically, Na⁺ is a competitor for uptake through plasma membrane K⁺ inward rectifying channels, such as those that are in the Shaker type family, e.g. AKT1 (Schachtman, 2000). K⁺ outward rectifying channels also may facilitate Na⁺ influx (Schachtman, 2000). The high affinity K transporter (HKT) from wheat and low affinity cation transporter (LCT) also may be responsible for Na⁺ influx across the plasma membrane (Schachtman, 2000; Amtmann and Sanders, 1999; Blumwald et al., 2000). Both HKT and LCT transport Na⁺ when expressed in heterologous systems, providing evidence of their function in Na⁺ uptake. Wheat HKT1 is a Na⁺-H⁺-dependent K⁺ transporter. Modifications to HKT1 that enhance K⁺ transport also reduce Na⁺ influx and enhance salt tolerance further establishing that Na⁺ conductance occurs through this protein (Rubio et al., 1999). Physiological data also implicate nonselective cation (NSC) channels in Na⁺ influx (Amtmann and Sanders, 1999).

Recently, the properties of HKT proteins from *Arabidopsis* (Kato et al., 2001; Uozumi et al., 2000), rice (Horie et al., 2001) and eucalyptus (Fairbairn et al., 2000) have been characterized. AtHKT1 is the only member of the *Arabidopsis* gene family while both rice and eucalyptus have at least two genes. AtHKT1 expression increases NaCl sensitivity of a yeast strain deleted for the plasma membrane Na⁺ efflux system (*ena1-4Δ*) but does not suppress the K⁺ deficiency of *trk1 trk2* mutant cells that have attenuated uptake of this essential cation. However, AtHKT1 expression does suppress the K⁺ deficient phenotype of an *E. coli* mutant for which acquisition of the cation is disrupted. Electrophysiological data indicate that AtHKT1 expressed in *Xenopus* oocytes specifically transports Na⁺ and conductance is K⁺, H⁺ and voltage independent (Uozumi et al., 2000).

The *in planta* function of AtHKT1 as an effector of Na⁺ influx has been confirmed recently (Rus et al., 2001). T-DNA insertional and deletion mutations of AtHKT1 were identified in a screen for suppressors of

NaCl sensitivity of the *sos3-1* mutant (Liu and Zhu, 1997; Rus et al., 2001). Suppression of *sos3-1* NaCl sensitivity is correlated with reduced cellular accumulation of Na⁺ and capacity to maintain [K⁺]_{int}. Together, these results establish that AtHKT1 controls Na⁺ influx into plants. It is likely that AtHKT1 is a Na⁺ influx system but its function as a regulator of Na⁺ and K⁺ influx systems cannot be precluded. Since the transcript is expressed predominantly in the roots, AtHKT1 most probably functions in the control of Na⁺ into the xylem for export to the shoot (Rus et al., 2001; Uozumi et al., 2000).

Rice (*Oryza sativa* L. Indica) OsHKT1 and OsHKT2 were identified based on sequence similarity with wheat HKT (Horie et al., 2001). *OsHKT1* and 2 transcripts accumulate in response to low K⁺ but their steady-state abundance is reduced by treatment with 30 mM NaCl. Yeast complementation and *Xenopus* oocyte expression data indicate that OsHKT1 functions as a Na⁺ influx system like AtHKT1 but OsHKT2 is a Na⁺/K⁺ symporter. The two Eucalyptus camaldulensis HKT1 (EcHKT1 and 2) orthologs have similar transport characteristics as the wheat protein (Fairbairn et al. 2000). Interestingly, activation of these proteins occurs in response to hypotonic treatment, implicating an osmosensing capacity.

The recent identification of *sos3-1 hkt1* double mutations in *Arabidopsis* has confirmed the existence of a Na⁺ entry system(s) different than HKT1 that functions *in planta*. Reduction in [Ca²⁺]_{ext} to μM concentrations abrogates the capacity for an *hkt1* knockout mutation to suppress Na⁺ sensitivity of *sos3-1*. These results indicate the presence of a Ca²⁺-inhibited Na⁺ influx system. For the last several years, physiological research has indicated the presence of Ca²⁺ insensitive and sensitive Na⁺ conductance in analysis of plant cell patches (Amtmann and Sanders, 1999). The Ca²⁺ sensitive component of Na⁺ uptake recently has been attributed to NSC channels (Davenport and Tester, 2000). The combined electrophysiological and *in planta* mutant dissection data indicate that there are least two Na⁺ influx systems, one whose activity is directly inhibited by Ca²⁺ and the other HKT, for which genetic evidence indicates may be regulated negatively by the SOS signal pathway (Figure 1).

Energy-dependent Na⁺ transport across the plasma membrane of plant cells is mediated by the secondary active Na⁺/H⁺ antiporter SOS1. Phylogenetically, SOS1 is similar to SOD2 of *Saccharomyces pombe*, NHA1 of *S. cerevisiae* and NhaA and NhaP of *Pseudomonas aeruginosa* (Shi et al., 2000). The SOS1 protein contains a large C-terminal domain (1162 amino acid) that distinguishes it from other members of the phylogenetic family. The SOS1 antiporter is distantly related to the plant endomembrane NHX type of antiporters. *SOS1* gene expression is upregulated by

NaCl stress and this is dependent on other components of the SOS signal pathway (see below).

**Na⁺ Vacuolar Compartmentalization.** A Na⁺/H⁺ antiporter that is energized by the ΔpH across the tonoplast facilitates vacuolar compartmentalization of the cation. The *Arabidopsis AtNHX1* was isolated by functional genetic complementation of a yeast mutant defected for the endosomal Na⁺/H⁺ antiporter yeast (ScNHX1) and has sequence similarity to mammalian NHE transporters (Apse et al., 1999; Gaxiola et al., 1999; Quintero et al., 2000). Transgenic *Arabidopsis* and tomato plants that over express AtNHX1 accumulate abundant quantities of the transporter in the tonoplast and exhibit substantially enhanced salt tolerance (Apse et al., 1999; Quintero et al., 2000; Zhang and Blumwald, 2001). These results implicate the pivotal function of the AtNHX family in vacuolar compartmentalization of Na⁺.

Predicted amino acid sequence and topological similarities to AtNHX1 led to the categorization of six loci in *Arabidopsis* as *AtNHX* gene family members (Yokoi et al., submitted). Phylogenetically, the proteins can be categorized into two subgroups, one containing four (AtNHX1-4) and the other two (AtNHX5 and 6) members. AtNHX2 and AtNHX5 expression suppresses the Na⁺/Li⁺ sensitive phenotype of a salt sensitive yeast mutant (*enal-4 nha1 nhx1Δ*) indicating that both AtNHX2 and AtNHX5 are orthologous to yeast ScNHX1 and AtNHX1. AtNHX2 suppresses the Na⁺/Li⁺ sensitive phenotype of the yeast mutant to a greater extent than *AtNHX1*. *AtNHX1* and *AtNHX2* are expressed constitutively in shoot and roots. Transcript abundance of *AtNHX1* and *AtNHX2* is induced by hyperosmotic stress (NaCl, sorbitol) and this osmotic response is dependent on the hormone abscisic acid (ABA). NaCl but not ABA induces *AtNHX5* transcript abundance (Yokoi et al., submitted). Steady-state transcript abundance of *AtNHX1*, 2 and 5 is greater in *sos* mutants than wild type Col-0 *gll* indicating that the SOS pathway negatively regulates transcriptional expression of these Na⁺/H⁺ antiporters genes. Yeast complementation and expression profiling data indicate that AtNHX2 and 5, like AtNHX1, are functional salt tolerance determinants. A common hyperosmotic stress signal pathways regulates the expression of *AtNHX1* and 2 but a different cascade controls *AtNHX5* expression. Post-transcriptional mechanisms that control AtNHX antiporter activation are still not known.

### Ca²⁺ Signaling and the Activation of the Salt Overly Sensitive (SOS) Signal Transduction Pathway

Jian-Kang Zhu and co-workers identified three genetically linked *Arabidopsis* loci (*SOS1*, *SOS2* and *SOS3*), which are components of a stress-signaling

pathway that controls ion homeostasis and salt tolerance (Hasegawa et al. 2000a; Sanders, 2000; Zhu, 2000; 2001). Genetic analysis of  $\text{Na}^+/\text{Li}^+$  sensitivity established that *sos1* is epistatic to *sos2* and *sos3* (Zhu, 2000). These *sos* mutants also exhibit a  $\text{K}^+$  deficient phenotype in medium supplemented with  $\mu\text{M}$   $[\text{K}^+]_{\text{ext}}$  and  $[\text{Ca}^{2+}]_{\text{ext}}$ .  $\text{Na}^+$  and  $\text{K}^+$  deficiency of *sos2* and *sos3* is suppressed with  $\text{mM}$   $[\text{Ca}^{2+}]_{\text{ext}}$  (Zhu et al., 1998). *sos1* exhibits hyperosmotic sensitivity unlike *sos3* and *sos2*. Together, these results indicate that the SOS signaling pathway regulates  $\text{Na}^+$  and  $\text{K}^+$  homeostasis and is  $\text{Ca}^{2+}$  activated.

SOS3 encodes a  $\text{Ca}^{2+}$  binding protein with sequence similarity to the regulatory B subunit of calcineurin (protein phosphatase 2B) and neuronal  $\text{Ca}^{2+}$  sensors (Ishitani et al., 2000; Liu and Zhu, 1998). Interaction of SOS3 with the SOS2 kinase (Liu et al., 2000) and SOS2 activation is  $\text{Ca}^{2+}$  dependent (Halfter et al., 2000). The *in planta* function of SOS3 as a salt tolerance determinant is dependent on  $\text{Ca}^{2+}$  binding and N-myristoylation (Ishitani et al., 2000).

The SOS2 serine/threonine kinase (446 amino acids) has a 267 amino acid N-terminal catalytic domain that is similar in sequence to yeast SNF1 (sucrose nonfermenting) kinase and the mammalian AMPK (AMP-activated protein kinase) (Liu et al., 2000; Zhu, 2000). The kinase activity of SOS2 is essential for its salt tolerance determinant function (Zhu, 2000). The SOS2 C-terminal regulatory domain interacts with the kinase domain to cause autoinhibition. A 21 amino acid motif in the regulatory domain of SOS2 is the site where SOS3 interacts with the kinase and is the autoinhibitory domain of the kinase (Guo et al., 2001). Binding of SOS3 to this motif blocks autoinhibition of SOS2 kinase activity. Deletion of the autoinhibitory domain results in constitutive SOS2 activation, independent of SOS3. Also, a Thr¹⁶⁸ to Asp mutation in the activation loop of the kinase domain constitutively activates SOS2.

Genetic and biochemical evidence indicates that components of the SOS signal pathway function in the hierarchical sequence outlined in Figure 1 (Hasegawa et al., 2000b; Sanders, 2000; Zhu, 2001).  $\text{Ca}^{2+}$  binds to SOS3, which leads to interaction with SOS2 and activation of the kinase. Among the SOS signal pathway outputs are transport systems that facilitate ion homeostasis. The plasma membrane sited  $\text{Na}^+/\text{H}^+$  antiporter SOS1 is controlled by the SOS pathway at the transcriptional and post-transcriptional level (Guo et al., 2001; Zhu, 2001). Recently, functional disruption of *AtHKT1* was shown to suppress the salt sensitive phenotype of *sos3-1*, indicating that the SOS pathway negatively controls this  $\text{Na}^+$  influx system (Rus et al., 2001). Also, the SOS pathway negatively controls expression of *AtNHX* family members that are implicated as determinants in the salt stress response (Yokoi et al., submitted).

$[\text{Ca}^{2+}]_{\text{ext}}$  enhances salt tolerance and salinity stress elicits a transient  $[\text{Ca}^{2+}]_{\text{cyt}}$  increase, from either an internal or external source, that has been implicated in adaptation (Knight et al., 1997, Lauchli, 1990). Data from recent experiments with yeast has provided insight into  $\text{Ca}^{2+}$  activation of salt stress signaling that controls ion homeostasis and tolerance (Matsumoto et al., 2001). The hyperosmotic component of high salinity induces a short duration (1 min) rise in  $[\text{Ca}^{2+}]_{\text{cyt}}$  that is due substantially to influx across the plasma membrane through the Cch1p and Mid1p  $\text{Ca}^{2+}$  transport system. The transient increase in  $[\text{Ca}^{2+}]_{\text{cyt}}$  activates the PP2B phosphatase calcineurin (a key intermediate in salt stress signaling controlling ion homeostasis) leading to the transcription of *ENA1*, which encodes the P-type ATPase that is primarily responsible for  $\text{Na}^+$  efflux across the plasma membrane (Nakamura et al., 1993; Mendoza et al., 1994; Matsumoto et al., submitted). The model proposes that the hyperosmotically-induced localized  $[\text{Ca}^{2+}]_{\text{cyt}}$  transient activates calmodulin that is tethered to Cch1p-Midp (Elhers et al., 1999; Sanders et al., 1999; Matsumoto et al., submitted). Calmodulin in turn activates signaling through the calcineurin pathway, which mediates ion homeostasis and salt tolerance (Matsumoto et al., submitted). From these results, a paradigm for salt-induced  $\text{Ca}^{2+}$  signaling and the activation of the SOS pathway can be suggested (Figure 1). Components of the SOS pathway, either SOS3 or upstream elements, might be associated with an osmotically responsive channel through which  $\text{Ca}^{2+}$  influx could initiate signaling through the pathway.

It is notable that a new elevated  $[\text{Ca}^{2+}]_{\text{cyt}}$  steady state is established in yeast cells, that are maintained in medium supplemented with NaCl, after the hyperosmotic induction of the short duration  $[\text{Ca}^{2+}]_{\text{cyt}}$  transient (Matsumoto et al., submitted). It is likely that the newly established  $[\text{Ca}^{2+}]_{\text{cyt}}$  contributes to cellular capacity for growth in salinity. The vacuolar membrane  $\text{H}^+/\text{Ca}^{2+}$  antiporter Vcx1p and endomembrane localized  $\text{Ca}^{2+}$ -ATPases are pivotal effectors that regulate the amplitude and duration of the  $[\text{Ca}^{2+}]_{\text{cyt}}$  transient (Miseta et al., 1999). The  $[\text{Ca}^{2+}]_{\text{cyt}}$  steady state established in salt containing medium presumably also involves coordination of channel activation that facilitates influx from external and internal sources and energy dependent transport systems that compartmentalize the divalent cation. It is reasonable to assume that the salt induced  $[\text{Ca}^{2+}]_{\text{cyt}}$  transient detected in plant cells (Knight, 1996) and, perhaps, a new  $[\text{Ca}^{2+}]_{\text{cyt}}$  steady-state are controlled by the ECA and ACA  $\text{Ca}^{2+}$ -ATPases and CAX1 and 2 transporters which are orthologs of Vcx1p (Sze et al., 2000). Nevertheless,  $\text{Ca}^{2+}$  has at least two roles in salt tolerance, a pivotal signaling function in the salt stress response leading to adaptation and a direct inhibitory effect on a  $\text{Na}^+$  entry system.

## Perspectives

Database analysis indicates that there are at least seven additional SOS2 isoforms (PKS:Protein Kinase S) and six SOS3 isoforms (SCaBPs:SOS3-like Calcium Binding Proteins) of SOS3. Whether these isoforms also are salt tolerance determinants has yet to be elucidated. One can speculate that these proteins have similar signalling intermediate functions as the prototype proteins but in different cell types or at unique stages of development. Perhaps these isoforms are constituents of signal pathways that respond to different inducers but are still components of the plant response to salt stress. Notwithstanding, it is likely that these proteins have both unique and overlapping functions. It is plausible also that some of these isoforms act as negative regulators of SOS signal transduction by physical interaction with the positive effector or competition for substrates required for signalling. Such positive and negative regulation of signal modulation may constitute a "fine tuning" necessary to achieve the appropriate plant response for stress adaptation and yield stability. Further insight regarding these suggestions may establish how the plant salt stress response is coordinated through gene families. The control system probably is even more complicated since other SOS signal pathway intermediates and outputs and other signalling cascades necessary for salt tolerance may exist.

Recent progress in the elucidation of salt stress signalling and effector output determinants that mediate ion homeostasis has uncovered some potential biotechnology tactics that may be used to obtain salt tolerant crop plants, i.e. enhance the yield stability under salinity. Two basic strategies are feasible; regulate the salt stress signal pathway that controls tolerance effectors or modulate effector activity or efficacy. The recent demonstration that a constitutively activated SOS2 kinase can be achieved by deletion of the auto inhibitory domain or by site-specific modifications to the catalytic domain of the protein kinase (Guo et al., 2001) offers an approach to regulate stress signaling that controls ion homeostasis. Constitutive activation of yeast calcineurin in the host or in plants increases salt tolerance by predisposing the plants to survive the stress episode (Mendoza et al., 1996; Pardo et al., 1998). Furthermore, overexpression of AtNHX1 enhances plant salt tolerance, presumably by increasing vacuolar Na⁺ compartmentalization that minimizes the toxic accumulation of the ion in the cytosol and facilitates growth in the saline environment (Apse et al., 1999; Zhang and Blumwald, 2001). Perhaps regulating net Na⁺ influx across the plasma membrane would enhance salt tolerance efficacy achieved by overexpressing the vacuolar antiporter. Control of net Na⁺ flux across the plasma membrane should be achieved by modulating the expression or

activation of SOS1 (Na⁺ efflux) and/or HKT1 (Na⁺ influx). Or, by expressing more efficacious forms of the Na⁺ transport proteins. For example, mutant variant forms of HKT1 transport more K⁺ at the expense of Na⁺ and render greater salt tolerance (Rubio et al., 1999). Promoters that direct tissue and inducer specific regulation of the target genes can condition the expression of the signal intermediates and the effectors. Thus regulation of the numerous salt tolerance determinants can be coordinated for an effective plant response but many of the costs associated with salt tolerance in nature might be minimized because some essential evolutionary necessities can be compensated for by agricultural practices.

## References

- Amtmann, A. and Sanders, D. (1999) Mechanisms of Na⁺ uptake by plant cells. In: eds Advances in Botanical Research. Academic Press, pp.76-114.
- Apse, M.P., Aharon, G.S., Snedden, W.A. and Blumwald, E. (1999) Salt tolerance conferred by overexpression of a vacuolar Na⁺/H⁺ antiporter in *Arabidopsis*. *Science* 285, 1256-1258.
- Blumwald, E., Aharon, G.S. and Apse, M.P. (2000) Sodium transport in plant cells. *Biochimica et Biophysica Acta* 1465, 140-151.
- Bohnert, H.J. and Jensen, R.G. (1996) Strategies for engineering waterstress tolerance in plants. *Trends in Biotechnology* 14, 89-97.
- Bohnert, H.J., Nelson, D.E. and Jensen, R.G. (1995) Adaptations to environmental stresses. *Plant Cell* 7, 1099-1111.
- Braun, Y., Hassidim, M., Lerner, H. and Reinhold, L. (1986) Studies on H⁺-translocation ATPase in plants of varying resistance to salinity. I. Salinity during growth modulates the proton pump in the halophyte *Atriplex nummularia*. *Plant Physiol.* 81, 1050-1056.
- Bressan, R.A., Hasegawa, P.M. and Pardo, J.M. (1998) Plants use calcium to resolve salt stress. *Trends in Plant Sci.* 3, 411-412.
- Casas, A.M., Bressan, R.A. and Hasegawa, P.M. (1991) Cell growth and water relations of the halophyte *Atriplex nummularia* L., in response to NaCl. *Plant Cell Rep.* 10, 81-84.
- Davenport, R.J. and Tester, M. (2000) A weakly voltage-dependent, nonselective cation channel mediates toxic sodium influx in wheat. *Plant Physiol.* 122, 823-34.
- Drozdowicz, Y.M. and Rea, P.A. (2001) Vacuolar H⁽⁺⁾ pyrophosphatases: from the evolutionary backwaters into the mainstream. *Trends Plant Sci* 6, 206-11.
- Ehlers, M.D. and Augustine, G.J. (1999) Cell signaling. Calmodulin at the channel gate. *Nature* 399, 105, 107-8.
- Fairbairn, D.J., Liu, W., Schachtman, D.P., Gomez-Gallego, S., Day, S.R. and Teasdale, R.D. (2000) Characterisation of two distinct HKT1-like potassium transporters from

- Eucalyptus camaldulensis. *Plant Mol. Biol.* 43, 515-25.
- Flowers, T.J., Hajibagheri, M.A. and Clipson, N.J.W. (1986) Halophytes. *The Quart. Rev. Biol.* 61, 313-337.
- Flowers, T.J. and Yeo, A.R. (1995) Breeding for salinity resistance in crop plants: where next? *Aust. J. Plant Physiol.* 22, 875-884.
- Gaxiola, R.A., Rao, R., Sherman, A., Grisafi, P., Alper, S.L. and Fink, G.R. (1999) The *Arabidopsis thaliana* proton transporters, AtNhx1 and Avp1, can function in cation detoxification in yeast. *Proc. Natl. Acad. Sci. USA* 96, 1480-1485.
- Greenway, H. and Munns, R. (1980) Mechanisms of salt tolerance in nonhalophytes. *Annu. Rev. Plant Physiol. Plant Mol. Biol.* 31, 149-190.
- Guo, Y., Halfter, U., Ishitani, M. and Zhu, J.-K. (2001) Molecular characterization of functional domains in the protein kinase SOS2 that is required for plant salt tolerance. *Plant Cell* 13, 1383-400.
- Halfter, U., Ishitani, M. and Zhu, J.-K. (2000) The *Arabidopsis* SOS2 protein kinase physically interacts with and is activated by the calcium-binding protein SOS3. *Proc. Natl. Acad. Sci. USA* 97, 3735-3740.
- Hasegawa, P.M., Bressan, R.A. and Pardo, J.M. (2000a) The dawn of plant salt to tolerance genetics. *Trends in Plant Sci.* 5, 317-319.
- Hasegawa, P.M., Bressan, R.A., Zhu, J.-K. and Bohnert, H.J. (2000b) Plant cellular and molecular responses to high salinity. *Annu. Rev. Plant Physiol. Plant Mol. Biol.* 51, 463-499.
- Hassidim, M., Braun, Y., Lerner, H. and Reinhold, L. (1990) Na⁺/H⁺ and K⁺/H⁺ antiport in root membrane vesicles isolated from the halophyte *Atriplex* and the glycophyte cotton. *Plant Physiol.* 94, 1795-1801.
- Hedrich, R. (1994) Voltage-dependent chloride channels in plant cells: identification, characterization, and regulation of guard cell anion channel. *Curr. Topics Membr.* 42, 1-33.
- Horie, T., Yoshida, K., Nakayama, H., Yamada, K., Oiki, S. and Shinmyo, A. (2001) Two types of HKT transporters with different properties of Na⁺ and K⁺ transport in *Oryza sativa*. *Plant J.* 27, 129-38.
- Ishitani, M., Liu, J., Halfter, U., Kim, C.-S., Shi, W. and Zhu, J.-K. (2000) SOS3 function in plant salt tolerance requires N-myristoylation and calcium binding. *Plant Cell* 12, 1667-1677.
- Kato, Y., Sakaguchi, M., Mori, Y., Saito, K., Nakamura, T., Bakker, E.P., Sato, Y., Goshima, S. and Uozumi, N. (2001) Evidence in support of a four transmembrane-pore-transmembrane topology model for the *Arabidopsis thaliana* Na⁺/K⁺ translocating AtHKT1 protein, a member of the superfamily of K⁺ transporters. *Proc. Natl. Acad. Sci. USA* 98, 6488-6493.
- Knight, H., Trewavas, A.J. and Knight, M.R. (1997) Calcium signaling in *Arabidopsis thaliana* responding to drought and salinity. *Plant J.* 12, 1067-78.
- Knight, H., Trewavas, A.J. and Knight, M.R. (1996) Cold calcium signaling in *Arabidopsis* involves two cellular pools and a change in calcium signature after acclimation. *Plant Cell* 8, 489-503.
- Läuchli, A. (1996) in *Calcium in Plant Growth and Development*, eds. Leonald, R. T. and Hepler, P. K. The American Society of Plant Physiologists Symposium Series (American Society of Plant Physiologists. Rockvill, MD) 4, 26-35
- Liu, J., Ishitani, M., Halfter, U., Kim, C.-S. and Zhu, J.-K. (2000) The *Arabidopsis thaliana* SOS2 gene encodes a protein kinase that is required for salt tolerance. *Proc. Natl. Acad. Sci. USA* 97, 3730-3734.
- Liu, J. and Zhu, J.-K. (1997) An *Arabidopsis* mutant that requires increased calcium for potassium nutrition and salt tolerance. *Proc. Natl. Acad. Sci. USA* 94, 14960-14964.
- Liu, J. and Zhu, J.-K. (1998) A calcium sensor homolog required for plant salt tolerance. *Science* 280, 1943-1945.
- Maathuis, F.J.M., Verlin, D., Smith, F.A., Sanders, D., Ferneáñdez, J.A. and Walker, N.A. (1996) The physiological relevance of Na⁺-coupled K⁺-transport. *Plant Physiol.* 112, 1609-1616.
- Maeshima, M. (2000) Vacuolar H⁽⁺⁾-pyrophosphatase. *Biochim. Biophys. Acta* 1465, 37-51.
- Maeshima, M. (2001) Tonoplast transporters : Organization and function. *Annu. Rev. Plant. Physiol. Plant Mol. Biol.* 52, 469-497.
- Matsumoto, T.K., Ellsmore, A.J., Cessna, S.G., S.Low, P., Pardo, J.M., Bressan, R.A. and Hasegawa, P.M. (2001) An osmotically induced cytosolic Ca²⁺ transient activates calcineurin signaling to mediate ion homeostasis and salt tolerance of *Saccharomyces cerevisiae*. in preparation.
- Mendoza, I., Rubio, F., Rodriguez-Navarro, A. and Pardo, J.M. (1994) The protein phosphatase calcineurin is essential for NaCl tolerance of *Saccharomyces cerevisiae*. *J. Biol. Chem.* 269, 8792-6.
- Mendoza, I., Quintero, F.J., Bressan, R.A., Hasegawa, P.M. and Pardo, J.M. (1996) Activated calcineurin confers high tolerance to ion stress and alters the budding pattern and cell morphology of yeast cells. *J. Biol. Chem.* 271, 23061-7.
- Miseta, A., Kellermayer, R., Aiello, D.P., Fu, L. and Bedwell, D.M. (1999) The vacuolar Ca²⁺/H⁺ exchanger Vcx1p/Hum1p tightly controls cytosolic Ca²⁺ levels in *S. cerevisiae*. *FEBS Lett* 451, 132-6.
- Morsomme, P. and Boutry, M. (2000) The plant plasma membrane H⁽⁺⁾-ATPase: structure, function and regulation. *Biochim. Biophys. Acta* 1465, 1-16.
- Nakamura, T., Liu, Y., Hirata, D., Namba, H., Harada, S., Hirokawa, T. and Miyakawa, T. (1993) Protein phosphatase type 2B (calcineurin)-mediated, FK506-sensitive regulation of intracellular ions in yeast is an important determinant for adaptation to high salt stress conditions. *EMBO J* 12, 4063-71.
- Niu, X., Bressan, R.A., Hasegawa, P.M. and Pardo, J.M. (1995) Ion homeostasis in NaCl stress environments. *Plant Physiol.* 109, 735-742.
- Niu, X., Narasimhan, M.L., Salzman, R.A., Bressan, R.A. and Hasegawa, P.M. (1993) NaCl regulation of plasma membrane H⁽⁺⁾-ATPase gene expression in a glycophyte and

- a halophyte. *Plant Physiol.* 103, 713-8.
- Nuccio, M.L., Rhodes, D., McNeil, S.D. and Hanson, A.D. (1999) Metabolic engineering of plants for osmotic stress resistance. *Curr. Opin. Plant Biol.* 2, 128-34.
- Pardo, J.M., Reddy, M.P., Yang, S., Maggio, A., Huh, G.-H., Matsumoto, T., Coca, M.A., Paino-D'Urazo, M., Koiwa, H., Yun, D.-J., Watad, A.A., Bressan, R.A. and Hasegawa, P.M. (1998) Stress signaling through  $Ca^{2+}$ /calmodulin-dependent protein phosphatase calcineurin mediates salt adaptation in plants. *Proc. Natl. Acad. Sci. USA* 95, 9681-9686.
- Quintero, F.J., Blatt, M.R. and Pardo, J.M. (2000) Functional conservation between yeast and plant endosomal  $Na^+$ /H⁺ antiporters. *FEBS Lett.* 471, 224-228.
- Rains, D. and Epstein, E. (1967) Sodium absorption by barley roots. Its mediation by mechanisms 2 of alkali cation transport. *Plant Physiol.* 42, 319-323.
- Ratajczak, R. (2000) Structure, function and regulation of the plant vacuolar H⁽⁺⁾-translocating ATPase. *Biochim. Biophys. Acta* 1465, 17-36.
- Rhodes, D. and Hanson, A.D. (1993) Quaternary ammonium and tertiary sulfonium compounds in higher plants. *Annu. Rev. Plant Physiol. Plant Mol. Biol.* 44, 357-384.
- Ribaut, J.-M. and Hoisington, D. (1998) Marker-assisted selection: new tools and strategies. *Trends in Plant Sci.* 3, 236-239.
- Rubio, F., Schwarz, M., Gassmann, W. and Schroeder, J.I. (1999) Genetic selection of mutants in the high affinity K⁺ transporter HKT1 that define functions of a loop site for reduced Na⁺ permeability and increased Na⁺ tolerance. *J. Biol. Chem.* 274, 6839-6847.
- Rus, A., Yokoi, S., Sharkhuu, A., Reddy, M., Lee, B.-H., Matsumoto, T.K., Koiwa, H., Zhu, J.-K., Bressan, R.A. and Hasegawa, P.M. (2001) AtHKT1 is a salt tolerance determinant that controls Na⁺ entry into plant roots. *Proc. Natl. Acad. Sci. USA* 98, 14150-14155.
- Sanders, D., Brownlee, C. and Harper, J.F. (1999) Communicating with calcium. *Plant Cell* 11, 691-706.
- Sanders, D. (2000) Plant biology: The salty tale of *Arabidopsis*. *Curr. Biol.* 10, 486-488.
- Schachtman, D.P. (2000) Molecular insights into the structure and function of plant K⁺ transport mechanisms. *Biochimica et Biophysica Acta* 1465, 127-139.
- Serrano, R., Culiañz-Maciá, A. and Moreno, V. (1999) Genetic engineering of salt and drought tolerance with yeast regulatory genes. *Sci Hortic* 78, 261-269.
- Serrano, R., Kielland-Brandt, M. and Fink, G. (1986) Yeast plasma membrane ATPase is essential for growth and has homology with (Na⁺K⁺), K⁺ and Ca²⁺-ATPases. *Nature* 319, 689-693.
- Shi, H., Ishitani, M., Kim, C. and Zhu, J.-K. (2000) The *Arabidopsis thaliana* salt tolerance gene SOS1 encodes a putative Na⁺/H⁺ antiporter. *Proc. Natl. Acad. Sci. USA* 97, 6896-6901.
- Sze, H., Liang, F., Hwang, I., Curran, A.C. and Harper, J.F. (2000) Diversity and regulation of plant Ca²⁺ pumps: insights from expression in yeast. *Annu. Rev. Plant Physiol. Plant Mol. Biol.* 51, 433-62.
- Taiz, L. and Zeiger, E. (1998) Plant Physiology. Sunderland, Massachusetts: Sinauer Associates, Inc.
- Tanksley, S.D. and McCouch, S.R. (1997) Seed banks and molecular maps: unlocking genetic potential from the wild. *Science* 277, 1063-1066
- Uozumi, N., Kim, E.J., Rubio, F., Yamaguchi, T., Muto, S., Tsuboi, A., Bakker, E.P., Nakamura, T. and Schroeder, J.I. (2000) The *Arabidopsis HKT1* gene homolog mediates inward Na⁺ currents in *Xenopus laevis* oocytes and Na⁺ uptake in *Saccharomyces cerevisiae*. *Plant Physiol.* 122, 1249-1259.
- Vitart, V., Baxter, I., Doerner, P. and Harper, J.F. (2001) Evidence for a role in growth and salt resistance of a plasma membrane H⁺-ATPase in the root endodermis. *Plant J.* 27, 191-201.
- Yokoi, S., Quintero, F.J., Bressan, R.A., Pardo, J.M. and Hasegawa, P.M. (2001) Differential expression and function of *Arabidopsis thaliana* NHX Na⁺/H⁺ antiporters in the salt stress response. In preparation.
- Zhang, H.X. and Blumwald, E. (2001) Transgenic salt-tolerant tomato plants accumulate salt in foliage but not in fruit. *Nat Biotechnol.* 19, 765-8.
- Zhu, J.-K. (2000) Genetic analysis of plant salt tolerance using *Arabidopsis*. *Plant Physiol.* 124, 941-948.
- Zhu, J.-K. (2001) Plant salt tolerance. *Trends in Plant Sci.* 6, 66-71.
- Zhu, J.-K., Liu, J. and Xiong, L. (1998) Genetic analysis of salt tolerance in *Arabidopsis*: Evidence for a critical role to potassium nutrition. *Plant Cell* 10, 1181-1191.



# Development of transformation methods toward producing transgenic plants with abiotic stress tolerance

**Francisco J. L. Aragão**

Embrapa Recursos Genéticos e Biotecnologia  
PqEB Av. W5 Norte, 70070-900 Brasília, DF, Brazil

## Abstract

---

Several methods have been developed for inserting genetic information into plant cells, such as *Agrobacterium*-mediated systems, direct DNA uptake into protoplasts and particle bombardment (biolistic). Several methodologies are available to transform almost all important crops. However, some systems are still not a routine and do not achieve the frequency of transformation required for obtaining genetically modified plants containing useful traits, such as abiotic stress tolerance. Considerable advances have been made in the methodologies to transform plants, mainly using *Agrobacterium* and the biolistic process. The biolistic process has been responsible for producing the majority of the new transgenic varieties that have reached the market. The apical region of embryonic axes has been an obvious target for the development of systems, by particle bombardment of meristematic cells. Based on the introduction of genes into the meristematic cells by particle bombardment, we developed an efficient and reproducible system to achieve routinely transgenic plants of several species, such as dry bean, soybean and cotton.

*Keywords: transgenic plants, genetic engineering, soybean, dry bean, cotton, plant transformation*

## Introduction

The use of genetic engineering techniques for introducing genes responsible for agronomic characteristics may facilitate the development of new varieties. In fact, the last two decades have seen significant developments in plant transformation technology, and many transgenic crop plants have now been released for commercial production. Advances in the technology have been due to the development of a range of *Agrobacterium*-mediated and direct DNA delivery techniques, along with appropriate tissue culture techniques for regenerating whole plants from plant cells or tissues in a large number of species.

To obtain a transgenic plant, methods of introducing the exogenous DNA into the vegetable tissue and regenerating the whole plant from such genetically transformed tissue are required. Depending upon the species to be transformed, various types of tissue have been used. The meristematic tissue has been preferably employed in various transformation processes, primarily

due to the ease of regeneration of a plant from this type of tissue. Several methods have been developed for inserting genetic information into plant cells, such as *Agrobacterium*-mediated systems, direct DNA uptake into protoplasts and particle bombardment (biolistic). However, although it was assumed that advances in the methodologies for gene delivery and plant tissue culture would make plant transformation routine for most important crops, some species have proved very difficult to transform. Several methodologies are available to transform almost all important crops, however, some systems are still not routine and do not achieve the frequency of transformation required for obtaining genetically modified plants containing useful traits, such as abiotic stress tolerance.

## Particle bombardment and plant transformation

Since the development of the biolistic process for the direct introduction of genes into vegetable cells at the



end of the 1980s, a great number of transgenic plants of several species have been obtained, including those species that were considered difficult to transform by other methods. This is due to the fact that it has become possible to introduce and express exogenous genes in any kind of vegetable tissue. Thus, any type of tissue having the potential to regenerate a completely fertile plant is suitable for transformation (Sanford et al. 1987).

The biolistic process has also been called the microprojectile bombardment method, "gene gun" method, and particle acceleration method, among others. Different systems have been developed and constructed which are capable of accelerating microparticles (made of tungsten or gold), coated with nucleic acid sequences, at speeds exceeding 1,500 km/h. All these systems are based on the generation of a shock wave with enough energy to displace microparticles coated with DNA. The shock wave can be generated by a chemical explosion (dry powder gun), a discharge of helium gas under high pressure, or vaporization of a drop of water through an electric discharge at high voltage and low capacitance or at low voltage and high capacitance. Those systems that use helium gas under high pressure and electric discharge have shown a broad range of uses. The accelerated particles penetrate the cellular wall and membrane in a non-lethal way, locating themselves randomly in the cellular organelles. Then the DNA is dissociated from the microparticles by the action of the cellular liquid, and the process of integrating the exogenous DNA in the genome of the organism to be modified takes place (Yamashita et al. 1991). In spite of the efficiency and universality of utilization of the biolistic process, it requires the optimization of various biological parameters, related to tissue culture, allowing regeneration of transgenic plants from genetically modified tissues.

Several protocols have been developed to *de novo* regenerate the most important crops. However, genetic modification of some of them is still not routine, with low frequency of transformation, or limited to some specific varieties. Consequently, the apical region of embryonic axes is an obvious target for the development of systems based on the bombardment of meristematic cells. Based on the introduction of genes into the apical meristematic cells, by particle bombardment we developed an efficient and reproducible system to achieve routinely transgenic plants of several species, such as soybean, dry bean and cotton.

The ability to recover a high number of fertile transgenic plants may facilitate the detection of the "key event(s)" that could be integrated into plant breeding programs for the development of transgenic crops that will be introduced into the market. The high frequency of transformation achieved allowed our group to introduce agronomically important traits into these crops: resistance to viruses, fungi and insects, herbicide

tolerance, expression of methionine-rich proteins, human growth factor and insulin. Molecular analyses and progeny tests of several generations of transgenic lines revealed the presence of a small number of integrated copies of the foreign genes and segregation in a Medelian fashion in most of them. This is extremely important, in order to accelerate the introduction of these plants in a breeding program as well as the production of transgenic commercial varieties. Embrapa's groups and others are utilizing these systems in order to introduce genes for abiotic stress in important crops such as bean and soybean, namely drought and cold tolerance.

### Dry bean transformation

The common bean (*Phaseolus vulgaris* L.) is one of the most important food legumes in the developing world. In Latin America, beans are a very important source of protein and calories. However, the production growth rates have been declining in Brazil and the Andean regions, mainly due to diseases, insects, nutritional deficiencies, and drought. Consequently, there is considerable interest in the introduction of agronomically useful traits into beans by breeding and genetic engineering.

Several methods have been developed for inserting genetic information into plant cells, such as *Agrobacterium*-mediated systems, direct DNA uptake into protoplasts and particle bombardment. Early efforts to transform the bean demonstrated its susceptibility to *Agrobacterium*, and some transgenic tissues such as callus, leaves, meristems, cotyledon and hypocotyl have been achieved (Lippincott et al. 1968, McClean et al. 1991, Franklin et al. 1993, Becker et al. 1994, Lewis and Bliss 1994, Brasileiro et al. 1996, Nagl et al. 1997). Mariotti et al. (1989) reported the production of transgenic bean plants through the utilization of the *Agrobacterium* system. However, there was no molecular evidence for genetic transformation or progeny analysis. Transient gene expression using either electroporation or PEG-mediated protoplast transformation was demonstrated (Crepuy et al. 1986, Bustos 1991, Leon et al. 1991, Giovanazzo et al. 1993). Dillen et al. (1995) demonstrated the applicability of electroporation of intact tissue to introduce and express the *gus* gene in bean embryonic axes. Nevertheless, no transgenic bean plants were obtained due to the difficulties of regenerating plants.

The applicability of particle bombardment to introduce and transiently express genes into apical meristematic cells of dry beans was demonstrated in the early 1990s (Genga et al. 1991, Aragão et al. 1992, 1993). However, it was not known how deep the particles should penetrate in order to reach the cells that

could generate transgenic plants. The different parts of the meristem have been divided in layers (L1, L2 and L3) (Satina et al. 1940). Layer L1 is the most external and forms the epidermis of the differentiated regions. Layers L2 and L3 divide preferentially in the anticlinal and periclinal planes to form the organs. Several studies have demonstrated that the differentiated *de novo* shoots originate from the sub-epidermal layers (L2 and L3) of the apical meristem. However, the L1 layer could participate in their formation (McClellan and Grafton 1989, Franklin et al. 1991, Mohamed et al. 1992). These shoots are formed in the peripheral regions of the apical meristem (Aragão and Rech 1997). The bombardment of *P. vulgaris* meristematic cells showed that it was possible to efficiently reach these layers, demonstrating that it would be possible to achieve transgenic plants (Aragão et al. 1993). In 1993, Russel et al. were able to achieve transgenic navy bean (cv. Seafarer) plants using an electrical particle acceleration device. It was the first report of *P. vulgaris* transformation, presenting molecular evidences and progeny. However, the frequency of transgenic plants obtained was much lower (0.03%) and variety-limited. In addition, their tissue culture protocol was time consuming, involving several temperature treatments and medium transfers of the bombarded embryos before recovery of transgenic shoots. Kim and Minamikawa (1996) achieved transformation by bombarding embryonic axes, obtaining stable transformed bean plants (cv. Goldstar).

We developed an efficient and reproducible system to achieve routinely transgenic bean plants. The bean transformation system was also based upon the development of a tissue culture protocol of multiple shoot induction, shoot elongation and rooting. The average frequency of transformation (the total number of putative transgenic plants divided by the total number of bombarded embryonic axes) was 0.9% (Aragão et al. 1996, Aragão and Rech 1997). In addition, we have been able to transform several varieties of *P. vulgaris*, including those that were considered difficult to transform in previous studies.

It has been assumed that the use of particle bombardment to introduce genes into apical meristematic cells can be extended to any genotype or variety (Sanford 1990). However, we have found that the morphology of the explants utilized during the bombardment process may greatly influence the successful recuperation achievement of transgenic bean plants (Aragão and Rech 1997). In some cultivars, the embryonic axes revealed the apical meristematic region partially exposed, whereas only the central region could be visualized. The number of meristematic cells that could be reached by the microparticles coated with DNA will be drastically reduced. Consequently, the efficiency of transformation could also be reduced. Several studies have shown that *de novo* shoot

differentiation in embryos of bean cultivated on cytokinins appeared in the peripheral layers of the meristematic ring (Franklin et al. 1991, McClellan and Grafton 1989, Aragão and Rech 1997). Thus, based on these concepts, cultivars with a non-exposed apical meristematic region are not suitable for particle bombardment transformation, considering the fact that removal of the leaf primordia is not practical.

Our group first introduced an agronomically important gene into Phaseolus. Mature embryos were transformed in order to transiently express a methionine-rich albumin gene from Brazil nut (*be2s1* gene), which could be detected by Western blot and ELISA, twenty-four hours later (Aragão et al. 1992). Recently, we stably transformed bean with the *be2s1* gene in order to improve the methionine content in the seeds. In two of the five transgenic lines, the methionine content was significantly increased by 14% and 23% over the non-transgenic plants (Aragão et al. 1999).

Recently, we obtained transgenic plants containing the bar gene that confers resistance to the herbicide glufosinate ammonium (Lyberty, Aventis). The bar gene was found to confer strong resistance in transgenic bean to the herbicide in the greenhouse. A field trial was carried out and one line presented high tolerance up to 400 g/ha of glufosinate ammonium (Figure 1; Aragão et al. 2001).



**Fig. 1.** Field trial conducted with transgenic dry bean plants tolerant to the herbicide glufosinate ammonium.

In order to achieve bean plants resistant to the bean golden mosaic geminivirus, which is responsible for one of the most important diseases in this crop in Latin America, plants containing the mutated *AC1* viral gene were obtained. We have identified two lines that presented immunity against the virus. These lines were introduced into the breeding program from the Center of Rice and Bean of EMBRAPA.

The bean transformation system developed in our lab is now available to introduce genes for abiotic stress tolerance. Indeed, other groups in Mexico and Brazil are

using this technology to introduce genes for tolerance to cold, drought and shade environment.

### Soybean transformation

The first two successful reports of soybean transformation involved the use of the *Agrobacterium* system to obtain plants regenerated from cotyledonary nodes and the biolistic system, which is based on acceleration of microparticles coated with DNA into the apical meristematic region of embryonic axes (Hinchee et al. 1988, McCabe et al. 1988). Since then, several groups have been actively involved in improving these systems by manipulating somatic embryogenesis and shoot morphogenesis (Chee et al. 1989, Finer et al. 1991, Barwale et al. 1986, Hooykaas and Schilperooort 1992, Hansen et al. 1994). However, the protocols published failed to produce a highly efficient system that would be easy to conduct and variety independent. In addition, an efficient selectable marker that would allow the regeneration of only transgenic material and increase the frequency of recovery of fertile transgenic plants is not available.

One important constraint in the transformation system based on the bombardment of meristematic tissue of embryonic axes was the difficulty of achieving efficient selection of transformed cells (Kantha et al. 1981, Aragão et al. 1996, 2000). In this case, only a few cells from the meristem are transformed, while the others, including those that are in contact with the culture medium and the selective agent, are not transformed. Antibiotics such as kanamycin have been used as selective agents, associated with the *nptII* gene (Aragão et al. 1996). However, this selection is not efficient. A soybean transformation technology that would allow the selection of transgenic meristematic cells and regeneration of fertile plants should facilitate the production of transgenic plants with improved agricultural characteristics.

To obtain transgenic soybean plants from the apical region of embryonic axes, there are two essential requirements: 1) introduction of exogenous genes with high frequencies into the cells of the apical regions, and integration of exogenous genes into the vegetable genome, and 2) regeneration and production of fertile transgenic plants from the resulting transformed cells. With the development of the biolistic process, the first requirement was achieved. However, one problem remained: it was difficult to select the transformed apical meristematic cells. To solve this problem, which is one of the most important limiting factors for achieving transgenic soybean with a high frequency, we have developed a novel system to select transgenic meristematic cells. The system is based on the use of the selective agent imazapyr, a herbicidal molecule of the

imidazolinone class, capable of systemically translocating and concentrating in the apical meristematic region of the plant. The mechanism of action of imazapyr is the inhibition of the enzymatic activity of acetohydroxyacid synthase (AHAS; acetolactate synthase, acetolactate pyruvate-lyase (carboxylating), EC 4.1.3.18), which catalyses the initial step in the biosynthesis of isoleucine, leucine and valine. The *ahas* selectable marker gene, previously isolated from *Arabidopsis thaliana*, contains a mutation at position 653 bp resulting in a serine to asparagine substitution that confers imidazolinone-specific resistance. This selectable marker system, combined with an improved multiple shooting induction protocol, resulted in a significant increase in the recovery of fertile, transgenic material (from 4 to 20%, number of transgenic plants related to number of embryonic axes bombarded) compared with the standard soybean transformation protocol (0.1%) (Aragão et al. 2000). Basically, mature seeds are surface sterilized and soaked in distilled water for 18-20 h. The embryonic axes are excised from seeds and the apical meristems are exposed by removing the primary leaves, and positioned for the bombardment. After bombardment, the embryonic axes are transferred and completely immersed in the induction medium (MS basal salts medium, supplemented with 22.2 µM benzylaminopurine, 3% sucrose and 0.6% agar, Sigma, pH 5.7), for 16 h in the dark. After this period, the explants are transferred to MS medium containing 500 nM imazapyr. As soon as the embryonic axes-derived shoots are 2 to 3 cm in length, they are analyzed for the presence of foreign genes and individually transferred to a plastic pot and acclimated (Figure 2).

We also demonstrate that this technique is variety-independent. It was possible to transform several commercial cultivars, such as BR-16, Doko RC, BR-91, Guarany and Conquista. One line, from the cultivar BR-16, was tested under field conditions and presented very high tolerance to the herbicide imazapyr (Figure 2; Aragão et al. 2000).

We believe that this new technology should have significant applications for the introduction of genes for agronomic characteristics such as biotic and abiotic stress tolerance. In fact, this soybean transformation system will be used for the introduction and expression of the *DREB1A* gene identified in *Arabidopsis thaliana* and involved in the response of the plants to abiotic stress (Liu et al. 1998, Shinozaki and Yamaguchi-Shinozaki 2000).

### Cotton Transformation

Cotton (*Gossypium hirsutum* L.) is considered a high value agricultural product, adapted for the industrial production of vegetable oil and mainly textile fiber. The

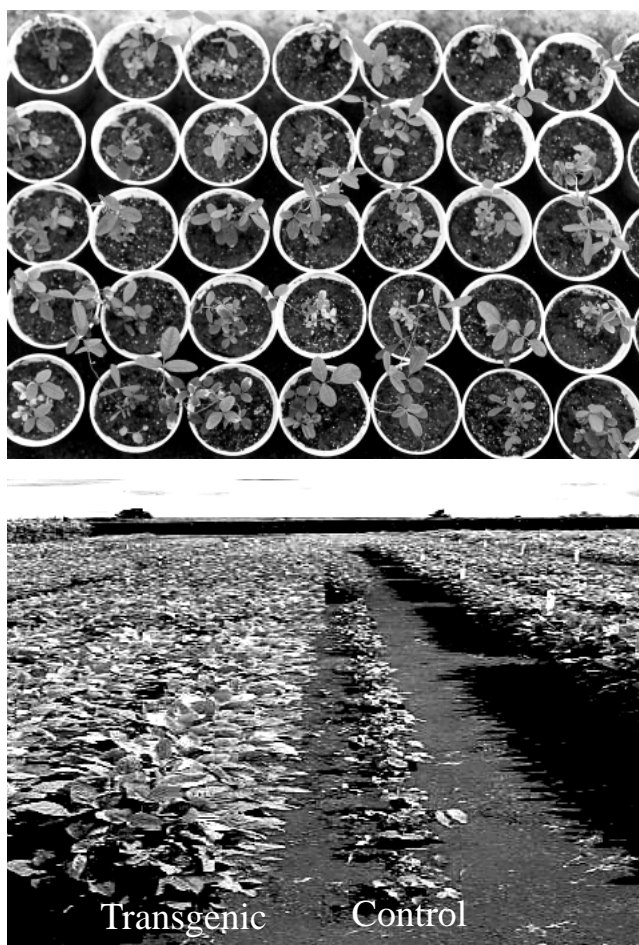


Fig. 2. Acclimated transgenic soybean plantlets in the greenhouse (above) and a field trial conducted with a transgenic soybean line tolerant to herbicide.

sharp increase in cotton consumption in the form of greater variety of products justifies the need to optimize the production and quality of this crop. Genetic engineering can help improve cotton breeding programs.

The first reports of cotton transformation, using *Agrobacterium tumefaciens*, were applicable to only a few varieties (Firoozabady et al. 1987, Umbeck et al. 1987, Finer et al. 1990, Cousins et al. 1991, Bayley et al., 1992). Most varieties of commercial interest proved difficult or impossible to regenerate into plants from the obligatory callus phase. Genes introduced into regenerable varieties could be bred into other lines but the process is lengthy and prone to somaclonal variation. Most of the varieties transformed by *Agrobacterium* systems are Coker and Coker-derived (Thomas et al. 1995, Rajasekaran et al. 1996, Agrawal et al. 1997). In this regard, we have been looking for an efficient system to transfer genes to elite cultivars, avoiding the need of many years of crossing and selection to reach new varieties.

Based on their experience with soybean, McCabe

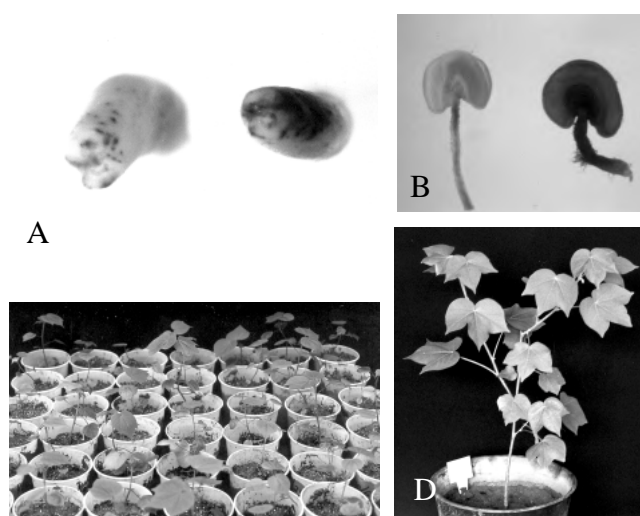
and Martinell (1993) developed a variety-independent protocol for the production of transgenic cotton. However, its efficiency was very low, from 0.027 to 0.2%, which is not sufficient for practical purposes.

Stable integration and expression of the genes have been achieved with both *Agrobacterium* and the biolistic process, however when only the epidermal cortex cell layer of a plant is transformed, the progeny will not inherit the transgene. Germline transformants, on the other hand, pass on the transgenes to their progeny and are suitable for conventional commercial cultivation (Keller et al. 1997). The frequency of cotton transformation has been relatively high (0.2 to 1%); nevertheless, the frequency of germline transformation has been very low. This is the most important constraint for the achievement of a variety-independent system with high frequency of cotton transformation.

We have successfully adapted the selection system developed for soybean (Aragão et al. 2000) to increase the cotton germline frequency of transformation. Indeed, the frequency of germline transformation was raised to 0.5%, using the herbicide imazapyr to select the shoots and plantlets originated from the apical meristematic tissue bombarded with the *ahas* gene. In summary, seeds of cotton, varieties CNPA-7MH and 7H, are surface sterilized and soaked in distilled water for 16 h. The water is removed and the seeds are incubated in the dark for an additional period of 16 h. Then, the embryonic axes are excised from seeds and the apical meristems are exposed by removing the primary leaves, and positioned for the bombardment (Figure 3). After bombardment the embryonic axes are transferred to MS medium containing 900 nM imazapyr, 0.1% activated charcoal, 3 mg/L BAP and 3% glucose. As soon as the embryonic axes-derived shoots are 2 to 3 cm in length, they are analyzed for the presence of foreign genes and individually transferred to a plastic pot and acclimated (Figure 3). Most of the elongated shoots showed the presence of foreign genes. The developed process should allow the introduction and expression of different genes in elite varieties of commercial cotton, with a frequency of germline transformation superior to those protocols described so far.

## Conclusion

Crop improvement through genetic engineering has become a reality (Dunwell 2000). For some crops, transformation is already routine. However, for other crops, despite the possibility of obtaining transgenic plants, the frequency is still not sufficient for practical purposes. In our experience, we have seen that for each 20 transgenic plants obtained, only one has the potential to be introduced in a breeding program to generate a commercial variety. Consequently, a transformation



**Fig. 3.** Cotton transformation system. A) Embryonic axes expressing the *gus* (*uidA*) gene 3 days after the bombardment. B) Transgenic (right) and non-transgenic anthers expressing the *gus* gene. C) Acclimated transgenic cotton plantlets (R0). D) A transgenic cotton plant in the greenhouse.

technology has to be very efficient in order to allow the selection of events with a desirable expression level, without severe somaclonal variation and unexpected segregation. This is particularly true for introducing genes for abiotic stress tolerance, since either the number of candidate genes or that of individual plants to be tested should be large. In addition, research in plant transformation is concentrating now not so much on the introduction of DNA into plant cells, but rather on the problems associated with stable integration and reliable expression of the DNA once it has been integrated.

Studies of the behavior of transgenic plants under field conditions need to be conducted. These studies should assess the interactions of the transgenic plants with other plants in the agricultural and natural environment. Moreover, the stability of foreign genes and factors related to their interaction with the complex physiology of these plants submitted to natural stress in tropical areas should be evaluated.

### Acknowledgments

This work was supported by Empresa Brasileira de Pesquisa Agropecuária (EMBRAPA) and Conselho Nacional de Desenvolvimento Científico e Tecnológico (CNPq), Brazil.

### References

Agrawal DC, Banerjee AK, Kolala RR, Dhage AB, Kulkarni AV, Nalawade SM, Hazra S and Krishnamurthy KV. 1997. *In*

*vitro* induction of multiple shoots and plant regeneration in cotton (*Gossypium hirsutum* L.). *Plant Cell Rep.* 16: 647-652.

Aragão FJL, Sá MFG, Almeida ER, Gander ES and Rech EL. 1992. Particle bombardment-mediated transient expression of a Brazil nut methionine-rich albumin in bean (*Phaseolus vulgaris* L.). *Plant Mol. Biol.* 20: 357-359.

Aragão FJL, Sá MFG, Davey MR, Brasileiro ACM, Faria JC and Rech EL. 1993. Factors influencing transient gene expression in bean (*Phaseolus vulgaris*) using an electrical particle acceleration device. *Plant Cell Rep.* 12: 483-490.

Aragão FJL, Barros LMG, Brasileiro ACM, Ribeiro SG, Smith FD, Sanford JC, Faria JC and Rech EL. 1996. Inheritance of foreign genes in transgenic bean (*Phaseolus vulgaris* L.) co-transformed via particle bombardment. *Theor. Appl. Genet.* 93: 142-150.

Aragão FJL, Ribeiro SG, Barros LMG, Brasileiro ACM, Maxwell DP, Rech EL and Faria JC. 1998. Transgenic beans (*Phaseolus vulgaris* L.) engineered to express viral antisense RNAs show delayed and attenuated symptoms to bean golden mosaic geminivirus. *Mol. Breeding* 4: 491-499.

Aragão FJL, Barros LMG, Sousa MV, Grossi-de-Sá MF, Almeida ERP, Gander ES and Rech EL. 1999. Expression of a methionine-rich storage albumin from Brazil nut (*Bertholletia excelsa* H.B.K., Lecythidaceae) in transgenic bean plants (*Phaseolus vulgaris* L., Fabaceae). *Gen. Mol. Biol.* 22: 445-449.

Aragão FJL, Sarokin L, Vianna GR and Rech EL. 2000. Selection of transgenic meristematic cells utilizing a herbicidal molecule results in the recovery of fertile transgenic soybean (*Glycine max* (L.) Merrill) plants at high frequency. *Theor. Appl. Genet.* 101: 1-6.

Aragão FJL, Vianna GR, Albino MM and Rech EL. 2001. Transgenic dry bean (*Phaseolus vulgaris* L.) tolerant to the herbicide ammonium glufosinate. *Crop Science (in press)*.

Aragão FJL and Rech EL. 1997. Morphological factors influencing recovery of transgenic bean plants (*Phaseolus vulgaris* L.) of a carioca cultivar. *Int. J. Plant Sci.* 158: 157-163.

Barwale UB, Kerns HR and Widholm JM. 1986. Plant regeneration from callus cultures of several soybean genotypes via embryogenesis and organogenesis. *Planta* 167: 473-481.

Bayley C, Trolinder N, Ray C, Quisenberry JE and Ow DW. 1992. Engineering 2,4-D resistance into cotton. *Theor. Appl. Genet.* 83: 645-649.

Becker J, Vogel T, Iqbal J and Nagl W. 1994. *Agrobacterium* mediated transformation of *Phaseolus vulgaris*. Adaptation of some conditions. *Annu. Rep. Bean Improv. Coop. USA.*, 37: 127-128.

Brasileiro ACM, Aragão FJL, Rossi S, Dusi DMA, Barros LMG and Rech EL. 1996. Susceptibility of common and tepari bean to *Agrobacterium* spp. strains and improvement of *Agrobacterium*-mediated transformation using microprojectile bombardment. *J. Amer. Soc. Hort. Sci.* 121: 810-815.

- Bustos M. 1991. Transgenic gene expression in *Phaseolus vulgaris* by direct gene transfer to protoplasts. *Plant Mol. Biol. Rep.* 9: 322-332.
- Chee P, Fober KA and Slightom JL. 1989. Transformation of soybean (*Glycine max*) by infecting germinating seeds with *Agrobacterium tumefaciens*. *Plant Physiology* 91: 1212-1218.
- Cousins YL, Lyon BR and Llewellyn DJ. 1991. Transformation of an Australian cotton cultivar: prospects for cotton improvement through genetic engineering. *Aust. J. Plant Physiol.* 18: 481-494.
- Crepney L, Barros LMG and Valente VRN. 1986. Callus production from leaf protoplasts of various cultivars of bean (*Phaseolus vulgaris* L.). *Plant Cell Rep.* 5: 124-126.
- Dillen W, Engler G, Van Montagu M and Angenon G. 1995. Electroporation-mediated DNA delivery to seedling tissues of *Phaseolus vulgaris* L. (common bean). *Plant Cell Rep.* 15: 119-124.
- Dunwell JM. 2000. Transgenic approaches to crop improvement. *J. Exp. Botany* 51: 487-496.
- Finer JJ and MacMullen MD. 1990. Transformation of cotton (*Gossypium hirsutum* L.) via particle bombardment. *Plant Cell Rep.* 8: 586-589.
- Finer, JJ and MacMullen, MD. 1991. Transformation of soybean via particle bombardment of embryogenic suspension culture tissue. *In Vitro Cell. Dev. Biol.* 27P: 175-182.
- Firoozabady E, DeBoer D, Merlo D, Halk E, Amerson L, Rashka K and Murray E. 1987. Transformation of cotton (*Gossypium hirsutum* L.) by *Agrobacterium tumefaciens* and regeneration of transgenic plants. *Plant Mol. Biol.* 10: 105-116.
- Franklin CI, Trieu TN, Cassidy BG, Dixon RA and Nelson RS. 1993. Genetic transformation of green bean callus via *Agrobacterium* mediated DNA transfer. *Plant Cell Rep.* 12: 74-79.
- Franklin CI, Trieu TN, Gonzales RA and Dixon RA. 1991. Plant regeneration from seedling explants of green bean (*Phaseolus vulgaris* L.) via organogenesis. *Plant Cell Tiss. Org. Cult.* 24: 199-206.
- Genga A, Cerjotti A, Bollini R, Bernacchia G and Allavena A. 1991. Transient gene expression in bean tissues by high velocity microprojectile bombardment. *J. Genet. Breed.* 45: 129-134.
- Giovinazzo G, Greco V and Bollini R. 1993. Optimization of cell suspension culture, protoplast isolation, and transient transformation of *Phaseolus vulgaris* L. *Annu. Rep. Bean Improv. Coop.* 36:14.
- Hansen G, Das A and Chilton MD. 1994. Constitutive expression of the virulence genes improves the efficiency of plant transformation by *Agrobacterium*. *Proceedings of the National Academy of Science, USA* 91: 7603-7607.
- Hinchee MAW, Conner-Ward DV, Newell CA, McDonnell RE, Sato SJ, Gasser CS, Fischhoff DA, Re DB, Fraley RT and Horsch RB. 1988. Production of transgenic soybean plants using *Agrobacterium*-mediated DNA transfer. *Bio/Technology* 6: 915-922.
- Hooykaas PJJ and Schilperoord RA. 1992. *Agrobacterium* and plant genetic engineering. *Plant Mol. Biol.* 19: 15-38.
- Kartha KK, Pahl K, Leung NL and Mroginski LA. 1981. Plant regeneration from meristems of grain legumes: soybean, cowpeas, peanut, chickpea and bean. *Canadian Journal of Botany.* 59: 1671-1679.
- Keller G, Spatola L, McCabe D, Martinell B, Swain W and John ME. 1997. Transgenic cotton resistant to herbicide bialaphos. *Transg. Res.* 6: 385-392.
- Kim JW and Minamikawa T. 1996. Transformation and regeneration of French bean plants by the particle bombardment process. *Plant Sci.* 117: 131-138.
- Leon P, Planckaert F and Walbot V. 1991. Transient gene expression in protoplasts of *Phaseolus vulgaris* isolated from a cell suspension culture. *Plant Physiol.* 95: 968-972.
- Lewis ME and Bliss FA. 1994. Tumor formation and  $\beta$ -glucuronidase expression in *Phaseolus vulgaris* inoculated with *Agrobacterium tumefaciens*. *J. Am. Soc. Hort. Sci.*, 119: 361-366.
- Lippincott JA, Lippincott BB and Khalifa MDE. 1968. Evidence for a tumor-associated factor active in the promotion of crown-gall tumor growth on primary pinto bean leaves. *Physiol. Plant.* 21: 731-737.
- Liu Q, Kasuga M, Sakuma Y, Abe H, Miura S, Yamaguchi-Shinozaki K and Shinozaki K. 1998. Two transcription factors, *DREB1* and *DREB2*, with an *EREBP/AP2* DNA binding domain separate two cellular signal transduction pathways in drought- and low-temperature-responsive gene expression, respectively, in *Arabidopsis*. *Plant Cell* 10: 1391-406.
- Mariotti D, Fontana GS and Santini L. 1989. Genetic transformation of grain legumes: *Phaseolus vulgaris* L. and *P. coccineus* L. *J. Genet. Breed.* 43: 77-82.
- McCabe DE and Martinell BJ. 1993. Transformation of elite cotton cultivars via particle bombardment of meristems. *Bio/Technology* 11: 596-598.
- McCabe DE, Swain WF, Martinell BJ and Christou P. 1988. Stable transformation of soybean (*Glycine max*) by particle acceleration. *Bio/Technology* 6: 923-926.
- McClellan P and Grafton KF. 1989. Regeneration of dry bean (*Phaseolus vulgaris*) via organogenesis. *Plant Sci.* 60: 117-122.
- McClellan P, Chee P, Held B, Simental J, Drong RF and Slightom J. 1991. Susceptibility of dry bean (*Phaseolus vulgaris* L.) to *Agrobacterium* infection: Transformation of cotyledonary and hypocotyl tissues. *Plant Cell Tiss. Org. Cult.* 24: 131-138.
- Mohamed MF, Read PE and Coyne DP. 1992. Plant regeneration from *in vitro* culture of embryonic axis explants in common and tepary beans. *J. Amer. Soc. Hort. Sci.*, 117: 332-336.
- Nagl W, Ignacimuthu S and Becker J. 1997. Genetic engineering and regeneration of *Phaseolus* and *Vigna*. State of the art and new attempts. *J. Plant Physiol.*, 150: 625-644.
- Rajasekaran K, Grula JW, Hudspeth RL, Pofelis S and Anderson DM. 1996. Herbicide-resistant Acala and Coker cottons transformed with a native gene encoding mutant forms of acetoxyacid synthase. *Mol. Breeding* 2: 307-319.

- Russel DR, Wallace KM, Bathe JH, Martinell BJ and McCabe DE. 1993. Stable transformation of *Phaseolus vulgaris* via electric-discharge mediated particle acceleration. *Plant Cell Rep.* 12: 165-169.
- Sanford JC, Klein TM, Wolf ED and Allen N. 1987. Delivery of substances into cell tissues using a particle bombardment process; *Journal of Particle Science and Technology*, 5: 27-37.
- Sanford JC. 1990. Biolistic plant transformation. *Physiol. Plant.* 79: 206-209.
- Santina S, Blakeslee AF and Avery AG. 1940. Demonstration of the three germ layers in the shoot apex of *Datura* by means of induced polyploidy in periclinal chimeras. *Am. J. Bot.*, 27: 895-905.
- Shinozaki K and Yamaguchi-Shinozaki K. 2000. Molecular responses to dehydration and low temperature: differences and cross-talk between two stress signaling pathways. *Curr. Opin. Plant Biol.* 3: 217-23.
- Thomas JC, Adams DG, Keppenne VD, Wasmann CC, Brown JK, Kanost MR and Bohnert HJ. 1995. Protease inhibitors of *Manduca sexta* expressed in transgenic cotton. *Plant Cell Rep.* 14: 758-762.
- Umbeck P, Johnson G, Barton K and Swain W. 1987. Genetically transformed cotton (*Gossypium hirsutum* L.) plants. *Bio/Technology* 5: 263-266.
- Yamashita T, Iida A and Morikawa H. 1991. Evidence that more than 90% of  $\beta$ -glucuronidase-expressing cells after particle bombardment directly receive the foreign gene in their nucleus. *Plant Physiology* 97: 829-831.



# Recent developments in transgenics for abiotic stress tolerance in rice

**Swapan K. Datta**

International Rice Research Institute  
Plant Breeding, Genetics, and Biochemistry Division  
DAPO Box 7777, Metro Manila, Philippines

## Abstract

---

Abiotic stress is a major environmental constraint to rice production in non-irrigated rice areas. Genetic engineering aims at cross-talk between different stress-signaling pathways and is expected to unravel the roadmap of the bioengineering pathway leading to stress tolerance. Multidisciplinary collaboration involving molecular biologists, plant breeders, agronomists, physiologists, and biotechnologists could genetically improve this trait in rice. Osmotic adjustment (OA) is an effective component of abiotic stress (drought and salinity) tolerance in many plants, including rice. When the plant experiences water stress, OA contributes to turgor maintenance of both shoots and roots. Osmoprotectants (compatible solutes), which accumulate in the cytoplasm of water-stressed plants, are used for OA. Conventional breeding could not achieve OA in rice except for a few rice cultivars that are well adapted to water-stress conditions. Several stress-related genes have now been cloned and transferred into rice to enhance the osmolytes and some transgenic lines showed increased tolerance of osmotic stress. However, tolerance of water stress could require multigene families or a transcription factor regulating several genes, which has been shown in *Arabidopsis* (Shinozaki and Yamaguchi-Shinozaki, *Current Opinion in Plant Biology*, 2000, 3:217-223).

To better understand water-stress tolerance in rice and to develop transgenic rice which can survive for a critical period under water-stress conditions, the following strategies could be effectively deployed:

1) Switching on a transcription factor regulating the expression of several genes related to abiotic stress; 2) using a suitable root-specific promoter driving the target gene for an efficient and directed expression in roots and modification of roots; 3) understanding phenotyping and G X E in a given environment; 4) selecting a few adaptive rice cultivars suitable for drought and salinity-prone areas; 5) using microarray, proteomics, QTLs and marker-aided selection to expedite the cloning and characterization of stress-inducible genes; and, finally, 6) using an efficient transformation system to generate a large number of transgenic rice cultivars of different background that will eventually help in selecting a desirable phenotype with adequate OA. The genetic engineering approach for abiotic stress tolerance in rice will be highlighted and discussed.

*Keywords: OA (osmotic adjustment), bioengineering, transcription factor, reactive oxygen species (ROS), osmoprotectants, oxidative stress-related genes, regulatory genes, phenotyping*

## Conclusions

Abiotic stress, particularly drought and salinity, is a complex phenotypic and physiological phenomenon in plants. The number of genes that regulate the process and how they coordinate it has yet to be unraveled. Nevertheless, adaptive cultivars that pyramid physiological traits using molecular markers/QTLs or

tools of functional genomics such as microarray or proteomics might help as the first step along the path to developing stress-tolerant cultivars. Once the regulatory gene(s) governing the stress-signaling pathways are available, selected transgenic rice lines in an adaptive background with adequate OA may lead us to desirable rice for abiotic stress tolerance.



## Introduction

Asia produces 92% of the world's rice. India and China together produce 58%. Only 4-5% of world rice production enters the global market. Any shortfall in the major rice-growing countries could be a disaster for food security (Hossain et al. 2000). The rice genome is as dynamic as that of other crop plants, but it needs to be more amenable to the addition of new genes for further rice production growth in different ecosystems. The irrigated ecosystem accounts for 55% of the total rice area and contributes 75% of global rice production. The remaining 25% of rice comes from unfavorable rice-growing areas (45%): rainfed lowland (25%), upland (12%), and flood-prone areas (8%). Water stress is the single most severe limitation to the productivity of rice in the rainfed ecosystem (Widawsky and O'Toole, 1990). Table 1 summarizes the yield loss caused by

**Table 1**  
Estimated yield loss caused by various abiotic factors

Country/ region	Yield loss (kg ha ⁻¹ )				
	All technical constraints	Abiotic factors	Drought	Cold	Submergence
Southern India	468	117	17	4	0
Eastern India	658	306	144	18	24
Bangladesh	635	284	93	10	140
Northeastern China	1350	1156	153	194	95
Central China	1515	1444	250	317	163
Nepal	1422	406	236	0	13
Southern China	1091	990	143	159	112
Northern China	1288	1033	169	160	79

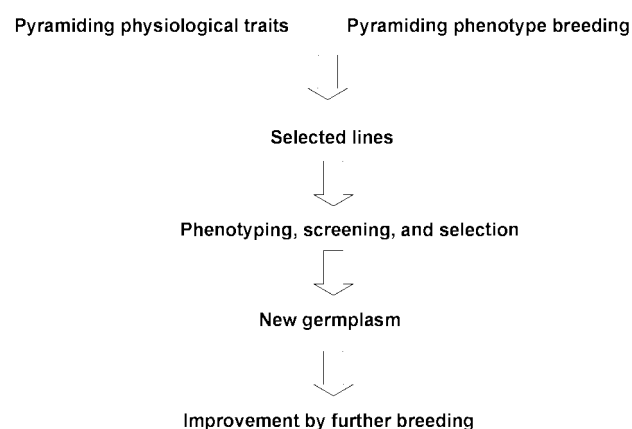
(from: Dey and Upadhyaya, 1996)

various abiotic stresses in South and Southeast Asia countries. In general, screening methods and phenotypic characterization are inadequate for improving drought tolerance in rice breeding. Marker-aided selection (MAS) and QTL mapping may speed up the process. However, recent developments in genetic engineering and functional genomics, particularly gene discovery of candidate genes, may address many unsolved questions of crop design for abiotic stress tolerance in plants, with special reference to rice. I will discuss a few recent research activities and strategies to develop abiotic stress-tolerant rice.

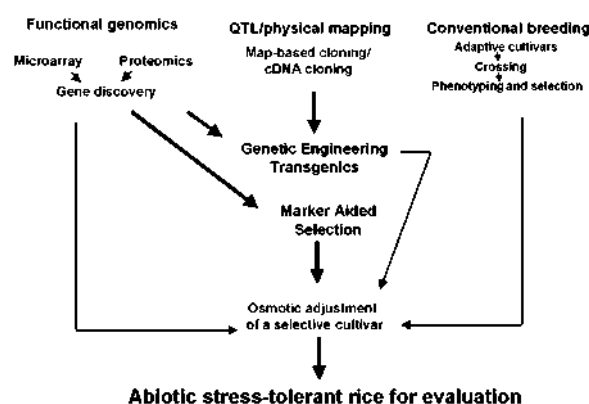
## Genomics and genetic engineering

Genomics involves DNA sequencing, the use of DNA microarray technology to analyze the gene expression profile at the mRNA level, and improved informatics tools to organize and analyze such data. Cultivated rice has evolved through domestication for

centuries, which has allowed a limited diversity of genetic resources. It is possible to combine the pyramiding of phenotype breeding and physiological traits and the further selection of germplasm may enhance crop improvement (Fig. 1). Genomics-based strategies for gene discovery, QTL/physical mapping, adaptive cultivars, MAS, and genetic engineering lead to the process of crop improvement as shown in Figure 2.



**Fig. 1.** Combining physiological traits and phenotype in breeding.

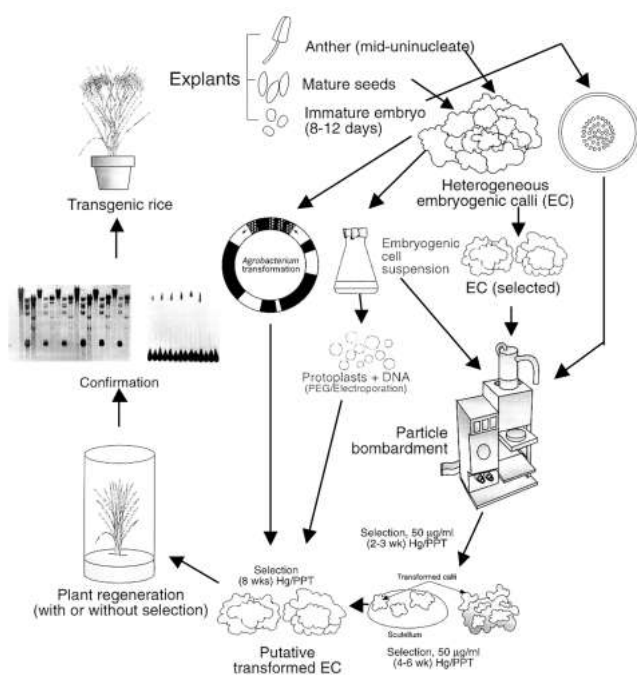


**Fig. 2.** Multidisciplinary approach for abiotic stress tolerance in rice.

Major crops such as rice, wheat, maize, cotton, soybean, sunflower, barley, canola, and sorghum have been transformed using various gene transfer technologies (Potrykus, 1991; James, 2000). However, the most reproducible and most unambiguous results have been obtained from protoplast, biolistic, and *Agrobacterium* methods as shown in Figure 3 (Datta et al. 1997; Datta, 2000).

## Osmotic adjustment and genotypic variation

Osmotic adjustment (OA) is a major component of abiotic stress tolerance, particularly for water stress



**Fig. 3.** Schematic protocol for production of transgenic rice plants using biolistic, protoplast, and *Agrobacterium* systems.

(either drought or salinity). Blum (1988) defined OA as follows: "As water is being removed from the plant cell, its osmotic potential (OP) is reduced due to the simple effect of solute concentration. However, if during the course of cellular water loss solutes are actively accumulated, OP would be reduced beyond the rate dictated by the mere effect of concentration. Such an active accumulation of solutes during the development of water deficit is termed OA". OA contributes to turgor maintenance of roots and shoots in response to water deficit. OA is reported to occur in rice under water deficit in the range of 0.4-0.6 MPa and it may extend to higher levels under prolonged stress in some rice cultivars, for example, up to 1.5 MPa in IR cultivars (Lilley and Ludlow, 1996). Lines with a japonica background showed poor dehydration tolerance and low OA, whereas indica lines had greater dehydration tolerance and higher OA. OA has been shown to be associated with yield and it has a positive influence on leaf rolling, tissue death, and retention of green leaf area in rice (Nguyen et al. 1997).

The biochemical mechanisms of action of solutes protecting plants are not known. Hence, several studies have focused on the physiological mechanisms of compatible solute action and ion homeostasis and water relations, C/N partitioning, reserve allocation and management of reducing power, and, finally, correlation of single or multiple functions of a single solute (Levitt, 1980; Bohnert et al. 1995, 2000).

A comprehensive study on transgenic plants

summarizing a correlation among solute amount, nature, and tolerance has been documented in Table 2 and particularly in rice in Table 3. The main solutes responsible for OA in response to water deficit in rice have not been characterized. Osmotic adjustment is time-dependent. Thus, a slow water deficit may allow the rice plant to accumulate solutes and may provide protection (Lilley and Ludlow, 1996; Nguyen et al. 1997).

### Osmoticum, drought, and salinity

Water deficit is the key cause of abiotic stress in rice. However, a minor water deficit results in a reduction in photosynthesis, while major deficits lead to complete inhibition of photosynthesis and the production of reactive oxygen species (ROS) such as superoxides and peroxides. These intermediates affect membrane integrity and cause severe impairment of several physiological processes and biochemical reactions. Several reports show that transgenic plants can scavenge or protect themselves from ROS (Bohnert et al. 1995, 2000).

Transgenic plants accumulate osmoprotectants (e.g., glycine betaine) and osmolytes, which have been shown to accumulate in response to drought, salinity, and cold stress. Osmolytes are molecules with low molecular mass and they could be quaternary amines, amino acids, or sugar alcohol. Enhanced accumulation of these molecules is known to increase the osmotic potential of the cell, which could help in combating water stress. Eventually, they could stabilize membranes and other macromolecular structures. A few genes incorporated in transgenic plants leading to enhanced osmolytes or another kind of stress-related protection are summarized below.

### Choline oxidase/glycine betaine

Glycine betaine is an important compatible solute widely distributed among plants. The *codA* (choline oxidase) gene isolated from the soil bacterium *Arthrobacter globiformis* converts choline to glycine betaine via betaine aldehyde (Deshnium et al. 1995). Salt-tolerant transgenic *Arabidopsis thaliana* was reported to use the *codA* gene (Hayashi et al. 1997). The transformed plant could easily grow at 200 mM NaCl, whereas control wild-type plants did not grow. About 80% enhancement of salt tolerance was reported in transgenic tobacco expressing the *E. coli betA* gene (Lilius et al. 1996). Transgenic *Arabidopsis* carrying the *codA* gene showed tolerance for light stress and increased accumulation of H₂O₂ and several other stress-related chemicals (Alia et al. 1998). Rice does not accumulate glycine betaine unlike other plants (Ishitani et al. 1993). Sakamoto et al. (1998) reported transgenic

**Table 2**

Recent progress in transgenic research for abiotic stress tolerance

Gene	Gene action	Species	Phenotypic expression	Reference
<b>Late embryogenesis abundant (LEA)-related genes</b>				
<i>COR15a</i>	Cold-induced gene	<i>Arabidopsis</i>	Increased freezing tolerance	Steponkus et al. (1998)
<i>HVA1</i>	Group 3 LEA protein gene	Wheat	Increased biomass and WUE ^a under stress	Sivamani et al. (2000)
<b>Regulatory genes</b>				
<i>ABI3</i>	Transcription factor	<i>Arabidopsis</i>	Enhanced freezing tolerance	Tamminen et al. (2001)
<i>ACC</i>	ACC deaminase	Tobacco	Increased flooding (waterlogging) tolerance	Grichko and Glick (2001)
<i>AtGluR2</i>	Transcription factor	<i>Arabidopsis</i>	Calcium use under ionic stress	Kim et al. (2001a)
<i>ATHB6</i>	Transcription factor	<i>Arabidopsis</i>	Cell division and /or differentiation in developing organs	Soderman et al. (1999)
<i>CBF1</i>	Transcription factor	<i>Arabidopsis</i>	Increased cold tolerance	Jaglo-Ottosen et al. (1998)
<i>DREB</i>	Transcription factor	<i>Arabidopsis</i>	Increased tolerance of cold, drought, and salinity	Kasuga et al. (1999)
<i>MsPRP2</i>	Transcription factor	Alfalfa	Increased salinity tolerance	Winicov and Bastola (1999)
<i>SCOF-1</i>	Transcription factor	<i>Arabidopsis</i>	Increased cold tolerance	Kim et al. (2001b)
<i>Tsi1</i>	Transcription factor	Tobacco	Increased osmotic stress tolerance	Park et al. (2001)
<b>Oxidative stress-related genes</b>				
<i>Sod</i>	Cu, MN, Fe, Zn-SOD	Alfalfa, rye grass	Increased winter hardiness	McKersie (2001)
	Cu/Zn superoxide dismutase	Tobacco, tomato	No protection seen against superoxide toxicity	Tepperman and Dunsmuir (1990)
	Cu/Zn superoxide dismutase	Tobacco	Retained 90% photosynthesis under chilling and heat stress	Gupta et al. (1993)
	Fe superoxide dismutase	Tobacco	Protected plants from ozone damage	Van Camp et al. (1996)
	Mn superoxide dismutase	Tobacco	Reduced cellular damage under oxidative stress	Bowler et al. (1991)
	Mn superoxide dismutase	Alfalfa	Increased tolerance to freezing stress	McKersie et al. (1993)
	Mn superoxide dismutase	Alfalfa	Increased tolerance to water deficit	McKersie et al. (1996)
	Mn superoxide dismutase	Alfalfa	Increased winter survival	McKersie et al. (1999)
	Mn superoxide dismutase	Tobacco	Increased tolerance to Mn deficiency	Yu et al. (1999)
<i>Apx3</i>	Ascorbate peroxidase	Tobacco	Increased protection against oxidative stress	Wang et al. (1999)
<i>GST/GPX</i>	Glutathione S-transferase with glutathione peroxidase	Tobacco	Increased stress tolerance	Roxas et al. (2000)
<i>MsFer</i>	Ferritin (iron storage)	Tobacco	Increased tolerance of oxidative damage caused by excess iron	Deak et al. (1999)
<i>Nt107</i>	Glutathione S-transferase	Tobacco	Sustained growth under cold and salinity stress	Roxas et al. (1997)
<i>parB</i>	Glutathione S-transferase	<i>Arabidopsis</i>	Protects against Al toxicity and oxidative stress	Ezaki et al. (2000)
<b>Genes encoding for molecular chaperones</b>				
<i>hs</i>	Heat shock transcription factor	<i>Arabidopsis</i>	Increased thermotolerance in transgenic plants	Lee et al. (1995)
<i>Hsp101</i>	Heat shock protein	<i>Arabidopsis</i>	Decreased thermotolerance in <i>Hsp101</i> -deficient ( <i>hot1</i> ) mutant	Hong and Vierling (2000)
<i>Hsp101</i>	Heat shock protein	<i>Arabidopsis</i>	Manipulated thermotolerance in transgenic plants	Queitsch et al. (2000)
<i>Hsp17.7</i>	Heat shock protein	Carrot	Increased or decreased thermotolerance	Malik et al. (1999)
<i>Hsp70</i>	Heat-inducible antisense HSP70	<i>Arabidopsis</i>	Increased thermotolerance in transgenic plants	Lee and Schoff (1996)
<i>P5CR</i>	Inducible heat shock promoter (IHSP)	Soybean	Increased proline accumulation	De Ronde et al. (2000)
<b>Genes encoding enzymes that synthesize osmoprotectants</b>				
<i>Adc</i>	Arginine decarboxylase	Rice	Reduced chlorophyll loss under drought stress	Capell et al. (1998)
<i>AtHAL3a</i>	Phosphoprotein phosphatase	<i>Arabidopsis</i>	Regulates salinity, osmotic tolerance, and plant growth	Espinosa-Ruiz et al. (1999)
<i>BADH-1</i>	Betaine aldehyde dehydrogenase	Tomato	Maintenance of osmotic potential	Moghaieb et al. (2000)
<i>betA</i>	Choline dehydrogenase (glycine betaine synthesis)	Tobacco	Increased tolerance of salinity stress	Lilius et al. (1996)
<i>codA</i>	Choline oxidase (glycine betaine synthesis)	<i>Arabidopsis</i>	Seedlings tolerant of salinity stress and increased germination under cold	Hayashi et al. (1997), Alia et al. (1998)
<i>codA</i>	Choline oxidase (glycine betaine synthesis)	<i>Arabidopsis</i>	Increased stress tolerance	Huang et al. (2000)
<i>IMT1</i>	Myo-inositol O-methyl transferase (D-ononitol synthesis)	Tobacco	Performed better under drought and salinity stress	Sheveleva et al. (1997)
<i>mt1D</i>	Mannitol-1-phosphate dehydrogenase (mannitol synthesis)	Tobacco	Increased plant height and fresh weight under salinity stress	Tarczynski et al. (1993)
<i>mt1D</i>		<i>Arabidopsis</i>	Increased germination under salinity stress	Thomas et al. (1995)
<i>otsA</i>	Trehalose-6-phosphatesynthase (trehalose synthesis)	Tobacco	Increased dry weight and photosynthetic activity under drought	Pilon-smits et al. (1996)
<i>otsB</i>	Trehalose-6-phosphate synthase (trehalose synthesis)	Tobacco	Increased dry weight and photosynthetic activity under drought	Pilon-smits et al. (1995)
<i>p5cs</i>	Pyrroline carboxylate synthetase (proline synthesis)	Tobacco	Increased biomass production and enhanced flower development under salinity stress	Kavi Kishor et al. (1995)

^aWU efficiency E = water use

**Table 3**

Progress in developing transgenic rice with genes conferring abiotic stress tolerance

Gene	Gene action	Phenotypic expression	Reference
<i>Adc</i>	Arginine decarboxylase	Reduced chlorophyll loss under drought stress	Capell et al. (1998)
<i>codA</i>	Choline oxidase (glycine betaine synthesis)	Increased tolerance of salinity and cold	Sakamoto et al. (1998)
<i>GS2</i>	Chloroplastic glutaminesynthetase	Increased salinity resistance and chilling tolerance	Hoshida et al. (2000)
<i>p5cs</i>	Pyrroline carboxylate synthetase (proline synthesis)	Increased biomass production under drought and salinity stress	Zhu et al. (1998)
<i>pdcl</i>	Pyruvate decarboxylase	Increased submergence tolerance	Quimio et al. (2000)
<i>HVA1</i>	Group 3 LEA protein gene	Increased tolerance of drought and salinity stress	Xu et al. (1996)
<i>OsCDPK7</i>	Transcription factor	Increased tolerance of cold, salinity, and drought	Saijo et al. (2000)
<i>wx</i>	Controls amylose synthesis	Increased amylose content at low temperature	Hirano and Sano (1998)
<i>TLP-D34</i>	Thaumatococcus-like protein (PR-5 member related to osmotin)	Enhanced fungal protection and osmotic adjustment	Datta et al. (2000)

rice expressing the *codA* gene in the chloroplast and the cytosol recovered to normal growth at a faster rate than the wild type after an initial growth inhibition under salt and low-temperature stress. This study demonstrated that the subcellular compartmentalization of the biosynthesis of glycine betaine was a critical step in attaining enhancement of tolerance for salinity and water stress.

#### **Trehalose-6-phosphate synthetase gene (*TPS1*)**

Trehalose, an osmoprotectant, non-reducing disaccharide, effectively stabilizes dehydrated enzymes and lipid membranes in some plants. Transgenic tobacco plants containing the yeast *trehalose-6-phosphate synthetase* gene (*TPS1*) producing trehalose exhibited multiple alteration and improved drought tolerance (Romero et al. 1997). Bacterial *trehalose-6-phosphate phosphatase* (*OtsB*) genes introduced in tobacco showed better growth under drought stress (Pilon-Smits et al. 1995). Transgenic plants also showed a better capacity to retain water and performed more efficient photosynthesis under stress.

#### **Fructans**

Fructans are polyfructose molecules produced by many plants and bacteria. About 45,000 plant species use fructans as their storage carbohydrates (Hendry 1993; Pilon-Smits et al. 1995). Fructans promote the process of root branching, thus increasing root surface and water uptake. Transgenic plants containing the *sacB* gene (producing fructans) showed a higher capacity for osmotic adjustment. The additional carbohydrates gained may lead to deeper rooting and greater water uptake (Sharp et al. 1996; Pilon-Smits et al. 1995; Schellenbaum et al. 1999).

#### ***Myo-inositol O-methyl transferase (IMT1)***

*Myo-inositol* and its stereoisomers can be methylated to form a variety of products such as D-ononitol and D-pinitol, which resemble similar products associated with plants that grow in salt and drought conditions (Ishitani et al. 1997). Sheveleva et al. (1997, 2000) showed that transgenic tobacco plants containing the *IMT1* gene produced methylated inositol D-ononitol and had higher tolerance for drought and salt stresses. Transgenic plants also showed efficient photosynthesis using higher CO₂.

#### **$\Delta^1$ pyrroline-5-carboxylate synthetase**

The potential value of proline accumulation during environmental stress has yet to be fully understood. Proline accumulation has been demonstrated to be associated with abiotic stress (Delauney and Verma, 1993). Overproduction of proline in transgenic tobacco (Kavi Kishor et al. 1995) and in rice with the P5CS ( $\Delta^1$  pyrroline-5-carboxylate synthetase) gene enhanced root biomass and flower development under water stress (Zhu et al. 1998). Further work on transgenic soybean plants transformed with the antisense *L- $\Delta^1$  pyrroline-5-carboxylate reductase* (*P5CR*) gene showed additional evidence that proline accumulation is correlated with the tolerance of water stress (De Ronde et al. 2000).

#### ***Mannitol-1-phosphate dehydrogenase (mt1D)***

It is reported that mannitol may play an important role in OA and provide enhanced tolerance in response to high salinity or water stress. Transgenic tobacco plants transformed with *E. coli mt1D* showed enhanced accumulation of mannitol, leading to increased tolerance of transgenic plants in response to salinity (Tarczynski et al. 1993). Enhanced mannitol

biosynthesis in the chloroplast of transgenic plants resulted in increased tolerance of oxidative stress (Shen et al. 1997).

### Late embryogenesis abundant (LEA) proteins

Certain plant proteins such as late embryogenesis abundant (LEA) proteins accumulate during seed desiccation and in response to water stress (Dure, 1993). HVA1, a group 3 LEA protein from barley transferred to rice (japonica), showed tolerance of water deficit and salt stress (Xu et al. 1996). Transgenic rice showed enhanced accumulation of the HVA1 protein, which led to higher growth rates, delayed stress-related damage symptoms, and improved recovery from the removal of stress conditions (Xu et al. 1996). Transgenic wheat plants containing the *HVA1* gene showed constitutive expression of the transgene resulting in improvement of growth characteristics under water-deficient conditions, more biomass, and more efficient water use (Sivamani et al. 2000). However, the size of the HVA1 protein found in transgenic wheat differed from that of transgenic rice. The exact function of the group 3 LEA protein has still not been clearly characterized. More studies are needed using homozygous transgenic wheat and rice to demonstrate the exact function of this protein.

### Oxidative stress-related genes

Several stresses such as high temperature, high light intensity, osmotic stresses, heavy metals, and several herbicides, and toxins lead to overproduction of reactive oxygen species (ROS), causing extensive cellular damage and inhibition of photosynthesis (Allen 1997). Plants have evolved systems to combat oxidative stress with a battery of gene products that aid in reducing the active oxygen species that damage membranes. Enzymes such as superoxide dismutase, glutathione reductase, glutathione- $\delta$ -transferase, catalase, glyoxalase, etc., are involved in such protective processes.

Transgenic tobacco plants containing oxidative stress-related genes showed elevated levels of glutathione reductase, superoxide dismutase, and ascorbate peroxidase, resulting in enhanced drought tolerance (Van Rensburg and Kruger 1994). However, the results are often not correlated with expectations as has been shown by Tepperman and Dunsmuir (1990) in transgenic tobacco and tomato with the Cu/Zn superoxide dismutase (*SOD*) gene, which failed to show any protection against superoxide toxicity. In contrast, constitutively overexpressed *Mn-SOD* in the chloroplast and mitochondria reduced cellular damage (Bowler et al. 1991). Overexpression of *Fe-SOD* in transgenic tobacco plants did not show any tolerance for the salt stress,

though expressing elevated levels of oxidative stress-related enzymes (Van Camp et al. 1996). However, *Arabidopsis Fe-SOD* in transgenic maize under the 35SP of CaMV + chloroplast targeting the transit peptide signal from pea Rubisco showed enhanced methyl biogenesis, resulting in higher growth rates at low temperature (Van Breusegem et al. 1999). Another report in transgenic tobacco containing the *Nt107* gene encoding glutathione- $\delta$ -transferase showed better seedling growth under cold and salt stress (Roxas et al. 1997).

### Anaerobiosis/anoxia

Most plants, including rice, are highly sensitive to anoxia during submergence. Submergence caused by flooding ranks next to drought as the most serious abiotic constraint to rice yields in Asia. During anoxia, ATP and NAD are generated not in the Krebs cycle and the respiratory chain but via glycolysis and fermentation. In this anaerobic pathway, several genes, such as alcohol dehydrogenase (*adh*) and pyruvate decarboxylase (*pdh*), induced during anoxia have been cloned and characterized (Bucher and Kuhlemeier, 1993; Umeda and Uchimiya 1994; Hossain et al. 1996).

Rice cultivars FR13A and IR42 are known to be tolerant and sensitive, respectively, under submergence conditions. It has been shown that a few genes encoding glucosephosphate isomerase, phosphofructokinase, glyceraldehyde phosphate dehydrogenase, enolase, and aldehyde kinase are induced faster in FR13A (Umeda and Uchimiya, 1994; Kawai et al. 1993). Besides *adh* and *pdh* the question remains as to how many genes govern tolerance of flooding stress. The exact answer is not yet known but surely more than one is required to solve the problem. Xu and Mackill (1996) reported localizing *Sub (t)* in rice chromosome 9, which is associated with variation of the phenotype of submergence tolerance. Further study based on tightly linked AFLP markers showed that researchers were now very close to cloning the gene (Kenong et al. 1997).

IRRI reported developing transgenic rice with the *adh* and *pdh* genes in several cultivars (Quimio et al. 2000). Results on transgenic lines with the *adh* gene are inconclusive. The rice *pdh1* (reported by Hossain et al. 1996) gene coding for pyruvate decarboxylase (PDC) is one of the enzymes involved in alcohol fermentation. The overexpression of the *pdh* gene was used not only to assess the role of alcohol fermentation but also to produce lines with enhanced metabolic capacity and submergence tolerance. Tillers of confirmed T₀ transgenic lines showed higher *pdh* gene activities and ethanol production than the untransformed control. Consequently, ethanol production of tillers of T₀ transgenic plants was positively correlated with survival after submergence. However, the exact mechanism of

the beneficial effects of overexpression of the *pdh* gene requires further metabolic studies. For example, overexpression of the *pdh* may have induced the expression of other genes that control the rate of carbon flow through the glycolytic and ethanolic fermentation pathways under anaerobic conditions. Transgenic lines with overexpression of both the *adh* and *pdh* genes may provide more information regarding the importance or validity of the fermentation pathway for inducing flooding tolerance (Minhas and Grover 1999).

### Adverse soils

About 11% of the world's land is currently used for cultivation and 24.4% of that is considered as potential cultivable or arable land (FAO 1991). Among the problems common to tropical regions, probably the most important is soil acidity, which constitutes about 3.95 billion hectares of land including 38% of tropical Asia. Nutrient deficiencies (P, Ca, Mg, K, and Fe) and acid soils caused by a combination of aluminum and manganese toxicity are major constraints to soil fertility and crop productivity. Aluminum toxicity problems are of enormous importance in the production of rice, maize, and sorghum in developing countries of Asia, Africa, and Latin America. Aluminum has a clear toxic effect on roots, disturbing plant metabolism by decreasing water absorption and mineral nutrition.

Besides aluminum toxicity, some essential elements such as P, Ca, Mg, and Fe form complexes with Al, resulting in their low availability and non-availability for root uptake. Several improved rice cultivars have been developed at IRRI that can survive partially under these adverse soil conditions (IRRI, 1999). The generation of transgenic metal-tolerant tobacco plants has been reported (Pan et al. 1994). Mexican scientists have developed transgenic rice conferring tolerance of a high concentration of aluminum (Conway and Toenniessen, 1999).

### Osmotin

Osmotin is a cationic protein with a  $pI^2$  value of >8.2 and it accounts for 10% to 12% of total cellular protein (Singh et al. 1987). Osmotin synthesis is regulated by abscisic acid but its accumulation is affected on adjustment of the cells, by NaCl or water stress (Singh et al. 1987). Osmotin strongly resembles the sweet protein thaumatin in its molecular amino acid composition, N-terminal sequence, and the presence of a signal peptide on the precursor protein (Singh et al. 1987). Transgenic rice containing the coding region of a thaumatin-like protein (TLP-D34), a member of the PR-5 group, has been shown to confer resistance against

sheath blight disease in rice (Datta et al. 1999). As this *tlp* gene has some sequence homologies with the osmotin gene, perhaps it would be worthwhile to evaluate the tolerance of homozygous transgenic plants in response to salinity.

### Adaptation to adverse conditions, higher grain filling, and C₄ rice

It is well known that the ice plant responds to drought or salt stress by switching from C₃ to crassulacean acid metabolism (CAM), which allows the plant to fix CO₂ at night, thus reducing transpiratory water loss. The key enzyme of the C₄ pathway is phosphoenolpyruvate carboxylase (PEPc), which, along with other enzymes, is regulated by osmotic stress at the transcriptional and translation levels (Dhaliwal et al. 1998). Transgenic C₄ rice has already been reported in a model japonica rice background (Ku et al. 1999). Transgenic elite indica rice is being developed at IRRI, which eventually may address many questions regarding the efficient use of CO₂ and water as they are needed (Matsuoka et al. 2000; our unpublished data). Transgenic rice with the *ferritin* gene to enhance high iron storage can reduce ROS (Deak et al. 1999). We are working on developing transgenic adaptive elite varieties for comprehensive study.

### Transcriptional activators and regulatory genes

For details, please see the chapter of Dr. Yamaguchi-Shinozaki in this volume. It has been reported (Fig. 4) that the dehydration response element (DRE) plays an important role in the response to drought stress in *Arabidopsis* (Shinozaki and Yamaguchi-Shinozaki 2000). It is also involved in low-temperature and salinity-related stress. The transcription factor DREB1A specifically interacts with DRE and induces

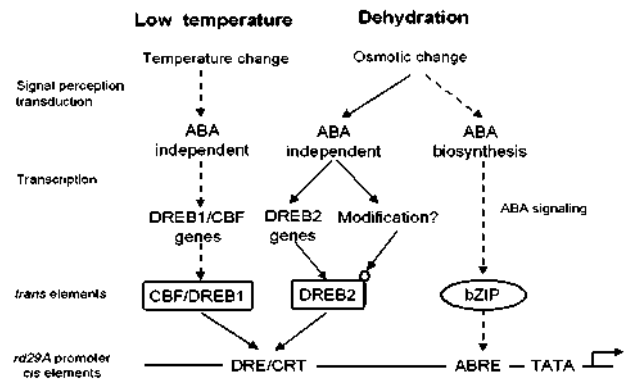


Fig. 4. Stepwise gene expression in molecular responses to dehydration and low temperature.

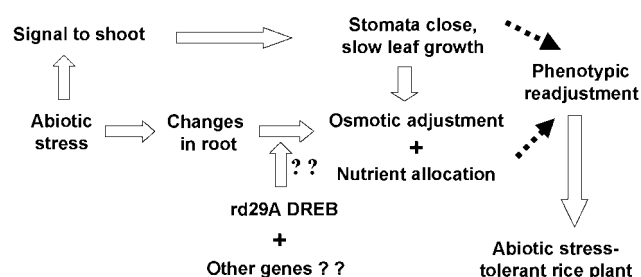


Fig. 5. Transgenic approach to abiotic stress-tolerant rice.

the expression of stress tolerance genes. Over-expression of DREB1A in transgenic *Arabidopsis* plants activated the expression of many of these stress tolerance genes and resulted in tolerance of freezing, salt loading, and drought (Liu et al. 1998; Kasuga et al. 1999; Seki et al. 2001; Urao et al. 1998, 2000). In collaboration with JIRCAS (Dr. Yamaguchi-Shinozaki's group), we are developing transgenic tropical rice with the *DRE* gene (along with rice homologous genes) driven by the stress-induced promoter *rd29A* (Fig. 5). Transgenic rice with a regulatory gene, such as the *DRE* gene, may help in understanding cross-talk between different stress-signaling pathways and is expected to unravel the roadmap of the bioengineering pathway leading to abiotic stress tolerance.

### Acknowledgments

I am grateful to Dr. Masa Iwanaga (JIRCAS) for developing the collaborative research program on abiotic stress and to Dr. Y. Yamaguchi-Shinozaki (also from JIRCAS) for providing the genes *rd29A* and *DREB*. I thank several colleagues from IRRI, particularly Drs. Mahabub Hossain, Brigitte Courtois, and John Bennett, for their valuable discussions; Dr. Niranjan Baisakh, Ms. Emilie Fradin, Mr. Norman Oliva, Ms. Editha Abrigo, Ms. Lina Torrizo, and Dr. Karabi Datta for their help; Michelle Viray for typing; and Bill Hardy for editorial assistance.

### References

Allen RD (1997) Use of transgenic plants to study antioxidant defenses. *Free Radic. Biol. Med.* 23: 473-479.  
 Alia HH, Chen THH, and Murata N (1998) Transformation with a gene for choline oxidase enhances the cold tolerance of *Arabidopsis* during germination and early growth. *Plant Cell Environ.* 21: 232-239.

Blum A (1988) Plant breeding for stress environments. Boca Raton, FL. CRC Press.  
 Bohnert HJ, Li XH, and Shen B (2000) Stress tolerance in crops. How many and which genes? In: Challenges of Plant and Agricultural Sciences to the Biosphere on the Earth in the 21st Century, Watanabe, K. and Komamine A (eds.) pp. 207-222. Landes Bioscience, Texas, USA.  
 Bohnert HJ, Nelson D, and Jensen RG (1995) Adaptations to environmental stress. *Trends Biotechnol.* 14: 89-97.  
 Bowler C, Slooten L, Vandenbranden S, Rycke RD, Botterman J, Sybesma C, Van MM, and Inze D (1991) Manganese superoxide dismutase can reduce cellular damage mediated by oxygen radicals in transgenic plants. *EMBO J.* 10: 1723-1732.  
 Bucher M, Kuhlemeier C (1993) Long-term anoxia tolerance: multi-level regulation of gene expression in the amphibious plant *Acorus calamus* L. *Plant Physiol.* 103(2): 441-448.  
 Capell T, Escobar C, Liu H, Burtin D, Lepri O, and Christou P (1998) Overexpression of the oat arginine decarboxylase cDNA in transgenic rice (*Oryza sativa* L.) affects normal development patterns *in vitro* and results in putrescine accumulation in transgenic plants. *Theor. Appl. Genet.* 97: 246-254.  
 Conway G, and Toenniessen G (1999) Feeding the world in the twenty-first century. *Nature* 402: 55-58.  
 Datta K, Koukoliková-Nicola Z, Baisakh N, Oliva N, and Datta SK (2000) *Agrobacterium*-mediated engineering for sheath blight resistance of indica rice cultivars from different ecosystems. *Theor. Appl. Genet.* 100:832-839.  
 Datta K, Velazhahan R, Oliva N, Mew T, Khush GS, Muthukrishnan S, and Datta SK (1999) Overexpression of the cloned rice thaumatin-like protein (PR-5) gene in transgenic rice plants enhances environmental friendly resistance to *Rhizoctonia solani* causing sheath blight disease. *Theor. Appl. Genet.* 98: 1138-1145.  
 Datta SK (2000) Potential benefit of genetic engineering in plant breeding: Rice, a case study. *Agric. Chem. Biotechnol.* 43(4): 197-206.  
 Datta SK, Torrizo L, Tu J, Oliva N, and Datta K (1997) Production and molecular evaluation of transgenic rice plants. IRRI Discussion Paper Series No. 21. International Rice Research Institute. P.O. Box 933, Manila 1099, Philippines.  
 De Ronde JA, Spreeth MH, and Cress WA (2000) Effect of antisense  $\Delta^1$ -pyrroline-5-carboxylate reductase transgenic soybean plants subjected to osmotic and drought stress. *Plant Growth Reg.* 32: 13-26.  
 Deak M, Horvath GV, Davletova S, Torok K, Sass L, Vass I, Barna B, Kiraly Z, and Dudits D (1999) Plants ectopically expressing the iron-binding protein ferritin are tolerant to oxidative damages and pathogens. *Nature Biotechnol.* 17: 192-196.  
 Delauney AJ, and Verma DPS (1993) Proline biosynthesis and osmoregulation in plants. *Plant J.* 4: 212-223.  
 Deshnum P, Los DA, Hayashi H, Mustardy L, and Murata N (1995) Transformation of *Synechococcus* with a gene for

- choline oxidase enhances tolerance to salt stress. *Plant Mol. Biol.* 29: 897-907.
- Dey MM, and Upadhyaya HK (1996) Yield loss due to drought, cold and submergence tolerance. In: *Rice Research in Asia: Progress and Priorities*, Evenson RE, Herdt RW, and Hossain M (eds.) International Rice Research Institute in collaboration with CAB International, United Kingdom. pp. 291-303.
- Dhaliwal HS, Kawai M, and Uchimiya H (1998) Genetic engineering for abiotic stress tolerance in plants. *Plant Biotechnol.* 15(1): 1-10.
- Dure L III (1993) The LEA proteins of higher plants. In: *Control of Plant Gene Expression*. Verma DPS (ed.) CRC Press, Boca Raton, FL. pp. 325-335.
- Espinosa-Ruiz A, Belles JM, Serrano R, and Culianez-Macia FA (1999) *Arabidopsis thaliana* AtHAL3: a flavoprotein related to salt and osmotic tolerance and plant growth. *Plant J.* 20: 529-539.
- Ezaki B, Gardner RC, Ezaki Y, and Matsumoto H (2000) Expression of aluminum-induced genes in transgenic *Arabidopsis* plants can ameliorate aluminum stress and/or oxidative stress. *Plant Physiol.* 122: 657-665.
- FAO (1991) FAOSTAT agriculture data. Food and Agriculture Organization of the United Nations.
- Grichko VP, and Glick BR (2001) Flooding tolerance of transgenic tomato plants expressing the bacterial enzyme ACC deaminase controlled by the 35S, ro1D or PRB-1b promoter. *Plant Cell Physiol.* 42: 245-249.
- Gupta AS, Heinen JL, Holaday AS, Burke JJ, and Allen RD (1993) Increased resistance to oxidative stress in transgenic plants that overexpress chloroplastic Cu/Zn superoxide dismutase. *Proc. Natl. Acad. Sci. USA* 90: 1629-1633.
- Hayashi HA, Mustardy L, Deshniun P, Ida M, and Murata N (1997) Transformation of *Arabidopsis thaliana* with the *codA* gene for choline oxidase: accumulation of glycine betaine and enhanced tolerance to salt and cold stress. *Plant J.* 12: 133-142.
- Hendry GAF (1993) Evolutionary origins and natural functions of fructans: a climatological, biogeographic and mechanistic appraisal. *New Phytol.* 123(1): 3-14.
- Hirano HY, and Sano Y (1998) Enhancement of Wx gene expression and the accumulation of amylose in response to cool temperatures during seed development in rice. *Plant Cell Physiol.* 39(8): 807-812.
- Hong SW and Vierling E. (2000) Mutants of *Arabidopsis thaliana* defective in the acquisition of tolerance to high temperature stress. *Proc. Natl. Acad. Sci. USA* 97: 4392-4397.
- Hoshida H, Tanaka Y, Hibino T, Hayashi Y, Tanaka A, and Takabe T (2000) Enhanced tolerance to salt stress in transgenic rice that overexpresses chloroplast glutamine synthetase. *Plant Mol. Biol.* 43: 103-111.
- Hossain M, Bennett J, Datta SK, Leung H, and Khush GS (2000) Biotechnology research in rice for Asia: priorities, focus and directions. In: *Agricultural Biotechnology in Developing Countries, Towards Optimizing the Benefits for the Poor*, Qaim M, Kratigger A, and J von Braun J. (eds.) Kluwer Academic Publishers. pp. 99-120.
- Hossain MA, Huq E, Grover A, Dennis ES, Peacock WJ, and Hodges TK (1996) Characterization of pyruvate decarboxylase genes from rice. *Plant Mol. Biol.* 31: 761-770.
- Huang J, Hirji R, Adam L, Rozwadowski KL, Hammerlindi JK, Keller WA, and Selvaraj G (2000) Genetic engineering of glycine betaine production toward enhancing stress tolerance in plants: metabolic limitations. *Plant Physiol.* 122: 747-756.
- IRRI (1999) Program report. International Rice Research Institute, Manila, Philippines.
- Ishitani M, Arakawa K, Mizuno K, Kishitani S, and Takabe T (1993) Betaine aldehyde dehydrogenase in the Gramineae: levels in leaves of both betaine-accumulating and non-accumulating cereal plants. *Plant Cell Physiol.* 34: 493-495.
- Ishitani M, Xiong L, Stevenson B, and Zhu JK (1997) Genetic analysis of osmotic and cold stress signal transduction in *Arabidopsis*: interaction and convergence of abscisic acid-dependent and abscisic acid-independent pathways. *Plant Cell* 9: 1935-1949.
- Jaglo-Ottosen KR, Gilmour SJ, Zarka DG, Schabenberger O, and Thomashow MF (1998) *Arabidopsis CBF1* overexpression induces *COR* genes and enhances freezing tolerance. *Science* 280: 104-106.
- James C (2000) Global review of commercialized transgenic crops: 2000. International Service for Acquisition of Agri-Biotech Applications Publ., New York, USA.
- Kasuga M, Liu Q, Miura S, Yamaguchi-Shinozaki K, and Shinozaki K (1999) Improving plant drought, salt and freezing tolerance by gene transfer of a single stress-inducible transcription factor. *Nature Biotechnol.* 17: 287-291.
- Kavi Kishor PB, Hong Z, Miao GH, Hu CAA, and Verma DPS (1995) Overexpression of  $\Delta^1$  pyrroline-5-carboxylate synthetase increases proline production and confers osmotolerance in transgenic plants. *Plant Physiol.* 108: 1387-1394.
- Kawai M, Umeda M, and Uchimiya H (1993) Molecular cloning and characterization of rice adenylate kinase genes. Sixth Annual Meeting of the International Program on Rice Biotechnology, Chiang Mai (Thailand). p. 187.
- Kenong X, Ronald PC, and Mackill DJ (1997) Development of a high-resolution map around the rice submergence tolerance locus Sub 1. General meeting of the International Program on Rice Biotechnology, Malacca (Malaysia). p. 158.
- Kim SA, Kwak JM, Jae SK, Wang MH, and Nam HG (2001a) Overexpression of the *AtGluR2* gene encoding an *Arabidopsis* homolog of mammalian glutamate receptors impairs calcium utilization and sensitivity to ionic stress in transgenic plants. *Plant Cell Physiol.* 42: 74-84.
- Kim JC, Lee SH, Cheng YH, Yoo CM, Lee SI, Chun HJ, Yun DJ, Hong JC, Lee SY, Lim CO, and Cho MJ (2001b) A novel cold-inducible zinc finger protein from soybean, SCOF-1, enhances cold tolerance in transgenic plants. *Plant J.* 25: 247-259.
- Ku MSB, Agarie S, Nomura M, Fukayama H, Tsuchida H, Oono



- K, Hirose S, Toki S, Miyao M, and Matsuoka M (1999) High-level expression of maize phosphoenol carboxylase in transgenic rice plants. *Nature Biotechnol.* 17: 76-80.
- Lee JH, and Schoff F (1996) An *Hsp70* antisense gene affects the expression of *HSP70/HSc70*, the regulation of *HSF*, and the acquisition of thermotolerance in transgenic *Arabidopsis thaliana*. *Mol. Gen. Genet.* 252: 11-19.
- Lee JH, Hubel A, and Schoff F (1995) Depression of the activity of genetically engineered heat shock factor causes constitutive synthesis of heat shock proteins and increased thermotolerance in transgenic *Arabidopsis*. *Plant J.* 8: 603-612.
- Levitt J (1980) Responses of plant to environmental stress: chilling, freezing, and high temperature stresses. 2nd ed. New York: Academic Press.
- Lilius G, Holmberg N, and Bulow L (1996) Enhanced NaCl stress tolerance in transgenic tobacco expressing bacterial choline dehydrogenase. *Bio/Technology* 14:177-180.
- Lilley JM, and Ludlow MM (1996) Expression of osmotic adjustment and desiccation tolerance in diverse rice lines. *Field Crops Res.* 48: 185-197.
- Liu Q, Kasuga M, Sakuma Y, Abe H, Miura S, Yamaguchi-Shinozaki K, and Shinozaki K (1998) Two transcription factors, DREB1 and DREB2, with an EREBP/AP2 DNA binding domain separate two cellular signal transduction pathways in drought-and low-temperature-responsive gene expression, respectively, in *Arabidopsis*. *Plant Cell* 10: 1391-1406.
- Malik MK, Slovin JP, Hwang CH, and Zimmerman JL (1999) Modified expression of a carrot small heat shock protein gene, *Hsp17.7*, results in increased or decreased thermotolerance. *Plant J.* 20: 89-99.
- Matsuoka M, Fukayama H, Tsuchida H, Nomura M, Agarie S, Ku MSB, and Miyao M (2000) How to express some *C₄* Photosynthesis Genes at high levels in rice. In: Redesigning rice photosynthesis to increase yield. Sheehy JE, Mitchell PL, and Hardy B (eds.). International Rice Research Institute in collaboration with Elsevier Science, The Netherlands. pp. 167-175.
- McKersie BD (2001) Stress tolerance of transgenic plants overexpressing superoxide dismutase (Abstract Society for Experimental Biology Annual Meeting). *J. Exptl. Bot.* 52 (supplement): p. 8.
- McKersie BD, Bowley SR, and Jones KS (1999) Winter survival of transgenic alfalfa overexpressing superoxide dismutase. *Plant Physiol.* 199: 839-847.
- McKersie BD, Bowley SR, Harjanto SR, and Leprince O (1996) Water deficit tolerance and field performance of transgenic alfalfa overexpressing superoxide dismutase. *Plant Physiol.* 111: 1177-1181.
- McKersie BD, Chen Y, Debens M, Bowley SR, Bowler C, Inze D, D'Halluin K, and Botterman J (1993) Superoxide dismutase enhances tolerance of freezing stress in transgenic alfalfa (*Medicago sativa* L.). *Plant Physiol.* 103: 1155-1163.
- Minhas D, and Grover A (1999) Towards developing transgenic rice plants tolerant to flooding stress. *PINSA* 65(1/2): 33-50.
- Moghaieb REA, Tanaka N, Saneoka H, Hussein HA, Yousef SS, Ewada MAF, Aly MAM, and Fujita K (2000) Expression of betaine aldehyde dehydrogenase gene in transgenic tomato hairy roots leads to the accumulation of glycine betaine and contributes to the maintenance of the osmotic potential under salt stress. *Soil Sci. Plant Nutr.* 46: 873-883.
- Nguyen HT, Chandra Babu R, and Blum A (1997) Breeding for drought resistance in rice: physiology and molecular genetics considerations. *Crop Sci.* 37: 1426-1434.
- Pan A, Yang M, Tie F, Li L, Chen Z, and Ru B (1994) Expression of mouse metallothionein-I gene confers cadmium resistance in transgenic tobacco plants. *Plant Mol. Biol.* 24: 341-351.
- Park JM, Park CJ, Lee SB, Ham BK, Shin R, and Paek KH (2001) Overexpression of the tobacco *Tsi1* gene encoding an EREBP/AP2-type transcription factor enhances resistance against pathogen attack and osmotic stress in tobacco. *Plant Cell* 13: 1035-1046.
- Pilon-Smits EAH, Ebskamp MJM, Jeuken MJW, van der Meer IM, Weisbeek PJ, Visser RGF, and Smeekens SCM (1996) Microbial production in transgenic potato plants and tubers. *Indust. Crops Prod.* 5: 35-56.
- Pilon-Smits EAH, Ebskamp MJM, Paul MJ, Jeuken MJW, Weisbeek PJ, and Smeekens SCM (1995) Improved performance of transgenic fructan-accumulating tobacco under drought stress. *Plant Physiol.* 107: 125-130.
- Potrykus I (1991) Gene transfer to plants: assessment of published approaches and results. *Annu. Rev. Plant Physiol. Plant Mol. Biol.* 42: 205-225.
- Queitsch C, Hong SW, Vierling E, and Lindquist S (2000) Heat shock protein 101 plays a crucial role in thermotolerance in *Arabidopsis*. *Plant Cell* 12: 479-492.
- Quimio CA, Torrizo LB, Setter TL, Ellis M, Grover A, Abrigo EM, Oliva NP, Ella ES, Carpena AL, Ito O, Peacock WJ, Dennis E, Datta SK (2000) Enhancement of submergence tolerance in transgenic rice overproducing pyruvate decarboxylase. *J. Plant Physiol.* 156: 516-521.
- Romero C, Belles JM, Vaya JL, Serrano R, Culiñez-Macia FA (1997) Expression of the yeast trehalose-6-phosphate synthase gene in transgenic tobacco plants: pleiotropic phenotypes include drought tolerance. *Planta* 201: 293-297.
- Roxas VP, Lodhi SA, Garrett DK, Mahan JR, and Allen RD (2000) Stress tolerance in transgenic tobacco seedlings that overexpress glutathione S-transferase/glutathione peroxidase. *Plant Cell Physiol.* 41: 1229-1234.
- Roxas VP, Smith RK Jr, Allen ER, and Allen RD (1997) Overexpression of glutathione-S-transferase/glutathione peroxidase enhances the growth of transgenic tobacco seedlings during stress. *Nature Biotechnol.* 15: 988-991.
- Saijo Y, Hata S, Kyojuka J, Shimamoto K, and Izui K (2000) Over-expression of a single Ca²⁺ dependent protein kinase confers both cold and salt/drought tolerance on rice plants. *Plant J.* 23: 319-327.
- Sakamoto A, Alia HH, and Murata N (1998) Metabolic engineering of rice leading to biosynthesis of glycine betaine

- and tolerance to salt and cold. *Plant Mol. Biol.* 38: 1011-1019.
- Schellenbaum L, Sprenger N, Schuepp H, Wiemken A, and Boller T (1999) Effects of drought, transgenic expression of a fructan synthesizing enzyme and of mycorrhizal symbiosis on growth and soluble carbohydrate pools in tobacco plants. *New Phytol.* 142(1): 67-77.
- Seki M, Narusaka M, Abe H, Kasuga M, Yamaguchi-Shinozaki K, Carninci P, Hayashizaki Y, and Shinozaki K (2001) Monitoring the expression pattern of 1300 *Arabidopsis* genes under drought and cold stresses by using a full-length cDNA microarray. *Plant Cell* 13: 61-72.
- Sharp RE, Boyer JS, Nguyen HT, and Hsio TC (1996) Genetically engineered plants resistant to soil drying and salt stress: How to interpret osmotic relations? *Plant Physiol.* 110: 1051-1052.
- Shen B, Jensen RG, and Bohnert HJ (1997) Increased resistance to oxidative stress in transgenic plants by targeting mannitol biosynthesis to chloroplasts. *Plant Physiol.* 113: 1177-1183.
- Sheveleva E, Chmara W, Bohnert HJ, and Jensen RG (1997) Increased salt and drought tolerance by D-ononitol production in transgenic *Nicotiana tabacum* L. *Plant Physiol.* 115: 1211-1219.
- Sheveleva EV, Jensen RG, Bohnert HJ, and Parry M (2000) Disturbance in the allocation of carbohydrates to regenerative organs in transgenic *Nicotiana tabacum* L. *J. Exp. Bot.* 51(342): 115-122.
- Shinozaki K, and Yamaguchi Shinozaki Y (2000) Molecular responses to dehydration and low temperature: differences and cross-talk between two stress signaling pathways. *Plant Biol.* 3: 217-223.
- Singh NK, Bracker CA, Hasegawa PM, Handa AK, Buckel S, Hermodson MA, Pfankoch E, Regnier FE, and Bressan RA (1987) Characterization of osmotin. *Plant Physiol.* 85: 529-536.
- Sivamani E, Bahieldin A, Wraith JM, Al-Niemi T, Dyer WE, Ho THD, and Qu RD (2000) Improved biomass productivity and water use efficiency under water deficit conditions in transgenic wheat constitutively expressing the barley *HVA1* gene. *Plant Sci.* 155: 1-9.
- Soderman E, Hjellstrom M, Fahleson J, and Engstrom P (1999) The HD-Zip gene *ATHB6* in *Arabidopsis* is expressed in developing leaves, roots and carpels and up-regulated by water deficit conditions. *Plant Mol. Biol.* 40: 1073-1083.
- Steponkus PI, Uemura M, Joseph RA, Gilmour S, and Thomashow MF (1998) Mode of action of the *COR15a* gene on the freezing tolerance of *Arabidopsis thaliana*. *Proc. Natl. Acad. Sci. USA* 95: 14570-14575.
- Tamminen I, Makela P, Heino P, and Palva ET (2001) Ectopic expression of *AB13* gene enhances freezing tolerance in response to abscisic acid and low temperature in *Arabidopsis thaliana*. *Plant J.* 25: 1-8.
- Tarczynski MC, Jensen RG, and Bohnert HJ (1993) Stress protection of transgenic tobacco by production of the osmolyte mannitol. *Science* 259: 508-510.
- Tepperman JM, and Dunsmuir P (1990) Transformed plants with elevated levels of chloroplast SOD are not more resistant to superoxide toxicity. *Plant Mol. Biol.* 14: 501-511.
- Thomas JC, Sepahi M, Arendall B, and Bohnert HJ (1995) Enhancement of seed germination in high salinity by engineering mannitol expression in *Arabidopsis thaliana*. *Plant Cell Environ.* 18: 801-806.
- Umeda M, and Uchimiya H (1994) Differential transcript levels of genes associated with glycolysis and alcohol fermentation in rice plants (*Oryza sativa* L.) under submergence stress. *Plant Physiol.* 106: 1015-1022.
- Urao T, Yakubov B, Yamaguchi-Shinozaki K, and Shinozaki K (1998) Stress-responsive expression of genes for two-component response regulator-like proteins in *Arabidopsis thaliana*. *FEBS Lett.* 427: 175-178.
- Urao T, Yamaguchi-Shinozaki K, and Shinozaki K (2000) Two-component systems in plant signal transduction. *Trends Plant Sci. Rev.* 5(2): 67-74.
- Van Breusegem F, Slooten L, Stassart JM, Moens T, Botterman J, Van Montagu M, and Inze D (1999) Overproduction of *Arabidopsis thaliana* FeSOD confers oxidative stress tolerance to transgenic maize. *Plant Cell. Physiol.* 40: 515-523.
- Van Camp W, Capiou K, Van Montagu M, Inze D, and Slooten L (1996) Enhancement of oxidative stress tolerance in transgenic tobacco plants overproducing Fe-superoxide dismutase in chloroplasts. *Plant Physiol.* 112: 1703-1714.
- Van Rensburg L, and Kruger GHJ (1994) Applicability of abscisic acid and (or) proline accumulation as selection criteria for drought tolerance in *Nicotiana tabacum*. *Can. J. Bot.* 72: 1535-1540.
- Wang J, Zhang H, and Allen RD (1999) Overexpression of an *Arabidopsis* peroxisomal ascorbate peroxidase gene in tobacco increases protection against oxidative stress. *Plant Cell Physiol.* 40: 725-732.
- Widawsky DA, and O'Toole JC (1990) Prioritizing rice biotechnology research agenda for Eastern India. New York (USA); The Rockefeller Foundation.
- Winicov I, and Bastola DR (1999) Transgenic overexpression of the transcription factor *Alfin1* enhances expression of the endogenous, *MSPRP2* gene in alfalfa and improves salinity tolerance of the plant. *Plant Physiol.* 120: 473-480.
- Xu KN, Mackill DJ (1996) A major locus for submergence tolerance mapped on rice chromosome 9. *Mol. Breed.* 2(3): 219-224.
- Xu D, Duan X, Wang B, Hong B, Ho TD, and Wu R (1996) Expression of a late embryogenesis abundant protein gene, *HVA1*, from barley confers tolerance to water deficit and salt stress in transgenic rice. *Plant Physiol.* 110: 249-257.
- Yu Q, Osborne LD, and Rengel Z (1999) Increased tolerance to Mn deficiency in transgenic tobacco overproducing superoxide dismutase. *Ann. Bot.* 84: 543-547.
- Zhu B, Su J, Chang MC, Verma DPS, Fan YL, and Wu R (1998) Overexpression of a pyrroline-5-carboxylate synthetase gene and analysis of tolerance to water and salt stress in transgenic rice. *Plant Sci.* 139: 41-48.



# Progress in the genetic engineering of wheat for water-limited conditions

**A. Pellegrineschi¹, J.-M. Ribaut¹, R. Trethowan¹,  
K. Yamaguchi-Shinozaki² and D. Hoisington¹**

¹Int. Maize and Wheat Improvement Center (CIMMYT)

Lisboa 27, Apdo. Postal 6-641, 06600 Mexico D. F. Mexico.

²Biological Resources Division

Japan International Research Center for Agricultural Sciences (JIRCAS)

1-2 Oowashi, Tsukuba, Ibaraki 305-8686, JAPAN

## Abstract

---

The overall objective of plant improvement can be defined as the accumulation of the maximum number of favorable alleles involved in the expression of target traits in a plant's genome. This task can be achieved through several approaches, including phenotypic and DNA marker selection or the introduction of new genes through genetic engineering. Regulation of plant responses to abiotic stresses is genetically complex due to the interaction between the environment and the plant genotype. Therefore, the major challenge when using genetic engineering for plant improvement of abiotic stress tolerance is to identify the nature and the number of genes that must be introduced to have a significant impact on the plant phenotype. Given that the number of genes that could be evaluated is large, the efficiency of the transformation system is a key issue. At CIMMYT, after an intensive germplasm screening, a 'Bobwhite' bread wheat line was selected for biolistic transformation work based on its transformation efficiency that exceeds 60%. In collaboration with other institutes, genes involved in abiotic stress tolerance have been identified and are being introduced into wheat. Our preliminary experiments conducted with the *DREB1A* gene demonstrated that when introduced into wheat, the transformed T₁ plants survived a short and intensive water stress at the plantlet stage, while the controls were completely desiccated. The next step is to test these plants under stress conditions that correspond more closely to field conditions, where water stress is a very slow and progressive phenomenon. The role of genetic engineering as a tool to better understand gene function under water-limited conditions and produce tolerant genotypes is discussed.

## Constraints to breeding for drought conditions

The reduction in land resources available for agriculture is due to loss of land to industrialization, urbanization, erosion, declining fertility, salinization, compaction, and acidification from fertilizer use. While crop yields and the sustainability of cropping systems in temperate areas are generally stable, if not improving, the opposite is often true for tropical environments, where inputs are usually unavailable or uneconomical. Both types of environments are affected by the destabilizing effects of global warming, which are predicted to increase variability in temperatures and rainfall (Curry et al. 1995). Nowhere are drought and declining fertility more acute than in sub-Saharan Africa, where fertilizer use in 1997 was only 15 kg/ha,

versus 91 kg/ha at the global level (FAO 2000).

Quantitative estimates of yield losses due to individual abiotic stresses are essential for setting research priorities and most estimates are based on extrapolation from trial data, the frequency of occurrence of the stress, and/or expert experience. Like most abiotic stresses, drought can induce major changes in the growth and development of cultivated crops through complex modifications in physiological pathways. For example, Subbarao et al. (1995) suggest that production could be increased over present levels in chickpea, pigeonpea, and groundnut by 49%, 57%, and 29%, respectively, if water was not a limiting factor. Empirical estimates of losses from stress result in "best guesses" such as those for maize (Edmeades et al. 2000), in which water and nutrient deficits are thought

to incur the greatest losses. Water deficit is also the most important abiotic stress affecting rice production. In the Asian uplands, water deficit results in an estimated average annual loss of 190 kg/ha, or 17% of production (Edmeades et al. 2001). Irrigated rice loses 134 kg/ha due to shortages of water, or 9.9 million tons of grain annually in Asia alone. These losses are expected to increase in the future, as water scarcity in Asia becomes more severe. At least 60 million hectares of wheat are grown in marginal rainfed environments in developing countries. National average yields range from 0.8 to 1.5 t/ha, approximately 10-50 % of their theoretical irrigated potential (Morris et al. 1991).

Due to its unpredictable nature, breeding for drought tolerance is more challenging than for tolerances to other abiotic stresses. Selected materials should be outstanding not only under water-limited conditions but they should also perform well when water is adequate. Establishing optimal environments to select for improved performance under drought is complicated by environmental variation; there is generally only one drought-prone season per year in the tropics and conventional selection for drought tolerance requires careful irrigation management, which is a constraint for many breeding programs. In addition, there is clearly a yield barrier for any plant and under drought this yield barrier is highly related to water supply. Grain production requires a plant to support and produce the floral structure(s), but without a minimum of water, there is little or no plant development. Moreover, the global impact of water-limited conditions is not easy to evaluate, especially when drought is combined with insect or pathogen attack, or with non-optimal soil conditions. For example, coastal areas often suffer from both salinity and submergence, and acid soils generally exhibit P deficiency as well. These limitations make it difficult to predict the level of the yield barrier under drought conditions.

Like for other crops, breeding wheat for tolerance to water-limited environments is fraught with difficulties as the genetic control of drought tolerance is poorly understood. Genetic increases in yield over time have therefore been significantly lower in the drier wheat production environments of the world (Derera et al., 1982; Sayre et al., 1997). Furthermore, it is often difficult to separate genetic improvement in yield from increased adoption of moisture conservation practices. Most plant breeders, when confronted with the challenge of developing cultivars for these environments, have opted to select for those traits for which the genetic control is clearly understood. They have targeted improved root development through the manipulation of genes controlling resistance to root pathogens and tolerance to micronutrient imbalances (Trethowan and Pfeiffer, 2000). The manipulation of plant height and flowering time, both under strong genetic control, have

also allowed breeders to better tailor genotypes to the dominant stress patterns found in particular regions (Richards et al., 2001). Significant progress has been achieved through conventional breeding (Trethowan et al., 2001), and the potential for genetic improvement of wheat production under drought conditions is still large. However, conventional breeding for yield improvement remains time-consuming and laborious, because carefully managed field conditions are required. In addition, there is a decrease in the genetic variance and heritability of yield components that parallels an increase in environmental stress, thereby inducing some bias for selection conducted on plant phenotypes. Although challenging, biotechnology approaches that combine QTL studies, functional genomics and genetic engineering should provide useful information and tools to effectively complement conventional selection for drought-tolerance improvement.

### **The biotechnology approach**

The development of molecular genetics and associated technologies has represented a quantum leap in our understanding of the underlying genetics of the traits sought through plant breeding. The usefulness of DNA markers for germplasm characterization, genetic dissection of target traits and marker-assisted selection has been well demonstrated (for a review, see the companion paper, Ribaut et al., in this volume). To date, the complete genome of *Arabidopsis* and rice have been sequenced and a large number of ESTs are available in public databases for other cereals. At the same time, several genes and pathways involved into the expression of morphological traits and physiological parameters involved in water-stress tolerance have been identified. Given this large volume of information, several candidate genes putatively involved in drought tolerance can be identified in the literature and gene databases (Skriver and Mundy 1990, Bray 1993, Ingram and Bartels 1996, Bohnert et al. 2000, Seki et al. 2001). The candidate genes potentially involved in the plant's response under water-limited conditions can be divided in three classes: (1) genes for which very strong evidence has already been published, which demonstrates their significant role under abiotic stresses conditions (Finkelstein and Lynch 2000); (2) genes that have been identified as being of interest, but which require further evaluation (Liu et al. 1998); and (3) those genes that have not been evaluated in a plant, and therefore still need to be confirmed under experimental conditions (Guiltinan et al. 1990).

Recent work has shown how different genes can provide new clues to understanding stress tolerance in plants (Shinozaki and Yamaguchi-Shinozaki 1996, Cushman and Bohnert 2000). They actively play a role

in the biosynthesis of various osmoprotectants (Tarczynski and Bohnert 1993), modification of cell membrane structure and sometimes code for enzymes that detoxify plant cells. Analyses of the expression of dehydration-induced genes have shown that at least four independent signal pathways function in response to dehydration. Two are abscisic acid (ABA) dependent (Abe et al. 1997, Chandler and Robertson 1994), and two are ABA-independent. Several stress-induced genes, such as *rd29A*, are induced through the ABA-independent pathway. The *rd29A* gene in particular is responsible for dehydration and cold-induced expression (Yamaguchi-Shinozaki and Shinozaki 1994). Expression of the *DREB1A* gene, under constitutive promoters such as CaMV 35S, leads to strong increases in tolerance to abiotic stresses; however, it also induces growth retardation under normal growth conditions (Liu et al. 1998), raising concerns about its possible use in plant breeding. However, plants produced using the stress regulated *rd29A* promoter demonstrated increased tolerance to freezing, salt and water limited stresses, without producing changes in the normal phenotype of the transformed plants. One way to validate these candidate genes is to introduce them into a genotype via genetic engineering and test if the plant's tolerance to water stress has been improved. This approach has been followed at CIMMYT to evaluate and characterize the effect of the *DREB1A* gene under water-limited conditions when introduced into wheat germplasm.

### Genetic engineering and evaluation of *DREB1A* containing wheat

Two plasmids were used in our transformation experiments. The plasmid pACH25 contained the *gusA* reporter gene and the *bar* selectable marker (conferring resistance to PPT), with each gene under the control of the maize ubiquitin promoter (Christensen et al., 1992). The second construct contained the *DREB1A* cDNA under the control of the *rd29* promoter. Immature embryos (0.8-1.2 mm) from the wheat variety MPB-Bobwhite26, were excised, scutella transferred to an osmotic medium (MS plus 15% maltose) and dehydrated for 4 hr. Plasmid DNA was precipitated onto gold particles as described in several reports (Nehra et al. 1994; Vasil et al., 1992). After microprojectile-DNA precipitation, the particles were washed in 250  $\mu$ l ethanol and resuspended in 250  $\mu$ l ethanol. For each bombardment, 10  $\mu$ l of microparticle-DNA were placed on the macrocarrier. Over 20 independent transformation experiments (bombarded rings) were conducted at a distance of 5 cm. from the stopping plate using a PDS 1000/He microprojectile

gun (Bio-Rad) with a pressure of 900 ics (inches cm. square), as described by Pellegrineschi et al. (2001). Eight hours after bombardment, the embryos were placed on MS medium (Murashige and Skoog 1962), containing 2.5 mg/L 2,4-dichlorophenoxyacetic acid (2,4-D), 30 g/L sucrose, and 8 g/L Bacto-Agar for somatic embryo induction. Twenty days later, the treated embryos were evaluated for somatic embryo production and transferred to MS medium (Murashige and Skoog 1962) with 5 mg/L phosphinothricin (PPT). After 30 days, green regenerating shoots that survived the treatment were again transferred to the same medium for plantlet development. After 20 days, surviving plantlets were transferred to soil and grown in a biosafety greenhouse. Twenty days later, when the plants were at the 5-6 leaf stage, they were sprayed with 0.3% w/v Bast™ herbicide, and the surviving plants were selected for molecular characterization (PCR and Southern blot analyses). All plants containing *bar* and *DREB1A* genes were selfed pollinated to produced seeds.

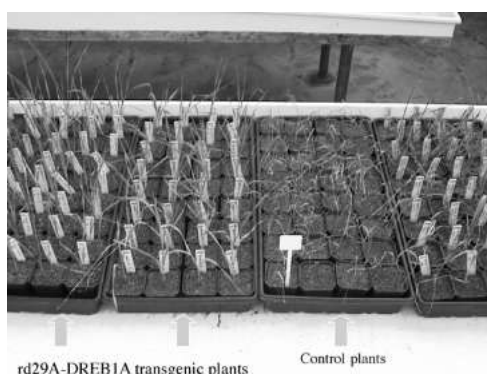
Twenty seeds from T₀ plants that were positive for the *bar* and *DREB* genes were planted in small square pots (5  $\times$  5 cm) and grown in CIMMYT's Biosafety Greenhouse until the 4-leaf stage. Water-limited conditions were generated by withholding water for up to 15 days. These conditions were determined by subjecting control plants to various periods of water deficit. Withholding water for 15 days gave the best discrimination.

After sowing the T₁ progeny, a retardation of germination was observed in the transgenic individuals. Control plants started to germinate after 2-3 days, while the *DREB* lines showed irregular germination. After germination, no significant differences in plant development were observed between the transgenic and control lines. At the 4-leaf stage, the plants were subjected to water-limited stress by withholding water. The wheat lines started to show differences in the wilting of the leaves after 10 days without water. Table 1 summarizes the water-limited stress development on transgenic and control plants. Controls started to show water-limited symptoms (loss of turgor and bleaching of the leaves) after 10 days of stress, and severe symptoms (e.g., senescence of all leaf tissue) were evident in the control samples after 15 days without water, while the transgenic plants either showed no or reduced symptoms (Fig. 1). These preliminary results suggest that the *rd26::DREB1A* gene has a general effect on tolerance to water-limited conditions. Whether this tolerance is attributable to reduced evapotranspiration of the transgenic plants or differential regulation of the water status in the cell (e.g., osmotic adjustment) clearly needs to be determined through future physiological measurements on both the control and the transgenic plants.

**Table 1**

Phenotypes of control and transgenic lines under water stress conditions

Genotype	Phenotype observed after 5 days withholding water	Phenotype observed after 10 days withholding water	Phenotype observed after 15 days withholding water
Transgenic	Normal	Plants showing bleaching, loss of turgor in young leaves, some leaves dead.	Plants showing reduced turgor in the leaves.
Control	Normal	Old leaves bleached, loss of turgor in young leaves, some leaves dead.	All plants dead.



**Fig. 1.** *rd29::ADREB1A* plants and control plants after 15 days drought stress. The stress treatment was performed as described in the text. After the stress treatment, the controls were placed in the same tray to show the different responses to the stress with respect to the transgenic plants.

### The next characterization phase

Like in other studies reporting gene characterization under abiotic stresses (e.g., Shannon 1998, Liu et al. 1998, de la Fuente-Martinez and Herrera-Estrella 1999, Kasuga et al. 1999) our phenotypic evaluation at the T₁ stage has been designed to test the survival of different genotypes at the plantlet stage. Although it has been noted that traits that enhance survival have greater relative value when the crop is young, our focus at CIMMYT is to test the general mechanisms by which crop plants cope with stress and identify genes that favor productivity rather than survival. In this regard, the experiments described in this paper for testing the *rd29DREB1A* gene in T₁ plants represent only the first step of our study. In the next generation (T₂), promising transformed wheat plants selected from T₁ families will be grown in large pots. The strategy will be to flood the pots when the plants are at the 4-5 leaf stage and then stop irrigation for the following two months. These experimental conditions should mimic, to some extent, stress conditions in the field by inducing a "long-term" stress, while the large soil capacity of the pots should

provide sufficient water for the most adapted genotypes to survive. This is a key validation step to test the impact of a transgene on plant performance under target conditions. Concomitant with this phenotypic testing, leaf tissue from the plants will be harvested at different stages of the stress to determine their relative water content, osmotic adjustment, and ABA content. This should help us better understand the effect of the transgene at the physiological level. In addition, the expression of the *DREB1A* gene will be characterized for the different families. Finally, to further understand the role of the *DREB* genes in drought tolerance, two different "rice versions" (*OsDREB1A* and *OsDREB1B*) will be evaluated, following the same protocol as for the *AtDREB1A*. These genes will be tested for their performance with stress-specific and constitutive promoters.

It is generally accepted that independent metabolic pathways control tolerance to different abiotic stresses in wheat. Therefore, improvement in tolerance to one stress does not necessarily lead to improvement in tolerance to secondary stresses (Gusta and Chen, 1987). However, due to spillover effects, improved field performance of a transgenic plant selected for drought tolerance might be expected under various abiotic stress (e.g., heat stress, salinity stress, or low nitrogen fertility). For that reason, the *DREB* transgenic wheat plants will be evaluated under diverse stress conditions in the field.

### Conclusions

Continued genetic progress in cultivar development for dry regions will depend upon a number of factors. First, the prevailing stresses, other than moisture availability, must be better understood. Second, our understanding of the genetic control of drought tolerance needs to be improved. Third, the selection methods used to screen for drought tolerance must be refined, and finally, new genetic variability for improved water-use efficiency must be found and exploited. Considering the limitations imposed by phenotypic selection, alternatives that take advantage of the explosion of new molecular technologies such as, functional genomics and genetic engineering, should be explored to efficiently complement phenotypic selection. Within this broad scope, genetic engineering is undoubtedly a very suitable approach to (1) confirm a gene's function *in planta*, (2) improve germplasm performance by introducing a new gene and/or changing the gene expression with suitable promoters, and (3) identify new genotypes by screening plants transformed with a large number of candidate genes under different stress conditions. Considering the complexity of abiotic stresses that vary in intensity and timing of the stress,

the introduction of one or a few genes may have only limited impact on productivity under abiotic stress conditions. However, it can be reasonably proposed that a genotype that performs well under a wide spectrum of stress intensities might combine properly-regulated transgenes with elite alleles at key genes, which have been selected through the use of DNA markers.

## References

- Abe H., Yamaguchi-Shinozaki K., Urao T., Iwasaki, T., Hosokawa D., Shinozaki K. 1997. Role of *Arabidopsis* MYC and MYB homologs in drought- and abscisic acid-regulated gene expression. *Plant Cell* 9: 1859-1868.
- Bohnert, H., Fischer, R., Kawasaki, S., Michalowski, C., Wang, H., Yale, J. and Zepeda, G. 2000. Cataloging stress-inducible genes and pathways leading to stress tolerance. In: Ribaut, J.-M. and Poland, D. (eds.) *Molecular Approaches for the Genetic Improvement of Cereals for Stable Production in Water-Limited Environments. A Strategic Planning Workshop held at CIMMYT, El Batan, Mexico, 21-25 June 1999*, CIMMYT, Mexico, D.F., Mexico, pp. 156-161.
- Bray, E.A. 1993. Molecular response to water deficit. *Plant Physiologist* 103: 1035-1040.
- Chandler, P.M. and Robertson, M. 1994. Gene expression regulated by abscisic acid and its relation to stress tolerance. *Annu. Rev. Plant Physiol. Plant Mol. Biol.* 45: 113-141.
- Christensen, A.H., Sharrock, R.A. and Quail, P.H. 1992. Maize polyubiquitin genes: genes, structure, thermal perturbation of expression and transcript splicing, and promoter activity following transfer to protoplast by electroporation. *Plant Mol. Biol.* 18: 675-689.
- Curry, R.B., Jones, J.W., Boote, K.J., Peart, R.M., Allen, L.H. and Pickering, N.G. 1995. Response of soybean to predicted climate change in the USA. In: *Climate Change and Agriculture: Analysis of Potential International Impacts*. ASA Special Publication No. 59. ASA, Madison, WI, pp. 163-182.
- Cushman, J.C. and Bohnert, H. 2000. Genomic approaches to plant stress tolerance. *Curr. Opin. in Plant Biol.* 3, 117-124.
- Derera, N.F., G.M. Bhatt, and Ellison, F.W.. 1982. Two decades of wheat improvement work at Narrabri. *J. Aust. Inst. Agric. Sci.* 48: 131-140.
- De la Fuente-Martinez, J. M. and Herrera-Estrella, L. 1999. Advances in the understanding of aluminum toxicity and the development of aluminum-tolerant transgenic plants. *Advances in Agronomy* 66, 103-120.
- Edmeades, G.O., Bolaños, J., Elings, A., Ribaut, J.-M., Bänziger, M. and Westgate, M.E. 2000 The role and regulation of the anthesis-silking interval in maize. In: Westgate, M.E. and Boote, K.J. (eds) *Physiology and Modeling Kernel Set in Maize. CSSA Special Publication No. 29*. CSSA, Madison, WI, pp. 43-73.
- Edmeades, G.O., Cooper, M., Lafitte, R., Zinselmeier, C., Ribaut, J.-M., Habben, J.E., Löffler, C. and Bänziger, M. 2001. Abiotic stresses and staple crops. In: J. Nosberger, H.H. Geiger, and P.C. Struik (eds). *Crop Science: Progress and Prospects. Proceedings of the Third International Crops Science Congress, 17-21 August, 2000*. CABI, Wallingford, UK. (in press).
- FAO. 2000. FAOStat Database - Agricultural production <http://apps.fao.org>.
- Finkelstein, R.R. and Lynch, T.J. 2000. The *Arabidopsis* abscisic acid response gene *ABI5* encodes a basic leucine zipper transcription factor. *Plant Cell* 12: 599-610.
- Gultinan, M.J., Marcotte, W.R. Jr., Quatrano, R.S. 1990. A plant leucine zipper protein that recognizes an abscisic acid response element. *Science* 250(4978): 267-271.
- Gusta, L.V. and Chen, T.H.H. 1987. The physiology of water and temperature stress. In: *Wheat and Wheat Improvement*, ed. E.G. Heyne. 2nd ed. Madison, Wisconsin. pp. 115-150.
- Ingram, J. and Bartels, D. 1996. The molecular basis of dehydration tolerance in plants. *Annual Review Plant Physiology Plant Molecular Biology* 47:377-403.
- Kasuga, M., Liu, Q., Miura, S., Yamaguchi-Shinozaki, K. and Shinozaki, K. 1999. Improving plant drought, salt, and freezing tolerance by gene transfer of a single stress-inducible transcription factor. *Nature Biotech.* 17:287-291.
- Liu, Q., M. Kasuga, Y. Sakuma, H. Abe, S. Miura, K. Yamaguchi-Shinozaki and Shinozaki, K. 1998. Two transcription factors, DREB1 and DREB2, with an EREBP/AP2 DNA binding domain separate two cellular signal transduction pathways in drought- and low-temperature-responsive gene expression, respectively, in *Arabidopsis*. *Plant Cell* 10:1391-1406.
- Morris, M.L., Belaid, A. and Byerlee, D. 1991. Wheat and barley production in rainfed marginal environments of the developing world. Part 1 of 1990-91 CIMMYT World Wheat Factors and Trends. CIMMYT, Mexico, D.F.
- Murashige, T. and Skoog, F. 1962. A revised medium for rapid growth and bioassays with tobacco tissue cultures. *Physiol. Plant.* 15:473-497.
- Nehra, N., Chibbar, R.N., Leung, N., Caswell, K., Mallard, C., Steinhauer, L., Baga, M., and Kartha, K.K. 1994. Self fertile transgenic wheat plants regenerated from isolated scutellar tissues following microprojectile bombardment with two distinct gene constructs. *The Plant Journal* 5:285-297.
- Pellegrineschi, A., McLean, S., Salgado, M., Velazquez, L., Hernandez, R., Brito, R.M., Noguera, M., Medhurst, A. and Hoisington, D. 2001. Transgenic wheat plants: a powerful breeding source. *Euphytica* 119:133-136.
- Richards, R.A., Condon, A.G., and Rebestzke, G.J. 2001. Traits to improve yield in dry environments. In 'Application of Physiology in Wheat Breeding' Chapter 7: 88-100. Reynolds, M.P., J.I. Ortiz-Monasterio and A.McNab (eds). Mexico, D.F.: CIMMYT.
- Sayre, K.D., Rajaram, S. and Fischer, R.A. 1997. Yield potential progress in short bread wheats in northwest Mexico. *Crop Sci.* 37:36-42.
- Seki, M., Narusaka, M., Abe, H., Kasuga, M., Yamaguchi-Shinozaki, K., Carninci P., Hayashizaki, Y. and Shinozaki, K. 2001. Monitoring the expression pattern of 1300

- arabidopsis genes under drought and cold stresses by using a full-length cDNA microarray. *The Plant Cell* 13: 61-72.
- Shannon, M.C. 1998. Adaptation of plants to salinity. *Advances in Agronomy* 60, 75-120.
- Shinozaki, K. and Yamaguchi-Shinozaki, K. 1996. Molecular responses to drought and cold stress. *Curr. Opin. Biotech.* 7:161-167.
- Skriver, K. and Mundy, J. 1990. Gene expression in response to abscisic acid and osmotic stress. *Plant Cell* 2:503-512.
- Subbarao, G.V., Johansen, C., Slinkard, A.E., Nageswara Rao, R.C., Saxena, N.P. and Chauhan, N.P. 1995. Strategies for improving drought resistance in grain legumes. *Critical Reviews in Plant Science* 14:469-523.
- Tarczynski, M. and Bohnert, H. 1993. Stress protection of transgenic tobacco by production of osmolyte mannitol. *Science* 259:508-510.
- Trethowan, R.M. and Pfeiffer, W.H. 2000. Challenges and Future Strategies in Breeding Wheat for Adaptation to Drought Stressed Environments: A CIMMYT Wheat Program Perspective. In *'Molecular Approaches for the Genetic Improvement of Cereals for Stable Production in Water-Limited Environments'* pp. 45-48. Ribaut, J.M, and D. Poland (eds.). A Strategic Planning Workshop held at CIMMYT El Batan, Mexico, 21-25 June 1999. Mexico D.F.: CIMMYT.
- Trethowan, R.M., Crossa, J., Ginkel, M. and Rajaram, S. 2001. Relationships among bread wheat international yield testing locations in dry areas. *Crop Sci.* 41:1475-1469.
- Vasil, V., Castillo, A. M., Fromm, M. E. and Vasil, I. K. 1992. Herbicide resistant fertile transgenic wheat plants obtained by microprojectile bombardment of regenerable embryogenic callus. *Bio/Technology* 10:667-674.
- Yamaguchi-Shinozaki, K. and Shinozaki K. 1993. A Novel *cis*-acting element in an arabidopsis gene is involved in responsiveness to drought, low-temperature, or high-salt stress. *The Plant Cell*, 6: 251-264.





# Recent developments in transgenics for abiotic stress in legumes of the semi-arid tropics

**Kiran K. Sharma and M. Lavanya**

Genetic Transformation Laboratory

International Crops Research Institute for the Semi-Arid Tropics (ICRISAT)

Patancheru, Andhra Pradesh 502 324, India.

## Abstract

---

The semi-arid tropics (SAT) are characterized by unpredictable weather, limited and erratic rainfall and nutrient poor soils and suffer from a host of agricultural constraints. Several biotic and abiotic stresses affect crop productivity. Mandated crops of ICRISAT that include groundnut, pigeonpea, chickpea, sorghum, and pearl millet are the main staple foods for nearly one billion people in the SAT. Judicious application of biotechnological tools holds great potential in alleviating some of the major constraints to productivity of these crops. Gains in crop productivity through research advances in genetic enhancement will help to achieve sustainable food security, poverty alleviation, and environmental protection in the SAT. ICRISAT has a commitment to transfer the benefits of plant biotechnology to the developing world, as genes relevant to their crops and environment become available. Genetic transformation provides a complimentary means for the genetic betterment of the genome of these crops. Therefore, the research in transgenic crops offers a new means to achieve ICRISAT's mission, i.e., applying science to improve agriculture in areas of the world where sub-optimal rainfall and biotic stresses are the major constraints for crop productivity. In this pursuit, efficient protocols for the genetic transformation of the important legumes of the SAT including groundnut, pigeonpea and chickpea have recently been developed at ICRISAT. More recently, in collaboration with our partners, we have initiated work on the development of transgenic plants for major abiotic stresses that include drought, salinity and low temperatures. Several gene transfer approaches have been shown to improve the stress tolerance of crop plants. The transferred genes include those encoding for enzymes required for the biosynthesis of various osmoprotectants, or those encoding enzymes for modifying membrane lipids, LEA proteins, detoxification enzyme, and stress-inducible transcription factors have been demonstrated to have great potential. This paper reviews the current status of transformation technology for the genetic improvement of legumes of the SAT and it's possible application for developing transgenic plants with enhanced tolerance/resistance to abiotic stresses.

*Keywords: Abiotic stress; chickpea; drought; groundnut; pigeonpea; semi-arid tropics; transgenic plants*

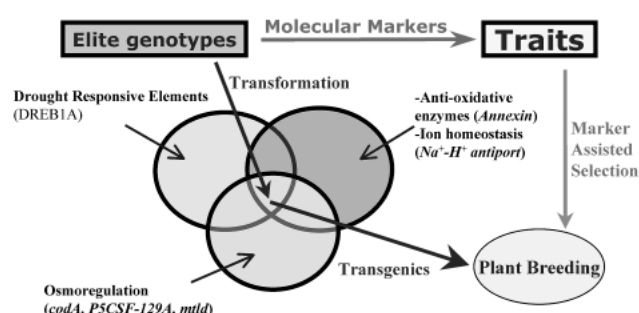
## Introduction

Abiotic stresses like drought, low temperature, and high salinity are environmental factors that dramatically limit plant growth and crop productivity (Boyer, 1982). It has been estimated that 10% of the arable land can be classified under the non-stress category, which implies that the crops grown under the 90% of arable land experience different environmental stresses, singly or in combination. The prediction is that the water deficits will continue to be the major single abiotic factor likely to affect crop yields globally.

The semi-arid tropics (SAT) are prone to hot summers and erratic rainfall having the season length of less than 100 days (Virmani and Singh, 1986). Agriculture in these environments means growing marginal crops on marginal lands with marginal resources. The productivity of crops in these regions is severely affected by drought besides several biotic constraints (Sharma and Ortiz, 2000). Some of the most important crops of this region include groundnut, chickpea, pigeonpea, sorghum, and pearl millet that are the mandated crops of ICRISAT and are the main staple food for nearly one billion people in the SAT. Amongst

these groundnut, chickpea and pigeonpea are legumes that are significant groups of agriculturally important crops and have been the subject of widespread efforts to improve desirable traits. Though, quantitative estimates of yield losses due to drought in tropics are scarce and imprecise, according to some predictions (Subbarao et al., 1995), the productivity could be increased over the present levels in groundnut, chickpea and pigeonpea by 29%, 49%, and 57% respectively, if water was not limiting. However, in rainfed agriculture, there seem to be very few options to increase the area under irrigation and the only option is to improve the realizable yields under water deficit conditions. Although drought management has been an option to increase realizable yields, it is now increasingly being realized that the genetic improvement of drought tolerance is more rewarding (Udaya Kumar et al., 1998; Saxena, 2001). The seed-based technology seems to be easier to transfer to farmers than the more complex knowledge-based agronomic practices. As irrigation water sources become more scarce, development of crop cultivars with improved adaptation to drought is a major goal in many crop breeding programmes. Although, in the last two decades very encouraging progress has been made in assessing the stress responses of several plants (Blum, 1985; Boyer, 1996; Ludlow, 1993; Edmeades et al., 1996), the progress in developing genotypes with enhanced tolerance to abiotic stress has been very slow. Due to the complexity in the physiological, biochemical, and genetic traits involved in drought tolerance, an imperfect understanding of nature of drought, and using yield as an empirical selection criteria, no single strategy may suffice to develop stress tolerant genotypes. It has been recognized that genetic improvement is one of the major components of an integrated approach to stabilizing and improving crop production in drought environments (Subbarao et al., 1995). New tool of biotechnology offer impressive options to supplement the ongoing efforts on developing genetically enhanced germplasm for achieving sustainable food production in the SAT. Drought tolerance breeding might be facilitated by marker-assisted selection in the near future based on the development of molecular linkage maps for crop species (Ribaut et al., 1996, 1997; Nguyen et al., 1997; Zhang et al., 1999; Forster et al., 2000). In addition to classical and molecular breeding approaches (see Fig. 1), genetic transformation to introduce novel genes into plants for better tolerance to water deficit offers an attractive option (Tarczynski et al., 1993; Pilon-Smits et al., 1995; Xu et al., 1996; Sivamani et al., 2000). In fact, the genetic engineering approaches have been shown to be relatively fast and precise means of achieving improved stress tolerance (Hanson and Burnet, 1994; Bohnert and Jensen, 1996; Bohnert and Shen, 1999; Kasuga et al., 1999).

#### Biotech Approaches for enhancing drought tolerance



**Fig. 1.** A schematic representation of an integrated approach employing biotechnological tools and traditional plant breeding to develop abiotic stress tolerant crops.

#### Drought as a major abiotic constraint to productivity of legumes in the SAT

Drought though a broad term can be defined as a meteorological event which implies the absence of rainfall for a period of time long enough to cause moisture depletion in soil and water deficit with a decrease of water potential in plant tissues (Kramer, 1980). It prevents the crops from reaching the determined and expected yield and drastically lowers the production thus affecting the economy of a country. In an agronomic sense, drought stress has been defined as a reduction in grain yield attributable to plant water deficit (Subbarao et al., 1995). Further, the grain legumes dependent on current rainfall are prone to intermittent drought stress during the vegetative or reproductive growth period; the crop recovery from the drought is determined by subsequent rainfall. Terminal drought stress, which occurs during the pod-filling phase of crops, is common and a major yield reducer for crops growing with current rainfall (Nageshwara Rao et al., 1985a,b). This is even more critical for crops grown during a post-rainy season and reliant on stored soil moisture. Groundnut, chickpea, and pigeonpea that are major crops in SAT are very sensitive to high temperatures and water deficits during the flowering stage and seed/pod development stage resulting in heavy loss to productivity.

**Groundnut.** Groundnut (*Arachis hypogaea* L.) is a major oilseed legume native to south America and forms an important legume in Asia and Africa. It is mainly grown under rainfed, irrigated, and residual moisture conditions. The crop is cultivated on 24.8 million hectares with an average productivity of 1.32 t^{ha}. About 93.8% of the world's production of groundnut is grown by resource-poor, small farmers in 96.9% of world's groundnut area in developing countries where scanty and unseasonal and unpredictable rainfall is

observed (Nageshwara Rao and Nigam, 2001). Asia accounts for 66.5% groundnut production on 56.8% area while Africa produces 24.7% on 38% area subjected to groundnut production. This also accounts for low average yields of 0.86 t ha in Africa and 1.55 t^{ha} in Asia as opposed to 2.5 t^{ha} in developed countries despite the potential to produce 10 t^{ha}. Poor yields in these countries is mainly due to the biotic and abiotic constraints like erratic rainfall, low residual moisture, lack of high yielding adapted cultivars, damage by pests and diseases, poor agronomic practices, and limited use of inputs (Nageshwara Rao and Nigam, 2001). In the event of end-of-season drought, which is common under rainfed and residual moisture conditions, the produce becomes vulnerable to aflatoxin contamination. The loss due to biotic factors that include various diseases caused by fungal pathogens, viruses, bacteria and nematodes is estimated to be US \$2 billion. (Sharma et al., 2001). Yield losses due to drought are highly variable in nature depending on timing, intensity, and duration coupled with other location-specific environmental stress factors such as high irradiance and temperature. An annual estimated loss in groundnut production equivalent to over US\$520 million are caused by drought. According to Johansen and Nigam (1994), almost half of it (US\$208 million) can be recovered through genetic enhancement for drought resistance with a benefit:cost ratio of 5:2.

Drought affects the calcium uptake by pods and nitrogen fixation in groundnut where the photosynthesis is also reduced. When the crop reaches the harvesting stage there is the possibility of high contamination of the seeds with aflatoxins which makes the seeds toxic and unfit for consumption by both humans and livestock. It has been suggested by Freeman et al. (1999) that in the medium-term groundnut production and consumption is likely to shift increasingly to developing countries; production will grow in all regions but most rapidly in Asia, slowly in sub-Saharan Africa, and decline in Latin America; and there would be a shift in the utilization of groundnut products from oil to confectionery products suggesting an urgent need and shift in research for exploring the available genetic resources for their traits to tolerate drought.

*Chickpea.* Chickpea (*Cicer arietinum* L.) is the world's second most important pulse crop that is cultivated in more than 41 countries covering more than 11 million hectares of land and producing around 8 million tons of high protein food grain (FAO, 1999). The mean protein content of chickpea is about 24% that serves as an important source of dietary nutrition to poor of the SAT. It also has tremendous beneficial effects on increasing the productivity of succeeding crops in rotation besides enhancing the sustainability and productivity of production systems (Kumar Rao et al., 1998).

It is predominantly a rainfed crop grown after the end of the rains in south Asia and eastern Africa. This makes the crop to complete its life cycle on stored and receding soil moisture where it is exposed to increasing drought (Saxena, 2001). Despite having the yield potential of 5 t ha, the average yield is only about 0.8 t ha due to poor management practices and diseases. The yield losses across the SAT and the west Asia and north Africa (WANA) regions range from 40-60%. Global yield losses due to drought in chickpea are estimated to be around 3.7 million t and around 2.1 million t of these can be recovered through crop improvement efforts (Johansen et al., 1993). The yield losses in chickpea can be completely overcome with irrigation. Although some of the drought effects can be alleviated through agronomic and genetic options that do not involve external input of irrigation, these options can be only partial solution to this problem since the yield will always be lower than what can be achieved with irrigation (Saxena, 2001). It was shown that the yield gap between the most drought tolerant variety ICC 4958 and many other varieties with irrigation was large where the yield of ICC 4958 was only 30% of the potential, irrigated yield of most of the varieties. Conventional plant breeding techniques to upgrade the quality of the variety to tolerate drought have not been successful in chickpea due to the unavailability of appropriate methods to screen and breed varieties tolerant to drought, and also the appropriate selection tools to select the tolerant varieties.

*Pigeonpea.* Pigeonpea [*Cajanus cajan* L. (Millsp.)] is an important grain legume crop of the SAT that has ability to withstand drought conditions to produce grain of high protein concentration and biomass products such as fuel wood and fodder (Nene et al., 1990). It ranks sixth in area and production in comparison to other legumes of developing countries. It is widely grown in India mainly by resource-poor farmers accounting for 90% of the world production. Other regions where pigeonpea is grown are south east Asia, Asia, Africa, and the Americas. Its seed has approximately 21% of the protein content and is known as poor man's meat. The crop is usually grown under rainfed conditions where intermittent and terminal drought stress are frequent. It can be exposed to intermittent drought stress during dry periods of the normal rainy season and to terminal drought stress in the post-rainy season. In recent years, the advent of shorter duration genotypes has widened the scope of pigeonpea cultivation in various, non-traditional cropping systems (Nam et al., 1993, 2000). Pigeonpea has an excellent deep and lateral rooted system that makes it salinity and alkalinity tolerant crop. Despite having such stress-tolerant traits in it, the yield and the productivity of pigeonpea, however, is very poor mainly due to the poor crop resource management (Lawn and Troedson, 1990).

While the traditional long duration pigeonpea can survive periods of drought stress during its growth cycle, the challenge is to improve the ability of the plant to produce under drought conditions. Studies in which irrigation has been given during the reproductive phase indicate that terminal drought usually reduces grain yield of landraces growing in their usual environment (Chauhan et al., 1992). A thorough characterization of the drought environments where pigeonpea is grown has not been adequately done so as to enable proper targeting of drought resistance traits (Johansen, 2001). There has been as yet no concerted breeding effort to enhance drought resistance of this crop due to the allocation of resources to other constraints like development of resistance to an important insect pest, *Helicoverpa armigera*.

### Strategies to combat drought

Drought tolerance in plants is a complex trait and is mediated by many environmental adaptations that may involve many genes (Bohnert et al., 1995). A single strategy cannot confer drought tolerance in these plants. The problem of drought can best be tackled following a holistic approach integrating genetic resistance for drought, matching of genotypes to environments, and cultural methods that lead to better conservation and utilization of soil moisture. Further, efforts involving conventional and biotechnological approaches (see Figure 1) for genetic enhancement can certainly promise to induce and enhance the required drought tolerance in these important crop plants of SAT.

#### Conventional Approaches

##### *a. Agronomic management options*

Various aspects like providing supplementary irrigation, timing, method and intensity of irrigation would effect the yield of the crop (Wright and Nageshwara Rao 1994). Since in legumes the pod filling stage is very sensitive to drought, tackling the crop at such stage with proper care would increase the yield. The pod yield in groundnut can be increased by 13-19% if the crop is irrigated adequately during the pre-flowering phase (Nageshwara Rao et al., 1985b). The adaptive response of groundnut to drought can also be increased by exposing the crop to short duration drought during the vegetative phase which may enhance the root development and reduce transpirational losses by limiting the leaf area development allowing the plant to utilize the soil moisture from the deeper soil profile. This would reduce the impact of the second drought at the seedling stage by carefully selecting the cultivar, manipulating the sowing date, matching the water availability in the soil and intercropping with other

crops can enhance the productivity and can ameliorate the severe effects of drought on groundnut productivity.

In chickpea too similar practices would have a positive impact on the crop productivity. However, being a post rainy crop and more sensitive to drought than groundnut few other simple input management options like improving the plant stand by timely sowing, using the high quality seeds, sowing the seed at soil depths so that it utilizes available soil moisture from the deeper regions of the soil profile, and seed dressing with fungicide which would increase the stability of plant stand per unit area (Saxena, 2001). Generally, sowing is done in surface layers where there is not adequate soil moisture after preparatory land cultivation. Advancing planting dates into autumn instead of traditional spring planting in WANA, and coinciding with late summer rains in south Asia and east Africa with disease tolerant varieties would allow plant to access to additional water concurrent with rainfall. Since the temperatures are low and evaporation is less during that rainy period, the evapotranspirational loss of water is reduced.

##### *b. Plant breeding*

In conjunction with the agronomic management, genetic management options in these crops can prove to be a better long-term strategy to improve the yield and performance of the crop in water limited and drought prone regions. At ICRISAT, genetic management approaches like developing short duration genotypes that can escape end-of-season drought, has resulted in 23% to 411% superior pod yield over the control varieties of groundnut (Nageshwara Rao and Nigam, 2001). Selecting the genotypes based on their fit to the historical weather and soil data of target location can also improve the overall efficiency of the crop. Alternatively genotypes which thrive well under limited moisture conditions show 12% to 144% pod yield superiority (see Nageshwara Rao and Nigam, 2001). Screening groundnut genotypes for better vegetative growth and pod yield under severe end-of-season and mid season drought has been an option. Genotypic variation for deep root system (Ketering 1984; Wright et al., 1991; Wright and Nageshwara Rao 1994), genotypes with lower mean SLA (surface leaf area) which have higher transcription efficiency has also been observed (Nageshwara Rao and Wright, 1994). Another way is to evaluate wild species for physiological traits associated with drought and aflatoxin resistance and identify suitable DNA markers for drought resistance gene[s] for use in inter-specific breeding to develop drought resistant lines (Nageshwara Rao and Nigam, 2001).

Conventional plant breeding with better agricultural management practices described above can promise to improve drought tolerance in the legume crops, however the major draw back of such conventional methods is that the available drought tolerant traits in the natural

system may not be readily amenable for breeding strategies due to species barrier and also the lacking of proper methods and techniques for screening the drought tolerant traits in the segregating populations thus obtained.

### Biotechnological Approaches

Plant biotechnology offers new ideas and techniques applicable to agriculture. It uses the conceptual framework and technical approaches of plant tissue culture and molecular biology to develop commercial processes and products. These techniques enable the selection of successful genotypes, better isolation and cloning of favourable traits, and the creation of transgenic crops of importance to agriculture. This ability has moved agriculture from a resource-based to a science-based industry (Sharma and Ortiz, 2000). Together, these generic techniques are both an extension and an integral part of classical breeding, contributing successfully to shortening breeding and selection cycles (see Sharma et al., 2002). New bio-techniques, in addition to conventional plant breeding, are necessary to boost yields of the crops that feed the world (Borlaug, 1997), thereby contributing to food security by helping to promote sustainable agriculture centered on small-holder farmers in developing countries (Serageldin, 1999; Sharma and Ortiz, 2000). Although more difficult to control and engineer than the usually monogenic traits of resistance to biotic stresses, the genetically complex response to abiotic stress is globally and regionally far more important. Judicious application of biotechnological tools holds great potential in alleviating some of the major constraints to productivity of crops grown in the SAT. Schematic representation of the application of tools of biotechnology to address complex issues in agriculture such as drought stress is shown in Figure 1.

#### a. Molecular markers and marker-assisted selection

Many of the agronomic traits in plants are quantitative in nature. The process of domestication and selection have resulted in a drastic narrowing of the genetic variation of crop species (Tanksley and McCouch, 1997). The genetic/ physiology interaction provides a potential means of identifying candidate genes/ mechanisms (Forster et al., 2000). It is possible to identify and map the factors controlling characters as intransigent as yield (Thoday, 1961). Few loci in crops and their allelic forms account for a significant genetic variation in traits. Such loci can be mapped using molecular markers based on random amplified polymorphic DNA (RAPD), restriction fragment length polymorphism (RFLP), amplified fragment length polymorphism (AFLP), DNA amplification polymorphism (DAF), sequence characterized amplified

regions (SCAR's), sequence-tagged sites (STS), expressed sequence tags (EST's), and amplicon length polymorphisms (ALPs) as long as polymorphism is observed in the segregating populations, the molecular marker is tightly linked to the trait of interest, and the phenotypic information on the population is available. Molecular markers have several advantages over the traditional phenotypic markers that were previously available to plant breeders. They offer great scope for improving the efficiency of conventional plant breeding by carrying out selection not directly on the trait of interest but on molecular markers linked to that trait. Moreover, these markers are not environmentally regulated and are, therefore, unaffected by the conditions in which the plants are grown and are detectable in all stages of plant growth (Mohan et al., 1997).

Although polymorphic variation in DNA has been detected in groundnut germplasm, the levels of genetic polymorphism have been very low (Bhagwat et al., 1997; He and Prakash, 1997; Hopkins et al., 1999; Subramanian et al., 2000). However, abundant polymorphism has been detected between related wild species in the section *Arachis* (Halward et al., 1991, 1992; Lanham et al., 1992; Paik-Ro et al., 1992). The information on biochemical and molecular basis for variation among the genotypes for drought resistance is very limited (Nageshwara Rao, et al., 1995). More recently, 43 drought-responsive mRNA transcripts (peanut transcripts responsive to drought; PTRD) that are up- or down-regulated following water stress have been identified in *Arachis hypogaea* (Jain et al., 2001). Amongst these 12 PTRD were completely suppressed due to prolonged drought while two were down-regulated, and two were up-regulated. Once the information is known, linkages can be developed between the drought resistance traits and the molecular markers to deploy the molecular tools to accelerate the plant breeding process for drought tolerant varieties.

The progress in genetic enhancement of chickpea and pigeonpea for drought tolerance is expected to progress faster with MAS for drought tolerance traits that would enhance the efficiency of breeding for this complex trait. According to Saxena (2001), the drought tolerant chickpea varieties already developed at ICRISAT and the segregating populations available for drought tolerant traits could be used to initiate such programs and build upon the information and material already available. However, genetic analysis particularly of quantitative traits associated with abiotic stress tolerance have associated errors. The detection of the loci involved is based on the probabilities and can be crude (Hay and Ellis, 1998), with different results in different environments. This approach may be limited to a few selective traits considering the practical difficulties involved in developing these genetic

markers for a given physiological trait and also the limitations associated with generating large numbers of early segregating materials to get a desired level of recombination if one has to handle several traits simultaneously in a breeding programme (Marshall, 1991; Subbarao et al., 1995). The application of molecular markers can promise more rigor when both the genetic and physiological analyses point to the same gene function, allowing greater confidence in identifying a candidate gene (Forster et al., 2000).

#### *b. Transgenic technology and genes for drought tolerance*

Genetic transformation provides a complementary means for the genetic betterment of the genome of field crops thus promising for alleviating some of the major constraints to crop productivity in developing countries (Sharma and Ortiz, 2000). The technology required for engineering transgenic plants is considerably more sophisticated than that required for production of hybrid plants by cross-fertilization (Goodman et al., 1987; Kung, 1993; Birch, 1997). Novel genes can be accessed from exotic sources-plants, animals, bacterial, even viral and introduced into a crop either physically through biolistics or by using binary vectors based in *Agrobacterium tumefaciens*. Further, it is possible to control the timing, tissue-specificity, and expression level of transferred genes for their optimal function. There are several traits whose correlative association with resistance has been tested in transgenic plants. The results of transgenic modifications of biosynthetic and metabolic pathways indicate that higher stress tolerance can be achieved by engineering, that tolerance is only marginally increased by the transfer of a single trait, and that multiple mechanisms to engineer water stress tolerance must be utilized (Bohnert et al., 1995).

Crops can be tailored to tolerate stress if only one knows the amount of damage that occurs to the plant at the physiological and cellular level. The physiological response to stress usually arises out of change in the cellular gene expression (Nanjo et al., 1999a). As a result changes in the integrity of the cellular membrane, imbalance in the homeostatic conditions and finally decline in the growth or death of the plant are usually noticed (Zhu, 2001). Such alteration in the gene expression is always involved in preparing the plant to thrive under stress. The distribution and occurrence of naturally stress-adapted plants in many different families like *Hydrilla verticillata*, *Najas indica*, *Najas graminia* belonging to submerged macrophytes (Rout and Shaw, 2001), the occurrence of stress-tolerant relatives in many glycophytic species like *Arabidopsis thaliana* (Zhu, 2001), and the occurrence of genetic variability in stress tolerance of crop plants per se makes the mechanisms that control the stress perception and the gene expression after the stress, universal in

plant kingdom (Bohnert et al., 1995).

Certain genes are expressed at elevated levels when a plant encounters stress (Bray, 1993). Hence, several gene transfer approaches have been employed to improve the stress tolerance of plants (Holmberg and Bulow, 1998; see also Fig. 1). These can be a product of single gene or a product of a regulatory gene that activates the whole cascade of other gene products in the plant in response to stress. Genetically engineered plants for single gene products include those encoding for enzymes required for the biosynthesis of osmoprotectants (Tarczynski et al., 1993; Kavikishore et al., 1995; Hayashi et al., 1997), or modifying membrane lipids (Kodama et al., 1994; Ishizaki-Nishizawa et al., 1996), LEA protein (Xu et al., 1996), and detoxification enzyme (McKersie et al., 1996). Similarly, many genes involved in stress response can be simultaneously regulated by using a single gene encoding stress-inducible transcription factor (Kasuga et al., 1999), thus offering possibility of enhancing tolerance towards multiple stresses including drought, salinity, and freezing. In general, very little attention has been given to genetic improvement to cope with intermittent drought (N.P. Saxena personal communication). It is believed that osmoregulation would be the best strategy for this kind of drought, especially if osmoregulatory genes could be triggered in response to drought. Some of the key strategies that have successfully been used in developing transgenic plants with some level of tolerance to abiotic stress are as follows:

**Osmoprotectants:** The maintenance of total water potential during water deficit can be achieved by osmotic adjustment. A reduction in cellular water potential below the external water potential, resulting from a decrease in osmotic potential, allows water to move into the cell. The osmotic potential inside the cell is lowered by the accumulation of osmoprotectants (compatible solutes) in the cytoplasm due to the induction of several genes (Bray et al., 1993). These are highly soluble compounds that carry no net charge at physiological pH and are non-toxic at high concentrations. Chemically, there are three types: betaines and allied compounds, polyols and sugars (e.g., betaines and trehalose), and amino acids such as proline (Pro) (Delauney and Verma, 1993; Stoop et al., 1996; McNeil et al., 1999). The first strategy involved in obtaining stress tolerant transgenic plants is to engineer such genes that encode enzymes for steps in the synthesis of these osmolytes. Various strategies are being pursued to genetically engineer increased osmoprotection in plants. Many osmoprotectants like glycine-betaine (Ishitani et al., 1995; McNeil et al., 2001), proline (Delauney and Verma, 1993; Nanjo et al., 1999a), choline oxidase (Sakamoto et al., 2000), glutamine synthetase (Hoshida et al., 2000), arginine decarboxylase (Roy and Wu, 2001), mannitol,

nonnitrol, fructans, ectoine, and other gene products have been studied which play a role in osmoregulation thereby protecting the membrane and protein complexes (Yang et al., 1996). Although improved stress tolerance has not been achieved when native stress-induced genes are expressed, transgenic tobacco plants expressing a foreign gene leading to mannitol accumulation (Tarczynski et al., 1993) does improve stress tolerance. Free Pro is regarded as having multiple roles in stress tolerance in plants such as mediator of osmotic adjustment (Handa et al., 1986), a stabilizer of subcellular structures (Schobert and Tschesche, 1978), a scavenger of free radicals (Pardha Saradhi et al., 1995), a buffer in cellular redox potential and a major constituent of cell wall structural proteins that may provide mechanical support for cells (Nanjo et al., 1999b).

More recently, a positive correlation between Pro accumulation and stress tolerance in *Arabidopsis thaliana* has been shown by Nanjo et al. (1999a) by using antisense proline dehydrogenase (*AtProDH*). Significant tolerance to drought stress has been observed in potato by using trehalose-6-phosphate synthase (TPS1) gene (Yeo et al., 2000). An improved protection of the photosynthetic apparatus was thought to be associated with the increased stress tolerance due to the introduced expression of *betA* gene that results in the production of glycine-betaine (Holmstrom et al., 2000).

Amongst the several groups of LEA proteins those belonging to the D-7 family are predicted to play a role in the sequestration of ions that are concentrated during cellular dehydration. These proteins have 11-mer amino acid motif with the consensus sequence TAQAAKEKAGE repeated as many as 13-times (Dure, 1993a). The D-19 family LEA proteins are predicted to have enhanced water-binding capacity, while the D-29 family is supposed to sequester ions during water loss. At least 30 different genes have been identified as members of lea group 2 (D-11 family) whose possible functions include a chaperone function or one that preserves protein structure (Dure, 1993b). However, further investigations combining physiological and genetic studies are needed to evaluate the role of water-deficit-induced genes and any adverse metabolic cost associated with osmoprotection.

**Ion-Compartmentalization:** Second strategy involves in protecting the crop against abiotic stress mainly salinity and water stress by regulating the ion uptake and compartmentalization of ions (Adams et al., 1992). These salts have detrimental effects on the biochemical processes of a plant resulting in the osmotic stress. Numerous metabolic changes occur in different salt sensitive plants which are subjected to ionic stress. The  $\text{Na}^+/\text{H}^+$  exchange across the membrane is activated so that  $\text{K}^+$  can be pumped across the cell membrane. Structurally plant cells are well suited for the

sequestration of ions because of the presence of the membrane-bound vacuoles. Many halophytes have a mechanism in them to compartmentalize  $\text{Na}^+$  into vacuoles through a vacuolar  $\text{Na}^+/\text{H}^+$  antiport. Such vacuolar  $\text{Na}^+/\text{H}^+$  antiport activity was first reported in tonoplast vesicles from red beet storage tissue (Blumwald and Poole, 1985), and also in various halophytes and salt tolerant glycophytic species (Barkla and Pantoja, 1996). In *Arabidopsis* a vacuolar chloride channel, *AtCLC*d gene was cloned which involves in cation detoxification and more recently in *Arabidopsis* *AtNHX1* gene which is homologous to *Nhx1* gene in yeast has been cloned and over expressed in *Arabidopsis* which confers salt tolerance by compartmentalizing the  $\text{Na}^+$  ions in the vacuoles. SOS1 (Salt Overly Sensitive 1) locus is one such locus in *Arabidopsis thaliana* which is similar to plasma membrane  $\text{Na}^+/\text{H}^+$  antiport from bacteria and fungi and encodes a putative  $\text{Na}^+/\text{H}^+$  antiporter that was cloned and over expressed using a CAMV35S promoter. *SOS1* gene expression in plants was up-regulated in response to salt tolerance (Shi et al., 2000).

**Regulatory genes:** Abiotic stress is a broad term which includes multiple stresses like heat, chilling, excessive light, drought, wounding, ozone exposure, UV-B irradiation, osmotic shock, where various cellular functions are disturbed. In order to restore the cellular function and make plant more tolerant to stress, transferring of a single gene encoding a single specific stress protein may not possibly show the required tolerance levels. To overcome such constraint enhancing tolerance towards multiple stress by a gene encoding a stress inducible cis-acting or trans-acting transcription factors that regulate a number of genes down stream or upstream of it thus activating a cascade of genes that act together in enhancing the tolerance towards the multiple stresses will prove to be a promising technology (Yamaguchi-Shinozaki et al., 1994; Kasuga et al., 1999). Both DREB1A cDNA and the *rd29A* promoter can be used to improve the dehydration, salt, and freezing tolerance of crops by gene transfer (Kasuga et al., 1999). Many genes respond to multiple stresses like dehydration and low temperature at the transcriptional level are also induced by ABA (Mundy and Chua, 1998) which protect the cell from dehydration. (Dure et al., 1989; Skriver and Mundy, 1990). Dehydration appears to trigger the production of ABA, which in turn induces expression of various genes (Ingram and Bartels, 1996; Shinozaki and Yamaguchi-Shinozaki, 1997). Transcription factors acting both *cis* as well as *trans* have been analyzed and a conserved sequence PyACGTGGC has been reported to function as ABA-responsive element (ABRE) (Marcotte et al., 1989). Genes which respond to these transcription factors or elements mostly have a basic domain and a leucine zipper structure (Guiltingan et al.,

1990; Oeda et al., 1991). Transgenic tobacco thus obtained by transferring the tetramer of a synthetic element conferred enhanced response to water stress (Lam and Chua, 1991).

There are other cis acting elements or factors of genes that have ABA independent expression (Yamaguchi-Shinozaki et al., 1992). A cis-acting element designated as dehydration responsive element (DRE) having the sequence TACCGACAT is known to be involved in ABA-independent gene expression under drought, high salt, and low temperature conditions in many dehydration responsive genes like *rd29A* that is responsible for dehydration- and cold-induced expression. The cDNAs encoding the DRE-binding proteins, DREB1A and DREB2A, have been isolated and the proteins shown to specifically bind and activate transcription of genes (*rd29A*) containing the DRE sequence in *Arabidopsis* (Liu et al., 1998). For detail discussion on these regulatory genes and sequences see chapter by Shinozaki-Yamaguchi et al. in this report. Transforming such drought responsive elements and transcription factors such as DREB1A cDNA and *rd29A* promoter into crops like groundnut and chickpea using genetic transformation either by *Agrobacterium*-mediated transformation or by using a Biolistic approach, can be an effective strategy for the development of crops having improved tolerance to abiotic stress.

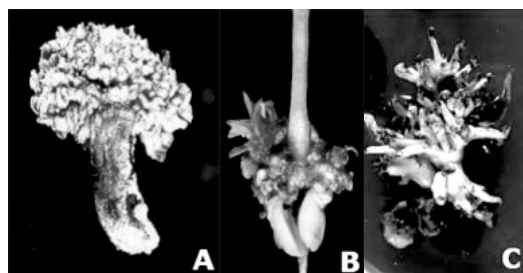
### Current Status of legume transgenics at ICRISAT

Genetic engineering of plants makes it feasible to transfer genes from totally unrelated organisms thus breaking the species barrier which is otherwise not possible by conventional plant breeding. Gene transfer technologies have widened the scope for agriculture in modifying the crops to increase the yield, to impart resistance against various diseases, increase the nutritional content, and enhance resistance against drought. The application of this technology for the improvement of important crops of the SAT has been shown to hold great potential (Sharma and Ortiz, 2000). However, for the successful genetic modification by the production of transgenic plants, effective regeneration and transformation systems are imperative. Transformation of crops involves the stable introduction of DNA sequences into the nuclear genome of cells capable of giving rise to a whole transformed plant (Sharma and Ortiz, 2000). At ICRISAT, these barriers have recently been overcome and efficient transformation and regeneration of transgenic plants of the mandate legumes including groundnut, pigeonpea and chickpea is now routinely possible for various biotic and abiotic constraints (Sharma, 1999; Sharma and Anjaiah, 2000a,b).

**Groundnut:** The method for genetic transformation of groundnut (Sharma and Anjaiah, 2000b) reported from ICRISAT is a significant improvement over the previously reported results where at least 55% of the treated explants resulted in one or more independently transformed shoots. Multiple shoots originating from a single explant (Fig. 2A) showed different integration patterns suggesting that the transformation frequency in fact is higher. The transformation procedure utilizing cotyledon explants is highly susceptible to *Agrobacterium*-mediated gene transfer, and also displays very high regeneration rates across a wide range of *Arachis hypogaea* varieties of both Spanish and Virginia type peanuts. A key feature of this procedure is the regenerability of the cells wounded during excision of the cotyledons at the time of culture initiation and *Agro*-infection, and these cells being mainly surface cells are readily accessible to the *Agrobacterium*. Shoot regeneration in this system is quite rapid and prolific, and a large proportion (>98%) of these shoots develop into phenotypically normal fertile plants where the transgene function is normal at transcriptional and translational levels. This system has been successfully utilized for the introduction of several genes such as those encoding for viral coat protein of Indian peanut clump virus (IPCV) and groundnut rosette assistor virus (GRAV), replicase of IPCV, *Bt CryIA(b)*, and chitinase from rice. A new initiative with JIRCAS is being developed to utilize their constructs (*rd29A:DREB1A*) carrying DRE of *Arabidopsis* into *Arachis* for inducing drought resistance in groundnut. Putative transformants obtained in *Agrobacterium*-mediated transformation are being characterized for presence and expression of the introduced genes. The confirmed transgenic groundnut plants will be characterized for their phenotype and physiologically under normal and drought stress conditions to study their drought tolerance potential. The drought tolerance trait can eventually be transferred to selected genotypes with specific adaptations by conventional plant breeding by using the introduced genes as molecular markers. This protocol provides a transformation scheme that allows cost-effective, routine, and highly reproducible use of peanut transformation as part of both basic and applied studies in gene expression, transgenics, and functional genomics.

**Pigeonpea:** Efficient systems for the tissue culture regeneration of pigeonpea have been developed by using the axillary tissue (Fig. 2B; Sharma and Anjaiah, 2000a) and leaflet explants (Dayal and Sharma, unpublished results). A transformation protocol for pigeonpea to incorporate novel genes is in the final stages of development. A large number of putative transformants of pigeonpea have been successfully transferred to glasshouse and preliminary evidence suggests the presence of introduced genes like *Bt Cry IA(b)*, soybean trypsin inhibitor (*SBTI*), and rice





**Fig. 2A-C.** Tissue culture systems in legumes for use in developing abiotic stress tolerance. A. Regeneration of multiple shoots from cotyledon explants of *Arachis hypogaea*; B. Regeneration of multiple shoots from axillary meristems of *Cajanus cajan*; C. Regeneration of multiple shoots from axillary meristem explants of *Cicer arietinum*.

chitinase. Insect bioassays with tobacco transgenics having insecticidal genes have shown the potential of the available *Bt CryIA(b)* and *SBTI* genes for insect control. Further work on developing resistance to fungal pathogens of pigeonpea is ongoing. These systems can be effectively used for developing drought resistant transgenics by employing the several strategies listed above.

**Chickpea:** A tissue culture system for chickpea has been optimized by using the embryo axis explants that produce multiple shoots (Fig. 2C). The axillary meristem tissues from embryo axis explants have been optimized to obtain a high frequency of shoots. Successful rooting and transplantation of these shoots is now possible with over 90% success rates. Putative transformants containing *Bt Cry IA(b)* and (*SBTI*) genes have been obtained. Recently, this system is being employed to introduce genes for abiotic stress tolerance such as *codA* (Alia et al., 1999), *P5CSF:129A*, (Kavi Kishore et al., 1995), *mtld* (Tarczynski et al., 1993) and *annexin* (Gidrol et al., 1996). The putative transgenics are being analyzed at the molecular level.

## Summary

Significant progress has been made in the field of agriculture to successfully enhance the drought tolerance in various plants using several strategies. The discovery of genes involved in osmoregulation, ion compartmentalization, and regulatory elements that are responsive to drought have opened up new avenues for developing crop plants with enhanced drought tolerance. Further research must be carried out in finding out the availability of stress responsive genes and transcripts in groundnut and chickpea and their expression under different environmental conditions. Wild species, due to their better adaptability offer unique opportunities for identifying and cloning new

genes and promoters that can be employed for developing stress tolerance by using an integrated approach as outlined in Figure 1. Gains in crop productivity through research advances in genetic enhancement will help to achieve sustainable food security, poverty alleviation, and environmental protection in the SAT. ICRISAT has a commitment to transfer the benefits of plant biotechnology to the developing world, as genes relevant to their crops and environment become available. Therefore, the research in transgenic crops offers a new means to achieve ICRISAT's mission, i.e., applying science to improve agriculture in areas of the world where sub-optimal rainfall and biotic stresses are the major constraints to crop productivity.

## Acknowledgements

We thank Dr. N.P. Saxena for his valuable comments and suggestions on the manuscript, and Dr. Masaru Ivanaga for his encouragement on the research related to groundnut transgenics for drought tolerance. The financial assistance from Indo-Swiss Collaboration in Biotechnology (ISCB) on work related to chickpea is gratefully acknowledged.

## References

- Adams, P., Vernon, D.M., Thomas, J.C., Bohnert, H.J., and Jensen, R.G., 1992. Distinct cellular and organismic responses to salt stress. *Plant Cell Physiol.*, 33: 1215-1223.
- Alia., Kondo, Y., Sakamoto, A., Nonaka, H., Hayashi, H., Pardhasaradhi, P., Tony H.H. Chen and Norio.M., 1999. Enhanced tolerance to light stress of transgenic *Arabidopsis* plants that express the *coaA* gene for a bacterial choline oxidase. *Plant Mol. Biol.*, 40: 279-288.
- Barkla, B.J and Pantoja, O., 1996. Physiology of ion transport across the tonoplast of higher plants. *Annu. Rev. Plant Physiol. Plant Mol. Biol.*, 47: 159-184.
- Bhagwat, A., Krishna, T.G. and Bhatia, C.R., 1997. RAPD analysis of induced mutants of groundnut (*A. hypogaea* L.). *J. Genet.*, 76: 201-208.
- Birch, R.G., 1997. Plant transformation: problems and strategies for practical application. *Annu. Rev. Plant Physiol. Mol. Biol.*, 48: 297-326.
- Blum, A., 1985. Crop varieties for stress environments. *CRC Crit. Rev. Plant Sci.*, 2: 199-238.
- Blumwald, E. and Poole, R.J., 1985.  $\text{Na}^+ / \text{H}^+$  antiport in isolated tonoplast vesicles from storage tissue of *Beta vulgaris*. *Plant Physiol.*, 78: 163-167.
- Bohnert, H.J. and Jensen, R.G., 1996. Strategies for engineering water stress tolerance in plants. *Trends Biotechnol.*, 14: 89-97.
- Bohnert, H.J. and Shen, B., 1999. Transformation and

- compatible solutes. *Sci. Hort.*, 78: 237-260.
- Bohnert, H.J., Nelson, D.E., Jensen, R.G., 1995. Adaptations to environmental stresses. *Plant Cell*, 7: 1099-1111.
- Borlaug, N.E., 1997. Feeding a world of 10 million people: The miracle ahead. *Plant Tiss. Cult. Biotech.*, 3:119-127.
- Boyer, J.S., 1996. Advances in drought tolerance in plants. *Adv. Agron.*, 56: 187-218.
- Boyer, J.S., 1982. Plant productivity and environments. *Science*, 218: 443-447.
- Bray, E.A., 1993. Molecular responses to water deficit. *Plant Physiol.*, 103: 1035-1040.
- Chauhan, Y.S., Saxena, N.P. and Johansen, C., 1992. Abiotic factors limiting chickpea and pigeonpea production. In: J.N. Sachan (ed.), *Proc. Natl. Symp. on New frontiers in Pulses Research and Development*, 10-12 November, 1989, Directorate of Pulses Research, Kanpur, India, pp. 111-123.
- Delauney, A.J. and Verma, D.P.S., 1993. Proline biosynthesis and osmoregulation in plants. *Plant J.*, 4: 215-223.
- Dure, L. III, 1993a. A repeating 11-mer amino acid motif and plant desiccation. *Plant J.*, 3: 363-369.
- Dure, L. III, 1993b. Structural motifs in Lea proteins. In: T.J. Close and E.A. Bray (eds), *Plant responses to cellular dehydration during environmental stress. Current Topics in Plant Physiology*, Vol. 100. American Society of plant Physiologists, Rockville, MD, U.S.A., pp. 91-103.
- Dure, L., III, Crouch, M., Harada, J., Ho., T.-h. D., Mundy, J., Quatrano, R., Thomas, T., and Sung, Z.R., 1989. Common amino acid sequence domains among the LEA proteins of higher plants. *Plant Mol. Biol.*, 12: 475-486.
- Edmeades, G.O., Bolanos, J., Banziger, M., Ribaut, J.M., White, J.W., Reynolds, M.P. and Lafitte, H.R., 1996. Improving crop yields under water deficits in the tropics. *Proc. 2nd Intl. Crop Sci. Congress on crop productivity and Sustainability-Shaping the future*, pp. 437-451.
- FAO (Food and Agriculture Organization of the United Nations) 1999. *FAO Production year book 1998*. Rome, Italy: FAO.
- Forster, B.P., Ellis, R.P., Thomas, W.T.B., Newton, A.C., Tuberosa, R., This, D., El-Enein, R.A., Bahri, M.H and Ben Salem, M., 2000. The development and application of molecular markers for abiotic stress tolerance in barley. *J. Exp. Bot.*, 51: 19-27.
- Freeman, H.A., Nigam, S.N., Kelly, T.G., N'tare, B.R., Subrahmanyam, P. and Boughton, D., 1999. The world groundnut economy: facts, trends, and outlook. *International Crops research Institute for the Semi-Arid Tropics: Patancheru, Andhra Pradesh 502 324, India*, p. 52.
- Gidrol, X., Sabelli, P.A., Fern, Y.S. and Kush, A.K., 1996. Annexin-like protein from *Arabidopsis thaliana* rescue  $\Delta$ oxyR mutant of *Escherichia coli* from H₂O₂ stress. *Proc. Natl. Acad. Sci. USA*, 93: 11268-11273.
- Goodman, R.M., Hauptli, H. and Crossway, A. et al., 1987. Gene transfer in crop improvement. *Science*, 236: 48-54.
- Guiltinan, M.J., Marcote, W.R., and Quatrano, R.S., 1990. A plant leucine zipper protein that recognizes an abscisic acid response element. *Plant Physiol.*, 93: 267-271.
- Halward, T.M., Stalker, H.T., LaRue, E. and Kochert, G., 1991. Genetic variation detectable with molecular markers among unadapted germplasm resources of cultivated peanut and related wild peanut species. *Genome*, 34: 1013-1020.
- Halward, T.M., Stalker, T., Larue, E. and Kochert, G., 1992. Use of single-primer DNA amplifications in genetic studies of peanut (*Arachis hypogaea* L.). *Plant Mol. Biol.*, 18: 315-325.
- Handa, S., Handa, A.K., Hasegawa, P.M. and Bressan, R.A., 1986. Proline accumulation and the adaptation of cultured plant cells to water stress. *Plant Physiol.*, 80: 938-945.
- Hanson, A.D. and Burnet, M., 1994. Evolution and metabolic engineering of osmoprotectant accumulation in higher plants. In: J.H. Cherry (ed.), *Biochemical and cellular mechanism of stress tolerance in plants*. Springer-Verlag, Berlin, pp. 105-124.
- Hay, R.K.M. and Ellis, R.P., 1998. The control of flowering in wheat and barley: what recent advances in molecular genetics reveal. *Ann. Bot.*, 82: 541-554.
- Hayashi, H., Mustardy, L., Deshniun, P., Ida, M and Murata, N., 1997. Transformation of *Arabidopsis thaliana* with the *codA* gene for choline oxidase: accumulation of glycine-betaine and enhanced tolerance to salt and cold stress. *Plant J.*, 12: 133-142.
- He, G. and Prakash, C.S., 1997. Identification of polymorphic DNA markers in cultivated peanut (*Arachis hypogaea* L.). *Euphytica*, 97: 143-149.
- Holmber, N. and Bulow, L., 1998. Improving stress tolerance in plants by gene transfer. *Trends Plant Sci.*, 3: 61-66.
- Holmstrom, K.O., Somersalo, S., Mandal, A., Palva, T.E. and Welin, B., 2000. Improved tolerance to salinity and low temperature in transgenic tobacco producing glycine betaine. *J. Exp. Bot.*, 51: 177-185.
- Hopkins, M.S., Casa, A.M., Wang, T., Michell, S.E., Dean, R.E., Kochert, G.D. and Kresovich, S., 1999. Discovery and characterization of polymorphic simple sequence repeats (SSRs) in peanut. *Crop Sci.*, 39: 1243-1247.
- Hoshida, H., Tanaka, Y., Hibino, T., Hayashi, Y., Tanaka, A., Tanaka, T., Takabe, T., 2000. Enhanced tolerance to salt stress in transgenic rice that overexpress chloroplast glutamine synthetase. *Plant Mol Biol.*, 43: 103-111.
- Ingram, J. and Bartels, D., 1996. The molecular basis of dehydration tolerance in plants. *Annu. Rev. Plant Physiol. Mol. Biol.*, 47: 377-403.
- Ishitani, M., Nakamura, T., Hans, S.Y., Takabe, T., 1995. Expression of betaine aldehyde dehydrogenase gene in barley in response to osmotic stress and abscisic acid. *Plant Mol. Biol.*, 27: 307- 315.
- Ishizaki-Nishizawa, O., Fujii, T., Azume, M., Sekiguchi, K., Murata, N., Ohtani, T. and Toguri, T., 1996. Low temperature resistance of higher plants is significantly enhanced by a nonspecific cyanobacterial desaturase. *Nat. Biotechnol.*, 14: 1003-1006.
- Jain, A.K., Basha, S.M. and Holbrook, C.C., 2001. Identification of drought-responsive transcripts in peanut (*Arachis hypogaea* L.). *Electronic J. Biotech. Vol. 4* [<http://www.ejb.org/content/vol4/issue2/full/2/index.html>]

- Johansen, C., 2001. An overview of prospects for genetic enhancement of drought resistance in pigeonpea. In: N.P. Saxena (ed.), Management of Agricultural Drought - Agronomic and Genetic Options. Oxford & IBH Publishing Co. Pvt. Ltd.: New Delhi. (in press).
- Johansen, C. and Nigam, S.N., 1994. Importance of drought stress and its alleviation in legumes. *Crop Sci.*, 24: 17-19.
- Johansen, C., Baldev, B., Brouwer, J.B., Erskine, W., Jermyn, W.A., Lang L.J., Maik, B.A., Ahad Miah, A. and Silim, S.N., 1993. Biotic and abiotic stresses constraining productivity of cool season food legumes in Asia, Africa, and Oceania. In: F.J. Mehbauer and W.J. Kaiser (eds), Proc. Intl. Food Legumes Research Conference II, 12-16 April, 1992, Kluwer: Dordrecht.
- Kasuga, M., Liu, Q., Miura, S., Yamaguchi-Shinozaki, K. and Shinozaki, K., 1999. Improving plant drought, salt, and freezing tolerance by gene transfer of a single stress-inducible transcription factor. *Nat. Biotechnol.*, 17: 287-291.
- Kavi Kishore, P.B., Hong, Z., Miao, G.-U., Hu, C.-A.H. and Verma, D.P.S., 1995. Overexpression of  $\Delta^1$ -pyrroline-5-carboxylate synthase increases proline production and confers osmotolerance in transgenic plants. *Plant Physiol.*, 108: 1387-1394.
- Ketering, D.L., 1984. Root Diversity among peanut genotypes. *Crop Sci.*, 24: 229-232.
- Kodama, H., Hamada, T., Horiguchi, G., Nishimura, M. and Iba, K., 1994. Genetic enhancement of cold tolerance by expression of a gene for chloroplast  $\Omega$ -3 fatty acid desaturase in transgenic tobacco. *Plant Physiol.*, 105: 601-605.
- Kramer, P. J., 1980. The role of physiology in crop improvement. In: R.C. Staples and R.J. Kuhr (eds), Linking Research to Crop Production, Plenum Press, New York, pp. 51-62.
- Kung, S.D., 1993. Introduction: from hybrid plants to transgenic plants. In: S.D. Kung and R. Wu (eds), Transgenic plants, engineering and utilization, vol. 1. Academic Press: San Diego, U.S.A., pp. 1-12.
- Kumar Rao, J.V.D.K., Johansen, C. and Rego, T.J., 1998. Concluding remarks. In: J.D.V.K. Kumar Rao, C. Johansen, T.J. and Rego (eds), Residual effects of legumes in rice and wheat cropping systems of the Indo-Gangetic plain. Oxford & IBH Publ. Co.: New Delhi, pp. 237-240.
- Lanham, P.G., Fennell, S., Moss, J.P. and Powell, W., 1992. Detection of polymorphic loci in *Arachis* germplasm using random amplified polymorphic DNAs. *Genome*, 35: 885-889.
- Lam, E., and Chua, N-H., 1991. Tetramer of a 21-base pair synthetic element confers seed expression and transcriptional enhancement in response to water stress and abscisic acid. *J. Biol. Chem.*, 266: 17131-17135.
- Lawn, R.J and Troedson, R.J., 1990. Pigeonpea: Physiology and yield formation. CAB International: Wallingford, U.K., pp. 179-208.
- Liu, Q., Kasuga, M., Sakuma, Y., Abe, H., Miura, S., Yamaguchi-Shinozaki, K. and Shinozaki, K., 1998. Two transcription factors, DREB1 and DREB2, with an EREBP/AP2 DNA binding domain separate two cellular signal transduction pathways in drought- and low-temperature-responsive gene expression, respectively, in *Arabidopsis*. *Plant Cell*, 10: 1391-1406.
- Ludlow, M.M., 1993. Physiological mechanisms of drought resistance. In: T.J. Mabry, H.T. Nguyen, R.A. Dixon and M.S. Bonness (eds.), Biotechnology for arid land plants. IC² Institute, The University of Texas at Austin, USA, pp. 11-34.
- Marcotte, W.R., Jr., Russel, S.H., and Quatrano, R.S., 1989. Abscisic acid-response sequences from the *Em* gene of wheat. *Plant Cell*, 1: 969-976.
- Marshall, D.R., 1991. Alternative approaches and perspectives in breeding for higher yields. *Field Crops Res.*, 26: 171-190.
- Mckersie, B.D., Bowley, S.R., Harjanto, E. and Leprince, O., 1996. Water deficit tolerance and field performance of transgenic alfalfa overexpressing superoxide dismutase. *Plant Physiol.*, 111: 1177-1181.
- McNeil, S.D., Nuccio, M.L. and Hanson, A.D., 1999. Betaines and related osmoprotectants. Targets for metabolic engineering of stress resistance. *Plant Physiol.*, 120: 945-949.
- McNeil, S.D., Nuccio, M.L., Ziemak, M.J. and Hanson, A.D., 2001. Enhanced synthesis of choline and glycine betaine in transgenic tobacco plants that overexpress phosphoethanolamine N-methyltransferase. *Proc. Natl. Acad. Sci. USA*, 98: 10001-10005.
- Mohan, M., Nair, S., Bhagwat, A., Krishna, T.G., Yano, M., Bhatia, C.R. and Sasaki, T., 1997. Genome mapping, molecular markers and marker-assisted selection in crop plants. *Mol. Breed.*, 3: 87-103.
- Mundy, J., and Chua, N.H., 1998. Abscisic acid and water stress induce the expression of novel rice gene. *EMBO J.*, 7: 2279-2286.
- Nageshwara Rao, R.C. and Nigam, S.N., 2001. Genetic options for drought management in groundnut. In: N.P. Saxena (ed.), Management of Agricultural Drought - Agronomic and Genetic Options. Oxford & IBH Publishing Co. Pvt. Ltd.: New Delhi. (in press).
- Nageshwara Rao, R.C., Singh, S., Sivakumar, M.V.K., Srivastava, K.L., and Williams, J.H., 1985a. Effect of water deficit at different growth phases of peanut. I. Yield responses. *Agron. J.*, 77, 782-786.
- Nageshwara Rao, R.C., Singh, S., Sivakumar, M.V.K., Srivastava, K.L., and Williams, J.H., 1985b. Effect of water deficit at different growth phases of peanut. II. Response to drought during pre-flowering phase. *Agron. J.*, 80, 431-438.
- Nageshwara Rao, R.C., and Wright, G.C., 1994. Stability of the relationship between specific leaf area and carbon isotope discrimination across environments in peanut. *Crop Sci.*, 34: 98-103.
- Nageshwara Rao, R.C., Udayakumar, M., Farquhar, G.D., Talwar, H.S., and Prasad, T.G., 1995. Variation in carbon isotope discrimination and its relationship to specific leaf area and ribulose-1, 5 bisphosphate carboxylase content in groundnut genotypes. *Aust. J. Plant Physiol.*, 22: 545- 551.

- Nam, N.H., Chauhan, Y.S. and Johansen, C., 1993. Comparison of extra-short duration pigeonpea with short-season legumes under rainfed conditions on Alfisols. *Exp. Agri.*, 29: 307-316.
- Nam, N.H., Chauhan, Y.S. and Johansen, C., 2000. Effects of timing of drought stress on extra-short duration pigeonpea. *J. Agric. Sci., Cambridge*, (in press).
- Nanjo, T., Kobayashi, M., Yoshiba, Y., Kakubari, Y., Yamaguchi-Shinozaki, K. and Shinozaki, K., 1999a. Antisense suppression of proline degradation improves tolerance to freezing and salinity in *Arabidopsis thaliana*. *FEBS Lett.*, 461: 205-210.
- Nanjo, T., Kobayashi, M., Yoshiba, Y., Sanada, Y., Wada, K., Tsukaya, H., Kakubari, Y., Yamaguchi-Shinozaki, K. and Shinozaki, K., 1999b. Biological functions of proline in morphogenesis and osmotolerance revealed in antisense transgenic *Arabidopsis thaliana*. *Plant J.*, 18: 185-193.
- Nene, Y.L., and Sheila, V.K., 1990. Pigeonpea: Geography and Importance. In: Y.L Nene, S.D. Hall and V.K. Sheila (eds), *The Pigeonpea*. CAB Intl: Wallingford, U.K., pp. 1-14.
- Nguyen, H.T., Babu, R.C. and Blum, A., 1997. Breeding for drought resistance in rice: physiology and molecular genetics considerations. *Crop. Sci.*, 37: 1426-1434.
- Oeda, K., Salinas, J., and Chua, N.-H., 1991. A Tobacco bZip transcription activator (TAF-1) binds to a G-box-like motif conserved in plant genes. *EMBO J.*, 10: 1793-1802.
- Paik-Ro, O.G., Smith, R.L. and Knauff, D.A., 1992. Restriction fragment length polymorphism evaluation of six peanut species within the *Arachis* section. *Theor. Appl. Genet.*, 84: 201-208.
- Pardha Saradhi, P., Alia, Arora, S. and Prasad, K.V.S.K., 1995. Proline accumulates in plants exposed to UV radiation and protects them against UV induced peroxidation. *Biochem. Biophys. Res. Commun.*, 201: 1-5.
- Peng, Z., Lu, Q., Verma, D.P., 1996. Reciprocal regulation of delta1-pyrroline-5-carboxylate synthetase and proline dehydrogenase genes controls proline levels during and after osmotic stress in plants. *Mol. Gen. Genet.*, 253: 334-341.
- Pilon-Smits, E.A.H., Ebskamp, M.J.M., Paul, M.J., Jeuken, J.W., Weisbeek, and Smeekens, S.C.M., 1995. Improved performance of transgenic fructan-accumulating tobacco under drought stress. *Plant Physiol.*, 107: 125-130.
- Ribaut, J.M., Hosington, D.A., Deitech, J.A., Jiang, C. and Gonzalez-de-Leon, D., 1996. Identification of quantitative trait loci under drought conditions in tropical maize. 1. Flowering parameters and the anthesis-silking interval. *Theor. Appl. Genet.*, 92: 905-914.
- Ribaut, J.M., Jiang, C., Gonzalez-de-Leon, D., Edmeades, G.O. and Hosington, D.A., 1997. Identification of quantitative trait loci under drought conditions in tropical maize. 2. Yield components and marker-assisted selection strategies. *Theor. Appl. Genet.*, 94: 887-896.
- Rout, N.P. and Shaw, B.P., 2001. Salt tolerance in aquatic macrophytes: Possible involvement of the anti oxidative enzymes. *Plant Sci.*, 160: 415-423.
- Roy, M. and Wu, R., 2001. Arginine decarboxylase transgene expression and analysis of environmental stress tolerance in transgenic rice. *Plant Sci.*, 160: 869-875.
- Sakamoto, A., Valverde, R., Alia, Chen, T.H., Murata, N., 2000. Transformation of *Arabidopsis* with the *codA* gene for choline oxidase enhances freezing tolerance of plants. *Plant J.*, 22: 449-453.
- Saxena, N.P., 2001. Management of drought in chickpea- a holistic approach. In: N.P. Saxena (ed.), *Management of Agricultural Drought - Agronomic and Genetic Options*. Oxford & IBH Publishing Co. Pvt. Ltd.: New Delhi. (in press).
- Schobert, B. and Tschesche, H., 1978. *Biochim. Biophys. Acta*, 541: 270-277.
- Serageldin, I., 1999. *Biotechnology and Food Security in the 21st century*. *Science*, 285: 387-389.
- Sharma, H.C., Sharma, K.K., Seetharama, N. and Ortiz, R., 2001. Genetic transformation of crop plants: Risks and opportunities for the rural poor. *Curr. Sci.*, 80, 1495-1508.
- Sharma, K.K., 1999. Genetic transformation of groundnut at ICRISAT. [http://www.icrisat.org/text/research/grep/homepage/archives_cd/archives/gtl.htm](http://www.icrisat.org/text/research/grep/homepage/archives_cd/archives/gtl.htm).
- Sharma, K.K. and Anjaiah, V., 2000a. Genetic Transformation of pigeonpea at ICRISAT. [http://198.93.234.24/homepage/archives_cd/archives/gtppatic.htm](http://198.93.234.24/homepage/archives_cd/archives/gtppatic.htm).
- Sharma, K.K. and Anjaiah, V., 2000b. An efficient method for the production of transgenic plants of peanut (*Arachis hypogaea* L.) through *Agrobacterium tumefaciens*-mediated genetic transformation. *Plant Sci.*, 159: 7-19.
- Sharma, K.K. and Ortiz, R., 2000. Program for the application of genetic transformation for crop improvement in the semi-arid tropics: *In Vitro Cell. Dev. Biol.-Plant*, 36: 83-92.
- Sharma, K.K., Sharma, H.C., Seetharama, N. and Ortiz, R., 2002. Development and deployment of transgenic plants: Biosafety considerations. *In Vitro Cell. Dev. Biol.-Plant* 86: 1-11.
- Shi, H., Ishitani, M., Kim, C. and Zhu, J.K., 2000. The *Arabidopsis thaliana* salt tolerance gene *SOS1* encodes a putative Na⁺ / H⁺ antiporter. *Proc. Nat. Acad. Sci. USA*: 97: 6896-6901.
- Shinozaki, K. and Yamaguchi-Shinozaki, K., 1997. Gene expression and signal transduction in water-stress response. *Plant Physiol.*, 115: 327-334.
- Sivamani, E., Bahieldin, A., Wraith, J.M., Al-Niemi, T., Dyer, W.E., Ho, T.H.D., Qu, R., 2000. Improved biomass productivity and water use efficiency under water deficit conditions in transgenic wheat constitutively expressing the barley *HVA1* gene. *Plant Sci.*, 155: 1-9.
- Skriver, K., and Mundy, J., 1990. Gene expression in response to abscisic acid and osmotic stress. *Plant Cell*, 5: 503-512.
- Stoop, J.M.H., Williamson, J.D. and Pharr, D.M., 1996. Mannitol metabolism in plants: a method for coping with stress. *Trends Plant Sci.*, 1: 139-144.
- Subbarao, G.V., Johansen, C., Slinkard, A.E., Nageshwara Rao, R.C., Saxena, N.P. and Chauhan, Y.S., 1995. Strategies for improving drought resistance in grain legumes. *Crit. Rev. Plant Sci.*, 14: 469-523.

- Subramanian, V., Gurtu, S., Nageshwara Rao, R.C and Nigam, S.N., 2000. Identification of DNA polymorphism in cultivated groundnut using random amplified polymorphic DNA (RAPD) assay. *Genome*, 43: 656-660.
- Tanskley, S.D., McCouch, 1997. Seed banks and molecular maps: unlocking genetic potential from the wild. *Science*, 227: 1063-1066.
- Tarczynski, M.C., Jensen, R.G., Bohnert, H.J., 1993. Stress protection of transgenic tobacco by production of osmolyte mannitol. *Science*, 259: 508-510.
- Thoday, J.H., 1961. Location of polygenes. *Nature*, 191: 368-370.
- Udaya Kumar, M., Sheshashayee, M.S., Nataraj, K.N., Bindu Madhava, H., Devendra, R., Aftab Hussain, I.S. and Prasad, T.G., 1998. Why has breeding for WUE not been successful? An analysis and alternate approaches to exploit this trait for crop improvement. *Curr. Sci.*, 74: 996-1000.
- Virmani, S.M. and Singh, P., 1986. Agroclimatological characteristics of the groundnut-growing regions in the semi-arid tropics. *Proceedings of international symposium ICRISAT, INDIA*, 35-46.
- Wright, G.C and Nageshwara Rao, R.C., 1994. Groundnut water relations. In: J. Smart (ed.), *The Groundnut Crop: A scientific basis for improvement*, Chapman & Hall, London, U.K., pp.281- 335.
- Wright, G.C., Hubick, K.T., and Farquhr, G.D., 1991. Physiological analysis of peanut cultivar response to timing and duration of drought stress. *Aust. J. Agric. Res.*, 42: 453-470.
- Xu, D., Duan, X., Wang, B., Hong, B., Ho, T.-H.D. and Wu, R., 1996. Expression of a late embryogenesis abundant protein gene, *HVA1*, from barley confers tolerance to water deficit and salt stress in transgenic rice. *Plant Physiol.*, 110: 249-257.
- Yamaguchi-Shinozaki, K., Koizumi, M., Urao S., and Shinozaki, K., 1992. Molecular cloning and characterization of 9 cDNAs for genes that are responsive to desiccation in *Arabidopsis thaliana*: Sequence analysis of one cDNA clone that encodes a putative trans-membrane channel protein. *Plant Cell Physiol.*, 33: 217-224.
- Yamaguchi-Shinozaki, K., Urao, T., Iwasaki, T., Kiyosue, T. and Shinozaki, K., 1994. Function and regulation of genes that are induced by dehydration stress in *Arabidopsis thaliana*. *JIRCAS J.*, 1: 69-79.
- Yang, G., Rhodes, D. and Joly, R.J., 1996. Effects of high temperature on membrane stability and chlorophyll fluorescence in glycinebetaine-deficient and glycinebetaine-containing maize lines. *Aust. J. Plant Physiol.*, 23: 437-443.
- Yeo, E.T., Kwon, H.B., Han, S.E., Lee, J.T and Byu, M.O., 2000. Genetic engineering of drought resistant potato plants by introduction of the trehalose-6-phosphate synthase (TPS1) gene from *Saccharomyces cerevisiae*. *Mol Cells*, 30: 263-268.
- Zhang, J.X., Nguyen, H.T. and Blum, A., 1999. Genetic analysis of osmotic adjustment in crop plants. *J. Exp. Bot.*, 50: 291-302.
- Zhu, J.K., 2001. Plant salt tolerance. *Trends Plant Sci.*, 6: 66-71.



# Challenges in biotechnology for abiotic stress tolerance on roots and tubers

**Kazuo N. Watanabe**

Gene Research Center & Institute of Biological Sciences, University of Tsukuba,  
1-1-1 Tennoudai, Tsukuba, Ibaraki, 305-8572, Japan

## Abstract

---

Roots and tuber crops such as potato, sweetpotato, cassava, yam and taro, could have a large impact as food, feed and industrial materials with far smaller investment than what have been made to cereals and pulses. Although the social status of these crops are regarded somewhat low, the contribution as staple crops should not be under-estimated to the subsistent farmers and to the production at the marginal lands and/or at a harsh climatic condition.

These root and tuber crops are vegetatively propagated and diverse biological constraints are encumbered with their crop reproductive nature. Furthermore, the crops get damages by series of the environmental stresses during the development of roots or tubers, and also at the storage. The importance of these environmental constraints varies with agroecology and by crop species. Principle environmental stresses of global and ecoregional concerns are drought, excess soil moisture and cold. High soil salinity is the upcoming issue where irrigation is practiced at marginal lands and/or at areas with rapid desertification. Improvement in the storage quality is another important aspect, and keeping moisture and longer dormancy in the storage organs are one of the key subjects for storing the foodstuff and for the wide application to industrial uses.

Progress should yet be expected on transgenic research on root and tuber crops. Many root and tuber crops have not been examined even for feasibility of biotechnology applications for alleviating their pitfalls in production and uses, and challenges should be made in exploiting these regionally important crops and seeking the potential by the biotechnological tools.

*Key words: root and tuber crops, biotechnology, diagnostics, genetic engineering, pathogen-free propagules, environmental stresses*

## Introduction

Root and tuber crops are important staple crops in many developing countries and also important industrial materials in developed nations (CIP 2001; Scott et al. 2000; Wheatley et al. 1995). Examples of the root and tuber crops are potato, sweetpotato, cassava, yam and taro, and many other locally important crop species are present and rather under-utilized (Hermann and Heller 1997; NRC 1989; NRC 1993; Watanabe and Arbizu 1997).

Common biological features of the root and tuber crops such as, would be: 1) vegetatively propagated; 2) genetically heterozygous, 3) outcrossing; 4) polyploids or polyploidization origin; 5) storage parts being underground; and 6) foliage could also be used for food and feed. General breeding objectives are on: 1) resistances against disease, insect and nematode pests,

especially vegetative organ born problems; 2) abiotic tolerances to drought, excess soil moisture, frost and freezing, and salinity; 3) general productivity and earliness. Improvements in the storage and in the processing quality are another important aspects in the root and tuber crops. Particularly keeping moisture without biological and abiotic stresses and longer dormancy in the storage organs are some of the key subjects for storing the food materials and for the wide application to industrial uses. However, this paper should focus on the general issues on the biotechnology application to the root and tuber crops.

Based on the biology of the root and tuber crops, crop protection and improvement for productivity and sustainability should be considered. A diverse range of biotechnology can be applied for the root and tuber crops. The examples are: tissue culture for germplasm

conservation and mass propagation of planting materials; diagnostic tools such as ELISA and NASH for crop health and quarantine, molecular markers for genebank management, cultivar identification and breeding; genetic engineering for alleviating the pitfalls that conventional breeding approaches could not overcome etc.

Major genetic resources on the root and tuber crops are conserved *ex situ* at national or international genebanks such as international agricultural research centers under CGIAR (Consultative group on International Agricultural Research) (NRC 1993). It should be noted that the total number of accessions on these root and tuber crops occupy only 4% of the entire PGR collections under CGIAR, and the figure must support breeding and crop production efforts for around one fifth of world population who mainly depending on the root and tuber crops are their major food and/or cash making materials (CIP 2001). Especially at marginal lands or at regions with harsh cropping conditions, root and tuber crops have far advantages to cereals and pulses as vegetative organs have less damage from the abiotic stresses under such difficult conditions, thus more possibility to provide food materials. Besides the discussion on the biotechnology applications, consideration should be relevantly made on the conservation and uses of the genetic resources on the root and tuber crops.

## Potatoes

The common potato (*Solanum tuberosum*) has been widely grown over the world and it has the fourth place as the important staple crops after rice, maize and wheat. Potatoes are unique over these cereals. The edible parts of cereals are botanical seeds that is specifically endosperms, in contrast, the edible part of the potato is the tuber that is underground stem. Thus its physiology is unique and tuberization and its physiology have been the major topics in potato science (Li 1985). Also due to its vegetative reproductive nature by tubers, potato can be damaged by many different biological stresses (Hooker 1981). Potatoes have many enemies in fields, and over five hundred species of pathogens and pests could infest or damage the crops and a series of environmental stresses such as low temperature at the early growing stage and drought at the tuberization period, could result in nil yield (Harris 1978).

Potatoes are cross-pollinating tetrasomic tetraploid and its genetics is far more complicated than self-pollinating diploid such as rice (Watanabe et al. 1997). Many of the breeding targets on potatoes are quantitatively inherited and gain in one generation of selection even on a single trait, is not efficient by

conventional breeding. Heritability varies among such quantitative traits, however, in general, breeding on multiple traits by phenotype evaluation has been cumbersome and only individual experiences by breeders could handle the pitfalls in making slow progresses, and more subjective and sophisticated methods have been desired to make efficiency in breeding.

Potatoes have approximately two hundred species of wild and cultivated relatives which consists of diploid to hexaploid. These species have been the abundant sources for breeding for biotic and abiotic stresses: important traits found in the wild species include resistance and/or tolerance to major biotic and abiotic stresses such as viruses, viroids, insects, nematodes, fungi, bacteria, heat and frost. However, due to the complication of the tetraploid genetics and quantitative nature of the breeding targets, it has been challenging to use especially the wild species into potato breeding. For example, it took several decades to use a single gene control trait on PVY resistance from a tetraploid species *S. stoloniferum* into potato cultivars (Ross 1986 In Watanabe et al. 1995a). Thus, to cope with the constraints in use of the valuable genetic resources, molecular markers have been studied and gradually employed in germplasm enhancement with potato species (Watanabe and Watanabe 2000).

Since also the most of the cultivated potatoes are tetraploid ( $2n = 4x = 48$ ), while approximately seventy percent of the wild relatives are diploid ( $2n = 2x = 24$ ). Ploidy manipulation is essential to introgress desirable traits from the diploid wild species into the high yielding tetraploid cultivated cultivars. Cell fusion and  $2n$  gametes have been considered as the tools to transfer the valuable traits from the breeding lines at diploids and substantial successes have been demonstrated in the ploidy manipulation for the potato breeding (Bradshaw and Mackay 1994; Watanabe et al. 1995a).

## Adoption of Old Biotechnology

Biotechnological tools have been employed to enhance potato production both in developed and developing countries. Since potatoes are usually propagated as tubers, disease and pest free tubers are important in making high yield and sustainable production. *In vitro* pathogen clean-up process by meristem culture has been established and this has been used widely in many countries. Diagnostic tools also followed after the clean-up processes, and a series of detection methods to viral, bacterial and fungal pathogens, insects, mites and nematodes are available at commercial basis. Among these technologies, NASH (Nucleic acid spot hybridization) method has been applied effectively to eliminate PSTVd (potato spindle tuber viroid) and common viruses such as PVX, PVY and PLRV from the germplasm and seed potatoes. A wide availability of ELISA methods using monoclonal

or polyclonal antibodies also helped monitoring the crop health at field and also a mass scale production of seed potatoes in many developing countries (Watanabe et al. 1995a,b, Watanabe et al. 1997).

Tissue and cell culture system on potato is a model for educational training and industrial applications. Tissue culture derived tubers have been used as the clean nuclear seeds for propagating the production seeds for decades and this accelerated the increasing the yield and cash income in many countries. Even in many developing countries, seed potatoes production by the tissue culture has been conducted, and the technology has been further adapted to small farm-family level: even with a small kitchen and net-house facility in backyard, the seed potatoes are produced in Southeast Asian countries. This is a successful example on low profile biotechnology application and technology acceptance by the endusers. Consequently the recipients of the technology could get cash income and the local community has received benefits (Watanabe et al. 1997).

#### **Genetic Markers for Potato Germplasm Management and Breeding**

Although conventional potato breeding has demonstrably resulted in improving potato crops, there are several key bottlenecks. 1) The most important cultivated potato is a tetraploid with tetrasomic inheritance; thus segregation is more complicated than disomic inheritance, and selection even for simply inherited characters is sometimes laborious and less cost-effective compared with that in diploids. 2) Major breeding targets tend to be quantitatively inherited, for example, resistances to bacterial wilt caused by *Pseudomonas solanacearum*; potato leaf roll virus; potato tuber moth; and root-knot nematodes, as well as tuber quality traits and yield components. 3) "Genotype by environment" interactions complicate the expression of the characters. 4) Identification of individual chromosomes by conventional cytogenetical methods is very difficult and it is very hard to monitor introgression in hybridization from wild species which are valuable sources of resistances to major diseases and pests (Watanabe and Watanabe 2000).

A major problem is the difficulty in monitoring introgression of target genes and elimination of undesirable characters, especially from wild species. Furthermore, confirmation of transmission of resistance(s) from progenitors by progeny testing is time-consuming but essential since several genetic factors such as cytoplasmic effects and female by male interactions influence the expression of resistance in progenies. However, molecular markers such as AFLP, RFLP and RAPD markers are actual DNA, thus use of these markers could alleviate these bottlenecks drastically (Watanabe and Watanabe 2000).

The cost of employing DNA markers is, however, an

impediment to their use. Compared with the inherent difficulty in screening and selection for many target characters in potato breeding, the cost of DNA markers may however prove to be reasonably competitive. For example, present phenotypic screening for bacterial wilt resistance requires preparation of much plant materials either by generation of seedlings or cuttings, and an incubation period of at least two weeks. It also requires repeated testing and progeny testing to identify target genotypes. Thus, these procedures require enormous labor, materials and time. On the other hand, linked DNA markers would require several days maximum to identify the genotypes of interest once small amounts of plant tissue are available. Cost reductions would be made by simplifying several procedures in the utilization of DNA markers. Sample preparation is one step which can be simplified. The employment of PCR based markers can also facilitate the screening and selection procedures and increase efficiency in labour, cost and time.

#### **Genetic Engineering Applications to Potatoes**

Molecular biology studies and genetic engineering also have been conducted on potato science and industrial uses. A wide range of transgenic research has been made with potatoes for elucidating questions on its physiology and genetics (Belknap et al. 1994; Bradsahw and Mackay 1994; Watanabe et al. 1997), and industrial applications have been demonstrated by the release of transgenic cultivars in North America as well known in common newsmedia.

#### *Transgenic potatoes on biological stresses:*

Transgenic research on potatoes have been widely conducted and a series of transgenic potatoes with abiotic tolerance have been reported (Watanabe and Watanabe 2000). Coleoptera insect resistances with a series of BT endotoxins, particularly against Colorado potato beetles, have been developed and commercial cultivars have been released in North America. Viral protection using the viral genes has been employed and coat protein based protection has been widely used in cultivar development. Some technology transfer has been implemented from the developed countries to modestly developed countries such as Mexico and South Africa, and extended field trials have been implemented on these transgenic potatoes (Watanabe et al. 1997).

#### *Carbohydrate synthesis:*

Industry supports the research on the carbohydrate biosynthesis on potatoes since decades ago, and knowledge has been accumulated on the area. Molecular biology has been focused on the tuberization and carbohydrate biosynthesis and various studies had been conducted on altering the metabolism associated with



starch accumulation (Belknap et al. 1994). However, no commercial cultivar has been released for supporting industrial uses such as increased processing efficiency in chipping and polylactic acid processing for biodegradable plastic materials yet.

*Production of functional substances for pharmaceutical uses:*

Since potato tubers can be mass-produced *in vitro*, the tubers have been regarded as the plant factory which could produce rare substances such for pharmaceutical uses (Galun and Galun 2001).

*Potato genetic engineering against environmental stresses:*

Specific environmental constraints for potatoes are: heat at tropics, low soil moisture / drought, cold, frost and salinity, and indeed, potato yield can be affected by any abiotic stresses. At an early growing stage, the potato buds are sensitive to the change in temperature and both low and high temperatures could sharply influence the successive growth and sometimes a severe damage could result in death of potato plants. Since potatoes can be growing highlands such at Andes, hill sides of East Africa and Central Asia, the drastic change in the night temperature, frost and freezing are also important matters for the crop success over the growing period. While tubers contain high amount of water, the low soil moisture at the early growing and tuberization stages lower the yield and drought at the tuberization period would damage severely on the crops as substantial amount of water is required for tuberization and development of the organs. Since potatoes are often grown at marginal lands such as dry areas, salinity is also another concern on the crop which is rather weak at high level of salt in the field and irrigated water (Harris 1978).

A series of basic research on potato molecular biology for the abiotic stresses have been conducted widely, particularly wounding associated gene expression (Vayda and Morelli 1994 in Belknap et al. 1994), however, the attempt to create tolerances against environmental stresses have not been demonstrated much for practical applications. This is a typical case that lab-based research does not have close-interdisciplinary association with field-oriented research problems and agriculture practice.

We have been employed for generating transgenic potatoes with the transcription factors, *DREB* genes and associated gene components (Kasuga et al. 1999). Our joint effort with JIRCAS, Japan International Research Center for Agricultural Sciences, demonstrates the provisional result on the performance of transgenic potatoes with multiple tolerance to abiotic constraints: drought, salinity and freezing. However, a downstream

research should be conducted to determine the appropriateness of the use of these genetic components and breeding shall be followed up with the finding to create the transgenic potato cultivars with multiple abiotic stresses.

**Sweetpotatoes (*Ipomoea batatas*):**

Sweetpotatoes are hexaploid and it is regarded as polysomic polyploid (Rao 1996). Thus, due to its polysomic genetics in many traits, even with a single dominant gene control, breeding effort has been very challenging. Furthermore, due to the presence of cross incompatibility genes and low seed set per pollination, production of botanical seeds for breeding has been a limiting factor to generate a large population (KNEAS 1997).

The same as potato, sweetpotato can be infested by various pathogens and pests, and also can be damaged by environmental stresses. The major biological constraints are viruses such as sweetpotato feathery mottle virus and sweetpotato weevils. Cold tolerance should be of critical on sweetpotato at Irian Jaya, Papua New Guinea and Hillside of Eastern Africa, and for the longer cultivation period in Inner Mongolia, winter cultivation in Southern China and Northern Vietnam (Clark and Moyer 1988; KNEAS 1997). By alleviating these constraints, the production shall be boosted up, but due to the low interest both at developed and developing countries, consequently, not much investment on the research has been made to break through the pitfalls in sweetpotato production.

Biotechnology applications have been, however, demonstrated on sweetpotatoes in tissue culture, diagnostics and some molecular marker as well as effort on genetic engineering (KNEAS 1997 and KNEAS 2000).

While extensive studies have been made on regeneration of the sweetpotatoes (Dhir et al. 1998; Gusukonda et al. 1995; Otani and Shimada 1996; Sihachakr et al. 1997; Zheng et al. 1996), there had not been substantial success on inventing a genotype-independent transgenic method. *Agrobacterium tumefaciens*-mediated transformation has been the most common and relatively successful approach (Gama et al. 1996; Otani et al. 1998; Watanabe et al. 1998), while particle-bombardment (Prakash and Varadarajan 1992), electroporation (Mitchell et al. 1998) and *A. ryzogenes* (Espinoza et al. 1987) had been also employed as the transformation methods. Overall yet no genotype-independent transgenic method for sweetpotato has been made in public.

We made a progress on improving efficiency in sweetpotato transformation system with genotype-

independence and some success has been shown to make transgenic sweetpotatoes with potential uses for bioremediation (Watanabe and Watanabe 2001, JPS 2001-223606; Watanabe et al. 2002 In reparation). Using the genotype independent method and some unique gene constructs provided by the collaborators, we shall be demonstrating in future on generating transgenic sweetpotatoes with multiple abiotic stress tolerances.

### **Cassava (*Manihot esculenta*)**

Cassava is the important crop in developing regions in tropical and subtropical climates. While to harvest the crops, it could take more than five months, the maximum yield could be over 100 ton / hectare with 10 months cultivation in some Southeast Asian region. Also there is no major requirement on crop care after planting except water at storage root formation, this crop is highly suitable for the rustic cultivation condition at a marginal land. On the other hand, the crops often contain a high amount of cyanoids which causes serious illness or death to consumers, thus, breeding effort is needed for low cyanoids quantity crops as one of major objectives in the crop improvement (Wheatley et al. 1995).

Tissue culture and micropropagation systems have been established by the support of international agricultural research centers, that are CIAT (Centro Internacional Agripecuraria Tropical and IITA (International Institute for Tropical Agriculture) and some strong national programs such as Brazil and Cuba (CIAT 2001).

Transgenic cassavas have been generated and international agriculture centers declare that genotype independent methods can be employed for the practical applications for specific molecular breeding purposes. (Li et al. 1996; Schopke et al. 1996; Vasil 1996). Specific efforts to reduce cyanogens by transgenic approach have been also supported by CIAT and IITA that stimulate networking South-North collaboration (Anderson et al. 2000; Zhang et al. 2000).

Furthermore, studies on cassava viruses and transgenic cassava have been indicated possibility of alleviating the viral infection and productivity pitfalls due to the biotic stresses (Frey et al. 2001).

However, no specific report on transgenic attempt has been made as substantial progress on the environmental stresses on Cassava, while the crop has to cope with drought and cold damages, and the low temperature tolerance on the storage roots is also of challenge.

### **Taro and yam**

Tissue culture systems have been developed both on taro (*Colocasia and Xanthosoma* spp.) and yam (*Dioscorea* spp.) for conservation and pathogen-cleaning processes at genebanks (Zu et al. 2000). But even the mass propagation of clean propagules based on tissue culture has not been disseminated to small farmers who can often get the severely pathogen-pest infested vegetatively maintained propagules for their crop production. Some useful information on the tissue culture is available in the local languages such in Japan and China, these shall be introduced by a review article and some reffort is in progress (M. Akita, personal communication, akita@bio.waka.kindai.ac.jp).

**Taro:** Some specific studies have been conducted on the storage protein components, such as tarin in the corms of taro that may be associated with the defense responses (Bezerra et al. 1995, de Castro et al. 1992; Monte-Neshich et al. 1995). However, a little knowledge has been obtained yet on the storage protein, and the function of the gene family which encode the isoforms of tarin that the major soluble proteins in taro corms (Guimaraes et al. 2001), should be elucidated further for practical application for creating stress tolerance into taro crops.

**Yam:** Only localized importance exists in the case of yam as a major crop in the West Africa particularly in Nigeria, while many subsistent farmers in tropical and temperate zones use the crops as basic nutritional sources (Orkwor et al. 1998). As previously mentioned, tissue culture system is available for the dissemination of biotechnology, however, no trial has been made with molecular biological approaches for crop improvement. On the other hand, pharmaceutical industry has been working on diosgenin in some *Dioscorea* species. Diosgenin is an effective medicinal substance against uterus cancer, and cellular, biochemical and moleculare biology studies have been conducted immensely for product development (Haraguchi et al. 1994, Savikin-Fodulovic et al. 1998). A small investment from such a wealthy industry shall improve the yam crops for food together with increased value as preventive medicine.

Overall, no major effort has been made widely on taro and yam for the agricultural application of the modern biotechnology. Basic tissue culture, embryogenesis and transformation methods should be enhanced on yam and taro. Pitfall studies on production and post harvest processing should be conducted to identify the major constraints whether application of the modern biotechnology such as transgenic approach could be desirable or not for the abiotic stresses.

### Challenges with locally important root and tuber crops: Examples on andean root and tuber crops

First of all, this section is revised after Watanabe and Arbizu (1997). There are many locally-important plant species in Andean region which must be protected and improved in the region, and they could be employed in other part of the world. These examples are: oca (*Oxalis tuberosa*), ulluco (*Ullucus tuberosus*), maswa (*Tropaeolum tuberosum*), yacon (*Polymia sonchifolia*), maca (*Lepidium meyenii*) and arracacha (*Arracacia xanthorrhiza*) in Andean region (Hermann and Heller 1997; NRC 1989). Four areas of biotechnology could assist in genetic resources management and utilization of under-exploited Andean domestic crops: a) in vitro germplasm conservation with tissue culture and cryoconservation, b) genetic fingerprinting of collections and monitoring genetic diversity with molecular markers, c) diagnosis of plant diseases and clean-seed propagation; and d) potentially on the application of genetic engineering. Among the diverse crops from the Andean regions, Andean root and tuber crops (ARTC) are focused in this chapter and a brief idea of other important plant species is discussed.

#### Features and Constraints in ARTC

Plant biotechnology tools assist in the management and utilization of potato and sweetpotato genetic resources. These biotechnology tools and their strategies for applications, could also be useful in managing at least nine species of Andean root and tuber crops, listed according to their economic importance on Andean region. These crops have comparatively balanced nutritional values as potatoes have, however, due to its social status as poor men's food, somehow the uses of the crops have been limited for harsh conditions.

Ulluco, oca, and mashua have been important components of potato-based farming systems for more than five thousand years in the tuber-growing areas of the Andes. Arracacha, yacón, achira, mauka, and ahipa have also been grown in the quechua zone of the warm Andean valleys as one of the main components of maize-based farming systems for thousands of years. Along with bitter potatoes, maca has played a major role in the herding-based economy of farmers living in the Puna zone of Peru above 4,000 m. Whereas maca and ahipa are seed-propagated crops, the others are vegetatively propagated.

#### Biotechnology Applications to ARTC

##### a. Genetic Resources Conservation and Micropropagation on ARTC

Ex situ conservation of the genetic resources of the nine species mentioned above has been attempted by 10 scientific institutes working in South America. In July,

1995, some 2,034 accessions of ulluco, 3,282 of oca, 725 of mashua, 921 of arracacha, 105 of yacón, 108 of achira, 48 of maca, 2 of mauka, and 2 of ahipa were being maintained by germplasm banks working with Andean root and tuber crops (Arbizu and Holle, unpublished data).

The in vitro conservation of ulluco, oca, and mashua tubers has been carried out for about 10 years by several Andean genebanks, and as a result, more than 60% of the ullucos, oca, and mashuas are being maintained in vitro. In the past three years, evidence has shown that more than 90% of maukas and 50% of yacóns have also been maintained in vitro. The entire collection of arracacha and achira, however, along with about 50% of yacóns, 40% of ullucos, oca, and mashuas, and 10% of maukas appear not to have been introduced in vitro yet. They have been maintained as field collections. Insufficient funding and biotic and abiotic stresses are the main constraints to their conservation under field conditions. The International Potato Center (CIP) has been playing a major role in the conservation of the genetic resources of Andean root and tuber crops in cooperation with nine South American National Agriculture Research Systems (NARS) working with this material. However, more logistic support is still needed to optimize their conservation, and fulfill their economic potentials.

Cryoconservation is an alternative for in vitro conservation of clonal germplasm. Technically speaking, many root and tuber crops, including common potatoes, can be maintained by cryoconservation, but no major genebank has employed the system as the principal conservation system. Cost is one of the key issues for the acceptance of this technology. For example, in the case of potatoes, an initial introduction of 5,000 in vitro clonal accessions into cryoconservation could cost US \$ 20,000, with annual maintenance costs of US \$ 3,000. A tissue culture-based sub-culturing system could cost US \$ 30,000 annually for the conservation of the same number of accessions. Further sub-cultures could cause mislabeling of accessions and contamination. But this is significantly reduced by cryoconservation. The current recovery rate of shoot tips after cryoconservation is very high in potato--more than 90% (Steponkus, personal communication), but no long-term and large-scale testing has been done for root and tuber crops in general, which could hamper the use of the cryoconservation technology.

##### b. Monitoring Genetic Variation and Fingerprinting in ARTC

The organization of a germplasm collection is often cumbersome, as the clonal accessions have to be evaluated for duplicate identification, as well as evaluation of genetic diversity in the collections. Molecular markers can assist in these tedious activities for more efficient

establishment of core collections. Furthermore, these same tools can be used for biosystematic studies and in situ management of the germplasm.

The genetic diversity of Andean root and tuber crops is not well known, while distinct phenotypic groups are recognized, as for root and tuber color and shape. Because Andean root and tuber crops are underexploited, a rapid assessment of genetic variation in nature, farmers' fields, and known collections and varieties is needed. The goal is: 1) to maintain genetic diversity, 2) to identify cultivars, and 3) to establish a comprehensive core collection. Evaluations are conducted using isozymes and protein-gel electrophoresis in many national genetic resources programs, in collaboration with international genebanks. The use of DNA marker-based tools such as RFLP and PCR-based RAPD, STS, DAF, and SSR is widely recommended for many crop genera, but simple tools could be applied initially with these Andean root and tuber crops for cost-effectiveness and because fewer skills are required for operations in resource-limited Andean genebanks.

#### *c. Plant Quarantine and Seeds*

Although pests and diseases of Andean root and tuber crops have not been well surveyed, some virus-like diseases are seen in crops such as ulluco, oca, and arracacha. A general assessment of pests is also essential to maintain and improve crop productivity and genetic resources. In order to enhance productivity, we need to diagnose plant diseases and produce clean propagules efficiently.

For example, for diseases caused by viruses and viroids, an ELISA (enzyme-linked immunosorbent assay) or NASH (nucleic acid spot hybridization) test should be effective, while identification and characterization of viruses causing diseases shall be enhanced and a service system should be established to provide antisera for ELISA and labeled probing for NASH, as widely demonstrated with common potatoes by CIP. A PCR-based detection system for fungal and bacterial diseases could be also an effective tool. But basic technology should previously be well established and widely distributed for diseases.

Seed production of the vegetatively propagated species using micropropagation can be enhanced and following production can be boosted by the assistance of plant disease diagnostics. Some knowledge has been accumulated on that virus detection and irradiation are of importance for these vegetatively propagated species; e.g. oca yield can be improved by using virus free seeds up to several folds and could avoid secondary infection to other crops at the same farms or in rotation.

#### *d. Potential for Genetic Engineering on ARTC*

Although the main constraints to the cultivation of Andean root and tuber crops have been pointed out, the

traits to be improved have not been indicated in detail. Therefore, more surveys on biotic and abiotic constraints should be conducted to see whether a plant quarantine and seed program in conjunction with efforts on integrated pest management and crop management could improve crop production or whether genetic improvement of crops is essential for increasing productivity and sustainability.

Potential areas for genetic studies would be: 1) improvement of the quantity and quality of nutritional traits, and a reduction in toxic substances, 2) day-length adaptation, and 3) dormancy. As the basic reproductive biology of these root and tuber crops is not understood well, and a true seed production system has not been established for many of them, the conventional breeding approach may be inappropriate. Furthermore, many of these root and tuber crops are known as polyploids with an outcrossing nature, so that a complicated segregation of the trait of interest could occur. This would be a disadvantage in conventional breeding, as demonstrated in potatoes and sweetpotatoes, but wild relatives and closely related crop genera are available for Andean root and tuber crops, and molecular marker-assisted germplasm enhancement may be an approach to improve these crops and make them available to farmers.

Genetic engineering could facilitate the improvement of Andean root and tuber crops. Two specific areas are given in the following.

1) Glucosinolate content appear to be high in mashua and may cause goiter, on the other hand, glucosinolates and their biologically active metabolites may be responsible for medicinal uses of this particular Andean tuber. These compounds and others may also provide variation in resistances to insects, nematodes and diseases so that genetic engineering could provide a specific change to get rid of the goitrogenic effects of glucosinolates. Now, using genetic engineering, manipulation of specific biochemical pathways would be becoming doable, so that control of specific fractions on toxic substances, but increase of the useful components could be simultaneously achieved. This can be applied to other crops such as oca to reduce unpleasant tastes that could come from oxalic acids and glycoalkaloids.

2) Yacon has been studied to use its fructose for diet food for diabetes. Also the high molecular weight carbohydrates could meet specific industrial needs. Due to these specific characteristics of sugar, the crops have been adopted to non-conventional regions such as New Zealand, Japan, and Italy.

#### **Conclusion**

The role of root and tuber crops in this century will be more important and further investment by public is essential for the crop improvement and integration of all

scientific knowledge for crop production (Scott 2000). Besides supporting the major root and tuber crops such as potato, sweetpotato and cassava, emphasis should be made conservation and enhancement of the use of regional important root and tuber crops such as oca, ulluco, maswa, yacon, maca and arracacha in Andean region (Hermann and Heller 1997; NRC 1989; Watanabe and Arbizu 1997); edible canna (*Canna edulis*), arrow heads (*Sagittaria torifolia*) and aroids (principally taro) in Asia and Africa (Scott 2000). While biotechnology application could be one of the methods for the purpose, however, in-depth analyses of the pitfalls in production and storage / processing and of demands should be conducted carefully point out the target of the research and development activities.

### Acknowledgments

Author would like to thank Japan Society for the Promotion of Sciences, Research for Future Program (JSPS-RFTF-96-L603 and JSPS-RFTF-00-L0162) on its financial aids to carry out the part of research introduced in this paper. Author also thank JIRCAS and Dr. K. Yamaguchi-Shinozaki, Biological Resources Division, Japan International Research Center for Agricultural Sciences (JIRCAS), Tsukuba, Japan for providing a set of precious gene constructs to generate abiotic-stress tolerant transgenic potatoes.

### References:

- Andersen, M.D., P. K. Busk, I. Svendsen and B. L. Moller 2000. Cytochrome P-450 from cassava (*Manihot esculenta* Crantz) catalyzing the first steps in the biosynthesis of the cyanogenic glucosides linamarin and lotaustralin. *J. Biol. Chem.* 275: 1966-1975.
- Belnap, W. R., M. E. Vayda and W. D. Park 1994. The molecular Biology and Cellular Biology of the Potato. 2nd edition. CAB International, Wallingford, UK.
- Bezerra, I.C., L.A.B. de Castro, G. Neshich, E.R.P. de Almeida, M.F. Grossi de Sa, L. V. Mello, D.C. Monte-Neshich 1995. A corm-specific gene encodes tarin, a major globulin of taro (*Colocasia esculenta* L. Schott). *Plant Mol. Biol.* 28: 137-144.
- Bradshaw, J. E. and G. R. Mackay 1994. Potato Genetics. CAB International, Wallingford, UK.
- CIAT 2001. Annual Report 2000. CIAT, Cali, Colombia
- CIP 2001. Scientist and Farmers - Partners in Research for the 21st Century. Programme Report 1999-2000. Centro Internacional de la Papa, Lima, Peru.
- Clark, C.A. and J. W. Moyer 1988. Compendium of Sweet Potato Diseases. American Phytopathological Society Press, St. Paul, Minnesota.
- de Castro, L.A.B., M. Carneiro, D.C. Monte-Neshich, GR Paiva 1992. Spatial and temporal gene expression patterns occur during corm development. *Plant Cell* 4: 1549-1559.
- Dhir, S. K., J. Oglesby and A. S. Bhagsari 1998. Plant regeneration via somatic embryogenesis, and transient gene expression in sweet potato protoplasts. *Plant Cell Reports* 17: 665-669.
- Espinoza, N., M. Yang, J. Jaynes and J. H. Dodds 1987. Sweetpotato transformation with *Agrobacterium* ryzogenes. *Bioessays* 6: 261-267.
- Frey, P. M., N.G. Scharer-Hernandez, J. Futterer, I. Potrykus and J. Puonti-Kaerlas 2001. Simultaneous analysis of the bidirectional African cassava mosaic virus promoter activity using two different luciferase genes. *Virus Genes* 22: 231-242.
- Galun, E. and E. Galun (2001) The Manufacture of Medical and Health Products by Transgenic Plants. Imperial College Press, London
- Gama, M. I. C. S., R. P. Leite Jr., A. R. Cordeiro and D. J. Cantliffe 1996. Transgenic sweet potato plants obtained by *Agrobacterium tumefaciens*-mediated transformation. *Plant Cell, Tissue and Organ Culture* 46: 237-244.
- Guimaraes, R. L., L. H. Marcellino, M. F. Grossi de Sa and D. de Castro Monte 2001. A storage protein gene from taro shows tuber-specific expression in transgenic potato. *Physiologia Plantarum* 111: 182-187.
- Gusukonda, R., C. S. Prakash and A. P. Dessai 1995. Shoot regeneration in vitro from diverse genotypes of sweetpotato and multiple shoot production per explant. *HortScience* 30: 1074-1077.
- Harris, P. M. 1978. The Potato Crop. Chapman and Hall, London.
- Haraguchi, M., A. P. Zaccarias Dos Santos, M. C. M. Young and E. P. Chui 1994. Steroidal prosapogenin from *Dioscorea olfersiana*. *Phytochemistry* 36:1005-1008.
- Hermann, M., and J. Heller (eds.) 1997. Andean Roots and Tubers: Ahipa, Arracacha, maca and yacon. Promoting the conservation and use of underutilized and neglected crops 21. Institute of Plant Genetics and Crop Plant Research, Gatersleben / International Plant Genetic Resources Institute, Rome, Italy.
- Hooker, W. J. 1981. Compendium of Potato Diseases. American Phytopathological Society, St. Paul, MN.
- Kasuga, M., Q. Liu, S. Miura, K. Yamaguchi-Shinozaki and K. Shinozaki 1999. Improving plant drought, salt and freezing tolerance by gene transfer of a single stress-inducible transcription factor. *Nature Biotechnology* 17: 287-291.
- KNAES 1997. Proceedings of International Workshop on Sweetpotato Production System toward the 21st Century. December 9-10, 1997, Kyusyu National Agricultural Experiment Station, Miyakonjojo, Miyazaki, Japan
- KNAES 2000. Proceedings on International Workshop on Sweetpotato Cultivar Decline Study. Kyusyu National Agricultural Experiment Station, September 8-9, 2000, Miyakonjojo, Miyazaki, Japan.
- Li, H. Q., C. Sautter, I. Potrykus and J. Puonti-Kaerlas 1996. Genetic transformation of cassava (*Manihot esculenta* Crantz). *Nat. Biotechnol.* 14: 736-740.

- Li, P. H. (ed.) 1985. Potato Physiology. Academic Press, New York Monte-Neshich D.C., T.L. Rocha, R.L. Guimaraes, E.F. Santana, M.E. Loureiro, M. Valle, M. F. Grossi de Sa 1995. Characterization and spatial localization of the major globulin families of taro (*Colocasia esculenta* L. Schott) tubers. *Plant Sci.* 112:149-159.
- Mitchell, T. D., A. S. Bhagsari, P. Ozias-Akins and S. K. Dhir 1998. Electroporation-mediated transient gene expression in intact cells of sweetpotato. *In Vitro Cellular Developmental Biology - Plant* 34: 319-324.
- National Research Council. 1989 Lost Crops of Incas. National Academy Press, Washington, D.C.
- National Research Council 1993. Managing Global Genetic Resources - Agricultural Crop Issues and Policies. National Academy Press, Washington, D.C.
- Orkwor, G. C., R. Asiedu and I. J. Ekeanayake (eds.) 1998. Food Yams : Advances in Research. International Institute of Tropical Agriculture, Ibadan, Nigeria; National Root Crops Research Institute, Umuhia, Nigeria (ISBN 978-131-100-2)
- Otani, M. and T. Shimada 1996. Efficient embryogenic callus formation in sweet potato (*Ipomea batatas* (L.) Lam.) *Breeding Sci.* 46: 257-260.
- Otani, M., T. Shimada, T. Kimura and A. Saito 1998. Transgenic plant production from embryogenic callus of sweetpotato (*Ipomoea batatas* (L.) Lam.) using *Agrobacterium tumefaciens*. *Plant Biotechnology* 15: 11-16.
- Prakash, C. S. and U. Varadarajan 1992. Genetic transformation of sweet potato by particle bombardment. *Plant Cell Reports* 11: 53-57.
- Rao, R. 1996. Proceedings of the Workshop on the Formation of a Network for the Conservation of Sweetpotato Biodiversity in Asia. Bogor, Indonesia, 1-5 May, 1996. International Plant Genetic Resources Institute, Rome, Italy.
- Savikin-Fodulovic, K. D. Grubisic, L. Culafic, N. Menkovic and M. Ristic 1998. Diosgenin and phytosterols content in five callus lines of *Dioscorea balcanica*. *Plant Science* 135: 63-67.
- Scott, G. J., M. W. Rosegrant and C. Ringler 2000. Global projections for root and tuber crops to the year 2020. *Food Policy* 25: 561-597.
- Shopke, C., N. Taylor, R. Carcamo, N.K. Konan, P. Marmey, C.G. Henshaw 1996. Regeneration of transgenic cassava plants (*Manihot esculenta* Crantz) from microbombarded embryogenic suspension cultures. *Nat. Biotechnol.* 14: 731-735.
- Sihachkr, D., R. Haicour, J. M. Cavalcante Alves, I. Umboh, D. Nzoghe, A. Servaes and G. Ducreux 1997. *Euphytica* 96: 143-152.
- Vasil, I.K. 1996. Milestones in crop biotechnology-transgenic cassava and *Agrobacterium*-mediated transformation of maize. *Nat. Biotechnol.* 14: 702-703.
- Watanabe, K. N., M. Orrillo and A. M. Golmirzaie 1995a. Potato germplasm enhancement for resistance to biotic stresses at CIP. Conventional and biotechnology-assisted approaches using a wide range of *Solanum* species. *Euphytica* 85:457-464.
- Watanabe, K. J. P. T. Valkonen and P. Gregory, 1995b. Use of Biotechnology Tools in Plant Protection, Genetic Resources Management and Crop Genetic Improvement in Potatoes with a Special Reference to the Technology Transfer to Developing Countries. In: Altman, D. W. and K. N. Watanabe (eds.), *Plant Biotechnology Transfer to Developing Countries*. R. G. Landes Co., Texas, USA, pp.179-190.
- Watanabe, K., A. M. Golmirzaie and P. Gregory 1997. Chapter 10. Use of Biotechnology Tools in Potato Genetic Resources Management and Breeding. In: Watanabe, K. and E. Pehu 1997. (eds.) *Plant Biotechnology and Plant Genetic Resources for Sustainability and Productivity*. R. G. Landes Co., Georgetown, Texas, USA, pp.145-154.
- Watanabe, K. and C. Arbizu 1997. Chapter 11. Potential of Plant Biotechnology Applications in Genetic Resources Management and Utilization of Andean Landrace Crop Genetic Resources. In: Watanabe, K. and E. Pehu 1997. (eds.) *Plant Biotechnology and Plant Genetic resources for Sustainability and Productivity*. R. G. Landes Co., Georgetown, Texas, USA, pp.155-160.
- Watanabe, K. N., F. Buitron, J. Benavides, A. Panta, C. Siguenas, F. Medina-Bolivar and J. H. Dodds 1998. Genetic transformation of sweetpotato via *Agrobacterium tumefaciens*. *Mem. Research Inst. BOST. Kinki Univ.* 1: 26-30.
- Watanabe, K.N. 2000. SNPs, Genetic Diversity and Gene pools for Germplasm Enhancement. Proceedings of the Workshop on the Integration of Biodiversity and Genome Technology for Crop Improvement. 28th Nov. 1st Dec., 2000, Tukuba. NIAR-MAFF, JISTEC/STA. pp.118-121.
- Watanabe, J. A and K. N. Watanabe 2000. Pest Resistance Traits Controlled by Quantitative Loci and Molecular Breeding Strategies in Tuber-bearing *Solanum*. *Plant Biotechnology* 17 (1): 1-16.
- Wheatley, C., G. J. Scott, R. Best, S. Wiersema 1995. Adding value to Root and Tuber Crops. CIAT, Cali, Colombia.
- Zhang, P., I. Potrykus and J. Puonti-Kaerlas 2000. Efficient production of transgenic casaava using negative and positive selection. *Transgenic Res.* 9: 405-415.
- Zheng, Q., A. P. Dessai and C. S. Prakash 1996. Rapid and repetitive plant regeneration in sweetpotato via somatic embryogenesis. *Plant Cell Reports* 15: 381-385.
- Zhu, D., P. B. Euzaguerre, M Zhou, L. Sears and G. Liu (eds.) 2000. Proceedings of the Symposium on Ethnobotany and Genetic Study of Taro in China: Approaches for the Conservation and Use of taro Genetic Resources, 10-12 November 1998 - Laiyang Agricultural College, Laiyang, Shangdong, China. International Plant Genetic Resources Institute (IPGRI), Rome, Italy.



# Genetic dissection and plant improvement under abiotic stress conditions: drought tolerance in maize as an example

**J.-M. Ribaut, M. Banziger, and D. Hoisington**

Int. Maize and Wheat Improvement Center (CIMMYT)

Lisboa 27, Apdo. Postal 6-641,

06600 Mexico D. F. Mexico.

## Abstract

---

Among abiotic stresses found in developing countries, drought and low soil fertility are paramount. Because of its genetic complexity, drought tolerance is probably the most difficult trait to improve through conventional plant breeding. The challenge is even greater for developing drought tolerant plants for water-limited environments where the occurrence, timing, and severity of drought may fluctuate from year to year. CIMMYT has devoted considerable effort during the past three decades to improving drought tolerance in maize. Extensive research has been conducted in the areas of breeding, physiology, agronomy, and most recently, biotechnology. The biotechnology work has focused on the genetic dissection of drought tolerance through the identification of quantitative trait loci (QTL) associated with yield components, secondary morphological traits of interest (e.g., anthesis-silking interval), and more recently, physiological parameters. To date, the genetic dissection of yield components and secondary traits of interest has been conducted in four different segregating crosses, under diverse water regimes and in several environments. In addition, to identify the QTLs for key physiological components (e.g., hormones, proteins, etc.) a recombinant inbred line (RIL) population has been developed by single seed descent from  $F_3$  families obtained by crossing one of the four crosses mentioned above. The same morphological traits measured in the  $F_3$  families have been evaluated in this RIL population. Based on these QTL results, several MAS experiments based on back crosses and new breeding approaches such as the Single Large-Scale MAS (SLS-MAS) have been successfully conducted, and will be presented in detail. However, based on our experience, we now recognize that germplasm improvement restricted to QTL manipulation presents several limitations, the most critical being the inability to predict the phenotype of any given genotype based on the allelic constitution. To overcome these limitations, improve the understanding of the genetic basis of drought tolerance, and develop the most efficient MAS strategies, future efforts at CIMMYT will concentrate on two main activities: (1) the construction of a consensus map that combines information related to QTL characterization and gene expression, and (2) the identification of key genes/pathways involved in maize drought response. The map and knowledge of key pathways will be used as selection tools in breeding programs. Concomitant with our QTL identification and manipulation efforts are several ongoing experiments based on functional genomics. We are convinced that emerging technologies based on gene expression have the potential to provide complementary information that will promote more efficient germplasm improvement. Indeed, understanding the genetic basis of the essential physiological parameters of drought tolerance in maize, together with the data generated by profiling experiments, should allow the identification of the key pathways involved in drought stress and further our understanding of how they interact. This, in turn, will lead to develop strategies to improve the tolerance of maize and other crops to water-limited conditions.

## Abiotic stresses: Focus on drought

Plants vary tremendously in their ability to withstand abiotic stresses, both between species and within populations of a single species. Abiotic stresses limit crop productivity in every season and in every crop worldwide, yet the nature of tolerance is not well

characterized. Understanding the mechanisms of tolerance will have a significant impact on crop productivity (Boyer 1982). In general, tolerance to abiotic stresses is associated with a host of morphological and physiological traits; these include root morphology and depth, plant architecture, variation in leaf cuticle thickness, stomatal regulation, osmotic

adjustment, antioxidant capacity, hormonal regulation, desiccation tolerance (membrane and protein stability), maintenance of photosynthesis, and the timing of events during reproduction (Bohnert et al. 1995, Shinozaki and Yamaguchi-Shinozaki 1996, Bray 1997, Nguyen et al. 1997, Edmeades et al. 2001). The complexity of these responses is not surprising, because under stress conditions plants must be able to tolerate significant variations in soil composition, temperature and water potential during development. One of the most challenging traits for which to breed for is drought tolerance, due in large part to its unpredictable nature. Selected materials need to perform well under both water-limited and well watered conditions. In addition, establishing optimal environments to select for improved performance under drought is complicated by environmental variation.

Loss to drought in the tropics alone is thought to exceed 20 million tons of grain per year, or around 17% of well-watered production (Edmeades et al. 1992), reaching up to 60% in severely affected regions such as southern Africa in 1991-92. The magnitude of these losses has made breeding for drought tolerance a major focus of the International Maize and Wheat Improvement Center, known by its Spanish acronym as CIMMYT (for review, see Heisey and Edmeades 1999). Drought and soil infertility are the major causes of grain yield reduction in developing countries (Beck et al. 1996), and considering ongoing climatic changes attributable primarily to global warming (Curry et al. 1995), the pressure on food production in water-limited environments will probably increase in the future. Impressive progress has been achieved through conventional breeding (for review, see Heisey and Edmeades 1999), and the potential for genetic improvement of maize production under drought conditions remains large. But it should be kept in mind that conventional breeding for yield improvement remains time consuming and laborious, because carefully managed field conditions are required. In addition, there is a decrease in the genetic variance and heritability of yield components that parallels an increase in environmental stress (Ribaut et al. 1997). Considering these limitations to efficient selection, and that only one relatively rainfree crop season per year is available for selection in most tropical countries, the use of molecular markers could provide a useful tool to complement phenotypic selection.

#### **Target traits and QTL identification under water-limited conditions**

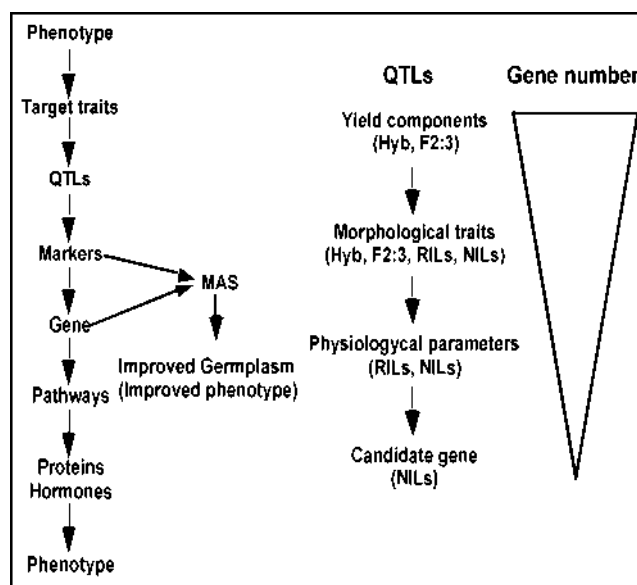
During the past two decades, molecular tools have aided tremendously in identifying, mapping, and

isolating quantitative trait loci (QTL) and genes in a wide range of crop species. The vast knowledge generated through the application of molecular markers has enabled scientists to analyze the plant genome and gain insight on how genes and pathways controlling important biochemical and physiological parameters are regulated. Three areas of biotechnology that have had significant impact are the application of molecular markers, tissue culture, and genetic transformation. The availability of molecular markers has enabled the identification of genes or genomic regions associated with the expression of an array of qualitative and quantitative traits, and made the manipulation of such genomic regions feasible through marker-assisted selection (MAS) processes. MAS for single gene, or few major genes, transfer has been well demonstrated. However, when several genomic regions must be manipulated, MAS turned out less convincing. The efficient and effective application of MAS for polygenic trait improvement certainly needs new technologies, but more importantly, it requires the development of innovative strategies that bypass the conceptual bottlenecks imposed by current approaches (Ribaut and Hoisington 1998). Molecular-marker applications have also helped us better understand the physiological parameters that control plant responses to abiotic stress factors, and, more generally, to those involved in plant structural development. Understanding these pathways has been one of the biggest challenges in plant improvement, because an observed plant phenotype is the result of the expression of many diverse plant physiological and biochemical pathways. Given that most physiological tests cannot be applied routinely in a breeding program, because their protocols are generally too complex or time consuming, the genetic dissection of target traits and physiological parameters is of primary importance for plant breeding.

Depending on the crop, different key secondary traits of interest involved in the plant response under water-limited environment have been identified. A suitable secondary trait is one that is (i) genetically associated with grain yield under drought; (ii) highly heritable; (iii) inexpensive and quick to measure; (iv) stable over the measurement period; (v) observed at or before flowering; and (vi) not associated with yield loss under unstressed conditions (Edmeades et al. 2001). In maize, when drought stress occurs just before and during the flowering period, a delay in silking is observed resulting in an increase in the length of the anthesis-silking interval (ASI) (Hall et al. 1982, Westgate and Bassetti 1990, Bolaños and Edmeades 1993). This asynchrony between male and female flowering has been associated with grain yield decrease under drought (Westgate and Boyer 1986,



Edmeades et al. 2000), is easy to measure in the field, and presents a high heritability under stress conditions. In sorghum, the term "stay green" is associated to a tolerance mechanism characterized by maintenance of green stems and upper leaves when water is limiting during grain filling. This post-flowering tolerance is especially important because of the negative impact of drought on yield at this stage. Yield reduction can result from reduced seed size as well as from factors associated with premature senescence, stalk rot, charcoal rot, and lodging of susceptible cultivars. Stay green genotypes maintain more photosynthetically active leaves than genotypes not possessing this trait (Rosenow et al. 1983) and produce significantly higher levels of sucrose, glucose, fructose, and starch, particularly in the stem (McBee and Miller 1982, McBee 1984, Duncan 1984). Since photosynthesis is maintained longer in stay green types, this may partly account for their higher yield in crops where carbohydrate is a main harvest component (Thomas and Smart 1993). In rice, scientists looking into drought tolerance focused more on the root structure and characteristics, as well as on osmotic adjustment (OA) in roots (Zhang et al. 2001). The rationale for selecting OA and root traits is that a well-developed deep root system can facilitate water uptake from lower soil layers, and OA can help maintain the turgor of both shoots and roots as plants experience water deficits (Nguyen et al. 1997, Zhang et al. 1999). Populations that segregate under water-limited conditions have been developed and QTLs involved in the expression of the target trait have been identified in all major crops (for review, see Ribaut and Poland 2000). However, the nature of QTLs at the gene level remains unclear, hence our understanding of the complexity of plant responses to drought stress continues to be incomplete. One of the weaknesses of the quantitative genetic approach that limits its use in plant breeding is that it provides very little information about the mechanisms and pathways involved in drought tolerance or about the multitude of genes involved in the plant's response. Recent developments in functional genomics should help overcome this problem, because these new approaches allow the simultaneous study of the expression of several thousand genes. Results produced by functional genomics studies, combined with QTL results, offer us a powerful approach to identify and characterize the key physiological/biochemical pathways involved in drought tolerance. The characterization of QTLs for yield that are correlated with secondary traits of interest and ultimately with QTL involved in the expression of key physiological parameters should allow us to bridge the gap between gene function and plant phenotype (Figure 1).



**Fig. 1.** Different regulatory levels involved into the plant phenotype (left side of the scheme). Depending on the nature of the target traits, the QTL identification involved in the expression of those traits requires different kind of segregating populations and present different levels of genetic complexity, the largest number of genes being involved in the expression of the yield components (right side of the scheme).

### **Genetic dissection of a maize plant's response under a water-limited environment at CIMMYT**

The construction of QTL linkage maps using segregating populations is routine at CIMMYT. During the past seven years, major efforts have been dedicated to the genetic dissection of drought tolerance components in maize under water-stress, before, during, and after flowering. These efforts resulted in the identification of QTLs involved in the expression of yield components and secondary morphological traits of interest, such as ASI. As presented earlier, of primary interest are secondary traits that are correlated with yield and demonstrate segregation with high heritability under water-limited conditions. To date, genetic dissection has been conducted in four different crosses, at different inbreeding levels (hybrids, F2:3 families, and RILs), under different water regimes (well-watered conditions (WW), intermediate stress (IS), and severe stress conditions (SS)) and in several environments (Kenya, Mexico, and Zimbabwe) (Table 1).

Much of our past QTL identification has focused on yield components and secondary traits of interest, each important measures for drought tolerance in maize but complex polygenic traits (Ribaut et al. 1996, 1997). To more deeply explore, at the genetic level, the maize plant's response under water-limited conditions, it is necessary to identify the QTL involved in the

**Table 1**

Segregating populations analyzed for yield components, morphological traits, and physiological parameters, under different stress regimes, in different locations, and at different inbreeding levels

Populations	Trials	Traits
Ac7643 x Ac7729/TZSRW (236 F ₂ /3 Families)	92A WW (TL) 94A IS, SS (TL) 96A/B LowN (PR) 96B HiN (PR)	MFLW, FFLW, ASI, LNO, EHT, PHT, ENO, GY, HK, KNO, CHL
Ac7643 X CML247 (236 F ₂ /3 Families)	96A SS (TL)	MFLW, FFLW, ASI, LNO, EHT, PHT, ENO, GY, HK, KNO
Ac7643 x Ac7729/TZSRW (236 RIL Families)	96A IS, SS (TL) 96B WW (TL) 99A WW, IS, SS (TL)	MFLW, FFLW, ASI, LNO, EHT, PHT, EPO, ENO, GY, HK, KNO
K64R x H16 (280 F ₃ Topcross Families)	99B IS, SS (ZW) 00A IS, SS (KY)	MFLW, FFLW, ASI, PHT, ENO, GY, SEN
K64R x H16 (170 F ₄ Families)	00B SS (ZW)	MFLW, FFLW, ASI, PHT, EHT, EPO, SEN, ENO, GY
CML444 x SC-Malawi (234 F ₃ Families)	00B WW, IS, SS (ZW) 01A IS, SS (TL)	MFLW, FFLW, ASI, PHT, SEN, TBNO, ENO, GY
Jalisco (teosinte) x LPC21 (200 BC3F ₂ Families)	01A IS, SS (TL)	MFLW, FFLW, ASI, ENO, GY
Ac7643 x Ac7729/TZSRW (236 RIL Families)	96A IS, SS (TL) 96B WW (TL) 99A WW, IS, SS (TL) 01A IS, SS (TL)	RWC, OP, OA, RCT, CHL(J), CHL(E), ABA(E), ABA(S), ABA (EL), EW, EGR, SW, SGR
Ac7643 x Ac7729/TZSRW (140 RIL Families)	98 (Laboratory test)	Root parameters under hydroponics
Ac7643 x Ac7729/TZSRW (220 RIL Families)	00 (Phytotron) Low temperature	Pigments, photosystem parameters, RWC, SHW, RW
Ac7643 x Ac7729/TZSRW (220 RIL Families)	01 (Phytotron) Drought, drought and low temperature	Pigments, photosystem parameters, RWC, SW, RW

*Abbreviations*

Location:

KY: Kenya / TL: Tlaltizapan, Mexico / PR: Poza Rica, Mexico / ZW: Zimbabwe.

Stress regime:

WW: Well Watered / IS: Intermediate Water Stress / SS: Severe Water Stress / LowN: Low Nitrogen Trial / HiN: High Nitrogen Trial.

Yield components:

GY: Grain Yield / ENO: Number of Ears / HK: Hundred Kernel Weight / KNO: Number of Kernels.

Morphological traits:

MFLW: Male Flowering / FFLW: Female Flowering / ASI: Anthesis-Silking Interval / LNO: Number of Leaves / EHT: Ear Height / PHT: Plant Height / EPO: ear position / SEN: senescence / TBNO: Number of Tassel Branches / EW: ear weight / EGR: ear growth rate for one week / SW: silk weight / SGR: silk growth rate for one week / SHW: shoot weight / RW: root weight.

Physiological parameters:

RWC: Relative Water Content / OP: Osmotic Potential / OA: Osmotic Adjustment / CHL: Chlorophyll content in a young leaf (J) and in the ear leaf (EL) / RCT: Root Conductivity / ABA: Abscisic Acid Content, in the ear (E) in the silk (S) and in the ear leaf (EL).

differential expression of the key physiological pathways that induce the drought tolerance phenotype. To achieve this objective, a RIL population was developed by single seed descent from F₃ families obtained by crossing Ac7643 with Ac7729/TZSRW (Table 1). The same morphological traits measured with the F₃ families have also been evaluated in this RIL population. RIL families are more suitable than F₃ families for physiological measurements because they are genetically fixed; on the other hand, they are poor material for evaluation of yield components because they usually demonstrate high inbreeding depression. In addition to the physiological parameters measured in-

house, such as relative water content, osmotic adjustment, and chlorophyll content, collaborations with other research groups allowed us to evaluate root growth under hydroponics (Roberto Tuberosa, Bologna University), quantify the ABA content in the ear leaf, the ear and the silks at the flowering stage (Tim Setter, Cornell University), and evaluate the photosynthetic apparatus and dehydration phenomena under low temperature conditions (Yvan Fracheboud, Institute of Plant Sciences ETH, Zurich). Although most of these physiological traits are not useful for routine screening purposes because they are too time consuming (the osmotic adjustment measurement being a typical example) once DNA markers closely linked to the QTL involved in the expression of a physiological trait are identified, they can be used efficiently in MAS experiments. Identification at the same genomic location of QTL related to physiological and morphological traits should be expected, given that changes in physiological pathways have an impact on the plant phenotype. As an example from our first field evaluation, a QTL for chlorophyll content was identified on chromosome 2, near a QTL for ASI (under IS and SS) and grain yield (under IS only). This QTL for chlorophyll content was consistent when measurements were conducted on the ear leaf and on a young leaf close to the tassel. On chromosome 6, a QTL for relative water content corresponds exactly to a QTL for ASI (under IS and SS) and grain yield (under IS and SS). At the same chromosomal region, the identification of a dehydrin gene (*dhn1*) has also been reported (Campbell and Close 1997). Since several physiological pathways involved in the drought tolerance mechanism are well known (e.g., ABA biosynthesis), the characterization of the gene(s) corresponding to identified QTL can be achieved, making the candidate gene approach an attractive option.

**MAS for maize line improvement under drought**

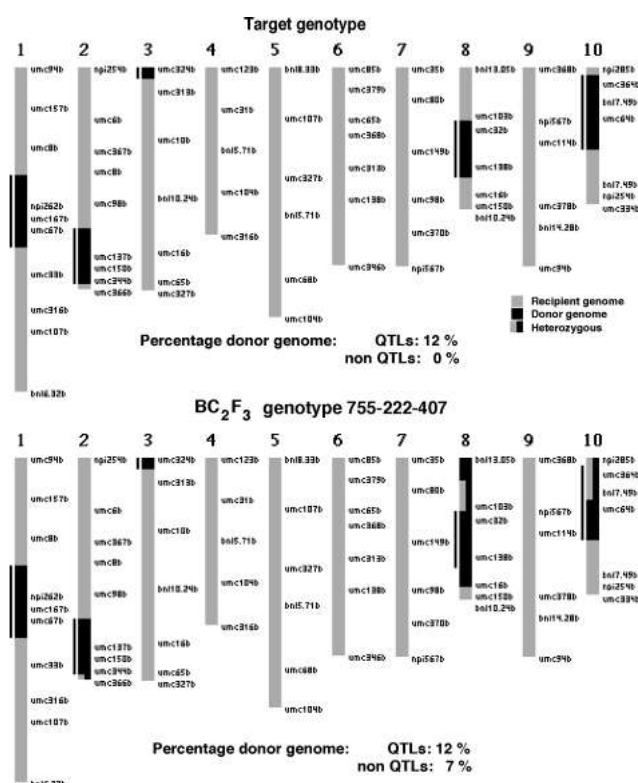
Based on the QTL and mapping information described earlier, a backcross marker-assisted selection (BC-MAS) project was initiated in 1994. The line P₁ (Ac7643) was used as the drought-tolerant donor line and CML247 was used as the recurrent parent. CML247 is an elite tropical inbred line developed by CIMMYT, with outstanding combining ability and good yield per se under well-watered conditions. It is susceptible to drought, in part because its ASI is large under drought. Genetic data from a segregating F₂ population derived from the P₁ × CML247 cross were combined with F₃ evaluations in the field under different water regimes to identify QTLs for traits of interest. The QTLs for ASI identified in this cross were quite consistent with those in the original P₁ × P₂ cross. Of the five QTLs originally

identified from P₁ that conferred a short ASI, only the QTL on chromosome 6 was not detected in the second cross. The QTL on the short arm of chromosome 1 was shifted by 40 cM in the new cross, and the three other QTLs on chromosomes 2, 8, and 10 were in similar positions in both. A new QTL for ASI was detected on the short arm of chromosome 3. These results demonstrate the need to make a new genetic map when the recurrent line is changed in BC-MAS schemes. A single good-quality trial under drought conditions, however, might be sufficient for identifying QTLs of interest, providing QTL identification has been previously carried out in another cross involving the donor line.

Five genomic regions involved in the expression of a short ASI were selected to be transferred from P₁ into CML247 genome. The screening of large populations (about 2,000 plants) at each selection cycle during backcrossing has been possible because of the development of reliable PCR-based markers, used here as preselection tools. After two BCs and two self-pollinations, the best genotype was fixed from the donor line for the five target regions (12% of the genome), as well as for 7% of the genome lying outside the QTL regions (Fig. 2). The 70 best BC₂F₃ (i.e., S₂ lines) were identified and crossed with two CIMMYT tester inbreds, CML254 and CML274. These hybrids, as well as the BC₂F₄ families (S₃ lines) derived from the selected BC₂F₃ plants, were evaluated in 1998, 1999, and 2000 under several water regimes. Results show that under stress conditions that induce a yield reduction of at least 80%, the mean of the 70 selected genotypes performed better than the control crossed with CML254 and CML274. In addition, the best genotype among the 70 selected (BC₂F₃ × testers) performed two to four times better than the control. This difference became less marked when the intensity of stress decreased; for a stress inducing less than 40% yield reduction, hybrids resulting from the MAS or developed with the "original" version of CML247 performed the same. Although which genotypes performed best depended on the stress intensity, few of the genotypes always performed significantly better than the controls across the six water-limited trials. Because the genotype performance is dependent to the environment or the stress level, those results demonstrate that different sets of gene might be involved in the plant response depending on the stress intensity. No yield reduction was observed under well-watered conditions.

### MAS strategies and consensus map

For approximately 15 years, genetic dissection of polygenic traits has been hailed as a promising



**Fig. 2.** With five selected regions, the target genotype of the BC-MAS for drought improvement conducted at CIMMYT is presented at the top of the figure. Those five regions, at which fixed donor genome contribution is expected, represent 12% of the mapped genome (70 loci/RFLP probes) and are presented in black. At the bottom of the figure is presented the best genotype identified after 4 cycles of MAS (2 BCs and 2 self-pollinations). For this genotype the remnant donor genome contribution outside the target regions represents about 7% of the mapped genome.

application of DNA markers, resulting in extensive mapping experiments aimed toward the development of MAS (Lee 1995). However, few concrete MAS results have been published that would justify the initial enthusiasm (Mohan et al. 1997, Ribaut and Hoisington 1998) because of the limited number of QTLs identified per trait, the reduced amount of phenotypic variance that they generally express individually, their interaction with the environment, plus the difficulty of epistasis evaluation. Until recently, a clear technical limitation has been the restricted population sizes that can be handled, limiting the flexibility and the power of selection. With the development of reliable PCR-based markers, a substantial increase in segregating population size that can be screened is now feasible. Another limitation was certainly the reduced flexibility of the "good by bad" concept, the transfer of genomic segments from a donor to a recipient elite genome through BC, which presents time and cost constraints, as

we came to realize in our BC-MAS for drought tolerance described in the previous section. However, when this project was initiated seven years ago, it then appeared to be an attractive option, given the limited amount of available information about elite line performance under drought. Today, the situation has evolved at both the germplasm and technology levels. New MAS strategies can be considered for the improvement of drought tolerance; some of these strategies are already being employed at CIMMYT. If the suitable germplasm is available, the pyramiding of favorable alleles through DNA markers in new germplasm by crossing two elite lines that perform well under the target environment conditions, "good by good," should open new doors for MAS (Ribaut and Betran 1999).

Another alternative is conducting MAS experiments based on "universal drought QTLs" identified on a consensus map that incorporates (1) QTL information for yield components, morphological traits and physiological parameters, (2) candidate genes and pathways, and (3) information provided by gene expression. The underlying rationale for this approach is that genes involved in drought response are most likely located at the same position in the maize genome, independently of the germplasm performance, and that phenotypic differences across germplasm is created by the nature/quality of the alleles at those genes. An accumulation of elite alleles at several genes will confer good drought tolerance, while poor alleles will induce susceptibility to drought. When a QTL is identified in a segregating population for a given trait, it means that the difference of the contribution between the two alleles coming from the two parental lines is significant at a certain genomic position. If in another segregating population the difference between the two alleles is not significant (e.g., they are both good or bad), although the gene(s) are still at the same location, no QTL will be identified. For this reason, the results of QTL identification for a given trait are cross dependent, making the extrapolation of this information questionable. However, one can postulate that if a QTL identification is conducted on various segregating populations for a target trait, the same key QTLs should be identified in more than one cross, thereby clearly demonstrating the importance of these genomic regions for the expression of the target trait.

To achieve this objective, a unique linkage map should be constructed, using the loci that are common for the four crosses as anchor markers. In a second phase, all of the QTL information available for each cross should be compiled on the consensus map (see Table 1), assigning a "weight" to each QTL. This weight will have two major components: (1) the nature of the trait and (2) the threshold value of the QTL identified

under a specific environment (likelihood ratio, LR). The highest weight will be attributed to yield components. For secondary traits, consideration should be given to the phenotypic correlation between the trait and yield components (mainly grain yield and ear per plant). The heritability of the trait might also be considered as a third component. With all the QTL information integrated into a single consensus map, outstanding regions involved in the expression of the same trait (different crosses or environments) or different target traits (same cross and/or different crosses or environments) should be identified. If such "universal" drought genomic regions are identified, the objective should be to conduct MAS experiments on those regions for new crosses (good by good lines with different genetic background), without making a QTL identification in each target cross.

### **Functional genomics**

The recent development of genomic technologies that provide structural and functional information, gene characterization (i.e., the localization, sequence, and expression framework of a gene) has received a significant boost during the last few years. To date, if one tries to establish a list of candidate genes for drought tolerance based on gene function, hundreds of genes can easily be listed (Skriver and Mundy 1990, Bray 1993, Ingram and Bartels 1996, Bohnert et al. 2000). The questions now are how to prioritize research aimed at characterizing the genes involved in the drought-tolerance process, and once those genes are characterized, how to identify and efficiently manipulate the elite alleles at those target loci to improve a given variety. The first question must be addressed principally by the research groups conducting basic genomic research. Of course, establishing such priorities is more or less a function of the available resources and research objectives of a group. The recent discovery of promoter regulatory elements, like DRE (dehydration-responsive element) or ABRE (ABA-responsive element) involved in both dehydration- and low-temperature-induced gene expression in *Arabidopsis* (Shinozaki and Yamaguchi-Shinozaki 1997), as well as the identification of transcriptional factors interacting with those promoters (Liu et al. 1998), are exciting developments. The characterization of the genes involved in the initiation phase of the stress response (e.g., genes encoding for stress-induced transcription factors) should be a logical priority, since they represent the "upstream keys" to global genomic responses that might involve hundreds of genes. Moreover, once they have been identified, expression of these key genes should serve as a "timing reference" to identify expression products

from downstream genes involved in stress responses. This can be achieved using microarray technology, as described by Chu (1998).

The new field of functional genomics will provide useful information through profiling experiments (Seki et al. 2001) and/or through the candidate gene approach based on genomic location or function of interest. The candidate gene approach is facilitated by looking at the large number of sequences and freely available gene information found in plant genetic databases (maize, *Arabidopsis*, rice, etc.) to identify potential candidate genes and pathways involved in drought tolerance. The expression profile of the candidate genes defined under "in house" experimental conditions will provide important information for evaluating the role of potential pathways in target germplasm. The correlation on a linkage map between a differentially expressed EST and a QTL related to the same physiological parameter will be a key step in the validation process of a candidate gene. The gene expression response, together with the phenotypic characterization and additional QTL information about a plant, serve as the basis of an integrated approach for better understanding the maize response to a water-limited environment. Indeed, these three sources of information are complementary because the QTL characterization, which defines the genetic basis of the key physiological parameters, represents the link between the differential gene expression mechanisms and the morphological plant response.

## Conclusion

It is clear that a multidisciplinary approach—including breeding, physiology, and biotechnology—is required for efficient germplasm improvement for greater drought tolerance in maize. The QTL characterization effort initiated at CIMMYT several years ago will continue, with particular emphasis given to the genetic dissection of physiological drought-adaptive traits. At the same time, we will explore the potential of functional genomics, which should provide useful information at the gene regulation level. Understanding the genetic basis (QTL characterization) of the essential physiological parameters of drought tolerance in maize, together with the data generated by profiling experiments, should allow the identification of the key pathways involved in drought stress and how they interact. The emergence of molecular genetics and associated technologies represents a major new breeding tool; the current challenge is to integrate this tool and the information it generates into breeding schemes to further the development of efficient MAS strategies. This, in turn, should lead to improved morphological maize response to water-limited conditions.

## References

- Beck, D., Betrán, J., Bänziger, M., Edmeades, G.O., Ribaut, J.-M., Willcox, M., Vasal, S.K. and Ortega, A. 1996. Progress in developing drought and low soil nitrogen tolerance in maize. *In*: Wilkinson D, editor. Proceedings 51st Annual Corn and Sorghum Research Conference, Chicago, 10-11 Dec. 1996. Washington, D.C. (USA): ASTA. pp. 85-111.
- Bohnert, H.J., Nelson, D.E. and Jensen, R.G. 1995. Adaptations to environmental stresses. *Plant Cell* 7: 1099-1111.
- Bohnert, H., Fischer, R., Kawasaki, S., Michalowski, C., Wang, H., Yale, J. and Zepeda, G. 2000. Cataloging stress-inducible genes and pathways leading to stress tolerance. *In*: Ribaut, J.-M. and Poland, D. (eds.) Molecular Approaches for the Genetic Improvement of Cereals for Stable Production in Water-Limited Environments. A Strategic Planning Workshop held at CIMMYT, El Batán, Mexico, 21-25 June 1999, CIMMYT, Mexico, D.F., Mexico, pp. 156-161.
- Bolaños, J. and Edmeades, G.O. 1993. Eight cycles of selection for drought tolerance in lowland tropical maize. II. Responses in reproductive behavior. *Field Crops Research* 31: 253-268
- Boyer, J.S. 1982. Plant productivity and environment. *Science* 218: 444-448.
- Bray, E.A. 1993. Molecular response to water deficit. *Plant Physiologist* 103: 1035-1040.
- Bray, E.A. 1997. Plant responses to water deficit. *Trends in Plant Sci* 2: 48-54.
- Campbell, S.A. and Close, T.J. 1997. Dehydrins: genes, proteins, and associations with phenotypic traits. *New Phytol.* 137: 61-74.
- Chu, S., J. DeRisi, M. Eisen, J. Jutholland, D. Botstein, P.O. Brown, and Herskowitz, I. 1998. The transcriptional program of sporulation in budding yeast. *Science* 282: 699-705.
- Curry, R.B., Jones, J.W., Boote, K.J., Peart, R.M., Allen, L.H. and Pickering, N.G. 1995. Response of soybean to predicted climate change in the USA. *In*: Climate Change and Agriculture: Analysis of Potential International Impacts. ASA Special Publication No. 59. ASA, Madison, WI, pp. 163-182.
- Duncan, R.R. 1984. The association of plant senescence with root and stalk disease in sorghum, *In*: L.K. Mughogho (ed) Sorghum root and stalk diseases, a critical review. Proc Consult group discussion of research needs and strategies for control of sorghum root and stalk diseases, 27 Nov - 2 Dec 1983, Bellagio, Italy, ICRISAT, Potancheru, AP, India, pp. 99-100.
- Edmeades, G.O., Bolaños, J. and Lafitte, H.R. 1992. Progress in breeding for drought tolerance in maize. *In*: Wilkinson DB (ed) Proceedings of the 47th Annual Corn & Sorghum Research Conference, ASTA, Washington, pp. 93-111.
- Edmeades, G.O., Bolaños, J., Elings, A., Ribaut, J.-M., Bänziger, M. and Westgate, M.E. 2000. The role and regulation of the anthesis-silking interval in maize. *In*: Westgate, M.E. and Boote, K.J. (eds) Physiology and Modeling Kernel Set in Maize. CSSA Special Publication No. 29. CSSA, Madison,

- WI, pp. 43-73.
- Edmeades, G.O., Cooper, M., Lafitte, R., Zinselmeier, C., Ribaut, J.-M., Habben, J.E., Löffler, C. and Bänziger, M. 2001. Abiotic stresses and staple crops. *In: J. Nosberger, H.H. Geiger, and P.C. Struik (eds). Crop Science: Progress and Prospects. Proceedings of the Third International Crops Science Congress, 17-21 August, 2000. CABI, Wallingford, UK. (in press).*
- Hall, A.J., Vilella, F., Trapani, N. and Chimenti, C. 1982. The effects of water stress and genotype on the dynamics of pollen-shedding and silking in maize. *Field Crops Research* 5: 349-363.
- Heisey, P.W. and Edmeades, G.O. 1999. Part 1. Maize production in drought stressed environments: technical options and research resource allocation. *In: CIMMYT (eds.) World Maize Facts and Trends 1997/98. CIMMYT, Mexico D.F., Mexico, pp. 1-36.*
- Ingram, J. and Bartels, D. 1996. The molecular basis of dehydration tolerance in plants. *Annual Review Plant Physiol. Plant Mol. Biol.* 47: 377-403.
- Lee, M. 1995. DNA markers and plant breeding programs. *Adv. Agron.* 55:265-344.
- Liu, Q., Kasuga, M., Sakuma, Y., Abe, H., Miura, S., Shinozaki-Yamaguchi, K. and Shinozaki, K. 1998. Two transcription factors, DREB1 and DREB2, with an EREBP/AP2 DNA binding domain separate two cellular signal transduction pathways in drought- and low- temperature-responsive gene expression, respectively, in *Arabidopsis*. *Plant Cell* 10, 1391-1406.
- McBee, G.G. and Miller, F.R. 1982. Carbohydrates in sorghum culms as influenced by cultivars, spacing, and maturity over a diurnal period. *Crop Sci.* 22: 381-385.
- McBee, G.G. 1984. Relation of senescence, nonsenescence, and kernel maturity to carbohydrate metabolism in sorghum. *In: L.K. Mughogho (ed) Sorghum root and stalk disease: A Critical Review. Proc Consul group discussion of research needs and strategies for control of sorghum root and stalk diseases, 27 Nov- 2 Dec 1983, Bellagio, Italy, pp. 119-129, ICRISAT, Patancheru, AP, India.*
- Mohan, M., Nair, S., Bhagwat, A., Krishna, T.G., Yano, M., Bhatia, C.R. and Sasaki, T. 1997. Genome mapping, molecular markers and marker-assisted selection in crop plants. *Mol. Breed.* 3, 87-103.
- Nguyen, H.T., Babu, R.C. and Blum, A. 1997. Breeding for drought resistance in rice: physiology and molecular genetics considerations. *Crop Sci.* 37: 1426-1434.
- Ribaut, J.-M., Hoisington, D.A., Deutsch, J.A., Jiang, C. and Gonzalez-de-Leon, D. 1996. Identification of quantitative trait loci under drought conditions in tropical maize. I. Flowering parameters and the anthesis-silking interval. *Theor. Appl. Genet.* 92: 905-914.
- Ribaut, J.-M., Jiang, C., Gonzalez-de-Leon, D., Edmeades, G.O. and Hoisington, D.A. 1997. Identification of quantitative trait loci under drought conditions in tropical maize. 2. Yield components and marker-assisted selection strategies. *Theor. Appl. Genet.* 94: 887-896.
- Ribaut, J.-M. and Hoisington, D.A. 1998. Marker-assisted selection: new tools and strategies. *Trends in Pl. Sc.* 3: 236-239.
- Ribaut, J.-M. and Betrán, F.J. 1999. Single large-scale marker-assisted selection (SLS-MAS). *Mol. Breed.* 5: 531-541.
- Ribaut, J.-M. and Poland, D. (eds.) 2000. Proceedings of Workshop on Molecular Approaches for the Genetic Improvement of Cereals for Stable Production in Water-Limited Environments. CIMMYT, El Batán, Mexico.
- Rosenow, D.T., Quisenberry, J.E., Wendt, C.W. and Clark, L.E. 1983. Drought tolerant sorghum and cotton germplasm. *Agric. Water Manag.* 7:207-222.
- Seki, M., Narusaka, M., Abe, H., Kasuga, M., Yamaguchi-Shinozaki, K., Carninci, P., Hayashizaki, Y. and Shinozaki, K. 2001. Monitoring the expression pattern of 1300 arabidopsis genes under drought and cold stresses by using a full-length cDNA microarray. *The Plant Cell*, 13: 61-72.
- Shinozaki, K. and Yamaguchi-Shinozaki, K. 1996. Molecular responses to drought and cold stress. *Curr. Opin. Biotech.* 7: 161-167.
- Shinozaki, K. and Shinozaki-Yamaguchi, K. 1997. Gene expression and signal transduction in water-stress response. *Plant Physiol.* 115, 327-334.
- Skriver, K. and Mundy, J. 1990. Gene expression in response to abscisic acid and osmotic stress. *Plant Cell* 2, 503-512.
- Thomas, H. and Smart, C.M. 1993. Crops that stay-green. *Ann. Appl. Biol.* 123: 193-219.
- Westgate, M.E. and Boyer, J.S. 1986. Reproduction at low silk and pollen water potentials in maize. *Crop Sci.* 26: 951-956.
- Westgate, M.E. and Bassetti, P. 1990. Heat and drought stress in corn: what really happens to the corn plant at pollination? *In: D.Wilkinson (ed) Proceedings of the 45th Annual Corn & Sorghum Research Conference, ASTA, Washington, pp. 12-28.*
- Zhang, J., Nguyen, H.T. and Blum, A. 1999. Genetic analysis of osmotic adjustment in crop plants. *J. Exp. Bot.* 50:291-302.
- Zhang, J., Zheng, H.G., Aarti, A., Pantuwan, G., Nguyen, T.T., Tripathy, J.N., Sorial, A.K., Robin, S., Babu, R.C., Nguyen, B.D., Sarkarung, S., Blum, A. and Nguyen, H.T. 2001. Locating genomic regions associated with components of drought resistance in rice: comparative mapping within and across species. *Theor. Appl. Genet.* 103: 19-29.



# Rice functional genomics via cDNA microarray: Systems for the microarray analysis and the expression profiles of stress responsible gene expression

Shoshi Kikuchi¹, Junshi Yazaki¹, Naoki Kishimoto¹, Masahiro Ishikawa¹,  
Keiichi Kojima², Takahiro, Namiki², Kanako Shimbo³, Fumiko Fujii¹,  
Tomoya Ohata¹, Zenpei Shimatani³, Akiko Hashimoto³, Yuko Nagata³,  
Sachiko Honda¹, Kazuko Toyoshima¹, Katsumi Sakata¹,  
Kimiko Yamamoto³, Takuji Sasaki¹

¹Head of the team of Gene Expression, Department of Molecular Genetics  
National Institute of Agrobiological Sciences(NIAS) Tsukuba, Ibaraki 305-8602, Japan

²Hitach Soft Engineering

³Society for Techno-innovation of Agriculture, Forestry and Fisheries

## Abstract

---

We have embarked on a large-scale functional genomics using the microarray system in order to obtain a global expression profile of rice genes. More than 11,000 partial cDNA sequences corresponding to unique genes have been identified at the Rice Genome Research Program (RGP). From these sequences, microarrays were constructed using 1265 cDNA clones (phase I) and 8978 clones (phase II) as probes. Both the full insert and the gene-specific portions (3'-UTR) of the cDNA clones were spotted on the glass slides using a high-speed robotic arrayer. About one third of the genes have the annotation from the sequence homology search with the public Data Bases such as NCBI Genbank.

These were used as probes to hybridize target RNAs prepared from normally grown rice tissues (as control) and some stress treated tissues, such as some low temperature conditions, a high salt condition, some nutrient deficient conditions, oxidative stress treatment such as UV-B and Gamma irradiation and the treatment with Hydrogen peroxide, the additions of excess hormones and the treatment with hormone biosynthesis inhibitors and so on. Normalized data among several experiments are summarized in Data Base and the expression profiles of the genes are compared. According to the reproducibility of the microarray data, change of the gene expression was focused more than three-fold difference. Genes can be clustered into some groups such as "commonly up regulated and commonly down regulated responsible for some stress conditions and in some stresses up regulated and in other stresses down regulated genes.

Summarizing the expression data from the microarray analyses, the full-length sequence data of cDNA clones, gene annotation data from the homology search (especially from the mapping data on the chromosomes) and the genomic sequence data from the Rice Genome Sequence Project, it is possible to assign the promoter sequences of the genes which show common profile in stress responsible expression.

*Keywords; Microarray, Gene expression, cDNA, Oryza sativa*

## Introduction

The Rice Genome Research Program (RGP) has undertaken an extensive rice genome analysis since its initial launching in 1991 that has resulted in the

establishment of a catalog of rice genes,¹ a high-density linkage map,² and a YAC-based physical map.³⁻¹⁰ An enormous collection of ESTs was generated from large-scale cDNA sequencing using cDNA libraries derived from rice callus cultured in different medium and tissues

such as root, shoot, leaf and panicle.¹¹ As of today, more than 40,000 ESTs are analysed thus far, approximately more than 11,000 partial cDNA sequences corresponding to unique genes have been identified. Based on the results of large scale cDNA analysis, microarray can be used to monitor gene expression profiles and to initiate functional analysis of the rice genome. The use of microarray for measuring gene expression level is advantageous over other established techniques such as Northern blots and RT-PCR because it facilitates analysis of a large number of genes simultaneously.¹² It will therefore provide a fast and efficient method of monitoring the expression profiles of thousands of genes that comprise the genome. In many systems such as human,^{13,14} yeast,¹⁵⁻¹⁷ *Drosophila*,¹⁸ microarray is already a widely used tool for functional analysis. In *Arabidopsis*, a microarray system has also been established.¹⁹ Although the use of plant microarrays is only at its beginning, this approach will soon be a standard investigative approach in plant biology as well.²⁰⁻²²

We initiated a rice cDNA microarray project beginning in April 1999 that aims to elucidate the function of all genes in rice using a gene expression monitoring system. The National Institute of Agrobiological Sciences (NIAS) and the Institute of the Society for Techno-innovation of Agriculture, Forestry and Fisheries (STAFF) are jointly conducting this project in collaboration with 64 research institutions all over Japan. We have constructed 1265 probes (phase I) and 8987 probes (phase II) microarrays and we have embarked on a rice functional genomics using the various target RNAs.²³ Sequence data and the homology search results of the probe clones are shown in our WEB site <http://microarray.rice.dna.affrc.go.jp>. In this manuscript, we have focused on the expression profiles of the genes which altered transcription pattern after UV-B and gamma irradiation. Comparing which genes are up- and down regulated we have discussed the similarity of the different stress treatments.

## Material and Methods

### Rice cDNA clones as probes for microarray

All cDNA clones were generated by large-scale cDNA analysis at RGP (Yamamoto et al. 1997). Gene clustering to obtain the unique clones was performed by BLASTN. Sequence homology search (BLASTN and BLASTX) was performed with the representative clones of the clusters as queries, the results are shown in our WEB site <http://microarray.rice.dna.affrc.go.jp>.

### Amplification of cDNA insert

The vectors used for the cDNA library constructions were  $\lambda$ ZAPII. Insert cDNA clones were amplified by

PCR using M13 as primer (TAKARA, Shiga, Japan); M4 (5'-GTTTTCCCAGTCACGAC) and RV (5'-CAGGAAACAGCTATGAC) were complementary to vector sequences flanking both sides of the cDNA insert. Plasmid template (1-2 ng) was added to 50  $\mu$ l PCR mixture containing 0.2  $\mu$ M of each nucleotide, 0.4  $\mu$ M of each primer, 2.5 mM of Mg²⁺ and 1.25 units of Taq polymerase. Inserts were amplified by PCR with 30 cycles of 94°C for 1 min, 60°C for 2 min, 72°C for 2 min, an initial denaturation at 94°C for 1 min and final extension at 72°C for 10 min. The 3'-UTR of the cDNA clones were amplified using each specific primer complementary to the specific region of each cDNA clone. The PCR was carried out in same condition as the cDNA full insert amplification. Both PCR products were purified using QIAquick 96-column (QIAGEN, Tsukuba, Japan), and mixed with water and reagent D (Amersham Pharmacia, Tokyo, Japan) for microarray fabrication. In general, the total quantity of each PCR product was greater than 1  $\mu$ g. The average size of full inserts and 3'-UTR in the cDNA clone was about 1000 and 200 bp, respectively.

### Spotting

We spotted cDNA probes in duplicate on aluminum-coated and DMSO optimized glass slide (1"  $\times$  3") using an Array Spotter Generation III (Amersham Pharmacia, Tokyo, Japan). The spot density is 4,608 spots of clones stored in twelve of 384-well microtiter plates are duplicated on the 20mm  $\times$  60 mm area. The spotter was maintained at 55% humidity. After spotting the slides were dried for about 1 hr under the same condition and exposed to UV for cross linking.

### Plant materials and RNA isolation

Mainly *Oryza sativa* L. cv. Nipponbare was used for RNA extraction and target preparation. Leaf and root tissues were collected from laboratory-cultured plants at several days post germination. Callus was induced from seeds cultured in MS medium supplemented with 2, 4-dichlorophenoxy acetic acid at 25°C for 20 days. Flower buds were collected at day one of developing stage. Stress treatments were performed to these tissues by several ways. Then the plants and calli were grown side by side and at some time points samples were taken.

Condition of UV-B and Gamma irradiation is as follows. Two week-old seedlings of *O. sativa* L. Nipponbare were irradiated with UV-B and Gamma rays from ⁶⁰Co. Dosage of UV-B is 3.8J/m² sec for 0.6 min. to 4.8 min and irradiated with Gamma rays from ⁶⁰Co (9.2 Gy /min) for 1.3 min to 8.5 min. Sampling was made at time 0 and 8hr to 3 days after irradiation.

Tissue samples for RNA preparation were quick-frozen in liquid nitrogen. Total RNA was prepared using the method of Chirgwin et al. (1979). Poly (A)+ RNA



was purified using Oligotex-dT super (TAKARA, Shiga, Japan) from 200 µg of total RNA.

#### Labeling and Hybridization

Each poly (A)+RNA was labelled by reverse transcript reaction with Cy-5 (Amersham Pharmacia, Tokyo, Japan). The reverse transcript reaction mixture was composed of 1µg poly(A)+RNA, oligo-(dT)25, random nonamer, control cRNA, 1xSSII reaction buffer, DTT, dATP 2mM, dGTP 2mM, dTTP 2mM, dCTP 1mM, Cy-5dCTP 1mM and SSII reverse transcriptase. The control cRNAs were synthesized by *in vitro* transcription from mouse platelet-derived growth factor receptor gene and *Homo sapiens* c-kit proto onco gene. These cRNAs were used as quantitative controls at 1 ng, 0.5 ng, 0.1 ng and 50 pg. The ratios of the control cRNA were 100:100 000, 50:100 000, 10:100 000 and 5:100 000. After incubation at 42°C for 2.5 hr, the reaction mixture was denatured at 94°C for 3 min and RNA was degraded by 2 µl 2N NaOH at 37°C for 15min. Following degradation, the mixture was treated with 10 µl 2M HEPES for neutralization. The labelled targets were purified with Qiaquick PCR Purification Kit (QIAGEN, Tsukuba, Japan) and dried using a vacuum concentrator. The dried targets were resuspended in a 6 µl water and denatured at 95°C for 4 min. A 1.5 µl Oligo A80 (1mg/ml) was added to the re-suspended targets and 7.5 µl 4 × hybridization buffer containing SSC, SDS, Denhardt's solution, salmon sperm DNA, formamide, 15 µl formamide. A final volume of 30 µl was used for hybridization.

#### Washing, Scanning and Data analysis

After 16 hr of hybridization, the glass slides were washed in 1 × SSC / 0.2% SDS for 10 min at 55°C under dark condition, then in 0.1 × SSC / 0.2% SDS for 10 min at 55°C twice in the dark condition and finally, in 0.1 × SSC for 1 min at room temperature twice. After the final wash, the slides were briefly rinsed with distilled water and air dried using air duster in a dust free environment. The hybridized and washed microarrays were scanned using an Array Scanner (Fujifilm FLA8000). Scanned spot data are indicated in Figure 1. A computer software, Array Gauge from Fujifilm was used to locate and delineate every spot in the array and to integrate spot intensities and volumes for each individual spot.

#### Volume detection

The control cRNA (1 ng, 0.5 ng, 0.1 ng and 50 pg) was added to 1 µg sample mRNA, thereby resulting in control cRNA to sample mRNA ratios of 100:100 000, 50:100 000, 10:100 000 and 5:100 000. The control cRNA and sample mRNA mixtures were reverse-transcribed in the presence of Cy-5dCTP into the first cDNA strand, and hybridized to complementary DNA elements on the microarray.

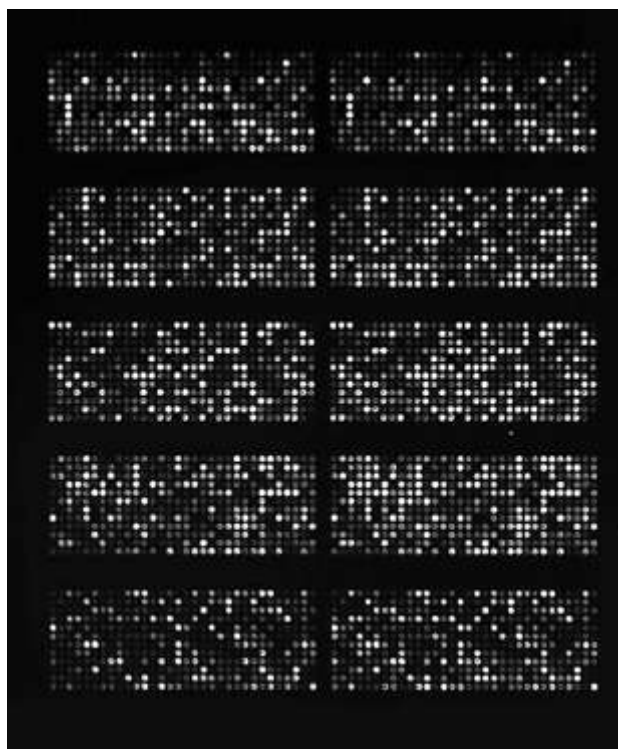


Fig. 1. Scanning pattern of Microarray slides

In this figure, five duplicated fields are shown. One field consists of 12 rows and 32 columns. Target RNAs were labelled with Cy3 and Cy5.

## Results and Discussion

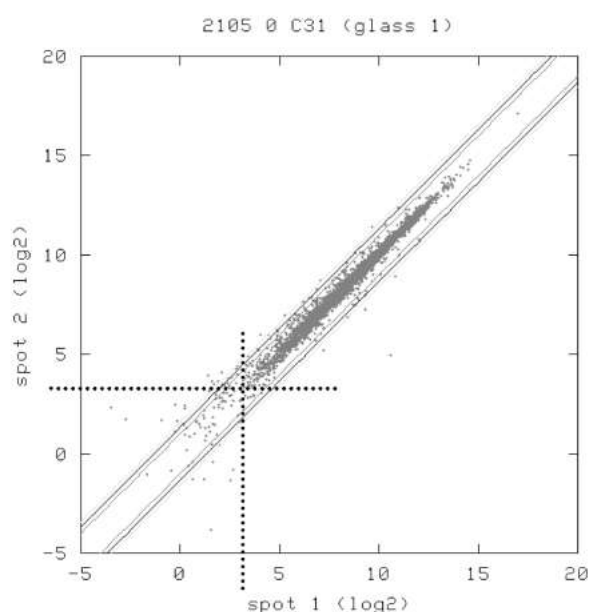
#### Reproducibility of the array data

At first for the microarray analysis, the reproducibility of the spot signal data is very important. We have performed two types experiments to check the reproducibility. One is to check the signal reproducibility of the duplicated spot data. The other is that the same target RNA labelled at the same time was hybridized with the different glasses. In both cases, scattered plots of the spot signals were drawn as indicated in Figure 2. Distribution of the spots were from 2 ( $\log_2 X=1$ ) to 32768 ( $\log_2 Y =15$ ). Then the threshold intensity is about 11 ( $\log_2 Z = 3.5$  indicated with a dotted line in Figure 2).

Almost all the spots, which have the intensity more than threshold, located within the three fold lines (the region between two green lines in Figure 2). Therefore we have determined to focus the genes which show the change of expression more than three times.

#### Gene expression profiles of UV-B irradiation and Gamma irradiation

In our data analysis rule, the spots which show irreproducible signal between the duplicated spots data



**Fig. 2. Scattered plot of the experiment checking the reproducibility of the micro array data**

To check the reproducibility with the signal of duplicated spot data, each spot signal data are plotted. Dotted lines indicate the threshold line of signal intensity. Green lines are  $\log_3$  and  $\log_{1/3}$  lines, blue lines are  $\log_{2.5}$  and  $\log_{1/2.5}$  lines, and red lines are  $\log_2$  and  $\log_{1/2}$  lines. Spots locate between the lines show the difference of signals are with the indicated folds.

are removed, then the genes which show the change of the spot intensity more than three folds after irradiation are listed. As shown in Table 1, about 1% of the genes show up-regulated gene expression pattern one day after UV-B irradiation, and 0.5% to 1% genes show down-regulation expression pattern in the same targets. On the other hand, three days after UV-B irradiation, number of the genes showing similar pattern increases, however the common genes listed in 1 day and 3 days after irradiation are few (Table 2). Only seven genes are commonly up-regulated and seven genes are commonly down-regulated in the case of low dosage condition ( $136.8 \text{ J/m}^2$ ). Methalothionein-like protein gene and alpha 1 tubulin gene are the member of commonly up-regulated genes. The gene which has an annotation of Brassica napus mRNA for CTP: phosphocholine cytidyltransferase and the other gene with *Glycine max* seed maturation protein PM36 are the member of commonly down-regulated genes. The same pattern is also observed in the high dosage ( $1094.4 \text{ J/m}^2$ ) condition. Among 22 commonly up-regulated genes, acidic class III chitinase OsChib3a, pathogenesis-related thaumatin-like protein, Methalothionein-like protein, Putative peroxidase are

**Table 1**

Number of genes showing more than three fold change of expression after UV-B irradiation to the two week-old rice seedlings

Condition of irradiation ( $\text{J/m}^2$ day after irradiation.)	Pattern of Alteration of Gene Expression	
	No of UP-regl clones	No of DOWN-regl clones
136.8 1	83	76
136.8 3	453	300
1094.4 1	95	43
1094.4 3	819	648

using 8,987 probe array

**Table 2**

Number of the genes which commonly regulated after one and three days after UV-B irradiation

Gene expression profile		
1 day after irradiation.	3 days after irradiation.	Number of genes
(136.8 $\text{J/m}^2$ )		
UP	UP	7
UP	DOWN	1
DOWN	UP	1
DOWN	DOWN	7
using 8,987 probe array		
(1094.4 $\text{J/m}^2$ )		
UP	UP	22
UP	DOWN	1
DOWN	UP	0
DOWN	DOWN	5
using 8,987 probe array		

involved. These data suggest that although some stress-related genes are listed up, however, the groups of the genes which show early response after UV-B irradiation (1day) and late response after UV-B irradiation (3 days) are different. Further analyses, such as the time course experiments, are needed.

In the case of Gamma irradiation similar patterns are observed. Eight hours after irradiation 173 and 569 genes are listed as up-regulators in low ( $11.96\text{Gy}$ ) and high ( $78.2\text{Gy}$ ) dosage conditions, respectively, and the number increased in the case of 24 hours after irradiation in low dosage condition (450 and 541). Down-regulators show the similar results (Table 3), however, the commonly regulated genes in both sampling times are very rare (Table 4). Among ten commonly up-regulated clones in low dosage condition, alcohol dehydrogenase I gene, beta tubulin gene, NADH-Ubiquinone oxidoreductase subunit and poly ubiquitin gene are involved. While in the high dosage condition, almost all members of 20 commonly up-regulated genes are unknown. These data also suggest that the groups of the genes which show early responses and late responses should be separated.

**Table 3**

Number of genes showing more than three fold change of expression after Gamma irradiation to the two week-old rice seedlings

Condition of irradiation (Gy hr after irradi.)	Pattern of Alteration of Gene Expression	
	No of UP-regl clones	No of DOWN-regl clones
11.96 8	173	46
11.96 24	450	264
78.2 8	569	471
78.2 24	541	432

using 8,987 probe array

**Table 4**

Number of the genes which commonly regulated after one and three days after UV-B irradiation

Gene expression profile			Number of genes
8 hr after irradi.	24 hr after irradi.		
(11.96 Gy)			
UP	UP		10
UP	DOWN		12
DOWN	UP		0
DOWN	DOWN		2
			using 8,987 probe array
(78.2 Gy)			
UP	UP		20
UP	DOWN		131
DOWN	UP		128
DOWN	DOWN		13
			using 8,987 probe array

UV-B and Gamma irradiations are both the DNA damage stresses and induce the Active Oxygen Species then the radical scavengers such as ascorbic acids and many kinds of flavonoids are known to accumulate in plant. Though these two stimuli induce the similar physiological effects to the plant, however, our microarray data show very small number of the genes commonly induced by both stimuli. Those are the gene with the annotation of Citrus iyo gene for polygalacturonase inhibitor (PGIP), major intrinsic protein, beta tubulin, eukaryotic initiation factor, lipid transfer protein, and methalothionein-like protein.

Using these gene expression profiles as parameters for checking the similarity of the stimuli, we have compared the list of genes which show the alteration of expression after several stress treatments such as the elicitor treatment, nutrition stress, cold stress, salt stress and treatment with several phytohormones. At this moment, we have the feeling that the gene expression profiles between the UV-B irradiation and the elicitor treatment are similar. Gamma irradiation and low temperature treatment commonly list up the similar genes. To confirm these data, further analysis and the

intensive comparison with the several conditions are necessary.

## Conclusion

At this moment we can conclude two advantageous points of Microarray technology. One is that Microarray technology is a powerful technology to obtain the genes which show the interesting expression pattern in target RNAs. The other point is that comparison of the expression profiles of the genes of different targets, it is possible to estimate the similarity or the difference of the compared stimuli.

## Acknowledgements

We thank Ms. A. Endoh, H. Hattori, S. Iizumi, S. Kimura, C. Miyamoto, Y. Satoh, T. Shibata, K. Takeyuchi, Y. Yoshida for the technical assistance to the microarray analysis.

This work was supported by a grant from the Ministry of Agriculture, Forestry and Fisheries of Japan (Rice Genome Project MA-1001, MA-2105.)

## References

- Sasaki, T., Song, J., Koga-Ban, Y., et al. 1994, toward cataloguing all rice genes: large-scale sequencing of randomly chosen rice codas from a callus cDNA library. *Plant J.*, **4**, 615-624.
- Harushima, Y., Yano, M., Shomura, A., et al. 1998, A high-density rice genetic linkage map with 2275 markers using a single F2 population., *Genetics*, **48**, 479-494.
- Antonio, B.A., Emoto, M., Wu, J., et al. 1996, Physical mapping of rice chromosomes 8 and 9 with YAC clones., *DNA Res.*, **3**, 393-400.
- Koike, K., Yoshino, K., Sue, N., et al. 1997 Feb 28, Physical mapping of rice chromosomes 4 and 7 using YAC clones, *DNA Res.*, **4**, 27-33.
- Saji, S., Umehara, Y., Kurata N., Ashikawa, I. and Sasaki, T. 1996, Construction of YAC contigs on rice chromosome 5., *DNA Res.*, **3**, 297-302.
- Shimokawa, T., Kurata, N., Wu, J., et al. 1996, Assignment of YAC clones spanning rice chromosomes 10 and 12., *DNA Res.*, **3**, 401-406.
- Tanoue, H., Shimokawa, T., Wu, J., et al. 1997, Ordered YAC clone contigs assigned to rice chromosomes 3 and 11., *DNA Res.*, **4**, 133-140.
- Umehara, Y., Tanoue, H., Kurata, N., et al. 1996, An ordered yeast artificial chromosome library covering over half of rice chromosome 6., *Genome Res.*, **10**, 935-942.
- Umehara, Y., Kurata, N., Ashikawa, I. and Sasaki, T. 1997 Apr 28, Yeast artificial chromosome clones of rice

- chromosome 2 ordered using DNA markers., *DNA Res.*, **4**, 127-131.
10. Wang, Z.X., Idonuma, A., Umehara, Y., et al. 1996, Physical mapping of rice chromosome 1 with yeast artificial chromosomes (YACs), *DNA Res.*, **3**, 291-296.
  11. Yamamoto, K. and Sasaki, T. 1997, Large-scale EST sequencing in rice., *Plant Mol Biol.*, **35**, 135-144.
  12. Brown, P.O. and Bostein, D. 1999, Exploring the new world of the genome with DNA microarrays, *Nature genetics*, **21**, 33-37.
  13. Iyer, V.R., Eisen M.B. and Brown P.O. 1999, The transcriptional program in response of human fibroblasts to serum, *Science*, **283**, 83-87.
  14. Schena, M., Shalon, D., Heller, R., et al. 1996, Parallel human genome analysis: Microarray-based expression monitoring of 1000 genes., *Proc. Natl. Acad. Sci. USA*, **93**, 10614-10619.
  15. DeRisi, J.L., Iyer, V.R. and Brown, P.O. 1997, Exploring the metabolic and genetic control of gene expression on a genomic scale, *Science*, **278**, 680-686.
  16. Eisen, M.B., Spellman, P.T., Brown, P.O. and Botstein, D. 1998, Cluster analysis and display of genome-wide expression patterns., *Proc. Natl. Acad. Sci. USA*, **95**, 14863-14868.
  17. Sudarsanam, P., Iyer, V.R., Brown, P.O. and Winston, F. 2000, Whole-genome expression analysis of *snf/swi* mutants of *Saccharomyces cerevisiae*., *Proc. Natl. Acad. Sci. USA*, **97**, 3364-3369.
  18. White, K.P., Rifkin, S.A., Hurban, P. and Hogness, D.S. 1999, Microarray analysis of *Drosophila* development during metamorphosis., *Science*., **10**, 2179-84.
  19. Ruan, Y., Gilmore, J. and Conner, T. 1998, Towards Arabidopsis genome analysis: monitoring expression profiles of 1400 genes using cDNA microarrays, *The Plant J.*, **15**, 821-833.
  20. Richmond, T. and Somerville, S. 2000, Chasing the dream: plant EST microarrays., *Curr Opin Plant Biol.*, **3**, 108-116.
  21. Schaffer, R., Landgraf, J., Perez-Amador, M. and Wisman, E. 2000, Monitoring genome-wide expression in plants, *Current Opinion in Biotechnology*, **11**, 162-167.
  22. Somerville, C. and Somerville, S. 1999, Plant functional genomics., *Science*, **285**, 380-383.
  23. Yazaki, J. et al. 2000 Embarking on functional Genomics via cDNA microarray: Use of 3' UTR Probes for specific gene expression analysis *DNA Research* **7**, 367-370.



# JIRCAS Visiting Research Fellowship Program at Tsukuba 2001

---

Japan International Research Center for Agricultural Sciences (JIRCAS) (formerly Tropical Agriculture Research Center) has implemented the “Visiting Research Fellowship Program at Tsukuba” since 1995.

The fellowship aims at the promotion of collaborative research to address various problems confronting the countries in developing regions on a global scale, including the critical situation of food production, the progression of desertification and the gradual disappearance of genetic resources.

JIRCAS which is located in Tsukuba Science City and is equipped with facilities for advanced research, is inviting young promising researchers from institutes in developing regions who will play a major role in the activities of these institutes in future to carry out collaborative research for the sustainable development or rapid progress of agriculture, forestry and fisheries compatible with the preservation of the natural environment.

Under the Fellowship Program, a total of ten (10) researchers will be invited, of which six (6) will undertake the JIRCAS type projects for a period of one (1) year and the other four (4) researchers will be engaged in the NIAR type projects for a period of five (5) months. The former six (6) will carry out collaborative research at JIRCAS HQ, while the latter four (4) will conduct research at the National Institute of Agrobiological Resources (NIAR) at Tsukuba.

## Fellowship Qualifications

- (1) Applicants should be outstanding researchers who will play a major role in the activities of the respective institutes in future. After the completion of the Fellowship, they should continue to carry out research at the same institute.

- (2) Hold a Master's degree in a field relating to socio-economics and natural sciences and technology or equivalent qualifications in related fields. Be preferably less than 35 years of age.
- (3) Carry out research related to one of the themes listed under "Research Themes".
- (4) Should enjoy a good health.
- (5) Have an adequate command of English or Japanese language.

## Tenure

In principle, starting from October 2001, the JIRCAS type projects will cover a period of one (1) year and the NIAR type projects will cover a period of five (5) months.

## Fellowship Conditions

- (1) A round-trip airline ticket (economy class) will be available (except for dependents).
- (2) Living allowance: 260,000yen per month.  
(including housing allowance)
- (3) Housing: International Guesthouse  
2-1-2, Kan-nondai, Tsukuba (single room)
- (4) Fixed-rate insurance package (for injury, sickness and damage, etc.) will be offered under the JIRCAS Fellowship Program. (except for dependents)

## Application Procedure (This year's application has come to a close.)

Applicants are required to submit the following documents to the Director General of JIRCAS.

(1) Application form

[pdf](#)

[Word 6.0/95\(*.doc\)](#)

(2) Copies of the most important articles (Up to 3)

## Deadline for Application

March 15, 2001

## Notification

JIRCAS will examine the application documents and notify the results of the selection to the successful applicants and their recommending authorities about three months after the deadline date for application.

Further information about the Visiting Research Fellowship Program can be obtained from the International Relation Section, Japan International Research Center for Agricultural Sciences, 1-2, Ohwashi, Tsukuba, Ibaraki, 305-8686 Japan.

*****

URL: <http://www.jircas.affrc.go.jp/>

E-mail: [irs@jircas.affrc.go.jp](mailto:irs@jircas.affrc.go.jp)

Tel: 81 - 298 - 38 - 6335

Fax: 81 - 298 - 38 - 6337

---

HOME

# JIRCAS Visiting Research Fellowship at Tsukuba 2002

Application Form to  
The Japan International Research Center  
for Agricultural Sciences (JIRCAS)

Photo-  
portrait  
(30 x 40)

(Do type or write in block letters)

**Name:** Dr./Mr./Ms. (please underline the family name)

**Date of birth:** (Day/Month/Year)

**Marital status:** ( ) Single ( ) Married

**Sex:** ( ) Male ( ) Female

**Nationality:**

**Religion:**

**Institution:**

Name:

Division:

Position:

Address:

Tel. No.: _____ Fax. No.: _____ E-mail : _____

**Education** (the last only)

Name of institution:

Subject majored:

Year of graduation:

Degree, diploma:

**Theme you wish to study** [check the theme ( )]

**I. JIRCAS type** (Period : One year)

1. JIRCAS Development Research Division

- ( ) a. Changes in agriculture and rural structure using a mathematical model.  
( ) b. Development of method of monitoring agricultural land use and crop production using remote sensing and GIS.  
( ) c. Research strategies for increase in food production and rural development in African Countries.



2. JIRCAS Biological Resources Division
  - ( ) a. Development of new types of crops with stress-tolerant traits by gene transformation.
  - ( ) b. Development of molecular methods for the evaluation and utilization of rice, wheat, soybean and their wild relatives.
3. JIRCAS Crop Production and Environment Division
  - ( ) a. Analysis and evaluation of climate and human impacts to natural resources cycles of nitrogen and related materials in agro-ecosystems.
  - ( ) b. Geological and mineralogical characterization of salt accumulation in dry-land agriculture and restoration technology development with locally available resources.
  - ( ) c. Physiological mechanism on nutrient acquisition of crops from low-fertility tropical soils.
4. JIRCAS Animal Production and Grassland Division
  - ( ) a. Studies for physiology and ecology of endophytic micro-organisms (nitrogen-fixing bacteria, chitinase-producing bacteria, etc.) in plants.
5. JIRCAS Food Science and Technology Division
  - ( ) a. Determination and analysis of natural antioxidants and antimutagens from indigenous plants to improve the economical value.
  - ( ) b. Development of practical methods of utilizing natural materials as insecticides, fungicides and antibacterial agents for reducing the postharvest losses.
  - ( ) c. Investigation of interaction of food components and developing a new food processing technology.
  - ( ) d. Development of technologies for food preservation, distribution and processing.
6. JIRCAS Forestry Division
  - ( ) a. Studies on material properties affecting pulp production of unused tropical lignocellulosic resources including oil palm.
7. JIRCAS Fisheries Division
  - ( ) a. Physiological studies on aquaculture fish (prawns will be included).

## II. NIAS type (Period : Five months)

- ( ) 1. Methods for the analysis and preservation of biodiversity.
- ( ) 2. Production of new biological resources through the application of biotechnological procedures.
- ( ) 3. Methods for the analysis and control of biological functions.

## Outline of your present study

Title: _____

---

---

---

---

---

---

---

---

---

---

---

---

## Designation by the Authority of the Institute

(to be filled in by the official representative or private authority of the institution where the applicant is employed)

**To: The President of JIRCAS**

I certify that I have examined the above documents and confirm that the information given by the applicant is authentic. I here by designate the applicant, _____ above, as a candidate for the fellowship awarded by the President of JIRCAS.

Signature: _____

(typed): _____

Institution: _____

Position: _____

Date: _____

**Your important publications:** *Please attach the photo copies of the most important articles (Up to 3)*

---

[Author(s), Date of publication, Title of article, Title of journal or publication, Volume/Page, Country where published]

1. Smith, J.T., Davidson, A.B.C and Yamada, T. (2000). Evaluation of structural characteristics of naturally ventilated multi-span greenhouses using computer simulation. JIRCAS Journal. Vol. 2, p. 45-49. Japan
  - 2.
  - 3.
-



# JIRCAS Visiting Research Fellowship Program at Okinawa 2001



---

Japan International Research Center for Agricultural Sciences (JIRCAS) (formerly Tropical Agriculture Research Center) has implemented the “Visiting Research Fellowship Program at Okinawa” since 1992.

The Fellowship emphasizes presently pioneer research on the conservation of the global environment and optimum utilization of bio-resources in the tropics and subtropics.

The successful candidates, the number of which will be about 10, will undertake relevant research pertaining to one of the four themes listed below. Research will be carried out at the Okinawa Subtropical Station of JIRCAS in Ishigaki City, Okinawa Prefecture which is located in the subtropical zone of Japan and is equipped with advanced facilities for research.

## Research Themes

- (1) Development of techniques for environmental control by using plants and microorganisms specific to the tropics and subtropics.
- (2) Elucidation of the mechanism of heat tolerance of tropical and subtropical plants.
- (3) Identification and evaluation of salt-tolerant crops.
- (4) Evaluation and utilization of useful traits of plant genetic resources in the tropics and subtropics.

## Fellowship Qualifications

- (1) Applicants should be nationals of developing countries, be currently employed in a research organization (institute or university, etc.) and be engaged in research relating to tropical or subtropical agriculture and forestry, in principle.
- (2) Hold a Ph. D. degree in a field relating to natural sciences and technology or equivalent qualifications in related fields.
- (3) Be a researcher who will take up research subjects related to one of the four themes listed in the forementioned "Research Themes".
- (4) Be preferably less than 45 years of age.
- (5) Should enjoy a good health.
- (6) Have an adequate command of English or Japanese language.
- (7) Be committed to pursuing research in fields related to tropical agriculture and forestry after the termination of the Fellowship.

## Tenure

In principle, one year, starting from October 2001.

## Fellowship Conditions

- (1) A round-trip airline ticket (economy class) will be available (except for dependents).

(2) Living allowance: 260,000yen per month.

(excluding housing allowance)

(3) Housing (cost borne by JIRCAS): Maison ICRS, 874 Maezato,

Ishigaki, Okinawa, 907-0002 JAPAN

(4) Fixed-rate insurance package (for injury, sickness and damage, etc.) will be offered under the JIRCAS Fellowship Program. (except for dependents)

## Application Procedure (This year's application has come to a close.)

Applicants are required to submit the following documents to the Director General of JIRCAS.

(1) Application form

[pdf](#)

[Word 6.0/95\(*.doc\)](#)

(2) Copies of the most important articles (Up to 3)

## Deadline for Application

March 15, 2001

## Notification

JIRCAS will examine the application documents and notify the results of the selection to the successful applicants and their recommending authorities about three months after the deadline date for application.

Further information about the Visiting Research Fellowship Program can be obtained from the International Relation Section, Japan International Research Center for Agricultural Sciences, 1-2, Ohwashi, Tsukuba, Ibaraki, 305-8686 Japan.

*****

URL: <http://ss.jircas.affrc.go.jp/index.html>

E-mail: [irs@jircas.affrc.go.jp](mailto:irs@jircas.affrc.go.jp)

Tel: 81 - 298 - 38 - 6335

Fax: 81 - 298 - 38 - 6337

---

HOME

# JIRCAS Visiting Research Fellowship at Okinawa 2002

Application Form to  
The Japan International Research Center  
for Agricultural Sciences (JIRCAS)

Photo-  
portrait  
(30 x 40)

(Do type or write in block letters)

**Name:** Dr./Mr./Ms. (please underline the family name)

**Date of birth:** (Day/Month/Year)

**Marital status:** ( ) Single ( ) Married

**Sex:** ( ) Male ( ) Female

**Nationality:**

**Religion:**

**Institution:**

Name:

Division:

Position:

Address:

Tel. No.: Fax. No.: E-mail:

**Education** (the last only)

Name of institution:

Subject majored:

Year of graduation:

Degree, diploma:

**Theme you wish to study** [check the theme ( )]

1. Efficient use of water and fertilizers

( ) a. Field evaluation and control of nutrient and water movement in soil profile.

( ) b. Development and/or analysis of water saving technique to use the sub-soil stored water.

2. Evaluation and utilization of heat- and salt-tolerant crops

( ) a. Elucidation of the mechanism of crop heat tolerance.

( ) b. Development of salt-tolerant crops.



- 3. Evaluation and characterization of tropical and subtropical fruits
  - ( ) a. Evaluation and characterization of functional constituents of tropic and subtropic fruits.
  - ( ) b. Research for photosynthetic carbon dioxide exchange, transpiration and water uptake of tropical fruit crops.
- 4. Evaluation and utilization of useful traits in sugarcane and sweet potato
  - ( ) a. Cloning of anthocyanin transcription activator genes and transformation in sweet potato.
  - ( ) b. Development of efficient Agrobacterium-mediated transformation method in sugarcane.
- 5. Integrated pest management of tropical and subtropical crops
  - ( ) a. Elucidation of the mechanism in transmission and propagation of citrus greening organism.
  - ( ) b. Purification of citrus greening organism and analysis of the pathogen-specific proteins.
  - ( ) c. Ecological studies on insect pests of tropical and subtropical crops and their natural enemies; (e.g. citrus psylla and its parasitic wasps).

**Outline of your present study**

Title: _____

---

---

---

---

---

---

---

---

---

---

---

**Designation by the Authority of the Institute**

(to be filled in by the official representative or private authority of the institution where the applicant is employed)

**To: The President of JIRCAS**

I certify that I have examined the above documents and confirm that the information given by the applicant is authentic. I here by designate the applicant, _____ above, as a candidate for the fellowship awarded by the President of JIRCAS.

Signature: _____

(typed): _____

Institution: _____

Position: _____

Date: _____

**Your important publications** *Please attach the copies of the most important articles (Up to 3)*

.....  
[Author(s), Date of publication, Title of article, Title of journal or publication, Volume/Page, Country where published]

1. Smith, J.T., Davidson, A.B.C and Yamada, T. (2000). Evaluation of structural characteristics of naturally ventilated multi-span greenhouses using computer simulation. JIRCAS Journal. Vol. 2, p. 45-49. Japan.
  - 2.
  - 3.
- .....

**Contents**

- [CO₂ Concentration and Flux in an Andisol and Simulation of Changes](#) Seiko YOSHIKAWA and  
Shuichi HASEGAWA
  
- [Semiochemicals in Prey-Locating Behavior of *Eocanthecona furcellata*](#) Tetsuya YASUDA
  
- [Fully Automatic Vegetable Transplanter](#) Konosuke TSUGA
  
- [Detection of Crop Transpiration and Water Stress Based on Temperature](#) Guo Yu QIU, Koichi MIYAMOTO,  
Sadanori SASE and  
Limi OKUSHIMA
  
- [Earthquake Damage to Fill Dams in Japan](#) Shigeru TANI
  
- [Controlled Application of Animal Wastes in Dairy Farms](#) Yoshikuni MASAOKA, Yusuke  
ARAKAWA and Taizo MASUDA
  
- [Varietal Differences in Palatability of Orchardgrass](#) Kazuhiko MIZUNO, Shigeru SHIOYA,  
Fumihiro FUJIMOTO and  
Shin-ichi SUGITA
  
- [Growth of Borneo Ironwood Seedlings in Degraded Forestland](#) Yoshiyuki KIYONO and HASTANIAH
  
- [Nitrogen Fixation by Algae in a Tropical Seagrass Bed](#) Hitoshi IIZUMI and  
Masumi YAMAMURO
  
- [Age Estimation of Oceanic Squids Based on Statolith Microstructure](#) Akihiko YATSU

 [First Page of JARQ](#)

 [What's New](#)

 [JIRCAS Home Page](#)

# Diurnal and Seasonal Changes in CO₂ Concentration and Flux in an Andisol and Simulation Based on Changes in CO₂ Production Rate and Gas Diffusivity

**Seiko YOSHIKAWA* and Shuichi HASEGAWA**

Department of Natural Resources, National Institute of Agro-Environmental Sciences  
(Tsukuba, Ibaraki, 305-8645 Japan)

Experimental results of this report were partly reported⁹⁾

Present address:

* Department of Integrated Research for Agriculture, Shikoku National Agricultural Experiment Station  
(Zentsuji, Kagawa, 765-0053 Japan)

Corresponding author: S. Yoshikawa (seikoyo@skk.affrc.go.jp, fax +81-877-62-1130)

## Abstract

Changes in the concentrations and fluxes of CO₂ were monitored to a depth of 100 cm in an Andisol, under both fallow and soybean crop for a period of one year. Gas flux was calculated by the diffusion equation. Diurnal concentrations at depths less than 40 cm followed a sinusoidal pattern similar to that of the soil temperature, with the highest value being recorded in the daytime. Heavy rainfall which closes air voids open to the atmosphere resulted in a higher CO₂ concentration in the shallow soil layers. The subsequent decrease in the concentration in the shallow layers by the recovery of diffusion paths to the atmosphere was accompanied by an increase in concentrations in the deeper soil layers. CO₂ concentration profile under soybean showed a peak at depths that increased gradually from 20 to 80 cm with the growth of the roots. Upward CO₂ fluxes decreased with depth in both fields, and the fluxes in the soil profile were high in summer and low in winter. CO₂ fluxes from the soil surface calculated by the diffusion equation and measured by the closed chamber method were fairly well correlated. Annual CO₂ fluxes were 3,522 g m⁻² under fallow and 4,975 g m⁻² under soybean. The CO₂ movement in soil was simulated by use of the diffusion first law combined with the mass conservation equation. This mechanistic model enabled to analyze phenomena occurring under field conditions, suggesting that soil aeration is controlled by gas diffusion.

Discipline: Soils, fertilizers and plant nutrition

Additional key words: carbon dioxide, gas diffusion

1)...13): [References](#)

(Received for publication, February 15, 1999)

## Introduction

Carbon dioxide (CO₂), amounting to about 0.03% in the air, is referred to as "the greenhouse-effect gas" in the same way as methane, nitrous oxide, ozone, etc. because it absorbs infrared rays. Increase of the concentration of greenhouse-effect gases induces the warming-up of the earth which affects biological phenomena. According to the IPCC (Intergovernmental Panel on Climate Change) report, the contribution of CO₂ to the warming-up of the earth is estimated at about half or more of the whole. CO₂ concentration in the atmosphere is controlled by exchange processes between the atmosphere, and the ocean and land biosphere. Therefore soils, which are the main habitat of land organisms, also play an important role in the changes in the CO₂ dynamics.

Quantitative analysis of CO₂ movement in soil profiles is essential for analyzing the carbon circulation and CO₂ emission from lands. De Jong and Schappert⁴⁾ studied the CO₂ flux and respiration rate at various depths in a soil by applying the diffusion equation combined with the mass conservation equation. They measured the CO₂ concentration in a virgin prairie in Canada from May to November and recorded the highest surface CO₂ flux in June ( $7.5 \times 10^{-4} \text{ g m}^{-2} \text{ s}^{-1}$ ) and the lowest one in November (almost zero). They observed that the highest CO₂ concentration shifted downward toward summer, and ascribed this phenomenon to the gradual increase in the soil temperature with depth as the season progressed, combined with a decrease in the moisture content due to evapotranspiration. Campbell and Frascarelli²⁾ measured CO₂ fluxes using sampling wells through which CO₂ was trapped by an absorbent solution. They showed that the CO₂ flux decreased with depth and increased throughout the profile about 2 weeks after the increase in the soil temperature.

However, CO₂ concentration profiles on an hourly basis and after rainfall events are poorly documented, and more data on the CO₂ flux from fallow and cultivated fields are needed for analyzing CO₂ emission from agricultural lands.

The objectives of the present study are to investigate the diurnal changes, rain-induced changes, and seasonal changes in CO₂ concentrations and fluxes, and to confirm that soil aeration is controlled by gas diffusion through the simulation of the characteristics in CO₂ concentration changes using a model based on the gas diffusion law.

[NEXT](#)[TOP](#)[:Contents](#)

## References

- 1) Agency for International Development, United States Department of Agriculture, Soil Conservation Service, Soil Management Support Services (1992): Keys to soil taxonomy by soil survey staff. SMSS Technical Monograph No.19 (5th ed.) Pocahontas Press, Inc. Blacksburg, Virginia.
- 2) Campbell, J. A. & Frascarelli, L. (1981): Measurement of CO₂ evolved from organic soil at different depths in situ. *Can. J. Soil Sci.*, 61, 137-144.
- 3) Currie, J. A. (1970): In sorption and transport processes in soil. *Soc. Chem. Ind. Monogr.*, 37, 152.
- 4) De Jong, E. & Schappert, J. V. (1972): Calculation of soil respiration and activity from CO₂ profiles in the soil. *Soil Sci.*, 113, 328-333.
- 5) Lundegardh, H. (1927): Carbon dioxide evolution of soil and crop growth. *Soil Sci.*, 23, 417-453.
- 6) National Institute of Agro-Environmental Sciences (1984): An outline of tests of soils and NPK elements in the fields of National Institute of Agricultural Sciences. *Rep. Dep. Soils & Fert.*, 3, 14.
- 7) Nelson, T. E. (1975): Effects of temperatures and moisture on carbon dioxide evolution in a mixed deciduous forest floor. *Soil Sci. Soc. Amer. Proc.*, 39, 361-365.
- 8) Osozawa, S. (1987): Measurement of soil-gas diffusion coefficient for soil diagnosis. *Soil Phys. Cond. Plant Growth, Jpn.*, 58, 528-535 [In Japanese with English summary].
- 9) Osozawa, S. & Hasegawa, S. (1995): Diel and seasonal changes in carbon dioxide concentration and flux in an Andosol. *Soil Sci.*, 160, 117-124.
- 10) Prichard, D. T. & Currie, J. A. (1982): Diffusion coefficients of carbon dioxide, nitrous oxide, ethylene and ethane in air and their measurement. *J. Soil Sci.*, 33, 175 -184.
- 11) Tulaphitak, T., Pairintra, C. & Kyuma, K. (1985): Changes in soil fertility and tilth under shifting cultivation. 3. Soil respiration and soil tilth. *Soil Sci. Plant Nutr.*, 31, 251-261.
- 12) Waksman, S. A. (1922): Microbiological analysis of soil as an index of soil fertility. 3. Influence of fertilization upon numbers of microorganisms in the soil. *Soil Sci.*, 14, 321-346.
- 13) Yagi, K. & Minami, K. (1990): Effect of organic matter application on methane emission from some Japanese paddy fields. *Soil Sci. Plant Nutr.*, 36, 599-610.

## Experimental procedures

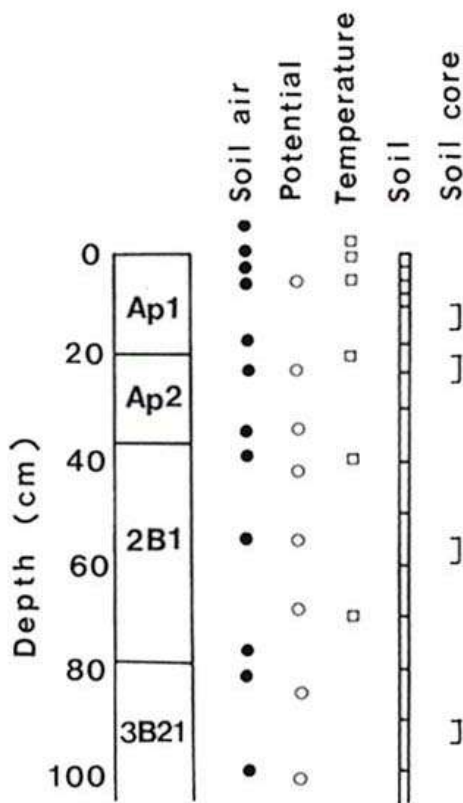
### 1) Field experiment

Field experiments to analyze the CO₂ behavior in an Andisol were conducted throughout a year from June 24, 1991 to June 25, 1992, in fields of the National Institute of Agro-Environmental Sciences (latitude 36°01' N and longitude 140°07' E). The soil was a Hydric Hapludand¹⁾, which extended over a 200 cm depth.

The soil profile was divided into 6 layers, Ap1 (0 to 20 cm), Ap2 (20 to 37 cm), 2B1 (37 to 79 cm), 3B21 (79 to 108 cm), 4B22 (108 to 155 cm) and 5B23 (155 to 200 cm). The top 4 layers were used in this study. A fallow field and a field cultivated with soybean (*Glycine max* Merr. (cv. Tachinagaha)) were used for the experiments. They were adjacent and the area of each field was 150 m². Soybean was sown on May 8, 1991, at a seed spacing of 15 cm on 65 cm rows and harvested on December 2. Plant residues above the ground were removed from the fields. Winter wheat (*Triticum aestivum* L. (cv. Norin No.61)) had been cultivated previously in both fields from the autumn of 1990 to the spring of 1991.

The soil profile and depths where measurements and samplings were performed are shown in [Fig. 1](#). Triplicate soil air samples were withdrawn into 3 cm³ vial bottles with a rubber cap *in vacuo* from gas-sampling tubes installed at depths of 2.5, 5, 17.5, 22.5, 34.5, 39.5, 55, 76.5, 81.5 and 100 cm below the soil surface. The gas sampling tubes were installed in the fields at least at 30 cm intervals. In the soybean field, the sampling tubes were buried between rows. The tube consisted of a polyethylene filter (8 mm in diameter, 10 cm in length), a hollow needle, a capillary tube (0.5 mm in inside diameter) connecting the filter and the needle, and an acrylic tube (10 mm in outside diameter)²⁾. The gas sampling tubes were inserted into holes bored in advance with a soil auger 21 mm in diameter, and the gap between the gas sampling tube and the wall of the hole was deliberately filled up by soils. The open end of the hollow needle was stuck into a rubber tap except at the time of the measurements. The air sample at 0-2 cm above the soil surface was drawn into the vial bottle through a hollow needle that pierced the rubber cap. Concentrations of CO₂ in the vial bottles were analyzed within 1 h after sampling by injecting 0.3 cm³ of sample air into a gas chromatograph (Hitachi gas analyzer, model 263-70, FID with Ni catalyst) using Porapak Q columns and N₂ as a carrier.





**Fig.1. Soil profile, measurements and sampling depths for air, water and temperature**

## 2) Gas diffusivity

The relative gas diffusion coefficient  $D/D_0$  was measured by the diffusion chamber method developed by Osozawa⁸. Undisturbed 100 cm³ soil cores sampled from individual layers were used for the measurement.  $D/D_0$  was measured at several moisture contents adjusted by a pressure plate method. The diffusion coefficient of CO₂ in air,  $D_0$  (cm² s⁻¹), was calculated from the equation  $D_0 = 0.139 \times (T/273.2)^{1.75}$ ¹⁰, where  $T$  was the absolute temperature (K) of the soil that was measured in the fields with thermocouples.

When the soil gas was sampled, the soil moisture content in the profile was measured to determine the gas diffusion coefficients in each soil layer  $D$ , based on the  $D/D_0$ -air-filled porosity curves. Duplicate soil samples were taken to a depth of 100 cm using a thin steel tube with a tip 27.5 mm in diameter and 110 cm long, and the soil water content profile was measured by the oven-dry method.

## 3) CO₂ flux from the soil surface

CO₂ fluxes from the soil surface were calculated by applying the diffusion equation (described in the next section) to the surface 0-2.5 cm layer. CO₂ concentration at 0 to 2 cm above the soil surface was considered to be the CO₂ concentration at the soil surface. The closed chamber method^{5,13} was also applied to evaluate the CO₂ flux from the soil surface.

The increase in the CO₂ concentration in the chambers placed on the soil surface was measured every 2 min for 10 min. Duplicate measurements were carried out in each field. The measurement time was set at only 10 min to avoid large changes in temperature in the chamber and a gradient of CO₂ concentration between soil and air in the chamber. Sunlight reaching directly the chamber was also avoided during the

measurements. As a result, the temperature changes in the chamber during the sampling were less than 3 °C. CO₂ fluxes were corrected for the temperature in the chamber.

#### **4) Other experiments**

Soil temperatures at 1, 5, 10, 20, 40 and 70 cm below the soil surface and atmospheric temperatures at 120 cm above the soil surface and in the closed chamber were measured with thermocouples.

After sampling on August 30, soybean roots were washed out from the duplicate soil blocks 15 x 10 cm in area to a depth of 80 cm. Root length was measured with a root scanner (Commonwealth Aircraft Co. Ltd.) .

Soil pH (H₂O) was measured using duplicate samples taken on July 4 from 12 depths for each field. Soil pH was measured after thorough stirring, with a soil: water ratio of 1 : 2.5.

Data about precipitation and evaporation were obtained from a weather station located at less than 500 m from the experimental fields.

Student's t test was conducted for testing the significance between data of CO₂ concentrations or CO₂ fluxes measured at different depths, fields, and times.

[NEXT](#)

[TOP](#)

## Calculation of CO₂ flux

Gas diffusion through soil water can be ignored because the value of the gas diffusion coefficient in water is about 1/10,000 of that in air, and the gradient of CO₂ concentrations in soil water is of the same order as that in soil air, assuming that the vapor-liquid equilibrium is attained. Thus, gas diffusion in soils can be written as:

$$q = -D \frac{dC_a}{dz} \dots \dots \dots (1)$$

where:

$q$  = flux of gas,  $\text{g cm}^{-2} \text{ s}^{-1}$ ,

$D$  = diffusion coefficient in soil,  $\text{cm}^2 \text{ s}^{-1}$ ,

$C_a$  = concentration of gas in soil air,  $\text{g cm}^{-3}$ ,

$z$  = depth, cm.

The mass conservation of a gas in soil is written as:

$$\frac{dG}{dt} = -dq/dz + p \dots \dots \dots (2)$$

where:

$G$  = amount of gas in soil,  $\text{g cm}^{-3}$ ,

$t$  = time, s,

$p$  = evolution rate of gas in soil,  $\text{g cm}^{-3} \text{ s}^{-1}$ .

The amount of a particular gas in soil is expressed by the following equation:

$$G = C_a V_a + C_w V_w \dots \dots \dots (3)$$

where:

$C_a$  = concentration of gas in soil air,  $\text{g cm}^{-3}$ ,

$V_a$  = air-filled porosity in soil,  $\text{cm}^3 \text{ cm}^{-3}$ ,

$C_w$  = concentration of gas in soil water,  $\text{g cm}^{-3}$ ,

$V_w$  = water-filled porosity in soil,  $\text{cm}^3 \text{ cm}^{-3}$ .

CO₂ concentration in soil water is linearly related to that in soil air when the soil water pH is constant.

$$C_w = a C_a \dots \dots \dots (4)$$

where  $a$  is a constant.

Thus, Eq. (3) becomes:

$$G = C_a V_a + a C_a V_w = C_a (V_a + a V_w) \dots \dots \dots (5)$$

Substituting Eq. (5) for Eq. (2) gives,

$$\frac{dC_a}{dt} = 1/(V_a + a V_w) (-dq/dz + p) \dots \dots \dots (6)$$

In these calculations, the soil profile was divided into 10 layers whose boundaries were the soil surface ( $z_0$ ) and the sampling depths of soil air ( $z_1, z_2, \dots, z_{10}$ ) shown in Fig. 1. Gas flux in the  $n$ th layer,  $q_n$ , is written as  $q_n = -D_n (C_n - C_{n-1}) / (z_n - z_{n-1})$ , where  $D_n$  and  $C_n$  are the gas diffusion coefficient and CO₂ concentration in the  $n$ th layer, respectively.

## Simulation model

A simulation for calculating flux and CO₂ concentration to analyze the above characteristics observed in the field experiments was carried out.

CO₂ concentration in water is identical with that in air, when the water pH is 5.81, on the assumption that

vapor-liquid equilibrium is attained.

Then, Eq. (6) becomes:

$$dC_a/dt = 1/V_p (-dq/dz + p) \dots \dots \dots (6')$$

where:

$V_p$  = porosity in soil,  $\text{cm}^3 \text{cm}^{-3}$ .

When the gas diffusion can be considered to be a steady-state process, i.e.  $C_a$  is constant with time, Eq. (6') becomes :

$$dq/dz = p \dots \dots \dots (7)$$

Eqs. (1), (6') and (7) were used to simulate the changes of CO₂ concentrations in the soil profile. For simplification of these calculations, it was assumed that the soil pH was 5.81, and that the pore space was 0.75 throughout the profile. The assumptions were close to the field conditions as described later. The unit distance was 5 cm in vertical length, and the unit time was 10 min.

**NEXT**

**TOP**

## Results and discussion

### 1) *Physical and chemical properties of soil*

Total carbon content and profile descriptions of the fields are shown in [Table 1](#).

The order of relative gas diffusion coefficient in the range of low air-filled porosities was inversely related to the total carbon content. This result was similar to that obtained in a former study. The gas diffusion coefficients of humic soils were smaller than those of soils with a blocky structure at the same level of air-filled porosity⁸.

Soil pH was not appreciably different with depths and fields. Soil pH throughout the profile was  $5.90 \pm 0.14$  under fallow and  $6.06 \pm 0.14$  under soybean.

### 2) *CO₂ movement in soil*

#### (1) Diurnal changes in CO₂ concentration and flux

CO₂ concentration and soil temperature were measured 6 times on fine summer days from August 8 to 9, 1991. The mean atmospheric temperature was 24.2 and 23.6 for August 8 and 9, respectively. There had been a rainfall of 23 mm on August 7. At the beginning of the measurements, i.e. 11:00 a.m. on August 8, the air-filled porosities at the 6 cm depth were 0.30 (the soil matric potential was -13.5 kPa) under fallow and 0.29 (the soil matric potential was -11.6 kPa) under soybean.

[Fig. 2](#) shows that the CO₂ concentrations at depths less than 40 cm tended to be high in the daytime and low during the night. CO₂ concentrations at 5 and 17.5 cm depths at 2:00 p.m. on August 8 were significantly (5% level) higher compared with those at 0:00 a.m. and 5:00 a.m. on August 9, based on Student's t test. Diurnal soil temperatures at 1 and 5 cm depths also followed a similar trend. CO₂ concentrations at depths more than 40 cm were relatively stable throughout the day from August 8 to 9, presumably due to the stable soil temperatures. Thus, the fact that both the CO₂ concentration and the temperature at shallower depths under fallow changed with time may be ascribed to the respiration of microorganisms, which is closely related to the soil temperature.

A similar trend was observed in the soil under soybean cultivation. However, the CO₂ concentrations were less related to the soil temperatures than in the fallow field, presumably because the respiration of the roots also affected the CO₂ concentrations.

Diurnal changes in CO₂ fluxes from the soil surface followed a sinusoidal pattern⁹.

Comparison of the CO₂ fluxes calculated by the diffusion equation method and those measured by the closed chamber method showed that both fluxes followed similar patterns. The difference between the fluxes measured by the 2 methods was not statistically significant (5% level) based on Student's t test. The calculation based on the mean fluxes determined by the diffusion method showed that the total fluxes for 24 h were 9.68 g m⁻² in soil under fallow, and 22.2 g m⁻² in soil under soybean, a value about twice that observed under fallow in the daytime from August 8 to 9, 1991.

#### (2) Turn-over time of CO₂

To determine the turn-over time of CO₂ in soil during the 24 h period from August 8 to 9, 1991, the total amount of CO₂ in soil under fallow to 100 cm depth was calculated based on the data of CO₂ concentrations and water contents measured at 11:00 a.m. on August 8. The values of 1.65 g m⁻² in soil

air, and  $6.03 \text{ g m}^{-2}$  in soil water were obtained by assuming that the vapor-liquid equilibrium of  $\text{CO}_2$  was attained and the soil water pH was 5.90, which was the average value of soil pH throughout the profile under fallow. The turn-over time, which is expressed as the total amount of  $\text{CO}_2$  within 100 cm depth divided by the  $\text{CO}_2$  flux from the soil surface was 0.57 day based on the  $\text{CO}_2$  flux calculated by the diffusion equation. Under ordinary field conditions,  $\text{CO}_2$  is considered to evolve rapidly into the atmosphere.

### (3) Changes in $\text{CO}_2$ concentration after heavy rainfall

Heavy rainfall which intercepts the open-air void pathway to the atmosphere must affect significantly the  $\text{CO}_2$  movement in soil. [Fig. 3](#) shows the changes in the  $\text{CO}_2$  concentration profile in soil under fallow and under soybean after heavy rainfall of 79 mm on August 20 and 30 mm on August 21. The  $\text{CO}_2$  peak under fallow appeared at 5 cm depth on August 22 but disappeared by August 23. However, the  $\text{CO}_2$  concentrations in the deeper layers on August 23 were higher than on the previous day. Thereafter, the  $\text{CO}_2$  concentration decreased markedly at shallow depths.

A more typical trend of  $\text{CO}_2$  concentration profiles was observed under soybean crop. The  $\text{CO}_2$  concentration at depths more than 55 cm was the highest on August 26, 5 days after the rainfall, although the  $\text{CO}_2$  concentrations in the shallower layers had started to decrease.

Soil matric potential in the surface layer (6 cm in depth) increased to -1 to -2 kPa by rainfall on August 20, and such conditions persisted for almost 1 day. During this period, air-filled porosity in the surface layer estimated from the soil water characteristic curve was about 10%, at which the  $D/D_0$  value was 0 based on laboratory experiments⁹.

Based on the above facts, the changes in the  $\text{CO}_2$  concentration with time and depth after heavy rainfall may be ascribed to the following process. First, the  $\text{CO}_2$  concentration increased in the shallow layers because of the lack of a continuous air-void pathway to the atmosphere. Second, with the progression of the drying process (drainage and evapotranspiration),  $\text{CO}_2$  in the shallow layers started to diffuse both upwards and downwards, resulting in a decrease of the  $\text{CO}_2$  concentration in the shallow layers and an increase in the deeper layers. Thereafter, the  $\text{CO}_2$  concentration throughout the soil profile decreased almost in the same way as under the initial conditions.

### (4) Rapid vapor-liquid equilibrium of $\text{CO}_2$ in the subsoil after heavy rainfall

The increase of the  $\text{CO}_2$  concentration in the subsoil by downward diffusion which appeared after heavy rainfall was investigated on the basis of the vapor-liquid equilibrium of  $\text{CO}_2$  in soil. The soil layer studied extended from the center of the 7th layer to that of the 10th layer, i.e. the depth between 47 and 91 cm under soybean, and gas fluxes in this layer were calculated from 12:00 a.m. on August 22 to 12:00 a.m. on August 23. The values of the 7th flux  $q_7$  and the 10th flux  $q_{10}$ , which were the average values on August 22 and 23 corresponded to downward fluxes of  $1.066 \times 10^{-5} \text{ g m}^{-2} \text{ s}^{-1}$  and  $2.42 \times 10^{-6} \text{ g m}^{-2} \text{ s}^{-1}$ , respectively. The value of the flux obtained by subtracting the value of  $q_{10}$  from the value of  $q_7$  was  $8.24 \times 10^{-6} \text{ g m}^{-2} \text{ s}^{-1}$  ( $1.88 \times 10^{-7} \text{ mol m}^{-2} \text{ s}^{-1}$ ) which must have contributed to the increase of the  $\text{CO}_2$  concentration both in the gaseous and liquid phases of the soil. The values of air and water volumes through the depth of 47 to 91 cm per  $1 \text{ cm}^2$  cross-section were  $4.6 \text{ cm}^3$  and  $30.1 \text{ cm}^3$ , respectively on an average between August 22 and 23. Thus, the amount of downward  $\text{CO}_2$  flux for 24 h must have increased the  $\text{CO}_2$  concentration in the air phase by 0.091% ( $3.81 \times 10^{-5} \text{ M}$ ) and in the dissolved state ( $\text{H}_2\text{CO}_3$ ,  $\text{HCO}_3^-$ , and  $\text{CO}_3^{2-}$ ) by  $4.80 \times 10^{-5} \text{ M}$ . In addition to the vapor-liquid equilibrium, the above

calculations were conducted on the assumption that the soil temperature was 20 and that the soil water pH was 6.06, which corresponded to the average value of the soil pH throughout the profile under soybean.

Measured values showed that the CO₂ concentration in the air phase increased by 0.089% on an average in the 47 to 91 cm layer during the 24 h period from August 22 to 23. Thus, the calculation fitted well to the increase of the CO₂ concentration observed in the field.

If the second term on the right side of Eq. (3) is not considered, the increase in the CO₂ concentration in the soil air phase becomes 0.84%, which is much larger than the value observed in the experiment. Thus, the results suggested that CO₂ which flowed into a specific layer through the gaseous phase was distributed rapidly into both the gaseous and liquid phases. Based on Eq. (6), the increase in the CO₂ concentration in the subsoil layers after heavy rainfall could be mainly attributed to the downward flux rather than to the increase in the evolution rate in the subsoil.

#### (5) Seasonal changes in CO₂ concentration

Seasonal changes in the CO₂ concentration were measured once a month, except in the summer, in 1991. Only the data collected between 11:00 a.m. and 2:00 p.m. on the days with negligible rain effect were used.

The seasonal changes in the CO₂ concentration are shown in [Fig. 4](#). At the beginning of the experiment on June 24, 1991, the CO₂ concentration profiles under fallow and soybean were statistically nonsignificant (5% level) based on Student's t test. The CO₂ concentrations under fallow increased with depth throughout the year, and showed maximum values toward the end of July. Thereafter, the CO₂ concentration began to decrease. On the other hand, the CO₂ concentrations under soybean showed maximum values at depths that shifted downward gradually with soybean growth from 20 to 40 cm on July 11 to 40 to 80 cm on August 30, suggesting the effect of root elongation. CO₂ concentrations from the end of autumn to winter again increased with depth. The CO₂ concentrations under soybean were significantly (5% or 1% level) higher than those under fallow, except on June 24, 1991, based on Student's t test.

Although the root length density decreased with depth, some roots reached 80 cm depth on August 30, 1991. The main factor influencing the difference in the CO₂ concentrations between fields under fallow and those under soybean may be the respiration of roots and the microbial activity in the rhizosphere.

#### (6) Changes in CO₂ concentration in the subsoil layer and determining factors

CO₂ concentrations at the depth of 79 cm (the average of CO₂ concentrations at 76.5 cm and 81.5 cm depths) including those after rainfall, and daily-mean soil temperatures at depths of 10 cm and 70 cm are shown in [Fig. 5](#). Total precipitation during one year was 1,977 mm and 51% of it occurred from late August to October.

CO₂ concentrations at 79 cm depth under fallow seemed to coincide well with the temperatures at 10 cm depth compared with those at 70 cm depth. This phenomenon may be explained as follows. The CO₂ increase in the surface layers by enhanced microorganism respiration associated with the increase in the temperature suppressed the CO₂ upward flux from the deeper layers due to the decrease in the concentration gradient between the surface and deeper layers. As a result, the CO₂ concentration at 79 cm depth increased when the soil temperature at 10 cm depth was high. The decrease in the surface temperature resulted in an inverse effect on the CO₂ concentration at 79 cm depth. This assumption is

based on the fact that most of the microorganisms are distributed in the surface layer where the seasonal changes in temperature are highly conspicuous¹²).

On the other hand, CO₂ concentrations under soybean increased until the middle of September when the temperature was lower than the maximum. Root respiration in addition to microorganism respiration is likely to influence the CO₂ concentration at 79 cm depth. CO₂ concentrations under soybean were higher than those under fallow, and the difference became more pronounced until October and still persisted until June of the following year.

Heavy rainfall clearly reflected the increase in the CO₂ concentration during 1-2 days after rainfall, even though only 3 measurements in August and September supported this assumption.

#### (7) Seasonal changes in CO₂ flux

The seasonal changes in upward CO₂ fluxes in each layer are shown in [Fig. 6](#). Fluxes decreased with depth in both fields. Fluxes in the upper to middle parts of the profile were higher under soybean than under fallow. Fluxes increased until the end of July and then decreased in both fields. However, fluxes under soybean in August were still high compared with those under fallow.

The CO₂ fluxes at depths deeper than that at which the CO₂ peak was observed from July 11 to August 30 under soybean (cf. [Fig. 4](#)) showed negative values. The negative values were smaller by 2 to 3 orders compared with those of the fluxes in shallow layers because the diffusion coefficient decreased with depth.

The seasonal changes in the CO₂ flux from the soil surface calculated by the diffusion equation are shown in [Fig. 7](#). Data for a few days after heavy rainfall exceeding 100 mm on August 22 and 23 were not included, because the CO₂ concentration changed so much after heavy rainfall in comparison with the seasonal changes that the CO₂ concentrations on such days were not suitable for following the seasonal changes. The values of the fluxes were high in summer and low in winter, and CO₂ fluxes under soybean were higher than those under fallow, especially during the growing season. Even after harvest, the difference in the values of the CO₂ flux under fallow and under soybean was statistically significant (5% level) based on Student's t test, presumably because of the increase in the microbial activity in the rhizosphere. CO₂ fluxes from the surface in summer were about 10 times higher than those in winter in both fields. The characteristics of the seasonal changes and amplitude of the CO₂ fluxes from the surface were similar to those previously reported^{2,4}. CO₂ fluxes from the surface under soybean were about 2 times higher than those under fallow in summer.

CO₂ fluxes from the soil surface measured by the closed chamber method (X) and calculated by the diffusion equation (Y) were expressed by the equation for a straight line that coincides with the origin:  $Y$  (g m⁻² d⁻¹) = 0.894 X (R = 0.893, n = 58), except for the fluxes after heavy rainfall. The correlation coefficient (R) between fluxes calculated by the diffusion equation (Y) and fluxes estimated by the equation (Y'):  $Y' = 1 X$  was 0.888 (n = 58). Therefore, the fluxes calculated by the chamber method and the diffusion method coincided relatively well.

#### (8) Estimation of annual respiration

Total CO₂ fluxes from the surface estimated from measurements throughout a year were 3,522 g m⁻² y⁻¹ under fallow and 4,975 g m⁻² y⁻¹ under soybean. De Jong and Schappert⁴ estimated that 2,300 g m⁻² of



CO₂ was emitted during the growing season from a virgin prairie in Canada. Tulaphitak et al.[11](#) estimated that 5,170 g m⁻² of CO₂ was emitted during a year from an upland cultivation field in Thailand. Our values were comparable to the published data.

[NEXT](#)

[TOP](#)

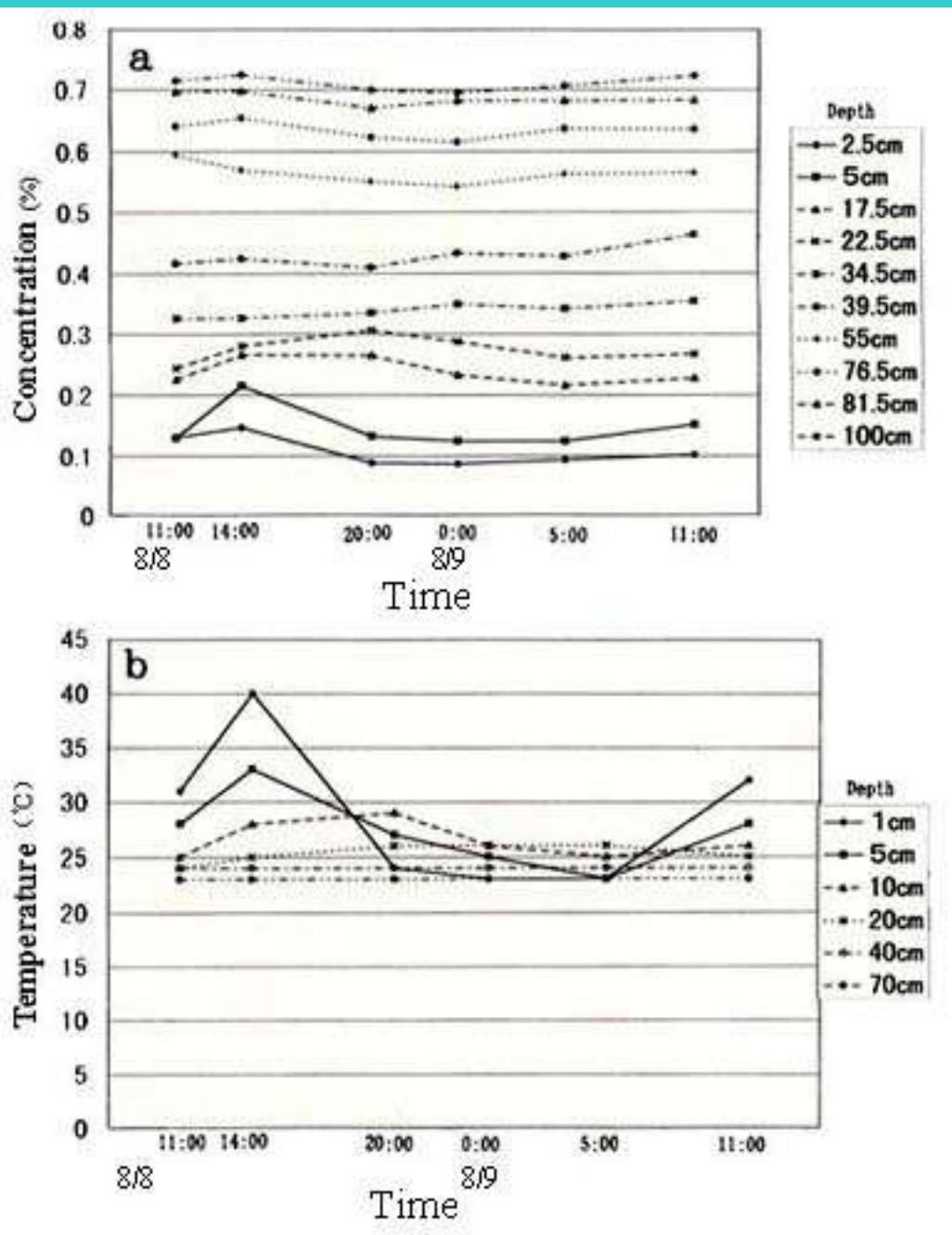
**Table 1. Description of soil profile of the fields**

Layer	Depth(cm)	Total-C(%)*	Color	Structure and pores
Ap1	0-20	4.25	very dark	fine granular
Ap2	20-37	3.17	very dark	weakly fine granular
2B1	37-79	1.58	dark	weakly blocky cracks(<1 mm) and tubular pores
3B21	79-	1.16	dark	blocky cracks(<1 mm) and tubular pores

*Data quoted from National Institute of Agro-Environmental Sciences 1984⁶⁾.

Total-C was measured by CN corder (Yanagimoto Co., Ltd.).

**BACK**

Fig.2. Diurnal changes in CO₂ concentration soil temperature under fallowa: CO₂ concentration. b: soil temperature.

BACK

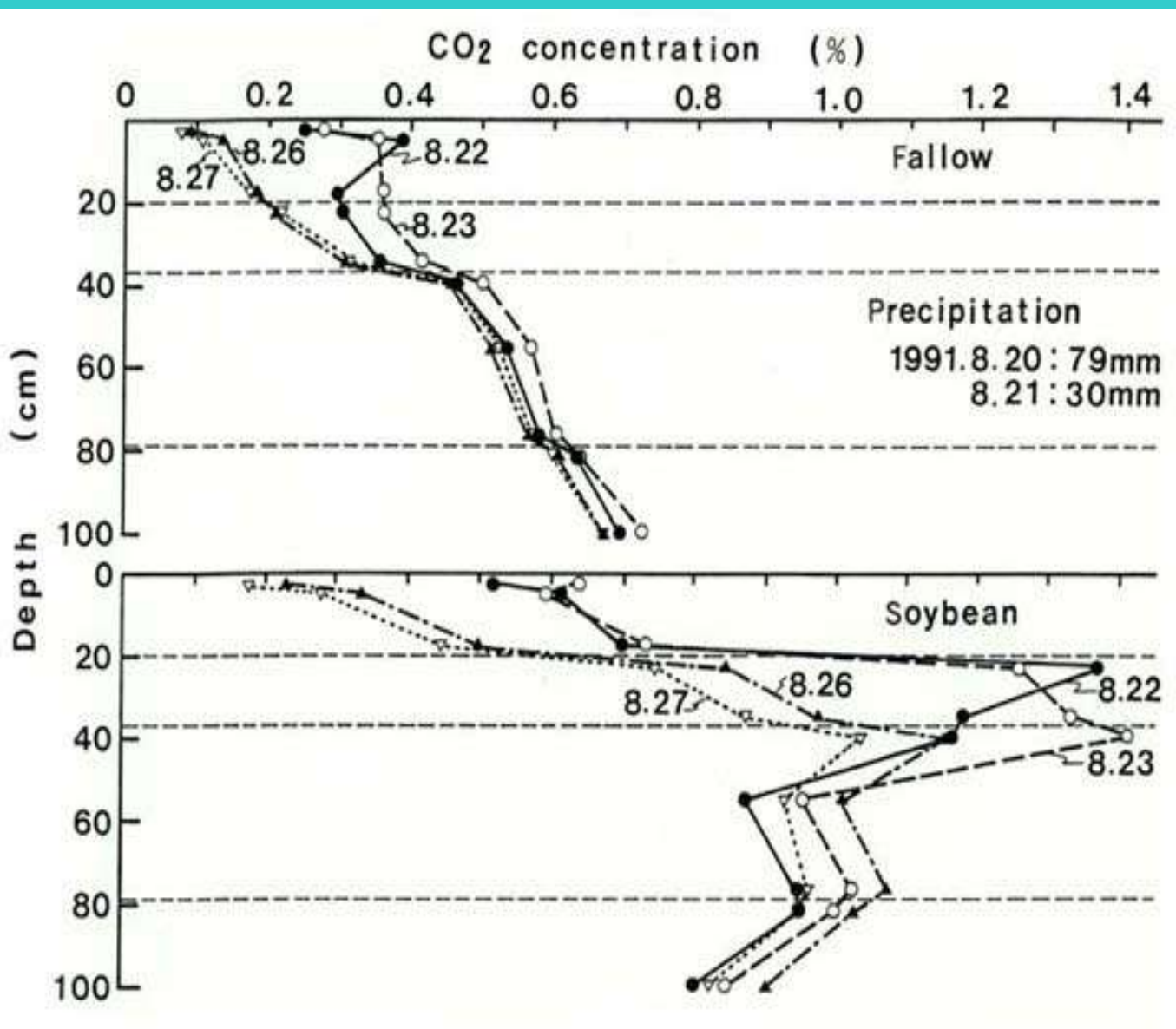


Fig.3. Changes in CO₂ concentration after heavy rainfall

----- : Layer boundaries.

BACK

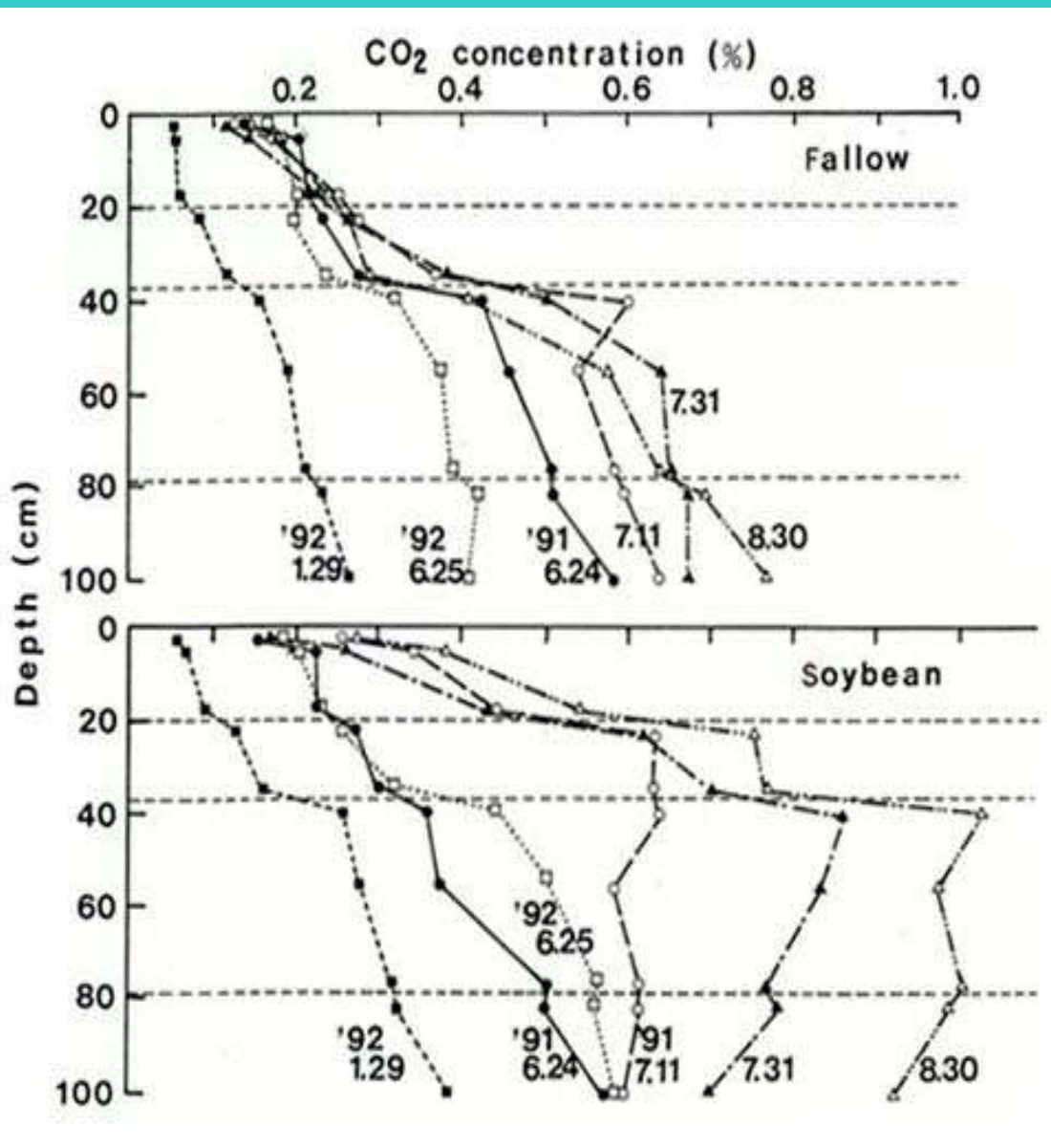


Fig.4. Seasonal changes in CO₂ concentration  
 -----: Layer boundaries.

BACK

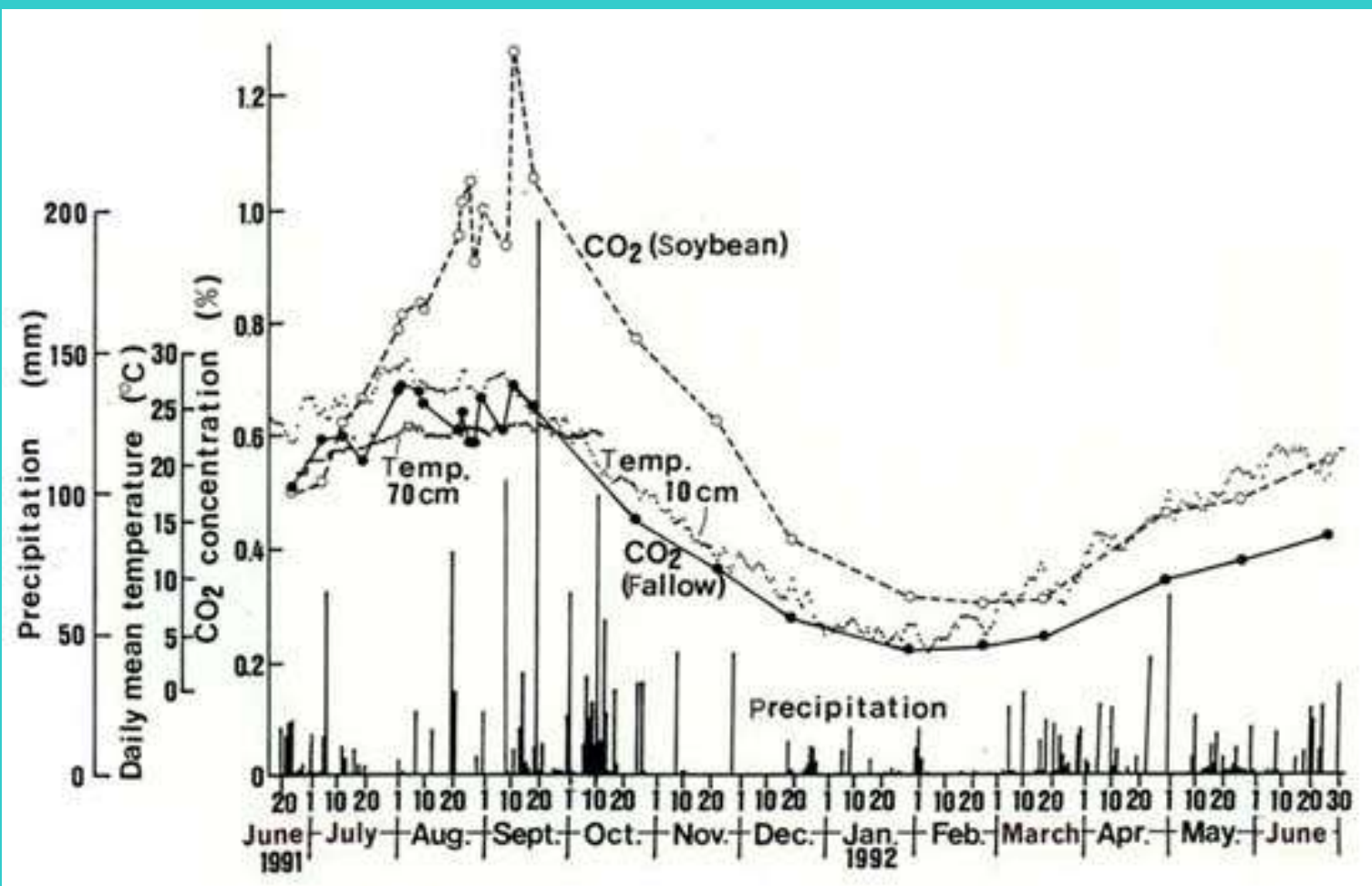


Fig.5. Seasonal changes in CO₂ concentration at 79 cm depth

BACK

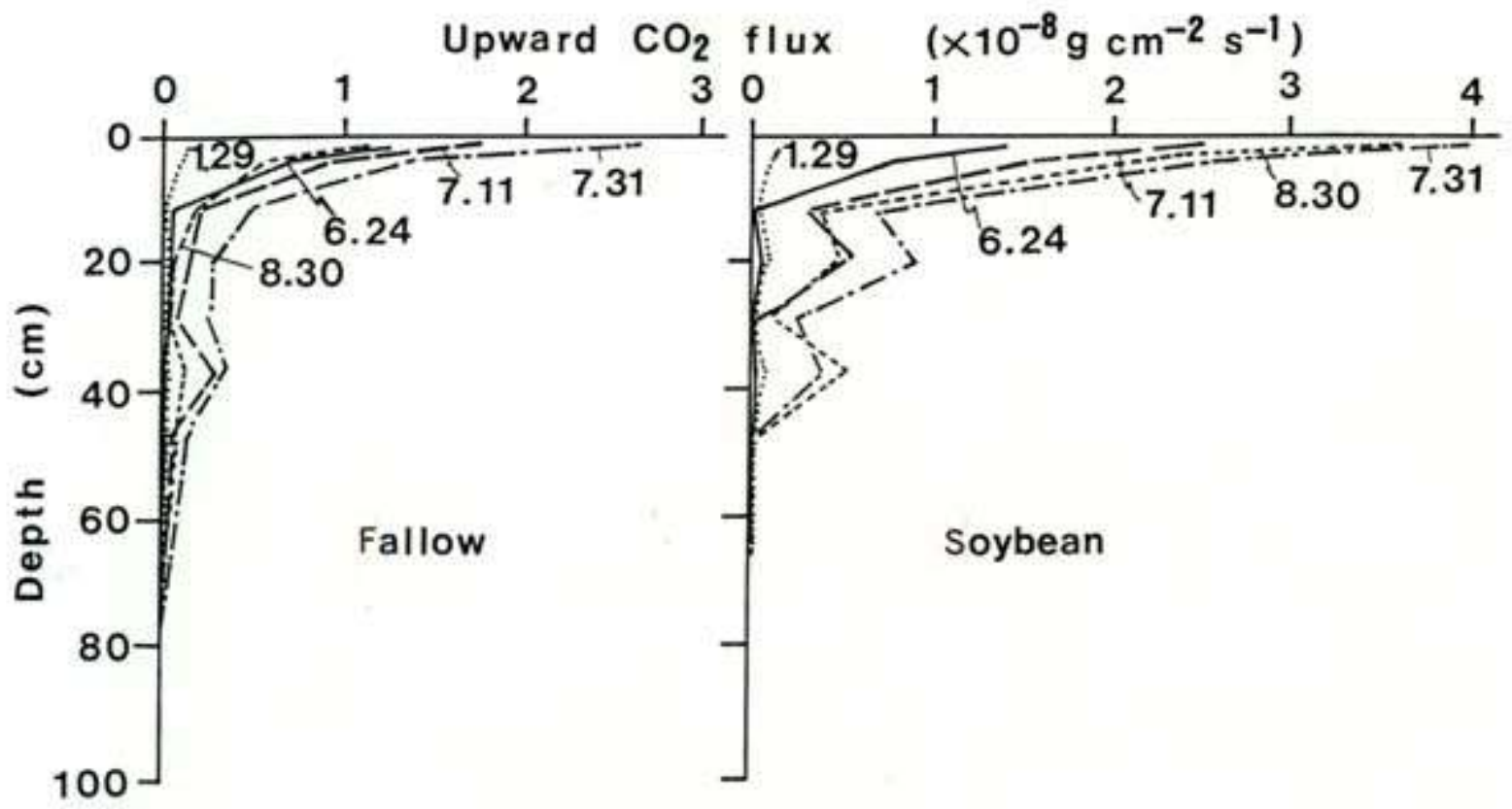


Fig.6. Seasonal changes in CO₂ flux profiles

BACK

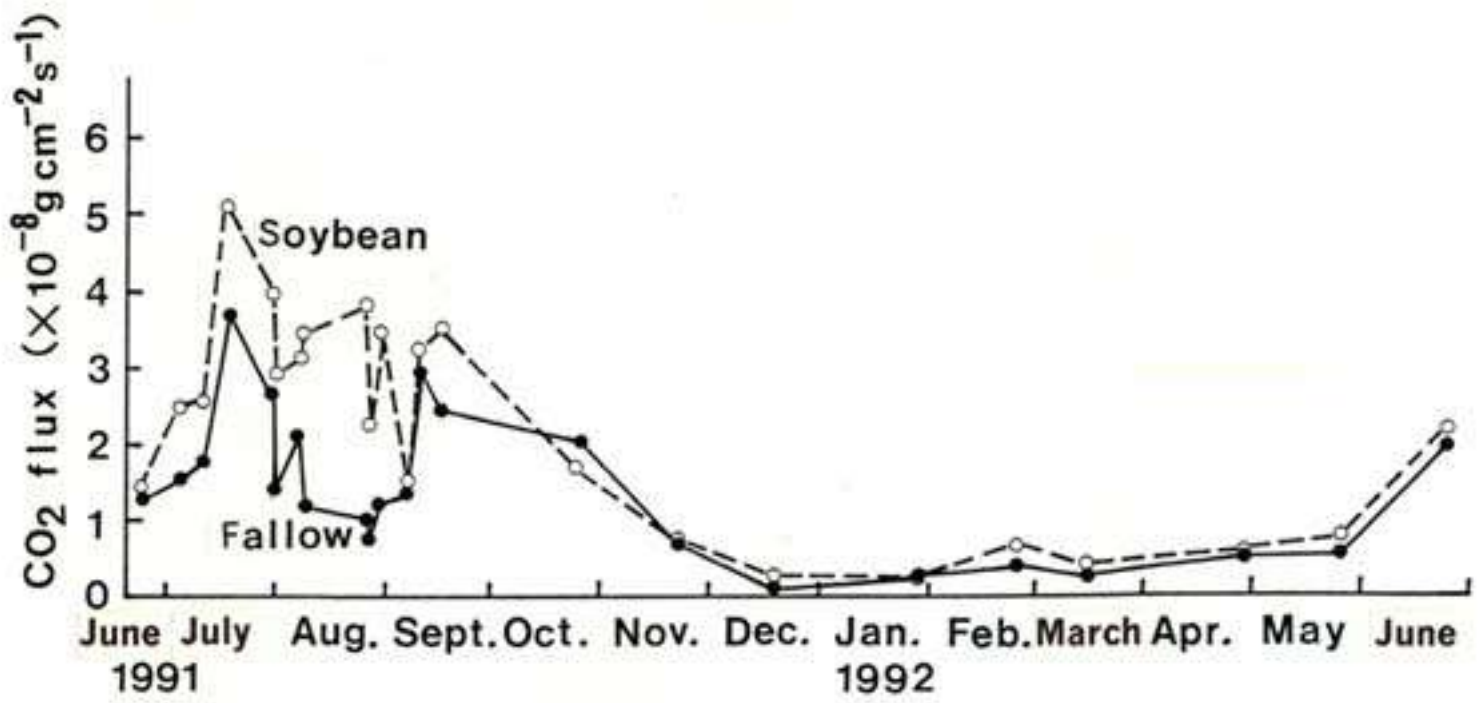


Fig.7. Seasonal changes in CO₂ flux from soil surface calculated by the diffusion equation

BACK



## Simulation model

### 1) Simulation of diurnal changes in CO₂ concentrations

In the field experiments, CO₂ concentrations at depths less than 40 cm from the soil surface followed a sinusoidal trend with the highest values observed in the daytime.

Simulation was conducted to analyze the diurnal changes in CO₂ concentrations. The initial conditions of CO₂ distribution and the diffusion coefficient in the profile were set to be approximately those recorded on August 8, 1991 as follows:

$$C_a = 8.0e10^{-6} + 2.7e10^{-7}eZ - 8.6e10^{-9}eZ^2 + 2.6e10^{-10}eZ^3 - 3.2e10^{-12}eZ^4 + 1.3e10^{-14}eZ^5,$$

$$D = 0.024 e^{-0.042 z} + 0.0012$$

where  $C_a$  = CO₂ concentration, g cm⁻³ of air,  $Z$  = depth, cm,  $D$  = CO₂ diffusion coefficient in soil, cm² s⁻¹. The CO₂ evolution in the steady-state was calculated from the initial conditions.

CO₂ evolution from soils has been reported to be 3 times as high with an increase of about 10 in the soil temperature between 15-40 [3,7](#). A simulation for the CO₂ diurnal changes was conducted based on the dependency of CO₂ evolution on the soil temperature, as shown in [Fig. 8](#). CO₂ concentration at a depth less than about 40 cm from the soil surface increased in the daytime and decreased in the night time, reflecting the characteristics of CO₂ changes in the field.

### 2) Simulation of changes in CO₂ concentrations induced by rain

In the field experiments, heavy rains (August 20-21) generated a CO₂ peak in the shallow layer at both sites. The peak gradually shifted downward with a decreasing magnitude accompanied with CO₂ accumulation in deeper layers. Soil matric potential in the surface layer (6 cm in depth) increased up to -1 ~ -2 kPa by rainfall. The value remained constant for almost 1 day. During this period, air-filled porosity in the surface layer estimated from the water retention curve was 10% , and the  $D/D_0$  value obtained from the curve of  $D/D_0$  - air-filled porosity was almost 0.

To reproduce the changes in the CO₂ distribution obtained in the field experiments, the simulation was carried out on the following assumptions: (1) The initial distribution of the CO₂ concentration and the gas diffusion coefficient were the same as those on August 8 (the nearest measurement day before August 20), (2) The gas diffusion coefficient of the surface layer was assumed to be 0 during the first day, namely the continuity of the air-filled porosity in the surface layer was intercepted by abundant water. Thereafter, the gas diffusivity was assumed to recover gradually for 2 days to the previous level.

The results of the simulation are shown in [Fig. 9](#). The CO₂ peak in the upper layer continued to increase along with the accumulation of CO₂ in deeper layers during 1 day while the continuity of the air pores was kept for interception. After the recovery of the continuity of air-filled pores, the CO₂ concentration in the upper layer began to decrease. On the other hand, the CO₂ concentration in the subsoil layers at 90 to 100 cm depths continued to increase from 1 day to about 4 days after the rain in spite of the disappearance of the maximum peak.

These simulations reproduced the typical characteristics of the changes in CO₂ concentration after a large amount of rain.

### 3) Simulation of seasonal changes in CO₂ concentrations

CO₂ concentrations throughout the profiles in the fallow and soybean fields increased toward

mid-summer and decreased toward winter. CO₂ distribution in the fallow field showed an almost monotonic increase with depth throughout the year, while that of the soybean site showed a distinct peak during the growing season from 20 to 80 cm depths.

Simulation was conducted to analyze the seasonal changes in CO₂ concentrations toward summer (from June 24 to July 31, 1991) by using the gas diffusion law. The initial conditions of CO₂ distribution and the diffusion coefficient in the profile corresponded approximately to those on June 24, 1991.

CO₂ evolution rates in the steady-state were calculated from the initial conditions. They were assumed to increase at constant rates corresponding to the changes in daily mean temperatures between June 24 and July 31, 1991. The changes in the CO₂ distribution based on these assumptions are shown in [Fig. 10](#).

The increase of the CO₂ concentration from shallow layers to deeper layers was attributed to the following factors: 1) Increase in the rates of CO₂ concentration in the upper layers was larger than that in the subsoil layers. 2) The upward CO₂ flux was suppressed by the decrease in the concentration gradient between the shallower layers and the deeper layers, and incidentally CO₂ accumulated in the deeper layers.

## Conclusions

The objective of this study was to investigate the factors that determine the CO₂ distribution in the soil profile by using a simulation model based on the calculation of the CO₂ flux by the gas diffusion equation. To achieve this objective, diurnal, rain-induced, and seasonal changes in CO₂ concentration were monitored along with the soil moisture content and soil temperature under fallow and soybean cultivation. The results were as follows.

Diel concentrations of CO₂ at depths less than 40 cm followed a sinusoidal pattern similar to that of the soil temperature, with the highest value being recorded in the daytime.

Heavy rainfall interrupted the continuity of the air pathway to the atmosphere, which resulted in a high CO₂ concentration in shallow layers at first, and a decrease in the concentration from shallow depths accompanied by an increase in the concentration in deeper layers with the progression of drying for a few days.

CO₂ concentration throughout the profile was high in summer and low in winter. CO₂ concentration under soybean increased from shallow to deeper layers with the increase of the rooting depth.

CO₂ fluxes from the soil surface based on calculations from the diffusion equation corresponded relatively well to those measured by the chamber method.

CO₂ gas was found to move rapidly through air-filled pores and to be swiftly equilibrated between the air phase and liquid phase.

A model was devised for calculating the CO₂ flux and CO₂ concentration to analyze the CO₂ changes observed in field experiments. CO₂ flux was calculated by the diffusion equation combined with the equation of continuity. CO₂ concentration in the air phase in each layer was assumed to change by CO₂ evolution and/or dissolution from/into the liquid phase as well as by CO₂ influx and efflux through the air phase and by CO₂ production.

In the model, the CO₂ production rate changed with the soil temperature, and the diffusivity changed with the soil water content. The model enabled to analyze the changes in the CO₂ concentrations observed in the field experiments fairly well in the absence of root respiration. However, if the root respiration for each layer could be measured with time, and the data could be introduced into the model, it would be possible to analyze the CO₂ concentration changes under vegetation. These results indicated that the changes in the CO₂ concentrations in soil were significantly influenced by the following 2 factors: (1) microorganism respiration, which is closely related to the soil temperature, and root respiration, which is closely related to the stage of crop growth, (2) soil moisture, which mainly affects the gas diffusivity in soil.

**NEXT**

[:Semiachemicals in Prey-Locating Behavior of *Ecoanthecona furcellata*](#)

**TOP**

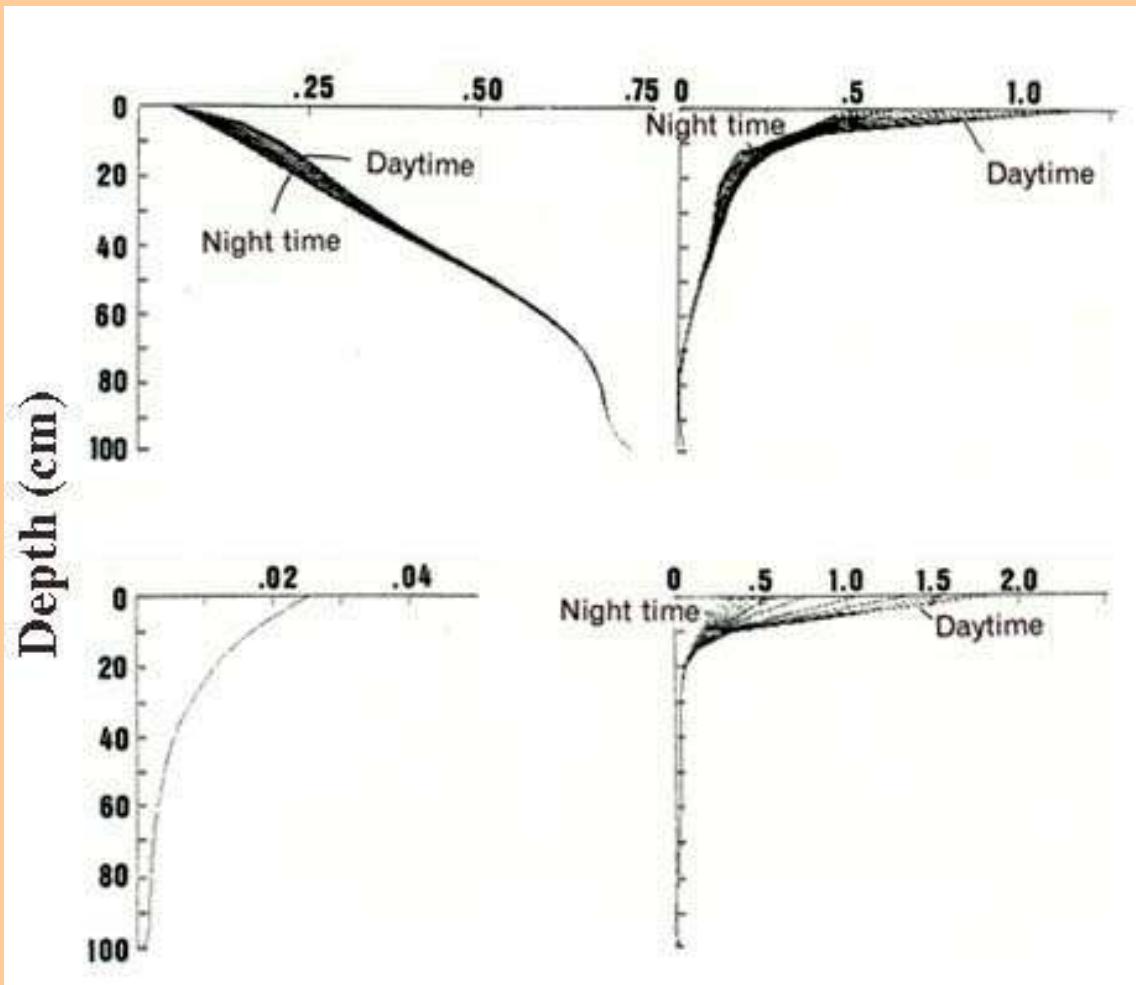
[:Contents](#)

**HOME**

[:JIRCAS Home Page](#)

CO₂ concentration (%)

Upward CO₂ flux (x10⁻⁸g cm⁻²s⁻¹)



Gas diffusion coefficient D(cm² s⁻¹)

CO₂ production (x 10⁻⁹g cm⁻³s⁻¹)

Fig.8. Simulation for CO₂ diurnal changes based on the dependency of CO₂ evolution on the soil temperature

BACK

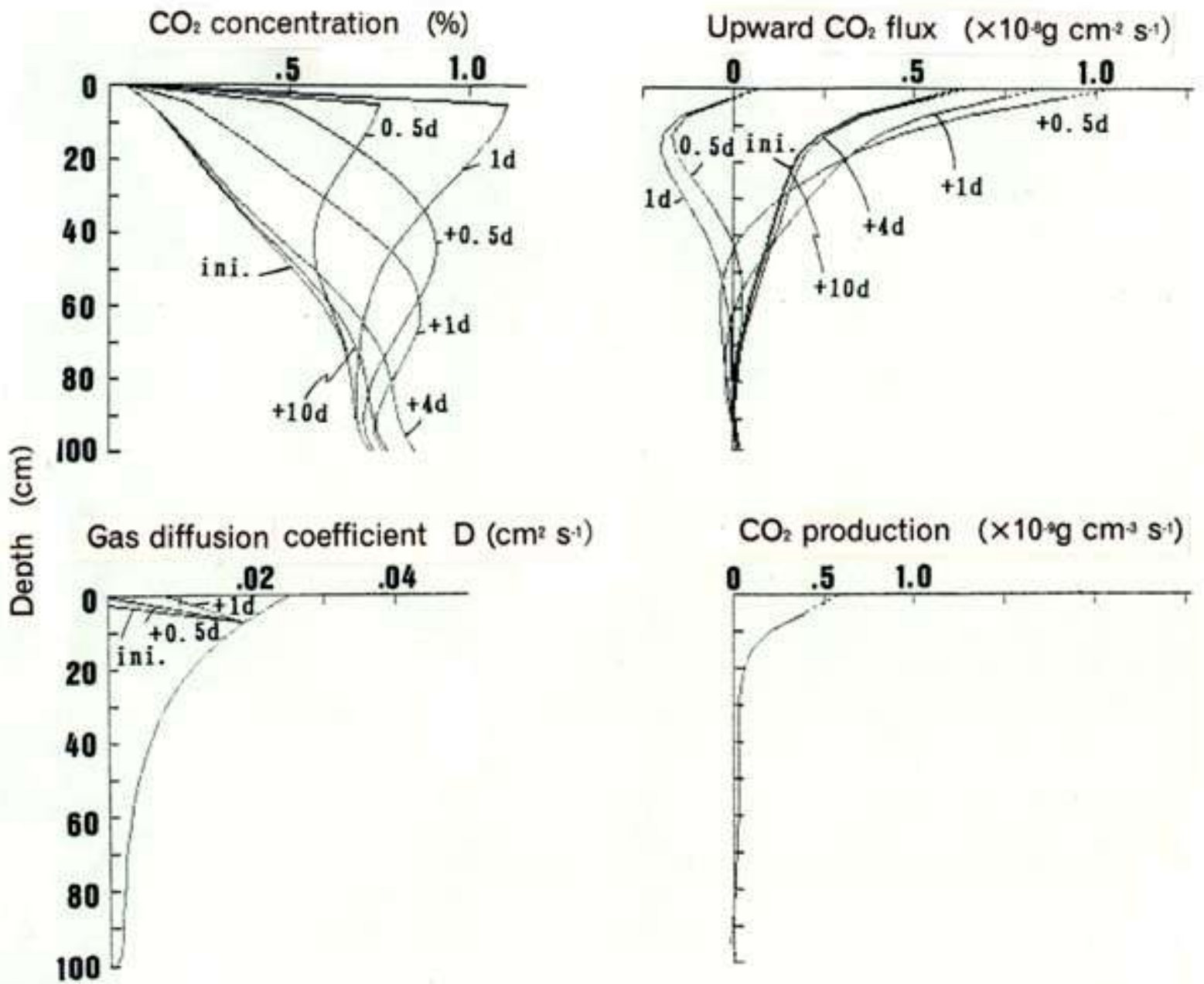


Fig.9. Simulation for CO₂ changes after heavy rain based on the decrease and recovery of the diffusivity in the surface soil layer

ini.: initial condition. d: day. +: time after gas diffusion occurred.

BACK

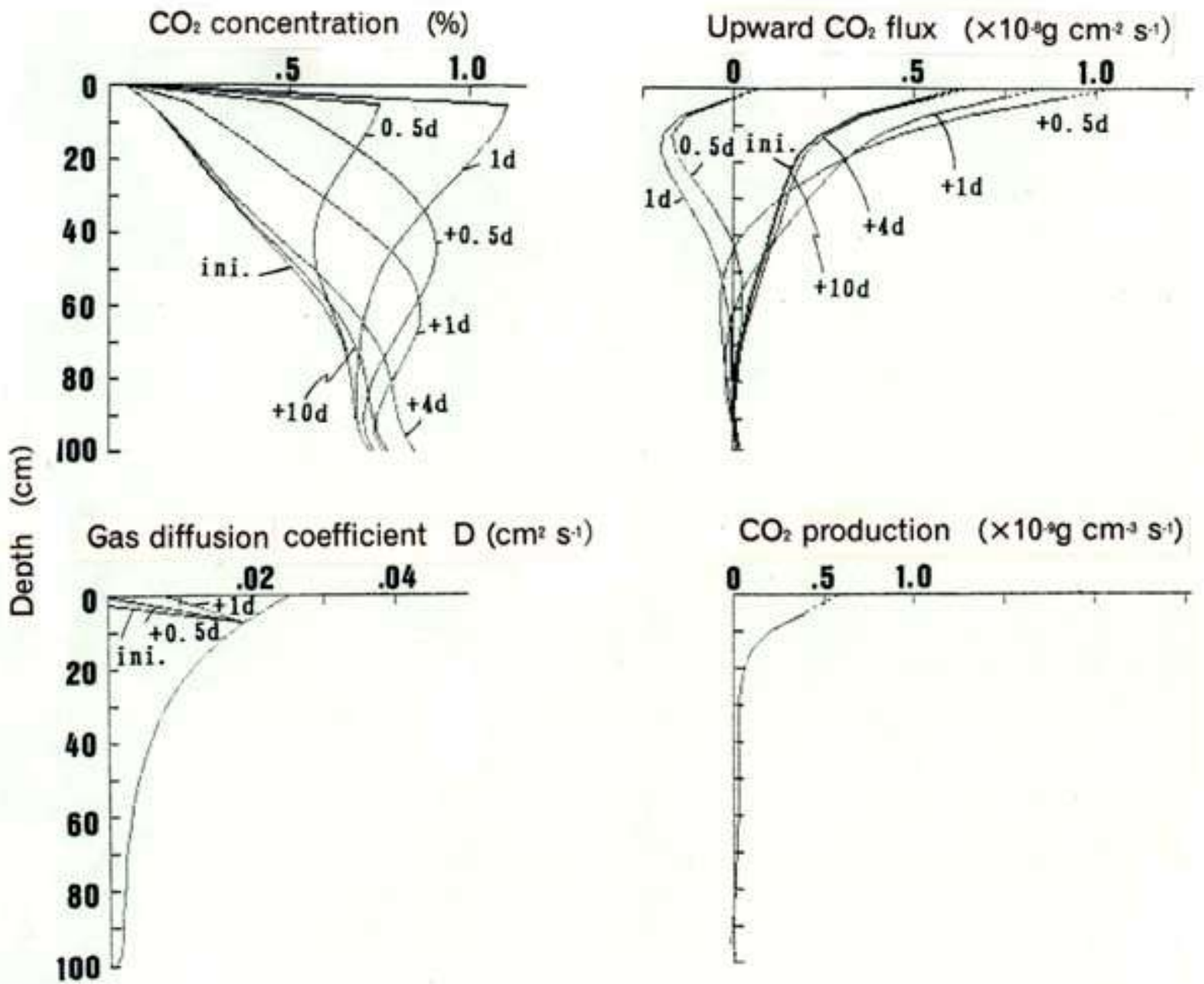


Fig.10. Simulation for CO₂ seasonal changes toward summer based on the dependency of CO₂ evolution on the soil temperature  
 ini: initial condition. d:day.

BACK

# Role of Semiochemicals in Prey-Locating Behavior of a Generalist Predatory Stink Bug, *Eocanthecona furcellata* (Wolff) (Heteroptera: Pentatomidae)

**Tetsuya YASUDA**

Department of Insect Physiology and Behavior, National Institute of Sericultural and Entomological Science  
(Tsukuba, Ibaraki, 305-8634 Japan)

This study was supported in part by a Grant-in-Aid (Bio Cosmos Program) from the Ministry of Agriculture, Forestry and Fisheries (BCP 99-I-B-3).

Corresponding author: T. Yasuda (tyasuda@nises.affrc.go.jp, fax +81-298-38-6028)

## Abstract

Behavioral responses of a generalist predatory stink bug, *Eocanthecona furcellata* towards larvae of several lepidopteran species were observed in order to analyze the role of semiochemicals in eliciting a prey-locating behavior in this bug. Extracts of *Spodoptera litura* larvae elicited approaching behavior in *E. furcellata*. A hexane-eluted fraction from silica gel chromatography of the larval extracts was also attractive to the bugs. The hexane fraction contained *n*-tetradecane, *n*-pentadecane, *n*-hepta- decane, *n*-heptacosane, *n*-nonacosane, *n*-hentriacontane and 2,6,10,15,19,23-hexamethyl-2,6,10,14,18,22-tetracosahexaene (squalene). Synthetic *n*-pentadecane was attractive to the bugs. On the other hand, a 15%-ether-in-hexane-eluted fraction from silica gel chromatography of the solvent extracts of *S. litura* stimulated bugs to display a proboscis-protruding behavior. (*E*)-3,7,11,15-Tetra- methyl-2-hexadecen-1-ol [(*E*)-phytol] was identified in this fraction, and synthetic (*E*)-phytol showed the same effect on the bugs as the fraction. (*E*)-Phytol content of larvae increased depending on the amount of chlorophyll in the diets. These results suggest that (*E*)-phytol in larvae, which is derived from chlorophyll in the prey diet, acts as an important cue in the prey-locating behavior of the generalist predatory stink bug, *E. furcellata*. In conclusion, the 2 different chemicals act as "kairomones" in the prey location for the predatory stink bug, *E. furcellata*.

Discipline: Insect pest

Additional key words: *n*-pentadecane, (*E*)-phytol, attractant, proboscis-protruding inducer, chlorophyll, kairomone

1...23):[References](#)

(Received for publication, February 26, 1999)

## Introduction

Many synthetic organic pesticides have contributed to the improvement of mass production of agricultural crops. However, unsuitable use for pest management has caused severe side-effects such as the development of pesticide resistance in pest insects, accumulation of residues in crops and agricultural environments. Under these circumstances, suitable use of natural enemies as one of the technical skills for the integrated pest management (IPM) is attracting worldwide attention.

Natural enemies of herbivorous insects use chemical, visual, acoustic and vibrational cues in foraging behavior. Especially, the importance of semiochemicals in foraging by parasitoids has been well documented⁶. Some studies have suggested the possibility of applying semiochemicals in pest management: by attracting and/or arresting the parasitoids in crop fields, or by enhancing the responses of parasitoids to hosts^{6,8,16}.

Some investigators have suggested that predators could be applied to pest management against various pest insects⁶. Since predators in general kill the pest insects immediately after catching them, an immediate effect of application of the predators in pest management is expected while parasitoids usually require a long period of time for killing pest insects. A few studies have revealed that chemicals related to prey insects are important cues in foraging for some predators. The eastern yellowjacket, *Vespula maculifrons*¹, the cylindrical bark beetle, *Lasconotus intricatus* Kraus², *Enoclerus lecontei* (Wolcott)⁹, *Temnochila chlorodia* Mannerheim¹⁵ and *Mederera bistrata* Parent¹⁸ are attracted to pheromone components of their respective preys. Lewis et al.⁷ reported that larvae of the green lacewing, *Chrysopa carnea*, use "kairomones" in scales of a moth, *Heliothis zea*. Hislop & Prokopy⁴ reported that acarine predators, *Amblyseius fallacis* and *Phytoseiulus macropilis*, respond to silk and feces of a prey mite, *Tetranychus urticae*. However, these studies deal with the relationships between a predator and its specific prey.



**Fig.1**  
Nymphs of *Eocanthecona furcellata* feeding on larvae of *Spodoptera litura*

The predatory stink bug, *Eocanthecona furcellata* (Wolff) (Heteroptera: Pentatomidae)(Fig. 1), is a generalist predator that feeds on larvae of Lepidoptera, Coleoptera and Heteroptera and is distributed in India, Southeast Asia, the southern part of China, Taiwan and the Okinawa region of Japan^{3,5,10,13}. Takai & Yasuoka¹⁴ demonstrated that *E. furcellata* could be a good biological control agent against the noctuid *Spodoptera litura* (Fabricius) (Lepidoptera: Noctuidae) in greenhouses. The bugs can be easily reared on live larvae of *Pieris rapae*³ and frozen-preserved larvae of *S. litura*²².

Over the last several years, I conducted a series of studies on the prey-locating behavior of *E. furcellata*, and identified 2 chemical cues eliciting this behavior^{19,21,23}. In this report, I summarized the results of these studies.

[NEXT](#)

[TOP](#)

[Contents](#)



## References

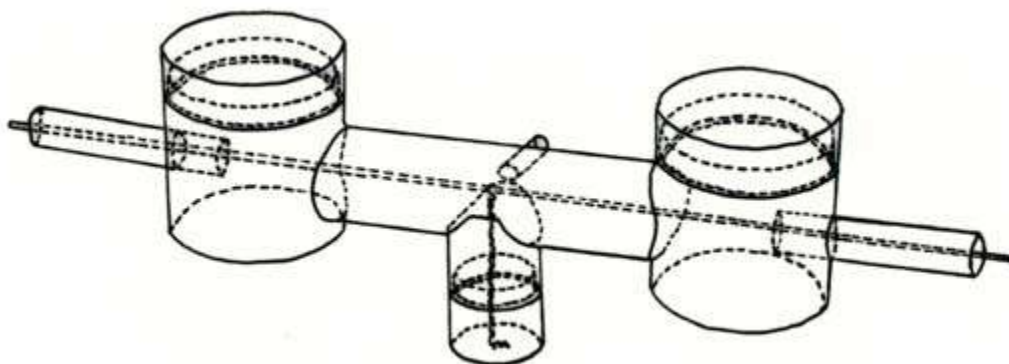
- 1) Aldrich, J. R., Kochansky, J. P. & Sexton, J. D. (1985): Chemical attraction of the eastern yellowjacket, *Vespula maculifrons* (Hymenoptera: Vespidae). *Experientia*, 41, 420-422.
- 2) Bowers, W. W. & Borden, J. H. (1992): Attraction of *Lasconotus intricatus* Kraus. (Coleoptera: Colydiidae) to the aggregation pheromone of the four-eyed spruce bark beetle, *Polygraphus rufipennis* (Kirby) (Coleoptera: Scolytidae). *Can. Entomol.*, 124, 1-5.
- 3) Chu, Y. (1975): Rearing density of *Eocanthecona furcellata*, with special consideration to its mass production (Asopinae: Pentatomidae). *Rostraria*, 24, 135-140 [In Japanese with English summary].
- 4) Hislop, R. G. & Prokopy, R. J. (1981): Mite predator responses to prey and predator-emitted stimuli. *J. Chem. Ecol.*, 7, 895-904.
- 5) Jakhmola, S. S. (1983): Natural enemies of Til leafroller and capsuleborer, *Antigastra catalaunalis* (Dup.). *Bull. Entomol.*, 24, 147-148.
- 6) Kainoh, Y. (1987): Behavior regulators of entomophagous insects. In A manual of bio-pesticides and growth regulators. eds. Okada, M. et al., 254-277 [In Japanese].
- 7) Lewis, W. J. et al. (1977): Kairomones and their use for management of entomophagous insects. V. Moth scales as a stimulus for predation of *Heliothis zea* (Boddie) eggs by *Chrysopa carnea* Stephens larvae. *J. Chem. Ecol.*, 3, 483-487.
- 8) Noldus, L. P. J. J. (1989): Semiochemicals, foraging behavior and quality of entomophagous insects for biological control. *J. Appl. Entomol.*, 108, 425-451.
- 9) Pitman, G. B. & Vite, J. P. (1971): Predator-prey response to western pine beetle attractants. *J. Econ. Entomol.*, 64, 402-404.
- 10) Prasad, D. et al. (1983): A new predator of new pest of jasmine in Delhi. *Bull. Entomol.*, 24, 140-141.
- 11) Sakuma, M. & Fukami, H. (1985): The linear track olfactometer; An assay device for taxes of the German cockroach, *Blattella germanica* (L.) (Dictyoptera: Blattellidae) toward their aggregation pheromone. *Appl. Entomol. Zool.*, 20, 387-402.
- 12) Smith, E. L. et al. (1983): Principles of biochemistry; General aspects (7 ed.). McGraw-Hill, New York, pp. 886.
- 13) Srivastava, A. S. et al. (1987): *Canthecona furcellata* Wolff. (Hemiptera: Pentatomidae) predating of *Menochilus sexmaculata* (F.) (Coleoptera: Coccinellidae). *J. Indian Entomol.*, 49, 558.
- 14) Takai, M. & Yasuoka, S. T. (1993): Biological control of *Spodoptera litura* (Fabricius) in plastic green house by the predatory stink bug, *Eocanthecona furcellata* (Wolff). *Proc. Assoc. Plant Prot. Shikoku*, 28, 103-108 [In Japanese].
- 15) Tilden, P. E. et al. (1983): Trapping *Dendroctonus brevicornis*; Changes in attraction release rate, dispersion of attractant, and silhouette. *J. Chem. Ecol.*, 9, 311-321.
- 16) Vet, L. E. M. & Dicke, M. (1992): Ecology of infochemical use by natural enemies in a tritrophic context. *Annu. Rev. Entomol.*, 37, 141-172.
- 17) Watts, R. B. & Kekwick, R. G. O. (1974): Factors affecting the formation of phytol and its incorporation into chlorophyll by homogenates of the leaves of the French bean *Phaseolus vulgaris*. *Arch. Biochem. Biophys.*, 160, 469-475.
- 18) Williamson, D. L. (1971): Olfactory discernment of prey by *Medetera bistriata* (Diptera: Dolichopodidae). *Ann. Entomol. Soc. Am.*, 64, 586-589.

## References

- 19) Yasuda, T. (1997): Chemical cues from *Spodoptera litura* larvae elicit prey-locating behavior by the predatory stink bug, *Eocanthecona furcellata*. *Entomol. Exp. Appl.*, 82, 349-354.
- 20) Yasuda, T. (1998a): Role of chlorophyll content of prey diets in prey-locating behavior of a generalist predatory stink bug, *Eocanthecona furcellata*. *Entomol. Exp. Appl.*, 86, 119-124.
- 21) Yasuda, T. (1998b): Effects of (*E*)-phytol of several lepidopteran species in prey-locating behavior of a generalist predatory stink bug, *Eocanthecona furcellata* (Heteroptera: Pentatomidae). *Entomol. Sci.*, 1, 159-164.
- 22) Yasuda, T. & Wakamura, S. (1992): Rearing of the predatory stink bug, *Eocanthecona furcellata* (Wolff) (Heteroptera: Pentatomidae), on frozen larvae of *Spodoptera litura* (Fabricius) (Lepidoptera: Noctuidae). *Appl. Entomol. Zool.*, 27, 303-305.
- 23) Yasuda, T. & Wakamura, S. (1996): Behavioral responses in prey location of the predatory stink bug, *Eocanthecona furcellata*, to chemical cues in the larvae of *Spodoptera litura*. *Entomol. Exp. Appl.*, 81, 91-96.

## Prey-locating behavior of *E. furcellata*

*E. furcellata* bugs were found to approach intact larvae of *S. litura*, and the bugs protruded their proboscis when they were in close vicinity to the larvae of *S. litura* and inserted it through the body surface of preys. This behavior was observed under contact illumination as well as under continuous darkness. A similar behavior was also elicited by dead larvae or solvent extracts of *S. litura* larvae. These findings indicated that odor, or chemical cue(s), from the prey apparently induced the prey-locating behavior of the predatory stink bug.



**Fig.2. Linear track olfactometer**

### 1) Approaching behavior

To evaluate the attractiveness of the larval extracts, a linear track olfactometer, which was designed according to Sakuma & Fukami¹¹) but with minor modifications²³), was used. The olfactometer consisted of a T-shaped wind tunnel and wire structures (**Fig. 2**). In this bioassay, test insects were made to climb up to a T-junction on the wire and choose a direction at one point. When a small piece of absorbent cotton impregnated with a crude extract of *S. litura* larvae (in 100- $\frac{1}{4}$ L acetone) was placed at one of the horizontal ends of the T-shaped wind tunnel (sample side) and a small piece of absorbent cotton impregnated with 100  $\frac{1}{4}$ L of acetone was placed at the other end (control side), 52 bugs chose the sample side and 15 bugs chose the control side. These results indicated that *E. furcellata* nymphs were apparently attracted to the crude extracts of *S. litura* larvae. *E. furcellata* nymphs were also found to be attracted to the ether-soluble layer of *S. litura* larvae (**Fig. 3**). When the ether-soluble layer of the larval extracts was fractionated on silica gel column chromatography, only the fraction eluted with hexane showed attractiveness.

When the hexane fraction was analyzed using GC-MS, one predominant peak and 6 minor peaks were observed. The predominant one corresponded to *n*-pentadecane ( $C_{15}$ )(2500 ng/larva). The minor peaks corresponded to *n*-tetradecane ( $C_{14}$ )(54 ng/larva), *n*-hepta-decane ( $C_{17}$ )(41 ng/larva), *n*-heptacosane ( $C_{27}$ )(61 ng/larva), *n*-nonacosane ( $C_{29}$ )(147 ng/larva), *n*-hentriacontane ( $C_{31}$ )(200 ng/larva) and 2,6,10,15,19,23-hexamethyl-2,6,10,14,18,22-tetracosahexaene (squalene)(323 ng/larva).

The approaching responses of *E. furcellata* nymphs in the linear olfactometer to the hexane fraction of *S. litura* larvae and synthetic hydrocarbons are shown in **Fig. 4**. The hexane fraction induced a significant approaching response in bugs at a dose of 0.4 larval equivalents (LE) containing ca. 1 $\frac{1}{4}$ g of  $C_{15}$  in a linear track olfactometer. However, 1  $\frac{1}{4}$ g of synthetic  $C_{15}$  did not induce a comparable response. More than 10 $\frac{1}{4}$ g of  $C_{15}$  was necessary to attract *E. furcellata* nymphs, but no increasing effect was obtained by the addition of the other 6 components,  $C_{14}$ ,  $C_{17}$ ,  $C_{27}$ ,  $C_{29}$ ,  $C_{31}$  and squalene, to  $C_{15}$ .

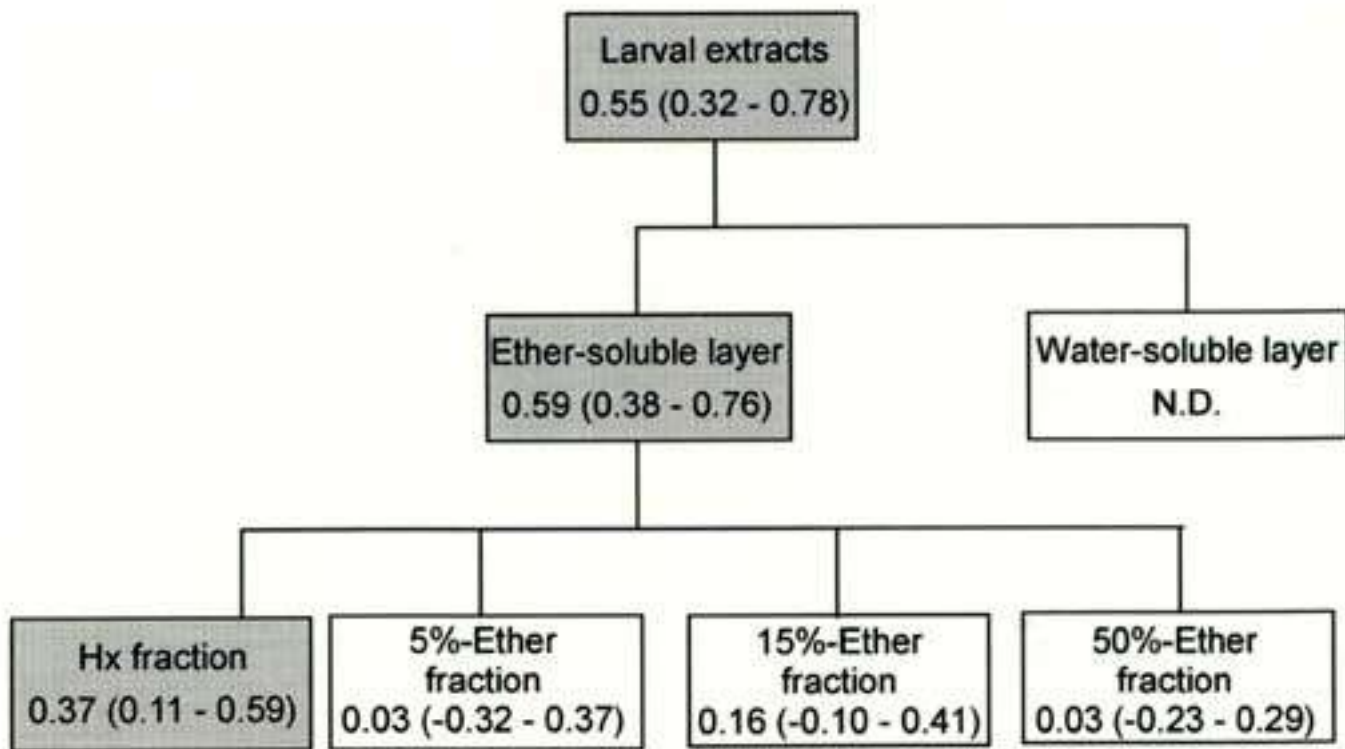
## 2) Proboscis-protruding behavior

In a preliminary observation, *E. furcellata* nymphs protruded their proboscis toward the crude extracts of *S. litura* larvae. However they did not protrude their proboscis when they were in close vicinity to a small piece of absorbent cotton impregnated with the hexane fraction or synthetic C₁₅. It seemed that any chemical(s) could elicit a proboscis-protruding behavior in the bugs.

A 15%-ether-in-hexane fraction from silica gel chromatography of the solvent extracts of *S. litura* larvae elicited the proboscis-protruding behavior in *E. furcellata* nymphs and a similar response was also observed with a neutral-layer fraction of the 15% fraction ([Fig. 5](#)).

Analysis of the neutral-layer fraction using GC-MS showed that it contained (*E*)-3,7,11,15-tetramethyl-2-hexadecen-1-ol [(*E*)-phytol]. Synthetic (*E*)-phytol elicited a proboscis-protruding response from the predators as well as the 15% fraction ([Fig. 6](#)).

[NEXT](#)[TOP](#)



**Fig.3. Chemical purification processes of the larval extracts of *Spodoptera litura* larvae together with attractiveness to nymphs of *Ecocanthecona furcellata* in the linear track olfactometer**

Values represent excess proportion index (EPI)¹¹. Positive values indicate a positive approach response. N.D.: not determined. Hx fraction: fraction eluted with hexane from silica gel chromatography. 5%-, 15%-and 50%-Ether fractions: fractions eluted with 5%-, 15%-and Ether fractions eluted with 5%-and 50%-Ether in hexane from silica gel chromatography, respectively.

**BACK**

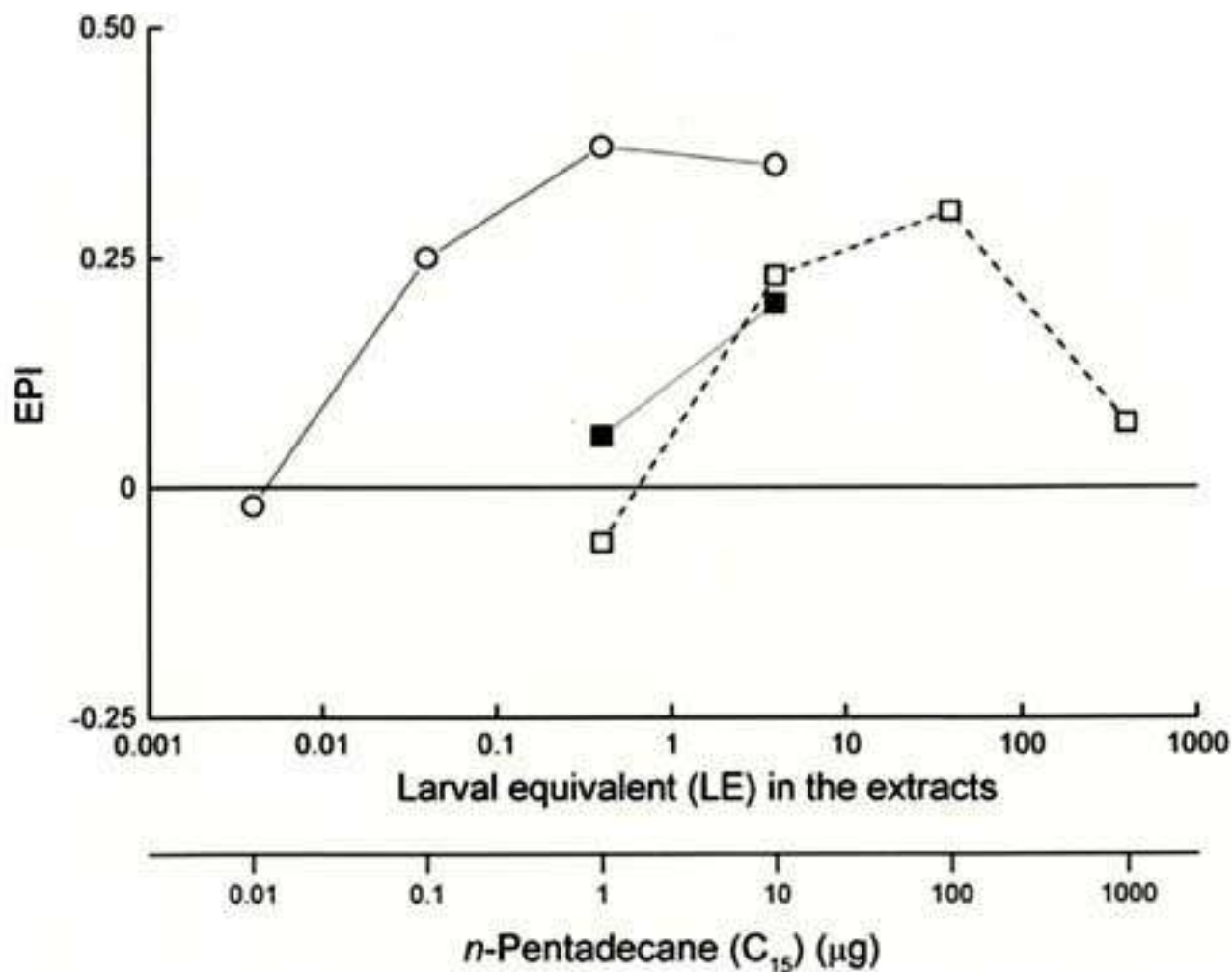


Fig. 4. The approaching responses of *Eocanthecona furcellata* nymphs in the bioassay using the linear track olfactometer

- the Hx fraction of solvent extracts of *Spodoptera litura* larvae.
- synthetic *n*-pentadecane (C₁₅).
- a mixture of C₁₅ and 6 other hydrocarbons.

BACK

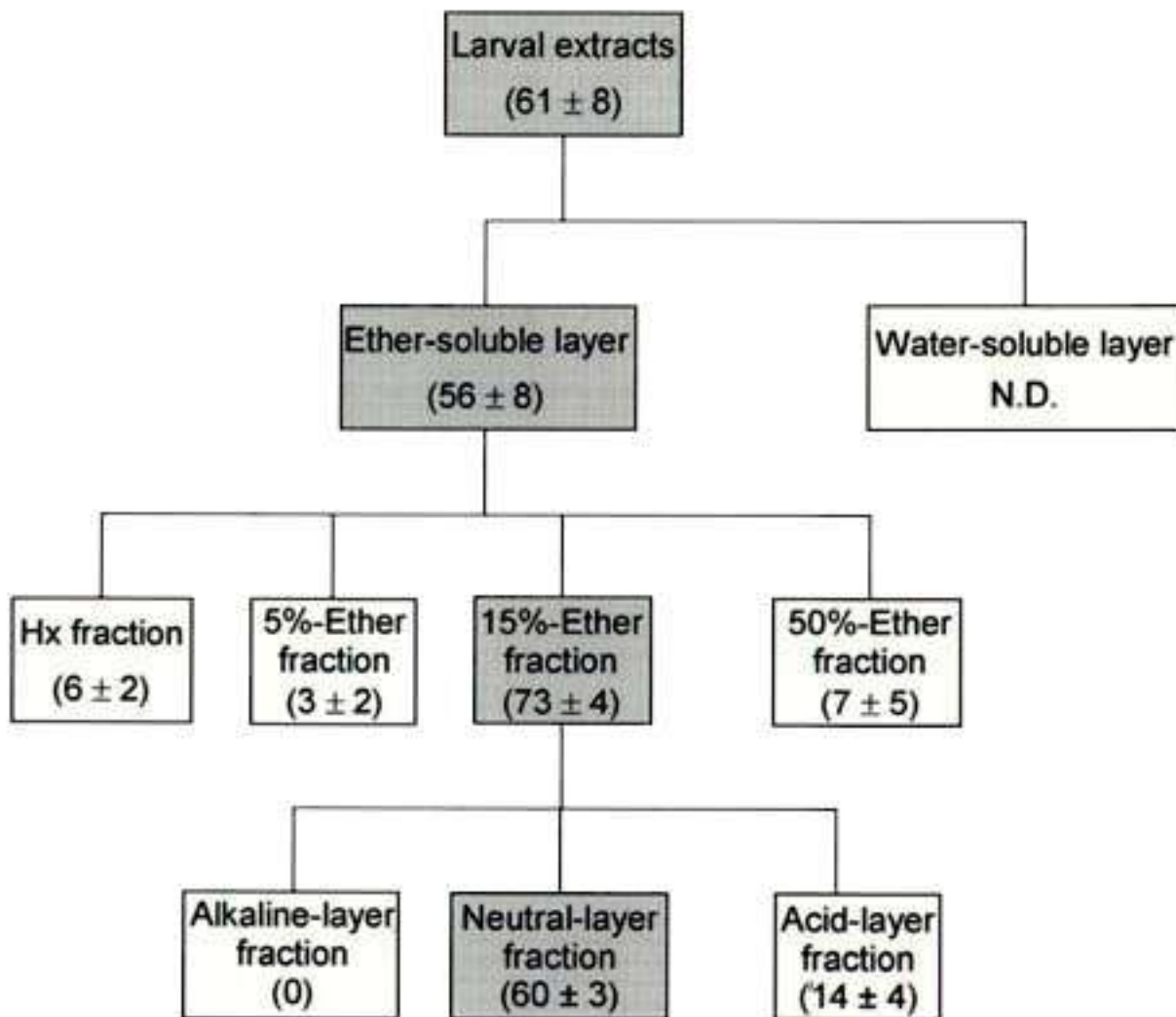
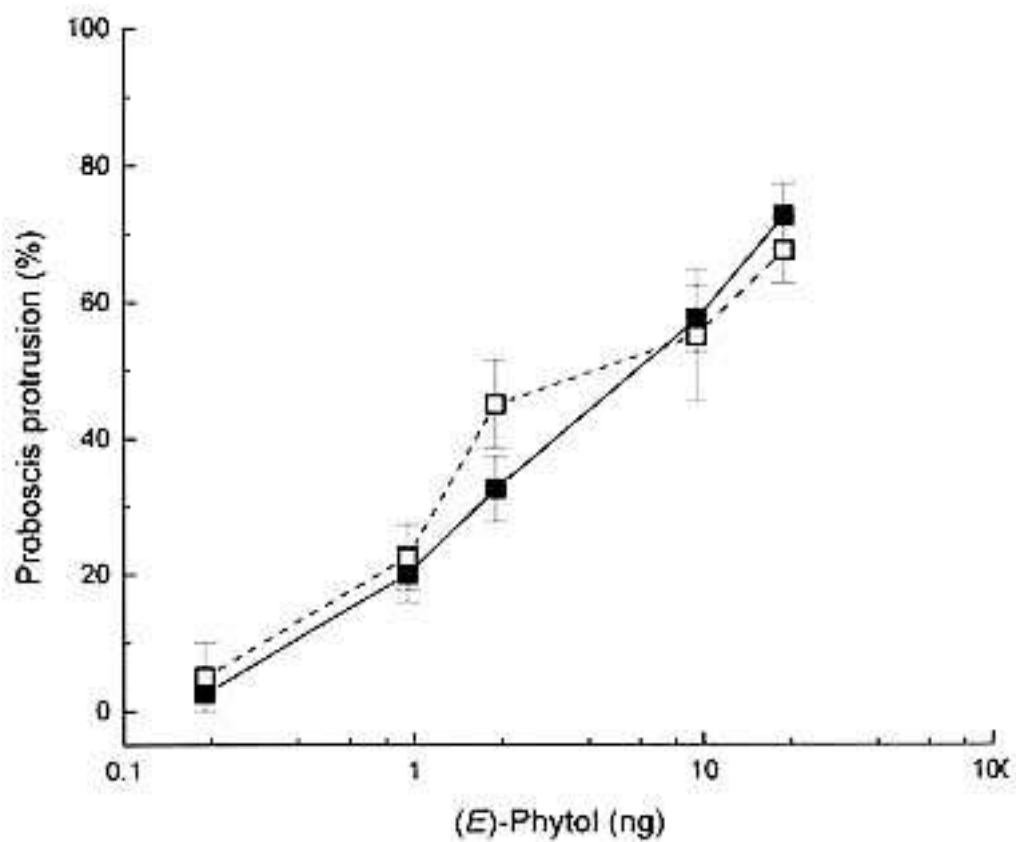


Fig.5. Chemical purification processes of the larval extracts of *Spodoptera litura* larvae together with proboscis-protruding activity for nymphs of *Eocanthecona furcellata*

Values in the parentheses are mean ( $\pm$ s.e.) percentage of positive response per 10 bugs.  
N.D.:not determined.

BACK



**Fig. 6. Dose-response in proboscis-protruding behavior of *Eocanthecona furcellata* nymphs**

■ the 15% fraction of the larval extracts of *Spodoptera litura*.

□ (E)-phytol.

Vertical bars indicated s.e.

BACK



## Effect of prey diet on bug's prey-locating behavior

(*E*)-Phytol generally occurs in green plants as an alcoholic moiety of the chlorophyll molecule ([Fig. 7](#)¹²) and the amount of free (*E*)-phytol is usually small in plant tissues. However, this compound is obtained by hydrolysis of chlorophyll in the laboratory¹⁷. (*E*)-Phytol contents in larvae and in their feces were positively correlated with the chlorophyll content in the artificial diets ([Fig. 8](#)). Therefore, it is possible that food items for prey insects considerably influence the prey-locating behavior of the predatory stink bug, *E. furcellata*.

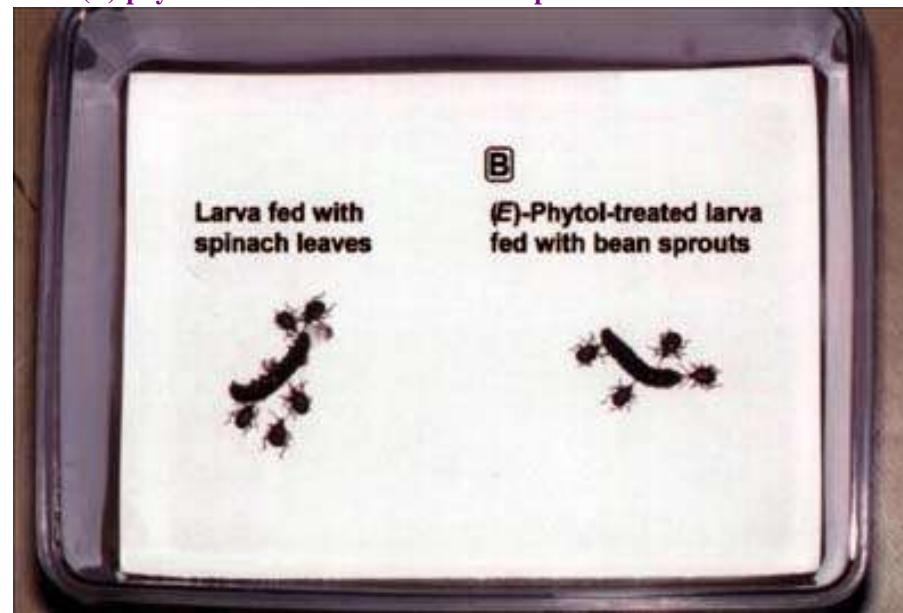
The bugs may prefer insects feeding on a chlorophyll-rich diet to those feeding on a chlorophyll-poor diet. When preference responses of *E. furcellata* nymphs to *S. litura* larvae fed with 2 food items, chlorophyll-rich spinach (*Spinacia oleracea*) leaves and bean sprouts (chlorophyll-poor seedlings of *Vigna radiata*), were observed, bugs preferred larvae fed with spinach leaves to those fed with bean sprouts ([Fig. 9A](#)): a total of 45 nymphs chose the former and 5 nymphs the latter. Solvent extracts of *S. litura* larvae given spinach leaves contained 9¼g/larva of (*E*)-phytol, but less than 0.001¼g/larva in those fed with bean sprouts. When a *S. litura* larva fed with bean sprouts was coated with 10 mg of (*E*)-phytol and presented to the bugs together with a larva fed with spinach leaves, almost the same number of *E. furcellata* bugs was located on these larvae ([Fig. 9B](#)): a total of 24 nymphs chose an (*E*)-phytol-treated larva fed with bean sprouts and 26 nymphs chose a larva fed with spinach leaves. The results indicated that (*E*)-phytol is utilized as a "kairomone" for prey-location by *E. furcellata* nymphs.

**Fig.9. Feeding preference response of *Eocanthecona furcellata* nymphs to *Spodoptera litura* larva fed with spinach leaves (left) versus A and B (right)**

**A: a larva fed with bean sprouts.**



**B: an (*E*)-phytol-treated larva fed with bean sprouts.**



(*E*)-Phytol was also detected in the extracts of larvae of the pellucid zygænid, *Pryeria sinica*, a giant silkworm, *Samia cynthia ricini*, an armyworm, *Pseudaletia separata*, the cabbage armyworm, *Mamestra brassicae*, which had been fed on diets containing chlorophyll. These extracts elicited the proboscis-protruding behavior of the bug, and the response depended directly on the (*E*)-phytol concentration in these larvae. Therefore, larvae of lepidopterans feeding on green plants could become potential preys for the generalist predatory stink bug, *E. furcellata*.

## Conclusion

The present studies demonstrated that the generalist predatory stink bug, *E. furcellata*, uses 2 different chemical cues as "kairomones" to locate larvae of several lepidopterans. *n*-Pentadecane (C₁₅) acts as a long-range (relatively long) attractant for the bug. On the other hand, (*E*)-phytol induced a proboscis-protruding behavior within a short distance. (*E*)-Phytol could be a key chemical associated with herbivorous lepidopterans for the prey location of this generalist predator, since the chemical originating from chlorophyll in prey diets is found in lepidopteran larvae feeding on green plants and the bugs protruded their proboscis toward an object, even a glass rod, treated with (*E*)-phytol.

The behavioral manipulation for *E. furcellata* with the semiochemicals has not yet been evaluated in the field. However, some applications in pest management have been speculated. C₁₅ and (*E*)-phytol could be used as an attractant and an arrestant, respectively, to recruit *E. furcellata* bugs and/or prevent their dispersal from the crop fields. The current studies suggested that (*E*)-phytol may be an indicator of the effects on pest control using *E. furcellata*, if the contents of (*E*)-phytol in pest insects could be measured. (*E*)-Phytol could also be used as a feeding stimulant in artificial diets for mass rearing of *E. furcellata*. Further studies should be carried out for using these compounds for pest management with *E. furcellata* bugs.

**NEXT** : [Development of Fully Automatic Vegetable Transplanter](#)

**TOP** : [Contents](#) **HOME** : [JIRCAS Home Page](#)

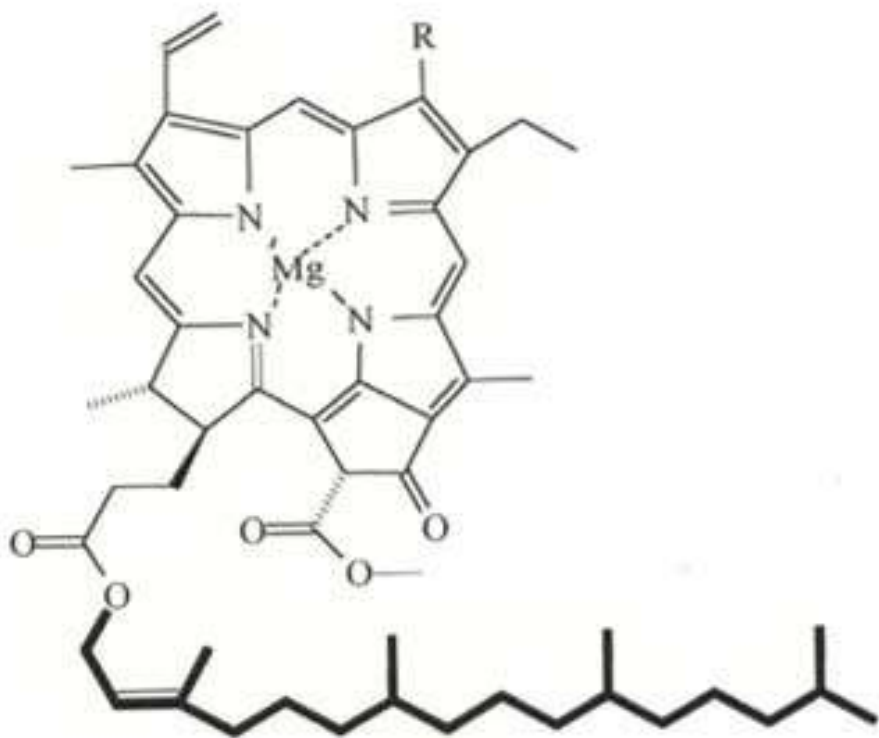


Fig.7. Chlorophyll molecule

Formula presented with a bold line applies to the (*E*)-phytol moiety.  
R=CH₃ or CHO for chlorophyll a or b, respectively.

BACK

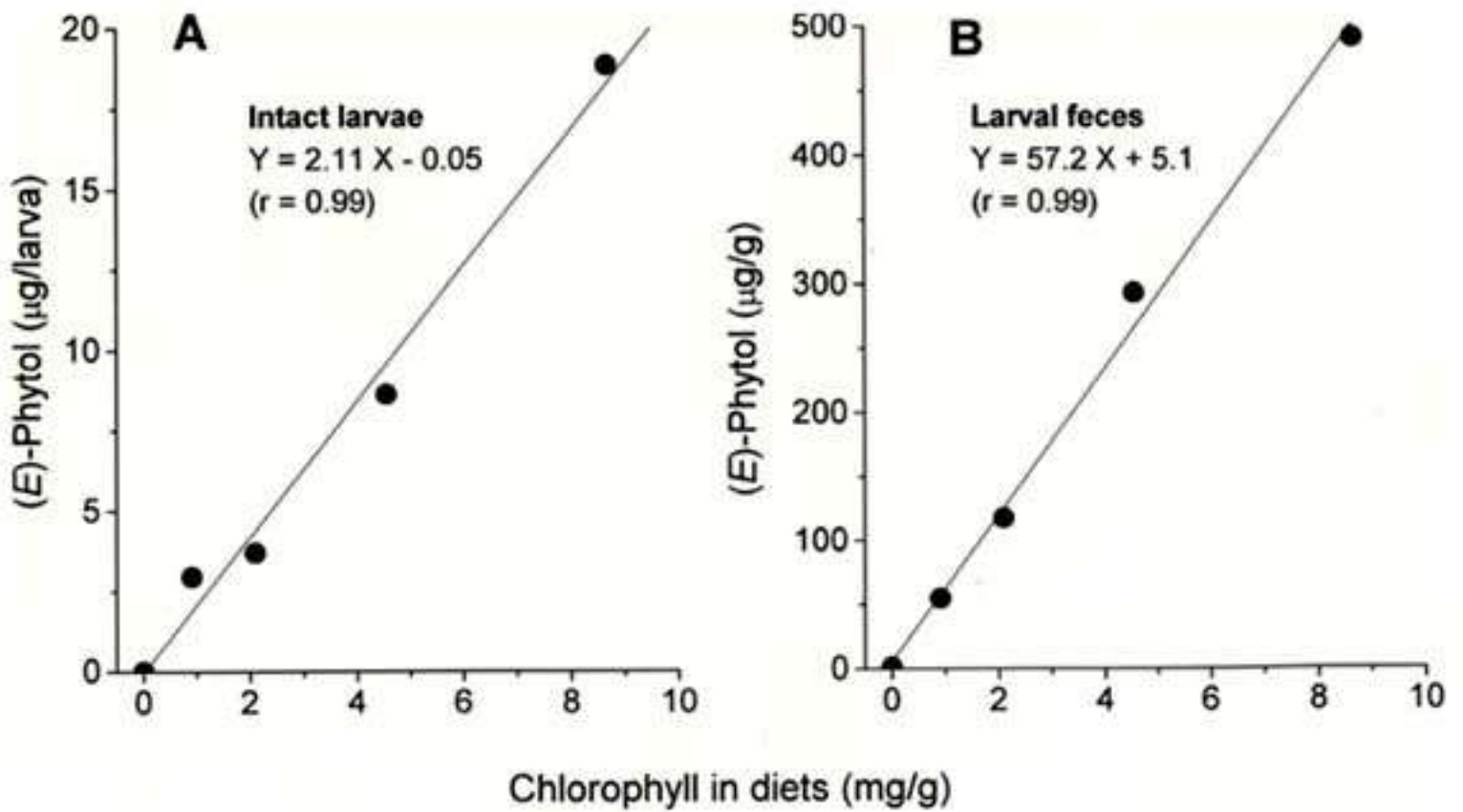


Fig.8. Concentration of (*E*)-phytol

A: in larvae of *Spodoptera litura* fed with artificial diets containing various amounts of chlorophyll.  
 B: in feces of *Spodoptera litura* fed with artificial diets containing various amounts of chlorophyll.

BACK

# Development of Fully Automatic Vegetable Transplanter

**Konosuke TSUGA**

Institute of Agricultural Machinery, Bio-oriented Technology Research Advancement Institution

(1-40-2, Nisshin, Ohmiya, Saitama, 331-8537 Japan)

Corresponding author: K. Tsuga (ktsuga@iam.brain.go.jp, fax +81-48-654-7130)

## Abstract

We developed 3 models of riding-type, fully automatic vegetable transplanters. These prototypes are suitable for cell mold seedlings and pulp mold cell pot seedlings, mainly of leaf vegetables such as cabbage, Chinese cabbage, and lettuce. The prototypes enabled continuous transplanting work on 2 rows simultaneously, at a planting speed of 60 cells/row/min, with vegetable seedlings fed automatically. The transplanting accuracy, in terms of the rate of misplanted hills, was 3% or less, and the working capacity per worker was approximately 10 a/h. We estimated that the annual coverage area of this machine for cultivating cabbage is 53 ha/year, and the minimum economically suitable area for use is 8.2 ha. Based on these prototypes, transplanters have been put on the market by several companies and are now being used in various areas. In this study, we presented a draft of the standards for seedling trays, such as cell mold seedling trays and pulp mold cell pots (paper pots), for possible use of a fully automatic vegetable transplanter. At present, 4 million or more trays are supplied to the market.

Discipline: Agricultural machinery

Additional key words: transplanting, machine, seedlings, cabbage, lettuce

(Received for publication, February 25, 1999)

## Introduction

Vegetable cultivation in Japan lags behind in terms of mechanization of transplanting and harvesting operations. Seeding and transplanting operations, in particular, are mainly performed manually, accounting for approximately 40% of total working hours. Recently, however, the mechanization of soil filling, seeding, germination, and the raising of seedlings has advanced, and mass raising of seedlings is performed now in production areas. Transplanters are presently used for leaf vegetables such as cabbage, Chinese cabbage, and lettuce.

Current vegetable transplanters are divided into 2 categories: fully automatic transplanters and semi-automatic transplanters. The semi-automatic transplanter has a limited operating speed due to the need for manual feeding of one seedling cell after another and is not suitable for continuous operation over a long period of time. The fully automatic transplanter allows for high-speed operation and labor-saving, because seedlings fed automatically by the machine itself can be planted. However, the fully automatic transplanters that have been developed so far can use only limited types of seedling trays and the working capacity is low because they are of the walking-type. There was a demand for fully automatic transplanters capable of higher speed and small labor load. Therefore, the Bio-oriented Research Technology Advancement Institution proposed standards for seedling trays of vegetables suitable for use with fully automatic transplanters in the "Urgent Development of Agricultural Machinery" implemented during the period from 1993 to 1995. The Institution also developed jointly with Iseki Noki Co., Ltd., Kubota Co., Ltd., and Yanmar Noki Co., Ltd. riding-type, fully automatic transplanters for vegetables.

In this paper, we will describe the transplanters, the kinds of seedlings, and the standards for trays (standardization), mainly for leaf vegetables, as well as introduce the outline of the riding-type, fully automatic transplanter that

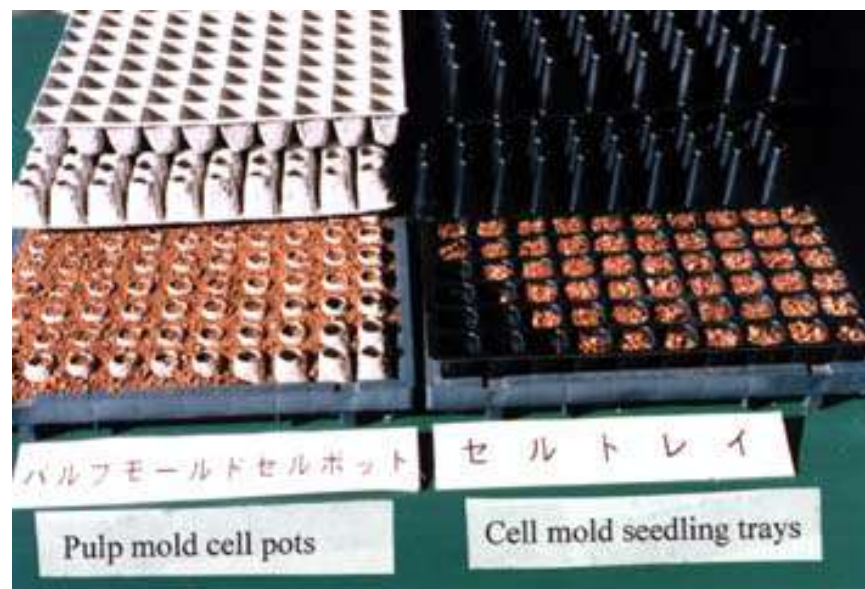
achieved the highest performance in Japan.

## Prototypes suitable for seedlings³⁾

Transplanters can be broadly divided into those to which seedlings are fed manually (semi-automatic transplanters) and those to which seedlings are fed automatically (fully automatic transplanters), as shown in [Table 1](#). These are further divided into the walking-type and the riding-type. In addition, the type of transplanter may vary depending on the seedlings to which it can adapt. Seedlings used for transplanting by a machine can be broadly divided into seedlings with soil and seedlings without soil (bare seedlings). Seedlings with soil can be further divided into cell mold seedlings, paper pot seedlings, kneaded nursery seedlings, and soil block seedlings. Recently, since the mechanization of seeding and that of transplantation are progressing in parallel, the use of seedlings with soil, adjustment of the properties of seedlings, and reduction in size of the seedlings are also making progress. In this study, we developed riding-type, fully automatic transplanters that are suitable for cell mold seedlings and pulp mold cell pot seedlings (a kind of paper pot seedlings).

## Standardization of seedling trays

To transplant cell pot seedlings and paper pot seedlings, the fully automatic transplanter requires the use of seedling trays in which the arrangement of the seedlings is suitable for the seedling feeding device applied. Therefore, seedlings must be grown in trays that are suitable for the particular transplanter to be used, and the seedling form will differ from one kind of tray to another. If the same types of trays are used, the machine has to be adjusted to the number of cells per tray. Therefore, attempts were made to develop trays that were interchangeable among the seedlings from various seedling centers and among transplanters from different manufacturers. In this study, we prepared a draft of the standards for seedling trays, such as cell mold seedling trays and pulp mold cell pots, for possible use of a fully automatic vegetable transplanter ([Fig. 1](#)). As a result, the form and dimensions of these trays have been standardized, as shown in [Table 2](#).



**Fig.1. Cell mold seedling trays and pulp mold cell pots (paper pots)**

The cell mold seedling tray is made of flexible plastic, and there are 3 types of trays, containing 128, 200, or 288 cells, in which the arrangement of cells is 8 x 16, 10 x 20, and 12 x 24. The shape of the trays is that of an inverted pyramid.

The pulp mold cell pot is a kind of paper pot, in which the pulp mold is made of used paper, etc. Pot dimensions are 30 mm² (128 pots) and 25 mm² (200 pots), and the seedlings are arranged in the form of a pyramid. The

arrangement of cells is 8 x 8 and 10 x 10, and each pair of pots is arranged on an under-tray.

Both types of standard trays can use a rice seedling box as the under-tray. Four million or more of these standard trays had been supplied to the market as of 1998.

## References

- 1) Bio-oriented Technology Research Advancement Institution (ed.) (1997): Full automatic vegetable transplanting machine. Outline of agricultural machines developed by the project of urgent development of agricultural machinery, 2.
- 2) Foundation Agricultural of Industry Development Assistance (Nousangyou-Shinkou-Shoureikai) (ed.) (1995): Technical report of field test on the project of urgent development of agricultural machinery, 25-64 [In Japanese].
- 3) Japanese Society of Agricultural Machinery (ed.) (1995): Vegetable machinery. Introduction to Japanese Agricultural Machinery (III), 31-37.
- 4) New Agricultural Mechanization Enhancement Co., Ltd. (Shinnouki) (ed.) (1996): Fully automatic vegetable transplanter. Mechanical cultivation manual, 1-18 [In Japanese].
- 5) Tsuga, K. (1997): Full automatic vegetable transplanter. *J. Jpn. Soc. Agric. Mach.*, 59 (2), 109-110 [In Japanese].

[NEXT](#)

[TOP](#)

[:Contents](#)

Table 1

Table 1. Classification of vegetable transplanters and seedling types			
Transplanter		Seedlings	
		Seedlings without soil (bare seedlings)	
Semi-automatic	Walking-type	Seedlings with soil	Soil block seedlings Cell mold seedlings Paper pot seedlings
	Riding-type		
Fully automatic	Walking-type	Seedlings with soil	Cell mold seedlings Pulp (paper) pot seedlings Linked paper pot seedlings
	Riding-type		

**BACK**

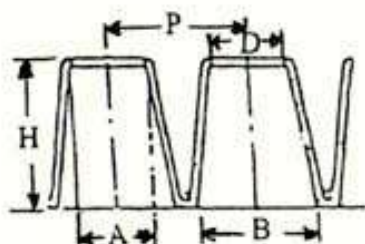


**Table 2. Standards of vegetable seedlings trays in Japan⁴⁾**

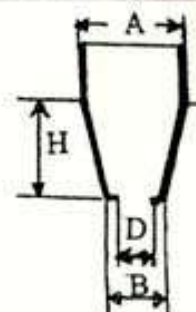
(Unit:mm)

Classification		Pulp mold pot		Classification		Cell tray			
		128	200			128	200	288	
Outer frame	Size	288×2	288×2	Outer frame	Size	590	590	586	
	R on Corner	8	8		R on Corner	10	10	10	
Arrangement of cell number		8×8	10×10	Arrangement of cell number		8×16	10×20	12×24	
Pitch	Longitudinal (P)	35.9	28.7	Pitch	Longitudinal	36.6	29.2	24.3	
	Lateral	34.5	27.7		Lateral	36	28.7	23.7	
Height(H)		40	32.5	Height (H)		44	44	38.5	
Cell size	Upper part	Length(A)	19.2	16	Cell size	Upper part (A)	31	26	21.5
	Side		17.8	16			10	7	6
	Lower part	Length(B)	29.9	24.7	Lower part (B)	18	12	9	
	Side		28.5	23.7			7	5	3
Diameter of seeding hole(D)		18	15	Diameter of hole (D)		12	9	7	
Volume of cell (cc)		about 23	about 12	Volume of cell (cc)		about 25	about 14	about 9	
Soil capacity per tray(L) including cover soil		about 5.7	about 4.0	Soil capacity per tray(L)		about 3.2	about 2.8	about 2.6	
				Cover soil capacity(L)		0.5	0.5	0.5	
Weight of tray (g)		about 71	about 76	Weight of tray (g)		about 150			
Thickness of cell (mm)		about 2		Thickness of cell (mm)		0.6(side · base0.1)			
Material		Used newspaper		Material		Polystyrene(PS)			

Remarks



Remarks



BACK

## Development of riding-type, fully automatic transplanters^{1,5)}

### 1) Outline of fully automatic transplanter

We developed 3 models of riding-type, fully automatic transplanters that allow continuous transplanting work on 2 rows simultaneously at a planting speed of 60 cells/row/min, with vegetable seedlings fed automatically. The prototypes manufactured in 1995 consist of 2 models for cell mold seedlings (Type A in [Fig. 2](#), Type B in [Fig. 3](#)) and a model for pulp mold cell pot seedlings ([Fig. 4](#)). The outline of each model is described below.



(1) These machines handle mainly leaf vegetables such as cabbage, Chinese cabbage, and lettuce ([Fig. 5](#)), with cell mold seedlings and pulp mold cell pot seedlings. As the under-tray, a rice seedling box is used. Since the numbers of cells (pots) per tray are 128 and 200, standard trays can be used.

**Fig.5. Chinese cabbage and lettuce seedlings**

(2) The basic configuration of these machines is that of a small, riding-type machine consisting of a 2-row planting device mounted on the back of a vehicle. The planting device is composed of the seedling feeding and transplanting sections. The vehicle has a 4 wheel-drive system and is well adapted to slopes. The standard adjustment range of the tread (distance between the right and left wheels) is 90 to 120 cm. Although usually riding-type machines are very long and require a considerable area at the end of the field for turning, the current machine is a compact 4-wheel-drive vehicle, adapted to such use, and requiring only 3 to 4 m of headland for turning. This riding-type is suitable for relatively small fields.

(3) The models for cell mold seedlings (Types A and B) pull out seedlings one at a time from the tray using a seedling take-out claw of the holding type and discharge seedlings into the bill-type opener. The opener, which is interlocked with the claw, transplants the seedlings to the tamped surface of the ridge, and the tamping ring at the rear presses soil from the left and right to cover the seedlings. The automatic-planting-depth control unit and the ridge-following control unit allow stable transplanting with the use of hydraulic devices. Since the seedlings are independent cells, growth control is easy, growth rates are similar, and they display an outstanding initial rooting capacity after transplanting. The vehicle consists of a 4-wheel-drive system with either a diesel engine (Type A) or a gasoline engine (Type B).

(4) The model for pulp mold cell pot seedlings holds seedlings that are each wrapped by a paper pot (pulp mold) and transplants them continuously by separating them into individual hills. It allows the transplanting of seedlings with a wide range of sizes over a long period of time and is suitable for transplanting regardless of the degree of growth of the individual seedlings.

The model for pulp mold cell pot seedlings scratches off seedlings with the paper attached (pulp mold), after separating them into each hill with a transplanting claw, and transplants them in the hole opened by the arm. After transplanting, the soil is tamped. This transplanting claw consists of 2 blade-like claws and an extrusion arm. The blade-like claws scrape each seedling pot to separate it from the others and hold it, and the arm extrudes the seedling pot into the soil to plant it. Soil is pressed then from both sides of the planted seedling by the tamping ring to complete transplanting. The automatic-planting-depth control unit and ridge-following control unit allow stable transplanting with the use of hydraulic devices. The vehicle has a 4-wheel-drive system that allows maneuvering of both front and rear wheels.

(5) Planting conditions common to all the 3 models include an adaptable ridge height of 0 to 25 cm, a hill space of 25 to 50 cm, and a ridge space of 45 to 60 cm, in which the model for cell mold seedlings (Type A) allows zigzag planting on 2 rows.

## **2) Performance of the prototypes**

### **(1) Working accuracy²⁾**

Based on operation tests on the prototypes using seedlings of cabbage, Chinese cabbage, and lettuce, we confirmed that hill spacing, planting depth, and soil cover can be adjusted easily, a planting speed of 60 to 70 hills/row/min is possible, and the ratio of misplanted hills is 3% or less (excluding non-seeded hills in the tray). Lateral displacement of planting positions (rows), changes in hill spacing, and the ratio of slanted hills were also small. In the case of planting on slopes (maximum of 10°), number of misplanted hills and changes in hill spacing were small. [Table 3](#) shows the results of the planting accuracy test performed in Aichi Prefecture in 1994.

### **(2) Working capacity⁴⁾**

We found that when 12 to 14 trays were mounted on the seedling tray and the auxiliary seedling tray, it was possible to transplant 2,400 or more hills without requiring the operator to get off the vehicle. Working time per 10 a per operator, including the planting time, seedling feeding time, turning time, etc., was approximately one hour. [Table 4](#) shows the results of the working capacity test performed in Aichi Prefecture in 1994, indicating that when one operator planted cabbage (at a hill spacing of 30 cm and row spacing of 60 cm), the working speed was 0.33 to 0.39 m/s, and all the 3 models showed a working capacity value of approximately 10 a/h. A similar value of working capacity of approximately 10 a/h was reported in a test on commercial machines.

## **3) Economic efficiency of the prototypes⁴⁾**

### **(1) Maximum working area**

We calculated the maximum transplanting working area per year achieved by these prototypes in the case of cabbage cultivation ([Table 5](#)). The time available for transplanting work was 2.8 h per day. This value was calculated on the assumption that half a day (4 h) can be used for transplanting work, to avoid other conflicting tasks and poor rooting conditions, as well as high temperatures in summer and low temperatures in early spring. Assuming that the actual working rate is 70%, the maximum working area per day was 0.29 ha/day, based on the time available for transplanting work and the working capacity of the machine. Next, the number of days available for working was 183, on the assumption that the ratio of days available for work is 75% because transplanting work is performed over a period of 8 months from April to November, including the days when rain prevents outdoor work. The maximum transplanting working area per year (cumulative working area per year) was 53.1 ha, based on the calculation of the maximum working area per day and the number of days available for working per year.

## (2) Cost and economic efficiency

We calculated the cost of using these machines in the case of cabbage cultivation. The costs included fixed costs (expenses required for owning the machine) and variable costs (operating costs, including fuel, lubricating oil, and labor). [Fig. 6](#) shows the relationship between the area covered and the cost of the machine. To evaluate the economic efficiency, we calculated the minimum economical area for using this machine based on the work contract wage for manual transplanting. Based on that wage, the result was 8.21 ha. Since the maximum transplanting working area per year is 53.1 ha, and since this machine can cover an area 6.5 times as large, we consider that this machine is economically efficient.

## Conclusion

We developed 3 models of small-sized, high speed, riding-type, and fully automatic vegetable transplanting machines for the first time in Japan. These machines feed vegetable seedlings automatically and enable continuous transplanting work on 2 ridges simultaneously at a planting speed of 60 hills/row/min. The machines can be used for cell mold seedlings and pulp mold cell pot seedlings. In Ogoori City, Fukuoka Prefecture, where the machine was put on the market and used, cabbage is cultivated over the year on a 15-ha field, using a transplanter model for cell mold seedlings (manufacturer, Yanmar Noki Co., Ltd.), as shown in [Fig. 7](#). This was part of a thorough mechanization system, including general-purpose use of this vehicle and the introduction of harvesters. [Fig. 8](#) shows another model for cell mold seedlings (manufacturer, Kubota Co., Ltd.), which is used for transplanting cabbage, etc., in a farm where cabbage, Chinese cabbage, and lettuce are cultivated (25 ha) in Takeda City, Kumamoto Prefecture. Six riding-type transplanters of the model for pulp mold cell pot seedlings (manufacturer, Iseki Noki Co., Ltd., [Fig. 9](#)) were used for a thorough mechanization system, including general-purpose use of this vehicle, in Kazuno City, Akita Prefecture, where a cabbage production center of 100 ha is being constructed. As a result, dozens of such riding-type, fully automatic transplanters have been introduced already in various areas and we anticipate that their use will be disseminated throughout the country.

We thank the Agricultural Experimental Stations of Iwate Prefecture and Aichi Prefecture for their cooperation during the field tests of the automatic transplanter.

## References

- 1) Bio-oriented Technology Research Advancement Institution (ed.) (1997): Full automatic vegetable transplanting machine. Outline of agricultural machines developed by the project of urgent development of agricultural machinery, 2.
- 2) Foundation Agricultural of Industry Development Assistance (Nousangyou-Shinkou-Shoureikai) (ed.) (1995): Technical report of field test on the project of urgent development of agricultural machinery, 25-64 [In Japanese].
- 3) Japanese Society of Agricultural Machinery (ed.) (1995): Vegetable machinery. Introduction to Japanese Agricultural Machinery (III), 31-37.
- 4) New Agricultural Mechanization Enhancement Co., Ltd. (Shinnouki) (ed.) (1996): Fully automatic vegetable transplanter. Mechanical cultivation manual, 1-18 [In Japanese].
- 5) Tsuga, K. (1997): Full automatic vegetable transplanter. *J. Jpn. Soc. Agric. Mach.*, 59 (2), 109-110 [In Japanese].

**NEXT** [:Detection of Crop Transpiration and Water Stress Based on Temperature](#)

**TOP** [:Contents](#) **HOME** [:JIRCAS Home Page](#)



Fig. 2. Fully automatic transplanter model PR2 for cell mold seedlings

BACK



**BACK**

Rack for auxiliary seedling trays

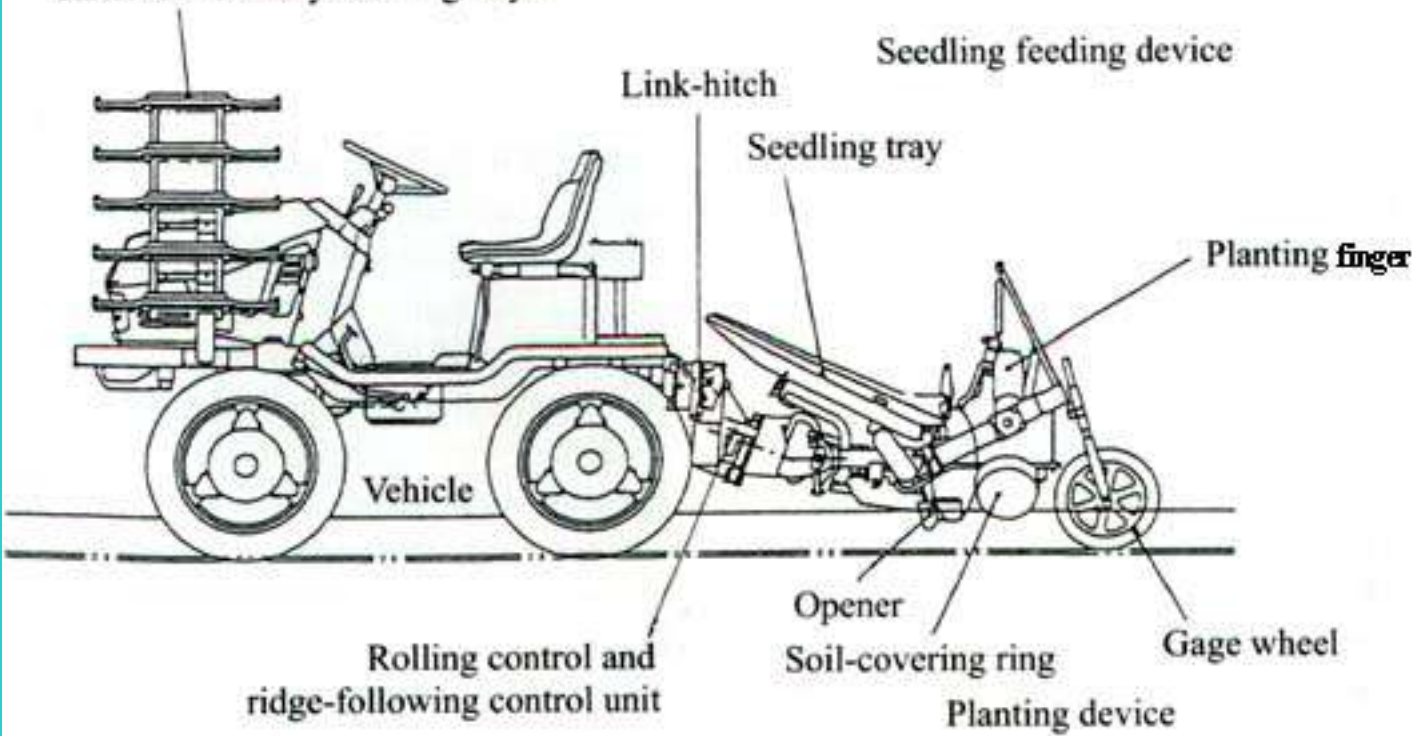


Fig. 4. Fully automatic transplanter model PVP200 for pulp mold cell seedlings

BACK



**Table 3. Test results on working accuracy (Aichi Prefecture Agricultural Experimental Station, as of 1994)**

Model under test	Planting speed (m/s)	Number of misplanted hills		Number of continuous misplanting positions	Changes in hill spacing	
		Left	Right		Left	Right (CV%)
For pulp mold cell pot seedlings	0.22	2	1	0	3.7	3.0
	0.30	0	4	0	2.6	1.9
	0.38	2	4	0	3.0	2.5
Type A for cell mold seedlings	0.22	2	0	0	3.2	3.0
	0.30	0	0	0	4.0	4.3
	0.37	0	1	0	4.2	4.7
Type B for cell mold seedlings	0.27	0	3	0	7.0	3.0
	0.31	1	0	0	3.9	3.7
	0.33	1	0	0	5.7	3.9

Sample seedling/hill spacing : Cabbage/30 cm. Number of hills measured : 200.

BACK

**Table 4. Test results on working capacity (Aichi Prefecture Agricultural Experimental Station, as of 1994)**

Model under test	Seedlings used	Working speed ( m/s )	Total working time ( min )	Time ratio of operation ( % )					
				Planting	Turning	Tray replenishing	Tray feeding	Adjustment	Others
For pulp mold cell pot seedlings	200 cells	0.35	52	70.4	10.6	10.4 (4 times)	8.1 (12 times)	0	0.5
Type A for cell mold seedlings	200 cells	0.39	54	61.2	12.7	9.6 (4 times)	12.6 (12 times)	2.0	1.9
Type B for cell mold seedlings	200 cells	0.33	54	73.9	8.7	7.0 (3 times)	10.4 (12 times)	0	0

**Test conditions**

Test field: 9.36 a (65m×12 strokes). Operator: 1.

Seedling: Cabbage. Planting: Row spacing, 60 cm; Hill spacing, 30 cm.

**BACK**

**Table 5. Sample calculation of the maximum working area of the machine**

	Item	Calculated value	
	Working capacity	0.103	ha/h
		9.71	h/ha
Per day	Working hours	4.0	h
	Actual working rate	70	%
	Time available for work	2.8	h
	Working area	0.29	ha
Per year	Fixed planting period	April ~ November	
	Number of working days	244	d
	Ratio of days available for working	75	%
	Number of days available for working	183	d
	Maximum working area	53.1	ha

**BACK**

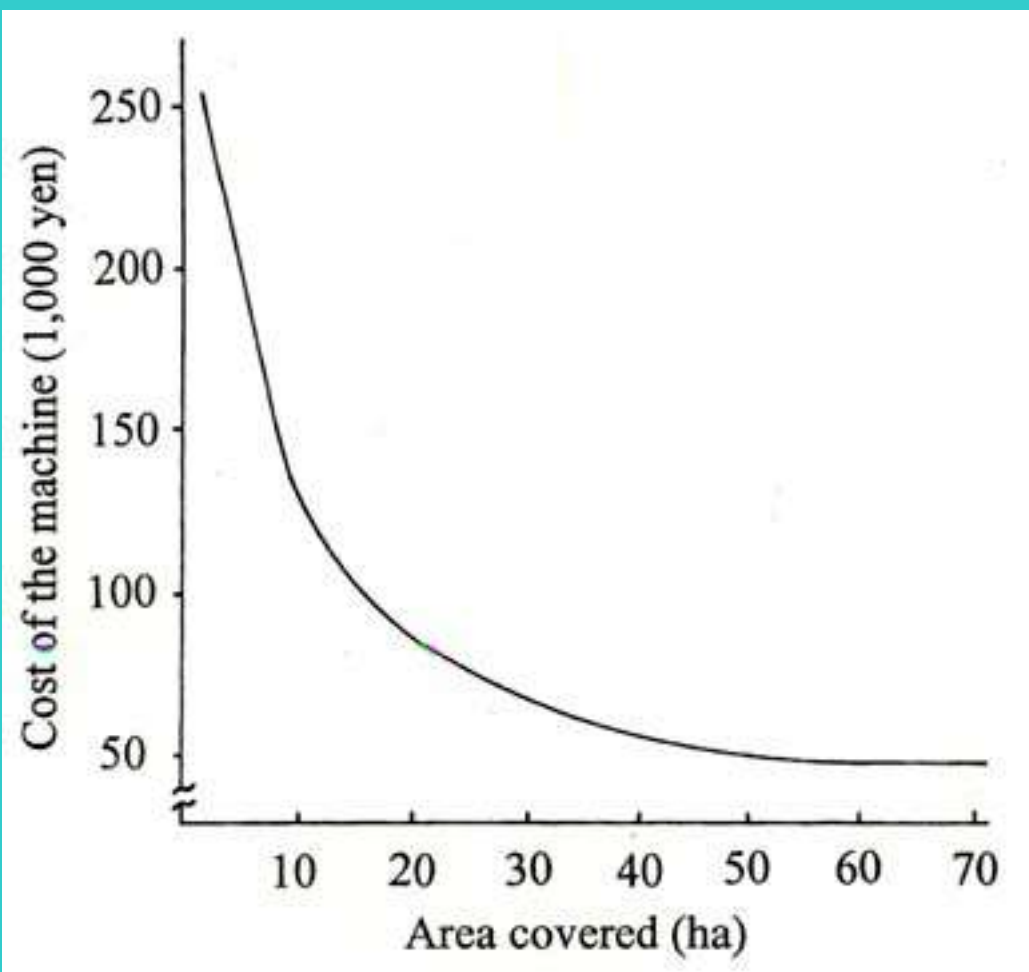


Fig.6. Relationship between the area covered and the cost of the machine

[BACK](#)



Fig.7. Fully automatic transplanter Model PR2 for cell mold seedlings  
(Yammer Noki, Co., Ltd, for cabbage in Ogoori, Fukuoka)

**BACK**



Fig.8. Fully automatic transplanter model SK20 for cell mold seedlings (Kubota, Co., Ltd., used in Takeda, Kumamoto)

**BACK**



Fig.9. Fully automatic transplanter model PVR200 for pulp mold cell pot seedlings (Iseki Noki, Co., Ltd., used in JA Kazuno, Akita)

**BACK**

# Detection of Crop Transpiration and Water Stress by Temperature-Related Approach under Field and Greenhouse Conditions

**Guo Yu QIU, Koichi MIYAMOTO, Sadanori SASE and Limi OKUSHIMA**

Department of Land Improvement, National Research Institute of Agricultural Engineering  
(Tsukuba, Ibaraki, 305-8609 Japan)

Corresponding author: G.Y. Qiu (alaguoyu@nkk.affrc.go.jp, fax +81-298-38-7609)

## Abstract

A new method for estimating crop transpiration and crop water stress index (*CWSI*) by using a temperature-related approach was developed and verified in this study. In the proposed method, 3 temperatures and a few meteorological variables (net radiation and humidity) are required. The 3 temperatures include sunlit leaf temperature, imitation leaf temperature, and air temperature. The imitation leaf refers to an artificial leaf without transpiration. The major advantage of the proposed method is that plant correction factors, empirical coefficients, and canopy and aerodynamic resistances are not required. Experiments for verification were conducted in a sandy field with sorghum crop and in a greenhouse with melon crop. Data obtained by the proposed method were compared with the amount of transpiration determined with lysimeters, soil water status determined by TDR, and *CWSI* estimated by Jackson's method. The calculated transpiration by the proposed method was consistent with the results obtained with lysimeters, with a regression coefficient  $r^2=0.88$ . Values of *CWSI* calculated by the proposed method were in agreement with Jackson's *CWSI*, with a regression coefficient approximately equal to 1. These results indicate that the proposed method can be applied to estimate crop transpiration and water stress index under both field and greenhouse conditions.

Discipline: Agro-meteorology

Additional key words: imitation leaf, sorghum, melon

1)...32): [References](#)

(Received for publication, February 25, 1999)

## Introduction

Water management in modern agriculture requires the determination of the crop water requirement and irrigation time as accurately and quickly as possible. Transpiration (*T*) is the key factor to estimate crop water requirement and crop water stress index (*CWSI*) is the key factor to evaluate the time when irrigation should be applied. Among the methods of estimation of *T* and *CWSI*, a temperature-related approach can be adopted. As cited by Jackson¹³⁾ and Jackson et al.¹⁶⁾, research on foliage temperature was started in 1843. The literature on this topic was rather sparse until the 1920s when thermocouples became standard equipment. Many of these early studies focused on the leaf and air temperature



differences^{18,32}). Subsequently, research results showed that the soil moisture status, foliage temperature, and plant transpiration rates were closely related^{3,4,6-8,12,14,30}).

As a result, a temperature difference method was developed to estimate  $T$ ^{5,12,17,21,30,31}). Mitchell and Hanks¹⁹) derived an empirical equation to predict  $T$  based on the temperature difference between canopy and air. Hatfield⁵), O'Toole and Real²³), and Ben-Asher et al.^{1,2}) evaluated aerodynamic and canopy resistances by using air temperature, canopy temperature, and vapor pressure deficits. Due to the complexity in evaluating the aerodynamic resistance, the temperature difference method is mainly applied for estimating the aerodynamic resistance with an already known  $T$ , rather than for the direct estimation of  $T$ . No studies have been reported on the direct estimation of  $T$  by air and canopy temperature without the use of aerodynamic resistance or empirical coefficients.

*CWSI* is another key factor for agricultural water management. Although maximum yields of crops are achieved only under non-limiting water supply, it remains to be determined how early water shortage should be detected to avoid a significant decrease in productivity. The use of canopy temperatures to detect water stress in plants is based upon the assumption that, as water becomes limiting, transpiration is reduced and plant temperature increases. Canopy temperature is determined based on the water status of the plants and by ambient meteorological conditions. *CWSI* based on the determination of the canopy temperature is derived as:  $CWSI=(T_c-T_{cl})/(T_{cu}-T_{cl})$ , where  $T_c$ ,  $T_{cl}$ , and  $T_{cu}$  are the canopy temperature, lower limiting canopy temperature, and upper limiting canopy temperature, respectively. The lower limiting canopy temperature can be reached when the crop transpires without water shortage. On the other hand, the upper limiting canopy temperature can be reached when plant transpiration is zero. O'Toole et al.²⁴) conducted a comprehensive comparison of 8 different measurement methods for assessing the plant water status and concluded that *CWSI* based on the determination of the canopy temperature was the best technique, stating that it was a significant advancement in assessing the water status of crop or natural plant communities. Two types of *CWSI* based on canopy temperature have been proposed to estimate the  $T_{cl}$ , an empirical approach reported by Idso⁹) and Idso et al.^{10,11}) and a theoretical approach reported by Jackson et al.^{15,16}). In the empirical method (Idso's *CWSI*), *CWSI* is estimated by determining "non-water-stressed baselines" for crops. In addition, estimation of  $T_{cu}$  is necessary. However, the non-water-stressed baselines change not only with the crop variety but also with the seasons¹⁶). Furthermore, the estimation of the upper limit of temperature is somewhat ambiguous. The third criticism has been that Idso's *CWSI* does not account for radiation and wind speed. In the theoretical method (Jackson's *CWSI*), *CWSI* is estimated based on the net radiation and an aerodynamic resistance factor, in addition to the temperature and vapor pressure terms required by the empirical method. Since these variables are site-specific, it is difficult to collect representative meteorological data for field practice in a small and heterogeneous crop area. Requirement of large uniform fields and local meteorological data is the main problem facing the application of Jackson's *CWSI*. Although Jackson's approach shows how the upper and lower limits can be evaluated, the complexity of the method precludes thorough field tests. Thus, there has been a long search for theoretically sound and simple procedures that would enable to overcome the shortcomings of the above methods.

The objectives of the current studies are: 1) to develop a method to assess  $T$  using temperatures and a few meteorological parameters without the requirement of crop correction factors, empirical coefficients, or canopy and aerodynamic resistances, 2) to verify the estimation accuracy of the proposed method by comparison with actual  $T$  obtained by a weighing lysimeter, and 3) to apply the developed theory to the

estimation of *CWSI* under both field and greenhouse conditions.

[NEXT](#)

[TOP](#)

[Contents](#)

## References

- 1) Ben-Asher, J. et al. (1989): Computational approach to assess actual transpiration from aerodynamic and canopy resistance. *Agron. J.*, 81, 776-782.
- 2) Ben-Asher, J., Phene, C. J. & Kinarti, A. (1992): Canopy temperature to assess daily evapotranspiration and management of high frequency drip irrigation systems. *Agric. Water Manage.*, 22, 379-390.
- 3) Gardner, B. R. et al. (1981): Relationships between crop temperature, grain yield, evapotranspiration and phenological development in two hybrids of moisture stressed sorghum. *Irrig. Sci.*, 2, 213-224.
- 4) Hatfield, J. L. (1983): Evapotranspiration obtained from remote sensing methods. *Adv. Irrig.*, 2, 395-416.
- 5) Hatfield, J. L. (1985): Wheat canopy resistance determined by energy balance techniques. *Agron. J.*, 77, 279-283.
- 6) Hatfield, J. L., Perrier, A. & Jackson, R. D. (1983): Estimation of evapotranspiration at one time-of-day using remotely sensed surface temperatures. *Agric. Water Manage.*, 7, 341-350.
- 7) Hatfield, J. L., Reginato, R. J. & Idso, S. B. (1984): Evaluation of canopy temperature-evapotranspiration models over various surfaces. *Agric. Meteorol.*, 32, 41-53.
- 8) Heilman, J. L. et al. (1976): Thermal scanner measurement of canopy temperatures to estimate evapotranspiration. *Remote Sens. Environ.*, 5, 137-145.
- 9) Idso, S. B. (1982): Non-water stressed baselines; a key to measuring and interpreting plant water stress. *Agric. Meteorol.*, 27, 59-70.
- 10) Idso, S. B. & Clawson, K. L. (1986): Foliage temperature; effects of environmental factors with implications for plant water stress assessment and the CO₂/climate connection. *Water Resour. Res.*, 22, 1702-1716.
- 11) Idso, S. B. et al. (1981): Normalizing the stress-degree-day parameter for environmental variability. *Agric. Meteorol.*, 24, 45-55.
- 12) Idso, S. B., Reginato, R. J. & Jackson, R. D. (1977): An equation for potential evaporation from soil, water and crop surfaces adaptable to use by remote sensing. *Geophys. Res. Lett.*, 4, 187-188.
- 13) Jackson, R. D. (1982): Canopy temperature and crop water stress. *Advances in irrigation*. Vol. 1. Academic Press, New York, 43-85.
- 14) Jackson, R. D. et al. (1983): Estimation of daily evapotranspiration from one time-of-day measurements. *Agric. Water Manage.* 7, 351-362.
- 15) Jackson, R. D. et al. (1981): Canopy temperature as a crop water stress indicator. *Water Resour. Res.*, 17, 1133-1138.
- 16) Jackson, R. D., Kustas, W. P. & Choudhury, B. J. (1988): A reexamination of the crop water stress index. *Irrig. Sci.*, 9, 309-317.
- 17) Jackson, R. D., Reginato, R. J. & Idso, S. B. (1977): Wheat canopy temperature; a practical tool for evaluating water requirements. *Water Resour. Res.*, 13, 651-656.
- 18) Miller, E. C. & Saunders, A. R. (1923): Some observations on the temperature of the leaves of crop plants. *J. Agric. Res.*, 26, 15.
- 19) Mitchell, A. R. & Hanks, R. J. (1985): Predicting evapotranspiration from canopy temperature. *In Advances in evapotranspiration*. National conference of ASAE in Chicago, ST. Joseph, MI, 114-121.

- 20) Monteith, J. L. (1965): Evaporation and environment. *Symp. Soc. Exp. Biol.*, 19, 205-234.
- 21) Monteith, J. L. (1981): Evaporation and surface temperature. *Quart. J. R. Met. Soc.*, 107, 1-27.
- 22) Monteith, J. L. & Unsworth, M. H. (1990): Principles of environmental physics (2nd ed.). Edward Arnold Press, London, 1-291.
- 23) O'Toole, J. C. & Real, J. G. (1986): Estimation of aerodynamic and crop resistances from canopy temperature. *Agron. J.*, 78, 305-310
- 24) O'Toole, J. C. et al. (1984): Comparison of some crop water stress measurement methods. *Crop Sci.*, 24, 1121-1128.
- 25) Qiu, G. Y. (1996): A new method for estimation of evapotranspiration. Doctoral dissertation, the Unite Graduate School of Agriculture Science, Tottori Univ., Jpn., 1-97.
- 26) Qiu, G. Y., Momii, K. & Yano, T. (1996a): Estimation of plant transpiration by imitation leaf temperature. I. Theoretical consideration and field verification. *Trans. JSIDRE*, 64, 401-410.
- 27) Qiu, G. Y., Yano T. & Momii, K. (1996b): Estimation of plant transpiration by imitation leaf temperature. II. Application of imitation leaf temperature for detection of crop water stress. *Trans. JSIDRE*, 64, 767-773.
- 28) Qiu, G. Y., Yano, T. & Momii, K. (1998): An improved methodology to measure evaporation from bare soil based on comparison of surface temperature with a dry soil. *J. Hydrol.*, 210, 93-105.
- 29) Stanghellini, C. & Lorenzi, F. D. (1994): A comparison of soil and canopy temperature-based methods for the early detection of water stress in a simulated patch of pastured. *Irrig. Sci.*, 14, 141-146.
- 30) Stone, L. R. & Horton, M. L. (1974): Estimating evapotranspiration using canopy temperatures; Field evaluation. *Agron. J.*, 66, 540-545.
- 31) Tanner, C. B. & Fuchs, M. (1968): Evaporation from unsaturated surface; a generalized combination method. *J. Geophys. Res.*, 73, 1299-1304.
- 32) Wallace, R. H. & Clum, H. H. (1938): Leaf temperatures. *Am. J. Bot.*, 25, 83-97.

## Theoretical development

Assuming that there is an imitation leaf canopy in the plant canopy with a relatively small volume, the temperature, humidity, wind speed, and other environmental parameters of the plant canopy are not significantly modified by the imitation leaf canopy. In other words, the imitation leaf canopy is one part of the plant canopy. It is assumed that temperatures of plant canopy and imitation leaf canopy are represented by temperatures of sunlit leaves and imitation leaves, respectively. Hereafter, we refer to the imitation leaf canopy as the imitation leaf and the temperature of the imitation leaf canopy as imitation leaf temperature. It is assumed that the radiation absorptive and albedo properties of these imitation leaves are similar to those of plant leaves. Transpiration does not occur from imitation leaves and the latent heat flux is zero.

The energy balance of the canopy is represented by the equation²²:

$$R = G + H + LE \dots\dots\dots(1)$$

where  $R_n$  is the net radiation of the canopy,  $G$  the heat flux to soil,  $H$  the sensible heat flux from canopy to air, and  $LE$  the latent heat flux to air. All the units are expressed in  $W m^{-2}$ . Since these variables can be positive or negative, depending on their direction, positive direction for  $R_n$  is toward the soil surface and positive directions for  $G$ ,  $H$ , and  $LE$  are away from the soil surface.

It should be emphasized that we only focus on the energy balance of the canopy by using Eq. (1). The exposed soil portion of the partially covered canopy is separated by using canopy coverage. In the canopy-covered area, the incident radiation is intercepted by the canopy so that the partitioning of energy on the soil surface is relatively negligible²⁰. Thus evaporation from the canopy-shadowed soil is generally low and  $LE$  is often expressed as canopy transpiration ( $T$ ).

In Eq. (1), the net radiation can be measured or estimated from solar radiation and temperature. Generally  $G$  is negligible for the canopy on a daily basis^{1,22}. Jackson¹³ expressed  $H$  by the following equation:

$$H = \frac{\dot{A}C_p (T_c - T_a)}{r_a} \dots\dots\dots(2)$$

where  $PC_p$  is the volumetric heat capacity ( $J m^{-3} K^{-1}$ ),  $T_c$  the canopy temperature (K),  $T_a$  the air temperature (K), and  $r_a$  the aerodynamic resistance ( $s m^{-1}$ ).

Since the imitation leaf is in the same canopy, the same value of  $r_a$  can be used for the imitation leaf^{25,26,28}. By assuming that the air temperature at reference height is the same everywhere and  $r_a$  of the canopy is approximately equal to the  $r_a$  of the imitation leaf,  $r_a$  can be expressed by the following equation:

$$r_a = \frac{\dot{A}C_p (T_p - T_a)}{R_{np}} \dots\dots\dots(3)$$

where  $T_p$  is the temperature of the imitation leaf surface (K) and  $R_{np}$  the net radiation of the imitation leaf ( $W m^{-2}$ ).

Combining Eq. (3) with Eqs. (1) and (2), an equation to estimate transpiration from plant canopy can be derived:

$$LE = \frac{R_n - R_{np}}{T_p - T_a} \frac{T_c - T_a}{\gamma + 3} \quad \text{.....(4)}$$

On the basis of the above data, the plant transpiration can be estimated by Eq. (4). The necessary input parameters of Eq. (4) are the temperature ( $T_c$ ,  $T_a$ , and  $T_p$ ) and net radiation ( $R_n$  and  $R_{np}$ ).

From the coupling of the energy balance equation to the transfer equations for both sensible and latent heat, assuming that the heat fluxes in soil are negligible, and defining  $\gamma$  as the slope of the saturated vapor pressure-temperature relation ( $(e_c^* - e_a^*) / (T_c - T_a)$ ), an expression for the temperature difference between the canopy and air can be derived [15,29](#):

$$T_c - T_a = \frac{r_a R_n \gamma^3 (1 + (r_c / r_a))}{\gamma + 3} \frac{e_a^* - e_a}{\gamma + 3} \quad \text{..... (5)}$$

where  $r_c$  is the crop canopy resistance ( $\text{s m}^{-1}$ ),  $e_c^*$  the saturated vapor pressure (mbar) at  $T_c$ ,  $e_a^*$  the saturated air vapor pressure (mbar) at  $T_a$ ,  $e_a$  the vapor pressure of air (mbar), and  $\gamma = 0.66 \text{ mbar } ^\circ\text{C}^{-1}$  the psychrometric constant.

Eq. (5) relates the difference between the canopy and air temperature to the vapor pressure deficit of air ( $e_a^* - e_a$ ), the net radiation, and the aerodynamic and crop resistances. Based on Eqs. (3) and (5), *CWSI* related to the canopy temperature will be analyzed.

The temperature of the imitation leaf  $T_p$  could be considered to be equivalent to the upper limiting canopy temperature  $T_{cu}$ . Therefore, the *CWSI* obtained by our approach can be expressed by the equation:

$$CWSI = \frac{T_c - T_{cl}}{T_p - T_{cl}} \quad \text{.....(6)}$$

The lower limiting canopy temperature ( $T_{cl}$ ), determined by setting  $r_c = r_{cp}$  in Eq. (5) and substituting Eq. (3) into Eq. (5) is:

$$T_{cl} = \frac{R_n (T_p - T_a)}{R_{np}} \frac{e_c^* - e_a}{\gamma + 3} \quad \text{.....(7)}$$

$$\gamma = \frac{r_{cp} R_{np}}{\gamma + 3} \frac{e_c^* - e_a}{T_p - T_a} \quad \text{.....(8)}$$

where  $r_{cp}$  is the canopy resistance without water shortage ( $\text{s m}^{-1}$ ). The value of  $r_{cp}$  is likely to vary with the crops and crop varieties.

#### Theoretical development

On the basis of the above data, it is concluded that by introducing the imitation leaf temperature, *CWSI* defined by Eq. (6) can be determined from temperatures (canopy, imitation leaf, and air), net radiation, and the vapor pressure. The aerodynamic resistance is eliminated and accordingly the complexity of application is significantly reduced.

[NEXT](#)

[TOP](#)

# Verification experiments

## 1) Experiment in a sandy field with sorghum crop

A 1 ha flat field with coarse grain sand (95.8% of sand in the 0.25-2.00 mm range) at the Arid Land Research Center, Tottori University (Tottori, Japan) was used in this study, where a weighing lysimeter had been installed. Sorghum (*Sorghum bicolor* (L) Moench.) crop was grown in the field. A sprinkler irrigation system was employed to irrigate the crop in the sandy soil field. Plant densities, both around and inside the lysimeter, were about 8 plants m⁻². Measurements were performed from June 20 to August 31, 1994. In this experiment, the imitation leaves were made from green paper by selecting a paper which had nearly the same color as the plant leaf and cutting the paper into the shape of a plant leaf. Then the green paper leaf was inserted in the upper part of the sorghum canopy to avoid shade from the canopy (Fig. 1). Actual evapotranspiration was measured by using a weighing lysimeter. Soil evaporation was measured daily with the microlysimeters. The plant leaf area was measured with a leaf area meter (AAC-400, Hayashi Electric Co., Ltd.) weekly throughout the experimental period to estimate plant coverage and calculate the leaf area index (LAI). Temperatures of the imitation leaf and canopy (sunlit leaf) were measured with Cu-Co thermocouples. Stomatal resistance was measured with LI-1600 Steady State Porometer (Li-Cor. Inc.). Solar radiation and air vapor pressure were obtained from the meteorological station of the Arid Land Research Center, Tottori University. The experimental procedures were also described in detail by Qiu et al. [26,27](#).



Fig.1. Imitation leaf used sorghum experiment

## 2) Experiments in a greenhouse with melon crop

This experiment was conducted from April to July, 1998 in a glasshouse at the National Research Institute of Agricultural Engineering (Tsukuba, Japan). The dimensions of the glasshouse were 60.4 m in length, 14.4 m in width, and 3.9 m in height (ridge). The orientation of the ridge line was South/North. Soil consisted of loam (2.60-2.65 g cm⁻³ specific gravity, 0.7-0.8 g cm⁻³ dry bulk density, and 70% porosity) and the soil surface was covered by a plastic film to prevent evaporation. Melon crop (*Cucumis melo* L.) was used in this experiment in rows 1.5 m apart and the distance between individual plants was 0.8 m. Water was supplied by the drip irrigation method under the film. Two irrigation treatments were arranged. One area was fully irrigated (area A, volumetric water content varied in the range of 0.3-0.4



$\text{m}^3\text{m}^{-3}$ ). Another area was not fully irrigated (area B, volumetric water content varied in the range of 0.2-0.3  $\text{m}^3\text{m}^{-3}$ ). Radiation, air humidity, and temperatures of the imitation leaf and air were measured by the same method as in the field experiment. Sunlit leaf temperature of melon was measured using an infrared thermometer (THI-500, Tasco Co., Ltd.). Soil water was measured using a TDR soil moisture measurement system (Campbell Scientific Inc.).

[NEXT](#)

[TOP](#)

## Results and discussion

### 1) Transpiration

**Fig. 2** depicts the daily variations of net radiation and temperatures of greenhouse melon. The canopy temperature and net radiation in Fig. 2 are the average values of area A and area B. During sunshine time, the  $R_n$  value was higher than that of  $R_{np}$ . The maximum value of  $R_n$  was close to  $550 \text{ W m}^{-2}$  and the maximum value of  $R_{np}$  was close to  $400 \text{ W m}^{-2}$ . The difference between the values could be as large as  $150 \text{ W m}^{-2}$  (Fig. 2a). Fig. 2b shows the diurnal changes in the measured  $T_p$ ,  $T_c$ , and  $T_a$ . The variation of temperature was affected by the radiation and other weather conditions. The maximum and minimum values of radiation and temperature appeared at the same time. Besides these common characteristics,  $T_p$ ,  $T_c$ , and  $T_a$  also displayed specific features.  $T_p$  was always higher than  $T_c$  and  $T_a$  during the daytime. The temperature difference between  $T_p$  and  $T_c$  could be as large as  $20^\circ\text{C}$  in the daytime. During the night, the values of  $T_p$  and  $T_c$  were identical. All the data of the other days over the experimental period showed similar results. Since the soil surface was not fully covered by the melon canopy, solar radiation could be directly absorbed by soil. Moreover, the plastic film used as a cover prevented evaporation from soil and the soil surface temperature could be as high as  $50^\circ\text{C}$ . Therefore, the absorbed solar energy directly affected the air temperature through sensible heat transfer and  $T_a$  was higher than  $T_c$ . However, as reported by other researchers,  $T_c$  could sometimes be higher or lower than the  $T_a$  under field conditions^{13,26,27}. These distribution features of the 3 temperatures enabled to detect crop transpiration and water stress.

In this study, by using the imitation leaves made from green paper, satisfactory results were obtained. However, if the paper were to be wetted due to rainfall or irrigation, the results may be affected. Therefore, further studies should be carried out to select different materials to replace the green paper.

**Fig. 3** shows the distribution of melon canopy temperatures in 2 different irrigation areas. During the experimental period, the soil water content varied in the ranges of  $0.3\text{-}0.4 \text{ m}^3\text{m}^{-3}$  in area A and  $0.2\text{-}0.3 \text{ m}^3\text{m}^{-3}$  in area B. Though daytime average canopy temperatures in both areas varied in the ranges of  $17\text{-}33^\circ\text{C}$ , in area A, since the soil water content was higher, the canopy temperature was consistently lower than in area B. The temperature difference between the 2 areas was usually less than  $1^\circ\text{C}$ . However, maximum difference could be as much as  $1^\circ\text{C}$ . These results suggest that the canopy temperature is a good indicator of the soil water status.

**Fig. 4** shows the daily transpiration of sorghum under field conditions. Daily estimated transpiration ( $T$ ) was obtained by  $ET-E$ , where  $ET$  was the evapotranspiration measured with the weighing lysimeter and  $E$  the soil evaporation measured with the microlysimeters. The calculated daily  $T$  was obtained from Eq. (4). Fig. 4 shows that calculated  $T$  agreed well with the estimated  $T$ . The maximum difference between calculated and estimated transpiration was less than  $1 \text{ mm day}^{-1}$ . The transpiration differences on most of the days were within  $0.5 \text{ mm day}^{-1}$ . The regression analysis showed that the estimated  $T$  was closely correlated with the calculated  $T$ . The regression coefficient was  $r^2=0.88$ . Crop transpiration can thus be accurately calculated by the proposed method.

**Fig. 5** shows a comparison of calculated  $T$  under different irrigation treatments of melon under greenhouse conditions. During the experimental period, calculated  $T$  in both irrigation areas varied with the changes of the weather conditions. On clear days, the  $T$  value could be as high as  $5\text{-}6 \text{ mm day}^{-1}$ ,

while on cloudy days the  $T$  value could be as low as 1-2 mm day⁻¹. However,  $T$  in area A was consistently higher than in area B, the difference being as large as 1 mm day⁻¹. Cumulative  $T$  was near 75 mm in area A and 65 mm in area B.

On the basis of the above data, it can be concluded that the proposed method gives a reasonable estimation of crop transpiration under field and greenhouse conditions.

## 2) Crop water stress

### (1) Upper limiting canopy temperature

In Jackson's method, upper limiting canopy temperature ( $T_{cu}$ ) is expressed by the equation:

$$T_{cu} = \frac{r_a R_n}{A C_p} + T_a \dots \dots \dots (9)$$

In the proposed method,  $T_{cu}$  is equal to  $T_p$ . [Fig. 6](#) shows that the measured  $T_p$  agreed with  $T_{cu}$  calculated by Eq. (9). Due to the assumption that the canopy resistance was infinite,  $T_{cu}$  was slightly larger than  $T_p$  in the high temperature ranges. The regression coefficient between  $T_p$  and  $T_{cu}$  was  $r^2=0.997$ .

### (2) Comparison with Jackson's CWSI

In addition to  $T_c$  and  $T_p$  (or  $T_{cu}$ ),  $T_{cl}$  is also required to evaluate CWSI by the proposed method and Jackson's method. As shown in Eq. (8), the canopy resistance without water shortage  $r_{cp}$  is required to estimate  $T_{cl}$ . Values of  $r_{cp}$  can be estimated by the following empirical equation^{1,27}:

$$r_{cp} = \frac{r_{sp}}{LAI} \dots \dots \dots (10)$$

where  $r_{sp}$  (s m⁻¹) is the stomatal resistance without water shortage and LAI is the leaf area index. During the early period of the field experiment, sorghum was well irrigated. From 520 measured values of stomatal resistance, 10 minimum values were selected to represent  $r_{sp}$ . The average value of these 10 data was 41.6 s m⁻¹. Therefore, the equation  $r_{cp}=r_{sp}/LAI=41.6/LAI$  was used to estimate CWSI in this study. [Fig. 7](#) shows that the CWSI determined by the proposed and Jackson's methods agreed well, with a regression coefficient  $r^2=0.997$ . Since Jackson's method is sound in theory, the agreement of the 2 methods indicates that CWSI by the proposed method is suitable for detecting crop water stress.

### (3) Relations with soil water status

[Fig. 8](#) shows a comparison of CWSI in the 2 different irrigation areas of greenhouse melon. During the experimental period, the soil water content in area A varied in the ranges of 0.3-0.4 m³m⁻³, values about 0.1 m³m⁻³ higher than the values in area B. Meanwhile, CWSI in area A was consistently lower than the CWSI in area B, with a difference as large as 0.1. Compared with the soil water content, fluctuations of the CWSI curves were larger than the fluctuations of the soil water content curves. This phenomenon revealed not only that CWSI was mainly affected by the weather conditions at a relatively high water content but also that the use of temperature-related CWSI enables to predict plant water stress earlier than the soil water-based method. Our results agreed with those of Qiu et al.²⁷ and Stanghellini and

Lorenzi²⁹⁾ who showed that canopy temperature-based crop water stress index methods are more likely to be suitable for early detection of water shortage than soil water-based methods.

## Summary

A new method for estimating crop transpiration and *CWSI* by using a temperature-related approach was developed and verified in this study. In the proposed method, 3 temperatures (sunlit leaf temperature, imitation leaf temperature, and air temperature) and a few meteorological variables (net radiation and humidity) were required. The imitation leaf referred to an artificial leaf without transpiration. The major advantage of the proposed method is that plant correction factors, empirical coefficients, and canopy and aerodynamic resistances are not required for calculating the plant transpiration and *CWSI*.

Experiments in a sandy field with sorghum crop (*Sorghum bicolor* (L) Moench.) and in a greenhouse with muskmelon crop (*Cucumis melo* L.) were conducted to verify the proposed method. Results were compared with the amount of transpiration determined by using a weighing lysimeter and microlysimeters, soil water status determined by TDR, and *CWSI* estimated by Jackson's method. The calculated transpiration by the proposed method was consistent with the results obtained by using a weighing lysimeter and microlysimeters, with a regression coefficient  $r^2=0.88$ . Values of *CWSI* calculated by the proposed method were in agreement with the Jackson's *CWSI*, with a regression coefficient  $r^2=0.997$ . These results indicate that the proposed method can be applied to estimate crop transpiration and water stress index under both field and greenhouse conditions.

[NEXT](#)[: Earthquake Damage to Fill Dams in Japan](#)[TOP](#)[:Contents](#)[HOME](#)[:JIRCAS Home Page](#)

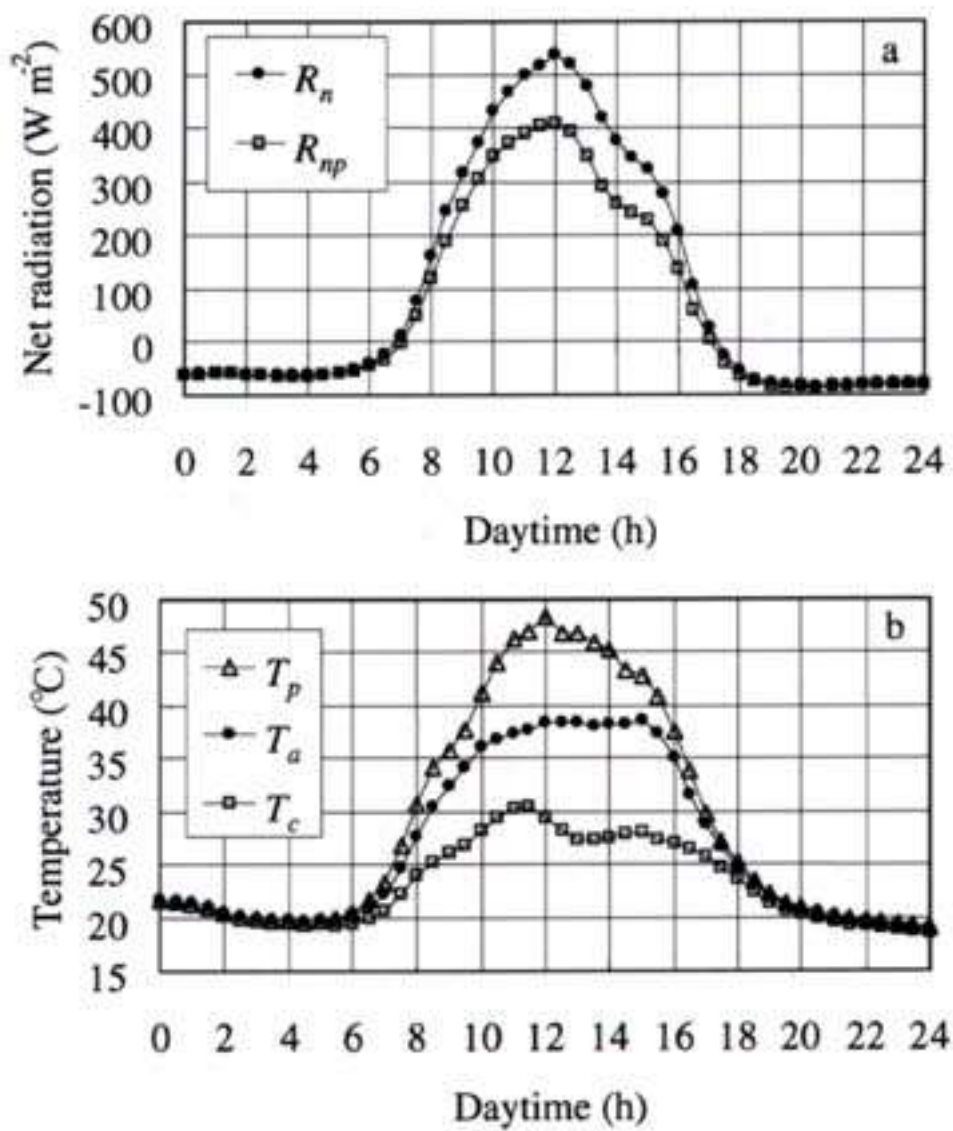


Fig.2. Daily variations of net radiation and temperatures of greenhouse melon

a: Net radiation. b: Temperature.

**BACK**

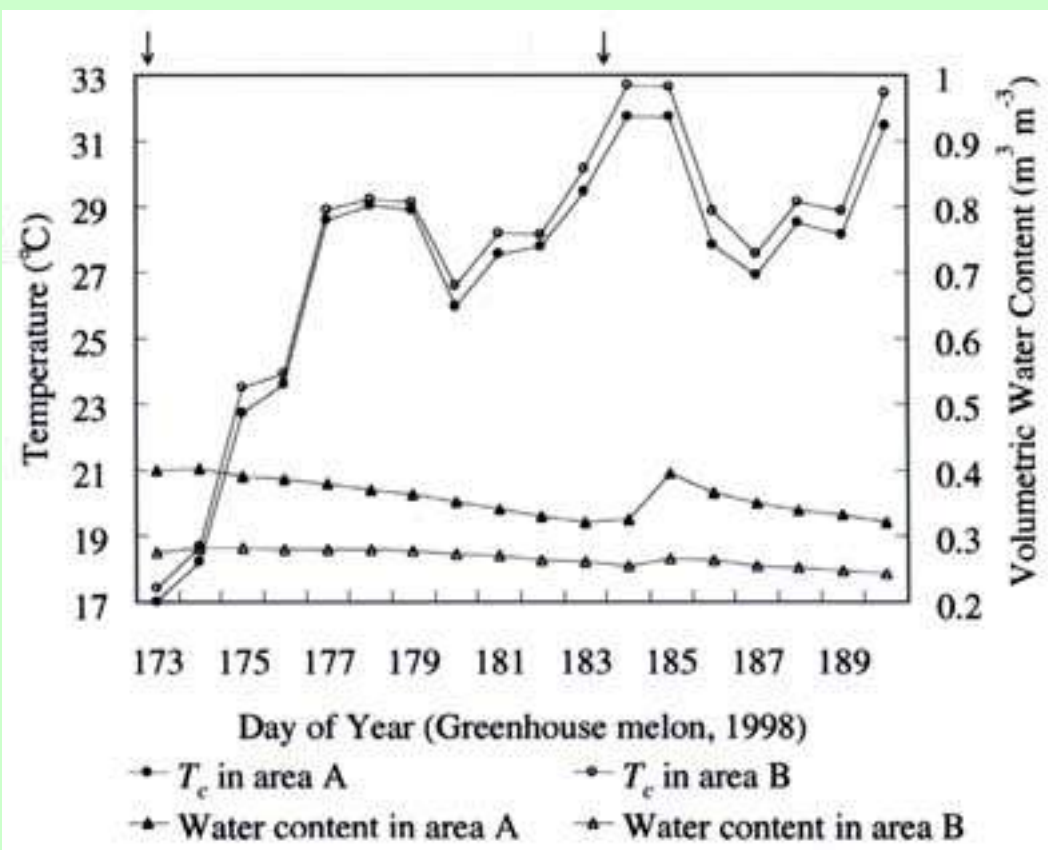


Fig.3. Distribution of greenhouse melon canopy temperatures in 2 different irrigation areas  
Arrows indicate the irrigation time.

BACK

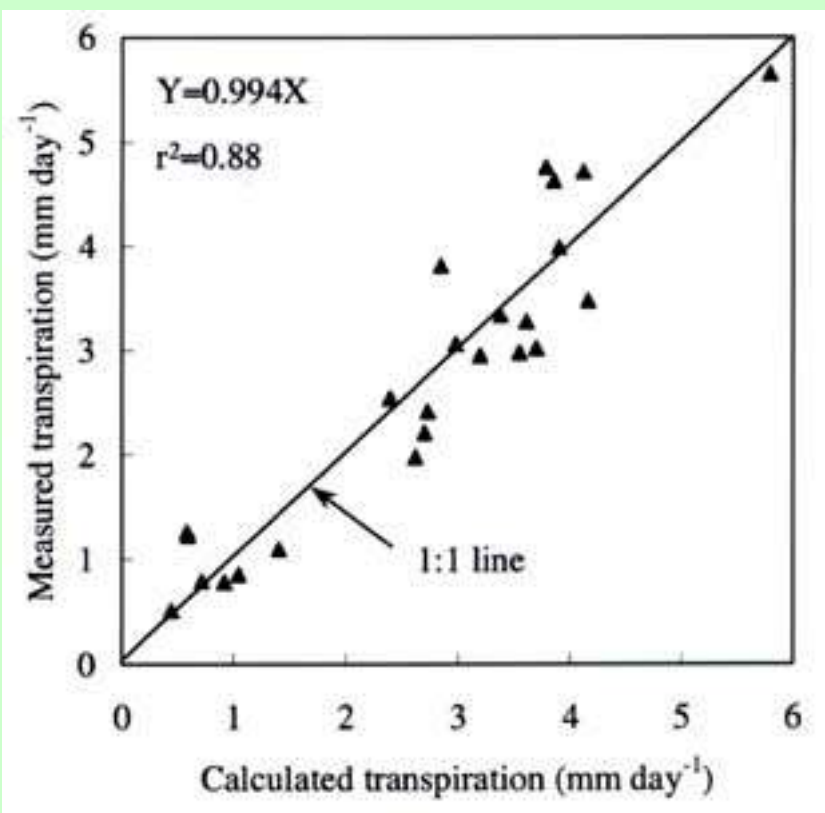


Fig.4. Relation between calculated and lysimeter-measured transpiration of field sorghum

**BACK**

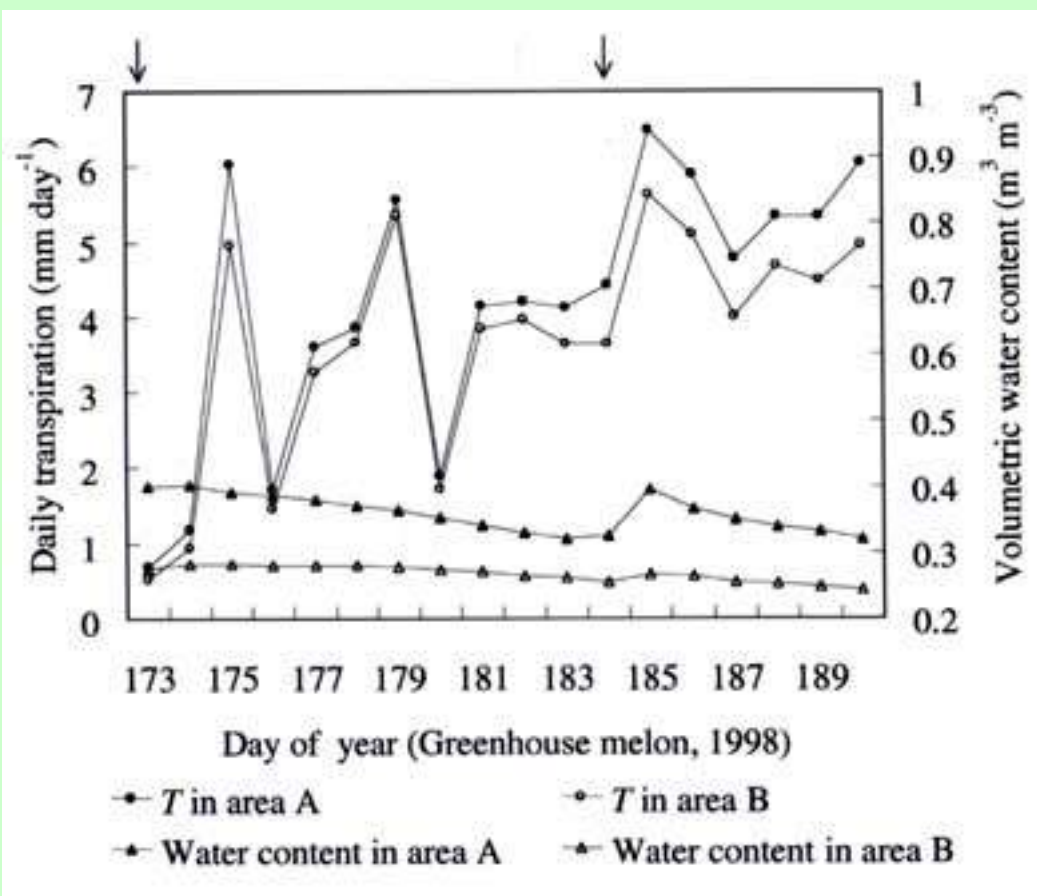


Fig.5. Calculated daily transpiration of greenhouse melon in 2 different irrigation areas

Arrows indicate the irrigation time.

BACK



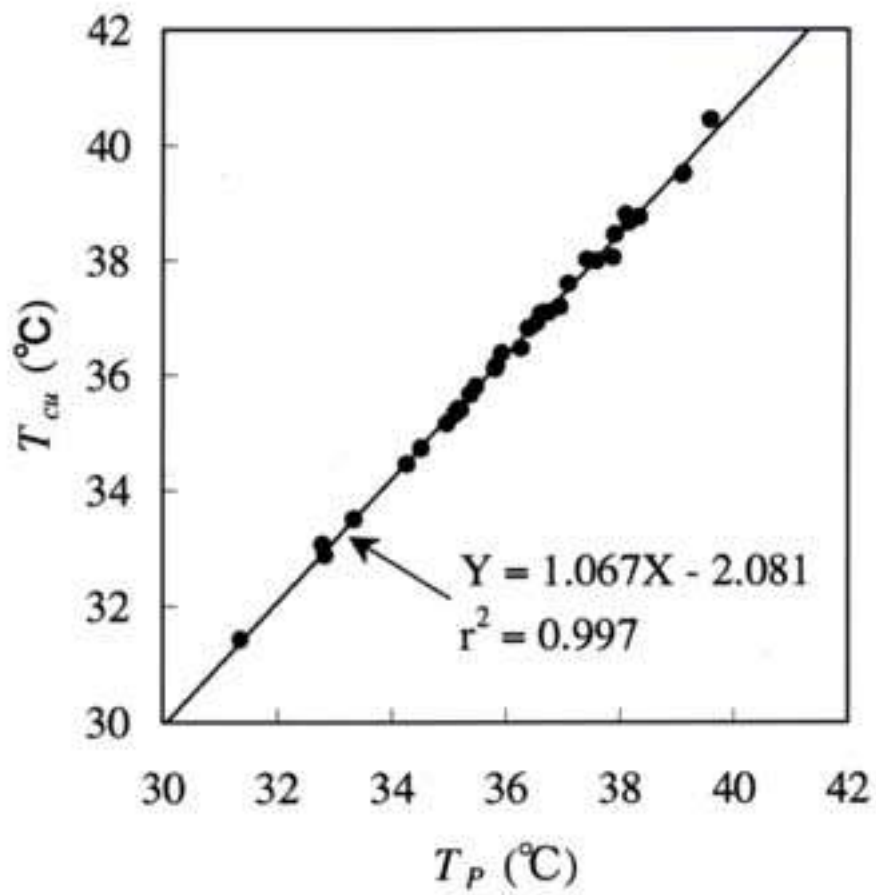


Fig.6. Comparison of the measured  $T_p$  and the calculated  $T_{cu}$  of field sorghum

BACK

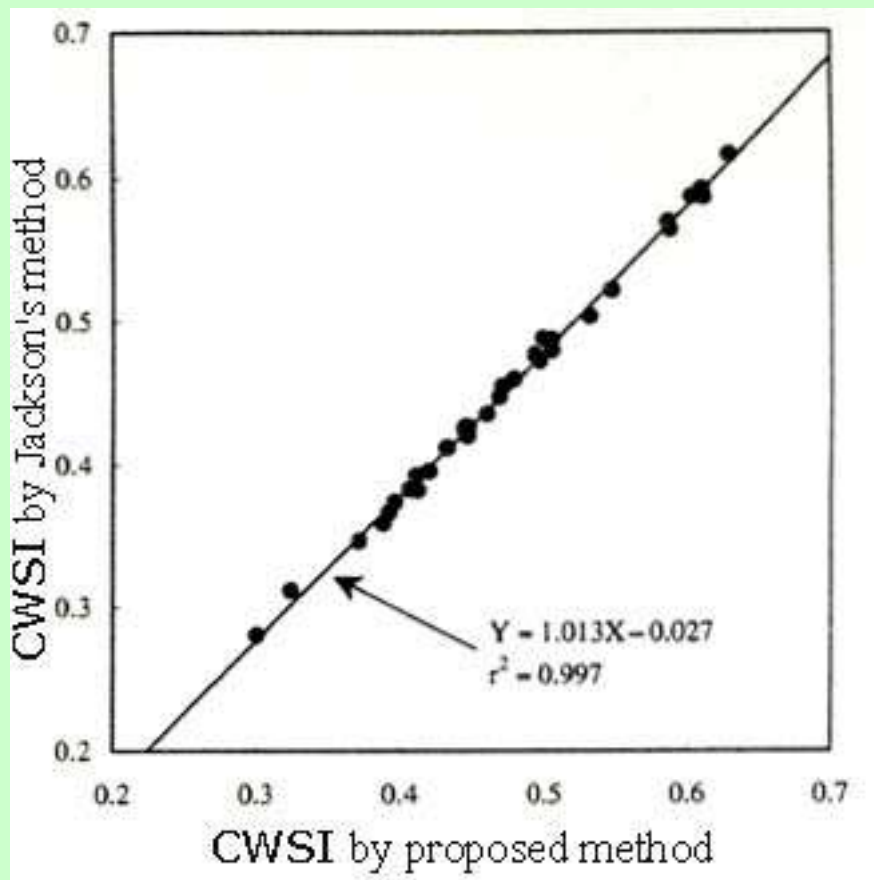


Fig.7. Comparison of *CWSI* estimated by the proposed method and *CWSI* by Jackson's method for field sorghum

BACK

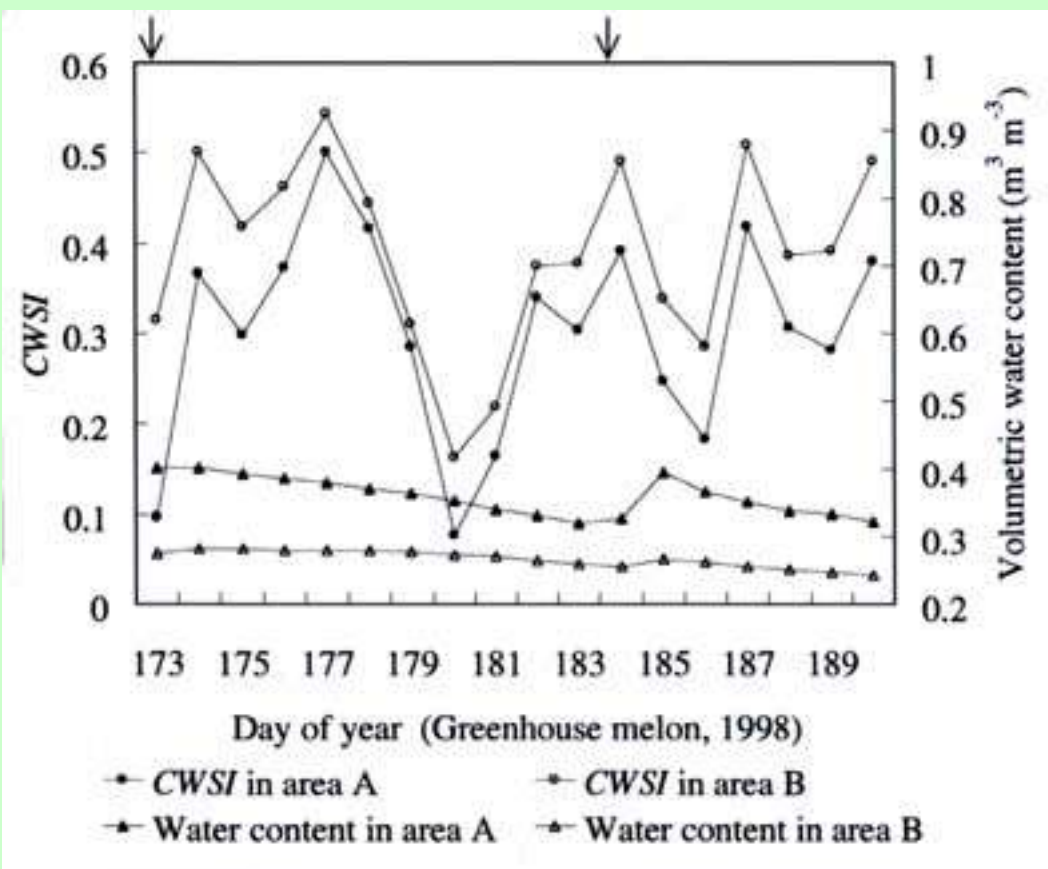


Fig.8. Distribution of the calculated *CWSI* of greenhouse melon in 2 different irrigation areas

Arrows indicate the irrigation time.

BACK

# Earthquake Damage to Fill Dams in Japan

**Shigeru TANI**

Department of Structural Engineering, National Research Institute of Agricultural Engineering  
(Tsukuba, Ibaraki, 305-8609, Japan)

Corresponding author: S. Tani (stani@nkk.affrc.go.jp, fax +81-298-38-7681)

## Abstract

Earthquakes have caused considerable damage to fill-type dams. Research into earthquake damage has contributed to the study of earthquake resistance of dams. However damage to fill dams occurred almost only in the case of small-scale earth dams, especially in the few cases of serious damage. This report describes the damage and performance of earth dams and fill dams more than 15 m high during earthquakes, based on literature data as well as field surveys. The results indicated that even stronger earthquakes than the designed earthquake intensity did not cause heavy damage to large well-constructed modern dams. The above analysis of the performance of fill dams during earthquakes shows that large-scale dams are earthquake-proof.

Discipline: Agricultural engineering

Additional key words: earth dam

1...7): [References](#)

(Received for publication, April 20, 1999)

## Introduction

A survey conducted in 1978 showed that there are more than 250,000 fill dams in Japan, 75% of the dams are more than 100 years old and generally small, and 80% are less than 10 m high. [Fig. 1](#) shows the distribution of earth dams and fill dams. Like other soil structures, fill dams have experienced damage in past earthquakes. Analytical geotechnical/soil-engineering surveys of earthquake damage to fill dams have provided useful information for implementing measures against earthquake damage. The surveys revealed that the majority of the fill dams which experienced earthquake damage were small-scale earth dams, while no large-scale fill dams higher than 15 m, except for the "Manno-ike" dam (which was damaged in the 1854 "Ansei Nankai" earthquake), experienced serious damage²). This report summarizes the behavior of fill-type dams higher than 15 m during earthquakes, including cases where fill dams were damaged.

## Earthquake damage to earth dams

Earthquake damage to fill dams in Japan has paralleled the history of fill dam construction. "Manno-ike" dam is the first reported case of earthquake damage to fill dams. The Manno-ike dam was damaged presumably due to the phenomenon referred to as "piping" that occurred one month after the Ansei Nankai earthquake (1854). The Nohbi earthquake (1891) damaged the "Iruka-ike" dam (Aichi Prefect.). The first post-earthquake survey was performed after the Kitatango earthquake (1927). [Table 1](#) reviews the earthquake damage to earth dams since 1927. The damage by Oga earthquake (1939) was surveyed by Akiba¹). The major conclusion was that earth dams with embankments of sandy soil experienced severe damage, suggesting that "liquefaction" could have been incriminated. Subsequently, detailed surveys of earth dam damage were conducted after the past several earthquakes^{5,6}).

Fig. 2 shows the relationship between the damage rate of earth dams and the average distance from the epicenter of the affected districts in the case of Hyogoken Nambu earthquake. The solid line in the Figure represents the maximum value for the relationship between the damage rate and distance from the epicenter. Although this relationship differs depending on the conditions of the ground and dam bodies, the line in the Figure represents the maximum values of the distance from the epicenter and the reservoir damage rate, which was attributable to the earthquake.

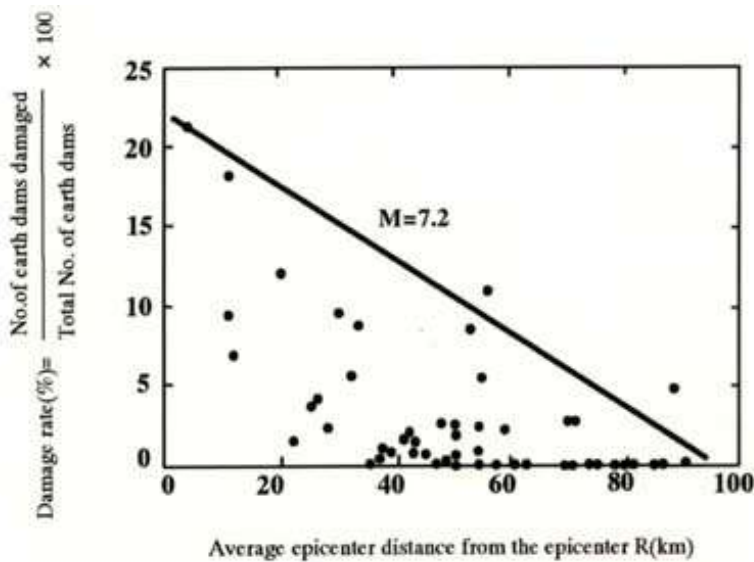


Fig.2. Average epicenter distance and damage rate of earth dams in the case of Hyogoken Nambu earthquake

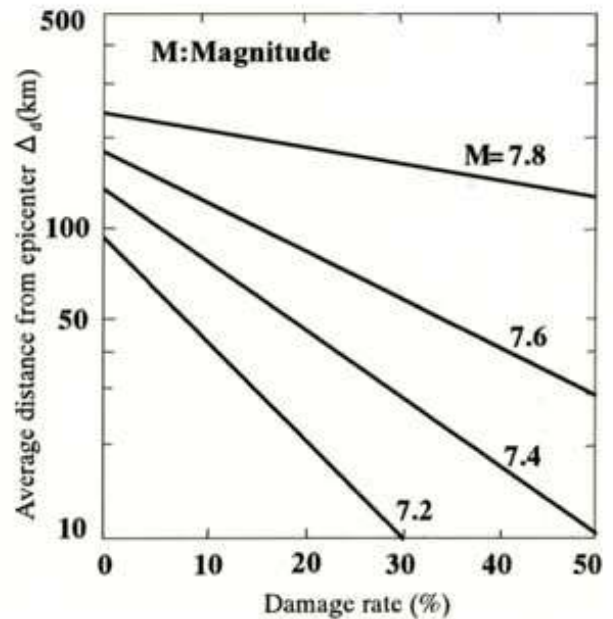


Fig.3. Relationship between average distance from epicenter and damage rate based on past earthquake data

Fig. 3 depicts the relationship between the average distance from the epicenter and estimated maximum damage rate as a function of the magnitude for the Tokachi-oki, Niigata, Nihonkai Chubu, and Hyogoken Nambu earthquakes shown in Table 1. Since the degree of damage and ground and dam conditions were not taken into account, the estimates are merely conservative.

Fig. 4 shows the relationship between the earthquake magnitude ( $M_j$ ) and the earth dam farthest from the epicenter, which was damaged by the earthquake (hereafter referred to as "critical distance from epicenter"). Using past data, the relationship between  $M_j$  and the critical distance from the epicenter can be expressed as:

$$\begin{aligned} R &= 11 && 5 M_j 6.1 \dots \dots (1) \\ \log R &= 0.846 M_j 4.14 && 6.1 f M_j 8 \dots \dots (2) \end{aligned}$$

where  $M_j$ : magnitude,  $R$ : critical distance from epicenter (km).

This relationship is indicated by the solid line in the Figure, which also delineates the boundary of the damaged area. The upper area did not sustain any damage and the lower area shows the zone where damage is likely to have occurred. Therefore, the damage rate increased in a downward direction in the Figure. It should be noted that the critical distance from the epicenter represents the distance from the epicenter shown in Fig. 4 at which the damage rate became zero. The value of Equation (1) depends on the properties of the earthquake, ground conditions, and earth dam conditions. However, the approximate distance from the epicenter at which damage starts to occur can be determined by calculating the distance from the epicenter and the magnitude.

Table 2 summarizes the outline of earth dam damage caused by 5 past earthquakes. The damage can be divided into the damage to the dam body and dam facilities (spillway, outlet works). In addition, the dam body damage can be classified into functional defects (crack, settlement, slip) and failure which prevents water storage. These damages may occur at the same time: e.g. settlement occurs along with slip, or settlement and crack may occur independently. Table 2 lists all the possible damages.

As for the cracks, most of them are longitudinal cracks parallel to the dam body axis. They are frequently generated on upper slopes and crests of dam, presumably due to the difference in stability between upper and lower slopes. Lateral cracks in the direction perpendicular to the dam axis can be associated with serious damage because water may leak from the dam bodies although such cracks occur only at a low rate. Most of the lateral cracks cross the dam body. In the Nihonkai Chubu earthquake, lateral cracks were generated on the border between the abutment and dam body, and near outlet works at a rate of about 50%. The same phenomenon was noted in the survey of Oga earthquake. This trend may be due to the difference in the behavior between the abutment and dam body, and between the dam body and outlet works.

## References

- 1) Akiba, M. & Senba, H. (1941): The Oga earthquake and its influence on earth dam. *J. Jpn. Soc. Agric. Eng.*, 13 (1), 31-59 [In Japanese].

- 2) Manno-ike irrigation association (1929): Construction history of Manno-ike dam [In Japanese].
- 3) Seed, H. B. (1979): Consideration in the earthquake resistant design of earth and rock-fill dams. *Geotechnique*, 29 (3), 215-263.
- 4) Sherard, J. R. et al. (1963): Earth and earth-rock dams. John Wiley and Sons, Inc., 156-170.
- 5) Takase, K. (1967): Statistic study of earth dam damage. Doctoral Dissertation [In Japanese].
- 6) Tani, S. & Hasegawa, T. (1988): Earthquake damage on earth dam by the 1983 Nihonkai Chubu earthquake. *J. Jpn. Soc. Agric. Eng.*, 55 (10), 17-25.
- 7) Tani, S. (1991): Consideration of earthquake damage to earth dam for irrigation in Japan. *In Int. Conf. Geotech. Earthquake Eng. Soil Dyn.*, 1137-1144

[NEXT](#)

[TOP](#)



**Table 1. Earth dam damage caused by several earthquakes**

No.	Name of earthquakes	Occurrence time	Magnitude (M _j )	Number of earth dams damaged
1	Kitatango	Mar. 7, 1927	7.5	90
2	Oga	May 1, 1939	7.0	74
3	Niigata	Jun. 16, 1964	7.5	146
4	Matsushiro	Aug. 1965~ Dec. 1970	Max. 5.4	57
5	Tokachi-oki	May 16, 1968	7.9	202
6	Miyagiken-oki	Jun. 12, 1978	7.4	83
7	Nihonkai Chubu	May 26, 1983	7.7	238
8	Chibaken Toho-oki	Dec. 17, 1987	6.7	9
9	Kushiro-oki	Jan. 15, 1993	7.8	1
10	Notohanto-oki	Feb. 7, 1993	6.6	21
11	Hokkaido Nansei-oki	July 12, 1993	7.8	18
12	Hokkaido Toho-oki	Oct. 4, 1994	8.1	0
13	Sanriku Haruka-oki	Dec. 28, 1994	7.5	7
14	Hyogoken Nambu	Jan. 17, 1995	7.2	1,362
16	Sorachichuo	Sep. 23, 1995	5.6	1
17	Miyagiken Hokubu	Sep. 11, 1996	5.9	5
18	Kagoshimaken Satsuma(1)	Mar. 16, 1997	6.3	1
19	Kagoshimaken Satsuma(2)	May 13, 1997	6.1	2
20	Yamaguchiken Hokubu	July 15, 1997	6.1	2

**BACK**



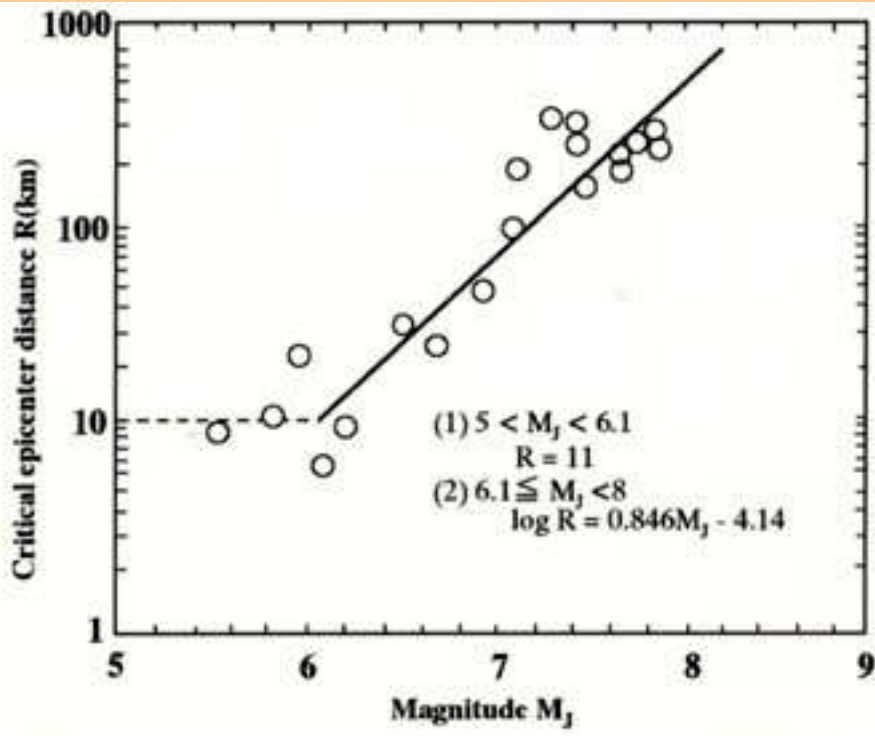


Fig.4. Relationship between magnitude  $M_j$  and critical distance from epicenter  $R$

BACK

**Table 2. Outline of earth dam damage**

Name of earthquakes	Number of surveyed earth dams	Damage of dam body									
		Damage of function of dam						Settle-ment	Failure	Outlet works	Spill-way
		Crack			Slip						
Lateral	Longi-tudinal	Both	Upper slope	Lower slope	Both						
Oga	58 (6)	43	0	5	17	6	6	42	12	9	6
Niigata	123(37)	87	3	8	34	16	1	30	7	38	7
Tokachi-oki	93 (8)		- 24 -		25	10	4	8	10		- 24 -
Miyagiken-oki	83 (5)		- 49 -			- 17 -		7	0		- 6 -
Nihonkai Chubu	218(15)	138	3	16	32	21	10	79	10	50	28

( ) : Number of earth dams with a height above 10 m.

**BACK**

## Type of earth dam damage

For grouping the type of damage in Nihonkai Chubu earthquake, a classification was carried out on the basis of the major causes of damage, according to the damage classification for river dikes and railway embankments. [Fig. 5](#) shows the classification of damage types. [Table 3](#) shows the types of damage. Types I and III accounted for 30% respectively, followed by Types II, IV and other types. Type V accounted for only 1.8%. In Type I (crack) the shape of the dam body was maintained with little settlement and cracks alone were generated. This type is characterized by the fact that many dam bodies are made of clay on good foundation ground. There were 3 examples of cracks generated along the line grouted in the past. In Type II (settlement) the shape of the dam body was maintained with accompanying cracks, and the major cause was attributed to the settlement of the foundation ground. Type III (failure of slope) and Type IV (slip) showed basically the same type of damage, but in Type III the damage was less severe than in Type IV. Most of the dam body remained sound and serious damage was not observed in Type III. A slip was recognized in Type IV, though this type accounted for only a few cases. Most part of the dam body experienced settlement by slip in Type IV, frequently causing large damage such as failure. In Type V, the dam body and the foundation ground were broken. Though the number of cases was very low, earth dam failure occurred in many cases like in Type III. The estimated causes included liquefaction of the dam body and foundation ground. In addition, outlet works, spillway, abutment break, and damage to only the covering block accounted for about 10% of the total.

[Table 4](#) shows the number of cases with damage and damage rate for each dam body soil obtained from a questionnaire for 218 damaged earth dams and 1,834 non-damaged earth dams in Nihonkai Chubu earthquake. The cases of damage in clay and gravelly clay soil accounted for 80% in comparison with sandy soil. On the other hand, the damage rate of sandy soil against all earth dams including non-damaged earth dams was as high as nearly 20%, which was nearly twice the rate of that in the case of clay and gravelly clay. This tendency was more obvious for the damage rate of earth dams with serious damage. Dam body soil was sampled in 39 areas of damaged earth dam and in 18 areas of non-damaged earth dam, and subjected to physical soil tests. As for the non-damaged earth dams, those located in a similar region, which showed similar geographic characteristics and height were selected as far as possible.

## Damage to fill dams more than 15 m high

[Table 5](#) shows the time of construction of fill dams for irrigation, with heights of more than 15 m prior to 1985. The total number of fill dams was 1,872, with 1,506 earth dams and 438 were very old, being constructed before the Meiji era (1868~1911). Most of these were brought into service during the Edo period (1603~1867). The following refers to the damage of fill dams with heights of 15-30 m in Japan. [Table 6](#) lists major earthquake damage to fill dams with heights of 15-30 m in Japan⁷⁾. This table shows that no large-scale fill dams with a height of 15-30 m had experienced serious earthquake damage, except for the Manno-ike dam. [Table 7](#) shows observations made during earthquakes in typical large fill dams with heights of more than 30 m in Japan. The table includes the Akita-Toho earthquake (1970) with  $M_J=6.5$  where the "Ainono Dam" was damaged. This dam was completed in 1961. It showed a uniform type and was 41 m high. This dam had a seismometer installed at the dam site. It was reported that the seismometer swung outside the scale, thus failing to register the earthquake intensity. An attempt to calculate the earthquake intensity, from an epicenter distance of 15 km, indicated that the maximum input acceleration of seismic waves transmitted to the bedrock was around 150 gal. The post-earthquake

survey report disclosed that major damage occurred on the crest of the dam in the form of several vertical cracks extending over 40 m, each 5 to 25 cm in width.

The Nihonkai Chubu earthquake was recorded at the Namioka dam, 146 km from the epicenter. The recorded data showed that the maximum input acceleration of seismic waves transmitted to the bedrock was 94 gal, with the embankment crest exhibiting a seismic response of 223 gal. The earthquake occurred when the dam was empty, and only slight damage occurred. The Naganoken Seibu earthquake (1984;  $M_J=6.9$ ) did not result in severe damage of the Makio dam close to the epicenter. This dam was completed in 1961 as a central core-type rock fill dam with a height of 105 m. The dam was equipped with strong-motion earthquake response seismometers, with a maximum scale limit of 300 gal, one on the top and another in the bedrock. It was suggested that the earthquake motion could have exceeded the scale, possibly reaching 500 to 600 gal. A post-earthquake investigation revealed that the downstream crest slipped along the slope over a width of 20-50 cm, and a height of 10-50 cm, without causing serious damage. The Makio dam design included protection against a horizontal seismic intensity of  $K_h = 0.15$ , and a minimum safety factor of 1.40. The Chibaken Toho-oki earthquake (1987;  $M_J=6.7$ ) damaged the Nagara dam. This dam was completed in 1985, and was an earth dam 52 m high, located at a distance of 29 km from the epicenter. The earthquake caused a maximum input seismic wave acceleration of 262 gal propagating in the bedrock in the upstream/downstream direction, and 365 gal recorded on the crest where only cracks occurred. The Hyogoken Nambu (Great Hanshin-Awaji) earthquake (1995;  $M_J=7.2$ ) damaged many soil structures but there was no serious damage affecting large fill dams. Taniyama Dam is located at a distance of about 7 km from the epicenter and as close as 3 km for the Nojima Fault.

These instances show that fill dams characterized by modern geotechnical/soil engineering designs are earthquake-proof and are not subject to heavy damage. Dams experienced only slight damage even with seismic intensities above that considered in the dam designs.

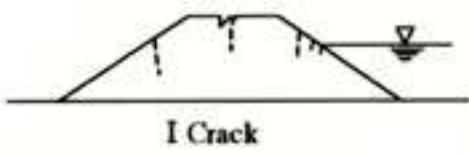
Some instances of earthquake damage to typical fill dams outside Japan are depicted in [Table 8](#). In the United States, the Santa Barbara earthquake (1925) damaged the Sheffield dam^{3,4}. The banks of this dam were 11 m high and were insufficiently compacted. They failed to withstand the rise in pore water pressure in the lower part of the dam and collapsed. The San Fernando earthquake (1971) caused serious damage to both the Lower San Fernando dam with a bank height of 43 m and the Upper San Fernando dam with a bank height of 25 m. These 2 dams had been constructed according to a hydraulic-fill process, and were in the neighborhood of a fault. Therefore they experienced damage. Recently, the Loma Prieta earthquake (1989) has caused slight damage to 9 earth dams. The seismic data from the Lexington dam show that the dam abutment (approximately corresponding to the bedrock) experienced a maximum seismic wave input acceleration of 452 gal.

The center of Luzon Island, Philippines, had an earthquake with a magnitude of 7.8 on July 16, 1990, and the Pantabangan (107 m high) and Masiway dams (25 m high) near the epicenter were damaged. The damage to the Pantabangan dam was relatively slight, including a settlement of the crest (25 cm) and the release of joints in the upstream concrete wall with gaps in some joints. Masiway dam suffered more severe damage than the Pantabangan dam. The earthquake caused a settlement of 1.5 m on the crest near the spillway. However, the dam remained safe to use in terms of leakage and sliding surface. Considering the distance of this dam from the epicenter, and the magnitude of the earthquake, it is estimated that the maximum input acceleration of the seismic waves transmitted to the dam was approximately 300 to 400 gal. These values clearly exceeded the design criteria for earthquake intensities, but no serious damage occurred.

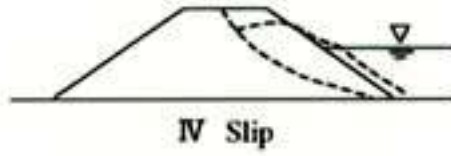
These findings based on earthquake surveys show that large-scale fill dams have never experienced serious damage, suggesting that current dam design methods (material characteristics and slope stability analysis method) are technologically sound.

[NEXT](#)

[TOP](#)



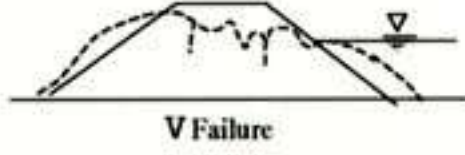
I Crack



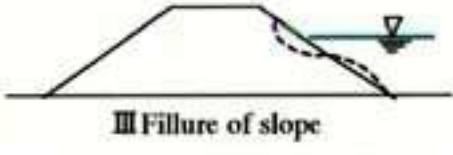
IV Slip



II Settlement



V Failure



III Failure of slope

Fig.5. Classification of damage types

BACK

**Table 3. Relationship between the type of damage and soil type in the case of the Nihonkai Chubu earthquake**

Type of damage	I	II	III	IV	V	Dam facilities	
	Crack	Settlement	Failure of slope	Slip	Failure		
Number of cases	69	47	62	13	4	23	
Material of embankment	Sandy soil	4	11	8	2	3	5
	Clay soil	57	30	48	11	1	17
	Others	8	6	6	0	0	1
Rate (%)	31.6	21.6	28.4	6.0	1.8	10.6	

**BACK**

**Table 4 . Relationship between soil type of dam body and damage of earth dam in the case of the Nihonkai Chubu earthquake**

Soil type	Number of dams	Number of cases	Number of cases with serious damage ^{a)}	Rate (total) (%)	Rate (serious damage) (%)
Sandy soil	215	43	10	20.0	4.7
Clay soil	1,258	130	5	10.3	0.4
Gravel clay soil	287	40	1	13.9	1.4
Others	74	5	0	6.8	0
Total	1,834	218	16	11.9	0.9

a) : Serious damage refers to failure or settlement above 1.0 m.

**BACK**



Table 5. Time of construction of fill dams with height above 15 m

Construction time	1868	1946	1951	1961	1971	1981	Under construction	Planned	Total
~ 1867	~ 1945	~ 1950	~ 1960	~ 1970	~ 1980	~ 1985			
Number	438	610	51	189	193	148	186	39	1,872 a)
	(23.4)	(32.6)	(2.7)	(10.1)	(10.3)	(7.9)	(9.9)	(2.1)	(100)

a) : 1,506 earth dams.

BACK

**Table 6. Observations of earthquake damage to fill dams with height of 15 – 30 m in Japan**

Earthquake	Date	Magnitude (Mj)	Name of dam	Date of completion	Height (m)	Type of dam	Characteristics of damage	Degree of damage
Ansei Nankai	Jul. 24, 1854	8.4	Manno-ike	Around 700	23	Earth	One month after the earthquake, leakage was reported in the embankment. Failure occurred 6 days later.	Serious(Failure)
Nobi	Oct. 28, 1891	8.4	Iruka-ike	1633	29	Earth	Longitudinal cracks on the crest.	Slight
Kanto-dai	Sept. 1, 1923	7.9	Ohno Reservoir	1914	34	Earth (concrete core)	Crest settlement of 24 cm. Lateral cracks on the crest.	Medium
			Maruyama					
			Upper	1923	24	Earth	Crest settlement of 20 cm.	Slight
			Lower	Under Construction	16(33)	Earth	Longitudinal cracks on the crest.	Slight
Oga	May 1, 1939	7.0	Iwakura Tameike	1931	17	Earth	Longitudinal cracks on the crest.	Slight
Matsushiro	Aug. 1965 –Dec. 1968	Max. 5.4	Ohike	1927	16	Earth	Longitudinal cracks.	Slight
			Shionoiri	1936	25		Longitudinal cracks.	Slight
Niigata	Jun. 16, 1964	7.5	Takinosawa	1954	15	Earth	Cracks on the slope.	Slight
			Fujita	1952	18	Earth	Cracks on the slope and crest.	Slight
			Bajin	1950	22	Earth	Cracks on the crest.	Slight
			Hasa-ike	1953	16	Earth	Leakage from downstream slope.	Slight
			Ohkura	1807	16	Earth	Cracks on the crest.	Slight
			Hirusawa	1948	24	Earth	Cracks on the crest.	Slight
			Kamonotani	1933	15	Earth	Heavy leakage from the bottom.	Serious
			Nishino	1935	18	Earth	Cracks on the crest.	Slight
			Shekishiba	1958	30	Earth	Unknown.	—
			Bakura	1931	21	Earth	Leakage from the bottom of the embankment.	Medium
Tokachi-oki	May 16, 1968	7.9	Tanosawa	1626	23	Earth	Cracks on the crest, settlement.	Medium
			Koganezawa	1938	21	Earth	Cracks on the crest.	Slight
Akita Toho	Oct. 26, 1970	6.5	Yunosawa	1930	27	Earth	Slide cracks on the crest. Cracks on the crest (20 cm wide).	Medium Slight
Miyagiken-oki	Jun. 12, 1978	7.4	Ushino	1965	23	Rock-fill	Slide of upstream surface.	Slight
			Irusawa	1948	24		Lateral cracks.	Slight
Nihonkai Chubu	May 26, 1983	7.7	Megurisekida	—	18	Earth	Cracks, leakage from the bottom.	Slight
			Hongo	1956	17	Earth	Crest settlement of 50 cm.	Medium
			Higashidaisa	1970	17	Earth	Leakage from the bottom.	Slight
			Ohzutsumi	1940	15	Earth	Cracks on the surface block.	Slight
Chibaken Toho-oki	Dec. 17, 1987	6.7	Konaka Tameike	1936	21	Earth	Cracks on the crest.	Slight

BACK

## Conclusion

We have compiled data on earthquake damage to fill dams in Japan and in other countries. The majority of the fill dams that experienced earthquake damage were small, and fill dams for which modern geotechnical/soil engineering designs were applied did not experience serious damage even with earthquake intensities above the design criteria. Therefore, it is considered that large-scale fill dams are markedly resistant to earthquakes. The conclusions are as follows.

### 1) For small earth dams

(1) Based on the data of 5 earthquakes, the distance from the epicenter at which earth dam damage occurs is expressed using magnitude as follows;

$$R = 1155 \quad 5M_J - 6.1 \quad \dots\dots\dots(1)$$

$$\log R = 0.846 M_J - 4.14 \quad 6.1 - 0.1 M_J \quad \dots\dots\dots(2)$$

where  $M_J$  : magnitude, R: critical distance from epicenter (km).

(2) Most cracks generated on dam bodies are longitudinal cracks parallel to the dam body. There are few lateral cracks perpendicular to the dam body and they occur frequently on the border of the abutment and near outlet works.

(3) As for the physical properties of the dam body, the damage is serious for sandy soil dams, particularly in the case of failure. It is estimated that liquefaction was the major cause of damage for many dams.

### 2) For large fill dams

(1) The only case of earthquake damage to a fill dam with a bank height of more than 15 m is that experienced by the Manno-ike dam.

(2) Earthquakes have subjected fill dams to maximum input accelerations of 260 to 600 gal. Conversion to static earthquake intensity shows that these values exceed the earthquake magnitudes considered in design criteria. It is evident that even such high intensities do not cause serious damage to large-scale fill dams.

(3) Although fill dams with heights above 15 m in the United States have experienced serious damage, it must be noted that they were constructed based on the hydraulic-fill process. The above review indicates that large fill dams with heights above 15 m and constructed with the current dam designs exhibit a high earthquake resistance and provide sufficient safety against earthquakes.

## References

- 1) Akiba, M. & Senba, H. (1941): The Oga earthquake and its influence on earth dam. *J. Jpn. Soc. Agric. Eng.*, 13 (1), 31-59 [In Japanese].
- 2) Manno-ike irrigation association (1929): Construction history of Manno-ike dam [In Japanese].
- 3) Seed, H. B. (1979): Consideration in the earthquake resistant design of earth and rock-fill dams. *Geotechnique*, 29 (3), 215-263.
- 4) Sherard, J. R. et al. (1963): Earth and earth-rock dams. John Wiley and Sons, Inc., 156-170.
- 5) Takase, K. (1967): Statistic study of earth dam damage. Doctoral Dissertation [In Japanese].
- 6) Tani, S. & Hasegawa, T. (1988): Earthquake damage on earth dam by the 1983 Nihonkai Chubu earthquake. *J. Jpn. Soc. Agric. Eng.*, 55 (10), 17-25.
- 7) Tani, S. (1991): Consideration of earthquake damage to earth dam for irrigation in Japan. *In Int. Conf. Geotech. Earthquake Eng. Soil Dyn.*, 1137-1144.

**NEXT**

[:Controlled Application of Animal Wastes in Daily Farms](#)

**TOP**

[:Contents](#)

**BACK**

[:JIRCAS Home Page](#)

# Decrease of Nitrate and Restoration of Mineral Balance in Forage Field Soil and Corn Plant in Dairy Farms

**Yoshikuni MASAOKA, Yusuke ARAKAWA and Taizo MASUDA***

Kyushu National Agricultural Experiment Station (2421 Nishigoshi, Kumamoto 861 - 1192 Japan)

Present address:

* Okinawa Subtropical Station, Japan International Research Center for Agricultural Sciences (Ishigaki Okinawa, 907-0002 Japan)

Corresponding author: Y. Masaoka (masaoka@knaes.affrc.go.jp, fax: +81-96-249-1002)

## Abstract

Excess nitrogen corresponding to about 2-3 times the amount required for forage plant growth had been applied continuously for many years in dairy farms at Shisui machi, Kumamoto Prefecture in Kyushu because of the limited area of crop fields. Field experiments with reduced application of animal wastes (RAAW) which contained only half the amount of requirements for corn plant growth were conducted to decrease nitrate nitrogen (NN) accumulation and restore the mineral balance in corn plants and crop field soil in 6 dairy farms. (1) The NN concentration in the corn stem decreased to less than 5 g/kg (dry matter basis) and no whole plant shoots with a NN concentration above 2 g/kg were observed after the reduction of animal waste application for 1 year. (2) The content of exchangeable potassium (EK) in the dairy farm soil decreased from 60 to 27 mg/100g after RAAW for 2 years. (3) Average dry yield of corn plants in the 4th year was 16% lower in the case of RAAW than in the case of excess utilization of animal composts, but the difference was not significant. The concentration of K was lower in RAAW, which resulted in the decrease of the K/(Ca+Mg) equivalent ratio from 1.78 to 1.15 in the corn plants. These data suggest that RAAW can improve the feed quality by reducing the NN content and restoring the mineral balance in plant.

Discipline: Soils, fertilizers and plant nutrition

Additional key words: environmental conservation, K/(Ca+Mg) equivalent ratio, nitrate nitrogen, potassium, sustainable agriculture

[1...11](#): [References](#)

(Received for publication, March 31, 1999)

## Introduction

Recycling of animal wastes in agrosystems is very important for sustainable agriculture and environmental conservation³⁾. Animal wastes contain most of the plant nutrients such as nitrogen, phosphorus and potassium (K). For example, nitrogen occurs in both ammonia and organic forms, while the latter one may be transformed into ammonia through the mineralization process in soil, which may be further transformed into nitrate through the nitrification process in soil under aerobic conditions. Nitrate can be readily taken up by plants. However, if an excessive amount of animal wastes is applied into

fields, the residue part of the nutrients which could not be absorbed by plants tends to accumulate in the soil, resulting in the pollution of the surrounded environment including surface water, groundwater and air through drainage, leaching, and denitrification processes.

In fact, excessive amounts of animal wastes have been applied onto many dairy farms for many years in Japan due to the limited area of forage crop fields²⁾. It is generally recognized that nitrate nitrogen (NN) from animal wastes is leaching into the groundwater and sometimes causes nitrate pollution of drinking water in some regions. Moreover, as the excessive amount of nitrate taken up by plant roots can not be metabolized into organic forms, nitrate tends to accumulate together with K in the stems of the forage. And if such kind of forage is fed to dairy cattle, nitrate will be converted into nitrite in the rumen. Nitrite can react directly with hemoglobin in livestock animals to produce methemoglobin, which impairs the ability of red blood cells to transport oxygen and damages livestock's health¹¹⁾.

Therefore it is essential to decrease the application volume of animal wastes onto forage fields. In this report the restoration of the nitrate and mineral balance in dairy farm soils and forage plants which had not been thoroughly investigated in Japan hitherto will be confirmed.

## Materials and methods

Six dairy farmers operating 16 forage fields were surveyed in this study. The dairy farms were located in Shisui machi, Kumamoto Prefecture in Kyushu. On the average, one farmer operates 6 ha of arable land and owns 67 milking cows. Usually forage corn is grown for summer cropping followed by Italian ryegrass for winter cropping every year, and sometimes corn is grown 2 times annually in summer and autumn. In 1994, we collected data about the application rate of animal wastes from these 6 farms, while soil and corn samples were taken from 10 fields belonging to 2 representative farmers. From late 1994, a composting facility was built in the dairy farm and part of the wastes was converted to organic fertilizer to be used in other farms, so as to reduce the load volume of animal wastes in some forage fields. Therefore, from late 1994, we recommended that the farmers reduce the application rate of animal wastes in part of their fields. The outline of the reduction of application of animal wastes (RAAW) is shown in [Table 1](#). About half the amount of nitrogen requirement for corn growth was applied to decrease NN accumulation in the corn plant and to restore the soil mineral balance. The soil pH (0-30 cm in depth) ranged from 6.01 to 6.85 at the time of corn harvest in 1994. We suggested that the volume of application of ground dolomitic limestone should decrease because a rate of 1 to 2 t/ha had been used every year until 1994. Three farmers reduced the application time every other year and the other 3 farmers discontinued the application in the following year. Soil pH did not change and remained stable after these treatments. In 1995 and 1996, 4 fields from 1 representative farmer were continuously monitored, and in 1997, soil and corn samples at the harvesting stage in all the 16 forage fields were collected to determine the effect of this practice on soil properties and corn growth.

[NEXT](#)[TOP](#)

## References

- 1) Goff, J. P. & Horst, R. L. (1997): Effect of the addition of potassium or sodium, but not calcium, to parturition rations on milk fever in dairy cows. *J. Dairy Sci.*, 80, 176-186.
- 2) Hakamata, T. & Hirata, H. (1997): Nutrient cycling considerations for sustainable agriculture. *TERRA*, 15, 39-43.
- 3) Harada, Y. & Yamaguchi, T. (1998): Properties of animal waste compost in Japan. *In Environmentally friendly management of farm animal waste*. ed. Matsunaka, T., 49-54.
- 4) Ito, Y., Shiozaki, H. & Hashimoto, H. (1982): Effect of continuous heavy-application of farmyard manure on the fertility of a humus-rich volcanic ash soil. *Bull. Kyushu Natl. Agric. Exp. Stn.*, 22, 259-320 [In Japanese with English summary].
- 5) Ito, Y. & Miyazawa, K. (1984): Effect of long-term heavy application of fresh farmyard manure on yield & nutrient status of forage crops. *JARQ*, 17, 242-247.
- 6) Koshino, M. (1994): Recent development in leaf diagnosis & soil testing as a guide to crop fertilization. *Food & Fert. Technol. Cent., Ext. Bull.*, 397, 1-20.
- 7) National Grassland Research Institute (1995): Guidelines for application of animal waste & composts. *Misc. Rep. NGRI*, 7 (4), 17-18 [In Japanese].
- 8) National Institute of Animal Industry (1997): Guidelines for application of animal waste & composts. *Misc. Rep. NIAI*, 98 (8), 8 [In Japanese].
- 9) Sugihara, S., Ishii, K. & Kondo, H. (1979): Studies on annual heavy application of dairy cattle manure to the field of the humus rich volcanic ash soil. I. The influence of annual heavy application of dairy cattle on the growth yields, nutrients uptake of some field crops & soil properties. *Bull. Tohoku Natl. Agric. Exp. Stn.*, 60, 17-40 [In Japanese with English summary].
- 10) Uwasawa, M., Koshino, M. & Kojima, M. (1987): New criteria for the necessity of the side dressing to silage corn. *In Saishin Gijutu Joho Ser. (Natl. Inst.)*, 83-84 [In Japanese].
- 11) Wright, M. J. & Davison, K. L. (1964): Nitrate accumulation in crops & nitrate poisoning in animals. *Adv. Agron*, 16, 197-247.

**Table 1. Average supply and absorption of nitrogen (N) and potassium (K) in 6 dairy farms**

Supply and absorption of N and K (kg/ha)	N	K
<b>Before 1994</b>		
Animal wastes	1,190*	727*
Chemical fertilizer	54	15
-----		
<b>Absorption by forage</b>		
Corn	247	365
Italian ryegrass	128	119
<b>Total</b>	<b>415</b>	<b>507</b>
<b>After 1994</b>		
Reduced application of animal wastes (RAAW)	139*	81*
Chemical fertilizer	54	15

Density of milking cows is 11.2 head/ha.

*Each average value was estimated based on statistical data of animal wastes⁽⁸⁾.

**BACK**

## Results

### *1) Nitrate accumulation and mineral imbalance in soil and forage before 1994*

Before the sowing of corn in the spring, chemical fertilizer had been applied to each field at the rates of 39 kg N, 54 kg P₂O₅ and 18 kg K₂O/ha. However most of the nutrients required for corn growth were derived from animal wastes. Table 1 shows the average input and output value of nitrogen and K estimated based on statistical data^{7,8)} from 6 dairy farms. In this Table we also listed the volume of chemical fertilizer and animal wastes utilized for corn production after RAAW treatment. As the dairy cattle density was very high, the farmers had to apply all the animal wastes in winter. Obviously, the amount of nitrogen applied in animal wastes was about 2-3 times higher than that removed by corn and Italian ryegrass. [Table 2](#) gives the mineral content in the soil and corn plant at the harvesting stage in 1994. The amounts of EK and magnesium (Mg) were very high in the soil, and hot water-soluble nitrogen¹⁰⁾ was still present in the soil at high concentrations even at the harvesting stage. A value as high as 0.2% nitrate nitrogen (NN) on a dry matter basis was detected in corn even at the yellow ripe stage. Therefore, it was demonstrated that an excessive amount of nutrients from animal wastes accumulated in the dairy farm every year and a larger amount of nitrate also accumulated in corn before 1994.

### *2) Effect of RAAW on forage NN content*

Reduced application of animal wastes decreased the NN content in the corn stems (Fig. 1). In Field 1, the NN content of the corn stems decreased significantly from 1994 to 1997. Especially, the value decreased by 50% in 1995 just after 1 year's practice. In Field 3, since animal wastes had been heavily applied for many years, the NN content remained high, but also decreased in 1997. Fields 2 and 4 showed different patterns, because these 2 fields were located far away from dairy cattle, and the animal waste load volume varied. In 1996, the nitrate nitrogen content of corn stems increased sharply in Field 4 due to the large increase of animal waste load volume. It is likely that nitrate accumulation in the corn stems depended on the animal waste load volume and might have decreased within 2 or 3 years if the load volume could have been controlled.



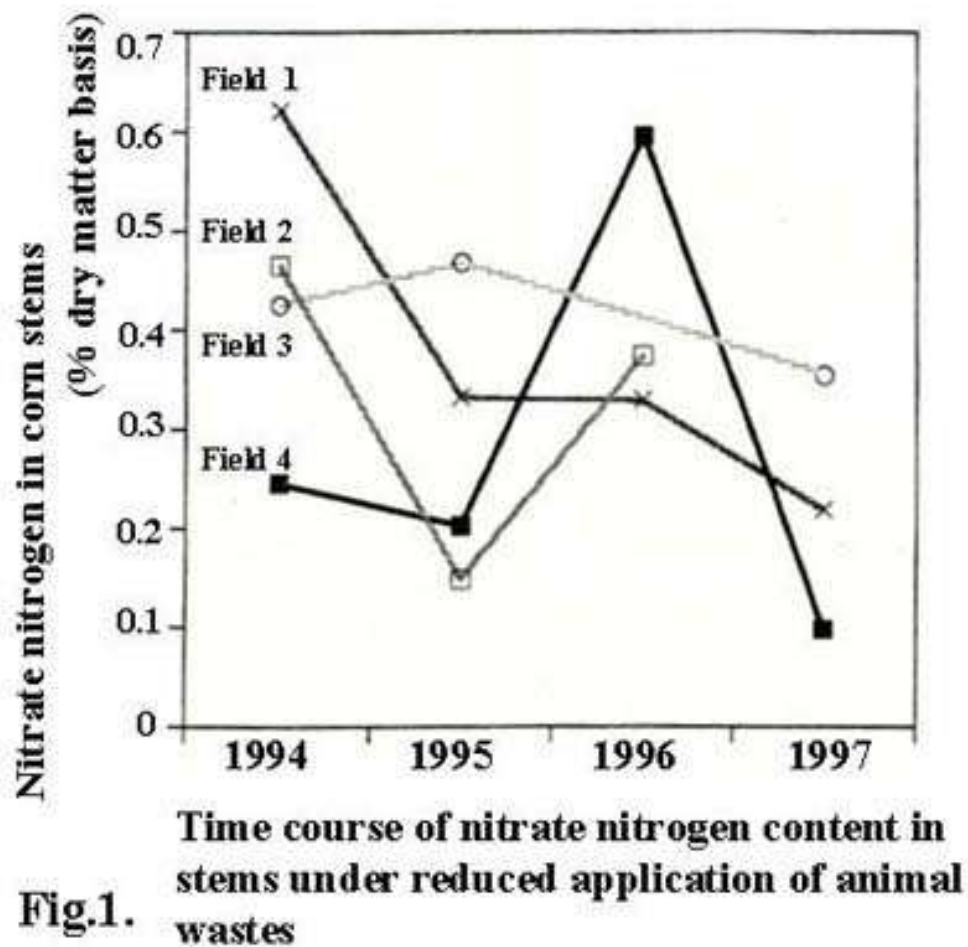
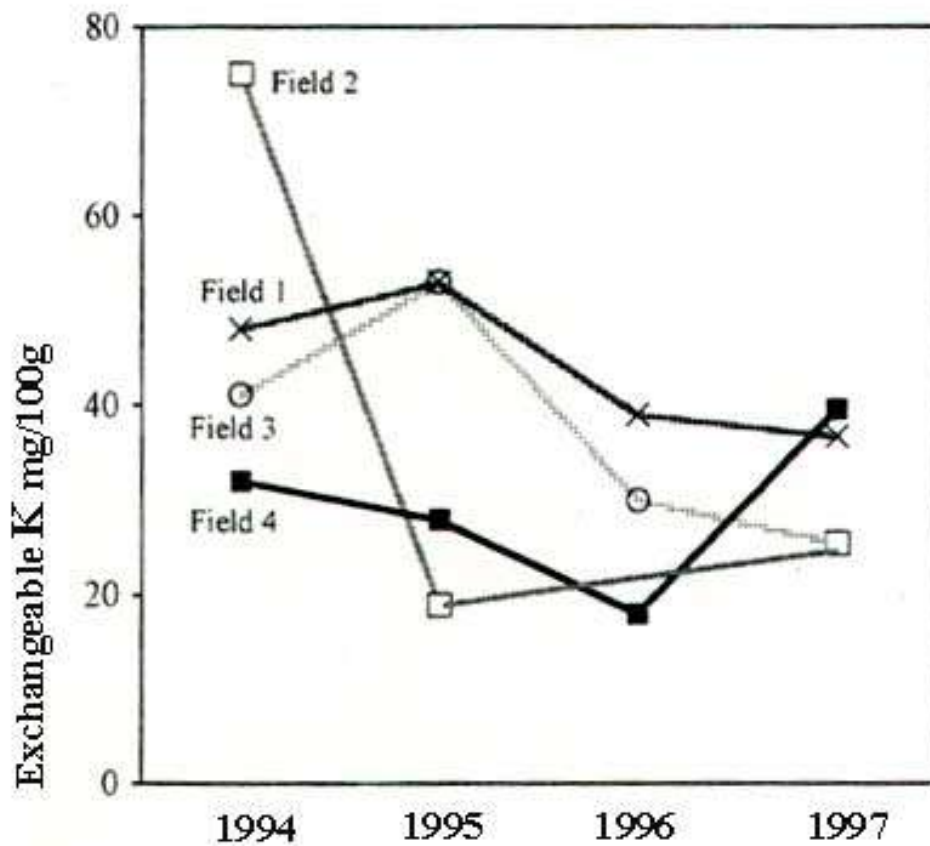


Fig.1.

wastes

### 3) Exchangeable K (EK) in soil

Fig. 2 shows the content of exchangeable K (EK) in soil. The EK content in all the fields was relatively higher at the beginning of the practice, but after 3 years, the EK content significantly decreased except in Field 4, which suggested that the EK content in soil could also decrease within 2 or 3 years.



**Fig. 2.** Time course of exchangeable potassium content in the forage field soil (0-30 cm in depth) under reduced application of animal wastes

#### 4) Effect of reduced application of animal wastes for 3 years

[Fig. 3](#) shows the effect of RAAW in the 16 farm fields in 1997. In 10 fields RAAW was implemented compared with 6 fields with continued heavy application of animal wastes. Although the corn dry yield relatively decreased due to the decrease of animal waste application, the nitrogen content, K content and K/(calcium(Ca)+Mg) equivalent ratio in the corn plant as well as the contents of hot water-soluble nitrogen and exchangeable K in soil decreased, while the contents of exchangeable Mg and Ca increased in soil.

## Discussion

Animal wastes are rich in nutrients for increasing crop yield and improving soil fertility. However, the nitrogen content in soil has increased significantly by heavy application of animal wastes for many years since large-scale animal production was introduced in Japan⁵⁾. Nitrogen enrichment in forage fields has caused problems in animal health¹¹⁾, and resulted in groundwater pollution by nitrate. Besides nitrogen enrichment, K also accumulated in such fields. Owing to the antagonistic effect of K, absorption of Ca and Mg by crops was retarded, resulting in the increase of the K/(Ca+Mg) equivalent ratio⁹⁾. It was

reported that if the  $K/(Ca+Mg)$  ratio in forage crops increases to a large extent, there will be a higher risk of grass tetany⁴⁾. Also, a high K level induces metabolic alkalosis in prepartum dairy cows, which reduces the ability of the cows to maintain Ca homeostasis¹⁾. Therefore, not only for the farmers but also for the people living in such rural areas better management of animal wastes should be implemented⁶⁾.

In the dairy farms, the nitrogen volume applied as animal wastes was estimated to amount to about 2 times that of the corn requirement before 1994 (Table 1). Even at the harvesting stage, a higher amount of hot water-soluble nitrogen was still present in the crop field soil (Table 2). The average EK content in the fields tested also increased to about 3 times that of the standard soil diagnosis value in volcanic soil.

From late 1994, the mean amount of nitrogen applied as animal wastes decreased to half of that required by corn approximately. However, the amount removed by corn still exceeded 200 kg/ha (Table 1), indicating that the organic nitrogen from the wastes which had accumulated in the soil for many years had undergone nitrification, and that the amount of nitrate was adequate for corn growth. Furthermore it is important to decrease nitrate accumulation in the corn stems (Fig. 1). Obviously, after several years of continuous RAAW, the amount of N and K nutrients in soil may become insufficient for plant growth. That is to say, soil nutrient diagnosis tests should be carried out every few years to determine the suitable application volume of animal wastes, should the nutrients be unable to meet the requirement for crop growth.

In the present investigation, we observed that exchangeable K had accumulated in soil in 1994, the content being 2-7 times higher than the standard value of soil diagnosis (Table 2). Ito et al. (1982) reported that the movement of K down the soil profile was fairly large in the case of humus-rich volcanic ash soil⁴⁾. It is possible that the EK may move out from the soils investigated by leaching in the rainy season. Furthermore, owing to the large biomass of corn and higher requirement of K, as much as 365 kg/ha K was removed during the cultivation of corn in summer (Table 1). These factors led to the decrease of the content of exchangeable K after the amount of animal waste application was reduced (Fig. 2).

As shown in Fig. 3, the mean value of corn yield after reduced application of animal wastes for 3 years exceeded 18 t/ha. The volume was about 4 t/ha less than that in the case of heavy application and no significant difference was observed. Moreover, the reduction of application of animal wastes led to the decrease of the nitrogen content and the restoration of the mineral balance in both forage field soil and corn plant as shown in Table 2 and Fig. 3. The  $K/(Ca+Mg)$  equivalent ratio is an important parameter to evaluate the mineral balance in plant. The decrease of this ratio was caused by the decrease of the EK value in soil. We also observed an increase of the contents of exchangeable Ca and Mg in soil with RAAW, for unknown reasons. The decrease of the K content in the plant should enable livestock to obtain more Ca and Mg, which are essential to maintain Ca homeostasis¹⁾ and to avoid the risk of grass tetany. It was considered that the restoration of the mineral balance in these field soils may require a long period of time. The present study shows that the restoration of the mineral balance in plant and soil was very rapid within 2 or 3 years of reduced application of animal wastes in the dairy farmer fields.

The farm size of the dairy farmers surveyed here is representative of that in Japan. Many of these farmers have been burdened by the large volume of animal wastes required for application in their fields. With the production of compost fertilizer, the application volume could be reduced, and nitrate accumulation and the mineral balance in forage could be improved simultaneously within 2 or 3 years.

**NEXT**

[: Varietal Differences in Palatability of Degraded Forestland](#)

**TOP**

[: Contents](#)

**HOME**

[: JIRCAS Home Page](#)

Table 2. Mineral content in soil and corn shoot at harvesting stage in 1994

Farm	Soil (0 – 30 cm depth)						Corn		
	PH	W.S.N ^{a)}	Exchangeable (mg/100g)			Dry matter yield (t/ha)	NN ^{b)} (% dry matter basis)		
			K	Mg	Ca		Stem	Shoot	
A	Mean	6.63	3.6	52	42	534	2.06	0.418	0.165
	Max	6.85	4.8	53	46	578	2.45	0.621	0.260
	Min	6.41	2.4	32	32	496	1.88	0.245	0.098
B	Mean	6.14	2.8	69	39	427	1.64	0.386	0.145
	Max	6.23	2.5	116	60	537	1.86	0.546	0.219
	Min	6.01	3.1	61	28	290	1.31	0.283	0.131
S.D ^{c)}	6.0 – 6.5	–	12 – 23	24	400				

a):Hot water-extracted nitrogen. b):Nitrate nitrogen. c):Standard value of soil diagnosis.

BACK

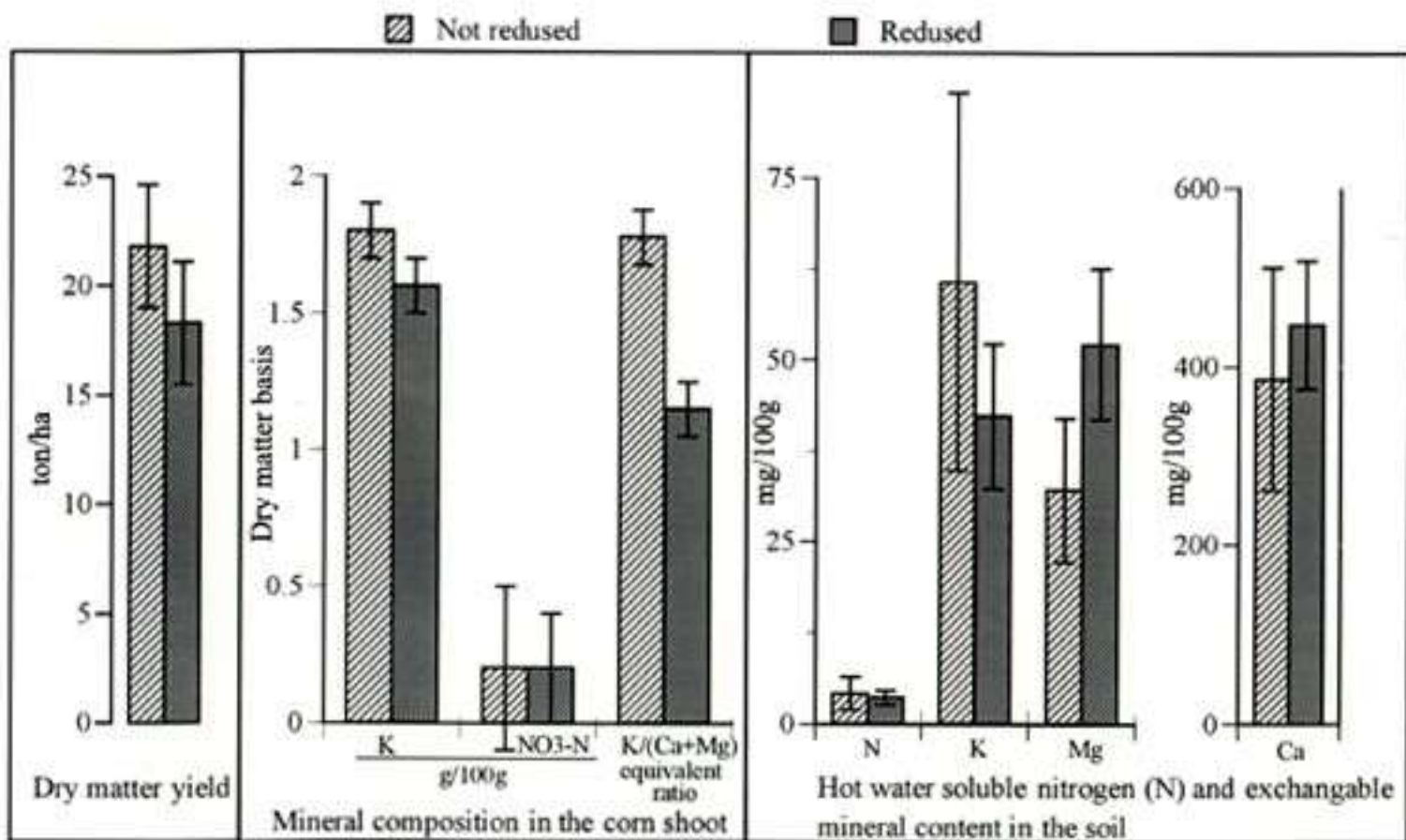


Fig. 3 Effect of reduced application of animal wastes on the dry matter yield and mineral composition in the corn shoot and mineral balances in the soil.

Results are means  $\pm$  SE.  $n=6$  (Not reduced),  $n=10$  (Reduced)

BACK

# Varietal Differences in Palatability of Orchardgrass (*Dactylis glomerata* L.) and Breeding for Palatability and Quality

**Kazuhiko MIZUNO*¹, Shigeru SHIOYA*², Fumihiro FUJIMOTO*³ and Shin-ichi SUGITA**

Department of Plant Breeding, National Grassland Research Institute  
(Nishinasuno, Tochigi, 329-2793 Japan)

Present address:

*1 Yamaguchi Agricultural Experiment Station (Ouchi mihori, Yamaguchi, 753-0214 Japan)

*2 Kyushu National Agriculture Experiment Station (Nishigoshi, Kumamoto, 861-1192 Japan)

*3 Faculty of Agriculture, Gifu University (Yanagido, Gifu, 501-1193 Japan)

Corresponding author: K. Mizuno (kazuhiko-mizuno@nourin.pref.yamaguchi.jp, fax +81-83-927-0214)

## Abstract

Palatability of 14 varieties of orchardgrass (*Dactylis glomerata* L.) was evaluated with Holstein heifers by using a trough cafeteria method for 4 years. Highly significant differences in the palatability of varieties were recognized throughout the growing seasons in each year. Multiple regression analysis was carried out in 15 cafeteria trials to identify the variables which could predict the palatability of varieties. Among 41 available variables, the best combinations of 2 variables were identified in each growing season. For all the seasons, the concentration of Ca, the concentration of P, and flexibility of leaf and stem were considered to be the best positive predictors for the palatability. In contrast, ADF and 3 kinds of diseases (Rhynchosporium scald, rust and total leaf diseases) were considered to be the best negative predictors for the palatability. Lude, a French variety, exhibited superior characteristics in quality compared with other varieties, namely, high palatability, resistance to rust and total leaf diseases, high flexibility of leaf and stem and the highest concentration of Ca among the tested varieties. Intake of fresh materials in 2 varieties, Lude and Akimidori was compared by using Holstein heifers. It was observed that the estimated increase of dry matter intake (DMI, g/kgBW^{0.75}) of Lude over Aki- midori was 3.49 g at the same DMD level. High palatability in Lude might have a positive effect on the DMI level and could increase it more than expected from the DMD level. A model for the improvement of both palatability and quality which includes digestibility and mineral-balances was proposed as a part of the forage breeding program in Japan.

Discipline: Grassland / Plant breeding

Additional key words: cafeteria trial, calcium, disease, flexibility, Holstein heifer, intake

1)...17): [References](#)

(Received for publication, March 31, 1999)

## Introduction

Orchardgrass (*Dactylis glomerata* L.) is one of the most important pasture grasses with high adaptability in a wide range of environments. It is grown in Japan very widely from cool regions (Hokkaido and Tohoku areas) to warm regions (Kanto to Kyushu areas). Several varieties with high yield and resistance to main diseases have been bred in Japan. However, compared with other temperate grasses, some reports indicated that the quality, palatability^{2,7,16,17}, and animal productivity^{1,3,4,6} in the case of orchardgrass were not appreciably high. Research and programs for the improvement of quality in orchardgrass should be urgently promoted in Japan. This study was conducted to analyze the variations among varieties of orchardgrass in palatability and quality traits with a view to developing a breeding program for both high palatability and high quality in Japan.

[NEXT](#)[TOP](#)[Contents](#)



## References

- 1) Alder, F. E. & Cooper, E. M. (1967): Comparative studies of perennial ryegrass and cocksfoot as food for the calf. *J. Agric. Sci. Camb.*, 68, 331-346.
- 2) Cowlshaw, S. J. & Alder, F. E. (1960): The grazing preferences of cattle and sheep. *J. Agric. Sci.*, 54, 257-265.
- 3) Davies, D. A. & Morgan, T. E. H. (1982a): Performance of ewes and lambs on perennial ryegrass, cocksfoot, tall fescue and timothy pastures under upland conditions. *J. Agric. Sci. Camb.*, 99, 145-151.
- 4) Davies, D. A. & Morgan, T. E. H. (1982b): Herbage characteristics of perennial ryegrass, cocksfoot, tall fescue and timothy pastures and their relationship with animal performance under upland conditions. *J. Agric. Sci. Camb.*, 99, 153-161.
- 5) Dohi, H., Mizuno, K. & Yamada, A. (1998): A comparison of volatile chemicals from orchardgrass (*Dactylis glomerata* L.) varieties with different palatabilities. *Grassl. Sci.*, 44, 185-188.
- 6) Grimes, R. C., Watkin, B. R. & Gallagher, J. R. (1967): The growth of lambs grazing on perennial ryegrass, tall fescue and cocksfoot, with and without white clover, as related to the botanical and chemical composition of the pasture and pattern of fermentation in the rumen. *J. Agric. Sci. Camb.*, 68, 11-21.
- 7) Ivins, J. D. (1952): The relative palatability of herbage plants. *J. Br. Grassl. Soc.*, 7, 43-54.
- 8) Mizuno, K., Kondo, T. & Kato, T. (1990): Predicting chemical compositions and sheep responses by near infrared reflectance spectroscopy in forage. *JARQ*, 24, 117-123.
- 9) Mizuno, K., Shioya, S. & Fujimoto, F. (1997a): Studies on palatability in varieties of orchardgrass (*Dactylis glomerata* L.). 1. Varietal differences in palatability and their interactions with seasons and years. *Grassl. Sci.*, 43, 306-315 [In Japanese with English summary].
- 10) Mizuno, K., Shioya, S. & Fujimoto, F. (1997b): Studies on palatability in varieties of orchardgrass (*Dactylis glomerata* L.). 2. Relationship between palatability of varieties and their agronomic characters in spring, summer and autumn seasons. *Grassl. Sci.*, 43, 316-324 [In Japanese with English summary].
- 11) Mizuno, K., Shioya, S. & Fujimoto, F. (1998a): Studies on palatability in varieties of orchardgrass (*Dactylis glomerata* L.). 3. Relationship between palatability of varieties and their fibrous, degradable and physical characters in spring, summer and autumn seasons. *Grassl. Sci.*, 43, 430-438 [In Japanese with English summary].
- 12) Mizuno, K. et al. (1998b): Studies on palatability in varieties of orchardgrass (*Dactylis glomerata* L.). 4. Relationship between palatability of varieties and their mineral elements and some chemical constituents in spring, summer and autumn seasons. *Grassl. Sci.*, 43, 439-448 [In Japanese with English summary].
- 13) Mizuno, K., Shioya, S. & Fujimoto, F. (1998c): Studies on palatability in varieties of orchardgrass (*Dactylis glomerata* L.). 5. Multivariate analysis of characters related to palatability and features of varieties with high palatability. *Grassl. Sci.*, 44, 158-168 [In Japanese with English summary].
- 14) Mizuno, K. et al. (1998d): Studies on palatability in varieties of orchardgrass (*Dactylis glomerata* L.). 6. Comparison of intake between varieties differed in palatability. *Grassl. Sci.*, 44, 278-285 [In Japanese with English summary].
- 15) Mizuno, K. (1999): Studies on palatability in varieties of orchardgrass (*Dactylis glomerata* L.). - Relationship between plant characters among varieties and the palatability measured by Holstein heifers and the analysis from viewpoints of plant breeding. *Bull. Natl. Grassl. Res. Inst.*, 58, 59-123 [In Japanese with English summary].
- 16) Saiga, S. (1990): Differences in intake among grass species and cultivars, and factors influencing them. *Grassl. Sci.*, 36, 60-66 [In Japanese].

## References

17) Simon, U. (1974): Palatability and voluntary intake of contrasting legume and grass varieties by grazing sheep. *In* Proc. 12th Int. Grassl. Congr., 487-494.

## Varietal differences in palatability

### 1) Analysis of relative palatability values

Palatability of varieties of orchardgrass was evaluated with Holstein heifers by using a trough cafeteria method during a period of 4 years⁹⁾ ([Table 1](#)). The 14 varieties used in this study were Akimidori, Makiba- midori, Kitamidori, Lude, Lully, Lutetia, Lucifer, Prairial, Potomac, Cambria, Sylvan, Jesper, Juno and Frode ([Table 2](#)). Among these varieties, Akimidori was used as the standard variety for all the cafeteria trials. [Table 3](#) shows the results of 45 trials. Relative palatability value of each variety was expressed in percentage of intake per diet of the variety within the same variety group. The analysis of variance was based on this value. F values of sources for the variety indicated that the differences in the relative palatability values among varieties were highly significant ( $P < 0.001$  or  $P < 0.01$ ) for 42 out of 45 trials.

According to the relative palatability value, [Table 3](#) shows that a French variety Lude (L) exhibited a high palatability in most seasons of the years in the current study. Compared with the standard variety Akimidori (A), significant differences ( $P < 0.05$ ) in the value of Lude (L) were recognized throughout the seasons of the years, except for the reproductive stage in the 2nd cutting, the 4th cutting in 1993 and 3rd cutting in 1994.

### 2) Palatability of the variety Lude

In order to compare the relative palatability values of the varieties obtained from 3 different variety groups in the same cutting period, as shown in [Table 3](#), the value of palatability (%) of each variety was defined as the difference between the relative palatability value of the variety and the value of the standard variety Akimidori. The values of palatability in Akimidori were always expressed as 0% in this definition. The values of palatability of Lude and Akimidori are shown in [Fig. 1](#) with the maximum and minimum values of palatability obtained from all the variety groups in the same cutting period. As pointed out in [Table 3](#), it was also confirmed in [Fig. 1](#) that Lude showed a high palatability among all the tested varieties for most of the seasons of the years.

## Predictors for palatability

Multiple regression analysis was carried out to identify variables which could predict the values of palatability of varieties in 15 cafeteria trials in spring, summer and autumn seasons¹³⁾. Characters used in this analysis are listed in [Table 4](#). Agronomic characters¹⁰⁾, fiber and degradability characters¹¹⁾, mineral elements¹²⁾, free sugars¹²⁾, leaf morphological¹⁰⁾ and physical characters¹¹⁾ were measured or analyzed to predict the values of palatability. Among 41 available variables, which represent these characters, best combinations of 2 variables were detected in each growing season ([Table 5](#)). Contribution ratios due to regression ( $R^2$ ) of the palatability on 2 best variables ranged approximately from 0.6 to 0.95 in all the 15 trials. For all the seasons, the concentration of Ca, the concentration of P and flexibility of leaf and stem measured by the hand-touching method were considered to be the best positive predictors for the palatability of varieties. In contrast, ADF and 3 kinds of diseases (Rhynchosporium scald, rust and total leaf diseases) were considered to be the best negative predictors for the palatability of varieties¹³⁾.

## Characters of the palatable variety Lude and positive effect of palatability on intake

### 1) Characters of the variety Lude

Lude, a French variety, exhibited superior characteristics in quality compared with other varieties in our study, namely, high palatability, resistance to rust and total leaf diseases¹⁰⁾, high flexibility of leaf and stem¹⁰⁾, the highest concentration of Ca and ratio of Ca/P, and the lowest ratio of  $K/(Ca+Mg)$  among all the tested varieties ([Fig. 1](#)). Although Lude is susceptible to summer blight and its value of DM degradability by cellulase solution is average among the varieties, it could become a promising breeding material for the improvement of both palatability and quality in orchardgrass, especially for the warm region of Japan because of its high adaptability to the climatic conditions.

### 2) Positive effect of palatability on intake

Intake of fresh materials in 2 varieties, Lude and Akimidori was compared by using Holstein heifers¹⁴⁾. Each measurement of the intake was carried out during a period of 3 days together with palatability tests. Mean value of dry matter intake (DMI,  $g/kgBW^{0.75}$ ) of Lude was 0.8 g, 2.3 g and 2.5 g higher than that of Akimidori in the first trial in July 1993, second trial in November 1993, and third trial in June 1994, respectively. Dry matter digestibility (DMD) of each variety was predicted from the degradability by 1% cellulase solution. Regression equation of DMI on DMD was calculated in each variety. According to the t-distribution statistics, the regression coefficient of original equations in each variety could be pooled statistically. The pooled equations were as follows: DMI of Akimidori =  $-44.72 + 1.79 \text{ DMD}$ ; DMI of Lude =  $-41.23 + 1.79 \text{ DMD}$  ([Fig. 2](#)). The intercept of regression line on these equations was, however, significantly different. Based on the difference in the values of intercept, the estimated increase of DMI value in Lude over Akimidori was 3.49 g at the same DMD level. Palatability of Lude measured by using the same heifers was also significantly higher than that of Akimidori in each trial¹⁴⁾. High palatability in Lude might have a positive effect on the DMI level and could increase it more than expected from the DMD level.

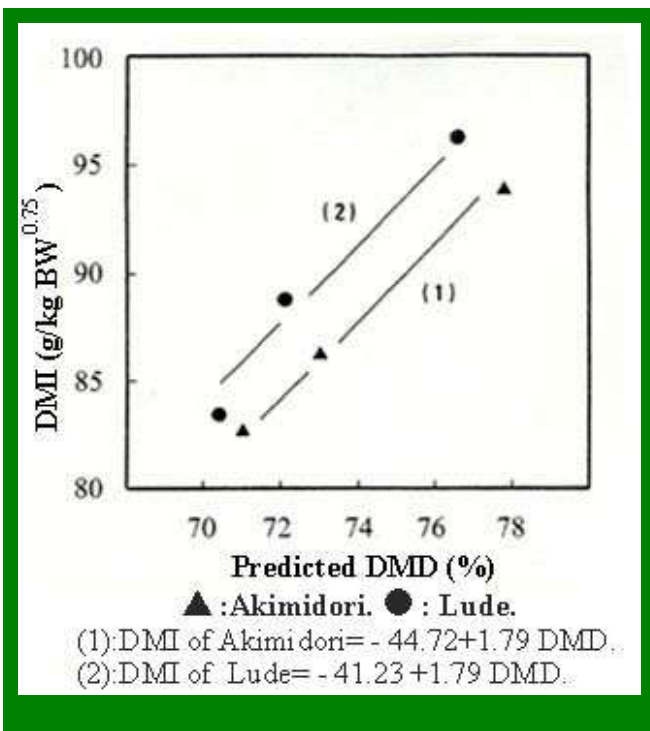


Fig.2.

Relationship between dry matter in take (DMI) and predicted dry matter digestibility (DMD)^{a)} in 2 varieties of orchardgrass

a): *In vivo* DMD (Y,%) was predicted from the following equation.  $Y = 25.1 + 0.917 \times (\text{DM degradability by 1\% cellulase solution for 48 h, \%})$ .

According to the t-distribution, the regression coefficient of the original equations on Akimidori and Lude can be pooled statistically to the value 1.79, but the intercept of the regression line on (1) and (2) is significantly different at 5% level.

## Proposed model for developing new varieties with high palatability in Japan

### 1) Methods for selection of palatability and digestibility

#### (1) Palatability

In order to develop useful selection criteria for palatability, the flexibility of leaf and stem and the concentration of Ca were considered¹⁵⁾. As for the flexibility, 6 persons gave independently similar scores for the flexibility of tested strains by using a simple method of hand-touching and it was considered that the method for measuring the flexibility might be easy and reliable. Therefore, it could be one of the most useful criteria for estimating the palatability of breeding materials in orchardgrass. As for the Ca concentration, the increase of the Ca concentration in orchardgrass was considered to be effective for the improvement of both palatability and mineral-balances with Mg, K and P.

#### (2) Digestibility

In addition to the palatability, digestibility is the most important character for the quality of grass varieties. Near infrared reflectance spectroscopy (NIRS) could successfully predict cellulase degradability of unknown samples of orchardgrass, and NIRS was considered to be one of the most effective methods to improve the digestibility in grass breeding^{8,15)}.

### 2) Proposed model for breeding

A model for developing new varieties with a high palatability was proposed¹⁵⁾ (Table 6), in which 3 stages were designed for 2 regions in Japan. For the breeding of varieties suitable for the cool region, promising plants in the original population could be selected based on winter hardiness and resistance to diseases, and their seeds would be harvested as maternal lines in Stage 1. Then, superior maternal lines could be selected based on the flexibility of leaf and stem and the Ca concentration in Stage 2. Finally, new varieties could be selected through the evaluation of palatability measured by using cattle from the final candidate lines in Stage 3.

For the breeding of varieties suitable for the warm region, variety Lude would be one of the most important breeding materials. Promising plants in the original population could be selected based on summer productivity and resistance to summer blight to breed maternal lines in Stage 1. Then, superior maternal lines could be selected based on the digestibility by using a cellulase solution or by NIRS in Stage 2. Finally, new varieties could be selected through the evaluation of palatability measured by using cattle in Stage 3.

This model was the first to be proposed for the improvement of both palatability and quality, which includes digestibility and mineral-balances in forage breeding in Japan.

[NEXT](#) : [Growth of Borneo Ironwood Seedlings in Degraded Forestland](#)

[TOP](#) : [Contents](#) [HOME](#) : [JIRCAS Home Page](#)

**Table 1. Animals used in the cafeteria trial**

Year	Cutting	Breed	Number of animals	Average liveweight (kg)
1991	1st – 6th	Holstein (heifer)	4 (2 pairs)	315 (Apr.) – 429 (Nov.)
1992	1st – 5th	Holstein (heifer)	4 (2 pairs)	271 (Apr.) – 361 (Nov.)
1993	3rd – 5th	Holstein (heifer)	4 (2 pairs)	269 (Jun.) – 303 (Oct.)
1994	3rd	Holstein (heifer)	4 (2 pairs)	347 (Jun.)

**BACK**

**Table 2. Orchardgrass varieties used in the study**

Variety	Symbol	Breeding country
Akimidori	A	Japan
Makibamidori	M	Japan
Kitamidori	K	Japan
Lude	L	France
Lully	Y	France
Lutetia	T	France
Lucifer	U	France
Prairial	R	France
Sylvan	S	UK
Cambria	C	UK
Jesper	J	Denmark
Potomac	P	USA
Juno	N	Canada
Frode	F	Sweden

**BACK**

**Table 3. Results of 45 trials during 4 years: F values in the analysis of variance and Tukey's studentized range tests for the relative palatability values of varieties in each cafeteria trial**

Year, Cutting	Group ¹⁾	Date of cutting and feeding	F values of sources			Abbreviation of variety name ²⁾ (relative palatability value %, letter ³⁾ )			
			Variety(VA)	Heifer pair(HA)	VA×HA				
1991 1st	1	Apr.23	12.90***	1.51	0.06	P (63.4 ^a ),	N (81.2 ^a ),	Y (60.7 ^a ),	A (19.6 ^b )
1991 1st	2	Apr.24	36.61***	0.00	1.75	T (38.2 ^b ),	S (78.9 ^a ),	K (88.3 ^a ),	A (30.7 ^b )
1991 1st	3	Apr.26	51.49***	0.03	3.00*	J (89.2 ^a ),	<b>L (57.6^b)</b> ,	C (30.1 ^c ),	A (30.7 ^c )
1991 2nd	1	May 21	31.14***	5.33*	0.21	P (40.0 ^b ),	N (21.5 ^c ),	Y (79.9 ^a ),	A (63.2 ^a )
1991 2nd	2	May 22	56.91***	0.01	1.58	T (82.0 ^b ),	S (73.2 ^a ),	K (17.7 ^c ),	A (51.3 ^b )
1991 2nd	3	May 23	5.60**	0.64	2.30	J (44.5 ^b ),	<b>L (75.8^a)</b> ,	C (70.5 ^a ),	A (62.7 ^{ab} )
1991 3rd	1	Jun.18	15.37***	0.09	0.94	P (81.4 ^a ),	N (70.4 ^a ),	Y (75.6 ^a ),	A (44.1 ^b )
1991 3rd	2	Jun.19	8.26***	2.06	0.11	T (57.3 ^b ),	S (78.5 ^a ),	K (74.6 ^a ),	A (52.1 ^b )
1991 3rd	3	Jun.21	13.80***	0.52	1.40	J (79.5 ^a ),	<b>L (79.2^a)</b> ,	C (52.5 ^b ),	A (44.5 ^b )
1991 4th	1	Jul.17	12.08***	6.60*	1.11	P (81.1 ^a ),	N (68.5 ^a ),	Y (69.6 ^a ),	A (50.0 ^b )
1991 4th	2	Jul.18	1.31	0.19	2.14	T (62.4 ^a ),	S (67.9 ^a ),	K (65.0 ^a ),	A (57.7 ^a )
1991 4th	3	Jul.19	18.31***	2.63	1.60	J (65.7 ^b ),	<b>L (83.9^a)</b> ,	C (40.3 ^c ),	A (51.2 ^{bc} )
1991 5th	1	Sep.11	17.74***	1.04	0.45	P (43.5 ^{bc} ),	N (55.8 ^b ),	U (79.3 ^a ),	A (33.2 ^c )
1991 5th	2	Sep.12	28.80***	4.25*	1.14	T (87.6 ^a ),	M (52.4 ^c ),	K (69.2 ^b ),	A (34.3 ^d )
1991 5th	3	Sep.13	8.02***	0.85	0.71	J (64.7 ^b ),	<b>L (62.3^a)</b> ,	F (37.8 ^b ),	A (43.4 ^b )
1991 6th	1	Nov.12	13.65***	3.04	1.14	<b>L (85.6^a)</b> ,	R (70.9 ^a ),	C (75.8 ^a ),	A (41.1 ^b )
1991 6th	2	Nov.13	6.74***	0.03	6.44***	T (83.9 ^a ),	S (66.1 ^{ab} ),	M (69.5 ^{ab} ),	A (51.0 ^b )
1991 6th	3	Nov.14	1.40	1.96	1.62	P (61.5 ^a ),	U (74.1 ^a ),	Y (69.9 ^a ),	A (57.0 ^a )
1992 1st	1	Apr.28	22.65***	0.07	0.26	J (67.7 ^a ),	Y (36.9 ^b ),	M (77.0 ^a ),	A (37.7 ^b )
1992 1st	2	Apr.30	25.37***	0.71	0.23	<b>L (76.9^a)</b> ,	R (49.1 ^b ),	S (69.1 ^a ),	A (29.2 ^c )
1992 1st	3	May 1	26.31***	0.21	0.48	P (86.4 ^a ),	T (44.1 ^b ),	C (35.8 ^b ),	A (32.9 ^b )
1992 2nd	1	Jun.2	32.41***	1.89	0.66	J (49.3 ^b ),	Y (38.8 ^b ),	M (46.8 ^b ),	A (84.3 ^a )
1992 2nd	2	Jun.3	192.95***	7.89**	2.98*	<b>L (33.7^b)</b> ,	R (19.8 ^c ),	S (40.8 ^b ),	A (91.0 ^a )
1992 2nd	3	Jun.4	94.26***	0.00	1.87	P (34.9 ^b ),	T (75.7 ^a ),	C (31.6 ^b ),	A (80.7 ^a )
1992 3rd	1	Jul.7	17.58***	0.03	1.73	J (55.2 ^b ),	Y (56.3 ^b ),	M (86.3 ^a ),	A (58.3 ^b )
1992 3rd	2	Jul.8	10.81***	0.15	1.53	<b>L (70.4^a)</b> ,	R (62.9 ^a ),	S (76.8 ^a ),	A (46.4 ^b )
1992 3rd	3	Jul.9	34.95***	3.11	0.99	P (76.5 ^a ),	T (39.7 ^b ),	C (78.7 ^a ),	A (33.5 ^b )
1992 4th	1	Sep.16	42.04***	0.14	5.35**	J (33.3 ^c ),	Y (71.8 ^a ),	M (55.9 ^b ),	A (34.4 ^c )
1992 4th	2	Sep.17	22.07***	0.14	0.19	<b>L (57.4^a)</b> ,	R (33.9 ^b ),	S (48.0 ^a ),	A (31.5 ^b )
1992 4th	3	Sep.18	16.68***	2.29	3.71*	P (41.3 ^b ),	T (51.0 ^{ab} ),	C (58.1 ^a ),	A (25.0 ^c )
1992 5th	1	Nov.17	18.76***	2.51	2.79*	J (37.4 ^b ),	Y (74.5 ^a ),	M (52.6 ^b ),	A (74.9 ^a )
1992 5th	2	Nov.18	11.92***	1.05	1.19	<b>L (80.1^a)</b> ,	R (45.4 ^c ),	S (74.7 ^{ab} ),	A (58.8 ^{bc} )
1992 5th	3	Nov.19	16.55***	0.07	3.21*	P (57.9 ^{bc} ),	T (41.7 ^c ),	C (85.5 ^a ),	A (64.1 ^b )
1993 3rd	1	Jun.29	7.20***	-	-	J (40.1 ^b ),	Y (52.0 ^{ab} ),	M (71.7 ^a ),	A (33.7 ^b )
1993 3rd	2	Jun.30	8.68***	-	-	<b>L (76.6^a)</b> ,	R (76.0 ^a ),	S (52.3 ^b ),	A (55.8 ^b )
1993 3rd	3	Jul.1	14.15***	-	-	P (67.0 ^{ab} ),	T (56.5 ^b ),	C (35.4 ^c ),	A (81.1 ^a )
1993 4th	1	Aug.24	11.60***	11.15**	6.34***	J (48.3 ^{ab} ),	Y (60.2 ^a ),	M (31.8 ^c ),	A (46.4 ^b )
1993 4th	2	Aug.25	21.82***	0.55	6.09**	<b>L (40.5^b)</b> ,	R (33.5 ^{bc} ),	S (24.4 ^c ),	A (59.1 ^a )
1993 4th	3	Aug.26	21.95***	0.80	0.33	P (50.8 ^a ),	T (13.3 ^b ),	C (46.2 ^b ),	A (57.5 ^a )
1993 5th	1	Oct.26	4.37**	0.50	0.38	J (38.5 ^b ),	U (59.8 ^a ),	Y (41.1 ^{ab} ),	A (33.4 ^b )
1993 5th	2	Oct.27	7.65***	0.30	0.84	<b>L (78.6^a)</b> ,	S (52.5 ^b ),	M (52.2 ^b ),	A (44.6 ^b )
1993 5th	3	Oct.28	14.79***	0.03	3.46*	P (73.8 ^a ),	T (29.1 ^b ),	C (73.3 ^a ),	A (48.0 ^b )
1994 3rd	1	Jun.27	1.82	0.23	2.11	J (65.0 ^a ),	Y (71.1 ^a ),	M (63.5 ^a ),	A (56.8 ^a )
1994 3rd	2	Jun.28	5.61**	0.54	1.71	<b>L (77.1^a)</b> ,	R (48.5 ^b ),	S (60.5 ^{ab} ),	A (63.6 ^{ab} )
1994 3rd	3	Jun.29	10.27***	0.87	2.67	P (77.2 ^a ),	T (52.5 ^b ),	C (57.8 ^b ),	A (46.1 ^b )

Relative palatability value was expressed in percentage of intake per diet of the variety within the same variety group.

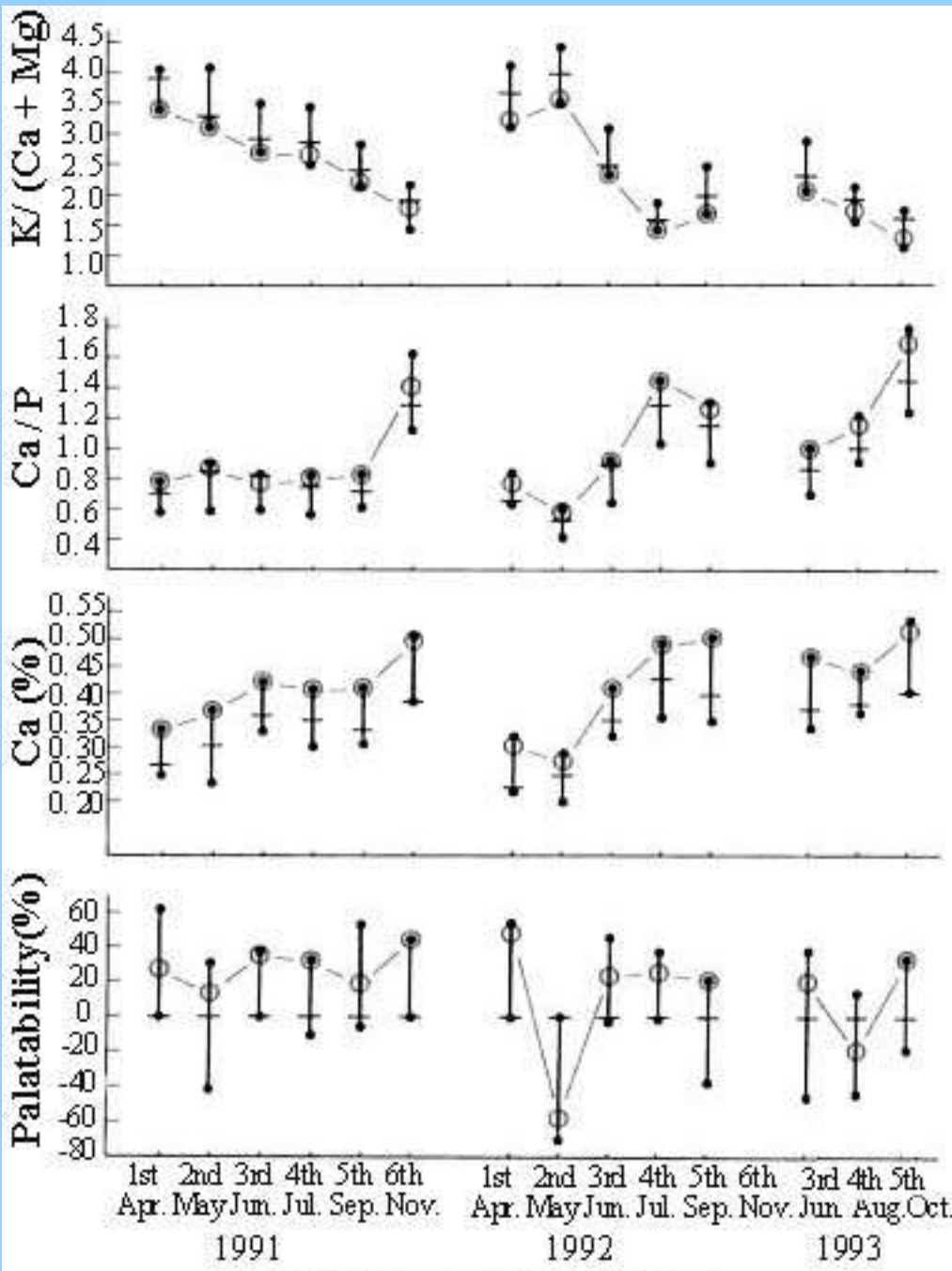
*, **, ***: Significant at 5%, 1% and 0.1% levels, respectively. The values of variety Lude are indicated in bold characters.

1): Different varieties were evaluated in each group. 2): See Table 2.

3): Different letters within the same variety group are significantly different at 5% level.

[BACK](#)





Cutting month and year

- : Maximum value of 10 varieties used.
- : Lude.
- ⊕ : Akimidori.
- : Minimum value of 10 varieties used.

BACK

**Table 4. Characters used for single and/or multiple regressions with palatability**

Number	Character	Scoring method or measuring unit	Abbreviation in Table 5
1.	Degree of heading	(1 to 9 = full)	HED
2.	Degree of booting	(1 = vegetative growth to 5 = first heading)	BOT
3.	Flexibility of leaf and stem	(1 to 9 = flexible)	FLX
4.	Green leaf / whole plant	(% DM)	
5.	Stem / whole plant	(% DM)	
6.	Dead leaf / whole leaf	(% DM)	RDL
7.	Leaf character; width	(mm)	
8.	Leaf character; serration	(1 to 9 = most)	
9.	Leaf character; trichome	(1 to 9 = most)	
10.	Disease; Rhynchosporium scald	(1 to 9 = severe occurrence)	DRS
11.	Disease; rust	(1 to 9 = severe occurrence)	DRT
12.	Disease; summer blight	(1 to 9 = severe occurrence)	
13.	Disease; mosaic	(1 to 9 = severe occurrence)	
14.	Disease; total leaf diseases	(1 to 9 = severe occurrence)	DTL
15.	Fiber character; neutral detergent fiber	(% DM)	NDF
16.	Fiber character; acid detergent fiber	(% DM)	ADF
17.	Fiber character; hemicellulose (NDF-ADF)	(% DM)	HEM
18.	DM Degradability = $a + b(1 - e^{-ct})$ ; a: instantly soluble fraction by buffer solution.	(% DM)	
19.	b: insoluble but potentially degradable fraction by 1% cellulase solution.	(% DM)	
20.	c: rate constant of the degradation of fraction b.	(h ⁻¹ )	
21.	a + b: potential degradability.	(% DM)	Dab
22.	Leaf tension; maximum load	(gf)	TLD
23.	Leaf tension; maximum stretch	(mm)	TST
24.	Leaf compression load	(kgf)	CLD
25.	Electric power consumption by grinding mill for leaf samples	(10 ⁻³ Wh)	GLF
26.	Dynamic viscoelastic measurement; dynamic modulus	(10 ⁹ dyn/cm ² )	VDM
27.	Dynamic viscoelastic measurement; loss tangent	(10 ⁻² )	
28.	Mineral element; N	(% DM)	
29.	Mineral element; P	(% DM)	P
30.	Mineral element; K	(% DM)	K
31.	Mineral element; Mg	(% DM)	Mg
32.	Mineral element; Ca	(% DM)	Ca
33.	Mineral element; Zn	(ppm DM)	

34.	Mineral element; Mn	(ppm DM)	Mn
35.	Mineral element; Cu	(ppm DM)	
36.	Mineral element; Co	(ppm DM)	Co
37.	Free sugar; sucrose	(% DM)	SUC
38.	Free sugar; glucose	(% DM)	GLU
39.	Free sugar; fructose	(% DM)	FRU
40.	Free sugar; total	(% DM)	
41.	Specific volatile compound ^{a)}		

a): Reported by Dohi et al³⁾.

**BACK**

**Table 5. Characters and their contribution ratios due to regression ( $R^2$  or  $r^2$ ) most closely correlated with palatability of 10 varieties used**

Season	Year, Cutting	Character ^{a)}	$R^2$ or $r^2$
Spring	1991 1st	- BOT + FRU	0.712*
		+ P - Mn	0.710*
	1992 1st	- K + TST	0.749**
Heading in spring	1991 2nd	+ Ca	0.933***
		- ADF	0.911***
		+ K	0.832***
		+ FLX	0.817***
	1992 2nd	- HED	0.821***
		- ADF	0.786***
		+ P - ADF	0.893***
	- HED - ADF	0.880***	
Early summer	1991 3rd	+ P - Mn	0.580*
	1991 4th	+ FLX	0.805***
		+ FLX - DRS	0.892***
	1992 3rd	- DRS	0.612**
		- DRS - VDM	0.843**
		- DRS + P	0.781**
	1993 3rd	- CLD	0.637**
		- CLD - HED	0.821**
		+ P - Mn	0.756**
	1994 3rd	- GLU + RDL	0.740**
- FRU + CLD		0.637*	
Late summer	1991 5th	+ N + SUC	0.843**
		- ADF - Mg	0.829**
	1992 4th	+ Ca	0.700**
		+ Ca - GLF	0.965***
		+ Ca - TST	0.868***
	1993 4th	- NDF	0.731**
		+ K	0.616**
		+ K - SUC	0.913***
	+ K + Co	0.877***	
Autumn	1991 6th	+ GLF	0.642**
		- DTL	0.610**
		+ FLX + TLD	0.849**
		- DTL + P	0.774**
	1992 5th	+ P - RDL	0.683*
		+ P - DRT	0.647*
	1993 5th	+ Dab + HEM	0.730*

*, **, ***: Significant at 5%, 1% and 0.1% levels, respectively.

+ : Positive coefficient of correlation.

- : Negative coefficient of correlation.

a): Abbreviations are the same as in Table 4.

BACK

**Table 6. Proposed model for breeding scheme to improve palatability of orchardgrass for 2 regions in Japan**

Adaptation area in Japan	Main breeding materials	Characters to be selected	Stage for selection 1	Stage for selection 2	Stage for selection 3
			5,000 plants → 100 to 200 plants	100 to 200 lines → 5 to 10 lines	5 to 10 lines → 1 to 2 varieties
Cool region (Hokkaido and Tohoku)	Winter-hardy type varieties	1. Palatability ^{a)}	—	—	◎
		2. Flexibility ^{b)}	—	◎	—
		3. Ca concentration	—	◎	—
		4. Digestibility ^{c)}	—	—	○
		5. Winter hardiness	◎	○	—
		6. Disease resistance	◎	○	—
		7. Other agronomic traits ^{d)}	—	◎	○
Warm region (Kanto to Kyushu)	Lude and Japanese varieties	1. Palatability ^{a)}	—	—	◎
		2. Digestibility ^{c)}	—	◎	○
		3. Resistance to summer blight	◎	○	—
		4. Resistance to other diseases	○	—	—
		5. Summer regrowth	◎	○	—
		6. Other agronomic traits ^{e)}	—	◎	○

◎ : Main characters to be selected at the given stage. ○ : Characters to be selected at the given stage.

a): Evaluated by cattle. b): Measured by hand-touching. c): Measured by NIRS or cellulase solution.

d): Including yield and persistency. e): Including yield, persistency and competitive ability with weeds.

**BACK**

# Growth of *Eusideroxylon zwageri* Seedlings and Silvicultural Changes in Logged-Over and Burned Forests of Bukit Soeharto, East Kalimantan, Indonesia

**Yoshiyuki KIYONO*1 and HASTANIAH*2**

*1 Kansai Research Center, Forestry and Forest Products Research Institute  
(Fushimi, Kyoto, 612-0855 Japan)

*2 Tropical Rain Forest Research Center, Mulawarman University  
(P. O. Box 1165, Samarinda, Kal-Tim, 75117 Indonesia)

This paper was produced within the framework of the Tropical Rain Forest Research Project, implemented by Directorate General of Higher Education, Ministry of Education and Culture, Republic Indonesia and Japan International Cooperation Agency (JICA), Japan, during the period from 1992 to 1998. Corresponding author: Y. Kiyono (kiono@fsm.affrc.go.jp, fax +81-075-611-1207)

## Abstract

*Ulin Ulin* (*Eusideroxylon zwageri*) is an ironwood species whose growing stock has decreased due to over-exploitation. *Ulin* trees occur in lowland forests as scattered individuals in Kalimantan and naturally regenerated seedlings are usually restricted in the area near seed parents. They are recruited almost every year although the recruitment rates fluctuate. Seedlings of *Ulin* in a closed rain forest seldom die. However, as they grow slowly, natural regeneration appears to be poor in terms of timber production. Canopy opening and weeding (release cutting) accelerate the seedling growth by improving the light conditions. Release cutting applied to seedlings about 5 years old and  $92 \pm 36$  cm tall in this study enabled to increase seedling growth rates and possibly decrease the time required for the *Ulin* stem to reach 10 cm in dbh (diameter at breast height) from 78 to 26 years. However, sudden felling caused an increase in the death rate of the seedlings. Since seedlings less than 3 years old are sometimes more sensitive to sunlight and dry weather conditions than older seedlings, release cutting should be carried out in the case of 3-year-old seedlings or older. *Ulin* is fire-resistant after becoming large. However, it is still sensitive during small seedling stages. Appropriate release cutting should thus shorten the time required for *Ulin* to become fire-resistant.

Discipline: Forestry and forest products

Additional key words: ironwood, endangered species, regeneration, fire, Borneo

[1...15: References](#)

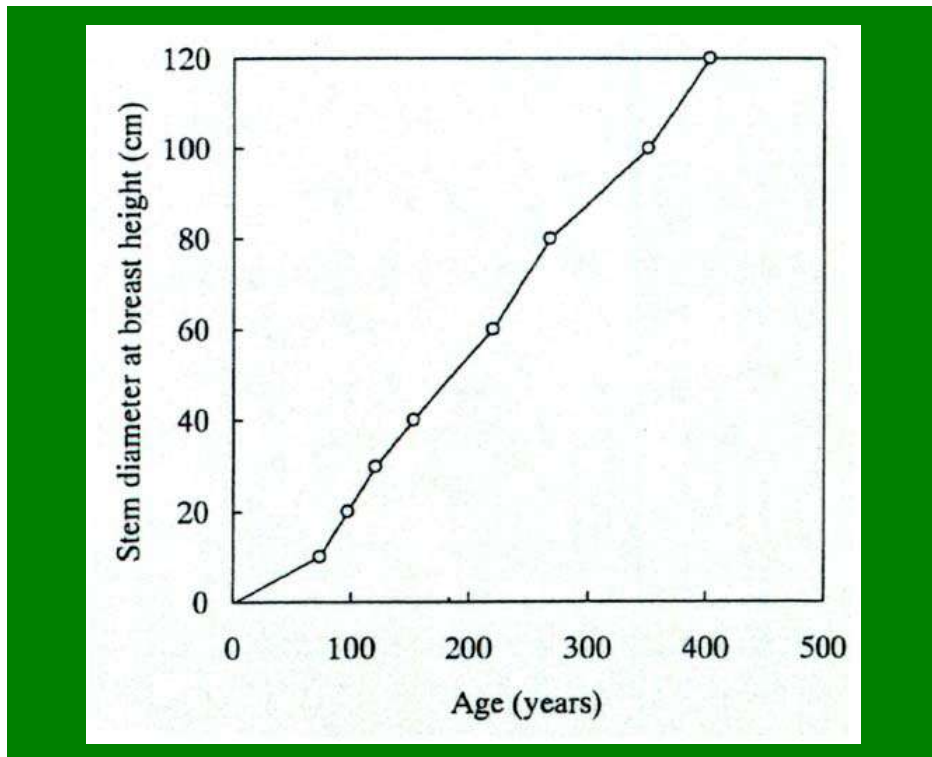
(Received for publication, April 6, 1999)

## Introduction

*Ulin* (Borneo ironwood, *Eusideroxylon zwageri*) is a species of Lauraceae that grows up to 40 m tall. Natural trees are found in South Sumatra, Kalimantan, and on the nearby small islands. In Kalimantan, *Ulin* is common along rivers and adjacent hills, sometimes forming pure stands in primary and secondary forests, up to 500 m altitude, on sandy well-drained soils⁶. In South Sumatra, it forms pure stands on clay-rich soils¹⁴ unlike in East Kalimantan¹⁵.

Since the wood is strong and extremely durable, it is in great demand for heavy construction, roofing, agricultural uses, and others. In Kalimantan, *Ulin* is originally a common species occurring in lowland areas. The original areas of *Ulin* forests in Borneo have been estimated to cover 1,440 km² but presently only about 40% of these areas remains⁸). Along roadways near Bukit Soeharto in East Kalimantan, farmers settled and started pepper farming using *Ulin* support stakes mostly in the 1970s⁷). By the late 1990s, *Ulin* trees with a large diameter were seldom observed in the region. In parts of Kalimantan, this species is already considered to be endangered⁹). The decrease in growing stock is due to exploitation beyond the growth.

In natural forests, *Ulin* grows slowly when its stem diameter at breast height (dbh) is below 10 cm (**Fig. 1**). The growth markedly accelerates when the dbh ranges between 10 and 30 cm. Growth is then reduced to a level intermediate between that of the former stages, and remains steady until the dbh reaches 1 m or more. By following the method of Brown¹), the time required for the *Ulin* stem to reach 30 cm in dbh is estimated at 120 years, and for 120 cm, at 403 years (Fig. 2). It is very easy to accelerate the growth at the initial stages silviculturally. Actually, one individual with a dbh of 6.85 cm (closed circle in Fig. 1) under a canopy gap grew faster than the others in the same diameter class. Appropriate treatment such as release cutting could accelerate the growth of the seedlings and such a silvicultural practice may prevent a decrease in the growing stock of *Ulin*.



**Fig.2**

Estimated stem growth rate of *Eusideroxylon zwageri* in logged-over and burned lowland forests (modified from Hastaniah and Kiyono, 1995⁴)

In the present study, we analyzed the effects of the variations in growing environments such as light on the growth of *Ulin* seedlings in Bukit Soeharto Education Forest (BSEF) in East Kalimantan. Such information could contribute to the improvement of silvicultural practices such as release cutting and enrichment planting to preserve *Ulin* resources in Indonesian forests.



[TOP](#) : [Contents](#)



## References

- 1) Brown, W. H. (1919): Vegetation of Philippine mountains. Manila (quoted from Richards, P. W. (1952): The tropical rain forest; an ecological study. Cambridge UP, New York).
- 2) Endert, F. H. (1937): Verslag van een dienstreis naar Billiton van 25 t/m 30 Augustus 1937 van den Adjunct-Adviseur Dr. F. H. Endert (Unpublished).
- 3) Goldammer, J. G. & Seibert, B. (1990): The impact of droughts and forest fires on tropical lowland rain forest of East Kalimantan. *In* Fire in the tropical biota: Ecosystem processes and global challenges. ed. Goldammer, J. G., Ecological studies 84, Springer-Verlag, 11-31.
- 4) Hastaniah & Kiyono, Y. (1995): Keadaan tempat tumbuh dan pertumbuhan ulin (*Eusideroxylon zwageri*) di hutan dataran rendah Kalimantan Timur. In Proc. PUSREHUT Research Seminar. Trop. Rain Forest Res. Cent., Res. Inst. Univ. Mulawarman, Samarinda, 46-52.
- 5) Jong, B. de (1932): Ervaringen met ijzerhout-culturen. *Tectona*, 25, 37-49.
- 6) Kesser, P. J. A. & Sidiyasa, K. (1994): Trees of the Balikpapan-Samarinda area, East Kalimantan, Indonesia; A manual to 280 selected species. Tropenbos Series 7, The Tropenbos Foundation, Wageningen.
- 7) Kiyono, Y. & Hastaniah (1997): Slash-and-burn agriculture and succeeding vegetation in East Kalimantan. PUSREHUT special publication 6, Univ. Mulawarman, Samarinda.
- 8) MacKinnon, J. & MacKinnon, K. (1986): Review of the protected area system in the Indo-Malayan Realm. IUCN, Gland.
- 9) MacKinnon, K. et al. (1996): The ecology of Kalimantan. Periplus Editions, Singapore.
- 10) Sasaki, S. & Mori, T. (1981): Growth responses of dipterocarp seedlings to light. *Malay For.*, 44, 319-345.
- 11) Tuyt, P. (1939): Schaduwrijen cultuur van ijzerhout in de residentie Palembang. *Tectona*, 32, 805-828.
- 12) Whitmore, T. C. & Burnham, C. P. (1984): Tropical rain forests of the Far East (2nd ed.). Clarendon Press, Oxford.
- 13) Whitmore, T. C. (1998): An introduction to tropical rain forests (2nd ed.). Oxford UP, New York.
- 14) Whitten, A. J. et al. (1987): The ecology of Sumatra (2nd ed.). Gadjah Mada UP, Yogyakarta.
- 15) Witkamp, H. (1925): De ijzerhout als geologische indicator. *Trop. Nat.*, 14, 97-103.

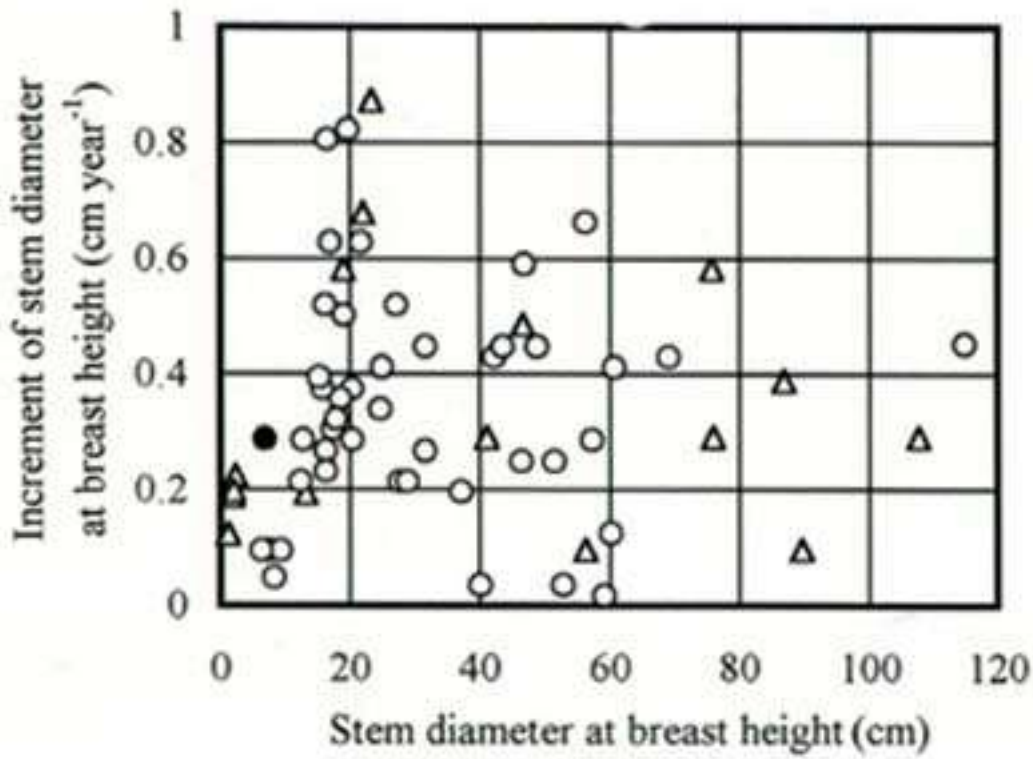


Fig.1. Stem growth at various stages of development of *Eusideroxlon zwageri* in logged-over and burned lowland forests (modified from Hastanish and Kiyono, 1995⁴)

• Trees at Bukit Soeharto.

▲ A tree at Bukit Soeharto, located in an open area in the forest.

▲ Trees at Lempake.

BACK

# Seedling growth in contrasting light environments

## 1) Setting of study sites

The forests of BSEF underwent commercial logging followed by logging and slash-and-burn by local people in the 1970s, then experienced drought and fires in 1982-1983. In 1992, trees more than 50 m tall survived the fires in some areas and among them mostly secondary trees of *Macaranga gigantea* and *Macaranga triloba* were established after the fires³. Fertile trees of *Ulin* partly remained in abundance. Seedlings are usually restricted to areas near seed trees because the fruit is heavy.

The effects of light environments on the seedling growth were examined in 2 experimental plots arranged in seedling banks on a slope with top soils consisting of sandy clay loam-sandy loam in July 1992 (Plots 1 and 2 in [Table 1](#)). Dominant overstory trees included *Ulin*, *Endospermum diadenum*, *Dipterocarpus tempehes*, and other trees. Both plots contained 2 fertile *Ulin* each. The 4 *Ulin* trees, 30-60 cm in dbh, flowered almost every year during the period 1991-1996. Under them were 467 naturally regenerated seedlings in Plot 1 and 190 seedlings in Plot 2 in July 1992. The *Ulin* seedlings were estimated to be mainly derived from the seeds from mast-fruiting around 1988 (Sopiyani, personal communication, 1996). For one plot (Plot 1), a canopy gap covering a 32 x 32 m land area was made and weeding was started in May 1993. Another plot (Plot 2) was used as the control. Based on the differences in the light environments, Plot 1 is referred to as gap site and Plot 2 as closed site.

All the seedlings including recruits in Plots 1 and 2 were labeled and their height, diameter at 0.3 m height, and other characteristics were measured in 1992, 1993, 1994, and 1996. The percentage of canopy opening was determined by hemisphere photographs 4 times in 1993-1996 in Plots 1 and 2. In each plot, top soils were sampled in 1995 and 5 seedlings were sampled in 1996 to determine the amounts of leaves, branches, stems, and roots. Since fresh fine roots of *Ulin* are dumpy, 1.2-2.2 mm in diameter, their surface area was easily measured.

The monthly rainfall at the research station of Bukit Soeharto Education Forest in 1988-1997 averaged  $163 \pm 94$  mm year⁻¹. After July 1992, low monthly rainfall of below 70 mm was observed in July-September and November 1993, in July-September 1994, in June and August-October 1997, and in January-April 1998 at the research station near the plots.

In March 1998, forest fires occurred in BSEF. Although almost all the seedlings were green before the fires, they burned to death, except for some seedlings in Plot 1. In October 1998, all the living seedlings in Plot 1 and some dead seedlings in each plot were selected and their height, diameter, and other characteristics were measured. Since the seedlings that had burned to death were standing with branches and leaves in perfect shape, their height and diameter were considered to correspond to the values recorded in March 1998. For the living seedlings, height and diameter in March 1998 were estimated from the values recorded in March 1996 and October 1998.

## 2) Growth of seedlings depending on changes of light conditions

The death rate of the seedlings at the closed site was 2.8% year⁻¹ ([Table 2](#)). This value is lower than that of red meranti-*Shorea* seedlings of almost the same age recorded in a similar rain forest in Sabah, Borneo

(9.8-16.0% year⁻¹)¹²) and shows that *Ulin* is a shade-tolerant species¹³.

Sudden canopy opening resulted in an increase in the seedling death rate. The death rate at the gap site was about twice as high as the death rate at the closed site (Table 2). For the first 5 months after canopy opening, the highest death rate (12.2% year⁻¹) was recorded ([Table 3](#)). One month after canopy opening, a low rainfall period occurred during 5 months. It is likely that the very high death rate was due to the drought and sun exposure.

The death rate after sudden canopy opening depended on the differences in seedling age. During the low rainfall period of 1994, some cohorts of below-3-year-old seedlings exhibited higher death rates than the older seedlings (Table 3). Jong⁵, Endert², and Tuyt¹¹ also reported that 3- to 8-year-old seedlings grew well when the canopy was open.

Although *Ulin* is considered to be a shade-tolerant species, the seedlings require appropriate canopy opening to grow faster. The seedlings at the gap site displayed higher relative growth rates for height and diameter than the seedlings at the closed site (Table 2). The diameter growth of the tallest 10 seedlings at the gap site averaged 0.389 cm year⁻¹, while that at the closed site was 0.123 cm year⁻¹. Assuming that these diameter growth rates remained unchanged, canopy opening and weeding at the gap site decreased the time required for the *Ulin* stem to reach 10 cm in dbh from 78 to 26 years.

The seedlings grown under strong light conditions developed thick leaves and large root systems. Canopy opening apparently resulted in low humid conditions on the forest floor. At 42 months after gap formation, the total dry mass of the seedlings at the gap site was 5.9 times higher than that at the closed site ([Table 4](#)). The thick roots at the gap site were 2.5 times longer horizontally and 1.7 times deeper than at the closed site. The total leaf area (LA)/fine-root mass ratios of individual seedlings were smaller (0.85 times) at the gap site than at the closed site. On the other hand, the leaf mass/fine-root mass ratios were 1.23 times larger at the gap site than at the closed site. Such morphological characteristics seem to be common for various tree seedlings grown under different light conditions¹⁰.

## **Influence of fire on seedling survival and regeneration**

Relatively large *Ulin* trees display a fire resistance capacity³, and also are less vulnerable to cutting owing to effective sprouting. Of 26 *Ulin* trees with a dbh of 44-92 cm, 24 (92%) sprouted new shoots from stumps in fallow land of slash-and-burn agriculture⁷. The ground fires in March 1998 burned the research sites. All of the 4 *Ulin* mother trees (30-60 cm in dbh) at the closed and gap sites survived the fires, whereas, only 30 (7.6%) seedlings at the gap site survived the fires. The vulnerability to the fires was higher in the case of smaller seedlings than in larger ones at the gap site. After the fire events at the gap site, the survivors were 302 ± 90 cm tall with a diameter of 2.37 ± 0.83 cm at 0.3 m height, while the dead seedlings at the gap site were 208 ± 73 cm tall with a diameter of 1.52 ± 0.77 cm. Considering that all the seedlings (110 ± 55 cm tall with a diameter of 0.90 ± 0.40 cm) died at the closed site, release cutting prevented some *Ulin* seedlings from burning to death.

**NEXT**

[: Nitrogen Fixation by Algae in a Tropical Seagrass Bed](#)

**TOP**

[: Contents](#)

**HOME**

[: JIRCAS Home Page](#)

**Table 1. General description of the research plots**

Plot	Land area (m ² )	Overstory	Canopy openness ^{a)} (%)				Weeding (times)
			May 1993	Dec. 1993	Aug. 1994	Nov. 1996	
1	484	Canopy gap	9.6	19.3	14.2	11.0	5 ^{b)}
2	484	Closed	2.6	6.0	0.8	0.8	0

a): By hemisphere photographs.      b): In 1993–1996.

**BACK**

**Table 2. Growth of *Eusideroxylon zwageri* seedlings in 1993 – 1996**

Plot	Age ^{a)} (years)	Mean height ^{a)} (cm)	Height growth rate (cm cm ⁻¹ year ⁻¹ )	Diameter growth rate (cm cm ⁻¹ year ⁻¹ )	Death rate (% year ⁻¹ )
1 (gap site)	About 5	92 ± 36	1.210	1.228	5.7
2 (closed site)	About 5	85 ± 30	1.080	1.084	2.8

a): In 1993.

**BACK**

**Table 3. Changes in survival rates in each cohort of *Eusideroxylon zwageri* seedlings at (a) gap site (Plot 1), (b) closed site (Plot 2)**

<b>(a)</b>							
Period of recruitment		Before	July 1992–	May 1993–	Dec. 1993–	Aug. 1994–	Jan. 1995–
		July 1992	May 1993	Dec. 1993	Aug. 1994	Jan. 1995	Mar. 1996
Months			10	7	8	5	14
Number of recruits/484m ²		476	6	3	14	2	4
Death rate		July 1992–May 1993	2.8(465)				
(% year ⁻¹ )		May–Dec. 1993	12.2(431)	27(5)			
(Number of survivors		Dec. 1993–Aug. 1994	3.8(420)	54(3)	0(3)		
at the end of each period)		Aug. 1994–Jan. 1995	7.3(407)	62(2)	0(3)	55(10)	
		Jan. 1995–Mar. 1996	2.7(394)	0(2)	0(3)	0(10)	0(2)
		Mar. 1996–Oct. 1998 ^{a)}	63.1(30)	100(0)	100(0)	100(0)	100(0)
<b>(b)</b>							
Period of recruitment		Before	July 1992–	May 1993–	Dec. 1993–	Aug. 1994–	Jan. 1995–
		July 1992	May 1993	Dec. 1993	Aug. 1994	Jan. 1995	Mar. 1996
Months			10	7	8	5	14
Number of recruits/484 m ²		190	5	7	5	0	2
Death rate		July 1992–May 1993	2.5(186)				
(% year ⁻¹ )		May–Dec. 1993	2.7(183)	0(5)			
(Number of survivors		Dec. 1993–Aug. 1994	4.1(178)	28(4)	40(5)		
at the end of each period)		Aug. 1994–Jan. 1995	1.3(177)	50(3)	42(4)	89(2)	
		Jan. 1995–Mar. 1996	2.9(171)	0(3)	22(3)	0(2)	
		Mar. 1996–Oct. 1998 ^{a)}	100 (0)	100(0)	100(0)	100(0)	100(0)

a): The fires occurred in March 1998. Before the drought in 1997 – 1998, low monthly rainfall of below 70 mm was observed in July-September and November 1993 and in July-September 1994 at the research station near the plots.

**BACK**



**Table 4. Organs of *Eusideroxylon zwageri* seedlings in November 1996**

Plot	Mean height (cm)	Total mass (g)	Leaves		Fine roots		LA/fine-root mass (m ² g ⁻¹ )	Thick root ranges	
			SLA ^{a)} (cm ² g ⁻¹ )	LA ^{b)} (m ² )	Mass (g)	Surface area (m ² )		Horizontal spread (cm)	Under-ground (cm)
1 (gap site)	174	769	86.5	1.34	23.5	18.9	0.0570	116	77
2 (closed site)	110	130	126	0.265	3.95	2.70	0.0671	35	36

All data are mean values of 5 seedlings. a): Leaf area/mass. b): Total leaf area.

**BACK**

# Nitrogen Fixation Activity by Periphytic Blue-Green Algae in a Seagrass Bed on the Great Barrier Reef

**Hitoshi IIZUMI*1 and Masumi YAMAMURO*2**

*1 Subarctic Oceanography Division, Hokkaido National Fisheries Research Institute  
(Kushiro, Hokkaido, 085-0802 Japan)

*2 Geological Survey of Japan, Agency of Industrial Science and Technology  
(Tsukuba, Ibaraki, 305-8567 Japan)

Corresponding author: H. Iizumi (hiizumi@hnf.affrc.go.jp, fax +81-154-91-9355)

## Abstract

Acetylene reduction activity, an index of nitrogen fixation, by epiphytic and epibenthic algae and coral debris was measured in seagrass beds around Green Island, Australia. Epiphytic blue-green algae showed a high activity, ranging from  $56.1 \pm 31.9$  to  $729 \pm 105$   $\mu\text{mol (g chl a)}^{-1} \text{d}^{-1}$  on a chlorophyll basis, or  $3.9 \frac{1}{4} \text{mol N}_2 \text{ m}^{-2} \text{ d}^{-1}$  to  $16 \text{ mol N}_2 \text{ m}^{-2} \text{ d}^{-1}$  on an areal basis. The activities on an areal basis were comparable to those reported in a Fijian seagrass bed, whereas activities on a chlorophyll basis were higher on Green Island than on Fiji. A relatively high activity was observed on the leeward side of the island, partly due to the high seagrass biomass and partly due to the high epiphyte biomass. This trend of high activity on the leeward side of the island suggested that the biomass and/or activity of nitrogen fixing blue-green algae could be affected by unknown mechanism(s) related to the island environment. Algae on (or in) coral debris, which were abundant around live corals, were able to reduce acetylene.

Discipline: Fisheries / Environment

Additional key words: acetylene reduction, stable isotope ratio

1...23): [References](#)

(Received for publication, March 18, 1999)

## Introduction

Seagrass beds in coastal waters in the tropics are among the most productive ecosystems¹⁾, although they are often washed with nutrient poor waters²⁰⁾. From seagrass beds, there are inevitable losses of nutrients by export of detached leaves, exudates, leaching, grazing¹⁴⁾, etc. To compensate for those losses, nutrients should be supplied, and the supply sometimes limits the production of dominant producers in seagrass beds, e.i. seagrasses themselves for nitrogen⁶⁾ or for phosphorus^{7,17)}.

In a Fijian seagrass bed, atomic ratio of nitrogen to phosphorus of nutrients in a water column ranged from 2.5 to 4.7, values which are lower than those of seagrasses (7.9 ~ 49) and epiphytes (87 ~ 102)²⁰⁾, suggesting that nitrogen might be the limiting nutrient for the primary producers in tropical seagrass beds. As tropical seagrasses take up nutrients mainly from sediments where nutrient concentrations are

relatively high, nitrogen supply to the sediments has been a main target of interest, and belowground nitrogen fixation has been investigated^{4,13,15}). However, in tropical coral reefs and seagrass beds, nitrogen-fixing blue-green algae commonly occur on reef sediments or seagrass shoots^{3,8,11,21,22}). In a Papuan seagrass bed, nitrogen fixation (acetylene reduction) activity was detected on the surface of almost every object at the bottom including seagrasses, shells, detrital leaves, etc.⁹). In a Fijian *Syringodium*-dominated bed, a nitrogen-fixing blue-green alga, *Hydrocoleum cantharidosmum* (Mont) Gom (= *Microcoleus lyngbyaceus* (Kutzing) Crouan, *sensu* Drouet), formed tuft-shape colonies on leaves, showing that the magnitude of nitrogen fixation was in the same order as that of nitrogen requirement for seagrass production¹⁰). Nitrogen fixed in the aboveground parts of seagrass beds are likely to be cycled through detrital microbial chains in water columns or sediments and utilized by primary producers.

In a seagrass bed on a lagoonal reef around Green Island on the Great Barrier Reef, Australia, spatial variability of nitrogen fixation (acetylene reduction) by blue-green algae was investigated to examine the significance of nitrogen fixation on a coral cay.

[NEXT](#)

[TOP](#) : [Contents](#)

## References

- 1) Aioi, K. & Polard, P. C. (1991): Estimation of growth and production of *Syringodium isoetifolium* in a Fijian seagrass bed. *In* Developmental processes and material flow in tropical seagrass beds. ed. Koike, I., 62-82.
- 2) Baxter, I. N. (1990): Green Island information review. A report to the Great Barrier Reef Marine Park Authority. *Res. publ. no. 25*, pp.78.
- 3) Capone, D. G. & Taylor, B. F. (1977): Nitrogen fixation (acetylene reduction) in the phyllosphere of *Thalassia testudinum*. *Mar. Biol.*, 40, 19-28.
- 4) Capone, D. G. et al. (1979): Relationship between productivity and N₂ (C₂H₂) fixation in a *Thalassia testudinum* community. *Limnol. Oceanogr.*, 2, 117 - 125.
- 5) Crossland, C. J. & Barnes, D. J. (1976): Acetylene reduction by coral skeletons. *Limnol. Oceanogr.*, 21, 153-156.
- 6) Fouereurean, J. W., Zieman, J. C. & Powel, G.V.N. (1992a): Relationships between porewater nutrients and seagrasses in a subtropical carbonate environment. *Mar. Biol.*, 14, 57-63.
- 7) Fouereurean, J. W., Zieman, J. C. & Powel, G. V. N. (1992b): Phosphorus limitation of primary production in Florida Bay; evidence from C:N:P ratio of the dominant seagrass *Thalassia testudinum*. *Limnol. Oceanogr.*, 37, 162-171.
- 8) Goering, J. J. & Parker, P. L. (1972): Nitrogen fixation by epiphytes on seagrasses. *Limnol. Oceanogr.* 17, 320-323.
- 9) Iizumi, H. (1992): Acetylene reducing activity at a tropical seagrass bed in Papua New Guinea. *J. Oceanogr. Soc. Jpn.*, 48, 377-384.
- 10) Iizumi, H. (1994): Nitrogen fixation, a nitrogen input to a tropical seagrass bed. *In* Developmental processes and material flow in tropical seagrass beds, 2nd phase. eds. Koike, I. & Mukai, H., 31-39.
- 11) Iizumi, H., Nakahara, H. & Umezaki, I. (1990): Nitrogen fixing blue-green algae at a coral reef. *Jpn. J. Phycol.*, 38, 69-70.
- 12) Miyajima, T. et al. (1998): Accumulation and transport of seagrass-derived organic matter in reef flat sediment of Green Island, Great Barrier Reef. *Mar. Ecol. Prog. Ser.*, 175, 251-259.
- 13) Moriarty, D. J. W. & O'Donohue, M. J. (1993): Nitrogen fixation in seagrass communities during summer in the Gulf of Carpentaria, Australia. *Aust. J. Mar. Freshwater Res.*, 44, 117-125.
- 14) Nojima, S. (1994): Grazing effect of *Caltomus spinidens* on defoliation of the seagrass, *Syringodium isoetifolium*, in a Fijian seagrass bed. *In* Developmental processes and material flow in tropical seagrass beds, 2nd phase. eds. Koike, I. & Mukai, H., 130-144.
- 15) Patriquin, D. & Knowles, R. (1972): Nitrogen fixation in the rhizosphere of marine angiosperms. *Mar. Biol.*, 16, 49-58.
- 16) Peterson, R. B. & Burris, R. H. (1976): Conversion of acetylene reduction rates to nitrogen fixation rates in natural populations of blue-green algae. *Anal. Biochem.*, 73, 404-410.
- 17) Short, F. T., Dennison, W. C. & Capone, D. G. (1990): Phosphorus-limited growth of the tropical seagrass *Syringodium filiforme* in carbonate sediments. *Mar. Ecol. Prog. Ser.*, 62, 169-174.
- 18) Stewart, W. D. P., Fitzgerald, G. P. & Burris, R. H. (1976): In situ studies on N₂-fixation using the acetylene

reduction technique. *Proc. Natl. Acad. Sci. USA*, 58, 2071-2078.

19) Suzuki, R. & Ishimaru, T. (1990): An improved method for the determination of phytoplankton chlorophyll using N,N-dimethylformamide. *J. Oceanogr. Soc. Jpn.*, 46, 190-194.

20) Yamamuro, M., Koike, I. & Iizumi, H. (1993): Partitioning of the nitrogen stock in the vicinity of a Fijian seagrass bed dominated by *Syringodium isoetifolium* (Ascherson) Dandy. *Aust. J. Mar. Freshwater Res.*, 44, 101-115.

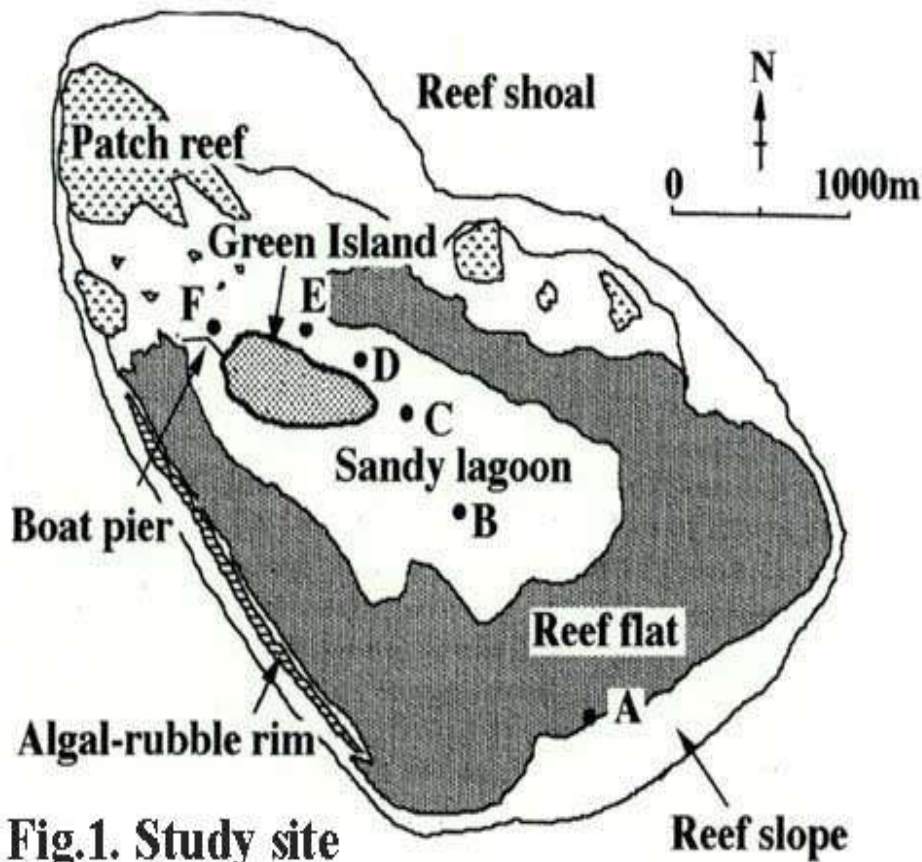
21) Yamamuro, M., Kayanne, H. & Minagawa, M. (1995): Carbon and nitrogen stable isotopes of primary producers in coral reef ecosystems. *Limnol. Oceanogr.*, 40, 617-621.

22) Wiebe, W. J., Johannes, R. E. & Web, K. L. (1975): Nitrogen fixation in a coral reef community. *Science*, 188, 257-259.

23) Wilkinson, C. R. & Sammarco, P. W. (1983): Effects of fish grazing and damselfish territoriality on coral reef algae. II. Nitrogen fixation. *Mar. Ecol. Prog. Ser.*, 13, 15-19.

# Materials and methods

## 1) Study site



**Fig.1. Study site**

Green Island (16°46'S., 145°58'E.) is a coral cay (ca. 4 km in long axis and ca. 2 km in short axis), ca. 27 km offshore from Cairns, Australia (Fig. 1). A lagoonal platform or planar reef has developed around the island²⁾, with a wider area on the windward sides (eastern and southern) of the island than on leeward sides. Several species of seagrasses (*Thalassia hemprichii*, *Cymodocea serrulata*, *Cymodocea rotundata*, *Halodule uninervis*, *Syringodium isoetifolium* and *Halophila ovalis*) formed meadows in the lagoon (Lee Long, W., personal communication). Dense patches were observed on the leeward side of the island, while sparse seagrass patches were scattered all over in the sandy lagoon. Six stations

(A, B, C, D, E, F) were set up in the lagoon along the water current over the reef (from SE to NW), namely Stn. A on the windward edge of the lagoon, ca. 1.7 km SSE of the island, and Stn. F on the leeward side, ca. 100 m NW of the island. Water depth at all the stations was shallow at low tide, less than 30 cm, except for that at Stn. F, which was ca. 3 m.

## 2) Acetylene reduction assay

Acetylene reduction activity was measured to estimate the nitrogen fixation activity¹⁸⁾. Samples consisted of intact leaves with epiphytes, epiphytes that were scraped from leaves with a razor blade, epibenthic algal mats that were carefully peeled from the sediment and cut into rectangles, and coral debris. Samples were put in plastic containers (80 or 230 mL in volume), together with GF/F glassfiber-filtered seawater so as to leave 40 or 110 mL of headspace. Acetylene was injected into the headspace through a rubber septum on the lid of the container. Final concentration of acetylene was 10 to 15% (v/v). Containers were incubated in an outdoor tank for one day. Ethylene concentration in the headspace was analyzed with an ethylene analyzer (GC-2, Kiya Seisakusho Co.). In situ temperature and irradiance were monitored at 10 min intervals with temperature and irradiance recorders (MDS-T, MDS-L, Alec Electronic Co.). Temperature in the tank, which was 22~27°C, was ca. 1°C higher than that in the field. Irradiance in the tank was 60% of in situ irradiance at Stn. E.

## 3) Isotope ratio analysis of blue-green algae

The entangled visible materials other than blue-green algae were removed with a pair of pincettes under a binocular microscope. After being freeze-dried, the organisms were powdered and homogenized by using

an agate mortar and pestle. To determine the stable isotope ratios, organisms were combusted at 1,050°C in a CN analyzer (Fisons Instruments EA1108), and the combustion products (N₂ gas) were introduced into an isotope-ratio mass spectrometer (Finigan Mat 252) in a continuous flow of He carrier. Isotope ratios were expressed as the deviation from a standard represented by the following equation:

$$\delta^{15}\text{N}(\text{‰}) = \{R(\text{sample})/R(\text{standard}) - 1\} \times 1000, \text{ where } R = {}^{15}\text{N}/{}^{14}\text{N}, \text{ standard} = \text{N}_2 \text{ in air.}$$

#### 4) Biomass

At each station, 3 quadrates (50 x 50 or 10 x 10 cm) were set up and seagrasses above the sediment were harvested. Samples were dried at ca. 60°C for dry weight measurement. Chlorophyll a content of epiphytes was analyzed fluorometrically after extraction with N,N-dimethylformamide¹⁹).

## Results and discussion

Seagrasses were widely observed on the reef ([Fig. 2](#)). At Stn. A, *T. hemprichii* formed sparse patches in sand pockets on reef flats. As the quadrates were placed on these patches, the biomass shown in the figure corresponded to that in the patches. Total aboveground bio-mass values were  $3.5 \pm 0.8$ ,  $63.4 \pm 72.9$ ,  $98.9 \pm 35.3$ ,  $42.6 \pm 5.6$ ,  $96.7 \pm 24.6$ , and  $55.2 \pm 16.0$  g m⁻² at Stns. A, B, C, D, E, and F, respectively. As shown by standard errors, the distribution of each seagrass was patchy, but seagrass beds, irrespective of their species composition, developed on the sandy lagoon around the island. This finding indicates that substrata to which surface epiphytes could become attached were commonly distributed on the reef, except on the windward edge of the reef.

Intact seagrass leaves showed a high acetylene reduction activity ([Table 1](#)). As young leaves, which accumulated few epiphytes, did not show any activity (data not shown), epiphytes were assumed to be responsible for the activity⁹). It was observed that a blue-green alga, *H. catharidosmum*, was the dominant alga, forming tufts on leaves of seagrasses, as observed in a Fijian seagrass bed¹⁰).

One-way analysis of variance (ANOVA) of the activity on a chlorophyll basis indicated that the activity of the epiphytes at Stn. C was significantly ( $p < 0.01$ ) higher compared with that of the epiphytes at other stations (Stns. B, E and F). It was observed that the concentrations of particulate organic carbon and nitrogen in seawater tended to increase when the seawater flowed around the island from Stns. A to F¹²). Concentrations of dissolved inorganic nitrogen and phosphorus in pore water of the sediments were higher in the seagrass beds than in unvegetated areas¹²), suggesting that the supply of nutrients for epiphytic algae could be more abundant at Stns. C to F than at Stns. A and B ([Fig. 2](#)). Nitrogenous and phosphorous nutrients recycled from organic matter which were supplied from seagrasses or transported from other areas and trapped in the seagrass beds may be an important source of nutrients for epiphytic algal communities. However, the low isotopic ratios of algal nitrogen suggested that nitrogen fixation is the main source of nitrogen for these algae ([Table 2](#)).

The same epiphytic algae with a tuft shape (*H. catharidosmum* was the dominant alga) were found to fix nitrogen in a Fijian seagrass bed¹⁰). Acetylene-reducing activity by the epiphytes was  $25.2 \pm 0.75$  mmol reduced (g chl a)⁻¹ d⁻¹. Epiphytes in seagrass beds on Green Island showed a higher reduction activity

than that in Fijian seagrass beds. The difference might be due to the grazing effect. A cage experiment on a coral reef on the Great Barrier Reef indicated that fish grazing reduces algal biomass and leads to the shift of the epiphytic community from red algae to rapidly colonizing and growing blue-green algae in a year²³). Though data on fish grazing or fish biomass at our study site were not available, fish were apparently abundant on Green Island whose environment is protected for a marine park. Instead, local people are fishing in the Fijian seagrass beds. Even if the dominant alga is the same, fish grazing is likely to improve microenvironments of light and/or nutrients on the leaf surface and stimulate the turnover of algae, hence the enhancement of the nitrogen fixation ability.

Acetylene reduction activity on an areal basis was higher on the leeward side than on the windward side ([Fig. 3](#)), partly due to the larger seagrass biomass on the leeward side, or to the larger abundance of nitrogen-fixing algae on seagrass leaves. *Thalassia hemprichii* on the eastern (windward) edge of the reef accumulated fewer epiphytes. This distribution of the nitrogen fixation activity around the island suggests that the biomass of epiphytic and epibenthic blue-green algae is controlled by factor(s) other than nitrogen supply through nitrogen fixation. Supply of nutrients from the island or mechanisms other than nutrient supply could enhance the production of epiphytes on seagrass leaves, resulting in the increase of nitrogen fixation. After seagrasses started to thrive since the construction of a resort on the northwestern side of the island (Lee Long, W., personal communication), the biomass and nitrogen fixation activity of epiphytes may have increased. Further studies should be carried out to analyze the effect of the island environment on nitrogen fixation around the island.

Nitrogen fixation activity was estimated to be  $3.9 \frac{1}{4} \text{mol N}_2 \text{ m}^{-2} \text{ d}^{-1}$  at Stn. A and  $16 \text{ mmol N}_2 \text{ m}^{-2} \text{ d}^{-1}$  at Stn. F, assuming that the  $\text{C}_2\text{H}_2/\text{N}_2$  conversion factor is 4.4¹⁶). The average activity at all the stations ( $5.2 \text{ mmol N}_2 \text{ m}^{-2} \text{ d}^{-1}$  or  $145 \text{ mg N m}^{-2} \text{ d}^{-1}$ ) was comparable to the rate estimated in a Fijian seagrass bed ( $113 \text{ mg N m}^{-2} \text{ d}^{-1}$ )¹⁰). However, these activities were larger by 2 to 3 orders of magnitude than those reported in seagrass beds at Weipa and Groote Eylandt in northern Australia¹⁴), for unknown reasons.

Coral debris displayed an acetylene reduction activity (Table 1). It remains to be determined whether the activity was related to algae on the surface of the samples or algae penetrating into the skeleton of corals⁵). Dead corals play an important role in supplying a support for nitrogen-fixing organisms and in enhancing nitrogen import to the ecosystem.

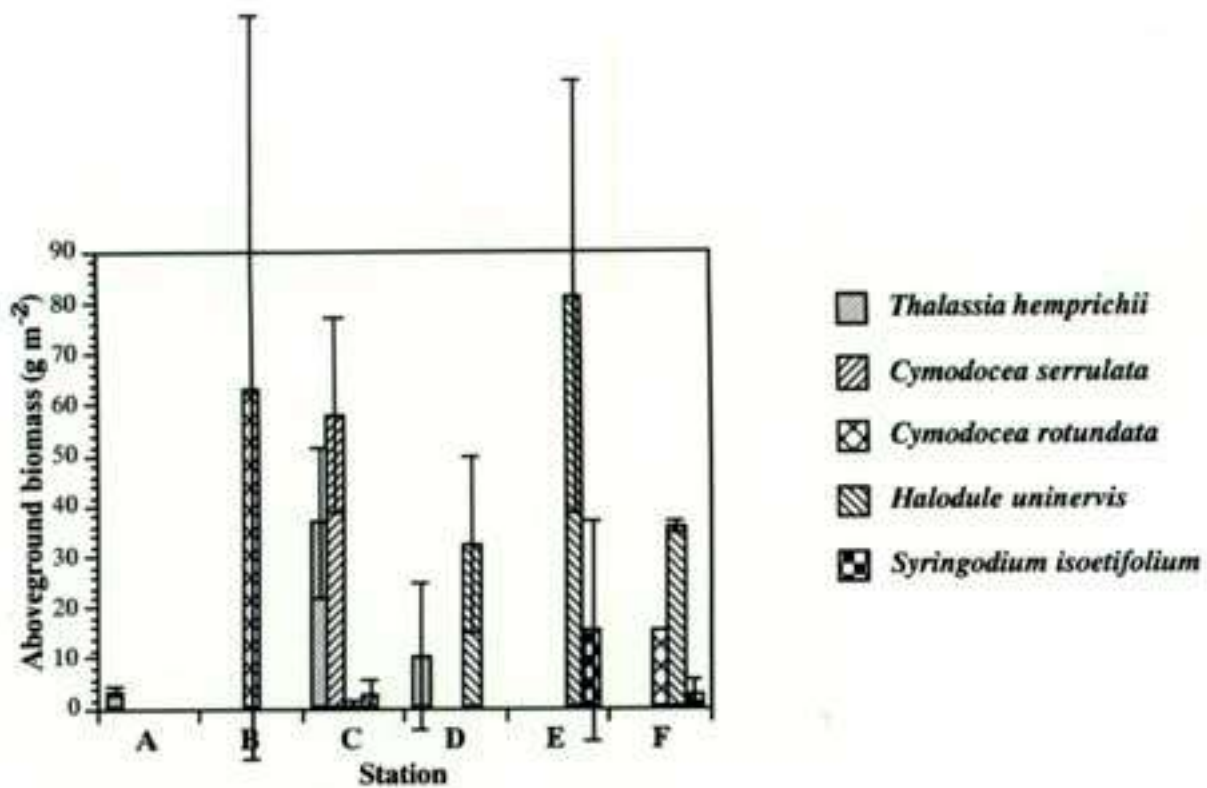
**NEXT**

[: Age Estimation of Oceanic Squids Based on Statolith Microstructure](#)

**TOP**

[: Contents](#)  [: JIRCAS Home Page](#)





BACK

**Table 1. Acetylene reduction activity by epiphytic algae and coral debris in seagrass beds around Green Island**

	Station	Acetylene reduction rate (mean $\pm$ s.e.)	Unit
Intact leaves	A	17.2 $\pm$ 9.54	$\mu\text{mol m}^{-2}\text{d}^{-1}$
	B	73.7 $\pm$ 41.5	
Epiphytes	B	56.1 $\pm$ 31.9	$\text{mmol (g chl a)}^{-1} \text{d}^{-1}$
	C	729 $\pm$ 105	
	D	nd ^{a)}	
	E	143 $\pm$ 1.7	
	F	234 $\pm$ 42.4	
Epibenthic algal mat	E	325 $\pm$ 82.5	$\mu\text{mol g}^{-1}\text{d}^{-1}$
	Southern reef	11.6 ^{b)}	
Coral debris	E	0.28 $\pm$ 0.08	

a) : Not determined. b) : Single determination.

**BACK**

**Table 2. Stable isotope ratio of organic nitrogen in algae on Green Island**

	$\delta^{15}\text{N}$ (‰), mean $\pm$ s.e.
Epiphytes on <i>Thalassia hemprichii</i>	$-0.73 \pm 0.03$
Filamentous algae on a dead macrophyte	$-1.11 \pm 0.02$
Epibenthic algae	$-0.79 \pm 0.1$

$\delta^{15}\text{N}(\text{‰}) = \{R(\text{sample})/R(\text{standard}) - 1\} \times 1000$ , where  $R = {}^{15}\text{N}/{}^{14}\text{N}$ , standard =  $\text{N}_2$  in air.  
All the samples were collected at Stns. E and F.

**BACK**

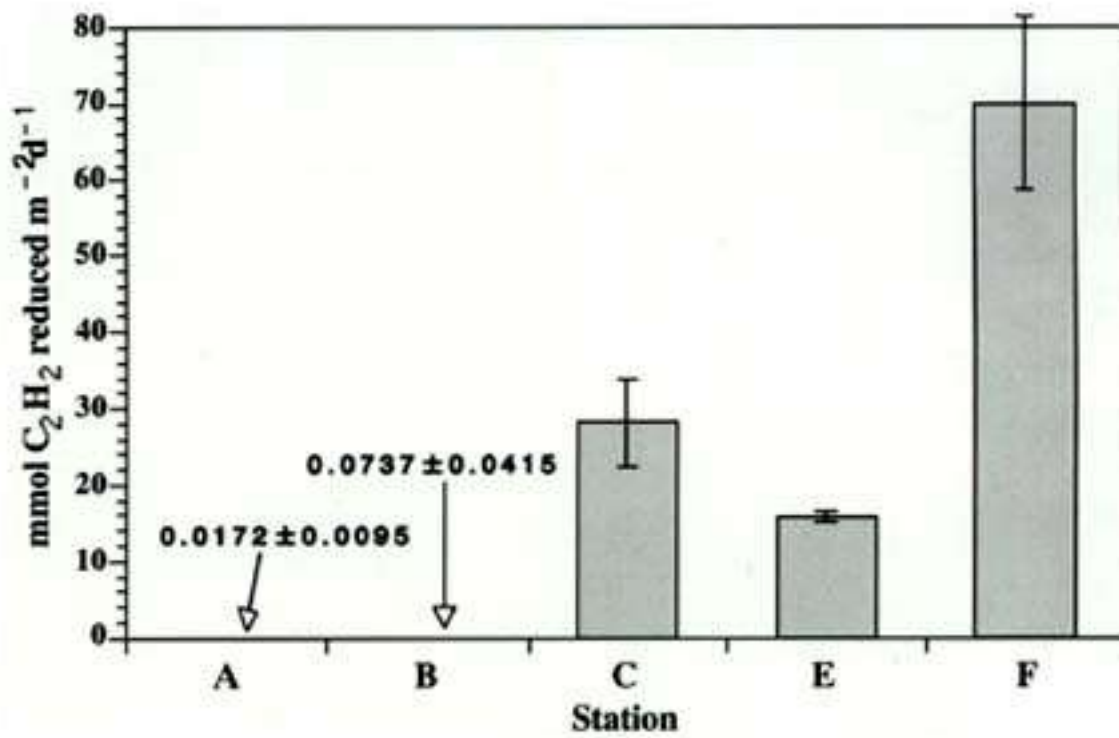


Fig.3. Acetylene reduction activity by epiphytic algae in seagrass beds around Green Island

Acetylene reduction by epibenthic algae is not included.

**BACK**

# Age Estimation of Four Oceanic Squids, *Ommastrephes bartramii*, *Dosidicus gigas*, *Sthenoteuthis oualaniensis*, and *Illex argentinus* (Cephalopoda, Ommastrephidae) Based on Statolith Microstructure

**Akihiko YATSU***

Oceanic Resources Division, National Research Institute of Far Seas Fisheries  
(Orido 5-7-1, Shimizu, Shizuoka, 424-8633 Japan)

Present address:

*Marine Bioecology Division, National Research Institute of Fisheries Science  
(Fukuoka, Kanazawa, Yokohama, 236-8648 Japan)

Corresponding author: A. Yatsu (yatsua@nrifs.affrc.go.jp, fax +81-45-788-5001)

## Abstract

Statolith preparation and observation methods adopted in Japan were reviewed for 4 ommastrephid squids, *Ommastrephes bartramii*, *Dosidicus gigas*, *Sthenoteuthis oualaniensis*, and *Illex argentinus*. Relationships between mantle length and age were exponential at the early life stages and almost linear at the subadult and adult stages.

Discipline: Fisheries

Additional key words: growth

[1...20](#): [References](#)

(Received for publication, January 14, 1999)

## Introduction

The flying squid family Ommastrephidae is an important component in the marine ecosystem and has been targeted by commercial fisheries in many coastal and pelagic waters of the world. *Todarodes pacificus*, *Illex argentinus*, *Ommastrephes bartramii* and *Dosidicus gigas* are major species accounting for about 50% of the world cephalopod catches which amounted to approximately 2.8 million t year⁻¹ during the early 1990s¹. Since most of these ommastrephid squids have a one-year life cycle, and are usually composed of several seasonal cohorts¹¹, it is essential for sustainable use of these stocks to determine their age, hatching date, and growth⁶. Until the late 1980s, growth of squids had been studied by using consecutive series of mantle length frequency distributions. Length-based methods, however, are generally inappropriate for fast-growing and highly migratory squids^{6,12}. Statolith microstructure is useful for age determination of squids as are otoliths in teleost fishes, and direct or indirect validation studies revealed daily deposition of increments in squids^{11,15}. Therefore, recent studies on squid growth are mostly relying on statolith daily increments, with a few exceptions where *gladius* were used. The purpose of this report is to describe (1) preparation methods of statoliths that have been adopted for age

determination in Japanese fisheries research institutes and (2) growth of 4 species targeted by international fisheries.

## Structure of statolith

Statoliths are mainly composed of calcium carbonate in the crystal form of aragonite and are located in statocysts in the cartilaginous cranium^{7,15}. A squid statolith consists of a dorsal dome, lateral dome, rostrum and wing (**Fig. 1**). Posterior plane of a statolith is convex, and anterior plane is slightly concave. Anterior surface of the wing is attached to the statocyst wall via connective tissue. Growth increments, with a 3-dimensional structure, are deposited from the core (nucleus) of a statolith.

## Statolith preparation

In order to extract a pair of statoliths from a squid, cartilaginous cranium was sectioned along a transverse plane in the center of the statocysts from the ventral side of the cranium with a small knife. Then, each statolith was extracted from a statocyst with fine forceps, cleaned with ethanol, and deposited in a pit (ca. 7 mm in diameter) of plastic trays, "microplate", which had been filled with liquid paraffin. After removal of liquid paraffin with xylene and ethanol, statoliths were suitable for preparation. Daily increments were observed in 4 different ways. Details of the preparation methods were described in previous reports^{5,8,13}.

### 1) Scanning electron microscopy (SEM)

Each statolith was mounted individually in a small mold with epoxy. After hardening, the epoxy block was removed from the mold, attached to a glass slide with the medial (wing) side up and ground on a longitudinal plane until the core was exposed (Figs. 1-3). Fine-grained carbon carbide (1500-grade) waterproof paper was used for grinding and statoliths were polished with 0.3  $\mu$ m alumina powder. Statoliths were etched with 1% HCl for 150 seconds and coated with gold for SEM observation at 15 kV.

### 2) Light microscopy (LM)

In order to enhance the contrast of increments, statoliths were heated in small glass tubes filled with silicone oil at about 190°C for 24 h. Then, silicone oil was removed with xylene and ethanol. Heating was not necessary for *I. argentinus* and small individuals (< 300 mm ML) of *O. bartramii*.

#### (1) Longitudinal sectioning

After the core of a statolith was exposed in a similar way for SEM observation, the epoxy block was detached from the glass slide, attached to a glass slide with the lateral side up, and ground again to the level immediately above the core. This method had been applied for *Ommastrephes bartramii*¹⁸ and *Dosidicus gigas*.

#### (2) Polishing of posterior plane

Each statolith was mounted on a glass slide with super glue or Eukitt with the posterior (convex) plane up. The posterior plane of the statoliths was slightly ground with fine-grained carbon carbide waterproof paper, and polished with 0.3  $\mu$ m alumina powder. This method had been used for *Illex argentinus* and *Dosidicus gigas*^{14,17}.

### (3) Polishing of anterior and posterior planes

Each statolith was mounted on a glass slide with Eukitt with the anterior plane up. Anterior plane of statoliths was slightly ground and polished as described in the previous method. Statoliths were removed by applying xylene, and attached on the glass slide with the posterior plane up. Then, statoliths were similarly ground and polished. This method had been applied for *Sthenoteuthis oualaniensis* and *Dosidicus gigas*^{14,16}.

NEXT

TOP

[: Contents](#)

## References

- 1) Anonymous (1994): Review of the state of world marine fishery resources. *FAO Fish. Tech. Pap.*, 335, pp.135.
- 2) Arkhipkin, A. & Perez, J. A. (1998): Life-history reconstruction. *FAO Fish. Tech. Pap.*, 376, 157-180.
- 3) Balch, N., Sirois, A. & Hurley, G. V. (1988): Growth increments in statoliths from paralarvae of the ommastrephid squid *Illex* (Cephalopoda: Teuthoidea). *Malacologia*, 29, 103-112.
- 4) Bigelow, K. A. & Landgraph, K. C. (1993): Hatch dates and growth of *Ommastrephes bartramii* paralarvae from Hawaiian waters as determined from statolith analysis. In Recent adv. cephalopod fish. biol. eds. Okutani, T., O'Dor, R. K. & Kubodera, T., 15-24.
- 5) Bower, J. R. (1996): Estimated paralarval drift and inferred hatching sites for *Ommastrephes bartrami* (Cephalopoda: Ommastrephidae) near the Hawaiian Archipelago. *Fish. Bull. U.S.*, 94, 398-411.
- 6) Caddy, J. E. (1991): Daily rings on squid statolith; an opportunity to test standard population model? In Squid age determination using statoliths. Proc. int. workshop Instituto di Tecnologia della Pesca e del Pescato. eds. Jereb, P., Ragonese, S. & von Boletzky, S., 53-66.
- 7) Clarke, M. R. (1978): The cephalopod statolith- an introduction to its form. *J. Mar. Biol. Assoc. U.K.*, 58, 701-712.
- 8) Dawe, E. G. & Natsukari, Y. (1991): Light microscopy. In Squid age determination using statoliths. Proc. int. workshop, Instituto di Tecnologia della Pesca e del Pescato. eds. Jereb, P., Ragonese, S. & von Boletzky, S., 83-95.
- 9) Dawe, E. G. et al. (1985): Validation and application of an ageing technique for short-finned squid (*Illex illecebrosus*). *NAFO Sci. Counc. Stud.*, 6, 107-116.
- 10) Haimovici, M. et al. (1998): *Illex argentinus*. *FAO Fish. Tech. Pap.*, 376, 27-58.
- 11) Jackson, G. D. (1994): Application and future potential of statolith increment analysis in squids and sepioids. *Can. J. Fish. Aquat. Sci.*, 51, 2612-2625.
- 12) Jackson, G. D. & Choat, J. H. (1992): Growth in tropical cephalopods; an analysis based on statolith microstructure. *Can. J. Fish. Aquat. Sci.*, 49, 218-228.
- 13) Lipinski, M. (1991): Scanning electron microscopy (SEM) and chemical treatment. In Squid age determination using statoliths. Proc. int. workshop, Instituto di Tecnologia della Pesca e del Pescato. eds. Jereb, P., Ragonese, S. & von Boletzky, S., 97-116.
- 14) Masuda, S. et al. (1998): Growth and population structure of *Dosidicus gigas* in the Southeastern Pacific Ocean. In Large pelagic squids. ed. Okutani, T., 107-118.
- 15) Rodhouse, P. G. & Hatfield, E. M. C. (1990): Age determination in squid using statolith growth increment. *Fish. Res.*, 8, 323-334.
- 16) Takagi, K. & Yatsu, A. (1998): Age determination using statolith microstructure of the purpleback flying squid, *Sthenoteuthis oualaniensis*, in the North Pacific Ocean. Ikaruishigen Gyokaikyou Kenkyu-Kaigi Houkoku (Rep. Annu. Meet. Resour. Fish. Squids, 1994), 118-122 [In Japanese].
- 17) Uozumi, Y. & Shiba, C. (1993): Growth and age composition of *Illex argentinus* (Cephalopoda: Oegopsida) based on daily increment counts in statolith. In Recent adv. cephalopod fish. biol. eds. Okutani, T., O'Dor, R.K. & Kubodera, T., 591-605.



## References

- 18) Yatsu, A. et al. (1997): Age and growth of the neon flying squid, *Ommastrephes bartrami*, in the North Pacific Ocean. *Fish. Res.*, 29, 257-270.
- 19) Yatsu, A. et al. (1998): Strontium/calcium ratios in statoliths of the neon flying squid, *Ommastrephes bartrami* (Cephalopoda), in the North Pacific Ocean. *Mar. Biol.*, 131, 275-282.
- 20) Yatsu, A., Tatur, R & Maravi, C. (1999): Embryos and rynchoteuthion paralarvae of the jumbo flying squid *Dosidicus gigas* (Cephalopoda) obtained through artificial fertilization from Peruvian waters. *Fish. Sci.*, 65, 904-908 (in press).

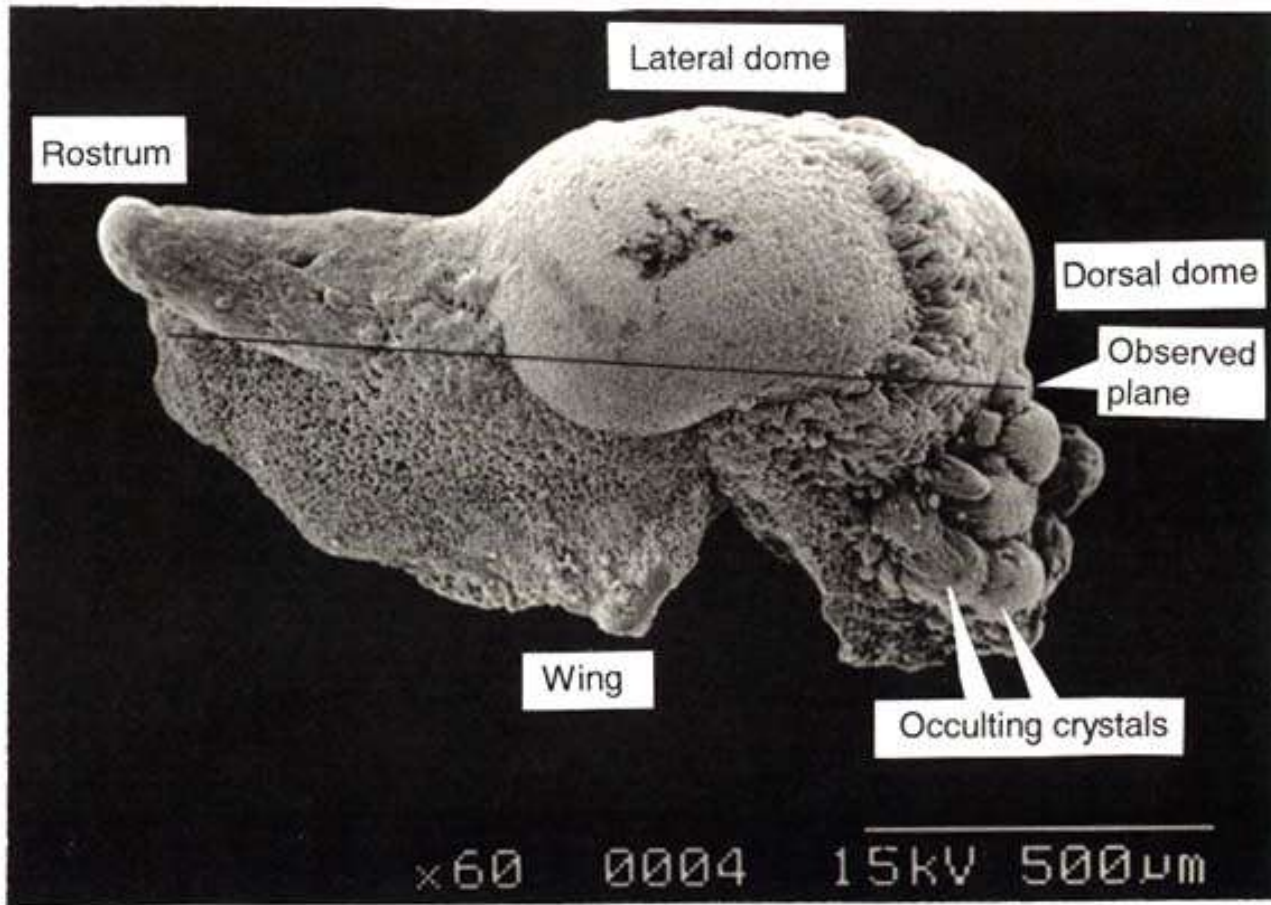


Fig.1. Scanning electron micrograph (SEM) of the left statolith from *Ommastrephes bartramii* (posterior view) showing major features

Observed plane refers to the sectioning position for SEM and light microscopy observations.

[BACK](#)

## Observation of daily increments

A light microscope (LM) equipped with objective lenses (x10, x20, x40, and x60) was connected to a TV camera and a high-resolution monitor, with final magnifications of 900-4500x. For LM observations, cover glasses are not necessary, but a drop of liquid paraffin markedly enhances the visibility of increments. Visibility may also be improved by controlling transmitted light with manipulation of a condenser and filters. Sketches of tracing increments⁸⁾ or graphics from an image-analyzing system are useful for precise counting, i.e. for checking results within multiple counts for a specimen by a reader or among multiple readers.



A single increment is composed of a pair of dark and light rings when viewed with LM ([Fig. 3A](#))¹¹⁾. The dark rings are more deeply etched with HCl because of the larger abundance of amino acids than in the light rings (Figs. 2 and [3B](#)). In the ommastrephids, increments are usually prominent on the anterior plane of statoliths, and counts were made from the core to the dorsal dome (Fig. 2).

### Fig.2

Scanning electron micrographs of a sectioned and etched statolith from a 390 mm ML *Dosidicus gigas*.

**A:** From core to dorsal dome.

**B:** Dorsal dome area.

The core (nucleus) is usually dark and oval, with a size of approximately 20-30  $\frac{1}{4}$ m x 15-20  $\frac{1}{4}$ m for *O. bartramii*, *I. illecebrosus* and *I. argentinus* (Figs. 3 and [4](#))^{2,4)}. The size of the core is considered to correspond to that at the time of hatching in *Illex illecebrosus*^{3,9)}. This assumption has been extended to other ommastrephid squids. In artificially reared *D. gigas*, the maximum diameters of 2 statoliths examined were 37 and 44  $\frac{1}{4}$ m on the day of hatching, and the size of the statolith linearly increased until the 6th day after hatching, but without distinct increments ([Fig. 5](#))²⁰⁾. Bigelow and Landgraph⁴⁾ also observed an inconsistent increment structure around the 10-to-15  $\frac{1}{4}$ m area immediately distal to the core. In some squid species, increments may not be produced daily during the embryonic development¹¹⁾. Therefore, caution must be paid to uncertainties in age estimation during the earliest life stage.

In *O. bartramii*, increment width increased from 3- 4  $\frac{1}{4}$ m near the core to up to 7  $\frac{1}{4}$ m at a distance of 200  $\frac{1}{4}$ m, then gradually decreased to 2  $\frac{1}{4}$ m or less after a distance of approximately 400  $\frac{1}{4}$ m¹⁹⁾. A similar pattern was also observed in *S. oualaniensis* and *D. gigas* (Fig. 2). In *Illex argentinus*, increment width increased from 1.5-3  $\frac{1}{4}$ m in the

post-nucleus zone, to 2-5  $\frac{1}{4}$ m in the dark zone and decreased to 1.5-3  $\frac{1}{4}$ m in the peripheral zone of the dorsal dome²⁾. Increment width is also subject to variation with environmental conditions, mainly temperature, which in turn results from the difference in the hatching season²⁾. In a stock of *I. argentinus* which spawns in summer, increment width may be as narrow as 0.9  $\frac{1}{4}$ m in the post-nucleus zone (Fig. 3). Such fine increments can be observed with SEM or LM equipped with a high magnification lens (x 60 objective lens).

## Comparison of preparation methods

In SEM observations, it was difficult to count the total number of increments from the core to the dorsal dome because some areas were not sufficiently etched for counting (Fig. 2). Increment width can be precisely measured with SEM photographs for adequately etched areas. In LM observations, increments were diffuse or duplicated depending on the thickness of the samples, magnification levels, and depth of focus. For example, subdaily rings (faint increments formed through non-endogenous rhythm, see Fig. 4 of Bigelow and Landgraph⁴) may become more prominent in over-ground statoliths for LM observation¹¹. For accurate (unbiased) age determination, therefore, SEM observation is recommended for a limited number of samples before routine counting with LM, where several hundreds of readings are required in fisheries research¹³.

The sectioning method for LM observation was effective for all the 4 species, and led to more reliable counting than the 2 other methods for LM, because it was possible to avoid occulting crystals and dark zones, where increments are sometimes not sufficiently clear to obtain consistent counts. Sectioning method is, however, more labor-intensive and it is difficult to estimate earlier growth (back-calculation) owing to the "curved axis" of the statoliths (Fig. 4)⁸. The polishing method of the posterior plane is suitable for *Illex argentinus* whose statoliths have few occulting crystals. Polishing of both anterior and posterior planes is indispensable for *Stheneteuthis oualaniensis* because of the existence of abundant occulting crystals.

## Growth

Growth at the early life stages has been estimated to be exponential based on statolith daily increment counts for either wild or artificially reared paralarvae (Fig. 6). ML-age relationships at the subadult and adult stages are more or less linear (Fig. 7)¹¹. Although Uozumi and Shiba¹⁷ applied a logistic curve for the autumn brood of *Illex argentinus* (Fig. 7), a linear model can be also valid for their data¹⁰. Growth rates vary with sex, seasonal cohorts, geographic area, and year^{2,14,18}. Females grew faster than males in all the 4 species examined, although the difference was small for *D. gigas*¹⁴. Since ambient temperature, food availability and maturation affect squid growth, these environmental and physiological factors should be considered for future analyses¹¹. Such growth histories may be reconstructed from increment width and trace element analyses^{11,19}.

## Conclusion

Squid growth is affected by geographic, seasonal, and year-to-year changes in environmental conditions. The growth variability, together with extended spawning season (seasonal cohorts) and short life span (usually 1 year), is an important aspect of squid ecology. For age and growth studies of squids, it is preferable not to use length-based methods and not to fit *a priori* asymptotic growth curves (or any single model), which are usually applied in fin-fish studies^{6,11}. Therefore, routine age estimation studies are essential for cephalopod fisheries management, although such a task is labor-intensive.

**BACK** [Contents](#)

**TOP** [First page of JARQ](#)

**HOME** [JIRCAS Home Page](#)



**Japan International Research Center for Agricultural Sciences  
Ministry of Agriculture, Forestry, and Fisheries  
1-2 Ohwashi, Tsukuba, Ibaraki, 305-8686 JAPAN  
www@jircas.affrc.go.jp  
<http://ss.jircas.affrc.go.jp/engpage/jarq/firstpage1.html>  
Telephone 0298-38-6304  
published on January 31, 2000**

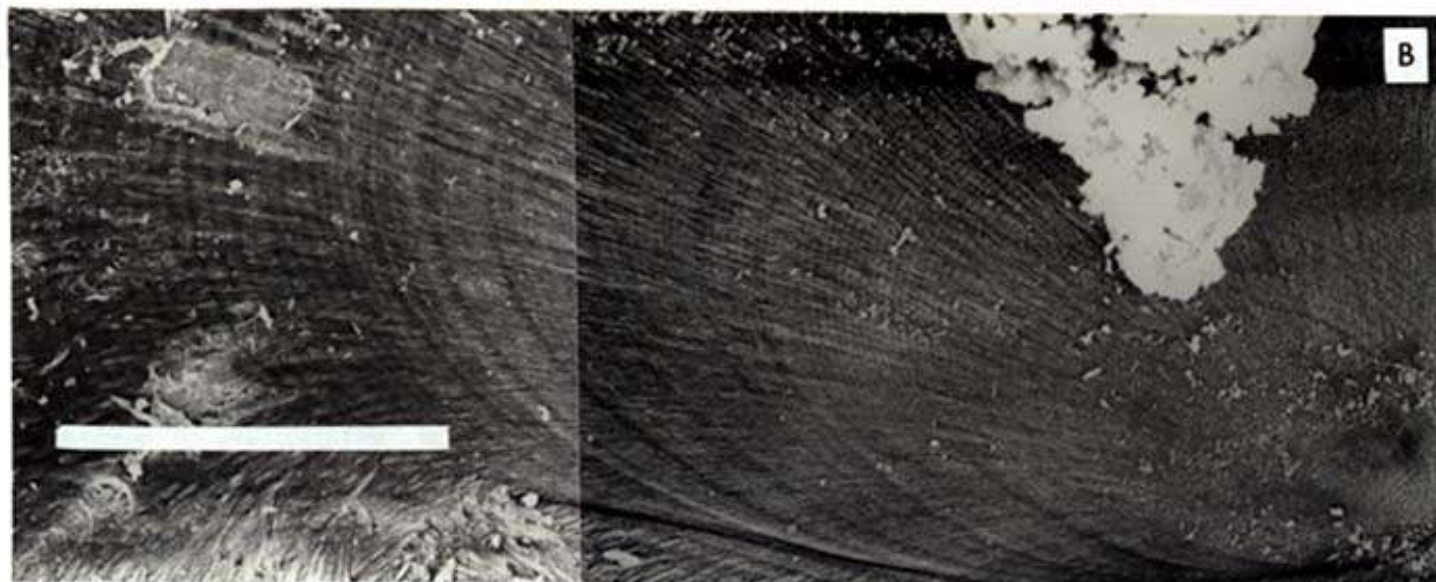
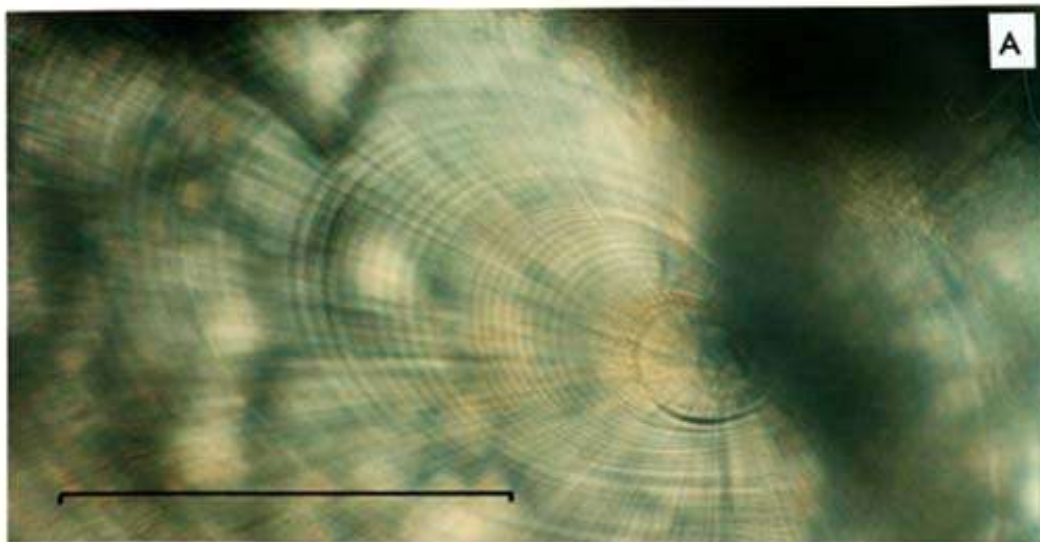


Fig.3. Light micrograph of the ground and polished left statolith (A) and scanning electron micrograph of the sectioned and etched right statolith (B) from a 244 mm ML *Illex argentinus*

Fine increments around the post-nucleus zone (B) can not be observed by light microscopy at low-magnifications (A).  
Bar = 50 $\mu$ m.

**BACK**

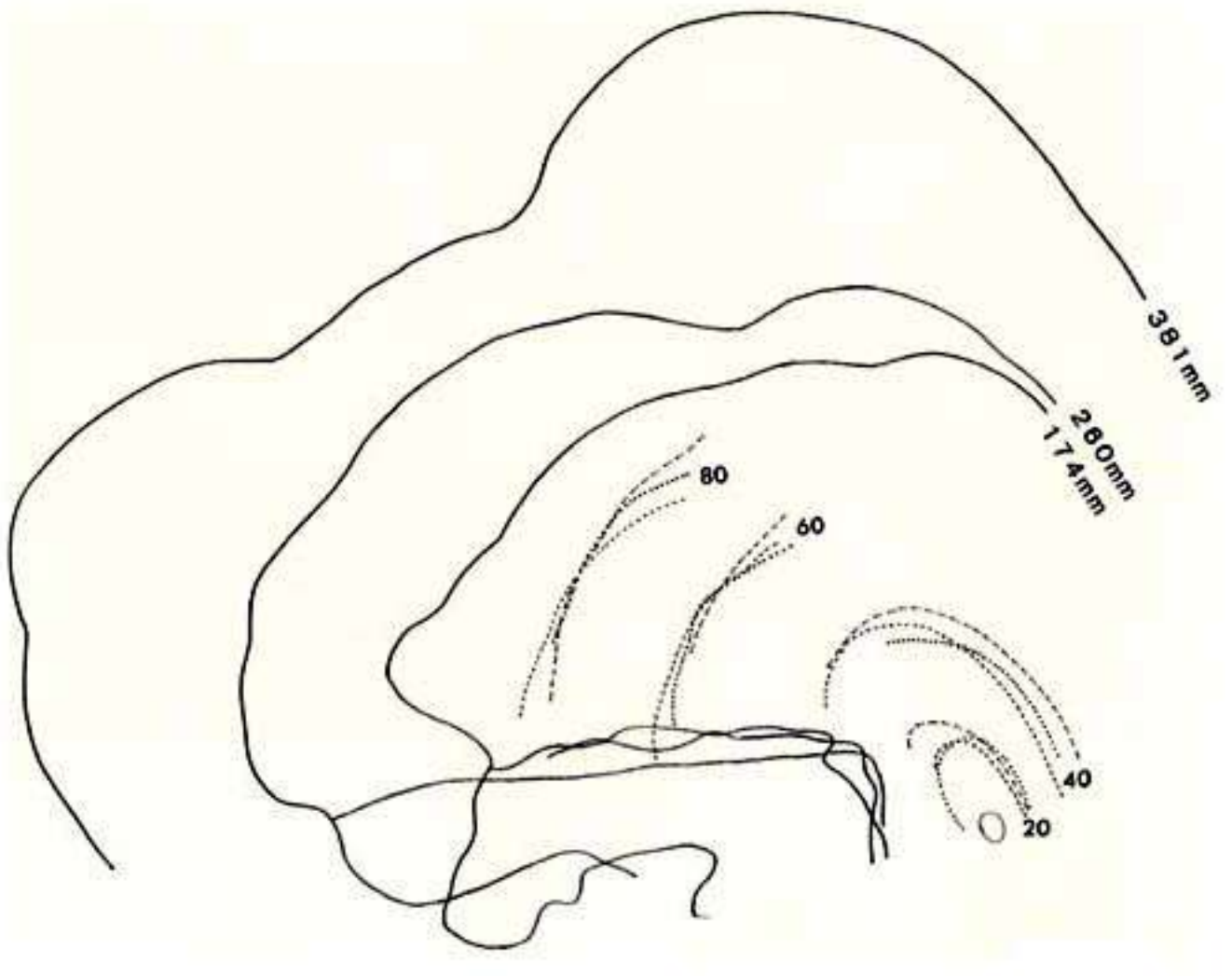


Fig.4  
Posterior view of ground and polished statoliths from three *Ommastrephes bartramii* (174, 260 and 381 mm ML), overlaying locations of 20th, 40th, 60th and 80th increments counted from the core

BACK

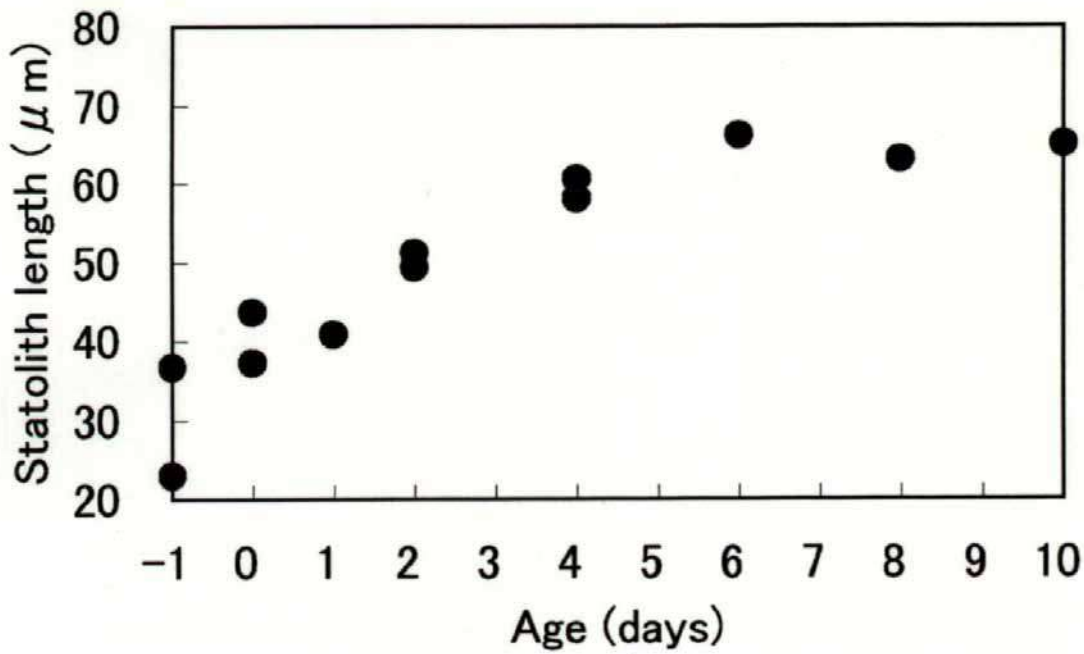


Fig.5. Relationship between age and statolith length (maximum diameter) of artificially fertilized and reared *Dosidicus gigas* (Yatsu et al., in press²⁰)

Growth in older paralarvae may be underestimated because they were starved after exhaustion of yolk, about 8 days after hatching.

**BACK**



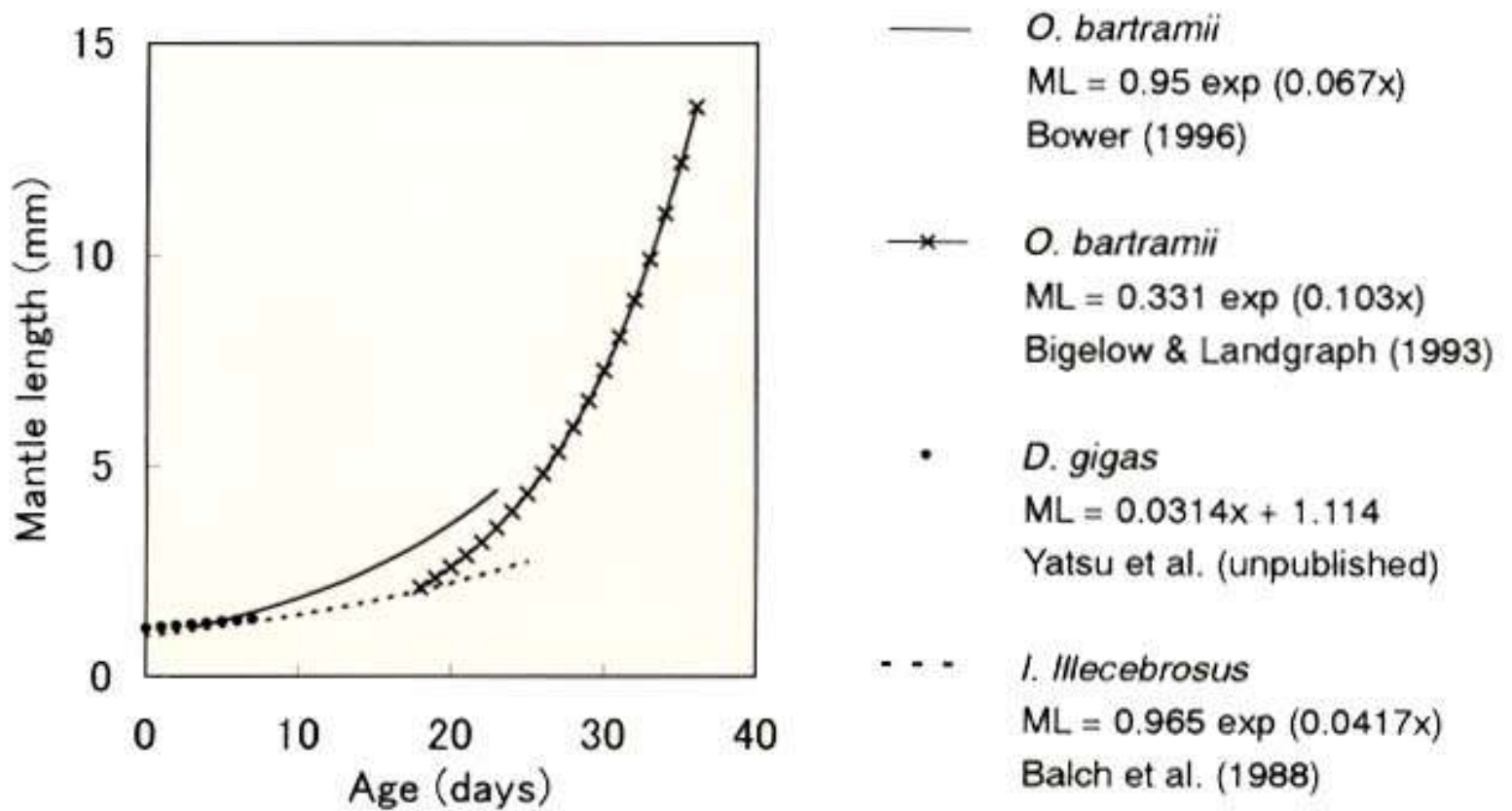


Fig.6. Growth curves of paralarvae of *Ommastrephes bartramii*, *Dosidicus gigas* and *Illex illecebrosus* estimated from statolith microstructure

ML: Mantle length (mm).  
 X: Age (days)

BACK

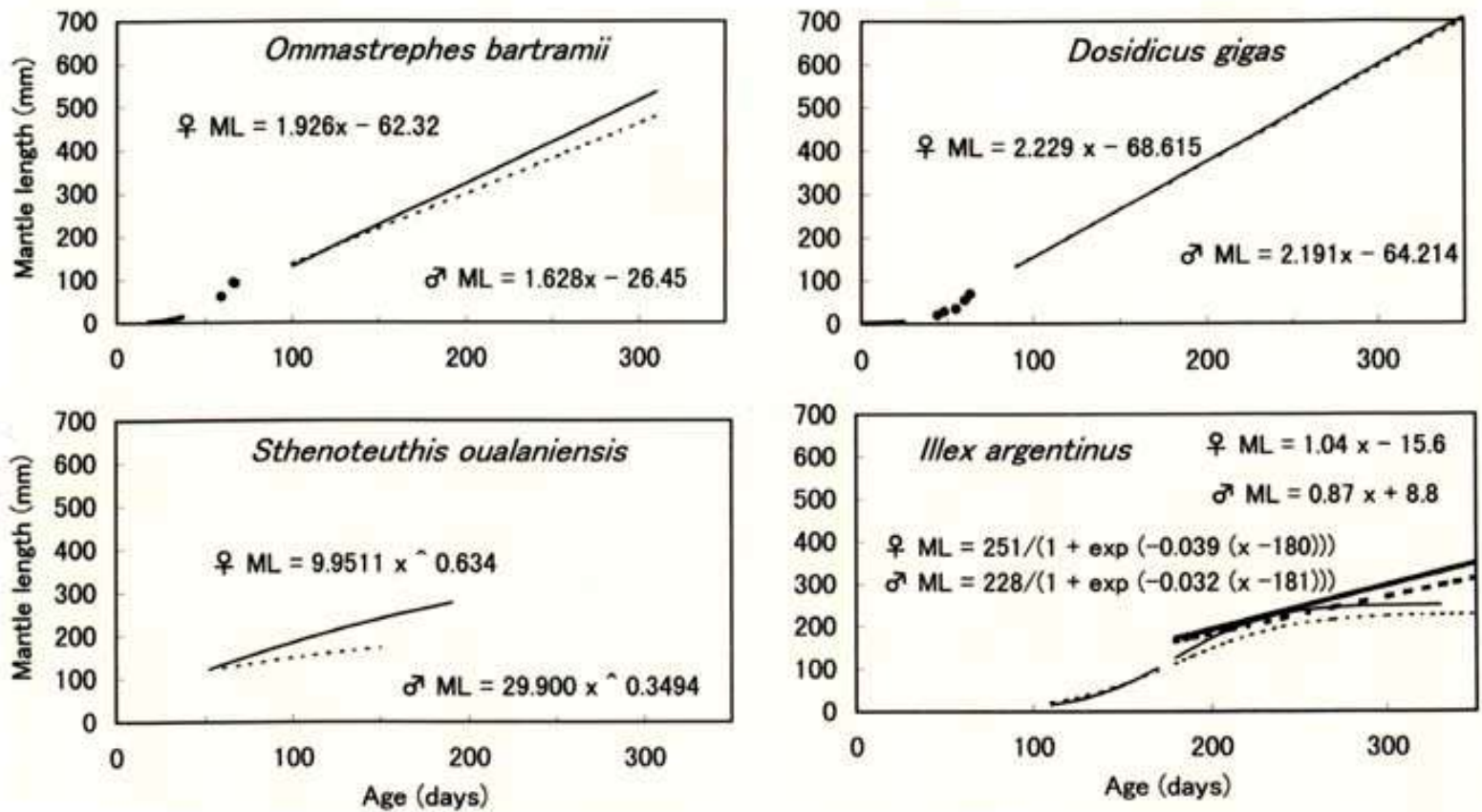


Fig.7. Composites of ML-age relationships in selected seasonal cohorts of *Ommastrephes bartramii*, *Dosidicus gigas*, *Sthenoteuthis oualaniensis*, and *Illex argentinus*, showing early exponential growth and later linear-like growth

Paralarval growth data were derived from [Fig.6](#). Adult and subadult growth data were cited from Yatsu et al. (1997) and unpublished data for *O.bartramii*, Masuda et al.(1998) for *D.gigas*, Takagi and Yatsu (1998) for *S.oualaniensis*, and Uozumi and Shiba (1993) for *I.argentinus* (logistic curves for autumn brood and lines for winter brood).

ML: Mantle length (mm). X: Age (days).

**BACK**

Table 7. Observations of earthquake damage to fill dams with height above 30 m in Japan

Earthquake	Date	Magnitude ( $M_L$ )	Name of dam	Date of completion	Height (m)	Type of dam	Epicenter distance	Maximum acceleration at the dam site (gal)	Characteristics of damage	Degree of damage
Kanto-dai	Sept. 1, 1923	7.9	Chino	1914	37	Earth (concrete core)	—	330 (based on post-earthquake toppled gravestone survey)	Crest settlement of 24 cm Lateral cracks perpendicular to the dam axis.	Slight
Akita Nanseibu	Oct. 26, 1970	6.5	Ainono	1962	41	Earth	15	150 (estimated from seismometer readings and other data)	Longitudinal 5 ~ 25 cm wide and 40 m long cracks.	Slight
Nihonkai Chubu	May 26, 1983	7.7	Namioka	1982	52	Rock fill (central core)	160	94 (estimated from seismometer in the upstream/downstream direction within the bedrock of the dam. Observed max. acc. Was 223 gal at the crest.)	Maximum crest settlement 6 cm. Earthquake at lowest water level	Slight
Naganoken Seibu	May 26, 1984	6.9	Makio	1961	106	Rock fill (central core)	29	500 ~ 600 (estimated from seismometer readings and other data)	Longitudinal cracks on the crest. Sliding of surface rock near the edge of crest.	Slight ~ Medium
Chibaken Toho-oki	Dec. 17, 1987	6.7	Nagara	1985	52	Earth (sloping core)	29	262 (estimated from seismometer in the upstream/downstream direction within the bedrock of the dam. Observed max. acc. was 369 gal on the crest.)	Cracks on the crest pavement. Crest settlement of 20 mm During reservoir testing.	Slight

BACK

Table 8. Earthquake damage to fill dams worldwide

Year	Magnitude (Ms)	Name of dam	Date of completion	Height (m)	Type of dam	Intensity of shock	Characteristics of damage	Degree of damage
1906	7.8	San Andreas	1870	33	Earth	$10^a)$	A single longitudinal crack 2 to 3 in. wide near the center of the crest.	Slight
		Upper Crystal Spring	1887	47	Earth		Longitudinal transverse cracks. Offset about 8 ft on the crest.	Slight
		Pilarcitos	1874	29	Earth		No damage	No
1925		Sheffield	1918	15	Earth	$9^b)$	Complete failure due to liquefaction of the lower portion of the embankment or the upper part of the foundation.	Serious (Failure)
1930		Chatsworth No.2	1918	11	Earth (hydraulic-fill)	$7^a)$	Longitudinal 1/4 to 3 in. wide cracks over the full length of the dam. Crest settlement of 1 to 3 in.	Medium
1952	7.8	South Haiwee	1912	27	Earth (hydraulic-fill)	$10^a)$	Several longitudinal cracks of 1/4 to 1 in. wide near the upstream edge of the crest. Total crest settlement of 1 in. in 2 weeks.	Slight
		Dry Canon	1912	17	Earth (hydraulic-fill)		Several longitudinal cracks on the crest. No further damage after sealing.	Slight
1955		Contra Costa	1928	15	Earth (concrete core)	$7^a)$	Longitudinal 0.1 to 0.2 ft. wide cracks near the crest. center just above the concrete cutoff wall.	Medium
1959		Hebgan	1914	27	Earth (concrete core)	$10^a)$	Crest settlement of 6 ft. near the middle of the dam. Overtopping at least four times due to a number of landslides around the reservoir edge.	Medium
1971	6.5	Lower San Fernando	1918	50	Earth (hydraulic-fill)	Max. Acc. $\approx 0.5$ g	Upstream slope failure.	Heavy
		Upper San Fernando		27				
1990	7.8	Pantabangan (Philippines)	1974	107	Rock fill	Max. Acc. $\approx 0.3-0.4$ g	Cracks settlement of 10 in. Longitudinal 1 ft. wide and 20 ft. long cracks.	Slight

a) : Modified Mercalli scale, b) : Rossi- Forel scale.

BACK

Contents	
<a href="#"><u>Identification of DNA Polymorphism Induced by X-Ray and UV Irradiation in Plant Cells</u></a>	S.Kuroda, H.Yano, Y.Koga-Ban, Y.Tabei, F.Takaiwa, T.Kayano and H.Tanaka
<a href="#"><u>Gamma-Ray-Induced Mutation Breeding in Japanese Pear</u></a>	T.Yoshioka, T.Masuda, K.Kotobuki, T.Sanada, and Y.Ito
<a href="#"><u>Technique for Deep Placement of Coated Urea Fertilizer in Soybean Cultivation</u></a>	Yoshihiko Takahashi and Takuji Ohyama
<a href="#"><u>Resource-Recycling System for Domestic Wastewater Treatment Using Biogeofilter Ditches</u></a>	Yasuo Ozaki
<a href="#"><u>Simulation of Soil Moisture in Upland Field of the Cerrados Area</u></a>	Kazuhiko Ohba
<a href="#"><u>Analysis of the Interaction between Surface Water and Groundwater Using Radon-222</u></a>	Hiromasa Hamada
<a href="#"><u>Effects of Medium Conditions on Mulberry Tissue Culture</u></a>	H.Yamanouchi, A.Koyama and H. Machii
<a href="#"><u>Development of Automatic Steering System for Tractor in Mulberry Fields</u></a>	Toru Kobayashi
<a href="#"><u>Harmful Effect of Dinoflagellate <i>Heterocapsa circularisquama</i> on Shellfish in Japan</u></a>	Yukihiko Matsuyama
<a href="#"><u>Microbial Conversion of Macroalgae into a Detrital Hatchery Diet</u></a>	Motoharu Uchida

# Identification of DNA Polymorphism Induced by X-Ray and UV Irradiation in Plant Cells

Shigeru KURODA*¹, Hiroshi YANO*², Yasunori KOGA-BAN,  
Yutaka Tabei*³, Fumio TAKAIWA, Toshiaki KAYANO*⁴ and Hiroshi TANAKA

Department of Biotechnology, National Institute of Agrobiological Resources  
(Tsukuba, Ibaraki, 305-8602 Japan)

## Present address:

*¹ Department of Rice Research, Hokuriku National Agricultural Experiment Station  
(1-2-1, Inada, Joetsu, Niigata, 943-01 Japan)

*² Department of Crop Breeding, Chugoku National Agricultural Experiment Station  
(6-12-1, Fukuyama, Hiroshima, 721-8514 Japan)

*³ Innovative Technology Division, MAFF Research Council Secretariat  
(1-2-1, Kasumigaseki, Chiyodaku, Tokyo, 100-8950 Japan)

*⁴ To whom correspondences should be addressed.

## Abstract

*Angelonia* protoplasts were irradiated with X-rays or UV to obtain a half survival rate. To evaluate the DNA damage, total genomic DNA was prepared from protoplasts irradiated with X-rays or UV and nonirradiated control protoplasts, respectively. An aliquot of DNA was subjected to polymerase chain reaction (PCR) with a decamer arbitrary primer in the presence of radiolabeled nucleotides under annealing conditions of low stringency. Randomly amplified PCR products were analyzed using a denaturing polyacrylamide gel. All the DNA bands detected by autoradiography were compared. The number of DNA bands detected in one lane was approximately ~150. The results indicate that the arbitrarily amplified PCR method is very sensitive for monitoring the DNA polymorphism caused by X-ray and UV irradiation. This novel procedure, designated as RI (radioisotope incorporated)-RAPD, could be applied to detect precise DNA polymorphism in plant cells.

Discipline: Biotechnology

Additional key words: RI-RAPD, *Angelonia salicariifolia*

● 1...12): [References](#)

(Received for publication, February 3, 1999)

## Introduction

Randomly amplified polymorphic DNA (RAPD) analysis has been widely used to identify genetic polymorphism in many organisms^{11, 12}). Using arbitrary decamer primers, polymerase chain reaction (PCR) is performed under the conditions of low stringency annealing temperature. PCR products are

conventionally separated on agarose gel, and stained with ethidium bromide (EtBr). This method is very simple and rapid. However, the resolution of detailed and complex DNA bands in agarose gel is limited. Another improvement was achieved by introducing silver staining²⁾ or digoxigenin (DIG)-based¹⁰⁾ methods into RAPD. Since the DNA bands observed in an agarose gel or an acrylamide gel are sometimes indistinct, the reproducibility of the RAPD methods has been doubtful.

We are currently examining the effects of X-ray and UV irradiation on mesophyll protoplasts of *Angelonia salicariifolia* to inactivate nuclear DNA. Protoplasts whose nuclear DNA is partly inactivated by the application of irradiation techniques are subsequently utilized for asymmetric plant cell hybridization^{1, 4)}.

To identify the DNA polymorphism induced immediately after the exposure of protoplasts to X-rays and UV, we applied an improved RAPD analysis procedure for the genomic DNA prepared from control and irradiated protoplasts. A conventional RAPD analysis of DNA from the 3 different protoplasts (control, X-ray irradiated, and UV irradiated) revealed only slight differences, while significant differences between the control and irradiated protoplasts were detected by the novel procedure. Here we describe the protocols for an improved RAPD method which could be applied in general.

## Materials and methods

### 1) X-ray and UV irradiation of protoplasts

Mesophyll protoplasts from leaf segments of *Angelonia salicariifolia* L. were cultured in liquid MS16 medium as previously described⁷⁾. Protoplasts (~5 x 10⁴ cells/mL) were irradiated with X-rays (60 kVp, 4 mA, dose of 15 K) or UV (2.5 mW/cm²/s, dose of 25 mW/cm² at 254 nm). Under these conditions, the cell division frequency of the irradiated protoplasts was reduced to half, compared to that of control cells after 7 days of culture (unpublished data). Immediately after the exposure to X-rays and UV, protoplasts were frozen and kept at -70°C until the preparation of DNA.

### 2) DNA preparation

Total genomic DNA from protoplasts was prepared according to the method of Comczynski³⁾ for simultaneous DNA and RNA extraction from tissues or cultured cells. We found that this single step procedure which is very simple and rapid can be used to prepare reasonable amounts of total genomic DNA from protoplasts. The guanidium isocyanate/phenol solution (ISOGENTM) was obtained from Nippon Gene.

### 3) Polymerase chain reaction (PCR)

Three decamer oligonucleotides, designated as RA1, RA3, and RA5 whose sequences were 5'-GTCTGACGGT-3', 5'-CGATCGAGGA-3', and 5'-AAGCAGCAAG-3', respectively, were used as RAPD primers⁸⁾. The standard PCR solution (20 $\mu$ L) was composed of 100 ng of template DNA, 20 $\mu$ M of primer, 200 $\mu$ M of dNTP, 10 $\mu$ Ci of [ $\pm$ -³²P]dCTP (Amersham, 3,000 Ci/mmol), 2.5 units of *Tth* Polymerase (Toyobo) in the recommended buffer. PCR was carried out in an IWAKI thermal sequencer (TSR-300) and the conditions were as follows; 94°C denaturation for 30 s, 42°C annealing for 60 s, and 72°C extension for 30 s with 40 cycles, and another 72°C extension for 5 min. For DNA standard molecular markers,  $\lambda$ Ex174/*Hae*III digests and DNA sequencing ladder (M13 DNA as a template) were used for an agarose gel and a denaturing polyacrylamide gel, respectively.

#### **4) Gel electrophoresis**

Following 1.5% agarose gel electrophoresis in TBE buffer, the PCR products were visualized by staining in EtBr solution (1¹/₄g/mL) and photographed. For denaturing gels, a 6% polyacrylamide gel (acrylamide : BIS=19 : 1) containing 42% urea was used in Tris borate buffer. The size of the denaturing gel was 200 mm (width) x 600 mm (length) x 0.35 mm (thickness). Electrophoresis was carried out for 8 h at 1,500 V, the gel was dried on 3MM paper (Whatman) subsequently, and autoradiographed overnight without the use of an intensifying screen.



[-Results and discussion-](#)



[Contents](#)



## References

- 1) Bates, G. W. (1992): Molecular analysis of nuclear genes in somatic hybrids. *Physiol. Plant.*, **85**, 308-314.
- 2) Caetano-Anolles, G., Bassam, B. J. & Gresshoff, P. M. (1991): DNA amplification fingerprinting using very short arbitrary oligonucleotide primers. *Bio/Technology*, **9**, 553-557.
- 3) Comczynski, P. (1993): A reagent for the single-step simultaneous isolation of RNA, DNA and proteins from cell and tissue samples. *BioTechniques*, **15**, 532-536.
- 4) Hall, R. D., Krens, F. A. & Rouwendal, G. J. A. (1992): DNA irradiation damage and asymmetric somatic hybridization: Is UV a potential substitute or supplement to ionizing irradiation in fusion experiments? *Physiol. Plant.*, **85**, 319-324.
- 5) Hall, R. D., Rouwendal, G. J. A. & Krens, F. A. (1992): Asymmetric cell hybridization in plants; II. Electrophoretic analysis of irradiation-induced DNA damage and repair following the exposure of sugar beet (*Beta vulgaris* L.) protoplasts to UV and gamma rays. *Mol. Gen. Genet.*, **34**, 315-324.
- 6) Kubota, Y., Shimada, A. & Shima, A. (1992): Detection of gamma-ray-induced DNA damage in malformed dominant lethal embryos of the Japanese medaka (*Oryzias latipes*) using AP-PCR fingerprinting. *Mutation Res.*, **283**, 263-270.
- 7) Kuroda, S. & Datta, S. K. (1987): Plant regeneration from leaf mesophyll protoplasts of *Angelonia salicariifolia*. *Jpn. J. Breed.*, **37** (suppl.2), 2-3.
- 8) Monna, L. et al. (1994): Determination of RAPD markers in rice and their conversion into sequence tagged sites (STSs) and STS-specific primers. *DNA Res.*, **1**, 139-148.
- 9) Stapleton, A. E., Mori, T. & Walbot, V. (1993): A simple and sensitive antibody-based method to measure UV-induced DNA damage in *Zea mays*. *Plant Mol. Biol. Rep.*, **11**, 230-236.
- 10) Tabei, Y. et al. (1996): Development of highly sensitive RAPD method by digoxigenin incorporated PCR: Application for the identification of cultivars. *Breed. Sci.*, **46**, 307-308.
- 11) Welsh, J. & McClelland, M. (1990): Fingerprinting genomes using PCR with arbitrary primers. *Nucleic Acids Res.*, **18**, 7213-7218.
- 12) Williams, J. G. K. et al. (1990): DNA polymorphisms amplified by arbitrary primers are useful as genetic markers. *Nucleic Acids Res.*, **18**, 6531-6535.

## Results and discussion

**Fig. 1** shows the PCR products derived from the X-ray irradiated (X)-, the control (C), and the UV-irradiated protoplasts (U), using 3 different primers (RA1, RA3, and RA5). In lane 1 using a primer RA1, some extra DNA bands were observed in the X-ray (X)- and UV (U)-irradiated cells compared to the control (C). Similar results were also obtained using RA3 (Fig. 1, lane 2) and RA5 (Fig. 1, lane 3), respectively. These results indicated that irradiation with X-rays and UV led to DNA rearrangements in the portion of genomic DNA.

To identify a RAPD profile more precisely, we adopted a radioisotope-incorporated PCR (RI-based PCR) method. **Fig. 2** shows one example of the autoradiograph of the PCR products. The order of samples was the same as that in Fig. 1. The DNA bands observed in the X-ray (X)- and UV (U)-irradiated protoplasts were distinct from those of the control (C). The sizes of the DNA bands were estimated to be in the range of ~100 to ~500 bp by comparison with the sequence ladder of M13 (data not shown). The total number of bands in each lane shown in Fig. 2 was determined (Table 1), and found to be larger than that shown in Fig. 1, presumably due to the higher resolution in polyacrylamide denaturing gels.

**Table 1. DNA bands detected by RI-based RAPD**

Primer	Total DNA bands			DNA bands appearing in (+) or disappearing in (-)			
	C ^{a)}	X ^{b)}	U ^{c)}	X		U	
RA1	159	157	150	+23	-25	+14	-23
RA3	126	138	132	+22	-10	+22	-16
RA5	153	153	152	+0	-0	+1	-2

The numbers of DNA bands detected in Fig. 2 are indicated.

a): C; Control. b): X; X-rays-irradiated protoplasts. c): U; UV-irradiated protoplasts.

Approximately 120 to 160 DNA bands were detected in the range of ~100 to ~500 bp in each lane. The total number of DNA bands was not significantly different among the primers, especially between RA1 and RA5. However, the number of bands that disappeared or the appearance of new DNA bands depended on the primer used (Table 1). It should be noted that PCR products less than 100 bp could not be detected easily by autoradiography because the amount of [ $\pm$ - 32 P]dCTP incorporated into the PCR products was very small. In brief, the present study revealed that (1) DNA rearrangement in protoplasts by X-rays and UV could be effectively monitored by RI-based PCR, (2) a denaturing polyacrylamide gel is superior to an agarose gel for the resolution of PCR products in the range of ~100 to ~500 bp, and (3) some primers enabled to detect DNA damage more effectively than others.

Hall et al.⁵⁾ examined the effects of X-rays and UV on DNA isolated from a protoplast culture of sugar beet (*Beta vulgaris*). They showed a significant fragmentation of nuclear DNA by pulsed-field gel and conventional agarose gel electrophoresis. They were the first to demonstrate the DNA damage by X-rays and UV at the molecular level. However, only large DNA fragments were analyzed in that study. To detect the DNA damage caused by UV irradiation, Stapleton et al.⁹⁾ measured pyrimidine dimers using a specific antibody. Since their method was based on immunoreactive detection and was quantitative, only the total amount of pyrimidine dimers induced by UV-irradiation could be measured. Our present work focused on the detailed and complex changes at the nucleotide level resulting from X-ray and UV irradiation of protoplasts, and the use of powerful tools (conventional RAPD, Fig. 1, and RI-based PCR, Fig. 2) to monitor such DNA rearrangements.

The length of the PCR products indicated in Figs. 1 and 2 seems to be relatively shorter than that of the products obtained in previous studies^{11, 12)}, which may be due to the shorter extension time (30 s) than in conventional methods (for example, 120 s in Refs. 11, 12). However, our procedure was effective for detecting polymorphic DNA bands. By using 20 mer sequence derived from the bacteriophage T3 promoter region, Kubota et al.⁶⁾ reported the detection of  3 -ray-induced DNA damage in the Japanese medaka. They obtained DNA-fingerprinting of fish genomic DNA, but the numbers of PCR products were still small, presumably due to the longer length of the arbitrary primer used in their study.

In conclusion, RI-based PCR is a very sensitive method to detect a very low DNA polymorphism. This method is rather

laborious and requires the use of radioisotope-labeled compounds in contrast to conventional RAPD analysis. However, the system consisting of a denaturing polyacrylamide enables to detect a difference of even one nucleotide. When conventional RAPD is not adequate for distinguishing a DNA band profile of PCR products, RI-based RAPD method would be a suitable alternative to detect polymorphic DNA.



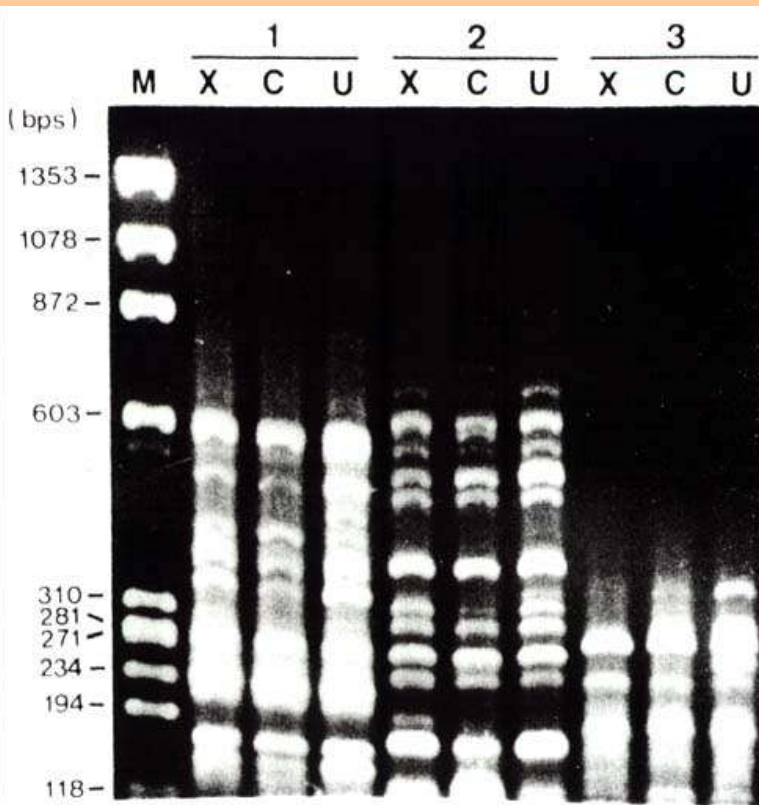
[Forward to: -Gamma-Ray-Induced Mutation Breeding in Japanese Pear-](#)



[Contents](#)



[JIRCAS Home Page](#)



Detection of damage of protoplasts by conventional RAPD

Lane 1: primer RA1, X: X-ray treatment,

Lane 2: primer RA3, C: control,

Lane 3: primer RA5, U: UV treatment.

**Fig. 1.**

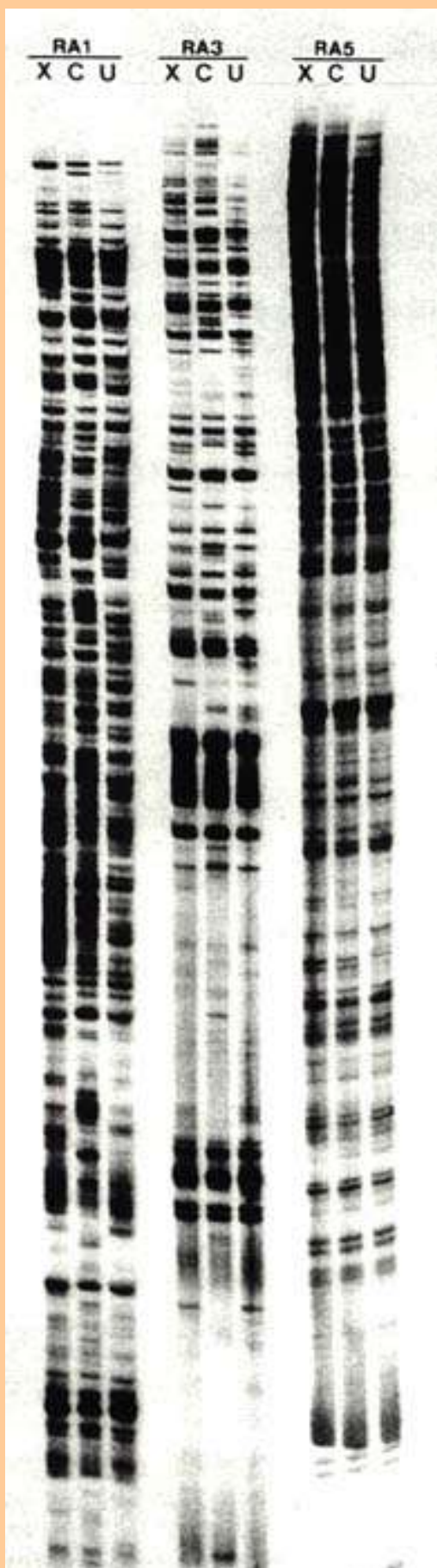
**Conventional RAPD pattern**

PCR products derived from X-ray (X)-, or UV (U)-irradiated, and control (C) protoplasts using arbitrary primers, RA1, RA3 and RA5, were electrophoresed in a 1.5% agarose gel and stained with EtBr.

(M) indicates  $\lambda$ Ex174/*Hae* III digests.



[Back](#)



**Fig. 2.**  
**RI-based RAPD pattern**

PCR products derived from X-ray (X)-, or UV (U)-irradiated, and control (C) protoplasts using arbitrary primers, RA1, RA3 and RA5 were electrophoresed in a 6% denaturing gel and autoradiographed overnight.



[Back](#)

# Gamma-Ray-Induced Mutation Breeding in Fruit Trees: Breeding of Mutant Cultivars Resistant to Black Spot Disease in Japanese Pear

Toji YOSHIOKA, Tetsuo MASUDA* ¹, Kazuo KOTOBUKI* ², Tetsuro SANADA* ³ and Yuji ITO

Institute of Radiation Breeding, National Institute of Agrobiological Resources (NIAR)  
(Ohmiya, Ibaraki, 319-2293 Japan)

## Abstract

Black spot disease, caused by *Alternaria alternata* Japanese pear pathotype, is the most important and serious disease of the susceptible cultivars of Japanese pear. The fungus produces a host-specific toxin (AK-toxin) which is highly toxic to the susceptible cultivars. Susceptibility to this disease is controlled by a single dominant gene, and all the susceptible cultivars are heterozygous. Mutants resistant to black spot disease were induced by irradiation of susceptible cultivars with gamma-rays. Nine resistant mutants were selected from chronically irradiated 'Nijisseiki'. One of these mutants was registered as 'Gold Nijisseiki'. A resistant mutant derived from acutely irradiated dormant scions of 'Shinsui' was registered as 'Kotobuki Shinsui'. One resistant mutant, which was induced from acutely irradiated dormant scions of 'Osanijisseiki', displayed unfavorable characteristics. Four resistant mutants were selected from chronically irradiated 'Osanijisseiki'. One of them was registered as 'Osa Gold'. A list of these resistant mutants is shown in [Table 4](#). It was confirmed that all of the mutants showed an intermediate resistance to black spot disease and conferred various levels of resistance. Moreover, mutations with a higher level of resistance than that of 'Gold Nijisseiki' were induced from 'Gold Nijisseiki' by acute and chronic gamma-ray irradiation. The reason why various levels of resistance were induced could not be elucidated.

**Discipline:** Plant breeding

**Additional key words:** gamma-ray irradiation, *Alternaria alternata*, AK-toxin, intermediate resistance

[1...19](#)): [References](#)

(Received for publication, February 4, 1999)

## Introduction

Black spot disease, caused by *Alternaria alternata* Japanese pear pathotype, is the most important and serious disease of the susceptible cultivars of Japanese pear (*Pyrus pyrifolia* NAKAI var. *culta* NAKAI), for example 'Nijisseiki', 'Shinsui' and 'Osanijisseiki'. The fungus produces a host-specific toxin (AK-toxin) which causes necrosis and permeability changes in the leaves and fruit of the susceptible cultivars^{11,17}).

Susceptibility to this disease is controlled by a single dominant gene³). It is known that the resistant cultivars are recessive homozygous and that susceptible cultivars are heterozygous for this gene.

Dominant homozygous cultivars have never been detected.

In many vegetatively propagated crops or fruit trees, natural mutations have made important contributions to breed improvement. We consider that artificial mutation breeding is an effective method for improving economic agricultural species.

To achieve this objective, induced mutation breeding of temperate fruit trees has been studied in our laboratory since 1962. Gamma-ray irradiation is a promising method to induce mutants resistant to black spot disease.

## **Development of selection method and selection of resistant mutants from Nijisseiki**

Nijisseiki, one of the leading cultivars of Japanese pear, is known to be susceptible to black spot disease. In 1962, grafted trees of Nijisseiki were planted at a distance of 53-93 m (at intervals of 10 m) from a  $^{60}\text{Co}$  source in a gamma-field, and were irradiated with gamma-rays chronically to induce resistant mutants.

In 1981, a twig without symptoms of the disease was detected on the tree at a distance of 53 m from the source (dose rate: 0.138 Gy/day, 20 h of irradiation). The scions from this mutated twig were grafted onto rootstocks outside the gamma-field. The resistant mutant was named  $^3\text{-1-1}$ . Consequently, it was confirmed that it was possible to induce resistant mutants by irradiation with gamma-rays.

Since there was no effective method for selecting mutants, other resistant mutants could not be selected. However, it is possible to test a large number of samples by treating leaf disks with a filtrate of *A. alternata* culture solution^{1,13,14}). By using this simple selection method, 4 resistant mutants ( $^3\text{-1-2}$ ,  $^3\text{-2-1}$ ,  $^3\text{-4-1}$  and  $^3\text{-5-1}$ ) were selected from Nijisseiki trees planted at a distance of 53-93 m from the source in a gamma-field¹).

On the other hand, young Nijisseiki trees were planted at a distance of 40-70 m (at intervals of 10 m) from the source in a gamma-field in 1983. Selection of resistant mutants was carried out together with the cutting back pruning method¹⁰). Four resistant mutants ( $^3\text{-A-1}$ ,  $^3\text{-B-1}$ ,  $^3\text{-C-1}$  and  $^3\text{-C-2}$ ) were selected from these trees^{13,14}).



*Fig.1. Appearance of black spot symptoms on crude AK-toxin treated leaf disks from 1st to 5th leaves of the shoot tip (upper to lower)*

**Left to right: Chojuro, Nijisseki and³⁻¹⁻¹(2 lanes each).**

The leaf disks from young leaves of these mutants showed a small necrotic area by treatment with AK-toxin, although no necrosis was observed on the resistant cultivars¹⁵⁾ (*Fig. 1*). It became obvious that all of the 9 mutants showed an intermediate resistance between resistant and susceptible cultivars.



[Registration of a new cultivar 'Kotobuki Shinsui'](#)



[Contents](#)



**Table 4. List of mutants resistant to black spot disease obtained by gamma-ray irradiation in I.R.B.**

Reference number	Tentative name	Original cultivar	Irradiation		Selection year	Cultivar name	Registration
			Method	Dose rate (mGy/h) Total dose (Gy)			
IRB 502-2	$\gamma$ -1-1	Nijisseiki	Chronic	7.1 616.2	1981	Gold Nijisseiki	Pear Norin No.15 No. 2,932 ^{a)} Plant 8,529 ^{b)}
IRB 502-3	$\gamma$ -1-2	Nijisseiki	Chronic	7.1 712.0	1984		
IRB 502-4	$\gamma$ -5-1	Nijisseiki	Chronic	2.5 252.1	1984		
IRB 502-5	$\gamma$ -2-1	Nijisseiki	Chronic	5.3 549.6	1985		
IRB 502-6	$\gamma$ -C-1	Nijisseiki	Chronic	5.8 57.5	1985		
IRB 502-7	$\gamma$ -4-1	Nijisseiki	Chronic	3.2 347.2	1986		
IRB 502-8	$\gamma$ -B-1	Nijisseiki	Chronic	8.7 134.5	1986		
IRB 502-9	$\gamma$ -C-2	Nijisseiki	Chronic	5.8 119.1	1987		
IRB 502-10	$\gamma$ -A-1	Nijisseiki	Chronic	14.2 436.2	1989		
IRB 502-11T	Shinsui-R	Shinsui	Acute	2,500.0 80.0	1989	Kotobuki Shinsui	Pear Norin No.18 No. 5,436 ^{a)} Application for U.S. patent
IRB 502-12T	Osa-Tottori	Osanijisseiki	Acute	2,500.0 80.0	1990		
IRB 502-13T	Osa2111	Osanijisseiki	Chronic	13.9 238.8	1991	Osa Gold	No. 5,620 ^{a)} Application for U.S. patent
IRB 502-14T	Osa2109	Osanijisseiki	Chronic	13.9 238.8	1991		
IRB 502-17T	Osa11108	Osanijisseiki	Chronic	13.9 277.0	1993		
IRB 502-18T	Osa1313	Osanijisseiki	Chronic	13.9 277.0	1993		
IRB 502-19T	Osa10 $\times$ $\times$	Osanijisseiki	Chronic	13.9 295.2	1994		
IRB 502-20	SG1602	Gold Nijisseiki	Acute	2,500.0 60.0	1994		
IRB 502-21	SG1614	Gold Nijisseiki	Acute	2,500.0 60.0	1994		
IRB 502-22	SG4706	Gold Nijisseiki	Acute	2,500.0 60.0	1994		
IRB 502-23	SG1705	Gold Nijisseiki	Acute	2,500.0 80.0	1994		
IRB 502-24	SG1439c	Gold Nijisseiki	Chronic	9.6 51.7	1994		
IRB 502-25	SG555	Gold Nijisseiki	Chronic	9.6 51.7	1994		

a): Registration number under the Seeds and Seedlings Law of Japan.

b): Patent number (application for United States patent).



[Back](#)

## References

- 1) Kotobuki, K. (1988): Screening method for selection of mutant resistant to black spot disease induced by gamma-rays irradiation. *Annu. Rep. Natl. Atomic Res. Jpn. 1987*, **28** (40), 5-7 [In Japanese].
- 2) Kotobuki, K. et al. (1992): 'Gold Nijisseiki', a new Japanese pear mutant cultivar resistant to black spot disease induced by chronic irradiation of gamma-rays. *Bull. Natl. Inst. Agrobiol. Resour.*, **7**, 105-120 [In Japanese with English summary].
- 3) Kozaki, I. (1973): Black spot disease resistance in Japanese pear. I. Heredity of the disease resistance. *Bull. Hort. Res. Stn.*, **A12**, 17-27 [In Japanese with English summary].
- 4) Masuda, T. & Yoshioka, T. (1997): New Japanese pear cultivar 'Kotobuki Shinsui' – A mutant resistant to the black spot disease of Japanese pear -. *Technical News*, **57**, 1-2 [In Japanese with English summary].
- 5) Masuda, T., Yoshioka, T. & Inoue, K. (1994): Selection of mutants resistant to black spot disease using the AK-toxin in Japanese pears irradiated with gamma-rays. *Gamma Field Symposia*, **33**, 91-102.
- 6) Masuda, T. et al. (1997): Selection of mutants resistant to black spot disease by chronic irradiation of gamma-rays in Japanese pear 'Osanijisseiki'. *J. Jpn. Soc. Hort. Sci.*, **66**, 88-92.
- 7) Masuda, T. et al. (1998): A new Japanese pear cultivar 'Osa Gold', resistant mutant to the black spot disease of Japanese pear (*Pyrus pyrifolia* Nakai) induced by chronic irradiation of gamma-rays. *Bull. Natl. Inst. Agrobiol. Resour.*, **12**, 1-11 [In Japanese with English summary].
- 8) Masuda, T. et al. (1999): Selection of mutants highly resistant to black spot disease in Japanese pear 'Gold Nijisseiki' by irradiation of gamma-rays. *Bull. Natl. Inst. Agrobiol. Resour.*, **13**, 135-144.
- 9) Murata, K. et al. (1994): Selection of mutant Japanese pears resistant to black spot disease by acute irradiation of gamma-rays. *J. Japan. Soc. Hort. Sci.*, **62** (4), 701-706.
- 10) Nakajima, K. (1977): Studies on the effective methods for induction of mutations of vegetatively propagated plants by the use of the gamma field. *Bull. Inst. Rad. Breed.*, **4**, 1-105 [In Japanese with English summary].
- 11) Nishimura, S., Sugihara, M. & Kohmoto, K. (1978): Two different phases in pathogenicity of the *Alternaria* pathogen causing black spot disease of Japanese pear. *J. Fac. Agric., Tottori Univ.*, **13**, 1-10.
- 12) Otani, H. et al. (1985): Two different phases in host cell damages induced by AK-toxin of *Alternaria alternata* Japanese pear pathotype. *J. Fac. Agric., Tottori Univ.*, **20**, 8-17.
- 13) Sanada, T. (1986): Induced mutation breeding in fruit trees: Resistant mutant to black spot disease of Japanese pear. *Gamma Field Symposia*, **25**, 87-108.
- 14) Sanada, T. (1988): Selection of resistant mutant to black spot disease of Japanese pear by using host-specific toxin. *Japan. J. Breed.*, **38**, 198-204.
- 15) Sanada, T., Nishida, T. & Ikeda, F. (1988): Resistant mutant to black spot disease of Japanese pear 'Nijisseiki' induced by gamma rays. *J. Japan. Soc. Hort. Sci.*, **57** (2), 159-166.
- 16) Sanada, T. et al. (1994): Inheritance of intermediate resistance to black spot disease in an induced Japanese pear mutant, 'Gold Nijisseiki'. *J. Japan. Soc. Hort. Sci.*, **62** (4), 689-693.
- 17) Tanaka, S. (1933): Studies on black spot disease of Japanese pear (*Pyrus serotina* Rehd.). *Mem. Coll. Agr., Kyoto Imp. Univ.* **28**, 1-31.
- 18) Yoshioka, T. & Masuda, T. (1996): Selection of mutants with high resistance to black spot disease derived from the Japanese pear 'Gold Nijisseiki' by irradiation of gamma-rays. *Technical News*, **52**, 1-2 [In Japanese with English summary].

summary].

19) Yoshioka, T. et al. (1996): Response to AK-toxin in the mutants with high resistance to black spot disease derived from Japanese pear 'Gold Nijisseiki'. *J. Japan. Soc. Hort. Sci.*, **65** (Suppl. 1), 106-107 [In Japanese].

## Registration of a new cultivar 'Gold Nijisseiki'

In 1986, local adaptability tests of ³-1-1, the first resistant mutant from Nijisseiki, were conducted at the National Institute of Fruit Tree Science, MAFF (Ministry of Agriculture, Forestry and Fisheries), and at 27 prefectural horticultural research stations in various pear-growing districts of Japan.

Although ³-1-1 is seldom infected with *A. alternata* in the field, very young leaves in the early growth stage and leaves on secondary growth shoots are slightly more susceptible to the disease. Many uninfected leaves remained on the tree even in late autumn, in contrast with Nijisseiki, in which all the leaves were infected at that time.

³-1-1 bears many fruit spurs and maintains them easily, though there are relatively few axillary flower buds. The flowers are white, and most of them have 5 petals. The flowering time is medium to late. The fruit weighs about 300-350 g. The skin of the fruit is yellowish green at early maturity, and becomes yellow at late maturity. Many russets occur on the skin when the fruit is cultivated without paper bagging. All of these characteristics, except for the slightly later fruit ripening time, are the same as those of Nijisseiki²⁾ ([Fig. 2](#)).

Based on the results obtained, ³-1-1 was designated as cultivar Gold Nijisseiki and registered as 'Pear Norin No. 15' by MAFF on June 22, 1990*. Also it was registered as 'No. 2,932' under the Seeds and Seedlings Law of Japan on December 16, 1991.

## Selection of resistant mutants from Shinsui and Osanijisseiki

Shinsui is a russet type pear cultivar whose fruit ripens earlier than that of 'Kosui' and is sweet and rich. Osanijisseiki, an excellent cultivar with a smooth skin, is a self-compatible spontaneous bud sport of Nijisseiki. Both cultivars are susceptible to black spot disease. Since 1987, the Institute of Radiation Breeding, NIAR, in collaboration with Tottori Horticultural Experiment Station, has carried out research on radiation breeding for the selection of mutants resistant to black spot disease from these 2 susceptible cultivars by using acute or chronic gamma-ray irradiation.

By using acute irradiation in a gamma-room, dormant scions were irradiated to a total exposure of 60 and 80 Gy at a dose of 2.5 Gy/h. Irradiated dormant scions were top-grafted onto mature trees of Japanese pear. By using a convenient selection method, one mutant resistant to black spot disease (IRB 502-11T) was selected from 5,736 leaves of 'Shinsui' tested ([Table 1](#), [Fig. 3](#)).

Additionally, one resistant mutant (IRB 502-12T) was selected from 5,762 leaves of Osanijisseiki tested⁹⁾ ([Table 2](#)). These results demonstrate that the development of mutants resistant to black spot disease is possible not only through chronic irradiation but also through acute irradiation. In IRB 502-12T, a resistant mutant from Osanijisseiki, chlorosis of leaves and dwarfing of leaf were clearly observed⁵⁾. These findings suggested that the frequency of unfavorable mutations induced together with desirable mutations by acute irradiation is much higher than that by chronic irradiation.

For chronic irradiation, nursery trees of Shinsui and Osanijisseiki were planted in a gamma-field at distances of 45-75 m and 40-70 m from the source, respectively, at intervals of 10 m. Screening tests

using the cutting back pruning method¹⁰⁾ and a convenient selection method were carried out. Four buds which sprouted were selected as resistant mutants (IRB 502-13T, -14T, -17T and -18T) from a total of 12,596 shoots of Osanijisseiki tested ([Table 3, Fig. 4](#)). All of these mutants were derived from the tree planted at a distance of 40 m from the source (dose rate is about 14 mGy/h)^{5,6)}. Resistant mutants from chronically irradiated Shinsui could not be selected.

All of these mutants, obtained 653y both acute and chronic irradiation, showed intermediate resistance to black spot disease, in the same way as 9 resistant mutants induced from Nijisseiki, including Gold Nijisseiki (Figs. 3 & 4)



[- Registration of a new cultivar 'Kotobuki Shinsui' -](#)



[Contents](#)

Fig.2.  
Fruit-bearing shoot of Gold Nijisseiki



 [Back](#)

Table 1

Table 1. Screening test using AK-toxin on gamma-ray-irradiated Shinsui⁹⁾

Year of grafting		No. of shoots in screening test				
		1987	1988	1989	1990	Total
60 Gy	1987	144	173	507	231	1,055
	1988		213	692	543	1,448
	1989			321	582	903
	1990				162	162
		144	386	1,520	1,518	3,568
80 Gy	1987	55	29	115	22	221
	1988		90	842a)	34	966
	1989			782	93	875
	1990				106	106
		55	119	1,739	255	2,168(5,736)

a): Mutant resistant to black spot disease selected.



[Back](#)

Fig.3. Appearance of black spot systems on crude AK-toxin treated leaf disks from 1st to 5th leaves of the shoot tip (upper to lower)

Left to right: Nijisseiki, Shinsui (2 lanes), IRB 502-11T (2 lanes), Gold Nijisseiki (2 lanes) and Chojuro.



 [Back](#)



Table 2

Table 2. Screening test using AK-toxin on gamma-ray-irradiated Osanijissekiki⁹⁾

Year of grafting		No. of shoots in screening test				
		1987	1988	1989	1990	Total
60 Gy	1987	94	90	272	266	722
	1988		97	473	326	896
	1989			740	717	1,457
	1990				352	352
		94	187	1,485	1,661	3,427
80 Gy	1987	22	59	210	41	332
	1988		146	575	88	809
	1989			1,012	87	1,099
	1990				95a)	95
		22	205	1,797	311	2,335(5,762)

a): Mutant resistant to black spot disease selected.



[Back](#)

Table 3

Table 3. Number of shoots tested for the selection of mutants resistant to black spot disease using crude AK-toxin on Osanjisseiki in the gamma-field⁶⁾.

Distance from ⁶⁰ Co source	No. of shoots in screening tests						
	1988	1989	1990	1991	1992	1993	Total
40 m	355	462	651	513b)	795	557c)	3,333
50	543	973	343	539	87	1,241	3,726
60	439	253	256	400	137	804	2,289
70	653	422	235	490	215	1,233	3,248
Total	1990	2,110	1,485	1,942	1,234	3,835	12,596

a): Nursery tree planted in the gamma-field on March 4, 1986.

b): Two mutants resistant to black spot disease selected.

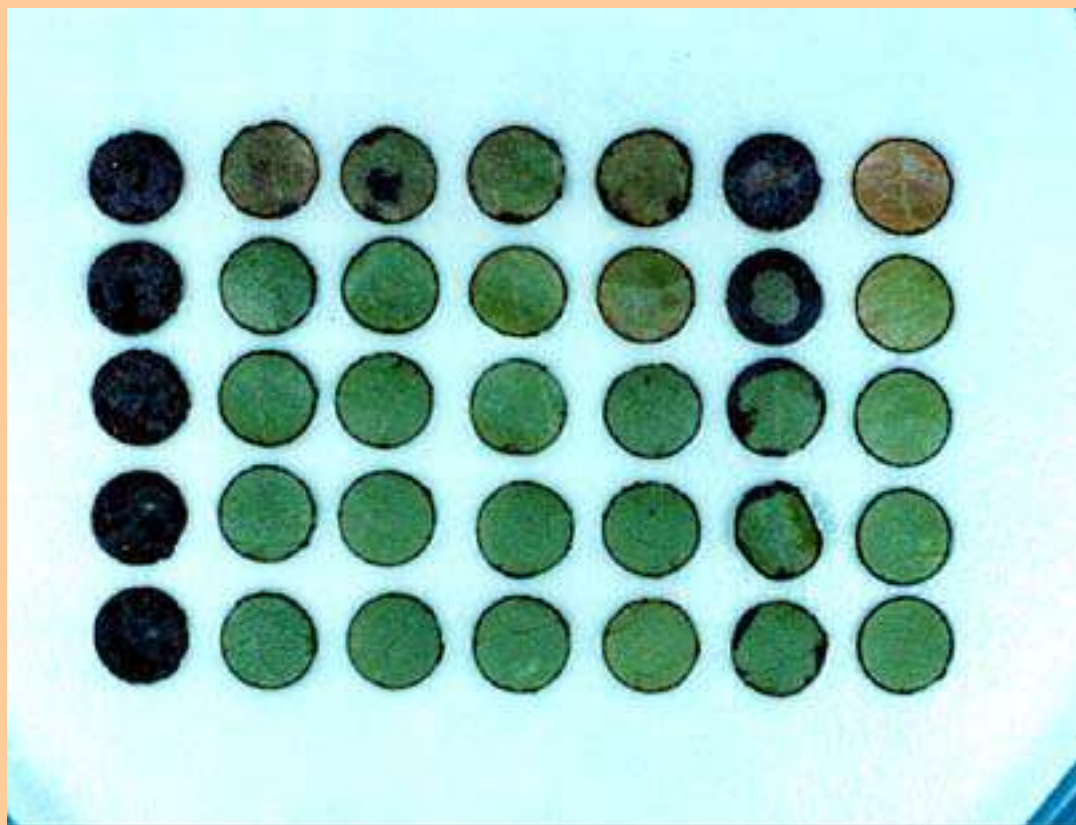
c): Two mutants resistant to black spot disease selected.



[Back](#)

Fig.4. Appearance of black spot symptoms on crude AK-toxin treated leaf disks from 1st to 5th leaves of the shoot top (upper to lower)

Left to right: Osanijisseiki, IRB 502-13T, -14T, -17T, -18T, Gold Nijisseiki and Chojuro.



[Back](#)

1...19):[References](#)

## Registration of a new cultivar 'Kotobuki Shinsui'

In 1993, IRB 502-11T, a mutant resistant to black spot disease induced from Shinsui, was designated as 'Pear Houiku No. 2'. Local adaptability tests of the mutant were conducted at the National Institute of Fruit Tree Science, MAFF, and at 25 prefectural horticultural research stations in various pear-growing districts of Japan.

*Fig.5. Fruit-bearing tree of Kotobuki Shinsui*



The characteristics of Pear Houiku No. 2 are the same as those of the original cultivar Shinsui, except for the resistance to black spot disease. There were no differences between Pear Houiku No. 2 and Shinsui in the tree configuration and fruit characteristics (Fig. 5). Based on these results, Pear Houiku No. 2 was designated as Kotobuki Shinsui and registered as 'Pear Norin No. 18' by MAFF on August 21, 1996*. Also it was registered as 'No. 5,436' under the Seeds and Seedlings Law of Japan on March 7, 1997⁴⁾.

## Registration of a new cultivar 'Osa Gold'

The scions from a twig of IRB 502-13T, one of the resistant mutants induced by chronic irradiation with gamma-rays, were grafted onto rootstocks outside the gamma-field. The characteristics of IRB 502-13T were compared with those of the original Osanijisseiki. Shoot and leaf characteristics of IRB 502-13T were similar to those of Osanijisseiki. Flower characteristics, including self-compatibility, of IRB 502-13T were also the same as those of Osanijisseiki. The fruit characteristics of IRB 502-13T were similar to those of Osanijisseiki⁶⁾ ([Fig. 6](#)).

Based on these results, IRB 502-13T was designated as cultivar Osa Gold and registered as 'No. 5,620' under the Seeds and Seedlings Law of Japan on July 15, 1997⁷⁾*.

## Selection of 'Super Gold' family lines

All the 9 resistant mutants induced from Nijisseiki by gamma-ray irradiation showed an intermediate resistance between resistant and susceptible cultivars. It was obvious that this character was inherited¹⁶⁾. Therefore, selection of mutants with a high level of resistance to black spot disease was performed by

gamma-ray irradiation of Gold Nijisseiki. By acute irradiation in a gamma-room, 4 mutants (IRB 502-20-23) with a high level of resistance were selected. By chronic irradiation in a gamma-field, 2 mutants (IRB 502-24 and -25) were selected^{8,18}. They were designated as 'Super Gold' family lines.

Investigation of the necrotic area resulting from AK-toxin treatment revealed that although these 6 mutants with a high level of resistance were clearly more resistant to black spot disease than Gold Nijisseiki, they still exhibited only an intermediate resistance¹⁸ ([Fig. 7](#)).

To estimate the resistance levels of these mutants to black spot disease, sensitivity to AK-toxin was tested based on the toxin-induced electrolyte loss from leaf tissues¹². The rate of increase of the electrolyte loss derived from AK-toxin for Gold Nijisseiki compared with deionized water was considerably lower than that for Nijisseiki. Toxin-induced losses of electrolytes for 'Super Gold' family lines were clearly lower than that of Gold Nijisseiki¹⁹. Moreover, differences in toxin-induced loss rates were confirmed among the 'Super Gold' family lines ([Fig. 8](#)).

We could not clearly determine why the induced mutants conferred various levels of resistance to black spot disease. It will be interesting to address this problem through further investigations. The 'Super Gold' family lines, including Gold Nijisseiki, will be good materials for studies of the mechanisms of the resistance function of host-specific toxin and mutation induction by gamma-ray irradiation.



[Forward to:-Technique for Deep Placement of Coated Urea Fertilizer in Soybean Cultivation-](#)



[Contents](#)



[JIRCAS Home Page](#)

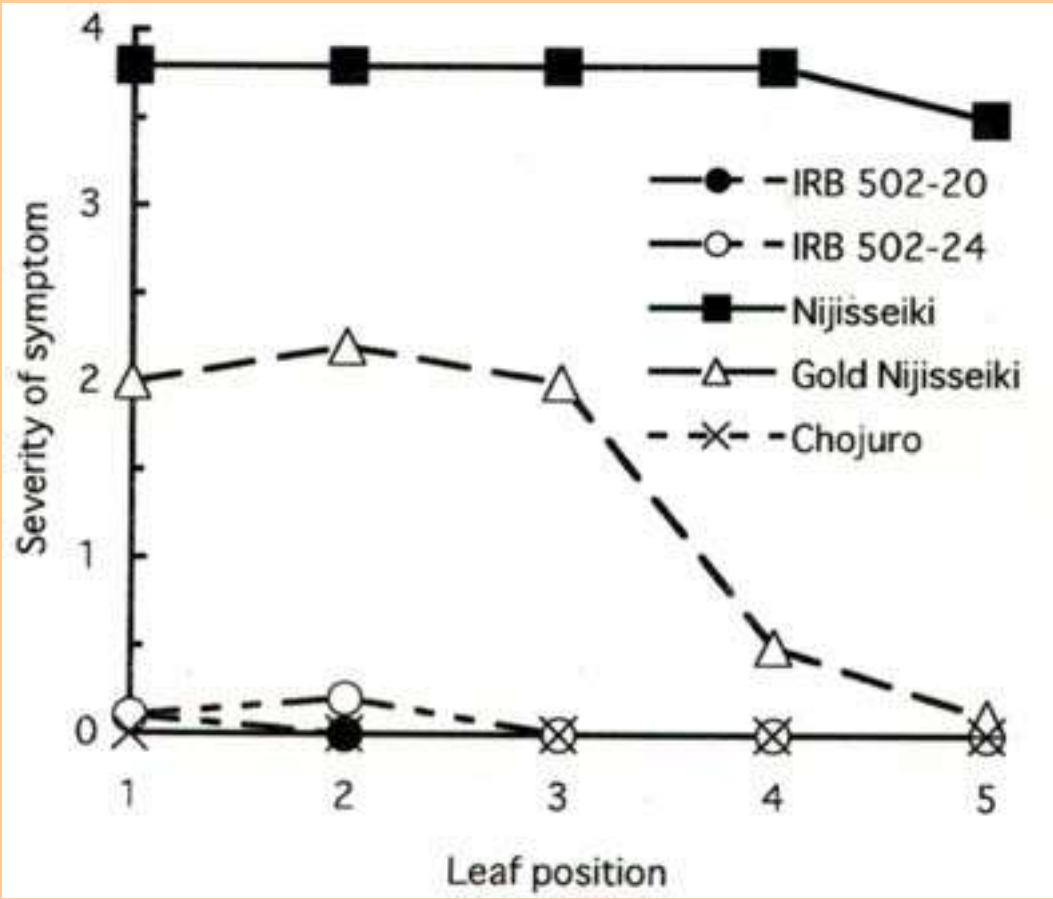
Fig.6. Fruit-bearing shoot of Osa Gold



 [Back](#)

Fig.7. Response to crude AK-toxin on the leaf disk of IRB 502-20 and -24, induced mutants with high resistance to blank spot disease¹⁸⁾

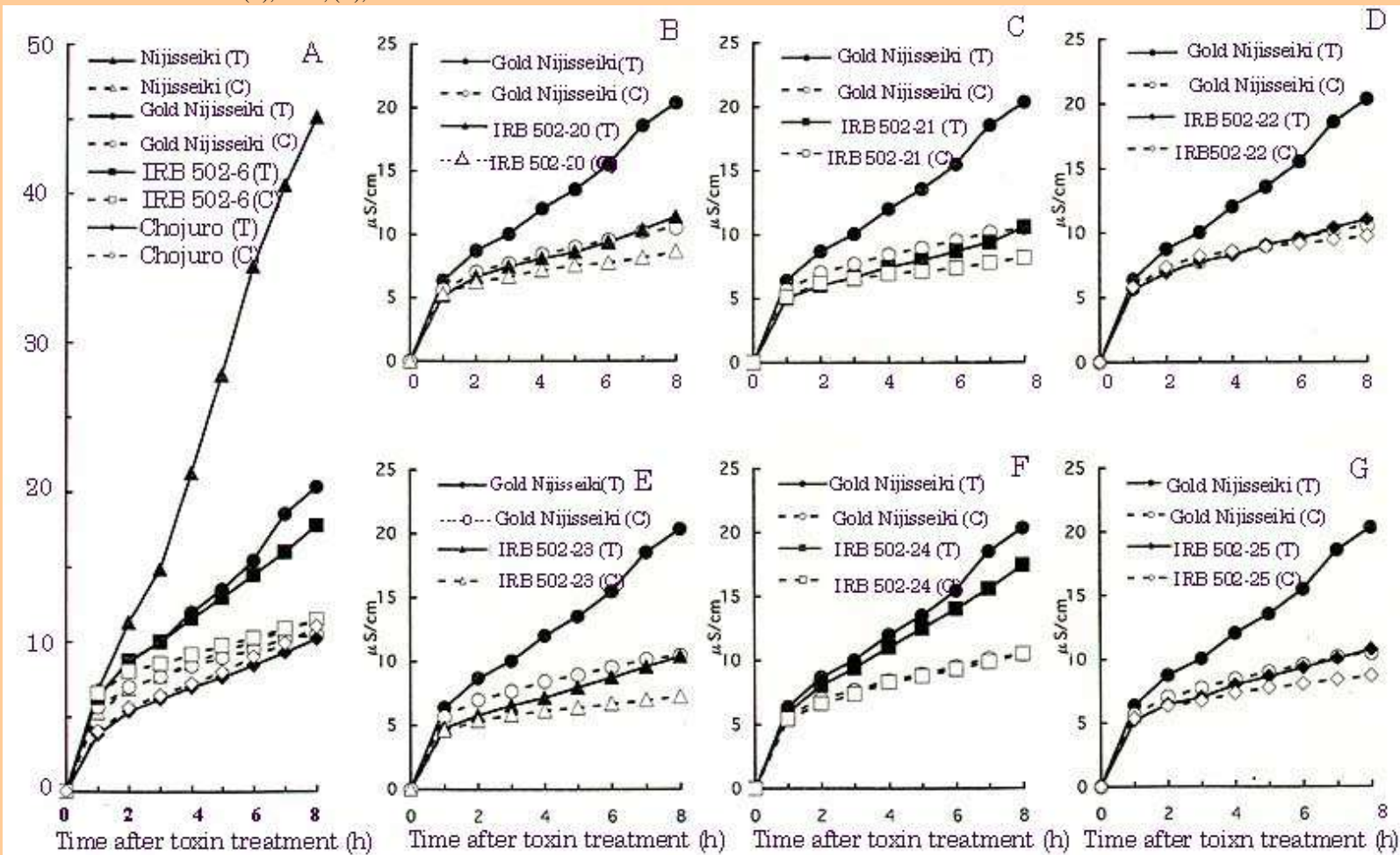
Leaf disks were checked at 48h after toxin treatment.



 [Back](#)

Fig.8. AK-toxin-induced electrolyte loss from leaf tissues of Nijisseiki, IRB 502-6 (³-C-1), Chojuro and Super Gold family lines¹⁹⁾

Treatments were as follows: (T); toxin, (C); deionized water.



[Back](#)



# Technique for Deep Placement of Coated Urea Fertilizer in Soybean Cultivation

**Yoshihiko TAKAHASHI*₁ and Takuji OHYAMA*₂**

*₁ Niigata Agricultural Research Institute, Crop Research Center  
(Nagakura, Nagaoka, Niigata, 940-0826 Japan)

*₂ Department of Applied Biological Chemistry, Niigata University  
(Ikarashi, Niigata, 950-2102 Japan)

## Abstract

The objective of this study was to increase the productivity of soybean seeds by the application of controlled release nitrogen fertilizers (coated urea). Based on the results obtained in field experiments carried out for 3 years (1989-1991), deep placement of coated urea consistently enabled to increase the seed yield by about 10-20% over the conventional treatment. Deep placement of coated urea did not depress the N₂ fixation activity throughout the growth stages until maturity, though N from fertilizer was actively absorbed. The basal deep placement of coated urea for soybean cultivation enabled to supply N from the lower part of roots without concomitant depression of N₂ fixation, and consequently seed yield increased. High recovery rate (over 60%) of fertilizer N was also advantageous from economical viewpoints.

Discipline: Soils, fertilizers and plant nutrition/Crop production  
Additional key words: N₂ fixation, ureide, root growth, Rb uptake

(Received for publication, February 9, 1999)

1...14): [References](#)

## Introduction

Soybean is the most important leguminous grain crop used by human beings and livestock as food or feed, respectively, worldwide. In Japan there are many traditional soybean products, such as 'tofu,' 'miso,' soy sauce, 'natto' (fermented soybean), etc. Soybean seeds are useful materials for the food industry, because they are very rich in oil and protein with a good nutritive value.

Soybean plants require a continuous supply of a large amount of N for maximum seed yield, and N is generally derived from 3 sources under field conditions; from symbiotic N₂ fixation by root nodules, from N absorbed from soil mineralized N and from fertilizer. In spite of the high demand for N, a large supply of N fertilizer markedly depresses nodule development and N₂ fixation activity, resulting in the reduction of the seed yield.

In Niigata Prefecture, about 80% of the soybean plants are cultivated in upland fields converted from drained rice paddy fields. The fields consist mostly of clayey Gray soil, and adverse soil conditions such

as poor water drainage lead to a low average soybean seed yield of  $1.3 \text{ Mg ha}^{-1}$ . On the other hand, the contribution of  $\text{N}_2$  fixation is estimated to be relatively high in soybean plants cultivated in drained paddy fields in Niigata, and about 60-80% of total accumulated N in shoot originates from fixed  $\text{N}_2$ .

In the present studies, a new technique consisting of deep placement of coated urea fertilizer has been developed to obtain high yield, efficient fertilizer utilization, and high  $\text{N}_2$  fixation activity^{6,8,14}).

## Materials and methods

### 1) Cultivation

Soybean *Glycine max* (L.) Merr. cv. Enrei plants were grown in an upland field converted from a drained paddy field of Niigata Agricultural Experiment Station. Seeds were sown on May 31-June 4, in 1989-1991. The seeds were stripe-sown at a density of  $8.9 \text{ seeds m}^{-2}$  ( $15 \times 75 \text{ cm}$ ) by single stem training. Cultivation method was applied according to the guidebook for soybean cultivation published by Niigata Prefecture. Main operation sequence was as follows: fertilization'tillage; harrowing'herbicide application'seeding-intertillage; earthing up (late in June^early in July). Agricultural chemicals were spread 2 or 3 times to control the insect pests.

The terminology of the reproductive stages followed that reported by Fehr and Caviness¹). Corresponding description with the stage numbers was as follows: R1, beginning of bloom; R3, beginning of pod development; R5, beginning seed of development, R7, beginning of maturity; R8, full maturity.

### 2) Field conditions

The experimental field had been converted from a paddy field in the previous year. The soil was a fine-textured Gray Lowland soil. Chemical properties of the soil were as follows: texture, clay loam; pH ( $\text{H}_2\text{O}$ ), 7.1; CEC ( $\text{cmol}(+)\text{kg}^{-1}$ ), 31.3; total carbon content ( $10^{-2} \text{ kg kg}^{-1}$ ), 1.0; total nitrogen content ( $10^{-2} \text{ kg kg}^{-1}$ ), 0.11; C/N, 9.1; amount of mineralized N determined by the incubation of air-dried soil under upland conditions for 4 weeks at  $30 \text{ } (10^{-7} \text{ kg kg}^{-1})$ , 4.8.

### 3) Fertilizer application

Fertilizer application is outlined in [Table 1](#). Three treatments were designed as follows:(a) control, basal dressing of ammonium sulfate ( $16 \text{ kg N ha}^{-1}$ );(b) deep placement, basal dressing of ammonium sulfate ( $16 \text{ kg N ha}^{-1}$ ) and deep placement of coated urea,100-day type ( $100 \text{ kg N ha}^{-1}$ ); (c) top dressing, basal dressing of ammonium sulfate( $16 \text{ kg N ha}^{-1}$ ) and top dressing of coated urea,70-day type ( $100 \text{ kg N ha}^{-1}$ ). In addition, phosphorus and potassium fertilizers were supplied as basal dressing for all the experimental plots ( $60 \text{ kg P}_{205} \text{ ha}^{-1}$ ,  $80 \text{ kg K}_2\text{O ha}^{-1}$ ), respectively. Each treatment was triplicated in randomized plots.

Two types of coated urea fertilizer were supplied by Chisso-Asahi Co., Ltd., namely the 100-day type of coated urea was used for the deep placement and 70-day type of coated urea for the top dressing treatment, which require 100 days and 70 days to release 80% of N by incubation in water at 25, respectively.

The deep placement of coated urea was carried out using the fertilizer injector ([Fig. 1a](#)) devised by Shioya (1985) or a fertilization machine ([Fig. 1b](#)) produced by Niigata Agric. Exp. Stn. on an experimented basis in 1991. Fertilizers were injected just under the seed-placement lines at a 20 cm depth along the ridges. Top dressing of 70-day type coated urea was carried out just before the flowering stage. In the control treatment, N 16 kg ha⁻¹ (NH₄)₂SO₄ was supplied as basal application.



[-Effect of deep placement-](#)



[Contents](#)

## References

- 1) Fehr, W. R. Caviness, C. E. (1977): Stages of soybean development. *Spec. Rep. Coop. Ext. Serv. Agric. Home Econ. Exp. Stn., Iowa State Univ.*, 80, 1-12.
- 2) Hargrove, W. L. (1985): Influence of tillage on nutrient uptake and yield of corn. *Agron. J.*, 77, 763-768.
- 3) Herridge, D. F. (1989): Methods for evaluating nitrogen fixation by nodulated legumes in the field. Australian Center for International Agricultural Research, Canberra, 22-46.
- 4) Ishizuka, J. (1970): Nitrogen metabolism in leguminous crop. *Agric. Hortic.*, 45, 1053-1057 In Japanese.
- 5) Ohyama, T. (1984): Comparative studies on the distribution of nitrogen in soybean plants supplied with N and NO₃ at the pod filling stage. a. Assimilation and transport of nitrogenous constituents. *Soil Sci. Plant Nutr.*, 30, 219-229.
- 6) Ohyama, T. et al. (1994): Effect of deep placement of coated urea slow release nitrogen fertilizer on chemical composition of soybean seeds. *Jpn. J. Soil Sci. Plant Nutr.*, 65, 41-47 In Japanese with English summary.
- 7) Shioya, T. (1985): Development of the technology to tillage and to fertilize in the subsoil. Development of the fertilizer-injector. *In Abstracts of the 1985 Meeting, Farm Work Research Congress*, 47-48 In Japanese.
- 8) Takahashi, Y. (1996): Effect of deep placement of controlled release nitrogen fertilizer on the growth of soybean plants and seed productivity in the upland field converted from a drained paddy field. *Bull. J. Niigata Agric. Exp. Stn.*, 41, 53-104 In Japanese with English summary.
- 9) Takahashi, Y., Chinushi, T. Ohyama, T. (1993): Quantitative estimation of N fixation activity and N absorption rate in field grown soybean plants by relative ureide method. *Bull. Fac. Agric. Niigata Univ.*, 45, 91-105.
- 10) Takahashi, Y. et al. (1994): Yield components of soybean plant with deep placement of N fertilizer, related to high productivity. *Bull. Fac. Agric. Niigata Univ.*, 40, 7-15.
- 11) Takahashi, Y. et al. (1991): Effect of deep placement of controlled release nitrogen fertilizer (coated urea) on growth, yield, and nitrogen fixation of soybean plants. *Soil Sci. Plant Nutr.*, 37, 223-231.
- 12) Takahashi, Y. et al. (1991): Effect of placement of coated urea fertilizer on root growth and rubidium uptake activity in soybean plant. *Soil Sci. Plant Nutr.*, 37, 735-739.
- 13) Takahashi, Y. et al. (1992): Evaluation of N fixation and N absorption activity by relative ureide method in field-grown soybean plants with deep placement of coated urea. *Soil Sci. Plant Nutr.*, 38, 699-708.
- 14) Takahashi, Y. et al. (1993): Behavior of fertilized N from top-dressed or deep placed coated urea in soil of soybean field. *Jpn. J. Soil Sci. Plant Nutr.*, 64, 338-340 In Japanese.

**Table 1. Fertilizer application treatments**

Treatment	Basal application ^{a)}			Top dressing		
	Type of N fertilizer	Applied N (kg ha ⁻¹ )	Placement depth (cm)	Type of N fertilizer	Applied N (kg ha ⁻¹ )	Placement depth (cm)
Control	(NH ₄ ) ₂ SO ₄	16	0-13			
Deep placement	(NH ₄ ) ₂ SO ₄	16	0-13			
	Coated urea ^{b)}	100	20			
Top dressing	(NH ₄ ) ₂ SO ₄	16	0-13	Coated urea ^{c)}	100	2- 5

a) : Fused magnesium phosphate ( 60 kg P₂O₅ ha⁻¹) and potassium chloride ( 80 kg K₂O ha⁻¹) fertilizers were used for basal application in all the experimental plots.

b) : 100-day type of coated urea which releases 80% of the N in water at 25 °C in 100 days.

c) : 70-day type of coated urea which releases 80% of the N in water at 25 °C in 70 days.



[Back](#)



**Fig.1. Fertilizer injector (a) and fertilization machine (b) used**

Fertilizer injector was used in 1989-1990

Fertilization machine was used in 1991.

 [Back](#)

## Effect of deep placement

The accumulation of dry matter and total N content in shoot were always the highest in the plants with the deep placement treatment at R7 stage ([Table 2](#)). On the other hand, in the top dressing treatment, the amount of N accumulated from the R3 to R7 stages was lower than in the deep placement treatment (Table 2). Consequently, the seed yield in the deep placement was 4.17-5.92 Mg ha⁻¹, surpassing that in the control (3.73-4.80 Mg ha⁻¹) and the top dressing (3.59-5.32 Mg ha⁻¹) treatments ([Table 3](#)).

The promotive effect of seed yield by the deep placement was analyzed from the characters in the shoots at the R8 stage. Since the number of pods per node of the plants with deep placement was higher than in the control ones, total pod and seed number increased by deep placement ([Tables 3, 4](#)).

The average seed size expressed as 100-seed weight shown in Table 3 indicates that the seed size in the deep placement was larger than or the same as that of the control or top dressing treatments. The chemical composition of seed such as, protein, oil, carbohydrates, minerals, etc., was almost similar among the treatments⁶⁾. Therefore, the seed quality was not lower in deep placement of coated urea.

## Evaluation of N₂ fixation

A modified relative ureide method has been employed for the estimation of the proportion of plant N derived from N₂ fixation by analyzing the N content of ureides, nitrate, and amino N in xylem sap collected from root bleeding xylem sap³⁾. We used the relative abundance of ureide-N (ureide-N/(ureide-N + NO₃-N + amide-N)) as an indicator for the relative dependence on N₂ fixation, based on the fact that the major part of fixed N₂ is transported in the form of ureides⁴⁾, whereas the transport forms of absorbed N from soil and fertilizer N, were mainly nitrate, amino acids, and amides⁵⁾. We compared the "relative ureide-N method" with the conventional "N-balance method" using nodulating (T202) and non-nodulating (T201) isolines grown in the field, and the results suggested that the relative ureide method is a useful technique for estimating the current ratio of N derived from N₂ fixation versus the total N assimilation⁹⁾.

By using the relative ureide method we obtained the following results ([Fig.2](#)). Top dressing treatment depressed the N₂ fixation activity during the maturation stage (R5-R7) and the N absorption rate was higher than that of the control plants. On the other hand, deep placement of coated urea did not depress the N₂ fixation activity throughout the growth stages until maturity, although active N absorption from fertilizer was confirmed by the ¹⁵N tracer experiments. The N recovery rate in the plants with deep placement of coated urea was about 62%, a value much higher than that of the plants with top dressing of coated urea (33%) at the R7 stage ([Table 5](#)).



[-Root growth and activity-](#)



[Contents](#)



**Table 2. Dry matter production and N accumulation in shoot of soybean plant**

Experiment year	Treatment	Dry weight of shoot (Mg ha ⁻¹ )		N accumulation in shoot (g m ⁻² )	
		R3	R7	R3	R7
		1989	Control	3.16a	7.40a
	Deep placement	3.68a	9.57b	9.69a	31.35b
	Top dressing ^{a)}	3.94	7.56	10.83	24.45
1990	Control	3.12a	9.13a	9.31a	34.77a
	Deep placement	3.83a	10.98c	11.69b	42.59b
	Top dressing	3.21a	9.85b	9.88ab	38.47ab
1991	Control	2.14a	6.58a	5.30a	24.77a
	Deep placement	2.29a	9.11b	6.30a	33.33b

Within a column, means followed by the same letter are not significantly different at 5% level LSD test.

a) : These data were considerably different in each block, and thus omitted for statistical calculation.



[Back](#)

**Table 3. Seed yield and yield components**

Experiment year	Treatment	Seed yield (Mg ha ⁻¹ )	Yield components			
			No. of pods (m ⁻² )	No. of seeds per pod	No. of seeds (m ⁻² )	100-seed weight (g)
1989	Control	3.73a	523a	2.06a	1080a	34.6a
	Deep placement	4.24b	571a	2.04a	1163b	36.4b
	Top dressing	3.59a	509a	2.01a	1023a	35.0a
1990	Control	4.80a	766a	1.86a	1423a	33.8a
	Deep placement	5.92c	928b	1.89ab	1752b	33.8a
	Top dressing	5.32b	836ab	1.91b	1597ab	33.8a
1991	Control	3.79a	596a	1.91a	1101a	34.5a
	Deep placement	4.17b	631b	1.89a	1193a	34.9a

Within a column, means followed by the same letter are not significantly different at 5% level LSD test.



[Back](#)

**Table 4. Characteristics of shoots of soybean plants at R8 stage**

Experiment year	Treatment	Main stem length (cm)	No. of nodes in main stem	No. of first blanches	Stem diameter (mm)	No. of total nodes (m ⁻³ )	No. of pods per node
1989	Control	56a	13.8a	4.5a	9.3a	315a	1.66
	Deep placement	56a	13.7a	4.9a	9.1a	334a	1.71a
	Top dressing	55a	13.5a	4.7a	8.9a	321a	1.60a
1990	Control	53a	13.5a	6.5a	9.4a	442a	1.83a
	Deep placement	53a	13.8a	7.0a	10.0a	451a	2.06b
	Top dressing	53a	13.6a	6.5a	9.7a	425a	1.97b
1991	Control	47a	12.4a	4.5a	9.3a	281a	2.05a
	Deep placement	51b	12.4a	4.8a	9.7a	287a	2.20b

Within a column, means followed by the same letter are not significantly different at 5% level LSD test.



[Back](#)

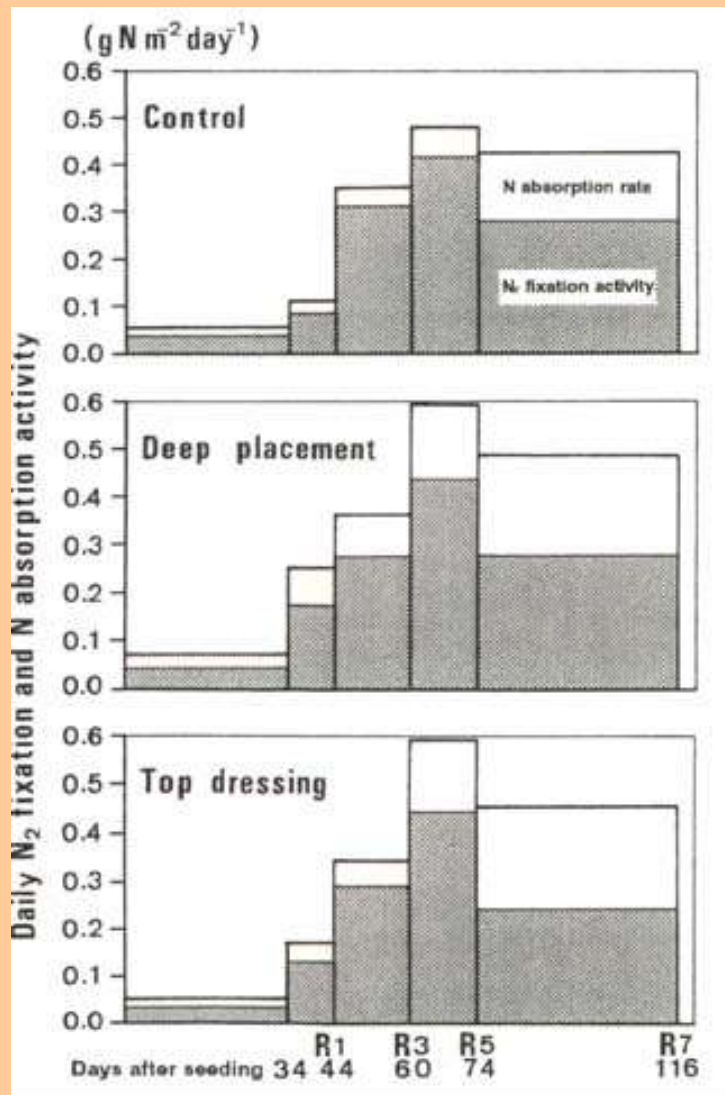


Fig.2.

Daily N₂ fixation activity and N absorption rate (from soil + fertilizer) depending on the plant stages and treatments



[Back](#)

**Table 5. Fertilizer-N recovery rates in the plant shoot**

Experiment year	Treatment	R3 stage		R7 stage	
		Absorbed N (g m ⁻² )	Recovery rate (%)	Absorbed N (g m ⁻² )	Recovery rate (%)
1989	Control ^{a)}	0.05	3.1	0.15	9.4
	Deep placement ^{b)}	2.10	21.0	4.75	47.5
	Top dressing ^{c)}	0.63	6.3	2.56	25.6
1990	Control ^{a)}	0.13	8.3	0.15	9.2
	Deep placement ^{b)}	1.23	12.3	6.24	62.4
	Top dressing ^{c)}	0.22	2.2	3.26	32.6

a) : ¹⁵N- (NH₄)₂SO₄. b) : ¹⁵N-Coated urea 100-d. type. c) : ¹⁵N-Coated urea 70-d. type.



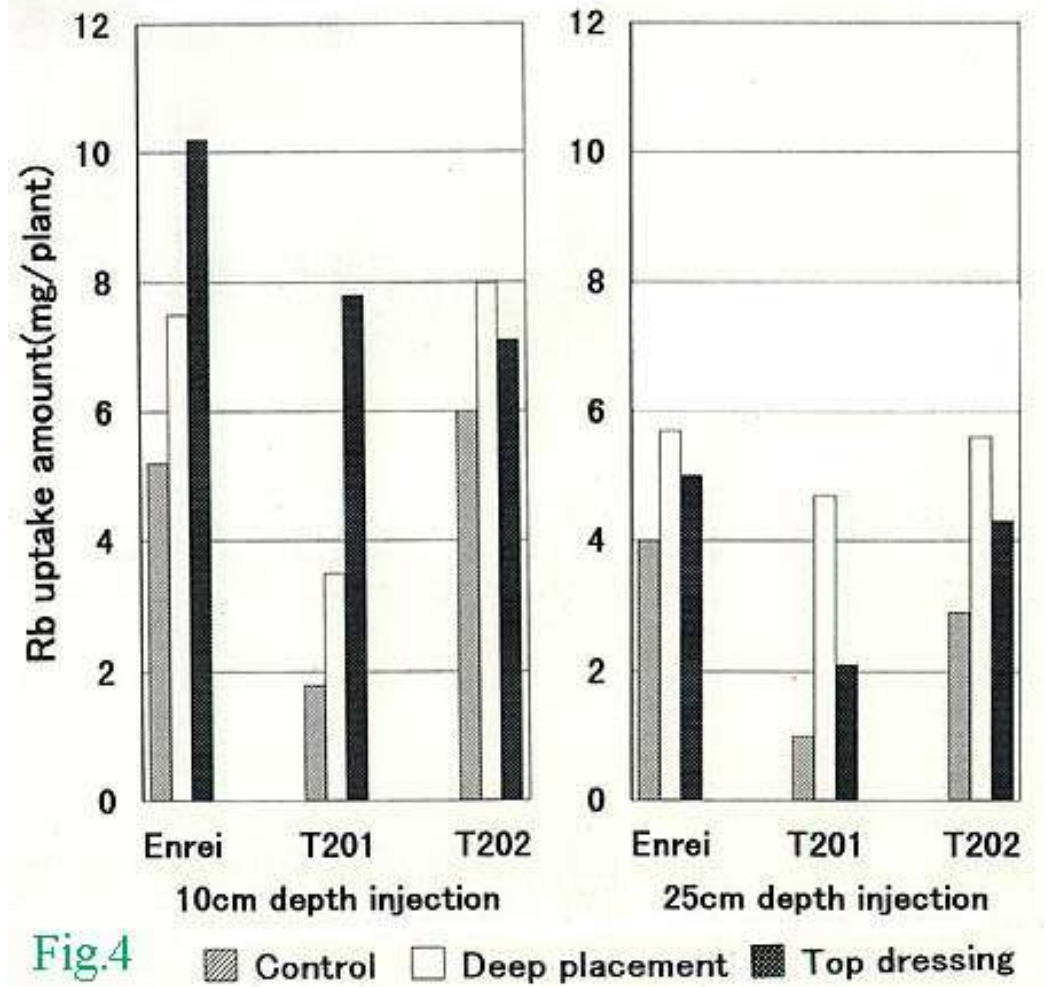
[Back](#)

## Root growth and activity

The effects of placement of coated urea fertilizer on the root growth and activity were investigated by measuring the root dry weight and Rubidium (Rb) absorption activity (Figs. 3, 4). Alternatively  $^{32}\text{P}$  and Eu tracer have been used to study the root activity. However these methods are expensive and require a special equipment for analysis.

### Fig.4. Amount of Rb uptake depending on the cultivarsts, and depth of Rb injection

Recently Rb has been used in field studies as a convenient tracer and some reports were published²⁾. We employed the Rb tracer method to measure the moisture uptake activity and the root density.



The results shown in Fig.3 suggested that the deep placement of coated urea promotes the growth of roots, especially during the reproductive stages (R1-R7). Also top dressing treatment slightly enhanced the root growth.

When Rb was injected at a 10 cm depth in soil, the total amount of Rb accumulated in the plants was larger in the sequence of control<deep placement<top dressing. On the other hand, the amount of Rb accumulated from an area at a 25 cm depth was always the largest in every variety subjected to deep placement of coated urea followed by the top dressing treatment. Consequently, it was considered that deep placement of coated urea exerts a beneficial effect on the growth of soybean plants, where the extended roots are able to absorb moisture from deeper areas and drought can be avoided. Moreover, it is possible that deep placement of coated urea does not exert a harmful effect on nodule development especially those located near the surface layer.

## Behavior of fertilizer-N in soil

The behavior of fertilizer-N in soil was investigated in order to analyze the effect of deep placement of

coated urea. At the same time, the deep placement technique was evaluated to prevent groundwater pollution by  $\text{NO}_3^-$  originating from fertilizer-N.

Theoretically, more than half of the amount of N should be released from deep placement of coated urea during the first half of the growth period in soybean plants ([Fig. 5](#)). Fertilizer-N was mainly absorbed during the latter half of the growth period as revealed by the  $^{15}\text{N}$  tracer experiment ([Table 5](#)). The time lag of the absorption was due to ammonium adsorption and accumulation in soil released from fertilizer  $\text{N}^{14}$  (data not shown). Although the eluted urea was rapidly hydrolyzed to ammonia by urease activity in soil, the  $\text{NH}_4^+$ -N could not be easily nitrified owing to the low activity of nitrification in the deep layers of soil ([Fig. 6](#)). And the adsorbed  $\text{NH}_4^+$ -N on the negative electric charge of clayey soil was absorbed effectively by the roots in deep layers. As a result, soybean plants could absorb N during the maturation stage when soybean required a large amount of N for seed production. Then, the absorbed N contributed effectively to the increase of soybean yield.

When the 70-day type of coated urea was applied in surface layers, the fertilizer-N was easily converted to  $\text{NO}_3^-$ -N due to the high activity of nitrification in the surface soil, and eluviated from the rhizosphere soil in the  $\text{NO}_3^-$  form⁸ (data not shown).

Several advantages of deep placement of coated urea include the high recovery rate of fertilizer-N by crop plants and prevention of groundwater pollution originating from fertilizer-N.

## Application in farmer's field

The deep placement technique was applied in a farmer's field. In 1993 soybean plants sustained damage from extremely cold weather and wet injury. However the seed yield in the case of deep placement of coated urea increased by 22% over that in the conventional treatment. As a result, due to deep placement of coated urea, the farmer's income increased by 43% compared with conventional fertilization. The increased income associated with a higher seed yield compensated for the cost of coated urea and fertilization machine.

## Conclusion

Deep placement of coated urea with whole layer basal dressing of ammonium sulfate enabled to increase the soybean seed yield by about 10-20% over that by the conventional whole layer basal dressing of ammonium sulfate. The promotive effect of deep placement on seed yield was due to the lack of depression of  $\text{N}_2$  fixation throughout the growth stages, and to the active absorption of fertilizer-N. The N recovery rate in the plants with deep placement of coated urea was about 62%, a value much higher than that of the plants with top dressing (33%) at the R7 stage. We confirmed that the deep placement of coated urea exerted a beneficial effect on the growth of deeper roots based on the Rb tracer experiment. Although the urea released from coated urea was rapidly hydrolyzed to ammonia,  $\text{NH}_4^+$ -N could not be easily nitrified owing to the low activity of nitrification in the deep soil layers. As a result, soybean plants could absorb the N during the maturation stage when soybean requires a large amount of N for seed production.



[Forward to: -Resource-Recycling System for Domestic Wastewater Treatment Using Biogeofilter Ditches-](#)

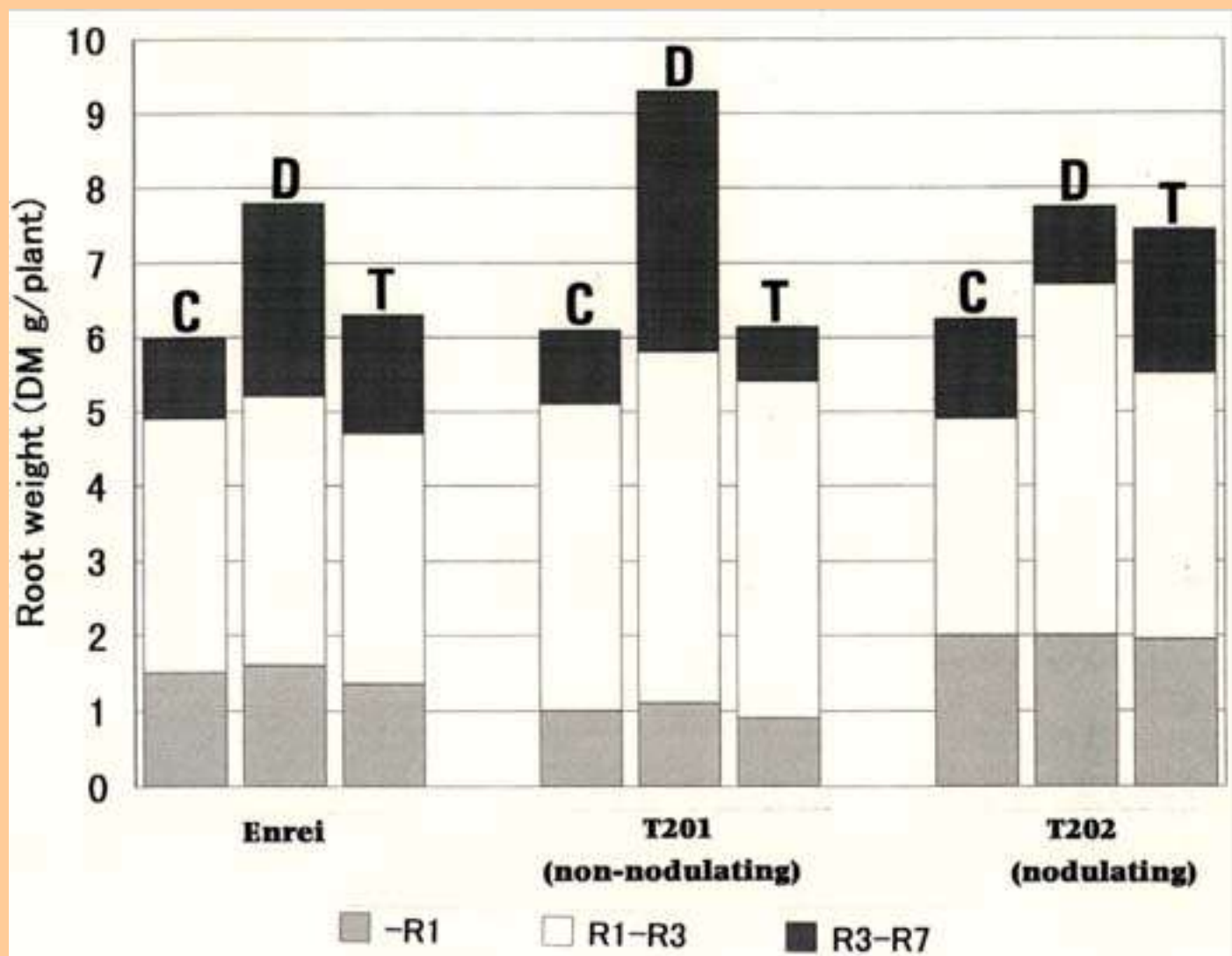


[Contents](#)



[JIRCAS Home Page](#)





[Back](#)

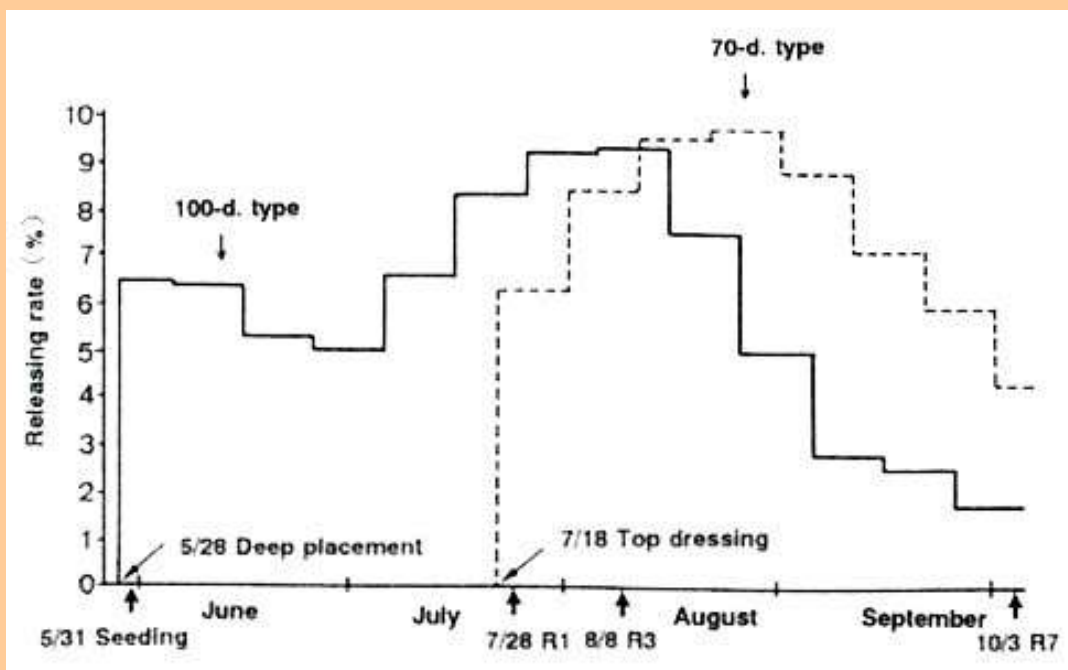
Fig.3.Amount of roots depending on the plant stages, cultivars, and treatments

C: Control.

D: Deep placement.

T: Top dressing.

Fig.5. Theoretical N releasing pattern from coated urea (pattern based on soil temperature in 1990)



 [Back](#)

**Table 5. Fertilizer-N recovery rates in the plant shoot**

Experiment year	Treatment	R3 stage		R7 stage	
		Absorbed N (g m ⁻² )	Recovery rate (%)	Absorbed N (g m ⁻² )	Recovery rate (%)
1989	Control ^{a)}	0.05	3.1	0.15	9.4
	Deep placement ^{b)}	2.10	21.0	4.75	47.5
	Top dressing ^{c)}	0.63	6.3	2.56	25.6
1990	Control ^{a)}	0.13	8.3	0.15	9.2
	Deep placement ^{b)}	1.23	12.3	6.24	62.4
	Top dressing ^{c)}	0.22	2.2	3.26	32.6

a) : ¹⁵N- (NH₄)₂SO₄. b) : ¹⁵N-Coated urea 100-d. type. c) : ¹⁵N-Coated urea 70-d. type.



[Back](#)

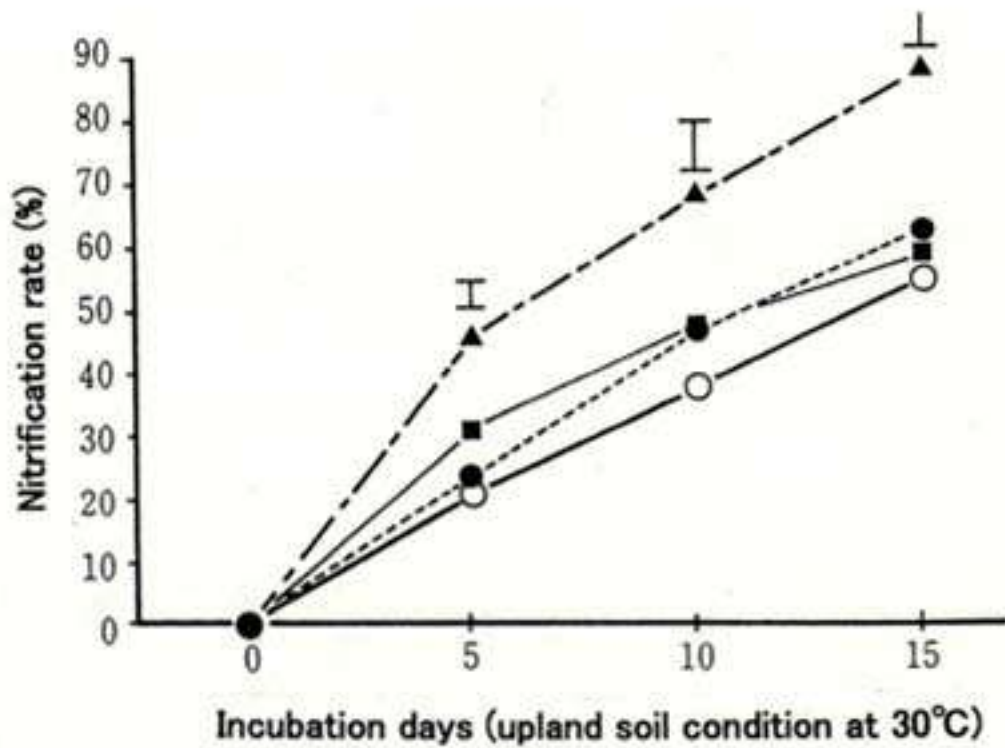


Fig.6. Nitrification activity of soil depending on the sampling time and soil depth

○: 5/22 0^10cm depth. ▲: 5/22 15^25cm depth.

●: 7/9 0^10cm depth. ■: 7/9 15^25cm depth.

Bars indicate LSD at 5 % level.



[Back](#)

# Resource-Recycling System for Domestic Wastewater Treatment Using Biogeofilter Ditches Planted with Useful Plants

**Yasuo OZAKI**

Department of Soils and Fertilizers, National Agriculture Research Center  
(Tsukuba, Ibaraki, 305-8666 Japan)

## Abstract

It is necessary to develop an energy-saving and resource-recycling system for water purification in rural and mountainous areas. This paper outlines the development of a resource-recycling system for water purification. The purification system consisted of a combination of anaerobic/aerobic treatment plant and biogeofilter (BGF) ditches filled with zeolite and Kanuma soil as bed filter materials. The BGF ditches were planted with useful aquatic and terrestrial plants. The average rates of total nitrogen (T-N) and total phosphorus (T-P) removal by the aquatic plants were  $1.34 \text{ g m}^{-2} \text{ d}^{-1}$  and  $0.34 \text{ g m}^{-2} \text{ d}^{-1}$ , respectively. The water purification system decreased the average T-N concentration to  $0.31 \text{ mg L}^{-1}$  and average T-P concentration to  $0.22 \text{ mg L}^{-1}$  from domestic wastewater in summer. The useful plants planted in the BGF ditches grew vigorously and produced more fruits indicating that the secondary effluent of the domestic wastewater contains essential nutrient elements. Thus, the use of this effluent for water culture of useful plants enables to purify the domestic wastewater and is also an effective means of nutrient recycling.

**Discipline:** Agricultural environment/Horticulture

**Additional key words:** domestic wastewater purification, nitrogen, phosphorus

1...13): [References](#)

(Received for publication, February 9, 1999)

## Introduction

The nitrogen (N) and phosphorus (P) contained in domestic wastewater have recently been the major causes of water pollution in semi-closed water bodies such as Kasumigaura Lake. Until about 1955, human feces and urine were mostly returned to farmlands and used as valuable manure resources⁸). As a result, the water of rivers and lakes remained clear and a large number of species of organisms were able to live there, while children were provided with areas to observe nature, play, fish, and engage in other recreational activities.

Based on previous basic studies^{3,5-7,12,13}), the researchers of the Water Quality Control Laboratory constructed on an experimental basis biogeofilter (BGF) ditches filled with filtering materials and planted with useful plants^{1,2,9-11}). These ditches can effectively use the adsorbing and filtering function of filtering materials, nutrient-absorbing function of plants, and water-purifying function of

microorganisms. Using BGF ditches, the Laboratory has developed a resource-recycling water purification system for rural and mountainous areas. This BGF ditch is not costly and functions as an energy-saving wastewater treatment system suited to rural areas.

## Characteristics and operation of BGF ditches

The resource-recycling water purification system consisted of a combination of anaerobic/aerobic treatment plant and 2 BGF ditches 0.4 x 19.5 x 0.4^H m in size. The BGF ditches were filled with zeolite and Kanuma soil as bed filter materials. The Kanuma soil is one of the volcanic ash soils rich in allophane. The packing height of the filtering materials in the ditch could be adjusted according to the moisture tolerance of plants ([Fig. 1](#)). In this way, vegetables, and other useful terrestrial plants could be used for water purification purposes. As an example, in the ditch where some terrestrial plants were planted, the filtering material was packed up to a height of about 10 cm above the water level.

The water purification experiment was initiated in October 1993 using the domestic wastewater effluent from a family of five. The amount of wastewater was about 1 m³ per day with 40 to 60 mg L⁻¹ total N (T-N) and 4.5 to 7.0 mg L⁻¹ total P (T-P). The domestic wastewater was treated in the combined anaerobic/aerobic treatment plant (Kirin Machinery Corp. Type KY-N7A) and introduced into the adjustment tank. Then the treated water was pumped to the BGF ditches at a rate of 30 to 45 L h⁻¹, which was measured by an instantaneous and integrating flowmeter. The amount of water flowing out of the ditches was measured by using tipping-water flowmeters ([Fig. 2](#)). Influent, water running in the ditch and effluent were sampled at least once a week and analyzed to evaluate the changes in the water purification function. The useful plants were replaced with new ones when they almost lost their nutrient-absorbing function after they had flowered and fruited.

## Comparison of water purification function between a ditch with terrestrial plants and a ditch with aquatic plants

[Fig. 3](#) shows the results of the water purification experiment in which terrestrial plants were grown in the first ditch (H ditch) while aquatic plants were grown in the second ditch (M ditch) in August 1996. In the M ditch planted with swamp cabbage (*Ipomoea aquatica* Forsk) and Chinese arrowhead (*Sagittaria sagittifolia* L.), the average reduction of the T-N concentration in the water was 12.7 mg L⁻¹. On the other hand, in the section of papyrus (*Cyperus papyrus* L.), the average decrease in the T-N concentration was 5.2 mg L⁻¹ while only 1.9 mg L⁻¹ in the section of rice (*Oryza sativa* L.). As a result, the average T-N concentration of effluents was 0.46 mg L⁻¹. In the H ditch, the concentration decreased roughly at the same rate when the water ran down to the end of the ditch. The T-N level of the effluents was reduced to 0.80 mg L⁻¹. The roots of the terrestrial plants reached only an area of about 10 cm below the water surface while the roots of papyrus, swamp cabbage and other aquatic plants reached the ditch bottom and displayed a much higher water purification function.



**Fig. 4.** shows the growth conditions of the plants cultivated in the BGF ditches. Tomato (*Lycopersicon esculentum* M.) plants produced more fruits while swamp cabbage, Chinese arrowhead grew very well. Kenaf (*Hibiscus cannabinus* L.) and papyrus planted in the rear of the ditches grew to a height of more than 2.5 m high. [Fig. 5](#) shows the growth stages of papyrus planted in the last section of the 7.3 m long M ditch.

The height of papyrus was 2.5 m in the upper part of the section but only about 1.2 to 1.5 m in the lower part. The plant growth decreased further when the growth of swamp cabbage and Chinese arrowhead planted in the upper ditch increased from mid-July to mid-September. This trend indicates that the papyrus in the upper part might have absorbed most of the nutrients from the influents. As shown in Fig. 3, the T-N concentration of the water in the lower part of the section was 0.2 to 0.3 mg L⁻¹, probably corresponding to the plants' critical purification function.



[-Simultaneous removal of T-N and T-P using zeolite and Kanuma soil-](#)



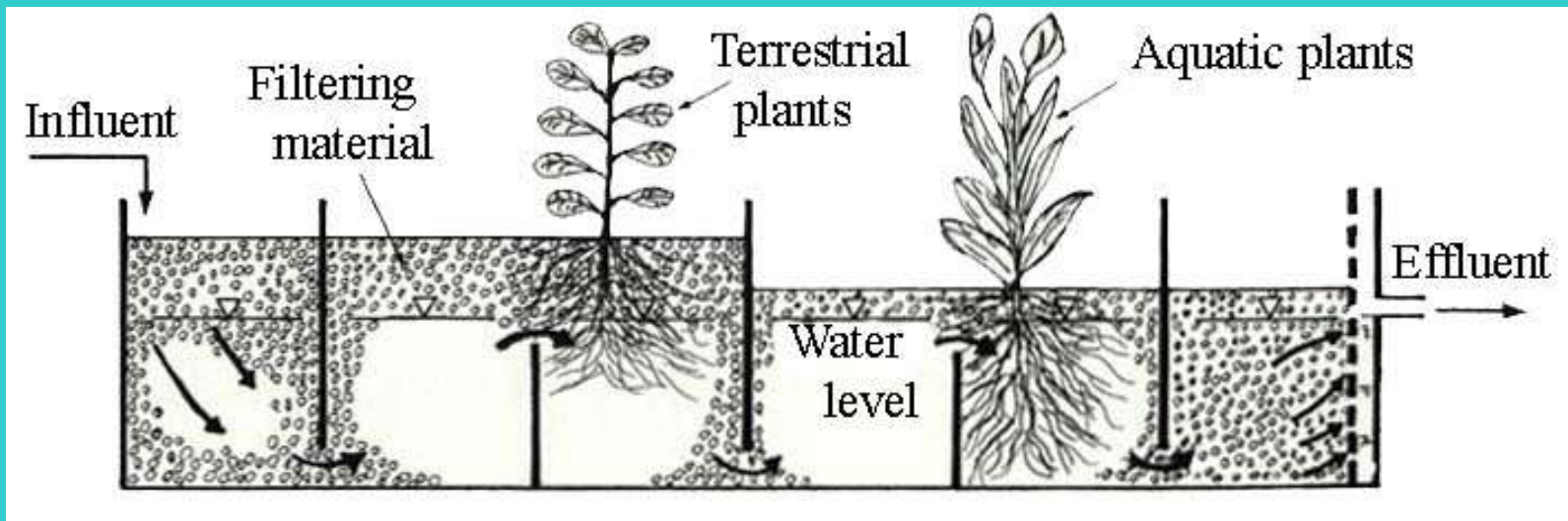
[Contents](#)

## References

- 1) Abe, K., Ozaki, Y. & Kihou, N. (1997): Introduction of fiber plants to plant bed filter systems for wastewater treatment in relation to resource recycling. *Soil Sci. Plant Nutr.*, **43**, 35-43.
- 2) Abe, K. & Ozaki, Y. (1998): Comparison of useful terrestrial and aquatic plant species for removal of nitrogen and phosphorus from domestic wastewater. *Soil Sci.Plant Nutr.*, **44**, 599-607.
- 3) Aoyama, I. (1982): Use of aquatic macrophytes for water quality improvement. *J. Water Waste*, **24**, 87-94 [In Japanese].
- 4) Environmental Agency, Government of Japan (1992): Quality of the environment in Japan. Ministry of Finance, Tokyo, Japan, 353-495.
- 5) Gearheart, R.A. (1992): Use of constructed wetlands to treat domestic wastewater, City of Arcata, California. *Water Sci. Tech.*, **26**, 1625-1637.
- 6) Hashimoto, S., Furukawa, K. & Minami, J. (1987): Advanced water treatment by biogeofilters. *Hakkokogaku Kaishi*, **65**, 45-52 [In Japanese with English summary].
- 7) Hosomi, M. & Sudo, R. (1991): Treatment of domestic wastewater by wetland system. *Jpn. J. Water Pollution Res.*, **14**, 674-681 [In Japanese with English summary].
- 8) Ozaki, Y. (1990): Water quality control and future perspective in agricultural production environments. *J. Water Waste*, **32**, 103-113 [In Japanese].
- 9) Ozaki, Y. & Abe, K. (1993): Present problem and view for resources recycling wastewater treatment using various plants - In order to construct beautiful landscape. *J. Water Waste*, **35**, 771-783 [In Japanese].
- 10) Ozaki, Y. et al. (1995): Resource-recycling system for domestic wastewater treatment using useful plants. *In Proc. of 6th Int. Conf. on the Conser. and Manage. of Lake Kasumigaura '95*, Vol. 2, 965-968
- 11) Ozaki, Y. (1997): Development of a resource-recycling system for domestic wastewater treatment using useful plants. *Jpn. J. Water Treatment Biol.*, **33**, 97-107 [In Japanese].
- 12) Reddy, K.R. & Sutton, D.L. (1984): Waterhyacinth for water quality improvement and biomass production, *J. Environ. Quality*, **13**, 1-8.
- 13) Wolverton, B. C. (1986): Artificial marshes for wastewater treatment. *In Aquatic plants for water treatment and resource recovery*. eds. Reddy, K.R. & Smith, W. H., Magnolia Publ., Orlando. FL, 153-174.

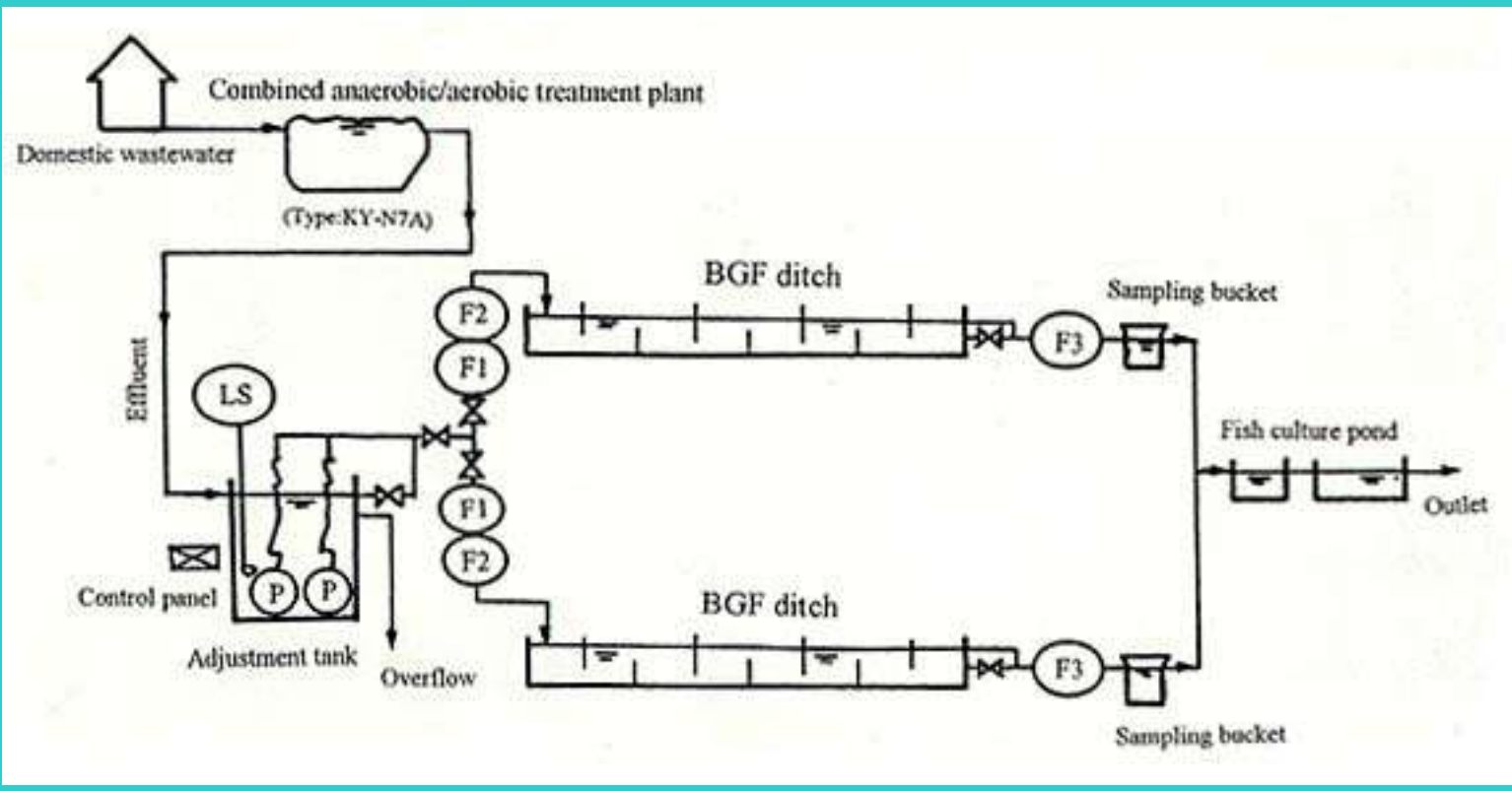


Fig. 1. Biogeofilter ditch with filtering materials



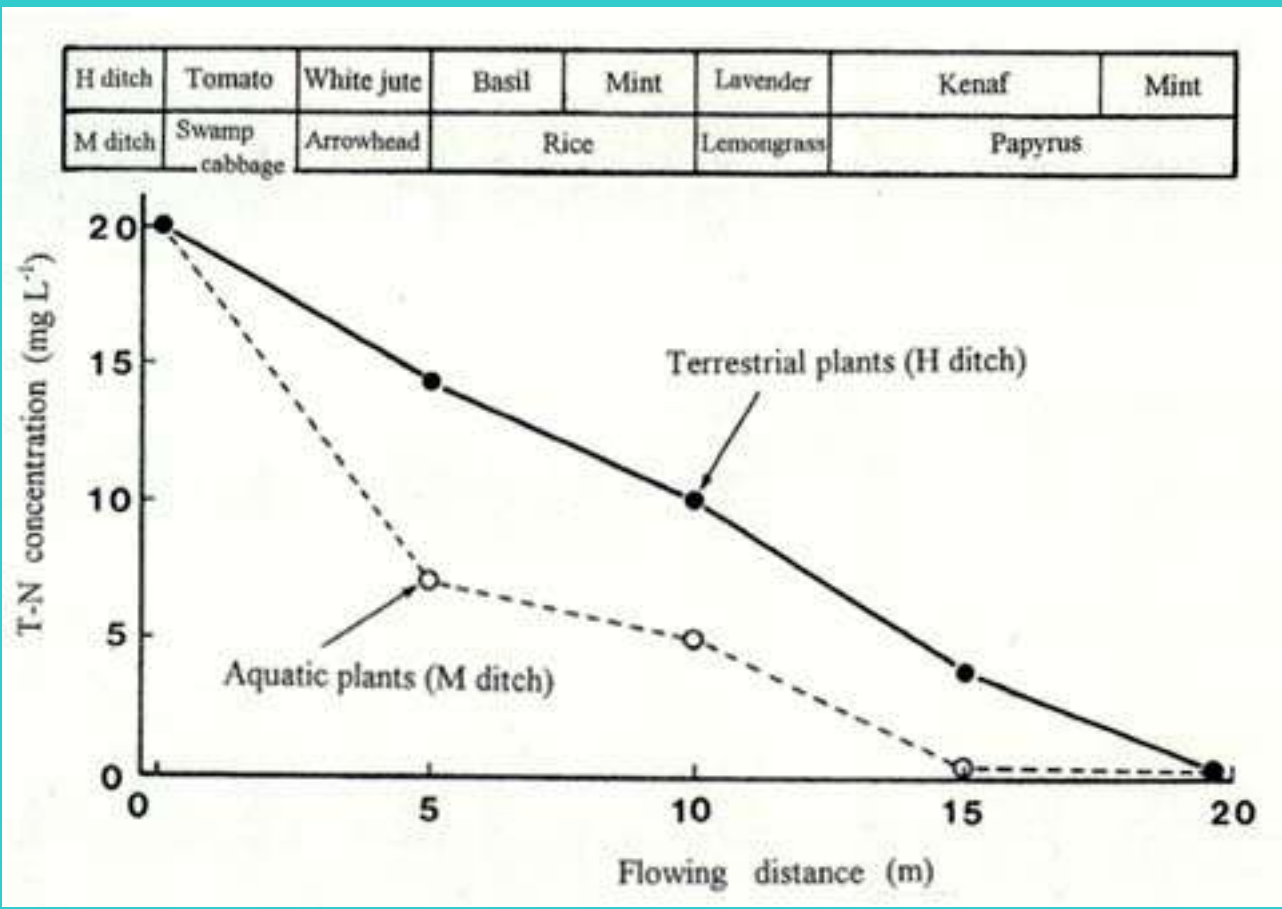
 [Back](#)

Fig. 2. Resource-recycling system for wastewater purification combining a treatment plant and BGF ditches



 [Back](#)

Fig. 3. Changes in total nitrogen concentration of wastewater effluent at varying flowing distances (August 1996)



 [Back](#)



Fig.5. Growth conditions of papyrus in the last section of M ditch



1...13): [References](#)

## Simultaneous removal of T-N and T-P using zeolite and Kanuma soil

The changes in the T-N concentration of the effluent in the M ditch, in which zeolite and Kanuma soil were used as bed filter materials, and in the H ditch, in which only zeolite was used, are shown in [Fig. 6](#). Transplanting was performed from April 20 to May 20. Aquatic plants such as swamp cabbage, Chinese arrowhead, taro (*Colocasia esculenta* S.C.) and papyrus were planted in the M ditch while terrestrial plants such as tomato, basil (*Ocimum basilicum* L.), mint (*Mentha* spp.) and kenaf were planted in the H ditch. The initial 5 mg L⁻¹ T-N concentration of the effluent from the H ditch decreased to 0.4 mg L⁻¹ when the growth rate of the terrestrial plants increased markedly at 6 weeks after planting. On the other hand, T-N concentrations of the effluent from the M ditch ranged from 0.21 to 0.54 mg L⁻¹.

The T-P concentration of the effluent from the H ditch ranged from 1.10 to 4.69 mg L⁻¹ while in the M ditch, from 0.01 to 1.63 mg L⁻¹ ([Fig. 7](#)). [Tables 1 and 2](#) indicate the total N and P contents of the effluents from the M ditch in summer. From August to September, the total N and P concentrations were lower than those corresponding to the environmental water quality standards (T-N £ 0.4 mg L⁻¹, T-P £ 0.03 mg L⁻¹) in Kasumigaura Lake⁴). Swamp cabbage, taro, tomato and garland chrysanthemum (*Chrysanthemum coronarium* L.) planted in the Kanuma soil showed similar growth rates to those when planted in zeolite. Moreover, no evidence of micronutrient deficiency symptoms was observed. Especially, the height of the taro plants was 2.3 m and the yield was 22 kg m⁻² ([Fig. 8](#)).

## Applications of the BGF ditch system

The members of the family who evaluated the resource recycling system using BGF ditches, reassessed their previous lifestyle and paid much attention to the cycle of resources. Since they voluntarily stopped using chemical pollutants such as bleach and synthetic detergents, the water from their BGF ditches became very clear and odorless. In the fish culture pond to which the water was discharged, fishes like killifish, loach and goldfish started breeding and dragonfly larvae and frogs built their habitat, creating an ecosystem similar to that of a natural pond.



**Fig.9. Tomato harvest in BGF in ditch (August 1996)**

The family ate tomato (Fig. 9), taro, swamp cabbage, garland chrysanthemum, radish (*Raphanus sativus* L.), and other crops grown in the ditch. The family also enjoyed a bath using the herbs harvested from the ditches. Moreover, in their papermaking classes, the pupils of the elementary schools in Tsukuba, Ibaraki Prefecture, became interested and tried to make paper out of the papyrus cultivated by the BGF ditch system.

In addition to the water purification function, the BGF system could supply the following functions:

1. Domestic waste water facilities for rural communities to provide parks with water amenities and areas to enjoy the waterside;
2. Facilities for islands and arid areas to recycle water resources and essential nutrient elements;
3. Horticultural facilities to efficiently use fertilizer resources and provide people with places for enjoying recreational and other activities;
4. Facilities for households to use home gardens, flower beds, and hedges;
5. Facilities for schools, nurseries, and similar establishments to provide children with areas for environmental education and nature observation; and
6. Facilities for hospitals, schools for handicapped children, homes for senior citizens and for providing patients and others with areas for herbal therapy.

## Conclusion

This study showed that domestic wastewater treated in a combined anaerobic/aerobic treatment plant became an excellent liquid fertilizer with a balanced nutrient composition. Consequently, by using this liquid for water culture of vegetables and useful plants, the natural cycle of resources and water purification could be achieved simultaneously.

The rapid population growth and increase in human activities today generate environmental issues. Population problems are not only due to food and agriculture production but also to the person's lifestyle including eating habits. For nature and human beings to coexist in a harmonious community, it is necessary to change the way of life into a more eco-friendly one.



[Forward to:-Simulation of Soil Moisture in Upland Fields of the Cerrados Area-](#)



[Contents](#)



[JIRCAS Home Page](#)

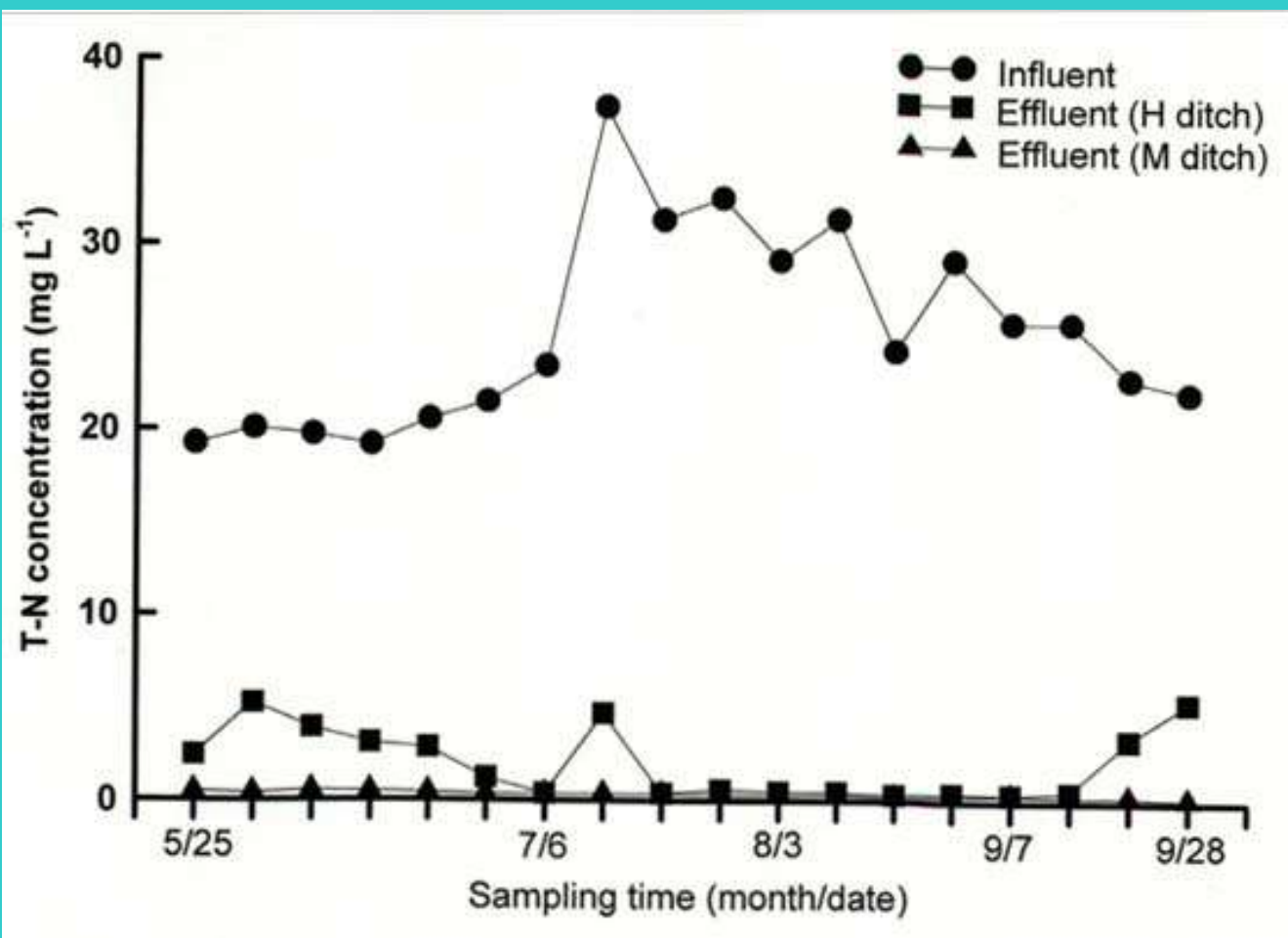


Fig. 6. Nitrogen purification of BGF ditches planted with useful plants in summer 1997

 [Back](#)

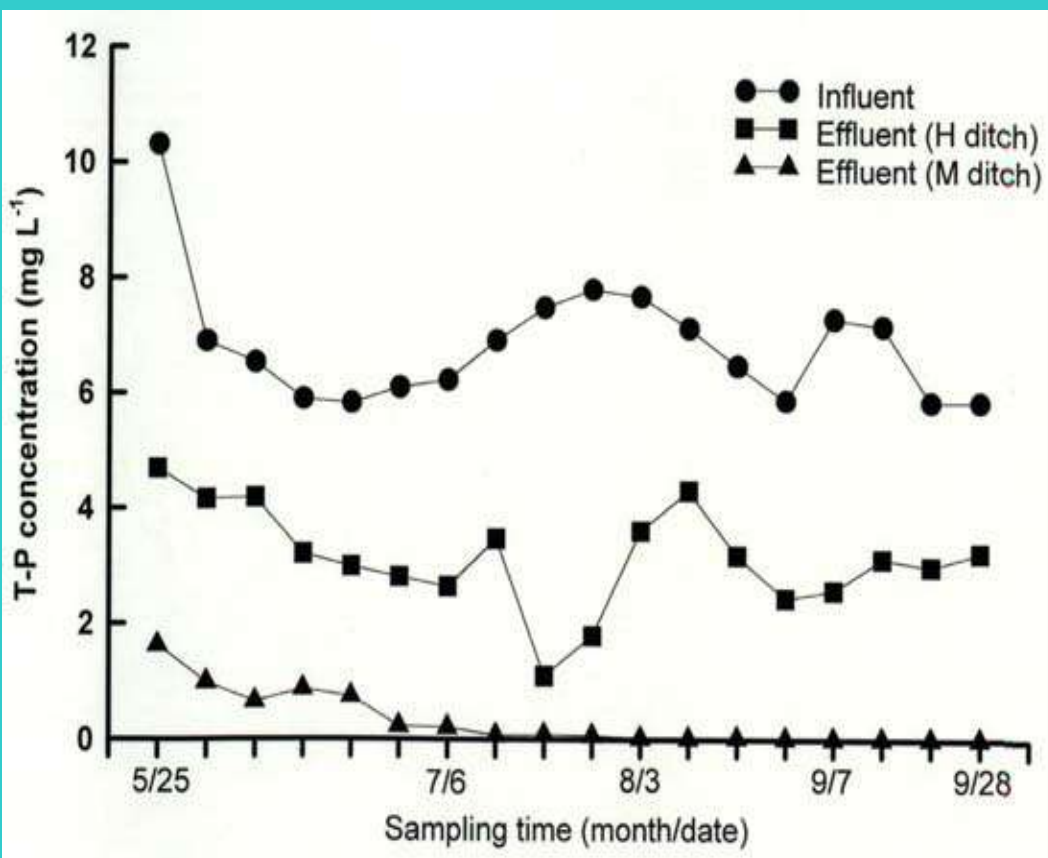


Fig. 7. Phosphorus purification of BGF ditches planted with useful plants in summer of 1997



[Back](#)



**Table 1. Total nitrogen purification from domestic wastewater effluent by BGF ditch planted with aquatic plants in summer 1997**

Date	Influent			Effluent			Removal rate ( $\text{gm}^{-2}\text{d}^{-1}$ )
	Flow rate ( $\text{Ld}^{-1}$ )	Concentration ( $\text{mg L}^{-1}$ )	Loading rate ( $\text{gm}^{-2}\text{d}^{-1}$ )	Flow rate ( $\text{Ld}^{-1}$ )	Concentration ( $\text{mg L}^{-1}$ )	Removal (%)	
June	372	20.22	0.96	271	0.38	99.0	0.95
July	419	30.73	1.65	252	0.31	99.4	1.64
August	425	28.51	1.55	283	0.26	99.4	1.54
September	394	24.17	1.22	308	0.29	99.2	1.21
Mean	403	25.90	1.35	279	0.31	99.3	1.34

note: 1) Bed filter materials: Kanuma soil and zeolite.

2) Transplanting of aquatic plants was terminated on May 20, 1997.

3) Transplanting of winter plants started on October 1, 1997.

**Table 2. Total phosphorus purification from domestic wastewater effluent by BGF ditch planted with aquatic plants in summer 1997**

Date	Influent			Effluent			Removal rate ( $\text{gm}^{-2}\text{d}^{-1}$ )
	Flow rate ( $\text{Ld}^{-1}$ )	Concentration ( $\text{mg L}^{-1}$ )	Loading rate ( $\text{gm}^{-2}\text{d}^{-1}$ )	Flow rate ( $\text{Ld}^{-1}$ )	Concentration ( $\text{mg L}^{-1}$ )	Removal (%)	
June	372	6.25	0.30	271	0.70	93.3	0.28
July	419	6.88	0.37	252	0.12	99.0	0.37
August	425	6.78	0.37	283	0.03	99.7	0.37
September	394	6.55	0.33	308	0.01	99.9	0.33
Mean	403	6.62	0.34	279	0.22	98.0	0.34

note: 1) Bed filter materials: Kanuma soil and zeolite.

2) Transplanting of aquatic plants was terminated on May 20, 1997.

3) Transplanting of winter plants started on October 1, 1997.



[Back](#)



Fig.8. Taro grown in BGF ditch (November 4, 1997)



[Back](#)

# Determination and Simulation of Soil Moisture Dynamics in Upland Fields in the Cerrados Area (Brazil)

**Kazuhiko OHBA**

Department of Agro-Environmental Management, Kyushu National Agricultural Experimental Station (Nishigoshi, Kumamoto, 861-1192 Japan)

## Abstract

The objective of the studies was to analyze the soil moisture dynamics of upland fields in the Cerrados area of Brazil. Soil moisture level obtained by using tensiometers set in the soil layers was compared with the soil moisture dynamics simulated by the TANK-model. It was found that the actual soil moisture dynamics agreed well with the simulated results, suggesting that the TANK-model could be used to predict the soil moisture dynamics of upland fields based on meteorological and soil property data.

**Disciplines:** Agro-meteorology, Irrigation, drainage and reclamation

**Additional key words:** water balance, TANK-model, groundwater

● 1...12): [References](#)

(Received for publication, February 9, 1999)

## Introduction

The Cerrados of Brazil account for about 21% of the total land area ( $850 \times 10^4 \text{ km}^2$ ). The annual mean temperature ranges between 22 in the southern part and 27 in the northern part. The monthly mean temperature at CPAC (Centro de Pesquisa Agropecuaria dos Cerrados) located in the center of this area ranges from 26.7 in October to 17.7 in July. Although the annual precipitation in this area is known to be in the range of 1,200~1,800 mm, 90% is concentrated in the warm rainy season from October to April. However, this warm rainy season is often interrupted by a relatively longer dry spell called "Veranico." During the remaining period of the year, the weather is dry with little precipitation.

Therefore, crop cultivation in this area is strongly affected by hydrological conditions as mentioned above. Major techniques for improving and stabilizing crop production in the area aim at the development of irrigation practices appropriate to the natural and farming conditions of this area, selection and cultivation of crop species and/or cultivars with higher drought resistance, and development of cropping systems suitable for the annual hydrological conditions.

The data on soil moisture dynamics play an important role in developing more appropriate farming systems in this region with a relatively longer dry spell. For this reason, several researchers^{3,7,9,10)} have studied the seasonal and geographical changes of potential and actual evapotranspiration in the Cerrados area. However, research on the soil moisture dynamics of crop fields in this area is too limited to enable

the development of farming systems appropriate to the climatic conditions.

## Modelling of waterbalance of upland fields

Data on soil moisture dynamics in surface soil layers (root zone) are very important to determine the initial and final time of application of irrigation water into crop fields. These data play also an important role in preventing the occurrence of nitrogen pollution of the soil in the root zone and shallow groundwater caused by long applications of nitrogen fertilizer.

Several methods have been applied to study the soil moisture dynamics in upland crop fields^{8,11,12}). In this paper, the TANK-model developed by Ohta et al. (1990)⁸), which was originally designed to predict evapotranspiration and the soil moisture level in upland fields consisting of Kanto loam, was applied to simulate the soil moisture dynamics in upland fields in the Cerrados area.

As shown in [Fig. 1](#), the TANK-model consists of 5 tanks and a groundwater tank. The first tank corresponding to the first surface soil layer has 2 holes ( $e_0$  and  $e_1$ ) for water evaporation, one hole ( $P_1$ ) for deeper percolation of water, and one hole ( $r_1$ ) for surface runoff of precipitation. Each tank from the second tank to the fifth one has, respectively holes ( $E_1, E_2, E_3, E_4, E_5$ ) for rupture of capillary water rise and holes ( $P_2, P_3, P_4, P_5$ ) for deep percolation of water. The 2 holes for evaporation of the first tank mentioned above were utilized to simulate the following 2 stages of evaporation of water¹): first evaporation hole ( $e_0$ ) simulates the constant-rate stage of evaporation, and second evaporation hole ( $e_1$ ) simulates the falling-rate stage of evaporation.

The water balance in the first tank is mathematically represented in Fig. 1, by the following equations:

$$H_1 = S_{10} + R_0 \text{ ----- (1)}$$

$$Q = (H_1 - P_0) \times r_1 \text{ ----- (2)}$$

$$ET = (H_1 - E_0) \times e_0 + (H_1 - E_1) \times e_1 \text{ ----- (3)}$$

$$F_1 = (H_1 - P_1) \times p_1 \text{ ----- (4)}$$

$$S_1 = H_1 - (Q + ET + F_1) \text{ ----- (5)}$$

In equations (1)-(5),  $Q$ ,  $ET$ , and  $F$  are the surface runoff (mm/day), evapotranspiration (mm/day), and percolation (mm/day), respectively;  $H_1$  and  $S_{10}$  are the daily retention (mm/day) and storage change in the previous day in the first tank.  $R_0$  is the precipitation on that day (mm/day).  $r_1$ ,  $e_0$ ,  $e_1$ , and  $p_1$  are the coefficients of ground surface runoff, evapotranspiration, and percolation, respectively.

The water balance in the second tank can then be written as:

$$H_2 = S_{20} + F_1 \text{ -----(6)}$$

$$MT_2 = (H_2 - E_2) \times e_2 \text{ -----(7)}$$

$$F_2 = (H_2 - P_2) \times p_2 \text{ -----(8)}$$

$$S_2 = H_2 - (MT_2 + F_2) \text{ -----(9)}$$

Where  $MT_2$  is the capillary rising water (mm/day).

As indicated previously, the water budget from the third to the fifth tank can be expressed by equations (6)⁹ in a similar way. The groundwater level is calculated from

$$H_6 = S_{60} + F_5 \text{ -----(10)}$$

$$F_6 = H_6 \times p_6 \text{ -----(11)}$$

$$Q_2 = H_6 \times r_2 \text{ -----(12)}$$

$$S_6 = H_6 - (F_6 + Q_2) \text{ -----(13)}$$

$$S_T = S_1 + S_2 + S_3 + S_4 + S_5 \text{ -----(14)}$$

Where  $S_6$ ,  $F_6$ ,  $Q_2$  and  $S_T$  are the groundwater level (mm), groundwater percolation (mm/day), discharge of groundwater (mm/day) and sum of storage soil-water amounts, respectively.  $r_2$  is the coefficient of discharge across groundwater movement. The subscripts 1~6 refer to the number of tanks, respectively.

The hydrological behavior of these tanks was characterized by hydrological constants as shown in each tank. These constants were estimated using experimental data on the soil-water relations in this area. The unit of calculation in the water balance was represented in terms of the water depth, and the volumetric water content corresponds to the thickness of the soil layer.



[-Experimental method-](#)



[Contents](#)

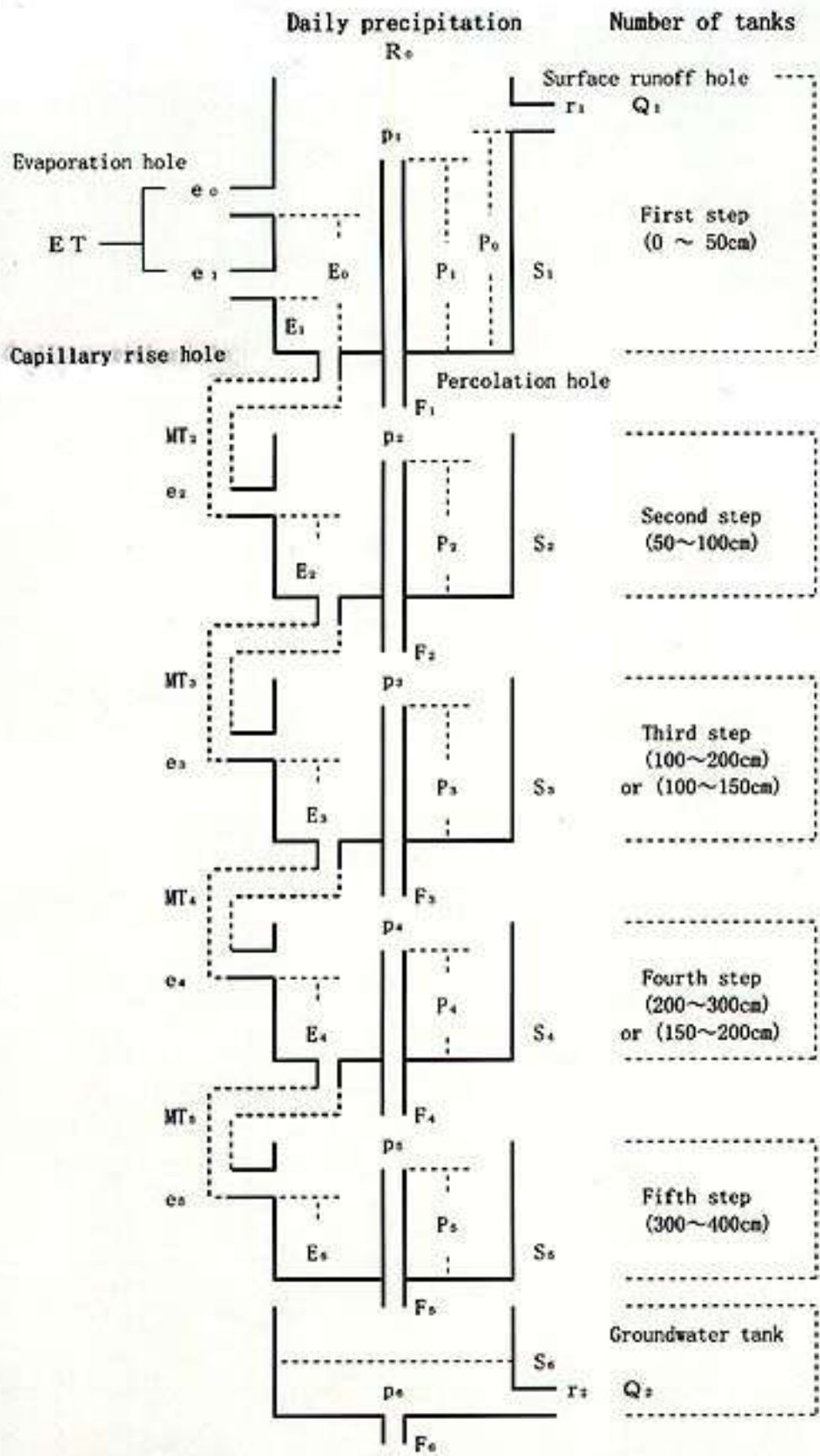
## References

- 1) Daniel, H. (1971): Soil and waterPhysical principles and process. Academic Press. , New York.
- 2) Hayasaka, T. & Ellas, F. J. (1987): On the behaviors of soil moisture and groundwater level concerned with the topography in Cerrados. Final report submitted to CPAC, 15-51In Japanese.
- 3) Horie, T. & Ariovald, L. Jr. (1981): Evapotranspiration rate from an irrigated soybean field in Cerrados as measured by energy balance method. Final report submitted to CPAC, 149-169.
- 4) Iwama, H. & Nakagawa, J. (1987): Soil manegement and fertilization of tropical upland soil in Brazil. TARC Shiryo No. 74, 1-114In Japanese.
- 5) JSIDRE (1980): Handbook of irrigation, drainage and reclamation engineering. JSIDRE, Tokyo In Japanese.
- 6) Kubota, T. & Joaquim, L. C. B. (1983): Physical properties of Cerrado soils and their changes caused by cultivation of arable crops. Final report submitted to CPAC, 3-19.
- 7) Miyazawa, K. et al. (1981): Final report submitted to CPAC, 1-100.
- 8) Ohta, K. et al. (1990): Modeling the soil moisture of upland field. *J. JSIDRE*, 58 (7), 5-9 In Japanese.
- 9) Oliveira, M. O., Mota, F. S. & Silva, J. B. (1980): Estimates of potential evapotranspiration from (Penman) as a function of geographical factors in Brazil. *Agric. Meteorol.*, 22, 123-139.
- 10) Sakuratani, T. & Ariovald, L. Jr. (1982): Methods for estimating potential evapotranspiration from climatic data in Cerrados. Final report submitted to CPAC, 123-139.
- 11) Seino, H. (1990): Soil physics in climatological model of plant productivityA climatological estimation of soil water content. *Soil Phys. Cond. Plant Growth Jpn.*, 61, 11-18In Japanese.
- 12) Suzuki, Y. (1973): Studies on the moisture in upland soil. *Bull. Kyushu Natl. Agric. Exp. Stn.*, 16, 383-592In Japanese.



[Back to the first page](#)

Fig.1. Schematic illustration of the TANK-model



[Back](#)

## Experimental method

### *1) Geographical characteristics of experimental fields*

[Fig. 2](#) illustrates the aerial distribution of soils and vegetation, and topographical characteristics of the experimental fields at the CPAC in Brazil. This figure was quoted from Hayasaka²⁾. As shown in Fig. 2, the experimental fields can be divided into 3 parts such as tertiary peneplain, diluvial declining slope, and alluvial deposit area. The diluvial declining slope can be furthermore classified into 3 subparts such as upper, middle, and lower parts. The most representative soil in the Brazilian Highlands is a latosol (oxisol in 4s soil Taxonomy).

However, soil types in the experimental fields ranged from red-yellow latosol on the Tertiary preneplain, through dark-red latosol in the middle subpart of the diluvial declining slope and hydromorphic soil in the lower subpart of the diluvial declining slope, to organic soil on the Alluvial deposit part.

### *2) Physical characteristics of vertical profiles in each pit*

In Fig. 2, Pit 1, Pit 2, and Pit 3 are located, respectively, in a non-irrigated upland field with red-yellow soil on the plateau, in an orchard field with dark-red soil on the upper diluvial declining slope, and in an irrigated upland field with dark red soil on the middle diluvial declining slope.

When the soil moisture corresponded to the field capacity, solid phase of soils collected at Pit 1, Pit 2, and Pit 3 was found to range from 35 to 45% of the volume. The saturated hydraulic conductivity of these sample soils changed from  $10^{-2}$  to  $10^{-3}$  cm/s. The vertical profile of the soil moisture level in the sample soil columns was found to be rather even, indicating that soil water can move very freely upward and / or downward. The groundwater levels at Pit 1 and Pit 2 were about 5 m and 2 m, respectively.

## Soil moisture and meteorological data and calculation method



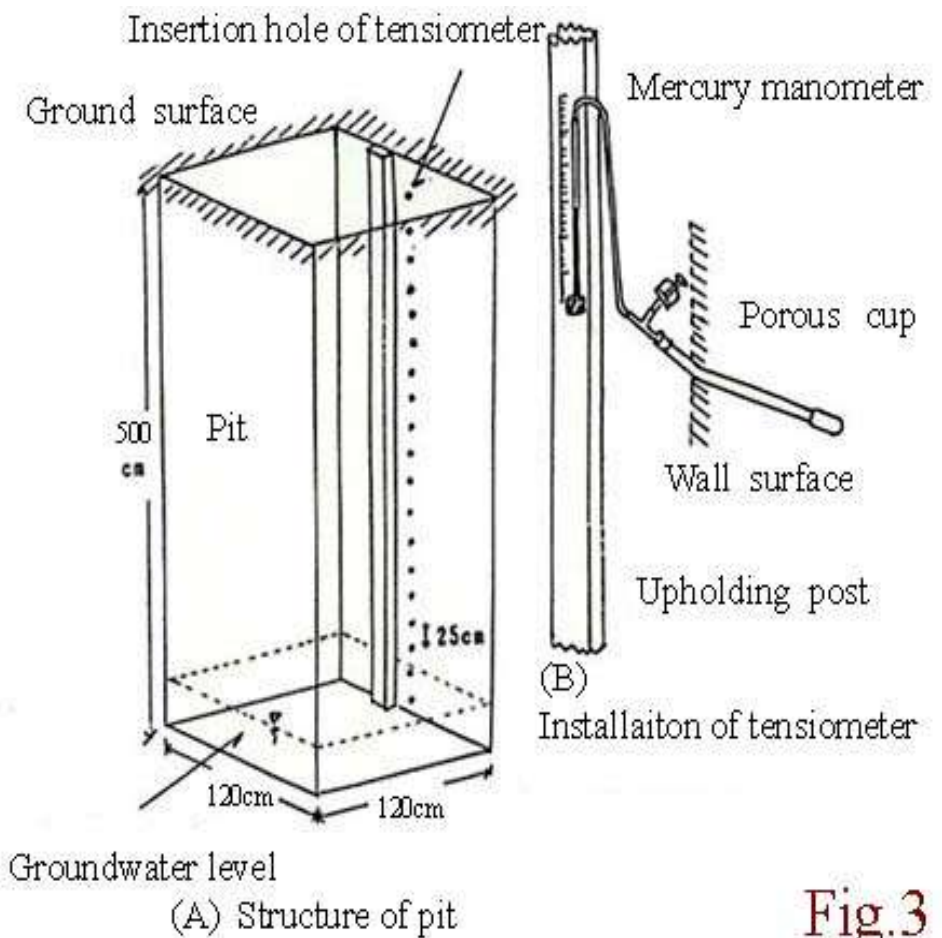
### 1) Method of measurement of soil moisture

As described already, in this report, the soil moisture dynamics simulated by the TANK-model using soil hydraulic constants estimated from experimental data was compared with the soil moisture data obtained by Hayasaka in upland fields in this area (personal communication).

**Fig.3. Method of measurement of soil moisture content²⁾**

As shown in Fig. 3, each Pit was a rectangular solid structure with 4 sides (square) measuring each 1.2 and 5.0 m in depth. The tensiometer was set up with the pit walled in on one side. The soil moisture data at these pits were obtained using tensiometers set in the soil at an interval of 25 cm from the surface

up to a 400 cm depth. Observation data of groundwater level and soil moisture tension in upland fields of the Cerrados were continuously obtained at 3⁷ days intervals during the period between 1983 and 1985. The soil moisture could not be measured in the soil layer of the ground surface in the dry season in and after April.



**Fig.3**

### 2) Water characteristics of soils in the Cerrados

Fig. 4 shows the water content – pF curve for representative soils obtained using undisturbed soil samples (red-yellow and dark-red latosols)^{2,4,6,7)}. Using a non-linear regression analysis, it was found that the following polynomial expression could approximate the dependence of the volumetric soil moisture content (Y : %) on the pF-value (X):

$$Y = 1.07X^3 - 5.38X^2 - 5.31X + 64.76 \text{ -----(15)}$$

The above equation can be used to estimate indirectly and easily the volumetric soil moisture from data of pF-value or soil-water suction (head cmH₂O) obtained by tensiometers.

### 3) Simulation method of soil moisture dynamics

The quantitative water movement in the soil profile can be predicted by the optimized simulation tank model. In the model each soil layer was considered as a tank having holes at different heights representing the water balance parameters including surface runoff, deep percolation, capillary water rise and evapotranspiration. Hole heights representing the limited magnitude of the parameters were determined based on the soil physical properties, namely water constants. Hole diameters representing the coefficient of the respective parameters in the model were determined by simulating the measured

values.

The individual tanks (Pits 1 & 3) of the TANK-model corresponded to the 0~50, 50~100, 100~200, 200~300, and 300~400 cm soil layers, and Pit 2 corresponded to the 0~50, 50~100, 100~150 and 150~200 cm soil layers, respectively. In the soil layer of Pit 2, the groundwater level appeared at about 200 cm. The measurements of the soil-water suction were performed in the upland field of the campus of CPAC. The measurements of the groundwater level were performed at staff gauges in the individual experimental sites. The soil moisture dynamics was simulated by the TANK-model using meteorological data, namely air temperature, solar radiation, wind speed, humidity, data (precipitation and evaporation of class A pan) obtained at the weather station of CPAC (15°35' S, 47°42' W, SL : 1,000 m) during the period between 1978 and 1990.



[-Results and discussion-](#)



[Contnets](#)

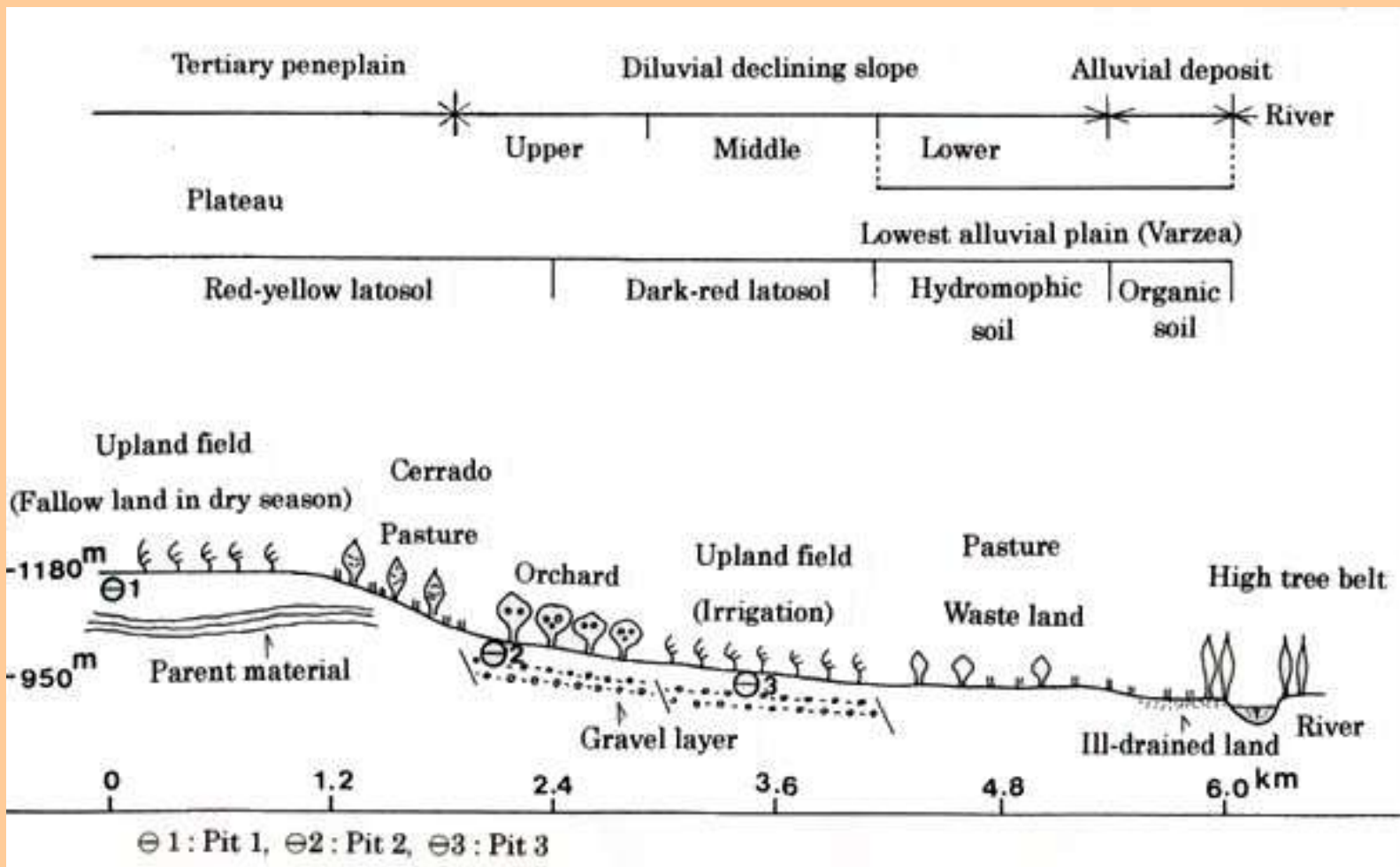


Fig.2. Distribution of soils and their relation to the topography and vegetation²⁾

 [Back](#)

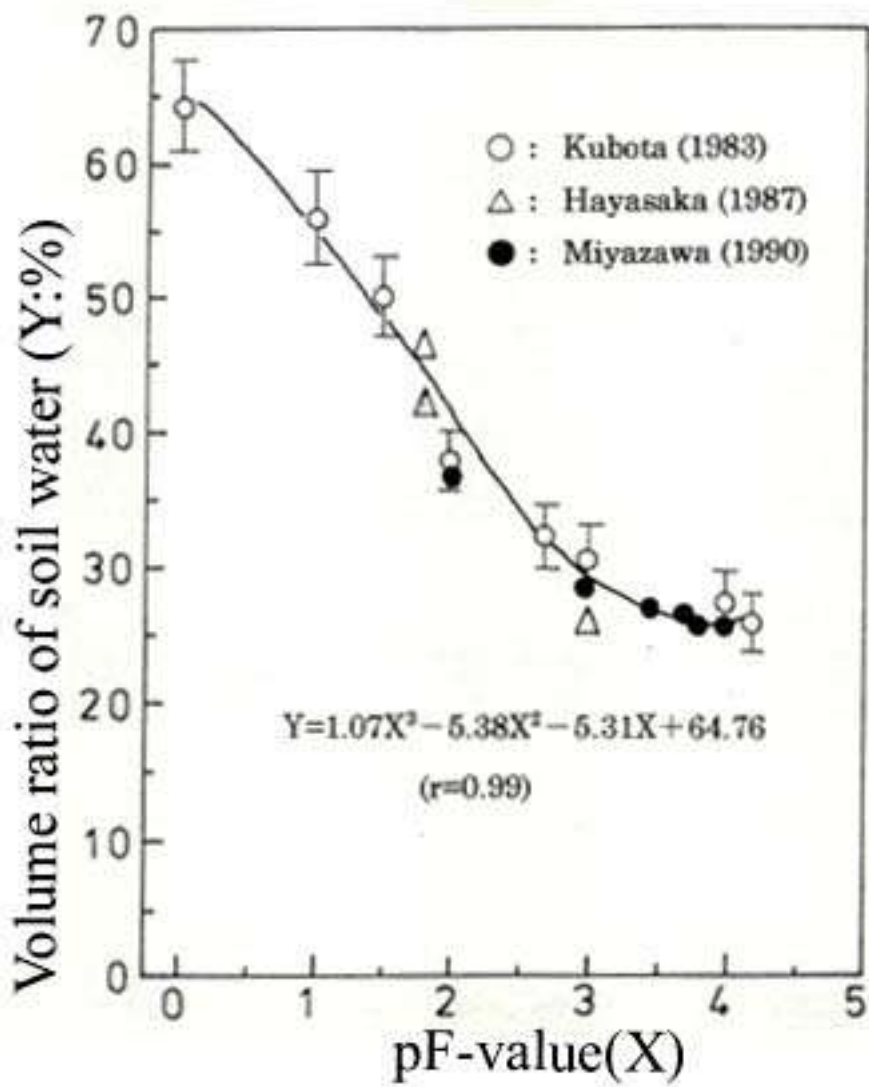


Fig.4. Curve of moisture characteristics of Cerrados soils



[Back](#)

## Results and discussion

### 1) Frequency of occurrence of "Veranico" phenomenon

As is well known, the term "Veranico" refers to a continuous period without rainfall exceeding 6 days during the rainy season. The frequency of occurrence of the "Veranico" phenomenon was investigated using daily precipitation data obtained at CPAC during the period from 1978 to 1990. It was found that the Veranico phenomenon is most frequent during the period from December to February.

During this study, the longest duration of the Veranico phenomenon was 32 days for the period between February and March. The frequency of occurrence of the Veranico phenomenon over a 20 day period was found to be about 4 times per year. Due to the Veranico phenomenon, upland crops in this area were damaged by drought, at a frequency of once every 3 years.

### 2) Application of TANK-model to the prediction of the soil moisture dynamics in upland fields

In semiarid and arid regions with a distinct dry spell in a year, crop production is markedly affected by the amounts of soil moisture available in the root zone. Therefore, the TANK-model as described in Fig. 1 was used to simulate the soil moisture dynamics in upland fields, using each coefficient empirically estimated. The coefficients are listed in [Table 1](#). The simulation results so obtained were compared with the data on the soil moisture dynamics obtained at the individual experimental sites (Pits 1 & 2).

[Figs. 5](#) and [6](#) show the seasonal changes in related meteorological data and the amounts of soil-water stored in each soil layer at different depths. The observation data of the amounts of soil-water can be calculated by equation (15) with the mean soil-water suction obtained with a tensiometer in each soil layer. The soil moisture dynamics simulated by the TANK-model was also presented to evaluate its applicability to upland fields. Comparison between the observed and simulated results was made using the meteorological data in 1984 with little precipitation.

As shown in Figs. 5 and 6, although there was some discrepancy between the observed soil moisture (circles) and simulated soil moisture (solid lines) data, it appears that the seasonal changes in the soil moisture of the upland fields simulated by the TANK-model agreed well in general with those determined with the tensiometers.

Soil moisture dynamics ( $S_1, S_2, S_3, S_4$ ) in each soil layer simulated by the TANK-model using weather data agreed well with the measured soil moisture dynamics ( $\ddot{E}$ ) with an error of  $\pm 10\%$ . Furthermore, the estimation error for the soil moisture dynamics ( $S_T$ ) in the total root zone decreased by about  $\pm 5\%$ .

Seasonal changes in the observed groundwater level (GWL) were found to follow those ( $S_6$ ) simulated by the TANK-model.

This general agreement indicates that the TANK-model can be applied to simulate seasonal changes in the soil moisture of upland fields using data on meteorological conditions and hydraulic characteristics of soils.

The calculation of the water balance for the root zone of upland fields revealed that the maximum deep percolation of water and the maximum capillary rise of water in this experimental field were 4.0 mm/day

and 1.8 mm/day, respectively. Expected maximum capillary water rise in this field agreed well with the recovery rate of the soil moisture in volcanic ash soils (Japan) during the night¹²). The runoff ratio calculated for the upland fields during the experimental period was found to be 26.3%, with a good agreement with that obtained in flat upland fields of Japan⁵).

### ***3) Soil moisture dynamics during the "Veranico" period***

The weather data during the Veranico period in 1981 were used to analyze the soil moisture dynamics for a longer and stronger Veranico period. The soil moisture dynamics simulated by the TANK-model using Pit 1 for this period are shown in [Fig. 7](#), which indicates that soil moisture in the surface soil layer (0~50 cm) decreased very drastically with the start of the Veranico phenomenon.

That is, the soil moisture in this layer decreased from 200 mm at the beginning (Jan. 31) to 156 mm at the end (March 15), because of the very high evaporation loss of water from heated soil surface and the absence of rainfall during this period. The soil moisture at the end (March 15) was about 70% of the field capacity of soils. For this reason, the growth and yield of the soybean crop in this year were severely reduced due to the considerable shortage of available soil moisture in the root zone.

The author thanks Dr. Z. Uchijima, Miyazaki Municipal University, for the correction of this report, and Drs. T. Hayasaka, N. Kosuge and T. Morinaka for their continued support.



[Forward to:-Analysis of Medium Condition on Mulberry Tissue Culture-](#)



[Contents](#)



[JIRCAS Home Page](#)

**Table 1. TANK coefficient used to estimate the soil moisture**

	Percolation level (mm)					Percolation coefficient						Discharge		
	P ₁	P ₂	P ₃	P ₄	P ₅	p ₁	p ₂	p ₃	p ₄	p ₅	p ₆	R ₁	r ₁	r ₂
Pit 1	205	197	361	343	332	0.5	0.5	0.3	0.2	0.1	0.0001	220	1.0	0.001
Pit 2	205	190	180	180	—	0.5	0.5	0.3	0.2	—	0.005	220	1.0	0.02
	Evapotranspiration level (mm) and capillary rising level (mm)					Evapotranspiration coefficient and capillary rising coefficient								
	E ₁	E ₂	E ₃	E ₄	E ₅	e ₀	e ₁	e ₂	e ₃	e ₄	e ₅			
Pit 1	160	135	160	320	320	0.06	0.03	0.02	0.01	0.0	0.0			
Pit 2	160	135	160	160	—	0.06	0.03	0.02	0.01	0.0	—			


[Back](#)

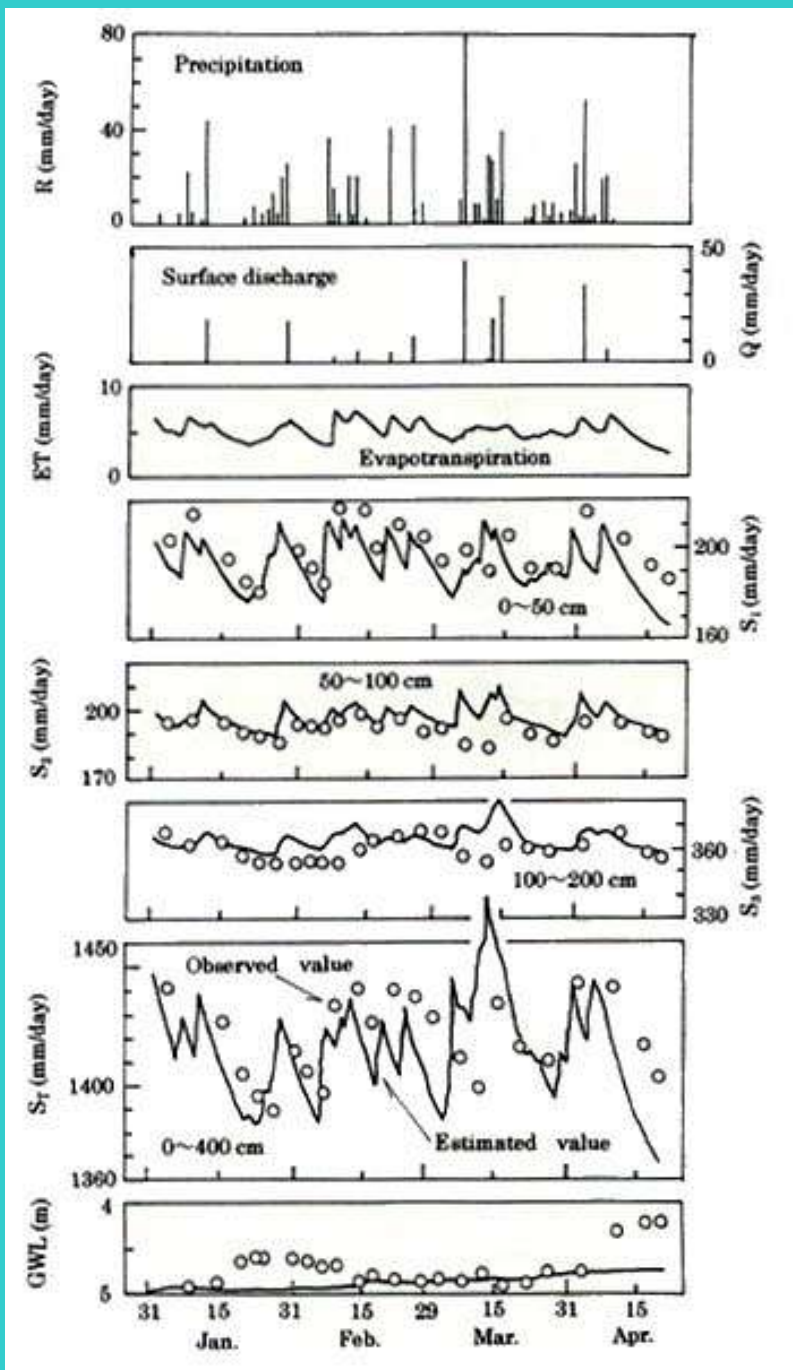


Fig.5. Comparison of estimated values of soil moisture, groundwater level and evapotranspiration at Pit 1 with observed values





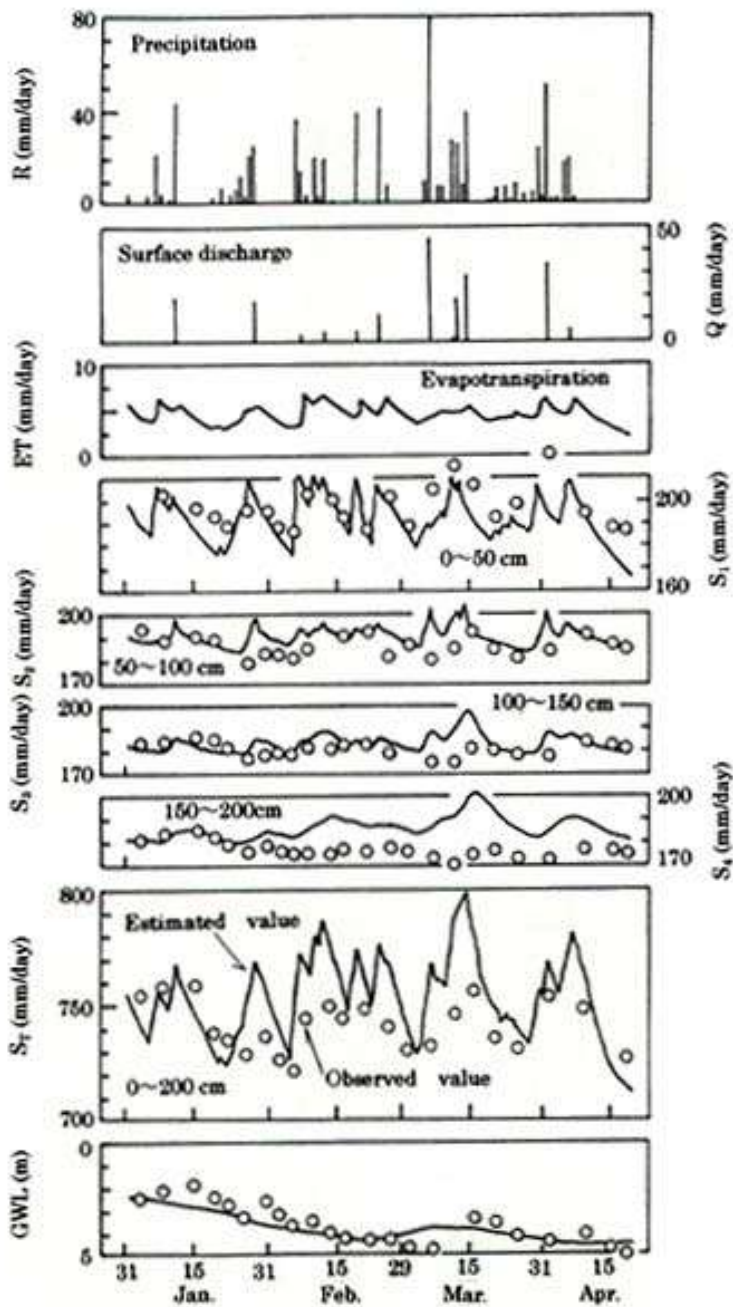


Fig.6.  
Comparison of estimated values of soil moisture,  
groundwater level and evapotranspiration at Pit 2  
with observed values



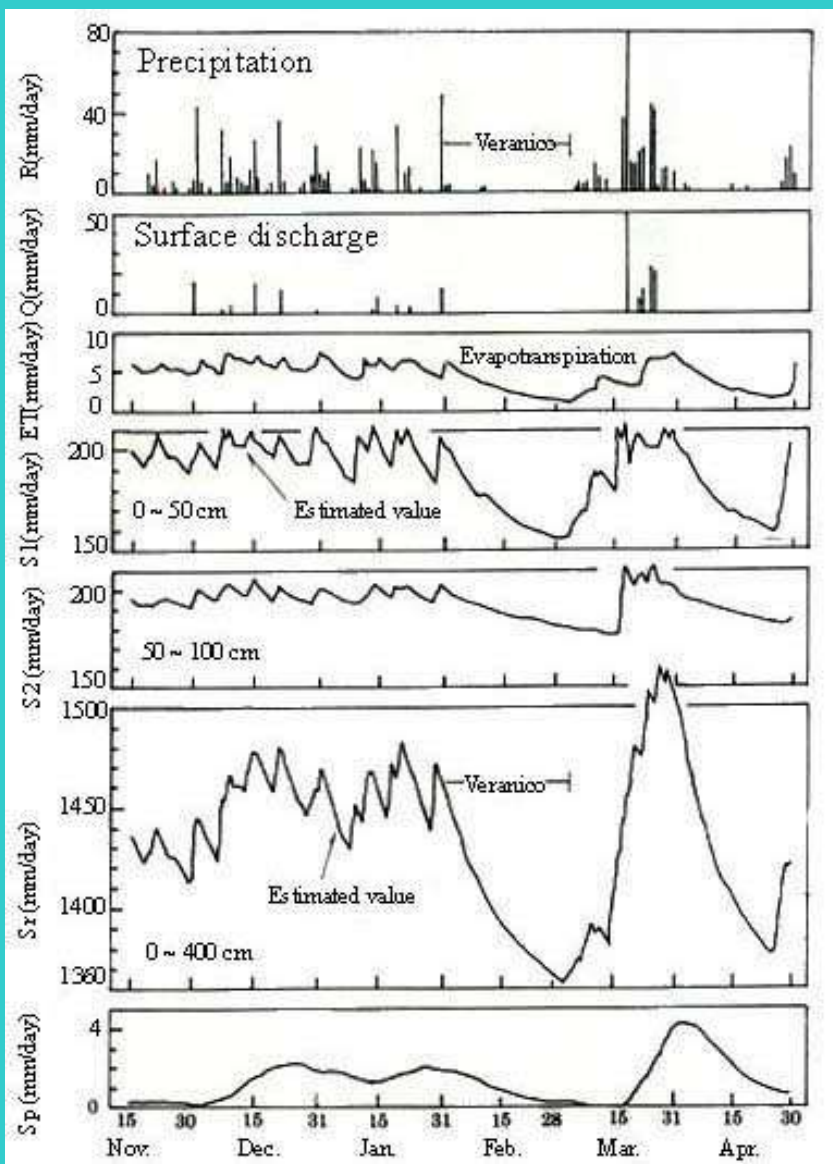


Fig.7. Seasonal variation of soil moisture estimated during a long period of "Veranico" in 1981 at CPAC



# Analysis of the Interaction between Surface Water and Groundwater Using Radon-222

**Hiromasa HAMADA**

Department of Regional Resources, National Research Institute of Agricultural Engineering (Tsukuba, Ibaraki, 305-8609 Japan)

## Abstract

It is essential to analyze the interaction between surface water and groundwater in order to use water effectively and predict water quality. The conventional method of analysis, however, measures only the flow of a stream and can not determine groundwater seepage accurately. Since the concentration of Radon-222 ( $^{222}\text{Rn}$ ) in groundwater is much higher than in surface water, the use of  $^{222}\text{Rn}$  was examined as an indicator for the analysis of the interaction between surface water and groundwater. Measurement of the  $^{222}\text{Rn}$  concentration in surface water was conducted to detect groundwater seepage into a stream. Furthermore, the simultaneous movement of water both into and out of a stream from the underlying strata was quantified by solving the  $^{222}\text{Rn}$  and water balance equations.

**Discipline:** Irrigation, drainage and reclamation

**Additional key words:**  $^{222}\text{Rn}$  balance, water balance

● 1...5): [References](#)

( Received for publication, February 9, 1999 )

## Introduction

It is essential to analyze the interaction between surface water and groundwater in order to use water effectively and predict the water quality. The conventional method of analysis, however, measures only the volume of flow in a river. As a result, only the difference between groundwater seepage from the river's bed into the river and river water percolation into the underlying strata can be determined, and it is impossible to quantify both if they occur simultaneously. Therefore, since the concentration of  $^{222}\text{Rn}$  in groundwater is much higher than in surface water,  $^{222}\text{Rn}$  was used to develop a new method of quantifying both groundwater effluent and river water influent, even when they occurred at the same time.

## Methodology

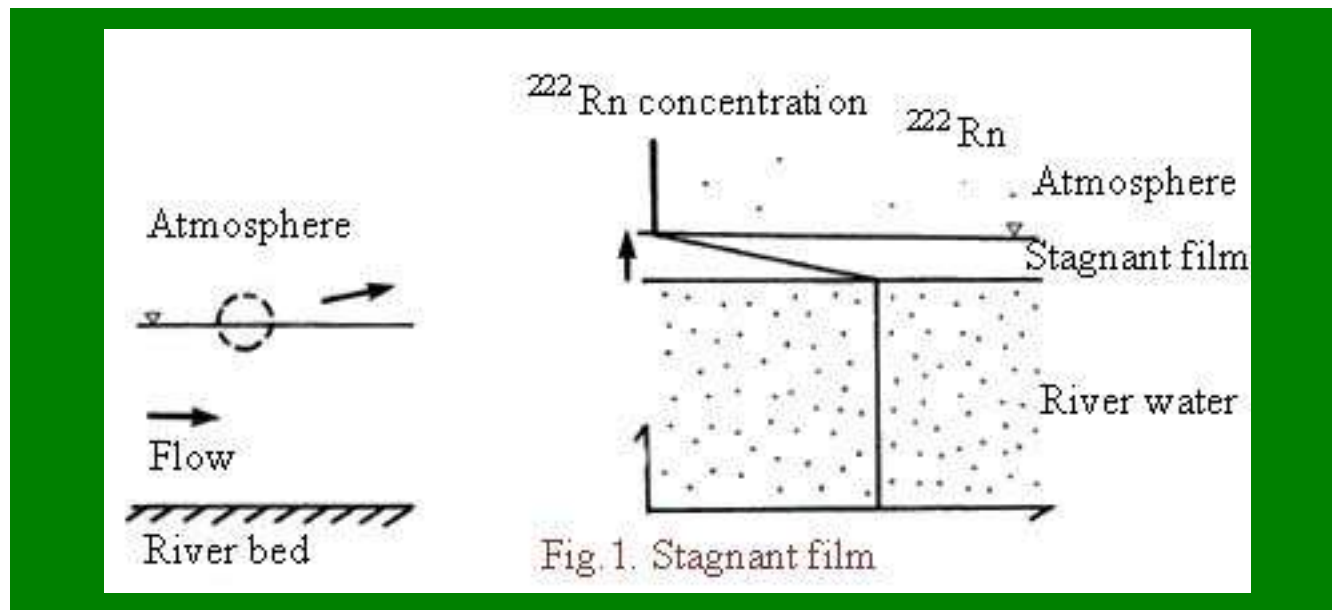
### 1) Characteristics of $^{222}\text{Rn}$

$^{222}\text{Rn}$  is a radioactive gas generated by the decay of  $^{226}\text{Ra}$  in strata, with a half life of about 1600 years.

When water infiltrates the strata,  $^{222}\text{Rn}$  concentration in water increases along with the increase of radioactivity. After  $\sim 3$  weeks, an equilibrium is reached between the supply, from the decay of  $^{226}\text{Ra}$ , and loss, through the decay of  $^{222}\text{Rn}$ , which has a half life of 3.8 days. Thus, the concentration levels off. When water leaves the strata as seepage or from a spring,  $^{222}\text{Rn}$  concentration begins to decrease, since the supply of  $^{222}\text{Rn}$  has ceased. Thus, the concentration in the groundwater is much higher than in the surface water. It is possible to determine where groundwater seeps into a river based on the distribution of  $^{222}\text{Rn}$  in water. Furthermore, the solution of the  $^{222}\text{Rn}$  and water balance equations enables to analyze quantitatively groundwater effluent and river water influent.

$^{222}\text{Rn}$  in river water is supplied both by groundwater seepage and directly from the sediments of the river bed. Since the latter is negligible, groundwater seepage, therefore, can be treated as the only source of  $^{222}\text{Rn}$  in river water.

$^{222}\text{Rn}$  is lost through river water infiltration, dispersion to the atmosphere and radioactive decay of  $^{222}\text{Rn}$ . River water infiltration affects the total amount of  $^{222}\text{Rn}$  but not the concentration. The amount of dispersion of  $^{222}\text{Rn}$  to the atmosphere is evaluated by assuming that there is a stagnant film which is the boundary layer between water and air (Fig. 1)¹.



The decrease in the  $^{222}\text{Rn}$  concentration in river water by dispersion to the atmosphere and by radioactive decay is expressed as follows:

$$C_2 = C_1 \exp(-aL) \dots\dots\dots (1)$$

$$a = ( D/zhv ) + \lambda/v \dots\dots\dots (2)$$

where

$C_1$  =  $^{222}\text{Rn}$  concentration at an upstream station ( $\text{Bq}/\text{m}^3$ );

$C_2$  =  $^{222}\text{Rn}$  concentration at a downstream station ( $\text{Bq}/\text{m}^3$ );

$D$  = molecular diffusivity of  $^{222}\text{Rn}$  ( $1.2 \times 10^{-9} \text{m}^2/\text{s}$  at 20);

$z$  = thickness of a stagnant film (m);

$h$  = average depth of a stream (m);  
 $v$  = average velocity of a stream (m/s);  
 $\lambda$  = decay constant of  $^{222}\text{Rn}$  ( $2.08 \times 10^{-6} \text{ s}^{-1}$ );  
 $L$  = distance between stations (m).

It has been reported that the thickness of a stagnant film is about  $20\frac{1}{4}\mu\text{m}$  when the distance between stations is several kilometers^{2,3}). It is, therefore, possible to calculate the  $^{222}\text{Rn}$  loss in a stream after measuring the average depth and velocity.

The amount of  $^{222}\text{Rn}$  supplied by groundwater is expressed by the following equation, assuming that groundwater flows into a river uniformly:

$$m = qC_g \{ 1 - \exp(-\lambda L) \} / \lambda \quad \text{.....(3)}$$

where

$m$  =  $^{222}\text{Rn}$  amount supplied by groundwater (Bq);

$q$  = groundwater flux ( $\text{m}^2/\text{s}$ );

$C_g$  =  $^{222}\text{Rn}$  concentration in groundwater ( $\text{Bq}/\text{m}^3$ ).

Using these equations, the  $^{222}\text{Rn}$  balance equation for a stream can be derived.

## 2) Measurement of $^{222}\text{Rn}$

The  $^{222}\text{Rn}$  concentration in water was measured using a liquid scintillation counter after extraction with toluene⁵). This method utilizes the greater solubility of  $^{222}\text{Rn}$  in toluene than in water.

In a field, sample water was poured carefully into a vessel and toluene containing scintillators (PPO 4 g/L and POPOP 0.1 g/L) was added. The closed vessel was shaken, and toluene was collected into a vial. The vials were then sent to the laboratory, and the radioactivity was counted for 50 min using a liquid scintillation counter (Packard 2250 CA for groundwater and Aloka LB-II for surface water) for 50 min. On the basis of the count rate, the  $^{222}\text{Rn}$  concentration in groundwater was calculated after 4 corrections, i.e. background, counting efficiency, extraction rate and decay.

In the case of groundwater, 40 mL of toluene was added to 500 mL of water and toluene was collected into a 20-mL glass vial. Since the  $^{222}\text{Rn}$  concentration in river water is lower than in groundwater, a large amount of water was necessary. In this investigation, 150 mL of toluene was mixed with 10,000 mL of river water and toluene was collected into a 100-mL Teflon vial. The detection limits were 0.04 Bq/L for groundwater and 0.004 Bq/L for river water.

## 3) Field investigation

The investigation undertaken to determine where groundwater seeped into a stream using the distribution of  $^{222}\text{Rn}$  concentrations was carried out along a stream in Kyonan City, Chiba Prefecture in an area that had been subjected to a landslide. Downstream in this study area, it was inferred that groundwater flowed into the stream⁴). The  $^{222}\text{Rn}$  concentration in the stream water and the volume of flow were measured at intervals of 20 m.

The investigation undertaken to quantify the groundwater effluent and river water influent was conducted in the Omoi River basin, Tochigi Prefecture. Since this area is an alluvial fan where many paddy fields are located, active exchange between river water and groundwater was expected. The  $^{222}\text{Rn}$

concentration in river water and groundwater, flow, water temperature and the groundwater level were measured. The investigation was carried out in June, a period coinciding with irrigation in Japan.



[-Results and discussion-](#)



[Contents](#)

# Results and discussion

## 1. Detection of groundwater seepage into a stream

The results of the investigation in the downstream landslide area are shown in [Fig. 2](#). Since the  $^{222}\text{Rn}$  concentration increased markedly in section 14-15, it was obvious that groundwater seeped into the stream in this section. Although the seepage increased the volume of flow in the stream, measurement of only the flow volume may be misleading. For example, in section 15-16, even though the flow volume increased, the  $^{222}\text{Rn}$  concentration decreased exponentially. No groundwater seepage at all was detected downstream from observation point 15. Thus, measurement of the  $^{222}\text{Rn}$  concentration in surface water enables to detect groundwater seepage more accurately than by measuring only the flow volume.

## 2. Quantitative between river water and groundwater

[Fig. 3](#) shows the observation points and the analytical model for the exchange between river water and groundwater. It was assumed that influent and effluent seepage was uniform since there was no change in the geology. Substituting  $h=0.48$  m,  $v=0.36$  m/s and  $D=1.1 \times 10^{-9}$  m²/s into the Equation (2), "a" was calculated to be 0.3 km⁻¹.

The water balance is:

$$Q_2 = Q_1 + Q_g - Q_r \dots\dots\dots(4)$$

Where

$Q_1$  = flow at the upstream station (m³/s);

$Q_2$  = flow at the downstream station (m³/s);

$Q_g$  = groundwater effluent (m³/s);

$Q_r$  = river water influent (m³/s).

The  $^{222}\text{Rn}$  balance is expressed as follows:

$$C_2 Q_2 = [ C_1 Q_1 \exp(-aL) + C_g Q_g \{ 1 - \exp(-aL) \} / aL ] (1-P) \dots\dots\dots (5)$$

$$P = Q_r / ( Q_1 + Q_g ) \dots\dots\dots(6)$$

Where

$C_1$  =  $^{222}\text{Rn}$  concentration in river water at the upstream station (Bq/m³);

$C_2$  =  $^{222}\text{Rn}$  concentration in river water at the downstream station (Bq/m³);

$C_g$  =  $^{222}\text{Rn}$  concentration in groundwater (Bq/m³);

L = distance between the stations (9 km).

The term (1-P) refers to river water infiltration. [Table 1](#) shows the results of the investigation.  $^{222}\text{Rn}$  concentration is an average value. Groundwater effluent was calculated to be 1.3 m³/s and river water influent to be 4.1 m³/s.

Using only the water balance, the amount of groundwater effluent can be considered to be zero and river water influent to be 2.8 m³/s. It was shown, however, that groundwater seeped into the river, because the  $^{222}\text{Rn}$  concentration at the downstream station was higher than at the upstream station. Therefore, the

proposed method gave more accurate results than the conventional method, in which only the water balance was calculated.

## Conclusion

$^{222}\text{Rn}$  was used as an indicator for analyzing the interaction between surface water and groundwater. Since the  $^{222}\text{Rn}$  concentration in groundwater was much higher than in surface water, it was possible to detect groundwater seepage into a stream by measuring the  $^{222}\text{Rn}$  concentration in surface water. Furthermore, by solving the  $^{222}\text{Rn}$  and water balance equations, the amounts of groundwater effluent and river water influent occurring simultaneously were quantified along a section of a river flowing among paddy fields. The results obtained were more accurate than when the conventional method was used, in which only the water balance was calculated. Thus, the method using the  $^{222}\text{Rn}$  concentration in water as an indicator is suitable for the analysis of the interaction between groundwater and surface water.

## References

- 1) Elsinger, R. J. Moore, W. S.(1983): Gas exchange in The Pee Dee River based on  $^{222}\text{Rn}$  evasion. *Geophys. Res. Lett.*, **10**, 443-446.
- 2) Hamada, H. Komae, T. (1994): Application of  $^{222}\text{Rn}$  to the analysis of the exchange between river water and groundwater. *Radioisotopes*, **43**, 770-775 [ In Japanese with English summary].
- 3) Hamada, H., Imaizumi, M. Komae, T. (1997): Methods of investigation and analysis on groundwater using radon as an indicator. *Natl. Res. Inst. Agric. Eng.*, **36**, 17-50 [ In Japanese with English summary].
- 4) Imaizumi, M. et al.(1993): Geochemical evolution of streamwater in a small watershed of landslide area using geochemistry and  $^{222}\text{Rn}$  in water to examine groundwater-streamwater interaction in Kyonan City, Chiba Prefecture. *J. Jpn. Soc. Groundwater*, **35**, 165-183 [ In Japanese with English summary ].
- 5) Noguchi, M. (1964): New method of radon activity measurement with liquid scintillator. *Radioisotopes*, **13**, 362-367 [ In Japanese with English summary ].



[Forward to: -Effects of Medium Conditions on Mulberry Tissue Culture-](#)



[Contents](#)



[JIRCAS Home Page](#)



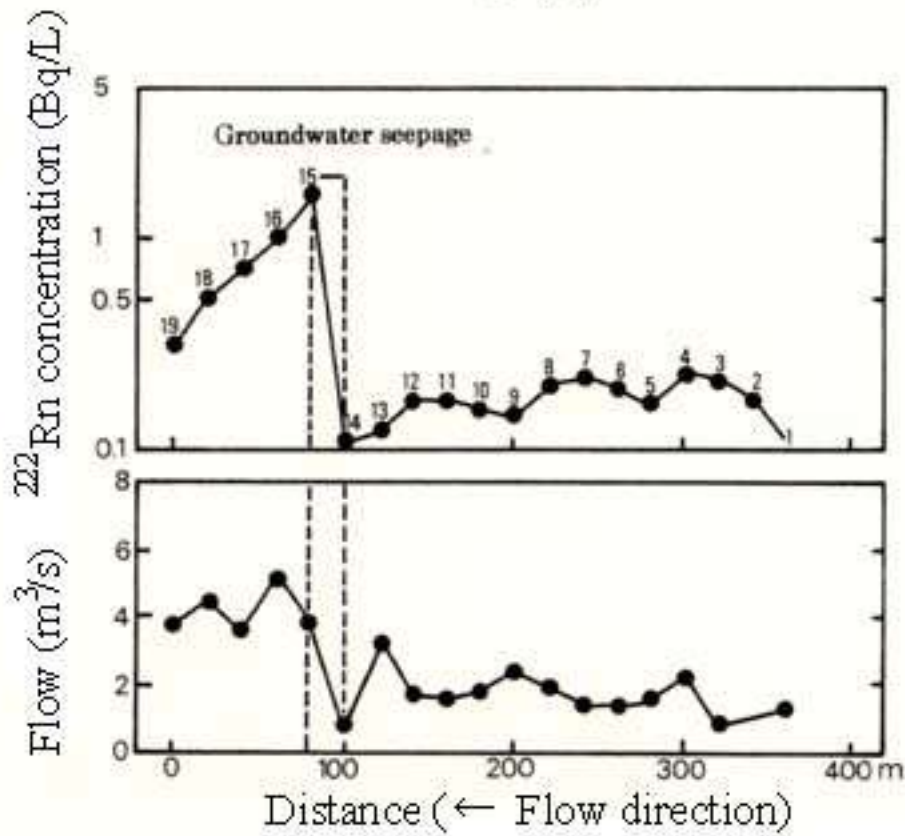
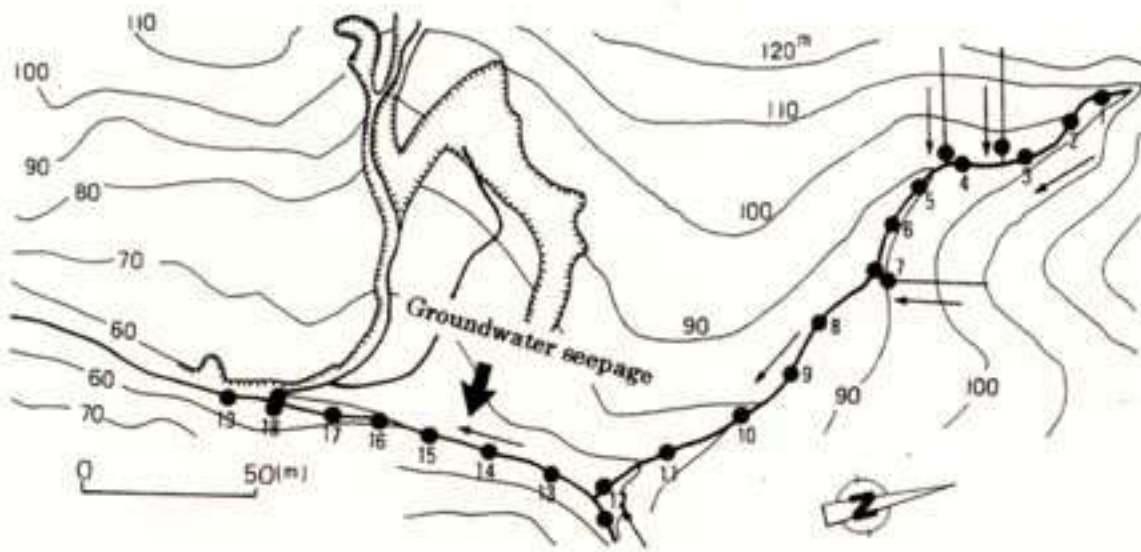


Fig.2. Results of investigation in the downstream landslide area

 [Back](#)

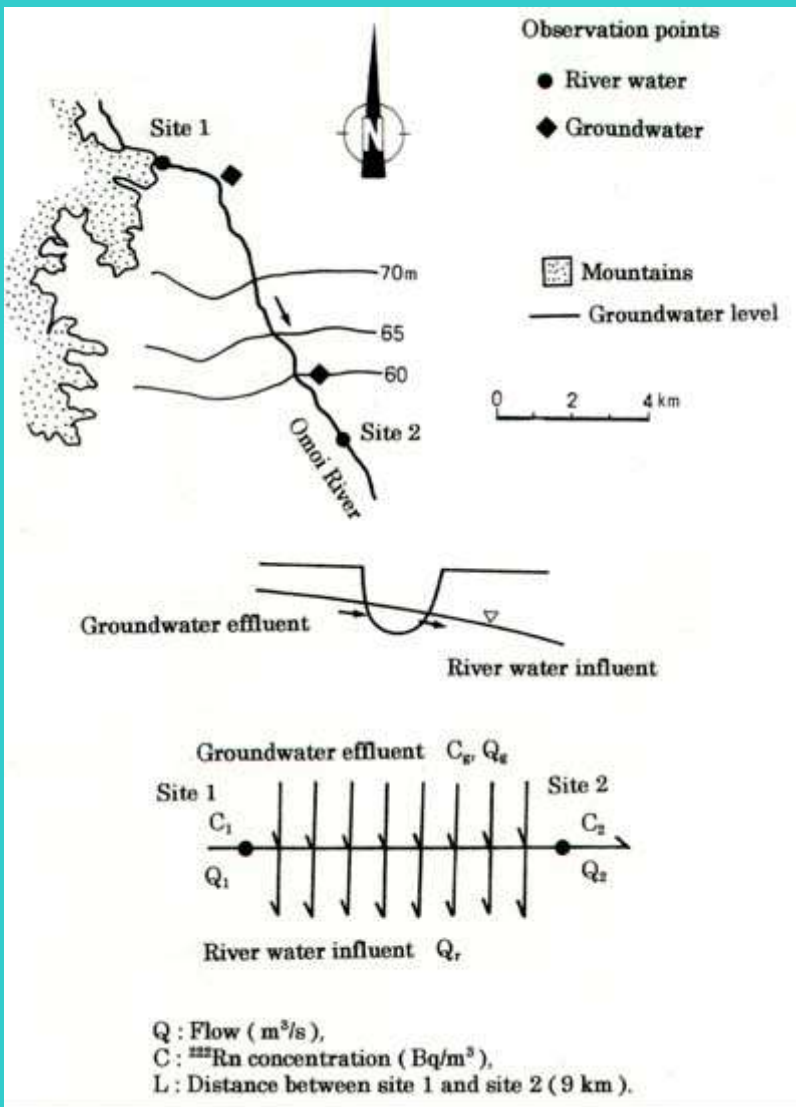


Fig.3.

Observation points and analytical model



[Back](#)

Table 1. Results of analysis of the exchange between river water and groundwater

Site 1	$C_1$	$0.80 \times 10^3$
	$Q_1$	8.2
Site 2	$C_2$	$1.2 \times 10^3$
	$Q_2$	5.4
Groundwater	$C_g$	$24 \times 10^3$
	$Q_g$	1.3*
River water	$Q_r$	4.1*

C :  $^{222}\text{Rn}$  concentration ( Bq/m³),

Q : Flow ( m³/s),

*: Calculated value using Eqns.(4), (5) and (6).



[Back](#)

# Effects of Medium Conditions on Adventitious Bud Formation in Immature Mulberry Leaves

**Hiroaki YAMANOUCHI, Akio KOYAMA and Hiroaki MACHII**

Department of Sericulture, National Institute of Sericultural and Entomological Science

(Tsukuba, Ibaraki, 305-8634 Japan)

## Abstract

Immature mulberry leaves isolated from winter buds were cultured on MS media⁷⁾ differing in the nitrogen source, sugar(s) or pH, or containing various kinds and concentrations of plant hormones, antibiotics or a herbicide. The ratio of the concentration of nitrate ion to that of ammonium ion remarkably affected the frequency of adventitious bud formation (FABF) and ratios in the ranges of 1:1 and 3:1 were optimum. The most suitable sugars for adventitious bud formation were sucrose, glucose and fructose among the tested sugars. The highest FABF was usually observed in the medium containing 1 ¼M thidiazuron and the addition of 1 ¼M abscisic acid further enhanced FABF. Changes of pH and addition of other plant hormones did not produce better results than in the control. Kanamycin, geneticin, hygromycin and bialaphos suppressed adventitious bud formation, showing that the antibiotics and the herbicide may be effective for the selection of transgenic plantlets of mulberry.

Discipline: Biotechnology

Additional key words: nitrogen source, sugar, thidiazuron, abscisic acid, antibiotic

1...20): [References](#)

(Received for publication, February 10, 1999)

## Introduction

Stable regeneration systems of crops are important for the application of more advanced techniques, i.e. genetic transformation by introduction of foreign gene(s). First successful adventitious bud formation of mulberry was reported by Oka and Ohyama¹¹⁾, who were able to induce adventitious buds on leaves removed from shoots cultured *in vitro*. On the basis of the first report, a more convenient single-step adventitious bud induction method was developed, whereby adventitious buds were formed on cultured immature leaves isolated from winter buds of field-grown mulberry¹³⁾. It is also possible to induce adventitious buds by culturing immature leaves isolated from lateral buds (unpublished data).

Presently, immature leaves inside of winter buds or in lateral buds are the most suitable materials for use for plant regeneration through tissue culture of mulberry for 2 reasons. First, stable regeneration of plantlets was observed only when 2 materials, i.e. immature leaves and leaves of cultured shoots were used. Adventitious bud formation on cultured immature leaves^{5,7,12-15,17-19)} and leaves of cultured shoots¹¹⁾ of mulberry was reported for many cultivars by a large number of researchers. Second, a large

number of materials can be collected easily from the field. Preparation of the leaves of cultured shoots requires previous shoot culture, which is laborious and takes time as in the case of the culture of leaves from cultured shoots. In the case of immature leaves inside of terminal buds, the number of explants is limited. Only several dozens of terminal buds can be obtained from a mulberry tree grown in the field, whereas several hundreds of winter or lateral buds can be obtained from the same tree¹⁷).

This method can be applied to a limited number of mulberry cultivars (unpublished data). Although there are several reports on the improvement of this culture system^{5,7,18}), optimum culture conditions, especially medium conditions, have not been fully elucidated. In this report, we studied the optimum medium conditions for adventitious bud formation using immature leaves isolated from winter buds. Furthermore, we examined the suppressive effect of antibiotics and of a herbicide on adventitious bud formation to identify suitable one(s) for selection of transformed plants.

## Materials and methods

### 1) Plant materials

Winter buds of mulberry (*Morus* spp. cv. Shin-ichinose, Hayatesakari, Kokuso 21, Unryu, Kyukyokusou, Kibajumonji, Garyu, Shidareguwa, Jikunashi, Ryomensou, Shinjiro, Keikansou and Turugisansou) grown in the field were used in this study.

### 2) Medium

#### (1) Effect of nitrogen sources¹⁸)

MS medium⁸) containing 3% fructose, 5¼M 6-benzylaminopurine (BAP) and 1% agar, and B5 medium³) containing 2% fructose, 5¼M BAP and 1% agar were used as basal media. The media were modified by the addition of various concentrations of nitrate ion and ammonium ion ([Table 1](#)). The media were adjusted to pH 5.8 and then autoclaved for 15 min before use.

#### (2) Effect of sugars

MS medium containing 10¼M BAP and 1% agar was used as basal medium. Eight kinds of sugars were tested at various concentrations alone or in combination ([Tables 2, 3](#)). The sugar(s) were added into the basal medium before or after 10 min of autoclaving ([Tables 2, 3](#)). In the latter case, a concentrated solution of sugar was added into the autoclaved medium. The medium was adjusted to pH 6.0 before autoclaving.

#### (3) Effect of pH

Liquid MS medium containing 10¼M BAP and 3% fructose was used as basal medium with a filter paper as a supporting material. Various volumes of 1N HCl or 1N NaOH were added into the medium before autoclaving. The medium was autoclaved for 10min followed by the measurement of the pH.

#### (4) Effect of cytokinins

MS medium containing 1% sucrose, 1% glucose, 1% fructose and 1% agar was used as basal medium. BAP, thidiazuron and kinetin were added before autoclaving. In the cases of 2-isopentenyladenine (2-IP) and zeatin, a concentrated solution was added into the medium after autoclaving.

#### (5) Effect of other plant hormones

MS medium containing 1% sucrose, 1% glucose, 1% fructose, 1¼M thidiazuron and 1% agar was used

as basal medium. 2,4-dichlorophenoxyacetic acid (2,4-D) and naphthylacetic acid (NAA) were added before autoclaving. In the cases of other plant hormones, i.e. 3-indoleacetic acid (IAA), indolebutyric acid (IBA), dicamba, gibberellin A₃, abscisic acid, brassinosteroid and methyl jasmonate, concentrated solutions were added into the autoclaved medium.

#### (6) Effects of antibiotics and a herbicide¹⁹⁾

MS medium containing 1% sucrose, 1% glucose, 1% fructose, 1¼M thidiazuron and 1% agar was used as basal medium. Antibiotics i.e. kanamycin, geneticin and hygromycin, and a herbicide, i.e. bialaphos, were likewise sterilized by filtering and added into the medium after autoclaving

### 3) Leaf culture

One-year-old elongated mulberry branches were collected in winter and stored in a refrigerator at 2.5. The winter buds excised from the branches were sterilized with 70% ethanol for 30 s followed by 0.5% sodium hypochlorite solution containing 0.005% Triton X-100 for 15 min. Then, the sterilized materials were rinsed 4 times with sterilized distilled water. Immature leaves were aseptically isolated from winter buds and were placed on the medium. Culture was conducted at 27 under 14 h light and 10 h dark conditions for 30 days. Frequency of adventitious bud formation (FABF) was calculated as the percentage of leaves on which adventitious bud(s) were formed to the number of leaves that survived after culture.



[Results](#)



[Contents](#)

## References

- 1) Chandler, P. M. & Robertson, M. (1994): Gene expression regulated by abscisic acid and its relation to stress tolerance. *Ann. Rev. Plant Physiol. Plant Mol. Biol.*, **45**, 113-141.
- 2) Fasolo, G. H., Zimmerman, R. H. & Fordham, I. (1989): Adventitious shoot formation on excised leaves of in vitro grown shoots of apple cultivars. *Plant Cell Tissue Organ Cult.*, **16**, 75-87.
- 3) Gamborg, O. L., Miller, R. A. & Ojima, K. (1968): Nutrient requirement of suspension cultures of soybean root cells. *Exp. Cell. Res.*, **50**, 151-158.
- 4) Huetteman, C. A. & Preece, J. E. (1993): TDZ; a potent cytokinin for woody plant tissue culture. *Plant Cell Tissue Organ Cult.*, **33**, 105-119.
- 5) Katagiri, K. & Thinh, N. T. (1994): Effect of rotary shaking on the induction of adventitious buds in mulberry leaves cultured *in vitro*. *J. Seric. Sci. Jpn.*, **63**, 278-283.
- 6) Machii, H. (1990): Leaf disc transformation of mulberry plant (*Morus alba* L.) by *Agrobacterium* Ti plasmid. *J. Seric. Sci. Jpn.*, **59**, 105-110.
- 7) Machii, H. (1992): Organogenesis from immature leaf cultures in mulberry, *Morus alba* L. *J. Seric. Sci. Jpn.*, **61**, 512-519.
- 8) Murashige, T. & Skoog, F. (1962): A revised medium for rapid growth and bioassays with tobacco tissue cultures. *Physiol. Plant.*, **15**, 473-497.
- 9) Murthy, B. N. S., Murch, S. J. & Saxena, P. K. (1998): Thidiazuron; a potent regulator of in vitro plant regeneration. *In Vitro Cell. Dev. Biol. –Plant*, **34**, 267-275.
- 10) Oka, S. & Ohyama, K. (1973): Induction of callus and effect of constituents of media on callus formation in mulberry tree. *J. Seric. Sci. Jpn.*, **42**, 317-324 [In Japanese].
- 11) Oka, S. & Ohyama, K. (1981): In vitro induction of adventitious buds and its modification by high concentration of benzyladenine in leaf tissue of mulberry. *Can. J. Bot.*, **59**, 68-74.
- 12) Saito, H. (1993): Relationships between leaf age and adventitious bud formation in immature leaf of mulberry. *J. Seric. Sci. Jpn.*, **62**, 435-436 [In Japanese].
- 13) Saito, H. & Katagiri, K. (1989): Adventitious-bud induction in leaves isolated from winter buds of mulberry. *J. Seric. Sci. Jpn.*, **58**, 46-51 [In Japanese].
- 14) Sawaguchi, T. et al. (1996): Effect of culture conditions on adventitious-bud formation from cotyledons and primary leaves of mulberry. *J. Seric. Sci. Jpn.*, **66**, 360-363.
- 15) Thinh, N. T. & Katagiri, K. (1994): Induction of adventitious buds in mulberry leaves by Thidiazuron. *J. Seric. Sci. Jpn.*, **63**, 514-516.
- 16) Tohjima, F. et al. (1996): Effect of plant hormones on the callus induction from mulberry cotyledons. *J. Seric. Sci. Jpn.*, **65**, 510-513.
- 17) Yamanouchi, H., Koyama, A. & Machii, H. (1999): Differentiation of adventitious buds on immature leaves isolated from shoots tops of mulberry. *J. Seric. Sci. Jpn.*, **68**, 77-80.
- 18) Yamanouchi, H., Machii, H. & Katagiri, K. (1993): Effect of inorganic nitrogen sources on adventitious bud formation from leaf cultures in mulberry. *J. Seric. Sci. Jpn.*, **62**, 145-151 [In Japanese].

## References

- 19) Yamanouchi, H. et al. (1993): Effect of three antibiotics and a herbicide on adventitious-bud formation in immature leaf culture and proliferation of multiple-bud body of mulberry. *J. Seric. Sci. Jpn.*, **66**, 493-496.
- 20) Zimmerman, J. L. (1993): Somatic embryogenesis; a model for early development in higher plants. *Plant Cell*, **5**, 1411-1423.



Table 1. Effect of concentration of nitrate ion and ammonium ion on adventitious bud formation in mulberry

	Basal medium	Concentration of nitrate ion (mM)	Concentration of ammonium ion (mM)	Ratio of nitrate ion concentration to ammonium ion concentration	Adventitious bud formation (%)
Series 1					
	MS	40	0	1 : 0	0
	MS	40	1	40 : 1	0
	MS	40	5	8 : 1	13
	MS	40	10	4 : 1	33
	MS	40	20	2 : 1	80
	MS	40	40	1 : 1	52
Series 2					
	MS	0	20	0 : 1	0
	MS	10	20	0.5 : 1	0
	MS	25	20	1.25 : 1	74
	MS	40	20	2 : 1	63
	MS	60	20	3 : 1	50
Series 3					
	B5	25	0	1 : 0	2
	B5	25	2	12.5 : 1	4
	B5	25	5	5 : 1	47
	B5	25	10	2.5 : 1	57
	B5	25	20	1.25 : 1	59
	B5	25	40	0.63 : 1	6
Series 4					
	MS	24	36	0.67 : 1	34
	MS	30	30	1 : 1	56
	MS	36	24	1.5 : 1	54
	MS	42	18	2.33 : 1	61

	MS	48	12	4 : 1	34
	MS	54	6	9 : 1	27
	MS	60	0	1 : 0	0

Concentrations of nitrate ion and ammonium ion in original MS medium⁸⁾ were 39.4 and 20.6 mM, respectively, and those in original B5 medium³⁾ were 24.7 and 2 mM, respectively.

a): All leaves plated on the medium died.



[Back](#)

Table 2. Effect of sugar kind on adventitious bud formation of mulberry.

Sugar	Adventitious bud formation (%)					
	Shin ichinose		Hayatesakari		Kokusou 21	
	A ^{a)}	F ^{b)}	A ^{a)}	F ^{b)}	A ^{a)}	F ^{b)}
Sucrose	64	52	28	31	53	54
Glucose	36	55	43	38	55	82
Fructose	63	33	30	40	70	76
Maltose	9	4	6	6	0	7
Lactose	3	10	4	9	4	7
Galactose	0	0	4	14	5	3
Xylose	0	19	1	19	15	24
Mannose	0	0	8	4	0	3
Sorbitol	3	3	0	0	3	6
Mannitol	0	0	0	0	0	0

a): Sugar was added into the medium before autoclaving.

b): Concentrated sugar solution which had been sterilized by filter was added into the medium after autoclaving.



[Back](#)

Table 3. Effect of sugar kind on the growth of cultured mulberry (cv. Hayatesakari) leaves

Sugar	Average length of cultured leaves (mm)	
	A ^{a)}	F ^{b)}
Sucrose	18.5	21.0
Glucose	21.7	22.8
Fructose	22.7	24.7
Maltose	5.1	6.3
Lactose	7.1	7.8
Galactose	11.4	12.1
Xylose	6.5	10.7
Mannose	6.7	7.3
Sorbitol	3.2	3.6
Mannitol	2.8	2.7

a), b): See table 2.



[Back](#)

## Results

### 1) *Effects of nitrogen sources*¹⁸⁾

FABF was remarkably influenced by the changes in the concentration of nitrate ion and ammonium ion in the medium ([Table 1](#)). Higher FABF than 50% was observed in the medium containing 40 mM nitrate ion and 20 and 40 mM ammonium ion in series 1, in the medium containing 25, 40 and 60 mM nitrate ion and 20 mM ammonium ion in series 2, and in the medium containing 25 mM nitrate ion and 10, 20 mM ammonium ion in series 3 (Table1). When the concentration of total inorganic nitrogen was adjusted to 60 mM (series 4), higher FABF than 50% was observed in the medium containing 30-42 mM nitrate ion (30-18 mM ammonium ion). These results indicated that the ratio of the concentration of nitrate ion to that of ammonium ion was more important rather than the concentration of either ion. It was reported that the optimum ratio for adventitious bud formation of apple was in the ranges of 10:1 and 4:1²⁾. The most suitable ratio of the concentration of nitrate ion to that of ammonium ion was in the ranges of 1:1 and 3:1. As for the nitrogen source composition, original MS medium is considered to be suitable for adventitious bud formation of mulberry.

### 2) *Effect of sugar(s)*

Sucrose, glucose and fructose were more suitable for adventitious bud formation than other sugars ([Table 2](#)). The average length of the leaves cultured on the medium containing each one of these 3 kinds of sugars exceeded 18 mm ([Table 3](#)). No adventitious bud was observed in the leaves cultured on the medium containing mannitol (Table 2). The average length of the leaves cultured on the medium containing mannitol was shortest (Table 3). It appeared that there was a positive correlation between FABF and the average length of leaves. Meanwhile, there were no apparent differences between the average length of leaves which formed adventitious buds and the length of leaves which did not form them among the leaves cultured under the same sugar conditions (data not shown). These results mean that the sugars suitable for the growth of cultured leaf were also suitable for adventitious bud formation and that a higher frequency of adventitious bud formation was not caused by more active growth of cultured leaves. The concentrations of sucrose, glucose, fructose and mixtures for suitable adventitious bud formation were in the ranges of 2% and 4 % ([Table 4](#)).

### 3) *Effect of pH*

FABF did not vary appreciably among the media, except for the medium with the highest pH (7.18) in which FABF was 0% ([Table 5](#)). It seemed that adventitious bud formation of mulberry was not appreciably affected by the pH of the medium. Since a large amount of precipitation was observed in the highest-pH medium, the inhibition of adventitious bud formation at highest pH was probably caused by nutrient deficiency.

### 4) *Effect of cytokinins*

So far, only BAP had been used as a cytokinin for the induction of adventitious buds from immature leaves of mulberry^{5,7,11-13,17-19)}. All the 3 adenine-type cytokinins used in this study were less suitable for mulberry adventitious bud formation compared with BAP ([Table 6](#)). Thidiazuron, which is a phenylurea compound with a strong cytokinin-like activity^{4,9)} and which induced adventitious buds on the immature leaves isolated from apical buds of mulberry¹⁵⁾, induced adventitious buds on the cultured

immature leaves isolated from winter buds ([Table 7](#)). The optimum concentration of thidiazuron which was about  $1\frac{1}{4}$ M was approximately 10 times lower than that of BA (Table 7). FABF was higher or similar when  $1\frac{1}{4}$ M thidiazuron was used compared with  $10\frac{1}{4}$ M BA in 8 of the 10 cultivars examined, although the reverse was observed in 2 cultivars ([Table 8](#)).

### 5) Effect of auxin, gibberellin A₃, abscisic acid, brassinosteroid and methyl jasmonate

The effect of auxin on FABF was not beneficial ([Table 9](#)). High concentrations of auxin suppressed adventitious bud formation and induced callus, except for IAA ([Tables 9, 10](#)). Addition of  $1\frac{1}{4}$ M abscisic acid promoted adventitious bud formation ([Table 11](#)). FABF was not significantly affected by gibberellin A₃, brassinosteroid and methyl jasmonate ([Tables 12, 13](#)).

### 6) Effect of antibiotics and a herbicide¹⁹⁾

All the antibiotics and the herbicide used in this study suppressed adventitious bud formation ([Table 14](#)). It was observed that precultured explants were more highly resistant to the antibiotics and the herbicide than the non-precultured ones. However, total suppression of adventitious bud formation was observed in the medium containing the highest concentration of geneticin, hygromycin and bialaphos even in the case of precultured conditions.

## Discussion

In a previous paper⁶⁾, successful genetic transformation of mulberry by *Agrobacterium* Ti-plasmid was reported, but the frequency was low. One possible modification for improving the mulberry transformation system is to increase the selection efficiency of the transformed organs. In this report, investigations were carried out to determine whether the genes that inactivate geneticin, hygromycin and bialaphos could be used as selection marker genes. Another possible modification is to improve the tissue culture system. We showed that the frequency of adventitious bud formation varied with the medium conditions. It may be important to analyze the physiological and molecular biological events that occur during the process of adventitious bud formation.

Callus was induced most efficiently on the medium that did not contain ammonium ion¹⁰⁾, on which no adventitious buds were formed. It is interesting to note that the optimum ratio of nitrate ion to ammonium ion for callus induction of mulberry was different from that of adventitious bud formation, which suggested that metabolic alterations affect directly or indirectly adventitious bud formation.

The kind of sugar rather than the concentration affected FABF. High FABF was observed in the medium containing sugar(s) that promoted vigorous growth of leaves, which indicates that metabolic pathways play a role in adventitious bud formation.

Abscisic acid exerted a beneficial effect on adventitious bud formation. It is generally recognized that abscisic acid promotes the expression of genes related to the resistance to various stresses¹⁾. Since the culture environment is a kind of stress, the beneficial effect of abscisic acid on adventitious bud formation may be related to stress resistance.

As mentioned above, various physiological reactions controlled by many genes may be related to

adventitious bud formation in mulberry. Many genes expressed during the regeneration process have been isolated²⁰⁾. This information is important to improve the tissue culture system of mulberry. On the other hand, it was reported that no adventitious buds were formed when immature leaves of sprouting winter buds of mulberry were cultured¹³⁾. We also previously reported that the regeneration potential of immature mulberry leaf was lowered and was completely lost with growth, even if the leaf size was 10 times smaller than that of the mature one¹⁷⁾. These observations indicate that the expression of genes related to regeneration varies with the development of the organ. On the other hand, adventitious buds were formed whereas callus was scarcely formed on the medium containing 10-100 $\frac{1}{4}$ M IAA and 1 $\frac{1}{4}$ M thidiazuron in this study, although callus was induced from cotyledon by 2-10 $\frac{1}{4}$ M IAA and 2 $\frac{1}{4}$ M thidiazuron in a previous study¹⁶⁾. These findings imply that the medium conditions and the endogenous differentiation potential of explant play a role in adventitious bud formation. Since immature leaf is one of the few organs with a potential for differentiation in mulberry, immature leaf culture system of mulberry should be used to analyze processes of regeneration.



[Forward to:-Development of an Automatic Steering System for Compact Tractor Used in Mulberry Fields-](#)



[Contents](#)



[JIRCAS Home Page](#)

Table 1

Table 1. Effect of concentration of nitrate ion and ammonium ion on adventitious bud formation in mulberry

	Basal medium	Concentration of nitrate ion (mM)	Concentration of ammonium ion (mM)	Ratio of nitrate ion concentration to ammonium ion concentration	Adventitious bud formation (%)
Series 1					
	MS	40	0	1 : 0	0
	MS	40	1	40 : 1	0
	MS	40	5	8 : 1	13
	MS	40	10	4 : 1	33
	MS	40	20	2 : 1	80
	MS	40	40	1 : 1	52
Series 2					
	MS	0	20	0 : 1	0
	MS	10	20	0.5 : 1	0
	MS	25	20	1.25 : 1	74
	MS	40	20	2 : 1	63
	MS	60	20	3 : 1	50
Series 3					
	B5	25	0	1 : 0	2
	B5	25	2	12.5 : 1	4
	B5	25	5	5 : 1	47
	B5	25	10	2.5 : 1	57
	B5	25	20	1.25 : 1	59
	B5	25	40	0.63 : 1	6
Series 4					
	MS	24	36	0.67 : 1	34
	MS	30	30	1 : 1	56
	MS	36	24	1.5 : 1	54
	MS	42	18	2.33 : 1	61



Table 1

	MS	48	12	4 : 1	34
	MS	54	6	9 : 1	27
	MS	60	0	1 : 0	0

Concentrations of nitrate ion and ammonium ion in original MS medium⁸⁾ were 39.4 and 20.6 mM, respectively, and those in original B5 medium³⁾ were 24.7 and 2 mM, respectively.

a): All leaves plated on the medium died.



[Back](#)

Table 2

Table 2. Effect of sugar kind on adventitious bud formation of mulberry.

Sugar	Adventitious bud formation (%)					
	Shin ichinose		Hayatesakari		Kokusou 21	
	A ^{a)}	F ^{b)}	A ^{a)}	F ^{b)}	A ^{a)}	F ^{b)}
Sucrose	64	52	28	31	53	54
Glucose	36	55	43	38	55	82
Fructose	63	33	30	40	70	76
Maltose	9	4	6	6	0	7
Lactose	3	10	4	9	4	7
Galactose	0	0	4	14	5	3
Xylose	0	19	1	19	15	24
Mannose	0	0	8	4	0	3
Sorbitol	3	3	0	0	3	6
Mannitol	0	0	0	0	0	0

a): Sugar was added into the medium before autoclaving.

b): Concentrated sugar solution which had been sterilized by filter was added into the medium after autoclaving.



[Back](#)

Table 3

Table 3. Effect of sugar kind on the growth of cultured mulberry (cv. Hayatesakari) leaves

Sugar	Average length of cultured leaves (mm)	
	A ^{a)}	F ^{b)}
Sucrose	18.5	21.0
Glucose	21.7	22.8
Fructose	22.7	24.7
Maltose	5.1	6.3
Lactose	7.1	7.8
Galactose	11.4	12.1
Xylose	6.5	10.7
Mannose	6.7	7.3
Sorbitol	3.2	3.6
Mannitol	2.8	2.7

a), b): See table 2.



[Back](#)

Table 4

Table 4. Effect of concentration of sugar on adventitious bud formation in mulberry (cv. Hayatesakari)

Concentration (%; w/v)	Adventitious bud formation (%)			
	Sucrose	Glucose	Fructose	Mixture ^{a)}
1	15	17	28	22
1.5	38	38	23	39
2	38	49	44	64
2.5	61	65	42	47
3	67	73	49	67
4	43	56	50	84
5	44	60	33	40

a): Sucrose, glucose and fructose were mixed at the same concentrations.



[Back](#)

Table 5

Table 5. Effect of pH on adventitious bud formation in mulberry (cv. Kokusou 21)

pH of medium	Adventitious bud formation (%)
3.25	17
3.6	20
3.88	40
4.1	33
4.34	37
4.54	33
5.09	20
5.57	33
6.16	20
7.18	0

[Back](#)

Table 6

Table 6. Effect of cytokinin on adventitious bud formation in mulberry (cv. Hayatesakari)

Cytokinin	Concentration ( $1/4M$ )	Adventitious bud formation (%)
BAP	1	0
	5	21
	20	45
2IP	1	0
	5	0
	20	0
Zeatin	1	0
	5	5
	20	0
Kinetin	1	0
	5	0
	20	0

[Back](#)

Table 7

Table 7. Effect of benzyladenine and thidiazuron on adventitious bud formation in mulberry (cv. Hayatesakari)

Concentration ( $\mu$ M)	Adventitious bud formation (%)	
	BAP	Thidiazuron
0.0	0	0
0.05	nt ^{a)}	0
0.1	nt	0
0.2	nt	13
0.5	nt	25
1.0	0	70
2.0	27	50
5.0	22	0
10	50	nt
20	43	nt

a): nt; not tested.

 [Back](#)

Table 8

Table 8. Effect of benzyladenine and thidiazuron on adventitious bud formation in mulberry cultivars

Cultivar	Adventitious bud formation (%)	
	10 ⁻⁴ M BAP	1 ⁻⁴ M Thidiazuron
Unryu	36	34
Kyukyokusou	56	79
Kibajumonji	47	69
Garyu	53	68
Shidareguwa	9	37
Jikunashi	44	16
Ryomensou	52	24
Shinjiro	7	5
Keikansou	27	33
Turugisansou	0	11


[Back](#)



Table 9

Table 9. Effect of auxin on adventitious bud formation in mulberry (cv. Hayatesakari)

Concentration of auxin ( $\mu$ M)	Adventitious bud formation (%)				
	IAA	IBA	NAA	2,4-D	Dicamba
0 (Control)	46	32	31	35	46
0.01	58	21	38	28	35
0.1	28	18	38	10	40
1	48	25	18	2.5	7.5
10	48	30	0	2.5	0
100	54	4.2	nt ^{a)}	nt	nt

a): nt; not tested.



[Back](#)

Table 9

Table 9. Effect of auxin on adventitious bud formation in mulberry (cv. Hayatesakari)

Concentration of auxin ( $\frac{1}{4}$ M)	Adventitious bud formation (%)				
	IAA	IBA	NAA	2,4-D	Dicamba
0 (Control)	46	32	31	35	46
0.01	58	21	38	28	35
0.1	28	18	38	10	40
1	48	25	18	2.5	7.5
10	48	30	0	2.5	0
100	54	4.2	nt ^{a)}	nt	nt

a): nt; not tested.

Table 10. Effect of auxin on callus formation of mulberry (cv. Hayatesakari)

Concentration of auxin ( $\frac{1}{4}$ M)	Frequency of adventitious bud formation (%)				
	IAA	IBA	NAA	2,4-D	Dicamba
0(Control)	0	0	0	0	0
0.01	0	0	0	0	0
0.1	0	0	0	0	0
1	0	8	28	35	68
10	0	15	93	90	70
100	2	67	nt ^{a)}	nt	nt

a): nt; not tested.


[Back](#)

Table 11

Table 11. Effect of abscisic acid on adventitious bud formation in mulberry (cv. Hayatesakari)

Concentration ( $\frac{1}{4}$ M)	Adventitious bud formation (%)
0	24
0.05	33
0.2	35
1	53
5	35
20	20

[Back](#)

Table 12. Effect of Gibberellin A₃ on adventitious bud formation in mulberry (cv. Hayatesakari)

Concentration(1/4M)	Adventitious bud formation (%)
0	58
0.002	58
0.01	43
0.05	53
0.2	58
1	63
5	45
20	10

Table 13. Effect of brassinosteroid and methyl jasmonate on adventitious bud formation in mulberry (cv. Hayatesakari)

Concentration (1/4M)	Adventitious bud formation (%)	
	Brassinosteroid	Methyl jasmonate
0	52	51
0.00001	43	nt ^{a)}
0.0001	47	nt
0.001	63	68
0.01	51	57
0.1	28	53
1	15	63
10	nt	54

a): nt; not tested.



[Back](#)

Table 14

Table 14. Effect of antibiotics and a herbicide on adventitious bud formation in mulberry (cv. Hayatesakari)

Concentration (mg/L)	Adventitious bud formation (%)			
	Kanamycin	Geneticin	Hygromycin	Bialaphos
(Not precultured)				
0	45	45	45	45
0.1	nt ^{a)}	33	nt	38
0.2	nt	42	67	48
0.5	nt	25	21	32
1	nt	4	21	0
2	33	0	0	_b)
5	46	0	0	-
10	17	0	0	-
20	0	nt	-	-
50	0	nt	-	nt
100	0	nt	nt	nt
(Precultured for 17 days)				
0	43	43	43	43
0.2	nt	50	44	nt
0.5	nt	38	34	31
1	nt	29	28	44
2	53	13	24	47
5	44	10	17	38
10	44	0	0	18
20	38	nt	0	7
50	25	nt	nt	0
100	8	nt	nt	nt

Table 14

a): nt; not tested.

b): -; All leaves plated on the medium died.



[Back](#)

# Development of an Automatic Steering System for Compact Tractor Used in Mulberry Fields

**Toru KOBAYASHI**

Department of Sericulture, National Institute of Sericultural and Entomological Science  
(Tsukuba, Ibaraki, 305-8634 Japan)

## Abstract

In order to promote sericultural labor saving and to decrease costs, this study was carried out to develop an automatic steering system for a compact tractor used in mulberry fields. A new experimental vehicle for automatic steering was developed characterized by hydraulic transmission, front-wheel drive, and microcomputer control. A magnetic azimuth sensor and an ultrasonic sensor were selected as noncontact-type position sensors. Then, the sensor systems were developed to determine the positions automatically by using a microcomputer. Moreover, an automatic steering system that consisted of a microcomputer (8-bit CPU), the position sensor systems and the vehicle was developed and tested. As a result, the system enabled to control the travel of the vehicle in a mulberry field.

**Discipline:** Agricultural machinery

**Additional keywords:** microcomputer, control, sensor, automatic travel

1....6): [References](#)

(Received for publication, February 10, 1999)

## Introduction

The mechanization of sericulture in Japan has proceeded only slowly, and silkworm rearing and mulberry cultivation are still mainly performed by human labor. Cocoon yield has been decreasing in recent years. Therefore, by expanding the scale of sericultural farming with multiple rearing of silkworms, it is important to save labor and reduce the cost of production in sericulture through the promotion of mechanization and automation.

Then, in order to increase sericultural productivity, this study was carried out to develop an automatic steering system for a compact tractor used in mulberry fields, based on the results of recent studies on agricultural machinery^{1,4-6}). This report gives an outline of the system developed, which is characterized by travel controlled by a microcomputer with hydraulic transmission, use of noncontact-type position sensor systems to detect the tractor travel position in the system and automatic steering and turning in mulberry fields.

## Experimental vehicle with automatic steering³⁾

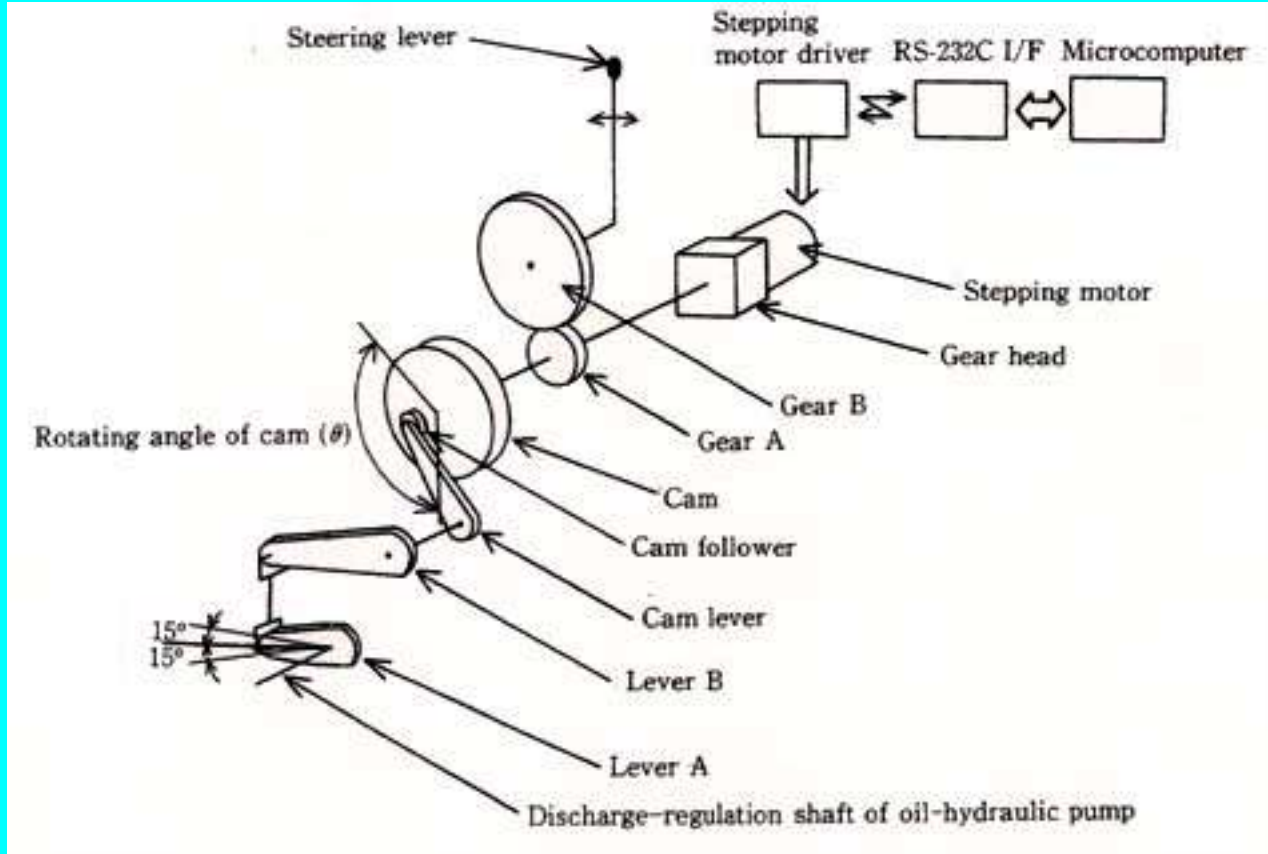
In order to improve the performance of the automatic steering system, based on the results of an



experimental study on a previously developed automatic steering system using a contact-type position sensor²⁾, we developed an experimental vehicle for automatic steering. The vehicle is characterized by hydraulic transmission, front-wheel drive, and microcomputer-controlled steering.

The size of the vehicle was approximately that of a compact 4-wheel tractor. The dimensions of this vehicle were as follows: 140 cm in overall length, 80 cm in overall width and 110 cm in overall height. A gasoline engine (4.4 kW, 6 Ps) and hydraulic transmission driven by independent front wheels, were used for the driving system. Double pumps with double swash plates type ran 2 oil-hydraulic motors, then front wheels (driving wheels) were driven through 1/5 speed-reduction gears ([Fig. 1](#)).

The vehicle was designed to move forward and backward at a continuously variable speed of 0 to 50 cm/s. The power wheeled steering method, with a difference in speed between right and left driving wheels by the operation of each discharge regulation shaft of the double oil-hydraulic pump, was applied for the design of the system for vehicle steering. The steering apparatus of the vehicle consisted of a microcomputer, RS-232C interface, stepping motor drivers, 4-phase stepping motors, gears, cams, etc. (Fig. 2).



**Fig.2. Steering mechanism of experimental vehicle**

Since the microcomputer could approximately control the revolution of each discharge regulation shaft of the oil-hydraulic pump, this vehicle could drive forward and backward at a continuously variable speed of 0 to 95 cm/s. As a result, the performance of the vehicle was similar to that outlined in the design specifications.



[Noncontact-type position sensors for compact tractor^{3\)}](#)



[Contents](#)

1...6): [References](#)

## Automatic steering system and automatic steering control³⁾

Based on the results of the above experiments, a position sensor system combining the 2 sensor systems was installed on the experimental vehicle, and then an automatic steering system was constructed. The automatic traveling trial of the experimental vehicle was operated by using a program developed in BASIC language for automatic steering control in a mulberry field.

### 1) Automatic steering system

The automatic steering system was equipped with a hand-held microcomputer (8-bit CPU, 3.68 MHz) as controller, an ultrasonic range finder (ultrasonic sensor system), a magnetic declinometer (magnetic azimuth sensor system) as sensors, and a steering mechanism and front-wheel drive by hydraulic transmission, etc. as actuators for the method of automatic steering control ([Figs. 7, 8](#)).

**Fig. 8. Experimental vehicle equipped with steering control system**

**A: Ultrasonic sensors, B: Bumper, C: Auto-battery, D: Control and instrumentation apparatus, E: Magnetic sensor.**



Two ultrasonic sensors for the ultrasonic range finder system were located 30 cm apart outside of the left front wheel of the vehicle. The system measured ranges at a maximum rate of 0.2 sec by using the microcomputer.

In order to avoid the influence of magnetic fields, the magnetic azimuth sensor was mounted on a plywood board on the right side of the rear of the vehicle because the magnetic declinometer was affected by the magnetic field of its iron body. The resolution of this azimuth was  $0.1^\circ$ .

Operation signals of the actuator were transferred through RS-232C, the multiplexer from the microcomputer in the automatic steering system. The actuator rotates the driving wheels of the vehicle at the same speed for starting the travel and traveling straight, and controls differentially rotational speeds between the right and left driving wheels in a steering, turning, and pivot turn.

Power was supplied by using +12 VDC automobile batteries and the voltage was transformed from +12 to +5, +12 and +15 VDC by DC-DC converters.

### 2) Method of automatic steering control

In a common mulberry field for automatic traveling, row spacing was assumed to be 2.0-2.5 m and intrarow spacing 0.5 m and left-hand sensing method was adopted. The vehicle traveled at a velocity of 24 cm/s along the mulberry stumps by automatic steering. Steering was applied continuously to move

straight or trim (lateral movement with a proportional control action) to maintain a distance from the vehicle to mulberry stumps constant by using both the ultrasonic range finder and magnetic declinometer. The target value for the control of the distance was set at 10 cm. As shown in [Fig. 9](#), after the vehicle turned 90° twice at a headland, it entered another inter-row space and only the magnetic declinometer was used to turn the vehicle.

### 3) *Steering control program*

The flowchart of an automatic steering control program is shown in [Fig. 10](#). After the start of traveling, the automatic steering system detected a mulberry stump by using the range finding and measuring azimuth. If the controller of this system did not detect a mulberry stump for 3 times continuously the vehicle stopped traveling. If the number of turns was not 0, the vehicle turned 90° twice and entered another inter-row space by the turning subroutine. On the other hand, when the controller continuously detected mulberry stumps, the traveling direction of the vehicle remained parallel to ridges with a turn of 5°. The controller also proceeded to trimming using the range finding and measuring azimuth 3 times. If trimming was needed, the controller trimmed the body by setting the value using the trimming subroutine and the vehicle traveled forward.

### 4) *Test of automatic steering control*

On a flat mulberry field with an inter-plant distance of 0.5 m immediately after shoot cut, which was used as test field, the vehicle traveled at a velocity of 24 cm/s using the control program over a distance of 70 cm along the row of mulberry stumps. The traveling trace in about the center of the vehicle's front body was drawn on the traveled path.

As a result, the traveling direction of the vehicle was almost parallel to the mulberry stumps and the system detected easily mulberry stumps using the ultrasonic range finder. Then the vehicle traveled automatically according to the row detected and turned at the headland ([Fig. 11](#)). However, the automatic steering control of the first turning at the headland was overrun at a distance of about twice 85 cm. The accuracy of turning at headlands was  $90 \pm 5^\circ$  by using the magnetic declinometer alone. Therefore, the results obtained suggested that for the most effective steering control, first the magnetic declinometer and second the ultrasonic range finder should be used, respectively, to maintain the traveling direction of the vehicle parallel to mulberry stumps (rows) within 6°.

## Conclusion

As stated above, by using noncontact-type position sensors, an automatic steering system was developed for a compact tractor used in mulberry fields. This system controls the steering, trimming, and turning of the experimental vehicle by the determination of the traveling positions of the vehicle using the range finder and the magnetic declinometer. Therefore, the vehicle was able to travel in the rows, along the mulberry stumps and turn at headlands on the mulberry field.

Moreover, the results suggest that pest control, herbicide spray and manuring could be automated by improving the performance of this system.

## References

- 1) Harries, G. O. & Ambler, B. (1981): Automatic ploughing A tractor guidance system using opto-electronic remote sensing techniques and microprocessor based controller. *J. Agric. Eng. Res.*, **26**(1), 33-53.

- 2) Kobayashi, T. et al. (1984): Automatic steering of cultivating machine for mulberry field. *J. Jpn. Soc. Agric. Mach.*, **48**(1), 91-94 [In Japanese].
- 3) Kobayashi, T. (1992): Studies on development of automatic steering system for small tractor on mulberry field. *Bull. Natl. Inst. Seric. Entomol. Sci.*, **6**, 1-112 [In Japanese with English summary].
- 4) McMahon, C. B., Burkhardt, T. H. & Tennes, B. R. (1982): Development of apple harvester microprocessor-based steering control system utilizing non-contact sensing. *In Spec. Publ. Soc. Automot. Eng.*, 13-27.
- 5) Upchurch, B. L., Tennes, B. R. & Surbrook, T. C. (1983): A microprocessor-based steering controller. *Trans. ASAE.*, **26**(1), 29-32, 37.
- 6) Yoshiaki, M. (1989): Studies on automatic steering system of farm tractor (part 1). *J. Jpn. Soc. Agric. Mach.*, **51**(1), 21-28 [In Japanese with English summary].



[Forward to:-Harmful Effect of Dinoflagellate *Heterocapsa circularisquama* on Shellfish Aquaculture in Japan-](#)



[Contents](#)



[JIRCAS Home Page](#)

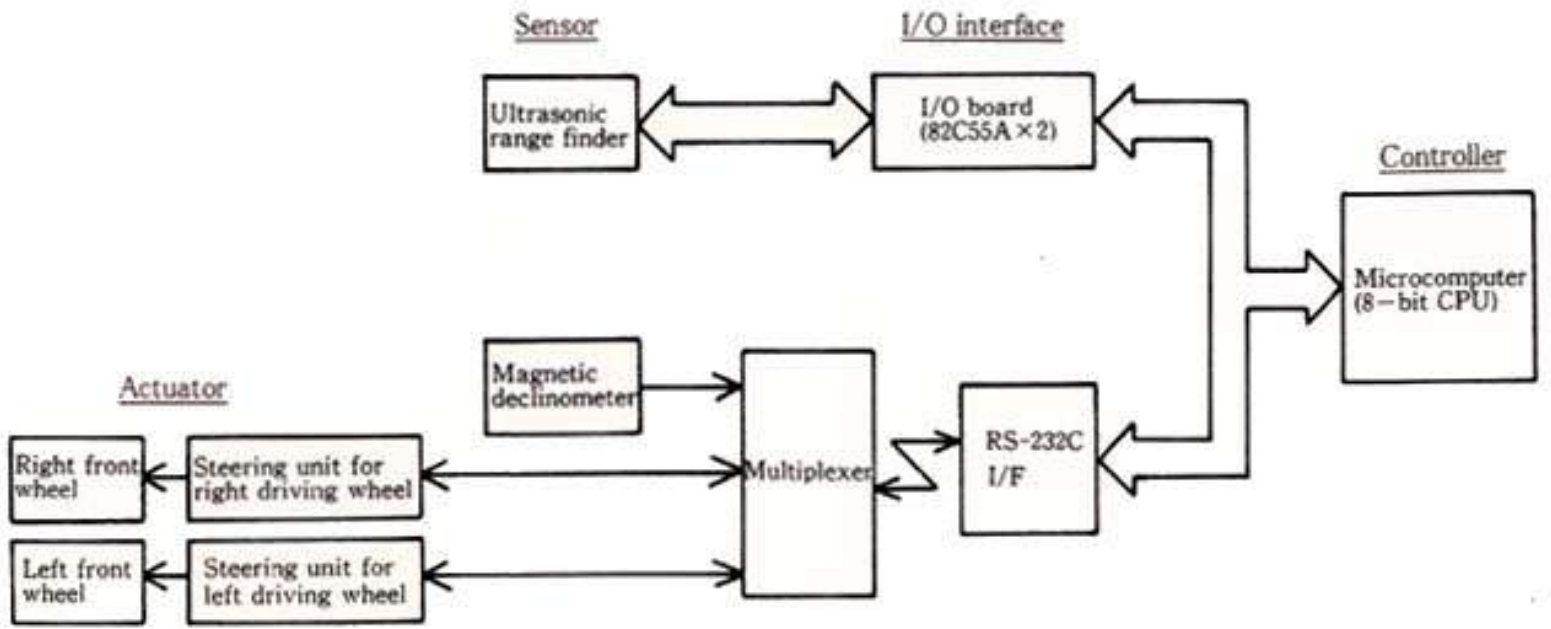
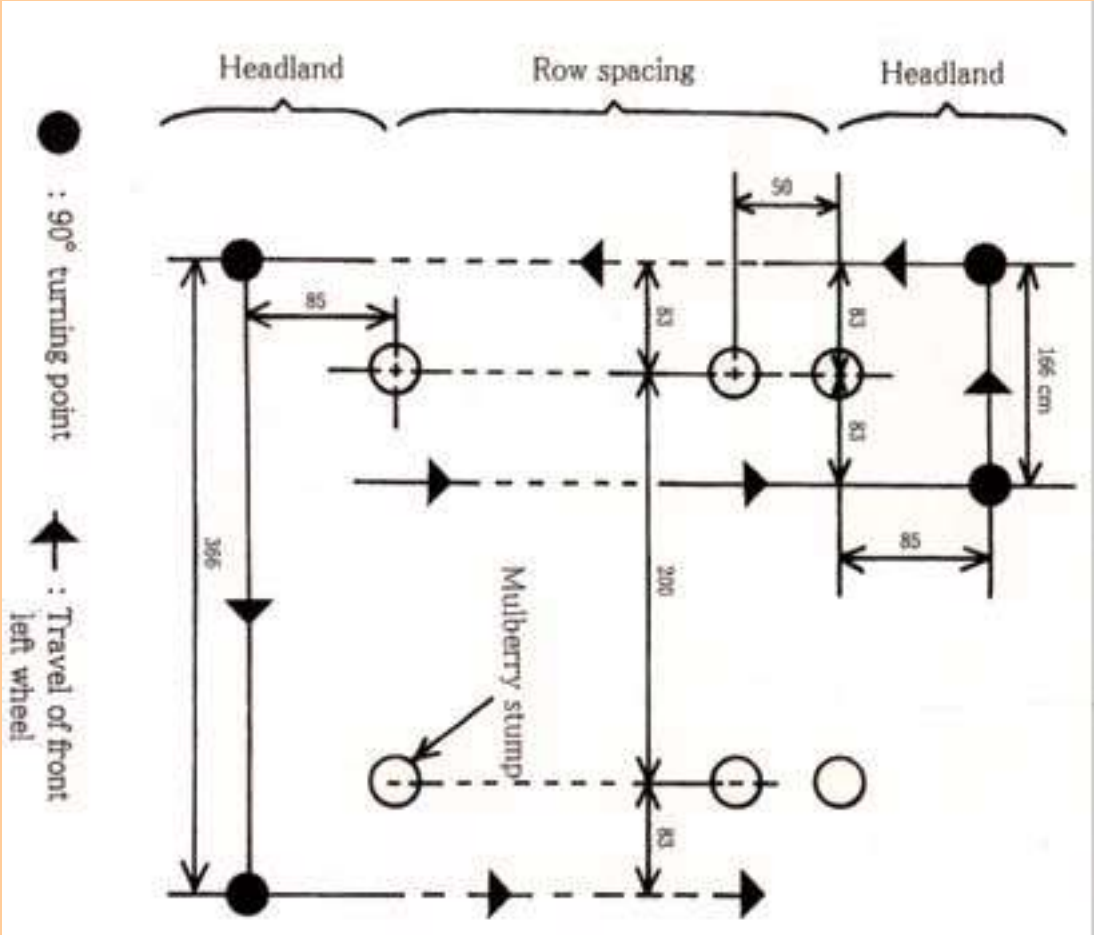


Fig. 7. Block diagram of steering control system



[Back](#)

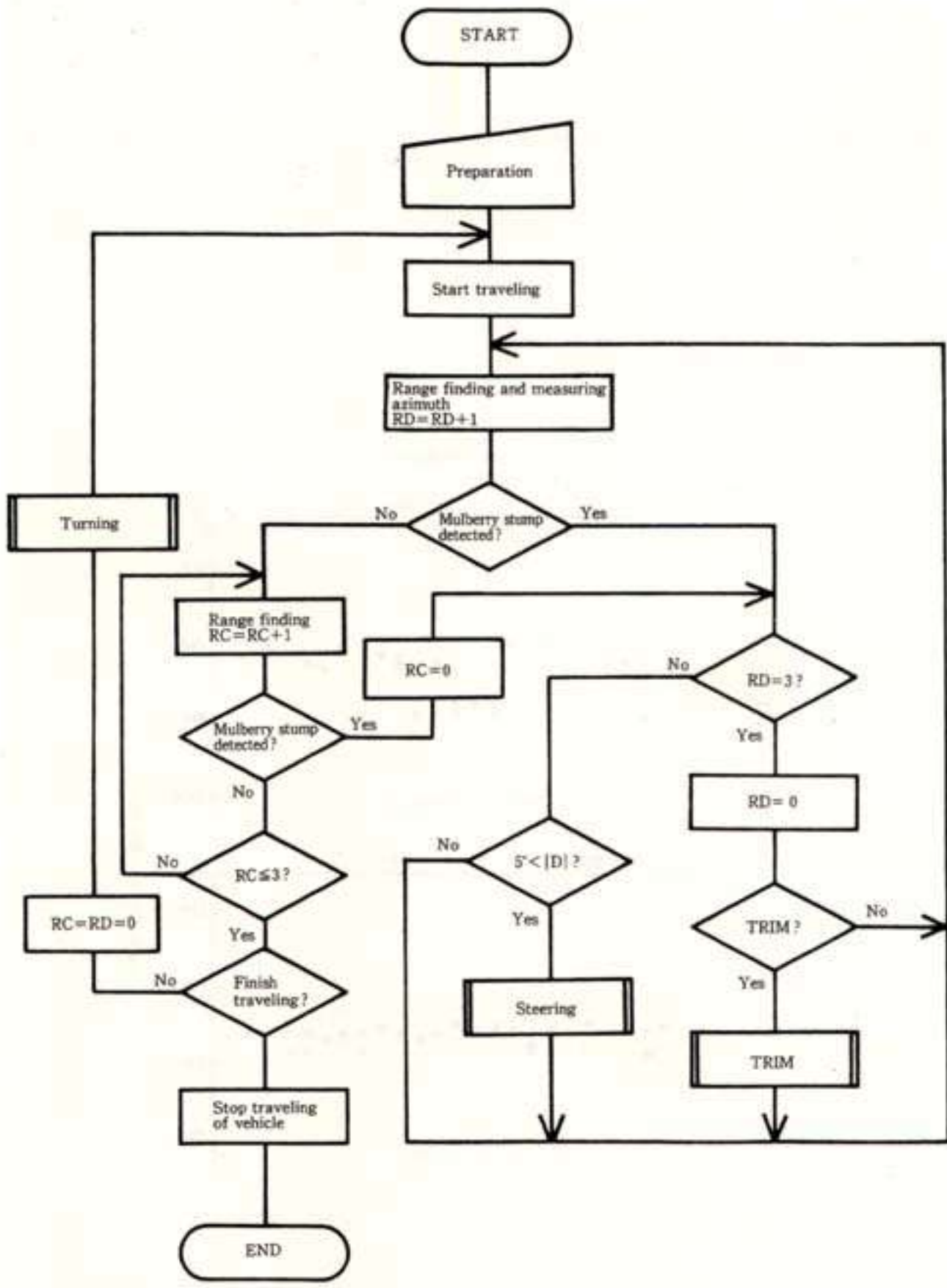
Fig. 9. Distance required to turn on asphalt road



I: 90° turning point  
 -2-: Travel of front left wheel

 [Back](#)

Fig. 10. Flowchart of automatic steering for compact tractor used in mulberry field



Back



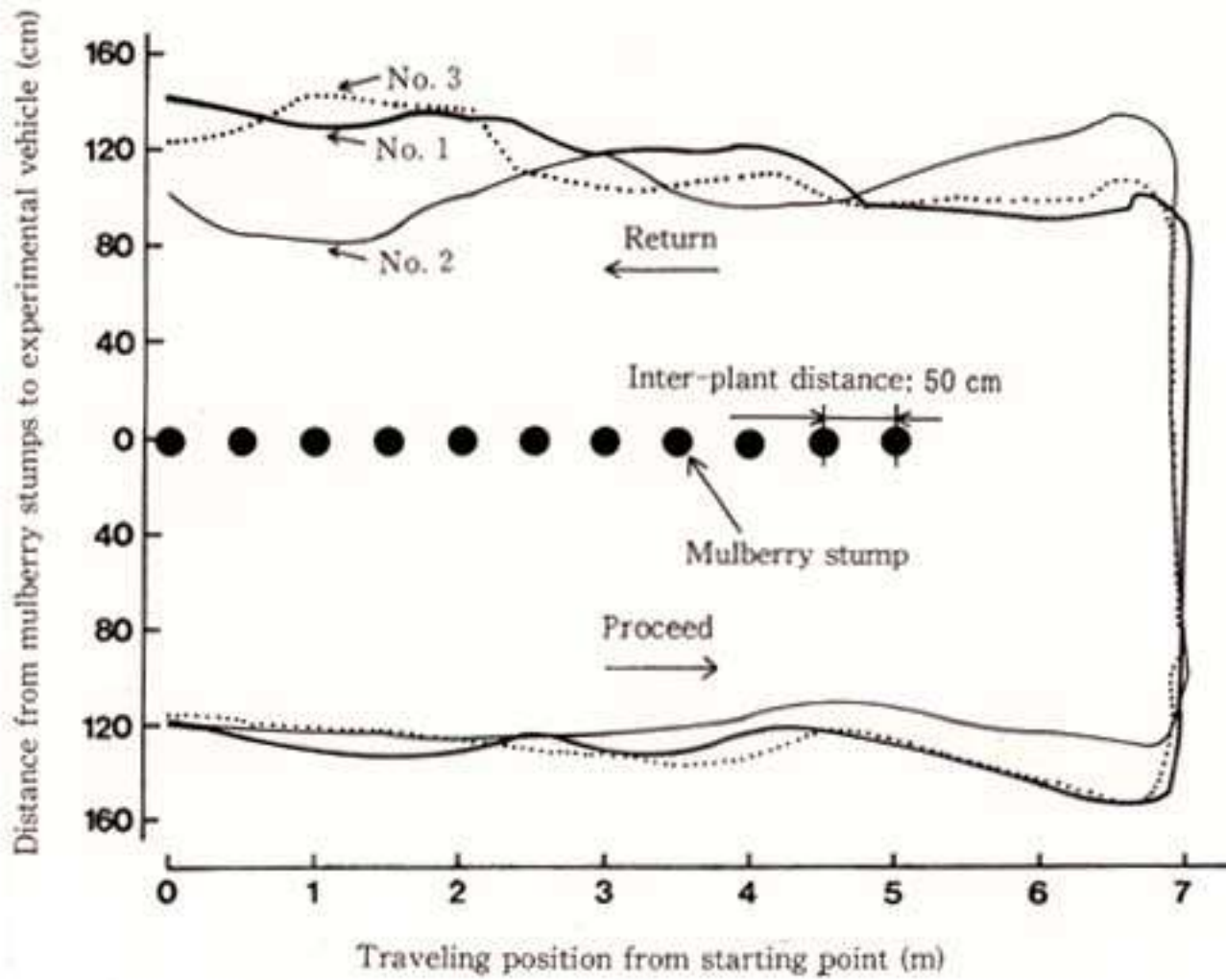


Fig. 11. Automatic steering in test filed



[Back](#)

# Harmful Effect of Dinoflagellate *Heterocapsa circularisquama* on Shellfish Aquaculture in Japan

**Yukihiko MATSUYAMA**

Harmful Algal Bloom Division, National Research Institute of Fisheries and Environment of Inland Sea (Maruishi, Ohno, Saeki, Hiroshima, 739-0452 Japan)

## Abstract

The marine dinoflagellate *Heterocapsa circularisquama* Horiguchi is the causal agent of red tide on the Japanese coast. In the last decade, *H. circularisquama* red tides have destroyed the shellfish aquaculture industries around the western part of Japan because this dinoflagellate shows a detrimental effect on shellfishes particularly on bivalve molluscs. The current proliferation of *H. circularisquama* throughout western Japan is a cause for concern due to economic loss. The outbreaks of *H. circularisquama* are closely related to the environmental conditions: water exchange rate, water temperature, local and global climate changes. Administrative measures such as algal monitoring systems can be successfully utilized for the distribution and short-term prediction of red tide due to *H. circularisquama* in several locations. However, secondary damage, i.e. decline of demand due to misinformation and cost of measures to prevent the damage, adversely affects the development of shellfish aquaculture even if direct killing of the products can be avoided.

Discipline: Animal pest/Aquaculture/Fisheries

Additional key words: red tide, bivalve, toxicity, secondary damage

1.....37): [References](#)

(Received for publication, February 3, 1999)

## Introduction

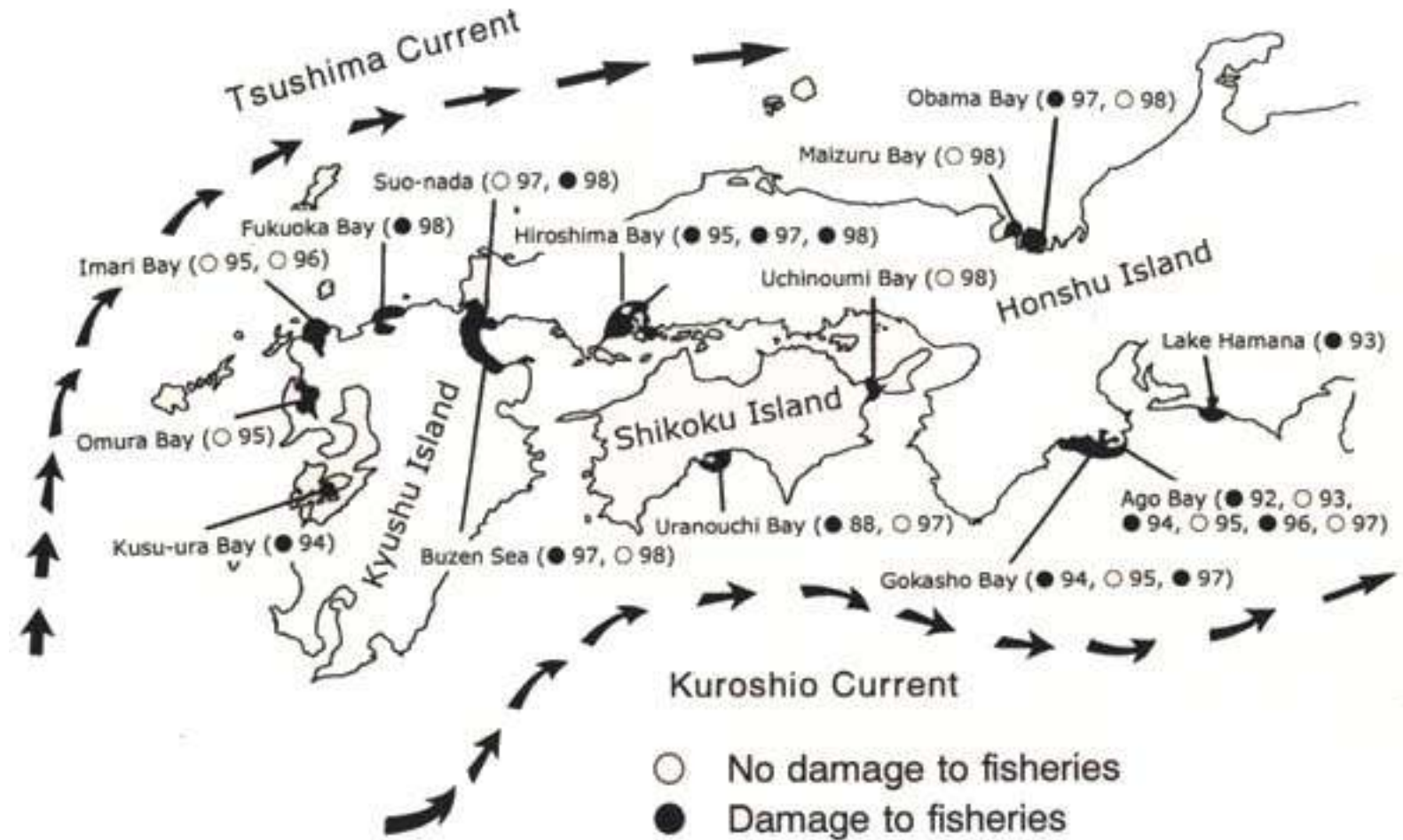
Worldwide development of harmful algal blooms causes serious problems for public health and fisheries industries^{1,4,5,21,23,24}). On the Japanese coast, new marine dinoflagellate *Heterocapsa circularisquama* Horiguchi⁹), appeared in 1988 and then rapidly expanded over the western area. The red tide due to *H. circularisquama* has damaged shellfish aquaculture in most of the region^{3,12,14,34,37}). Although *H. circularisquama* blooms mainly affect bivalve aquaculture, no harmful effects on wild and cultured fish, other marine vertebrates, and public health hazard were recorded. Therefore, this phenomenon is referred to as "novel red tide." Incidence of this species has increased recently, and the economic losses in aquaculture have been a cause for concern for the industry and society¹⁴).

In the present paper, environmental conditions conducive to the red tide occurrence, review of damage caused to aquaculture, toxicity of the organism, and recent monitoring programs based on scientific data are outlined.

## Environmental conditions causing *Heterocapsa circularisquama* bloom

### 1) Coastal currents and water exchange rate

**Fig. 1** shows the distribution of red tide events due to *H. circularisquama* ( $>10^6$  cells  $L^{-1}$ ) on the Japanese coast. *H. circularisquama* is distributed over the western part of Japan, especially on the southern coast of Mie, western coast of Seto Inland Sea, and western coast of Kyushu Island. The most frequent area for red tide is Ago Bay, where *H. circularisquama* has been observed every year since 1992. The areas where *H. circularisquama* blooms were recorded are embayments affected by the warm currents: Kuroshio and Tsushima currents (**Fig. 1**).



**Fig.1. Records of red tide ( $>10^6$  cells  $L^{-1}$ ) due to *Heterocapsa circularisquama* in western Japan**

The red tide caused by *H. circularisquama* is commonly observed in semi-closed bays, such as Ago Bay, Uranouchi Bay, and Hiroshima Bay. Dense assemblages of *H. circularisquama* cells have been found in the innermost part of the inlets, but not offshore and in the channels. The distribution pattern of *H. circularisquama* seems to be strongly affected by the water exchange rate. Natural populations of *H. circularisquama* cells significantly increase during the neap tide and decrease during the spring tide (**Fig. 2**). This observation clearly indicates that *H. circularisquama* populations are released from semi-closed bays into the offshore zone responsible for spring tidal current. Similar findings have been reported in *Alexandrium tamarense* blooms on the Maine coast²⁾ and *Gymnodinium mikimotoi* in Gokasyo Bay²⁷⁾. Therefore, water exchange mainly influences the horizontal distribution and the periodic changes of red

tide due to *H. circularisquama* and other harmful algal species.

## 2) Water temperature and salinity

Red tide associated with *H. circularisquama* occurs between July and November in the embayments of western Japan. In Ago Bay, the water temperature and salinity level during the *H. circularisquama* bloom ranged from 15 to 31 and from 24 to 34 psu, respectively¹⁴⁾. Generally, *H. circularisquama* blooms appear mainly under high water temperature (>23) and salinity (>30 psu) conditions. The results of field surveys show that *H. circularisquama* grows well under high water and salinity conditions.

Based on laboratory culture experiments, optimal growth of *H. circularisquama* occurred in a combination of water temperature of 30 and salinity of 30 psu. However, the growth of *H. circularisquama* decreased significantly below 15³¹⁾. These growth responses to temperature and salinity obtained in laboratory culture correspond to those recorded in field surveys. On the other hand, the optimal growth of representative harmful algae (*Alexandrium tamarense*, *Chattonella antiqua*, *Gymnodinium mikimotoi*, *Heterosigma akashiwo*, etc.) which often cause red tide on the Japanese coast occurred in a combination of water temperature from 20 to 25 and salinity ranging from 20 to 25 psu, respectively^{32,33,35,36)}.

On the coast of western Japan, since the maximum water temperature seldom exceeds 30, the growth pattern of *H. circularisquama* in relation to the temperature is different from that of other harmful algae appearing on the Japanese coast. Based on these physiological characters, *H. circularisquama* seems to be a species of tropical or subtropical origin.

## 3) Vertical mixing of seawater

Field surveys revealed that seawater mixing and concomitant upwelling of bottom water enhanced the proliferation of *H. circularisquama* blooms. In Ago Bay, strong disturbances of water stratification by typhoons preceded the red tide outbreaks of *H. circularisquama* in summer ([Fig. 3](#)). In the 1988 red tide at Uranouchi Bay, a large-scale intrusion of oceanic water into the bay and resultant seawater mixing were observed before the occurrence of red tide due to *H. circularisquama*¹⁸⁾. In the western part of Seto Inland Sea, where water columns are very stable due to stratification, *H. circularisquama* bloom hardly occurs in early to mid-summer. However, in autumn when the stratification begins to break down due to the decrease of the surface water temperature, *H. circularisquama* frequently causes red tide in embayments¹⁵⁾. Temporary or sustained water mixing throughout the water column may provide nutrients and growth-promoting substances from the bottom to the euphotic layer, resulting in increased salinity. Thus, the proliferation of *H. circularisquama* in coastal areas is considered to be triggered by vertical mixing of seawater.

## 4) Competition with other phytoplankton species

The competition between *H. circularisquama* and other microalgae is also noteworthy. According to field observations carried out over 3-year period in Ago Bay, the growth of *H. circularisquama* occurs when the populations of dominant diatoms *Chaetoceros* spp. begin to decrease ([Fig. 4](#)). Maximum yield and duration of *H. circularisquama* bloom seem to be strongly affected by the *Chaetoceros* spp. populations. It is considered that the decrease of the dominant diatom population is conducive to *H. circularisquama* growth. Uchida et al.²⁹⁾ reported that the growth of *H. circularisquama* was suppressed under bialgal cultures with diatom species including *Chaetoceros didymum*, *Stephanopyxis palmeriana* and *Licmophore* sp. Under the effect of diatoms, the cells of *H. circularisquama* became round to elliptical and were considered to be temporary cysts. It is assumed that diatom populations regulate the

development and decline of red tide due to *H. circularisquama*.

Furthermore, *H. circularisquama* was found to kill a mixotrophic dinoflagellate *Gyrodinium instriatum* and tintinnid ciliate *Favella taraikaensis*^{10,28}). The results show that *H. circularisquama* is toxic to active predators and competitors. From the ecological point of view, this characteristic might be advantageous for bloom formation in natural environments^{10,16}).

#### 5) Long-term trend of *Heterocapsa circularisquama* blooms

The records of red tide due to *H. circularisquama* are shown in [Fig. 5](#). The red tide incidence associated with *H. circularisquama* has rapidly increased since the early 1990s. Why can *H. circularisquama* appear and colonize the Japanese coast? Laboratory experiments reveal that *H. circularisquama* can not grow at 10 or less ³¹), and does not form typical resting cysts that can survive below 10 (Uchida & Matsuyama, unpub. data). Hence, the overwintering vegetative cells are the likely seed population for bloom initiation of this species. This growth strategy is considered to be disadvantageous for the occurrence of this species in temperate and cold seas.

On the Japanese coast, however, the water temperature in winter has significantly increased since the late 1980s¹¹), probably due to global climate change (green house effect and El Nino phenomenon). Recently, the tropical and subtropical dinoflagellate *Prorocentrum sigmoides* Bohm has frequently appeared in western Japan³⁰). In the Seto Inland Sea, the water temperature in winter considerably increased in the last decade, except for the period 1995-1996 (Fig. 5). Accordingly, tropical marine animals, e.g. green shell mussel *Perna viridis*, have frequently appeared in the Seto Inland Sea since the early 1990s. This hydrographic change may be conducive to the overwintering of *H. circularisquama* on the Japanese coast. The relationship between the water temperature in winter and initial occurrence of red tide due to the dinoflagellate *G. mikimotoi* was also observed in the previous study⁷). Hydrographic change in terms of water temperature is likely to bring about changes of the phytoplankton communities in the Japanese coastal waters.

#### 6) Possible origin

There have been no records of *H. circularisquama* red tide and related shellfish mortality in Japan before 1988. It remains to be determined whether *H. circularisquama* is a native species of Japan. Considering the growth response to water temperature, it is possible that *H. circularisquama* originates from tropical or subtropical regions, and has recently invaded Japanese coastal areas by warm current and/or artificial transportation. Recently, simulated experiments have revealed that *H. circularisquama* could easily migrate to distant areas in association with shellfish transportations⁸). During the last 2 decades, large shellfish spats, especially pearl oyster and short-necked clam, have been imported to Japan from Southeast Asia for aquaculture. It is therefore possible that *H. circularisquama* invaded Japan from tropical or subtropical seas (T. Honjo, pers. commun.). However, further studies should be carried out to analyze the artificial dispersal of *H. circularisquama*.



[-Damage of fisheries and toxicity-](#)



[Contents](#)

## References

- 1) Anderson, D. M. (1994): Red tide. *Sci. Am.*, **271**, 52-58.
- 2) Balch, W. M. (1981): An apparent lunar tidal cycle of phytoplankton blooming and community succession in the Gulf of Maine. *J. Exp. Mar. Biol. Ecol.*, **55**, 65-77.
- 3) Etou, T., Kuwamura, K. & Satou, H. (1998): The occurrence of a *Heterocapsa circularisquama* red tide and subsequent damages to shellfish in the Buzen Sea in Autumn 1997. *Bull. Fukuoka Fish. Mar. Technol. Res. Cent.*, **8**, 91-96 [In Japanese].
- 4) Hallegraeff, G. M. (1993): A review of harmful algal blooms and their apparent global increase. *Phycologia*, **32**, 79-99.
- 5) Honjo, T. (1994): The biology and prediction of representative red tides associated with fish kills in Japan. *Rev. Fish. Sci.*, **2**, 225-253.
- 6) Honjo, T. (1994): Overview on prediction and prevention of red tides causing death of marine life. *Farming Jpn.*, **28**, 9-15.
- 7) Honjo, T. et al. (1991): A relationship between winter water temperature and the timing of summer *Gymnodinium nagasakiense* red tides in Gokasyo Bay. *Nippon Suisan Gakkaishi*, **57**, 1679-1682.
- 8) Honjo, T. et al. (1998): Potential transfer of *Heterocapsa circularisquama* with pearl oyster consignments. In Harmful algae. eds. Reguera, B., Blanco, J., Fernandez, M. L. & Wyatt, T., Xunta de Galicia & Intergovernmental Oceanographic Commission of UNESCO, 224-226.
- 9) Horiguchi, T. (1995): *Heterocapsa circularisquama* sp. nov. (Peridinales, Dinophyceae); a new marine dinoflagellate causing mass mortality of bivalves in Japan. *Phycol. Res.*, **43**, 129-136.
- 10) Kamiyama, T. & Arima, S. (1997): Lethal effect of the dinoflagellate *Heterocapsa circularisquama* upon the tintinnid ciliate *Favella taraikaensis*. *Mar. Ecol. Prog. Ser.*, **160**, 27-33.
- 11) Kodama, J., Nagashima, H. & Izumi, Y. (1995): Long-term variations in the "Mangoku Herring," *Clupea pallasii* Valenciennes resources in relation to ocean environments in the waters off Sanriku and Joban. *Bull. Miyagi Pref. Fish. Res. Dev. Cen.*, **14**, 17-36 [In Japanese].
- 12) Lesser, M. P. & Shumway, S. E. (1993): Effects of toxic dinoflagellates on clearance rates and survival in juvenile bivalve molluscs. *J. Shellfish Res.* **12**, 377-381.
- 13) Matsuyama, Y. et al. (1995): Ecological features and mass mortality of pearl oysters during the red tide of *Heterocapsa* sp. in Ago Bay in 1992. *Nippon Suisan Gakkaishi*, **61**, 35-41 [In Japanese with English summary].
- 14) Matsuyama, Y. et al. (1996): Biological and environmental aspects of noxious dinoflagellate red tides by *Heterocapsa circularisquama* in the west Japan. In Harmful and toxic algal blooms. eds. Yasumoto, T., Oshima, Y. & Fukuyo, Y., Intergovernmental Oceanographic Commission of UNESCO, Paris, 247-250.
- 15) Matsuyama, Y. et al. (1997): Occurrence of *Heterocapsa circularisquama* red tide and subsequent damages to shellfish in western Hiroshima Bay, Seto Inland Sea, Japan in 1995. *Bull. Nansei Natl. Fish. Res. Inst.*, **30**, 189-207 [In Japanese with English summary].
- 16) Matsuyama, Y., Uchida, T. & Honjo, T. (1997): Toxic effects of the dinoflagellate *Heterocapsa circularisquama* on clearance rate of the blue mussel *Mytilus galloprovincialis*. *Mar. Ecol. Prog. Ser.*, **146**, 73-80.
- 17) Matsuyama, Y., Koizumi, Y. & Uchida, T. (1998): Effect of harmful phytoplankton on the survival of the abalones, *Haliotis discus* and *Sulculus diversicolor*. *Bull. Nansei Natl. Fish. Res. Inst.*, **31**, 19-24.

- 18) Muneke, Y. et al. (1991): Intrusion of external saline water influencing anoxic water in Uranouchi Bay. *Nippon Suisan Gakkaishi*, **57**, 1635-1643 [In Japanese with English summary].
- 19) Nagai, K. et al. (1996): Toxicity and LD₅₀ levels of the red tide dinoflagellate *Heterocapsa circularisquama* on juvenile pearl oysters. *Aquaculture*, **144**, 149-154.
- 20) Nielsen, M. V. & Strømgren, T. (1991): Shell growth response of mussels (*Mytilus edulis*) exposed to toxic microalgae. *Mar. Biol.*, **108**, 263-267.
- 21) Okaichi, T. (1989): Red tide problems in the Seto Inland Sea, Japan. In Red tides, biology, environmental science, and toxicology. eds. Okaichi, T., Anderson, D. M. & Nemoto, T., Elsevier, 137-142.
- 22) Shiota, A. (1989): Red tide problem and countermeasures. a *Int. J. Aqua. Fish. Technol.*, **1**, 195-223.
- 23) Shumway, S. E. (1990): A review of the effects of algal blooms on shellfish and aquaculture. *J. World Aquaculture Soc.*, **21**, 65-104.
- 24) Smayda, T. (1990): Novel and nuisance phytoplankton blooms in the sea: evidence for a global epidemic. In Toxic marine phytoplankton. eds. Granéli, E., Sundström, B., Elder, L. & Anderson, D. M. Elsevier, New York, 29-40.
- 25) Smolowitz, R. & Sumway, S. E. (1997): Possible cytotoxic effects of the dinoflagellate, *Gyrodinium aureolum*, on juvenile bivalve molluscs. *Aquaculture Int.*, **5**, 291-300.
- 26) Tangen, K. (1977): Bloom of *Gyrodinium aureolum* (Dinophyceae) in north European waters, accompanied by mortality in marine organism. *Sarsia*, **62**, 123-133.
- 27) Toda, S. et al. (1994): Effect of water exchange on the growth of the red-tide dinoflagellate *Gymnodinium nagasakiense* in an inlet of Gokasyo Bay, Japan. *Bull. Natl. Res. Inst. Aquaculture, Suppl.*, **1**, 21-26.
- 28) Uchida, T. et al. (1995): The red-tide dinoflagellate *Heterocapsa* sp. kills *Gyrodinium instriatum* by cell contact. *Mar. Ecol. Prog. Ser.*, **118**, 301-303.
- 29) Uchida, T. et al. (1996): Growth interactions between a red tide dinoflagellate *Heterocapsa circularisquama* and some other phytoplankton species in culture. In Harmful and toxic algal blooms. eds. Yasumoto, T., Oshima, Y. & Fukuyo, Y., Intergovernmental Oceanographic Commission of UNESCO, Paris, 369-372.
- 30) Ueda, H. et al. (1998): *Prorocentrum sigmoides* Böhm (Dinophyceae) red tide in Uranouchi Inlet, Kochi, Japan. *Bull. Plankton Soc. Japan*, **45**, 149-153.
- 31) Yamaguchi, M. et al. (1997): Effects of temperature and salinity on the growth of the red tide flagellates *Heterocapsa circularisquama* (Dinophyceae) and *Chattonella verruculosa* (Raphidophyceae). *J. Plank. Res.*, **19**, 1167-1174.
- 32) Yamaguchi, M. & Honjo, T. (1989): Effects of temperature, Salinity and irradiance on the growth rates of the noxious red tide flagellates *Gymnodinium nagasakiense* (Dinophyceae). *Nippon Suisan Gakkaishi*, **55**, 2029-2036 [In Japanese with English summary].
- 33) Yamaguchi, M., Imai, I. & Honjo, T. (1991): Effects of temperature, Salinity and irradiance on the growth rates of the noxious red tide flagellates *Chattonella antiqua* and *C. marina* (Raphidophyceae). *Nippon Suisan Gakkaishi*, **57**, 1277-1284 [In Japanese with English summary].
- 34) Yamamoto, C. & Tanaka, Y. (1990): Two species of harmful red tide plankton increased in Fukuoka Bay. *Bull. Fukuoka Pref. Fish. Exp. Stn.*, **16**, 43-44 [In Japanese].
- 35) Yamamoto, T., Yoshizu, K. & Tarutani, K. (1995): Effects of temperature, salinity and irradiance on the growth of toxic dinoflagellate *Alexandrium tamarense* isolated from Mikawa Bay, Japan. *Jpn. J. Phycol.*, **43**, 91-98 [In Japanese with English summary].

- 36) Yamochi, S. (1984): Effects of temperature on the growth of six species of red-tide flagellates occurring in Osaka Bay. *Bull. Plank. Soc. Jpn.*, **31**, 15-22 [In Japanese with English summary].
- 37) Yoshida, Y. & Miyamoto, M. (1995): Growth of *Heterocapsa circularisquama* population in Kusu-ura Bay and variation of diurnal motion of red tide in 1994. *Rep. Kumamoto Pref. Fish. Res. Cent.*, **3**, 31-35 [In Japanese].



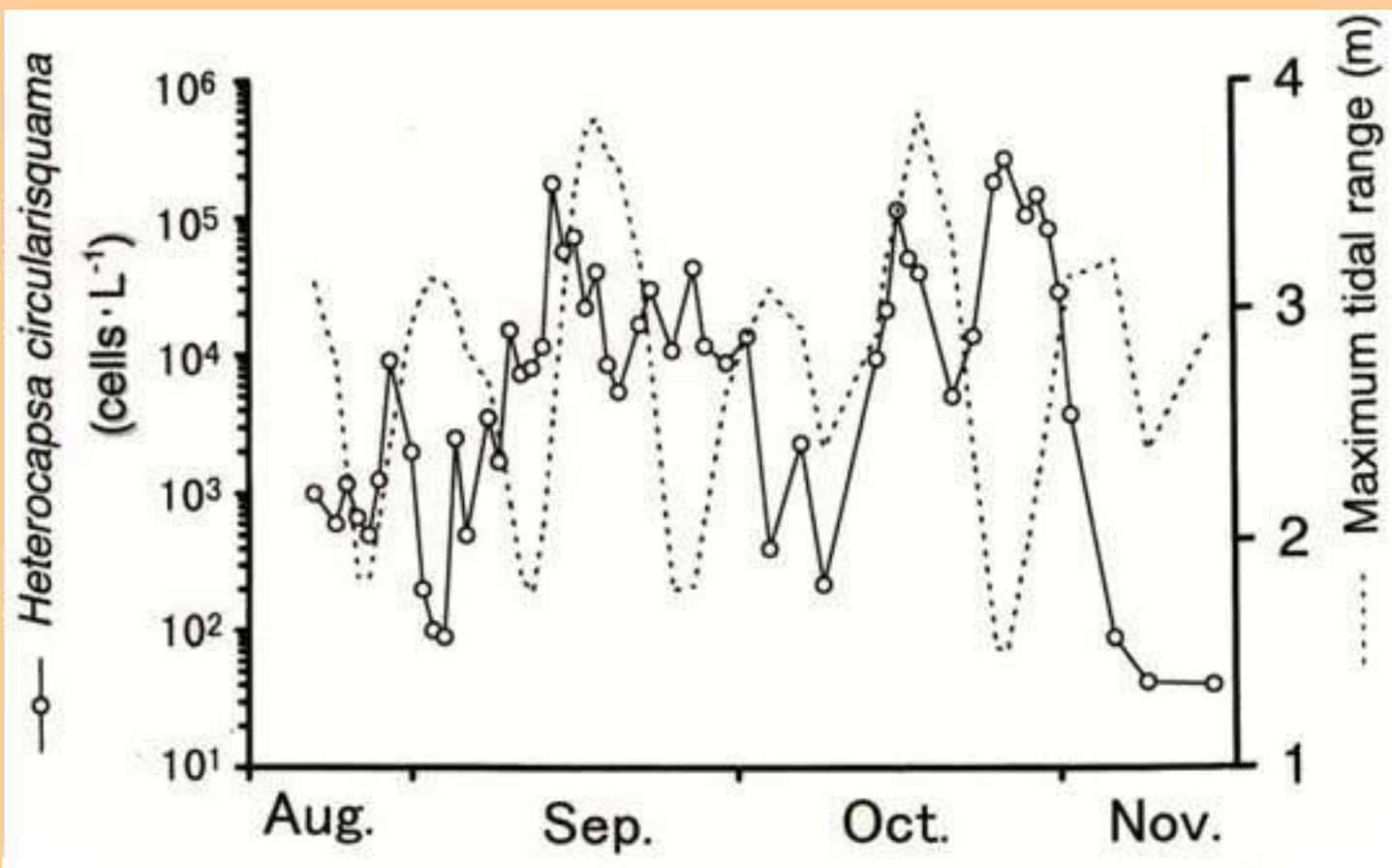


Fig.2. Relationship between cell densities of *Heterocapsa circularisquama* and maximum tidal range in Ohno strait, Hiroshima Bay in 1997

Maximum tidal range correspond to the daily height rages between high and low sea level. *H. circularisquama* population increases during the neap tide period and decreases during the spring tide period.

 [Back](#)

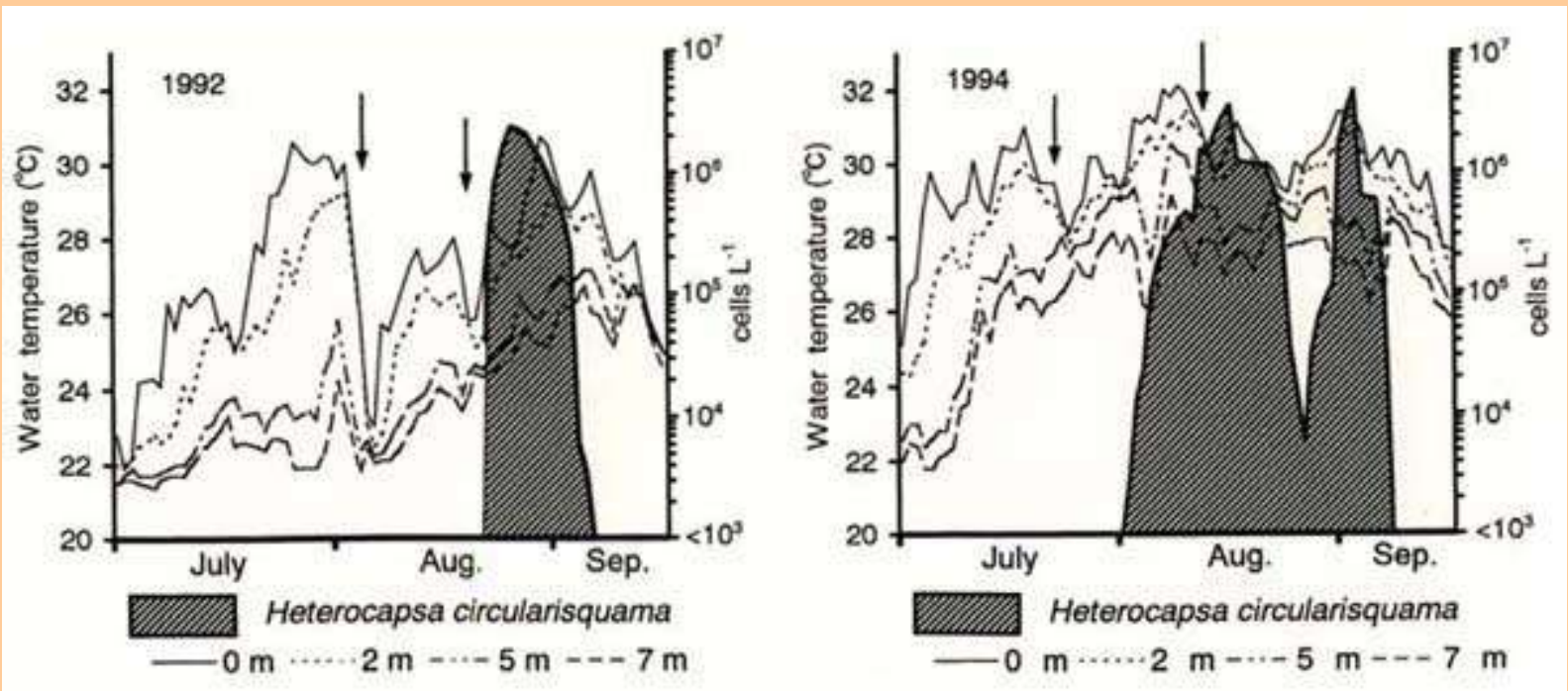


Fig.3. Changes in water temperature at 4 different depths and mean cell density of *Heterocapsa circularisquama* in Ago Bay  
 Arrows denote the typhoon events (Matsuyama et al., 1996).

 [Back](#)

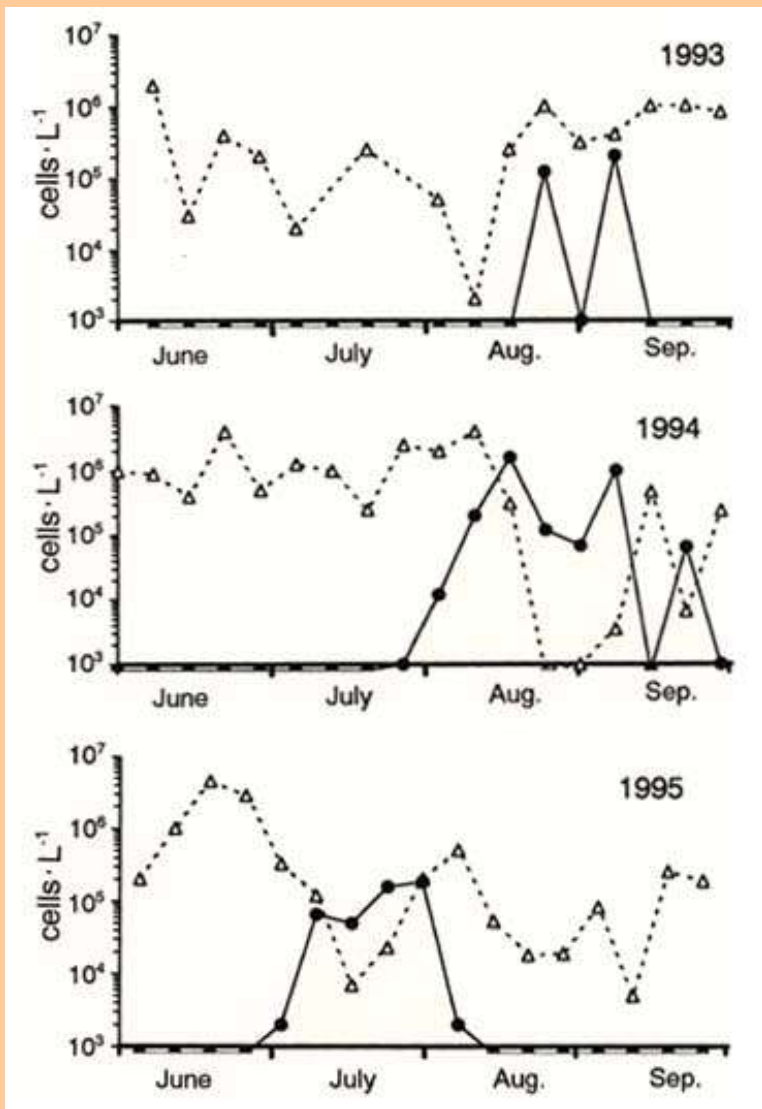


Fig.4.

Changes in cell densities of *Heterocapsa circularisquama* (P) and predominant diatom *Chaetoceros* spp.(g) in Tategami Inlet, Ago Bay(1993-1995)

*H. circularisquama* frequently appears when the population of *Chaetoceros* spp. is low (niche) which is probably due to the high water temperature and strong stratification.

Massive bloom(>10⁶ cells L⁻¹) and concomitant death of pearl oyster were observed during the 1994 bloom period. The date sets were provided in part by T. Kobayashi, Mie Prefectural Technical Center.



[Back](#)

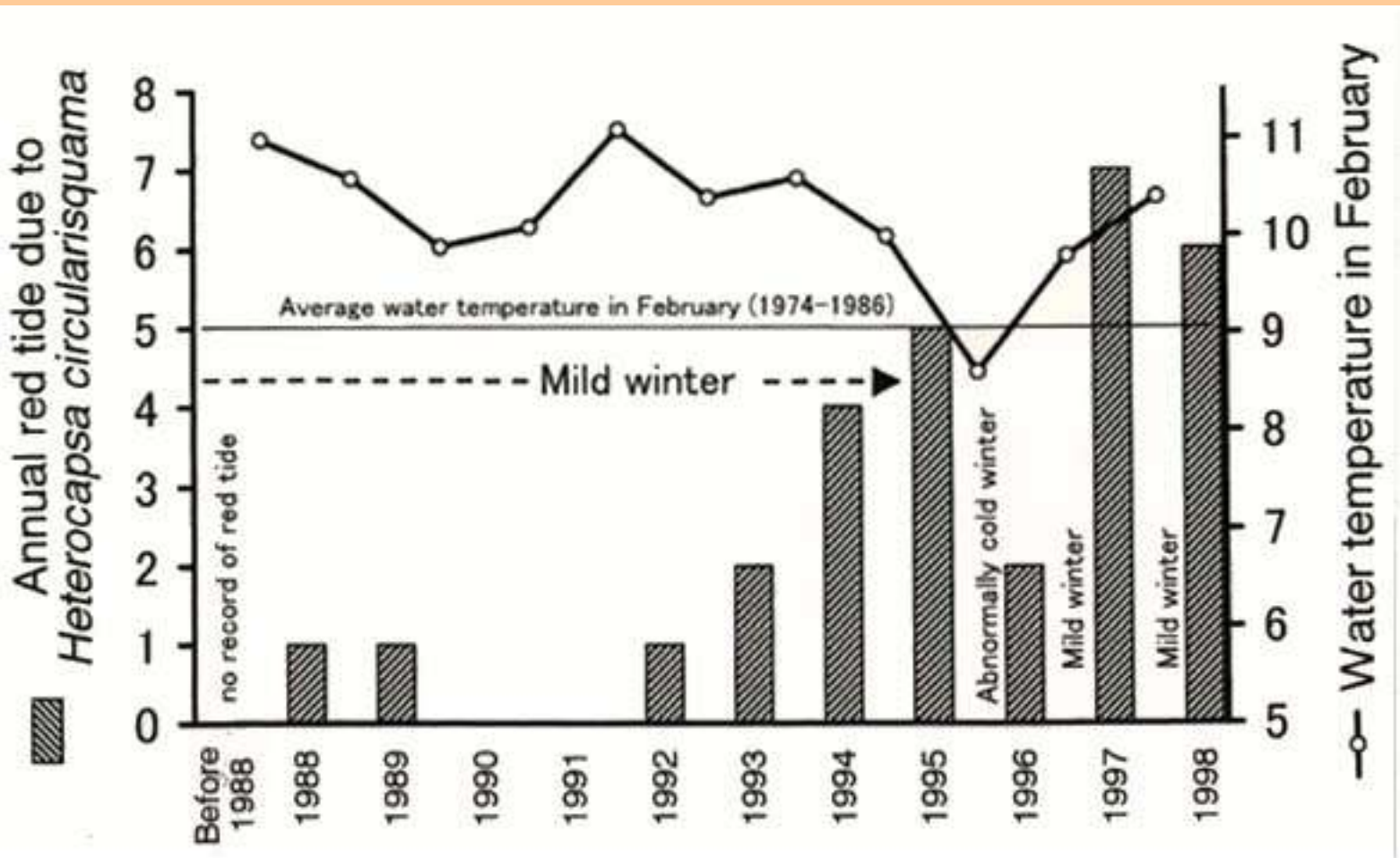


Fig.5. Long-term trend of red tide events due to *Heterocapsa circularisquama* in Japan and winter water temperature (February) in eastern Seto Inland Sea (Harima-nada)

The data sets of water temperature were provided by Y. Hori, Hyogo Prefectural Fisheries Experimental Station.

 [Back](#)

## Damage to fisheries and toxicity

### 1) Shellfish damage to aquaculture industries

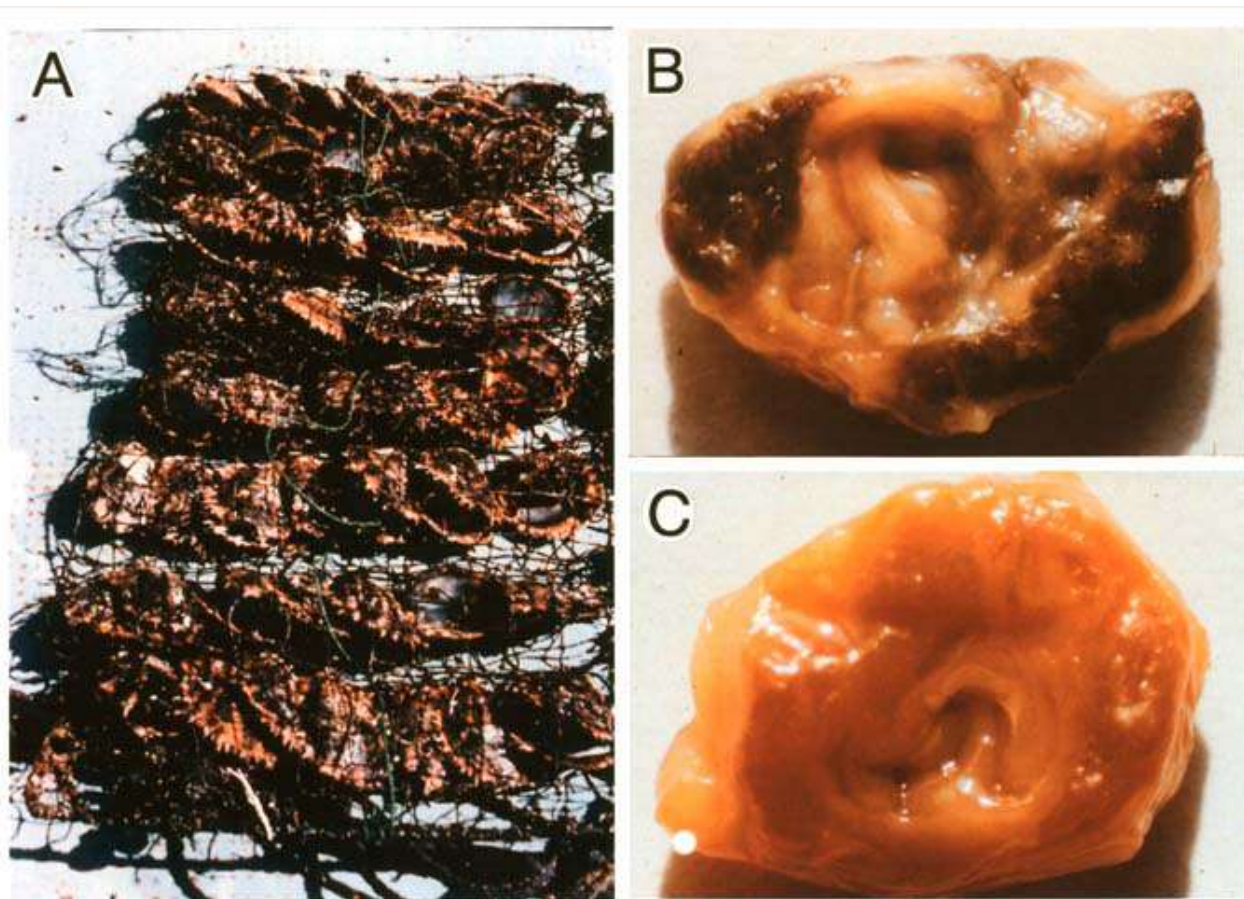
In September 1988, extensive red tide due to *H. circularisquama* and subsequent death of short-necked clams *Ruditapes philippinarum* occurred in Uranouchi Bay, Kochi Prefecture ([Table 1](#)). Red tide due to *H. circularisquama* occurred at Fukuoka Bay in 1989, and at Ago Bay in 1992, resulting in high mortality of shellfish^{13,34}).

Until 1998, 26 cases of *H. circularisquama* red tide (including 15 incidences leading to fisheries damage) had been recorded in 14 locations of western Japan ([Fig. 1](#)). The red tide due to *H. circularisquama* was associated with massive killing of commercially important bivalve species: short-necked clam *R. philippinarum*, pacific oyster *Crassostrea gigas*, pearl oyster *Pinctada fucata*, blue mussel *Mytilus galloprovincialis edulis*, etc^{13,14,34,37}). The current proliferation of *H. circularisquama* throughout western Japan destroyed the local shellfish mariculture. Economic losses of shellfish aquaculture by direct killing of marketable products were estimated about at least 10 billion-yen in the last decade.

On the other hand, there are no records of death of finfish and crustacean species or public health hazard due to the consumption of shellfish and other seafood products in association with the red tide of *H. circularisquama*¹⁶). This type of biohazard in marine animals is markedly different from previous damage caused by harmful algae responsible for paralytic shellfish poisoning (PSP), diarrhetic shellfish poisoning (DSP), amnesic shellfish poisoning (ASP), neurotoxic shellfish poisoning (NSP), ciguatera poisoning, and ichthyotoxicity.

### 2) General characteristic of shellfish affected by red tide

The effects of *H. circularisquama* on bivalve molluscs were described in previous studies^{3, 14,15,19}). Matsuyama et al.¹⁴) observed that exposure of pearl oysters to 5-10 x 10⁶ *H. circularisquama* cells L⁻¹ resulted in death within several days although the level of dissolved oxygen was not critical. The dead individuals were characterized by a marked shrinkage of the mantle, decrease of glycogen lobe attached to the mantle and gut discoloration ([Fig. 6](#)).



**Fig. 6.**  
 Photographs of  
 pearl oyster  
*Pinctada fucata*  
 affected by  
*Heterocapsa*  
*circularisquama* in  
 1992

A: Dead pearl  
 oysters.  
 B: Individual  
 cultured at site  
 without red tide.  
 C: Individual  
 cultured at site with  
 red tied.

The symptoms  
 clearly reflected  
 the direct  
 cytotoxic effect  
 of *H.*  
*circularisquama*

on pearl oyster physiology. Similar harmful effects on oyster *C. gigas* and the mussel *M. galloprovincialis* were observed during the red tide which occurred in Hiroshima Bay¹⁵). Based on detailed field surveys, in most of the bivalve species, the filtration rate is significantly reduced at a density of  $5\text{-}20 \times 10^4$  *H. circularisquama* cells  $L^{-1}$ . As a result, alterations of bivalve physiology clearly started from a cell density below 1%.

### 3) Exposure experiment using cultured strain

Nagai et al.¹⁹) showed that the mortality of pearl oyster spats by *H. circularisquama* depends on the cell density of this alga. Pearl oysters exposed to *H. circularisquama* cells at a density above  $10^7$  cells  $L^{-1}$  showed an unusual contraction of the mantle and gills, clapping, sustained valve closure, paralysis, and heartbeat stop within 24 hours. Furthermore, the mussel *M. galloprovincialis* significantly reduced its feeding activity when exposed to  $10^4$  cells  $L^{-1}$  of *H. circularisquama*, but not in culture with  $10^6$  cells  $L^{-1}$  of morphologically similar dinoflagellates *Scrippsiella trochoidea* and *Heterocapsa triquetra*¹⁶). Some harmful algae are known to be toxic to marine shellfish. The blooms associated with the unarmored dinoflagellate *Gyrodinium aureolum* and picoplankton *Aureococcus anophagefferens* referred to as "brown tide" lead to considerable failure in mussel and scallop farming²³). Laboratory-rearing experiments using these algae showed considerable detrimental effects on various bivalve species^{12,20,25}). However, the effect of these harmful algae on marine animals is not species-specific. Red tide due to *G. aureolum* kills not only shellfish but also finfish and crustacean species²⁶). Although *H. circularisquama* frequently kills various bivalve species within a short period of time (<24 h) as described previously^{15,19}), no death and adverse effects were observed in finfish and crustacean. These facts suggested that the harmful effect of *H. circularisquama* on bivalves is specific and pronounced compared to other harmful algal species ([Table 2](#)).

#### 4) *Harmful effects of Heterocapsa circularisquama on other animals*

Laboratory exposure experiments showed that various marine animals such as bivalves, gastropods¹⁷⁾, solitary acidians, and jellyfish are affected by *H. circularisquama* unlike vertebrates, crustaceans, starfish, and sea urchins (Table 2). On the other hand, although the occurrence of illness associated with the consumption of bivalves that accumulated *H. circularisquama* cells may be a cause for concern in humans, shellfish poisoning has never been observed in samples collected from red tide areas. Direct HPCL analysis failed to detect PSP toxins or DSP toxins in the cells of *H. circularisquama*¹⁶⁾. No death or symptoms were observed in 5 mice to which a cultured cell pellet of *H. circularisquama* had been injected intraperitoneally at a rate of  $10^6$  cells individual⁻¹.

#### 5) *Characterization of Heterocapsa circularisquama toxicity*

Nagai et al.¹⁹⁾ suggested that the toxicity of *H. circularisquama* to bivalves was mediated by a chemical agent. Thereafter, it was shown that the toxic effect of *H. circularisquama* on bivalves was not due to extracellular metabolites, cell exudates, and "naked cells" prepared by sonication and centrifugation. Furthermore, trypsin and SDS (sodium dodecyl sulfate) treatments were found to decrease drastically the toxicity of *H. circularisquama* cells ([Fig. 7](#)). Therefore, labile protein-like complex localized on the cell surface presumably exerts a detrimental effect on bivalves¹⁶⁾. However, purification and characterization of toxic fractions have not been successful because this agent is highly labile under neutral conditions.

#### 6) *Secondary damages to fisheries industries*

Secondary damage to fisheries may occur during the *H. circularisquama* red tide periods, sometimes causing serious economic losses. As mentioned above, *H. circularisquama* bloom does not cause human illness associated with the consumption of harvested products. This fact should be recognized and fishermen and consumers should be informed that "shellfish killing" during red tide due to *H. circularisquama* is different from "shellfish poisoning" due to toxic dinoflagellate blooms such as those of the genera *Alexandrium*, *Gymnodinium*, and *Dinophysis*. This information may lead to a considerable decrease in the demand for shellfish and market price²³⁾. Massive *H. circularisquama* bloom occurred in a restricted area of Hiroshima Bay, in 1997. Although no outbreaks of shellfish poisoning occurred, oyster demand rapidly declined when the occurrence of red tide due to *H. circularisquama* was broadcasted in several TV programs. Market price of oyster decreased by 10-30% due to the decrease of the demand compared with the previous year. In the oyster farming industry of Hiroshima Bay, approximately several hundred persons are employed as oyster shuckers with a low salary. The decrease of the market price directly affects shucker employment.

## **Monitoring, prediction, and methods of prevention of red tide**

### **1) *Monitoring of red tide due to H. circularisquama***

In Japan, monitoring systems for harmful algal blooms have been developed by the Fisheries Agency and local government organizations (mainly Prefectural Fisheries Experimental Stations) since the early 1970s. These monitoring systems operate successfully and provide information on the incidence of red tide and shellfish poisoning as mentioned previously²¹⁾. Since 1992, in several locations, regular monitoring systems on *H. circularisquama* blooms have been set up. The local government uses early warning systems based on the data obtained from regular oceanographic surveys. Fishermen are routinely able to obtain the information about harmful algal bloom (cell density, water temperature, and distribution of cell assemblages, etc.).

## 2) **Prevention of fisheries damage due to *H. circularisquama***

To our knowledge, it is difficult to control or destroy the large natural populations of red tide organisms by applying direct prevention methods. Various prevention techniques (i. e. spraying of active clay, hydrogen peroxide, and coagulants, etc.) were developed previously^{6,22}). However, widespread application of these procedures for marine environments may exert a secondary harmful effect on other valuable organisms (i.e. diatoms, zooplankton, fish, benthos, etc.). The simple and most effective method is the transfer of cultured organisms from a red tide area to a non-red tide area. In Ago Bay, pearl oyster aquaculturists began to remove the pearl oysters when the cell density of *H. circularisquama* exceeded about  $10^5$  cells  $L^{-1}$ . No fisheries damage has occurred in this bay recently. However, oyster and clam aquaculturists are still affected by red tide caused by *H. circularisquama* because the removal procedure is costly and labor-intensive. As described above, red tide damage caused by *H. circularisquama* leads to a loss of marketable products and secondary damage such as decrease of demand for the products and loss of competitiveness in the market due to the high cost of the products to compensate for the cost of prevention of the damage.



[Forward to:-Microbial Conversion of Macroalgae into a Detrital Hatchery Diet-](#)



[Contents](#)



[JIRCAS Home Page](#)



Table 1

Table 1. Records of damage to shellfish species due to red tide associated with *Heterocapsa circularisquama* in western Japan.

<u>Date</u>	<u>Shellfish species affected</u>	<u>Notes</u>	<u>Loccasion</u>	<u>Reference</u>
1988	<i>Ruditapes philippinarum</i>	1,560 t losses	Uranouchi Bay	
1989	<i>Crassostrea gigas</i> <i>Macra chinensis</i> <i>Mytilus galloprovincialis</i> <i>Ruditapes philippinarum</i> <i>Solen strictus</i>	mass mortality	Fukuoka Bay	34
1992	<i>Pinctada fucata</i>  <i>Crassostrea gigas</i> <i>Mytilus galloprovincialis</i> <i>Chlamys nobilis</i>	30-90% mortality loss of >18 million individuals mass mortality	Ago Bay	13
1993	<i>Ruditapes philippinarum</i> <i>Crassostrea gigas</i>	50-90% decrease of harvest mass mortality	Lake Hamana	
1994	<i>Pinctada fucata</i>	40-90% mortality in areas with extensive assemblages	Ago Bay	14
1994	<i>Pinctada fucata</i> <i>Ruditapes philippinarum</i> <i>Crassostrea gigas</i> <i>Solen strictus</i> <i>Macra veneriformis</i> <i>Musculista senhousia</i> <i>Anomalocardia aquamosus</i> <i>Dosinorbis japonica</i> <i>Glossaulax didyma</i>	mean 65.4% mortality in 2 years old individuals mean 69.5% mortality mass mortality	Kusu-ura Bay	37
1995	<i>Pinctada fucata</i>  <i>Crassostrea gigas</i> <i>Ruditapes philippinarum</i> <i>Mytilus galloprovincialis</i>	5-36% mortality  36-68% mortality, 610 t losses >70% mortality, 210 t losses 10-55% mortality	Ago Bay  Hiroshima Bay	  15
1996	<i>Pinctada fucata</i>	mass mortality losses of 1.5 million individuals	Ago Bay	
1997	<i>Pinctada fucata</i> <i>Crassostrea gigas</i> <i>Mytilus galloprovincialis</i>  <i>Crassostrea gigas</i> <i>Mytilus galloprovincialis</i> <i>Sulculus diversicolors</i>	mass mortality   mass mortality in spats and adults 75% mortality in assemblage areas mortality in natural population	Obama Bay   Hiroshima Bay	

Table 1

	<i>Ruditapes philippinarum</i>	210 t losses	Buzen Sea	3
	<i>Ruditapes philippinarum</i>	50% decrease of spat yield	Suo-nada	
	<i>Crassostrea gigas</i>	considerable mortality		
	<i>Macra veneriformis</i>			
1998	<i>Crassostrea gigas</i>	30-98% mortality ca. 5,000 t losses	Hiroshima Bay	
	<i>Ruditapes philippinarum</i>	50-90% mortality		
	<i>Atrina pectinata</i>	considerable mortality	Suo-nada	

The data sets were obtained from Fishery Regulation Office, Fisheries Agency of Japan.



[Back](#)

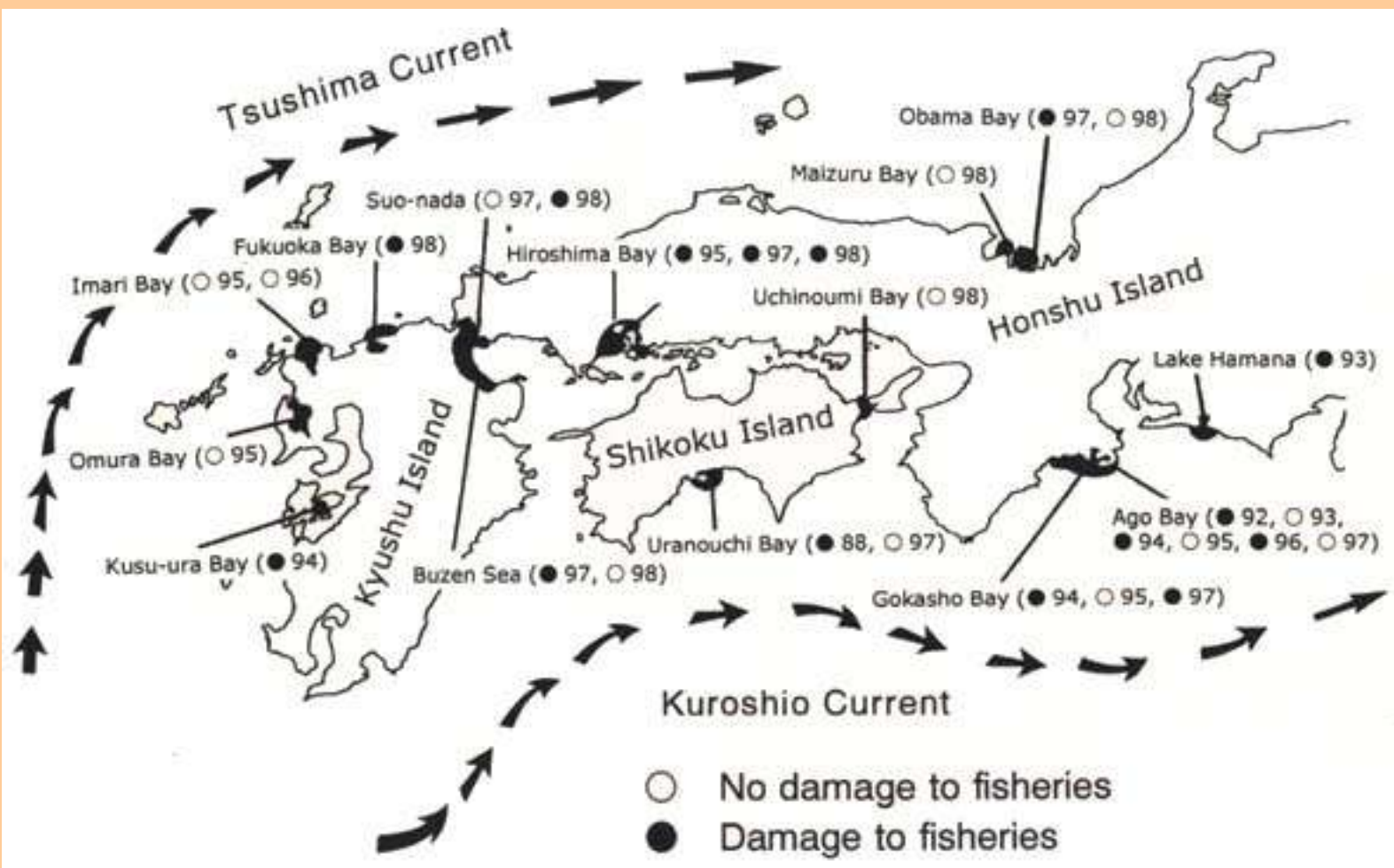


Fig.1. Records of tide (>106 cells L-1) due to *Heterocapsa circularisquama* in western Japan



[Back](#)

Table 2. Effects of *Heterocapsa circularisquama* on various animals

Animals	cells L ⁻¹	Symptoms	Reference
Bivalves	10 ⁴ -10 ⁵	Feeding inhibition	15, 16
	>10 ⁶	Death	3, 15, 19
Gastropods	10 ⁴ -10 ⁵	Unusual locomotion	17
	>10 ⁶	Death	17
Solitary acidians	>10 ⁶	Feeding inhibition	
Jellyfish	>10 ⁶	Tentacle shrinkage	
Protozoa ^{a)}	10 ⁵ -10 ⁶	Feeding inhibition	10
	>10 ⁶	Death	10
Dinoflagellates	>10 ⁶	Death by cell contact	28
Mouse	>10 ⁹ b)	-	16
Finfish	>10 ⁶	-	
Crab	>10 ⁷	-	
Lobster, shrimp	>10 ⁷	-	
Star fish	>10 ⁷	-	
Copepods	>10 ⁷	-	
Diatoms	>10 ⁷	-	29

-: Not affected. a) Species-specific. b) Intraperitoneal injection.



[Back](#)

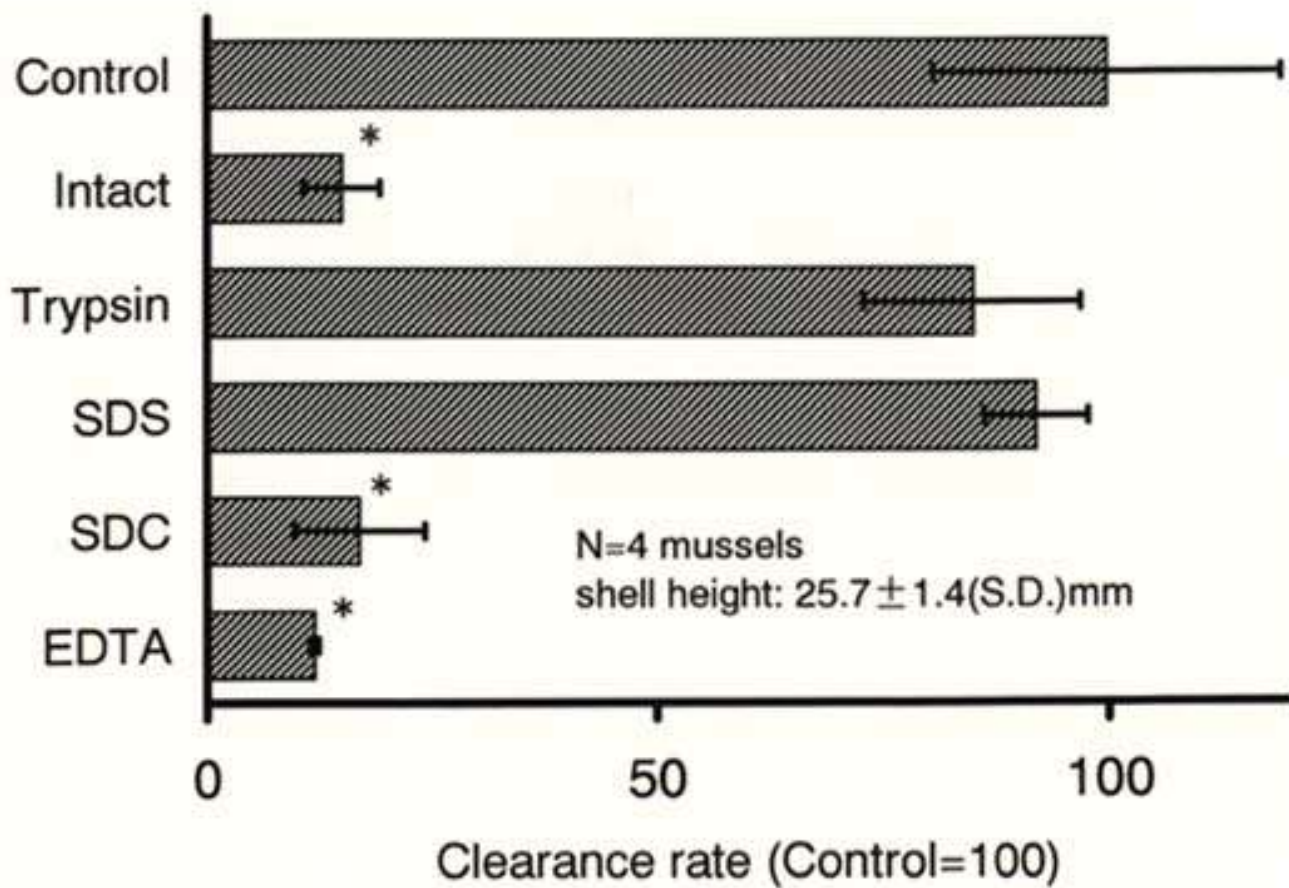


Fig.7

Relative clearance rates of *Mytilus galloprovincialis* exposed to chemically treated *Heterocapsa circularisquama* cells (Control: *Isochrysis galbana*,  $8 \times 10^6 \text{ cell}^{-1}$ )

Initial cell density of *H. circularisquama* ranged from  $2.5\text{-}2.8 \times 10^5 \text{ cells L}^{-1}$ .

SDS: sodium dodecylsulfate.

SDC: sodium deoxycholate.

Each chemical was used at a concentration lower than which would inhibit the swimming of *H. circularisquama*. Error bars show  $\pm$  S.D. * $p < 0.005$  (t-test).



[Back](#)

# Microbial Conversion of Macroalgae into a Detrital Hatchery Diet

**Motoharu UCHIDA**

Marine Biochemistry Division, National Research Institute of Fisheries Science  
(Fukuura, Kanazawa, Yokohama, 236-8648 Japan)

## Abstract

The formation of algal detrital particles in a completely cell-detached form, namely, single cell detritus (SCD) was reported for the first time by the author during the microbial degradation process of macroalgal thalli. SCD display 3 characteristics suitable for feed for aquatic hatchery animals: 1) The size of SCD is in the 2-14  $\frac{1}{4}$  $\mu$ m range, which is similar to that of dietary phytoplankton; 2) The cell wall components of SCD are partially degraded which facilitates digestion; 3) Bacterial cells are attached to SCD, which modifies the algal detritus to protein-rich particles. The use of SCD as a potential hatchery diet instead of phytoplankton culture, which is labor-intensive, was successfully demonstrated based on feeding experiments with *Artemia*. Further modification of SCD could include the attachment of bacteria to SCD which would exert beneficial effects on the hatchery animals. Use of SCD diets in fish feeding regimes is an attempt to introduce the concept of detrital food web to aquaculture systems, which could contribute to the development of sustainable fish nursery systems.

**Discipline:** Aquaculture

**Additional key words:** detritus, food chain, *Pseudoalteromonas*, seaweed, *Ulva*

This paper is primarily based on a previous paper entitled "Conversion of Macroalgae into a Detrital Hatchery Diet - An Attempt to Introduce Detrital Food Webs into Aquaculture"(in Japanese) published in TechnoInnovation⁹).

This work was supported in part by a grant (Development of highly functional materials by structural modification of carbohydrates) from the Research Council Secretariat of the Ministry of Agriculture, Forestry, and Fisheries, Japan (1991-1996).

● 1...12): [References](#)

(Received for publication, February 3, 1999)

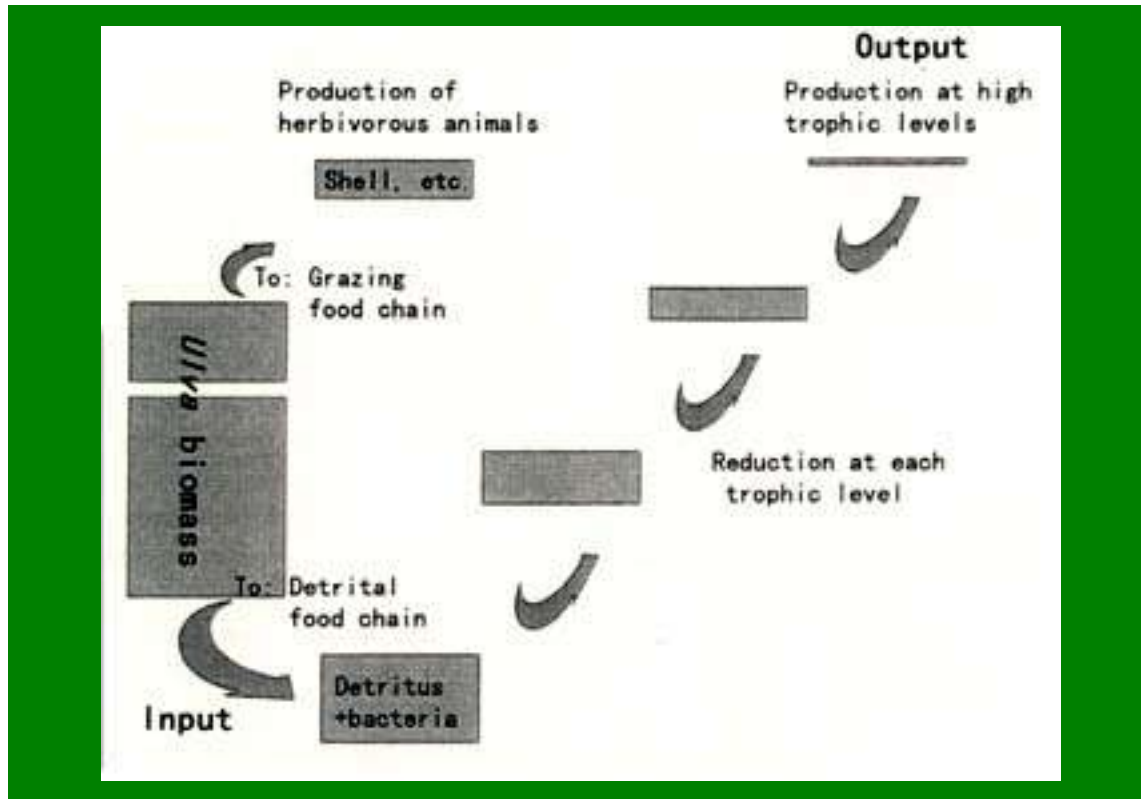
## Introduction

Aquaculture techniques have markedly progressed over the last decades, and enabled to produce and release millions of seed fishes important to the aquatic environment. On the other hand, however, the prevalence of fish diseases has become a serious problem in many countries, and an increasing number of people consider that current aquaculture systems require significant changes, both technical and conceptual, for sustainable development.

In the natural aquatic environment, larval fish develop by feeding on grazing and detrital food chain systems (Fig. 1).

However, the present aquaculture systems utilize only the grazing food chain principle⁶). Since the

detrital food web can be considered to be a system whereby biological resources not utilized as feed in the grazing food chain are recycled, a more efficient system could be developed by introducing this recycling system into the present fish-feeding regime. Although our understanding of the detrital food web is still limited, there is an increasing number of studies showing the effectiveness of using detritus^{1, 2, 4}). Since the detrital system has a large input, if it enhances the ecological efficiency, the system could have a large impact on biological production in the natural ecosystems. This paper describes a method of preparing algal detrital materials with a high dietary value to improve the ecological efficiency of the detrital food chain system and introduce it to the present fish culture system.



**Fig. 1. The detrital food chain as a system to recycle wastes from biological production**

The input (the quantity not grazed and decomposed to detrital materials) is large but the output (the quantity linked to production at a higher trophic level) is rather small in the detrital system.



[- Initial observations of single cell detritus \(SCD\) -](#)



[Contents](#)

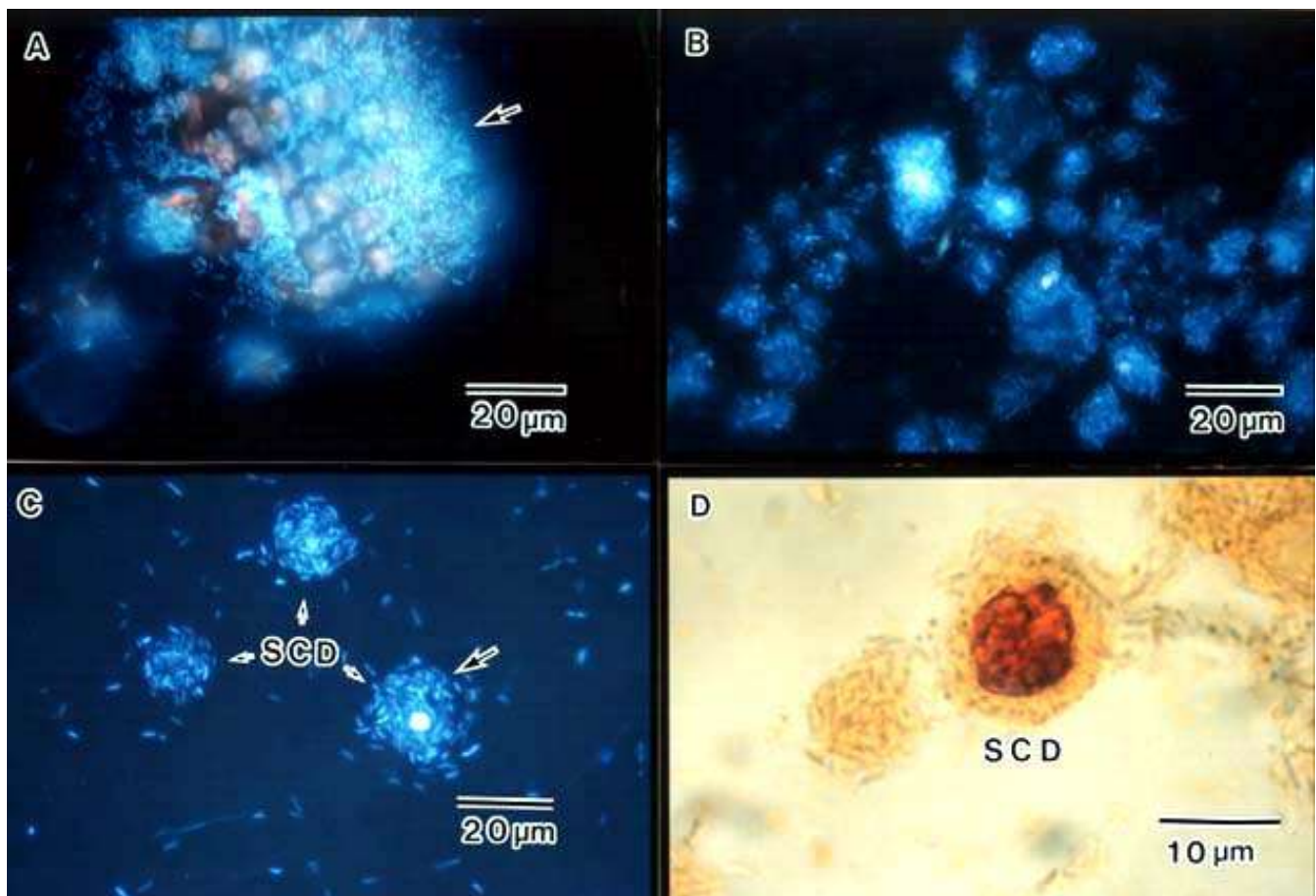
**References**

1. Azam, F. et al. (1983): The ecological role of water-column microbes in the sea. *Mar. Ecol. Prog. Ser.*, **10**, 257-263.
2. Bombeo-Tuburan, I., Guanzon, N.G. Jr. & Schroeder, G.L. (1993): Production of *Penaeus monodon* (Fabricius) using natural food types in an extensive system. *Aquaculture*, **112**, 57-65.
3. Gorospe, J.N. et al. (1996): Potential use of *Pseudomonas* as food for brine shrimp *Artemia*. *Jpn Aqua. Soc.*, **44**, 315-323.
4. Honculada Primavera, J. & Gakutanc, R.Q. (1987): Preliminary results of feeding aquatic macrophytes to *Penaeus monodon* juveniles. *Aquaculture*, **80**, 189-193.
5. Intriago, P. & Jones, D. A. (1993): Bacteria as food for *Artemia*. *Aquaculture*, **113**, 115-127.
6. Sorgeloos, P. (1995): Bioengineering of hatcheries for marine fish and shellfish. *J. Mar. Biotechnol.*, **3**, 42-45.
7. Takeuchi, T., Watanabe, T. & Ogino, C. (1978): Optimum ratio of protein to lipid in diets of rainbow trout. *Bull. Jpn. Soc. Sci. Fish.*, **44**, 683-688.
8. Uchida, M. (1996): Formation of single cell detritus densely covered with bacteria during experimental degradation of *Laminaria japonica* thalli. *Fish. Sci.*, **62**, 731-736.
9. Uchida, M. (1998): Conversion of macroalgae into a detrital hatchery diet – An attempt to introduce detrital food webs into aquaculture. *TechnoInnovation*, **8(2)**, 24-29.
10. Uchida, M., Nakata, K. & Maeda, M. (1997): Introduction of detrital food webs into an aquaculture system by supplying single cell detritus produced from *Laminaria japonica* as a hatchery diet for *Artemia* nauplii. *Aquaculture*, **154**, 125-137.
11. Uchida, M., Nakata, K. & Maeda, M. (1997): Conversion of *Ulva* fronds to a hatchery diet for *Artemia* nauplii utilizing the degrading and attaching abilities of *Pseudoalteromonas espejiana*. *J. Appl. Phycol.*, **9**, 541-549.
12. Uchida, M. & Numaguchi, K. (1996): Formation of protoplasmic detritus with characteristics favorable as food for secondary animals during microbial decomposition of *Ulva pertusa* (Chlorophyta). *J. Mar. Biotechnol.*, **4**, 200-206.



## Initial observations of single cell detritus (SCD)

Our laboratory maintains a collection of over 100 bacterial strains which were isolated from coastal waters of Japan and are able to degrade macroalgal thalli. Strain AR06 (MAFF120006, FERM BP-5024) shows the strongest activity within our collection. AR06 exhibits a decomposing activity toward various kinds of algal polysaccharides such as algin, fucoidan, agar, etc. and is able to degrade macroalgal thalli from brown and green algae, and also presumably from red algae. In our previous studies, we observed the formation of algal detritus in a completely cell-detached form (Fig. 2), namely, single cell detritus (SCD) during the microbial degradation process of *Laminaria japonica*⁸⁾ and *Ulva* sp.¹²⁾. AR06 which was assigned to *Alteromonas espejiana* based on the results of biological and physiological tests⁸⁾, is presently assigned to *Pseudoalteromonas atlantica* based on the results of phylogenetic analysis using 16S rDNA sequence and DNA-DNA hybridization tests with type strains (in preparation). SCD were also found to be formed during the experimental degradation of *Ulva* fronds soaked in natural seawater supplemented with peptone at 5 g/L level. Therefore, SCD can be produced by the activity of indigenous microbial populations without the presence of AR06 which suggests that SCD formation may occur in natural environments.



**Fig. 2. Microphotographs showing the decomposition process of *Laminaria japonica* (A, B) and the resulting production of single cell detritus (SCD) by the activity of *Pseudoalteromonas atlantica* AR06 (C, D)**

The SCD surface is densely covered with bacterial cells (arrow), which were observed after fluorescent staining (A, B, C) with 4,6'-diamino-2-phenylindole (DAPI).

The size of the SCD formed in these studies is in the 2-14  $\frac{1}{4}$ m range, which is similar to that of dietary

phytoplankton such as *Nannochloropsis* sp., *Isochrysis galbana*, and *Tetraselmis tetrathele*. SCD partially lose their cell wall components by microbial degradation and appear as spheroplasts in the case of *Laminaria* or protoplasts in the case of *Ulva*. Many bacterial cells were attached to the surface of the SCD, especially in the case of SCD produced from *Laminaria*. SCD from *Laminaria* have an algin layer on their surface, which may facilitate the attachment of the bacteria.

It takes about 3-5 days until the production of SCD is observed during the experimental degradation of macroalgal thalli if the degradation is performed by bacterial activity alone. However, the number of particles with the size of SCD increases more rapidly if the degradation is performed with a combination of magnet-stirring during the incubation although the SCD prepared in this manner appear to be more disintegrated compared with intact spheroplasts or protoplasts.

## Use of SCD as a hatchery diet

The characteristics of SCD, i.e. a size appropriate for ingestion and a structure associated with digestibility for hatchery animals, suggest that SCD can be used instead of dietary phytoplankton. The preparation of SCD is easy and requires only one to a few days, which is a major advantage compared to the use of phytoplankton. The potential use of SCD as a hatchery diet was tested by feeding experiments with *Artemia*¹⁰). When *Artemia* were given *Laminaria* particles, 105-177¼m in diameter, they could not ingest them because of the size and scarcely grew. In contrast, *Artemia* fed on the same *Laminaria* particles that were degraded to SCD by the AR06 strain exhibited a much better growth and survival rates ([Figs. 3, 4a](#)). When the feeding level was compared to that of a commercial phytoplankton diet consisting of *Nannochloropsis* sp. (Marine Alpha, from Nisshin Science), the growth rate was nearly the same, although the survival rate was slightly lower. In another experiment where *Laminaria* particles less than 44¼m in diameter were used as a control diet, it was demonstrated that the macroalgal thalli themselves had a high dietary value if given as a material with a size suitable for ingestion ([Fig. 4b](#)). However, the degradation of the *Laminaria* particles by contact with AR06 did not result in an increase of the initial dietary value for *Artemia*. In this experiment, a marked increase in the number of detrital particles suitable for ingestion by *Artemia* was observed in case of axenic control when mechanical degradation by magnet-stirring was used while only a gradual increase of SCD was observed when the diet was prepared by contact with AR06 ([Fig. 5](#)). The moderate increase in the number of SCD products was ascribed to the characteristics of AR06 and also to the fact that it consumes the SCD. This assumption is supported by the following observations made during a feeding experiment using another detrital diet prepared by contact with *Pseudoalteromonas* sp. strain TO01. The TO01 strain is able to decompose *Laminaria* particles but does not produce SCD. As a result, the number of detrital particles in the size range of that of SCD, 2-14 ¼m, decreased markedly in TO01-treated *Laminaria*. The dietary value of the detritus was the lowest among the 3 applications of Axenic *Laminaria*, AR06-treated *Laminaria*, and TO01-treated *Laminaria*.

The results from this experiment indicated that the dietary value of the macroalgae differs depending on the kind of microorganisms involved in the macroalgal decomposition. The above results show that the dietary value of the macroalgae is maximum if the decomposition of the macroalgae is performed with a view to producing the maximum number of detrital particles with a size suitable for ingestion. We are currently accumulating information for developing algal detrital diets with a high dietary value through feeding experiments with *Artemia*.

# Potential use of surface-attached bacteria as a tool for enhancing the nutritive value of SCD

There are 2 main objectives in our attempts to utilize SCD as a hatchery diet ([Fig. 6](#)). One is to utilize macroalgae resources as a diet by converting them to microalgae. The other is to utilize the bacteria attached to the detrital materials as a diet. Fish require a high level of protein accounting for 35-50% for their diet⁷⁾, while most macroalgae species contain only 10-20% protein. Bacteria have a protein content of about 60-70% on a dry weight basis and therefore have a high potential as a diet^{3,5,11)}. In the case of the SCD diets, bacteria attached to the algal detritus grow by absorbing nutrients from the environment and, as a result, contribute to modifying the algal detritus to protein-rich materials. In our observations, the protein level of the *Ulva* detritus was nearly double, which accounts for the fact that the SCD diets have such a high dietary value^{10,11)}.

In the case of the present SCD diets, bacteria are utilized while still alive, which is a unique characteristic different from the phytoplankton diets or artificial micro-diets. The bacterial strain AR06, which we used for our serial studies, is specialized in the degradation of macroalgae and is not necessarily used for the enhancement of a diet. Diets with specific activities for feeding of animals can be developed by attaching bacteria with beneficial characteristics for fish, for example, regulation of the growth of pathogenic microorganisms or production of growth-promoting materials such as eicosapentaenoic acid (EPA) and docosahexaenoic acid (DHA), and growth hormones for fish with or without the application of genetic engineering techniques.



[-Concept of " trophic enhancement" based on detrital macroalgae-](#)



[Contents](#)

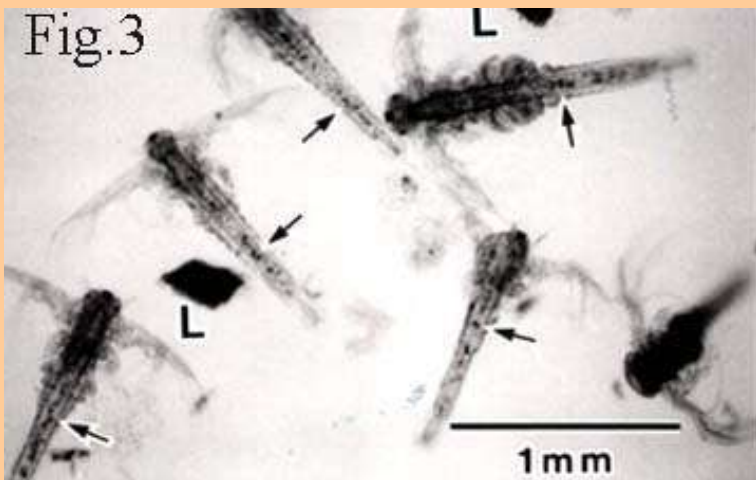


Fig. 3. Microphotograph of *Artemia* larvae ingesting the SCD diets (arrow) prepared from *Laminaria japonica*

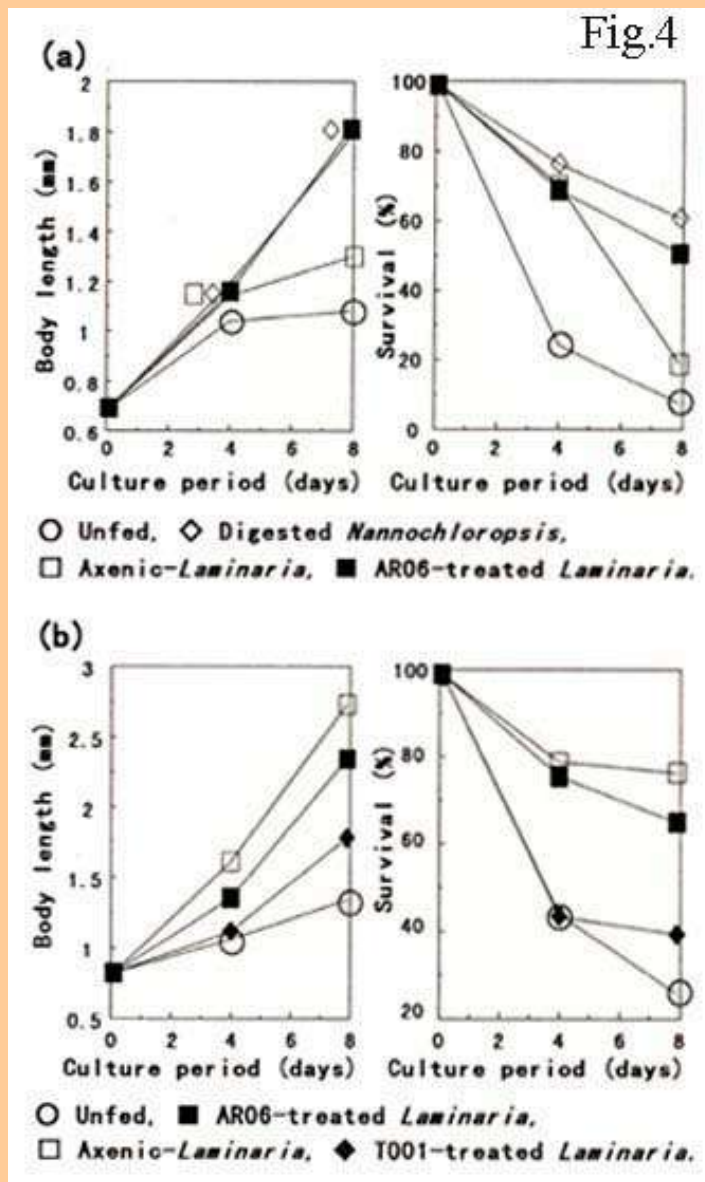
Undecomposed *Laminaria* (L) is not suitable for ingestion by *Artemia*.

Fig. 4 (a). Results from the *Artemia* feeding experiment using diets prepared from *Laminaria*, 105-177 $\frac{1}{4}$  $\mu$ m in diameter

Fig. 4 (b). Results from the *Artemia* feeding experiment using diets prepared from *Laminaria*, <44 $\frac{1}{4}$  $\mu$ m in diameter



[Back](#)



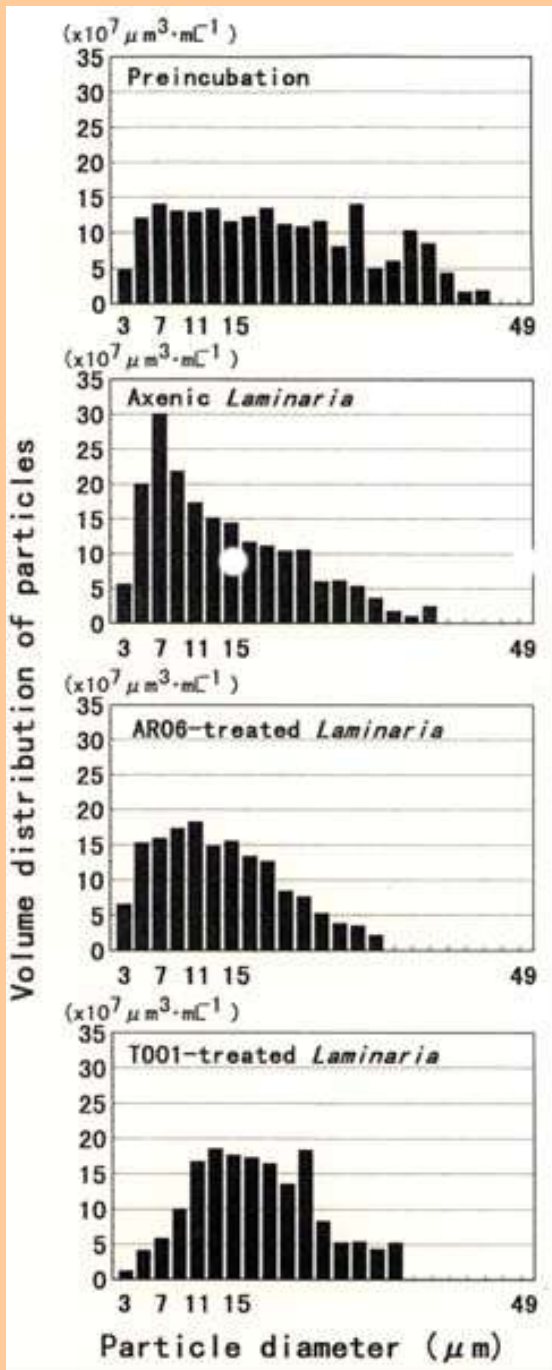


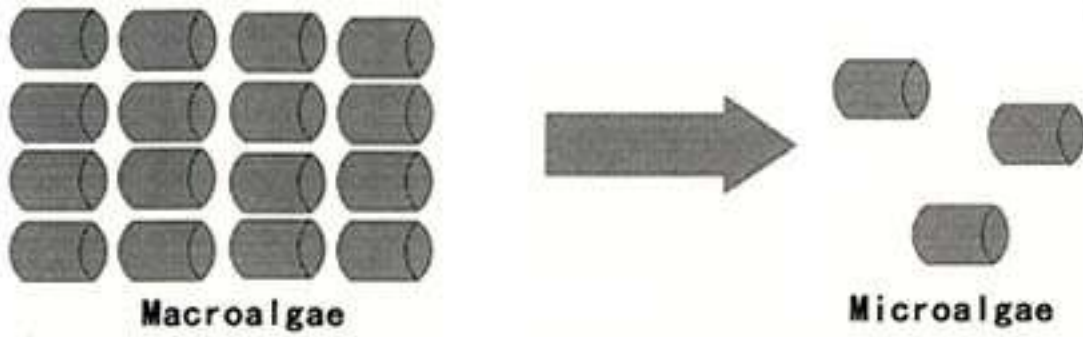
Fig.5.

Volume distribution of detritus particles contained in *Laminaria*-diets after axenic incubation with stirring (preincubation) and following a 24h incubation without (Axenic *Laminaria*) or with the presence of AR06 (AR06-treated *Laminaria*) or T001 bacteria (T001-treated *Laminaria*)



[Back](#)

1) Decomposition of macroalgae to microalgae for hatchery diets



2) Preparation of bacterial-detrital complexes:  
Even small bacterioplankton can be preyed efficiently

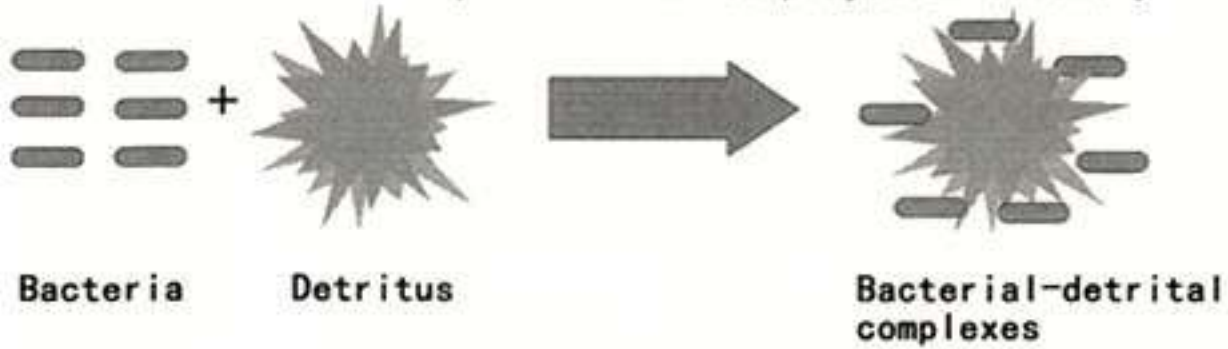


Fig.6. Two strategies for developing SCD diets



## Concept of "trophic enhancement" based on detrital macroalgae

We are presently considering the possibility of converting macroalgal biomass resources to SCD and to utilize them as a hatchery diet in extensive aquaculture systems. This attempt corresponds to the "trophic enhancement" of marine habitats ([Fig. 7](#)). Then, what kind of macroalgae could be converted to SCD, and what kind of aquatic animals could be cultured in this system?

Recently, cumbersome blooms of *Ulva* have been reported from coastal waters in Japan and various foreign countries. *Ulva*, after decaying causes oxygen-limited environmental conditions which often kill marine animals, especially bivalves. To address this problem, fishermen and local governments remove these algal accumulations by labor-intensive methods. The collected materials have no commercial value and their disposal is a major problem in several areas in Japan. Against this background, we attempted to utilize the *Ulva* resources. Coastal waters with large *Ulva* blooms are often good fishing grounds for Manila clams, *Ruditapes philippinarum*, a bivalve with a high commercial value. Moreover, the hatchery season of the bivalve larvae, i.e. June to July, corresponds to the period of growth and subsequent decay of *Ulva* fronds. The hatched bivalve larvae have only a limited mobility and are easily transported, depending on the wind and water current, to the same area where *Ulva* fronds are concentrated. Therefore, if we succeed in preparing detritus with a high dietary value from *Ulva* fronds, it may be possible to link this activity to the production of Manila clam larvae. As a preliminary experiment, we prepared hatched larvae from adult Manila clams caught from Uminokouen, Yokohama, and administered a SCD diet prepared from *Ulva* which was also collected from the same area. Some of the larvae ingested the *Ulva* SCD during overnight incubation in a 300 mL-volume beaker. Whether the SCD diet can contribute to the growth of the larvae or not is now being examined.

Blooms of *Ulva* are attributed to eutrophication caused by human activities. Our attempt to culture fishes in "a trophic enhancement system" utilizing bacterially degraded macroalgal resources is different from the conventional aquaculture systems in that compatibility between commercial fish culture and human activities causing the eutrophication problem could be achieved.



[Contents](#)



[First page of JARQ](#)



[JIRCAS Home Page](#)



**Japan International Research Center for Agricultural Sciences**  
**Ministry of Agriculture, Forestry, and Fisheries**  
**1-2 Ohwashi, Tsukuba, Ibaraki, 305-8686 JAPAN**  
**[www@jircas.affrc.go.jp](http://www.jircas.affrc.go.jp)**  
**Telephone 0298-38-6304**  
**published on October 15, 1999**

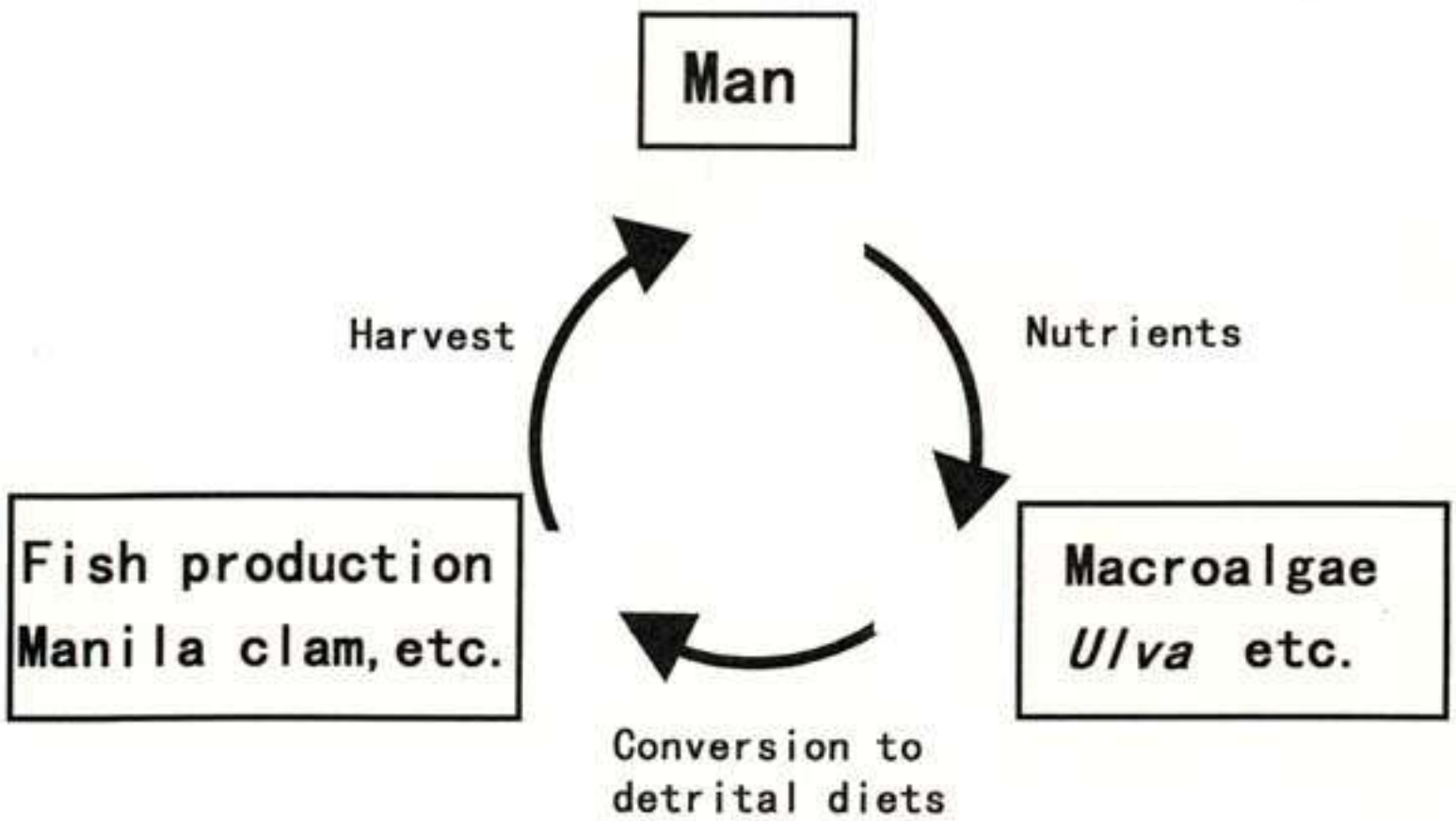


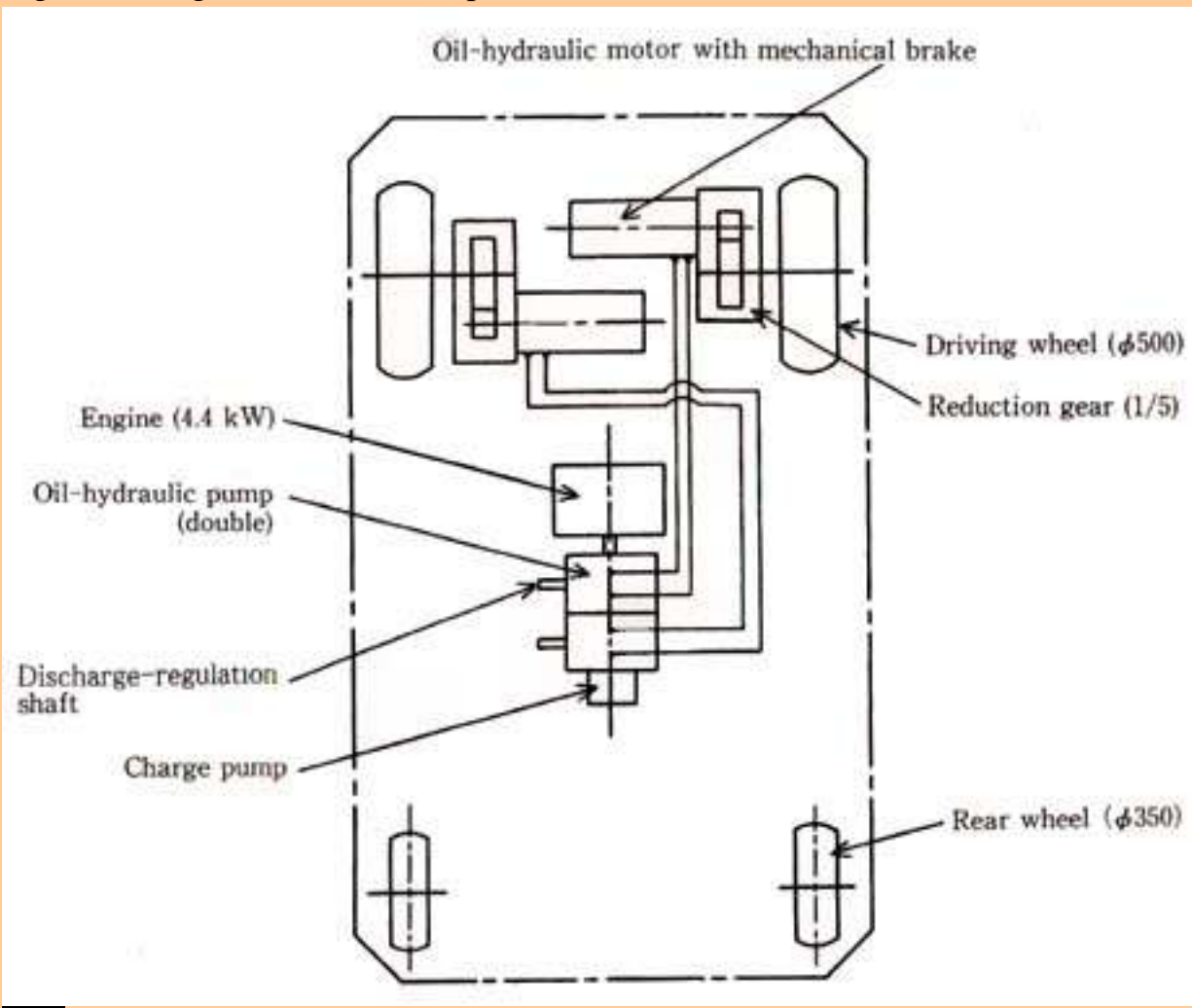
Fig.7. Concept of trophic enhancement using detrital macroalgal particles



[Back](#)



Fig.1. Driving mechanism of experimental vehicle



 [Back](#)

1...6): [References](#)

## Noncontact-type position sensors for compact tractor³⁾

The traveling direction (heading) of the tractor and the distance from the tractor to mulberry stumps are the basic information required for the position for automatic travel of the small tractor in mulberry fields. Therefore, the noncontact-type position sensors that were readily connected to an 8-bit CPU microcomputer were studied and selected. A magnetic azimuth sensor was used to determine the direction of travel and an ultrasonic range sensor was used to detect the distance from the tractor to mulberry stumps.

Then, the sensor systems were developed to measure the positions automatically by the microcomputer. The magnetic and ultrasonic sensor systems were equipped with a microcomputer, interfaces, sensors (an ultrasonic range finder and a magnetic declinometer), power supply, detecting programs, etc. ([Figs. 3, 4](#)).

We studied the characteristics of the systems and the adaptation to automatic steering control.

### 1) *Magnetic azimuth sensor system*

The magnetic azimuth sensor system enables to detect terrestrial magnetism and inputs azimuth data through an RS-232C interface every 50 milliseconds. The microcomputer can read the serial data whenever it is necessary by a program in BASIC language. This system was tested using the experimental vehicle equipped with the azimuth sensor. The measuring accuracy of this system ranged from 0.3 to 3.5° in the traveling direction of the vehicle.

### 2) *Ultrasonic range system*

A reflection-type ultrasonic range finder inputs 12 bits parallel data to an I/O board (82C55A) connected to a microcomputer. The microcomputer reads the range data through the I/O board. Resolution of the system is 4 mm and the ultrasonic frequency is 49.1 kHz. The measurement has a range of 0.29 to 10 m.

This system was tested within the distance from the sensor to model stumps made of polyvinyl chloride pipe and mulberry stumps were measured continuously. That is, the distance was measured by using the sensor, moving at a velocity of 3.7 cm/s in laboratory experiments (analogue data) and using the experimental vehicle equipped with the sensors, traveling at a velocity of 24 cm/s (digital data). Two ultrasonic sensors were installed outside of the left front wheel of the experimental vehicle at a height of 25 cm above the ground. When the distance to the stumps ranged between 60 and 70 cm, the target could be detected continuously by using 2 ultrasonic sensors, which were arranged, at a distance of 30 cm apart. To measure the range with accuracy within a distance of 15 cm, the position of the ultrasonic sensors should be controlled by rotation and tilt of about 5°, respectively ([Figs. 5, 6](#)).

The results obtained suggested that the magnetic azimuth sensor system enabled to determine the traveling direction of the compact tractor and the ultrasonic range system enabled to detect a row of mulberry stumps for automatic steering of the experimental vehicle.



[- Automatic steering system and automatic steering control^{3\)}-](#)



[Contents](#)

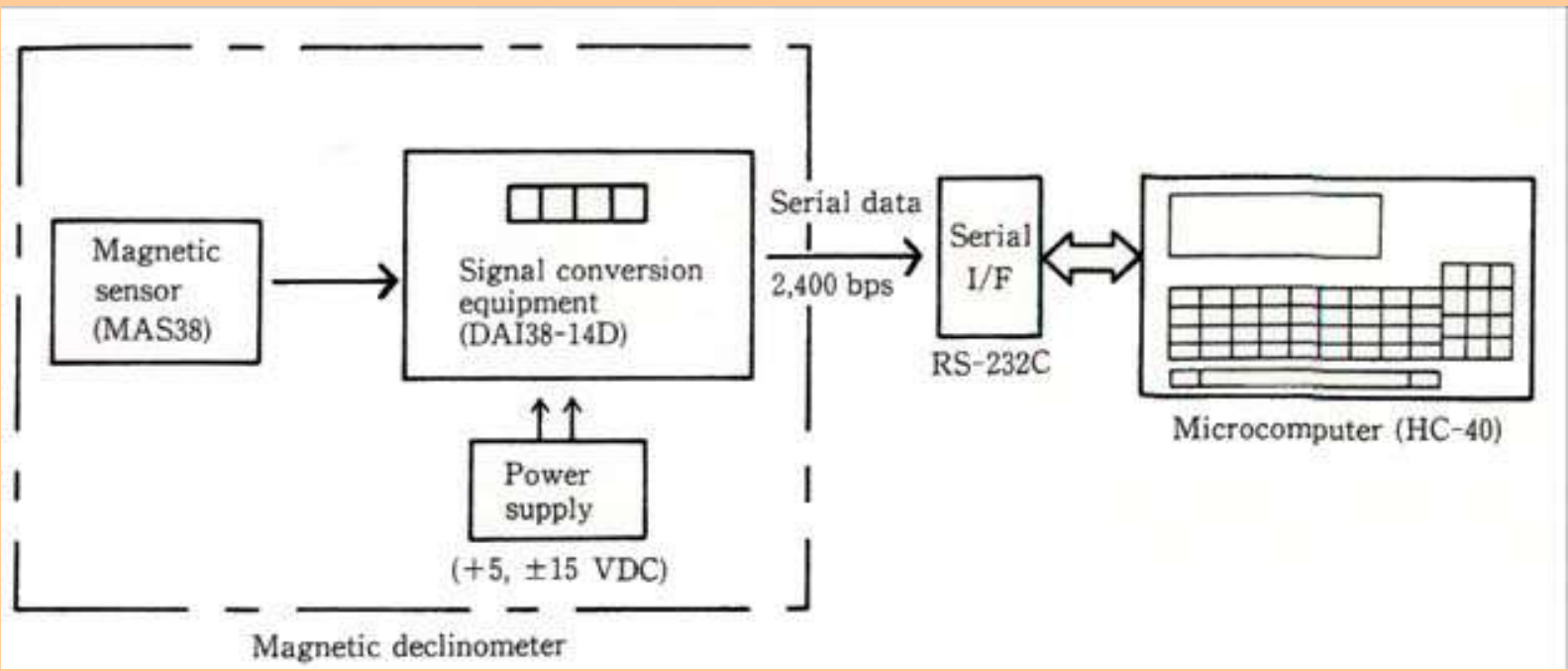


Fig.3. Block diagram of magnetic sensor system

 [Back](#)

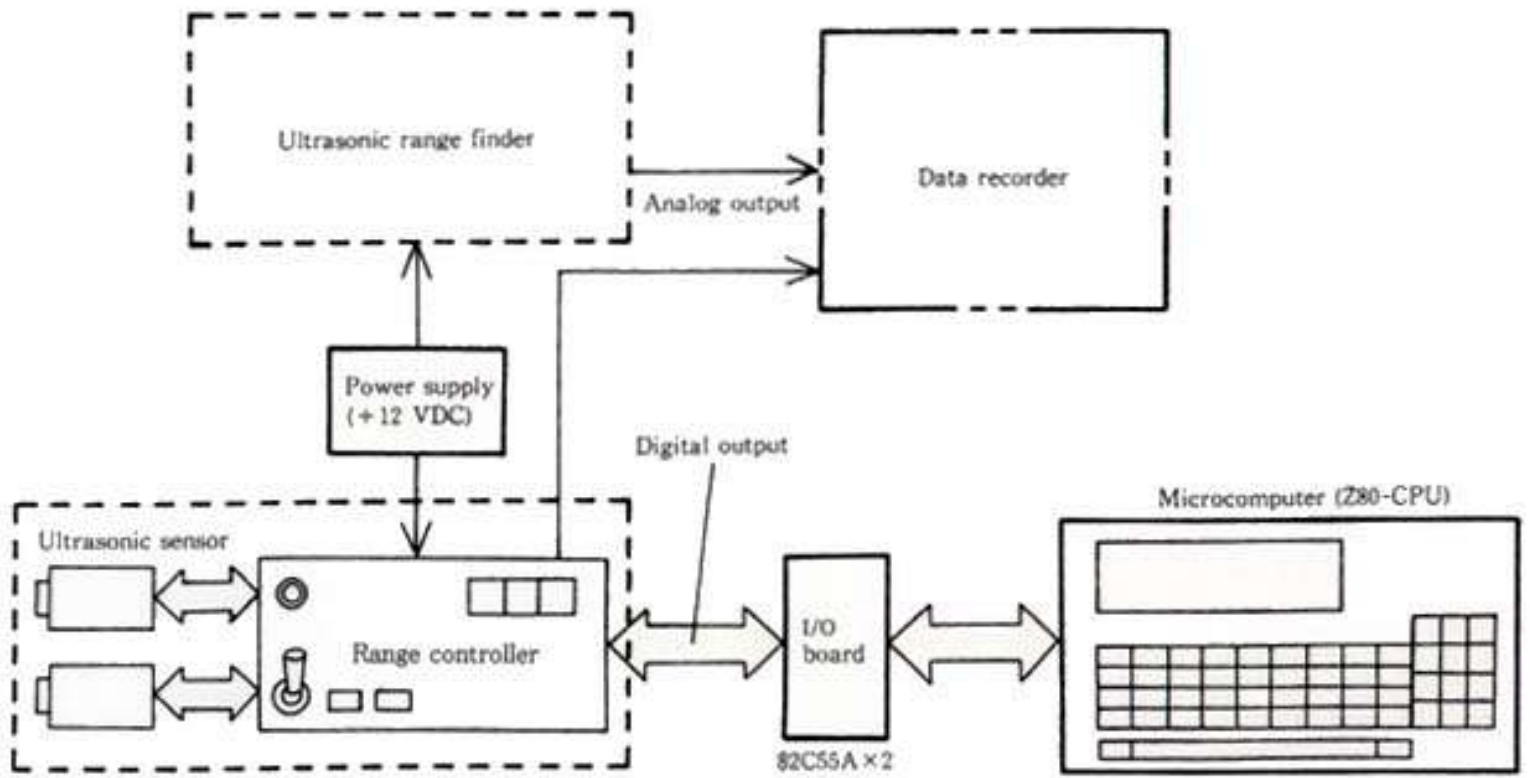


Fig.4. Block diagram of ultrasonic system



[Back](#)

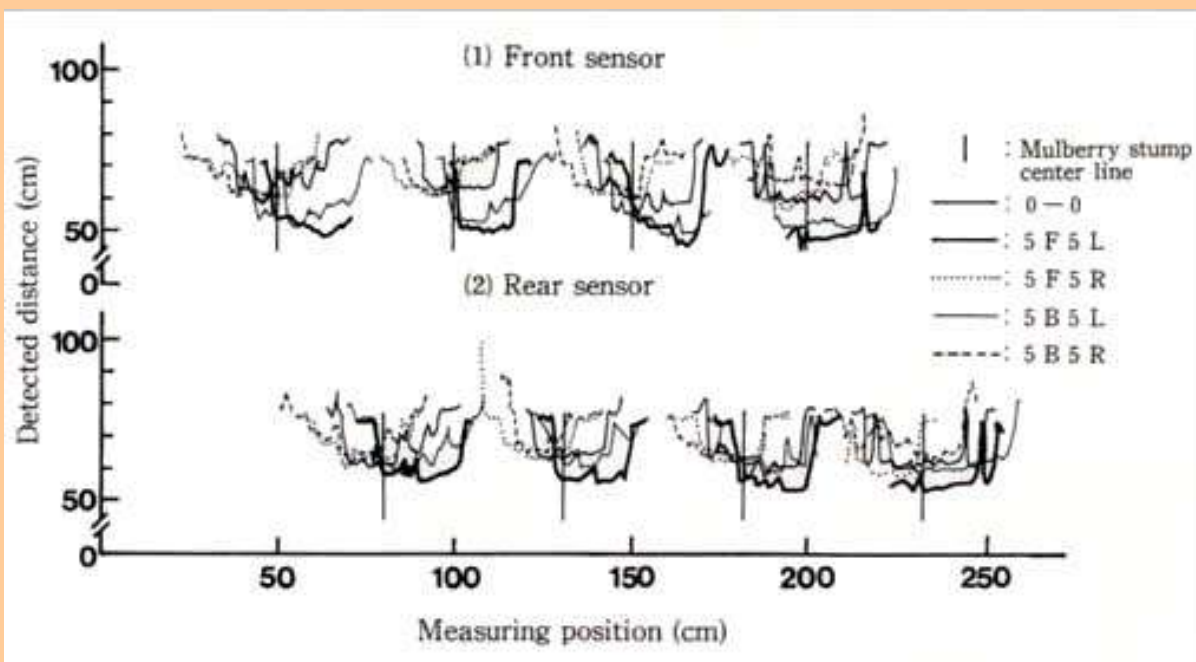


Fig. 5. Continuous range-finding of mulberry stumps (sensor tilted 5° and rotated 5°)

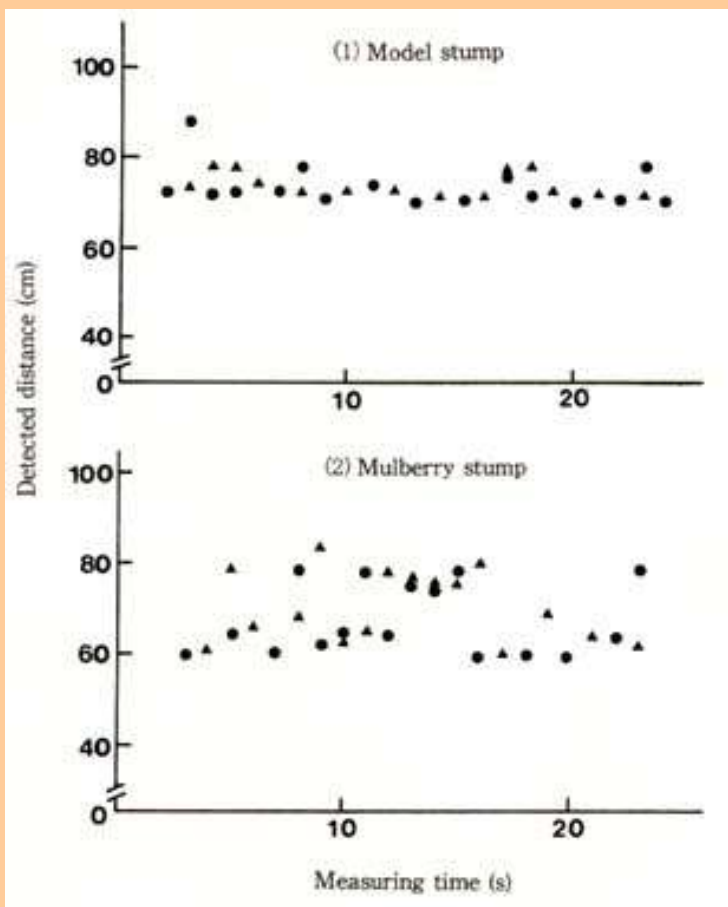


Fig. 6. Continuous range-finding in experimental vehicle travel (distance of 70 cm from stumps)


●: Front sensor,  
 ▲: Rear sensor.




[Back](#)

## Contents

<a href="#"><u>Use of <i>lacZ</i> and <i>gusA</i> Reporter Genes to Trace the Infection Process of Nitrogen-Fixing Bacteria</u></a>	Shoichiro AKAO et al.
<a href="#"><u>Use of Soil Animals as Bioindicators of Various Kinds of Soil Management in Northern Japan</u></a>	Yoshinari ENAMI et al.
<a href="#"><u>Evaluation of Soil Fertility Status of Lowland Areas in the Philippines</u></a>	Kenzo MIURA & Rodrigo B.BADAYOS
<a href="#"><u>Operation of a Diesel Engine Using Unrefined Rapeseed Oil as Fuel</u></a>	Chiyuki TOGASHI & Jun-ichi KAMIDE
<a href="#"><u>Estimation of Flowering Date and Temperature Characteristics of Fruit Trees by dts method</u></a>	Sukeyuki ONO & Takamitsu KONNO
<a href="#"><u>Mechanism of Off-Flowing Production in <i>Brassica</i> Vegetables under Anaerobic Conditions</u></a>	Kazuhiro DAN et al.
<a href="#"><u>Development of Silk Yarns for Knitted Fabrics</u></a>	Hirohsi KATO & Tamako HATA
<a href="#"><u>Screening of Thermophilic Lactic Acid Bacteria Producing Bacteriocins in the Tropics</u></a>	Sadahiro OHMOMO et al.
<a href="#"><u>Cloning and Identification of the Lactococcin A and M Gene Cluster from <i>Lactococcus lactis</i> subsp. <i>Lactis</i> biovar <i>deacetylactis</i> DRC1</u></a>	Yasuhito FUJITA and Takashi OKAMOTO
<a href="#"><u>Pathology of Acute Necrotizing Mastitis Caused by <i>Staphylococcus aureus</i> in a Dairy Cow</u></a>	Tomoyuki SHIBAHARA & Kikuyasu NAKAMURA

 [First page of JARQ](#)

 [What's New](#)

 [JIRCAS Home page](#)

# Use of *lacZ* and *gusA* Reporter Genes to Trace the Infection Process of Nitrogen-Fixing Bacteria

Shoichiro AKAO*1, Yasuo MINAKAWA*2, Hiromi TAKI*3, M. K. Khan,*4  
 Ken-Ichi YUHASHI*2, Yasuji NAKAYAMA*1, Constancio A. ASIS Jr*2,  
 Vladimir CHEBOTAR*5, Ui-Gum KANG*6, Kiwamu MINAMISAWA*2 and Robert W. RIDGE*3

*1--Department of Plant Physiology, National Institute of Agrobiological Resources  
 (Tsukuba, Ibaraki, 305-8602 Japan)

*2--School of Agriculture, Ibaraki University  
 (Ami, Ibaraki, 300-0393 Japan)

*3--International Christian University  
 (Mitaka, Tokyo, 181-8585 Japan)

*4--Bangladesh Institute of Nuclear Agriculture  
 (P.O. Box 4, Mymensingh-2200, Bangladesh)

*5--All-Russia Research Institute for Agricultural Microbiology  
 (Saint-Petersburg, Pushkin 8, 189620 Russia)

*6--National Yeongnam Agricultural Experiment Station  
 (P.O. Box 6, Milyang, 627-130 Korea)

## ---Abstract -----

To determine whether the *gusA* gene, which encodes ²-glucuronidase (GUS) and *lacZ* gene, which encodes ²-galactosidase are suitable for tracing nitrogen-fixing bacteria in the infection process, *Bradyrhizobium japonicum* strains labelled with each gene were constructed. Both introduced genes were expressed in rhizobia, but it was difficult to specify the sites where *lacZ*-labelled bacteria were present, since endogenous ²-galactosidase levels were high in soybean root tissues. On the other hand, endogenous ²-glucuronidase activity has not been detected in soybean root tissues. The *gusA*-marked *Bradyrhizobium*, *Rhizobium* and *Azospirillum* strains were constructed for assessing the use of their GUS-marked bacteria to trace the presence of introduced bacteria manifested by colonization on the root surface, as well as infection sites, invasion modes and nodulation competitiveness between bacteria. *Bradyrhizobium japonicum* inoculated to soybean colonized in the form of spots on the root surface. In the spots, curling roots with infection threads were observed. In this report, we describe only the *gusA*-marked (*Brady*)*rhizobium* and *Azospirillum* strains which we constructed.

**Discipline:** Biotechnology

**Additional key words:** ²-glucuronidase, ²-galactosidase, *Azospirillum*, nitrogen fixation, reporter genes

Received for publication, July 14, 1998

[1...23\):References](#)



## ---Introduction-----

Studies for practical use of the biological nitrogen-fixing (BNF) system are being increasingly important, since BNF contributes significantly to the maintenance and promotion of sustainable agricultural production. Ecological studies of the nitrogen-fixing bacteria in soil, root surface, intercellular spaces and nodules of host plants are essential to increase the contribution of nitrogen-fixing bacteria.

Antibiotic-resistant markers and immunofluorescence have been used for these objectives. The strains marked with antibiotic resistance cannot be distinguished by light microscopy from the wild strain. The immunofluorescence method enables the detection of specific bacteria *in situ*, especially in tissues, but it requires a high technological level due to the interference from the background of host tissues. Recently, reporter genes such as *lacZ* and *gusA* have been used to facilitate the detection of individual marked strains of bacteria. Many plants and bacteria of economic importance do not contain indigenous glucuronidase (GUS) and do not show background GUS activity [20](#).

The (*Brady*)*rhizobium* strain encoded with the *gusA* reporter gene can be identified very clearly on the root surface or in infection threads by its blue color, because the marked bacteria turn blue when treated with the substrate. This finding may enable to trace the colonization and movement of marked bacteria and thus the mode of early stages of infection. Moreover, studies on the competition for nodule occupancy, fate of introduced bacteria in the plant-soil ecosystem, and also on the interaction with plants could be very efficiently carried out with the use of the GUS reporter gene.

Evaluation of the advantages and disadvantages of various reporter genes for practical application may enable to use this new technique for future research work in ecological and molecular studies of microorganisms and plant-microbe interaction. Here in this report attempts were made to evaluate the use of reporter genes for tracing introduced bacteria, and the infection mode of rhizobia in the non-nodulating soybean mutant T201 after treatment with synthetic auxin 2,4-dichlorophenoxyacetic acid (2,4-D).

## ---Materials and methods-----

### 1) Bacterial strains, plasmids and media

Bacterial strains and plasmids used in this study are listed in [Table 1](#).(40 KB)

*Bradyrhizobium* and *Rhizobium* were grown at 28-30 in yeast-mannitol (YM) medium for 3-6 days. The antibiotics used in the media for culturing *gusA*-marked *Bradyrhizobium* (*B. japonicum* MA172, MA173, USDA61A124a and *B. elkanii* MA31), *Rhizobium* (*R. meliloti* YAO3M2 and *R. leguminosarum* bv. *trifolii* ANU843 (Tp3) and *B. japonicum* NA-A1017 carrying plasmid pRKRT290 were spectinomycin (50¹/₄g mL⁻¹) and kanamycin (200¹/₄g mL⁻¹), respectively. *Escherichia coli* was grown overnight at 36 in LB medium [13](#)) or in HM medium [14](#)).

### 2) Plants

Soybean (*Glycine max* (L.) Merr.) cultivar Enrei, T202 and its non-nodulating isoline T201, wild type soybean (*Glycine soja*), siratro (*Macroptilium atropurpureum*), alfalfa (*Medicago sativa* L. cv. Vernal) and clover (*Trifolium repens* L. cv. California ladino) were used. Seeds of soybean cultivars (Enrei T202 and T201) were kindly provided by Dr. Kokubun (National Agriculture Research Center) and the wild type soybean seeds were provided by Dr. Harada (National Institute of Agrobiological Resources), while siratro, alfalfa and clover seeds were obtained from Yukijirushi Co., Japan.

### 3) Plant culture and inoculation

The seeds were surface-sterilized by immersion in 70% ethanol for 20 min, followed by soaking in 3% hydrogen peroxide for 5-10 min and then washed 5 times with sterile deionized water. Sterilized seeds were germinated in 2% agar plates or sterile vermiculite placed in 500 mL glass jars. Seedlings were transferred to sterile growth pouches (MEGA International of Minneapolis, USA) supplied with 30 mL of half-strength N-free nutrient solution¹⁾ or to sterile vermiculite placed in 500 mL glass jars supplied with 90 mL of N-free nutrient solution.

Cultures of rhizobial strains as described above were centrifuged at 7,000 rpm, 4 for 15 min. Cells were washed twice with sterile saline and resuspended in sterile deionized water. Cell density of the suspension was measured using a Thoma's haemocytometer and the suspension was diluted with sterile water to  $10^7$ - $10^8$  cells mL⁻¹. For the co-inoculation test, the number of viable cells in the bacterial suspension was confirmed by the plate counting method using 10-fold serial dilution.

### 4) Conjugal transfer of pRKRT290 through mating

Transfer of the plasmid pRKRT290 carrying *lacZ* gene to *B. japonicum* A1017 was achieved by triparental mating. Culture of the donor *E. coli* HB101 (pRKRT290), HB101 harboring the helper plasmid pRK2013 and the recipient rhizobia from the mid-log phase were mixed on nitrocellulose filters (pore size 0.45 $\frac{1}{4}$ m), grown on YM agar, and incubated at 28 for 3 days. The colonies were suspended in 5 mL of sterile physiological saline solution, and the transconjugants were selected by plating onto HM medium⁷⁾ containing 200 $\frac{1}{4}$ g mL⁻¹ of kanamycin. Transconjugants were again restreaked on selective medium to obtain single colony isolates. The galactosidase activity of the isolates was checked by the presence of the blue color after growth on YM medium supplied with 5-bromo-4-chloro-3-indolyl-²-D-galactopyranoside (X-Gal) as substrate for the blue color staining.

### 5) Conjugal transfer of transposons through mating

Introduction of transposon into *B. elkanii* USDA31 was achieved by biparental mating. Donor *E. coli* S17-1 $\gg$ -pir with plasmid pmTn5SS*gusA*20 and recipient rhizobia were mixed on nitrocellulose filter, and incubated. Cells on the filters were washed and resuspended with sterile saline. The suspension was spread on HM plates containing 100 $\frac{1}{4}$ g mL⁻¹ of spectinomycin, and then tested for their GUS activity in stab-culture of HM medium containing 100 $\frac{1}{4}$ g mL⁻¹ of spectinomycin and 50 $\frac{1}{4}$ g mL⁻¹ of 5-bromo-4-chloro-3-indolyl-²-D-glucuronide cyclohexylammonium salt (X-Gluc) at 28 for 6 days.

### 6) X-Gal staining

The staining was performed by the method of Bovin et al.²⁾. Primary root segments 3 cm long were placed in 10 mL test tubes containing 0.5% glutaraldehyde buffer with 0.2 M sodium cacodylate, pH 7.2, under vacuum for 60 min, cut into three 1 cm segments. One cm segments including nodules were embedded in 5% agar medium and transversely sectioned (0.1 mm thick) with a microslicer. The sections of root with nodules were immersed in the solution containing 800 $\frac{1}{4}$ L of 0.2 M sodium cacodylate pH 7.2, 50 $\frac{1}{4}$ L of 50 mM K₃Fe(CN)₆ and 50 mM K₄Fe(CN)₆, and 40 $\frac{1}{4}$ L of 2% X-Gal in N, N-dimethylformamide overnight.

### 7) X-Gluc staining

For the detection of GUS-marked rhizobia in the plant tissues, transversal sections (0.1 mm thick) of root

with nodules were used, as well as nodulated root segments (about 3 cm) for nodule occupancy. The samples were immersed in a test tube containing the GUS assay solution (5 mL 0.1 M sodium phosphate buffer at pH 7.0, 20¹/₄L 2% X-Gluc, and 50¹/₄L 10% SDS), *in vacuo* for 15-60 min, and incubated overnight.



[Continue to: Results and Discussion](#)



[Contents](#)

## ----- References -----



[Back to the first page](#)

- 1) Akao, S. & Kouchi, H. (1989): Light microscopic observation of root hair curling of soybean induced by *Rhizobium* infection. *Jpn. Soil Sci. & Plant Nutr.*, 60, 53-55.
- 2) Bovin, C. et al. (1990): *Rhizobium meliloti* genes encoding catabolism of trigonelline are induced under symbiotic condition. *Plant Cell*, 2, 1157-1170.
- 3) Boyer, H. W. & Roulland-Dussoix, D. (1969): A complementation analysis of the restriction and modification DNA in *Escherichia coli*. *J. Mol. Biol.*, 41, 459-472.
- 4) Casadaban, M. J., Chou, J. & Cohen, S. N. (1980): In vitro gene fusion that join an enzymatically active galactosidase segment to amino-terminal fragments of exogenous proteins: *Escherichia coli* plasmid vectors for the detection and cloning of translational initiation signals. *J. Bacteriol.*, 143, 971-980.
- 5) Chandler, M. R. (1978): Some observations on infection of *Arachis hypogaea L.* by *Rhizobium*. *J. Exp. Bot.*, 29, 749-755.
- 6) Chandler, M. R., Date, R. A. & Roughley, R. J. (1982): Infection and root-nodule development in *Stylosanthes species* by *Rhizobium*. *J. Exp. Bot.*, 33, 47-57.
- 7) Cole, M. A. & Elkan, G. H. (1973): Transmissible resistance to penicillin G., neomycin, and chloramphenicol in *Rhizobium japonicum*. *Antimicrob. Agents Chemother.*, 4, 248-253.
- 8) Ditta, G. et al. (1980): Broad host range DNA cloning system for Gram-negative bacteria; Construction of gene bank of *Rhizobium meliloti*. *Proc. Natl. Acad. Sci.*, 77, 7347-7351.
- 9) Figurski, D. H. & Helinski D. R. (1979): Replication of an origin-containing derivative of plasmid RK2 dependent on a plasmid function provided in *trans*. *Proc. Natl. Acad. Sci.*, 76, 1648-1652.
- 10) Itzigsohn, R. et al. (1993): Physiological and morphological aspects of interaction between *Rhizobium meliloti* and alfalfa (*Medicago sativa*) in association with *Azospirillum brasilense*. *Can. J. Microbiol.*, 39, 610-615.
- 11) Jefferson, R. A., Kavanagh, T. A. & Bevan, M. W. (1987): GUS fusions, ( $\beta$ -glucuronidase as a sensitive and versatile gene fusion marker in higher plants. *EMBO J.*, 6, 3901-3907.
- 12) Kang, Ui-G. et al. (1997): Nodulation competitiveness and nitrogenase activity of *gusA*-marked *Rhizobium meliloti* in Alfalfa. *Soil Microorganisms*, 50, 45-49.
- 13) Maniatis, T., Fritsch, E. F. & Sambrook, J. (1982): Molecular cloning: A laboratory manual. Cold Spring Harbor Laboratory, Cold Spring Harbor, New York.
- 14) Nieukoop, A. J. et al. (1987): A locus encoding host range is linked to the common nodulation genes of *Bradyrhizobium japonicum*. *J. Bacteriol.*, 169, 2631-2638.
- 15) Plazinski, J. & Rolfe, B. G. (1985): Influence of *Azospirillum* strains on the nodulation of clovers by *Rhizobium strains*. *Appl. Environ. Microbiol.*, 49, 984-989.
- 16) Sarig, S., Kapulnik, Y. & Okon, Y. (1986): Effect of *Azospirillum* inoculation on nitrogen fixation and growth of several winter legumes. *Plant & Soil*, 90, 335-342.
- 17) Streit, W., Kosch, K. & Werner, D. (1992): Nodulation competitiveness of *Rhizobium leguminosarum* bv. *Phaseoli*

and *Rhizobium tropici* strains measured by glucuronidase (GUS) gene fusions. *Biol. Fertil. Soils*, 14, 140-144.

18) Streit, W. et al. (1995): Competition for nodule occupancy on *Phaseolus vulgaris* by *Rhizobium elti* and *Rhizobium tropici* can be efficiently monitored in an ultisol during the early stages of growth using a constitutive GUS gene fusion. *Soil Biol. Biochem.*, 27, 1075-1081.

19) Tchebotar, V. K. et al. (1998): The use of GUS-reporter gene to study the effect of *Azospirillum-Rhizobium* coinoculation on nodulation of white clover. *Biol. & Ferti. Soils*, 27, 349-352

20) Wilson, K. J., Giller, K. E. & Jefferson, R. A. (1991): (²-glucuronidase (GUS) operon fusions as a tool for studying plant-microbe interactions. *Advances in Molecular Genetics of Plant-Microbe Interactions*, 1, 226-229.

21) Wilson, K. J. (1995): Molecular techniques for the study of rhizobial ecology in the field. *Soil Biol Biochem.*, 27, 501-514.

22) Yahalom, E., Okon, Y. & Dovrat, A. (1987): *Azospirillum* effects on susceptibility to *Rhizobium* nodulation and on nitrogen fixation of several forage legumes. *Can. J. Microbiol.*, 33, 510-514.

23) Yuhashi, K. et al. (1997): Nodulation and competitiveness of *gusA*-marked *Bradyrhizobium japonicum* A1017 in soybean. *Soil Sci. Plant Nutr.*, 43, 473-478.



[Back](#)

**Table 1. Bacterial strains and plasmids used in this study**

Designation	Source or reference
<b>Strains</b>	
<i>Escherichia coli</i>	
S17-1 $\lambda$ -pir	Wilson (1995) ²¹⁾
HB101	Boyer et al. (1969) ²⁾
<i>(Brady)rhizobium</i>	
<i>B. japonicum</i> A1017	Takahashi ^{a)}
<i>B. japonicum</i> MA172	Yuhashi et al. (1997) ²³⁾
<i>B. japonicum</i> MA173	Yuhashi et al. (1997) ²³⁾
<i>B. japonicum</i> USDA61A124a	Gresshoff ^{b)}
<i>B. japonicum</i> USDA110	Keyser ^{c)}
<i>B. elkanii</i> MA31	This study
<i>R. meliloti</i> YAO3	Kang et al. (1997) ¹²⁾
<i>R. meliloti</i> YAO3M2	Kang et al. (1997) ¹²⁾
<i>R. leguminosarum</i> bv. <i>trifolii</i> ANU843 (Tp3)	The CAMBIA Molecular Genetic Service, Australia
<i>Azospirillum</i>	
<i>A. lipoferum</i> 137	Vassyuk ^{d)}
<i>A. lipoferum</i> T137-1	Tchebotar (1998) ¹⁹⁾
<b>Plasmids</b>	
pmTn5SSgusA20	Wilson (1995) ²¹⁾
pMC1403	Casadaban et al. (1980) ⁴⁾
pRK290	Ditta et al. (1980) ⁸⁾
pRK2013	Figurski and Helinski (1979) ⁹⁾
pRKRT290	This study

- a): Agricultural Research Institute, Tokachi Federation of Agricultural Cooperatives.  
 b): The University of Tennessee, USA.  
 c): United States Department of Agriculture, Beltsville, MD.  
 d): Research Institute for Agricultural Microbiology, Russia.



[Back](#)

## ---Results and discussion-----

### 1) Tracing microbes in plant tissues

Soybean inoculated with *BradyRhizobium japonicum* A1017 harboring the *lacZ lacZ* gene shows a deep blue color inside the nodules (infection zone) and some other parts of the plant tissues when stained with the substrate X-Gal ([Fig. 1A](#)). The plant tissues contain indigenous galactosidase, which reacts with the substrate and forms a deep blue color. As a result, it is difficult to trace the infection zone. Hence, to suppress the indigenous galactosidase, root with nodules was treated with glutaraldehyde buffer containing a high concentration (200 mM) of potassium ferri- and ferrocyanide. However, some parts showing a blue color remained along the vascular bundles, and most parts of the rhizobial infection zone filled with bacteroids did not stain. The former indicates that it is difficult to entirely suppress the indigenous galactosidase, while the latter suggests that the induced plasmid pRKRT290 carrying *lacZ* was lost during rhizobial multiplication ([Fig. 1B](#)). As a result, the bacterial infection zone could not be clearly traced by using the *lacZ* gene.

Then the soybean plants were inoculated with *BradyRhizobium japonicum* marked with the GUS (²-glucuronidase) reporter gene. When the root with nodules was treated with GUS substrate X-Gluc., a uniform and clear blue color was observed only in the infection zone ([Fig. 1C](#)), whereas no color was observed in the nodule (infection zone) inoculated with the unmarked (*gus*-) *BradyRhizobium japonicum* strain ([Fig. 1D](#)), because the soybean root nodule tissues did not contain indigenous glucuronidase and there was no background activity in plant.

Jefferson et al. [11](#)) reported that the *gusA* gene, encoding GUS, is the most widely used reporter gene in plant molecular biology and the GUS substrate also enables to detect the spatial localization of reporter gene activity. As such (*Brady*)*Rhizobium* encoded with ²-glucuronidase (GUS) was found to be highly suitable for bacterial infection studies.

* [Fig.1.\(78 KB\)](#)

### 2) Infection mode of nodulating soybean cultivars and non-nodulating mutants with rhizobia

We previously reported that nitrogen-fixing nodules can be induced in a non-nodulating soybean mutant T201, which is defective in nodulation, by 2,4-D treatment and rhizobial inoculation [1](#)). Nodulating soybeans develop spherical determinate nodules, while the nodules induced in a non-nodulating isolate by 2,4-D treatment are unusual and appear as paired or gourd-like nodules. In the case of the nodulating soybean cultivar Enrei T202, the bacteria colonize the root surface ([Fig. 2A](#)), and in the colonized zone, curled root hairs are observed ([Fig. 2B](#)). The bacteria penetrate into the root tissues through the curled root hair and infection thread ([Fig. 2C](#)), and thus form a nodule ([Fig. 2D](#)). While in the case of the non-nodulating soybean mutant T201, the bacteria colonize the root surface and multiply rapidly, causing the swelling of the root ([Fig. 2E](#)), where no root hair curling ([Fig. 2F](#)) but infection threads are observed ([Fig. 2G](#)). The bacteria penetrate into the plant root tissues through the infection thread. Inside the plant tissues, the bacteria multiply rapidly and form a nodule ([Fig. 2H](#)). In the distal lobe of the paired nodules, *gusA*-marked bacteria are observed showing a blue color.

* [Fig.2.\(89 KB\)](#)

The *gusA*-marked bradyrhizobia are very useful for tracing infection sites of nodules in that the bacteria stain blue and can be clearly identified. In the case of nodulating soybean T202, the bacteria penetrated into the root cells through root hair curling and subsequently infection thread formation, while in the non-nodulating soybean T201, there was no evidence of root hair curling and the bacteria invaded through both intercellular spaces and infection threads. Chandler [5](#)) and Chandler et al. [6](#)) reported that *Arachis* and *Stylosanthus* do not form infection threads and rhizobia penetrate into spaces between epidermal cells and invade cortical cells through their cell walls. Thus, root hair curling and formation of the infection thread may be independent phenomena controlled by different factors in

the nodulation process. Hence, root hair curling or infection threads are not always necessary for the formation of symbiosis, and the plants may receive rhizobia by various ways which can be studied using GUS reporter genes.

### 3) Competition between host and bacteria

Many leguminous plants can be nodulated by more than one (*Brady*)*Rhizobium* species. Also some bacteria can form effective nodules in several host plants. *Glycine max* cv. Enrei, *Glycine soja* and *Macroptilium atropurpureum* form effective nodules by infection with both *BradyRhizobium japonicum* (USDA110) as well as *BradyRhizobium elkanii* (MA31). *BradyRhizobium elkanii* (MA31) is a *gusA*-marked mutant of *BradyRhizobium elkanii* USDA31. When the above plants were co-inoculated with the bradyrhizobial strains, USDA110 and MA31 at 1:1 ratio, in *Glycine max* cv. Enrei, 81% of the nodules were formed by USDA110 and 19% by MA31, while in *Glycine soja*, 55% of the nodules were formed by USDA110 and 45% by MA31. In *Macroptilium atropurpureum* only 20% of the nodules were formed by USDA110 and 80% by MA31 ([Table 2](#)). These findings indicate that USDA110 is more competitive for nodulation in *Glycine max* cv. Enrei, while MA31 is more competitive for nodulation in *Macroptilium atropurpureum*. However, both strains, USDA110 and MA31 are almost equally effective for nodulation in *Glycine soja*.

Furthermore, a large number of nodules were formed in *Glycine max* cv. Enrei (142) by USDA110 and in *Macroptilium atropurpureum* (64) by MA31, while fewer nodules were formed in *Glycine soja* by either strains USDA110 or MA31.

The GUS transposon was found to be very useful for studying the competition for nodulation in common bean ([17,18](#)). Also, Yuhashi et al. ([23](#)) and Wilson et al. ([20](#)) described the advantages of using the *gusA* reporter gene as a marker for rhizobial competition studies.

**Table 2. Relationship between host and rhizobia**

Host plant	Nodule numbers			Nodule occupancy(%)	
	USDA110	MA31	total	Usda110	Ma31
<i>G. max cv. Enrei</i>	142	33	175	81	19
<i>G. soja</i>	27	22	49	55	45
<i>M. atropurpureum</i>	16	64	80	20	80

### 4) Plant-Azosopilium-Rhizobium interaction

Increase in the nodule number and grain yield of various crops has been reported by combined inoculation of *Azosopilium* spp. and *Rhizobium* spp. ([16,22](#)). The role of *Azosopilium* spp. in the infection and nodulation of plants can be clearly examined by using the GUS-reporter gene.

Colonization on the root surface and root tips of white clover was observed when the plant was inoculated with *gusA*-marked *Azosopilium lipoferum* T137-1 alone ([Fig. 3A](#)). However, when white clover was inoculated with both *Azosopilium lipoferum* T137-1 and *Rhizobium leguminosarum* bv. *trifolii* ANU843, many nodules and *Azosopilium* colonization of or near the nodules were observed ([Fig. 3B](#)). Nodule number and acetylene reduction activity in clover increased by more than 100% at 20 days after inoculation by combined inoculation of *Azosopilium lipoferum* T137-1 and *Rhizobium leguminosarum* bv. *trifolii* ANU843 ([Fig. 4](#)).

* [Fig.3.\(16 KB\)](#), [Fig.4.\(21 KB\)](#)

Increase in the nodule number and acetylene reduction activity in white clover by dual inoculation with *Azosopilium lipoferum* T137-1 and *Rhizobium leguminosarum* bv. *trifolii* ANU843 may be due to the fact that *Azosopilium* contributes to the development of additional sites for the rhizobia to form more nodules. Plazinski and Rolfe ([15](#)) and Yahalom et al. ([22](#)) reported that in the case of co-inoculation of *Azosopilium* and *Rhizobium*, *Azosopilium* stimulated the formation of a larger number of epidermal cells that differentiated into infective root hair cells, or created



additional infection sites which were later occupied by the rhizobia. Increase in shoot length, dry weight, number of root hairs and root diameter of alfalfa was also observed by combined inoculation of *Azosopilium* spp. and *Rhizobium* spp. [10](#)).



[Forward to:-Use of Soil Animals Bioindicators of Various Kinds of Soil Management in Northern Japan-](#)

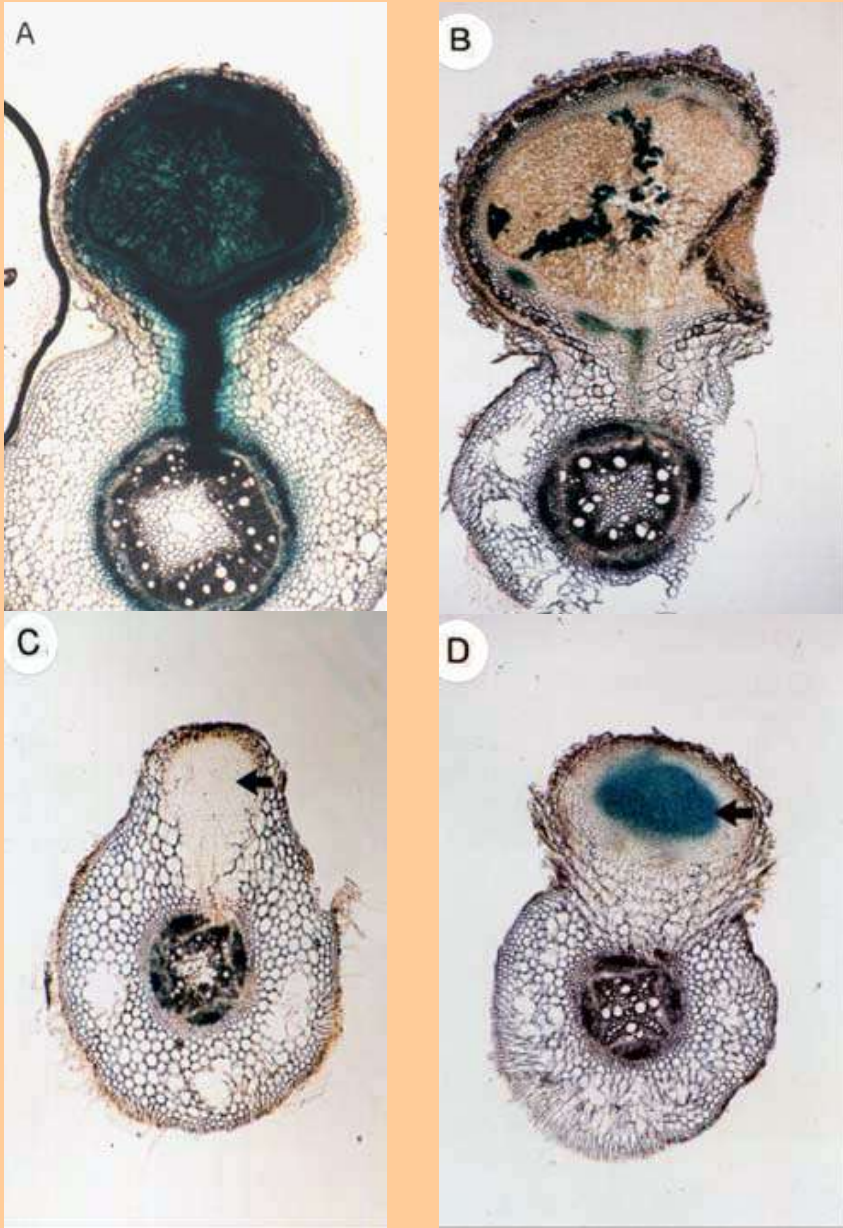


[Contents](#)



[JIRCAS Home Page](#)

Fig1. ²-Galactosidase activity in root nodule inoculated with *lacZ*-marked *B. japonicum*

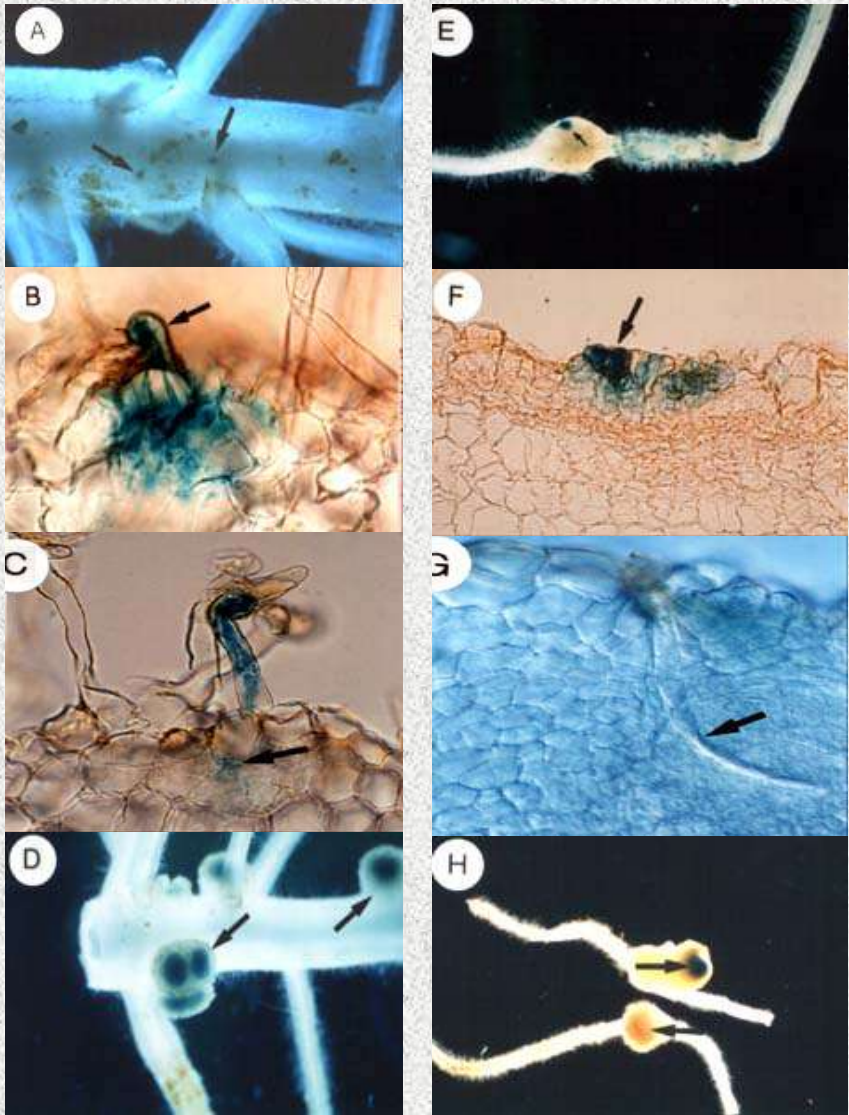


Addition of 50 mM potassium ferri-and ferrocyaniide (A), and 200 mM potassium ferri-and ferrocyaniide (B) to *lacZ* detection buffer.  
²-Glucuronidase (GUS) activity in root nodules. Root nodule induced by *B.japonicum* 61A124a (C), and *gusA*-marked *B. japonicum* USDA110 (D).

 [Back](#)



Fig.2. Infection process of nodulating (a,b,c,d) and non-nodulating (e,f,g,h) soybean



**A**, bradyrhizobial colonization on root surface and root infection (arrow);  
**B**, transverse section of infected root portion showing root hair curling and **C**, infection (arrow);  
**D**, invasion of rhizobia inside developing nodule (arrow);  
**E**, swelling caused by 2,4-D treatment and formation of nitrogen-fixing nodule;  
**F**, transverse section of swelling portion showing bacterial infection but no root hair curling (arrow) and  
**G**, invasion of bacterial infection thread (arrow);  
**H**, nodules formed by 2,4-D treatment (Gus-marked bacteria are present inside of the distal lobe of the nodule).




 [Back](#)

Fig.3.

Colonization and nodulation of white clover at 20 dai by *gusA*-marked *A. lipoferum* T1371 alone (A), and nodulation by coinoculation with *R. l. bv. Tirifolii* anu 843 and *gusA*-marked *A. lipoferum* T1371 (B)  
Blue staining (arrows) indicates GUS ( $\beta$ -glucuronidase) activity of the bacteria.



[Back](#)

-  *R.l. bv. trifolii* ANU843 (Tp3)
-  *R.l. bv. t. ANU843* (Tp3) + *A.l.* 137
-  *R.l. bv. t. ANU843* + *A.lipoferum* T137-1

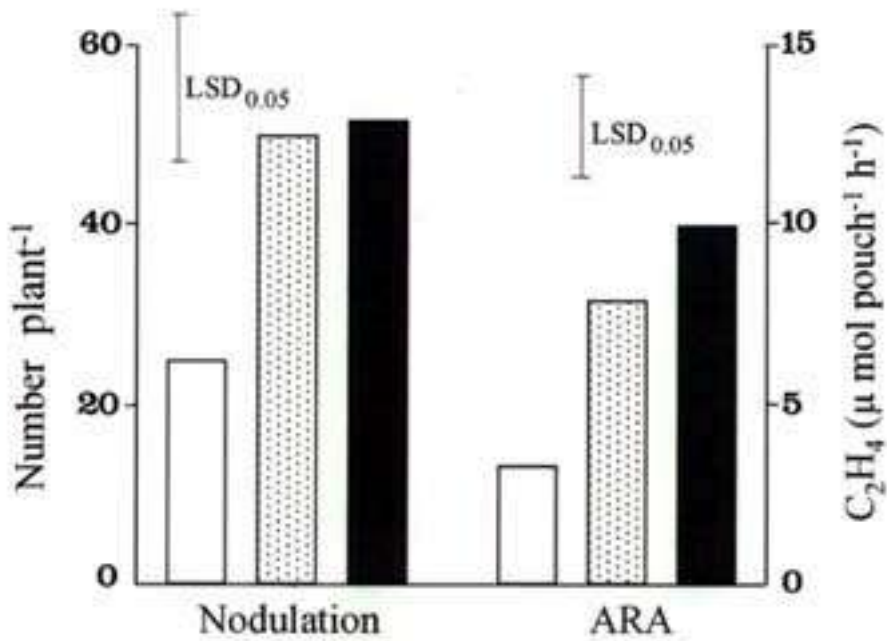


Fig.4. Nodulation and acetylene reduction activity (ARA) of white clover at 20 DAI as influenced by *Rhizobium* spp. and *Azospirillum* spp. inoculation

 [Back](#)

# Use of Soil Animals as Bioindicators of Various Kinds of Soil Management in Northern Japan

Yoshinari ENAMI, Hiroyoshi SHIRAISHI and Yoshio NAKAMURA

Upland Farming Division, Tohoku National Agricultural Experiment Station  
(Arai, Fukushima, 960-2156 Japan)

## ---Abstract-----

As the soil invertebrate fauna is expected to modify several properties of upland soils in agriculture, the effect of the soil fauna on the soil properties and soybean growth under several kinds of soil management depending on the soil type, nitrogen source, tillage, insecticide and herbicide was investigated. Numbers of hand-sorted earthworms were positively correlated with the amount of soil aggregates (>diam.2 mm) ( $r=0.85$ ,  $p<0.01$ ), and those of oribatid mites (Acari: Cryptostigmata) extracted by using modified Tullgren funnels were positively correlated with the nitrate nitrogen concentration in the soil ( $r=0.89$ ,  $p<0.01$ ). Numbers of oribatid mites were positively correlated with the content of total soil nitrogen and the content of total soil carbon in a Gray Lowland soil (both:  $r=0.99$ ,  $p<0.01$ ) and a Brown Forest soil (not significant), but negatively in an Andosol. The stem length of soybean cultivated on those soils showed a positive correlation with the numbers of earthworms ( $r=0.54$ ,  $p<0.05$ ) and oribatid mites ( $r=0.62$ ,  $p<0.05$ ), while the stem weight of soybean with the numbers of macrofauna organisms ( $r=0.61$ ,  $p<0.05$ ) and earthworms ( $r=0.8$ ,  $p<0.01$ ), respectively. The correlations between the number of soil invertebrates and yield or quality of soybean grain were not significant in this survey.

**Discipline:** Soils, fertilizers and plant nutrition

**Additional key words:** soil invertebrates, earthworms, oribatid mites

Received for publication, June 2, 1998

[1..17:References](#)

## ---Introduction-----

Soil animals are affected by agricultural practices such as tillage, fertilization and weeding ([2,4,10,13](#)), and they influence the physico-chemical properties of soil through fragmentation of crop residues, grazing of microflora and improvement of the soil structure ([8,15](#)). Therefore, the population, biomass and diversity of soil invertebrates could be used as bioindicators to monitor quantitative and qualitative changes of the environment affected by soil use ([14](#)).

In Japan, our group had reported that organic or chemical fertilizer affected crop yield and quality along with the changes of the soil fauna ([5,6](#)). In addition, we observed that fungivorous Collembola and oribatid mites inhibited the incidence of some plant diseases caused by fungal pathogens by grazing of their mycelia ([3,12,16](#)). In this study, attempts were made to study the relation of the soil fauna, especially oribatid mites and earthworms, which were considered to be more useful as indicators than other types of fauna based on preliminary investigations in fields, with the physico-chemical properties of soil and soybean yield under various kinds of soil management.

## ---Materials and methods-----

### 1) Experimental design and treatments

The experiment was conducted in the fields of the Upland Farming Division, Tohoku National Agricultural Experiment Station (37°43'N, 140°23'E), Fukushima city, northern Japan. Soil fauna was investigated in Fields I and II as mentioned below. Soil management of the experimental plots in Fields I and II is summarized in [Table 1](#).

Field I was divided into 12 plots (A-L) enclosed with concrete blocks. Soil type of plots A, D, H and K consisted of Gray Lowland soil, that of plots B, E, I and L, Brown Forest soil and that of plots C, F, G and J, Andosol (high-humic). Plot size was 3.3 m x 3.3 m and the soil had been subjected to the following kinds of management for 7 years: Plots A-C and G-I; no-tillage with mulch made of organic materials (wheat plants or soybean plants), and weeds were cut by hand and put onto the soil surface. Plots D-F and J-L; tillage using rotary machine after inorganic (NN444, Nihon Kasei, Japan) or organic (rice straw) fertilization, and weeds cut by hand were brought out from the plots. Kinds of fertilizer applied to each plot are shown in [Table 1](#) (30KB). Total amount of fertilizer applied to each plot was 0.2 kg nitrogen per 10 m². Cherry tomato had been grown for 5 years in this field after cultivation of dent- and sweet corn for 2 years.

Field II on light-colored Andosol was cultivated and divided into 15 plots (a-o). The plot size was 2 m x 6 m and the soil had been subjected to the following kinds of management for 4 years: 10 plots (a-j); no-tillage, weeding by hand, no application of insecticides or herbicides, mulch consisting of 4 kinds of organic materials (rice straw, bokashi, mulberry branches and chopped weeds) except for plots a and f, control plots. 5 plots (k-o); rotary digging after fertilization (organic materials applied were plowed under and the soil surface was maintained without mulch), application of Elsan (PAP) and Sumithion (MEP) as insecticides and Simazine (CAT) as herbicide once a year before sowing. Kinds and amount of fertilizer applied are listed in [Table 1](#). Total amount of fertilizer applied was the same as in Field I. Soybean had been grown for 3 years in this field after 2 years of upland rice cultivation.

## 2) Identification of soil animals and determination of soil properties

In Field I, earthworms were sorted by hand from 2 quadrates (each 50 cm x 50 cm in area, 10 cm in depth) in each plot in October 1993. For the determination of the percentage of aggregation, soil sample (10 cm in diam., 15 cm in depth) was taken from each plot with 2 replications in October 1994, and sifted by the Tiulin-Yorder method. Amount of soil aggregates (%SA,  $\geq 2$  mm) was obtained from the following calculation.

$$\%SA = 100 \times (A-P) / (T-P)$$

where A; weight of total aggregates ( $>2$ mm), P; weight of aggregates with single-grained structure ( $>2$ mm), T; total weight of tested soil sample.

In Field I, 2 samples were taken from each plot in July and October 1995 by using a rectangular metal sampler (5 cm x 4 cm in area, 5 cm in depth) to extract oribatid mites with Tullgren funnels. Mean number of oribatid mites collected in July and October was used to calculate the correlation coefficient with the values of the soil parameters mentioned below. For the analysis of the soil chemical properties, in October 1995, 3 soil samples (10 cm in diam., 15 cm in depth) were taken from each plot, air-dried for 1 week and passed through a 5 mm mesh sieve. The contents of total soil carbon (T-C) and nitrogen (T-N) were measured by CN-corder (MT-600, Yanaco, Kyoto, Japan) and the concentration of nitrate nitrogen (water-soluble  $\text{NO}_3^-$ ) in soil was determined by ion-chromatography (HPLC column, Hitachi, Tokyo, Japan).

In Field II, 2 soil samples were taken using the above-mentioned sampler to collect oribatid mites, and hand-sorting was performed to collect macro-invertebrates (over 2-3 mm in length) in 2 quadrates in each plot before harvest of soybean in October 1994. Mean values of dry stem weight and length were obtained from 7 soybean plants selected randomly in each plot.



[Continue to: Results and Discussion](#)



[Back to: Contents](#)



**---Results-----**

Species richness and abundance in this study are indicated in [Table 2](#). The values were higher in plots A-C and G-I. Similarly a high density of earthworms was found in these plots, except for G. In Field II, species number of oribatid mites and individual numbers of macroarthropods differed among the 15 plots. No earthworms were found in plots a, f and k-o. [Fig. 1](#) shows that the lack of uniformity of the oribatid mite abundance among the experimental plots was maintained in 2 seasons, July and October, in other words, the density of oribatid mites was stable in each plot. As for the soil invertebrates used as indicators of soil properties, mean number of oribatid mites in July and October was positively correlated with the concentration of nitrate nitrogen ( $\text{NO}_3^-$ ) measured in October, with a coefficient  $r=0.89$ ;  $p<0.01$  ([Fig. 2](#)). The number of oribatid mites also was positively correlated with the content of total soil carbon and with the content of total soil nitrogen in the Gray Lowland soil (both:  $r=0.99$ ;  $p<0.01$ ) and in the Brown Forest soil (not statistically significant), but negatively in the Andosol ([Fig. 3](#)).

**Table 2. Species richness and abundance of soil fauna**

	Field I	A	B	C	D	E	F	G	H	I	J	K	L
Oribatidsa)	No. of species	14	13	17	4	5	5	16	15	13	5	7	7
	Individual no.	136	107	140	18	24	23	154	389	115	21	42	34
Earthworms	Individual no.	49	14	12	3	0	0	4	22	16	4	6	1

	Field II	a	b	C	d	e	F	G	h	i	j	k	l	m	n	o
Oribatids	No. of species	6	6	9	13	10	3	4	6	12	14	4	4	6	4	6
	Individual no.	87	170	178	348	114	88	55	299	133	109	114	17	28	44	58
Earthworms	Individual no.	0	3	4	1	1	0	6	10	10	3	0	0	0	0	0
No. of macroarthropods		28	90	71	109	59	12	63	57	113	121	19	47	24	37	44

Number relating to oribatids: /200 mL. No. to earthworms and macroarthropods: /2 quadrates.

a): Species and individual number of oribatid mites are expressed as average of July and October.

[•Back](#)

Number of earthworms hand-sorted was positively correlated with the amount of soil aggregates with a diameter above 2 mm ( $r=0.85$ ;  $p<0.01$ ) ([Fig. 4](#)), but the correlation was not significant for the aggregates with a diameter below 2 mm.

As for the relation between the number of soil invertebrates and the growth of soybean in Field II, stem length of soybean was positively correlated with the numbers of earthworms and oribatid mites ( $r=0.62$  and  $0.54$ , respectively, both  $p<0.05$ ) ([Fig. 5](#)). Stem weight of soybean was positively correlated with the number of macroarthropods and earthworms, with coefficients  $r=0.61$ ;  $p<0.05$  and  $r=0.8$ ;  $p<0.01$ , respectively ([Fig. 6](#)).

* [Fig.1&2.\(30 KB\)](#), [Fig.3.\(15 KB\)](#), [Fig.4.\(15 KB\)](#), [Fig.5&6.\(37 KB\)](#)

## ---Discussion-----

Fujita⁴) reported that the seasonal fluctuations of the density of oribatid mites were different between 2 crop fields (one covered with grass mulch and not tilled, the other treated with chemical fertilizer and tilled using a rotary machine). This study, however, showed that the density of oribatid mites did not change appreciably in 2 seasons in most of the plots of Field I ([Fig. 1](#)). These findings may be attributed to the rather small size of the experimental plots enclosed with concrete blocks and subjected to specific soil management for 7 years. In Field I, the density of soil invertebrates was much higher in plots A-C and H-J covered with organic materials than in the cultivated plots ([Table 2](#)). A similar tendency was found in Field II, suggesting that the soil animals benefit from the organic mulch which provides them a better habitat in keeping the soil moisture and supplying food. Paoletti³) noted that the amount of total soil nitrogen, but not the content of total soil carbon, was positively correlated with earthworm numbers. He, however, did not consider oribatid mites. This study indicated that the correlations between the numbers of oribatid mites and the content of total soil carbon or total soil nitrogen depended on the soil types ([Fig. 3](#)), being positive in the Gray Lowland soil and the Brown Forest soil, whereas slightly negative in the Andosol. These results suggest that the Andosol differs from the other 2 soils in the decomposition pattern of soil organic matter, because oribatid mites must probably play an important role in the decomposition of organic substances in the soil by feeding on various diets, from microbes to dead remains of higher plants. The number of oribatid mites was correlated with the concentration of nitrate nitrogen regardless of the soil types. This fact may indicate that the determination of the number of oribatid mites is a useful indicator of the amount of nitrogen mineralized from organic matter. Earthworm numbers were positively correlated with the amount of soil aggregates ([Fig. 4](#)), which contribute to the structure stability of earthworm casts^{7,9}). High crop yield and stem elongation of soybean were associated with a high density of earthworms¹¹). It was reported that earthworm casts exert a hormone-like effect on plant growth^{1,17}). Although some correlations were also detected between the numbers of soil invertebrates and stem length and weight of soybean in this study, the mechanisms have not been elucidated.

## ---References-----



[Back to the first page](#)

- 1) Dell' Agnola, G. & Nardi, S. (1987): Hormone-like effect and enhanced nitrate uptake induced by depolycondensed humic fractions obtained from *Allolobophora rosea* and *A. caliginosa faeces*. *Biol. Fertil. Soils*, 4, 115-118.
- 2) Edwards, C. A. & Lofty, J. R. (1969): The influence of agricultural practice on soil micro-arthropod populations. *In* The soil ecosystem. Systematics association publication No.8. ed. Sheals, J. G., 237-247.
- 3) Enami, Y. & Nakamura, Y. (1996): Influence of *Shelorbitates azumaensis* (Acari: Oribatida) on *Rhizoctonia solani*, the cause of radish root rot. *Pedobiologia*, 40, 251-254.
- 4) Fujita, M. (1989): A comparison of abundance of Acari, Collembola and Enchytraeidae in soil of crop field under different soil management. *Edaphologia*, 40, 1-12 [In Japanese with English summary].
- 5) Itakura, J. et al. (1993): Effect of organic matter application on soil properties in dry land cropfield 3. Change of crop and soil animals in quality and quantity at the third year. *Tohoku Agric. Res.*, 46, 147-148 [In Japanese].
- 6) Itakura, J., Nakamura, Y. & Shiraishi, H. (1994): Effect of organic matter mulch and no tillage on physico-chemical properties and meso- and macro-animals of soils. *Tohoku Agric. Res.*, 47, 169-170 [In Japanese].
- 7) Lal, R. & Akinremi, O. O. (1983): Physical properties of earthworm casts and surface soil as influenced by management. *Soil Sci.*, 135, 116-122.
- 8) Lee, K. E. & Pankhurst, C. E. (1992): Soil organisms and sustainable productivity. *Aust. J. Soil Res.*, 30, 855-892.

- 9) Matsumoto, S. et al. (1990): The role of earthworms on soil fertility of reclaimed land. *Edaphologia*, 43, 41- 49 [In Japanese].
- 10) Nakamura, Y. (1988): The effect of soil management on the soil faunal makeup of a cropped Andosol in central Japan. *Soil Tillage Res.*, 12, 177-186.
- 11) Nakamura, Y. (1992): Earthworms and soil formation in land improvement; 1985 and after. *Farming Jpn.*, 26, 36-42.
- 12) Nakamura, Y., Matsuzaki, I. & Itakura, J. (1992): Effect of grazing by *Sinella curviseta* (Collembola) on *Fusarium oxysporum* f. sp. *cucumerinum* causing cucumber disease. *Pedobiologia.*, 36, 168-171.
- 13) Paoletti, M. G. (1988): Soil invertebrates in cultivated and uncultivated soils in northeastern Italy. *Redia*, 71, 501-563.
- 14) Paoletti, M. G. et al. (1991): Invertebrates as indicators of soil use. *Agric. Ecosystems Environ.*, 34, 341-362.
- 15) Reichele, D. E. (1977): The role of soil invertebrates in nutrient cycling. Soil organisms as components of ecosystems. *Proc. 6th Int. Coll. Soil Zool., Ecol. Bull. (Stockholm)*, 25, 145-156.
- 16) Shiraishi, H. & Nakamura, Y. (1994): Biological control of soil-borne fungal disease for plant seedlings by Collembola, *Folsomia hidakana*. *Tohoku Agric. Res.*, 47, 171-172 [In Japanese].
- 17) Tomati, U. et al. (1990): Effect of earthworm casts on protein synthesis in radish (*Raphanus sativum*) and lettuce (*Lactuca sativa*) seedlings. *Biol. Fertil. Soils*, 9, 288-289.



[Forward to:-Evaluation of Soil Fertility Status of Lowland Areas in the Philippines-](#)



[Back to: Contents](#)



[Back to: JIRCAS Home Page](#)

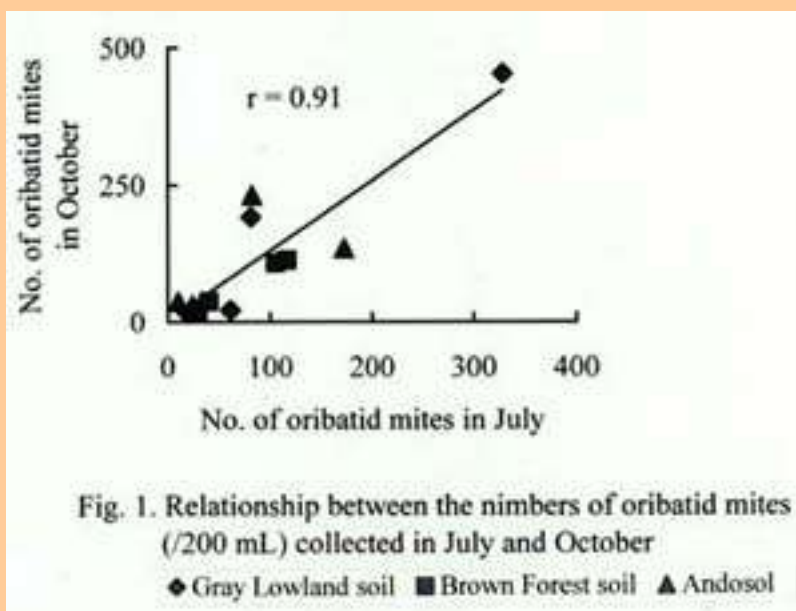


Fig.1.

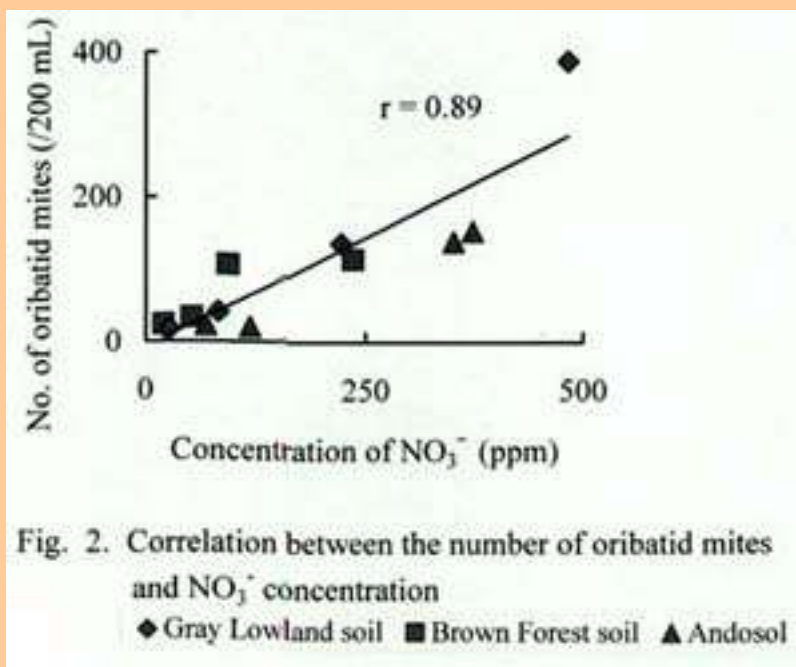


Fig.2.





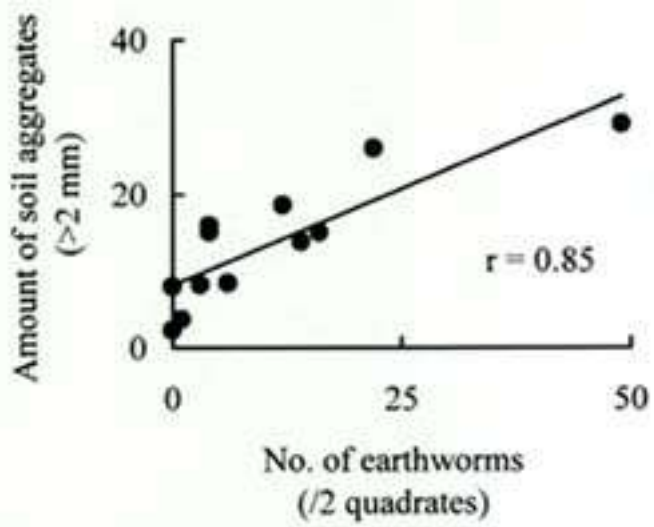


Fig. 4. Correlation between the number of earthworms and the amount of soil aggregates

Fig.4.



[Back](#)

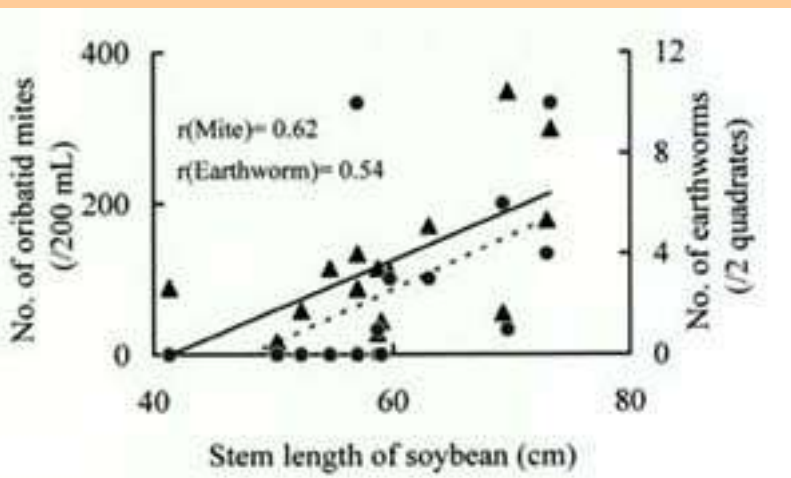


Fig. 5. Correlation between stem length of soybean and the number of oribatid mites or earthworms

▲ Oribatid mites    ● Earthworms

Fig.5.

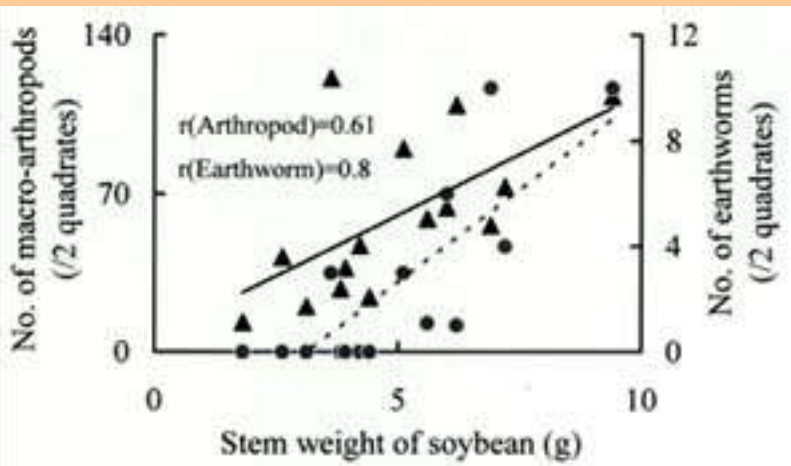


Fig. 6. Correlation between stem weight of soybean and the number of earthworms or macro-arthropods

▲ Macro-arthropods    ● Earthworms

Fig.6.



[Back](#)

Table 1.

Table 1. Management of experimental plots of Fields I and II

Field I	A	B	C	D	E	F	G	H	I	J	K	L				
Soil type ^{a)}	Gl	Bf	An	Gl	Bf	An	An	Gl	Bf	An	Gl	Bf				
Tillage using rotary machine				+	+	+				+	+	+				
Nitrogen source (kg/10 m ² )																
Inorganic				0.2	0.2	0.2										
Wheat plants	0.2	0.2	0.2													
Soybean plants							0.2	0.2	0.2							
Rice straw										0.2	0.2	0.2				
Field II	a	b	c	d	e	f	g	h	i	j	k	l	m	n	o	
Tillage using rotary machine												+	+	+	+	+
Insecticides and herbicides												+	+	+	+	+
Nitrogen source (kg/10 m ² )																
Inorganic	0.2	0.1	0.1	0.1	0.1							0.2	0.1	0.1	0.1	0.1
Rice straw		0.1					0.2					0.1				
Bokashi ^{b)}			0.1					0.2						0.1		
Mulberry branches				0.1					0.2						0.1	
Chopped weeds					0.1					0.2						0.1

a): Gl; Gray Lowland soil, Bf; Brown Forest soil, An; Andosol.

b): Bokashi is an organic fertilizer made mainly from rice bran and chicken droppings.



[Back](#)



# Evaluation of Soil Fertility Status of Lowland Areas in the Philippines

**Kenzo MIURA*1 and Rodrigo B. BADAYOS*2**

*1 Environmental Resources Division, Japan International Research Center for Agricultural Sciences (Tsukuba, Ibaraki, 305-8686 Japan)

*2 Department of Soil Science, College of Agriculture, University of the Philippines at Los Banos (College, Laguna, 4031 Philippines)

## ---Abstract-----

Attempts were made to evaluate the regional fertility characteristics of the Philippine lowland soils and to identify the factors determining their productivity for rice cultivation. Eight soil characters, i.e. organic C, total N, available P₂O₅, total P₂O₅, exchangeable K, available SiO₂, clay contents, and CEC for 52 surface soil samples were considered. By factor analysis, 3 factors were extracted, representing the organic matter status, available potassium and silica status, and available phosphorus status. The scores of these 3 fertility components were computed for each sample and based on the mean values for each region, regional characteristics of soil fertility status were determined. Based on the relationship between each of the 3 fertility component scores and rice yield for the 30 plow-layer samples, any of the 3 fertility components was found to be significant for rice production. Furthermore, the lowest among the 3 fertility component scores was considered to control the productivity for rice cultivation. Thus, emphasis was placed on identifying and alleviating the soil constraints, in order to achieve rational nutrient management for higher rice production.

**Discipline:** Soils, fertilizers and plant nutrition

**Additional key words:** Factor analysis, fertility components, rice production, soil constraints, soil characters

Received for publication, October 8, 1998

**1..8):**[References](#)

## ---Introduction-----

In the Philippines, the rice area has not increased since 1975, due to the limit of expansion²⁾. Thus, it is necessary to increase rice production by raising the yield to meet the requirements of the rapidly growing population. In this regard, it is essential to determine the potential capability of the Philippine lowland soils for rice production and to improve nutrient management to achieve a higher yield. The characteristics and fertility evaluation of the Philippine lowland soils were reported by Kawaguchi and Kyuma³⁾. Based on this information, Miura et al.⁵⁾ confirmed that the Philippine lowland soils exhibited a relatively high potential for rice production among the tropical Asian lowland soils, although some regional differences were significant, especially in the organic matter status associated with the rainfall conditions. On the other hand, based mainly on the data from the field experiments carried out during the rainy season in the Philippines, inherent productivity level and response to N rates were revealed for 4 soil orders, i.e. Entisols, Inceptisols, Mollisols, and Vertisols, although the results varied considerably

due to the limited number of experiments⁶). It thus appeared that the relationship of the soil fertility status with rice production had not been well documented.

The present study aims at reevaluating the fertility characteristics of the Philippine lowland soils through the use of factor analysis of selected soil characters and to identify the constraints on rice production.

## ---Materials and methods-----

### 1) Study areas and samples

The soil samples used in this study covered 32 lowland soils selected from 6 lowland rice areas in the Philippines ([Table 1](#)). According to Flores and Balagot¹), the mean annual temperature in the Philippines is 27.0 with negligible regional variations, while the mean annual rainfall is 2,533 mm with considerable regional differences ranging from 934 to 4,305 mm. By setting a value of <100 mm rainfall for the dry months, as proposed by Manalo⁴), the whole country can be divided into 3 zones from the humid to arid extreme ([Fig. 1](#)).

An attempt was made to select typical lowland soils which cover large areas in a region. At each site, soil samples were taken from each horizon for laboratory analysis. Furthermore, information pertaining to the cropping pattern, use of fertilizer, rice yield, etc. was collected from the local farmers. Rice yield here refers to rough rice yield, which may not be a quantitative parameter but indicates the representative value for a long period of time under normal growth. As shown in [Table 1](#), rice cultivation was practiced at 30 of the 32 sites examined. For the 24 sites with double or triple cropping of rice, a larger amount of fertilizer was applied in the dry season than in the rainy season since growth was more vigorous in the dry season due to the larger number of sunshine hours. As a result, in general, rice yield was higher in the dry season cropping (average of 5.3 Mg ha⁻¹) than in the rainy season one (4.7 Mg ha⁻¹), although significant differences in rice yield among the sites were observed. In the present paper, rice yield of the rainy season cropping was selected for analysis, since more data were available. As for the rice cultivars, high-yielding modern varieties were adopted except for 1 site, i.e. CO1. In the Philippines, almost 3 million ha or 94% of the total rice area were planted to modern varieties in 1992²).

[*Table 1\(61 KB\) Fig.1. \(26 KB\)](#)

### 2) Analytical methods

For the soil chemical analysis, the air-dried fine earth samples (<2 mm) were ground to pass through a 0.5 mm mesh sieve. The amount of organic C was determined by wet combustion with a mixture of K₂Cr₂O₇ and H₂SO₄ (Walkley-Black procedure). Total N content was determined by digestion with H₂SO₄, distillation and titration (Kjeldahl procedure). Available P₂O₅ was extracted with an acidic ammonium fluoride and the content was determined by spectrophotometry (Bray & Kurz No. 2 procedure). The total content of P₂O₅, was determined by X-ray fluorescence spectrometry using samples subjected to a pressure of 20 t/cm² for 1 min. The exchangeable bases were extracted with 1 M NH₄OAc (pH 7.0) by percolation. The amounts of exchangeable Ca and Mg were determined by atomic absorption spectrophotometry, and that of exchangeable K by flame emission spectrophotometry. After replacement of exchangeable bases with NH₄OAc, washing with ethanol and replacement of NH₄⁺ with 100g L⁻¹ KCl were successively performed by leaching. To measure the CEC of the sample, NH₄-N content was determined by distillation and titration. Available SiO₂ was extracted with an acetate buffer

solution (pH 4) and the content was determined by spectrophotometry.

For particle size analysis using the fine earth samples, the silt (2 to 20  $\mu\text{m}$ ) and clay ( $<2 \mu\text{m}$ ) fractions were analyzed by the pipette method, after removal of organic matter with  $\text{H}_2\text{O}_2$  and free Fe oxides by the DCB method, and dispersion with NaOH.

### **3) Statistical methods**

For the statistical analysis, 52 surface samples among the 32 soils examined were processed. In order to characterize these surface soil samples, a factor analysis was adopted⁷⁾. Factor analysis aims at transforming the original set of correlated variables into a new set of mutually uncorrelated variables in such a way that a few factors represent a large proportion of the total variance in the original data. In the course of preliminary trials, various attempts were made to select the variables which should be subjected to the final factor analysis. A set of 8 characters, i.e. organic C (OC), total N (TN), available  $\text{P}_2\text{O}_5$  (AvP), total  $\text{P}_2\text{O}_5$  (TP), exchangeable K (ExK), available  $\text{SiO}_2$  (AvSi), clay (Clay) contents, and cation exchange capacity (CEC) of the 52 surface soil samples was used in the final factor analysis.



[Continue to: Results and discussion](#)



[Back to: Contents](#)

## ---Results and discussion-----

### 1) Extraction of fertility component

Based on the factor analysis, 3 factors with eigenvalues larger than 1 were extracted, which together accounted for about 80% of the total variance, as shown in [Table 2](#), implying that these 3 new compound characters retain most of the information in the original variables.

As seen from the final factor loadings after varimax rotation ([Table 2](#)), Factor 1 was significantly related to OC and TN. Highly positive loadings on Clay and CEC reflected the control of organic matter accumulation by the clay content and the contribution of the amount of organic matter to CEC, respectively. Much lower factor loading on TP was ascribed to organic phosphorus to some extent. Thus, Factor 1 which was considered to be related to the characters determined by the amount of organic matter, was thought to represent the "organic matter status (OM)". Factor 2 which was highly related to ExK and AvSi, represented the "available potassium and silica status (AK&Si)". Moderately high loading on CEC may be related to the base status, since positive correlations of the score of Factor 2 with exchangeable Ca ( $r=0.498$ , significant at the 0.1% level) and with exchangeable Mg ( $r=0.473$ , significant at the 0.1% level) were observed. Factor 3 clearly represented the "available phosphorus status (AP)", since the contribution of the other variables except for AvP and TP was negligible.

Therefore, it can be considered that these 3 fertility components which are mutually independent, represent different aspects of soil fertility.

**Table 2. Eigenvalues, cumulative percentage of the total variance, factor loading of the 3 factors, and communality estimates of the 8 soil characters**

	<u>Factor 1</u>	<u>Factor 2</u>	<u>Factor 3</u>	<u>Communality</u>
Eigenvalue	3.21	1.74	1.44	
Cumulative (%)	40.1	61.9	79.9	
Soil character				
OC	0.926	0.025	0.056	0.860
TN	0.928	-0.015	0.029	0.862
AvP	-0.269	0.200	0.807	0.763
TP	0.325	-0.139	0.779	0.731
ExK	0.046	0.792	0.291	0.714
AvSi	0.148	0.872	-0.251	0.846
Clay	0.884	0.189	-0.118	0.832
CEC	0.713	0.507	0.139	0.785

[Back](#)

### 2) Regional characteristics of the 3 fertility components

The factor scores were computed for individual soil samples in order to evaluate numerically the fertility characteristics of the lowland soils examined. The scores computed for the samples were standardized with a mean of zero and a variance of unity. Therefore, positive score values indicate above-average status with reference to the overall mean for the 52 sample soils, while negative values below-average status.

The mean values of the 3 fertility component scores estimated for each of the 4 regions on Luzon Island are shown in [Fig. 2](#). The mean values for the Iloilo and Cotabato regions were not used for the analysis due to the limited number of samples. The highest OM score was found in Bicol, due to the highest mean of OC, TN, and Clay. The highest mean of OC and TN was likely to be associated with the effect of humid climatic conditions on the accumulation of organic matter in Bicol ([Fig. 1](#)). The highest mean of Clay may be ascribed to the topography of the sampling sites, mostly on or near the back swamps of the lower reaches of the Bicol River. On the other hand, the lowest mean of OM score was observed in Central Luzon under the much drier climatic conditions ([Fig. 1](#)), although the 3 samples located on or near the back swamps with relatively high Clay, OC, and TN, showed exceptionally positive scores.

The mean AK&Si score was highest in Laguna, while the lowest in Central Luzon. However, appreciable differences in the score were observed among the Cagayan Valley samples: 1 sample on the river terrace showed a very low score, while 2 samples on the valley plain very high scores. The moderately positive correlation of the AK&Si score with the CEC/Clay ratio ( $r=0.523$ , significant at the 0.1% level) may indicate that available potassium and silica status is associated with the nature of clay, determined by the parent materials or degree of weathering, or both.

The mean AP score was by far the highest in Cagayan Valley, although 1 sample on river terrace showed a very low score. On the other hand, the lowest score was recorded in Bicol, although 2 samples showed very high scores, one of them located on the flood plain in the vicinity of the foot of a mountain where unweathered materials can be easily transported. The weak positive correlation between the AP score and CEC/Clay ratio ( $r=0.400$ , significant at the 1% level) roughly indicates that the available phosphorus status is related to the nature of clay. The above results on the regional characteristics are in agreement with those obtained previously⁵, suggesting that the adoption of a factor analysis is valid.

[Fig.1.\(26 KB\)](#), [Fig.2.\(14 KB\)](#)

### 3) Limiting factors to rice production

To analyze the relationship between the soil fertility status and rice yield, a plow-layer soil sample was used here for each of the 30 lowland soils under rice cultivation in the 6 study areas. Based on the relationship between the OM score and rice yield, it appeared that the samples with a higher score tended to show a higher rice yield, except for the 6 samples with relatively high OM scores ([Fig. 3a](#)), suggesting that organic matter exerts a beneficial effect on rice production. The lower rice yield than expected from the OM score for the 6 samples may be

ascribed to some factors, as shown in [Table 3](#). The lowest rice yield in 1 sample from Cotabato, CO1 should be attributed to the cropping of a traditional cultivar which can not attain a higher yield, since no particular constraints were identified from the 3 scores. For the other 5 samples, either of the other 2 fertility components showing a lower score may be significant for determining rice production. As for the relationship between the AK&Si score and rice yield, samples with a higher score tended to show a higher yield, except for 5 samples, indicating the beneficial effect of available potassium and silica ([Fig. 3b](#)). The limiting fertility components for the 5 samples could be deduced from Table 3. A similar trend was observed from the relationship between the AP score and rice yield ([Fig. 3c](#)), except for 6 samples ([Table 3](#)).

Based on the above results, all the 3 fertility components appeared to play a significant role in rice production. Based on the law of the minimum according to which any essential nutrient with a deficient level determines crop production, any fertility component with the lowest level may control rice yield. As shown in [Table 4](#), the possible cause of low rice yield of <4 Mg ha⁻¹ could be identified for the 6 samples. In the case of 3 samples, NE4, IS1, and IL1, all the 3 scores showed negative values, indicating that all these constraints could be responsible for the low rice yield.

Therefore, it is essential to determine the actual soil fertility status in individual rice fields, e.g. through soil diagnosis, in order to identify and alleviate soil constraints on rice production. Rational nutrient management involving adequate and balanced fertilizer application should be applied in the Philippine lowland soils, in order to increase rice production or to secure a stable supply as a whole.

* [Fig.3.\(14 KB\)](#)

**Table 3. Three fertility component scores for exceptional samples**

No ^{a)}	Region	Sample	OM	AK&Si	AP	Yield (Mg ha ⁻¹ )
1) Exceptional samples for the relationship between OM score and rice yield						
a1	Cotabato	CO1	2.61	0.09	0.27	2.0
a2	Bicol	CS4	2.33	-1.25	1.99	3.3
a3	Bicol	CS3	2.27	0.25	-0.57	5.0
a4	Bicol	CS1	2.01	-0.14	-0.67	6.0
a5	Bicol	CS5	1.73	-0.60	0.17	5.5
a6	Central Luzon	NE8	1.39	-1.11	0.95	4.0
2) Exceptional samples for the relationship between AK&Si score and rice yield						
b1	Laguna	LA1	0.49	2.75	-0.44	4.0
b2	Cagayan Valley	CA1	0.31	1.62	1.63	4.0
b3	Laguna	LA2	-0.20	1.45	0.58	5.5
b4	Central Luzon	PA1	-0.54	0.64	1.17	2.8
b5	Cotabato	CO1	2.61	0.09	0.27	2.0
3) Exceptional samples for the relationship between AP score and rice yield						
c1	Bicol	CS4	2.33	-1.25	1.99	3.3
c2	Cotabato	CO2	-0.77	0.12	1.72	4.0
c3	Cagayan Valley	CA1	0.31	1.62	1.63	4.0
c4	Bicol	AL1	-0.14	0.35	1.52	4.4
c5	Central Luzon	PA1	-0.54	.064	1.17	2.8
c6	Cotabato	CO1	2.61	0.09	0.27	2.0

a): The number corresponds to the number indicated in [Fig.3](#).

[Back](#)

**Table 4. Three fertility component scores for the samples with lowest 6 rice yields**

Region	Sample	OM	AK&Si	AP	Yield (Mgha-1)
Cotabato	CO1a)	2.61	0.09	0.27	2.0
Central Luzon	NE4	-1.03	-1.20	-0.88	2.3
Cagayan Valley	IS1	-1.01	-1.69	-0.86	2.8
Central Luzon	PA1	-0.54	0.64	1.17	2.8
Bicol	CS4	2.33	-1.25	1.99	3.3
Iloilo	IL1	-0.34	-0.94	-0.73	3.5

a): The lowest rice yield was caused by the cultivation of a traditional variety.

[Back](#)

---References-----



[Back](#)

- 1) Flores, J. F. & Balagot, V. F. (1969): Climate of the Philippines. *In* Climates of northern and eastern Asia. World survey of climatology Vol. 8. ed. Arakawa, H., Elsevier Publishing Co., Amsterdam, 159-213.
- 2) International Rice Research Institute (1995): World rice statistics, 1993-94. Los Banos.
- 3) Kawaguchi, K. & Kyuma, K. (1977): Paddy soils in tropical Asia; Their material nature and fertility. Univ. Press Hawaii, Honolulu.
- 4) Manalo, E. B. (1977): Agroclimatic map of the Philippines. IRRI, Los Baons.
- 5) Miura, K., Badayos, R. B. & Briones, A. M. (1997): Characteristics of soils of lowland areas in the Philippines with special reference to parent materials and climatic conditions. *JIRCAS J.*, 5, 31-42.
- 6) Raymundo, M. E., Mamaril, C. P. & De Datta, S. K. (1989): Environment, classification, and agronomic potentials of some wetland soils in the Philippines, Ser. No. 85. PCARRD & IRRI, Los Banos.
- 7) SAS Institute Inc. (1990): SAS/STAT User's guide, Ver. 6 (4th ed.), Vol. 1 & 2. Cary.
- 8) Soil Survey Staff (1994): Keys to Soil Taxonomy (6th ed.). USDA, Washington, D.C.



[Forward to:-Operation of Diesel Engine Using Unrefined Rapeseed Oil as Fuel-](#)

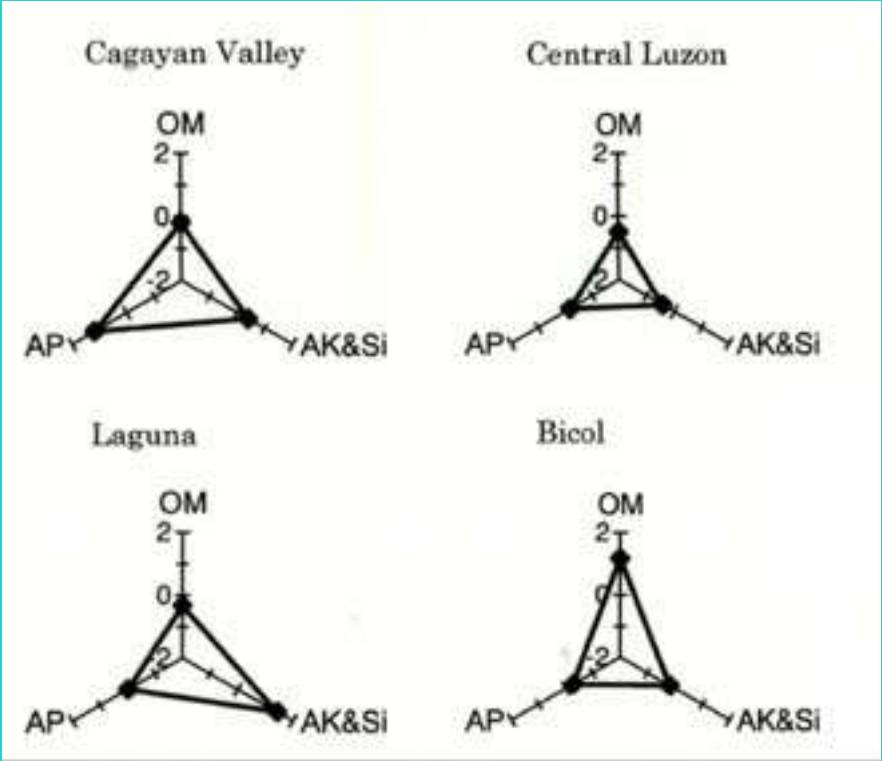


[Back to: Contents](#)



[Back to: JIRCAS Home Page](#)

Fig.2. Pattern of the mean fertility component scores for the 4 study areas



 [Back](#)

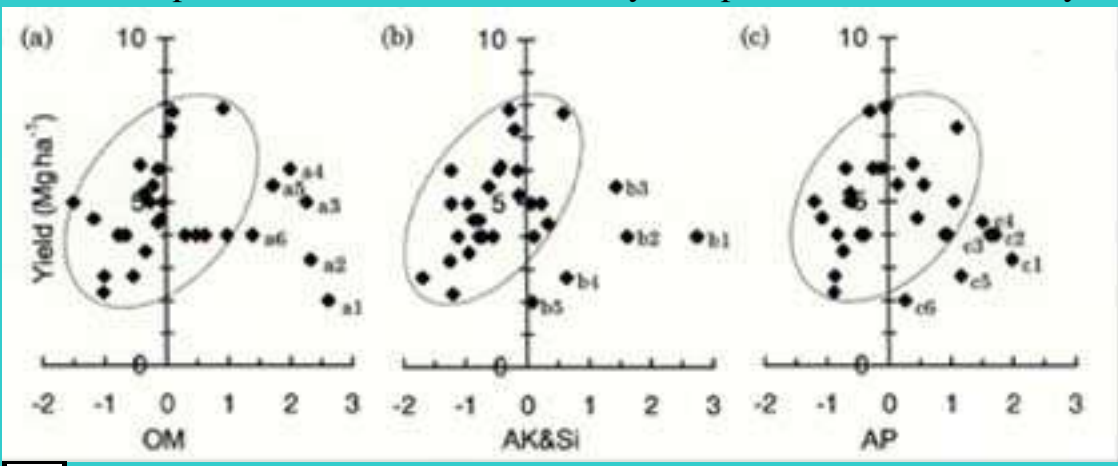
Fig.1.  
Classification of climatic zones in the Philippines based on the number of dry months



[Back](#)



Fig.3.  
Relationship between each of the 3 fertility component scores and rice yield



 [Back](#)

Table 1. Cropping pattern, rice yield, and soil classification of the sites examined

Sample designation and location	Cropping pattern	Yield (Mg ha ⁻¹ )		Soil classification ^{a)}
		Cropping season		
		Rainy	Dry	
1) Cagayan Valley				
IS1 Echague, Isabela	Double cropping	2.8	2.3	Typic Epiaquult
IS2 Cabatuan, Isabela	Double cropping	7.3	5.5	Typic Epiaquulf
CA1 Solana, Cagayan	Triple cropping	4.0	4.0	Vertec Tropaquept
2) Central Luzon				
NE1 Muñoz, Nueva Ecija	Fallow	-	-	Oxyaquic Ustropept
NE2 Talavera, Nueva Ecija	Single cropping ^{b)}	5.3	-	Fluvaquentic Epiaquoll
NE3 Muñoz, Nueva Ecija	Double cropping	4.5	6.5	Ustic Epiaquert
NE4 Llanera, Nueva Ecija	Double cropping	2.3	2.3	Chromic Vertic Epiaqualf
NE5 Jaen, Nueva Ecija	Mango field	-	-	Typic Ustropept
NE6 Zaragoza, Nueva Ecija	Double cropping	4.0	8.0	Typic Epiaqualf
NE7 San Leonardo, Nueva Ecija	Double cropping	4.0	5.0	Vertic Tropaquept
NE8 San Leonardo, Nueva Ecija	Double cropping	4.0	5.8	Vertic Tropaquept
NE9 San Leonardo, Nueva Ecija	Double cropping	4.0	5.8	Ustic Epiaquert
BU1 San Miguel, Bulacan	Double cropping	6.0	6.0	Vertic Tropaquept
PA1 Villasis, Pangasinan	Single cropping ^{b)}	2.8	-	Fluventic Ustropept
TA1 San Manuel, Tarlac	Single cropping ^{b)}	4.5	-	Aeric Tropaquept
TA2 La Paz, Tarlac	Single cropping	5.0	-	Vertic Tropaquept
TA3 La Paz, Tarlac	Single cropping ^{b)}	5.0	-	Oxyaquic Ustropept
3) Laguna				
LA1 Santa Rosa, Laguna	Double cropping	4.0	4.0	Vertic Tropaquept
LA2 Bay, Laguna	Double cropping	5.5	5.5	Aeric Vertic Epiaqualf
LA3 Santa Cruz, Laguna	Double cropping	6.1	6.1	Fluvaquentic Endoaquoll
4) Bicol				
CS1 Milaor, Camarines Sur	Double cropping	6.0	6.0	Vertic Fluvaquent
CS2 Minalabac, Camarines Sur	Triple cropping	7.9	7.9	Vertic Tropaquept
CS3 Canaman, Camarines Sur	Double cropping	5.0	5.0	Vertic Fluvaquent
CS4 Minalabac, Camarines Sur	Triple cropping	3.3	4.5	Vertic Fluvaquent
CS5 Minalabac, Camarines Sur	Triple cropping	5.5	6.0	Vertic Fluvaquent
AL1 Polangui, Albay	Double cropping	4.4	6.0	Typic Tropaquept
SO1 Casiguran, Sorsogon	Double cropping	5.0	4.3	Vertic Fluvaquent
5) Iloilo				
IL1 Sara, Iloilo	Double cropping	3.5	3.0	Vertic Tropaquept
IL2 San Miguel, Iloilo	Double cropping	7.8	6.3	Vertic Tropaquept
6) Cotabato				
CO1 Cotabato, Maguindanao	Single cropping	2.0	-	Vertic Fluvaquent
CO2 Tacurong, Sultan Kudarat	Double cropping	4.0	4.0	Vertic Tropaquept
CO3 Kabacan, North Cotabato	Double cropping	6.0	7.0	Typic Tropaquept

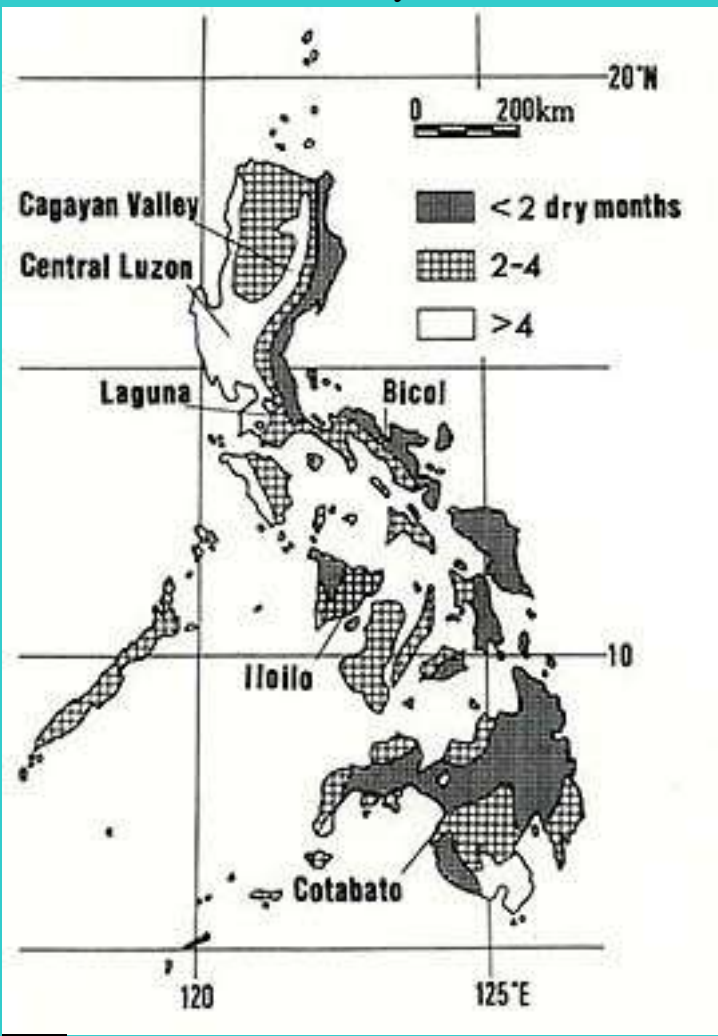
a): Based on Soil Taxonomy^{b)}.

b): Field crops such as vegetables or tobacco were cultivated in the dry season.



[Back](#)

Fig.1. Classification of climatic zones in the Philippines based on the number of dry months



 [Back](#)

# Operation of a Diesel Engine Using Unrefined Rapeseed Oil as Fuel

Chiyuki TOGASHI* and Jun-ichi KAMIDE*

* :Department of Agricultural Engineering, Miyagi Agricultural College  
(Sendai, Miyagi, 982-0215 Japan)

* :Faculty of Agriculture, Yamagata University  
(Tsuruoka, Yamagata, 997-8555 Japan)

## ---Abstract-----

This report deals with experiments carried out to examine the possibility of using unrefined rapeseed oil as a substitute for light oil in a small diesel engine. The authors carried out tests on short-term performance, long-term operation and no-load continuous operation using various kinds of unrefined rapeseed oil (deacidified oil, degummed oil and crude oil) produced in the process of refining, and refined rapeseed oil and light oil for comparison. Specific fuel consumption, thermal efficiency, exhaust-gas temperature, and density of black smoke in exhaust-gas were examined in tests on short-term performance and long-term operation. The amount of deposits in the precombustion chamber and on the injection nozzle was determined in tests on no-load continuous operation. As a result, it was considered that deacidified rapeseed oil can be used as fuel for a diesel engine. Degummed oil and crude rapeseed oil were found to be unsuitable for use as fuel due to the high level of incombustible materials in oil.

**Discipline:** Agricultural machinery

**Additional key words:** substitute fuel, deacidified oil, degummed oil, crude oil, incombustibility

Received for publication, January 5, 1998

## 1...11):References

## ---Introduction-----

Many studies on the use of plant oil as substitute fuel for a diesel engine have been carried out after the oil price increased in 1973^{2,3,6,7,9-11}). The authors also carried out experiments on the possibility of using unrefined rapeseed oil as a substitute for light oil in a small diesel engine. The main reason for using plant oil as a substitute fuel is that farmers can produce the fuel material by themselves, without requiring the complex process of refining from crude oil. Rapeseed oil was selected in this study because rapeseed is cultivated widely and conveniently in Japan.

The engine must be easily started, and requires low combustion noise and good load performance¹). In addition to these 3 conditions, reliability and stable operation performance over long running periods and low carbon coating to the combustion chamber in the no-load operation with the substitute oil are required.

In this paper, the authors carried out short-term performance tests, long-term operation tests and no-load continuous tests using various kinds of unrefined rapeseed oil (deacidified oil, degummed oil and crude

oil).

## ---Materials and methods-----

### 1) Materials

The fuel used for the experiments consisted of various kinds of unrefined rapeseed oil (deacidified, degummed and crude oil) and refined rapeseed and light oil. Preparations of deacidified, crude and refined rapeseed oil were produced by N Co., degummed rapeseed oil by R Co. and light oil consisted of No.2 diesel oil.

The characteristics of each kind of fuel were defined by measuring the density, net calorific value, kinematic viscosity, content of incombustible materials and fatty acid composition ([Table 1](#)). The content of incombustible materials was determined by a method involving the measurement of carbon residues.

The short-term performance tests and long-term operation tests were conducted on an A-diesel engine, and no-load continuous tests on a B-diesel engine ([Table 2](#)).

Engine power was measured with an electric dynamometer connected to a diesel engine by 2 V-belts of B-type. Fuel was supplied through a burette, and fuel capacity was calculated by determining the consumption time of the volume of fuel.

Density of black smoke in exhaust-gas which was inhaled for 4 s through a filter paper was measured with a smoke tester. The measuring point of exhaust-gas temperature was located about 10 cm inside of the muffler.

* [Table 1.\(19 KB\)](#), [Table 2.\(20 KB\)](#)

### 2) Short-term performance tests

The operating mode of the short-term engine performance tests was as follows: warming operation time was 20 min(1,800 and 2,000 rpm), 75 load operation time 160 min(2,200 rpm), no-load operation time 5 min, and rated load operation⁸) time 25 min ([Fig. 1](#)). Engine power, fuel capacity, density of black smoke in exhaust-gas and exhaust-gas temperature were measured every 10 min in 75 load operation, and every 5 min in rated load operation.

Fuels used included, in the following order, light oil, deacidified oil, degummed oil and crude oil in the test.

### 3) Long-term operation tests

The conditions for the long-term operation involved rated revolutions and 75 load. The total target time of the long-term operation was 200 h, and of the continuous operation about 5 h in each operation. Engine performance tests were carried out every 25 h in the same way as in the rated load operation shown in [Fig.1\(18 KB\)](#). For the engine performance tests, light oil was used as fuel every 100 h.

The amount of deposits in the precombustion chamber and on the injection nozzle in the long-term operation was monitored. Accordingly, the precombustion chamber and the injection nozzle were replaced each time fuel was replaced.

### 4) No-load continuous operation tests

The conditions for no-load continuous operation for each kind of fuel included rated revolutions(2,400 rpm), and the target time of the continuous operation was 100 h. As in the long-term operation, the precombustion chamber and the injection nozzle were replaced each time fuel was replaced.

The incombustibility in the precombustion chamber was expressed by the residual quantity after the deposits of the no-load continuous operation were put in the electric furnace at 550 for 30 min. In addition, the combustible materials in the electric furnace consisted of carbon.



[Continue to: Results and discussion](#)



[Back to: Contents](#)

## ---Results and discussion-----

### 1) Short-term performance tests

[Figs.2 and 3](#) depict the 75 load operation performance and rated load operation performance.

* [Fig.2.\(30 KB\)](#), [Fig.3.\(28 KB\)](#)

The consumption of deacidified oil was almost the same as or slightly lower than that of light oil. The thermal efficiency of deacidified oil was 2.2-5.8 higher than that of light oil in each performance test. The combustion speed of deacidified oil was high because of the oxygen content in the fuel, and the exhaust-gas temperature of this oil was 3-20 lower than that of light oil. Deacidified oil also had a lower density of black smoke in exhaust-gas than light oil.

The fuel consumption of degummed oil was almost the same as or slightly lower than that of deacidified oil and light oil. The thermal efficiency of degummed oil was the same as that of deacidified oil. The exhaust-gas temperature and density of black smoke in the exhaust-gases of degummed oil were about the same as those of deacidified oil and were lower than those of light oil.

The consumption of crude rapeseed oil as fuel was higher than that of deacidified oil and light oil. The thermal efficiency of crude rapeseed oil showed a lower value than that of deacidified oil. The exhaust-gas temperature of crude rapeseed oil in the 75% load operation increased gradually in relation to the running time and increased suddenly after 2 h and 30 min. The density of black smoke in the exhaust-gas also increased suddenly after 2 h and 30 min of operation.

The thermal efficiency of refined rapeseed oil in a diesel engine with 2.57 kW rated power, 2,000 rpm rated revolution and 21.6 compression ratio, was almost the same as that of light oil⁶⁾. The thermal efficiency of refined rapeseed oil in a diesel engine with 4.41 kW rated power, 1,200 rpm rated revolution and 20.0 compression ratio was higher for high load and high revolutions, and lower for low load and low revolutions⁴⁾ than that of light oil. And the thermal efficiency of refined rapeseed oil in a large diesel engine with 41 kW rated power, 3,000 rpm rated revolution was about 2% higher than that of light oil in low to high load operations⁵⁾.

It was considered that the thermal efficiency increased not only under high load but also low load operation conditions, because deacidified oil with defective ignition showed a shorter ignition lag, causing high temperature in the combustion chamber when the engine conditions involved high compression ratio and high revolutions.

Incombustible deposits were detected on the injection nozzle and injected fuel spray was adversely affected by this build-up, which was associated with the incombustible materials present in crude rapeseed oil. As a result, the loaded performance decreased while the exhaust-gas temperature and density of black smoke in exhaust-gas increased.

### 2) Long-term operation tests

[Fig. 4](#)(33 KB) shows the thermal efficiency of engine performance every 25 h.

Through out the 200 h of operation using deacidified oil, the power was stable for the entire period and no accumulation of deposits was found on the injector nozzle although an amount of 0.153 g of incombustible deposits was detected in the precombustion chamber.

Irregular revolution and detonation noise started to occur after about 20 h of operation in the engine when degummed oil was used as fuel, leading to the interruption of the operation after 25 h. A large quantity of incombustible deposits was detected around and on the injection nozzle after 25 h of operation. Therefore degummed oil produced a large quantity of incombustible materials in the combustion chamber, precombustion chamber and on the injection nozzle. This phenomenon is due to the fact that degummed oil contains a large quantity of incombustible materials which affected the length of the operation time. Since the injected fuel spray was impeded by the incombustible deposits on the nozzle, the ignition lag increased and the engine performance was reduced. Therefore the operation of the engine was impossible under such adverse conditions. Engine operation using degummed oil was satisfactory only when the build-up of incombustible deposits was low.

In the engine fueled by crude oil, irregular revolution and detonation noise started to occur after about 40 h of operation. After 50 h, the precombustion chamber and the injection nozzle were cleaned. But, again after 160 h, irregular revolution and detonation noise were observed, leading to the interruption of the operation after 175 h. A large amount of incombustible deposits was detected in the port connected to the combustion chamber, on the injection nozzle and in the precombustion chamber ([Fig. 5](#))(9KB)

### 3) No-load continuous operation tests

[Fig. 6](#)(18 KB) shows the relationship between the amount of deposits in the precombustion chamber and the content of incombustible materials in fuel. [Fig. 7](#)(17 KB), shows the amount of incombustible materials in the precombustion chamber.

The amounts of carbon and incombustible materials in the precombustion chamber were 0.222 g and 0.003 g, respectively in the no-load operation when deacidified oil was used ([Table 3](#)). The deposits consisted almost completely of carbon due to the incomplete combustion associated with the low combustion temperature. The content of incombustible materials of the fuel was significantly correlated with the accumulation of deposits in the precombustion chamber in the no-load operation, and the amount of accumulated deposits could be estimated by measuring the content of incombustible materials. In the fuel a very small amount of carbon was found around the injection nozzle when deacidified oil, refined oil and light oil were used as fuel.

**Table 3.**  
**Deposits and incombustibility in the precombustion chamber after 100 h of no-load continuous operation**

	(unit:g)		
	Deposits ^{b)}	Incombustibility	
Rapeseed oil			
/Deacidified oil	0.225	0.003	
/Degummed oil ^{a)}	1.103	0.833	
/Crude oil	0.655	0.245	a): Operation time: 85 h.
/Refined oil	0.208	0.001	b): Carbon = deposits - incombustibility.
Light oil	0.123	0.012	

During the no-load operation, irregular revolution and detonation noise started to occur after about 80 h of operation in the engine fueled by degummed oil. As a result the operation of the engine stopped after 85 h. The accumulation of deposits in the precombustion chamber of the engine operating with degummed oil was 1.103 g, a value about 5 times higher than when deacidified oil was used. The amount of incombustible materials was 0.833 g. The accumulated deposits contained a large quantity of gum which coated the wall of the precombustion chamber and produced a thin film on the injection nozzle. The gum adhered to the head of the injection nozzle in the no-load operation when degummed oil was used as fuel ([Fig. 8](#)) (8 KB).

Accumulated deposits amounted to 0.655 g in the precombustion chamber when crude rapeseed oil was used, a value 3 times higher than when deacidified oil was used. The amount of incombustible materials was 0.245 g. Gum accounted for a large part of the accumulated deposits and it adhered to the wall of the precombustion chamber and the port connected to the combustion chamber. Gum adhered to the head of the injection nozzle in the no-load operation when crude rapeseed oil was used, in the same way as when degummed oil was used as fuel.

A recently developed method of removing gum from rapeseed oil by the elimination of organic acids does not always remove all of gum present in oil. Therefore, in terms of diesel fuel the degummed oil provided by the manufacturer is, in fact considered to be comparable to crude oil.

The maximum content of incombustible materials in oil for use as substitute fuel was estimated to be about 0.01%.

### ---Conclusion-----

This report deals with experiments carried out to examine the possibility of using various kinds of unrefined rapeseed oil (deacidified oil, degummed oil and crude rapeseed oil) as a substitute for light oil in a small diesel engine.

The results are summarized as follows:

(1) Deacidified rapeseed oil was superior to light oil in terms of load performance and black smoke density in exhaust-gas. The amount of accumulated deposits in the precombustion chamber and on the injection nozzle after long-term load operation and no-load continuous operation tests was almost the same for deacidified rapeseed oil and refined oil. Deacidified rapeseed oil was considered to be suitable for use as fuel for a diesel engine.

(2) The degummed oil provided by the manufacturer was considered to be comparable to crude oil. When there were no incombustible deposits on the nozzle, the use of degummed oil was preferable to that of light oil in terms of operation performance, and both the exhaust-gas temperature and the density of black smoke in exhaust-gas were lower compared with light oil. However in the long-term load operation and no-load continuous operation, deposits of incombustible materials consisting essentially of gum adhered to the inside of the precombustion chamber and the injection nozzle. The normal spray of injected fuel was difficult, leading to a reduction of the performance and to the interruption of the operation of the engine.

Rapeseed degummed oil produced by the method of removal of organic acids was found to be unsuitable for use as diesel fuel.

(3) The load performance when crude rapeseed oil was used was slightly lower than when deacidified oil was used. A large quantity of incombustible materials, chiefly gum, was deposited in and adhered to the combustion chamber, precombustion chamber and the injection nozzle. The size of the build-up was related to the running time. As a result, the nozzle became blocked, detonation noise occurred and eventually the engine stopped. Crude rapeseed oil with a high content of incombustible materials was found to be unsuitable for use as fuel for a diesel engine.

### ---References-----

[Back to the first page](#)

- 1) Araya, K. (1991): An analysis of diesel engine startability fueled with sunflower oil. *J. Environ. Sci. Lab. Senshu Univ. Hokkaido*, 2,1-166.
- 2) Bansal, B. B. & Juneja, N. N. (1982): Rapeseed oil as supplementary diesel engine fuel. *Pap. Am. Soc. Agric. Eng., ASAE Paper No.1033*.
- 3) Hamasaki, K. et al. (1987): An application of rape-seed oil fuel to a small diesel engine. *Res. Rep. Fac. Eng. Kagoshima Univ.*, 29,17-24.
- 4) Hayashi, S. et al. (1992): Effect of rapeseed-oil on a pre-chamber type diesel engine. *J. Jpn. Soc. Agric. Mach.*, 54(2),11-21.



- 5) Hemmerlein, N. et al. (1991): Performance, exhaust emissions and durability of modern diesel engines running on rapeseed oil. SAE Tech. Pap. Ser., SAE No. 0848.
- 6) Iimoto, M. (1977): On the operation of small diesel engine for farm use using rape-seed oil as fuel (I). *J. Jpn. Soc. Agric. Mach.*, 38(4), 483-487.
- 7) Iimoto, M. (1979): On the operation of small diesel engine for farm use using rape-seed oil as fuel (II). *J. Jpn.Soc. Agric. Mach.*, 40 (1), 5-8.
- 8) JIS B8018 (1989): Small size water cooled diesel engines for land use.
- 9) Peterson, C. L.& Wagner, G. K. (1981): Performance testing of vegetable oil substitutes for diesel fuel. Pap. Winter Meet. Am. Soc. Agric. Eng., Paper No.81-3578,1-30.
- 10) Tamura, Y. (1937): Operation of a diesel engine using soybean oil as fuel. *J. Jpn. Soc. Agric. Mach.*, 1 (1), 3-6.
- 11) Wagner, G. L.& Peterson C. L. (1982): Performance of winter rape (*Brassica napus*) based fuel mixtures diesel engine. *In* Veg. oil fuels, 329-336.



[Forward to:-Estimation of Flowering Date and Temperature Characteristics of Fruit Trees-](#)



[Back to: Contents](#)



[Back to: JIRCAS Home Page](#)

Fig.2.  
Engine performance in 75% load operation

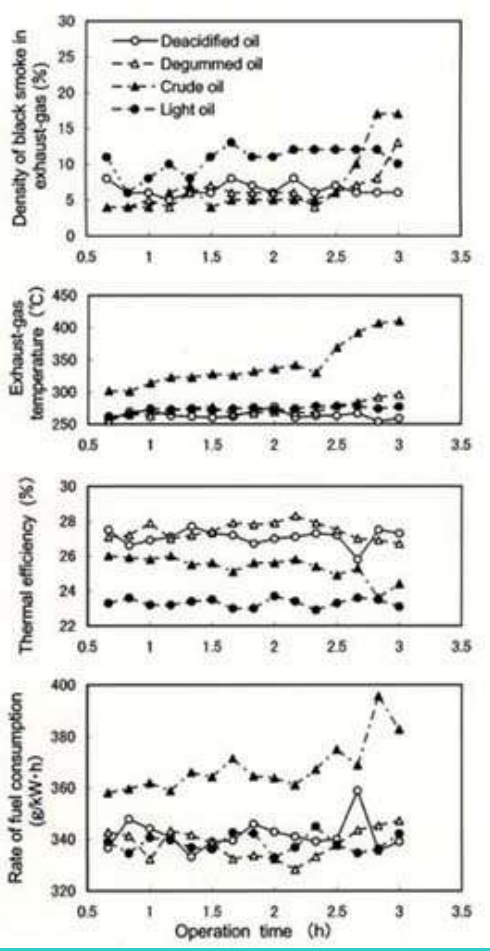


Fig.3.  
Engine performance in rated operation

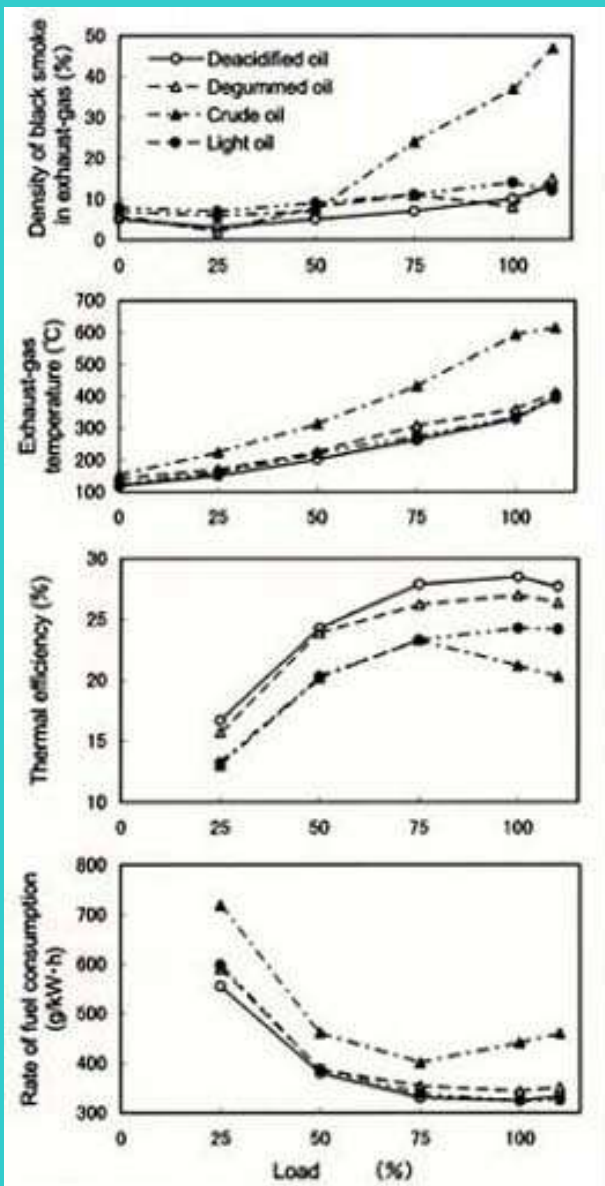


Fig.4.  
Thermal efficiency in rated load operation

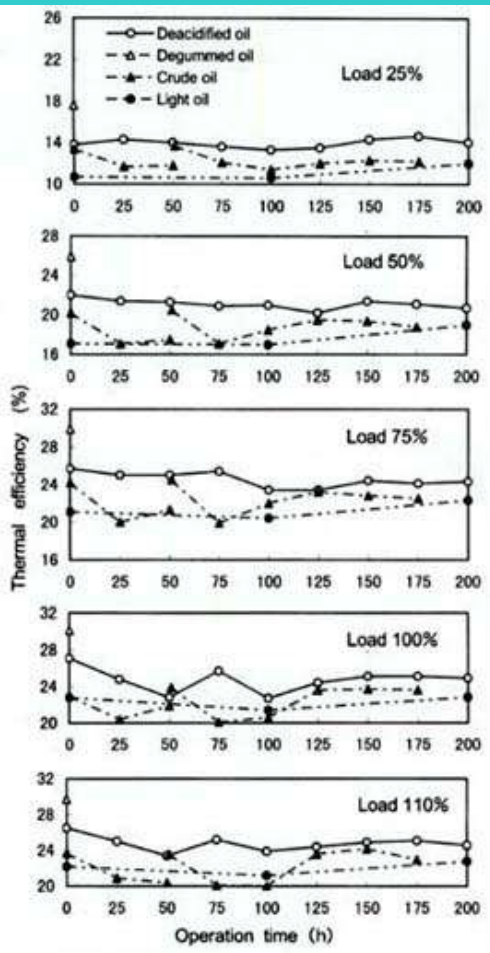




Fig.5.  
Injection nozzle after long-term operation using  
crude rapeseed oil



[Back](#)

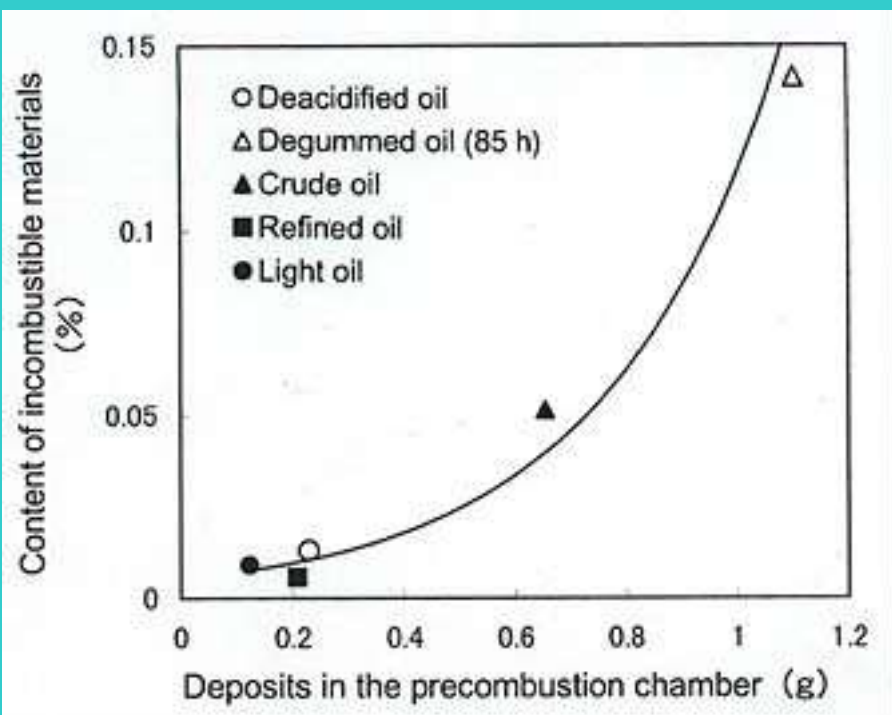
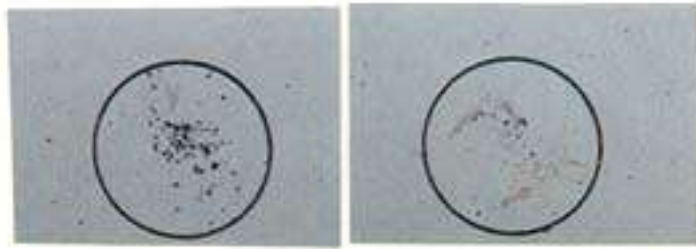


Fig.6.  
Relationship between the amount of deposits in the precombustion chamber and the content of incombustible materials in fuel

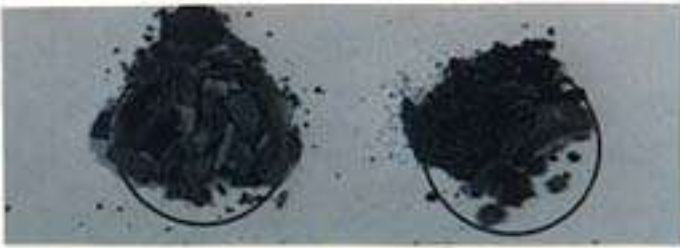


[Back](#)



Refined oil

Deacidified oil



Degummed oil

Crude oil

Fig.7.  
Amount of incombustible materials in the percom-  
bustion chamber after no-load continuous operation  
using rapeseed oil



[Back](#)



Fig.8.  
Injection nozzle after no-load continuous  
operation using degummed rapeseed oil



[Back](#)



Table 1. Characteristics of used

	Rapeseed oil				Light oil
	Deacidified oil	Degummed oil	Crude oil	Refined oil	
Density (20°C, g/cm ³ )	0.920	0.919	0.919	0.922	0.837
Net calorific value (MJ/kg)	38.9	38.8	38.6	39.1	45.6
Kinematic viscosity (20°C, mm ² /s)	63.4	76.6	63.9	83.4	1.64
(40°C, mm ² /s)	29.4	35.2	29.7	36.9	1.20
Content of incombustible materials ^{a)} (%)	0.012	0.141	0.050	0.004	0.007
Fatty acids (%)					
Palmitic acid	4.0	4.3	4.3		
Oleic acid	60.3	60.9	59.1		
Linoleic acid	21.1	20.9	22.4		
Arachidic acid	10.7	10.0	10.2		

a): Method involving the measurement of carbon residues.


[Back](#)

Table 2. Secification of engines

	A-Engine	B-Engine
Manufacturing company	Yanmar Diesel Co., Ltd.	Yanmar Diesel Co., Ltd.
Engine model	NSA40G	HA4B
Type	4-Stroke cycle diesel engine	4-Stroke cycle diesel engine
Combustion system	Precombustion chamber type	Precombustion chamber type
Bore × stroke (mm × mm)	ø66 × 66	ø66 × 66
Rated output (kW/rpm)	2.57/2,200	2.57/2,400
Maximum output (kW/rpm)	2.94/2,200	2.94/2,400
Compression ratio	23.5	23.5
Injection time	10° BTDC	16.5° BTDC
Injection nozzle	Pintle type	Pintle type
Nozzle opening pressure (MPa)	13.7	15.7

A-Engine: Tests on short-term performance and long-term operation.

B-Engine: Test on no-load continuous operation.



[Back](#)

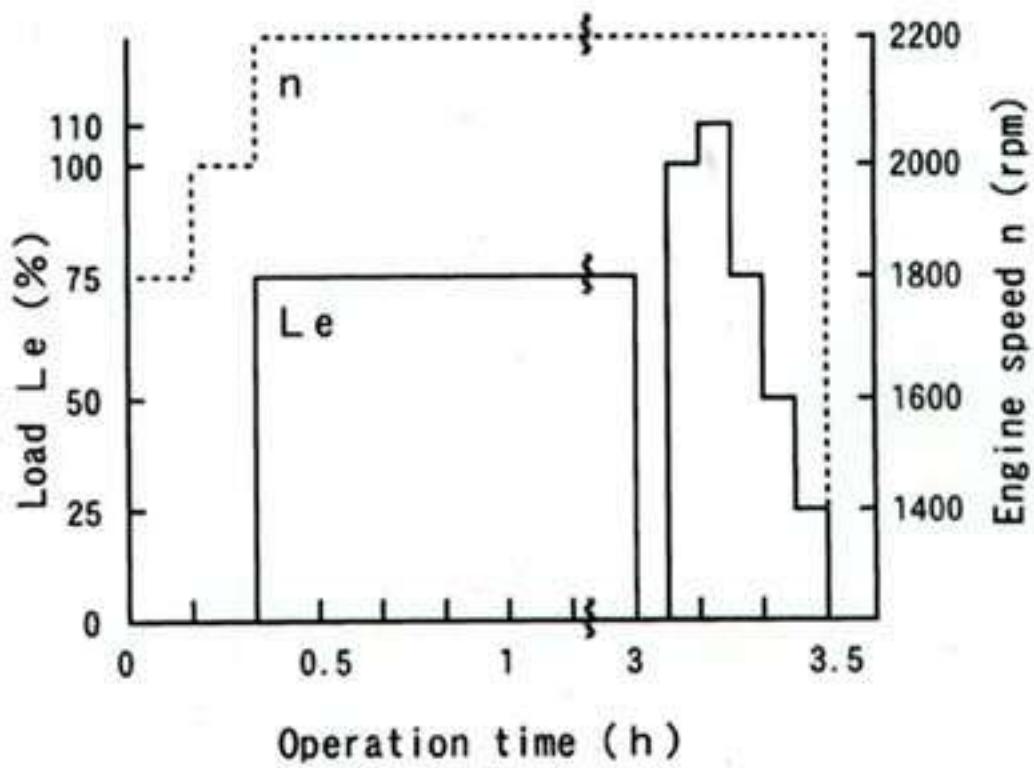


Fig.1.  
Operating mode of short -term engine performance tests



[Back](#)

# Estimation of Flowering Date and Temperature Characteristics of Fruit Trees by DTS Method

Sukeyuki ONO*1 and Takamitsu KONNO*2

*1 Department of Citriculture, National Institute of Fruit Tree Science  
(Kuchinotsu, Nagasaki, 859-2501 Japan)

*2 Department of Soils and Fertilizers, National Agriculture Research Center  
(Tsukuba, Ibaraki, 305-8666 Japan)

## ---Abstract-----

A theory and a method were developed for obtaining temperature characteristics for the flowering period of deciduous and citrus fruit trees from the number of days transformed to standard temperature (DTS) based on the Arrhenius law. Three temperature characteristics, i.e. (1) starting date of calculation (ST day), (2) temperature sensitivity (Ea) or temperature coefficient of growth rate (K) and (3) DTS from ST day to flowering time, were determined in a total of 186 cultivars from 11 species on the Main Island of Japan (Honshu) based on the daily mean air temperature and flowering date recorded over a period of at least 10 years. These temperature characteristics differed among cultivated species and may enable to estimate the flowering date.

**Discipline:** Horticulture

**Additional key words:** temperature sensitivity, Arrhenius law, deciduous and citrus fruit trees

Received for publication, November 2, 1998

## [1...10:References](#)

This paper is designated as contribution No.1119, from the National Institute of Fruit Tree Science. This work was supported in part by a Grant-in-Aid (Development of Information Management for Agricultural Technique System) from MAFF. Part of this research was carried out in collaboration with the Project Research Team of the National Agriculture Research Center.

**Present address:**

*2 Faculty of Agriculture, Niigata University (Niigata, 950-2102 Japan)

## ---Introduction-----

The climate of the islands of Japan ranges from subpolar to subtropical. Most of the fruit orchards are located on hillsides and are exposed to extreme weather conditions due to the elevation and topography of the sites. Development of new land for fruit production depends on the accurate estimation of the growing period. Predictive methods for estimating the flowering period could facilitate orchard management practices such as artificial pollination, hormone treatment and cultivation control. A theory was proposed based on the number of days transformed to standard temperature (DTS) derived from the Arrhenius law, and a method (DTS method) was developed by analyzing the relationship between the biological activity and temperature⁴. Although the Arrhenius law has been applied to higher plants ^{6-8,10}, there is no report in which temperature characteristics have been used to improve plant growth. We have shown that temperature characteristics based on the Arrhenius plot can be used effectively to determine the budding and flowering period of Japanese pear trees¹⁰. Omoto and Aono⁹ were able to estimate the flowering date of *Prunus yedoensis* at 21 meteorological stations in Japan by using the DTS method.

An Arrhenius plot of the growth of higher plants has been reported to give a straight line with a negative slope or a line broken into 2 parts, in the range between the temperature of physiological zero and that at which protein denaturation occurs^{6,8}. Our experiments have shown that the Arrhenius plot of the flowering period of Japanese pear trees gives linear plots at 7-20, and that the Arrhenius law can be effectively applied to the flowering period ¹⁰. Thus, temperature characteristics were calculated assuming that the Arrhenius law could also be applied to fruit trees other than Japanese pear.

## ---Theory and methods-----

The relationship between the growth rate constant(k) and temperature can be expressed by equation (1) according to the Arrhenius law. The DTS is defined as the number of days transformed to standard temperature. The equation for the calculation of DTS can be derived as follows :

The ratio of the growth rate constant (k) at arbitrary temperature (T) to (ks) at a standard temperature (Ts) can be represented by equation (4) using equation (1).

$$k = A \exp(-Ea/RT) \text{-----(1)}$$

$$dk/dT = A \exp(-Ea/RT) \cdot Ea/RT^2 = k \cdot K \text{-----(2)}$$

$$K = Ea/RT^2 \text{-----(3)}$$

$$m = k/ks = \exp;Ea(T-Ts)/RTTs \text{-----(4)}$$

where k: growth rate constant (day⁻¹),

Ea : apparent activation energy (Jmol⁻¹ ),

R : gas constant (8.314 JK⁻¹ mol⁻¹),

T : absolute temperature (deg⁻¹),

K : temperature coefficient of growth rate (deg⁻¹),

A : constant,

ks : growth rate constant at standard temperature Ts,

m : conversion coefficient.

Selecting 20 as the standard temperature, the daily 20 DTS can be expressed as follows.

$$\text{Daily 20 DTS} = \exp;Ea (t-293)/586T \text{-----(5)}$$

where t is the daily mean temperature.

The following 3 temperature characteristics must be obtained for each tree species to estimate the flowering date.

(1) ST day : Starting date of calculation,

(2) Ea : Temperature sensitivity¹⁰,

(3) DTS : DTS from ST day to the flowering date.

First step was to calculate the mean DTS from arbitrary Ea in each year using the flowering date for at least 10 years. The next step was to compute the residual sum of squares (RSS)for the difference between the estimated and observed flowering period. The optimal temperature characteristics, i.e. ST day, Ea, DTS, gave the minimum RSS.

Calculation was conducted using the personal computer program FLOWER based on the date for fullbloom and the daily mean air temperatures in each year, using 20 as the standard temperature. Phenological data were recorded for apple, pear, grape, peach, persimmon, chestnut, plum, blueberry, satsuma mandarin and other citrus trees. Data used included the daily mean air temperatures. Data on the date of flowering were kindly provided by 57 public research institutes.

## ---Results and discussion-----

Temperature characteristics were obtained with considerable accuracy from the calculation of the observed dates and the estimated dates of flowering in 186 cultivars from 11 fruit tree species in Honshu. Typical dates for apple, pear, peach, plum, grape, persimmon, chestnut, satsuma mandarin and navel orange trees are shown in [Fig. 1](#). In some cases the estimated dates that were different from the actual observed dates were obtained during a year with unusual weather. These results show that temperature characteristics up to the flowering period can be obtained with a good accuracy using the DTS method from Kagoshima to Hokkaido for almost all the

cultivated species of fruit trees.

The ST day for navel orange was estimated to be January 10 when RSS was smallest, and that for persimmon February 25 when minimum RSS was observed between February 20 through March 1. Except for some cases, estimation of the ST day was easily obtained. Therefore, it is important to give a physiological interpretation to the ST day, rather than a mathematical interpretation. The estimated ST day in the present study fell in early January for citrus trees, early February for peach trees, mid-February for apple, pear and plum trees, late February to early March for grape, persimmon and chestnut trees. Based on the reports on cold hardiness and dormancy, these periods were found to correspond to those when endodormancy had been terminated (1-3,5).

[Fig. 2](#) shows the relationship between the standard temperature and DTS obtained from temperature sensitivity ( $E_a$ ) values of various fruit trees in the central part of Honshu Island. Since the  $E_a$  value varied among tree species, the change in the rate of DTS was different at various standard temperatures and could be classified into 2 groups([Fig. 2](#)). At 20, the first group consisting of apple, pear, peach and plum trees, flowered between 10 and 25 days, the second group consisting of grape, persimmon, chestnut and citrus trees, flowered between 47 and 58 days. In the central part of Honshu, the first group flowered from late March through mid-April, while the second group flowered from mid-May through early June. In the second group, the ST day for citrus fell early in mid-January while that for grapes, persimmons and chestnuts fell in late February. Interestingly, there was a difference in the growth period from the endodormancy to the flowering period even though the groups showed the same flowering period.

[Fig.1.\(59KB\)](#), [Fig.2.\(19KB\)](#)

Temperature characteristics of cultivated species in the central part of Honshu are shown in [Table 1](#).  $E_a$  values ranged from 75 to 92 kJ mol⁻¹ except for plums, the difference being negligible among the cultivated species. The K values calculated from equation (3) were in the range of 0.105-0.129, suggesting that the change of one degree in the air temperature caused a 10.5-12.9 change in the growth rate. Plums had a K value of 0.152 and were the most sensitive to the change in the air temperature among the cultivated species. Such a difference in  $E_a$  was reflected in the DTS. For example, chestnuts flowered within approximately 58 days at the standard temperature of 20, being the slowest among the tested trees, and yet, below 12.5, they showed the shortest flowering period ([Fig. 2](#)).

**Table 1. Values of temperature characteristics determined by DTS method for fruit tree flowering (central part of Honshu Island)**

Leading cultivar	Days transformed to the standard temperature (DTS)		Temperature sensitivity ( $E_a$ )		Starting date for estimating DTS	$r^2$ (d)	Number of years used for calculation	Observation site
	DTS(a)	RSS(b)	$E_a$ (c)	RSS(b)				
Apple (Fuji)	23.3	1.03	79.41	5.43	Feb.15	0.882	16	Nagano
Japanesepear(kousui)	21.3	1.16	83.59	8.78	Feb.15	0.902	16	Tochigi
Peach(Hakuto)	19.1	1.18	75.23	7.10	Jan.20	0.888	19	Nagano
Plum(Santa Rosa)	10.1	0.67	108.66	10.03	Feb.10	0.908	12	Gunma
Grape(Delaware)	49.4	0.82	83.59	6.27	Feb.20	0.868	22	Yamagata
Persimmon(Fuyu)	54.9	0.32	79.41	7.10	Feb.25	0.870	31	Gifu
Chestnut(Tanzawa)	58.4	0.72	75.23	18.39	Mar.15	0.781	18	Ibaraki
Satsuma mandarin (Aoshima Unshiu)	49.7	1.22	83.59	9.19	Jan.15	0.865	14	Shizuoka
Navel orange (Morita Navel)	47.9	1.35	91.95	7.52	Jan.10	0.856	13	Shizuoka

a):DTS; days.

b):RSS; Residual sum of squares, difference between estimated and actual flowering period.

c): $E_a$ ; kJ mol⁻¹.

d):Correlation coefficient between observed an estimated flowering dated.



[Forward to:-Mechanism of Off-Flowering Date and Temperature Characteristics of Fruit Trees-](#)

ono



[Back to: Contents](#)



[Back to: JIRCAS Home Page](#)

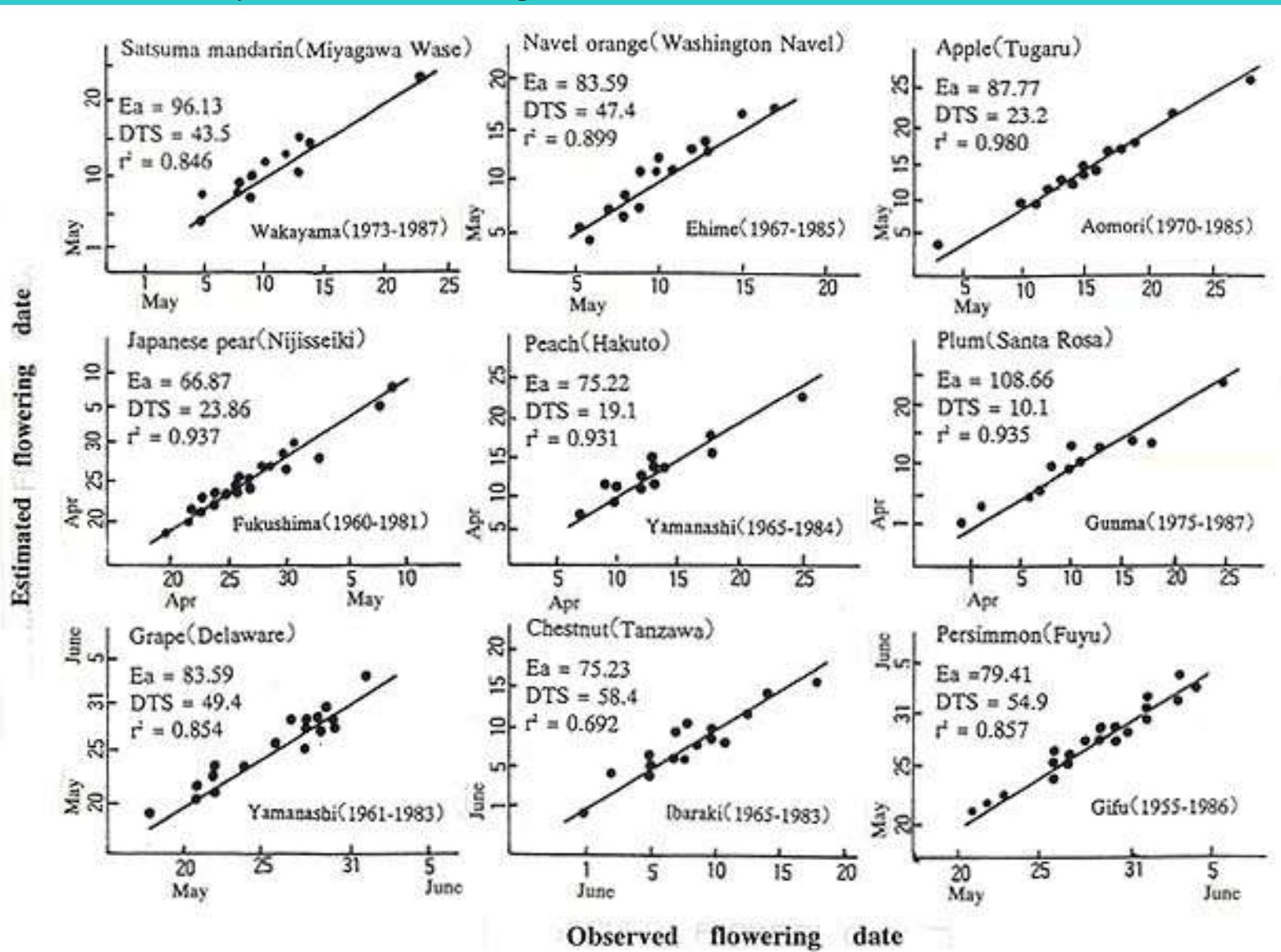
**---References-----**[Back](#)

- 1) Aono, Y. Omoto, Y. (1990): Estimation of blooming date for *Prunus yedoensis* using DTS combined with chill-unit accumulations. *J. Agric. Meteorol.*, 45, 243-249.
- 2) Chandler, W. H. Tufts, W. P. (1934): Influence of the rest period on opening of buds of fruit trees in spring and on development of flower buds of peach trees. *Proc. Am. Soc. Hort. Sci.*, 30, 180-186.
- 3) Fuchigami, L. H. & Cheng-Chu, N. (1987): Degree of growth stage model and rest-breaking mechanisms in temperate woody perennials. *HortScience*, 22, 836-845.
- 4) Konno, T. & Sugihara, S. (1986): Temperature index for characterizing biological activity in soil and its application to decomposition of soil organic matter. *Bull. Natl. Inst. Agro-Environ. Sci.*, 1, 51-68.
- 5) Lang, G. A. (1987): Dormancy; a new universal terminology. *HortScience*, 22, 817-820.
- 6) Lyons, J. M. & Paison, J. K. (1970): Oxidative activity of mitochondria isolated from plant tissues and resistance to chilling injury. *Plant Physiol.*, 45, 386-389.
- 7) Minchin, A. & Simon, E. W. (1973): Chilling injury in cucumber leaves in relation to temperature. *J. Exp. Bot.*, 24, 1231-1235.
- 8) Nishiyama, I. (1975): A break on the Arrhenius plot of germination activity in rice seeds. *Plant Cell Physiol.*, 16, 533-536.
- 9) Omoto, Y. & Aono, Y. (1989): Estimation of blooming date for *Prunus yedoensis* by means of kinetic method. *J. Agric. Meteorol.*, 45, 25-31.
- 10) Ono, S. et al. (1988): Effect of temperature on the number of days for budding and flowering of Japanese pear. *J. Agric. Meteorol.*, 44, 203-208.

[Back](#)



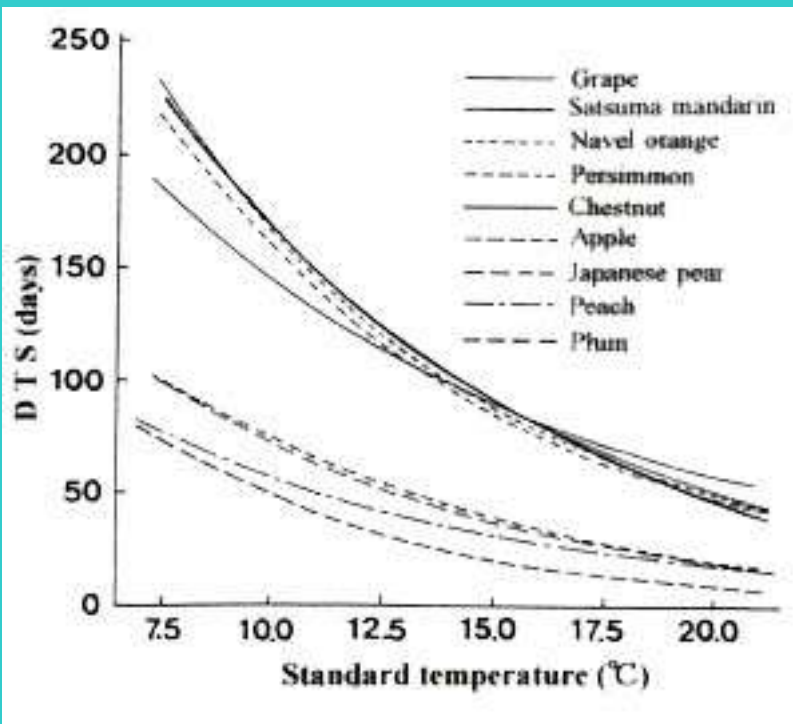
Fig.1. Relationship between observed and estimated flowering data by dts method in fruit trees  
 Ea: kJ mol⁻¹, dts: days with 20 standard temperature.



[Back](#)

Fig.2.

Relationship between standard temperature and DTS based on temperature sensitivity ( $E_a$ ) in various fruit trees ([Table 1](#))



[Back](#)

# Mechanism of Off-Flavor Production in *Brassica* Vegetables under Anaerobic Conditions

Kazuhiro DAN, Masayasu NAGATA and Ichiji YAMASHITA

Department of Applied Plant Physiology, National Research Institute of Vegetables, Ornamental Plants and Tea  
(Ano, Mie, 514-2392 Japan)

## ---Abstract-----

Mechanism of the production of off-flavor in *Brassica* vegetables, mainly broccoli stored under anaerobic conditions was studied. Methanethiol and dimethyl disulfide were identified as the volatile sulfur compounds in the headspace of anaerobically stored *Brassica* vegetables, including broccoli. When the activity of C-S lyase, a key enzyme for the formation of volatile sulfur compounds, was measured, no significant changes were observed in the C-S lyase activity in broccoli kept under anaerobic and aerobic conditions. The most obvious difference between anaerobically and aerobically kept broccoli was the degradation of the cell membranes. These results suggest that under anaerobic conditions volatile sulfur compounds are formed by the degradation of cellular membrane lipids and loss of intracellular compartmentation, allowing the enzyme-substrate reaction to proceed. Furthermore, the factors which affect the production of the volatile sulfur compounds, under anaerobic conditions were also investigated. Methanethiol which was one of the first compounds formed under anaerobic conditions appears to be primarily responsible for the off-flavor. Therefore, the chemical nature of the formation processes of methanethiol was also analyzed.

**Discipline:** Postharvest technology

**Additional key words:** broccoli, storage, volatile sulfur compounds

Received for publication, October 29, 1998

[1....12\):References](#)

## ---Introduction-----

Modifying the storage atmosphere by lowering O₂ and/or increasing CO₂ prolongs storage life and enables to preserve the high quality of many fresh fruits and vegetables. Packaging with polymeric films with specific gas permeabilities creates a modified atmosphere which exerts a beneficial effect on the extension of the storage life of various fruits and vegetables. The composition of the atmosphere in the package depends on the respiration rate of the commodity and the gas permeation rate of the film. However, when the respiration rate increases because of the increase in the holding temperature, O₂ concentration decreases and CO₂ concentration increases in the package to levels that result in the development of an off-flavor if the gas permeability of the film is insufficient.

In Japan, *Brassica* vegetables are commercially important crops, and among *Brassica* vegetables, broccoli is a highly perishable commodity and its quality and shelf-life markedly depend on the storage conditions. Modifying the atmosphere storage of broccoli under suitable O₂ and CO₂ conditions has enabled to extend the shelf-life of broccoli. However, fresh broccoli kept in modified atmosphere storage with very low O₂ and/or very high CO₂ levels produced an off-flavor, although the original appearance was retained⁷⁾. Although the production of this offensive flavor appears to be a critical factor responsible for market losses in broccoli, the mechanism of off-flavor formation under anaerobic conditions has not been elucidated. An understanding of the mechanism(s) involved in the development of off-flavor could contribute to the improvement of the shelf-life of broccoli and the extension of its postharvest availability. In this paper, the mechanism of the formation of undesirable flavor in *Brassica* vegetables, especially broccoli stored under anaerobic conditions is described.

## --Off-flavor production in *Brassica* vegetables stored under anaerobic conditions--

*Brassica* vegetables stored under anaerobic conditions developed off-flavor. As shown in [Fig. 1](#) (10 KB), ethanol, acetaldehyde, methanethiol, and dimethyl disulfide were identified as the volatile compounds in the headspace of anaerobically stored broccoli (*Brassica oleracea* L. var. *italica*). Ethanol and acetaldehyde formation may result from anaerobic respiration. Volatile sulfur compounds, such as methanethiol and dimethyl disulfide, are mainly involved in the production of the undesirable flavor of broccoli stored under anaerobic conditions. These volatile compounds were also formed in other *Brassica* vegetables, such as cabbage (*B. oleracea* L. var. *capitata*), cauliflower (*B. oleracea* L. var. *botrytis*), Chinese cabbage (*B. campestris* L. ssp. *pekinensis*) and komatsuna (*B. campestris* L.) stored under anaerobic conditions. In *Brassica* vegetables, broccoli easily developed a strong off-flavor under anaerobic conditions. Therefore, broccoli was used as a material for the following experiments.

**--Factors controlling the production of volatile sulfur compounds under anaerobic conditions--****1) Plant parts**

A number of microorganisms have been reported to produce methanethiol. However, a recent study carried out by Derbali et al.⁽⁸⁾ suggested that volatile sulfur compounds produced in broccoli under anaerobic conditions were of plant origin, which was confirmed by using sterile broccoli seedlings. The proposed mechanism for the formation of volatile sulfur compounds in *Brassica* vegetables is illustrated in [Fig. 2](#) (19 KB). To determine the levels of volatile sulfur compounds, fresh broccoli florets were divided into flower buds and pedicels which were analyzed for the content of S-methyl-L-cysteine sulfoxide and the activity of C-S lyase. Production of methanethiol and dimethyl disulfide under anaerobic conditions was significantly higher in flower buds than in pedicels ([Fig. 3](#)) (18 KB), and likewise, the content of their precursor, S-methyl-L-cysteine sulfoxide, was about 4 times higher in flower buds ([Table 1](#)). The activity of C-S lyase, which catalyzes the conversion of S-methyl-L-cysteine sulfoxide to methanethiol and dimethyl disulfide, was significantly higher in flower buds than in pedicels ([Table 1](#)).

**Table 1. Concentration of S-methyl-L-cysteine sulfoxide and activity of C-S lyase in fresh broccoli flower buds and pedicels⁽⁶⁾**

Plant part	S-Methyl-L-cysteine sulfoxide (mg/g f.w.)	C-S lyase activity (units/g f.w.)
Flower buds	2.12 ± 0.004	7.7 ± 0.57
Pedicels	0.51 ± 0.086	1.2 ± 0.06

**2) Temperature**

Fresh broccoli florets were stored at 10, 20, and 30 under anaerobic conditions. High temperature promoted the production of methanethiol and dimethyl disulfide from anaerobically treated florets ([Fig. 4](#)) (20 KB). It is well known that temperature is the major environmental factor in the postharvest life of fresh vegetables because, within the physiological temperature range, the velocity of a biological reaction, increases 2- to 3-fold for every 10 rise in temperature. Therefore, the formation of methanethiol and dimethyl disulfide from anaerobically treated broccoli was affected by the temperature.

**3) Effect of the duration of the low temperature pre-storage period**

After fresh heads were pre-stored in the air at 1 for 7, 14 and 21 days, the florets were kept under anaerobic conditions. Low temperature pre-storage reduced the production of volatile sulfur compounds under anaerobic conditions, even though the S-methyl-L-cysteine sulfoxide content and C-S lyase activity did not decrease⁽⁶⁾. It is thus assumed that the decrease in the production of volatile sulfur compounds is due to other factors, along with the increase in the duration of the pre-storage period. The visual appearance, such as green color and tightness of head, deteriorated with the increase of the duration of the period of pre-storage at low temperatures.

 [Continue to: Mechanism of formation of volatile sulfur compounds](#)

 [Back to: Contents](#)

## ---Mechanism of formation of volatile sulfur compounds-----

### 1) Loss of intracellular compartmentation

To analyze the mechanism of formation of volatile sulfur compounds, freshly harvested broccoli were stored under anaerobic conditions. During the storage, there was no significant difference in the activity of *C-S* lyase between the anaerobically kept and aerobically kept broccoli, though a large amount of volatile sulfur compounds was generated³). These observations suggest that the formation of volatile sulfur compounds may not be associated with the increase in the activity of *C-S* lyase. The percentage of electrolyte leakage from flower buds sections of aerobically kept broccoli increased gradually during storage ([Fig.5](#))(13 KB), whereas that from flower buds sections of anaerobically kept broccoli increased rapidly. Furthermore, the free fatty acid to total fatty acid ratio of both aerobically and anaerobically kept broccoli increased during storage, while the ratio in anaerobically kept broccoli was significantly higher than that in aerobically kept broccoli³)(data not shown). These results suggest that anaerobic treatment accelerated cell membrane degradation compared to natural senescence of broccoli under aerobic conditions. Significant cell membrane degradation was reflected by the large increase in the percentage of electrolyte leakage and the rise in the free fatty acid to total fatty acid ratio. Free fatty acid accumulation in the bilayered membrane has been correlated with the appearance of gel phase domains^{1,11,12}). The occurrence of gel phase lipid domains in the membrane leads to a packing defect resulting in the loss of selective membrane permeability, particularly to ions and small molecules. Presumably, the loss of membrane integrity contributes to the loss of intracellular compartmentation.

Much of the characteristic odor and flavor associated with *Brassica* vegetables is due to the degradation of non-protein sulfur-containing amino acids, such as S-methyl-L-cysteine sulfoxide by *C-S* lyase in the tissues without reaction with the substrate until the tissues are physiologically and/or physically damaged.

These results indicate that, under anaerobic conditions, volatile sulfur compounds, such as methanethiol and dimethyl disulfide are formed by the degradation of cellular membrane lipids and the loss of intracellular compartmentation, thus, allowing enzymes and their substrates to react.

### 2) Methanethiol production

Methanethiol which was one of the first compounds formed under anaerobic conditions appears to be primarily responsible for the offensive odor. Dimethyl disulfide may evolve from the oxidation of methanethiol. However, the chemical nature of the formation processes of methanethiol in *Brassica* has not been well-characterized. In this study, broccoli tissues were mechanically injured in order to disrupt intracellular compartmentation and the factors responsible for the formation of methanethiol from S-methyl-L-cysteine sulfoxide were investigated.

A solution of disrupted fresh broccoli tissues was mixed with one of the reagents. Addition of L-methionine, L-cystine or oxidized glutathione to the solution did not induce the formation of methanethiol, whereas the addition of L-cysteine or reduced glutathione to the solution resulted in the production of a considerable amount of methanethiol and small amounts of some other unknown volatile sulfur compounds ([Table 2](#)). Reducing agents (L-ascorbic acid or sodium borohydride), however, did not induce the production of more methanethiol, which indicates that free SH of L-cysteine or reduced glutathione is responsible for the formation of methanethiol.

The fresh tissue solution was passed through a filter with a molecular weight cut off of 10,000. The filtrate was mixed with L-cysteine. A significant amount of methanethiol evolved after the addition of L-cysteine ([Table 3](#)), suggesting that the reaction leading to the formation of methanethiol by the addition of L-cysteine, may not be enzymatic. However, the same tests with a tissue solution prepared from previously autoclaved broccoli failed to reveal the production of methanethiol, which indicates that enzyme(s) were involved in some steps of the pathway of methanethiol formation.

**[Table 2. Effects of sulfur-containing amino acids, glutathione, L-ascorbic acid, and sodium borohydride on the formation of methanethiol in the headspace of stoppered test tubes containing a disrupted tissue solution of fresh broccoli⁴](#)**

<u>Treatment</u>	<u>Methanethiol (peak area x 10⁻⁴)</u>	
Control	0.7	
L-Cysteine	131.4	
L-Methionine	0.7	
L-Cystine	0.6	
Glutathione (reduced form)	91.1	
Glutathione (oxidized form)	0.8	
L-Ascorbic acid	0.7	<a href="#">Back</a>
Sodium borohydride	0.8	

The reaction mixture with each 10 mM reagent except for the control was incubated at 20 for 1 h.

**Table 3. Formation of methanethiol from disrupted tissue solution of broccoli⁴⁾**

<u>Treatment</u>	<u>Addition of L-cysteine(a)(mM)</u>	<u>Methanethiol (peak area x 10⁻⁴)</u>	
Disrupted fresh tissue solution	No	0.7	
	5	108.7	
Disrupted fresh tissue solution (Mol. wt. ≤ 10,000 fraction)	No	1.3	
	5	119.4	
Disrupted tissue solution prepared from heat-treated tissues	No	0.6	
	5	1.6	<a href="#">Back</a>

The reaction mixture was incubated 20 for 1 h. a): Final concentration in the reaction mixture.

Methanethiol is considered to be produced as a result of the conversion of S-methyl-L-cysteine sulfoxide to an unstable methanesulfenic acid intermediate by C-S lyase in *Brassica* which is then condensed and dehydrated to form more stable methyl methanethiosulfinate. The amount of methyl methanethiosulfinate which was detected in the solution of disrupted fresh tissues immediately after preparation ([Table 4](#)), increased about 10 times during a 2-h incubation at 20. The reaction mixture of the solution of disrupted fresh tissues and S-methyl-L-cysteine sulfoxide released a large amount of methyl methanethiosulfinate. When L-cysteine was mixed with the solution of disrupted fresh tissues, methyl methanethiosulfinate disappeared. No methyl methanethiosulfinate was detected in the disrupted tissue solution, prepared from heat-treated broccoli. The thiolsulfonates, -SO-S-, react rapidly with L-cysteine²⁾. The following reaction might have occurred in the mixture solution of methyl methanethiosulfinate and L-cysteine.



**Table 4. Methyl methanethiosulfinate formation in the disrupted tissue solution of broccoli after each treatment ⁴⁾**

<u>Treatment</u>	<u>Methyl methanethiosulfinate</u> (peak area x 10 ⁻⁴ )
Disrupted fresh tissue solution (initial)	5.2
Disrupted fresh tissue solution incubated at 20 for 2 h	58.9
Disrupted fresh tissue solution + 10 mM S-methyl-L-cysteine sulfoxide ^a ) incubated at 20 for 2h	229.9
Disrupted fresh tissue solution + 5 mM L-cysteine ^a ) incubated at 20 for 2 h	Not detected
Disrupted tissue solution prepared from tissues exposed to 100 for 10 min	Not detected
a): Final concentration in the reaction mixture.	Not detected

In our study, only a trace amount of methanethiol was produced after fresh tissue disruption, and almost concurrently with methyl methanethiosulfinate. Derbali et al.⁸) and Di Pentima et al.⁹) reported that a considerable increase in the content of free amino acids, particularly sulfur-containing amino acids and their derivatives, was observed in broccoli stored under anaerobic conditions, which resulted in the production of volatile sulfur compounds including methanethiol. Their findings suggest that methanethiol may be formed as a result of the reaction of methanethiosulfinate with free SH-containing amino acids and peptides under anaerobic conditions.

### ---Prevention of off-flavor production-----

Methanethiol and dimethyl disulfide are derived from a common precursor, methyl methanethiosulfinate, which is a product of the C-S lyase-catalyzed degradation of S-methyl-L-cysteine sulfoxide. The selection of or breeding for cultivars with low S-methyl-L-cysteine sulfoxide content or C-S lyase activity may enable to develop broccoli with fewer undesirable volatile sulfur compounds under anaerobic conditions. Presently, there are no broccoli cultivars with an extremely low production of volatile sulfur compounds under anaerobic conditions⁵). Moreover, in common to *Brassica* vegetables, the production of volatile sulfur compounds is significantly higher in flower buds than in leaves or stems⁵). These findings suggest that the off-flavor is readily generated in broccoli compared with other *Brassica* vegetables, because the main edible portion of broccoli consists of flower buds. Therefore, proper storage and distribution management is presumably the major condition for postharvest handling of *Brassica* vegetables, especially broccoli.

### ---References-----



[Back to the first page](#)

- 1) Barber, R. F. & Thompson, J. E. (1983): Neutral lipids rigidify unsaturated acyl chains in senescing membranes. *J. Exp. Bot.*, 34, 268-276.
- 2) Cavallito, C. J., Buck, J. S. & Suter, C. M. (1944): Allicin, the antibacterial principle of *Allium sativum*. II. Determination of the chemical structure. *J. Am. Chem. Soc.*, 66, 1952-1954.
- 3) Dan, K. et al. (1997): Formation of volatile sulfur compounds in broccoli stored under anaerobic condition. *J. Jpn. Soc. Hort. Sci.*, 65, 867-875.
- 4) Dan, K., Nagata, M. & Yamashita, I. (1997): Methanethiol formation in disrupted tissue solution of fresh broccoli. *J. Jpn. Soc. Hort. Sci.*, 66, 621-627.

- 5) Dan, K., Nagata, M. & Yamashita, I. (1997): S-methyl-L-cysteine sulfoxide content, C-S lyase activity and methanethiol production in broccoli cultivars. *J. Jpn. Soc. Hort. Sci.*, 66 (suppl. 2), 78-79 [In Japanese].
- 6) Dan, K., Nagata, M. & Yamashita, I. (1998): Effects of pre-storage duration and storage temperatures on the formation of volatile sulfur compounds in broccoli under anaerobic conditions. *J. Jpn. Soc. Hort. Sci.*, 67, 544-548.
- 7) Dan, K., Nagata, M. & Yamashita, I. (1998): Volatile sulfur compounds production and visual quality of broccoli. *J. Jpn. Soc. Hort. Sci.*, 67 (suppl. 1), 304.
- 8) Derbali, E., Makhlof, J. & Vezina, L.-P. (1998): Biosynthesis of sulfur volatile compounds in broccoli seedlings stored under anaerobic conditions. *Postharv. Biol. Technol.*, 13, 191-204.
- 9) Di Pentima, J. H. et al. (1995): Biogenesis of off-odor in broccoli storage under low-oxygen. *J. Agric. Food Chem.*, 43, 1310-1313.
- 10) Marks, H. S. et al. (1992): S-Methylcysteine sulfoxide in *Brassica* vegetables and formation of methyl methanethiosulfinate from Brussels sprouts. *J. Agric. Food Chem.*, 40, 2098-2101.
- 11) McKersie, B. D., Crowe, J. H. & Crow, L. M. (1989): Free fatty acid effects on leakage, phase properties and fusion of fully hydrated model membranes. *Biochim. Biophys. Acta*, 982, 156-160.
- 12) Yao, K., Paliyath, G. & Thompson, J. E. (1991): Nonsedimentable microvesicles from senescing bean cotyledons contain gel phase-forming phospholipid degradation products. *Plant Physiol.*, 97, 502-508.



[Forward to:-Development of Silk Yarns for Knitted Fabrics-](#)



[Back to: Contents](#)



[Back to: JIRCAS Home Page](#)



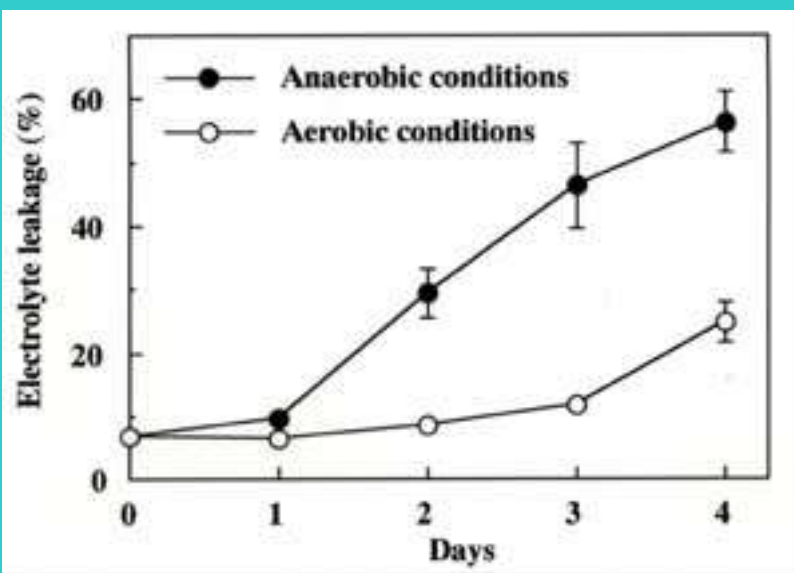


Fig.5.  
Change in percentage of electrolyte leakage from  
broccoli sections during storage

Flower buds were cut longitudinally into 2 parts with a razor and shaken in a flask containing deionized water. Electric conductivity of the sample medium was measured using a conductivity meter.

Total electrolyte leakage was obtained by boiling samples³⁾



[Back](#)

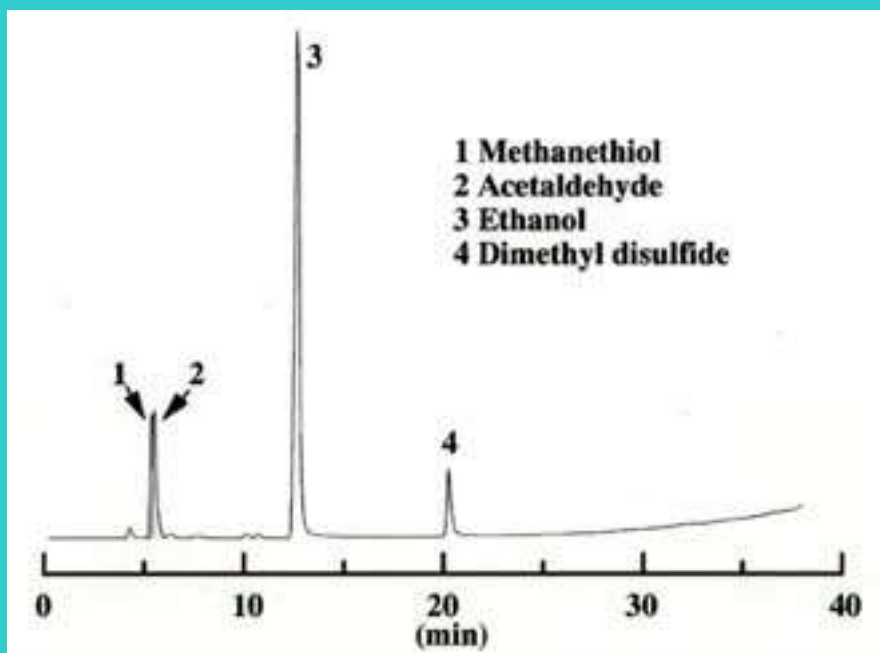


Fig.1.  
GC-FID chromatogram of volatile compounds  
in the headspace from anaerobically stored broccoli³⁾



[Back](#)

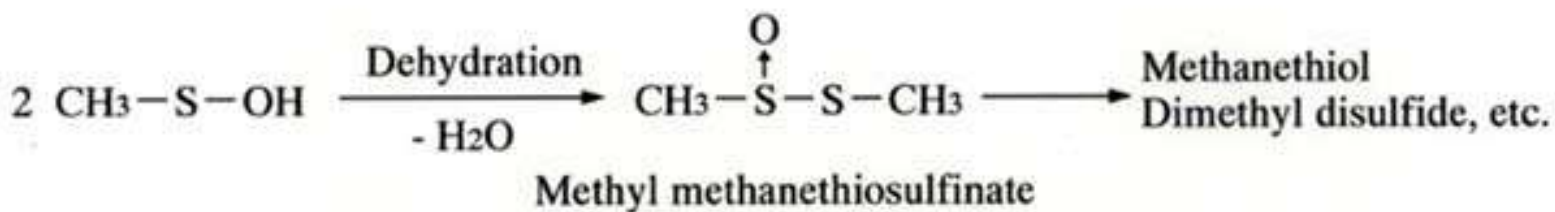
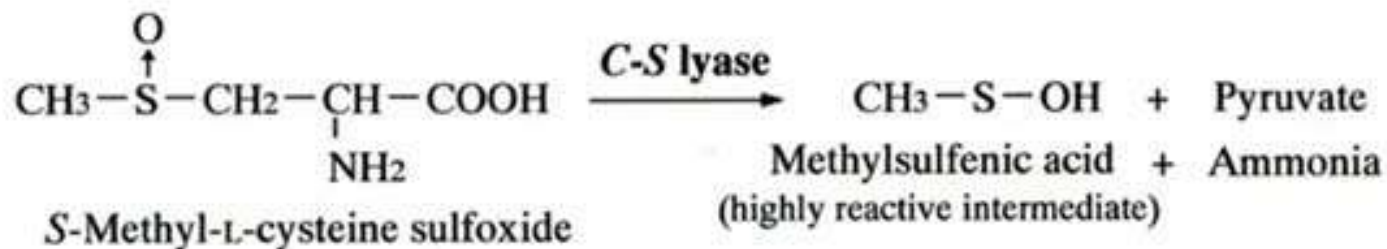


Fig.2.  
Proposed mechanism for the formation of volatile sulfur compounds  
(Marks et al., 1992)¹⁰



[Back](#)

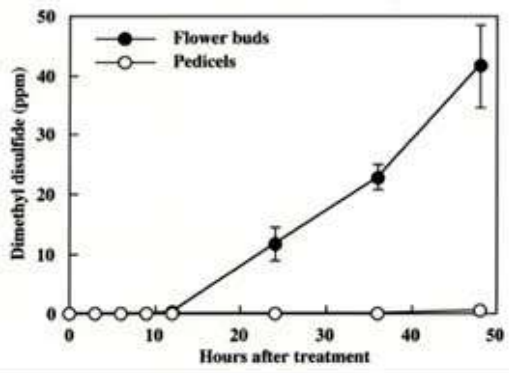
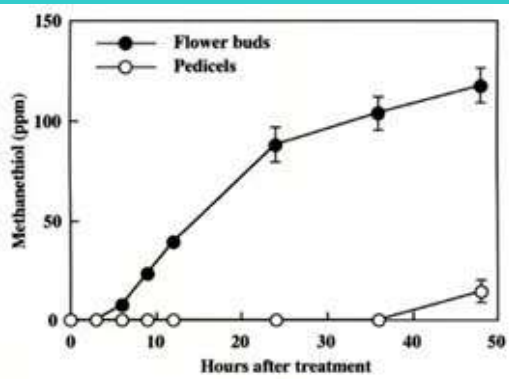


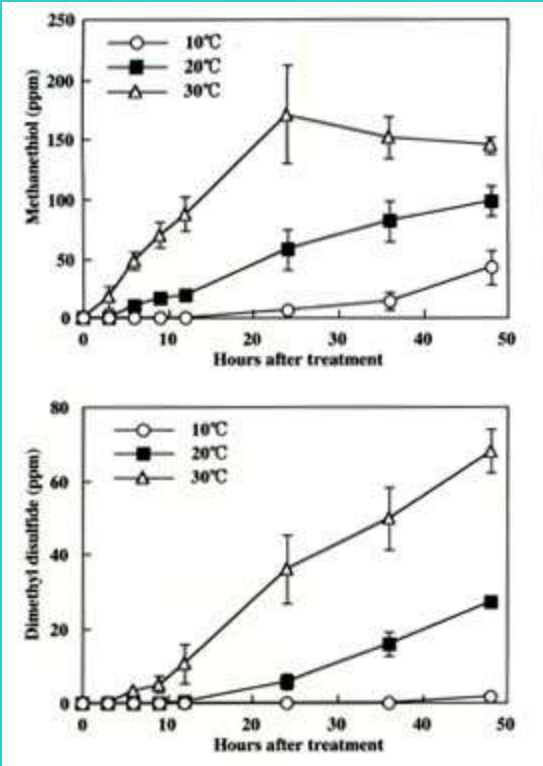
Fig.3. Methanethiol and dimethyl disulfide production from broccoli flower buds or pedicels under anaerobic conditions

Fresh flower buds or pedicels were sealed in glass bottles with 100% N₂ and held at 20 °C



Fig.4.  
Effect of holding temperature on the formation of methanethiol and dimethyl disulfide from broccoli florets under anaerobic conditions

Fresh florets were sealed in glass bottles with 100% N₂ and held at 10, 20 and 30 °C



# Development of Silk Yarns for Knitted Fabrics

**Hiroshi KATO and Tamako HATA**

Department of Insect Processing Engineering, National Institute of Sericultural and Entomological Science  
(Tsukuba, Ibaraki, 305-8634 Japan)

## ---Abstract-----

The mechanical characteristics of knitted silk fabrics prepared using salt-shrunk, fiber-dispersed and resin-treated silk yarns were determined based on the Kawabata Evaluation System for Fabrics (KES-FB). These knitted fabrics had a very soft feel and were fluffy and light. The amount of starting material yarn needed to obtain a knitted fabric of the same thickness was smaller in the case of the processed yarns compared with the unprocessed control yarn. Among the mechanical properties determined, the fabrics made from the processed yarns had higher values for the LT, WT, B, 2HB, LC, WC, MMD and SMD parameters, and lower values for the G, 2HG and 2HG3 parameters than fabrics made from the control yarn. These changes in mechanical characteristics suggest that knitted fabrics made from the processed silk yarns are flexible and elastic, have a higher resilience, and are soft and stretching. Although the primary hand feel (HV) parameters like 'Koshi' (stiffness), 'Fukurami' (fullness and softness), and 'Numeri' (smoothness) of the knitted fabrics made for winter outer garments from the processed silk yarns were about the same as those of knitted fabrics made from the control yarn, the former had a higher total hand feel value (THV) which is used for assessing fabric quality. Based on the determination of the various mechanical properties and the results of evaluation by users who wore the silk sweaters, it is considered that the salt-shrunk, fiber-dispersed and resin-treated silk yarns after a good potential as yarns for knitted fabrics.

**Discipline:** Sericulture/Agricultural environment

**Additional key words:** silk

Received for publication, November 9, 1998

[1.....12\):References](#)

## ---Introduction-----

Larger amounts of apparel fibers are currently used for making knitted fabrics than woven fabrics. However, in the case of silk yarns, more than 80% is used as material for Japanese dresses which are made of woven fabrics. Only several percent of the total is used for the manufacture of western style woven or knitted products like dresses, women's undergarments, ties, etc. Various attempts have been made to produce silk yarns with a crimped shape, as in the case of cotton, wool, and synthetic spun yarns, in order to expand the use of silk yarns for making knitted products³⁾.

The present author attempted to develop a crimped silk yarn with good fiber dispersion characteristics by applying the salt-shrinking technique¹⁾. By immersing twisted silk yarn with a twist coefficient of 1,500-2,500 in a hot (80) concentrated solution of calcium nitrate with a specific gravity about of 1.42 for about 1 min, the fiber shrank by 10-40%. Then, by applying the fiber dispersion treatment and resin treatment to the surface, very fine irregular crimping could be obtained in the yarn provided that the fibers were well dispersed. Knitted silk fabrics made from these processed yarns were bulky and showed a high resilience against deformation, while being flexible and elastic.

## ---Materials and methods-----

### 1) Materials

- (1) Raw silk (27d x 6, Z200T/m) x 5, S150T/m, first twist coefficient= 2,546
- (2) Raw silk (27d x 4, Z200T/m) x 3, S150T/m, first twist coefficient= 2,078, 25 skeins
- (3) Raw silk (27d x 4, Z150T/m) x 3, S100T/m, first twist coefficient= 1,559, 16 skeins

Samples (2) and (3) consisting of a total of 41 skeins of raw twisted yarn, were placed in a cotton fabric sack and degummed in the sack, in a 10 g/L solution of Marseille soap. The degumming was performed at 95 to the boiling temperature, for 60 min, and the degumming operation was repeated twice. Thereafter, the silk yarn samples were soaped and washed in warm water. The degumming loss was 24.2%. Sample (1) was used as unprocessed yarn (control) for making knitted fabrics. This yarn was also boiled in a sack for degumming, under the same conditions.

### 2) Preparation of salt-shrunk, fiber-dispersed and resin-treated yarn

The degummed twisted yarn samples (2) and (3) were soaked and treated for about 30 to 60 sec at 80 in a concentrated calcium nitrate solution with a specific gravity of 1.415 to obtain a shrinkage scatter in the range of 30-50%. Thereafter, the yarn samples were washed, subjected to fiber dispersion, surface-treated with resin, and treated with an anti-static agent, in that order. Processed yarns Nos. 2 and 3 with salt shrinkage values of 32.3 and 48.8%, respectively, were prepared from sample (2) and processed yarn No. 4 with a salt shrinkage of 39.0% was prepared from sample (3) ([Table 1](#)). The shrinkage level was calculated from the original length of the yarn and the yarn length after the treatment, i.e. after soaking in the calcium nitrate solution, washing with warm water to remove the calcium nitrate, washing, and drying, according to the formula given below.

$$\text{Salt shrinkage (\%)} = [(\text{Original yarn length} - \text{Yarn length after treatment}) / \text{Original yarn length}] \times 100$$

**Table 1.**  
Salt shrinkage, resin uptake of yarns and weight of knitted silk fabric used for making measurements

Yarn	Degumming loss (%)	Salt shrinkage (%)	Resin uptake (%)	Gauge No.a) (Rows x stitches)	Wale No.	Course No.	Weight (g)
No.1 (Raw silk,27d x 6,Z200) x 5 ,S150	25.4	--	--	48 x 36	56	36	13.74 (5.50) ^{b)}
No.2 (Raw silk,27d x 4,Z200) x 3, S150	24.2	32.3	9.5	50 x 36	60	36	6.27
No.3 (Raw silk,27d x 4, Z200) x 3, S150	24.2	48.8	9.1	48 x 36	52	36	7.31
No.4 (Raw silk,27d x 4, Z150) x 3, S100	24.2	39.0	10.8	52 x 38	60	38	6.13

a): Gauge No., and course No. refer to a 10 x 10 cm area of fabric.

b): The weight given inside the parenthesis for the yarn No.1 is the value after conversion to the size (324d) of the processed yarns Nos.2 and 4.

### 3) Electron micrographs

The processed silk yarn was coated with gold and observed at an acceleration voltage of 15 kV using a scanning electron microscope JXA-733S (Nihon Denshi).

#### **4) Preparation of knitted fabrics**

The fabric samples were machine-knitted and set by applying a steam iron for several minutes after placing a piece of cotton cloth over the fabric. The processed yarn samples Nos. 2-4 listed in Table 1 were used for making the knitted products. Two lady's sweaters were prepared from each type of yarn, with a total of 6 sweaters, and evaluated by wearing. Separately, one piece of knitted fabric each, with about the same thickness, was made from the processed yarns Nos. 1-4 ([Table 1](#)) for determining the mechanical properties.

To maintain uniform knitting conditions, it is generally desirable to keep the same gauge number for all the yarns (Nos. 1-4). However, since the thickness of the processed yarns varied depending on the extent of shrinkage, for measuring the Kawabata Evaluation System (KES) hand values, it was seemed necessary to obtain fabrics with about the same thickness, rather than using the same gauge number for knitting. Therefore, the person who operated the knitting machine set the gauge number (yarn density) at 48 to 50 rows x 36 to 38 stitches (10 cm x 10 cm), by observing the processed yarn ([Table 1](#)). The knitting machine operator had a high level of professional skill and a long experience.

#### **5) Determination of mechanical properties of the knitted fabrics**

Five groups of mechanical properties were determined, each 3 times, with a sample of the knitted fabric, using the "KPM-3-M" program for knitted fabrics(4,5,8). The means of the values along the wale direction and the course direction were used to express the tensile, bending, shearing, and surface characteristics of the knitted fabrics.

#### **6) End use tests with the knitted products**

Four ordinary consumers in their 30's and 40's were asked to evaluate the knitted sweaters. They used the sweaters for about 4 months after which they were asked to evaluate their performance by answering a questionnaire. Resistance to washing was examined with the sweater samples that were worn and washed repeatedly. The questions included in the questionnaire and the method of testing adopted followed the "Testing of commercial washable silk products" manual prepared by Kokumin Seikatsu Center(7).

Washing and handling were performed as follows: washing for 2 min in warm water by repeatedly pressing down; squeezing out the water by pressing, rinsing for about 2 min, removing the water by placing the sweater in a net and spin drying for 10 sec, and drying by hanging in the shade on a rod. The neutral detergent Acron manufactured by Lion K.K. was used for the washing.

The initial quality evaluation was performed before the first washing, through a questionnaire on the quality and wearing comfort of the sweaters. For quality evaluation after washing, the users were asked to give their opinion about wearing comfort after 5 washings, through a questionnaire. The shrinkage due to washing was measured and the fading of color and gloss was determined using a color computer SM-3-SCH manufactured by Suga Shikenki K.K. For determining the shrinkage, the length and bust size of the sweater before and after washing were measured following JIS L 1018(2) and calculated according to the formula given below.

Shrinkage after washing (%) = [(Size before washing - Size after washing) / Size after washing] x 100



[Continue to: Results and discussion](#)



[Back to: Contents](#)



## ---References-----

[Back to the first page](#)

- 1) Hoshiai, F., Yoneda, K. & Ariga, M. (1986): Evaluation of knitted silk products. Asahi Kasei Sen-i Kako Kenkyusho, 12-25 [In Japanese].
- 2) JIS L 1018 (1990): Method of testing stockinette fabric. 23-27 [In Japanese].
- 3) Kato, H., Hata, T. & Takahashi, T. (1997): Characteristics of wild silk fibers and processing technology for their use. *JARQ*, 31, 287-294.
- 4) Kawabata, T. (1973): Research on hand evaluation and standardization. *Sen-i Kogaku*, 26, 715-728 [In Japanese].
- 5) Kawabata, T. (1980): The standardization and analysis of the evaluation of hand feel (2nd ed.). Nihon Sen-i Kikai Gakkai, Osaka, 289 [In Japanese].
- 6) Kobayashi, K. & Tomizuka, M. (1990): Interrelation of tactile and visual senses on assessment of fabric hand. *Sen-i Gakkaishi*, 46, 251-257 [In Japanese].
- 7) Kokumin Seikatsu Center (1989): Results of testing washable silk products. Product Testing Department, 63-68 [In Japanese].
- 8) Ly, N. G. (1989): Error analysis of measurements made with the KES-F system. *Textile Res. J.*, 59, 17-25.
- 9) Matsuo, T. (1968): A development in the objective measurement of the quality of knitted fabrics used for underwear. *Sen. Ki. Shi.*, 21, T260 [In Japanese].
- 10) Mori, T. (1988): Mechanical properties and handle of twisted yarn-twistless yarn composite fabrics. *Kasei-Shi*, 39, 29-37 [In Japanese].
- 11) Murase, R. (1949): Studies on the shrinking of silk fibroin by the concentrated aqueous solution on neutral salt. *Sen-i Gakkaishi*, 5, 217-219, 334-340 [In Japanese].
- 12) Sakaguchi, H., Niwa, M. & Kawabata, T.(1989): Objective evaluation of tactile soft-feeling of underwear knitted-fabrics. *Sen-i Gakkaishi*, 45, 214-222 [In Japanese].

[Back](#)

**---Results and discussion-----****1) Properties of knitted fabrics**

Electron micrographs showing the surface morphology of salt-shrunk, fiber-dispersed and resin-treated yarn are shown in [Fig. 1](#). The yarns had a very good fiber dispersion and the fibers did not stick together. The twisting and bending of the yarn became more extensive with increased salt shrinkage. The trial products knitted from this type of processed yarn had a very soft hand feel and touch and were very light with good bulkiness and heat retention ([Fig. 2](#)).

*[Fig.1.\(81 KB\)](#), [Fig.2.\(19 KB\)](#)

[Table 1](#) gives the values for the degumming loss, salt shrinkage and resin uptake of the processed yarns, the gauge number, the actually observed wale number and course number of a 10 x 10 cm area; and the weight of a 20 x 20 cm piece of the knitted fabric.

The weight and thickness of the knitted fabric were closely related to the denier and yarn density. The weight of the fabric knitted from the unprocessed yarn (No. 1) was, on the average, 2.1 times larger than that of the fabric samples made from the processed yarns (Nos. 2-4). This is a reflection of the fact that the total denier of the raw twisted yarn used for making the unprocessed yarn was 810 d (27 d x 30), while it was 324 d (27 d x 12) in the raw untwisted yarn used for making the processed yarns. Thus, the former showed a 2.5 times larger weight, to begin with.

In the case of the processed yarns, because of the resin treatment of the yarn surface, about 10% of the weight is due to resin uptake. [Fig. 1](#) clearly indicated that the yarn structure is crimped and not straight. Even though the structure of the crystalline region of the silk fiber was destroyed and became amorphous during the salt shrinkage treatment, and the degree of molecular orientation in the amorphous part, which is considerably higher in silk compared to other fibers, was also lowered by the salt shrinkage treatment, leading to a reduction of the specific gravity of the silk, the 2.1 times larger weight of the knitted fabric made from the unprocessed yarn was within an acceptable range.

In spite of the 2.5 times difference in denier to begin with, when the initial pressure of 0.5 g/cm² was applied to the knitted fabric and its thickness was measured using the KES-FB4 device, the thickness of the knitted fabric made from the unprocessed yarn was 1.91 mm and that made from the processed yarns was in the range of 1.85-2.03 mm. The difference between the two types of fabrics was very small, being only 0.03-0.12 mm (1.6-6.3%) ([Table 2](#)), presumably because after salt shrinkage, fiber dispersion and resin treatments, the silk fiber became slightly thicker, the twisted yarn itself became well-dispersed, crimped and bulky, and the knitted fabric made from it was very fluffy and light. Therefore, although the processed yarn experienced a salt shrinkage of about 40%, a much smaller amount of processed yarn was needed for preparing a knitted fabric that was quite bulky.

**Table 2. Mechanical properties of test-made knitted silk fabrics**

Group	Parameter	Unit	No.1	No.2	No.3	No.4
Strength	LT	none	0.45	0.54	0.52	0.51
	W/T	gf x cm/cm ²	40.1	48.1	55.3	56.5
	RT	%	22.7	22.8	21.5	15.7
	EMT	%	35.46	35.6	44.0	44.2
Bending	B	gf x cm ² /cm	0.079	0.054	0.088	0.049
	2HB	gf x cm/cm	0.087	0.077	0.122	0.073
Shearing	G	gf/cm x deg	0.33	0.38	0.23	0.19
	2HG	gf/cm	1.38	1.66	0.85	0.75
	2HG3	gf/cm	1.98	1.71	1.07	0.89
Compression	LC	none	0.57	0.52	0.75	0.56
	WC	gf x xm/cm ²	0.65	0.73	0.74	0.79
	RC	%	40.8	42.2	37.9	42.1
Surface	MIU	none	0.24	0.27	0.30	0.26
	MMD	none	0.0089	0.9124	0.0144	0.0128
	SMD	¼m	4.86	4.31	5.06	4.42
Thickness	Ta)	mm	1.91	1.85	2.03	1.88
Weight	W	mg/cm ²	34.3	15.8	18.3	15.3

a): T is the thickness if the fabric when 0.5gf /cm² pressure was applied, calculated from the compression characteristics.

**2) Mechanical properties**

Only in very few cases has the fabric quality been evaluated through the measurement of the primary hand values, which is considered to be an objective method of quality evaluation (12). If the warp and weft directions of woven fabrics are considered, respectively, to be equivalent to the wale and course directions of knitted fabrics, the primary hand values calculated from the mechanical properties determined in feel testing may enable to evaluate the performance of the fabric (4). On the basis of this assumption, we determined the

mechanical properties of knitted fabric samples, all having about the same thickness ([Table 2](#)).

#### (1) Tensile characteristics

Tensile energy (WT) of the fabric was higher in the processed fiber, i.e. the salt-shrunk, fiber-dispersed and resin-treated yarn fabric, compared with the unprocessed fiber. The greater the shrinkage and the lower the number of twists in the yarn, the higher was the WT value of the fabric. The resilience (RT), i.e. the force of recovery from a deformative load, was more affected by the number of twists than by the processing of the yarn. When we compared the processed yarns Nos. 2 and 3 (Z200/S150) with the processed yarn No. 4 (Z150/S100), the former showed about the same RT value of the fabric as the unprocessed yarn, while the latter had a clearly lower fabric RT value. Apart from this, the value of the LT parameter which is a measure of tensile rigidity, was slightly increased by the processing of the yarn. Therefore, the fabric knitted from the processed yarn had smaller spaces in the knitted structure, with increased inter-fiber and inter-yarn contact, compared with the fabric made from unprocessed yarn. In spite of this, the fabric knitted from the processed yarn showed a high EMT (elongation or strain) against tensile force and therefore could be easily stretched. The results suggest that tensile recovery and tensile elasticity can be retained at the same levels as in the fabrics made from the unprocessed yarn, if the number of twists is not very low and the salt shrinkage is about 40%. All these findings suggest that soft, flexible and stretching knitted fabric can be prepared from the processed yarns.

#### (2) Bending characteristics

The values of the B and 2HB parameters were higher in the fabric made from processed yarn No. 3, which exhibited a greater salt shrinkage, than in the fabric made from yarn No. 2. Crimping induced by processing was optimum when the silk yarn had a twist coefficient of 1,500-2,500 and a salt shrinkage of 30-40%. Even when the original yarn had the same twist coefficient, the degree of twisting increased with increased salt shrinkage and resulted in greater final twisting, which affected the crimping and the processed yarn became somewhat hard in hand feel and lacked fluffiness and bulkiness. These characteristics may account for the increased resistance torque against the bending deformation and the increased bending strength and hysteresis in this type of fabric.

On the other hand, fabrics made from the processed yarns Nos. 2 and 4 showed about the same values for the B and 2HB parameters, which were lower than in the fabric made from the unprocessed yarn. These results suggest that knitted fabrics made from the processed yarns displayed a greater ease of bending and bending recovery. Therefore, if salt shrinkage and the twist number are controlled in a suitable range, well-crimped processed yarn can be obtained. It was found that processing enabled the fiber and yarn to move easily in response to bending deformation and the fabric had a flexible and smooth feel during bending. Based on these results, salt shrinkage of 48.8% for the yarn No. 3 appears to be excessive.

#### (3) Shearing characteristics

The values for the parameters G, 2HG and 2HG3, which reflect the shearing characteristics of fabrics, all showed a similar response to processing. Compared with the fabric made from the unprocessed yarn, these values were generally lower in processed yarn fabrics, although some of the values were comparable in the 2 types of fabrics ([Fig. 3](#)) (14 KB). Shearing deformation which is determined by factors like yarn pressure and slipping at the crossing points, bending deformation of the yarn, etc. is generally considered to be closely related to the bending characteristics⁹). In the present study, the fabric samples were produced under the same knitting conditions, to obtain the same knitted structure. Therefore, the effect due to the difference in the knitted structure is considered to be minimal.

The fabric made of unprocessed yarn had a high value of G. It showed a high yarn density and very close contact between yarns. Therefore, when a shearing deformative force was applied, the contact area between the yarns at the crossing points increased and the resistance torque increased making it difficult to change the angle of crossing¹⁰). Therefore, the knitted fabric was very hard, with little space within the fabric. In contrast, since the processed yarn fabrics had smaller hysteresis values (2HG and 2HG3), the fabric was resilient and fabrics made from yarn with high salt shrinkage had a small G value and the shape easily changed in response to shearing deformation force. In short, from the point of view of shearing characteristics also, knitted fabrics made from the processed yarns were soft and flexible.

#### (4) Compression characteristics


In the processed yarns, the values for the WC and RC parameters of the fabric tended to be higher. When we compared the fabrics made from Nos. 2 and 3 processed yarns, the No. 2 yarn fabric which had a lower salt shrinkage showed lower LC and higher RC values, compared with the No. 3 yarn fabric. The WC value was slightly higher in all the processed yarns, including No. 4 which had a small twist number. These results suggest that knitted fabrics made from the processed yarns could be easily compressed and showed a good recovery from compression also. This is believed to be due to fiber intertwining and the increased space in the yarn because of the crimping. However, as discussed in the section on bending characteristics, processed yarn with large salt shrinkage (No. 3 yarn) had high LC and low RC values because it had less crimping, and the fabric was not resilient.

It is known that woven wool fabrics made wholly from untwisted yarn, or in which untwisted yarn is mixed, show smaller LC and greater RC and WC values with an increased proportion of untwisted yarn in the fabric because the untwisted yarn is bulkier and has more space. It is however interesting to note that some of the compression characteristics of the fabrics made from processed yarns in the present study were similar to those of woven wool fabrics.

(5) Surface characteristics

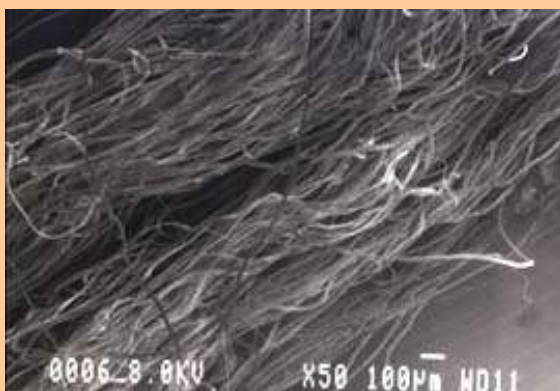
In the surface characteristics of the processed yarn knitted fabrics, the values of both the MIU and MMD parameters (the mean deviation of MIU) were higher than in the fabric made from unprocessed yarn. This increase in the MIU and MMD values in the processed yarn fabrics was ascribed to the fact that the processed yarns had a crimped shape and dispersed fibers and therefore, knitted fabrics made from them did not have a uniform surface. The space within the yarns, the intertwining or misalignment of fibers, fluff formation, etc. all enhanced the surface unevenness of the knitted fabrics.

The results obtained suggest that soft fluffy and resilient knitted fabrics can be produced from salt-shrunk, fiber-dispersed and resin-treated yarns. This is because the twisted silk yarns acquire irregular and minute crimping and good fiber dispersion so that the intertwining of fibers and space in the yarns are increased, giving flexibility and bulkiness to the fabric.

 [Continue to:\(3\) Hand feel, \(4\) End use tests, and References](#)

 [Back to: Contents](#)

Fig.1. Scanning electron micrographs of salt-shrunk, fiber-dispersed and resin-finished silk yarns and an unprocessed control silk yarn  
Yarns Nos.1, 2 & 3: (27d x 4, Z200T/m) x 3, SI50T/m,  
Yarns No.4: (27d x 4, Z150T/m) x 3. S100T/m.



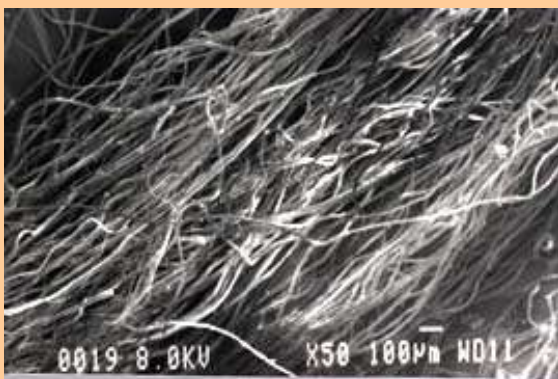
Yarn No.1, salt shrinkage 32.3%, resin uptake 0 %



Yarn No.3, salt shrinkage 48.8%, resin uptake 9.1%



Yarn No.2, salt shrinkage 32.2%, resin uptake 9.5%



Yarn No.4, salt shrinkage 39.0%, resin uptake 10.8%



[Back](#)

Fig

Fig.2.

Trial knitted products made from salt-shrunk, fiber-dispersed and resin-treated silk yarn

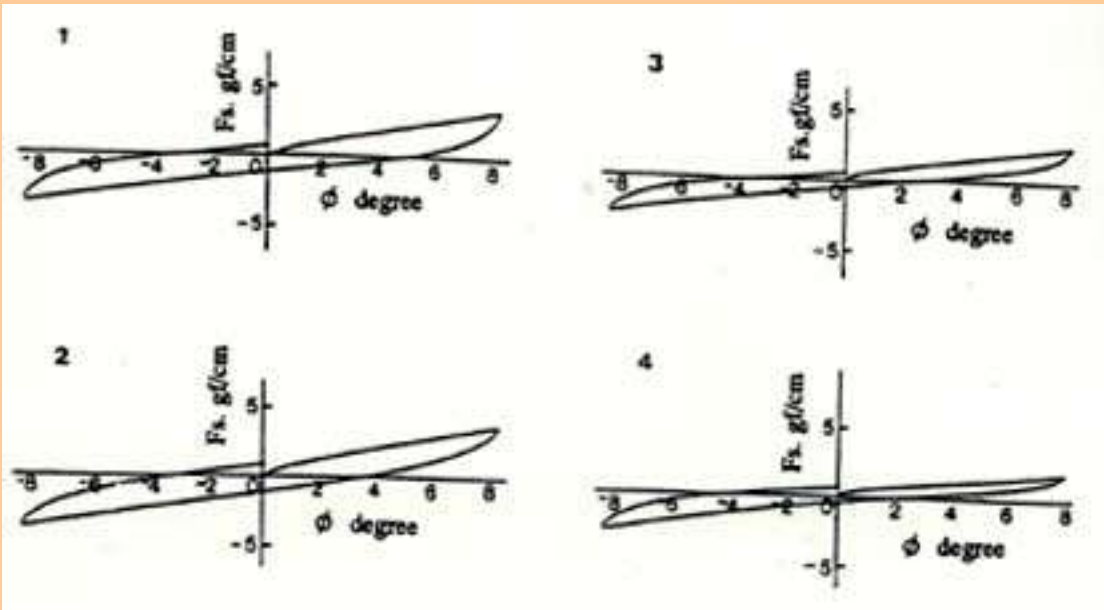


Left: Resin-treated,  
Right: Not treated with resin.



[Back](#)

Fig.3. Shearing characteristics of knitted fabrics made from salt-shrunk, fiber-dispersed and resin-treated silk yarns



Measurements were performed in the wale direction.

The number correspond to those given in [Table 1](#).



[Back](#)

**1....12):References**

## 3) Hand feel

The primary hand value (HV) which is a quantified feel parameter calculated based on the determination of the mechanical properties, reflects the stiffness, fullness and softness, crispness, and the anti-drape stiffness. HV is considered to be closely related to the fabric characteristics⁵⁾. We obtained 3 of the HV parameters, 'Koshi' (stiffness), 'Fukurami'(fullness and softness) and 'Numeri'(smoothness), and the total hand value (THV) using the mechanical values > HV and the HV > THV conversion formulae of Kawabata. We used the "KPC-5-N" program for the KES-FB system to carry out these conversions and for preparing the knitted fabric snake charts. [Table 3](#) gives the results of calculations using the criteria for outer winter garments (A) and winter undergarments (B). In the case of undergarments, the thermolab measurements could not be performed because of the limitations of the KES system. We therefore ignored the heat and moisture transfer characteristics that are obtained from thermolab measurements, and calculated HV and THV from the values of the mechanical characteristics KES-FB1 to KES-FB4.

**Table 3. Primary hand values of test-made knitted silk fabrics**

<u>Hand values</u>	<u>Criteria</u> ^{a)}	<u>No.1</u>	<u>No.2</u>	<u>No.3</u>	<u>No.4</u>
'Koshi'	A	1.7	1.8	2.1	1.1
	B	5.8	5.4	3.8	2.7
'Fukurami'	A	5.0	3.1	3.2	3.2
	B	16.3	16.3	16.6	18.8
'Numeri'	A	8.6	7.9	7.7	7.9
	B	9.6	8.8	9.7	10.9
THV	A	2.2	3.2	3.4	3.2
	B	6.0	2.2	2.2	1.5

a): A; For winter outer garments, B; For winter undergarments.

With the criteria for outer winter garments, the values for the 'Koshi' , 'Fukurami' and 'Numeri' parameters of the processed yarn fabrics were all about the same as in the unprocessed yarn knitted fabric. However, the values of THV, which is a parameter used for evaluating the fabric quality, were in the range of 3.2-3.4 in the processed yarn fabrics, compared with 2.2 in the unprocessed yarn fabric. The hand feel values were not affected by the salt shrinkage and number of twists. It became clear from these results that fabrics knitted from the processed yarns were superior in terms of THV, although they were not appreciably different from the unprocessed yarn fabric in terms of 'Koshi', 'Fukurami' and 'Numeri'.

The THV and mechanical properties determined above suggest that knitted fabrics made from processed yarns in the present study had the characteristic properties and good feel of the processed yarns and such yarns have the potential of becoming attractive silk yarns for knitted fabrics, which would expand the range of application of silk products and satisfy the requirements of consumers.

**4) End use tests**

## (1) Evaluation of initial quality

Four users were asked to evaluate the wearing comfort of the sweaters made from the processed yarns before washing. The users answered "Difficult to say" or "Somewhat poor" when asked about the flexibility of the garment. But regarding the feel of the fabric and wearing comfort, 3 out of 4 users answered "Fairly good". No users stated that the initial wearing quality of the sweaters was poor ([Table 4](#)). The knitted fabric made from processed yarns with 32.3 to 48.8% salt shrinkage lacked the silky gloss and was more like wool in external appearance. Therefore, all the users thought that the sweaters were made of wool, before they were told that they were made of silk. But after wearing them, many of the users said that they were "Very light and easy to wear" compared to woolen sweaters which are generally considered to have just the opposite characteristics⁶⁾. In fact, one of the users suggested that



### 3) Hand feel

perhaps the material was suitable for undergarments like slips and summer blouses because it was light, soft to touch, moisture absorbing, and not stuffy. The "light feel" of garments is an important feature for summer wear. This is an impression about the fabric which is closely related to the "cool touch".

**Table 4. Evaluation of users after wearing the new (unwashed) sweater**

	Poor (-2)	Somewhat (-1)	Difficult to say (0)	Moderately good (+1)	Good (+2)
Touch			2a)	2a)	
Flexibility		3a)	1		
Wearing comfort			3	1	

a): The figures refer to the number of users.

In one study on the evaluation of knitted fabrics for undergarments involving a group of 18 expert technologists having 1-20 years of experience in undergarment manufacture and a group of 9 ladies consumers in the 22-38 age group, the 2 groups showed no significant difference in the perception of hand feel, with a high inter-group correlation, the evaluation rather differing from person to person¹²⁾. The 4 users in the present study had a high level of knowledge about garments and acquired a wide experience from managing households. If we take into consideration the report of Sakaguchi et al.¹²⁾, according to which the judgement of consumers was quite reliable, it is clear that the knitted fabrics made from the processed yarns in the present study had a good fabric quality while they were new.

#### (2) Evaluation of quality after washing

Shrinkage caused by washing of the knitted garments is shown in [Fig. 4\(35 KB\)](#). There was a considerable scatter in the values, perhaps because of slight variations in the method of taking measurements by the users. However, the overall trend showed that the shrinkage varied depending on the extent of salt shrinkage of the yarn. In sweaters made from yarn with a low salt shrinkage (32.3%), after one washing, the length decreased by 5.0 cm while the bust size increased by 4.0 cm, resulting in the change of the shape of the garment. However, after repeated wearing and washing, the dimensions became more or less similar to those of the new sweater. Thus, there was no problem of shrinkage caused by washing. The sweaters made from yarn with a high salt shrinkage (48.8%) showed a reduction in both length and bust size as the garments were washed repeatedly. After 5 washings, the average shrinkage of the 2 sweaters was 7.9% for the length and 2.0% for the bust size, showing significantly higher shrinkage in the length direction. Thus, it may be necessary to improve the quality.

The opinion of the users about the qualities of the garments, such as the feel, flexibility, wearing comfort, etc. after 5 washings was that the sweaters were not appreciably different from the new sweaters with respect to shrinkage, color fading, gloss, hand feel, fluff formation, feel, flexibility and wearing comfort ([Table 5](#)).

**Table 5. Evaluation of 4 users for the sweaters after 5 washings**

### 3) Hand feel

	Poor (-2)	Somewhat poor(-1)	Not different from when the sweater was new (0)	Moderately good (+1)	Good (+2)
Shrinkage			4 ^{a)}		
Color fading			4		
Gloss		2 ^{a)}	2		
Hand feel		2	2		
Fluff formation		2	2		
Touch	1 ^{a)}		2	2 ^{a)}	
Flexibility		2	1		
Wearing comfort			3	1	

a): The figures refer to the number of users.

It has been reported that the value of silk blouses and undergarments decreased after washing because of shrinking, yellowing, and changes in gloss and hand feel⁷⁾. In one report¹⁾, it was stated that knitted garments made from spun silk yarns shrank after hand washing with a neutral detergent, their color faded, and the gloss and hand feel were poor, the flexibility characteristic of silk disappeared and the hand feel of the garments became similar to that of garments made from low quality cotton. However, knitted garments made from processed silk yarn in our study showed a lower decrease in quality than anticipated.

The results shown in Figs. 5 and 6 suggest that the sweaters were resistant to washing. However, when asked to give their overall opinion about the sweaters after 5 washings, some users gave comments like "It does not slip well", "It sticks to the body", "It got slightly stretched after repeated use", "It lacks stiffness", "It has a coarse feel", "It lacks smoothness", etc.

There were opinions like "Overall, I do not like the sweater" and "I do not wish to wear this type of sweater". We do not think that all these negative comments can be attributed to the quality of the processed yarns. The sweaters were rather thickly knitted, did not have much gloss which made them look like wool, and had a design that was not very sophisticated. Thus, the fact that samples had just the opposite image to the generally held delicate image of silk garments may have exerted an adverse effect.

 [Forward to: -Screening of Thermophilic Lactic Acid Bacteria Producing Bacteriocins in the Tropics-](#)

 [Back to: Contents](#)

 [Back to: JIRCAS Home Page](#)

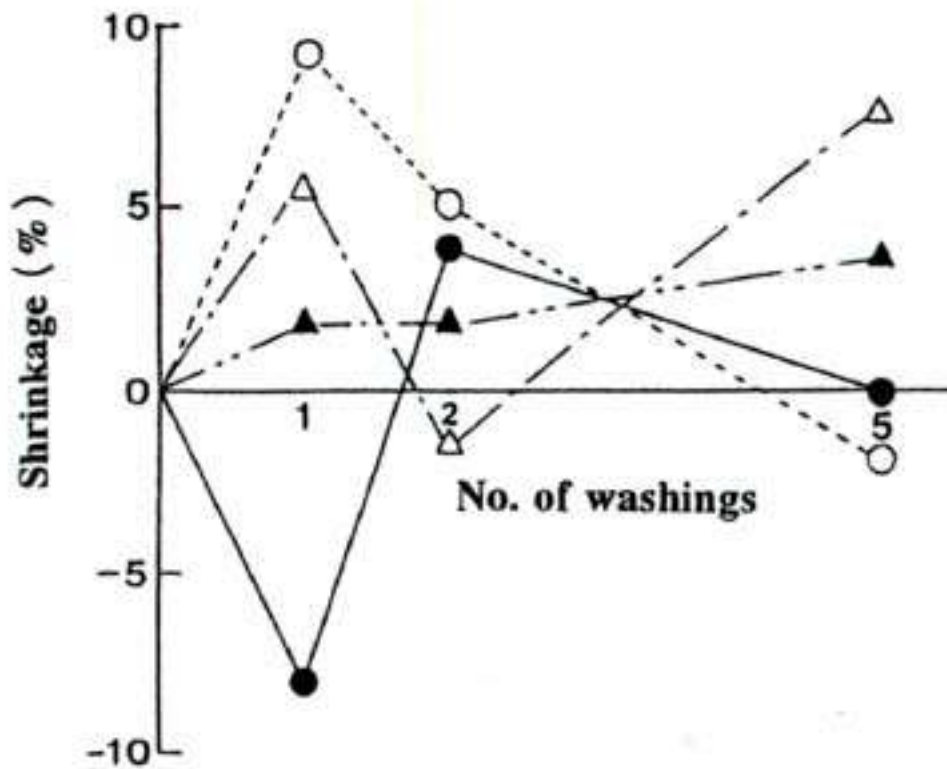


Fig. 4. Changes in shrinkage caused by repeated washing  
 ...○...: Length of garment made from yarn No. 2 (salt shrinkage 32.3%),  
 —●—: Bust size of garment made from yarn No. 2 (salt shrinkage 32.3%),  
 —△—: Length of garment made from yarn No. 3 (salt shrinkage 48.8%),  
 —▲—: Bust size of garment made from yarn No. 3 (salt shrinkage 48.8%).



[Back](#)

# Screening of Thermophilic Lactic Acid Bacteria Producing Bacteriocins in the Tropics

Sadahiro OHMOMO*1, Miho KOBAYASHI*2, Mizuo YAJIMA*3, Puangpen SUYANANDANA*4, Paipan BUDKA*5 and Praphaisri SOMCHAI*4

*1,2: Department of Animal Products, National Institute of Animal Industry(NIAI)  
(Tsukuba, Ibaraki, 305-0901 Japan)

*3: Products Developing Section, Asama Chemical Co. Ltd.  
(Nihonbashi-Kodenmacho, Chuoh-ku, Tokyo, 103-0001 Japan)

*4,6: Biological Science Research Department, Thailand Institute of Scientific and Technological Research(Chatuchak, Bangkok 10900, Thailand)

*5: Microbiological Resources Center, Thailand Institute of Scientific and Technological Research (Chatuchak, Bangkok 10900, Thailand)

A part of this study was supported by a Grant from the Science and Technology Agency (STA), Japan.

Present address:

*1:Department of Animal Nutrition, NIAI (Tsukuba, Ibaraki, 305-0901 Japan)

## ---Abstract-----

Bacteriocin-like activity (BLA) was screened in 50 and 30 strains of thermophilic lactic acid bacteria (LAB) isolated from silages and fermented vegetables, respectively. The BLA of the isolates against some bacterial strains was hardly detected by the paper disk method, while in the isolates of 50 strains (62.5% of all) it was clearly detected by the spot-on-lawn method. Only one strain K-4 isolated from grass silage showed a clear BLA against *Enterococcus faecium* in both methods. The strain belonging to the genus *Enterococcus* produced BLA in the logarithmic growth phase in MRS medium. The BLA was completely inhibited by treatment with trypsin, remained stable under boiling conditions and the molecular weight was about 20,000 based on SDS-PAGE analysis. The BLA produced by this strain was due to bacteriocin and positive against only *Ec.faecium* and *Ec.faecalis*.

**Discipline:** Food

**Additional key words:** Enterococcus sp.

Received for publication, October 8, 1998

[1...15:References](#)

## ---Introduction-----

We have a long history of association with lactic acid bacteria (LAB) and hardly experience any damage due to LAB. Therefore, it is considered that LAB and bacteriocins produced by LAB are generally safe (10). Actually, a typical bacteriocin "nisin" has already been used in the food industry as a bacteriocidal additive in more than 50 countries of the world. However, the actual use of nisin is limited because of its low solubility in water and lower activity in neutral pH solution. Information on other bacteriocins produced by LAB is limited and bacteriocin except for nisin has not been applied to the food industry.

Therefore, many research groups^{2,3,5}) have attempted to screen new bacteriocins produced by LAB. In these screenings, LAB were mainly isolated from dairy products in the temperate and frigid zones. However, screening in the tropical zone has not been conducted although some LAB isolated from tropical fermented vegetables and silages may produce new bacteriocins with properties suitable for adaptation to a tropical niche. Therefore, LAB strains that can produce bacteriocin-like activity (BLA) were screened in Thailand, a tropical country.

In this paper, the results of screening conducted in Thailand together with the production of BLA by a selected strain and some of the properties of BLA are described.

## ---Materials and methods-----

### 1) Microorganisms

The bacterial strains used in this experiment as target strains and their culture conditions are listed in Table 1.

**Table 1. Culture conditions and medium for target strains**

<u>Strain</u> ^{a)}	<u>Medium</u> ^{b)}	<u>Culture conditions</u>
<i>Enterococcus faecalis</i> IFO 12964	MRS	37, 20 h, Anaerobic
<i>Enterococcus faecium</i> IFO 13712	MRS	37, 20 h, Anaerobic
<i>Lactobacillus plantarum</i> IFO 14711	MRS	37, 20 h, Anaerobic
<i>Lactobacillus plantarum</i> TISTR 541	MRS	37, 20 h, Anaerobic
<i>Pediococcus acidilactici</i> TISTR 952	MRS	37, 20 h, Anaerobic
<i>Leuconostoc mesenteroides</i> TISTR 473	MRS	37, 20 h, Anaerobic
<i>Staphylococcus aureus</i> IFO 15035	NB	37, 20 h, Aerobic
<i>Staphylococcus aureus</i> TISTR 029	NB	37, 20 h, Aerobic
<i>Salmonella typhimurium</i> TISTR 292	NB	37, 20 h, Aerobic
<i>Escherichia coli</i> MAFF 911145	NB	37, 20 h, Aerobic
<i>Escherichia coli</i> TISTR 527	NB	37, 20 h, Aerobic
<i>Klebsiella pneumoniae</i> JGRI G-1	NB	37, 20 h, Aerobic

a): Abbreviations for strain numbers of culture collections are as follows; IFO(Institute for Fermentation, Osaka), TISTR(Thailand Institute of Science and Technological Research, Bangkok.), MAFF(Ministry of Agriculture, Fisheries and Forestry, Tsukuba), NGRI(National Grassland Research Institute, Nishi-nasuno).

b): Both media were purchased from Difco Laboratories, USA. MRS; Lactobacilli MRS broth, NB; Nutrient broth.

### 2) Screening

Fifty LAB strains from silages prepared by using plastic bags¹⁴) in Khon Kaen and Bangkok, Thailand, and gathered in Chiang Mai, Thailand, were subjected to the screening. Thirty LAB strains from fermented vegetables bought in the market in Bangkok, Thailand, were also subjected to the screening. These strains were anaerobically isolated by an ordinary plate culture method using an agar plate with Lactobacilli MRS broth (MRS: Difco, USA) containing 1.6% agar and 0.5% CaCO₃ at 43. For each isolate, the ability to produce BLA was examined by the spot-on-lawn method and the paper disk method.

Spot-on-lawn method⁴): Each isolate was inoculated onto the MRS agar plate to form a colony less than 8 mm in diameter and cultured at 43 for 24 h, anaerobically. After the culture, the surface of the agar plate (surface with colony formation) was overlaid with a suspension of a target strain at the concentration of ca. 10⁶ cfu/mL in soft agar medium and then incubated to grow the target strain for 24 h under favorable conditions as shown in Table 1. Thereafter, the BLA of the isolate was evaluated based on the formation of a clear zone around the colonies. The medium containing 0.7% agar which is suitable for the growth of the target strains ([Table 1](#)) was used as a soft agar medium.

Paper disk method⁴⁾: A paper disk (diameter 8 mm, thin type, Toyo Roshi, Japan) with adsorbed 30¼L of cell-free culture filtrate was put on an agar plate containing a target strain at the concentration of ca. 10⁶ cfu/mL. Then, the agar plate was incubated under conditions suitable for the growth of the target strain ([Table 1](#)). After incubation for 24 h, the BLA of each isolate was evaluated based on the formation of a clear zone around the paper disk. Each isolate was cultured in the MRS broth at 43 for 20 h and the culture filtrate was adjusted to pH 6.0 with a NaOH solution before adsorption onto the paper disk.

### 3) *Partial purification of the BLA*

Partially purified BLA was obtained by ultra-filtration, ammonium sulfate precipitation and ion exchange chromatography. The culture filtrate of strain K-4 using 1 L of MRS broth at 43 for 12 h under anaerobic conditions was subjected to ultra-filtration by using a Diaflow YM-10 membrane (MW cut off, 10,000) (Amicon Inc., USA), the same operation was repeated after the addition of 200 mL of 20 mM acetate buffer (pH 4.0) and the sample was concentrated to 50 mL after the addition of 20 mM of the same buffer. Thereafter, solid ammonium sulfate was added step-wise for more than 60 min to the concentrate to reach 75% saturation at 4 and allowed to be stirred for 1 h on a magnetic stir plate. The precipitated suspension was centrifuged for 20 min at 10,000 x g at 4 and decanted. The pellet was dissolved in 50 mL of the same buffer and dialyzed against distilled water using a Spectra/por 1 tube (MW cut off, 6,000-8,000) (Funakoshi Co. Ltd., Tokyo). The dialysate yielded about 2 g of powder by freeze-drying. The powder was dissolved in 10 mL of the same buffer and used for column chromatography (1.6 cm diameter x 40 cm length) with CM Sephadex C-50 (Amersham Pharmacia Biotech Ltd, Sweden) equilibrated with the same buffer. After adsorption of the solution onto the gel, the column was washed with 100 mL of the same buffer and eluted with the same buffer containing 0.8 M sodium chloride. The fraction eluted with the sodium chloride solution was dialyzed against distilled water and yielded 650 mg of powder by freeze-drying. The powder was used for SDS-PAGE analysis and the test of characteristics of BLA.

### 4) *SDS-PAGE*

The BLA was analyzed by sodium dodecyl sulfate polyacrylamide gel electrophoresis (SDS-PAGE) on a high cross-linked gel (15%T, 3 x 51 x 58 mm)⁸⁾ at 30mA for 2 h. Calibration proteins (Combithek, Boehringer Mannheim Biochemica, Germany) were used as molecular weight markers.

### 5) *Sensitivity to heat, pH and trypsin*

The partially purified powder was dissolved in 20 mM acetate buffer (pH 4.0), the pH of the solution was adjusted to 5.0, 6.0 and 7.0 with a NaOH solution and the activity of each pH solution was assayed. The solution prepared in the same manner (pH 6.0) was heated at 100 for 20 min and the remaining activity was assayed. Furthermore, the same solution was treated with trypsin (Sigma Chemical Co., USA) at a final concentration of 0.5 mg/mL. Samples with or without trypsin were filter-sterilized and incubated at 37 for 12 h. The remaining activity was assayed. All the BLA was assayed by the paper disk method.

### 6) *Standard line for determining bacteriocin activity*

The bacteriocin activity was quantitatively determined by the paper disk method using nisin (1,000 IU/mg, Aplin & Barrett Co., UK) as standard bacteriocin and *Ec. faecium* IFO 13712 as a target strain. The logarithmic concentration of nisin between 500-10,000 IU/mL gave an essentially straight line against the diameter of the clear zone formed around the paper disk by the target strain. This straight line (referred to as standard line) showed in [Fig. 1](#) (13 KB) was used for determining the bacteriocin activity.



[Continue to: Results and Discussion](#)



[Back to: Contents](#)

## -----Results-----

### 1) BLA of isolates

**Table 2** shows the BLA of typical isolates obtained by the spot-on-lawn method and the paper disk method. Among 50 LAB strains isolated from silages, 20 strains (40% of all) displayed a BLA against some target strains when the spot-on-lawn method was used. All the LAB strains isolated from fermented vegetables displayed a BLA against some target strains when the spot-on-lawn method was used. However, strains found positive by the spot-on-lawn method hardly showed a BLA when the paper disk method was used except for strain K-4. Only the culture filtrate of strain K-4 showed a clear BLA against *Ec. faecium* IFO 13712. Strain K-4 was used for further experiments.

**Table 2. BLA of typical isolates**

<u>Strain No.</u>		<u>Spot-on-lawn method^{b)}</u>			<u>Paper disk method^{b)}</u>			<u>Shape^{c)}</u>
<u>Isolate</u>	<u>TISTR^{a)}</u>	<u>(1)</u>	<u>(2)</u>	<u>(3)</u>	<u>(1)</u>	<u>(2)</u>	<u>(3)</u>	<u>(Gram stain)</u>
KS-3	1300	++	-	+++	-	-	-	Short rod (+)
4	1301	++	±	+++	-	-	-	Long rod (+)
5	1302	++	±	+++	-	-	-	Long rod (+)
KLD-1	1303	+	-	++	-	-	-	Cocci (+)
5	1304	++	-	+++	-	-	-	Cocci (+)
8	1305	+	-	+++	±	-	-	Cocci (+)
10	1306	+	-	++	-	-	±	Cocci (+)
14	1307	+	-	++	±	-	-	Cocci (+)
K-4	1285	+++	-	++	+	-	-	Cocci (+)
FB 1-7	1308	++	+	++	-	-	-	Long rod (+)
3-5	1309	++	+	++	-	-	-	Cocci (+)
4-5	1310	++	+	++	-	-	-	Short rod (+)
4-6	1311	++	++	+++	-	-	±	Short rod (+)
5-2	1312	++	+	++	-	-	-	Long rod (+)

a): Each strain was deposited in the culture collection of TISTR as described in **Table 1**.

b): Target strains used were as follows; (1)*Ec. Faecium* IFO 13712, (2)*Ped. Acidilactici* TISTR 952, (3)*Leuc. mesenteroides* TISTR 473. Symbols denote the diameter of the clear zone as follows: + + + ; more than 15 mm, + + ; 15-12 mm, + ; 12-8 mm, ±; indistinct, -; not detected.

c): (+) denotes Gram-positive reaction.

### 2) Identification of selected strain K-4 at generic level

Bacteriological properties of strain K-4 were examined and the results are summarized in **Table 3**. The strain was Gram-positive with a typical long chain. The strain grew at 45 in MRS broth and did not produce gas. The strain also grew in MRS broth with the pH adjusted to 9.6 and NaCl concentration to 6.5%. Based on a manual⁶⁾, the strain was tentatively assigned to the genus *Enterococcus*. Therefore, this strain was designated as *Enterococcus* sp. K-4.

**Table 3. Bacteriological properties of strain K-4**

<u>Parameter or test</u>	<u>Reaction or character</u> ^{a)}	
Shape	Cocci	
Gram stain	+	
Gas from glucose	-	
Fermentation	Homo	
Growth		
at 45	+	
at 50	-	
at 37 ^{b)}	+	a):+; Positive, -; Negative
at 37 ^{c)}	+	b):Under anaerobic conditions.
at pH 9.6	+	c):under aerobic conditions.
in NaCl 6.5%	+	

### 3) Spectrum of BLA produced by *Enterococcus* sp. K-4

The spectrum of BLA produced by *Enterococcus* sp. K-4 against 11 bacterial strains is shown in [Table 4](#). The BLA of this strain was positive to only the strains of the genus *Enterococcus* such as *Ec.faecium* IFO 13712 and *Ec.faecalis* IFO 12964 and negative to another strains of the genera *Lactobacillus*, *Pedio- coccus*, *Leuconostoc*, *Staphylococcus*, *Salmonella*, *Escherichia* and *Klebsiella*.

**Table 4. Inhibitory spectrum of bla produced by *Enterococcus* sp. K-4**

<u>Target strain</u>	<u>Inhibition by the culture filtrate</u> ^{a)}
<a href="#">Enterococcus faecalis IFO 12964</a>	+
<a href="#">Enterococcus faecium IFO 13712</a>	+
<a href="#">Lactobacillus plantarum IFO 14711</a>	-
<a href="#">Lactobacillus plantarum TISTR 541</a>	-
<a href="#">Pediococcus acidilactici TISTR 952</a>	-
<a href="#">Leuconostoc mesenteroides TISTR 473</a>	-
<a href="#">Staphylococcus aureus IFO 15035</a>	-
<a href="#">Staphylococcus aureus TISTR 029</a>	-
<a href="#">Salmonella typhimurium TISTR 292</a>	-
<a href="#">Escherichia coli MAFF 911145</a>	-
<a href="#">Escheichia coli TISTR 527</a>	-
<a href="#">Klebsiella pneumoniae NGRI G-1</a>	-

a): +; Positive, - ; Negative.

### 4) Culture conditions of *Enterococcus* sp. K-4 for the production of BLA

**Culture temperature:** The effect of the culture temperature on the production of bacteriocin in MRS broth was examined as shown in [Fig. 2.\(16 KB\)](#). The maximum bacteriocin activity during 20 h of culture was observed at 42-45 and the activity was 2 times higher than that at 37 while the maximum lactic acid production was observed at 37-38.

**Time course of production of BLA:** The production of bacteriocin in MR broth at 43 was associated with the logarithmic growth of the strain. The highest activity was observed in the maximum growth phase and then the activity gradually decreased as shown in [Fig. 3.\(20 KB\)](#).

**Inoculum size:** The effect of the inoculum size at the levels of  $10^5$ ,  $10^6$  and  $10^7$  cfu/mL was examined for maximum production of bacteriocin in MRS



broth at 43. As shown in [Fig.4. \(25 KB\)](#), the culture time for maximum production of the activity decreased with the increase of the inoculum size. The viable cells by inoculation at  $10^7$  cfu/mL reached maximum counts of  $10^9$  cfu/mL within 4 h of culture and required only 7 h for maximum bacteriocin activity. Regardless of the inoculum size, the maximum cell counts and bacteriocin activity showed almost the same level ( $10^9$  cfu/mL and 6,200 IU/mL).

#### 5) Properties of BLA produced by *Enterococcus* sp. K-4

The BLA produced by *Enterococcus* sp. K-4 was stable under boiling conditions (100 for 20 min) and the level was almost the same at pH 5.0 to 7.0. However, the activity was completely inhibited by treatment with trypsin. The partially purified powder showed a clear BLA zone in the area with an Rf-value of about 0.4-0.5 in SDS-PAGE. The area corresponded to the Rf-value of trypsin inhibitor (MW 20,100) as a standard protein.

### ---Discussion-----

Strain K-4, which was isolated from tropical grass silage and belonged to the genus *Enterococcus*, was selected as a bacteriocin-producing strain. When the paper disk method was used, only one strain K-4 showed a clear BLA while 62.5% of the strains among the isolates showed some BLA when the spot-on-lawn method was used in this screening. It is well known that the BLA detected by the spot-on-lawn method can not be reproduced when the paper disk method [10,12](#)) is used. In liquid culture, proteolytic enzymes are released from the producing strain into the culture broth and bacteriocin might be digested by the enzymes. For further detailed studies, the production of BLA in liquid culture is an important and essential factor from the view-points of isolation in large quantity and purification of bacteriocin.

The production of bacteriocin by this strain was activated by the temperature during the culture and 42-45 was the optimum temperature while maximum lactic acid production occurred at 37-38 as shown in [Fig. 2](#). Generally for the strains of the genus *Enterococcus*, a temperature of 42-45 during the culture is rather high for bacteriocin production [7,11](#)) The production of bacteriocin by the current strain at such high temperatures may be due to the origin of the strain which appeared to be a thermophilic strain isolated at 43 in Thailand. It is possible that the bacteriocin produced by this strain showed properties suitable for adaptation to a tropical niche. The production of bacteriocin by this strain occurred during the logarithmic growth phase and the inoculum size did not increase the amount of bacteriocin production, while the culture time was shortened for maximum production. When the inoculum size increased, maximum bacteriocin production and viable cell counts were 6,200 IU/mL and  $10^9$  cfu/mL, respectively. To increase the bacteriocin production, it is necessary to increase the cell density in the medium together with the modification of the medium composition.

The BLA produced by strain K-4 was positive against only the strains of the genus *Enterococcus*. Usually, bacteriocins show a narrow inhibitory spectrum and give a positive reaction to the same and/or related genus species [9](#)). This tendency was also observed in the current study since strain K-4 which belonged to the genus *Enterococcus*, was active only against *Ec. faecium* and *Ec. faecalis*. The BLA of this strain was thermotolerant and was detected in solutions with a neutral and acidic pH. The apparent molecular weight of main bacteriocin was about 20,000 in SDS-PAGE (data not shown). Some bacteriocins produced by the strains of the genus *Enterococcus* have been reported by several research groups [1,7,11,13,15](#)). These bacteriocins had a molecular weight of less than 10,000 and were active against *Listeria monocytogenes*. Further studies should be carried out for the purification and analysis of the chemical properties of the new bacteriocin produced by this strain.

### ---References-----



[Back to the first page](#)

1) Aymerich, T. et al. (1996): Biochemical and genetic characterization of enterocin A from *Enterococcus faecium*, a new antilisterial bacteriocin in the pediocin family of bacteriocin. *Appl. Environ. Microbiol.*, 62(5), 1676-1682.

2) Barefoot, S.F. & Klaenhammer, T.R. (1983): Detection and activity of lactacin B, a bacteriocin produced by *Lactobacillus acidophilus*. *Appl. Environ. Microbiol.*, 45(6),

## Results

1808-1815.

- 3) Daba, H. et al. (1991): Detection and activity of a bacteriocin produced by *Leuconostoc mesenteroides*. *Appl. Environ. Microbiol.*, 57(12), 3450-3455.
- 4) Hoover, D.G. & Harlander, S.K. (1993): Screening methods for detecting bacteriocin activity. *In* Bacteriocins of lactic acid bacteria, eds. Hoover, D. G. & Steenson, L.R., Academic Press Inc., San Diego, California, 23-39.
- 5) Kato, T. et al. (1993): Isolation of *Enterococcus faecium* with antibacterial activity and characterization of its bacteriocin. *Biosci. Biotech. Biochem.*, 57(4), 551-556.
- 6) Kozaki, M. (1992): Manuals for experiments of lactic acid bacteria. Asakura Shoten, Tokyo, 126-135 In Japanese.
- 7) Kramer, J. & Brandis, H. (1975): Purification and characterization of two bacteriocins from *Streptococcus faecium*. *J. Gen. Microbiol.*, 88, 93-100.
- 8) Laemmli, U.K. (1970): Cleavage of structural proteins during the assembly of the head of bacteriophage T4. *Nature*, 227, 680-685.
- 9) Lopez-Lara, I. et al. (1991): Purification, characterization and biological effects of a second bacteriocin from *Enterococcus faecalis* ssp. *liquefaciens* S-48 and its mutant strain B-48-28. *Can. J. Microbiol.*, 31, 769-774.
- 10) Muriana, P.M. & Luchansky, J.B. (1993): Biochemical methods for purification of bacteriocin. *In* Bacteriocins of lactic acid bacteria, eds. Hoover, D.G. & Steenson, L.R., Academic Press Inc., San Diego, California, 41-61.
- 11) Parente, E. & Hill, C. (1992): Characterization of enterocin 1146, a bacteriocin from *Enterococcus faecium* inhibitory to *Listeria monocytogenes*. *J. Food Protect.*, 55(7), 497-502.
- 12) Schillinger, U. & Lucke, F.-K. (1989): Antibacterial activity of *Lactobacillus sake* isolated from meat. *Appl. Environ. Microbiol.*, 55(8), 1901-1906.
- 13) Siragusa, G.R. (1992): Production of bacteriocin inhibitory to *Listeria* species by *Enterococcus hirae*. *Appl. Environ. Microbiol.*, 58(11), 3508-3513.
- 14) Tanaka, O. & Ohmomo, S. (1995): A simple method of laboratory silage fermentation by using a plastic pouch for packing. *Grassl. Sci.*, 41(1), 55-59 In Japanese with English summary.
- 15) Villani, F. et al. (1993): Enterocin 226NWC, a bacteriocin produced by *Enterococcus faecalis* 226, active against *Listeria monocytogenes*. *J. Appl. Bacteriol.*, 74, 380-387.



[Forward to:- Lactococcin Genes from *L. lactis* DRC1-](#)



[Back to: Contents](#)



[Back to: JIRCAS Home Page](#)

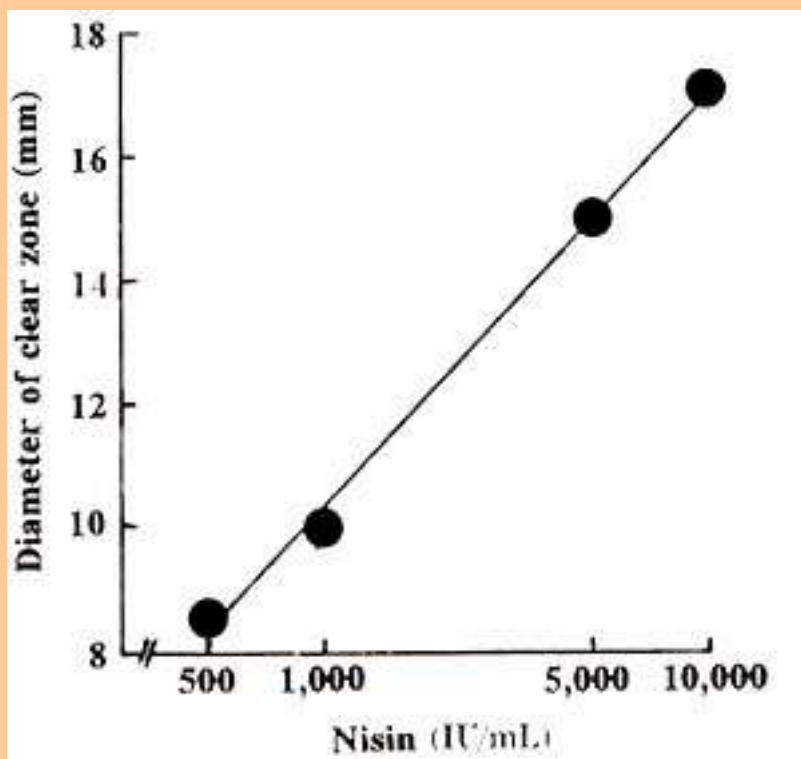


Fig.1.  
Standard line for determining bacteriocin activity Nisin and *Enterococcus faecium* IFO 13712 respectively.  
The activity was detected by the Paper disk method using a certain concentration of nisin.



[Back](#)

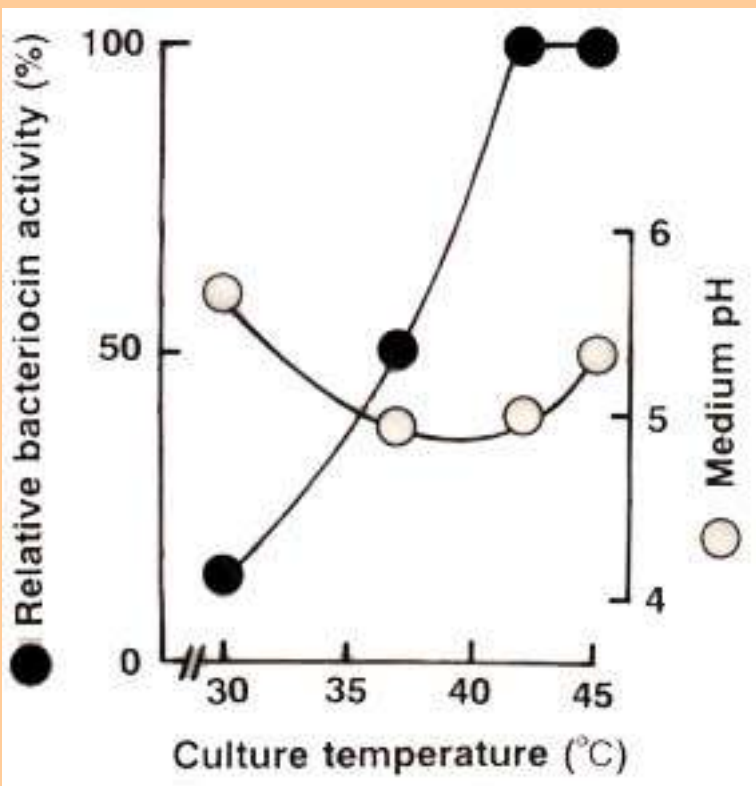


Fig.2.

Effect of culture temperature on the production of bacteriocin by *Enterococcus* sp. K-4

The strain was cultured in MRS broth at variout temperatures. The bacteriocin activity of each culture filtrate was detected by the paper disk methods, calculated from the standard line and expressed as relative activity.



[Back](#)

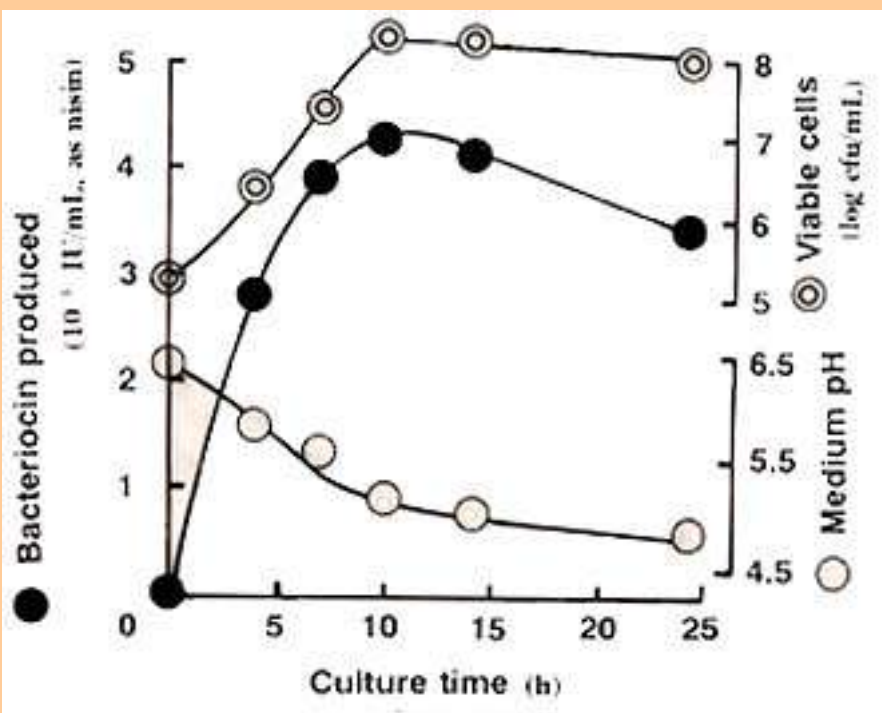


Fig.3.  
 Typical time course of production of bacteriocin by *Enterococcus* sp.  
 The strain was cultured in MRS broth at 43.  
 The bacteriocin activity was analyzed as indicated in [Fig.2](#).  
 The viable cells were counted by the agar plate method using MRS broth.



[Back](#)

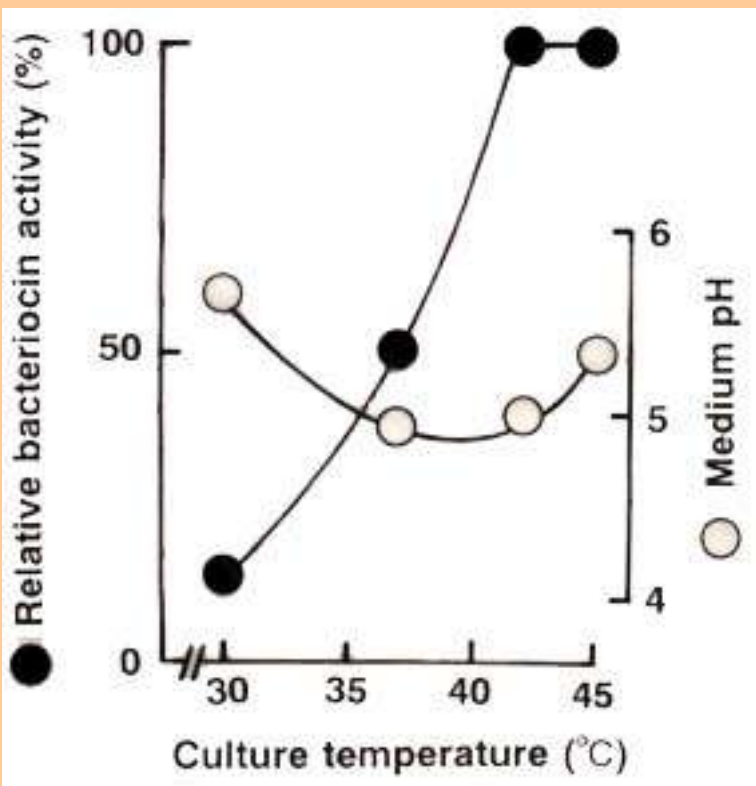


Fig.2.

Effect of culture temperature on the production of bacteriocin by *Enterococcus* sp. K-4

The strain was cultured in MRS broth at variout temperatures. The bacteriocin activity of each culture filtrate was detected by the paper disk methods, calculated from the standard line and expressed as relative activity.



[Back](#)

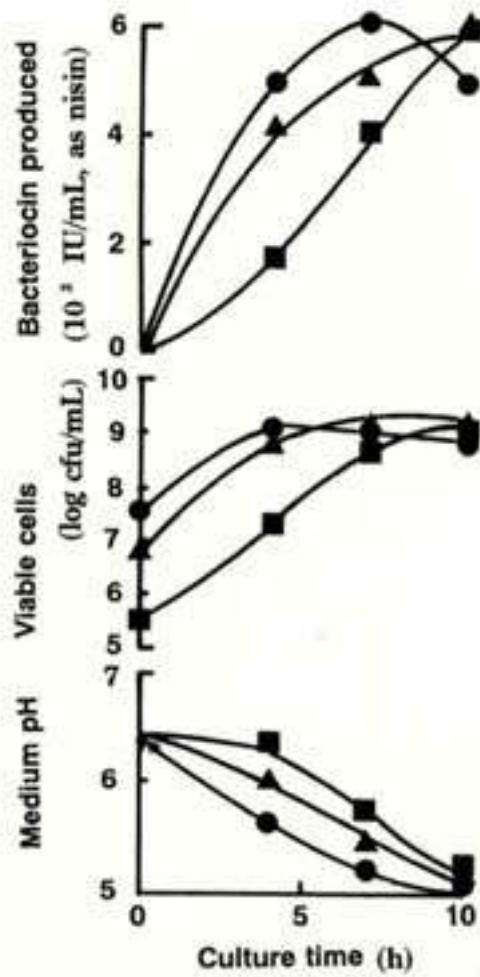


Fig. 4. Effect of inoculum size on the production of bacteriocin by *Enterococcus* sp. K-4

The experimental conditions were the same as those indicated in Fig. 3.

Inoculum size: ■;  $5.6 \times 10^5$  cfu/mL, ▲;  $7.9 \times 10^6$  cfu/mL, ●;  $5.8 \times 10^7$  cfu/mL.



[Back](#)

# Cloning and Identification of the Lactococcin A and M Gene Cluster from *Lactococcus lactis* subsp. *lactis* biovar *diacetylactis* DRC1

Yasuhito FUJITA and Takashi OKAMOTO

Department of Animal Products, National Institute of Animal Industry  
(Tsukuba, Ibaraki, 305-0901, Japan)

## ---Abstract-----

The bacteriocin genes from the plasmid pDR1-6 of *Lactococcus lactis* subsp. *lactis* biovar *diacetylactis* DRC1 were cloned into pGKV21 and pGKV259 as 4.0 kb *Hind*III and 9.5 kb *Eco*RI fragments, and expressed in plasmid free and bacteriocin-non-producing strain *L.l.lactis* DRC1021. The nucleotide sequences of the genes were identified as a part of operons of lactococcins A and M.

**Discipline:** Biotechnology

**Additional key words:** bacteriocin, lactococcin, dricin

Received for publication, October 8, 1998

## ● 1....17):[References](#)

The nucleotide sequence data reported in this paper will appear in the DDBJ, EMBL and GenBank nucleotide sequence databases with the following accession numbers D86737 and D86738.

## ---Introduction-----

Bacteriocins are proteinaceous bactericidal compounds that are produced by some microorganisms, including lactic acid bacteria. The best-known bacteriocin of lactic acid bacteria origin is probably nisin, which is an antibiotic type bacteriocin produced by certain strains of *Lactococcus lactis*. A large number of new bacteriocins in the group of lactic acid bacteria have been characterized mainly biochemically due to the development of efficient protocols for purification of these hydrophobic and cationic peptides in recent years. In several cases it has been demonstrated that bacteriocin production is associated with plasmid DNA. However, only a few genetic determinants for these substances have been cloned and sequenced^{8,10}.

Previously, Powell et al. reported that *L. lactis* DRC1 (Commonwealth Scientific and Industrial Research Organization, Dairy Research Laboratory collection) produced dricin which is a heat-stable proteinous bacteriocin and suggested that the gene involved in dricin production is carried on a conjugative plasmid¹¹. We also found that an antagonistic substance against other lactococci was produced by *L.l.lactis* biovar *diacetylactis* DRC1 in our laboratory collection, formerly designated as *Streptococcus lactis* subsp. *diacetylactis* DRC1 originally obtained from the National Institute for Research in Dairying (now AFRC Institute of Food Research)⁵.



In this report, we demonstrated that the inhibitory activity is due to the concerted action of at least 2 bacteriocins, lactococcins A and M in *L.l.lactis* DRC1 by cloning and sequencing of the genes coding for bacteriocin production.

### ---Materials and methods-----

The bacterial strains and plasmids used in this study are listed in [Table 1](#) (36 KB). Thirty-eight lactococcal strains in our laboratory collection [5](#)) were examined for cross-antagonistic activity using the agar spot test. Colonies of bacteria that could produce bacteriocin were grown on M17G agar plate overnight [14](#)). A lawn of 4mL of M17G soft agar (0.7%) containing 100  $\frac{1}{4}$ L of a fresh culture of the indicator organism was poured over a plate. After incubation overnight at 30, the colonies were examined for zones of growth inhibition.

Plasmid DNA was isolated from lactococcal strains by the method of Anderson and McKay [1](#)). Transformation of plasmid free strain *L.l.lactis* DRC1021 was performed by electroporation, with a Bio-Rad gene pulser (Bio-Rad Laboratories, Richmond, Calif.) according to the method of Holo and Nes [7](#)). Recombinant DNA analysis was performed as described by Sambrook et al. [12](#)). DNA was sequenced by Taq Dye Deoxy Cycle sequencing on an Applied Biosystems 373A DNA sequencer (Applied Biosystems, Foster City, Calif.). For sequencing, stepwise deletion derivatives of cloned DNA fragments were constructed with ExoIII/Mung Bean deletion kit from Stratagene. The GENETYX-MAC program (Software Co., Japan) was used to analyze DNA sequences. For Southern hybridization, DNA was transferred to Hybond N (Amersham, Buckinghamshire, United Kingdom), using Vacu-gene (Pharmacia, Uppsala, Sweden) according to the manufacturer's specifications. Nonradioactive DNA probes were prepared using a random-primed labeling and detection kit (Boehringer Mannheim, GmbH, Germany). Hybridization and immunological detection were performed as recommended by the supplier.

### ---Results and discussion-----

As a result of the cross-antagonistic test, *L.l.lactis* DRC1 and ATCC13675 inhibited the growth of the majority of the lactococcal strains such as *L.l.lactis* 527 and 1061. These strains exhibited a cross-immunity to each other and the antagonistic agent was heat-stable under acidic conditions and inactivated by incubation with pronase E, protease K, subtilisin and trypsin. These properties suggested that the strains produced the same polypeptide bacteriocin.

Several plasmid-cured derivatives from *L.l.lactis* DRC1 were isolated after growth in broth containing acridine orange and compared with their plasmid profile and phenotype. *L.l.lactis* DRC1 harbored 6 distinct plasmids originally. Plasmid-free derivatives *L.l.lactis* DRC1021 and *L.l.lactis* DRC104, which contained a cryptic 7.9 kb plasmid pDR1-1, were unable to inhibit the growth of the indicator strain *L.l.lactis* 1061, and were sensitive to the bacteriocin produced by *L.l.lactis* *L.l.lactis* DRC1. Since *L.l.lactis* DRCg4, which contained the large (more than about 60 kb) plasmids pDR1-6 and pDR1-1, still displayed a bacteriocin activity, it was suggested that the presence of pDR1-6 was required for bacteriocin production and its immunity. Plasmid pDR1-6 extracted from *L.l.lactis* DRCg4 was digested with *Bam*HI, *Eco*RI, *Hind*III, *Pst*I and *Sal*I, respectively. These fragments were ligated into the multiple cloning sites of the pWV01-derived cloning vectors pGKV21 [16](#)) and pGKV259 [17](#)), and transformed into *L.l.lactis* DRC1021.

Erythromycin-resistant transformants were overlaid with indicator cells to screen the bacteriocin activity. Plasmid pDR405 (4 kb *HindIII* fragment in pGKV21) which contained the transformant inhibited the growth of the indicator strain but did not inhibit the growth of the bacteriocin-producing strains DRC1 and ATCC13675.

The restriction endonuclease map and nucleotide sequence of the 4 kb *HindIII* fragment specifying antagonistic activity were determined (Fig. 1A). The 4093 bp nucleotide sequence was identical with the lactococcin A gene cluster described by Stoddard et al. (13), including 3 complete open reading frames, *lcnD*, *lcnA* and *lciA*. Incomplete open reading frame of *lcnC*, interrupted by the *HindIII* site, was also present upstream of *lcnD*. Downstream of *lciA* the sequence was identical with the promoter and N-terminal regions of *lcnB*, which was described by van Belkum et al. (4).

[*Fig. 1.\(33 KB\)](#)

Complete lactococcin A gene cluster contained *lcnC* and *lcnD* genes as well lactococcin A structural and immunity genes. It is now generally accepted that *lcnC* and *lcnD* are required for the secretion via a system oriented to bacteriocin export. In this experiment, *L.l.lactis* DRC1021 was able to produce externalizing active lactococcin A in the absence of the plasmid-encoded *lcnC* gene. It was suggested that the chromosomal *lcnC* gene may be present in *L.l.lactis* DRC1021 as in the case of *L.l.lactis* IL1403 (15). A 1.6 kb *HindIII*-Sau3AI fragment encompassing internal *lcnC* was used as the probe in Southern hybridization. A signal was indeed found on the chromosomal DNA of *L.l.lactis* DRC1021.

Lactococcin A which belongs to class II bacteriocin, was purified from *L. l.* subsp. *cremoris* LMG2130 by Holo et al. (6) and is produced by several strains of *L.l.lactis*. The conjugative 60 kb plasmid p9B4-6 isolated from *L. l. cremoris* 9B4 contained 3 operons coding for lactococcins A, B, and M as well as for the corresponding immunity proteins (2-4). Recently, Morgan et al. have reported that the genes encoding lactococcins A, B, and M are located on a 72- and a 78- kb nonmobilizable plasmid in *L.l.lactis* DPC938 and DPC3286, respectively (9). This finding prompted us to determine whether *L.l.lactis* DRC1 carries genes homologous to the other lactococcins. By using pDR403 encompassing incomplete *lcnA* operon as a probe, 2 signals, 9.5 kb and 24 kb, were obtained in *EcoRI* fragments of pDR1-6.

The 9.5 kb *EcoRI* fragment was cloned into competent *E.coli* XL-1 Blue by using the vector pBluescript II, designated as pDR413, and the 9.5 kb fragment was then religated into the *EcoRI* site of pGKV259 and transformed into *L.l.lactis* DRC1021. Resultant transformants also exhibited bacteriocin activity. This recombinant plasmid was designated as pDR430 (9.5 kb *EcoRI* fragment in pGKV259). However, *L.l.lactis* DRC1021 harboring pDR430 did not confer a resistance against *L.l.lactis* DRC1. The restriction map of 9.5 kb *EcoRI* fragment presented in Fig. 1B revealed a similarity to the restriction map of pMB200, which encoded the low antagonistic activity of p9B4-6 described by van Belkum et al., and it was shown that the lactococcin M operon was located on the internal 1.8 kb *ScaI*-*ClaI* fragment (2,3). Therefore, pDR413 was subcloned in *E.coli*, and the following 1.8 kb *ScaI*-*ClaI* fragment was obtained as pDR422. The nucleotide sequence of this 1782bp fragment was determined and identified with lactococcin M operon completely including a part of *lcnD* and 3 open reading frames of *lcnM*, *lcnN* and *lciM* (Fig. 1B) (2,3).

In this experiment, we were not able to clone the 24 kb *EcoRI* fragment of pDR1-6, which contains the operons of lactococcins A and B. *LcnB* operon was located near *lcnA* operon on p9B4-6 (4) and pSM72 (9).

The nucleotide sequence analysis showed that downstream of *lciA* on pDR403 a sequence was present which was identical with the N-terminal sequence of *lcnB*. These findings suggest that pDR1-6 also encoded the third bacteriocin gene.

Initially, it was considered that the inhibitory activity of *L.l.lactis* DRC1 was due to the action of a single bacteriocin(dricin) as described by Powell et al. [11](#)). However, cloning and sequencing revealed that the observed activity was probably due to the combination of at least two different bacteriocins, namely lactococcins A and M

We thank Dr. Jan Kok of Groningen University for kindly providing the vectors.



[Forward to:-Pathology of Acute Necrotizing Mastitis Caused by Staphylococcus aureus in a Dairy Cow-](#)



[Back to: Contents](#)



[JIRCAS Home Page](#)

## ---References-----



[Back](#)

- 1)Anderson, D. G. & McKay, L. L.(1983): Simple and rapid method for isolating large plasmid DNA from lactic streptococci. *Appl. Environ. Microbiol.*, 46, 549-552.
- 2)Belkum, M. J. van et al.(1989): Cloning for two bacteriocin genes from a lactococcal bacteriocin plasmid. *Appl. Environ. Microbiol.*, 55, 1187-1191.
- 3)Belkum, M. J. van et al.(1992): Organization and nucleotide sequences of two lactococcal bacteriocin operons. *Appl. Environ. Microbiol.*, 57, 492-498.
- 4)Belkum, M.J. van, Kok, J. & Venema, G.(1992): Cloning, sequencing, and expression in *Escherichia coli* of *lcnB*, a third bacteriocin determinant from lactococcal bacteriocin plasmid p9B4-6. *Appl. Environ. Microbiol.*, 58, 572-577.
- 5)Fujita, Y., Okamoto, T.& Irie, R.(1984): Plasmid distribution in lactic streptococci. *Agric. Biol. Chem.*, 48, 1895-1898.
- 6)Holo, H., Nilssen, O. & Nes, I. F.(1991): Lactococcin A, a new bacteriocin from *Lactococcus lactis* subsp. *cremoris*; isolation and characterization of the protein and gene. *J. Bacteriol.*, 173, 3879-3887.
- 7)Holo, H. & Nes, I. F.(1989): High-frequency transformation by electroporation of *Lactococcus lactis* subsp. *cremoris* growing with glycine in osmotically stabilized media. *Appl. Environ. Microbiol.*, 55, 3119-3123.
- 8)Klaenhammer, T. R.(1993): Genetics of bacteriocins produced by lactic acid bacteria. *FEMS Microbiol.Rev.*, 12, 39-86.
- 9)Morgan, S., Ross, R. P. & Hill, C.(1995): Bacteriolytic activity caused by the presence of a novel lactococcal plasmid encoding lactococcin A, B, and M. *Appl. Environ. Microbiol.*, 61, 2995-3001.
- 10)Nes, I. F. et al.(1990): Biosynthesis of bacteriocins in lactic acid bacteria. *Antonie van Leeuwenhoek*, 70, 113-128.
- 11)Powell, I. B. et al.(1990): Simultaneous conjugal transfer in *Lactococcus* to genes involved in bacteriocin production and reduced susceptibility to bacteriophages. *FEMS Microbiol. Lett.*, 72, 209-214.
- 12)Sambrook, J., Fritsch, E. F. & Maniatis, T.(1989): *Molecular cloning; a laboratory manual*, 2nd ed. Cold Spring Harbor Laboratory, Cold Spring Harbor, N.Y. (1989).
- 13)Stoddard, G. W. et al.(1992): Molecular analyses of the lactococcin A gene cluster from *Lactococcus lactis* subsp. *lactis* biovar *diacetylactis* WM4. *Appl. Environ. Microbiol.*, 58, 1952-1961.
- 14)Terzaghi, B. E & Sandine, W. E.(1975): Improved medium for lactic streptococci and their bacteriophages. *Appl. Microbiol.*, 29, 807-813.
- 15)Venema, K. et al.(1996): The genes for secretion and maturation of lactococcins are located on the chromosome of *Lactococcus lactis* II1403. *Appl. Environ. Microbiol.*, 62, 1689-1692.
- 16)Vossen, J.M.B.M. van der, Kok, J. & Venema, G.(1985): Construction of cloning, promoter-screening and terminator-screening shuttle vectors for *Bacillus subtilis* and *Streptococcus lactis*. *Appl. Environ. Microbiol.*, 50, 540-542.
- 17)Vossen, J.M.B.M. van der, Lelie, D. van der & Venema, G.(1987): Isolation and characterization of *Streptococcus cremoris* WG2-specific promoters. *Appl. Environ. Microbiol.*, 53, 2452-2457.

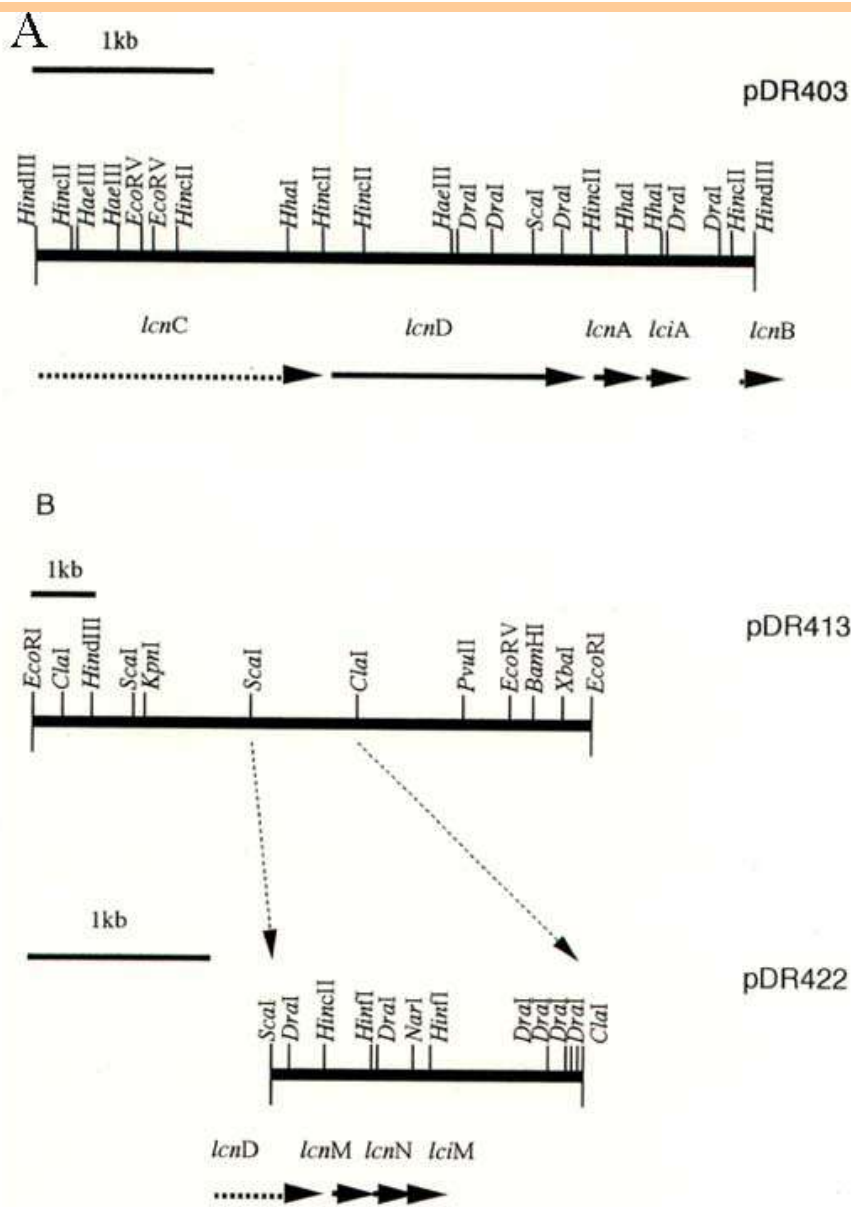


[Back](#)

Table 1. Bacterial strains and plasmids

Bacterial strain or plasmid	Remarks	Reference or source
<b>Strain</b>		
<i>E. coli</i>		
XL-1Blue		Stratagene
DH11S		Bethesda Research Laboratory
<i>L. l. lactis</i>		
527	Sensitive indicator	4)
1061	Plasmid-free derivative of 527, sensitive indicator	This study
DRC1	Wild type (Lac ⁺ , Cit ⁺ , Bac ⁺ )	4)
ATCC13675	Wild type (Lac ⁺ , Cit ⁺ , Bac ⁺ )	4)
DRCg4	Plasmid-cured derivative of DRC1 (Lac ⁻ , Cit ⁻ , Bac ⁺ )	This study
DRC1021	Plasmid-free derivative of DRC1 (Lac ⁻ , Cit ⁻ , Bac ⁻ )	This study
<b>Plasmid</b>		
pBluescriptII	<i>E. coli</i> cloning vectors, Amp ^r	Stratagene
pGKV21	<i>E. coli</i> , <i>B. subtilis</i> and <i>L. lactis</i> shuttle vector, Em ^r	9)
pGKV259	<i>E. coli</i> , <i>B. subtilis</i> and <i>L. lactis</i> shuttle vector, Em ^r	10)
pDR1-6	Bac ⁺ plasmid	This study
pDR403	SKII+; <i>Hind</i> III 4 kb	This study
pDR405	pGKV21; <i>Hind</i> III 4 kb (Bac ⁺ )	This study
pDR407	SKII+; <i>Hind</i> III- <i>Sau</i> 3AI 1.6 kb	This study
pDR413	SKII+; <i>Eco</i> RI 9.5 kb	This study
pDR422	SKII+; <i>Sca</i> I- <i>Cl</i> aI 1.8 kb	This study
pDR430	pGKV259; <i>Eco</i> RI 9.5 kb (Bac ⁺ )	This study


[Back](#)



**Fig.1. Physical map of the cloned lactococin operons from *L.lactis* DRC1**

**A: Restriction map of the recombinant plasmid., pDR403.**

**The DDBJ accession number of this sequence is D86737.**

**B: Restriction map of the recombinant plasmids, pDR413 and pDR422.**

**The DDBJ accession number of this sequence is D86738. Arrows show the putative open reading frames.**



[Back](#)

# Pathology of Acute Necrotizing Mastitis Caused by *Staphylococcus aureus* in a Dairy Cow

Tomoyuki SHIBAHARA* and Kikuyasu NAKAMURA

Department of Pathology and Physiology, National Institute of Animal Health  
(Tsukuba, Ibaraki, 305-0856 Japan)

Present address:

* Hokkaido Research Station, National Institute of Animal Health  
(Hitsujigaoka, Toyohira, Sapporo, 062-0045 Japan)

## ---Abstract-----

Acute necrotizing mastitis in a cow was investigated pathologically. The udder was firmly enlarged to twice the size of a basketball. Histologically, the epithelium of the interlobular duct of the mammary glands was displaced by necrotic debris and bacterial clumps (Gram-positive cocci). The intralobular ducts were also necrotic. The alveoli showed scattered necrotic foci varying in size and containing bacterial clumps. The vascular walls of the interlobular stroma exhibited fibrinous necrosis with fibrinous thrombi. The liver showed centrolobular fatty and droplet degeneration of the hepatocytes. Extramedullary hematopoiesis was observed in the liver, spleen, adrenal glands, lungs and kidneys. The bacteria observed in the lesions of the mammary glands were stained positively with immunoperoxidase using an antibody against *Staph. ylococcus aureus*. Ultrastructurally, the bacteria were round or oval in shape and had thick cellular walls. Capsule-like fibrous material was present around the surface of the bacteria. Bacteriologically, *Staph. aureus* was isolated in pure culture from the mammary gland. These findings suggest that *Staph. aureus* caused the acute necrotizing mastitis. The pathogenesis of the disease was examined.

**Discipline:** Animal health

**Additional key words:** bovine mastitis

Received for publication, October 8, 1998

[1...8\): References](#)

## ---Introduction-----

Bovine mastitis is caused by various bacteria (*Streptococcus*, *Staph. ylococcus*, *Corynebacterium*, *Pseudomonas*, *Pasteurella*, *Brucella* and *Escherichia coli*), *Mycoplasma* and fungi (*Candida*) [2,3,7](#). Gangrenous mastitis is caused mainly by *Staph. aureus* [2,3](#) and *E. coli* [1-3](#). *Staph. aureus* and *Clostridium perfringens* were isolated from gangrenous mastitis [6](#). *Staph. aureus* and *E. coli* are often present in the cow's skin and in the environment around the cow. Therefore the localization of these bacteria in the mammary lesions should be investigated in order to determine the relationship between the bacteria and the lesions. Although there are some reports concerning the bacteriology [4,6](#) or histology of the disease [1,5](#), there are no reports on histological, immunohistochemical and ultrastructural features of gangrenous (necrotizing) mastitis.

This paper describes the histological, immunohistochemical and ultrastructural features of acute necrotizing mastitis caused by *Staph. aureus* in a cow.

## ---Materials and methods-----

An adult Holstein cow delivered a calf uneventfully. A few days after the delivery, the cow developed swelling of the udder, bloody diarrhea, pyrexia, difficulty in standing, and a positive reaction for the complement-fixation test of Johne's disease. Ten days after the delivery, the cow was sent to our laboratory for pathological examination.

The cow was euthanized with anesthesia for necropsy. The udder, liver, spleen, kidneys, lungs, heart, adrenal glands, stomach, small intestine, large intestine, and other tissues were collected, and fixed in 10% neutral-buffered formalin. The tissues were processed routinely and stained with hematoxylin and eosin (HE). Selected sections were stained with Azan stain, Gram stain and phosphotungstic acid hematoxylin (PTAH). The paraffin sections were stained using an avidin-biotin-peroxidase complex (ABC)-immunostaining kit (Vector Lab., U.S.A.). A rabbit antibody against *Staph. aureus* was used at 1:2,000 dilution. Mammary gland tissues were fixed in 2.5% glutaraldehyde and post-fixed in 1% osmic acid, dehydrated with alcohol, and embedded in epoxy resin. Thin sections were stained with 1% uranyl acetate and Reynold's lead citrate, and examined with a transmission electron microscope (TEM). Attempts to isolate bacteria from the mammary glands, the granuloma in the liver and the colon of the cow were made by aerobically culturing the samples on sheep blood agar plates and desoxycholate-hydrogen sulfide-lactose (DHL) agar plates.

## ---Results-----

The udder (all 4 quarters of the udder) was firmly enlarged to twice the size of a basketball. Cheese-like material oozed from the lactiferous ducts of the teat papilla and the cut surface of the parenchyma. Encapsulated abscesses (about 2 cm in diameter) were observed in the omentum



and in the peritoneum in addition to pathological findings such as, nutmeg liver, stagnation of the bile in the gall bladder, subcutaneous gelatinous infiltration and jaundice, and congestion and hemorrhages in the small and large intestines. *Staph.aureus* was isolated in pure culture from the mammary glands of the cow.

In the mammary gland, interlobular ducts were severely affected. The epithelium of the interlobular duct was displaced by necrotic debris and bacterial clumps (Gram-positive cocci) ([Fig. 1](#)). The intralobular ducts of most of the lobules of the mammary glands were also necrotic. The alveoli shows scattered necrotic foci varying in size and containing bacterial clumps. In the small necrotic foci, bacterial clumps were surrounded by the alveolar epithelial cells showing necrosis. Fusion of such necrotic foci led to the formation of larger foci. The intact area of the parenchyma revealed hyperemia. The interlobular stroma showed edematous loosening with some neutrophils and mononuclear cells. The vascular walls of the interlobular stroma showed fibrinous necrosis with fibrinous thrombi (PTAH-positive) ([Fig. 2](#)).

[*Fig.1.&Fig.2\(87 KB\)](#)

In the liver, the hepatocytes underwent fatty and droplet ([Fig. 3](#)) degeneration. Occasionally, megakaryocytes, erythroblasts and granulocytes migrated into the sinusoids ([Fig. 4](#)). The spleen showed a marked congestion with megakaryocytes and granulocytes migrating into the red pulp. Severe migration of megakaryocytes, erythroblasts and granulocytes was observed into the blood capillaries of the cortex of the adrenal gland. Occasionally, megakaryocytes were seen in the alveolar walls of the lung and in the blood capillaries of the kidney. Granulomatous nodules, consisting of eosinophilic debris surrounded by multinucleated giant cells and macrophages with proliferation of the fibrous connective tissue, were noted in the pleura on the rib. Gram-positive, small, rod-shaped bacteria were seen in the debris which were present in the granuloma. The cocci observed in the lesions of the mammary glands were stained positively with ABC stain using an antibody against *Staph.aureus* ([Fig. 5](#)), unlike the rods in the granuloma of the pleura. In the mammary glands, the bacteria which were round or oval in shape and had thick cellular walls showed the characteristics of Gram-positive bacteria ([Fig. 6-a](#)). The size of the bacteria ranged from 0.8 to 1.0  $\mu\text{m}$  in diameter. Ruthenium-red-positive fibrous material (capsule) was present around the surface of the bacteria ([Fig. 6-b](#)).

[*Fig.3.&Fig.4.\(79 KB\)](#), [Fig.5.&Fig.6.\(65 KB\)](#)

## ---Discussion-----

In the present case, the lesions of the mammary glands consisted of vascular necrosis with fibrinous thrombosis. These changes had been reported previously in Staphylococcal mastitis³). This vascular damage may have played a role in the acute coagulative necrosis of the mammary gland parenchyma observed in our case also. Acute Staphylococcal mastitis occurs shortly after parturition³). Extramedullary hematopoiesis in the liver, spleen, adrenal glands, lung, and kidney observed in the present case suggests that the cow may have been anemic, presumably due to parturition. The cow showed a positive reaction to the complement-fixation test of Johne's disease and had small nodules of encapsulated abscesses in the omentum and in the peritoneum. The stresses of parturition, anemia, and infection with another bacterium may have led to a higher sensitivity to Staphylococcal infection.

Previously, researchers had examined histologically 47 cows from an abattoir, and mastitis was recorded in 36 cows⁵), of which, two showed necrotizing mastitis. Bacteriological investigation was not performed, but cocci were observed in the alveoli in that report⁵). Necrotizing mastitis in cows from which *E.coli* were isolated has been reported¹). Although the etiological bacteria of mastitis have been usually identified by bacterial isolation from mastitis, there have been no immunohistochemical demonstrations of bacteria in mastitis. Etiological agents of mastitis are usually present in the skin of cattle and in the environment in which the cattle are housed. Immunohistochemical demonstration of the bacteria in the mastitis lesions is important to evaluate the pathogenicity of the bacteria isolated from the lesions. In our present study, the immunohistochemical detection of *Staphylococcus* in the necrotic foci of the mammary gland indicates that necrotizing mastitis may be caused by *Staph.aureus* infection.

We observed capsular materials (ruthenium-red-positive) in *Staph. aureus* within the necrotic lesions of the mammary glands. Encapsulated strains of *Staph.aureus* from bovine milk were isolated by Yokomizo & Isayama⁸). Their report suggests that encapsulated *Staph.aureus* may play a role in the pathogenesis of bovine mastitis. Further studies on the relationship between necrotizing mastitis and encapsulated *Staph.aureus* should be carried out.

## ---References-----



[Back](#)

- 1) Inui, S. et al. (1979): Pathological survey on bovine mastitis. *Bull. Natl. Inst. Anim. Health*, 78, 25-38 [In Japanese].
- 2) Jones, T. C. & Hunt, R. D. (1983): Bovine mastitis. *In* Veterinary pathology (5th ed.). Lea & Febiger, Philadelphia, 1543-1562.
- 3) Jubb, K. V. F., Kennedy, P. C. & Palmer, N. (1993): The mammary gland. *In* Pathology of domestic animals (4th ed.) Vol. 3. Academic Press, San Diego, California, 454-470.
- 4) Mura, D. & Altieri, M. (1950): Sull'etiologia, la patogenesi e la profilassi della mastite gangrenosa delle pecore e delle capre. *Zooprofilassi*, 5, 449-465.
- 5) Ohshima, K. et al (1971): Pathological studies on bovine mastitis. *J. Fac. Agric. Iwate Univ.*, 10, 245-267 [In Japanese with English summary].

- 6) Parshall, C. J. (1934): Natural and experimentally gangrenous mastitis in cows. *Cor. Vet.*, 24, 146-155.
- 7) Watts, J. L. (1988): Etiological agents of bovine mastitis. *Vet. Microbiol.*, 16, 41-66.
- 8) Yokomizo, Y. & Isayama, Y. (1977): Isolation of encapsulated strains of *Staphylococcus aureus* from bovine mastitis milk. *Res. Vet. Sci.*, 22, 158-160.



[Contents](#)



[First page of JARQ](#)



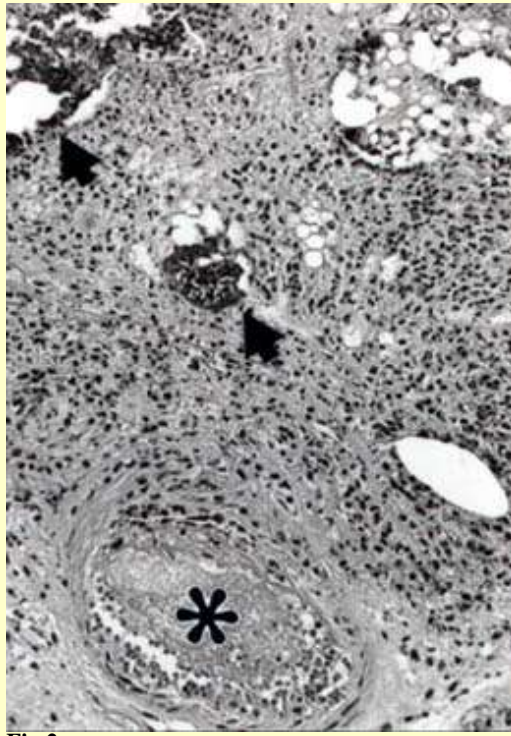
[JIRCAS Home Page](#)



**Japan International Research Center for Agricultural Sciences**  
**Ministry of Agriculture, Forestry, and Fisheries**  
**1-2 Ohwashi, Tsukuba, Ibaraki 305-8686 JAPAN**  
**Telephone 0298-38-6304**  
**[www@jircas.affrc.go.jp](http://www.jircas.affrc.go.jp)**  
**published on April 19, 1999**



**Fig.1.**  
Severe necrosis of interlobular and intralobular ducts  
The lesions affected the intralobular duct,  
intralobular ducts and alveoli (Azan x 30).



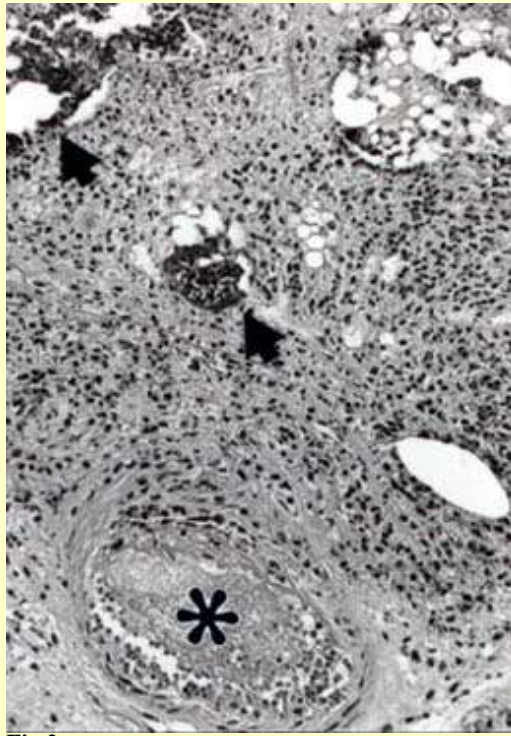
**Fig.2.**  
Bacterial clumps(arrows)surrounded by alveolar epithelial cells  
undergoing necrosis  
Thrombus(*)is seen in the blood vessel(He x 100).



[Back](#)



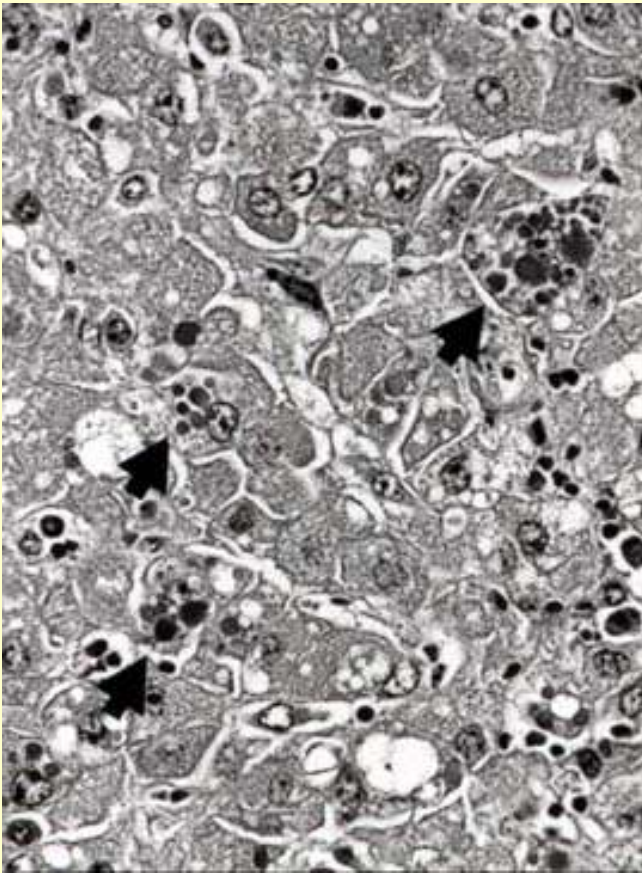
**Fig.1.**  
Severe necrosis of interlobular and intralobular ducts  
The lesions affected the intralobular duct,  
intralobular ducts and alveoli (Azan x 30).



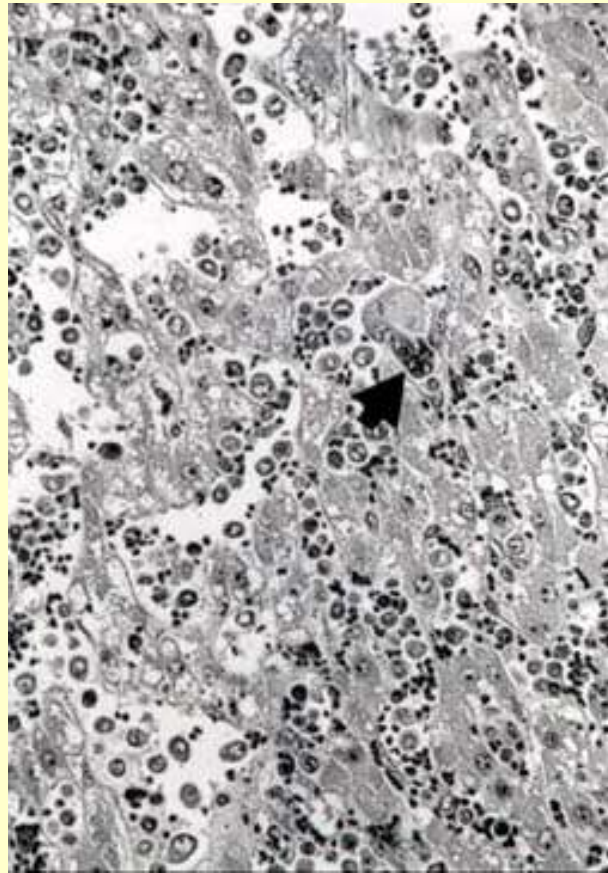
**Fig.2.**  
Bacterial clumps(arrows)surrounded by alveolar epithelial cells undergoing  
necrosis  
Thrombus(*)is seen in the blood vessel(He x 100).



[Back](#)

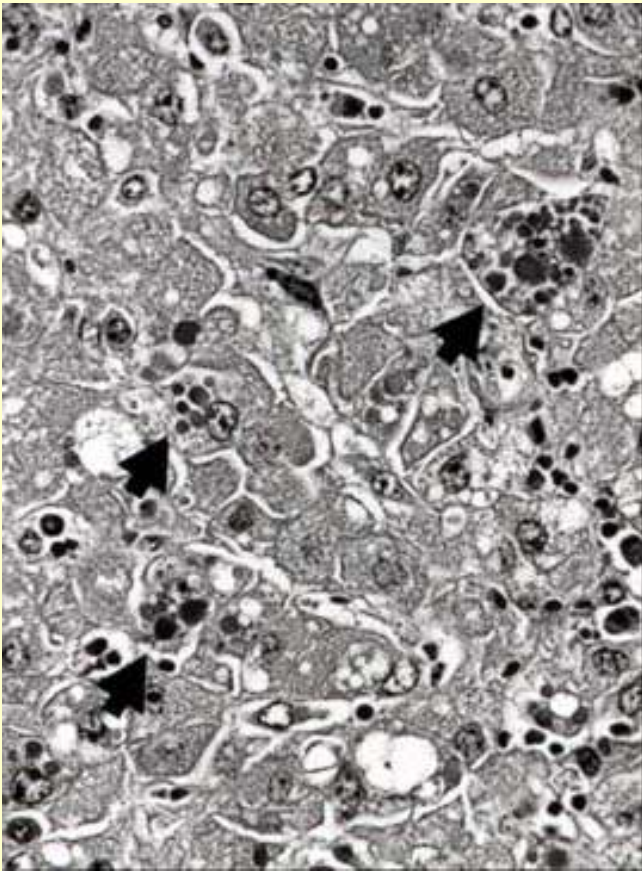


**Fig. 3.**  
Droplet (arrows) and fatty degeneration of hepatocytes (HE x 400)



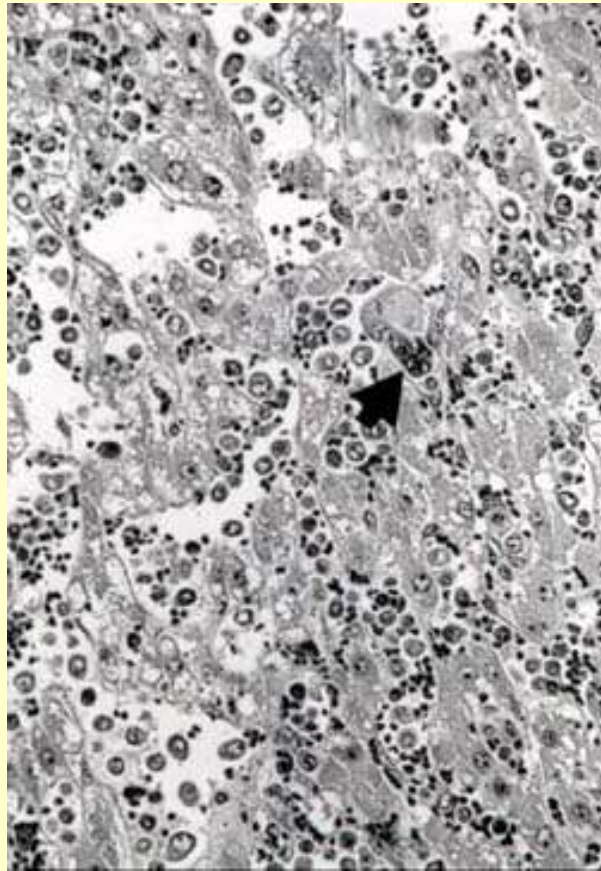
**Fig. 4.**  
Extramedullary haematopoiesis in the liver  
Migration of megakaryocytes (arrow), erythroblasts and granulocytes into hepatic sinusoids (HE x 200).

 [Back](#)

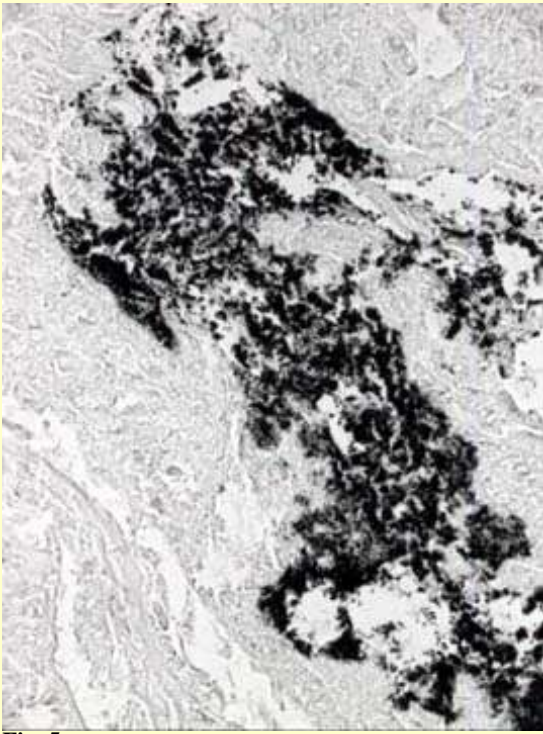


**Fig. 3. Droplet (arrows) and fatty degeneration of hepatocytes (HE x 400)**

 [Back](#)



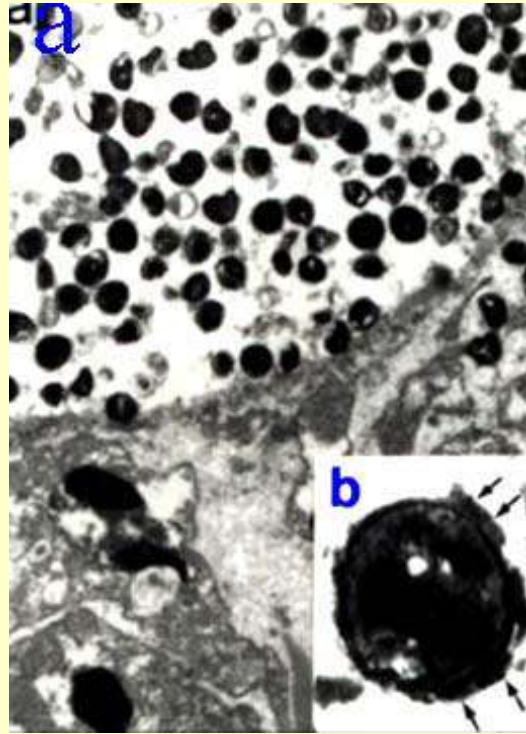
**Fig. 4. Extramedullary haematopoiesis in the liver  
Migration of megakaryocytes (arrow), erythroblasts and granulocytes into hepatic sinusoids (HE x 200).**



**Fig. 5.**  
The cocci in the lesions of the mammary glands show a positive reaction to antibody against *Staph.aureus* (ABC x 200)



[Back](#)



**Fig. 6**  
**a.** The bacteria were round or oval in shape, showing a thick cell wall, characteristic of gram-positive bacteria (TEM. X 40,000)  
**b.** Fibrous material (arrows) stained by ruthenium-red, around the bacterial cell wall, which forms a capsule (TEM.X 250,000)

**Contents**

<a href="#"><u>Distribution and RFLP Mapping of Complementary Genes Causing Hybrid Breakdown in Asian Cultivated Rice, <i>Oryza sativa</i> L.</u></a>	<b>Kazutoshi OKUNO and Shinichi FUKUOKA</b>
<a href="#"><u>Groundwater Pollution by Cattle Slurry Stored in Unlined Lagoon</u></a>	<b>Kenji KANAZAWA et al.</b>
<a href="#"><u>Direct Acquisition of Organic Nitrogen by Crops</u></a>	<b>Makoto YAMAGATA and Noriharu AE</b>
<a href="#"><u>Papaya Ring Spot, Banana Bunch Top, and Citrus Greening in the Asia and Pacific Region: Occurrence and Control Strategy</u></a>	<b>Keizi KIRITANI and Hong-Ji SU</b>
<a href="#"><u>Raising and Transplanting Technology for Long Mat with Hydroponically Grown Rice Seedlings</u></a>	<b>Kohei TASAKA</b>
<a href="#"><u>Study on the Development of a Precision Control Method for Semi-Trailed Agricultural Machinery for Tracing the Track of the Tractor</u></a>	<b>Nobuki YAMANA et al.</b>
<a href="#"><u>Evaporation and Percolation Control in Small Farm Ponds in Thailand</u></a>	<b>Kosho DAIGO and Virote PHAOVATTANA</b>
<a href="#"><u>Summer-Sown Cultivation of Forage Oats and Breeding in Japan</u></a>	<b>Masaaki KATSURA</b>
<a href="#"><u>Infection and Development of <i>Nosema</i> sp. NIS H5 (Microsporida: Protozoa) in Several Lepidopteran Insects</u></a>	<b>Syoji HAYASAKA and Naoyuki YONEMURA</b>
<a href="#"><u>Production of Shochu Spirit from Crushed Rice by Non-Cooking Fermentation.</u></a>	<b>Kenryo NISHIMURA et al.</b>

[First page of JARQ](#)[What's New](#)[JIRCAS Home page](#)



# Distribution and RFLP Mapping of Complementary Genes Causing Hybrid Breakdown in Asian Cultivated Rice, *Oryza sativa* L.

**Kazutoshi OKUNO*** and **Shuichi FUKUOKA**

Department of Genetic Resources I, National Institute of Agrobiological Resources (NIAR)  
(Tsukuba, Ibaraki, 305-8602 Japan)

Present address:

*Department of Research Planning and Coordination, NIAR (Tsukuba, Ibaraki, 305-8602 Japan)

## Abstract

Weak plants were found in the BC₁F₁ generation in a backcrossing program aimed at introducing the *wx* gene from a Thai cultivar, Col.No.15, into a Japanese cultivar, Sasanishiki, in Asian cultivated rice. These weak plants were characterized by poor growth and discoloration at the tillering stage, but they were fertile. Hybrid breakdown, which is defined as hybrid weakness and sterility detected in the F₂ and later inbred generations from varietal crosses, is controlled by a pair of complementary recessive genes, *hwd1* and *hwd2*, at unlinked loci. Two dominant genes at either the same or different loci, *Hwd1/Hwd1 hwd2/hwd2*, *hwd1/hwd1 Hwd2/Hwd2* or *Hwd1/hwd1 Hwd2/hwd2* are needed for normal growth. Using tester lines homozygous for a pair of complementary recessive genes selected in the BC₁F₃, the genotypes for hybrid breakdown of 100 Asian rice cultivars were tested based on the phenotype of F₁ plants. Clinal variation for hybrid breakdown was observed. Cultivars with 2 dominant alleles at either *hwd1* or *hwd2* locus, were mainly found in insular Asia (Japan, Philippines and Indonesia), while the frequency of cultivars with 4 dominant alleles was more common in cultivars from continental Asia. Linkage analysis using RFLP markers mapped over 12 rice chromosomes indicated that *hwd1* from Col.No.15 was located between RFLP markers, C701 and R2309, on chromosome 10, and *hwd2* of Sasanishiki was tightly linked to 4 RFLP markers on chromosome 7. Role of hybrid breakdown in genetic differentiation of Asian cultivated rice is discussed.

**Discipline:** Plant breeding/ Genetic resources

**Additional key words:** reproductive barrier, hybrid weakness, geographical differentiation, RFLP markers

**Received for publication:** February 5, 1998

1-19): [References](#)

## Introduction

Isolating mechanisms prevent or restrict the exchange of genes between and within species and may be either external or internal in type¹⁸. External barriers include eco-geographical isolation of interspecific and intraspecific variation and result in unique genotypes adapted to distinct environments. Internal barriers restrict gene flow between plants growing sympatrically and play an important role in plant speciation and genetic differentiation.

In addition to partial cross-incompatibility¹⁴⁾, different types of reproductive barriers have been found in varietal crosses of Asian cultivated rice, *Oryza sativa* L. These post-hybridization reproductive barriers include, hybrid weakness or F₁ lethality^{1,8,16)}, hybrid sterility^{9,10)}, hybrid breakdown^{3,6,8,11-13,19)}, hybrid chlorosis¹⁷⁾ and distorted segregation⁷⁾. Among these post-hybridization reproductive barriers, hybrid breakdown which is defined as weakness and sporophytic sterility found in the F₂ and later inbred generations, is distinct from F₁ weakness or lethality. F₁ weakness and hybrid breakdown have been detected in remote crosses of Asian cultivated rice. Whereas a pair of complementary dominant genes causes weakness and lethality in F₁ plants^{1,8,16)}, a pair of complementary or duplicate recessive genes is responsible for weakness in the F₂ and later generations^{3,8,13)}. These characters are free from direct artificial selection and are useful for research into evolution and differentiation in plants. The geographical distribution of genes conferring reproductive barriers reflects the phylogenetic relationship of the varietal groups of rice.

In a breeding program aimed at producing isogenic lines for the wx genes, 30 glutinous cultivars from different Asian countries were used for crosses to introduce the wx gene into the Japanese cultivar, Sasanishiki. When a Thai glutinous cultivar of upland rice, Col.No.15 was used for the cross, weak plants appeared among BC₁F₁ plants backcrossed to Sasanishiki.

In this report, the genetic basis of hybrid breakdown found in the above cross, the geographical distribution of the genes responsible for hybrid breakdown, mapping of genes using RFLP markers and the role of hybrid breakdown in genetic differentiation of Asian cultivated rice will be discussed.

## **Inheritance of hybrid breakdown**^{13,15)}

To analyze the mode of inheritance of weakness, various populations were produced. Reciprocal crosses were made between Sasanishiki and Col.No.15. F₁ plants were backcrossed to both cultivars and were also self-pollinated. Weak BC₁F₁ and BC₂F₁ segregants were crossed to Sasanishiki. Seeds from self-pollinated spikelets of weak BC₁F₁ plants were bulked to detect segregation in the BC₁F₂ generation. Each BC₁F₂ plant was separately harvested to analyze segregation in the BC₁F₃ generation. All the materials were transplanted in the field at the same time and observed for their growth and morphology. BC₁F₂ bulked populations originating from weak BC₁F₁ segregants were planted in the field and investigated for heading time, culm length and the number of panicles per plant.

The segregation for hybrid weakness in different generations is shown in [Table 1](#). F₁ plants of reciprocal crosses between Sasanishiki and Col.No.15 showed vigorous growth and were fertile. BC₁F₁ plants backcrossed to both cultivars segregated into 3 normal : 1 weak types. Weakness did not appear at the seedling stage. The weak BC₁F₁ segregants became yellow at the tillering stage and stunted. Weak plants produced one or a few panicles with fertile seeds. When weak BC₁F₁ and BC₂F₁ segregants were backcrossed to Sasanishiki, BC₂F₁ and BC₃F₁ plants segregated into 1 normal : 1 weak plants. BC₁F₂ bulked populations derived from weak BC₁F₁ plants segregated into 1 normal : 3 weak plants. BC₁F₃ lines derived from a random sample of BC₁F₂ plants segregated into 1 normal : 2 heterozygous : 1 weak lines. F₂ plants from reciprocal crosses between Sasanishiki and Col.No.15 segregated into 11 normal : 5 weak plants. Also, F₂ plants of reciprocal crosses between Sasanishiki and weak BC₁F₃ segregants showed a good fit to the segregation ratio 1 normal : 3 weak plants.

[Table 1. Segregation ratios for hybrid weakness observed in each generation\(32KB\)](#)

The frequency distribution for heading time, culm length and number of panicles per plant in the BC₁F₂ bulked population is shown in [Fig. 1](#). Heading time occurred from August 5 to August 30 (99 to 124 days after sowing) and no relation between heading time and weakness was detected. Three-fourths of BC₁F₂ plants had a very short culm and few panicles and the others showed normal growth, reflecting segregation for hybrid weakness.

[Fig.1:Frequency distribution for heading time, culm length and number of panicles per plant on BC₁F₂ population from weak BC₁F₁ plants of the cross, Sasanishiki/Col.No.15//Sasanishiki\(17KB\)](#)

The genetic basis of hybrid breakdown found in the progeny of the cross between Sasanishiki and Col.No.15 could be elucidated by assuming the presence of a pair of complementary loci in the same manner as postulated by Oka⁸). The segregation ratio for weak and normal plants in all the generations analyzed fitted well to the expected ratios in each population for this mode ([Table 1](#)). Based on this model, if Sasanishiki and Col.No.15 have the genotypes, AAbb and aaBB, segregants with only one or no dominant gene, Aabb, aaBb and aabb, are likely to express the weakness. At least 2 dominant genes at either the same or different loci, AAbb, aaBB and AaBb, are necessary for normal growth.

Based on the results obtained in this study, a pair of complementary loci causing hybrid breakdown in Asian cultivated rice was symbolized as *hwd1* and *hwd2*. Col.No.15 and Sasanishiki carry recessive alleles at the *hwd1* and *hwd2* loci, respectively.



[Continue to -Distribution of a pair of complementary genes for hybrid breakdown-](#)



[Contents](#)

## References



[Back to the first page](#)

- 1) Amemiya, A. & Akemine, H. (1963): Biochemical genetic studies on the root growth inhibiting complementary lethal genes on rice plants. *Bull. Nat. Inst. Agric. Sci. Ser. D*, 10, 139-226.
- 2) Fukuoka, S., Namai, H. & Okuno, K. (1998): RFLP mapping of the genes controlling hybrid breakdown in rice (*Oryza sativa* L.). *Theor. Appl. Genet.*, 97, 446-449.
- 3) Ise, K., Sekizawa, K. & Sato, H. (1992): Inheritance of hybrid weakness in indica/japonica rice crosses. *IRRN*, 17, 5.
- 4) Kurata, N. et al. (1994): A 330 kilobase interval genetic map of rice including 883 expressed sequences. *Nat. Genet.*, 8, 365-372.
- 5) Lander, E. S., Green, P. & Abrahanson, J. (1987): MAPMAKER: An interactive computer package for constructing primary genetic linkage maps of experimental and natural populations. *Genomics*, 1, 174-181.
- 6) Li, Z. K. et al. (1997): Genetics of hybrid sterility and hybrid breakdown in an intersubspecific rice (*Oryza sativa* L.) population. *Genetics*, 145, 1139-1148.
- 7) Nakagahra, M. (1972): Genetic mechanism on the distorted segregation of marker genes belonging to the eleventh linkage group in cultivated rice. *Jpn. J. Breed.*, 22, 232-238.
- 8) Oka, H. I. (1957a): Phylogenetic differentiation of cultivated rice. XV. Complementary lethal genes in rice. *Jpn. J. Genet.*, 32, 83-87.
- 9) Oka, H. I. (1957b): Genic analysis for the sterility of hybrids between distantly related varieties of cultivated rice. *J. Genetics*, 55, 397-409.
- 10) Oka, H. I. (1974): Analysis of genes controlling F1 sterility in rice by the use of isogenic lines. *Genetics*, 77, 521-534.
- 11) Oka, H. I. (1978): Phylogenetic differentiation of cultivated rice. XXI. The sporophytic pollen sterility: its genetic basis and intervarietal relationship as shown by F₂ sterility. *Jpn. J. Genet.*, 53, 397-410.
- 12) Oka, H. I. & Doida, Y. (1962): Phylogenetic differentiation of cultivated rice. XX. Analysis of the genetic basis of hybrid breakdown in rice. *Jpn. J. Genet.*, 37, 24-35.
- 13) Okuno, K. (1985): Complementary recessive genes controlling hybrid breakdown found in a varietal cross of rice. *Rice Genet. Newsl.*, 2, 52-54.

- 14) Okuno, K. (1996): Partial cross-incompatibility in cultivated rice. *Rice Genet. Newsl.*, 13, 117-118.
- 15) Okuno, K. (1999): Geographical distribution of genes causing hybrid breakdown in varietal crosses of Asian cultivated rice. *Genetic Res. & Crop Evol.*, 46 (in press).
- 16) Sato, Y. I. & Hayashi, K. (1983): Distribution of the complementary genes causing F₁ weakness in the common rice and its wild relatives. I. *L-2-a* gene in Asian native cultivars. *Jpn. J. Genet.*, 58, 411-418.
- 17) Sato, Y. I. & Morishima, H. (1988): Distribution of the genes causing F₁ chlorosis in rice cultivars of the Indica and Japonica types. *Theor. Appl. Genet.*, 75, 723-727.
- 18) Stebbins, G. L. (1950): Isolation and the origin of species. *In* Variation and evolution in plants. ed. Stebbins, G. L., 189-250.
- 19) Yokoo, M. (1984): Female sterility in an Indica-Japonica cross of rice. *Jpn. J. Breed.*, 34, 219-227.



[Back to the first page](#)

Table 1. Segregation ratios for hybrid weakness observed in each generation

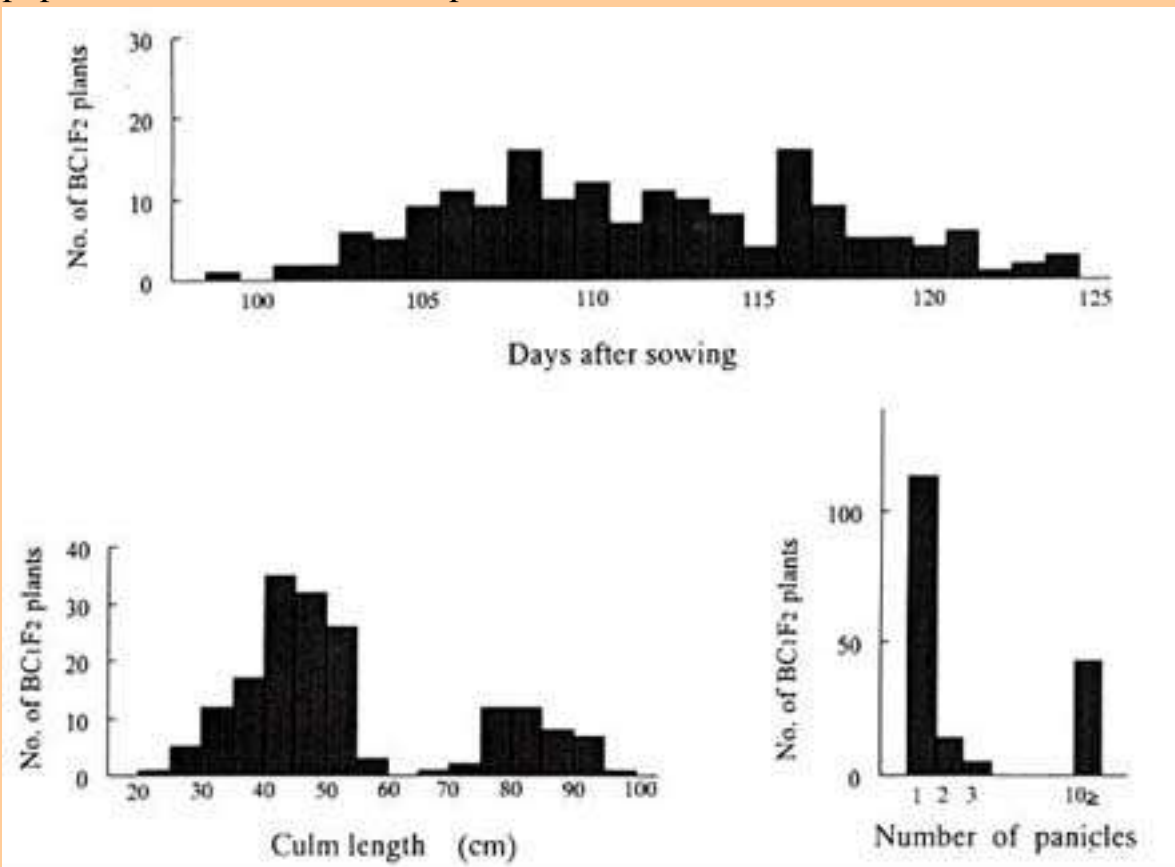
Generation	Cross-combination ^{a)}	Number of plants			Ratio expected	$\chi^2$
		Normal	Seg. ^{b)}	Weak		
F ₁	Sas/Col. 15	45		0	1 : 0	0.000
	Col. 15/Sas	105		0	1 : 0	0.000
F ₂	Sas/Col. 15	474		226	11 : 5	0.350
	Col. 15/Sas	326		165	11 : 5	1.267
BC ₁ F ₁	Sas/Col. 15//Sas	30		12	3 : 1	0.286
	Sas/Col. 15//Col. 15	23		8	3 : 1	0.011
BC ₂ F ₁	Col. 15/Sas//2*Sas	15		13	1 : 1	0.143
BC ₃ F ₁	Sas/Col. 15//3*Sas	22		15	1 : 1	1.324
BC ₁ F ₂	Sas/Col. 15//Sas	46		142	1 : 3	0.028
BC ₁ F ₃	Sas/Col. 15//Sas	46	83	54	1 : 2 : 1	2.279
F ₂	Sas/weak BC ₁ F ₃ segregant	85		255	1 : 3	0.000
	Weak BC ₁ F ₃ segregant/Sas	130		473	1 : 3	3.808

a): Sas; Sasanishiki, Col. 15; Col. No. 15. b): Lines segregating into weak and normal plants.



[BACK](#)

**Fig.1:**Frequency distribution for heading time, culm length and number of panicles per plant on BC₁F₂ population from weak BC₁F₁ plants of the cross, Sasanishiki/Col.No.15//Sasanishiki



 [BACK](#)

## Distribution of a pair of complementary genes for hybrid breakdown¹⁵⁾

Early maturing and fertile BC₁F₃ lines in which double recessive homozygotes express weakness, were selected as tester lines. Using BC₁F₃ lines lacking dominant genes, *hwd1/hwd1 hwd2/hwd2*, for hybrid breakdown, a total of 100 Asian rice cultivars were tested for complementary genes at a pair of unlinked loci. Five to 10 F₁ plants from each of the crosses were grown in the field and analyzed for weakness based on their growth pattern and morphology. F₂ plants from reciprocal crosses between Sasanishiki and one of the tester lines were also investigated.

When the F₁ plants between a tester line and a given cultivar show vigorous growth, the cultivar is likely to carry 2 pairs of dominant genes, *Hwd1/Hwd1 Hwd2/Hwd2*. When the F₁ plants show weakness, the cultivar is likely to carry one pair of dominant genes, *Hwd1/Hwd1 hwd2/hwd2* or *hwd1/hwd1 Hwd2/Hwd2*. When the F₁ plants were intermediate between normal and weak plants, their F₂ progeny was further tested to determine the genotype for hybrid breakdown of cultivars.

Geographical distribution of a pair of complementary genes causing hybrid breakdown in Asian cultivated rice is presented in [Fig. 2](#). Clinal variation was observed in the frequency of genotypes for hybrid breakdown among Asian cultivars. A majority of cultivars with 2 dominant genes, *Hwd1/Hwd1 hwd2/hwd2* or *hwd1/hwd1 Hwd2/Hwd2*, was found in insular Asia, Japan, Philippines and Indonesia. On the other hand, the frequency of cultivars with 4 dominant genes, *Hwd1/Hwd1 Hwd2/Hwd2* was more common in continental Asia, China, Vietnam, Laos, Thailand and Myanmar. All the Nepalese cultivars analyzed in this study carried four dominant genes.

[*Fig.2: Geographical distribution of a pair of complementary genes responsible for hybrid breakdown in Asian cultivated rice\(23KB\)*](#)

## Mapping of complementary genes using RFLP markers²⁾

The location of the complementary genes causing hybrid breakdown was analyzed using RFLP markers. Two cultivars with 2 dominant genes at either locus were used for one of the parents to produce mapping populations. Nepalese cultivar Siborunauli 1 is dominant for *hwd1* and recessive for *hwd2*. Thai cultivar Col.No.15 is dominant for *hwd2* and recessive for *hwd1*. Crosses between these cultivars and one of the tester lines (W26) which is recessive homozygote for these 2 loci were made to produce F₂ mapping populations. F₁ plants from both cross-combinations had only one dominant allele and showed weakness. Two hundred and twenty-five F₂ plants from the cross between W26 and Siborunauli 1 and 184 F₂ plants from the cross between Col.No.15 and W26 were analyzed for segregation into weak and normal plant types.

Total DNA was isolated from the leaves of each F₂ plant using standard procedures and was digested with restriction enzymes. Southern hybridization and signal detection were conducted using ECL direct nucleic acid labeling and a detection kit (Amersham). RFLP markers mapped on the rice linkage map⁴⁾ were used for mapping. Segregation patterns of RFLP markers and plant types in F₂ populations were analyzed with MAPMAKER/EXP 3.0⁵⁾. The map position of 2 loci controlling hybrid breakdown was determined by multipoint linkage analysis.



F₂ plants from the cross between W26 and Siborunauli 1 segregated into 52 normal : 173 weak types. F₂ plants from the cross between Col.No.15 and W26 segregated into 56 normal : 128 weak types. These data fitted to the expected ratio of 1 : 3. Linkage analysis using F₂ population from the cross between W26 and Siborunauli 1 revealed that the gene *hwd1* was located in the proximal region on chromosome 10. The gene, *hwd1*, was linked between RFLP markers C701 and R2309 at a distance of 0.9 centiMorgans (cM) and 0.6 cM, respectively ([Fig. 3](#)). In the F₂ population from the cross between Col.No.15 and W26, 4 RFLP markers (C796B, R1382, C145, C492) co-segregated with plant types, indicating that *hwd2* was located in the central region of chromosome 7 ([Fig. 4](#)).

[Fig.3:Linkage map showing the position of *hwd1* responsible for hybrid breakdown in rice\(17KB\)](#)

[Fig.4:Linkage map showing the position of *hwd2* responsible for hybrid breakdown in rice\(19KB\)](#)

## Role of hybrid breakdown in varietal differentiation of Asian cultivated rice

Hybrid weakness in F₁ and hybrid breakdown including weakness in F₂ and later generations have been observed in particular crosses among Asian rice cultivars. The former occurs under a complementary dominant gene system and F₁ plants heterozygous for 2 complementary loci are not viable^{1,8,16}. The latter occurs under a complementary or duplicate recessive gene system and F₂ progeny segregates into weak^{8,3,13}, partially sterile^{6,11,12,19} or chlorotic¹⁷ plants according to Mendelian segregation ratios.

Hybrid weakness analyzed in this study was detected in F₂ and later generations in the cross between a Japanese and a Thai cultivar. Therefore, this weakness is categorized into hybrid breakdown and is controlled by a pair of complementary recessive genes with a segregation ratio of 11 normal : 5 weak plants in the F₂. These results are the same as those reported in the F₂ of a cross between an Indian cultivar and a Japanese cultivar⁸). On the other hand, a duplicate recessive gene system with a segregation ratio of 15 normal : 1 weak or chlorotic plants in the F₂ has also been reported^{3, 17}). If hybrid breakdown contributes to promoting *indica-japonica* differentiation of Asian cultivated rice, these complementary or duplicate genes causing hybrid breakdown must be distributed independently in *indica* and *japonica* rices. In this study, one of the complementary genes for hybrid breakdown, *hwd1*, was carried by the indica cultivar, Col.No.15, and the other gene, *hwd2*, the *japonica* cultivar, Sasanishiki. These findings suggest that the genes may have caused or accelerated *indica-japonica* differentiation. However, to gain a better understanding of the role of hybrid breakdown in varietal differentiation, the distribution pattern of *hwd1* and *hwd2* in rice cultivars with the genotypes, *Hwd1/Hwd1 hwd2/hwd2* and *hwd1/hwd1 Hwd2/Hwd2*, will be further analyzed.



[Forward to:-Groundwater Pollution by Cattle Slurry Stored in Unlined Lagoon-](#)



[Contents](#)

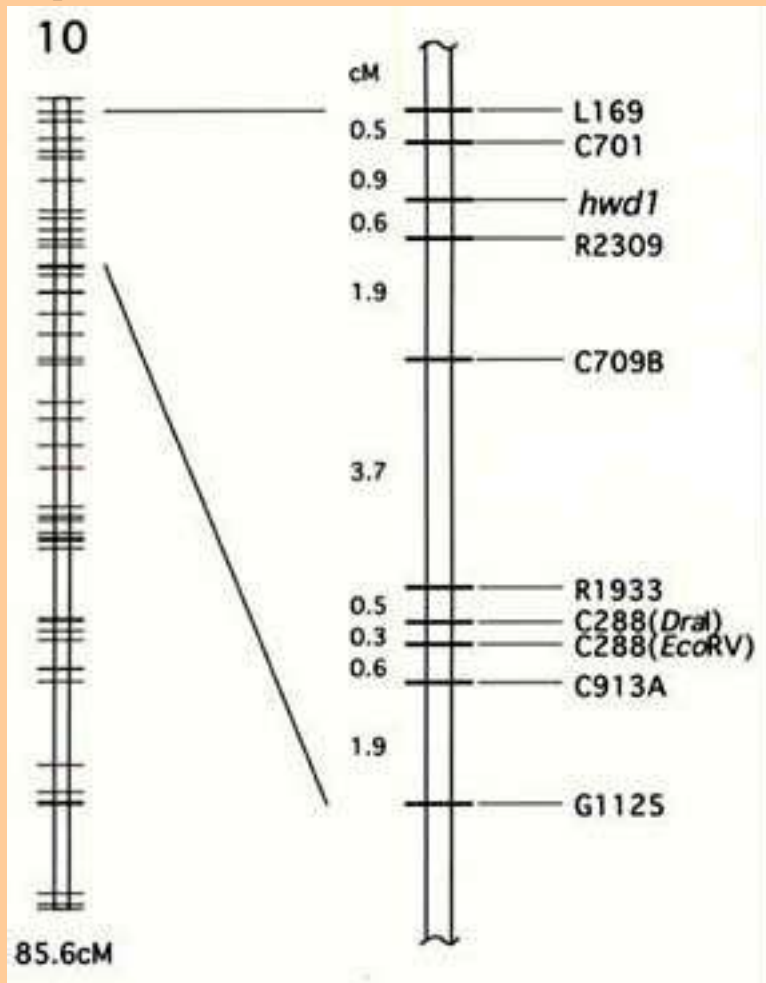


[JIRCAS Home Page](#)

**Fig.3.**

Linkage map showing the position of *hwd1* responsible for hybrid breakdown in rice

Loci are shown on the right side map and the distance (cM) among rflp markers is shown on the left side map of chromosome10.

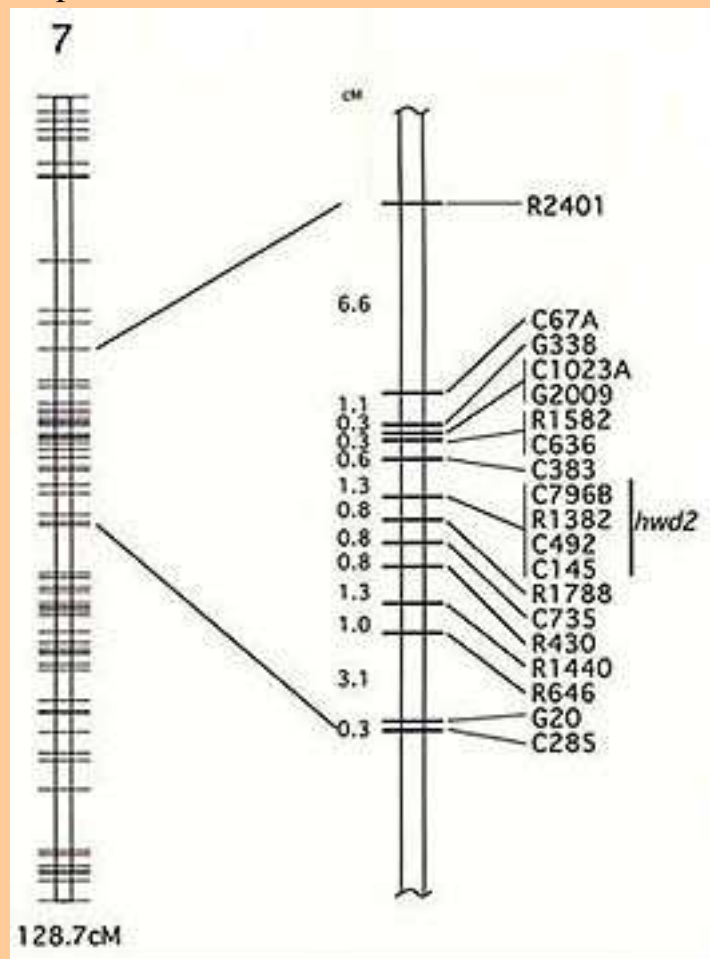


[BACK](#)

**Fig.4.**

Linkage map showing the position of *hwd2* responsible for hybrid breakdown in rice

Loci are shown on the right side map and the distance (cM) among rflp markers is shown on the left side map of chromosome 7.



[BACK](#)

# Groundwater Pollution by Cattle Slurry Stored in Unlined Lagoon

Kenji KANAZAWA*1, Naomichi MIYAJI*2, Takashi KUSABA*2, Kazuaki BAN*1,  
Yoshihiko HAYAKAWA*3 and Ryusuke HATANO*4

*1,3 Department of Forage Crop Breeding and Grasslands, Hokkaido National Agricultural Experiment Station (Sapporo, Hokkaido, 062-8555 Japan)

*2 Department of Agro-Environment Sciences, Hokkaido National Agricultural Experiment Station (Sapporo, Hokkaido, 062-8555 Japan)

*4 Faculty of Agriculture, Hokkaido University (Sapporo, Hokkaido, 060-8589 Japan)

## Abstract

The influence of dairy wastes stored in an unlined lagoon on the total nitrogen concentration of shallow groundwater was investigated in western Hokkaido. The lagoon was constructed in a meadow consisting of an Andosol with a high water table. Increase of the total nitrogen concentration in groundwater was observed at a distance of 75 m from the lagoon within 4 days after a low concentration dairy slurry was loaded into the lagoon. At a distance of 15 m from the lagoon, higher total nitrogen concentration was still observed 85 days after slurry loading. These facts clearly indicate that groundwater contamination by cattle slurry stored in the unlined lagoon occurs very quickly and persists for a very long period of time.

**Discipline:** Agricultural environment

**Additional key words:** nitrogen leaching, Andosols

**Received for publication, June 3, 1998**

1~9):[References](#)

## Introduction

In Japan, the largest dairy farming areas are located in the eastern and the northern parts of Hokkaido. The farms are getting larger and the number of dairy cattle is increasing in these areas. Dairy wastes were usually separated into solid and liquid materials. However, increasing volume of dairy wastes recently has tended to be handled as slurry. Slurry is sometimes stored in unlined earthen pits, namely lagoons, for economic reasons. Lagoons have already been used in more concentrated animal industries such as swine production in Japan.

Obviously, the utilization of such lagoons is associated with the risk of groundwater contamination. Ozaki et al.⁶⁾ observed an increase in the concentration of nitrate in shallow groundwater at a distance of 50 m from a swine waste lagoon. Shimura and Tabuchi⁸⁾ pointed out that the nitrate concentration of the river increased in proportion to the livestock density of the catchments where lagoons are used.

On the other hand, there are conflicting reports on the influence of lagoons^{1, 3)} because the infiltration rates of slurry vary depending on the experimental conditions^{2, 7)}. In a test conducted under drastic conditions, using a 2 ha lagoon filled with relatively dilute beef cattle manure, Miller et al.⁵⁾ observed the rapid self-sealing of the lagoon within 2 weeks. They concluded that the lagoon had no effect on the downstream groundwater quality. However, Culley and Phillips³⁾ concluded that lagoons were not effectively sealed in an experiment covering a 5-year period using 3 lagoons constructed in areas with different soil types.

In this study, the objective was to examine the risk of utilizing an unlined lagoon. Influence of dairy wastes stored in a lagoon on the total nitrogen concentration of shallow groundwater was investigated. In order to observe the influence clearly, an experiment was conducted under drastic but possible conditions in actual farms. In the experimental design, special attention was paid to both areal expansion and temporal changes of groundwater contamination. Detailed process of contamination is described and its magnitude was analyzed.

## Materials and methods

### 1) Site description

The experiment was conducted at Hokkaido National Agricultural Experiment Station, Sapporo (43° 0' N., 141° 24' E.). A cylindrical lagoon, 10 m i.d.x1.8 m depth, was excavated in a meadow in June 1995. The experimental field was located on a gentle slope on Tsukisamu terrace. Inclination of the slope was 1.7° (Fig. 1).

[Fig. 1. Contour map of experimental site\(40KB\)](#)

The soil belonged to Cumulic Andosols⁹⁾. Tsukisamu terrace is composed of the Tsukisamu clay Formation of Late Pleistocene, covered with volcanic ashes. Soil survey revealed that volcanic ashes could be divided into a humus accumulation layer and Eniwa loamy layer. A transitional layer was observed beneath the Eniwa loamy layer. The upper part of the Tsukisamu clay Formation was divided into 3 layers based on structural differences, namely upper, middle and lower Tsukisamu clay layers (Fig. 2). Based on properties such as texture of soil layers or spurting out of groundwater, the transitional layer and middle Tsukisamu clay layer were considered to be the main paths of

groundwater flow, although their hydraulic conductivity was not appreciably different from that of the Eniwa loamy layer. Lower Tsukisamu clay layer was an impermeable layer, whose hydraulic conductivity was the lowest. Middle Tsukisamu clay layer was an aquifer because it was underlain by an impermeable layer.

[Fig. 2. Soil profile at the location of the lagoon\(33KB\)](#)

### 2) Operation

One hundred two tons of dilute dairy cattle slurry, with a concentration of 0.8 gN/L total nitrogen, were loaded into the lagoon on June 14, 1995. Since the slurry was rapidly depleted within a few days, additional 23 t were applied on June 21, 1995 in order to keep sufficient loads of slurry.

Groundwater samples were collected from 38 monitoring wells surrounding the lagoon during the period of June 8 and September 7, 1995 ([Fig. 1](#)). Thereafter, the lagoon was overflowed by heavy rainfall, and groundwater sampling was discontinued. Sampling of groundwater was carried out almost every day in the first week after slurry loading, and every 1 or 2 weeks, thereafter. A polyvinyl chloride pipe 26 mm in diameter was used as monitoring well. The pipe was perforated in the lower part up to 60 cm from the bottom, and was set at a 2 m depth from the soil surface ([Fig. 3](#))

[Fig. 3. Profile of survey line along the slope\(26KB\)](#)

### 3) Analysis

Total nitrogen concentration of the groundwater samples was analyzed chromatically after potassium peroxosulfide degradation⁴⁾. Samples contained a large amount of suspended solids, and they were allowed to stand for a week before analysis in order to induce the precipitation of the suspended solids. Nevertheless, the groundwater samples could not be analyzed by ion chromatography because of the residual suspension.

Soil samples were analyzed for water soluble inorganic ions. Analysis was carried out using 0.45 mm filtrate of water : soil = 5 : 1 extracts by ion chromatography (DX-AQ, Nippon Dionex K. K., Osaka, Japan). Results were expressed as ion concentrations in soil water.



[Continue to: \[Results\], \[Discussion\]](#)



[Contents](#)

## References



[Back to the first page](#)

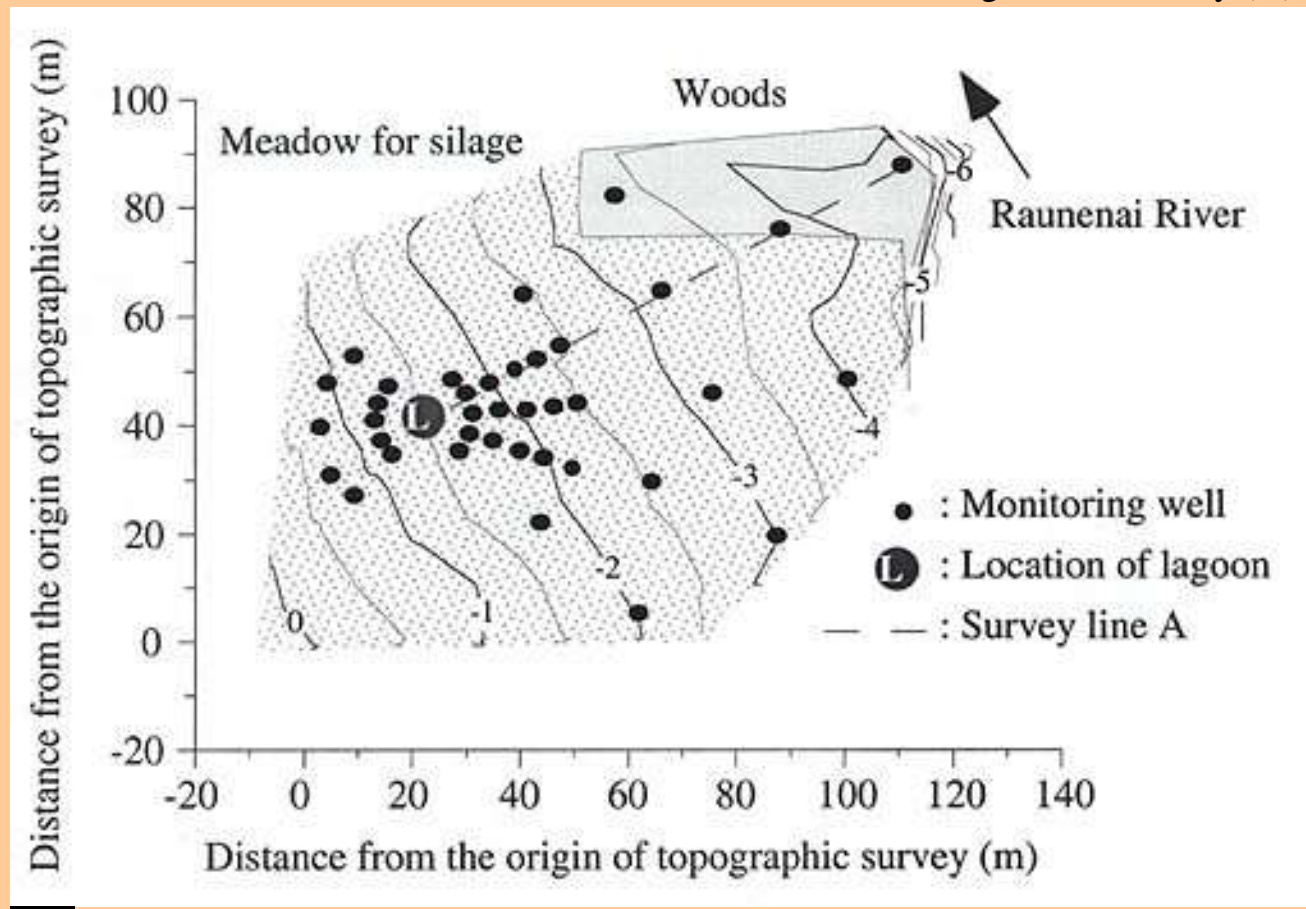
- 1) Ciravolo, T. G. et al. (1979): Pollutant movement to shallow ground water tables from anaerobic swine waste lagoons. *J. Environ. Qual.*, **8**, 126-130.
- 2) Culley, J. L. B. & Phillips, P. A. (1989): Retention and loss of nitrogen and solids from unlined earthen manure storages. *Trans. Am. Soc. Agric. Eng.*, **32**, 677-683.
- 3) Culley, J. L. B. & Phillips, P. A. (1989): Groundwater quality beneath small-scale, unlined earthen manure storages. *Trans. Am. Soc. Agric. Eng.*, **32**, 1443-1448.
- 4) Japanese Association of Water Pollution Research (1982): Survey manuals for lake environment. Association of Environmental Pollution Control, 134-136 [In Japanese].
- 5) Miller, M. H., Robinson, J. B. & Gillham, R. W. (1985): Self-sealing of earthen liquid manure storage ponds: I. A case study. *J. Environ. Qual.*, **14**, 533-538.
- 6) Ozaki, Y. et al. (1991): Effects of nutrients leached from pig waste reservoir on shallow groundwater. *Div. Environ. Planning Res. Rep., Natl. Inst. Agro-Environ. Sci.*, **7**, 117-132 [In Japanese].
- 7) Rowsell, J. G. Miller, M. H. & Groenevelt, P. H. (1985): Self-sealing of earthen liquid manure storage ponds: II. Rate and mechanism of sealing. *J. Environ. Qual.*, **14**, 539-543.
- 8) Shimura, M. & Tabuchi, T. (1996): The relation between nitrogen concentration of stream waters and pig stocking density. Research on nitrogen outflow from high stocking density area (III). *Trans. JSIDRE* (Jpn. Soc. Irrig. Drain. & Reclam. Eng.), **182**, 17-23 [In Japanese].
- 9) The National Institute of Agro-Environmental Sciences(1995): Classification of cultivated soils in Japan third approximation. The National Institute of Agro-Environmental Sciences, Tsukuba [In Japanese].



[Back to the first page](#)

**Fig.1.**Contour map of experimental site

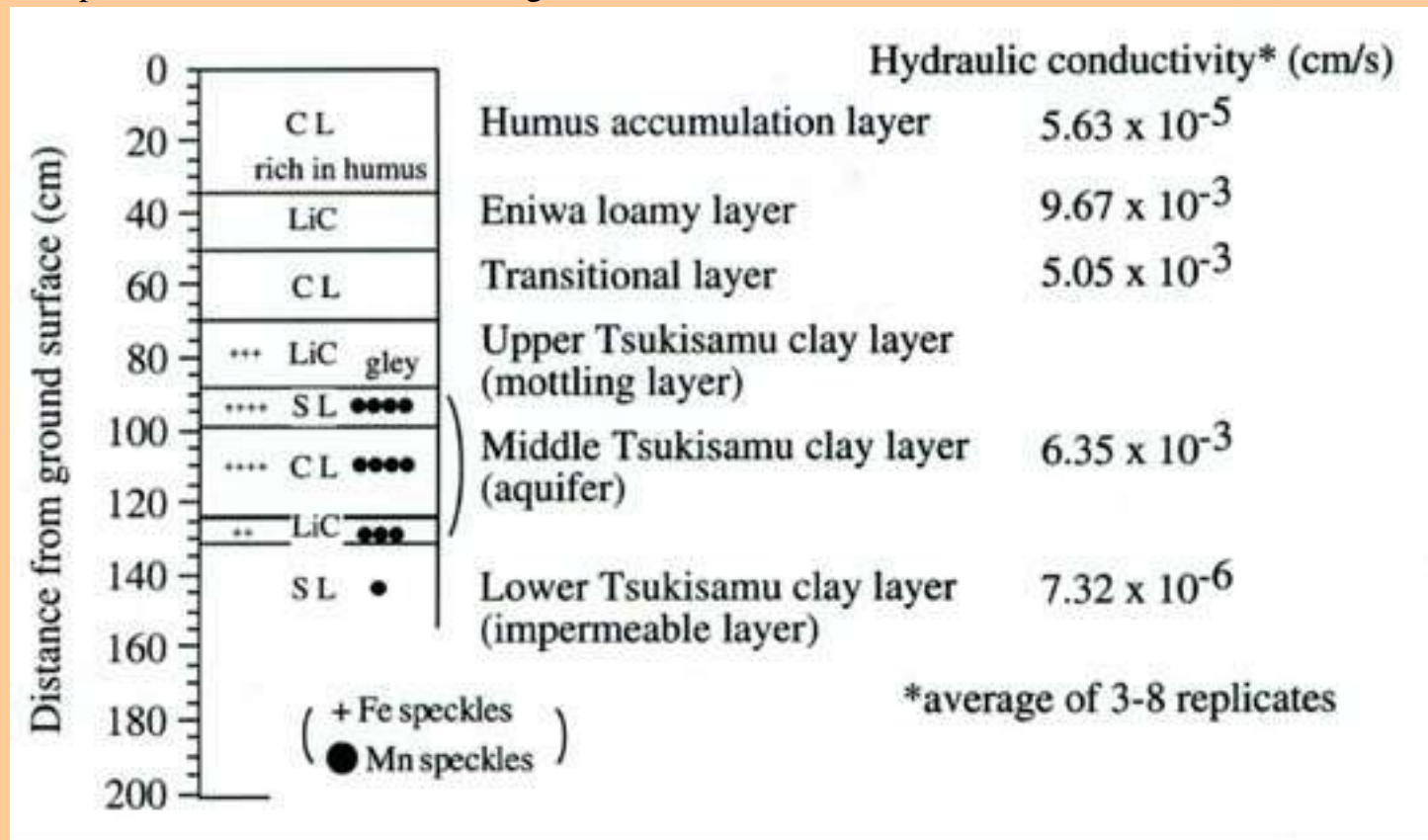
Contour lines are indicated with relative altitude values to the origin of the survey (m).



 [BACK](#)

**Fig.2.**

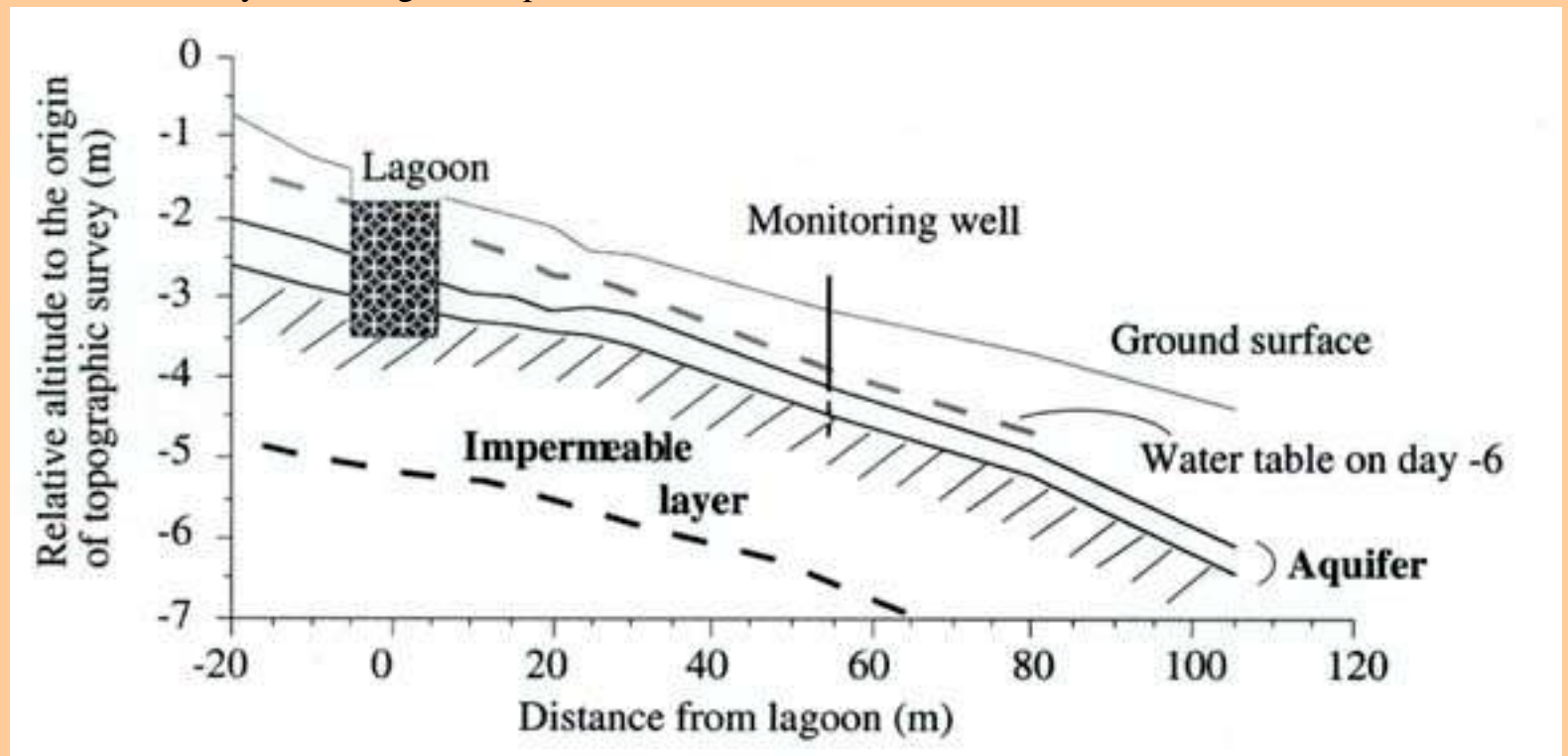
Soil profile at the location of the lagoon



 [BACK](#)



**Fig.3.**  
Profile of survey line along the slope



 [BACK](#)

## Results

### 1) Effect of slurry application on total nitrogen concentration of shallow groundwater

Highly contaminated groundwater was observed immediately after the first slurry loading. Contamination spread rapidly. Expansion of contaminated groundwater occurred mainly along the slope inclination (Fig. 4). After 9 days of the first loading, the contaminated area decreased. However, contamination still persisted at 85 days after the first loading in the vicinity of the lagoon

#### Fig. 4. Expansion of groundwater containing a high concentration of total nitrogen(43KB)

In order to analyze the temporal changes of the total nitrogen concentration in detail, data of 8 monitoring points on line A (Fig. 1) are shown in Table 1. Based on the background level, 1.2 mgN/L at most, the data over 2 mgN/L were considered to indicate the contamination of groundwater by the slurry (depicted in shadowed boxes). On the next day of the first slurry loading, the total nitrogen concentration exceeded the background level at a distance of 50 m from the lagoon. On the 4th day, 75 m point was also contaminated. After 9 days, the concentration decreased at most of the monitoring points. However, contamination still persisted at 85 days after the first loading at 15 m point.

**Table 1. Temporal changes in total nitrogen concentration of groundwater**

Distance from lagoon	Total nitrogen concentration (mgN/L)									
	Days after slurry loading									
	-6 d	1 d	2 d	4 d	7 d	9 d	15 d	22 d	43 d	85 d
5 m	0.6	142.6	180.7	217.1	208.7	184.8	210.9	87.6	113.7	17.2
10 m	0.7	82.8	127.9	143.0	112.2	96.0	69.4	46.3	41.5	10.6
15 m	0.6	50.5	19.4	91.3	80.4	64.5	38.1	28.9	26.9	3.5
20 m	0.5	33.3	10.5	30.9	43.4	44.2	29.6	19.8	7.5	1.9
25 m	0.5	3.5	11.5	17.5	19.2	21.1	20.4	3.3	2.5	1.5
50 m	0.5	2.0	3.0	11.1	11.8	7.9	1.8	3.8	2.2	1.1
75 m	0.1	0.3	0.6	2.6	3.9	4.1	4.2	2.9	1.4	0.7
100 m			0.2	0.3	0.0	0.5	0.5	0.3	0.3	0.6

Samples were collected from wells on survey line A (Fig.1).

Values over 2 mgN/L are shadowed.

### 2) Contamination path

After monitoring of the total nitrogen concentration in the groundwater, the slurry was removed and the surrounding soils were analyzed for water-extractable inorganic ions.

In order to analyze the running path of contaminated groundwater, soil samples were collected from every 20 cm layer at 5 sites on line A (Fig. 1). Influence of slurry was obvious at 5 m point down the lagoon (Fig. 5). Ammonium, potassium and chloride were mainly detected in the middle Tsukisamu clay layer. This fact corresponded to the observation that the middle Tsukisamu clay layer was an aquifer, suggesting that most of the contaminated water moved through this aquifer. Interestingly, the nitrate distribution was very different for unknown reasons.

#### Fig.5.Distribution of water-extractable ions in soils(along the slope)(31KB)

Downward seepage of slurry was examined using soils beneath the bottom of the lagoon. Ammonium, potassium, nitrate and sulfate were mainly distributed within a 20 cm area under the bottom. Chloride was detected slightly deeper, but most part remained within the 50 cm zone (Fig. 6). These facts indicate that downward seepage of the slurry was negligible in this study compared to the horizontal expansion of the contamination.

#### Fig.6.Distribution of water-extractable ions in soils(25KB)

## Discussion

We examined the influence of slurry stored in an unlined lagoon on the total nitrogen concentration of groundwater. Experimental conditions were drastic. The lagoon was constructed where a continuous flow of shallow groundwater was expected, and the slurry which had a very low viscosity would easily percolate into soils. These conditions allowed us to clearly demonstrate the areal expansion, temporal changes and running path of groundwater contamination.

Through an aquifer, an immediate leakage of slurry was observed. On the other hand, decrease of contamination was also observed at the early stage, suggesting that self-sealing effect of the lagoon had occurred. However, this fact may not rule out the risk of continued leakage of slurry because the contamination of groundwater was still detectable at 85 days after the first loading. Moreover, although we constructed a lagoon as large as possible, it was even smaller than those used in actual dairy farms. With 50 cows, our model lagoon might be filled up in approximately 40 days, only half of the period during which the influence of slurry on the contamination of groundwater was still observed. Persisting contamination was also detected in a swine farm in Japan⁶, where a lagoon kept polluting the groundwater at a distance of 50 m

even after 20 years of use which should have been long enough for self-sealing to occur.

Special attention must be paid to the presence of macropores. They largely contribute to the groundwater flow, but precise evaluation of their contribution is difficult. We detected a contamination at a distance of 50 m on the next day of slurry loading, which suggests that contaminated water moved down through some paths with a  $10^{-0}$  cm/s order hydraulic conductivity. Average hydraulic conductivity was  $10^{-3}$  cm/s order in permeable layers, and even the highest value of all the data obtained was  $10^{-2}$  cm/s order. Contribution of a considerable number of macropores was ruled out in the estimation of hydraulic conductivity despite repeated tests. Therefore, it is unlikely that the velocity of the groundwater flow can be predicted based on the hydraulic conductivity.

Evaluation of the slurry loss is important to consider the risk of a lagoon. In this study, the depth of stored slurry was monitored ([Fig. 7](#)). It decreased rapidly at the earlier stages and gradually at the later stages. Increase after 54 days was due to heavy rainfall. Precise estimation of slurry loss was impossible because precise estimation of evaporation and dilution of slurry was uncertain. Therefore only a rough estimation was carried out by comparing the monitored slurry depth and the calculated one, assuming the absence of leakage, dilution and maximum evaporation (5 mm a day) from the lagoon. Calculated depth surpassed the monitored one, and the difference between the two increased throughout the period until 54 days after slurry application to the lagoon, when the monitored depth was only 77% of the calculated one. As the slurry had actually been diluted by rainfall during the experiment and the evaporation rate used for the estimation is maximum in this region, more than 23% of total nitrogen in the slurry initially stored in the lagoon was lost within 85 days.

[Fig.7.Temporal changes in depth of slurry\(21KB\)](#)

Dotted line shows calculated depth of slurry. Line with closed circles shows observed depth (refer to text). Average air temperature was 18.8 °C during the experiment (June 14 - September 7, 1995).

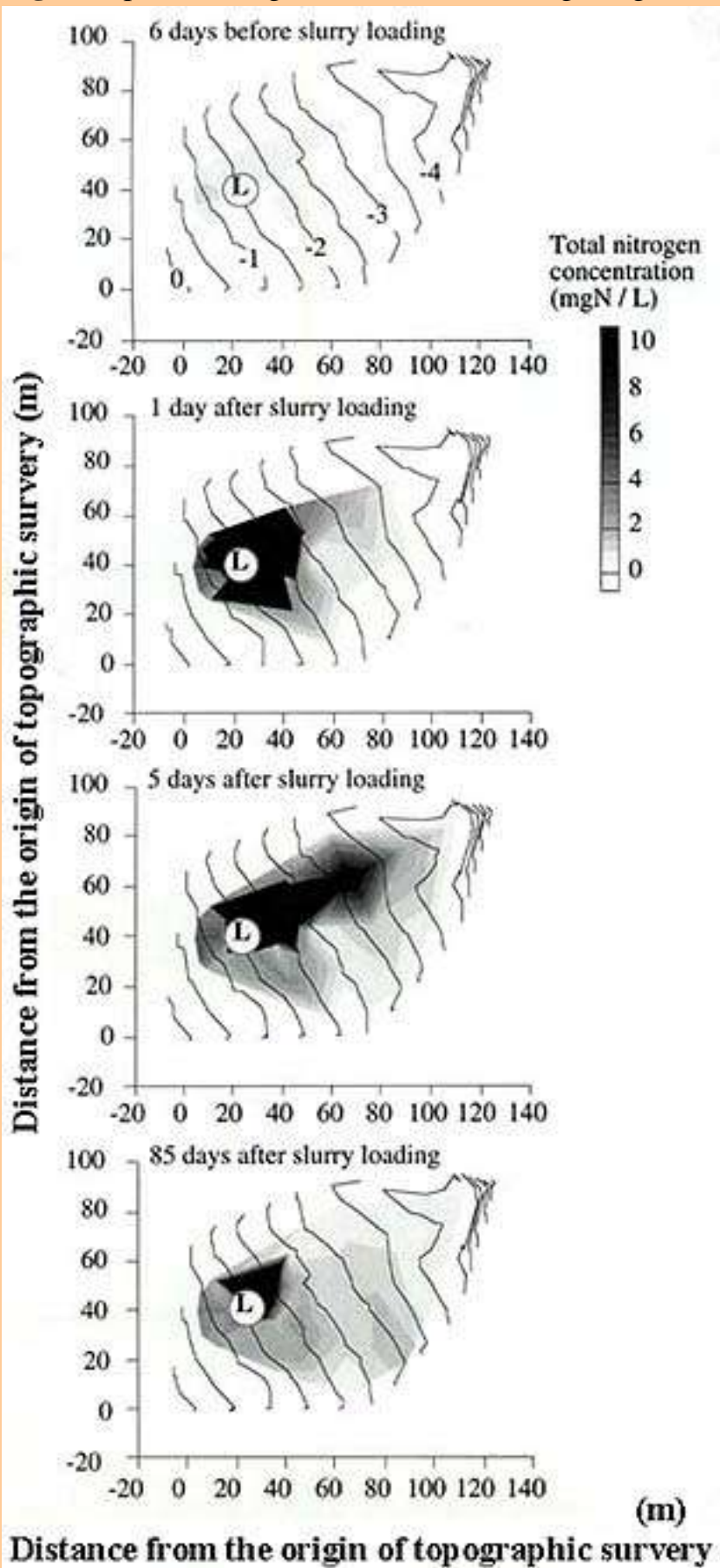
This study demonstrated the risk of using an unlined lagoon for dairy waste storage although experimental conditions were drastic. Environmental problems around livestock farms are a major cause for concern in Japan as they may become more serious in the absence of proper measures. In particular, for the storage of animal excreta, further caution should be paid and risky constructions should be avoided.

 [Forward to:-Direct Acquisition of Organic Nitrogen by Crops-](#)

 [Contents](#)

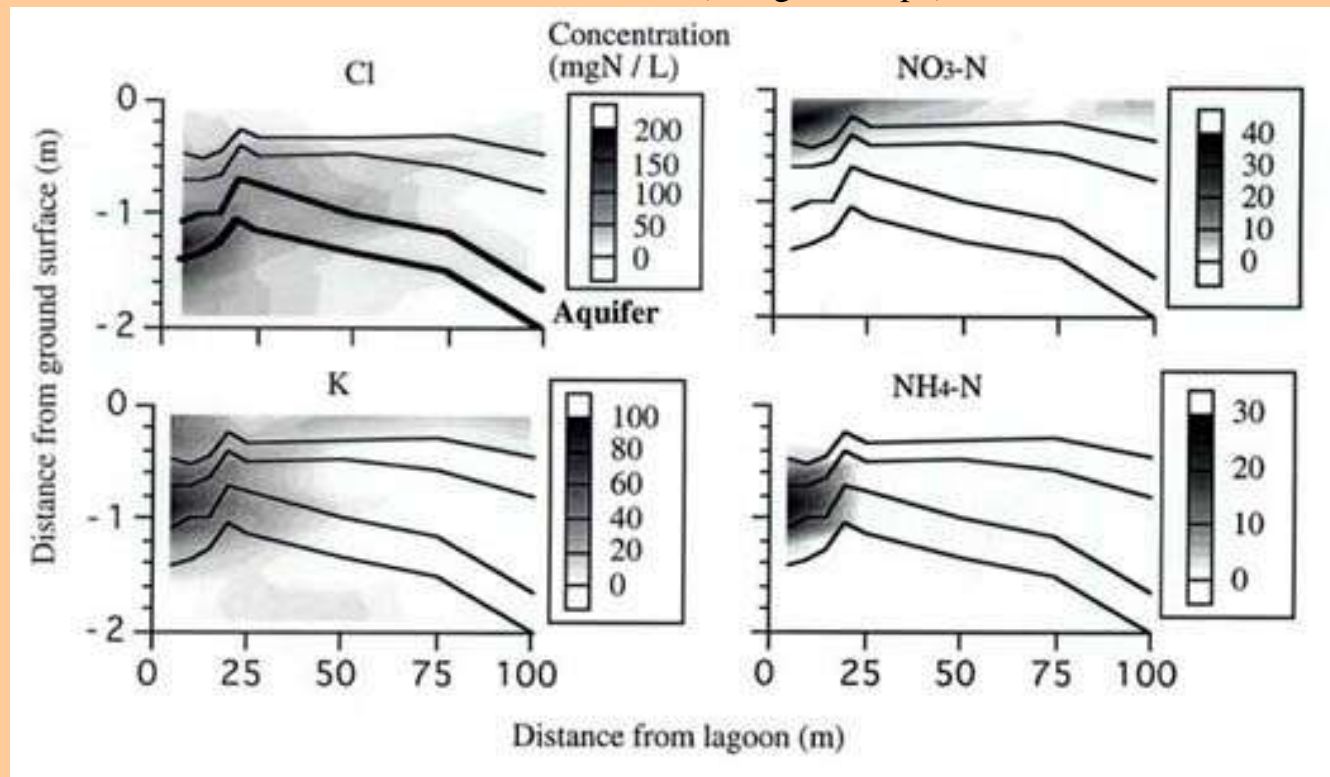
 [JIRCAS Home Page](#)

**Fig.4.** Expansion of groundwater containing a high concentration of total nitrogen



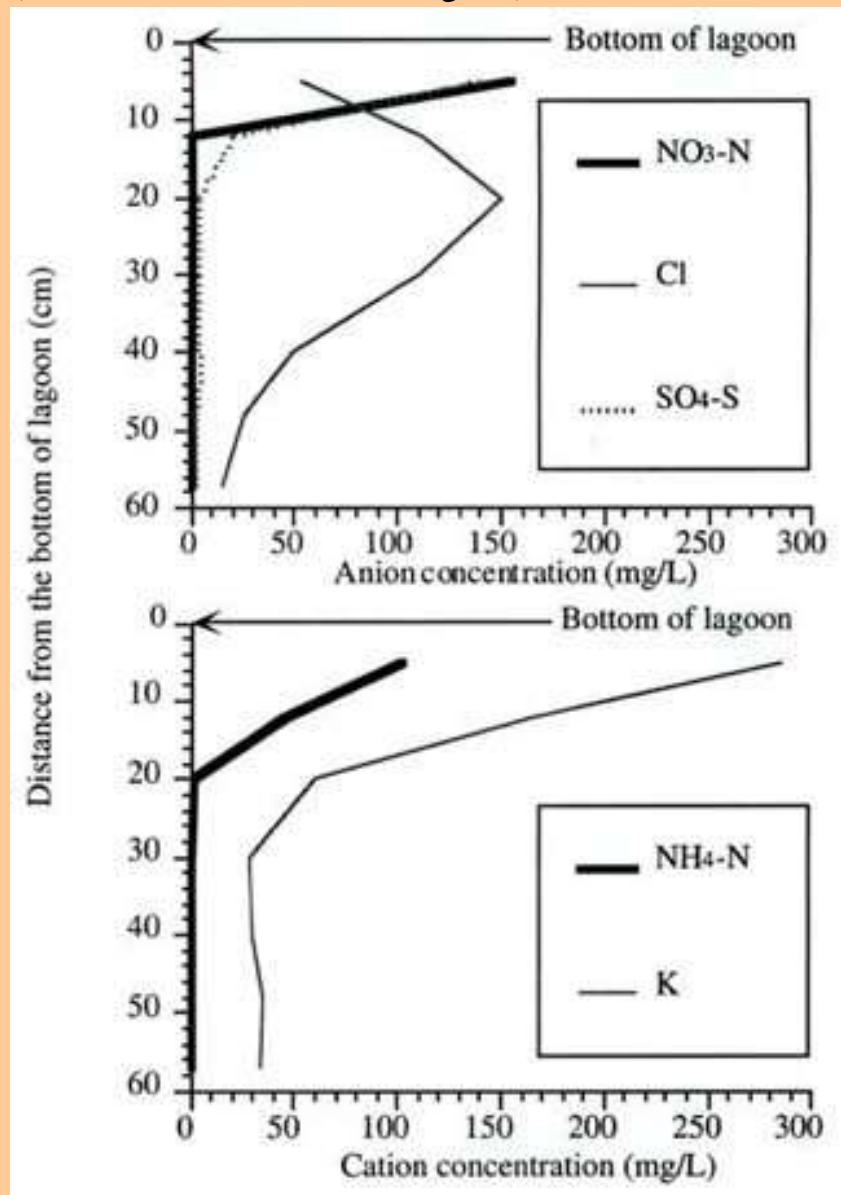
[BACK](#)

**Fig.5.**  
Distribution of water-extractable ions in soils (along the slope)



 [BACK](#)

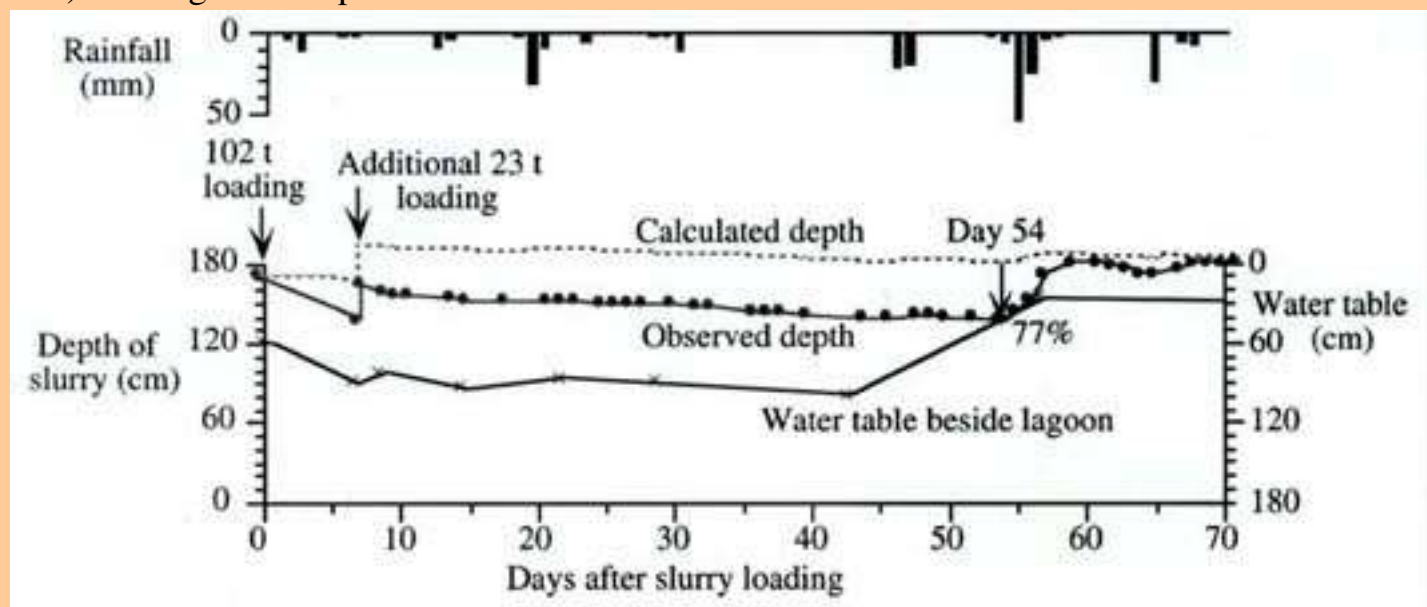
**Fig.6.** Distribution of water-extractable ions in soils (beneath the bottom of the lagoon)



 [BACK](#)

**Fig.7.** Temporal changes in depth of slurry

Dotted line shows calculated depth of slurry. Line with closed circles shows observed depth (refer to text). Average air temperature was 18.8°C during the experiment (June 14-September 7, 1995).



[BACK](#)

# Direct Acquisition of Organic Nitrogen by Crops

**Makoto YAMAGATA* and Noriharu AE**

Department of Natural Resources, National Institute of Agro-Environmental Sciences  
(Tsukuba, Ibaraki, 305-8604 Japan)

Present address:

*Upland Agriculture Research Center, Hokkaido National Agricultural Experiment Station(Memuro, Hokkaido)

## Abstract

Growth response to organic nitrogen application was observed among various crops. We used rice bran mixed with rice straw as organic nitrogen source with a C/N ratio of 20. Nitrogen was not readily released from the organic matter because of the high C/N ratio. Organic nitrogen was applied with chemical fertilizers in an upland field to various crops such as upland rice, maize, potato, sugar beet and soybean. Inorganic nitrogen level in fallow soil was lower until the middle of the growth stage when organic nitrogen and chemical N-P-K fertilizers were applied, compared to the application of chemical fertilizers, only. In contrast to the inorganic nitrogen level in soil, upland rice grew better with organic nitrogen than chemical fertilizer, and took up more nitrogen than other crops during the first 100 days after amendment with organic nitrogen. These results can be attributed to 2 factors. (1) Higher mineralization rate in the rhizosphere of upland rice compared with other crops. Upland rice may enhance nitrogen mineralization in soil by the secretion of some enzymes such as protease and/or materials promoting microorganism activity. (2) Upland rice has a greater ability to take up organic nitrogen directly. If a crop is capable of taking up organic nitrogen in the form of amino acids, peptides and protein, the crop could absorb nitrogen with less competition for nitrogen with microorganisms compared with a crop which absorbs nitrogen mainly as nitrate. The protease activity in the soil planted with maize and sugar beet was higher than that in the soil planted with upland rice and in fallow soil. These results show that the enhancement of nitrogen mineralization is not essential for upland rice. In relation to hypothesis (2), upland rice took up more amino acids than maize in a solution culture containing some kinds of amino acids. The amino acid and protein contents in the soils from the rhizosphere and non-rhizosphere zones of upland rice (hereafter referred to as "rhizosphere and non-rhizosphere soils") were lower than those in the case of maize, soybean and fallow soil. We also observed that upland rice took up nitrogen before mineralization based on a  $^{15}\text{N}$ -labelled rice bran application test. These results suggest that upland rice may take up organic nitrogen preferentially compared with other crops. We examined on the nitrogen uptake mechanism of upland rice and maize. Upland rice takes up nitrogen preferentially in the organic form rather than as nitrate which is the favorite form for maize. Endocytosis is one of the mechanisms for organic nitrogen uptake by upland rice.

**Discipline:** Soils, fertilizers and plant nutrition

**Additional key words:** maize, nitrogen uptake, rice bran, upland rice

**Received for publication, June 3,1998**

1-15):[References](#)



## Introduction

Sustainability of agriculture became a major issue of global concern during this decade. Agronomic practices aimed at reducing the dependence on inputs such as chemical fertilizers can contribute to sustainability. Nitrogen is the most limiting and commonly applied nutrient for crop production. The development of nutrient-responsive cultivars especially during the past 3 decades led to an intensive use of nitrogen fertilizers in many agricultural systems. Environmental and economic problems associated with such a practice have, however, generated an interest in alternative management systems, including the exploitation of beneficial biological functions and substitution of chemical fertilizers with farm-generated products.

Application of organic matter has long been known to improve the soil physical properties besides providing several nutrients including nitrogen. Nitrogen fertility of soils is determined by the amount of inorganic nitrogen released from soils during incubation in the laboratory⁴). In fact, the nitrogen fertility measured by this method is positively correlated with the nitrogen uptake by plants¹⁰). There are several arguments, however, against the use of this method. The amount of nitrogen uptake by plants does not always correspond to the amount of nitrogen released from soils, but depends on plants under the same growth conditions. This does not occur if plants take up inorganic nitrogen formed from organic nitrogen in soils through natural mineralization. It is thus suggested that some crops take up nitrogen in a special form.



[Continue to: \[Nitrogen uptake response of crops to organic nitrogen application\]](#)



[Contents](#)

## References



[Back to the first page](#)

- 1) Arnebrant, K. & Chalot, M. (1995): Uptake of ammonium and alanine by intact birch mycorrhizal systems. Dynamics of physiological processes in woody roots. Booklet of Abstracts, ITHACA, New York, 64.
- 2) Chapin, F. S., Moilanen, L. & Kielland, K. (1993): Preferential use of organic nitrogen for growth by a non-mycorrhizal arctic sedge. *Nature*, **361**, 150-153.
- 3) Clarholm, M. (1985): Interactions of bacteria, protozoa and plants leading to mineralization of soil nitrogen. *Soil Biol. Biochem.*, **17**, 181-187.
- 4) Harmsen, G. W. & Van Schreven, D. A.(1955): Determination of the mineralization of nitrogen in soil. *Adv. Agron.*, **7**, 361.
- 5) Ladd, J. N. & Butler, J. H. (1972): Short-term assays of soil proteolytic enzyme activity using proteins and dipeptide derivatives as substrates. *Soil Biol. Biochem.*, **4**, 19-30.
- 6) Mori, S. (1986): High response of naked barley growth to RNA. *Jpn. J. Soil Sci. Plant Nutr.*, **57**, 171-178 [In Japanese] .
- 7) Nishizawa, N. & Mori, S. (1980): Vacuole formation as a result of intracellular digestion. *Soil Sci. Plant Nutr.*, **26**, 525-540.
- 8) Noguchi, K. (1992): Composition of organic fertilizer and decomposition and change in soil microflora. *Tsukuba Res. Inst. Rep.*, **1**, 14-41 [In Japanese with English summary].
- 9) Rovira, A. D. & Mcdougall, B. (1967): Plant root exudates. *In* Soil biochemistry. eds. Maclaren & Peterson, G.H., Marcel Dekker, New York, 417-463.
- 10) Stanford, G., Ayres, A. S. & Doi, M. (1965): Mineralizable soil nitrogen in relation to fertilizer needs of sugarcane in Hawaii. *Soil Sci.*, **99**, 132-137.
- 11) Yamagata, M. & Ae, N. (1996): Nitrogen uptake response of crops to organic nitrogen. *Soil Sci. Plant Nutr.*, **42**, 389-394.
- 12) Yamagata, M., Ae, N. & Otani, T. (1996): Nitrogen uptake response of crops to organic nitrogen. *Jpn. J. Soil Sci. Plant Nutr.*, **67**, 345-353 [In Japanese with English summary].
- 13) Yamagata, M. & Ae, N. (1997): Preferential use of organic nitrogen by upland rice compared to maize. *In* Plant nutrition for sustainable food production and environment. ed. Ando, T. et al., 509-510.

14) Yamagata, M., Nakagawa, K, & Ae, N. (1997a): Difference of protease activity between crops in rhizosphere. *Jpn. J. Soil Sci. Plant Nutr.*, **68**, 291-294 [In Japanese with English summary].

15) Yamagata, M., Nakagawa, K, & Ae, N. (1997b): Differences among crops on nitrogen uptake from rice bran using the  $^{15}\text{N}$  tracer technique. *Jpn. J. Soil Sci. Plant Nutr.*, **68**, 295-300 [In Japanese with English summary].



[Back to the first page](#)

1~15):[References](#)

## Nitrogen uptake response of crops to organic nitrogen application

Growth response to organic nitrogen application has been studied in upland rice and maize in a field experiment using an inorganic nitrogen source (ammonium fertilizer) and an organic nitrogen source, consisting of a mixture of rice bran and rice straw as amendments. [Fig. 1](#) shows the nitrogen mineralization pattern from soils with rice bran and/or rice straw application.

[*Fig.1:Changes in the amount of nitrogen released from soil amended with rice bran and rice straw singly or in combination \(RBS\) at 30o C\(25KB\)*](#)

### 1) Field experiment

In 1992, maize (*Zea mays* L. var. DK250), potato (*Solanum tuberosum* L. var. Toyoshiro), soybean (*Glycine max* Merr. var. Tachinagaha), sugar beet (*Beta vulgaris* L. var. Beetmonobar) and upland rice (*Oryza sativa* L. var. Toyohatamochi) were grown in an Andosol (41.7 g C kg⁻¹, 3.4 g N kg⁻¹ dry soil) field at the National Institute of Agro-Environmental Sciences, Tsukuba, Japan. All the cultivations were performed under upland field conditions. Organic nitrogen was supplied as a 4:1 mixture of rice bran and straw (RBS). The C/N ratio of this mixture was 20. In 1993, only maize and upland rice were cultivated to confirm the reproducibility.

Nitrogen uptake by upland rice, soybean and potato supplied with organic nitrogen was higher than that of the control ([Fig. 2](#)). However, the amount of inorganic nitrogen in the fallow plot amended with organic nitrogen was lower than in the control ([Fig. 3](#)). These facts indicate that nitrogen uptake by some crops did not reflect the nitrogen levels in soil, and that they displayed a nitrogen uptake ability in the presence of organic nitrogen sources¹¹).

[*Fig.2:Nitrogen uptake response of various crops to organic nitrogen at various inorganic nitrogen rates applied as ammonium sulfate under field conditions\(32KB\)*](#)

[*Fig.3:Changes in inorganic nitrogen content at each depth of the fallow plot amended with ammonium sulfate at 80 kg ha-1 nitrogen rate\(25KB\)*](#)

### 2) Pot experiment

Pot experiments were conducted to study this phenomenon more precisely by avoiding the effect of root spread. In 1992 and 1994, maize, soybean (non-nodulated cultivar, var. T201) and upland rice were cultivated in pots (vol 3.8 L) containing approximately 3 kg dry soil (Andosol). Organic nitrogen was supplied with RBS at a rate of 0.1 g kg⁻¹ soil.

Nitrogen uptake by upland rice was higher than that by the other crops, and showed a positive relationship with the amount of organic matter applied ([Fig. 4](#)). In contrast, maize took up nitrogen actively in the ammonium sulfate plot, indicating that the nitrogen uptake response to organic nitrogen does not depend on the root spread but on crop properties.

[*Fig.4:Nitrogen uptake by various crops at two growth stages following the application of rbs and ammonium sulfate in a pot experiment in 1992\(25KB\)*](#)

We proposed 2 hypotheses for the higher nitrogen uptake of upland rice compared with maize as follows:

Upland rice (1) accelerates nitrogen mineralization from organic nitrogen, by secreting some enzymes⁹⁾ or by stimulating the activity of microorganisms³⁾, and (2) takes up nitrogen as protein, amino acids and ammonium preferentially with little competition with microorganisms before mineralization¹²⁾.



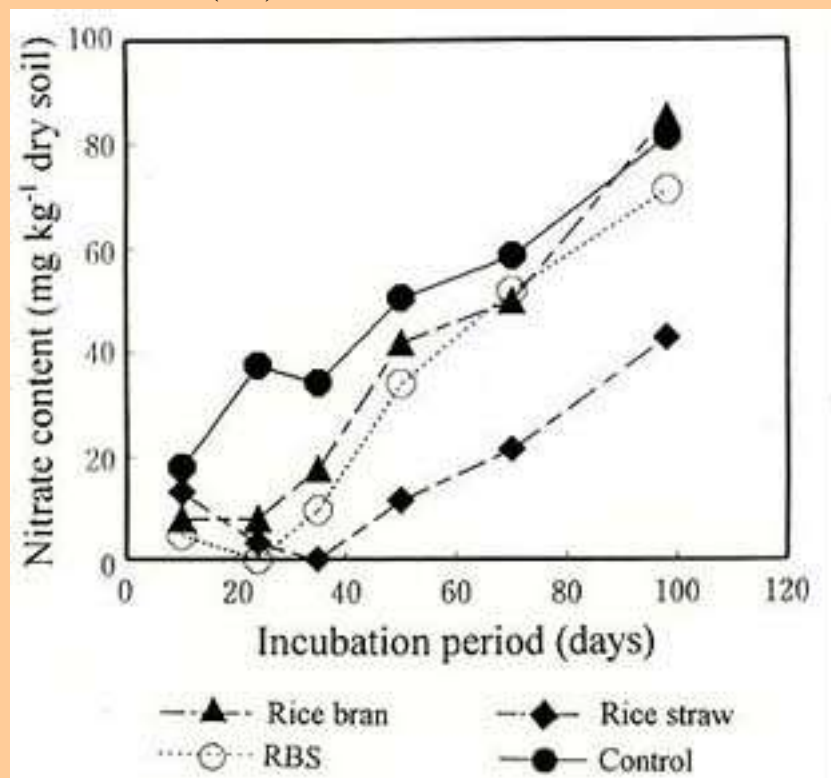
[Continue to: \[Factors for differences in nitrogen uptake among crops\]](#)



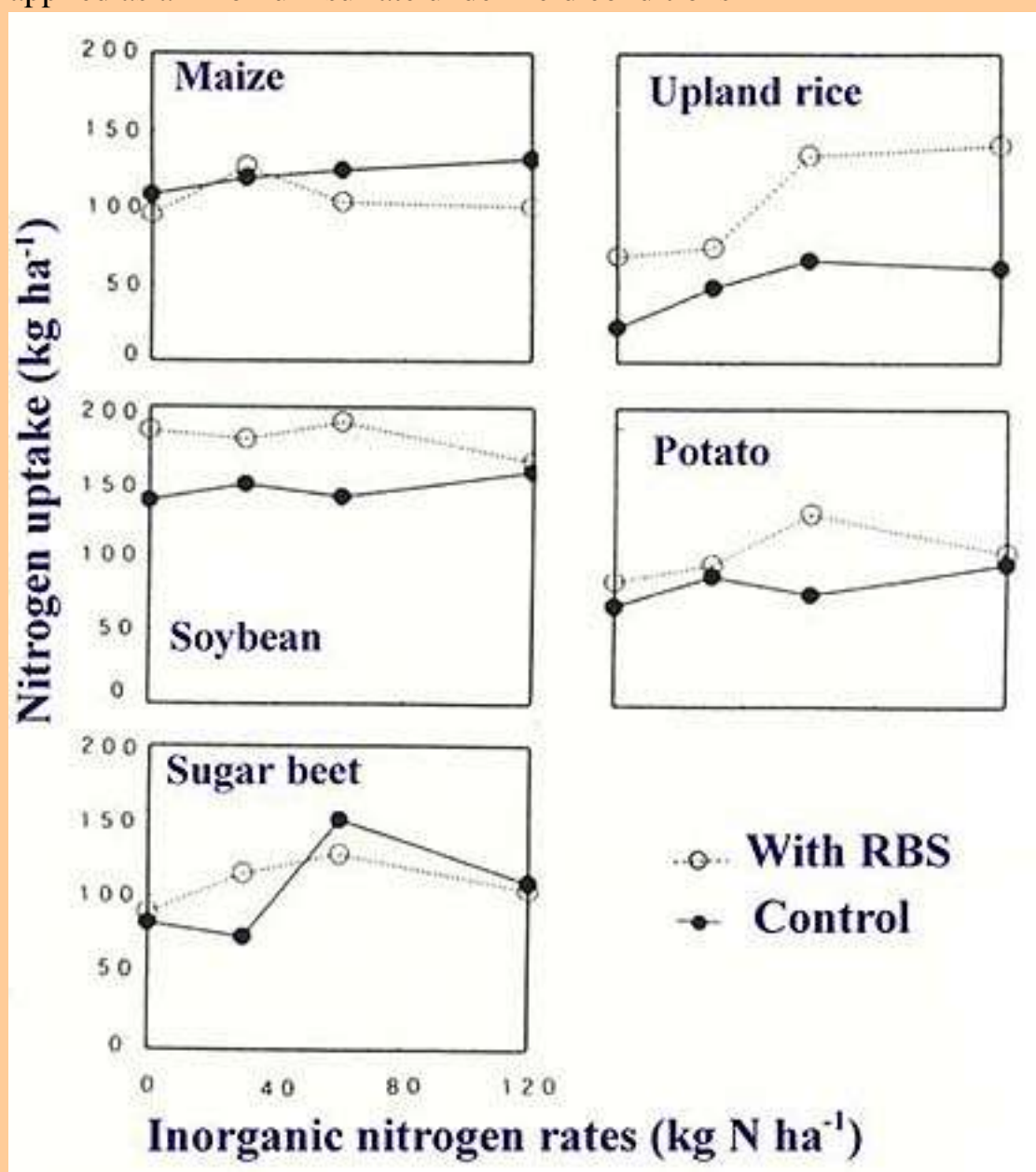
[Contents](#)

**Fig.1.**

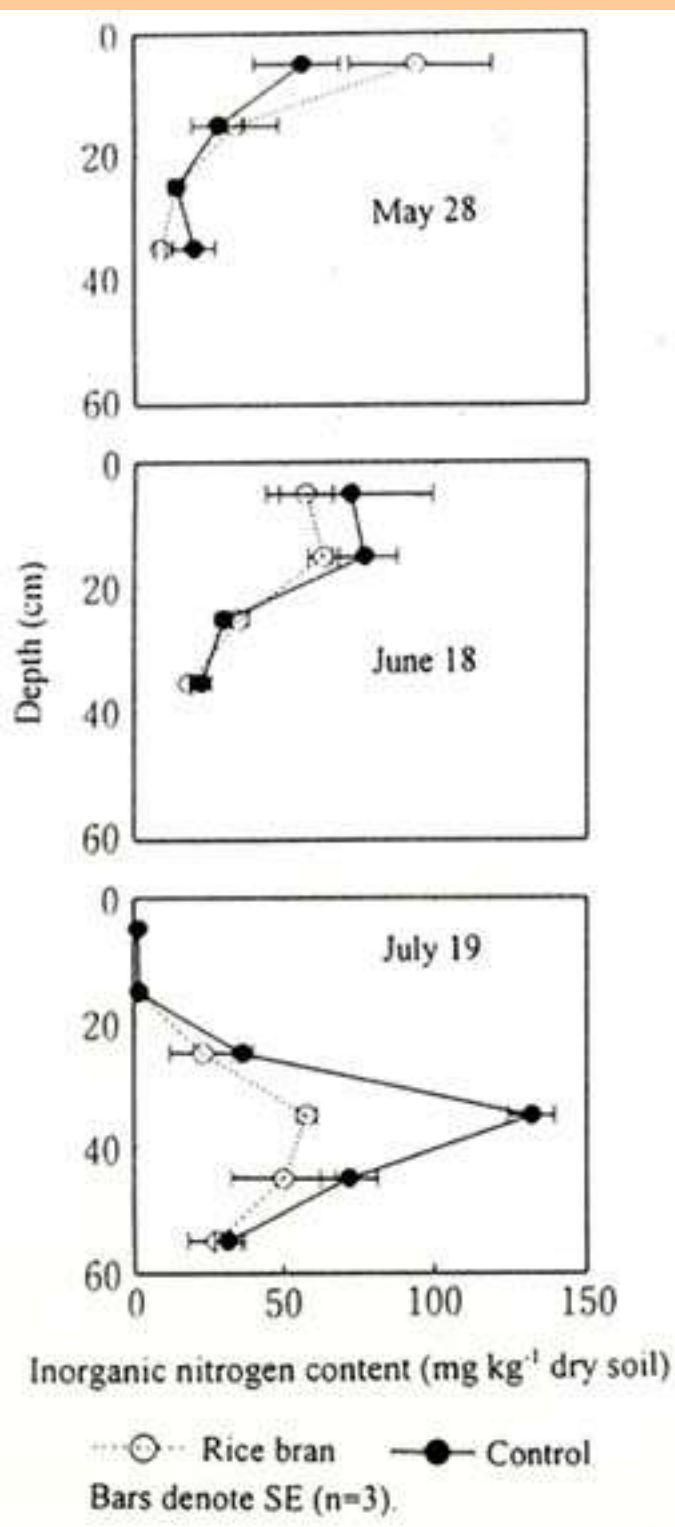
Changes of the amount of nitrogen released from soil amended with rice bran and rice straw singly or in combination (rbs) at 30°C

[BACK](#)

**Fig.2.** Nitrogen uptake response of various crops to organic nitrogen at various inorganic nitrogen rates applied as ammonium sulfate under field conditions



[BACK](#)

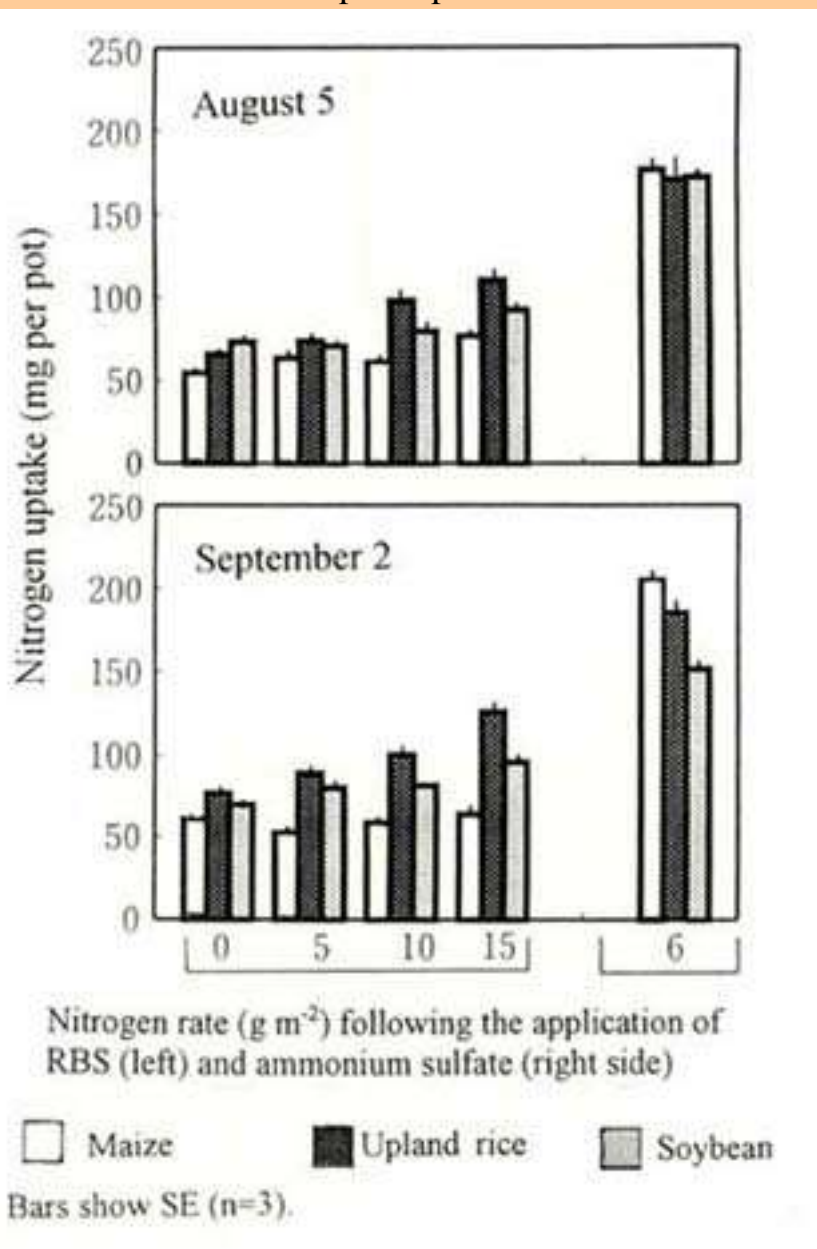
**Fig.3.**

Changes in inorganic nitrogen content at each depth of the fallow plot amended with ammonium sulfate at 80 kg ha⁻¹ nitrogen rate





**Fig.4.** Nitrogen uptake by various crops at two growth stages following the application of RBS and ammonium sulfate in a pot experiment in 1992



[BACK](#)

## Factors for differences in nitrogen uptake among crops

### 1) Differences in nitrogen uptake derived from $^{15}\text{N}$ -labelled rice bran among crops

Upland rice, maize, and soybean were cultivated with  $^{15}\text{N}$ -labelled rice bran in pot trials. The crops and soils were sampled to determine the nitrogen and  $^{15}\text{N}$  contents at 3 stages. The total nitrogen content in the plants and inorganic nitrogen content in the soils were determined by a calorimetric method following Kjeldahl digestion and KCl extraction, respectively. The content of  $^{15}\text{N}$  was measured by emission spectrometry.

The  $^{15}\text{N}$  content of upland rice was highest among other crops ([Table 1](#)), suggesting that upland rice is more likely to take up nitrogen in the form of ammonium, amino acids and peptides than nitrate which would reduce  $^{15}\text{N}$  concentration in a plant, because nitrate would be diluted by the nitrate presence in soil¹⁵). This assumption was supported by the fact that no differences were detected in the ammonium chloride plot.

**Table 1.  $^{15}\text{N}$  Concentration (atom%) of nitrogen taken up by various crops using  $^{15}\text{N}$ -labelled rbs and ammonium, chloride**

<u>$^{15}\text{N}$-labelled source</u>		<u>Days after sowing</u>		
		56	69	82
RBS	Upland rice	1.44±0.04	1.53±0.01	1.54±0.02
	Maize	1.39±0.06	1.36±0.01	1.38±0.03
	Soybean	1.26±0.03	1.33±0.03	1.38±0.01
Ammonium chloride	Upland rice	3.11±0.10	3.05±0.02	3.02±0.04
	Maize	3.06±0.06	3.09±0.03	2.90±0.04
	Soybean	2.80±0.06	2.90±0.02	2.89±0.02

### 2) Differences in protease activity in rhizosphere among crops

Protease activity in the soil planted with crops was measured to determine how much the so-called "rhizosphere effect" contributed (xcm) containing Andosol in 1995. We sampled the soils in the rhizosphere and non-rhizosphere zones separately at 26 and 34 days after sowing, and measured the protease activity of these soils using both casein and Z-phe-leu as substrates⁵).

[Table 2](#) shows the protease activity in whole pot soil for each crop including rhizosphere and non-rhizosphere soils. The activity in the case of maize was higher than that of upland rice, while in the case of soybean an intermediate activity between these 2 crops was detected for both substrates. These results suggest that the rhizosphere effect involved in nitrogen mineralization is not related to the high nitrogen uptake by upland rice¹⁴).

**Table2. Protease activity in pot soil planted with various crops in rbs plot at original pH**

<u>Crops</u>	<u>Protease activity ($\mu\text{mol h}^{-1} \text{g}^{-1}$ dry soil)</u>			
	<u>Caseine method</u>		<u>Z-phe-leu method</u>	
	<u>26 days</u>	<u>34 days</u>	<u>26 days</u>	<u>34 days</u>
Upland rice	1.62	1.64	1.57	1.78
Maize	2.67	2.11	1.56	1.96
Soybean	1.52	1.78	1.71	1.90
Fallow	2.19	1.31	1.48	1.67

### 3) Amino acid application in solution culture

Rice and maize seedlings were initially grown for 30 days in perlite pots without any addition of nutrients. After sterilization in an ampicillin solution, the seedlings were supplied with a nutrient solution consisting of 1 M nitrogen solution of nitrate, ammonium,

aspartate, glutamate and arginine, individually. These amino acids are considered to be the major components of rice bran protein⁸).

Nitrogen uptake efficiency of ammonium, aspartate and arginine in upland rice was much higher than in maize with the exception of glutamate (Fig. 5). These results suggest that upland rice could directly take up amino acid nitrogen more effectively than maize.

[Fig.5:Nitrogen uptake efficiency in the form of ammonium and amino acids in upland rice and maize expressed as ratio to nitrate uptake \(=100\) in solution culture\(27KB\)](#)

#### 4) Contents of various forms of nitrogen in pot soil

Upland rice and maize were grown in an Andosol. The contents of protein in the rhizosphere soils of upland rice at all sampling dates after sowing were the lowest among other crops (Fig. 6). The fractionated protein contents of all the rhizosphere soils at 62 DAS were lower than those of fallow soil (Fig. 7). The protein content in fallow soil without RBS was lower than that in fallow soil with RBS, but still higher than that in the rhizosphere soil of crops. These facts indicate that upland rice took up protein over a wide range of molecular weights from the soil, exceeding the amount of protein derived from RBS. As the protease activity in the rhizosphere soil of upland rice was lower than that of maize, the lower concentration of protein in the rhizosphere soil of upland rice did not result from the hydrolysis of protein by the rhizosphere protease¹³).

[Fig.6:Protein content in rhizosphere soil of upland rice and maize in a pot trail with rbs](#)

[Fig.7:Content of protein fractionated into molecular fractions followed by extraction with phosphate buffer in rhizosphere and fallow soil amended and not amended with rbs at 62 days after sowing\(36KB\)](#)

#### Differences in nitrogen uptake between upland rice and maize

Fig. 8 shows the nitrogen dynamics in the rhizosphere soil and differences in nitrogen uptake between upland rice and maize. In this scheme, protein originating from organic matter was decomposed into amino acids via peptides, changed to ammonium and transformed into nitrate. There was a strong competition with microorganisms for nitrogen.

[Fig.8:Scheme of nitrogen mineralization-immobilization cycle in soil and utilization of various nitrogen forms by crops and microorganisms\(22KB\)](#)

In the previous section, we proposed 2 hypotheses for the high nitrogen uptake by upland rice. Hypothesis (1) was ruled out, because the rate of organic nitrogen degradation to amino acids was not essential for the high nitrogen uptake by upland rice. Hypothesis (2) was supported based on ¹⁵N-labelled RBS application, amino acid supply test and the analysis of the cultivated soils. We concluded that upland rice preferentially takes up ammonium, amino acids and protein, whereas maize takes up nitrate mainly.

#### Mechanism of organic nitrogen uptake in crops

Plants take up amino acids to incorporate them with less energy compared to nitrate because amino acids can be directly incorporated into metabolic processes. In fact, sedge grass in tundra soils preferentially took up amino acid nitrogen to inorganic one compared with barley²). Also birch growing in moist land took up amino acids rather than nitrate¹). We estimated that similar phenomena may occur in the rhizosphere of upland rice under upland field conditions when organic materials such as RBS were applied.

There are several reports on the absorption of protein by plants. For example, upland rice and barley also absorbed proteins such as albumin and hemoglobin and grew well in solution culture, while naked barley grew better in RNA solution than in nucleotides derived from the decomposition of RNA⁶). A mechanism of "heterophagy" for direct protein uptake has been reported in upland rice⁷). Hemoglobin molecules were taken up by the cell membrane in upland rice through PL-invasion, then moved to vacuoles to be digested for nitrogen nutrition. This mechanism suggests that direct protein uptake by upland rice under upland field conditions may occur. This mechanism can be attributed to the strong response of upland rice to organic nitrogen, since nitrogen in the protein form would be taken up with less competition for soil nitrogen.

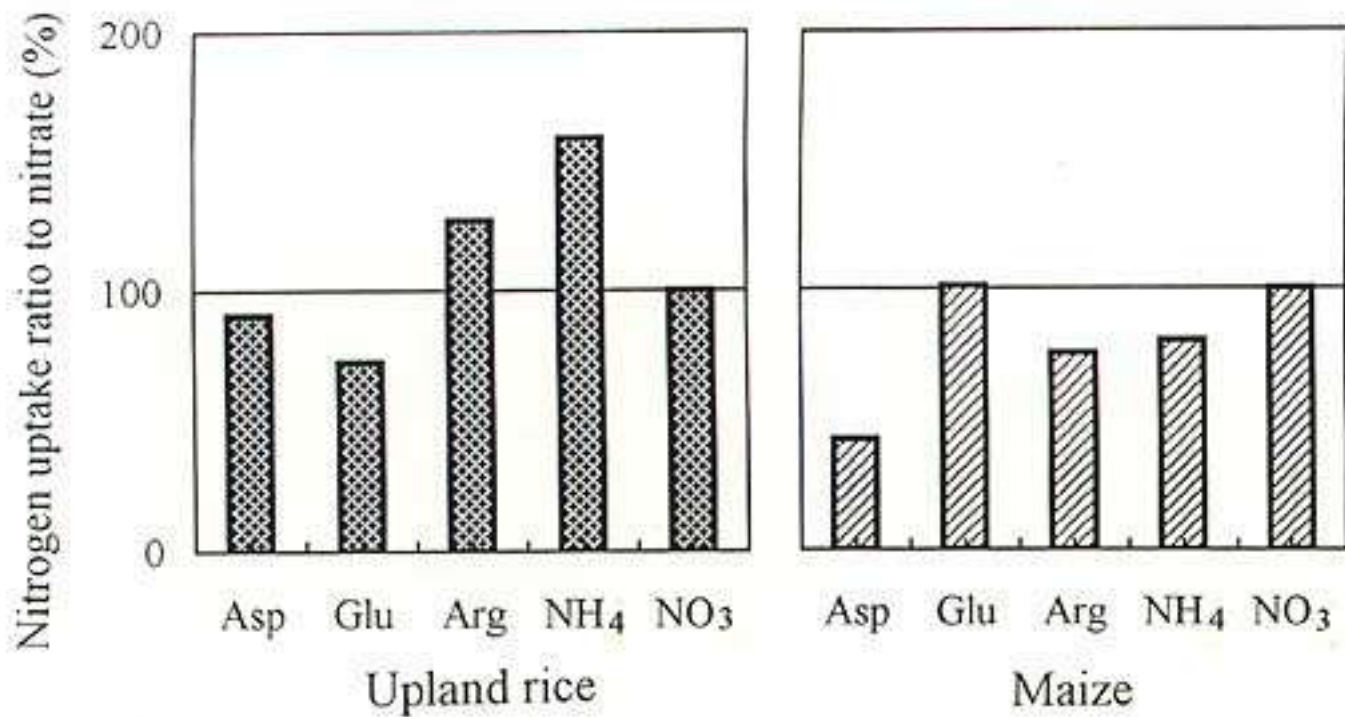
 [Forward to:-Occurrence and Control Strategy of PRSV,BBTV and Greening Diseases-](#)

 [Contents](#)



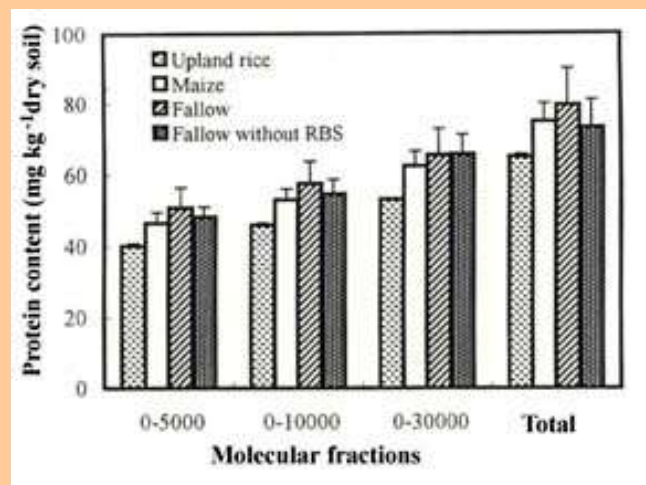
**Fig.5.**

Nitrogen uptake efficiency in the form of ammonium and amino acids in upland rice and maize expressed as ratio to nitrate uptake (=100) in solution culture

[BACK](#)



**Fig.6.** Protein content in rhizosphere soil of maize in a pot trial with RBS  
Bars indicate SE (n=3).

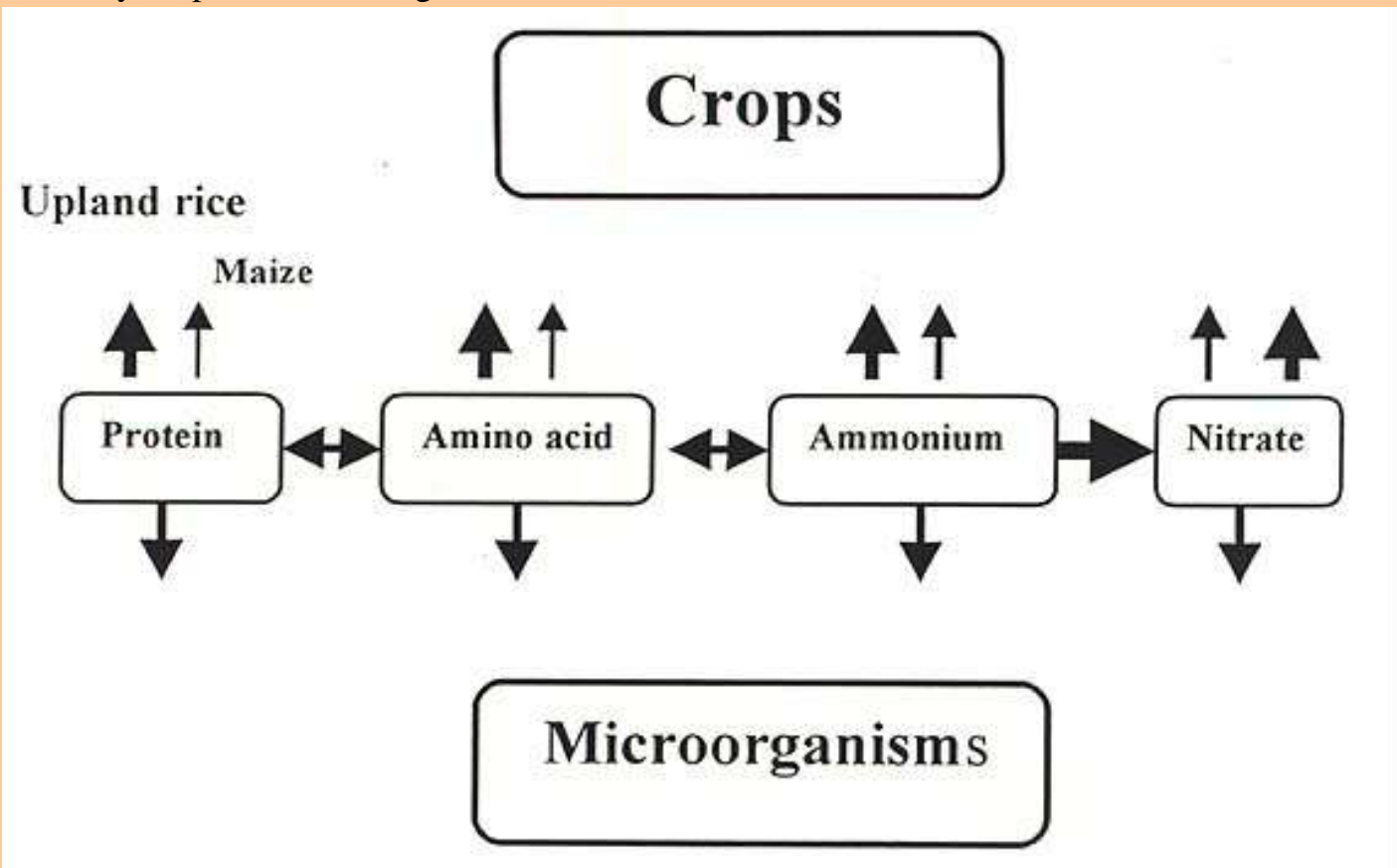


**Fig.7.** Content of protein fractionated into molecular fractions followed by extraction with phosphate buffer in rhizosphere and fallow soil amended and not amended with RBS at 62 days after sowing  
Bars indicated SE (n=3).



[BACK](#)

**Fig.8.** Scheme of nitrogen mineralization-immobilization cycle in soil and utilization of various nitrogen forms by crops and microorganisms



 [BACK](#)

# Papaya Ring Spot, Banana Bunchy Top, and Citrus Greening in the Asia and Pacific Region: Occurrence and Control Strategy

**Keizi KIRITANI*1 and Hong-Ji SU*2**

*1 Food and Fertilizer Technology Center for the Asian and Pacific Region  
(Taipei-10616, Taiwan)

*2 Department of Plant Pathology & Entomology, National Taiwan University  
(Taipei-10764, Taiwan)

Present address:*1Division of Entomology, National Institute of Agro-Environmental Sciences  
(Tsukuba, Ibaraki, 305-8604 Japan)

## Abstract

Results obtained in a special project on insect-borne virus/virus-like diseases of tropical fruit trees implemented during the period 1991-1995 are presented. Incidence of papaya ring spot virus (PRSV), papaya leaf-distortion mosaic virus (PLDMV), banana bunchy top virus (BBTV), cucumber mosaic virus (CMV), citrus greening and citrus tristeza virus (CTV) was examined by ELISA tests for virus diseases of papaya, banana and citrus, and by DNA probes for citrus greening. The FFTC survey teams visited countries in the Asia and Pacific region including Fiji, Guam, Indonesia, Japan (Okinawa), Korea (Cheju), mainland China, Peninsular Malaysia (West Malaysia), Sabah and Sarawak (East Malaysia), New Caledonia, Palau, the Philippines, Pohnpei, Saipan, Taiwan, Thailand, Tonga, Vietnam and West Samoa. The distribution of PRSV and PLDMV diseases is expanding. A large area covering East Malaysia, Mindanao, Fiji, Indonesia, New Caledonia, Palau, Pohnpei, Tonga, Western Samoa was found to be free from these diseases. In Okinawa, Taiwan and Saipan which are located in the northern marginal area of distribution of PRSV, the incidence of PLDMV was also observed. BBTV used to occur together with CMV. BBTV had a wider distribution than had been previously assumed, because banana plants did not show lesions when infected with the symptomless mild strain of BBTV. Except for some Pacific islands including those in Micronesia and New Caledonia, all the countries visited were found to be infected with both BBTV and CMV. Citrus was affected by the greening disease and CTV except for some islands in Micronesia. The distribution of a new greening strain which infects pomelo is now expanding. In addition to Taiwan and Mainland China, Okinawa, Mindanao, Palau and Thailand, citrus trees including pomelo are likely to be destroyed unless appropriate control measures are taken. Integrated management system of insect-borne diseases of fruit trees was analyzed in terms of the development of a production system for virus-free seedlings, protection of seedlings from attacks of viruliferous vectors and the elimination of virus sources.

Discipline: Plant disease/Insect pest

Additional key words: insect-borne diseases, IPM, fruit tree, aphids, citrus psyllids

**Received for publication, July 8, 1998**

1~23):[References](#)



## Introduction

The Food and Fertilizer Technology Center for the Asian and Pacific Region (FFTC/ASPAC) conducted a Special Project on insect-borne virus (-like) diseases in the tropics and subtropics. This project was funded by the Japanese Government, but some activities conducted in Taiwan were supported by the Council of Agriculture (COA), Taiwan.

Emphasis was placed on fruit trees, because there is no international research institute dealing with tropical fruits except for banana, and because the control of insect-borne diseases requires inter-disciplinary cooperation between e.g. entomologists and virologists. Furthermore, perennial crops such as fruit trees are likely to be exposed for a relatively long period of time to infection with viruses, making the control of the diseases extremely difficult.

The FFTC organized survey teams, composed of entomologists and virologists, on insect-borne diseases of citrus, papaya and banana to be conducted in countries of the Asia and Pacific region. Since 1988, when the first survey was conducted in the Philippines and Thailand, survey teams have visited many countries in the Asia and Pacific region, including Fiji, Malaysia (East and West), New Caledonia, Palau, the Philippines, Pohnpei, Saipan, Taiwan, Thailand, Tonga, Vietnam and Western Samoa.

The incidence of fruit tree diseases in the Asia and Pacific region is reported in this paper, i.e. diseases caused by banana bunchy top virus (BBTV), papaya ring spot virus (PRSV), papaya leaf distortion mosaic virus (PLDMV), citrus tristeza virus (CTV) and greening (GO), and strategy for the application of IPM for the control of these diseases is also outlined.



[Continue to: Papaya ring spot virus \(PRSV\) and papaya leaf-distortion mosaic virus \(PLDMV\) diseases](#)



[Contents](#)

## References



[Back](#)

- 1) Altamirano, D. M., Gonzales, C. I. & Vinas, R. C. (1976): Analysis of the devastation of leaf-mottling (greening) disease of citrus and its control program in the Philippines. *In Proc. 7th conf. int. organ. of citrus virologists*, 22-26.
- 2) Aubert, B. (1988): Management of the citrus greening disease in Asian orchards. *In Proc. 2nd FAO-UNEP regional workshop, Asian/Pacific citrus greening*. November 20-26, Lipa, Philippines, 51-52.
- 3) Chien, C. C. & Chu, Y. I. (1996): Biological control of citrus psyllid, *Diaphorina citri* in Taiwan. *In Biological pest control in systems of integrated pest management*. ed. Murakami, Y., Kiritani, K., & Grey, G., FFTC Book Ser. 47, 93-105.
- 4) Dickson, R. C. et al. (1956): Flying aphid populations in southern California citrus groves and their relation to the transmission of the tristeza virus. *Phytopathology*, 46, 204-210.
- 5) FFTC (1981): Citrus Likubin, Psylla might be a possible vector. *FFTC Newsl.* 52, 1-2.
- 6) Ieki, H. (1989): The use of cross-protection with mild strains of citrus tristeza virus (CTV) to control stem pitting disease of citrus in Japan. *FFTC Extension Bull.*, 284, 7-14.
- 7) Imada J. (1994): Virus diseases of vegetables and fruit trees in tropical countries. 1. Fruit tree diseases in Thailand. *JIRCAS Workshop Pap.*, 1, 48-50.
- 8) Imada, J., Prommintara, M. & Deema, N. (1992): Studies on virus and virus-like diseases of tropical fruits. Rep. of the coop. res. work between Thailand and Japan. DOA, Thailand and TARC, Japan, pp. 45.
- 9) Jones, D. R. (1992): Priorities for *Musa* crop protection research. INIBAP Annu. Rep. 1991, 55-59.
- 10) Kawano, S. & Yanaha, T. (1992): The occurrence of papaya leaf-distortion mosaic virus in Okinawa. *FFTC Tech. Bull.* 132, 12-23.
- 11) Kawano, S. & Su, H. J. (1992): Occurrence of banana bunchy top virus in Okinawa (abstract). *Annu. Meet. Phytopathol. Soc. Jpn.*, 59, 53.
- 12) Ke, C. (1991): The present status of citrus Huanglungbin and its control in China. *In Proc. 6th int. Asia Pacific workshop on integrated citrus health management*. June 24-30, Kuala Lumpur, Malaysia, 10-14.
- 13) Komazaki, S. (1993): Biology and virus transmission of citrus aphids. *In Proc. RDA/FFTC int. symp. on the management of insect-borne virus diseases in temperate and subtropical Asia*. April 13-16, Suwon, Korea, pp. 16.
- 14) Lin, C. C., Su, H. J. & Wang, D. N. (1989): The control of papaya ringspot virus in Taiwan, ROC. *FFTC Tech. Bull.*, 114, 1-13.

- 15) Lin, C. C., Wang, H. L. & Wang, D. N. (1991): Integrated management of papaya ringspot virus disease in Taiwan. Paper presented at the workshop on the control of insect-borne diseases of fruit trees at TARI. November 1991, pp. 7.
- 16) Maoka, T. & Usugi, T. (1993): Detection of two plant viruses of papaya by ELISA. *In* TARC Res. Highlights, 1993, 15-17.
- 17) Nurhadi (1988): Integrated approaches to formulate control measure against greening vector, *Diaphorina citri* Kuw. in Indonesia. *In* Proc. 2nd FAO-UNEP regional workshop, Asian/Pacific citrus greening. November 20-26, Lipa, Philippines, 47-49.
- 18) Otake, A. (1990): Bibliography of citrus greening disease and its vectors attached with indices, and a critical review on the ecology of the vectors and their control. Jpn. Int. Coop. Agency, March 1990, pp. 161.
- 19) Su, H. J. & Tsai, M. C. (1991): The etiological nature and transmission of fruit virus and virus-like diseases. *FFTC Suppl.*, 1, 83-97.
- 20) Su, H. J., Hung, T. H. & Tsai, M. C. (1991): Recent developments on detection of citrus greening disease. *In* Proc. 6th int. Asia Pacific workshop on integrated citrus health management, June 24-30, Kuala Lumpur, Malaysia, 89.
- 21) Volkl, W., Stechmann, D. H. & Sary, P. (1990): Suitability of five species of Aphididae (Hymenoptera) for the biological control of the banana aphid *Pentalonia nigronervosa* Coq. (Homoptera, Aphididae) in the South Pacific. *Trop. Pest Manage.*, 36, 249-257.
- 22) Wellings, P. W. & Hart, P. J. (1995): An attempt at biological control of the banana aphid, *Pentalonia nigronervosa*, using the parasitoid *Aphidius colemani* in the Kingdom of Tonga. 2nd Workshop on biol. control in the South Pacific. Oct. 1995, Fiji, pp. 3.
- 23) Wu, R. Y. & Su, H. J. (1990): Purification and characterization of banana bunchy top virus. *J. Phytopathol.*, 128, 153-160.

## Papaya ring spot virus (PRSV) and papaya leaf-distortion mosaic virus (PLDMV) diseases

### 1) Expansion of papaya virus diseases

PRSV disease was first detected in Kaoshung, Taiwan in 1975, and in Luzon, the Philippines in 1982. In Taiwan, 44% of a total of 2,100 ha of papaya orchards were not able to produce fruits in 1978 due to PRSV disease, which spread all over the island in 1980¹⁵⁾.

The FFTC survey team confirmed the incidence of PRSV disease in Johore, Malaysia based on serological diagnosis in 1991. We also confirmed the occurrence of PRSV disease in Southern China (1990), Central Thailand (1990), Vietnam (1992), Luzon, the Philippines (1993), Saipan, Commonwealth of the Northern Marianas (1994) and Guam (1994). No infection had been detected in Northern Thailand, Mindanao and Cebu (Philippines), Sabah and Sarawak (East Malaysia), Java (Indonesia), New Caledonia, Fiji, West Samoa, Tonga, Palau and Pohnpei (Table 1).

### [Table 1. Distribution of virus \(like\) diseases of fruit trees in the Asia and Pacific region\(42KB\)](#)

Papaya trees infected with PLDMV display symptoms characterized by rosettes on leaves with slender stems on the crown top, and swellings around the ring spots on the fruit. Neither of these symptoms are observed in plants infected with PRSV. PLDMV disease was first identified in Okinawa island in 1954¹⁰⁾. During the 1960s it spread to the adjacent Miyako and Yaeyama islands, but it has not yet been detected on nearby Minami-Daito or Kita-Daito island¹⁰⁾. In 1993, collaborative studies between scientists in Taiwan and Japan confirmed that these 2 virus diseases occurred in both Okinawa and Taiwan, i.e. PLDMV also occurs in Taiwan, and PRSV in Okinawa¹⁶⁾. However, the symptoms of PLDMV had not been observed in Taiwan until the mid-1980s.

### 2) Control of papaya virus diseases

More than 60 species of aphids are considered to be able to transmit PRSV. Both PRSV and PLDMV are mainly transmitted by *Aphis gossypii* and *Myzus persicae* in a non-persistent manner. They are the "transit visitors or itinerant vectors" of papaya plants and do not colonize papaya ([Table 2](#)). These virus diseases are currently spreading throughout the Asian tropics and Pacific islands.

**Table 2. Characteristics of papaya ring spot virus (prsv), banana bunchy top virus (bbtv), and citrus greening diseases**

	<a href="#">PRSV</a>	<a href="#">BBTV</a>	<a href="#">Greening</a>
Host plant	Papaya	Banana	Citrus
Country of origin	South America	S. E. Asia	Asia
Resistance gene/cultivar	No	No	No
Cropping system	Annual/Perennial	Annual/Perennial	Perennial
Disease-free planting material	Seeding	Tissue culture of meristem	Shoot-tip grafting
Pathogen	Virus	Virus	Fastidious bacteria
Culture of inoculum	Possible	Possible	Impossible
Indexing techniques	ELISA	ELISA	DNA probe
Transmission type	Semi-persistent	Semi-persistent	Persistent
Cross-protection	Not dependable	Not dependable	Not available
Chemical therapy	No	No	Antibiotics
Vector	Polyphagous aphids No, transit visitors	Banana aphid	Citrus psyllid
Colonization of host plants	as winged forms Difficult in open fields	Yes, attended by ants	Yes
Biological control		Failed (interference by ants)	Not successful (hyperparasitism)
Chemical control	Difficult to control disease vectors with a low control threshold		

A great variety of control methods has been used in order to protect young seedlings from the aphid vectors. These include the selection of planting time to avoid the peak incidence of winged aphids, intercropping with barrier crops such as corn, the use of silver mulch to prevent winged aphids from visiting young seedlings, and covering the plants with netting.

A basic part of any control program is to promote the eradication of infected plants in order to eliminate the source of virus. The cultivation of cucurbits, which are important hosts for PRSV and PLDMV should be avoided in the vicinity of papaya plantations. Once PRSV and PLDMV diseases occurred in a papaya orchard, they spread very rapidly within the orchard by winged aphids, usually in February and March in Taiwan¹⁴⁾, and December to April in Okinawa¹⁰⁾. Roguing infected plants away from the orchard is effective to reduce the rate of infection.

Since there is no PRSV resistance gene, the breeding of tolerant cultivars such as Taichung No. 5 has been attempted. These varieties, however, have not been widely accepted by consumers because of their poor eating quality.

Difficulty encountered in controlling non-persistent aphid-borne virus like PRSV is due to the fact that many of the available pesticides do not kill incoming vectors before they transmit the virus to the crop.

Cross-protection with attenuated virus strains was widely practiced in Taiwan. Since this protection is strain-specific, it often breaks down within half a year and loses its effectiveness. The high level of mutability of PRSV might be another reason for the loss of cross-protection¹⁴.

### 3) Losses

Concerning the losses due to PRSV, the occurrence of the disease was compared between papaya orchards in Fengshan, Taiwan for which netting was used and those left uncovered. Netting was so effective in preventing PRSV transmission that the production was 10 times higher compared with that of the uncovered trees¹⁵. In Taiwan, papaya is planted each year as if it were an annual crop. Therefore, protecting young papaya plants from vector aphids by netting is effective in producing marketable fruits, because late infection, which occurs when the net is removed after fruiting, causes little damage to the yield. The economic gains, however, have to be evaluated taking into account the cost of building the structure, labor-consuming operation for pollination and the risk of damage caused by typhoons. Another added cost is the annual planting of papaya, which used to be a perennial crop grown for 3-4 years before 1975, when the incidence of PRSV was first observed in Taiwan.

The areas where papaya is free from these virus disease should be protected by restricting the importation of infected plants. These viruses, however, are not vertically transmitted through seeds. Since the seeds of papaya are free from virus, they can be used in plant nurseries without risk of infection.

 [Continue to: \[Banana bunchy top virus \(BBTV\) disease\]](#)

 [Contents](#)

Table 1. Distribution of virus(-like) diseases of fruit trees in the Asia and Pacific region

Country / locality	Papaya		Banana		Citrus	
	PRSV	PLDMV	BBTV	CMV	GO	CTV
Fiji	—	—	○	○	○	○
Guam	○	—	—	—	NE	NE
Indonesia / Java	—	—	○	NE	○	○
Japan / Okinawa	○	○	○	○	⊗	○
Korea / Cheju	—	—	—	—	—	○
Mainland China / South	○	—	○	NE	⊗	○
Malaysia / West	○	—	○	○	○	○
Malaysia / Sabah	—	—	○	NE	○	NE
Malaysia / Sarawak	—	—	○	NE	○	NE
New Caledonia	—	—	—	NE	—	—
Palau	—	—	—	—	⊗	—
Philippines / Luzon	○	—	○	NE	○	○
Philippines / Cebu	—	—	○	NE	⊗	○
Philippines / Mindanao	—	—	○	○	⊗	○
Pohnpei	—	—	—	NE	—	—
Saipan	○	○	—	—	—	—
Taiwan	○	○	○	○	⊗	○
Thailand / North	—	—	○	○	⊗	○
Thailand / Central	○	—	○	○	○	○
Tonga	—	—	○	○	○	○
Vietnam	○	—	○	○	○	○
Western Samoa	—	—	○	○	○	○

GO: Greening, —: Absence, ○: Presence, ⊗: Strain attacking pomelo, NE: Not examined.



[BACK](#)

## Banana bunchy top virus (BBTV) disease

### 1) *Ubiquitous potential infection with mild strains*

BBTV is transmitted semi-persistently by a single vector, the banana aphid, *Pentalonia nigronervosa* ([Table 2](#)). Sometimes the damage caused by BBTV disease is overlooked due to the apparent losses due to Fusarium wilt and Sigatoka disease, and banana plants are considered to be free from BBTV.

However, the FFTC surveys demonstrated that BBTV has a wider distribution than had previously been assumed. BBTV is widespread in tropical and subtropical Asia ([Table 1](#)). It was first reported in Fiji in 1889 and Taiwan in 1900¹⁹). It was also reported in Okinawa, Japan by Nohara in 1968 and was serologically confirmed by the FFTC survey team in 1992¹¹). In almost all of the countries except for the islands located in Micronesia, banana plants were found to be infected with BBTV. The existence of BBTV was newly confirmed by ELISA tests in Indonesia (1989), Thailand (1991), West Malaysia (1991), South China (1992), Okinawa (1992), Vietnam (1992), East Malaysia (1993), Mindanao, the Philippines (1993), Fiji (1994), Tonga (1994) and Western Samoa (1994). On the other hand, we have not found BBTV in Micronesian islands including Saipan/Northern Marianas, Guam, Belau/Palau, and Pohnpei.

Why has BBTV remained undetected for so long in so many countries? There are 2 main reasons for this. First, no serological tests had ever been attempted, because of the lack of suitable techniques and equipment for indexing. Secondly, BBTV occurring in Malaysia and Thailand produces either mild symptoms or no symptoms in banana plants. An overall abnormality such as dwarf growth habit caused by infection with the virus has often been mistaken for a normal characteristic of the cultivar or for a nutritional disorder due to deficiency of nutrients.

Although a certain level of cross-protection with naturally occurring mild strains takes place inadvertently, this latent infection with BBTV is probably causing significant losses in terms of both banana yield and general fruit quality.

A field survey using ELISA tests for banana plants which was conducted in several locations in southern Taiwan revealed that mixed infection with BBTV and cucumber mosaic virus (CMV) was observed at a rate as high as 70% in symptomless plants²³). Asynchronized maturation of fingers in a bunch of bananas grown for export seems to be caused by a mixed latent infection of the viruses. Almost the same situation was also observed in the South Pacific islands including Fiji, Western Samoa and Tonga, in that only one-fifth of the banana samples was free from both virus diseases. Imada et al.⁸), based on ELISA tests, showed that both BBTV and CMV are widely distributed in Thailand and samples with double infection accounted for more than 10% of the total.

### 2) *Control of BBTV*

To control BBTV disease, a system of virus-free seedling production is highly recommended ([Table 2](#)). The occurrence of BBTV was the lowest in plants produced by tissue culture at 0.2% followed in increasing order by plants grown from suckers and ratoons (Su et al. unpublished).

No plant resistance to BBTV has been identified, which limits conventional breeding approaches to this problem⁹). In fact, propagation of virus-free seedlings by tissue culture is commonly attempted in almost

all the banana-growing countries. In some cases, however, all of the seedlings assumed to be virus-free were found by ELISA tests to be infected with BBTV. Supplying virus-free plantlets grown by tissue culture to growers for planting is the best measure currently available for control.

Various methods of protection of seedlings from infection in the field should then be applied, including cross-protection, though this technique has not been effective against BBTV. In order to promote the control of the banana aphid by naturally occurring biological control agents, farmers should be instructed to use in their banana plantations selective insecticides, which are less toxic to natural enemies of banana aphids.

Biological control of *P. nigronervosa* is being attempted in Tonga introducing a braconid, *Aphidius colemani*, native to Australia. Through the reduction of the total population of aphids, a reduction in the number of alate aphids moving between plants may occur, resulting in a decrease of the rate of spread of the BBTV^{21,22}). Although the presence of *A. colemani* on Tongatapu island was confirmed when it was recovered from *Aphis gossypii* on taro, no evidence of parasitism has been obtained from *P. nigronervosa*. The intensive attendance of *P. nigronervosa* colonies by ants may have significantly reduced the opportunity for this parasitoid to attack *P. nigronervosa* in Tonga²²).

## Citrus greening disease and citrus tristeza virus (CTV) disease

### 1) Citrus groves are being devastated by the greening disease in the tropics

Citrus is most widely grown next to grape in the world. Citrus originated in southern China, India and Indochina peninsula. However, countries in Southeastern Asia are not included in the major citrus production countries, due to the epidemics of the greening disease in this area. Indonesia has experienced complete destruction of its citrus industry due to greening in northern Bali. The citrus-growing area of 12,000 ha in the early 1950s decreased to 4,000 ha in 1988 due to the disease in Thailand. In the Philippines, the area planted to mandarins and sweet oranges covered 25,000 ha in 1961-1962. By 1965 the area had been reduced to 17,300 ha and by 1974 to only 8,300 ha mainly due the greening disease^{1,18}).

Except for some islands located in Micronesia and New Caledonia, all of the countries and areas were found to be affected by this disease. The incidence of CTV was also commonly observed in all of the countries except for the islands in Micronesia, i.e. Saipan, Pohnpei and Palau. Development of the citrus industry in tropical and subtropical Asia, therefore, largely depends on the extent to which the control of greening disease is successful.

The causal agent of the greening disease is a fastidious bacterium, which is transmitted persistently by the Asian citrus psyllid, *Diaphorina citri*, while CTV is vectored non-persistently by aphids, mainly *Toxoptera citricidus* and *Aphis gossypii*¹³).

### 2) Development of strains attacking pomelo

An important finding from the surveys was that pomelo, which was considered to be resistant to both greening and CTV diseases, has become susceptible recently in some areas. Greening was first noticed in the beginning of the 1950s in Taiwan by A. Sasaki^{5,20}), but the incidence of this disease in Mainland China can be traced back to 1919 in northeastern Guangdong¹²). Although pomelo began to be affected by greening disease in the beginning of the 1970s in Taiwan, in other countries it was yet free from this disease until the 1990s. Currently, greening disease is affecting pomelo in southern China and the



Philippines, while pomelo grown in Vietnam and Thailand still seems to be free from this disease. It has been reported, however, that the infection of pomelo with symptoms of greening in Thailand was observed in a pomelo orchard in Chiang-Rai in 1994 (Bauman, personal communication, Koizumi, personal communication).

Surveys conducted in 1994 in some islands in the North Pacific revealed that greening did not occur in Saipan/North Marianas and Pohnpei, but that a pomelo-infective strain of greening was found in Palau/Belau which is located close to Mindanao, the Philippines. The islands in the South Pacific were considered to be free from greening, because of the absence of the vector insects. The survey teams, however, observed citrus trees with greening disease in Fiji, Western Samoa and Tonga. Since fruit trees normally reproduce vegetatively by grafting and layering, it is likely that all the scions and nursery stocks derived from an infected mother plant, which was introduced outside of the island, are congenitally infected with the greening pathogen.

In Japan, greening was first discovered by electron microscopy in Iriomote island, Yaeyama islands, Okinawa Prefecture by Dr. Miyagawa in 1989 when he was working for the FFTC Special Project. Since the incidence was limited to this particular island, an eradication program was successfully carried out. The FFTC organized a second survey to follow-up the status of greening in Okinawa in 1993. The survey team again found citrus trees affected by greening in this island. The causal agent was confirmed by DNA probes for greening prepared by Su and his colleagues at the National Taiwan University. In 1994, it was also detected in Okinawa island, suggesting that the distribution had expanded. Greening was found to be due to the strain which affects pomelo. Further inspection and eradication of the greening pathogen are recommended in order to prevent the spread of this disease to the other southern islands of Japan where the vector psyllids are common insects.

### **3) Control of greening disease and CTV**

Greening is responsible for economic losses of entire citrus orchards within 5 or 6 years following an initial spread of epidemics²⁾. Eradication is an essential measure. Trees already affected by greening disease should be cut down and destroyed to ensure that they do not act as sources of inoculum.

So far, no plant resistance has been identified. Treatment with tetracycline reduces the population of bacteria, but symptoms usually reappear after 1 to 2 years. Heavy pruning and top-working of diseased trees and cutting off of infected branches for corrective control are often only useful for the elimination of potential inoculum of the greening.

Providing farmers with disease-free planting stock at a reasonable price is at the basis of any program to control virus disease in perennial crops. In Taiwan, since 1985, citrus planting stock, which is free from virus and greening, has been produced either by shoot-tip grafting with heat therapy or by nucellar line selection. There is also a budwood certification program, which ensures that the young seedlings distributed to farmers are free from diseases.

The feeding site of *D. citri* is confined to the flush or fresh shoots triggered mainly by rainfall in wet areas and irrigation in dry areas. Chemical control is applied at 10- to 20-day intervals in order to control psyllids which act as vectors during the sprouting period. Pesticides are commonly applied 36-48 times a year by Indonesian farmers¹⁷⁾. Spray or trunk injection of systemic insecticides, such as dimethoate and monocrotophos, has been suggested without any adverse effect on the fauna of natural enemies in the

citrus grove¹⁸). The use of IGRs (insect growth regulators) could be suggested for this purpose.

An ornamental plant often used as a hedge in Taiwan, jasmine orange, *Murraya paniculata*, does not harbor the pathogen of greening but is a favorite host plant of the psyllids. For this reason, jasmine orange should not be planted near citrus orchards. Biological control of the psyllids is carried out in Taiwan using an eulophid parasitoid, *Tamarixia radiata*, which was introduced from Reunion Island during the period 1984-1988. This parasitoid in association with an indigenous parasitoid, *Diaphorencyrtus diaphorinae*, is considered to contribute to the suppression of *D. citri*, particularly in jasmine orange³).

When citrus orchards are to be established, the site of new orchards should be far enough from the old orchards to avoid or retard the infestation with psyllids. Shifting of planting areas from warm lowlands to cool highlands is also practiced to avoid the attack of psyllids in Taiwan. The CTV is spread by aphid vectors mainly by *Toxoptera citricidus* and to a lesser extent by *T. aurantii* and *Aphis gossypii* in a semi-persistent manner¹³) and by propagation with infected buds. The control strategy of CTV disease is similar to that of other insect-borne virus diseases. The use of attenuated CTV for cross-protection has been applied for navel orange, *Citrus sinensis*, in Japan⁶). The CTV is not readily transmitted between trees even in the presence of a fairly large number of vector aphids in a grove^{4,7}). In fact, greening spreads more rapidly than CTV in newly planted orchards in Taiwan.



[Continue to:\[Conclusion\]](#)



[Contents](#)

## Conclusion

Systems for the integrated control of virus diseases of fruit trees have 3 basic objectives: (1) the development of a production system for virus-free seedlings, (2) the protection of seedlings from the attack of viruliferous vectors, and (3) the elimination of virus sources. Various techniques are currently available for achieving these objectives and are applied in a number of countries in this region, partly as a result of the work of the FFTC survey team ([Tables 2 and 3](#)).

**Table 3. Difference in IPM strategy in relation to the occurrence of insect-borne diseases**

	<a href="#">Area with diseases</a>	<a href="#">Area without diseases</a>
Quarantine	Less important	Important to restrict the importation of infected plants Not necessary
Disease-free planting material	Should be developed by mass production system Annual planting or with the shortest vegetative growth	Perennial
Cropping system	Young plants must be protected from vectors ^{a)}	Control only when vectors may cause direct damage
Protection measures from infection	Good yield with healthy fruits for the first cycle of fruiting	Sustainable yield with high/standard quality of fruits for a number of years
Objective		

a): Because the earlier the infection with diseases, the heavier the damage.

A very important problem identified by the members of the survey is the widespread incidence of fruit trees which showed multiple infections with different viruses or diseases. Many banana plants were infected with BBTV and CTV, while papaya was often simultaneously infected with PRSV and papaya mosaic virus (PMV), or with PRSV and PLDMV, and citrus with greening disease and CTV.

Simultaneous multiple infections of this kind often give rise to more severe symptoms than single infection. Presently, control is limited to the use of the integrated system mentioned above to prevent plants from being simultaneously affected by multiple virus diseases.

It was considered that the lack of techniques and expertise for precise indexing of the diseases for plant quarantine and production of disease-free planting materials were one of the major constraints on the implementation of IPM strategy for the insect-borne virus and virus-like diseases of fruit trees.

An IPM strategy has been suggested for the control of insect-borne diseases of tropical fruit trees as follows: (1) Distribution of disease-free planting material to growers. (2) Control of vectors; Planting time, use of barrier crops, silver mulch, netting, insecticides and biological control. (3) Shift of cropping system from perennial to annual crops. (4) Eradication of virus sources. Roguing and avoidance of cultivation of potential host plants close to orchards, e.g. cucurbits for PRSV and jasmine orange for greening. (5) Cross-protection techniques are not dependable or not available. The use of tolerant cultivars or antibiotics may often result in an increase of inoculum sources.

In conclusion, the difference in the IPM strategy between areas with and without disease is shown in [Table 3](#). It should also be emphasized that some islands in the Pacific are now free from these devastating diseases, suggesting the importance of quarantine in preventing these diseases from invading the disease-free areas.

 [Forward to :-Long Mat with Hydroponically Grown Rice Seeding Diseases-](#)

 [Contents](#)

 [JIRCAS Home Page](#)

# Raising and Transplanting Technology for Long Mat with Hydroponically Grown Rice Seedlings

Kohei TASAKA*

Department of Farm Mechanization, National Agriculture Research Center (Tsukuba, Ibaraki, 305-8666 Japan)

Present address:

*Department of Integrated Research for Agriculture, Kyushu National Agricultural Experiment Station (Chikugo, Fukuoka, 833-0041 Japan)

## Abstract

Long mat with hydroponically grown rice seedlings (hereafter referred to as LMHS) with a mat size of 6 m in length and 28 cm in width, was designed to develop a labor-saving rice transplanting system. The rice seedlings were grown in a newly developed nursery device for about 2 weeks and the plant length reached 10 to 15 cm. The seedling mat was composed of entangled plant roots and nonwoven cloth and it was strong enough to be handled. LMHS were transformed into roll type seedlings by rolling up. The weight of a mat with roll type seedlings was about 12 kg and approximately 1/5 of that of a conventional mat with young seedlings raised in a soil bed (hereafter referred to as CMSS). A rice transplanter was designed and tested to transplant the roll type seedlings in paddy fields. The rate of damaged seedlings immediately after transplanting was 30 to 50%. However, the minimum rate of missing hills after rooting was 3%, when the number of plants per hill ranged from 7 to 8. Working rate of the transplanter was approximately 0.5 ha/h for a working speed of 1.13 m/s and a working width of 1.8 m. Rice yield in the case of LMHS was assumed to be equal to that of CMSS.

**Discipline: Agricultural machinery**

**Additional key words: nonwoven cloth**

**Received for publication, January 11, 1998**

## Introduction

In Japan, the percentage of transplanting in rice production exceeds 99%. Most popular seedlings used for rice transplanting are referred to as mat type seedlings and they are grown on soil in a seedling box (58 cm long, 28 cm wide and 3 cm deep). The carriage of the seedling boxes is laborious and is associated with major problems for the following reasons: (1) the weight of one seedling box is approximately 6 kg, (2) 2,000 seedling boxes are necessary for paddy fields with an area of 10 ha, and (3) during the period from seeding to transplanting, the seedling boxes must be carried from the seeder to the nursery chamber, greenhouse, truck and rice transplanter.

The objective of this study was to reduce the weight and the carriage frequency of the seedling boxes. Specific objectives were: (1) to raise rice seedlings with long mat (6 m long) by hydroponics in a nursery device, (2) to roll up the seedlings to a small size, and (3) to develop a rice transplanter to transplant the seedlings in paddy fields.

## Materials and methods

### 1) *Outline of nursery device*

The nursery device developed to raise LMHS is illustrated in [Fig. 1](#). The nursery device which consists of a nursery bed, a liquid fertilizer tank and a liquid fertilizer pump was fixed on the ground in a vinyl house. The nursery bed fixed horizontally on the ground comprised 4 nursery trays. A nursery tray (6.5 m long, 28 cm wide and 6 cm deep) made of stainless steel was developed. The height of the nursery tray from the ground surface was set at 60 cm to work without bending the waist. Liquid fertilizer circulates in the tank and on the tray of the nursery device through a pump.

[Fig.1:Hydroponic nursery device\(25KB\)](#)

### 2) *Seeding method*

A nonwoven cloth was spread on the dry nursery tray and fixed at both ends on the tray with 2 plates like a comb. Liquid fertilizer was circulated in the nursery device and then germinated rice seeds were scattered on the tray with a self-propelled seeder as shown in [Fig. 2](#). Mass of the seeds ranged from 100 to 250 g per unit area corresponding to the size of a conventional seedling box (28x58 cm). The nonwoven cloth was made of cotton and it was used to obtain a seedling mat sufficiently strong to be rolled up and transplanted.

[Fig. 2. Nursery device and self-propelled seeder\(30KB\)](#)

### 3) *Supply of fertilizer and air temperature in the vinyl house*

Water without fertilizer was circulated in the nursery device for several days after seeding. Fertilizer commercially available for hydroponically grown vegetables, Otsuka No. 1 and No. 2, was dissolved in the water in the liquid fertilizer tank on the 5th day after seeding. Electric conductivity (EC) of the liquid fertilizer was adjusted to reach values ranging from 1.3 to 1.4 mS/cm every day.

Water temperature in the nursery device was adjusted to be compatible with the raising of the seedlings by controlling the air temperature in the vinyl house with heaters or ventilators.

### 4) *Rolling up of seedlings*

Tests of rolling up of LMHS on the 6 m long mat were conducted for transfer to the paddy fields and loading on a rice transplanter.

### 5) *Development of a rice transplanter for LMHS*

A riding type rice transplanter currently manufactured was remodeled to transplant the roll type seedlings in paddy fields. The basic performance of the rice transplanter was as follows: working width of 1.8 m (6-row planter with 30 cm row spacing) and maximum working speed of 1.4 m/s.

### 6) *Experimental methods*

Experiments for raising the seedlings were conducted to investigate the relationship between plant length, root length and number of roots of the seedlings and temperature. Varieties of rice used were Koshihikari, Kinuhikari, Akitakomachi and Himenomochi. In this test, air temperature, water temperature, EC and pH of liquid fertilizer were measured in addition to the examination of the plant conditions.

Field experiments were conducted to determine the working accuracy and working rate of the

transplanter in paddy fields. In the experiments, more attention was directed to determine the rate of damaged seedlings and missing hills after transplanting and rooting. Field tests were also performed to evaluate the rice yield in the case of the LMHS from 1996 to 1997 in 3 prefectures, i.e. Ibaraki, Saitama and Iwate.

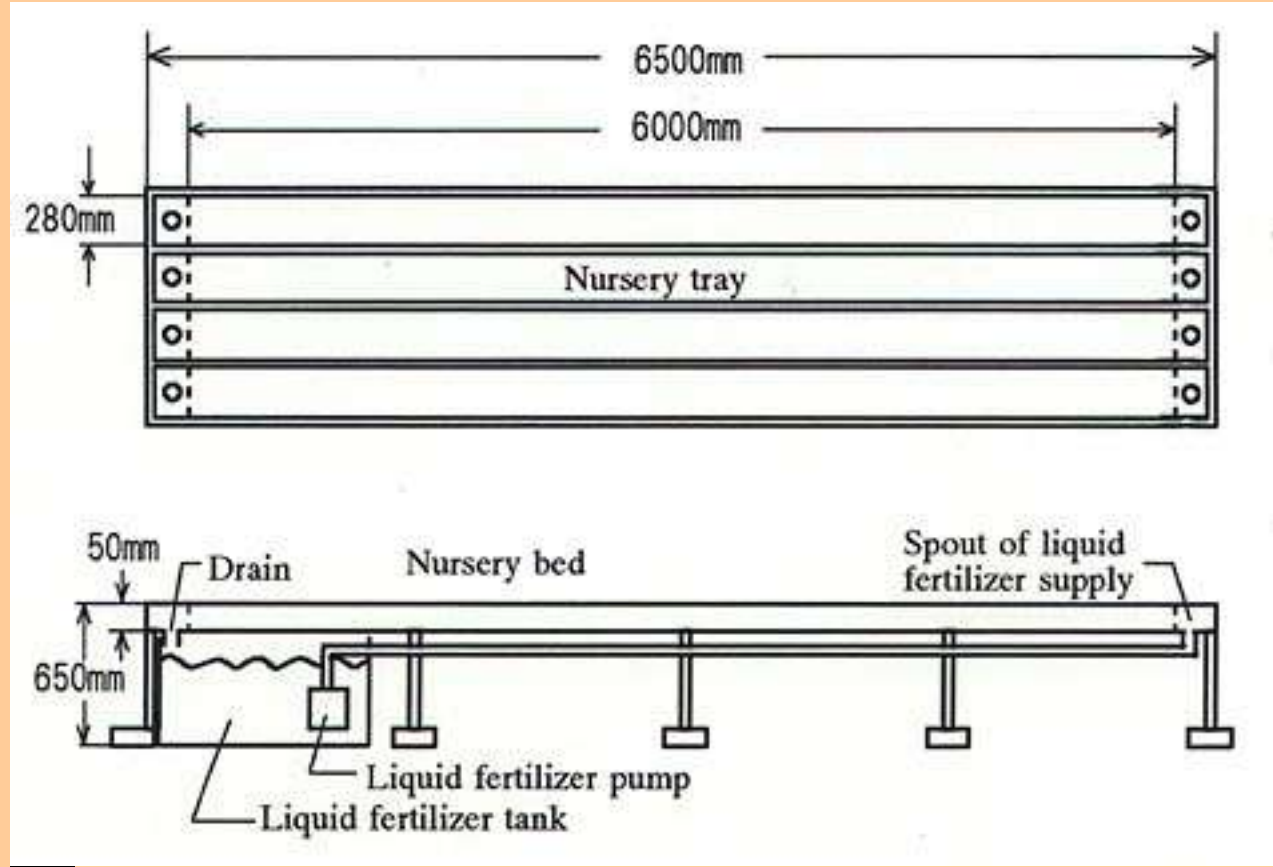


[Continue to: \[Results and discussion\]](#)



[Contents](#)

**Fig.1.**  
Hydroponic nursery device



 [BACK](#)



fig.2 Nursery device and self-propelled seeder



[BACK](#)



## Results and discussion

### *1) Raising of seedlings*

Rice seeds and seedlings on the nursery tray immediately after seeding and 2 weeks after seeding are illustrated in [Fig. 3](#). Roots of the seedlings became entangled after penetrating into the nonwoven cloth on the nursery tray. The mat composed of the entangled plant roots and the nonwoven cloth was strong enough to be handled. Appearance of the seedlings on the tray on the 10th day after seeding is illustrated in [Fig. 4](#).

[*Fig.3:Cross-section of seeds and seeding on the nursery tray\(51KB\)*](#)

[*Fig.4:Appearance of the seedlings on the tray at 10 days after seeding\(25KB\)*](#)

### *2) Relationship between plant length, root length and number of roots of the seedlings and temperature*

The relationship between accumulated lowest water temperature and the plant length is depicted in [Fig. 5](#) and then the relationships between accumulated lowest water temperature and the maximum root length or number of roots are depicted in [Fig. 6](#). These data were obtained when the highest water temperatures ranged from 30 to 34°C. The plant length as well as the maximum root length reached values of 10 to 12 cm at the accumulated lowest water temperature of 20°C. The number of roots increased from 5 to 7 at the accumulated lowest water temperature of 16°C.

[*Fig.5:Relation between accumulated lowest water temperature and plant length\(47KB\)*](#)

[*Fig.6:Relation between accumulated lowest water temperature and maximum root length or number of roots\(47KB\)*](#)

### *3) Roll type seedlings*

Method of rolling up the LMHS on the 6 m long mat was eventually developed. Method of rolling up the seedlings was as follows: (1) pushing down the seedlings with a cylinder of approximately 15 kg, (2) putting a steel plate of 60 cm long, and 27.5 cm wide and a mass of 3 kg on the seedlings, (3) rolling up the seedlings on the circumference of a pipe with a diameter of 15 cm and (4) wrapping the seedlings in a cloth. These operations are illustrated in [Fig. 7](#) and the mats with roll type seedlings are shown in [Fig. 8](#). Diameter and weight of the mats with roll type seedlings ranged from 40 to 45 cm and 12 kg per 6 m, respectively. Comparison between the seedlings subjected to the new and conventional methods for the same length of the mat showed that the mass of the roll type seedlings was approximately 1/5 of that of the CMSS.

[*Fig.7:Method of rolling up of the lmhs\(38KB\)*](#)

[*Fig.8: Roll type seedlings\(33KB\)*](#)

The number of seedling boxes for the CMSS shown in [Fig. 9](#) was approximately 60 and the 6 mats with roll type seedlings shown in [Fig. 8](#) corresponded to the seedling boxes shown in [Fig. 9](#). Based on the data described above, the use of the mats with roll type seedlings enabled to reduce the weight and carriage frequency of seedling boxes.

[*Fig. 9. Conventional mat type seedlings\(34KB\)*](#)

#### **4) Development of a rice transplanter for LMHS**

A 6-row riding type rice transplanter currently manufactured was remodeled to transplant the roll type seedlings in paddy fields as shown in [Fig. 10](#). Some equipment was developed to attach the roll type seedlings to 6 seedling platforms of the transplanter. Ability of feeding belts of seedlings increased for reliable and steady feeding by the use of a driving roller in addition to the top and bottom rollers. Two seedling racks were fixed to carry 8 extra mats with roll type seedlings on both sides of the operator's seat. The capacity of the hopper of fertilizer was twice as high and enabled to reduce the frequency of supply of fertilizer to the transplanter.

[Fig.10:Rice transplanted for roll type seedlings\(27KB\)](#)

#### **5) Working accuracy of the rice transplanter**

In the field experiments conducted in 1996 to 1997, the working accuracy of the rice transplanter resulted in a 30 to 50% rate of damaged seedlings immediately after transplanting and the minimum rate of missing hills after rooting was 3% when the number of plants per hill was 7 to 8. Working speed did not affect significantly the working accuracy.

The rate of damaged seedlings was not related to the working speed of the transplanter but was related to the strength of the seedling mat depending on the mass of seeds per unit area, days of raising of seedlings and variety of rice. In particular, the strength of the seedling mat depended on the mass of seeds per unit area: the larger the latter, the stronger the former. As a result, the rate of damaged seedlings increased. However, a seed mass less than 150 g per unit area (28x58 cm) led to a reduction of the volume of the seedling mat, resulting in the increase of the rate of missing hills. Therefore, optimum mass of seeds was considered to be 180 to 200 g per unit area.

#### **6) Working rate of the rice transplanter**

Working rate of the transplanter with one operator was approximately 0.5 ha/h for a working speed of 1.13 m/s. It took 12 min to supply 6 mats with roll type seedlings to the transplanter.

Although one operator and one helper are required, working rate of a transplanter with the same size under the same conditions when a conventional seedling box was used was nearly 0.3 ha/h. Supply of conventional seedlings to a transplanter requires a helper in addition to the operator and reduces the working rate. Therefore, the use of the transplanter for the roll type seedlings resulted in a considerable saving of labor.

#### **7) Yield of LMHS**

Rice yield in the case of the LMHS and the CMSS in 1996 to 1997 is shown in [Fig. 11](#). Rice yield in the 2 kinds of rice seedlings varied with the years and the locations but did not show a particular tendency. As a result, rice yield in the case of LMHS was assumed to be equal to that of CMSS, although more detailed comparison will be needed in future.

[Fig.11:Rice yield in the case of LMHS\(36KB\)](#)

## Conclusion

Studies were conducted to develop a long mat with hydroponically grown rice seedlings (LMHS). The rice seedlings were grown in a newly developed nursery device for about 2 weeks, and the plant length reached 10 to 15 cm. The seedling mat composed of entangled plant roots and nonwoven cloth was 6 m long and 28 cm wide. The seedling mat was strong enough to be handled by using a nonwoven cloth.

Roll type seedlings were obtained by rolling up the LMHS. The weight of the mat with roll type seedlings was about 12 kg per 6 m and approximately 1/5 of that of a conventional mat with seedlings raised in a soil bed (CMSS).

A rice transplanter was remodeled to transplant the roll type seedlings in paddy fields. Working accuracy of the transplanter was as follows. Damaged seedling rate immediately after transplanting ranged from 30 to 50% and the minimum rate of missing hills after rooting was 3% when the number of plants per hill was 7 to 8. Working rate of the transplanter was approximately 0.5 ha/h for a working speed of 1.13 m/s and a working width of 1.8 m.

Rice yield in the case of the LMHS was assumed to be equal to that of CMSS, although more detailed comparison will be needed in future.

## References

- 1) Tasaka, K. et al. (1997): Development of hydroponic raising and transplanting technology for mat type rice seedlings (Part 1). *J. Jpn. Soc. Agric. Mach.*, 58 (6), 89-99 [In Japanese].
- 2) Tasaka, K. et al. (1997): Development of hydroponic raising and transplanting technology for mat type rice seedlings (Part 2). *J. Jpn. Soc. Agric. Mach.*, 59 (1), 87-98 [In Japanese].



[Forward to :-Precision Control Method for Semi-Trailed Agricultural Machinery-](#)



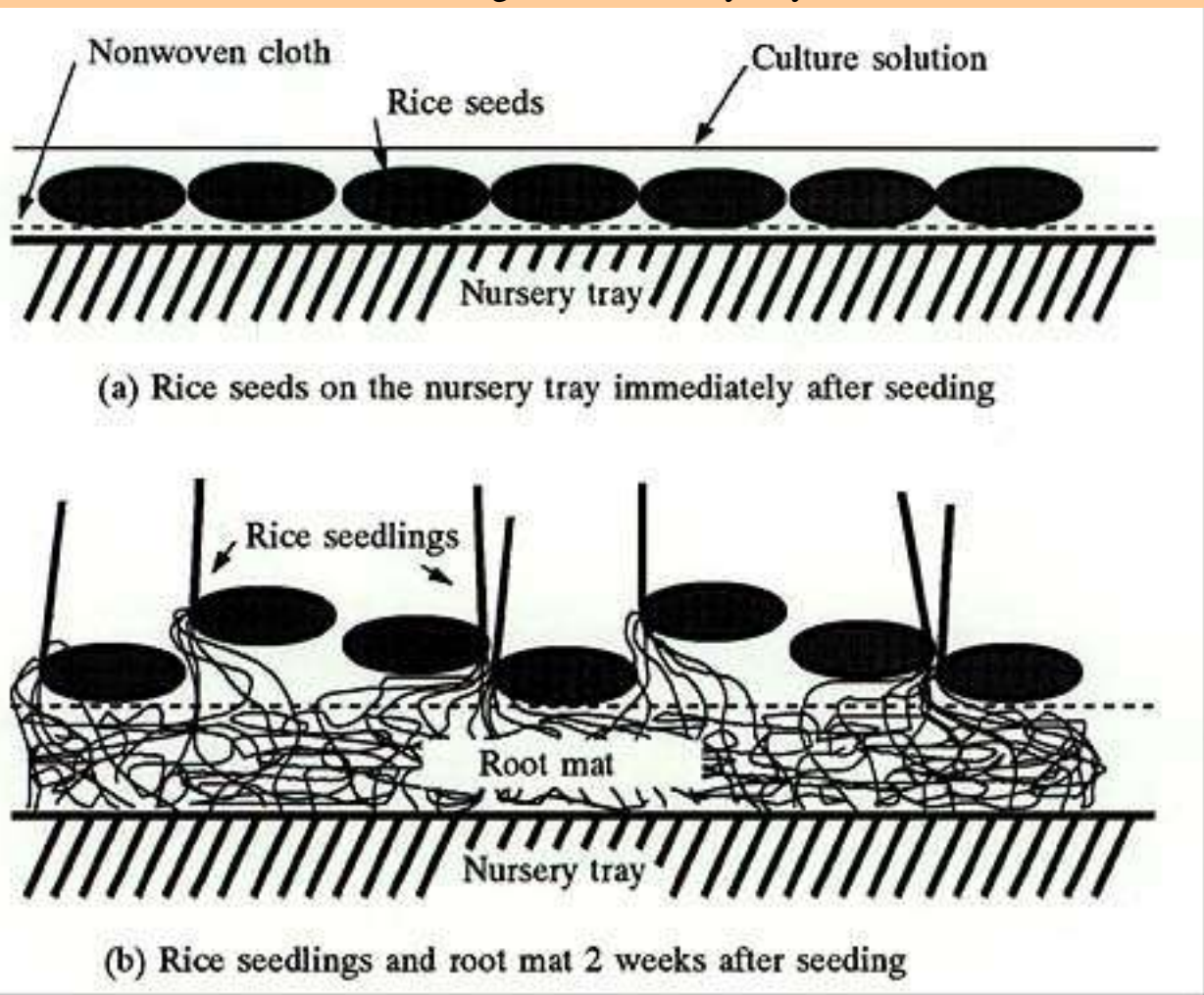
[Contents](#)



[JIRCAS Home Page](#)

**Fig.3.**

Cross-section of seeds and seedlings on the nursery tray



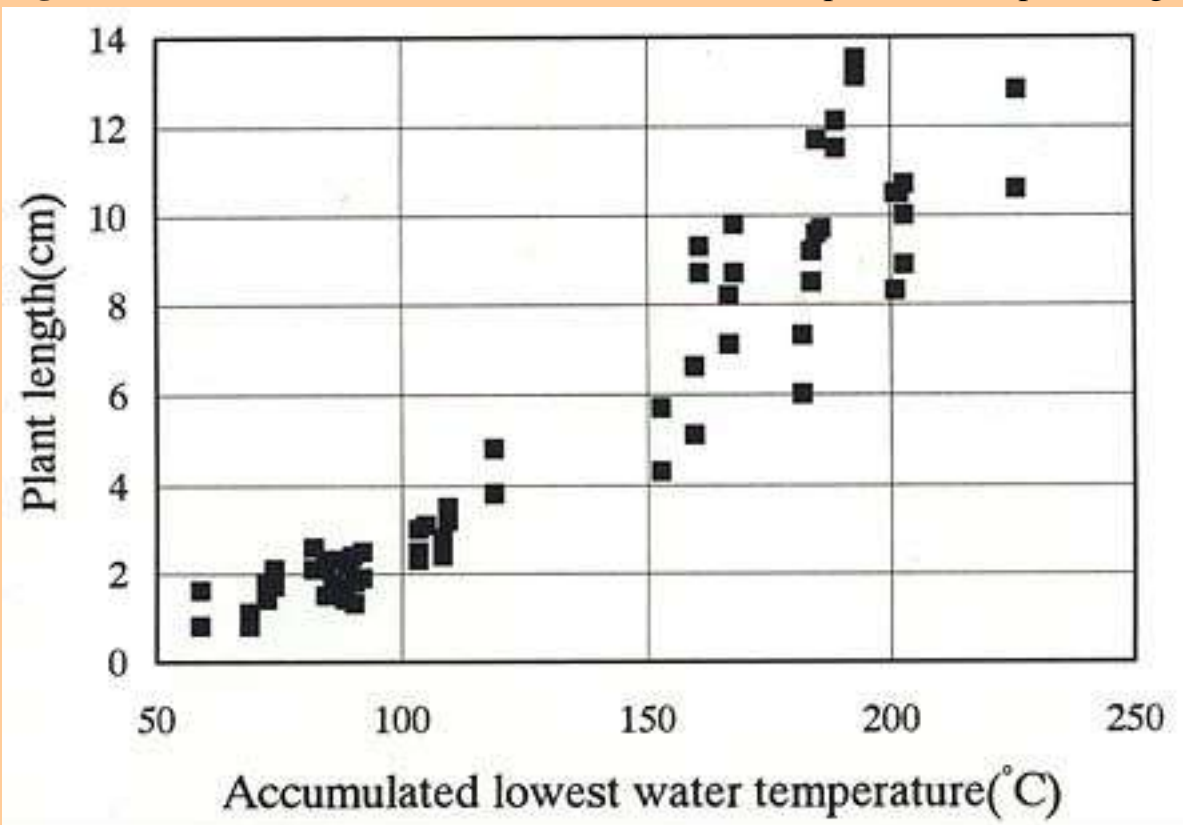
[BACK](#)

**Fig.4.**  
Appearance of the seedlings on the tray at 10 days after seeding

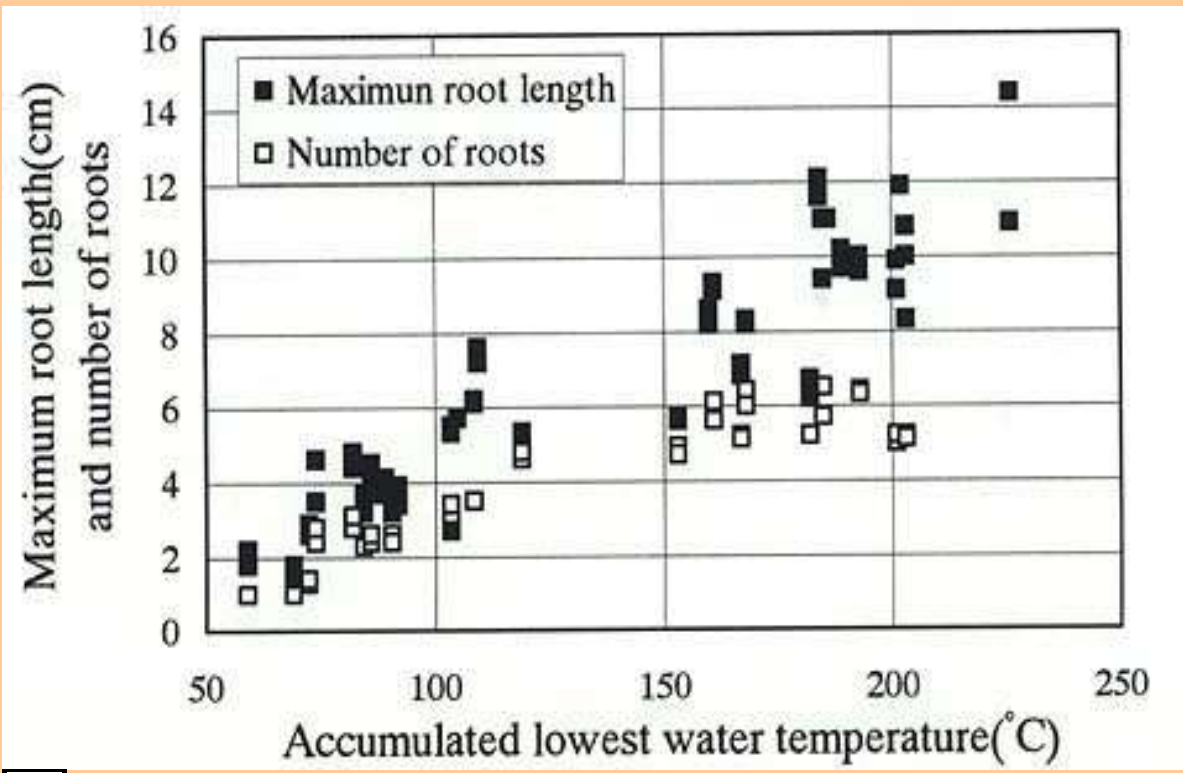


 [BACK](#)

**Fig.5.** Relation between accumulated lowest water temperature and plant length

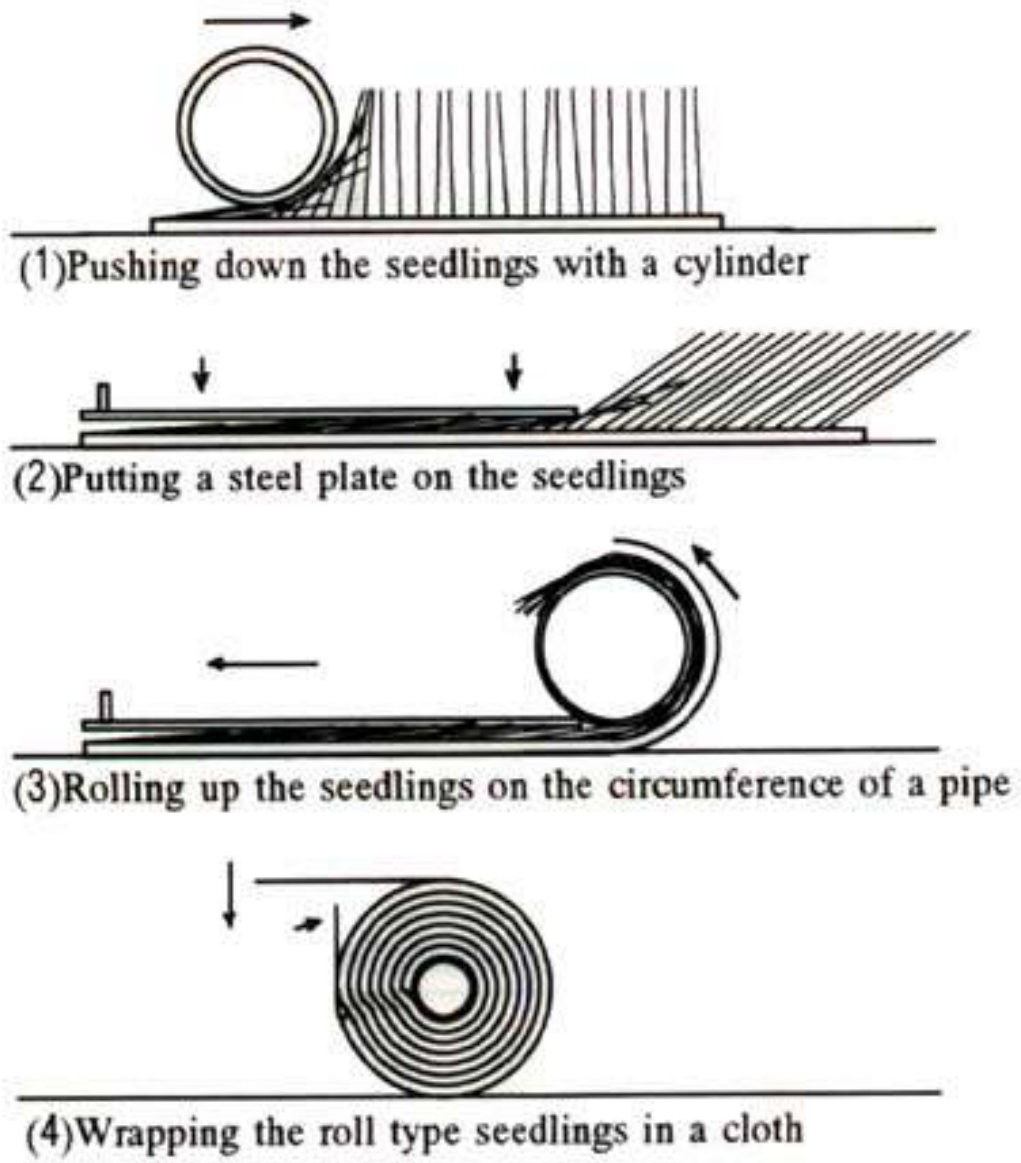


**Fig.6.** Relation between accumulated lowest water temperature and maximum root length or number of roots



 [BACK](#)

**Fig.7.** Method of rolling up the LMHS



 [BACK](#)

**Fig.8.** Roll type seedlings



[BACK](#)



**Fig.9.**  
Conventional mat type seedlings



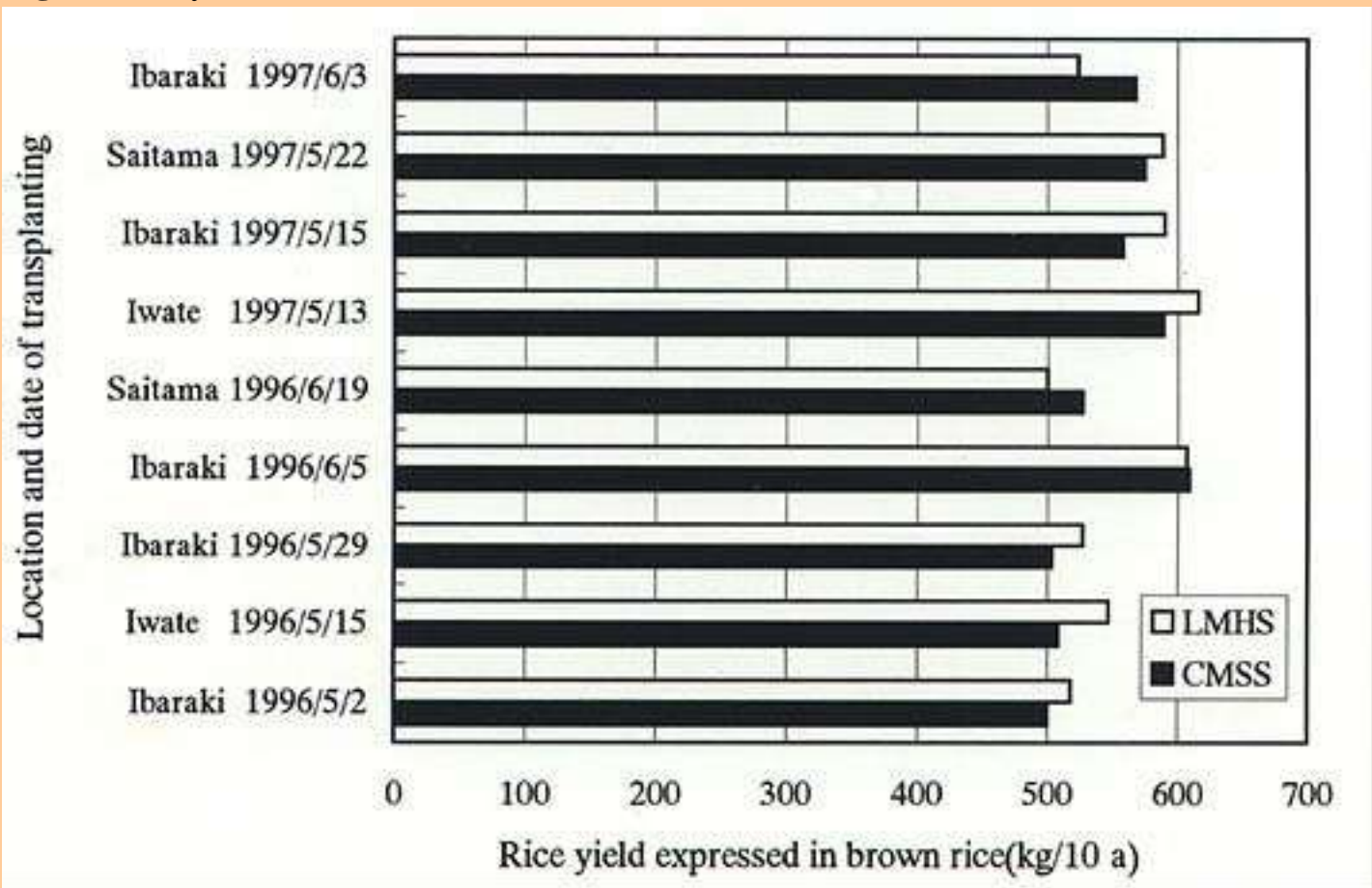
 [BACK](#)

**Fig.10.** Rice trasplanter for roll type seedlings



 [BACK](#)

**Fig.11.** Rice yield in the case of LMHS



 [BACK](#)

# Study on the Development of a Precision Control Method for Semi-Trailed Agricultural Machinery for Tracing the Track of the Tractor

**Nobuki YAMANA, Tomohiro TAKIGAWA *1, Akira HIRATA and Masahiro KAMEI*2**

Animal Industry Engineering Department, Bio-oriented Technology Research Advancement Institution (BRAIN) (Omiya, Saitama, 331-8537 Japan)

Present address:

1 Institute of Agricultural and Forest Engineering, University of Tsukuba (Tsukuba, Ibaraki, 305-8572 Japan)

2 Department of Crop Breeding, Chugoku National Agricultural Experiment Station (Fukuyama, Hiroshima, 721-8514 Japan)

## Abstract

A new steering control method for wheel systems of agricultural machinery to enhance the follow-up performance with a tractor was developed to improve the operability of semi-trailed agricultural machinery. The basic concept of this control method is the alignment of the turning radius of the tractor and machine for a constant turn, and a formula was derived for expressing this geometrical relationship. Based on this formula, a control method was developed which uses the steering angle of the wheel system of an agricultural machine as a variable for the steering angle of the tractor's front wheels and the angle of traction. Thereafter, this control method was applied to the in-line type prototype test trailer and a commercially available roll baler and running tests were conducted. The results showed a significant improvement in the follow-up performance of the trailer and roll baler attached to the tractor. However, since the need to measure the steering angle of the tractor's front wheels is difficult for practical application, the steering angle of the tractor's front wheels was estimated and the estimated values were used for the control for application to the commercially available roll baler. The results of this test showed that the same level of follow-up performance could be achieved as when the steering angle measured for the tractor's front wheels was used and that applications were possible. It was also confirmed that by the addition of a compensation coefficient for a slope to the estimated figures, a high follow-up performance could be achieved even on sloped grassland.

**Discipline:** Agricultural machinery

**Additional key words:** semi-trailer, steering control method, roll baler

**Received for publication, April 14, 1998**

1~4):[References](#)

## Introduction

Semi-trailed agricultural machinery is widely used for forage harvesting and transport. This system is selected because part of the agricultural machine mass can be supported by the wheel system of the machine. As a result, large mass machines can be easily handled and attachment to a tractor is relatively simple. However, the follow-up performance of this type of machine with the tractor is inadequate as

seen in the off-tracking when turning and improvements in operability and maneuverability are necessary.

In recent years, mechanisms for steering the wheel systems of agricultural machines in accordance with the angle of traction (refraction angle at the hitch point) have become commercially available to improve the operability of manure spreaders and sugar beet harvesters. The so-called link method enables to obtain uniform tracks of the tractor and the machine for a constant turn. However, for driving states in which the turning radius changes constantly, such as zigzag driving or a 90° turn (referred to as the non-constant turning state), no significant improvement is expected in the follow-up performance because the control is passive. Since ordinary agricultural machines often perform this type of non-constant turning, it is necessary to solve this problem in order to improve the operability of semi-trailed agricultural machinery.

Under these circumstances, examination of an active steering control method (referred to as active precision control method) for a single axle, 2-wheel agricultural machine using the actual steering angle of the tractor's front wheels in addition to the angle of traction was initiated to develop a method for high-precision follow-up by semi-trailed agricultural machinery of a tractor's driving track even in a non-constant driving state. In this report the method for deducing the basic equality to control the system and the results of driving tests for a test trailer, used as a model of agricultural machine are presented. A commercially available roll baler to which this control method was applied for a driving system with the agricultural machine attached in the straight rear of the tractor (referred to as the in-line format) is described.

## Deducing the basic equality to control the system²⁾

### 1) Turn under constant radius circle

The conditions of the tractor and agricultural machine state when the machine is steered so that the constant turning radius is aligned are shown in [Fig. 1](#) as the 2-wheel model. The A and B points in Fig. 1 are arbitrary points on the central line of the tractor and machine and the system is designed to make the tracks of these 2 points uniform for a constant radius circle.

#### [Fig.1: Concept of development of steering method\(22KB\)](#)

The following equation is derived when a perpendicular line is drawn from the central point T of the machine wheels to OP and a triangular shape is formed by point T, point P and the perpendicular line.

$$\tan(\phi + \theta) = \frac{l_h + l_t \cos \phi}{R_r - l_t \sin \phi} \dots\dots\dots (1)$$

In this equation,  $\phi$  is the angle of traction,  $\theta$  is the steering angle of the machine wheels,  $l_h$  is the distance from the center of the tractor's rear wheels to the hitch point,  $l_t$  is the distance from the hitch point to the machine wheels and  $R_r$  is the turning radius.

When  $\tan(\phi + \theta) = (\tan \phi + \tan \theta) / (1 - \tan \phi \tan \theta)$  is used to rearrange this equation, the following equation is derived.

$$R_r(\cos\phi \tan\theta + \sin\theta) = l_t + l_h(\cos\phi - \sin\phi \tan\theta) \dots\dots\dots (2)$$

Also, since points A and B are located on the perimeter of the same circle with the radius  $(R_r^2 + l_a^2)^{1/2}$ , when the distance from point A to the tractor's rear wheels is defined as  $l_a$ , the following equation is derived.

$$l_a^2 - l_b^2 - l_h^2 = 2 l_b (l_h \cos\phi - R_r \sin\phi) \dots\dots\dots (3)$$

When  $R_r$  is eliminated using equations (2) and (3), the equation showing the relationship which provides the alignment of the tracks of points A and B for a constant radius circle is derived.



Furthermore, when the equation is simplified using the approximations of  $\sin\theta \approx \theta$  and  $\cos\theta \approx 1$ , the following is derived.

$$\theta = \frac{(l_a^2 - l_b^2 - l_h^2 + 2 l_b l_t) \phi}{(-l_a^2 + l_b^2 + l_h^2 + 2 l_b l_h)} \dots\dots\dots (5)$$

In this equation,  $l_t$  is the wheel base of the tractor and is defined as  $l_t = -R_r \tan\delta$ . Now,  $\delta$  is the steering angle of the tractor's front wheels.

## 2) Non-constant turning state

The plane movement of the tractor and agricultural machine is considered assuming the absence of side slip of the wheels. In [Fig. 2](#), when the line which connects the hitch point and the T point, in the center of the machine wheels, is the base, since the traveling speed of the tractor and the machine in the direction of this line is aligned, the following is derived.

[Fig.2: Model used for the tractor and trailed machine\(18KB\)](#)

$$V_t \cos(\phi - \theta) = V \cos(\phi - \beta) - (l_r + l_h) r \sin\phi \dots\dots\dots (6)$$

Next, when the speed element which intersects the base line is considered and the drawing angle  $\beta$  representing the change of speed  $V$  is determined, the following is derived.

$$\dot{\phi} = \frac{V_t \sin(\phi - \theta) - (l_r + l_h) r \cos\phi - V \sin(\phi - \beta)}{l_t} - r \dots\dots\dots (7)$$

In this equation,  $V_t$  is the traveling speed of the agricultural machine,  $V$  is the tractor driving speed,  $r$  is the tractor yaw angular velocity,  $\beta$  is the side slip angle at the tractor's center of gravity position and  $l_r$  is

the distance from the tractor's rear wheels to the center of gravity.

$\delta$  and  $r$  in the absence of side slip of wheels are represented by  $\tan^2 \delta = l_r \tan \delta / l$  and  $r = V \tan \delta \cos^2 \delta / l$ . Then the equation is rearranged by deriving  $V_t$  from equation (6) and substituting it in equation (7) and the following is derived.

$$\dot{\phi} = V \{ -l\phi - (l_h + l_t)\delta - l\theta \} / l l_t \dots\dots\dots (8)$$

Meanwhile, by substituting  $R_r = -l / \tan \delta$  in equation (2), further simplifying and determining the relationship between the target angle of traction  $\delta$  and the tractor front wheels' steering angle necessary for obtaining identical trajectories of points A and B, the following is derived.

$$\phi_t = \{ (l_b + l_h)^2 - l_a^2 \} \delta / l l_b$$

At this point, in order to provide a control for aligning  $\delta$  with  $\delta_t$ , a feedback technique is applied in which the  $\delta$  changing speed ( $\dot{\phi}$ ) is expressed by the following equation.



The target steering angle  $\delta_t$  of the agricultural machine necessary for achieving this feedback is indicated by the following equation.

$$\theta_t = (\alpha - k_2)\phi / k_2 - (\alpha k_1 + k_3)\delta / k_2 \dots\dots\dots (9)$$

In this equation,

Based on the equation, the target steering angle of the machine wheels for aligning the track in a non-constant turning condition is determined. The machine wheels should be controlled for steering to meet the target steering angle.

 [Continue to: \[Test trailer overview and driving test\]](#)

 [Contents](#)

## References

- 1) Hirata, A., Yamana, N. & Takigawa, T. (1994): Development of precision control system for agricultural semi-trailer tracing the track of tractor (Part 4). *J. JSAM*, 56 (4), 61-66 [In Japanese with English summary].
- 2) Takigawa, T., Yamana, N. & Hirata, A. (1992): Development of precision control system for agricultural semi-trailer tracing the track of tractor (Part 1). *J. JSAM*, 54 (1), 57-65 [In Japanese with English summary].
- 3) Yamana, N., Takigawa, T. & Hirata, A. (1993): Development of precision control system for agricultural semi-trailer tracing the track of tractor (Part 2). *J. JSAM*, 55 (4), 23-31 [In Japanese with English summary].
- 4) Yamana, N., Takigawa, T. & Hirata, A. (1994): Development of precision control system for agricultural semi-trailer tracing the track of tractor (Part 3). *J. JSAM*, 56 (3), 69-75 [In Japanese with English summary].



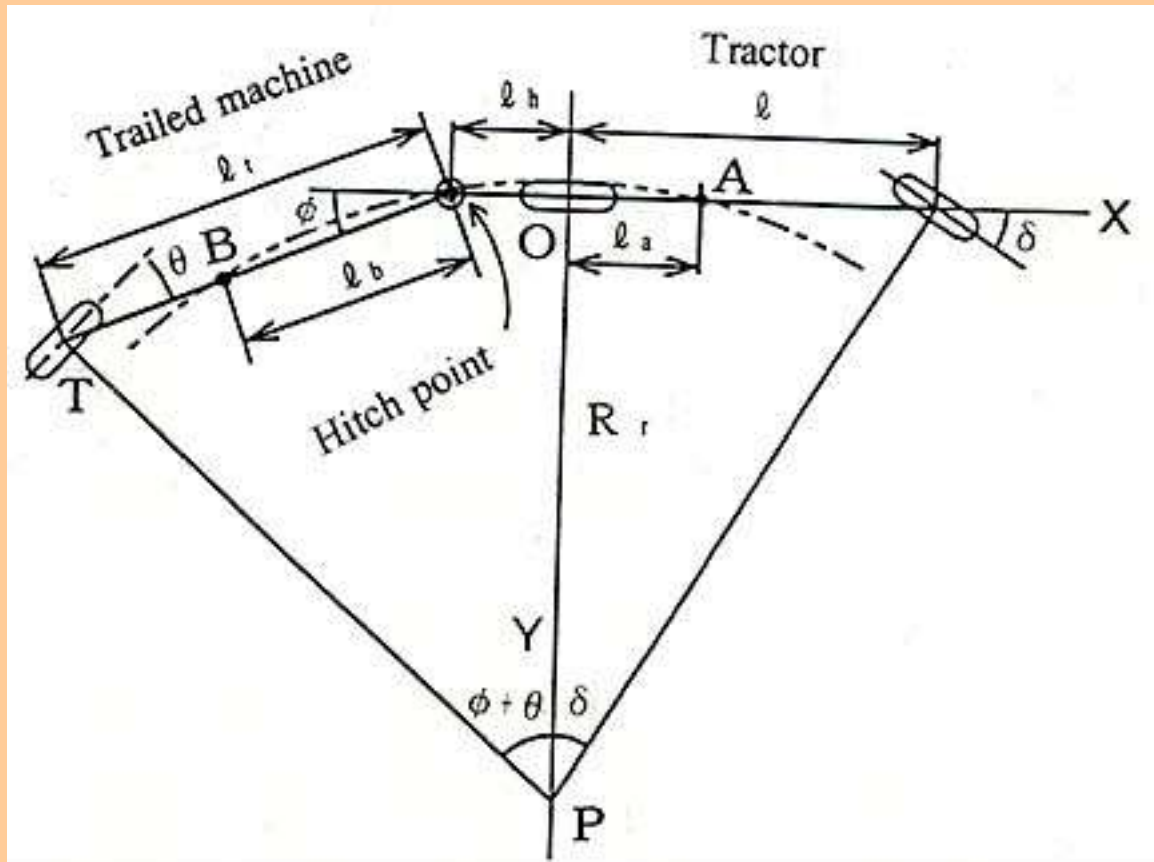
[Back to the first page](#)



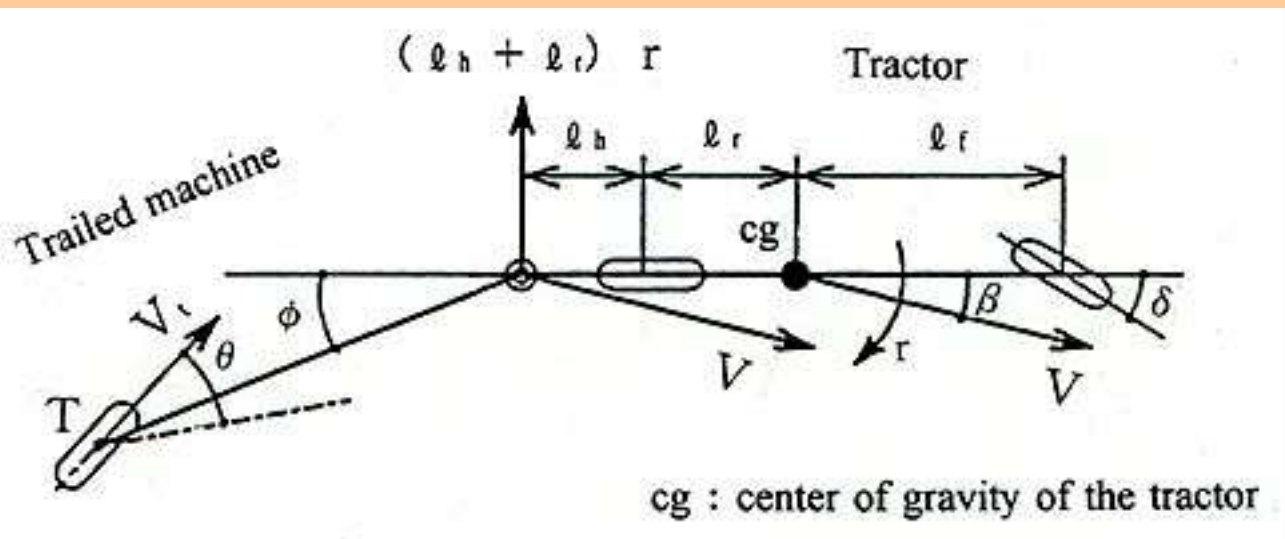
**Fig.1.**

Concept of development of steering method

Radii at point **A** and at point **B** are the same.



[BACK](#)



**Fig.2.**  
Model used for the tractor and trailed machine



[BACK](#)

1~4):[References](#)

## Test trailer overview and driving test 2,3)

### 1) Test trailer overview

[Fig. 3](#) shows the test trailer prototype attached to the tractor. The sizes of the steering angle of the tractor's front wheels, the angle of traction and the steering angle of the trailer's wheels are measured by potentiometers installed at relevant positions. Based on the values of the angles determined by potentiometers, **ON-OFF** of the electromagnetic, hydraulic direction control valve is controlled via a relay and the hydraulic cylinder expands and becomes contacted to drive the trailer wheels. In the test, a control program was run which uses interruptions every 10 ms based on an interval timer built into the control computer in order to maintain a constant control interval. The cylinder used for steering the trailer wheels is a bilateral rod type cylinder with an internal diameter of 30 mm, a rod diameter of 16 mm and a stroke of 250 mm.

[Fig.3:Test trailer and tractor\(24KB\)](#)

### 2) Driving test results using the test trailer

In the driving test, drops of water are left on the surface at set points to draw the track and the tracks are compared to align the tracks of the tractor and trailer. Tests of a constant radius circle with the tractor side point set in the rear wheel center and the trailer side point set in the trailer wheel base center when the control was applied, were carried out. Based on the results obtained, while a track offset of 8.5 cm and 26 cm occurred for steering angles of 18° and 31°, respectively for the tractor's front wheels, there was almost no off-tracking when the control was applied. [Fig. 4](#) shows a comparison with the calculated values for cases in which a constant radius circle is driven with different actual steering angles for the tractor's front wheels and measurements of the angle of traction and the steering angle of the trailer's wheels are taken. The link indicated in the figure corresponds to the case when the link method is used for control with the target steering angle based on equation (5) being determined and applied for actual control. The wavy line and alternate long and short dash line in the figure show the results of driving when the trailer side setting point position changed in the active precision control method and in both cases, the calculated values and the measured values agreed well.

[Fig.4:  \$\delta_e\$  /  \$\delta_r\$  characteristic diagrams\(30KB\)](#)

Next, [Fig. 5](#) shows a comparison between the active precision method and absence of control and steering control by the link method for a turning track when a 90° angle turn is performed through an abrupt turn of the handle by the operator driving the tractor on a flat concrete street surface. The driving speed at this time is 0.38 m/s, the points at which the system attempts to align the track when the control is applied correspond to the center of the tractor's rear wheels for the tractor and the center of the machine wheels for the machine and a neutral zone of  $\pm 1^\circ$  is set for the angle of traction when control is applied. When there is no control, once the 90° turn begins, the trailer cuts to the inside and the track for the setting point goes way off course. Furthermore, the trailer track is not aligned with the tractor track even after reverting to a straight course. When the link method control is applied, the track is not as far off as without any control, but even though the control is set to align the tracks for a constant radius circle, in the first part of the circle, the trailer crosses outside of the tractor's track and for the latter half of the circle, it crosses inside of the tractor's track. In contrast, when the newly developed active

precision control method is used, while there is a slight amount of crossing on the inside by the trailer initially, the follow-up performance is excellent afterwards. The return to a proper track after the tractor reverts to a straight course is also quick. The reason why some crossover to the inside at the beginning of the turn is observed with the active precision control method is that since the tractor and the trailer are controlled to follow the same turning circle with the same turning point, when the tractor's front wheels are adjusted, the trailer's wheels are turned to be on the turning track which matches the angle of the tractor's adjustment although the trailer is still on the tractor's straight course track.

[Fig.5:Top view of trajectories in 90° turn\(22KB\)](#)

These results show that the introduction of the active precision control method significantly improves the follow-up performance of a semi-trailed agricultural machinery attached to a tractor.

## **Application of control system to a middle-sized commercialized roll baler and tests⁴⁾**

Based on the results obtained with the test trailer and in order to study the suitability of the active precision control method, a middle-sized roll baler available in the market with a pick-up width of 1 m and a bale-forming chamber diameter of 90 cm was retooled for steering control and used in driving tests as well as field work. The tractor selected for these tests had an engine output of 22 kW, a wheel base ( $l$ ) of 1.79 m, a distance from the rear wheels to the hitch point ( $l_h$ ) of 0.96 m, a distance from the baler hitch point to the wheels ( $l_t$ ) of 1.76 m and a distance from the hitch point to the center of the baler pick-up device ( $l_b$ ) of 0.995 m. Also, steering of the baler wheels was handled by a hydraulic cylinder and oil was supplied by a hydraulic unit (with an output of 2.4 L/min when the tractor PTO base rotation is 540 rpm) built in the baler. The points at which the control system attempted to align the track corresponded to the center of the rear wheels ( $l_a = 0$ ) on the tractor side and to the center of the pick-up device on the baler side.

In [Fig. 6](#), a comparison of the results is shown for the absence of control and a model of link method control for the track when a 90° turn is performed at a speed of 1.65 m/s on a flat concrete surface. As in the case of the test trailer, the track alignment is off to the greatest extent for the absence of control and the amount of dislocation decreases in the link method and then in the active precision control method. Even when bales weighing nearly 140 kg are loaded in the bale-forming chamber and a 90° turn is performed, the follow-up performance using the active precision control method shows almost no change. In field work as well, excellent follow-up performance is achieved. Furthermore, by applying a control process, since the risk of interference of the tractor with the baler is reduced even with larger angles of traction and a smaller turning radius, the turning performance is also enhanced in addition to the better follow-up performance.

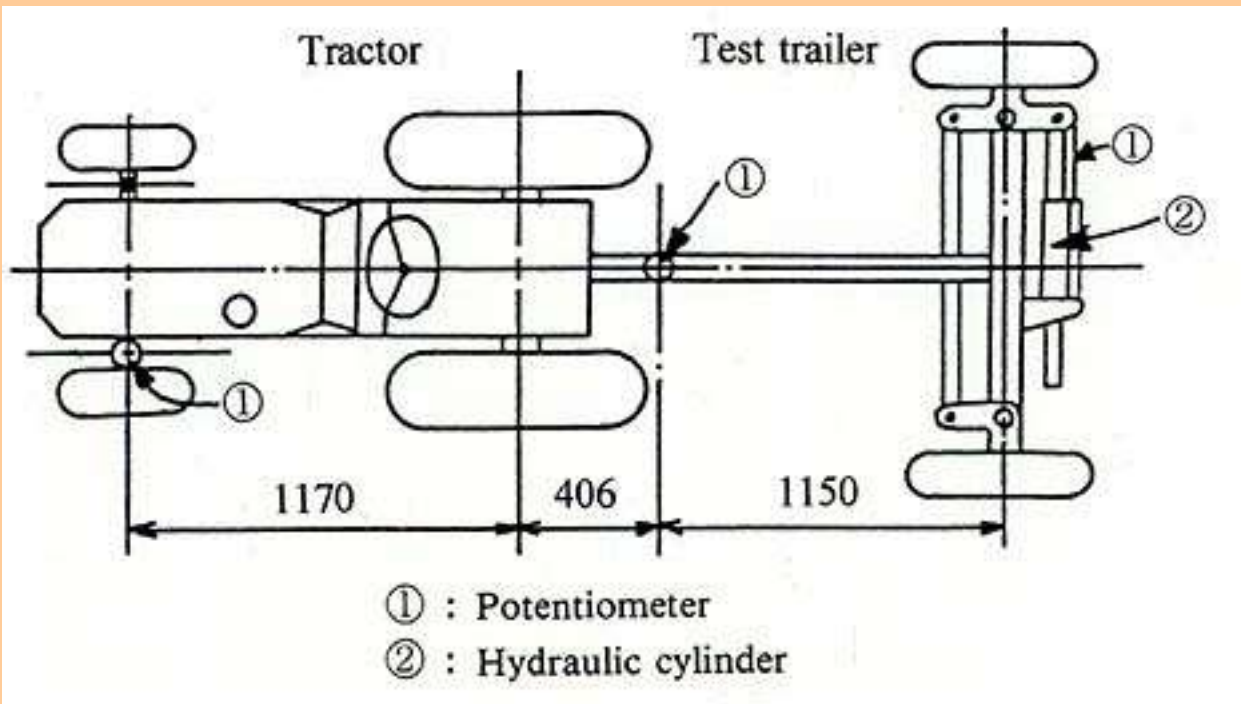
[Fig.6:Top view of trajectories in 90° turn\(24KB\)](#)



[Continue to: \[Improvement of the control method and effect1\)\] and \[Conclusion\]](#)



[Contents](#)

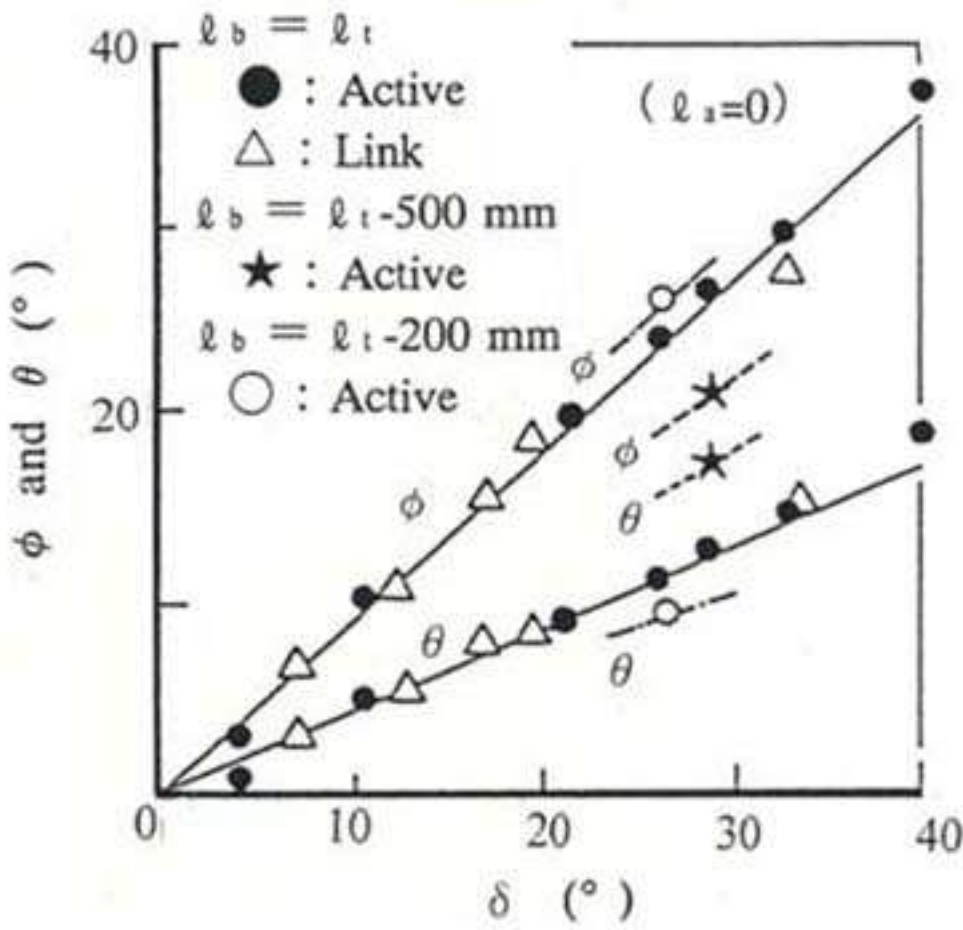


**Fig.3.**  
Test trailer and tractor

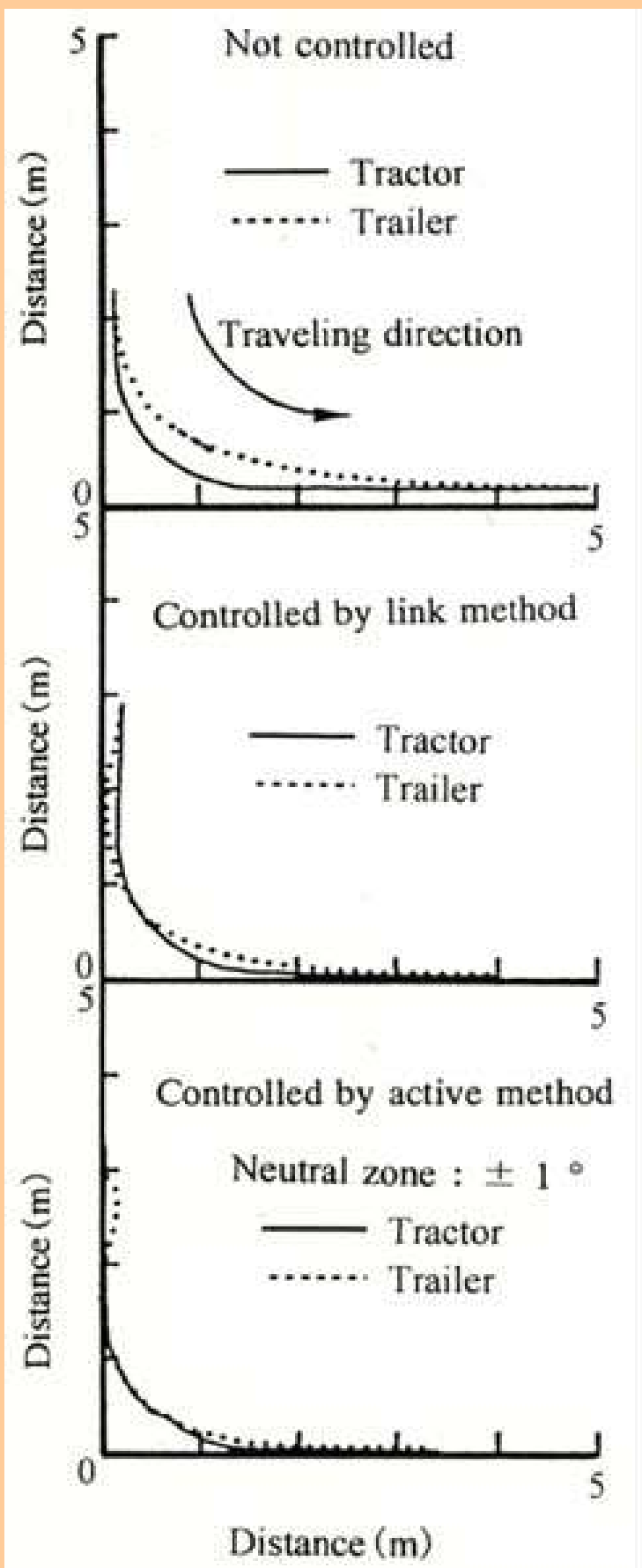
 [BACK](#)

**Fig.4.**  $\delta/\phi$  characteristic diagrams  
 Trailer wheel control system was applied

$\phi$ : The angle between the tractor and the trailer  
 $\theta$ : Steering angle of the trailer wheels  
 $\delta$ : Steering angle of the tractor wheels



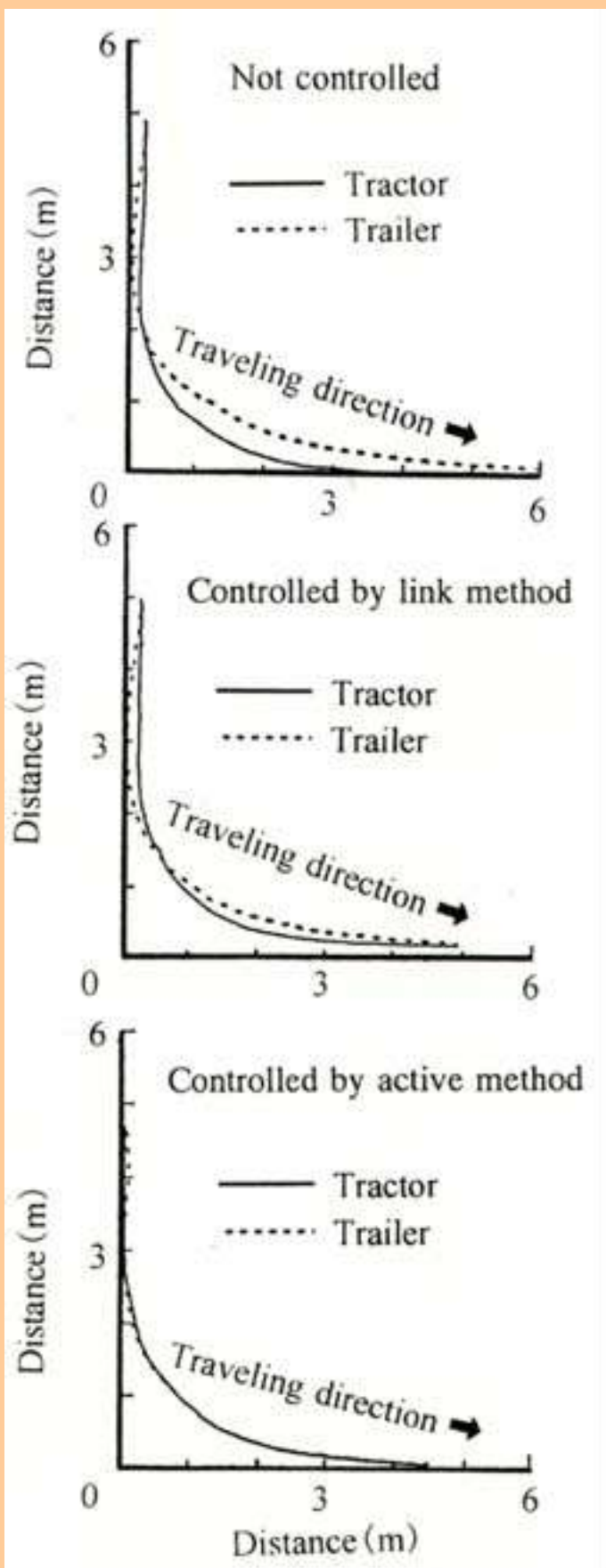
 [BACK](#)



**Fig.5.**

Top view of trajectories in 90° turn Traveling velocity is 0.38 m/s.





**Fig.6.**

Top view of trajectories in 90° turn (in-line type roll baler of real size)

Traveling velocity is 1.65 m/s.





## Improvement of the control method and effect¹⁾

The active precision control method as described thus far involves the measurement of the steering angle of the tractor's front wheels using a potentiometer and applying control based on the results of measurement. This method requires that sensors be attached to the tractor for measurement of the steering angle of the front wheels or the rotary angle of the handle, and this requirement is not suitable for practical use. Therefore, instead of a method which measures the steering angle, a method which uses estimates of the actual steering angle from the angle of traction and the angular velocity of the angle of traction was examined.

In equation (8), the angular velocity of the angle of traction was determined from the angle of traction and the steering angle of the tractor's front wheels or the steering angle of the machine wheels. This equation (8) can be derived as follows.

$$\dot{\phi} = -k_2\dot{\phi} - k_2\theta - k_3\delta$$

Note that  $k_2 = V/l_t$  and  $k_3 = V(l_h + l_t)/ll_t$ . In this case,  $\delta$  and  $\dot{\phi}$  are determined and  $\delta$  can be calculated as the change in  $\phi$  measured over time. Therefore, the actual steering angle of the tractor's front wheels necessary for control can be estimated by the following equation.

$$\delta = -(\dot{\phi} + k_2\phi + k_2\theta)/k_3 \dots\dots\dots(10)$$

When the relationship expressed in equation (10) is substituted in equation (9), it is assumed that the target steering angle corresponds to the measured steering angle ( $\theta_t = \theta$ ) and the equation is simplified. As shown in the following equation, it is possible to determine the target steering angle from the angle of traction and the angular velocity of the angle of traction.

$$\theta_t = \frac{l_a^2 - l_b^2 - l_h^2 + 2l_b l_t}{-l_a^2 + l_b^2 + l_h^2 + 2l_b l_h} \phi - \frac{l_t}{V} \times \left[ 1 - \frac{2l_b(l_h + l_t)V'}{\alpha l_t \{ (l_b + l_h)^2 - l_a^2 \}} \right] \dot{\phi} \dots\dots(11)$$

Here,  $\pm$  is the feedback gain,  $V$  is the actual driving speed and  $V'$  is the fixed speed value input in advance.

This revised control method is referred to as the "new active precision control method" in contrast to the original "active precision control method", and [Fig. 7](#) shows a comparison of this method applied to the previously described roll baler for a track resulting from zigzag driving over a flat concrete surface with the absence of control, link method control and active precision control. For this control application, the feedback gain is set at 0.84 and  $V'$  at 1.2 m/s with a driving speed of 1.7 m/s. Also, the angle of traction neutral zone for control is set at  $\pm 10^\circ$ , and the driving speed is set by inputting a value which is compatible with the defined driving zone in order to simplify the control device. Without any control, the dislocation is 52 cm (maximum) and for the link control method, the maximum track dislocation is 23 cm with phase delay. By comparison, the active precision control method and the active precision control method based on the estimation of the steering angle gave a maximum dislocation value of 10 cm and 7 cm, respectively. It is thus obvious that the track follow-up performance can be achieved at the same levels as

with the active precision control method, and considering the lack of requirement for special work on the tractor itself, this method is highly suitable.

**[Fig.7:Top view of trajectories in zig-zag running test\(36KB\)](#)**

When work is being conducted on sloped grassland, since the agricultural machinery slips towards the valley side of the slope, the work performance deteriorates compared to flat land. To alleviate this shortcoming, a sensor which detects the slope angle is attached to the machine and if this angle is used as compensation to equation (11) for the application of steering control to the machine wheels, it is possible to achieve an excellent follow-up performance and work results even on sloped grasslands. Specifically, the following equation is used to determine the steering angle.

$$\theta_t = F_1 \phi - F_2 \dot{\phi} - F_3 \omega \dots\dots\dots(12)$$

In this equation,  $F_1$  and  $F_2$  are the coefficients of  $\phi$  and  $\dot{\phi}$  in equation (11),  $\dot{\phi}$  is the slope angle and  $F_3$  is the compensation coefficient based on the slope.

When a driving test was conducted on an 8° slope using a roll baler (with a bale diameter of 100 cm) to which this slope compensation had been applied, the results showed that while a dislocation of about 7 cm occurred in the absence of control or without slope compensation, there was practically no dislocation when slope compensation with  $F_3$  fixed at 0.3 was applied. Also, when a zigzag traveling test was applied to the same land, while the track dislocation between the tractor and the baler was nearly 20 cm without any control, a maximum value of about 5 cm was maintained when the control was applied. These results emphasize the value of this technique for improving the follow-up performance of the machine on sloped land.

## Conclusion

- (1) For semi-trailed agricultural machinery, a method for controlling the steering of the machine wheels based on the angle of traction and the steering angle of the tractor's front wheels was developed in order to improve the follow-up performance with the tractor.
- (2) The basic approach for the control technique was to obtain identical values for the turning radius of the tractor and the machine wheels for a constant radius circle and a theoretical equation was introduced. Furthermore, the effectiveness of this approach was verified using a test trailer.
- (3) To align the tracks for a non-constant radius turn, the active precision control method which provides a steering control based on the following equation using the angle of traction and the steering angle of the tractor's front wheels was developed, and this control method was applied to a test trailer and a commercially available roll baler for driving tests. The results showed that this control method improved the follow-up performance of the machine with the tractor.

$$\theta_t = (\pm k_2) \dot{\phi} / k_2 - (\pm k_1 + k_3) \dot{\phi} / k_2$$

- (4) The active precision control method was further improved by estimating the steering angle of the tractor's front wheels and using these values in the following equation to determine the steering angle for the machine wheels based on the angle of traction and the angular velocity of the angle of traction. This improved method which is referred to as the active precision control method based on the estimation of

the steering angle was applied to the roll baler for driving tests. The results showed that the follow-up performance reached levels similar to those obtained with the active precision control method. Also, this control method was suitable for practical use because it does not require the installation of sensors for measuring the actual steering angle of the tractor's wheels or other changes.

$$\theta_t = \frac{\ell_a^2 - \ell_b^2 - \ell_h^2 + 2\ell_b\ell_t}{-\ell_a^2 + \ell_b^2 + \ell_h^2 + 2\ell_b\ell_h} \phi - \frac{\ell_t}{V}$$

$$\times \left[ 1 - \frac{2\ell_b(\ell_h + \ell_t)V'}{\alpha\ell_t\{(\ell_b + \ell_h)^2 - \ell_a^2\}} \right] \dot{\phi}$$

Additionally, the follow-up performance can be further enhanced by applying a compensation coefficient for sloped grassland.



[Forward to:-Evaporation and Percolation Control in Small Farm Ponds in Thailand-](#)



[Contents](#)



[JIRCAS Home Page](#)



# Evaporation and Percolation Control in Small Farm Ponds

**Kosho DAIGO*1 and Virote PHAOVATTANA*2**

*1 International Trade and Tariff Division, Economic Affairs Bureau, Ministry of Agriculture, Forestry and Fisheries  
(Kasumigaseki, Chiyoda, Tokyo, 100-8950 Japan)

*2 Land Development Regional Office 2, Department of Land Development, Ministry of Agriculture and Cooperatives  
(Ao-Udom, Sriracha, Chonburi 20230, Thailand)

## Abstract

In savanna and tropical monsoon areas where the dry and rainy seasons can be clearly distinguished, it is important for farmers to secure as much irrigation water as possible in the dry season in order to produce fruits and vegetables. Though the Department of Land Development, Ministry of Agriculture and Cooperatives, Thailand recommends that farmers excavate small farm ponds for the purpose mentioned above, the irrigation water stored in the farm ponds in the rainy season is not effectively used in the dry season because of evaporation from the surface of water and percolation from the bottom and lateral parts of the ponds. Therefore, the authors developed methods to control the evaporation and percolation in small farm ponds. They selected 4 methods mentioned below, based on the results of experiments carried out in the eastern region of Thailand by Kobayashi. They developed low cost and sustainable methods which farmers can apply themselves as follows: (1) Covering the surface of water with floating materials. (2) Management of irrigation water using several ponds. (3) Changes in the pond shape. (4) Compaction of the bottom of the pond after crushing. The authors confirmed the effectiveness of the 4 methods through field experiments and model calculations.

**Discipline:** Irrigation, drainage and reclamation

**Additional key words:** floating materials

**Received for publication, April 6, 1998**

## Introduction

The climate of Thailand can generally be classified into 2 main types, savanna and tropical monsoon. For example, the major part of the eastern region in Thailand has a savanna climate where the dry and rainy seasons can be clearly distinguished by the amount of rainfall. Consequently, rainfall in the eastern region of Thailand is concentrated during the rainy season from May to October and the amount is very small during the dry season, especially from December to March.

Presently the authorities concerned have attempted to promote crop diversification including the development of orchards in order to improve the standard of living of the farmers. To achieve this objective, the farmers must secure water resources for the dry season. For example, since some of the tropical fruits in the eastern region of Thailand pollinate from January to February, irrigation water must be preserved at least until February through the utilization of farm ponds, groundwater, etc. However, water resources in this region are mainly derived from surface water with some supply from groundwater.

Construction of farm ponds is one of the measures to alleviate these shortcomings. However, valuable irrigation water in farm ponds gradually evaporates and percolates under the strong sun in the dry season. Therefore, it is important for the authorities concerned to implement sustainable measures to preserve farm pond irrigation water as much as possible.

The authors studied and conducted some experiments related to the development of methods to control evaporation and percolation in small farm ponds for

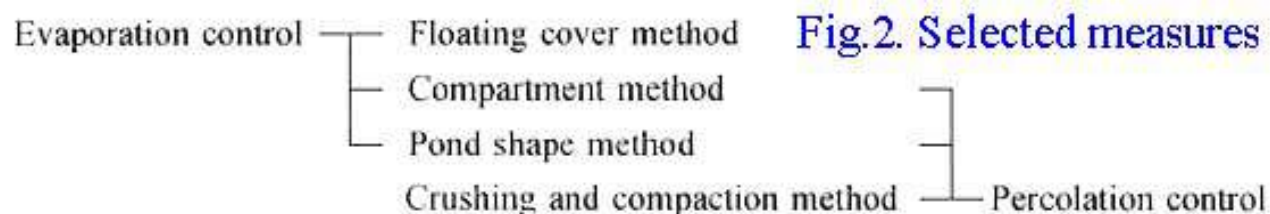
2 years (1995~1996), based on experiments carried out by Kobayashi in 1994²⁾. In the current report, the results of this study are described.

## Selected measures

In this study the authors aimed at implementing water conservation measures in small farm ponds, especially in standard-type small farm ponds (Fig. 1) recommended by the Department of Land Development (DLD), Ministry of Agriculture and Cooperatives, Thailand. Moreover, the authors aimed at implementing practical water conservation measures which farmers can apply themselves.

### Fig.1:DLD standard-type small farm pond (excavated type)(21KB)

The following 4 methods were selected: (1) Covering the surface water with floating materials (hereafter referred to as Floating cover method). (2) Use of several ponds (hereafter referred to as Compartment method). (3) Changes in pond shape (hereafter referred to as Pond shape method). (4) Crushing and compaction of the bottom of the pond (hereafter referred to as Crushing and compaction method) (Fig. 2).



### 1) Floating cover method

The authors carried out 2 experiments in the 1995 and 1996 dry seasons. The results of these experiments are shown in Table 1.

**Table1: Floating cover experiments**

Method	<u>1995 Experiment</u>			<u>1996 Experiment</u>		
	77-day-cumulative evaporation total (mm)	Daily average evaporation (mm/day)	Evaporation reduction rate (%)	77-day-cumulative evaporation total (mm)	Daily average evaporation (mm/day)	Evaporation reduction rate (%)

Control	494.57	6.42(100%) ^{a)}	-	433.02	4.98(%) ^{a)}	-
Polystyrene foam	304.85	3.96(62%)	38	-	-	-
Bamboo	370.64	4.81(75%)	25	-	-	-
Drinking water bottles	331.97	4.31(67%)	33	-	-	-
Duckweed	450.00	5.84(91%)	9	379.75	4.13(83%)	17

a): Rate taking "Control" as 100%

Based on the 1995 experiment, though the results showed that polystyrene foam was most effective in reducing evaporation from farm ponds, the authors selected duckweed (a kind of floating weed) as the most suitable and sustainable floating material in taking account of the cost and load on the environment.

In the 1996 experiment, the authors confirmed again the effectiveness of duckweed for evaporation control. Based on these experiments, the authors observed that duckweed used as floating cover reduced the evaporation by about 10%.

## 2) *Compartment method*

### (1) Method1)

A schematic diagram illustrating the method is shown in Fig. 3. The ponds were operated as follows:

#### *Fig.3:Schematic cross-section diagram of 3-compartment ponds(37KB)*

- 1.They were full of water at the end of the rainy season (Stage 1).
- 2.Water for consumptive use was pumped from pond 1 until the evaporation and percolation losses from pond 2 and pond 3 were equal to the amount of water remaining in pond 1 (Stage 2).
- 3.A pump was used to transfer the water remaining in pond 1 to fill the unused capacity of pond 2 and pond 3 (Stage 3), which eliminated further evaporation and percolation losses from pond 1.
- 4.Water was withdrawn as needed for consumptive use from pond 2 until the amount of water remaining in pond 2 was equal to the unused capacity in pond 3 (Stage 4).
- 5.A pump was used again to transfer the remaining water from pond 2 into pond 3 (Stage 5). At this stage, pond 3 was filled and pond 1 and pond 2 were empty, which eliminated further evaporation and percolation from pond 2.

### (2) Results

Based on a computer calculation, it was observed that this method was effective for the control of evaporation and percolation.

When the method is applied to DLD standard-type small farm ponds, it is considered that there are 2 systems. In one, a pond is divided into various compartments, and in the other some standard-type small farm ponds are used with water consumption corresponding to the number of ponds. Therefore, the authors examined 7 cases as shown in [Table 2](#). Case-A corresponded to the DLD standard-type small farm pond. In Case-B1 to Case-B3 the former system was used and in Case-C1 to Case-C3 the latter system was employed.

[**Table 2. Calculation of water reduction in the Compartment method\(42KB\)**](#)

The assumptions for the calculations were as follows: evaporation amounted to 5.0 mm/day, percolation to 5.0 mm/day, there was no rain and the daily water consumption per standard-type pond was 5.0 m³ /day.

The results of calculation are shown in Tables 2, 3 and Fig. 4. The conclusions were as follows:

[**Fig.4: Effectiveness of Compartment method in reducing evaporation and percolation\(19KB\)**](#)

- In the Case-C series, consisting of some DLD standard-type small farm ponds which were used with water consumption corresponding to the number of ponds, evaporation and percolation control of farm ponds was effective.
- The more farm ponds were used in Case-C series, the greater the effectiveness.
- Using the figures listed above in the calculation, farmers could reduce evaporation and percolation from ponds by 13% and secure irrigation water for 16 days more in Case-C3 (use of 4 ponds) than in Case-A (DLD standard-type small farm pond).
- The effectiveness based on the number of ponds was almost the same in all 3 cases of the Case-C series. Since the reduction of evaporation and percolation per pond in Case-C3 was about 1.6 times greater than in Case-C1, 4 ponds should be used in the Case-C series.

### **3) Pond shape method**

Based on the computer calculation, it was observed that the steeper the slope, the greater the effectiveness for evaporation and percolation control. Furthermore, round farm ponds were more effective for evaporation and percolation control than rectangular farm ponds, based on the same calculation method.

Sixteen cases were analyzed as shown in Table 4. In Case-A to Case-L the rectangular ponds were used and in Case-M to Case-T round ponds were used. Four patterns of slopes were examined = 1:2.0, 1:1.5, 1:1.2 and 1:1.0.

[**Table 4:Calculation of water reduction on the ponds \(pond shape method\)\(62KB\)**](#)

The assumptions for the calculations were as follows: evaporation rate was 5.0 mm/day, percolation rate was 5.0 mm/day, there was no rain and the daily water consumption per pond was 5.0 m³/day.

The results of the calculations are shown in [Table 4](#) and [Fig. 5](#). The conclusions were as follows:

[**Fig.5:Role of pond shape in reducing evaporation and percolation\(27KB\)**](#)

- The steeper the slope, the greater the effectiveness for evaporation and percolation control.
- Round ponds were more effective for evaporation and percolation control than rectangular farm ponds.
- Steeper slopes and round shape resulted in greater effectiveness when the compartment method was applied than when it was not applied.



- Using the figures mentioned above in the calculation, farmers could reduce evaporation and percolation from ponds by 23% and secure irrigation water for 28 days more in Case-P (slope 1:1.0, round shape, application of the compartment method using four ponds) than in Case-A (DLD standard-type small farm pond).

#### 4) *Crushing and compaction method*

The authors carried out a percolation control experiment in December 1996 using a simulated farm pond. The results of the experiment are shown in [Table 5](#). The soil of the bottom of the simulated farm pond consisted of gravelly sandy loam soil.

**Table 5. Percolation control experiment**

Case	Percolation						Average of 1st to 4th trials
	1st trial	2nd trial	3rd trial	4th trial	5th trial	6th trial	
Unimproved(A)	$5.7 \times 10^{-2}$	$5.7 \times 10^{-2}$	$4.9 \times 10^{-2}$	$5.1 \times 10^{-2}$	$3.7 \times 10^{-2}$	$3.1 \times 10^{-2}$	$5.3 \times 10^{-2}$
Crushing and compaction(B)	$1.5 \times 10^{-2}$	$1.0 \times 10^{-2}$	$8.9 \times 10^{-2}$	$7.4 \times 10^{-2}$	--	--	$9.8 \times 10^{-2}$
Ratio of (B)to(A)	26.3%	17.5%	18.2%	14.5%	--	--	18.5%

Based on the results of the experiment, the crushing and compaction method was effective in reducing percolation from farm ponds. At the bottom of the simulated pond where the crushing and compaction method was used, the percolation rate decreased to about 20% compared with the rate in the unimproved area.

Though we observed that the crushing and compaction method was able to cut the percolation rate by 80% on gravelly sandy loam soil, we could not determine whether the same phenomenon occurred on clay soil which is suitable for the bottom of the ponds. Therefore, similar experiments should be conducted on clay soil, at the bottom of several actual farm ponds, especially, to confirm the effectiveness of the method.

#### (References)

- 1): Civff, C. B., (1975): Water harvesting systems in arid lands. *Destination*, 72, 154-155.
- 2): Kobayashi, H., (1996): Current approach to soil and water conservation for upland agriculture in Thailand. *JARQ*, 30, 43-48.

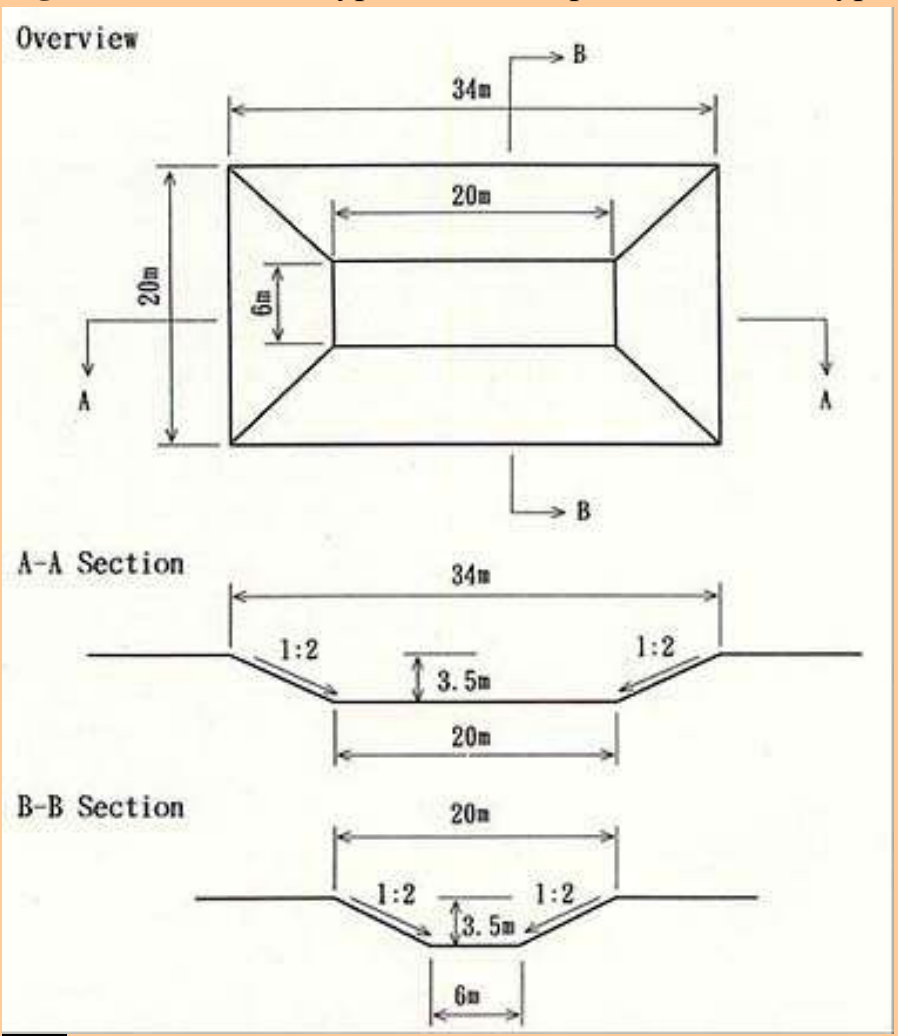


[Continue to :\[Integrated application of the 4 methods\]](#)



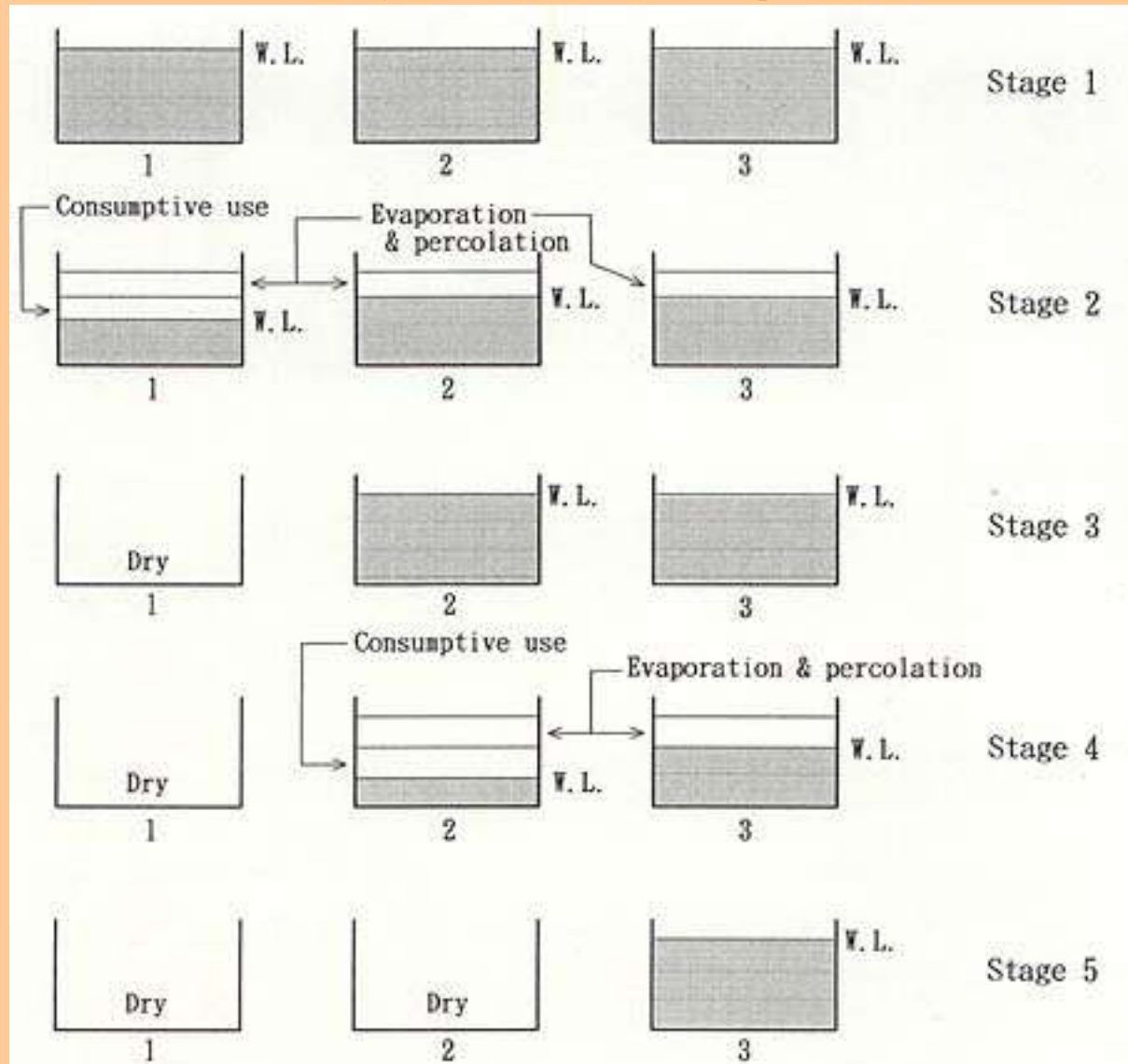
[Contents](#)

**Fig.1.** DLD standard-type small farm pond (excavated type)



 [BACK](#)

**Fig.3.** Schematic cross-section diagram of 3-compartment ponds  
 Water levels at various stages in the annual cycle of operation are indicated.



Stage 1 : End of rainy season

Stage 2 : Just before 1st pumping

Stage 3 : Just after 1st pumping, surface area reduced by 33%

Stage 4 : Just before 2nd pumping

Stage 5 : Just after 2nd pumping, surface area reduced by 67%



**Table 2.** Calculation of water reduction on the Compartment method

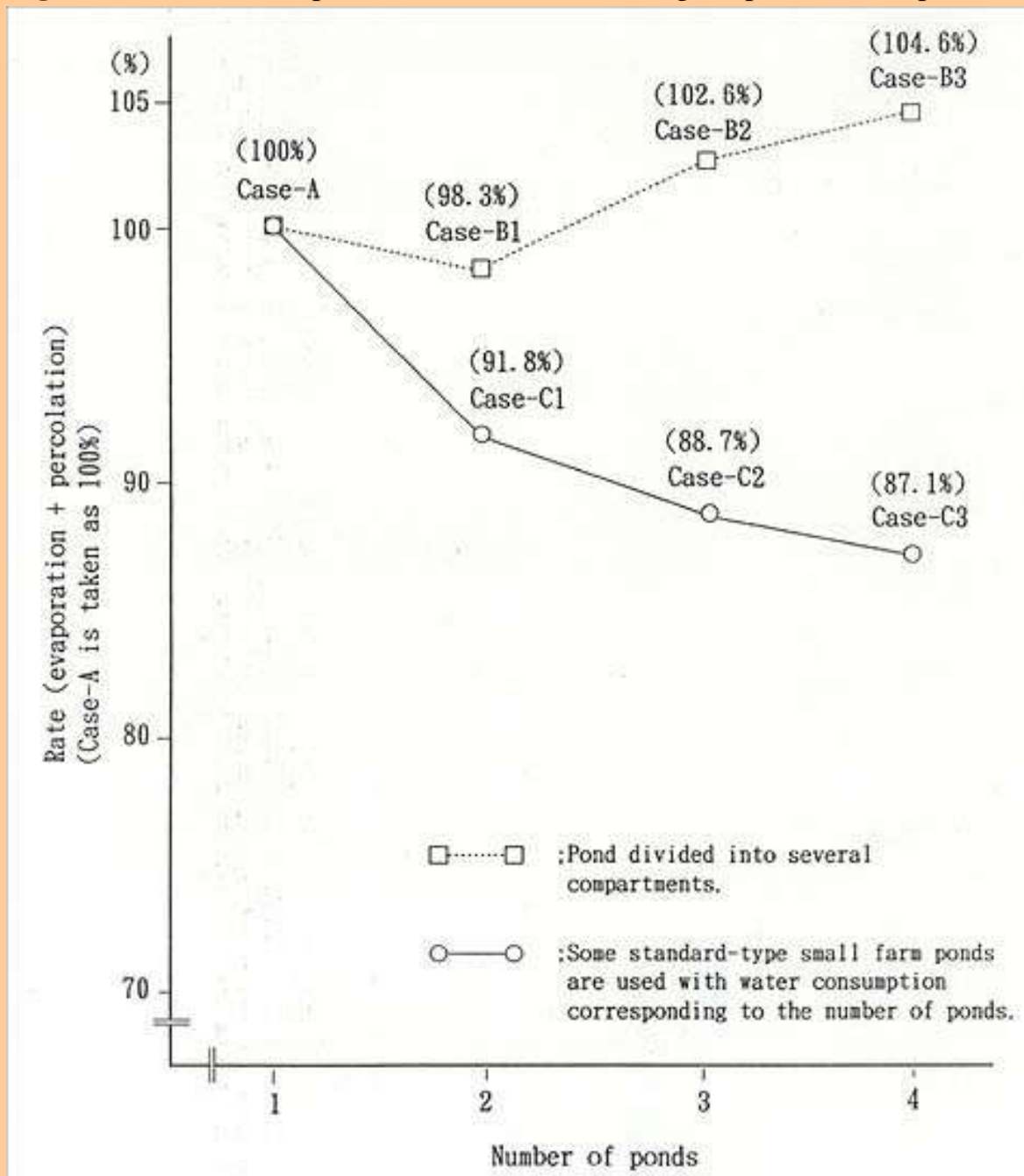
Case	Number of ponds	Storage capacity of each pond (m ³ )	Water reduction (m ³ )				Water availability (days)
			Consumption	Evaporation	Percolation	Total	
Case-A	1	1,285.7 < 5.0 m ³ > ^{a)}	691.7	285.0	308.9	1,285.7	138
Case-B1	2	664.1 < 5.0 m ³ >	704.6	277.5	306.1	1,288.2	141
Case-B2	3	430.3 < 5.0 m ³ >	681.7	288.3	321.2	1,291.0	136
Case-B3	4	321.8 < 5.0 m ³ >	666.0	293.5	327.7	1,287.2	133
Case-C1	2	1,285.7 <10.0 m ³ >	1,480.9	521.7	568.7	2,571.4	148
Case-C2	3	1,285.7 <15.0 m ³ >	2,276.5	755.3	825.2	3,857.2	152
Case-C3	4	1,285.7 <20.0 m ³ >	3,072.7	988.8	1,081.4	5,142.9	154

a) : < > daily water consumption in each case.



[BACK](#)

**Fig.4.**Effective of Compartment method in reducing evaporation and percolation



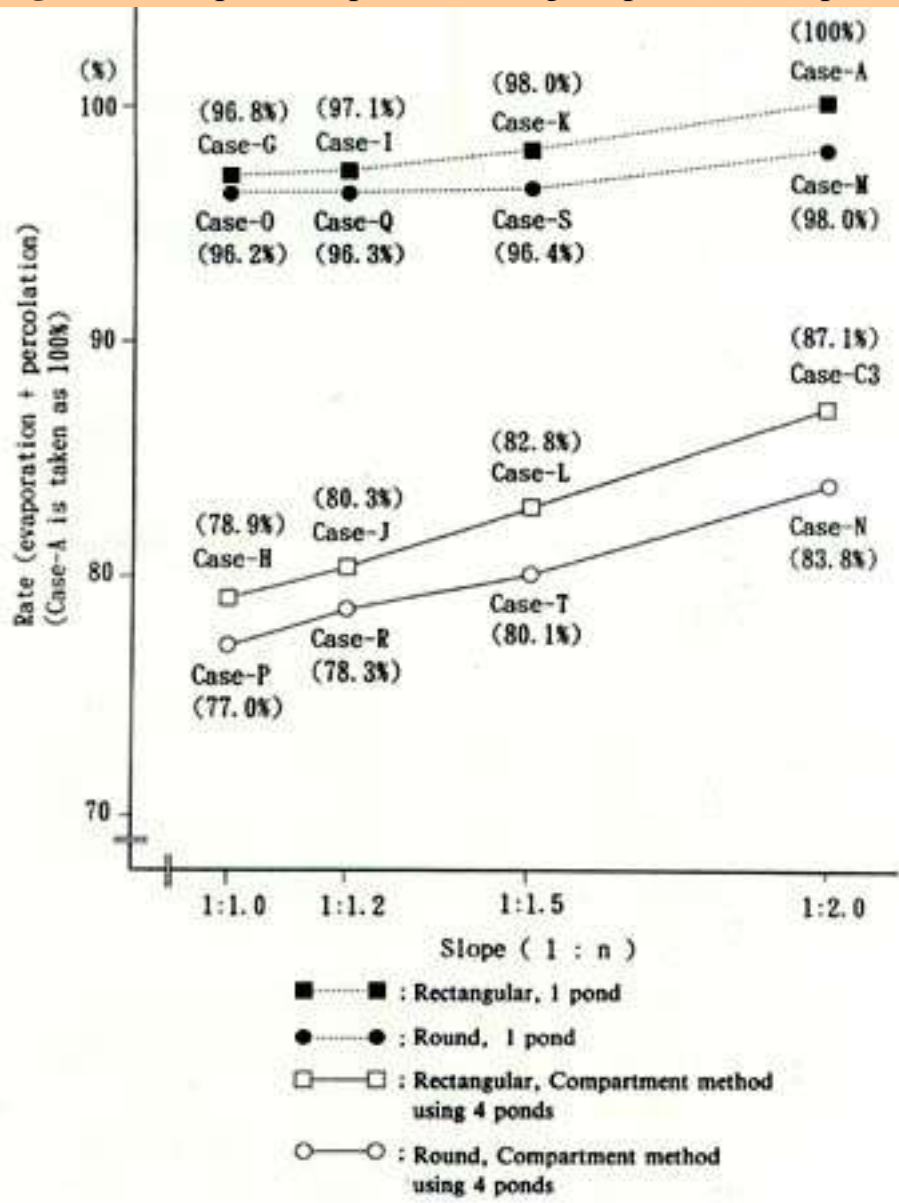
[BACK](#)

**Table 4.** Calculation of water reduction in the ponds (Pond shape method)

Case				Water reduction (m ³ )				Water availability (days)
Name	Shape	Slope	Number of ponds	Consumption	Evaporation	Percolation	Total	
Case-A	Rect.	1:2.0	1	691.7	285.0	308.9	1,285.7	138
Case-C3	Rect.	1:2.0	4	3,072.7	988.8	1,081.4	5,142.9	154
Case-G	Rect.	1:1.0	1	710.0	267.3	307.8	1,285.1	142
Case-H	Rect.	1:1.0	4	3,266.5	852.9	1,021.0	5,140.4	163
Case-I	Rect.	1:1.2	1	710.0	270.5	306.3	1,286.8	142
Case-J	Rect.	1:1.2	4	3,239.6	880.5	1,027.1	5,147.2	162
Case-K	Rect.	1:1.5	1	705.1	275.9	306.1	1,287.1	141
Case-L	Rect.	1:1.5	4	3,182.0	922.6	1,043.9	5,148.4	159
Case-M	Round	1:2.0	1	705.3	281.1	301.0	1,287.4	141
Case-N	Round	1:2.0	4	3,159.0	955.7	1,034.9	5,149.6	158
Case-O	Round	1:1.0	1	715.1	268.1	303.4	1,286.6	143
Case-P	Round	1:1.0	4	3,316.2	840.9	989.2	5,146.4	166
Case-Q	Round	1:1.2	1	715.0	270.4	301.4	1,286.8	143
Case-R	Round	1:1.2	4	3,287.3	865.8	994.2	5,147.2	164
Case-S	Round	1:1.5	1	713.1	273.3	299.0	1,285.4	143
Case-T	Round	1:1.5	4	3,240.0	898.3	1,003.5	5,141.6	162


[BACK](#)

**Fig.5.** Role of pond shape in reducing evaporation and percolation



[BACK](#)

## Integrated application of the 4 methods

The authors studied the effectiveness in each case where all or some of the 4 methods described above (Floating cover method, Compartment method, Pond shape method and Crushing and compaction method) were integrated, based on the computer calculations. [Table 6](#) shows the 16 calculation cases. In Case-a, none of the methods listed above were used. In Case-b to Case-e we used only one method, in Case-f to Case-k we combined 2 methods, in Case-l to Case-o we used 3 methods together and in Case-p we integrated all of the 4 methods.

### [Table 6: Calculation of water reduction in the ponds \(integration of methods\)\(56KB\)](#)

The assumptions for the calculations were as follows:

- Evaporation was assumed to be 5.0 mm/day.
- Evaporation was assumed to be 4.5 mm/day when the floating cover method was employed because the experiments showed that this method reduced evaporation by about 10%.
- Percolation was assumed to be 5.0 mm/day.
- Percolation was assumed to be 2.0 mm/day at the bottom of the farm ponds when the crushing and compaction method was applied because the experiments showed that the method was effective in reducing percolation and the reduction rate was about 80% in the case of gravelly sandy loam soil.
- There was no rain.
- The daily water consumption per pond was assumed to be 5.0 m³/day.

The results of the calculations are shown in [Tables 6, 7](#) and [8](#). The conclusions were as follows:

- When only one method was applied, the Compartment method was the most effective in reducing evaporation and percolation, followed by the Crushing and compaction method and the Pond shape method, while the Floating cover method (duckweed) was the least effective.
- The more methods we applied, the greater the effectiveness, except for Case-c and Case-i where the Compartment method was employed.
- We could expect greater effectiveness by applying the Pond shape method together with the Compartment method and/or the Crushing and compaction method. For example, in Case-i, the reduction rate of "evaporation + percolation"(21.7%) was higher than the total (16.6%) of the rate when the Compartment method was applied (12.9%) and the rate when the Pond shape method was applied (3.7%).
- Using the figures mentioned above in the calculation, farmers could reduce evaporation and percolation from ponds by 31% and secure irrigation water for 38 days more in Case-p (the 4 methods were integrated) than in Case-a (DLD standard-type small farm pond).

### [Table 7: Degree of effectiveness\(55KB\)](#)

### [Table 8: Effectiveness of Pond shape method when combined with another method\(36KB\)](#)

## Conclusion

Though the experiments on the Floating cover method and the Crushing and compaction method should be continued, and the degree of effectiveness of these methods in reducing evaporation and percolation should be

- Considerable reduction of evaporation and percolation could be expected by employing only the



Floating cover method (duckweed) and the Crushing and compaction method. These methods should be disseminated among farmers because they are cheap and easy to apply by farmers under the support of the government.

- When new ponds are excavated, the shape of the ponds should be round. Furthermore, the lateral parts of the ponds should be as steep as possible.

- The use of several ponds (Compartment method) was very effective for evaporation and percolation control. Therefore, the DLD should ask the farmers to form small groups, excavate several farm ponds and let them manage water use by employing the Compartment method.



[Forward to :-Summer-Shown Cultivation of Forage Oats and Breeding in Japan-](#)



[Contents](#)



[JIRCAS Home Page](#)

**Table 6.** Calculation of water reduction in the ponds (integration of methods)

Case	Method				Water reduction (m ³ )				Water availability (days)
	Floating cover method (duck-weed)	Compartment method (using 4 ponds)	Pond shape method (round, slope 1:1.2)	Crushing and compaction method	Consumption	Evaporation	Percolation	Total	
Case-a					691.7	285.0	308.9	1,285.7	138
Case-b	○				706.7	263.0	316.0	1,285.7	142
Case-c		○			3,072.7	988.8	1,081.4	5,142.8	154
Case-d			○		715.0	270.4	301.4	1,286.8	143
Case-e				○	721.2	295.4	269.1	1,285.7	145
Case-f	○	○			3,120.2	913.2	1,109.4	5,142.8	156
Case-g	○		○		730.1	248.7	308.0	1,286.8	146
Case-h	○			○	737.0	273.0	275.8	1,285.7	147
Case-i		○	○		3,287.3	865.8	994.2	5,147.2	164
Case-j		○		○	3,138.7	1,017.8	986.4	5,142.8	157
Case-k			○	○	777.0	292.8	216.9	1,286.8	155
Case-l	○	○	○		3,338.4	794.7	1,014.1	5,147.2	167
Case-m	○	○		○	3,195.1	938.0	1,009.7	5,142.8	160
Case-n	○		○	○	795.0	269.6	222.2	1,286.8	159
Case-o		○	○	○	3,454.6	918.1	774.6	5,147.2	173
Case-p	○	○	○	○	3,511.7	844.4	791.1	5,147.2	176


[BACK](#)

**Table 7.** Degree of effectiveness

Order	Case	Method				Rate when Case-a is taken as 100% (%)		Water availability (days)
		Floating cover method (duck-weed)	Compartment method (using 4 ponds)	Pond shape method (round, slope 1:1.2)	Crushing and compaction method	Total (=Evaporation+percolation)		
							Difference between this case and Case-a	
1	Case-p	○	○	○	○	68.8	-31.2	176
2	Case-o		○	○	○	71.3	-28.7	173
3	Case-l	○	○	○		76.1	-23.9	167
4	Case-i		○	○		78.3	-21.7	164
5	Case-m	○	○		○	82.0	-18.0	160
6	Case-n	○		○	○	82.8	-17.2	159
7	Case-j		○		○	84.4	-15.6	157
8	Case-f	○	○			85.1	-14.8	156
9	Case-k			○	○	85.8	-14.2	155
10	Case-c		○			87.1	-12.9	154
11	Case-h	○			○	92.4	- 7.6	147
12	Case-g	○		○		93.7	- 6.3	146
13	Case-e				○	95.0	- 5.0	145
14	Case-d			○		96.3	- 3.7	143
15	Case-b	○				97.5	- 2.5	142
16	Case-a					100.0	-	138



[BACK](#)

**Table 8.** Effectiveness of Pond shape method when combined with another method

(Unit : %)

Case	Trend	Floating cover method (2.5)	Compartment method (12.9)	Pond shape method (3.7)	Crushing and compaction method (5.0)	Total
Case-p (31.2)	>	○	○	○	○	(24.1)
Case-o (28.7)			○	○	○	(21.6)
Case-l (23.9)		○	○	○		(19.1)
Case-n (17.2)		○		○	○	(11.2)
Case-i (21.7)				○	○	(16.6)
Case-k (14.2)					○	○
Case-h (7.6)	=	○			○	( 7.5)
Case-g (6.3)		○		○		( 6.2)
Case-m (18.0)	<	○	○		○	(20.4)
Case-j (15.6)			○		○	(17.9)
Case-f (14.8)		○	○			(15.4)

Note : ( ) indicates the reduction rate of " evaporation + percolation " .


[BACK](#)

# Summer-Sown Cultivation of Forage Oats and Breeding in Japan

**Masaaki KATSURA**

Department of Grassland, Kyushu National Agricultural Experiment Station  
(Nishigoshi, Kikuchi, Kumamoto, 861-1192 Japan)

## Abstract

Oats are mainly used as forage in Japan. A new cultivation type, in which oats are sown in late summer and harvested as silage or hay in December or later, has been adopted in the warm region of Japan. This type which is referred to as "summer-sown cultivation" enables to make good use of the field from late summer to early winter. However, this system is not satisfactory for oats, because high temperatures persist until mid-September, the day-length shifts from long to short, and the temperature from high to low. We have been engaged in the breeding of oats for summer-sown cultivation to overcome such adverse conditions. Therefore we focused on early heading habit in fall. Based on the evaluation of introduced varieties and lines for heading habit, we observed that some Mexican varieties headed early in summer-sown cultivation. Then we released 'Haeibuki' which is a progeny from a cross between a Mexican cultivar, 'Guelatao' and an old Japanese one, 'Hayate'. Haeibuki is characterized by very early heading in summer-sown cultivation and a high dry matter percentage at harvest. Through field trials in the breeding process, we observed differences among cultivars in germination under summer-sown conditions, presumably associated with high temperature.

**Discipline:** Plant breeding

**Additional key words:** *Avena sativa* L., heading, germination

**Received for publication, February 9, 1998**

1~8):[References](#)

## Introduction

Oats, *Avena sativa* L., are mainly used as forage in Japan, while as grain and for grazing in other countries. The total area of forage crops in Japan was estimated at 980,200 ha in 1995, of which the seeding area covers 188,582 ha. The seeding area of oats is estimated at 10,500 ha and oats rank third after maize and sorghum except for grasses, including Italian ryegrass. Oats are mainly distributed in Kyushu, which is located in the southwestern part of Japan, with an area accounting for about 65% of the total oats area.

Oats have been sown in fall in the southwestern part of Japan and harvested in the next spring for many years. This system is referred to as "fall-sown cultivation". When oats are used as forage, another cultivation type has been adopted in the warm region of Japan, which is referred to as "summer-sown cultivation". In this type, oats are sown in late summer and harvested as silage or hay in December or later. We have been engaged in the breeding of forage oats for summer-sown cultivation since 1988. In this review, various aspects relating to the breeding of oats for summer-sown cultivation will be described along with the characteristics observed through our breeding process.

## Summer-sown cultivation of oats and breeding objectives

The main forage crops in Japan are summer crops such as corn and sorghum. They are sown in spring and harvested in summer and fall. Farmers try to get high yield with high nutritive value by growing them. Therefore, some farmers implement double cropping of corn. In this case, since the interval between the first harvest and second seeding is very short, the system is very laborious.

In the warm region of Japan, corn tends to be sown earlier for avoiding typhoons in late summer while paddy rice is transplanted in early spring. Therefore, it is necessary to make good use of the field from late summer to early spring after harvesting rice or corn by mid-August because the area of arable land in Japan is small. Oats are an important crop for producing feed in early winter and next spring as well as Italian ryegrass. In the case of summer-sown cultivation of oats, in which oats are sown in late summer and harvested in early winter, farmers have enough time to make preparations for the growth of the next crops. As stated above, to save labor and avoid risk, summer-sown cultivation of oats is an important alternative. Then, the weather from fall to early winter is mild in the southwestern part of Japan, particularly in southern Kyushu, i.e. Miyazaki and Kagoshima ([Fig. 1](#)). There is enough rain and the weather is mild in fall. Therefore, this cultivation type enable to make the best use of the climatic conditions.

[Fig.1: Monthly total precipitation and average temperature\(29KB\)](#)

However, the conditions of summer-sown cultivation are not favorable for oats which are a long-day plant. High temperature persists until mid-September, and this period corresponds to the germination stage. The day-length shifts from long to short and the temperature from high to low ([Figs. 1 and 2](#)). These conditions influence panicle emergence and subsequent growth. In order to overcome such shortcomings, we developed the following breeding objectives: (1) stable germination under high temperature conditions, and (2) early heading in fall to reach a stage beyond the milky stage at harvest. Particularly, we focused on early heading in fall to obtain a high dry matter percentage at harvest. Then the high dry matter percentage may decrease the labor for prewilting in the field before harvesting at a low temperature.

## Evaluation of germplasm for heading habi

Many studies on heading habit have been performed. Peterson⁵⁾ pointed out in his review that the time required for inflorescence development and emergence is affected by the temperature and photoperiod in oats. While the optimal temperature for the most rapid development varies among studies, both warmer and cooler temperatures were found to delay heading. Griffiths³⁾ reported that panicle emergence was entirely suppressed under photoperiods of 12 h and less in some varieties. In addition, he dissected the growing points of plants which failed to emerge under short days. As a result, he observed that floral differentiation had not been inhibited by short days, but that the full elongation of the internodes, especially the upper internodes, had been suppressed.

As stated above, the day-length shifts from long to short, and the temperature from high to low in summer-sown cultivation (Figs. 1 and 2). Considering the climatic conditions and the results mentioned above, panicle emergence may be affected. In order to head under such unfavorable conditions, cultivars should be characterized by a low chilling requirement and low sensitivity to day-length. Ueyama⁸⁾ evaluated 28 introduced cultivars and lines for heading habit in summer-sown and fall-sown cultivation ([Table 1](#)). He divided these cultivars and lines into 5 groups. The panicle emergence of group I was early in summer-sown cultivation and very early in fall-sown cultivation. Heading in group II was earlier than that in group I in summer-sown cultivation and later than that in group I in fall-sown cultivation. Heading in group III was later than that in group I and as early as that in group I, respectively. Heading in group IV was later than that in group I in both types of cultivation. Group V did not reach the heading stage within a year in summer-sown cultivation. Many Japanese commercial varieties belonged to group I and group III. Group II included Mexican cultivars and their progenies. As a result, he pointed out that the characteristics of group II were important to develop a new cultivar for summer-sown cultivation.

**Table 1. Days to heading of introduced cultivars and lines in summer-and fall-sown field tests**

Group	Cultivar, line	Summer-sown		Fall-sown	
		Aug.29, 1988	Aug.29, 1989	Oct.27, 1988	Oct.25, 1989
I	Irwin	67	60	162	156
	Hayate	65	65	159	156
	West	71	68	160	159
	Early Queen	72	66	160	160
II	Diamante R31	58	51	161	163
	Paramo	58	60	168	167
	Akiwase	62	62	166	169
	Tarahumara	61	64	166	161
	Guelatao	65	66	169	168
	Hokkai-45	68	69	168	168
III	Gokuwase	85	70	163	159
	Enducks	84	71	162	161
	Hayabusa	83	74	163	160
	Suwan	87	73	163	160
IV	Satsukei63	74	68	170	166
	M.D.Dolphin	77	79	171	170
	Pacsun	77	80	172	170
	Donald	80	71	168	169
	Humantla	83	75	167	166
	Coker 820	80	72	165	162
	Chihuahua	79	77	175	172
V	Kairyo Grainoats	87	--	174	171
	Coker 87-9	95	--	174	171
	Mametank	--	73	165	163
	S-1	--	--	165	161
	Kagoshima 1	--	--	164	163
	Hyugakairyokuro	--	--	171	171
	Honkei-998	--	--	173	170

Cited from Ueyama⁸⁾

These tests were performed under spaced planting. Heading date was based on the date when the first panicle emerged from the flag leaf per plant until December (summer-sown) and the second panicle in spring (fall-sown).

--: No heading.



[Continue to:\[Development of a new cultivar 'Haeibuki'\]](#)



[Contentsts](#)

## References

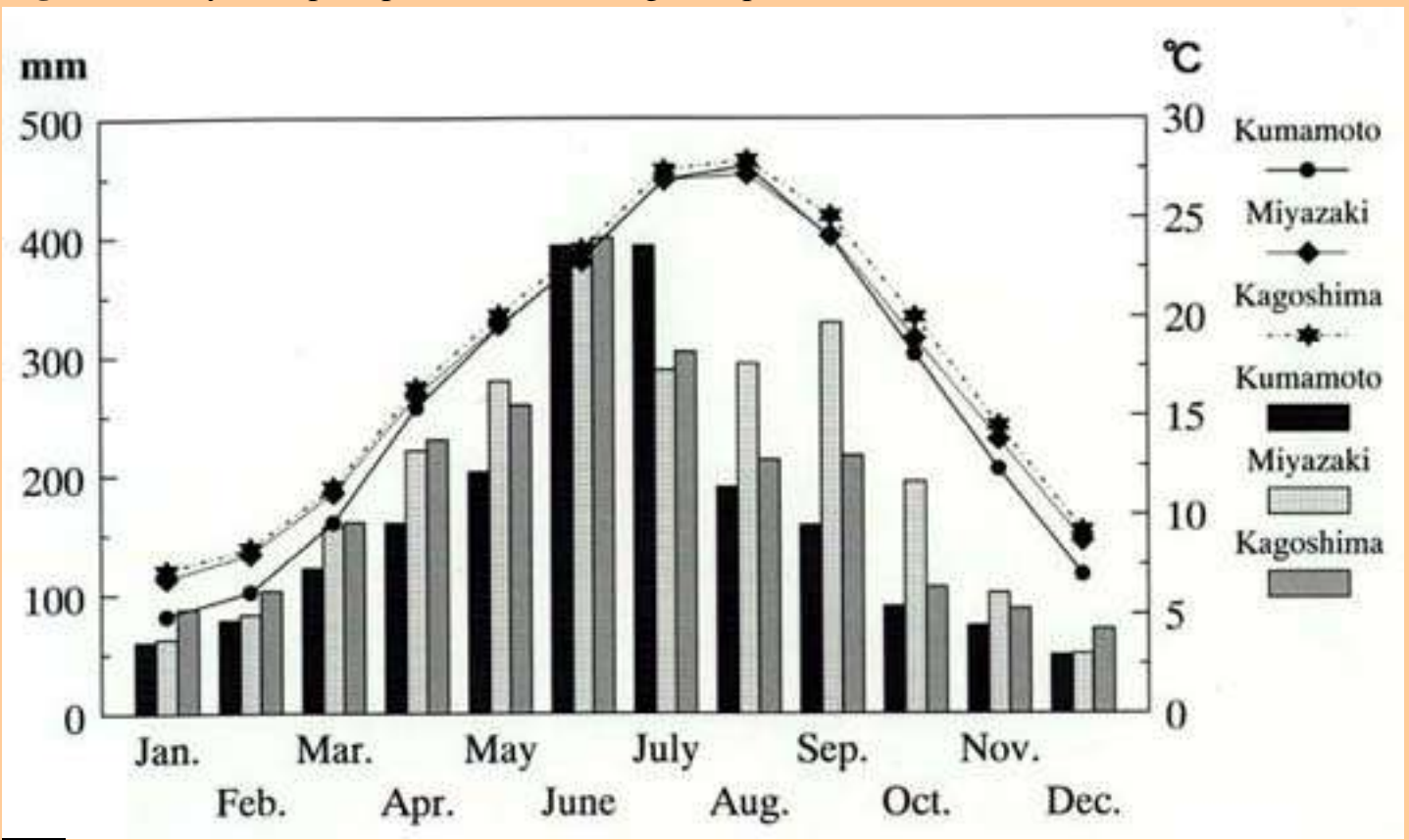


[Back to the first page](#)

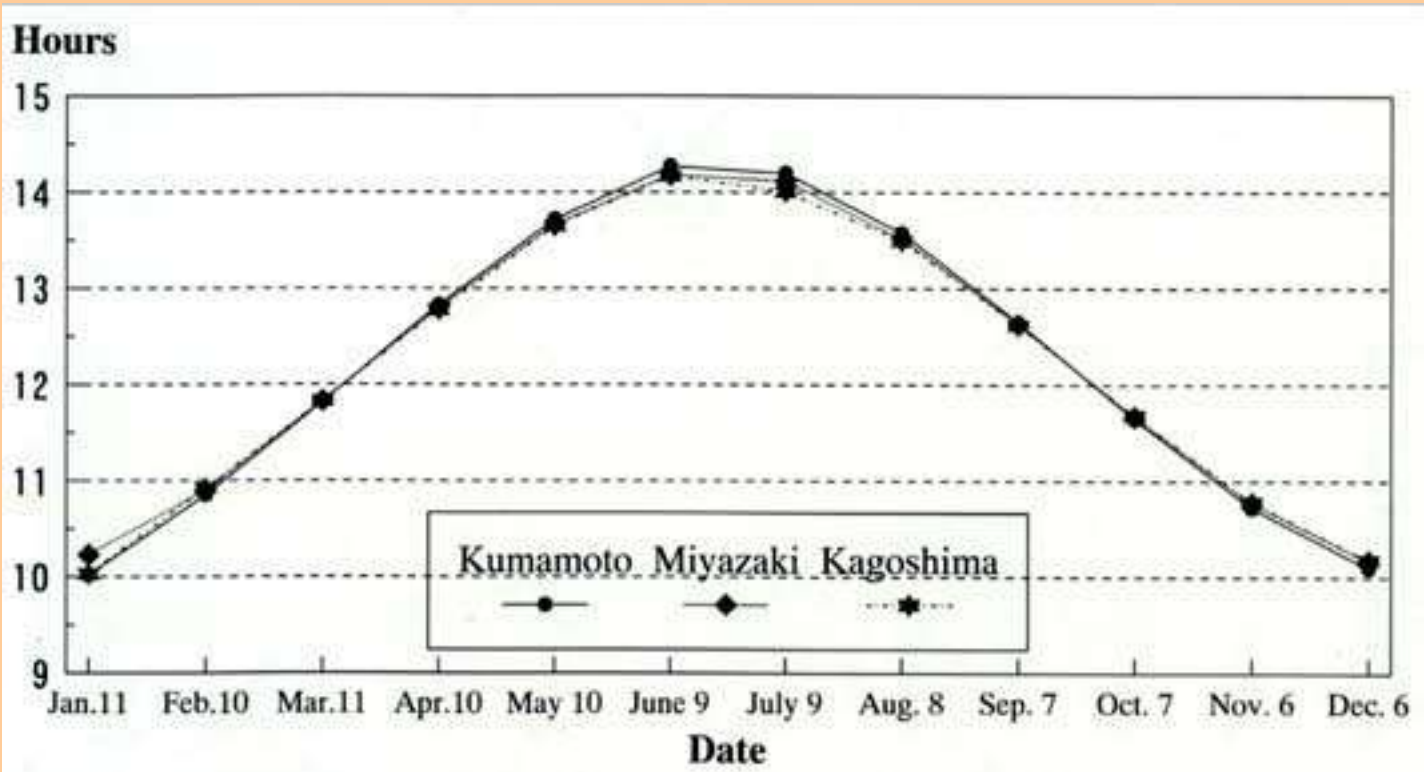
- 1) Corbineau, F., Lecat, S. & C^ome, D. (1986): Dormancy of three cultivars of oat seeds (*Avena sativa* L.). *Seed Sci. & Technol.*, 14, 725-735.
- 2) Corbineau, F., Black, M. & C^ome, D. (1993): Induction of thermodormancy in *Avena sativa* seed. *Seed Sci. Res.*, 3, 111-117.
- 3) Griffiths, D. J. (1961): The influence of different daylengths on ear emergence and seed setting in oats. *J. Agric. Sci.*, 57, 279-288.
- 4) Katsura, M., Ueyama, Y. & Matsuura, M. (1996): Breeding of very early oat maturing in late fall. *5th IOC & 7th IBGS Proceedings*, 2, 511-513.
- 5) Peterson, D. M. (1992): Physiology and development of the oat plant. *In* Oat science and technology. eds. Marshall, H. G. & Sorrells, M. E., American Society of Agronomy, Madison, 77-114.
- 6) Radford, B. J. & Key, A. J. (1993): Temperature affects germination, mesocotyl length and coleoptile length of oats genotypes. *Aust. J. Agric. Res.*, 44, 677-688.
- 7) Tsukiboshi, T., Katsura, M. & Shimanuki, T. (1996): Resistance to *Helminthosporium* leaf blotch on oats and mechanism of plant reaction. *Grassl. Sci.*, 42 (suppl.), 160-161 [In Japanese].
- 8) Ueyama, Y. (1994): Breeding of forage oat for warm region and its genetic resources. *Rep. Kyushu Branch of Jpn. Grassl. Sci.*, 24, 28-34 [In Japanese].



**Fig.1.** Monthly total precipitation and average temperature



 [BACK](#)

**Fig.2.** Daylight in Kyushu, Japan (hours)[BACK](#)

## Development of a new cultivar 'Haeibuki'

We released a new cultivar 'Haeibuki' for summer-sown cultivation in 1996⁴⁾. Haeibuki is a progeny from a cross between 'Guelatao' and 'Hayate'. Guelatao, released by the National Institute of Agriculture Research in Mexico, is able to head in early fall. Hayate, introduced from Australia, has been used in summer-sown cultivation for many years. The cross, Guelatao x Hayate, was made in the greenhouse in 1988. The F1, F2 and F3 were advanced in the greenhouse without selection. The F4 plants were grown from late summer to winter in 1989, and individual selection was performed for early heading in fall. The F5 lines derived from the selected F4 plants were selected for early heading in fall again in 1990. The F6 plants were multiplied by removing abnormal plants in the spring of 1991. The F7 lines were evaluated for yield and the other agronomic characteristics in summer-sown cultivation in 1991. As a result, 2 lines were selected, and named Kyushu-1 and Kyushu-2. After the F8 generation, Kyushu-1 and Kyushu-2 were examined in the local adaptability tests. Lastly, we chose Kyushu-2, and it was registered as Haeibuki. The characteristics of Haeibuki are shown in [Table 2](#). The significant characteristics were early heading in summer-sown cultivation and high dry matter percentage at harvest. Moreover, the dry matter yield was slightly higher than that of other leading cultivars.

**Table 2. Characteristics of Haeibuki in summer-sown field test^{a)}**

<u>Cultivar</u>	<u>Days to heading^{b)}</u>	<u>Plant height^{c)}</u> (cm)	<u>Dry matter yield</u> (t/ha)	<u>Dry matter percentage</u> (%)
Haeibuki	44	102.2	4.47	30.4
Guelatao	48	124.2	4.44	26.7
Hayate ^{d)}	54	99.8	4.02	21.5
Akiwase ^{d)}	45	113.7	3.53	26.1

a): Average of 1992-1994. b): The date when 3 panicles emerged from the flag leaf per 1 m².  
c): At harvest. d): Japanese leading cultivars.

## Germination habit of oat cultivars for summer-sown cultivation

Throughout breeding process, we observed differences among cultivars and lines in germination in the summer-sown field test. Our experimental lines showed good germination, while some cultivars displayed poor germination. Then we carried out the germination test using the seeds harvested in 1994 and 1995 at constant temperatures of 20 and 30 on the date corresponding to the seeding time in summer-sown cultivation, because we considered that poor germination was due to high soil temperature. Mean maximum/minimum soil temperatures in the fields in Kumamoto at a depth of 2 cm were 32/23 in 1995 during the seeding and germination period from August 31 to September 10, and at a depth of 5 cm in 1996 the values were 30/22.

**Table 3. Influence of temperature on the germination percentage on the date corresponding to the seeding time in summer-sown cultivation**

<u>Cultivar</u>	<u>Year when harvested</u>	<u>Temperature (°C)</u>
-----------------	----------------------------	-------------------------

Haeibuki	1994	<u>20</u>	<u>30</u>
	1995	98	100
Guelatao	1994	95	94
	1995	94	88
Hayate	1994	96	89
	1995	88	62
Early Queen	1994	84	21
	1995	90	45
Enducks	1994	93	24
	1995	84	6
Super Hayate Hayabusa	1994	85	0
	1995	86	46
Sabitsuyoshi	1994	89	0
	1995	89	60
	1995	97	78

Germination test was started on September 12, 1994 and August 29, 1995. Seeds were harvested in the spring 1994 and 1995, and stored at room temperature after threshing and cleaning. Seeds of Super Hayate Hayabishi in 1994 were bought from a seed company. Fifty seeds were placed in a petri dish (9 cm in diameter) with 2 sheets of filter paper imbibed with distilled water at the constant temperatures of 20 and 30 C. A seed was considered to have germinated when the radicle protruded through the seed coat. Germination counts were expressed as mean germination percentage obtained from 2 replications.

[Table 3](#) shows the results of the germination test. There was a significant difference among cultivars at 30, while all of them showed a germination percentage of more than 80% at 20. The germination percentages of Haeibuki and Guelatao were very high, and those of 'Enducks' and 'Super Hayate Hayabusa' were very low. Radford and Key⁶⁾ determined how the temperature affects germination, mesocotyl length and coleoptile length in 16 oat (*Avena* spp.) genotypes. They defined germination as the emergence of the shoot from the seed, and observed that the critical temperature for the differentiation of genotypic effects on germination was 30. Our results were in agreement with those findings. Observation of the state of germination in the field test of summer-sown cultivation in 1995, revealed a difference similar to the results mentioned above. That is, cultivars except for Super Hayate Hayabusa and Enducks reached the germination stage within 5 days after seeding, while in the former 2 germination was delayed. [Fig. 3](#) shows the state of germination of Haeibuki and Super Hayate Hayabusa in the test in summer-sown cultivation in 1997. Apparently the germination of Super Hayate Hayabusa was delayed compared with that of Haeibuki. Then, we performed germination tests at a constant temperature of 30 in 1995 using the seeds stored at room temperature, which were harvested in 1994 ([Fig. 4](#)). As a result, all the cultivars germinated with a percentage of more than 80%, because the non-germination habit decreased during the storage, as stated by Corbineau et al.¹⁾ They examined the dormancy of cultivated oat (*Avena sativa*) seeds, and its elimination during dry storage at 30. They showed that the longer the dry storage at 30, the more easily the coated caryopses germinated at high temperatures. Therefore, the new cultivar Haeibuki was able to germinate at high temperatures better than the other cultivars and the non-germination habit at high temperature could be removed more rapidly than in the other cultivars. In addition, regarding the relation between germination and high temperature in oats, Radford and Key⁶⁾ reported that high temperature induced a temporary dormancy or state of "suspended animation". Corbineau et al.²⁾ also studied the induction of thermodormancy using dormant seeds and non-dormant ones in oats, and showed that the incubation of imbibed dormant seeds at 30 induced a thermodormancy. The results obtained and observations may be related to the induction of a temporary dormancy or a thermodormancy and studies on this phenomenon are currently in progress.

[Fig.3: Conditions of germination in summer-sown cultivation in 1997\(34KB\)](#)

[Fig.4: Effect of storage period on the germination percentage at constant 30°C\(34KB\)](#)

## Perspectives

In the breeding of forage oats for summer-sown cultivation, we focused on early heading in fall. We were able to develop Haeibuki and other very early heading lines. However, new problems related to early heading should be addressed. Nagatani (pers. comm.) observed that some diseases spread after heading stage in the field tests, suggesting that the early type may be readily affected, and special attention was paid to crown rust and Helminthosporium leaf blotch. There are many descriptions about crown rust resistance, but very few about Helminthosporium leaf blotch resistance. Tsukiboshi et al.⁷⁾ evaluated 56 cultivars and lines including *A. strigosa* and *A. byzantina* for their resistance to Helminthosporium leaf blotch based on seedling tests using spore spray inoculation, and they examined the mechanism of plant reaction. They could not detect any cultivars with true resistance. However, they classified the cultivars into 4 categories according to the level of susceptibility to the disease. Therefore we plan to introduce the seedling test of Helminthosporium leaf blotch into individual selection schemes.

Lodging resistance is also an important characteristic for summer-sown cultivation. Lodging leads to damage of growing plants and consequently the quality and yield decrease. Actually, we developed an experimental line with a strong lodging resistance which is currently undergoing in local adaptability tests.

In this way, in order to make the best use of the period from late summer to early winter, oat cultivars can be improved. The major purpose of summer-sown cultivation is to achieve stable yield every year. However, the yield of forage oats in summer-sown cultivation seems to be largely affected by the weather conditions. Breeding work can play a very important role in stabilizing the yield of forage oats.



[Forward to:-Infection and Development of *Nosema* sp. NIS H5 in Lepidopteran Insects-](#)



[Contents](#)

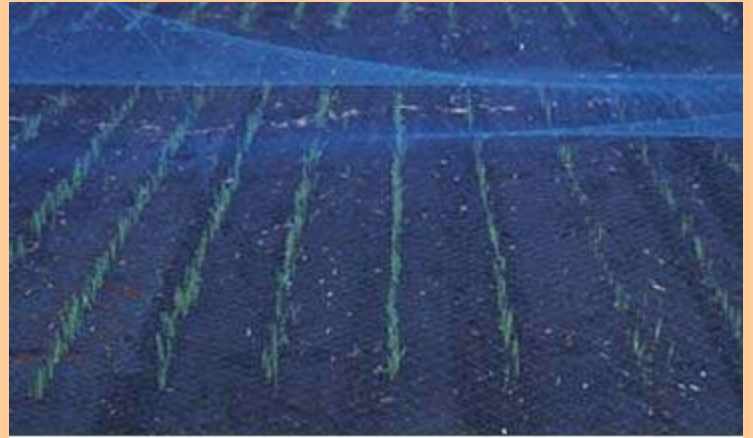


[JIRCAS Home page](#)



Haeibuki

Super Hayate Hayabusa



Haeibuki

Super Hayate Hayabusa

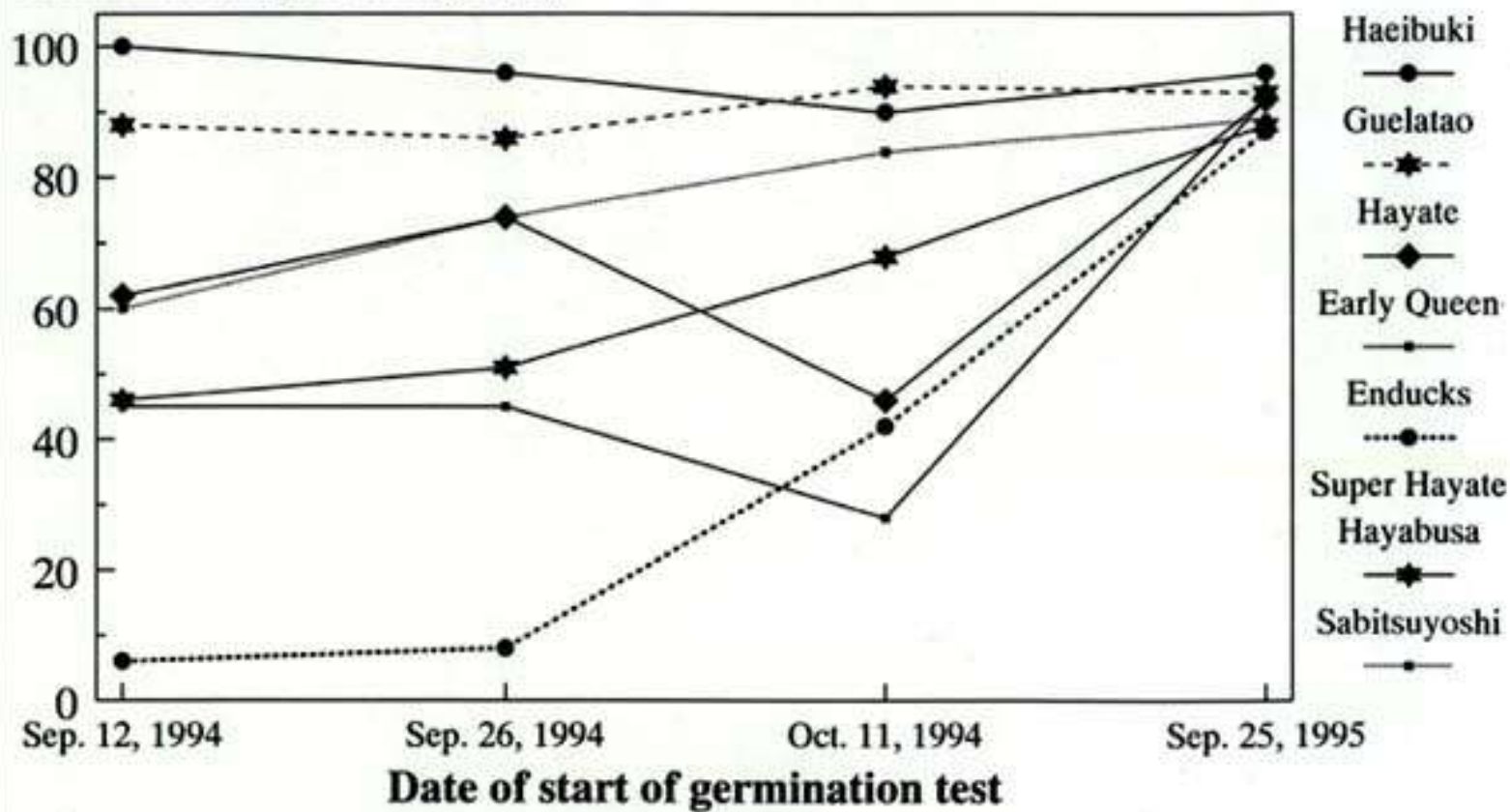
**Fig.3.** Conditions of germination in summer-sown cultivation in 1997  
Seeds were harvested in spring, 1997 and stored at 30°C after threshing and cleaning. Seeding date was August 29.

**Left:** The conditions on September 5, 7 days after seeding.

**Right:** The conditions on September 8, 10 days after seeding. Germinating date of Haeibuki was September 4, and that of Super Hayate Hayabusa September.

 [BACK](#)

## Germination percentage (%)



**Fig.4.** Effect of storage period on the germination percentage at constant 30°C  
Germination tests were conducted in the same way as shown in [Table 3](#).

 [BACK](#)

# Production of Shochu Spirit from Crushed Rice by Non-Cooking Fermentation

**Kenryo NISHIMURA*¹, Kenji KIDA*², Masaru NAKAGAWA*¹, Kimi TSUCHIYA*¹ and Yorikazu SONODA*³**

*¹ Department of Applied Microbiology, Kumamoto Industrial Research Institute  
(3-11-38 Higashi-machi, Kumamoto, 862-0901 Japan)

*² Department of Applied Chemistry, Faculty of Engineering, Kumamoto University  
(2-39-1 Kurokami, Kumamoto, 860-0862 Japan)

*³ Prefectural University of Kumamoto  
(3-1-100 Tsukiide, Kumamoto, 862-0920 Japan)

## Abstract

A non-cooking fermentation system for shochu spirit production was evaluated using both small-scale and bench pilot-scale equipment. This system employed a commercially available fungal enzyme preparation as saccharifying agent together with citric acid. The fermentation products from bench-scale equipment were distilled under vacuum or atmospheric conditions and the distillates were evaluated by a taste panel. Distillates produced under atmospheric conditions by the non-cooking fermentation method compared favorably with those produced by the cooking fermentation method. This method of production could result in significant savings of labor and energy if operated on a production scale. A case study and an analysis of economic aspects were carried out in a medium-scale shochu spirit factory.

**Discipline:** Food

**Additional key word:** atmospheric and vacuum distillation, flavor and aroma components, economic aspects

**Received for publication, May 13, 1998**

1~7):[References](#)

## Introduction

Economic pressures on many small to medium-sized shochu spirit distilleries require a reduction in the labor force. In spirit production in Japan, pretreatment of cereal raw materials by cooking and preparation of "koji" for saccharification are the most labor-intensive operations and account for 30% of the total work load.

Recently, because of the trend toward milder tasting spirits, distillers have concentrated their attention to the development products that will meet this trend, by use of vacuum distillation or ion exchange treatments. Investment in the equipment needed for these processes will lead to unavoidable increases in costs. Investigations have therefore been carried out on systems based on a non-cooking method and employing exogenous saccharifying enzymes. These are designed to produce a mild spirit while saving labor and energy. A "non-cooking fermentation" method²⁾ was developed by the addition of citric acid,



and the fermentation progression depended on the commercial enzyme preparations used. It was also evident that the aroma and flavor compounds were derived from the cereal mash, especially higher fatty acid esters.

This paper describes investigations on the practical applications of these results. A bench-scale pilot plant was then used to follow the changes in the concentrations of the flavor and aroma compounds with time. Finally, sensory tests were carried out on the products obtained by atmospheric and vacuum distillation. In the case study, attempts were made to determine whether this non-cooking fermentation system could be introduced into a shochu spirit factory. From the economic point of view, this system may enable to reduce of cost for manufacturing by about 10% .

## Materials and methods

### 1) *Bench-scale fermentation test*

The production of spirit by non-cooking and cooking fermentation methods was investigated using the bench-scale plant shown in [Fig. 1](#). The stainless steel fermentation tank had a 130 L capacity and the temperature was controlled at 25. Crushed rice grains (50 kg) were steeped in tap water overnight and filtered for 1 h; 75 L of mashing water (mashing water rate 150%) containing 0.2% (w/v) of citric acid and 100.6 g of enzyme preparation E (0.1 g protein/100 g crushed rice) were added to the fermentation tank, followed by 4.5 L of suspended yeast. The temperature was controlled at 25. A cooking fermentation test was conducted as a control using cooked rice that had been boiled for 30 min. The mashes were stirred 2-3 times a day with a paddle. The yeast inoculum used in this fermentation test was prepared as follows: 100 mL of seed prepared as in the small-scale fermentation test was added to a 30 L fermenter containing 18 L of sterilized medium and cultured at 25 for 20 h at an aeration rate of 0.1 v/v min.

[Fig.1: Scheme of non-cooking and cooking fermentation systems in the bench-scale plant\(28KB\)](#)

### 2) *Distillation method*

After the completion of the fermentation, the 120 L mash was divided into 2 equal parts, and one-half was subjected to distillation in a 100 L vessel that could be adapted to either atmospheric or vacuum distillation. Distillation at atmospheric pressure was carried out at 99 for 60-70 min, whereas vacuum distillation was carried out for 75-90 min until the temperature had risen from the starting temperature of 35 to a final temperature of 43. The distillates were stored at 2 for 10 days and then filtered through No. 2 filter paper. Tap water was added to the filtrates to obtain products with an ethanol concentration adjusted to 25% (v/v).

### 3) *Analytical methods*

The acidity of the mash was analyzed according to the analytical method stipulated by the National Tax Administration Agency¹⁾. The concentration of ethanol in the mash was estimated using a gas chromatograph (GC-7A Shimadzu, Kyoto). The column (3x1 mm) was packed with Porapak Q and equipped with a flame ionization detector. Isopropanol was used as an internal standard. Flavor components with a low boiling point other than isoamyl acetate and ethyl capronate, were analyzed by the direct injection method according to Nishiya's method⁵⁾. The contents of isoamyl acetate and ethyl caproate were determined by gas chromatography based on the head-space method. One mL of the internal standard solution (10₃mg/L *n*-isoamyl alcohol solution) was added to a 30 mL vial containing 5

g of mash or 5 g of the product. The vial was hermetically sealed with a septum and an aluminum cap, and heated at 50 for 20 min, then 1 mL of the head-space gas from the vial was subjected to gas chromatography (14A, HHS-2A, Shimadzu, Kyoto). The temperature gradient employed was 5/min from 50 to 120. The detailed analytical conditions were described in the previous report ²⁾. The flavor components with a high boiling point in the mash after distillation were extracted by the addition of 60 mL of ether to 5 mL of the distillate and assayed by gas chromatography. The products obtained by distillation were also analyzed in the same way. The concentration of glucose in the mash was analyzed according to the gluco-stat method using an F-kit (Yamanouchi Seiyaku K. K., Tokyo), and organic acid components were analyzed by the post-label method³⁾ using a high-speed liquid chromatograph.



[Continue to: \[Results and discussion\]](#)



[Contents](#)

## References

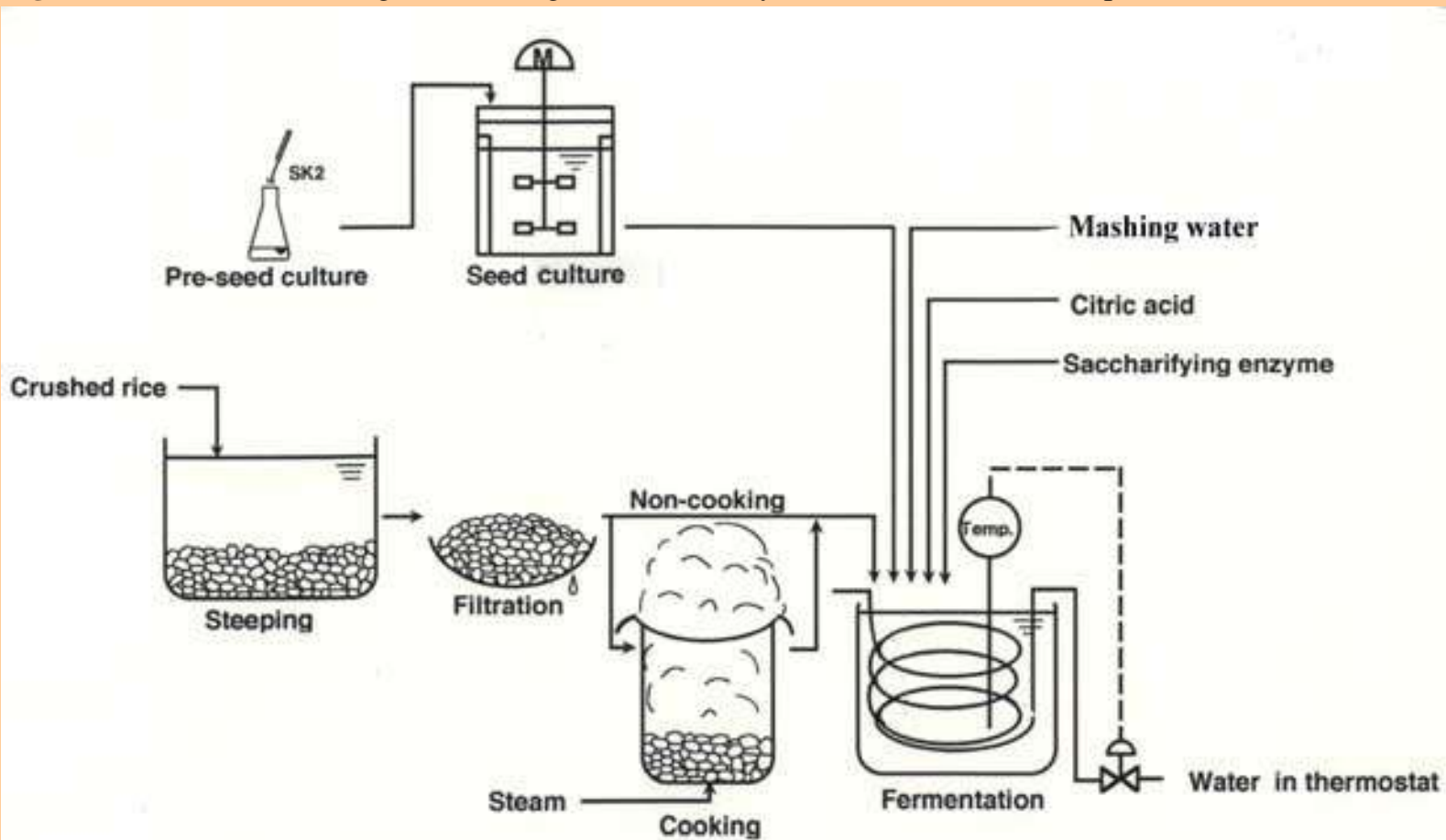


[Back to the first page](#)

- 1) Editorial Committee of Official Methods of Analysis (1974): Official methods of analysis of national tax administration (3rd ed.). Brewing Society of Japan, Tokyo [In Japanese].
- 2) Kida, K. et al. (1991): Production of shochu from crushed rice by non-cooking fermentation with saccharifying enzyme. *J. Soc. Brew. Jpn.*, 86, 962-968 [In Japanese with English summary].
- 3) Kida, K. (1991): Influence of mineral nutrients on high performance during anaerobic treatment of wastewater from a beer brewery. *J. Ferment. Bioeng.*, 72, 54-57.
- 4) Nishiya, T. (1980): Aroma and flavour in traditional shochu. *J. Soc. Brew. Jpn.*, 75, 641-649 [In Japanese with English summary].
- 5) Nishiya, T. (1983): Qualitative analysis on aroma and flavour of shochu by gas chromatograph. *J. Soc. Brew. Jpn.*, 78, 275-278 [In Japanese].
- 6) Shinoki, S. et al. (1987): Shochu making with use of various uncooked cereals. *J. Soc. Brew. Jpn.*, 82, 651-654 [In Japanese with English summary].
- 7) Yoshizawa, K. & Ishikawa, T. (1985): Changes of lipids during sake brewing and their contribution to ester formation by yeast. Monograph. *Hakkokogaku*, 63, 161-171 [In Japanese with English summary].



[Back to the first page](#)

**Fig.1.** Scheme of non-cooking and cooking fermentation systems in the bench-scale plant[BACK](#)

1~7):[References](#)

## Results and discussion

### *1) Production of spirit based on the bench-scale fermentation test*

The conditions of the bench-scale fermentation test were established based on the results from the small-scale fermentation test, i.e. 3% seed inoculum and a fermentation temperature of 25 were used. The time course of fermentation is shown in [Fig. 2](#). Fermentation was completed on the 10th day in the non-cooking fermentation method, which is only slightly different from the 9 days required for the completion of the fermentation process in the case of the cooking fermentation method. The difference was due to the initial concentration of glucose in the mashes; this concentration for the cooking fermentation method was 22.3 g/L, whereas 1.3 g/L for the non-cooking fermentation method. The rate of saccharification therefore limited the fermentation rate in the non-cooking fermentation methods. A clear advantage of this system, however, was the lower level of bacterial contamination.

[*Fig.2:Time course of ethanol and glucose concentrations in mash in 2 types of fermentation using the bench-scale plant\(32KB\)*](#)

### *2) Flavor and aroma components during the fermentation*

The changes in the concentrations of the aroma and flavor components during the fermentation are shown in Figs. 3-5. Isoamyl alcohol concentration increased in both the cooking and non-cooking fermentation systems at the early stage of fermentation, but decreased in the latter period. The concentration of isoamyl acetate derived from isoamyl alcohol increased during the latter period of fermentation in the non-cooking fermentation system ([Fig. 3](#)). The amounts of b-phenethyl alcohol and b-phenethyl acetate formed in both the cooking and non-cooking fermentation systems are shown in [Fig. 4](#). Both components were present at different concentrations in the cooking and non-cooking fermentation systems but the concentrations increased with the progression of the fermentation and then reached a constant level ([Fig. 4](#)).

[*Fig.3:Time course of isoamyl alcohol and isoamyl acetate concentrations in mash during batch fermentation using the bench-scale plant\(23KB\)*](#)

[*Fig.4:Time course of ²-phenethyl alcol and²-phenethyl acetate concentrations in mash during batch fermentation using the bench-scale plant\(23KB\)*](#)

Since the changes in the concentrations of ethyl myristate, ethyl oleate and ethyl linoleate showed almost the same behavior, the increase of the concentration of ethyl linoleate is shown in [Fig. 5](#). The amount of ethyl linoleate reached the highest level during the middle stages of fermentation in the cooking fermentation system and decreased in the latter period of fermentation, whereas the ethyl linoleate concentration increased during the latter period of the fermentation in the non-cooking fermentation system. The analytical values of the flavor components with a high boiling point therefore confirmed the data from the small-scale fermentation test, the values being 11/32 as high as the values obtained in the conventional method (small-scale fermentation test²). A system using the enzyme preparation E was therefore considered to be suitable for the production of mild spirit.

[*Fig.5:Time course of ethyl linoleate concentrations in mash during batch fermentation using the bench-scale plant\(19KB\)*](#)

The above results suggest that the concentrations of all the aroma and flavor components formed with low, medium and high boiling points were high in the non-cooking fermentation system. These results are similar to those obtained in the small-scale fermentation test as described in the previous report²⁾, because the free fatty acids contained in the raw materials were volatilized by cooking⁷⁾.

### ***3) Effect of distillation method on aroma and flavor product components***

The mashes from the non-cooking and cooking fermentation systems were subjected to atmospheric and vacuum distillations using the same still. The sensory test for the products was carried out according to a 5-point method by 14 panelists.

The ratios of the principal aroma and flavor components in the distillate produced by vacuum distillation are shown in [Fig. 6](#). In the sensory test, the value for the product obtained by the non-cooking fermentation method was satisfactory, 2.64 compared with 2.86 for the product obtained by the cooking fermentation method. As mentioned above, these results were due to the high concentration of the flavor components of the products obtained by distillation, and the higher concentrations of the flavor components from the mash in the non-cooking fermentation system compared with the mash in the cooking fermentation system. The product obtained by the cooking fermentation system was of a dry type because the aroma was weak and almost no higher fatty acid esters were detected. In contrast, the product obtained by the non-cooking fermentation system had a good aroma and mild taste because the concentrations of flavor components with low and medium boiling points were higher. The A/B ratio was as high as 2.6 but the taste was rather dry because of the low concentration of higher fatty acid esters.

#### **[Fig.6:Sensory test of spirit \(25% \(v/v\)\) made by the application of the non-cooking and cooking fermentation with the saccharifying enzyme preparation E\(42KB\)](#)**

The ratios of the principal aroma and flavor components of the products obtained by atmospheric distillation are also shown in [Fig. 6](#). Generally, both aroma and flavor components are present in large quantities in spirits distilled under atmospheric pressure, but a product with well-balanced A/B, A/P (isoamyl alcohol/*n*-propyl alcohol) and B/P (isobutyl alcohol/*n*-propyl alcohol) ratios of higher alcohols is preferable⁴⁾. Spirit obtained by the cooking fermentation method had a low A/B ratio (1.34 and 1.32 under vacuum and atmospheric distillation, respectively) because isobutyl alcohol was present in large quantities. However, spirit obtained by the non-cooking fermentation method had a high A/B ratio (2.6 under both vacuum and atmospheric distillation) because isoamyl alcohol was present at higher concentrations. As the product obtained by atmospheric distillation had a slightly increased higher fatty acid ester content than that obtained by vacuum distillation, it was superior to the product obtained by vacuum distillation in terms of roundness to receive an evaluation point of 2.28. This product therefore could satisfy the taste of the public.

It has been stated that the characteristics of the raw materials are well developed in the product obtained by the non-cooking fermentation method⁶⁾. In this study, the product obtained by the non-cooking fermentation method was superior to that obtained by the cooking fermentation method in terms of both aroma and flavor components. The product had a milder taste than that obtained by atmospheric distillation from the second mash in the conventional method. This was due to the low fatty ester content, as shown in [Fig. 6](#) in this paper and Table 5 in the previous report²⁾. Therefore, this product received a high evaluation point from the panelists.

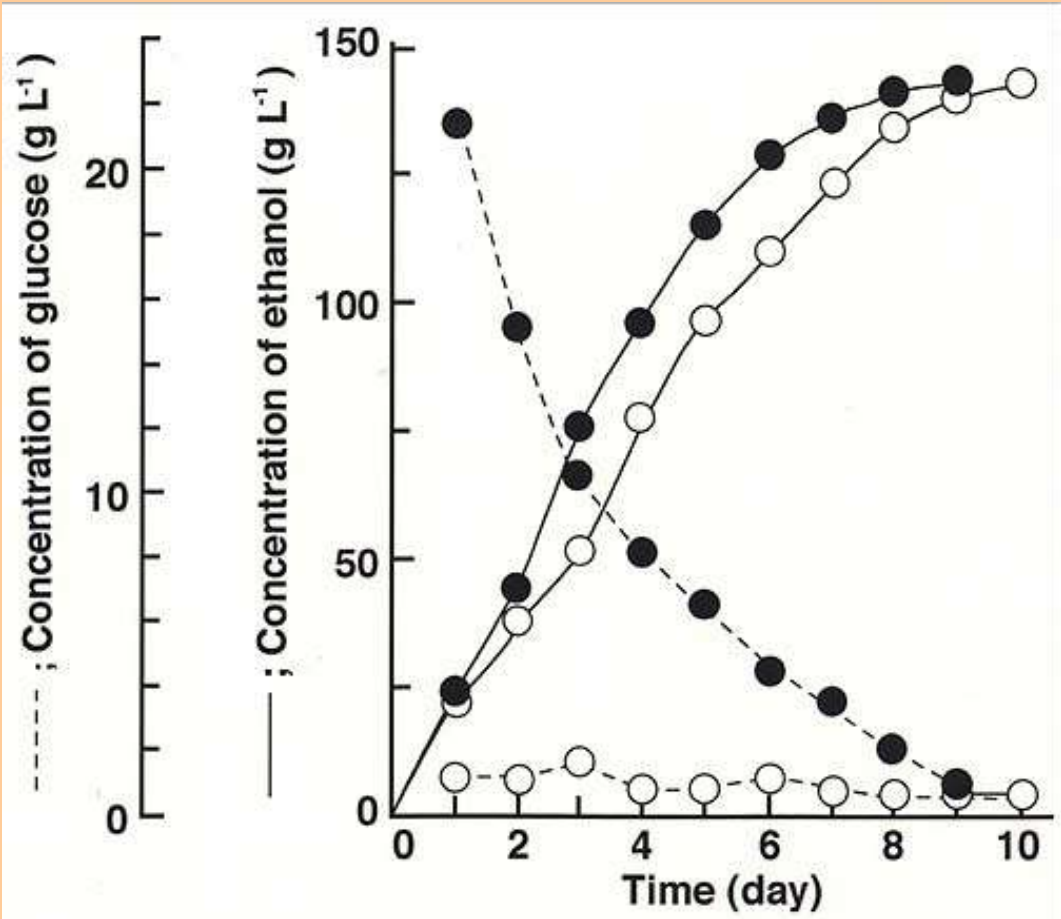


[Continue to: *\[\(4\) Conditions used in the case study in the shochu spirit factory\]*](#)



[Contents](#)

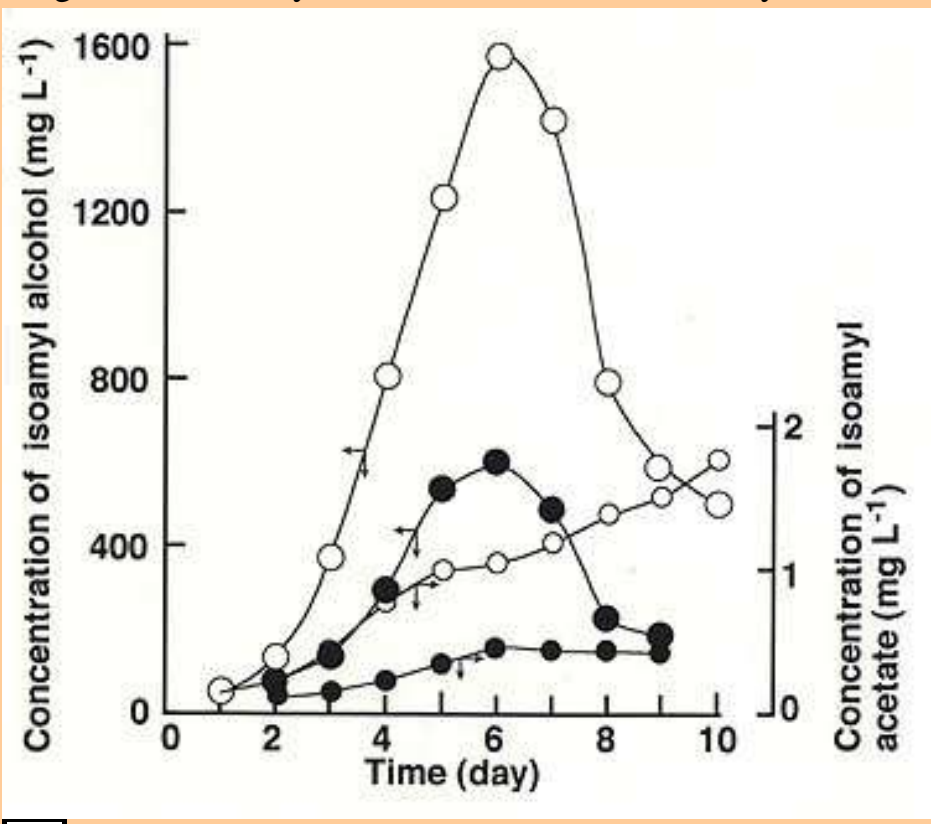
**Fig.2.** Time course of ethanol and glucose concentrations in mash in 2 types of fermentation using the bench-scale plant.  
Ë; Non-cooking, Ì; Cooking.



 [BACK](#)

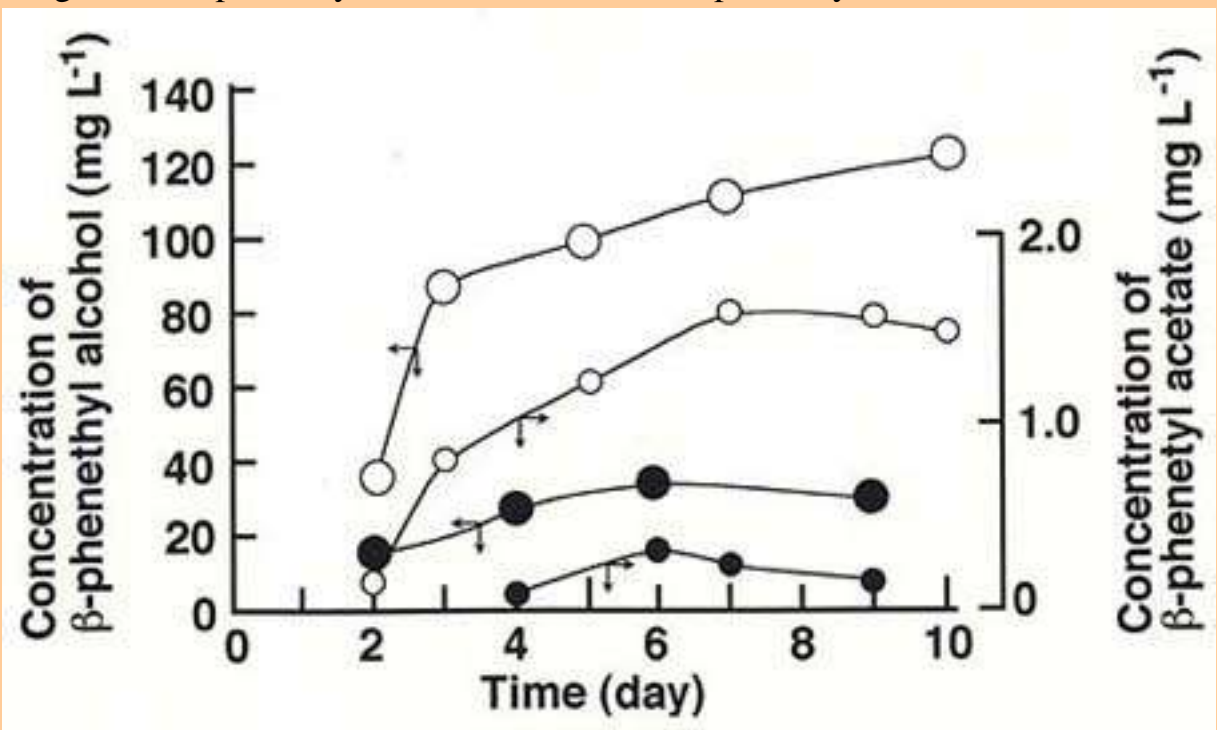


**Fig.3.** Time course of isoamyl alcohol and isoamyl acetate concentrations in mash during batch fermentation using ht bench-scale plant  
 Ë; Non-cooking Ì; Cooking  
 Large circle; Isoamyl alcohol, Small circle; Isoamyl acetate.



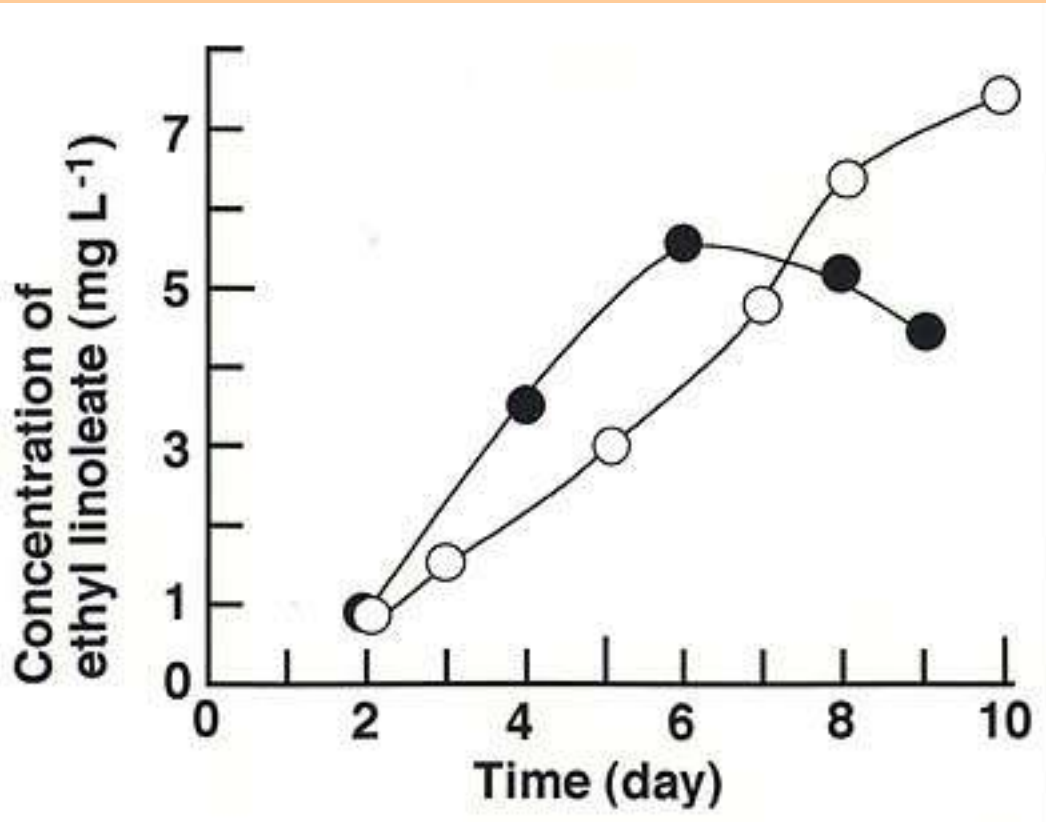
 [BACK](#)

**Fig.4.** Time course of ²-phenethyl alcohol and ²-phenethyl acetate concentrations in mash during batch fermentation using the bench-scale plant  
 Ë; Non-cooking, İ; Cooking.  
 Large circle; ²-phenethyl alcohol, Small circle; ²-phenethyl acetate.



 [BACK](#)

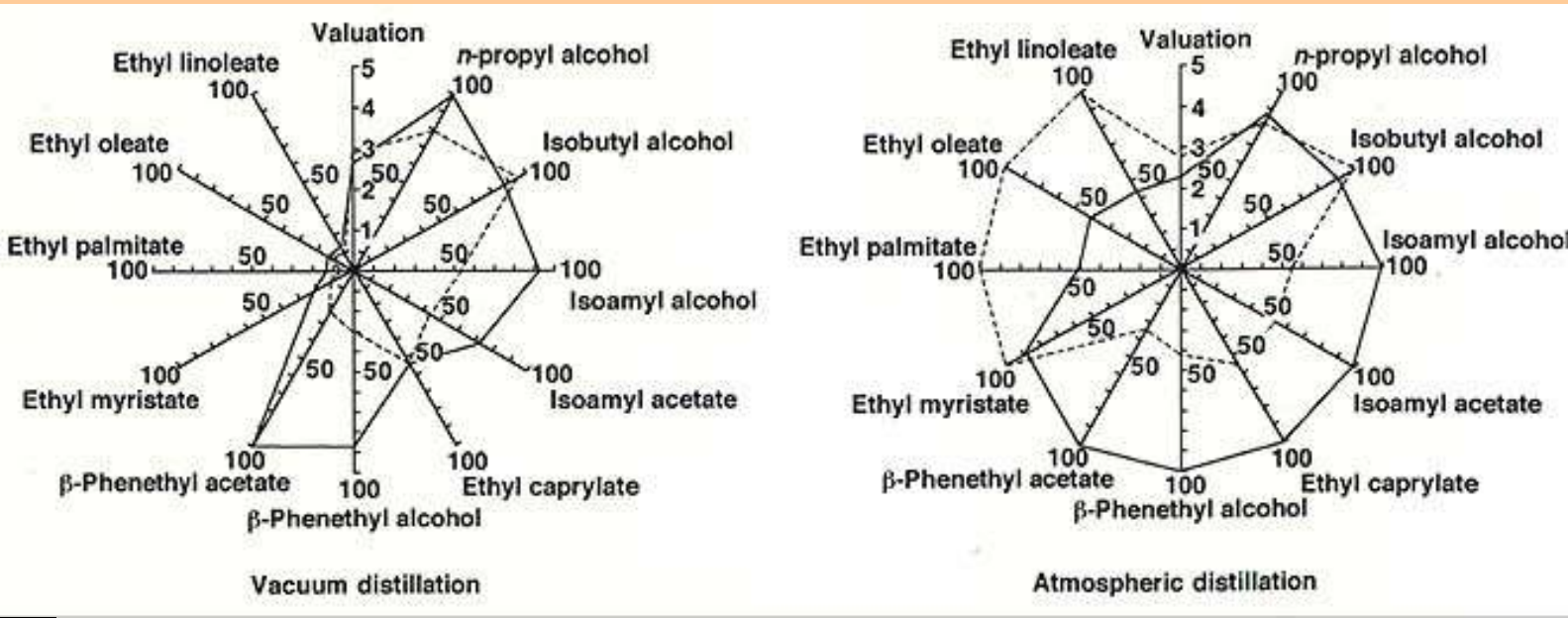
**Fig.5.** Time course of ethyl linoleate concentration in mash during batch fermentation using the bench-scale plant  
Ë; Non-cooking Ì; Cooking.



[BACK](#)

**Fig.6.** Sensory test of spirit (25% (v/v)) made by the application of the non-cooking and cooking fermentation methods with the saccharifying enzyme preparation E.

_____; Non-cooking, - - - - ;Cooking.



[BACK](#)

4) Conditions used in the case study in the shochu spirit factory

**4) Conditions used in the case study in the shochu spirit factory**

The shochu spirit factory surveyed this time used 630 kg of rice per fermentation, and the proportion of raw materials and water is shown in [Table 1](#). Two workers were engaged in the factory's manufacturing process: 650 L of crude shochu was manufactured from 630 kg of raw materials with an alcohol percentage of 43.5%. Considering that the ordinary percentage of alcohol of distributed shochu is 25%, the value can be converted to 1,131 L of commercialized shochu. Although the case study was carried out under these conditions, the cost calculation will be based on the conversion of actually measured figures 1,131 L into 1,000 L (1,131 L/1,000 L).

**Table 1. Proportion of raw materials and water**

	<u>First fermentation</u>	<u>Second fermentation</u>	<u>Total</u>
Rice koji	180 kg		180 kg
Rice (main raw material)		450 kg	450 kg
Water	216 L	792 L	1,008 L

Regarding the energy aspect, the amount of water in the boiler, exhaust gas temperature, oxygen concentration in exhaust gas, the amount of heavy oil used, the amount of drain of the koji-making machine and the amount of drain of the distillation machine were measured, and the energy consumption was examined. The total energy consumption required to manufacture 1,000 L of 25% shochu is shown in [Table 2](#). The steam amount in a shochu factory using 630 kg of rice was 656 kcal/kg, and 172 L as A-grade heavy oil.

**Table 2. Ratio of working process and workers^{a)}**

<u>Manufacturing process</u>	<u>Ratio of process</u>	<u>Workers</u>	<u>Note</u>
Raw material treatment	11.0 (%)	0.22(person)	Saving of labor 0.75 person x 20,000yen = 15,000 yen
Koji process	19.1	0.38	
First fermentation	7.7	0.15	
Second fermentation	32.0	0.64	
Distillation	18.0	0.36	
Refining & blending	3.6	0.02	
Others	8.1	0.16	
----- Total	100.0	2.00	-----

Two workers were engaged in the manufacturing process and the number of worked hours depending on each process is shown in [Table 3](#). By introducing an automatic koji process machine, the ratio of the koji process which is the most time and labor-consuming process during the manufacture process, decreased to 19.1%. The characteristics of the non-cooking fermentation system removed the processes of rice steaming, koji-making and the first fermentation stage. Without these processes, 0.75 manpower could be saved. If the daily wage for 1 person is 20,000yen, 15,000yen can be saved.

**Table 3. Consumption of energy for working process an cost**

<u>Current manufacturing process(A)</u>	<u>Manufacturing process in non-cooking fermentation system(B)</u>	<u>(A-B)/(A)</u>	<u>A-B</u>
-----------------------------------------	------------------------------------------------------------------------	------------------	------------

4) Conditions used in the case study in the shochu spirit factory

Amount of energy	Amount of steam	1,851.1 L	1,352.8 L		
		-----	-----	26.8%	2,259 yen
	A heavy oil	172.0 L	125.9 L		
		-----	-----		
		8,428 yen	6,169 yen		
Raw materials	Koji fee or enzyme fee	-----	-----		
		24,155 yen	Enzyme ----4,504 yen Citric acid---- 4,680 yen Total----9,184 yen	62.0%	14,971 yen
Amount of work	Number of workers and personnel expenses	-----	-----		
		2.00 persons	1.25 persons		
		-----	-----		
Saving		20,000yen x 2.00 persons = 40.000yen	20.000yen x 1.25 persons = 25.000yen	37.5%	15.000 yen
		-----	-----		
			--		32,230 yen

The manufacturing cost per 1 kg of koji, including the raw material cost was 299yen, and in this factory the koji cost was 53,800yen. The koji manufacturing cost excluding the raw material cost was therefore 24,155yen. In the non-cooking fermentation system, as mentioned before, enzyme and citric acid were used. The cost of the enzyme was 4,504yen (1,126 g x 4yen) and that of citric acid was 4,680yen (1,800 g x 2.6yen).

**5) Economic aspects of the introduction of the non-cooking fermentation system into a rice shochu factory**

In taking account of the energy consumption and labor force, the present conditions of a medium rice shochu factory were examined. Thereafter the economic effectiveness of the introduction of the non-cooking fermentation system into this shochu factory, was estimated. Since the non-cooking fermentation system is characterized by the elimination of the rice steaming process, energy can be saved and thus manpower in the manufacturing process can also be reduced. Due to the possibility of reducing labor to 38.8% and eliminating the first fermentation stage in the manufacturing process, it was possible to reduce the whole process to half. Based on the results obtained, a comparison between the existing manufacturing system and the non-cooking fermentation system is shown in Table 3. In terms of energy, 2,259 yen could be saved and this figure represented 26.8% of the whole energy cost. Since the koji process could be eliminated, 24,173 yen could possibly be saved. However, a sum of 4,504 yen for enzyme treatment and 9,184 yen for citric acid is necessary in the non-cooking fermentation system. Based on the figures listed above, a total sum of 14,471 yen could be saved. Due to labor-saving, 15,000 yen could be saved resulting in an economic benefit of 32,248 yen in terms of cost-saving. In addition, since the non-cooking fermentation system can be applied to the existing facility, new plant and equipment investment is not necessary. As a result, in the process of manufacturing 1,000 L of 25% alcohol shochu, it was evident that 32,248 yen could be saved, suggesting that 58 yen per bottle of ordinarily distributed 25% shochu could be saved, which amounted approximately to 10% of the cost of shochu production.



[Contents](#)



[First page of JARQ](#)




[JIRCAS Home Page](#)



Japan International Research Center for Agricultural Sciences  
Ministry of Agriculture, Forestry, and Fisheries  
1-2 Ohwashi, Tsukuba, Ibaraki 305-8686 JAPAN  
Telephone 0298-38-6304  
published on January 18, 1999

## Contents

<a href="#">Isolation of Individual Quantitative Trait Loci Causing Long Grain in Rice</a>	<b>Tsuneo KATO</b>
<a href="#">Optimizing the Particle Bombardment Method for Efficient Genetic Transformation</a>	<b>Takashi HAGIO</b>
<a href="#">Development of Automatic Fog Culture System for Year-Round Rice Production in Greenhouse</a>	<b>Yuichi NAGAYA et al.</b>
<a href="#">Study on Grade Judgment of Fruit Vegetables Using Machine vision</a>	<b>Masateru NAGATA and Qixin CAO</b>
<a href="#">Varietal Differences in Female Flower Bearing Ability and Evaluation Method in Watermelon</a>	<b>Keita SUGIYAMA</b>
<a href="#">Improvement of Postharvest Life in Several Cut Flowers by the Addition of Sucrose</a>	<b>Kazuo ICHIMURA</b>
<a href="#">Plant Regeneration via Shoot Organogenesis from Cotyledones in Two Wild <i>Cucumis</i> Species, <i>C. figarei</i> and <i>C. metuliferus</i></a>	<b>Yutaka TABELI et al.</b>
<a href="#">Agrobacterium tumefaciens-Mediated Gene Transfer to Tea Plant (<i>Camellia sinensis</i>) Cells</a>	<b>Satoru MATSUMOTO and Masaoki FUKUI</b>
<a href="#">Decontamination of Dry Food Ingredients with "Soft-Electrons" (Low-energy Electrons)</a>	<b>Toru HAYASI</b>
<a href="#">Alginate Encapsulation Technique and Cryogenic Procedures for Long-Term Storage of the Tropical Forest Tree <i>Guazuma crinita</i> Mart. <i>In Vitro</i> Cultures</a>	<b>Emilio MARUYAMA et al.</b>

 [Back to the first page of JARQ](#)

 [Back to What's New](#)

 [Back to JIRCAS home page](#)



# Isolation of Individual Quantitative Trait Loci Causing Long Grain in Rice

**Tsuneo KATO**

School of Bioresources, Hiroshima Prefectural University (Shobara, Hiroshima, 727-0023 Japan)

## Abstract

To evaluate the gene action and interaction of quantitative trait loci (QTLs) as a single Mendelian factor, attempts were made in this study to isolate individual QTLs causing long grain in a large-grain rice cultivar 'BG 1', in other words, to establish a series of near-isogenic lines which had long-grain alleles derived from BG 1 at only one QTL and the short-grain alleles at the other QTLs. In the course of developing recombinant inbred lines from the cross between BG 1 and a short-grain cultivar Koshihikari, the lines were surveyed through backcrossing of the recombinant inbreds and by progeny test. Until the BC₂F₂ generation, a total of 8 lines, which obviously showed monogenic segregation within the respective progenies in which a single QTL was involved, were obtained. All of the long-grain alleles at the isolated QTLs were recessive to the short-grain alleles. The process of isolation of 2 different QTLs was described in detail as an example of the strategy adopted in this study. These isolines for isolated QTLs should contribute significantly not only to the characterization of individual QTLs and their combinations but also to breeding programs as gene sources to be used directly.

**Discipline:** Plant breeding

**Additional key words:** gene action, near-isogenic line, progeny test, recombinant inbred line 1~14): [Click here for References](#)

## Introduction

Most of the agronomic traits exhibit continuous variations in populations consisting of different genotypes, like genetically segregating populations after crossing. These traits are referred to as quantitative traits, and their genetic control is attributed to a number of loci which are designated as quantitative trait loci (QTLs), or polygenes. Generally, each of the QTLs is assumed to affect the trait cumulatively and less dominantly compared with non-genetic factors. As a result, it is very difficult to evaluate QTLs individually for their locations along chromosomes as well as their gene actions and interactions.

Some efforts have been made to localize the individual QTLs along chromosomes by detecting linkage relationships between QTLs and some suitable genetic markers^{7,11}). Recent advances in molecular biology have provided many kinds of molecular markers which can cover all the chromosomes with a high density. Using these high-resolution molecular linkage maps with an adequate software, a large number of QTLs controlling various complex agronomic characters have been located in limited chromosomal regions in many crops^{1,10}). Several kinds of software for the QTL mapping can also estimate some of the gene effects for each QTL, the interaction of QTL with the environment, etc., from the same mapping population^{6,12}).

From a plant breeder's standpoint, on the other hand, it is very important to evaluate the gene actions of individual QTLs as single Mendelian factors which can actually show monogenic segregation, and not as

regions estimated on the linkage map by calculations under some assumptions. To achieve this kind of QTL evaluation, it is essential to isolate the individual QTLs through recombination and selection. This QTL isolation so far has not been sufficiently carried out, because it is a time-consuming procedure.

In this study special attention was paid to the grain length of rice as an example of quantitative trait, because this trait was generally considered to be controlled by a number of QTLs, as well as a single major gene, and had agronomic significance in determining the grain size and finally the grain yield in this crop. In the current study, then, attempts were made to isolate the individual QTLs causing long grain length in a large-grain rice cultivar 'BG 1'. The final objective is to establish a series of near-isogenic lines with long-grain alleles derived from BG 1 at only one QTL and short-grain alleles at the other QTLs in relation to grain length. Although this objective has not been fully achieved yet, in this paper, the progress made and some of the results obtained are reported.

## Materials and methods

A rice (*Oryza sativa* L.) cultivar BG 1 showing an extremely large (long) grain size⁸ was crossed as a female parent with a cultivar 'Koshihikari' showing a small (short) grain size (or a standard grain size in Japanese cultivars). Fifty F₂-derived F₅ progeny lines, which corresponded nearly to a set of recombinant inbred lines, were developed by the single-seed descent method from randomly selected F₂ plants of this cross-combination. In the F₅ population, several recombinant inbred lines showing different grain lengths were selected and crossed as a male parent with a cultivar 'Gimbozu' which showed a nearly equal or shorter grain length compared with Koshihikari. The crosses between recombinant inbreds and Gimbozu aimed at estimating the number of QTLs related to grain length involved in these inbreds. In each F₂ population of these crosses, F₂-derived progeny lines were developed from several F₂ plants with different grain lengths. Among these F₂-derived lines, the candidates which seemed to have only one QTL carrying the allele for long grain from BG 1 were crossed with Gimbozu recurrently until monogenic segregation in grain length was clearly confirmed within the respective progeny lines. Allelism test for long grain length was conducted when different lines of interest were obtained in the course of the study.

Grain length of a plant was determined as the average length of 5 unhulled grains collected from the basal parts of the 3rd, 4th, and 5th primary branches from the top of a typical panicle of this plant. The length of an unhulled grain was measured as the distance between the top of the apiculus except for awn and the bottom of the glume up to the F₅ generation after the crossing of BG 1/Koshihikari. From the F₁ generation of the crosses between recombinant inbreds and Gimbozu, the distance between the base of the apiculus and the bottom of the palea was defined as grain length.



[Continue to: Results and discussion](#)



[Back to: Contents](#)

## References



[Back to the first page](#)

- 1) Dudley, J. W. (1993): Molecular markers in plant improvement; Manipulation of genes affecting quantitative traits. *Crop Sci.*, 33, 660-668.
- 2) Kajiya, H., Yano, M. & Sasaki, T. (1995): Molecular tagging of the gene *wgl^m(t)* conferring glume width in rice. *Breed. Sci.*, 45 (suppl. 1), 77 [In Japanese].
- 3) Kato, T. (1989): Diallel analysis of grain size of rice (*Oryza sativa* L.). *Jpn. J. Breed.*, 39, 39-45.
- 4) Kato, T. (1997): Inheritance of grain size in rice. 6. Development of near-isogenic lines for major genes causing long grain. *Breed. Sci.*, 47 (suppl. 2), 232 [In Japanese].
- 5) Kearsey, M. J. & Pooni, H. S. (1996): Designer chromosomes. *In* The genetical analysis of quantitative traits. Chapman & Hall, London, 165-185.
- 6) Lander, E. S. et al. (1987): MAPMAKER; An interactive computer package for constructing primary genetic linkage maps of experimental and natural populations. *Genomics*, 1, 174-181.
- 7) Sax, K. (1923): The association of size differences with seed-coat pattern and pigmentation in *Phaseolus vulgaris*. *Genetics*, 8, 552-560.
- 8) Takita, T. (1983): Breeding of a rice line with extraordinary large grains as a genetic source for high yielding varieties. *JARQ*, 17, 93-97.
- 9) Takita, T. (1985): Inheritance of grain size and the relationship between grain size and other characters in rice. *Bull. Natl. Agric. Res. Cent.*, 3, 55-71 [In Japanese with English summary].
- 10) Tanksley, S. D. (1993): Mapping polygenes. *Annu. Rev. Genet.*, 27, 205-233.
- 11) Thoday, J. M. (1961): Location of polygenes. *Nature*, 191, 368-370.
- 12) Tinker, N. A. & Mather, D. E. (1995): MQTL; Software for simplified composite interval mapping of QTL in multiple environments. *JQTL*, 1, <http://probe.nalusda.gov:8000/otherdocs/jqtl/>.
- 13) Yano, M. & Sasaki, T. (1997): Genetic and molecular dissection of quantitative traits in rice. *Plant Mol. Biol.*, 35, 145-153.
- 14) Yano, M., Yamamoto, T. & Sasaki, T. (1997): Epistatic interaction of expression among photoperiod-sensitive genes, *Hd-1*, *Hd-2* and *Hd-3* in rice. *Breed. Sci.*, 47 (suppl. 2), 224 [In Japanese].

(Received for publication, January 5, 1998)

1~14): [Click here for References](#)

## Results and discussion

**Fig. 1** shows the changes in the frequency distribution for grain length with generation advancement after the crossing of BG 1/Koshihikari. In the F₂ and F₃ generations, typical continuous distributions were observed for this trait, indicating that the genetic difference in grain length between these 2 parents was due to a number of QTLs and not to a single locus. In the F₄ and F₅ generations, on the other hand, several peaks emerged in the distribution, resulting in a multimodal distribution. In addition, several F₂-derived lines appeared to show within-family segregation in a monogenic manner in the F₃ and F₄ generations (data not shown). This monogenic-like segregation within a derived line had already been observed by Takita⁹⁾ in his materials. In all the generations, no plant exhibited extreme transgressive segregation beyond the range between the 2 parents.

**[Fig.1: Frequency distribution of grain length in F₂, F₃, F₄, and F₅ populations from the cross of BG 1/Koshihikari, developed by the single-seed descent method \(23 KB\)](#)**

These results suggest that every QTL for grain length converged into either of the parental genotypes, a large-grain homozygote (BG 1 type) or a short-grain homozygote (Koshihikari type). The population thus consisted of several and not numerous kinds of recombinant homozygotes showing different grain lengths by F₄ and F₅ generations. Among these homozygotes, there were genotypes where only one or a few QTLs carried the alleles for long grain derived from BG 1. Several recombinant inbred lines with different grain lengths were selected and crossed with a cultivar Gimbozu to estimate the number of QTLs carrying the long-grain allele in their genotypes and to initiate backcrossing. The use of Gimbozu instead of Koshihikari as a recurrent parent aimed at comparing other kinds of near-isogenic lines involving major genes for long grain under the same background as that of Gimbozu⁴⁾. As an example of the following processes, the progenies of the cross between Gimbozu and a recombinant inbred T34 are described hereafter.

A part of **Fig. 2** shows the distribution of grain length in the F₂ population of Gimbozu/T34. Apparently, a bimodal-like distribution was observed in this population, in contrast with the distribution in the F₂ population of BG 1/Koshihikari (**Fig. 1**). A total of 20 F₂ plants with different grain lengths was selected and F₂-derived F₃ progeny lines were developed for the progeny test of grain length. The other part of **Fig. 2** shows the distributions in 7 F₃ lines out of 20, as examples. In this figure, several types of F₃ lines could be distinguished: non-segregating lines whose single modes of grain length were similar to that of either of the parents, Gimbozu (line *a* in Fig. 2) or T34 (*g*); non-segregating lines whose single modes showed either of the 2 intermediates between the 2 parents (*c* and *e*); and segregating lines which showed discontinuous distributions with 2 modes or more (*b*, *d*, and *f*). In the segregating F₃ lines, each of the modes in the distribution roughly corresponded to one of the modes of the parents and intermediates.

**[Fig. 2: Frequency distribution of grain length in the F₂ population and F₂-derived F₃ lines from the cross of Gimbozu/T34 \(a recombinant inbred from BG1/Koshihikari\)\(23 KB\)](#)**

These results imply that a recombinant inbred line T34 received the alleles for long grain from BG 1 at 2 different QTLs, and the alleles for short grain from Koshihikari at the other QTLs. Each of the F₂-derived

F₃ lines showing an intermediate grain length, i.e. line c and line e in [Fig. 2](#), should have either of the 2 QTLs as above where the long-grain allele from BG 1 occurred under a homozygous condition, whereas the segregating lines, lines b, d, and f, had these QTLs under heterozygous conditions. These lines of intermediate grain lengths, therefore, might indeed be the final objectives in this study. After checking homozygosity for grain length in the F₄ generation, each F₄ progeny of these lines was crossed as a female donor parent with Gimbozu.

[Fig. 3](#) shows the segregation of grain length in the BC₁F₂ populations (Gimbozu/T34//Gimbozu). The donor parents of the populations depicted in Fig. 3-a and -b were the progenies of line c and line e shown in Fig. 2, respectively. Obviously, a bimodal distribution in grain length was observed in each population. In Fig. 3 the results of the progeny test using BC₁F₃ families derived from individual BC₁F₂ plants were superimposed. The ratio of the short-grain, segregating, and long-grain families fitted well to the expected ratio of 1:2:1 ( $\chi^2 = 1.51$  and 0.08 in Fig. 3-a and -b, respectively). The range of grain length of the short-grain group considerably overlapped with the range of Gimbozu in each population. These results strongly suggest that in both populations only one QTL should be involved in the segregation of grain length, and the short-grain allele at this QTL was dominant over the long-grain allele. Consequently, it is concluded that, in the long-grain segregants of each BC₁F₂ population, a single QTL should be isolated as a monogenically segregating factor from a number of QTLs causing long grain in BG 1. In each population, one of these segregants was subjected to successive recurrent backcrossings with Gimbozu, and also to allelism tests between these 2 QTLs.

[Fig. 3: Frequency distribution of grain length in the BC₁F₂ populations \(Gimbozu/T34//Gimbozu\)\(21 KB\)](#)

[Fig. 4](#) shows the segregation of grain length in the BC₂F₂ populations. Apparently, typical monogenic segregation with a ratio of 3 short- to 1 long-grain group was observed ( $=\chi^2 1.63$  and 0.01 in Fig. 4-a and -b, respectively), confirming that only one QTL carried the recessive allele for long grain in the long-grain segregants in each population. The average grain length of the long-grain group in Fig. 4-a was obviously shorter than that of the long-grain group in Fig. 4-b. Also, as observed in [Fig. 2](#), the average grain length of line c, was shorter than that of line e. These results suggest that in the 2 isolated QTLs gene expression showed different magnitudes.

[Fig. 4: Frequency distribution of grain length in the BC₂F₂ populations \(Gimbozu/T34//2*Gimbozu\) \(13 KB\)](#)

[Fig. 5](#) shows the results of the allelism test between the 2 isolated QTLs as indicated above, where a continuous distribution with a wide range was observed in this F₂ population, although no transgressive segregant in the direction of shorter grain length was recorded. The results of the allelism test confirmed that the 2 isolated QTLs for long grain were different from each other. The isolated QTLs in the populations shown in Fig. 4-a and -b were, thus, tentatively designated as 'QTL-A' and 'QTL-B', respectively. As shown in Fig. 5, there were many transgressive segregants beyond the grain length of the parent with longer grain (a long-grain segregant shown in Fig. 3-b) which should include the QTL-B. This fact indicates that QTL-A and QTL-B induced long grain in an additive manner. Hence, the genetic variation of grain length depicted in Fig. 5, and also in Fig. 2, might be attributed mainly to the

segregation in QTL-B and partly to that in QTL-A.

**[Fig. 5: Frequency distribution of grain length in the F₂ population from the cross between a long-grain segregant of BC₁F₂ shown in Fig. 3-a and that in Fig. 3-b \(13 KB\)](#)**

Until the BC₂F₂ generation, 6 QTLs for long grain were isolated besides the QTL-A and QTL-B via other recombinant inbreds than T34, although allelism test among them has not been completed. In all of the isolated QTLs, the short-grain alleles were dominant over the corresponding long-grain alleles. Kato³) conducted a diallel analysis of rice grain length using 6 cultivars including BG 1 and Koshihikari, the parents of the progenies used in this study. In this analysis, the genes conferring long grain were considered to be recessive, and BG 1 and Koshihikari were assigned to a completely recessive parent and a completely dominant parent, respectively. These results from the diallel analysis agreed well with the present results.

A series of isolines involving every single QTL, the final objective of the attempt as described above, corresponded to the "substitution lines" for chromosomal regions which are expected to be a very suitable tool for analyzing QTL action and location^{5,13}). In rice, several QTLs related to heading date¹³) and one QTL related to grain width²) had already been isolated as a form of near-isogenic lines through backcrossing by monitoring the graphical genotypes of the progenies. The actions and interactions were evaluated also for the QTLs of heading date using these isolines¹⁴). The present attempt will be continued until every QTL causing long grain, at least with sufficient gene action to be detected, is isolated. The tagging of individual QTLs with molecular markers should certainly facilitate the enumeration and handling of the QTLs in this study, whereas the detection of suitable markers has not fully progressed because of insufficient polymorphisms among the present materials. In any case, these isolines for individual QTLs may raise various issues about the nature of a quantitative trait. In addition, plant breeders could directly utilize these materials themselves as gene sources in their breeding programs. A larger number of QTLs should be isolated as a monogenic Mendelian factor in various agronomic traits for achieving these purposes.



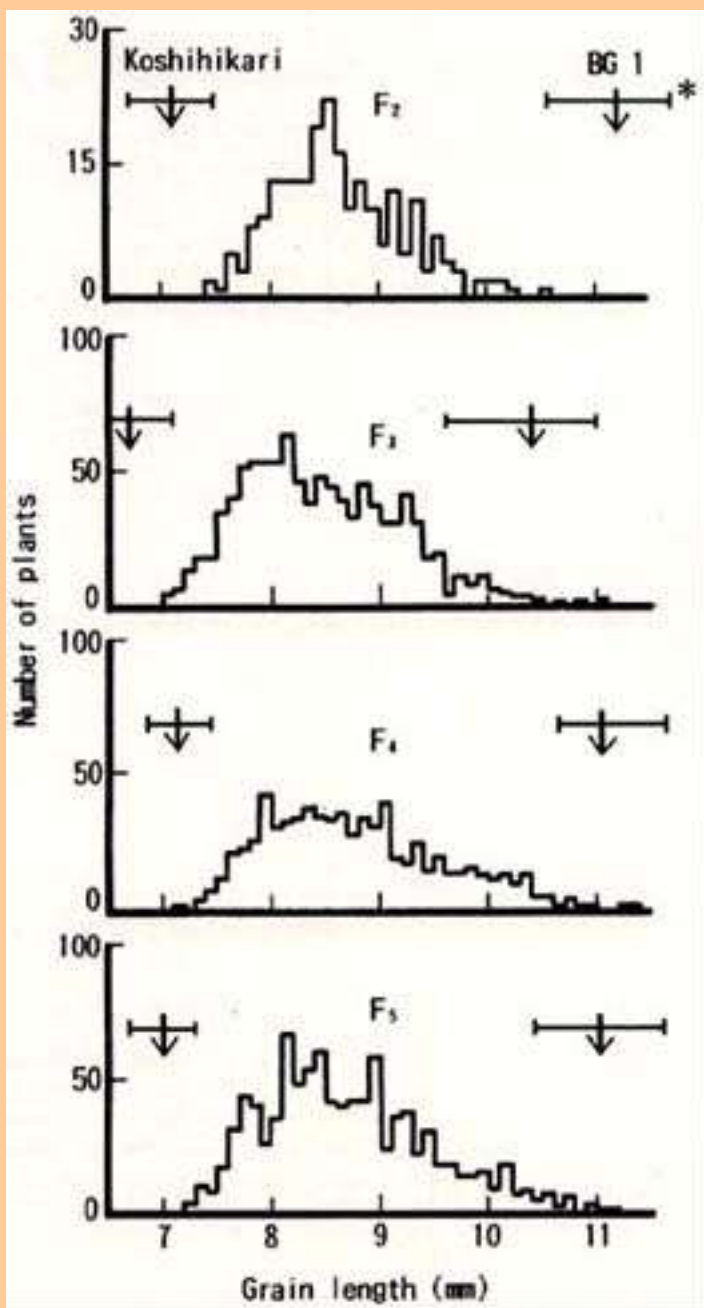
[Forward to: -Optimizing the Particle Bombardment Method for Efficient Genetic Transformation-](#)



[Back to: Contents](#)



[Back to: JIRCAS home page](#)



**Fig. 1.**

Frequency distribution of grain length in F₂, F₃, F₄, and F₅ populations from the cross of BG 1/Koshihikari, developed by the single-seed descent method

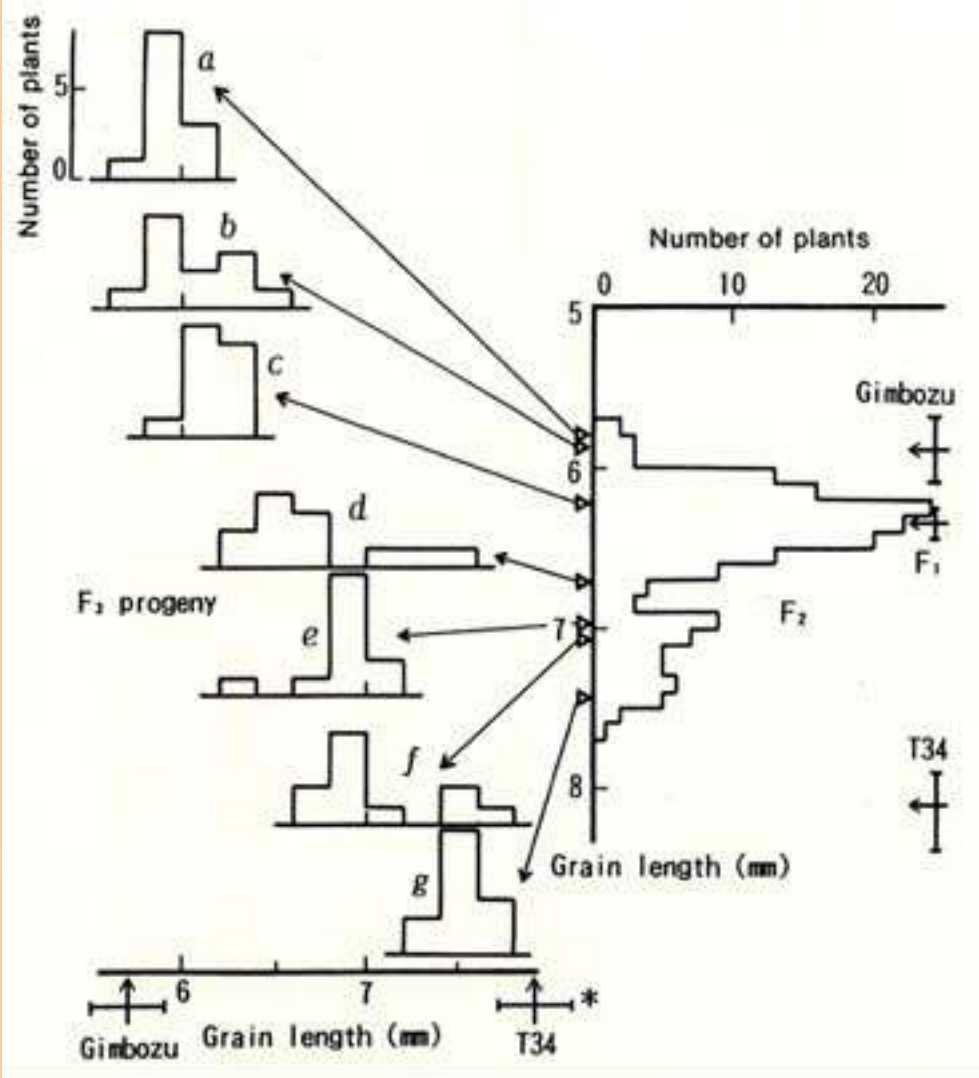
* Means and ranges of Koshihikari and BG 1.



[BACK](#)

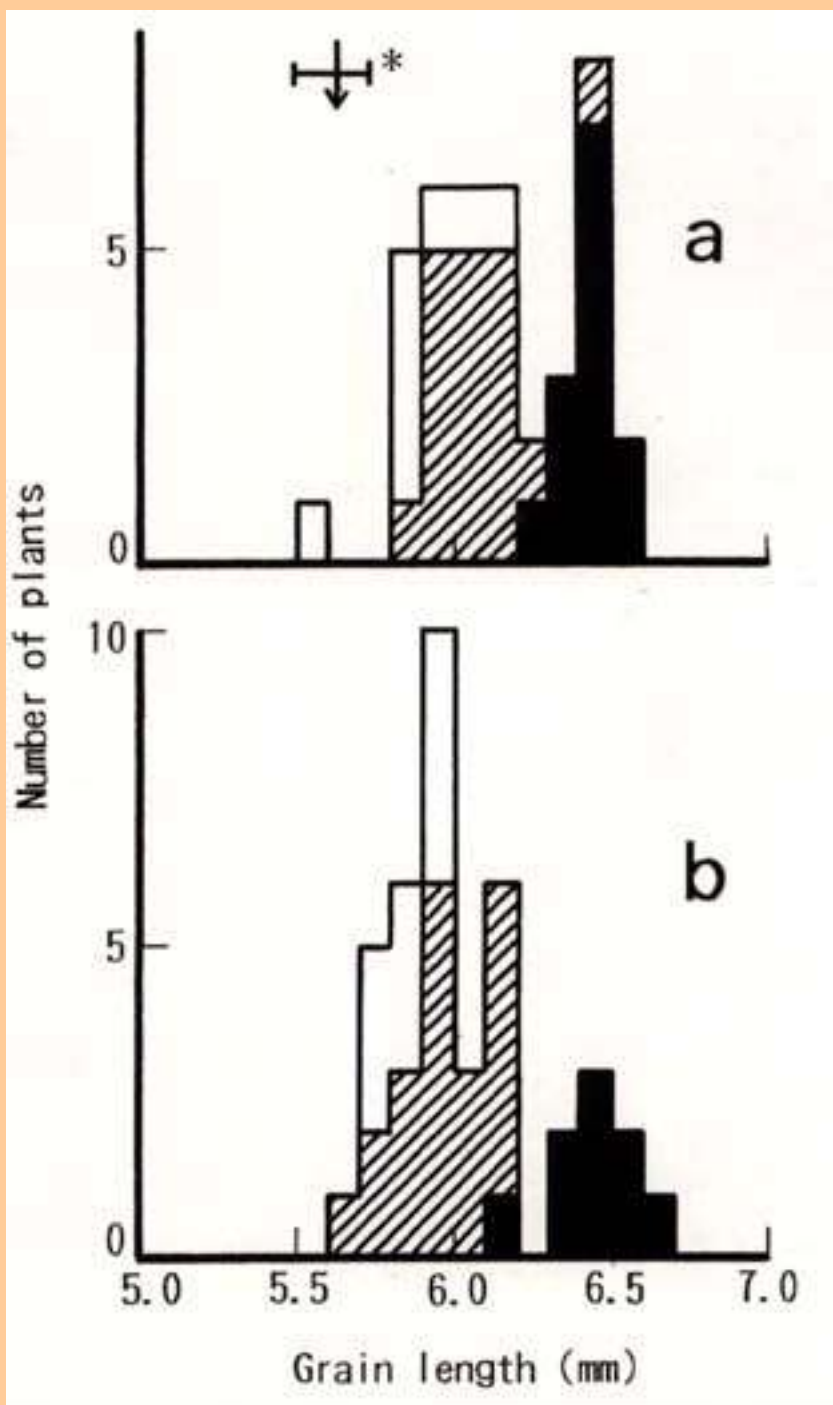
**Fig. 2.**  
 Frequency distribution of grain length in the F₂ population and  
 F₂-derived F₃ lines from the cross of Gimbozu/T34 (a recombinant inbred from BG 1/Koshihikari)

* Means and ranges of Gimbozu, T34, and their F₁.



 [BACK](#)





**Fig. 3.**

Frequency distribution of grain length in the BC₁F₂ populations (Gimbozu/T34//Gimbozu)

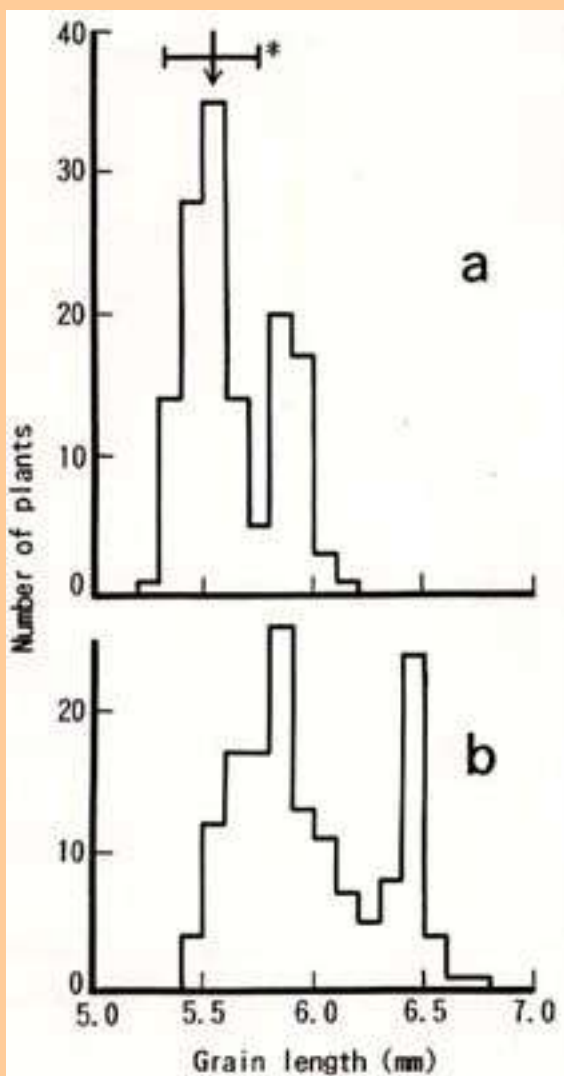
The donor parents of the populations in Fig. 3-a and -b are the progenies of line c and line e in Fig. 2, respectively.

Open, hatched, and closed segments refer to the BC₁F₂ plants generating the short-grain, segregating, and long-grain BC₁F₃ families, respectively.

* Mean and range of Gimbozu.



[BACK](#)



**Fig. 4.**

Frequency distribution of grain length in the BC₂F₂ populations (Gimbozu/T34//2Gimbozu)

The donor parents of the populations in Fig. 4-**a** and -**b** are the progenies of line *c* and line *e* in [Fig. 2](#), respectively.

* Mean and range of Gimbozu.

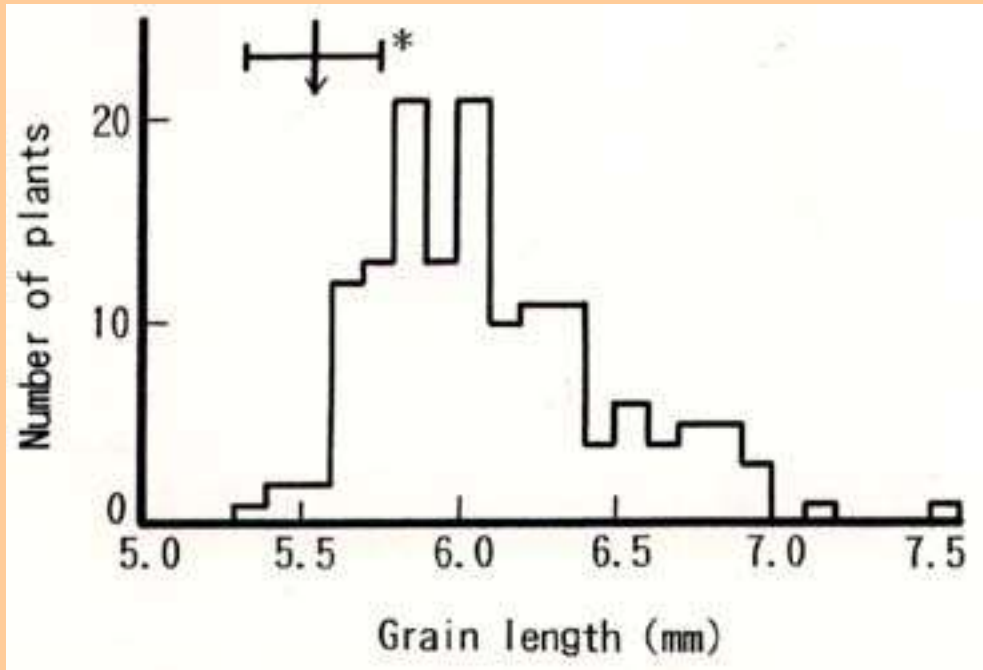


[BACK](#)

**Fig. 5.**

Frequency distribution of grain length in the F₂ population from the cross between a long-grain segregant of BC₁F₂ shown in Fig. 3-a and that in Fig. 3-b

* Mean and range of Gimbozu.



[BACK](#)

# Optimizing the Particle Bombardment Method for Efficient Genetic Transformation

**Takashi HAGIO**

Department of Biotechnology, National Institute of Agrobiological Resources  
(Tsukuba, Ibaraki, 305-8602 Japan)

## Abstract

Particle bombardment method has evolved into a useful tool for biotechnologists, allowing direct gene transfer to a broad range of cells and tissues over the past several years. Some of the important applications of the process include the production of fertile transgenic crops including maize, soybean, rice, wheat, barley, sorghum, etc. Recent results have extended the range of gene transfer to animal and bacterial cells. In this article the method of particle bombardment is reviewed and discussed, and practical suggestions for improving transformation efficiency are presented.

**Discipline:** Biotechnology

**Additional key words:** biolistic, particle gun, direct gene transfer

1~49): [Click here for References](#)

## Introduction to particle bombardment method

Particle bombardment method which is one of the technologies for introducing foreign genes into cells was developed by John Sanford and co-workers^{23, 37)} at Cornell University in the United States. This technique involves accelerating DNA-coated particles (microprojectiles) directly into intact tissues or cells. The research was conducted with a view to avoiding the host-range restrictions of *Agrobacterium tumefaciens*, and the regeneration problems of protoplast transformation.

In the early system, DNA-coated tungsten powder (spherical particles 4  $\mu$  m in diameter) was placed, as a suspension in a small aqueous volume, at the front end of a bullet-like plastic macroprojectile ([Fig. 1](#)). The macroprojectile was accelerated by a gunpowder charge. Upon impact with a plastic stopping plate at the end of the acceleration tube, the macroprojectile extruded through a small orifice. This extrusion further accelerated the microprojectiles. Although the gunpowder model was found to be successful for genetic transformation of various plant species in several laboratories, lack of control over the power of the bombardment as well as physical damage to target cells limited the number of stable transformations^{22, 37)}.

[Fig.1: Schematic diagrams of the gunpowder-driven particle gun developed by Klein et al.25\) \(18KB\)](#)

The current model, PDS-1000/HeTM, which is now marketed by BIO RAD Laboratories, represents a significant technical improvement over the gunpowder device. The basic design was developed by Sanford et al.³⁷⁾. The PDS-1000/HeTM device is powered by a burst of helium gas that accelerates a macrocarrier, upon which millions of DNA-coated microcarriers have been dried ([Figs. 2 and 3](#)). Compared to the gunpowder device, it is cleaner and safer, allows better control over bombardment parameter, distributes microcarriers more uniformly over target cells, is more gentle to target cells, is

more consistent from bombardment to bombardment, and yields several fold more transformations in the species tested²²).

[**Fig.2: Schematic diagrams of the helium-driven particle gun\(from the catalog of BIO RAD PDS-1000/HeTM\) \(14 KB\)**](#)

[**Fig.3 Helium-driven particle gun \(BIO RAD PDS-1000/HeTM\)\(15 KB\)**](#)

Sanford et al.³⁸) suggested the term "biolistic" which is a coined word derived from "biological and ballistic", though the terms particle gun or particle bombardment are becoming generic terms. This method has also been called the microprojectile bombardment method, the gene gun method, the particle acceleration method, etc. Therefore, one must pay attention to the choice of key words when searching for literature.

Since the development of the first particle bombardment system, several different types of bombardment devices have been developed, including an electrically triggered discharge gun²⁹), pneumatic particle guns³²), helium, nitrogen and carbon dioxide-powered devices^{13,43}) and a micro-targeting gun³⁹). These devices have been developed toward the same goals: more simplicity, safety, accuracy, and a lower cost for DNA delivery⁵). The basic principle of all these devices is the same as that originally developed by Sanford and co-workers^{23,25,37}).

This method was originally developed as a means of delivering foreign genes into the nuclear genome of higher plants and successful transformation of a wide range of tissues in a wide range of plant species was reported ([**Table 1**](#)). Tested plant tissues include cell suspensions, calli, immature embryos, microspores, etc. Transformed species include those for which transformation was otherwise impossible or very difficult.

[**Table 1: Production of transgenic plants by particle bombardment \(focused mainly on cereals\) \(46 KB\)**](#)

This method has also been found to be effective in microbial species, including *Bacillus megaterium*, *Pseudomonas syringae*, *Agrobacterium tumefaciens*, *Erwinia amylovora*, *Escherichia coli*, etc.³⁸). It first made possible the transformation of organelles. Chloroplasts of *Chlamydomonas*³) and mitochondria of yeast and *Chlamydomonas*²¹) can be transformed. In 1990, Svab et al.⁴²) reported the transformation of animal cells using particle bombardment.

In 1996, the advanced design of the hand-held particle gun was released in the U.S.A. It has become commercially available in Japan since March 1997. This device called "HeliosTM Gene Gun System" is marketed by BIO RAD ([**Fig. 4**](#)). In contrast to the conventional particle guns where the overall size of the target to be transformed is limited by the size of the chamber and the target tissue is subject to a vacuum during bombardment, the new device does not require vacuum and any target accessible to the barrel can be transformed. It may be used in a much wider variety of gene transfer applications and provides a tool for both *in vitro* and *in vivo* transformations.

[**Fig.4: Hand-held particle gun \(BIO RAD HeliosTM Gene Gun System\) \(16KB\)**](#)

In this article the method of particle bombardment is reviewed and discussed, and practical suggestions for improving transformation efficiency are presented. Most of the discussion will relate to BIO RAD

PDS-1000/He™ which was developed by Sanford et al.(23,37) and is most widely used in the world. Basic principle of the particle bombardment method is the same regardless of the device used.



[Continue to : Characteristics of the method](#)



[Back to : Contents](#)

## References



[Back to the first page](#)

- 1) Altpeter, F. et al. (1996): Accelerated production of transgenic wheat (*Triticum aestivum* L.) plants. *Plant Cell Rep.*, 16, 12-17.
- 2) Bower, R. & Birch, R. (1992): Transgenic sugarcane plants via microprojectile bombardment. *Plant J.*, 2, 409-416.
- 3) Boynton, J. E. et al. (1988): Chloroplast transformation in *Chlamydomonas* with high velocity microprojectiles. *Science*, 240, 1534-1538.
- 4) Brar, G. S. et al. (1994): Recovery of transgenic peanut (*Arachis hypogaea* L.) plants from elite cultivars utilizing ACCL technology. *Plant J.*, 5, 745-753.
- 5) Brown, D. et al. (1994): Development of a simple bombardment device for gene transfer into plant cells. *Plant Cell Tissue Organ Culture*, 37, 47-53.
- 6) Cabrera-Ponce, J. L. et al. (1997): An efficient particle bombardment system for the genetic transformation of asparagus (*Asparagus officinalis* L.). *Plant Cell Rep.*, 16, 255-260.
- 7) Cao, J. et al. (1992): Regeneration of herbicide resistant transgenic rice plants following microprojectile-mediated transformation of suspension culture cells. *Plant Cell Rep.*, 11, 586-591.
- 8) Casas, A. M. et al. (1993): Transgenic sorghum plants via microprojectile bombardment. *Proc. Natl. Acad. Sci. USA*, 90, 11212-11216.
- 9) Casas, A. M. et al. (1995): Cereal transformation through particle bombardment. *Plant Breed. Rev.*, 13, 235-264.
- 10) Christou, P. et al. (1991): Production of transgenic rice (*Oryza sativa* L.) plants from agronomically important indica and japonica varieties via electric discharge particle acceleration of exogenous DNA into immature zygotic embryos. *Bio/Technology*, 9, 957-962.
- 11) Christou, P. (1992): Genetic transformation of crop plants using microprojectile bombardment. *Plant J.*, 2, 275-281.
- 12) Ellis, D. D. et al. (1993): Stable transformation of *Picea glauca* by particle acceleration. *Bio/Technology*, 11, 84-89.
- 13) Finer, J. J. et al. (1992): Development of particle inflow gun for DNA delivery to plant cells. *Plant Cell Rep.*, 11, 323-328.
- 14) Fitch, M. et al. (1990): Stable transformation of papaya via microprojectile bombardment. *Plant Cell Rep.*, 9, 189-194.
- 15) Fromm, M. E. et al. (1990): Inheritance and expression of chimeric gene in the progeny of transgenic maize plants. *Bio/Technology*, 8, 796-839.
- 16) Gordon-Kamm, W. et al. (1990): Transformation of maize cells and regeneration of fertile transgenic plants. *Plant Cell*, 2, 603-618.
- 17) Hagio, T. et al. (1995): Production of fertile transgenic barley (*Hordeum vulgare* L.) plant using the hygromycin-resistance marker. *Plant Cell Rep.*, 14, 329-334.
- 18) Hagio, T. et al. (1996): Transgenic sorghum plants produced by particle bombardment using hygromycin-resistance marker. *In Abst. 2nd Asia-Pacific conference on plant cell and tissue culture*, July 28-August 1, 1996, Beijing, China, 122.
- 19) Hagio, T. et al. (1997): Production of transgenic barley plants resistant to barley mild mosaic virus by particle bombardment. *J. Soc. In Vitro Biol.*, 33-II, 68.

- 20) June, A. et al. (1994): Regeneration of transgenic, microspore-derived, fertile barley. *Theor. Appl. Genet.*, 89, 525-533.
- 21) Johnston, S. A. et al. (1988): Mitochondrial transformation in yeast by bombardment with microprojectiles. *Science*, 240, 1538-1541.
- 22) Kikkert, J. R. (1993): The biolistic PDS-1000/He device. *Plant Cell Tissue Organ Culture*, 33, 221-226.
- 23) Klein, T. M. et al. (1987): High-velocity microprojectiles for delivering nucleic acids into living cells. *Nature*, 327, 70-72.
- 24) Klein, T. M. et al. (1988): Stable genetic transformation of intact *Nicotiana* cells by the particle bombardment process. *Proc. Natl. Acad. Sci. USA*, 85, 8502-8505.
- 25) Klein, T. M. et al. (1992): Transformation of microbes, plants and animals by particle bombardment. *Bio/Technology*, 10, 286-291.
- 26) Knittel, N. et al. (1994): Transformation of sunflower (*Helianthus annuus* L.); a reliable protocol. *Plant Cell Rep.*, 14, 81-86.
- 27) Kuehnle, A. & Sugii, N. (1992): Transformation of *Dendrobium* orchid using bombardment of protocorms. *Plant Cell Rep.*, 11, 484-488.
- 28) Li, L. et al. (1993): An improved rice transformation system using the biolistic method. *Plant Cell Rep.*, 12, 250-255.
- 29) McCabe, D. E. et al. (1988): Stable transformation of soybean (*Glycine max*) by particle acceleration. *Bio/Technology*, 6, 923-926.
- 30) McCown, B. H. et al. (1991): Stable transformation of *Populus* and incorporation of pest resistance by electric discharge particle acceleration. *Plant Cell Rep.*, 9, 590-594.
- 31) Nehra, N. S. et al. (1994): Self-fertile transgenic wheat plants regenerated from isolated scutellar tissues following microprojectile bombardment with two distinct gene constructs. *Plant J.*, 5, 285-297.
- 32) Oard, J. H. et al. (1990): Transient gene expression in maize, rice, and wheat cells using an airgun apparatus. *Plant Physiol.*, 92, 334-339.
- 33) Pereira, L. F. & Erickson, L. (1995): Stable transformation of alfalfa (*Medicago sativa* L.) by particle bombardment. *Plant Cell Rep.*, 14, 290-293.
- 34) Potrykus, I. (1990): Gene transfer to cereals : an assessment. *Bio/Technology*, 8, 535-542.
- 35) Ritala, A. et al. (1994): Fertile transgenic barley by particle bombardment of immature embryos. *Plant Mol. Biol.*, 24, 317-325.
- 36) Russell, D. R. et al. (1993): Stable transformation of *Phaseolus vulgaris* via electric-discharge mediated particle acceleration. *Plant Cell Rep.*, 12, 165-169.
- 37) Sanford, J. C. (1990): Biolistic plant transformation. *Physiologica Plantarum*, 79, 206-209.
- 38) Sanford, J. C. et al. (1993): Optimizing the biolistic process for different biological applications. *Methods in Enzymology*, 217, 483-509.
- 39) Sautter, C. (1993): Development of a microtargeting device for particle bombardment of plant meristems. *Plant Cell Tissue Organ Culture*, 33, 251-257.
- 40) Serres, R. et al. (1992): Gene transfer using electric discharge particle bombardment and recovery of transformed cranberry plants. *J. Amer. Hort. Sci.*, 117, 174-180.
- 41) Somers, D. A. et al. (1992): Fertile, transgenic oat plants. *Bio/Technology*, 10, 1589-1594.
- 42) Svab, Z. et al. (1990): Stable transformation of plastids in higher plants. *Proc. Natl. Acad. Sci. USA*, 87, 8526-8530.
- 43) Vain, P. et al. (1993): Development of the particle inflow gun. *Plant Cell Tissue Organ Culture*, 33, 237-246.
- 44) Vain, P. et al. (1993): Osmotic treatment enhances particle bombardment-mediated transient and



stable transformation of maize. *Plant Cell Rep.*, 12, 84-88.

45) Vasil, V. et al. (1992): Herbicide resistant fertile transgenic wheat plants obtained by microprojectile bombardment of regenerable embryogenic callus. *Bio/Technology*, 10, 667-674.

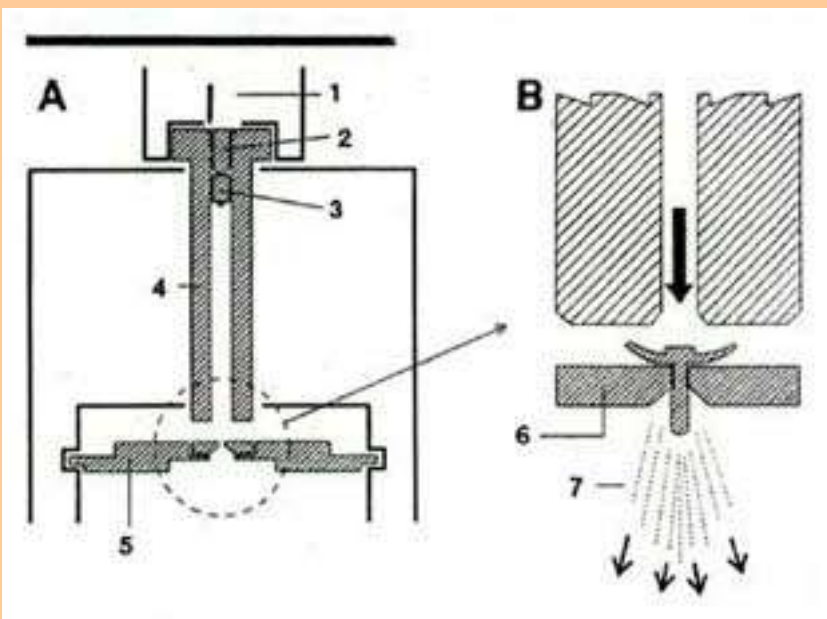
46) Wan, Y. & Lemaux, P. G. (1994): Generation of large numbers of independently transformed fertile barley plants. *Plant Physiol.*, 104, 37-48.

47) Weeks, J. T. et al. (1993): Rapid production of multiple independent lines of fertile transgenic wheat (*Triticum aestivum*). *Plant Physiol.*, 102, 1077-1084.

48) Ye, X. et al. (1997): Transgenic Italian ryegrass (*Lolium multiflorum*) plants from microprojectile bombardment of embryogenic suspension cells. *Plant Cell Rep.*, 16, 379-384.

49) Zhong, H. et al. (1993): Transgenic plants of turfgrass (*Agrostis palustris* Huds.) from microprojectile bombardment of embryogenic callus. *Plant Cell Rep.*, 13, 1-6.

(Received for publication, January 5, 1998)



**Fig.1.**

Schematic diagrams for the gunpowder-driven particle gun development by Klein et al.²⁵⁾

A: Before firing, B: After firing,

1: Firing pin

2: Gunpowder charge

3: Macrocarrier(plastic bullet)with microcarriers (tungsten particles)

4: Acceleration tube

5: Stopping plate shelf with stopping plate

6: Stopping plate with extruded macrocarrier (plastic bullet)

7: Launched microcarriers (tungsten particles)

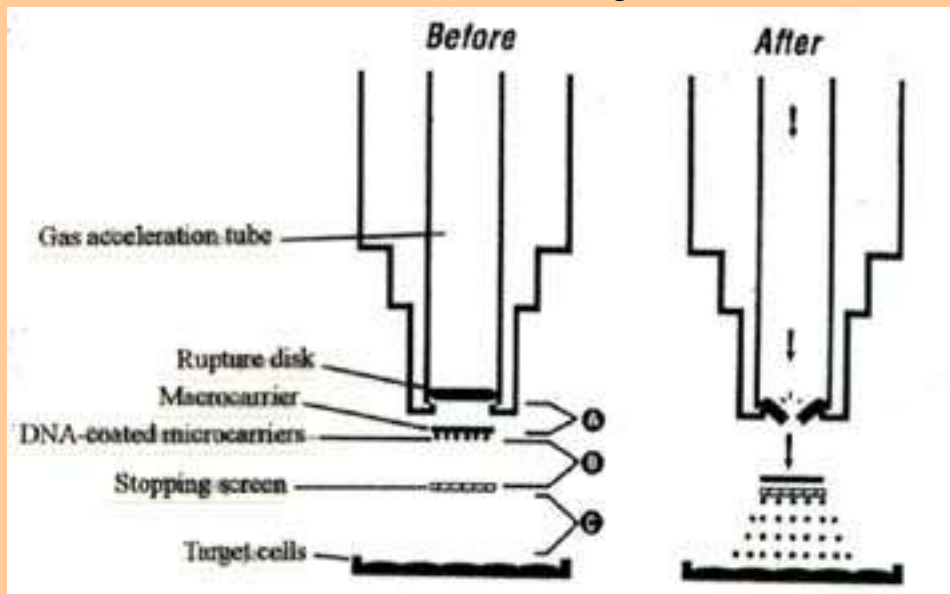


[BACK](#)

**Fig.2.**

Schematic diagrams of the helium-driven particle gun  
(from the catalog of BIO RAD PDS-1000/He™)

The distance of **A**, **B**, and **C** can be changed.



[BACK](#)

**Fig.3.**

Helium-driven particle gun (BIO RAD PDS-1000/He™)



[BACK](#)

**Table 1.**

Production of transgenic plants by particle bombardment (focused mainly on cereals)

Plant	Target	Gene	Reference
Tobacco	Suspension cell	<i>Gus</i> ^{a)} , <i>nptII</i> ^{b)}	24)
Soybean	Embryonic axes	<i>Gus</i> , <i>nptII</i>	29)
Papaya	Immature embryo, etc.	<i>Gus</i> , <i>nptII</i>	14)
Maize	Callus, Suspension cell	<i>Gus</i> , <i>bar</i> ^{c)}	15)
Maize	Suspension cell	<i>Gus</i> , <i>bar</i>	16)
<i>Populus</i>	Protoplast-derived cell	<i>Gus</i> , BT ^{d)}	30)
Cranberry	Stem section	<i>Gus</i> , <i>nptII</i> , BT	40)
Rice	Immature embryo	<i>Gus</i> , <i>bar</i>	10)
Rice	Suspension cell	<i>bar</i>	7)
Rice	Immature embryo	<i>Gus</i> , <i>hpt</i> ^{e)}	28)
Sugarcane	Callus	<i>Gus</i> , <i>nptII</i>	2)
<i>Dendrobium</i> orchid	Protocorm	<i>nptII</i> , virus CP ^{f)}	27)
Oat	Suspension cell	<i>Gus</i> , <i>bar</i>	41)
Wheat	Callus	<i>Gus</i> , <i>bar</i>	45)
Wheat	Immature embryo	<i>Gus</i> , <i>bar</i>	47)
Wheat	Scutellar tissue	<i>Gus</i> , <i>bar</i>	31)
Wheat	Immature embryo	<i>Gus</i> , <i>bar</i>	1)
<i>Phaseolus vulgare</i>	Seed meristem	<i>Gus</i> , <i>bar</i>	36)
Turfgrass	Callus	<i>Gus</i>	49)
<i>Picea glauca</i>	Somatic embryo	<i>Gus</i> , <i>nptII</i>	12)
Sorghum	Immature embryo	<i>Gus</i> , <i>bar</i>	8)
Sorghum	Immature embryo	<i>Gus</i> , <i>hpt</i>	18)
Peanut	Embryo axis	<i>Gus</i> , <i>bar</i> , virus CP	4)
Sunflower	Shoot apices	<i>Gus</i> , <i>nptII</i>	26)
Barley	Immature embryo	<i>Gus</i> , <i>bar</i>	46)
Barley	Immature embryo	<i>nptII</i>	35)
Barley	Microspore	<i>Gus</i> , <i>bar</i>	20)
Barley	Immature embryo	<i>Gus</i> , <i>hpt</i>	17)
Barley	Immature embryo	virus CP	19)
Alfalfa	Callus	<i>Gus</i> , <i>nptII</i>	33)
Italian ryegrass	Suspension cell	<i>Gus</i> , <i>hpt</i>	48)
Asparagus	Callus	<i>Gus</i> , <i>hpt</i> , <i>bar</i>	6)


[BACK](#)

a): *Gus*;  $\beta$ -Glucuronidase, b): *nptII*; Neomycin phosphotransferase II, c): *bar*; (PAT) Phosphinothricin acetyl transferase, d): BT; *Bacillus thuringiensis*, e): *hpt*; Hygromycin phosphotransferase, f): CP; Coat protein.



**Fig.4.**

Hand-held particle gun (BIO RAD Helios™ Gene Gun System)

Rice leaves are bombarded. The lid of the plastic petri dish is placed behind the leaves to prevent them from being blown.



[BACK](#)

## Characteristics of the method

This method has become the second most widely used vehicle for plant genetic transformation after *Agrobacterium*-mediated transformation⁹). The number of researchers using particle gun has been increasing in spite of the availability of protoplast transformation because the protoplast-to-plant method of obtaining transgenic plants is laborious and time-consuming⁹).

This method of genetic transformation offers both advantages and disadvantages over *Agrobacterium* or protoplast-mediated transformation as follows.

### 1) Advantages

(1) Almost any kinds of cells or tissues can be treated.

(2) Device operation is easy.

Transformation protocols are simplified. A large number of samples can be treated within a short time by technicians once the method has been routinized by researchers.

(3) Plasmid construction is simplified.

DNA sequences essential for T-DNA replication and transfer in *Agrobacterium* are not required. Furthermore, the introduction of multiple plasmids (co-transformation) is routinely accomplished.

(4) False positive results arising from the growth of *Agrobacterium* in host tissues are eliminated.

(5) Small amount of plasmid DNA is required. Only 0.8  $\mu$ g DNA is required for one bombardment in BIO RAD PDS-1000/HeTM.

(6) Transient gene expression can be examined within a few days.

It is conveniently used for evaluating transient expression of different gene constructs in intact tissues.

### 2) Disadvantages

(1) Generally, transformation efficiency is still low.

Even though this method has become one of the most widely used vehicles for plant genetic transformation, transformation frequency is still low compared with *Agrobacterium*-mediated or protoplast transformation.

(2) Consumable items are expensive in some models.

The cost of one bombardment is 260 yen in the case of BIO RAD PDS-1000/HeTM using standard pressure kit (130,000 yen for 500 bombardments).

(3) One must consider patent royalty in commercial use.

This is a very delicate and complicated issue. One should consult with a specialist in patent issues.

## Basic operation of the device

BIO RAD PDS-1000/HeTM is routinely used in our laboratory. The protocol we currently use to prepare DNA-coated microcarrier (tungsten or gold particles) is as follows. The method is generally applied by following the instruction manual but some modifications were made by the author to enhance the transformation efficiency. This is one of the most important sources of variation affecting the transformation efficiency³⁸). One should strive to make the precipitation reaction mixture as homogeneous and reproducible as possible.

(1) Vortex the microcarrier suspension prepared in 50% glycerol (60 mg/mL) for at least 5 min on a platform vortex (Fig. 5) to resuspend and disrupt agglomerated particles. [Fig.5: Platform vortexTM \(23 KB\)](#)

(2) Remove 5  $\mu$  L (3 mg) of microcarrier suspension and put it into a 1.5 mL microfuge tube. It is important to vortex the tube containing the microcarriers continuously in order to maximize uniform sampling. In the previous manual, it was recommended that particles be sonicated to maximize uniform sampling. From the author's experience this is not beneficial and under certain conditions can make particle agglomeration worse rather than better, especially when gold particles are used.

(3) While vortexing vigorously, add in order:

5  $\mu$  L DNA (1  $\mu$  g/  $\mu$  L),

50  $\mu$  L CaCl₂ (2.5 M),

20  $\mu$  L spermidine (free-base, 0.1 M).

(4) Continue vortexing for 3 min.

(5) Allow the microcarriers to settle for 3 min.

(6) Pellet microcarriers by spinning 2 sec in a micro-centrifuge. (approx. 5,000 rpm)

(7) Remove liquid and discard.

(8) Add 150  $\mu$  L of 70 % ethanol without disturbing the pellet.

(9) Remove liquid and discard.

(10) Add 150  $\mu$  L of 100 % ethanol without disturbing the pellet. 99.5 % ethanol can also be used.

(11) Remove liquid and discard.

(12) Add 55 - 60  $\mu$  L of 100 % ethanol. 99.5 % ethanol can also be used.

(13) Resuspend the pellet by tapping the side of the tube.

(14) Remove 6  $\mu$  L aliquots of microcarriers and transfer them to the center of a macrocarrier.

Spread microcarriers over the central 1 cm of the macrocarrier ([Fig. 6](#)).

Wait until microcarriers dry.

[Fig.6: Coating microcarriers \(DNA-coated particles\) over a macrocarrier. \(13 KB\)](#)

If fewer bombardments are needed, prepare enough microcarriers for 3 bombardments by reducing all volumes by one-half.

The operation of the device is as follows. The method is generally applied by following the instruction manual but some modifications were also made by the author. Regardless of the apparatus used the basic



principle of how to bombard the target is the same.

- (1) Turn on the vacuum pump and the power switch.
- (2) Set the helium regulator roughly at 200 psi above the selected rupture disk.
- (3) Load the rupture disk.
- (4) Load the stopping screen.
- (5) Load the microcarrier assembly.
- (6) Place the target cells or tissue.
- (7) Press the VAC switch.
- (8) When the vacuum gauge registers the desired vacuum level (above 27.5), put the VAC switch on the HOLD position.
- (9) Turn off the vacuum pump to prevent overheating.
- (10) Keep pressing the FIRE button until the rupture disk automatically bursts.
- (11) After the bombardment is completed, put the VAC switch on the VENT position.
- (12) Remove the sample.
- (13) Remove the microcarrier assembly. Stopping screen may be used a few more times.
- (14) Remove the rupture disk. If you continue the work, repeat the process from (3).
- (15) Clean the chamber with 70% ethanol.
- (16) Close the valve of helium tank.
- (17) Release the helium from the device.
- (18) Turn off the power switch.



[Continue to: Improvement of the method for more efficient gene transfer](#)



[Back to: Contents](#)



**Fig.5.** Platform vortex^{TX}

Tubes must be shaken on the platform vortexTM while adding microcarriers (tungsten or gold particles), DNA, and other solutions.



[BACK](#)



**Fig.6.**

Coating microcarriers (DNA-coated particles) over a macrocarrier

Six  $\mu\text{L}$  aliquots of microcarriers are being transferred to the center of the macrocarrier.

Once needs some practice to obtain uniform coating.



[BACK](#)

## **Improvement of the method for more efficient gene transfer**

In some research articles the authors stated that "Particle bombardment is an efficient method for delivery of DNA into plant cells. This method is especially beneficial for those plants which appear to be a poor host for *Agrobacterium*."5), "Particle bombardment offers a rapid method for delivery of DNA to plant cells for both transient gene expression and stable transformation studies."13), or "These advances have given us the opportunity to create, characterize and select plant cultivars which could not be obtained by traditional breeding methods."11).

Although such optimism is understandable and gives a reader hopes for the future, my experience in working towards genetic transformation using particle gun convinces me that we still have problems to overcome. Success requires more than occasional gene transfer into experimentally well-suited varieties of some species. It requires routine and efficient gene transfer into any desired variety of any species³⁴).

Some suggestions for improving transformation efficiency which are presented below are based on our accumulated experience and are still more empirical than scientific, in the author's laboratory.

### (1) Water:

Use autoclaved ultra pure water when preparing buffers and solutions.

### (2) Spermidine:

After adjusting the concentration to 0.1 M, pour the solution into 1.5 mL microcentrifuge tubes. Keep them in a deep freezer (- 80°C). At the start, when the solution is being used, keep the tube in an ordinary freezer (- 20°C) and finish using it within 2 weeks. Discard it even if some solution is left after 2 weeks.

### (3) Ethanol:

Use fresh ethanol. When using 70% ethanol, prepare it just before the experiment. Absolute ethanol is better than commercially available 99.5% ethanol. Molecular sieve(SIGMA, M-9882) is recommended to absorb water in ethanol.

### (4) Particle wash:

Remove the supernatant as much as possible. After the second wash with absolute ethanol, one more ethanol wash is recommended to remove the residues of spermidine and water. Once particles have been coated with DNA they should be used as soon as possible.

### (5) Centrifuge:

The particles must be gently pelleted. Lower speed is recommended (3,000-5,000 rpm for 1-2 sec is enough). Higher speed enhances particle agglomeration.

### (6) Plasmid DNA:

Plasmid DNA must be very pure. Do not use the sample containing RNA sometimes derived from miniprep extraction method.

### (7) Carrier DNA:

Do not use carrier DNA. Carrier DNA is often used in electroporation of protoplasts but carrier DNA is also absorbed by the particles.

(8) Microcarrier (particle) coating on the macrocarrier:

Uniform coating is very important. For more reproducible coating procedures one needs some practice to master the uniform coating method. DNA-coated macrocarrier should be used within 2 h.

(9) Osmoticum (Osmotic treatment):

Addition of an osmoticum (mannitol or sorbitol) to the bombardment medium increases the rates of transient and stable transformation 44). The author has observed that this holds true for some plant species, although the optimum concentration for each species varies. Increased osmoticum concentrations may enable to protect the cells from leakage and bursting, and may also improve particle penetration itself. The optimum osmotic concentration for tobacco BY-2 cell is approximately 0.4-0.5 M mannitol, however, the cells grow slowly.

(10) Routinize:

Operation of the particle gun device itself is easy. The method can be routinized once the researcher sets up the bombardment parameters.

(11) Bombardment of the sample in which there are no references about the bombardment parameters:

The following conditions are applied in the author's laboratory.

Microcarrier : 1.6  $\mu$  m gold particles.

Target position : 9 cm from the stopping screen to the target cells or tissues.

Helium gas pressure : 1,100 psi and 1,300 psi.

Bombardment time : 2 times per sample.

Promoter gene : Dicot ; 35 S,

Monocot ; 35 S, Adh, or rice actin.

Reporter gene : *Gus*.

If there are no blue spots, another method of gene transfer or construction of the new promoter suited to the sample is strongly recommended. If there are one or more blue spots, it is suggested that the experiment should be continued to identify optimum conditions.

## Conclusion

It is not necessary to rely on the particle bombardment method if *Agrobacterium* or a protoplast transformation system is available because the transformation frequency of particle bombardment is still low. The method is sometimes too labor-intensive and rather expensive to obtain large numbers of independently transformed plants.

The author considers that the protoplast transformation system is most appropriate. The advantage of isolated protoplasts is that they represent a true single cell system because each protoplast is completely separated from other cells and gene transfer can be performed by a relatively simple method without using specialized equipment like a particle gun. An electroporator device is easily constructed and is also commercially available. The PEG method does not require any special device.

Particle bombardment is certainly not a panacea. There are still major technical and scientific obstacles that need to be overcome in order to bring the technology to its full potential¹¹). However, in the past few years the author learned a great deal about how to make the process more effective. Some research

groups including ours are still trying to determine how to optimize the process with its diverse fields of application.

In the near future this method will become a tool for wider application of molecular and genetic approaches to crop improvement.



[Forward to : -Development of Automatic Fog Culture System for Year-Round Rice Production in Greenhouse-](#)



[Back to : Contents](#)



[Back to : JIRCAS home page](#)

# Development of Automatic Fog Culture System for Year-Round Rice Production in Greenhouse

Yuichi NAGAYA*1, Takeshi MATSUOKA*2, Takanori KOBAYASHI*2 and Tetsuro TANIYAMA*1

*1 Faculty of Bioresources, Mie University (Kamihama, Tsu, Mie, 514-8507 Japan)

*2 Matsuoka Sangyo K. K. (Nakamura, Nagoya, Aichi, 450-0003 Japan)

## Abstract

Though there are some drawbacks in the design of this rice culture system, the results showed that these can be alleviated. The culture system was set up in a glass greenhouse to avoid yield loss due to typhoon and heavy rain which led to an inadequate amount of solar radiation even during the summer. Inclining the seeding bed southwards at 30° did not enable to improve the light absorption. Some favorable aspects of this fog culture system, however, are worth considering. Subsoil water temperature particularly in winter became more manageable. Carbon dioxide concentration in a particular growth phase could be enhanced. Nutrients could be replenished in the most suitable growing period and with the most appropriate amount. The oxygen supply to the root system was provided adequately during atomization. With all these advantages, year-round production increased 3 times or more due to the absence of seasonal effect. This experiment also indicated that the apparent photosynthetic rate could be enhanced by increasing the amount of insolation and solar energy conversion. This should certainly exert a beneficial effect on the panicle number, ripening efficiency and grain-straw ratio or total grain yield in general. Lastly, our group aims at redesigning the set-up in order to increase the production. In Japan, we are focusing on a stable, high-yielding and automatic year-round rice production while aiming at the same time at preserving the environment by reducing the consumption of expendable energy. To some extent, this study provides a basis for the development of a technology for desert or arid areas and subfrigid zones to increase productivity.

**Discipline:** Crop production/Agricultural facilities

**Additional key words:** apparent photosynthetic rate, grain-straw ratio, root system, solar radiation 1-9): [Click here for References](#)

## Introduction

More than half of the 5.8 billion world population is eating rice as staple food. Though rice is usually produced in the tropical zone, Japan has been cultivating rice which is genetically resistant to cold temperature. Moreover, through recent varietal improvement studies, high-yielding cultivars with good quality have been developed. Nowadays, among the rice-producing countries, Japan is considered to be the world's northernmost area.

With the progress in farming technology and varietal improvement, Japanese rice can now withstand cold weather injury^{2,4}). The cold summer in 1993 caused the greatest postwar rice shortage in Japan which led to emergency rice importation. Another factor which is a cause for concern regarding the future supply of rice, the staple food in Japan, is the ageing population of rice farmers with no successors

to continue rice farming. Recently, for rice culture as well as for the production of other crops, heavy input of chemicals and other practices causing environmental pollution have become a global problem^{5,6}).

The objective of this study was to develop a rice culture system that would: 1) minimize yield losses due to natural disasters, 2) reduce environmental pollution, and 3) lead to sustainable year-round production.

This paper reports partial results obtained during several years of research on the development of an automatic fog culture system for rice production.

## **Automatic fog culture system set-up**

A system similar to that shown in [Fig. 1](#) was set up in a glass greenhouse. The cultivation area was 172 cm long and 235 cm wide. To obtain satisfactory sunlight penetration within the rice population and during the winter season, seeding beds were inclined southwards at 30°. A vinyl chloride culture room was constructed inside the glass greenhouse. Room temperature was controlled by an air-conditioner to maintain the most suitable temperature for paddy production. A small scale fan was set up over the paddy so that the leaves would sway constantly to a certain degree. This ventilation helped to secure a satisfactory CO₂ diffusion and a high canopy photosynthetic rate. It was reported that under lowland field conditions, root respiratory activity decreases as the paddy develops and reaches the reproductive phase, causing a remarkable decrease in yield, mainly due to an inadequate oxygen supply in the rhizosphere³. The special characteristic of our rice fog culture set-up is that the root system is aerated. The nutrient solution is atomized intermittently such that the O₂ supply is satisfactory and root growth is optimum. Plant growth decline due to root rot can be avoided using this culture system.

### [Fig.1: Automatic fog culture system \(34 KB\)](#)

The composition of the basic nutrient solution (Kasugai A) is shown in [Table 1](#). The concentration of the solution was renewed weekly to compensate the plant nutrient uptake. The nutrient solution temperature, pH and EC were monitored regularly. The pH was adjusted automatically with a NaOH solution using a peristaltic pump to pH 5.0-5.5 which is the optimum pH for rice. The temperature was maintained at 25°C. After noting the difference between the daytime and nighttime temperature, the atomization time was set to be longer during the daytime. During winter the root space and seedbed temperature were kept at 25°C but in the summer planting season the temperature was not regulated.

### [Table 1. Kasugai A solution used in this experiment](#)



(NH ₄ ) ₂ SO ₄ .....	188.7 (Unit: mg/L)
Na ₂ HPO ₄ .....	40.0
CaCl ₂ .....	7.9
Fe-EDTA.....	27.4
MnCl ₂ .....	0.75
KCl.....	47.5
SiO ₂ .....	137.3
N.....	40
P ₂ O ₅ .....	20
CaO.....	4
MgO.....	6
K ₂ O.....	30

Foam styrol beads 5.8 mm in diameter were glued onto the bedding material (STIRODOREN, Mitsubishi Chemical BASF Co. Ltd.). With this seeding block, sufficient space is provided between beads so that root elongation becomes easier. Seeding holes were bored as shown in [Fig. 2](#). The orientation of the seed to the seeding box and the space for tillers are illustrated in [Fig. 3](#). The sown seeds were covered with sand up to a thickness of 1 cm to prevent the emerging seeds from moving upwards due to the pressure from the elongating roots. In fact, the permeability of STIRODOREN was quite adequate for the rooting of the rice plant ([Fig. 4](#)). Since rice shows intrinsically a high tillering potential, the sowing holes were oriented transversally to prevent lodging. After heading, when the translocation of photosynthates to the paddy starts, the ear weight becomes heavier and the culm's bending momentum also increases. In the present planting system, however, lodging was not observed because the culm was confined within the walls of the rectangular seeding hole. Moreover, with this bedding material, hill to hill distance and interrow spacing could be manipulated in response to the growth stage such that an optimum leaf area index could be obtained.

[Fig.2: Seeding block and seeding hole \(16 KB\)](#)

[Fig.3: Outline of seeding method \(20 KB\)](#)

[Fig.4: Seeding block, STIRODOREN and rooting of rice \(33 KB\)](#)

In the tropics, the major activity in rice culture is the transplanting of seedlings in the field. In the current system, seeds are sown directly and cultural management is possible from sowing to harvest. Since the seedlings do not undergo transplanting injury, the growing period is shorter⁹). The main advantage of hydroponics is that fertilizer management is considerably easier and can be adjusted depending on the growth stage such that the plant intrinsic photosynthetic capacity can be enhanced.

Furthermore, by using fluorescent lamps and a timer, photoperiodism can be regulated and the plant growth phase modified. The potential of an automatic year-round production scheme is the most remarkable advantage of the current planting system over field cultivation. [Fig. 5](#) illustrates the seeding bed after sowing (vinyl chloride sheets removed). The nutrient solution is sprayed on both top and root sections. This spraying also supplies the water required by the emerging seeds or seedlings. As the seedlings grow, only the underground area is atomized. The time of spraying depends on the elongation of the roots such that nutrient absorption is sufficient for plant growth.

[Fig.5: Seeding bed \(18 KB\)](#)

## Materials and methods

Early season variety (*Oryza sativa* L. cv. Koshihikari) and standard season variety (*O. sativa* L. cv. Harebare) were used in this fog culture experiment. After seed treatment to hasten germination, both varieties were sown at a row spacing of 17 cm and hill distance of 12 cm and 14 cm on March 7, 1992. Ordinary tap water was used for the first 6 days before replenishing with the basic nutrient solution (Kasugai A) at gradually increasing concentrations of 0.25, 12.5, 25, 50 to 100%. [Fig. 6](#) clearly shows the relative concentration of the Kasugai A solution in relation to the plant age.

[*Fig.6: Relative concentrations of Kasugai A solution used in fog culture system \(20 KB\)*](#)

Between March 12 - June 1, illumination was provided by fluorescent lamps for 4 h from 6 pm - 10 pm to simulate a long-day environment. Heading was observed on July 10 for Koshihikari, while Harebare headed 8 days later. Apparent photosynthetic rate was measured before heading (July 2). Leaf age, plant length, tiller number, internode length, root length, grain yield and yield components were determined at the harvest stage on August 24, 1992.



[Continue to: Results and discussion](#)



[Back to: Contents](#)

## References

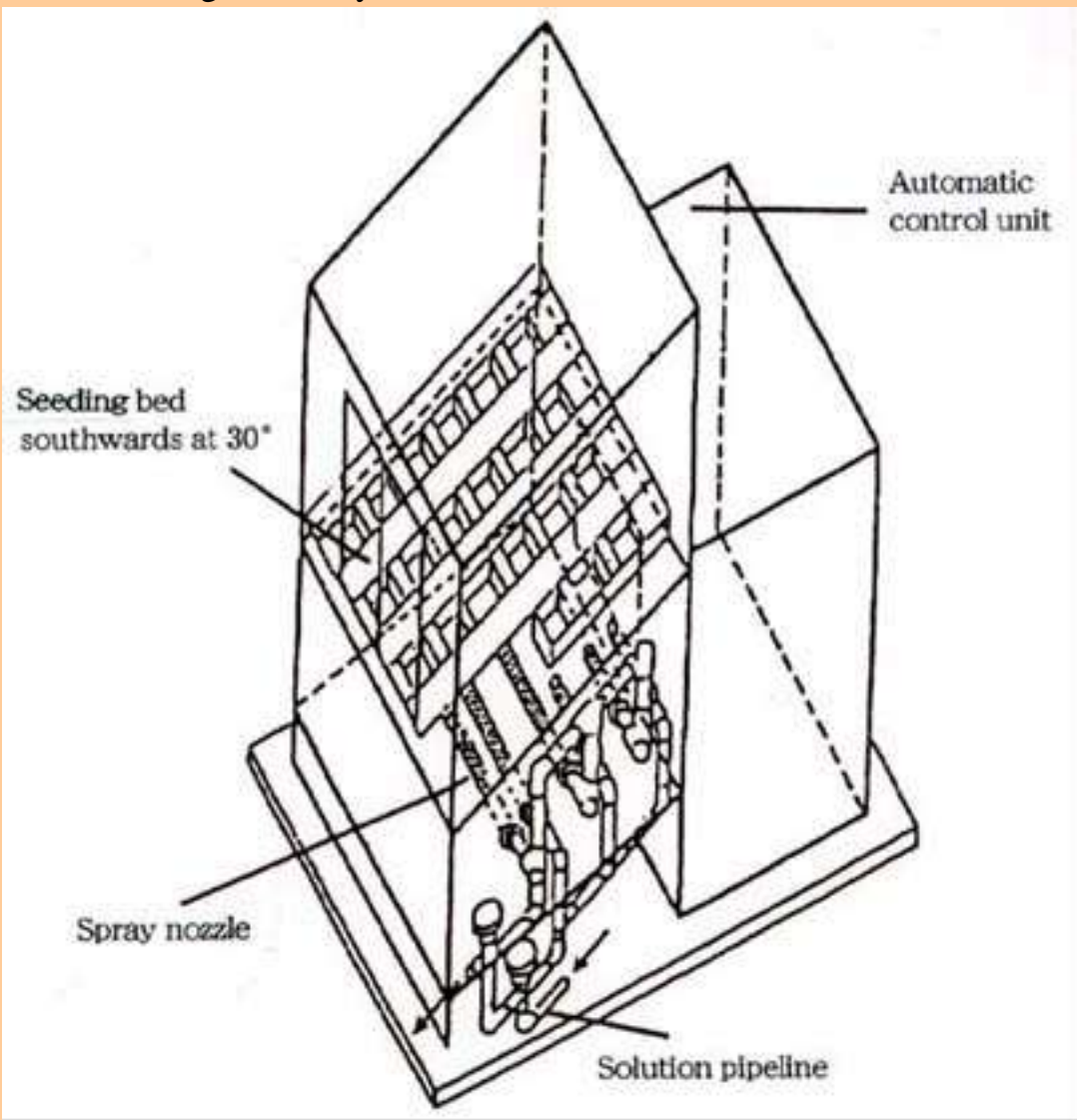


[Back to the first page](#)

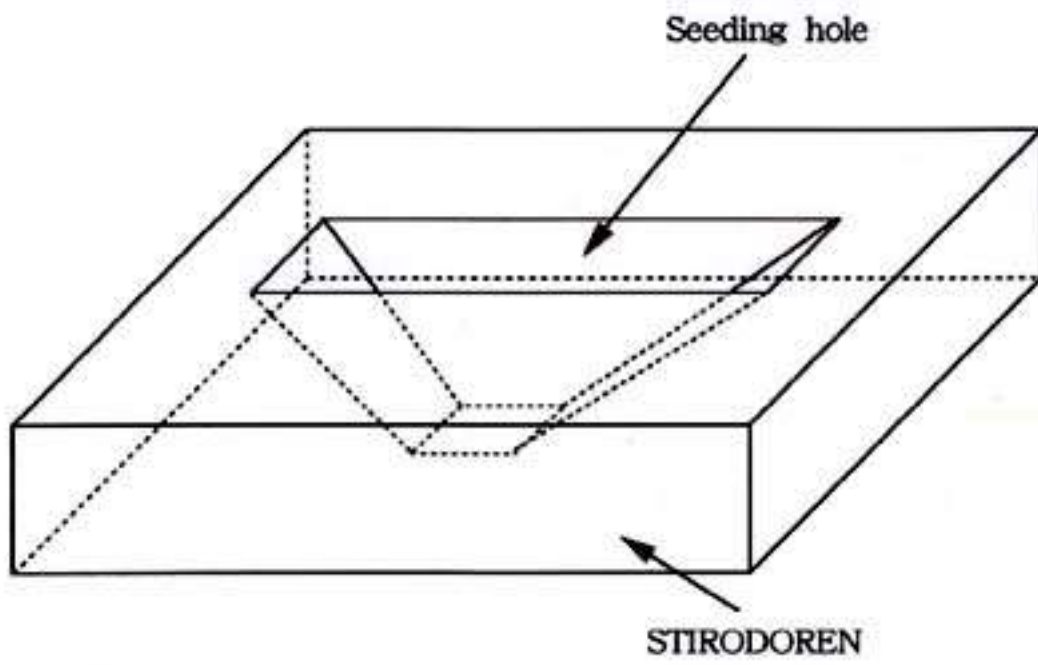
- 1) Hirose, T. (1990): Development and growth of vegetable crop. Vegetable crop science. Kawashimashoten, Tokyo, 89 [In Japanese].
- 2) Hoshikawa, K. (1980): Alimentary crop science. Yokendo, Tokyo, 22-27 [In Japanese].
- 3) Ishihara, K. (1993): Soil environment. *In Science of the rice plant. Vol. 2. Physiology.* Food and Agriculture Policy Research Center, Tokyo, 630-635.
- 4) Kawada, S. (1976): Japanese crop culture. Yokendo, Tokyo, 2-219 [In Japanese].
- 5) Matsuoka, Y., Ito, S. & Watanabe, H. (1985): Environmental conservation. *Jpn. J. Soil Sci. Plant Nutr.* 56 (6), 571-581 [In Japanese].
- 6) Ozaki, Y. (1990): Issues in future and measures on water conservation in agricultural production. *J. Water & Waste*, 32 (2), 3-13 [In Japanese].
- 7) Tange, M. (1996): Environment. *In Crop science.* Asakurashoten, Tokyo, 140 [In Japanese].
- 8) Taniyama, T. (1991): Outline on the global environment conservation. Tokyo Univ. Press, 40 [In Japanese].
- 9) Yamamoto, Y., Maeda, K. & Hayashi, K. (1978): Studies on transplanting injury in rice plant. 1. The effects of root cutting treatments on the early growth of rice seedlings after transplanting. *Jpn. J. Crop Sci.*, 47 (1), 31-38 [In Japanese with English summary].

(Received for publication, December 19, 1997)

**Fig. 1.**  
Automatic fog culture system

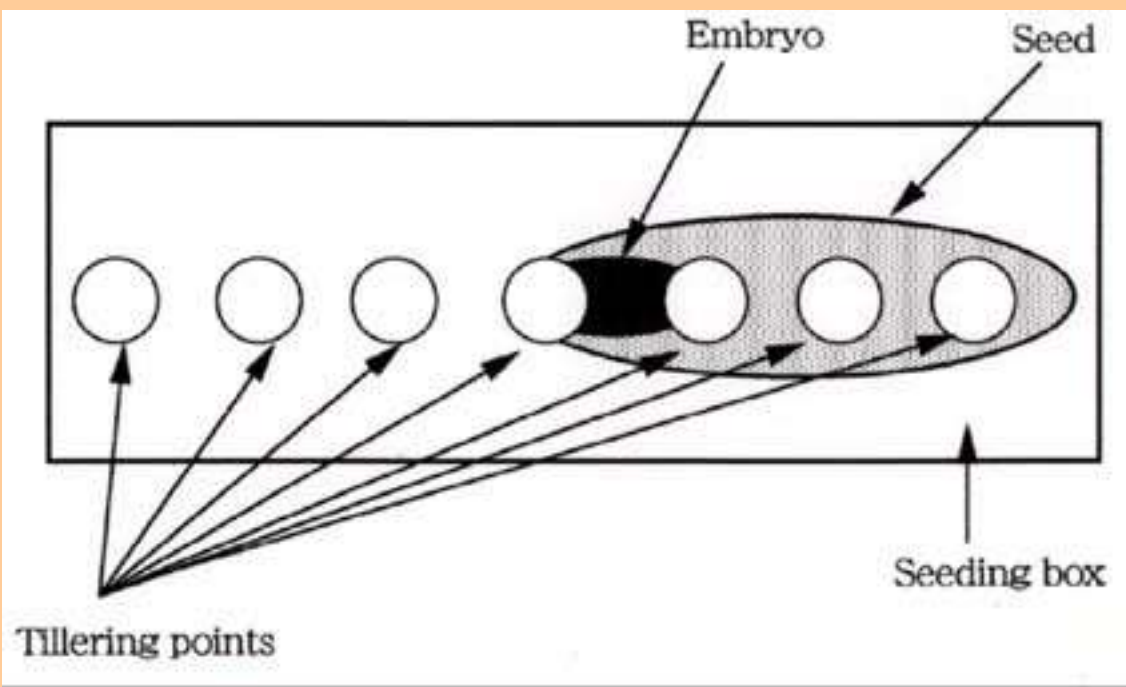


 [BACK](#)



**Fig. 2.**  
Seeding block and seeding hole

 [BACK](#)



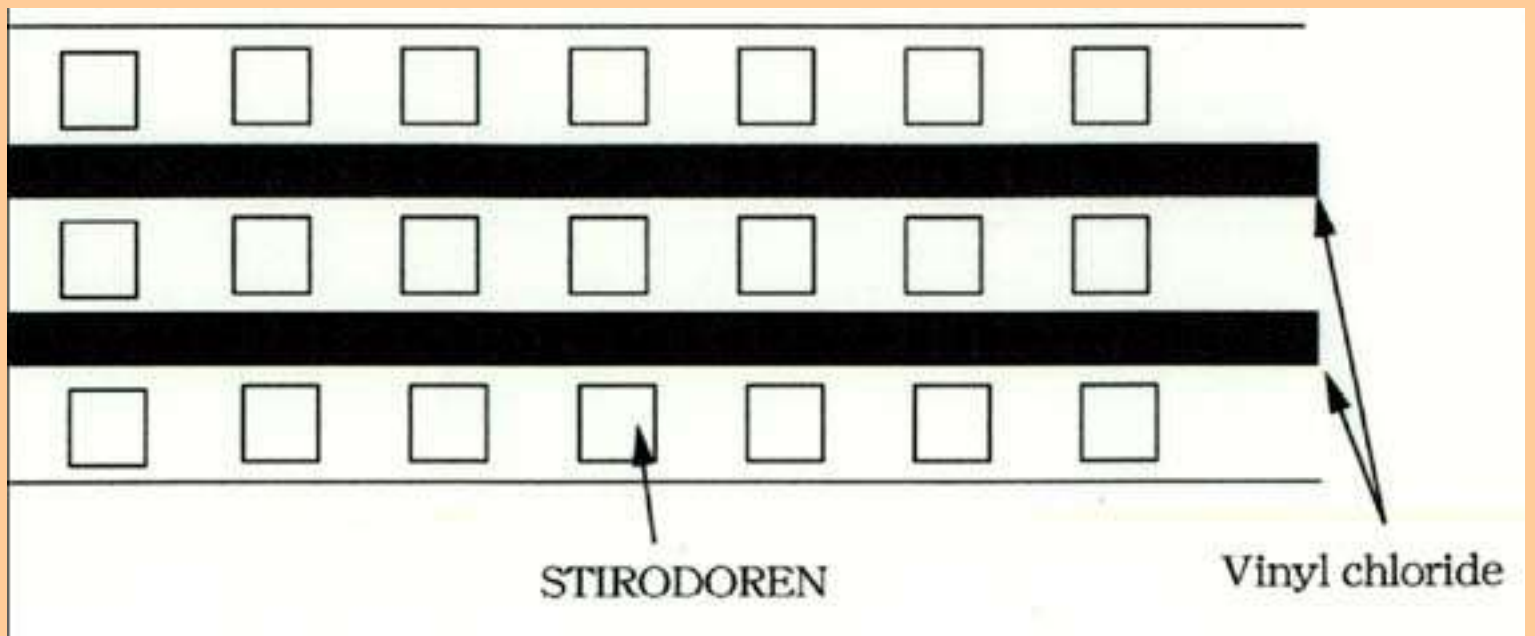
**Fig. 3.**  
Outline of seeding method

 [BACK](#)

**Fig. 4.**  
Seeding block, STIRODOREN and rooting of rice



[BACK](#)



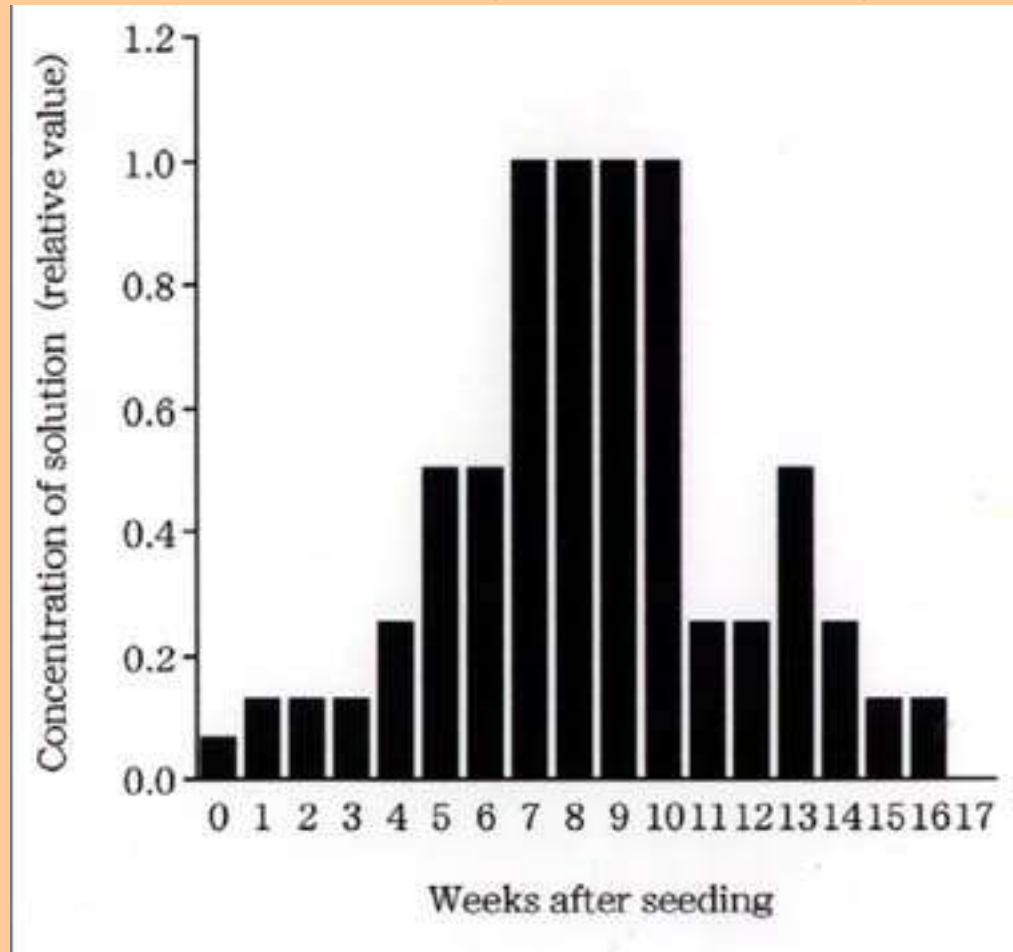
**Fig.5.**  
Seeding bed

 [BACK](#)



**Fig.6.**

Relative concentrations of Kasugai A solution used in fog culture system



[BACK](#)

## Results and discussion

The fluctuations in the maximum, minimum and mean temperatures during the growing period are shown in [Fig. 7](#). The daily maximum temperature exceeded 40°C several times. Moreover, in the second half of the growing period, particularly during the ripening stage, a relatively high temperature was observed. The high temperature after the rainy season affected ripening. Even the daily mean temperature tended to affect the plant growth during the later stage. Tange (1973) reported that for rice growth the optimum temperature is in the range of 30-32°C. Since the present rice culture system was set up inside a glass greenhouse, the temperature build-up was higher than the ambient temperature in the field. The comparatively high temperature was also compounded by the low cooling-off efficiency of the set-up. These observations suggest that the fog culture system could be improved by avoiding the set-up inside a glass or greenhouse with a low cooling efficiency.

[Fig.7: Changes in air temperature during the experiment \(32 KB\)](#)

The concentration of the nutrient solution was adjusted based on the leaf color and growth conditions. Regarding the nutrient balance, a nearly normal transition was observed from the maximum tillering stage to the grain maturation stage. The growing tillers during the active tillering stage are shown in [Fig. 8](#). The changes in the leaf age for both varieties are depicted in [Fig. 9](#). The turning point of the leaf-emergence rate corresponded to the 8th leaf stage. After the 8th leaf had emerged, the leaf-emergence rate was one leaf higher in the Harebare variety. This pattern continued until harvest. Nevertheless, based on the leaf age the growth was considered to be normal. In [Fig. 10](#) the changes in plant length are compared. Harebare grew up to 100 cm while Koshihikari reached 120 cm. Elongated growth was observed in the Koshihikari variety which did not affect significantly the final yield. [Fig. 11](#) shows the changes in the tillering pattern. The Harebare variety continued to develop more tillers during the most active tillering stage. Tiller number was high, as much as 12 tillers per hill which also resulted in a large number of non-productive tillers. On the other hand, non-productive tillers were not observed in the Koshihikari variety. This difference clearly indicates that the tillering potential is a varietal characteristic. In this experiment, the planting density was higher than under the usual paddy field conditions. Based on the response of Koshihikari to dense planting, this variety could be considered to belong to the erect plant type. The changes in the maximum root length are shown in [Fig. 12](#). Both varieties responded similarly and no remarkable differences were observed.

[Fig.8: Active tillering stage of rice \(31 KB\)](#)

[Fig.9: Changes in leaf age during the experiment \(15 KB\)](#)

[Fig.10: Changes in plant length \(12 KB\)](#)

[Fig.11: Changes in the number of tillers \(14 KB\)](#)

[Fig.12: Changes in maximum root length \(14 KB\)](#)

In [Fig. 13](#), the apparent photosynthetic rate of the top 4 leaves was compared at light saturation. The top, most actively developing leaf was designated as Leaf 1 and Leaf 2 was the leaf just below Leaf 1, etc. Data were gathered on a clear, fine day just before heading. The apparent photosynthetic rate in each leaf was highest in Leaf 1 but the rate decreased with the decrease of the leaf position. In Koshihikari the rate of decline was more remarkable. Leaves 2-4 in Harebare tended to display a higher rate than leaves in the same position in Koshihikari. The level of the photosynthetic rate in either variety, however, was only 1/3 of the rate in the rice plants grown under normal field conditions. During the measurement, leaf sampling units were maintained in the vertical position and the leaf surface received sunlight directly. At a normal light intensity, data were not considerably low. The low photosynthetic rate was mainly due to the reduced penetration of sunlight because the system was set up inside a glass greenhouse. The glass wall acted as a twofold screen and decreased the sunlight intensity by as much as threefold. Though some plants show a low light compensation point, lettuce, honewort and other vegetables for instance can yield optimally even at 20,000 lux¹) while rice requires at least 50,000 lux⁸).

**[Fig.13: Comparison of photosynthetic rate among leaf positions from top \(19 KB\)](#)**

The top and root system at harvest are shown in **[Figs. 14 and 15](#)**, respectively. After harvesting, internode length and yield components were determined. To reduce the experimental error, data obtained from hills with good growth and poor growth were segregated. **[Fig. 16](#)** shows the length of the internode from the top. In both varieties, the topmost internode was the longest while there was an abrupt decline in the second internode. The relative decrease between internodes 2, 3, 4, and 5 was gradual. In Koshihikari, regardless of the internode position, the growth stand did not affect the internode length. In Harebare, however, the length of internodes 1 and 2 from hills with poor growth was considerably shorter, presumably due to mutual shading which led to a large number of non-productive tillers in the Harebare variety. The decline in the over-all apparent photosynthesis was due to the low light transmittance caused by dense tillering and short internodes.

**[Fig.14: Panicles at harvest stage](#)**

**[Fig.15: Root system at harvest stage \(47 KB\)](#)**

**[Fig.16: Comparison of length of internode from top \(19 KB\)](#)**

The grain yield and yield components are listed in **[Table 2](#)**. Sampling was performed in 5 hills with 4 replications. In both varieties, the number of panicles per hill and 1,000 grain weight from rice hills with good growth were generally satisfactory. However, the number of panicles per hill and the percentage of ripened grains were very low. These 2 parameters contributed to the low grain yield. The maximum yield of Koshihikari was 808 kg/10 a and Harebare produced only half of this. The major difference may be attributed to the inefficient ripening in Harebare. Grain yield from hills with poor growth was even much lower mainly due to the small number of panicles and was aggravated by the large number of unfilled grains. One obvious reason for the low maximum yield was the light competition caused by dense planting. The plant density in the paddy field using a transplanting machine is usually 23 hills/m². In this experiment, at a hill distance of 12 cm the rice population was 49 hills/m². A distance of 17 cm then results in a population of 42 hills/m² or almost twice the normal paddy field population. The wide variation in the actual grain weight implies that some hills were dominant and were more efficient in tapping solar energy. Hills with few panicles were undoubtedly poor hills. In this experiment, if the hill distance had exceeded 17 cm (sparse planting density), it is probable that the yield would have been higher because the light competition effect would have been minimal.

**[Table 2. Comparison of yield components among hills](#)**

	<u><a href="#">Number of panicles per hill</a></u>	<u><a href="#">Number of spikelets per panicle</a></u>	<u><a href="#">Percentage of ripened grains</a></u>	<u><a href="#">1,000 grain weight (g)</a></u>	<u><a href="#">Grain-straw ratio</a></u>	<u><a href="#">Yield (kg/10 a)</a></u>
Koshihikari (1) ^{a)}	21.6	60.2	69.7	21.2	0.37	808
Koshihikari (2) ^{b)}	6.8	58.0	48.6	18.9	0.19	108
Harebare (1) ^{a)}	25.0	62.7	32.9	19.8	0.15	463
Harebare (2) ^{b)}	6.4	28.3	17.2	18.2	0.047	23

a): (1); Hill with good growth, b) : (2); Hill with poor growth.

Furthermore, comparison of the grain yield with the straw yield showed that the ratio was very low, suggesting that the plants did not receive enough insolation to sustain the ripening process. In general, low yield was expected because of the low light energy absorption. Our set-up, however, indicated that even when the solar radiation was low, rice production in a fog culture system was possible because the nutrients could be supplied when the plant required them most.



[Forward to: -Study on Grade Judgment of Fruit Vegetables Using Machine Vision-](#)

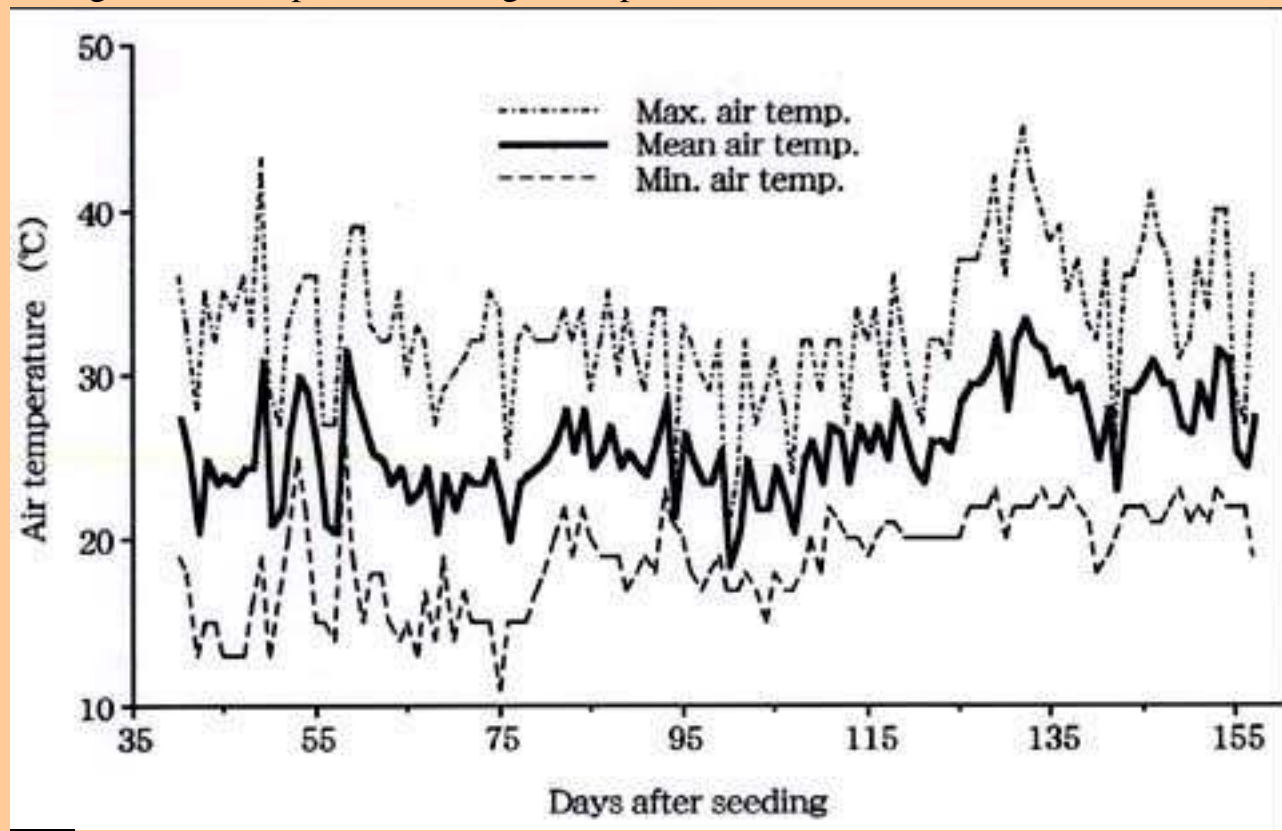


[Back to: Contents](#)



[Back to: JIRCAS home page](#)

**Fig.7.**  
Changes in air temperature during the experiment

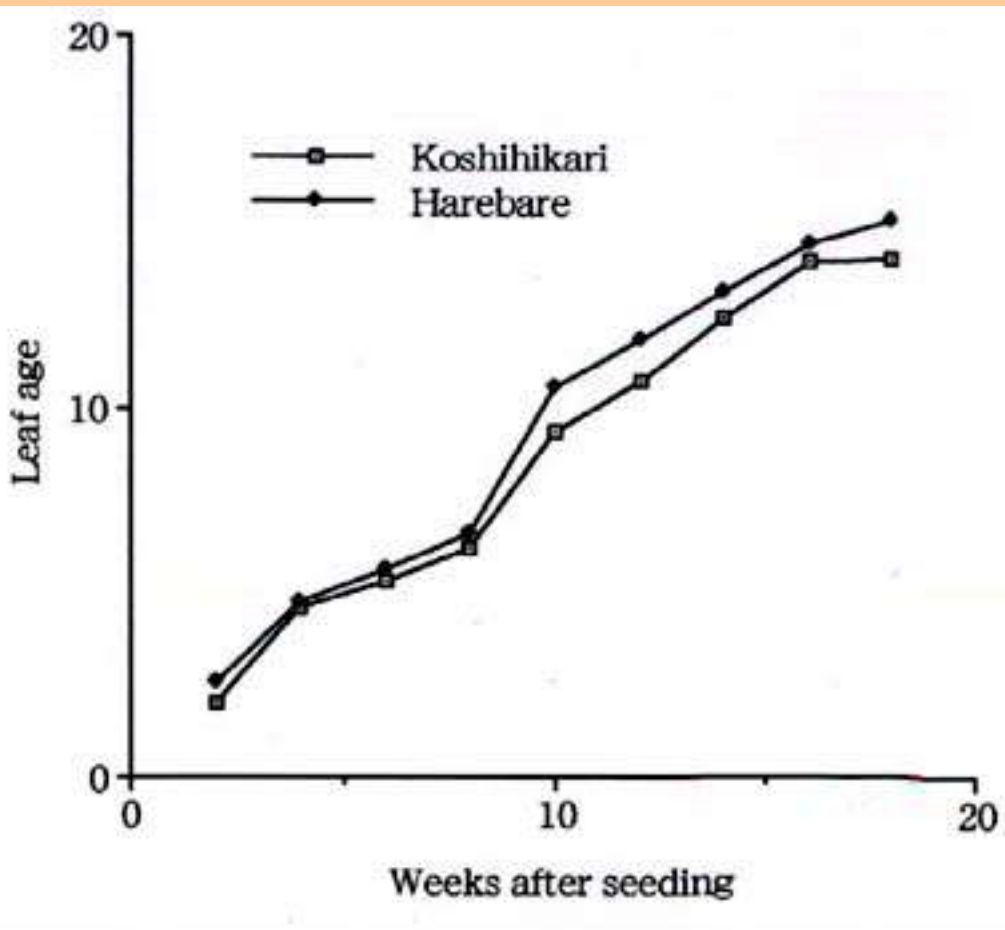


 [BACK](#)

**Fig.8.**  
Active tillering stage of rice

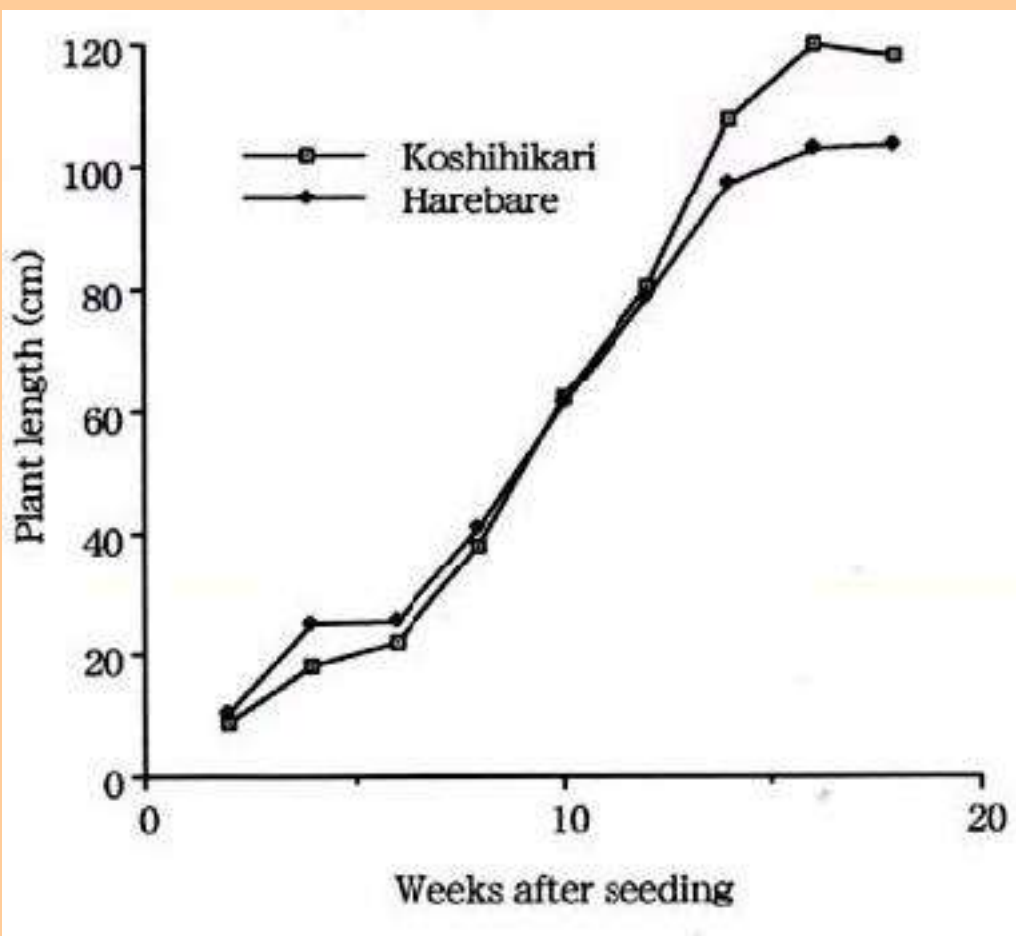


[BACK](#)



**Fig.9.**  
Changes in leaf age during ht experiment

 [BACK](#)

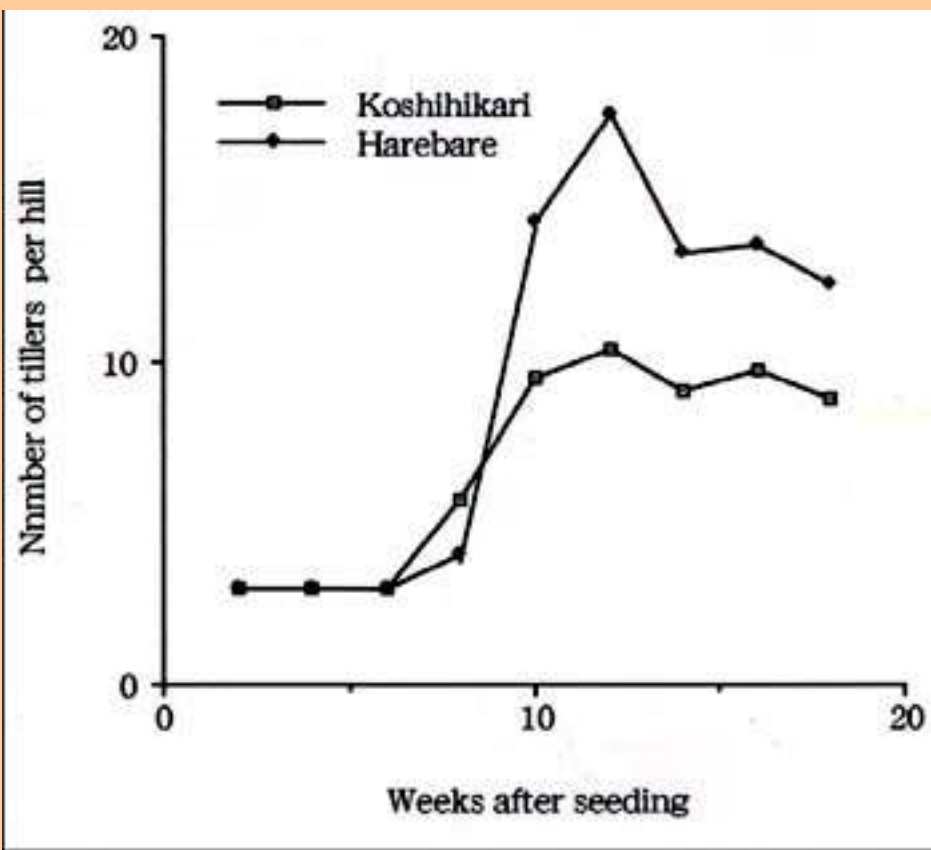


**Fig.10.**  
Changes in plant length



[BACK](#)

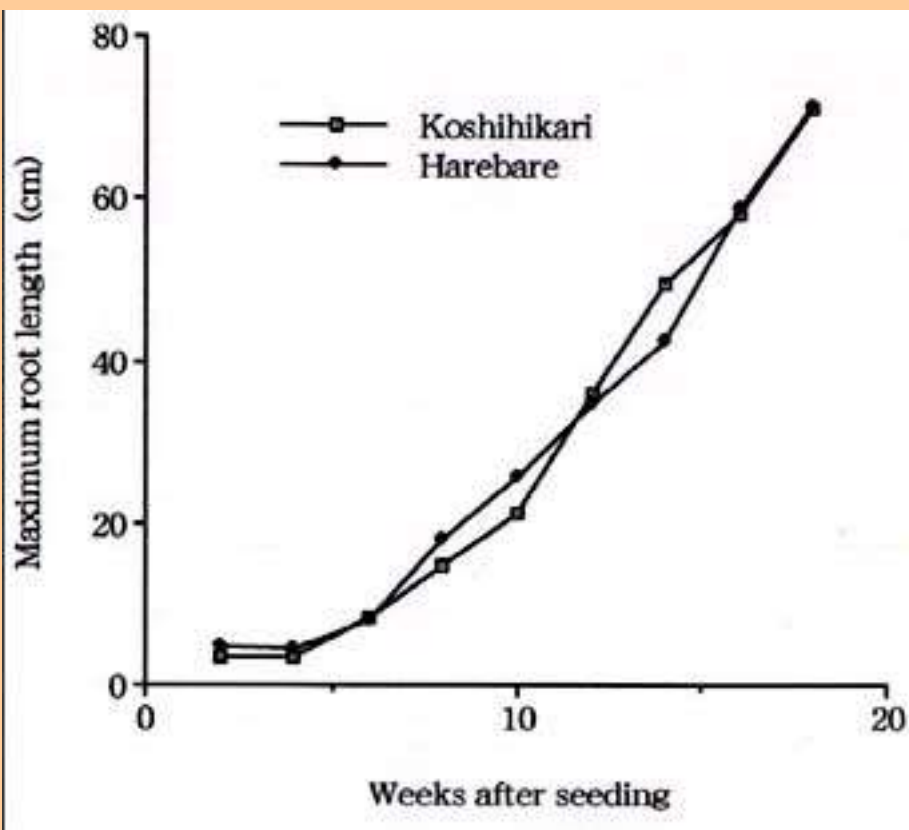




**Fig.11.**  
Changes in the number of tillers



[BACK](#)

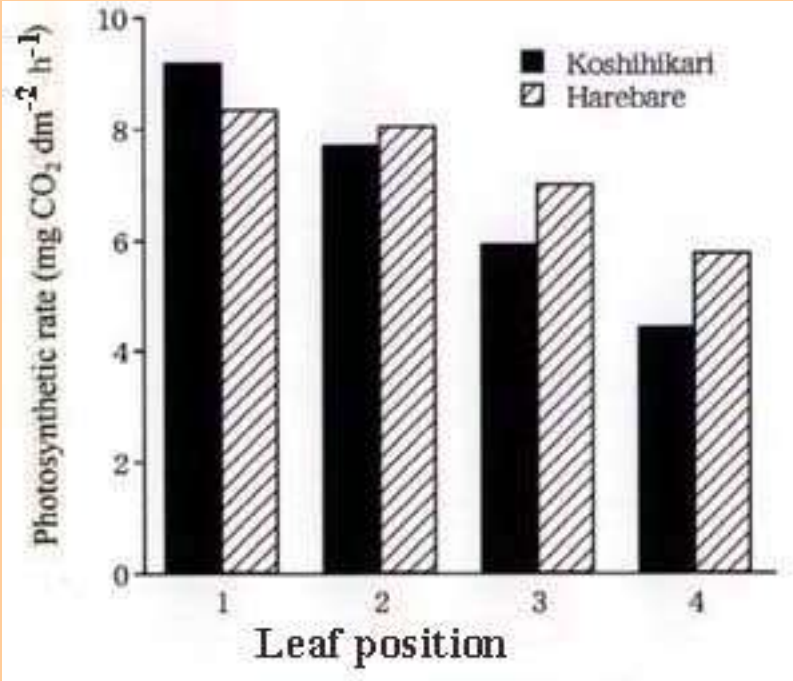


**Fig.12.**  
Changes in maximum root length



[BACK](#)

**Fig.13.**  
Comparison of photosynthetic rate among  
leaf positions from top



 [BACK](#)



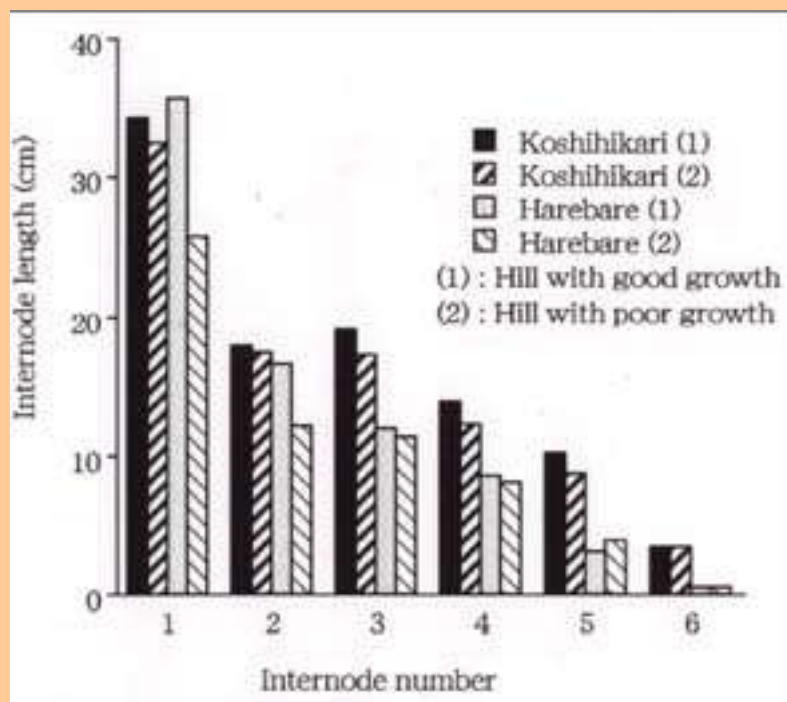
**Fig.14.**  
Panicles at harvest stage



[BACK](#)



**Fig.15.**  
Root system at harvest stage



**Fig.16.**  
Comparison of length of internode from top

 [BACK](#)

# Study on Grade Judgment of Fruit Vegetables Using Machine Vision

Masateru NAGATA*¹ and Qixin CAO*²

*¹Faculty of Agriculture, Miyazaki University (1-1 Gakuen Kibanadai Nishi, Miyazaki, 889-2192 Japan)

*²Research Institute of Robotics, Shanghai Jiao Tong University (1954 Hua Shan Road, Shanghai, 200030 China)

## Abstract

Grade judgment is an essential component of a vegetable and fruit sorting system. Judgment of capability should be integrated with the collection of raw data from an object, and classification of algorithm of processed data. Machine vision is a useful tool for collecting raw data and for classification. Recently, machine vision applications for sorting and inspecting some fruit vegetables have been studied by many scientists^{4-7, 10, 12-16}). However, the traditional image recognition and image understanding methods cannot evaluate satisfactorily irregularly shaped fruit vegetables. Thus, in this article a new feature extraction procedure and neural network were applied to the machine vision system to precisely evaluate fruit vegetables. As the newly developed machine vision system has a learning capability, it can evaluate more than one variety of fruit vegetables. The results obtained for 4 kinds of strawberry varieties and 1 variety of green pepper showed a high accuracy, confirming that the system has a great potential for grade judgment^{3, 9}).

**Discipline:** Agricultural machinery

**Additional key words:** image processing, feature extraction, strawberry, green pepper  
1-16):[Click here for references](#)

## Introduction

In Japan, to upgrade the commodity value, fruit vegetables are generally sorted into grades based on shape, damage and color and into grades based on size or weight before marketing. For most of the fruit vegetables, grade sorting according to size or weight has already been mechanized. However, grade sorting based on shape, internal quality, etc., such as in the case of orange, apple, and cucumber, is still in the initial stage and in most cases performed manually. Along with the unprecedented severe shortage of farm labor, the rapid ageing of Japan's experienced growers and producers with few potential successors pose a difficult problem to the industry. Therefore, to eliminate the errors of judgment of producer and inspector, to meet the consumers' demand for strict standardization and to be able to market fruit vegetables uniformly, it is essential to improve the sorting methods.

At present, because of the advances in electronic technology, machine vision can be applied to research on the development of an automatic sorter. Machine vision enables to handle a large amount of raw data and perform remote judgment. It is used extensively in fruit vegetables sorters. On the other hand, there are conventional image recognition methods such as matching, statistical method and logical method of computation. However, they are not suitable for determining the shape of fruit vegetables because of the complexity and ambiguity involved.

This paper describes a general-purpose grade judgment system with high performance rate and capability of evaluating more than one kind of fruit vegetables using image processing technology and multiple-valued neural network theory^{1, 2, 8, 11}). One of the unique characteristics of this system is that it enables to evaluate fruit vegetables according to their standard patterns, which are learned by the software before the actual judging operation is performed. The system also enables to evaluate different kinds of fruit vegetables by learning their corresponding extracted shape characteristics.

## Concept of sorting fruit vegetables

### *1) Shape features of fruit vegetables and representation*

The fruit vegetables are biological products. Although vegetables or fruits may be cultivated in the same way, their shape, size, color and other characteristics are different. Moreover, one vegetable or fruit may consist of many varieties, which requires that sorting standardization for each kind be performed. Using machine vision to evaluate the shape of fruit vegetables, expression and extraction of shape features become an important element because compared with an industrial product, the shape standard of vegetables or fruits does not follow quantitative rules. In this article a set of shape features, which are expressed as thickness, length and curve is proposed, and a method of extraction of characteristic patterns from an object of standard shape is described.

### *2) Sorting of fruit vegetables*

After harvest, sorting of many fruit vegetables is still carried out manually. Inspection standard table classified those that have a good shape and color into grade A, while those with inferior characteristics were graded B. The strawberry inspection standard was set up by the Agricultural Cooperative Association in Miyazaki Prefecture, Japan. Accordingly, there are 3 grades based on shape, namely: A, B and C, and 5 grades based on the size: 3L, 2L, L, M, and S as shown in [Fig. 1](#).

[Fig.1: Standard table for strawberry sorting in Miyazaki Prefecture \(38 KB\)](#)

It is important that a machine vision judging system has learning and fuzzy process functions. Such a system enables to overcome the weakness of traditional type systems. Therefore, the researchers have developed an advanced judging system using machine vision, involving image processing, shape feature extraction, neural network and computer technologies. The system can grade various fruit vegetables according to their shape using the learned standard pattern.



[Continue to: Materials and methods](#)



[Back to: Contents](#)

## References



[Back to the first page](#)

- 1) Cao, Q. et al. (1993): Algorithm and implementation of a learning multiple-valued logic network. *In* The 23rd international symposium on multiple-valued logic, IEEE, 202-207.
- 2) Cao, Q., Nagata, M. & Kinoshita, O. (1995): Analysis of image recognition by multiple-valued neural network for automatic strawberry sorting system. *In* Proceedings of international agricultural mechanization conference, 42-47.
- 3) Cao, Q. & Nagata, M. (1997): Study on grade judgement of fruit vegetables using machine vision (Part 3). *J. Soc. High Technol. Agric. Jpn.*, 9 (1), 49-59.
- 4) Elster, R. T. & Goodrum, J. W. (1991): Detection of cracks in eggs using machine vision. *Trans. ASAE*, 34 (1), 307-312.
- 5) Maeda, H., Mizuno, T. & Kouno, Y. (1993): Current trends in the development of fruit sorters in Japan. *In* Proceedings of international conference for agricultural machinery & proceeds engineering, 1302-1311.
- 6) Miller, B. K. & Delwiche, M. J. (1991): Peach defect detection with machine vision. *Trans. ASAE*, 34 (6), 2588-2597.
- 7) Nagata, M. et al. (1994): Sorting system of strawberry by using computer and robot. *Proc. 1st Asian Control Conf.*, 2 (3), 13-16.
- 8) Nagata, M. et al. (1995): Application of the multiple-valued neural network for judgement of strawberry's size and shape. *Int. Symp. Automation & Robotics in Bioproduction & Processing, Kobe, Jpn.*, 3, 41-48.
- 9) Nagata, M. et al. (1996): Study on grade judgement of fruit vegetables using machine vision (Parts 1&2). *J. Soc. High Technol. Agric. Jpn.*, 8 (4), 219-236.
- 10) Suh, S. R. & Sung, J. H. (1996): Detection and classification of defects on apple using machine vision. *In* Proceedings of international conference on agricultural machinery engineering, Seoul, Korea, 852-862.
- 11) Tang, Z. et al. (1993): Algebraic properties of a learning multiple-valued logic network. *In* The 23rd international symposium on multiple-valued logic, IEEE, 198-201.
- 12) Tao, Y. et al. (1995): Fourier-based separation technique for shape grading of potatoes using machine vision. *Trans. ASAE*, 38 (3), 949-957.



- 13) Tao, Y. et al. (1995): Machine vision for color inspection of potatoes and apples. *Trans. ASAE*, 38 (5), 1555-1561.
- 14) Woebbecke, D. M. et al. (1995): Color indices for weed identification under various soil, residue, and lighting conditions. *Trans. ASAE*, 38 (1), 259-269.
- 15) Woebbecke, D. M. et al. (1995): Shape features for identifying young weeds using image analysis. *Trans. ASAE*, 38 (1), 271-281.
- 16) Zhang, N. & Chaisattapagon, C. (1995): Effective criteria for weed identification in wheat fields using machine vision. *Trans. ASAE*, 38 (3), 965-974.

(Received for publication, December 25, 1997)

Head	Reiko					Toyonoka				
Standard color state										
Grade by sorting	A					Grade A with bright red color		Grade A with pale red color		
	B					Grade A with bright red color		Grade A with pale red color		
	C					Substandard fruits				
Packet model filling up with 200g strawberries	3L		2L	L	M		S			
	8 + 9		12	15	8 + 14		20 + 18			

**Fig.1.**  
Standard table for strawberry sorting in Miyazaki Prefecture

 [BACK](#)

## Materials and methods

### 1) Strawberry and green pepper

Four kinds of strawberry varieties, namely 'Reiko', 'Toyonoka', 'Nyoho' and 'Akihime', and one green pepper variety 'Sadowarahikari super' were used in the experiment.

The characteristics of each variety are as follows:

Reiko variety has a large fruit with a circular conical shape and a strong pericarp. The flesh has an excellent taste. It is fragrant and has high sugar and acid contents. Generally, the fruits with deformed shape account for about 4 to 5%, while those with a good shape account for 80%.

Toyonoka variety has a large fruit with a short circular conical shape. The color of the pericarp, which develops more slowly when shaded by other plant parts from sunlight, is cherry-like. The pulp density is high. As the flesh is not porous, the juice content is high.

Nyoho variety shows a circular conical shape and the top is not sharp. The occurrence of an odd shape is low. Its shape resembles that of Reiko because it was produced by cross-fertilization with the Reiko variety. The size of the fruit is medium. Pericarp and pulp are cherry-like in color and hard, and the flesh is not porous. The sugar and acid contents are high and the taste is good.

Akihime fruit is large with a long circular conical shape. The occurrence of an odd shape is very low. The pericarp is lustrous and cherry-like in color.

Sadowarahikari super is well suited to greenhouse cultivation. This variety of pepper has a medium size with a dark green color. Under low temperature and daylight conditions, the flesh is thick and of high quality which makes it highly marketable.

### 2) Proposed method for shape feature extraction

Reading and writing of image dot data require a long processing time. By decreasing the frequency of readings, length of processing can be reduced. This paper describes a new shape feature extraction method for easy calculation and faster operation.

The 3 parameters, i.e. thickness, length and bend are illustrated in [Fig. 2](#). After preprocessing of the fruit image into a binary form using the image processing technique, 5 horizontal widths,  $W_1$ ,  $W_2$ ,  $W_3$ ,  $W_4$ , and  $W_{max}$ ; one vertical height  $H$  and a length  $L$  of a line which connects the midpoints of  $W_1$  and  $W_{max}$  were extracted.  $H$  is the perpendicular distance of the topmost point of the image from the maximum horizontal width,  $W_{max}$ , while  $W_1$ ,  $W_2$ ,  $W_3$ ,  $W_4$  are  $0.1H$ ,  $0.2H$ ,  $0.4H$ , and  $0.7H$ , respectively, from the topmost point of the fruit's binary image. From these measured parameters,  $K_1$ ,  $K_2$ ,  $K_3$ ,  $K_4$ ,  $K_5$ , and  $K_6$  were calculated as follows:

#### [Fig.2: Feature extraction of fruit vegetables \(18 KB\)](#)

$$\begin{aligned} K_1 &= W_1 / W_{max} \\ K_2 &= W_2 / W_{max} \\ K_3 &= W_3 / W_{max} \\ K_4 &= W_4 / W_{max} \\ K_5 &= H / W_{max} \\ K_6 &= L / H \text{ ----- (1)} \end{aligned}$$

### 3) Neural network and algorithm

The machine vision system must be able to recognize a vegetable or fruit when it "sees" one and must decide to what grade or class the fruit should belong based on its shape and size. This is essentially the function which the judging component has to accomplish by employing appropriate software.

In this study, the multiple-valued neural network (MVNN) theory, generally accepted as a useful tool for the recognition of various patterns, and image processing technique were used for the development of the desired software. For example, [Fig. 3](#) shows a 3-layer neural network model consisting of an input, a hidden and an output layer. Six input units,  $K_1$ ,  $K_2$ ,  $K_3$ ,  $K_4$ ,  $K_5$ , and  $K_6$ , representing a set of features, are fed into the network through the input layer. Each unit is connected to all the nodes of the hidden layer which is in turn connected to the 2 nodes of the output layer. Computation of the value of each unit in the hidden and output layers is then carried out using a piecewise linear operation expressed as:

$$Y = f(X) \text{-----} (2)$$

[Fig.3: Model of multiple-layer neural network \(17 KB\)](#)

where  $f$  is the arithmetic function and  $X$  is the weighted sum of the units in the previous layer, as shown in [Fig. 4](#).

$$f(X) = \begin{cases} X & X > 0 \\ 0 & X < 0 \end{cases} \text{-----} (3)$$

[Fig.4: Basic unit for multiple-valued neural network \(16 KB\)](#)

An algorithm using the back-propagation method was applied to the neural network model to calculate the weight (synapse) values. That is,  $K_1, K_2, K_3, K_4, K_5,$  and  $K_6$  were fed to the MVNN as inputs for learning, the weight values were then adjusted until the output value became very close to that of the teaching signal.

#### 4) Machine vision judging system and its software

The machine vision system for grade judgment of fruit vegetables is illustrated in [Fig. 5](#). The turntable moves automatically and draws the position of strawberry exactly under a CCD camera (ELMO EC-202 II lens: 16 mm,  $f = 1.5 - 1.0$ ). The frozen image of fruit could be viewed in the monitor (SONY PVM 9221) through the image digitizer board FDM-4-256. The developed software, loaded into NEC PC 9801 RA analyzes the image of fruit to ascertain its shape and size. Soon after the shape of strawberry is ascertained, the 5-joint robot picks up and transports the fruit to predefined locations. As shown in Fig. 5 (b), the robot arm distributes the fruits subjected to evaluation.

[Fig.5: Machine vision judging system \(50 KB\)](#)

The flowchart of the judging system software is shown in [Fig. 6](#). This software displays learning and judging components as follows:

[Fig.6: Flowchart of machine vision judging system software \(45 KB\)](#)

##### (1) Learning program

1. The name of the fruit vegetables to be handled and the kind are inputted.
2. Input the standard shape of an object from a CCD camera in order to develop a pattern for learning. (Shape features  $K_1, K_2, K_3, K_4, K_5,$  and  $K_6$  are generated from this.)
3. The teaching signal is inputted from the computer keyboard.
4. The numbers of layers in the middle, number of units in each layer, learning coefficients are adjusted to a specific MVNN model.
5. According to the teaching signal, the MVNN model learns a set of standard patterns.
6. If learning succeeds, data are saved then go to end, if not, go to "4", until the learning operation is completed.

##### (2) Judging program

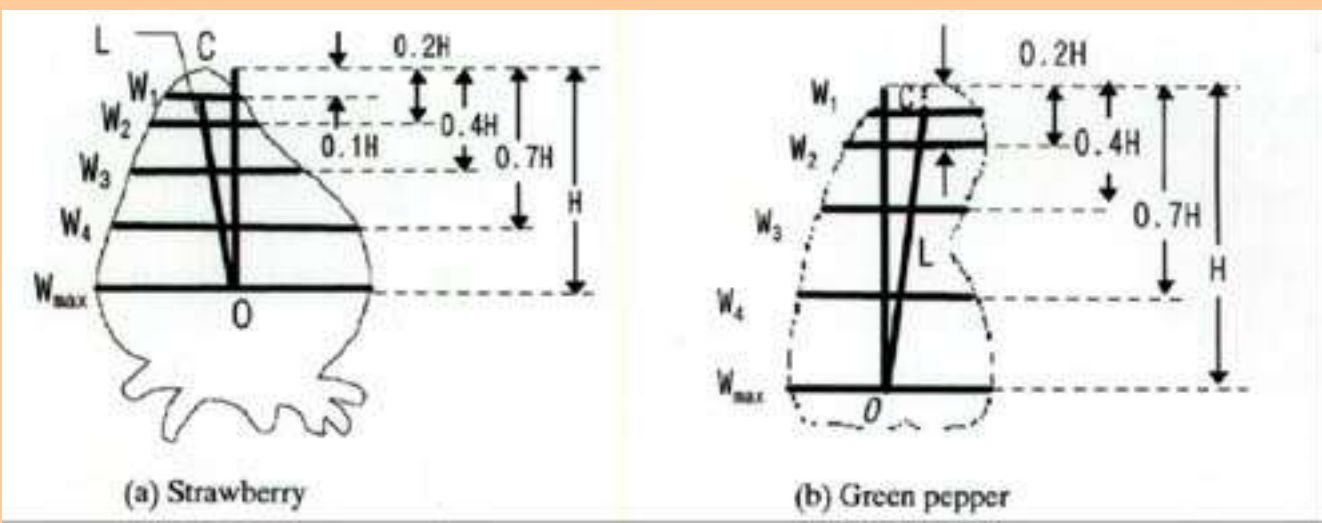
1. Determine, in interactive style, whether the learning operation for the kinds of fruit vegetables has already been completed for evaluation, if not, the learning program is called upon.
2. Load synapse or weight data to MVNN.
3. Rotate turntable, and the specimen is brought to a location under the CCD camera.
4. Image processing and feature extractions are performed.
5. The MVNN evaluates shape features, and sends control signals to the robot.
6. The robot carries the object evaluated to the correct area in the collection unit.



[Continue to: Results and discussion](#)

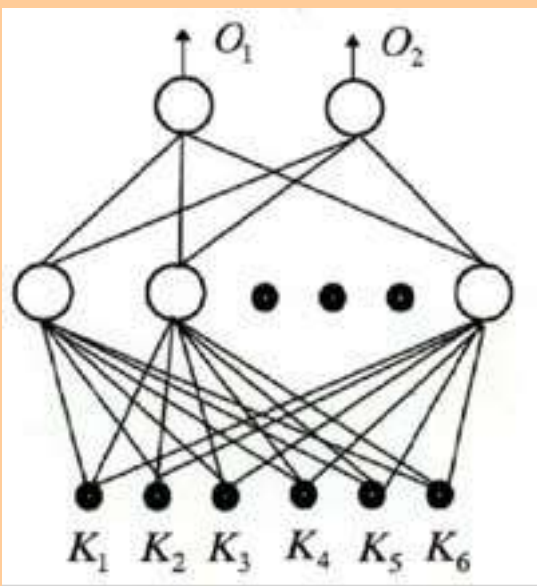


[Back to: Contents](#)



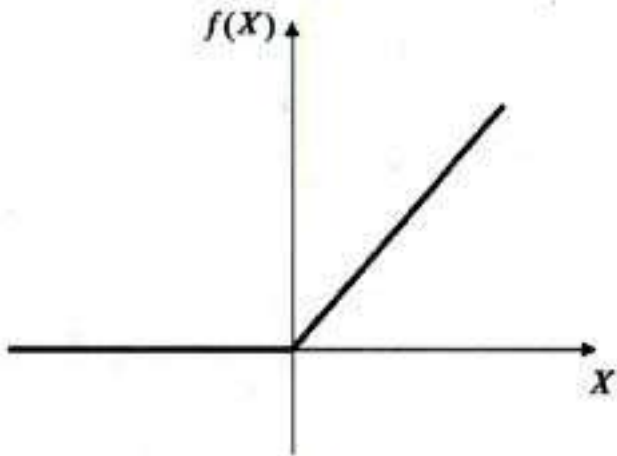
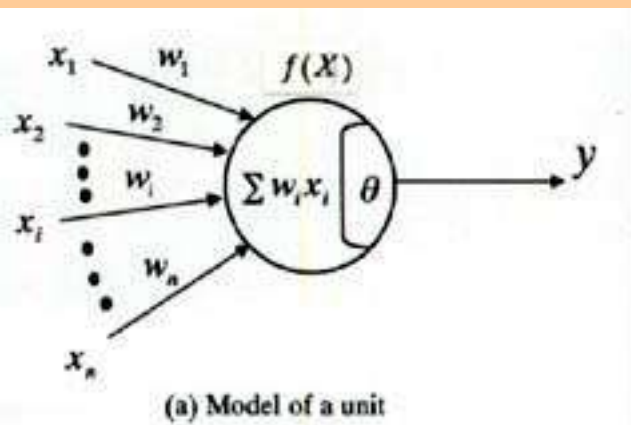
**Fig.2.**  
Feature extraction of fruit vegetables

 [BACK](#)



**Fig.3.**  
Model of multiple-layer neural network

 [BACK](#)

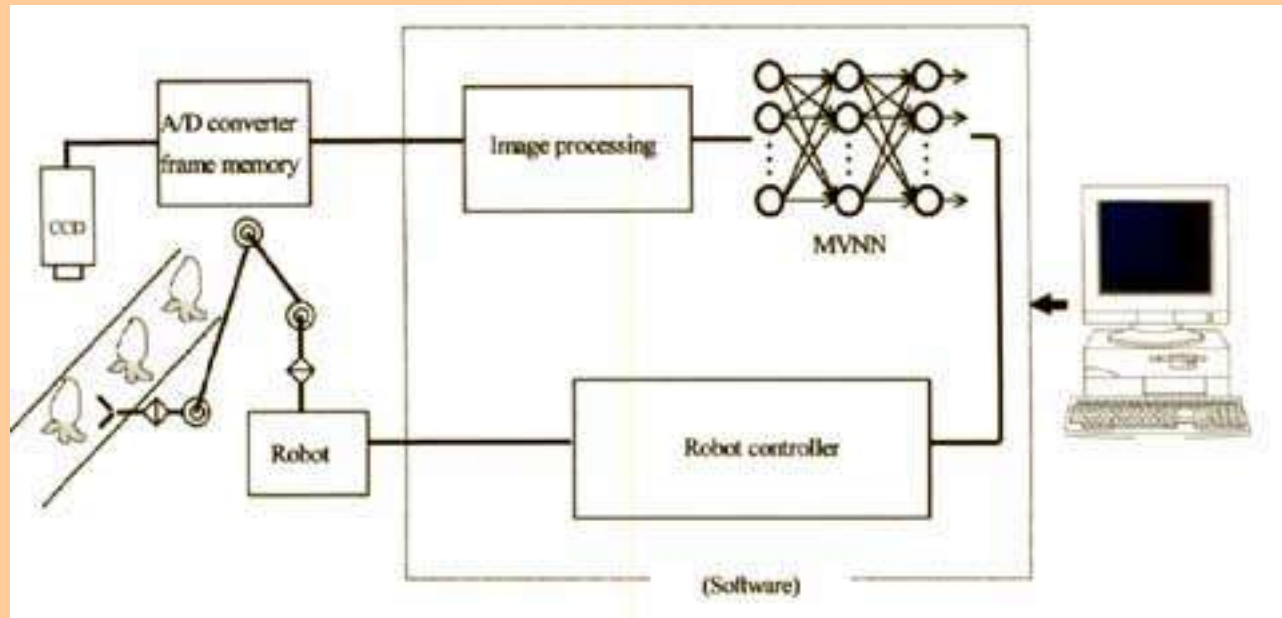


**Fig.4.**  
Basic unit for multiple-valued neural network



[BACK](#)

**Fig.5.** Machine vision judging system



(a) Configuration of judging system



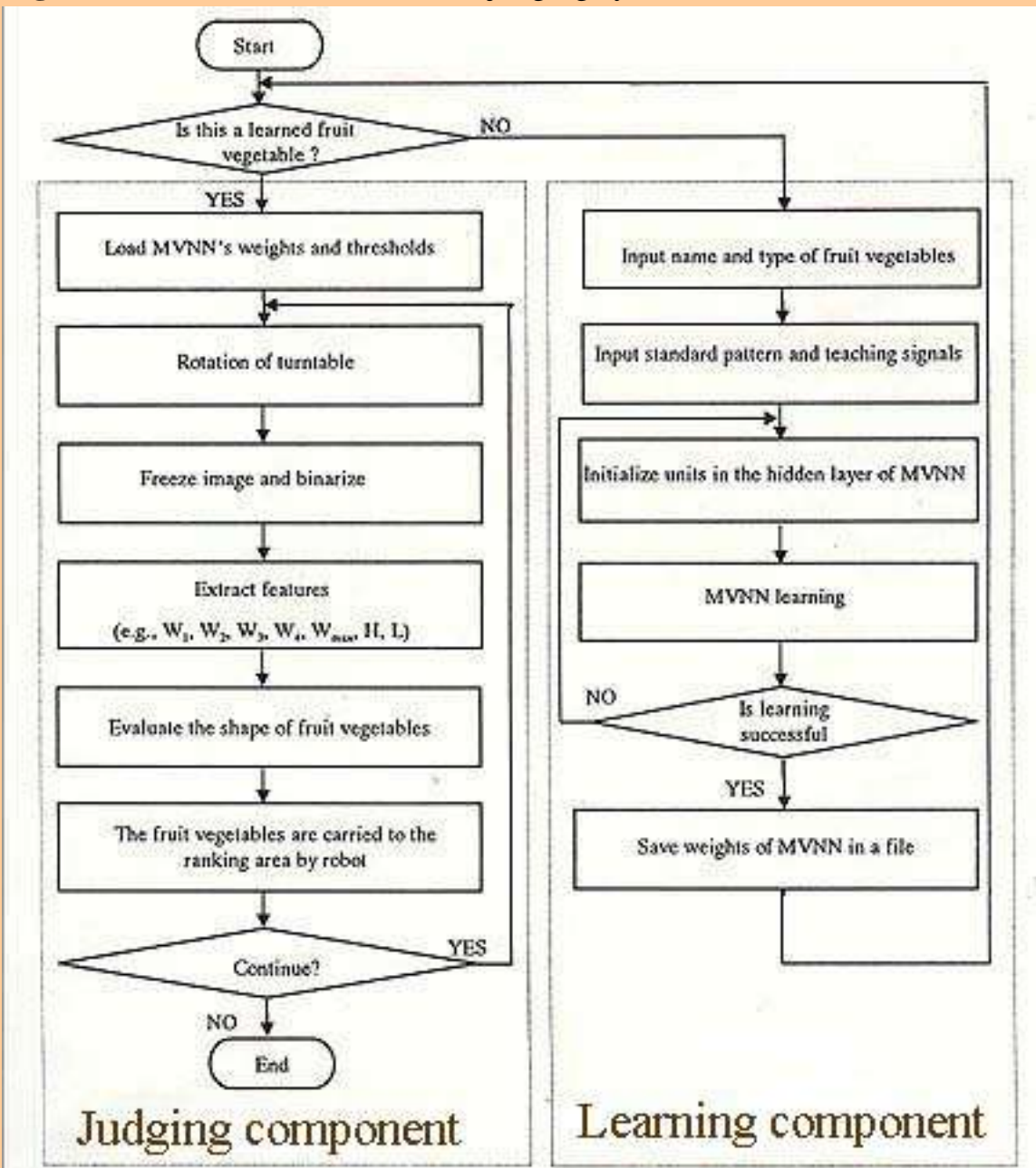
- 1. Turntable
- 2. CCD Camera
- 3. Computer
- 4. Model of MVNN
- 5. Robot
- 6. Ranking area
- 7. Monitor

(b) Judging system set-up

 [BACK](#)



**Fig.6.** Flowchart of machine vision judging system software



## Results and discussion

### 1) Shape judging standards and learning patterns

Shape judging standards of fruit vegetables are determined in every producing district. This time, the shape judging standards of Fukuoka, Miyazaki and Tochigi Prefectures were used. The shape grade of 4 varieties of strawberry and 1 variety of green pepper is shown in [Table 1](#). Based on Table1, learning patterns of fruit vegetables used in the experiment were generated and are shown in [Fig. 7](#).

*Table 1: Standard shape ranks of 4 varieties of strawberry and 1 variety of pepper*

<u>Variety</u>	<u>Shape class</u>				
Reiko	A	B	C		
Toyonoka	A	B	C		
Nyoho	Superfine	LA	2A	3A	B
Akihime	A	B			
Sadowarahikari super	A	B			

*Fig.7: Learning patterns of 4 strawberry varieties and 1 variety of green pepper (46 KB)*

### 2) Input and acquisition of learning patterns

According to the learning patterns ([Fig. 7](#)), one by one, the standard pattern is put under a CCD camera and the teaching signal (A=0, 0; B=1, 0; C=0, 1) is inputted accordingly from the computer keyboard in every set of learning patterns. Here, the error limit is defined as 0.01, 5 kinds of learning patterns were acquired, and the learned results all succeeded. Therefore, after learning, the machine vision judging system could evaluate more than 1 variety of vegetables.

### 3) Judgment and appraisal

Judging system requires attention because the fruit should be placed on the turntable vertically (see Fig. 8) in order to extract features correctly. Experimental judging results were compared with those of manual judging to assess the accuracy rate. Since the judging standard of fruit vegetables is fuzzy, it is likely that different results will be obtained from different persons for the same object. Thus, manual judging results as defined above should be agreed upon by 3 persons aside from an instructor and student, i.e. a total of 5 persons in the laboratory. For example, when 5 persons determined that the strawberry shape is A, A, B, A, B, respectively, the human judging results are taken as A.

In this judging experiment, fresh fruit vegetables were used, including Reiko (122 fruits), Toyonoka (187 fruits), Nyoho (170 fruits), Akihime (167 fruits), and Sadowarahikari super (100 fruits). The agreement rate of human judging results and the machine vision judging system are shown in [Table 2](#).

*Table 2. Agreement rates of shape judgment*

<u>Variety</u>	<u>Accuracy</u>	<u>Error</u>
Reiko	95%	5%
Toyonoka	97%	3%
Nyoho	98%	2%
Akihime	94%	6%
Sadowarahikari super	89%	11%

The test results of the machine vision sorting system displayed a high degree of precision. Table 2 shows that robotic sorting and manual sorting exhibited only a marginal difference in terms of accuracy. Percentage accuracy ranged from 89 to 98% and the percentage of error in shape judgment for different varieties ranged from 2 to 11%.

### 4) Future problems

It is important for MVNN to produce learning patterns in the machine vision judging system. Since a given set of precise learning pattern is acquired by MVNN, the accuracy of the machine vision judging system increases. Moreover, it is necessary to increase the number of features and to improve the components of the extracting method, because there is still a difference in the judgment from human. In order to evaluate fruit vegetables such as green pepper that have a complex shape, it is necessary to develop a

judging method that combines fuzzy and MVNN theories to improve the judgment accuracy.

## Conclusion

In order to evaluate more than one kind of fruit vegetables, according to the shape, the machine vision system was studied. The shape judgment of fruit vegetables is difficult compared to industrial products of fixed form because of the naturally unique outline. In this study image processing and MVNN technologies were used for the advanced machine vision judging system, which enabled to alleviate the fuzzy judging problem of shape. Due to its learning capability, the system was able to evaluate different kinds of fruit vegetables according to their learned standard pattern. In the judging experiments, 4 varieties of strawberry, Reiko, Toyonoka, Nyoho, Akihime and 1 variety of green pepper Sadowarahikari super were used. The results showed that the judging accuracy for strawberry ranged from 94 to 98% while 89% for green pepper. Therefore, the system has a high potential in grade judging of fruit vegetables which is still in the developmental stage.



[Forward to: -Varietal Differences in Female Flower Bearing Ability and Evaluation Method in Watermelon-](#)






[Back to: Contents](#)






[Back to: JIRCAS home page](#)





Fig.7. Learning patterns of 4 strawberry varieties and 1 variety of green pepper

Shape class	Standard pattern	Teaching signal	
	$K_1, K_2, \dots, K_4$	$T_1$	$T_2$
A		0	0
B		1	0
C		0	1







(a) Reiko

Shape Class	Standard pattern	Teaching signal	
	$K_1, K_2, \dots, K_4$	$T_1$	$T_2$
A		0	0
B		1	0
C		0	1







(b) Toyonoka

Shape class	Standard pattern	Teaching signal	
	$K_1, K_2, \dots, K_4$	$T_1$	$T_2$
Super fine		0	0
LA		1	0
2A		0	1
3A		1	1

(c) Nyoho

Shape class	Standard pattern	Teaching signal	
	$K_1, K_2, \dots, K_4$	$T_1$	$T_2$
A		0	0
			
			
B		1	0
			
			

(d) Akihime

Shape class	Standard pattern			Teaching signal	
	$K_1$	$K_2$	$K_3$	$T_1$	$T_2$
A	① 	② 	③ 	1	0
B	④ 	⑤ 	⑥ 	0	1

(e) Sadownahikari super



[BACK](#)

# Varietal Differences in Female Flower Bearing Ability and Evaluation Method in Watermelon

Keita SUGIYAMA

Kurume Branch, National Research Institute of Vegetables, Ornamental Plants and Tea  
(Kurume, Fukuoka, 839-8503 Japan)

## Abstract

These studies were carried out to identify varieties with a high female flower-bearing ability among genetic resources and develop a simple method to evaluate the female flower bearing ability of watermelon before transplanting. The results showed that Japanese F₁ varieties bore more female flowers than the other varieties except for those from China and Taiwan. Also varieties with many female flowers among wild species could be used as breeding materials to improve the female flower bearing ability of other watermelon varieties. Watermelon varieties with a high female flower bearing ability bore the first female flower at a lower node than those with a low female flower bearing ability, when sprayed with silver thiosulfate, STS, at the cotyledonary stage. Correlation between the number of female flowers in the F₂ population sprayed with 6 mM STS and the node order of the first female flowers was high. In a progeny selected from the F₂ population, the female flower was borne at a lower node order of the main stem, whereas in another, the first female flower differentiated at a higher node order; the former bore more female flowers than the latter. These results indicate that it is possible to select plants with a high female flower bearing ability by STS treatment before transplanting.

**Discipline:** Plant breeding

**Additional key words:** *Citrullus lanatus*, STS, selection

1~14): [Click here for References](#)

## Introduction

Watermelon varieties have fewer female flowers than other cucurbit crops such as cucumber and melon. The formation of female flowers in watermelon is easily affected by the temperature^{8,9,11,12}), day-length^{8,9,11,12}) and fertilizer conditions¹).

A long pollination period is required in watermelon because the species differentiates few female flowers under high temperature and long day-length conditions and when excess nitrogen is applied. Furthermore, abortion of female flowers or low fruit-setting ratio is caused by weather conditions characterized by a low temperature and little sunshine. Also, to set the fruit at the nodes which are convenient for improving fruit quality and reducing cultivation labor, varieties with a tendency to differentiate relatively more female flowers should be used.

A testing method to evaluate juvenile plants with a high female flower bearing ability would be advantageous because much time is required to evaluate the female flower bearing ability of watermelon. There are many reports in testing methods for gynococious line breeding in cucumber³⁻⁶), but only a few in watermelons. Hence, we attempted to develop a simple method to evaluate the female flower bearing

ability of watermelon before transplanting by using silver thiosulfate (STS).

## Materials and methods

### *Experiment 1: Varietal differences in female flower bearing ability in watermelon*

Forty-five Japanese watermelon varieties (19 pure-bred varieties, 12 F₁ small-sized watermelon varieties and 14 F₁ large-sized watermelon varieties), 10 watermelon varieties derived from China and Taiwan, 12 watermelon varieties derived from America, Russia, Europe and other countries and 9 wild watermelon varieties were used in this experiment ([Table 1](#)). They were sown on March 21 and transplanted to a greenhouse on April 15, 1994. Four plants per variety were used with 2 replications. The total number of female flowers up to the 30th node on the main stem was recorded. Hermaphrodite flowers and degenerated female flowers were categorized as female.

#### [Table 1: List of watermelon varieties\(46 KB\)](#)

### *Experiment 2: Effect of STS on the induction of female flowers*

Seedlings of watermelon, 'Red Seeded 3b', 'Koryou 200', 'Beijing Xi C', 'Fujihikari TR', 'Aohanagawa', 'Summit', 'Klekley Sweet' and 'Green Seeded' sown on March 24, 1993, were sprayed with 0 (distilled water, control), 1, 3 and 6 mM STS at the cotyledonary stage (seeds sown on October 5) on October 14. The amount of solution sprayed was about 2 mL per plant. Ten plants per variety were used with 2 replications in all the treatments. The node order of the first female flower and the first male flower and the total number of female flowers up to the 10th or the 20th node on the main stem were recorded. Hermaphrodite flowers and degenerated female flowers were categorized as female.

### *Experiment 3: Selection effect of female flower bearing ability by STS treatment*

F₂ seedlings were derived from the cross between Red Seeded 3b with many female flowers and Green Seeded with a few female flowers. The F₂ progenies (117) were sprayed with 6 mM STS at the cotyledonary stage on April 5, 1994 (seeds sown on March 24). From this population, RG94 and RG33 were selected; the former bore the first female flower at a basal node, whereas RG33 bore its first female flower at a more distal node. These selections were self-pollinated. Seeds of the F₂ population (79) and seeds of the F₃ population of RG94 (58) and RG33 (24) were sown on September 20. These plants were not treated with STS. The number of female flowers up to the 30th node on the main stem was recorded in the F₂ and F₃ seedling populations. Hermaphrodite flowers and degenerated female flowers were categorized as female as above.



[Continue to: Results](#)



[Back to: Contents](#)

## References



[Back](#)

- 1) Brantley, B. B. & Warren, G. F. (1960): Effect of nitrogen on flowering, fruiting, and quality in watermelon. *Proc. Amer. Soc. Hort. Sci.*, 75, 644-649.
- 2) Christopher, D. A. & Loy, J. B. (1982): Influence of foliarly applied growth regulators on sex expression in watermelon. *J. Amer. Soc. Hort. Sci.*, 107, 401-404.
- 3) Fujieda, K. (1963): Cucumber breeding. III. Studies on the method of established the Inbred Gynoecious strains in cucumber. *Bull. Hort. Res. Stn.*, D1 (Kurume), 101-116 [In Japanese with English summary].
- 4) Fujita, Y. et al. (1981): Studies on the testing method of cucumber breeding for female line. 1. Induction of male flower by silver nitrate treatment. *In Abst. Jpn. Soc. Hort. Sci.*, Spring Meet., 174-175 [In Japanese].
- 5) Fujita, Y., Uragami, A. & Fujieda, Y. (1981): Studies on the testing method of cucumber breeding for female line. 2. Early testing method on it. *In Abst. Jpn. Soc. Hort. Sci.*, Autumn Meet., 156-157 [In Japanese].
- 6) Fujita, Y. (1982): Studies on the early testing method of sex expression in cucumber. Ph. D. Thesis. J. Fac. Agric., Kyushu Univ. [In Japanese with English summary].
- 7) Gopalkrishnan, P. K. & Choudhury, B. (1969): Effect of plant regulator sprays on modification of sex, fruit set and development in watermelon. *Ind. J. Hort.*, 35, 235-240.
- 8) Kurata, H. (1970): Studies on the formation of a pistillate flower in cucurbits.II. Effect of temperature on the formation of a pistillate flower in winter squash and watermelon. *Tech. Bull. Fac. Agric., Kagawa Univ.*, 21, 23-33 [In Japanese with English summary].
- 9) Kurata, H. (1976): Studies on the sex expression of flowers induced by day-length and temperature in pumpkin and watermelon. *Mem. Fac. Agric., Kagawa Univ.*, 29, 1-49 [In Japanese with English summary].
- 10) Kurata, H. & Torichigai, M. (1983): The effect of silver nitrate in watermelon. *Tech. Bull. Fac. Agric., Kagawa Univ.*, 34, 139-146 [In Japanese with English summary].
- 11) Rudich, J. & Peles, A. (1976): Sex expression in watermelon as affected by photoperiod & temperature. *Scientia Hort.*, 5, 339-344.
- 12) Shibuya, S., Kinoshita, K. & Istumi, H. (1967): Effects of environmental condition on sex expression in cultivation of watermelon. *Agric. & Hort.*, 42, 1557-1558 [In Japanese].

- 13) Sugiyama, K., Iwanaga, Y. & Kanno, T. (1993): Method for testing the ability of bearing female flowers by the application of temperature and day-length treatment in young seedlings of watermelon. *Bull. Veg. & Ornam. Crops Res. Stn.*, A9, 103-111 [In Japanese with English summary].
- 14) Tyagi, I. D. (1975): Modification of sex expression in watermelon. *Ind. J. Hort.*, 32, 165-167.

(Received for publication, January 22, 1998)



**Table1.** List of watermelon varieties

Japanese varieties	Foreign varieties	
<b>Pure-bred varieties</b>	<b>Wild species</b>	
Akashi 3	Red Seeded 3b	AFRICA ^{a)}
Asahiyamato	Africa 22857	AFRICA
Fumin	Ind 22858	INDIA
Ginyamato	Wild 22859	AFRICA
Kurobe	Wild bitter Tamma	RUSSIA
Mikasa	WIR-4801-3	RUSSIA
Miyako 1	Africa 22860	AFRICA
Miyako 3	Citron Green Seeded	AFRICA
Nishikiyamato		
Oukan	<b>America, Russia and other countries</b>	
Shinyamato 3	Demintus	?
Tabata	Dr. Much	?
Tabatakanro	FR-71	USA
Yamatokuriimu 2	Fair fax	USA
Benikodama	Ginza No. 1	EGYPT
Otome	Gzauudela	RUSSIA?
Ounikukodama	Klondike blue ribbon striped	USA
Tomoe	Klekley Sweet	USA
Kuriiimu	Metitopeal skj	RUSSIA
<b>F₁ varieties (Large-sized watermelon)</b>	Summit	USA
Fujihikari TR	Skospelka	RUSSIA?
Wasenishou	Torkmen Skijmramorgj	RUSSIA
Zuisho	Tom Watson	URUGUAY
Koryou 200	Calhoun Gray	ITALY
Koudai	Crimson Sweet	USA
Kansen	Sugar baby	USA
Shimao Max KE	WM-92001	BANGLADESH
Parnassus queen		
Kyoho L	<b>China and Taiwan</b>	
Kunzan	Qing hoa pi	
Tenryu 2	Beijing Xi C	
Daimonji	Jia bao	
Honey charmant	Lu quan	
Lemony	Zheng za 5 hou	
<b>F₁ varieties (Small-sized watermelon)</b>	S-7	
Madder bowl	Yi xuan	
Kinsuzu	Hu mi 3 hou	
Otori 2	Zao jiang	
Kogane kodama	Zhu lan	
Kodama baby		
Maiko		
Rabbit		
Midget		
Coney		
Repo		
New kodama		
Benitubasa		

a): Name of country or region of introduction.



[BACK](#)

## Results

### *Experiment 1: Varietal differences in female flower bearing ability in watermelon*

Average number of female flowers up to the 30th node on the main stem was 3.7 flowers ([Fig. 1](#)). Red Seeded 3b bore the largest number of female flowers (7.1 female flowers) followed by Africa 22860 with 6.1 female flowers. It was found that Green Seeded bore the lowest number with 0.5 female flowers. Thus, wild species displayed a wide range of female flower bearing ability.

### [Fig.1: Varietal differences in number of female flowers in genetic resources \(20 KB\)](#)

The varieties from America, Russia, Europe and other countries bore fewer female flowers than the Japanese varieties. However, the varieties of China and Taiwan showed almost the same number of female flowers as the Japanese F₁ varieties.

Japanese pure-bred varieties were found to display a wide range of female flower bearing ability. However, small-sized and large-sized watermelons and Japanese F₁ varieties bore about 3 to 4.5 and 4 to 5 female flowers, respectively. Thus, large-sized watermelon and Japanese F₁ varieties were found to bear the largest number of female flowers.

### *Experiment 2: Effect of STS on the induction of female flowers*

Spraying STS at the cotyledonary stage was effective in inducing female flowers ([Table 2](#), [Fig. 2](#)). Treatment with 6 mM STS lowered the node order of the first female flower on the main stem in varieties with many female flowers by 2 nodes compared to that in the control. In Red Seeded 3b treated with 6 mM STS, which showed the highest frequency of female flowers, the mean node order for the first female flower was 3.4, whereas in Koryou 200 and Beijing Xi C, which bear many female flowers, the mean node order was 3.8 and 4.4, respectively. With the same treatment, the basal nodes with the first female flowers of Aohanagawa and Klekley Sweet were 7 and 8, respectively, a value significantly lower than that in the control. Yet, the node order was still higher than for all the other varieties except for Green Seeded. The node order of the first female flower of Green Seeded was lowered by the 1 mM STS treatment, while the application of 3 or 6 mM STS was ineffective.

**Table 2: Effect of STS treatment at the cotyledonary stage on sex expression in watermelon**

Variety	Node order bearing the first female flower ^{a)}				Number of female flowers up to 10th node ^{a)}				Node order bearing the first male flower			Number of female flowers ^{c)}	
	0 mM ^{b)}	1 mM	3 mM	6 mM	0 mM	1 mM	3 mM	6 mM	0 mM	1 mM	3 mM		6 mM
Red Seeded 3b	5.4ad)	4.0a	3.6a	3.4a	2.5a	2.9a	3.6a	3.8a	3.1a	3.6a	5.5bc	5.1ab	4.8a
Koryou 200	6.1a	5.6ab	4.9ab	3.8ab	2.0b	1.7b	2.3b	3.0b	4.4b	5.1c	5.0ab	5.0ab	3.7b
Beijing Xi C	6.6a	5.4ab	4.9ab	4.4ab	1.5bc	1.9b	2.2b	2.3cd	4.9b	4.6b	5.6bc	5.6bc	3.6bc
Fujihikari TR	7.7a	6.5b	6.1bc	5.6bc	1.2c	1.2c	1.6c	1.9d	4.4b	4.2ab	4.4a	4.4a	3.1c
Aohanagawa	11.7b	7.7b	7.0cd	7.2cd	0.4d	0.6c	1.4cd	1.1ef	6.8d	7.3d	7.2e	6.6c	1.5d
Klikley Sweet	13.4bc	14.0c	8.5d	8.0d	0.3d	0.0d	0.9d	0.8fg	5.7c	6.9d	6.8de	6.2c	1.4de
Green Seeded	15.0c	13.3c	15.4e	15.8e	0.1d	0.3d	0.3e	0.3g	5.0b	6.0c	5.6cd	5.7bc	0.8e
r ^e	-0.97**	-0.89**	-0.84**	-0.84**									

Sowing date: Oct. 5, 1993. STS treatment was applied on Oct. 14, 1993

a): On the main stem, including hermaphrodite.

b): STS concentration.

c): Up to 20th node on the main stem in control.

d): Mean separation within columns by Duncan's multiple range test, at 5% level.

e): Correlation coefficient between node order of the first female flower and total number of female flowers up to 20th node in control.

** Significant at 1% level.

### [Fig.2: Effect of STS on first female flower setting \(21 KB\)](#)

Spraying of 1 mM STS was slightly effective in lowering the node order of the first female flower. Differences in the female flower bearing ability among varieties were clearly revealed when seedlings were sprayed with 6 mM STS.

Spraying of seedlings with 3 or 6 mM STS was effective in increasing the number of female flowers; concurrently, the node order bearing the first male flower tended to decrease by STS treatment.

Correlation coefficient between the node order of the first female flower in the STS-treated plants and the number of female flowers up to the 20th node in the nontreated plants was very high.

### ***Experiment 3: Selection effect of female flower bearing ability by STS treatment***

A wide range of node orders bearing the first female flower was observed in the F₂ population of the watermelon varieties tested. The lowest node order bearing the first female flower was 3, while the highest node order bearing the first female flower was 14 ([Fig. 3](#)). The watermelon plants bearing many female flowers tended to bear the first female flower at a lower node. In contrast, the watermelon varieties bearing fewer female flowers tended to bear them at a higher node. Correlation coefficient between the number of female flowers up to the 30th node on the main stem and the node order bearing the first female flower was significantly high.

[Fig.3: Relationship between the node order of the first female flower and the number of female flowers after application of 6 mM STS at the cotyledonary stage in F₂ \(17 KB\)](#)

Two plants were selected from the F₂ population: one was RG94 for which the first female flower bearing node order was 4 and the other one was RG33 which bore the first female flower on the 10th node.

The F₃ plants derived from RG94 bore more female flowers than those derived from RG33 and F₂ plants ([Fig. 4](#)).

[Fig.4: Frequency distribution of number of female flowers of F₂, RG33\(F₃\) and RG94\(F₃\) \(19 KB\)](#)

## **Discussion**

Female flower bearing ability in the Japanese F₁ varieties is higher than that of Japanese pure-bred varieties or varieties from other countries except for China and Taiwan. It is assumed that recently Japanese F₁ varieties have been improved to become adapted to greenhouse culture. The varieties were altered with a high bearing ability to stabilize the setting of fruits as well as to advance maturity and reduce the cultivation labor. However, the Japanese F₁ varieties did not bear many female flowers. This problem may have been solved by the application of a training method which enabled to increase the number of female flowers by growing 3 or 4 lateral vines of watermelon plant. However, since the female flower bearing is easily affected by the weather conditions, it is necessary to genetically alter varieties to increase their female flower bearing ability. Red Seeded 3b and Africa 22860 with a high female flower bearing ability are suitable for use as breeding materials.

It is generally recognized that the number of female flowers (including hermaphrodite flowers) of watermelon can be increased by aminoethoxyvinylglycine²⁾, silver nitrate^{2,10)} and maleic hydrazide¹⁴⁾ applications. Triiodobenzoic acid treatment increased the production of female flowers and induced the formation of the first female flower at lower nodes of the main stem⁷⁾. On the other hand, ethephon treatment decreased the number of female flowers²⁾. It was assumed that the use of some methods may enable to carry out selection for female flower bearing ability. In one method, selection involved plants which differentiated female flowers under conditions inhibitory to female flower formation such as long day-length, high temperature, or with treatments with certain plant growth regulators such as ethephon or conversely, the selection involved plants which initiate female flowers under favorable conditions, such as short day-length, low temperature or with some of the above-mentioned substances.

Sugiyama et al.¹³⁾ exposed watermelon seedlings to high temperature and long photoperiod to select plants with a high female flower bearing ability but the method requires a large and expensive phytotron for a long duration.

We applied STS which is more easily absorbed by the plant than silver nitrate. STS was applied at the cotyledonary stage to induce the first female flower at a lower node on the main stem and to increase the number of female flowers. It was assumed that the varieties with many female flowers tended to bear the first female flower at a lower node under STS treatment.

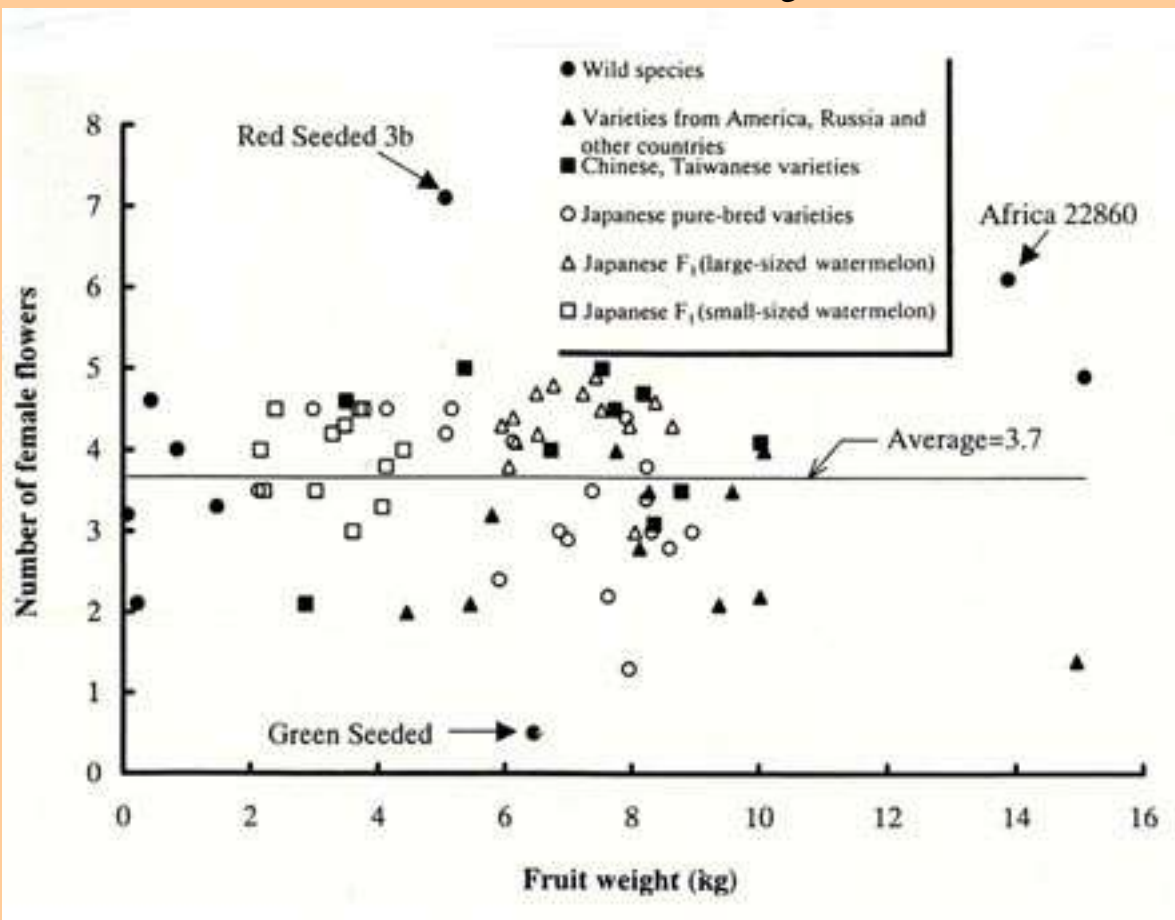
By selecting 2 progenies from an F₂ population bearing female flowers at lower or upper nodes on the main stem, we demonstrated that this bearing habit is heritable. Hence, we were able to select plants with a high female flower bearing ability by STS treatments. This testing method should enable to select plants with a high female flower bearing ability before transplanting, in order to improve the efficiency by shortening the turnover generation in watermelon breeding.

 [Forward to: -Improvement of Postharvest Life in Several Cut Flowers by the Addition of Sucrose-](#)

 [Back to: Contents](#)

 [Back to: JIRCAS home page](#)

**Fig.1.**  
Varietal differences in number of female flowers in genetic resources



 [BACK](#)



**Fig.2.**  
Effect of STS on first female flower setting

Right: Plantlet in which 1st female flower was induced at the 3rd node on the main stem by STS treatment.

Left: Control plant sprayed with distilled water, with 5 nodes but no female flowers.

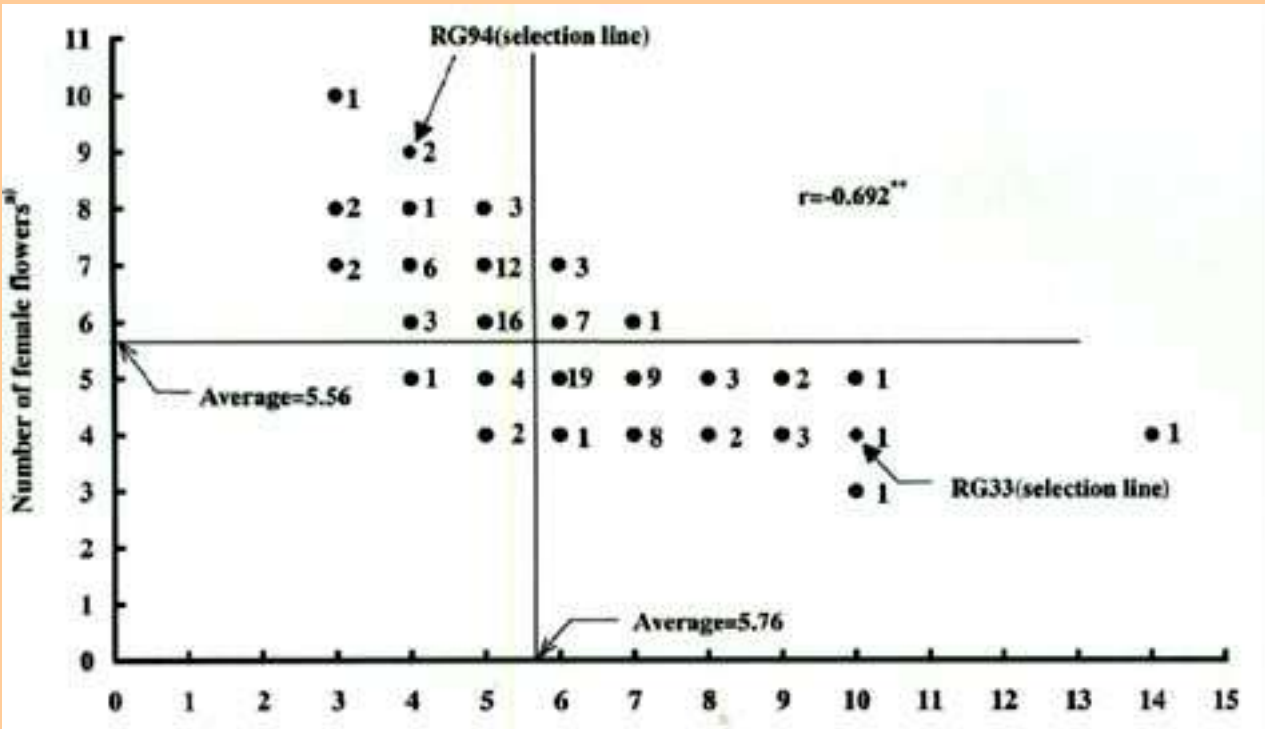


[BACK](#)

**Fig.3.**  
 Relationship between the node order of the first female flower and the number of female flowers after application of 6 mM STS at the cotyledonary stage in F₂

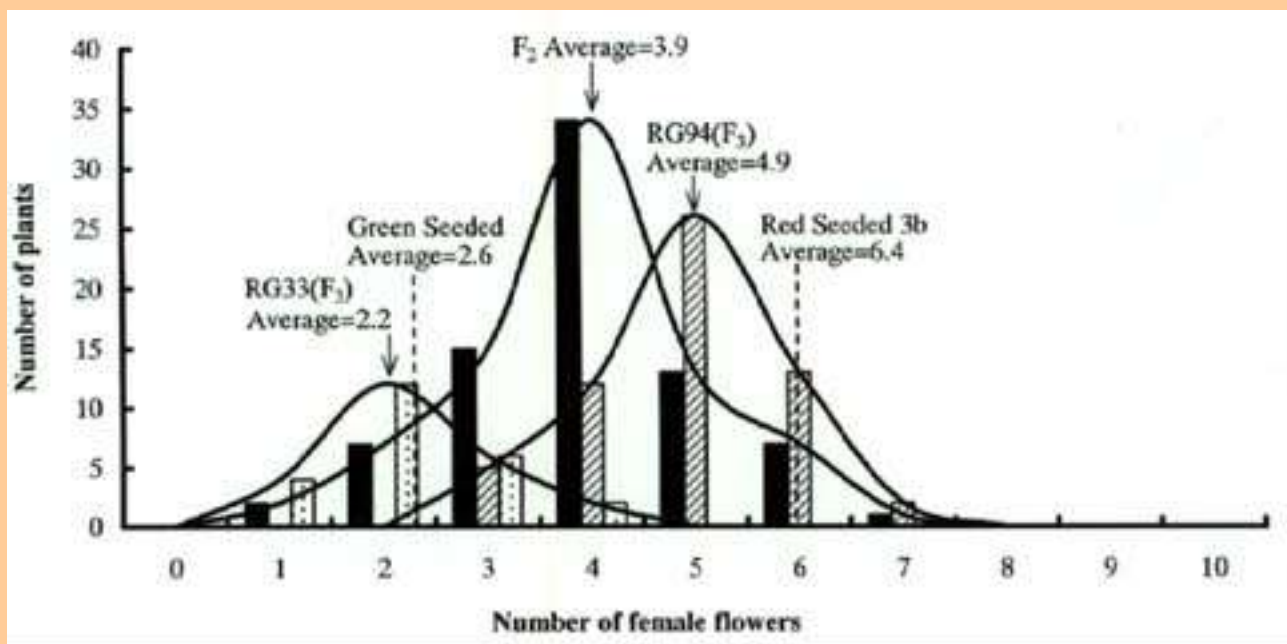
F₂ seeding derived from the cross between Red Seeded 3d and Green Seeded.  
 Sowing date: March 24, 1994. STS treatment date: April 5, 1994.

a) Up to the 30th node on the main stem.  
 ** Significant at 1% level.  
 Arabic numerals: Number of plants. 117 plants were used.



Node order of the first female flower

 [BACK](#)



Number of female flowers

**Fig.4.**  
 Frequency distribution of number of female flowers of F₂, RG33(F₃) and RG94(F₃)  
 Sowing date: Sept.20, 1994  
 The number of female flowers was counted up to the 30th node on the main stem.



[BACK](#)



# Improvement of Postharvest Life in Several Cut Flowers by the Addition of Sucrose

**Kazuo ICHIMURA**

Department of Floriculture, National Research Institute of Vegetables, Ornamental Plants and Tea  
(Ano, Mie, 514-2392 Japan)

## Abstract

Sugars play important roles in keeping the quality of cut flowers because the amount of sugar contained in cut flowers is limited. Effects of sucrose treatment on the vase life of several cut flowers were investigated. Continuous treatment with sucrose markedly promoted floret opening and extended the vase life of cut sweet pea flowers. Pulse treatment with sucrose was also fairly effective in improving the vase life of these flowers. Continuous treatment with sucrose increased anthocyanin concentrations in petals as well as extended the vase life of several cultivars of cut *Eustoma* flowers. This treatment was also effective in improving the vase life of cut snapdragon flowers. Although pulse treatment with sucrose was fairly effective in improving the vase life of cut hybrid Limonium, pulse treatment with sucrose in combination with  $\alpha$  aminoisobutyric acid (AIB), an ethylene biosynthesis inhibitor, was markedly effective in improving the vase life. Role of the application of sucrose to cut flowers was reviewed and discussed.

**Discipline:** Horticulture

**Additional key words:** *Eustoma grandiflorum*, hybrid Limonium, snapdragon, sugar, sweet pea  
1~36): [Click here for References](#)

## Introduction

In Japan, cut flowers have been increasingly distributed in markets along with the increase of flower production in recent years. Furthermore, transportation of cut flowers over long distances has increased. These conditions are unsuitable for keeping the quality of cut flowers. Development of postharvest technology in cut flowers is, thus, being promoted.

Sugars play important roles in plants as substrates for respiration and cell walls as well as osmolytes. Since the amount of sugar contained in cut flowers is limited, the addition of sugars such as sucrose to vase water is effective in improving the vase life of some cut flowers8).

In this report, I described the role of sugars in improving the vase life of cut flowers. Furthermore, here I reported the improvement of the vase life of cut sweet pea, hybrid *Limonium*, *Eustoma* and snapdragon flowers by treatment with sucrose.

## Role of sugars in cut flowers

Addition of sugars to vase water not only extends the vase life of cut flowers but also promotes flower opening. Furthermore, the expression of the flower color is improved by treatment with sugars in some cut flowers such as carnation¹⁵⁾ and rose^{7,27)}. Effects of sugars on the extension of the vase life of cut flowers are considered to be associated with the improvement of the water balance. However, since inorganic ions did not extend the vase life more than sugar¹⁹⁾, it is suggested that the effect of sugars on the improvement of the vase life is due not only to the effect of osmolytes but also to that of substrates of respiration and synthetic materials.

### 1) Promotion of flower opening by sugars

A large amount of soluble carbohydrates is required for flower bud opening as substrates for cell walls and respiration as well as for their osmotic properties. Since the carbon source of cut flowers is limited, addition of sugars such as sucrose and glucose to vase water is highly effective in promoting flower opening^{5,6,18,28)}.

Petal growth associated with flower opening results from cell expansion¹⁴⁾, which is required for the influx of water and osmolytes such as sugars into cells. In hybrid *Limonium* and carnation, the concentration of sucrose in petals decreased, and that of glucose and fructose increased^{23,31,36)}. In *Hemerocallis*, fructans are degraded to monosaccharides during flower opening²⁾. Monosaccharides derived from sucrose or fructans increase the osmotic pressure, which contributes to flower opening. Woodson and Wang (1987)³⁶⁾ showed with carnation that these changes in the sugar composition are accompanied with the increase in invertase activity.

### 2) Extension of longevity of cut flowers

In many cut flowers, sugars such as sucrose extend the vase life. We observed that sucrose extends the vase life of cut sweet pea flowers.

Flowers of sweet pea are highly sensitive to ethylene^{22,25,35)}, and the vase life is very short. When cut spikes of sweet peas were treated with 40 g L⁻¹ sucrose, the vase life became twice as long¹²⁾. This treatment increased the glucose, fructose and sucrose concentrations ([Fig. 1](#)) and inhibited ethylene production of florets ([Fig. 2](#)). These findings suggest that the sugar concentration increased by the sucrose treatment may lead to the inhibition of ethylene production.

[Fig. 1. Changes in sugar concentrations of petal and the other parts of sweet pea floret with time \(32 KB\)](#)

[Fig. 2. Changes in ethylene production of sweet pea floret with time \(16 KB\)](#)

To further clarify the relationships between ethylene production and the sugar concentration of flowers, cut spikes were treated with sucrose continuously (continuous treatment) or only for 24 h (pulse treatment) after harvest. Vase life of control spikes was about 3 days. The continuous and pulse treatments with sucrose extended the vase life of spikes by 8 and 6 days, respectively. Climacteric ethylene production was advanced by the pulse treatment compared to continuous treatment. Furthermore, the sugar concentration decreased with the time after pulse treatment whereas it remained at a high level by continuous treatment. Therefore, ethylene production was largely affected by the sugar concentration in floret.

To determine whether sucrose inhibits the ethylene action, the effect of sucrose on ethylene production of floret was compared to that of silver thiosulfate complex (STS), an ethylene action inhibitor⁹). Although sucrose inhibited ethylene production more than STS ([Fig. 3](#)), STS extended the vase life more than sucrose. STS is known to suppress autocatalytic ethylene production by inhibiting ethylene action. These findings suggest that sucrose may not inhibit the ethylene action although it remains to be determined whether sucrose directly inhibits ethylene production.

[Fig.3. Changes in ethylene production of sweet pea floret with time \(17 KB\)](#)

### 3) Improvement of flower color expression by sucrose

Treatment with sugars such as sucrose improved the expression of petal colors in some cut flowers such as rose^{7,27}), sweet pea⁹) and Eustoma¹¹). Pigments of these flowers are mainly anthocyanins.

Anthocyanins are synthesized via several enzymatic steps such as chalcone synthase and chalcone flavanone isomerase⁴). Tsukaya et al. (1991)³²) and Moalem-Beno et al. (1997)²¹) reported that in petunia the gene expression of chalcone synthase, a key enzyme of anthocyanin biosynthesis was induced by sucrose. Similarly, Kusuhara et al. (1996)¹⁶) reported that in *Eustoma* sucrose increased the expression of genes involved in anthocyanin biosynthesis such as chalcone isomerase, dihydroflavanone reductase and chalcone synthase. Thus, the stimulation of anthocyanin expression of cut flowers by sucrose may be involved in the promotion of anthocyanin biosynthesis gene expression. Furthermore, this promotive effect is possibly due to the supply of sugars as glycoside residues of anthocyanin because anthocyanins are usually present as glycosides.

To determine whether the amount of other flower pigments such as carotenoid and betacyanins increased by sugar treatment, further studies will be required.



[Continue to: Effects of sucrose treatment on the vase life of various cut flowers](#)



[Back to: Contents](#)

## References

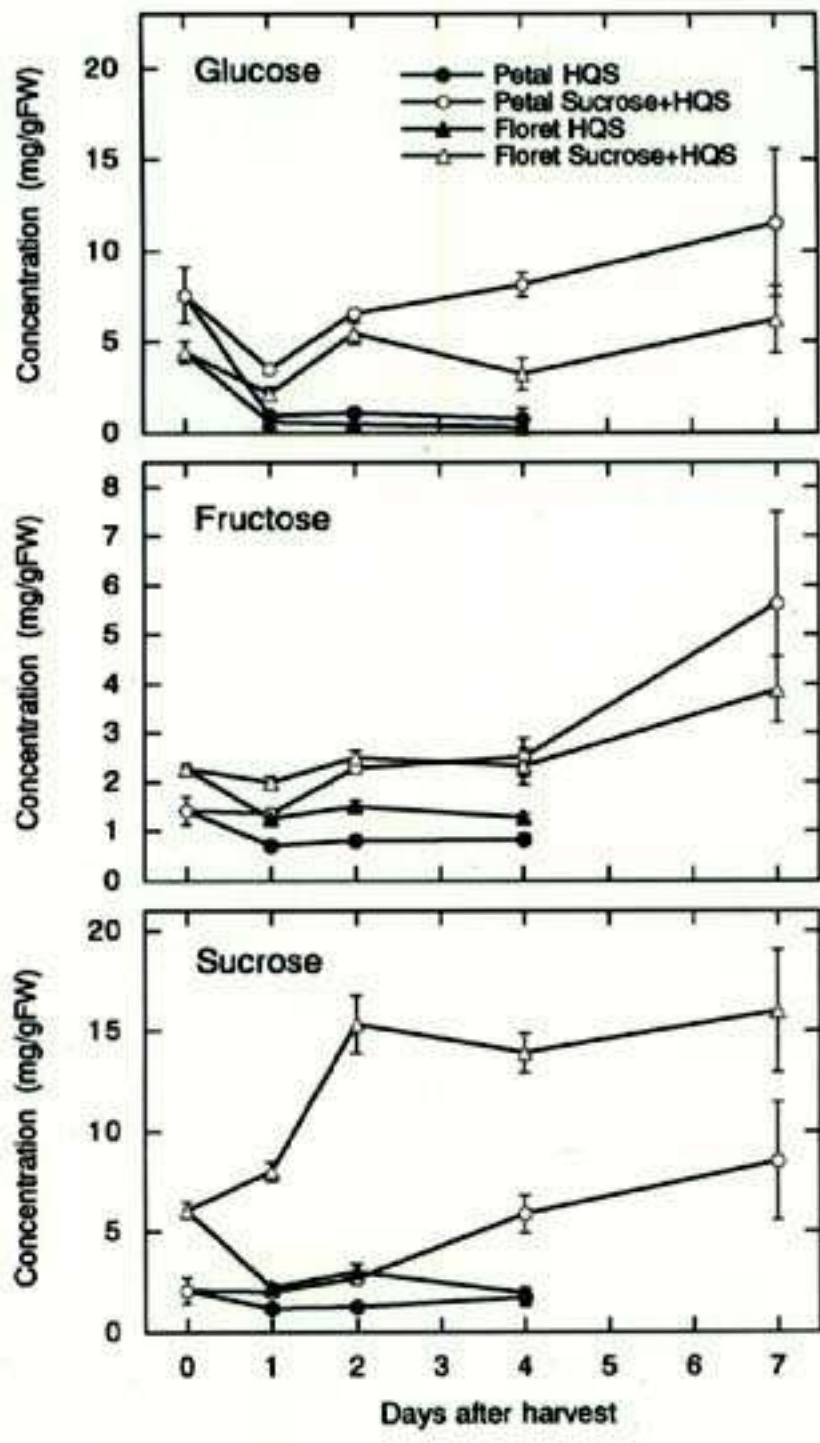


[BACK](#)

- 1) Baker, J. E. et al. (1977): Delay of senescence in carnations by a rhizobitoxine analog and sodium benzoate. *HortScience*, 12, 38-39.
- 2) Bielecki, R. L. (1993): Fructan hydrolysis drives petal expansion in the ephemeral daylily flower. *Plant Physiol.*, 103, 213-219.
- 3) Broun, R. & Mayak, S. (1981): Aminoxyacetic acid as an inhibitors of ethylene synthesis and senescence in carnation flowers. *Sci. Hort.*, 22, 173-180.
- 4) Dooner, H. K. & Robbins, T. P. (1991): Genetic and developmental control of anthocyanin biosynthesis. *Annu. Rev. Genet.*, 25, 173-199.
- 5) Downs, C. G., Reihana, M. & Dick, H. (1988): Bud-opening treatments to improve *Gypsophila* quality after transport. *Sci. Hort.*, 34, 301-310.
- 6) Farnham, D. S., Kofranek, A. M. & Kubota, J. (1978): Bud opening of *Gypsophila paniculata* L. cv. Perfecta with Physan-20. *J. Am. Soc. Hort. Sci.*, 103, 382-384.
- 7) Gilman, K. F. & Steponkus, P. L. (1972): Vascular blockage in cut roses. *J. Am. Soc. Hort. Sci.*, 97, 662-667.
- 8) Halevy, A. H. & Mayak, S. (1979): Senescence and postharvest physiology of cut flowers, part 1. *Hort. Rev.*, 1, 204-236.
- 9) Ichimura, K. & Hiraya, T. (1998): Effect of silver thiosulfate complex (STS) in combination with sucrose on the vase life of cut sweet pea flowers. *J. Jpn. Soc. Hort. Sci.*, 68 [In press].
- 10) Ichimura, K. & Hisamatsu, T.: Effects of continuous treatment with sucrose on the vase life of cut snapdragon flowers. *J. Jpn. Soc. Hort. Sci.*, 68 [In press].
- 11) Ichimura, K. & Korenaga, M. (1998): Improvement of vase life and petal color expression in several cultivars of cut Eustoma flowers by sucrose with 8-hydroxyquinoline sulfate. *Bull. Natl. Res. Inst. Veg., Ornam. Plants & Tea*, 13, 31-39 .
- 12) Ichimura, K. et al. (1998): Improvement of postharvest life and changes in sugar concentrations by sucrose treatment in bud cut sweet pea. *Bull. Natl. Res. Inst. Veg., Ornam. Plants & Tea*, 13, 41-49.
- 13) Ishihara, Y., Ohkawa, K. & Hyodo, H. (1991): Senescence of cut sweet pea flowers and ethylene production. *J. Jpn. Soc. Hort. Sci.*, 60, 141-147 [In Japanese with English summary].
- 14) Kenis, J. D., Silvente, S. T. & Trippi, V. S. (1985): Nitrogen metabolism and senescence-associated changes during growth of carnation flowers (*Dianthus caryophyllus*). *Physiol. Plant.*, 65, 455-459.
- 15) Koyama, Y. & Uda, A. (1994): Effects of temperature, light intensity and sucrose concentration on bud forcing and carnation flower quality. *J. Jpn. Soc. Hort. Sci.*, 63, 203-209 [In Japanese with English summary].
- 16) Kusuhara, Y., Kawabata, S. & Sakiyama, R. (1996): Effects of light intensity and sucrose concentration on the petal color and the expression of anthocyanin biosynthetic genes in detached flowers of *Eustoma grandiflorum*. *J. Jpn. Soc. Hort. Sci.*, 65 (suppl. 2), 550-551 [In Japanese].
- 17) Larsen, F. E. & Scholes, J. F. (1966): Effects of 8-hydroxyquinoline citrate, N-dimethyl aminosuccinamic acid, and sucrose on vase-life and spike characteristics of cut snapdragons. *Proc. Am. Soc. Hort. Sci.*, 89, 694-701.
- 18) Mayak, S. et al. (1973): Improvement of opening of cut gladioli flowers by pretreatment with high sugar concentrations. *Sci. Hort.*, 1, 357-365.

- 19) Mayak, S., Kofranek, A. M. & Tirosh, T. (1978): The effect of inorganic salts on the senescence of *Dianthus caryophyllus* flowers. *Physiol. Plant.*, 43, 282-286.
- 20) Midoh, N. et al. (1996): Effects of 1,1-dimethyl-4-(phenylsulfonyl)semicarbazide (DPSS) on carnation flower longevity. *Plant Growth Regul.*, 20, 195- 199.
- 21) Moalem-Beno, D. et al. (1997): Sugar-dependent gibberellin-induced chalcone synthase gene expression in petunia corollas. *Plant Physiol.*, 113, 419-424.
- 22) Mor, Y., Reid, M. S. & Kofranek, A. M. (1984): Pulse treatments with silver thiosulfate and sucrose improve the vase life of sweet peas. *J. Am. Soc. Hort. Sci.*, 109, 866-868.
- 23) Nichols, R. (1973): Senescence of the cut carnation flower: respiration and sugar status. *J. Hort. Sci.*, 48, 111-121.
- 24) Nowak, J. (1981): Chemical pre-treatment of snapdragon spikes to increase cut-flower longevity. *Sci. Hort.*, 15, 255-262.
- 25) Ohkawa, K. et al. (1991): Bud drop of sweet pea (*Lathyrus odoratus* L.) as affected by ethylene. *J. Jpn. Soc. Hort. Sci.*, 60, 405-408 [In Japanese with English summary].
- 26) Onozaki, T. & Yamaguchi, T. (1992): Effect of  $\pm$ -aminoisobutyric acid (AIB) application on the prolongation of the vase life of cut carnation flowers. *Bull. Natl. Res. Inst. Veg., Ornam. Plants & Tea*, A5, 69-79 [In Japanese with English summary].
- 27) Parups, E. V. & Molnar, J. M. (1972): Histochemical study of xylem blockage in cut roses. *J. Am. Soc. Hort. Sci.*, 97, 532-534.
- 28) Paulin, A. & Jamain, C. (1982): Development of flowers and changes in various sugars during opening of cut carnations. *J. Am. Soc. Hort. Sci.*, 107, 258-261.
- 29) Serrano, M. et al. (1990): Action and mechanism of  $\pm$ -aminoisobutyric acid as a retardant of cut carnation senescence. *Sci. Hort.*, 44, 127-134.
- 30) Sexton, R. et al. (1995): Effects of diazocyclopentadiene (DACP) and silver thiosulfate (STS) on ethylene regulated abscission of sweet pea flowers (*Lathyrus odoratus* L.). *Ann. Bot.*, 75, 337-342.
- 31) Shimamura, M. et al. (1997): Effects of  $\pm$ -aminoisobutyric acid and sucrose on the vase life of hybrid *Limonium*. *Postharvest Biol. Technol.*, 12, 247-253.
- 32) Tsukaya, H. et al. (1991): Sugar-dependent expression of the CHS-A gene for chalcone synthase from petunia in transgenic *Arabidopsis*. *Plant Physiol.*, 97, 1414-1421.
- 33) Uda, A., Yamanaka, M. & Fukushima, K. (1997): Pretreatment effect of novel ethylene inhibitors on extending longevity of carnation, larkspur and sweet pea cut flowers. *Kinki Chugoku Agric. Res.*, 93, 65-70 [In Japanese with English summary].
- 34) Wang, C. Y. et al. (1977): Effects of two analogs of rhizobitoxine and sodium benzoate on senescence of snapdragons. *J. Am. Soc. Hort. Sci.*, 102, 517-520.
- 35) Woltering, E. J. & van Doorn, W. G. (1988): Role of ethylene in senescence of petals-morphological and taxonomical relationships. *J. Exp. Bot.*, 39, 1605-1616.
- 36) Woodson, W. R. & Wang, H. (1987): Invertases of carnation petals. Partial purification, characterization and changes in activity during petal growth. *Physiol. Plant.*, 71, 224-28.

(Received for publication, January 22, 1998)



**Fig.1.**

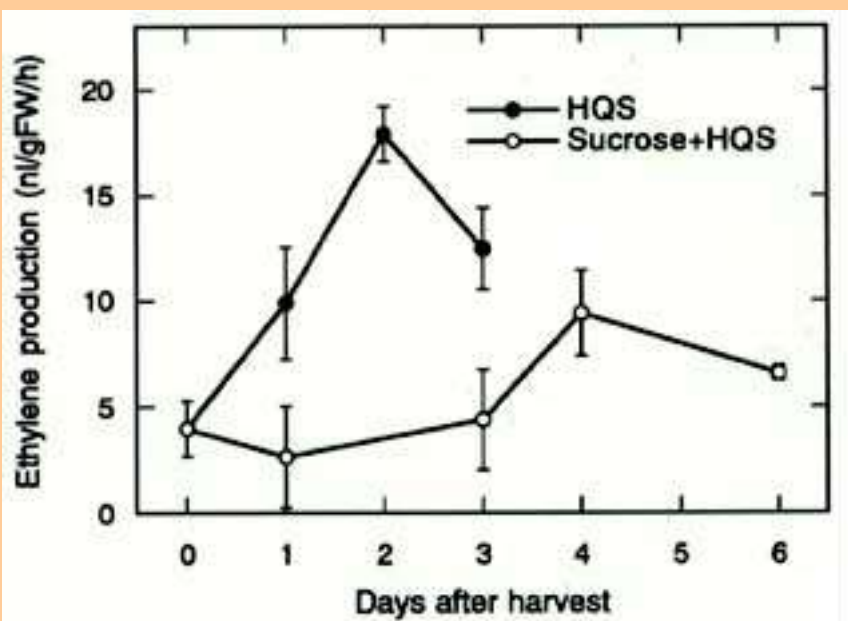
Changes in sugar concentrations of petal and the other parts of sweet pea floret with time

Values are means of 3 replications  $\pm$  standard errors.

Cut sweet at 23°C.

HQS solution was used as control.





**Fig.2.**  
Changes in ethylene production of sweet pea floret with time.

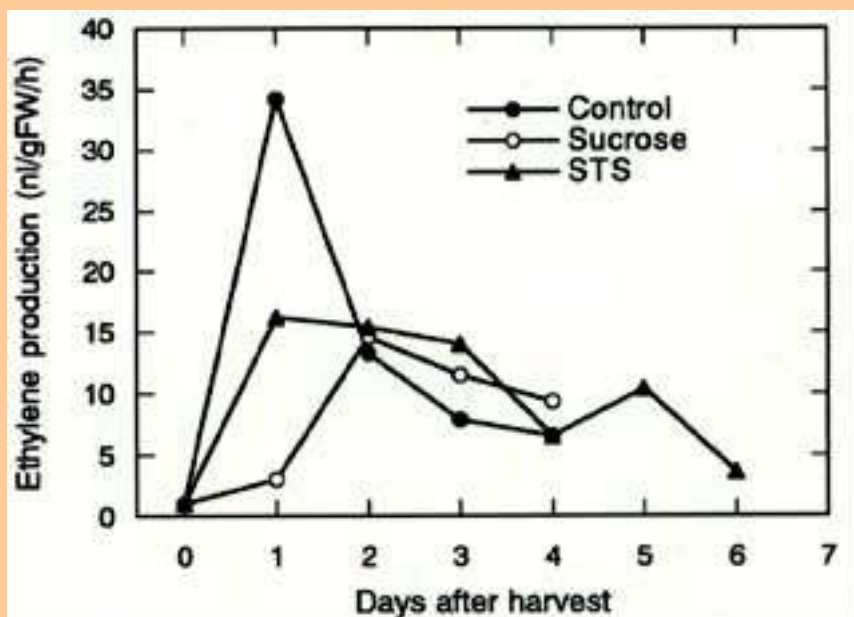
Values are means of 3 replications  $\pm$  standard errors.

Cut sweet pea flowers were kept at 23°C.

HQS solution was used as control.



[BACK](#)



**Fig.3.**  
Changes in ethylene production of sweet pea floret with time

Cut sweet pea flowers were kept at 23°C.  
Flower spikes were treated with water (control),  
0.2 mM STS, and 100 g L⁻¹ sucrose.



[BACK](#)



1~36): [Click here for References](#)

## Effects of sucrose treatment on the vase life of various cut flowers

Since sugars such as sucrose are effective in improving the vase life of cut flowers, they are included in preservatives. I describe here that sucrose improves the vase life of several important cut flowers.

### 1) Sweet pea

Sweet pea (*Lathyrus odoratus* L.) is a very suitable cut flower because of its wide range of colors and exceptional fragrance. The vase life of the cut flowers is very short^{22,25,35}). Since the flower of sweet pea is sensitive to ethylene, STS has been shown to be very effective in prolonging the vase life of sweet pea^{13,22,30}). STS, however, contains silver, a heavy metal, which is a potent environmental pollutant. Therefore, other chemicals will be required. Aminoxyacetic acid³),  $\alpha$ -aminoisobutyric acid^{26,29}), aminoethoxyvinyl glycine¹) and 1,1-dimethyl-4-phenylsulfonylsemicarbazide²⁰), inhibitors of ethylene biosynthesis, have been found to be effective in prolonging the longevity of cut carnation flowers. These compounds, however, are only slightly effective in extending the vase life of cut sweet pea flowers³³). On the contrary, diazocyclopentadiene, an ethylene action inhibitor, is fairly effective in extending the longevity of cut sweet peas³⁰).

We therefore investigated the effect of sucrose on the vase life of bud-cut sweet peas. Continuous treatment with sucrose markedly promoted floret opening and extended the floret longevity in cut sweet peas¹²). The vase life of florets treated with 100 g L⁻¹ sucrose was 3 times longer than that of control florets.

Although STS is a potent environmental pollutant, the use of this compound is not prohibited as preservative. We thus examined the effects of pulse treatment with sucrose and STS on the vase life of sweet pea flowers harvested at conventional times for farmers⁹). The cut spikes were treated with 100 g L⁻¹ sucrose for 16 h, 0.2 mM silver thiosulfate complex (STS) for 2 h and 0.2 mM STS for 2 h followed by 100 g L⁻¹ sucrose for 16 h. Treatment with STS followed by sucrose was the most effective in promoting floret opening ([Fig. 4](#)) as well as extending the vase life ([Table 1](#)). Anthocyanin concentrations increased by treatments with sucrose alone or STS followed by sucrose ([Table 2](#)). These results show that the addition of STS followed by sucrose is more effective than that of STS alone in improving the vase life of cut sweet pea flowers.

### [Fig.4. Effect of combined treatment with STS and sucrose on floret bud opening \(18 KB\)](#)

[Table 1: Effects of combined treatment with sucrose and STS on the vase life of cut sweet pea flowers](#)

<u>Treatment</u>	<u>Vase life (days)</u>	
	<u>Floret</u>	<u>Spike^{a)}</u>
Control (water)	1.7	2.5
Sucrose (100 g L ⁻¹ )	3.0	5.9
STS(0.2 mM)	4.4	7.2
STS (0.2 mM) + Sucrose (100 g L ⁻¹ )	6.0	8.7

a): Vase life of spikes was determined as the time from harvest to the time when all the florets wilted. Cut flowers were kept at 23 °C.

**Table 2: Effects of combined treatment with sucrose and STS on anthocyanin concentrations of petals in cut sweet pea flowers**

<u>Treatment</u>	<u>Anthocyanin</u> (OD530 nm gFW ⁻¹ )
Control (water)	0.84
Sucrose (100 g L ⁻¹ )	2.62
STS (0.2 mM)	1.11
STS (0.2 mM) + Sucrose(100 g L ⁻¹ )	1.76

Cut flowers were kept at 23 °C.

As mentioned above, the use of STS is not recommended. Since the treatment with sucrose alone was also considerably effective in improving the vase life of cut sweet pea, it is assumed that the use of sucrose in combination with ethylene inhibitors, other than STS, may improve the vase life of sweet pea in the same way as STS.

## 2) Hybrid *Limonium*

Hybrid *Limonium*, cultivar 'Blue fantasia 100', is an interspecific hybrid between *L. bellidifolia* Gouan and *L. latifolium* Kuntzn. The inflorescence has many small florets, which are at various developmental stages between bud and opened floret. In the cut inflorescence, buds seldom open and the floret longevity is short. Thus, the effects of sucrose on the vase life of hybrid *Limonium* were investigated³¹).

The cut flowers were treated with sucrose for 24 h, and thereafter placed in water. Sucrose at 10 and 20 g L⁻¹ significantly increased the percentage of open florets, but did not affect appreciably the floret senescence. Since sucrose alone did not improve the vase life sufficiently, we further examined the effect of combined treatment with 20 g L⁻¹ sucrose and 10 mM  $\alpha$ -aminoisobutyric acid (AIB), an inhibitor of 1-aminocyclopropane-1-carboxylic acid (ACC) oxidase on the vase life. The combined treatment with sucrose and AIB promoted floret opening and inhibited floret senescence. This effect is probably due to the promotion of floret opening by sucrose and extension of longevity by AIB. Petal color was expressed well and florets fully opened after the treatment. Therefore, this treatment can be practically used as preservative for farmers.

## 3) *Eustoma*

*Eustoma grandiflorum* (Raf.) Shinn., which is native to the southern United States, was introduced into Japan more than 60 years ago. *Eustoma* is widely produced in the world, particularly in Japan. Although the vase life of cut *Eustoma* flowers is relatively long, small buds do not open fully and the color of petals is slightly expressed. We therefore investigated the effect of sucrose with 8-hydroxyquinoline

sulfate (HQS) on the vase life in 6 cultivars of *Eustoma* flowers¹¹).

Continuous treatment with 20 g L⁻¹ sucrose combined with 200 mg L⁻¹ HQS significantly promoted flower opening and extended the vase life of all the cultivars tested ([Table 3](#)). This treatment also increased anthocyanin concentrations of petals, particularly in 'Azuma-no-ginga' and 'Azuma-no-kasumi', both of which show a light color ([Table 4](#)).

**Table 3: Effect of sucrose with HQS on vase life in various cultivars of cut *Eustoma grandiflorum***

Cultivar	Vase life ^{a)} (days)	
	Control (water)	Sucrose + HQS
Azuma-no-ginga	9.8	14.4
Azuma-no-kasumi	11.1	16.0
Azuma-no-shirabe	14.4	20.1
Piccolo blue	10.7	19.0
Piccolo blue picoty	11.9	24.0
Piccolo rose	12.4	19.4

a): Vase life was determined as the time from harvest to the time when all the florets wilted. Cut flowers were kept at 23°C.

**Table 4: Effect of sucrose with HQS on anthocyanin concentrations in various cultivars of cut *Eustoma grandiflorum***

Cultivar	Anthocyanin concentration (OD530 nm gFW ⁻¹ )	
	Control (water)	Sucrose + HQS
Azuma-no-ginga	0.40	4.31
Azuma-no-kasumi	0.17	2.52
Piccolo blue	3.65	10.10
Piccolo rose	1.20	4.85

Cut flowers were kept at 23°C.

Cut *Eustoma* flowers used in this study were transported in a cardboard box without water for 1 day, and then they were immersed in tap water and kept at 23°C for 3 days. In spite of unsuitable conditions for cut flowers, the use of sucrose with HQS improved considerably the vase life of cut *Eustoma* flowers. Therefore, the use of sucrose with HQS could become a practical treatment in improving the vase life for consumers as preservative.

#### 4) *Snapdragon*

The flowers of snapdragon (*Antirrhinum majus* L.) are sensitive to ethylene, and the vase life of the cut flowers is relatively short. Furthermore, most of the buds do not open fully and the color of their petals is slightly expressed^{17,24,34}).

We examined the effects of sucrose application on the vase life of cut snapdragon flowers¹⁰). Continuous treatment with sucrose at 25, 50, 75 or 100 g L⁻¹ in combination with 200 mg L⁻¹ HQS markedly promoted floret opening and extended the vase life of flower spikes ([Table 5](#)). In addition, petal color expression was markedly improved by these treatments. The optimum concentration was 50 g L⁻¹. This treatment increased the sugar concentrations of petals and suppressed ethylene production of florets. These results suggest that the effect of sucrose in promoting bud opening and inhibiting flower senescence is probably due to the increase in sugar concentration and inhibition of ethylene synthesis.

**Table 5: Effects of various concentrations of sucrose with HQS on the vase life of cut snapdragon flowers**

<u>Treatment</u>	<u>Vase life^{a)} (days)</u>
DW	8.2
0 g L ⁻¹ sucrose + HQS	10.2
25 g L ⁻¹ sucrose + HQS	17.4
50 g L ⁻¹ sucrose + HQS	20.7
75 g L ⁻¹ sucrose + HQS	17.7
100 g L ⁻¹ sucrose + HQS	15.0

a): Vase life was determined as the time from harvest to the time when all the florets wilted. Cut flowers were kept at 23°C.

## Conclusion

As described above, treatment with sucrose not only extended the vase life but also promoted flower opening. In addition, sucrose improved the petal color expression. In this paper, I observed that continuous treatment with sucrose is very effective in improving the vase life of cut sweet pea, *Eustoma* and snapdragon flowers. Pulse treatment with sucrose was also effective in cut sweet pea and hybrid *Limonium* flowers. These findings suggest that sugars are effective in improving the vase life of many cut flowers. In addition, sugars are cheap and safe compounds. However, sugars are not much utilized practically in Japan. To keep the quality of cut flowers, the utilization of sugars should be further promoted



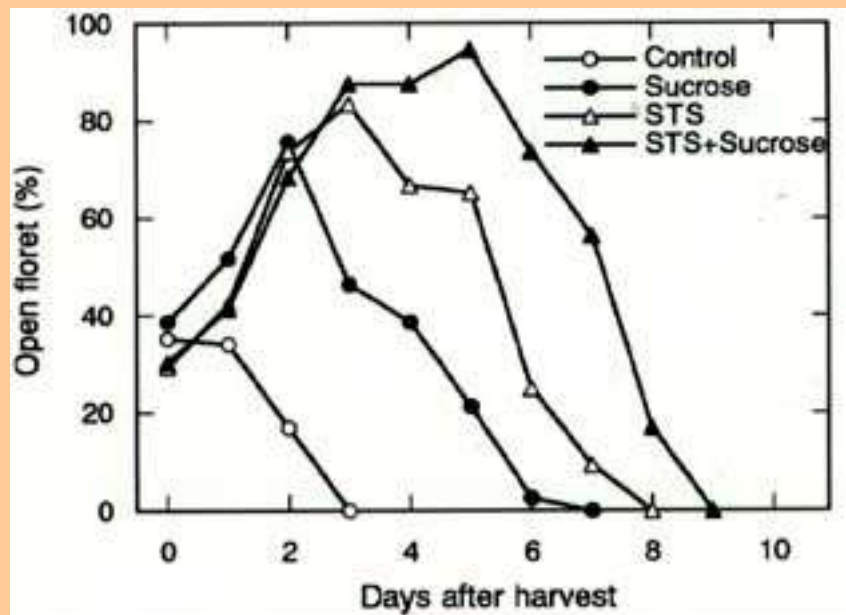
[Forward to: -Plant Regeneration via Shoot Organogenesis from Cotyledons in Two Wild Cucumis Species, C. figarei and C.metuliferus-](#)



[Back to: Contents](#)



[Back to: JIRCAS home page](#)



**Fig.4.**  
Effect of combined treatment with STS  
and sucrose on floret bud opening

Cut sweet pea flowers were kept at 23°C.  
Flower spikes were treated with water (control),  
0.2mM STS.100g⁻¹ sucrose and 0.2mM STS  
followed by 100g⁻¹ sucrose.  
Date were taken from only the bud with maximum  
growth of each flowering stem.

 [BACK](#)

# Plant Regeneration via Shoot Organogenesis from Cotyledons in Two Wild *Cucumis* Species, *C. figarei* and *C. metuliferus*

Yutaka Tabei*¹, Tomohiro Yamada*^{2,3}, Toshikazu Morishita*^{2,4} and Takeshi OSAKI*³

*^{1,2} Department of Biotechnology, National Institute of Agrobiological Resources  
(Tsukuba, Ibaraki, 305-8602 Japan)

*³ College of Agriculture, Osaka Prefecture University  
(Sakai, Osaka, 599-8531 Japan)

*⁴ Department of Crop Breeding, Kyushu National Agricultural Experiment Station  
(Kikuchi-gun, Kumamoto, 861-1192 Japan)

Present address:

*¹ Innovative Technology Division, Agriculture, Forestry and Fisheries Research Council Secretariat, Ministry of Agriculture, Forestry and Fisheries  
(Kasumigaseki, Chiyoda, Tokyo, 100-8590 Japan)

## Abstract

Efficient plant regeneration system of *Cucumis figarei* and *C. metuliferus* from cotyledon was developed. Excised cotyledon explants from young seedlings after 3 days of germination were cultured on MS medium containing 30 g/L sucrose, 2.5 g/L gelrite and several combinations of phytohormones. In *C. figarei*, the effect of the combination of BA and IAA on shoot organogenesis was investigated. Adventitious shoots were induced from cotyledonary explants and the highest regeneration frequency was 40% on MS basal medium supplemented with 1 mg/L BA. It was demonstrated that the use of IAA decreased the regeneration frequency, and the application of 2 mg/L IAA suppressed shoot organogenesis completely. Subsequently, other combinations of phytohormones were investigated to improve the regeneration frequency. Combination of 1 mg/L BA and ABA (1 or 2 mg/L) increased the regeneration frequency (ca. 60%), while the combination of 1 mg/L BA and Zeatin (0.5, 1 and 2 mg/L) did not enhance shoot organogenesis and the addition of TDZ (0.2, 0.5, 1 and 2 mg/L) inhibited shoot organogenesis. In *C. metuliferus*, the highest regeneration frequency was 92.5% when cotyledonary explants were cultured on MS medium with 1 mg/L BA and 0.2 mg/L IAA. Lower concentration of IAA (0.2 mg/L) stimulated shoot organogenesis, while a higher concentration of IAA (2, 4 and 8 mg/L) exhibited an adverse effect, and especially, shoot organogenesis was suppressed completely by the addition of 8 mg/L IAA. Regenerated shoots were transferred onto MS medium containing 1 mg/L IAA to induce adventitious roots. Elongated shoots with adventitious roots were acclimatized and grew to normal plants in the greenhouse.

**Discipline:** Biotechnology

**Additional key words:** tissue culture

1~23): [Click here for References](#)

## Introduction

Melon (*Cucumis melo* L.) is cultivated over a wide area in the world, and up to now, breeding of melon had been progressing to improve many characters, especially disease and insect resistance. It was reported that several wild *Cucumis* species display a resistance to diseases and insect pests, including the resistance to viruses, *Fusarium* wilt and greenhouse whitefly of *C. metuliferus*^{5,7,14}, virus resistance of *C. figarei*¹³ and root knot nematode resistance of *C. angria*^{5,7}). However, in most of the wild species, crossability with cultivated melon is limited^{2,9}), and it is very difficult to promote the introgression of the resistance to diseases and/or insect pests of wild

*Cucumis* species into cultivated melon by cross-pollination. Under these conditions, cell fusion is considered to be a suitable method for the production of hybrids between cultivated melon and wild *Cucumis* species.

To produce somatic hybrids by cell fusion, it is essential that an efficient protoplast culture system be established and reliable selection methods be also developed. Protoplast culture of melon was already reported by several researcher groups^{19,23}). In contrast, attempts at plant regeneration of *C. metuliferus* from protoplasts have been unsuccessful²¹), and protoplast culture of other wild *Cucumis* species has not been reported yet. Although the production of somatic hybrids between melon and pumpkin was reported²²), the production of interspecific hybrids between melon and wild *Cucumis* species by cell fusion has not been successful. In the production of somatic hybrids by cell fusion, it is important to develop an efficient regeneration system from protoplasts and reliable methods for the selection of somatic hybrids. Several selection methods of somatic hybrids in cell fusion had already been reviewed by Bajaj¹). In the review, reliable selection of somatic hybrids by marker genes, e.g. antibiotic resistance genes, introduced into plant through recombinant DNA technology was described. To apply this selection method to the production of somatic hybrids between melon and wild *Cucumis* species, it is essential that selective marker gene(s) be introduced into wild *Cucumis* species. However, the plant regeneration procedure applied to *C. metuliferus*^{15,16}) and *C. angria*¹¹) was found to be ineffective practically while that of *C. figareii* has not been reported yet.

In the present study, the use of phytohormones was evaluated to develop efficient plant regeneration in *C. figareii* and *C. metuliferus*. We succeeded in recovering whole plants from cotyledonary explants in *C. figareii* and improving the regeneration system in *C. metuliferus*.

## Materials and methods

### 1) Plant materials and culture conditions

Peeled seeds of *C. figareii* and *C. metuliferus* were surface-sterilized by dipping in a hypochlorite solution containing ca. 1% active chlorite for 10 min, followed by 3 rinses in sterile distilled water. To ensure uniform germination, seeds were placed in a shallow dish and on a wet filter paper with sterile distilled water for 3 days at 28°C in darkness. Afterwards, each cotyledon dissected from seed was cut into 2 pieces and cultured onto MS medium¹⁰) containing 30 g/L sucrose, 2.5 g/L gelrite and phytohormones. The pH of all the media was adjusted to 5.8 prior to autoclaving sterilization at 121°C for 15 min. All the cultures except for the seed germination period were carried out under cool-white fluorescent lamps (ca. 2000 lux) and 16 h photoperiod and at 25°C.

### 2) Plant regeneration from cotyledonary explants in *C. figareii*

Media: Combinations of benzyladenine (BA) (0.5, 1 and 2 mg/L) and indole-3-acetic acid (IAA) (0, 0.2 and 2 mg/L) were used to evaluate the effect on shoot organogenesis. Subsequently, effects of 1 mg/L BA combined to several concentrations of abscisic acid (ABA) (0.2, 1, 2 and 4 mg/L), Zeatin (0.5, 2 and 4 mg/L) and thiazuron (TDZ) (0.2, 0.5, 1 and 2 mg/L) on shoot organogenesis were evaluated. The explants were cultured onto the media in plastic petri dishes ( $\phi$  90x20 mm). At 4 weeks after the initial culture, the regeneration frequency was calculated based on the number of explants forming adventitious shoots to that of total explants cultured. The experiment was replicated 3 times, and 10 explants were used in each treatment. Adventitious shoots were transferred to MS medium containing 30 g/L sucrose, 2.5 g/L gelrite and 1 mg/L IAA to elongate shoots and induce adventitious roots. Plantlets with adventitious roots were acclimatized and grew to normal plants.

### 3) Plant regeneration from cotyledonary explants in *C. metuliferus*

Media: Combinations of BA (0.1, 0.5, 1 and 2 mg/L) and IAA (0, 0.2, 2, 4 and 8 mg/L) were used to evaluate the effect on shoot organogenesis. At 4 weeks after the initial culture, the regeneration frequency was calculated based on the number of explants forming adventitious shoots to that of total explants cultured. The experiment was replicated 3 times, and 24 explants were used in each treatment. Other conditions were the same as those described above.



[Continue to: Results and Discussion](#)



[Back to: Contents](#)

## References



[Back to the first page](#)

- 1) Bajaj, Y. P. S. (1989): Recent advances in the isolation and culture of protoplasts and their implications in crop improvement. *In Biotechnology in agriculture and forestry* No. 8. ed. Bajaj, Y. P. S., Springer-Verlag Berlin, Heidelberg, 3-22.
- 2) Deakin, J. R., Bohn, G. W. & Whitaker, T. W. (1971): Interspecific hybridization in *Cucumis*. *Econ. Bot.*, 25, 195-211.
- 3) Dirks, R. & Buggenum, M.v. (1989): In vitro plant regeneration from leaf and cotyledon explants of *Cucumis melo* L. *Plant Cell Rep.*, 7, 626-627.
- 4) Dong, J. Z. & Jia, S. R. (1991): High efficiency plant regeneration from cotyledons of watermelon (*Citrullus vulgaris* Schrad). *Plant Cell Rep.*, 9, 559-562.
- 5) Fassuliotis, G. (1967): Species of *Cucumis* resistant to the root-knot nematode, *Meloidogyne incognita acrita*. *Plant Dis. Rep.*, 51, 720-723.
- 6) Giraudat, J. et al. (1994): Current advances in abscisic acid action and signaling. *Plant Mol. Biol.*, 26, 1557-1577.
- 7) Igarashi, I., Kanno, T. & Kawaide, T. (1987): Disease and pest resistance of wild *Cucumis* species and their compatibility as rootstock for muskmelon, cucumber and watermelon. *Bull. Natl. Res. Inst. Veg., Ornam. Plants & Tea*, A1, 173-185.
- 8) Kathal, R., Bhatnagar, S. P. & Bhojwani, S. S. (1988): Regeneration of plants from leaf explants of *Cucumis melo* cv. Pusa sharbati. *Plant Cell Rep.*, 9, 449-451.
- 9) Kho, Y. O., Den Nijs, A. P. M. & Franken, J. (1980) : Interspecific hybridization in *Cucumis* L. II. The crossability of species, an investigation of in vivo pollen tube growth and seed set. *Euphytica*, 29, 661-672.
- 10) Murashige, T. & Skoog, F. (1962): A revised medium for rapid growth and bioassays with tobacco tissue culture. *Plant Physiol.*, 15, 473-497.
- 11) Orczyk, W., Nadolska-Orczyk, A. & Malepszy, S. (1988): Plant regeneration of wild *Cucumis* species. *Acta Societatis Botanicorum Poloniae*, 57 (2), 195-200.
- 12) Oridate, T. & Oosawa, K. (1986): Somatic embryogenesis and plant regeneration from suspension callus culture in melon (*Cucumis melo* L.). *Jpn. J. Breed.*, 36, 424-428.
- 13) Osaki, T. et al. (1994): Reaction of *Cucumis melo* and wild relatives to several viruses. *Proc. Kansai Pl. Prot.* 36, 13-20.
- 14) Provvidenti, R. & Robinson, R. W. (1974): Resistance to squash mosaic virus and watermelon mosaic virus in *Cucumis metuliferus*. *J. Amer. Soc. Hort. Sci.*, 105, 174-180.
- 15) Punja, Z. K. et al. (1990): Regeneration of *Cucumis sativus* var. sativus and *C. sativus* var. *hardwickii*, *C. melo*, and *C. metuliferus* from explants through somatic embryogenesis and organogenesis. *Plant Cell, Tissue & Organ Culture*, 21, 93-102.
- 16) Raharjo, S. H. T. & Punja, Z. K. (1993): Plantlet regeneration from petiole explants of the African horned cucumber, *Cucumis metuliferus*. *Plant Cell, Tissue & Organ Culture*, 32, 169-174.
- 17) Shetty, K. et al. (1992): Stimulation of benzyladenin-induced in vitro shoot organogenesis from cotyledons of *Cucumis sativus* L. by proline and abscisic acid. *Plant Tissue Cult. Lett.*, 9, 104-108.
- 18) Tabei, Y., T. Kanno, T. & Nishio, T. (1991): Regulation of organogenesis and somatic embryogenesis by auxin in melon, *Cucumis melo* L. *Plant Cell Rep.*, 10, 225-229.
- 19) Tabei, Y., Nishio, T. & Kanno, T. (1992): Plant regeneration from cotyledonary protoplast in melon.



*J. Jpn. Soc. Hort. Sci.*, 61, 317-322.

- 20) Tabei, Y., Yamanaka, H. & Kanno, T. (1993): Adventitious shoot induction and plant regeneration from cotyledons of mature seed in watermelon (*Citrullus lanatus* S.). *Plant Tissue Cult. Lett.*, 10, 235-241.
- 21) Tang, F. A. & Punja, Z. K. (1989): Isolation and culture of protoplasts of *Cucumis sativus* and *Cucumis metuliferus* and method for their fusion. *Cucurbit Genet. Coop. Rep.*, 12, 29-34.
- 22) Yamaguchi, J. & Shiga, T. (1993): Characteristics of regenerated plants via protoplast electrofusion between melon (*Cucumis melo*) and pumpkin (interspecific hybrid, *Cucurbita maxima* x *C. moschata*). *Jpn. J. Breed.*, 43, 173-182.
- 23) Yamanaka, H., Amagasa, K. & Yoshida, Y. (1990): Plant regeneration from cotyledon protoplast of *Cucumis melo* L. *Plant Tissue Cult. Lett.*, 7, 103-107.

(Received for publication, January 12, 1998)

## Results

### 1) Production of adventitious shoots in *C. figarei*

Adventitious shoots of *C. figarei* were induced on media containing only BA as plant growth regulator ([Table 1](#) and [Fig. 1-A](#)). Especially, the highest regeneration frequency (43.3%) was achieved at 1 mg/L BA. Lower concentration of BA (0.5 mg/L) was insufficient to promote adventitious shoots, and higher concentration of BA (2 mg/L) slightly decreased the regeneration frequency (36.7%). However, the addition of IAA into the shoot induction media decreased the regeneration frequency remarkably. It was shown that the combination of BA and IAA inhibited shoot organogenesis from cotyledonary explants in *C. figarei*

**Table1: Effect of application of phytohormones on shoot organogenesis in *C. figarei***

		IAA (mg/L)		
		0	0.2	2
BA (mg/L)	0.5	10.0±5.8	13.3±3.3	0
	1.0	43.3±5.8	10.0±5.8	0
	2.0	36.7±5.8	10.0±5.8	0

The experiment used 10 explants in each treatment and was triplicated.

### [Fig.1: Shoot organogenesis and plant regeneration in *C. figarei* and *C. metuliferus* \(42 KB\)](#)

As we considered that the regeneration frequency (43.3%) obtained from these experiments was not satisfactory for practical application, other conditions, including the combination of 1 mg/L BA and other phytohormones (ABA, Zeatin and TDZ), were investigated to enhance the regeneration frequency. Combination of 1 mg/L BA and ABA (0.2 to 2 mg/L) increased the regeneration frequency, and the highest regeneration frequency (63.3%) was achieved when cotyledonary explants were cultured with a combination of 1 mg/L BA and 0.2 mg/L ABA ([Table 2](#)). However, the addition of 4 mg/L ABA did not improve the frequency of shoot organogenesis. The regeneration frequency under the combination of 1 mg/L BA and 2 mg/L Zeatin was the same as that with 1 mg/L BA only, while the combination of 0.5 mg/L Zeatin decreased the regeneration frequency compared to 1 mg/L BA only (Table 2). TDZ exerted adverse effects on shoot organogenesis in *C. figarei*, and the regeneration frequency decreased remarkably (data not shown). These experiments, indicated that the combination of 1 mg/L BA and 0.2 mg/L ABA promoted shoot organogenesis in *C. figarei* efficiently.

**Table 2. Effect of addition of Zeatin and ABA on shoot organogenesis in *C. figarei***

Control ^{a)}	Zeatin (mg/L)			ABA (mg/L)			
	0.5	2	4	0.2	1	2	4
40.0±5.8	30.0±5.8	43.3±3.3	45.0±5.0	63.3±0	60.0±5.8	60.0±10.0	45.0±5.0

The experiment used 10 explants in each treatment and was triplicated.

a): Explants were cultured on MS medium containing 1 mg/L BA, 30 g/L sucrose and 2.5 g/L gelrite.

Most of the regenerated shoots were elongated and induced adventitious roots on MS medium supplemented with 1 mg/L IAA ([Fig. 1-C](#)). Plantlets acclimatized grew vigorously in the greenhouse.

## 2) Production of adventitious shoots in *C. metuliferus*

The use of BA only or of a combination of BA and IAA resulted in the induction of adventitious shoots from cotyledonary explants in *C. metuliferus* (Fig. 1-B). The application of 1 and 2 mg/L BA could induce adventitious shoots, and the frequencies were 84.4% and 80.0%, respectively. However, lower concentrations (0.1 and 0.5 mg/L) of BA induced adventitious shoots less efficiently than higher ones. Moreover, the combination of BA (0.1, 0.5, 1 and 2 mg/L) and 0.2 mg/L IAA enhanced shoot organogenesis, and the frequencies ranged from 78.8 to 92.5%. Especially, the highest regeneration frequency (92.5%) was obtained under combinations of 1 mg/L BA and 0.2 mg/L IAA. However, a higher concentration of IAA decreased the frequencies gradually, and the addition of 8 mg/L IAA suppressed shoot organogenesis completely at all the concentrations of BA in this experiment (Table 3).

Table 3. Effect of application of phytohormones on shoot organogenesis in *C. metuliferus*

BA (mg/L)	IAA (mg/L)					
	0	0.2	2	4	8	
0.1	47.2±19.6	78.8±5.3	35.4±8.0	49.6±4.4	0	
0.5	50.4±12.3	91.1±5.1	62.5±22.0	25.0±17.6	0	
1.0	84.4±4.4	92.5±10.6	85.4±4.2	50.1±8.8	0	
2.0	80.0±7.1	89.6±14.7	66.7±18.0	6.3±8.8	0	

The experiment used 24 explants in each treatment and was triplicated.

Most of the regenerated shoots were elongated and induced adventitious roots under the same conditions as those for *C. figareii* (Fig. 1-D). Plantlets of *C. metuliferus* also grew vigorously in the greenhouse.

## Discussion

Combination of phytohormones often determines the course of morphogenesis, e.g. shoot organogenesis or embryogenesis. The use of plant growth regulators is essential for the control of morphogenesis in tissue culture. In this report, first of all, the effects of combinations of BA and IAA on shoot organogenesis in *C. figareii* and *C. metuliferus* were analyzed, because BA and IAA have been most often used for shoot organogenesis in melon^{3,8,18}) and cucumber¹⁷). Combination of BA and IAA was also reported to be effective for shoot organogenesis in watermelon^{4,20}).

Shoot organogenesis and embryogenesis in *C. figareii* had not been reported yet, and *C. figareii* was considered to be a recalcitrant plant for plant regeneration from tissues. In this report, the regeneration system of *C. figareii* was investigated and developed as in the case of *C. metuliferus*. When cotyledons 3 days after forced sprouting were cultured in the presence of BA (0.5, 1, 2 mg/L) only or in combination with 0.2 mg/L IAA and BA (0.5, 1, 2 mg/L), several adventitious shoots were induced. Addition of IAA into the shoot induction medium suppressed shoot organogenesis. In some regeneration systems via shoot organogenesis in melon and cucumber, it was reported that the utilization of auxin was not essential^{3,17}). In the tissue culture of *C. figareii*, the combination of cytokinin and auxin had tended to stimulate callus proliferation, and efficient shoot organogenesis was not achieved, because the conditions of shoot induction from dedifferentiated callus and proliferation were not favorable. Subsequently, BA was combined with several kinds of phytohormones to improve the regeneration frequency. It was found that the combination of BA and ABA stimulated shoot organogenesis from cotyledons 3 days after forced sprouting. Recently, it has been reported that the addition of ABA improved the regeneration frequency via shoot organogenesis and somatic embryogenesis^{6,17}). However, the mechanisms of action of ABA in tissue culture have not been elucidated. One of the assumptions was as follows: the induction of ABA when plants experienced several stresses, e.g./low and high temperature, desiccation, microbial infection and injury, conferred a certain degree of tolerance against these stresses⁶). Addition of ABA into the regeneration medium may induce tolerance to tissue culture as a kind of stress.

In *C. metuliferus*, adventitious shoots were induced effectively in the presence of BA only or in combinations of BA and IAA, especially, the highest regeneration frequency was obtained under the combination of 1 mg/L BA and 0.2 mg/L IAA. Orczyk et al.¹¹) attempted to induce plant regeneration from a leaf of *C. figareii* and *C. metuliferus* in the presence of several concentrations of 2,4-dichlorophenoxyacetic acid (2,4-D) and 6( $\gamma$ ,  $\gamma$ -dimethylallylamino)-purine (2iP). Raharjo and

Punja¹⁶⁾ succeeded in the induction of shoot callus derived from petioles in the presence of 2,4-D and BA. Punja et al.¹⁵⁾ also succeeded in the induction of adventitious shoots from cotyledon, leaves and petiole. The highest regeneration frequency of 30% was obtained from leaf cultured on MS medium with 5  $\mu$  M IAA and 5  $\mu$  M BA. However, Punja et al.¹⁵⁾ failed to achieve plant regeneration when these explants were cultured under a combination of  $\alpha$ -naphthaleneacetic acid (NAA) and BA, or 2,4-D and BA. Based on this information, including our results, it was considered that the utilization of IAA and BA was essential for efficient shoot organogenesis in *C. metuliferus*. Although concentrations of BA and IAA reported by Punja et al.¹⁵⁾ and those we used were very close, the regeneration frequency was different between the 2 groups. The difference between these reports was attributed to the difference in the explant used in tissue culture, namely Punja et al.¹⁵⁾ used cotyledon from 8 to 10 days old seedlings and leaves and petiole from 3 to 4 weeks old seedlings, while we used cotyledons 3 days after forced sprouting in our experiment. Cotyledons of mature seed or very young seedlings were used for tissue culture in Cucurbitaceae^{3,4,12,17,18,20)}. Potential for regeneration of several kinds of explants was examined for shoot organogenesis and embryogenesis in melon, and the regeneration ability of cotyledons of mature seeds was found to be higher than that of cotyledons from 7 days old seedlings and leaves and petiole from 3 weeks old seedlings¹⁸⁾. Based on these reports, it was assumed that the ability of cotyledons of melon^{8,18)}, and watermelon^{4,20)} for plant regeneration gradually decreased when the duration of the period after germination increased. For the development of an efficient plant regeneration system in *C. metuliferus*, it is essential to use a combination of BA and IAA as phytohormones for shoot organogenesis and young cotyledons 3 days after forced sprouting were also used as explants.

The results of our study suggest that efficient regeneration conditions for *C. figarei* and *C. metuliferus* may enable to produce transgenic wild Cucumis species, and contribute to the development of a regeneration system of protoplast culture in *C. figarei* and *C. metuliferus*.

 [Forward to: -Agrobacterium tumefaciens-Mediated Gene Transfer to Tea Plant \(Camellia sinensis\) Cells-](#)

 [Back to: Contents](#)

 [Back to: JICAS home page](#)

**Fig. 1.**  
Shoot  
organogenesis  
and plant  
regeneration in  
*C. figarei* and *C.*  
*metuliferus*

A: Shoot  
organogenesis from  
cotyledonary  
explants in *C.*  
*figarei* on MS  
medium containing  
1 mg/L BA and 1  
mg/L ABA.

B: Shoot  
organogenesis from  
cotyledonary  
explants in *C.*  
*metuliferus* on MS  
medium containing  
1 mg/L BA and 0.2  
mg/L IAA.

C, D: Plantlet in *C.*  
*figarei* and *C.*  
*metuliferus* growing  
on MS medium  
containing 1 mg/L  
IAA, respectively.

E: Regenerated  
plant in *C.*  
*metuliferus* growing  
in greenhouse.



[BACK](#)

# *Agrobacterium tumefaciens* -Mediated Gene Transfer to Tea Plant (*Camellia sinensis*) Cells

Satoru MATSUMOTO and Masaoki FUKUI*

Department of Tea Agronomy, National Research Institute of Vegetables, Ornamental plants and Tea  
(Kanaya 2769, Shizuoka, 428-8501 Japan)

Present address:

*Fukujuen Co., Ltd. (Yamashiro, Kyoto, 619-0295 Japan)

## Abstract

Acetosyringone, which is one of the phenolic compounds produced by wounding plant tissues, actively induces the transfer of T-DNA from *Agrobacterium* to plant. To produce transgenic calli from tea plant (*Camellia sinensis*), leaf explants of the tea plant were co-cultivated with *Agrobacterium tumefaciens* LBA4404 harboring pBI121 under different acetosyringone concentration conditions. After the infection, these explants were placed on a medium containing 200 mg/L kanamycin and then resistant calli were selected. Although callus differentiation was not observed without acetosyringone at 10  $\mu$ M application, resistant calli were obtained from the explants treated with acetosyringone. In particular, the application of 500  $\mu$ M of acetosyringone promoted the production of resistant calli. When the fluorogenic assay was carried out to detect the GUS gene expression, one resistant callus showed the activation. In addition, PCR and PCR Southern blot analyses confirmed that the resistant calli were transformants.

**Discipline:** Biotechnology/Plant breeding/Tea industry

**Additional key words:** acetosyringone

1-17): [Click here for References](#)

## Introduction

Plant genetic transformation has been applied to many crop plants and some of the transgenic plants have been used commercially in recent years. Although some transformed woody plants also have been produced, such as apple⁶⁾, kiwi fruit¹⁷⁾, citrus¹¹⁾ and poplar¹⁾, the number of woody plants species giving rise to transformants is limited. Since successful transformation is based on tissue culture techniques, regeneration from plant tissues or protoplasts, cannot be easily established for many woody plants.

Tea plant (*Camellia sinensis*), one of the important crops for beverage, is a woody plant. No stable technique of foreign gene introduction to the tea plant has been developed. For tea plant breeding, transformation technology will be a powerful tool. 'Yabukita', a leading variety of tea which covers 74% of the tea fields in Japan, is susceptible to several pathogens. To alleviate these shortcomings, genetic engineering including a reliable transformation system is required. Several gene introduction methods, such as electroporation, PEG, bombardment and *Agrobacterium*-gene mediation, have been developed up to the present. In tea tissue culture, regeneration from protoplasts to a whole plant is difficult but possible from stem tissues or cotyledons. Although the ratio of infection is low, *Agrobacterium* can infect tea. In addition, *Agrobacterium*-gene transfer method does not require any expensive equipment, such as particle gun. Therefore, the *Agrobacterium*-gene mediated system is considered to be suitable for tea. At first we attempted to improve the ratio by the application of acetosyringone which is one of the phenolic compounds produced by wounding plant tissues and which induces the transfer of T-DNA from *Agrobacterium* to plants^{1,10,16)}. In this study, we demonstrated that the use of acetosyringone is effective for *Agrobacterium*-gene transfer to the tea plant and enables to produce some transformed tea calli.

## Materials and methods

### 1) Plant tissues and co-cultivation

Leaf was cut from *in vitro*-cultured tea plant which was a natural seedling of 'Sayamakaori' and prepared to approximately 10x10 mm fragments as an explant. The plant medium used in this study consisted of Murashige and Skoog¹²⁾ standard 0.8% agar solid medium containing 3% sucrose, 0.5 mg/L IBA, 10 mg/L BA. Co-cultivation media with *Agrobacterium* contained acetosyringone at final concentrations of 10, 100 and 500  $\mu$ M. *Agrobacterium tumefaciens* LBA4404 containing a binary vector pBI121 was used. The leaf explants were inoculated with *Agrobacterium* and cultured on the media for 2 days in the dark at 28°C. The leaf explants were washed with water, treated with carbenicillin (500 mg/L) to kill *Agrobacterium* and then transferred to a selective medium containing kanamycin (200 mg/L) and carbenicillin (500 mg/L). These explants were cultured under a 16 h/light, 8 h/dark, regime in a clean room controlled at 25°C and also transferred to fresh selective medium every 2 weeks.

### 2) Callus proliferation and evaluation

We developed a growth index(G.I.) indicated below and evaluated the degree of differentiation of callus from the explant 2 months after transfer to the selective medium.

0; Callus did not differentiate.

1; Callus differentiation only occurred at the periphery of the explants.

2; Callus covered about less than 30% of the explants.

3; Callus covered about more than 30% of the explants.

### 3) GUS fluorogenic assay

A binary vector plasmid (pBI121) contained a selective gene, NPTII, and a marker gene encoding the GUS controlled by the CaMV35S promoter. The fluorogenic assay was carried out as described by Jefferson⁷). One resistant callus was ground with sand in lysis buffer (50 mM NaH₂PO₄, pH 7.0, 10 mM EDTA, 0.1% Triton X-100). After centrifugation, 1 mM MUG buffer was added to the supernatant solution and the solution was incubated at 37°C for 2 h. A tube containing the solution was placed on an ultraviolet light box and the blue fluorescence was observed.

#### 4) PCR and PCR Southern blot analyses

DNA was isolated from the resistant or non-resistant calli according to the method of Guillemat³) with modifications and less than 10 ng DNA was used for the PCR template. Primer sequences were 5-GCATACGCTTGATCCGGCTACC-3 and 5-TGATATTCGGCAAGCAGGCAT-3 for the NPTII gene and 5-GAACAACGAACTGAACTGGCA-3 and 5-CTAGTGCCTTGTCAGTTGC-3 for the GUS gene. Length of target DNA fragments of the NPTII or the GUS genes was 221 bp and 291 bp, respectively. Samples for enzymatic amplification were subjected to 30 repetitions of the following thermal cycle: 1 min at 95 °C, 2 min at 55°C and 3 min at 72°C.

The amplified DNAs were electrophoresed in 0.8% agarose gel, stained with ethidium bromide and visualized by illumination with ultraviolet light. Then DNAs were transferred to Hybond N+ (Amersham) membranes and hybridized with fluorescein-labeled probes from the NPTII or the GUS DNA fragments. Hybridization was performed at 65°C overnight. After hybridization, the membranes were washed with 0.2xSSC, 0.1% SDS at 65°C for 15 min twice. Chemical detection was carried out on X-ray film according to the manufacturers' manual (Amersham) .

## Results

Results of callus differentiation from tea explants are shown in [Table 1](#). Tea calli differentiated at the periphery of the explants and proliferated on the MS agar solid medium containing BA and IBA without antibiotics after 2 months. Fourteen explants showed a growth index (G.I.) of 2 and calli from 6 explants also proliferated up to G.I. 3. On the other hand, calli on the selective medium containing 200 mg/L kanamycin did not grow even to G.I. 1. Therefore, the selection of kanamycin 200 mg/L was effective for the inhibition of normal differentiation or proliferation from the explants. These results also indicated that acetosyringone did not affect kanamycin selection since no relationship between the concentration of applied acetosyringone and the G.I. was observed.

*Table 1. Effect of acetosyringone application on differentiation of resistant callus from tea leaf explants*

<u>Concentration of acetosyringone</u>	<u>No Agrobacterium inoculation</u>				<u>Agrobacterium inoculation</u>			
		<u>Growth index</u>				<u>Growth index</u>		
<u>(¼Mm)</u>	<u>0</u>	<u>1</u>	<u>2</u>	<u>3</u>	<u>0</u>	<u>1</u>	<u>2</u>	<u>3</u>
0 ^{a)}	0	0	14	6	20	0	0	0
0	10	0	0	0	17	3	0	0
10	4	6	0	0	9	7	4	0
100	4	6	0	0	5	9	2	5
500	4	6	0	0				

a): No. of differentiated with on a medium without antibiotics.

None of the explants inoculated with *Agrobacterium* on the medium without acetosyringone or application of 10 mM induced calli on the selective medium. When 100 mM acetosyringone was used, 4 of the 20 explants induced G.I. 3 calli, and 5 calli in the 500 mM experiment could proliferate up to G.I. 3. These calli continued to grow on the selective medium and became green. Multiple transfers to the fresh medium were carried out to prevent the loss of antibiotics and contamination of *Agrobacterium*. Elimination may occur since *Agrobacterium* was not detected when part of the resistant calli was placed on LB agar medium. Therefore we attempted to use 5 calli in 500 mM for further analyses to determine whether these calli consisted of transformed cells.

To detect the expression of the GUS gene, we carried out a fluorogenic assay. The intense blue fluorescence of the resistant calli under UV light was stronger than that of the negative control ([Fig. 1](#)). In the PCR analysis, 221 bp (NPTII) and 291 bp (GUS) DNA fragments were detected by staining callus No. 2 ([Fig. 2, lane 5](#)) with ethidium bromide as in the case of the positive control, pBI121, and a weak signal which showed the amplified 221 bp of NPTII was observed in callus No. 1 (lane 6). Hybridized fragments were observed not only in No. 1 and 2 calli but also in No. 5 callus ([Fig. 3](#)). Since the target DNA in a negative control experiment was not amplified, we assumed that calli No. 1, 2 and 5 consisted of transformed cells.

[Fig.1: Detection of GUS activity in resistant callus by fluorogenic assay \(10 KB\)](#)

[Fig.2: Detection of amplified DNA fragments which are parts of NPTII \(left\) and GUS genes \(right\) in resistant callus genome by PCR analysis](#)

[& Fig.3: Detection of hybridized DNA fragments with fluorescein-labelled probes, NPTII\(left\) and GUS genes \(right\)by Southern analysis of PCR products \(18 KB\)](#)

## Discussion

Several attempts to produce transgenic tea plants made until now had not been successful. The tea plant is, therefore, considered to be one of the recalcitrant plants for transformation. We selected the *Agrobacterium*-mediated gene transfer system as mentioned above. Tea plant is infected with *Agrobacterium* but shows a tendency to be resistant in the field, because the probability of observing natural crown galls on tea roots is low and even if it occurred, the damage would not reach an economic level. In the process of transformation through *Agrobacterium*, the low efficiency of

the infection is a disadvantage which must be overcome. At first we tried to improve the ratio by using acetosyringone which had been employed to obtain transgenic plants, not only dicotyledonous plants such as Arabidopsis¹⁵⁾, sugar beet⁵⁾ and tomato⁸⁾, efficiently but also monocotyledonous plants including rice⁴⁾. In these reports, acetosyringone was used at final concentrations ranging between 0.1 and 100 mM. The promotion of the expression of *Vir* genes began at 0.1 and reached a maximum level at 100  $\mu$ M¹⁶⁾. In this study the resistant calli only emerged by the application of higher concentrations of acetosyringone. Application of 100  $\mu$ M also promoted tea callus differentiation and callus grew up to G.I. 2. Since the G.I. 2 callus was resistant to kanamycin, it was considered that it consisted of transformed cells. These results indicated that the application of acetosyringone to the medium was very effective for tea cell transformation using leaf explants and the concentration for tea was higher than that of other plants.

One resistant callus showed the GUS gene expression, and PCR and Southern blot analyses revealed that 3 calli were transgenic. However, we could not confirm that 2 of the 5 resistant calli were transformants by PCR and PCR Southern analyses. The lack of amplification of the target DNA fragments of the 2 calli could not be explained, but may be due to the low concentration of template DNA under the current PCR thermal conditions.

Our final objective is to develop a technique for the introduction of foreign genes in the tea cells and production of transgenic tea plants by practical gene introduction. The tea plant can regenerate from cotyledon¹³⁾ and stem^{9,14)} in *in vitro* tissue culture. To produce a whole transgenic tea plant, it is necessary to combine 2 techniques for foreign gene introduction and regeneration from transgenic cells. We demonstrated that acetosyringone application was effective in the production of transgenic tea cells. These results will be applied in a following study to produce whole transgenic tea plants.



[Forward to: -Decontamination of Dry Food Ingredients with "Soft-Electrons"\(Low-Energy Electrons\)-](#)



[Back to: Contents](#)



[Back to: JIRCAS home page](#)



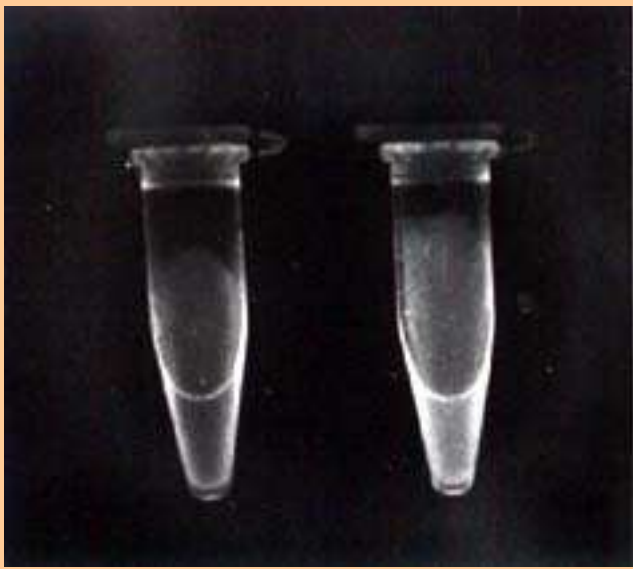
## References



[Back](#)

- 1) Fillatti, J. et al. (1987): *Agrobacterium* mediated transformation and regeneration of *Populus*. *Mol. Gen. Genet.*, 206, 192-199.
- 2) Godwin, I. et al. (1991): The effects of acetosyringone and pH on *Agrobacterium*-mediated transformation vary according to plant species. *Plant Cell Rep.*, 9, 671-675.
- 3) Guillemaut, P. & Laurence, M. D. (1992): Isolation of plant DNA; A fast, inexpensive, and reliable method. *Plant Mol. Biol. Rep.*, 10, 60-65.
- 4) Hiei, Y. et al. (1994): Efficient transformation of rice (*Oryza sativa* L.) mediated by *Agrobacterium* and sequence analysis of the boundaries of the T-DNA. *Plant J.*, 6, 271-282.
- 5) Jacq, B. et al. (1993): Factors influencing T-DNA transfer in *Agrobacterium*-mediated transformation of sugar beet. *Plant Cell Rep.*, 12, 621-624.
- 6) James, D. J. et al. (1989): Genetic transformation of apple *Malus pumila* Mill using a disarmed Ti-binary vector. *Plant Cell Rep.*, 7, 658-661.
- 7) Jefferson, R. A., Kavanagh, T. A. & Bevan, M.W. (1987): GUS fusions;  $\beta$ -glucuronidase as a sensitive and versatile gene. *EMBO J.*, 6, 3901-3907.
- 8) Joao, K. H. L. & Brown, T. A. (1993): Enhanced transformation of tomato co-cultivated with *Agrobacterium tumefaciens* C58 C1RIF-R PGSFR1161 in the presence of acetosyringone. *Plant Cell Rep.*, 12, 422-425.
- 9) Kato, M. (1985): Regeneration of plantlets from tea stem callus. *Jpn. J. Breed*, 35, 317-322.
- 10) Lee, Y. M. et al. (1995): Genetic evidence for direct sensing of phenolic compounds by the *VirA* protein of *Agrobacterium tumefaciens*. *Proc. Natl. Acad. Sci. USA*, 92, 12245-12249.
- 11) Moore, G. A. (1992): *Agrobacterium*-mediated transformation of *Citrus* stem segments and regeneration of transgenic plants. *Plant Cell Rep.*, 11, 238-242.
- 12) Murashige, T. & Skoog, F. (1962): A revised medium for rapid growth and bioassays with tobacco tissue culture. *Physiol. Plant*, 15, 473-497.
- 13) Nakamura, Y. (1988): Efficient differentiation of adventitious embryos from cotyledon culture of *Camellia sinensis* and other *Camellia species*. *Tea Res. J.*, 67, 1-7 [In Japanese with English summary].
- 14) Nakamura, Y. (1989): Differentiation of adventitious buds and its varietal difference in stem segment culture of *Camellia sinensis* (L.) O. Kuntze. *Tea Res. J.*, 70, 41-49 [In Japanese with English summary].
- 15) Sheikholeslam, S. N. & Weeks, D. P. (1987): *Acetosyringone* promotes high efficiency of *Arabidopsis thaliana* explants by *Agrobacterium tumefaciens*. *Plant Mol. Biol.*, 8, 291-298.
- 16) Stachel, S. E. et al. (1985): Identification of the signal molecules produced by wounded plants cells that activate T-DNA transfer in *Agrobacterium tumefaciens*. *Nature*, 318, 624-629.
- 17) Uematsu, C. et al. (1991): *Agrobacterium*-mediated transformation and regeneration of kiwi fruit. *Plant Cell Rep.*, 10, 286-290.

(Received for publication, January 7, 1998)



**Fig.1.**

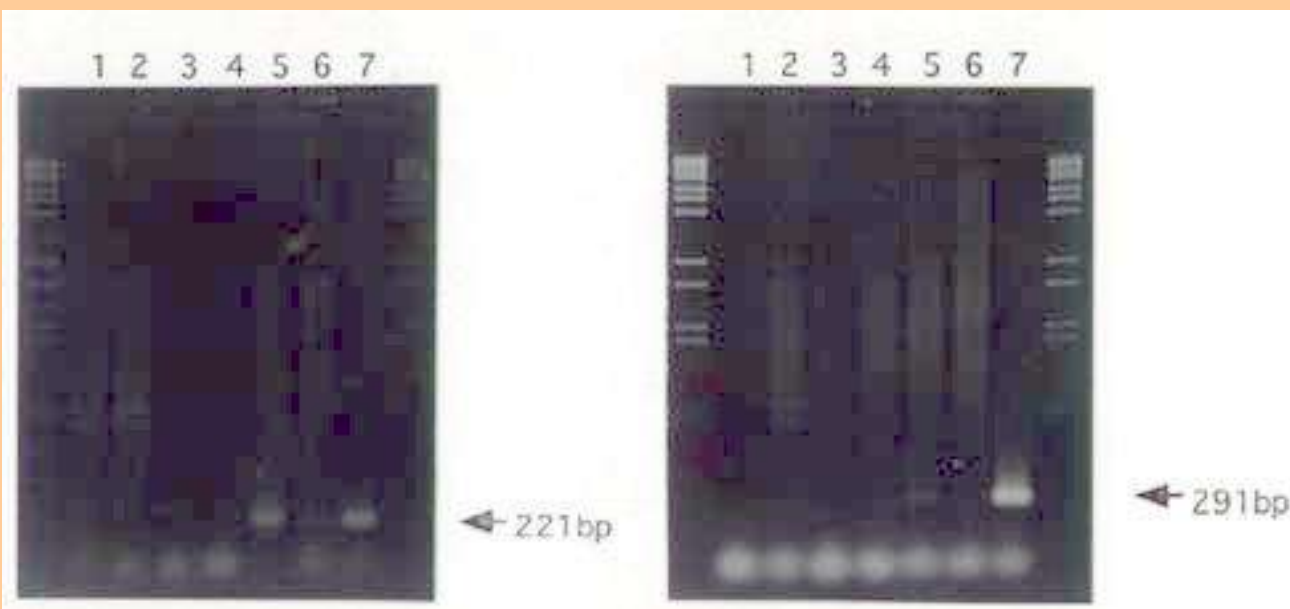
Detection of GUS activity in resistant callus by fluorogenic assay

Left: Non-resistant callus,

Right: Resistant callus.



[Back](#)



**Fig.2.**

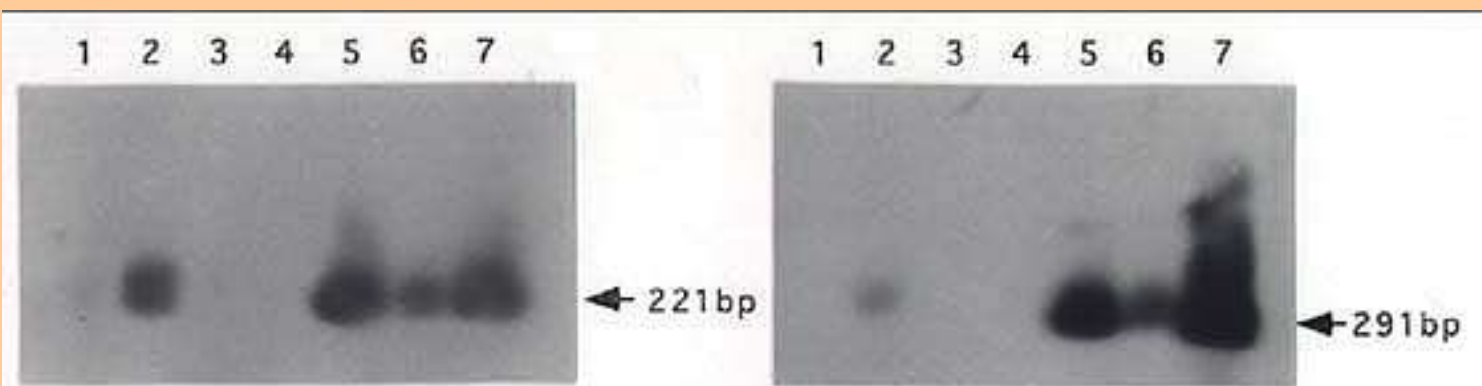
Detection of amplified DNA fragments which are parts of NPTII (left) and GUS genes (right) in resistant callus genome by PCR analysis

Arrows indicate length of target DNA amplified by PCR.

Lane 1: non-resistant callus (as negative control).

Lane 2 to 6: resistant calli, calli No.5,4,3,2,and 1, respectively.

Lane 7: pBI121 (as positive control).



**Fig.3.**

Detection of hybridized DNA fragments with fluorescein-labelled probes, NPTII (left) and GUS genes (right) by Southern analysis of PCR products

Arrow indicate length of target DNA amplified by PCR.

Lane1: Non-resistant callus (as negative control).

Lane2 to 6: Resistant calli, calli No.5,4,3,2, and 1, respectively.

Lane7: pBI121 (as positive control).



[Back](#)

# Decontamination of Dry Food Ingredients with "Soft-Electrons" (Low-Energy Electrons)

**Toru HAYASHI***

Postharvest Technology Division, National Food Research Institute  
(Tsukuba, Ibaraki, 305-8642 Japan)

Present address:

* Research Planning and Coordination Division, National Food Research Institute  
(Tsukuba, Ibaraki, 305-8642 Japan)

## Abstract

Electrons with energies of 300 keV or lower were defined as "soft-electrons". Soft-electrons eradicated microorganisms residing on the surface of grains, pulses, spices and dehydrated vegetables, and reduced their microbial loads to levels lower than 10 CFU/g. Soft-electrons penetrated only into the surface of grains and did not significantly degrade starch molecules inside grains. The use of electrons with a higher energy and with a higher penetration capacity resulted in a higher thiobarbituric acid value (TBA, parameter for lipid oxidation) of brown rice. Milling of rice at a yield of 90% or 88% after exposure to electrons resulted in a TBA value of rice treated with electrons at 65 keV almost the same as that of untreated rice, indicating that the milling process removed the portion of brown rice exposed to soft-electrons. It is concluded that soft-electrons can decontaminate dry food ingredients with few adverse effects on the quality.

**Discipline:** Food

**Additional key words:** grains, pulses, spices, dehydrated vegetables

1~12): [Click here for References](#)

## Introduction

Grains, pulses, spices and dehydrated vegetables are frequently contaminated with microorganisms, especially heat-resistant bacterial spores, although they are widely used for food processing. Bacterial spores contaminating these dry food ingredients can not be inactivated completely by heating processes such as steaming and boiling at food processing plants. Thus dry ingredients for food processing should be decontaminated to prevent food spoilage and food-borne diseases. Decontamination techniques including fumigation with ethylene oxide gas (EOG), irradiation with ionizing radiation and treatment with super-heated steam are applied to some of the dry food ingredients. However, these techniques are associated with some drawbacks. EOG fumigation is prohibited in Japan, because of the carcinogenic effect of the residues. Irradiation with gamma-rays or electron beams can effectively inactivate bacterial spores contaminating spices and dehydrated vegetables with minimal quality alteration, and irradiation of spices is practiced on a commercial basis in more than 20 countries¹²). However, irradiation of food products other than potato is not approved in Japan. Irradiation at high doses for decontamination is not applicable to grains such as rice and wheat. Ionizing radiation causes oxidation and degradation of components such as lipid and starch molecules^{1,11,12}), which results in quality deterioration of grain products such as noodles and rice cake in terms of flavor and texture. Treatment with super-heated steam

is the only method widely used for decontaminating dry ingredients in Japan. However, super-heated steam sometimes brings about changes of flavor and color of dehydrated vegetables and herbs. No method has been developed for decontaminating all the dry food ingredients.

It is generally recognized that since most of the microorganisms contaminating dry food ingredients reside on their surfaces, the inner parts do not have to be exposed to heat, gas or radiation for decontamination. The penetration capacity of an electron beam is controlled by the energy; electrons with lower energies display lower penetration capacities²⁾. We have defined low-energy electrons at 300 keV or lower as "soft-electrons". Soft-electrons reach only the surface of food, and the quality changes of food caused by such electrons are expected to be much more limited than those caused by gamma-rays or high-energy electron beams with much higher penetration capacities. We carried out studies on the efficacy of soft-electron treatment to decontaminate dry food ingredients.

## Equipment for soft-electron treatment

Dry ingredient samples were treated with soft-electrons under rotation to expose all the sample surfaces to electrons with low penetration capacity. A grain rotator was developed which enabled samples to rotate by shaking and vibrating them simultaneously at variable speeds (*Fig. 1*). The rotator was placed under the window of a Van de Graaff electron accelerator (Nissin High Voltage Engineering Co., Ltd., Kyoto, Japan), which generated electrons at acceleration voltages of 170-300 kV. The distance between the window of the electron accelerator and the plastic tray of the grain rotator was 17 cm.

[*Fig. 1. Grain rotator for treating grains with low-energy electrons \(22 KB\)*](#)

## Penetration capacity of soft-electrons

Penetration capacities of soft-electrons at different energies were determined based on depth-dose curves. Several pieces of radiochromic film dosimeter (RCF) (5.94 mg/cm², FWT-60-00, Far West Technology Inc., Goleta, California, USA) were stacked together in layers at the bottom of the plastic tray of the grain rotator (C of *Fig. 1*) which was placed under the window of the electron accelerator at a distance of 17 cm, and irradiated with electrons for 60 min under various conditions (170 kV, 4  $\mu$ A; 180 kV, 8  $\mu$ A; 190 kV, 10  $\mu$ A; 200 kV, 14  $\mu$ A). Absorbances at 510 nm of all RCF films before and 30 min after irradiation were measured and the dose absorbed by each RCF film was determined according to the method of McLaughlin et al.⁸⁾.

Energies of electrons at a distance of 17 cm (air) from the window (50  $\mu$ m thick titanium) of the electron accelerator were lower than those of the electrons at the window (acceleration voltage). The energies of electrons irradiating samples at 17 cm from the window were estimated to be 60, 75, 90, 100, 130, 160 and 210 keV for acceleration voltages of 170, 180, 190, 200, 225, 250 and 300 kV, respectively, based on the mass stopping power of air and titanium^{7,10)}.

Depth-dose curves of electrons at various energies were developed by plotting all the absorbed doses determined with RCF films (*Fig. 2*)⁶⁾. The penetration capacity of electrons at 60 keV was about 6 mg/cm² and that at 75 keV was about 10 mg/cm², while those at 90 and 100 keV were lower than 17.82 mg/cm² (5.94 mg/cm² x 3 pieces). Doses absorbed by the first RCF film for 1 h were about 30, 58, 70 and 110 kGy at 60, 75, 90 and 100 keV, respectively (*Fig. 2*)⁶⁾.

[Fig. 2. Depth-dose curves of electrons determined with radiochromic film dosimeter \(RCF\) \(25 KB\)](#)

## **Sterility and viscosity of grains exposed to soft-electrons**

Energies of electrons necessary to reduce microorganism levels to less than 10 CFU/g were 75 keV for brown rice, 130 keV for rough rice, 75 keV for wheat and 160 keV for buckwheat ([Table 1](#))⁵. The results suggested that most of the contaminating microorganisms resided in the region that the electrons with such low energies could reach. Gamma-rays at 7.5-12.5 kGy were necessary to achieve the same levels of sterility.

[Table 1: Sterility of grains exposed to low-energy electrons or gamma-rays \(CFU/g\) \(73 KB\)](#)

Viscosity of heat-gelatinized grain suspensions decreased with the energy of electrons ([Table 2](#))⁵. Viscosity of brown rice and wheat treated with electrons at 75 keV was almost the same as that of untreated samples. Viscosity of rough rice and buckwheat exposed to electrons at 130 keV was slightly lower than that of untreated samples, but much higher than that of the samples irradiated with gamma-rays at 10 kGy. The viscosity values of a grain suspension which was heat-gelatinized under an alkaline condition is a parameter for starch degradation^{3,4}. The results suggested that electrons with minimum energy for decontamination did not degrade starch molecules inside the grains.

[Table 2: Viscosity of 7.5% aqueous suspensions of grains exposed to low-energy electrons or gamma-rays \(mPa.s\) \(39 KB\)](#)

The applicability of soft-electrons to wheat depended upon the variety of wheat. Soft-electrons could decontaminate wheat grains of Australian Standard White (ASW), Shirogane and Western White (WW) varieties, but could not decontaminate those of Dark Northern Spring (DNS), Norin No. 61 and No. 1 Canadian White (1CW) varieties ([Table 3](#)). No relationship was observed between the application of soft-electrons and the sensitivity of the contaminating microorganisms to gamma-rays. The difference in the application of soft-electrons was ascribed to the structure of the wheat grain. In varieties such as DNS, Norin No. 61 and 1CW, microorganisms would reside in areas which soft-electrons did not reach.

[Table 3: Sterility of various wheat samples exposed to low-energy electrons or gamma-rays \(CFU/g\) \(42 KB\)](#)



[Continue to: Quality of milled rice prepared from brown rice treated with soft-electrons](#)



[Back to: Contents](#)

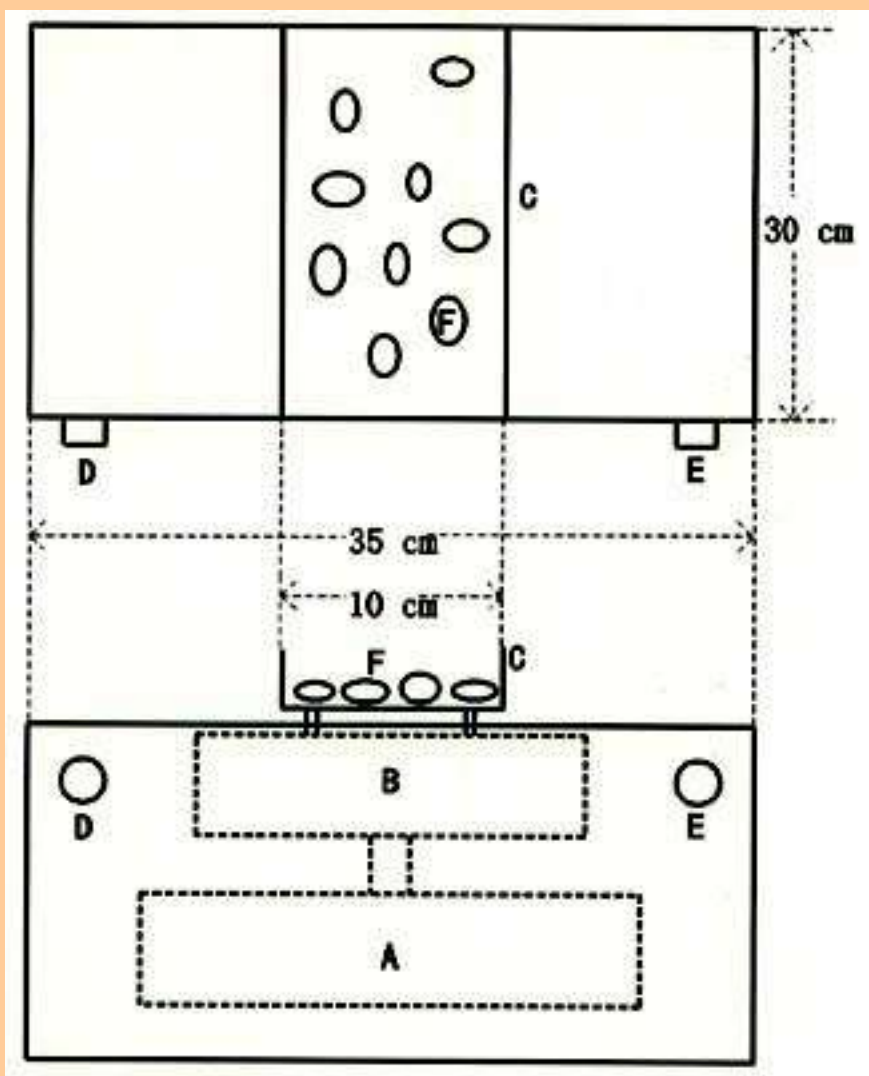
## References



[Back to the first page](#)

- 1) Diehl, J. F. (1990): Safety of irradiated foods. Marcel Dekker, Inc., New York, USA.
- 2) Hayashi, T. (1991): Comparative effectiveness of gamma rays and electron beams in food irradiation. *In Food irradiation*. ed. by Thorne, S. Elsevier Science Publisher, Inc., London, UK, 167-216.
- 3) Hayashi, T., Todoriki, S. & Kohyama, K. (1993): Applicability of viscosity measuring method to the detection of irradiated spices. *J. Jpn. Soc. Food Sci. Technol.*, 40, 456-460.
- 4) Hayashi, T., & Todoriki, S. (1996): Detection of irradiated peppers by viscosity measurement at extremely high pH. *Radiat. Phys. Chem.*, 48, 101-104.
- 5) Hayashi, T., Takahashi, Y. & Todoriki, S. (1997): Low-energy electron effects on the sterility and viscosity of grains. *J. Food Sci.*, 62, 858-860.
- 6) Hayashi, T. et al. (1998): Rheological properties and lipid oxidation of rice decontaminated with low-energy electrons. *J. Food Prot.*, 61, 73-77.
- 7) International Commission on Radiation Units and Measurements (1984): Stopping powers for electrons and positrons. ICRU Rep. 37., Bethesda, USA.
- 8) McLaughlin, W. L. et al. (1979): The response of plastic dosimeters to gamma rays and electrons at high absorbed dose rates. *Radiat. Phys. Chem.*, 14, 535-550.
- 9) Okadome, H., Toyoshima, H. & Ohtsubo, K. (1996): Many-sided evaluation of physical properties of cooked rice grains with a single apparatus. *J. Jpn. Soc. Food Sci. Technol.*, 43, 1004-1011 [In Japanese with English summary].
- 10) Tabata, T. & Tanaka, R. (1990): Fundamental data on electron beam dosimetry. *In Radiation dosimetry of electron beams for radiation processing*. ed. Moriuchi, Y. Chijinshokan Publisher, Inc., Tokyo, Japan, 109-135 [In Japanese].
- 11) Urbain, W. M. (1986): Food irradiation. Academic Press, Inc., Orlando, USA.
- 12) WHO (1994): Safety and nutritional adequacy of irradiated food. World Health Organization, Geneva, Switzerland.

(Received for publication, February 3, 1998)



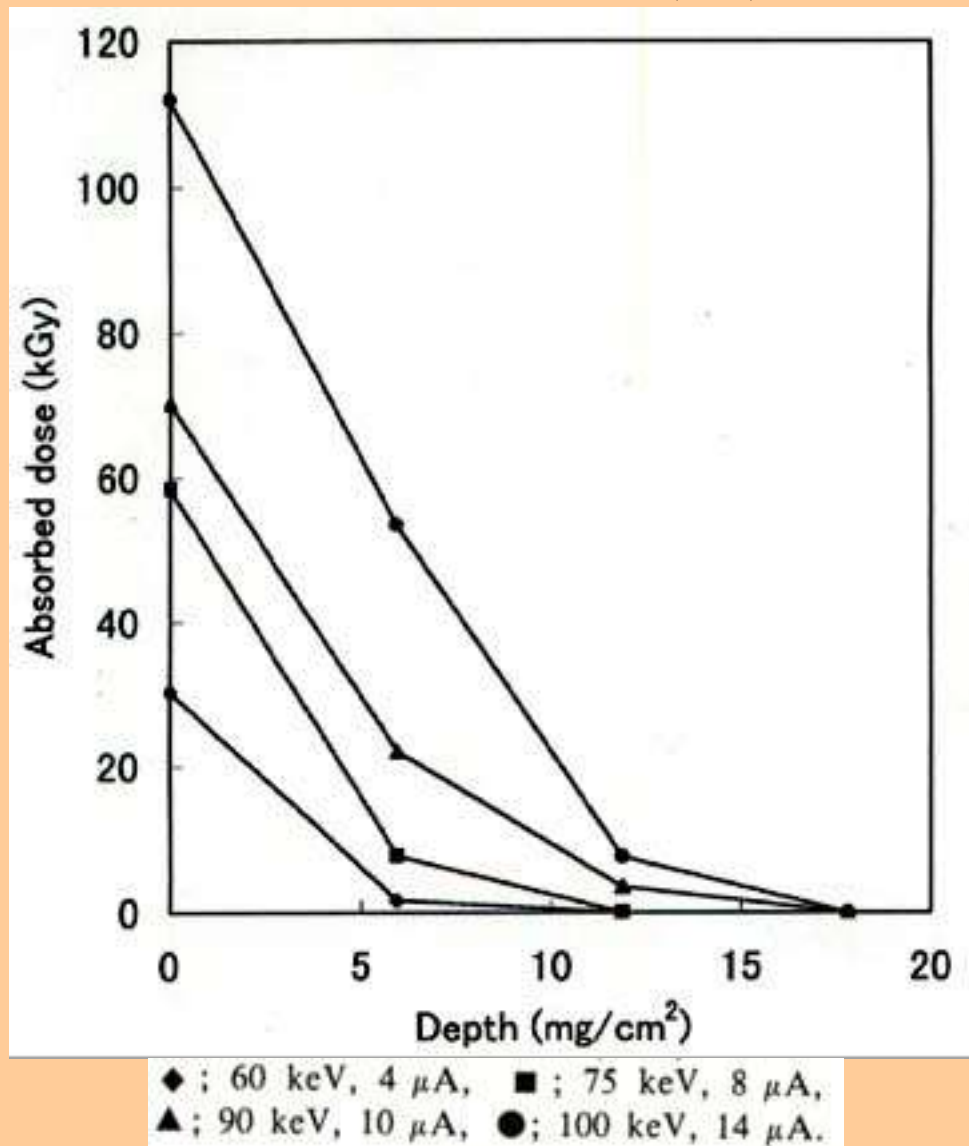
**Fig.1.**  
Grain rotator for treating grains with  
low-energy electrons

A; Shaker,  
B; Vibrator,  
C; Plastic tray,  
D; Speed controller for shaker,  
E; Speed controller for vibrator,  
F; Grain.





**Fig.2.** Depth-dose curves of electrons determined with radiochromic film dosimeter (RCF)



[Back](#)

**Table 1.**

Sterility of grains exposed to low-energy electrons of gamma-rays (CFU/g)

	Brown rice	Rough rice	Wheat	Buckwheat
Control ^{a)}	$4.1 \times 10^6 \pm 4.6 \times 10^5$	$4.7 \times 10^7 \pm 1.5 \times 10^7$	$2.7 \times 10^4 \pm 1.2 \times 10^4$	$1.4 \times 10^6 \pm 6.8 \times 10^5$
75 keV, 8 $\mu$ A, 10 min	$5.1 \times 10^2 \pm 2.1 \times 10^2$	----- b)	$1.2 \times 10^3 \pm 8.3 \times 10^2$	-----
75 keV, 8 $\mu$ A, 20 min	<100	-----	$2.3 \times 10^2 \pm 1.6 \times 10^2$	-----
75 keV, 8 $\mu$ A, 30 min	<10	-----	<100	-----
75 keV, 8 $\mu$ A, 40 min	<10	-----	<10	-----
100 keV, 14 $\mu$ A, 5 min	$1.2 \times 10^3 \pm 5.6 \times 10^2$	$5.8 \times 10^5 \pm 7.0 \times 10^4$	$3.1 \times 10^2 \pm 2.1 \times 10^2$	$1.4 \times 10^3 \pm 9.2 \times 10^2$
100 keV, 14 $\mu$ A, 10 min	$7.5 \times 10^2 \pm 1.3 \times 10^2$	$1.8 \times 10^5 \pm 1.0 \times 10^5$	$1.1 \times 10^2 \pm 9.1 \times 10^1$	$3.7 \times 10^2 \pm 1.7 \times 10^2$
100 keV, 14 $\mu$ A, 15 min	<10	$9.6 \times 10^3 \pm 3.1 \times 10^3$	<10	$4.4 \times 10^2 \pm 3.8 \times 10^2$
100 keV, 14 $\mu$ A, 20 min	<10	$6.3 \times 10^3 \pm 1.3 \times 10^3$	<10	$3.3 \times 10^2 \pm 3.6 \times 10^2$
130 keV, 22 $\mu$ A, 1 min	$2.5 \times 10^3 \pm 1.6 \times 10^3$	$1.6 \times 10^5 \pm 3.8 \times 10^4$	$2.9 \times 10^3 \pm 1.8 \times 10^3$	$1.8 \times 10^3 \pm 9.0 \times 10^2$
130 keV, 22 $\mu$ A, 2 min	$1.5 \times 10^2 \pm 1.3 \times 10^2$	$5.3 \times 10^4 \pm 2.1 \times 10^4$	$5.9 \times 10^2 \pm 2.8 \times 10^2$	<100
130 keV, 22 $\mu$ A, 4 min	<10	$1.0 \times 10^4 \pm 6.6 \times 10^3$	<10	<10
130 keV, 22 $\mu$ A, 6 min	<10	<100	<10	<10
160 keV, 40 $\mu$ A, 0.5 min	$7.4 \times 10^2 \pm 1.8 \times 10^2$	$1.3 \times 10^5 \pm 4.5 \times 10^4$	$2.0 \times 10^3 \pm 8.9 \times 10^2$	$9.7 \times 10^2 \pm 8.0 \times 10^2$
160 keV, 40 $\mu$ A, 1 min	$1.3 \times 10^2 \pm 1.1 \times 10^2$	$5.7 \times 10^3 \pm 2.8 \times 10^3$	$4.3 \times 10^2 \pm 1.1 \times 10^2$	$1.3 \times 10^2 \pm 1.6 \times 10^2$
160 keV, 40 $\mu$ A, 2 min	<10	$2.2 \times 10^2 \pm 2.0 \times 10^2$	<10	<10
160 keV, 40 $\mu$ A, 3 min	<10	<10	<10	<10
210 keV, 40 $\mu$ A, 0.5 min	$1.4 \times 10^3 \pm 7.1 \times 10^2$	$1.3 \times 10^5 \pm 3.5 \times 10^4$	$1.7 \times 10^3 \pm 1.3 \times 10^2$	$6.7 \times 10^2 \pm 2.6 \times 10^2$
210 keV, 40 $\mu$ A, 1 min	<100	$8.0 \times 10^2 \pm 4.4 \times 10^2$	$4.5 \times 10^2 \pm 2.8 \times 10^2$	<100
210 keV, 40 $\mu$ A, 2 min	<10	<10	<10	<10
210 keV, 40 $\mu$ A, 3 min	<10	<10	<10	<10
$\gamma$ -ray, 2.5 kGy	$2.2 \times 10^4 \pm 3.6 \times 10^3$	$3.2 \times 10^5 \pm 4.2 \times 10^4$	$2.5 \times 10^4 \pm 4.7 \times 10^3$	$2.0 \times 10^3 \pm 2.1 \times 10^3$
$\gamma$ -ray, 5.0 kGy	$3.3 \times 10^3 \pm 1.6 \times 10^3$	$8.4 \times 10^4 \pm 3.8 \times 10^4$	$4.6 \times 10^3 \pm 1.4 \times 10^3$	<100
$\gamma$ -ray, 7.5 kGy	$5.8 \times 10^2 \pm 1.9 \times 10^2$	$7.4 \times 10^3 \pm 3.2 \times 10^3$	$7.5 \times 10^2 \pm 6.3 \times 10^1$	<10
$\gamma$ -ray, 10.0 kGy	<10	$6.3 \times 10^2 \pm 3.2 \times 10^2$	<10	<10
$\gamma$ -ray, 12.5 kGy	<10	<100	<10	<10

a): Untreated sample. b): Data not obtained. Source: Hayashi et al. (1997)⁵⁾.[Back](#)

**Table 2.**

Viscosity of 7.5% aqueous suspensions of grains exposed to low-energy electrons or gamma-rays (mPa.s)

	Brown rice	Rough rice	Wheat	Buckwheat
Control ^{d)}	211.1 ± 12.5 ^{c)}	149.5 ± 7.7 ^{c)}	287.4 ± 18.2 ^{b,c)}	211.3 ± 21.6 ^{c)}
75 keV, 8 μA, 40 min	206.0 ± 3.5 ^{c)}	----- ^{e)}	293.6 ± 12.5 ^{b,c)}	-----
100 keV, 14 μA, 20 min	185.9 ± 8.6 ^{a,c)}	147.3 ± 8.9 ^{c)}	246.6 ± 10.8 ^{a,c)}	199.9 ± 25.4 ^{c)}
130 keV, 22 μA, 6 min	146.7 ± 11.9 ^{a,b)}	137.3 ± 7.3 ^{c)}	206.4 ± 3.5 ^{a,b)}	192.5 ± 6.4 ^{c)}
160 keV, 40 μA, 3 min	136.2 ± 4.6 ^{a,b,c)}	133.4 ± 4.8 ^{a,c)}	192.8 ± 8.0 ^{a,b,c)}	165.6 ± 7.5 ^{a,b,c)}
210 keV, 40 μA, 3 min	88.5 ± 3.0 ^{a,b,c)}	105.5 ± 6.8 ^{a,b)}	133.6 ± 3.6 ^{a,b,c)}	108.7 ± 10.9 ^{a,b,c)}
γ-ray, 0.1 kGy	198.4 ± 4.1 ^{c)}	138.3 ± 5.6 ^{c)}	246.5 ± 3.4 ^{a,c)}	189.6 ± 12.2 ^{c)}
γ-ray, 0.5 kGy	160.8 ± 8.3 ^{a,b)}	117.9 ± 5.5 ^{a,b)}	211.3 ± 4.7 ^{a,b)}	143.2 ± 8.3 ^{a,b)}
γ-ray, 10.0 kGy	21.1 ± 1.0 ^{a,b,c)}	31.9 ± 4.9 ^{a,b,c)}	34.6 ± 1.7 ^{a,b,c)}	26.8 ± 4.6 ^{a,b,c)}

a): Significantly different from control (P < 0.05).

b): Significantly different from samples irradiated at 0.1 kGy with gamma-rays (P < 0.05).

c): Significantly different from samples irradiated at 0.5 kGy with gamma-rays (P < 0.05).

d): Untreated sample. e): Data not obtained.

Source: Hayashi et al. (1997)⁵⁾.



[Back](#)

**Table 3.**

Sterility of various wheat samples exposed to low-energy electrons or gamma-rays (CFU/g)

	ASW	Shirogane	DNS	Norin No. 61	WW	ICW
Control ^{a)}	$2.7 \times 10^4 \pm 1.2 \times 10^4$	$3.5 \times 10^4 \pm 1.5 \times 10^4$	$3.3 \times 10^5 \pm 3.7 \times 10^5$	$9.0 \times 10^4 \pm 5.1 \times 10^4$	$6.0 \times 10^4 \pm 2.1 \times 10^4$	$2.8 \times 10^5 \pm 1.1 \times 10^5$
75 keV, 4 $\mu$ A, 45 min	<10	<10	$2.2 \times 10^4 \pm 8.9 \times 10^3$	$3.0 \times 10^3 \pm 1.8 \times 10^3$	<10	$1.8 \times 10^4 \pm 7.3 \times 10^3$
75 keV, 4 $\mu$ A, 90 min	<10	<10	$3.6 \times 10^4 \pm 1.7 \times 10^4$	$2.1 \times 10^3 \pm 1.1 \times 10^3$	<10	$2.1 \times 10^4 \pm 8.9 \times 10^3$
100 keV, 14 $\mu$ A, 15 min	<10	<10	$1.8 \times 10^4 \pm 1.7 \times 10^4$	$3.6 \times 10^3 \pm 1.2 \times 10^3$	<10	$2.2 \times 10^4 \pm 5.4 \times 10^3$
100 keV, 14 $\mu$ A, 30 min	<10	<10	$2.7 \times 10^4 \pm 1.4 \times 10^4$	$9.1 \times 10^3 \pm 7.7 \times 10^3$	<10	$1.7 \times 10^4 \pm 7.9 \times 10^3$
210 keV, 40 $\mu$ A, 2 min	<10	<10	$1.4 \times 10^4 \pm 1.1 \times 10^4$	$6.5 \times 10^3 \pm 8.0 \times 10^3$	<10	$2.3 \times 10^4 \pm 1.3 \times 10^4$
210 keV, 40 $\mu$ A, 4 min	<10	<10	$1.4 \times 10^4 \pm 1.1 \times 10^4$	$3.8 \times 10^3 \pm 1.7 \times 10^3$	<10	$1.9 \times 10^4 \pm 9.5 \times 10^3$
400 keV, 40 $\mu$ A, 2 min	<10	<10	<10	<10	<10	<10
$\gamma$ -ray, 2.5 kGy	$2.5 \times 10^4 \pm 4.7 \times 10^3$	$3.2 \times 10^3 \pm 7.0 \times 10^2$	$2.8 \times 10^4 \pm 7.7 \times 10^3$	$7.3 \times 10^2 \pm 2.3 \times 10^2$	$3.9 \times 10^3 \pm 5.4 \times 10^2$	$5.2 \times 10^2 \pm 9.2 \times 10^1$
$\gamma$ -ray, 5.0 kGy	$4.6 \times 10^3 \pm 1.4 \times 10^3$	$1.3 \times 10^2 \pm 5.7 \times 10^1$	$1.2 \times 10^4 \pm 3.3 \times 10^3$	<100	$1.3 \times 10^2 \pm 4.5 \times 10^1$	<100
$\gamma$ -ray, 7.5 kGy	$7.5 \times 10^2 \pm 6.3 \times 10^1$	<100	$6.5 \times 10^2 \pm 3.2 \times 10^2$	<10	<100	<10
$\gamma$ -ray, 10.0 kGy	<10	<10	<10	<10	<10	<10

a): Untreated sample.

[Back](#)

## Quality of milled rice prepared from brown rice treated with soft-electrons

Both Koshihikari and Nihonbare could be decontaminated with soft-electrons even at 60 keV⁶). No significant difference in the viscosity was observed at any milling yield between the control and the rice grains exposed to electrons at 60-90 keV. Milling reduced the effect of electrons on the viscosity; milling of rice grains at a yield of 88% did not result in a significant difference in the viscosity between untreated samples and 100 keV-electron treated samples⁶). However, milling did not affect the viscosity of rice irradiated with gamma-rays. The results suggested that soft-electrons degraded starch molecules near the surface of rice grains, which could be removed easily by milling. On the contrary, gamma-rays degraded all the starch molecules in rice grains most of which could not be removed by milling⁶).

Thiobarbituric acid (TBA) value is a parameter of lipid oxidation. TBA value of brown rice increased with the energy of electrons. TBA values of brown rice samples exposed to electrons at 60-100 keV were significantly higher than that of untreated control ([Table 4](#))⁶). The use of gamma-rays at 7.5 kGy resulted in a higher TBA value than that of electrons with energies of 60-100 keV. Milling decreased the TBA values of all the samples, especially those of electron-treated samples. Accordingly, the differences in the TBA values between the control and the electron-treated rice grains decreased markedly after milling. The difference in the TBA values between the control and the rice samples exposed to electrons at 60 keV was not significant at a milling yield of 90% or lower, and the difference between the values of the control and the rice samples exposed to electrons at 75 keV was not significant at a milling yield of 88%. The results suggested that most of the lipids oxidized by electrons at 60 and 75 keV were removed by milling at yields of 90 and 88%, respectively.

### [Table 4: TBA values of rice exposed to low-energy electrons or gamma-rays \(22 KB\)](#)

Hardness and stickiness under low and high compressions of cooked rice grains (90% milling yield) exposed to electrons at 60-75 keV were almost the same as those of the control ([Table 5](#))⁶). Hardness and stickiness under low and high compressions of gamma-irradiated samples were lower than those of the control. Hardness and stickiness under low compression are parameters for rheological properties of the surface of cooked rice grains, and those under high compression are parameters for the properties of overall cooked rice grains⁹). The results showed that rice grains which were exposed to electrons at 60-75 keV and milled at a yield of 90% displayed the same rheological properties as the control. The results shown in Tables 4 and 5 indicate that milling at yields of 88-90% removed the portion of rice exposed to electrons at 60 keV which could eradicate most of the microorganisms contaminating brown rice.

### [Table5: Physical properties of cooked rice graina\) \(34 KB\)](#)

## Decontamination of other ingredients

Soft-electrons at 100 keV reduced the microbial loads of shredded dehydrated vegetables to levels lower than 10 CFU/g, although the time necessary for electron treatment was different ([Table 6](#)). Longer duration of electron treatment was necessary for dehydrated vegetable samples which required a higher dose of gamma-rays for disinfection. The microorganisms contaminating dehydrated vegetables showed

the same resistance to soft-electrons as to gamma-rays. Black pepper could be decontaminated with electrons at 210 keV, while white pepper, basil and coriander could be decontaminated at 100 keV. Pulses such as soybean, adzuki bean and black soybean could be decontaminated with electrons at 60 keV.

[Table 6: Sterility of dehydrated vegetables exposed to low-energy electrons \(CFU/g\) \(59 KB\)](#)

## Conclusion

Soft-electrons can decontaminate dry food ingredients such as grains, dehydrated vegetables, spices and pulses with minimal quality deterioration. The portion of grains exposed to electrons is removed as husk and bran by dehusking and/or milling. Therefore chemical compounds formed by electron exposure are removed by dehusking or milling and no such compounds occur in the edible parts of grains.

Electrons with such low energies do not require a thick shield due to their low penetration capacity, which enables in-line decontamination at food processing plants. Facility to expose all the ingredient surfaces uniformly to soft-electrons on a large scale in a short period of time should be developed to industrialize this decontamination technique.



[Forward to: -Long-Term Storage of Guazuma crinita Mart.In Vitro Cultures-](#)



[Back to: Contents](#)



[Back to: JIRCAS home page](#)

**Table 4.**

TBA values of rice exposed to low-energy electrons or gamma-rays followed by milling (nmol/g of rice)

	Milling yield			
	100% ^{b)}	92% ^{b)}	90% ^{b)}	88% ^{b)}
Control ^{a)}	17.69 ± 1.55	4.95 ± 0.38	4.75 ± 0.69	4.23 ± 0.81
60 keV, 4 μA, 45 min	29.68 ± 2.66 ^{c)}	7.98 ± 0.20 ^{c)}	5.18 ± 0.70	4.75 ± 0.57
75 keV, 8 μA, 30 min	34.21 ± 0.49 ^{c)}	9.05 ± 0.83 ^{c)}	8.37 ± 0.80 ^{c)}	5.43 ± 0.77
90 keV, 10 μA, 25 min	41.45 ± 0.90 ^{c)}	15.55 ± 3.96 ^{c)}	9.47 ± 0.71 ^{c)}	9.43 ± 0.93 ^{c)}
100 keV, 14 μA, 15 min	57.66 ± 2.47 ^{c)}	19.74 ± 0.67 ^{c)}	14.33 ± 0.28 ^{c)}	13.70 ± 0.74 ^{c)}
γ-ray, 7.5 kGy	60.59 ± 5.64 ^{c)}	46.59 ± 3.96 ^{c)}	43.83 ± 3.08 ^{c)}	43.23 ± 4.70 ^{c)}

a): Untreated sample. b): n=3; mean ± standard deviation.

c): Significantly different from control (P<0.05).

Source: Hayashi et al. (1998)⁶⁾



[Back](#)

**Table.5**Physical properties of cooked rice grain^{a)}

	Low compression		High compression	
	Hardness ^{c)} (10 ⁴ dyne)	Stickiness ^{c)} (10 ⁴ dyne)	Hardness ^{c)} (10 ⁶ dyne)	Stickiness ^{c)} (10 ⁵ dyne)
Control ^{b)}	7.02 ± 0.57	2.13 ± 0.28	2.03 ± 0.25	4.88 ± 0.49
60 keV, 4 μA, 45 min	6.94 ± 0.48	1.94 ± 0.23	1.99 ± 0.33	5.03 ± 0.41
75 keV, 8 μA, 30 min	7.08 ± 0.56	2.09 ± 0.28	1.99 ± 0.21	4.83 ± 0.38
90 keV, 10 μA, 25 min	6.74 ± 0.44	1.64 ± 0.29 ^{d)}	1.71 ± 0.18	4.76 ± 0.72
100 keV, 14 μA, 15 min	6.57 ± 0.51	1.59 ± 0.19 ^{d)}	1.52 ± 0.13 ^{d)}	4.81 ± 0.48
γ-ray, 7.5 kGy	4.89 ± 0.89 ^{d)}	0.77 ± 0.17 ^{d)}	1.06 ± 0.14 ^{d)}	4.46 ± 0.45

a): Rice sample were exposed to electrons or gamma-rays followed by milling at 90% yield, and then cooked.

b): Untreated sample. c): n=3; mean + standard deviation. d): Significantly different from control (P&lt;0.05).

Source: Hayashi et al. 19986).

[Back](#)



Table.6.

Sterility of dehydrated vegetables exposed to low-energy electrons (CFU/g)

	Orange peel	Green laver	Parsley	Leek	Onion	Burdock	Carrot	Mushroom
Control	$4.8 \times 10^5 \pm 2.6 \times 10^5$	$1.6 \times 10^7 \pm 2.5 \times 10^6$	$2.7 \times 10^4 \pm 1.1 \times 10^4$	$9.0 \times 10^4 \pm 5.1 \times 10^4$	$1.2 \times 10^3 \pm 6.4 \times 10^2$	$9.0 \times 10^3 \pm 1.4 \times 10^3$	$8.7 \times 10^4 \pm 4.5 \times 10^4$	$2.4 \times 10^5 \pm 7.6 \times 10^4$
200 keV, 15 min	$2.8 \times 10^4 \pm 3.1 \times 10^3$	$7.3 \times 10^6 \pm 2.9 \times 10^6$	<100	$5.0 \times 10^2 \pm 2.8 \times 10^1$	<100	<100	$1.2 \times 10^2 \pm 8.2 \times 10^1$	$2.5 \times 10^2 \pm 5.7 \times 10^1$
200 keV, 30 min	$1.4 \times 10^3 \pm 9.1 \times 10^2$	$3.3 \times 10^5 \pm 1.2 \times 10^5$	<10	<10	<10	<10	<100	<100
200 keV, 45 min	<100	$1.3 \times 10^5 \pm 2.3 \times 10^4$	<10	<10	<10	<10	<10	<10
200 keV, 60 min	<10	$2.8 \times 10^4 \pm 1.1 \times 10^4$	<10	<10	<10	<10	<10	<10
200 keV, 90 min	<10	$1.5 \times 10^3 \pm 1.2 \times 10^3$	<10	<10	<10	<10	<10	<10
200 keV, 120 min	<10	<100	<10	<10	<10	<10	<10	<10
200 keV, 150 min	<10	<10	<10	<10	<10	<10	<10	<10
$\gamma$ -ray, 2.5 kGy	$1.9 \times 10^4 \pm 9.0 \times 10^3$	$3.3 \times 10^6 \pm 1.6 \times 10^6$	$1.2 \times 10^3 \pm 2.6 \times 10^2$	$4.3 \times 10^2 \pm 9.6 \times 10^1$	<100	$1.4 \times 10^3 \pm 2.8 \times 10^2$	$1.0 \times 10^3 \pm 2.2 \times 10^2$	$1.8 \times 10^2 \pm 6.1 \times 10^1$
$\gamma$ -ray, 5.0 kGy	$1.3 \times 10^3 \pm 9.7 \times 10^2$	$1.1 \times 10^6 \pm 4.4 \times 10^5$	<100	$1.1 \times 10^2 \pm 6.2 \times 10^1$	<10	<100	$1.8 \times 10^2 \pm 5.1 \times 10^1$	<10
$\gamma$ -ray, 7.5 kGy	<100	$3.4 \times 10^5 \pm 1.9 \times 10^5$	<10	<10	<10	<10	<10	<10
$\gamma$ -ray, 10.0 kGy	<10	$1.1 \times 10^5 \pm 4.9 \times 10^4$	<10	<10	<10	<10	<10	<10
$\gamma$ -ray, 20.0 kGy	<10	$9.0 \times 10^3 \pm 2.0 \times 10^3$	<10	<10	<10	<10	<10	<10
$\gamma$ -ray, 30.0 kGy	<10	<100	<10	<10	<10	<10	<10	<10


[Back](#)

# Alginate Encapsulation Technique and Cryogenic Procedures for Long-Term Storage of the Tropical Forest Tree *Guazuma crinita* Mart. *In Vitro* Cultures

**Emilio MARUYAMA, Katsuaki ISHII* and Isao KINOSHITA**

Bio-resources Technology Division, Forestry and Forest Products Research Institute (Tsukuba, Ibaraki, 305-8687 Japan)

*To whom correspondence should be addressed.

## Abstract

Long-term storage of the tropical forest tree *Guazuma crinita* Mart. following alginate encapsulation technique and cryogenic procedures was attempted. Shoot tips excised from *in vitro* plantlets were encapsulated in calcium alginate beads and stored on different substrates at 12, 20, and 25°C. Viability was retained when encapsulated shoot tips were stored on substrate containing only water solidified with 1% (w/v) agar. Percentage of viability 12 months after storage was 90% at 25°C and 70% at 20°C. For cryogenic experiments, shoot tip, nodal segment, root tip, and adventitious bud cluster explants were stored in liquid nitrogen following 4 cryopreservation methods: (1) simple freezing, (2) rapid freezing, (3) slow pre-freezing, and (4) encapsulation/dehydration method. High survival rates (about 80%) were achieved when the adventitious bud cluster explants were exposed to a cryoprotectant mix solution containing (w/v), 25% glycerol, 15% sucrose, 15% ethylene glycol, 13% dimethyl sulfoxide, and 2% polyethylene glycol (4,000), at 25°C for 15-60 min prior to storage in liquid nitrogen.

**Discipline:** Biotechnology/Forestry and forest products/Genetic resources

**Additional key words:** artificial seed, bolaina blanca, cryopreservation, germplasm conservation, vitrification

1~30): [Click here for References](#)

## Introduction

Bolaina blanca (*Guazuma crinita* Mart., Sterculiaceae) is a useful fast-growing tree endemic in the Amazon forest region⁸). This tree is a light hardwood species with good working properties that has been used for light construction, panelling, interior joinery, mouldings, cases, matches, packing, etc. *G. crinita* has a fast initial growth rate of up to 3 m in height per year (final rotation age of 10 to 15 years) and shows an excellent adaptability to a wide range of sites including areas with poorly drained heavy clay soils which are widespread throughout the tropics. It has been used for reforestation in the Peru-Amazon¹⁷).

Germplasm conservation has become necessary for future sustainable harvesting systems, and as a means of maintaining species diversity to prevent genetic erosion.

The propagation and conservation of this species traditionally take place by seeds. However, propagation and conservation by vegetative means are desirable for better preservation of true-to-type genetic

characteristics. The conservation of desirable genetic materials using conventional *in situ* or *ex situ* methods such as a field genebank is costly and prone to possible catastrophic losses due to diseases and pest attacks, and is liable to environmental and political threats. Although the use of *in vitro* genebanks alleviates these problems, the maintenance of large collections under conventional *in vitro* storage systems requires much handling and is expensive because most cultures need subculturing at regular intervals to prevent browning and loss of viability, hence the increasing risk of contamination.

Alginate encapsulation technique and cryogenic procedures may be reliable methods for long-term storage of plant genetic resources without apparent risk of genetic instability using minimum space and with lower labor and maintenance costs.

This paper describes the storage of shoot tips encapsulated in calcium alginate beads under temperature conditions above freezing (12, 15, and 20°C), and the cryogenic procedures for the long-term storage of *G. crinita* using *in vitro*-cultured plant materials.

## Materials and methods

### 1) Storage following alginate encapsulation technique

#### (1) Plant material

Shoot tips, about 3-4 mm long, were aseptically excised from *in vitro*-cultured plants regenerated by the method described by Maruyama et al. (1996)¹⁷.

#### (2) Encapsulation

Calcium alginate beads were produced by encapsulation according to the method of Kinoshita and Saito (1990)¹². Shoot tips were immersed in autoclaved standard woody plant medium (WPM)¹⁵ supplemented with 1  $\mu$  M kinetin containing 4% (w/v) sodium alginate and 2% (w/v) sucrose. Next, the shoot tips in the alginate medium were picked up individually with tweezers and dropped into a sterile solution of 1.4% (w/v) calcium chloride where they remained for 30 min. The calcium chloride solution was then decanted and the alginate beads, each containing 1 shoot tip, were rinsed 3 times with the same autoclaved medium.

#### (3) Storage

Encapsulated shoot tips were transferred to 200 mL Erlenmeyer flasks containing about 75 mL of the following substrates: water, water containing 2% (w/v) sucrose, and sucrose and plant growth regulator-free WPM. All the substrates were solidified with 1% (w/v) agar (Wako Pure Chem. Ind.). Storage lasted for 3, 6, and 12 months at 25 to 20°C (16 h photoperiod under photon flux density of about 35  $\mu$ mol m⁻² s⁻¹) and 12°C (in the dark).

#### (4) Plant regeneration

Stored encapsulated shoot tips were transferred to germination media (WPM with 1  $\mu$  M KIN) and incubated in a culture room at 25°C under a photon flux density of about 65  $\mu$  mol m⁻² s⁻¹ for 16 h daily. About 60 days after the transfer to the germination media, encapsulated shoot tips regenerated to plantlets were counted.

#### (5) Data and analysis

Five encapsulated shoot tips were employed for each of 2 replicates per treatment, at 3 storage temperatures, on 3 storage substrates, over 3 storage periods. Data were analyzed quantitatively by

calculating rates of plant regeneration from stored encapsulated shoot tips. The standard error of means was calculated according to Snedecor (1957)25).

## 2) *Storage following cryogenic procedures*

### (1) Plant material

Shoot tips, nodal segments and root tips, excised from 2 to 3-month-old plantlets regenerated in vitro by the method described by Maruyama et al. (1996)17), were cut into segments about 2 mm long.

Adventitious bud clusters obtained from petiole culture by the method described by Maruyama et al. (1997)18) were cut into small (1.0-1.5 mm³) or large (3.0-4.0 mm³) cubic segments.

### (2) Cryoprotectant mix

The following cryoprotectant mix solutions, modified from Sakai et al. (1991)23) and Towill (1990)27), were tested containing (w/v), Mix A: 20% glycerol and 15% sucrose; Mix B: 30% glycerol, 15% sucrose, 15% ethylene glycol, and 15% dimethyl sulfoxide (DMSO); Mix C: 25% glycerol, 15% sucrose, 15% ethylene glycol, 13% DMSO, and 2% polyethylene glycol (PEG); Mix D: 35% ethylene glycol, 10% DMSO, and 5% PEG. The aqueous volume added consisted of WPM without sucrose and growth regulators. All the cryoprotectant mix solutions were filter-sterilized.

### (3) Cryopreservation methods

#### a) Simple freezing

Explants were treated with cryoprotectant mix solution A at 25°C for 5, 10, 15, 20, 30, 45, and 60 min and then cooled in a freezer at -30°C for 1 h prior to immersion in liquid nitrogen (LN) and kept there for at least 1 h.

#### b) Rapid freezing

Explants were treated with cryoprotectant mix solutions A, B, C, D, alone or in succession at 25°C for different periods of time (0 to 90 min) and then directly immersed in LN and kept there for at least 1 h.

#### c) Slow pre-freezing

Explants were treated with cryoprotectant mix solutions A, B, C, alone or in succession at 25°C for different periods of time (0 to 45 min) and then cooled to -40°C at a rate of 0.5°C/min prior to immersion in LN and held there for at least 1 h.

#### d) Encapsulation/dehydration

Explants were progressively pre-cultured at 5°C by successive daily transfer onto solidified WPM containing 5, 10, and 20% (w/v) sucrose. Then, they were encapsulated or not, in 3% (w/v) alginate-coated beads containing 20% (w/v) sucrose. Encapsulated (constructed beads about 5 mm in diameter containing one shoot tip or nodal segment by the same method as that described previously) and non-encapsulated explants were treated with the same medium supplemented with 30% (w/v) sucrose for 16 h at 5°C. After treatments with sucrose they were subjected to dehydration at 25°C for 0 to 24 h in the laminar flow cabinet or inside petri dishes (9 cm in diameter) containing about 50 g silica gel sterilized by heating at 110°C for 16 h, and then cooled in LN by the slow pre-freezing or by the rapid freezing method.

### (4) Survival and plant regeneration

Explants were thawed by rapid transfer of cryotubes in a water bath at 37°C. After thawing, cryoprotectant mix solutions were drained from the cryotubes and replaced with a medium containing 40% (w/v) sucrose and kept for 20 min. Then, shoot tip and nodal segment explants were transferred onto solidified WPM containing 10  $\mu$  M zeatin and cultured at 25°C under a photon flux density of 65

$\mu$  mol m⁻² s⁻¹. The root tip and adventitious bud cluster explants were transferred into liquid WPM containing 10  $\mu$  M zeatin and cultured on a bio-shaker at 73 rpm under a photon flux density of 25  $\mu$  mol m⁻² s⁻¹. All the explants were cultured at 25°C and under a 16 h photoperiod provided by cool white fluorescent lamps (100 V, 40 W; Toshiba Co.). Examination of the explants for survival was performed at weekly intervals. Survival was recorded when explants had turned green and produced leaves or adventitious buds. Plant regeneration was considered to have occurred when explants had developed into plantlets.

#### (5) Acclimatization of plantlets

Plantlets regenerated from cryopreserved explants were transplanted into plastic pots filled with vermiculite after washing the roots with tap water to free any adhering agar. They were acclimatized in a growth cabinet at 25-30°C at a photon flux density of 35  $\mu$  mol m⁻² s⁻¹ under a 16 h photoperiod, and were irrigated with water for the first 2 weeks and then with 0.1% (v/v) Hyponex plant food solution (The Hyponex Co., Inc.) containing (w/v): 5.00% N, 4.36% P, and 4.15% K. During the first 2 weeks plantlets were kept in a closed container with a transparent cover inside the growth cabinet. After that, the cover was opened gradually during another 2 weeks and removed completely about 1 month after transplanting.



[Continue to: Results and discussion](#)



[Back to: Contents](#)

## References



[Back to the first page](#)

- 1) Bapat, V. A. et al. (1987): Propagation of *Morus indica* L. (Mulberry) by encapsulated shoot buds. *Plant Cell Rep.*, 6, 393-395.
- 2) Bapat, V. A. & Rao, P. S. (1988): Sandalwood plantlets from synthetic seeds. *Plant Cell Rep.*, 7, 434-436.
- 3) Brison, M. et al. (1995): Cryopreservation of *in vitro* grown shoot tips of two interspecific *Prunus* rootstocks. *Plant Sci.*, 105, 235-242.
- 4) Brodelius, P. et al. (1982): Viability and biosynthetic capacity of immobilized plant cells. *In Plant tissue culture 1982*, Proc. 5th int. cong. of plant tissue and cell culture. ed. Fujiwara, A., 371.
- 5) Chen, T. H. H. & Kartha, K. K. (1987): Cryopreservation of woody species. *In Cell and tissue culture in forestry*, Vol. 2. Specific principles and methods; Growth and developments. ed. Bonga, J. M. & Durzan, D. J., 305-319.
- 6) Dodds, J. H. & Roberts, L. W. (1995): Experiments in plant tissue culture. Cambridge University Press, New York, 195-203.
- 7) Endress, R. (1994): Plant cell biotechnology. Springer-Verlag, Berlin, 256-269.
- 8) Freytag, G. F. (1951): A revision of the genus *Guazuma*. *Ceiba* (Hond.), 1, 193-225.
- 9) Grout, B. (ed.) (1995): Genetic preservation of plant cells *in vitro*. Springer-Verlag, Berlin.
- 10) Kartha, K. K. (ed.) (1985): Cryopreservation of plant cell and organs. C. R. C. Press, Boca Raton, Florida.
- 11) Kartha, K. K. & Engelmann, F. (1994): Cryopreservation and germplasm storage. *In Plant cell and tissue culture*. ed. Vasil, I. K. & Thorpe, T. A., 195-230.
- 12) Kinoshita, I. & Saito, A. (1990): Propagation of Japanese white birch by encapsulated axillary buds. (1) Regeneration of plantlets under aseptic conditions. *J. Jpn. For. Soc.*, 72, 166-170.
- 13) Kinoshita, I. & Saito, A. (1992): Regeneration of Japanese white birch plants from encapsulated axillary buds. *In 5th Int. conf. on biotechnology in the pulp and paper industry*. ed. Kuwahara, M. & Shimada, M., 493-496.
- 14) Kohmura, H. et al. (1992): Cryopreservation of *in vitro*-cultured multiple bud clusters of asparagus (*Asparagus officinalis* L. cv Hiroshimagreen) (2n=30) by the techniques of vitrification. *Plant Cell Rep.*, 11, 433-437.
- 15) Lloyd, G. & McCown, B. (1980): Commercially-feasible micropropagation of mountain laurel, *Kalmia latifolia*, by use of shoot-tip culture. *Comb. Proc. Int. Plant Propagator' Soc.*, 30, 421-427.
- 16) Machii, H. (1992): *In vitro* growth of encapsulated adventitious buds in mulberry, *Morus alba* L. *Jpn. J. Breed.*, 42, 553-559.
- 17) Maruyama, E. et al. (1996): Micropropagation of bolaina blanca (*Guazuma crinita* Mart.), a fast-growing tree in the Amazon region. *J. For. Res.*, 1, 211-217.
- 18) Maruyama, E. et al. (1997): Micropropagation of *Guazuma crinita* Mart. by root and petiole culture. *In Vitro Cell. Dev. Biol.-Plant*, 33, 131-135.
- 19) Matsumoto, T. et al. (1994): Cryopreservation of *in vitro*-grown apical meristems of wasabi (*Wasabia japonica*) by the vitrification and subsequent high plant regeneration. *Plant Cell Rep.*, 13, 442-446.
- 20) Niino, T. et al. (1992): Cryopreservation of *in vitro*-grown shoot tips of apple and pear by vitrification. *Plant Cell Tiss. Org. Cult.*, 28, 261-266.

- 21) Niino, T. & Sakai, A. (1992): Cryopreservation of alginate-coated *in vitro*-grown shoot tips of apple, pear and mulberry. *Plant Sci.*, 87, 199-206.
- 22) Reed, B. M. (1988): Cold acclimation as a method to improve survival of cryopreserved *Rubus* meristems. *Cryo-Lett.*, 9, 166-171.
- 23) Sakai, A. et al. (1991): Survival by vitrification of nucellar cells of naval orange (*Citrus sinensis* var. *brasiliensis* Tanaka) cooled to -196°C. *J. Plant Physiol.*, 137, 465-470.
- 24) Sakai, A. (1995): Cryopreservation for germplasm collection in woody plants. *In Somatic embryogenesis in woody plants*, Vol. 1. History, molecular and biochemical aspects, and applications. ed. Jain, S. M. et al., 293-315.
- 25) Snedecor, G. W. (1957): Statistical methods (5th ed.). Iowa State College Press, Ames, Iowa.
- 26) Suzuki, M. et al. (1994): Cryopreservation of shoot tips of kiwifruit seedlings by the alginate encapsulation-dehydration technique. *Plant Tissue Cult. Lett.*, 11, 122-128.
- 27) Towill, L. E. (1990): Cryopreservation of isolated mint shoot tips by vitrification. *Plant Cell Rep.*, 9, 178-180.
- 28) Wilkins, C. P. (1991): Conservation of tree crops. *In In vitro methods for conservation of plant genetic resources*. ed. Dodds, J. H., 151-237.
- 29) Withers, L. A. (1985): Cryopreservation and storage of germplasm. *In Plant cell culture; a practical approach*. ed. Dixon, R. A., 169-192.
- 30) Yuehua, C. & Wenming, L. (1994): Study on the conservation of *Eucalyptus* germplasm encapsulated in alginate beads at room temperature. I. Studies on the condition of conservation. *In Abstract collection of IUFRO workshop Asia-Pacific symposium on forest genetic improvement*, Beijing, China, 91-92.

(Received for publication, December 25, 1997)

## Results and discussion

### 1) Storage following alginate encapsulation technique

Attempts at growth suppression using alginate encapsulation techniques in combination with temperature reduction and/or omission of some nutrients essential for normal growth were made in order to develop an efficient method for germplasm conservation under temperature conditions above freezing. [Table 1](#) shows the results of plant regeneration from alginate encapsulated shoot tips after 3, 6, and 12 months of storage under various conditions. When the encapsulated shoot tips were stored on a water substrate, the growth process was suppressed or reduced at all the storage temperatures tested. However, the percentage of plant regeneration varied with the temperature and period of storage.

#### [Table 1: Effect of substrates and storage temperature on plant regeneration from stored alginate-encapsulated shoot tips of *G.crinita* \(18 KB\)](#)

Although the addition of 2% sucrose into the water substrate promoted rooting (not shown) in beads stored at 25°C, it did not induce conspicuous growth under the other storage conditions. However, the effect of sucrose on the stored beads was not beneficial because plant regeneration 6 months after storage was only achieved at 12°C. These results suggest that (1) although conspicuous growth did not occur in stored beads, metabolic processes for germination were induced, (2) the addition of sucrose into the agar substrate enhanced the deterioration of stored beads at storage temperatures of 25 and 20°C, and (3) the beads deteriorated least at a storage temperature of 12°C.

The results may be summarized as follows: (1) in general, water was the optimum substrate for suppressing growth in alginate encapsulated shoot tips, (2) the optimum temperature for storage of encapsulated shoot tips was 25°C, (3) 20°C was the lowest temperature recommendable for storage of alginate encapsulated shoot tips of *G. crinita* under temperature conditions above freezing, and (4) shoot tips encapsulated in alginate beads could be stored for more than 12 months without considerable loss of viability ([Fig. 1A](#)).

#### [Fig.1: Storage of *G_crinia* in vitro cultures \(47 KB\)](#)

Storage of alginate encapsulated shoot tips under temperature conditions above freezing was found to be a suitable method for conservation of *in vitro*-cultured germplasm. After storage for 12 months, the rate of plant regeneration was up to 90%. Development of germplasm conservation techniques, based on the storage of shoot tips under temperature conditions above freezing, is an important alternative for many species that do not tolerate conventional reduced temperature storage systems (generally at about 4°C).

The alginate bead effect on growth immobilization or minimal growth storage may be attributed to a reduction in the respiration process in encapsulated cells⁴). Alginate is one of the most commonly used polymers for immobilization of plant cells and production of manufactured seeds because it is available in large quantities, is inert, non-toxic, cheap, and easily handled⁷). In addition, while the conventional conservation of *in vitro*-cultured germplasm requires about 4 to 6 subcultures in fresh media within a year to prevent browning and loss of viability, with the method of storage using alginate encapsulation techniques, the handling, cost of maintenance, and risk of contamination, can be reduced four to sixfold.

*In vitro* germplasm conservation methods based on conditions that permit minimal rates of growth, generally achieved by reducing the temperature of culture or using growth retardants, have been published for many species^{6, 9, 28}). However, studies on *in vitro* germplasm conservation using alginate encapsulation techniques have been reported for only a few species. Embryogenic tissues of *Santalum album*²), axillary buds of *Morus indica*¹), and adventitious buds of *Morus alba*¹⁶) have been encapsulated in alginate or agar beads and then stored for 45-80 days at 4°C without loss of viability. Kinoshita and Saito (1992)¹³) reported that the encapsulated axillary buds of *Betula platyphylla* var. *japonica* could be stored at 4°C for more than 80 days without loss of viability. Micro-cuttings of *Eucalyptus grandis* x *E. urophylla*, encapsulated in alginate beads and kept on a nutrient-free agar medium,



were stored for 10 months at 30/25°C with a plant regeneration rate of at least 52% after storage³⁰).

Although more studies to determine the optimum temperature, photon flux density, concentration of alginate in gel matrix, concentration of essential nutrients into substrate, and other conditions for minimal growth storage, are necessary to further improve the efficiency of the system, the method developed here can be used as a good alternative for the germplasm conservation of many tropical forest trees species that do not tolerate conventional reduced temperature storage systems.

## 2) Storage following cryogenic procedures

The effects of cryopreservation methods on the survival and plant regeneration of different explants are shown in [Table 2](#). Survival of explants after immersion in LN was not achieved in any of the treatments tested by the simple freezing and encapsulation/dehydration method. Only the use of the rapid freezing and the slow pre-freezing method resulted in plant recovery after storage in LN. These results suggest that the explants tested were not suitable materials for cryopreservation by simple freezing since this method had been successfully applied to cultured cells²⁴), and that treatments in media with a high concentration of sucrose by the encapsulation/dehydration method that has been reported as a successful cryopreservation method for some species^{21, 24, 26}), caused damage to explants apparently due to the fact that this species does not tolerate drastic dehydration processes.

**Table 2: Effects of different cryopreservation methods on the survival (S) and plant regeneration (PR) rates of *G. crinita* after cooling in**

<u>Explants</u>	<u>Simple freezing method^{a)}</u>		<u>Rapid freezing method^{b)}</u>		<u>Slow pre-freezing method^{c)}</u>		<u>Encapsulation/dehydration method^{d)}</u>	
	<u>S(%)</u>	<u>PR(%)</u>	<u>S(%)</u>	<u>PR(%)</u>	<u>S(%)</u>	<u>PR(%)</u>	<u>S(%)</u>	<u>PR(%)</u>
Shoot tip	0	0	0	0	50	15	0	0
Nodal segment	0	0	0	0	5	0	0	0
Root tip	0	0	30	5	30	5	0	0
Adv. Bud cluster			85	25				

a): Explants were treated with cryoprotectant mix and then cooled in a freezer at -30°C for 1 h prior to immersion in LN.

b): Explants were treated with cryoprotectant mix and then cooled by direct immersion in LN.

c): Explants were treated with cryoprotectant mix and then cooled to -40°C at a rate of 0.5°C/min prior to immersion in LN.

d): Explants, with or without alginate encapsulation, were treated with a medium enriched with sucrose before dehydration in a laminar flow cabinet or inside petri dishes containing silica gel, and then cooled in LN by slow pre-freezing or by the rapid freezing method.

Shoot tip, nodal segment, and root tip explants were cut into segments about 2 mm long. Adventitious bud cluster explants were cut into about 1.0-1.5 mm³ cubic segments.

Slow pre-freezing was the optimum method for cryopreservation of shoot tip explants ([Fig. 1B](#)). Rates of 50% for survival and 15% for plant regeneration were achieved when shoot tips were treated with cryoprotectant mix A and B for 20 and 10 min, respectively, and then cooled to -40°C at a rate of 0.5°C/min prior to storage in LN. For root tip explants no difference between the rapid freezing method and the slow pre-freezing method was found ([Table 2](#)). As in the case of shoot tip explants, plant regeneration from cryopreserved root tips was obtained through adventitious bud formation ([Fig. 1C](#)) and subsequently shoot differentiation on medium supplemented with 10 and 1  $\mu$ M ZEA, respectively. Although this method is time-consuming and laborious, and requires controlled freezing equipment and complicated procedures, it is the most commonly used method for the cryopreservation of meristems/shoot tips, cell cultures and somatic embryos. Several species have been successfully cryopreserved following slow pre-freezing methods^{5, 9-11, 24, 29}).

In the present study, although rapid freezing failed to cryopreserve the shoot tip and nodal segment explants, this method was effective for the cryopreservation of adventitious bud clusters of *G. crinita*. Survival of adventitious bud clusters after storage in liquid nitrogen varied depending on the size of explant, cryoprotectant mix and on the duration of the cryoprotectant mix treatment. High survival rates (73-85%) were achieved for small cubic

segments (1.0-1.5 mm³) pretreated with cryoprotectant mix B or C. In contrast, large cluster explants (3.0-4.0 mm³) and cryoprotectant mix D-treated bud clusters did not survive after storage in liquid nitrogen ([Fig. 2A](#)). These results suggest that (1) the large size of the explants is not favorable for the dehydration-cryoprotective action of the vitrification solution, or that (2) the duration of the cryoprotectant mix treatments for large cluster explants was insufficient and that (3) glycerol and sucrose are necessary as components of the cryoprotectant mix solution for cryopreservation of bud clusters of *G. crinita* by the rapid freezing method. Based on these results, large-sized cluster explants and cryoprotectant mix D were not used for further experiments.

Survival of small cluster explants did not differ when they were treated with either mix B or C at 25°C for various periods of time prior to direct immersion into liquid nitrogen. The highest rate of survival was obtained with the explants treated with mix B for 15-45 min or with mix C for 15-60 min, respectively. In both cryoprotectant mix treatments, a pretreatment of 5 min in a cryoprotectant solution was insufficient, and pretreatment for 90 min was inhibitory to the survival of explants ([Fig. 2B](#)). The original green color of the bud cluster segments was evident immediately following cooling but was lost within 24-48 h after warming. However, the successfully vitrified bud cluster segments regained their green color within 1 to 2 weeks after transfer to recovery growth medium ([Fig. 1D](#)). After 45 days of culture, clumps of numerous bulbous structures about 5 mm in diameter were formed ([Fig. 1E](#)). When transferred onto agar-solidified WPM containing 1  $\mu$ M zeatin, after 60 days, about 30% of the surviving cryopreserved explants formed shoots ([Fig. 1F](#)). No differences were observed among the rates of shoot development from untreated control and surviving cryopreserved explants. Regenerated plantlets were successfully acclimatized and all survived and grew well. No morphological abnormalities were observed in the plants regenerated from cryopreserved explants.

[Fig.2: Cryopreservation of adventitious bud cluster explants of *G.crinita* cultured in vitro \(41 KB\)](#)

Rapid freezing is the simplest method of cryopreservation and it does not require sophisticated and expensive controlled freezing equipment and complicated cryoprotective procedures, but allows cells and meristems to be cryopreserved by direct immersion into liquid nitrogen^{14,19,24,27,29}).

Although several authors have indicated that cold hardening and/or pre-culturing with a high concentration of sugar medium are essential to successful cryopreservation of *in vitro*-cultured plant materials^{11,20,22}), adventitious bud clusters of *G. crinita* cryopreserved by the rapid freezing method showed high survival rates without any cold-hardening and/or pre-culturing treatments. Similar results were reported in the vitrified bud clusters of asparagus¹⁴). On the other hand, cold-hardening and/or pre-culturing with sugar-enriched medium were not found to be effective to induce dehydration tolerance in this species. Attempts at using several cold-hardening and/or pre-culturing treatments modified from Niino & Sakai (1992)²¹), Suzuki et al. (1994)²⁶), Matsumoto et al. (1994)¹⁹), and Brison et al. (1995)³), to enhance the survival and plant regeneration rate (data not presented) were not successful.

The results of the cryopreservation experiments may be summarized as follows: (1) slow pre-freezing was the optimum method for cryopreservation of shoot tips, (2) rapid freezing was not effective for the cryopreservation of the shoot tip and nodal segment explants, however this method was found to be effective for the cryopreservation of adventitious bud clusters, (3) for root tip explants, there was no difference between the rapid freezing and slow pre-freezing method, (4) the simple freezing and encapsulation/dehydration method failed to cryopreserve all explants tested, and (5) cold-hardening and/or pre-culturing treatments were not effective in enhancing the survival or plant recovery rate after storage in LN.

Although the plant recovery rates should be improved in the near future for a more effective cryopreservation system, in our opinion, these results can be used at present without inconvenience because, considering that more than 823,000 shoots can be obtained in a year from only one shoot tip explant¹⁷), further propagation of *G. crinita* from a few cryopreserved surviving explants is really possible. Thus, cryopreservation by using both the slow pre-freezing and rapid freezing methods can be considered to be a suitable alternative for the long-term storage of *G. crinita* germplasm. Cryopreserved germplasm of tropical forest tree species will be the major source for planting stocks in the so-called biotechnology-assisted reforestation in the tropics soon.

Storage of selected germplasm following the alginate encapsulation technique and/or cryogenic procedures described here is an attractive possibility for

the conservation of genetically superior tropical forest trees for many decades.



[Back to: Contents](#)



[Back to: JARQ first page](#)



[Back to: JIRCAS home page](#)



Japan International Research Center for Agricultural Sciences  
Ministry of Agriculture, Forestry, and Fisheries  
1-2 Ohwashi, Tsukuba, Ibaraki 305-8686 JAPAN  
Telephone 0298-38-6304  
published on October 15, 1998

**Table.1.**

Effects of substrates and storage temperature on plant regeneration from stored alginate-encapsulated shoot tips of *G. crinita*

Months of storage	25°C			20°C			12°C		
	W	W+S	M	(W)	W+S	M	W	W+S	M
	Percentage of plant regeneration (Mean ± SE)			Percentage of plant regeneration (Mean ± SE)			Percentage of plant regeneration (Mean ± SE)		
3	90 ± 10	10 ± 10	10 ± 10	90 ± 10	50 ± 10	20 ± 0	80 ± 0	70 ± 10	30 ± 10
6	100 ± 0	0 ± 0	0 ± 0	100 ± 0	0 ± 0	0 ± 0	20 ± 20	50 ± 10	0 ± 0
12	90 ± 10	0 ± 0	0 ± 0	70 ± 10	0 ± 0	0 ± 0	0 ± 0	0 ± 0	0 ± 0

Data were calculated from 5 beads for each of 2 replicates per treatment.

After 3,6, and 12 months of storage, respectively beads were transferred to WPM supplemented with 1 ¼M kinetin for inducing germination and shoot growth.

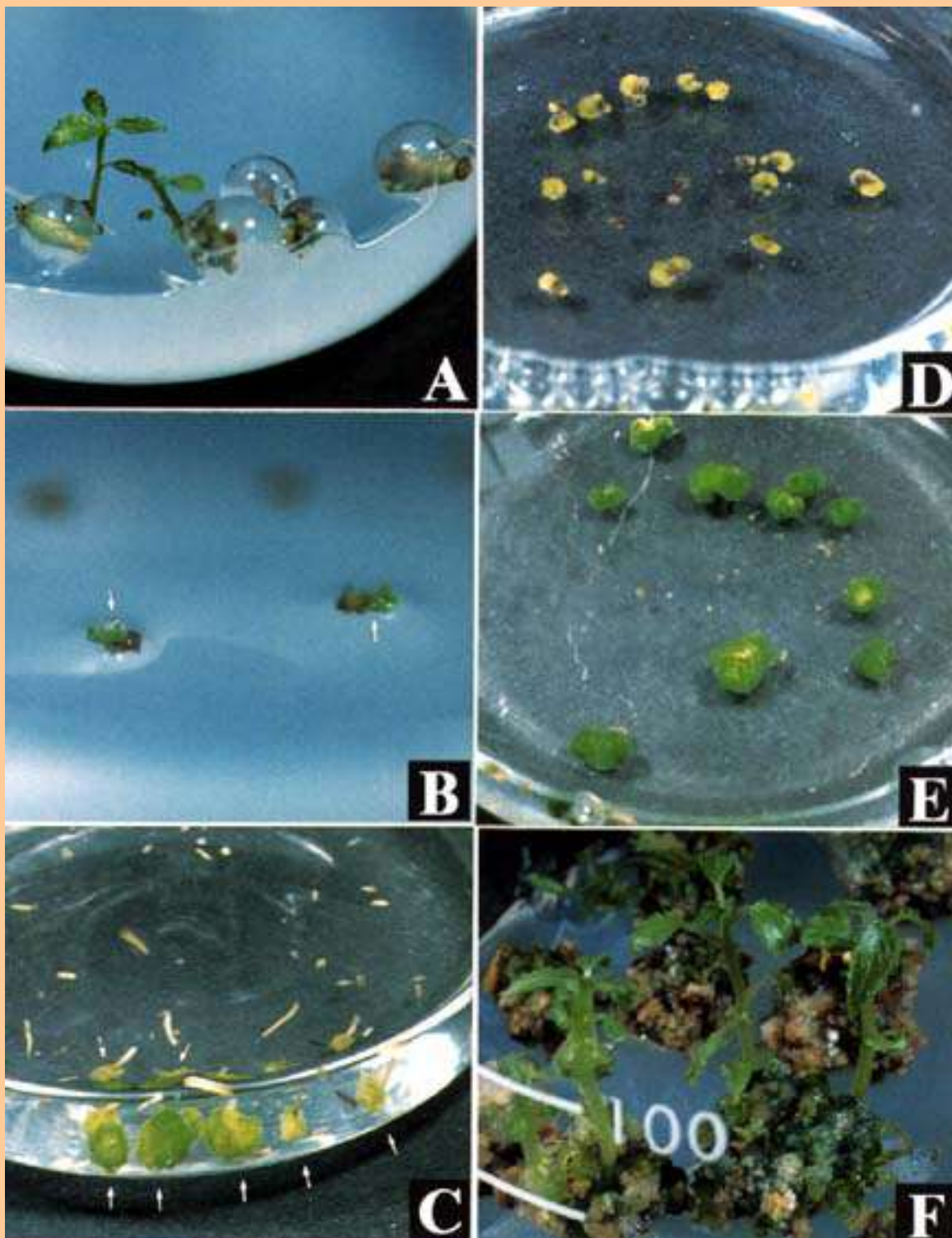
The results are expressed as percentage of beads that produced plants.

W: Water. W+S: Water containing 2% (w/v) sucrose.

M: Sucrose and plant growth regulator-free WPM. All the with 1% (w/v) agar.



[Back](#)



**Fig.1.**  
Storage of *G. crinita* *in vitro* cultures

(A) Germination of shoot tips encapsulated in calcium alginate after storage for 12 months at 25°C on water substrate solidified with 1% (w/v) agar.

(B) Survivors (arrows) of shoot tips after storage in LN by slow per-freezing method

(C) Adventitious bud cluster formation (arrows) on root tips after storage in LN by rapid freezing.

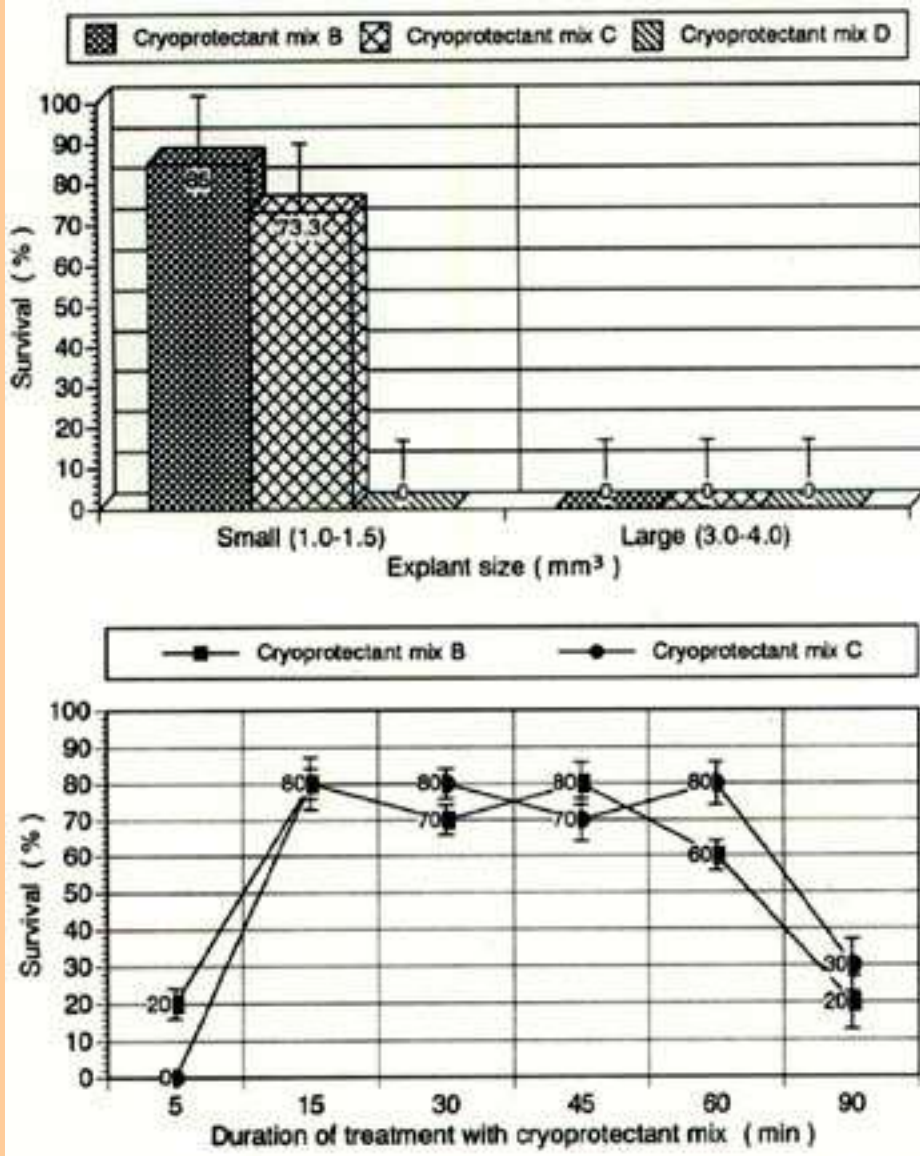
(D) Cryopreserved adventitious bud cluster segments after 15 days of culture in recovery growth medium.

(E) Cryopreserved adventitious bud cluster segments after 45 days of culture in recovery growth medium.

(F) Shoot development from cryopreserved adventitious bud cluster segments after 60 days of culture onto WPM supplemented with 1/4M zeatin.



[Back](#)



**Fig.1.**

Cryopreservation of adventitious bud cluster explants of *G. crinita* cultured *in vitro*

**A:** Effect of explant size and cryoprotectant mix solution on survival after storage in liquid nitrogen (LN).

Explants were treated with a cryoprotectant mix solution for 45 min at 25°C and then into LN.

**B:** Effect of duration of treatment of treatment with cryoprotectant mix solution prior to cooling on survival after storage in LN.

Explants placed in 1.5mL cryotube were treated with a cryoprotectant mix solution for different periods of time at 25°C and then directly immersed into LN.

Ten segments were treated for each of 4 replicates.

Bars indicate standard error.



[Back](#)

## Contents

<a href="#">Function of Male Pheromone of the Leaf-Footed Plant Bug, <i>Leptoglossus australis</i> (Fabricius) (Heteroptera: Coreidae) and Its Kairomonal Effect</a>	<b>Koji YASUDA</b>
<a href="#">Black Rot of Crucifers and Sources of Resistance in Brassica Crops</a>	<b>Alexandre IGNATOV, et al.</b>
<a href="#">Development of Microcomputer-Controlled Unmanned Air Blast Sprayer</a>	<b>Koichi TOSAKI et al.</b>
<a href="#">Water Hyacinth Control Program through Community Development Approach: A Case Study in Bangladesh Village</a>	<b>Haruo UCHIDA and Kazuo ANDO</b>
<a href="#">Physico-Chemical Characteristics of Soluble Lignin Fractions Released from Forage Grasses by Ruminant Digestion</a>	<b>Tsuneo KONDO, Takashi WATANABE, et al.</b>
<a href="#">Estimation of Fine Root Production in Coniferous Forests in Japan</a>	<b>Nobuhiko KASUYA</b>
<a href="#">Animal Waste Problems and Their Solution from the Technological Point of View in Japan</a>	<b>Kiyonori HAGA</b>
<a href="#">Removal of Colored Substances from Molasses Waste Water by Biological Treatment System Combined with Chemical Treatment</a>	<b>Suntud SIRIANUNTAPIBOON et al.</b>
<a href="#">Postmortem Changes in Skeletal Muscle Connectin(titin) and Its Structure</a>	<b>Ryoichi TANABE</b>
<a href="#">Study on Relationships between Serum Gamma-Globulin Concentration and Pathological Characteristics in Bovine Lymphosarcoma</a>	<b>Seishi ISHINO et al.</b>



[Back to the first page of JARQ](#)



[Back to What's New](#)



[Back to JIRCAS home page](#)

# Function of the Male Pheromone of the Leaf-Footed Plant Bug, *Leptoglossus australis* (Fabricius) (Heteroptera:Coreidae) and Its Kairomonal Effect

**Koji YASUDA**

Okinawa Subtropical Station, Japan International Research Center for Agricultural Sciences

(Ishigaki, Okinawa, 907-0002 Japan)

Present address: Department of Environmental Biology, National Institute of Agro-Environmental Sciences

(Tsukuba, Ibaraki, 305-8604 Japan)

## Abstract

A function of the male pheromone of *Leptoglossus australis* (Fabricius) in its migration process was investigated on Ishigaki Is., the southernmost part of Japan. It was observed that the immigration of adults into particular fields of bitter melon or loofah occurred suddenly within a short period of time. Immigrants landed mostly on a male-baited cage placed in a cucurbit field (a host plant of the bug) rather than on crop plants themselves without males, suggesting that cues inducing landing of immigrants are not their host plants, but the pheromone emitted by males. Moreover, an egg parasitoid, *Gryon pennsylvanicum* (Ashmead) (Hymenoptera: Scelionidae), was attracted to the male pheromone of *L. australis*, which may act as a kairomone for host searching of the parasitoid.

**Discipline:** Insect pest

**Additional key words:** attraction, *Gryon pennsylvanicum*, immigration, parasitoid

1~15): [Click here for References](#)

## Introduction

It is well known that male adults in some Heteroptera emit a pheromone that attracts conspecific adults of both sexes^{1,2,4,8,12}). Another remarkable performance of Heteroptera is that adult bugs suddenly invade crop fields, including orchards^{6,7,9}) and they gregariously attack crops, often causing severe damage. However, it remains to be determined whether flying adults are attracted to pheromone-emitting males or to the cue of host plants.

The leaf-footed plant bug, *Leptoglossus australis* (Fabricius), is a serious pest of a limited kind of cucurbits and various fruits in the tropics and subtropics³). Outbreaks of adults have been reported from Sri Lanka and Papua New Guinea^{5,11}). On Ishigaki Island, the southernmost part of Japan, the bug breeds mainly on a wild melon, *Diplocyclos palmatus* C. Jefferey, in spring, and ensuing adults disperse in seeking fruits appropriate as food, but scarcely visit cucurbit fields. From late June to July when the wild melon has decayed, substantial immigration of adults to cucurbit fields often occurs^{13,14}).

In order to clarify the role of adult males of *L. australis* in the induction of landing of immigrants, a number of host plant fields were investigated for the relation between the previous presence of males in the field and ensuing adult immigration.

In addition, the attractiveness of male or female *L. australis* to its egg parasitoid, *Gryon pennsylvanicum* (Ashmead), was examined, since a preliminary experiment suggested that the host-searching behavior of the parasitoid is elicited by the presence of *L. australis* adults.



## Materials and methods

### 1) Detection of immigrants in cucurbit fields

To detect the immigration of *L. australis*, adults were visually counted in 17 fields of bitter melon or loofah, both being host plants of the bug. These fields were located within an experimental area 2 km in diameter on Ishigaki Is. and each had enough fruits for bug's food. The census was conducted from June 15 to July 11, 1987 at intervals of 1-3 days after the onset of immigration.

### 2) Influence of male attraction on immigrants

A cage containing 5 *L. australis* males (male-baited cage) was placed in each crop field (Nos. 14, 16 and 17) on July 4, 1987. Another one was also set on June 15, 1987 in a shrubbery surrounded by non-host plants, i.e. sugarcane, in the experimental area. Adults attracted to the male-baited cages were counted until July 11.

The cage consisted of a plastic basket (21 cm in diameter and 9 cm in height) and a plywood cover, and the confined males were supplied with water and bitter melon seeds in the basket ([Fig. 1-B](#))[17 KB].

### 3) Ovarian development of females attracted by male-baited cages and of those from crop plants

Some of the adults settling on male-baited cages or on crop plants were collected and all the females were dissected to examine the status of ovarian development. A female which showed fully developed eggs with a chorion or eggs of almost the same size was recorded as a mature one.

### 4) Attraction of *G. pennsylvanicum* by *L. australis* adults

A trap baited with male or female bugs was used to examine the attractiveness of *L. australis* adults to *G. pennsylvanicum*. The trap consisted of a water pan (35 cm in diameter x 8.5 cm in height) filled with water and of the same type of cage as that used in the male attraction experiment (see the section 2) previously), which was kept ca. at 5 cm above the water surface ([Fig. 1](#))[17 KB]. Three different types of traps were used: a male-baited trap with 5 males in the cage, a female-baited trap with 5 females, and a control trap without bugs. Each cage was provided with a water container and bitter melon seeds.

A group of 4 traps was placed in each of the 3 plots separated by ca. 50 m from a field of bitter melon where *L. australis* naturally occurred. The traps of each plot were arranged in a square with a spacing of 10 m. Trap type was the same in all the 4 traps in each plot, but different among plots. The arrangement of the traps is shown in [Fig. 2](#)[10 KB]. The trap types were rotated among the plots every day. *L. australis* adults and *G. pennsylvanicum* caught by the traps were collected and their number counted daily during 7 days in September 1989.



[Continue to: \[ Results\]](#)



[Back to: Contents](#)

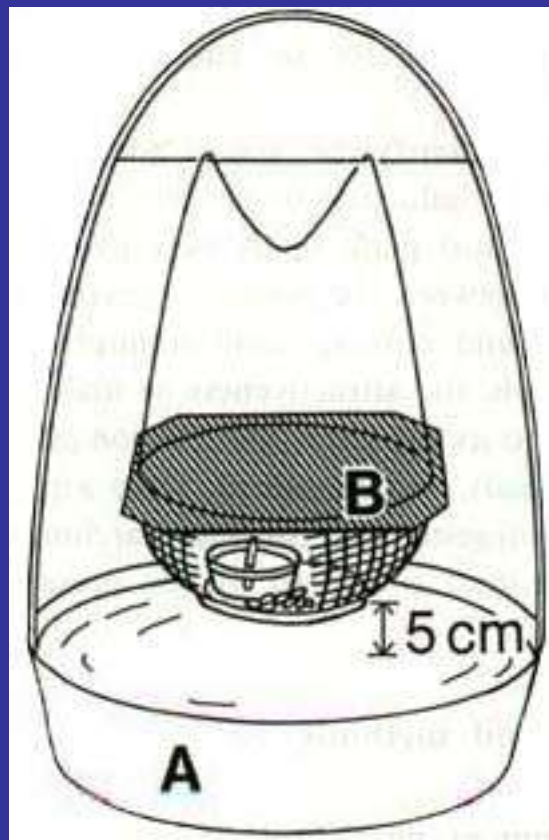
**References**[BACK](#)

- 1) Aldrich, J. R. (1988): Chemical ecology of the Heteroptera. *Ann. Rev. Entomol.*, 32, 211-238.
- 2) Aldrich, J. R., Kochansky, J. P. & Abrams, C. B. (1984): Attractant for a beneficial insect and its parasitoids: Pheromone of predatory spined soldier bug, *Podisus maculiventris* (Hemiptera: Pentatomidae). *Environ. Entomol.*, 13, 1031-1036.
- 3) Allen, R. C. (1969): A revision of the genus *Leptoglossus* Guerin (Hemiptera: Coreidae). *Entomologica Americana*, 45, 35-140.
- 4) Brennan, B. M., Chang, F. & Mitchell, W. C. (1977): Physiological effects on sex pheromone communication in the southern green stink bug, *Nezara viridula*. *Environ. Entomol.*, 6, 169-173.
- 5) Fernando, H. E. (1957): The biology and control of *Leptoglossus membranaceus* Fabricius (Fam. Coreidae Ord. Hemiptera). *Tropical Agriculturist*, 113, 107-118.
- 6) Kiritani, K. et al. (1965): Imaginal dispersal of the southern green stink bug, *Nezara viridula* L., in relation to feeding and oviposition. *Jpn. J. Appl. Entomol. Zool.*, 9, 291-297.
- 7) Moriya, S. (1995): Ecological studies on the brown-winged green stink bug, *Plautia stali* Scott, with special reference to its occurrence and adult movement. In *Bull. Okinawa Pref. Agric. Exp. Stn.* (suppl. 5), pp. 135.
- 8) Moriya, S. & Shiga, M. (1984): Attraction of the male brown-winged green bug, *Plautia stali* Scott (Heteroptera: Pentatomidae) for males and females of the same species. *Appl. Entomol. Zool.*, 19(3), 317-322.
- 9) Oda, M. (1980): Ecology of the brown-winged green bug, *Plautia stali* Scott. *Plant Protection*, 34, 309-314 [In Japanese].
- 10) Shiga, M. & Moriya, S. (1989): Temporal and spatial differences in the conditions of the internal organs of adults of the brown-winged green bug, *Plautia stali* Scott (Heteroptera: Pentatomidae). *Bull. Fruit Tree Res. Stn.*, A 16, 133-168 [In Japanese with English summary].
- 11) Szent-Ivany, J. J. H. & Catley, A. (1960): Observations on the biology of the black leaf-footed bug *Leptoglossus australis* (F.) (Heteroptera, Coreidae) in the Territory of Papua and New Guinea. *Papua New Guinea Agric. J.*, 13, 70-75.
- 12) Yasuda, Keiji (1990): Ecology of the leaf footed plant bug, *Leptoglossus australis* Fabricius (Heteroptera: Coreidae), in the sub-tropical region of Japan. *Tropical Agriculture Research Series*, 23, 229-238.
- 13) Yasuda, Koji (1989): Damage of cucurbit vegetables caused by the leaf-footed plant bug, *Leptoglossus australis* (Fabricius) (Heteroptera: Coreidae). *Plant Protection*, 43, 82-84 [In Japanese].
- 14) Yasuda, Koji & Tsurumachi, M. (1994): Immigration of the leaf-footed plant bug, *Leptoglossus australis* (Fabricius) (Heteroptera: Coreidae), to cucurbit fields on Ishigaki Island, Japan, and the role of a male pheromone. *Jpn. J. Appl. Entomol. Zool.*, 38, 161-167 [In Japanese with English summary].
- 15) Yasuda, Koji & Tsurumachi, M. (1995): Influence of male adults of the leaf-footed plant bug, *Leptoglossus australis* (Fabricius) (Heteroptera: Coreidae), on host-searching of the egg parasitoid, *Gryon pennsylvanicum* (Ashmead) (Hymenoptera: Scelionidae). *Appl. Entomol. Zool.*, 30, 139-144.

(Received for publication, October 8, 1997)

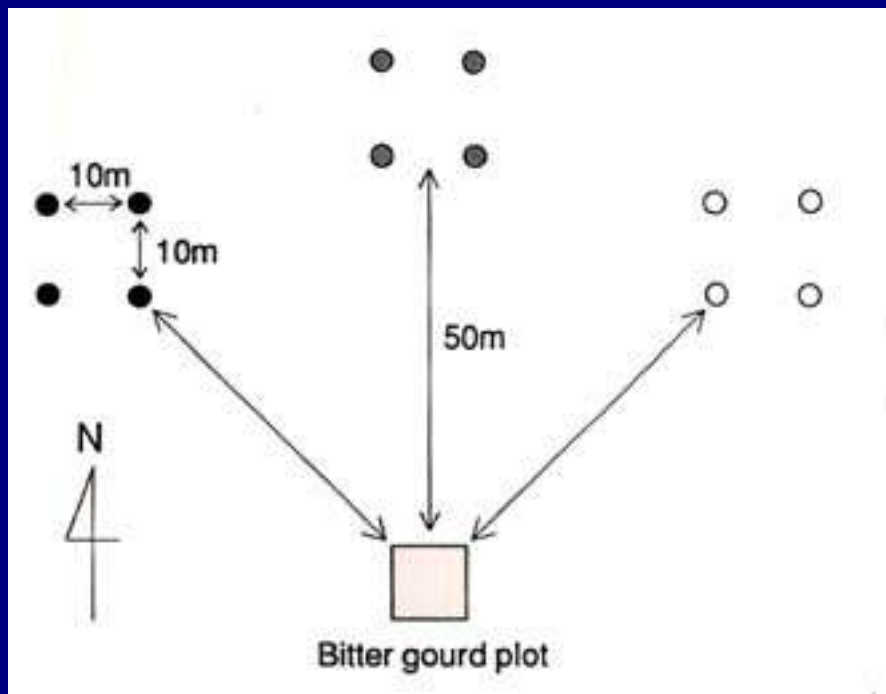
[BACK](#)

**Fig.1. Design of trap**  
Cage (B) used in the experiment of male attraction of immigrants, contained a water container and bitter gourd seeds.  
A trap in the experiment of attraction of *Gryon Pennsylvanicum* consisted of a water pan (A) and the cage(B).



 [BACK](#)

**Fig.2** Layout of 3 different traps  
(male-baited, female-baited and control)  
The same marks indicate the same type of traps.



[BACK](#)

## Results

### 1) *Detection of immigrants in cucurbit fields*

In some fields, *L. australis* adults already appeared in mid-June when censuses had started, but there was no substantial increase in number until the beginning of July. Hence, only the number of adults in the census fields from July 1 to 11 is shown in [Table 1](#). Numerical figures in parentheses indicate the number of adults removed from the field for the examination of ovarian development.

During the period from July 1 to 8, conspicuous immigration was observed. Average number of adults per census field was 2.9 on July 1-2, then 96.3 on July 7-8. Only 36% (5/14) of the census fields were inhabited by adults on July 1-2, but the proportion of census fields suddenly increased to 88% (14/16) on July 7-8.

There were differences in the number of immigrants among the fields and the immigration occurred within a short period of time to some particular fields. For instance, a sudden increase in number was found in field 8 from July 3-4, whereas no concomitant increase was observed in field 9 which was only 200-300 m apart from field 8. A similar difference in the extent of immigration was observed between fields 10 and 11, 200-300 m apart from each other, in 2 days from July 1-3.

Sex ratio of adults during the census period was about 0.45. Nymphs were hardly observed in any fields.

### 2) *Influence of male attraction on immigrants*

The number of adults settling on male-baited cages is given in [Table 2](#), with reference to the number of adults on the crop where the cage was placed.

Numerical figures in parentheses indicate the number of adults removed from the fields for the examination of ovarian development.

The male-baited cage set in the shrubbery on June 15 displayed a distinct increase in the number of adults on July 3-5, when immigration simultaneously occurred in other census fields.

On July 4 when male-baited cages were placed in fields 14, 16 and 17, no bugs, 1 female and 11 adults of both sexes were recorded, respectively. In fields 14 and 16 where no males were present, immigrants initially gathered on the male-baited cages and a few on the crop plant. In field 17 with both sexes, immigrants preferred the crop plant to the male-baited cage.

### 3) *Ovarian development of females attracted by male-baited cages and of those from crop plants*

Sampling sites were divided into 3 groups, that is, crop plants, male-baited cages in crop fields and male-baited cages in the shrubbery. Percentages of mature females in each group were 37, 24 and 9%, respectively. Most of the females seemed to be immature.

### 4) *Attraction of *G. pennsylvanicum* by *L. australis* adults*

*G. pennsylvanicum* was primarily caught in male-baited traps, and no wasps were caught in female-baited traps ([Table 3](#)). The control trap (without bugs) captured 2 individuals once, but no bugs on the other 6 days. All the parasitoids trapped were females. *L. australis* adults (15 females and 7 males) were caught only in male-baited traps.

***Table 3. Number of *G.pennsylvanicum* and *L.australis* individuals in traps baited with 5 *L.australis* males and those with females***

Trap

No.of insects^{a)}

*G.pennsylvanicum*

*L.australis*

Male-baited	5.6+4.1**	3.1+1.8*
Female-baited	0.0+0.0	0.0+0.0
Control	0.3+0.7	0.0+0.0

*,** : A significant difference from control at  $P < 0.05$  and  $P < 0.01$ , respectively, by the randomization test.

a) : Values are means (insects / 4 traps / day) with SD (n=7).

## Discussion

Male-baited cage was apparently selected by immigrants as a landing place when the crop plants in the surroundings were not inhabited by males, suggesting that the male pheromone emitted from caged males stimulated the landing of flying adults. Therefore concentrated immigration was likely to be induced by a male pheromone released from certain fields. However, this fact does not necessarily imply that immigrants disregard host plants. Pioneer individuals seeking host plants must depend on other materials than male bugs as a cue for landing and host plants may be one of the candidates.

Consequently, the male pheromone of *L. australis* attracts both sexes to develop an adult population on the host plant. However the ecological significance of the male attraction remains to be elucidated. In the case of the brown-winged green bug, *Plautia stali* Scott, one of the fruit-piercing stink bugs in Japan, which exhibits male attraction to the conspecific adults of both sexes, adults attracted to caged males were mostly underfed, sexually immature¹⁰) and did not mate between them⁸). Accordingly, the male attraction in *P. stali* was considered to be effective in the exploitation of temporally and spatially limited food resources rather than in mate-finding¹⁰). Indeed, adults may be able to save their energy and time for searching host plants by using an easily detectable sign which indicates the location of host plants. However the benefit which a pheromone-emitting male on a host plant can obtain by informing the location of the plant to other individuals remains unknown.

Another hypothesis is that a male on a host plant emits its pheromone to call females and simultaneously the other males aggregate to mate with the females attracted to the male pheromone²). In *L. australis*, mating was occasionally observed between the attracted adults (Yasuda, unpublished), suggesting that the male pheromone plays a role in mate-finding. More detailed studies should be conducted to confirm this assumption.

*L. australis* males attracted the egg parasitoid *Gryon pennsylvanicum*. It was reported that the attracted parasitoids attacked host eggs in the vicinity and eventually caused a high parasitism of eggs¹⁵). When adult bugs concentrate in particular host plant fields, the presence of male bugs rather than host plants may effectively indicate the area where host eggs probably occur.

Some of the chemicals emitted from male bugs certainly function as a kairomone for the parasitoid in its host-searching process. The chemicals may be related to the male pheromone of the bug, although this assumption should be confirmed by experiments using a synthetic pheromone. If so, the development of the synthetic pheromone may enable the effective control of *L. australis* through the manipulation of the host-searching behavior of the parasitoid.



[Forward to: - Black Rot of Crucifers and Sources of Resistance in Brassica Crops -](#)



[Back to: Contents](#)



[Back to: JIRCAS Home Page](#)

**Table1.**  
**Number of *L. australis* adults in cucurbit fields on Ishigaki Is. In July 1987**

Field No.	Crop ^{a)}	July												
		1	2	3	4	5	6	7	8	9	10	11		
1	L		18		8			8						
2	L				0	0	0	1		0				0
3	L		0		0	0	1	10		8				2
4	L		0		1	2	12	31		92				175
5	L		0		1	13	50	40		42				23
6	L		0		38 ⁽⁶⁾	16	30			18				
7	L		0		0	0	0	0	0	0	0	0	0	0
8	B, L			1	65	48				544				
9	L		0	8	3	12	16		3	17				17
10	B, L	2		0	1	2	45 ⁽²¹⁾		3861	201	0			
11	B, L	0	9	78 ⁽²²⁾	401	18	100 ⁽²⁰⁾		248	1	15			
12	B, L		11		59	41	52	10	20		25			
13	B, L		1		31	60	67	45	30	68	55	30		
14	B, L		0		0*	21	45 ⁽⁷⁾	30	36	51	24 ⁽¹⁵⁾	8		
15	B, L		0		0	0	0	0	0	0	0	0		
16	B, L				1*	1	28	29	103	81	25 ⁽¹⁷⁾	13		
17	L	0		7	11 ^{(7)*}	7	10	24	66	77	43 ⁽³²⁾	13		

a): B: Bitter gourd, L: Loofah. *: Setting of mail-baited cage in field.  
 Figures in parentheses indicate the number of adults collected after the census.



**Table 2.**  
**Comparison in the number of *L. australis* on a male-baited cage and on plants in cucurbit fields**

Site ^{a)}	Male-baited cage or cucurbit crop	June		July										
		15	23	1	2	3	4	5	6	7	8	9	10	11
Shrubbery	Male-baited cage	*	0		1	7(7)	25(23)	35	30(22)	20	5	5	0	
	Cucurbit crop													
Field 14	Male-baited cage						*	20	20(7)	6	10	22	14(11)	1
	Cucurbit crop	0			0		0	1	25	24	26	29	10(4)	7
Field 16	Male-baited cage						*	0	25	4	23	24	13(13)	1
	Cucurbit crop						1	1	3	25	80	57	12(4)	12
Field 17	Male-baited cage						*	0	0	0	20	39	33(28)	10
	Cucurbit crop	0	0	0		7	11(7)	7	10	24	46	38	10(4)	3

a): Refer to Table 1. *: Setting of male -baited cage in field.

Figures in parentheses indicate the number of adults collected the census.



[BACK](#)



# Black Rot of Crucifers and Sources of Resistance in Brassica Crops

**Alexandre IGNATOV, Ken'ichi HIDA and Yasuhisa KUGINUKI**

Department of Vegetable Breeding, National Research Institute of Vegetables, Ornamental Plants and Tea  
(Ano, Mie, 514-2328 Japan)

## Abstract

Since the early 1990s, diseases caused by *Xanthomonas campestris* have been spreading on new host plants and in new regions, that had not been previously affected by the pathogen. Still, vegetable crops of *Brassica oleracea* are the most damaged plants by black rot. Recent achievements in the studies on resistance to black rot were reviewed. For the first time resistance genes were identified based on gene-for-gene interaction with different races of the pathogen. Some East Asian cabbage and Portuguese Penca kale cultivars seemed to carry the homologous genes for race-specific resistance. Their origin in Asian cabbages was traced to the Flat Dutch group of varieties and to heading Mediterranean kale. It is suggested that novel non-specific stem resistance found in Chinese kale, broccoli and cabbage might be an alternative means of genetic protection against the pathogen.

**Discipline:** Plant disease/Plant breeding

**Additional key words :** race-specific resistance, race structure, leaf spot diseases

1~39): [Click here for References](#)

## Introduction

Incidence of black rot caused by *Xanthomonas campestris* pv. *campestris* on horticultural brassicas is well recognized worldwide. Periodical epidemics of the disease were usually ascribed to the introduction of susceptible cultivars, careless application of contaminated seeds and seedlings and weather conditions favorable for disease development³⁷). Studies on the recent outbreaks caused by *X. campestris* on oilseeds suggested that spreading of new highly aggressive variants of the pathogen was the main reason for these epidemics^{21,23}). However, breeding of *B. oleracea* for resistance to black rot has been undertaken without recognition of the existence of pathogenic variants (races). As a result, control of the disease by the introduction of some resistant cultivars may not be effective.

## Characteristics of the pathogen

*Table 1. Diseases produced by the pathovars of Xanthomonas campestris on different host plants*

<u>Pathovar</u>	<u>Typical symptoms</u>	<u>Race</u>	<u>Reaction of brassicas with genome</u>		
			<u>A</u>	<u>B</u>	<u>C</u>
<i>campestris, aberance</i>	blac rot, leaf blight	1, 4	RS ¹⁹ )	RS ^{17,19} )	RS ¹⁷ )
<i>campestris</i>	leaf blight, black rot	0	NS ^{17,19} )	NS ^{17,19} )	NS ¹⁷ )
<i>raphani</i>	leaf spot, black rot	3	RS ¹⁷ )	na	RS ¹⁷ )
<i>armoracea</i>	leaf spot	na	Na	na	NS ¹¹ )

Na : No available data, RS: Race-specific response, NS : Non-specific response.

The most common races for each group were designated according to the reaction on the Kamoun et al.¹⁹⁾ differential set of varieties.

*Xanthomonas campestris* pv. *campestris* (Xcc) belongs to the genus that causes diseases on at least 124 monocotyledonous and 268 dicotyledonous plant species including all major crop plants²⁰⁾. According to a recent reclassification based on DNA analysis³⁵⁾, Xcc was assigned to the same genetic group as that of other pathovars infecting a wide range of crucifers as systemic or leaf pathogens (**Table 1**). The clear difference between leaf spot and black rot symptoms was attributed to the expression of a few genes, present in these pathovars¹⁰⁾. Factors responsible for the pathogenicity of Xcc include plant-stimulated proteins produced by pathogenicity genes targeted to plant nucleus³⁹⁾, several enzymes and extra-cellular polysaccharides¹⁰⁾. No highly toxic compounds were detected in association with the pathogenicity²⁶⁾.

It was shown that Xcc is composed of genetic and serologically heterogeneous groups of strains¹⁾. Kamoun et al.¹⁹⁾ reported that isolates of the pathogen could be grouped into 5 races according to the response of *B. rapa* and *B. juncea* cultivars. Race 4 was prevalent in Japan and in Portugal, while race 1 in UK, USA and it was also found on seeds of *B. oleracea* imported to Japan and England^{17,25)}. Race 0 was found in USA and Portugal (**Table 2**). Race 2, represented by only isolate 2D520, did not express pathogenicity in particular varieties of *B. oleracea*, *B. napus* and *Arabidopsis thaliana*^{6,17)}. Race 3, also represented by one isolate, showed the same interaction with differential varieties as isolates of *X. campestris* pv. *raphani* did¹⁷⁾. It is likely that these 2 races were designated by Kamoun et al.¹⁹⁾ based on some other types of interaction with the host plants than avirulence-resistance matching pairs of genes, and further use of these races is questionable.

**Table 2. Geographical distribution of *Xanthomonas campestris* pv. *campestris* races**

<u>Country</u>	<u>No. tested isolates</u>	<u>Race frequency (%)</u>				
		<u>0</u>	<u>1</u>	<u>2</u>	<u>3</u>	<u>4</u>
Japan ¹⁷⁾	65	0	35.0	0	0	65.0
UK ²⁵⁾	100	0	72.0	0	0	28.0
Portugal ³⁷⁾	61	31.0	18.0	0	0	51.0
USA ¹⁹⁾	na	Present	Present	Present	Present	Present
Europe, Russia ¹⁷⁾	25	0	42.0	0	0	58.0
<b>Total</b>	<b>251</b>	<b>7.8</b>	<b>51.2</b>	<b>na</b>	<b>na</b>	<b>41.0</b>

na: Not available.

Races were designated based on the Kamoun et al.¹⁹⁾ set of differential varieties.

Evidence of new races was suggested on the basis of interaction between worldwide collection of Xcc and new differential varieties in *B. oleracea* and *B. napus*^{16,17)}. The variability of Xcc continuously endangers cultivars with a narrow genetic base of resistance. The spreading of the disease on new host crops

considerably increases the chance of outbreaks on more susceptible vegetables grown in the same locations. Pathotyping of the pathogen populations may be necessary to provide a scientific base for breeding and introduction of resistant varieties in the areas endangered by black rot.

Since the pathogen can remain in soil even in plant debris only for 1 or 2 growing seasons²⁹), survival in contaminated seeds and on weed crucifers is considered to be most essential for the cycle of the disease. In Southeast Asia, although pak-choi, pet-tsai and other oriental brassicas are less damaged by black rot than vegetables of the *B. oleracea* group, they could become a source of inoculum.



[Continue to: \[Resistance to black rot in brassicas\]](#)



[Back to: Contents](#)

## References



[Back to the first page](#)

- 1) Alvarez, A. M. et al. (1994): Serological, pathological, and genetic diversity among strains of *Xanthomonas campestris* infecting crucifers. *Phytopathology*, 84, 1449-1457.
- 2) Bain, D. (1952): Reaction of brassica seedlings to blackrot. *Phytopathology*, 42, 316-319.
- 3) Bain, D. (1955): Resistance of cabbage to black rot. *Phytopathology*, 45, 35-37.
- 4) Bain, D. (1955): Disappearance of blackrot symptoms in cabbage seedlings. *Phytopathology*, 45, 55-56.
- 5) Bretschneider, K. E., Gonella, M. P. & Robeson, D. J. (1989): A comparative light and electron microscopical study of compatible and incompatible interactions between *Xanthomonas campestris* pv. *campestris* and cabbage. *Physiol. Molec. Plant Pathol.*, 34, 285-297.
- 6) Buell, R. & Sommerville, S. C. (1995): Expression of defense-related and putative signaling genes during tolerant and susceptible interaction of *Arabidopsis* with *Xanthomonas campestris* pv. *campestris*. *Molec. Plant Mic. Interact.*, 8, 435-443.
- 7) Camargo, L. E. A., Williams, P. H. & Osbourn, T. C. (1995): Mapping of quantitative trait loci controlling resistance of *Brassica oleracea* to *Xanthomonas campestris* pv. *campestris* in field and greenhouse. *Phytopathology*, 85, 1296-1300.
- 8) Cook, D. & Robeson, D. J. (1986): Active resistance of cabbage (*Brassica oleracea*) to *Xanthomonas campestris* pv. *campestris* against the causal agent of black rot by coinoculation. *Physiol. Molec. Plant Pathol.*, 28, 41-52.
- 9) Cook, A. A., Walker, J. C. & Larson, R. H. (1952): Studies on the disease cycle of black rot of crucifers. *Phytopathology*, 42, 162-167.
- 10) Daniels, M. J. et al. (1993): Plant and bacterial genes involved in interactions between *Xanthomonas* and crucifers. *Advances in molecular genetics of plant microbe interactions*. Seattle, Washington, USA, 433.
- 11) Dickson, M. D. & Hunter, J. E. (1987): Inheritance of resistance in cabbage seedlings to black rot. *HortScience*, 22, 108-109.
- 12) Ferreira, M. E. et al. (1993): Screening of Portuguese cole landraces (*Brassica oleracea* L.) with *Leptosphaeria maculans* and *Xanthomonas campestris* pv. *campestris*. *Euphytica*, 65, 219-227.
- 13) Guo, H., Dickson, M. H. & Hunter, J. E. (1991): *Brassica napus* sources of resistance to black rot in crucifers and inheritance of resistance. *HortScience*, 26, 1545-1547.
- 14) Hansen, L. N. & Earle, E. D. (1995): *Transfer of resistance to Xanthomonas campestris* pv. *campestris* into *Brassica oleracea* L. by protoplast fusion. *Theor. Appl. Genetics*, 91, 1293-1300.
- 15) Ho, B. L. (1986): Screening of cabbage varieties for resistance to bacterial blight disease. *MARDI Research Bull.*, 14, 35-38.
- 16) Ignatov, A. et al. (1997): Identification of *Xanthomonas campestris* pv. *campestris* races and sources of resistance. In ISHS Symposium on brassicas. 10th Crucifer Genetics Workshop. 23-27 Sept. Rennes-France, 215.
- 17) Ignatov, A., Hida, K. & Kuginuki, Y. (1998): Pathotypes of *Xanthomonas campestris* pv. *campestris* and resistance inheritance in *Brassica* species. *Sel'scokhozaistvennaya Biologiya* [In Russian] (in press).
- 18) Jamwal, R. S. & Sharma, P. P. (1986): Inheritance of resistance to black rot (*Xanthomonas campestris* pv. *campestris*) in cauliflower. *Euphytica*, 35, 941-943.

- 19)** Kamoun, S. et al. (1992): Incompatible interaction between crucifers and *Xanthomonas campestris* involves a vascular hypersensitive response, role of the hrpX locus. *Molecular Plant-Microbe Interactions*, 5, 22-33.
- 20)** Leyns, F. et al. (1984): The host range of the genus *Xanthomonas*. *Botanical Review*, 50, 308-356.
- 21)** Leite, R., Ruano, O. & Komori, N. (1994): Characterization of *Xanthomonas campestris* pv. *campestris* isolated from canola. *Summa Phytopath.*, 20, 35-38.
- 22)** Lizgunova, T. V. (1984): Crop plants of USSR; Cabbage. Kolos. Leningrad [In Russian].
- 23)** Mihail, J. D. et al. (1993): Bacterial blight of *Crambe abyssinica* in Missouri caused by *X. campestris*. *Plant Disease*, 77, 569-574.
- 24)** Pastuglia, M. et al. (1997): Rapid induction by wounding and bacterial infection of an S gene family receptor-like kinase gene in *B. oleracea*. *Plant Cell*, 9, 49-60.
- 25)** Redstone, S. et al. (1997): Review of *Xanthomonas campestris* pv. *campestris* in the cauliflower crop in West Cornwall, UK. In ISHS Symposium on brassicas. 10th Crucifer Genetics Workshop, 23-27 Sept. Rennes-France, 216.
- 26)** Robeson, D. J. & Cook, D. R. (1985): Production of low molecular weight carboxylic acid by *X. campestris* pv. *campestris* in relation to the amino acid composition of the medium and their possible involvement in pathogenesis. *Physiol. Molec. Plant Pathol.*, 26, 219-230.
- 27)** Robinson, R. A. (1969): Disease resistance terminology. *Rev. Appl. Mycology*, 48, 593-605.
- 28)** Ruissen, M. A. & Gielink, A. J. (1994): The development of black rot in cabbage as a result of differences in guttation between cultivars and the relation of guttation to infectiousness. In Proc. of the 8th International conference on plant pathogenic bacteria, June 9-12. Versailles, France, 767-777.
- 29)** Schaad, N. W. & White, W. G. (1974): Survival of *Xanthomonas campestris* in soil. *Phytopathology*, 64, 1518-1520.
- 30)** Sharma, B. R., Swarup, V. & Chatterjee, S. S. (1977): Resistance to black rot disease (*Xanthomonas campestris*) in cauliflower. *Scientia Horticulturae*, 7, 1-7.
- 31)** Shinohara, S. (1959): Cabbage. Sangyo-Tosho, Tokyo [In Japanese].
- 32)** Studentsov, O. V. (1971): Resistance of some types and varieties of coles to bacterial and fungal diseases. *Appl. Bot. Genet. Plant Breed.*, 45, 165-179 [In Russian].
- 33)** Tewari, R. N., Chatterjee, S. S. & Swarup, V. (1979): Inheritance of resistance to black rot (*Xanthomonas campestris*) in cabbage. *Vegetable Science*, 6, 27-36.
- 34)** Tsuji, J. & Somerville, S. C. (1992): First report of natural infection of *Arabidopsis thaliana* by *Xanthomonas campestris* pv. *campestris*. *Plant Diseases*, 76, 539.
- 35)** Vauterin, L. et al. (1995): Reclassification of *Xanthomonas*. *Int. J. Syst. Bacteriol.*, 45, 472-489.
- 36)** Vicente, J. G., Dias, J. S. & Taylor, J. D. (1997): Occurrence and distribution of *Xanthomonas campestris* pv. *campestris* races in Portugal. In ISHS Symposium on brassicas. 10th Crucifer Genetics Workshop, 23-27 Sept. Rennes-France, 214.
- 37)** Williams, P. H. (1980): Black rot; a continuing threat to world crucifers. *Plant Disease*, 64, 736-742.
- 38)** Williams, P. H., Staub, T. & Sutton, J. C. (1972): Inheritance of resistance in cabbage to black rot. *Phytopathology*, 62, 247-252.
- 39)** Yang, Y. & Gabriel, D. W. (1995): *Xanthomonas* avirulence/pathogenicity gene family encodes functional plant nuclear targeting signals. *Molecular Plant-Microbe Interaction*, 8, 627-631.

(Received for publication, November 26, 1997)

## Resistance to black rot in brassicas

The term "resistance" has been sometimes applied to very distinctive events, which results in a reduced damage of plants under natural conditions, including specific morphological characteristics and disease escape due to environmental factors²⁷). Several studies have clearly revealed the ability of plants to decrease their susceptibility to black rot after inoculation with some micro-organisms⁸). Plant morphology and life cycle may play a very important role in the degree of black rot development in the field. The rate of guttation plays a major role in the difference in disease development between susceptible cultivars²⁸). Here, the word "resistance" will be used here only for the genetic factors specific to host-pathogen interaction.

Ability of the pathogen to multiply in the vascular system of plant plays a major role in the expression of black rot symptoms. Vein plugging in plants infected with Xcc seems to be due to the accumulation of fibrillar material in vessels to prevent pathogen spreading inside the vascular system. Due to water deficiency, wilt and death of leaf segments between affected veins are the main reasons for the V-shaped lesions, typical of black rot⁵). It is less known that Xcc can produce some other symptoms. Under common nursery conditions, the disease can appear as yellowing of cotyledons and deformation of first true leaves on seedlings. At low temperatures, after the fall of diseased leaves, plants may remain infected but symptomless until the occurrence of warm weather³⁷). Alternatively, they could recover under cool temperature⁴). Systemic invasion often causes symptoms of "chlorotic spotting" or "pale mottle" on susceptible plants^{1,9}) - local whitish deformation of the epidermis on parts of leaves affected by the compounds produced by the bacteria. The proposed toxic nature of these compounds⁹) has not been confirmed experimentally and other factors like pathogenicity proteins or bacterial hormones should be considered.

Area of pathogen spreading in plant vessels is much more extensive than the area of visual symptoms⁹) and sometimes, typical V-shaped marginal lesions can appear as a result of systemic infection as well as after hydathode infection. Under wet and cool weather conditions, when intercellular spaces in leaves are soaked with water, the bacteria can penetrate into plants through stomata and induce extensive leaf spot lesions without systemic symptoms⁹). In several cases, Xcc caused rapidly expanding lesions referred to as "blight"^{1,15}). Vascular spreading of the bacteria in some other crucifers can be symptomless³⁴).

The resistant reaction in plant occurs in hydathodes, the natural gateway for the pathogen penetration into plant⁹), and in the vascular system, where the pathogen spreads and multiplies⁵). In early studies, a difference between leaf and stem susceptibility of cabbages was noticed. With the same leaf reaction as in European cultivars, the Japanese cultivars exhibited a lower stem susceptibility^{3,32}). This novel stem resistance can be represented as the arrest of the pathogen in the stem vascular system. It was observed that in the progeny of a cross between stem-resistant Chinese kale and leaf-resistant cabbage, these types of plant reaction were controlled by different genes and could be evaluated separately¹⁷). Routine observation of visual symptoms of black rot produced by conventional inoculation methods had ignored the difference between the resistance types and gave data that did not enable to distinguish the different types of resistance. Thus, selection for one type can result in the loss of another.

Race-specific resistance in brassicas was normally associated with hypersensitive response (HR) at the site of inoculation with incompatible race of Xcc¹⁹), but sometimes only partial expression was observed¹⁶). The distribution of the resistance to Xcc among Brassica species displays some interesting similarities ([Table 3](#)). The dominant single gene in plants with B genome^{13,14}) conferred the highest level of resistance to all races except for race 0. The high frequency of dominant resistance to race 4 was found in *B. rapa* of Japanese and Central Asian groups as well as in cultivars of oilseed *B. napus*^{16,17}).

Presently, plants of the *B. oleracea* group, especially cabbage and cauliflower, are most severely damaged by the disease³⁷). The frequency of black rot resistance in *B. oleracea* is very low. Although, there are no true resistant accessions among several hundreds of varieties and landraces of cabbage and cauliflower^{30,32,38}), many additive genes were responsible for the reduced damage by black rot in the field in diallel crosses between varieties or breeding lines of cabbages³³) and cauliflower²⁵). Attempts to introduce into *B. oleracea* the dominant monogenic resistance from *B. carinata* PI199947 (previously designated as *B. napus*) were made via protoplast fusion, but the progeny obtained was more susceptible than the resistant parent, suggesting that some other genes were important as well¹⁴).

Since the first report of resistant cabbage cultivars by Bain²), the existence of resistance has been detected in several other *Brassica oleracea* plants^{11,12,18,30}) ([Table 3](#)). Since plant defense includes several biochemical events, such as synthesis of receptor-like kinase (SRK), defense proteins, chitinase and enzymes of phenylpropanoid metabolism²⁴), several genes should be involved in the phenotypic expression of the resistance. Although, single resistance genes in cabbage varieties Huguonot and cauliflower SN455 were reported, the participation of a larger number of genes could not be ruled out^{3,18}).

Two accessions of *B. oleracea* var. *capitata* Fujiwase and PI436606 have been widely used to breed commercial cultivars. Unfortunately, the resistance of these cultivars showed complex relationships with the genetic background and race-specific action^{11,17,38}). The black rot resistance of variety Fujiwase was controlled by a single recessive factor affected by 2 gene-modifiers³⁸), as well as the resistance of plants selected from line PI436606¹¹). Recently, by the use of quantitative trait loci (QTL) mapping, the resistance in Fujiwase progeny has been found to be associated with several additive loci in different linkage groups and one of them, responsible for the resistance in both adult and young stages was dominant, while the other was recessive⁷).

In the progenies of Chinese kale, cabbage line PI436606 and the Penca kale, a homologous recessive gene was responsible for the race-specific resistance to the newly designated race 5 of Xcc and a dominant gene provided resistance to race 1. Several cabbage lines of Japanese origin and Penca kale landraces displayed similar patterns of race-specific reaction and inheritance of resistance to races 1 and 5 of Xcc17) ([Table 4](#)).

**Table 4. *Brassica oleracea* accessions grouped according to their postulated resistance genes¹⁷⁾.**

<u>Subspecies</u>	<u>Accession</u>	<u>Postulated resistance genes (R)</u>
alboglabra	S1	1
trachuda	ISA55, ISA454	1, 2
Capitata	Badger Inbred 16, Kinkei DH01, Reiho DH01 Fujiwase 1; Fujiwase DH01, 02, 05; Harukei DH01	1, 2
	PI436606; DH M9606; Aichi dai Bansei DH01, 02	2
	Reiho DH01, 03; Fujiwase DH 03, 04; Matsunami DH22	2, 4
	Matsunami DH77; DH M9602, 9603	4

If an accession showed a variable reaction, single plant selection was made prior to the test; DH, doubled haploid lines, obtained from Japanese cultivars resistant to black rot.

The genes of resistance were proposed on the basis of both resistance-avirulence matching pairs in the gene-for-gene interaction between the resistant varieties and Xcc races and the resistance inheritance. Gene R1 conferred the resistance to race 1, gene R2 - to race 5, gene R4 - to race 4.

Cabbages have been introduced to Japan relatively recently and in most of them the pedigree included some varieties of the Flat Dutch group³¹⁾ This group was selected from heading Mediterranean kale related to the landrace Penca de Mirandella, which is also resistant to black rot^{12,22)}. As tested by Bain²⁾, all open-pollinated varieties related to Flat Dutch contained a large number of resistant plants in bulk. In the same experiments, suggesting a similar race composition of the applied inoculum, the frequency of resistance in the Fujiwase stock was about 95%. Since Fujiwase has a documented origin from Flat Dutch, it is highly probable that its resistance was inherited from Flat Dutch or from heading Mediterranean kale. We can assume that the race-specific resistance to black rot in Asian cabbages did not appear *de novo* under the pressure of the disease, as suggested by some researchers³⁷⁾, but probably was inherited from the plants related to heading Portuguese kales. Only the use of genetic markers in the analysis of race-specific HR will enable to determine whether the genes studied in one cultivar are the same as in others.

After these recent achievements, sources of race-specific leaf and non-specific stem resistance among *B. oleracea* became available for plant breeding. The discovery of the race structure of Xcc populations for the first time enabled to design a breeding program based on the recognition of different genes and different mechanisms of resistance to black rot.



[Forward to: -Development of Microcomputer-Controlled Unmanned Air Blast Sprayer-](#)



[Back to: contents](#)



[Back to: JIRCAS home page](#)

**Table.3**  
Some reported accessions of brassicas resistant to black rot

Species, subspecies	Genome	Accession	Resistance type	
<i>B. oleracea</i> var. <i>capitata</i>	CC	Fujiwase (Early Fuji) ²³⁾	rs	
		PI436606 ¹¹⁾	rs	
		Singapura (F ₁ ) ¹⁷⁾	S	
		Penca kales ^{12,17)}	rs	
		var. <i>costata</i>	SN455 ³⁰⁾	na
		var. <i>botrytis</i>	Marathon (F ₁ ) ¹⁷⁾	S
var. <i>italica</i>	SI ¹⁷⁾	S, rs		
var. <i>alboglabra</i>				
<i>B. rapa</i> var. <i>rapifera</i>	AA	Just Right (F ₁ ) ¹⁹⁾	rs	
		Tokyo Hybrid (F ₁ ) ¹⁹⁾	rs	
		Seven Top Green ¹⁹⁾	rs	
		var. <i>parachinensis</i>	RCBr ¹⁷⁾	rs
<i>B. napus</i>	AACC	Cobra ¹⁶⁾	rs	
		CrGC-5 ¹⁶⁾	rs	
		Giant English ¹⁶⁾	rs	
<i>B. carinata</i>	BBCC	PI199947 ¹³⁾	rs	
<i>B. juncea</i>	AABB	Florida Broad Leaf ¹⁹⁾	rs	

rs: Race-specific resistance, S: Stem resistance, na: Not available.



[BACK](#)



# Development of Microcomputer-Controlled Unmanned Air Blast Sprayer

Koichi TOSAKI*¹, Sumihiko MIYAHARA*¹, Tomohiko ICHIKAWA*¹,  
Shiro TANIAI*², Yoshiharu MIZUKURA*², Hiroshi MORIKI*³ and Susumu MIYASHITA*³

*1 Institute of Agricultural Machinery, Bio-oriented Technology Research Advancement Institution  
(Omiya, Saitama, 331-8537 Japan)

*2 Yanmar Agricultural Equipment Co. Ltd. (Oyamazaki, Kyoto, 618-0061 Japan)

*3 Kioritz Corporation (Ome, Tokyo, 198-8711 Japan)

## Abstract

A microcomputer-controlled unmanned air blast sprayer was developed to avoid the operator's exposure to agricultural chemicals or mechanical noise, and to improve the work efficiency during application for pest control in orchards. The developed sprayer moves automatically without a driver along a guiding cable, which is set up along the work course between the tree rows of the orchard. Unmanned application system developed controls automatically steering gears of the sprayer by detecting a magnetic field, which was generated by feeding an alternating current to the guiding cable. The cable can be installed underground (at a depth of less than 30 cm), on the ground surface, or at a height of 150 to 200 cm from the ground along the work course. The maximum total length of the cable is about 1,000 m. During unmanned application, the machine sprays agricultural chemicals automatically along the work course. However, if it is unnecessary to spray outward at the end of the tree rows where the sprayer turns, the machine is able to stop spraying outward while turning, due to a special system. All the functions of the sprayer stopped automatically when the sprayer reached the end point of application work. The sprayer has several safety devices controlled by the unmanned application system to avoid any accidents during unmanned application work. As a result of the performance test, deposition of sprayed chemicals on the fruit trees and work efficiency by this sprayer were as good as in any conventional manned air blast sprayers.

**Discipline:** Agricultural machinery

**Additional key words:** guiding cable, unmanned pest control, unmanned traveling, orchard

1~5): [Click here for References](#)

## Introduction

Since the application of chemicals for pest control in orchards involves upward spraying, exposure of the operators to agricultural chemicals during the application has become a cause for concern. Protective wear, therefore, is used, but it is extremely unpleasant during hot months. A cabin may be attached to an air blast sprayer to avoid exposure, but for trellis fruit trees, for example, where the space is limited between the upper part of the equipment and the overhead branches, cabins may not be practical. Also the blower and other mechanical noises cause problems for the operators. As a result, a safe and comfortable work environment should be created.

The microcomputer-controlled unmanned air blast sprayer was developed to alleviate these shortcomings. In addition, this type of sprayer is the first unmanned air blast sprayer for orchards ever to be commercialized in Japan.

## Purpose of development

Various systems of unmanned traveling can be used. In the current studies, we installed a guiding cable along the work course in the orchard, and when an electric current was fed to this cable, it generated a magnetic field around, which then could be detected by an electromagnetic sensing system^{1,2}).

Magnetic field is generated around the cable in which the current runs and around the coils placed within the magnetic field where the magnetic flux varies. As a result, electromotive force is generated according to the change of speed of the flux. These basic principles of electromagnetics were applied in this system.

The unmanned application system in the sprayer controls automatically steering gears of the sprayer depending on the degree of deviation from the guiding cable detected by an electromagnetic sensor, which is referred to as "guiding sensor" described later in this paper.

Compared with the standard application of chemicals with a conventional manned air blast sprayer, the application procedures for the unmanned sprayer are as follows:

- (1) The sprayer is brought manually to the starting point for the spraying operation.
- (2) Electric current is fed to the guiding cable.
- (3) The unmanned operation system of traveling and spraying is activated.
- (4) Unmanned operation continues until the liquid tank becomes empty.
- (5) The sprayer is then transported by an operator to an area where the chemicals may be replenished and then to the area where the application is to resume.
- (6) At the end of the entire application work, all the functions of the sprayer should come to an automatic stop.

We expected that the sprayer would be as efficient as the current manned air blast sprayer used for pest control in orchards.



[Continue to: \[Specifications of the unmanned sprayer\],\[Guiding cable\],\[Unmanned application system\]](#)



[Back to: Contents](#)

## References



[Back to the first page](#)

- 1) Miura, K. et al. (1980): Research on control system of unmanned low volume applicator; Research on unmanned low volume applicator. *Res. Rep. Inst. Agric. Mach.*, 55 (1), 19-26 [In Japanese].
- 2) Takenaga, T. et al. (1980): Research on application apparatus of unmanned low volume applicator, Research on unmanned low volume applicator; *Res. Rep. Inst. Agric. Mach.*, 55 (1), 27-33 [In Japanese].
- 3) Tosaki, K. et al. (1995): Development of microcomputer controlled driverless air blast sprayer. *Proc. Int. Symp. Automation & Robotics in Bioproduction and Processing (JSAM)*, 2, 73-80.
- 4) Tosaki, K. et al. (1996): Development of microcomputer controlled driverless air blast sprayer (Part 1), Unmanned traveling system. *J. Jpn. Soc. Agric. Mach.*, 58 (6), 101-110 [In Japanese].
- 5) Tosaki, K. et al. (1997): Development of microcomputer controlled driverless air blast sprayer (Part 2), Unmanned application system. *J. Jpn. Soc. Agric. Mach.*, 59 (4), 87-96 [In Japanese].

(Received for publication, November 12, 1997)

## Specifications of the unmanned sprayer

The specifications of the unmanned sprayer are listed in [Table 1](#), and a diagram of the major parts is shown in [Fig. 1^{3,4}](#). A photograph of the sprayer, the guiding signal generator (referred to as "signal generator" in this paper), guiding cable set up on the ground, and palm-sized remote control transmitter (referred to as "transmitter" in this paper) are shown in [Fig. 2](#).

*Table 1. Specifications of the unmanned sprayer*

<a href="#">Dimensions</a>	Length: 399 cm, Width: 145 cm Height: 129 cm (except for antenna) Weight: 1,350 kg (with empty tank)
<a href="#">Engine</a>	Diesel engine: 31.8 kW/2,800 rpm
<a href="#">Traveling apparatus</a>	Type: 4 driving wheels/4WD/4WS Shift range: Main 1/2/3, Sub.: H/M/L/R Forward: 9 steps (0.9-13.2 km/h) Backward: 3 steps (1.2-7.5 km/h)
<a href="#">Tank capacity</a>	1,000 L
<a href="#">Fan</a>	Revolution: 2,280 and 1,550 rpm Air volume: 726 and 494 m ³ /min
<a href="#">Pump</a>	Type: Plunger type (3 cylinders) Discharge rate: 108 L/min
<a href="#">Nozzle</a>	Type: Disk nozzle (31 pieces)

➡ [Fig. 1 Major parts of unmanne sprayer \(61KB\)](#)



*Fig. 2 Unmanned sprayer, guiding cable, guiding signal generator and palm-sized remote control transmitter*

## Guiding cable

The guiding cable is laid along the work course. Examples of cable installation are shown in [Fig. 3](#).

[Fig. 3 Examples of guiding cable installation\(59 KB\).](#)

The depth at which the cable should be buried is either right under the surface or up to 30 cm beneath the surface for apple or other upright fruit trees, or the cable may be installed overhead at a height of 150 to 200 cm from the ground for trellis fruit trees such as pears and grapes.

Any parts of the cable should be about 1.5 m apart, considering the distance between dwarfed apple trees. Although the standard-specification cable is an automotive

## Specifications of the unmanned sprayer

low-voltage wire (JIS cord: AV3), any electric cable larger than 3 mm² in cross-section can be used.

The length of the cable to be installed is limited by the capacity of the signal generator or electric resistance of the cable, and in the present stage of technology, the maximum length of the cable is about 1,000 m. A cable of this length is capable of covering 30 to 40 a, including turning radii, in the case of dwarfed apple orchards where the trees are planted 4 to 4.5 m apart from each other.

The guiding cable is fed with an AC current of 1.5 kHz and 185 mA as the guiding signals from the signal generator. This signal generator is powered with a rechargeable battery that can be recharged in 5 h, using an exclusively built charger, and then it may be used for 8 consecutive hours. The signal generator provides 2 output-terminals, and the machine may be used for 2 cable systems by changing the switch.

## Unmanned application system^{3,5)}

[Fig. 4\(Block diagram of unmanned application system\[44 KB\]\)](#) shows a block diagram of the unmanned application system of the sprayer. The major sensing devices of the system consist of a guiding sensor ([Fig. 1 Major part of unmanned sprayer\[61 KB\]](#)) and [Fig. 5 Guiding sensor and main controller\[30 KB\]](#) and steering angle sensor (Fig. 1).

The guiding sensor has 2 sensing heads placed on both right and left sides of a radiator in the forward portion of the sprayer. This sensor detects the degree of deviation of the sprayer from the guiding cable by sensing the magnitude of the magnetic field generated around the guiding cable.

The steering angle sensor installed in the steering gear detects the angle of steering, i.e. the direction of the wheels.

An oil hydraulic cylinder actuated by an electromagnetic valve actuates the 4-wheel steering gears, traveling clutch and brake of the sprayer.

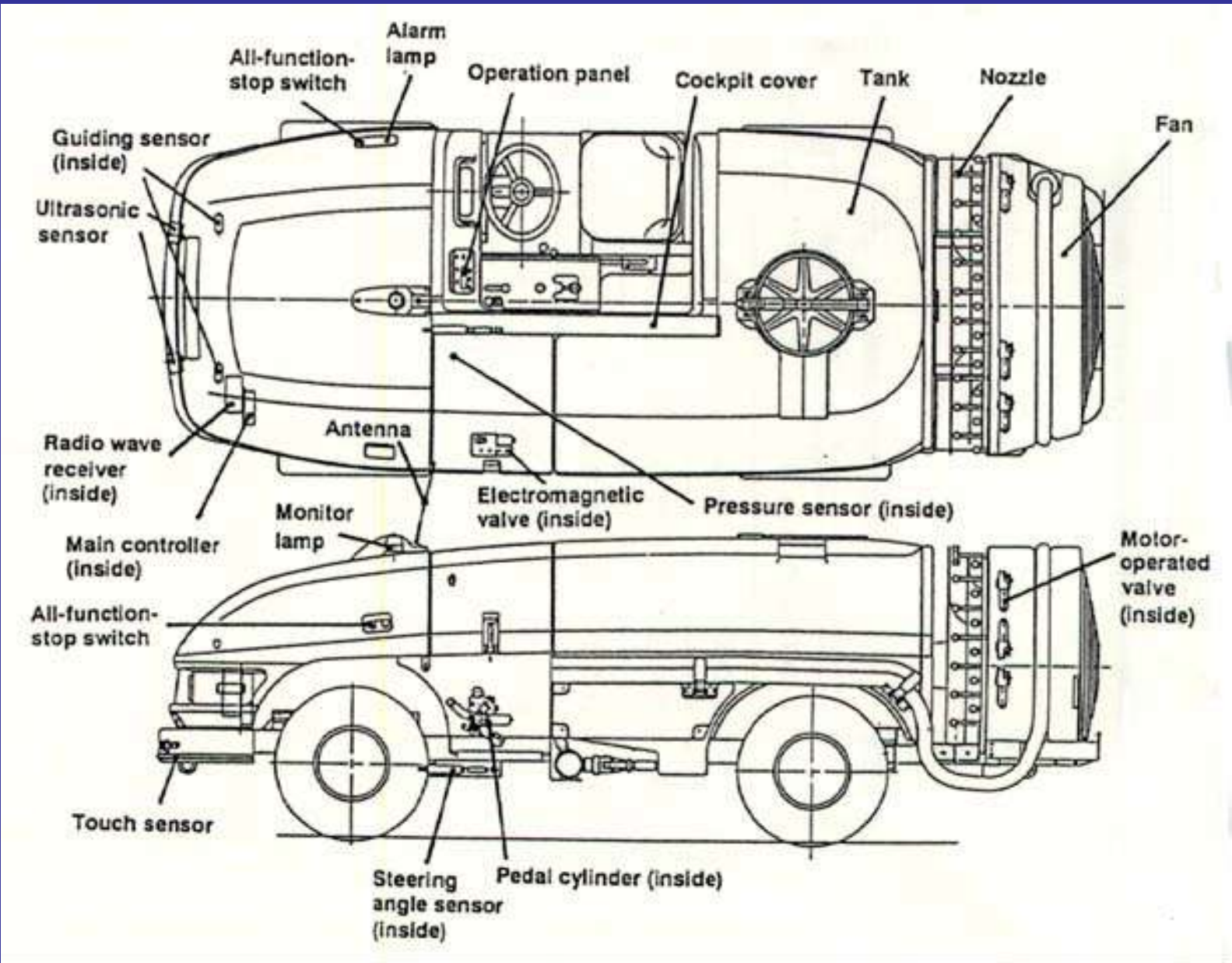
Based on the output of the sensors, the microcomputer (CPU: 20 MHz/16 bits, ROM: 32 Kbytes, RAM: 1 Kbytes) inside the unmanned traveling and spraying control device (referred to as "main controller" shown in [Fig. 5](#)) calculates the target steering range, in other words, the angle of turning for the steering in the case of a manned operation, based on which the steering gear is controlled just as the human operator would steer his/her wheels. Thus the unmanned sprayer may travel without any human attendance along the work course where the guiding cable is installed.

 [Continue to: \[Algorithm of automatic steering control^{3,4\)}\],\[Auxiliary remote control system^{3,4\)}\].....](#)

 [Back to: Contents](#)

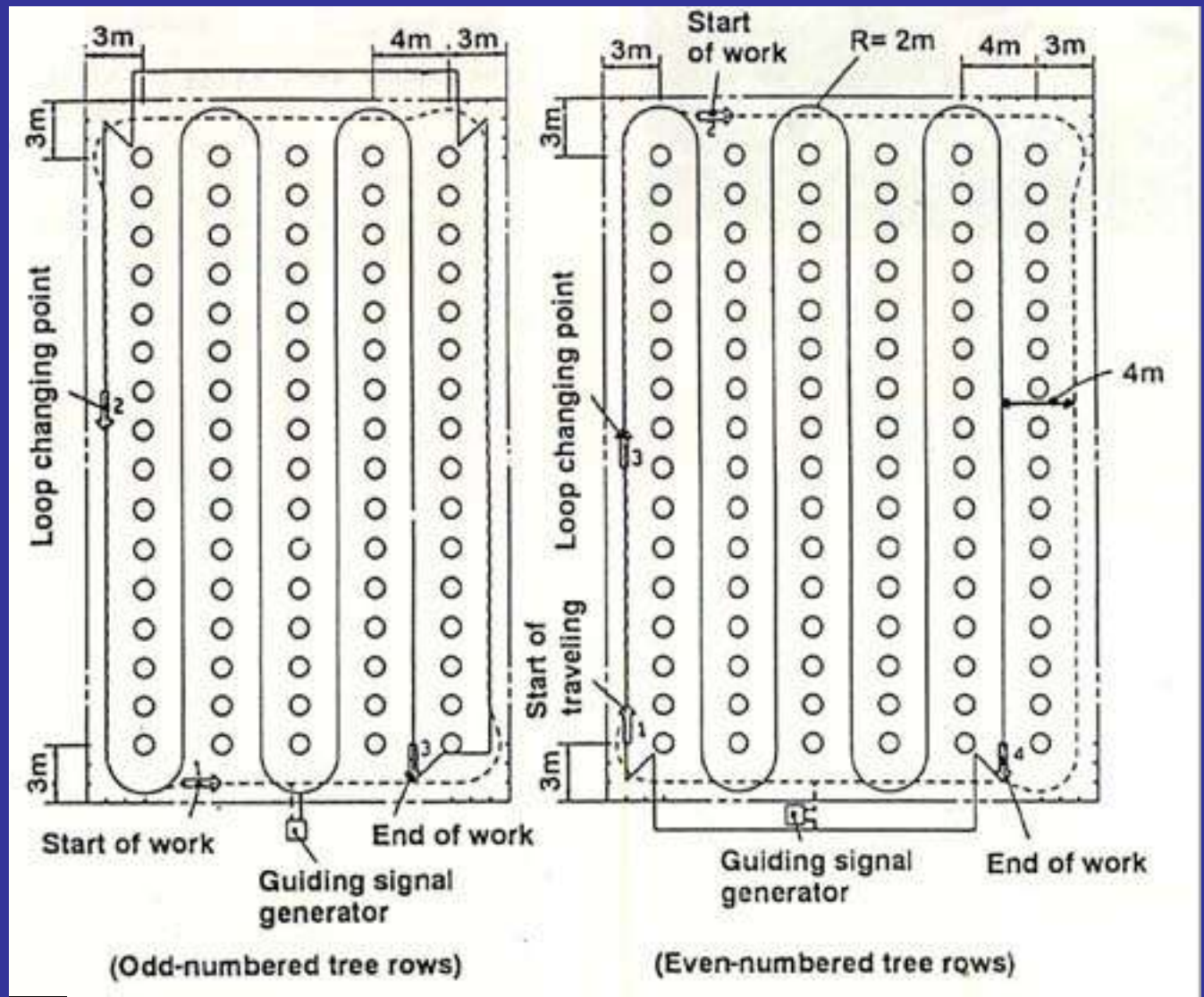
 [Back to: JIRCAS home page](#)

Fig. 1. Major parts of unmanned sprayer



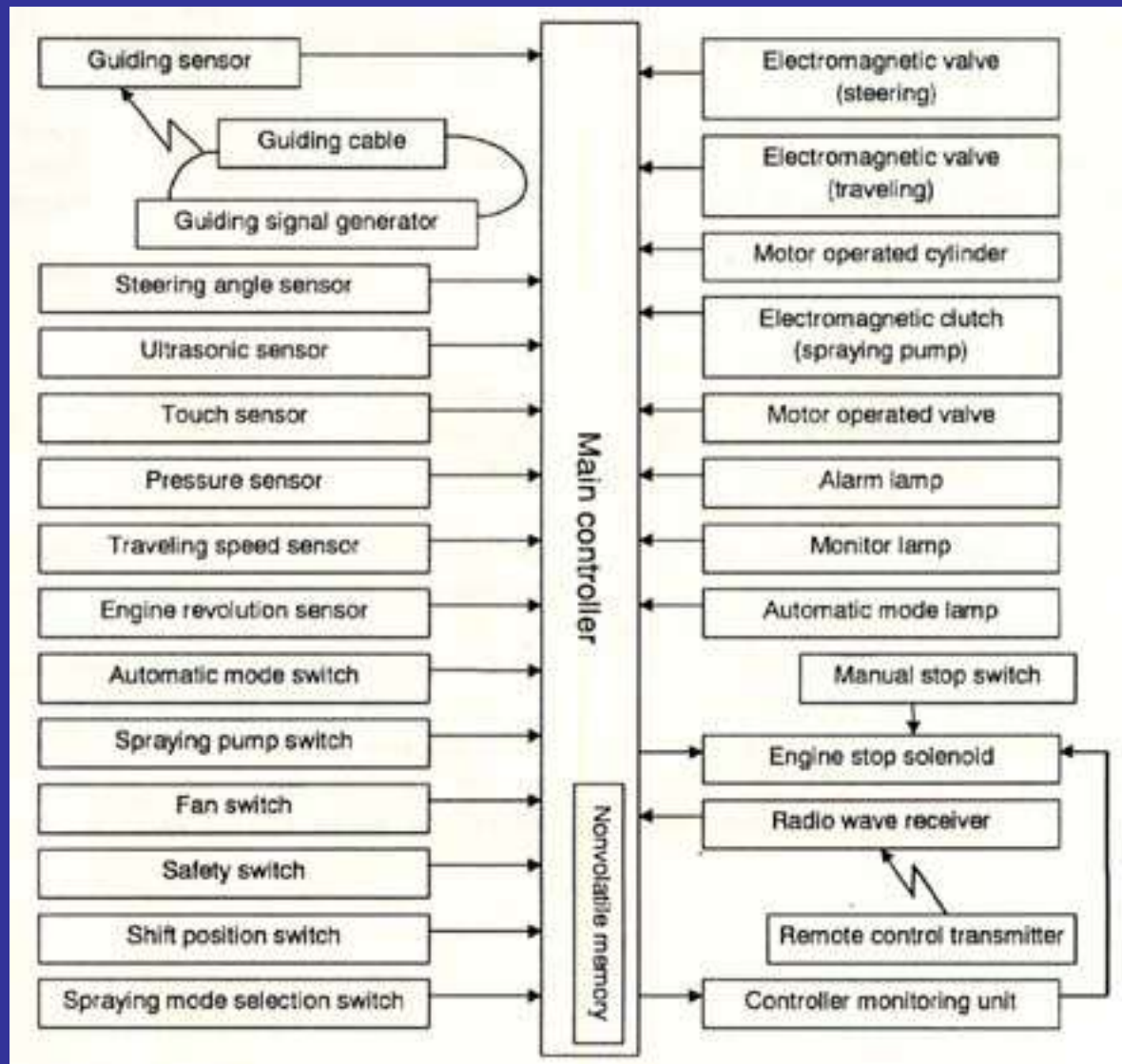
 [BACK](#)

**Fig3.**  
**Examples of guiding cable installation**



 [BACK](#)

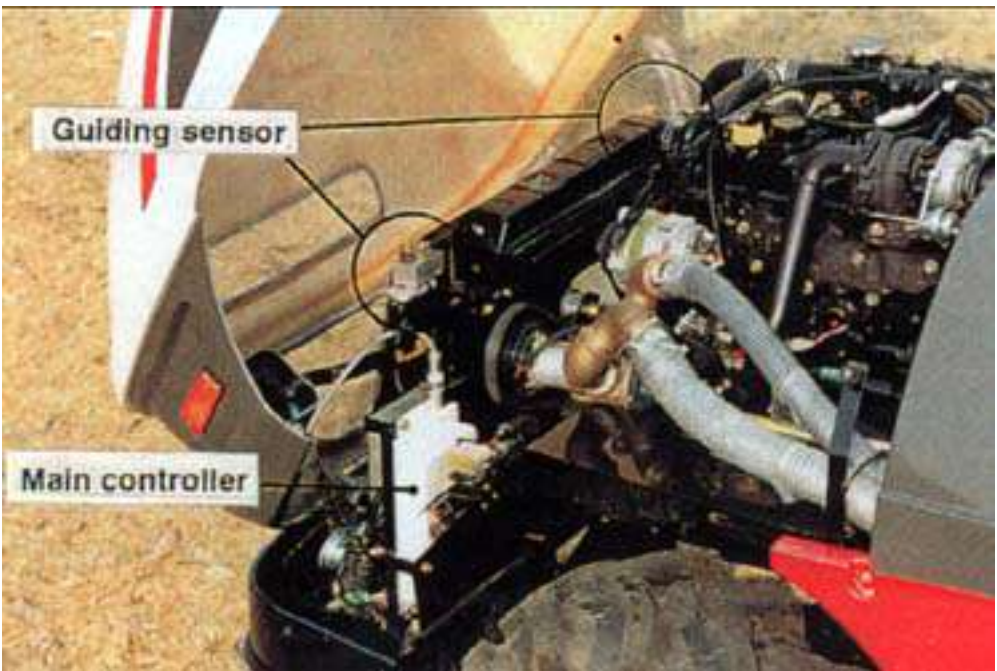
Fig. 4  
Block diagram of unmanned application system



 [BACK](#)



Fig.5 Guiding sensor and main controller



 [BACK](#)

1~5): [Click here for References](#)

## Algorithm of automatic steering control^{3,4)}

If variable  $V_d$  is the output of the guiding sensor, variable  $V_{dm}$  is the moving average of  $V_d$ , variable  $V_{off}$  is the offset value from  $V_{dm}$  to the center of the sprayer body,  $\Delta V_d$  is the displacement of  $V_d$ ,  $\Delta V_s$  is the control variable of steering, displacement of the body from the target position is represented by variable (1), and the direction of the body is represented by variable (2), as follows:

$$V_d - (V_{dm} + V_{off}) \dots\dots\dots (1)$$

$$\Delta V_d \dots\dots\dots (2)$$

Then,  $\Delta V_s$  was obtained using those variables with the following 6 rules of fuzzy reasoning.

Rule 1: If the body is on the right side and the direction is right, steer left.

Rule 2: If the body is on the right side and the direction is straight, steer left.

Rule 3: If the body is on the right side and the direction is left, don't steer.

Rule 4: If the body is on the left side and the direction is right, don't steer.

Rule 5: If the body is on the left side and the direction is straight, steer right.

Rule 6: If the body is on the left side and the direction is left, steer left.

Then, variable  $V_{sr}$  is the actual steering angle and variable  $V_{sg}$  is the target steering angle,  $V_{sg}$  is expressed as follows:

$$V_{sg} = V_{sr} + \Delta V_s \dots\dots\dots (3)$$

The actuators for automatic traveling control of the unmanned application system are controlled by  $V_{sg}$ .

## Auxiliary remote control system^{3,4)}

The start of the unmanned operation (onset of the application work) is controlled by the transmitter ([Fig. 2](#))[13 KB] of the auxiliary remote control system so that the operator may be protected from any exposure to the chemicals or noise. Radio waves of the system are in the range of specific low-power radio waves, requiring no particular license, and the accessible distance of radio waves is guaranteed at 150 m in common orchards. This system is capable of starting or stopping the traveling, blowing and spraying functions of the sprayer, as well as application work.

In addition, a single operator can control simultaneously more than 2 unmanned sprayers with this system in every adjoining orchard. Application work is more efficient and labor-saving than in any of the conventional manned air blast sprayers.

## Functions during unmanned operation³⁻⁵⁾

Functions during unmanned operation are as follows:

(1) During application by unmanned operation, chemicals are sprayed in all directions between the tree rows (right, left and upward of the sprayer). However, when the sprayer turns at the end of a tree row, it is designed to automatically stop spraying chemicals unnecessarily outside of the turning area without trees. In this instance, the steering condition is constantly monitored by the unmanned application system. The system proceeds straight or turns based on the output of the sensors for steering angle, for velocity, etc. and controls the spraying device of the sprayer. Automatic spray stopping function may be disengaged when spraying is desired even during turns.

(2) When the chemicals in the tank run out during the unmanned operation, traveling, blowing and spraying stop automatically through the effect of the pressure sensor ([Fig. 6 Pressure sensor for sensing when the tank is empty\[29 KB\]](#)) installed with the spraying pump built inside the sprayer. This device detects the reduction in the discharge of the pump, signaling the depletion of the chemicals, thus automatically halting traveling, blowing and spraying.

(3) When the application work is complete, the cable installed is bent at a certain sharp angle, which allows the magnetic fields to interfere with each other. As a result, the guiding sensor is unable to detect the specific magnetic field at this spot, and all the functions stop automatically.

It may be noted that the release of the unmanned application system enables manned operation of the sprayer as required, just as in any other conventional manned air blast sprayers.

## Safety devices

Since emphasis must be placed on safety in unmanned operation, unmanned application system of the sprayer incorporates safety devices as follows:

(1) A couple of obstacle-detecting sensors (2 ultrasonic sensors shown in [Fig. 1\[61 KB\]](#) and [Fig. 4\[44 KB\]](#)) built in the front bumper, upon detecting an obstacle about 1 m ahead, halts traveling, blowing and spraying.

(2) A touch sensor ([Fig. 1](#) and [Fig. 7](#)) built in the bumper, in the case of an obstruction, stops all functions of the sprayer including the engine automatically.

(3) Should the system be out of control in emergency, the engine may be stopped by all-function-stop switches ([Fig. 1](#)) which are located on both sides of the bonnet (hood) of the sprayer body.

(4) In case of the interruption of the transmission of radio waves because of the exhaustion of the battery in the transmitter of the auxiliary remote control system, or due to trouble or accidental switch-off, traveling, blowing and spraying come to a halt automatically.

(5) When the guiding sensor is unable to detect the magnetic fields generated around the guiding cable, since the battery of the signal generator is exhausted (battery exhaustion is indicated through a gauge set in the signal generator), the cable is broken, or the sprayer is derailed from the cable, the engine is automatically put to a stop, i.e. all functions of the sprayer come to an end.



## Performance tests and results³⁻⁵⁾

### 1) Functional confirmation tests

Functional confirmation tests in which the range of velocity was 0.9 to 2.7 km/h were conducted on flat ground in several test courses and orchards. An example of the results of the functional confirmation tests is shown in [Table 2 . Results of tests for function confirmation \(45 KB\)](#).

The unmanned sprayer could travel smoothly along the guiding cable on the work course. It was confirmed that the system stopped spraying outward outside of the tree rows while turning, stopped traveling, blowing and spraying when the tank became empty, and stopped all functions at the end point of the work course. Moreover, each safety device was functioning during the unmanned operation.

## 2) Deposition performance

Deposition performance tests based on IAM test code No.12-1989 were conducted in a range of application velocities of 1.8 to 2.5 km/h, and the application rates ranged from 310 to 450 L/10 a in an orchard of dwarfed apple trees (variety: “Fuji”, age: 18 years, height: 4 m, width: 3 m, planting pattern: 4x2.5 m). The results of the tests were satisfactory and similar to those with a conventional manned air blast sprayer.

## 3) Work efficiency

Work efficiency tests were also conducted in several orchards of dwarfed apple trees ([\(Fig. 8\)Unmanned application test \[44 KB\]](#)), trellis pears and trellis grapes ([\(Fig. 9\)Unmanned application test \[44 KB\]](#)).

According to the test results, the rate of work with the unmanned sprayer was almost the same as or higher than that with any conventional manned air blast sprayers.

However, the application work with the unmanned sprayer was more labor-saving and efficient than that with a conventional manned air blast sprayer, because the operator himself/herself of the unmanned sprayer could prepare agricultural chemicals to replenish the empty liquid tank during the unmanned operation without any assistant.

## Conclusions

Advantages of the unmanned sprayer developed are as follows:

- (1) This newly developed sprayer prevents operator's exposure to agricultural chemicals, noise or danger involved.
- (2) During the operation of the unmanned sprayer, the operator may carry out himself/herself other activities such as preparation of agricultural chemicals, hence the reduction of labor and enhancement of work efficiency.
- (3) Theoretically, a single operator can manipulate simultaneously more than 2 unmanned sprayers, thus contributing to labor-saving and timely pest control.

In consequence, introduction of the unmanned air blast sprayer ensures efficient and labor-saving application work of chemicals for pest control in a comfortable environment.



[Forward to -Water Hyacinth Control Program through Community Development Approach-](#)



[Back to Contents](#)



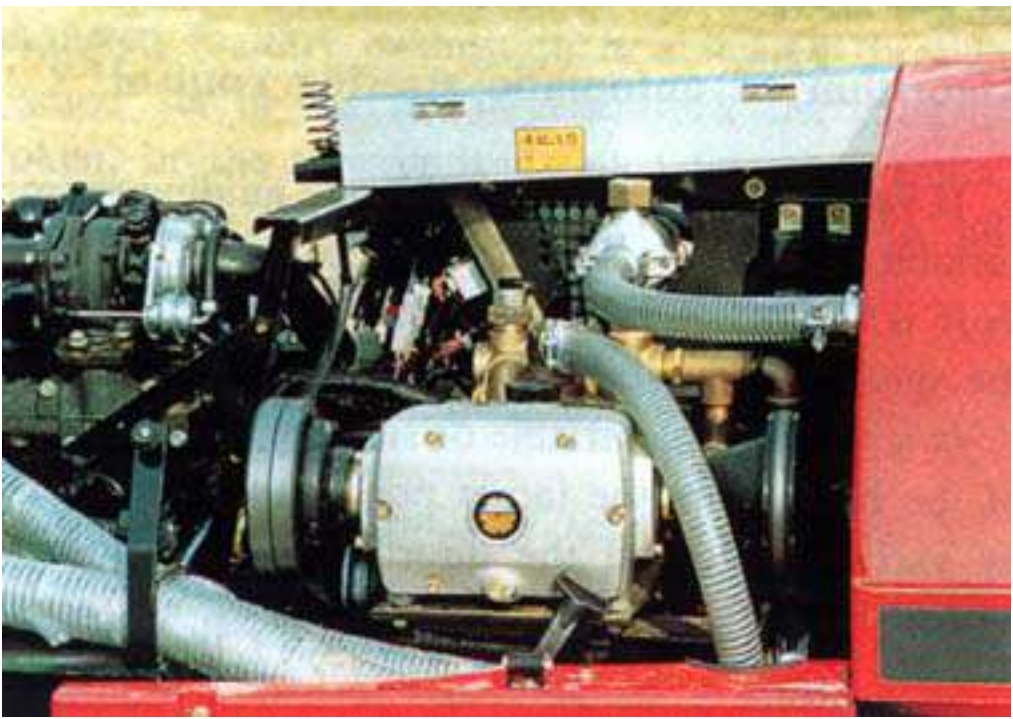
[Back to JIRCAS home page](#)

Fig.2. Unmanned sprayer, guiding cable, guiding signal generator and Palm-sized remote control transmitter



[BACK](#)

Fig. 6. Pressure sensor for sensing when the tank is empty



 [BACK](#)

**Table 2.**  
**Results of tests for function confirmation**

Items	Shift range	
	L-1	M-2
Displacement from the cable (straight traveling)	0.08	0.14
Stopping distance when the tank becomes empty	0.25	0.56
Minimum turning radius of cable	1.70	1.50
Allowable distance from cable to cable	1.50	1.50
Stopping distance upon detection of an obstacle	0.50	0.31
Stopping distance upon contact with an obstacle	0.05	0.21
Stopping distance by operation with the transmitter of auxiliary remote control system	0.09	0.20
Stopping distance with inaccessible remote control radio wave	0.90	2.51
Stopping distance with breakdown of guiding signal on the guiding cable	0.31	1.12
Stopping distance with all-function-stop switch "on"	0.61	1.78
Maximum accessible distance of radio wave	850	
All the data listed above were derived from the tests conducted on a test course (soil surface).		



[BACK](#)

Fig. 8. Unmanned application test (dwarfed apple orchard)



Fig.9. Unmanned application test (trellis grape orchard)



 [BACK](#)



# Water Hyacinth Control Program through Community Development Approach: A Case Study in a Bangladesh Village

**Haruo UCHID*1 and Kazuo ANDO*2**

*Department of Hilly Land Agriculture, Shikoku National Agricultural Experiment Station  
(Zentsuji, Kagawa, 765-0053 Japan)

*Center for Southeast Asian Studies, Kyoto University (Sakyo-ku, Kyoto, 606-8304 Japan)

## Abstract

A Village Committee was established for the organization of the rural development activities in a village, Dakshin Chamuria, in Bangladesh under the JICA (Japan International Cooperation Agency) Project of JSRDE (Joint Study on Rural Development Experiment). The committee consists of so-called traditional village leaders 'matabbors', who are mostly active in enhancing the villagers' unity and devoted to the village public affairs. The authors outline the Community Development Approach to establish the Village Committee and its performance to control an aquatic weed (water hyacinth) in order to protect deep water rice in the study village. The paper describes the procedure adopted to establish the Village Committee representing all the villagers, as a key part in the Community Development Approach of JSRDE. Secondly, the water hyacinth control program as a study case under the Community Development Approach was also evaluated. Overall, the results of this study indicate that the Community Development Approach may contribute significantly to the solution of the rural development problems in Bangladesh.

* This paper is based primarily on our previous study entitled "Rural Development Program by Community Approach in a Bangladesh Village" (in Japanese) submitted to the Journal of Agricultural Development Studies. However, a large part of the paper has been revised and newly added.

**Discipline:** Irrigation, drainage and reclamation/Agricultural environment

**Additional key words:** rural development, village community, village committee, matabbor

1~4): [Click here for References](#)

## Background

The target group approach is presently the main approach for the rural development programs in Bangladesh. Although the target group approach organizes landless farmers, women, the poor, etc., they are supervised and controlled by non-villagers who provide the services of loan, job training, etc. Although the supplied goods and services reach target groups, most of the time, this approach enhances the dependency of the groups in the program. Consequently, the villagers become passive and dependent, which is not favorable for sustainable rural development¹⁾.

We consider that it is difficult to achieve sustainable rural development without the Community Development Approach. Thus, we introduced rural development programs in a village, 'Dakshin Chamuria' (D village) in Bangladesh, to involve the whole village community and include indigenous technologies under the Joint Study on Rural Development Experiment (JSRDE) from 1992 to 1995. The project was funded by the Japan International Cooperation Agency (JICA) and jointly implemented by JICA and the Ministry of Local Government and Rural Development & Cooperative, Bangladesh. This paper describes the establishment of the Village Committee which played a key role in the community development approach of the JSRDE, including the water hyacinth control program proposed by the Village Committee. The paper also briefly indicates why such an approach may contribute significantly to sustainable rural development in Bangladesh.

## 'Matabbors' and the Village Committee

'Matabbors' are the traditional village leaders, some of whom are active and devoted to the village public affairs, village court for example. These leaders are not necessarily rich or educated. Some of them have a small land holding even less than 1 acre and are illiterate. However, the villagers recognize them as leaders because of their eloquence and ability to collect information.

In addition to acting as mediators in the village court, matabbors also contact organizations outside the village such as the government agencies and NGOs interested in implementing new programs in the village. According to the survey conducted in 1988, more than 70% of the matabbors indicated that they usually go to the 'Thana' office (local administrative office) more than once a month⁴). Thus matabbors are active persons of a village who usually gather useful information from the government agencies, NGOs, etc. On the other hand, when outside organizations attempt to initiate some programs in the village, matabbors are also a good source of information about the village. By such connection, matabbors always receive various types of and new information earlier than the other villagers. This situation is sometimes misused by the matabbors for monopolizing profitable information. It has been often observed in villages that the tricky matabbors are selfish and may not serve the interests of the village people. Such characteristics of matabbors have been often criticized and matabbors are considered as 'touts' by the officials concerned with the rural development programs. Therefore, it is important that the matabbors' activities/performance related to the village public affairs including building of a village school and development of 'hat' (regular market in the village) be evaluated²).

Usually, the matabbor acts as a leader when villagers face problems and unite the villagers for possible solutions. On such occasions, matabbors become significant for the community interest of the villagers. Against this background, the JSRDE project adopted the Community Development Approach aiming at utilizing the leadership qualities of matabbors but, at the same time, at supplying everybody with useful information that tended to be monopolized by the matabbors. For this purpose, the Village Committee was established in D village.

A village in Bangladesh usually consists of several small communities called 'para'. The village under the study, D village, has 4 paras and each of these paras has several matabbors. To set up a Village Committee, a general meeting was held in the classroom of the primary school in D village on January 2, 1993. The selection of the matabbors was carried out during this meeting by about 200 people from all paras. Matabbors from each para were selected according to the number of households in each para. The committee had 18 members including 4 female, 1 from each para. Other procedures included the selection of the executing body, a chairman and secretaries on the basis of the villagers' recommendation (Fig.1).

### [Fig.1. Village Committee Meeting\(21 KB\)](#)

The Village Committee is assumed to fulfill the following 3 main functions: (1) To hold a monthly meeting for discussing the common problems. (2) To prepare programs for possible solutions. (3) To hold a coordination meeting with the field workers of the rural development agencies, the government and NGOs.

It is important to mention that 6 months after the start of the Village Committee, there was a distinct gap in information flow between the Village Committee and the common villagers. To fill this gap, the Para Meeting was started within each para between the project staff and the common villagers including the Village Committee members of the para. As expected, the Para Meeting also played an important role in encouraging the villagers' participation in the project. Therefore, the Para Meeting was deemed indispensable for the Community Development Approach in D village.

In the following part of the paper, the aquatic weed(water hyacinth) control program designed and implemented by JSRDE and the Village Committee is outlined.



[Continue to: \[Action program for water hyacinth control\], \[Discussion\]](#)



[Back to: Contents](#)

## References

- 1) Ando, K.(1995): *Status quo of rural development and AID in Bangladesh. In Industrial development in developing countries.* ed. Kawai, A., 172-186 [In Japanese].
- 2) Ando, K. et al.(1995): Matabbors and village development; An account of action research in Dakhsin Chamuria village, Bangladesh. *Southeast Asian Studies*, 33(1), 39-65 [In Japanese with English summary].
- 3) Farming system research development program team(1991): Fact searching and intervention, FSRDP publication no. 33. BAU, Mymensingh, 59-60.
- 4) JSARD project team(1990): Key questions and issues from village-based studies 1986-1989, JSARD publication no. 20. Dhaka, JICA Bangladesh.

(Received for publication, November 5, 1997)



[BACK](#)

Fig1: Village Committee Meeting



[BACK](#)

1~4): [Click here for References](#)

## Action program for water hyacinth control

### 1) Background

During the rainy season, all of the land except homesteads and roads in D village were usually inundated to a large extent. The water flowing from the neighboring village carried water hyacinth and deep water rice growing in the flooded fields was damaged. In September 1993, a Village Committee member, Mr. Rahman who is a primary school teacher introduced this problem for discussion during the Village Committee Meeting. He suggested that laborers should be hired by the local government aid program, namely Test Relief, to control the water hyacinth problem. However the Village Committee could not obtain this assistance, because the program had a shortage of wheat as wages for laborers. However, the committee discussed some of the measures that should be adopted to address this problem as the damage caused by water hyacinth occurs frequently and is severe.

In order to solve this problem, JSRDE suggested the introduction of 'African Doncha' (*Sesbania rostrata*) which is a plant used to stop the invasion of water hyacinth into rice fields.

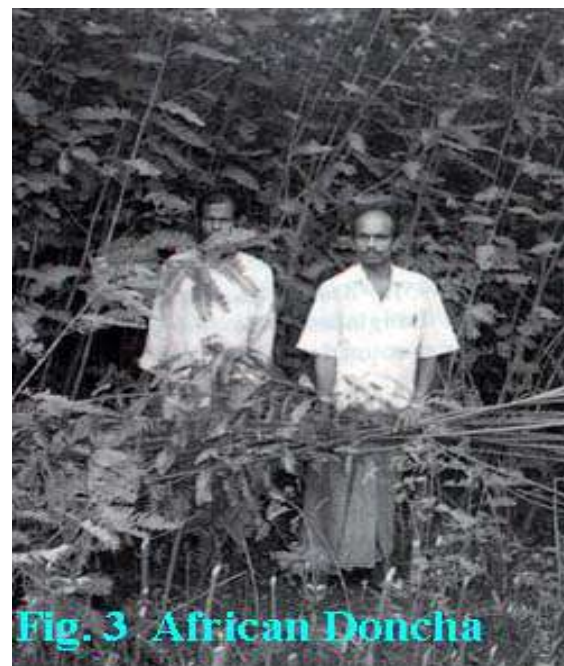
African Doncha was cultivated during the late dry season to obtain the seedlings (stem cuttings). Firstly, at the beginning of the rainy season, the seedlings were planted in the field, which remained fallow during the rainy season and was located just in front of 'Chinamura Doch' (water depression in the neighboring village) from where water hyacinth flows out. Secondly, the seedlings were also planted on the drainage sides of water hyacinth in the deep water rice growing area in order to guide water hyacinth to 'Ronger Doch' (water depression in D village) directly. Thirdly, at the same time, African Doncha was cultivated on the levees around the rice fields to prevent the invasion of water hyacinth to the deep water rice growing fields ([Fig. 2](#)).

### [Fig.2: Water hyacinth control program \(26 KB\)](#)

In addition to the water hyacinth control program, African Doncha, as described later, was newly introduced to Bangladesh for use as green manure, forage, fuel, fence and article for sale. Before 1993, the seeds of African Doncha had not been readily available to common villagers even though, as told by the counterparts of JSRDE from the Bangladesh Agriculture University (BAU), a large quantity of seeds was produced in their experimental farm. Therefore, suggestions were made to the Village Committee that this plant should be introduced to D village in cooperation with the BAU counterparts. The cultivation of African Doncha was successfully promoted by the effective coordination of the Village Committee and motivation at the Para Meeting in D village.

## 2) African Doncha

Professor Altaf Hossain, one of the BAU counterparts, introduced for the first time African Doncha, an annual legume, to Bangladesh in 1986 from the International Rice Research Institute. The plant grows up to a few meters. 'Deshi Doncha' (*Sesbania aculeata*), a local variety of Doncha (*Sesbania* spp.), had grown traditionally in Bangladesh for the same use as that of African Doncha. However, nowadays, dry season's modern rice varieties (high-yielding varieties) are cultivated to a large extent in the fields where Deshi Doncha used to be broadcasted at the end of the dry season, March to April. Unfortunately, these rice varieties are usually harvested in May. Thus, Deshi Doncha had disappeared gradually along with the introduction of these rice varieties. On the other hand, African Doncha can be cultivated using seedlings (young plants and stem cuttings) under waterlogged conditions. Therefore, it can be cultivated at any time even during the rainy season if the seedlings are available. There is no competition for land between the modern rice varieties and African Doncha, unlike in the case of Deshi Doncha. Research has revealed that African Doncha is more effective than Deshi Doncha as green manure and that rooting occurs 2-3 days and leafing 5-6 days after planting of a stem cutting 50 cm high for normal cultivation and 1 m for deep waterlogged conditions, respectively³). For use as a green manure, the appropriate timing of incorporation of African Doncha in soil is 40-60 days after planting ([Fig. 3](#)).



Since 1989, after the initiation of the field experiment, BAU has started to distribute the seeds to the research organizations and the Agricultural Extension Department. Based on the activities of BAU, JSRDE decided to introduce this plant for one of the development programs as mentioned earlier.

## 3) Performance of the program

It was eventually decided to implement the water hyacinth control program during the meeting of the Village Committee held in November 1993, in agreement with the suggestion made by Mr. Rahman in September. During the same meeting, it was also decided to rent a piece of land, 31 decimals in size (1 decimal is about 40 m²) to cultivate African Doncha in the village. At the end of February 1994, the seeds of African Doncha were broadcasted on the rented land and cuttings were planted tentatively in the rented rice field in April, at the end of the dry season. On June 1, the stem cuttings were planted in the field located in front of Chinamura Doch as mentioned before. During the meeting of the Village Committee held on June 6, the villagers were informed that the stem cuttings would be supplied to them upon request. The villagers who thought that African Doncha was the same as native Doncha (*Sesbania aculeata*) were skeptical and reluctant to plant the stem cuttings. They pretended that the stem cuttings and also the young plants of Doncha would not take root. They did not agree with the program. On the other hand, many villagers took the stem cuttings and realized that African Doncha was different from Deshi Doncha. Moreover, some villagers stole the stem cuttings from the rented rice field without permission and all the stem cuttings disappeared. During the meeting of the Village Committee held on June 24, 1994, it was decided that the program would be discontinued.

Although the program was discontinued, the villagers continued to grow African Doncha and harvested it

at the end of the rainy season for home consumption or to sell seeds and stems. Three, 9, 6 and 11 villagers cultivated African Doncha in the fallow fields, on levees of the aman rice growing fields, around the homesteads and the ponds, respectively. Sixty-four villagers cultivated African Doncha in total and 35 of them used the plant to control water hyacinth in their deep water rice fields. Eighty villagers could not obtain the stem cuttings although they wanted to get them.

Fortunately, in 1994, the water hyacinth did not overflow from Chinamura Doch as in a normal flooding year. On the contrary, the unexpected large flood washed away the planted stem cuttings of African Doncha in the following year. Therefore, the efficiency of the water hyacinth control program could not be substantiated. The program was successful, nevertheless, from the viewpoint of introduction of a new plant as well as the spontaneous response of the villagers. African Doncha was cultivated in the next year.

#### **4) Role of the Village Committee**

The water hyacinth control program was initiated after the proposal of a member of the Village Committee. This type of problem, damage by water hyacinth, was considered to be an individual problem formerly. However, when the problem was raised at the Village Committee Meeting, it became a common issue to the villagers. In this sense, the committee considered that the problem could be solved and asked the villagers to implement the program.

The main function of the Village Committee is to control the matabbors who exclusively keep the information by holding discussions with the villagers and invite them to make decisions about matters relating to the village public affairs. Moreover, the Village Committee played the role of contact outside of the village. The chairman and the chief secretary, after the decision of the Village Committee, went to Chinamura and other villages as the representatives of the village to negotiate some issues. And, in some cases, they took formal letters to the matabbors of other villages upon the request of their Village Committee. Such negotiations had been traditionally conducted after consultation among matabbors, but the common villagers were seldom involved in the process until a decision was made. However, the villagers were informed of all the actions taken such as negotiations during the Village Committee Meeting. The Village Committee can be expected to benefit from the services from organizations outside the village.

JSRDE and the committee members explained frequently the purpose and use of African Doncha to the villagers in order to obtain their agreement on the program in the Village Committee. Especially during the Para Meeting, ease of cultivation of African Doncha in the fallow fields by planting the stem cuttings and use as green manure and fuel were emphasized in order to disseminate it even to villagers whose fields had not been damaged by water hyacinth. It is considered that, without the Para Meeting, African Doncha would not have been introduced to the village so actively and widely.

## **Discussion**

The ecological characteristics of African Doncha as well as the Village Committee and the Para Meeting contributed significantly to the promotion of the program. The matabbors became active in the program when they were formally recognized as the authority of the village. Information was given to all the villagers through the Village Committee and the Para Meeting. The matabbors did not act as touts and

their original function in the community was fulfilled by the villagers. Thus, they could not monopolize the benefit from new information as previously. The power of the community increased by the introduction of the new Community Development Approach. The Village Committee and the Para Meeting paved the way for the awareness of the villagers of common problems and the villagers' unity increased during the programs.

Results of the JSRDE programs are highly significant for people's participation in FAP (Flood Action Plan), National Development Program and some rural development programs in Bangladesh. It is essential to evaluate and utilize the local village system and indigenous knowledge of villagers to promote people's participation.

The authors are grateful to colleagues of the JSRDE Tangail project site and the villagers of Dakshin Chamuria for their cooperation. They especially thank Dr. Niaz Ahmad, JSPS Research Fellow at the Center for Southeast Asian Studies, Kyoto University for his valuable comments and cooperation in this report.



[Forward to: -Soluble Lignin Fractions Program through Community Development Approach-](#)



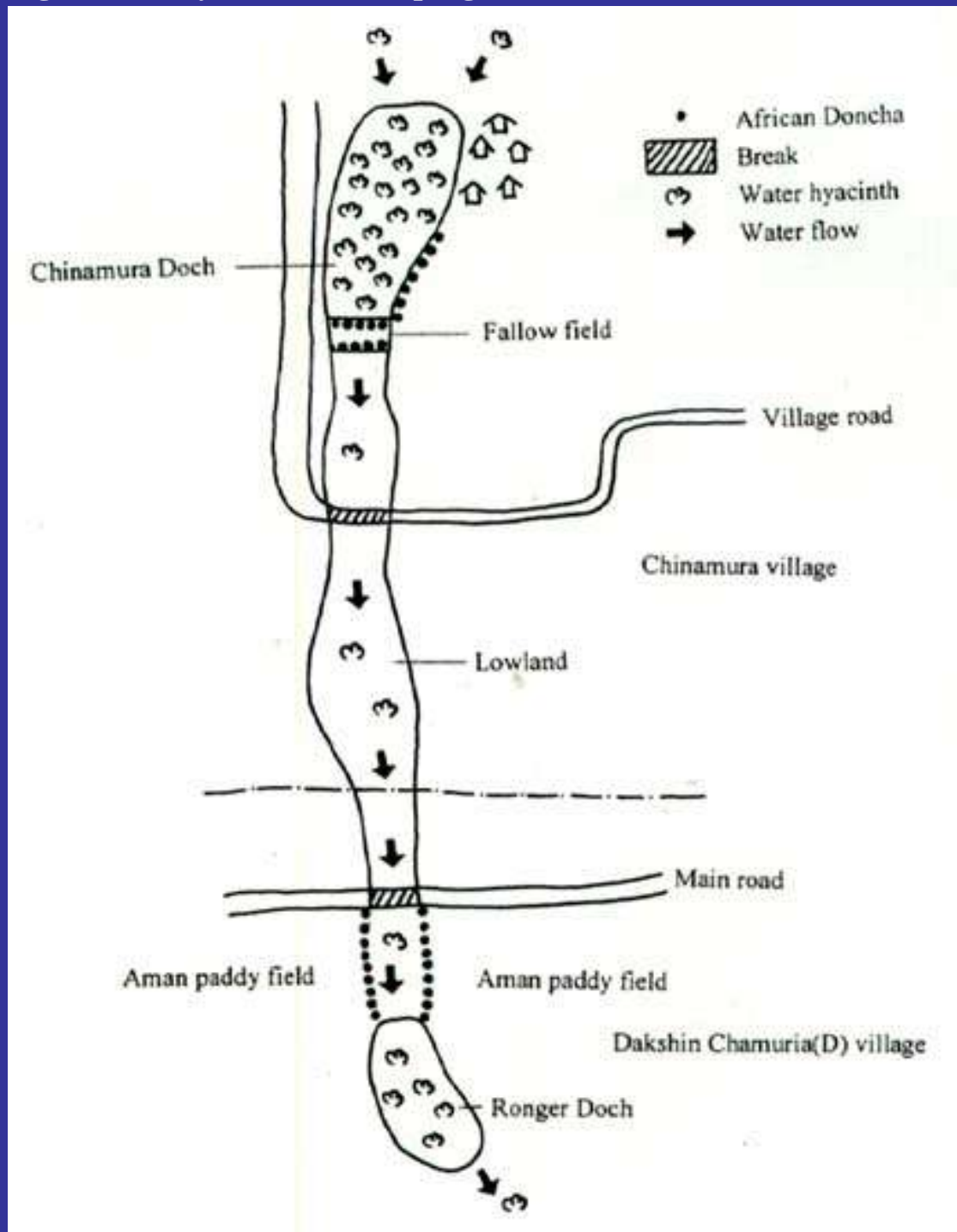
[Back to: Contents](#)



[Back to: JIRCAS home page](#)



Fig 2. Water hyacinth control program



[BACK](#)

# Physico-Chemical Characteristics of Soluble Lignin Fractions Released from Forage Grasses by Ruminant Digestion

Tsuneo KONDO*1, Takashi WATANABE*2, Tomoko OHSHTA*3 and Tadashi KYUMA*4

*1,3,4 Department of GrasslandsTohoku National Agricultural Experiment Station  
(Shimokuriyagawa, Morioka, 020-0123 Japan)  
*2 Wood Research Institute, Kyoto University (Gokasho, Uji, Kyoto, 611-0011 Japan)

Present Adress:

*3 Department of Animal Industry, Hokkaido National Agricultural Experiment Station  
(Toyohira-ku, Sapporo, 062-0045 Japan)  
*4 Faculty of Agriculture, Shinshu University (Nobeyama, Minamisaku, Nagano, 384-1305 Japan)

## Abstract

To analyze the structural modifications of forage grass lignin during digestion in ruminant animals, dioxane-soluble lignin fractions were isolated from the feces and rumen digesta of ruminants that received forage grasses, without any pretreatments such as ultragrinding, acid and alkali hydrolysis, and their physico-chemical characteristics were compared with those of undigested original lignin preparations of forage grasses. Both dioxane-soluble lignin fractions from the feces and rumen digesta were composed mostly of guaiacyl-syringyl lignin with *p*-hydroxyphenylpropane units and contained only small amounts of non-lignin constituents. When compared with the undigested original lignin preparations, the dioxane-soluble lignin fractions contained a larger amount of syringylpropane units, and a much smaller amount of bound phenolic acids and showed a lower molecular size. Dioxane-soluble lignin fractions from the *in vitro* rumen-digested residues of forage grass contained a smaller amount of bound phenolic acids and associated carbohydrates and showed a lower molecular size than those from the cellulase-treated residues. These results indicate that soluble lignin fragments, which are likely to be degradation products of grass lignins or lignin-carbohydrate complexes involving bound phenolic acids, are released in the rumen and then excreted in feces.

**Discipline:** Animal industry/Grassland

**Additional key words:** lignin structure, phenolic acids, rumen

1~20): [Click here for References](#)

## Introduction

Lignin is a complex macromolecular substance composed of 3 phenylpropanoid residues, guaiacyl-, syringyl- and *p*-hydroxyphenylpropane units, and their ratios vary depending on the plant species, organs, tissues and maturity. It has been widely recognized that lignin in forages is virtually undigested and inhibits rumen fermentation of forage cell wall poly-saccharides, thereby reducing the utilization of forage by ruminant animals. The inhibitory effect of lignin is closely related to its structure and thus probably affected by modifications which lignin undergoes in the digestive tract of ruminants^{3,11}). Research on the fate of lignin in the digestive tract demonstrated that some part of lignin fed to ruminants is solubilized as a complex with carbohydrates in the rumen^{6,7}) and, after leaving the rumen, the complex is excreted as solid matter in the feces¹⁸). Evidence for the solubilization or degradation of grass lignins by rumen microorganisms was provided by *in vitro* experiments^{1,16,19}). In addition, rumen digestion has been reported to lead to the decomposition of lignin model dimers into monoaromatic compounds and their metabolites^{4,5}) and demethylation of the syringyl units of grass lignin¹⁷). However, little is known about the composition and structure of solubilized or degraded lignin fractions. Characterization of the lignin fractions may provide further information not only on the nutritional effect of forage lignin but also on the biodegradation of plant lignins in an anaerobic environment.

We conducted a series of studies on the structural characteristics of lignin fractions solubilized or degraded during digestion in ruminant animals¹²⁻¹⁵). We found that an organic

solvent-extractable lignin fraction was present in the rumen digesta and feces of ruminants fed on forage grasses, and characterized the soluble lignins by chemical analysis, nitrobenzene oxidation, UV, IR and ¹³C-NMR spectroscopy and gel permeation chromatography, compared with undigested original lignin preparations of forage grasses.

## Isolation and partial characterization of soluble lignin fractions from feces of sheep

### 1) Isolation procedure of soluble lignin fractions from feces

Orchardgrass (*Dactylis glomerata* L.), timothy (*Phleum pratense* L.) and Italian ryegrass (*Lolium multiflorum* Lam.) were grown as pure swards, harvested at the heading stage of the first growth and, after wilting for a half-day, dried in an air-forced drier to give grass hays. Hay of each type of grasses was offered to 4 sheep at a maintenance level during a 7-day adaptation period and a 7-day collection period. Feces were sampled during the collection period and representative samples were dried at 55°C and ground with a Wiley mill to pass a 1 mm screen.

The fecal samples from 4 different sheep were bulked and pre-extracted with ethyl ether. After air-drying, the pre-extracted residue was extracted with 90% (v/v) aqueous dioxane for 48 h at room temperature, and the dioxane extract was dried under reduced pressure to give a crude dioxane-soluble lignin fraction. The crude lignin fraction was dissolved in 90% (v/v) acetic acid and precipitated in ethyl ether. After drying, the precipitate was suspended in water to remove water-soluble contaminants. The insoluble material was collected by centrifugation and purified by re-dissolution in acetic acid followed by re-precipitation in ethyl ether.

### 2) Composition, UV and IR spectra of soluble lignin fractions from feces

**Table.1**

*Yield and composition of the dioxane-soluble lignin fractions isolated from feces of sheep fed on orchardgrass, timothy and Italian ryegrass*

	<u>Orchardgrass</u>	<u>Timothy</u>	<u>Italian ryegrass</u>
Yield (g kg ⁻¹ feces)	12.4	15.6	9.5
Elemental Composition (g kg ⁻¹ soluble lignin)			
C	581	574	585
H	56	59	61
N	8	7	12
Chemical composition (g kg ⁻¹ soluble lignin)			
Klason lignin	875	844	818
Carbohydrate	18	23	20

The yield of dioxane-soluble lignin from the feces was in the range of 9.5-15.6 g kg⁻¹ dry feces ([Table 1](#)).

The forage grass samples did not contain any significant amount of dioxane-soluble lignin. The dioxane-soluble lignin fractions contained only small amounts of non-lignin constituents such as nitrogenous compounds and carbohydrate, and most part of the lignin was converted into an acid-insoluble residue (Klason lignin) by 72% sulfuric acid hydrolysis for all the grasses. The 3 soluble lignin fractions showed similar UV absorption spectra with a maximum at 278 nm and a shoulder peak at around 320 nm ([Fig. 1](#)).

#### [Fig.1 UV spectra of the dioxane-soluble lignins from feces of sheep fed on forage grasses\(22 KB\)](#)

The absorption maximum was attributed to hydroxylated aromatic nuclei and the latter shoulder peak to bound phenolic acids. No appreciable differences were found in the absorption coefficient among the 3 soluble lignin fractions. IR spectra showed distinct bands at 1,600, 1,510 and 1,425 cm⁻¹ attributable to aromatic nuclei of lignin ([Fig. 2](#)).

#### [Fig.2 IR spectra of the dioxane-soluble lignins from feces of sheep fed on forage grasses\(28 KB\)](#)

Bands associated with guaiacylpropane units were observed at 1,030 and 1,270 cm⁻¹, and a band assigned to syringylpropane units appeared at 1,330 cm⁻¹.

## Physico-Chemical Characteristics of Soluble Lignin Fractions Released from Forage Grasses by Ruminant Digestion

The present analytical and spectral data revealed the presence of soluble lignin fractions consisting mostly of lignin components in the feces of sheep fed on forage grasses. The dioxane-soluble lignin fractions were insoluble in water but soluble in 80% ethanol, neutral and acid detergents; fibrous residues prepared with these reagents from feces were free of dioxane-soluble lignin. Consequently, the presence of dioxane-soluble lignin in feces of ruminants accounted partly for the incomplete fecal recovery of dietary lignin, which has often been reported.



[Continue to: \[Structure of lignin fractions isolated from forage grasses and from feces of sheep fed on them\].....](#)



[Back to: Contents](#)

## References



[Back to the first page](#)

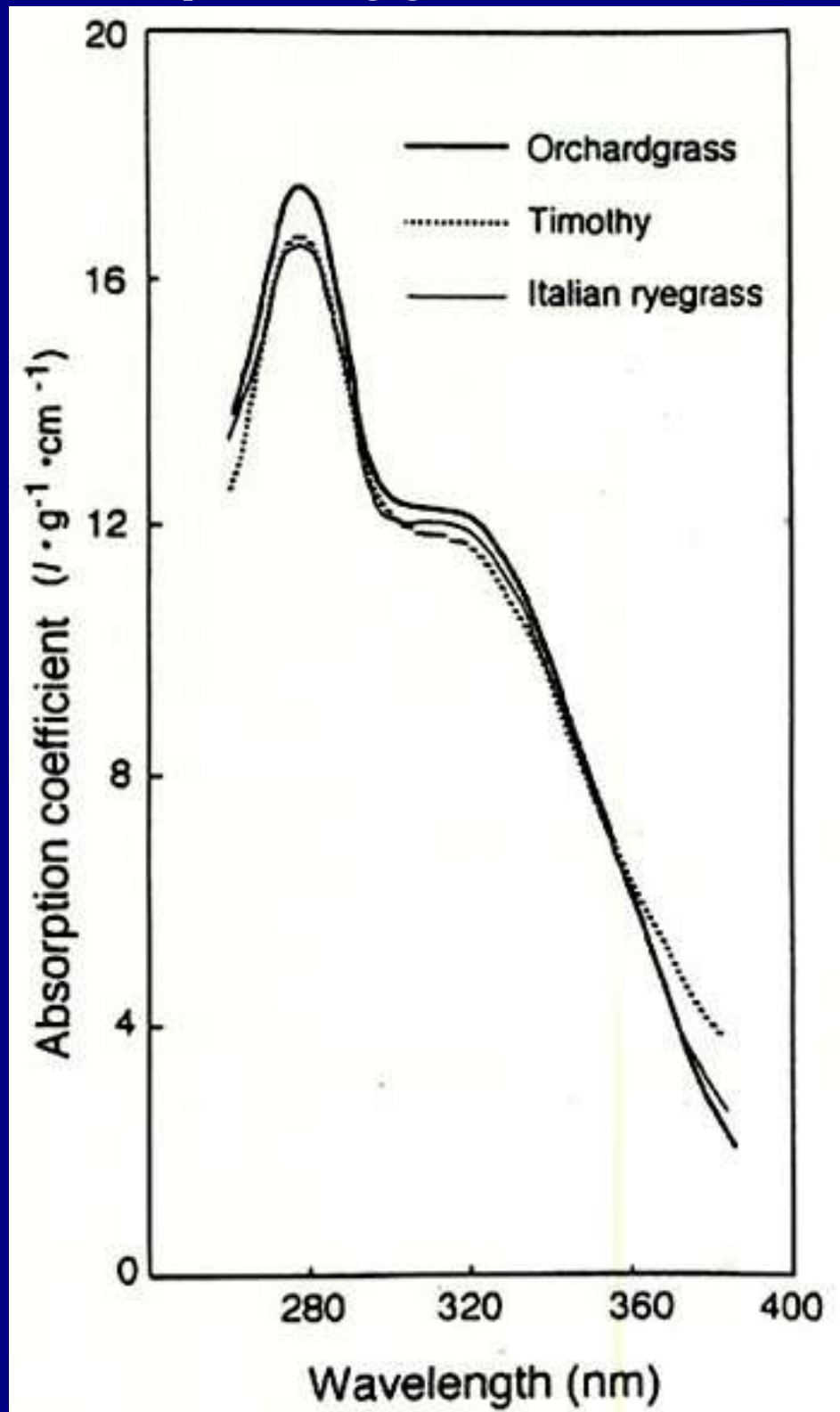
- 1) Akin, D. E. & Benner, R. (1988): Degradation of polysaccharide and lignin by ruminal bacteria and fungi. *Appl. Environ. Microbiol.*, 54, 1117-1125.
- 2) Akin, D. E. & Chesson, A. (1989): Lignification as the major factor limiting forage feeding value especially in warm conditions. *In Proc. XVIth Int. Grassl. Congr. Nice.* ed. Desroches, R. Association Francaise pour Productions Fourrageres, INRA, Versailles, France, 1753-1760.
- 3) Belse, J-M., Cornu, A. & Jouany, J-P. (1994): Roles of structural phenylpropanoids in forage cell wall digestion. *J. Sci. Food Agric.*, 64, 171-190.
- 4) Chen, W. et al. (1985): Anaerobic degradation of vetratrylglycerol-?-guaiacyl ether and guaiacoxycetic acid by mixed rumen bacteria. *Appl. Environ. Microbiol.*, 50, 1451-1456.
- 5) Chen, W. et al. (1987): Anaerobic degradation of dehydrodiisoeugenol by rumen bacteria. *J. Ferment. Technol.*, 65, 221-224.
- 6) Conchie, J., Hay, A. J. & Lomax, J. A. (1988): Soluble lignin-carbohydrate complexes from sheep rumen fluid: their composition and structural features. *Carbohydr. Res.*, 177, 127-151.
- 7) Gaillard, B. D. E. & Richards, G. N. (1975): Presence of soluble lignin-carbohydrate complexes in the bovine rumen. *Carbohydr. Res.*, 42, 135-145.
- 8) Higuchi, T. et al. (1967): Chemical properties of milled wood lignin of grasses. *Phytochemistry*, 6, 1551-1556.
- 9) Hon, D. N. S. (1983): Mechanochemical reactions of lignocellulosic materials. *J. Appl. Polymer Sci.*, 37, 461-481.
- 10) Iiyama, K., Lam, T. B. T. & Stone, B. A. (1990): Phenolic acid bridges between polysaccharides and lignin in wheat straw internodes. *Phytochemistry*, 29, 733-737.
- 11) Jung, H. G. & Fahey, G. C. (1983): Nutritional implications of phenolic monomers and lignin: a review. *J. Anim. Sci.*, 57, 206-219.
- 12) Kondo, T., Ohshita, T. & Kyuma, T. (1993): Isolation and characterisation of dioxane-soluble lignins from faeces of sheep fed on orchardgrass hay and silage. *Anim. Feed Sci. Technol.*, 41, 213-221.
- 13) Kondo, T., Ohshita, T. & Kyuma, T. (1994): Release of soluble lignin fragments from orchardgrass during its passage through the rumen. *J. Sci. Food Agric.*, 65, 429-431.
- 14) Kondo, T. et al. (1995): Comparative characterisation of dioxane-soluble lignins released by ball milling and by sheep digestion from forage grasses. *J. Sci. Food Agric.*, 68, 383-388.
- 15) Kondo, T., Ohshita, T. & Kyuma, T. (1997): Structural changes of forage grass lignin by rumen digestion: Characteristics of soluble lignin released from timothy (*Phleum pratense* L.) by in vitro rumen digestion. *JARQ*, 31, 49-54.
- 16) McSweeney, C. S. et al. (1994): Solubilization of lignin by ruminal anaerobic fungus *Neocallimastix patriciarum*. *Appl. Environ. Microbiol.*, 60, 2985-2989.
- 17) Mosoni, P. et al. (1994): Transformations of (¹⁴C-lignin) cell walls of wheat by rumen microorganisms. *J. Sci. Food Agric.*, 64, 379-387.
- 18) Neilson, M. J. & Richards, G. N. (1978): The fate of the soluble lignin-carbohydrate complex produced in the bovine rumen. *J. Sci. Food Agric.* 29, 513-519.
- 19) Nordkvist, E., Graham, H., & Aman, P. (1989): Soluble lignin complexes isolated from wheat straw (*Triticum arvense*) and red clover (*Trifolium pratense*) stems by an in-vitro method. *J. Sci. Food Agric.*,

48, 311-321.

**20)** Scalbert, A. et al. (1985): Ether linkage between phenolic acids and lignin fractions from wheat straw. *Phytochemistry*, 24, 1359-1362.

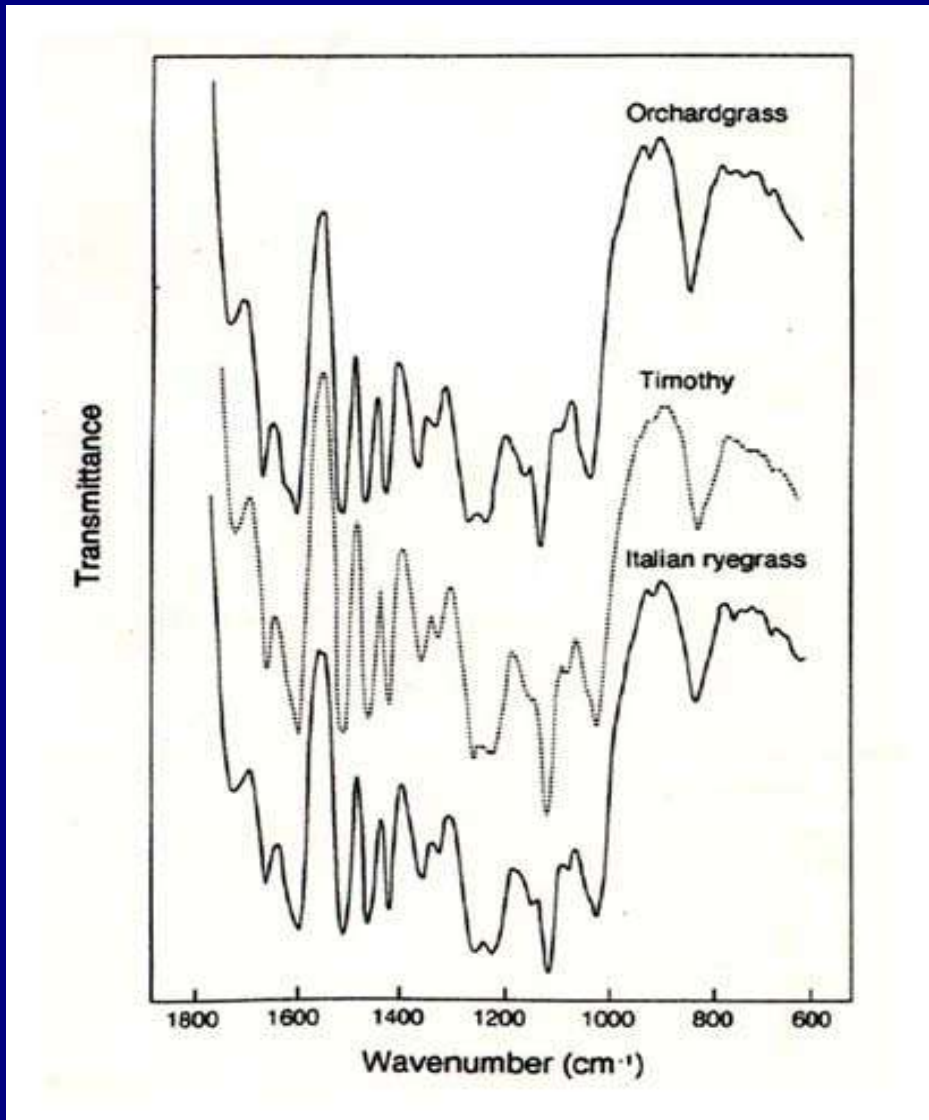
(Received for publication, December 12, 1997)

Fig.1.  
UV spectra of the dioxane-soluble lignins from  
feces of sheep fed on forage grasses



 [BACK](#)

**Fig.2.**  
**IR spectra of the dioxane-soluble lignins from**  
**feces of sheep fed on forage grasses**



[BACK](#)



## Structure of lignin fractions isolated from forage grasses and from feces of sheep fed on them

### 1) Isolation procedure of lignin fractions from forage grasses and from feces

Two undigested original lignin preparations (ball-milled lignin, BML and ball-milled and cellulase-treated lignin, CTL) were isolated from orchardgrass and timothy hay samples harvested at the heading stage. The grass hay samples were boiled with 80% (v/v) ethanol under reflux for 1 h, the residues collected by filtration and dried. The dried residues were ultraground with a vibratory ball mill in the dry state under N₂ atmosphere with external cooling by water for 24 h. The ultraground sample was extracted with a 90% dioxane solution for 24 h at room temperature, and the extract was dried under reduced pressure to give a crude lignin fraction (BML). The ultraground and dioxane-extracted residue was treated with cellulase at 40°C for 24 h under a toluene atmosphere. The resultant insoluble residue was collected by centrifugation and washed with water. Crude lignin (CTL) in the insoluble residue was obtained by extraction with 90% dioxane. The crude soluble lignin fractions were dissolved in 90% acetic acid and then precipitated in water. The precipitated lignins were further purified by re-dissolution in 90% acetic acid followed by re-precipitation in ethyl ether.

Dioxane-soluble lignin fractions (fecal soluble lignin, FSL) in feces of sheep fed on forage grasses were prepared by the same method as that described above.

### 2) Characteristics of different soluble lignin fractions

#### [Table 2. Chemical composition, neutral sugar composition, and nitrobenzene oxidation products of the 3 dioxane-soluble lignin fractions from forage grasses \(38 KB\)](#)

BML and CTL, extracted from the ball-milled grasses, were relatively rich in associated carbohydrates ([Table 2](#)). The major neutral sugars of associated carbohydrates in BML and CTL were D-xylose and L-arabinose. In contrast to BML and CTL, FSL from the feces of sheep contained much less carbohydrate, which was poor in D-xylose. The analytical data agreed with the ¹³C-NMR spectra ([Fig. 3](#)). In the spectra of BML and CTL, signals derived from ²-1, 4-linked xylan chains were observed at 63.2-63.7 (C-5), 74.6-75.0 (C-3), 75.5-75.8 (C-4) and 101.4-102.1 (C-1) ppm, together with those of the acetyl group in the xylans at 20.7-21.3 ppm. In the spectra of FSL, on the other hand, NMR signals from the xylan backbone were below the background noise level. These results suggest the occurrence of marked degradation of the lignin-associated xylans by digestion in sheep.

Grass lignins are characterized by high levels of ester-linked *p*-coumaric acid⁸). The undigested original lignin preparations of forage grasses, BML and CTL, contained 10-21 g kg⁻¹ ester-linked *p*-coumaric acid while the *p*-coumaric acid ester content of FSL from the feces was very low ([Table 2](#)). This difference was confirmed by the ¹³C-NMR spectra ([Fig. 3](#)). A prominent signal at 130.2-130.5 ppm originating from C-2 and C-6 in *p*-coumaric acid ester was observed in the spectra of BML and CTL, whereas the corresponding signal was virtually absent in the spectra of FSL.

[Fig.3. ¹³C NMR spectra of the dioxane-soluble lignins from ball milled orchardgrass\(BML\),ballmilled and cellulase-treated orchardgrass\(CTL\),and feces of sheep fed on orchardgrass\(FSL\)\(37 KB\)](#)

The major phenolic aldehydes produced by nitrobenzene oxidation were *p*-hydroxybenzaldehyde, vanillin and syringaldehyde ([Table 2](#)), which were derived from *p*-hydroxyphenylpropane, guaiacylpropane and syringylpropane units, respectively. The yield of *p*-hydroxybenzaldehyde decreased in the following order: CTL, BML and FSL. Although no large differences were found in the yields of vanillin and syringaldehyde among the 3 lignins, the molar ratio of syringaldehyde (S) to vanillin (V) was higher for FSL than for BML and CTL. In the ¹³C-NMR spectra ([Fig. 3](#)), FSL showed higher relative intensities of a signal originating from C-2 and C-6 in syringyl units (104.0-104.7 ppm) to those of C-2 (111.3-111.9 ppm) and C-6 (119.1-119.7 ppm) in guaiacyl units than for BML and CDL. The increased molar ratio of S to V in FSL and the ¹³C-NMR data indicate that the dioxane-soluble lignin fractions from feces of sheep were richer in syringyl units. Based on a microscopic study, plant tissues with syringyl type lignin are more readily degraded by rumen microorganisms than tissues with other types of lignin²). A recent study using ¹⁴C-lignin cell wall preparations of wheat has revealed a more extensive solubilization of syringyl units by *in vitro* rumen fermentation¹⁷).

[Fig.4. Gel permeation chromatograms of the dioxane soluble lignin fractions from ball-milled grasses \(BML, ___\), ball-milled and cellulase-treated grasses\(CTL, ___\), and feces of sheep fed on grasses \(FSL,---\)\(20 KB\)](#)

The gel permeation chromatograms of BML, CTL and FSL are shown in [Fig. 4 \(17 KB\)](#). For both grasses, FSL contained a larger amount of low molecular size fractions than CTL and BML; CTL contained higher molecular size fractions that eluted at the void volume. Similar differences were observed with the saponified lignin preparations. Ball milling breaks bonds in the lignin-carbohydrate complex and causes depolymerization of lignin macromolecules due to the cleavage of ether bonds⁹) and thereby part of native lignin is converted to an organic solvent-extractable form. The elution profiles of gel permeation chromatography show that FSL was composed of lignin fragments with lower molecular sizes, compared with BML and CTL, and hence it is likely that the soluble lignin fragments released by digestion in sheep corresponded to depolymerization products of the forage grass lignins.



[Continue to: \[Comparison of soluble lignin fractions from rumen digesta and feces of heifer\]](#)



[Back to: Contents](#)

Table 2.

Chemical composition, neutral sugar composition, and nitrobenzene oxidation products of the 3 dioxane-soluble lignin fractions from forage grasses

	Orchardgrass			Timothy		
	BML	CTL	FSL	BML	CTL	FSL
Chemical composition (g kg ⁻¹ soluble lignin)						
Klason lignin	643	653	875	626	648	844
Carbohydrate	210	191	18	217	175	23
Ester-linked <i>p</i> -coumaric acid	10.3	16.8	3.4	12.8	21.1	4.3
Ester-linked ferulic acid	4.9	3.5	1.1	5.4	3.4	tr
Neutral sugar composition (g kg ⁻¹ total sugars)						
L-Rhamnose	5	tr	61	19	4	85
L-Arabinose	91	144	119	89	182	124
D-Xylose	855	767	383	846	729	389
D-Mannose	2	tr	33	1	tr	21
D-Galactose	17	11	143	9	8	96
D-Glucose	30	78	257	36	77	285
Nitrobenzene oxidation products						
Yield (g kg ⁻¹ Klason lignin in soluble lignin)						
<i>p</i> -Hydroxybenzaldehyde	8.6	11.9	6.6	8.5	11.2	5.9
Vanillin (V)	85	102	85	108	112	90
Syringaldehyde (S)	65	83	84	80	98	100
Molar ratio of S to V	0.64	0.68	0.83	0.62	0.73	0.92

BML: extracted from ball-milled grass, CTL: extracted from ball-milled and cellulase-treated grass, FSL: extracted from feces of sheep fed on grass, tr: traces.



[BACK](#)

**Fig.3.**  
 $^{13}\text{C}$ -NMR spectra of the dioxane-soluble lignins from  
 ball-milled orchardgrass (BML),  
 ball-milled and cellulase-treated orchardgrass(CTL), and  
 feces of sheep fed on orchardgrass(FSL)



[BACK](#)

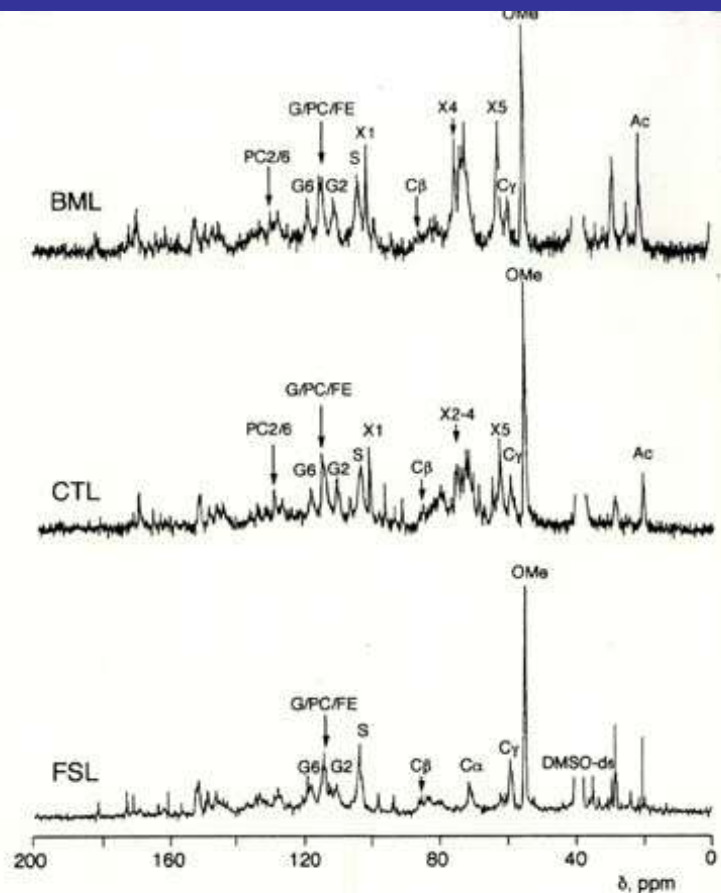
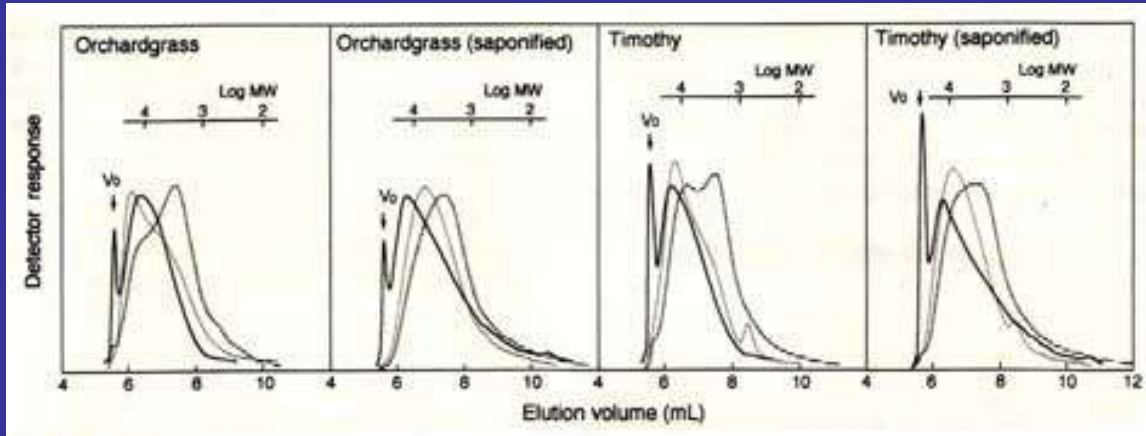


Fig. 3.  $^{13}\text{C}$ -NMR spectra of the dioxane-soluble lignins from ball-milled orchardgrass (BML), ball-milled and cellulase-treated orchardgrass (CTL), and feces of sheep fed on orchardgrass (FSL)

Ac: acetyl group in xylans, OMe: methoxyl group in guaiacyl and syringyl units and ferulic acid, C $\alpha$ : C- $\alpha$  in  $\beta$ -O-4, C $\beta$ : C- $\beta$  in  $\beta$ -O-4, C $\gamma$ : C- $\gamma$  in  $\beta$ -O-4, X1: C-1 in  $\beta$ -xylose (1 $\rightarrow$ 4), X2-4: C2/3/4 in  $\beta$ -xylose (1 $\rightarrow$ 4), X5: C-5 in  $\beta$ -xylose (1 $\rightarrow$ 4), S: C-2/6 in syringyl unit, G2: C-2 in guaiacyl unit, G6: C-6 in guaiacyl unit, G/PC/FE: C-5 in guaiacyl unit and C-3/5 in *p*-coumaric acid ester and C- $\beta$  in ferulic acid ester, PC2/6: C-2/6 in *p*-coumaric acid ester.

Fig.4. Gel permeation chromatograms of the dioxane soluble lignin fractions from ball-milled grasses (BML, —), ball-milled and cellulase-treated grasses(CTL, —), and feces of sheep fed on grasses (FSL,---)



 [BACK](#)

## Comparison of soluble lignin fractions from rumen digesta and feces of heifer

### 1) Isolation procedure of soluble lignin fractions

Orchardgrass hay harvested at the pre-heading stage was offered to a heifer (Japanese Black Cattle) fitted with a rumen fistula during a 14-day adaptation period and a 2-day collection period. A rumen digesta sample was taken prior to 09:00 feed for 2 days, freeze-dried and bulked. Feces collected during the 2-day period were mixed thoroughly and a representative sample of the feces was freeze-dried. Soluble lignin fractions were extracted from the rumen digesta and fecal sample with 90% dioxane and purified as described above.

### 2) Physical and chemical characteristics of soluble lignin fractions

[Table 3. Chemical composition, nitrobenzene oxidation products and molecular size on of the dioxane-soluble lignin fractions from rumen digesta and feces of heifer fed on orchardgrass\(24 KB\)](#)

The yields of the dioxane-soluble lignin were 3.3 g kg⁻¹ for the rumen digesta and 8.2 g kg⁻¹ for the feces. It was preliminarily confirmed that the orchardgrass hay sample did not contain any significant amounts of dioxane-soluble lignin. Most of the dioxane-soluble lignin was recovered as Klason lignin by 72% sulfuric acid hydrolysis ([Table 3](#)). There were no considerable differences in the levels of bound phenolic acids and the yields of phenolic aldehydes produced by nitrobenzene oxidation between the rumen digesta and feces samples ([Table 3](#)). Both dioxane-soluble lignin fractions showed a wide molecular size distribution ranging from monomer up to 15,000. Elution maxima appeared at a molecular weight of 1,500 for the rumen digesta and at a molecular weight of 1,480 for the feces. The rumen and fecal dioxane-soluble lignin fractions had similar number-average molecular weights (Mn) and weight-average molecular weights (Mw) ([Table 3](#)).

The presence of dioxane-soluble lignin fractions in the rumen digesta indicates that, part of the orchardgrass lignin fed was released in the rumen as soluble lignin fragments. The chemical and physical properties of the fecal dioxane-soluble lignin were similar to those of the rumen dioxane-soluble lignin, suggesting that the soluble lignin fragments did not undergo any significant modifications after leaving the rumen.

## Characteristics of soluble lignin fractions formed by in vitro rumen digestion of forage grass

### 1) Isolation procedure of soluble lignin fractions

Timothy hay harvested at the seed setting stage, supplemented with soybean meal, was offered to a heifer (Japanese Black Cattle) fitted with a rumen cannula during a 7-day adaptation and a 3-day collection period. Hay and feces were sampled during the collection period and their representative samples were dried, ground to pass a 1 mm screen. The hay sample was boiled with 80% ethanol under reflux for 1 h. The ethanol-extracted and dried residue was ultraground with a porcelain ball-mill for 10 days and then pre-extracted with 90% dioxane. The dioxane-extracted and air-dried residue was divided into 2 parts: one was subjected to enzymatic treatment and the other subjected to in vitro rumen digestion.

One part was treated with cellulase at 40pC under a toluene atmosphere for 72 h. The insoluble residue after the enzymatic hydrolysis was collected by centrifugation, washed with water and freeze-dried. The dried residue was extracted with 90% dioxane. The dioxane extract, after drying by evaporation, was dissolved in 90% acetic acid and then precipitated in water. The precipitated lignin was further purified by dissolution in 90% acetic acid followed by precipitation in ethyl ether to give cellulase-treated lignin (CTL).

The other part was digested in rumen liquor in vitro for 72 h. The rumen liquor used was taken from the fistulated heifer that received the timothy hay and soybean meal. The in vitro rumen-digested residue was collected by centrifugation, washed with water and freeze-dried. A soluble lignin fraction in the residue (rumen-digested lignin, RDL) was extracted with 90% dioxane and purified by re-dissolution and re-precipitation.

Dioxane-soluble lignin (heifer-digested lignin, HDL) in the fecal sample of the heifer was extracted and purified in the same way as described above.

### 2) Physical and chemical characteristics of soluble lignin fractions

[Table 4. Chemical composition of the 3 dioxane-soluble lignin fractions from timothy](#)

[CTL](#)

[RDL](#)

[HDL](#)

(g kg⁻¹ soluble lignin)

Klason lignin	708	887	889	CTL: extracted from ball-milled and cellulase-treated timothy, RDL: extracted from ball-milled and rumen-digested timothy, HDL: extracted from feces of heifer fed on timothy.
Carbohydrate	189	50	37	
<i>P</i> -Coumaric acid				
Ester-linked	15.0	3.7	3.4	
Ether-linked	2.3	1.5	1.5	
Ferulic acid				
Ester-linked	2.1	0.4	0.6	
Ether-linked	6.5	2.3	3.4	

Although CTL and RDL were prepared from the same timothy sample, the 2 lignin fractions differed considerably in chemical and physical properties. RDL contained less carbohydrate, ester- and ether-linked *p*-coumaric and ferulic acids than CTL ([Table 4](#)). The lower levels of the bound phenolic acids in RDL than in CTL suggest the removal or degradation of the bound phenolic acids from timothy lignin by rumen fermentation. This assumption does not conflict with the similarity in the composition between RDL and HDL. Phenolic acid ethers are reported to form a cross-linking unit between lignin and polysaccharides in grass cell walls^{10,20}). The decrease in the carbohydrate and phenolic acid ether contents in RDL may be indicative of ruminal degradation of a lignin-carbohydrate complex involving cross-linking phenolic acid ethers.

[Fig.5 Gel permeation chromatograms of the dioxane-soluble lignin fractions from ball-milled and cellulase-treated timothy\(CDL, _____\), ball-milled and rumen-digested timothy\(RDL,.....\), and feces of heifer fed on timothy \(HDL, _____\)\[20 KB\]](#)

Appreciable differences were observed in the molecular size distribution among the 3 lignin fractions ([Fig. 5](#)). CTL was distributed in a higher molecular size region than RDL and HDL. About 30% of CTL, based on the area ratio of the chromatogram, was eluted at the void volume. Saponification did not substantially affect the differences in molecular size distribution among the 3 lignin fractions ([Fig. 5](#)), although saponification reduced the carbohydrate content of all the soluble lignin fractions extensively and liberated ester-linked phenolic acids. Consequently, it is considered that RDL consisted of lignin fragments with lower molecular sizes than CTL. This finding suggests that rumen microorganisms are able to modify the macromolecular structure of forage grass lignin.



[Forward to: - Estimation of Fine Root Production in Coniferous Forests in Japan -](#)



[Back to: Contents](#)



[Back to: JIRCAS home page](#)

**Table 3.**

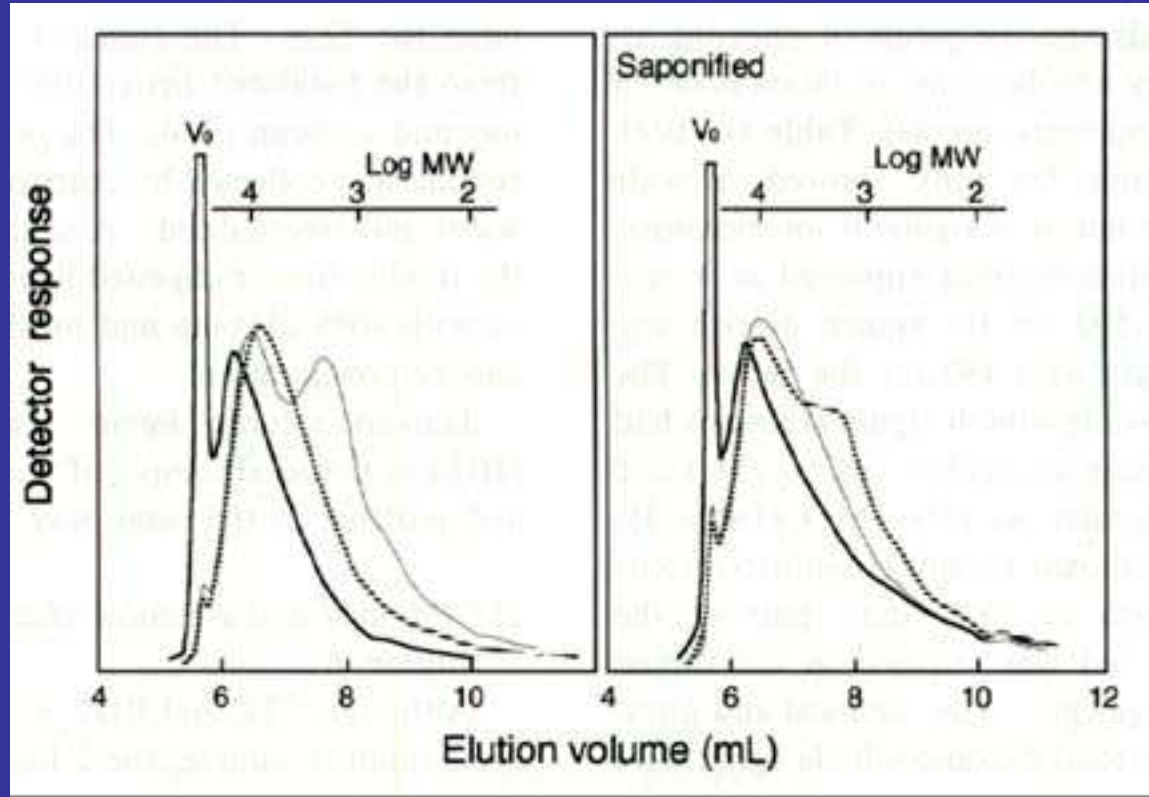
**Chemical composition, nitrobenzene oxidation products and molecular size of the dioxane-soluble lignin fractions from rumen digesta and feces of heifer fed on orchardgrass**

	Rumen digesta	Feces
Chemical composition (g kg ⁻¹ soluble lignin)		
Klason lignin	821	856
Carbohydrate	29	31
Nitrogen	25	18
<i>p</i> -Coumaric acid		
Ester-linked	3.0	2.8
Ether-linked	1.4	1.6
Ferulic acid		
Ester-linked	1.3	1.3
Ether-linked	1.8	2.1
Yields of nitrobenzene oxidation products (g kg ⁻¹ soluble lignin)		
<i>p</i> -Hydroxybenzaldehyde	5	5
Vanillin	55	58
Syringaldehyde	44	47
Molecular size		
Number average (M _n )	690	650
Weight average (M _w )	1,480	1,450
Polydispersity (M _n /M _w )	2.14	2.23

[BACK](#)



Fig.5  
Gel permeation chromatograms of the dioxane-soluble lignin fractions from ball-milled and cellulase-treated timothy (CDL,—), ball-milled and rumen-digested timothy (RDL,.....), and feces of heifer fed on timothy (HDL,—)



 [BACK](#)

# Estimation of Fine Root Production in Coniferous Forests in Japan

Nobuhiko KASUYA

Faculty of Agriculture, Kyoto Prefectural University (Sakyo-ku, Kyoto, 606-8522 Japan)

## Abstract

It is well documented that fine root production (FRP) in forest ecosystems is large due to rapid turnover in spite of the small standing crop. Several methods have been applied to measure FRP: sequential coring, ingrowth core, nitrogen budget, soil carbon budget, and mini-rhizotron methods. The processes as well as advantages and disadvantages of each method were briefly reviewed in this report. The soil micromorphological method applied in a Japanese coniferous forest was described. This method enables to determine the fine root distribution and microstructure of the organic layer where fine roots are mostly concentrated. The ability to observe root cross-sections may improve the classification of the physiological status of the roots. The data obtained by this method at one time indicated that those fine and active roots were distributed mostly in the superficial litter layer of the soil. In the fermentation layer below, a smaller number of active types of roots were found. Periodical collections of samples may enable to study seasonal changes of fine roots and supply additional information on root ecology. The most difficult problem in the study of fine root dynamics is still the methodology. Over- and underestimation should be corrected to acquire more accurate information on forest production ecology and the role of forests in carbon and nutrient balance.

**Discipline:** Forestry and forest products

**Additional key words:** ecosystem, ingrowth, root free soil core, soil micromorphology, turnover

1-36): [Click here for References](#)

## Introduction

Fine roots (including mycorrhizae) play an important role in the carbon and nutrient economy in temperate forest ecosystems. In many cases, more than 50% of annual net primary production (NPP) is allocated belowground^{9, 10, 17}, and nutrient return to the soil by fine root death may exceed that by aboveground litterfall³²). However, there had been discrepancies in the methods of measuring the fine root production (FRP) and turnover in the past decades^{7, 8, 19, 23-26, 29, 31}). Hendricks et al. (1993)¹⁴ raised an important question: Is belowground NPP positively or negatively correlated to aboveground NPP? They concluded that a positive correlation was more likely, despite many conflicting data.

This review compares several methods used to estimate FRP, examines the contribution of belowground components to the forest productivity, and offers a new approach, that is, micromorphological method of studying the fine root dynamics in a coniferous forest in Japan.

## Methods of estimating fine root production

Several methods have been developed to estimate fine root production^{27, 33, 36}). In this paragraph, I will describe each method and the results obtained. First of all, in the "sequential coring" method attempts are made to detect seasonal fluctuations by the following procedures: a certain number of small volumetric soil samples are collected at regular intervals, and the differences in the mean root biomass are summed to represent fine root production. Unexpectedly a large fine root production was first reported by Edwards and Harris (1977)⁵ in a mixed deciduous forest. They measured fine root biomass several times over a period of 2 years and found distinct seasonal changes expressing bimodal peaks each year. Persson (1978)²⁴ suggested that the supply of dead fine root materials to the soil was considerably higher than that conventionally expected. Here it must be noted that some types of calculations give a wide range of values^{7, 8, 29}). In the simplest way, production is estimated by subtracting the minimum from maximum fine root standing crop, while in other cases either all differences or only significant differences are summed. McClaughy et al. (1982)²⁰ developed a decision matrix to account for the simultaneous occurrence of production and death, assuming rapid fine root turnover. They compared some values from different calculations plus decomposition data and suggested that lower estimates of production were more accurate.

In the "ingrowth core" method soil cores are taken, the roots are removed from them and the soil samples are buried after packing them into meshbags so that the roots can penetrate into the root-free soil cores through the mesh from the surrounding soil^{27, 33}). The advantage of this method is that it enables to compare different experimental treatments and it is less laborious than sequential coring. However it is difficult to convert the data on an area basis³³). Persson (1983)²⁶ actually compared FRP estimates based on "sequential coring" and "ingrowth core" method in boreal forests, and found only small differences in magnitude. My preliminary experiment with this method¹⁵) in a Japanese cedar (*Cryptomeria japonica* D. Don) plantation showed that fine root regrowth into the root-free soil cores was more abundant from midsummer to late fall than from spring to midsummer ([Fig. 1](#)). This finding contrasted with shoot growth which occurred most rapidly from early to midsummer in this stand. Surprisingly, the amounts of very fine roots (less than 1 mm in diameter) in the ingrowth core were considerably larger (more than double) than those in the original soil core after a 4-month incubation period from midsummer to late fall. However, the effect of severing roots in installing the cores and the difference in soil texture as a rooting medium should be considered in interpreting the results from this method.

[Fig.1:Amount of roots which regrew into root-free soil cores during 2 periods  \$d\$  =diameter of roots. Bars indicate standard errors of the mean.\(21 KB\)](#)

Aber et al. (1985)¹⁾ and Nadelhoffer et al. (1985)²⁾ presented in the same year another approach to estimate FRP, namely, the "nitrogen (N) budget" method. Raich and Nadelhoffer (1989)²⁸⁾ introduced an innovative "soil carbon (C) budget" method. These 2 methods can be combined and are referred to as the "budget" method. N budget method determines the amount of N mineralized in soil by soil incubation, N uptake by aboveground part of plants, N content in the aboveground litterfall. FRP estimates can then be calculated. Soil carbon budget can only set the upper limits to FRP, but it can verify the overestimation of FRP. The upper limits can be obtained by subtracting the C amount in litterfall from that of soil respiration. The resultant limits are referred to as total root allocation which expresses live root respiration plus belowground detritus production. These authors were able to define the relationship between aboveground litterfall data and FRP from N budget, and they suggested that annual FRP increases with aboveground production²³⁾. Also their analysis showed that FRP values from "sequential coring" exceeded the predicted upper limits by "soil C budget" in some cases, which may suggest overestimation.

"Minirhizotron" experiments were carried out in North American hardwood forests¹¹⁻¹³⁾. This method requires facilities such as glass tubes inserted into the soil, borescopes equipped with a video camera, and the software suitable for processing data to periodically record root images and analyze them. The most striking feature is that it can provide demographic data, though the root growth may perhaps be different on the interfaces between the soil and the glass tube. Hendrick et al. (1993)¹²⁾ converted their data on a mass basis and obtained FRP estimates of 8,000 and 7,300 kg.ha⁻¹.yr⁻¹ at the 2 sites, which illustrated the important role of fine roots in forest production.

Finally the method of "soil micromorphology" is often used in pedogenesis and soil taxonomy. In the next section, I will present an example of this method in a Japanese coniferous forest.

## Application of soil micromorphology to fine root dynamics study

[Table 1. Classification of roots in soil thin sections](#)

<a href="#">Root type</a>	<a href="#">Characteristic</a>
Type 1	Showing annual growth ring(s)
Type 2	Both stele and cortex stained(blue)
Type 3	Only stele stained (blue) and cortex suberized (brown)
Type 4	Both stele and cortex suberized
Type 5	Part of stele and/or cortex decomposed (missing)
Type 6	Only epidermis and endodermis remaining

A larger number of root types reflect the status of roots with low activity, except for type 1, which has a thick xylem layer.

The experimental site was a natural Hinoki cypress (*Chamaecyparis obtusa* Endl.) forest. The stand density (larger than 2 cm in diameter at breast height) was 2,700 (no. ha⁻¹) and the basal area was 46.5 m².ha⁻¹. The soil samples were collected in October 1993, and impregnated with polyethylene glycol (molar mass 4,000) at the site and again in the laboratory and cut with a rock slicer. The sampling depth was limited to the organic layer because of the hardness of the resin used. Fine roots were, however, mostly concentrated in the organic layer. Thus the soil thin sections were stained with methylene blue. The detailed description is presented in the reports of Takeda (1987)³⁰⁾ and Kasuya, Takeda & Iwatsubo (1992)¹⁶⁾. The roots that appeared in the soil thin sections were examined under a microscope and classified by the degree of staining, suberization and decomposition ([Table 1](#), [Fig. 2](#)). The diameters of roots of each type are depicted in [Fig. 3](#).

[Fig.2:Photographs of cross-sections of roots in soil thin sections\(28 KB\)](#)

[Fig.3:Frequency distribution of root diameter in soil thin sections\(46 KB\)](#)

As anticipated, type 1 which shows secondary thickening displayed the largest diameter, while other types, which all consisted of absorbing roots, did not exhibit any difference in the pattern of distribution of root diameter values. Type 2 (the most active roots in terms of absorption capacity) was concentrated in the shallowest layer ([Fig.4](#)).

[Fig.4:Number and percentage of roots of each type in soil cross-sections at each soil depth The type with a low number represents the roots with a more vigorous appearance.\(39 KB\)](#)

This layer corresponded to the litter layer of the forest floor (about 1 cm thick), and the fermentation layer was 3 to 4 cm thick. Although the results were recorded at one time and not in a time series, this method enabled to obtain an accurate classification of root activity by observing directly a cross-section of roots and the fine distribution of roots especially in ecosystems showing distinct seasonal changes in growth. Takeda (1987)³⁰⁾ proposed the use of the method in the classification of organic layers of soil. Also the method can be applied to mycorrhizal research and soil biology after improvement of staining or microscopic techniques⁸⁾.

## Future research

Since belowground NPP is positively correlated with aboveground NPP based on data obtained by the "budget" method, the most difficult problem is to determine why fine root decomposition is slow (usually less than 30% per year, from data compiled by Vogt et al. (1991)³⁴) though many data indicate the large contribution of fine roots to annual NPP. Bloomfield and Vogt (1996)⁴ reported that the higher lignin content of fine roots than that of senescent foliage may inhibit decomposition in coniferous as well as in other forest ecosystems. Fahey (1994)⁶ attributed the slow decomposition rate of fine roots to the disturbance effect of the litterbag method used for measuring the decomposition, whereas Vogt et al. (1991)³⁴ compared litterbag and other methods such as trenching, and suggested that the former method gave smaller decomposition rates. It is hoped that the discrepancies in the data of rapid turnover rate and slow decomposition rate of fine roots will be resolved. Atkinson (1992)³ also pointed out that root consumption by herbivores should be re-examined. In the current micromorphological study, it appeared that a substantial amount of roots were grazed since many fecal pellets of collembola were found all around the root cross-sections (*Fig. 2*). Furthermore, if the amount of fine root biomass is low in high productivity sites³⁵, how can a tree compensate for the decrease in surface area for absorbing water and nutrients? Some researchers have suggested that woody coarse roots must be responsible for these functions^{2, 18}). Hendricks et al. (1993)¹⁴ noted that the pattern of antiherbivore compound allocation and retranslocation along a N availability gradient remained unknown, since 40-70% of the macronutrients were reabsorbed in fine roots prior to senescence in some coniferous forests²¹).

It remains to be determined whether there is a positive or negative correlation between belowground and aboveground NPP not only in forest production studies but also in relation to the global climatic changes in the near future since forests can mitigate the carbon dioxide increase by acting as a sink

 [Forward to: -Animal Waste Problems and Their Solution from the Technological Point of View in Japan -](#)

 [Back to: Contents](#)

 [Back to: JIRCAS home page](#)

## References

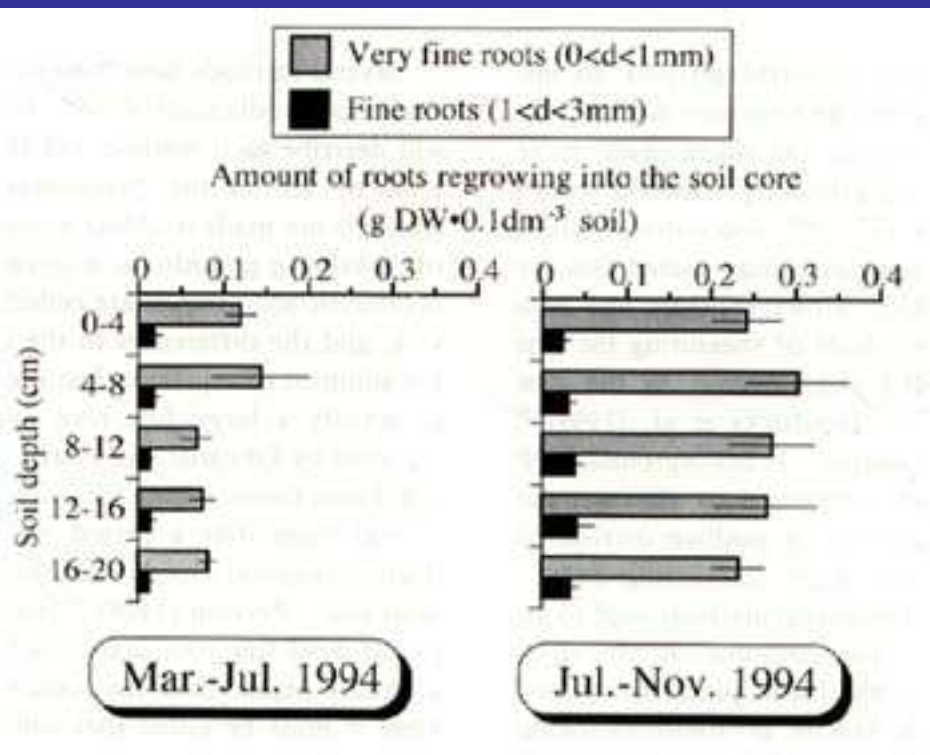


[BACK](#)

- 1) Aber, J. D. et al. (1985): Fine root turnover in forest ecosystems in relation to quantity and form of nitrogen availability: a comparison of two methods. *Oecologia*, 66, 317-321.
- 2) Atkinson, D. (1983): The growth, activity and distribution of the fruit tree root system. *Plant Soil*, 81, 23-35.
- 3) Atkinson, D. (1992): How long is the life span of a root? *Tree*, 7, 173-174.
- 4) Bloomfield, J., Vogt, K. A. & Wargo, P. M. (1996): Tree root turnover and senescence. *In* Plant roots: the hidden half (2nd ed.). eds. Waisel, Y., Eshel, A. & Kafkafi, U., 363-381.
- 5) Edwards, N. T. & Harris, W. F. (1977): Carbon cycling in a mixed deciduous forest floor. *Ecology*, 58, 431-437.
- 6) Fahey, T. J. & Hughes, J. W. (1994): Fine root dynamics in a northern hardwood forest ecosystem, Hubbard Brook Experimental Forest, NH. *J. Ecol.*, 82, 533-548.
- 7) Fairley, R. I. & Alexander, I. J. (1985): Methods of calculating fine root production in forests. *In* Ecological interactions in soil. ed. Fitter, A. H. et al., 37-42.
- 8) Fogel, R. (1983): Root turnover and productivity of coniferous forests. *Plant Soil*, 71, 75-85.
- 9) Fogel, R. (1985): Roots as primary producers in below-ground ecosystems. *In* Ecological interactions in soil. ed. Fitter, A. H. et al., 23-36.
- 10) Fogel, R. & Hunt, G. (1979): Fungal and arboreal biomass in a western Oregon Douglas-fir ecosystem: distribution pattern and turnover. *Can. J. For. Res.*, 9, 245-256.
- 11) Hendrick, R. L. & Pregitzer, K. S. (1992): The demography of fine roots in a northern hardwood forest. *Ecology*, 73, 1094-1104.
- 12) Hendrick, R. L. & Pregitzer, K. S. (1993): The dynamics of fine root length, biomass, and nitrogen content in two northern hardwood ecosystems. *Can. J. For. Res.*, 23, 2507-2520.
- 13) Hendrick, R. L. & Pregitzer, K. S. (1993): Pattern of fine root mortality in two sugar maple forests. *Nature*, 361, 59-61.
- 14) Hendricks, J. J., Nadelhoffer, K. J. & Aber, J. D. (1993): Assessing the role of fine roots in carbon and nutrient cycling. *Tree*, 8, 174-178.
- 15) Kasuya, N. & Takeda, H. (1995): Seasonal changes of fine roots and some aboveground characteristics in a *Cryptomeria japonica* plantation. *Trans. Jpn. For. Soc.*, 106, 239-240 [In Japanese].
- 16) Kasuya, N., Takeda, H. & Iwatsubo, G. (1992): Application of the soil micromorphological methods to the fine root studies in a *Chamaecyparis obtusa* forest. *Bull. Kyoto Univ. For.*, 64, 42-50 [In Japanese with English summary].
- 17) Keyes, M. R. & Grier, C. C. (1981): Above- and below-ground net production in 40-year-old Douglas-fir stands in low and high productivity sites. *Can. J. For. Res.*, 11, 599-605.
- 18) Kozlowski, T. T. & Pallardy, S. G. (1997): *Physiology of woody plants* (2nd ed.). Academic Press, San Diego, pp. 411.
- 19) Lauenroth, W. K. et al. (1986): Reply to Vogt et al. *Ecology*, 67, 580-582.
- 20) McLaugherty, C. A., Aber, J. D. & Melillo, J. M. (1982): The role of fine roots in the organic matter and nitrogen budgets of two forested ecosystems. *Ecology*, 63, 1481-1490.
- 21) Meier, C. E., Grier, C. C. & Cole, D. W. (1985): Below- and aboveground N and P use by *Abies amabilis* stands. *Ecology*, 66, 1928-1942.

- 22)** Nadelhoffer, K. J. , Aber, J. D. & Melillo, J. M. (1985): Fine roots, net primary production, and soil nitrogen availability: a new hypothesis. *Ecology*, 66, 1377-1390.
- 23)** Nadelhoffer, K. J. & Raich, J. W. (1992): Fine root production estimates and belowground carbon allocation in forest ecosystems. *Ecology*, 73, 1139-1147.
- 24)** Persson, H. (1978): Root dynamics in a young Scots pine stand in Central Sweden. *Oikos*, 30, 508-517.
- 25)** Persson, H. (1980): Spatial distribution of fine-root growth, mortality and decomposition in a young Scots pine stand in Central Sweden. *Oikos*, 34, 77-87.
- 26)** Persson, H. (1983): The distribution and productivity of fine roots in boreal forests. *Plant Soil*, 71, 87-101.
- 27)** Persson, H. (1990): Methods of studying root dynamics in relation to nutrient cycling. *In* Nutrient cycling in terrestrial ecosystems. ed. Harrison, A. F. , Ineson, P. & Heal, O. W. , 198-217.
- 28)** Raich, J. W. & Nadelhoffer, K. J. (1989): Belowground carbon allocation in forest ecosystems: global trends. *Ecology*, 70, 1346-1354.
- 29)** Santantonio, D. & Grace, J. C. (1987): Estimating fine-root production and turnover from biomass and decomposition data: a compartment-flow model. *Can. J. For. Res.* , 17, 900-908.
- 30)** Takeda, H. (1987): A rapid slicing method for the carbowax embedding samples and its application to the micro-morphological observation of soil organic layers. *Bull. Kyoto Univ. For.*, 58, 1-11 [In Japanese with English summary].
- 31)** Vogt, K. A. et al. (1986): Overestimation of net root production: a real or imaginary problem? *Ecology*, 67, 577-579.
- 32)** Vogt, K. A. , Grier, C. C. & Vogt, D. J. (1986): Production, turnover, and nutrient dynamics of above- and belowground detritus of world forests. *Adv. Ecol. Res.* , 15, 303-377.
- 33)** Vogt, K. A. & Persson, H. (1991): Measuring growth and development of roots. *In* Techniques and approaches in forest tree ecophysiology. ed. Lassoie, J. P. & Hinckley, T. M., 477-501.
- 34)** Vogt, K. A. , Vogt, D. J. & Bloomfield, J. (1991): Input of organic matter to the soil by tree roots. *In* Plant roots and their environment. ed. McMichael, B. L. & Persson, H. , 171-190.
- 35)** Vogt, K. A. et al. (1987): Conifer and angiosperm fine-root biomass in relation to stand age and site productivity in Douglas-fir forests. *J. Ecol.* , 75, 857-870.
- 36)** Vogt, K. A. et al. (1989): Methodological considerations in measuring biomass, production, respiration and nutrient resorption for tree roots in natural ecosystems. *In* Applications of continuous and steady-state methods to root biology. ed. Torrey, J. G. & Winship, L. J. , 217-232.

(Received for publication, January 7, 1997)



**Fig.1**  
**Amount of roots which regrow into root-free soil cores during 2 periods**  
**d = diameter of roots.**  
**Bars indicate standard errors of the mean.**



[BACK](#)

**Fig.2**

**Photographs of cross-sections of roots  
in soil thin sections**

**a) Type 2, only epidermis is brown.**

**b) Type 3, fecal pellets in the lower part.**

**c) Type 6, cortical tissues missing.**



[BACK](#)

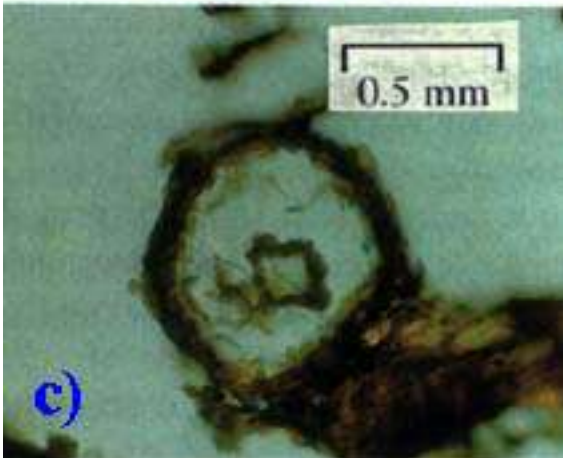
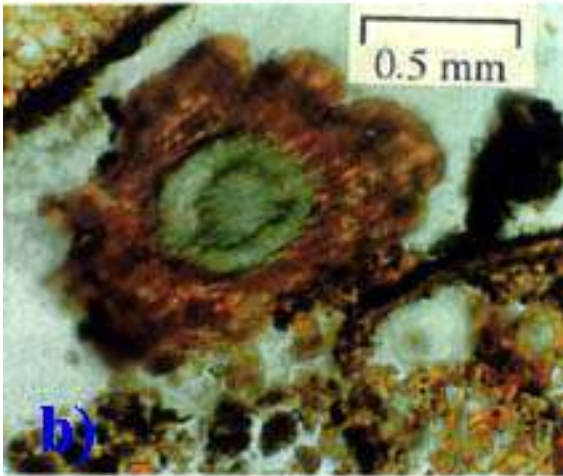
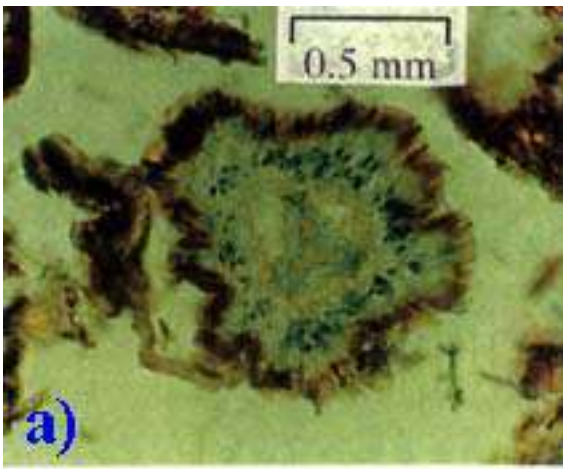
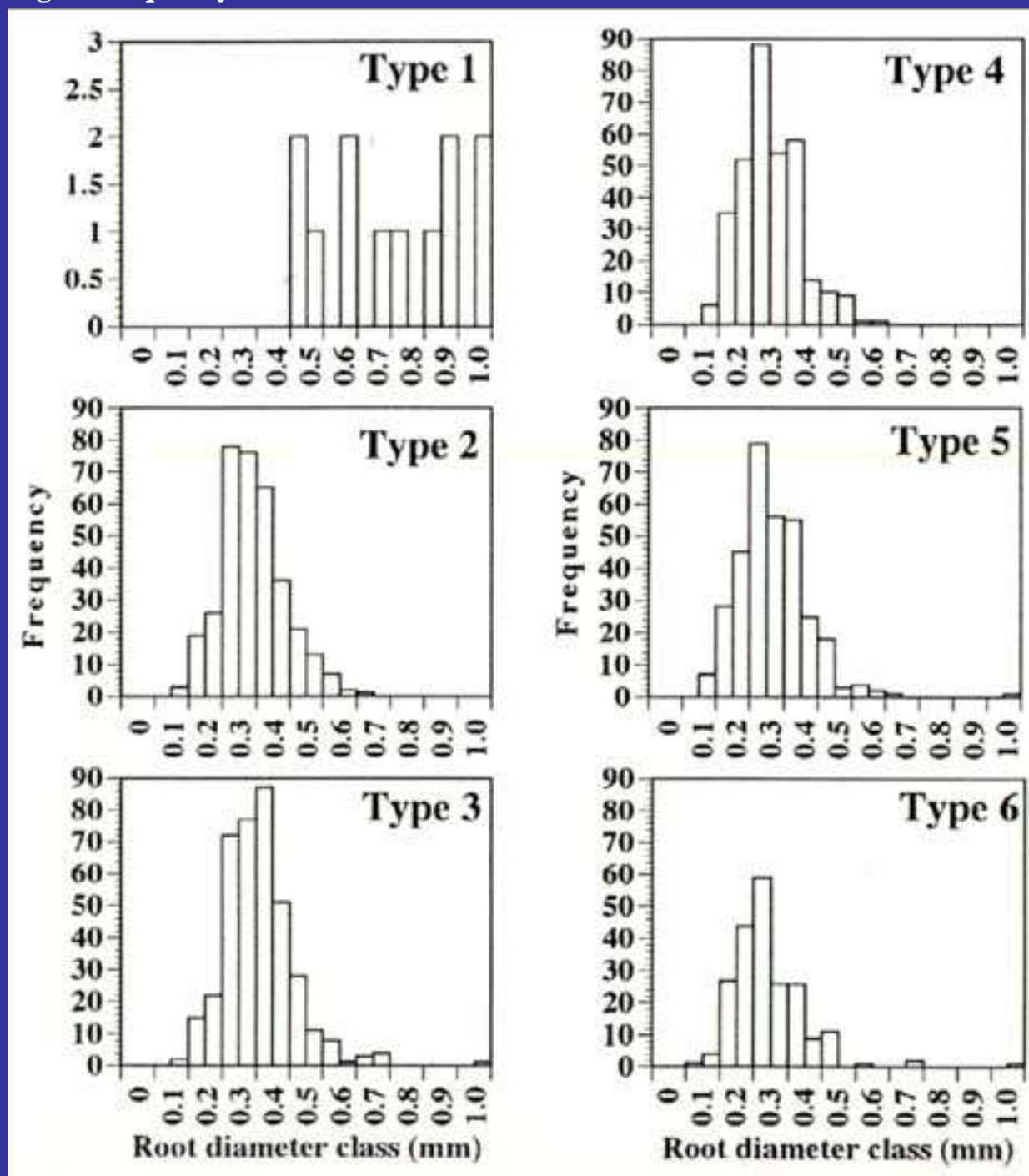


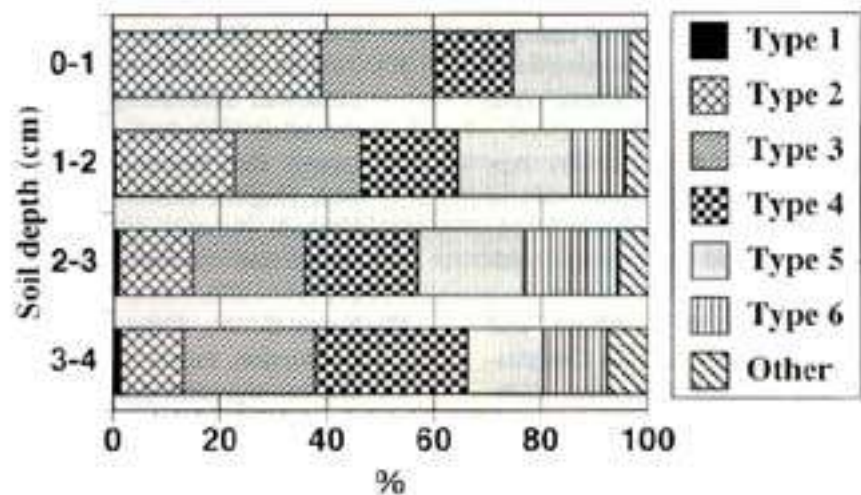
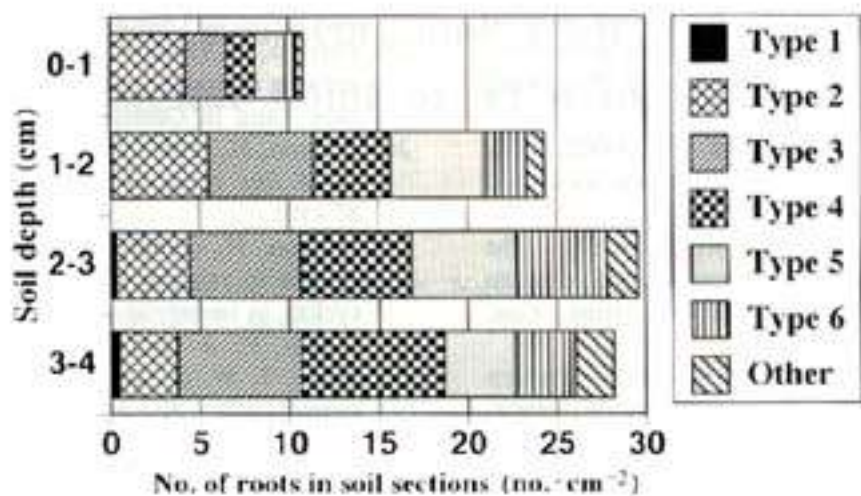


Fig.3. Frequency distribution of root diameter in soil thin sections



 [BACK](#)

**Fig.4**  
**Number and percentage of roots of each type in soil cross-sections at each soil depth**  
 The type with a low number represents the roots with a more vigorous appearance.



[BACK](#)

# Animal Waste Problems and Their Solution from the Technological Point of View in Japan

Kiyonori HAGA

Department of Feeding and the Environment, National Institute of Animal Industry  
(Tsukuba, Ibaraki, 305-0901 Japan)

## Abstract

Intensive animal raising in limited areas such as in Japan results in a large accumulation of animal wastes which have been causing serious pollution problems. Animal farms are bound by strict regulations to control environmental pollution, especially water pollution and offensive odor evolution. Animal wastes which are taken out from the farm are classified into 3 types; solid, slurry and waste water. Solid wastes are treated by drying or composting. Dried wastes are used not only as fertilizer but also as fuel for combustion to obtain energy. Compost is the main product from animal wastes in Japan. Slurry is treated by liquid composting or methane fermentation to produce biogas. But slurry spreading to the field is almost restricted to regions such as Hokkaido where there is enough space to apply a large amount of slurry. Waste water is treated by the activated sludge process to obtain clean water or simplified aeration method to produce liquid fertilizer. The most appropriate techniques of animal waste management involve proper treatment followed by application of the treated wastes to cropland for agricultural use as organic fertilizer sources.

**Discipline:** Animal industry

**Additional key words:** drying, composting, broiler litter boiler, activated sludge process

1-10): [Click here for Conferences](#)

## Background

### 1) Animal industry in Japan

The animal industry in Japan has expanded rapidly, for the last few decades, with increasing demand for animal products by the Japanese people. The expansion of the animal industry is characterized by a drastic increase in the number of animals per farm. For example, the average number of pigs per farm in 1996 (618.8 head per farm) was about 86 times that in 1966 (7.2 head per farm) ([Table 1](#)). This kind of expansion of animal industry results in the accumulation of wastes in limited areas.

[Table.1 Changes in the number of pigs, farms and the average number of pigs per farm\(16 KB\)](#)

### 2) Output of animal wastes

The amount of animal wastes excreted in 1996 was estimated at 85,450,000 t per year ([Fig. 1](#)), an amount exceeding Japanese people night soil and domestic wastes. In 1966, cattle wastes accounted for 75% of the total wastes. The amount of pig and poultry wastes steeply increased during the 1970s and now it accounts for about 50% of the total. In recent years, the total amount of animal wastes has remained at around 90,000,000 t due to the small changes in the number of animals.

[Fig.1. Annual changes in animal wastes\(25 KB\)](#)

### 3) Occurrence of animal waste pollution problems

The number of complaints against animal waste pollution increased steeply until 1973 (11,676 per year) and then gradually decreased ([Fig. 2](#)). The number of complaints in 1996 decreased to 2,576 which is less than one fourth of the number in 1973. Apparently, it appears that the occurrence of pollution problems is on the decrease. However, in the meantime, the decrease in animal farms is much more drastic while the number of complaints per farm has been rather increasing, suggesting that the problems are becoming increasingly more complicated and serious for each farm.

[Fig.2. Annual changes in the number of complaints about pollution problems by animal wastes\(25 KB\)](#)

### 4) Legislation

### (1) Legislation system

Animal farms are controlled by strict regulations ([Fig. 3](#)). Government legislation of environmental pollution control has been developed due to social needs around 1970. The enactment of the Basic Law for Environmental Pollution Control of 1967 was followed by the enactment of many other laws, namely the Water Pollution Control Law in 1970, the Waste Disposal and Public Cleansing Law in 1970, the Offensive Odor Control Law in 1971, etc. Recently, the Basic Law of 1967 has been fully revised into the Environment Basic Law of 1993 which involves the establishment of social systems for environmental conservation and introduces the concept of preservation of the global environment. Animal waste pollution problems are mainly related to water pollution and offensive odor evolution.

[Fig.3. Legal constraints related to animal wastes\(26 KB\)](#)

### (2) Water pollution control

*Table 2. Criteria of discharged water*

<u>Items</u>	<u>Units</u>	<u>Limits</u>
pH	--	5.8~8.6
BOD	mg/L	160(Daily average 120)
COD	mg/L	160(Daily average 120)
SS	mg/L	200(Daily average 150)
Coliform	number/mL	3,000
N	mg/L	120(Daily average 60)
P	mg/L	16(Daily average 8)

[Table 2](#) shows the regulation standards of discharged water closely related to animal wastewater. These criteria are governmental ones. Each prefecture can promulgate much stricter criteria depending on the local conditions, such as the presence of a national park, water catchment area, etc. Nitrogen and phosphorus were newly introduced in 1985 to cope with the eutrophication of lakes and sea. Limits until 2,000 for nitrogen and phosphorus contents in animal waste water are less than 140 mg/L (daily average 70 mg/L) and less than 34 mg/L (daily average 17 mg/L), respectively. In 1994, the concentration of substances with a trihalomethane forming potential (THMFP)¹⁰ which are the precursors of trihalomethanes considered as carcinogens was regulated in various catchment areas. The criteria for animal waste water range from 1.3 to 5.2 mg/L.

### (3) Offensive odor control

[Table 3](#) shows the regulation standards of 22 offensive odor substances which correspond to an odor intensity of 2.5 to 3.5. Among them, 9 substances, such as ammonia, methyl mercaptan, hydrogen sulfide, dimethyl sulfide, dimethyl disulfide, propionic acid, n-butyric acid, n-valeric acid, and isovaleric acid are closely related to animal waste odor. Each prefecture can set up an initial criterion between the governmental ranges listed in Table 3 depending of the local conditions. In April 1996, a new regulation of odor index between 11 to 20 based on sensory tests was enacted additionally.

[Table 3. Criteria of offensive odors\(26 KB\)](#)



[Continue to : \[The-state-of -the-art of animal waste management\].....](#)



[Back to : Contents](#)

## References



[BACK](#)

- 1) Haga, K. (1982): Methane fermentation of livestock and poultry wastes. *Jpn. J. Zootech. Sci.*, 53, 235-250 [In Japanese].
- 2) Haga, K. (1990): Production of compost from organic wastes. *FFTC (Food and Fertilizer Technology Center)/ASPAC Extension Bull.*, 311, 1-18.
- 3) Haga, K. (1991): Energy production from animal wastes. *Farming Japan*, 25 (4), 28-38.
- 4) Haga, K. (1993): Utilization of animal wastes for arable land. *J. Water Wastes*, 35, 919-929 [In Japanese].
- 5) Haga, K. (1995): Animal wastewater treatment for pollution control. *J. Water Wastes*, 37, 44-49 [In Japanese].
- 6) Harada, Y. et al. (1993): Quality of compost produced from animal wastes. *JARQ (Jpn. Agric. Res. Q.)*, 26, 238-246.
- 7) Nishimura, Y. (1990): Practical operation of composting facilities for animal wastes. *Animal Husbandry*, 44, 175-182 [In Japanese].
- 8) Osada, T., Haga, K. & Harada, Y. (1989): Removal of nitrogen from swine wastewater by the limited aeration process. *Jpn. J. Water Pollut. Res.*, 12, 122-130 [In Japanese with English summary].
- 9) Osada, T., Haga, K. & Harada, Y. (1991): Removal of nitrogen and phosphorus from swine wastewater by the activated sludge units with the intermittent aeration process. *Water Res.*, 25, 1377-1388.
- 10) Tanaka, Y. et al. (1995): Characteristics of livestock barn wastewater in determination of trihalomethane formation potential. *Anim. Sci. Technol.*, 66, 610-617 [In Japanese with English summary].

(Received for publication, November 12, 1997)

## The-state-of-the-art of animal waste management

Animal wastes which are taken out from the farm are classified into 3 types; solid, slurry and waste water ([Fig. 4](#)). Solid wastes are treated by drying or composting. Dried wastes are used not only as fertilizer but also as fuel for combustion to obtain energy. Slurry is treated by liquid composting or methane fermentation. Waste water is treated by the activated sludge process to obtain clean water or simplified aeration method to produce liquid fertilizer. The most appropriate techniques of animal waste management should involve proper treatment prior to the application to land. Drying, composting, energy production and waste water treatment are popular and well-studied in Japan.

[Fig.4. Methods generally used for animal waste management in farms\(25 KB\)](#)

### Drying

Raw wastes with a high water content are dirty, offensive, putrescible and troublesome in handling. Reduction of water content is necessary for convenience in handling of animal wastes. Drying in a greenhouse with solar heating is superior to that with oil heating, because expenses can be reduced and energy saved. The evaporation power by the greenhouse system is 4.5~5 L/m² in summer and 1.5~2 L/m² in winter in Japan⁴). The area of greenhouse required for construction can be easily estimated based on the evaporation power and the amount and water content of animal wastes to be dried.

### Composting

Compost is the main product from animal wastes in Japan. The objectives in composting are to stabilize the biodegradable organic matter (BOD) in raw wastes, to reduce offensive odors, to kill weed seeds and pathogenic organisms, and finally, to produce a uniform organic fertilizer suitable for land application.

#### 1) Conditions for composting

Controlled conditions are important for composting, to distinguish it from other natural biological decomposition processes such as rotting and putrefaction²). Animal wastes contain a sufficient amount of nutrients (biodegradable organic matter) for microorganisms and an adequate number of microorganisms to enhance the composting process. However, the water content of raw wastes is too high to supply oxygen to the microorganisms. Moisture control of the raw wastes at around 65% by the addition of dry materials such as sawdust, rice hull and dried compost or by pre-drying in greenhouses is necessary to achieve suitable composting. The active degradation of organic matter by the microorganisms under controlled conditions leads to heat generation during composting. The high temperature (higher than 60) contributes to the killing of weed seeds and pathogenic organisms, to the evaporation of water and production of sanitary compost for convenience in handling. With occasional turning of the compost pile, the complete composting process requires a few months.

#### 2) Facilities of composting

Various types of composting facilities are available in Japanese farms and compost centers jointly used by several farms²). Facilities can be classified into 5 types; the pile type, the box type, the rotary kiln type, the enclosed vertical type and the open elongated type with turning device ([Fig. 5](#)). For cattle wastes, the pile type and the open elongated type are generally used. For swine and poultry wastes, the open elongated type and the enclosed vertical type are popular

[Fig.5. Composting facilities for animal wastes\(27 KB\)](#)

#### 3) Quality of compost

Chemical nutrients in composts vary with the type of animals producing manure and the type of additional materials used⁴). Many methods have been proposed to estimate the degree of maturity of composts from animal wastes⁶). Only a few methods, however, are easy to use and reliable. Recommended quality index of animal waste composts was temporarily presented as shown in Table 4 in 1993.

[Table.4 Recommended quality index of animal waste compost](#)

#### A. Items to be indicated

<u>Items</u>	<u>Standard</u>
Organic matter	More than 60% DW
Carbon-nitrogen ratio	less than 30%
Total N	more than 1% DW
P ₂ O ₅	more than 1% DW
K ₂ O	more than 1% DW

#### B. Items not to be indicated

<u>Items</u>	<u>Standard</u>
Moisture	less than 70% FW
Electric conductivity	less than 5 mS/cm

1)As, Cd and Hg contents should be less than 50, 5 and 2 mg/kg DW, respectively.

2)Abnormal growth should not be observed for the Komatsuna (*Brassica rapa*) seedling test.

3)Cu and Zn contents should be less than 600 and 1,800 mg/kg DW, respectively.

4)DW: Dry weight, FW weight.

## Energy production

Animal feces contain a large amount of organic matter (around 80% of dry matter) and have a high value as energy source. Five methods of energy recovery from animal wastes³⁾, such as combustion, pyrolysis gas, oil conversion, heat recovery from compost and biogas can be applied.

### 1) Heat of combustion

Dried wastes have a fuel value of about 3,000 kcal/kg. For example, broiler litter taken out from a farm has been dried to a moisture content of about 30%. Since broiler farms need energy for floor heating with hot water, it is effective to recycle this dried litter as fuel for a broiler litter boiler and use it for heating purposes. This method enables to save 70 to 80% of the conventional energy consumption³⁾. The residual ash can be used as inorganic fertilizer rich in phosphorus and calcium.

### 2) Biogas

Biogas can be produced from animal waste slurry by the action of microorganisms in a methane fermenter¹⁾. To achieve efficient methane fermentation, it is necessary to provide favorable conditions to these microorganisms in the fermenter. These conditions include anaerobic conditions, mesophilic temperature (about 35), neutral pH (6 to 8), appropriate organic matter loading (about 3 kg of organic matter/m³ d) and proper retention time (10 to 20 days). For example, 150 to 250 L of biogas are produced from one head of pig per day, and the capacity of a fermenter required for a pig is about 150 L³⁾. The biogas produced contains 60% of methane and 40% of carbon dioxide, and has a fuel value of about 5,500 kcal/m³. It can be used not only as domestic fuel but also for many other purposes, such as agriculture and power generation.

## Waste water treatment

### [Fig.6. Time chart of conventional, limited aeration and intermittent aeration methods\(22 KB\)](#)

Activated sludge process is one of the typical treatments of animal waste water to secure strict regulations of the effluent⁵⁾. The process consists of a 4-stage cycle, namely sedimentation, discharge, charge and aeration. [Fig. 6](#) shows the time chart of conventional, limited and intermittent aeration methods. The shortcoming of the conventional activated sludge process is the low capacity to remove nitrogen and phosphorus. In the limited aeration method, aeration stops just after charge for several hours⁸⁾. Although most of the nitrogen remains as nitrate nitrogen in the conventional aeration method, most of nitrate nitrogen is removed under anaerobic conditions in the limited aeration method.

The intermittent aeration method⁹⁾ is considered to be more effective to remove nitrogen, because in the intermittent method the limited process is repeated several times a day. [Fig. 7](#) shows the changes in pH, DO (dissolved oxygen) and TOC (total organic carbon) values by the intermittent aeration process. Intermittent increase and decrease of DO values were observed. Nitrification and denitrification occurred intermittently and the efficiency of nitrogen removal increased ([Fig. 8](#)). Phosphorus was also removed and accumulated in the microorganism body. In conclusion, limited and intermittent aeration methods were found to be effective in removing not only nitrogen but also phosphorus. These methods could be performed with minimal improvement of conventional facilities and may enable to achieve the objective at a low cost and with a high efficiency.

### [Fig.7. Changes in pH, DO \(dissolved oxygen\) and TOC \(total organic carbon\) values by the intermittent aeration process\(13 KB\)](#)

### [Fig.8. Changes in nitrogen forms during intermittent aeration process\(11KB\)](#)

## Conclusion

Agricultural use of animal wastes as compost is presently mainly recommended in Japan. Total amounts of nitrogen (N), phosphorus (P₂O₅) and potassium (K₂O) contained in animal wastes are estimated to be 680,000, 450,000 and 550,000 t per year, respectively. These amounts of nutrients are nearly equal to those of chemical fertilizers applied to arable land in Japan. Environmentally friendly use of both animal wastes and chemical fertilizer is recommended. It is difficult to use slurry (liquid wastes) in Japan, except for a part of Hokkaido. Insufficient treatment and/or illegal dumping of excess animal wastes cause serious pollution problems. Then, recycling of animal wastes without any environmental pollution will be closely related to the development of sustainable agriculture with organic fertilizer in Japan.



[Forward to: -Removal of Colored Substances from Molasses Waste Water-](#)

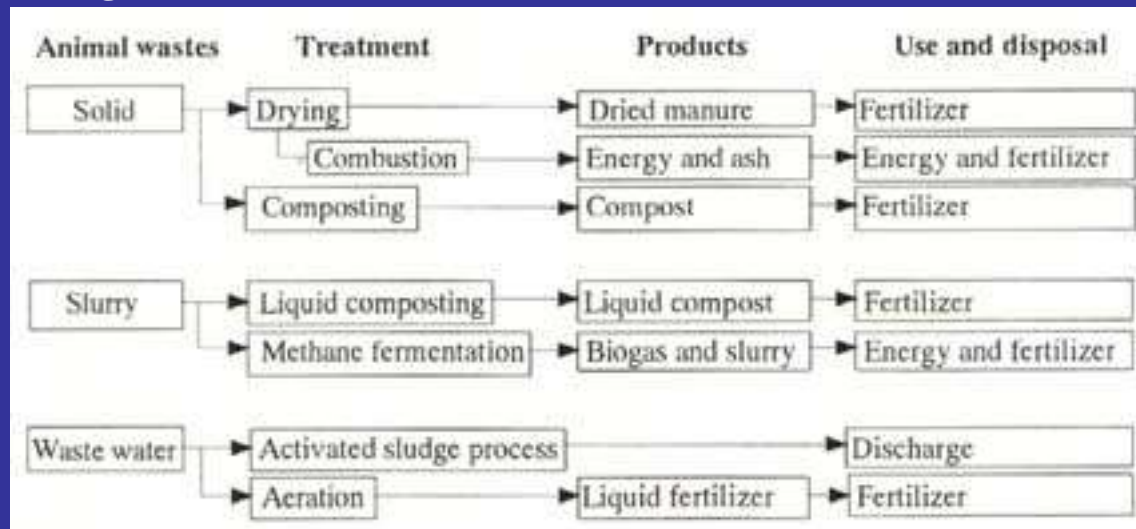


[Back to: Contents](#)



[Back to: JIRCAS home page](#)

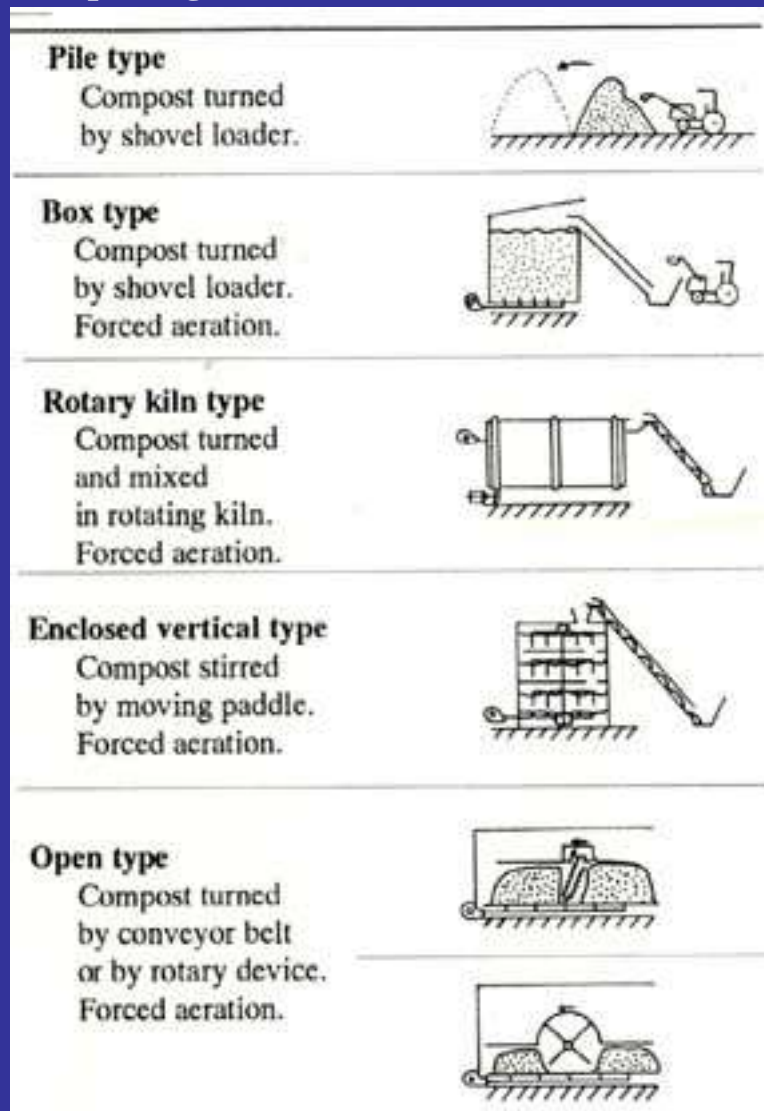
**Fig.4**  
**Methods generally used for animal waste management in farms**



 [BACK](#)

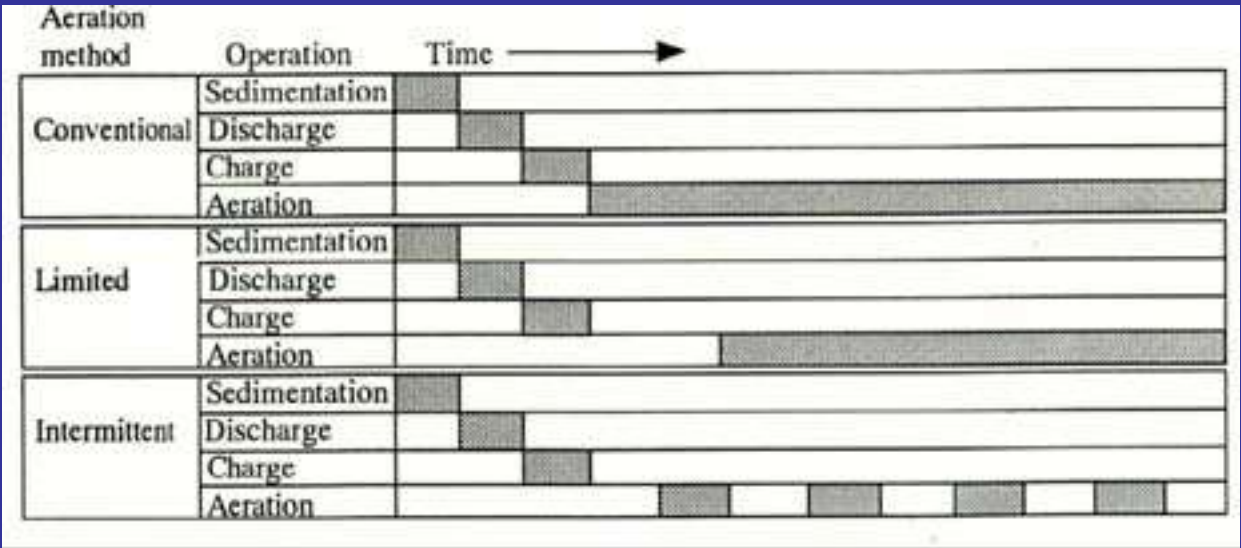


**Fig.5**  
**Composting facilities for animal wastes⁷⁾**



[BACK](#)

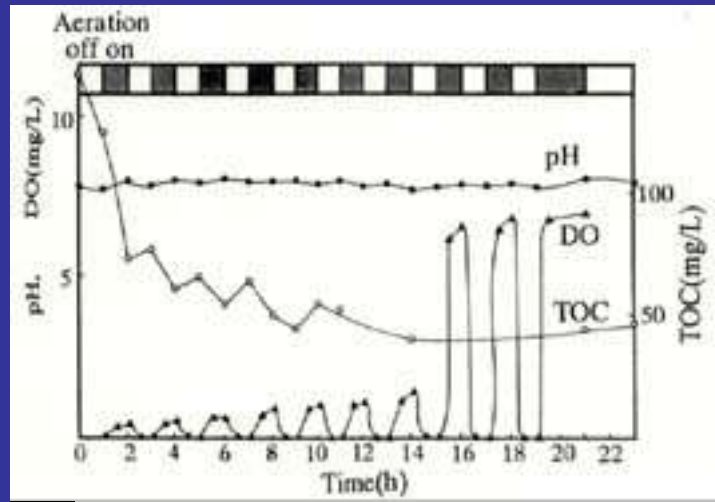
**Fig.6**  
**Time chart of conventional, limited aeration and**  
**intermittent aeration methods**



 [BACK](#)

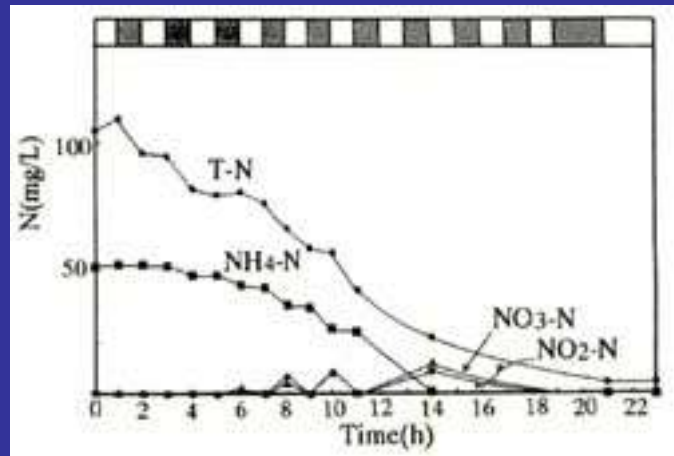
**Fig.7**  
**Changes in pH, DO and TOC values during**  
**intermittent aeration process⁹⁾**

**DO :Dissolved oxygen,**  
**TOC: Total organic carbon.**



 [BACK](#)

Fig.8  
Changes in nitrogen forms during intermittent aeration process⁹⁾



 [BACK](#)

# Removal of Colored Substances from Molasses Waste Water by Biological Treatment Systems Combined with Chemical Treatment

Suntud SIRIANUNTAPIBOON*1, Kanidta CHAIRATTANAWAN*2 and Sadahiro OHMOMO*3

*1:Department of Environmental Technology, School of Energy and Materials, King-Mongkut's Institute of Technology Thonburi (Bangkok 10140, Thailand)

*2:Faculty of Engineering, Sripatum University (Bangkhen, Bangkok 10900, Thailand)

*3:Department of Animal Products, National Institute of Animal Industry (Tsukuba, Ibaraki, 305-0901 Japan)

## Abstract

In this study, we attempted to combine a biological treatment process which used Bi-Act SCBA system (SCBA) and chemical treatment process to remove chemical impurities such as COD, BOD₅ and nutrients as well as colored substances from the molasses waste water (MWW). In the pilot plant experiment, SCBA unit A (SCBA-A) was used for the pre-aeration and uniformity of the MWW before biological treatment. The sludge volume (SV₃₀) was about 50 ml/l in the aeration unit of the SCBA-A. The COD and colored substances could not be removed in this step. However, in both SCBA-B and SCBA-C, SV₃₀ increased up to 350-400 ml/l. At the same time, approximately 44.0% and 22.9% of COD of the effluents from SCBA-B and SCBA-C were removed, respectively. On the other hand, the removal of colored substances in SCBA-B and SCBA-C (about 25.0 and 13.3%) was not appreciable. However, the colored substances in the MWW passing through SCBA-B and SCBA-C could be easily precipitated by chemical agents compared with the original MWW. About 93% of the colored substances of the effluent from SCBA-C could be removed in the chemical precipitation step, while the colored substances in the original MWW could not be precipitated.

**Discipline:** Food

**Additional key words:** melanoidin, molasses waste water, Bi-Act SCBA, chemical precipitation

1-30): [Click here for References](#)

## Introduction

Many by-products such as molasses, bagasses and fiber cake are produced from cane sugar factories. Among them, molasses is the most important product^{4,10}) because molasses has a high commercial value due to its use as a carbon source for fermentation industries, biofertilizer and feed for domestic animals⁵). However, the use of molasses as a raw material for fermentation industries is associated with the presence of a large amount of colored substances which remain in the fermentation residue after recovery of the products. The main colored substance, melanoidin, can hardly be decomposed by usual biological treatment processes^{1,11}) and accounts for the high COD value, which is a major problem for pollution control⁵).

In Thailand, all the alcohol-producing factories use molasses as raw materials and discharge molasses waste water (MWW) accounting for about 10 times the amount of alcohol produced. Several processes⁷⁻⁹) were used for treating the MWW. The use of MWW as feed for aquatic organisms is not suitable economically due to the small volume used. For biofertilizer use, the quality is not as high as that of other biofertilizers or chemical fertilizers (it may be similar to that of soil conditioners). Several alcohol factories have attempted to treat MWW by anaerobic methods such as methane fermentation, anaerobic pond or facultative anaerobic pond, followed by aerobic treatment such as activated sludge, aerated lagoon or oxidation pond^{3,6}). However in these treatment processes, the colored substances of MWW still remained and the COD content in the treated waste water was higher than the standard value authorized by the Ministry of Industry, Thailand. Presently, treatment processes such as chemical precipitation, chemical adsorption or carbon adsorption are used for the removal of the colored substances. However, color removal by the above processes still has disadvantages due to the high operation cost, high consumption of chemicals, fluctuation of the color removal efficiency and the high volume of solid waste produced.

Against this background, we applied biological and chemical processes to MWW from the anaerobic pond of the alcohol factory to remove colored substances, COD

and BOD₅ with high efficiency and at a low cost. The experiments on the biological process were carried out on a pilot plant scale, using the Bi-Act SCBA system¹²) which is characterized by low energy consumption and high efficiencies for aeration and mixing in the aeration tank. In this paper, we report the results of the experiments.

## Materials and methods

**Bi-Act SCBA unit:** Three units of Bi-Act SCBA (SCBA)¹²) supplied by Uni San Pol. Co. Ltd. were used in these experiments. The scheme of the processes shown in [Fig. 1](#) was as follows: 1 unit of 10 m³ storage tank, 2 units of 10 m³ SCBA (unit A and unit B), 1 unit of 4 m³ SCBA (unit C) and 2-tanks for 1 m³ of nutrient supply.

This pilot plant was installed in the waste water treatment plant of Sang Som Distillery Co. Ltd., Nakhon Pathom Province, Thailand.

[Fig.1.Scheme of the pilot plant of Bi-Act SCBA system\(22 KB\)](#)

**MWW:** The MWW used in this experiment was collected from the anaerobic pond of Sang Som Distillery Co. Ltd.

Supply of nutrients: Cassava flour was supplied as a nutrient for increasing the BOD₅ content in the MWW. Twenty kg of cassava flour was fermented for 1 week in the S1 tank as shown in Fig. 1. The supernatant from S1 tank was transferred to S2 tank before being fed to the SCBA system.

**Start-up procedure and operation of the pilot plant unit:** The concentrated sludge suspension (MLVSS=10,000 mg/l) from the central waste water treatment plant of BANG-PA-IN Industrial Estate, Ayuthaya, Thailand, was used as the inoculum for starting this pilot plant. The start-up procedure was performed as follows: First, 4, 4 and 2 m³ of concentrated sludge suspensions were put in SCBA-A, SCBA-B and SCBA-C (aeration tank), respectively. Second, water (softened water) was added in all 3 units up to the optimum level and the system was operated without influent feeding overnight. Thereafter, the MWW from the storage tank was fed into the SCBA system at the flow rate of 2 m³ /day. At the same time, the nutrients from tank S2 were fed into SCBA-B at the flow rate of 2 m³/day. The system reached the steady state after 2 weeks' operation. The flow rate of the influent from the storage tank slowly increased up to 4 m³/day within 1 week. Also the flow rate of water (underground water or river water) used instead of the nutrient solution increased up to 4 m³/day within 1 week. The MLSS, SV₃₀ and pH of the system were monitored until the system became steady. The effluent from the clarifier of each SCBA unit was taken for the analysis of BOD₅, COD, SS, TKN, TP, pH and color intensity. Also the mixed liquid from the aeration section of each SCBA unit was collected for measuring the pH and SV₃₀ during the period February-December 1996.

**Color removal by chemical precipitation:** The effluent from the clarifier of SCBA-C was collected and used for the determination of optimum concentrations of chemical agents to remove the colored substances. The chemical agents used for precipitation of the colored substances were FeCl₃, Al₂(SO₄)₃ and sodium hydroxide. The effluents from each SCBA unit were used to determine the optimum color removal efficiency. All the experiments were performed on a laboratory scale. A certain amount of FeCl₃ (range of 1 to 8 g) or Al₂(SO₄)₃ (range of 4 to 32 g) was added into 1,000 ml of the effluent from SCBA-C. Thereafter, the mixtures were adjusted to pH 7 by the addition of sodium hydroxide solution. The supernatants were collected for the determination of the color intensity, pH and COD.

**Assay of chemical composition of the waste water:** The BOD₅, COD, TKN, TP and SV₃₀ were determined by a standard method of analysis²⁾.

**Estimation of color intensity of the waste water and removal yield:** The sample was diluted with 0.1 M acetate buffer solution (pH 6.0) after centrifugation at 6,000×g for 15 min and the color intensity of the diluted solution was measured at 475 nm with a spectrophotometer (LKB, model Biochrom Ultra-space 2, England). The percentage of color removal was expressed as the color intensity of the waste water treated against that of original waste water. The removal yield was expressed as the degree of decrease in the absorbance at 475 nm against the initial absorbance at the same wavelength.



[Continue to: \[Results\], \[Discussion\]](#)



[Back to: Contents](#)

## References



[Back](#)

- 1) Aoshima, I. et al. (1985): Production of decolorizing activity for molasses pigment by *Coriolus versicolor* Ps4a. *Agric. Biol. Chem.*, 49, 2041-2045.
- 2) APHA, AWWA WPCF (1980): Standard methods for the examination of water and waste water (10th ed.). American Public Health Association, New York, 489-495.
- 3) Benefield, L. D. Randall, C. W. (1980): Attached growth biological treatment processes. *In* Biological process design for waste water treatment. Prentice-Hall Inc., New Jersey, 410-412.
- 4) Chang, T. C. Yang, W. L. (1973): Study on feed yeast production from molasses distillery stillage. *Taiwan Sugar*, 20, 422-427.
- 5) Chang, T. C. Lai, C. T. (1987): Study on treatment and utilization of molasses alcohol slop. *In* Proceedings of the international conference on water pollution control in developing countries. Asia Institute of Technology, Bangkok, Thailand, 475-480.
- 6) Fortes, C. F. Wase, D. W. J. (1987): Aerobic process. *In* Environmental biotechnology. Ellis Horwid Ltd., New York, 1-60.
- 7) Hammer, M. J. (1977): Water and waste water technology, J. Wiley & Sons Co., New York, 53-63.
- 8) Metcalf Eddy Inc. (1991): Waste water engineering; Treatment, disposal and reuse (3rd ed.). McGraw-Hill Inc., New York, 10-150.
- 9) Sirianuntapiboon, S. et al. (1988): Screening of filamentous fungi having the ability to decolorize molasses pigments. *Agric. Biol. Chem.*, 52, 387-392.
- 10) Underkofler, L. A. Hickely, J. (1954): Alcohol fermentation of molasses industrial fermentation. Chemical Publishing Co., New York, 2-25.
- 11) Watanabe, Y. et al. (1982): Enzymatic decolorization of melanoidin by *Coriolus* sp. No. 20. *Agric. Biol. Chem.*, 46, 1623-1630.
- 12) Yaibuathes, U. (1994): Combined bio-treatment. Patent No. 3710, Thailand.

(Received for publication, October 22, 1997)

**Fig.1**  
**Scheme of the pilot plant of Bi-Act SCBA system**



 [BACK](#)



1~12): [Click here for References](#)

## Results

**Chemical properties of the MWW:** The MWW collected from the anaerobic pond of the waste water treatment plant of Sang Som Distillery Co. Ltd. for this experiment still contained a high level of chemicals and showed a high color intensity as indicated in [Table 1](#). Chemical properties such as COD, BOD₅, contents of total solids and total volatile solids were 33,643, 3,500, 42,250 and 23,180 mg/l, respectively. The color intensity was about 33-35 (optical density at 475 nm).

[Table.1. Chemical properties of MWW from anaerobic pond of Sang Som Distillery Co. Ltd., Thailand\(26 KB\)](#)

**Start-up of the SCBA system:** By using the concentrated sludge solution from the central waste water treatment plant of BANG-PA-IN Industrial Estate, the microorganisms in both SCBA-B and SCBA-C could easily grow. The SV30 in the aeration tanks of SCBA-B and SCBA-C reached values of 300 and 350 ml/l, respectively within 2-3 weeks, while the level of SV30 was low (( 50 ml/l) in the aeration tank of SCBA-A. The SV30 in the aeration tank of both SCBA-B and SCBA-C remained at the levels of 300 and 350 ml/l during the treatment as shown in [Fig. 2](#).

[Fig.2. SV30 profiles in the aeration tank of each SCBA unit in the start-up of the system\(16 KB\)](#)

**Continuous treatment by SCBA system:** At 3 weeks after the start-up step, the system reached a steady state with an influent flow rate of 4 m³/day and diluted water was fed into the SCBA-B at the rate of 4 m³/day. The removal percentage of the impurities of the waste water (COD, BOD₅, SS and TKN) was high in effluents from SCBA-B and SCBA-C as shown in [Table 2](#), while in the SCBA-A system, the impurities could not be removed effectively. The COD content in the effluent from both SCBA-B and SCBA-C decreased to 44.0 and 22.9%, respectively. Other impurities such as SS, TKN and total phosphate were also removed. For color removal, in SCBA-A the level was only 4.0%, while in the SCBA-B and SCBA-C systems, the removal of the colored substances reached values of 25.0 and 13.3%, respectively, as shown in [Table 2](#). The system could be operated smoothly with a constant COD concentration of the effluents from each SCBA unit up to 36 days, as shown in [Fig. 3](#).

[Table.2. Cheical properties of influent and effluent of each SCBA unit\(49KB\)](#)

[Fig.3. COD profiles of the influents and effluents of each SCBA unit during the continuous operation\(20KB\)](#)

**Color removal by chemicals:** The effluent from the clarifier of SCBA-C was used as the color solution in the chemical precipitation step. Various concentrations of FeCl₃ in the range of 0-12% were added to the effluent and the mixed solution was adjusted to pH 7.0. The results are shown in [Fig. 4](#). Addition of FeCl₃ at a concentration of 6% in the solution resulted in the highest color removal efficiency. Various concentrations of Al₂(SO₄)₃ solution in the range of 8-30% were also added to the effluent and the

mixed solution was adjusted to pH 7.0. The results are shown in [Fig. 5](#). Addition of  $\text{Al}_2(\text{SO}_4)_3$  at a concentration of 20% in the solution was adequate for color removal.

On the other hand, 3 effluents from SCBA-A, SCBA-B and SCBA-C were tested for the removal of color by the addition of  $\text{FeCl}_3$  (6%) or  $\text{Al}_2(\text{SO}_4)_3$  (20%). After adjustment of the pH to 7.0, the colored substances in the effluents from SCBA-B and SCBA-C were easily removed at the rates of about 28 and 93%, respectively, while those from SCBA-A could not be removed as shown in [Table 3](#). The removal rate by the addition of  $\text{FeCl}_3$  and  $\text{Al}_2(\text{SO}_4)_3$  was almost the same.

[Fig.4.Removal of colored substances from the effluent of SCBA system by the addition of various concentrations of  \$\text{FeCl}_3\$  solutions\(11 KB\)](#)

[Fig.5.Removal of colored substances from the effluent of SCBA system by the addition of various concentrations of  \$\text{Al}_2\(\text{SO}_4\)_3\$  solutions\(9 KB\)](#)

[Table.3. Comparison of percentage of color removal by chemical precipitation in various kinds of effluents\(26 KB\)](#)

## Discussion

We carried out experiments to remove chemicals such as COD, BOD₅, TKN, total phosphorus and colored substances by using the SCBA system combined with the chemical treatment process. The SCBA system, which is a kind of activated sludge system, consisted of a new compact unit for biological treatment used in both domestic and industrial waste water treatment plants in Thailand. The rotary drum in the aeration tank of the system was specially designed, and the mixed liquid in the aeration tank was fully supplied with air and completely mixed.

Actually, each unit of SCBA displayed several characteristics. The chemical properties of the effluent from SCBA-A were not different from those of the influent. Sludge (MLSS) generation in the aeration tank was minimal and there was a high concentration of toxic substances in the waste water⁹). The effluent from SCBA-A was diluted with water and transferred to SCBA-B. In SCBA-B, the BOD₅ and COD were removed easily as shown in [Table 2](#). The sludge concentration in the aeration tank (SV30) increased up to 400-500 mg/l, reflecting normal conditions of activated sludge process^{3,6}). In SCBA-C, the results were the same as in SCBA-B. By the SCBA system, the colored substances in the influents of SCBA-B and SCBA-C could be removed at percentages of 25.0 and 13.3%, respectively.

For color removal by the chemical treatment process, the effluent from SCBA-A was hardly precipitated by  $\text{FeCl}_3$  and  $\text{Al}_2(\text{SO}_4)_3$  even when a high concentration of chemicals was used. However, the color of effluents from both SCBA-B and SCBA-C could be easily removed and the percentages of color removal were 28 and 93%, respectively, as shown in [Table 3](#).

Based on the results obtained, the SCBA system was found to be suitable for the treatment of MWW as well as the hitherto known activated sludge system^{3,6,8}). Furthermore, the SCBA system enabled to remove colored substances in comparison with the activated sludge system. Namely, the colored substances could be removed at a percentage of about 10% by this system directly and about 90% of the

colored substances remaining in the effluent from the system were easily precipitated by treatment with 6%  $\text{FeCl}_3$  or 20%  $\text{Al}_2(\text{SO}_4)_3$ . The reason for easy precipitation could not be determined. It is suggested that the colored substances may have changed or that their structure may have been modified during the passage through the SCBA system.



[Forward to: -Postmortem Changes in Skeletal Muscle Connectin and Its Structure-](#)



[Back to: Contents](#)



[Back to: JIRCAS home page](#)

**Table.1**  
**Chemical properties of MWW from anaerobic pond of Sang Som Distillery Co. Ltd., Thailand**

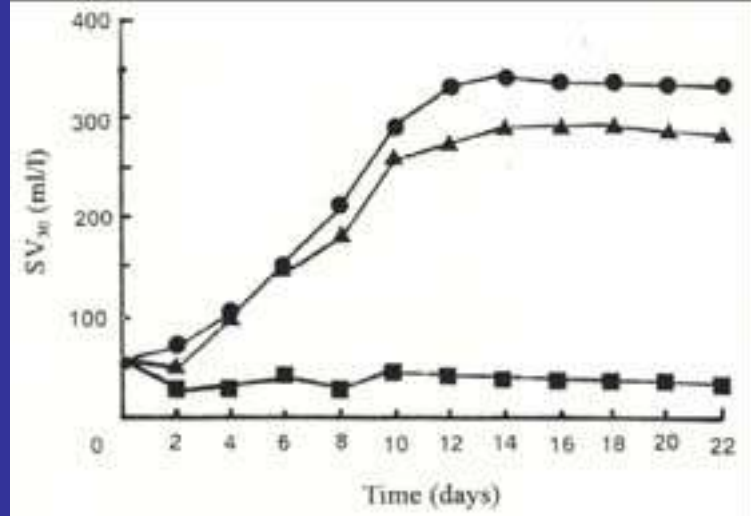
Properties	Value (mg/l) ^{a)}
pH	7.91
COD	33,643
BOD ₅	3,500
Alkalinity as CaCO ₃	11,100
Total solids	42,250
Suspended solids	3,575
Settled solids	-
VFA	814
Phosphate	0.0289
Sulfate	286
TKN	1,280
Potassium	7,875
Calcium	2,775
Sodium	115
Total volatile solids (TVS)	23,180
Color intensity (optical density at 475 nm)	33 - 35

a): Average value during the period April-December 1996.



[BACK](#)

**Fig.2**  
**SV₃₀ profiles on the aeration tank of each SCBA**  
**in the start-up of the system**



**Fig. 2.** SV₃₀ profiles in the aeration tank of each SCBA unit in the start-up of the system  
■ : SCBA-A, ▲ : SCBA-B, ● : SCBA-C.



[BACK](#)

Table.2

## Chemical properties of influent and effluent of each SCBA unit

Properties ^{a)}	Influent			Effluent			Removal (%)		
	A	B	C	A	B	C	A	B	C
pH	8.20	8.50	8.50	8.64	8.50	8.50	-	-	-
SV ₃₀ ^{b)} (ml/l)	-	-	-	50-100	300	350	-	-	-
Color intensity at 475 nm	33.5	10.0	7.5	32.15	7.5	6.5	4.0	25.0	13.3
COD (mg/l)	33,643	10,000-15,000	6,000-8,000	32,868	6,000-8,000	5,000-5,800	2.3	44.0	22.9
BOD ₅ (mg/l)	3,500	1,800	200	2,500	200	70	28.6	88.9	65.0
SS (mg/l)	3,500	1,300	450	3,500	450	200	-	65.4	55.6
TKN (mg/l)	1,280	700	300	1,250	300	200	2.3	57.1	33.3
Total phosphate (mg/l)	0.29	0.08	0.02	0.17	0.02	0.02	41.4	75.0	-

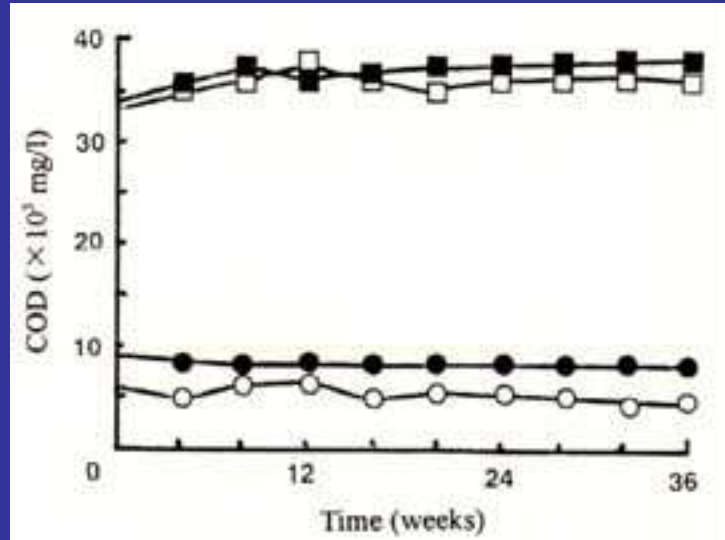
a): Average value during the April-December 1995 experiment.

b): SV₃₀ of mixed liquid in the aeration tank of SCBA unit.



[BACK](#)

**Fig.3**  
**COD profiles of the influents and effluents**  
**of each SCBA unit during the continuous operation**



**Fig. 3.** COD profiles of the influents and effluents of each SCBA unit during the continuous operation

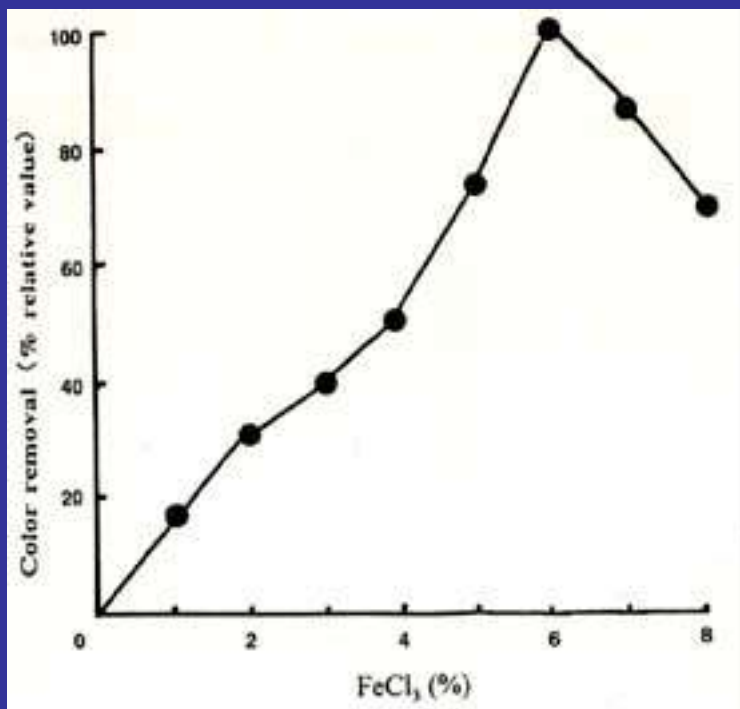
■ : Influent of SCBA-A, □ : Effluent from SCBA-A, ● : Effluent from SCBA-B, ○ : Effluent from SCBA-C.



[BACK](#)

**Fig.4**

**Removal of colored substances from the effluent of SCBA system by the addition of various concentrations of FeCl₃ solutions**



The FeCl₃ solution was added to 500 ml of effluent from the clarifier of SCBA-C and final concentrations of FeCl₃ in the mixture were 1,2,3,4,5,6,7 and 8%. Thereafter, the mixtures were adjusted to pH 7.0.

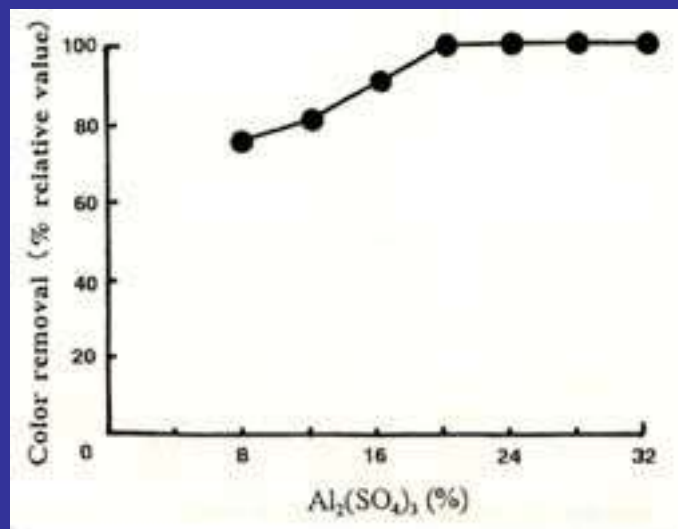


[BACK](#)



Fig.5

Removal of colored substances from the effluent of SCBA system by the addition of various concentrations of  $\text{Al}_2(\text{SO}_4)_3$  solutions



The  $\text{Al}_2(\text{SO}_4)_3$  solution was added to 500 ml of effluent from the clarifier of SCBA-C and final concentrations of aluminum in the mixture were 8,12,16,20,24,28 and 32%. Thereafter, the mixtures were adjusted to pH 7.0.



[BACK](#)

**Table.3****Comparison of percentage of color removal by chemical precipitation in various kinds of effluents**

Chemical treatment process	Color intensity at 475 nm		
	Effluent from SCBA-A	Effluent from SCBA-B	Effluent from SCBA-C
Before treatment	33.0	10.0 ^{a)}	7.2
After treatment	33.0	7.2	0.2
Removal (%)	0	28	93

a): The effluent from SCBA-A (color intensity of 33.0 at 475 nm) was diluted with water (final color intensity of 10.0 at 475 nm) before being sent to the SCBA-B as influent.

[BACK](#)

# Postmortem Changes in Skeletal Muscle Connectin (titin) and Its Structure

Ryoichi TANABE

Department of Animal Products, National Institute of Animal Industry (Tsukuba, Ibaraki, 305-0901 Japan)

## Abstract

The splitting of the connectin (titin) molecule during meat conditioning and its primary structure were analyzed. Using immunofluorescence microscopy and immunoelectron microscopy, it was shown that the connectin molecule split into  $\beta$  connectin and a 1,200 kDa-subfragment at a point  $0.34 \mu\text{m}$  apart from the Z-disc during meat conditioning. Differences in molecular weight and partial amino acid sequences of connectin were determined for cattle, pig and chicken skeletal muscles. Results of peptide mapping analysis differed according to animal species. Amino acid sequences deduced from partial nucleotide sequences of connectin also differed according to animal species at immunoglobulin-like (Ig) and fibronectin type 3 (FN3) domains. In chicken, the molecular weight of connectin from leg muscles differed from the value recorded in pectoral muscles. It is suggested that meat texture and conditioning may be related to the splitting of the connectin molecule and its structure.

**Discipline:** Animal industry

**Additional key words:** splitting of connectin, localization of 1,200 kDa-subfragment, primary structure, meat conditioning, meat texture

1~30): [Click here for References](#)

## Introduction

Connectin is an elastic protein of striated muscle initially reported by Maruyama et al.¹⁶⁾, and also called titin³⁰⁾. The apparent molecular mass of connectin is 3,000 kDa^{14,28)}. Each connectin molecule extends as a long ( $\sim 1.2 \mu\text{m}$ ) filament from the Z disc to the M line in a sarcomere and comprises an elastic segment at the level of the I band and an inelastic segment at the level of the A band. Connectin filaments keep the thick filaments centered within the sarcomere during force generation⁶⁾.

During meat conditioning, the connectin molecule splits into 2 polypeptides. The molecular mass of one peptide is 1,200 kDa (1,200 kDa-subfragment); the other peptide is called  $\beta$ -connectin. This splitting occurred nonenzymatically when myofibrils were treated with a solution containing 0.1 mM  $\text{CaCl}_2$  and 30  $\mu\text{g}$  of leupeptin/ml²²⁾. This splitting is very important for meat texture, because it reduces the elasticity of meat during conditioning²³⁾. Connectin filaments split more rapidly in more tender meat^{1,8)}. However, Fritz et al.³⁾ concluded that the connectin content did not enable to distinguish "tough" from "tender" beef. The time required for conditioning varies according to animal species. Within meat conditioned quickly, splitting is also rapid^{1,8,18)}. Differences in molecular structures of connectin may thus be a determinant of meat texture.

Labeit and Kolmerer¹²⁾ determined the complete cDNA sequence of human cardiac connectin and showed that its structure consisted primarily of 2 main types of repeating domains (an immunoglobulin-like (Ig), a fibronectin type 3 (FN3)) and a PEVK domain. They suggested that the PEVK domain primarily accounted for the elasticity of the connectin molecule. They indicated that after the extensibility of the PEVK domain had been exhausted, the stable fold of the Ig domains would resist further extension. These domains may thus determine the meat texture. The molecular structures of connectin in humans, rabbit and experimental animals have been studied extensively^{4,9,10,12,15,17,21)}. However, there are few reports on the molecular structure of connectin in domestic animals.

In this report, it was revealed that the splitting of the connectin molecule occurs at a point 0.34  $\mu$ m apart from the Z-disc during meat conditioning^{25,26}). The differences in the molecular weight of connectin and amino acid sequences of Ig, FN3 and PEVK domains in cattle, pig, chicken and muscle types were described²⁴).

## Materials and methods

### 1) Preparation and Ca treatment of myofibrils

Myofibrils were prepared according to the method of Perry and Grey¹⁹) from cattle, pig and chicken. To induce the splitting of connectin into a 1,200 kDa-subfragment and  $\beta$ -connectin in vitro, freshly prepared myofibrils were treated with 0.1 mM  $\text{CaCl}_2$  as described by Takahashi et al.²²).

### 2) Electrophoresis

Myofibrillar proteins were separated by sodium dodecyl sulfate polyacrylamide gel electrophoresis (SDS-PAGE) according to the method of Tatsumi and Hattori²⁷).

### 3) Preparation of antiserum and immunohistochemical observation

Antiserum against the 1,200-kDa subfragment of the connectin molecule was prepared as previously described²⁶). Indirect immunofluorescence microscopy and immunoelectron microscopy observation using that antiserum was carried out as previously described²⁶).

### 4) Peptide mapping

Connectin was digested by V8 protease as described previously²⁴). The peptides produced by V8 protease digestion were separated by SDS-PAGE.

### 5) PCR amplification and sequencing of segments from the connectin gene

Sequences of the oligonucleotide primers were based on the sequences of pig connectin reported by Fritz et al.⁴). The connectin molecule has Ig and FN3 domains. The sense primer for amplification of the Ig domain was 5'-CAGGTGGCTCCTTAAGGTTATTTGTTCC-3' and the antisense primer for the Ig domain was 5'-CAAAGGCAGACTTTGTTCCACTGCTGTT-3'. The sense primer for amplification of the FN3 domain was 5'-CCAGGACCTCCAAACAATCCCAAAGT-3' and the antisense primer was 5'-AGCACAGATACGGAAGTTGTATTCATG-3'. The positions of these primers on the sequence determined by Fritz et al.⁴) were 509-536, 691-718, 154-179 and 361-387, respectively. Genomic DNA was extracted from cattle, pig and chicken. PCR amplification was conducted according to the method of Chikuni et al.²). Both strands of amplified DNA were sequenced. From the nucleotide sequence, the amino acid sequence was deduced.



[Continue to: \[Results and discussion\]](#)



[Back to: Contents](#)

## References



[Back to the first page](#)

- 1) Anderson, T. J. & Parrish, Jr. F. C. (1989): Postmortem degradation of titin and nebulin of beef steaks varying in tenderness. *J. Food Sci.*, 54, 748-749.
- 2) Chikuni, K. et al. (1994): Direct sequencing of the water buffalo (*Bubalus bubalis*)  $\kappa$ -casein gene. *Anim. Sci. Technol. (Jpn.)*, 65, 652-655.
- 3) Fritz, J. D. et al. (1993): Titin content of beef in relation to tenderness. *Meat Sci.*, 33, 41-50.
- 4) Fritz, J. D., Wolff, J. A. & Greaser, M. L. (1993): Characterization of partial cDNA clone encoding porcine skeletal muscle titin: comparison with rabbit and mouse skeletal muscle titin sequences. *Comp. Biochem. Physiol. B*, 105, 357-360.
- 5) Horowitz, R. (1992): Passive force generation and titin isoforms in mammalian skeletal muscle. *Biophys. J.*, 61, 392-398.
- 6) Horowitz, R. et al. (1986): A physiological role for titin and nebulin in skeletal muscle. *Nature*, 323, 160-164.
- 7) Hu, D. H., Kimura, S. & Maruyama, K. (1986): Sodium dodecyl sulfate gel electrophoresis studies of connectin-like high molecular weight proteins of various types of vertebrate and invertebrate muscles. *J. Biochem.*, 99, 1485-1492.
- 8) Huff-Lonergan, E., Parrish, Jr. F. C. & Robson, R. M. (1995): Effect of postmortem aging time, animal age, and sex on degradation of titin and nebulin in bovine longissimus muscle. *J. Anim. Sci.*, 73, 1064-1073.
- 9) Jin, J. P. (1995): Cloned rat cardiac titin class I and class II motifs. *J. Biol. Chem.*, 270, 6908-6916.
- 10) Labeit, S. et al. (1990): A regular pattern of two types of 100-residue motif in the sequence of titin. *Nature*, 345, 273-276.
- 11) Labeit, S. et al. (1992): Towards a molecular understanding of titin. *EMBO J.*, 11, 1711-1716.
- 12) Labeit, S. & Kolmerer, B. (1995): Titins: giant proteins in charge of muscle ultrastructure and elasticity. *Science*, 270, 293-296.
- 13) Locker, R. H. & Wild, D. J. C. (1986): A comparative study of high molecular weight proteins in various types of muscle across the animal kingdom. *J. Biochem.*, 99, 1473-1484.
- 14) Maruyama, K. (1994): Connectin, an elastic protein of striated muscle. *Biophys. Chem.*, 50, 73-85.
- 15) Maruyama, K. (1994): A partial connectin cDNA encoding a novel type of RSP motifs isolated from chicken embryonic skeletal muscle. *J. Biochem.*, 115, 147-149.
- 16) Maruyama, K., Natori, R. & Nonomura, Y. (1976): New elastic protein from muscle. *Nature*, 262, 58-60.
- 17) Muller-Seitz, M. et al. (1993): Chromosomal localization of the mouse titin gene and its relation to "muscular dystrophy with myositis" and nebulin genes on chromosome 2. *Genomics*, 18, 559-561.
- 18) Paxhia, J. M. & Parrish, Jr. F. C. (1988): Effect of postmortem storage on titin and nebulin in pork and poultry light and dark muscles. *J. Food Sci.*, 53, 1599-1601.
- 19) Perry, S. V. & Grey, T. C. (1956): A study of substrate concentration and certain relaxing factors on the magnesium-activated myofibrillar adenosine triphosphatase. *Biochem. J.*, 64, 184-192.
- 20) Schiaffino, S. & Reggiani, C. (1996): Molecular diversity of myofibrillar proteins: gene regulation and functional significance. *Physiol. Rev.*, 76, 371-423.
- 21) Sebestyen, M. G., Wolff, J. A. & Greaser, M. L. (1995): Characterization of a 5.4 kb cDNA fragment from the Z-line region of rabbit cardiac titin reveals phosphorylation sites for proline-directed kinases. *J. Cell Sci.*, 108, 3029-3037.
- 22) Takahashi, K. et al. (1992): Calcium-induced splitting of connectin filaments into²-connectin and a 1,200-kDa subfragment. *J. Biochem.*, 111, 778-782.
- 23) Takahashi, K. & Saito, H. (1979): Postmortem changes in skeletal muscle connectin. *J. Biochem.*, 85, 1539-1542.
- 24) Tanabe, R. et al. (1997): Skeletal muscle connectin primary structures as related to animal species and muscle type. *J. Food Sci.*, 62, 451-453, 461.
- 25) Tanabe, R., Nakai, H. & Takahashi, K. (1992): Postmortem changes in skeletal muscle connectin. *Proc. 38th Int. Congr. Meat Sci. & Technol.*, 3, 427-430.
- 26) Tanabe, R., Tatsumi, R. & Takahashi, K. (1994): Purification and characterization of the 1,200-kDa subfragment of connectin filaments produced by 0.1 mM calcium ions. *J. Biochem.*, 115, 351-355.
- 27) Tatsumi, R. & Hattori, A. (1995): Detection of giant myofibrillar proteins connectin and nebulin by electrophoresis in 2% polyacrylamide slab gels strengthened with agarose. *Anal. Biochem.*, 224, 28-31.
- 28) Trinick, J. (1994): Titin and nebulin: protein rulers in muscle? *Trends Biochem. Sci.*, 19, 405-409.

**29)** Wang, K. et al. (1991): Regulation of skeletal muscle stiffness and elasticity by titin isoforms: A test of the segmental extension model of resting tension. *Proc. Natl. Acad. Sci. U.S.A.*, 88, 7101-7105.

**30)** Wang, K., McClure, J. & Tu, A. (1979): Titin: major myofibrillar components of striated muscle. *Proc. Natl. Acad. Sci. U.S.A.*, 76, 3698-3702.

(Received for publication, November 12, 1997)

## Results and discussion

[Fig. 1-A](#) shows the postmortem changes of myofibrillar proteins in chicken M. tensor fasciae latae stored at 4(25 KB). With increasing postmortem time, the band of connectin became weaker, while the band of  $\beta$ -connectin became stronger. Furthermore, the 1,200 kDa-subfragment appeared during storage. The densitometric analysis suggested that these changes continued until about 4 days postmortem, and  $\beta$ -connectin and the 1,200 kDa peptide were produced stoichiometrically from the entire connectin molecule (data not shown). The same changes were observed in chicken M. semimembranosus and M. adductor 25). These data suggest that the connectin molecule is degraded to-connectin and the 1,200 kDa-subfragment until about 4 days postmortem in chicken leg muscles. [Fig. 1-B](#) shows the changes of myofibrillar proteins of chicken leg muscles during the Ca treatment. Basically, the changes of connectin during the Ca treatment were the same as those occurring in stored muscles. However, the band of the 1,200 kDa-subfragment was stronger and sharper than in the stored muscles. It was confirmed immunologically that the 1,200 kDa-subfragment was derived from the connectin molecule and not from-  $\beta$  connectin by immunoblot analysis using the antiserum against the 1,200 kDa-subfragment26). Takahashi et al.22) demonstrated that connectin is not degraded in a Ca treatment solution containing 5 mM EDTA. Therefore, they concluded that these changes are nonenzymatically induced reactions caused by 0.1 mM Ca ion.

[Fig. 1-A. Postmortem changes of connectin in chicken M. tensor fasciae latae stored at 4](#)

[Fig. 1-B. Changes of connectin during Ca treatment of chicken leg myofibrils\(25KB\)](#)

Localization of the 1,200 kDa-subfragment in a sarcomere was revealed by indirect immunofluorescence microscopy ([Fig. 2-A](#)). When myofibrils were treated with antiserum against the 1,200 kDa-subfragment, Z-disks were strongly fluorescent, the regions of both sides of the Z-disks were fairly fluorescent, and the A-band was absent. Immunoelectron microscopy revealed a heavy deposition of antibodies on the Z-disk and the formation of a stripe in each I-band, which was about 0.34  $\mu$  m apart from the Z-disk for a sarcomere length of 2.6  $\mu$  m ([Fig. 2-B](#)). The other deposits were scattered and not common to both I-bands. These results indicate that the 1,200-kDa subfragment is a portion of connectin filaments that may become attached to the Z-disk. A single connectin molecule forms an elastic filament connecting a thick filament with a Z-disk, extending its distal end nearly to the M-line. The distance between the Z-disk and the stripe in the I-band, 0.34  $\mu$  m, was in good agreement with the difference between the length of a connectin molecule (approximately 1.30  $\mu$  m, which is half the length of the sarcomeres we observed) and  $\beta$ -connectin (approximately 0.90  $\mu$  m). Therefore, we estimated that the length of the 1,200 kDa-subfragment was about 0.34  $\mu$  m for a sarcomere length of 2.6  $\mu$  m.

[Fig. 2-A. Immunofluorescence staining of myofibrils with antiserum against the 1,200 kDa-subfragment](#)

[Fig. 2-B. Immunoelectron micrographs showing the localization of the 1,200 kDa-subfragment \(32 KB\)](#)

These results indicate that the splitting of connectin filaments occurs at a point 0.34  $\mu$ m apart from the Z-disc in a sarcomere during meat conditioning. [Fig. 3](#) gives a schematic diagram of that splitting.

[**Fig. 3. Splitting of connectin molecule in a sarcomere during meat conditioning\(14 KB\)**](#)

Locker and Wild¹³) reported that the molecular weight of connectin was essentially the same in vertebrate skeletal muscle. However, Hu et al.⁷) observed differences in the molecular weight depending on animal species and muscle types after analyzing many sources of vertebrate striated connectin and non-vertebrate connectin-like protein. Tatsumi and Hattori²⁷) noted that the molecular weight differed between chicken leg, rabbit leg and rabbit back muscles using the same SDS-PAGE conditions as those applied in this study. Molecular weight was found to differ according to the muscle type in chicken ([Fig. 4](#)). The molecular weights in *M. pectoralis profundus* and *M. pectoralis superficialis* were lower than in *M. semitendinosus*, *M. semimembranosus*, *M. sartorius* or *M. biceps femoris* ([Fig. 4, lane 1-6](#)). The sample, which consisted of a mixture of 2 types of pectoral muscles, produced a single band of connectin ([Fig. 4, lane 7](#)). On the other hand, the sample which consisted of a mixture of a pectoral muscle and leg muscles produced 2 bands of connectin ([Fig. 2, lane 8](#)). Thus, it was confirmed that the molecular weight of connectin differed according to the muscle types in chicken. Many muscle proteins are present in different isoforms²⁰). Connectin in rabbit fast muscles showed a higher mobility on SDS-PAGE than connectin in slow muscles and this difference was correlated with the resting tension of muscle fibers^{5,29}). Differences in the molecular weight of connectin in chicken depending on skeletal muscles would thus appear to be derived from physiological differences between fast and slow muscles.

[**Fig. 4. SDS-PAGE analysis of connectin from various muscle types in chicken \(14 KB\)**](#)

By peptide mapping analysis using V8 protease, SDS-PAGE patterns of cattle, pig and chicken were clarified. They indicated that the primary structure of the entire connectin molecule differed according to animal species ([Fig. 5](#)). V8 protease specifically cleaved peptide bonds on the carboxyl side of aspartic and glutamic acid residues. Due to the large molecular mass and the existence of repeating domains in a connectin molecule, V8 protease digestion produced many bands with varying intensities. The patterns of peptide mapping were reproducible. Arrowheads indicate typical bands, which differed from those in other animal species (a, b: cattle; c: pig; d: chicken). Although the 'b' and 'c' bands were close in mobility, the 'c' band was distinctly lower than the 'b' band.

[**Fig. 5. Digestion patterns of connectin in *M. semimembranosus* by *S. aureus* V8 protease \(17 KB\)**](#)

To reveal differences in the primary structure of connectin according to animal species more clearly, partial nucleotide sequences encoding connectin were determined. The connectin molecule contains the Ig and FN3 domains^{10,12}). Most of the connectin molecule consists of repeats of these domains in succession. Partial nucleotide sequences encoding single Ig and FN3 domains of pig, cattle and chicken muscle connectin were determined, on the basis of which, the amino acid sequences were identified ([Fig. 6](#)). Amino acid sequences of pig domains were the same as those indicated by Fritz et al.⁴). The amino acid sequences of the Ig domain in cattle and chicken differed from those of the pig at 1 and 6 points, respectively. Amino acid sequence of the FN3 domain in cattle was different from that of the pig at 2



points. The Ig and FN3 domains of connectin were thus found to display amino acid sequences that differed according to animal species. These results indicate that the primary structure of connectin is completely different in cattle, pig and chicken.

[Fig. 6. Comparison of the corresponding amino acid sequences of connectin Identity of amino acids is indicated by a single dot.\(23 KB\)](#)

Labeit and Kolmerer¹²) determined the complete cDNA sequence of human cardiac muscle connectin. The partial sequences of skeletal muscle connectin of several animal species such as humans, rabbit and chicken have been elucidated^{11,12,15}). It was suggested that tissue-specific connectin was expressed by alternative splicing. Those studies showed that the primary structure of connectin differed according to animal species and muscle types. These findings were confirmed by our data for cattle, pig and chicken.

Connectin is an elastic filament whose splitting results in changes in the meat texture during conditioning²³). The primary structure of connectin was different in cattle, pig and chicken. And the Ig and FN3 domains have been shown to interact with F-actin and myosin^{9,11}). The connectin molecule is anchored to the Z-disc by the binding of the 1,200 kDa-subfragment to  $\alpha$ -actinin, which is the major protein constituent of the Z-disc²⁵). Although the sequence changes were mostly conservative (T for S; D for E; Y for F), the interactions between connectin and myofibrillar proteins such as actin, myosin and  $\alpha$ -actinin may not be equally strong in different animal species. In many studies, conditioning changes in meat are considered to result from endogenous protease concentration or levels of activation. However, conditioning of meat may be related to the structure of myofibrillar proteins such as connectin.

In this paper, it was revealed that the connectin molecule split at a point 0.34  $\mu$ m apart from the Z-disc during the conditioning of meat, and that this site corresponded to the N2-line of a sarcomere. The region of connectin molecules, which is situated near the N2-line, is called the PEVK region and is comprised predominantly of 4 amino acid residues. The sequence of this region differs from those of the Ig and FN3 domains¹²). The PEVK region may also account for the capacity of connectin filament extension¹²), and thus may also be a factor of meat texture and rate of conditioning. Primers for the amplification of the PEVK region of the connectin gene were synthesized, based on sequences that would not include introns and would be conserved in human skeletal and cardiac muscle connectin. These primers, however, failed to amplify the sequence of the PEVK region in cattle, pig and chicken (data not shown). The primary structure of the PEVK region thus appears to differ in those species. It was suggested that the PEVK domain primarily accounted for the elasticity of the connectin molecule³). Therefore, meat texture may be related to differences in the PEVK domain of connectin.



[Forward to: -Gamma-Globulin and Pathology in Bovine Lymphosarcoma-](#)



[Back to: Contents](#)



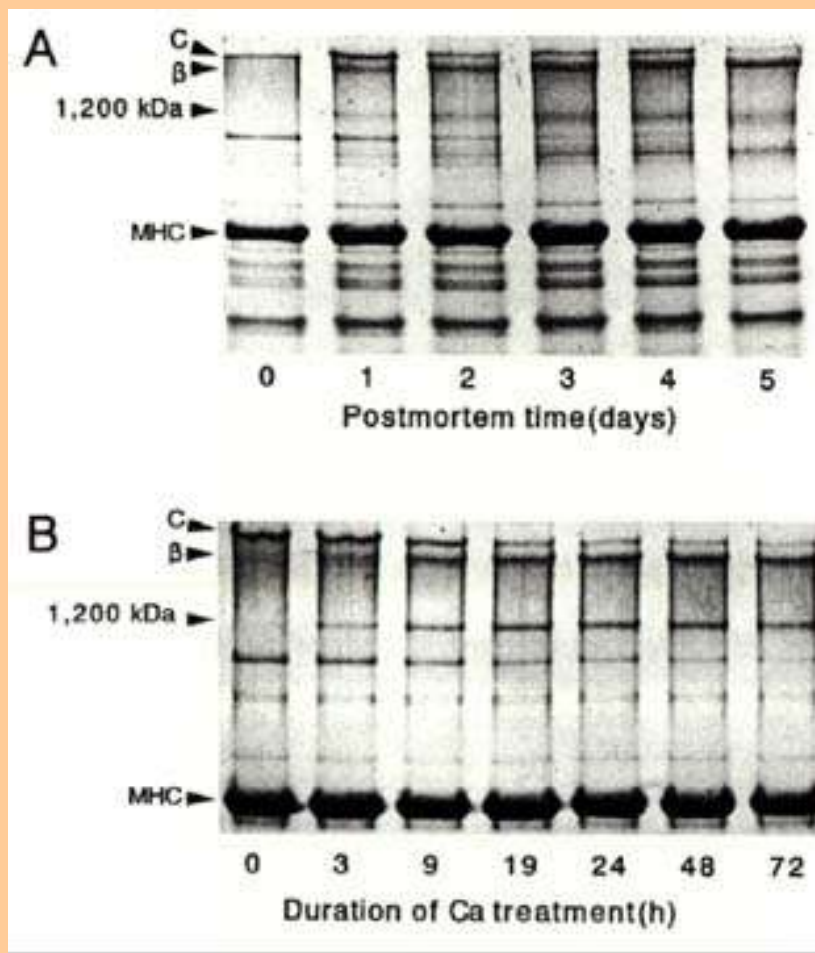
[Back to: JIRCAS home page](#)

**Fig. 1-A:** Postmortem changes of connectin in chicken *M. tensor fasciae latae* stored at 4°C

**1-B:** Change of connectin Ca treatment of chicken leg myofibrils

C: connectin, ²:²-connectin,

1,200 kDa: 1,200 kDa-subfragment, MHC: myosin heavy chain.



 [BACK](#)

**Fig.2**

-**A.** Immunofluorescence staining of myofibrils with antiserum against the 1,200 kDa-subfragment

Upper panel: phase-contrast image, lower panel: immunofluorescence image.

-**B.** Immunoelectron micrographs showing the localization of the 1,200 kDa-subfragment

Antibodies were heavily deposited on the Z-disk indicated in brackets, and formed a stripe in each I-band indicated by an arrowhead.

Upper panel: control, lower panel: treatment with antiserum. Z: Z-disk, M: M-line. Scale bar:  $0.3\frac{1}{4}\mu\text{m}$ .

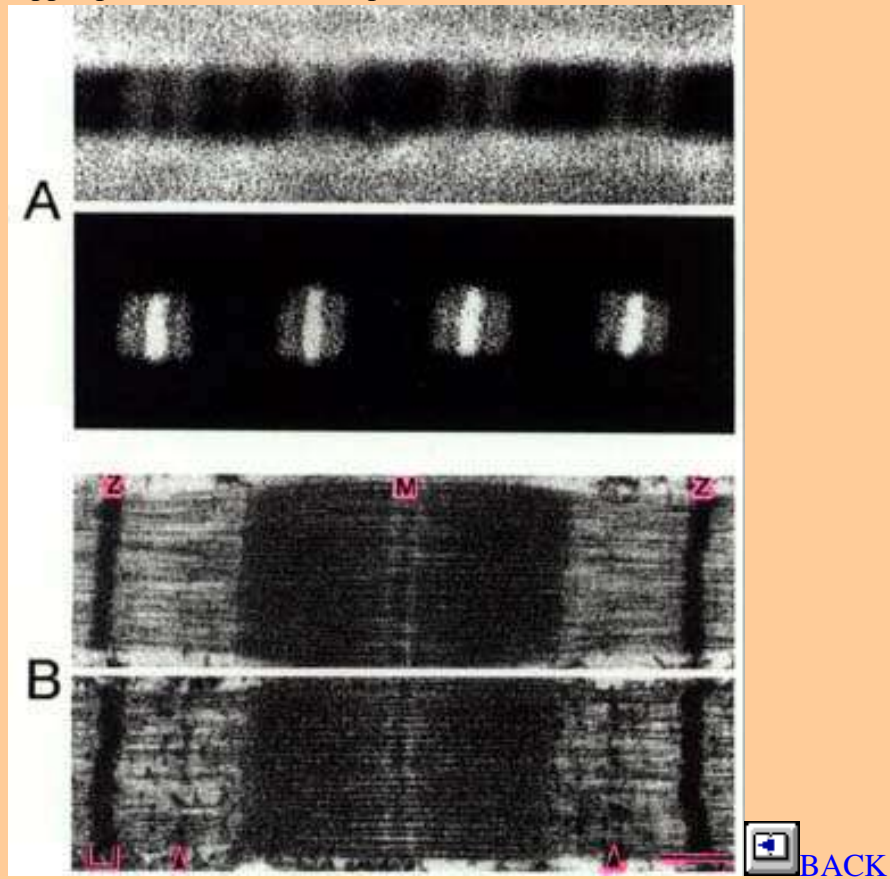
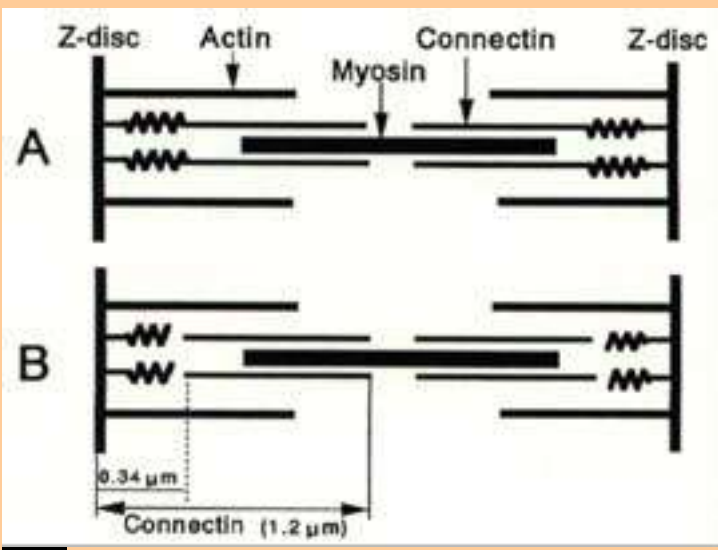


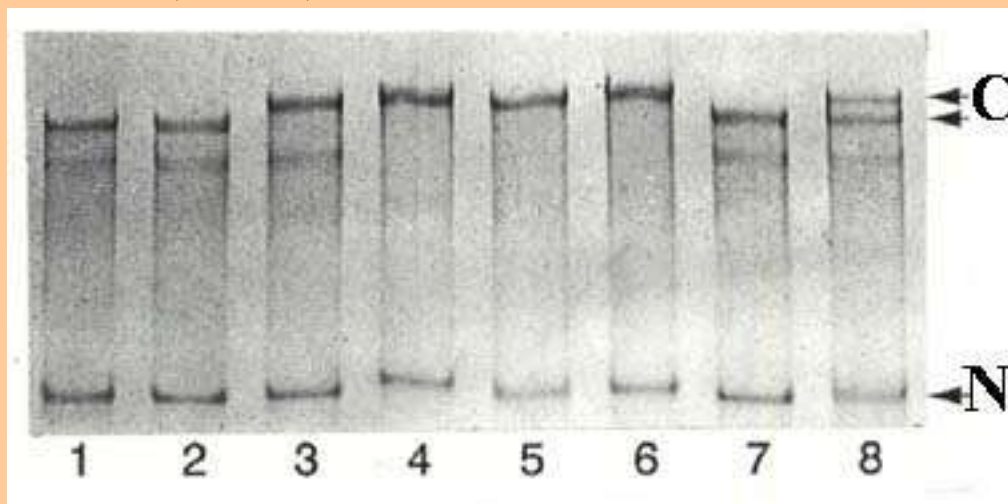
Fig. 3.  
Splitting of connectin molecule in a sarcomere during meat conditioning  
**A:** just after slaughtering, **B:** after conditioning



 [BACK](#)

Fig. 4. SDS-PAGE analysis of connectin from various muscle types in chicken

1: *M. pectoralis profundus*, 2: *M. pectoralis superficialis*,  
3: *M. semimembranosus*, 4: *M. semitendinosus*, 5: *M. sartorius*,  
6: *M. biceps femoris*, 7: mixture of 1 and 2, 8: mixture of 1,3,4,5 and 6.  
C: connectin,  
N: nebulin(700 kDa).



 [BACK](#)

Fig. 5  
Digestion patterns of connectin in *M. semimembranosus*  
by *S. aureus* V8 protease

Arrowheads indicate typical bands, which differ from those in other animal species. **M**: marker, **1**: cattle, **2**: pig, **3**: chicken, **4**: protease alone, **a**, **b**: typical bands of cattle, **c**: typical band of pig, **d**: typical band of chicken.



 [BACK](#)

Fig. 6

Comparison of the corresponding amino acid sequences of connectin

Identity of amino acids is indicated by a single dot.

**A:** partial sequence of immunoglobulin-like (Ig) domain,

**B:** partial sequence of the fibronectin type3 (FN3) domain.

The nucleotide sequence data revealed in this report appeared in the

DDBJ, EMBL and GenBank nucleotide sequence databases with the

following accession numbers D85838-D85842.

		10	20	30	40	50	
<b>A</b>	CATTLE	IRGRPTPEVK	WGKVDGEIRD	AAI IDSTSSF	TSLVLDNVNR	YDSGKYTLTL	E
	PIG	•K••••••••••	••••••••••	••••••••••	••••••••••	••••••••••	•
	CHICKEN	••••••••••	••••••••••E	••••••••••T•••••	••••••••••S•••••	F•T••••••••••	•
		10	20	30	40	50	60
<b>B</b>	CATTLE	TDITRSSVFL	SWGKPIYDGG	CEIQGYIVEK	CDTSVGEWTM	CTPPTGINKT	NIEVEKLLEK
	PIG	••••••••••	••••••••••	••••••••••	••V••••••••••	••••••••••	••••••••••



[BACK](#)

# Study on Relationships between Serum Gamma-Globulin Concentration and Pathological Characteristics in Bovine Lymphosarcoma

Seishi ISHINO*1, Harumichi YAMANAKA*2 and Koichi KADOTA*3

*1Department of Pathology and Physiology, National Institute of Animal Health (NIAH) (Tsukuba, Ibaraki, 305-0856 Japan)

*2Department of Immunology, NIAH (Tsukuba, Ibaraki, 305-0856 Japan)

*3Hokkaido Research Station, NIAH (Sapporo, Hokkaido, 062-0045 Japan)

## Abstract

We investigated the relationships between the serum  $\bar{\gamma}$ -globulin concentration and the pathological characteristics in 4 types of bovine lymphosarcoma including the adult, calf, thymic and skin forms. In 5 cases of the adult form, there were extensive neoplastic proliferations in the lymph nodes and the  $\bar{\gamma}$ -globulin concentration was low. Four cases of the calf form showed systemic lymph node involvement, and the concentration was low in one case and much lower in 3 cases. IgM was absent in 3 cases. In the thymic form, one case showed a slightly high concentration with systemic neoplastic lesions in the lymph nodes, whereas in the other the concentration was normal and lesions were localized. In a cow with the skin form, the concentration was low in the tumor stage but markedly increased in the regressive stage.

**Discipline:** Animal health

**Additional key words:** bovine leukosis, immunoglobulin, serum protein

1~25): [Click here for References](#)

## Introduction

Bovine leukosis has been classified into enzootic and sporadic forms²). The former is almost invariably seen in bovine leukaemia virus (BLV)-infected adult cattle, and is referred to as the adult form⁵). The latter consists of 3 clinicopathological types; the calf, thymic and skin forms¹⁴). These neoplasms are malignancies of the lymphoid system²), which is closely related to immunological functions. It is likely that generalized immunological disorders occur in cattle with the lymphoid malignancies. Abnormal electrophoretic patterns of serum proteins are recognized in some of the human lymphomas¹⁶). Although serum protein concentrations have been determined in some cattle with lymphosarcoma^{1,9,10,15}), few studies have dealt with the relations between serum protein concentration and pathological characteristics. The purpose of the present study was to analyze the relationships between the serum  $\gamma$ -globulin concentration and pathological characteristics in 4 types of bovine lymphosarcoma.

## Materials and methods

### 1) Animals

Leukosis in cattle was classified into 4 groups: (1) the adult form including 5 cases, (2) the calf form consisting of 4 cases in which 3 cases older than the age of calves were included, due to the presence of characteristic calf form lesions^{21,24}), (3) the thymic form including 2 cases and (4) the skin form in a cow¹¹). A 2-year-old healthy heifer, which was negative for BLV antibodies, was used as a control animal.

### 2) Hematological, serological and serum protein analyses



Number of peripheral lymphocytes was calculated based on leukocyte counts and the percentage of differential leukocytes in blood smears stained with Giemsa solution. The agar gel immunodiffusion test was applied to serum samples for the demonstration of antibodies to BLV(13).

The total serum protein concentrations were determined by the biuret method according to the method of Coles(3). The serum protein patterns were examined by electrophoresis on a cellulose-acetate membrane(4,8) and the electrophoretic graphs were analyzed using a spectrophotometer DU-8 (Beckman Co., U.S.A.). Agar gel immunoelectrophoresis was carried out on microscope slides using anti-bovine  $\gamma$ -globulin rabbit serum (Miles Lab., U.S.A.) and anti-bovine IgM rabbit serum ( $\mu$ -chain specific, Miles Lab., U.S.A.)(8).

### 3) Cell surface markers

Mononuclear cells were isolated from the peripheral blood and neoplastic tissues of cattle with lymphosarcoma, and also from the peripheral blood, lymph nodes and thymus of a healthy heifer by the sodium metrizoate/Ficoll procedure (Lymphoprep, Nyegaard Co., Norway). The erythrocyte rosette-forming (RF) test for the demonstration of T-cells was performed by Paul's method(17). Aliquots of  $1 \times 10^6$  mononuclear cells suspended in 100  $\mu$ l of RPMI-1640 medium were mixed with 200  $\mu$ l of 1% sheep erythrocytes (SRBC). The suspension was incubated at 37°C for 10 min and later at 4°C overnight. A drop of 0.5% trypan blue was added and 200 live cells were counted. When each cell adhered to more than 3 SRBC, the reaction was considered to be positive. For the surface membrane immunoglobulin (sIg), a marker of B-cells,  $1 \times 10^6$  cells were resuspended in 50  $\mu$ l of 1:20 dilution of fluoresceinated anti-bovine IgM rabbit serum ( $\mu$ -chain specific, EY Lab., U.S.A.) and incubated at 4°C for 30 min. Then 200 live cells were counted under a Zeiss Axiophoto microscope equipped with an epifluorescent apparatus. The standard deviation (SD) of mean was calculated from the results of RF and sIg tests.

### 4) Pathological examination

Tissue samples were fixed in 10% neutral buffered formalin and processed by a routine paraffin wax sectioning method. Thin sections were stained with haematoxylin and eosin (HE) or by silver impregnation.

Small blocks of neoplastic tissues were fixed in 2.5% glutaraldehyde, postfixed in 1% osmium tetroxide, and embedded in Epon. Ultrathin sections were stained with uranyl acetate and lead citrate, and then examined under an electron microscope (JEOL 100CX).

The immunoperoxidase method was applied to paraffin sections. After deparaffinization, sections were incubated with primary antibodies; rabbit anti-bovine IgM ( $\mu$ -chain specific, Miles Lab., U.S.A.), rabbit anti-bovine IgG (Fc specific, EY Lab., U.S.A.) or rabbit anti-bovine IgA ( $\alpha$ -chain specific, Miles Lab., U.S.A.). A biotin-streptavidin system (BioGenex Lab., U.S.A.) was used in the subsequent processes.



[Continue to: \[Results\],\[Discussion\]](#)



[Back to: Contents](#)

## References



[Back to the first page](#)

- 1) Abramova, E. N., Kondratef, V. S. & Sytinskii, I. A. (1974): The biochemistry of leucosis in cattle. *Vet. Bull.*, 44, 689-711.
- 2) Bendixen, H. J. (1965): Bovine enzootic leukosis. *Adv. Vet. Sci.*, 10, 129-204.
- 3) Coles, E. H. (1974): Plasma proteins. In *Veterinary clinical pathology* (2nd ed.). W. B. Saunders Co., London, 558-560.
- 4) Ek, N. (1969): Studies on electrophoresis on cellulose acetate membrane of bovine serum proteins in healthy animals. *Acta Vet. Scand.*, 10, 118-126.
- 5) Ferrer, J. F. (1980): Bovine lymphosarcoma. *Adv. Vet. Sci. Comp. Med.*, 24, 1-68.
- 6) Gate, I. M. H., Lavin, M. F. & Daniel, R. C. W. (1990): Serum immunoglobulin concentrations in cattle naturally infected with bovine leukemia virus. *Zbl. Vet. Med.*, B37, 575-580.
- 7) Harris, J. & Bagai, R. C. (1972): Immuno deficiency states associated with malignant disease in man. *Med. Clin. North Am.*, 56, 501-514.
- 8) Hirai, S. et al. (1989): Experimental methods of electrophoresis. Bunkodo Co., Tokyo, 21-212 ;In Japanese=.
- 9) Ichijo, S., Kim, D. H. & Konishi, T. (1981): Clinical and clinicopathological findings on bovine leukosis III. Blood clinico-chemical findings. *J. Vet. Med. (Jpn.)*, 724, 640-645 ;In Japanese with English summary=.
- 10) Ishihara, K. et al. (1980): Clinical studies on bovine leukemia in Japanese black cattle IV. Serum immunoglobulin concentrations in leukemic cattle and those with negative and positive serum antibodies to bovine leukemia virus. *Jpn. J. Vet. Sci.*, 42, 427-434.
- 11) Ishino, S. et al. (1988): Histopathological observations on regression of skin lymphosarcoma in five cows. *Zbl. Vet. Med.*, A35, 578-585.
- 12) Jelinek, D. F. & Lipsky, P. E. (1987): Regulation of human B-lymphocyte activation, proliferation and differentiation. *Adv. Immunol.*, 40, 1-59.
- 13) Kono, Y. et al. (1982): Changes in antibody titers in cattle infected clinically and subclinically with bovine leukemia virus. *Int. J. Cancer*, 30, 655-657.
- 14) Marshak, R. R. (1968): Criteria for the determination of the normal and leukotic state in cattle. *J. Natl. Cancer Inst.*, 41, 243-263.
- 15) Matthaues, W. & Straub, O. C. (1975): Das serum ³-Globulinbild bei leukosekranken Rindern und Schafen. *Zbl. Vet. Med.*, B22, 758-763.
- 16) Michaux, J-L. & Heremans, J. F. (1969): Thirty cases of monoclonal immunoglobulin disorders other than myeloma or macroglobulinemia. A classification of disease associated with the production of monoclonal-type immunoglobulins. *Am. J. Med.*, 46, 562-579.
- 17) Paul, P. S. et al. (1979): Enumeration of T-cells, B-cells and monocytes in the peripheral blood of normal and lymphocytic cattle. *Clin. Exp. Immunol.*, 35, 306-316.
- 18) Prasad, A. (1958): The association of hypogammaglobulinemia and chronic lymphatic leukemia. *Am. J. Med. Sci.*, 230, 610-613.
- 19) Rosset, G., Farquet, J-J. & Cruchaud, A. (1978): The serum immunoglobulins in lymphoproliferative malignancies. *Europ. J. Cancer*, 14, 369-376.
- 20) Takashima, I. et al. (1977): B-lymphocytes and T-lymphocytes in three types of bovine lymphosarcoma, *J. Natl. Cancer Inst.*, 59, 1205-1209.
- 21) Theilen, G. H. & Dungworth, D. L. (1965): Bovine lymphosarcoma in California. III. The calf form. *Am. J. Vet. Res.*, 26, 696-709.
- 22) Trainin, Z. et al. (1973): Levels of IgM and IgG in the sera of normal and leukaemic calves. *J. Comp. Pathol.*, 83, 87-90.
- 23) Ultmann, J. E. (1959): The clinical implications of hypogammaglobulinemia in patients with chronic lymphocytic leukemia and lymphocytic lymphosarcoma. *Ann. Intern. Med.*, 51, 501-516.
- 24) Yamamoto, H. et al. (1982): Histopathological definition of the adult and calf types of bovine leukosis. *Natl. Inst. Anim. Health Q. (Jpn.)*, 22, 115-125.
- 25) Zwahlen, R. D., Tontis, A. & Scheider, A. (1987): Cutaneous lymphosarcoma of helper/inducer T-cell origin in a calf. *Vet. Pathol.*, 24, 504-508.

(Received for publication, November 4, 1997)



## Results

### 1) Hematological, serological and serum protein analyses

The lymphocyte counts, antibodies to BLV, serum protein concentrations and the results of the immunodiffusion test are presented in [Table 1](#). A marked increase of the number of peripheral lymphocytes was noted in 2 cases of the adult form (Nos. 1 and 3) and 2 cases of the calf form (Nos. 6 and 9). Antibodies to BLV were detected in all the cases of the adult form.

#### [Table.1. Results of hematological and serum protein analyses\(41 KB\)](#)

The albumin concentration was low in some animals and there were slight variations in  $\alpha$ - and  $\beta$ -globulin concentrations among the cases.

The  $\gamma$ -globulin concentration markedly decreased to 1.1-1.5 g/dl in 3 cases of the adult form (Nos. 1 to 3), and moderately to 1.7 g/dl in 2 cases of the same form (Nos. 4 and 5). In 3 cases of the calf form (Nos. 6 to 8), the  $\gamma$ -globulin concentration was 0.3-0.5 g/dl and much lower than that of the adult form. The other case (No. 9) showed a moderate hypogammaglobulinemia and the concentration of  $\gamma$ -globulin was 1.7 g/dl. In one case of the thymic form (No. 10), the  $\gamma$ -globulin concentration slightly increased to 2.9 g/dl. In the other case (No. 11), a normal value of 2.4 g/dl was recorded. In a cow with the skin form (No. 12), the concentration of  $\gamma$ -globulin decreased to 0.8 g/dl in the tumor stage, but increased to 3.4 g/dl in the regressive stage.

#### [Fig. 1. Electrophoresis of sera from a healthy heifer \(A\) and leukotic cattle \(No. 8\) with calf form \(B\)\(19 KB\)](#)

Immunoelectrophoresis revealed the absence of IgM lines in 3 out of 4 cases of the calf form (Nos. 6, 7 and 9) ([Figs. 1A and 1B](#)). The remaining one (No. 8) had a weak IgM line.

### 2) Cell surface markers

The mean value of sIg-positive cells in the adult form markedly increased to 82.8% (SD $\pm$ 6.4) and that of RF-positive cells significantly decreased to 5.7% (SD $\pm$ 2.5) in peripheral lymphocytes ([Table 2](#)). In the lymph nodes with extensive neoplastic involvement of one case, the percentage of sIg-positive cells increased to 66.4% and that of RF-positive cells decreased to 6.4% (No. 2), though the moderately involved lymph nodes in 2 cases contained sIg-positive cells and RF-positive cells with percentages of 51.0 and 28.4% in one case (No. 4), and 54.4 and 27.9% in the other case (No. 5), respectively. Most of the neoplastic cells in the adult form were considered to harbor B-cell markers. In the calf form, the levels of sIg-positive cells and RF-positive cells were, respectively, only 7.6% (SD $\pm$ 2.2) and 7.1% (SD $\pm$ 5.9) in the peripheral lymphocytes, and 6.2% (SD $\pm$ 2.4) and 4.7% (SD $\pm$ 4.1) in the neoplastic lymph nodes. The neoplastic cells were considered to have neither a B- nor T-cell marker. In the thymic form, the percentages of sIg-positive cells and RF-positive cells in peripheral lymphocytes were different in each case. Although one case (No. 10) showed 31.9% of RF-positive cells, a similar value to that of a normal control, the percentage of sIg-positive cells decreased to 3.4%. In the other case (No. 11), the level of RF-positive cells increased moderately to 52.3%, while that of sIg-positive ones decreased slightly to 27.6%. In the neoplastic thymus, the mean values of sIg- positive cells and RF-positive cells were 3.5% (SD $\pm$ 1.5) and 3.8% (SD $\pm$ 1.6), respectively. The neoplastic cells in the thymic form were considered to have neither a B- nor T-cell maker. Surface markers of neoplastic cells in the skin form were not examined.

#### [Table.2. Results of surface marker and intracytoplasmic immunoglobulin examinations\(50 KB\)](#)

In a healthy heifer, sIg-positive cells and RF-positive cells amounted to 36.9 and 35.8% in the peripheral blood, 52.5 and 38.6% in the lymph nodes, and 4.6 and 62.2% in the thymus, respectively.

### 3) Pathological findings

**Adult form:** In 3 cases (Nos. 1 to 3), there was an almost generalized neoplastic involvement of the lymph nodes, which consisted of extensive proliferation of neoplastic cells. The original structure of many lymph nodes was almost completely absent except for one case (No. 3). In the moderately involved lymph nodes, the neoplastic cells tended to proliferate in the sinuses. The other 2 cases (Nos. 4 and 5) showed a localized neoplastic involvement of the lymph nodes. The various extra-nodal tissues were also invaded ([Table 3](#)). Ultrastructurally, neoplastic cells varied in size from small cells with scanty cytoplasm to large cells with abundant cytoplasm. The nuclei showed irregular contours with indentations, and contained coarse chromatin and large nucleoli ([Fig. 2](#)). The rough-surfaced endoplasmic reticulum (RER) was poorly developed. There were a few mitochondria and small areas of Golgi apparatus in the cytoplasm, and free ribosomes were abundant, especially in the large cells.

[Tabel.3. Results of pathological examination of neoplastic lesions\(43 KB\)](#)

[Fig. 2. Electron micrograph of neoplastic cell in adult form \(No. 2\)\(35 KB\)](#)

**Calf form:** In all the cases, systemic neoplastic involvement was observed in the lymph nodes, and also characteristic involvement was observed in the Glisson capsule of the liver and in the bone marrow²⁴). The neoplastic tissues were also present in other sites (Table 3). In 3 cases (Nos. 6 to 8), the lymphatic parenchyma was crowded with neoplastic cells, and normal lymphatic structures were absent. The other case (No. 9) showed very small areas of normal lymphatic tissue surviving among severe neoplastic proliferation. Ultrastructurally, the size of the neoplastic cells differed in each case ranging from small to medium. Small cells had scanty cytoplasm with poorly developed RER and a few mitochondria, and their nuclei were oval and chromatin was coarse. Medium-sized cells displayed oval nuclei and abundant cytoplasm, in which organelles similar to those of small cells were observed ([Fig. 3](#)).

[Fig. 3. Electron micrograph of neoplastic cell in calf form \(No. 9\)\(35 KB\)](#)

**Thymic form:** One case (No. 10) showed a large mass of neoplastic thymus and systemic neoplastic lesions, which resembled those of the calf form. In the other case (No. 11), neoplastic lesions were localized in the thymus and a few lymph nodes surrounding it. Ultrastructurally, the neoplastic cells were small with round or slightly indented nuclei with condensed chromatin and inconspicuous nucleoli. The organelles were poorly developed like those in the calf form ([Fig. 4](#)).

[Fig. 4. Electron micrograph of neoplastic cell in thymic form \(No. 10\)\(35 KB\)](#)

**Skin form:** In addition to the neoplastic lymphoid-cell proliferation in the skin, there were palpable swellings of the superficial and pelvic lymph nodes in the tumor stage. In the regressive stage, the neoplastic cells disappeared from the dermis, and most of the neoplastic cells in the lymph nodes and kidneys degenerated with infiltration of normal lymphocytes and macrophages¹¹). Numerous plasma cells infiltrated many lymph nodes without neoplastic involvement. Ultrastructurally, neoplastic cells were polygonal in shape, and the organelles consisted of poorly developed RER, a few mitochondria and numerous ribosomes. The nuclei were round to oval in shape, and contained a small amount of chromatin and distinct nucleoli. Nuclear convolution was not observed ([Fig. 5](#)).

[Fig. 5. Electron micrograph of neoplastic cell in skin form \(No. 12\)\(35 KB\)](#)

Intracytoplasmic IgM, IgG and IgA were not detected in the neoplastic cells of the 4 types of bovine lymphosarcomas ([Table 3](#)). In contrast, the lymph nodes of a healthy heifer contained plasma cells and immunoblasts, which gave a positive reaction for IgM, IgG or IgA.

## Discussion

Human lymphomas are frequently accompanied by abnormalities of serum  $\gamma$ -globulin, such as hypergammaglobulinemia with M-component and hypogammaglobulinemia^{7,16,18,19,23}). Electrophoretic patterns for serum  $\gamma$ -globulin have revealed normal, increased or decreased concentrations in bovine lymphosarcomas¹). In the present study, animals in the adult form had antibodies to BLV and typical lymphosarcoma as described previously²⁴). The values of serum protein suggest that an increase of involved lymph nodes causes a decrease of the level of serum  $\gamma$ -globulin. Since the neoplastic cells gave a positive reaction for sIg, they were presumably derived from the B-cell series²⁰). However, these neoplastic cells showed a poorly developed RER and lacked intracytoplasmic immunoglobulins. It is considered that the neoplastic cells could not differentiate into immunoglobulin-producing cells, and extensive proliferation of these cells in the lymph nodes may cause a decrease of the concentration of

serum  $\gamma$ -globulin.

The characteristic lesions of the calf form consisted of systemic involvement of the lymph nodes and neoplastic proliferation in the bone marrow and in the Glisson capsule of the liver^{21,24}). Although the calf form is most common in calves younger than 6 months of age, similar lesions may be observed in adolescent or adult cattle without antibodies to BLV²⁴), as in the 3 cases in the present study. Neither a B- nor T-cell marker was present in our cases, and the inability to produce immunoglobulins was demonstrated by the absence of intracytoplasmic immunoglobulins and poorly developed RER. Severe hypogammaglobulinemia in 3 cases (Nos. 6 to 8) was probably due to the absence of normal tissue in the lymph nodes, which was replaced by neoplastic proliferation. The moderate decrease of the concentration of serum  $\gamma$ -globulin in one case (No. 9) was presumably associated with the small area of residual lymphatic tissues in the lymph nodes.

The thymic form showed typical involvement in the thymus and the neoplastic cells had neither a B- nor T-cell marker. These cells may originate from thymocytes lacking a T-cell marker due to malignant transformation. In one case, the  $\gamma$ -globulin concentration slightly increased despite the generalized involvement of the lymph nodes, which may be associated with the activation of remaining B-cells by the stimulation of neoplastic cells. It is suggested that the normal value in the other case was due to the fact that in the various lymph nodes without neoplastic lesions normal immunological functions were maintained.

In the skin form, the neoplastic lesions were formed in the lymph nodes and various organs as well as in the skin. These lesions may regress within a few months after the initial recognition of the tumor¹¹). In a study of cutaneous lymphosarcoma, the neoplastic cells gave a negative reaction for the RF test¹¹), while another study showed that the neoplastic cells had a marker for helper/inducer T-cells²⁵). In our study, hypogammaglobulinemia in the tumor stage may be associated with the proliferation of neoplastic cells in the lymph nodes, and hypergammaglobulinemia in the regressive stage may be due to the presence of numerous plasma cells in the lymph nodes.

A lower level of IgM fraction in the sera was observed in BLV-positive cattle with persistent lymphocytosis⁶). In cattle with lymphosarcoma, the absence of IgM was pointed out²²), although the level of IgM did not decrease significantly in other studies¹⁵). Ichijo described a decrease of IgM level in the adult form and IgG in the calf form⁹). No IgM line was detected in our 3 cases with the calf form. It was reported that the immunoblasts, which correspond to one stage of B-cell differentiation, produced initially IgM during differentiation to plasma cells¹²). When the lymphoid tissues are damaged rapidly by malignant growth, the IgM-producing cells may be affected first. In the remaining case of the calf form, with a weak IgM line, it is possible that IgM-producing cells may remain elsewhere including the extra-nodal lymphoid tissues or that IgM which had already been produced may keep a detectable concentration in the serum.

The authors thank Professor Emeritus Dr. Y. Kono, Tokyo University of Agriculture and Technology for the assay of antibodies against BLV.



[Back to: Contents](#)



[Back to: The first page of JARQ](#)



[Back to: JIRCAS home page](#)



Japan International Research Center for Agricultural Sciences  
Ministry of Agriculture, Forestry, and Fisheries  
1-2 Ohwashi, Tsukuba, Ibaraki 305-8686 JAPAN  
Telephone 0298-38-6304  
published on July 15, 1998

Table.1  
Results of hematological and serum protein analyses

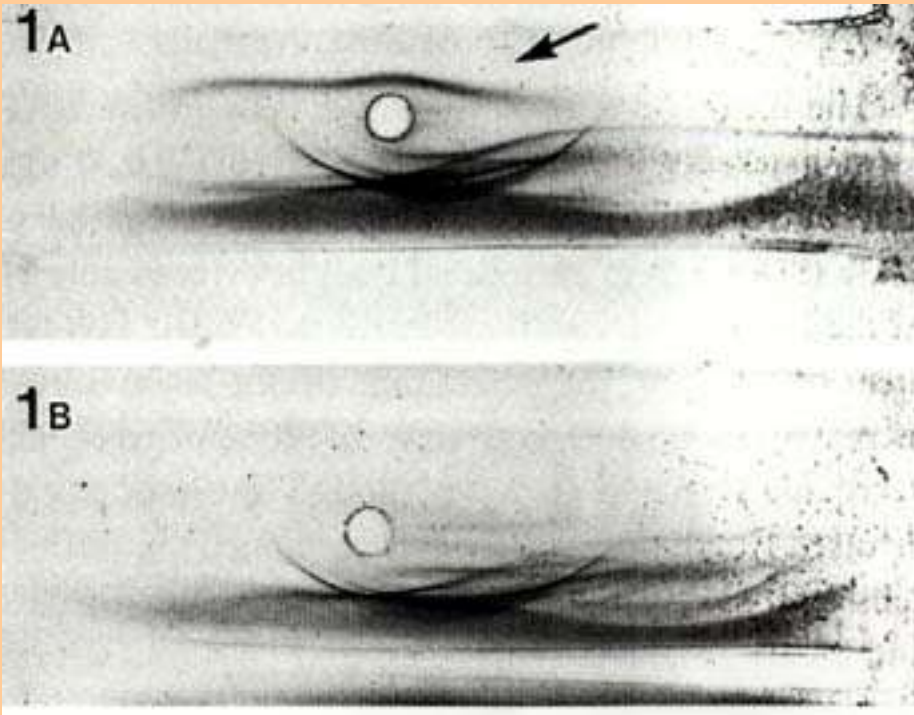
No.	Breed	Age (years)	Sex	BLV antibodies	Number of lymphocytes ( $10^3/\mu\text{l}$ )	Albumin (g/dl)	Globulin (g/dl)			Total protein (g/dl)	IgM line
							$\alpha$	$\beta$	$\gamma$		
<b>(Adult form)</b>											
1	H ^{a)}	4.01	F	+	17.1	3.4	1.4	0.7	1.1	6.6	+ ^{c)}
2	H	8.0	F	+	9.3	3.8	2.0	1.1	1.2	8.1	+
3	H	2.0	F	+	21.0	4.5	1.2	0.8	1.5	8.0	+
4	H	5.0	F	+	8.3	3.6	1.5	0.7	1.7	7.5	+
5	J ^{b)}	4.10	F	+	7.2	3.0	1.4	0.8	1.7	6.9	+
<b>(Calf form)</b>											
6	H	6.0	F	-	107.6	3.8	1.5	0.7	0.3	6.3	-
7	H	1.06	F	-	4.4	2.9	1.5	0.6	0.5	5.5	$\pm$ ^{d)}
8	H	0.03	F	-	4.4	2.9	1.1	0.7	0.5	5.2	-
9	H	2.04	F	-	60.2	2.3	2.0	1.3	1.7	7.3	-
<b>(Thymic form)</b>											
10	H	2.08	F	-	6.7	3.0	1.0	0.9	2.9	7.8	+
11	H	1.03	F	-	3.4	3.9	1.3	1.3	2.4	9.0	+
<b>(Skin form)</b>											
12	Tu ^{e)}	2.03	F	-	5.0	4.4	1.8	1.2	0.8	8.2	+
	Re ^{f)}					2.7	1.3	0.8	3.4	8.2	+
<b>(Control)</b>											
13	H	2.0	F	-	6.1	3.5	1.0	0.6	2.2	7.3	+

a): H; Holstein. b): J; Japanese Black. c): +; Clear line. d):  $\pm$ ; Weak line. e): Tu; Tumor stage. f): Re; Regressive stage.



[BACK](#)

Fig. 1  
Electrophoresis of sera from a healthy heifer (A)  
and leukotic cattle (No. 8) with calf form (B)  
IgM line (arrow) is absent in leukotic cattle.



 [BACK](#)



Table.2

Results of surface marker and intracytoplasmic immunoglobulin examinations

No.	Surface markers of blood lymphocytes (%)		Surface markers in lymph nodes or thymus (%)		cIg ^{a)} in lymph nodes		
	sIg ^{b)}	RF ^{c)}	sIg	RF	IgM	IgG	IgA
<b>(Adult form)</b>							
1	88.2	6.6	ND ^{d)}	ND	-	-	-
2	90.2	8.8	66.4L ^{e)}	6.4	-	-	-
3	80.8	1.7	ND	ND	-	-	-
4	78.3	7.3	51.0L	28.4L	-	-	-
5	72.8	4.3	54.5L	27.9L	-	-	-
Mean	82.8 ± 6.4 ^{g)}	5.7 ± 2.5	64.0 ± 2.2	20.9 ± 10.2			
<b>(Calf form)</b>							
6	9.1	2.0	ND	ND	-	-	-
7	7.3	14.3	8.7L	0L	-	-	-
8	10.0	11.8	7.1L	10.1L	-	-	-
9	4.2	0.5	2.8L	4.2L	-	-	-
Mean	7.6 ± 2.2	7.1 ± 5.9	6.2 ± 2.4	4.7 ± 4.1	-	-	-
<b>(Thymic form)</b>							
10	3.4	31.9	2.0T ^{f)}	5.4T	-	-	-
11	27.6	53.2	5.1T	2.2T	-	-	-
Mean	15.5 ± 12.1	45.5 ± 10.6	3.5 ± 1.5	3.8 ± 1.6	-	-	-
<b>(Skin form)</b>							
12	ND	ND	ND	ND	-	-	-
<b>(Control)</b>							
13	36.9	35.8	(52.5L) ^{h)} (4.6T)	(38.6L) (62.2T)	(+) ⁱ⁾	(+)	(+)

a): cIg; Intracytoplasmic immunoglobulin-positive cells. b): sIg; Surface immunoglobulin-positive cells. c): RF; Cells positive for rosette-forming test. d): ND; Not done. e): L; Lymph nodes. f): T; Thymus. g): Standard deviation of the mean. h): Figures in parenthesis indicate values in normal lymph nodes(L) and thymus(T). i): Normal plasma cells.


[BACK](#)

Tabel.3

Results of pathological examination of neoplastic lesions

No.	Lymph nodes	Spleen	Liver	Kidneys	Heart	Lungs	Abomasum	Uterus	Bone marrow	Thymus	Skin	Other organs
<b>(Adult form)</b>												
1	+++G ^{a)}	+	-	+	+++	+	+++	+++	-	-	-	++
2	+++G	-	-	-	+	-	+	+	-	-	-	++
3	++ G	+++	-	+++	+++	++	+	+++	-	-	-	+++
4	+ L ^{b)}	-	-	-	+++	-	+++	+++	-	-	-	++
5	+ L	-	-	-	+++	-	+++	+++	-	-	-	++
<b>(Calf form)</b>												
6	+++S ^{c)}	+++	+++	+++	+	+	-	++	++	-	-	+++
7	+++S	+++	+++	+++	-	+++	-	+	+	+	-	+++
8	+++S	-	+++	++	-	+	-	+	+++	+	-	++
9	+++S	++	+	++	+	++	+	+	+	-	-	+
<b>(Thymic form)</b>												
10	++ S	+++	++	++	-	-	-	++	+	+++	-	+
11	+ L	-	-	-	-	-	-	-	-	+++	-	-
<b>(Skin form)</b>												
12	+ L	-	-	+	-	-	-	-	-	-	+++ B ^{d)}	-
<b>(Control)</b>												
13	-	-	-	-	-	-	-	-	-	-	-	-

+++ : Severe neoplastic lesions without normal structure of the organs. ++ : Moderate neoplastic lesions with small area of normal structure of organs. + : Mild lesions with slight neoplastic cell proliferation. - : No lesions. a): G; General distribution. b): S; Systemic distribution. c): L; Local distribution. d): B; Biopsied material.


[BACK](#)

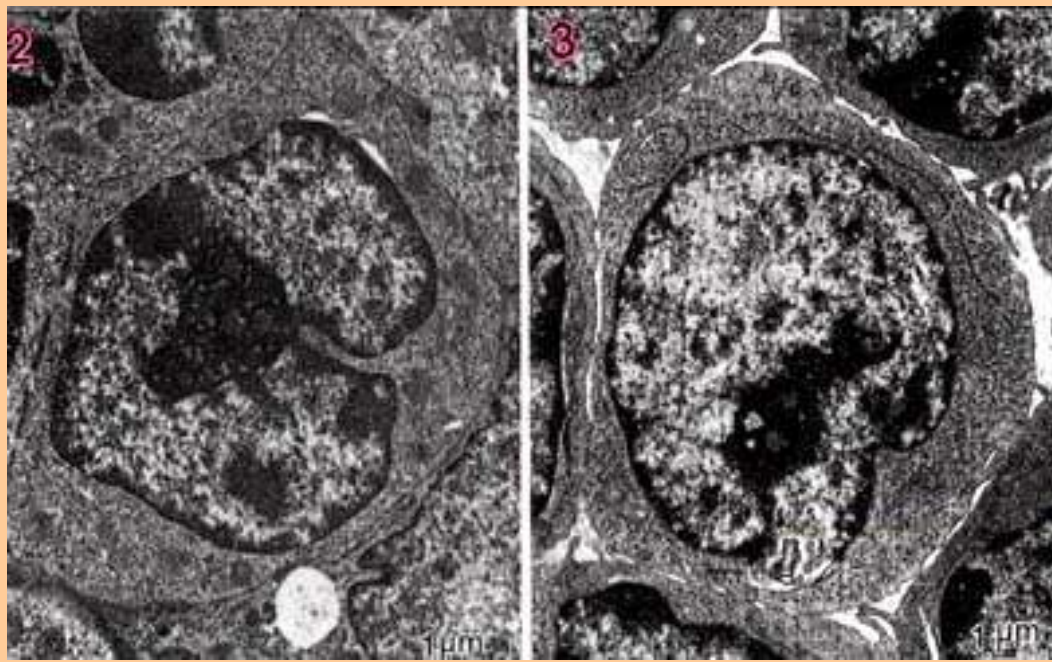


Fig. 2. (left)

Electron micrograph of neoplastic cell in adult form (No. 2)

The cell shows on irregularly indented nucleus and poorly developed organelles. (x3,300)

Fig. 3. (right)

Electron micrograph of neoplastic cell in calf form (No. 9)

The cell shows on oval-shaped nucleus and poorly developed organelles. (x3,300)



[BACK](#)

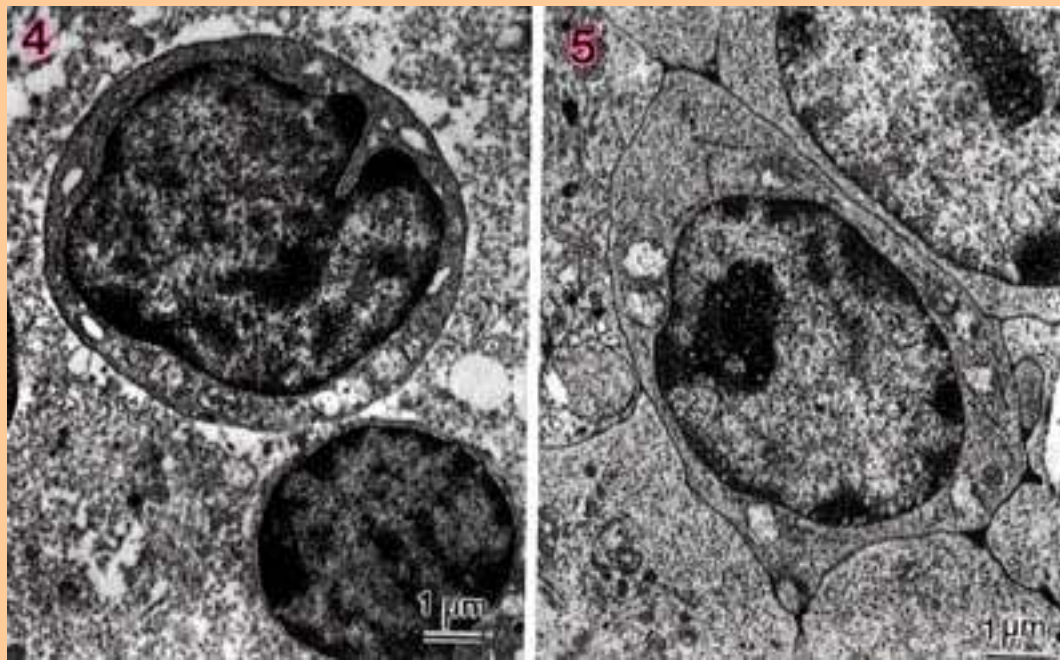


Fig. 4.(left)

Electron micrograph of neoplastic cell in thymic form (No. 10)  
The cell shows an oval-shaped nucleus with a small indentation and  
poorly developed organelles. (x3,300)

Fig. 5.(right)

Electron micrograph of neoplastic cell in skin form (No. 12)  
The cell shows a round nucleus and poorly developed organelles. (x3,300)



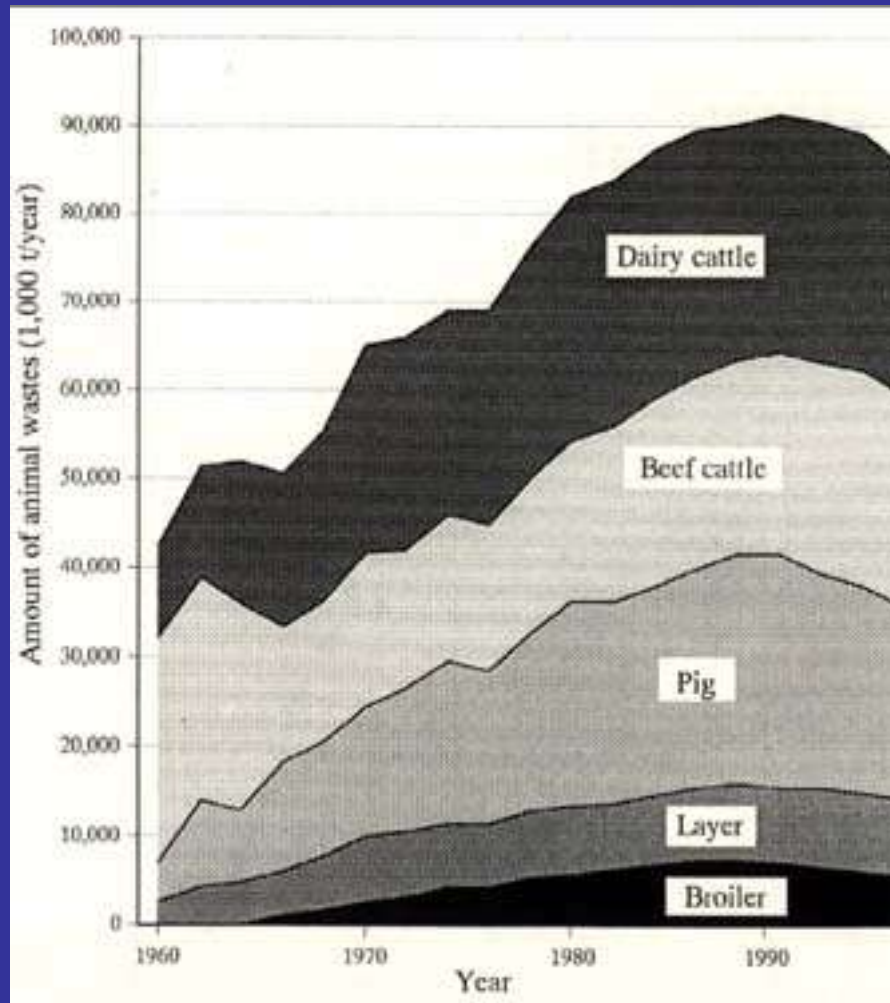
[BACK](#)

**Table.1****Changes in the number of pigs, farms and the average number of pigs per farm****Table 1. Changes in the number of pigs, farms and the average number of pigs per farm**

Items		1966	1971	1976	1981	1986	1991	1996
Number of farms	(1,000 farms)	714.3	398.3	195.6	126.7	74.2	36.0	16.0
Number of pigs	(1,000 head)	5,158	6,904	7,459	10,065	11,061	11,335	9,900
Average number of pigs per farm	(head/farm)	7.2	17.3	38.1	79.4	149.1	314.9	618.8

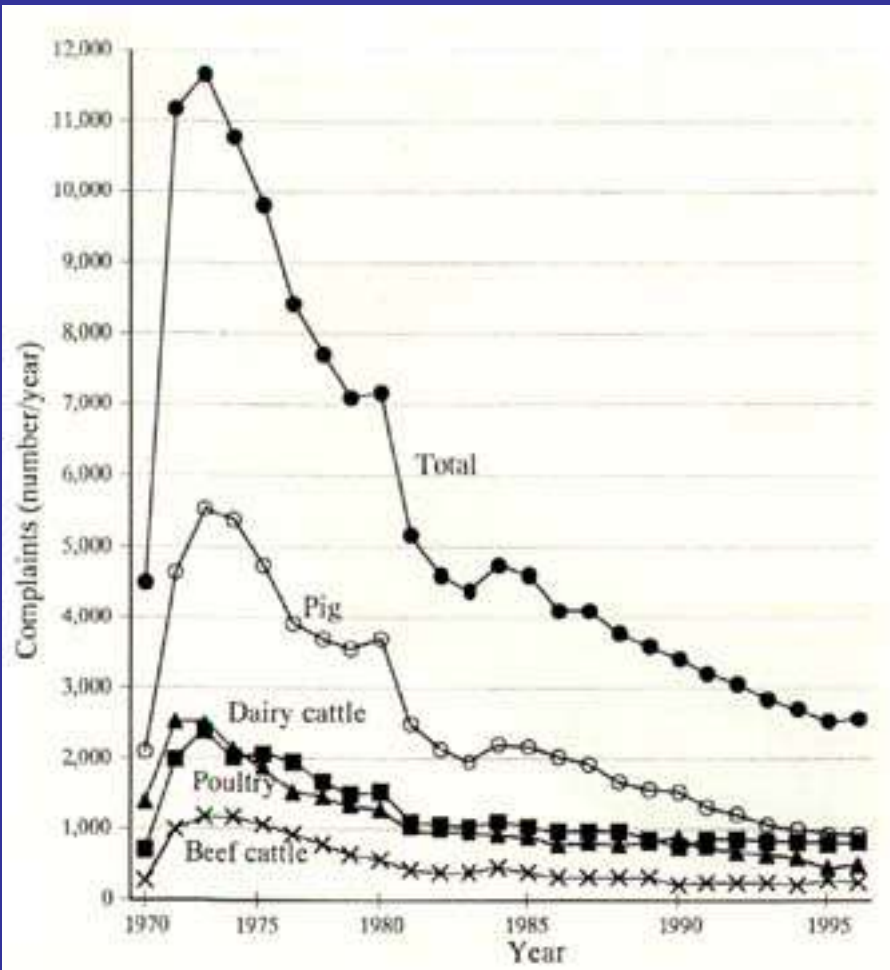
[BACK](#)

**Fig.1**  
**Annual changes in animal wastes**



[BACK](#)

**Fig.2**  
**Annual changes in the number of complaints about pollution problems by animal wastes**

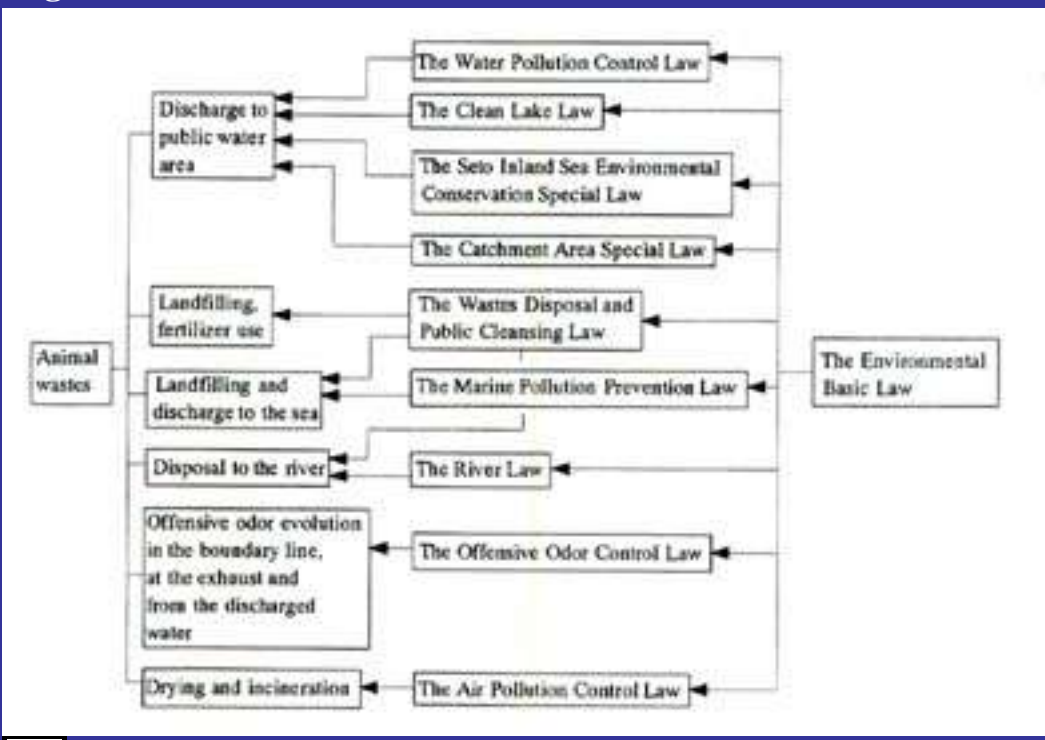


**Fig. 2.** Annual changes in the number of complaints about pollution problems by animal wastes



[BACK](#)

**Fig.3**  
**Legal constraints related to animal wastes**



 [BACK](#)



**Table.3**  
**Criteria of offensive odors**

Unit: ppm (mL/m ³ )	
Items	Range
1. Ammonia	1 - 5
2. Methylmercaptan	0.002 - 0.01
3. Hydrogen sulfide	0.02 - 0.2
4. Dimethyl sulfide	0.01 - 0.2
5. Dimethyl disulfide	0.009 - 0.1
6. Trimethylamine	0.005 - 0.07
7. Acetaldehyde	0.05 - 0.5
8. Propionaldehyde	0.05 - 0.5
9. n-Butyraldehyde	0.009 - 0.08
10. Isobutyraldehyde	0.02 - 0.2
11. n-Valeraldehyde	0.009 - 0.05
12. Isovaleraldehyde	0.003 - 0.01
13. Isobutanol	0.9 - 20
14. Ethyl acetate	3 - 20
15. Methyl isobutyl ketone	1 - 6
16. Toluene	10 - 60
17. Styrene	0.4 - 2
18. Xylene	1 - 5
19. Propionic acid	0.03 - 0.2
20. n-Butyric acid	0.001 - 0.006
21. n-Valeric acid	0.0009 - 0.004
22. Isovaleric acid	0.001 - 0.01



[BACK](#)

Welcome to JIRCAS home page!

## Japan International Research Center for Agricultural Sciences

[JIRCAS HOME PAGE in Japanese \(SJIS\)](#)

### JIRCAS Information

[What's JIRCAS?](#)

[Fellowship Program at Tsukuba 2002](#)

[Fellowship Program at Okinawa 2002](#)

[What's New?](#)

[JIRCAS International Symposium 2002](#)

[JIRCAS International WorkShop](#)

[Research Highlights](#)

[JIRCAS English language publications](#)

[Annual Report \(2000\)](#)

[JIRCAS Newsletter](#)

[JARQ \(Japan Agricultural Research Quarterly\)](#)

[JIRCAS Journal](#)

[JIRCAS Working ReportI](#)

[Map to JIRCAS & Transportation](#)

[AFFRC HOME PAGE](#)

### Related English Language Sites

[MAFF \(Ministry of Agriculture, Forestry and Fisheries\)](#)

[FAO \(Food and Agricultural Organization\)](#)

[CGIAR \(Consultative Group on International Agricultural Research\)](#)

[JICA \(Japan International Cooperative Agency\)](#)

[National Research Institutes](#)

**(Web Pages last updated 04/Oct./2002)**

---

[www@jircas.affrc.go.jp](mailto:www@jircas.affrc.go.jp)

Japan International Research Center for Agricultural Sciences

1-1, Ohwashi, Tsukuba, Ibaraki 305-8686 JAPAN

Telephone 0298-38-6313

Facsimile 0298-38-6316



# JIRCAS Visiting Research Fellowship Program at Tsukuba 2002

---

Japan International Research Center for Agricultural Sciences (JIRCAS) has implemented the "Visiting Research Fellowship Program at Tsukuba" since 1995.

The fellowship aims at the promotion of collaborative research to address various problems confronting the countries in developing regions on a global scale, including the critical situation of food production, the progression of desertification and the gradual disappearance of genetic resources.

JIRCAS which is located in Tsukuba Science City and is equipped with facilities for advanced research, is inviting young promising researchers from institutes in developing regions who will play a major role in the activities of these institutes in future to carry out collaborative research for the sustainable development or rapid progress of agriculture, forestry and fisheries compatible with the preservation of the natural environment.

Under the Fellowship Program, a total of fourteen (14) researchers will be invited, of which ten (10) will undertake the JIRCAS type programs for a period of one (1) year and the other four (4) researchers will be engaged in the NIAS type programs for a period of five (5) months. The former ten (10) will carry out collaborative research at JIRCAS HQ, while the latter four (4) will conduct research at the National Institute of Agrobiological Sciences (NIAS) at Tsukuba.

## Fellowship Qualifications

(1) Applicants should be outstanding researchers who will play a major role in the activities of the respective institutes in future. After the completion of the Fellowship, they should continue to carry out research at the same institute.

- (2) Hold a Master's degree in a field relating to socio-economics and natural sciences and technology or equivalent qualifications in related fields. Be preferably less than 35 years of age.
- (3) Carry out research related to one of the themes listed under "Research Themes".
- (4) Should enjoy a good health.
- (5) Have an adequate command of English or Japanese language.

## Tenure

In principle, starting from October 2002, the JIRCAS type program will cover a period of one (1) year and the NIAS type program will cover a period of five (5) months.

## Fellowship Conditions

- (1) A round-trip airline ticket (economy class) will be available (except for dependents).
- (2) Living allowance: 260,000yen per month.  
(including housing allowance)
- (3) Housing: International Guesthouse  
2-1-2, Kan-nondai, Tsukuba
- (4) Fixed-rate insurance package (for injury, sickness and damage) will be offered under the JIRCAS Fellowship Program. (except for dependents)

## Application Procedure

Applicants are required to submit the following documents to the President of JIRCAS.

- (1) Application form

[pdf](#)

(2) Copies of the most important articles (Up to 3)

## Deadline for Application

March 15, 2002(keep strictly)

## Notification

JIRCAS will examine the application documents and notify the results of the selection to the applicants about three months after the deadline date for application.

Further information about the Visiting Research Fellowship Program can be obtained from the International Relation Section, Japan International Research Center for Agricultural Sciences, 1-1, Ohwashi, Tsukuba, Ibaraki, 305-8686 Japan.

*****

URL: <http://www.jircas.affrc.go.jp/>

E-mail: [irs@ml.affrc.go.jp](mailto:irs@ml.affrc.go.jp)

Tel: 81 - 298 - 38 - 6335

Fax: 81 - 298 - 38 - 6337

HOME



# JIRCAS Visiting Research Fellowship Program at Okinawa 2002



Japan International Research Center for Agricultural Sciences (JIRCAS) has implemented the "Visiting Research Fellowship Program at Okinawa" since 1992.

The Fellowship emphasizes presently pioneer research on the conservation of the global environment and optimum utilization of bio-resources in the tropics and subtropics.

The successful candidates, the number of which will be about 10, will undertake relevant research pertaining to one of the five themes listed below. Research will be carried out at the Okinawa Subtropical Station of JIRCAS in Ishigaki City, Okinawa Prefecture which is located in the subtropical zone of Japan and is equipped with advanced facilities for research.

## Research Themes

- (1) Efficient use of water and fertilizers
- (2) Evaluation and utilization of heat- and salt-tolerant crops
- (3) Evaluation and characterization of tropical and subtropical fruits
- (4) Evaluation and utilization of useful traits in sugarcane and sweet potato
- (5) Integrated pest management of tropical and subtropical crops

## Fellowship Qualifications

- (1) Applicants should be nationals of developing countries, be currently employed in a research organization (institute or university, etc.) and be engaged in research relating to tropical or subtropical agriculture and forestry, in principle.
- (2) Hold a Ph. D. degree in a field relating to natural sciences and technology or equivalent qualifications in related fields.
- (3) Be a researcher who will take up research subjects related to one of the four themes listed in the forementioned "Research Themes".
- (4) Be preferably less than 45 years of age.
- (5) Should enjoy a good health.
- (6) Have an adequate command of English or Japanese language.
- (7) Be committed to pursuing research in fields related to tropical agriculture and forestry after the termination of the Fellowship.

## Tenure

In principle, one year, starting from October 2002.

## Fellowship Conditions

- (1) A round-trip airline ticket (economy class) will be available (except for dependents).
- (2) Living allowance: 260,000yen per month.  
(excluding housing allowance)
- (3) Housing (cost borne by JIRCAS):  
Maison ICRS, 874 Maezato,



Ishigaki, Okinawa, 907-0002 JAPAN

(4) Fixed-rate insurance package (for injury, sickness and damage) will be offered under the JIRCAS Fellowship Program. (except for dependents)

## Application Procedure

Applicants are required to submit the following documents to the President of JIRCAS.

(1) Application form

[pdf](#)

(2) Copies of the most important articles (Up to 3)

## Deadline for Application

March 15, 2002 (keep strictly)

## Notification

JIRCAS will examine the application documents and notify the results of the selection to the applicants about three months after the deadline date for application.

Further information about the Visiting Research Fellowship Program can be obtained from the International Relation Section, Japan International Research Center for Agricultural Sciences, 1-1, Ohwashi, Tsukuba, Ibaraki, 305-8686 Japan.

*****

URL: <http://ss.jircas.affrc.go.jp/index.html>

E-mail: [irs@ml.affrc.go.jp](mailto:irs@ml.affrc.go.jp)

Tel: 81 - 298 - 38 - 6335

Fax: 81 - 298 - 38 - 6337

[HOME](#)



**International Workshop  
on Nitrogen Fertilization  
and the Environment  
in East Asian Countries**

**5-9 Feb. 2001, Tsukuba, Japan**

**February 5 - 6:**

**International Symposium  
at Tsukuba International Congress Center (Epochal Tsukuba)**

**February 7 - 9:**

**Japan/China Project Meeting and Field Excursion  
in Ibaraki, Yamanashi and Shizuoka Prefectures**

**Thanks for you Collaboration!!**

**Closed with a Great Success!!**

A total of 100 scientists from 15 countries participated

The proceedings of the symposium will be published in  
a special issue of *Nutrient Cycling in Agro-Ecosystems*

**POST MEETING PAGES**

-  [Participants List](#)
-  [Photographs](#)
-  [Summary of the Discussion Session](#)
-  [Publication Info.](#)

 [Background](#)

 [General Information](#)

 [Program of International Symposium](#)

 [Japan/China Project Meeting and Field Excursion](#)

Japan International Research Center for Agricultural Sciences (JIRCAS)

1-2 Owashi, Tsukuba, Ibaraki 305-8686, JAPAN

Fax: +81-298-38-6651

E-mail: [annas@jircas.affrc.go.jp](mailto:annas@jircas.affrc.go.jp)

HOME

**Speakers and Chairs**

果酷伏  
中国科学院南京土壤研究所

**Cai, Guixin**  
Institute of Soil Science (ISS),  
Chinese Academy of Sciences  
Nanjing, China  
Phone: +86-25-7713781  
Fax: +86-25-3353590  
E-mail: gxcai@issas.ac.cn

果怕艦  
中国科学院南京土壤研究所

**Cai, Zucong**  
Institute of Soil Science (ISS),  
Chinese Academy of Sciences  
Nanjing, China  
Phone: +86-25-3353608-8001  
Fax: +86-25-3353590  
E-mail: zccai@issas.ac.cn

穉櫛椌  
メリーランド大学

**Ellis, Erle C.**  
University of Maryland, Baltimore County  
Baltimore, U.S.A.  
Phone: +1-410-455-3078  
Fax: +1-410-455-1056  
E-mail: ece@umbc.edu

波多野隆介  
北海道大学

**Hatano, Ryusuke**  
Hokkaido University  
Sapporo, Japan  
Phone: +81-11-706-3857  
Fax: +81-11-706-4960  
E-mail: hatano@chem.agr.hokudai.ac.jp

宝川靖和  
国際農林水産業研究センター

**Hosen, Yasukazu**  
Japan International Research Center for Agricultural Sciences  
(JIRCAS)  
Tsukuba, Japan  
Phone: +81-298-38-6354  
Fax: +81-298-38-6354  
E-mail: yhosen@jircas.affrc.go.jp

井上隆弘  
国際農林水産業研究センター

**Inoue, Takahiro**  
Japan International Research Center for Agricultural Sciences  
(JIRCAS)  
Tsukuba, Japan  
Phone: +81-298-38-6301  
Fax: +81-298-38-6337  
E-mail: tinoue@jircas.affrc.go.jp

**Participants List**  
**Speakers and Chairs**

*International Symposium  
on Nitrogen Fertilization and the Environment  
in East Asian Countries  
February 5-6, 2001, Tsukuba, Japan*

伊藤治  
国際農林水産業研究センター

**Ito, Osamu**  
Japan International Research Center for Agricultural Sciences  
(JIRCAS)  
Tsukuba, Japan  
Phone: +81-298-38-6306  
Fax: +81-298-38-6651  
E-mail: osamuito@jircas.affrc.go.jp

金錫哲  
農業科学技術院

**Kim, Seok-Cheol**  
National Institute of Agricultural Science and Technology  
(NIAST)  
Suwon, Korea  
Phone: +82-31-290-0255  
Fax: +82-31-290-0261  
E-mail: kimsc@rda.go.kr

熊澤喜久雄  
東京大学

**Kumazawa, Kikuo**  
The University of Tokyo  
Tokyo, Japan  
Phone: +81-3-3930-3369  
Fax: +81-3-3930-3369  
E-mail: kumazawa@bekkoame.ne.jp

前田守弘  
農業研究センター

**Maeda, Morihiro**  
National Agriculture Research Center (NARC)  
Tsukuba, Japan  
Phone: +81-298-38-8829  
Fax: +81-298-38-8837  
E-mail: mun@narc.affrc.go.jp

幕多賀戸  
スコットランド農業大学

**McTaggart, Iain**  
Scottish Agricultural College  
Edinburgh, UK  
Phone: +44-131-535-4181  
Fax: +44-131-667-2601  
E-mail: i.mctaggart@ed.sac.ac.uk

陽捷行  
農業環境技術研究所

**Minami, Katsuyuki**  
National Institute for Agro-Environmental Sciences (NIAES)  
Tsukuba, Japan  
Phone: +81-298-38-8141  
Fax: +81-298-38-8200  
E-mail: minami@niaes.affrc.go.jp

**Participants List**  
**Speakers and Chairs**

*International Symposium  
on Nitrogen Fertilization and the Environment  
in East Asian Countries  
February 5-6, 2001, Tsukuba, Japan*

三島慎一郎  
農業環境技術研究所

**Mishima, Shin-ichiro**  
National Institute for Agro-Environmental Sciences (NIAES )  
Tsukuba, Japan  
Phone: +81-298-38-8224  
Fax: +81-298-38-8199  
E-mail: shin@niaes.affrc.go.jp

宮地直道  
静岡県農業試験場海岸砂地分場

**Miyaji, Naomichi**  
Shizuoka Prefecture Agricultural Experiment Station  
Hamaoka, Japan  
Phone: +81-537-86-2218  
Fax: +81-537-86-5244  
E-mail: miyaji@ss.sand.agri-exp.pref.shizuoka.jp

毛愛文  
アメリカ農務省農業研究サービス

**Mosier, Arvin**  
United States Department of Agriculture-Agricultural Research  
Service (USDA-ARS)  
P. O. Box E, Fort Collins, CO 80522, USA  
Phone: +1-970-490-8250  
Fax: +1-970-490-8213  
E-mail: amosier@lamar.colostate.edu

中野明正  
野菜・茶業試験場

**Nakano, Akimasa**  
National Research Institute of Vegetables, Ornamental Plants  
and Tea (NIVOT)  
Taketoyo, Japan  
Phone: +81-569-72-1647  
Fax: +81-569-73-4744  
E-mail: anakano@nivot-pc.affrc.go.jp

新美洋  
九州農業試験場

**Niimi, Hiroshi**  
Kyushu National Agricultural Experiment Station  
Miyakonojo, Japan  
Phone: +81-986-22-1506  
Fax: +81-986-23-1168  
E-mail: niimi@mykz.affrc.go.jp

緻酸攪  
中国農業科学院土壤肥料研究所

**Pang, Huancheng**  
Institute of Soils and Fertilizers (ISF), Chinese Academy of  
Agricultural Sciences  
Beijing, China  
Phone: +86-10-68919739  
Fax: +86-10-68975161  
E-mail: hcpang@ppic.caas.ac.cn

**Participants List**  
**Speakers and Chairs**

*International Symposium  
on Nitrogen Fertilization and the Environment  
in East Asian Countries  
February 5-6, 2001, Tsukuba, Japan*

朴良昊  
農業科学技術院

**Park, Yang-Ho**  
National Institute of Agricultural Science and Technology  
(NIAST)  
Suwon 441-707, Korea  
Phone: +82-31-290-0255  
Fax: +82-31-290-0261  
E-mail: yhpark@rda.go.kr

袋瀧辛  
カルロヴィルヘルミナ工科大学

**Roelcke, Marco**  
Technical University Carolo-Wilhelmina  
Braunschweig, Germany  
Phone: +49-531-3915912  
Fax: +49-531-3918170  
E-mail: m.roelcke@tu-bs.de

盧基安  
農業科学技術院

**Roh, Kee-An**  
National Institute of Agricultural Science and Technology  
(NIAST)  
Suwon, Korea  
Phone: +82-31-290-0281  
Fax: +82-31-290-0277  
E-mail: karoh@rda.go.kr

庄子貞雄  
東北大学

**Shoji, Sadao**  
Tohoku University  
Sendai, Japan  
Phone: +81-22-245-0120  
Fax: +81-22-245-0120  
E-mail: sshoji@sm.rim.or.jp

橘正躬  
チッソ株式会社

**Tachibana, Masami**  
Chisso Corporation  
Minamata, Japan  
Phone: +81-966-63-7144  
Fax: +81-966-62-2099  
E-mail: m.tachibana@chisso.co.jp

戸田任重  
信州大学

**Toda, Hideshige**  
Shinshu University  
Matsumoto, Japan  
Phone: +81-263-37-2460  
Fax: +81-263-37-2460  
E-mail: h-toda@gipac.shinshu-u.ac.jp



**Participants List**  
**Speakers and Chairs**

*International Symposium  
on Nitrogen Fertilization and the Environment  
in East Asian Countries  
February 5-6, 2001, Tsukuba, Japan*

鶴田治雄  
農業環境技術研究所

**Tsuruta, Haruo**  
National Institute for Agro-Environmental Sciences (NIAES)  
Tsukuba, Japan  
Phone: +81-298-38-8276  
Fax: +81-298-38-8276  
E-mail: tsuruta@niaes.affrc.go.jp

渡辺武  
国際農林水産業研究センター

**Watanabe, Takeshi**  
Japan International Research Center for Agricultural Sciences (JIRCAS)  
Tsukuba, Japan  
Phone: +81-298-38-6355  
Fax: +81-298-38-6355  
E-mail: watatake@jircas.affrc.go.jp

オリ・クリスナ  
北海道大学

**Woli, Krishna P.**  
Hokkaido University  
Sapporo, Japan  
Phone: +81-11-706-2503  
Fax: +81-11-706-4960  
E-mail: kpwoli@chem.agr.hokudai.ac.jp

俾苧鈞  
中国農業科学院土壤肥料研究所

**Xu, Minggang**  
Institute of Soils and Fertilizers (ISF), Chinese Academy of Agricultural Sciences  
Beijing, China  
Phone: +86-10-68918649  
Fax: +86-10-68975161  
E-mail: mgxu@ppic.caas.ac.cn

八木一行  
国際農林水産業研究センター

**Yagi, Kazuyuki**  
Japan International Research Center for Agricultural Sciences (JIRCAS)  
Tsukuba, Japan  
Phone: +81-298-38-6353  
Fax: +81-298-38-6651  
E-mail: kyagi@jircas.affrc.go.jp

冲 坏  
国際農林水産業研究センター

**Yan, Xiaoyuan**  
Japan International Research Center for Agricultural Sciences (JIRCAS)  
Tsukuba, Japan  
Phone: +81-298-38-6353  
Fax: +81-298-38-6651  
E-mail: yanxy@jircas.affrc.go.jp

**Participants List**  
**Speakers and Chairs**

*International Symposium  
on Nitrogen Fertilization and the Environment  
in East Asian Countries  
February 5-6, 2001, Tsukuba, Japan*

嫖費

中国農業科学院土壤肥料研究所

**Zhang, Rui**

Institute of Soils and Fertilizers (ISF), Chinese Academy of  
Agricultural Sciences

Beijing, China

Phone: +86-10-68919739

Fax: +86-10-68975161

E-mail: rzhang@ppic.caas.ac.cn

嫖募卜

中国農業科学院土壤肥料研究所

**Zhang, Shuxiang**

Institute of Soils and Fertilizers (ISF), Chinese Academy of  
Agricultural Sciences

Beijing, China

Phone: +86-10-68918664

Fax: +86-10-68975161

E-mail: sxzhang@ppic.caas.ac.cn

幘秀忽

中国科学院南京土壤研究所

**Zhu, Jianguo**

Institute of Soil Science (ISS), Chinese Academy of Sciences  
Nanjing, China

Phone: +86-25-3601015

Fax: +86-25-3353590

E-mail: jgzhu@issas.ac.cn

幘孛措

中国科学院南京土壤研究所

**Zhu, Zhaoliang**

Institute of Soil Science (ISS), Chinese Academy of Sciences  
Nanjing, China

Phone: +86-25-3605791

Fax: +86-25-3353590

E-mail: zlzhu@issas.ac.cn

## **Participants List**

*Others*

*International Symposium  
on Nitrogen Fertilization and the Environment  
in East Asian Countries  
February 5-6, 2001, Tsukuba, Japan*

## **Other Participants**

阿部薫  
農業研究センター

**Abe, Kaoru**  
National Agriculture Research Center (NARC)  
Tsukuba, Japan  
Phone: +81-298-38-8829  
Fax: +81-298-38-8837  
E-mail: abekaoru@narc.affrc.go.jp

S. Acruaye  
千葉大学

**Acquaye, Solomon**  
Chiba University  
Matsudo, Japan  
Phone: +81-47-308-8720  
Fax: +81-47-308-8816  
E-mail:

バートマン  
国際農林水産業研究センター

**Bartman, J.**  
Japan International Research Center for Agricultural  
Sciences (JIRCAS)  
Tsukuba, Japan  
Phone: +81-298-38-6338  
Fax: +81-298-38-6337  
E-mail:

蛎秀勲  
千葉大学

**Chen, Jianyao**  
Chiba University  
Chiba, Japan  
Phone: +81-43-290284  
Fax: +81-43-2902859  
E-mail: CHJIAN@EARTH2.s.chiba-u.ac.jp

殷禕忽  
農業環境技術研究所

**Cheng, Weiguo**  
National Institute for Agro-Environmental Sciences  
(NIAES)  
Tsukuba, Japan  
Phone: +81-298-38-8257  
Fax: +81-298-38-8199  
E-mail: cheng@niaes.affrc.go.jp

江口定夫  
農業環境技術研究所

**Eguchi, Sadao**  
National Institute for Agro-Environmental Sciences  
(NIAES)  
Tsukuba, Japan  
Phone: +81-298-38-8276  
Fax: +81-298-38-8276  
E-mail: sadao@niaes.affrc.go.jp

## **Participants List**

### **Others**

*International Symposium  
on Nitrogen Fertilization and the Environment  
in East Asian Countries  
February 5-6, 2001, Tsukuba, Japan*

A. E. Eneji  
鳥取大学

**Eneji, Anthony E.**  
Tottori University  
Tottori, Japan  
Phone: +81-857-31-5366  
Fax: +81-857-31-5365  
E-mail: egrinyaeneji@hotmail.com

濱田浩正  
国際農林水産業研究センター

**Hamada, Hiromasa**  
Japan International Research Center for Agricultural  
Sciences (JIRCAS)  
Tsukuba, Japan  
Phone: +81-298-38-6336  
Fax: +81-298-38-6337  
E-mail: hamadah@affrc.go.jp

浜崎忠雄  
農業環境技術研究所

**Hamazaki, Tadao**  
National Institute for Agro-Environmental Sciences  
(NIAES)  
Tsukuba, Japan  
Phone: +81-298-38-8234  
Fax: +81-298-38-8234  
E-mail: hamazaki@niaes.affrc.go.jp

昆啾  
中国科学院南京土壤研究所

**Han, Yong**  
Institute of Soil Science (ISS),  
Chinese Academy of Sciences  
Nanjing, China  
Phone: +86-25-335-3608  
Fax: +86-25-3353590  
E-mail: hanyong@issas.ac.cn

長谷川浩  
東北農業試験場

**Hasegawa, Hiroshi**  
Tohoku National Agricultural Experiment Station  
Fukushima, Japan  
Phone: +81-24-593-6177  
Fax: +81-24-593-2155  
E-mail: hasegawa@affrc.go.jp

平岡洋  
国際協力事業団

**Hiraoka, Hiroshi**  
JICA  
Machida, Japan  
Phone: +81-42-725-4655  
Fax: +81-42-725-4655  
E-mail: hiraokah@attglobal.net

## **Participants List**

### **Others**

*International Symposium  
on Nitrogen Fertilization and the Environment  
in East Asian Countries  
February 5-6, 2001, Tsukuba, Japan*

寶示戸雅之  
草地試験場

**Hojito, Masayuki**  
National Grassland Research Institute  
Nishinasuno, Japan  
Phone: +81-287-37-7558  
Fax: +81-287-36-6629  
E-mail: legato@ngri.affrc.go.jp

Md.M. Hoque  
千葉大学

**Hoque, Md. Mozammed**  
Chiba University  
Matsudo, Japan  
Phone: +81-47-308-8908  
Fax: +81-47-308-8816  
E-mail: hoque@green.h.chiba-u.ac.jp

仔肴昶  
中国農業科学院土壤肥料研究所

**Huang, Hongxiang**  
Institute of Soils and Fertilizers (ISF),  
Chinese Academy of Agricultural Sciences  
Beijing, China  
Phone: +86-10-68918645  
Fax: +86-10-68975161  
E-mail:

今泉眞之  
農業工学研究所

**Imaizumi, Masayuki**  
National Research Institute of Agricultural Engineering  
Tsukuba, Japan  
Phone: +81-298-38-7200  
Fax: +81-298-38-7609  
E-mail: imaizuma@nkk.affrc.go.jp

稲垣善之  
森林総合研究所四国支所

**Inagaki, Yoshiyuki**  
Forestry and Forest Products Research Institute  
Kochi, Japan  
Phone: +81-88-844-1121  
Fax: +81-88-844-1130  
E-mail: yinagaki@ffpri-skk.affrc.go.jp

稲垣昌宏  
国際農林水産業研究センター

**Inagaki, Masahiro**  
Japan International Research Center for Agricultural  
Sciences (JIRCAS)  
Tsukuba, Japan  
Phone: +81-298-38-6360  
Fax: +81-298-38-6360  
E-mail: inagaki@affrc.go.jp

## **Participants List**

### **Others**

*International Symposium  
on Nitrogen Fertilization and the Environment  
in East Asian Countries  
February 5-6, 2001, Tsukuba, Japan*

犬伏和之  
千葉大学

**Inubushi, Kazuyuki**  
Chiba University  
Matsudo, Japan  
Phone: +81-47-308-8720  
Fax: +81-47-308-8816  
E-mail: inubushi@midori.h.chiba-u.ac.jp

石川雅也  
東京大学

**Ishikawa, Masaya**  
The University of Tokyo  
Tokyo, Japan  
Phone: +81-3-5841-5370  
Fax: +81-3-5841-8169  
E-mail: aimasa@m.ecc.u-tokyo.ac.jp

石川隆之  
国際農林水産業研究センター

**Ishikawa, Takayuki**  
Japan International Research Center for Agricultural  
Sciences (JIRCAS)  
Tsukuba, Japan  
Phone: +81-298-38-6354  
Fax: +81-298-38- 6354  
E-mail: tishi@jircas.affrc.go.jp

石川ツェベレスレン  
国際農林水産業研究センター

**Ishikawa, Tsevelsuren**  
Japan International Research Center for Agricultural  
Sciences (JIRCAS)  
Tsukuba, Japan  
Phone: +81-298-38-6354  
Fax: +81-298-38- 6354  
E-mail:

伊藤純雄  
農業研究センター

**Itoh, Sumio**  
National Agriculture Research Center (NARC)  
Tsukuba, Japan  
Phone: +81-298-38-8827  
Fax: +81-298-38-8837  
E-mail: sumi@narc.affrc.go.jp

神田健一  
国際農林水産業研究センター

**Kanda, Ken-ichi**  
Japan International Research Center for Agricultural  
Sciences (JIRCAS)  
Tsukuba, Japan  
Phone: +81-298-38-6353  
Fax: +81-298-38- 6651  
E-mail: kandak@jircas.affrc.go.jp

**Participants List**  
**Others**

*International Symposium  
on Nitrogen Fertilization and the Environment  
in East Asian Countries  
February 5-6, 2001, Tsukuba, Japan*

加藤英孝  
農業環境技術研究所

**Katou, Hidetaka**  
National Institute for Agro-Environmental Sciences  
(NIAES)  
Tsukuba, Japan  
Phone: +81-298-38-8257  
Fax: +81-298-38-8199  
E-mail: katouh@niaes.affrc.go.jp

木方展治  
農業環境技術研究所

**Kihou, Nobuharu**  
National Institute for Agro-Environmental Sciences  
(NIAES)  
Tsukuba, Japan  
Phone: +81-298-38-8269  
Fax: +81-298-38-8199  
E-mail: kihou@niaes.affrc.go.jp

金完鎮  
農村振興庁研究管理局

**Kim, Wan-Jin**  
Research Management Bureau,  
Rural Development Administration (RDA)  
Suwon, Korea  
Phone: +82-31-299-2592  
Fax: +82-31-299-2607  
E-mail: ojkim@rda.go.kr

木村龍介  
農業環境技術研究所

**Kimura, Ryusuke**  
National Institute for Agro-Environmental Sciences  
(NIAES)  
Tsukuba, Japan  
Phone: +81-298-38-8262  
Fax: +81-298-38-8199  
E-mail: kimurar@niaes.affrc.go.jp

久保田徹  
国際農林業協力協会

**Kubota, Toru**  
Association for International Cooperation of Agriculture and  
Forestry  
Tokyo, Japan  
Phone: +81-3-3263-7377  
Fax: +81-3-3234-5137  
E-mail:

黒田久雄  
茨城大学

**Kuroda, Hisao**  
Ibaraki University  
Ami, Japan  
Phone: +81-298-88-8602  
Fax: +81-298-88-8525  
E-mail: kuroda@ipc.ibaraki.ac.jp

**Participants List**  
**Others**

*International Symposium  
on Nitrogen Fertilization and the Environment  
in East Asian Countries  
February 5-6, 2001, Tsukuba, Japan*

B. C. Liyanage  
大阪大学

**Liyanaga, Bandunee**  
Osaka University  
Osaka, Japan  
Phone: +81-6-6879-7674  
Fax: +81-6-6879-7675  
E-mail: bandunee.liyanage@env.eng.osaka-u.ac.jp

増田欣也  
果樹試験場

**Masuda, Kinya**  
National Institute of Fruit Tree Science  
Tsukuba, Japan  
Phone: +81-298-38-6504  
Fax: +81-298-38-6437  
E-mail: kinya@fruit.affrc.go.jp

南川和則  
筑波大学大学院

**Minamikawa, Kazunori**  
Tsukuba University  
Tsukuba, Japan  
Phone: +81-298-53 - 2557  
Fax:  
E-mail: technix@bres.tsukuba.ac.jp

三浦覚  
森林総合研究所

**Miura, Satoru**  
Forestry and Forest Products Research Institute  
Tsukuba, Japan  
Phone: +81-298-73-3211  
Fax: +81-298-73-1542  
E-mail: miura@affrc.go.jp

三浦周  
農業環境技術研究所

**Miura, Shu**  
National Institute for Agro-Environmental Sciences  
(NIAES)  
Tsukuba, Japan  
Phone: +81-298-38-8223  
Fax: +81-298-38-8227  
E-mail: miurashu@niaes.affrc.go.jp

三輪睿太郎  
農業研究センター

**Miwa, Eitaro**  
National Agriculture Research Center (NARC)  
Tsukuba, Japan  
Phone: +81-298-38-8491  
Fax: +81-298-38-8574  
E-mail: emiwa@narc.affrc.go.jp



**Participants List**  
**Others**

*International Symposium  
on Nitrogen Fertilization and the Environment  
in East Asian Countries  
February 5-6, 2001, Tsukuba, Japan*

森昭憲  
草地試験場

**Mori, Akinori**  
National Grassland Research Institute  
Nishinasuno, Japan  
Phone: +81-287-37-7558  
Fax: +81-287-36-6629  
E-mail: amori@ngri.affrc.go.jp

森田明雄  
静岡大学

**Morita, Akio**  
Shizuoka University  
Shizuoka, Japan  
Phone: +81-54-238-4591  
Fax: +81-54-238-4591  
E-mail: aamorit@agr.shizuoka.ac.jp

中野恵子  
農業環境技術研究所

**Nakano, Keiko**  
National Institute for Agro-Environmental Sciences  
(NIAES)  
Tsukuba, Japan  
Phone: +81-298-38-8433  
Fax: +81-298-38-8199  
E-mail: nakak@niaes.affrc.go.jp

中曾根英雄  
茨城大学

**Nakasone, Hideo**  
Ibaraki University  
Ami, Japan  
Phone: +81-298-88-8600  
Fax: +81-298-88-8525  
E-mail: nakasone@ipc.ibaraki.ac.jp

西村誠一  
農業環境技術研究所

**Nishimura, Seiichi**  
National Institute for Agro-Environmental Sciences  
(NIAES)  
Tsukuba, Japan  
Phone: +81-298-38-8312  
Fax: +81-298-38-8199  
E-mail: ssnn@niaes.affrc.go.jp

太田充  
静岡県茶業試験場

**Ohta, Mitsuru**  
Shizuoka Prefecture Tea Experiment Station  
Kikugawa, Japan  
Phone: +81-548-27-2883  
Fax: +81-548-27-3935  
E-mail: dohia@tea-exp.pref.shizuoka.jp

## **Participants List**

### **Others**

*International Symposium  
on Nitrogen Fertilization and the Environment  
in East Asian Countries  
February 5-6, 2001, Tsukuba, Japan*

尾崎保夫  
農業研究センター

**Ozaki, Yasuo**  
National Agriculture Research Center (NARC)  
Tsukuba, Japan  
Phone: +81-298-38-8829  
Fax: +81-298-38-8837  
E-mail: yozaki@narc.affrc.go.jp

Praphan Prasertsak  
スパンブリ フィールドクワツ研究センター

**Prasertsak, Praphan**  
Suphan Buri Field Crops Research Centre  
U-Thong, Suphan Buri 72160, Thailand  
Phone: +66-35-551433  
Fax: +66-35-551543  
E-mail: praphan_p@hotmail.com

dela C.M.J. Ramos  
茨城大学

**Ramos, de la Cruz Mary Jane**  
Ibaraki University  
Ami, Japan  
Phone: +81-908-492-6721  
Fax: +81-298-88-8688  
E-mail: kuroda@ipc.ibaraki.ac.jp

酒井千春  
国際農林水産業研究センター

**Sakai, Chiharu**  
Japan International Research Center for Agricultural  
Sciences (JIRCAS)  
Tsukuba, Japan  
Phone: +81-298-38-6353  
Fax: +81-298-38-6651  
E-mail: annas@jircas.affrc.go.jp

瀬戸智子  
(社)科学技術国際交流センター

**Seto, Tomoko**  
Japan International Science and Technology Exchange  
Center (JISTEC)  
Tokyo, Japan  
Phone: +81-3-3818-0730  
Fax: +81-3-3818-0750  
E-mail: seto@jistec.or.jp

志村もと子  
中国農業試験場

**Shimura, Motoko**  
Chugoku National Agricultural Experiment Station  
Fukuyama, Japan  
Phone: +81-849-23-4100  
Fax: +81-849-24-7893  
E-mail: shimura@cgk.affrc.go.jp

## **Participants List**

### **Others**

*International Symposium  
on Nitrogen Fertilization and the Environment  
in East Asian Countries  
February 5-6, 2001, Tsukuba, Japan*

凌祥之  
農業工学研究所

**Shinogi, Yoshiyuki**  
National Research Institute of Agricultural Engineering  
Tsukuba, Japan  
Phone: +81-298-38-7552  
Fax: +81-298-38-7553  
E-mail: yshinogi@nkk.affrc.go.jp

G.V. スバラオ  
国際農林水産業研究センター

**Subbarao, Guntar V.**  
Japan International Research Center for Agricultural  
Sciences (JIRCAS)  
Tsukuba, Japan  
Phone: +81-298-38-6354  
Fax: +81-298-38-6354  
E-mail: subbarao@jircas.affrc.go.jp

鈴木克拓  
農業環境技術研究所

**Suzuki, Katsuhiko**  
National Institute for Agro-Environmental Sciences  
(NIAES)  
Tsukuba, Japan  
Phone: +81-298-38-8257  
Fax: +81-298-38-8199  
E-mail: suzuku@niaes.affrc.go.jp

田淵俊雄  
東京大学

**Tabuchi, Toshio**  
The University of Tokyo  
Tokyo, Japan  
Phone: +81-298-87-2729  
Fax: +81-298-87-2729  
E-mail:

高島浩子  
国際農林水産業研究センター

**Takashima, Hiroko**  
Japan International Research Center for Agricultural  
Sciences (JIRCAS)  
Tsukuba, Japan  
Phone: +81-298-38-6354  
Fax: +81-298-38-6354  
E-mail: thiroko@jircas.affrc.go.jp

高橋正樹  
岩手県農業研究センター

**Takahashi, masaki**  
Iwate Agricultural Research Center  
Kitakami, Japan  
Phone: +81-197-68-4423  
Fax: +81-197-68-2361  
E-mail:

## **Participants List**

### **Others**

*International Symposium  
on Nitrogen Fertilization and the Environment  
in East Asian Countries  
February 5-6, 2001, Tsukuba, Japan*

C. Tang  
千葉大学

**Tang, Changyuan**  
Chiba University  
Chiba, Japan  
Phone: +81-43-290-2843  
Fax: +81-43-290-2859  
E-mail: cytang@earth.s.chiba-u.ac.jp

谷本岳  
農業工学研究所

**Tanimoto, Takashi**  
National Research Institute of Agricultural Engineering  
Tsukuba, Japan  
Phone: +81-298-38-7555  
Fax: +81-298-38-7609  
E-mail: tani@nkk.affrc.go.jp

梅宮善章  
果樹試験場

**Umemiya, Yoshiaki**  
National Institute of Fruit Tree Science  
Tsukuba, Japan  
Phone: +81-298-38-6504  
Fax:  
E-mail: umemiya@fruit.affrc.go.jp

渡辺巖

**Watanabe, Iwao**  
6-58-18 Jindaiji-kita  
Chofu, Tokyo 182, Japan  
Phone: +81-424-42-8300  
Fax: +81-424-42-8301  
E-mail: gan2@asahi.email.ne.jp

Chairoj Wongwiwatchai  
コンケン フィールドクローブ 研究センター

**Wongwiwatchai, Chairoj**  
Khon Kaen Field Crops Research Center  
Khon Kaen, Thailand  
Phone: +66-43-246669  
Fax: +66-43-244879  
E-mail: chairojw@hotmail.com

山岡賢  
農業工学研究所

**Yamaoka, Masaru**  
National Research Institute of Agricultural Engineering  
Tsukuba, Japan  
Phone: +81-298-38-7553  
Fax: +81-298-38-7553  
E-mail: saru@nkk.affrc.go.jp

Y.H. Yang  
国立環境研究所

**Yang, Yonghui**  
National Institute for Environmental Studies  
Tsukuba, Japan  
Phone: +81-298- 50-2599  
Fax: +81-298- 51-4732  
E-mail: yonghui.yang@nies.go.jp

## **Participants List**

### **Others**

*International Symposium  
on Nitrogen Fertilization and the Environment  
in East Asian Countries  
February 5-6, 2001, Tsukuba, Japan*

横田明彦  
国際農林水産業研究センター

**Yokota, Akihiko**  
Japan International Research Center for Agricultural  
Sciences (JIRCAS)  
Tsukuba, Japan  
Phone: +81-298-38-6360  
Fax: +81-298-38- 6360  
E-mail: ayokota@jircas.affrc.go.jp

米村正一郎  
農業環境技術研究所

**Yonemura, Seiichiro**  
National Institute for Agro-Environmental Sciences  
(NIAES)  
Tsukuba, Japan  
Phone: +81-298-38-8205  
Fax: +81-298-38-8199  
E-mail: yone@niaes.affrc.go.jp

M. Zaman  
千葉大学

**Zaman, Mohammad**  
Chiba University  
Matsudo, Japan  
Phone: +81-47-308-8818  
Fax: +81-47-308-6226  
E-mail: zamanm_99@yahoo.com

孕爽銅  
中国農業科学院土壤肥料研究所

**Zhao, Linping**  
Institute of Soils and Fertilizers (ISF),  
Chinese Academy of Agricultural Sciences  
Beijing, China  
Phone: +86-10-68919739  
Fax: +86-10-68975161  
E-mail: lpzhao@ppic.caas.ac.cn

孕応族  
農業研究センター

**Zhao, Bingzi**  
National Agriculture Research Center (NARC)  
Tsukuba, Japan  
Phone: +81-298-38-8829  
Fax: +81-298-38-8837  
E-mail: bzzhao@narc.affrc.go.jp







# Photographs

HOME  
HOME

HOME  
HOME







# Group A

## Participants:

Zhu, Z., Inst. of Soils Science, CAS, China (Chair)

Hosen, Y., JIRCAS, Japan (Rapporteur)

Chen, J., Chiba Univ., Japan

Eguchi, S., NIAES, Japan

Hasagawa, H., Tohoku Natl. Agric. Exp. Stn., Japan

Ishikawa, T., JIRCAS, Japan

Katou, H., NIAES, Japan

McTaggart, I., Scottish Agric. College, UK

Minami, K., NIAES, Japan

Mishima, S., NIAES, Japan

Niimi, H., Kyushu Natl. Agric. Exp. Stn., Japan

Wan, Q., Geographical Survey Institute, China

1. There must be a compromise between environment, economy and production.
2. Customers must be prepared to pay more for food produced in environmentally suitable method.
3. We need researchers who observe trees and who observe forest; and they should exchange their opinions.



# Group B

## Participants:

Mosier, A., USDA-ARS, USA (Chair)

Yan, X., JIRCAS, Japan (Rapporteur)

Abe, K., NARC, Japan

Cai, Z., Inst. of Soils Science, CAS, China

Hojito, M., National Grassland Res. Inst.

Park, Y.-H., NIAST, RDA, Korea

Watanabe, T., JIRCAS, Japan

Xu, M., Inst. of Soils and Fertilizers, CAAS, China

Zhao, L., Inst. of Soils and Fertilizers, CAAS, China

Zhu, J., Inst. of Soils Science, CAS, China

## A. Gaps in knowledge

1. The fate of fertilizer N is not clearly known.
2. How much of the environmental problems were resulted from fertilization?

## B. Methodology issue

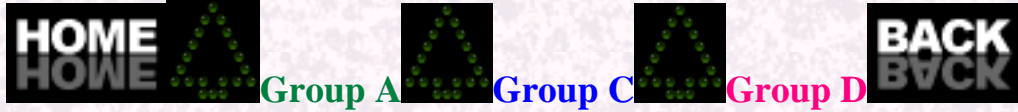
1. There is imbalance between the research advances of different countries. A good method should be developed and distributed to estimate N losses.
2. Many ways of nitrogen losses cause environmental problems, but there exists, sometimes, a trade-off relationship between different losses. There is disagreement in the priority to mitigate losses. Therefore, a comprehensive index is needed to indicate the whole all environmental risks of N fertilization.

## C. Mitigation options

1. To replace chemical N supply with natural N supply, to replace dangerous fertilizer with less dangerous fertilizer.
2. To have various land-use systems in a watershed therefore to improve N use efficiency by crop and to reduce loss. The function of paddy field as a biological purifier of excessive N is to be verified.

## D. What is changing?

Fortunately, in developed nations such as Japan, high crop yield is no more the top priority. Farmers are considering crop quality and environmental regulations. In developing countries such as China, high crop yield is no more the sole purpose of fertilization. They are considering the best combination of •gthree highs•h, i.e., high crop yield, high crop quality and high fertilizer use efficiency.





## **Participants:**

Ito, O., JIRCAS, Japan (Chair)  
Han, Y., Inst. of Soils Science, CAS, China (Rapporteur)  
Inagaki, M., JIRCAS, Japan  
Kim, S.-C., NIAST, Korea  
Minamikawa, K., Tsukuba Univ., Japan  
Miyaji, N., Shizuoka Pref. Agric. Exp. Stn., Japan  
Roelcke, M., Braunschweig Technical University, Germany  
Suzuki, K., NIAES, Japan  
Tachibana, M., Chisso Corp., Japan  
Woli, K.P., Hokkaido Univ., Japan  
Zhao, P., NARC, Japan  
Zhang, R., Inst. of Soils and Fertilizers, CAAS, China

## **A. What is the target of research on nitrogen fertilization and the environment?**

Company point of view:

- Consumers (farmers) and environment

Researcher's point of view:

- Farmers, ordinary citizens, all people involved in the system.

## **B. How large are the environmental impacts?**

In China: Becoming more and more serious.

Taihu Region: N fertilizers are not the main (or only) source for groundwater pollution, compared to livestock, human settlements, etc.

But N-China: N-deficiency, water shortage. N uptake by plants is small. High groundwater poll.

In Japan: North (Hokkaido):

Only 8% from human wastes, 92% from animal raising. Impact is increasing. But in the S (Kyushu): Animal wastes, excessive fertilizer appl. Rates, NO₃-N has reached the groundwater.

N₂O and NO pollution from farmland is not being controlled, while urban sources (traffic) is being

controlled.

### **C. How is the impact changing?**

N-China: First goal has to be food production, but the environmental impact will be large. Then gradually improve the environment, according to the development of society's basic needs.

Well water table is falling, nitrogen pollution even in the deep wells.

Japan: Impact will continue to increase, because the scientists are a minority compared to the majority of the people; major scientific breakthrough needed.

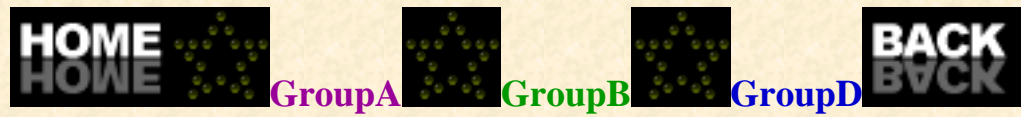
In Shizuoka tea gardens: N application rates have been reduced from 1000 to 600 kg N/ha during the past 4 years. Nitrate standard has been lowered 2 years ago, consumers are environment conscious, farmers older, apply less fertilizer. GW pollution dependent on the depth of GW table.

### **D. How can we mitigate the impact?**

- Make best use of compost production.
- Combine with controlled release fertilizers.
- In South China: Reduce fertilizer application rates; fertilizer recommendations by the local officials often only aim at maximum yields. So education of extension services, farmers, etc. has to be improved. Young farmers lack experience.
- Provide suitable models as advisory tools.
- Rules and regulations by the government needed to reduce the environmental impact in sensitive areas (drinking water catchments, etc.).
- Price of controlled-release fertilizers are too high for Chinese farmers at present!
- Reduce the burning of crop residues in the field.
- Organic manure should not be neglected. Prepare new kinds of processed organic manure, user-friendly compost preparation; volume reduced.
- If manure has to be dumped, then at least it should be processed before.
- How can the farmers be motivated to take mitigation options?
- User-friendly techniques for the farmers.
- Profitability has to be considered, for example prices for organic farming products.
- Farmers will react to policy changes, such as the lowering of purchasing prices for poor-quality grain; they will shift to higher quality products.
- Several model-farms can be established through the strong leadership of local governments in Japan.
- Then the positive results can be transferred to others.
- Situation in S-Korea: Introduction and adoption of slow-release fertilizers required.

## E. What is the gaps in our knowledge on interpretation of results from experiment and real situation?

- We need to fill the gaps in knowledge on the processes of the N-cycle, needed to make better simulation models, to serve as advisory tools for the farmers.
- A network between prefectures in Japan, carrying out research in different areas, the results must be inter-linked.





# Group D

## **Participants:**

Ellis, E.C., Univ. of Maryland, BC, USA (Chair)

Maeda, M., NARC, Japan (Rapporteur)

Hatano, R., Hokkaido Univ., Japan

Kanda, K. JIRCAS, Japan

Liyanage, B., Osaka Univ., Japan

Mori, A. Natl. Grassland Res. Inst., Japan

Nakano, A., NIVOT, Japan

Shoji, S., Tohoku Univ., Japan

Zhang, S., Inst. of Soils and Fertilizers, CAAS, China

## **Impact mitigation:**

### **1. Technical measures:**

- i) Efficient recovery of fertilizer N through cropping system / land use / new types of fertilizer;
- ii) Coordination of crop, soil, and fertilizer;
- iii) Barriers to N losses from agricultural fields / watersheds using land use;
- iv) Efficient use of natural N (Nitrogen fixation);
- v) Recycling of organic wastes.

### **2. Political measures:**

Establishment of environmentally sound agriculture:

- i) Recycling of organic matter;
- ii) Development of controlled fertilizers;
- iii) Financial / technical support by government.

### **3. Educational measures:**

- i) Farmer extension;
- ii) Guidance for students;
- iii) Information on web sites;

- iv) Consciousness of consumers;
- v) Community supported agriculture.

#### 4. Economical measures:

- i) Control of importing / exporting agricultural products / livestock food;
- ii) Display for products enabling consumer choice.

#### Gaps of knowledge:

1. Are nitrates really toxic?
2. Is it possible that denitrification for reducing nitrates causes other environmental problems?
3. Is production of crops with high yield / quality compatible with conservation of the environment (Zero pollution)?



Group A



Group B



Group C



# Publication

The papers presented at the Workshop will be published in a special issue of *Nutrient Cycling in Agro-Ecosystems*. Workshop contributors are strongly encouraged to submit full papers to the mailing address indicated in this web page by **March 31, 2001**. Please refer the instructions for manuscript preparation at the web-site of [Kluwer Publishers](#).

Your manuscript will be assigned to a member of editorial committee, who will obtain at least two anonymous reviews [[schedule for publication](#)]. The decision on acceptability for publication will be made by the editorial committee and journal editors.

## Editorial Committee:

Dr. Zucong Cai, Institute of Soil Science, Academia Sinica

Dr. Erle C. Ellis, University of Maryland, Baltimore County

Dr. Iain McTaggart, Scottish Agricultural College

Dr. Arvin Mosier, USDA/ARS

Dr. Yasukazu Hosen, Japan International Research Center for Agricultural Sciences (JIRCAS)

Dr. Marco Roelcke, Technical University Carolo-Wilhelmina

Dr. Kazuyuki Yagi, Japan International Research Center for Agricultural Sciences (JIRCAS)

Dr. Jianguo Zhu, Institute of Soil Science, Academia Sinica

(in alphabetical order)

For further information, please contact:

Secretary of the Organizing Committee for the International Workshop on Nitrogen Fertilization and the Environment in East Asian Countries

Japan International Research Center for Agricultural Sciences (JIRCAS)

1-2 Owashi, Tsukuba, Ibaraki 305-8686, JAPAN

Fax: +81-298-38-6651

E-mail: [annas@jircas.affrc.go.jp](mailto:annas@jircas.affrc.go.jp)



# **PUBLICATION**

In a Special Issue of  
*Nutrient Cycling in Agro-Ecosystems*

---

- **February 2001: Submission**



**Review**

- **June 2001**



**Revision**

- **September 2001**



**2nd Review and Revision (if needed)**

- **December 2001: Final Decision**



**Publication**

**BACK HOME**  
**BACK HOME**

International Workshop  
on Nitrogen Fertilization  
and the Environment  
in East Asian Countries



## Background

The global cycle of nitrogen has been altered by human activity to a greater extent than that of any other element. The production of nitrogen fertilizer, cultivation of legume, and incidental nitrogen fixation in internal combustion engines together transfer more nitrogen from the atmosphere into biological available forms than is fixed by all natural processes combined. Additionally, biomass burning and land-use change mobilize large quantities of nitrogen from stored into dynamics forms. In the past decade, we do have seen a large increase in global and regional environmental problems attributable to increased nitrogen cycling through the atmosphere and waters of the world.

East Asian countries, including Japan, China, and Korea, are characterized by intensive agriculture with high input of fertilizer, pesticides, and labors due to recent economical development and high population density. The intensive agriculture with introducing new technologies has promised high grain yield in this region. On the other hand, its adverse effects on the environment have recently become apparent and the sustainability of land resources and environment has become a cause of concern. Many of these problems have resulted from use of agricultural land in a manner that overloads nutrients, in particular nitrogen. Indeed, consumption of nitrogen fertilizer in this region has considerably increased during last three decades and accounted for more than 30% of the world in 1995.

We must now address serious issues in this area: How large is the environmental impact of intensive cropping systems? How is the impact changing? What will happen in future? How can we mitigate the impact?

## Themes

**This workshop will address the following themes:**

- (1) Overview of the issues related to nitrogen fertilization and the environment in east Asian countries and the world,
- (2) Effects of nitrogen fertilization on aquatic systems,
- (3) Effects of nitrogen fertilization on the atmosphere,
- (4) Evaluation of nitrogen cycling in agro-ecosystem at field and regional scales, and
- (5) Technologies that minimize the environmental impact of nitrogen fertilization

**And will aim;**

- (1) to exchange the understanding of the issues related to nitrogen fertilization and the environment in east Asian countries,
- (2) to identify gaps in our knowledge, and
- (3) to discuss future research needs and possible forms of cooperation.

[Background](#)

[General Information](#)

[Program](#)

[Site Map](#)

[BACK](#)



International Workshop  
on Nitrogen Fertilization  
and the Environment  
in East Asian Countries

## General Information

<b>Date &amp; Venue</b>	February 5 and 6, 2001: International Symposium At Tsukuba International Congress Center ( <a href="#">EPOCHAL TSUKUBA</a> ) February 7, 8 and 9, 2001: Japan/China Project Meeting and Field Excursion In Ibaraki, Yamanashi, and Shizuoka Prefectures
<b>Registration (International Symposium)</b>	The International Symposium (Feb. 5&6) is an open meeting. We welcome anybody to participate. However, we suggest to make a registration with accessing the registration form at our home page at the address below and send the completed form to us by email. <a href="#">*Registration form</a> You may also use the following forms that to be send to our secretary by FAX (+81-298-38-6651). <i>*Word for windows (*.doc) style, *PDF style</i> There is no cost but pre-registration is recommended.
<b>Registration (Excursion)</b>	Number of persons for the excursion tour is limited, but there is still some room. Please contact our secretary if you would like to participate the excursion tour. It costs 32,000 Japanese Yen.
<b>Reception</b>	The Symposium Reception will be held from 19:00 to 21:00 p.m. Monday, February 5, in the Myojo-no-Ma Room on the second floor of the Tsukuba Dai-ichi Hotel.
<b>Official Language</b>	The official language of the Workshop will be English. However, voluntary service of simultaneous translation for any East Asian languages is welcome, in particular during the discussion sessions.
<b>Publication</b>	The papers presented at the Workshop will be published in a special issue of Nutrient Cycling in Agro-Ecosystems. Workshop contributors are strongly encouraged to submit full papers to the mailing address indicated below by <b>February 28, 2001</b> . Please refer the instructions for manuscript preparation at the web-site of <a href="#">Kluwer Publishers</a> .
<b>Workshop Organization Committee</b>	<i>Coordinators:</i> Dr. Kazuyuki Yagi, Japan International Research Center for Agricultural Sciences (JIRCAS) Dr. Zucong Cai, Institute of Soil Science, Academia Sinica  <i>Members:</i> Dr. Yasukazu Hosen, Japan International Research Center for Agricultural Sciences (JIRCAS) Dr. Hidetaka Katou, National Institute of Agro-Environmental Sciences (NIAES) Dr. Morihiro Maeda, National Agricultural Research Center (NARC) Dr. Naomichi Miyaji, Shizuoka Agricultural Experiment Station Dr. Hideshige Toda, Shinshu University Dr. Minggang Xu, Institute of Soils and Fertilizers, Chinese Academy of Agricultural Sciences Dr. Jianguo Zhu, Institute of Soil Science, Academia Sinica (in alphabetical order)

<b>Sponsors</b>	Japan International Research Center for Agricultural Sciences (JIRCAS), Ministry of Agriculture, Forestry and Fisheries Ministry of Education, Culture, Sports, Science and Technology
<b>Secretary</b>	<b>For further information, please contact:</b> Secretary of the Organizing Committee for the International Workshop on Nitrogen Fertilization and the Environment in East Asian Countries Japan International Research Center for Agricultural Sciences (JIRCAS) 1-2 Owashi, Tsukuba, Ibaraki 305-8686, JAPAN Fax: +81-298-38-6651 E-mail: <a href="mailto:annas@jircas.affrc.go.jp">annas@jircas.affrc.go.jp</a> Homepage address: <a href="http://ss.jircas.affrc.go.jp/index.html">http://ss.jircas.affrc.go.jp/index.html</a>

**Background**

**General Information**

**Program**

**Excursion**

**BACK**





**International Workshop  
on Nitrogen Fertilization  
and the Environment  
in East Asian Countries**

**Program**

Date: 5 and 6 February 2001

Venue: Tsukuba International Congress Center:  
Epochal Tsukuba

**Monday, February 5**, at Epochal Tsukuba, Room 101

**0800** *Registration*

**Opening Session**

Chair: Yagi, K. & Cai, Z.C.

**0900** Opening Address Inoue, T. (JIRCAS, Director General)

**Keynote Lectures**

Chair: Yagi, K. & Cai, Z.C.

**0910** Essential Nitrogen: Environmental Challenges Associated with Increased Global Nitrogen Fixation  
Mosier, A. (USDA-ARS)

**0955** Nitrogen Fertilization: Contribution to the Development of Agriculture and Impact on Environment in  
China

Zhu, Z.L. (Institute of Soil Science)

**1040** Nitrogen Fertilization Nitrate Pollution in Groundwater in Japan  
Kumazawa, K. (The Univ. of Tokyo)

**1125** Technologies Using Controlled Release Fertilizers to Improve the Environmental Impacts of Nitrogen  
Fertilization

Shoji, S. (Tohoku Univ.)

**1210** *Lunch*

**Nitrogen Cycling in Agro-Ecosystems** Chair: Toda, H.

**1330** Nitrogen Fertilizing Management for Rice Cultivation in Korea  
Park, Y.-H. and Kim, P.-J. (NIAST)

**1350** Nitrogen Budgets in Farm-Systems in Large-Scale Karst Region of Qibainong, Southern China  
Hatano, R. (Hokkaido Univ.) et al.

**1410** Estimating the Long-Term Impacts of Nitrogen Fertilizers Across Village Landscapes

Ellis, E.C. (Univ. of Maryland)

1430 Recent Trend of Nitrogen Fertilizers Use in Japan and Mitigation Plan

Mishima, S. (NIAES)

**Environmental Impact on Water Systems** Chair: Roelcke, M.

1450 Evaluating Impact of Land Use and Nitrogen Budgets at Community Scale on Stream Water Quality in Hokkaido, Japan

Woli, K.P. (Hokkaido Univ.) et al.

1510 Effect of Different Chemical Fertilizer Combination on Yield and Nitrate Distribution in Chao Soil Profile

Zhang, S.X. (ISF) et al.

1530 *Tea Break*

1600 Nitrogen Leaching and Balance in Volcanic Ash Soil Affected by Different Fertilizers

Maeda, M. (NARC) et al.

1620 Reduction in Nitrogen Load from Tea Garden by Fallow Paddy Fields at Shizuoka Prefecture, Central Japan

Miyaji, N. (Shizuoka Pref. AES) et al.

1640 Denitrification in Shallow Groundwater in a Coastal Agricultural Area of Japan

Toda, H. (Shinshu Univ.) et al.

**Nitrogen Dynamics in Upland Soils** Chair: Xu, M.

1700 The Effect of Soil Moisture on Mineral Nitrogen, Soil Electrical Conductivity and pH

Zhang, R. (ISF) and Wienhold, B.J. (Univ. of Nebraska)

1720 Studies on Interaction between Nitrogen and NaCl in Winter Wheat Growth and Yield

Pang, H.C. (ISF) et al.

1740 Dynamics of Nitrogen in Upland Field Applied with a Large Amount of Slurry Barnyard Manure in Southern Kyushu

Niimi, H. (Kyushu AES)

1800 *Adjourn*1900 *Workshop Reception*

☐ Tuesday, February 6, at Epochal Tsukuba, Room 101

**Environmental Impact on the Atmosphere** Chair: Watanabe, T.

0900 Ammonia Volatilization from Fertilizers Applied to Rice, Maize and Wheat in China

Cai, G.X. (ISS) et al.

**0920** Effects of Deep Application of Nitrogen Fertilizer on NO and N₂O Emissions from an Andisol

Hosen, Y. (JIRCAS) et al.

**0940** Mitigating Environmental Impacts Resulted from N Fertilization to a Japanese Andisol Field: Effects of Controlled Release Fertilizer and Deep Application of Urea

Yan, X.Y. (JIRCAS) et al.

**1000** Influence of Soil Physical Conditions and Fertiliser Type on N₂O and NO Emissions from Nearly Saturated Japanese Soils

McTaggart, I. (Scottish Agric. College) et al.

**1020** *Tea Break*

**1040** Major Factors Controlling N₂O and NO Emissions from Fertilised Soils

Tsuruta, H. (NIAES)

### **Nitrogen Dynamics in Paddy Soils** Chair: Park, Y.-H.

**1100** Nitrogen Balance during Rice Cultivation in Sandy Soil affected by the Fertilizer Management

Roh, K.A. (NIASST)

**1120** Effect of Nitrogen Application Scheme on Growth of Rice

Zhu, J.G. (ISS)

**1140** Nitrogen Mineralization in Paddy Soils of the Chinese Taihu Region under Aerobic Conditions

Roelcke, M. (Brawnschweig Tech. Univ.) et al.

**1200** *Lunch*

**1300** Ammonium Transformation in Paddy Soils affected by the Presence of Nitrate

Cai, Z.C. (ISS)

**1320** Transformation and Balance of Nitrogen in Paddy Soil under Different Chemical Fertilizers Combining with Manure Applied in Double-Rice Regions of Southern China

Xu, M.G. (ISF) et al.

### **Mitigation Technologies** Chair: Zhu, J.G.

**1340** Increasing Nitrogen Efficiency by Slow Release Fertilizers in Paddy Soils

Kim, S.-C. and Kim, P.-J.(NIASST)

**1400** Effects of Low Sulfate Slow Releasing Fertilizer (LSR) on the Growth and Fruits Yield of Tomato Plant (*Lycopersicon esculentum* Mill. Saturn)

Nakano, A. (NIVOT) et al.

**1420** Recoveries of MEISTER N by Crops in Japan

Tachibana, M. (Chisso Corp.) et al.

**1440** *Tea Break*

**Group and General Discussion** Chair: Yagi, K. & Cai, Z.C.

**1500** Objectives of the discussion

**1515** Group discussion (at Epochal Tsukuba, Room 202)

*4 break-out groups will discuss and work on draft plan*

Chairs: Zhu, Z.L.

Mosier, A.

Ito, O.

Ellis, E.C.

Rapporteurs: Han, Y.

Maeda, M.

Hosen, Y.

Yan, X.Y.

**1630** Group reports and general discussion

**Closing Remarks**

**1720** The Nitrogen Cycle and the Environment

Minami K. (NIAES, Director General)

**1800** *Adjourn*




**International Workshop  
on Nitrogen Fertilization  
and the Environment  
in East Asian Countries**

## Japan/China Project Meeting and Field Excursion

Date: 7, 8, and 9 February 2001

● **Wednesday, February 7**

### **Field Tour I**

Visiting JIRCAS experimental field  
Having lunch at Asahi Beer Brewery at Moriya town, Ibaraki Prefecture  
Then going to the foot of Mt. Fuji  
Staying at Hotel Regina Kawaguchi-ko,  
5239-1 Funatsu, Kawaguchi-ko-machi, Minami-tsuru-gun, Yamanashi prefecture  
Phone: +81-555-20-9000, Fax: +81-555-72-2561

● **Thursday, February 8, at Hotel Regina Kawaguchi-ko**

### **4th Planning Meeting of Japan/China Project**

Activity 1: Cycles of Major Elements in Agro-Ecosystems in Huang-Huai-Hai Plain and their Controls (ISF-JIRCAS)  
Activity 2: Evaluation of Nitrogen Losses in Agro-Ecosystems in Jing-Jin-Tang Region (ISF-JIRCAS)  
Activity 3: Evaluation of the Environmental Impact of Non-Point Sources in Tai-hu Catchments (ISS-JIRCAS)  
Activity 4: Nitrogen Cycling in Agro-Ecosystems in Tai-hu Region and Strategies for Environmental Sound Management (ISS-JIRCAS)  
Activity 5: Development of Farming Systems in paddy fields aimed at Environmental Conservation (ISF-JIRCAS)

● **Friday, February 9**

### **Field Tour II**

Visiting Shizuoka Prefecture Tea Experiment Station  
And an Experimental Field of Shizuoka Prefecture Agricultural Experiment Station  
Having lunch at a Tea Park, Greenpia Makinohara, Sagara-machi, Shizuoka Prefecture  
Enjoying Mt. Fuji, then returning to Tsukuba or Narita

[Background](#)

[General Information](#)

[Program](#)

[Site Map](#)

[BACK](#)

# *Annual Report*

● [2000](#)

● [1999](#)

● [1998](#)

● [1997](#)

● [1996](#)

● [1995](#)



*Published by :Japan International Research Center for  
Agricultural Sciences  
Ministry of Agriculture, Forestry and Fisheries  
Tsukuba, Ibaraki, 305-8686 Japan  
[www@jircas.affrc.go.jp](http://www.jircas.affrc.go.jp)*

HOME

BACK

# CONTENTS

---

Message from the Director General .....	2
Highlights from 2000 .....	4
JIRCAS and the Ministry of Agriculture, Forestry and Fisheries .....	14

## Research Overview

International research at JIRCAS .....	20
JIRCAS Research Divisions .....	36
Research Information Division .....	36
Biological Resources Division .....	37
Environmental Resources Division .....	41
Crop Production and Postharvest Technology Division .....	44
Animal Production and Grassland Division .....	54
Forestry Division .....	58
Fisheries Division .....	59
Okinawa Subtropical Station .....	62
Miscellaneous projects outline .....	70

## Training and Invitation Programs and Information Events

Invitation programs at JIRCAS .....	74
Administrative Invitation .....	74
Counterpart Researcher Invitation .....	79
Fellowship Programs .....	82
Symposia and workshops .....	86

## Appendix

Publishing at JIRCAS .....	104
Official publications and library holdings .....	104
Research staff activity .....	109
Journal articles, book chapters, and monographs .....	109
Published proceedings and conference presentations .....	113
Other publications .....	129
Financial overview .....	132
Advisors and principal staff members .....	133
The Japanese fiscal year, miscellaneous data .....	137
JIRCAS organization and staff as of April 1, 2001 .....	140

EDITORIAL BOARD



# ANNUAL REPORT 1998

## CONTENTS

### Introduction

- Ⓞ [Message from the Director General](#)
- Ⓞ [Highlights from 1998](#)
- Ⓞ [JIRCAS and the Ministry of Agriculture, Forestry and Fisheries](#)

### Research Overview

- Ⓞ [International Research at JIRCAS](#)

### JIRCAS Research Divisions

- Ⓞ [Research Information Division](#)
- Ⓞ [Biological Resources Division](#)
- Ⓞ [Environmental Resources Division](#)
- Ⓞ [Crop Production and Postharvest Technology Division](#)
- Ⓞ [Animal Production and Grassland Division](#)
- Ⓞ [Forestry Division](#)
- Ⓞ [Fisheries Division](#)
- Ⓞ [Okinawa Subtropical Station](#)
- Ⓞ [Miscellaneous Projects Outline](#)

### Training and Invitation Programs and Information Events

- Ⓞ [Fellowship Programs](#)
- Ⓞ [Symposia and Workshops](#)

### Appendix

- Ⓞ [Official publications and library holdings](#)
- Ⓞ [Research Staff activity](#)
- Ⓞ [Advisors and principal staff members](#)
- Ⓞ [Financial Overview](#)

---

HOME





# Message from the Director General

## JIRCAS celebrates its fifth anniversary



Director General  
*Dr. Nobuyoshi Maeno*

Five years have now passed since the Tropical Agricultural Research Center (TARC) was reorganized into the present Japan International Research Center for Agricultural Sciences. This reorganization was not merely a name change but also considerably widened our research activities and the number of partner countries and regions with which we maintain cooperative research programs.

In these past five years JIRCAS has enjoyed numerous achievements in the field of agricultural science through a variety of successful programs. In addition to enlarging and strengthening comprehensive agricultural research, we have also implemented multi-national collaborative research programs and developed domestic research by focusing on problems relevant to our international activities. In addition, our visiting fellow invitation program at our Sub-tropical Research Station in Okinawa and at our main campus in Tsukuba supports these research efforts. New research strategies in conjunction with strong inter-institutional cooperation has also contributed to our outstanding research record. Furthermore, JIRCAS recently established two new overseas offices in Beijing, China and Londrina, Brazil as bases for regional research activities, complementing our existing office in Bangkok, Thailand. All of the above activities have been made possible through the generous allotment of funds from the budgets of various government ministries and agencies and BRAIN (Bio-oriented Technology Research Advancement Institution), a government-affiliated, semi-private research institution.

A [map](#) indicating the comprehensive research projects being conducted by JIRCAS throughout the world as of June 1999.

Through our strong cooperation with international research institutes, such as the Japan International Cooperation Agency (JICA) and those affiliated to the Consultative Group on International Agriculture (CGIAR), JIRCAS has received international prestige and attention for its activities. The success we have enjoyed is owed solely to the efforts of the people and organizations with which we have excellent collaborative relationships.

Though such problems as food supply instability and environmental degradation are major contributing factors to poverty throughout the world, their negative effects are magnified in developing regions. Therefore, international cooperation is urgently needed to solve these and other obstacles confronting developing countries. The aim of JIRCAS is to play a leading role in the achievement of this goal.

Under current Japanese Government administrative and financial reforms national institutions are being reorganized to streamline costs and increase efficiency. Although government-affiliated research institutes, like JIRCAS, will become independent administrative corporations, the resultant changes will not affect Japan's resolve to actively participate in and contribute to the international community. In fact, the reforms have reaffirmed the necessity of such actions. The importance of JIRCAS and similar research institutes was confirmed in a recent national survey concerning basic food and agricultural problems and subsequently delineated in the new law, "The Basic Law on Food, Agriculture and Rural Areas," written by the Ministry of Agriculture, Forestry and Fisheries (MAFF). In the law the Japanese Government ordered the continuation of agricultural assistance to developing countries; and JIRCAS will be one of the major organs providing the aid.

In any organizational form, JIRCAS will not lose focus on its mission to contribute to the international community through agricultural research. As JIRCAS grows over the next 10-15 years, we must continue to play an active role in solving the world's agricultural problems. To do so, we must not simply adhere to current methods of research and management, but develop new ones so that we may most efficiently and most advantageously utilize our existing resources. In the current discussion of reform programs it is said that it may become possible to more independently manage research resources. Therefore, in maximizing this advantage, I hope for even greater cooperative efforts between JIRCAS and our partner institutes.



*JIRCAS front entrance*

**Note About Annual Report 1998**

In keeping with our recent efforts to highlight JIRCAS activities in particular regions of the world, Annual Report 1998 will focus on China. In this year's issue, detailed descriptions of research sites at several Chinese universities and institutions can be found in the section entitled "International Research at JIRCAS." When viewed in full, however, JIRCAS activities range widely across the globe. It is our hope that the increasingly international scope of research at JIRCAS will be equally evident within Annual Report 1998.

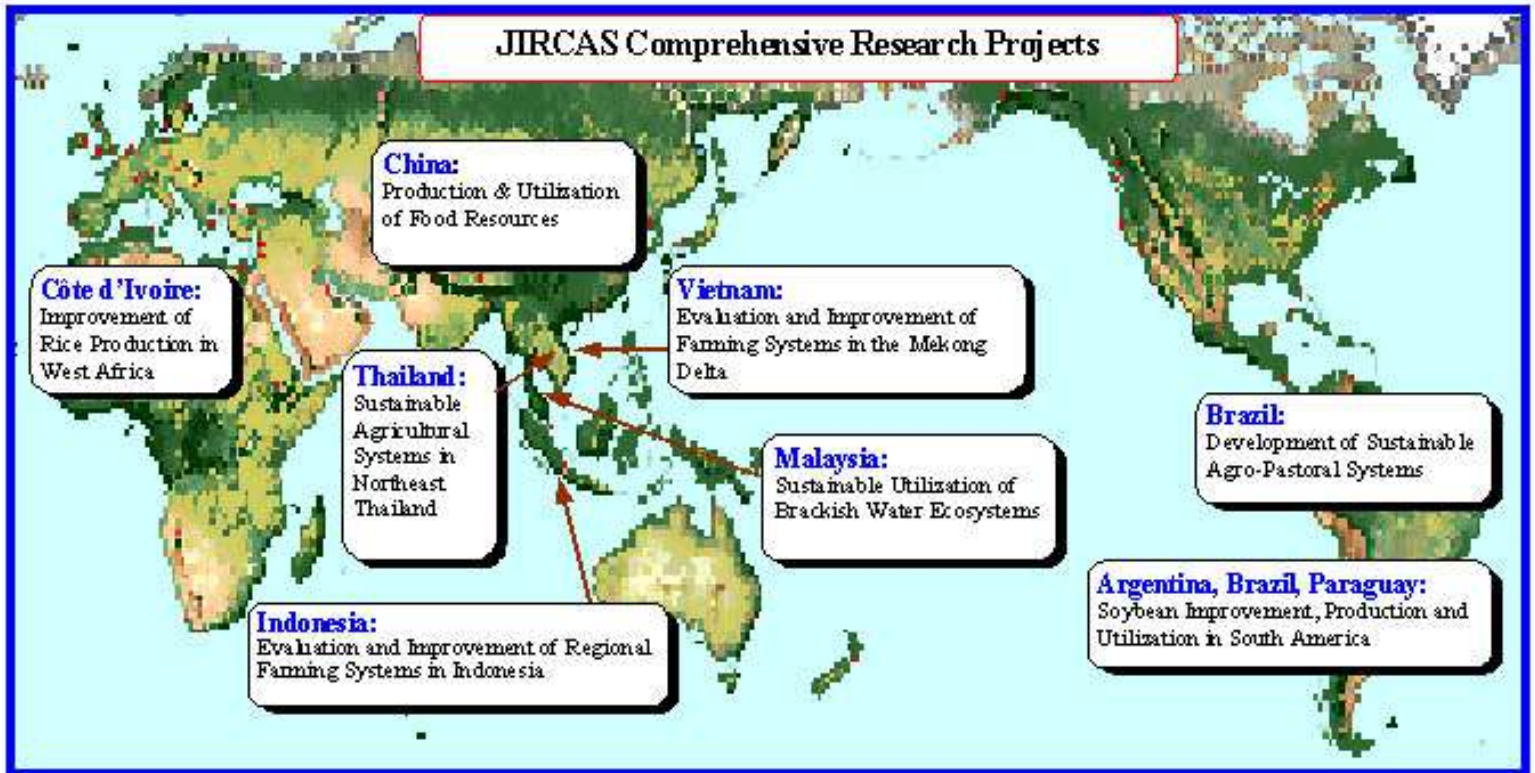
A handwritten signature in black ink, appearing to be 'Nobuyoshi Maeno', written on a light-colored background.

*Director General Nobuyoshi Maeno*

[HOME](#)

[BACK](#)

## JIRCAS Comprehensive Research Projects





## HIGHLIGHTS FROM 1998

### @ IMPORTANT NEW DEVELOPMENTS

During Fiscal Year 1998, the Japan International Research Center for Agricultural Sciences (JIRCAS) witnessed a number of noteworthy happenings. One such example is Tanzanian President Benjamin William Mkapa's visit to JIRCAS in December 1998. Others include the production of freshwater fish surimis in China by JIRCAS researchers and the successful development of a heat-tolerant snap bean variety at the Okinawa Subtropical Station. We are pleased to highlight these activities and achievements in greater detail below.

- [Highlight #1](#): Development of Surimi Made from Freshwater Fish in China
- [Highlight #2](#): Inheritance and Physiological Mechanisms of Crop Heat Tolerance and Development of Heat-tolerant Crops
- [Highlight #3](#): Visit of Tanzanian President Benjamin William Mkapa to JIRCAS
- [Highlight #4](#): Research Meetings and Conferences during Fiscal Year 1998

*Photo: The Main Building of JIRCAS in Tsukuba, Japan*

---

### @ NEW RESEARCH COLLABORATION

Since its establishment in 1993, JIRCAS has consistently sought to expand the depth of its collaborative efforts with research organizations and universities in a geographically diverse range of developing countries. In keeping with the JIRCAS mandate, collaborative efforts have become increasingly multidisciplinary in their focus and complex in their approach, often involving formal cooperative agreements between JIRCAS and foreign governmental entities. During Fiscal Year 1998, JIRCAS proudly initiated a new Memoranda of Understanding (MOU) solidifying project ties with the People's Republic of China (PRC).

- Click [here](#) for information on the evaluation of plant genetic resources, development of novel breeding materials and their effective utilization in [China](#).
- 

### @ ACADEMIC PRIZES AND AWARDS

- For a listing of JIRCAS staff members who have been the recipients of [academic prizes and awards](#) during the previous Fiscal Year, please click [here](#).

HOME

BACK



## Highlight #1: Development of Surimi Made from Freshwater Fish in China

Although the level of ocean fisheries resources is presumed to have reached capacity, aquaculture technology is thought to have great potential for expansion and is already serving as a significant source of animal protein. This includes freshwater fisheries resources. China's inland water regions are examples of locations where this technology is being utilized. China's freshwater fisheries catch has increased more than ten times in the last 50 years, reaching more than 10 million tons, equivalent to about 10% of the total world catch. The Food and Agriculture Organization (FAO) has forecasted that the freshwater fisheries catch will account for about 25% of the total world catch in 2010. However, freshwater fisheries resources lack the diversity of consumption when compared to ocean-based resources because the transportation and processing technologies of the freshwater fisheries resources remain behind those of ocean-based resources.

To address postharvest problems, JIRCAS has initiated research on the development of frozen surimi made from freshwater fish with the Shanghai Fisheries University as part of the comprehensive collaborative research project "Development of sustainable production and utilization of major food resources in China." Originally a Japanese term, surimi is an intermediate foodstuff with a high potential for free productivity of texturized products, such as imitation crab, and a long frozen shelf life. Because surimi is manufactured simply by washing, dehydrating, and adding cryoprotectants to minced fish meat, the initial aim of surimi development research was to identify fish species that have a high potential for surimi production.

We carried out studies on the gel-forming properties of surimi made from cultured freshwater fish in China, comparing them with walleye pollack surimis, a typical commercial marine fish surimi that accounts for more than 60% of world surimi production. Consequently, we were able to determine that the main freshwater fish species of China, silver carp, bighead carp, grass carp, and tilapia can be utilized as raw materials for surimi. To appreciate the practical value of these newly developed freshwater fish surimis, we held a tasting party of surimi-based products in a Chinese restaurant in Shanghai, and the foods were very popular with the Chinese people ([Photo](#)).

We presented the results of our collaborative research at the China-Japan joint workshop entitled "Development of utilization technology of freshwater fisheries resources," held at Shanghai Fisheries University, March 25-27, 1999. From our results, the Shanghai Fisheries University is now planning the production of freshwater fish surimis and related products with various Chinese administrative prefectures.

The practical use of fresh water fish surimi will greatly contribute to solving China's food problems. Confronting the problem of a lack of animal protein in their daily diet, developing countries will also be encouraged by this success in China.

---

[BACK](#)

[HOME](#)

[NEXT](#)



Surimi products used in Chinese cooking  
(Photo: T. Hayashi)

BACK



## **Highlight #2: Inheritance and Physiological Mechanisms of Crop Heat Tolerance and Development of Heat-tolerant Crops**

Vegetables constitute an important source of human nutrition. In the tropics, however, high temperatures constrain vegetable production leading to serious problems of nutritional imbalance in large parts of the region. In Okinawa, for example, winter and spring are the major seasons for vegetable production whereas only a few vegetables are produced during summer because of high temperatures. As a result, Okinawans are forced to rely on vegetables imported from the Japanese main islands. Development of heat-tolerant vegetables is urgently needed in order to solve this problem

The JIRCAS Okinawa Subtropical Station has been attempting to address the above problem through the development of new heat-tolerant vegetable varieties by evaluating and utilizing crop germplasm collected from tropical countries. We utilized snap bean germplasm from Southeast Asian countries collected and introduced by foreign research institutions including the International Center for Tropical Agriculture (CIAT) and the United States Department of Agriculture (USDA). By screening the germplasm for heat-tolerance (young pod setting under hot conditions), we successfully developed a heat-tolerant snap bean variety, Haibushi (literally southern star in the Okinawan dialect).

This heat-tolerant genotype of Haibushi has spawned further analysis of the heat-tolerance mechanism and comparisons with other heat-sensitive genotypes. In 1998, five crop scientists at the Okinawa Subtropical Station began a collaborative study entitled "Inheritance and physiological mechanisms of crop heat-tolerance during the reproductive process" in collaboration with BRAIN (Bio-oriented Technology Research Advancement Institution). The research program will focus on snap beans and attempt to answer the following questions: 1) which stages are the most sensitive to high temperature during the reproductive process? 2) which organs (or tissues) are damaged by high temperature? 3) how do tolerant genotypes respond to high temperatures? 4) how is tolerance controlled genetically? and 5) how do heat shock proteins function in exhibiting heat tolerance? Through these analyses, we hope to contribute to the further development of heat-tolerant crops.

---

[BACK](#)

[HOME](#)

[NEXT](#)



### Highlight #3: Visit of Tanzanian President Benjamin William Mkapa to JIRCAS

The President of the United Republic of Tanzania, Benjamin William Mkapa visited Japan in December, 1998 following the Second Tokyo International Conference on African Development (TICAD II) held in October, 1998. Since gaining its independence, Tanzania has maintained close ties with Japan and continues to receive Japanese technical and economic assistance for development in many areas such as agriculture, health, telecommunications and human resources. During his stay in Japan, President Mkapa visited JIRCAS on December 15. After a welcoming ceremony, Dr. Nobuyoshi Maeno, Director General of JIRCAS, briefed President Mkapa on current JIRCAS research activities, highlighting the collaborative international agricultural research projects which the institute is currently conducting in Asia, Africa and Latin America. President Mkapa showed interest in the advanced state of Japanese agricultural research and possible cooperation between Japanese and Tanzanian institutions to implement such research activities in Tanzania. After the ceremony and discussion, President Mkapa and his group observed the JIRCAS Biotechnology Unit where research on "Improving plant tolerance to environmental stresses by gene transfer" is being carried out by the staff of the Division of Biological Resources.

Photo: *President Benjamin William Mkapa of Tanzania visit to JIRCAS in December 1998*

The Tanzanian economy depends heavily on the agricultural sector, accounting for about 60% of the GDP, over 61% of export earnings and about 84% of rural employment. The majority of the people (>90%) live in rural areas and are engaged in subsistence farming, with an average of 1.2 hectares per household. Although the national population has grown by about 2.8% per annum in the last 10-15 years, overall agricultural production has thus far been able to match this growth, and the country is nearly self-sufficient in most food crops, excluding drought years. This is a result of horizontal expansion of cultivated area and improvements in productivity of several food and commercial crops, such as maize, rice, cotton and tea. However, due to service and industrial sector expansion, the overall share of the agricultural sector in the national economy, though significant, has continued to decline over the years. The agricultural sector can become more productive by utilizing new technology, taking into consideration the specific agro-ecological and socio-economic environment of various farming communities. The National Agricultural and Livestock Research Project (NALRP), has been attempting to establish an efficient, cost-effective and sustainable research service capable of developing appropriate technologies for the farming communities. Now in phase II, NALRP is initiating prioritized research projects for each agro-ecological zone and crop commodity. Due to the great need for new research, many areas are contending to receive such important projects.

In Africa, JIRCAS is currently carrying out four projects with a variety of international research centers (i.e. ICIPE, ILRI, WARDA and IFDC). Many African nations have requested JIRCAS to increase its efforts to review major issues in African agriculture and examine possible collaborative research projects in the region. Keeping with this request, JIRCAS endeavors to organize missions to African countries whenever the opportunity arises. JIRCAS sent a preliminary mission in March 1999 to Tanzania to clarify its needs and to assess possible areas for future collaboration. President Mkapa's visit may mark the beginning of active communication to explore possible cooperation between Japan and partners African countries.

---

[BACK](#)[HOME](#)[NEXT](#)





*President Benjamin William Mkapa of Tanzania visit to JIRCAS in December 1998*

BACK



## **Highlight #4: Research meetings and conferences**

During FY 1998, JIRCAS played proud host to a great number of research meetings, academic seminars, workshops, and conferences. Discussion topics ranged from postharvest technology in Asia to sustainable agricultural systems in Thailand, and from cryopreservation of tropical plant germplasm to plant signaling. Invited guests included fellow researchers from affiliates of the Consultative Group on International Agricultural Research (CGIAR) and other prominent international research organizations, numerous national universities, and local experts from China, Malaysia, Vietnam, Thailand, India, the Netherlands, the USA, the Philippines, and many other countries.

These gatherings provided an important opportunity for JIRCAS researchers to share the fruits of their ongoing projects with one another and with their counterparts in other institutions. By the same token, contact with researchers most intimately familiar with local conditions enhanced opportunities for learning and influenced the direction of future research. More information on the meetings, seminars, workshops, and conferences sponsored by JIRCAS during the previous year can be found under the "Symposia and Workshops" heading within the section of this Annual Report entitled "Training and Invitation Programs and Information Events."

---

[BACK](#)

[HOME](#)



*The Main Building of JIRCAS in Tsukuba, Japan*

BACK



## **People's Republic of China**

### **Evaluation of the plant genetic resources, development of novel breeding materials and their effective utilization**

Fiscal Year 1998 witnessed a second Memorandum of Understanding (MOU) between JIRCAS and the China National Rice Research Institute (CNRRI). The first, signed August 20, 1997, launched the integrated project "Development of sustainable production and utilization of major food resources in China," a collaborative research program to investigate rice breeding and effective utilization of genetic resources. Before starting the program, it was agreed that genetic resources and breeding materials would be managed by mutual consent in both Japan and China because of their designation as indigenous property.

This agreement was followed by Dr. Cai Hong-Fa's, Director General of CNRRI, visit to JIRCAS during February 21-27, 1999. During the visit, Dr. Cai and his staff met with JIRCAS officials, led by Dr. Nobuyoshi Maeno, JIRCAS Director General. Based on a JIRCAS-CNRRI MOU, the discussions focused generally on the study "Evaluation of plant genetic resources, development of novel breeding materials and their effective utilization," and specifically on rice breeding materials relating to the project. At the conclusion of the Chinese delegation's visit, the timeline for the above project was set for March 1999 to March 2003.

*Photo: Ceremony in Fuyan Province, China at which Dr. Nobuyoshi Maeno, Director General of JIRCAS, and Dr. Cai Hong Fa, Director General of CNRRI, signed a Memorandum of Understanding.*

The discussion resulted in several other mutual understandings between JIRCAS and CNRRI, including an agreement to mutually supply and utilize breeding materials, to register and mutually utilize breeding materials bred within the project framework, and to protect the intellectual property rights of the researchers who have developed the new varieties of rice. In addition, the two parties consented to research achievements and new breeding materials obtained within the project framework and to resolve any differences in interpretation of the terms included in the Meeting Minutes and related matters. In accordance with the MOU and the Meeting Minutes, a JIRCAS rice breeder has been dispatched to CNRRI to initiate the research project.

The combination of advanced technology in Japan with the abundant genetic resources and high yielding potential of rice varieties in China will likely lead to the establishment of an efficient methodology to develop new, high-yielding, yet environmentally friendly, means of sustainable agricultural production.

---

[BACK](#)

[HOME](#)

[NEXT](#)



*Ceremony in Fuyan Province, China at which Dr. Nobuyoshi Maeno, Director General of JIRCAS, and Dr. Cai Hong Fa, Director General of CNRRI, signed a Memorandum of Understanding.*

[BACK](#)



## Academic Prizes and Awards

JIRCAS is pleased to note that many of its staff members have been the recipients of academic prizes and awards from scientific societies and other organizations. The following is a brief summary of a special achievement received during the previous Fiscal Year. The Institute is proud to include this award in the Highlights of Annual Report 1998.

**Dr. Yukiyo Yamamoto, Senior Researcher in the Environmental Resources Division**, received the 1998 Research Encouragement Award from the Japanese Society of Grassland Science for "Study of grassland evaluation and planning methods using regional information." The award is given to a researcher as the Society's recognition of the individual's achievement in grassland science and as encouragement for successful career evolution.

[Photo](#): *Dr. Yamamoto at the Japanese Society for Grassland Science award ceremony.*

---

BACK



*Dr. Yamamoto at the Japanese Society for Grassland Science award ceremony.*

BACK

# JIRCAS AND THE MINISTRY OF AGRICULTURE,

## FORESTRY, AND

## FISHERIES



## Administration of the MAFF Research Institutes

The Japan International Research Center for Agricultural Sciences (JIRCAS) is one of twenty-nine research institutes belonging to the [Ministry of Agriculture, Forestry and Fisheries \(MAFF\)](#), the Government of Japan. In this age, in which we have seen remarkable progress in advanced fields of science and technology including biotechnology, MAFF's research institutes are playing a key role in the development of new technologies to pave the way for further development of the food industry, and promotion of agriculture, forestry and fisheries activities in the twenty-first century. MAFF's institutes work in close collaboration with local governments, universities, and private research organizations and aim to contribute to the overall prosperity of Japan while making significant contributions to the international community.

Nineteen of the twenty-nine institutes including JIRCAS are directly overseen by the [Agriculture, Forestry and Fisheries Research Council \(AFFRC\)](#), which is a special agency attached to MAFF. The main duties of the AFFRC are overall research planning and coordination, liaison and coordination between research and administration, administration and guidance of the institutes, and research assistance to prefectural organizations and the private sector. The AFFRC is headed by a chairman, and its advisory members consist of independent university faculty members and previous MAFF research institute directors and high officials ([Table 1](#)). The remaining ten institutes, which include one institute devoted to forestry and nine fisheries research institutes, are also attached to the AFFRC. However, they are overseen by the Forestry Agency and the Fisheries Agency, administrative agencies under the direct supervision of MAFF. The overall structure of research at MAFF is as shown in [Fig. 1](#).

JIRCAS is unique among the twenty-nine research institutes in that it serves as an international research center but is, at the same time, part of the MAFF infrastructure. Thus, it is involved in active exchange and collaboration with the other twenty-eight institutes. JIRCAS is located in the Tsukuba Science City, which is about 50 km northeast of Tokyo ([Fig. 2](#)). Many other MAFF institutes are also located in Tsukuba, and the AFFRC secretariat maintains a Tsukuba office, forming the Tsukuba Institutional Complex. Tsukuba itself is home to numerous other research institutes and experimental facilities belonging to other ministries and agencies of the Japanese Government, as well as to the private sector.

## Administration and Research at JIRCAS

JIRCAS has a current staff of 162, including research scientists and administrators. Thirty-nine of these staff members are located at the JIRCAS Okinawa Subtropical Station on Ishigaki Island. JIRCAS is headed by a Director General. The Research Planning and Coordination Division oversees seven research divisions which are comprised of the Research Information Division, Biological Resources Division, Environmental Resources Division, Crop Production and Post Harvest Technology Division, Animal Production and Grassland Division, Forestry Division, and the Fisheries Division, as well as the Okinawa Subtropical Station. The Administration Division is responsible for general administrative affairs. The structure of research at JIRCAS is delineated in [Fig. 3](#).

### ● Research Planning and Coordination Division

The Research Planning and Coordination Division in itself does not act as a research division, but rather serves to oversee and support the activities of the Research Divisions and Subtropical Station. The Division consists of four sections which are the Research Planning Section, the Research Coordination Section, the International Relations Section, and the Publication and Documentation Section. In addition, an International Research Coordinator and a Research Information Officer are assigned to the Division.

In order to promote the implementation of research programs both overseas and in Japan, the first three sections are responsible for the overall planning of JIRCAS research projects, dispatching of researchers on long- or short-term bases, implementation of programs for the invitation of researchers and administrators, and liaison and coordination with international and domestic institutions and agencies. The Publication and Documentation Section is responsible for the collection, classification, and supply of bibliographic materials from both overseas and domestic sources, as well as the release of public relations materials. The International Research Coordinator is responsible for overseeing collaborative



work in Southeast Asia while serving as JIRCAS's Thai Office Representative. The Research Information Officer develops computer information networks and coordinates the exchange of data between JIRCAS and related research institutions. Additionally, the Division coordinates the organization of various meetings and workshops including JIRCAS's International Symposia.

### ● Administration Division

The Administration Division consists of three sections: the General Affairs Section, the Accounting Section, and the Overseas Support Section. The General Affairs Section is responsible for the management of official documents, personnel-related matters, and social affairs pertaining to JIRCAS staff. The Accounting Section handles overall accounting, all budgeting, settlements and wage distribution. Lastly, the Overseas Support Section is in charge of all matters pertaining to JIRCAS's overseas operations, which includes general international affairs, overseas expenditures, and overseas shipments of equipment and materials.

### ● Other

The Okinawa Subtropical Station has its own General Affairs Section which is independent of the Administration Division. Additionally, JIRCAS has two field management sections which oversee JIRCAS's experimental fields. The Okinawa Section is directly under the Subtropical Station management and the Tsukuba Section is attached to the Crop Production and Postharvest Technology Division.

## Domestic institutional support of JIRCAS international collaborative research

JIRCAS's main role is to promote sustainable development of agriculture, forestry and fisheries compatible with the preservation of the environment in developing regions of the world through integrated, collaborative research programs. In performing this role, JIRCAS aims to play an active part in the international community. JIRCAS collaborative projects in developing countries take a multi-disciplinary approach by focusing on each country's socio-economic conditions when evaluating and implementing research programs. JIRCAS and local specialists carry out "comprehensive research" in an effort to address the region's most pressing agricultural problems. Domestic research at JIRCAS facilities in Japan, the JIRCAS visiting fellow invitation program, and strong cooperation with international research institutes all contribute to and support these research efforts abroad.

To orchestrate a project, JIRCAS first systematically collects and analyzes data from a variety of sources including food supply and agricultural research in developing regions and then proposes international collaborative research strategies and policies targeting the specific needs of a country. In this capacity, by devising comprehensive research and policy proposals, JIRCAS essentially functions as a think-tank. Next, JIRCAS utilizes existing technologies, policies, and research to broaden its role into the initiation of research programs to effectively confront such pressing matters as sustainable agricultural development, food security, and environmental problems. At present, JIRCAS is conducting 8 comprehensive projects around the world including ones in Southeast Asia, China, South America, and Africa. Each project is guided and administered by a working group and a project committee, which make on-going adjustments as the project evolves. A JIRCAS staff member directs each project and is supported when necessary on short-term bases by researchers from other agriculture, forestry, and fisheries institutes.

JIRCAS maintains over 100 researchers, 40 of which are on long-term research assignments abroad. Once a topic is decided upon, the details of the research project, such as its parameters, research aim, and length, are presented and the most suitable researchers are selected. When a project requires the long-term assignment of researchers from outside JIRCAS, those scientists participate as JIRCAS staff members for the duration of their assignment. JIRCAS staff members and scientists from other research institutions assist JIRCAS-centered research activities abroad on short-term bases of usually one to two months. Furthermore, about 40 JIRCAS researchers in Tsukuba, Ibaraki Prefecture and Ishigaki Island, Okinawa Prefecture support the international collaborative projects by conducting related domestic research.

In these ways, JIRCAS international collaborative research projects enjoy great support from the Ministry of Agriculture, Forestry and Fisheries' 29 affiliated research organizations and their 2,700 strong research staff. Finally, JIRCAS conducts an Annual Meeting for Review and Promotion of Research for International Collaboration in order to ensure each project proceeds smoothly. In this meeting, the previous year's activities are evaluated and strategies and goals are set for the coming year's research.

---

## JIRCAS ANNUAL REPORT EDITORIAL BOARD

JIRCAS's Annual Report is managed by the Research Planning and Coordination Division and an editorial board formed by staff administrators and researchers. In addition to a Chairman and Vice-Chairman, Editors-in-Chief, Advisory Panel, and Editorial Committee, the Board receives the participation of a graduate student intern from Harvard University's Regional Studies East Asia Program who Serves as a Special Assistant to the Editors -in Chief.



Back row: N. Ueno, M. N. Inagaki, T. Ishitani, H. Eguchi, Y. Yamagishi  
Front row: T. Hayashi, M. N. Wilder, R.B. Gates

---

[BACK](#)

[HOME](#)

Table1

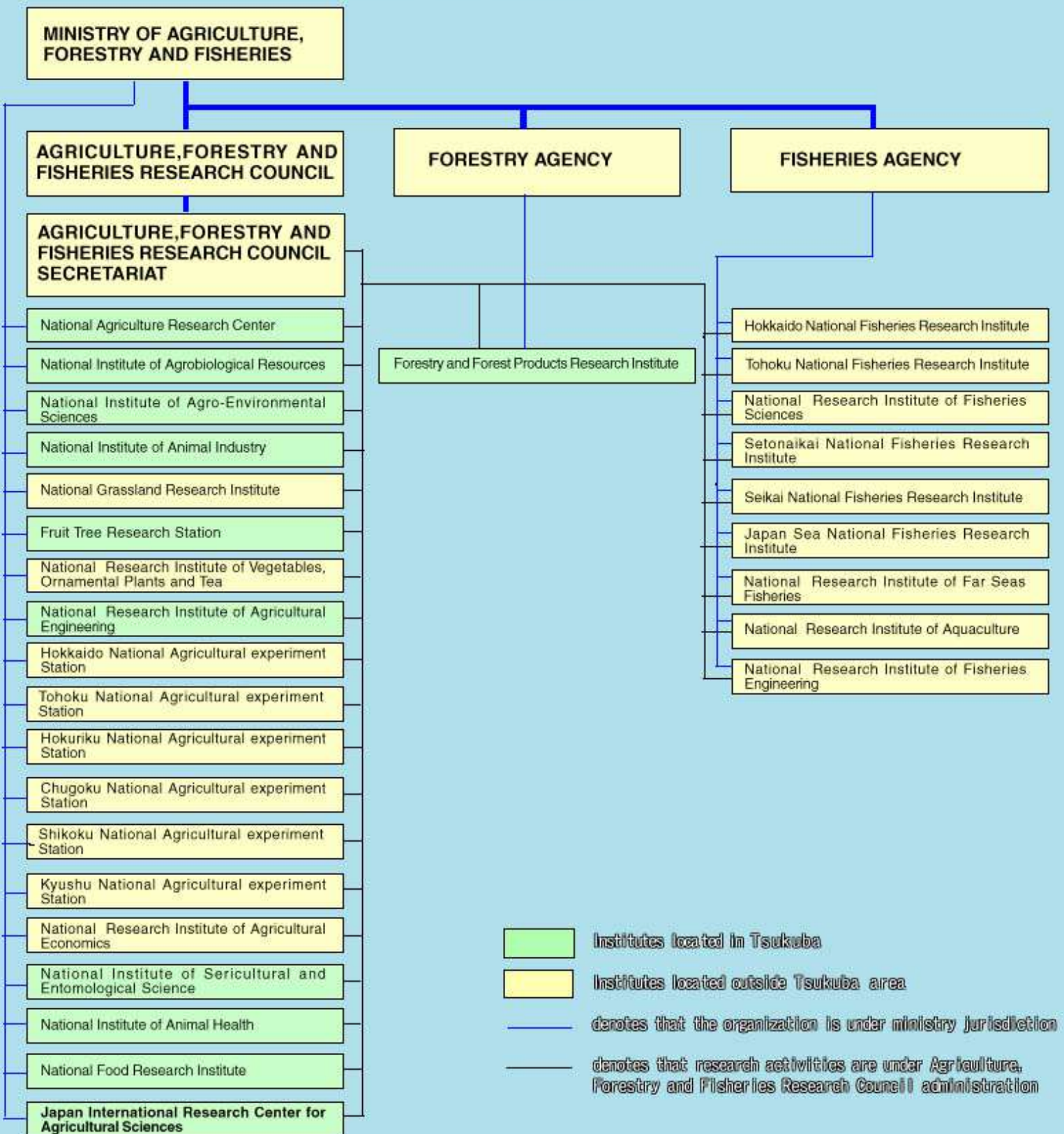
<b>Chairman</b>	<table border="0"> <tr> <td data-bbox="329 161 618 260"><b>SakueMatsumoto</b></td> <td data-bbox="618 161 1529 260"><b>Former Vice-Minister, Ministry of Agriculture, Forestry and Fisheries</b></td> </tr> </table>	<b>SakueMatsumoto</b>	<b>Former Vice-Minister, Ministry of Agriculture, Forestry and Fisheries</b>										
<b>SakueMatsumoto</b>	<b>Former Vice-Minister, Ministry of Agriculture, Forestry and Fisheries</b>												
<b>Advisory Members</b>	<table border="0"> <tr> <td data-bbox="329 323 618 422"><b>TakaharuHatanaka</b></td> <td data-bbox="618 323 1529 422"><b>President, Society for Techno-Innovation of Agriculture, Forestry, and Fisheries</b></td> </tr> <tr> <td data-bbox="329 422 618 520"><b>Tetsuo Iino</b></td> <td data-bbox="618 422 1529 520"><b>Professor of Genetics, Waseda University</b></td> </tr> <tr> <td data-bbox="329 520 618 619"><b>MasatoshiYoshino</b></td> <td data-bbox="618 520 1529 619"><b>Professor of Meteorology, Aichi University</b></td> </tr> <tr> <td data-bbox="329 619 618 718"><b>Takenori Inoki</b></td> <td data-bbox="618 619 1529 718"><b>Professor of Economics , Osaka University</b></td> </tr> <tr> <td data-bbox="329 718 618 816"><b>Kazuo Takahashi</b></td> <td data-bbox="618 718 1529 816"><b>Governor, Yamagata Prefecture</b></td> </tr> <tr> <td data-bbox="329 816 618 938"><b>AkinoriSuzuki</b></td> <td data-bbox="618 816 1529 938"><b>Former Vice-President, University of Tokyo</b></td> </tr> </table>	<b>TakaharuHatanaka</b>	<b>President, Society for Techno-Innovation of Agriculture, Forestry, and Fisheries</b>	<b>Tetsuo Iino</b>	<b>Professor of Genetics, Waseda University</b>	<b>MasatoshiYoshino</b>	<b>Professor of Meteorology, Aichi University</b>	<b>Takenori Inoki</b>	<b>Professor of Economics , Osaka University</b>	<b>Kazuo Takahashi</b>	<b>Governor, Yamagata Prefecture</b>	<b>AkinoriSuzuki</b>	<b>Former Vice-President, University of Tokyo</b>
<b>TakaharuHatanaka</b>	<b>President, Society for Techno-Innovation of Agriculture, Forestry, and Fisheries</b>												
<b>Tetsuo Iino</b>	<b>Professor of Genetics, Waseda University</b>												
<b>MasatoshiYoshino</b>	<b>Professor of Meteorology, Aichi University</b>												
<b>Takenori Inoki</b>	<b>Professor of Economics , Osaka University</b>												
<b>Kazuo Takahashi</b>	<b>Governor, Yamagata Prefecture</b>												
<b>AkinoriSuzuki</b>	<b>Former Vice-President, University of Tokyo</b>												

**Current Members of the Agriculture, Forestry and Fisheries Research Council.**

[BACK](#)

**Fig. 1 General organization of the research institutes of the Ministry of Agriculture, Forestry and Fisheries.**

Twenty-nine research organizations are affiliated to the Ministry of Agriculture, Forestry and Fisheries: 19 are directly overseen by the AFFRC; 1 forestry and 9 fisheries institutes are under the administration of the Forestry Agency and the Fisheries Agency, respectively.



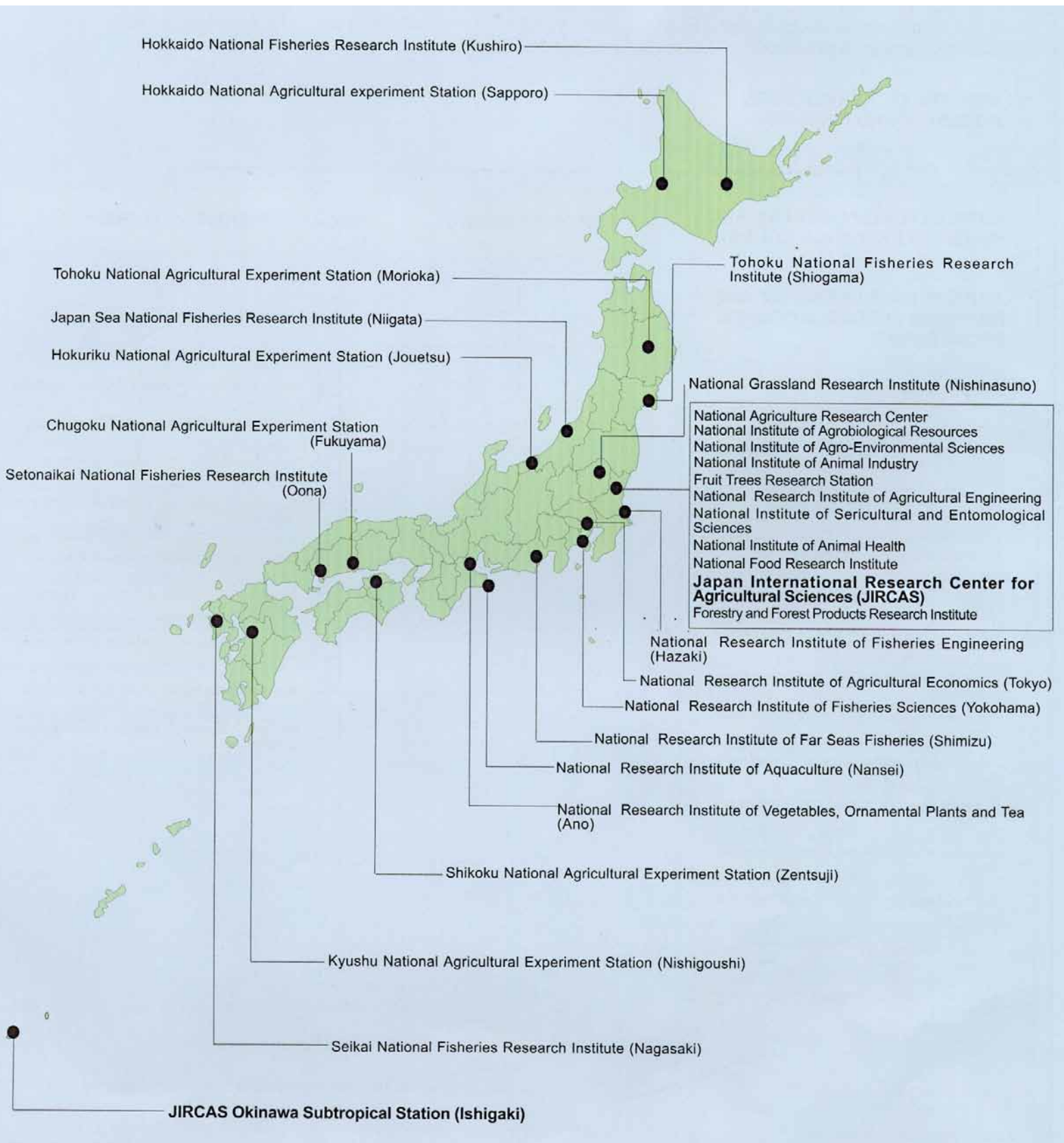


Fig.2 Location of the 29 research institutes of the Ministry of Agriculture, Forestry and Fisheries.

**Fig. 3 Organization**





## INTERNATIONAL RESEARCH AT JIRCAS

International collaborative projects at JIRCAS encompass all fields of agriculture, forestry and fisheries and are carried out in collaboration with counterpart institutions, including international research centers, national research organizations, and universities. A series of comprehensive projects commenced when the Tropical Agricultural Resource Center (TARC), the predecessor of JIRCAS, was restructured to create the present institution. These projects are focused on answering the difficult agricultural problems, such as developing sustainable agricultural systems, and addressing food supply and environmental problems, which presently confront developing countries. Projects combine research in both the natural and social sciences. Within the scope of a project, JIRCAS dispatches long- and short-term researchers to the target countries and may also sponsor research-related conferences and workshops with the partner country. In addition to comprehensive-type projects, JIRCAS continues to promote specific, focused, unidisciplinary types of projects originally carried out at TARC.

The following section presents recent developments in several ongoing comprehensive projects and, in keeping with this year's focus on the People's Republic of China, spotlights important research sites in China where several collaborative projects are currently being pursued. A [complete listing of comprehensive and unidisciplinary projects](#) undertaken by JIRCAS researchers can be found [here](#).

### ◆ COMPREHENSIVE PROJECTS

In 1998, JIRCAS was involved in eight comprehensive projects in Vietnam, Thailand, Malaysia, the People's Republic of China, Brazil, Indonesia, South America (Brazil, Argentina and Paraguay), and West Africa. These projects have been divided into three classifications, "Site-specific Comprehensive Projects," "Country-based Comprehensive Projects," and "Multinational Comprehensive Projects."

Site-specific comprehensive projects first systematically analyze the agricultural, forestry, and fisheries issues of a specific region through an understanding of the relationships between various factors such as natural resources, environment, technology, and administration, and then conduct multidisciplinary research addressing the needs of the region. Projects in [Vietnam](#), [Thailand](#), [Malaysia](#), and [Indonesia](#) are examples of site-specific projects. Country-based comprehensive projects identify the most significant food supply and agricultural problems of the partner state and then select several representative research fields and themes in which JIRCAS can best contribute toward the resolution of these problems. In addition, these projects promote comprehensive joint research through collaboration with the government of the partner state. Both the [China](#) and [Brazil](#) projects fall under this classification. Multinational comprehensive projects incorporate researchers in many fields from a wide region covering multiple countries in a cooperative effort to resolve strategically important issues. The projects in [South America](#) (soybeans) and [West Africa](#) (rice) are multinational projects.

Each comprehensive project has a research coordinator in the Research Information Division who assumes the role of project leader, organizing and overseeing collaboration among researchers in participating research divisions. During the planning stages of these comprehensive projects, socio-economic studies are conducted to identify research priorities in counterpart countries.

- Click [here](#) to learn about soybean improvement, production and utilization in [South America](#).
- Click [here](#) to learn about the development of sustainable agro-pastoral systems in sub-tropical zones in [Brazil](#).
- Click [here](#) to learn about evaluation and improvement of regional farming systems in [Indonesia](#).
- Click [here](#) to learn about improving food security through the increase in productivity of rice systems in [West Africa](#).
- Click [here](#) to learn about the development of sustainable farming systems in [Thailand](#).
- Click [here](#) to learn about the development of new technologies and their practice for sustainable farming systems in the [Mekong Delta in Vietnam](#).
- Click [here](#) to learn about the development of sustainable production and utilization of major food resources in [China](#).
- Click [here](#) to learn about food-chain mechanisms and productivity in brackish water mangrove ecosystems in [Malaysia](#).

## RESEARCH SITES IN CHINA

As a part of this year's spotlight on JIRCAS initiatives in China, the following pages detail sites at which JIRCAS researchers are currently undertaking projects with Chinese governmental and university researchers. The opening of JIRCAS's China office in Beijing is also highlighted in this section.

- Find information about JIRCAS's new Beijing, China Office [here](#).
- Find information about JIRCAS activities at the China National Rice Research Institute (CNRRI) [here](#).
- Find information about JIRCAS activities at China Agricultural University (CAU) [here](#).

---

[BACK](#)

[HOME](#)



## INTERNATIONAL COLLABORATIVE PROJECTS

Projects are designated as either comprehensive or unidisciplinary. All projects are handled by the JIRCAS Research Divisions.

### (A) COMPREHENSIVE

Time Frame	Project Title	Research Site
1994-1998	Evaluation and improvement of farming systems combining agriculture, animal husbandry, and fisheries in the Mekong Delta (Phase I)	Cuu Long Delta Rice Research Institute (CLRRI) and Cantho University (CTU), Vietnam
1999-2003	Development of new technologies and their practice for sustainable farming systems in the Mekong Delta (Phase II)	Cuu Long Delta Rice Research Institute (CLRRI) and Cantho University (CTU), Vietnam
1995-2001	Development of sustainable agricultural technology in northeast Thailand	Department of Agriculture, Department of Livestock Development, Land Development Department, Asian Institute of Technology, Khon Kaen University, Thailand
1995-1999	Productivity and sustainable utilization of tropical and subtropical brackish water ecosystems	Department of Fisheries (DOF), Forestry Research Institute (FRIM), and the Ministry of Agriculture (MOA), University of Malaya, Malaysia
1996-2002	Comprehensive studies on the development of a sustainable agro-pastoral system in the sub-tropical zone of Brazil	Brazilian Agricultural Research Corporation (EMBRAPA), Center for Tropical Agriculture (CIAT), and JATAK International Center for Agriculture Technology, Brazil
1997-2003	Development of sustainable production and utilization of major food resources in China	Institute of Agricultural Economics, Institute of Natural Resources and Regional Planning, Research Center for Rural Economy, China Agricultural University, Institute of Soils and China National Rice Research Institute, and the Shanghai Fisheries University, People's Republic of China
1997-2006	Comprehensive soybean research project in South America (multinational)	Agricultural Technology Center in Paraguay (CETAPAR), Paraguay; Brazilian Agricultural Research Corporation (EMBRAPA), Brazil; and the National Institute for Agricultural Technology (INTA), Argentina
1998-2002	Evaluation and improvement of regional farming systems in Indonesia	Agency for Agricultural Research and Development (AARD), Indonesia
1998-2002	Improving food security in West Africa through increased productivity in rainfed rice systems	West Africa Rice Development Association (WARDA), Côte d'Ivoire

### (B) UNIDISCIPLINARY

Time Frame	Project Title	Research Site
1995-1998	Rehabilitation of secondary degraded forest	Forest Research Institute Malaysia (FRIM), Malaysia
1995-1998	Improvement of technologies for raising small livestock in the tropics	Malaysia Agricultural Research and Development Institute (MARDI), Malaysia
1995-1998	Ecology and control of insect pests in reforested areas at Luasong Forestry Center, Tawau	Sabah Forest Research Institute Malaysia (FRIM), Malaysia

1995-1998	Methods of soybean cultivation in cropping systems with low pesticide input in Indonesia	Research Institute for Legumes and Tuber Crops (RILET), CRIFC, and the Agency for Agricultural Research and Development (AARD), Indonesia
1995-1999	Biorational approaches to long term and sustainable management of desert locusts in east and northeast Africa	International Center for Insect Physiology and Ecology (ICIPE), Kenya
1996-1998	An explanation of the ecology and methods for control of weeds in direct seeded rice cultivation in Malaysia	Malaysia Agricultural Research and Development Institute (MARDI), Malaysia
1996-1998	Improvement of logging techniques in hill dipterocarp forests	Forest Research Institute Malaysia (FRIM), Malaysia
1996-1999	Development of effective water management in paddy fields in the dry season	International Irrigation Management Institute (IIMI), Sri Lanka
1996-2000	Development of technology for sustainable management of grasslands in Central Asia.	Kazakh Institute of Agriculture, Republic of Kazakhstan
1996-2000	Afforestation technology for useful tropical tree species and the development of related research	University of the Philippines at Los Baños, Philippines
1997-1998	Early interactions between <i>Theileria parva</i> and bovine immune cell populations	International Livestock Research Institute (ILRI), Kenya
1997-1999	The role of local people in the degradation and rehabilitation of tropical forests	International Center for Research in Agroforestry (ICRAF)-South East Asia, Indonesia
1997-1999	Improvement of high-yielding wheat varieties through biological procedures	International Maize and Wheat Improvement Center (CIMMYT), Mexico
1997-1999	Studies on technology for sustainable production in closed coastal zones	Kasetsart University, Thailand
1997-1999	The development of methods for the use of under-utilized timber resources in the tropics	School of Industrial Technology, Universiti Sains, Malaysia
1997-2001	Development of diagnosis and prevention technology for shrimp viral diseases	Fisheries Research Institute (FRI), Malaysia
1998-2001	Development of technology for water distribution management for large scale paddy fields in tropic monsoon area	Muda Agricultural Development Authority (MADA) and Malaysian Agricultural Research and Development Institute (MARDI), Malaysia



## **VIETNAM:**

### **Comprehensive Project on the Development of New Technologies and their Practice for Sustainable Farming Systems in the Mekong Delta**

Although this project conducted with Vietnamese institutes was JIRCAS's first foray into collaborative research projects, the recently concluded project, "Evaluation and improvement of farming systems combining agriculture, animal husbandry, and fisheries in the Mekong Delta," ran smoothly from its initiation in 1994 owing to the efforts of long- and short-term visiting researchers and counterpart scientists, as well as to strong organizational cooperation. As Phase I of the project, the research provided the foundation for Phase II, entitled, "Development of new technologies and their practice for sustainable farming systems in the Mekong Delta." Results obtained under Phase I of this project relate to the following topics: 1) characterization of the natural and social conditions of typical Mekong Delta agriculture; 2) clarification of primary technological structures of some farming systems; 3) demonstration of possible improvements in rice cropping, pest management, hog raising and aquaculture; 4) clarification of the primary structure of farming households; and 5) presentation of possible directions for future farming system development. Though some of these results had already been obtained by Vietnamese scientists, many were new achievements in this project. Research has been presented not only as individual papers but also as co-published monographs.

Results from this project may be considered as an analytical study of existing farming systems in the Mekong Delta and as a first step in conducting interdisciplinary research. Since the significance of this interdisciplinary project is its role within an overall research framework designed to achieve concrete goals, the next research project will examine and evaluate farming systems with newly developed technologies and regimes in order to achieve sustainability in a variety of ecosystems in the Mekong Delta.

The themes of Phase II of the project are as follows: 1) Development of new technologies for farming systems in the Mekong Delta; three components of farming systems - rice cropping, hog raising, and aquaculture - will be studied in order to increase efficiency, lower costs and reduce pollution in combined farming systems. 2) Farm management and the functions of farmers' organizations; since farming systems are a reflection of natural and social conditions of a region, geographical effects on salt-affected areas and acid-sulfate soil areas, as well as irrigated areas, will be studied. The possibility of establishing farmers' organizations responsible for such services as crediting and delivery of goods will also be studied. 3) Evaluation of sustainability of newly developed farming systems; new farming systems will be proposed and the cycling of nitrogen and other materials in agro-ecosystems will be assessed. General assessment of the agricultural economy and sustainability will be carried out as well.

To be conducted over a 5 year period (1999-2003), the comprehensive research should achieve the following results: 1) new technologies for rice cropping, hog raising and aquaculture will be developed to make farming systems complete as production systems; 2) new farming systems with developed technologies will be proposed for differing ecosystems within the Mekong Delta; 3) new farming systems will be examined and evaluated for their sustainability on the bases of material cycling and agricultural economy. Our Vietnamese counterpart institutes, Cantho University (CTU) and Cuu Long Delta Rice Research Institute (CLRRI), will be responsible for the organization of the new project.

---

[BACK](#)

[NEXT](#)



## **CHINA:**

### **Comprehensive Project on the Development of Sustainable Production and Utilization of Major Food Resources**

JIRCAS officially inaugurated its first comprehensive research project with the national government of the People's Republic of China (PRC) on May 28, 1997, with the signing of a memorandum by representatives from JIRCAS, the Japanese Agriculture, Forestry and Fisheries Research Council (AFFRC), and the Chinese Ministry of Agriculture (MOA). The Memorandum of Understanding commits the institutions to a collaborative research program spanning seven years.

The comprehensive project aims to develop technologies for sustainable production and utilization of major food resources in China. Such resources, including rice, soybeans, corn, and freshwater fish, will become increasingly important as economic development strengthens the purchasing power of ordinary Chinese citizens and enhances their concern for dietary nutrition.

On June 10, 1998, JIRCAS celebrated the opening of its Beijing Office. Composed of a variety of research fields, ranging from the social to the natural sciences, the comprehensive research project involves 10 research institutes of the People's Republic of China, 8 research institutes of MAFF including JIRCAS, and several prefectural research institutes. The newly opened Beijing office will play a pivotal role in facilitating and promoting this and future Japan-China research collaboration.

A report entitled "Who will feed China? Wake-up call for a small planet" (L. Brown, The World Watch Institute, 1995) provided the initial impetus behind concerns about the future of China's food supply. In response, many Chinese and foreign researchers have made analyses and projections regarding food supply problems in China, focusing their studies primarily on the grain sector. These reports reveal little agreement on future scenarios for food production and demand, most likely due to differences in underlying assumptions, data, and estimation processes. Nevertheless, there exists sufficient consensus that food demand will increase continuously during the next three decades and that available supplies will not meet this demand. Consequently, rising demands for imported foodstuffs will likely occur.

The major factors inhibiting agricultural production increases in China include the area of arable land, the poor quality of farmland, the weak response of soils to fertilizer, and the small-holder structure of private Chinese farms. In the process of rapid economic growth, it is inevitable that more farmland will be put toward non-agricultural uses. New efforts to reclaim land and recent increases in crop indices do not seem to have halted the trend toward declining levels of land under cultivation. Moreover, crop yields in China remain significantly lower than in advanced industrial countries.

At the same time, major factors influencing food demand will include the expansion of the population, changes in the structure of Chinese society due to rural-urban migration, the growth of income,

alterations in the prices of agricultural products, and the persistence of poor infrastructure. Due to the inevitable shrinkage of agricultural resources and the natural, structural, financial, and economic constraints on yield potentials, demand for food in China will continue to rise even as agricultural production fails to keep pace.

In light of these trends, this project marks an attempt to develop an effective production and distribution system for food resources in order to cope with changing structures for the supply and demand of agricultural products. Efforts to achieve this objective will require not only an evaluation of the dissemination of new technologies in selected areas and their economic impacts on rural areas and individual farmers, but also modeling for the supply and demand of food resources in selected areas, analysis of the structure of corresponding farming areas and agricultural products, and design of more effective control systems also will be required to improve food supply and demand in selected areas. Joint workshops by JIRCAS, the Institute of Agricultural Economics, and the Chinese Academy of Agricultural Sciences (CAAS) were held on food supply-demand and dissemination of new agricultural technologies in China on November 26, 1998, at JIRCAS. A follow-up workshop was held in Beijing on March 12, 1999, to report the progress of this project and to elucidate and evaluate current research on the dissemination of new agricultural technologies.

In addition, the project seeks to generate technologies for the sustainable and stable production of major food resources. Toward this end, project participants intend to evaluate existing genetic resources, create new species, and develop and evaluate environmentally sensitive agricultural technologies. On the evaluation and development of the methods for sustainable agriculture and environmental conservation, a second planning workshop was held on March 23-25, 1999, in Beijing ([Photo](#)), jointly by JIRCAS, the Institute of Soils and Fertilizers, CAAS, and the Institute of Soil Sciences of the Chinese Academy of Science. Finally, the project aims to develop food technologies that will enhance the utilization and distribution of major food resources. These efforts will include evaluating the quality of major food resources, developing new food ingredients, and improving preservation and distribution technologies for major food resources. The results from the study on the development of new technology to utilize and process freshwater fish meat were presented in the first joint workshop between JIRCAS and Shanghai Fisheries University, March 25-27, 1999, in Shanghai.

---

[BACK](#)[NEXT](#)



Joint workshop in Beijing in March 1999.

BACK



## **BRAZIL:**

### **Comprehensive Project on the Development of Sustainable Agro-pastoral Systems in Sub-tropical Zones**

Initiated by JIRCAS in 1996, the project entitled "Comprehensive studies on the development of sustainable agro-pastoral systems in the subtropical zone of Brazil" is another South America-based research program. By emphasizing land utilization through the adoption of crop-pasture rotation systems, this project focuses on the development of highly productive, sustainable farming systems in the environmentally degraded areas of Brazil's sub-tropical zone. Current research involves collaborative efforts from CNPGC (National Research Center for Beef Cattle), [EMBRAPA](#), and JATAK (International Center of Agricultural Technology). In cooperation with JIRCAS, these institutes are conducting research on four themes, including analysis and evaluation of indigenous and traditional land utilization systems for agriculture, multidisciplinary studies on the adoption as sustainable crop-pasture rotation systems, socio-economic evaluation of crop-pasture rotation, and newly developed agro-pastoral systems.

**Photo:** *Experimental field for the study of agro-pastoral systems at CNPGC (National Research Center for Beef cattle), Campo Grande, Brazil.*

---

BACK

NEXT



*Experimental field for the study of agro-pastoral systems at CNPGC  
(National Research Center for Beef cattle), Campo Grande, Brazil.*

BACK





## **SOUTH AMERICA:**

### **Comprehensive project on Soybean Improvement, Production and Utilization**

The soybean, *Glycine max*, is considered to be one of the principal crops for human sustenance. Soybeans provide a major source of food, oil, and protein-rich livestock feed. Production of this valuable crop has increased rapidly in the past three decades in comparison with that of rice, wheat, corn, and other major grains. Encouraging the continuation of this trend may aid efforts to stabilize the world food supply.

At present, Brazil, Argentina, and Paraguay (MERCOSUR countries) account for approximately one-third of global soybean production, placing them among the leading soybean export countries. However, soybean production in South America has often been carried out under environmentally vulnerable conditions in arid, acid soils characterized by low-fertility. Of additional concern, the history of soybean cultivation in these areas is relatively short, giving rise to concerns that continuous cropping, pest and disease outbreaks, and soil erosion may adversely affect future soybean production.

Comprehensive, multinational research efforts focused on the development of sustainable and more efficient systems of soybean production in South America can be considered an important means of addressing these constraints.

The JIRCAS research project entitled "Soybean improvement, production and utilization in South America" marks a new initiative by the institute to promote multi-disciplinary studies on soybean production and utilization in MERCOSUR countries through collaborative research linking Japanese and South American specialists. The project involves collaboration with several South American research institutes, including those affiliated to [EMBRAPA \(The Brazilian Agricultural Research Corporation, Brazil\)](#), MAG (Ministry of Agriculture and Livestock, Paraguay) and INTA (National Institute of Agricultural Technology, Argentina), as well as [JICA/CETAPAR \(Japan International Cooperation Agency - Centro Tecnológico Agropecuario en Paraguay\)](#). This comprehensive project complements earlier efforts in the field by focusing research in five areas: genetics and breeding, soil management and pest control, crop management and production, post harvest technology, and socio-economic factors.

---

BACK

NEXT



## **WEST AFRICA:**

### **Comprehensive Project on Improving Food Security through Increased Productivity in Rainfed Rice Systems**

Demand for rice in sub-Saharan Africa is growing faster than that for any other major food staple, with consumption broadening across all socio-economic classes, including the poor. Rapid demographic expansion and urbanization in Africa has changed food preferences from traditional food-stuffs to more easily prepared rice and bread. These patterns are especially evident in West Africa where the substitution of rice for coarse grains and traditional root and tuber crops has fueled rice demand at an annual growth rate of 5.6% between 1961 and 1992.

Rice is no longer a luxury food. The poorest urban households in West Africa obtain larger shares of their cereal-based calories from rice than do higher income households, and rice purchases represent a greater share of their total cash expenditures. Rice availability and rice prices directly impact the welfare of the poorest West African consumers who are the least food secure.

Increased rice production in Africa is hampered by a number of constraints, including disease and pests, weed infestation, inadequate water management, soils with low fertility, lack of suitable varieties, and socio-economic factors. To address these problems, JIRCAS initiated a 5-year collaborative research project with the [West Africa Rice Development Association \(WARDA\)](#) in April, 1998. The project aims to develop and distribute rice cultivars which are well suited to local socio-economic conditions, technological levels, and farming practices, with a special focus on resource-poor farmers in the region. Two JIRCAS scientists have been dispatched to the Upland Rice Program and Policy Support Program of WARDA to carry out the following research: 1) genetic and eco-physiological characterization of indigenous rice varieties and inter-specific progenies (*Oryza glaberrima* x *Oryza sativa*), with emphasis placed on tolerance to drought and acid soil conditions, and 2) studies on socio-economic aspects in relation to the sustainability of lowland rice cultivation in West Africa.

---

BACK



## **THAILAND:**

### **Comprehensive studies on sustainable agricultural systems in northeast Thailand**

The agricultural environment in northeast Thailand is characterized by the alternation of a rainy season followed by a half-year dry season and the wide distribution of infertile sandy and saline soils. Due to these disadvantageous agricultural conditions, the region is not economically blessed. Farmers in the region have been planting rice as a cash crop on rain-fed paddy fields since the 1960s when farmland was extensively expanded through deforestation. Recently, areas used for the harvesting of sugarcane have expanded rapidly as has the breeding of large-sized ruminants. Demands for milk and meat are expected to increase along with the country's recent high economic growth.

Deforestation and the expansion of saline soils have changed the hydrolic environment. In particular, soil erosion and deterioration of soil fertility in cassava fields have resulted in decreased productivity. Cash crop profitability is also waning due to the depression in the market price of agricultural products.

In order to promote agriculture in the region, it is necessary to maintain an environment favorable to reforestation and to utilize water resources effectively. At the same time, it is also necessary to shift the agricultural system from one which is dependent on a few cash crops to a sustainable agricultural system in which local resources are utilized much more effectively. This collaborative project is focused on areas of rain-fed paddy fields in northeast Thailand and is aimed at developing technologies in rice and field crop harvesting, vegetable and fruit cultivation, the livestock industry and sericulture, as well as attaining sustainable agricultural systems that combine farming and animal husbandry.

*Photo: Mechanization in crop tending in Thailand*

*Photo: Non-tillage seeding exhibited an advantage in weed control through pre-seeding herbicide treatment in Thailand*

In this project, JIRCAS is focusing on farmers who are eager to diversify agricultural production. Research concerns such topics as: 1) labor reduction through the introduction of direct seeding in dry paddy fields, 2) the introduction of profitable and durable vegetables and forage crops in upland field farming, 3) full utilization of regional resources in order to supply livestock forage on a year-round basis 4) the introduction of small-sized machines in order to improve working efficiency, and 5) the improvement of the hydrolic environment by constructing reservoirs and afforestation. Other research focuses on evaluating the material cycle of organic and inorganic components in crop and livestock production, improving the quality of agricultural and livestock products, and evaluating managerial and economic activities. Complete activities, which comprise 5 main themes are summarized as follows:

#### I. Evaluation and effective utilization of environmental and biological resources in the area

1. To evaluate characteristics of agricultural conditions based on topography, water and soils and apply the information obtained to proper utilization of land.
2. To clarify the circulation nutrients in the use of organic and inorganic components and to indicate guidelines for the effective use of organic compounds.
3. To evaluate the durability of circulation of materials under the proposed "sustainable agricultural system"

#### II. Development of sustainable crop production systems

1. Profitable rice cropping: reduction of labor and mechanization by direct sowing on dry paddy fields and subsequent efficient utilization of materials for production purposes.
2. New utilization of sugarcane: development of various technologies including cultivation of sugarcane for use as whole forage crop and cultivation with minimum inputs of nitrogen fertilizer.
3. Profitable cultivation of vegetables: clarification of the effectiveness of silviculture in farmland and alley cropping and to development of water-saving technology for the cultivation of marketable vegetables as well as legumes and potatoes.
4. Development of practical utilization methods of organic fertilizer using livestock excreta.

#### III. Improvement of feeding management using locally available feed resources

1. To develop technology for animal feed production by making use of local resources.

2. To develop technology for breeding cows for dairy or meat production using local fodder resources.

#### IV. Development of postharvest technologies for local agricultural products

1. Improvement of rice quality/development of preservation technology

2. Establishment of quality evaluation procedures for dairy and meat products and improvement of conditions for distribution.

#### V. Economic evaluation of multi-cropping and livestock farming

1. To evaluate energy conservation and profitability in rice production.

2. To evaluate profitability by clarifying external conditions for introduction of highly productive agricultural products such as vegetables.

3. To evaluate profitability of dairy products along with introduction of new forage crops.

4. To evaluate managerial and economic aspects of multiple farming systems based on the introduction of new crops and improvement of cropping systems.

This project has thus far achieved a number of beneficial results. In the field of biological resources, the usefulness of newly introduced cow-pea and sweet potato varieties were evaluated. Sugarcane genes, including those of wild sugarcane, collected from various regions in Thailand were studied in order to improve yield. It was determined that sugarcane and pineapple fix atmospheric nitrogen and that future cultivation of these crops can be accomplished by decreasing the amount of nitrogen. The above findings are useful for the establishment of sustainable agricultural systems in this region.

In an effort to develop a sustainable agricultural production system, the proper interval of planting leguminous trees for alley cropping was determined and a mechanized working system suitable for the region was also investigated. Moreover, the possibility of introducing direct sowing of rice on dried paddy fields was studied. By studying drought-resistant tropical pastures, developing methods for silage preparation, and evaluating the nutritional characteristics of grass pasture, leguminous pasture, feed trees and sugarcane, considerable progress was made in this project from the point of view of improving the utilization of animal resources. We also clarified the metabolizable energy and protein requirements for the maintenance of locally utilized ruminants.

On the postharvest technology research front, the flavor component of Khao Dawk Mali, one of the most important rice varieties in northeast Thailand, was quantitatively analyzed using a 0.5 g rice sample. By developing a process to identify rice varieties using DNA it became possible to determine rice mixing rates.

---

BACK

NEXT



*Mechanization in crop tending in Thailand*

BACK



*Non-tillage seeding exhibited an advantage in weed control through pre-seeding herbicide treatment in Thailand*

BACK



## **MALAYSIA:**

### **Comprehensive Project on Productivity and Sustainable Utilization of Brackish Water Mangrove Ecosystems**

There is presently wide public and scientific concern to achieve a fuller and more effective understanding of all of Earth's natural ecosystems. For that objective to be realized with tropical mangrove systems will require undiminished effort throughout the present decade and probably well into the next century, because our understanding of mangrove forests lags behind that of many other ecosystems. Nevertheless, as will be seen from the several reports, great advancements have been made during the last decade, particularly in understanding the structure and function of mangrove ecosystems in the Indo-Pacific region.

Many human communities have a traditional dependence on mangroves for their subsistence and a wide range of natural products from mangroves is presently utilized. For some time, however, there has also been exploitation of mangrove resources for broader economic objectives, e.g. forestry. Harvests of that kind, when well-managed, are probably sustainable in the long term as evidenced by the continued high yield of timber products and charcoal from the Matang Mangrove Forest in Malaysia. On the other hand, some other forms of exploitation, often for short-term gain, can be irreversibly destructive. Clear felling of virgin forests for wood chips and paper pulp is a notable example. The conversion of mangrove forests for mariculture ponds on large scale, notwithstanding the recovery of fishery products, is also, of course destructive of the native forests and, at least in practical terms, irreversible. Reclamation of mangrove forests for agricultural, industrial, urban and other forms of land-based development is also increasing and causing irreversible damage in coastal regions throughout the tropics. Such impacts, not to mention the additional burdens of pollution and changes in hydrological regimes caused by freshwater diversion projects, have adverse effects not only on subsistence dwellers in and near mangrove habitats, but also on other members of society, who depend indirectly on intact coastal resources. A consequence of this has been greater public concern for coastal lands, including mangrove forests, and increased research and management effort throughout the tropics.

In order to better understand the functions of these valuable ecosystems, JIRCAS has initiated a collaborative research project on the productivity and sustainable utilization of brackish water mangrove ecosystems in cooperative with leading Malaysian scientists. The project covers a five-year period from 1995-2000 and prioritizes four principal research topics, including production and decomposition processes in differential brackish water mangrove ecosystems, nutrient flux from rivers to coastal ecosystems, energy flow and carrying capacity in differential brackish water mangrove ecosystems, and socio-economic evaluations of brackish water mangrove ecosystems. Research touching upon issues in fisheries is now being conducted in collaboration with the Fisheries Research Institute (FRI) and the [University of Malaya \(UM\)](#).

At present, three research sites in Peninsular Malaysia have been selected for the project. The Matang Mangrove Forest in Perak State is located within a forest reserve measuring 40,711 hectares. The area consists of numerous islands and adjacent water ways and is populated primarily by *Rhizophora apiculata* trees. Under sustainable management since the early part of the century, Matang Mangrove Forest is reputed to be the world's best managed mangrove forest. As such, it will provide a valuable location for analyzing the role of fish populations in mangrove ecosystems. In contrast, disturbance through partial deforestation characterizes Merbok Mangrove

Forest Reserve in Kedah State. The loss of mangroves continues due to the persistence of destructive land uses, especially the conversion of mangrove areas into shrimp culture ponds. The third site, the Lumut Mangrove Forest has experienced much more extensive deforestation. Surveys conducted between 1997 and 1998 in the Selinsing River of the Matang Mangrove indicate the presence of a certain C-N isotopic ratio gradient. This finding suggests the presence of a food pathway that begins with leaf-based detritus in the mangrove, continues upwards to herbivorous shrimp and crab species, and culminates in carnivorous fish and squid. In other words, series of trophic relationships is fulfilled in the Matang brackish water mangrove ecosystem.

Additional research comparing populations of larval and juvenile anchovies, *Stolephorus* spp., at the research sites indicates population densities at least 1.5 times greater in the intact brackish water mangrove ecosystem at Matang than those in the disturbed ecosystem at Merbok. Biomass at Matang also measured 4.3 times higher than that in the Merbok Mangrove. These results confirm our assumptions that the undisturbed nature of Matang Mangrove would generate much higher levels of productivity for larval and juvenile anchovy, when measured as the product of biomass and daily growth rates calculated through otolith ring analysis.



Photo: *Oyster cage culture in a mangrove estuary in Malaysia.*

We have presented the results of these and other studies conducted during the past four years in an annual seminar held under the auspices of the comprehensive project. Two seminar proceedings have already been published. As a result of these studies, integrated criteria on tree and aquatic production under suitable forest management can now be standardized. Information obtained in this project will be useful to scientists in many fields in their efforts to improve techniques for the sustainable utilization of brackish water mangrove ecosystems, benefiting local residents as well as policy makers.

---

BACK

NEXT





## **INDONESIA:**

### **Comprehensive Project on the Evaluation and Improvement of Regional Farming Systems**

Agricultural production in Indonesia varies greatly from location to location, depending on the natural environmental and socio-economic conditions of each locale. For instance, rapid economic growth, industrialization, and urbanization on Java Island has exacerbated gaps between cities and villages and fundamentally altered the social and economic conditions of rural areas. On the outer islands, generally poor living conditions reflect the slow pace of economic development and the lack of suitable technologies with which to overcome the difficulties of resource exploitation.

Most agricultural research in Indonesia has been focused on lowland farming systems based on the cultivation of rice. This focus, when combined with the effects of other governmental programs to aid rice farmers, allowed Indonesia to achieve its national goal of self-sufficiency in rice by 1984. However, upland crop areas have benefited little from new agricultural techniques in spite of the many research projects that have targeted upland or rainfed lands. Consequently, upland agriculture remains much less developed than lowland agriculture throughout the country. Thus, in addition to the recent shortfalls in rice production in these areas, food crop production enhancement in both lowland and upland areas has become the principal target of agricultural research and development in Indonesia.

*Photo: A sampling of vegetables grown locally in Indonesia.*

The comprehensive research project entitled "Evaluation and improvement of regional farming systems in Indonesia" aims to shed light on socio-economic and technical evaluations of past and present farming systems research practices and extension in Indonesia. A bottom-up participatory process and an emphasis on multi-disciplinary approaches to problems characterize a "farming systems research approach." The project commenced in April, 1998 and is scheduled to last for five years. The collaborating research institutes of Indonesia include the Center for Agro-Socio Economic Research (CASER), the Research Institute for Legume and Tuber Crops (RILET) of the Central Research Institute for Food Crops (CRIFC), and other organizations under the Agency for Agricultural Research and Development (AARD) of the Ministry of Agriculture of the Republic of Indonesia.

Current research activities include 1) a study on the farmer-state linkages in upland farm development, 2) evaluation of Indonesian soybean varieties for the processing and improvement of traditional fermented foods, and 3) analysis of physical environmental resources using remotely sensed data and GIS for the evaluation and improvement of regional farming systems. JIRCAS recently initiated the third project in collaboration with CASER and the Center for Agroclimate Research (CSAR).

Attempting to deepen the understanding of past and present farming systems research activities, JIRCAS-CASER held an international workshop titled "Learning from farming systems research experiences in Indonesia" in Bogor, Indonesia, March 3-4, 1999. The workshop emphasized the importance of the newly established Assessment Institute for Agricultural Technology (AIAT) in its role to develop and apply new agricultural technologies suitable to farmers engaging in upland agriculture.

[BACK](#)

[NEXT](#)



Although various vegetables are available in Indonesia, they are mainly produced on a small-scale and marketed locally.

BACK



## *JIRCAS Opens China Office*

On June 10, 1998, the JIRCAS Beijing Office was officially opened in the Beijing Friendship Hotel, located in the northwestern district of Beijing and near the Chinese Academy of Agricultural Sciences (CAAS).

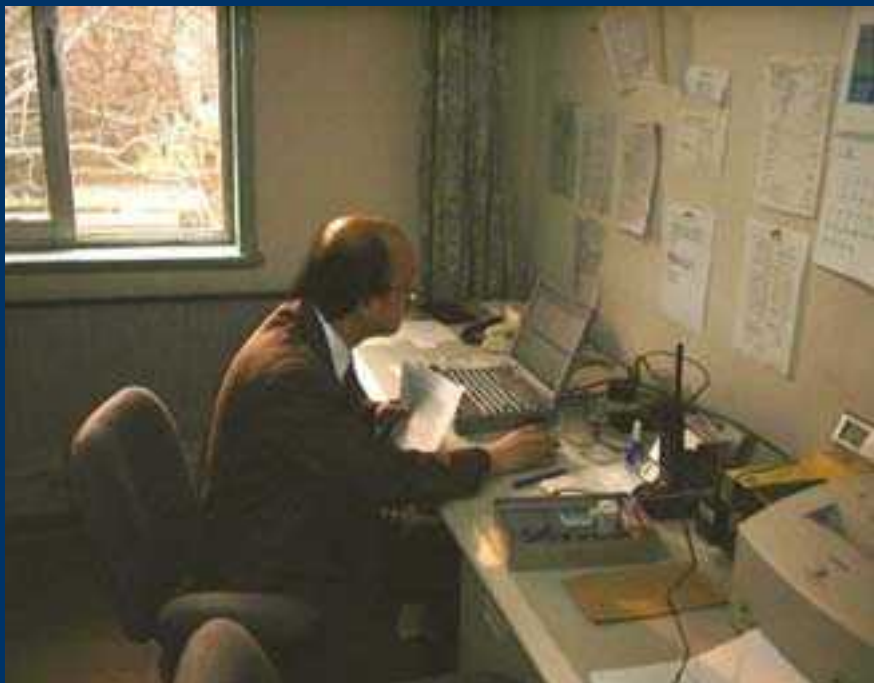
Photo: *Dr. Ikegami, Head of JIRCAS's China Office.*

The opening ceremony was held in the hotel's Friendship Palace room. Sixteen Japanese guests, including Mr. Sakue Matsumoto, Chairman of the Agriculture, Forestry and Fisheries Research Council (AFFRC), Ministry of Agriculture, Forestry and Fisheries (MAFF), Mr. Toshiaki Namba, Director of the International Research Division, Secretariat for AFFRC, MAFF, Dr. Nobuyoshi Maeno, Director General of JIRCAS, and members of the Embassy of Japan and the [Japan International Cooperation Agency \(JICA\)](#), attended the ceremony. The Chinese delegation included Mr. Lu Ming, Vice-Minister of the Ministry of Agriculture (MOF), Prof. Lu Feijie, President of CAAS, Prof. Mao Daru, President of China Agricultural University, Mr. Wang Wenzhe, President of the China National Food Industry Association and Mr. Gan Zuofu, Minister-Counselor of the Embassy of the People's Republic of China.

The Office plays an important role in coordinating collaborative research projects between JIRCAS and China. It has established close connections with MOF, CAAS and other research organizations in China and has received over 100 guests from JIRCAS, other research institutes of MAFF and other organizations in the first year of its establishment. The Office will contribute to further promotion of Japan-China agricultural cooperation.

---

BACK



Dr. Ikegami, Head of JIRCAS's China Office.

BACK



## *China National Rice Research Institute:*

### *A national research center for rice sciences and technologies*

A Chinese proverb states "Food is God for the people." Rice is the most important staple food crop in China, with approximately 19.5 billion tons of rice being harvested in roughly 30 million ha of paddy fields each year. China accounts for 37% of world rice production, and 23% of the world's rice land. Inaugurated in 1989 as a national research center for rice sciences and technologies to contribute to rice self-sufficiency, the China National Rice Research Institute (CNRRI) was authorized by the Chinese State Council in 1981 under the financial and academic support of the World Bank, UNDP, the Rockefeller Foundation and the International Rice Research Institute (IRRI). One of China's largest agricultural research institutions, the CNRRI is directly affiliated to the Ministry of Agriculture, but is also partially under the control of Zhejiang Province. The Chinese Academy of Agricultural Sciences in Beijing has supervised CNRRI research activities since 1996. Since its inception, CNRRI has maintained its principle of "Basing the foothold in Zhejiang Province, keeping in mind the whole country and in view the whole world." CNRRI is located in Fuyang Basin, about 40 km southwest of Hangzhou City, Zhejiang Province. Lying along the Fuchunjiang River, the Fuyang Basin is a rice-dominated agricultural area, where both indica and japonica rice are planted under sub-tropical monsoon climatic conditions.

An integrated research institution, CNRRI projects are multi-disciplinary incorporating rice science and technology and are supported by the administrative and farm operation sections. Four Deputy Directors, each under the CNRRI Director General, head these two sections, along with CNRRI's enterprise and research sections. CNRRI is supervised and evaluated by a Board of Trustees and Academic Advisory Committee. The major tasks of CNRRI are summarized as follows:

1. Collection, conservation, evaluation and utilization of rice germplasm resources.
2. Improvement of rice varieties and high-yielding technologies, and increase of profitability of rice agriculture.
3. Planning and coordination of national rice research projects, and promotion of international research collaborations.
4. Exchange and extension of scientific and technological information on rice agriculture, training and education of research personnel, and publication of rice research articles.

Two hundred-fifteen research staff including about 70 senior researchers (with doctoral and master degrees or the equivalent) work at CNRRI supported by about 45 post-graduate research fellows from universities and other institutions. There are 7 research departments: 1) Breeding and Genetics, 2)

Germplasm Resources, 3) Biotechnology, 4) Plant Protection, 5) Agronomy, 6) Plant Physiology and Soil Chemistry, and 7) Agricultural Economy and Information. Each department consists of 3 to 5 research groups, with each group containing one senior and several junior researchers.

At present, JIRCAS is the only foreign institute that dispatches scientists to CNRRI for long-term research collaboration. This collaboration was initiated in 1992 based on an agreement established at the 10th Meeting (1991) of the Japan-China Agricultural Science and Technology Exchange Group. The Tropical Agriculture Research Center (TARC: forerunner to JIRCAS) and the General Station of Plant Protection (currently the National Agro-Technical Extension and Service Center, GSPP) agreed to a collaborative research project on "Long range migration of rice plant hoppers in the monsoon area of East Asia" with the Chinese Ministry of Agriculture and CNRRI. Ending in January 1997, TARC (JIRCAS) and CNRRI entomologists from the project clarified basic patterns of monsoon-dependent migrations of rice planthoppers from northern Vietnam to Japan through China.

Diagram: *CNRRI-JIRCAS Cooperative Research Unit*

At the 16th Meeting of Japan-China Agricultural Science and Technology Exchange Group, the Ministries of Agriculture of both countries signed a comprehensive agreement for a new project entitled "Development of sustainable production and utilization of major food resources in China" on May 28, 1997. This was followed by a MOU signed on August 20, 1997 by JIRCAS and CNRRI in which the two institutes agreed to conduct 2 new projects on rice breeding and plant protection. "Evaluation of plant genetic resources, development of novel breeding materials and their effective utilization (1997-2003)" and "Integrated management for migratory insect pests of rice (1997-2001)" are the working titles of the 2 collaborative sub-projects, which have been incorporated into the overarching comprehensive project.

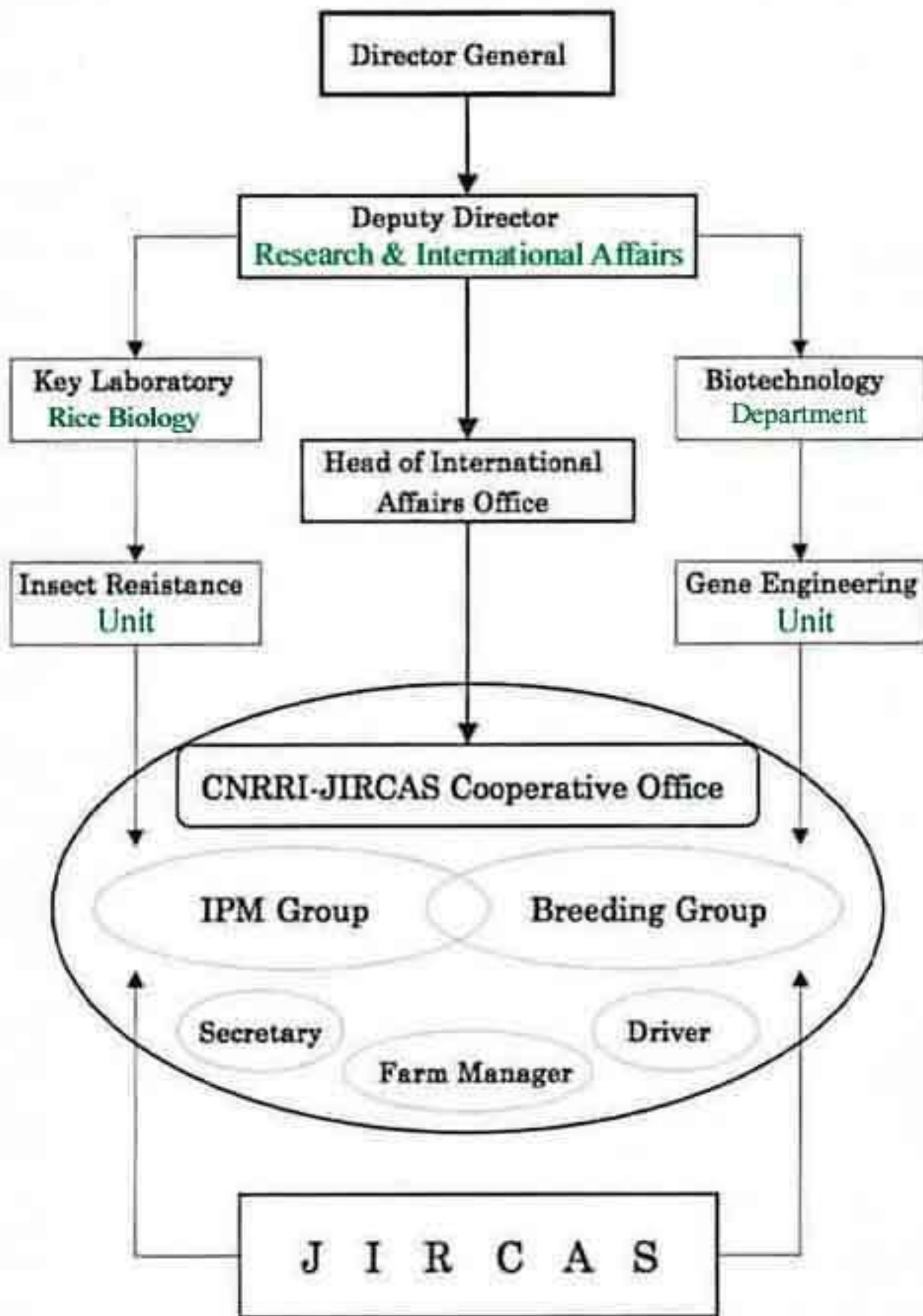
CNRRI has made special arrangements to promote collaboration by establishing a cooperative research unit for JIRCAS scientists and their CNRRI counterparts, which is independent from existing CNRRI research departments. This is important to maintain the independence and priority of JIRCAS-CNRRI cooperative research at CNRRI, as well as to avoid unnecessary conflicts due to different fiscal systems between the two institutes. CNRRI provides an office, laboratories, paddy fields, and greenhouse space to the CNRRI-JIRCAS cooperative unit. The cooperative unit is directly supervised by the Director General and administered by the International Cooperation Section, whose chief is concurrently assigned as the Chief Manager of the unit. In addition, CNRRI also collaborated with the Japanese Ministry of Agriculture, Forestry and Fisheries in the joint surveillance of bio-diversity in Chinese rice paddy ecosystems from 1996 to 1998.

The sustainable development of agriculture for food security will continue to be the most fundamental problem facing China. Future JIRCAS-CNRRI collaboration will play an important role in addressing this problem.

---

BACK

# ORGANIZATION OF CNRRI-JIRCAS COOPERATIVE RESEARCH UNIT





*CNRRI-JIRCAS Cooperative Research Unit*

[BACK](#)



## *Collaborative research to develop postharvest technology at China Agricultural University*

Formed following the merger of Beijing Agricultural University (the present West Campus) and Beijing Agricultural Engineering University (the present East Campus) in 1995, China Agricultural University (CAU) is a leading agricultural education and research institution in China. Now under the auspices of the Ministry of Agriculture, the University's roots are in the College of Agriculture established in 1905 in the Capital University (the present Peking University), the oldest university in China.

CAU consists of two campuses, the West and East, about 10 kilometers apart. It boasts 6 academicians from the Chinese Academy of Sciences, 5 academicians from the Chinese Academy of Engineering Sciences, 223 professors, and 617 associate professors. With a constant rise in student population over the past few years, the university is currently home to 1,050 graduate and 7,100 undergraduate students enrolled in 16 colleges. The Food College, founded in 1983, has 4 departments: Food Science and Technology, Food Nutrition and Biotechnology (West Campus), Food Engineering, and Biochemical Engineering (East Campus). Ten professors, seven doctoral supervisors, and twenty-three associate professors serve in the college faculty.

Photo: *Main entrance of China Agricultural University (CAU: East Campus).*

In collaboration with CAU, JIRCAS has been conducting research entitled "Development of technologies for food processing and distribution." Initiated in November 1997, this research aims to develop food technologies for better utilization and distribution of major food resources such as rice, soybean, and freshwater fishes. More specific objectives include quality evaluation of major food resources and development of new food ingredients, and improved preservation and distribution technologies for major food resources.

As purchasing power has increased with the drastic development of the Chinese economy so has the demand for a high-quality diet. While this is certainly true in urban areas, rural Chinese do not have direct access to the benefits of economic development. Indeed, the income differential between rural and urban workers has been steadily rising, a factor contributing to rural-urban migration, thereby altering the structure of the Chinese population. In an effort to reverse this trend and maintain economic development, the Chinese government put the industrialization of farming systems at the forefront of its national policy. The development of food processing technology is one way China hopes to execute the above national policy.

To solve the multiple problems the Chinese face on the food processing front, the government has developed extensive cooperative relationships with domestic food research organizations and the food industry, as well as with JIRCAS. Because almost all foods are manufactured using conventional procedures and techniques, without the benefits of modern science, one of the most pressing problems

for the food industry is the mechanization of traditional food processing.

As an important source of protein, the soybean, specifically tofu, is found readily throughout China. Chinese momen-tofu (cotton tofu), kinugoshi (silken tofu), and packed tofu, similar to their Japanese counterparts, are currently being mass-produced in some factories by Japanese mechanized equipment. However, unlike the tofu mentioned above, products peculiar to China, such as "tofu-skin" (sheet-like tofu), a kind of momen-tofu but with a relatively low water content (about 70%), are produced by the traditional methods and equipment. Since, under traditional methods, the product is manufactured at midnight and then sold the following morning due to its short shelflife, researchers are now attempting develop technology for processing mechanization and for shelf-life extension. To this end, CAU researchers are currently collaborating with JIRCAS, the National Food Research Institute, the Akita Research Institute of Food and Brewing, the Niigata Food Research Center, and other Japanese research organizations.

[Photo](#): *One corner of the JIRCAS-CAU joint laboratory.*

---

BACK



*Main entrance of China Agricultural University (CAU: East Campus).*

BACK



*One corner of the JIRCAS-CAU joint laboratory.*

BACK



## RESEARCH INFORMATION DIVISION

The Research Information Division fulfills three main responsibilities relating to research operations at JIRCAS. First, the Division collects and analyzes information pertaining to socio-economic conditions and the state of agricultural sciences in developing countries. Second, it attempts to formulate and coordinate collaborative research projects with public and private organizations in developing countries. In recent years, this role has grown in relative importance as JIRCAS has become increasingly involved in large-scale, comprehensive research projects with countries throughout the world. Finally, in an effort to coordinate rising flows of data to and from partner countries, the Division has assumed the responsibility of developing and operating information systems at JIRCAS.

The Division's research coordinators and senior scientists undertake these tasks from two distinct perspectives. The first is a strategic perspective focusing on critically important world regions, including China, other monsoonal areas of Asia, arid and semi-arid Asian areas, Africa, and Latin America. The second perspective focuses on particular issues, with an emphasis on global problems generated by environmental degradation, food insecurity, and imbalanced patterns of rural development. Combining these two perspectives, research coordinators in the Research Information Division conduct studies on agriculture in specific regions and consider the prospects for collaborative studies. They design and coordinate comprehensive projects in which scientists representing different disciplinary backgrounds can work together toward common goals. Thus far, eight major comprehensive projects have been implemented since the establishment of JIRCAS.

In 1994, JIRCAS launched its first comprehensive research project in Vietnam in an effort to promote improved efficiency in the combined farming systems currently used in the Mekong Delta region. Following the conclusion of Phase I of this project in 1998, JIRCAS initiated preparation for the implementation of Phase II to begin in FY 1999. The Division launched comprehensive projects on tropical brackish water ecosystems in Malaysia and sustainable agricultural technologies in northeast Thailand during 1995, and another comprehensive project on sustainable agro-pastoral rotation systems in subtropical Brazil during 1996. In FY 1997, two new comprehensive projects began, one targeting sustainable production and processing of major food resources in China and the other investigating new technological developments for soybean production and utilization in South American countries. Additionally, the Division has launched comprehensive projects on rice development in West Africa and farming systems in Indonesia in FY 1998.

The Research Information Division is also involved in analyzing global issues. In collaboration with the Food and Agriculture Organization (FAO) and other international agencies, the Division helped to develop a sophisticated world food model that can be used to project world food supply and demand and to simulate the effects of proposed policy changes. At the same time, findings derived from ongoing collaborative research projects at JIRCAS are often incorporated into forecast simulations. Currently, researchers are attempting to elaborate the model so that the impact of environmental changes and resource constraints can also be analyzed. In addition, researchers within the Division are studying rural development strategies, with particular emphasis on farming systems research, by reviewing recent development strategies and assisting researchers in the natural sciences who are involved in integrated rural development projects.

Another important task of the Division is to develop and operate the computer-based JIRCAS information system. Since 1996, the Division has been operating a comprehensive statistical database on agriculture, forestry and fisheries, containing data from many international agencies. The Division is currently developing a database of geographical datasets which can be used as basic materials for GIS-related studies. In addition, the Division maintains bibliographic and photo (slides) databases on tropical agriculture and other institutional information systems.

*Photo: Crop market in Mosi, Tanzania*

Finally, the Division works as the secretariat for the numerous international seminars and workshops that JIRCAS researchers conduct throughout the year. The largest is the JIRCAS International Symposium, which addresses a topic of central importance in agricultural research. In FY 1998, the International Symposium concerned "Postharvest Technology in Asia" and was attended by 230 participants from over twenty countries (see "Symposia and Workshops" section for additional details).

● [Division Topic 1: Farming Systems combining agriculture, animal husbandry, and fisheries in the Mekong Delta.](#)

● [Division Topic 2: Coordinating multidisciplinary research on agriculture in the Mekong Delta](#)

● [Division Topic 3: No-tillage cultivation of soybean in South America](#)

BACK

HOME



*Crop market in Mosi, Tanzania*

BACK



RESEARCH INFORMATION DIVISION TOPIC NO.1

## **Farming Systems Combining Agriculture, Animal Husbandry, and Fisheries in the Mekong Delta**

It is essential for nations to produce sufficient amounts of agricultural commodities in order to achieve food security. In the Mekong Delta region of Vietnam, the economic policy Doi Moi has contributed to rapid economic growth through a unique agricultural system which combines rice cultivation, animal husbandry, aquaculture, and horticulture. JIRCAS implemented a five-year research project starting in 1994 that aimed to clarify the technological and socioeconomic structures of the farming systems and to specify and develop new technology necessary for higher productivity.

The Mekong Delta was formed about 10 thousand years ago at the mouth of the Mekong River. Covering roughly 4 million hectares, the region, except for small hills near the Cambodian border, is less than 1 m above sea level. Large scale flooding follows the rainy season and washes away damaging salt and acid sulfate, providing fresh fertile soil and fish. Depending on the topography, the Delta's soils range from alluvial to acid sulfate to saline. Houses line the banks of the well-developed canal network due to the high elevation and the convenience of waterway transportation. In addition, ponds are also dug for stocking fish and as a source of soil with which to expand farm areas.

The market-oriented economy under the Doi Moi policy has brought about a rapid increase in agricultural production, particularly in rice harvesting. The farming system, a type of compound agriculture, is based on rice cultivation but also includes livestock breeding, aquaculture and horticulture. These systems operate by cycling agricultural products through several stages of production in order to minimize waste, maximize benefits, and contribute to sustainable management. In one model, swine are fed with broken rice and rice bran produced locally. Waste products from the swine are then washed into fish ponds, raising fertility levels in the water and enhancing growth in cultured fish. To complete the cycle, water from the fish ponds is then diverted back into paddy fields, where the abundance of nitrogen and other elements contributes to more fruitful rice production.

The project was successful in obtaining practical information that will increase farming system efficiency and production. Researchers discovered that rice yields can be stabilized at high levels if lodging is prevented by nitrogen dressing at the booting stage and by draining water for several days during the cropping period. Moreover, sheath blight, bacterial blight, blast, and red stripe were determined to be the main diseases constraining rice production in the Delta. To combat these diseases, researchers specified bacterial blight and blast resistance genes in rice and succeeded in transferring the genes to other varieties of rice. In addition, scientists eliminated swine parasites and thus decreased the time necessary for pigs to reach shipping weight. Finally, researchers clarified the physiological processes of growth and maturation in the giant freshwater prawn (*Macrobrachium rosenbergii*) so that seed production may be improved.

*Photo: Example of an integrated farming system which combines rice cultivation, animal husbandry, aquaculture and horticulture (S. Matsui).*

Mekong Delta farms average about 1 ha in size, larger than that of any other region in Vietnam. Since settlement of people to this area is relatively recent, there is not as strong a community structure as the Red River Delta in northern Vietnam, which has been settled for a comparatively longer period of time. Consequently, people in the Mekong Delta are not experienced in organizing themselves for infrastructure management, crediting, marketing, and so forth. Although the number of smaller sized or land less farmers is increasing as one negative effect of the Doi Moi policy, farmers utilizing farming systems maintain stable management of their farms.

To further develop Mekong Delta farming systems, JIRCAS research will focus on such areas as the stable production of better quality rice, the extension of integrated pest management of crops and fruit trees and the improvement of feed and hygiene for hog raising. In addition, a more advanced hog waste treatment system, a stable supply of prawn and fish seeds for aquaculture, and disease control in aquaculture will also be studied. Finally, communal cooperation in trade, water management, and crediting will be fostered. (S. Matsui)

BACK

HOME





*Example of an integrated farming system which combines rice cultivation, animal husbandry, aquaculture and horticulture (S. Matsui).*

BACK



RESEARCH INFORMATION DIVISION TOPIC NO.2

## Coordinating multidisciplinary research on agriculture in the Mekong Delta

The first phase of international collaborative research on Mekong Delta farming systems with Cantho University (CTU) and Cuu Long Delta Rice Research Institute (CLRRI), Vietnam was recently completed. JIRCAS's first venture into international collaborative research, much of the project's success is owed to the cooperation of Vietnamese organizations as well as to the efforts of participants dispatched to the Mekong Delta.

The project originated with a visit to the Delta in 1991 by Tropical Agriculture Research Center (TARC) staff members, who were interested in the unique agriculture systems utilized in the region. Although individual farms were as small as 1 ha in area, farmers seemed to make good use of available resources through systems which consisted of rice cultivation, animal husbandry, fisheries and horticulture. In 1994 JIRCAS and the AFFRC initiated a research project entitled "Evaluation and improvement of farming systems combining agriculture, animal husbandry, and fisheries in the Mekong Delta." Since the project targeted crop, animal, fishery and socio-economic disciplines, researchers in these fields were dispatched on both long- and short-term assignments to Vietnamese counterpart institutes. It was decided that the entire project would be steered by a working group (WG) consisting of the directors of the relevant research divisions and the international research coordinator.

The role of working group is as follows:

1. The WG should always be aware that it is indispensable for the whole project to have a concrete objective that is aimed at by all participants from different fields of research. With the support of division directors, individual subjects should have clear targets that are compatible with the overall project objectives.
  - . project objectives
  - . implementation, dispatching and budget plans
  - . periodical review and evaluation
  - . public relation activities
2. Division directors should draft implementation and dispatching plans for specific research subjects and the budget should be proposed by the research coordinator, who is not associated with a specific research field. The proposal and the evaluation of research activities should be discussed openly.
3. Public relations are critically important for the development of the project. The WG must be responsible for such activities.
4. The research coordinator should always correspond with the dispatched researchers and collect and report important information to the WG and Director General. Discussions in the WG should also be announced to the dispatched researchers and the Director General .

Under the guidance of the working group, the project had the objective to clarify the technological and socio-economic structure of farming systems in the Mekong Delta and develop new technologies to improve the systems. To this end, JIRCAS dispatched 6 long-term and 47 short-term researchers in the fields of crop science, plant pathology, animal science, socio-economic science, and fisheries science during the project's 5-year duration. In return, JIRCAS received 23 counterpart researchers including administrators and workshop participants during the same period. Research results have been published by JIRCAS in 50 scientific reports and 16 articles. Some of these are contained in a book entitled "Development of farming systems in the Mekong Delta of Vietnam." (Vo-Tong Xuan and Shigeo Matsui, eds., H.M.C. Publishing House, Ho Chi Minh City, Vietnam).

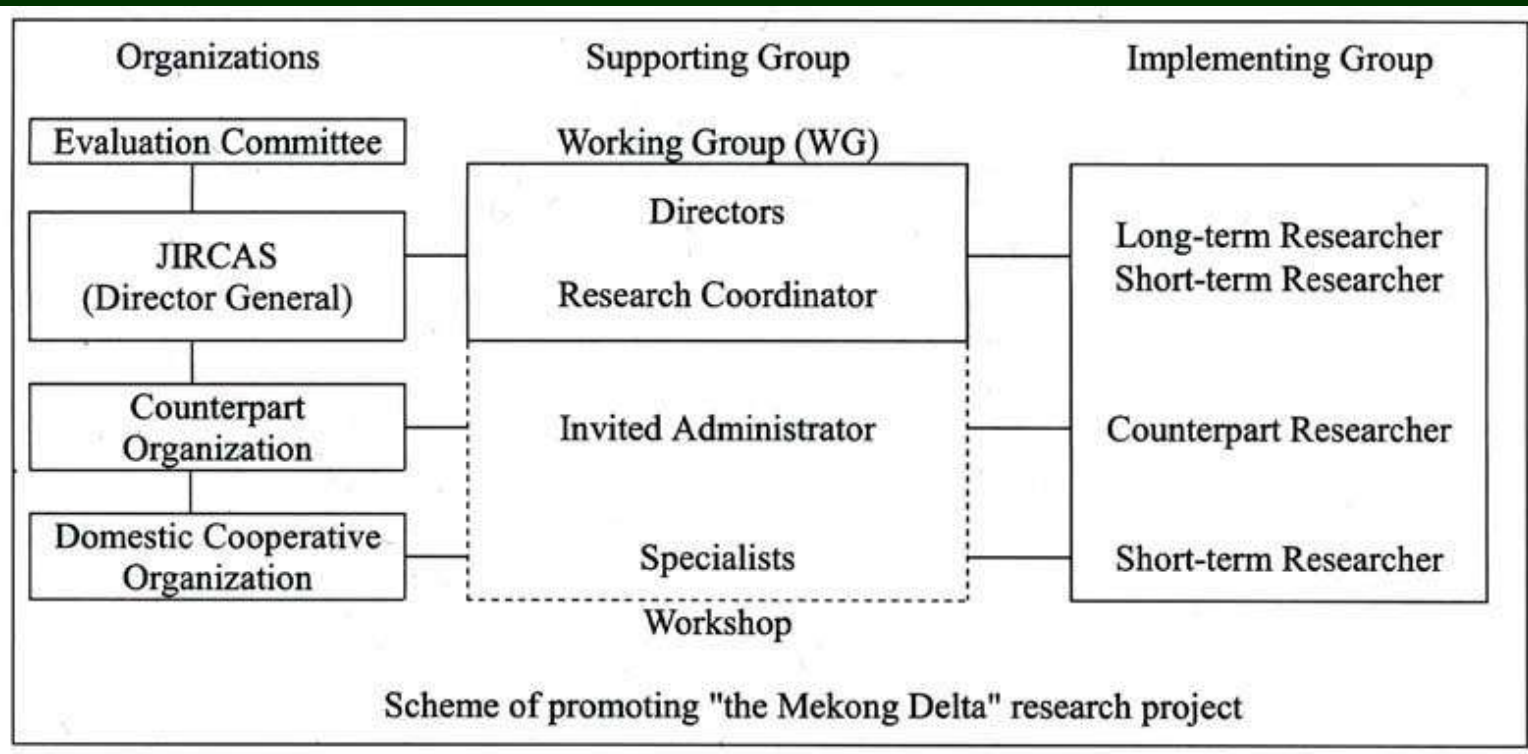
Following the successful completion of the first phase in March 1999, the second phase, entitled "Development of new technologies and their practice for sustainable farming systems in the Mekong Delta" was initiated and will run until 2003 .

Table : *Scheme of promoting "the Mekong Delta" research project*

(S. Matsui)

BACK

HOME



*Scheme of promoting "the Mekong Delta" research project*

BACK



## **No-tillage cultivation of soybean in South America**

The soybean is an important crop serving human life, especially as a source of oil for human consumption, and as a protein source for livestock feed. Increases in soybean production have been very rapid compared with those of other major crops during the past three decades, and continuous growth is very important for the stabilization of the world food supply. Soybean production in South America, mainly in the MERCOSUR countries (Brazil, Argentine and Paraguay), amounts to approximately one-third of total world production, and thus the MERCOSUR countries play a major role as leading soybean export countries. However, it is generally recognized that disease and pest outbreak due to continuous cropping and soil erosion are adversely affecting soybean production in this region. In order to address these problems, JIRCAS has initiated a new research project entitled "Comprehensive studies on soybean improvement, production and utilization in South America." In this project, we place emphasis on multinational collaboration among South American countries through the exchange of scientists, joint organization of seminars and conferences, as well as the exchange of samples, materials and information. The project will run until 2006.

To commemorate the initiation of this project, a seminar entitled "No-tillage cultivation of soybean and future research needs" was held March 5-6, 1998 in Foz do Iguassu, Brazil and Yguazu, Paraguay under the joint organization of JIRCAS and the Centro Tecnológico Agropecuario en Paraguay (CETAPAR-JICA). This was the first JIRCAS seminar on soybean research held in South America. This seminar focused on no-tillage systems of soybean production, as this type of cultivation system, which may aid the alleviation of soil erosion, is rapidly expanding in major soybean producing areas in South America and is contributing to a stabilized yield of soybeans. Sixty scientists from 6 countries participated and exchanged views concerning the current situation and future prospects of no-tillage cultivation systems and discussed the potential demands and uses of soybeans. As pointed out by the contributors, many problems remain to be solved in order to achieve further successful application of this cultivation method. Among the problems which should be addressed by future research efforts are physical and chemical deterioration of soil, increased incidence of soil-borne diseases, increased dependence on herbicides and limited variation of crop combinations, all of these tend to be accelerated under no-tillage systems.

The proceedings of the seminar was published by JIRCAS in December 1998. The proceedings contains 11 papers as follows;

- 1) Historical review of no-tillage cultivation of crops (Rolf Derpsch);
- 2) Effects of no-tillage system on chemical and physical characteristics of soil in Paraguay (Cantalicio Paredes Benegas);
- 3) Effect of no-tillage on physical and chemical characteristics of soil in Argentina (Rodolfo C. Gil); 4) Disease management in no-tillage soybean systems (Silvia Vallone);
- 5) Control of weeds in no-tillage cultivation (Dionisio Luiz Pisa Gazziero);
- 6) Establishment of no-tillage system of soybeans in Paraguay (Yoshiro Seki, Wataru Asada and Ken Hoshiba);
- 7) Cropping systems in no-tillage cultivation (Jose Eloir Denardin and R. A. Kochhann);
- 8) An innovative cropping system of soybean: agro-pastoral system in Brazilian Savannas (Manuel Macedo, Jose Bono, Armindo Kichel, Ademir Zimmer and Tsutomu Kanno);
- 9) Role of soybean with reference to global food supply and demand (Hideki Ozeki and Yoshihiko Sugai);
- 10) Potential uses of soybean as food in South America (Mercedes C. Carrao-Panizzi);
- 11) Potentialities for industrial utilization of soybean (John P. Cherry).

Photo : Seminar participants observing a soybean field where soybeans are being grown under no-tillage systems.

(M. Kokubun)

BACK

HOME



*Seminar participants observing a soybean field where soybeans are being grown under no-tillage systems.*

[BACK](#)



## BIOLOGICAL RESOURCES DIVISION

Many developing regions of the world are now faced with the need to increase and stabilize agricultural production through methods compatible with the preservation of the environment. Agricultural technologies that optimize the use of biological resources will play an important role in determining whether or not this objective can be met. In response to these concerns, the Biological Resources Division has placed considerable emphasis on collaborative on-site breeding projects in foreign countries and on biotechnology in Tsukuba. The objective of such projects is to utilize available genetic resources and biotechnological procedures to develop new crop varieties.

We have carried out collaborative projects with two centers supported by the Consultative Group on International Agricultural Research (CGIAR). In cooperation with the International Rice Research Institute (IRRI) in the Philippines, the Division has been studying rice blast resistance. We have clarified the rice blast resistant genes in IR varieties that are being used worldwide without the information of resistant genes. This information is prerequisite for the development of all types of durable resistance, for example the pyramiding of major genes and the accumulation of minor genes. We have developed isogenic lines with a few rice blast resistant gene isogenic lines that have several genetic backgrounds and dozens of resistant genes, with more soon to be completed. Among them IR49830-7-1-2-2 and IR24 background isogenic lines can be put into practical use to reduce the usage of fungicide and the damage of blast for long periods. Working with the International Maize and Wheat Improvement Center (CIMMYT) in Mexico, the Division has a project on marker-assisted selection, which may contribute to gene-pyramiding and increased breeding efficiency. In addition, different sources of resistance genes to *Fusarium* head blight (FHB) are being mapped using RFLP and SSR markers.

Under the guidance of JIRCAS integrated projects, our researchers helped develop soybean varieties resistant to viral diseases and nematode pests at the Soybean Institute of the Jilinan Academy of Agricultural Sciences in the People's Republic of China (PRC). The soybean mosaic virus and cucumber mosaic virus (soybean stunt strains) were isolated from soybean plants in the northeast region of China, Inoculation tests suggested that the B strain of the soybean mosaic virus was a dominant soybean virus disease in this region. In the rice program, several researchers have been working with the Yunnan Academy of Agricultural Sciences to analyze genes that provide resistance to blast, bacterial leaf blight and rice stripe virus diseases, and cool-weather tolerance at the booting stage in rice strains. Together with visiting scientists, researchers have also attempted to screen genetic resources that may provide salt tolerance among local varieties of rice from Vietnam.

In the field of soybean production in tropical and subtropical areas, one of the most severe problems is damage caused by insects. As highly resistant germplasms have not been found except for some moderate level resistant ones, the pyramiding of moderate level resistance to *Spodoptera litura* (the most important foliage feeder of soybean in Indonesia) by back-cross was carried out in cooperation with the Research Institute for Legume and Tuber Crops (RILET) in Indonesia. As a result, higher resistant soybean lines to *S. litura* were selected from progeny of the hybrids between moderate resistant germplasms.

[Photo: Damage caused by Fusarium head bnght in wheat spikes \(Photo: T. Ban\).](#)

The molecular biology group of the Division, including several visiting scientists, has recently utilized biotechnological methods to study tolerance to environmental stresses such as drought, salinity, and freezing in higher plants. In particular, the researchers are examining how to use genes and regulatory factors in the production of environmental stress tolerant transgenic crops. They isolated a number of genes that function in stress tolerance using *Arabidopsis* and cowpea plants and analyzed the regulatory transcription factors of these genes in the stress response. Many genes encoding the transcription factors have been isolated that control the expression of the stress tolerance genes. They also identified regulatory elements in promoters that control stress-responsive gene expression. Using the gene's encoding transcription factors and the stress-responsive promoters, they have succeeded in improving multi-stress tolerance to freezing, drought, and salinity in transgenic *Arabidopsis* as a model. The existence of similar regulatory systems has been reported in other crop plants such as rice, tobacco, and cowpea. These observations suggest that both the gene for the transcription factor and the stress-responsive promoter can be used to improve the stress tolerance of agriculturally important crops by gene transfer. Their research will contribute to the development of commercial crops capable of withstanding potentially damaging environmental stresses, perhaps thereby helping to mitigate problems relating to the food crisis and environmental degradation in developing countries.

● [Division Topic : Evaluation of doubled haploid breeding scheme in wheat improvement](#)

BACK

HOME



*Damage caused by Fusarium head blight in wheat spikes  
(Photo: T. Ban).*

BACK



## **Evaluation of doubled haploid breeding Scheme in Wheat improvement**

Practical breeding programs for self-pollinating crops, such as wheat (*Triticum aestivum* L.), must include a process of genetic fixation for uniformity of agronomic traits after genetic recombination to increase variations. Pedigree selection (PS) is the conventional method of achieving genetic recombination in each generation. Repeated pedigree selection of heterozygous materials can increase uniformity, but many generations are required to reach homozygosity in loci associated with agronomic traits ([Photo.1](#)). The artificial production of haploid plants followed by chromosome doubling offers the quickest method for developing homozygous breeding lines from heterozygous parental genotypes in a single generation. The doubled haploid (DH) method has an obvious advantage in that yield evaluation can begin earlier and varietal development is speeded up. This method also has the great advantage of increasing the efficiency of selection because DH lines do not express dominance variation and segregation within lines.

A technique for producing wheat haploids using ultra-wide crosses followed by embryo rescue has been developed over the last two decades. Significant technical advances have been achieved familial species and applying plant growth regulators. Efficient crossing procedures were developed using stored pollen and detached-tiller culture. They enabled scientists to avoid having to synchronize flowering times of both parents and resulted in considerable savings in terms of labor and space required for growing parent plants.

In this study, field performance of wheat lines selected by the DH and PS methods from three F1 crosses were compared with the aim of evaluating the doubled haploid method in wheat breeding programs ([Fig. 1](#)). Yield evaluation of each group of the top ten wheat lines selected by DH and PS methods was performed at the F6 generation of PS lines along with DH lines in a two-year field experiment. It took only two years from the planting of wheat materials for DH production to the planting of selected DH lines for yield evaluation. There was no significant difference in grain yield between DH lines and PS lines selected from an F1 cross whose parental varieties were closely related in their pedigrees. In two crosses with low coefficients of parentage and large variation in their progenies, grain yield of selected DH lines was significantly lower than those of selected PS lines. These results confirm that the DH method has the advantage of saving time in obtaining recombinant inbred lines ready for yield evaluation and of increasing selection efficiency. However, a larger DH population is required to achieve the same level of genetic advance with the PS method in crosses containing greater genetic variation.

The application of a doubled haploid breeding scheme with selected breeding objectives can thus complement conventional breeding programs and accelerate the release of new varieties in developed countries, as well as in developing countries where rapid varietal development is critical for sustainable wheat production systems.

[Photo1](#): *Doubled haploid wheat lines in field evaluation showing uniformity within the lines.*

[Fig1](#): *Grain yields of top ten wheat lines selected by doubled haploid and pedigree selection methods in two F1 crosses.*

(M. N. Inagaki)

BACK

HOME

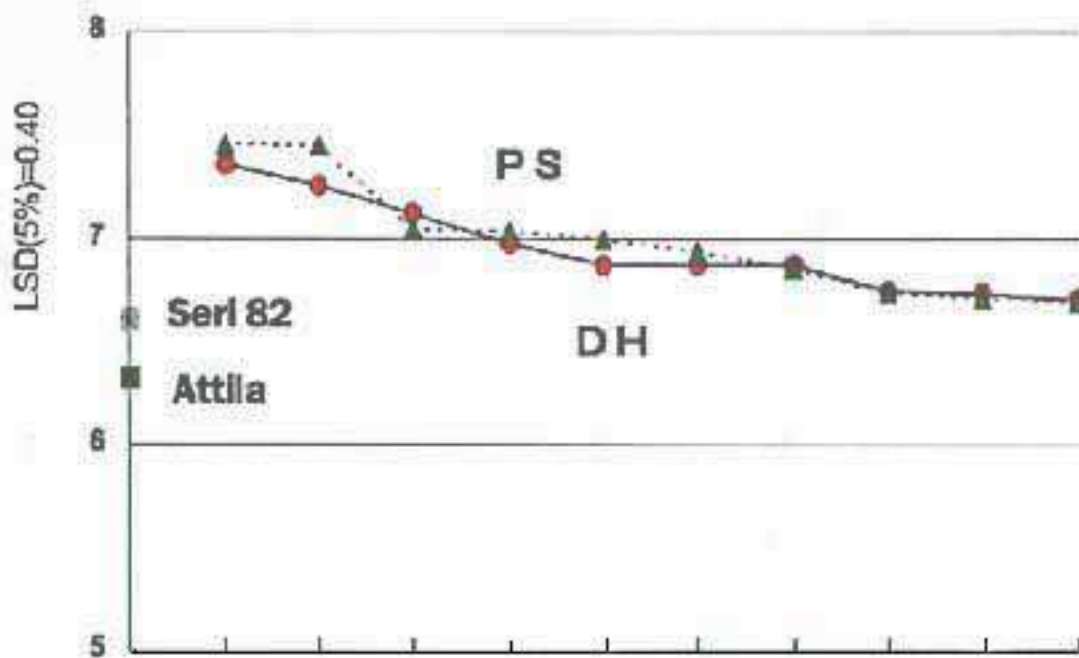




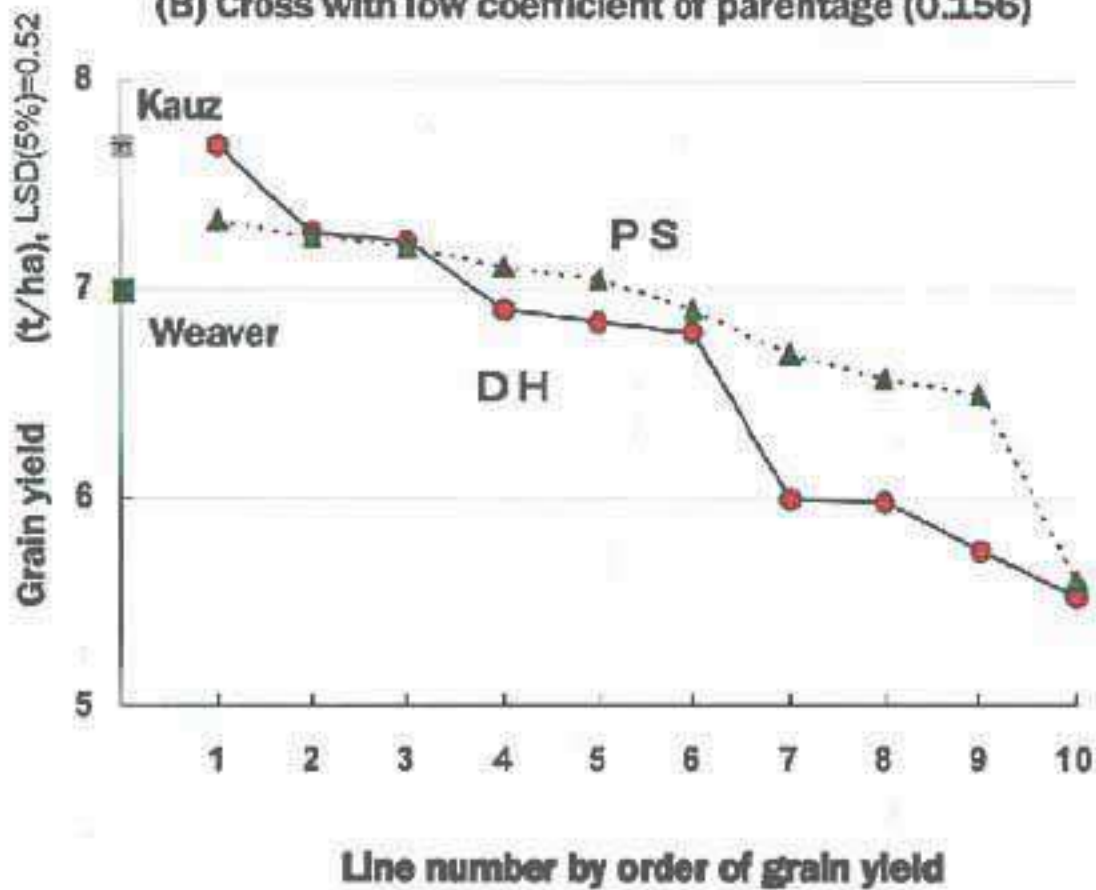
*Doubled haploid wheat lines in field evaluation showing uniformity within the lines.*

BACK

(A) Cross with high coefficient of parentage (0.383)



(B) Cross with low coefficient of parentage (0.156)



*Grain yields of top ten wheat lines selected by doubled haploid and pedigree selection methods in two F1 crosses.*

[BACK](#)



## ENVIRONMENTAL RESOURCES DIVISION

A recent estimate suggests that the world population could reach 6.3 billion by the year 2000 and 10 billion by 2050. To feed this ever-increasing population, existing agricultural land is likely to be subjected to a higher intensity of cultivation in populous areas, and farmland development is likely to be extended to areas marginally suited for agriculture. Trade liberalization in recent years has led to a sharp increase in commercial crop importation and is stimulating production in exporting countries. This may result in excessive load to farmland soils as well as the continuation of single cropping and deforestation in many countries. Past experience has shown us that these practices accelerate farmland degradation and desertification on a global-scale. Such drastic changes in land use would cause climatic transformation over extended regions and bring about unpredictable constraints to existing agricultural and forest ecosystems.

From the middle of this century, patterns of land utilization have been changing due to population expansion. These changes, along with a rapid increase in fossil fuel consumption, have had tremendous impact on the atmosphere through intensified emission of carbon, nitrogen, and sulfur gases. If the present level of consumption continues, CO₂ concentration will increase by 0.5 percent per year and double by the middle of the next century. The 1995 International Panel on Climate Change (IPCC) report suggests that a two-fold increase in CO₂ concentrations could cause an increase in mean global surface temperature by about 2^oC by the year 2100. Furthermore, research has shown that the atmospheric concentrations of other greenhouse gases such as methane and nitrous oxide have also increased greatly within the past two decades. If the effects of these trace gases are jointly taken into account, global warming is estimated to take place more rapidly than in the case where the effects of CO₂ are considered alone.

To address these problems, the Environmental Resources Division is organizing research to identify and develop technologies for the improvement of agricultural activities compatible with the environment and the ecosystems, such as arid lands, wetlands, sloped lands and degraded lands. Other projects are aimed at developing technologies for sustainable agriculture through analyzing mechanisms of nutrient cycling within agro-ecosystems and for reduction of polluting substances to conserve the global environment.

[Division Topic1 : Suppression of nitrification and nitrous oxide emission by a tropical grass](#)

[Division Topic2 : Effects of depth on the site of NO and N₂O production in upland Soil on emission rates to the atmosphere](#)

BACK

HOME



## Suppression of nitrification and nitrous oxide emission by a tropical grass

Nitrification is the reaction in which ammonium-N is changed into nitrite-N and nitrite-N is changed into nitrate-N in soil by microorganisms. By controlling nitrification, it is possible not only to increase the nitrogen absorption efficiency of plants but also to minimize the nitrogen loss by leaching and volatilization. It was reported that the amount of nitrate-N accumulated in the soil where a tropical grass grew seemed to be smaller than that in the soil where other tropical grasses grew. The objective of this study was to demonstrate the ability of this tropical grass to suppress nitrification in soil and nitrous oxide emission to the atmosphere.

Three tropical grasses (*Brachiaria decumbens* (Bd), *B. humidicola* (Bh), and *Melinis minutiflora* (Mm)) supplied by CIAT were grown for 8 weeks in Wagner pots and soils were sampled. Ammonium-N was applied to the sampled soils and the nitrification process was observed. In soils with Bd and Mm treatments, the content of ammonium-N started to decrease 4 days after ammonium-N application and nitrification started rapidly. However, the content of ammonium-N in the soil with Bh treatment did not change until the 12th day and there was a lag period before the onset of nitrification. The results indicate that only *B. humidicola* suppressed nitrification in soil.

Simultaneously, nitrous oxide emission from soil was measured. From soils with Bd and Mm treatments, nitrous oxide emission was observed remarkably. However, nitrous oxide emission from the soil with the Bh treatment was low throughout the experimental period. The amount of nitrous oxide emitted from the soil with the Bd and Mm treatments were 31.0 and [29.3¼g-N/m²-hr](#), respectively. However, that from the Bh treatment was [5.0¼g-N/m²-hr](#) and 1/6 smaller than that from the Bd and Mm treatments. If cannotread [Click here](#)

In another experiment, it appeared that *B. humidicola* suppressing the multiplication of ammonium-oxidizing bacteria specifically but had no effect on the nitrite-oxidizing bacteria. Of the two nitrification processes, it is assumed that the process in which ammonium-N is changed into nitrite-N is a rate-determining process. By suppression of the multiplication of ammonium-oxidizing bacteria, *B. humidicola* suppresses nitrification in soil and nitrous oxide emission to the atmosphere ([Fig. 1](#)). Generally it is considered that tropical grasses preferentially use nitrate-N compared to ammonium-N. Among the *Brachiaria* species, it is assumed that only *B. humidicola* can utilize both forms of nitrate-N and ammonium-N and that this function of *B. humidicola* may lead to an efficient use of nitrogen in soil.

Native pastures are widely distributed in various countries of the tropical zone but their productivity is very low. In order to increase livestock production, if *B. humidicola* could be introduced, it would be possible to decrease the nitrogen input for agriculture in addition to preserving the environment and ecosystems.

[Fig. 1.](#) The mechanisms of nitrification suppression and inhibition of nitrous oxide emission by *Brachiaria humidicola*.

(T. Ishikawa)

BACK

HOME

29.3  $\mu$  g-N/m²·hr,

$5.0 \mu \text{g-N/m}^2 \cdot \text{hr}$

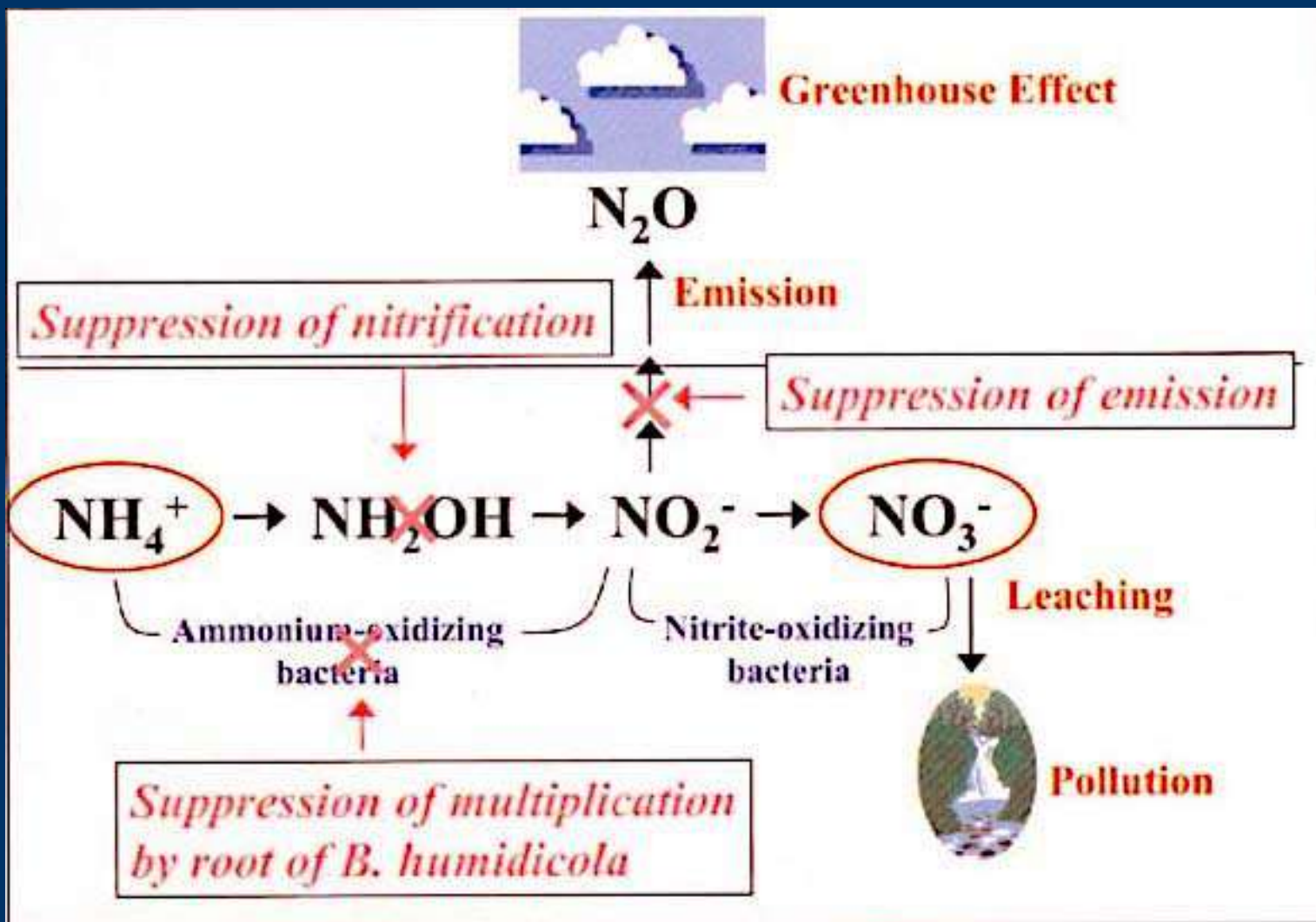


Fig. 1 . The mechanisms of nitrification suppression and inhibition of nitrous oxide emission by *Brachiaria humidicola*.

BACK





## **Effects of depth on the site of NO and N₂O production in upland Soil on emission rates to the atmosphere**

Driven by the necessity of increased food production, the rate of chemical fertilizer application to arable land is increasing rapidly in developing countries. With this increase comes the heightened possibility of harmful effects on the environment. Two chemical compounds commonly found in fertilizer and possessing potential negative side-effects for the environment and atmosphere are nitric oxide (NO) and nitrous oxide (N₂O). NO is known to be a cause of photochemical atmospheric pollution, acid rain, and is linked to increased tropospheric ozone, one of the green house effect gases. N₂O is a substance that causes global warming and stratospheric ozone layer destruction. Because its damaging influence is estimated to be at a level equal to that of fossil fuel combustion, arable land should not be overlooked as a source of these gases.

Using numerical model analysis and a laboratory experiment, we focused on the effects of depth on fertilizer placement in an attempt to develop a method for mitigating the emissions of these gases from upland fields. The simulation model was prepared based on pre-existing survey data of NO and N₂O soil concentration profiles in the upland fields of Andosol, a volcanic ash soil. It was assumed that the soil conditions are uniform in the horizontal direction; gas diffusion in soil was considered as a one-dimensional vertical flow, fundamentally following Fick's law. In this model, the effects of the depth of gaseous production in soil on concentration profiles and emission rates were estimated.

The estimated results were verified in the laboratory experiment with soil columns. Each soil column, 1 m in height and 0.194 m in diameter, was made of topsoil from Andosol and fertilized with ammonium sulfate at a rate of 20 gNm⁻² at a specific depth (0-10, 5-15 or 10-20 cm). The soil was filled at the bulk density of 0.60 and 0.75 g cm⁻³ at the depth of 0-20 cm and 20-100 cm, respectively. Then content in the soil was set at 49 (q0,9) o/o and the soil columns were then put in a thermostatic chamber (22.2 q 0.6 °C) without a water supply. After two weeks, the ground water level was set and kept at a depth of 100 cm. Soil gas was sampled from PVC tubes in the soil and the gas emission rate was measured using a closed-chamber method.

In the model analysis, we obtained the results that (1) the NO concentration gradient near the soil surface became gentler and the rate of NO emission became lower with the production depth, while (2) the depth of N₂O production had less effect on the emission rate (Fig.1). Results supporting (1) and (2) were obtained by the laboratory experiment. The rate of NO emission from columns fertilized at 10-20 cm depth was reduced to almost the same rate as that of the unfertilized column and to 0.9-20 % of that from the fertilized at the depth of 0-10 cm (Fig.2). However, a remarkable effect of the production depth was not observed in N₂O.

Our findings demonstrate that there is a strong possibility that NO emission from arable land can be mitigated by applying fertilizer deeper into the soil. Because the depth at which the NO emission was mitigated corresponds to the depth utilized in some conventional deep fertilizer applications, the practical application of our findings does not seem difficult. The deep application of fertilizer should be reconsidered not only because of its high efficiency of fertilizer utilization, but also because of its potential for mitigating NO emission.

The phenomena of gaseous production and consumption depend on various soil conditions. We obtained the results mentioned above using Andosol soil, which has a comparatively high gaseous conductance under ideal conditions for NO production, especially in deeper soil. It is our contention that the same or even more considerable effects may be expected under other conditions.

At present, our knowledge regarding possible reductions of NO and N₂O emissions are too uncertain to justify quantification and implementation of strategies designed to mitigate emissions, such as the use of inhibitors, and changing cultivation or land use. This is because the mechanism and factors affecting production and consumption of NO and N₂O in soil during nitrification and denitrification are not clear. In the future we will address the problem of quantifying the effects of each factor on NO and N₂O production and consumption.

[Fig. 1 , Effect of the depth of NO and N₂O producing site in Andosol on their emission rate to the atmosphere estimated by model analysis.](#)

[Fig. 2. Observed effect of the depth of ammonium sulfate application to Andosol on their emission rate to the atmosphere.](#)

(Y. Hosen)

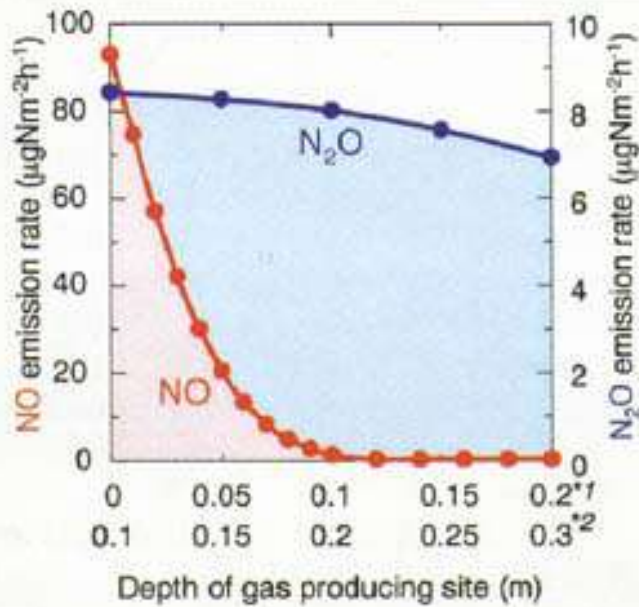


Fig. 1. Effect of the depth of NO and N₂O producing site in Andosol on their emission rate to the atmosphere estimated by model analysis.  
 *1: Upper end of gas producing site (m)  
 *2: Lower end of gas producing site (m)

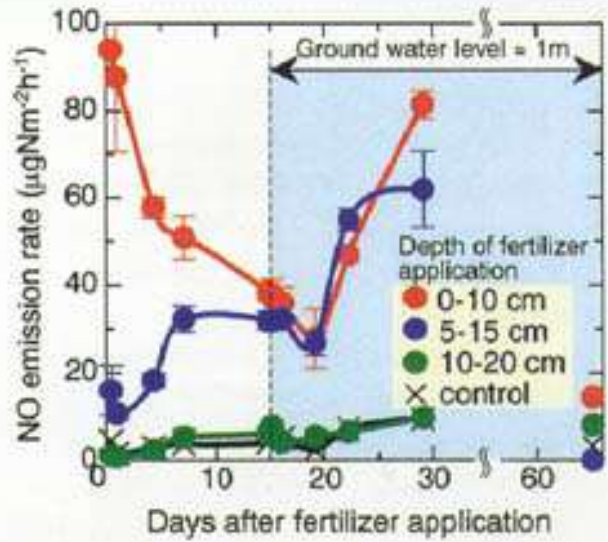


Fig. 2. Observed effect of the depth of ammonium sulfate application to Andosol on their emission rate to the atmosphere.

Fig. 1 , Effect of the depth of NO and N2O producing site in Andosol on their emission rate to the atmosphere estimated by model analysis.

Fig. 2. Observed effect of the depth of ammonium sulfate application to Andosol on their emission rate to the atmosphere.

BACK



# CROP PRODUCTION AND POSRHARVEST TECHNOLOGY DIVISION

Although world population growth rates have declined steadily since 1970, the global population will continue to increase by 90 to 100 million people annually for the next several years. Some 95 percent of the growth will occur in developing regions, where food deficits are already severe, and where alternative employment opportunities and economic growth are limited. Clearly, population growth will provide the primary impetus behind growing demands for food. Yet, food markets will also be influenced by shifts in the purchasing power of local consumers. As development proceeds, changing patterns of consumption may dramatically increase demand for greater varieties of vegetables, fruits, and meats.

For these reasons, self-reliance in food, rather than complete economic self-sufficiency, will become an increasingly important objective in developing regions. There are no definitive models for achieving this goal. However, various methods exist for ensuring self-reliance within the particular natural and environmental constraints of each country.



The Crop Production and Postharvest Technology Division promotes research projects on topics ranging from production and storage to the processing and marketing of agricultural products. Our research activities encompass a variety of disciplines including agronomy, plant protection (pest, disease and weed control), agricultural mechanization, irrigation, drainage, cropping systems, food storage, post harvest technology, farm management and agricultural economics.

Because the total area of arable land in the world is limited, we believe that sustainable production of agricultural products can be achieved only by increasing overall productivity. While various technological problems must be resolved, productivity growth must be pursued in ways compatible with the preservation of the natural environment. Therefore, it is necessary to reduce as much as possible the amount of chemical inputs in agricultural endeavors. To achieve this, research should address the need for integrated pest management through biological control systems and better utilization of information. Topics requiring additional attention include ecological studies of insect pests and their natural enemies and the development of predictive methodologies for outbreaks of insects and diseases.



Far too often the problems of feeding the world's hungry is conceived in terms of producing sufficient food. Equally pressing problems related to preservation and distribution, issues which affect food products between harvest and consumption, are frequently neglected. Post-production operations of agricultural and horticultural products include a wide range of functions necessary for supplying good quality food, reducing transaction costs, and raising domestic welfare. It is necessary to stress postharvest studies of agricultural products, such as quality improvement, safety, the extension of shelf life, and the control of the presence of insects and microorganisms in foodstuffs. These constitute important objectives of this Division.

Finally, sustainable production of agricultural commodities can only be supported by the development of sustainable markets. Technology for enhancing the value of agricultural products is being developed with the goal of increasing incentives for farmers to promote sustainable production. Economic studies are requisite in furthering the development of target countries.

[Division Topic1: Pathogenicity of *Xanthomonas oryzae* pv. *oryzae* strains in Vietnam](#)

[Division Topic2: Antioxidant and antimutagenic properties of local agricultural products in Thailand](#)

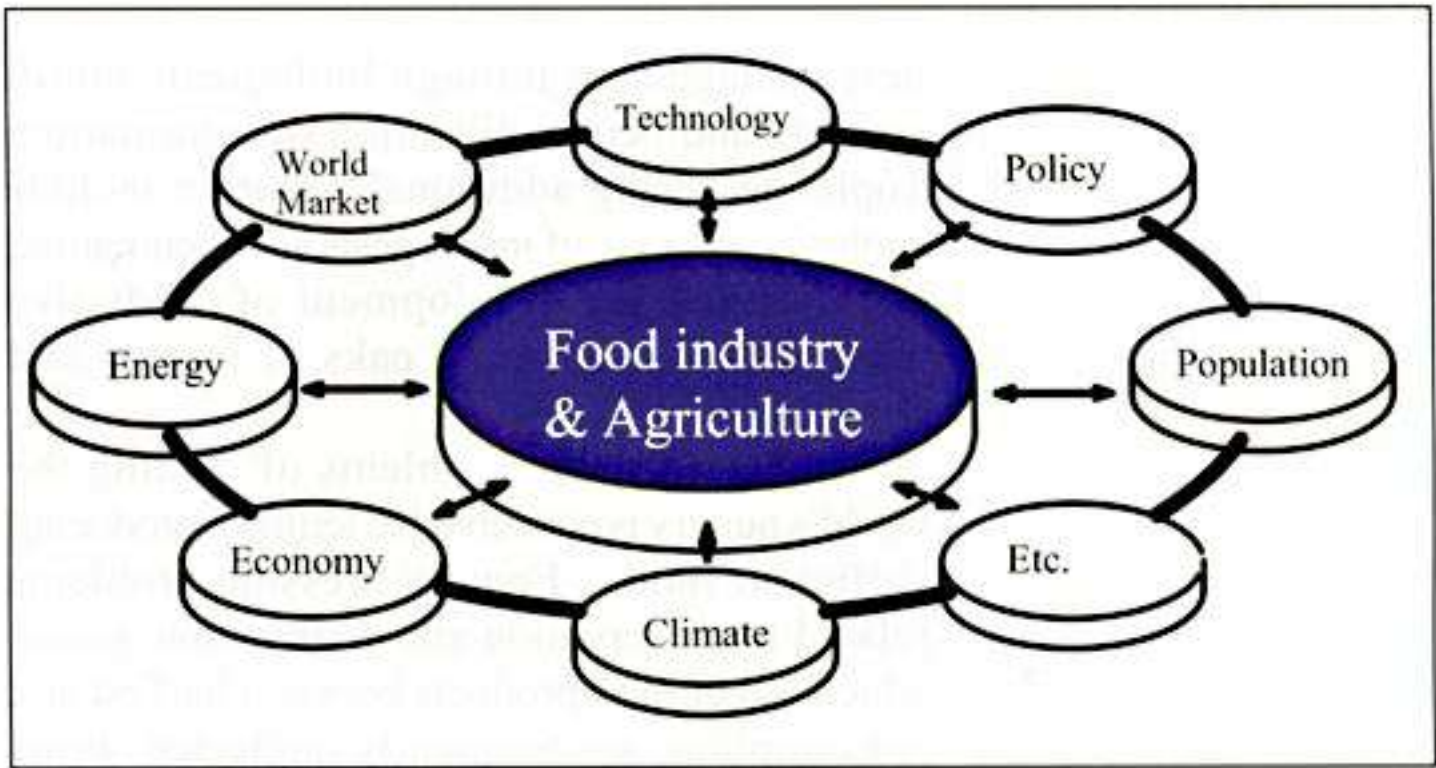
[Division Topic3: Quality evaluation of Khao Dawk Mali 105, an aromatic variety of rice from northeast Thailand](#)

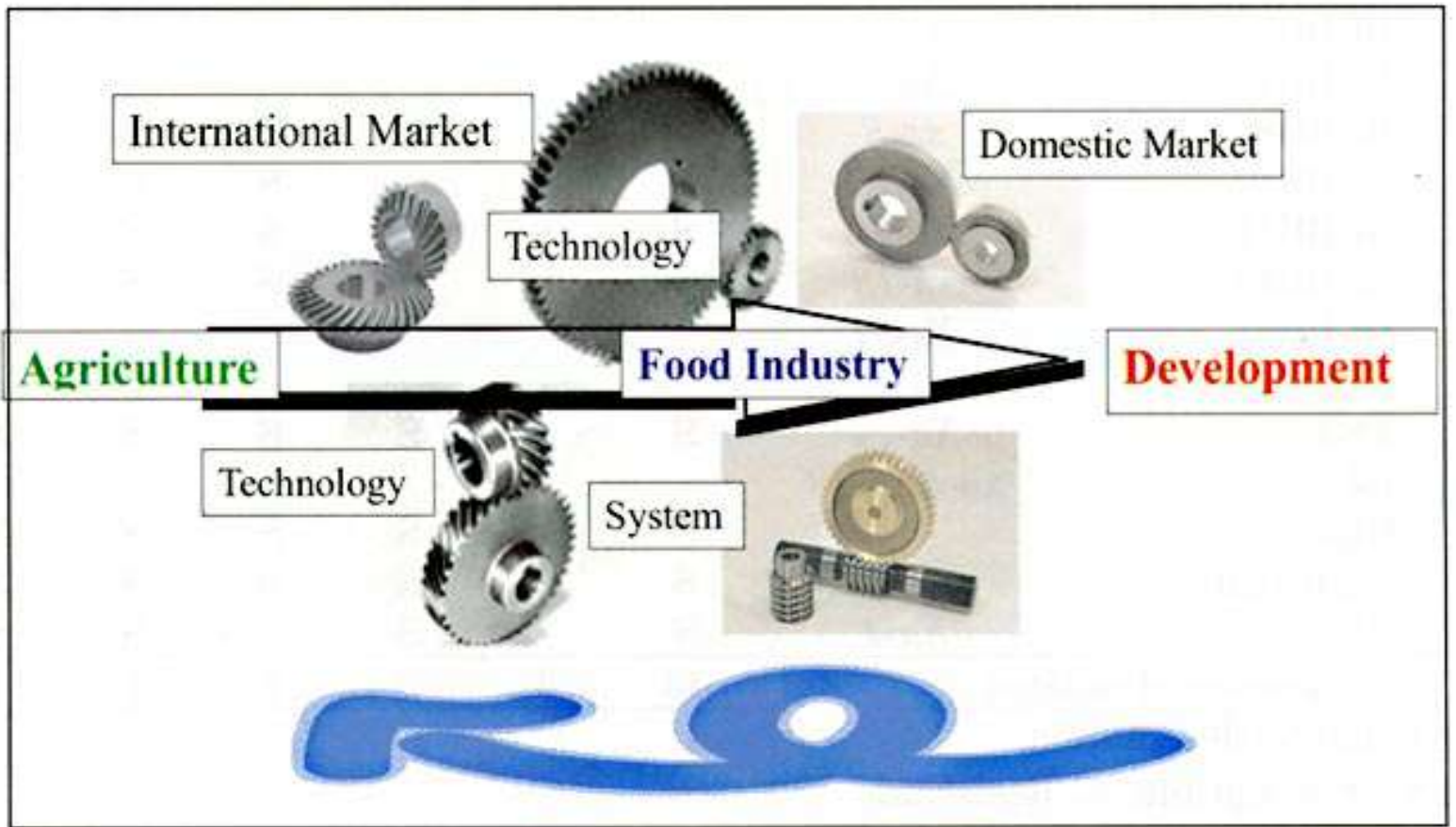
[Division Topic4: Multiple herbicide-resistant *Limnocharis flava* \(L.\) Buchenau in Malaysia](#)

---

[BACK](#)

[HOME](#)







## **Pathogenicity of *Xanthomonas oryzae* pv. *oryzae* strains in Vietnam**

Bacterial leaf blight (BLB) of rice caused by *Xanthomonas oryzae* pv. *oryzae* (Xoo) is one of the major constraints on rice production in Vietnam, especially in the rainy season. Although BLB is very severe in the northern part of Vietnam as well as in the Mekong River Delta (MRD), the pathogenic variability of Xoo and varietal resistance have not yet been investigated in detail.

Because the cultivation of resistant varieties is the most promising method to control BLB, characterizing the virulence of the causal bacterium Xoo and surveying the distribution of each race are essential. Therefore, we collected 52 isolates of Xoo throughout Vietnam and examined their variability in virulence based on the reactions of the 18 differential varieties. As a result, 52 isolates were divided into six groups (races) (Table 1). Among the races, Race A predominated with more than 80% of the isolates classified into this race, one which was distributed throughout Vietnam. Although the other nine isolates, belonging to Races B to F, were minor races, the pathogenic characteristics of these six races were relatively similar. Therefore, the diversity in the pathogenicity of the Vietnamese BLB strains may be low based on their virulence to differential varieties.

Almost all the Vietnamese rice varieties were susceptible to the predominant Race A. However, some Race A isolates showed different reactions to varieties cultivated in Vietnam. Furthermore, the pathogenicity of the isolates tested differed slightly depending on the sampling location.

Although Races B and D were avirulent to IR 20, Race D was virulent to IR-BB4, which carried the resistance gene Xa-4 as in the case of IR20 (Table 1), thus exhibiting that IR20 may harbor a resistance gene or genes to Race D. The rice cultivar IR36 may also harbor an additional resistance gene or genes to Race B, though the genetic background of IR36 to BLB has not been studied yet. Furthermore, some local varieties and wild rices may also harbor unknown resistance gene(s). Based on these results, the pathogenic diversity of the isolates in Vietnam seems to be complex despite their simple pathogenic characteristics to the differential varieties.

Most of the local varieties tested were generally susceptible to the Vietnamese isolates. Before the introduction of agronomically improved but susceptible rice varieties, BLB was not a serious disease under traditional cultivation practices even though the local varieties were susceptible. Recently, BLB has been severe in some areas, mainly because of the recent adoption of intensive cultural practices, such as high-density direct seeding (more than 200 kg/ha), the utilization of nitrogen-saturated fertilizers, and the cultivation of three crops per year - a practice introduced after modern, improved rice varieties increased the area cultivated.

In this study, we observed that some differential varieties, IR-BB5 (Xa-5), IR-BB7 (Xa-7) and Asominori (Xa-17), were resistant to all the isolates tested, while IR-BB3 (Xa-3) and IR-BB21 (Xa-21) were susceptible only to four and one isolates, respectively. Therefore, a breeding program should be initiated to transfer these resistance genes from differential varieties to high quality Vietnamese rice varieties to control the disease effectively.

*Table 1: Resistance of differential rice varieties to races of bacterial leaf blight collected in Vietnam*

(T. Noda)

---

BACK

HOME



Differential varieties	Resistance genes	Race ^{a)}					
		A	B	C	D	E	F
IR24	<i>Xa-16, Xa-18</i>	S ^{b)}	S	S	S	S	S
IR-BB1	<i>Xa-1, Xa-12</i>	S	S	S	S	S	S
IR-BB2	<i>Xa-2</i>	S	S	S	S	S	S
IR-BB3	<i>Xa-3</i>	-	S	-	-	S	-
IR-BB4	<i>Xa-4</i>	S	-	S	S	S	S
IR-BB5	<i>xa-5</i>	-	-	-	-	-	-
IR-BB7	<i>Xa-7</i>	-	-	-	-	-	-
IR-BB8	<i>xa-8</i>	S	S	S	S	S	S
IR-BB10	<i>Xa-10</i>	S	S	-	S	S	-
IR-BB11	<i>Xa-11</i>	S	S	S	S	S	S
IR-BB13	<i>xa-13</i>	S	-	S	S	S	S
IR-BB21	<i>Xa-21</i>	-	-	-	-	-	S
Asominori	<i>Xa-17</i>	-	-	-	-	-	-
TN1	<i>Xa-14</i>	S	S	S	S	S	S
BJ1	<i>xa-5, xa-13</i>	-	-	-	-	-	-
IR36	?	S	-	S	S	S	S
Sigadagabo	?	S	S	S	S	S	S
IR20	<i>Xa-4</i>	S	-	S	-	S	S
Number of isolates		43	3	2	2	1	1

a) Tentative designation.

b) S : Susceptible, - : Resistant.

Table 1. Resistance of differential rice varieties to races of bacterial leaf blight collected in Vietnam



## Antioxidant and antimutagenic properties of local agricultural products in Thailand

A wide variety of indigenous plant species are utilized for agriculture and daily consumption in Thailand. Many of these species maintain a long tradition of use in folk remedies. Tropical plant species are known to be rich in phytochemicals that exhibit various biological functions, such as vitamins, terpenoids, flavonoids, alkaloids, organosulfur compounds, and pigments. It has been suggested that many local Thai agricultural products may play an important role in the prevention and/or cure of human chronic diseases as well as cancer. Studies on the biological functions of edible plants in Thailand may be able to elucidate their role in a natural, functional diet. Moreover, information on plant biological functions may contribute to the improvement of public health in Thailand and other tropical countries. In addition, the widespread consumption of such local agricultural products would most likely elevate and stabilize local Thai farmer incomes. In this research, a number of local agricultural products were examined for two important biological functions, antioxidant activity and antimutagenic activity, mainly under the JIRCAS Visiting Research Fellowship Program at Tsukuba from October 1996 to September 1998.

After collecting forty-eight samples of edible plants from several local markets in Thailand, the edible portions were immediately freeze dried and extracted with 80% methanol (methanolic extract). The antioxidant activity of the methanolic extracts was measured by the beta-carotene bleaching method, which is based on the inhibition of discoloration of beta-carotene coupled with the peroxidation of linoleic acid. Butylated hydroxyanisole (BHA) was used as a standard antioxidant. More than 70% Thai plant species showed high antioxidant activity, while only one-third of common edible plants in Japan exhibited high activity ([Photo 1](#)). In particular, three plant species (4 samples) showed significantly potent activity. Pak kra doon (*Careya sphaerica* Roxb.), a leafy vegetable, exhibited the highest activity (121.0 mg BHA equivalent/g), and the leaf of Pak sa meg (*Syzygium gratum* Wall.) and the fruit and the leaf of Kra thin (*Leucaena leucocephala* de wit) showed high activity (40.2, 38.8 and 44.7 mg BHA equivalent/g, respectively), as well.

The antimutagenic activity of the methanolic extracts was determined by an Ames test in the presence of the methanolic extracts, and performed with *Salmonella typhimurium* TA98 (frameshift mutant) as a tester strain and 3-amino-1, 4 dimethyl-5H-pyrido-[4,3-b]indole (Trp-P-I) as an indirect-acting mutagen. The number of *his*⁺ revertant colonies were counted and expressed into a percentage of antimutagenic activity, after subtracting spontaneous revertants. Several plant extracts have a potent inhibitory effect on the mutagenicity of Trp-P-I. The methanolic extracts from 1.25 mg of freeze-dried Pak pai (fragrant knotweed; *Polygonum odoratum* Lour.), a common condiment in Thailand and Vietnam, suppressed 96% of the mutagenicity of 50 ng Trp-P-I, followed by Pak chee (coriander; *Coriandrum sativum*; 94%), Hoom yae (*Trachyspermum roxburghianum* Craib; 92%) and Pegah (Indian trumpet flower; *Oroxylum indicum* Vent.; 90%).

The antimutagenic properties of two Thai gingers, fingerroot and galanga ([Photo 2](#)), were also investigated. These gingers are commonly consumed in Thailand as spices or condiments. The methanolic extracts of fingerroot and galanga showed substantially potent inhibitory effects to the mutagenesis induced by Trp-P-I of 97 to 98% at a concentration of 0.3 mg/plate. Four active compounds from fingerroot and two active compounds from galanga were then isolated to determine their chemical structure. The compounds obtained from fingerroot were identified as chalcone derivatives and flavanone derivatives and exhibited high mutagenic inhibition in a range of 90% to 95% at a concentration of 25 mg/plate. Compounds from galanga were identified as phenyl propanoid derivatives and showed less antimutagenic activity than the fingerroot compounds, 21% and 51%, respectively, at a concentration of 25 mg/plate. All the isolated compounds remained active as antimutagens after heat treatment at 105°C for 15 min, which is considered to be important for food ingredients. Fingerroot and galanga, both important edible plant spices, may play a role in cancer chemoprevention, and, may have potential as effective functional foods.

[Photo 1 : Two kinds of common Zingiberaceae spices in Thailand, and galanga](#)

[Photo 2: Antioxidant activity of edible plants in Thailand and Japan](#)

(K. Nakahara)

BACK

HOME







*CROP PRODUCTION AND POSTHARVEST TECHNOLOGY DIVISION Topic3*  
**Quality evaluation of Khao Dawk Mali 105, an aromatic variety of rice from northeast Thailand**

Since world rice production exceeds demand, rice farmers must produce rice that follows global consumption trends. With a stronger aroma than ordinary rice, aromatic rice has been very popular in Southeast Asia and has recently gained wider acceptance in Europe and the United States. One such variety, Khao Dawk Mali 105 (KDML105), is mainly produced in northeast Thailand and is increasingly in demand in both domestic and international markets due to widespread consumer appreciation of its high quality. Although there is an urgent need for increased production, infertile and drought-stricken sandy soil has hampered such efforts. Unstable rainfall at the beginning of the rainy season and transplanting labor shortages are other factors destabilizing the production of KDML 105. In addition, since an objective evaluation for this variety of aromatic rice does not currently exist, trade of counterfeit KDML 105 has been rampant.

In Japan, rice is distributed as brown rice, which can be germinated, thus presenting adequate information about its variety. Yet, in Southeast Asia, mostrice is distributed as milled rice, which cannot germinate. Though evaluating similar varieties of milled rice with conventional methods, such as the length-width ratio, are inadequate, DNA based cultivar identification methods like microsatellite analysis (e.g. RAPD and AFLP) could be very useful rice variety evaluations. Thus, there was a need to develop a rapid and simple DNA extraction method for milled rice. We developed such a method to remove starch and protein, the main components of milled rice, by a freeze-thaw cycle. The method uses a single grain for checking the adulterate and, from that grain, recovers 200 ng of DNA. Taking 3 hours and lacking any harmful reagents, this rapid DNA extraction method called the "freeze-thaw" method was combined with a PCR-based microsatellite analysis of KDML 105 (Fig.1). This is a more reliable method for identifying rice varieties than the observation of morphological characteristics.

Furthermore, the potent volatile and aromatic compound in the aromatic rice was identified as 2-acetyl-1-pyrroline (AcPy; Fig.2), and the concentration of AcPy was correlated to aroma quality of the aromatic rice. While conventional quantitative analysis of AcPy was carried out by utilizing a large sample, by applying the GC/MS/SIM method, the sample is reduced by an amount of 0.5g. (Fig.2) Although it is commonly maintained that the aroma quality of KDML 105 depends on growth conditions, especially growth area, there is no direct information proving this conclusion. Accordingly, much more work is urgently needed concerning the objective evaluation of KDML 105. As the main variety of rice under production in northeast Thailand's most important industry, more research is required to improve the quality of KDML 105.

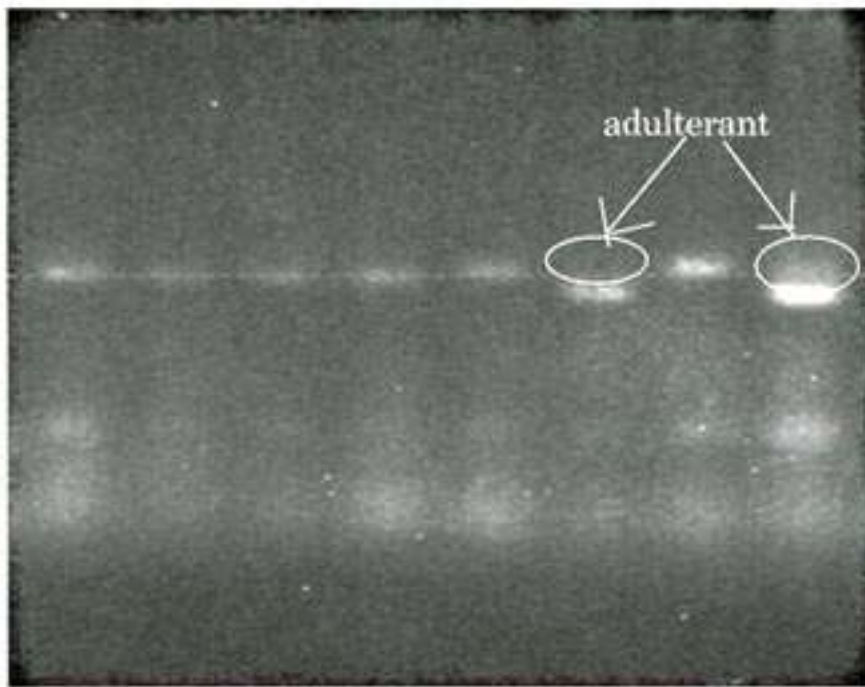
*[Fig1:Agarose gel electrophoresis showing microsatellite polymorphism of KDML 105](#)*

*[Fig2:Quantitative analysis of AcPy in KDML 105 and Koshihikari by GC/MS/SLM](#)*

(T. Yoshihashi)

BACK

HOME

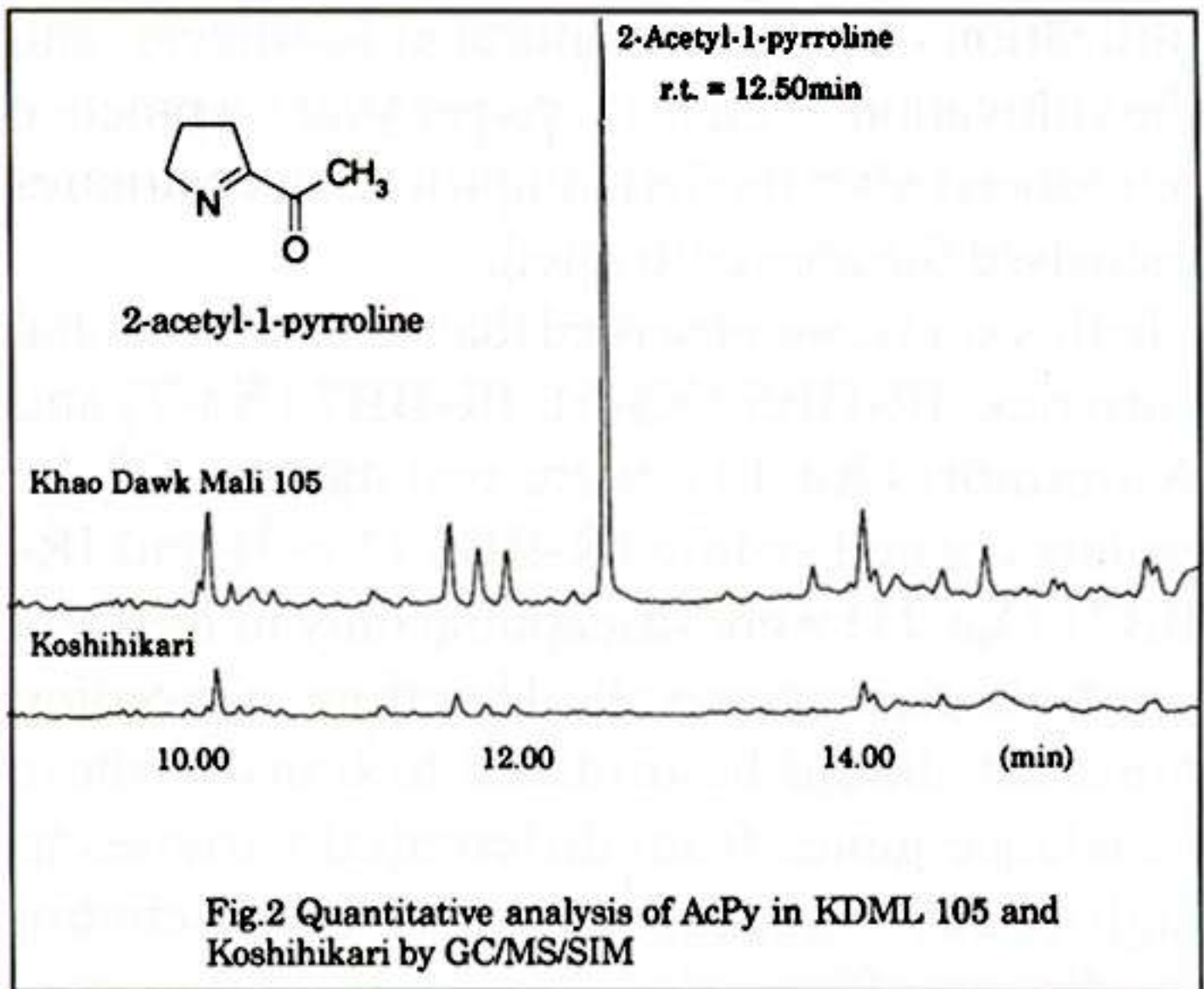


**Fig.1. Agarose gel electrophoresis showing microsatellite polymorphism of KDML 105**

A

B

A: authentic KDML  
B: fake KDML 105





***CROP PRODUCTION AND POSTHARVEST TECHNOLOGY DIVISION Topic4***  
**Multiple herbicide-resistant *Limnocharis flava* (L.) Buchenau in Malaysia**

2,4-D and sulfonylurea herbicides, such as bensulfuron-methyl, are widely used by farmers in Malaysia to control broad-leaved weeds in paddy fields. In the Muda area, the largest granary area in Malaysia, the former has been widely used since the early 1970s and is still popular today. The latter was introduced to Muda farmers in 1988.

Acetolactate-synthase (ALS) inhibitors, including sulfonylurea herbicides, are used widely because of their high control efficacy on broad-leaved weeds, low mammalian toxicity, and low herbicide injury in many crops. In recent years, however, ALS-inhibitor-resistant biotypes have been reported in many weed species in numerous countries .

At the Malaysia Agricultural Research and Development Institute Seberang Perai Station (MARDI S.P.), a rice breeder observed that *Limnocharis flava* in his experimental field was not killed by the application of 2,4-D and bensulfuron-methyl, a kind of sulfonylurea herbicide. This study was conducted to evaluate the susceptibility to 2,4-D and bensulfuron-methyl in *L. flava* collected from MARDI S.P. and other locations on the west coast of Peninsular Malaysia, and to develop effective control methods against the weed.

MARDI plants were not killed by 2,4-D at the recommended application rate. On the other hand, susceptible plants collected from an abandoned paddy field in Lahar Ikan Mati were completely killed by 2,4-D even at 1/16th the recommended rate. To determine I50 (50% inhibition dose) values, we utilized a logistic curve described by

equation (1): 
$$Y = C + \frac{D + C - f \times x}{1 + e^{(x-a)}}$$

Equation(1) was fitted to the relationship between dry weight of the weed and 2,4-D dosage by the non-linear least square method. The I50value in MARDI plants was 0.94 times the recommended rate, while it was 0.02 times in Lahar Ikan Mati ramets (Fig.1). An approximate difference of 50 times in I50 value was observed between the two collections. Similarly, the I50 value for bensulfuron-methyl in the MARDI collection was calculated at 28. 1 times the recommended rate. These results confirmed the development of a multiple herbicide-resistant biotype (resistant to 2,4-D and bensulfuron-methyl) of *L. flava* in the weed population in MARDI S.P. The discovery of bensulfuron-methyl resistance in this study is expected to be the first report on an ALS-inhibitor-resistant biotype in paddy weeds in tropical Asia.

In a field study utilizing various seedling rates of cultivated rice, it was determined that the density of rice seedlings strongly affected the growth of multiple herbicide-resistant *L. flava*. The study established a linear relationship between the density of rice seedling in a logarithmic scale and the dry weight of the weed in an ordinary scale. Moreover, the results suggest that an adequate density of rice seedlings can be an effective means of control for this multiple herbicide-resistant weed in an integrated weed management system.

Except for the MARDI collection, only the Seberang Perak Rice Estate collection was resistant to 2,4-D and not one of the 12 collections from the west coast of Peninsular Malaysia was resistant to bensulfuron-methyl. Conditions where herbicides represent the only form of selection pressure, however, are favorable to the development of herbicide-resistant biotypes. Such conditions are often observed in unmanaged fields in Malaysia, that is, in vacant areas in fields caused by poor rice germination (Photo.1). Therefore, extensive infestation of herbicide-resistant weeds would become unavoidable if vacant areas in fields were left untreated.

As there are few or no alternative herbicides to control resistant biotypes, multiple resistant weeds are of great concern to farmers. If the multiple resistant *L. flava* were to go unchecked, the economic impact would be great. Fortunately, bentazone was able to effectively control this multiple herbicide-resistant biotype. The use of a single type of herbicide, however, may give rise to the risk of additional herbicide resistance. Therefore, integrated weed management becomes much more important in the control of herbicide-resistant weeds.

[Fig. 1 . Dosage response of *L.flava* collected from a paddy field in MARDI Seberang Perai\(R\) and an abandoned paddy field in Lahar Ikan Mati\(S\) to 2,4-D dimethylamine.](#)

[Photo 1. An unmanaged field showing vacant areas due to poor rice germination.](#)



[BACK](#)

[HOME](#)

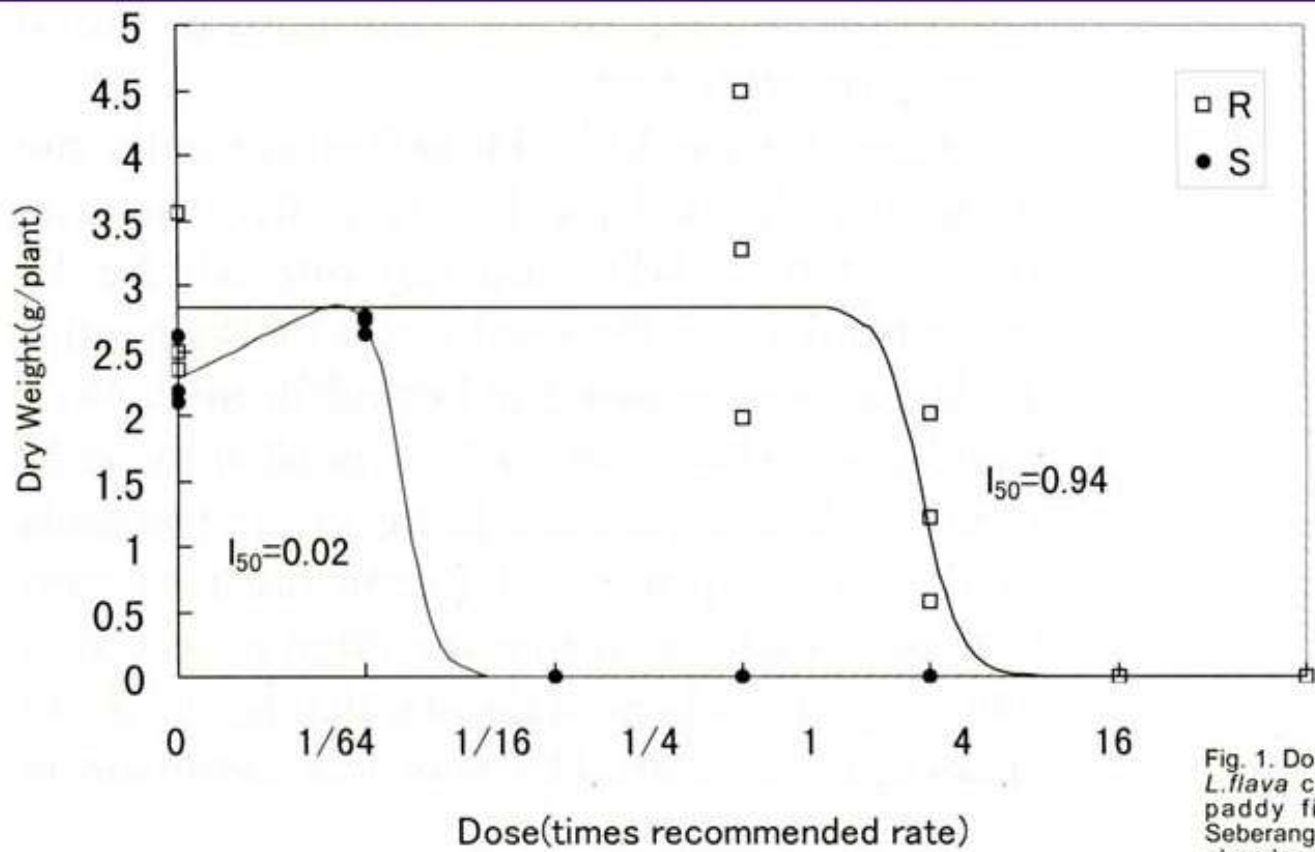


Fig. 1. Dosage response of *L. fiava* collected from a paddy field in MARDI Seberang Perai(R) and an abandoned paddy field in Lahar Ikan Mati(S) to 2,4-D dimethylamine.



**Photo 1. An unmanaged field showing vacant areas due to poor rice germination.**



# ANIMAL PRODUCTION AND GRASSLAND DIVISION

In developing countries, domesticated animals contribute to the betterment of people's lives. Animals not only produce meat milk and hide, which are essential in daily life and are an important source of income, but also generate draft power for tillage and transportation and produce wastes for use as fertilizer and fuel. Despite these benefits, livestock production remains at low levels throughout the developing world due to constraints such as low genetic potentials, poor quality feeds, disease prevalence, harsh climatic conditions, and management inexperience.

The Animal Production and Grassland Division carries out research aimed at achieving sustainable increases in animal production without generating adverse environmental consequences. In order to reach this goal, the Division seeks to enhance the productive capacity of natural resources, manage grasslands to secure feed resources, enhance the utilization of agro-industrial by-products, control invasive animal diseases, and improve management practices in developing regions of the world.

During Fiscal Year (FY) 1998, one overseas collaborative research project and two supporting projects in Tsukuba moved toward successful conclusion. The first project involved cooperation between Division researchers and scientists from the Malaysian Agriculture Research and Development Institute (MARDI) to improve local raising methods of small livestock. The two domestic research projects were carried out to identify endophytic fungi in pasture plants in tropical regions and their utilization in plants via biotechnological methods. Moreover, a Division researcher dispatched to Cantho University in Vietnam until the end of FY 1997 completed research concerning the *Ascaris* infection in swine in the Mekong Delta and the application of anthelmintic.

In addition to these projects, four long-term international research projects lasting from two to five years are currently underway. Division researchers are working with the Thai Department of Livestock Development (DLD) to improve cattle production with the feed resources available in northeastern Thailand. The cooperative research on agro-pastoral systems being carried out with the National Center for Research on Beef Cattle (CNPGC-EMBRAPA) and the National Center for Soybean Research (CNPSo) in Brazil focuses on the sustainable management and utilization of grasslands and the analysis of raising technology of small livestock, respectively. Finally, collaborative research on the role of the [TNF- \$\alpha\$](#)  gene in trypanosomiasis began in 1998 with the International Livestock Research Institute (ILRI) in Kenya.

In addition to long-term projects, the following studies were carried out by researchers on short-term assignments of one to three months: 1) studies on the nutritive requirements of tropical ruminant and evaluation of nutritive value in ruminant feeds in Thailand with the Khon Kaen Animal Nutrition Research Center and DLD; 2) studies with Cantho University in Vietnam on environmental pollution caused by hog production in farming systems in the Mekong Delta; 3) research on the physiological characteristics of forage grasses in agropastoral systems in Brazil at CNPGC; 4) an evaluation of the feed value of corn stalk and agricultural by-products with the Chinese Agricultural University in northern China; 5) studies on the acute phase response in [TNF- \$\alpha\$](#)  deficient mice after *Trypanosome congolense* infection conducted with ILRI in Kenya; 6) studies on the relationship between fertility and grassland vegetation in the steppe soils of central Asia with the Kazakh Institute of Agriculture (KIA); 7) investigation of the production of cloned sheep in central China; and 8) studies of methods for sustaining pasture plants in South America in collaboration with the International Center for Tropical Agriculture (CIAT) in Colombia.

The Division receives numerous requests from developing countries to pursue collaborative research, primarily concerning the incorporation of biotechnological applications and enhancement of overall levels of research. In order to address such needs, the Division has been promoting basic research on JIRCAS's Tsukuba premises in support of overseas activities. Beginning in 1999, one domestic project will investigate nitrogen-fixing endophytic bacteria in pastures.

[Photo: The number of water buffalo is now declining in Thailand. However, a series of trials revealed its superior adaptability to a low quality diet](#)

[Division Topic1: Analysis of chitinolytic enzyme genes of a mycoparasitic bacterium *Flexibacter* sp. FL824A](#)

[BACK](#)

[HOME](#)

TNF- $\alpha$





## **Analysis of chitinolytic enzyme genes of a mycoparasitic bacterium *Flexibacter* sp. FL824A**

The purpose of this study was to develop a means of disease control in plants by utilizing lytic microorganisms. We detected lytic activity in mycoparasite *Flexibacter* sp. FL824A toward several plant pathogenic fungi. This lytic activity consisted of the secretion of lytic enzymes, chitinolytic enzymes (chitinases and N-acetylglucosaminidases),  $\beta$ -1,3-glucanases and proteases. Because chitin, poly- $\beta$ -1,4-N-acetylglucosamine [(GlcNAc)_n], is a major structural component of the cell walls of fungi, chitinolytic enzymes are considered to play an important role in the mycoparasitic process. In the first step of our study, we analyzed the genes of chitinolytic enzymes from *Flexibacter* sp. FL824A.

We first constructed a genomic library of *Flexibacter* sp. FL824A using pUC19 and *Escherichia coli*. Hydrolysis activity of the crude protein of the transformants was determined by using analogs of chitin derivatives, 4-methylumbelliferyl- $\beta$ -D-N,N'-diacetylchitobioside [4-MU-(GlcNAc)₂] or 4-methylumbelliferyl- $\beta$ -D-N,N,N''-triacetylchitotriose [4-MU-(GlcNAc)₃] as substrates. Among 6,000 transformants tested, four clones showed positive activity and fell into two groups according to their specificity to the substrates ([Table 1](#)). We selected two clones CHF 1149 and CHF 1351, based on activity level, specificity to the substrates, size of DNA-inserted fragments, and digestion pattern of the inserts using restriction endonucleases.

An open reading frame (ORF) of 4236 bp was found to code for a chitinase with 1412 amino acids based on the nucleotide sequence and deduced amino acid sequencing of an 8.7-kbp insert of pCHF 1149. Homology analysis of the deduced amino acid sequence of this protein revealed that the enzyme had a multiple domain structure consisting of at least seven domains ([Fig. 1](#)). The most interesting property of the enzyme was that it had two catalytic domains, one homologous to the catalytic domain of chitinase A1 of *Bacillus circulans* WL-12 on the N-terminal side of the protein, and the other homologous to that of chitinase D of the same bacterium on the C-terminal side.

The DNA sequence of 5.0 kbp of the DNA-inserted fragment of pCHF 1351 was determined after subcloning. An open reading frame (ORF) of 1962 bp was found to code for a putative protein with 654 amino acids. The protein shared a 25% homology with endo- $\beta$ -N-acetylglucosaminidase of *Clostridium perfringens*.

Strong lytic activity of *Flexibacter* sp. FL824A may be due to the presence of a unique chitinase with two catalytic domains. Further studies on the chitinase should be carried out in order to analyze the chitin degradation of this mycoparasitic bacterium.

[Table 1. : Enzymatic activity of positive clones using 4-MU-acetylchitooligoside as a substrate](#)

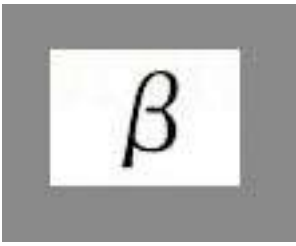
[Fig. 1: Schematic representation of the domain structures of chitinases](#)

(Y. Ando)

BACK

HOME





**Table 1. Enzymatic activity of positive clones using 4-MU-*N*-acetylchitooligoside as a substrate**

Clone	Enzymatic activity ( $\mu$ Unit/ml) ¹⁾		Ratio of activity (dimer/trimer)
	dimer ²⁾	trimer	
Group A			
CHF2778	7.63	10.36	0.74
CHF2601	15.81	26.16	0.60
CHF1149	232.19	446.39	0.52
Group B			
CHF1351	768.50	40.33	19.06

1) 1 Unit of enzymatic activity was defined as 1  $\mu$ mol of 4-MU/min at 37°C.

2) Dimer, 4-MU-(GlcNAc)₂; trimer, 4-MU-(GlcNAc)₃.

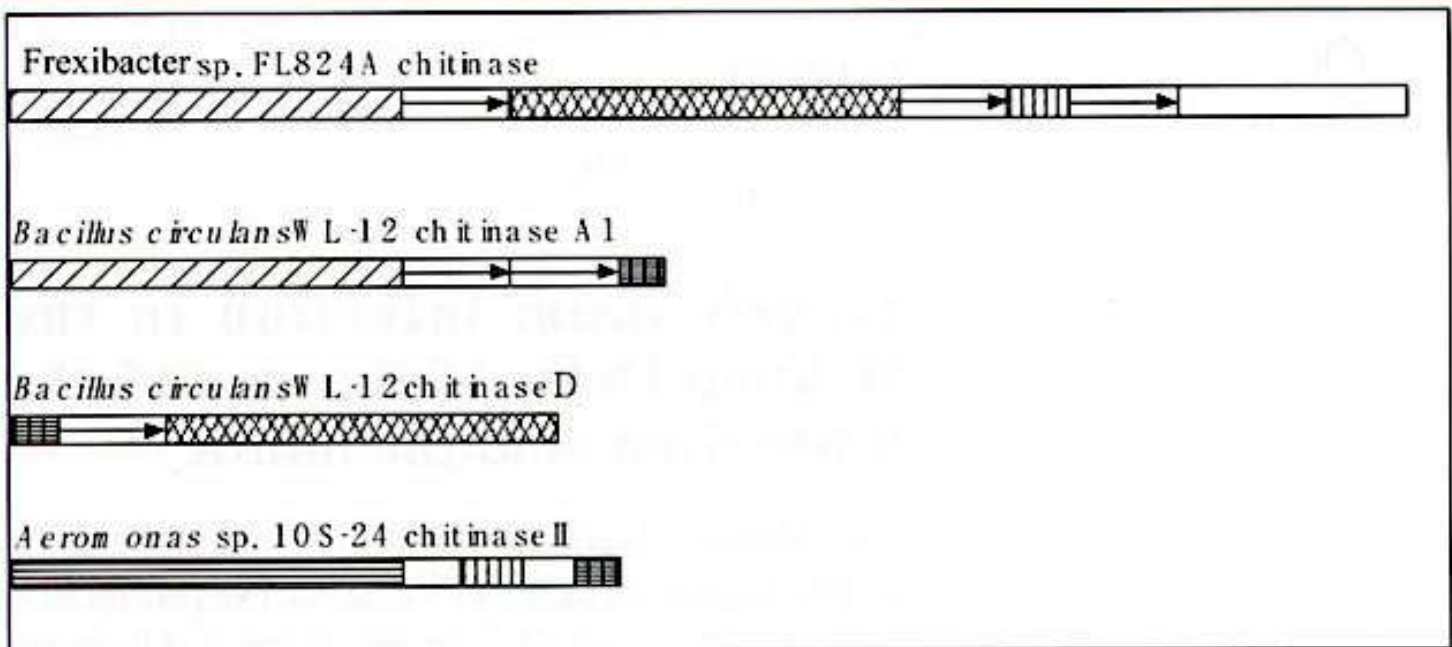

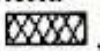







Fig. 1. Schematic representation of the domain structures of chitinases from several bacteria

 ,  ,  , catalytic domain;  , chitin binding domain;

 , fibronectin type III repeating domain;

 ,  , unknown domain.



## **Ascaris suum infection in the Mekong Delta Vietnam and the application of anthelmintic**

The Mekong Delta is an important region for the pig production industry in Vietnam. Pig production is conducted on small farms in integrated farming systems or in the Vuon-Ao-Chung (VAC: Vietnamese for garden-pond-livestock) system that combines agriculture, animal husbandry and fisheries for feed from agricultural by-products. Both the economic efficiency of these farms and the income of the farmers are very low. In order to increase pig productivity and thus farmer income, it is important to prevent the occurrence of various problems relating to feeds and diseases. Helminthic diseases are considered to be associated with low productivity in the VAC

system, the main cause of economic hardship of the farmers. One of the aims of the present study was to survey the actual conditions of nematode infection in the Mekong Delta area. An attempt was also made to investigate the effects of the application of anthelmintic on pig growth.

Eighty-seven fecal samples were collected from pigs from 38 farms in VAC systems in the Mekong Delta area (four provinces). The Watanabe sedimentation method was then applied to detect nematode eggs. Counts of eggs per gram (EPG) were carried out to demonstrate the effect of anthelmintics on *Ascaris suum* using a McMaster EPG counting plate, if necessary.

Eggs of *A. suum* were detected in 51% (44) of 87 pigs, *Metastrongylus* spp. in 14% (12), *Trichuris suis* in 26% (23), *Oesophagostomum* spp. in 14% (12), and *Strongyloides ransomi* in 5%(4). Results of the investigation also showed that the infective rate of lung worms (*Metastrongylus* spp.) was low. However, swine metastrongylosis is a leading cause of swine pneumonia and disturbs their growth in the Mekong Delta. There were distinct differences between the regions surveyed in the infective rate of *A. suum*. For example, the rate of this nematode in the pigs from 12 farms near Cantho University was 100%, whereas it was about 30% in other regions.

Since the morbidity rate of the *A. suum* infection is very high, the effect of the *Ascaris* infection on pig growth was investigated. Each positive for the *A. suum* eggs, six littermates and crossbreeds of Ba Xuyen and Yorkshire weighing approximately 40 kg from the Experimental Animal Farm of Cantho University were used in the experiment. Group 1 consisted of 3 pigs treated with 1 ml per 15 kg of Polystrongle (injectable form teteramizole hydrochloride, France). Group 2 consisted of 3 untreated pigs. Their body weight was checked biweekly for 12 weeks and an EPG count was taken every day for 10 days after treatment. The presence of *A. suum* eggs was also checked by the sedimentation method every week. All the animals were raised under the standard management system utilized by the university's animal farm. In the 3 pigs of the treated group, *A. suum* worms were eliminated within a few days after treatment, and the EPG of this nematode reached a value of zero. However, since *A. suum* eggs were found again 6 weeks later, treatment was resumed. After ingestion of *A. suum* eggs, about 9 weeks were required for adult stage development ([Table 1](#)). Therefore, it is considered that the presence of this anthelmintic in the intestine was effective against nematodes in the adult stages, but not against those in the immature stages.

While the growth rate of the untreated pigs was low, the growth rate of the treated pigs improved ([Photo 1](#)). In the untreated group, the small intestine of an emaciated animal contained 12 *Ascaris* worms ([Photo 2](#)). The growth of the untreated pigs, which reached a weight of 80 kg, was delayed by 2 weeks compared with the treated pigs. Anorexia and diarrhea were not observed in pigs of either group during the examination.

Comparison of treated and untreated pigs showed that the growth rate of the untreated pigs was very low and that this nematode infection might be a cause of heavy economic losses for farmers. Calculations showed that the economic loss was about 25,000 Vietnam dong (about US\$ 2.00) per head on an experimental farm. Low nutrition levels including protein and vitamin A deficiency may exert more deleterious effects on the infected hosts. If farmers use anthelmintic therapy for their pigs, the growth period of the pigs may be shortened by at least 2 weeks. The total cost for the treatment was about 5,000 Vietnam dong. It may be necessary for farmers to use anthelmintic in order to increase productivity and produce high quality meat.

[Table.1 Changes in eggs counts in feces of pigs after tetramizole treatment](#)

[Table. 2 Body weight of treated and untreated pigs](#)

[Photo 1 . Treated \(back\) and untreated \(front\) pigs on an experimental farm.](#)

[Photo 2. The small intestine and Ascaris Worms from pig No.6.](#)

(S. Yoshihara)

[BACK](#)

[HOME](#)

**Table 1. Changes in egg counts in feces of pigs after tetramizole treatment**

Group	Pig No.	Days after treatment										
		1	2	3	4	5	6	7	8	9	10	
Treatment	1	800 a)	a) 0	0	0	0	0	0	0	0	0	0
	2	900	0	0	0	0	0	0	0	0	0	0
	3	300	100	0	0	0	0	0	0	0	0	0
Control	4	700	800	900	800	800	1000	900	1100	900	1100	
Non treatment	5	800	900	800	800	800	800	800	900	1000	1000	
	6	400	400	400	300	400	400	400	400	400	600	

a) ;Number of eggs per g in feces.

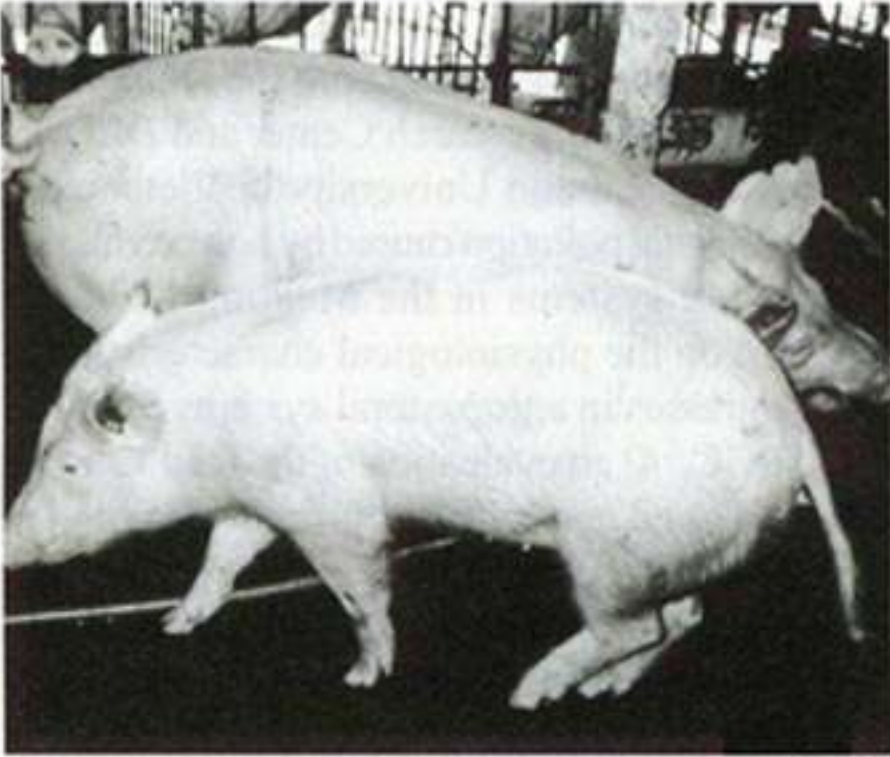


Photo 1. Treated (back) and untreated (front) pigs on an experimental farm.



Photo 2. The small intestine and *Ascaris* worms from pig No.6.



**Table 2. Body weight of treated and untreated pigs**

(Unit: kg)

Group	Pig No.	Weeks after treatment						
		0	2	4	6	8	10	12
Treatment	1	37	44	51	60	79	81	89
	2	40	45	52	60	70	82	89
	3	39	44	51	58	68	80	90
Control	4	41	46	52	59	66	74	82
Non treatment	5	39	44	50	57	64	72	81
	6	42	46	51	58	66	69	72



# FORESTRY DIVISION

As increasing demands for food compel farmers to exploit ever greater levels of arable land, natural forest cover has declined sharply, particularly in developing areas of the world. In turn, forest degradation has generated serious economic and environmental problems, not only at local levels but also on a global scale. Providing for rehabilitation and sustainable management of forest areas therefore remains an urgent issue, and improving forest production systems and post harvest technologies in local communities can be viewed as an essential means of stanching forest decline.

The Forestry Division conducts a wide range of research in developing countries, addressing issues from production to end-use. Projects undertaken by the Division generally fall under one of two categories, consisting of silvicultural and forest management technologies and processing technologies for forest products. These projects involve our researchers in disciplines such as silviculture, plant ecology and eco-physiology, soil science, entomology, mycology, forest mechanization, socio-economics, and wood technology.

Enrichment and rehabilitation of degraded forests are the first steps in the development of sustainable management in forest reserves. In an effort to make these initial goals attainable, the Forestry Division has concentrated its research on developing relevant technologies in silviculture, site evaluation and pest control, while paying due consideration to natural environmental conditions.

At the same time, the Division has recently initiated studies on species behavior, systems for natural forest regeneration, enrichment planting methods, and harvesting systems. These are designed to support sustainable production of forest products, which constitute a principal trading commodity in thirty-three developing countries around the world. If achieved, sustainable production will help to stabilize levels of exploitation, both in natural forests and plantations .

Finally, the Forestry Division has focused research on problems of shifting cultivation, which remains a leading cause of forest degradation in some areas. Such problems require the development of forest production and planning systems for stimulating local economies. As rapid deforestation continues, the disappearance of various lesser-known tree species and the loss of potential forestry products associated with them also grows. For these reasons, the Division believes that evaluative studies are urgently needed, while efforts to upgrade wood processing technologies currently available in developing regions should be given greater priority.

*[Photo : Homogeneous stand of Rhizophora mangroves in Matang along Sangga Bears River, Malaysia](#)*



[Division Topic1: Vegetation and litter fall in the Matang Forest Reserve, Malaysia](#)

[Division Topic2: Chlorine-free bleaching of kraft pulp from oil palm empty fruit bunches](#)

BACK

HOME





## Vegetation and litter fall in the Matang Forest Reserve, Malaysia

A JIRCAS comprehensive research project entitled "Productivity and sustainable utilization of tropical and subtropical brackish water ecosystems" is currently underway in 40,711 ha of the Matang Mangrove Forest Reserve near Taiping City, 200 km north of Kuala Lumpur. This project has been jointly implemented by the Forestry and Fisheries Divisions of JIRCAS, the Forest Research Institute Malaysia, the University of Malaya, and the Fisheries Research Institute of Malaysia. Through studies on mangroves, crabs, plankton, fish, and human activities, researchers are evaluating the concept of sustainable management of mangrove forests. This area is particularly well known as an example of sustainable management. Under a 30-year rotation system, *Rhizophora apiculata* (a major species of tree in the mangroves) is simultaneously harvested for charcoal and re-planted.

As part of this project, the Forestry Division of JIRCAS is investigating litter fall (any material that falls from mangrove trees) in three different types of mangrove forest. Common types of mangrove forest in this area are a) a mixture of *Avicennia* spp. and *Sonneratia* spp., b) *Rhizophora* spp., and c) *Bruguiera* spp. The distance separating type A from the sea is the shortest of the three, followed by types B and C. During the spring tide, the maximum water level of types A and B is 90 and 70 cm above land, respectively. Type A is under water 16 hours a day during the spring tide and 10 hours a day during neap tide. In comparison, type B is under water 11 hours and 8 hours respectively, while, even during the spring tide, type C is slightly above water level during the majority of the year. The variety in vegetation of the mangroves is a result of the difference in water level.

Litter fall for each type throughout the year is shown in [Fig. 1](#). The total mass of litter fall in types B and C is nearly equivalent ([Fig. 1](#)), while that of type A is roughly half. Despite the difference in total mass, the percentage of leaf weight is similar in all forest types. Leaves account for 56-58% of the total litter fall mass, implying that leaves are the major components of litter fall in all the forest types.

The mangrove tree is unique not only for its shape but also for the movement of its fallen leaves. In lowland and hill forests, which are also present in Peninsular Malaysia, most fallen leaves decompose on the forest floor. In contrast, in type A mangrove forests most fallen leaves are washed out to sea during both spring and neap tides. In a type B forest, fallen leaves are washed out during the spring tide, although most of the leaves remain during the neap tide. Finally, most leaves remain in the spring and during neap tides in a type C forest. Leaf movement determines the fertility of the soil and the food chain of the mangrove ecosystem.

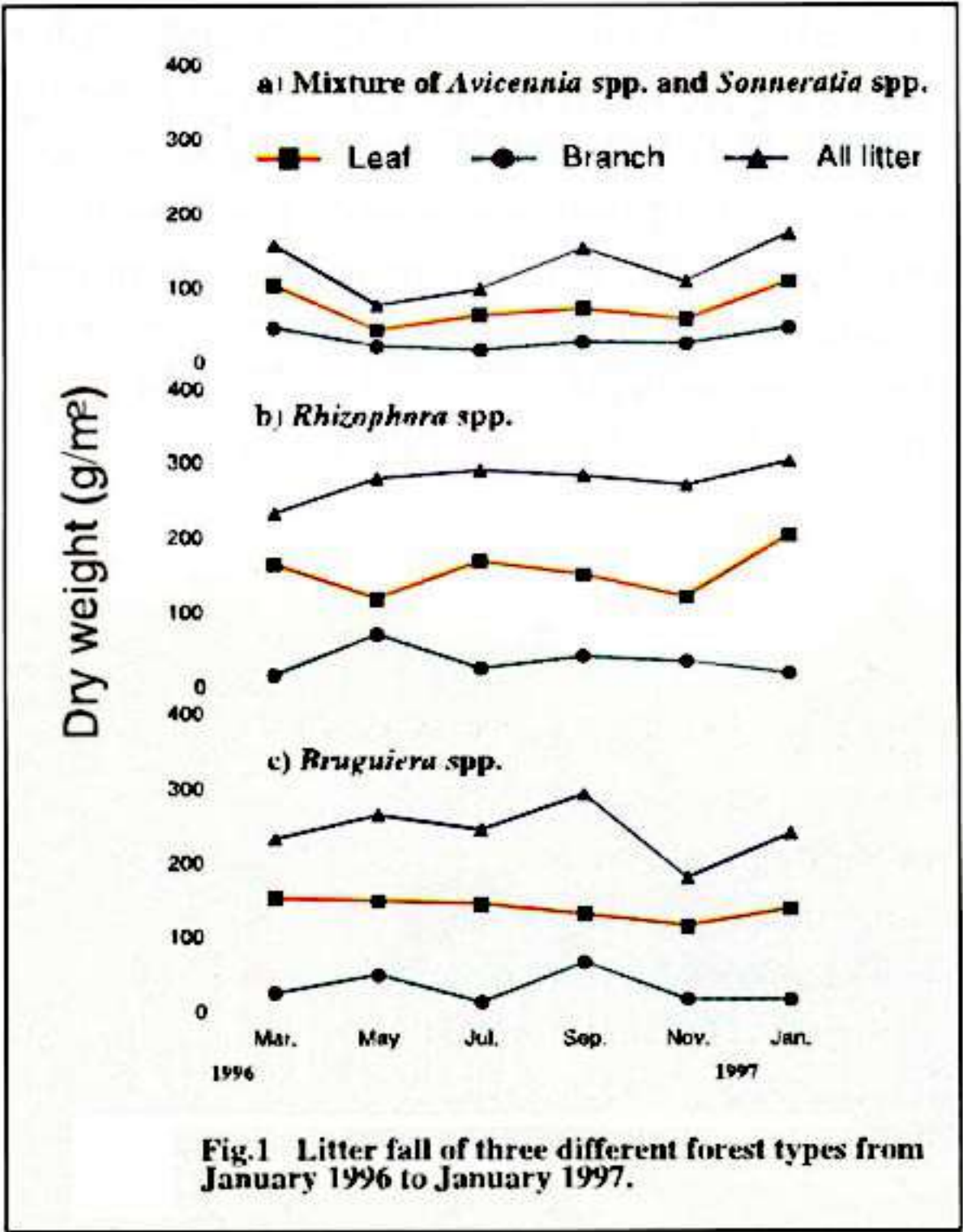
Although the flora of mangrove forests is relatively simple compared to that of the other forest types in Malaysia, it prevents the land from sinking and protects the sea from becoming polluted with sewerage output. Unfortunately, mangroves are disappearing rapidly due to the development of fish and prawn ponds and other human activities. The Matang Forest Reserve offers an excellent example of sustainable forest management.

[Fig.1 : Litter fall of three different forest types from January 1996 to January 1997.](#)

(Y. Ochiai)

BACK

HOME



**Fig.1 Litter fall of three different forest types from January 1996 to January 1997.**



# Chlorine-free bleaching of kraft pulp from oil palm empty fruit bunches

Empty fruit bunches (EFB, [Photo 1](#)) are lignocellulosic residues from palm oil production in Malaysia and other tropical countries. Recent attempts to produce pulp for paper-making from EFB by mechanical and chemical pulping mark the first efforts to utilize this potential resource. However, little work has been done on bleaching EFB pulp, especially utilizing the more environmentally friendly chlorine-free bleaching method.

In this study, we carried out chlorine-free bleaching on EFB kraft pulp. The bleaching process employed the application of oxygen ( $O_2$ ), sulfuric acid ( $H_2SO_4$ ), ozone ( $O_3$ ), and hydrogen peroxide ( $H_2O_2$ ). After bleaching, the

k-number (indicator of lignin content) of the pulp became negligible ([Table 1](#)), indicating that most of the lignin contained in the pulp can be removed without using chlorine compounds as bleaching agents. Both chlorine-bleached and unbleached handsheets of the EFB pulp were produced and the paper properties were determined as shown in the table. The brightness, a measure of the whiteness of paper, of the bleached pulp handsheets was about 75%. Though this figure is slightly lower than the required brightness of 80% for bleached kraft paper, this result shows a strong possibility of achieving the requisite brightness through chlorine-free bleaching of EFB pulp. Opacity is the ability of paper to hide or mask a color or object. The figure obtained for the bleached handsheet in this study was found to be comparable to that of commercial paper.

Handsheets paper strength, which is indicated by tensile index, stretch, tear index, and burst index, did not change significantly from before and after the bleaching process. Thus, the effects of the bleaching process on handsheet properties are negligible. Moreover, the EFB bleached pulp displayed comparable strength to some hardwood pulps, indicating that EFB has potential to serve as a raw material for chemical pulp through chlorine-free bleaching.

*[Photo 1. Oil palm tree with a bunch of ripe fruit. An empty fruit bunch \(EFb\) consists of the remaining bunch after fruit removal](#)*

*[Table 1. Properties of EFB kraft pulp](#)*

(R. Tanaka)

---

BACK

HOME



Bleaching processes	unbleached	$O_2 \rightarrow \text{acid} \rightarrow O_3$	$O_2 \rightarrow \text{acid} \rightarrow O_3 \rightarrow H_2O_2$
$\kappa$ -number	14.9	3.3	-
Brightness (%)	27.6	55.3	73.9
Opacity (%)	98.4	85.6	72.4
Tensile index (Nm/g)	67.3	67.5	63.9
Stretch (%)	4.87	5.88	4.98
Tear index (mNm ² /g)	12.5	13.0	11.7
Burst index (kPam ² /g)	5.33	5.60	5.05

Table1. Properties of EFB kraft pulp





# FISHERIES DIVISION

As an initial phase (1994-1998) in international collaborative activity in the field of fisheries, the Fisheries Division has initiated five major research projects in Asian countries, including efforts to improve the management of fisheries resources and the coastal environment in Malaysia and Indonesia, aquaculture in Thailand and Vietnam, and fisheries product processing in China. In addition to these studies, the Division has also endeavored to secure the participation of Southeast Asian countries in a research project targeting prawn viral diseases.

In 1995, the Division initiated its first international collaborative research project on fisheries resource management in Malaysia with the Fisheries Research Institute (FRI) and the University of Malaya (UM). This multidisciplinary project, which examines the productivity and sustainable utilization of brackish water mangrove ecosystems, involves the integration of studies in fisheries, forestry, agriculture, and socio-economics. JIRCAS has successively dispatched two senior researchers to Penang and Kuala Lumpur, Malaysia, to provide long-term oversight for the project, and several short-term scientists specializing in fish larval ecology, crustacean ecology, and marine chemistry have also participated. In December 1998, members of the project team conducted an international seminar on brackish water mangrove ecosystems that brought together researchers from FRI, UM, and the Forest Research Institute Malaysia (FRIM).

At the same time, the Division remains involved in several other ongoing projects. These include collaborative studies on the environmental management of coastal water in Indonesia based on ecological and chemical analyses now being conducted in Maros, South Sulawesi, Indonesia, in conjunction with the Research Institute for Coastal Fisheries (RICF) under the jurisdiction of the Central Research Institute for Fisheries (CRIFI). The project aims to deepen understanding of the ecology of plankton and related environmental factors in ways that may improve marine resource management methods. One researcher has been dispatched to Maros as a long-term residing scientist.



The Division's collaborative work on the development of sustainable aquaculture technology in Southeast Asia also continued at Kasetsart University in Bangkok, Thailand. In addition, the Division has been participating in a comprehensive project entitled "Evaluation and improvement of farming systems combining agriculture, animal husbandry, and fisheries in the Mekong Delta" with the College of Agriculture at Cantho University in Vietnam. This project involves multidisciplinary studies of integrated farming systems to address problems in rice production, animal husbandry, freshwater aquaculture, and socio-economics. Research in fisheries and freshwater aquaculture comprises an important part of the project, in particular as it relates to technologies for the production of prawn and fish fry, the prevention of disease among prawn and fish, and the utilization of new feed resources for freshwater aquaculture. To oversee components of the project which relate to fisheries management, JIRCAS has dispatched on short-term bases one researcher specializing in crustacean endocrinology and two Fisheries Agency scientists specializing in fish disease and fisheries nutrition.

Concerning the processing of fisheries products, the Division has continued collaborative research on postharvest and processing of freshwater fish in China with the Faculty of Food Science and Technology at the Shanghai Fisheries University. One senior researcher has been dispatched successively to Shanghai, and short-term scientists specializing in postharvest technology have visited to lend support to the project.

Finally, under the auspices of the JIRCAS Visiting Research Fellowship Program, one counterpart scientist from Cantho University in Vietnam currently resides in Tsukuba and is undertaking cooperative studies on aquatic animal physiology over a two-year period. Past and future fellows are expected to become core scientists in JIRCAS's counterpart institutions and to contribute to the continued development of collaborative studies.

[*Photo1 : Prawn and mussel polyculture in a pond in Thailand*](#)

[*Photo2 : Mussels attached to a bamboo stalk kept in a culture pond for black tiger prawn*](#)

[Division topic1: Gel formation properties of surimis made from freshwater fish in China](#)

[Division topic2: Characterization of vitellogenin from the giant freshwater prawn *Macrobrachium rosenbergii*](#)

[BACK](#)

[HOME](#)







## **Gel formation properties of surimis made from freshwater fish in China**

Despite the fact that freshwater fish resources in China have expanded rapidly, their distribution sphere and storage period are very limited since most freshwater fish are transported as live fish without treatment, such as freezing and processing. As an animal protein resource, freshwater fish have not been fully utilized, as in the case of marine fisheries.

In order to address the above problem, JIRCAS has promoted the development of frozen surimi made from freshwater fish meat in cooperation with Shanghai Fisheries University. Frozen surimi is an intermediate foodstuff with high potential for longer shelf life, wider distribution area, and diversification of products. In an effort to identify fish species harboring high potential for surimi production, we carried out studies on the forming properties and its mechanism of cultured freshwater fish in China.

Gel forming properties depended on the heating temperature and heating time of different species of freshwater fish. The configuration of contour maps was classified into two types ([Fig.1](#)). That is, the surimi gels of the left line in Fig.1 showed the shape of a U character, since the gels tends to collapse by heating at an intermediate temperature zone (around 60°C). The surimi gels of the right line showed the shape of a plateau, since the gels degradation phenomena was small at an intermediate temperature. Surimis made from tilapia and grass carp showed a stable gel forming ability at high heating temperatures (around 85°C) and a high resistance of gel degradation at intermediate heating temperatures (around 60°C). However, in the two-step heating process, these species of fish did not form a strong gel under low temperatures (around 30°C) and a subsequent heating at high temperatures (around 85°C). Therefore, it was determined that tilapia and grass carp surimis form a gel in a wide range of heating temperatures and times. Surimis of silver carp and bighead carp showed an enhanced efficiency in gel strength under a two-step heating process, although the gels of both surimis demonstrated degradation under heating at intermediate temperatures. It was determined that, although silver and bighead carp surimis form a strong gel, their optimum heating temperatures and time zone is narrow. Consequently, these four species have a high potential for surimi production.

In contrast, surimis made from blunt snout bream, common carp, and Chinese snake head have little surimi potential, since the gel forming ability at high temperatures was unstable, and gel enhancing ability under the two-step heating was almost non-existent.

This collaborative research on gel formation properties has led to the production of high quality surimi-based foodstuffs from freshwater fish in China. The ultimate goal of this collaborative research is the widespread distribution and consumption of surimi-based products in China.

[Fig.1: Contour map of surimi gels made from freshwater fish and walleye pollack depending on the beating temperature and time](#)

(Y. Fukuda)

[BACK](#)

[HOME](#)

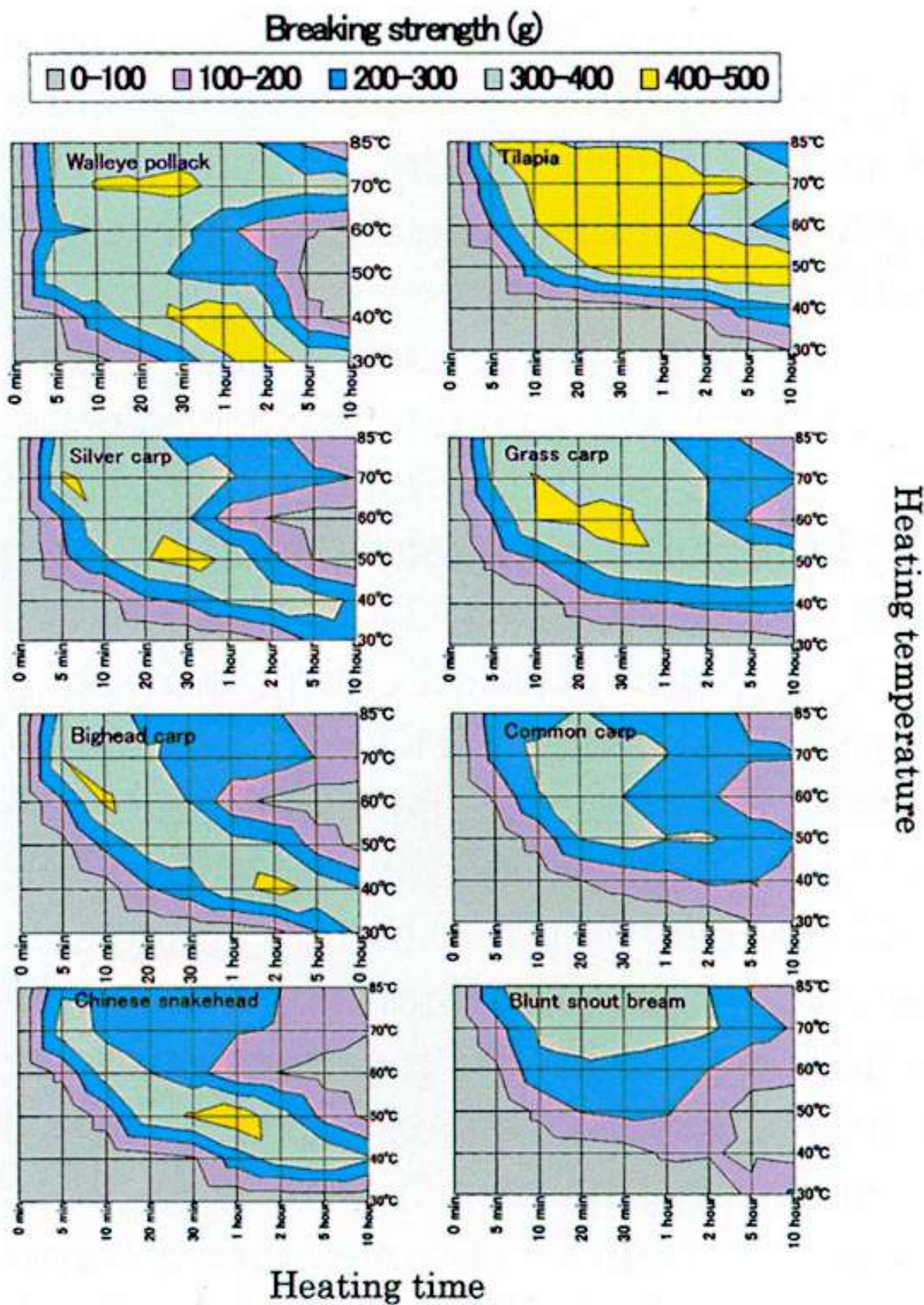


Fig. 1 Contour map of surimi gels made from freshwater fish and walleye pollack depending on the heating temperature and time





## Characterization of vitellogenin from the giant freshwater prawn *Macrobrachium rosenbergii*

The giant freshwater prawn, *Macrobrachium rosenbergii* (Photo 1), is a commercially important crustacean species cultured extensively throughout Southeast Asia. In Vietnam, where JIRCAS is currently implementing a comprehensive project entitled "Evaluation and improvement of farming systems combining agriculture, animal husbandry and fisheries in the Mekong Delta," *M. rosenbergii* is considered to be an important target species by the Vietnamese Government, and its aquaculture is being actively promoted. Farmers have traditionally depended on wild sources to obtain seed for aquaculture but are now faced with dwindling resources and a shortage of natural spawners. Development of improved means of artificial seed production for *M. rosenbergii* in the Mekong Delta is essential.

JIRCAS is currently implementing basic studies on the reproductive endocrinology of *M. rosenbergii* as part of the Mekong Delta project. Biochemical and molecular biological research is being conducted both at the project site, Cantho University's College of Agriculture, in Cantho Province, Vietnam in collaboration with Vietnam counterparts, and on JIRCAS's Tsukuba premises. In addition, although not directly related to the project, some of these studies have been carried out under the JIRCAS Visiting Fellowship Program at Tsukuba.

In *M. rosenbergii* and most other species of decapod Crustacea, reproduction is thought to be under the control of various hormones, including vitellogenesis inhibiting hormone (VIH) and vitellogenesis stimulating hormone (VSH). The presence of VIH in the eyestalk has been well-established, but less is known about VSH which is thought to originate in the brain and thoracic ganglia. Furthermore, regulatory mechanisms of vitellogenesis in Crustacea remain unclassified; this is due in great part to the fact that the biochemical nature of vitellogenin (yolk protein) is not fully known. Thus, the chemical characterization of vitellogenin and the elucidation of regulatory hormones responsible for reproduction are highly urgent.

In most crustacean species, vitellogenin exists as the precursor of yolk protein and has a molecular mass of more than 200 KDa. In *M. rosenbergii*, vitellogenin is thought to be first synthesized in the hepatopancreas and thereafter secreted into the hemolymph. Then, during vitellogenesis, vitellogenin is taken into the ovary and processed into several subunits to serve as an important source of nutrients during the processes of ovarian and embryonic development. These subunits are known as vitellin.

In this research, vitellin was first extracted from a mature ovary. After filtering the extracts with microconcentrators to cut off low molecular weight proteins, the filtrate was subjected to reversed-phase high pressure liquid chromatography (HPLC). Four major proteins (fractions A, B, C and D) were separated using a linear gradient of acetonitrile/trifluoroacetic acid (TFA) (Fig. 1). The results of Western blotting suggested that the 4 fractions were vitellins. Using TOF (time-of-flight) mass spectrometry, it was observed that the 4 fractions recovered from HPLC exhibited protonated molecular ion peaks at  $m/z$  89560.7, 88721.1, 88963.6, and 88900.9, respectively, indicating molecular weights of approximately 90 KDa for all vitellins. The four fractions were initially subjected to N-terminal amino acid sequence analysis, and we were able to identify more than 30 amino acid residues. To obtain more information about the amino acid sequences, the four fractions were digested with lysyl endopeptidase and the digested fragments were separated by reversed-phase HPLC on an ODP-50 column with a linear gradient of acetonitrile/TFA. A total of 48, 53, 57 and 46 fragments (for fractions A, B, C and D, respectively) were thus obtained and amino acid sequences for several of these fragments were determined.

In order to clone the four cDNA-encoding fractions (fractions A, B, C and D), total RNA isolated from the ovary and hepatopancreas was subjected to reverse transcription (RT) reaction in order to synthesize cDNA. Then, the resultant cDNA were subjected to polymerase chain reaction (PCR) using degenerate oligonucleotide primers. The PCR products were subcloned into a plasmid vector and analyzed to determine the DNA sequences. The complete DNA sequences of the four vitellin cDNAs were determined and the conceptually translated amino acid sequences were identical to those of the N-terminal and lysyl endopeptidase fragment sequences. In subsequent research, this will enable us to determine the DNA sequences of the four vitellins by constructing cDNA libraries from the ovary and hepatopancreas. The genes encoding the four vitellins will then be screened from the cDNA libraries using probes and their sequences will be determined using a DNA sequencer.

In addition, in order to identify the synthetic site of vitellogenin, specific expression of mRNA is being analyzed by Northern-hybridization. The site of expression of mRNA for fractions C and D has already been identified as the hepatopancreas. Furthermore, in order to obtain a complete picture of the dynamics of vitellogenin synthesis, expression of mRNA in various tissues (hepatopancreas, ovary, hemocytes, subepidermal adipose tissue and muscle) are being analyzed at different stages of reproduction.

The expression of the four vitellin mRNAs will serve as a basic tool for developing a bioassay system which will enable us to identify VIH and VSH. Using such a bioassay system, the role of VIH and VSH, as well as of other factors in regulating vitellogenesis, may be examined.

This research will contribute to a further understanding of the endocrine regulation of vitellogenesis in Crustacea and this knowledge will be useful not only from the point of view of basic research but will also have practical applications in commercial culture of *M. rosenbergii*.



This research is expected to be especially relevant in controlling female reproduction in captivity and improving seed production technology.

(M.N. Wilder and Y-J. Yang)

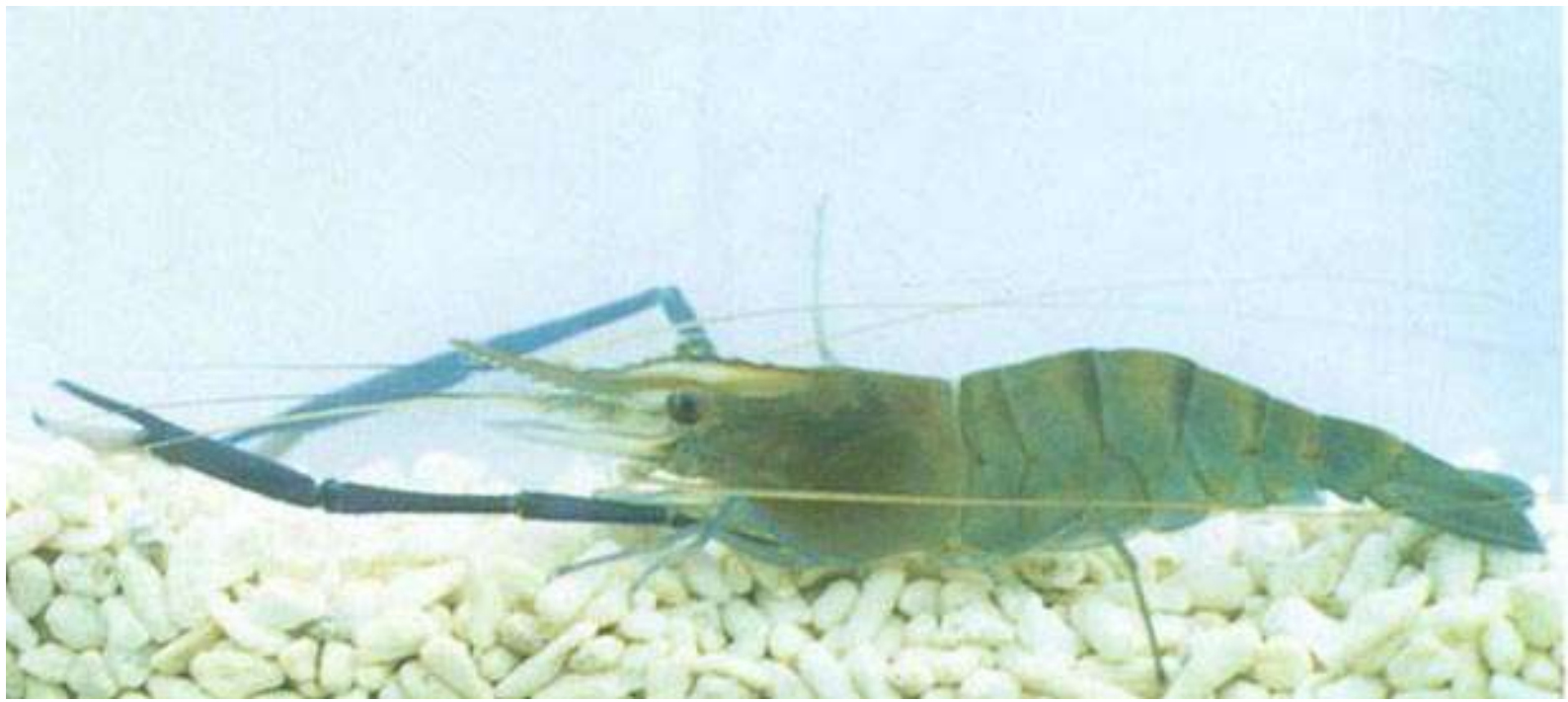
[Photo1. *Macrobrachium rosenbergii* being main-tained at JIRCAS.](#)

[Fig.1. Reversed- phase HPLC elution profile of extracts from *Macrobrachium rosenbergii* ovary.](#)

---

BACK

HOME



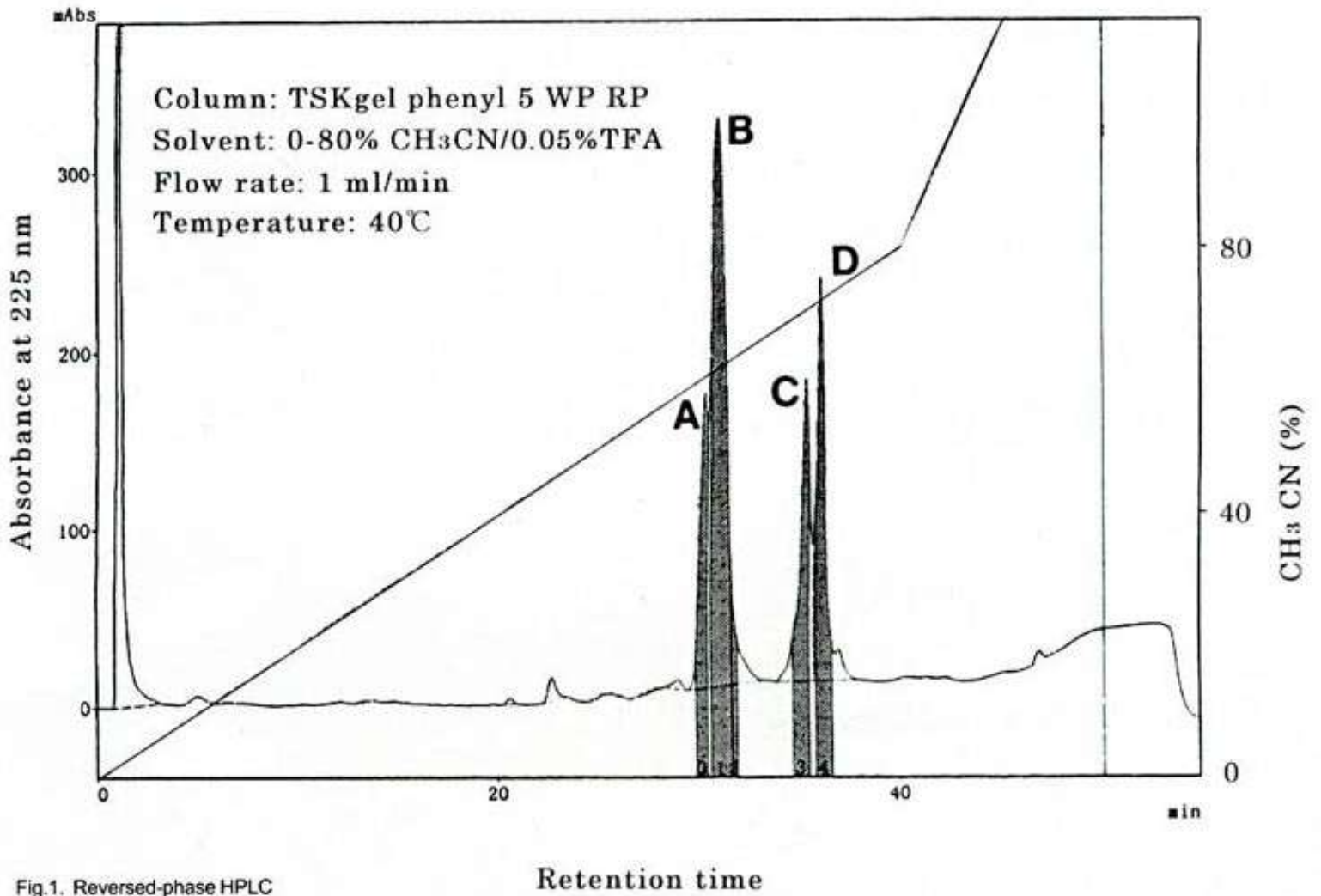


Fig.1. Reversed-phase HPLC elution profile of extracts from *Macrobrachium rosenbergii* ovary.



# OKINAWA SUBTROPICAL STATION

The Okinawa Subtropical Station was established in 1970 as a field experiment station for the Tropical Agriculture Research Center (TARC), which was reorganized into JIRCAS in 1993. It is located on Ishigaki Island, nearly 2,100 km southwest of Tokyo. As annual temperatures on the island average 24°C, the Station provides the most suitable location in Japan for research concerning subtropical and tropical agriculture and the development of techniques and technologies appropriate for the constraints of warm climates.



During Fiscal Year 1998, Station personnel consisted of 24 researchers divided among 7 research sections involved in projects relating to genetic resources, biotechnology, plant physiology, plant breeding, plant protection, and soil science. In addition to the permanent research staff, 9 scientists were invited from Bangladesh, China, Cuba, Ecuador, India, and Thailand under the auspices of the Visiting Research Fellowship Program at Okinawa overseen by the International Research Section.

One notable achievement of the researchers and visiting fellows was the development and official release of a heat-tolerant vegetable variety in 1998. Named "Haibushi," this snap bean can attain great yields of more than 2 tons/ha/season, even during the very warm mid-summer of Ishigaki Island. The success of the bean prompted the Station to initiate research on the physiological and genetic analysis of heat-tolerance in crops and on the practical development of successful varieties. Having commenced

in 1998, this five-year research program will be done in cooperation with Ryukyu University, Nagoya University, and the Tokyo University of Agriculture and is sponsored by the Bio-oriented Technology Research Advancement Institution's (BRAIN) grant of approximately 100 million yen per year.

*[Photo: Rice planting in Okinawa](#)*

[Division Topic1: Partial male sterility observed in some Japanese varieties of rice caused by short day-length conditions on Ishigaki Island](#)

[Division Topic2: Detection of bruchid-resistant strains in wild relatives of the azuki bean](#)

[Division Topic3: A fungal epiphyte\(*Ephelis* sp.\)of grasses on Ishigaki island and its effect on the feeding of two insect pests](#)

BACK

HOME





## Partial male sterility observed in some Japanese varieties of rice caused by short day-length conditions on Ishigaki Island

A low degree of seed fertility has been observed in some varieties of Japanese rice when cultivated under short day-length conditions on Ishigaki Island. In this study, the seed sterility of Shinrei, a Japanese cultivar, under shorter day-length conditions was 30% (sown on July 15) and 61 % (sown on August 28) as compared with a seed sterility of 4% when it was cultivated under longer day-length conditions (sown on March 4). In the three plots cited above (July 15, August 28, and March 4), the average day-length of the 20 days before heading was 12 hours and 51 minutes, 11 hours and 53 minutes and 13 hours and 4 minutes, respectively. The average temperature of the 2 weeks before heading was 27.4°C, 25.6°C and 23.0°C, respectively. A similar tendency in seed sterility was observed in the varieties of Nipponbare, Akenohoshi, and Hinohikari, which were adapted mainly to the region west of the Kanto plain.

On the other hand, there were some varieties that showed no difference in the degree of seed sterility among the three plots. The seed sterility of Koshihikari was 8%, 7%, and 9% for plots sown on July 15, August 28 and March 4, respectively. This tendency was observed in the varieties of Akitakomachi, Sasanishiki, and Hitomebore, which were adapted mainly in the Tohoku and Hokuriku areas.

When Shinrei was cultivated under short-day treatment (9 hours day-length), we observed a decrease in the length of the anthers at the flowering stage ([Fig. 1](#)), however the length of the palea was not affected. The number of pollen grains per anther was 320 and the seed sterility was 280/0 under short-day treatment, while 820 pollen grains per anther and 3% seed sterility were observed under long-day treatment (14 hours day-length). The seed fertility of Shinrei grown under short day-length was restored to the normal level by cross-pollinating with Koshihikari. When long-day treatment (14 hours day-length) was given to Shinrei after flower bud formation, partial restoration of anther length, number of pollen grains per anther, and seed fertility were observed.

It was concluded that the partial male sterility observed in some Japanese varieties of rice with underdeveloped anthers and reduced pollen grains per anther was caused by both the extremely accelerated flower bud formation and rapid reproductive growth under short day-length conditions on Ishigaki Island.

(O. Ideta and M. Okamoto)

*[Fig. 1. Underdeveloped anthers at flowering stage observed in Shinrei. Underdeveloped anthers caused by the short-day treatment are shown in the center and on the right. A normal type of anther developed under the long-day treatment is shown on the left.](#)*

BACK

HOME





OKINAWA SUBTROPICAL STATION Topic2

## Detection of bruchid-resistant strains in wild relatives of the azuki bean



The azuki bean, *Vigna angularis* var. *angularis* ( $2n=22, 2x$ ) is one of the most familiar legumes to Japanese people. It is known that several related wild species of azuki bean occur in Asia. Wild relatives (germplasm) are the primary and secondary gene pools for breeding of the cultigens. Wild germplasm, however, is now confronted with gradual extinction due to natural habitat disturbance. Against this background, we have collected wild azuki bean germplasm in Southeast Asian countries.

The azuki bean weevil (*Callosobruchus chinensis*) causes serious damages to azuki bean, mungbean and cowpea seeds during storage. One accession of wild progenitor species of mungbean (*V. radiata* var. *sublobata*), TC1966, is known to exhibit a complete resistance against *C. chinensis*. However, since reproductive isolation exists between the azuki bean and mungbean, it was impossible to incorporate the resistance from TC 1966 to the azuki bean through conventional crossing procedures. Therefore, we examined wild azuki bean germplasm, including *V. angularis* var. *nipponensis* (wild progenitor of azuki bean), *V. nakashimae*, *V. nepalensis*, *V. minima* var. *minor*, *V. hirtella*, *V. umbellata* and *V. trinervia*, etc., to detect within them the occurrence of bruchid-resistant strains.

In feeding tests of the azuki bean weevil, *V. hirtella*, *V. umbellata* and *V. trinervia*, exhibited resistance against the infestation by *C. chinensis*, although other species were highly susceptible. *V. hirtella* is distributed in India (Assam, Bengal), Myaumar, Thailand, Indo-China, South China and Malaysia. The

strains examined here were collected from northern Thailand by JIRCAS. Cross-compatibility of *V. hirtella* with the azuki bean was high and we successfully obtained fertile F₁ hybrids between them ([Photo 1](#)). At present, we are backcrossing the F₁ hybrids with the azuki bean to develop bruchid-resistant lines. The wild form of *V. umbellata* is distributed widely in northern Thailand and several accessions have been collected by JIRCAS. Hybridization between the azuki bean and *V. umbellata* was impossible. *V. minima* var. *minor* was, however, cross-compatible with both the azuki bean and *V. umbellata* and could be useful as a bridging species for gene flow between them. To develop a resistant line of the azuki bean, we will transfer the resistance gene(s) of *V. umbellata* first to *V. minima* var. *minor* by backcrossing this species recurrently to a hybrid of *V. umbellata* and *V. minima* var. *minor*, and will then incorporate the resistance to the azuki bean from *V. minima* var. *minor*. Geographical distribution of *V. trinervia* ranges from Madagascar, through South India, Sri Lanka, Myaumar and Indonesia, to New Guinea. We have successfully collected a sufficient amount of accessions from peninsular Malaysia. Cross-compatibility of *V. trinervia* with the azuki bean has yet to be analysed.

(Y. Egawa and K. Kohno)

[Photo 1 : Cross-compatibility of *V. hirtella* with the azuki bean was high and we successfully obtained fertile F₁ hybrids between them](#)

BACK

HOME







## A fungal epiphyte(*Ephelis* sp.)of grasses on Ishigaki island and its effect on the feeding of two insect pests

*Ephelis* sp., a fungus belonging to the family Clavicipitaceae, was found on fifteen species of grasses on Ishigaki island, Okinawa; *Brachiaria mutica* (Forsk.) Stpf, *Chloris barbata* Swarzt, *C. divaricata* R. Br., *Chrysopogon aciculatus* (Retz.) Trin, *Cynodon Dactylon* (L.) Pers., *C. pletostachyus* (K. Schm.) Pilger, *Digitaria decumbens* var. *koenigii* (Retz.) Durand et Schinz, *Leptochloa panica* (Retz.) Ohwi, *Panicum Crus-galli*, Beauv. var. *praticola* Ohwi, *P repens* L., *Paspalum scrobiculatum* G. Forst, *P urvillei* Steud. and *Erichloa procera* C. H. Hubb. Sites with the *Ephelis* infection were most commonly wet areas that had remained undisturbed for many years. The relationship of the *Ephelis* fungus to grasses was essentially that of an epiphyte.

Insect feeding deterrence associated with the presence of the *Ephelis* sp. was detected in choice tests involving infected and uninfected leaves. Larvae of the Japanese army worm, *Pseudaletia separata*, and the adult grasshopper, *Aiolopus thalassimus*, preferred the uninfected leaves of *Digitaria decumbens* to infected ones. The life-span of adult grasshoppers *A. thalassimus* that fed on *Ephelis*-infected *Digitaria decumbens* leaves was shorter than those that fed on *Ephelis*-free leaves.

(K. Takahashi)

[Photo 1 . *Ephelis* stroma on the inflorescence of *Brachiaria mutica*.](#)

[Photo 2. Adult grasshopper preferential feeding on *Ephelis*-free leaf.](#)

---

BACK

HOME



Photo 1. Ephelis stroma on the inflorescence of *Brachiaria mutica*.

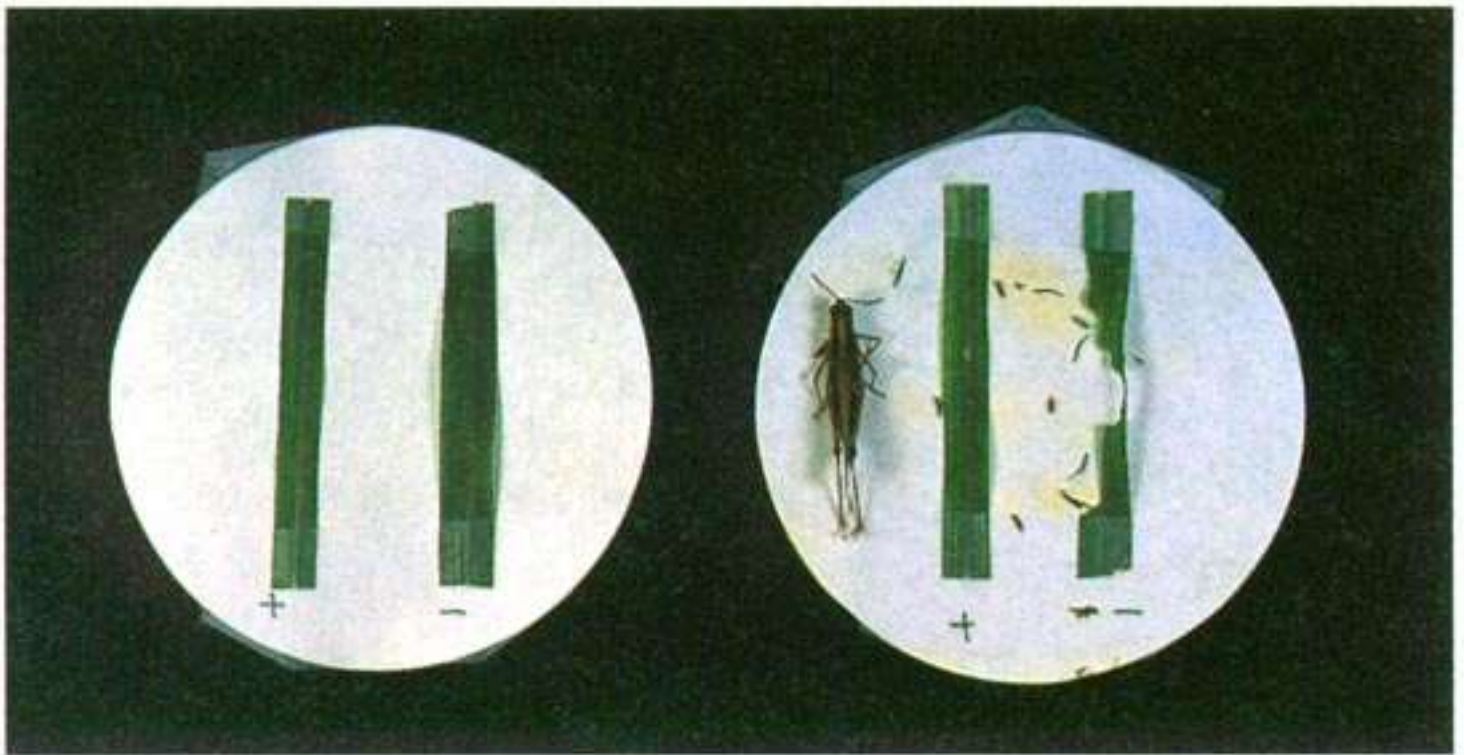


Photo 2. Adult grasshopper preferential feeding on *Ephelis*-free leaf.



## MISCELLANEOUS PROJECTS OUTLINE

In addition to international collaborative projects, JIRCAS conducts a variety of miscellaneous projects: domestic projects in cooperation with other MAFF institutes; commissioned research, principally in cooperation with universities; cross-ministry and cross-agency projects currently involving the Science and Technology Agency and the Environment Agency; and special allotment projects .

### DOMESTIC PROJECTS

In close cooperation with other related Japanese research institutes, JIRCAS conducts domestic research at its main premises in Tsukuba and at its Okinawa Subtropical Station in an effort to support its international collaborative projects. JIRCAS further complements its comprehensive projects through its Tsukuba and Okinawa research fellowship programs in which foreign researchers from JIRCAS counterpart organizations are invited to carry out studies in support of on-going collaborative projects abroad.

In addition, these programs also promote positive relationships between JIRCAS and foreign institutions and facilitate future exchanges of individual research staff. JIRCAS domestic research has produced a variety of significant results, especially in the areas of drought-resistant crop development and world food supply and demand analysis. By focusing on fields where it can effectively utilize its relative superiority in research management and coordination, JIRCAS is able to effectively utilize its limited budget and personnel in resolving critical agricultural and food supply problems in developing countries. Current domestic research focuses on 1) world food supply analysis; 2) development of sustainable agriculture; 3) technology development for the utilization of animal resources; 4) crop tolerance to drought, blight, and low temperatures; 5) circulation of nitrogen in soil; 6) the utilization of remote sensing technology for evaluating environmental resources; 7) technology for the preservation and utilization of environmental resources; 8) evaluation of foodstuff quality in developing countries; and 9) cultivation and practical application of fisheries resources.

### DOMESTIC PROJECTS

#### **Simulation analysis of world food policies**

(Research Information Division, 1994 - 1998)

#### **A comprehensive evaluation of the effects of international trade fluctuation on resources and the environment**

(Research Information Division, 1996 - 2000)

#### **Analysis and settlement of macro indicators (MI) for water resource changes, affected by changes in agricultural production and industrial structure**

(Research Information Division, 1996 - 2000)

#### **Development of tools for agricultural information analysis using GIS**

(Research Information Division, 1997 - 2002)

#### **Development of remote sensing methods to evaluate major food crops in Asia**

(Research Information Division, 1998 - 2001)

**Analysis of genes that are induced by dehydration stress in higher plants**

(Biological Resources Division, 1993 - 1999)

**Effect of cold stress on the phenological development of plants and the analysis of mechanisms for acquiring tolerance to cold stress**

(Biological Resources Division, 1998 - 2007)

**Development of wheat lines highly resistant to *fusarium* head blight by utilizing rice DNA markers**

(Biological Resources Division, 1998 - 2000)

**Genetic analysis of pathogenic microorganisms and the development of its application techniques**

(Biological Resources Division, 1995 - 2000)

**Rice-genome analysis and related projects**

(Biological Resources Division and Okinawa Subtropical Station, 1998 - 2008)

**Development of a predictive MI method for salt accumulation in semiarid areas**

(Crop Production and Postharvest Technology Division, 1996 - 1998)

**Search for possible natural enemies of the golden apple snail and evaluation of their efficacy**

(Crop Production and Postharvest Technology Division, 1997 - 2000)

**Search for endophytes from tropical grasses**

(Animal Production and Grassland Division, 1996 - 1998)

**Elucidation of antagonistic mechanisms of lytic microorganisms against plant pathogenic fungi and development of a means of disease control**

(Animal Production and Grassland Division, 1996 - 1998)

**Establishment of highly profitable agricultural technologies in subtropical ,regions through the introduction of vegetables and flowers**

(Okinawa Subtropical Station, 1998 - 2002)

**Primary characterization of rice genetic resources**

(Okinawa Subtropical Station, 1993 - 2000)

**Rapid generation advance breeding of high quality wheat for blend usage**

(Okinawa Subtropical Station, 1996 - 1998)

**Development of the experimental rice Nipponbare**

(Okinawa Subtropical Station, 1998 - 2000)

**Rapid generation advance breeding of rice with adaptability to direct seeding and combined tolerance**

(Okinawa Subtropical Station, 1995 - 2000)

**Evaluation of genetic resources in sugarcane**

(Okinawa Subtropical Station, 1992 - 1998)

**COMMISSIONED RESEARCH**

**Evaluation of salinity tolerance in wild species of rice and elucidation of tolerance mechanisms**

(Okinawa Subtropical Station in cooperation with the University of the Ryukyus, 1996 - 1999)

**Mapping of genes related to drought tolerance**

(Biological Resources Division in cooperation with the Institute of Physical and Chemical Research (RIKEN), 1997 - 1999)

**Climatic changes in cool, dry areas and accompanying environmental changes for cattle raising**  
(Environmental Resources Division in cooperation with Tsukuba University, 1998 -2000)

## RESEARCH PROJECTS WITH OTHER GOVERNMENT AGENCIES AND MINISTRIES

### In cooperation with the Science and Technology Agency

**Oceanographic investigations: Fluctuations in tropical mangrove forests and evaluation of possible influences**  
(Forestry Division, 1990 - 1999)

**Studies on occurrence mechanism of physiological injury in legumes and vegetables**  
(Okinawa Subtropical Station, 1998)

**Improvements in postharvest quality and safety of tropical agricultural products**  
(Crop Production and Postharvest Technology Division, 1998)

**Efficiency of controlled availability of fertilizers on controlling nitrogen cycling in East Asian cropland**  
(Environmental Resources Division, 1998)

**Control of reproduction in shrimps and prawns under artificial conditions**  
(Fisheries Division, 1998)

### In cooperation with the Environment Agency

**Studies on the development of technology for soil rehabilitation with salt accumulation in Central Asia**  
(Research Information Division, 1996 - 1998)



**In cooperation with BRAIN  
(Bio-oriented Technology Research Advancement Institution)**

**Molecular analysis of drought and salt stress tolerant mechanisms and its application to breeding**

(Biological Resources Division, 1996 - 2000)

**Physiological and genetic studies of heat-tolerance of crops and development of tolerant crops**

(Okinawa Subtropical Station, 1998 - 2002)

**MAFF SPECIAL RESEARCH ALLOTMENTS**

**Stabilization of rice culture under water stress in the tropics utilizing a broader spectrum of genetic resources**

(JIRCAS in cooperation with the International Rice Research Institute (IRRI), 1994 - 1999)

**Sustainable cultivation of upland crops in the semiarid tropics**

(JIRCAS in cooperation with International Crops Research Institute for the Semi-Arid Tropics (ICRISAT), 1994-1999)

[BACK](#)

[HOME](#)

## **INVITATION PROGRAMS AT JIRCAS**

In keeping with its role as an international research center, JIRCAS has implemented several programs for the invitation of foreign researchers and administrators at counterpart organizations. These programs serve to facilitate the exchange of information and opinion concerning agriculture, forestry and fisheries administration and to strengthen international research ties with scientists and administrators in other countries. Current programs are described in greater detail below.

### **1) Administrative Invitation**

Under the Administrative Invitation program, JIRCAS invites administrators from counterpart organizations to the Tsukuba premises to engage in discussions and to review ongoing research in order to ensure the smooth running of collaborative projects. Additionally, the program introduces administrators to current activities at JIRCAS and related MAFF research organizations. Finally, the program provides opportunities for the exchange of information and opinion at the administrative level concerning policy-making and project design, thereby contributing to deeper mutual understanding and international cooperation.

Fifty-seven individual visits to JIRCAS were made during FY 1998 under the Administrative Invitation program, including sixteen invitations to the International Symposium and twenty-one invitations to the International Workshop. Invited administrators and their home institutions are [listed here](#).

### **2) Counterpart Researcher Invitation**

The Counterpart Researcher Invitation program provides invitations for periods of up to six months to researchers engaged in collaborative work with members of the JIRCAS research staff. Counterparts conduct in-depth research at JIRCAS, at other MAFF research institutes, at prefectural research institutes, or at national universities. This invitation program aims both to enhance the quality of research conducted in foreign countries and to facilitate exchanges between individual research staff. Thirty researchers were invited under the Counterpart Researcher Invitation program during FY 1998. Invited researchers, their affiliated research organizations, and their research activities are [summarized here](#).

### **3) JIRCAS Visiting Research Fellowship Program at Okinawa**

The Okinawa Visiting Research Fellowship Program was initiated in FY 1992, prior to the reorganization of the Tropical Agricultural Research Center (TARC) into JIRCAS. The program invites post-doctoral scientists to conduct research for a period of one year at the Okinawa Subtropical Station. Researchers must focus on important topics relating to tropical agriculture in developing countries within one of several broad categories: the development of techniques for environmental control utilizing plants and microorganisms specific to the tropics and subtropics, studies on heat-tolerance mechanisms in tropical and subtropical crops, the identification and evaluation of salt-tolerant crops, or the evaluation and development of long-term conservation techniques of the genetic resources of vegetatively propagated crops in the tropics and subtropics. Ten fellows are chosen each year, beginning their terms on October 1 and ending on September 30 of the following year. Recent invitees and their research activities are [summarized here](#).



More information on the Okinawa Visiting Research Fellowship Program can be obtained by contacting the International Relations Section, Japan International Research Center for Agricultural Sciences, 1-2, Ohwashi, Tsukuba, Ibaraki, 305-8686, Japan. (Tel.: +81-298-38-6335 Fax: +81-298-38-6337; e-mail: [irs@jircas.affrc.go.jp](mailto:irs@jircas.affrc.go.jp)).

[Photo : Okinawa Fellows in 1998 pose for group photograph](#)

### **4) JIRCAS Visiting Research Fellowship Program at Tsukuba**

A program similar to the Okinawa Visiting Research Fellowship Program has been implemented on the Tsukuba premises since October 1995. The Tsukuba Visiting Research Fellowship Program aims to promote collaborative research to address various problems confronting countries in developing regions. The program allows for the invitation of six to eight researchers per year. Four researchers engage in two-year projects at JIRCAS and two to four researchers conduct short five-month projects at the National Institute for Agrobiological Resources (NIAR). Recent invitees and their research activities are [listed here](#).



More information on the Tsukuba Visiting Research Fellowship Program can be obtained by contacting the International Relations Section, Japan International Research Center for Agricultural Sciences, 1-2, Ohwashi, Tsukuba, Ibaraki, 305-8686. Japan. (Tel. : +81-298-38-6335 Fax: +81-298-38-6337; e-mail: [irs@jircas.affrc.go.jp](mailto:irs@jircas.affrc.go.jp) ).

[Photo : Host scientist and Tsukuba fellow engaged in experiment on prawn physiology at the Fisheries Division](#)

## 5) Other fellowships for visiting scientists

The Government of Japan sponsors a post-doctoral fellowship program for both Japanese and foreign scientists through the Science and Technology Agency (STA). The program places post-doctoral fellows in national research institutes throughout Japan according to research theme and prior arrangement with a host scientist for a term of generally 1-3 years. Fellowships can be undertaken in any of the ministries and many fellows are currently working at the various institutes of the Ministry of Agriculture, Forestry and Fisheries (MAFF). In 1998, the following visiting scientists resided at JIRCAS: Dr. Chien Hsiaoping (People's Republic of China), Research Information Division; Dr. Park Kwang-Lai (Korea), Environmental Resources Division; Dr. Wei-Jun Yang (People's Republic of China), Fisheries Division; Dr. Harvinder Singh Talwar (India), Okinawa Subtropical Station; Dr. Yan Xiaoyuan (People's Republic of China), Environmental Resources Division; and Mr. Michael J. Christensen (New Zealand), Okinawa Subtropical Station. In addition, three Japanese fellows, Dr. N. Aoki, Biological Resources Division; Dr. T. Kitamado, Fisheries Division; and Dr. M. Sakagawa, Environmental Resources Division, also conducted research at JIRCAS. The Environment Agency of Japan also sponsors a post-doctoral fellowship program for foreign scientists. Dr. Yao Heng (People's Republic of China) resided at the Environmental Resources Division, JIRCAS.

[BACK](#)

[HOME](#)



## Administrative Invitation Program Invitees

Under the Administrative Invitation program, JIRCAS invites administrators from counterpart organizations to the Tsukuba premises to engage in discussions and to review ongoing research in order to ensure the smooth running of collaborative projects. Additionally, the program introduces administrators to current activities at JIRCAS and related MAFF research organizations. Finally, the program provides opportunities for the exchange of information and opinion at the administrative level concerning policy-making and project design, thereby contributing to deeper mutual understanding and international cooperation.

Fifty-seven individual visits to JIRCAS were made during FY 1998 under the Administrative Invitation program, including sixteen invitations to the International Symposium and twenty-one invitations to the International Workshop Invited administrators and their home institutions are listed below.

FY 1998		
Dr. Akke van der Zijpp	Deputy Director General International Center of Insect and Physiology and Ecology (ICIPE) Kenya	Jul 5-7, 1998
Mr. Panus Songserm	Director Khon Kaen Field Crop Research Center Thailand	Sep. 3-12, 1998
Dr. H. Suyamto	Director Research Institute for Legume and Tuber Crops (RILET) Indonesia	Sep. 8-15, 1998
Dr. Monty Patrick Jones	Leader of Rainfed Program, Principal Rice Breeder West Africa Rice Development Association (WARDA) Cote d'Ivoire	Oct. 5-15, 1998
Dr. Ronald P. Cantrell	Director General International Rice Research Institute (IRRI) The Philippines	Nov. 17-20, 1998
Dr. Zhu Xigang	Director General Institute of Agricultural Economy, Chinese Academy of Agricultural Sciences People's Republic of China	Nov. 23-Dec. 4, 1998
Dr. Ananta Dalodom	Director General Department of Agriculture Thailand	Dec.7-12, 1998
Mr. Paiwit Watanavitawas	Director International Training Center for Agricultural Development (ITCAD) Thailand	Dec.7-12, 1998
Dr. Abdul Razak bin Mohd Ali	Director General Forest Research Institute Malaysia Malaysia	Feb.7-14, 1999
Dr. Mohd. Azemi Mohd. Noor	Dean School of Industrial Technology, University Sains Malaysia Malaysia	Feb. 12-19, 1999
Mr. Pan Honggen	Sub-leader Support Group of Sino & Japan Collaborative Research, Shanghai Fisheries University People's Republic of China	Feb. 17-24, 1999

Mr. Cai Hong fa	Director General China National Rice Research Institute People 's Republic of China	Feb. 21-27, 1999
Mr. Lu Yong liang	Section Chief China National Rice Research Institute People 's Republic of China	Feb. 21-27, 1999
Ms. Xu Qing	Deputy Section Chief China National Rice Research Institute People's Republic of China	Feb. 21-27, 1999
Mr. Ismail bin Awang Kechik	Director Fisheries Research Institute, Department of Fisheries Malaysia Malaysia	Mar. 8-17, 1999
Dr. Henk Breman	Director General International Fertilizer Development Center (IFDC)-Africa Togo	Mar. 13-20, 1999
Dr. Stella Zerbino	Entomologist Instituto Nacional de Investigacion Agropecuaria, La Estanzuela Uruguay	Mar. 22-27, 1999
Dr. Azmi Man	Senior Research Officer Food and Industrial Crop Center Malaysian Agricultural Research and Development Institute (MARDI) Malaysia	Mar. 22-27, 1999
Mr. Ho Nai Kirl	Senior Agricultural Officer Agricultural Division, Muda Agricultural Development Authority (MADA) Malaysia	Mar. 22-27, 1999
Dr. Pham Sy Tan	Head of Agronomy Division Cuu Long Delta Rice Research Institute (CLRRI) Vietnam	Mar. 25-31, 1999
Dr. Vo-tong Xuan	Director Mekong Delta Farming System Research and Development Institute, Cantho University Vietnam	Mar. 26-31, 1999

### International Symposium Invitees, FY 1998

Dr. Le Van To	Director Post-Harvest Technology Institute Vietnam	Sep. 8-12, 1998
Dr. Silvesta C. Andales	Executive Director Bureau of Postharvest Research and Extension The Philippines	Sep. 7-12, 1998
Dr. Jingtair Siriphanich	Associate Professor Kasetsart University Thailand	Sep. 8-12, 1998
Dr . Feng Shuangqing	Director Department of Food Service, China Agricultural University People's Republic of China	Sep. 8-12, 1998
Dr. Ananthaswamyao Ramesh	Head of Food Engineering Department Central Food Technological Research Institute India	Sep. 8-12, 1998
Dr. Bruce R. Champ	Former Consultant Australian Center for International Agricultural Research Australia	Sep. 8-12, 1998

Dr. Filipinas Caliboso	Director Bureau of Postharvest Research and Extension The Philippines	Sep. 8-12, 1998
Dr. Prisnar Siriacha	Researcher Kasetsart Agricultural and Agro-industrial Product Improvement Institute, Kasetsart University Thailand	Sep. 8-11, 1998
Dr. Mulyo Sidik	Assistant to Ministry of Food and Horticulture Indonesia	Sep. 8-12, 1998
Dr. Greg Johnson	Program Manager Australian Center for International Agricultural Research Australia	Sep. 8-12, 1998
Dr. Saipin Maneepun	Director Institute of Food Research and Product Development, Kasetsart University Thailand	Sep. 8-12, 1998
Dr. Josue S. Falla	Director Bureau of Postharvest Research and Extension The Philippines	Sep. 8-12, 1998
Dr. Deng Yong	Director Department of Food Engineering, China Agricultural University People's Republic of China	Sep. 8-12, 1998
Dr. Aman Wirakartakusumah	Vice Rector for Academic Affairs Department of Food Science and Technology, Inter University Indonesia	Sep. 8-12, 1998
Dr. Liu Tin-Yin	Director Food Industry Research & Development Institute Taiwan	Sep. 8-12, 1998
Dr. Cherl-Ho Lee	Professor Center for Advanced Food Science & Technology, Graduate School of Biotechnology, Korea University Korea	Sep. 7-11, 1998

### JIRCAS/IPGRI Joint International Workshop invitees, FY 1998

Dr. Bart Panis	Research Scientist Catholic University of Leuvan Belgium	Oct. 19-25, 1998
Dr. David Cyr	Research Scientist BC Research/Silvagen Inc. Canada	Oct. 18-24, 1998
Mr. Yongjie Wu	Research Scientist Changli Pomology Institute People's Republic of China	Oct. 19-24, 1998
Dr. Roosevelt Escobar	Research Scientist Centro Internacional de Agricultura Tropical (CIAT ) Colombia	Oct. 19-25, 1998
Dr. Dominique Dumet	Research Scientist University of Abertay Dundee England	Oct. 18-24, 1998
Dr. Poula Reinhoud	Research Scientist Leiden University Holland	Oct. 19-24, 1998

Dr. B.B. Mandal	Research Scientist National Bureau of Plant Genetic Resources India	Oct. 18-24, 1998
Dr. Enny Sudamonowati	Research Scientist R&D Center for Biotechnology, Indonesian Institute of Sciences Indonesia	Oct. 19-24, 1998
Prof. N. Normah	Professor University Kebangsaan Malaysia Malaysia	Oct. 19-24, 1998
Dr. S.Y. Choy Ng	Research Scientist International Institute of Tropical Agriculture Nigeria	Oct. 19-25, 1998
Dr. P.M. Kyesmu	Senior Lecturer Jos University Nigeria	Oct. 19-24, 1998
Dr. Ali Golmirzaie	Research Scientist International Potato Center (CIP) Peru	Oct. 19-25, 1998
Ms. Alfinetta B. Zamora	Laboratory Chief Institute of Plant Breeding, University of the Philippines at Los Banos The Philippines	Oct. 19-24, 1998
Prof. Patricia Berjak	Research Scientist University of Natal South Africa	Oct. 20-25, 1998
Dr. Chalernpol Kirdmanee	Research Scientist National Center for Genetic Engineering and Biotechnology Thailand	Oct. 19-23, 1998
Dr. Barbara Reed	Research Scientist United States Department of Agriculture-Agriculture Research Station (USDA-ARS) National Clonal Germplasm Repository USA	Oct. 18-25, 1998
Dr. Darren Touchell	Research Scientist United States Department of Agriculture-Agriculture Research Station (USDA-ARS) National Clonal Germplasm Repository USA	Oct. 19-24, 1998
Dr. Tien Thinh Nguyen	Research Scientist Nuclear Research Institute Vietnam	Oct. 19-24, 1998
Dr. Maria Elena Aguilar	Research Scientist Centro Agronomico Tropical de Investigation Ensenanza Costa Rica	Oct. 19-24, 1998
Ms. Ana Abdelnour Esquivel	Professor Costa Rica Institute of Technology Costa Rica	Oct. 19-24, 1998

[BACK](#)
[HOME](#)



## Counterpart Researcher Invitation

The Counterpart Researcher Invitation program provides invitations for periods of up to six months to researchers engaged in collaborative work with members of the JIRCAS research staff. Counterparts conduct in-depth research at JIRCAS, at other MAFF research institutes, at prefectural research institutes, or at national universities. This invitation program aims both to enhance the quality of research conducted in foreign countries and to facilitate exchanges between individual research staff. Thirty researchers were invited under the Counterpart Researcher Invitation program during FY 1998. Invited researchers, their affiliated research organizations, and their research activities are summarized below.

### FY 1998

*(At Japan International Research Center for Agricultural Sciences, Apr. 1-12, 1998)*

Ms. Zhou Li-pin	Shanghai Fisheries University People's Republic of China	Gel formation in freshwater fish meat by ohmic heating
-----------------	----------------------------------------------------------	--------------------------------------------------------

*(At Japan International Research Center for Agricultural Sciences and National Institute of Sericultural and Entomological Science, Apr. 1-29, 1998)*

Ms. Anchalee Chuaboonmee	Sisaket Sericultural Research Center Thailand	Studies on the physical properties of Thai poly voltine raw silk for warp yarn
--------------------------	-----------------------------------------------	--------------------------------------------------------------------------------

*(At Japan International Research Center for Agricultural Sciences and National Food Research Institute, Apr 1-May 1, 1998)*

Dr. Vipapom Na Thalang	Department of Research, Kasetsart University Thailand	Study on antioxidant activity of various vegetables
------------------------	-------------------------------------------------------	-----------------------------------------------------

*(At Japan International Research Center for Agricultural Sciences, June 27-Sept. 30, 1998)*

Mr. Anrulfo Gesite	Bureau of Soils and Water Management The Philippines	Introduction of a low cost runoff under sugarcane with various cover crops for erosion control
--------------------	------------------------------------------------------	------------------------------------------------------------------------------------------------

*(At Japan International Research Center for Agricultural Sciences and National Food Research Institute, July 13-Sept. 14, 1998)*

Mr. Cheng Yong Qiang	China Agricultural University People's Republic of China	Processing technologies of soybean for improved food ingredients
----------------------	----------------------------------------------------------	------------------------------------------------------------------

*(At Japan International Research Center for Agricultural Sciences, July 15-Sept. 29, 1998)*

Mr. Hoang Dinh Dinll	Cuu Long Delta Rice Research Institute Vietnam	Epidemiology of rice blast disease in the Mekong Delta
----------------------	------------------------------------------------	--------------------------------------------------------

*(At Japan International Research Center for Agricultural Sciences, July 15-Sept. 29, 1998)*

Mr. Lai VanE	Cuu Long Delta Rice Research Institute Vietnam	Study on pathogenic diversity of <i>Xanthomonas oryzae pv. oryzae</i> distributed in the Mekong Delta
--------------	------------------------------------------------	-------------------------------------------------------------------------------------------------------



*(At Japan International Research Center for Agricultural Sciences, Aug. 3, 1998-Feb. 1, 1999)*

Dr. Xu Ming Gang	Institute of Soils and Fertilizer, Chinese Academy of Agricultural Sciences People 's Republic of China	Study on nitrogen removal function of paddy fields
------------------	---------------------------------------------------------------------------------------------------------	----------------------------------------------------

*(At Japan International Research Center for Agricultural Sciences and National Institute of Agro-Environmental Sciences, Aug. 26-Oct. 22, 1998)*

Mr. Surasit Attajarusit	Soil Science Division, Department of Agriculture (DOA) Thailand	Analysis of soil micro-nutrients of Thai upland soils by plasma source micro-nutrient spectrometry
-------------------------	-----------------------------------------------------------------	----------------------------------------------------------------------------------------------------

*(At Japan International Research Center for Agricultural Sciences, Sept. 2-Nov 25, 1998)*

Dr. Prapai Chairroj	Soil Science Division, Department of Agriculture (DOA) Thailand	Development of mitigation techniques for gases including nitrogen emitted from agro-ecosystems in tropical areas
---------------------	-----------------------------------------------------------------	------------------------------------------------------------------------------------------------------------------

*(At Japan International Research Center for Agricultural Sciences, Sept. 7-16, 1998)*

Dr. Segenet Kelem	International Center for Tropical Agriculture (CIAT) Colombia	Seminar on the endophyte project
-------------------	---------------------------------------------------------------	----------------------------------

*(At Japan International Research Center for Agricultural Sciences and National Food Research Institute, Sept. 22-Oct. 30, 1998)*

Ms. Erliana Ginting	Research Institute for Legume and Tuber Crops (RILET) Indonesia	Evaluation of Indonesian soybean varieties for the processing and improvement of fermented foods
---------------------	-----------------------------------------------------------------	--------------------------------------------------------------------------------------------------

*(At Japan International Research Center for Agricultural Sciences, Sept. 29-Nov 19, 1998)*

Mr. Phongchate Pichitkul	Kasetsart University Thailand	Studies on nuinent cycles in aquaculture systems in Southeast Asia
--------------------------	----------------------------------	--------------------------------------------------------------------

*(At Japan International Research Center for Agricultural Sciences and Hokkaido National Agricultural Experiment Station, Sept.30, 1998-Mar 26, 1999)*

Mr. Ye Changrong	Crop Germplasm Station, Yunnan Academy of Agricultural Sciences People's Republic of China	Genetic analysis of cool-weather tolerant rice genetic resources using molecular markers
------------------	--------------------------------------------------------------------------------------------	------------------------------------------------------------------------------------------

*(At Japan International Research Center for Agricultural Sciences and Hokkaido National Agricultural Experiment Station, Sept. 30, 1998-Mar 26, 1999)*

Mr. Yang Qinzhong	Crop Protection Institute, Yunnan Academy of Agricultural Sciences People's Republic of China	Genetic analysis on blast disease resistance of rice genetic resources using molecular markers
-------------------	-----------------------------------------------------------------------------------------------	------------------------------------------------------------------------------------------------

*(At Japan International Research Center for Agricultural Sciences and National Agriculture Research Center, Oct. 1, 1998-Mar 31, 1999)*

Dr. Zhao Guilan	Soybean Institute, Jilin Academy of Agricultural Sciences People's Republic of China	Establishment of soybean transformation methods
-----------------	--------------------------------------------------------------------------------------	-------------------------------------------------

*(At Japan International Research Center for Agricultural Sciences, Oct. 6-Nov 5, 1998)*

Dr. Ren Tianzhi	Institute of Natural Resources and Regional Planning, Chinese Academy of Agricultural Sciences People's Republic of China	Modeling methods for managing regional food balance
-----------------	---------------------------------------------------------------------------------------------------------------------------	-----------------------------------------------------

*(At Japan International Research Center for Agricultural Sciences, Nov. 23-Dec. 4, 1998)*

Ms. Xue Guica	Institute of Agricultural Economy, Chinese Academy of Agricultural Sciences People's Republic of China	Extension of new technology and regional agricultural economy management
---------------	--------------------------------------------------------------------------------------------------------	--------------------------------------------------------------------------

*(At Japan International Research Center for Agricultural Sciences, Dec. 1, 1998-Feb. 27, 1999)*

Ms. Liao Lin	Soybean Institute, Jilin Academy of Agricultural Sciences People's Republic of China	Genetic analysis of soybean mosaic virus resistance
--------------	--------------------------------------------------------------------------------------	-----------------------------------------------------

*(At Japan International Research Center for Agricultural Sciences and National Institute of Animal Industry, Jan. 13-Feb. 11, 1999)*

Mr. Taweesak Chuenpreecha	Khon Kaen Animal Nutrition Research Center Thailand	Evaluation of new feed resources by the in-vitro method
---------------------------	-----------------------------------------------------	---------------------------------------------------------

*(At Japan International Research Center for Agricultural Sciences and National Institute of Animal Industry, Jan. 13-Feb. 11, 1999)*

Mr. Pimpapom Pholsen	Khon Kaen Animal Nutrition Research Center Thailand	Comparison of various protein evaluation methods
----------------------	-----------------------------------------------------	--------------------------------------------------

*(At Japan International Research Center for Agricultural Sciences and Akita Prefectural Food Research Institute, Jan. 27-Feb. 25, 1999)*

Dr. Xue Wentong	China Agricultural University People's Republic of China	Mechanism of gel formation of plant proteins during processing
-----------------	----------------------------------------------------------	----------------------------------------------------------------

*(At Japan International Research Center for Agricultural Sciences and National Food Research Institute, Jan. 27-Feb. 25, 1999)*

Dr. Han Dong Hai	China Agricultural University People's Republic of China	Suitable technologies for food packaging to maintain and extend food quality
------------------	----------------------------------------------------------	------------------------------------------------------------------------------

*(At Japan International Research Center for Agricultural Sciences, Feb. 6-Mar 5, 1999)*

Mr. Suchart Reanthung	Soil Survey and Classification Division, Land Development Department Thailand	Analysis and evaluation of site conditions for sustainable agricultural systems through the use of GIS and remote sensing data
-----------------------	-------------------------------------------------------------------------------	--------------------------------------------------------------------------------------------------------------------------------

*(At Japan International Research Center for Agricultural Sciences, National Food Research Institute and Ibaraki University, Feb. 12-Mar. 26, 1999)*

Mr. Gontijo Mandarina Jose Marcos	National Center for Soybean Research, EMBRAPA Brazil	Chemical analysis on sugars, saponins, and related qualitative characteristics of Brazilian cultivars and breeding lines of soybean
-----------------------------------	------------------------------------------------------	-------------------------------------------------------------------------------------------------------------------------------------

*(At Japan International Research Center for Agricultural Sciences and Kyushu National Agricultural Experiment Station, Feb. 12-Mar 26, 1999)*

Mr. Moises de Aquino	National Center for Soybean Research, EMBRAPA Brazil	Comparative analysis of micronutrients in soybean plants and soil
----------------------	------------------------------------------------------	-------------------------------------------------------------------

*****

*(At Japan International Research Center or Agricultural Sciences, Feb. 14-23, 1999)*

Mr. Ja Shangang	Scientech Documentation and Information Center People's Republic of China	Agricultural information network in China
-----------------	------------------------------------------------------------------------------	-------------------------------------------

*(At Japan International Research Center for Agricultural Sciences, Feb. 14-23, 1999)*

Mr. Shao Changlei	Scientech Documentation and Information Center People's Republic of China	Agricultural information network in China
-------------------	------------------------------------------------------------------------------	-------------------------------------------

*(Agricultural information network in China At Japan International Research Center or Agricultural Sciences, Feb. 26-Mar 26 1999)*

Ms. Bazaryn T. Sevelsuren	Institute of Meteorology and Hydrology, Ministry of Nature and Environment Mongolia	Management of spatial data related to meteorology and hydrology in Mongolia
---------------------------	----------------------------------------------------------------------------------------	--------------------------------------------------------------------------------

*(At Japan International Research Center for Agricultural Sciences, Mar 4-25, 1999)*

Mr. Kanit Likhitvidhayavuth	Bureau of Agricultural Economic Research, Office of Agricultural Economics Thailand	Consideration of the future perspectives of Thai agriculture : Focusing on upland crop production
--------------------------------	----------------------------------------------------------------------------------------	------------------------------------------------------------------------------------------------------

---

[BACK](#)[HOME](#)



## JIRCAS Visiting Research Fellowship Program at Okinawa

The Okinawa Visiting Research Fellowship Program was initiated in FY 1992, prior to the reorganization of the Tropical Agricultural Research Center (TARC) into JIRCAS. The program invites post-doctoral scientists to conduct research for a period of one year at the Okinawa Subtropical Station. Researchers must focus on important topics relating to tropical agriculture in developing countries within one of several broad categories: the development of techniques for environmental control utilizing plants and microorganisms specific to the tropics and subtropics, studies on heat-tolerance mechanisms in tropical and subtropical crops, the identification and evaluation of salt-tolerant crops, or the evaluation and development of long-term conservation techniques of the genetic resources of vegetatively propagated crops in the tropics and subtropics. Ten fellows are chosen each year, beginning their terms on October 1 and ending on September 30 of the following year. Recent invitees and their research activities are summarized below.

*Photo: Okinawa Fellows in 1998 pose for group Photograph.*

### from October 1997 to September 1998

#### *Development of techniques for environmental control by using plants and microorganisms specific to the tropics and subtropics*

El-KI Iawas Hussein Moustafa	Cairo University Egypt	Utilization of plant growth promoting rhizobacteria (PGPR) for promoting plant growth and saving fertilizer
Wang Bujun	Institute of Crop Breeding and Cultivation People's Republic of China	Associations between methane emission and methanogenic and methanotrophic bacteria in flooded soil as affected by rice cultivars

#### *Studies on the mechanism of heat-tolerance of tropical and subtropical crops*

Liu Jian	Institute of Stress Plant of Shandong People's Republic of China	Expression of heat tolerance-relative genes in tomato reproductive organs.
----------	------------------------------------------------------------------	----------------------------------------------------------------------------

#### *Identification and evaluation of salt-tolerant crops*

Safdar Hussain Shah	Agricultural Research Station, Dhodial Mansehra Pakistan	Physiological, biochemical and genetic characterization of salinity tolerance in rice
Li Chengyun	Plant Protection Research Institute Yunnan Academy of Agricultural Sciences People's Republic of China	Selection and detection of salt responsive mutants in rice ( <i>Oryza sativa</i> L.)
Sumana-singhe Vithanaa ra-chchige Ariyawanse	University of Peradeniya Sri Lanka	Expression and evaluation of salinity stress related genes in <i>Oryza sativa</i> L.
Masood M. Shahid	National Agricultural Research Center Pakistan	Identification and evaluation of salinity tolerance in rice ( <i>Oryza sativa</i> L.) using molecular markers
Bakhtiyor Yaku:bov	Institute of Genetics Uzbekistan	Molecular study of the heat-shock inducible genes in a highly heat-tolerant variety of <i>Brassica oleracea</i> var. <i>capitata</i> L.

#### *Evaluation and development of long-term conservation techniques of genetic resources of vegetatively propagated crops in the tropics and subtropics*

Narinder Pal Singh Dhillon	Punjab Agricultural University India	RAPD and AFLP analysis of genetic diversity in sweet potatoes ( <i>Ipomea batatas</i> L.)
-------------------------------	--------------------------------------	-------------------------------------------------------------------------------------------

### from October 1998 to September 1999

#### *Development of techniques for environmental control by using plants and microorganisms specific to the tropics and subtropics*

Wang Bujun	Institute of Crop Breeding and Cultivation People's Republic of China	Methane emission and carbon cycling in rice fields as affected by elevated atmospheric CO ₂ concentration and environmental factors
------------	--------------------------------------------------------------------------	------------------------------------------------------------------------------------------------------------------------------------------------

#### *Studies on the mechanism of heat-tolerance of tropical and subtropical crops*

Md. Abdul Karim	Institute of Postgraduate Studies in Agriculture Bangladesh	Interactive effect of thermal and irradiance stresses on some physiological and biochemical parameters of grain legumes and mangos
Liu Jian	Shandong Teachers' University People's Republic of China	Cloning of heat tolerance-related genes from tomato reproductive tissue
Hu Xinwen	National Key Biotechnology Laboratory for Tropical Crops, Chinese Academy of Tropical Agricultural Sciences People's Republic of China	Development of microsatellite markers in snap beans
<i>Identification and evaluation of salt-tolerant crops</i>		
M. Arumugam Pillai	Tamilnadu Agricultural University India	Screening of a cDNA library for a salt tolerant gene in rice
<i>Evaluation and development of long-term conservation techniques of genetic resources of vegetatively propagated crops in the tropics and subtropics</i>		
Rubio Calderon Armando	Instituto Nacional Autonomo de Investigaciones Agropecuarias Ecuador	Evaluation and characterization of oligofructan content in yacon germplasm
Chamwan B angwaek	Prachinburi Rice Research Center Thailand	Enzyme activity related to sugar accumulation in sugarcane
Maribel R. Quintana Sanz	Institute of Pastures and Forages Research Cuba	Evaluation of genomic diversity of sugar related enzyme genes and sugarcane genetic resources
Narinder Pal Singh Dhillon	Punjab Agricultural University India	Genetic variation and relationships in sweet potato populations detected with RAPD and AFLP markers

[BACK](#)
[HOME](#)





## JIRCAS Visiting Research Fellowship Program at Tsukuba

A program similar to the Okinawa Visiting Research Fellowship Program has been implemented on the Tsukuba premises since October 1995. The Tsukuba Visiting Research Fellowship Program aims to promote collaborative research to address various problems confronting countries in developing regions. The program allows for the invitation of six to eight researchers per year. Four researchers engage in two-year projects at JIRCAS and two to four researchers conduct short five-month projects at the National Institute for Agrobiological Resources (NIAR). Recent invitees and their research activities are listed below.

More information on the Tsukuba Visiting Research Fellowship Program can be obtained by contacting the International Relations Section, Japan International Research Center for Agricultural Sciences, 1-2, Ohwashi, Tsukuba, Ibaraki, 305-8686, Japan. (Tel. : +81-298-38-6335 Fax: +81-298-38-6337; e-mail: [irs@jircas.affrc.go.jp](mailto:irs@jircas.affrc.go.jp) ).

*Photo : Host scientist and Tsukuba fellow engaged in experiment on prawn physiology at the Fisheries Division*

### Long-term JIRCAS from October 1996 to September 1998

#### *Methods for optimum utilization of biological resources*

Zabta Khan Shinwari	National Agricultural Research Center Pakistan	Analysis of plant responses to environmental stresses and gene expression
Gassinee Trakoontivakorn	Kasetsart University Thailand	Development of practical methods for the evaluation of the quality of indigenous crops and for the analysis of components and functionality of foods

#### *Analysis and evaluation of the impact of climatic and anthropogenic factors on environmental resources*

Qian Minze	Tsinghua University People's Republic of China	Relation between climatic changes and biomass in agro-ecosystems
Yang Hao	The Institute of Soil Science, Academia Sinica People's Republic of China	Investigations of the process of rock-weathering through the analysis of the rock surface by electron spectroscopy

### Long-term at JIRCAS from October 1997 to September 1999

#### *Methods for optimum utilization of biological resources*

Mohammad Masud Parvez	Bangladesh Agricultural Institute Bangladesh	Molecular analysis of abscisic acid-mediated control of gene expression in higher plants under water stress
Vuong Dinh Tuan	Cuu Long Delta Rice Research Institute Vietnam	Tagging and cloning of salt tolerant genes in rice using AFLP markers

#### *Analysis and evaluation of the impact of climatic and anthropogenic factors on environmental resources*

Li Zhong	Institute of Soil Science, Academia Sinica People's Republic of China	Effects of doubling CO ₂ concentration on carbon and nitrogen cycles in soil-rice ecosystems
Muhammad Akhtar Abbas	University of Agriculture, Faisalabad Pakistan	Analysis of land environmental change in semi-arid areas using remote sensing and GIS

### Long-term at JIRCAS from October 1998 to September 2000

#### *Methods for optimum utilization of biological resources*

Joseph Gogo Dubouzet	University of the Philippines, The Philippines	Molecular analysis of drought stress responses in rice
Vipaporn Na Thalang	Kasetsart University Thailand	Chemical and biological evaluation of Thai vegetables (Fam. Leguminosae)
Do Thi Thanh Huong	Cantho University Vietnam	Physiological studies on reproduction and osmoregulation in the giant freshwater prawn, <i>Macrobrachium rosenbergii</i>

#### *Systems analysis of food problems and rural development*

Guo Jianjun	Research Center for Rural Economy People's Republic of China	Econometric analysis on food consumption by Chinese farm households
<b>Short-term at NIAR from October 1998 to February 1999</b>		
Irina Olegovaa Vvedenskaya	All-Russian Institute of Plant Industry Russia	The molecular basis of protein markers in wild relatives of crops
<b>Short-term at NIAR from 1998 to March 1999</b>		
Dea de Lima Vidal	University of Zaragoza Brazil	Economic and breeding evaluation of animal genetic resources in developing countries
Aboagye Lawrence Misa	Plant Genetic Resources Center Ghana	Evaluation of diversity for a starch synthetic gene in wheat
Dennis Yeo	National Institute of Agrobiological Resources Singapore	Development of strategy to generate male-sterile plants using a transcription factor gene

---

[BACK](#)
[HOME](#)





# SYMPOSIA AND WORKSHOPS

## 1) INTERNATIONAL SYMPOSIA

Between 1967 and 1993, the Tropical Agricultural Research Center (TARC) sponsored annual international symposia for the purposes of promoting scientific exchange and accurately gauging and responding to the agriculture, forestry, and fishery needs of the world's developing areas. Since its transition from TARC, JIRCAS has continued this practice, organizing its first International Symposium in Fiscal Year (FY) 1994. At present, each symposium is organized around a theme of central importance to international agricultural research, and roughly ten researchers and administrators from concerned research institutes and international agencies are invited as speakers. Symposia are ordinarily held in joint sponsorship with a relevant scientific society or research organization. The program from the FY 1998 International Symposium appears below.

- [The 5th JIRCAS International Symposium Postharvest Technology in Asia - A step forward to stable supply of food products -.](#)

## 2) SPECIAL PROGRAMS

- [International Workshop on Learning from Farming Systems Research in Indonesia.](#)
- [Workshop on a Cooperative Research Project Between Thai Institutes and JIRCAS on Sustainable Agricultural Systems in Northeast Thailand.](#)
- ["Plant Signaling": Molecular Responses to Environmental Stimuli and Stress.](#)
- [JIRCAS / IPGRI Joint International Workshop on Cryopreservation of Tropical Plant Germplasm.](#)
- [Fourth Seminar for "Brackish Water Project" Held in Malaysia.](#)

## 3) WORKSHOP AND SEMINARS

- [International Research Seminars](#)
- [International Research Workshops](#)

## 4) MISCELLANEOUS MEETINGS AND WORKING GROUPS

- [Annual Meeting for the Review and Promotion of Research](#)
- [JIRCAS Return Seminars](#)
- [Review and Promotion of International Research Collaboration - Committee Meetings](#)
- [Comprehensive Project Working Group Meetings](#)



## **The 5th JIRCAS International Symposium POSTHARVEST TECHNOLOGY IN ASIA - A STEP FORWARD TO STABLE SUPPLY OF FOOD PRODUCTS -**

*(Held September 9 -10, 1998, in Tsukuba, Japan, in conjunction with the National Food Research Institute (NFRI), National Agriculture Research Center, Food Forum Tsukuba, and the Nestle Science Promotion Committee).*

### **Opening addresses**

- Inaugural address by Dr. Nobuyoshi Maeno, Director General, Japan International Research Center for Agricultural Sciences (JIRCAS), Ministry of Agriculture, Forestry and Fisheries (MAFF), Japan
- Welcome address by Mr. Sakue Matsumoto, Chairman, Secretariat of the Agriculture, Forestry and Fisheries Research Council (AFFRC), Ministry of Agriculture, Forestry, and Fisheries(MAFF), Japan

### **Keynote speech**

“Role of postharvest technology research for promoting a sustainable food supply” by Dr. Keiji Kainuma, Vice-President, Bio-oriented Technology Research Advancement Institution, (BRAIN), Japan

### **Session 1: Main priorities and constraints of postharvest technology in Asia**

**Chaired by Dr. Silvestre C. Andales, Bureau of Postharvest Research and Extension, the Philippines and Dr. Kunio Tsubota, JIRCAS, Japan**

- Priorities and constraints of postharvest technology in Vietnam. L. V. To, Postharvest Technology Institute, Vietnam
- Priorities and constraints of postharvest technology in the Philippines. S. C. Andales, Bureau of Postharvest Research and Extension, the Philippines
- Postharvest problems in Thailand: Priorities and constraints. J. Siripanich, Kasetsart University, Thailand
- Main postharvest problems and countermeasures for agricultural products in China. S. Q. Feng, China Agricultural University, People’s Republic of China
- Priorities and constraints of postharvest technology in India. A. Ramesh, Central Food Technological Research Institute, India

### **Session 2: Current development and future orientation for technology of grain storage and preservation in the tropics**

**Chaired by Dr. Bruce R. Champ, formerly of the Australian Center for International Agricultural Research, Australia and Dr. Hiroshi akakita, NFRI, Japan**

- Alternative chemicals for methyl bromide. B. R. Champ, formerly of the Australian Center for International Agricultural Research, Australia
- Hermetic storage of grains in the tropics. F. M. Caliboso, Bureau of Postharvest Research and Extension, the Philippines
- Role of biological control in grain storage in the tropics. H. Nakakita, NFRI, Japan
- Minimizing aflatoxin production in grains in the tropics. P. Siriacha, Kasetsart University, Thailand
- Strategies to maintain grain quality in the humid tropics. M. Sidik, Ministry of Food and Horticulture, Indonesia

### **General discussion and conclusions for Sessions 1 and 2**

**Chaired by Dr. Silvestre C. Andales, Bureau of Postharvest Research and Extension, the Philippines and Dr. Kunio Tsubota, JIRCAS, Japan**

- General comments "Postharvest technology in Asia: ACIAR’s framework for collaborative research and development." G. I. Johnson, Australian Center for International Agricultural Research, Australia
- General discussion

### **Session 3: Current situation and future orientation of technology for food industries in Asia**

**Chaired by Dr. Akinori Noguchi, JIRCAS, Japan and Dr. Cherl-Ho Lee, Korea University, Korea** Brief introduction by the Chairperson

- Development and constraints of food industries in Thailand. S. Maneepun, Kasetsart University, Thailand
- Development and constraints of food industries in the Philippines. J. S. Falla, Bureau of Postharvest Research and Extension, the Philippines
- Development and constraints of food industries in China. D. Yong, China Agricultural University, People's Republic of China
- Development and constraints of food industries in Indonesia. M. A. Wirakartakusumah, Institute Pertanian Bogor, Indonesia
- Development and constraints of food industries in Taiwan. T. Y. Liu, Food Industry Research and Development Institute, Taiwan
- Development and constraints of food industries in Korea. C. H. Lee, Korea University, Korea
- Development and constraints of food industries in Japan. H. Uehara, Nihon University, Japan

***General discussion and conclusions for Session 3***

**Chaired by Dr. Saipin Maneepun, Kasetsart University, Thailand and Dr. Akinori Noguchi, JIRCAS, Japan**

- Summary of Session 3 by the Chairperson
- General comments by Dr. Yoshihito Kadoma, Nihonyushi Co., Ltd., Japan
- General comments by Dr. Hajime Taniguchi, NFRI, Japan
- General comments by Dr. Cherl-Ho Lee, Korea University, Korea
- General discussion
- Summarization and conclusive remarks by the Chairperson

***Closing remarks*** by Dr. Hajime Taniguchi, Director General, NFRI, Japan

---



## INTERNATIONAL WORKSHOP ON LEARNING FROM FARMING SYSTEMS RESEARCH IN INDONESIA

An international workshop “Learning from farming systems research in Indonesia,” jointly organized by JIRCAS and the Center for Agro-Socioeconomic Research (CASER), the Agency for Agricultural Research and Development (AARD), the Ministry of Agriculture, the Republic of Indonesia, was held in Bogor, Indonesia on March 3-4, 1999. This two-day workshop outlined an on-going collaborative study between CASER and JIRCAS on the history and present conditions of farming systems research within the AARD organizations of Indonesia.

An international workshop “Learning from farming systems research in Indonesia,” jointly organized by JIRCAS and the Center for Agro-Socioeconomic Research (CASER), the Agency for Agricultural Research and Development (AARD), the Ministry of Agriculture, the Republic of Indonesia, was held in Bogor, Indonesia on March 3-4, 1999. This two-day workshop outlined an on-going collaborative study between CASER and JIRCAS on the history and present conditions of farming systems research within the AARD organizations of Indonesia.

The workshop participants approached the following key questions from various angles and with diverse personal experiences.

- How can we interpret the past 25 years of FSR in Indonesia?
- What are the roles and relationships of researchers and extension specialists in FSR?
- What are the roles of the social and natural sciences in the farming systems (FS) approach?
- How adequate or inadequate is the institutional framework for FSR in Indonesia today?
- Foreign assistance, commitment, and intervention in FSR: How can Indonesia use these most effectively?
- Technology and the FS approach: “Assessment of Agricultural Technology” vs. Technology of “Assessment”

Approximately fifty individuals from Indonesia, Japan, Australia, and the USA participated in the workshop. Supported by the experienced staff of CASER, the workshop went smoothly with a high level of focus. All participants realized that the FSR system still needs improvement and stressed the importance of mutual learning and exchanging diverse views. The proceedings of the workshop will be published by JIRCAS in 1999/2000.

### *Workshop schedule*

#### *Day 1*

- Welcome address. Erwidodo, Center for Agro-Socioeconomic Research (CASER), Indonesia
- Welcome address. Kunio Tsubota, Japan International Center for Agricultural Sciences (JIRCAS), Japan
- Opening remarks. Joko Budianto, Agency for Agricultural Research and Development (AARD), Indonesia
- Farming Systems Research: Evolution, issues, and new directions building on 25 years of contributions. J. S. Caldwell, Virginia Polytechnic Institute and State University, USA
- Farming Systems Research in Indonesia: Lessons learned and future directions. M. O. Adnyana, Center for Agro-Socioeconomic Research (CASER), Indonesia
- Foreign assistance and commitment. A. Rachman and A. Abdurachman, Center for Soil and Agroclimate Research, Indonesia

- Collaboration between natural and social scientists. Sumarno, H. Taslim, and D. Pasaribu, Central Research Institute for Food Crops, Indonesia
- Institutional framework and restructuring. Hermanto, Assessment Institutes for Agricultural Technology (AIAT-Ungaran), Indonesia
- Technology and the Farming Systems approach. A. Dimiyati, Assessment Institutes for Agricultural Technology (AIAT-Lembang), Indonesia

## **Day 2**

- Challenge for today's research and extension community. A. Martaamidjaja, Center for Agricultural Extension, Indonesia
- Case study presentations from previous and on-going research projects
- Rural transformation under rapid economic growth in West Java. S. Yokoyama, National Research Institute of Agricultural Economics, Japan, W. Sudana, A. S. Bagyo, and A. K. Zakaria Center for Agro-Socioeconomic Research (CASER), Indonesia
- A follow-up socio-economic study of the banana-based farming systems research project in Cibinong, Cianjur, West Java. J. Goto, Japan International Research Center for Agricultural Sciences (JIRCAS), Japan, H. Mayrowani, and Austian, Center for Agro-Socioeconomic Research (CASER), Indonesia
- Research and extension linkage in FS: A field experience. Surachman and Kuscahyo, Assessment Institutes for Agricultural Technology (AIAT-Ungaran), Indonesia
- Case study presentations from previous and on-going research projects
- Farming systems research in South Sumatera: Lessons learned and their implications. M. O. Adnyana, Center for Agro-Socioeconomic Research (CASER), Indonesia
- The perspective of a sustainable agricultural farming system in the Imperata grassland area in Indonesia. I. W. Rusastra, Center for Agro-Socioeconomic Research (CASER), Indonesia and K. Menz, Australian Center for International Agricultural Research, Australia
- Discussion on new orientation, application and follow up
- Closing remarks



## **WORKSHOP ON A COOPERATIVE RESEARCH PROJECT BETWEEN THAI INSTITUTES AND JIRCAS ON SUSTAINABLE AGRICULTURAL SYSTEMS IN NORTHEAST THAILAND**

On December 9, 1998, JIRCAS welcomed Dr. Ananta Dalodom, Director General, Department of Agriculture (DOA), and Mr. Pawit Watanavitawas, Director, International Training Center for Agricultural Development (ITCAD), DOA, Thailand to a workshop on a cooperative research project between Thai Institutes and JIRCAS on sustainable agricultural systems in northeast Thailand. Following a welcome address given by JIRCAS Director General Dr. N. Maeno, Dr. Dalodom and Mr. Watanavitawas each addressed the audience and then took questions concerning their speeches. The project's research coordinator and directors of the relevant JIRCAS divisions then commented briefly on their current work.

In the course of the address, Dr. Dalodom requested JIRCAS cooperation on two new research projects: 1) forecasting crop production in Thailand and the utilization of advanced technologies for planning and monitoring that production; and 2) research and development of postharvest technology. This request is now under consideration at JIRCAS.

- Ⓢ Welcome address: N. Maeno, Director General, Japan International Research Center for Agricultural Sciences (JIRCAS), Japan
- Ⓢ Research activities for sustainable agriculture in northeast Thailand. A. Dalodom, Director General, Department of Agriculture (DOA), Thailand
- Ⓢ Collaboration of ITCAD in the field management study. P. Watanavitawas, Director, International Training Center for Agricultural Development (ITCAD), Department of Agriculture (DOA), Thailand
- Ⓢ Question and answer period
- Ⓢ General situation of the project from the Japanese side. S. Matsui, Research Coordinator, Japan International Research Center for Agricultural Sciences (JIRCAS), Japan
- Ⓢ Studies on environmental resources. T. Hamazaki, Director, Environmental Resources Division, Japan International Research Center for Agricultural Sciences (JIRCAS), Japan
- Ⓢ Studies on bio-resources. T. Hoshino, Director, Bio-resources Division, Japan International Research Center for Agricultural Sciences (JIRCAS), Japan
- Ⓢ Studies on livestock production. S. Shimizu, Director, Animal Production and Grassland Division, Japan International Research Center for Agricultural Sciences (JIRCAS), Japan
- Ⓢ Studies on agricultural systems. A. Noguchi, Director, Crop Production and Postharvest Technology Division, Japan International Research Center for Agricultural Sciences (JIRCAS), Japan
- Ⓢ Studies on socio-economics. K. Tsubota, Director, Research Information Division, Japan International Research Center for Agricultural Sciences (JIRCAS), Japan
- Ⓢ Studies on reforestation. K. Tanaka, Director, Forestry Division, Japan International Research Center for Agricultural Sciences (JIRCAS), Japan
- Ⓢ General discussion



## "PLANT SIGNALING": MOLECULAR RESPONSES TO ENVIRONMENTAL STIMULI AND STRESS

An international symposium on "Plant Signaling: Molecular Responses to Environmental Stimuli and Stress" organized by JIRCAS, in conjunction with the Institute of Chemical and Physical Research (RIKEN) and the Bio-oriented Technology Research Advancement Institution (BRAIN) was held at JIRCAS, Tsukuba, on August 12th, 1998. This symposium gathered scientists researching plant signal transduction and responses to biotic and abiotic environmental stresses to share their results and ideas for the future.

In recent years, food supply and environmental deterioration problems on a global scale have become increasingly critical, especially in developing regions. Biotechnology could be a useful method to increase food production through the development of crops with improved tolerance to biotic and abiotic environmental stresses. To develop the biotechnology to breed stress tolerant crops, basic research on plant molecular biology is important. Recently, considerable progress has been made in understanding how plants sense and respond to the varied stimuli in their environment.

Molecular and genetic approaches have led to great progress in many aspects of plant signaling research, including the explanation of how environmental stimuli and stress elicit the production of second messengers and how plant cells perceive the messengers. In addition, these approaches have led to an increased understanding of the induction of specific responses to and the

physiological consequences of environmental stimuli and stress. The most active scientists specializing in plant signaling were invited to present lectures at the symposium. From 10 countries, 191 scientists participated in the symposium. Dr. Nobuyoshi Maeno, Director General of JIRCAS and Dr. Keiji Kainuma, Vice President of BRAIN, gave the welcome addresses. The keynote lecture was delivered by Professor Nam-Hai Chua, Rockefeller University, USA, and 10 foreign scientists from the USA, France, Germany, England, Austria and 4 Japanese scientists presented papers in three sessions: ethylene signaling and biotic stress response, ABA signaling and water stress response, and short talks. The symposium was successful and valuable information was exchanged throughout the discussions.

### **Keynote lecture**

*Chaired by Dr. K. Shinozaki, The Institute of Physical and Chemical Research (RIKEN), Japan*

- Ⓢ Molecular and genetic dissection of plant signaling pathways. N.H. Chua, The Rockefeller University, USA

### **Session I: Ethylene signaling and biotic stress response**

*Chaired by Dr. K. Yamaguchi-Shinozaki, Japan International Research Center for Agricultural Sciences (JIRCAS), Japan*

- Ⓢ Ethylene gas signaling from the membrane to the nucleus. J. R. Ecker, University of Pennsylvania, USA
- Ⓢ Regulation of gene expression by plant hormone ethylene. H. Shinshi, National Institute of Bioscience and Human-Technology (NIBHT), Japan



- Ⓢ Function of a tobacco ethylene-insensitive 3 homolog as a transcription factor. S. Kosugi and Y. Ohashi, National Institute of Agrobiological Resources (NIAR), Japan

**Session II: ABA signaling and water stress response**

Chaired by Dr. J. R. Ecker, University of Pennsylvania, USA and Dr. J. Giraudat, Centre National de la Recherche Scientifique (CNRS), France

- Ⓢ Genetic analysis of abscisic acid signaling in Arabidopsis. J. Giraudat, Centre National de la Recherche Scientifique (CNRS), France
- Ⓢ Gene expression and signal transduction in water stress responses. K. Yamaguchi-Shinozaki, Japan International Research Center for Agricultural Sciences (JIRCAS), Japan
- Ⓢ Genetic Analysis of salt stress signal transduction in Arabidopsis thaliana. J. K. Zhu, University of Arizona, USA
- Ⓢ Gene expression during dehydration studied in a resurrection plant. D. Bartels, Max Planck Institute, Germany
- Ⓢ Role of drought-inducible genes in stress response and tolerance. K. Shinozaki, The Institute of Physical and Chemical Research (RIKEN), Japan

**Session III: Short Talks**

Chaired by Dr. K. Shinozaki, The Institute of Physical and Chemical Research (RIKEN), Japan

- Ⓢ Protein kinase pathways involved in plant pathogen signaling. H. Hirt, Vienna Biocenter, Austria
- Ⓢ Promoter complexes and transacting factors involved in ABA regulated gene expression. T. D. D. Ho, Washington University, USA
- Ⓢ A unique way to identify an abscisic acid signaling component. B. Leyman, London University, UK
- Ⓢ Stress-regulated ion channels in guard cells. S. Luan, University of California, USA
- Ⓢ Integration of sugar and stress signal transduction pathways. T. Roitsch, University Regensburg, Germany
- Ⓢ Plant hormones and the tomato wound response. D. Bowles, University of York, UK



## **JIRCAS / IPGRI JOINT INTERNATIONAL WORKSHOP ON CRYOPRESERVATION OF TROPICAL PLANT GERMPLASM**

Intensive exploration and collection activities in recent years have encouraged the collection of plant germplasm throughout the world. The development of safe and cost effective techniques for the long-term conservation of the specimens, especially recalcitrant seed- and vegetatively propagated species, is considered a priority research area.

For long-term conservation of problem species, cryopreservation is the only method currently available. Dramatic progress has been made in recent years in the development of new cryopreservation techniques, and cryopreservation protocols have been established for over 100 different plant species. However, cryopreservation of tropical and sub-tropical species has been less extensively investigated than that of temperate species.

Against this background, JIRCAS and the International Plant Genetic Resources Institute (IPGRI) jointly organized an international workshop on “Cryopreservation of tropical plant germplasm: Current research progress and application” held at JIRCAS, Tsukuba, Japan, October 20-23, 1998. In an increasing number of national programs in the tropics there has been a growing awareness of the importance of cryopreservation, and research activities in this field have been recently initiated. Thus, the workshop was timely in providing a unique opportunity for cryopreservation researchers to meet to exchange information and discuss numerous aspects of the cryopreservation of tropical plant species.


The workshop enjoyed active discussions concerning the current status of research, its present application, and existing problems with cryopreservation of plant germplasm. With a strong focus on tropical species, the workshop also identified priority areas for collaborative research and the development, transfer, and application of technology. It was pointed out that the workshop could be a good start for establishing a network in the field of germplasm conservation to facilitate international research collaboration.

### ***Opening address***

***Inaugural address by Dr. Nobuyoshi Maeno, Director General, Japan International Research Center for Agricultural Sciences (JIRCAS)***

### ***Keynote addresses***

***Chaired by Dr. Tsuguhiro Hoshino, Japan International Research Center for Agricultural Sciences (JIRCAS)***

- Development of cryopreservation techniques. A. Sakai, Hokkaido University, Japan
  - Importance of cryopreservation for the conservation of plant genetic resources. F. Engelmann, International Plant Genetic Resources Institute (IPGRI), Italy
- 

**Session 1: Fundamental aspects of cryopreservation**

Chaired by Dr. David Cyr, BC Research Inc., Canada

- Freezing behaviors in plant tissues as visualized by NMR microscopy and their regulatory mechanisms. M. Ishikawa, National Institute of Agrobiological Resources (NIAR), Japan
- Ultrastructural aspects for freezing adaptation of cells by vitrification. S. Fujikawa, Hokkaido University, Japan

Chaired by Dr. Patricia Berjak, University of Natal, South Africa

- The use of physical and biochemical studies to elucidate and reduce cryopreservation-induced damage in hydrated/desiccated plant germplasm. D. Dumet, University of Abertay-Dundee, UK
- Physiological and molecular changes in tobacco suspension cells during development of tolerance to cryopreservation by vitrification. P. J. Reinhoud, Leiden University, the Netherlands
- Molecular mechanisms of freezing and drought tolerance in plants. K. Yamaguchi-Shinozaki, Japan International Research Center for Agricultural Sciences (JIRCAS), Japan
- Cryopreservation of medicinal plant resources: Retention of bio-synthetic capabilities in transformed cultures. K. Yoshimatsu, National Institute of Health Sciences, Japan

**Session 2: Cryopreservation techniques**

**[Cryopreservation of plant cells]**

Chaired by Dr. Masaya Ishikawa, National Institute of Agrobiological Resources (NIAR), Japan

- Cryopreservation of undifferentiated plant cells. P. J. Reinhoud, Leiden University, the Netherlands
- Cryopreservation of banana embryogenic cell suspensions: A tool for genetic engineering. B. Panis, Catholic University of Leuven, Belgium
- Cryopreservation of sugarcane embryogenic callus using a simplified freezing process. F. Engelmann, International Plant Genetic Resources Institute (IPGRI), Italy

**[Cryopreservation of pollen]**

Chaired by Dr. William Roca, International Center for Tropical Agriculture (CIAT), Colombia

- Use of stored pollen for wide crosses in wheat haploid production. M. N. Inagaki, Japan International Research Center for Agricultural Sciences (JIRCAS), Japan
- Storage of pollen for long-term conservation of yam genetic resources. N.Q. Ng, International Institute of Tropical Agriculture (IITA), Nigeria

**[Cryopreservation of embryos]**

Chaired by Dr. H.F. Chin, International Plant Genetic Resources Institute (IPGRI), Italy

- Cryopreservation of embryonic axes. P. Berjak, University of Natal, South Africa
- Cryopreservation of zygotic embryos of tropical fruit trees: A study on *Lansium domesticum* and *Baccaurea* species. M.N. Normah, University Kebangsaan Malaysia, Malaysia
- Cryopreservation of coffee (*Coffea arabica* L.) seeds: Towards a simplified protocol for routine use in coffee genebanks. S. Dussert, Institute de Recherche Pour le Developpement (ORSTOM), France
- Cryopreservation of melon somatic embryos by the desiccation method. K. Shimonishi, Kagoshima Biotechnology Institute, Japan
- Cryopreservation of oil palm (*Elaeis guineensis* Jacq.) polyembryonic cultures. D. Dumet University of Abertay-Dundee, UK

**[Cryopreservation of apices]**

Chaired by Dr. Florent Engelmann, International Plant Genetic Resources Institute (IPGRI), Italy

- Recent development in cryopreservation of shoot apices of tropical species. H. Takagi, Japan International Research Center for Agricultural Sciences (JIRCAS), Japan

Cryopreservation of vegetatively propagated species (mainly mulberry). T. Niino, Tohoku National Agricultural Experimental Station, Japan

Genotype considerations in temperate fruit crop cryopreservation. B.M. Reed, United States Department of Agriculture-Agricultural Research Station, USA

*Chaired by Dr. Tsukasa Nagamine, National Institute for Agrobiological Resources (NIAR), Japan*

Cryopreservation of in vitro-grown meristems of potato (*Solanum tuberosum* L.) by encapsulation vitrification. D. Hirai, Hokkaido Prefectural Plant Genetic Resources Center, Japan

Cryopreservation of in vitro-cultured meristems of wasabi. T. Matsumoto, Shimane Agricultural Experiment Station, Japan

Cryopreservation of citrus apices using the encapsulation-dehydration technique. F. Engelmann, International Plant Genetic Resources Institute (IPGRI), Italy

Development of cassava cryopreservation. R.H. Escobar, International Center for Tropical Agriculture (CIAT), Colombia

*Chaired by Dr. Mary Taylor, Secretariat for the Pacific Community, Fiji*

Cryopreservation of in vitro-grown shoot tips of five vegetatively propagated tropical monocots by the vitrification technique. N.T. Thin, Nuclear Research Institute, Vietnam

Cryopreservation of yam apices: A comparative study with three different techniques. B.B. Mandal National Bureau of Plant Genetic Resources, India

Cryopreservation of proliferating meristem cultures of banana. B. Panis, Catholic University of Leuven, Belgium

#### **Poster session**

Fifty-one technical papers were presented in this session.

#### **Discussion on cryopreservation techniques**

*Chaired by Dr. Barbara M. Reed, United States Department of Agriculture-Agricultural Research Station, USA*

Dr. M.N. Normah, Universiti Kebangsaan Malaysia, Malaysia

Dr. Bart Panis, Catholic University of Leuven, Belgium

#### **Session 3: On-going cryopreservation projects: Research and its application**

*Chaired by Dr. S. K. Ng, International Institute of Tropical Agriculture (IITA), Nigeria*

Application of cryopreservation protocols at a clonal gene bank. B. M. Reed, United States Department of Agriculture-Agricultural Research Station, USA

Advances in potato cryopreservation at the International Potato Center, Peru. A. Golmirzaie, International Potato Center (CIP), Peru

The in vitro germplasm collection at the Musa INIBAP Transit Center and the importance of cryopreservation. B. Panis, Catholic University of Leuven, Belgium

Cryopreservation: Roles in clonal propagation and germplasm conservation of conifers. D. Cyr, BC Research Inc., Canada

Conservation of threatened flora by cryopreservation of shoot apices. D. Touchell, United States Department of Agriculture-Agricultural Research Station, US

Conservation and cryopreservation of tropical tree species. C. Kirdmanee, National Center for Genetic Engineering and Biotechnology, Thailand

Conservation and cryopreservation of tropical tree species. C. Kirdmanee, National Center for Genetic Engineering and Biotechnology, Thailand

#### **Session 4: Current status of cryopreservation research and future perspectives of its application in national programs**

*Chaired by Dr. H.F. Chin, International Plant Genetic Resources Institute (IPGRI), Italy*

- [India]: Cryopreservation research in India: Current status and future perspectives. B.B. Mandal, National Bureau of Plant Genetic Resources, India
- [Malaysia]: Current status of cryopreservation research and future perspectives of its application in Malaysia. M.N. Normah, Universiti Kebangsaan Malaysia, Malaysia
- [Indonesia]: Cryopreservation of tropical plants: Current research status in Indonesia. E. Sudarmonowati, Indonesian Institute of Sciences, Indonesia
- [Thailand]: Status and future prospects of cryopreservation in Thailand. C. Kirdmanee, National Center for Genetic Engineering and Biotechnology, Thailand
- [Philippines]: Philippines: Conservation and cryopreservation research. A. Zamora University of the Philippines Los Baños, the Philippines
- [Vietnam]: Current status and future perspectives of plant cryopreservation in Vietnam. N.T. Thinh, Nuclear Research Institute, Vietnam
- [China]: Cryopreservation of plant germplasm in China. T. G. Lu, Chinese Academy of Sciences, China
- [South Africa]: Current status of cryopreservation research and future perspectives of its application in South Africa. P. Berjak, University of Natal, South Africa
- [Nigeria]: Applying cryopreservation techniques in national programs in Nigeria. P.M. Kyesmu, University of Jos, Nigeria
- [Costa Rica]: Current status of cryopreservation research and future perspectives for its application in Costa Rica. A. A. Esquivel, Costa Rica Institute of Technology, Costa Rica
- [South Pacific]: Current status of cryopreservation research and future perspectives of its application in the South Pacific. M. Taylor, Secretariat for the Pacific Community, Fiji

***General Discussion and Summarization***

*Chaired by Dr. H.F. Chin, International Plant Genetic Resources Institute (IPGRI), Italy*

- Dr. Barbara M. Reed, United States Department of Agriculture-Agricultural Research Station, USA
- Dr. M.N. Normah, Universiti Kebangsaan Malaysia, Malaysia
- Dr. Bart Panis, Catholic University of Leuven, Belgium
- Dr. Masaya Ishikawa, National Institute of Agrobiological Resources (NIAR), Japan

***Closing address***

*Dr. Florent Engelmann, International Plant Genetic Resources Institute (IPGRI), Italy*



## FOURTH SEMINAR FOR “BRACKISH WATER PROJECT” HELD IN MALAYSIA

On December 8-9, 1998, the 4th “Brackish Water Project” seminar was held in the Conference Room of the Hotel Equatorial Penang, Penang, Malaysia. This project, “Productivity and Sustainable Utilization of Tropical and Subtropical Brackish Water Mangrove Ecosystems,” aims to evaluate the productivity of the above areas and identify the criteria for sustainable resource utilization. The west coast of Peninsular Malaysia was initially selected as the study area due to the presence of various managed or exploited types of mangrove forests. Project counterpart organizations include the Fisheries Research Institute (FRI), the University of Malaya (UM), and the Forest Research Institute of Malaysia (FRIM).

Subjects addressed in the seminar were as follows: 1) forest and litter fall, 2) benthic communities, 3) aquatic organisms, 4) socio-economic aspects, and 5) environmental aspects. About 40 scientists and government officials from Japan, Malaysia, and Australia participated in the seminar, which included the presentation of fourteen papers. Mr. Hashim Ahmad, Deputy Director General, Department of Fisheries, Malaysia, gave the opening address and Dr. Shiroh Uno of JIRCAS presented closing remarks. The contents of seminar presentations are summarized below.

### *Forest and litter fall*

- Litterfall of three different vegetations in the Matang Mangrove Forest, Peninsular Malaysia. Y. Ochiai, Japan International Research Center for Agricultural Sciences (JIRCAS), H. Tanouchi, S. Nakamura, Forestry and Forest Products Research Institute(FFPRI), Japan and A. Hassan, Forest Research Institute of Malaysia (FRIM)
- Stand structures and aboveground biomass of *Rhizophora apiculata* and *Rhizophora bruguiera* mixed forests in Matang, Perak, Malaysia. S. Nakamura, H. Tanouchi, Forestry and Forest Products Research Institute(FFPRI), Japan, Y. Ochiai, Japan International Research Center for Agricultural Sciences (JIRCAS), and A. Hassan, Forest Research Institute of Malaysia (FRIM)
- Biomass profile of a *Rhizophora-Bruguiera* forest in Matang, Perak, Peninsula Malaysia. S. Nakamura, H. Tanouchi, Forestry and Forest Products Research Institute(FFPRI), Japan, Y. Ochiai, Japan International Research Center for Agricultural Sciences (JIRCAS), and A. Hassan, Forest Research Institute of Malaysia (FRIM)
- Benthic diatoms and their possible contributions to the diet of herbivorous gastropods in mangrove areas in Okinawa, Japan. T. Kawamura, National Food Research Institute, Japan
- Relationship between meiofauna biomass and logging residues in mangrove: Three post-felling temporal and spatial variations. S. Ibrahim, Forest Research Institute of Malaysia (FRIM)
- Benthic macrofaunal distribution in the Sungai Selinsing, Matang Mangrove Forest Reserve, M. A. S. Hussein, A. Sasekumar and C. V. Ching, University of Malaysia (UM)
- Importance of mangroves toward sustainable fisheries resources on the west coast of Peninsular Malaysia (Research Scope). K. Kiso, Japan International Research Center for Agricultural Sciences (JIRCAS) and M. M. Isa, Fisheries Research Institute (FRI), Malaysia
- Comparison of ecological and taxonomic features of *Scylla* sp., in Balik Pulau, Merbok and Matang Mangroves. C. Daniels and C. P. Sze, Fisheries Research Institute (FRI), Malaysia
- Fish distribution and abundance in Matang / Merbok Mangrove brackish waters on the west coast of Peninsular Malaysia: Results in 1997 / 1998. S. Hayase, Seikai National Fisheries Research Institute, Japan
- Prawn production in the Matang and Sungai Dinding Mangroves: Species distribution and seasonal recruitment. L. C. Beng, C. V. Ching and L.H.S. Lim, University of Malaysia (UM), S. Hayase, Seikai National Fisheries Research Institute, Japan
- Sustainable commercialized utilization and local response to the wise use of Matang Mangroves. L. H. Fui, Forest

Research Institute of Malaysia (FRIM)

Physico-chemical environment of the Matang and Sungai Dinding Mangroves (Malaysia). C. V. Ching, A. Sasekumar, L. C. Beng and M. A. S. Hussein, University of Malaysia (UM)

Influence of nutrient out-welling from the mangrove swamps on the distribution of phytoplankton in the Matang Mangrove Estuary, Malaysia. K. Tanaka, National Research Institute of Fisheries Science (NRIFS), Japan and C. P. Sze, Fisheries Research Institute (FRI), Malaysia

Environmental valuation of the utilization of mangrove forests in the Kuala Selangor District, Selangor (Malaysia). L. L. Fun, University of Malaysia(UM)

---





## WORKSHOPS and SEMINARS

### International Research Seminars

International research seminars are held throughout the year, either at JIRCAS premises or overseas, with foreign guests, Japanese specialists, or JIRCAS staff presenting on topics of importance to international agricultural research. The following four seminars were held in FY 1998.

- September 8, 1998      **Research activities at the Australian Center for International Agricultural Research (ACIAR)**  
*Greg Johnson, Australian Center for International Agricultural Research (ACIAR)*
- December 1-2, 1998      **High-value timber species for plantation establishment-teak and mahoganies**  
*Datuk Musa Haji Aman, INNOPRISE Corp., Malaysia, Haman Anjin, Sabah Forestry Department, Indonesia, and Kiyoshi Tanaka, Japan International Research Center for Agricultural Sciences (JIRCAS)*
- December 8-9, 1998      **Fourth seminar on productivity and sustainable utilization of tropical and subtropical brackish water mangrove ecosystems**  
*Hashim Ahmad, Department of Fisheries, Malaysia, and Shiro Uno, Japan International Research Center for Agricultural Sciences (JIRCAS)*
- March 17, 1999      **Evaluation, restoration, and preservation of soil productivity to establish sustainable agricultural systems in Sub-Saharan Africa**  
*Hank Breman, International Fertilizer Development Center (IFDC-Africa)*

### International Research Workshops

Attended jointly by JIRCAS researchers and foreign invitees, these workshops aim to facilitate discussion regarding the numerous collaborative research projects which JIRCAS is currently undertaking with counterpart institutions throughout the world.

- November 26, 1998      **Workshop on food supply-demand and extension systems for new agricultural technology in China**  
*Attended by representatives of JIRCAS; the Institute of Agricultural Economics, Chinese Academy of Agricultural Sciences (CAAS), People's Republic of China; Niigata University, and Tottori University, Japan*
- December 9, 1998      **Workshop on new technologies for the development of sustainable agriculture in northeast Thailand**  
*Attended by representatives of JIRCAS, the National Agricultural Research Center (NARC) and the Forestry and Forest Products Research Institute (FFPRI), Japan*
- February 22, 1999      **Workshop on development of utilization technology of freshwater fisheries resources**  
*Attended by representatives of JIRCAS; Shanghai Fisheries University, People's Republic of China; National Research Institute of Fisheries Science, the University of Tokyo, Hokkaido University, and Kyoto University, Japan*



March 3-4, 1999

**Learning from farming systems research experiences in Indonesia**

*Attended by representatives of JIRCAS, National Agricultural Research Center (NARC), National Research Institute of Agricultural Economics (NRIAE), Japan; Agency for Agricultural Research and Development (AARD), Center for Agro-Socio Economic Research (CASER), Center for Soil and Agroclimate Research (CSAR), Central Research Institute for Food Crops (CRIFC), Indonesia; Virginia Polytechnic Institute & State University, USA; and Australian Center for International Agricultural Research (ACIAR), Australia*

March 12, 1999

**Workshop on extension of new agricultural technology and evaluation of the effects of its extension in China**

*Attended by representatives of JIRCAS; the Institute of Agricultural Economics, Chinese Academy of Agricultural Sciences (CAAS), People's Republic of China*

March 23-25, 1999

**Workshop on evaluation and development of methods for sustainable agriculture and environmental conservation**

*Attended by representatives of JIRCAS; Chinese Academy of Agricultural Sciences (CAAS), the Institute of Soils and Fertilizers Agricultural Economics, CAAS, the Institute of Soil Science, Academia Sinica, People's Republic of China*

March 24, 1999

**Workshop on the management of biotic agents in direct seeded culture in Malaysia**

*Attended by representatives of JIRCAS; the Muda Agricultural Development Authority (MADA) and the Malaysian Agricultural Research and Development Institute (MARDI), Malaysia; and Saga University and Fukuoka Agricultural Research Center, Japan*





## **MISCELLANEOUS MEETINGS and** **WORKING GROUPS**

### **Annual Meeting for Review and Promotion of Research**

JIRCAS conducts its Annual Meeting for the Review and Promotion of Research for International Collaboration in February, as the end of the fiscal year approaches. The purpose of the meeting is to review and evaluate the year's activities in detail in preparation for the subsequent fiscal year. All operations of JIRCAS are outlined, and research achievements deemed of particular importance are highlighted (see Research Overview: Research Division topics for more detail). Those in attendance at the meeting include JIRCAS directors and invited representatives from the Agriculture, Forestry and Fisheries Research Council (AFFRC), the Forestry Agency, the Fisheries Agency, and various research institutes affiliated with the Ministry of Agriculture, Forestry and Fisheries. In 1998, the meeting considered, as its principal theme, the agricultural field in current international cooperative efforts. Recognizing the importance of preserving and stabilizing food and environmental resources, the meeting focused on ways to advance JIRCAS's comprehensive project research in developing countries. Participants agreed that the comprehensive approach to regional agricultural problems, with its method of strategic planning and policy suggestions followed by multi-disciplinary research including socio-economic studies, best fulfilled JIRCAS commitment to international cooperation in agriculture.

### **JIRCAS Return Seminars**

At JIRCAS, researchers returning from overseas dispatches or research projects give an oral presentation accompanied by a written summary of activities which is distributed to JIRCAS staff. These sessions are termed "JIRCAS Return Seminars" and are held during the interim or upon the completion of research projects and dispatch assignments. Such seminars are ordinarily held twice per month, and each year approximately thirty scientists give presentations.

### **Review and Promotion of International Research Collaboration - Committee Meetings**

A series of committee meetings are convened throughout the year in order to review and promote international collaborative research. This body, which is responsible for all executive decisions pertaining to JIRCAS's activities, is headed by the Director of the Research Planning and Coordination

Division and consists of all directors of the Research Divisions and International Research Coordinators. Under this body, arrangements concerning dispatches of JIRCAS researchers on overseas assignments, project support by other domestic institutions are evaluated and authorized; the committee members are as well responsible for the evaluation of on-going projects and final decisions concerning the implementation of new research projects.

## **Comprehensive Project Working Group Meetings**

During FY 1997, participants in eight comprehensive research projects gathered regularly in working groups to discuss the structure and progress of their studies on Mekong Delta farming systems, sustainable agricultural systems in northeastern Thailand, brackish water mangrove ecosystems in Malaysia, sustainable agropastoral systems in subtropical Brazil, the food production and distribution industries in the People's Republic of China, soybean cultivation in the Southern Cone of South America, rainfed rice cultivation in West Africa, and regional farming systems in Indonesia. Researchers studying Malaysia, Thailand, and Indonesia held formal meetings as highlighted above in this section. Beginning in 1999, researchers involved in the development of new technologies and their practice for sustainable farming systems in the Mekong Delta will also convene in similar discussion sessions to evaluate the progress of their project.



***PUBLISHING AT JIRCAS during FISCAL YEAR 1998*****Official JIRCAS Publications**

In English	
1) JIRCAS Journal for Scientific Papers	No. 6, No. 7
2) JARQ (Japan Agricultural Research Quarterly)	Vol. 32 - No. 2, No. 3, No. 4 Vol. 33 - No. 1
3) Annual Report	No. 4 (1997)
4) JIRCAS Newsletter	No. 15, No. 16, No. 17, No. 18
5) JIRCAS International Symposium Series	No. 7 Postharvest Technology in Asia
6) JIRCAS Working Report	No. 13 No-tillage Cultivation of Soybean and Research Needs in South America      Future No. 14 Proceedings of Workshop on Heat-      tolerance of Crops
7) JIRCAS/IPGRI Joint Workshop	Cryopreservation of Tropical Plant Germplasm

## In Japanese

1) JIRCAS News	No. 15, No. 16, No. 17, No. 18
2) JIRCAS Working Report	No.12 Current State and View of International Collaborative Research in Fisheries Postharvest Technology
3) JIRCAS International Agriculture Series	No. 5 Insect resources in Asia No. 6 Supply and Demand for World Food Resources
4) JIRCAS Research Highlights	No. 5

***OFFICIAL HOLDINGS of the JIRCAS LIBRARY***

(Between April 1,1998 – March 31, 1999)

	<i>BOOKS</i>			<i>PERIODICALS (titles)</i>			<i>MATERIALS (Proceedings, maps, etc.)</i>		
	<i>Purchase</i>	<i>Gift</i>	<i>Total</i>	<i>Purchase</i>	<i>Gift</i>	<i>Total</i>	<i>Purchase</i>	<i>Gift</i>	<i>Total</i>
<i>Japanese</i>	32 (17)	311 (1)	343 (18)	35 (29)	450 (8)	475 (37)	10	440	450
<i>Foreign</i>	47 (4)	403 (0)	450 (4)	97 (28)	570 (11)	667 (39)	10	200	210

<i>Total</i>	79 (21)	714 (1)	793 (22)	132 (57)	1020 (19)	1152 (76)	20	640	660
--------------	------------	------------	-------------	-------------	--------------	--------------	----	-----	-----

( ) Indicates separate holdings of the Okinawa Subtropical Station.

---

**BACK**

# RESEARCH STAFF ACTIVITY during FISCAL YEAR 1998

## Contents

- [Journal Articles, Book Chapters, and Monographs](#)
- [Published Proceedings and Conference Presentations](#)
- [Explanation of Symbols Used in Citations](#)

## Journal Articles, Book Chapters, and Monographs

- Asanuma, S.** (1998). Agricultural research and development (R & D) and policy in Indonesia. *International Cooperation of Agriculture and Forestry*, 21(6): 369-386. (J)
- Baset, A., **Tobita, S.**, Li, C. Y., **Yashima, S.** and Senboku, T. (1998). Micropropagation and in vitro culture of wild rice species. *Acta Horticulturae*, 461: 259-266.
- Cai, Z., Shen, G., Yan, X., Tsuruta, H., **Yagi, K.** and Minami, K. (1998). Effects of soil texture, soil temperature and Eh on methane emissions from rice paddy fields. *Acta Pedologica Sinica*, 35(2): 145-154.
- Cai, Z., Xing, G., Shen, G., Xu, H., Yan, X., Tsuruta, H., **Yagi, K.** and Minami, K. (1999). Measurement of CH₄ and N₂O emissions from rice paddies in Fengqiu, China. *Soil Science and Plant Nutrition*, 45(1): 1-13.
- Dhillon, N. P. S. and **Ishiki, K.** (1998). Yield stability of gynococious F1 hybrids of cucumber in subtropical field conditions. *Advances in Horticultural Science*, 12: 183-185.
- Dionisio-Sese, M. D. and **Tobita, S.** (1998). Antioxidant responses of rice seedlings to salinity stress. *Plant Science*, 135: 1-9.
- Goto, J.** (1998). Visit to an experimental farm in the Mekong Delta, Vietnam. *Journal of the Rural Planning Association*, 17(3): 225-232. (J)
- Gunarto, L., **Adachi, K.** and Senboku, T. (1999). Isolation and selection of indigenous *Azospirillum* spp. from a subtropical island, and the effects of inoculation on growth of lowland rice under several levels of N application. *Biology and Fertility of Soils*, 28(2): 129-135.
- Hamanishi, T., **Hatta, T.**, Jong, F.S., Takahashi, S. and Kainuma, K. (1998). Physicochemical properties of starches obtained from various parts of Sago Palm trunks at different growth stages. *Journal of Applied Glycoscience*, 46(1): 39-48. (J)
- Hamazaki, T.** (1998). Classification of cultivated soils in Japan: Third approximation. *Japanese Journal of Soil Science and Plant Nutrition*, 69(2): 206-211. (J)
- Hashino, Y., Fujii, T., **Yoshihashi, T.**, Nakamura, S. and Ohtsubo, K. (1998). Cultivar identification of milled rice within 21 domestic varieties. *Journal of the National Food Research Institute*, 62: 9.
- Hidaka, T.** (1999). Tropical and subtropical fruits in Japan. *Saplings of Fruit Trees*, 73: 15-18. (J)
- Hien, T.T.T., Minh, T.H., Phuong, N.T. and **Wilder, M. N.** (1998). Current status of freshwater prawn culture in the Mekong River Delta of Vietnam. *JIRCAS Journal*, 6: 89-100.
- Hiraoka, H.**, Kanetani, Y. and Kin, H. N. (1998). Farm operation and seedling establishment in dry seeding of rice in the Muda area of Malaysia. *International Symposium on Wild and Weedy Rices in Agro-ecosystems, Ho Chi Minh, Vietnam*: 147-154.

- **Hiraoka, H.** (1998). Compromised direct seeding culture of rice in Northern Island of Japan. Agricultural Extension Institute: 201-209. (J)
- **Ikegami, A.** (1999). Outlook and situation of Chinese agriculture. Journal of the Japan-China Economic Association, 63: 43-51. (J)
- **Ikegami, A.** (1999). The present situation and problems of grain marketing systems. Chinese Agriculture in 1998: 89-101. (J)
- **Ikegami, A.** (1999). The present situation of agricultural extension systems. Chinese Agriculture in 1998: 79-88. (J)
- **Inagaki, M. N.,** Varughese, G., Rajaram, S., van Ginkel, M. and Mujeeb-Kazi, A. (1998). Comparison of bread wheat lines selected by doubled haploid, single-seed descent and pedigree selection methods. Theoretical and Applied Genetics 97(4): 550-556.
- **Inagaki, M. N.,** Pfeiffer, W. H., Mergoum, M. and Mujeeb-Kazi, A. (1998). Variation of the crossability of durum wheat with maize. Euphytica 104(1): 17-23.
- **Inagaki, M. N.** and Hash, C. T. (1998). Production of haploids in bread wheat, durum wheat and hexaploid triticale crossed with pearl millet. Plant Breeding 117(5): 485-487.
- **Ise, K.** (1998). A close relationship in rice cultivation and cultivars between an African country, Rwanda, and Yunnan Province, China. Agriculture and Horticulture, 73(7): 768-774. (J)
- **Ise, K.,** Li, C., Sun, Y. and Ye, C. (1998). Inheritance of resistance to bacterial leaf blight in the differential rice variety Asominori. International Rice Research Notes, 23(3): 13-14.
- **Ise, K.,** Sun, Y. and Liu, J. (1998). Japan and China joint program for rice breeding using a wide diversity of genetic resources in Yunnan Province, China. Breeding Research, 1(1): 9-13. (J)
- **Ise, K.,** Sun, Y., Liu, J., Zhou, T. and Jiang, Z. (1998). Wide adaptability of new rice cultivars developed by the Japan-China collaborative project in Yunnan, China. International Rice Research Notes, 23(2): 21-22.
- **Ishikawa, A.** and **Kohno, K.** (1999). New record of Dilpatys (*Syndiplatys*) flavicollis (*Dermaptera: Diplatyidae*) from Japan. Tettigonia, 1(2): 99-100.
- **Ishiki, K.** (1998). Visit to the center of the origin of yacon. Report of the Association of Yacon Research, 1: 10. (J)
- **Ishitani, T.** (1998). Food preservation techniques. Data Book of Food Processing and Distribution: 471-531.
- **Ishitani, T.** (1999). Diverse processed soybean foods and food culture in Asia. Farming Japan, 33(1): 21-26.
- **Ishitani, T.** (1999). Modified atmosphere packaging: Packaging materials for food and food distribution. Food Preservation Technology: 219-261.
- **Ishitani, T.** (1999). The processing of rice noodles in Asia. Food Processing for Regional Use: 217-232.
- **Ishitani, T.** (1999). Viewpoints on processed food development as regional specialties. Farming Japan, 33(1): 9-15.
- **Ito, O.** (1998). Strategy for rice production technologies at IRRI. In: Sustainable Agricultural Development Compatible with Environmental Conservation in Asia. JIRCAS: 191-202.
- **Kanda, K.** and Suga, Y. (1998). Effect of irrigation intensity and soil temperature on the nitrate concentration in leaching water from upland soil. Japanese Journal of Soil Science and Plant Nutrition, 69(3): 249-255. (J)
- **Kasuga, M.,** Liu, Q., Miura, S., **Yamaguchi-Shinozaki, K.** and Shinozaki, K. (1999). Improving plant drought, salt, and freezing tolerance by gene transfer of a single stress-inducible transcription factor. Nature Biotechnology, 17: 287-291.
- **Katayama, K., Ito, O.** and Rao, T. P. (1998). Seedling characteristics and retention of current photosynthates in leaves in relation to initial growth in pigeonpea (*Cajanus cajan* L. Mill sp.) and cowpea (*Vigna sinensis* Endl.). Soil Science and Plant Nutrition, 44(3): 477-480.



- Kato, K., Kikuchi, S., **Ando, S.** and Arima, Y. (1998). Nitrate adaptability of Rhizobium sp.(Phaseolus) strains isolated from Tokachi (Hokkaido, Japan) fields revealed in symbiosis parameters with a common bean cultivar. *Japanese Journal of Soil Science and Plant Nutrition*, 69(5): 506-515. (J)
- Kato, K., Chairroj, P., **Yagi, K.**, Tsuruta, H. and Cholitkul, W. (1998). Effects of rice straw application, rice planting and soil characteristics on methane flux in pot experiments. *Soil Microorganisms*, 51: 73-78.
- Khawas, H. and **Adachi, K.** (1999). Identification and quantification of auxins in a cultural medium of *Azospirillum* and *Klebsiella* and their effect on rice roots. *Biology and Fertility of Soils*, 28(4): 377-381.
- **Kohno, K.** (1998). Thermal effect on reproductive diapause induction in *Orius sauteri* (*Heteroptera: Anthocoridae*). *Applied Entomology and Zoology*, 33(4): 487-490.
- **Kohno, K.** and Kashio, T. (1998). Development and prey consumption of *Orius sauteri* (*Poppius*) and *O. minutus* (L.) (*Heteroptera: Anthocoridae*) fed on *Frankliniella occidentalis* (Pergande) (*Thysanoptera: Thripidae*). *Applied Entomology and Zoology*, 33(2): 227-230.
- **Kokubun, M.** (1998). International collaboration on soybean research in South America. *Journal of Agricultural Science* 53(8):374-377. (J)
- **Kokubun, M.** (1998). No-tillage cultivation of soybean and future research needs in South America. JIRCAS Working Report No.13, 118pp.
- **Komori, S.**, Soejima, J., Ito, Y., Bessho, H., Abe, K. and Kotoda, N. (1998). Analyses of the self-incompatibility genotypes in some apple cultivars. *Journal of the Japanese Society for Horticultural Science*, 67(6): 917-926. (J)
- **Komori, S.**, Soejima, J., Kudo, K., Komatsu, H., Abe, K. and Kotoda, N. (1998). Selection of apple cultivars and strains possessing the Sg-allele. *Journal of the Japanese Society for Horticultural Science*, 67(Supplement 2): 175. (J)
- **Komori, S.**, Soejima, J., Kudo, K., Komatsu, H., Kyotani, H., Ito, Y., Bessho, H., Abe, K. and Kotoda, N. (1999). Selection of apple cultivars and strains corresponding to each S-allele genotype. *Journal of the Japanese Society for Horticultural Science*, 68(1): 73-82. (J)
- **Komori, S.**, Soejima, J., Kudo, K., Kyotani, H., H., Abe, K., Kotoda, N., Komatsu, H., Ito, Y. and Bessho, H. (1998). Determination of S-allele genotypes of 21 apple cultivars and confirmation of 45 others by controlled crosses. *Journal of the Japanese Society for Horticultural Science*, 67(6): 880-889. (J)
- Kuroda, S., **Kato, H.** and Ikeda, R. (1998). Heterosis and combining ability for callus growth rates in rice. *Crop Science*, 38: 933-936. (J)
- Kyono, A., Kimata, K., Shimizu, M., Saito, S., Nishida, N. and **Hatta, T.** (1999). Synthesis of thallium-leucite pseudomorph after analcime. *Mineralogical Magazine*, 63(1): 75-83.
- Liu, J. and **Shono, M.** (1999). Characterization of the mitochondrial-located small heat shock protein from the tomato (*Lycopersicon esculentum* L.). *Plant & Cell Physiology*, 40(Supplement): 107.
- Liu, Q., **Kasuga, M.**, Sakuma, Y., Abe, H., Miura, S., **Yamaguchi-Shinozaki, K.** and Shinozaki, K. (1998). Two transcription factors, DREB1 and DREB2, with an EREBP/AP2 DNA binding domain separate two cellular signal transduction pathways in drought- and low-temperature-responsive gene expression, respectively, in Arabidopsis. *Plant Cell*, 10: 1391-1406.
- **Maoka, T.** (1998). Dwarf of *Eutrema wasabi maxim.* *In: Plant Disease in Japan, Zenkoku Nouseon Kyouiku Kyoukai*, Ed. Kishi, K., Tokyo, Japan: 366-367. (J)
- **Maoka, T.** (1998). Papaya leaf-distortion mosaic. *In: Plant Disease in Japan, Zenkoku Nouseon Kyouiku Kyoukai*, Ed. Kishi, K., Tokyo, Japan: 758-759. (J)
- **Maoka, T.** (1998). Viruses of *Eutrema wasabi maxim.* *In: Plant Disease in Japan, Zenkoku Nouseon Kyouiku Kyoukai*, Ed. Kishi, K., Tokyo, Japan: 367. (J)
- **Maoka, T.** (1998). Viruses of cucumber. *In: Plant Disease in Japan, Zenkoku Nouseon Kyouiku Kyoukai*, Ed. Kishi, K.,

Tokyo, Japan: 377-378. (J)

- Matsumoto, S., **Komori, S.**, Kitahara, K., Imazu, S. and Soejima, J. (1999). S-genotypes of 15 apple cultivars and self-compatibility of "Megumi." *Journal of the Japanese Society for Horticultural Science*, 68(2): 236-241. (J)
- Matsuoka, M.**, Fukuoka, H., Ogawa, T., Yano, H., Ujihara, K. and Sugimoto, H. (1998). Efficient plant regeneration from sugarcane protoplast. *Plant Biotechnology*, 15(3): 135-137.
- Mikami, K., Katagiri, T., Iuchi, S., **Yamaguchi-Shinozaki, K.** and Shinozaki, K. (1998). A gene encoding phosphatidylinositol-4-phosphate 5-kinase is induced by water stress and abscisic acid in *Arabidopsis thaliana*. *Plant Journal*, 15: 563-568.
- Minami, K. and **Yagi, K.** (1998). Mitigation of methane emissions from rice cultivation. *Global Environmental Research*, 2(1): 15-19.
- Mishima, S., **Matsumoto, N.** and Oda, K. (1998). Database for estimation of nitrogen flow in a region. *In: Ecosystems and Sustainable Development*. Ed. Uso, J. L., Brebbia, C. A. and Power, H. Computational Mechanics Pub., Southampton, UK: 243-252.
- Miyata, S., **Urao, T.**, **Yamaguchi-Shinozaki, K.** and Shinozaki, K. (1998). Characterization of genes for two-component phosphorelay mediators with a single HPT domain. *FEBS Letters*, 437: 11-14.
- Mukherjee, S. K. and **Asanuma, S.** (1998). Possible role of cellular phosphate pool and subsequent accumulation of inorganic phosphate on aluminum tolerance in *Bradyrhizobium japonicum*. *Soil Biology and Biochemistry*, 30(12): 1511-1516.
- Nakahara, K.** and Trakoontivakorn, G. (1999). Antioxidant and antimutagenic properties of some edible Thai plants. *JIRCAS Newsletter*, 17: 5.
- Nakahara, K.**, Shinmoto, H., Kobori, M., Kameyama, M., Nagata, T. and Tsushida, T. (1998). 3T3-L1 adipose-differentiation inhibitors from miso. *Nougeikagaku*, 72(3): 111. (J)
- Nakashima, K.** and **Yamaguchi-Shinozaki, K.** (1998). Isolation of genes essential for molecular breeding of drought tolerant plants. *Research Journal of Food and Agriculture*, 21: 52-55. (J)
- Nakashima, K.**, Satoh R., Kiyosue T., **Yamaguchi-Shinozaki, K.** and Shinozaki, K. (1998). A gene encoding proline dehydrogenase is not only induced by proline and hypoosmolarity but is also developmentally regulated in reproductive organs in *Arabidopsis thaliana*. *Plant Physiology*, 118: 1233-1241.
- Ochiai, Y.** (1998). Research at the Matang Mangrove Forest in Peninsular Malaysia. *JIRCAS News*, 17: 8. (J)
- Ochiai, Y.** (1999). Silvics of tropical trees in Meranti Sarang Punai. *Tropical Forestry*, 44: 86-88.
- Ohtsu, Y.**, Nakashima, K., Prommintara, M. and Tomiyasu, Y. (1999). Typical symptoms of citrus greening on mandarin trees in Nepal, supported by detection and characterization of ribosomal DNA of the causal organisms. *Annals of the Phytopathological Society of Japan*, 64: 532-545.
- Ohwaki, Y.** (1998). Comparative studies on phosphorus and iron nutrition of tropical legumes. *Japanese Journal of Soil Science and Plant Nutrition*, 69(3): 239-240. (J)
- Rao, T. P. and **Ito, O.** (1998). Differences in root system morphology and root respiration in relation to nitrogen uptake among six crop species. *Japan Agricultural Research Quarterly*, 32(2): 97-103.
- Sanetra, C. M., **Ito, O.**, Virmani, S. M. and Vlek, P. L. G. (1998). Remobilization of nitrogen from senescing leaves of pigeonpea (*Cajanaou cajan* (L.) Millsp.): Genotypic differences across maturity groups? *Journal of Experimental Botany*, 49: 853-862.
- Shinmoto, H., **Nakahara, K.**, Ichikawa, R., Kobori, M. and Tsushida, T. (1998). Preparation of human immortalized B-cells secreting antibodies against food allergens. *Biotechnology Techniques*, 12(7): 545-547.
- Shinmoto, H., **Nakahara, K.**, Ichikawa, R., Kobori, M. and Tsushida, T. (1998). Establishment of human-mouse hybridomas secreting antibodies to rice-allergens. *The Japanese Association for Animal Cell Technology and the European*

- **Shinogi, Y.**, Nakano, Y. and Kuroda, M. (1998). Simulation and evaluation on irrigation water planning affected by factors concerning growing stage and meteorological conditions. *Transaction of the Japan Society of Irrigation, Drainage and Reclamation Engineering*, 193: 9-16. (J)
- Shinozaki, K., **Yamaguchi-Shinozaki, K.**, Mizoguchi, T., **Urao, T.**, Katagiri, T., Nakashima, K., Abe, H., Ichimura, K., Liu, Q., Nanjyo, T., Uno, Y., Inchi, S., Seki, M., Ito, T., Hirayama, T. and Mikami, K. (1998). Molecular responses to water stress in *Arabidopsis thaliana*. *Journal of Plant Research*, 111: 345-351.
- Shinozaki, K., **Yamaguchi-Shinozaki, K.**, Mizoguchi, T., **Urao, T.**, Katagiri, T., Hirayama, T., Ichimura, K., Abe, H. and Mikami, K. (1998). Role of MAP kinase, two component histidine kinase and calcium dependent protein kinase in water stress response. *In: Protein Phosphorylation in Plants*, Eds. Gadal, P., Dron, M., Brulfert, J., Bergounioux, C., and Vidal, J., Institute de Biotechnologie des Plantes: Orsay, France: 11-17.
- Shinwari, Z. K., **Nakashima, K.**, Miura, S., **Kasuga, M.**, Seki, M., **Yamaguchi-Shinozaki, K.** and Shinozaki, K. (1998). An *Arabidopsis* gene family encoding DRE/CRT binding proteins involved in low-temperature-responsive gene expression. *Biochemical and Biophysical Research Communications*, 250: 161-170.
- Sun, Y., **Ise, K.**, Okuno, K., Zhou, Y. and Yang, X. (1998). Genetic analysis of five low amylose content mutants induced from the Japonica rice Hexi 4. *Chinese Journal of Rice Science*, 13(1): 15-18. (C)
- Suzuki, Y., **Ise, K.**, Li, C., Honda, Y., Imai, Y. and Matsukura, U. (1999). Volatile components in stored rice [*Oryza sativa* (L.)] of varieties with and without lipoxygenase-3 in seeds. *Journal of Agricultural and Food Chemistry*, 47(3): 1119-1124.
- Taji, T., Seki, M., **Yamaguchi-Shinozaki, K.**, Kamada, H., Giraudat, J. and Shinozaki, K. (1998). Mapping of 25 drought-inducible genes, RD and ERD, in *Arabidopsis thaliana*. *Plant Cell Physiology*, 40: 119-123.
- Takase, K. and **Yagi, K.** (1999). Environmental issues. *In: Advanced Paddy Field Engineering*, Eds. Mizutani, M., Hasegawa, S., Koga, K., Goto, A. and Murty, V. V. N., Shizan-Sha Science & Technology, Tokyo: 341-365.
- **Terauchi, T.**, **Matsuoka, M.**, Kobayashi, M. and Nakano, H. (1999). Effect of temperature and fertilizer application on sugar accumulation in relation to invertase activity in sugarcane. *Japanese Journal of Tropical Agriculture*, 43(1): 18-25. (J)
- Thinh, N.T., **Takagi, H.** and **Yashima, S.** (1999). Cryopreservation of *in vitro*-grown shoot tips of banana (*Musa* Spp) by the vitrification method. *Cryo Letters*, 20(3): 163-174, 461, 485-494.
- **Uchida, S.** (1998). Extraction of soil characteristics and monitoring of agricultural land use in the semi-arid tropics of India using remote sensing. *JIRCAS Journal*, 6: 39-52.
- Uno, Y., **Urao, T.**, **Yamaguchi-Shinozaki, K.**, Kanechi, M., Inagaki, N., Maekawa, S. and Shinozaki, K. (1998). Early salt-stress effects on expression of genes for aquaporin homologues in the halophyte sea aster (*Aster tripolium* L.) *Journal of Plant Research*, 111: 411-419.
- **Urao, T.**, **Yakubov, B.**, **Yamaguchi-Shinozaki, K.** and Shinozaki, K. (1998). Stress-responsive expression of genes for two-component response regulator-like proteins in *Arabidopsis thaliana*. *FEBS Letters*, 427: 175-178.
- **Wilder, M.N.**, Ikuta, K., Atomomarsono, M., **Hatta, T.** and Komuro, K. (1998). Changes in osmotic and ionic concentrations in the hemolymph of *Macrobrachium rosenbergii* exposed to varying salinities and correlation to ionic and crystalline composition of the cuticle. *Comparative Biochemistry and Physiology, Part A*, 119: 941-950.
- **Yamada, R.** (1998). The meaning and problems of the support systems for regional agriculture and forestry in hilly and mountainous areas: A case study in the hilly and mountainous areas of Shikoku. *Japanese Journal of Farm Management*, 36(1): 169-174. (J)
- **Yamada, R.** (1997). Significance and Direction of Forest Use in Hilly and Mountainous Areas.
- **Yamada, R.**, Vo, Q. M., **Hiraoka, H.** and Nguyen, V. S. (1999). Classification of farming systems in the Mekong Delta. *Journal of Rural Problems*, 7(Special Issue): 159-164.
- **Yamada, Y.** (1998). Agricultural Production and Agro-Environmental Changes in Northeast Thailand. *Papers of the*

annual meeting of the Japan Society of Photogrammetry and Remote Sensing: 7-10. (J)

- Yamada, Y.** (1998). Construction of a GIS database in northeast Thailand and its evaluation for agricultural land use. Papers of the Chiba University Environment Remote Sensing Research Center Symposium.
- Yamada, Y.** (1998). GIS technology application for agricultural development. ARDEC, 13: 4-14.
- Yamada, Y.** (1998). GIS and remote sensing technology application for agricultural development. JICA Training Course Text: 1-11.
- Yamada, Y.** (1998). Prototype system for international agricultural statistics using a web GIS tool. Papers for the GISA Annual Meeting, 7: 297-298.
- Yamada, Y.** (1998). The characteristics between agricultural changes and water resources in the food trade in northeast Thailand. Report of the Academic Meeting of Macro Indicators of the Agro-environment on Water Resources: 13-18.
- Yamaguchi-Shinozaki, K.** and Shinozaki, K. (1998). Molecular responses to water stress in plant drought tolerance and gene expression in plants. Agriculture and Horticulture, 73(5): 21-26. (J)
- Yamamoto, Y.** (1998). Achievement of the semi mountainous area study 5-3: Landscape conservation and amenity in grasslands. Agricultural Research Series of National Agricultural Research Center, 33: 352-358. (J)
- Yamamoto, Y.** (1999). Grassland planning and evaluation methods using a regional dataset. Animal Husbandry, 53(3): 356-360. (J)
- Yonemura, S., **Yajima, M.**, Sakai, H. and Morokuma, M. (1998). Estimation of Japanese rice yield under elevated CO₂ and increased temperature conditions by using third mesh climate data. Journal of Agricultural Meteorology, 54(3): 235-245. (J)
- Yoneyama, T. and **Ando, S.** (1999). Endophytic nitrogen fixation in non-leguminous plants. Radioisotopes, 48(1): 77-78. (J)
- Yoshihara, S.** (1998). Latest information on pig production in the Mekong Delta, Vietnam. All About Swine, 13: 17-25. (J)
- Yoshihara, S.**, Hung, N. H., Hung, N. P. and Goto, N. (1998). An erratic parasitism found in the lungs of sheep during experimental infection with *Fasciola gigantica* (Japanese strain). Journal of Helminthology, 72: 227-230.
- Yoshihara, S.**, Hung, N. H., Hung, N. P. and Kobayashi, M. (1998). Detection of the swine trematode, *Fasciolopsis buski*, in small scale farms in the Mekong Delta. JIRCAS Journal, 6: 53-58.
- Yoshihashi, T.**, Nakamura, S., Fujii, T., Kawasaki, S. and Ohtsubo, K. (1999). Identification of domestic rice cultivars by RAPD analysis using one grain of milled rice as a sample. Journal of the Japanese Society of Food Science and Technology, 46(4): 250-254. (J)

[return to top](#)

[back to main contents](#)

## **Published Proceedings and Conference Presentations**

- Abe, H., **Urao, T.**, **Yamaguchi-Shinozaki, K.**, Hosokawa, D. and Shinozaki, K. (1998). Analysis of an activation domain of an *Arabidopsis* MYC homologue rd22BP1. Plant and Cell Physiology, 39(Supplement): 105.
- Abe, H., **Urao, T.**, **Yamaguchi-Shinozaki, K.** and Shinozaki, K. (1999). Analysis of the regulation of drought-inducible gene expression of the *Arabidopsis* rd22 gene. Plant & Cell Physiology, 40(Supplement): 127. (J)
- Adachi, K.** (1998). Application of a separation method for hydrogen-utilizing methanogenic bacteria in subtropical paddy fields. Soil and Microorganisms, 52: 87. (J)

- **Ando, S.**, Meunchang, S., Thippayarugs, S., Prasertsak, P., Matsumoto, N., Wadisirisuk, P. and Yoneyama, T. (1998). Estimation of biological nitrogen fixation associated with field-grown sugarcane. Proceedings of the Third National Cane and Sugar Conference, Khon Kaen, Thailand: 274-278.
- **Ando, S.**, Meunchang, S., Thippayarugs, S., Prasertsak, P., Matsumoto, N., Wadisirisuk, P. and Yoneyama, T. (1999). Estimation of biological nitrogen fixation in field-grown sugarcane, cassava and pineapple in Thailand. *In: Highlights of Collaborative Research Activities between Thai Research Organizations and JIRCAS: Proceedings of JIRCAS Seminar in Bangkok 1999*, Eds. Suzuki, M. and Ando, S., Bangkok, Thailand: 44-46.
- **Ando, S.**, Meunchang, S., Wadisirisuk, P. and Yoneyama, T. (1998). Estimation of biological nitrogen fixation associated with field-grown pineapple in Thailand. Abstracts of the Third International Pineapple Symposium, Pattaya, Thailand: 26.
- **Ando, Y.** and Miyashita, K. (1998). Molecular cloning of gene encoding hydrolytic enzymes of chitin from a lytic bacterium, *Flexibacter* sp. FL824A. *Annals of the Phytopathological Society of Japan*, 64(4): 366. (J)
- **Ando, Y.**, Saito, A. and Miyashita, K. (1999). Analysis of chitinolytic-enzyme genes of *Flexibacter* sp. FL824A: A chitinase gene possessing two catalytic domains. *Nippon Nogeikagaku Kaishi*, 73(Extra issue): 28. (J)
- Arao, T., Paisanchoen, K. and **Matsumoto, N.** (1999). Changes of microbial biomass and community structure after application of organic matter in upland soil. *In: Highlights of Collaborative Research Activities between Thai Research Organizations and JIRCAS: Proceedings of JIRCAS Seminar in Bangkok 1999*, Eds. Suzuki, M. and Ando, S., Bangkok, Thailand: 49-52.
- Ban, T., **Suenaga, K.** and **Inagaki, M. N.** (1998). Genetic analysis of resistance to *Fusarium* head blight caused by *Fusarium graminearum* in wheat, II: Resistance of the local variety "Nobeokabouzu-komugi." *Breeding Science*, 48(Supplement 2): 258.
- Ban, T. and **Suenaga, K.** (1998). Genetic analysis of resistance to *Fusarium* head blight caused by *Fusarium graminearum* in wheat. *Proceedings of the 9th International Wheat Genetic Symposium*, Ed. Slinkard, A. E., 1: 192-196.
- Cadalen, T. and **Tobita, S.** (1999). Développement d'une capacité de marquage à l'ADRAO visant à l'identification de QTL et à leur utilisation en sélection pour des caractères tels que la compétition avec les adventices et la résistance à la sécheresse. Résumés des communications de l'Atelier sur le thème "Méthodes et Techniques de biochimie et de biologie moléculaire pour assister la sélection des espèces résistantes à la sécheresse". Thiès, Sénégal, Session III: 19. (F)
- **Chien, H. P.** (1998). Structure of pork production and its demand perspective in China. *Proceedings of the Annual Conference of the Agricultural Economics of Japan 1998*: 283-287. (J)
- **Chien, H. P.** (1998). Present situation and perspectives of feed production in China. *Journal of Agricultural Science*, 53(9): 33-40.
- Dhillon, N.P.S. and **Ishiki, K.** (1998). Genomic variation and genetic relationships in *Ipomoea* spp. based on RAPD analysis. *Breeding Science*, 48(Supplement 2): 210.
- Dhillon, N.P.S., Singh, P. P. and **Ishiki, K.** (1999). Screening of cucumber germplasm for downy mildew. *Breeding Research*, 1(Supplement 1): 191.
- Du, P. V. and **Noda, T.** (1999). Studies on some aspects of red stripe disease in the Mekong Delta. Planning Workshop on the Etiology of Red Stripe. Ho Chi Minh City, Vietnam.
- **Egawa, Y.**, Niide, T., Matsuura, S., **Suzuki, K.**, **Takeda, H.** and Nakano, H. (1998). Geographical distribution of *Vigna minima* var. minor, a wild relative of adzuki bean, in Ishigaki island, Okinawa prefecture and resistance to adzuki bean weevil. *Japanese Journal of Tropical Agriculture*, 42(Extra issue 2): 73-74. (J)
- **Egawa, Y.**, Tomooka, N. and Fujii, K. (1998). Heat tolerance of *Phaseolus vulgaris* 3. High-yielding ability of "Haibushi," a heat-tolerant snap bean variety, under summer cultivation on Ishigaki island, Okinawa prefecture. *Japanese Journal of Tropical Agriculture*, 42(Extra issue 2): 73-74. (J)
- El-Khawas, H. and **Adachi, K.** (1998). Response of lowland rice to inoculation with different plant growth-promoting rhizobacteria. *Soil and Microorganisms*, 52: 90.

- **Fukamachi, H.**, Kawamitsu, Y., **Komori, S.** and **Hidaka, T.** (1998). Effect of temperature on diurnal gas exchange characteristics in mangos. *Journal of the Japanese Society for Horticultural Science*, 67(2): 232. (J)
- **Goto, J.**, Mayrowani, H. and Agustian, A. (1999). A follow-up socio-economic study of the banana-based farming systems research project in Cibinong, Cianjur, West Java. CASER-JIRCAS International Workshop on Learning from Farming Systems Research Experiences in Indonesia, Bogor, Indonesia: 1-15.
- Hamada, A., Hayakawa, T., **Shono, M.**, Xia, T., Hayashi, Y. and Tanaka, A. (1999). Cloning and characterization of the Na⁺/H⁺ antiporter gene from the halophyte *Atriplex gmelini*. 1999 Annual Meeting and 39th Symposia of Japanese Society of Plant Physiologists, 168. (J)
- Hamada, A., Hayakawa, T., **Shono, M.**, Xia, T., Hayashi, Y. and Tanaka, A. (1999). Cloning and characterization of Na⁺/H⁺ antiporter gene from the halophyte *Atriplex gmelini*. *Plant & Cell Physiology* 40(Supplement): 100.
- **Hamazaki, T.**, Obara, H. and Kato, K. (1998). New classification system of Japan. *Summaries of the 16th World Congress of Soil Science*, 2: 764.
- Hashimoto, T. and **Asanuma, S.** (1998). Investigation on the effect of soil environmental factors on the activity of denitrification. Regional Annual Meeting of the Kyushu Branch of the Japanese Society for Soil Science and Plant Nutrition, Fukuoka, Japan. (J)
- **Hatta, T.**, Nemoto, S. and Kainuma, K. (1998). State analysis on the surface of starch. *Journal of Applied Glycoscience*, 45(3): 335. (J)
- Hayashi, T., **Kawashima, T.**, Chaithiang, R. and Gatkamalat, S. (1999). Nutritive value of para rubber seed for cattle and calves. *In: Highlights of Collaborative Research Activities between Thai Research Organizations and JIRCAS: Proceedings of JIRCAS Seminar in Bangkok 1999*, Eds. Suzuki, M. and Ando, S., Bangkok, Thailand:154-156.
- **Hidaka, T.** and **Komori, S.** (1998). Investigation of tropical and subtropical fruit crops on Okinawa Island. *Annual Report on Exploration and Introduction of Plant Genetic Resources*, 14: 39-43.
- **Hidaka, T.**, **Komori, S.** and **Fukamachi, H.** (1998). Effects of rooting methods on rooting and survival rates in papaya tissue cultures. *Journal of the Japanese Society for Horticultural Sciences*, 67(Extra 2): 231. (J)
- **Hiraoka, H.**, Kanetani, Y. and Ho, N. K. (1998). Farm operation and seedling establishment in dry seeding of rice in the Muda area of Malaysia. *International symposium on wild and weedy rices in agro ecosystems*, Ho Chi Minh, Vietnam: 147-154. (J)
- **Hosen, Y.** and **Yagi, K.** (1999). Annual report of related activities in Japan: Experiment in an upland field. 2nd Planning Workshop on Evaluation and Development of Methods for Sustainable Agriculture and Environmental Conservation, Beijing, China, 2: 63-67.
- **Hosen, Y.**, Tsuruta, H. and Minami, K. (1998). Effect of the depth of NO and N₂O productions in soil on their emission rates to the atmosphere. *ASA-CSSA-SSSA Annual Meeting Abstracts*. Baltimore, MD, USA, 90: 338-339.
- **Hosen, Y.**, Tsuruta, H. and Minami, K. (1998). NO and N₂O dynamics in soil: Verification of the effects of deep fertilizer application on their concentration profiles and emissions by laboratory experiments. *Abstracts of the Annual Meeting of the Japanese Society of Soil Science and Plant Nutrition*, 44: 215. (J)
- Hosono, T., Paisancharoen, K. and **Matsumoto, N.** (1999). Evaluation of water balance in a cassava field in Northeast Thailand. *In: Highlights of Collaborative Research Activities between Thai Research Organizations and JIRCAS: Proceedings of JIRCAS Seminar in Bangkok 1999*, Eds. Suzuki, M. and Ando, S., Bangkok, Thailand: 98-99.
- **Ikegami, A.** (1999). Features of agricultural extension systems in Japan and its implications for China. Paper Presented for the Workshop on Agricultural Extension: Contribution to Food Production Increase and Rural Development, Beijing, China.
- Imbe, T., Tsunematsu, H., **Kato, H.** and Khush, G. S. (1998). Genetic analysis of blast resistance in IR varieties. 2nd International Rice Blast Conference: 11.
- **Ishikawa, T.**, **Hosen, Y.** and Minami, K. (1998). The effects of tropical grass on nitrification in soil: The influence on emission of nitrous oxide from soil. *Abstracts of the Annual Meeting in the Kanto Area, Japanese Society of Soil Science and*

Plant Nutrition: 34. (J)

- Ishikawa, T., Kawashima, T., Matsumoto, N., Kobkiet, P. and Hamazaki, T.** (1998). Environmental adaptability of root development of some crops during the dry season in the monsoon tropics. International Symposium: World Food Security and Crop Production Technologies for Tomorrow, Kyoto, Japan: 219-222.
- Ishikawa, T., Watanabe, T. and Minami, K.** (1998). The effects of tropical rice grass on nitrification in soil. Abstracts from the Annual Meeting of the Soil Science Society of America, Baltimore, MD, USA: 335.
- Ishiki, K. and Nakanishi, T.** (1998). Flowering induction of yacon (*Polymnia sonchifolia*) by grafting onto sunflowers in Ecuador. Breeding Science, 48(Supplement 2): 341. (J)
- Ishiki, K., Arellano, J. and Salgado, V.** (1998). Yield of achira (*Canna edulis*) cultivated in South America. Japanese Journal of Tropical Agriculture, 43(Extra issue 1): 69-70. (J)
- Ishiki, K., Galarza, R., Salgado, V., Vinueza, J. and Salazar, C.** (1998). Karyotype of ulluco (*Ullucus tuberosus*) cultivated in Ecuador. Japanese Journal of Tropical Agriculture, 42(Extra issue 2): 11-12. (J)
- Ishiki, K., Salazar, C., Salgado, V., Galarza, R. and Vinueza, J.** (1999). Karyotype of aracacha (*Arracacia xanthorrhiza*) cultivated in Ecuador. Japanese Journal of Tropical Agriculture, 43(Extra issue 1): 3-4. (J)
- Ishiki, K., Salgado, V. and Arellano, J.** (1998). Morphotype and yield of yacon (*Polymnia sonchifolia*). Breeding Science, 48(Supplement 1): 319. (J)
- Ishiki, K., Vinueza, J., Salgado, V., Galarza, R. and Salazar, C.** (1998). Karyotype of oca (*Oxalis tuberosa*) cultivated in Ecuador. Japanese Journal of Tropical Agriculture, 13-14. (J)
- Ishiki, K., Vinueza, J., Salgado, V., Galarza, R. and Salazar, C.** (1999). Karyotype analysis of oca (*Oxalis tuberosa*). Breeding Research, 1(Supplement 1): 201. (J)
- Ishiki, K., Vinueza, J., Salgado, V., Galarza, R. and Salazar, C.** (1999). Karyotype analysis of oca (*Oxalis tuberosa*). Japanese Journal of Tropical Agriculture, 43(Extra issue 1): 1-2. (J)
- Ishiki, K., Salgado, V. and Arellano, J.** (1998). Yield of yacon (*Polymnia sonchifolia*) cultivated in South America. Japanese Journal of Tropical Agriculture, 43(Extra issue 1): 71-72. (J)
- Iuchi, S., Kobayashi, M., Yamaguchi-Shinozaki, K. and Shinozaki, K.** (1999). Analysis of the drought-inducible cowpea gene encoding neoxanthin cleavage enzyme, a key enzyme in ABA biosynthesis. Plant & Cell Physiology, 40(Supplement): 91. (J)
- Iuchi, S., Yamaguchi-Shinozaki, K. and Shinozaki, K.** (1998). A gene for a key enzyme in ABA biosynthesis induced by drought stress in cowpeas. 16th International Conference on Plant Growth Substances, Makuhari, Japan.
- Iuchi, S., Yamaguchi-Shinozaki, K. and Shinozaki, K.** (1998). A gene for a key enzyme in ABA biosynthesis is induced by drought stress in cowpea. Plant and Cell Physiology, 39(Supplement): 105.
- Kaihotsu, I., Ohno, H., Miyazaki, S., Hayashi, Y., Maruyama, A. and Yasunari, T.** (1998). Report on the large area of soil moisture on the ground in Mongolia. Preprints of the 1998 Conference of Japan Society of Hydrology and Water Resources: 25. (J)
- Kainoh, Y., Tanaka, C. and Nakamura, S.** (1998). Foraging behaviour of *Exorista japonica* (Diptera: Tachinidae). Proceedings of the 17th Congress of the Japan Ethological Society, 17: 18. (J)
- Kaku, H. and Noda, T.** (1999). Histopathology of red stripe disease in rice. Planning Workshop on the Etiology of Red Stripe. Ho Chi Minh City, Vietnam.
- Kanno, T., Macedo, M. C., Euclides, V. P. B. and Bono, J. A.** (1999). Root biomass and population structure of five tropical grasses under continuous grazing in *Brasilian savannas*. Proceedings of the 54th Annual Conference of the Japanese Association of Grassland Science: 234-235. (J)
- Kanno, T., Uozumi, S. and Macedo, M. C.** (1999). Drought resistance of four *Brachiaria species*. Proceedings of the 54th Annual Conference of the Japanese Association of Grassland Science: 232-233. (J)

- **Kasuga, M.,** Miura, S., Liu, Q., **Yamaguchi-Shinozaki, K.** and Shinozaki, K. (1998). Analysis of overexpression of DREB1A and DREB2A cDNA for transcription factors involved in dehydration and cold responsive gene expression in transgenic *Arabidopsis*. *Plant and Cell Physiology*, 39(Supplement): 106. (J)
- **Kasuga, M.,** Miura, S., Liu, Q., **Yamaguchi-Shinozaki, K.** and Shinozaki, K. (1998). Analysis of the environmental stress tolerance of transgenic *Arabidopsis* that overexpress DREB1A cDNA for transcription factors involved in dehydration and cold responsive gene expression. The 21st Annual Meeting of the Molecular Biology Society of Japan: 432. (J)
- Katamoto, H., **Kawashima, T.** and Pholpark, S. (1998). Tetanoid syndrome and blood selenium concentration in water buffalo in northeast Thailand. *Proceedings of the 94th Annual Meeting of the Japanese Society of Zootechnical Science*: 59. (J)
- **Kawashima, T.,** Hayashi, Y., Sumamal, W., Pholsen, P., Chaithiang, R. and Boonpakdee, W. (1999). Sugarcane stalk as a roughage for cattle. *In: Highlights of Collaborative Research Activities between Thai Research Organizations and JIRCAS: Proceedings of JIRCAS Seminar in Bangkok 1999*, Eds. Suzuki, M. and Ando, S., Bangkok, Thailand: 161-165.
- **Kawashima, T.,** Pholpark, S., Sumamal, W. and Boonpakdee, W. (1999). Mineral status of dairy cattle in northeast Thailand. *In: Highlights of Collaborative Research Activities between Thai Research Organizations and JIRCAS: Proceedings of JIRCAS Seminar in Bangkok 1999*, Eds. Suzuki, M. and Ando, S., Bangkok, Thailand: 172-175.
- **Kawashima, T.,** Sumamal, W., Pholsen, P., Chaithiang, R., Boonpakdee, W. and Kurihara, M. (1998). Comparative study on energy and protein metabolisms between Brahman cattle and swamp buffalo fed with a low quality diet. *Proceedings of the 8th World Conference on Animal Production*, Seoul, Korea, 1: 396-397.
- Kikuchi, A., **Adachi, T.,** Shimada, H. and Takada, Y. (1999). Collection of the Wild Soybean *Glycine soja* around the Tohoku District: The Basin of the Mogami River in Yamagata Prefecture, 14: 25-31. (J)
- Kitahara, K., Furuta, N., **Komori, S.,** Komatsu, H., Soejima, J. and Matsumoto, S. (1998). S-allele genotypes of 16 *Malus x domestica* cultivars: Sg-allele within 'American Summer Pearmain', 'Indo', 'Kitanosachi' and 'Meku 10.' *Journal of the Japanese Society for Horticultural Science*, 67(1): 117.
- Kobayashi, Y., **Nakano, M.,** Shiota, A. and Honda, Y. (1998). Sequence analysis of several strains of the broad bean wilt virus. *Annals of the Phytopathological Society of Japan*, 64(4): 398. (J)
- **Kohno, K.** (1998). Effects of prey supply on larval development of *Campalita chinense* (Kirby). *Proceedings of the 42nd Annual Meeting of the Japanese Society of Applied Entomology and Zoology*: 158. (J)
- **Kohno, K.,** Egawa, N., **Takahashi, K.,** Tomooka, N. and Bujang, I. (1998). Resistance against *Callosobruchus chinensis* by wild *Vigna* spp. distributed in Southeast Asia. *Japanese Journal of Tropical Agriculture*, 42(Extra issue 2): 73-74. (J)
- **Komori, S.,** Ogawa, K., Fukamachi, H. and Hidaka, T. (1998). Exploration and collection of tropical fruit tree germplasm in Thailand, 1997. *Japanese Journal of Tropical Agriculture*, 42(Extra issue 2): 9-10. (J)
- **Komori, S.** and Ogawa, K. (1998). Exploration and collection of tropical fruit tree germplasm in Thailand, 1997. *Annual Report on Exploration and Introduction of Plant Genetic Resources*, 14: 185-217.
- **Komori, S.,** Soejima, J., Abe, K., Kotoda, N. H., Ito, Y. and Bessho, H. (1999). Re-analyses of the self-incompatibility genotypes of "Ralls Janet" "Kinsei" "Redgold." *Journal of the Japanese Society for Horticultural Science*, 67(Supplement 1): 116. (J)
- **Kondo, M.,** Aragonés, D., Agbisit, R., Pablico, P., Chaitep, W., George, T., Singh, C. V. and Reoma, V. (1998). Interaction of nutrients and water in upland rice in the tropics through root development and water uptake. *Proceedings of the 3rd Asian Crop Science Conference*, Taichung, Taiwan: 564-569.
- **Kondo, M.,** Aragonés, D. and Agbisit, R. (1998). Effect of nitrogen management on development of roots in soil in upland rice. *The Philippine Journal of Crop Science*. Abstract of paper presented at the 14th Annual Scientific Conference of the Federation of Crop Societies of the Philippines, Cebu, the Philippines, 23(Supplement 1): 46.
- **Kondo, M.** (1998). Improvement of water and nitrogen use in upland rice farming. *Extended summaries of First International Agronomy Congress*, New Delhi, India: 539.



- **Kondo, M.**, Agbisit, R. and Pablico, P. (1998). Effect of nitrogen application method on nitrogen recovery and distribution in upland rice. The Philippine Journal of Crop Science. Abstract of paper presented at the 14th Annual Scientific Conference of the Federation of Crop Societies of the Philippines, Cebu, the Philippines, 23(Supplement 1): 46.
- **Kondo, M.**, Aragonés, D., Pablico, P., Murty, M., Okada, K., Abe, J. and Morita, S. (1998). Approaches in plant-soil interaction to improve upland rice production. Proceedings of International Symposium: World Food Security and Crop Production Technologies for Tomorrow, Kyoto, Japan: 221-224.
- **Kondo, M.**, Pablico, P., Aragonés, D., Agbisit, R., Chaitep, W., George, T., and Singh, C. V. (1998). Performance and possible benefits of controlled-release nitrogen fertilizer in upland rice culture in the tropics. Proceedings of the 3rd Asian Crop Science Conference, Taichung, Taiwan: 430-435.
- **Kondo, M.**, Winn, T. and Okada, K. (1998). Structure of nodal root system of rice as affected by soil water regime and nitrogen. The Philippine Journal of Crop Science. Abstract of paper presented at the 14th Annual Scientific Conference of the Federation of Crop Societies of the Philippines, Cebu, the Philippines: 23(Supplement 1): 47.
- **Kondo, M.**, Aguilar, A. Morita, S. and Abe, A. (1998). Anatomical characteristics of roots in tropical upland rice: Varietal comparison in stale proportion and sclerenchyma development in nodal roots. Japanese Journal of Crop Science. Tsukuba, Japan, 67(Extra Issue 1): 80. (J)
- Kotoda, N., **Komori, S.**, Soejima, J., Abe, K., Kato, H., Masuda, T., Inomata, Y. and Wada, M. (1998). The expression of AFL gene during floral bud formation in apples. Plant & Cell Physiology, 39(Supplement): 63.
- Krishnamurthy, L., **Ito, O.**, Johansen, C. and Saxena, N. P. (1998). Length to weight ratio of chickpea roots under progressively receding soil moisture conditions in vertisol. Field Crops Research, 58: 177-185.
- Kudo, S., Dai, L., Ye, C., Liao, X., Zhang, J., Xiong, J., **Ise, K.**, Tanno, H. and Tomita, H. (1998). Varietal difference of cold tolerance in rice genetic resources of Yunnan Province, China. Breeding Science, 48(Supplement 1): 316. (J)
- Kurihara, M., **Kawshima, T.**, Pholsen, P. and Boonpakdee, W. (1999). Comparative study on energy and protein metabolisms between Brahman cattle and swamp buffalo fed with a low quality diet. In: Highlights of Collaborative Research Activities between Thai Research Organizations and JIRCAS: Proceedings of JIRCAS Seminar in Bangkok 1999, Eds. Suzuki, M. and Ando, S., Bangkok, Thailand: 168-169.
- Li, C. Y., **Tobita, S.**, **Yashima, S.**, **Hayashi, T.**, Yanagihara, S., Toyoshima, T., Shindoh, K., Ohtsubo, K., Yasui, A. and **Ise, K.** (1998). Rice varietal difference in salt tolerance at the booting stage and the effects of salinity stress on brown rice. Breeding Science, 48(Supplement 2): 253. (J)
- Li, C.Y., **Tobita, S.**, **Yashima, S.**, **Hayashi, T.**, **Yanagihara, S.**, Toyoshima, H., Shindou, K., Ohtsubo, K., Yasui, A. and **Ise, K.** (1998). Rice varietal difference in salt tolerance at the booting stage and effects of salinity stress on brown rice. Breeding Science, 48(Supplement2). (J)
- Liu, J. and **Shono, M.** (1999). Characterization of the mitochondrial-located small heat shock protein from the tomato (*Lycopersicon esculentum* L.). 1999 Annual Meeting and 39th Symposia of the Japanese Society of Plant Physiologists: 175. (J)
- **Maoka, T.** (1998). Studies on epidemiology, identification, diagnosis and taxonomy of papaya viruses in Japan and Southeast Asia. Abstract of doctoral thesis, Tokyo Agricultural University: 255-259. (J)
- **Maoka, T.**, **Noda, C.**, **Usugi, T.**, Kashiwazaki, S., Tsuda, S. and Hibino, H. (1998). The papaya leaf-distortion mosaic potyvirus (PLDMV) has a non-papaya infective type. Abstracts of the 7th International Congress of Plant Pathology, Edinburgh, Scotland: 2(1): 11.
- **Maoka, T.**, Prommintara, M., Doon, Y.B., Xiao, H., Bergonia, H., Usugi, T. and **Noda, C.** (1998). Comparison of properties and capsid protein genes of papaya ringspot virus (PRSV) Asian isolates distinct in geographic origin and pathogenicity. Annals of the Phytopathological Society of Japan: 399-400. (J)
- **Maoka, T.**, **Noda, C.**, **Usugi, T.**, Kashiwazaki, S., Tsuda, S. and Hibino, H. (1998). Papaya leaf-distortion mosaic potyvirus (PLDMV) has a non-papaya infective type. Abstracts of the 7th International Congress of Plant Pathology, 1(11): 61.

- **Matsumoto, K.** (1999). Seminar on “High value timber species for plantation establishment”: Teak and mahogany. *JIRCAS News*, 18: 8. (J)
- **Matsumoto, N., Kabaki, N., Kataoka, K. and Wangkahart, T.** (1999). Nutrient cycles of alley cropping systems in Khao Suan Kwang, Khon Kaen Province. *In: Highlights of Collaborative Research Activities between Thai Research Organizations and JIRCAS: Proceedings of JIRCAS Seminar in Bangkok 1999*, Eds. Suzuki, M. and Ando, S., Bangkok, Thailand: 38-39.
- **Matsumoto, N., Paisanchaen, K. and Trelo-ges, V.** (1999). Nitrogen cycles on agricultural practices in Khon Kaen province. *In: Highlights of Collaborative Research Activities between Thai Research Organizations and JIRCAS: Proceedings of JIRCAS Seminar in Bangkok 1999*, Eds. Suzuki, M. and Ando, S., Bangkok, Thailand: 32-33.
- **Matsumoto, N., Paisanchaen, K., Ando, S. and Thippayarugs, S.** (1999). Nutrient cycles of cassava and sugarcane fields in northeast Thailand. *In: Highlights of Collaborative Research Activities between Thai Research Organizations and JIRCAS: Proceedings of JIRCAS Seminar in Bangkok 1999*, Eds. Suzuki, M. and Ando, S., Bangkok, Thailand: 34-37.
- **Matsumoto, N.** (1998). Nutrient cycles in cassava field. *Proceedings of the Meeting on Nutrient Cycles and Soil Management on Cassava Production. Khon Kaen, Thailand*: 11-24.
- **Matsuoka, M., Fukuoka, H., Ogawa, T., Yano, H. and Sugimoto, H.** (1998). Efficient plant regeneration from sugarcane protoplast. *Breeding Science*, 48(Supplement 1): 144. (J)
- **Matsuoka, M., Ujihara, K. and Sugimoto, H.** (1999). Efficient plant regeneration from sugarcane protoplasts isolated from long-term suspension cultures. *Proceedings of the International Society of Sugarcane Technologists 23rd Congress, New Delhi, India*: 257-261.
- **Matsuno, Y., Elkaduwa, W. K. B. and Shinogi, Y.** (1998). Irrigation water quality in the southeastern dry zone of Sri Lanka National Water Conference in Sri Lanka.
- **Meunchang, S., Tangchum, B., Wadisirisuk, P. and Ando, S.** (1998). Characteristics of nitrogen-fixing endophytic bacteria associated with pineapple. *Abstracts of the Third International Pineapple Symposium, Pattaya, Thailand*: 60.
- **Meunchang, S., Tangchum, B., Wadisirisuk, P. and Ando, S.** (1998). Distribution and effectiveness of associative nitrogen fixing bacteria in the western sugarcane belt of Thailand. *Proceedings of the Third National Cane and Sugar Conference, Khon Kaen, Thailand*: 262- 270. (J)
- **Meunchang, S., Tangchum, B., Wadisirisuk, P. and Ando, S.** (1999). Isolation and characterization of nitrogen-fixing endophytic bacteria in pineapple. *In: Highlights of Collaborative Research Activities between Thai Research Organizations and JIRCAS: Proceedings of JIRCAS Seminar in Bangkok 1999*, Eds. Suzuki, M. and Ando, S., Bangkok, Thailand: 47-48.
- **Miyamoto, M.** (1999). Trends of a transmigration project in an Indonesian forest. *Transactions of the JFS*, 109: 25-28. (J)
- **Miyata, S., Urao, T., Yamaguchi-Shinozaki, K. and Shinozaki, K.** (1998). Molecular cloning of novel *Arabidopsis* genes for two-component system proteins that contains a HPT domain. *Plant and Cell Physiology*, 39(Supplement): 124. (J)
- **Miyata, S., Urao, T., Yamaguchi-Shinozaki, K. and Shinozaki, K.** (1998). Molecular cloning and analysis of novel two-component system genes for ATHP in *Arabidopsis thaliana*. *The 21st Annual Meeting of the Molecular Biology Society of Japan, Yokohama*: 557. (J)
- **Miyata, S., Urao, T., Yamaguchi-Shinozaki, K. and Shinozaki, K.** (1999). Functional analysis of *Arabidopsis* ATHP1-3 genes that encode phosphorelay mediators. *Plant & Cell Physiology*, 40(Supplement): 76. (J)
- **Motohashi, R., Ito, T., Seki, M., Yamaguchi-Shinozaki, K. and Shinozaki, K.** (1998). Transposon-tagged lines that have Ds-insertion mutations in the CIC3B1 region of *Arabidopsis* chromosome 5. *9th International Conference on Arabidopsis Research, WI, USA*.
- **Motohashi, R., Ito, T., Seki, M., Yamaguchi-Shinozaki, K. and Shinozaki, K.** (1998). Transposon-tagged lines that have Ds-insertion mutations in a region of *Arabidopsis* chromosome 5. *Plant and Cell Physiology*, 39(Supplement): 115. (J)
- **Motohashi, R., Ito, T., Yamaguchi-Shinozaki, K. and Shinozaki, K.** (1999). The two-component transposon system Ac/Ds as a mutagen in *Arabidopsis*: Identification of albino mutation induced by Ds insertion. *Plant & Cell Physiology*, 40(Supplement): 156. (J)

- Mukherjee, S. K., and **Asanuma, S.** (1998). Al-tolerance and phosphate metabolism in *Bradyrhizobium japonicum*. Eighth Congress of the African Association for Biological Nitrogen Fixation, Cape Town, South Africa.
- Nakamura, I., Murayama, S., Kawamitsu, S., **Tobita, S.** and **Yanagihara, S.** (1998). Differences in physiological reactions to salt stress in wild rice. *Japanese Journal of Crop Science*, 38(1): 76-77. (J)
- **Nakahara, K.** (1998). Food components preventing disease. *Proceedings of the Sino-Japanese Workshop on Advanced Food Technology*: 28-33.
- **Nakahara, K.**, and Trakoontivakorn, G. (1999). Antioxidative and antimutagenic properties of some local agricultural products in Thailand. *In: Highlights of Collaborative Research Activities between Thai Research Organizations and JIRCAS: Proceedings of JIRCAS Seminar in Bangkok 1999*, Eds. Suzuki, M. and Ando, S., Bangkok, Thailand: 141-143.
- **Nakai, M.** and Hamazaki, T. (1998). Soils of the world. *Soils and Food*: 107-112. (J)
- **Nakano, M.** and Liao, L. (1998). International comparison of soybean mosaic virus strains. *Annals of the Phytopathological Society of Japan*, 64(4): 403. (J)
- **Nakashima, K.**, Satoh, R., Kiyosue, T., **Yamaguchi-Shinozaki, K.** and Shinozaki, K. (1998). A gene encoding proline dehydrogenase is not only induced by proline and hypoosmolarity but also developmentally regulated in reproductive organs in *Arabidopsis thaliana*. 9th International Conference on Arabidopsis Research, WI, USA.
- **Nakashima, K.**, Satoh, R., Kiyosue, T., **Yamaguchi-Shinozaki, K.** and Shinozaki, K. (1998). Expression of the *erd5* gene that encodes proline dehydrogenase in *Arabidopsis thaliana*. 16th International Conference on Plant Growth Substances, Makuhari, Japan.
- **Nakashima, K.**, **Yamaguchi-Shinozaki, K.** and Shinozaki, K. (1998). Analysis of the expression of the *erd 1* gene encoding a chloroplast-targeted Clp protease regulatory subunit homolog. *Plant and Cell Physiology*, 39(Supplement): 105.
- Nanjyo, T., Yoshiba, Y., Sanada, Y., Wada, K., Tsukaya, H., Kakubari, Y., **Yamaguchi-Shinozaki, K.** and Shinozaki, K. (1998). Role of proline in osmotolerance and morphogenesis of *Arabidopsis thaliana*. *Plant and Cell Physiology*, 39(Supplement): 104.
- Nanjyo, T., Yoshiba, Y., Sanada, Y., Wada, K., Tsukaya, H., Kakubari, Y., **Yamaguchi-Shinozaki, K.** and Shinozaki, K. (1998). Antisense suppression of proline biosynthesis results in an abnormal morphology of leaves and hypersensitivity to osmotic stress in *Arabidopsis thaliana*. 9th International Conference on Arabidopsis Research, WI, USA.
- Nanjyo, T., Yoshiba, Y., Sanada, Y., Wada, K., Tsukaya, H., Kakubari, Y., **Yamaguchi-Shinozaki, K.** and Shinozaki, K. (1998). Role of proline in osmotolerance and morphogenesis of *Arabidopsis thaliana*. 16th International Conference on Plant Growth Substances, Makuhari, Japan.
- Nanjyo, T., Yoshiba, Y., Sanada, Y., Wada, K., Tsukaya, H., Kakubari, Y., **Yamaguchi-Shinozaki, K.** and Shinozaki, K. (1998). Role of proline in osmotolerance and morphogenesis of *Arabidopsis thaliana*. *Plant and Cell Physiology*, 39(Supplement): 104.
- Narusaka, Y., Shinwari, K., **Nakashima, K.**, **Yamaguchi-Shinozaki, K.** and Shinozaki, K. (1999). The roles of the two cis-acting elements, DRE and ABRE, in the dehydration, high salt and low temperature responsive expression of the *rd29A* gene in *Arabidopsis thaliana*. *Plant & Cell Physiology*, 40(Supplement): 91. (J)
- **Nawa, Y.**, **Takagi, H.**, **Noguchi, A.** and **Tsubota, K.** (1999). Postharvest technology in Asia: A step forward to stable supply of food products. *The 5th JIRCAS International Symposium Series, No.7*, Tsukuba, Japan.
- **Nikkuni, S.**, Nakajima, H., Hoshina, S., Ohno, M., Suzuki, C., Kashiwagi, Y., and Mori, K. (1998). Evolutionary relationships among *Aspergillusoryzae* and related species based on the sequences of 18S rRNA genes and internal transcribed spacers. *The Journal of General and Applied Microbiology*, 44(3): 225-230. (J)
- **Noda, C.** and **Maoka, T.** (1998). A potyvirus isolated from tobacco on Ishigaki Island. *Annals of the Phytopathological Society of Japan*, 64(4): 422. (J)
- **Noda, T.**, Loc, N. T. and Du, P. V. (1998). Rice pest management in the Mekong Delta. *In: Development of Farming Systems in the Mekong Delta*, Eds. Xuan, V. T. and Matsui, S., H. M. C. Publishing House, Ho Chi Minh City, Vietnam:

- **Noda, T.**, Du, P. V. and Hayashi, N. (1998). Race distribution of rice blast fungus, *Magnaporthe grisea*, in the Mekong Delta. *Omonrice*, 6: 84-86.
- **Noda, T.** and Kaku, H. (1999). Growth of *Xanthomonas campestris* pv. *oryzae* in plants and the guttation fluid of rice. *Annals of the Phytopathological Society of Japan*, 65(1): 9-14. (J)
- Noji, M., **Urao, T.**, **Yamaguchi-Shinozaki, K.** and Shinozaki, K. (1998). Molecular cloning of two cDNAs encoding novel Myb homologues from *Arabidopsis thaliana*. *Plant Physiology*, 117: 720 (PGR 98-111).
- **Ochiai, Y.** (1997). Litterfall and stand structure of the mangrove forest in Matang, Perak, Malaysia. *Proceedings of the 4th Seminar on the Results for the 1996/97 Research Project: Productivity and Sustainable Utilization of Brackish Water Mangrove Ecosystems*.
- **Ochiai, Y.** (1999). Silvics of tropical trees (15) Meranti Sarang Punai. *Tropical Forestry*, 44: 86-88.
- **Ohno, H.**, Yokoyama, K., Kominami, Y., Inoue, S., Takami, S. and Wiesinger, T. (1998). Catch ratios of gauges for solid precipitation in the Hokuriku region. *Journal of the Japanese Society of Snow and Ice*, 60(3): 225-231. (J)
- **Ohwaki, Y.**, **Suzuki, K.**, Fukuhara, T. and **Sugahara, K.** (1998). Activation of proton extrusion and depression of nitrate absorption in response to iron deficiency in chickpea (*Cicer arietinum* L). Abstracts, Sixth International Symposium on Genetics and Molecular Biology of Plant Nutrition: 20.
- **Okuda, S.** (1998). Change in photosynthesis rate of some dipterocarps species exposed to drying. *Proceedings of the International Conference on Tropical Forest and Climate Change, Manila, the Philippines*.
- Paisanchoen, K., Nakaviroj, C. and **Matsumoto, N.** (1999). Improvement of cassava production by intercropping with cowpeas in northeast Thailand. *In: Highlights of Collaborative Research Activities between Thai Research Organizations and JIRCAS: Proceedings of JIRCAS Seminar in Bangkok 1999*, Eds. Suzuki, M. and Ando, S., Bangkok, Thailand: 40-43.
- Pholsen, P., Sumamal, W., Chaithiang, R., Chuenprecha, T. and **Kawashima, T.** (1999). Nutritive value of *Centrosema pascuorum* cv. cavalcade in Brahman cattle. *In: Highlights of Collaborative Research Activities between Thai Research Organizations and JIRCAS: Proceedings of JIRCAS Seminar in Bangkok 1999*, Eds. Suzuki, M. and Ando, S., Bangkok, Thailand: 157-158.
- Pholsen, P., Chaithiang, R., Cheunprecha, T., **Kawashima, T.** and Boonpakdee, W. (1999). Nutritive values of some legume tree forage species. *In: Highlights of Collaborative Research Activities between Thai Research Organizations and JIRCAS: Proceedings of JIRCAS Seminar in Bangkok 1999*, Eds. Suzuki, M. and Ando, S., Bangkok, Thailand: 159-160.
- Reoma, V., **Kondo, M.**, George, T., and Aragones, D. (1998). Effect of N and P on root spatial development in upland rice in acidic soil in Leyte. *The Philippine Journal of Crop Science*. Abstract of paper presented at the 14th Annual Scientific Conference of the Federation of Crop Societies of the Philippines, Cebu, the Philippines, 23(Supplement 1): 22.
- Rubio, A. and **Ishiki, K.** (1999). Oligofructan content of Ecuadorian yacon. *Abstract of Association of Yacon Research, Ibaraki, Japan*. (J)
- Sakai, H., **Yagi, K.**, Kobayashi, K. and **Yajima, M.** (1998). The gas chamber system for studying plant growth and gas exchange under elevated CO₂ conditions. *Proceedings of the Annual Meeting of the Japanese Society of Agricultural Meteorology*: 444-445. (J)
- Sakai, H., Yagi, K., Kobayashi, K. and **Yajima, M.** (1998). Chamber systems for plant growth and gas exchange studies under elevated CO₂ conditions. *Abstract of the Joint Meeting of the Societies of Agrometeorology and Bio-environmental Control*: 444-445. (J)
- Sakuma, Y., Liu, Q., Abe, H., **Kasuga, M.**, Miura, S., **Yamaguchi-Shinozaki, K.** and Shinozaki, K. (1999). Binding specificity of DRE binding proteins, DREBs, involved in dehydration-responsive transcription in *Arabidopsis*. *Plant & Cell Physiology*, 40(Supplement): 92. (J)
- Sakuma, Y., Liu, Q., Abe, H., **Kasuga, M.**, **Miura, S.**, **Yamaguchi-Shinozaki, K.** and Shinozaki, K. (1998). Characterization of genes encoding dehydration-responsive-element (DRE) binding proteins. *Plant and Cell Physiology*,

39(Supplement): 106. (J)

- Samejima, H., Laureles, E., **Kondo, M., Ito, O.** and Kirk, G. (1998). Root activity in relation to productivity of tropical rice: Differences between new plant types and IR72 in root system development and root function during the reproductive stage. The Philippine Journal of Crop Science. Abstract of paper presented at the 14th Annual Scientific Conference of the Federation of Crop Societies of the Philippines, Cebu, the Philippines, 23(Supplement 1): 81.
- Sasaki, S.**, Yamada, K., Endo, T., Sasaki, T., and Ito, M. (1998). Floating suspension and altitude control systems for an all-terrain vehicle. Program and Abstracts, 109th Annual JFS Meeting: 261. (J)
- Sato, K.**, Nashiki, M. and Takahashi, S. (1999). Grassland agriculture in Kazakstan. Symposium Book of Grassland Science: 19-21. (J)
- Sato, R., **Nakashima, K.**, Kiyosue, T., **Yamaguchi-Shinozaki, K.** and Shinozaki, K. (1998). Analysis of the expression of the *erd5* gene encoding proline dehydrogenase. Plant and Cell Physiology, 39(Supplement): 105.
- Sato, R., **Nakashima, K.**, Kiyosue, T., **Yamaguchi-Shinozaki, K.** and Shinozaki, K. (1998). Expression analysis of gene encoding proline dehydrogenase in *Arabidopsis thaliana*. The 21st Annual Meeting of the Molecular Biology Society of Japan: 432. (J)
- Sato, R., **Nakashima, K.**, **Yamaguchi-Shinozaki, K.** and Shinozaki, K. (1999). Expression analysis of the ProDH gene that encodes proline dehydrogenase in *Arabidopsis thaliana*. Plant & Cell Physiology, 40(Supplement): 147. (J)
- Shah, S. F., **Tobita, S.** and **Shono, M.** (1998). Sodium-calcium interaction and proline regulation in cell suspension cultures of *Oryza sativa* L. 16th Annual Meeting and Symposia of the Society for Plant Cell and Molecular Biology: 59.
- Shah, S. F., **Tobita, S.** and **Shono, M.** (1998). The cation co-tolerance phenomenon and in vitro selection of salt tolerant somaclones of *Oryza sativa* L. in cell suspension cultures. Breeding Science, 48(Supplement 2): 252.
- Shah, S. H., **Tobita, S.** and **Shono, M.** (1998). Sodium-calcium interaction and proline regulation in cell suspension cultures of *Oryza sativa* L. Abstracts of the 16th Symposium on Plant Cell and Molecular Biology, Sendai, Japan: 59.
- Shibata, M., **Kawashima, T.** and Sumamal, W. (1999). The energy metabolism measurement system for cattle. *In: Highlights of Collaborative Research Activities between Thai Research Organizations and JIRCAS: Proceedings of JIRCAS Seminar in Bangkok 1999*, Eds. Suzuki, M. and Ando, S., Bangkok, Thailand: 152-153.
- Shimada, H., Takahashi, K., Takada, Y., **Adachi, T.**, Tabuchi, K. and **Kikuchi, A.** (1998). Varietal difference and inheritance of characteristics needed for machinery harvesting in soybean *Glycinmax Merr.* Tohoku Agricultural Research, 51: 73-74. (J)
- Shimase, T., Ryuko, H., and **Miyamoto, M.** (1997). Rethinking forest unions: recruitment, facilities and worker motivation. Free Fresh Future, 1: 57-68.
- Shindo, K., Wichitphun, S., Udchachon, S. and **Kawashima, T.** (1999). Photosynthesis rate of several tropical grasses in the early dry season. *In: Highlights of Collaborative Research Activities between Thai Research Organizations and JIRCAS: Proceedings of JIRCAS Seminar in Bangkok 1999*, Eds. Suzuki, M. and Ando, S., Bangkok, Thailand: 176-178.
- Shinoda, M., **Kawashima, T.**, Chaithiang, R. and Chuenpreecha, T. (1999). Evaluation of Napier grass silage quality. *In: Highlights of Collaborative Research Activities between Thai Research Organizations and JIRCAS: Proceedings of JIRCAS Seminar in Bangkok 1999*, Eds. Suzuki, M. and Ando, S., Bangkok, Thailand: 166-167.
- Shinogi, Y.**, Makin, I. and Witharana, D. D. P. (1998). Simulation of the water balance in a dry zone tank cascade. National Water Conference in Sri Lanka.
- Shinozaki, K. and **Yamaguchi-Shinozaki, K.** (1998). Signal transduction in the water stress response of *Arabidopsis*. Third Congress of the Asian-Pacific Organization for Cell Biology, Osaka, Japan.
- Shinozaki, K. and **Yamaguchi-Shinozaki, K.** (1998). Molecular responses to drought stress. International Workshop on Molecular Biology of Drought Tolerance in Crop Plants, Varna, Bulgaria.
- Shinozaki, K. and **Yamaguchi-Shinozaki, K.** (1998). Molecular mechanisms of drought stress response. 4th Symposium

on Plant Biomembranes, Sapporo, Japan. (J)

- Shinozaki, K. and **Yamaguchi-Shinozaki, K.** (1998). Molecular mechanisms of drought and salt stress responses. The 71st Annual Meeting of the Biochemistry Society of Japan, Nagoya, Japan. (J)
- Shinwari, K., Nakashima, K.,** Miura, S., **Kasuga, M., Yamaguchi-Shinozaki, K.** and Shinozaki, K. (1998). Identification of gene family encoding dehydration-responsive-element (DRE) binding proteins in *Arabidopsisthaliana* and analysis of its promoter. *Plant and Cell Physiology*, 39(Supplement): 106. (J)
- Shono, M.,** Wada, M., and Fujii, T. (1998). Characterization and molecular cloning of Na⁺-ATPase on the plasma membrane of the marine raphidophycean *Heterosigma akashiwo*.
- Shono, M.,** Wada, M., and Fujii, T. (1999). Molecular cloning of Na⁺-ATPase of the marine raphidophycean *Heterosigma akashiwo*. 1999 Annual Meeting and 39th Symposia of Japanese Society of Plant Physiologists, 240. (J)
- Shono, M.,** Wada, M. and Fuji, T. (1999). Molecular cloning of Na⁺-ATPase of the marine raphidophycean *Heterosigma akashiwo*. *Plant & Cell Physiology*, 40(Supplement): 169.
- Soejima, J., Yoshida, Y., Hanyuda, T., Bessho, H., Masuda, T., **Komori, S.,** Tsuchiya, S., Ito, Y., Sanada, T., Abe, K., Kashimura, Y., Kotoda, N. and Kudo, K. (1998). The apple new cultivar "Kitaro." *Journal of the Japanese Society for Horticultural Science*, 67(Supplement 2): 173. (J)
- Suenaga, K.** (1998). Variation in grain yield and agronomic traits among the doubled haploid population derived from a heterotic F1 combination. *Proceedings of the 9th International Wheat Genetics Symposium*, 2: 357-359.
- Suenaga, K.** (1998). Evaluation of teosinte lines as pollen parents for wheat haploid production. *Cereal Research Communications*, 26(2): 119-125.
- Sugahara, K. and Ohwaki, Y.** (1998). Characterization of bacteria isolated from the heart-rot lesion of Chinese cabbage. *Program & Abstracts, Eighth International Symposium on Microbial Ecology*, 317.
- Sugahara, K. and Ohwaki, Y.** (1998). Characterization of bacteria isolated from the heart-rot lesion of Chinese cabbage. *Abstracts of the 61st Meeting of the Society of Kyushu for Agricultural Research*, 26. (J)
- Suzuki, K., Takeda, H., Egawa, Y.,** Matsumoto, D., Sakuma, H., Boonmalison, D. and Nikornpun, C. (1999). Studies on the morphological and growth characteristics of the pod radish (Pakkihood). *In: Highlights of Collaborative Research Activities between Thai Research Organizations and JIRCAS: Proceedings of JIRCAS Seminar in Bangkok 1999*, Eds. Suzuki, M. and Ando, S., Bangkok, Thailand: 102-104.
- Suzuki, K., Takeda, H. and Egawa, Y.** (1998). Morphological study on snap bean anther development under high temperatures. *Abstracts of the 3rd Asian Crop Science Conference, Taichung, Taiwan*: 49.
- Suzuki, K., Takeda, H., Matuura, S., You, S. and Egawa, Y.** (1999). Morphological study on the injury to snap bean pollen by heat stress. *Proceedings of the International Symposium "World Food Security," Kyoto, Japan*: 203-206.
- Suzuki, K., Takeda, H., Sakuma, H. and Egawa, Y.** (1998). Morphological aspect of blossom-end rot in tomatoes. *Abstracts, XXVth International Horticultural Congress*: 186.
- Suzuki, K., Takeda, H., Sakuma, H. and Egawa, Y.** (1998). The effects of nutrient solution changes on the incidence of blossom-end rot in tomatoes at several growing stages. *Supplement Journal of the Japanese Society for Horticultural Science*, 67(1): 182. (J)
- Tabuchi, K., **Adachi, T.,** Shimada, H., **Kikuchi, A.,** Takahashi, K. and Takada, Y. (1998). Agronomic characteristics of the new soybean variety "Ohsuzu." *Tohoku Agricultural Research*, 51: 75-76. (J)
- Tabuchi, K., Adachi, T., Shimada, H., Kikuchi, A.,** Takahashi, K., Takada, Y., **Nakamura, S.,** Yumoto, S., Kowata, M., Banba, H., Takahashi, N., Okabe, A., Watanabe, I., Nagasawa, T., Murakami, S., Hashimoto, K., Sakai, S. and **Igita, K.** (1999). A new soybean variety "Ohsuzu." *Bulletin of the Tohoku National Agricultural Experiment Station*, 95: 13-26. (J)
- Takagi, H.,** Thinh, N. T. and Kyesmu, P. M. (1998). Cryopreservation of vegetatively propagated tropical crops by vitrification. *Proceedings of the International Symposium on Biotechnology Tropical Species. Acta Horticulture*, 461:

- Takahashi, K., Takada, Y., Shimada, H., **Adachi, T.**, Tabuchi, K. and **Kikuchi, A.** (1998). Tofu processing properties of soybean lines characterized by a high 11S globulin content. *Tohoku Agricultural Research*, 51: 71-72. (J)
- Takahashi, M., **Kokubun, M.**, Arihara, J. and Akao, S. (1998). Genetic improvement of the growth and yield of a supernodulating soybean. *Japanese Journal of Crop Science*, 67(Extra issue 1): 36-37. (J)
- Takata, K. and **Ohno, H.** (1998). Review and intercomparison of land-surface models for evaluating large scale evapotranspiration. *JIRCAS Working Report*, 9: 45. (J)
- Takeda, H.**, Ancha, S., Senboku, T., **Suzuki, K.** and **Egawa, Y.** (1998). Physiological study of reproductive development under high temperature stress in chickpea and pigeonpea. Abstracts, The 3rd Asian Crop Science Conference, 50.
- Takeda, H.**, Hossain, M.M., Senboku, T., Suzuki, K. and Egawa, Y. (1998). Proline accumulation in Brassica crops under high temperature stress. Abstracts, XXVth International Horticultural Congress, Brussels, Belgium: 305.
- Tamang, J. P. and **Nikkuni, S.** (1998). Effect of temperatures during pure culture fermentation of Kinema. *World Journal of Microbiology and Biotechnology*, 14(6): 847-850.
- Tanaka, R.**, Hatakeyama, T. and Hatakeyama, H. (1997). Gelation mechanism of the locust bean gum-water system by freezing-thawing. *Reports on Progress in Polymer Physics in Japan*, 40: 155.
- Tanaka, R.**, Hatakeyama, T. and Hatakeyama, H. (1998). Formation of locust bean gum hydrogel by freezing-thawing. *Polymer International*, 45: 118.
- Tanaka, R.**, Suzuki, Y., Taniuchi, H. and Hirai, N. (1997). Piezoelectric behavior of wood treated with liquid ammonia. *Journal of the Society of Material Science Japan*, 46: 132. (J)
- Tanaka, R.**, Yoshida, T., Fujiwara, J., **Takahashi, M.**, Hatakeyama, T. and Hatakeyama, H. (1997). Gel forming characteristics of polysaccharide aqueous solutions. *Reports on Progress in Polymer Physics in Japan*, 40: 191.
- Terada, F., **Kawashima, T.** and Chaithiang, R. (1999). Nutrient requirement of Brahman cattle for maintenance. *In: Highlights of Collaborative Research Activities between Thai Research Organizations and JIRCAS: Proceedings of JIRCAS Seminar in Bangkok 1999*, Eds. Suzuki, M. and Ando, S., Bangkok, Thailand: 170-171.
- Trakontivakorn, G., **Nakahara, K.**, Shinmoto, H., and Tsushida, T. (1999). Determination of antimutagenic constituents of fingerroot and galanga. *In: Highlights of Collaborative Research Activities between Thai Research Organizations and JIRCAS: Proceedings of JIRCAS Seminar in Bangkok 1999*, Eds. Suzuki, M. and Ando, S., Bangkok, Thailand: 138-140.
- Uchida, S.** (1998). Utilization of remote sensing and GIS technology for international collaborative research programs. *Journal of Agricultural Science*, 53(5): 201-205. (J)
- Uchida, S.** (1999). Geographic information on agricultural studies in semi-arid areas. *Proceedings of the Global Mapping Mini Forum, Tsukuba, Japan: 1-9.* (J)
- Uchida, S.** (1998). Analysis of the change in agricultural land use in the suburbs of Beijing, China using multi-temporal satellite data. *Proceedings of the Japan Society of Photogrammetry and Remote Sensing Kyoto*, 10: 271-276. (J)
- Uno, Y., Furihata, T., Abe, H., Parvez, M., **Yamaguchi-Shinozaki, K.** and Shinozaki, K. (1999). Analysis of AREB genes which are involved in the dehydration and ABA-responsive expression of the RD29B gene in *Arabidopsis*. *Plant & Cell Physiology*, 40(Supplement): 128. (J)
- Uno, Y., **Yamaguchi-Shinozaki, K.** and Shinozaki, K. (1998). Cloning of cDNAs encoding bZIP-type proteins which bind to the cis-acting element involved in the dehydration and ABA-responsive expression of the rd29B gene. 16th International Conference on Plant Growth Substances, Makuhari, Japan.
- Uno, Y., **Yamaguchi-Shinozaki, K.** and Shinozaki, K. (1998). Cloning of cDNAs encoding bZIP-type proteins which bind to the cis-acting element involved in the dehydration- and ABA-responsive expression of the rd29B gene in *Arabidopsis thaliana*. *Plant and Cell Physiology*, 39(Supplement): 106. (J)
- Uno, Y., **Yamaguchi-Shinozaki, K.**, Abe, H., Furihata, T., Parvez, M. and Shinozaki, K. (1998). Analysis of the AREB

genes encoding bZIP-type proteins which bind to the cis-acting element involved in the dehydration and ABA-responsive expression of the rd29B gene. The 21st Annual Meeting of the Molecular Biology Society of Japan: 432. (J)

□ **Urao, T., Miyata, S., Yamaguchi-Shinozaki, K.** and Shinozaki, K. (1998). Molecular analysis of novel interacting factors with the histidine kinase ATHK1 in *Arabidopsis*. The 21st Annual Meeting of the Molecular Biology Society of Japan: 557. (J)

□ **Urao, T., Miyata, S., Yamaguchi-Shinozaki, K.** and Shinozaki, K. (1999). Molecular analysis of *Arabidopsis* two-component systems. *Plant & Cell Physiology*, 40(Supplement): 78. (J)

□ **Urao, T., Yakubov, B., Miyata, S., Yamaguchi-Shinozaki, K.** and Shinozaki, K. (1998). Cloning of cDNA encoding two-component response regulator in *Arabidopsis thaliana*. *Plant and Cell Physiology*, 39(Supplement): 124. (J)

□ Wang, B. and **Adachi, K.** (1998). Associations of methane emission with methanogenic and methanotrophic bacteria in flooded soils as affected by rice cultivars. IRRRI-UNDP Final Workshop, International Research Program on Methane Emission from Rice Fields: 22.

□ Wang, B. and **Adachi, K.** (1998). Differences in root exudates and root oxidative activity among rice cultivars in relation to methane emission. *Soil and Microorganisms*, 52: 88.

□ **Wilder, M. N., Hien, T. T. T., Phu, T. Q., Phuong, N. T.** and Ogata, Y. (1999). Effects of diet on growth and reproductive development in freshwater prawns in the Mekong Delta region of Vietnam. Abstracts, U.S. Chapter Meeting of the World Aquaculture Society, Tampa, FL, USA: 211.

□ **Wilder, M. N.** (1998). Reproductive mechanisms in *Macrobrachium rosenbergii* and *Penaeus japonicus*: Endocrinological research and applications in aquaculture. Nutrition and Technical Development of Aquaculture. Proceedings of the 26th U.S.-Japan Aquaculture Panel Symposium, Durham, NH, USA: 113-123.

□ **Wilder, M. N., Atmomarsono, M., Hien, T. T. T., Phu, Q. T.** and Yang, W. J. (1998). Na/K-ATPase activity in the giant freshwater prawn, *Macrobrachium rosenbergii*. Proceedings of the Japan Society for Comparative Endocrinology: 13, 47.

□ **Yagi, K.** and Minami, K. (1998). Methane emission from paddy fields as affected by soil properties and its implications for global estimation. Abstracts of the Final Workshop of Interregional Research Program on Methane Emission from Rice Fields: 34.

Yagi, K. and Minami, K. (1998). Preliminary estimation of global methane emission rates from paddy fields. 1998 Annual Meeting Abstracts of the American Society of Agronomy: 30.

□ **Yagi, K., Chairaj, P.** and Katoh, K. (1998). Survey of the remaining organic matter in paddy fields of Thailand. Proceedings of the Annual Meeting of the Japanese Society of Soil Science and Plant Nutrition, 44: 217. (J)

□ **Yagi, K., Watanabe, T.** and Minami, K. (1999). Nitrous oxide emissions from cropped soils in Japan and other Asian countries and their mitigation. Abstracts of the International Workshop of Reducing N₂O Emissions from Agroecosystems, Banff, AB, Canada.

□ **Yamada, R., Vo, Q. M., Hiraoka, H.** and Nguyen, V. S. (1999). Classification of farming systems in the Mekong Delta. *Journal of Rural Problems*, 7(Special Issue): 159-164.

□ **Yamada, Y.** (1998). Construction of GIS Database in northeast Thailand and its evaluation for agricultural land use. Proceedings of the 1st CEReS Symposium on Environmental Remote Sensing: 13-19. (J)

□ **Yamada, Y.** (1998). Agriculture: View from space, "Thinking better of the Earth." Board of Education, Shibuya Ward, Tokyo: 1-3.

□ **Yamada, Y.** (1998). The use of Geographic Information Systems for a graphic user interface. Proceedings of the Annual Meeting of Japanese Society of Irrigation, Drainage and Reclamation Engineering: 806-807. (J)

□ **Yamada, Y.** (1998). Macro indicator to the relation between agro-environmental change and international food trade in northeast Thailand. Proceedings of International Conference on Modeling, Geographical and Environmental Systems with Geographical Information Systems (GIS), 1: 146-151.

□ **Yamaguchi-Shinozaki, K.** (1998). Regulation of ABA-dependent and ABA-independent gene expression under drought



stress. Gordon Research Conference on the Cellular Basis of Adaptation to Salt and Water Stress in Plants, Oxford, U.K.

- Yamaguchi-Shinozaki, K.** (1998). Gene expression and signal transduction in water stress responses. *Plant Signaling: Molecular Responses to Environmental Stimuli and Stress*, Tsukuba, Japan.
- Yamaguchi-Shinozaki, K.**, Liu, Q., **Kasuga, M.**, Sakuma, Y., Uno, Y., Abe, H., Miura, S. and Shinozaki, K. (1998). Regulation of ABA-dependent and ABA-independent gene expression under drought stress. 16th International Conference on Plant Growth Substances, Makuhari, Japan.
- Yamaguchi-Shinozaki, K.**, **Kasuga, M.**, Liu, Q., Sakuma, Y., Abe, H., Miura, S. and Shinozaki, K. (1998). Improving drought and freezing stress tolerance using a single gene for a stress-inducible transcription factor in transgenic plants. International Workshop on Breeding and Biotechnology for Environmental Stress in Rice, Sapporo, Japan.
- Yamaguchi-Shinozaki, K.** and Shinozaki, K. (1998). Molecular mechanisms of freezing and drought tolerance in plants. JIRCAS/IPGRI Joint International Workshop 1998, Cryopreservation of Tropical Plant Germplasm, Tsukuba, Japan.
- Yamaguchi-Shinozaki, K.** and Shinozaki, K. (1998). Improving drought, salt and freezing stress tolerances in transgenic plants. The 12th TOYOTA Conference, Challenge of Plant and Agricultural Sciences to the Crisis of the Earth Biosphere in the 21st century, Mikkabi, Japan.
- Yamaguchi-Shinozaki, K.** and Shinozaki, K. (1998). Improving drought, salt and freezing stress tolerances using a single gene for a stress-inducible transcription factor in transgenic plants. Workshop on Genetic Improvement of Rice for Water-limited Environments, Los Banos, the Philippines.
- Yamamoto, Y.** (1998). Study of grassland planning and evaluation methods using regional datasets. *Grassland Science*, 44(Addition): 11-14. (J)
- Yamamoto, Y.**, Sukchan, S. and Ogawa, S. (1998). Analysis of soil-environmental characteristics in northeast Thailand. *Journal of the Japanese Agricultural Systems Society*, 14(Addition 1): 12-13. (J)
- Yamamoto, Y.**, Uchida, S., Ohno, H., Watanabe, T., Suyama, T., Sasaki, H. and Shoji, A. (1998). Development of land degradation assessment methods in desertificated areas: Analysis of vegetation stability using satellite data. *Grassland Science*, 44(Addition): 390-391. (J)
- Yamamoto, Y.**, Uchida, S., Ohno, H., Watanabe, T., Suyama, T., Sasaki, H. and Shoji, A. (1998). Development of land degradation assessment methods in desertificated areas: Development of neural network model for land degradation assessment. *Grassland Science*, 44(Addition): 392-393. (J)
- Yang, D. and **Ohno, H.** (1998). Bias correction of gauge-measured precipitation data: Methods and results. Preprints of the 1998 Conference of Japanese Society of Snow and Ice: 67.
- Yasuda, K.**, **Sogawa, K.** and **Takahashi, A.** (1998). Abstracts of the 57th Annual Meeting of the Japanese Society of the Entomology: 236. (J)
- Yoneyama, T., Terakado, J., Matsumaru, T., **Ando, S.** and Meunchang, S. (1999). Estimation of possible input of fixed nitrogen in field-grown non-leguminous plants. *Plant and Cell Physiology*, 40(Supplement): 137. (J)
- Yoshiba, Y., Miura, S., **Yamaguchi-Shinozaki, K.** and Shinozaki, K. (1998). Promoter analysis of an *Arabidopsis* gene for *f $\epsilon$ 1*-pyrroline-5-carboxylate synthetase (P5CS) in transgenics under water stress. 16th International Conference on Plant Growth Substances, Makuhari, Japan.
- Yoshiba, Y., Urano, K., Sekiguchi, F., **Yamaguchi-Shinozaki, K.** and Shinozaki, K. (1999). Differential expression of two genes encoding arginine decarboxylase of polyamine synthesis in *Arabidopsis thaliana*. *Plant & Cell Physiology*, 40(Supplement): 91. (J)
- Yoshihashi, T.** (1999). Quality evaluation of Khao Dawk Mali 105. *In: Highlights of Collaborative Research Activities between Thai Research Organizations and JIRCAS: Proceedings of JIRCAS Seminar in Bangkok 1999*, Eds. Suzuki, M. and Ando, S., Bangkok, Thailand: 144-145.

[return to top](#)  
[back to main contents](#)

---

Symbols: (J) Denotes articles written in Japanese; (C) denotes articles written in Chinese; **bold** lettering indicates authors who were staff members ([see staff list](#)) or STA post-doctoral fellows ([see fellowship explanation](#)) at JIRCAS during FY1998.

# ADVISORS AND PRINCIPAL STAFF

## JIRCAS Technical Advisory Committee FY 1998

The JIRCAS Advisory Committee members generally convene one time each year for a round table discussion regarding policy formation, research direction, and project design at JIRCAS. The Committee consists of scientists and administrators representing various fields of international development. We actively seek their advice and opinions throughout the year and greatly value their participation in the affairs of JIRCAS. The Committee was initiated at the request of the Ministry of Agriculture, Forestry and Fisheries (MAFF) and the Agriculture, Forestry, and Fisheries Research Council (AFFRC).

Advisors	
Dr. Hisao Azuma	Vice-President, Japan International Cooperation Agency
Dr. Ronald P. Cantrell	Director General, International Rice Research Institute
Mr. Tadao Chino	Executive Director, Nomura Research Institute
Dr. Keiji Kainuma	Board Member, Bio-oriented Technology Research Advancement Institute
Dr. Fujio Kobayashi	Vice Chairman, Japan Forestry Association
Ms. Midori Miyazaki	Journalist
Dr. Kazuo Shima	President, Japan Fisheries Resource Conservation Association
Dr. Kunio Takase	Board Member, International Development Center of Japan
Dr. Saburo Yamada	Professor, College of Agriculture and Veterinary Medicine, Nihon University

**FINANCIAL OVERVIEW** Fiscal Year 1998*thousands of yen*

<b>TOTAL BUDGET</b>	<b>2,863,944</b>
<b>OPERATING COSTS</b>	<b>1,781,876</b>
Personnel	1,360,852
Director General	
Administrators I	
Administrators II	
Researchers	
*Number of persons shown in ()	
**General administration	
***Field management and transportation	
Administrative Costs	421,024

<b>RESEARCH PROMOTION COSTS</b>	<b>1,082,068</b>
Research Development	35,379
Overseas Dispatches	278,684
Research Exchange/Invitation	42,802
Research Information Collection	16,104
International Collaborative Projects	475,988
Comprehensive	415,399

Unidisciplinary	60,589
Fellowship Programs	233,111

**Budget FY 1998 (Graph)**

Director General 1 person	Administrators I 32 persons, 20%	Administrators II 13 persons, 8%	Researchers 116 persons, 72%
------------------------------	-------------------------------------	-------------------------------------	---------------------------------

Operating Costs 1,781,876, 62%	Research Promotion Costs 1,082,068, 38%
-----------------------------------	--------------------------------------------

**BACK**



# ANNUAL REPORT 1997

## CONTENTS

### Introduction

- [② Message from the Director General](#)
- [② Highlights from Fiscal Year 1997](#)
- [② JIRCAS and the Ministry of Agriculture, Forestry and Fisheries](#)

### Research Overview

- [② International Research at JIRCAS](#)

### JIRCAS Research Divisions

- [② Research Information Division](#)
- [② Biological Resources Division](#)
- [② Environmental Resources Division](#)
- [② Crop Production and Postharvest Technology Division](#)
- [② Animal Production and Grassland Division](#)
- [② Forestry Division](#)
- [② Fisheries Division](#)
- [② Okinawa Subtropical Station](#)
- [② Miscellaneous Projects Outline](#)

### Invitation Programs and Information Events

- [② Fellowship Programs](#)
- [② Symposia and Workshops](#)

### Appendix

- [② Official Publications and Library Holdings](#)
- [② JIRCAS Staff during Fiscal Year 1997](#)
- [② Research Staff Activity during Fiscal Year 1997](#)



## Message from the Director General



*Dr. Nobuyoshi Maeno, Director General,  
Japan International Research Center for Agricultural Sciences*

### **Building New Structures for Collaborative Research**

During the time of the Tropical Agricultural Research Center (TARC), the predecessor of JIRCAS, collaborative research came to be conducted primarily in individual fields of research with particular research organizations in specific countries. There is no doubt that, based on unidisciplinary collaborative research efforts under such institute-to-institute relationships, we have achieved numerous valuable research results.

However, when TARC was reorganized into the present Japan International Research Center for Agricultural Sciences (JIRCAS) in 1993, the scope of our research objectives and, concomitantly, the number of partner countries and regions in our cooperative research program widened considerably. In order to respond to this newly expanded mandate within the constraints of limited resources, an emphasis on collaborative research and research structures differing from those previously utilized became necessary. As a result, a variety of new initiatives have been undertaken since the start of JIRCAS. One such initiative involves efforts to strengthen comprehensive research programs aimed at systematic multidisciplinary research in complement to the unidisciplinary approach characteristic of the past. At present, comprehensive research projects are underway in Thailand, Vietnam, Malaysia, the People's Republic of China, Brazil, Indonesia, and various other countries.

A [map](#) indicating the [comprehensive research projects being conducted by JIRCAS throughout the world](#) as of June, 1998.

As the scope of our research has broadened from unidisciplinary to multidisciplinary, the number of research organizations in partner countries with whom we maintain relationships has also quite naturally expanded. Consequently, institution-to-institution relationships of the past have become what might be called government-to-government relationships. In other words, relations which were once modest and cozy have been transformed into diplomatic ties. For this reason, a variety of formalities have become necessary in launching collaborative research projects, and I cannot deny that this invites some complications. At the same time, I can also say that relationships with partner countries have become more formalized and systematized.

These changes have allowed JIRCAS to pursue a broad range of additional international initiatives, some of which are described below.

### **Multinational Initiatives**

In one new initiative, we have developed structures allowing us to implement research in collaboration with multiple countries regarding research problems spanning broad areas. Our collaborative soybean research project with the MERCOSUR countries Brazil, Paraguay, and Argentina provides one example. It marks our attempts since the days of TARC to move from cooperative relationships with individual countries toward cooperative multilateral relations within which we can work together with several countries simultaneously. Through these efforts, we have become better able with limited research resources to implement efficient and effective collaborative research for addressing problems common to several countries.

Furthermore, in the South American soybean project, we have created new research systems amenable to the participation of experts outside those organizations formally affiliated with the Ministry of Agriculture, Forestry and Fisheries. These arrangements

might be described as the practical application of the power of post-doctoral research, as they allow JIRCAS to complement the abilities of its own staff by adopting, for relatively long periods of time, outside experts to assist with multinational research projects. Many of these researchers have previously accumulated invaluable experience in conducting collaborative research in targeted areas of the developing world.

Additionally, in our comprehensive project on the "Sustainable production and utilization of major food resources in China," we have made possible the participation of researchers from Japanese prefectural agricultural organizations, which often conduct research highly relevant to the developing areas with which JIRCAS is most concerned. Now, in cooperation with JIRCAS, these organizations can take advantage of opportunities to dispatch personnel overseas and develop links with foreign countries.

Through these initiatives, the Institute hopes to be able to plan for further expansion in the ranks of researchers interested in international agricultural research collaboration, particularly with developing countries.

*Photo: [Okinawa Visiting Research Fellows display their national colors](#) with JIRCAS staff and Director General Nobuyoshi Maeno in front of the International Collaborative Research Section at the Okinawa Subtropical Station on Ishigaki Island.*

## **New Cooperative Relationships with CGIAR Centers**

Since the beginning of Fiscal Year 1997, we have been promoting a project on "New technologies for agricultural research" in cooperation with the [International Service for National Agricultural Research \(ISNAR\)](#). The project will be funded with a special allotment to ISNAR from the Japanese Ministry of Foreign Affairs, but JIRCAS has been selected to cooperate in the implementation of technical matters. This marks for us a new cooperative relationship with one of the international research organizations under the umbrella of the [Consultative Group on International Agricultural Research \(CGIAR\)](#). Up to this point, we have had relationships in which JIRCAS researchers are dispatched to CGIAR research organizations and utilize available research infrastructure to implement particular research projects. Hereafter, however, it will be necessary to expand these types of new cooperative relationships.

With the restructuring of TARC into JIRCAS, our mandate has grown. Because it would prove difficult to respond to this new mandate using only established methods, new structures for research cooperation are becoming increasingly necessary. Therefore, in the future, by commissioning research to organizations in developing countries and by devising a variety of other new structures, we hope to realize more efficient, effective cooperative research.

## **Note on Annual Report 1997**

In keeping with our recent efforts to spotlight JIRCAS activities in particular regions of the world, Annual Report 1997 will focus on projects involving JIRCAS research in Southeast Asia countries. In this year's issue, detailed descriptions of research sites in Thailand and Vietnam can be found in the section entitled [International Research at JIRCAS](#). When viewed in full, however, JIRCAS activities range widely across the globe. It is our hope that the increasingly international scope of research at JIRCAS will be equally evident within Annual Report 1997.

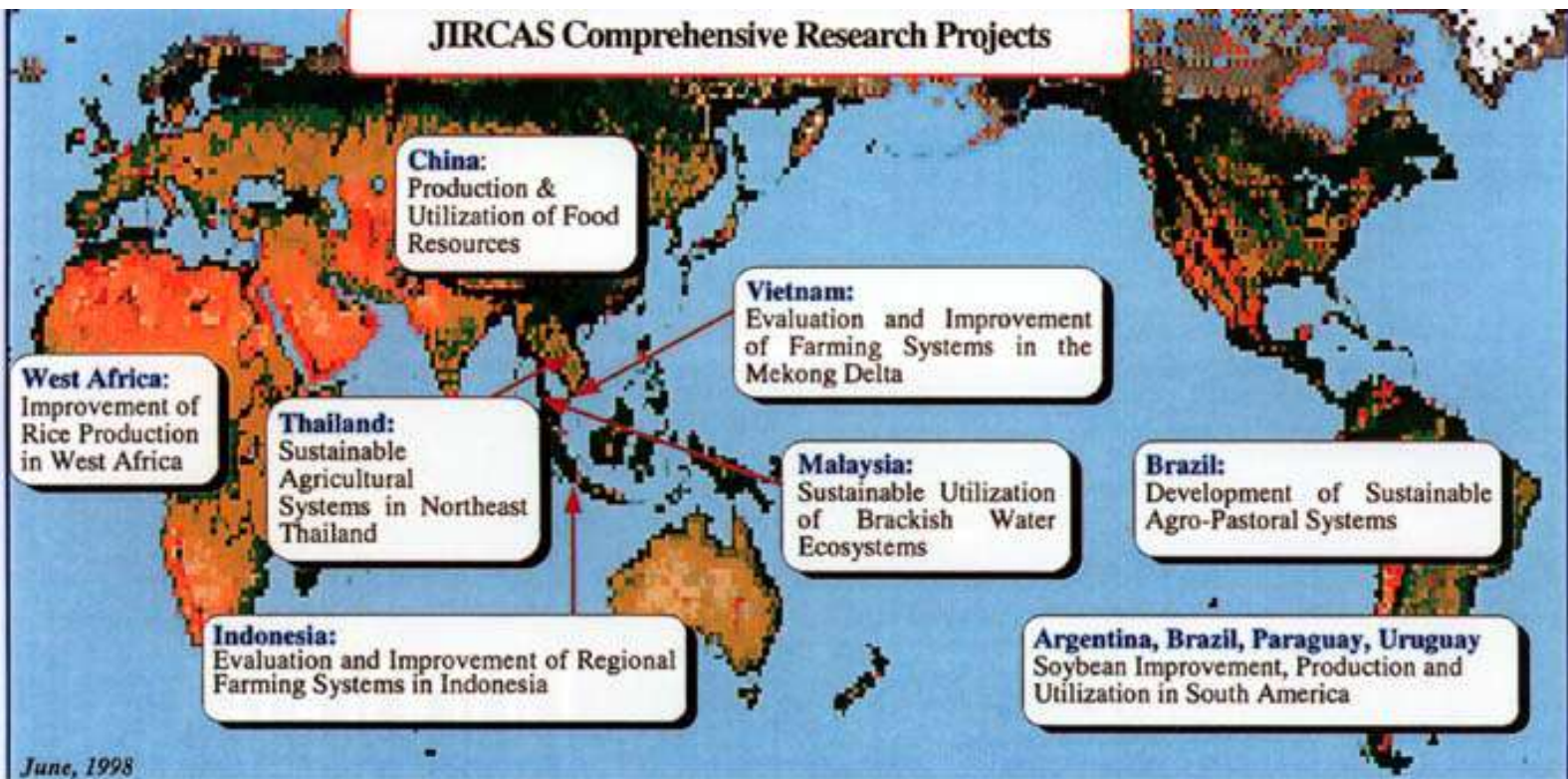


*Dr. Nobuyoshi Maeno, Director General*

Back to [the Annual Report Main Contents](#) page.



## JIRCAS Comprehensive Research Projects



June, 1998





## INTERNATIONAL RESEARCH AT JIRCAS

International collaborative projects at JIRCAS encompass all fields of agriculture, forestry, and fisheries and are often carried out in collaboration with counterpart institutions, including international research centers, national research organizations, and universities. Projects fall into one of two broad classifications. A series of comprehensive projects commenced when the Tropical Agricultural Research Center (TARC), the predecessor of JIRCAS, was restructured to create the present institute. Six such comprehensive projects are currently underway in Vietnam, Thailand, Malaysia, Brazil, the People's Republic of China, and South America. In addition, JIRCAS continues to promote the specific, focused, unidisciplinary types of projects originally carried out at TARC.

The following section presents recent developments in several ongoing comprehensive projects and, in keeping with this year's focus on Southeast Asia, spotlights important research sites in Thailand and Vietnam where collaborative projects are currently being pursued. A [complete summary of all collaborative and unidisciplinary projects](#) currently being undertaken by JIRCAS researchers can be found [here](#).

### @ COMPREHENSIVE PROJECTS

In 1997, JIRCAS was involved in six comprehensive projects in Vietnam, Thailand, Malaysia, Brazil, the People's Republic of China, and the Southern Cone of South America. In addition, new projects in Indonesia and West Africa are scheduled to begin during FY 1998. These studies continue the comprehensive research system begun shortly after the founding of JIRCAS in 1994. Under this program, a research coordinator in the Research Information Division assumes the role of project leader, helping to conduct socio-economic studies to identify the most pressing research priorities in counterpart countries. The research coordinator then helps to organize and oversee collaboration among researchers in all participating Research Divisions of the Institute. Information on developments in the most recent of these projects can be accessed below.

- Click [here](#) to learn about the evaluation and improvement of regional farming systems in [Indonesia](#).
- Click [here](#) to learn about improving food security through rainfed rice systems in [West Africa](#).
- Click [here](#) to learn about soybean improvement, production and utilization in [South America](#).

### @ RESEARCH SITES IN SOUTHEAST ASIA

As a part of this year's spotlight on JIRCAS initiatives in Southeast Asia, the following articles detail collaborative projects that JIRCAS researchers are currently undertaking with governmental organizations and university institutes in northeastern Thailand and the Mekong Delta region of Vietnam.

- Find information about JIRCAS research sites in [northeastern Thailand](#) [here](#).
- Find information about JIRCAS research sites in the [Mekong Delta region](#) of Vietnam [here](#).

Back to the Annual Report [Main Contents](#) page.



## International Collaborative Projects

JIRCAS research projects are designated as either comprehensive or unidisciplinary. Regardless of designation, all projects are undertaken and maintained principally by JIRCAS Research Divisions. Listings marked with an asterisk (*) indicate projects whose budgets have been specifically authorized by the Agriculture, Forestry and Fisheries Research Council (AFFRC) of the Ministry of Agriculture, Forestry and Fisheries. Remaining projects are funded by JIRCAS through other budget instruments.

### (A) COMPREHENSIVE PROJECTS

Time Frame		Project Title	Research Site	
1994	-	1998	Evaluation and improvement of farming systems combining agriculture, animal husbandry, and fisheries in the Mekong Delta	Cuu Long Delta Rice Research Institute (CLRRI) and Cantho University (CTU), Vietnam
1995	-	2001	Development of sustainable agricultural technology in Northeast Thailand	Khon Kaen University, Thailand
1995	-	1999	Productivity and sustainable utilization of tropical and subtropical brackish water ecosystems	Department of Fisheries (DOF), Forestry Research Institute Malaysia (FRIM), and Ministry of Agriculture (MOA), Malaysia
1996	-	2002	Comprehensive studies on the development of a sustainable agro-pastoral system in the sub-tropical zone of Brazil	Brazilian Agricultural Research Corporation (EMBRAPA), Center for Tropical Agriculture (CIAT), and JATAK International Center for Agriculture Technology, Brazil
1997	-	2003	Development of sustainable production and utilization of major food resources in China	Institute of Agricultural Economics, Institute of Natural Resources and Regional Planning, Research Center for Rural Economy, China Agricultural University, Soil and Fertilizer Institute, China National Rice Research Institute, and the Shanghai Fisheries University, People's Republic of China
1997	-	2006	Comprehensive soybean research project in South America (multinational)	Agricultural Technology Center in Paraguay (CETAPAR) and the Ministry of Agriculture and Livestock (MAG), Paraguay; Brazilian Agricultural Research Corporation (EMBRAPA), Brazil; and the National Institute for Agricultural Technology (INTA), Argentina

1998	-	2002	Evaluation and improvement of regional farming systems in Indonesia	Agency for Agricultural Research and Development (AARD), Indonesia
1998	-	2002	Improving food security in West Africa through increased productivity in rainfed rice systems	West Africa Rice Development Association (WARDA), Côte d'Ivoire

## (B) UNIDISCIPLINARY PROJECTS

Time Frame		Project Title	Research Site	
1993	-	1997	Development of sustainable agriculture in dry areas based on environmental improvement	Xinjiang Institute of Biology, Pedology and Desert Research and the Chinese Academy of Sciences, People's Republic of China
1993	-	1997	Analysis of environmental changes in agricultural lands after forest clearing in the tropics and development of sustainable land use systems *	International Crop Research Institute for the Semi-Arid Tropics (ICRISAT), India
1993	-	1997	Studies of technology for the evaluation of environmental changes in the transfer of tropical forest into farm land and methods for sustainable use *	International Crop Research Institute for the Semi-Arid Tropics (ICRISAT), India
1994	-	1997	Investigations on the mechanical properties of typical soils distributed in Northeast Thailand for the construction of irrigation facilities	Asian Institute of Technology (AIT), Thailand
1995	-	1997	Evaluation of changes in agricultural production structure associated with economic development and clarification of agricultural development trends using model analysis *	Research Center for Rural Economy, People's Republic of China; Universiti Pertanian Malasia (UPM), Malaysia; Thai Development Research Institute (TDRI), Thailand; Center for Agro-Socioeconomic Research (CASER), Indonesia
1995	-	1997	Long range migration of rice plant hoppers in the monsoon area of East Asia	China National Rice Research Institute, People's Republic of China
1995	-	1997	Breeding of hybrid rice varieties in Malaysia	Malaysian Agricultural Research and Development Institute (MARDI), Malaysia
1995	-	1997	Studies on the development of methods of preservation of tropical wood in Malaysia	School of Industrial Technology, Universiti Sains Malasia, Malaysia
1995	-	1998	Rehabilitation of secondary degraded forest	Forest Research Institute Malaysia (FRIM), Malaysia
1995	-	1998	Improvement of technologies for raising small livestock in the tropics	Malaysia Agricultural Research and Development Institute (MARDI), Malaysia
1995	-	1998	Ecology and control of insect pests in reforested areas at Luasong Forestry Centre, Tawau, Sabah	Forest Research Institute Malaysia (FRIM), Malaysia
1995	-	1998	Methods of cultivation of soybean in cropping systems with low pesticide input in Indonesia	Research Institute for Legumes and Tuber Crops (RILET), and the Agency for Agricultural Research and Development (AARD), Indonesia
1995	-	1999	Biorational approaches to long term and sustainable management of desert locusts in East and Northeast Africa	International Center for Insect Physiology and Ecology (ICIPE), Kenya

## INTERNATIONAL COLLABORATIVE PROJECTS

1996	-	1998	An explanation of the ecology of and methods for control of weeds in direct seeded rice cultivation in Malaysia	Malaysian Agricultural Research and Development Institute (MARDI), Malaysia
1996	-	1998	Improvement of logging techniques in hill dipterocarp forests	Forest Research Institute Malaysia (FRIM)
1996	-	1999	Development for effective water management in paddy fields in the dry season	International Irrigation Management Institute (IIMI), Sri Lanka
1996	-	2000	Development of technology for sustainable management of grasslands in Central Asia	Kazakh Institute of Agriculture, Republic of Kazakhstan
1996	-	2000	Afforestation technology for useful tropical tree species and the development of related research	University of the Philippines at Los Baños, The Philippines
1997	-	1998	Early interactions between <i>Theilelia parva</i> and bovine immune cell populations	International Livestock Research Institute (ILRI), Kenya
1997	-	1999	The role of local people in the degradation and rehabilitation of tropical forests	International Center for Research in Agroforestry (ICRAF)-South East Asia, Indonesia
1997	-	1999	Improvement of high-yielding wheat varieties through biological procedures	International Wheat and Maize Improvement Center (CIMMYT), Mexico
1997	-	1999	Studies on Technology for sustainable Production in Closed Coastal Zone	Kasetsart University, Thailand
1997	-	1999	The development of methods for the use of underutilized timber resources in the tropics	School of Industrial Technology, Universiti Sains Malasia, Malaysia
1997	-	2001	Development of the diagnosis and prevention technology for shrimp viral diseases	Fisheries Research Institute (FRI), Malaysia
1998	-	2001	Development of technology for water distribution management for large scale paddy fields in tropic monsoon area	Muda Agricultural Development Authority (MADA) and Malaysian Agricultural Research and Development Institute (MARDI), Malaysia

Back to

the [Research Overview menu](#).



## **INDONESIA**

### **Comprehensive Project on the Evaluation and Improvement of Regional Farming Systems**

Food production levels in Southeast Asia have increased rapidly during the past several decades, in keeping with high rates of economic growth. Nevertheless, problems in food production persist. Income difference between urban citizens and rural farmers have expanded with rapid industrialization. Large-scale migration from villages to cities has detrimentally impacted agricultural conditions. Consequently, efforts to strengthen agricultural activities and improve living conditions in rural areas will have an important role to play in generating stable, sustainable economic development in the region.

Approximately two hundred million people live in Indonesia, scattered across several thousand islands under humid tropical conditions. Agriculture, forestry, and fisheries production are conducted in great variety, depending upon natural environmental conditions and the types of exploitation possible in each locale. Forms of production and development in villages differ with each unique socio-economic and historical situation. For instance, rapid economic growth, industrialization, and urbanization on Java Island has exacerbated gaps between cities and villages and fundamentally altered social and economic conditions in rural areas. On the outer islands, generally poor living conditions reflect the slow pace of economic development and the lack of suitable technologies with which to overcome the difficulties of resource exploitation.

A "farming systems approach" has become popular among researchers, extension workers, and agricultural officials working to raise educational levels among local farmers, tackle persistent problems in agricultural production, and improve rural conditions overall. This farming systems approach is characterized by a bottom-up participatory process and an emphasis on multi-disciplinary approaches to problems.

Most agricultural research in Indonesia has remained focused on lowland farming systems based on the cultivation of rice. This focus, when combined with the effects of other governmental programs to aid rice farmers, allowed Indonesia to achieve its national goal of self-sufficiency in rice by 1984. However, upland crop areas have benefited little from the new techniques in spite of the many research projects, with or without the title of farming systems research, that have targeted upland or rainfed lands. Consequently, the state of upland agriculture remains much less developed than lowland agriculture throughout the country.

*Photo: [Farmers in central Java prepare cowpeas](#) before taking them to market.*

The comprehensive research project entitled "Evaluation and improvement of regional farming systems in Indonesia" aims to shed light on the development and implementation of farming systems in Indonesia. Specific objectives include efforts to clarify problems and evaluate on-going farming systems from the viewpoints of environmental resources, biological resources, production, processing, and socio-economic factors. At the same time, the project will attempt to improve regional farming systems in consideration of the need to achieve sustainability, maintain an ecological balance, and generate greater profit.

The project is scheduled to last five years starting from April, 1998, and involves close collaboration with Indonesian research institutes, such as the Center for Agro Socio-Economic Research (CASER), the Research Institute for Legumes and Tuber Crops (RILET), and other organizations under the Agency for Agricultural Research and Development (AARD) of the Ministry of Agriculture of the Republic of Indonesia.

Back to	the <a href="#">Research Overview menu</a> .
Forward to	learn about rainfed rice systems in <a href="#">West Africa</a> , or to learn about soybean production and utilization in <a href="#">South America</a> .







## **WEST AFRICA** **Comprehensive Project on Improving Food Security through Rainfed Rice Systems**

During the past two years, JIRCAS workshops on African agricultural problems have consistently suggested that the institute enhance its efforts to review major issues in African agriculture and examine possible collaborative research projects in the region. In March, 1998, in keeping with this recommendation, JIRCAS launched a collaborative research project with the [West Africa Rice Development Association \(WARDA\)](#) to increase rice productivity in West Africa.

According to World Bank estimates, 49.7% of all sub-Saharan Africans will be living in conditions of absolute poverty as we enter the new millennium. Demand for rice in sub-Saharan Africa is growing faster than that for any other major food staple, with consumption broadening across all socioeconomic classes, including the poor. These patterns are clearest in West Africa where the substitution of rice for coarse grains and traditional roots and tubers has fueled demand growth at an annual rate of 5.6% between 1961 and 1992, double the rate of population growth.

Rice is no longer a luxury food. The poorest urban households in West Africa obtain larger shares of their cereal-based calories from rice than do higher income households, and rice purchases represent a greater share of their total cash expenditures. Rice availability and rice prices directly impact the welfare of the poorest West African consumers who are the least food secure.

The research project on interspecific hybridization between the African and Asian rice species (*Oryza glaberrima* and *O. sativa*) was initiated at WARDA in January, 1997. The main goal of the project is to improve the welfare of rice producers and consumers by developing through interspecific hybridization low-management rice varieties that are well suited to resource-poor farmers in West Africa. The new interspecific progenies included a significant percentage of intermediate types combining seedling vigor, high tillering and weed suppression traits of *O. glaberrima* with the panicle and grain type characteristics of *O. sativa*. They are considered promising new breeding materials. Further efforts for combining high-yield and stress tolerance characteristics into new generations could prove beneficial to the farmers in the region.

*Photo: Introducing a new rice genotype produced through the interspecific hybridization of *Oryza sativa* and *O. glaberrima* to villagers in the northern part of Côte d'Ivoire, Africa.*

JIRCAS has initiated collaboration by dispatching senior researchers to WARDA to pursue several specific research topics as first steps in the five-year project. These include studies of the genetic and eco-physiological characterization of indigenous varieties and interspecific progenies, especially for tolerances to drought and acid soil conditions. On a broader level, researchers will analyze major constraints to productivity increases in rainfed rice systems.

Back to the

[Research Overview menu](#), or to  
 learn about regional farming systems in [Indonesia](#).

Forward to

learn about soybean production and utilization in [South America](#).





## **SOUTH AMERICA** **Comprehensive Project on Soybean Improvement, Production and Utilization**

The soybean, *Glycine max*, is considered to be one of the principal crops for human sustenance. Soybeans provide a major source of food, oil, and protein-rich livestock feed. Production of this valuable crop has increased rapidly during the past three decades in comparison with rice, wheat, corn, and other major grains. Encouraging the continuation of this trend may aid efforts to stabilize the world food supply.

At present, Brazil, Argentina, and Paraguay account for approximately one-third of global soybean production, placing them among the leading soybean exporting countries. However, soybean production in South America has often been carried out under environmentally vulnerable conditions in arid, acidic soils characterized by low fertility. Of additional concern, the history of soybean cultivation in these areas has been relatively short, giving rise to concerns that continuous cropping, outbreaks of pests and diseases, and soil erosion may adversely affect future soybean production. Comprehensive, multinational research efforts focused on the development of sustainable and more efficient systems of soybean production in South America can be considered an important means of addressing these constraints.

Japan possess rich experience in the cultivation of soybeans and the their use in traditional foods and has contributed significantly to the understanding of this important industrial crop through soybean research programs initiated under JIRCAS and the [Japan International Cooperation Agency \(JICA\)](#). In Brazil, JIRCAS recently implemented a major project on subtropical agro-pastoral systems in which soybeans will constitute the main crop in the development of mixed multi-cropping systems. Moreover, a cooperative JICA project in Paraguay has been working since 1996 to propagate a no-tillage cultivation system useful for sustainable soybean production in the fertile Terras Roxas areas of Paraguay and neighboring countries.

The JIRCAS research project entitled “Soybean improvement, production, and utilization in South America” marks a new initiative by the Institute to promote multidisciplinary studies on soybean production and utilization in Southern Cone countries through collaborative research linking Japanese and South American specialists. The project will involve collaboration with JICA personnel and incorporate that agency’s ongoing research with the Agricultural Technology Center in Paraguay (CETAPAR) as one of several anticipated research sites.

This comprehensive project will complement earlier efforts in the field by focusing research in five areas, including genetics and breeding, soil management and pest control, crop management and production, post harvest technology, and socioeconomic factors. Cooperative arrangements with the [National Institute for Agriculture Technology \(INTA\)](#) of Argentina and the Ministry of Agriculture and Livestock (MAG) of Paraguay have already been secured, as reported in the Highlights section of this Annual Report. In addition, the participation of research organizations affiliated with the [Brazilian Agricultural Research Corporation \(EMBRAPA\)](#) of Brazil is anticipated.

Back to

the [Research Overview menu](#), or to  
 learn about regional farming systems in [Indonesia](#), or to  
 learn about rainfed rice systems in [West Africa](#).

Forward to

the Research Site introduction for [northeastern Thailand](#).



## **THAILAND RESEARCH SITE: Collaborative research on sustainable agricultural systems in northeastern Thailand**

Environmental changes in northeastern Thailand have severely impacted local agriculture during the past thirty years. In an effort to better understand and overcome agricultural problems in the region, JIRCAS initiated a project on the “Development of sustainable agricultural technology in northeastern Thailand” two years ago. The objective of the program is to propagate sustainable agricultural practices in northeastern Thailand by generating simple yet effective new techniques for crop and livestock production. These techniques will then be transferred to local farmers during the seven year term of the project in an effort to enhance agricultural productivity.

The JIRCAS Thailand Office, which coordinates this and other collaborative efforts, is located on the campus of Kasetsart University on the outskirts of Bangkok. The present office was constructed in 1989 and shares the first floor with the Soil Science Division, an office of the Department of Agriculture within Thailand’s Ministry of Agriculture and Cooperatives. The office boasts eight rooms and faces onto a small Japanese garden constructed by Dr. M Hayashi, a former staff member now residing in Thailand. Four Japanese staff members, consisting of three researchers and one administrator, maintain daily operations with the assistance of six local employees.

*Photo: JIRCAS researchers and local staff pose with Dr. Masaaki Suzuki, the JIRCAS Representative to Thailand, outside the [JIRCAS office in Bangkok](#).*

The International Training Center for Agricultural Development (ITCAD), a division of the Department of Agriculture located in the city of Khon Kaen, provides additional office space for the comprehensive research project. Originally constructed with aid from the Japan International Cooperation Agency (JICA) and now staffed by three Japanese researchers and two Thai employees, the small office serves as an important gateway to research sites in northeastern Thailand.

Researchers on the comprehensive project team have recently reported significant progress in their studies of northeastern Thailand. Scientists exploring mechanisms by which groundwater salinization takes place conducted dynamic analyses to confirm their hypothesis of salinization through fault cracks. At the same time, studies of the mechanical properties of local soils have allowed project researchers to propose improved ways for estimating properties of unsaturated soils and methods for constructing dams and small ponds. In order to improve cattle production with locally available feed resources, livestock specialists have been examining the use of sugarcane stalks as feed appropriate to the metabolism of local species of Brahman cattle and water buffalo. Additionally, agronomists working in the region have established that cropping systems using tree alleys hold promise for sustainable cultivation in upland areas, just as cropping systems characterized by direct dry seeding of rice plants should prove sustainable in regional lowlands. Finally, aware that biological nitrogen fixation may help to raise soil fertility levels, other experts have undertaken evaluations of nitrogen fixation in leguminous crops and initiated a study on indigenous rhizobias.

The broad scale of the northeastern Thailand project has been made possible by the extensive knowledge of local conditions that JIRCAS staff members have accumulated over many years of research in Thailand. This year marks the thirtieth anniversary of cooperative efforts between the two countries. Collaborative research activities originated in 1967, linking researchers at the Tropical Agricultural Research Center (TARC) with counterparts in the Thai Department of Agriculture, Kasetsart University, and the Department of Livestock Development. Since the creation of JIRCAS in 1993, these collaborative activities have expanded to include other organizations, such as the Asian Institute of Technology, Khon Kaen University, the Land Development Department, and the Agricultural Development Research Center in Northeast Thailand.

Extensive cooperative relationships with public and private agricultural research organizations in Thailand have allowed JIRCAS to undertake a number of projects in addition to the comprehensive research in northeastern Thailand. A long-term experiment examining the effects of organic material utilization on the chemical and physical properties of upland soil has continued for twenty years in collaboration with the Thai Department of Agriculture. More recently, researchers from the JIRCAS Fisheries Division have initiated a collaborative project entitled “Studies on technology for the development of sustainable aquaculture in Southeast Asia,” intended to address problems of coastal environmental degradation and increased disease outbreak that characterize the intensive cultivation of giant tiger prawn, *Penaeus monodon*.

In the course of thirty years of collaboration, TARC and JIRCAS have dispatched to Thailand more than 100 researchers on long-term projects lasting one year or more. With the addition of short-term visiting scientists and administrators, the number of researchers involved in collaborative bilateral projects now surpasses 1500.

Back to	the <a href="#">Research Overview menu</a> .
Forward to	the Research Site introduction for the <a href="#">Mekong Delta region</a> of Vietnam.





## VIETNAM RESEARCH SITE: Collaborative research on methods to improve farming systems in the Mekong Delta region

In collaboration with Cantho University and the Cuu Long Delta Rice Research Institute (CLRRI) in Vietnam, JIRCAS has been carrying out a comprehensive research project entitled "Evaluation and improvement of farming systems combining agriculture, animal husbandry, and fisheries in the Mekong Delta." This project, initiated in 1994, aims to clarify the structure of farming systems, to identify and develop necessary technology currently lacking in these systems, and to specify conditions for the application of these systems to other regions.

Cantho University was founded in 1966 in the Mekong Delta city of Cantho, where agriculture has long been the dominant economic activity. Affiliated with the university are numerous colleges and institutes concerned with problems in agricultural sciences and agricultural production. In one such organization, the Mekong Delta Farming Systems Research and Development Institute, JIRCAS staff members have been pursuing research on the socio-economic aspects of farming systems called VACs, which combine agricultural activities such as rice cultivation, swine farming, and aquaculture. These systems operate by cycling agricultural products through several stages of production in order to minimize waste, maximize benefits, and contribute to sustainable management. In one model, swine are fed with broken rice and rice bran produced locally. Waste products from the swine are then washed into fish ponds, raising fertility levels in the water and enhancing growth in cultured fish. To complete the cycle, water from the fish ponds is then diverted into paddy fields, where the abundance of nitrogen and other elements contributes to more fruitful rice production. In effect, waste material in each stage of production can thus be recycled to produce commodities without seriously polluting the environment.

*Photo: [The campus of Cantho University](#) in the Mekong Delta region of Vietnam.*

Over the past two years, an animal parasitologist from JIRCAS has worked with animal scientists in the Cantho University College of Agriculture on problems, including environmental conservation issues, encountered in swine farming in VAC systems. During the same period, fisheries scientists have visited annually to work with university researchers studying the physiology of freshwater fish and crustacean species and disease outbreaks occurring in freshwater prawn culture. These efforts will help to strengthen current means of livestock management and to improve existing technologies for commercial aquaculture in Vietnam.

Located nearby in the city of Omon, Cantho Province, the Cuu Long Delta Rice Research Institute is a national organization affiliated with the Ministry of Agriculture and Cooperatives in Vietnam. The institute is charged with developing new varieties and production technologies useful for the cultivation of rice. Dr. Nobuyoshi Maeno, the Director General of JIRCAS, attended a ceremony held in Omon to mark CLRRI's twentieth anniversary last year. Under the auspices of the collaborative project, both an agronomist and a plant pathologist from JIRCAS have conducted research at the institute, pursuing research topics related to improved rice culture and disease control. Current efforts focus on developing new methods for growing high yielding rice and controlling disease in rice plants through integrated pest management (IPM) methods.

Vietnam became the world's second largest rice exporter in 1997, shipping approximately 3.5 million tons, mainly to Asian and African nations. Rice production in the Mekong Delta region now contributes nearly half of total national production. Among the widest alluvial plains in Southeast Asia, the Mekong Delta accounts for four million hectares of Vietnamese territory. The area is characterized by favorable agricultural conditions, including vast fertile land, ample quantities of river water, adequate temperature and sunshine, and a well-educated, diligent labor force. Improved irrigation and drainage, the introduction of modern varieties of rice, the development of integrated management methods for rice production, and the introduction of the market-oriented *doi moi* economic policy have played large roles in raising agricultural productivity to current levels.

However, problems requiring attention remain. The relatively low quality of Vietnamese rice in comparison with that produced in Thailand, for example, has kept export prices problematically low. Additionally, the Mekong Delta area still harbors expanses of wasteland covered with acid sulfate or saline soils and is prone to periodical flooding and the threat of salt water intrusion. Socioeconomic problems including low farm incomes, the lack of agricultural organizations for marketing or crediting, and underdeveloped transportation infrastructure need to be studied during the remaining project term. Such cooperative research would further contribute to the development of technologies for sustainable growth in the area and lead to better lives for its people.

Back to

the [Research Overview menu](#), or to

the Research Site introduction for [northeastern Thailand](#).









## HIGHLIGHTS FROM 1997

### @IMPORTANT NEW DEVELOPMENTS

During Fiscal Year 1997, the Japan International Research Center for Agricultural Sciences (JIRCAS) witnessed a number of noteworthy happenings. Peruvian President Alberto Fujimori visited the Ministry of Agriculture, Forestry and Fisheries (MAFF) Tsukuba Institutional Complex, which houses JIRCAS and several related research institutes. Researchers in JIRCAS laboratories made significant progress in the use of genetic engineering to improve stress tolerance in plants, while the Okinawa Subtropical Station intensified its research program on heat tolerance in commercially cultivated cash crops. Finally, the Institute helped to disseminate findings from these and other ongoing research projects through a large number of international seminars and workshops ranging in focus from food production problems in China to soybean utilization in South America. We are pleased to highlight these activities and achievements in greater detail below.

- [Highlight #1](#): Genetic Engineering to Improve Environmental Stress Tolerance in Crops
- [Highlight #2](#): Heat Tolerance as a Research Strategy at the Okinawa Subtropical Station
- [Highlight #3](#): Visit of Peruvian President Alberto Fujimori to the Tsukuba Institutional Complex
- [Highlight #4](#): Research Meetings and Conferences during Fiscal Year 1997

*Photo: The [Main Building of JIRCAS](#) in Tsukuba, Japan.*

### @NEW RESEARCH COLLABORATION

Since its establishment in 1993, JIRCAS has consistently sought to expand the depth of its collaborative efforts with research organizations and universities in a geographically diverse range of developing countries. In keeping with the JIRCAS mandate, collaborative efforts have become increasingly multidisciplinary in their focus and complex in their approach, often involving formal cooperative agreements between JIRCAS and foreign governmental entities. During Fiscal Year 1997, JIRCAS proudly initiated new Memoranda of Understanding (MOU's) solidifying project ties with countries in East and Southeast Asia, the Southern Cone of South America, and Western Africa. The following segments detail several of these agreements.

- Click [here](#) for information on the production and utilization of food resources in [China](#).
- Click [here](#) for information on rice hybridization and food supply stabilization in [West Africa](#).
- Click [here](#) for information on the production of soybeans in [MERCOSUR countries](#)
- Click [here](#) for information on the monitoring of grassland evapo-transpiration in [Mongolia](#).

### @ACADEMIC PRIZES AND AWARDS

● For a listing of JIRCAS staff members who have been the recipients of academic [prizes and awards](#) during the previous Fiscal Year, please click [here](#).

Back to

the Annual Report [Main Contents](#) page.



## ***Highlight #1: Genetic Engineering to Improve Environmental Stress Tolerance in Crops***

Plant productivity is greatly affected by environmental stresses, including drought, salinization, and freezing. These factors, in turn, may be exacerbated by rising levels of ambient pollution, environmental degradation, and climatic change around the world. In order to cope with such conditions, the breeding of crops tolerant to a wide variety of environmental stresses has become increasingly important. Genetic engineering can be used as a fast and precise means of improving these stress tolerance factors.

Scientists have made considerable progress in genetically altering commercial crop plants for resistance to disease, damage, and pests, and in actually cultivating such crops in the field. However, the development of crop plants tolerant to environmental stresses has lagged behind, due to the relative complexity of biological mechanisms necessary for the acquisition of tolerance factors. While announcements concerning laboratory breakthroughs have been frequent, generally the prospects for practical utilization have not appeared promising.

Several different approaches to improve the stress tolerance of plants by gene transfer have been attempted. Until now, a single protective protein or enzyme has been produced in each approach, even though a number of genes have been shown to function in environmental stress tolerance and response. In order to develop commercially viable crops tolerant to environmental stresses, however, it will be necessary to allow for the simultaneous transformation of multiple genes connected with stress tolerance ([Figure 1](#)).

To improve multi-stress tolerance to drought, salinization, and freezing by gene transfer, scientists at JIRCAS manipulated a single gene for stress-inducible transcription factors that regulates many stress-inducible genes involved in environmental stress tolerance. The team used not only the *35S CaMV* constitutive promoter but also a stress-inducible *rd29A* promoter for the expression of the gene for the transcription factor.

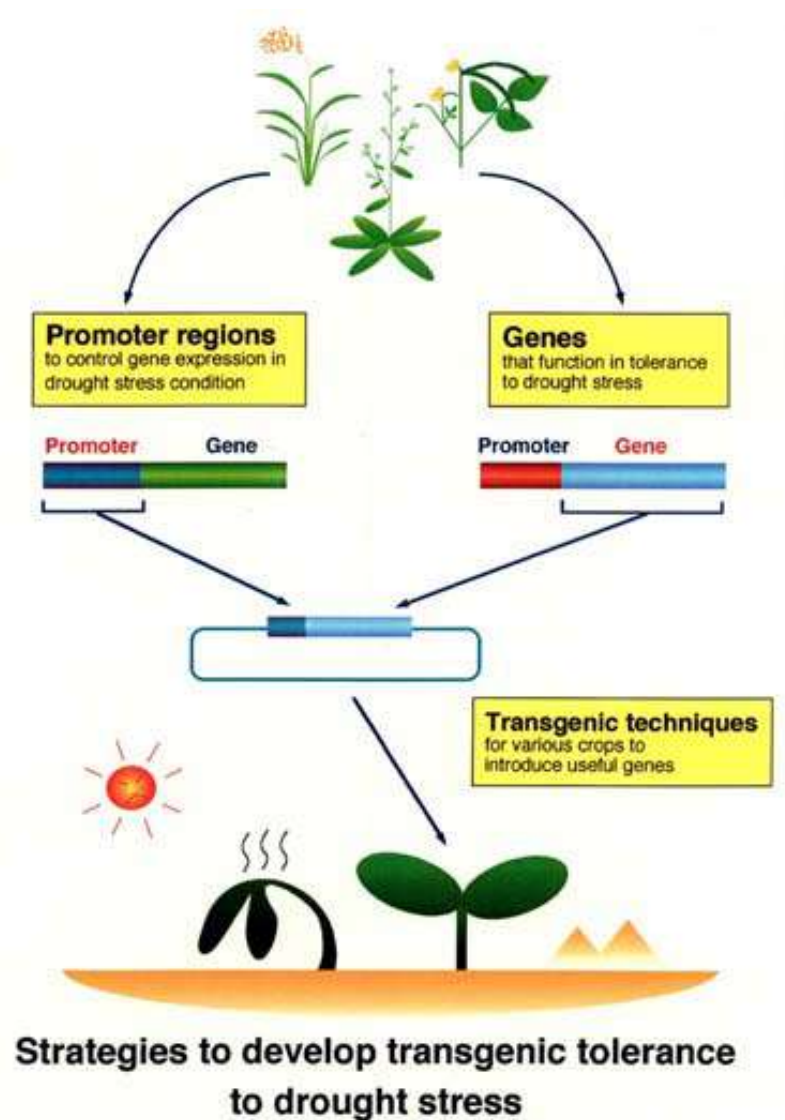
Previously, these researchers reported that a *cis*-acting element named DRE (Dehydration Responsive Element) plays an important role in gene expression induced by dehydration, salt, and low temperature in *Arabidopsis thaliana* and isolated cDNA encoding transcription factors DREB1A and DREB2A that specifically interact to DRE and activate many stress-inducible genes. Overproduction of the DREB1A protein in transgenics activated the expression of many target genes involved in stress tolerance and significantly improved stress tolerance to drought, salinization, and freezing. Moreover, the stress-inducible *rd29A* promoter minimized negative effects on growth of plants while the constitutive *35S CaMV* constitutive promoter caused severe growth retardation under normal growth conditions.

As the DRE regulatory element is not limited to *Arabidopsis*, the DREB1A cDNA and the stress-inducible *rd29A* promoter may be useful to improve the dehydration, salt and freezing tolerance of crop plants. By introducing the newly identified promoter and transcription factor into plants, the simultaneous alteration of a group a genes functioning in multiple tolerance mechanisms may at last prove possible.

If so, the knowledge gained from these experiments at JIRCAS would enable scientists to induce guided genetic expression in response to environmental stresses within a relatively short period of time. Such a breakthrough would allow for great strides toward commercially viable crop plants genetically engineered for tolerance to a wide variety of potentially damaging environmental stresses.

Back to	the <a href="#">Highlights menu</a> .
Forward to	<a href="#">Highlight #2: Heat Tolerance as a Research Strategy at the Okinawa Subtropical Station</a> , or to <a href="#">Highlight #3: Visit of Peruvian President Alberto Fujimori to the Tsukuba Institutional Complex</a> , or to <a href="#">Highlight #4: Research Meetings and Conferences during Fiscal Year 1997</a>

## **Highlight #1: Genetic Engineering to Improve Environmental Stress Tolerance in Crops**



*Figure 1. Strategies for developing transgenic tolerance to drought stress in commercial crop plants.*

Back to

[Highlight #1: Genetic Engineering to Improve Environmental Stress Tolerance in Crops.](#)



## ***Highlight #2: Heat Tolerance as a Research Strategy at the Okinawa Subtropical Station***

The Okinawa Subtropical Station is the only division of JIRCAS located in a subtropical environment. For this reason, the Station seeks to promote research on subtropical agriculture and to develop agricultural technology pertinent to subtropical environments in ways that are possible neither at the Tsukuba headquarters of JIRCAS nor at other national research institutions affiliated with the Ministry of Agriculture, Forestry and Fisheries.

Among the major research initiatives of the Station have been projects relating to the heat tolerance of crops. Fundamental knowledge of heat tolerance mechanisms remains important, considering the fact that vegetables make strategic cash crops for addressing problems of malnutrition, meeting increasing demands for food, and sustaining rural development in the lowland tropics where heat acts as a major constraint on agricultural activities.

In order to promote greater awareness of this field of study, the Okinawa Subtropical Station hosted a Workshop on Heat Tolerance of Crops from October 7-8, 1997. The workshop focused on two priorities, including a review of results from the station's previous research activities and an effort to develop new techniques for mitigating heat stress and otherwise improving the heat tolerance of crops.

*Photo: Participants in the [Workshop on Heat-Tolerance of Crops](#) at the Okinawa Subtropical Station.*

During the first day of discussion, Dr. Chungchi George Kuo of the [Asian Vegetable Research and Development Center](#) spoke on the "Improvement of heat tolerance in vegetables under tropical conditions," and Dr. Anthony Hall of the Department of Botany and Plant Science, University of California, presented findings on the "Positive and potential negative effects of heat tolerance genes on crops." After these keynote addresses, six researchers from the Okinawa Subtropical Station and three visiting scientists from the Visiting Research Fellowship Program at Okinawa presented results from several heat tolerance research projects.

On the following day, Dr. Mitsuo Ishige, former Director of the Biological Resources Division at JIRCAS headquarters in Tsukuba, served as commentator and chairman for the final plenary sessions. Participants exchanged views on progress in heat tolerance research and outlined strategies for future collaborative studies of the subject at the Station. They raised numerous questions and held a lively discussion which continued after the presentations.

The workshop provided valuable intellectual stimulation for members of the Okinawa Subtropical Station research staff, who have since organized themselves into a heat tolerance working group for the promotion of improved heat tolerance in crop plants. Toward this end, the group is currently planning a series of collaborative projects for FY 1998 involving Nagoya University, the University of the Ryukyus, and the Tokyo University of Agriculture.

Back to	the <a href="#">Highlights menu</a> , or to <a href="#">Highlight #1</a> : Genetic Engineering to Improve Environmental Stress Tolerance in Crops.
Forward to	<a href="#">Highlight #3</a> : Visit of Peruvian President Alberto Fujimori to the Tsukuba Institutional Complex, or to <a href="#">Highlight #4</a> : Research Meetings and Conferences during Fiscal Year 1997.





### **Highlight #3: Visit of Peruvian President Fujimori to the Tsukuba Institutional Complex**

During the afternoon of July 4, 1997, Peruvian President Alberto Fujimori took time out from a state visit to Japan to make a short stop at the Ministry of Agriculture, Forestry, and Fisheries (MAFF) Tsukuba Institutional Complex. The opportunity was arranged at the request of President Fujimori, a specialist in agricultural engineering and a former professor and administrator at the National Agrarian University of Peru. Designed to highlight the advanced state of Japanese agricultural research, the visit served equally well as a recognition of the international importance of JIRCAS and ten related research organizations located in the vicinity of Tsukuba Science City.

Takao Fujimoto, the Minister of Agriculture, Forestry and Fisheries at the time, welcomed President Fujimori amid tight security at the entrance to the Tsukuba Office of the [Agriculture, Forestry, and Fisheries Research Council \(AFFRC\)](#). Other dignitaries awaiting the President's arrival included AFFRC Secretary General Eitaro Miwa, Tsukuba Mayor Junichi Fujisawa, and related government officials. Three Peruvian trainees dispatched to the Tsukuba International Center under an exchange agreement with the Japan International Cooperation Agency (JICA) were also present to offer bouquets of flowers during a short welcoming ceremony.

After receiving their greetings, President Fujimori listened to a brief overview of research programs currently in progress throughout the complex. He then proceeded to the Tsukuba Research Gallery at the [National Agricultural Research Center](#), where a series of displays offered more specific details on the recent successes and accomplishments of each of the national research institutes. At the JIRCAS booth, the President spoke with Director General Nobuyoshi Maeno about collaborative international agricultural research projects which the institute is currently conducting in the People's Republic of China, South and Southeast Asia, Africa, and Latin America. Relating his discussions to the needs of his own country, President Fujimori requested that recent findings on the role of forests in environmental protection be forwarded to researchers in Peru. Then, stopping at a nearby display for the Fruit Tree Research Station where improved varieties of commercial fruit crops were introduced, he sampled large-seeded *kyoho* grapes indigenous to Japan. "Delicious, aren't they?" he declared, to the delight of his hosts.

*Photo: [President Alberto Fujimori of Peru speaking with Dr. Nobuyoshi Maeno](#), Director General of JIRCAS, about the current state of international collaborative agricultural research during his official visit to the Tsukuba Research Gallery on July 4, 1997..*

Expressing a strong interest in the future of biotechnology and the potential for human improvement of plant varieties, President Fujimori also requested a visit to the [MAFF DNA Bank](#) housed within the [National Institute of Agrobiological Resources \(NIAR\)](#). The bank preserves DNA and molecular information on agricultural organisms for the support of national research activities in the agricultural sciences. The sophistication of ongoing research at the institute seemed to pique the President's curiosity. Secretary General Miwa, who led the tour, noted that, "In addition to knowing agricultural sciences very well, President Fujimori understood expert descriptions down to the finest point."

At the conclusion of the Tsukuba tour, President Fujimori remarked on the similar agricultural challenges faced by Japan and Peru. Both countries lack sufficient flatland areas suitable for farming, thus necessitating the utilization of steeply graded land for agricultural purposes. These characteristics may generate common interests in support of future agricultural cooperation, he suggested. Thus, the President's visit may mark the beginning of greater cooperation between institutions such as JIRCAS and partner countries in developing regions, such as Peru.

<p>Back to</p>	<p>the <a href="#">Highlights menu</a>, or to  <a href="#">Highlight #1</a>: Genetic Engineering to Improve Environmental Stress Tolerance in Crops, or to  <a href="#">Highlight #2</a>: Heat Tolerance as a Research Strategy at the Okinawa Subtropical Station.</p>
<p>Forward to</p>	<p><a href="#">Highlight #4</a>: Research Meetings and Conferences during Fiscal Year 1997.</p>







## **Highlight #4: Research Meetings and Conferences during Fiscal Year 1997**

During FY 1997, JIRCAS played proud host to a greater number of research meetings, academic seminars, workshops, and conferences than in previous years. Discussion topics ranged from the sustainable harvesting of brackish water mangrove ecosystems to the reclamation of salt-accumulated soils through recent technological developments, and from the diversification of methods for the utilization of acacia woods to the manufacture and distribution of secure supplies of food. Invited guests included fellow researchers from affiliates of the [Consultative Group on International Agricultural Research \(CGIAR\)](#) and other prominent international research organizations, numerous national universities, and local experts from China, Vietnam, Thailand, Malaysia, Indonesia, the Philippines, Brazil, Argentina, Paraguay, and Kazakhstan.

These gatherings provided an important opportunity for JIRCAS researchers to share the fruits of their ongoing projects with one another and with their counterparts in other institutions. By the same token, contact with the researchers most intimately familiar with local conditions enhanced opportunities for learning and influenced the direction of future research. More information on the meetings, seminars, workshops, and conferences sponsored by JIRCAS during the previous year can be found under the [Symposia and Workshops](#) section of this Annual Report.

Back to	the <a href="#">Highlights menu</a> , or to <a href="#">Highlight #1</a> : Genetic Engineering to Improve Environmental Stress Tolerance in Crops, or to <a href="#">Highlight #2</a> : Heat Tolerance as a Research Strategy at the Okinawa Subtropical Station, or to <a href="#">Highlight #3</a> : Visit of Peruvian President Fujimori to the Tsukuba Institutional Complex.
Forward to	information on the production and utilization of food resources in <a href="#">China</a> .

# **SYMPOSIA AND WORKSHOPS**

## **1) INTERNATIONAL SYMPOSIA**

Between 1967 and 1993, the Tropical Agricultural Research Center (TARC) sponsored annual international symposia for the purposes of promoting scientific exchange and accurately gauging and responding to the agriculture, forestry, and fishery needs of the world's developing areas. Since its transition from TARC, JIRCAS has continued this practice, organizing its first International Symposium in FY 1994. At present, each symposium is organized around a theme of central importance to international agricultural research, and roughly ten researchers and administrators from concerned research institutes and international agencies are invited as speakers. Symposia are ordinarily held in joint sponsorship with a relevant scientific society. The program from the FY 1997 International Symposium appears below.

- [**FY 1997 International Symposium: Sustainable Agricultural Development Compatible with Environmental Conservation in Asia.**](#)

## **2) SPECIAL PROGRAMS**

- [**JIRCAS/ILRI Joint Workshop on the International Contributions of Japan and ILRI to World Animal Production Research.**](#)
- [**International Workshop on the Development of Farming Systems in the Mekong Delta.**](#)
- [**International Seminar on New Technologies for the Development of Sustainable Farming in Northeast Thailand.**](#)
- [**First Seminar on Comprehensive Soybean Research in South America.**](#)
- [**Workshop on the Recent Situation and Future Orientation of the Food Industry in China.**](#)

## **3) WORKSHOPS AND SEMINARS**

- [**JIRCAS Workshop Series: Facets of International Agricultural Research**](#)
- [**International Research Seminars**](#)
- [**International Research Workshops**](#)

## **4) MISCELLANEOUS MEETINGS AND WORKING GROUPS**

➡ [Annual Meeting for the Review and Promotion of Research](#)

➡ [JIRCAS Return Seminars](#)

➡ [Comprehensive Project Working Groups](#)

Back to

the Annual Report [Main Contents](#) menu.



## SUSTAINABLE AGRICULTURAL DEVELOPMENT COMPATIBLE WITH ENVIRONMENTAL CONSERVATION IN ASIA

(Held August 26 - 28, 1997, in Tsukuba Science City in conjunction with the Tsukuba Center for Institutes, a division of the Science and Technology Agency of Japan).

### **Opening addresses**

Ⓢ Inaugural address by Dr. Nobuyoshi Maeno, Director General, Japan International Research Center for Agricultural Sciences (JIRCAS), Japan

Ⓢ Welcome address by Mr. Sakue Matsumoto, Chairman, Secretariat of the Agriculture, Forestry and Fisheries Research Council (AFFRC), Ministry of Agriculture, Forestry, and Fisheries, Japan

### **Keynote speech**

“Main issues for sustainable agricultural development in Asia” by George H. L. Rothschild, Director General, International Rice Research Institute (IRRI), The Philippines

### **Session 1: Food problems in Asia**

Chaired by Dr. Wen S. Chern, Institute of Economics, Taiwan

Ⓢ Food security in Asia: A demand side analysis. W. S. Chern, Institute of Economics, Taiwan

Ⓢ Asian food supply and demand situation from a global perspective. O. Koyama, Japan International Research Center for Agricultural Sciences (JIRCAS), Japan

Ⓢ Food problems and future outlook in China. K. Bingsheng, China Agriculture University, People's Republic of China

Ⓢ Problems and future outlook in agriculture in Thailand. N. Poapongsakorn, M. Ruhs, and S. Tangjitwisuth, Thailand Development Research Institute, Thailand

Ⓢ Food problems and future outlook in India. K. P. Rao, National Institute of Agricultural Extension Management, India

### **Session 2: Agriculture and environment in Asia**

Chaired by Dr. Dennis Keeney, Iowa State University, USA

Ⓢ Sustainable agriculture and the environment. D. Keeney, Iowa State University, USA

Ⓢ Global warming and sustainable agriculture. K. Minami, Japan International Research Center for Agricultural Sciences (JIRCAS), Japan

Ⓢ Technology for conservation of soil and water resources in China. Z. Qi-Guo, Institute of Soil Science, People's Republic of China

Ⓢ Technology for conservation of soil and water resources in Korea. P. K. Jung and N. J. Lee, National Institute of Agricultural Science and Technology, Korea

Ⓢ Material balance and ecological functions of paddy farming in Japan. H. Iwama, National Institute of Agro-Environmental Sciences, Japan

Ⓢ External economies of agriculture. E. Nishizawa and K. Yoshida, National Research Institute of Agricultural Economics, Japan

### **Session 3: Technological issues after the Green Revolution**

Chaired by Dr. Osamu Ito, International Rice Research Institute (IRRI), The Philippines

Ⓢ JIRCAS projects for the development of technologies for sustainable agriculture in Asia. M. Kokubun, Japan International Research Center for Agricultural Sciences (JIRCAS), Japan

- ④ Development of rice production technology in Southeast Asia. N. Kabaki, Japan International Research Center for Agricultural Sciences (JIRCAS), Japan
- ④ Sustaining rice-wheat cropping system productivity in the Indo-Gangetic Plains. I. P. Abrol, International Crops Research Institute for the Semi-Arid Tropics, India
- ④ Rural development through commodity-based and agribusiness-oriented farming systems. A. Suryana and S. Bahri, Center for Agro-Socioeconomic Research, Indonesia
- ④ Production systems and farming systems in the Mekong Delta. D. K. Son, Cuulong Delta Rice Research Institute, Vietnam
- ④ Strategy for rice production technologies at the International Rice Research Institute. O. Ito, International Rice Research Institute (IRRI), Philippines

### **General discussion**

*Chaired by Dr. Kunio Tsubota, Japan International Research Center for Agricultural Sciences (JIRCAS), Japan*

- ④ Summary of Session 1, by Dr. Wen S. Chern, Institute of Economics, Taiwan
- ④ Summary of Session 2, by Dr. Dennis Keeney, Iowa State University, USA
- ④ Summary of Session 3, by Dr. Osamu Ito, IRRI, the Philippines

### **Conclusion**

- ④ Comments by Dr. William Coyle, Department of Agriculture, USA
- ④ Comments by Dr. Keiji Ohga, Japan International Research Center for Agricultural Sciences (JIRCAS), Japan

**Closing remarks** by Dr. Toru Nagata, Director General, National Institute of Agro-Environmental Sciences (NIAES), Japan

Back to

the [Symposia and Workshops](#) menu.



## JIRCAS/ILRI JOINT WORKSHOP ON THE INTERNATIONAL CONTRIBUTIONS OF JAPAN AND ILRI TO WORLD ANIMAL PRODUCTION RESEARCH

On February 13, 1998, the Japan International Research Center for Agricultural Sciences (JIRCAS) and the International Livestock Research Institute (ILRI) conducted a joint workshop in the JIRCAS International Conference Room to address the role of each in international animal production research. Workshop discussions were designed to assist ILRI, a CGIAR organization formed in 1995 through the consolidation of the International Laboratory for Research on Animal Diseases (ILRAD) in Kenya and the International Livestock Centre for Africa (ILCA) in Ethiopia, in its efforts to broaden the scope of its research activities to developing Asian countries. The workshop was organized by the Secretariat of the Agriculture, Forestry and Fisheries Research Council (AFFRC), JIRCAS, and ILRI in collaboration with the National Institute of Animal Industry (NIAI), the National Grassland Research Institute (NGRI), and the National Institute of Animal Health (NIAH) under the sponsorship of the Japan Livestock Technology Association.

Dr. Eitaro Miwa, Director General of the Agriculture, Forestry and Fisheries Research Council (AFFRC), and Dr. Neville P. Clarke, Chairman of the ILRI Board of Trustees, opened the workshop with welcoming remarks. Following these addresses, five researchers presented reports and discussed their significance. In concluding the workshop at day's end, Dr. Mamoru Kashiwazaki, Director General of NIAH, noted the continuing importance of such discussions in preparing future strategies for livestock production research, not only in developing Asian countries, but also in developing countries throughout the world. As such, information exchanged through workshop discussions will serve to deepen mutual understanding and collaborative relationships between Japanese and ILRI scientists, ensuring greater cooperation in the near future. Contents of the workshop presentations are summarized below.

### *Session 1*

- Ⓢ Global livestock research workshop: International livestock research. H. Fitzhugh, Director General, International Livestock Research Institute (ILRI)
- Ⓢ New priorities and future directions in research and development for livestock production in Southeast Asia. C. Chantalakhana, International Livestock Research Institute (ILRI)
- Ⓢ International collaboration in agricultural research. N. Maeno, Director General, Japan International Research Center for Agricultural Sciences (JIRCAS)
- Ⓢ Recent developments in livestock research in Japan. H. Kobayashi, Director General, National Grassland Research Institute
- Ⓢ International contribution of Japanese scientists to livestock research at ILRAD/ILCA/ILRI and other organizations. E. Imaizumi, Japan International Research Center for Agricultural Sciences (JIRCAS)

### *Session 2*

- Ⓢ General discussion

Back to

the [Symposia and Workshops](#) menu.



## INTERNATIONAL WORKSHOP ON THE DEVELOPMENT OF FARMING SYSTEMS IN THE MEKONG DELTA

Although rice production has markedly increased in the Mekong Delta of Vietnam, incomes and living standards among farmers in the region have remained low. Researchers involved in the comprehensive collaborative project entitled “Evaluation and improvement of farming systems combining agriculture, animal husbandry, and fisheries in the Mekong Delta” have been examining these and other problems affecting efforts to modernize agricultural production in Vietnam. On December 8-9, 1997, these researchers conducted a workshop to review progress and develop closer cooperation between Japanese and Vietnamese organizations. The workshop invited six researchers from Vietnam, led by Dr. Vo-Tong Xuan, Director of the Farming Systems Research and Development Institute at Cantho University. Among Japanese participants, several have studied agriculture in the Mekong Delta for extended periods. They include Dr. Matsuno of the Tokyo University of Agriculture, Dr. Cho of Kyushu University, Dr. Furukawa of Kyoto University, and Dr. Oe of the Tokyo University of Agriculture and Technology.

The workshop started with opening remarks by Dr. Nobuyoshi Maeno, Director General of JIRCAS, and a key note address by Dr. Vo-Tong. After a day of presentations, the workshop concluded that the development of sustainable farming systems combining rice cultivation, animal husbandry, and aquaculture constitutes an important priority for the region. Creation of viable credit and marketing channels, as well as the promotion of technology transfer, may also provide keys to further agricultural development in the Mekong Delta.

### **Keynote address**

“History, present conditions and perspectives on the development of farming systems in the Mekong Delta of Vietnam,” by Dr. Vo-Tong Xuan, Director, Mekong Delta Farming Systems Research and Development Institute and Vice Rector, Cantho University

### **Session 1: Characterization of Mekong Delta farming systems**

*Moderated by Dr. Le Thanh Duong, Cantho University, and Dr. Ryoichi Yamazaki, Rakuno Gakuen University*

- ⊙ Characteristics of farming systems: A case study of the O Mon District. N. X. Lai, Cuulong Delta Rice Research Institute
- ⊙ Diversification and specialization of farming systems: A case study of the Thot Not District. D. N. Thanh, Cantho University
- ⊙ Melaleuca forestation and farmers’ organizations in Hoa An Village. D. V. Ni, Cantho University

### **Session 2: Development of technologies for farming systems in the Mekong Delta**

*Moderated by Dr. Nico Vromant, Flemish Development Association, and Dr. Koji Kawashima, Japan International Research Center for Agricultural Sciences (JIRCAS)*

- ⊙ Rice production and research in the Mekong Delta. T. Kon, Tohoku National Agricultural Experiment Station
- ⊙ Swine production and research in the Mekong Delta. S. Yoshihara, National Institute of Animal Health
- ⊙ Aquaculture and research in the Mekong Delta. M.N. Wilder, Japan International Research Center for Agricultural Sciences (JIRCAS)

### **Session 3: Farmers’ organizations**

*Moderated by Dr. Vo-Tong Xuan, Director, Mekong Delta Farming Systems Research and Development Institute*

- ⊙ Farmers’ organizations in Vietnam. K. Sho, Japan International Research Center for Agricultural Sciences (JIRCAS)
- ⊙ Organizing farmers toward Vietnamese agricultural modernization. R. Yamazaki, Rakuno Gakuen University
- ⊙ Comments by Vietnamese participants

### **Session 4: Orientation of collaborative research projects**

*Moderated by Dr. Shigeo Matsui, Japan International Research Center for Agricultural Sciences (JIRCAS)*



- ② Farming system research in the Mekong Delta. L. T. Duong, Cantho University
- ② Collaborative research on aquaculture in the Mekong Delta. N. Vromant, Flemish Development Association
- ② Research on farm management in the Mekong Delta. R. Yamada, Japan International Research Center for Agricultural Sciences (JIRCAS)

***General discussion***

*Chaired by Dr. Kunio Tsubota, Japan International Research Center for Agricultural Sciences (JIRCAS)*

Back to

the [Symposia and Workshops](#) menu.



## INTERNATIONAL SEMINAR ON NEW TECHNOLOGIES FOR THE DEVELOPMENT OF SUSTAINABLE FARMING IN NORTHEAST THAILAND

Large areas of forest in northeastern Thailand have been cleared to provide fields for cash crops such as cassava, corn, and sugar cane. Removing trees and exposing fragile tropical soils to sun, wind, and rain has contributed to significant land deterioration. However, as farmers in the region remain desperately poor, they can ill afford to introduce agricultural techniques capable of increasing productivity and incomes without further exacerbating land degradation.

This seminar examined new agricultural technologies, such as the utilization of small machinery or rotations between certain fruit and vegetable crops, that might aid in efforts to achieve sustainable agricultural systems in northeastern Thailand. Jointly sponsored by JIRCAS and the International Training Center for Agricultural Development (ITCAD) of Thailand, seminar sessions were held in the auditorium of ITCAD in Khon Kaen, Thailand, on March 24, 1998. Approximately seventy scientists attended, primarily from Khon Kaen University, the Thai Departments of Agriculture, Land Development, and Livestock Development, and Japanese research institutes, including JIRCAS. The governor of Khon Kaen and the head of the Provincial Office of Agriculture and Cooperatives welcomed participants. Summaries of the remainder of the day's activities follow.

*Photo: Shigeo Matsui, chairman of Session III, directs discussion at the International Seminar.*

### **Session I**

*Chaired by Dr. Anek Topark-ngarm, Dean, Khon Kaen University*

- ⊙ Development of direct seeding technology for rice in Japan. N. Kabaki, Japan International Research Center for Agricultural Sciences (JIRCAS)
- ⊙ Land classification and improved efficiency in production of Hom Mali rice in northeastern Thailand. R. Katawatin, Khon Kaen University, Thailand

### **Session II**

*Chaired by Dr. Montien Somabhi, Khon Kaen Department of Agriculture*

- ⊙ New methods for crop protection. C. Noda, Japan International Research Center for Agricultural Sciences (JIRCAS)
- ⊙ Development of papaya lines tolerant to papaya ring spot virus. V. Prasartsri, Khon Kaen Department of Agriculture, Thailand
- ⊙ Sustainable vegetable growing through cropping systems. M. Yamada and I. Nakagawa, National Agricultural Research Center, Japan

### **Session III**

*Chaired by Dr. Shigeo Matsui, Japan International Research Center for Agricultural Sciences (JIRCAS)*

- ⊙ Development of culturing practices for vegetables and crop introduction at the Okinawa Subtropical Station. K. Suzuki, Japan International Research Center for Agricultural Sciences (JIRCAS)
- ⊙ Peanut breeding and production for specific purposes in northeastern Thailand. P. Sorawat, Khon Kaen Department of Agriculture, Thailand
- ⊙ Tree species for reforestation in cultivated areas. R. Tabuchi, Forestry and Forest Products Research Institute, Japan

### **Session IV**

*Chaired by Dr. Sho Kosugi, Japan International Research Center for Agricultural Sciences (JIRCAS)*

- ⊙ Effect of stocking density and water turbidity on production of *Macrobrachium lanchesteri de Man* in concrete tanks. N. Sriputinipondh, Department of Fisheries, Thailand
- ⊙ Use of small machinery in upland field cropping. K. Otsuka, National Agricultural Research Center, Japan

### **Session V**

*Chaired and moderated by Dr. Waewchark Kongpolprom, Head, Khon Kaen Provincial Office of Agriculture and Cooperatives*

© Comments from Dr. Montien Somabhi, Khon Kaen Department of Agriculture, Thailand

© Comments from Dr. Aran Patanothai, Khon Kaen University, Thailand

© Comments from Dr. Tadao Hamazaki, Japan International Research Center for Agricultural Sciences (JIRCAS)

**General Discussion** on further strengthening collaborative research topics suited for the development of sustainable farming systems in northeastern Thailand

Back to

the [Symposia and Workshops](#) menu.





## FIRST SEMINAR ON COMPREHENSIVE SOYBEAN RESEARCH IN SOUTH AMERICA

In 1997, JIRCAS initiated a research project entitled “Comprehensive studies on soybean improvement, production and utilization in South America” in collaboration with national research organizations in MERCOSUR countries and the Japan International Cooperation Agency (JICA). The main objective of this seminar was to provide opportunities for the exchange of scientific information among soybean scientists from South American countries and thereby to stimulate the generation of innovative and collaborative ways to resolve the constraints and problems facing soybean production and utilization in this region. This seminar was co-organized by JIRCAS and a joint program between JICA and the Agricultural Technology Center in Paraguay (CETAPAR). Following opening addresses by Dr. Nobuyoshi Maeno, Director General of JIRCAS, and Dr. Mitsuhiro Ota, Director of the JICA-CETAPAR project, researchers from a number of countries gave presentations and engaged in a lively discussion of relevant concerns. The central issues involved in the seminar were as follows.

### ***Session 1: The present and future of no-tillage cultivation of soybeans***

*Chaired by Dr. Norman Neumaier, National Center for Research on Soybeans (EMBRAPA-CNPSo), Brazil*

- Ⓢ Historical review of no-tillage cultivation of crops. R. Derpsch, German Society for Technical Cooperation (MAG/GTZ), Germany
- Ⓢ Effects of no-tillage methods on chemical and physical characteristics of soil in Paraguay. C. Paredes Benegas, Regional Center for Agricultural Research (MAG-CRIA), Paraguay
- Ⓢ Effect of no-tillage system on chemical and physical characteristics of soil in Argentina. R.C. Gil, Research Center for Natural Resources (CIRN), Argentina
- Ⓢ Disease management in no-tillage soybean system. S. Vallone, National Institute for Agricultural Technology (INTA-EEA Marcos Juarez), Argentina
- Ⓢ Control of weeds in no-tillage cultivation. D. L. P. Gazziero, National Center for Research on Soybeans (EMBRAPA-CNPSo), Brazil
- Ⓢ Establishment of no-tillage method for soybean cultivation in Paraguay. Y. Seki, W. Asada, and K. Hoshiba, JICA-CETAPAR, Japan
- Ⓢ Cropping systems under no-tillage cultivation. J. E. Denardin and R. A. Kochhann, National Center for Research on Wheat (EMBRAPA-CNPT), Brazil
- Ⓢ An innovative cropping system for soybeans: Agro-pastoral systems in Brazil. M. Macedo, J. Bono, A. Kichel, and A. Zimmer, National Center for Research on Beef Cattle (EMBRAPA-CNPGC), Brazil, and T. Kanno, JIRCAS, Japan

### ***Session 2: Perspective of Demand for Soybean and Future Research Needs***

*Chaired by Dr. Laura M. Giorda, National Institute for Agricultural Technology (INTA-EEA Manfredi), Argentina*

- Ⓢ Role of soybeans with reference to global food supply and demand. H. Ozeki, National Agricultural Research Center (NARC), Japan, and Y. Sugai, Brazilian Agriculture Research Corporation (EMBRAPA), Brazil
- Ⓢ Perspectives on demand for the utilization of soybeans. O. S. de Oliveira, EXIMCOOP, Brazil
- Ⓢ Potential uses of soybean as food in South America. M. C. Carrao-Panizzi, National Center for Research on Soybeans (EMBRAPA-CNPSo), Brazil
- Ⓢ Potential for industrial utilization of soybeans. J. P. Cherry, United States Department of Agriculture, Agriculture Research Service (USDA-ARS), USA

Back to

the [Symposia and Workshops](#) menu.



## WORKSHOP ON THE RECENT SITUATION AND FUTURE ORIENTATION OF THE FOOD INDUSTRY IN CHINA

The first comprehensive project linking JIRCAS and the government of the People's Republic of China began on May 28, 1997, with the signing of a Memorandum of Understanding between JIRCAS, the Agriculture, Forestry and Fisheries Research Council (AFFRC), and the Ministry of Agriculture of the People's Republic of China. This project aims to address increasing expectations for high-quality dietary resources generated by high rates of economic growth and rising purchasing power in China. Specifically, the project targets the development of sustainable production capacities for major food resources in China, including rice, soybeans, corn, and freshwater fishes. If successful, this project can be expected to improve average eating habits. Such bold objectives, however, will require not only a better understanding of the development of agricultural production but also of trends within the rapidly growing Chinese food industry.

With these goals in mind, JIRCAS convened a workshop in Tokyo from March 23-24, 1998, under the kind support of Ajinomoto Co., Inc., and with participation of leaders in the Chinese food industry. The contents of workshop presentations are summarized below.

### *Session 1: The Japanese food industry and demand and supply for food in China*

- ④ Status of the Japan-China project. A. Noguchi, Japan International Research Center for Agricultural Sciences (JIRCAS), Japan
- ④ Demand, supply, and distribution of food in China. S. Yan, St. Andrew's University, Japan
- ④ Present situation and topics in the food industry of Japan. Y. Nagara, Center for Food Industry, People's Republic of China

### *Session 2 Chinese food industry, its present and future*

- ④ Structural readjustments in food and food industry development in China. J. Jianping, Academy of Agricultural Sciences, People's Republic of China
- ④ Present situation of the food industry in China. W. Wenzhe, China National Food Industry Association, People's Republic of China
- ④ Present situation of the food distribution industry in China. C. Shiguan, Department of Consumer Goods Circulation, Ministry of Internal Trade, People's Republic of China
- ④ Present and future markets for stock farm products in China. L. C. Xiang, Northeast Agricultural University, People's Republic of China
- ④ Future orientation of the food industry in China. B. Qingyan, Department of Planning, China National Food Industry Association, People's Republic of China

Back to

the [Symposia and Workshops](#) menu.



## WORKSHOPS and SEMINARS

### JIRCAS Workshop Series: Facets of International Agricultural Research

In addition to the annual international symposia, JIRCAS sponsors research workshops focusing on specific themes several times per year. Workshops are hosted by the relevant JIRCAS research divisions and are attended by JIRCAS staff, speakers invited from within Japan, and interested persons from various government research institutes, private companies and universities. The following workshops were held at JIRCAS during FY 1997.

- |                 |                                                                                                                                                              |
|-----------------|--------------------------------------------------------------------------------------------------------------------------------------------------------------|
| April 4, 1997   | <b>Fourth research meeting on problems in African agriculture</b><br>(JIRCAS Research Information Division)                                                  |
| March 4-5, 1998 | <b>Aquaculture and related environmental problems in Southeast Asian countries</b><br>(JIRCAS Fisheries Division)                                            |
| March 17, 1998  | <b>Research meeting on the establishment of technologies for recovering salt-accumulated soils in Central Asia</b><br>(JIRCAS Research Information Division) |

### International Research Seminars

International research seminars are held informally throughout the year, with one to three foreign guests, Japanese specialists, or JIRCAS staff presenting on topics of importance to international agricultural research. The following two seminars were held in FY 1997.

- |                    |                                                                                                                                                                                                                                                    |
|--------------------|----------------------------------------------------------------------------------------------------------------------------------------------------------------------------------------------------------------------------------------------------|
| September 30, 1997 | <b>South American agriculture and international collaborative research</b><br><i>Fumio Iwata, Japan International Cooperation Agency (JICA), and Kiyoko Hitsuda, Japan International Research Center for Agricultural Sciences (JIRCAS), Japan</i> |
| December 8-9, 1997 | <b>Productive capacity of tropical mangrove habitats and their sustainable utilization</b><br><i>Chong Ving-Ching, University of Malaya</i>                                                                                                        |

### International Research Workshops

Nine International Research Workshops were convened on JIRCAS premises during FY 1997. Attended jointly by JIRCAS researchers and foreign invitees, these workshops aimed to facilitate discussion regarding the numerous collaborative research projects which JIRCAS is currently undertaking with counterpart institutions throughout the world.

- |                          |                                                                                                                                                                                                                                                                                                                                                                                                         |
|--------------------------|---------------------------------------------------------------------------------------------------------------------------------------------------------------------------------------------------------------------------------------------------------------------------------------------------------------------------------------------------------------------------------------------------------|
| December 2-5, 9-10, 1997 | <b>Cooperative soybean research in South America</b><br><i>Attended by representatives of JIRCAS, the Brazilian Agriculture Research Corporation (EMBRAPA), Brazil; the Ministry of Agriculture and Cattle (MAG), Paraguay; and the National Institute for Agricultural Technology (INTA), Argentina</i>                                                                                                |
| December 8-9, 1997       | <b>International workshop on the development of farming systems in the Mekong Delta</b><br><i>Attended by representatives of JIRCAS; Cantho University and the Cuu Long Delta Rice Research Institute, Vietnam; the Flemish Development Association, Belgium; and Rakuno Gakuen University, the Tohoku National Agricultural Experiment Station, and the National Institute of Animal Health, Japan</i> |



February 4, 1998

**Development and evaluation of environmentally sensitive agricultural production technologies in China**

*Attended by representatives of JIRCAS and the Soil and Fertilizer Institute of the Chinese Academy of Agricultural Sciences and the Institute of Soil Science of the Chinese Academy of Sciences, People's Republic of China.*

February 13, 1998

**International contributions of Japan and the ILRI to world animal production research**

*Attended by representatives of JIRCAS; the International Livestock Research Institute (ILRI), Kenya; and the National Grasslands Research Institute (NGRI), Japan*

March 16-18, 1998

**Properties and uses of acacia wood**

*Attended by representatives of JIRCAS and the Universiti Sains Malaysia (USM), Malaysia.*

March 20, 1998

**Summary meeting on the results of Japanese-Chinese collaborative research on environmental problems**

*Attended by representatives of JIRCAS and the Xinjiang Institute of Biology, Pedology, and Desert Research, People's Republic of China.*

March 23-24, 1998

**Manufacture of foodstuffs in China: Present conditions and future directions**

*Attended by representatives of JIRCAS; the Food Manufacturers' Association, Northeast China Agricultural University, and the Chinese Academy of Agricultural Sciences, People's Republic of China; and Mie University, Niigata University, Momoyama Gakuin University, and Nihon University, Japan.*

March 24, 1998

**Workshop on new technologies for the development of sustainable agriculture in northeast Thailand**

*Attended by representatives of JIRCAS, the National Agricultural Research Center (NARC) and the Forestry and Forest Products Research Institute (FFPRI), Japan*

March 25-27, 1998

**Problems of water management and Malaysian agriculture**

*Attended by representatives of JIRCAS, the Muda Agricultural Development Authority (MADA), the Malaysian Agricultural Research and Development Institute (MARDI), the Department of Irrigation and Drainage (DID), and the National Hydraulic Research Institute of Malaysia (NAHRIM), Malaysia, and the National Research Institute of Agricultural Engineering (NRIAE), Japan*

Back to

the [Symposia and Workshops](#) menu.



## ***MISCELLANEOUS MEETINGS and WORKING GROUPS***

### **Annual Meeting for Review and Promotion of Research**

JIRCAS conducts its Annual Meeting for the Review and Promotion of Research for International Collaboration in February, as the end of the fiscal year approaches. The purpose of the meeting is to review and evaluate the year's activities in detail in preparation for the subsequent fiscal year. All operations of JIRCAS are outlined, and research achievements deemed of particular importance are highlighted (see Research Overview: Research Division topics for more detail). Those in attendance at the meeting include JIRCAS directors and invited representatives from the Agriculture, Forestry and Fisheries Research Council (AFFRC), the Forestry Agency, the Fisheries Agency, and various research institutes affiliated with the Ministry of Agriculture, Forestry and Fisheries. In 1997, the meeting considered, as its principal theme, prospects for cooperation between international agricultural projects and domestic research. After reporting on the present state of JIRCAS's international agricultural projects and their relation to important domestic research subjects, project leaders proposed concrete topics on which to focus their cooperation with related domestic research centers. Based on these proposals, a variety of opinions on establishing cooperative arrangements between these institutes and each international project were exchanged, and participants confirmed their intention to consider further cooperation in the future.

### **JIRCAS Return Seminars**

At JIRCAS, researchers returning from overseas dispatches or research projects give an oral presentation accompanied by a written summary of activities which is distributed to JIRCAS staff. These sessions are termed "JIRCAS Return Seminars" and are held during the interim or upon the completion of research projects and dispatch assignments. Such seminars are ordinarily held twice per month, and each year approximately fifty scientists give presentations.

### **Comprehensive Project Working Group Meetings**

During FY 1997, participants in six comprehensive research projects gathered regularly in working groups to discuss the structure and progress of their studies on Mekong Delta farming systems, sustainable agricultural systems in northeastern Thailand, brackish water mangrove ecosystems in Malaysia, sustainable agropastoral systems in subtropical Brazil, the food production and distribution industries in the People's Republic of China, and soybean cultivation in the Southern Cone of South America. Researchers studying Vietnam, Malaysia, and the Southern Cone held formal meetings as highlighted above in this section. Beginning in 1998, researchers involved in the evaluation of regional farming systems in Indonesia and the rainfed rice project in West Africa will also convene in similar discussion sessions to evaluate the progress of their projects.

Back to

the [Symposia and Workshops](#) menu.



## **PEOPLE'S REPUBLIC OF CHINA**

### **Project on the Sustainable Production and Utilization of Food Resources**

JIRCAS officially inaugurated its first comprehensive research project with the national government of the People's Republic of China on May 28, 1997. During a ceremony timed to coincide with the sixteenth meeting of the Japan-China Agricultural Science and Technology Exchange Group in Tokyo, representatives from JIRCAS, the Japanese Agriculture, Forestry and Fisheries Research Council (AFFRC), and the Ministry of Agriculture (MOA) of the People's Republic of China signed a memorandum of understanding committing the institutions to a collaborative research program spanning eight years.

*Photo: Akinori Noguchi, Director of the Crop Production and Postharvest Technology Division, and Dr. Nobuyoshi Maeno, Director General of JIRCAS, sign a Memorandum of Understanding with President Mao Daru and Vice President Li Lite of the China Agricultural University in Beijing.*

The comprehensive project aims to develop technologies for sustainably producing and utilizing major food resources in China. Such resources, including rice, soybeans, corn, and freshwater fish, will become increasingly important as economic development strengthens the purchasing power of ordinary Chinese citizens and enhances their expectations concerning dietary nutrition.

A report entitled "Who Will Feed China? Wake-Up Call for a Small Planet" (L. Brown, The World Watch Institute, 1995) provided the initial impetus behind concerns about the future of China's food supply. In response, many Chinese and foreign researchers have made analyses and projections regarding food supply problems in China, focusing their studies primarily on the grain sector. These reports reveal little agreement on future scenarios for food production and demand, most likely due to differences in underlying assumptions, data, and estimation processes. Nevertheless, there exists sufficient consensus to conclude that food demand will increase continuously during the next three decades and that available supplies will not meet this demand. Consequently, rising demands for imported foodstuffs will likely occur.

The major factors inhibiting agricultural production increases in China include the area of arable land, the poor quality of farmland, the weak response of soils to fertilizer, and the small-holder structure of private Chinese farms. In the process of rapid economic growth, it is inevitable that more farmland will be put toward non-agricultural uses. New efforts to reclaim land and recent increases in crop indices do not seem to have halted the trend toward declining levels of land under cultivation. Moreover, crop yields in China remain significantly lower than in advanced industrial countries.

At the same time, major factors influencing food demand will include the expansion of the population, changes in the structure of Chinese society due to rural-urban migration, the growth of income, alterations in the prices of agricultural products, and the persistence of poor infrastructure. Due to the inevitable shrinkage of agricultural resources and the natural, structural, financial, and economic constraints on yield potentials, demand for food in China will continue to rise even as agricultural production fails to keep pace.

In light of these trends, this project marks an attempt to develop an effective production and distribution system for food resources in order to cope with changing structures for the supply and demand of agricultural products. Efforts to achieve this objective will require not only an evaluation of the dissemination of new technologies in selected areas and their economic impacts on rural areas and individual farmers, but also modeling for the supply and demand of food resources in selected areas, analysis of the structure of corresponding farming areas and agricultural products, and design of more effective control systems to improve food supply and demand in selected areas.

In addition, the project seeks to generate technologies for the sustainable and stable production of major food resources. Toward this end, project participants intend to evaluate existing genetic resources, create new species, and develop and evaluate environmentally sensitive agricultural technologies. Finally, the project aims to develop food technologies that will enhance the utilization and distribution of major food resources. These efforts will include evaluating the quality of major food resources, developing new food ingredients, and improving preservation and distribution technologies for major food resources.

Back to

the [Highlights menu](#).

Forward to

information on rice hybridization in [West Africa](#), or to  
information on the production soybeans in [MERCOSUR countries](#), or to  
information on the monitoring of grassland evapo-transpiration in [Mongolia](#).





## **WEST AFRICA** **Project on Rice Hybridization and Food Supply Stabilization**

On the basis of recommendations from the ongoing Workshop on African Agriculture, JIRCAS has long promoted collaborative efforts to improve agricultural conditions in African countries, many of which suffer from high population growth, poor economic performance, desertification, and urbanization problems that rank among the most severe in the world. In an effort to address some of these problems as they impact the development of major food crops, JIRCAS signed a Memorandum of Understanding with the [West Africa Rice Development Association \(WARDA\)](#), a research organization based in Côte d'Ivoire, in early March, 1998.

Under terms of the agreement, the two institutes will pursue cooperative research on the inter-specific hybridization of two rice species, *Oryza sativa* and *Oryza glaberrima*, a field in which Japanese scientists can contribute effectively. On a larger scale, the project aims to improve the income level of individual cultivators and help to stabilize the overall food balance in Sub-Saharan Africa.

*Photo: Introducing a [new rice genotype produced through the interspecific hybridization](#) of *Oryza sativa* and *Oryza glaberrima* in the northern part of Côte d'Ivoire, Africa.*

As such, the project remains consistent with the intention of JIRCAS to develop and distribute agricultural products which are relevant to local socioeconomic conditions, technological levels, and farming practices and to do so within the framework of small-scale, water-efficient cropping rather than the large-scale irrigated farming characteristic of more advanced farming systems. The project is slated to continue for five years.

Back to	the <a href="#">Highlights menu</a> , or to information on the production and utilization of food in <a href="#">China</a> .
Forward to	information on the production of soybeans in <a href="#">MERCOSUR countries</a> , or to information on the monitoring of grassland evapo-transpiration in <a href="#">Mongolia</a> .



## **SOUTH AMERICA** **Project on the Production and Utilization of Soybean Resources**

During the second week of March, 1998, JIRCAS signed Memoranda of Understanding with two South American organizations, the [National Institute for Agricultural Technology \(INTA\)](#) of Argentina and the Ministry of Agriculture and Livestock (MAG) of Paraguay. This agreement commits the organizations to a new collaborative research project entitled “Soybean improvement, production, and utilization in South America” initiated by JIRCAS in April, 1997.

*Photo: Ceremony in Buenos Aires, Argentina, at which Dr. Nobuyoshi Maeno, Director General of JIRCAS, and Luis M. Firpo Brenta, Vice President of INTA, signed a Memorandum of Understanding pledging cooperation under the South American soybean project. March 12, 1998.*

The project will promote multidisciplinary studies on soybean production and utilization in Southern Cone countries through the encouragement of collaborative research linking Japanese and South American specialists. Cooperation in this area is particularly important given the large role which South American countries play in the international production of soybeans, a major source of food, oil, and livestock feed. The recent agreements with INTA and MAG complement earlier soybean research projects by focusing efforts in five areas, including genetics and breeding, soil management and pest control, crop management and production, post harvest technology, and socioeconomic factors. Research efforts will proceed on a continuing basis with no ending date set. The cooperation of the [Brazilian Agriculture Research Corporation \(EMBRAPA\)](#) is also expected.

*Photo: Following the signing ceremony, Mr. Firpo Brenta led guests on [a tour of agricultural sites in northeastern Argentina](#).*

Back to	the <a href="#">Highlights menu</a> , or to information on the production and utilization of food in <a href="#">China</a> , or to information on rice hybridization in <a href="#">West Africa</a> .
Forward to	information on the monitoring of grassland evapo-transpiration in <a href="#">Mongolia</a> .









## **MONGOLIA**

### **Project on the Monitoring of Grassland Evapo-Transpiration**

In September, 1998, JIRCAS Director General Nobuyoshi Maeno signed a Memorandum of Understanding with the Institute of Meteorology and Hydrology, a division of the Mongolian Ministry of Nature and Environment. The agreement is entitled “Studies on heat and water exchange in the atmosphere-vegetation-soil system for the determination of evapo-transpiration distribution.”

Under terms of the agreement, scheduled to run for three years, the two institutes will focus cooperative efforts on developing techniques for monitoring turbulence flux over grassland areas and applying remote sensing techniques for hydrological monitoring. More specifically, plans call for observations of eddy transfer characteristics in the Arvayheer area toward the development of suitable corrections for the Band Pass Covariance Method. The same region will be utilized for time-sequential and sub-pixel analysis of surface and satellite data that may help to improve algorithms for soil moisture and snow-water equivalency factors.

*Photo: JIRCAS researchers sampling soil and measuring moisture levels on the [steppes of Mongolia](#).*

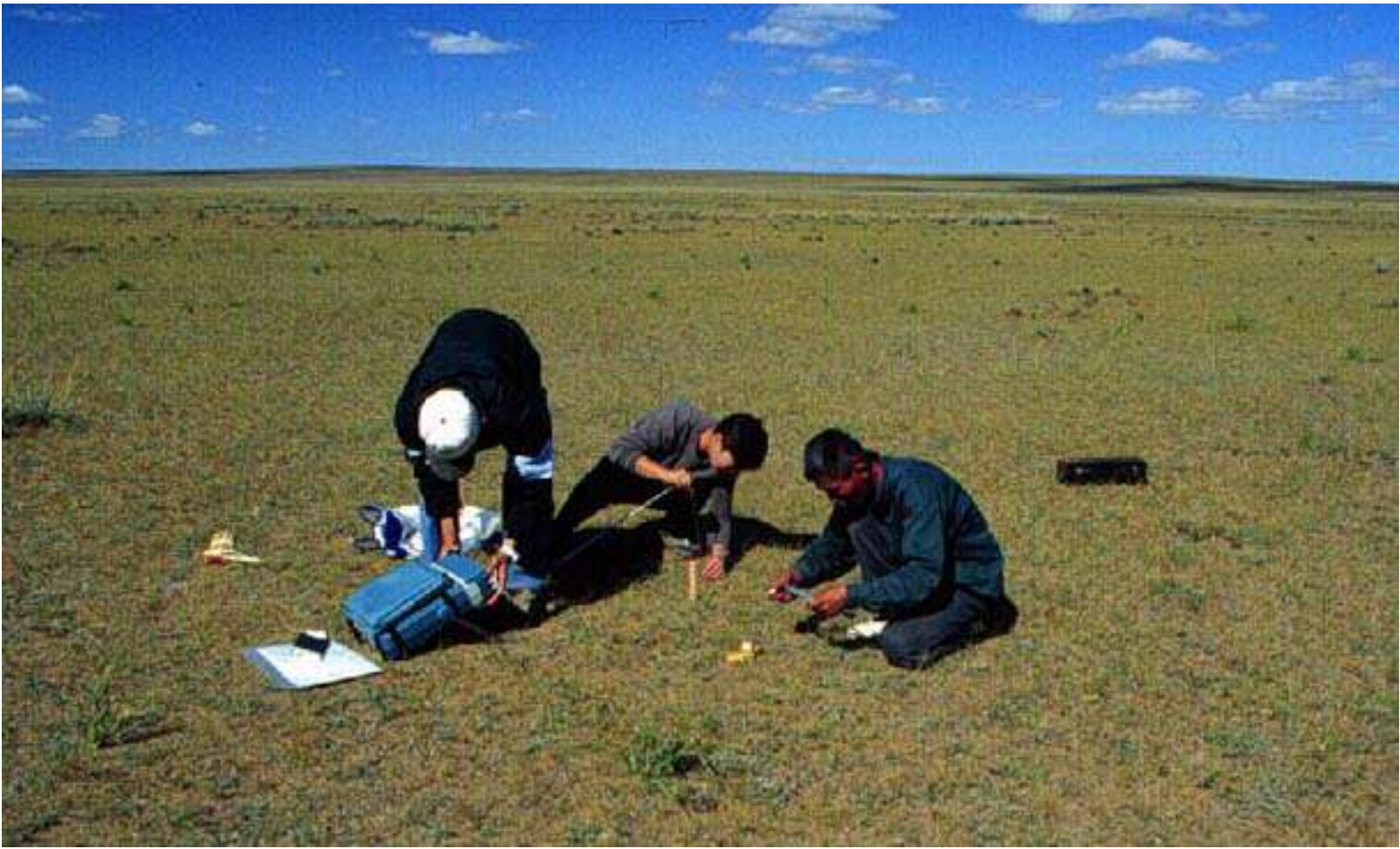
### **Other important Memoranda of Understanding**

A number of other important MOU's have been concluded during the previous year. Seven such documents signed in August, 1997, commit JIRCAS to pursue cooperative studies with research institutes and organizations in the People's Republic of China, including the China Agricultural University, the Research Center for Rural Economy, and the Jilin Academy of Agricultural Sciences. Also signing on to collaborative research projects are four affiliates of the Chinese Academy of Agricultural Sciences: the Institute of Natural Resources and Regional Planning, the Soil and Fertilizer Institute, the Institute of Agricultural Economics, and the China National Rice Research Institute.

In addition, JIRCAS has concluded MOU's with the [International Maize and Wheat Improvement Center \(CIMMYT\)](#) located in Mexico City, Mexico, and the [International Center for Research in Agroforestry \(ICRAF\)](#) located in Nairobi, Kenya.

*Photo: Mitsuo Ishige, former director of the Biological Resources Division at JIRCAS, sign a Memorandum of Understanding with Director General Cun Shan Ying of the China National Rice Research Institute in Hangzhou, Zhejiang Province..*

Back to	the <a href="#">Highlights menu</a> , or to information on the production and utilization of food in <a href="#">China</a> , or to information on rice hybridization in <a href="#">West Africa</a> , or to information on the production of soybeans in <a href="#">MERCOSUR countries</a> .
Forward to	Academic <a href="#">Prizes and Awards</a> .







## Academic Prizes and Awards

JIRCAS is pleased to note that many of its staff members have been the recipients of academic prizes and awards from scientific societies and other organizations. The following is a brief summary of special achievements received during the previous Fiscal Year. The Institute is proud to include these awards in the Highlights of Annual Report 1997.

### Glaciology

**Dr. Hiroyuki Ohno, Senior Researcher in the Environmental Resources Division**, received the 1997 Hirata Award from the Japanese Society of Snow and Ice for “Study on heat transfer on thick snow and ice mass.” The award is given to a researcher as the Society’s recognition of individual’s achievement on glaciology and encouragement for successful career evolution.

### Soil Science and Plant Nutrition

**Dr. Yoshinari Ohwaki, Senior Researcher at the Okinawa Subtropical Station**, received the 1998 Young Scientist Award for Soil Science and Plant Nutrition from the Japanese Society of Soil Science and Plant Nutrition for “Comparative studies on phosphorous and iron nutrition of legumes.” The award is given to a rising, young researcher as the Society’s recognition of individual achievement and promise.

Back to the [Highlights menu](#).



# JIRCAS AND THE MINISTRY OF AGRICULTURE,



## FORESTRY, AND FISHERIES



## Administration of the MAFF Research Institutes

The Japan International Research Center for Agricultural Sciences (JIRCAS) is one of twenty-nine research institutes belonging to the [Ministry of Agriculture, Forestry and Fisheries \(MAFF\)](#), a department of the Japanese government. As Japan faces the twenty-first century, these agricultural research institutes are playing a key role in the development of new technologies, such as biotechnology, which will powerfully influence further developments in the food industry and help to promote agriculture, forestry and fisheries activities both in Japan and abroad. MAFF's institutes work in close collaboration with local governments, universities, and private research organizations with the dual objectives of contributing to the overall prosperity of Japan while making significant contributions to the international community.

Including JIRCAS, nineteen of the twenty-nine institutes affiliated with MAFF are directly overseen by the [Agriculture, Forestry and Fisheries Research Council \(AFFRC\)](#), a special administrative body attached to the Ministry. Principal duties of the AFFRC include overall research planning and coordination, liaison and coordination between researchers and administrative entities, administration of the institutes, and provision of research assistance to local organizations and the private sector. The AFFRC is headed by a chairman, and its advisory members consist of independent university professors, former directors of research institute, and high officials who previously served within MAFF ([Table 1](#)). The ten remaining national agricultural research institutes, include one in the field of forestry and nine devoted to fisheries research, are attached to the AFFRC but are overseen, respectively, by the Forestry Agency and the Fisheries Agency, administrative agencies under the direct supervision of MAFF. [Figure 1](#) provides further details of these organizational arrangements.

JIRCAS is unique among the national agricultural research institutes in that it serves as an international research center while, at the same time, remaining an integral part of the MAFF infrastructure. Therefore, JIRCAS both dispatches researchers overseas and remains involved in active exchange and collaboration with the other twenty-eight institutes. The Institute is located in Tsukuba Science City, nearly 50 km northeast of Tokyo ([Figure 2](#)), along with a number of other research institutes affiliated with MAFF. The AFFRC Secretariat maintains a Tsukuba Office, which constitutes the administrative center of the Tsukuba Institutional Complex. Tsukuba itself is home to many other research institutes and experimental facilities belonging to other ministries and agencies of the Japanese government, as well as to the private sector.

## Administration and Research at JIRCAS

The JIRCAS staff currently includes a total of 163 research scientists and administrators, including forty-three staff members posted to the JIRCAS Okinawa Subtropical Station on Ishigaki Island. A Director General heads the Institute from the Main Building in Tsukuba. The Research Planning and Coordination Division oversees the seven Research Divisions that comprise JIRCAS: the Research Information Division, Biological Resources Division, Environmental Resources Division, Crop Production and Postharvest Technology Division, Animal Production and Grassland Division, Forestry Division, and the Fisheries Division, as well as the Okinawa Subtropical Station. The Administration Division is responsible for general administrative affairs. The administrative structure of JIRCAS is further delineated in [Figure 3](#).

### ● Research Planning and Coordination Division

The Research Planning and Coordination Division functions as a central organ for overseeing and supporting the activities of the seven Research Divisions and the Okinawa Subtropical Station. The Division consists of a Research Planning Section, a Research Coordination Section, an International Relations Section, and a Publication and Documentation Section. Their activities are supported by the work of an International Research Coordinator and a Research Information Officer assigned to the Division.

The Research Planning Section, Research Coordination Section, and International Relations Section are jointly responsible for the implementation of research programs involving JIRCAS researchers both overseas and in Japan. Staff members within the three divisions undertake comprehensive planning of JIRCAS research projects, arrange the dispatch of researchers on long and short-term bases, assist in the implementation of invitation programs for visiting researchers and administrators, and maintain communication with relevant international and domestic organizations. The Publication and Documentation Section handles the collection, classification, and supply of bibliographic materials both from overseas and from domestic sources and prepares public relations materials for the Institute. The International Research Coordinator oversees collaborative efforts in Southeast Asia while serving in the Bangkok Office as the JIRCAS Representative to Thailand. The Research Information Officer is responsible for developing the JIRCAS computer information network and coordinating the exchange of data between JIRCAS and related research institutions. Additionally, the Division as a whole coordinates the organization of various meetings and workshops, including the annual International Symposium.

### **● Administration Division**

The Administration Division consists of a General Affairs Section, an Accounting Section, and an Overseas Support Section. The General Affairs Section manages official documents, personnel-related matters, and social affairs pertaining to JIRCAS staff. The Accounting section handles accounting activities, budgeting, settlements and wage distribution. Finally, the Overseas Support Section assumes responsibility for all matters pertaining to the overseas operations of JIRCAS, including general international affairs, overseas expenditures, and overseas shipments of equipment and materials.

### **● Other**

The Okinawa Subtropical Station maintains a separate General Affairs Section independent of the Administration Division. Additionally, JIRCAS has two field management sections which oversee experimental fields belonging to the Institute. The Okinawa Field Management Section falls under the direct supervision of the Okinawa Subtropical Station management, while the Tsukuba Field Management Section is attached to the Crop Production and Post Harvest Technology Division.

Back to	the Annual Report <a href="#">Main Contents</a> page.
---------	-------------------------------------------------------



# JIRCAS and the Ministry of Agriculture, Forestry, and Fisheries

**Table 1. Current Members of the Agriculture, Forestry and Fisheries Research Council.**

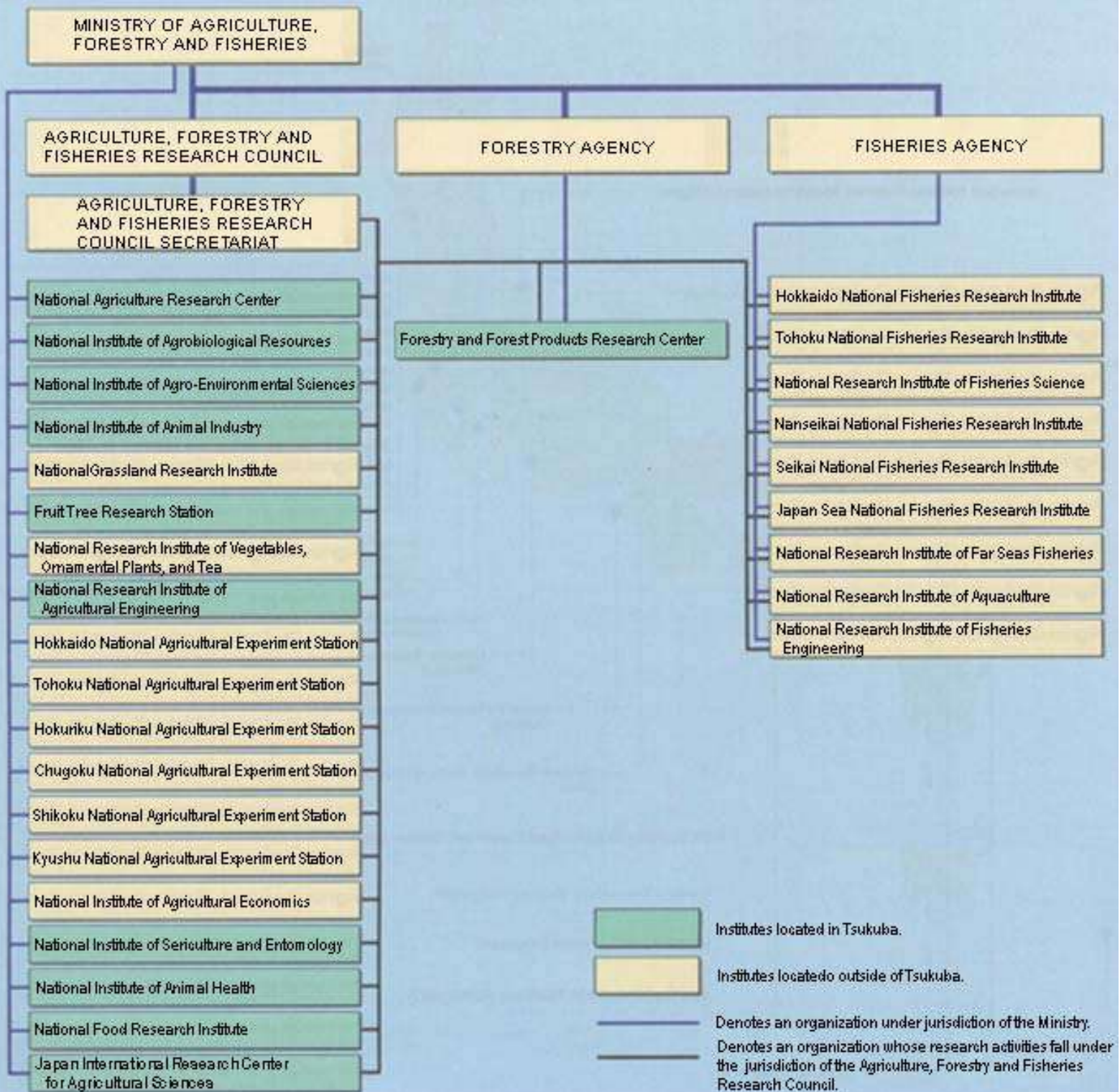
Chairman	Sakue Matsumoto	Former Vice-Minister of the Ministry of Agriculture, Forestry and Fisheries
Advisory Members	Ryoichi Kawashima	Former Director General of the National Agriculture Research Center
	Tetsuo Iino	Professor, Waseda University (Genetics)
	Masatoshi Yoshino	Professor, Aichi University (Meteorology)
	Takenori Inoki	Professor, Osaka University (Economics)
	Kazuo Takahashi	Governor, Yamagata Prefecture
	Akinori Suzuki	Former Vice-President, University of Tokyo

Back to

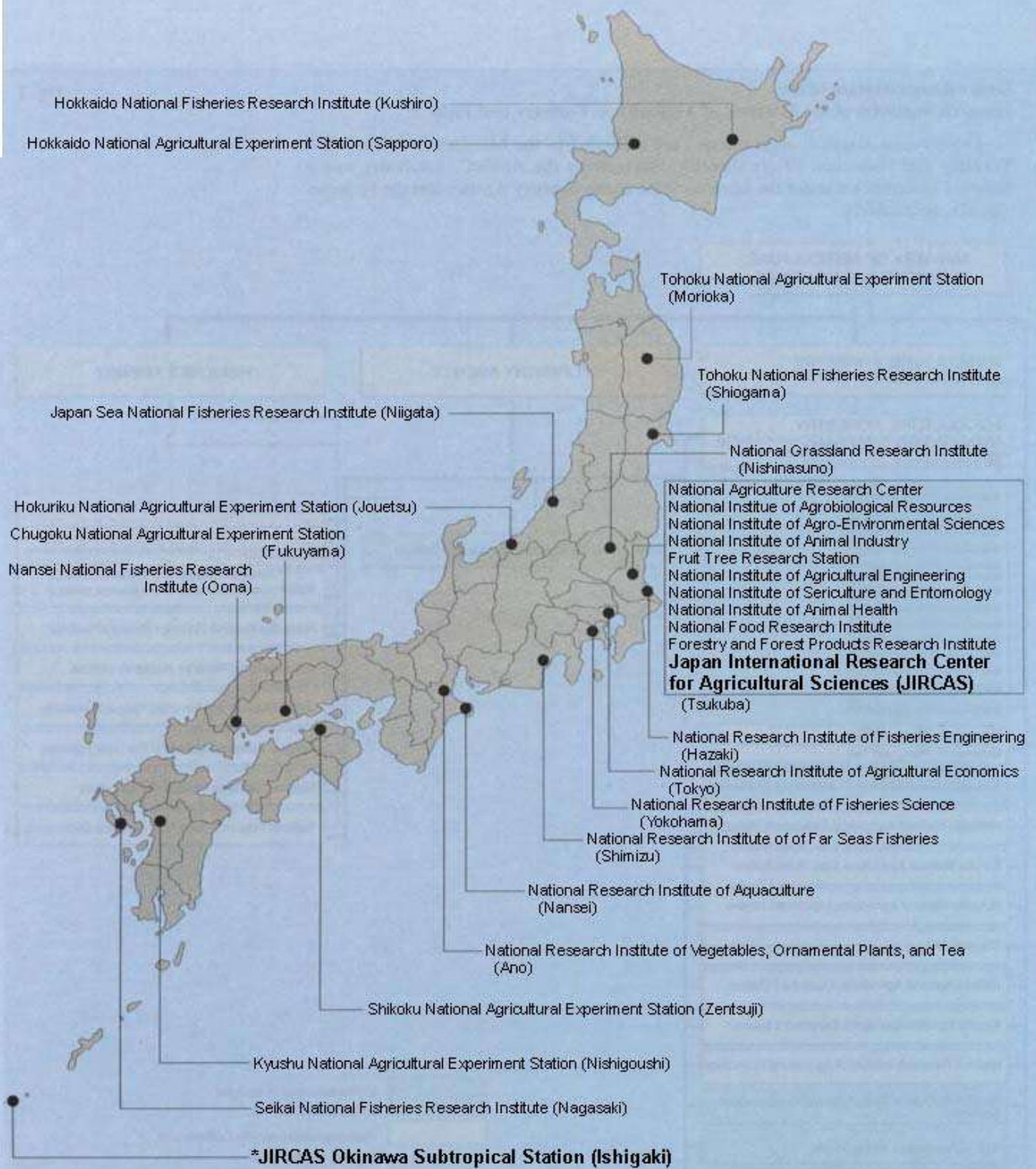
[JIRCAS and the Ministry of Agriculture, Forestry and Fisheries.](#)

## General Organization of the Research Institutes Affiliated with the Ministry of Agriculture, Forestry and Fisheries

Twenty-nine research organizations are affiliated with the Ministry of Agriculture, Forestry and Fisheries. Nineteen are directly overseen by the Agriculture, Forestry and Fisheries Research Council (AFFRC), and one forestry and nine fisheries institutes fall under the administration of the Forestry Agency and the Fisheries Agency, respectively.



## Locations of the Twenty-Nine Institutes of the Ministry of Agriculture, Forestry and Fisheries





## JIRCAS Organization





## RESEARCH INFORMATION DIVISION

The Research Information Division fulfills three main responsibilities relating to research operations at JIRCAS. First, the Division collects and analyzes information pertaining to socioeconomic conditions and the state of agricultural sciences in developing countries. Second, it attempts to formulate and coordinate collaborative research projects with public and private organizations in developing countries. In recent years, this role has grown in relative importance as JIRCAS has become increasingly involved in large-scale, comprehensive research projects with countries throughout the world. Finally, in an effort to coordinate rising flows of data to and from partner countries, the Division has assumed the responsibility of developing and operating information systems through mainframe computers located at JIRCAS.

The Division's research coordinators and senior scientists undertake these tasks from two distinct perspectives. The first is a strategic perspective focusing on critically important world regions, including China, other monsoonal areas of Asia, arid and semi-arid Asian areas, Africa, and Latin America. The second perspective focuses on particular issues, with an emphasis on global problems generated by environmental degradation, food insecurity, and unbalanced patterns of rural development. Combining these two perspectives, research coordinators in the Research Information Division conduct studies on agriculture in specific regions and consider the prospects for collaborative studies. They design and coordinate comprehensive projects in which scientists representing different disciplinary backgrounds can work together toward common goals. Thus far, eight major comprehensive projects have been designed and implemented since the establishment of JIRCAS.

In 1994, JIRCAS launched its first comprehensive research project in Vietnam in an effort to promote improved efficiency in the combined farming systems currently used in the Mekong Delta region. Subsequently, the Division launched comprehensive projects on tropical brackish water ecosystems in Malaysia and sustainable agricultural technologies in Northeast Thailand during 1995, and another comprehensive project on sustainable agro-pastoral rotation systems in subtropical Brazil during 1996. In FY 1997, two new comprehensive projects began, one targeting sustainable production and processing of major food resources in China and the other investigating new technological developments for soybean production and utilization in South American countries. Additionally, the Division has been planning comprehensive projects on rice development in West Africa and farming systems in Indonesia scheduled to begin during the next fiscal year.

*Photo: [Chongwenmen Food Market in Beijing](#) teems with shoppers on a recent weekend afternoon.*

The Research Information Division is also involved in analyzing global issues. In collaboration with the FAO and other international agencies, the Division recently helped to develop a sophisticated world food model that can be used to project world food supply and demand and to simulate the effects of proposed policy changes. At the same time, findings derived from ongoing collaborative research projects at JIRCAS are often incorporated into simulations conducted using the model. Currently, researchers are attempting to elaborate the model so that the impact of environmental changes can also be analyzed. In addition, researchers within the Division are studying rural development strategies, with particular emphasis on farming systems research, by reviewing recent development strategies and assisting researchers in the natural sciences who are involved in integrated rural development projects.

Another important task of the Division is to develop and operate the computer-based JIRCAS information system. In addition, the Division has constructed a database of bibliographic articles on tropical agriculture published in Japan which is available to JIRCAS researchers. The Division has developed an integrated information system including statistical data, documents and imagery data based on PC windows and UNIX. JIRCAS researchers have access to this information as well as access to external sources through the Internet system.

Finally, the Division works as the secretariat for the numerous international seminars and workshops which JIRCAS researchers conduct throughout the year. The largest is the JIRCAS International Symposium, which addresses a topic of central importance in agricultural research. The [International Symposium for FY1997](#) concerned "Sustainable agricultural with environmental conservation in Asia" and was attended by 230 participants from over twenty countries.

 [Division Topic](#): Modeling Food Demand and Supply in Shandong, China.

Back to

the Annual Report [Main Contents](#) page.

Forward to

the [Biological Resources Division introduction](#) page.







***RESEARCH INFORMATION DIVISION TOPIC***  
**Modeling Food Demand and Supply in Shandong, China**

Questions regarding the future of China's food supply are matters of great concern among both national leaders and specialists throughout the world. Such concerns derive from the wide regional gaps which exist in patterns of food supply and demand in China, as evidenced in per capita agricultural land statistics, the unequal distribution of income, patterns of food intake, and the persistence of policy priorities favoring certain commodities. In order to better estimate future trends affecting food supply in the midst of such factors, analyses based on detailed regional information is essential. Our study examined the case of Shandong province, an eastern coastal province which has played a significant role in Chinese agriculture since the beginning of market-oriented reforms.

In order to suggest tentative prospects for the food balance in Shandong Province in the year 2010, we constructed an econometric model covering thirteen commodities, namely wheat, rice, maize, tubers, soybeans, groundnuts, pork, beef, mutton, poultry, eggs, fish and milk. We examined demand functions separately for urban and rural areas of the province. Most parameters used in the model were estimated econometrically, based on historical data, including artificial compound prices combining government procurement prices with the market retail prices that have emerged since the introduction of market-oriented reforms. We allowed substantial time lags between agricultural investment from local authorities and changes in fertilizer prices and their impacts on crop yields.

Our model utilized two possible scenarios for estimating future changes in procurement prices and fertilizer prices. Scenario A assumed that price evolution would continue along the same trajectory as average price changes between 1980 and 1995. Scenario B assumed convergence at the level of world market prices by the year 2010, a probable outcome in the case that China gradually opens its agricultural markets through international negotiation. Assumptions were also made for other exogenous variables based on historical data ([Table 1](#)). Combining A and B with three different possibilities for economic and population growth generated a total of six scenarios simulated within the model.

Our simulations produced several useful suggestions about the food balance in Shandong Province in the near future. Regardless of scenarios, the model predicts that the region will experience increasing surplus levels of wheat and rice ([Figure 1](#)), along with meat and eggs. At the same time, the regional deficit for maize, which is mostly used for animal feed, appears poised to deepen over time ([Figure 2](#)). These results suggest that more agricultural land in the region may be designated for maize production, and that utilization of imported feed may become more common in Shandong, as in neighboring Asian countries.

Future grain production will also be affected by market and procurement prices, as well as the relative share of commodity sales falling under each category. Thus, the response of supplies to price changes will remain the key element for improvement in the model, requiring intense studies of the progress of relevant local policies. Our model also suggests that different livestock raising systems will heavily affect the predicted outcomes for feed requirements, as the efficiency of feed-livestock conversion has a large impact on feed usage within the model.

With limited sources of information and constant change affecting contemporary Chinese economic institutions, outputs from this model should be treated as tentative and conditional. However, further efforts to construct such models will continue at JIRCAS, and the advantages of this type of study will become increasingly evident as models expand to cover each province in China.

(O. Koyama)

Back to	the <a href="#">Research Information Division introduction</a> page, or to the Annual Report <a href="#">Main Contents</a> page.
---------	----------------------------------------------------------------------------------------------------------------------------------

Forward to	the <a href="#">Biological Resources Division introduction</a> page.
------------	----------------------------------------------------------------------

**RESEARCH INFORMATION DIVISION TOPIC****Modeling Food Demand and Supply in Shandong, China****Table 1.** Assumptions used in the simulation scenarios. (Figures represent percentage p.a.).

SCENARIO	INVESTMENT	INCOME		POPULATION	URBANIZATION
		Rural	Urban		
I: Baseline	1.9	5.7	6.7	0.99	6.0
II: Optimistic	3.6	4.7	5.7	0.87	5.0
III: Pessimistic	1.0	7.7	9.0	1.29	7.0

Back to

[Division Topic #1](#): Modeling Food Demand and Supply in Shandong, China.

### Wheat and Rice Transference in Shandong Province

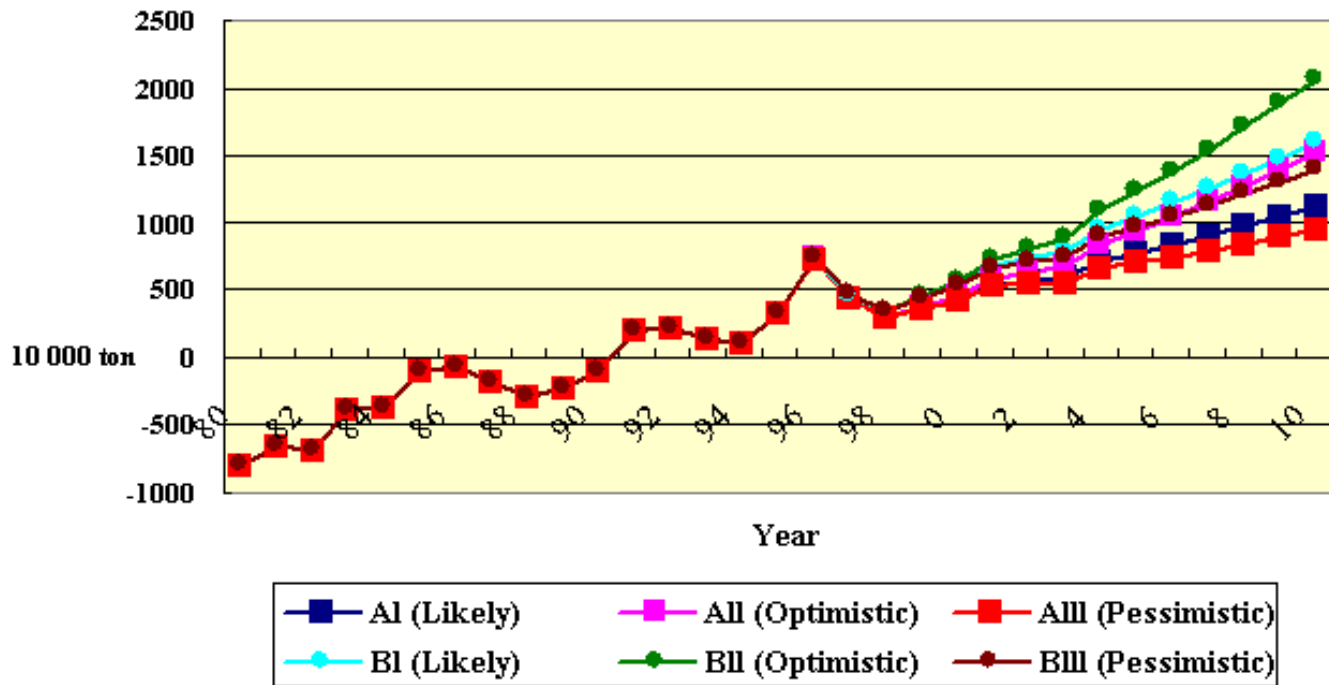


Figure 1. Wheat and rice transference in Shandong Province.

Back to

[Division Topic #1: Modeling Food Demand and Supply in Shandong, China.](#)

### Maize Transference in Shandong Province

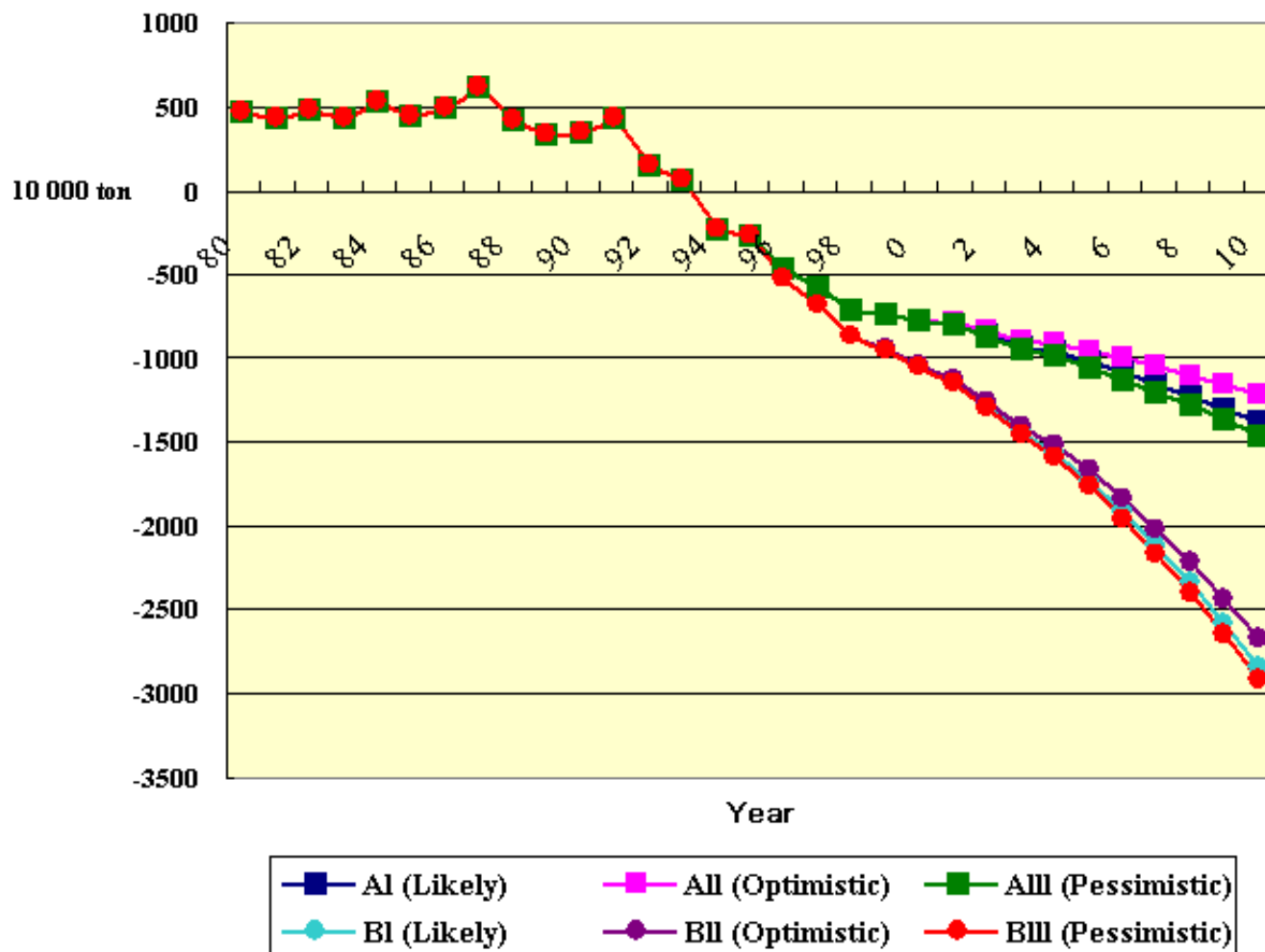


Figure 2. Maize transference in Shandong Province.

Back to

[Division Topic #1: Modeling Food Demand and Supply in Shandong, China.](#)



## BIOLOGICAL RESOURCES DIVISION

In many developing regions of the world, rapidly increasing populations combined with problems of progressively deteriorating natural resources have led to widespread malnutrition and serious instability in crop production. As a result, such areas are now faced with the need to increase and stabilize agricultural production through methods compatible with the preservation of the environment. Agricultural technologies that optimize the use of biological resources will play an important role in determining whether or not this objective can be met.

*Photo: An Andean market in Ulluco, Peru, is a treasure house of plant genetic resources.*

In response to these concerns, the Biological Resources Division has placed considerable emphasis on collaborative on-site breeding projects in foreign countries. The objective of such projects is to utilize available genetic resources and biotechnological procedures to develop new crop varieties. In cooperation with the International Rice Research Institute (IRRI) in the Philippines, for example, the Division has been involved in a recent project examining blast resistance in several rice varieties, results of which allowed for the selection of near-isogenic lines of rice and the development of several pre-isogenic lines with different single genes with blast resistance. Working with the International Maize and Wheat Improvement Center (CIMMYT) in Mexico, the Division has conducted research on the doubled haploid system and marker-assisted selection, which may assist wheat breeders in developing countries in increasing the efficiency of their operations. Additionally, in collaboration with the Soybean Institute of the Jilin Academy of Agricultural Sciences in the People's Republic of China, our researchers helped to develop soybean varieties resistant to viral diseases and nematode pests. At the same time, experts dispatched by the Division to the International Crop Research Institute for the Semi-Arid Tropics (ICRISAT) evaluated sorghum and pigeonpea germoplasm to obtain genetic resources highly adaptable to soils with low nitrogen and phosphorus levels. And at Khon Kaen University in Thailand, Division scientists analyzed cowpea cultivars during the dry season to test the possibility of utilizing them as feed or green manure.

Using technology available in Tsukuba to support these overseas efforts, researchers from the Biological Resources Division have been studying genetic resources and crop production in selected crops and experimental plants. Several have been working with the Yunnan Academy for Agricultural Sciences in the People's Republic of China to analyze genes that provide disease and cool-weather tolerance in rice strains, to screen relatives of wheat to help understand disease resistance in particular wheat strains, and to utilize molecular markers for analyzing genetic resistance to *Fusarium* head blight. The molecular biology group of the Division, including several visiting scientists, has recently utilized biotechnological methods to study environmental stress patterns in higher-order plants, in particular examining how to use genes and regulatory factors for the production of drought-tolerant transgenic crops. The researchers isolated a number of genes that function in drought tolerance and, using *Arabidopsis* and cowpea plants, analyzed the regulatory factors of these genes in stress response. Their research will contribute to the development of commercial crops capable of withstanding potentially damaging environmental stresses, perhaps thereby helping to mitigate problems relating to the food crisis and environmental degradation in developing countries.

● [Division Topic #1](#): Improving Plant Tolerance to Environmental Stress by Gene Transfer.

● [Division Topic #2](#): Hybrid Rice Yields under Low Direct Seeding Rate Conditions in Malaysia.

Back to	the Annual Report <a href="#">Main Contents</a> page.
Forward to	the <a href="#">Environmental Resources Division introduction</a> page.





## **BIOLOGICAL RESOURCES DIVISION TOPIC 1**

### **Improving Plant Tolerance to Environmental Stress by Gene Transfer**

Drought, salinization and freezing are environmental conditions that dramatically affect the growth of plants and the productivity of crops. Genetic engineering, through the use of gene transfer technology, has the potential to improve stress tolerance in crops. Recently, several different approaches to improve the stress tolerance of plants by gene transfer have been attempted. Approaches yielding partial improvement involved the introduction of gene encoding enzymes required for the biosynthesis of various osmoprotectants, such as mannitol, proline, glycine, and betaine. The introduction of genes which encode enzymes for modifying membrane lipids, late embryogenesis abundant (LEA) proteins, and detoxification enzymes has also been attempted.

In each approach, a single protective protein or enzyme has been produced in the test plants. However, comprehensive studies suggest that a number of genes function in environmental stress tolerance and response. In order to contribute to improvements in biotechnology for stress tolerance, we analyzed plant responses to environmental stress. During the course of our research, we cloned more than 40 cDNAs for dehydration-inducible genes from *Arabidopsis* and subsequently analyzed the gene expression, the gene products functions, and the signal transduction cascades under water stress for each. Our findings matched earlier suggestions that genes induced during stress conditions protect cells from environmental stress not only by producing important metabolic proteins but also by regulating genes for signal transduction in stress response.

One of the isolated genes, *rd29A*, is induced by the stress of drought, high salt and low temperature. We analyzed the *rd29A* promoter and identified a novel cis-acting element containing 9 bp, TACCGACAT (DRE, Dehydration Responsive Element), that is involved in dehydration-, salt- and cold-responsive gene expression. We isolated two cDNA clones that encode DRE binding proteins, DREB1A and DREB2A, by yeast one-hybrid screening. The DREB1A and DREB2A proteins contain a conserved DNA binding motif found in the ethylene-responsive element binding protein and AP2 proteins (EREBP/AP2 motif) that function in ethylene-responsive expression and floral morphogenesis, respectively. Both proteins specifically bound to the DRE sequence *in vitro* and activated the transcription of the b-glucuronidase reporter gene driven by the DRE sequence in *Arabidopsis* leaf protoplasts. Expression of the DREB1A gene was induced by low-temperature stress while expression of the DREB2A gene was induced by dehydration. Thus, two independent DREB proteins, DREB1A and DREB2A, function as trans-acting factors in two separate signal transduction pathways under low temperature and dehydration conditions, respectively ([Figure 1](#)).

Overexpression of the DREB1A cDNA in transgenic *Arabidopsis* plants using constitutive cauliflower mosaic virus 35S promoter induced strong expression of the target genes under unstressed conditions. These target genes include *kin1*, *cor6.6*, *rd17*, *cor15a* and *erd10*, which are induced by both dehydration and cold stresses. Proteins encoded by these target genes have been shown to function in protecting plant cells from dehydration and low temperature stress. These transgenic plants revealed multi-stress tolerance to drought, salt and freezing. Higher levels of the transcripts of the DREB1A gene in the transgenic plants increased their stress tolerance to dehydration and freezing. However, the higher level of the transcripts also caused the growth retardation of plants grown in unstressed conditions and remarkably reduced plant productivity.

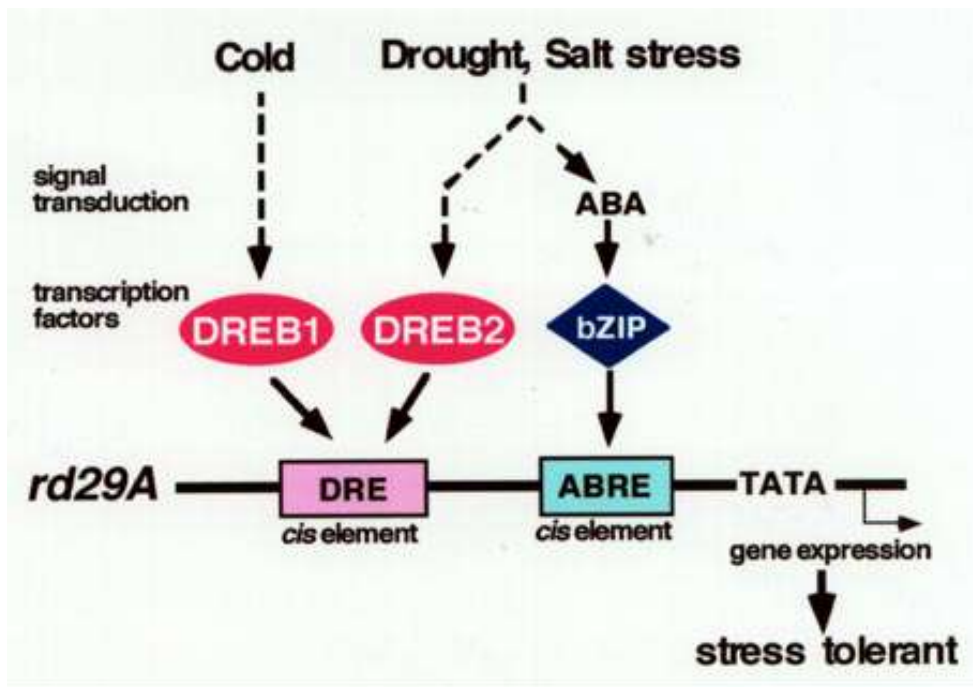
We avoided this problem by using the stress inducible *rd29A* promoter. The DREB1A gene driven by the *rd29A* promoter was expressed at low levels under controlled conditions but was immediately induced to very high levels by dehydration, salt and low temperature stress. In transgenic plants, the stress tolerance was high, but growth retardation was not severe and the productivity of the plants was almost the same as in the natural state ([Figure 2](#)). Previously, we showed that the cis-element DRE also functions in tobacco plants and DRE-related motifs have been reported in the promoter region of the cold-inducible *Brassica napus* gene. These observations suggest that both the DREB1A cDNA and *rd29A* promoter may be useful for improving dehydration, salt and freezing tolerance in crop plants.

(K. Yamaguchi-Shinozaki)

Back to	the <a href="#">Biological Resources Division introduction</a> page.
Forward to	<a href="#">Division Topic #2</a> : Hybrid rice yields under low direct seeding rate conditions in Malaysia





**BIOLOGICAL RESOURCES DIVISION TOPIC 1****Improving Plant Tolerance to Environmental Stress by Gene Transfer**

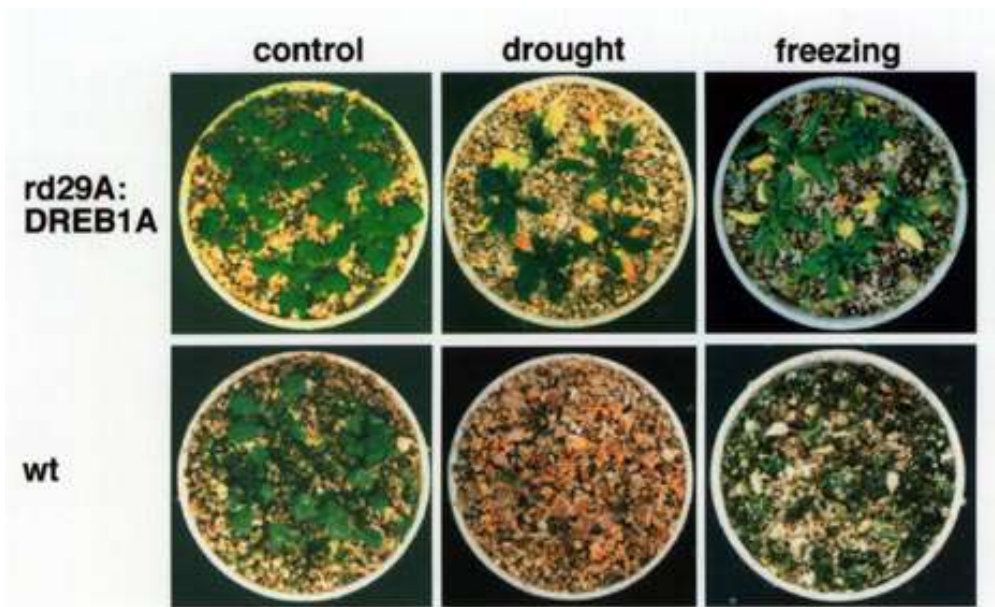
**Figure 1.** A model for the induction of *rd29A* gene expression under dehydration, high-salt, and low-temperature conditions. There are at least two independent signal transduction pathways, ABA-independent and ABA-responsive, between environmental stress and expression of the *rd29A* gene. DRE functions in the ABA-independent pathway, and ABRE is one of the cis-acting elements in the ABA-responsive induction of *rd29A*. Two independent DRE binding proteins, DREB1A and DREB2A, function as trans-acting factors and separate two signal transduction pathways in response to cold and drought/high salinity stresses, respectively.

Back to

[Division Topic #1: Improving Plant Tolerance to Environmental Stress by Gene Transfer](#)

**BIOLOGICAL RESOURCES DIVISION TOPIC 1**

**Improving Plant Tolerance to Environmental Stress by Gene Transfer**



**Figure 2.** Freezing, drought and salt stress tolerance of rd29A:DREB1A transgenic plants. Plants in drought stress experiments were denied water for two weeks, while freezing stress experiments involved exposure to temperatures of  $-6^{\circ}\text{C}$  for 2 days and  $22^{\circ}\text{C}$  for 5 days. Comparison is with control plants grown for three weeks under normal conditions.

Back to

[Division Topic #1: Improving Plant Tolerance to Environmental Stress by Gene Transfer.](#)



## ***BIOLOGICAL RESOURCES DIVISION TOPIC 2***

### **Hybrid Rice Yields under Low Direct Seeding Rate Conditions in Malaysia**

Direct seeding of rice is common throughout Malaysia. In order to control detrimental weed growth in paddy fields, seeding rates that reach 100 kg/ha are often employed. These practices present problems in efforts to raise the productivity of rice cultivation in Malaysia, as high-yielding hybrid rice seeds are more expensive than normal rice seeds. Hybrid rice cannot be used economically without reducing excessively high seeding rates. Initial testing elsewhere has demonstrated that hybrid rice lines experience high rates of initial growth, suggesting that their use in direct-seeded paddy fields may offset weed competition sufficiently to produce comparative advantages over common rice lines. Our research tested this hypothesis.

We conducted low seeding rate yield trials of high-yielding hybrids from the International Rice Research Institute (IRRI) in the Philippines and from India and checked their competitive abilities against *Echinochloa* spp., namely, *E.oryzicola*, *E.crus-galli* var. *formosensis* and *E.crus-galli* var. *crus-galli*.

*Photo: Hybrid rice growing in Bumbung Lima, Malaysia.*

The highest varietal heterosis across seeding rates was 115.5 by IR69690H. This heterosis level is considered to be low. All four IRRI hybrids were confirmed at about 20 percent of heterosis over MR84 in transplanted yield trials for four consecutive seasons in Malaysia. One reason for the relatively low heterosis in hybrids may be the fact that hybrids have never been selected in a direct seeding condition, even at the IRRI and in India. Adaptability for direct seeding might prove different from that for transplanting.

The highest varietal yield of 3.23 t/ha was achieved by MR185 with *Echinochloa* spp. The hybrids used here did not show any superiority over the control variety MR185 in direct seeding conditions where the fields were very much infested with *Echinochloa* spp. plants. The average dry whole weight of *Echinochloa* spp. was 2.13 t/ha. In this experiment the infestation of *Echinochloa* spp. is considered to be very serious. With the increase in culm length that ranged from 65 cm to 80 cm, the yield of hybrids clearly increased. Even within this range of variation of culm length, their yield increased according to the height of rice. For the purpose of controlling weeds in paddy fields, seeding rates have to be as high as about 100 kg/ha, whereas in the case of transplanting, the seeding rates can be reduced to about 20 kg/ha.

Hybrid rice seeds are 5 to 10 times more costly than normal rice seeds. According to the results of this experiment, hybrid rice was not more competitive against weeds than the usual rice lines in direct seeding paddy fields. These findings imply that utilizing high-yield hybrids in direct-seeded paddy fields under drastically reduced seed rates will, ultimately, prove impractical.

By introducing transplanters, seed rates can be reduced by up to 20 kg/ha. The increase in seed cost is estimated at no more than RM (Malaysian ringgit) 200/ha. With the addition of labor and other cost incurred in using transplanters, the total increase in cost is RM 475.4/ha. To cover this cost increase, 0.63 t/ha increase in yield is necessary, and a yield increase of roughly 1.0 t/ha would allow farmers to profit even with hybrid rice. Therefore, the use of transplanters appears to be the most practical means of utilizing hybrid rice in Malaysia.

(H. Kato)

Back to	the <a href="#">Biological Resources Division introduction</a> , or to <a href="#">Division Topic #1: Improving Plant Tolerance to Environmental Stress by Gene Transfer</a> .
Forward to	the <a href="#">Environmental Resources Division introduction</a> .





## ENVIRONMENTAL RESOURCES DIVISION

Recent estimates suggest that the world population could reach the 6.3 billion mark by the year 2000 and the 6.8 billion mark by 2025. To feed this ever-increasing population, existing agricultural land is likely to be subjected to a higher intensity of cultivation in populous areas, and farmland development is likely to be extended to areas only marginally suited for agriculture. Trade liberalization in recent years has led to a sharp increase in the importation of commercial crops and is encouraging increased production in exporting countries. This may result in excessive load to farmland soils as well as continuous single cropping and deforestation in many countries. Past experience has shown that these practices accelerate farmland degradation and desertification on a global-scale. Such drastic changes in land use cause climatic transformation over extended regions and bring about unpredictable constraints to existing agricultural and forest ecosystems.

*Photo: JIRCAS researchers sampling soil and measuring moisture levels on the [steppes of Mongolia](#).*

From the middle of this century, patterns of land utilization have been changing due to population expansion. These changes, along with a rapid increase in fossil fuel consumption, have had tremendous impact on the atmosphere through intensified emission of carbon, nitrogen, and sulfur gases. The annual consumption of fossil fuel now exceeds 5 billion tons of carbon. If the present level of consumption continues, CO₂ concentration will increase by 0.5 per year and double by the middle of the next century. The 1995 report from the International Panel on Climate Change (IPCC) suggests that a two-fold increase in CO₂ concentrations could cause an increase in mean global surface temperature by about 2C by the year 2100.

Furthermore, research has shown that the atmospheric concentrations of other greenhouse gases such as methane, nitrous oxide and chlorofluorocarbons have also increased greatly within the past two decades. If the effects of these trace gases are taken into account, global warming is estimated to take place more rapidly than in the case where the effects of CO₂ are considered alone. These trace gases move from the troposphere to the stratosphere and participate in the destruction of stratospheric ozone. The depletion of the ozone layer allows more ultraviolet rays to reach the Earth's surface where millions of species of organisms live without any means of protection from ultraviolet radiation.

To address these problems, this Division is organizing research to identify and develop technologies for the improvement of agricultural activities and the rehabilitation of degraded lands. The target technology must be compatible with the conservation of the environment and ecosystems such as arid lands, wetlands and sloped lands which have long been considered of little use for agriculture. Other projects aim at the development of technology for sustainable agriculture through analyzing mechanisms of nutrient cycling within arable land ecosystems. To conserve the global environment in harmony with agricultural activities, research on sustainable agriculture should be given foremost emphasis.

- [Division Topic #1](#): Using Neural Networks to Assess Vegetation Stability.
- [Division Topic #2](#): Using Remote Sensing to Monitor Land Use in Semi-arid Tropical India.
- [Division Topic #3](#): Nitrous Oxide Emission from Fertilized Upland Fields in Thailand.

Back to	the Annual Report <a href="#">Main Contents</a> page.
Forward to	the <a href="#">Crop Production and Postharvest Technology Division introduction</a> page.



## ***ENVIRONMENTAL RESOURCES DIVISION TOPIC 1*** **Using Neural Networks to Assess Vegetation Stability**

In arid regions, declining levels of vegetation cover have contributed to the intensification of desertification. Manifold complex factors are involved in this type of land degradation, including land factors such as topography and soil characteristics, climatic factors such as average temperatures and rainfall variations, and human-induced factors such as grazing intensity and land use. Proper assessment of these factors requires analytical methods capable of considering numerous variables simultaneously. This project applied remote sensing and neural network algorithms in order to analyze relationships between environmental factors and land degradation and to make assessments of vegetation stability. We selected the Kunoth Paddock (153 km²), located in an arid region of central Australia, as the test site for the study.

Neural networks are characterized by high parameters and data availability, which permit automatic definition through the self-learning of supervised data sets. They often operate in pattern analysis problems to provide a means of resolving relationships between factors and phenomena. Consequently, neural networks are commonly utilized for classification purposes and are regarded as effective modeling methods for use with the Geographic Information System (GIS).

Proper evaluations of vegetation stability should consider two principal site characteristics, the richness of vegetation and vegetation change. Prior to construction of our assessment model, we analyzed these characteristics of the test site using LANDSAT/TM data. Richness and change of vegetation were measured with categorized PD54, the specific vegetation index from satellite data provided by the Division of Wildlife and Ecology of the Commonwealth Scientific and Industrial Research Organisation (CSIRO). Results of this analysis indicated that the relative richness of vegetation was higher on the eastern side than the western and southern parts of Kunoth Paddock, while vegetation change in the eastern part was high and areas of low vegetation remained small.

Neural networks contain both an input layer and an output layer, which correspond respectively to factors and phenomena. In this study, vegetation richness and vegetation change as indicated by PD54 analysis represented the output layer. Inputs consisted of seven environmental factors, which we assigned as geomorphic systems, hydrological units, soil units, vegetation units, slope, distance from water points, and distance from ridges. Two neural network models were constructed through the self-learning of supervised data sets, which included 271 points of data combining the seven input factors and the output properties of vegetation. Each model scored 74.5% accuracy in relation to the supervised data sets, and this figure was regarded as the reliability of the models.

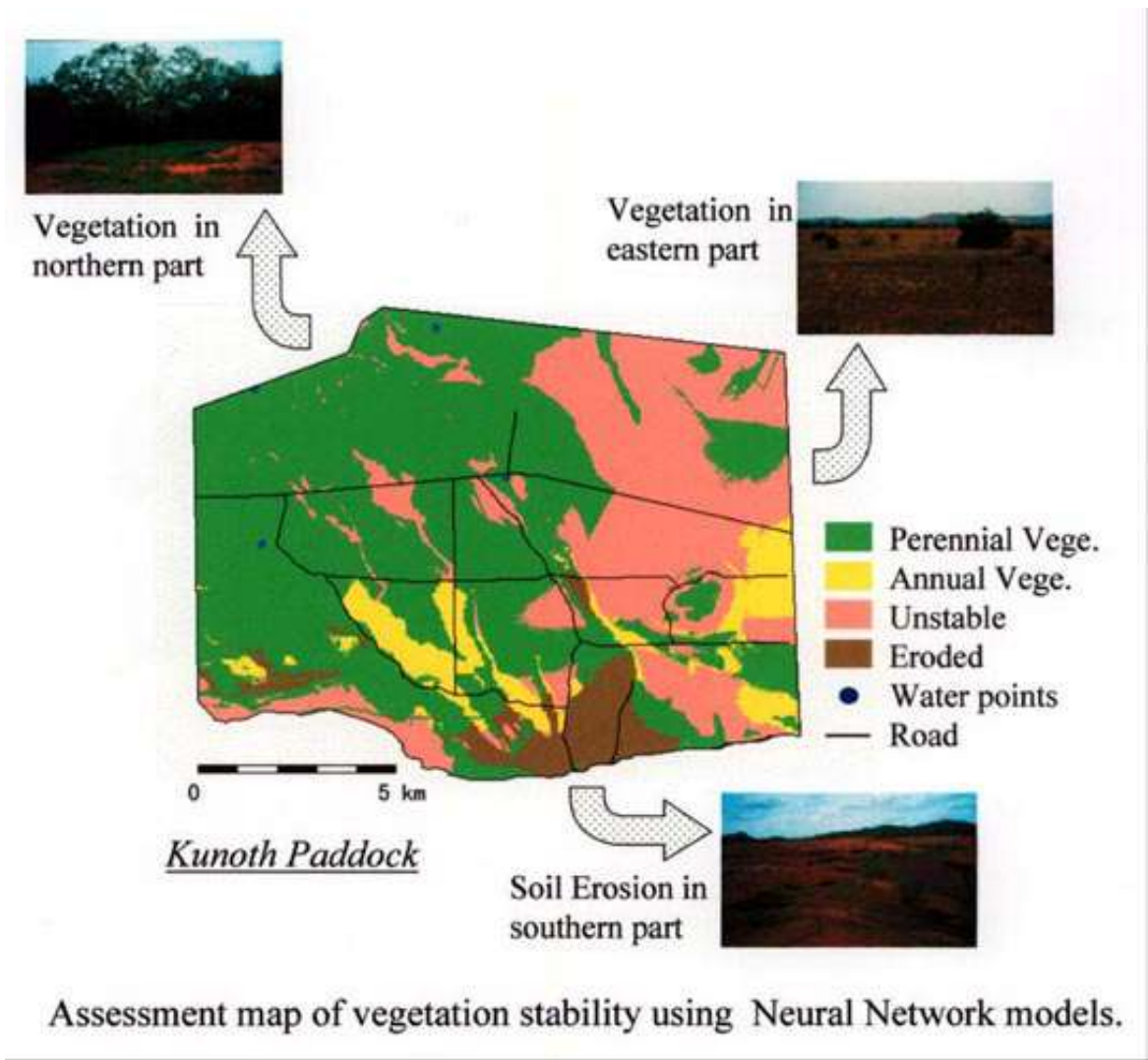
Based on these models, we utilized GIS data to perform map calculations in an effort to estimate vegetation richness and change across the full test site. Two maps produced by map calculation were integrated into the assessment. We then compared data from the models to field observations executed in February and November, 1997, to verify properties of the test ([Figure 1](#)). Observations suggested that shrub land consisting largely of mulga shrubs dominated the northern to western part of the Kunoth Paddock, while annual short-grass characterized the east. In the south, large-scale soil erosion had occurred. These conditions generally matched results of our neural network assessments, suggesting that neural networks may provide significant advantages as modeling methods. Because they prepare reliable supervised data sets, neural network work well with GIS modeling.

(Y. Yamamoto)

Back to	the <a href="#">Environmental Resources Division introduction</a> page.
Forward to	<a href="#">Division Topic #2</a> : Using Remote Sensing to Monitor Land Use in Semi-arid Tropical India. <a href="#">Division Topic #3</a> : Nitrous Oxide Emission from Fertilized Upland Fields in Thailand.

***ENVIRONMENTAL RESOURCES DIVISION TOPIC 1***

**Using Neural Networks to Assess Vegetation Stability**



*Figure 1. Assessment map and photographs showing vegetation stability at Kunoth Paddock using neural network models.*

Back to

[Division Topic #1: Using Neural Networks to Assess Vegetation Stability](#)



## ENVIRONMENTAL RESOURCES DIVISION TOPIC 2

### **Using Remote Sensing to Monitor Land Use in Semi-Arid Tropical India**

In the semi-arid tropics of India, agricultural land use varies in relation to physical factors such as soil and climatic conditions. The lack of reliable geographical information for most of the semi-arid region renders the task of measuring changes in land use extremely problematic. This study aims to develop better methods for monitoring both the spatial and temporal aspects of agricultural land use through the use of remote sensing, one of the few technologies available for the observation of ground conditions worldwide.

In our test site in the central Deccan Plateau region, cropping seasons known as the *kharif* and the *rabi* are generally recognized. During the *rabi* season, which begins in November and ends in March, cloud coverage remains comparatively low, allowing us to collect high-quality remote sensing data during each of the past several years. Throughout the project, we utilized data from the Indian Remote Sensing Satellite (IRS), which had four spectral bands ranging in wavelength between visible and near infrared.

The procedure we developed for monitoring cultivated land use during each *rabi* season consisted of two steps. First, we calculated the normalized vegetation index (NDVI), the value of which reflects the strength of vegetation growth. During the *rabi* season, the green leaves of crops grew to cover a considerable percentage of the ground surface, generating NDVI values for cultivated land that measured much higher than those for grasslands, forests, or other types of land use. Consequently, NDVI values could be employed as adaptable indicators for discriminating between cultivated land and other types of land use. As a second step, we estimated temporal changes in the threshold values of NDVI for extracting cultivated land. This step was necessary because the date of satellite observation and, accordingly, the growth condition of crops proved somewhat inconsistent from year to year.

[Figure 1](#) shows the intensity of land use for cultivation in the *rabi* season during the period between 1988-1989 and 1995-1996, excluding the year 1991-1992 when IRS data was unavailable. Our observations show that the most heavily utilized areas were located near river courses and that intensity of use decreased toward the characteristically black soils of upper hills, which dominate the western half of the study area. This study also revealed a positive correlation between the area of cultivation in the *rabi* season and the amount of rainfall during the sowing period. The method developed in this study can be utilized for monitoring agricultural land use in areas where a regular cropping season is repeated annually.

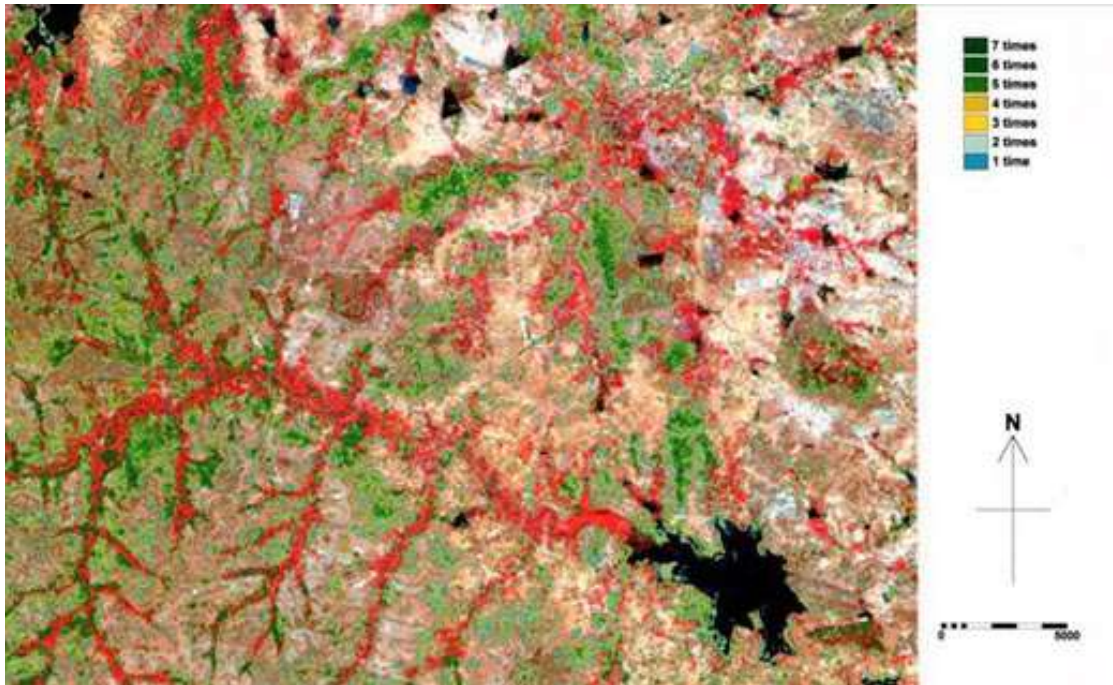
(S. Uchida)

Back to	the <a href="#">Environmental Resources Division introduction</a> page, or to <a href="#">Division Topic #1</a> : Using Neural Networks to Assess Vegetation Stability.
Forward to	<a href="#">Division Topic #3</a> : Nitrous Oxide Emission from Fertilized Upland Fields in Thailand.



**ENVIRONMENTAL RESOURCES DIVISION TOPIC 2**

**Using Remote Sensing to Monitor Land Use in Semi-Arid Tropical India**



*Figure 1. Remote sensing map showing the frequency of cultivation (one to seven times) in the rabi season between 1988 and 1996, excluding the period 1991-92.*

Back to

[Division Topic #2: Using Remote Sensing to Monitor Land Use in Semi-Arid Tropical India.](#)



***ENVIRONMENTAL RESOURCES DIVISION TOPIC 3***

**Nitrous Oxide Emission from Fertilized Upland Fields in Thailand**

Nitrous oxide ( $N_2O$ ) has garnered considerable attention, due to its potential for environmental disruption as an agricultural byproduct.  $N_2O$  contributes to global warming and has also been linked to ozone destruction in the stratosphere. Considerable data concerning nitrous oxide emissions from natural and cultivated soils already exists, but most measurements have been made in the temperate zone. There has been insufficient research conducted in the tropics, especially in tropical Asia, despite the critical importance of  $N_2O$  emissions from these regions. This project aims to further our understanding of  $N_2O$  emissions from fertilized upland fields in Thailand.

We measured nitrous oxide emissions from upland soils over the course of one year, using closed chamber methods at four experimental sites in Thailand. Two sites were located in central Thailand, one in the north, and the other in the northeast. At each experimental site, we applied two treatments in triplicate, one with nitrogen fertilizer and the other without. Maize was cultivated in the experimental plots in accordance with methods common to each district. Gas was sampled eleven to fourteen times during the crop season and every month during the dry season. At each sampling, the soil cores were also taken on the ridge of the experimental plots at depths of 0-15 and 15-30 cm, then stored in a freezer until analyzed. Field-moist soil samples were extracted by with potassium chloride (KCl) to determine levels of ammonia ( $NH_4^+$ ) and nitrate ( $NO_3^-$ ).

[Figure 1](#) displays the results of this research project. Nitrous oxide flux increased just after fertilizer application at three experimental fields, excepting the fields at Khon Kaen. The  $NO_3^-$  concentration in the soils also increased after fertilization. It seems that the increased  $N_2O$  flux and  $NO_3^-$  concentration derived from the application of nitrogen fertilizer by nitrification. At Khon Kaen the concentration of  $NH_4^+$  decreased gradually after fertilization. However, the concentration of  $NO_3^-$  did not increase. It seemed that nitrification activity in surface soil was low.

The average measured  $N_2O$  flux from unfertilized plots through the crop season was  $4.16 \pm 1.52 \frac{1}{4} g N_2O-N/m^2 hr$ ,  $5.05 \pm 1.65 \frac{1}{4} g N_2O-N/m^2 hr$ ,  $5.25 \pm 1.68 \frac{1}{4} g N_2O-N/m^2 hr$ ,  $6.74 \pm 2.95 \frac{1}{4} g N_2O-N/m^2 hr$ , at Nakhon Sawan, Phra Phutthabat, Khon Kaen and Chiang Mai, respectively. We estimated that  $N_2O$  emission from nitrogen fertilized field was 0.22-0.44 %, 0.19-0.38 %, 0.12-0.24 % and 0.08-0.15% of the total nitrogen applied at the respective experimental sites. These values were calculated from the difference of emitted  $N_2O$  between fertilized and unfertilized plots after fertilizer application. These estimated values for nitrogen loss as  $N_2O$  do not differ significantly from temperate zone values estimated by other researchers.

Our results demonstrate that rates of  $N_2O$  emission to applied nitrogen were not significantly different between tropical and temperate zones. The average  $N_2O$  flux in dry season was between 0.7 and  $3.5 N_2O-N \frac{1}{4} g m^{-2} hr^{-1}$ . Average flux from nitrogen-fertilized fields and from unfertilized fields was significantly different only at Khon Kaen.

(T. Watanabe)

Back to	the <a href="#">Environmental Resources Division introduction</a> page, or to <a href="#">Division Topic #1</a> : Using Neural Networks to Assess Vegetation Stability, or to <a href="#">Division Topic #2</a> : Using Remote Sensing to Monitor Land Use in Semi-arid Tropical India.
Forward to	the <a href="#">Crop Production and Postharvest Technology Division introduction</a> page.

**ENVIRONMENTAL RESOURCES DIVISION TOPIC 3**

**Nitrous Oxide Emission from Fertilized Upland Fields in Thailand**

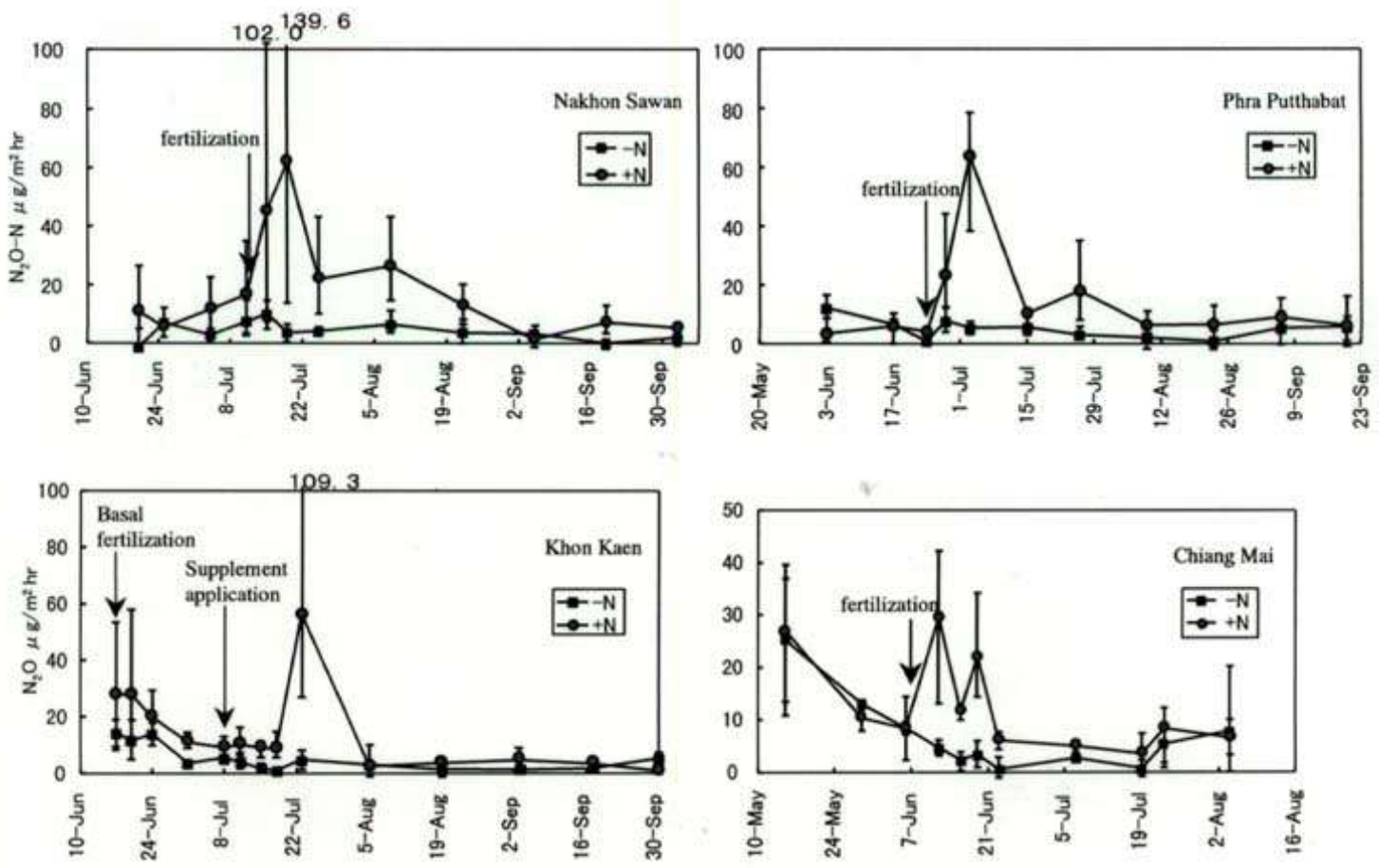


Fig. The change of N₂O flux at upland fields in Thailand

Figure 1. Changes in N₂O flux levels observed at selected upland fields in Thailand.

Back to

[Division Topic #3: Nitrous Oxide Emission from Fertilized Upland Fields in Thailand.](#)



## CROP PRODUCTION AND POSTHARVEST TECHNOLOGY DIVISION

Although world population growth rates have declined steadily since 1970, the global population will continue to increase by ninety to one hundred million people annually for the next several years. Some 95 percent of this population growth will occur in developing regions, where food deficits are already severe. Clearly, population growth will provide the primary impetus behind growing demands for food. Yet food markets will also be influenced by shifts in the purchasing power of local consumers. As development proceeds, changing patterns of consumption may dramatically increase demand for greater varieties of vegetables, fruits, and meats.

For these reasons, self-reliance in food, rather than complete economic self-sufficiency, will become an increasingly important objective in developing regions. There are no definitive models for achieving this goal. However, various methods exist for ensuring self-reliance within the particular natural and environmental constraints of each country.

*Photo: Villagers in the Cuu Long Delta region of Vietnam spread recently harvested rice to dry under the sun.*

The Crop Production and Postharvest Technology Division promotes research projects on topics ranging from production and storage to the processing and marketing of agricultural products. Our research activities encompass a variety of disciplines including agronomy, plant protection (pest, disease, and weed control), agricultural mechanization, irrigation, drainage, cropping systems, food storage, postharvest technology, farm management and agricultural economics.

Because the total area of arable land in the world is limited, we believe that sustainable production of agricultural products can be achieved only by raising overall productivity. While various technological problems must be resolved, productivity growth must be pursued in ways compatible with the preservation of the natural environment. Therefore, it is necessary to reduce as much as possible the amount of chemical inputs in agricultural endeavors. Instead, research should address the need for integrated pest management through biological control systems and better utilization of information. Topics requiring additional attention include ecological studies of insect pests and their natural enemies and the development of predictive methodologies for outbreaks of insects and diseases.

Far too often the problem of feeding the world's hungry is conceived in terms of producing sufficient food. Equally pressing problems related to preservation and distribution, issues which affect food products between harvest and consumption, are frequently neglected. Postproduction operations in agricultural and horticulture include a wide range of functions necessary for supplying good quality food, reducing transaction costs, and raising domestic welfare. It is necessary to stress postharvest studies of agricultural products, such as quality improvement, safety, the extension of shelf life, and the control of the presence of insects and microorganisms in foodstuffs. These constitute important objectives of this Division.

Finally, sustainable production of agricultural commodities can only be supported by the development of sustainable markets. Technology for enhancing the value of agricultural products is being developed with the goal of increasing incentives for farmers to promote sustainable production. Economic studies are requisite in furthering the development of target countries.

- [Division Topic #1](#): Case Study of Edible Insects in Enzaro Village, Kenya.
- [Division Topic #2](#): Monsoon-Dependent Long-Range Migrations of Rice Planthoppers in East Asia.
- [Division Topic #3](#): Serological Diagnosis of Citrus Greening Disease.
- [Division Topic #4](#): Evaluation Methods to Quantify Mechanical Properties of Collapsible Soils.
- [Division Topic #5](#): Improving Rice Cropping Techniques in the Mekong Delta, Vietnam.
- [Division Topic #6](#): Structural Changes in Vietnamese Agricultural under the *Doi Moi* Policy.

Back to	the Annual Report <a href="#">Main Contents</a> page.
Forward to	the <a href="#">Animal Production and Grassland Division introduction</a> page.





## **CROP PRODUCTION AND POSTHARVEST TECHNOLOGY DIVISION TOPIC 1** **Case Study of Edible Insects in Enzaro Village, Kenya**

For generations, indigenous peoples have utilized insects as food resources. Although insects such as locusts, grasshoppers, weevils, and termites may compete with humans as crop pests, they are frequently harvested for use in traditional foods, especially in Africa. As potential sources of proteins, lipids, and other essential nutrients, edible insects may also play an important role in human nutrition.

Field surveys and interviews with nine ethnic groups in Kenya have revealed that human consumption spans at least eight insect families representing six orders. Insects utilized for food in this region include *Isoptera* (termites), *Orthoptera* (locusts, grasshoppers, crickets), *Coleoptera* (beetles), *Hymenoptera* (honey bees), *Lepidoptera* (moths), and *Diptera* (lake flies). Most commonly eaten are termites, particularly in their winged reproductive phase, which are highly valued as food resources throughout Kenya.

In Enzaro Village, a community in the Vihiga District of western Kenya, human consumption of insects concentrates on three termite species. Villagers can easily distinguish species and are familiar with the emergence patterns of termites. *Microtermes* sp., the most common edible insect in the district, exhibits circadian rhythms which induce emergence at roughly two o'clock in the afternoon following rain. Villagers know this behavior well and prepare for catching termites with various types of traps.

*Photo: A heavy blanket trap covering a termite emergence hole in Enzaro Village, Kenya.*

One method involves the construction of a cone-shaped or tent-like structure of sticks, branches, and leaves over active emergence holes. This structure is covered tightly with banana leaves or blankets, except for a small side opening facing the sun, to which flying termites will be attracted. A dugout hole is then plastered with moistened soil and lined with banana leaves. Termites drop through the opening and collect into the hole. In case of cold weather, villagers light a small fire nearby to warm the air, so that the emergence of termites will not be inhibited. In another method for trapping termites, villagers place a simple light source inside a bucket, line the bucket with slippery wet banana leaves, then place the bucket near an active mound. In urban areas, termites can be caught easily in water receptacles left under or near electric lights, which attract the insects at night.

During the dry season, villagers must induce termites to emerge from their earthen nests in the early morning or afternoon. To do so, they blow smoke from burning roots, stems, and leaves of black jack or other wild plants into emergence holes while striking stones or beating a large piece of wood with sticks to create a slow rhythmic vibration. The sound produced may simulate heavy rainfall and appears quite effective in stimulating termites to emerge.

When other food resources may be lacking, active termite mounds are identified and sprinkled with cold water, an action that stimulates worker termites to start forming emergence holes. Villagers then construct a complicated structure of circular clay pipes leading from emergence holes, with wet perforated leaves placed nearby to direct flying termites towards collection receptacles. Several informants reported that beating wood with sticks near the termite mounds triggered certain species to emerge. Similar techniques have been reported in Uganda.

Enzaro Village boasts several methods for preparing termites to be eaten. It is most common to fry them lightly in their own fat over a low heat, sometimes with the wings removed and with a dash of salt. Fried winged termites are tastiest after being dried in the sun and can be preserved for a rather long period of time. In some areas, termites are used as marriage gifts. Raw termites are also frequently eaten. In some areas of western Kenya, sun-dried termites are packed in containers for sale in the local markets during the rainy season and may even find their way to urban markets in large East African cities, such as Kisumu, Kampala, and Nairobi.

*Photo: Termites sold at an open market in Kampala, Uganda.*

Our survey of Enzaro Primary School children from November, 1995, through February, 1996, showed that all twenty-one children in the first grade ate termites at least once per week. Nutritional chemical analysis showed that dried termites collected in Enzano Village contained 40 percent fat, about 20 percent carbohydrate, and more than 10 percent protein. These results suggest that termites play an important role in the Vihiga District, especially during the rainy season, when there are shortages in maize or sorghum supplies. We concluded that termites provide an especially valuable food source for children and pregnant women who require a high calorie diet and nutritious food.

*[Photo: A child enjoys a snack of termites in Enzaro Village, Kenya.](#)*

Research conducted in collaboration with the International Center for Insect Physiology and Ecology (ICIPE) and Kenyatta University should be further promoted to raise awareness of the importance of insects as a good, inexpensive source of lipids and animal protein. We may castigate insects as unpleasant creatures when we lack a full realization of the many benefits they bring to human beings, not all of which are properly exploited. Developing farming methods for production of edible insects and establishing an edible insect agro-industry to process and package different insect species would improve their marketability and create future socio-economic benefits for the people of East Africa.

(S. Yagi)

Back to	the <a href="#">Crop Production and Postharvest Technology Division introduction</a> page.
Forward to	<a href="#">Division Topic #2</a> : Monsoon-Dependent Long-Range Migrations of Rice Planthoppers in East Asia, or to <a href="#">Division Topic #3</a> : Serological Diagnosis of Citrus Greening Disease, or to <a href="#">Division Topic #4</a> : Evaluation Methods to Quantify Mechanical Properties of Collapsible Soils, or to <a href="#">Division Topic #5</a> : Improving Rice Cropping Techniques in the Mekong Delta, Vietnam, or to <a href="#">Division Topic #6</a> : Structural Changes in Vietnamese Agricultural under the <i>Doi Moi</i> Policy.











## ***CROP PRODUCTION AND POSTHARVEST TECHNOLOGY DIVISION TOPIC 2*** **Monsoon-Dependent Long-Range Migrations of Rice Planthoppers in East Asia**

Two species of rice planthoppers are found throughout rice-growing areas of Asia. *Nilaparvata lugens*, commonly known as the brown planthopper (BPH), and *Sogatella furcifera*, or white-backed planthopper (WBPH) feed only on the *Oryza sativa* species of rice.

In Japan, these planthoppers have long been known as destructive rice pests, and famines caused by planthopper plagues have been recorded throughout history. For many years, however, it remained unclear whether planthoppers are indigenous to and winter in Japan or migrate annually to Japan from across the sea. The controversy was solved only in 1967, when a Japanese weather ship encountered a swarm of planthoppers in the western Pacific Ocean. Since that time, many aspects of planthopper migration and associated meteorological phenomena have been investigated. Scientists now widely accept that rice planthoppers cannot winter in temperate areas of East Asia, but instead repeat migrations from tropical to temperate rice areas every year.

Between 1983 and 1987, a national research project on the long-distance migration of insect pests was conducted in Japan. This project examined relationships between the known migratory patterns of rice planthoppers and the early summer monsoon rains, known as the *baiu* phenomena. The results did not allow for clear forecasting of overseas planthopper migrations.

As a result, JIRCAS and the Chinese Ministry of Agriculture agreed to conduct a collaborative research project entitled “Long range migration of rice insect pests in monsoonal East Asia” at the China National Rice Research Institute between 1992 and 1997. The project has attempted to trace the basic patterns of planthopper migration from source areas to Japan, and then to relate these patterns to rice cropping systems and weather changes in East Asia.

We used comparative studies of brown planthopper (BPH) biotypes to determine source areas from which planthoppers migrate to temperate East Asia. For example, planthopper populations in Japan and China consist of BPH biotypes 1 and 2 at a ratio of about one to two. Similar populations are distributed only in the Red River Delta and adjacent coastal areas of North Vietnam. In contrast, BPH biotypes in southern Vietnam, Cambodia, Thailand, and other Southeast Asian countries proved to be distinct from those in northern Vietnam, China and Japan.

These findings led us to conclude that migratory planthoppers originate in the northern part of Vietnam. Following the 19° C January isotherm, the Red River Delta marks the northern limit of year-round breeding habitats for planthoppers. Moreover, the region constitutes the largest area in northern Indochina under rice cultivation. Well-synchronized rice double-cropping is practiced, allowing planthoppers to repeat a perennial life cycle on two rice crops.

The overseas migration zone for planthoppers ranges between 15° N and 40° N latitude and 105° E to 140° E longitude, covering almost all irrigated rice areas in East Asia. Northward expansion of rice planting areas in the spring and summer provides vast resources to planthoppers far to the north of their perennial breeding habitats. Shifting rice cropping seasons and highly seasonal monsoon climates play critical roles in the migration and distribution of planthoppers in this typical insect migration zone. Migration surges of planthoppers usually occur in southwest monsoons accelerated by frontal depressions.

We determined that planthopper migrations from northern Vietnam to Japan can be divided into a two-staged habitat displacement ([Figure 1](#)). In the first stage, planthoppers migrate from winter-spring rice fields in northern Vietnam to early rice maturing in southern China between April and May. As winter-spring rice in Vietnam is transplanted from January through February, increasing planthopper populations thrive on it from March into April. Newly emerged macropterous adults then emigrate from April to May.

During this period, the front between the retreating Continental High and the warm, humid tropical air mass tends to remain stationary over southern China. This situation mediates the first stage of planthopper migration. Southwest monsoons strengthened by frontal depressions displace planthoppers from the winter-spring rice in northern Vietnam, pushing them toward the early rice in southern China. Air masses at 850 kPa of pressure follow trajectories leading

from northern Vietnam to southern China within 48 hours, while backward trajectories from southeastern regions in southern China also reach the Red River Delta region.

Early rice in southern China is usually transplanted in April, between two and three months later than winter-spring rice in northern Vietnam. Thus, early rice in southern China offers a fresh habitat to planthoppers recently transported from northern Vietnam. These planthoppers reproduce one to two generations on the early rice, and their population densities grow quickly from mid-June to mid-July.

In the second stage of habitat displacement, planthoppers migrate from the early rice in southern China to the summer rice in Japan between June and July. This migration follows a change in the weather front from southern to central China. This shift occurs when the mid-latitude westerly moves from the southern to northern side of the Tibetan Plateau and forms a stationary *baiu* front over central China and Japan. During the *baiu* season, the southwest monsoon bursts into central China and Japan. Migrations of rice planthoppers to Japan occur in association with a low-level jet stream (LLJ), a strong wind core that appears in the lower troposphere in the warm sector of depressions on the *baiu* front, producing defined surges over the East China Sea. The most active planthopper migrations take place on LLJs between late June and early July

The jet streams which transport planthoppers to Japan extend to Fujian, Jiangxi and Guangdong Provinces in southern China within 36-48 hours of back-tracking. Emigrants from the early rice in southern China are carried downwind toward the frontal zone in central China, and a group of them is transported beyond the East China Sea as far as Japan ([Figure 2](#)).

We found a specific synoptic pattern facilitating the overseas migration of planthoppers from southern China to Japan. The pattern consists of a subtropical high pressure system developing in the western Pacific Ocean, the stationary *baiu* front running from 32° N to 35° N latitude across the East China Sea, and the depressions which generate LLJs and move eastward along the front. This pattern may be described as an overseas transporting synoptic weather pattern (OTSWP), under which simultaneous migrations of planthoppers both to central China and to Japan are brought about by eastward-moving frontal depressions. In central China and Japan, summer rice is usually transplanted in June, about two to two and one-half months later than early rice in southern China. This newly transplanted summer rice provides suitable habitat for planthoppers migrating from early rice cropping regions.

The exploitation of fresh resources confers a temporary adaptation to habitat-shifting northeastward migrations of rice planthoppers. However, without return migrations before winter, the offspring of migrants which invaded the temperate regions are destined to perish during the harsh winters. In eastern China, the prevalent wind direction veers from southwest to northeast in autumn, making a return migration plausible. However, return migrations from Japan are impossible because the northwest winds prevailing in autumn force planthoppers into the Pacific Ocean. Thus, migrations to Japan suggest a follow-the-leader pattern with no adaptive significance.

The habitat-shifting concept described above allows for enhanced forecasting of planthopper migrations and subsequent outbreaks in the East Asian insect migration zone (IMZ). The distribution of planthoppers expands swiftly from localized source habitats in northern Vietnam throughout the IMZ by way massive habitat-shifting migrations along the southwest monsoons. Consequently, our ability to predict planthopper migrations hinge largely on wintering conditions in the source area and the dynamics of monsoon climates in the IMZ. Under such conditions, international cooperation to cope with planthopper migrations appears essential.

(K. Sogawa and A. Takahashi)

Back to

the [Crop Production and Postharvest Technology Division introduction](#) page, or to  
[Division Topic #1: Case Study of Edible Insects in Enzaro Village, Kenya.](#)

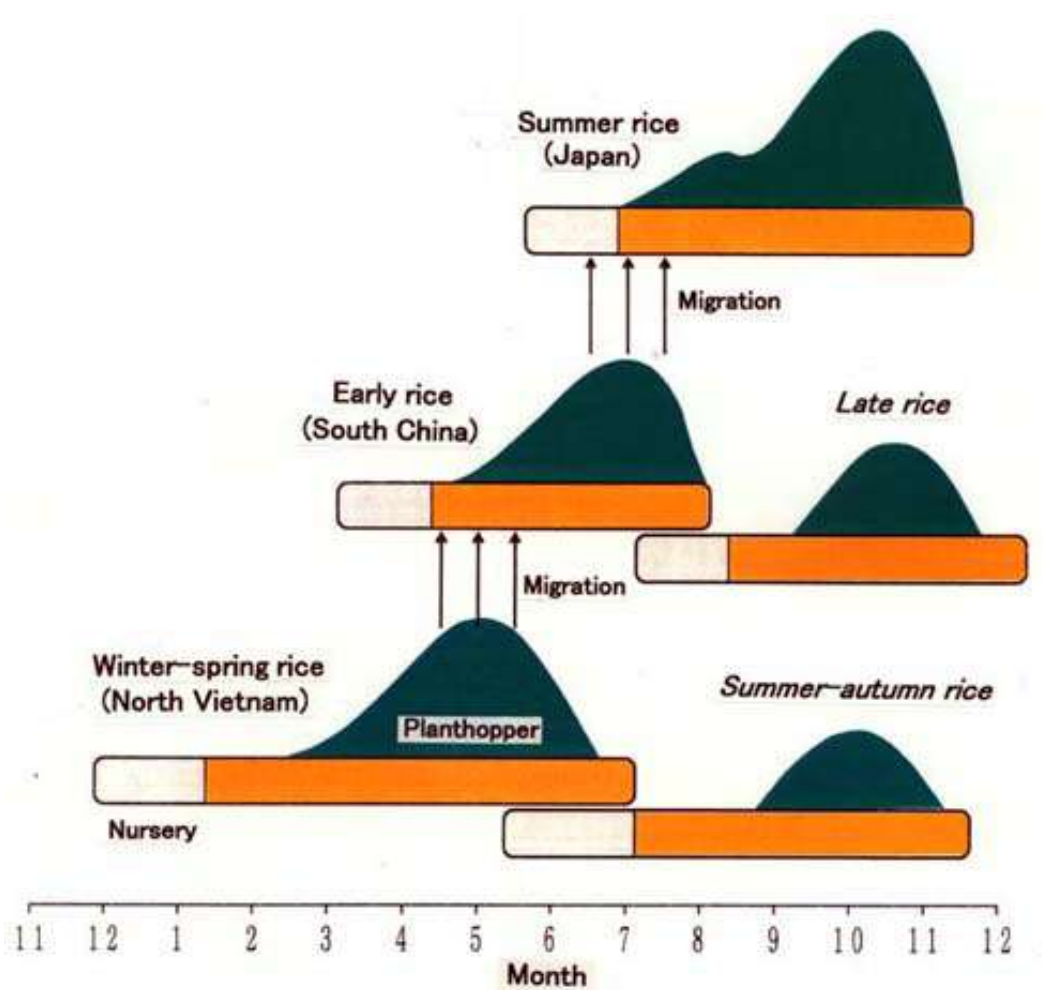
Forward to

[Division Topic #3](#): Serological Diagnosis of Citrus Greening Disease, or to

[Division Topic #4](#): Evaluation Methods to Quantify Mechanical Properties of Collapsible Soils, or to

[Division Topic #5](#): Improving Rice Cropping Techniques in the Mekong Delta, Vietnam, or to

[Division Topic #6](#): Structural Changes in Vietnamese Agricultural under the *Doi Moi* Policy.

**CROP PRODUCTION AND POSTHARVEST TECHNOLOGY DIVISION TOPIC 2****Monsoon-Dependent Long-Range Migrations of Rice Planthoppers in East Asia**

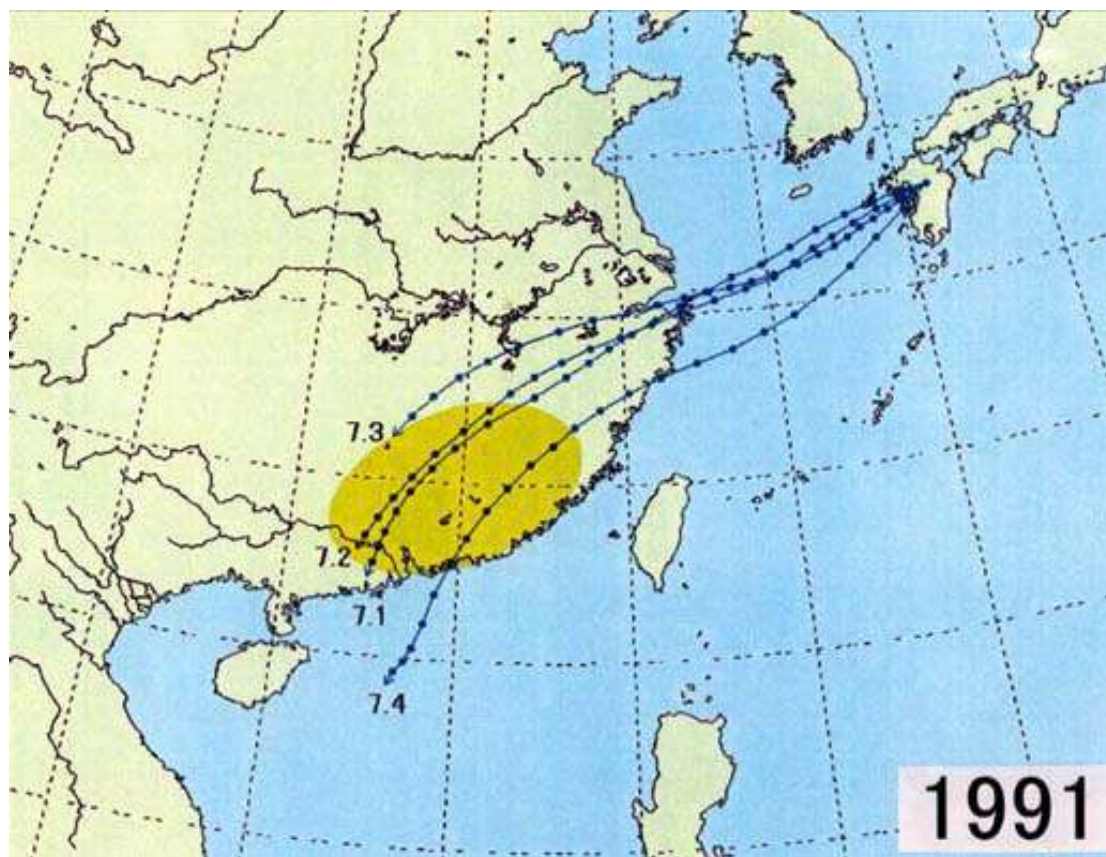
**Figure 1.** Schematic illustration of two-staged migrations by rice planthoppers from winter-spring rice fields in northern Vietnam to summer rice fields in Japan via early rice fields in southern China.

Back to

[Division Topic #2: Monsoon-Dependent Long-Range Migrations of Rice Planthoppers in East Asia.](#)

**CROP PRODUCTION AND POSTHARVEST TECHNOLOGY DIVISION TOPIC 2**

**Monsoon-Dependent Long-Range Migrations of Rice Planthoppers in East Asia**



*Figure 2. Trajectory analysis of wind-borne planthopper migrations from South China to Japan, July 1-4, 1991.*

Back to

[Division Topic #2: Monsoon Dependent Long-Range Migrations of Rice Planthoppers in East Asia](#)



## **CROP PRODUCTION AND POSTHARVEST TECHNOLOGY DIVISION TOPIC 3** **Serological Diagnosis of Citrus Greening Disease**

Citrus greening disease occurs in the African and Asian tropics and constitutes one of the most destructive diseases affecting citrus trees. One pathogen of the disease is a bacterium restricted to the phloem of infected plants. These organisms are called bacterium-like organisms (BLOs) or greening organisms (GOs) and are transmitted by two psyllid vectors, *Diaphorina citri* in Asia and *Trioza erytreae* in Africa. The scientific names of *Liberobacter africanum* and *Liberobacter asiaticum* were proposed for the African and Asian isolates of GOs in 1994.

Although PCR diagnosis of citrus greening disease has been developed, serological methods may offer simple diagnoses that are more cost effective. Several attempts in this direction have been reported in recent years. Whitlock and Chippindall (1993) produced an antiserum against an extract of greening infected citrus material in South Africa. However, the antiserum reacted with a disease shock protein common to all the diseases. C. Ke et al (1993) produced a polyclonal ascite antiserum against a partially purified periwinkle material infected with the huanglungbin strain of GO in Taiwan. However, the titer of the antiserum was low and interference from non-specific reactions were obvious.

Our research produced an antiserum against a partially purified periwinkle material infected with the Nakhon-Pathum isolate of GO found in Thailand. We tried to remove the pathogen related protein (a disease shock protein described by Whitlock and Chippindall) and to prepare the citrus antigen for serological tests in as high a concentration as possible. Serological diagnosis with a microprecipitin test was developed for greening disease.

To produce an antiserum, phloem tissues of infected periwinkle leaves with yellowing symptoms were separated in extraction solution after digestion of the diseased midribs in enzyme solution for one night. The phloem tissues were washed five times in extraction solution, and homogenized in 5 ml of the extraction solution. Partially purified GOs were obtained by suspending final pellets after one cycle of centrifugation of the homogenate of the phloem tissues. The suspension was dialyzed in 4% glutaraldehyde in extraction solution for one night, and then dialyzed in the extraction solution for one day and night. Supernatant was carefully collected after low-speed centrifugation using a 20% sucrose cushion at high speed. The pellet was re-suspended in 500-1000 $\mu$ l of the 0.85% NaCl solution. Preparations for the antiserum were obtained three weeks after six injections into rabbits of the emulsion of the partially purified GOs suspension and Freund's incomplete adjuvant.

To prepare the citrus antigen for microprecipitin testing, phloem tissues were separated after digestion of the diseased midribs in enzyme solution. Partially purified GOs concentrated up to 40 times the midrib weight were obtained from final pellets after one cycle of centrifugation of homogenate of the phloem tissues.

A microprecipitin test was conducted by adding one drop (5 $\mu$ l) of the partially purified GO to one drop of the GO antiserum without mixing drops. Clear plus reactions were observed as strong aggregations with translucent parts around central aggregates in the reactant drop of the infected citrus and the antiserum ([Figure 1](#)). The plus reaction could be found in the mixture with diseased citrus at least at a dilution level of 16 times that of the antiserum, but could not be found in the mixture with the healthy citrus or with the citrus extract infected with attenuated citrus *tristeza* virus that contained pathogen related proteins.

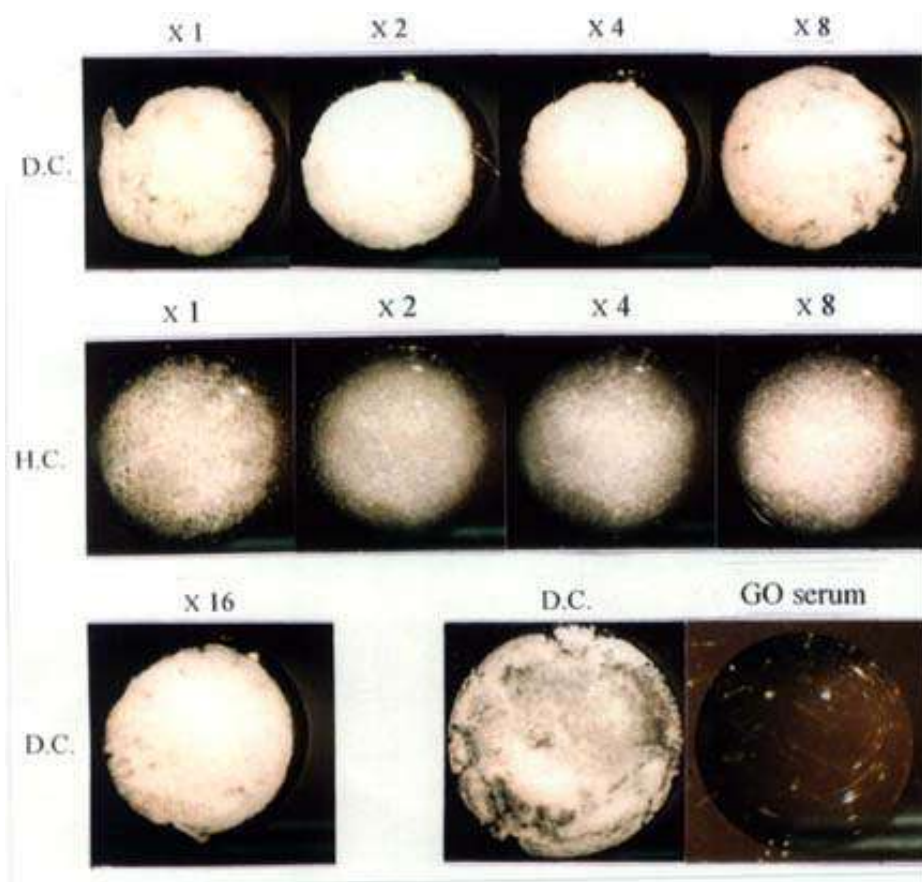
Serological diagnosis with microprecipitin testing was established for greening disease by preparing the extract of phloem tissues concentrated up to 40 times the midrib weight. Midribs of about 50 leaves of candidate citrus are convenient to use and can be stored at  $-80^{\circ}$  C until testing.

(Y. Ohtsu)



Back to	the <a href="#">Crop Production and Postharvest Technology Division introduction</a> page, or to <a href="#">Division Topic #1</a> : Case Study of Edible Insects in Enzaro Village, Kenya, or to <a href="#">Division Topic #2</a> : Monsoon-Dependent Long-Range Migrations of Rice Planthoppers in East Asia.
Forward to	<a href="#">Division Topic #4</a> : Evaluation Methods to Quantify Mechanical Properties of Collapsible Soils, or to <a href="#">Division Topic #5</a> : Improving Rice Cropping Techniques in the Mekong Delta, Vietnam, or to <a href="#">Division Topic #6</a> : Structural Changes in Vietnamese Agricultural under the <i>Doi Moi</i> Policy.

**Serological Diagnosis of Citrus Greening Disease**



**Figure 1.** Microprecipitin tests of the Thai isolate of greening organisms in citrus plants showing healthy extracts of citrus phloem (HC) and diseased extracts of citrus phloem (DC) in dilutions of antiserum against GO (x1-x16).

Back to

[Division Topic #3: Serological Diagnosis of Citrus Greening Disease](#)



## ***CROP PRODUCTION AND POSTHARVEST TECHNOLOGY DIVISION TOPIC 4*** **Evaluation Methods to Quantify Mechanical Properties of Collapsible Soils**

Soils subjected to compressive deformation due to wetting, or saturation collapse, under natural conditions are referred to as collapsible soils. As compressive deformation in collapsible soils is comparatively large, damage to structures from saturation collapse may prove quite serious. One type of collapsible soil, known as loess, covers about eleven percent of total land area in the world. Loess consists primarily of silt or fine sand particles transported and loosely deposited by wind. In northeastern Thailand, for example, most surface soils are loosely deposited sediments of sandstones and siltstones which exhibit the features of collapsible soils.

This research project examined the mechanical properties of collapsible soils, also called yellow soils, sampled from Khon Kaen city in northeastern Thailand and targeted the development of improved methods for estimating these properties based on field observations. Such methods are of fundamental importance to the future design and construction of irrigation facilities.

The red squares in [Figure 1](#) reveal results from a series of oedometer tests, in which soil samples measuring 6 cm in diameter and 2 cm in height were compressed within a ridged ring by increasing vertical loads. Under these conditions, soil samples could deform only vertically, permitting measurements of vertical displacement and vertical load. Values of  $x$  and  $y$  for each sample express the vertical stress and the void ratio, or the ratio between pore volume and the volume of soil particles. Small void ratio values indicate relatively large reductions in volume, otherwise known as compressive deformation.

Our experimental data reveal that increasing volume reduction in soil samples occurs with increasing vertical stress. Adding water to our sample at vertical stress = 320 kPa produced a markedly increased reduction in volume, indicating the presence of saturation collapse at this point. Simulation was conducted using a consolidation analysis method with a generalized elastoplastic model for unsaturated soils, which had been suggested to us for estimating the properties of collapsible soils. The results, shown as a solid blue line, remain consistent with our experimental data. Collapse behavior can also be easily simulated.

Saturation collapse behavior is one of the typical properties of unsaturated soils and has remained a difficult problem in the field of soil mechanics. With further development, our research on saturation collapse should allow us to estimate real problems, including the failure of natural slopes following heavy rainfall and the complex behavior of dams during reservoir filling.

(Y. Kohgo)

Back to

the [Crop Production and Postharvest Technology Division introduction](#) page, or to

[Division Topic #1](#): Case Study of Edible Insects in Enzaro Village, Kenya, or to

[Division Topic #2](#): Monsoon-Dependent Long-Range Migrations of Rice Planthoppers in East Asia, or

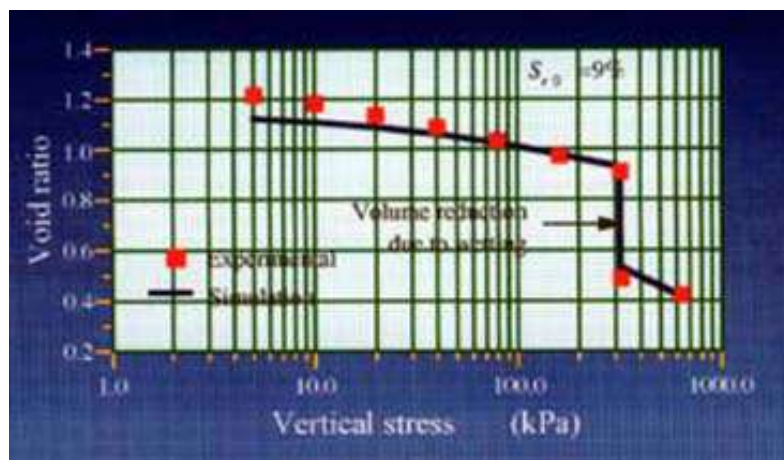
to

[Division Topic #3](#): Serological Diagnosis of Citrus Greening Disease.

Forward to

[Division Topic #5](#): Improving Rice Cropping Techniques in the Mekong Delta, Vietnam, or to

[Division Topic #6](#): Structural Changes in Vietnamese Agricultural under the *Doi Moi* Policy

***CROP PRODUCTION AND POSTHARVEST TECHNOLOGY DIVISION TOPIC 4*****Evaluation Methods to Quantify Mechanical Properties of Collapsible Soils**

**Figure 1.** Results of oedometer test demonstrating the relation between vertical stress and void ratios in collapsible soils. In this experiment, saturation collapse occurred at stress levels of 320kPa.

Back to

[Division Topic #4: Evaluation Methods to Quantify Mechanical Properties of Collapsible Soils.](#)



## **CROP PRODUCTION AND POSTHARVEST TECHNOLOGY DIVISION TOPIC 5** **Improving Rice Cropping Techniques in the Mekong Delta, Vietnam**

The Mekong Delta covers an area of 5.9 million hectares, of which two-thirds are located in Vietnam. This region possesses climatic conditions highly favorable to agricultural development. According to the Cantho Meteorological Station, annual temperatures average 26.6° C, precipitation reaches 1,632 mm, and roughly 2,592 hours of sunshine fall on fields during an average year. Despite these conditions, agricultural productivity had remained stagnant for many years, primarily due to an uninterrupted series of wars affecting the country from its independence in 1954 through the early 1980s.

Since 1986, the *doi moi* policy has encouraged “farming system” approaches to agricultural development in the region. The policy promotes activities such as rural infrastructure improvement through the excavation of canals, the construction of dikes for water control, the introduction and breeding of high-yielding crop varieties resistant to diseases and insects, and the improvement and extension of direct seeding techniques for rice. In response to the market stimuli permitted in recent years, land reclamation has increased total cropping area, and the growth of double or triple rice cropping methods, together with higher yields in newly hybridized varieties, has resulted in rapid growth both in productivity and in total rice production.

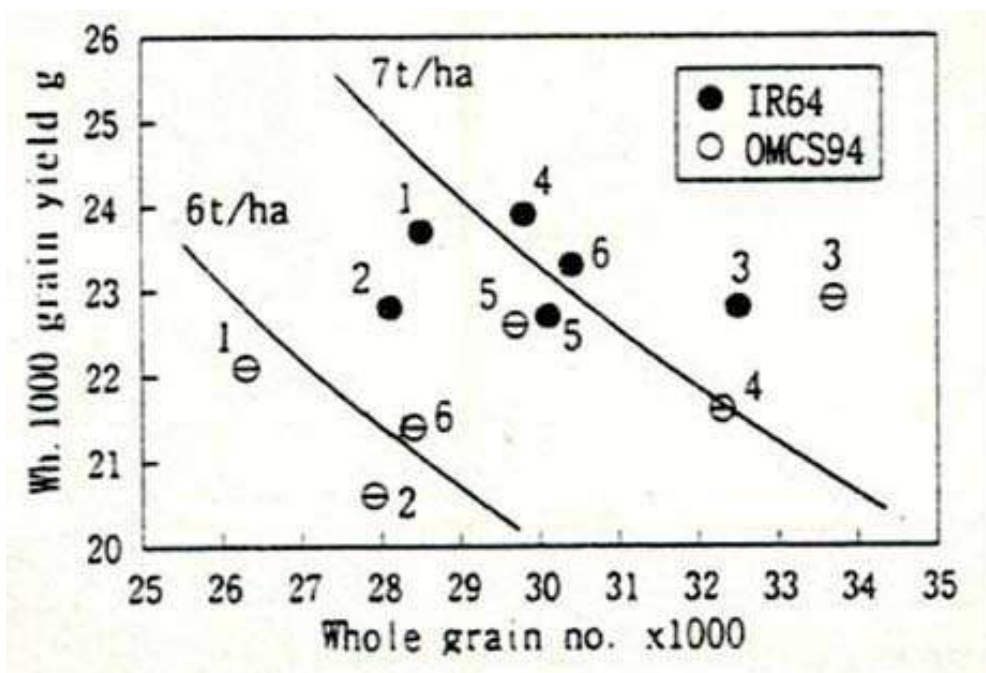
In this collaborative project with Cuu Long Rice Research Institute (CLRRI) of Vietnam, we tested two rice varieties, OMCS94 and IR64, and several rice cropping techniques in an effort to promote higher yields per hectare. The effects of nitrogen application on yield components are shown in [Figure 1](#). The highest yields were obtained in Plot Three, which received 40 kg of nitrogen in the first week after sowing and at the booting stage, which occurred during the eighth week for OMCS94 and one week later for IR64. Our observations revealed that the number of grains increased and ripening ability remained relatively high with the application of nitrogen at the booting stage. Obviously, nitrogen recovery was improved by this application method.

In contrast, the nutrients were spent for excess growth of stems and leaves and did not affect the increase of grains in Plots One and Two, which received 40 kg nitrogen only before the booting stage. In tests with heavy manuring, such as Plot Five hosting both varieties and Plot Six hosting OMCS94, rice plants experienced early lodging and gave low yields. These results suggest the need to reconsider the use of top dressing in early stages, given the fertile clay soils of the Mekong Delta.

The validity of techniques for controlling growth through the application of nitrogen is accepted throughout the Mekong Delta. Therefore, adjusting fertilizer application to achieve growth regulation and higher efficiencies in nitrogen utilization would result in high, stable yields to input and would minimize adverse effects on local ecosystems. Additional contributions to the development of low-input sustainable rice production in the Mekong Delta may come from other studies currently underway, such as initiatives to prevent lodging in directly seeded rice through improved water management or efforts to better control the growth and yield components of rice based on knowledge from leaf color measurements.

(T. Kon)

Back to	the <a href="#">Crop Production and Postharvest Technology Division introduction</a> page, or to <a href="#">Division Topic #1</a> : Case Study of Edible Insects in Enzaro Village, Kenya, or to <a href="#">Division Topic #2</a> : Monsoon-Dependent Long-Range Migrations of Rice Planthoppers in East Asia, or to <a href="#">Division Topic #3</a> : Serological Diagnosis of Citrus Greening Disease, or to <a href="#">Division Topic #4</a> : Evaluation Methods to Quantify Mechanical Properties of Collapsible Soils.
Forward to	<a href="#">Division Topic #6</a> : Structural Changes in Vietnamese Agricultural under the <i>Doi Moi</i> Policy.

***CROP PRODUCTION AND POSTHARVEST TECHNOLOGY DIVISION TOPIC 5*****Improving Rice Cropping Techniques in the Mekong Delta, Vietnam**

**Figure 1.** Yield components for rice varieties OMCS94 and IR64 in response to various fertilizer application methods during the 1996-97 dry season at CLRRRI. Symbols 1 through 6 denote experimental plot numbers.

[Back to](#)

[Division Topic #5: Improving Rice Cropping Techniques in the Mekong Delta, Vietnam.](#)





***CROP PRODUCTION AND POSTHARVEST TECHNOLOGY DIVISION TOPIC 6***  
***Structural Changes in Vietnamese Agricultural under the Doi Moi Policy***

In 1986, the Vietnamese Communist Party forged a new national policy, called *Doi Moi*, to promote comprehensive socioeconomic revitalization. As a part of this effort, Politburo Resolution Number Ten implemented reforms in the agricultural sector beginning in 1988. Reforms proved immediately successful in boosting agricultural growth rates. Since 1989, Vietnam has not only produced enough paddy rice to meet domestic consumption, but has also produced surplus for export.

The success of the *doi moi* policy may be attributed to several factors. First, Resolution Number Ten undermined the dominance of inefficient agricultural cooperatives by confirming farm households as completely autonomous economic units. Moreover, the resolution mandated that land held by the cooperatives be assigned to individual farm households for long-term periods of use. The resolution further recognized the farmers' private ownership rights to essential means of production other than land. And finally, the policy conferred upon farmers the right to enjoy profits from their activities on assigned fields after the deduction of taxes and contributions to cooperatives.

*Photo:* In recent years, rural development projects in Vietnam's Mekong Delta have focused on poverty alleviation. In [Hoa An village](#), 180 landless households received 1500 m² of home and garden lands and 2.2 million dong to provide for stock in 1997.

Despite remarkable achievements in agricultural production, potential problems in rural land relations have also emerged since the introduction of the *doi moi* reforms. The contractual mode initially used to divide land under Resolution Number Ten assigned small plots to each household in ways that have proven unsustainable. Poor farm households with little farm management experience and no capital received "equivalent land plots per labor power" as wealthy farm households with extensive experience and capital resources. Many poor farmers could not retain their assigned lands and, as a result, were forced by the circumstances to deliver the lands to their wealthier neighbors.

This process has strengthened emerging patterns of differentiation among farmers and encouraged the development of commercial agricultural production. However, it has also generated a rapid increase in the number of households earning their living by working for hire. Work for hire, which now characterizes a large proportion of households in rural areas, is associated with problems of landlessness that are leading to renewed income disparity in rural areas.

Of further concern, rural incomes have generally lagged behind urban incomes. This problem may derive from several factors, including the shortage of rural infrastructure and the insufficiency of facilities for agricultural product processing, the shortage of working capital for farmers, and continuing disorder in agricultural extension systems under the *doi moi* policy. Nevertheless, income disparities are important social issues which will require great attention if social stability is to be ensured.

One solution to these problems may rest on efforts to reestablish influential farmer organizations. Such organizations have been lacking since the demise of agricultural cooperatives.

(R. Yamazaki)

Back to	the <a href="#">Crop Production and Postharvest Technology Division introduction</a> page, or to <a href="#">Division Topic #1</a> : Case Study of Edible Insects in Enzaro Village, Kenya, or to <a href="#">Division Topic #2</a> : Monsoon-Dependent Long-Range Migrations of Rice Planthoppers in East Asia, or to <a href="#">Division Topic #3</a> : Serological Diagnosis of Citrus Greening Disease, or to <a href="#">Division Topic #4</a> : Evaluation Methods to Quantify Mechanical Properties of Collapsible Soils, or to <a href="#">Division Topic #5</a> : Improving Rice Cropping Techniques in the Mekong Delta, Vietnam.
Forward to	the <a href="#">Animal Production and Grasslands Division introduction</a> page.





## ANIMAL PRODUCTION AND GRASSLAND DIVISION

In developing countries, domesticated animals contribute to the betterment of people's lives. Animals not only produce meat, milk, and hide, which are essential in daily life and are an important source of income, but also generate draft power for tillage and transportation and produce wastes for use as fertilizer and fuel. Despite these benefits, livestock production remains at low levels throughout the developing world due to constraints such as low genetic potentials, poor quality feeds, disease prevalence, harsh climatic conditions, and management inexperience.

The Animal Production and Grassland Division carries out research aimed at achieving sustainable increases in animal production without generating adverse environmental consequences. In order to reach this goal, the Division seeks to enhance the productive capacity of natural resources, manage grasslands to secure feed resources, enhance the utilization of agro-industrial by-products, control invasive animal diseases, and improve management practices in developing regions of the world.

During FY 1997, two collaborative research projects moved toward successful conclusion. One involved cooperation between Division researchers and scientists from the International Livestock Research Institute (ILRI) on immuno-histological studies aimed at developing a vaccine against the East Coast Fever commonly found among livestock in Kenya. The second project involved the long-term dispatch of Division personnel to Cantho University in Vietnam, where a research team has been examining improved methods for animal production under combined farming systems that integrate agriculture, animal husbandry, and fisheries in the Mekong Delta area. Although the long-term research position has ended, the Division will continue to dispatch researchers to Vietnam on a short-term basis.

*Photo: Hornless Boran cattle grazing in East African pastures owned by the International Livestock Research Institute (ILRI).*

In addition to these projects, four long-term international research projects lasting from two to five years are currently underway. Division researchers are working with the Thai Department of Livestock Development (DLD) to improve cattle production with feed resources available in northeastern Thailand. In Malaysia, a cooperative agreement with the Malaysian Agricultural Research and Development Institute (MARDI) seeks to improve local methods for raising small livestock. Sustainable management and utilization of grasslands marks the theme of cooperative research on agro-pastoral systems being carried out with the National Center for Research on Beef Cattle (CNPGC-EMBRAPA) in Brazil. Finally, a new collaborative effort with the ILRI has begun to investigate the role of the TNF- $\pm$  gene in trypanosomiasis. This project replaces the immuno-histological study of East Coast Fever, which ended during this Fiscal Year.

In addition to long-term projects, the following studies were carried out by researchers on short-term assignments of one to three months: 1) studies on the nutritive requirement of tropical ruminant in Thailand with the Khon Kaen Animal Nutrition Research Center and the DLD; 2) studies with Cantho University in Vietnam on environmental pollution caused by hog production under the farming systems in Mekong Delta; 3) collection and classification of parasitic protozoa in swine in Mekong Delta, also in collaboration with Cantho University; 4) research with MARDI on the influence of large-scale duck operations on water pollution levels in ponds and their surroundings in Malaysia; 4) an evaluation of the feed value of corn stalk and agricultural by-products with the Chinese Agricultural University in northern China; 5) genetic analysis of the cattle tolerance to Trypanosomiasis conducted with the ILRI in Kenya; 6) studies on the relationship between the fertility and grassland vegetation in the steppe soils of Central Asia with the Kazakh Institute of Agriculture (KIA); 7) an examination of seed-pellet seeding methods for the improvement of settlement in grassland vegetation in Central Asia, also conducted with the KIA; 8) identification of endophytic fungi in pasture plants in South America with Colombia's CIAT; 9) and studies of methods for sustaining mixed pasture plants in South American savanna, also in collaboration with CIAT.

The Division receives numerous requests from developing countries to pursue collaborative research, primarily concerning the incorporation of biotechnological applications and enhancement of overall levels of research. In order to address such needs, the Division has begun promoting basic research on JIRCAS's Tsukuba premises in support of overseas activities. At present, a project on the identification of endophytic fungi in pasture plants in tropical regions and their utilization in plants via biotechnological methods constitutes the focus of domestic research.

● [Division Topic #1](#): Immunohistological Analysis of the Attachment Sites of *Rhipicephalus appendiculatus* Ticks Infected with *Theileria parva*.

● [Division Topic #2](#): *In Situ* Hybridization to Detect Bovine Cytokine mRNAs Involved in Protozoan Disease.

Back to	the Annual Report <a href="#">Main Contents</a> page.
Forward to	the <a href="#">Forestry Division introduction</a> page.





***ANIMAL PRODUCTION AND GRASSLAND DIVISION TOPIC 1***

***Immunohistological Analysis of the Attachment Sites of *Rhipicephalus appendiculatus* Ticks Infected with *Theileria parva****

*Theileria parva*, the protozoan that causes East Coast Fever (ECF) in African cattle, is transmitted by the brown ear tick *Rhipicephalus appendiculatus*. Inoculation of *T. parva* sporozoites occurs over a period of time commencing several days after infected ticks attach themselves to cattle, by which time a pronounced inflammatory reaction becomes evident in cattle previously exposed to ticks. The precise location at which sporozoites invade lymphocytes is not known, and the immune cell populations contributing to the reactions at tick attachment sites have not been characterized. Nevertheless, as early interactions between parasites and the immune system have considerable bearing on the success of sporozoite neutralization, a better understanding of the environment into which sporozoites are delivered would contribute greatly to the development of optimal vaccination strategies.

To enhance our understanding of early events associated with *T. parva* infection *in vivo*, we investigated the distribution of immune cell subsets at tick attachment sites through immunohistochemical analyses of cattle. We took skin-punch biopsies from Boran calves at various times after their infection with *T. parva*. Frozen sections were then cut and stained using monoclonal antibodies against bovine leukocyte surface antigens, the results of which are indicated in [Table 1](#).

[Table 2](#) details immune cell populations at the attachment sites of ticks carrying *T. parva* sporozoites on Boran calves previously immunized against ticks. Before infestation (day zero), Langerhans cells in the epidermis and dermal dendritic cells stained positively for class two major histocompatibility complex (MHC). No CD1⁺ and CD11b⁺ cells were present in the epidermis, although small numbers of other T lymphocytes, including CD4⁺, CD8⁺, and WC1⁺ T cells, were detected. Cell clusters containing CD4⁺, CD8⁺, and WC1⁺ T cells with CD1⁺ dendritic cells and both CD11b⁺ and WC6⁺ cells were observed in the papillary dermis.

After infestation, we observed inflammatory reactions near the tick attachment sites. Increasing numbers of CD4⁺, CD8⁺, and WC1⁺ T cells and increasing skin thickness were also observed. WC1⁺ T cells were present in larger numbers than were CD4⁺ and CD8⁺ T cells. These cells were localized at the superficial dermal layer after the second day. Infiltration of lymphocytes and granulocytes was observed deeper in the dermis after the fourth day. CD4⁺ T cells were present in the dermis in larger numbers than CD8⁺ T cells, while CD8⁺ T cells infiltrated the epidermis in larger numbers than did CD4⁺ T cells. Class II MHC⁺ cells infiltrated the dermis in large numbers, with almost all bearing CD11b⁺. Both CD1⁺ dendritic cells and cells expressing CD11b⁺ were observed in the epidermis after day four.

After the sixth day, we observed intense staining of WC1, class II MHC and CD11b both in the dermis and epidermis. Severe inflammatory edema and infiltration of all subsets of lymphocytes, as well as dendritic cells, were observed after one week.

The precise function of such large numbers of lymphocytes in cattle is not known. These cells seem to play a role in inflammatory reactions and tissue degeneration at the attachment site of *R. appendiculatus*. CD8⁺ T cells appear to infiltrate the epidermis more readily than do CD4⁺ T cells, despite being present in lesser numbers in the dermis. Sub-populations of dendritic cells in the skin of cattle are not well characterized. CD1⁺ dendritic cells do not contribute a significant proportion of the dermal infiltrate, although, in contrast to the CD11b⁺ population, these cells enter the epidermis easily. CD1⁺ dendritic cells may be a sub-population of WC6⁺ dendritic cells. Clarification of this issue will require further investigation through the double-staining of specific markers. These findings may also be useful for understanding immune reactions of the skin in other tick-borne disease.

(Y. Matsubara)

Back to	the <a href="#">Animal Production and Grassland Division introduction</a> page.
Forward to	<a href="#">Division Topic #2: In Situ Hybridization to Detect Bovine Cytokine mRNAs Involved in Protozoan Disease.</a>

**ANIMAL PRODUCTION AND GRASSLAND DIVISION TOPIC 1****Immunohistological Analysis of the Attachment Sites of *Rhipicephalus appendicuratus* Ticks Infected with *Theileria parva*****Table 1.** Tissue distribution and functions of bovine leukocyte cell surface antigens.

ANTIGEN	CLONE	PRIMARY DISTRIBUTION	FUNCTION
CD1	TH97A	DC, Cort. Thy	Ag presentation
CD4	IL-A12	Thy, T-sub (helper)	Adhesion, signaling
CD8	IL-A105	Thy, T-sub (cytotoxic)	Adhesion, signaling
CD11b	IL-A15	Mono, Granulo	Adhesion, CR3± chain
WC1	CC15	Thy, T-sub (3')	Receptor?
WC6	IL-A53	DC, Thy, T-sub, B	CD45?
Class II MHC	R1	DC, Mono, Macro, B	Ag presentation
IgM	IL-A30	B	Ag receptor

Abbreviations used: Ag, antigen; B, B lymphocytes; Cort. Thy, cortical thymocytes; CR, complement receptor; DC, dendritic cells; Granulo, granulocytes; Macro, macrophages; Mono, monocytes; Thy, thymocytes; sub, sub-population; T, T lymphocytes.

Back to

[Division Topic #1](#): Immunohistological Analysis of the Attachment Sites of *Rhipicephalus appendicuratus* Ticks Infected with *Theileria parva*.

ANIMAL PRODUCTION AND GRASSLAND DIVISION TOPIC 1**Immunohistological Analysis of the Attachment Sites of *Rhipicephalus appendiculatus* Ticks Infected with *Theileria parva*****Table 2.** Immune cell populations in tick-immune Boran calves at the attachment sites of *Rhipicephalus appendiculatus* ticks infected with *Theileria parva*.

SITE	DAYS AFTER INFESTATION	CD4	CD8	WC1	MHC II	CD1	CD11B	WC6	IGM
Epidermis	Day 0	±	±	+	+	-	-	±	-
	Day 2	+	±	+	+	-	-	±	-
	Day 4	+	+	+	++	±	+	+	-
	Day 6	±	+	++	+++	±	+	+	-
Dermis	Day 0	++	+	++	+++	+	+++	+++	-
	Day 2	++	+	++	+++	+	+++	+++	-
	Day 4	++	+	+++	++++	++	++++	++++	-
	Day 6	++	++	++++	++++	++	++++	++++	±

-, +, ± indicates subjective quantitative assessment from very few (±) to very many (++++).

Back to [Division Topic #1](#): Immunohistological Analysis of the Attachment Sites of *Rhipicephalus appendiculatus* Ticks Infected with *Theileria parva*.





## ***ANIMAL PRODUCTION AND GRASSLAND DIVISION TOPIC 2***

### ***In situ Hybridization to Detect Bovine Cytokine mRNAs Involved in Protozoan Disease***

Cytokines are a family of regulatory protein molecules responsible for communication between cells in the immune system. In the case of infectious diseases, cytokines mediate protective immunity as well as pathophysiology. As their reaction cascades form complex networks, it is believed that variable cytokine expression may strongly influence pathophysiological conditions. The examination of both local and systemic cytokine expression profiles, therefore, may prove to be of primary importance in developing diagnostic and protective procedures against protozoan diseases that affect livestock.

Recent research has demonstrated the critical role that cytokines can play in the pathogenesis and control of infections. Their ability to function as adjuvants in facilitating the activation of immune responses may allow cytokines to counteract the suppression of immune systems that is symptomatic of the worst protozoan diseases. For example, it is believed that TNF- $\pm$ , a cytokine which shows anti-parasitic effects in cattle infected with trypanosomiasis, is also responsible for the physical wasting and malnutrition, or cachexia, associated with the disease. Similarly, in cell lines infected with *Theileria parva*, the protozoan parasite responsible for deadly East Coast Fever in African cattle, RT-PCR analysis has revealed the consistent expression of mRNA for the interleukin IL-10, an immunosuppressant affecting cellular immunity. Utilizing cytokines may allow scientists to maintain the proper functioning of livestock immune systems while battling these protozoan infections.

Accordingly, the International Livestock Research Institute (ILRI) has heightened its efforts to develop recombinant sub-unit vaccines in combination with several cytokines in order to combat theileriosis. One goal of this initiative has been to establish *in situ* hybridization techniques for the detection of bovine cytokine mRNAs at the cytological level, which will contribute to a better understanding of local immune responses.

Our research employed an *in situ* hybridization protocol using non-radioactively labeled RNA probes to detect bovine cytokine mRNAs, including TNF- $\pm$ , IFN- $\gamma$ , and the interleukins IL-2, IL-4, IL-6, IL-10, and IL-12p35, in cytospin preparations. We first prepared bovine peripheral blood mononuclear cells (PBMC) under the Ficoll-paque method and cultured them with concanavalin A (Con A) for three days, then cyto-centrifuged Con A-stimulated PBMC onto silane-coated slides for inspection. The results of these pre-hybridization treatments, which are intended to increase the efficiency of hybridization and decrease non-specific backgrounds, are summarized in [Table 1](#).

We found that optimal types of pretreatment differed among the several cytokines selected for analysis. Only treatment with Triton X-100 proved consistently effective in detecting the presence of IL-4 and IL-12p35. We also observed that treatment with hydrochloric acid (HCl) helped to decrease background staining and that, an acetylation step following pretreatment helped to reduce non-specific backgrounds.

Investigations of cattle infected with trypanosoma demonstrated that one typical symptom is a dramatic increase in the level of CD5⁺ B cells present in peripheral blood and the spleen. These CD5⁺ B cells express CD11b. Our RT-PCR analysis further revealed increases in the levels of IL-10 mRNA in the blood, lymph node and spleen of infected cattle. *In situ* hybridization showed that CD11b⁺ B cells expressed IL-10 mRNA in normal cattle ([Figure 1a](#)), but that CD11b⁻ B cells did not ([Figure 1b](#)). Thus, it appears that CD11b⁺ B cells contribute to increasing levels of IL-10 characteristic of trypanosomiasis.

We also investigated the patterns of cytokines expressed by seven *T. parva*-infected lymphoblast cell lines using *in situ* hybridization. Our observations suggested considerable variation in cytokine profiles among the lines. IL-2 and IL-10 were universally expressed, and an IL-2 receptor (IL-2R) $\pm$ chain was immunohistochemically detected in all cell lines. These findings suggest that an IL-2/IL-2R autocrine loop may contribute to the proliferation lines

## TOPIC 2

infected with *T. parva*. Additionally, it is tempting to speculate that the expression of IL-10 by lymphocytes infected with *T. parva* may be associated with the pathogenesis of East Coast fever in naive animals, because IL-10 can dampen the T-cell response in bovines which is responsible for killing parasitized cells.

On a larger scale, *in situ* hybridization to detect bovine cytokine mRNAs may be useful for analyzing immune responses not only in protozoan diseases but also in other infectious diseases. The aforementioned cytokines and the RNA probes (TNF- $\alpha$ , IFN- $\gamma$ , IL-1 $\alpha$ , IL-1 $\beta$ , IL-3, IL-5, IL-7, IL-12p40 and IL-15) utilized in this study were provided by ILRI.

(Y. Matsubara)

Back to	the <a href="#">Animal Production and Grassland Division introduction</a> page, or to <a href="#">Division Topic #1</a> : Immunohistological Analysis of the Attachment Sites of <i>Rhipicephalus appendicuratus</i> Ticks Infected with <i>Theileria parva</i> .
Forward to	the <a href="#">Forestry Division introduction</a> page.

**ANIMAL PRODUCTION AND GRASSLAND DIVISION TOPIC 2*****In situ* Hybridization to Detect Bovine Cytokine mRNAs Involved in Protozoan Disease****Table 1.** Assessments of pre-hybridization treatments for the detection of bovine cytokine mRNAs on Con A-stimulated PBMC.

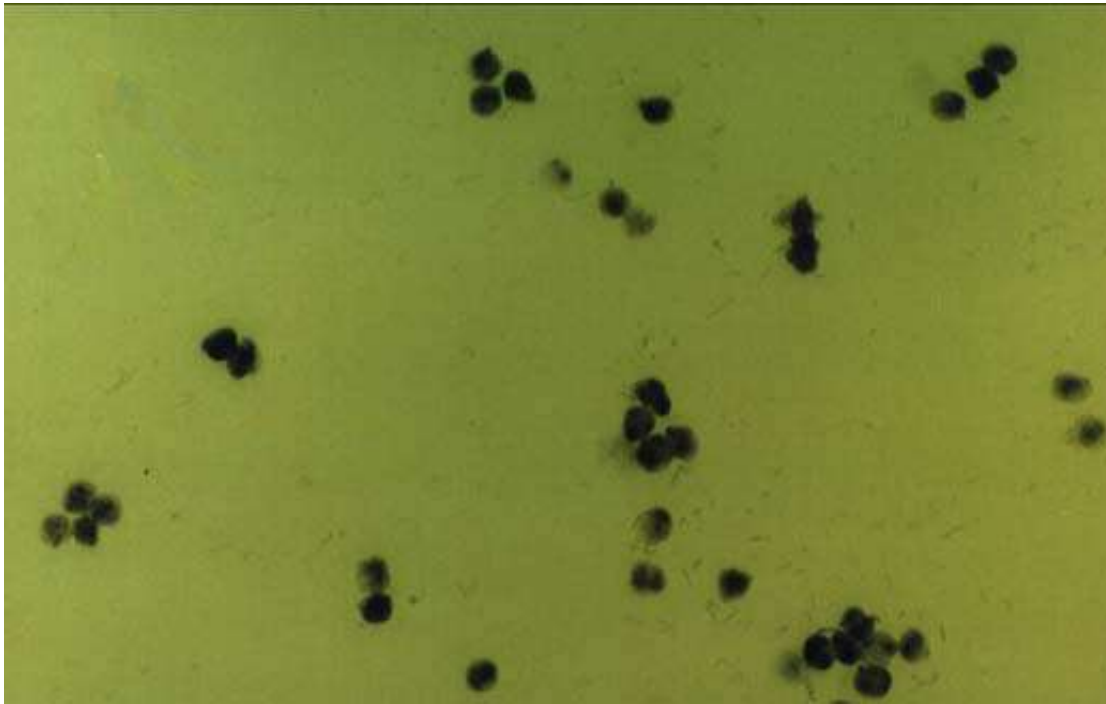
<i>CYTOKINE</i>	<i>NO TREATMENT</i>	<i>0.02N HCL</i>	<i>0.25% TRITON X-100</i>	<i>0.02N HCL AND 0.25% TRITON X-100</i>
TNF- $\pm$	+	+	-	-
IFN- $\gamma$	+	+	+	+
IL-2	+	+	+	-
IL-4	-	-	+	-
IL-6	+	+	+	+
IL-10	+	+	+	+
IL-12p35	-	-	+	-

+ *positive*; - *negative*

Back to	<a href="#">Division Topic #2: <i>In situ</i> Hybridization to Detect Bovine Cytokine mRNAs Involved in Protozoan Disease.</a>
---------	--------------------------------------------------------------------------------------------------------------------------------

**ANIMAL PRODUCTION AND GRASSLAND DIVISION TOPIC 2**

***In situ* Hybridization to Detect Bovine Cytokine mRNAs Involved in Protozoan Disease**



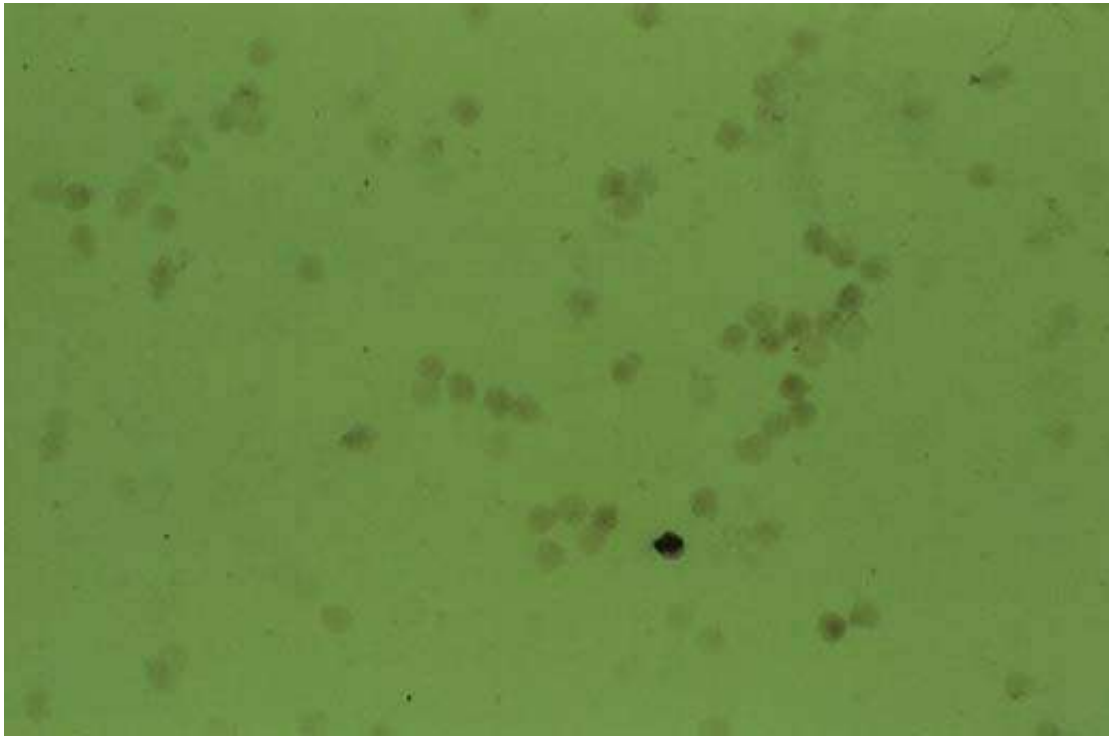
**Figure 1a.** Expression of IL-10mRNA observed in CD11b positive B cells.

Back to

[Division Topic #2: *In situ* Hybridization to Detect Bovine Cytokine mRNAs Involved in Protozoan Disease.](#)

ANIMAL PRODUCTION AND GRASSLAND DIVISION TOPIC 2

***In situ* Hybridization to Detect Bovine Cytokine mRNAs Involved in Protozoan Disease**



**Figure 1b.** Expression of IL-10mRNA not observed in Cd11b negative B cells.

Back to

[Division Topic #2: *In situ* Hybridization to Detect Bovine Cytokine mRNAs Involved in Protozoan Disease.](#)



## FORESTRY DIVISION

As increasing demands for food compel farmers to exploit ever greater levels of arable land, natural forest cover has declined sharply, particularly in developing areas of the world. In turn, forest degradation has generated serious economic and environmental problems, not only at local levels but also on a global scale. Providing for rehabilitation and sustainable management of forest areas therefore remains an urgent issue, and improving forest production systems and post harvest technologies in local communities can be viewed as an essential means of stanching forest decline.


The Forestry Division conducts a wide range of research in developing countries, addressing issues from production to end-use. Projects undertaken by the Division generally fall under one of two categories, consisting of silvicultural and forest management technologies and processing technologies for forest products. These projects involve our researchers in disciplines such as silviculture, plant ecology and eco-physiology, soil science, entomology, mycology, forest mechanization, socio-economics, and wood technology.

Enrichment and rehabilitation of degraded forests are the first steps in the development of sustainable management in forest reserves. In an effort to make these initial goals attainable, the Forestry Division has concentrated its research on developing relevant technologies in silviculture, site evaluation and pest control, while paying due consideration to natural environmental conditions.

*Photo: Teak trees after one year of growth at a reforested [plantation in Gurun, Kedah State, Malaysia](#).*

At the same time, the Division has recently initiated studies on species behavior, systems for natural forest regeneration, enrichment planting methods, and harvesting systems. These are designed to support sustainable production of forest products, which constitute a principal trading commodity in thirty three developing countries around the world. If achieved, sustainable production will help to stabilize levels of exploitation, both in natural forests and plantations.

Finally, the Forestry Division has focused research on problems of shifting cultivation, which remains a leading cause of forest degradation in some areas. Such problems require the development of forest production and planning systems for stimulating local economies. As rapid deforestation continues, the disappearance of various lesser-known tree species and the loss of potential forestry products associated with them also grows. For these reasons, the Division believes that evaluative studies are urgently needed, while efforts to upgrade wood processing technologies currently available in developing regions should be given greater priority.

 [Division Topic](#): Location and Properties of Caoutchouc in Teak Wood.

Back to	the Annual Report <a href="#">Main Contents</a> page.
Forward to	the <a href="#">Fisheries Division introduction</a> page.





## **FORESTRY DIVISION TOPIC 1**

### **Location and Properties of Caoutchouc in Teak Wood**

Teak (*Tectona grandis* L. f.) constitutes one of the most commercially important timber species in the world as it consistently produces high-quality general-purpose lumber. For this reason, the cultivation of teak trees has become common in many parts of the tropics. The wood has outstanding properties in terms of durability, dimensional stability, and resistance to abrasion and iron stains. These properties have been ascribed to the relatively high incidence of caoutchouc, a hydrophobic natural rubber compound. The presence of caoutchouc in teak wood xylem was first reported in 1959, at which time it was assumed to occur in parenchyma cells located in the heartwood.

The desirable characteristics of teak wood, however, cannot be wholly explained by the presence of the compound in the parenchyma cell lumen. Therefore, in order to determine the location and distribution of caoutchouc and its influence on commercially significant properties of teak wood, we organized a collaborative study with the Unit of Wood Paper and Coating of the School of Industrial Technology, Universiti Sains Malaysia.

To observe caoutchouc formation, we cut sections 2¼m thick from fresh teak samples fixed with two percent glutaraldehyde and one percent osmium tetroxide, then examined the region between the cambium and the heartwood under a light microscope. Granules stained with osmium tetroxide were not observed in the cambial zone and the outer sapwood, but osmium black granules, consisting mainly of caoutchouc, appeared with increasing prevalence from the middle sapwood inward. We observed that the granules became larger toward the sapwood boundary and that dark substances occurred mainly in the lumen of parenchyma cells in the sapwood. In the heartwood, these substances usually fused into one large granule or several smaller granules in a parenchyma cell and were distributed in most of the fiber lumens ([Figure 1](#)).

Radial dried heartwood sections of 60¼m in thickness were extracted with acetone to remove extractives other than caoutchouc, or were extracted with acetone and chloroform successively to remove both extractives and caoutchouc. These sections were examined using scanning electron microscopy (SEM). Unextracted sections revealed that the heartwood lumen of all cell types, as well as the cut-surfaces of parenchyma cell walls, were more or less covered with extraneous materials ([Figure 2a](#)). These extractives might have diffused to the cut-surface from the underlying cell walls after sectioning. An enrichment of wood extractives, forming a thin layer on the surfaces of cut cell walls, might also have taken place. However, extraction with acetone, which removes extractives other than caoutchouc, did not produce marked changes in surface morphology, suggesting that the extraneous layer remaining on the wood surfaces consisted of caoutchouc. After successive extraction with acetone and chloroform, most extraneous materials were absent, and the lumen surfaces of parenchyma cells became smooth and clear ([Figure 2b](#)). SEM examination revealed the presence of caoutchouc, not only in the lumens of the parenchyma cells, but also in those of fibers and vessel elements.

Subsequently, we analyzed the surface of untreated and extracted heartwood sections using X-ray photoelectron spectroscopy (XPS). Unextracted sections produced a C1s spectrum rich in C1 (C-C or C-H) components, possibly indicating the migration of extractives after sectioning ([Figure 3a](#)). The CPS oxygen-to-carbon ratio was 0.24. Extraction with acetone caused a slight decrease in levels of C2 (C-OH) and a slight increase in C1, with a lower XPS O/C ratio of 0.16. Both the decrease of the O/C ratio and the increase of C1 demonstrated the removal of hydrophilic wood extractives. Because of its hydrophobic nature, caoutchouc remained on the surface. Successive extraction with acetone and chloroform caused clear reductions in the level of C1, combined with increases in C2 levels ([Fig. 3b](#)), probably due to the removal of caoutchouc from the section surfaces. The rise in the O/C ratio to 0.40 also supports this finding.

Next, we utilized electron spin resonance spectroscopy (ESR) on the sections in order to examine the formation of free radicals under sunlight irradiation. The ratio of the relative signal intensity of organic free radicals at  $g_{\text{eff}}=2.005$  (10G line width) before sunlight irradiation to the intensity following irradiation indicated the effectiveness of the wood surface in absorbing sunlight. After irradiation for six hours, ESR measurements produced high ratios (4.4) for specimens extracted with acetone and low ratios (1.8) for those treated with acetone-chloroform, while ratios for unextracted specimens measured 2.1. These results suggest that extraction with acetone may expose caoutchouc by depriving the wood of other protective compounds, leaving residual caoutchouc, with its unsaturated bonds, to absorb sunlight. The effects of these properties on teak wood durability are not clear.

We also measured water contact angles on the wood surfaces in an effort to evaluate hydrophobicity. Our results indicated a high degree of water repellency in unextracted teak sections relative to other wood species reported in the literature ([Figure 4](#)), thereby confirming the hydrophobic properties of teakwood. Extraction with acetone increased contact angles slightly, suggesting that the acetone removed hydrophilic extractives. Apparently, residual caoutchouc was also redistributed and enriched on the surface of the sections, resulting in a slight increase in water repellency. Successive chloroform treatments removed caoutchouc, resulting in a significant decrease of contact angles.



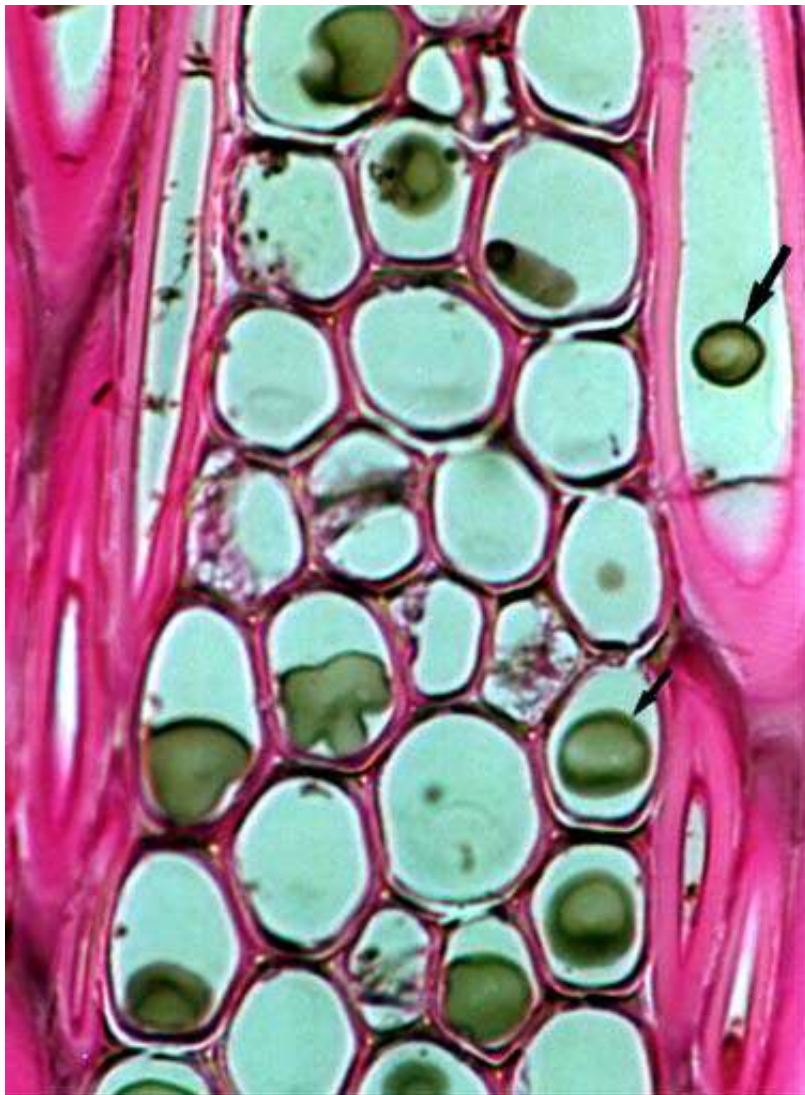
Finally, we evaluated the ability of teak wood to resist decay by exposing particleboard samples reconstructed from unextracted, ethanol extracted, and ethanol-chloroform extracted wood meal to white rot fungus, *Coriolus versicolor* (L. ex. Fr.) for twelve weeks. Particleboard specimens from untreated wood meal showed only 3.2 percent weight loss. Specimens made from ethanol and ethanol-chloroform extracted wood meal lost 14.2 percent and 16.3 percent of total weight respectively. These results demonstrate that the substances responsible for decay resistance properties in the samples were removed with the ethanol extract and that residual caoutchouc contributed little to resistance properties.

(K. Yamamoto)

Back to	the <a href="#">Forestry Division introduction</a> page.
Forward to	the <a href="#">Fisheries Division introduction</a> page.

**FORESTRY DIVISION TOPIC 1**

**Location and Properties of Caoutchouc in Teak Wood**



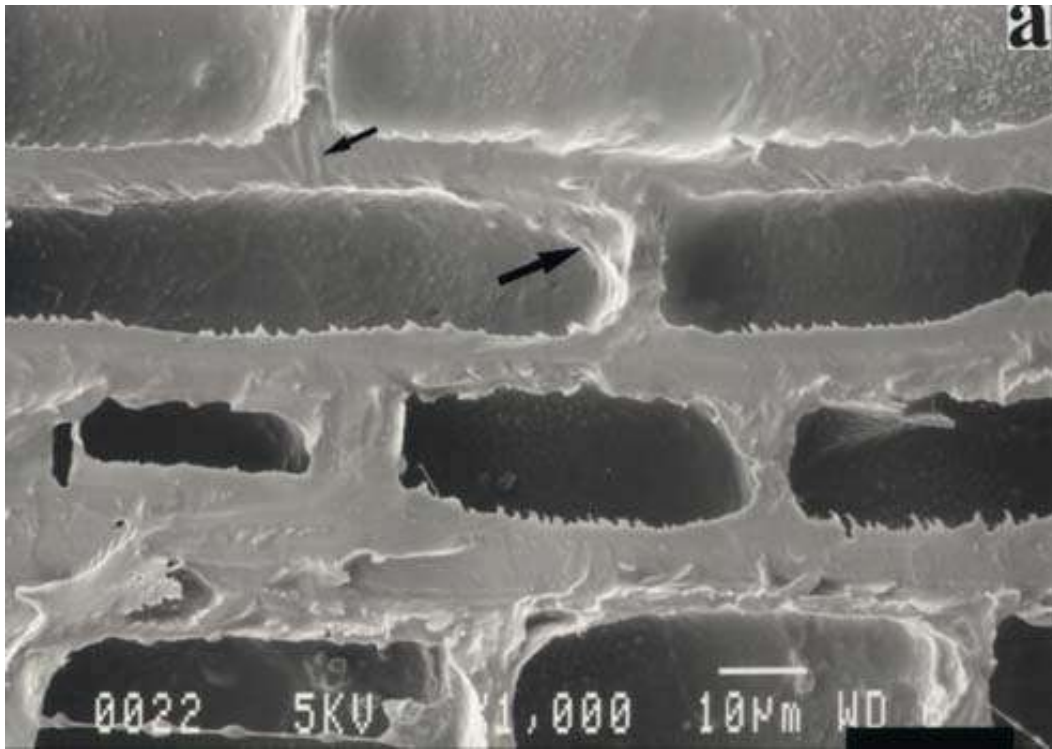
**Figure 1.** Light micrograph of ray parenchyma cells in teak heartwood fixed with glutaraldehyde and osmium tetroxide. Large and small arrows denote osmium black substances indicating the presence of caoutchouc in a fiber and a ray parenchyma cell, respectively. Bar measures 20  $\mu$ m.

Back to

[Division Topic](#): Location and Properties of Caoutchouc in Teak Wood

**FORESTRY DIVISION TOPIC 1**

**Location and Properties of Caoutchouc in Teak Wood**



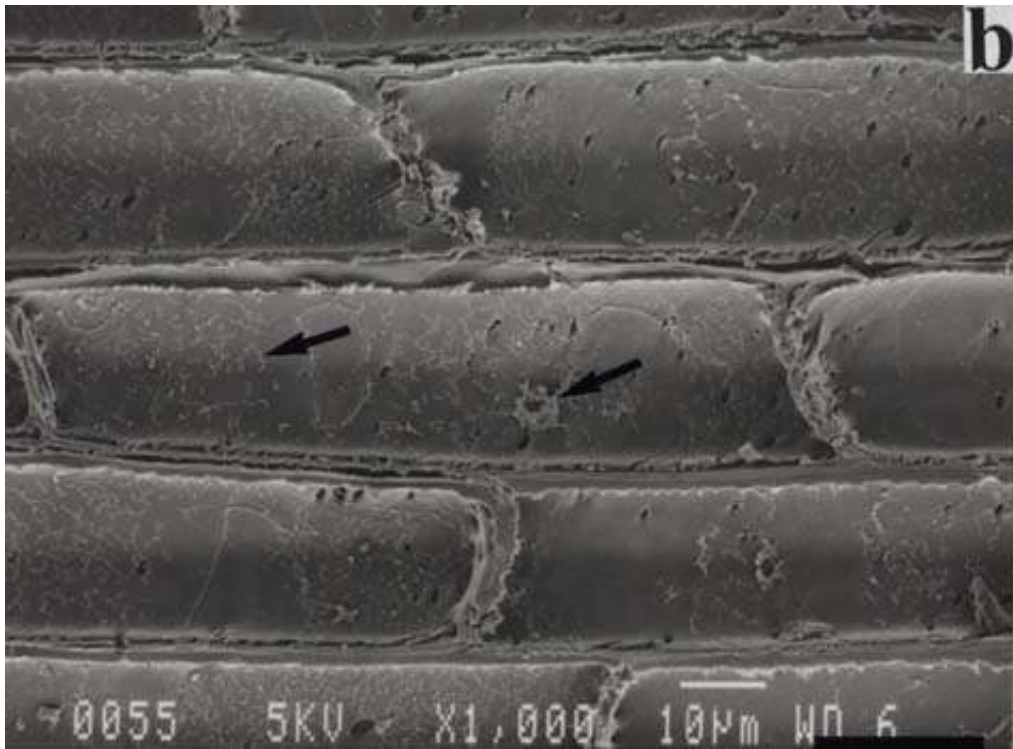
**Figure 2a.** Scanning electron micrograph of radial surfaces of ray parenchyma cells of teak heartwood, showing lumen (large arrow) and cut surface (small arrow) covered with extraneous material in the unextracted section. Bars measure 20 $\mu$ m.

Back to

[Division Topic](#): Location and Properties of Caoutchouc in Teak Wood

**FORESTRY DIVISION TOPIC 1**

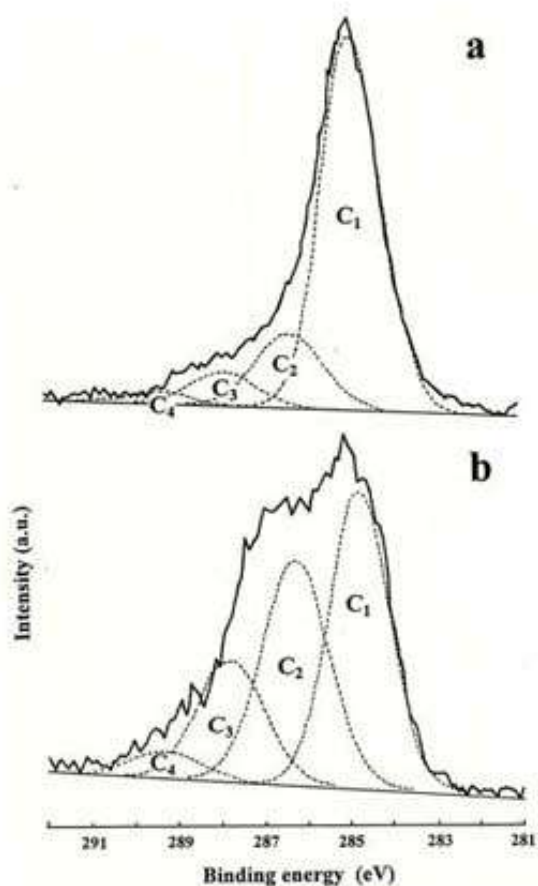
**Location and Properties of Caoutchouc in Teak Wood**



**Figure 2b.** Scanning electron micrograph of radial surfaces of ray parenchyma cells of teak heartwood, showing residues of extractives or cytoplasmic organelles (arrows) in the section extracted with acetone and chloroform. Bar measures 20 $\mu$ m.

Back to

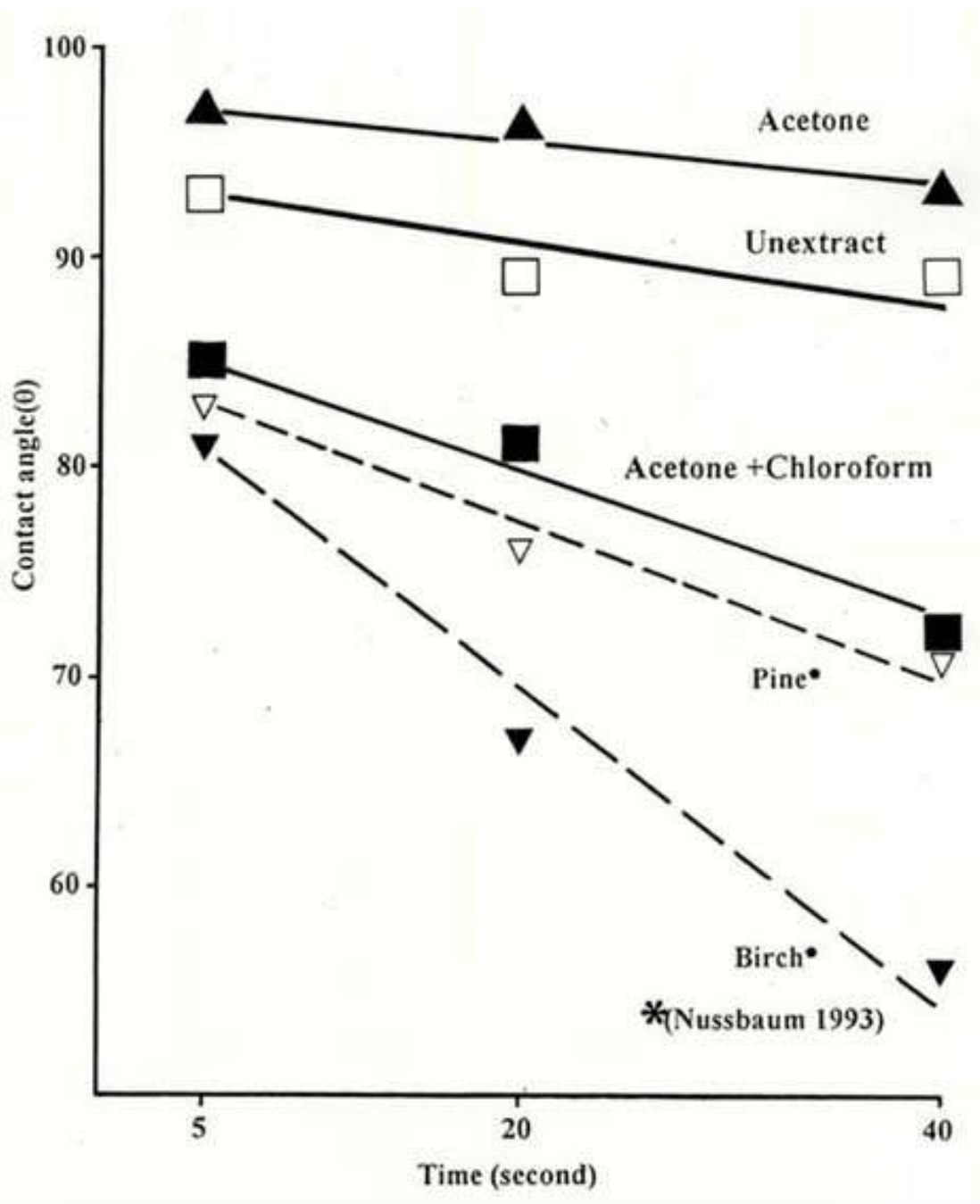
[Division Topic](#): Location and Properties of Caoutchouc in Teak Wood

**FORESTRY DIVISION TOPIC 1****Location and Properties of Caoutchouc in Teak Wood**

**Figure 3.** C1s spectra derived from X-ray photoelectron spectroscopy of teak heartwood, showing an unextracted section with percentage of C1 (C-C and C-H) at 73, of C2 (C-OH) at 17, C3 (O-C-O or C=O) at 7, and C4 (O-C=O) at 3 (Fig. 3a), and a section extracted with acetone and chloroform in which the percentage of C1, C2, C3, and C4 measured 42, 35, 19, and 4, respectively (Figure 3b).

Back to

[Division Topic](#): Location and Properties of Caoutchouc in Teak Wood

**FORESTRY DIVISION TOPIC 1****Location and Properties of Caoutchouc in Teak Wood**

**Figure 4.** Time course for contact angles in teak heartwood, showing unextracted section (a), section extracted with acetone (b), and section extracted with acetone and chloroform (c). Comparison with pine and birch data from Nussbaum (1993) cited.

Back to

[Division Topic: Location and Properties of Caoutchouc in Teak Wood](#)



## FISHERIES DIVISION

As an initial phase (1994-1998) in international collaborative activity in the field of fisheries, the Fisheries Division has initiated five major research projects in Asian countries, including efforts to improve the management of fisheries resources in Malaysia and Indonesia, aquaculture in Thailand and Vietnam, and fisheries product processing in China. In addition to these studies, the Division has also endeavored to secure the participation of Southeast Asian countries in a research project targeting prawn viral diseases.

During FY 1997, the Division initiated its first international collaborative research project on fisheries resource management in Malaysia with the Fisheries Research Institute (FRI) and the University of Malaya (UM). This multidisciplinary project, which examines the productivity and sustainable utilization of brackish water mangrove ecosystems, involves the integration of studies in fisheries, forestry, agriculture, and socio-economics. JIRCAS has successively dispatched two senior researchers to Penang, Malaysia, to provide long-term oversight for the project, and several short-term scientists specializing in fish larval ecology, crustacean ecology, and marine chemistry have also participated. In December, 1997, members of the project team conducted a workshop on brackish water mangrove ecosystems that brought together researchers from FRI, UM, and the Forest Research Institute Malaysia (FRIM).

At the same time, the Division remains involved in several other ongoing projects. These include collaborative studies on the life history of major coastal fishes in Indonesia based on otolith analyses now being conducted in Maros, South Sulawesi, Indonesia, in conjunction with the Research Institute for Coastal Fisheries (RICF) under the jurisdiction of the Central Research Institute for Fisheries (CRIFI). The project aims to deepen understanding of the ecology and life history of important coastal fish species in ways that may improve resource management methods. One researcher has been dispatched to Maros as long-term residing scientist.

*Photo: Sampling from a fish market in Ujung Pandang, Indonesia.*

The Division's collaborative work on the development of sustainable aquaculture technology in Southeast Asia also continues at Kasetsart University in Bangkok, Thailand. In addition, the Division has been participating in a comprehensive project entitled "Evaluation and improvement of farming systems combining agriculture, animal husbandry, and fisheries in the Mekong Delta" with the College of Agriculture at Cantho University in Vietnam. This project involves multidisciplinary studies of integrated farming systems to address problems in rice production, animal husbandry, freshwater aquaculture, and socio-economics. Research in fisheries and freshwater aquaculture comprises an important part of the project, in particular as it relates to technologies for the production of fish and prawn fry, the prevention of disease among fish and prawn, and the utilization of new feed resources for freshwater aquaculture. To oversee components of the project which relate to fisheries management, JIRCAS has dispatched on short-term bases one researcher specializing in crustacean endocrinology and three Fisheries Agency scientists specializing in fish disease and fisheries nutrition.

Concerning the processing of fisheries products, the Division has continued collaborative research on postharvest and processing of freshwater fish in China with the Faculty of Food Science and Technology at the Shanghai Fisheries University. Two senior researchers have been dispatched successively to Shanghai, and short-term scientists specializing in postharvest technology have visited to lend support to the project.

Intensive aquaculture has been well-developed in recent years and has become one of the most important industries in many countries, but self-contamination and fish disease in culture ponds have given rise to serious environmental and social problems. In order to promote effective management and prevent problems from occurring, the Fisheries Division in March, 1998, organized a research workshop to consider aquaculture and related environmental problems in Southeast Asia. Five foreign scientists from four countries joined two Japanese university professors to share perspectives on the conditions prevailing in the regional and discuss the direction of future research efforts.

Finally, under the auspices of the JIRCAS Visiting Research Fellowship Program, one scientist from the Central Research Institute for Fisheries (CRIFI) in Indonesia has been invited to Tsukuba to undertake cooperative studies of aquatic animal physiology and pathology over a two-year period. Other invitees will soon follow. Participating Tsukuba Fellows are expected to become core scientists in JIRCAS's counterpart institutions and to contribute to the continued development of collaborative studies.

● [Division Topic #1](#): Food-Chain Mechanisms and Productivity in Brackish Water Mangrove Ecosystems.

● [Division Topic #2](#): Age Determination of Tropical Fishes in Indonesia.

Back to	the Annual Report <a href="#">Main Contents</a> page.
Forward to	the <a href="#">Okinawa Subtropical Station introduction</a> page.







## **FISHERIES DIVISION TOPIC 1**

# **Food-Chain Mechanisms And Productivity in Brackish Water Mangrove Ecosystems**

Brackish waters form where sea water and freshwater mix, usually within regions characterized by flat topography stretching between rivers and seas. In tropical and subtropical areas, brackish water coastlines often play host to mangrove forests, which serve as nursery grounds for fish and prawns while playing critical roles in protecting coasts from the threat of hurricanes and erosion. Humans also utilize mangrove trees for fuel, charcoal, chips, timber and medicinal products.

In recent years, processes of urbanization, resort development, farmland clearing, and the expansion of commercial shrimp pond enterprises in the tropics have generated excessive levels of water pollution, soil erosion, and sediment accumulation that threatens the survival of many brackish water mangrove ecosystems. Already the world has witnessed widespread reduction of nursery grounds and the occurrence of red tides as a consequence of the destruction of brackish water mangrove ecosystems.

In order to better understand the functions of these valuable ecosystems, JIRCAS has initiated a collaborative research project on the productivity and sustainable utilization of brackish water mangrove ecosystems in cooperation with leading Malaysian scientists. The project covers a five-year period from 1995-2000 and prioritizes four principal research topics, including production and decomposition processes in differential brackish water mangrove ecosystems, nutrient flux from rivers to coastal ecosystems, energy flow and carrying capacity in differential brackish water mangrove ecosystems, and socio-economic evaluations of brackish water mangrove ecosystems. Research touching upon issues in fisheries is now being conducted in collaboration with the Fisheries Research Institute (FRI) and the University of Malaya (UM).

At present, three research sites in Peninsular Malaysia have been selected for the project. The Matang Mangrove Forest in Perak State is located within a forest reserve measuring 40,711 hectares. The area consists of numerous islands and adjacent waterways and is populated primarily by *Rhizophora apiculata* trees. Under sustainable management since the early part of the century, Matang Mangrove Forest is reputed to be the world's best managed mangrove forest. As such, it will provide a valuable location for analyzing the role of fish populations in mangrove ecosystems. In contrast, disturbance through partial deforestation characterizes Merbok Mangrove Forest Reserve in Kedah State. During the past ten years, the mangrove cover at the site has declined from 9,037 ha in 1980 to 8,034 ha in 1990, amounting to roughly 11% of the original forested area. The loss of mangroves continues due to the persistence of destructive land uses, especially the conversion of mangrove areas into shrimp culture ponds. The third site, the Lumut Mangrove Forest, has experienced much more extensive deforestation.

Measurement of natural  $^{13}\text{C}/^{12}\text{C}$  and  $^{15}\text{N}/^{14}\text{N}$  isotopic ratios provide a powerful tool in determining sources of nutrition for consumers and trophic relationships among organisms. Such measurements are often used in the study of marine food webs. It is known that  $^{13}\text{C}$  measurements primarily indicate the main sources of carbon to consumers, while  $^{15}\text{N}$  values provide information on the trophic distance of consumers from their food bases. Therefore, the simultaneous use of  $^{13}\text{C}$  and  $^{15}\text{N}$  values allows elucidation of trophic relationships in food webs.

Surveys conducted between 1996 and 1997 in the Selinsing River of the Matang Mangrove indicate the presence of a certain C-N isotopic ratio gradient (Figure 1). This finding suggests the presence of a food pathway that begins with leaf-based detritus in the mangrove, continues upwards to herbivorous shrimp and crab species, and culminates in carnivorous fish and squid. In other words, a series of trophic relationships is fulfilled in the Matang brackish water mangrove ecosystem.

Additional research comparing populations of larval and juvenile anchovies, *Stolephorus* spp., at the research sites indicates population densities (number/100 m³) at least 1.5 times greater in the intact brackish water mangrove ecosystem at Matang than those in the disturbed ecosystem at Merbok. Biomass (mg/100 m³) at Matang also measured 4.3 times higher than that in the Merbok Mangrove (Figure 2). These results confirm our assumptions that the undisturbed nature of Matang Mangrove would generate much higher levels of productivity for larval and juvenile anchovy, when measured as the product of biomass and daily growth rates calculated through otolith ring analysis.

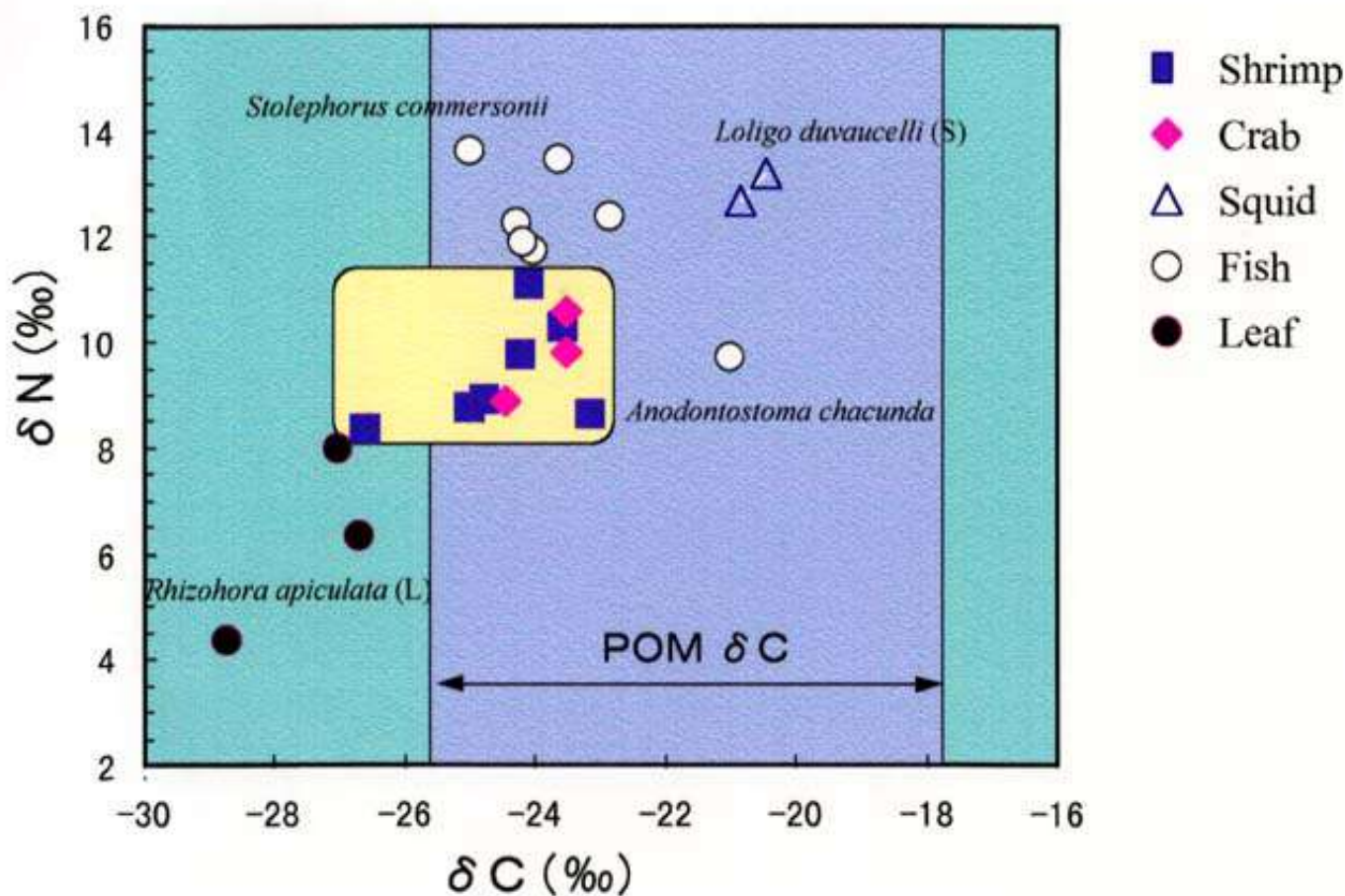
We have presented the results of these and other studies conducted during the past two years in an annual seminar held under the auspices of the comprehensive project. Two seminar proceedings have already been published. As a result of the studies, integrated criteria on tree and aquatic production under suitable forest management can now be standardized. Information obtained in this project will be useful to scientists in many fields in their efforts to improve techniques for the sustainable utilization of brackish water mangrove ecosystems, benefiting local residents as well as policy makers.

Our results may also help countries facing problems in the development and sustainable utilization of their brackish water mangrove

ecosystems. However, the task of linking comprehensive studies on trees and aquatic animals and of identifying criteria for sustainable utilization of brackish water mangrove ecosystems remains. These tasks will form the focus of our remaining research before the end of the project in the year 2000.

(S. Hayase)

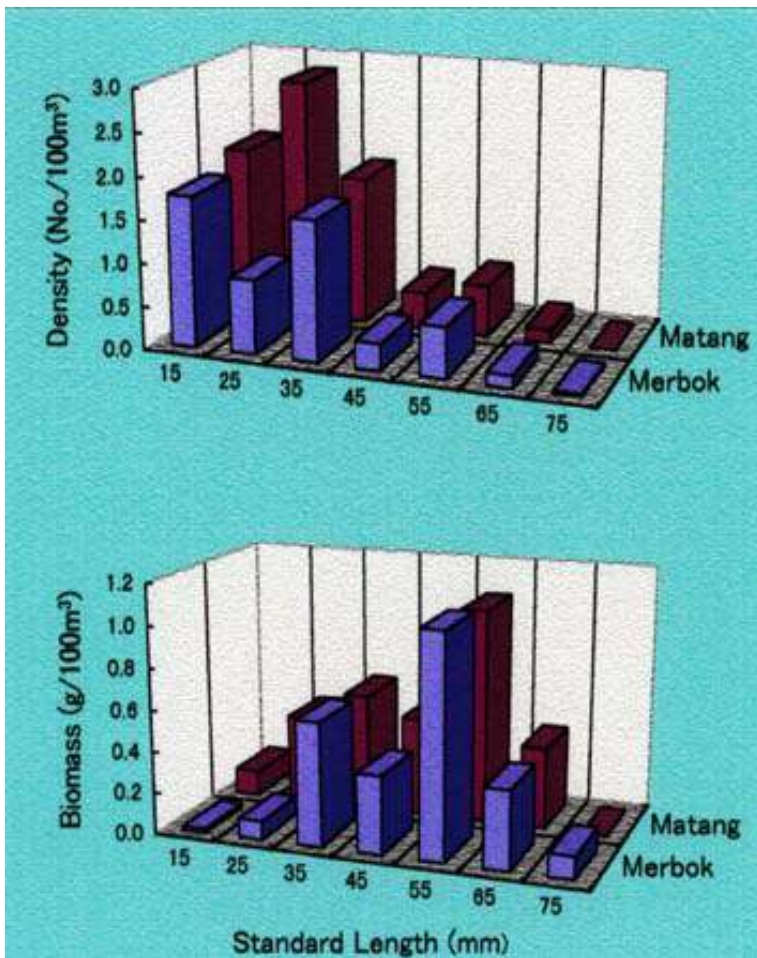
Back to	the <a href="#">Fisheries Division introduction</a> page.
Forward to	<a href="#">Division Topic #2</a> : Age Determination of Tropical Fishes in Indonesia.

**FISHERIES DIVISION TOPIC 1****Food-Chain Mechanisms And Productivity in Brackish Water Mangrove Ecosystems**

**Figure 1.** Map of mangrove leaves, animals, and particulate rate of organic matter (POM) in the Matang brackish water mangrove system.

Back to

[Division Topic #1: Food-Chain Mechanisms And Productivity in Brackish Water Mangrove Ecosystems](#)

**FISHERIES DIVISION TOPIC 1****Food-Chain Mechanisms And Productivity in Brackish Water Mangrove Ecosystems**

**Figure 2.** Density (number/100 m³) by length and biomass (g/100 m³) by length for larval and juvenile anchovies, *Stolephorus* spp., in the Matang and Merbok brackish water mangrove systems, November 1996.

Back to

[Division Topic #1: Food-Chain Mechanisms And Productivity in Brackish Water Mangrove Ecosystems](#)



## **FISHERIES DIVISION TOPIC 2** **Age Determination of Tropical Fishes in Indonesia**

Scientists know little about the life histories of many commercial fish species utilized in tropical areas. In order to achieve sustainable management of fisheries resources greater knowledge of age, growth, reproductive cycles, and migratory habits are necessary. Therefore, in 1996, JIRCAS initiated a collaborative project to study the life cycles of major coastal fish species in Indonesia with the Central Research Institute for Fisheries (CRIFI). Among the main purposes of this project is an analysis of age based on daily otolith growth increments in tropical fish.

Studies of age and growth in fish species have generally examined annual growth rings found in scales, otoliths, bones, or spines. However, due to the lack of seasonal variation in tropical regions, tropical fish exhibit no such annual markings. In 1971, Pannella discovered very thin otolith growth rings which form daily. Since that time, considerable research has been conducted on the basis of these increments, primarily examining fish from temperate zones. Nevertheless, this method is considered effective for studying tropical fishes and was applied in our study.

We analyzed eight species collected from South Sulawesi, Indonesia, including *Spratelloides gracilis*, *Stolephorus indicus*, *Rastrelliger kanagurta*, *R. negructus*, *Liognathus* sp., *Atherinomorus lacunosus*, *Vallamugil* sp. and *Sphaeramia ordicularis*. Otoliths were extracted, washed with water, air-dried and mounted with epoxy resin on a glass slide. After the epoxy resin hardened, otoliths were ground by lapping film (grind paper for hard tissues, 9¼m and 3¼m) under a light microscope until the focus was at the ground surface of the otolith. Ground otoliths were observed and growth increments counted by light and scanning electron microscopy.

Two of the eight species, *Atherinomorus lacunosus* and *Sphaeramia ordicularis*, had clear increments which enabled the estimation of age in days. Specimens of *Atherinomorus lacunosus*, which ranged from 5.7 to 7.3 cm in total length, had from 88 to 141 increments, suggesting ages that ranged from three to five months ([Figure 1](#)). *Sphaeramia ordicularis*, and *Vallamugil* sp. clearly exhibited increments, but they were so complicated that we could not count the total number accurately. Other species exhibited only dim increments, which also proved too difficult to count

Additionally, we verified the daily periodicity of increment formation of *Sphaeramia ordicularis* using rearing experiments. Fish were reared in a floating cage and immersed in alizarin complexion (ALC) solutions on two occasions, January 15 and 20, 1998. Otoliths were then extracted from the fish and examined under a light microscope. Two distinct increments colored by ALC could be observed ([Figure 2](#)), while four additional increments were counted between these distinct increments. This result indicated that the observed increments were daily growth increments, each having formed on a daily basis.

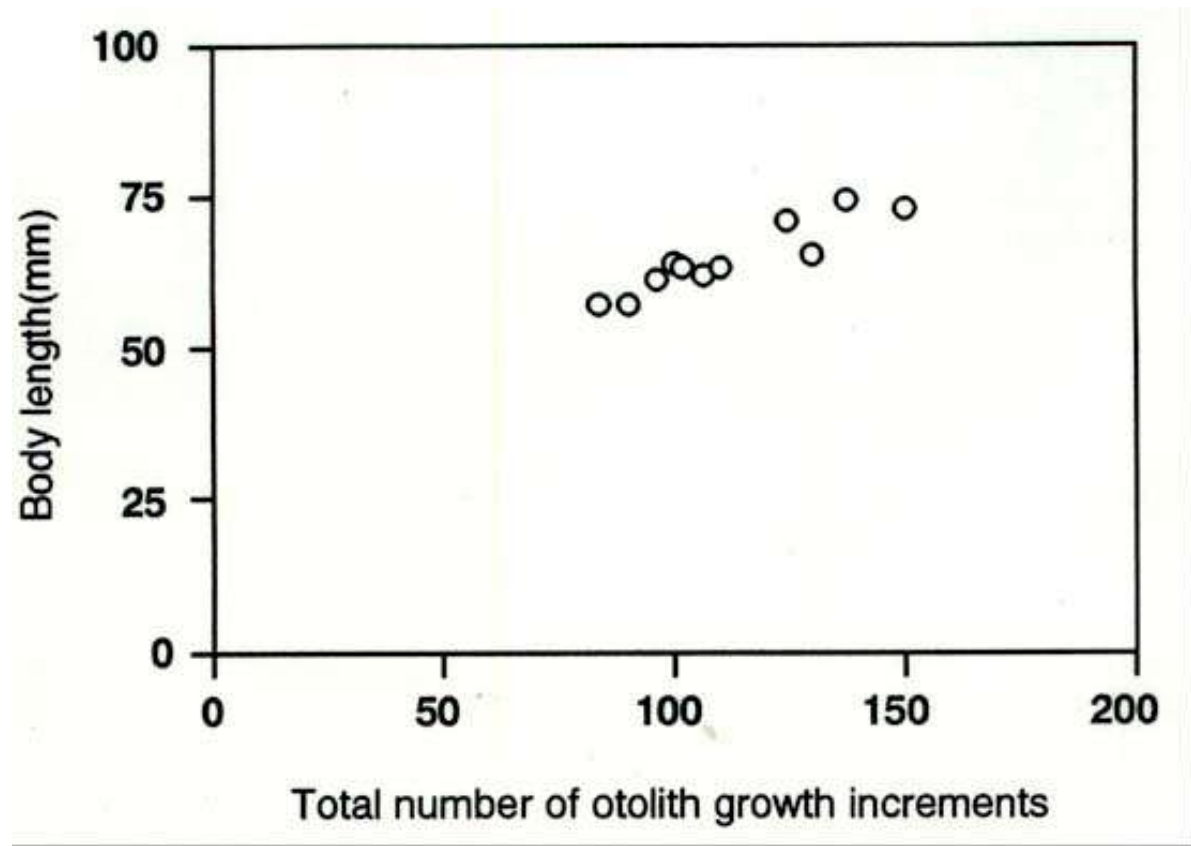
Our results demonstrate that analysis of daily growth increments is possible in tropical fishes. However, our results also suggest that this technique may prove very difficult or impossible for particular fish species. Further investigation is required to determine which species can be analyzed using this method.

(S. Suyama)

Back to	the <a href="#">Fisheries Division introduction</a> page, or to <a href="#">Division Topic #1: Food-Chain Mechanisms and Productivity in Brackish Water Mangrove Ecosystems</a> .
Forward to	<a href="#">Okinawa Subtropical Station introduction</a> page.

**FISHERIES DIVISION TOPIC 2**

**Age Determination of Tropical Fishes in Indonesia**

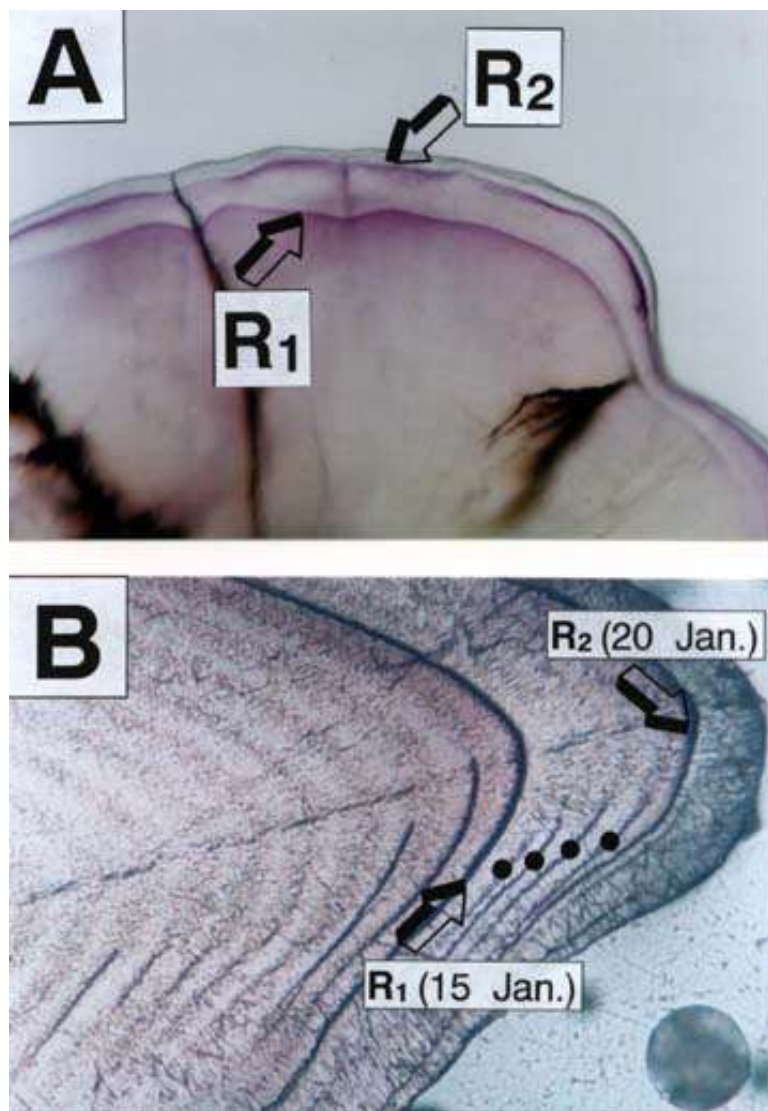


*Figure 1. Relationship between the body length and total number of otolith growth increments in Atherinomorus lacunosus.*

Back to [Division Topic #2: Age Determination of Tropical Fishes in Indonesia](#)

***FISHERIES DIVISION TOPIC 2***

**Age Determination of Tropical Fishes in Indonesia**



**Figure 2.** Light microscope photographs of *Sphaeramia ordicularis* otolith showing the whole otolith (A) and ground otolith (B). Arrows indicate increments colored by ALC on January 15 (R1) and January 20 (R2).

Back to

[Division Topic #2: Age Determination of Tropical Fishes in Indonesia](#)





## OKINAWA SUBTROPICAL STATION

The Okinawa Subtropical Station was established in 1970 as a field experiment station for the Tropical Agriculture Research Center (TARC), which was reorganized into JIRCAS in 1993. It is located on Ishigaki Island, nearly 2100 km southwest of Tokyo. As annual temperatures on the island average 24° C, the Station provides the most suitable location in Japan for research concerning subtropical and tropical agriculture and the development of techniques and technologies appropriate for the constraints of warm climates.

*Photo: New [experimental facility for tropical fruit tree research](#) constructed in 1997.*

During FY 1997, Station personnel consisted of twenty-five researchers divided among seven research sections involved in projects relating to genetic resources, biotechnology, plant physiology, plant breeding, plant protection, and soil science. In addition to the permanent research staff, ten specialists were invited from Burkina Faso, China, Egypt, India, Nigeria, Pakistan, the Philippines and Vietnam under the auspices of the Visiting Research Fellowship Program at Okinawa overseen by the International Research Section. Visiting fellows conducted basic research on plant physiology and soil microorganisms in collaboration with Station researchers and participated in the International Workshop on Heat-Tolerance of Crops held in October, 1997.

- [Division Topic #1](#): Assessing Watershed Levels Using Routine Irrigation Data.
- [Division Topic #2](#): Enzyme Activity Of Early-Maturing High Sugar Content Sugarcane Stalks.
- [Division Topic #3](#): Evaluating Mungbean Cultivars for Resistance to Iron Deficiency.

Back to	the Annual Report <a href="#">Main Contents</a> page.
Forward to	the <a href="#">Miscellaneous projects outline</a> page.





## OKINAWA SUBTROPICAL STATION TOPIC 1 **Assessing Watershed Levels Using Routine Irrigation Data**

It is widely believed that proper analysis of watershed levels and water balances requires large-scale monitoring systems supported by extensive man power and financial resources. This may explain the relative lack in developing countries of water balance studies and effective means for increasing efficient utilization of irrigation resources. Our collaborative research with Malaysia's Muda Agriculture Development Authority (MADA) has produced a simple method for analyzing watershed levels and water balances using twelve sets of data calculated routinely in the daily operation of irrigation systems.

In this method, two kinds of assessment indicators are used to assess management and identify constraints to proper performance in the irrigation system. A *performance indicator* expresses the ratio of performance to target and indicates the extent of target achievement. For instance, the ratio of actual irrigation supply to targeted irrigation supply is a performance indicator that demonstrates the sufficiency of irrigation supply. On the other hand, an *impact indicator* expresses the ratio of performance to total quantity and indicates constraints to proper performance when performance is not adequate. The ratio of irrigation intake to river flow constitutes one impact indicator that could be used, for instance, to show deficiencies in irrigation canal capacity despite sufficient river flow. This problem might further suggest reduced volumes in canal sections due to sedimentation. Ratios comparing the delivery of water to terminal systems against the levels of total water intake constitute a second impact indicator which can be utilized to assess excessive conveyance losses caused by damaged canal linings or the inadequate operation of control gates.

In its daily operations, MADA conducts routine measurements that clarify twelve sets of primary data. These include changes in dam storage, spillage from dams, controlled release from dams (DMRL), total runoff into rivers below dams (uncontrolled river flow, or RVIN), rainfall in the command area (RF), total levels of intake at headwork (IRIN), irrigation supplies delivered to subsystems (IRDL), recycled drainage water (IRRC), target water supplies (WRF), field water use (WUF), evapo-transpiration rates (estimated from pan-evaporation rates), and seepage and percolation (estimated through field experiments). In turn, these primary data sets can be used to derive nine sets of secondary data, including dam inflow (DMIN), river flow at canal headwork, effectively used uncontrolled river flow (RVE), unused uncontrolled river flow, effective rainfall (RFE), ineffective rainfall, canal loss, recyclable drainage water (DR), and rates of disposal to sea.

Our study utilized these twelve data points to calculate one performance indicator and five impact indicators useful for assessing watershed levels and water balances in the watershed managed by MADA, as shown in [Table 1](#). Our figures suggest strengths and weaknesses in the management of water resources in the area. They also demonstrate that analyses of watershed levels and water balances can be fruitfully conducted using data routinely monitored in most large-scale irrigation projects in developing countries.

For instance, our real performance indicator (WUF'/WRF) implies that MADA faced a water shortage in the first season of study. At the same time, authorities appeared to release dam storage at rates excessively high compared to dam inflow (DMRL/DMIN), resulting in annual reductions in dam storage and the surrender of first season rice crops every five to ten years. Utilization of uncontrolled river flow was low due to discrepancies between the timing of river flow and irrigation demand. In other words, when irrigation demand rose steeply during the dry season, river flow remained small and increased only when demand sank to low levels during the wet season.

Our statistics suggest that it is not realistic to raise effective rainfall or canal conveyance efficiency in order to improve irrigation management in the Muda watershed, as these ratios are already appropriate. However, we found ratios for recycling drainage water into the irrigation system that reached only ten percent during the first season, a figure which suggests that the development of drainage water recycling systems may provide one solution to water shortage problems in the Muda area.

(S. Yashima)

Back to	the <a href="#">Okinawa Subtropical Station introduction</a> page.
Forward to	<a href="#">Division Topic #2</a> : Enzyme Activity Of Early-Maturing High Sugar Content Sugarcane Stalks, or to <a href="#">Division Topic #3</a> : Evaluating Mungbean Cultivars for Resistance to Iron Deficiency.

**OKINAWA SUBTROPICAL STATION TOPIC 1****Assessing Watershed Levels Using Routine Irrigation Data****Table 1.** Assessment indicators in the Muda Irrigation Project.

Name of indicator	Formula	1 st season	2 nd season	Year
Performance indicator	WUF'/WRF	0.767	0.987	0.851
Dam inflow utilization ratio	DMRL/DMIN	1.767	0.764	1.152
Uncontrolled flow utilization ratio	RVE/RVIN	0.270	0.320	0.304
Rainfall utilization ratio	RFE/RF	0.756	0.663	0.712
Canal conveyance efficiency	IRDL/IRIN	0.790	0.708	0.754
Drainage water recycling ratio	IRRC/DR	0.108	0.160	0.124

Note:  $WUF' = WUF - 120$  (adjusted excessive dam release)

Back to

[Division Topic #1](#): Assessing Watershed Levels Using Routine Irrigation Data.



**OKINAWA SUBTROPICAL STATION TOPIC 1**  
**Assessing Watershed Levels Using Routine Irrigation Data**

The role of enzymes in storing sugars in sugarcane stalk remains unclear. This study sought to address the question by measuring acid invertase (AI) activity, a negative factor, and sucrose phosphate synthase (SPS) activity, a positive factor, in sugar accumulation processes within sugarcane storage tissues.

NiF4 is an early maturing Japan variety of sugarcane characterized by high sugar content. When compared to conventional sugarcane varieties, this variety exhibits relatively high brix, even during the growing season. Invert sugars of this variety decrease remarkably in November, whereas conventional types decrease in January ([Figure 1](#)). To clarify the physiological functions of high sugar content varieties, this study examined samples of NiF4 and the more conventional F172.

First, we measured seasonal changes in the level of AI activity. We found AI activity in NiF4 to be higher than that of F172 through most of the season ([Figure 2](#)). The negative factor for sugar accumulation was high in the high sugar content variety NiF4, suggesting that AI activity does not play an important role in sugar accumulation.

SPS activity in NiF4 was higher than in F172, both during the maturing season and during the harvest season. Particularly in the NiF4 variety, SPS activity increased throughout the maturing season into the harvest season ([Figure 3](#)).

Cold temperatures are the primary determinant of maturation in sugarcane. Sugarcane samples grown at 24° C, the temperature characterizing the maturing season, indicated high brix and low invert sugar content compared to samples grown at 32° C, the temperature characteristic of the vegetative growing season. Sugarcane grown at 24° C also demonstrated higher SPS activity than that grown at 32° C ([Figure 4](#)).

The fact that SPS activity increased under maturing conditions with increments of brix and decrements of invert sugars suggests that the SPS enzyme plays an important role in sugar accumulation in sugarcane storage tissues.

(T. Terauchi)

Back to	the <a href="#">Okinawa Subtropical Station introduction</a> page, or to <a href="#">Division Topic #1: Assessing Watershed Levels Using Routine Irrigation Data.</a>
Forward to	<a href="#">Division Topic #3: Evaluating Mungbean Cultivars for Resistance to Iron Deficiency.</a>

**OKINAWA SUBTROPICAL STATION TOPIC 2**

**Enzyme Activity Of Early-Maturing High Sugar Content Sugarcane Stalks**

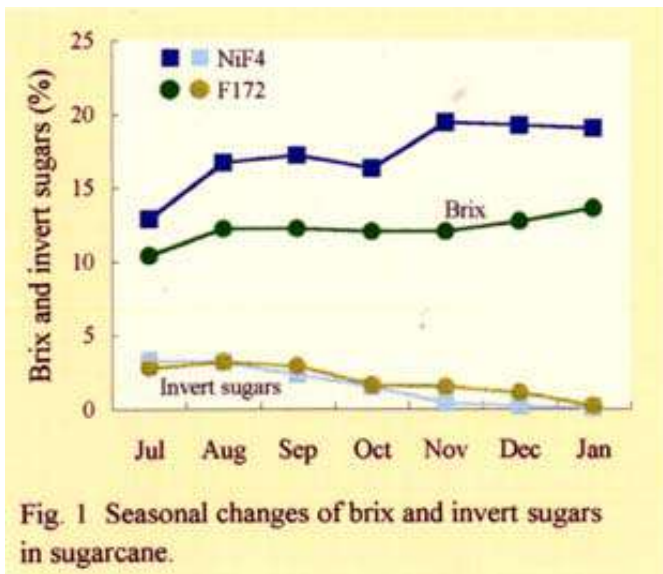


Fig. 1 Seasonal changes of brix and invert sugars in sugarcane.

*Figure 1. Seasonal changes of brix and invert sugars in sugarcane.*

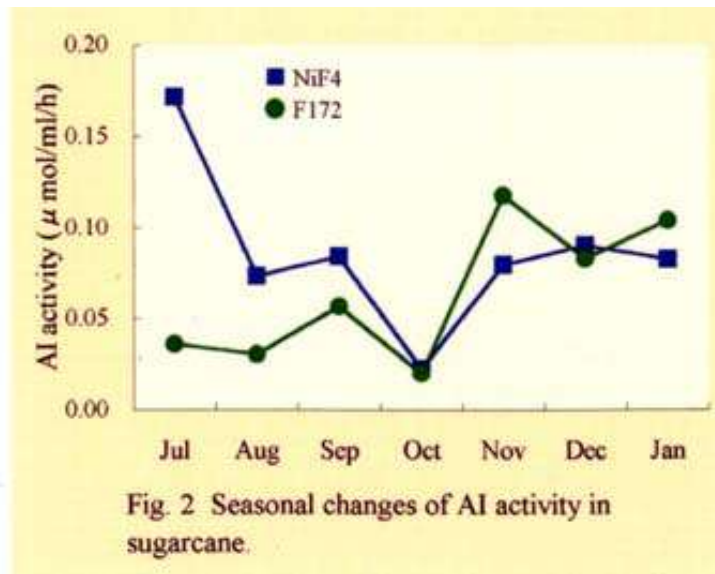


Fig. 2 Seasonal changes of AI activity in sugarcane.

*Figure 2. Seasonal changes in AI activity in sugarcane.*

Back to

[Division Topic #2: Enzyme Activity Of Early-Maturing High Sugar Content Sugarcane Stalks.](#)

**OKINAWA SUBTROPICAL STATION TOPIC 2**

**Enzyme Activity Of Early-Maturing High Sugar Content Sugarcane Stalks**

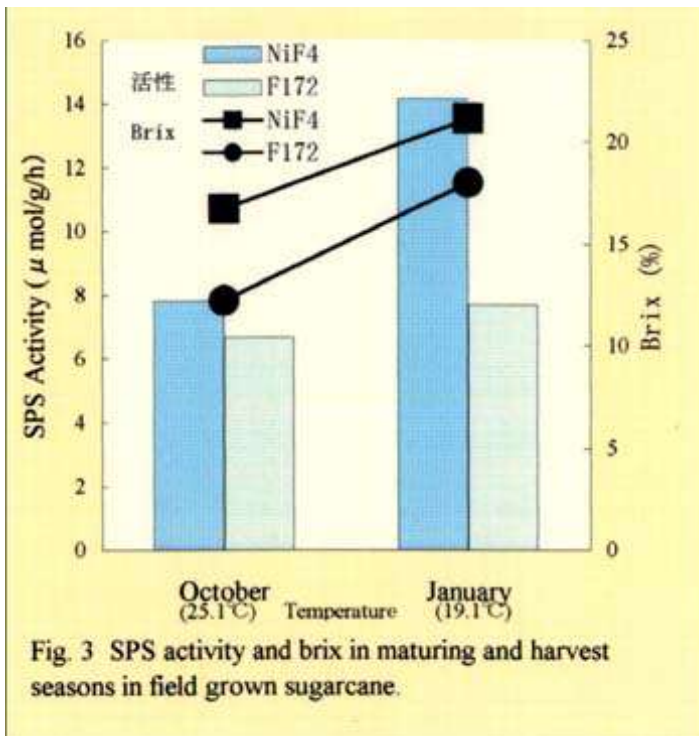


Fig. 3 SPS activity and brix in maturing and harvest seasons in field grown sugarcane.

*Figure 3. SPS activity and brix in maturing and harvest seasons in field-grown sugarcane.*

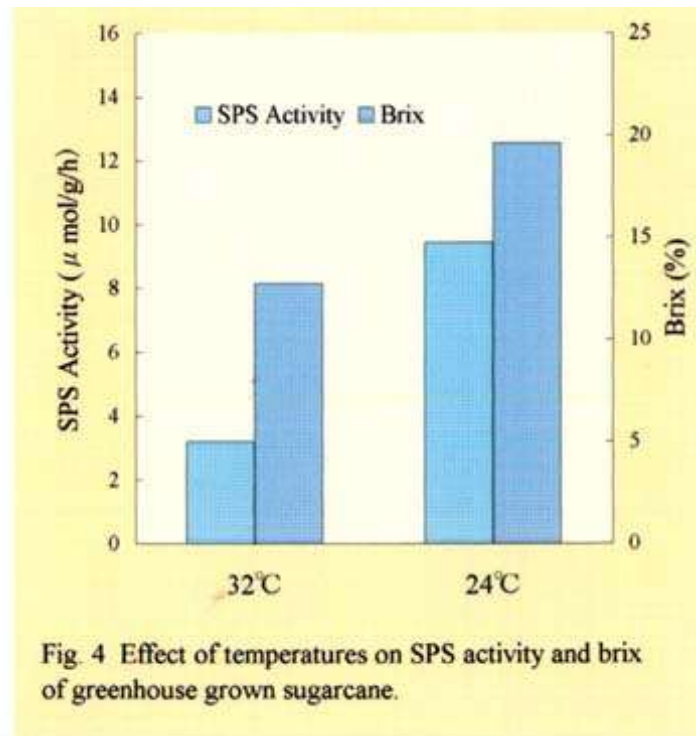


Fig. 4 Effect of temperatures on SPS activity and brix of greenhouse grown sugarcane.

*Figure 4. Effect of temperatures on SPS activity and brix in greenhouse-grown sugarcane.*

Back to

[Division Topic #2: Enzyme Activity Of Early-Maturing High Sugar Content Sugarcane Stalks](#)



**OKINAWA SUBTROPICAL STATION TOPIC 3**  
**Evaluating Mungbean Cultivars for Resistance to Iron Deficiency**

Iron deficiency is a major factor limiting the growth and production of crop plants grown on calcareous soils. Foliar and soil application of iron may be employed, but currently the only economical alternative for alleviating iron-deficiency is the selection of cultivars efficient in iron uptake. The purpose of the present study is to evaluate mungbean cultivars for their resistance to iron-deficient soils under field conditions and to identify the physiological factors involved in differential responses of mungbean cultivars to iron deficiency using solution culture.

A field experiment was conducted at the Nakhon Sawan Field Crops Research Center, Thailand. Ten mungbean cultivars/lines were evaluated for their resistance to iron deficiency in view of chlorosis symptoms, plant growth and seed yield under field characterized by calcareous soil. Ten cultivar lines grown in the field exhibited various susceptibilities to iron deficiency. Of the ten cultivar lines examined, the KPS2 proved highly susceptible; the KPS1, PSU1 and Pag-asa 1 somewhat susceptible; the VC1163B moderately tolerant; the CN36, CN60, UT1 and CNM-I tolerant; and the CNM8509B very tolerant to iron deficiency. Foliar application of a solution of 5g L⁻¹ ferrous sulphate was effective in correcting chlorosis induced by iron deficiency, and it enhanced both the growth and the yield of susceptible cultivars.

*Photo: [Mungbean cultivated on alkaline calcareous soils](#) at Nakhon Sawan Field Crops Research Center, Thailand.*

Two cultivars which differ in chlorosis resistance in the field, KPS2 and UT1, were examined for their ability to lower the pH of the nutrient solution under iron-deficient conditions. Compared with the susceptible cultivar KPS2, the tolerant cultivar UT1 had a greater ability to lower the pH of the nutrient solution in response to iron deficiency. Recovery from chlorosis was observed only in UT1 after acidification of the nutrient solution. Acidification of the medium in response to iron deficiency might contribute to the efficient solubilization of iron from calcareous soils and relates closely to the resistance to iron deficiency in mungbean cultivars. These results suggest that, when mungbean is grown on calcareous soils, loss of yield due to iron deficiency can be eliminated by the selection of cultivars with high-level resistance to iron deficiency.

(Y. Ohwaki)

Back to	the <a href="#">Okinawa Subtropical Station introduction</a> page, or to <a href="#">Division Topic #1</a> : Assessing Watershed Levels Using Routine Irrigation Data, or to <a href="#">Division Topic #2</a> : Enzyme Activity Of Early-Maturing High Sugar Content Sugarcane Stalks.
Forward to	the <a href="#">Miscellaneous projects outline</a> page.







## MISCELLANEOUS PROJECTS OUTLINE

In addition to international collaborative projects, JIRCAS conducts a variety of miscellaneous projects: domestic projects in cooperation with other MAFF institutes; commissioned research, principally in cooperation with universities; cross-ministry and cross-agency projects currently involving the Science and Technology Agency and the Environment Agency; and special allotment projects.

### DOMESTIC PROJECTS

**Analysis of genes that are induced by dehydration stress in higher plants**

(Biological Resources Division, 1993-1999)

**Primary characterization of rice genetic resources**

(Okinawa Subtropical Station, 1993-2000)

**Rapid generation advance breeding of high quality wheat for blend usage**

(Okinawa Subtropical Station, 1993-1999)

**Simulation analysis of world food policies**

(Research Information Division, 1994-1998)

**A comprehensive evaluation of the effects of international trade fluctuation on resources and the environment**

(Research Information Division, 1996-2000)

**Elucidation of characteristics of water resource changes by agricultural production and change of industrial structure and settlement of a suitable macro indicator**

(Research Information Division, 1996-2000)

**Search for endophytes from tropical grasses**

(Animal Production and Grassland Division, 1996-1998)

**Elucidation of antagonistic mechanisms of lytic microorganisms against plant pathogenic fungi and development of a means of disease control**

(Animal Production and Grassland Division, 1996-1998)

**Characterization and primary evaluation of blackgram germplasma**

(Okinawa Subtropical Station, 1996-2000)

**Development of a predictive MI method for salt accumulation in semi-arid areas**

(Crop Production and Post Harvest Technology Division, 1996-1999)

**Analysis of high-yielding "Haibushi," a heat tolerant snap bean variety, in summer cultivation on Ishigaki Island, Okinawa**

(Okinawa Subtropical Station, 1997-2002)

**Search for possible natural enemies of the Golden apple snail and evaluation of their efficacy**

(Crop Production and Post Harvest Technology Division, 1997-2000)

**Development of detection and control methods for citrus greening organisms**

(Biological Resources Division, 1997-2002)

**Development of tools for agricultural information analysis with GIS**

(Research Information Division, 1997-2006)

**COMMISSIONED RESEARCH**

**Desertification in cool, dry areas and accompanying changes in systems of agricultural dynamics**

(Environmental Resources Division in cooperation with Nihon University, 1995-1997)

**Evaluation of salinity tolerance in wild species of rice and elucidation of tolerance mechanisms**

(Okinawa Subtropical Station in cooperation with the University of the Ryukyus, 1996-1999)

**RESEARCH PROJECTS WITH OTHER GOVERNMENT AGENCIES AND MINISTRIES**

**In cooperation with the Science and Technology Agency**

**Oceanographic investigations: Fluctuations in tropical mangrove forests and evaluation of possible influences**

(Forestry Division, 1990-1997)

**Molecular analysis of two-component histidine kinases in higher plants**

(Biological Resources Division, 1997)

**Evaluation of the effects of controlled availability fertilizer on nitrous oxide production and emission**

(Environmental Resources Division, 1997)

**Durability of *Acacia mangium* wood as a fast growing plantation species**

(Forestry Division, 1997)

**In cooperation with the Environment Agency**

**Research for the development of technology to inhibit the production and emission of methane and nitrous oxide from agricultural fields**

(Environmental Resources Division, 1995-1997)

**MAFF SPECIAL RESEARCH ALLOTMENTS**

**Stabilization of rice culture under water stress in the tropics utilizing a broader spectrum of genetic resources**

(JIRCAS in cooperation with the International Rice Research Institute [IRRI], 1994 - 1999)

**Sustainable cultivation of upland crops in the semi-arid tropics**

(JIRCAS in cooperation with the International Crops Research Institute for the Semi-Arid Tropics [ICRISAT], 1994-1999)

**New technologies for agricultural research: A proposal for management training in information and biotechnology research**

(JIRCAS in cooperation with the International Service for National Agricultural Research [ISNAR], 1997-2000)

Back to

the Annual Report [Main Contents](#) menu.

# **INVITATION PROGRAMS AT JIRCAS**

In keeping with its role as an international research center, JIRCAS has implemented several programs for the invitation of foreign researchers and administrators at counterpart organizations. These programs serve to facilitate the exchange of information and opinion concerning agriculture, forestry and fisheries administration and to strengthen international research ties with scientists and administrators in other countries. Current programs are described in greater detail below.

## **1) Administrative Invitation**

Under the Administrative Invitation program, JIRCAS invites administrators from counterpart organizations to the Tsukuba premises to engage in discussions and to review ongoing research in order to ensure the smooth running of collaborative projects. Additionally, the program introduces administrators to current activities at JIRCAS and related MAFF research organizations. Finally, the program provides opportunities for the exchange of information and opinion at the administrative level concerning policy-making and project design, thereby contributing to deeper mutual understanding and international cooperation. Sixty-nine individual visits to JIRCAS were made during FY 1997 under the Administrative Invitation program, including thirteen invitations to the International Symposium. Invited administrators and their home institutions are [listed here](#).

## **2) Counterpart Researcher Invitation**

The Counterpart Researcher Invitation program provides invitations for periods of up to six months to researchers engaged in collaborative work with members of the JIRCAS research staff. Counterparts conduct in-depth research at JIRCAS, at other MAFF research institutes, or at national universities. This invitation program aims both to enhance the quality of research conducted in foreign countries and to facilitate exchanges between individual research staff. Twenty-three researchers were invited under the Counterpart Researcher Invitation Program during FY 1997. Invited researchers, their affiliated research organizations, and their research activities are [summarized here](#).

## **3) JIRCAS Visiting Research Fellowship Program at Okinawa**

The Okinawa Visiting Research Fellowship Program was initiated in FY 1992, prior to the reorganization of the Tropical Agricultural Research Center (TARC) into JIRCAS. The program invites post-doctoral scientists to conduct research for a period of one year at the Okinawa Subtropical Station. Researchers must focus on important topics relating to tropical agriculture in developing countries within one of several broad categories: the development of techniques for environmental control utilizing plants and microorganisms specific to the tropics and subtropics, studies on heat-tolerance mechanisms in tropical and subtropical crops, the identification and evaluation of salt-tolerant crops, or the evaluation and development of long-term techniques for conserving the genetic resources of vegetatively propagated crops in the tropics and subtropics. Ten fellows are chosen each year, beginning their terms on October 1 and ending on September 30 of the following year. Recent invitees and their research activities are [summarized here](#).

More information on the Okinawa Visiting Research Fellowship Program can be obtained by contacting the International Relations Section, Japan International Research Center for Agricultural Sciences, 1-2, Ohwashi, Tsukuba, Ibaraki, 305, Japan. (Tel.: 81-298-38-6335 Fax: 81-298-38-6337 Telex: 3652456 JIRCAS J).

## **4) JIRCAS Visiting Research Fellowship Program at Tsukuba**

A program similar to the Okinawa Visiting Research Fellowship Program has been implemented on the Tsukuba premises since October, 1995. The Tsukuba Visiting Research Fellowship Program aims to promote collaborative research to address various problems confronting countries in developing regions. The program allows for the invitation of six to eight researchers per year. Four researchers engage in two-year projects at JIRCAS and two to four researchers conduct short five-month projects at the National Institute for Agrobiological Resources (NIAR). Recent invitees and their research activities are [listed here](#).

More information on the Tsukuba Visiting Research Fellowship Program can be obtained by contacting the International Relation Section, Japan International Research Center for Agricultural Sciences, 1-2, Ohwashi, Tsukuba, Ibaraki, 305, Japan. (Tel.: 81-298-38-6335 Fax: 81-298-38-6337 Telex: 3652456 JIRCAS J).

## 5) Other fellowships for visiting scientists

The Government of Japan sponsors a post-doctoral fellowship program for both Japanese and foreign scientists through the Science and Technology Agency (STA). The program places post-doctoral fellows in national research institutes throughout Japan according to research theme and prior arrangement with a host scientist for a term of generally 1-3 years. Fellowships can be undertaken in any of the ministries and many fellows are currently working at the various institutes of MAFF. During FY 1997, Dr. Chien Hsiaoping from the People's Republic of China pursued research in the Research Information Division and Dr. Park Kwang-Lai (Korea) conducted experiments in the Environmental Resources Division. In addition, two Japanese fellows, Dr. Naohiro Aoki and Dr. Makiko Sakagawa, conducted research at JIRCAS. Dr. Tsuyoshi Urao, previously a fellow, became a member of the Biological Resources Division staff in April, 1998.

Back to

the Annual Report [Main Contents](#) page.



## Administrative Invitation Program Invitees

Under the Administrative Invitation program, JIRCAS invites administrators from counterpart organizations to the Tsukuba premises to engage in discussions and to review ongoing research in order to ensure the smooth running of collaborative projects. Additionally, the program introduces administrators to current activities at JIRCAS and related MAFF research organizations. Finally, the program provides opportunities for the exchange of information and opinion at the administrative level concerning policy-making and project design, thereby contributing to deeper mutual understanding and international cooperation. Sixty-nine individual visit to JIRCAS were made during FY 1997 under the Administrative Invitation program, including thirteen invitations to the International Symposium. Invited administrators and their home institutions are listed below.

FY 1997		
Dr. Bui Chi Buu	Vice Director Cuu Long Delta Rice Research Institute Vietnam	July 22-Aug. 5, 1997
Dr. Li Lite	Vice President China Agricultural University People's Republic of China	July 31-Aug. 11, 1997
Mr. Paiwit Watanavitawas	Director General Agricultural Development Research Center Thailand	Aug. 24-Sept. 5, 1997
Dr. Chau Ba Loc	Dean Faculty of Animal Husbandry and Veterinary Medicine Cantho University Vietnam	Aug. 24-Sept. 3, 1997
Dr. Wan Razali Wan Mohammad	Deputy Director General Forest Research Institute Malaysia Malaysia	Aug. 24-Sept. 6, 1997
Dr. Zhang Zhitao	Deputy Director General China National Rice Research Institute People's Republic of China	Aug. 25-Sept. 5, 1997
Dr. Taufic Ahmad	Director Research Institute for Coastal Fisheries Indonesia	Sept.28-Oct.8, 1997
Dr. Anthony E. Hall	Professor Department of Botany and Plant Sciences University of California U.S.A.	Oct. 5-11, 1997
Dr. Chungchi George Kuo	Director of Crop Improvement Program Asian Vegetable Research and Development Center Taiwan	Oct. 6-10, 1997
Dr. Suwithaya Pollarp	Director General Department of Livestock Development Thailand	Oct. 12-19, 1997
Mr. Watcharin Boonpakdee	Director Khon Kaen Animal Nutrition Research Center Thailand	Oct. 12-19, 1997

## 1) Administrative Invitation

Dr. Yoshihiko Sugai	Researcher Secretary of Strategic Administration Brazilian Agriculture Research Corporation (EMBRAPA) Brazil	Oct.13-Nov.10, 1997
Dr. Celso Boin	Director General National Center for Research on Beef Cattle (EMBRAPA-CNPGC) Brazil	Nov. 4-12, 1997
Dr. Jose Francisco Ferraz de Toledo	Head National Center for Research on Soybeans (EMBRAPA-CNPSo) Brazil	Dec. 1-6, 1997
Dr. Paulo Roberto Galerani	Associate Head of Technical Cooperation National Center for Research on Soybeans (EMBRAPA-CNPSo) Brazil	Dec. 1-6, 1997
Dr. Norman Neumaier	International Liaison Officer National Center for Research on Soybeans (EMBRAPA-CNPSo) Brazil	Dec. 1-6, 1997
Dr. Vo-Tong Xuan	Director General Mekong Delta Farming Systems Institute Cantho University Vietnam	Dec. 8-12, 1997
Mr. Duong Le Thanh	Deputy Director Mekong Delta Farming Systems Institute Cantho University Vietnam	Dec. 8-12, 1997
Mr. Duong Ngoc Thanh	Deputy Head of Sustainable Resource Management Department Mekong Delta Farming Systems Institute Cantho University Vietnam	Dec. 8-12, 1997
Mr. Duong Van Ni	Lecture and Senior Researcher Mekong Delta Farming Systems Institute Cantho University Vietnam	Dec. 8-12, 1997
Mr. Nico Vromant	Researcher Mekong Delta Farming Systems Institute Cantho University Vietnam	Dec. 8-12, 1997
Mr. Nguen Xuan Lai	Researcher Agricultural Technology Transfer Center Cuu Long Delta Rice Research Institute Vietnam	Dec. 8-12, 1997
Dr. Laura M. Giorda	National Coordinator of Soybean Research National Institute for Agricultural Technology (INTA) Argentina	Dec. 8-13, 1997
Mr. Mario Nuñez	General Coordinator Ministry of Agriculture and Livestock Direction of Agricultural Research Paraguay	Dec. 8-13, 1997



## 1) Administrative Invitation

Mr. Martin F. Naumann	International Liaison Officer National Institute for Agricultural Technology (INTA) Argentina	Dec. 8-13, 1997
Dr. Huang Hongxiang	Vice Director Soil and Fertilizer Institute Chinese Academy of Agricultural Sciences People's Republic of China	Feb. 3-7, 1998
Dr. Liu Jifang	Assistant Professor Soil and Fertilizer Institute Chinese Academy of Agricultural Sciences People's Republic of China	Feb. 3-7, 1998
Dr. Zhang Weili	Associate Professor Soil and Fertilizer Institute Chinese Academy of Agricultural Sciences People's Republic of China	Feb. 3-7, 1998
Dr. Xu Minggang	Associate Professor Soil and Fertilizer Institute Chinese Academy of Agricultural Sciences People's Republic of China	Feb. 3-7, 1998
Dr. Liu Fulai	Director General Soil and Fertilizer Institute Chinese Academy of Agricultural Sciences People's Republic of China	Feb. 3-7, 1998
Dr. Cao Zhihong	Director General Institute of Soil Science Chinese Academy of Sciences People's Republic of China	Feb. 3-7, 1998
Dr. Cai Zucong	Professor Institute of Soil Science Chinese Academy of Sciences People's Republic of China	Feb. 3-7, 1998
Dr. Zhu Jianguo	Associate Professor Institute of Soil Science Chinese Academy of Sciences People's Republic of China	Feb. 3-7, 1998
Dr. Zhou Ying Qi	President Shanghai Fisheries University People's Republic of China	Feb. 23-Mar. 4, 1998
Ms. Celia R. Lavilla Pitogo	Associate Scientist Aquaculture Department, Southeast Asian Fisheries Development Center (SEAFDEC) The Philippines	Mar. 1-8, 1998
Mr. Tadokoro Yasuo	Deputy Chief Aquaculture Department Southeast Asian Fisheries Development Center (SEAFDEC) The Philippines	Mar. 1-8, 1998
Dr. Yont Musig	Dean Faculty of Fisheries Kasetsart University Thailand	Mar. 1-8, 1998

## 1) Administrative Invitation

Dr. Taufik Ahmad	Director General Research Institute for Coastal Fisheries Indonesia	Mar. 1-8, 1998
Dr. Chong Ving-Ching	Lecturer Institute of Postgraduate Studies and Research University of Malaya Malaysia	Mar. 1-8, 1998
Dr. Yang Guoting	Northeastern Forestry College People's Republic of China	Mar. 3-9, 1998
Mr. Anim Boanyo Danson	Visiting Researcher Hokkaido University Japan (Ghana)	Mar. 3-9, 1998
Mr. Sattar Nyaz	Visiting Researcher Hokkaido University Japan (People's Republic of China)	Mar. 3-9, 1998
Ms. Ishikawa Noemia Kazue	Visiting Researcher Hokkaido University Japan (Brazil)	Mar. 3-9, 1998
Dr. Dongshen Cheng	Beijing Forestry University People's Republic of China	Mar. 3-31, 1998
Dr. Ge Mao quan	Dean Faculty of Food Science and Technology Shanghai Fisheries University People's Republic of China	Mar. 17-26, 1998
Dr. Pan Borong	Vice Director Xinjiang Institute of Biology, Pedology and Desert Research People's Republic of China	Mar. 18-25, 1998
Dr. Yin Linke	Director Turpan Desert Research Station Xinjiang Institute of Biology, Pedology and Desert Research People's Republic of China	Mar. 18-25, 1998
Mr. Wang Wenzhe	President China National Food Industry Association People's Republic of China	Mar. 22-26, 1998
Mr. Bi Qingyan	Director and Senior Engineer Department of Planning China National Food Industry Association People's Republic of China	Mar. 22-26, 1998
Mr. Chu Shiguan	Vice Director Department of Consumer Goods Circulation Ministry of Internal Trade People's Republic of China	Mar. 22-26, 1998
Dr. Jiang Jianping	Professor Macro Agriculture Research Department Chinese Academy of Agricultural Sciences People's Republic of China	Mar. 22-26, 1998
Dr. Luo Cheng Xiang	Director Food Science Department Northeast Agricultural University People's Republic of China	Mar. 22-26, 1998

## 1) Administrative Invitation

Dr. John S. Caldwell	Associate Professor Virginia Polytechnic Institute & State University United States of America	Mar. 22-28, 1998
Mr. Teoh Weng Chaw	Senior Engineer Water Management Muda Agricultural Development Authority (MADA) Malaysia	Mar. 24-28, 1998
Dr. Hosni B. Bardan	Director Division of Research and Training Department of Irrigation and Drainage Ministry of Agriculture Malaysia	Mar. 24-28, 1998
Dr. Abdul Aziz Ibrahim	Director General National Hydraulic Research Institute of Malaysia (NAHRIM) Ministry of Agriculture Malaysia	Mar. 24-28, 1998

<b>International Symposium Invitees, FY 1997</b>		
--------------------------------------------------	--	--

Dr. George H. L. Rothschild	Director General International Rice Research Institute (IRRI) The Philippines	Aug. 25-31, 1997
Dr. Wen S. Chern	Institute of Economics Academia Sinica Taiwan	Aug. 25-29, 1997
Dr. Ke Bingsheng	China Agriculture University People's Republic of China	Aug. 25-29, 1997
Dr. Nipon Poapangsakorn	Thailand Development Research Institute Foundation Thailand	Aug. 25-29, 1997
Dr. K. Purnachandra Rao	Director (Economics) National Institute of Agricultural Extension Management India	Aug. 25-29, 1997
Dr. Dennis Keeney	Director General Leopold Sustainable Center Iowa State University United States of America	Aug. 25-30, 1997
Dr. Zhao Qi Guo	Institute of Soil Science Academia Sinica People's Republic of China	Aug. 25-29, 1997
Dr. Pil-Kyun Jung	Agricultural Science and Technology Institute Republic of Korea	Aug. 25-29, 1997
Dr. Osamu Ito	International Rice Research Institute (IRRI) The Philippines	Aug. 24-31, 1997
Dr. I. P. Abrol	Rice-Wheat Consortium for the Indo-Gangetic Plains International Crops Research Institute for the Semi-Arid Tropics (ICRISAT) India	Aug. 25-30, 1997
Dr. Achmad Suryana	Center for Agro Socio-Economic Research Indonesia	Aug. 25-29, 1997

1) Administrative Invitation

Dr. Dang Kim Son	Agricultural Technology Transfer Center Cuu Long Delta Rice Research Institute Vietnam	Aug. 25-Sept. 1, 1997
Dr. William Coyle	Economic Research Service United States of America	Aug. 25-29, 1997

Back to

the [Fellowship Programs menu](#).



## Counterpart Researcher Invitation Program Invitees

The Counterpart Researcher Invitation program provides invitations for periods of up to six months to researchers engaged in collaborative work with members of the JIRCAS research staff. Counterparts conduct in-depth research at JIRCAS, at other MAFF research institutes, or at national universities. This invitation program aims both to enhance the quality of research conducted in foreign countries and to facilitate exchanges between individual research staff. Twenty-three researchers were invited under the Counterpart Researcher Invitation Program during FY 1997. Invited researchers, their affiliated research organizations, and their research activities are summarized below.

### FY 1997

*(At Japan International Research Center for Agricultural Sciences, Aug. 18-30, 1997)*

Ms. Nussipbayeva Assem	Kazakh Institute of Agriculture Kazakhstan	Seeding methods of grasses and legumes on natural grassland
------------------------	-----------------------------------------------	-------------------------------------------------------------

*(At Japan International Research Center for Agricultural Sciences, National Research Institute of Fisheries Science, National Research Institute of Fisheries Engineering, and National Research Institute of Far Sea Fisheries, Sept. 2-Nov. 15, 1997)*

Mr. Syarifuddin Tonnek	Research Institute for Coastal Fisheries Indonesia	Age determination of fish and squid based on daily growth increments of otoliths and statoliths
------------------------	-------------------------------------------------------	-------------------------------------------------------------------------------------------------

*(At Japan International Research Center for Agricultural Sciences, National Institute of Agro-Environmental Science, National Agriculture Research Center and Tohoku National Agricultural Experiment Station, Sept. 9-Oct. 14, 1997)*

Dr. Pham Sy Tan	Cuu Long Delta Rice Research Institute Vietnam	Fertilizer management for rice in the Mekong Delta region of Vietnam
-----------------	---------------------------------------------------	----------------------------------------------------------------------

*(At Japan International Research Center for Agricultural Sciences and National Institute of Agro-Environmental Science, Oct. 1-Dec. 27, 1997)*

Mr. Ping Xiaofei	China National Rice Research Institute People's Republic of China	Development of insecticide resistance in long range migratory rice planthoppers
------------------	----------------------------------------------------------------------	---------------------------------------------------------------------------------

*(At Japan International Research Center for Agricultural Sciences, National Institute of Agro-Environmental Science, and National Agriculture Center, Oct. 1-Dec. 27, 1997)*

Mr. Precha Wadisirisuk	Ministry of Agriculture and Cooperatives Department of Agriculture (DOA) Thailand	Nitrogen uptake in legume-rhizobium symbiosis in Thailand
------------------------	-----------------------------------------------------------------------------------------	-----------------------------------------------------------

## 2) Counterpart Researcher Invitation

(At Japan International Research Center for Agricultural Sciences, National Institute of Agro-Environmental Science, National Agriculture Center, and Tohoku National Agricultural Experiment Station, Oct. 6-Nov. 14, 1997)

Dr. Meow-Chan Feng	Universiti Sains Malasia (USM) Malaysia	Allelopathy of some Malaysian plants
--------------------	--------------------------------------------	--------------------------------------

(At Japan International Research Center for Agricultural Sciences, Seikai National Fisheries Research Institute, and National Research Institute of Aquaculture, Oct. 22, 1997-Feb. 11, 1998)

Ms. Tran Thi Thanh Hien	Cantho University Vietnam	The effects of stock origin and feed on growth and reproductive development in the giant freshwater prawn, <i>Macrobrachium rosenbergii</i>
-------------------------	------------------------------	---------------------------------------------------------------------------------------------------------------------------------------------

(At Japan International Research Center for Agricultural Sciences, Seikai National Fisheries Research Institute, and National Research Institute of Aquaculture, Nov. 17, 1997-Feb. 11, 1998)

Mr. Truong Quoc Phu	Cantho University Vietnam	The effects of feed quality and level on growth and reproductive development in the giant freshwater prawn, <i>Macrobrachium rosenbergii</i>
---------------------	------------------------------	----------------------------------------------------------------------------------------------------------------------------------------------

(At Japan International Research Center for Agricultural Sciences and Forestry and Forest Products Research Institute, Nov. 17, 1997-Jan. 15, 1998)

Dr. Othman Sulaiman	Universiti Sains Malasia (USM) Malaysia	Effect of lignin on preservative fixation
---------------------	--------------------------------------------	-------------------------------------------

(At Japan International Research Center for Agricultural Sciences, National Food Research Institute, and National Research Institute of Fisheries Science, Dec. 3, 1997-Mar. 31, 1998)

Ms. Zhou Li-Pin	Shanghai Fisheries University People's Republic of China	Gel formation and its properties in freshwater fish meat by Ohmic heating
-----------------	-------------------------------------------------------------	---------------------------------------------------------------------------

(At Japan International Research Center for Agricultural Sciences, Jan. 9-Mar. 27, 1998)

Dr. Divaagiin Erdenetsetseg	Institute of Meteorology and Hydrology Mongolia	Heat and water exchange in atmosphere-vegetation-soil systems for the determination of evapotranspiration distribution
-----------------------------	----------------------------------------------------	------------------------------------------------------------------------------------------------------------------------

(At Japan International Research Center for Agricultural Sciences, Jan. 12-Mar. 10, 1998)

Mr. Suksun Horpibulsuk	Asian Institute of Technology Thailand	Investigation on the mechanical properties of typical soils distributed in Northeast Thailand for the construction of irrigation facilities
------------------------	-------------------------------------------	---------------------------------------------------------------------------------------------------------------------------------------------

(At Japan International Research Center for Agricultural Sciences, Jan. 13-Mar. 12, 1998)

Dr. H. Muhammad Dimiyati	Ministry of Public Works Indonesia	Analysis of land use change using remote sensing and GIS
--------------------------	---------------------------------------	----------------------------------------------------------

(At Japan International Research Center for Agricultural Sciences and National Institute of Animal Industry, Jan. 28-Mar. 31, 1998)

## 2) Counterpart Researcher Invitation

Ms. Wanna Anghong	Ministry of Agriculture and Cooperatives Department of Livestock Development Thailand	Methods for estimating energy values in feed for dairy cattle
-------------------	---------------------------------------------------------------------------------------------	---------------------------------------------------------------

*(At Japan International Research Center for Agricultural Sciences and National Food Research Institute, Feb. 16-Mar. 31, 1998)*

Ms. Vipaporn Na Thalang	Institute of Food Research and Product Development, Department of Research Thailand	Antioxidant activity of various Thai vegetables
-------------------------	----------------------------------------------------------------------------------------	-------------------------------------------------

*(At Japan International Research Center for Agricultural Sciences, Feb. 17-Mar. 25, 1998)*

Mr. Tang Lisong	Xinjiang Institute of Biology, Pedology and Desert Research People's Republic of China	Sustainable agricultural techniques for improving environmental conditions in marginal agricultural areas and arid lands
-----------------	-------------------------------------------------------------------------------------------	--------------------------------------------------------------------------------------------------------------------------

*(At Japan International Research Center for Agricultural Sciences and Forestry and Forest Products Research Institute, Mar. 16-30, 1998)*

Dr. Zulkifli Yusop	Forest Research Institute Malaysia (FRIM) Malaysia	Study on watershed management and its impact on harvesting
--------------------	-------------------------------------------------------	------------------------------------------------------------

*(At Japan International Research Center for Agricultural Sciences and National Institute of Sericultural and Entomological Science, Feb.25-Mar. 31, 1998)*

Ms. Anchalee Chuaboonmee	Sisaket Sericultural Research Center Thailand	The physical properties of Thai poly voltine raw silk used in warp yarn
--------------------------	--------------------------------------------------	-------------------------------------------------------------------------

*(At Japan International Research Center for Agricultural Sciences, Feb.16-19, 1998)*

Dr. Wongkrajang Karuna	Kasetsart University Thailand	Research on food problems in Asian countries
------------------------	----------------------------------	----------------------------------------------

*(At Japan International Research Center for Agricultural Sciences, Feb.16-19, 1998)*

Dr. Gombosuren Enkhtaivan	College of Industrial Technology Mongolia	Research on food problems in Asian countries
---------------------------	----------------------------------------------	----------------------------------------------

*(At Japan International Research Center for Agricultural Sciences, Feb.16-19, 1998)*

Dr. Truong Nam Hai	National Institute of Biotechnology Vietnam	Research on food problems in Asian countries
--------------------	------------------------------------------------	----------------------------------------------

*(At Japan International Research Center for Agricultural Sciences, Feb.16-19, 1998)*

Dr. Khare Sunil Kumar	National Central Institute of Agricultural Engineering India	Research on food problems in Asian countries
-----------------------	-----------------------------------------------------------------	----------------------------------------------

*(At Japan International Research Center for Agricultural Sciences, Mar.9-27, 1998)*

2) Counterpart Researcher Invitation

Mr. Yin Chang Bin	Institute of National Resources and Regional Planning Chinese Academy of Agricultural Science People's Republic of China	Economic analysis of provincial data from Shandong Province, People's Republic of China
-------------------	--------------------------------------------------------------------------------------------------------------------------------	-----------------------------------------------------------------------------------------

Back to

the [Fellowship Programs menu](#).





## JIRCAS Visiting Research Fellowship Program at Okinawa

The Okinawa Visiting Research Fellowship Program was initiated in FY 1992, prior to the reorganization of the Tropical Agricultural Research Center (TARC) into JIRCAS. The program invites post-doctoral scientists to conduct research for a period of one year at the Okinawa Subtropical Station. Researchers must focus on important topics relating to tropical agriculture in developing countries within one of several broad categories: the development of techniques for environmental control utilizing plants and microorganisms specific to the tropics and subtropics, studies on heat-tolerance mechanisms in tropical and subtropical crops, the identification and evaluation of salt-tolerant crops, or the evaluation and development of long-term techniques for conserving the genetic resources of vegetatively propagated crops in the tropics and subtropics. Ten fellows are chosen each year, beginning their terms on October 1 and ending on September 30 of the following year. Recent invitees and their research activities are listed below.

*Photo: [Okinawa Fellows conduct research](#) in the laboratories of the Okinawa Subtropical Station.*

### Okinawa Fellows from October 1996 to September 1997

*Subject: Development of techniques for environmental control by using plants and microorganisms specific to the tropics and subtropics*

Dianou Dayeri	Institute of Agricultural Study and Research Burkina Faso	Biological regulation mechanisms for methane emission in rice paddy fields with reference to development of techniques for environmental control
El-Khawas Hussein Moustafa	Cairo University Egypt	Response of lowland rice to inoculation with plant growth promoting rhizobacteria (PGPR) and their culture supernatants

*Subject: Studies on the mechanism of heat-tolerance of tropical and subtropical crops*

Harvinder Singh Talwar	International Crops Research Institute for the Semi-Arid Tropics (ICRISAT) India	Physiological basis for heat tolerance during flowering and pod setting stages in groundnuts ( <i>Arachis hypogaea</i> L.)
Padmanaban Annamalai	University of Madras India	Molecular study on the function of heat shock responsive genes in <i>Brassica Oleracea</i> var. <i>Capitata</i> L.

*Subject: Identification and evaluation of salt-tolerant crops*

Li Chengyun	Yunnan Academy of Agricultural Sciences People's Republic of China	Studies on the relationship between salinity tolerance and cold tolerance at the booting stage of rice ( <i>Oryza sativa</i> L.)
Safdar Hussain Shah	Agriculture Research Station Dhodial Pakistan	Salinity tolerance in rice at the whole-plant and cellular levels
Maribel Dionisio-Sese	University of the Philippines Philippines	Photosynthetic and antioxidant responses of rice seedlings to salinity stress: Effects of proline and betaine on heat inactivation of <i>Rubisco</i>
Qian Qian	China National Rice Research Institute People's Republic of China	Coordinated gene responses to salt stress in rice ( <i>Oryza sativa</i> L.)

*Subject: Evaluation and development of long-term conservation techniques of genetic resources of vegetatively propagated crops in the tropics and subtropics*

Nguyen Tien Thinh	Nuclear Research Institute Vietnam	Cryopreservation of taro ( <i>Colocasia esculenta</i> ) shoot tips by encapsulation / dehydration
-------------------	---------------------------------------	---------------------------------------------------------------------------------------------------

Pius Michael Kyesmu	University of Jos Nigeria	Cryopreservation of shoot apices of <i>Dioscorea</i> species by vitrification
---------------------	------------------------------	----------------------------------------------------------------------------------

**from October 1997 to September 1998**

*Subject: Development of techniques for environmental control by using plants and microorganisms specific to the tropics and subtropics*

El-Khawas Hussein Moustafa	Cairo University Egypt	Utilization of plant growth promoting rhizobacteria (PGPR) for promoting plant growth and saving fertilizer
Wang Bujun	Institute of Crop Breeding and Cultivation People's Republic of China	Associations between methane emission and methanogenic and methanotrophic bacteria in flooded soil as affected by rice cultivars
Nora S. Meneses	La Granja Agricultural Research and Extension Center Philippines	Biological control of pest insects of <i>Gramineae</i>

*Subject: Studies on the mechanism of heat tolerance of tropical and subtropical crops*

Liu Jian	Shandong Teachers' University Institute of Plant Stress People's Republic of China	The expression of the heat tolerance-relative genes in tomato reproductive organs
----------	------------------------------------------------------------------------------------------	-----------------------------------------------------------------------------------

*Identification and evaluation of salt-tolerant crops*

Safdar Hussain Shah	Agricultural Research Station at Dhodial, Mansehra Pakistan	Physiological, biochemical and genetic characterization of salinity tolerance in rice
Li Chengyun	Plant Protection Research Institute People's Republic of China	Selection and detection of salt-responsive mutants in rice ( <i>Oryza sativa</i> L.)
Sumanasinghe Vithanaarachchige Ariyawanse	University Peradeniya Sri Lanka	Expression and evaluation of salinity stress related genes in <i>Oryza sativa</i> L.
Masood M. Shahid	National Agricultural Research Center Pakistan	Identification and evaluation of salinity tolerance in rice ( <i>Oryza sativa</i> L.) using molecular markers
Bakhtiyor Yakubov	Institute of Genetics Uzbekistan	Molecular study of the heat-shock inducible genes in a highly heat-tolerant variety of <i>Brassica oleracea</i> var. capitata L.

*Subject: Evaluation and development of long-term conservation techniques of genetic resources of vegetatively propagated crops in the tropics and subtropics*

Narinder Pal Singh Dhillon	Punjab Agricultural University India	RAPD and AFLP analysis of genetic diversity in sweet potatoes ( <i>Ipomea batatas</i> L.)
----------------------------	-----------------------------------------	-------------------------------------------------------------------------------------------

Back to

the [Fellowship Programs menu](#).





## JIRCAS Visiting Research Fellowship Program at Tsukuba

A program similar to the Okinawa Visiting Research Fellowship Program has been implemented on the Tsukuba premises since October, 1995. The Tsukuba Visiting Research Fellowship Program aims to promote collaborative research to address various problems confronting countries in developing regions. The program allows for the invitation of six to eight researchers per year. Four researchers engage in two-year projects at JIRCAS and two to four researchers conduct short five-month projects at the National Institute for Agrobiological Resources (NIAR). Recent invitees and their research activities are noted below.

*Photo: [Tsukuba Fellows conduct experiments](#) with the help of JIRCAS staff members in the state-of-the-art Biotechnology Unit at JIRCAS headquarters in Tsukuba, Japan.*

### Long-Term Tsukuba Fellows at JIRCAS from October 1996 to September 1998

*Subject: Methods for optimum utilization of biological resources*

Zabta Khan Shinwari	National Agricultural Research Center Pakistan	Analysis of plant responses to environmental stresses and gene expression
Gassinee Trakoontivakorn	Kasetsart University Thailand	Development of practical methods for the evaluation of the quality of indigenous crops and for the analysis of components and functionality of foods

*Subject: Analysis and evaluation of the impact of climatic and anthropogenic factors on environmental resources*

Qian Minze	Tsinghua University People's Republic of China	Relation between climatic changes and biomass in agro-ecosystems
Yang Hao	The Institute of Soil Science Academia Sinica People's Republic of China	Investigations of the process of rock-weathering through the analysis of rock surfaces by electron spectroscopy

### Long-Term Tsukuba Fellows at JIRCAS from October 1997 to September 1999

*Subject: Methods for optimum utilization of biological resources*

Mohammad Masud Parvez	Bangladesh Agricultural Institute Bangladesh	Analysis of plant responses to environmental stresses and gene expression
Vuong Dinh Tuan	Cuulong Delta Rice Research Institute Vietnam	Analysis of plant responses to environmental stresses and gene expression

*Subject: Analysis and evaluation of the impact of climatic and anthropogenic factors on environmental resources*

Li Zhong	Institute of Soil Science Academia Sinica People's Republic of China	Relation between climatic changes and biomass in agro-ecosystems
Muhammad Akhtar Abbas	University of Agriculture at Faisalabad Pakistan	Development of techniques for environmental and resource assessment, including remote sensing and GIS

### Short-Term Tsukuba Fellows at NIAR from September 1997 to March 1998

Konarev Alexander	All Russian Institute for Plant Protection Russia	Methods for the analysis and preservation of plant biodiversity
-------------------	------------------------------------------------------	-----------------------------------------------------------------

**Short-Term Tsukuba Fellows at NIAR from August 1997 to March 1998**

Iftikhar Farida	National Agricultural Research Center Pakistan	Production of new biological resources through the application of biotechnological procedures
-----------------	---------------------------------------------------	-----------------------------------------------------------------------------------------------

**Short-Term Tsukuba Fellows at NIAR from November 1997 to March 1998**

Xie Guanlin	Zhejiang Agricultural University People's Republic of China	Production of new biological resources through the application of biotechnological procedures
-------------	----------------------------------------------------------------	-----------------------------------------------------------------------------------------------

**Short-Term Tsukuba Fellows at NIAR from September 1997 to March 1998**

Tewary Prakash Kumar	Central Sericultural Research and Training Institute India	Methods for the analysis and control of biological functions
----------------------	------------------------------------------------------------------	--------------------------------------------------------------

Back to

the [Fellowship Programs menu](#).



***PUBLISHING AT JIRCAS during FISCAL YEAR 1997*****Official JIRCAS Publications****In English**

1) JIRCAS Journal for Scientific Papers	No. 5
2) JARQ (Japan Agricultural Research Quarterly)	Vol. 32 - No. 1 Vol. 31 - No. 2, No. 2, No. 3;
3) Annual Report	No. 3 (1996)
4) JIRCAS Newsletter	No. 11, No. 12, No. 13, No. 14
5) JIRCAS International Symposium Series	No. 5 Biosafety Results of Field Tests of Genetically Modified Plants and Microorganisms  No. 6 Sustainable Agricultural Development Compatible with Environmental Conservation in Asia
6) JIRCAS Working Report	No. 10 Status and Requirement of Minerals in Ruminants in Thailand: Current Knowledge and Future Research  No. 11 Comparative Studies on Phosphorous and Iron Nutrition of Tropical Legumes

## In Japanese

1) JIRCAS News	No. 11, No. 12, No. 13, No. 14
2) JIRCAS Working Report	No. 7 Agriculture and Soybean in South America: Present and Future No. 8 Changes in Food Supply and Demand in China under Economic Reform No. 9 Review and Comparison of Land-Surface Models for Evaluating Large Scale Evapo-Transpiration
3) JIRCAS International Agriculture Series	No. 4 Tropical Fruit Trees and Their Utilization
4) JIRCAS Research Highlights	No. 4

***OFFICIAL HOLDINGS of the JIRCAS LIBRARY****(Between April 1, 1997 – March 31, 1998)*

	BOOKS			PERIODICALS (titles)			MATERIALS (Proceedings, maps, etc.)		
	Purchase	Gift	Total	Purchase	Gift	Total	Purchase	Gift	Total
<i>Japanese</i>	44 (15)	260 (1)	304 (16)	43 (29)	450 (8)	493 (37)	5	450	455
<i>Foreign</i>	50 (2)	390 (0)	440 (2)	110 (28)	570 (11)	680 (39)	10	200	210



<i>Total</i>	94 (17)	650 (1)	744 (18)	153 (57)	1020 (19)	1173 (76)	15	650	665
--------------	------------	------------	-------------	-------------	--------------	--------------	----	-----	-----

( ) Indicates separate holdings of the Okinawa Subtropical Station.

Back to the Annual Report [Main Contents](#) page.

# *JIRCAS Staff during Fiscal Year 1997*

---

## Contents

- [Ⓢ Office of the Director General](#)
  - [Ⓢ Research Planning and Coordination Division](#)
  - [Ⓢ Administration Division](#)
  - [Ⓢ Research Information Division](#)
  - [Ⓢ Biological Resources Division](#)
  - [Ⓢ Environmental Resources Division](#)
  - [Ⓢ Crop Production and Postharvest Technology Division](#)
  - [Ⓢ Animal Production and Grasslands Division](#)
  - [Ⓢ Forestry Division](#)
  - [Ⓢ Fisheries Division](#)
  - [Ⓢ Okinawa Subtropical Station](#)
  - [Ⓢ Part-Time Employees](#)
- 

### **Ⓢ Office of the Director General Ⓢ**

**Director General:** Nobuyoshi Maeno

[return to top](#)

[back to main contents](#)

---

### **Ⓢ Research Planning and Coordination Division Ⓢ**

**Director:** Keiji Ohga

#### **Research Planning Section**

**Section Head:** Mitsunori Oka

Akinori Oshibe, Senior Researcher

Kensuke Okada, Senior Researcher

Marcy N. Wilder, Researcher

Eizo Tatsumi*, Researcher

#### **Research Coordination Section**

**Section Head:** Masahito Sato

Shoichi Kawasugi, Senior Researcher

#### **International Relations Section**

**Section Head:** Kenji Kataoka  
Tomohide Sugino, Senior Researcher  
Takeshi Urao*, Senior Researcher

**International Research Coordinator**

Masaaki Suzuki, Representative to Thailand

**Research Information Officer**

Tadahiro Hayashi, Information Engineering

**Publication and Documentation Section**

Chuichi Sato, Chief Librarian  
Kiriko Hashimoto, Librarian

[return to top](#)

[back to main contents](#)

---

**Ⓜ Administration Division Ⓜ**

**General Manager:** Akihiko Nishiyama

**General Affairs Section**

**Section Chief:** Toshio Umemoto  
Harumi Yakushiji, Assistant Section Chief  
(Hisashi Hashimoto*, Assistant Section Chief)  
Yoshihiro Saito, Section Manager  
Yukie Kuwahara, Section Officer  
Takeshi Kubo, Personnel Head  
Makoto Suzuki, Personnel Officer  
(Nobuo Shinotsuka*, Personnel Officer)  
Yoshiaki Takamatsu, Social Affairs Head

**Accounting Section**

**Section Chief:** Masami Sakamoto  
Teruki Kurihara, Assistant Section Chief  
Katsuhiro Inuzuka, Financial Manager  
Nobuo Shinotsuka, Financial Officer  
(Makoto Suzuki*, Financial Officer)  
Hiroyuki Okubo, Accounting Manager  
Junko Kondo, Accounting Officer  
Yoshiwo Tanaka, Auditing Head  
Tetsuo Yamada, Supplies/Equipment Manager  
Tomonori Ichinose, Supplies/Equipment Officer  
Mutsuo Sato, Transportation  
Koji Abe, Facilities Manager

### **Overseas Staff Support Section**

**Section Chief:** Yoshinori Tanaka

Fumikazu Kenmochi, Overseas Affairs Officer  
Hideko Shimada, Overseas Operations Overseer  
Hiroshi Tanaka, Overseas Expenditures Officer  
(Kazunori Eguchi*, Overseas Expenditures Officer)  
Joji Ikeda, Overseas Shipments Overseer  
Kazutoshi Tateyama, Officer Stationed Overseas

[return to top](#)

[back to main contents](#)

---

### **© Research Information Division ©**

**Director:** Kunio Tsubota

#### **International Research Coordinators**

Kozo Fujisaki*, Veterinary Pathology  
Hisataro Horiuchi, Farm Economics  
Makie Kokubun, Agronomy  
Sho Kosugi, Rural Socio-Economics  
Osamu Koyama, Agricultural Economics  
Shigeo Matsui, Agronomy  
Yoshihiko Nawa, Food Biochemistry  
Akinori Noguchi*, Food Engineering  
Hiroko Takagi-Watanabe, Plant Breeding

#### **Research Staff**

Junko Goto, Rural Development  
Hiroaki Kobayashi, Agricultural Economics  
Minoru Tada*, Agricultural Economics  
Yasuharu Yamada, Geographic Information System

[return to top](#)

[back to main contents](#)

---

### **© Biological Resources Division ©**

**Director:** Teruo Ishige

Tomohiro Ban, Wheat Breeding  
Takaharu Hayashi*, Plant Pathology  
Tokio Imbe, Rice Breeding  
Masanori Inagaki, Wheat Breeding  
Kazuo Ise, Rice Breeding

Koshun Ishiki*, Plant Genetic Resources  
Mie Kasuga, Biochemistry  
Hiroshi Kato, Rice Breeding  
Hiroshi Nakano, Plant Nutrition  
Masaaki Nakano, Plant Pathology  
Kazuo Nakashima, Plant Molecular Biology  
Kazuhiro Suenaga, Wheat Breeding  
Takeshi Urao, Plant Molecular Biology  
Iwao Watanabe*, Crop Physiology  
Kazuko Yamaguchi-Shinozaki, Plant Molecular Biology

[return to top](#)

[back to main contents](#)

---

## © Environmental Resources Division ©

**Director:** Tadao Hamazaki,  
(**Director:** Katsuyuki Minami*)  
Shotaro Ando, Soil Microbiology  
Tamao Hatta, Geology  
Yasukazu Hosen, Soil Physics and Chemistry  
Masayuki Imaizumi*, Water Management  
Takayuki Ishikawa, Plant Physiology  
Osamu Ito, Plant Physiology  
Ken-ichi Kanda, Soil Fertility  
Motohiko Kondo, Soil Fertility  
Naruo Matsumoto, Environmental Conservation  
Hiroyuki Ohno, Meteorology  
Satoshi Tobita, Plant Nutrition and Physiology  
Satoshi Uchida, Remote Sensing and GIS  
Kazuyuki Yagi, Bio-geochemistry  
Yukiyo Yamamoto, GIS and Remote Sensing  
Takeshi Watanabe, Soil Chemistry

[return to top](#)

[back to main contents](#)

---

## © Crop Production and Postharvest Technology Division ©

**Director:** Akinori Noguchi  
(**Director:** Koji Kawashima*)  
Hiroyuki Hiraoka, Agronomy  
Naoki Horikawa, Water Management  
Kazunori Igita, Soybean Breeding  
Nobuyuki Kabaki, Agronomy

Yuji Kogo, Soil Mechanics  
Tadao Kon*, Agronomy  
Seiichi Moriya, Insect Physiology  
Kazuhiko Nakahara, Food Chemistry  
Satoshi Nakamura, Insect Ecology  
Souichi Nakayama, Weed Ecology  
Sayuki Nikkuni, Fermentation  
Takahito Noda, Plant Pathology  
Yoshiyuki Shinogi, Soil Physics  
Kazushige Sogawa, Insect Ecology  
Eizo Tatsumi, Food Science  
Akihiko Takahashi*, Insect Ecology  
Shigemi Yagi, Insect Physiology  
Ryuichi Yamada, Agricultural Economics  
Emiko Yamamoto, Nematology  
Ryoichi Yamazaki*, Agricultural Economics  
Tadashi Yoshihashi, Food Evaluation

**Field Management Section**

Haruo Tamura, Chief  
Takashi Komatsu, Field Operator  
Akio Yoshida, Machine Operator

[return to top](#)

[back to main contents](#)

---

**© Animal Production and Grasslands Division ©**

**Director:** Eitaro Imaizumi  
Yasuo Ando, Plant Pathology  
Tutomu Kanno, Pasture Ecology  
Tomoyuki Kawashima, Animal Feeding  
Hiroshi Kitani, Cell Biology  
Kiyomi Kosaka, Animal Nutrition  
Yutaka Matsubara*, Animal Immunology  
Kenji Sato, Grassland Management  
Shinobu Yoshihara*, Animal Parasitology

[return to top](#)

[back to main contents](#)

---

## © Forestry Division ©

**Director:** Kiyoshi Tanaka  
Tasturo Kawasaki, Silviculture  
Kazuma Matsumoto, Entomology  
Motoe Miyamoto, Social Forestry  
Yukihito Ochiai, Silviculture  
Shiro Okuda, Silviculture  
Shozo Sasaki, Forest Engineering  
Ryohei Tanaka, Cellulose Chemistry  
Koichi Yamamoto, Wood Science  
Akihiko Yokota, Mycology

[return to top](#)

[back to main contents](#)

---

## © Fisheries Division ©

**Director:** Shiroh Uno  
Yutaka Fukuda, Food Chemistry  
Shigeo Hayase, Coastal Ecology  
Junya Higano, Coastal Ecology  
Norihisa Oseko, Fish Pathology  
Satoshi Suyama, Fish Biology  
Marcy N. Wilder, Crustacean Endocrinology

[return to top](#)

[back to main contents](#)

---

## © Okinawa Subtropical Station ©

**Director:** Shigeo Yashima  
(**Director:** Tadaaki Yamashita*)  
Associate Director: Masaharu Yajima

### General Affairs Section

Section Chief: Tetsuro Kayano  
Kazuomi Asanuma, Section Manager  
Yuichiro Ito, Section Officer  
Makoto Yamazaki, Transportation  
Kaori Fujimoto, Accounting Head  
Hisashi Harima, Accounting Officer  
Fumihiko Hisada*, Accounting Officer  
Hideki Yoneyama, Accounting Officer  
(Satoshi Kawamitsu*, Accounting Officer)

### **International Collaborative Research Section**

Head: Takaharu Hayashi, Plant Virology  
Katsuki Adachi, Soil Microbiology  
Koshun Ishiki, Plant Breeding and Genetic Resources  
Mariko Shono, Plant Morphology  
Hiroko Takagi-Watanabe*, Plant Breeding and Genetic Resources  
Satoshi Tobita*, Plant Nutrition and Physiology  
Seiji Yanagihara, Plant Breeding

### **Crop Introduction and Cultivation Laboratory**

Head: Yoshinobu Egawa, Plant Genetic Resources  
Katsumi Suzuki, Plant Morphology  
Hiroyuki Takeda, Plant Physiology

### **Crop Breeding Laboratory**

Head: Masahiro Okamoto, Rice Breeding  
Shunsuke Oda, Wheat Breeding  
Takayoshi Terauchi, Crop Breeding

### **Tropical Fruit Tree Laboratory**

Head: Tetsushi Hidaka, Photosynthesis  
Hiroshi Fukamachi, Pomology  
Sadao Komori, Fruit Tree Breeding

### **Crop Protection Laboratory**

Head: Chiyoichi Noda, Plant Virology  
Katsuyuki Kono, Entomology  
Tetsuo Maoka, Plant Virology  
Keiichi Takahashi, Entomology  
Tomio Usugi, Plant Virology (Dispatched Researcher)

### **Soil Fertility Laboratory**

Head: Kazuo Sugahara, Soil Science  
Yosinari Ohwaki, Soil Science

### **Field Management Section**

Head: Yoshimitsu Katsuda, Crop Breeding  
Masakazu Hirata, Machine Operator  
Hirokazu Ikema, Machine Operator  
Eiichi Kuroshima, Machine Operator  
Seisho Maetsu, Machine Operator  
Yuho Maetsu, Machine Operator  
Yasuteru Shikina, Machine Operator  
Masato Shimajiri, Machine Operator  
Koji Yamato, Machine Operator



[return to top](#)

[back to main contents](#)

---

## Ⓢ **Part-Time Employees** Ⓢ

Nearly 90 persons are working at JIRCAS as non-permanent staff. They serve as editorial advisors for many of JIRCAS's publications, perform much of the institute's secretarial work, function as laboratory technicians, and maintain the buildings and laboratories. Their services to JIRCAS are highly valued.

[return to top](#)

[back to main contents](#)

---

* Indicates transfer within JIRCAS, relocation, or retirement during the Fiscal Year covered by this Annual Report.

() Indicates a previous position holder.



# RESEARCH STAFF ACTIVITY during FISCAL YEAR 1997

## Contents

- [@Journal Articles, Book Chapters, and Monographs](#)
- [@Published Proceedings and Conference Presentations](#)
- [@Explanation of Symbols Used in Citations](#)

## @Journal Articles, Book Chapters, and Monographs

- Abe, H., Yamaguchi-Shinozaki, K., Urao, T., Iwasaki, T., Hosokawa, D. and Shinozaki, K. (1997). Role of *Arabidopsis* MYC and MYB homologs in drought- and abscisic acid-regulated gene expression. *Plant Cell*, 9: 1859-1868.
- Adachi, K., Chaitep, W. and Senboku, T. (1997). Promotive and inhibitory effects of rice straw and cellulose application on rice plant growth in pot and field experiments. *Soil Science and Plant Nutrition*, 43(2): 369-386.
- Akiyama, H., Tsuruta, H. and Hosen, Y. (1998). NO and N₂O emission from nitrogen fertilized soil (2): Flux from soil applied by coated Ca(NO₃)₂, Ca(NO₃)₂, and coated urea. *Research Report of Division of Environmental Planning, National Institute of Agro-Environmental Sciences*, 14: 39-45. (J)
- Ban, T. (1997). Evaluation of resistance to *Fusarium* head blight in indigenous Japanese species of *Agropyron* (*Elymus*). *Euphytica*, 97(1): 39-44 .
- Cai, Z., Xing, G., Yan, X., Xu, H., Tsuruta, H., Yagi, K. and Minami, K. (1997). Methane and nitrous oxide emissions from rice paddy fields as affected by nitrogen fertilizers and water management. *Plant and Soil*, 196: 7-14.
- Chien, H. (1997). Food and agricultural prospects in china. *Farming Japan*, 31(3): 28-36.
- Chien, H. (1997). Meat trade and pork production in Sichuan Province, China. *In: Production and Marketing of Pork in China, Agriculture and Livestock Industries Corporation*: 23-43. (J)
- Chien, H. (1997). Rice supply and demand in China: Trends and perspectives. *Journal of Rural Issues*, 45: 40-50. (J)
- Chien, H., Irie, N. and Nakagawa, M. (1998). Changes in food supply and demand in China under economic reform. *JIRCAS Working Report*, 8: 1-28, 51-61. (J)
- Cole, C. V., Duxbary, J., Freney, J., Heynemeyer, O., Minami, K., Mosier, A. and Rosenberg, N. (1997). Global estimates of potential mitigation of green house gases. *Nutrient Cycling in Agroecosystems*, 49: 221-228.
- Dianou, D., Espiritu, B.M., Adachi, K. and Senboku, T. (1997). Isolation and some properties of methane-oxidizing bacteria from a subtropical paddy field. *Soil Science and Plant Nutrition*, 43(3): 735-740.
- Egawa, Y., Bujang, I.B., Chotechuen, S. and Tomooka, N. (1997). Origin of a tetraploid Asian *Vigna* species, *V. glabrescens*. *GRP Newsletter*: 29.
- Espiritu, B.M., Adachi, K. and Senboku, T. (1997). Effect of application of rice straw and cellulose on methane emission and biological nitrogen fixation. (III): Populations of methane-oxidizing bacteria in soil and rice rhizospheres. *Soil Science and Plant Nutrition*, 43(3): 729-734.
- Fukamachi, H., Komori, S. and Hidaka, T. (1997). Photosynthesis in mango. *Okinawa Agricultural Research*, 36: 32-33. (J)
- Goto, J. (1996). Agriculture and the environment in Australian LANDCARE. *National Research Institute of Agricultural*

Economics, 29: 127-137. (J)

- **Goto, J.** (1997). Integrated farming systems development in the Mekong Delta, Vietnam. Informative Bulletin of the Association for International Cooperation of Agriculture & Forestry, 19(6): 23-31. (J)
- **Goto, J.** (1997). Rural development in the developing world: A review of the postwar history of Japanese official development aid. Journal of the Rural Planning Association, 16(1): 40-48. (J)
- Goto, N., Kato, H., Maeyama, J., Shibano, M., Saito, T., Yamaguchi, J. and **Yoshihara, S.** (1997). Local tissue-irritating effects and adjuvant activities of calcium phosphate and aluminum hydroxide with different physical properties. Vaccine, 15(12-13): 1364-1371.
- Hanano, Y., Fujii, Y., **Sato, K.**, Osozawa, S. and Fujihara, S. (1998). Weed control using hairy vetch (*Vicia villosa* LOTH.) in the Shikoku area: Vegetation tests and field survey from 1993 to 1997. Bulletin of the Shikoku National Agricultural Experiment Station, 62: 45-70. (J)
- **Hatta, T.** (1997). Surface analysis techniques of minerals using XPS (ESCA). Journal of the Mineralogy Society Japan, 26(4): 198-202. (J)
- **Hatta, T.** (1997). Surface analysis. Journal of the Japanese Society of Food Science and Technology, 44(7): 533-534. (J)
- **Hatta, T.** (1997). The World of Clay (Clay Science Society of Japan), KDD Publishing, Tokyo: 118-122. (J)
- **Hatta, T.** and Kainuma, K. (1997). Surface analysis of saccharides by high resolution XPS. Isotope News, 1997(7): 6-7. (J)
- **Hiraoka, H.** (1998). Compromised direct seeding culture of rice in the northern islands of Japan. Ine-no-Shoryokuka Gijutsu-Japan Agricultural Development and Extension Association: 201-209. (J)
- **Hosen, Y.**, Tsuruta, H. and **Minami, K.** (1998). Effects of the depth of NO and N₂O production in soil on their emission rates into the atmosphere: Verification of the effects of deep fertilizer application by laboratory experiments. Research Report of the Division of Environmental Planning, National Institute of Agro-Environmental Sciences, 14: 79-88. (J)
- Imagawa, T., Fukuhara, M. and **Watanabe, T.** (1997). A monitoring method of land cover/land use change in Naiman, Inner Mongolia Autonomous Region, China, using Landsat data. Japan Agricultural Research Quarterly, 31: 163-169.
- **Imbe, T.**, Oba, S., Yanoria, M. J. and Tsunematsu, H. (1997). A new gene for blast resistance in rice cultivar, IR24. Rice Genetics Newsletter, 14: 60-61.
- Imura, M., Kosaka, T., **Sato, K.**, Noda, H. and Kawano, M. (1998). Stable performance of grazing steers and conditions to sustain good vegetation on Zoysia type grassland in the Shikoku District. In: Research on Grassland Dynamics (Fifth Interim Report). Miscellaneous Publications of the National Grassland Research Institute: 9-12. (J)
- **Inagaki, M. N.**, Nagamine, T. and Mujeeb-Kazi, A. (1997). Use of pollen storage and detached-tiller culture in wheat polyploid production through wide crosses. Cereal Research Communications, 25(1): 7-13.
- **Inagaki, M. N.**, Pfeiffer, W. H., Mergoum, M. and Mujeeb-Kazi, A. (1997). Effects of D-genome chromosomes on crossability of hexaploid triticale (*X Triticosecale* Wittmack) with maize. Plant Breeding, 116(3): 387-390.
- **Ishiki, K.** and Salgado, V. (1997). Root and tuber crops of the Incas (7): Information for the Promotion of Root and Tuber Crops, 50: 15-21. (J)
- Isobe, T., Shimizu, S., **Yoshihara, S.** and Suzuki, K. (1998). Immunoblot analysis of humoral immune responses to *Leucocytozoon caulleryi* in chickens. Journal of Parasitology, 84(1): 62-66.
- Itahashi, S., Tsuruta, H., Akiyama, H., **Hosen, Y.** and Eguchi, S. (1998). N₂O emission from nitrogen fertilized soil (3): Vertical distributions of gas concentrations in soils applied with calcium nitrate, coated calcium nitrate, or coated urea. Research Report of the Division of Environmental Planning, National Institute of Agro-Environmental Sciences, 14: 47-76. (J)
- **Ito, O.**, Matsunaga, R., **Tobita, S.**, Rao, T. P., Gayatri, D. and Lee, K. K. (1997). Minirhizotron observation of pigeonpea

root system after water logging. Japanese Journal of Crop Science, 66(2): 288-292.

- Ito, Y., **Komori, S.**, Omura, M., Kanayama, Y., Yamaki, S. and Soejima, J. (1997). Tissue culture system for apple transformation and its usage. Cloning of Quality-Related Genes and Production of Transgenic Plants for Fruit Breeding: 116-135. (J)
- **Kanda, K.** (1997). Manual of environmental agricultural technology (5): Sweet potato. Agriculture, 1362: 89-93. (J)
- **Kanda, K.**, Kimiwada, K., Niimi, H., Suga, Y. and Ito, S. (1997). Estimation methods for the amount of nitrogen leached from upland. Kyushu Agriculture Research, 59: 57. (J)
- Kanno, T., Miura, Y., Tsuruta, H. and **Minami, K.** (1997). Methane emission from rice paddy fields in all Japanese prefectures. Nutrient Cycling in Agroecosystems, 49: 147-151.
- **Kato, H.** (1997). Development of hybrid rice in Malaysia. JIRCAS/MARDI/MADA Collaborative Study Final Report (1994 – 1997).
- **Kawashima, T.**, Henry, P. R., Ammerman, C. B., Littell, R. C. and Price, J. (1997). Bioavailability of cobalt sources for ruminants (2): Estimation of the relative value of reagent grade and feed grade cobalt sources from tissue cobalt accumulation and vitamin B12 concentrations. Nutrition Research, 17(6): 957-974.
- **Kawashima, T.**, Henry, P. R., Bates, D. G., Ammerman, C. B., Littell, R. C. and Price, J. (1997). Bioavailability of cobalt sources for ruminants (3): *In vitro* ruminal production of vitamin B12 and total corrinoids in response to different cobalt sources and concentrations. Nutrition Research, 17(6): 975-987.
- **Kawashima, T.**, Pholpark, S., Sumamal, W., Boonpakdee, W. and Srihakim, S. (1998). Mineral status of dairy cattle and available mineral sources in Northeast Thailand. JIRCAS Working Report, 10: 63-73.
- Ketama, J., Panichphon, V. and **Kawashima, T.** (1998). Mineral contents in feed resources in Thailand. JIRCAS Working Report, 10: 91-98.
- Kiyosue, T., Abe, H., **Yamaguchi-Shinozaki, K.** and Shinozaki, K. (1998). ERD6, a cDNA clone for an early dehydration-induced gene of *Arabidopsis*, encodes a putative sugar transporter. Biochimica Biophysica Acta, 1370: 187-191.
- **Kobayashi, H.** (1997). Recent trends in the world food market: Reading agricultural white papers. Agricultural Economy: 94-99. (J)
- Kobayashi, M., **Terauchi, T.**, Nakano, H. and **Egawa, Y.** (1998). Utilization of turfgrass as cover crop between pineapple rows for soil conservation on Ishigaki Island. Journal Japanese Society of Turfgrass Science, 26: 157-169. (J)
- **Kohgo, Y.** and Tamrakar, S. B. (1997). Photographic feature: Specially designed triaxial apparatus for measuring the shear behavior of unsaturated soils with influence of suction. Geotechnical Engineering, Journal of the Southeast Asian Geotechnical Society, 28(1):
- **Kohgo, Y.** (1997). Method of analysis of saturation collapse behavior. JIRCAS Journal, 4: 1-28.
- **Kohgo, Y.** and Moriyama, H. (1997). Interpretations of the mechanical behavior of unsaturated soils under triaxial stress conditions based on an elastoplastic model. Transactions of the Japanese Society of Irrigation, Drainage and Reclamation Engineering, 192: 47-57. (J)
- **Kohgo, Y.** and Moriyama, H. (1998). Volume change and shear behavior of unsaturated silt and sand/clay mixed soil under triaxial stress conditions. Transactions of the Japanese Society of Irrigation, Drainage and Reclamation Engineering, 193: 35-49. (J)
- **Kohgo, Y.** 1997. Mechanical properties of soils. *In: Soils in environmental regions*, Eds. Iwata, S. and Kita, D., Fuji Technosystem: 119-157. (J)
- **Kokubun, M.** (1997). No-tillage soybean cultivation in the Yguazu district of Paraguay. Agriculture and Horticulture, 72(3): 379-382. (J)
- **Kokubun, M.** (1997). Soybean production in the world and future of its breeding and cultivation technology. Farming Japan, 31(4): 21-26.

- **Kokubun, M. and Fujisaki, K.** (Eds.) (1997). Agriculture and soybeans in South America. JIRCAS Working Report, No. 7. (J), 69 pp.
- **Komori, S.,** Soejima, J., Tsuchiya, S., Masuda, T., Bessho, H. and Ito, Y. (1997). Two types of infertility found in artificial apple hybrids. *Journal of the Japanese Society for Horticultural Science*, 66(2): 289-295. (J)
- Konishi, T., **Ban, T.,** Iida, Y. and Yoshimi, R. (1997). Genetic analysis of disease resistance to all strains of BaYMV in a Chinese barley landrace, Mokusekko 3. *Theoretical Applied Genetics*, 94: 871-877.
- Konohira, E., Yoh, H., Toda, H., **Yagi, K.,** Tsubota, J. and Tsukamoto, R. (1997). Denitrification in valley soil of a forested catchment: Analysis based on the natural abundance of ¹⁵N nitrates. *Journal of the Japanese Forest Society* 79: 883-884. (J)
- Konohira, E., Yoh, M., Toda, H., **Yagi, K.** and Tsubota, R. (1997). Variation in the natural abundance of ¹⁵N in NO₃-N substances in streamwater during a rainfall event. *Journal of the Japanese Society of Hydrology and Water Resources*, 10: 360-366. (J)
- **Koyama, O.** (1997). Projections of world food supply and demand for 2020. *Farming Japan*, 31(3): 19-27.
- Lee, K. K., Wani, S. P., Sahrawat, K. L., Trimurtulu, N. and **Ito, O.** (1997). Nitrogen and/or phosphorus fertilization effects on organic carbon and mineral contents in the rhizosphere of field grown sorghum. *Soil Science Plant Nutrition* 43(1): 117-126.
- Li, C., Yang, Q., Zhen, F., Lou, C. and **Ise, K.** (1997). Cross-fertility and pathogenicity of the blast fungus *Magnaporthe grisea* Sac. isolated from cultivated and wild rice in Yunnan. *International Rice Research Notes (IRRN)*, 22(3): 14-15.
- Li, C. and **Ise, K.** (1997). A brief review on rice pest control and varietal resistance in Yunnan Province of China. *Agriculture and Horticulture*, 72(10): 1054-1060. (J)
- **Matsui, S.** (1998). International cooperative research by JIRCAS: Development of farming systems in the Mekong Delta. *Science & Techno-news*, Tsukuba, 45: 26-27. (J)
- **Matsui, S.** (1997). Drought- and salinity-tolerance of crops for the sustainable development of world agriculture. *Research Journal of Food and Agriculture*, 20(12): 6-9. (J)
- **Matsui, S.,** Miyazaki, S., Kasamo, K., (Eds.), (1997). The 4th International Symposium on the Biosafety Results of Field Tests of Genetically Modified Plants and Microorganisms. JIRCAS International Symposium Series No.. (J)
- **Matsumoto, N.** (1997). Evaluation of nitrogen flows in rural areas. *Japanese Journal of Soil Science and Plant Nutrition*, 68(3): 247-248. (J)
- **Matsumoto, N.** (1998). Nutrient cycles in agro-ecosystems. *In: Environmental Conservation and Agriculture and Forestry*, Ed. Minami, K.: 157-167. (J)
- **Matsumoto, K.,** Kusdi, M. and Ragil, S. B. I. (1997). A promising method to protect mahogany plantations from attack by the shoot borer, *Hypsipyla robusta* Moore (Lepidoptera: Pyralidae). *JIRCAS Journal*, 5: 23-29.
- Mikami, K., Ichimura, K., Iuchi, S., **Yamaguchi-Shinozaki, K.** and Shinozaki, K. (1997). Molecular characterization of cDNA encoding a novel small GTP-binding protein from *Arabidopsis thaliana*. *Biochemica Biophysica Acta*, 1354: 99-104.
- **Minami, K.** (1997). Atmospheric methane and nitrous oxide. *Nutrient Cycling in Agro-ecosystems*, 49: 203-211.
- **Minami, K.** and Takata, K. (1997). Atmospheric methanes: Sources, sinks, and strategy for reducing agricultural emissions. *Water Science Technology*, 36: 509-516.
- **Miyamoto, M.** (1997). Land tenure situation of settlers at logged forest sites near home villages and decision factors of cultivation site: A case study in East Kalimantan, Indonesia. *Transactions of the Japanese Forestry Society*, 108: 85-88. (J)
- **Miyamoto, M.,** Ryuko, H. and Tsuzuki, N. (1997). Diversified management and local employment. *Free Fresh Future*, 1: 38-46. (J)

- Miyatake, T., **Moriya, S.**, Kohama, T. and Shimoji, Y. (1997). Dispersal potential of male *Cylas formicarius* (Coleoptera: Brentidae) over land and water. *Environmental Entomology*, 26(2): 272-276.
- Moriguchi, T., Motomura, T., **Hidaka, T.**, Akihama, Y. and Oomura, T. (1997). Analysis of mitochondrial genomes among citrus plants produced by interspecific somatic fusion of 'Seminole' tangelo with rough lemon. *Plant Cell Reports*, 16: 397-400.
- **Moriya, S.** (1997). Measurement of locomotion and flight abilities of the West Indian sweet potato weevil and the sweet potato weevil. *Kongetsu-no-Nogyo*, 41(9): 60-65. (J)
- **Nakamura, S.** (1996). Inbreeding and rotational breeding of the parasitoid fly, *Exorista japonica* (Diptera: Tachinidae), for successive rearing. *Applied Entomology and Zoology*, 31(3): 433-441.
- **Nakamura, S.** (1997). Clutch size regulation and host discrimination of the parasitoid fly, *Exorista japonica* (Diptera: Tachinidae). *Applied Entomology and Zoology*, 32(2): 283-291.
- **Nakamura, S.** (1997). Ovipositional behaviour of the parasitoid fly, *Exorista japonica* (Diptera: Tachinidae), in the laboratory: Diel periodicity and egg distribution in a host. *Applied Entomology and Zoology*, 32(1): 189-195.
- **Nakamura, S.** (1997). Parasitoid flies as biological control agents. *Phytoparasitica*, 25(4): 354-355.
- **Nakano, H.**, Momonoki, T., Miyashige, T., Otsuka, H., Hanada, T., Sugimoto, A., Nakagawa, H., Matsuoka, M., **Terauchi, T.**, Kobayashi, M., Oshiro, M., Yasuda, K., Vanichwattanarumruk, N., Chotechuen, S. and Boonmalison, D. (1997). "Haibushi", a new variety of snap bean tolerant to heat stress. *JIRCAS Journal*, 5: 1-12.
- **Nakashima, K.**, Kiyosue, T., **Yamaguchi-Shinozaki, K.** and Shinozaki, K. (1997). A nuclear gene, *erd1*, encoding a chloroplast-targeted Clp protease regulatory subunit homolog is not only induced by water stress but also developmentally upregulated during senescence in *Arabidopsis thaliana*. *Plant Journal*, 12: 851-861.
- **Nakashima, K.** and **Yamaguchi-Shinozaki, K.** (1997). Molecular breeding of drought tolerant plants. *Research Journal of Food and Agriculture*, 21(3): 52-55. (J)
- **Nikkuni, S.** (1997). Swelling of packaged miso by a hetero-fermentative lactic acid bacteria, *Lactobacillus fructivorans* L-1. *Journal of the Brewing Society of Japan*. 92(10): 713-718. (J)
- **Nikkuni, S.** (1997). Natto, kinema and thua-nao: Traditional non-salted fermented soybean foods in Asia. *Farming Japan*, 31(4): 27-36.
- **Ochiai, Y.** (1996). Kapur. *Silvicultural Characteristics of Tropical Tree Species*. 1 : 157-160. (J)
- **Ochiai, Y.** (1996). Seraya. *Silvicultural Characteristics of Tropical Tree Species*, : 174-179. (J)
- **Ochiai, Y.** and **Sasaki, S.** (1996). Upun. *Silvicultural Characteristics of Tropical Tree Species*, 1: 180-183. (J)
- **Oda, S.** and Schofield, J. D. (1997). Characterisation of friabilin polypeptides. *Journal of Cereal Science*, 26: 29-36.
- **Ohno, H.** (1998). Heat budget in a snow pack. *In: Snow and Ice Science in Hydrology, International Hydrological Program (IHP) Training Course on Snow Hydrology* Eds. Nakawo, M. and Hayakawa, N., INP: 69-88.
- **Ohno, H.** (1998). Heat exchange over a snow surface. *In: Observations on Snow Hydrology, Supplement to the International Hydrological Program (IHP) Training Course on Snow Hydrology*, Eds. Nakao, M. and Hayakawa, N., INP: 7-19.
- **Ohno, H.**, Yokoyama, K., Kominami, Y., Inoue, S., Takami, S. and Wiesinger, T. (1998). Catch ratios of gauges for solid precipitation in the Hokuriku region. *Journal of the Japanese Society Snow and Ice*, 60(3): 226-231. (J)
- **Ohwaki, Y.** and **Sugahara, K.** (1997). Active extrusion of protons and exudation of carboxylic acids in response to iron deficiency by root of chickpea (*Cicer arietinum*). *Plant and Soil*, 189: 49-55.
- **Ohwaki, Y.**, Kraokaw, S., Chotechuen, S., **Egawa, Y.** and **Sugahara, K.** (1997). Differences in response to iron deficiency among various cultivars of mungbean (*Vigna radiata* (L.) Wilczek). *Plant and Soil*, 192: 107-114.

- **Ohwaki, Y., Sugahara, K., Suzuki, K.,** Moriyama, H., Fukuhara, T. and Nitta, T. (1997). Iron stress response in chickpea (*Cicer arietinum*): Morphological changes and levels of H-ATPase mRNA in root tips. *In: Plant Nutrition for Sustainable Food Production and Environment*, Eds. Ando, T., Fujita, K., Mae, T., Matsumoto, H., Mori, S. and Sekiya, J., Kulwer Academic Publishers: 261-262.
- **Oka, M.** (1997). Current situation of agriculture and constraints on its research development in Central Asia. *Journal of Agricultural Science*, 52(9): 414-419. (J)
- **Oka, M.** (1997). Recent international collaboration in tropical agricultural research. *Japanese Journal of Tropical Agriculture*, 41(2): 123-127. (J)
- **Oka, M.** (1998). Agricultural characteristics and subjects for development. *Kyrgyzstan ga hoshi kelinyzder 1997*: 23-31. (J)
- **Oshibe, A.** (1997). Control of somatotropin secretion of ruminant animals by administration of nutrients through the digestive tract. Doctoral dissertation, Tohoku University. (J)
- **Oshibe, A.,** Ando, S., Yamada, A. and Hodate, K. (1997). Responses of growth hormone and insulin to intraduodenal infusion of six amino acids in calves. *Journal of Animal Physiology and Animal Nutrition*, 76: 151-159.
- Rao, T. P., **Ito, O.,** Matsunaga, R. and Yoneyama, T. (1997). Kinetics of ¹⁵N-labelled nitrate uptake by maize (*Zea mays* L.) root segments. *Soil Science Plant Nutrition*, 43(3): 491-498.
- Sakuma, H. and **Suzuki, K.** (1997). Development of energy-saving hydroponics systems without requiring electricity. *JIRCAS Journal*, 4: 73-77.
- **Sasaki, S.** (1998). Situation of Malaysian Forestry. *Agricultural Machine News*: 2. (J)
- **Sato, K.** (1997). Over-seeding method for grass in early winter on grasslands located in warm temperate and low altitude areas. *Bokuso-to-Engei*, 45(10):5-7. (J)
- Shimitsu, K., Chien, H. and Kanata, K. (1998). Present situation and prospectives of the feed industry in China. *Agriculture and Livestock Industries Corporation*: 1-81. (J)
- **Shinogi, Y.,** Nakano, Y., and Kuroda, M. (1998). Simulation and evaluation of irrigation water planning affected by factors concerning growing stage and meteorological conditions. *Transactions of the Japan Society of Irrigation, Drainage and Reclamation Engineering*, 193: 9-16. (J)
- Shinozaki, K. and **Yamaguchi-Shinozaki, K.** (1998). Molecular responses to drought stress. *In: Stress Responses of Photosynthetic Organisms.*, Eds. Satoh, K. and Murata, N., Elsevier Science: 149-163.
- Shinozaki, K., **Yamaguchi-Shinozaki, K.,** Mizoguchi, T., **Urao, T.,** Katagiri, T., Hirayama, T., Ichimura, K., Abe, H. and Mikami, K. (1998). Role of MAP kinase, two component histidine kinase and calcium-dependent protein kinase in water stress response. *In: Protein Phosphorylation in Plants*, Eds. Gadal, P., Kreis, M., Dron, M., Brulfert, J., Bergounioux, C. and Vidal, J., Universite de Paris-Sud Press: 155-161.
- Shinozaki, K. and **Yamaguchi-Shinozaki, K.** (1997). Gene expression and signal transduction in water stress response. *Plant Physiology*, 115: 327-334.
- **Suenaga, K.,** Morshedi, A. R. and Darvey, N. L. (1997). Haploid production of Australian wheat (*Triticum aestivum* L.) cultivars through wheat x maize (*Zea mays* L.) crosses. *Australia Journal of Agricultural Research*, 48: 1207-1211.
- **Sugahara, K.** (1997). Sewage sludge and animal wastes. *Tsuchi-no-KankyoKen*, Fuji Technosystems: 519-527. (J)
- **Sugahara, K.** (1997). Soil Respiration. *Dojyo Kankyo Bunseki-hou*, Hakuyusha: 123-129. (J)
- **Suzuki, M.** (1997). Present agriculture in Thailand. *Hiryo (Fertilizer, a quarterly publication)*, 77: 76-81. (J)
- **Suzuki, K.** (1997). New introduced crop, Sayadaikon. *Shisetu-Engei*, 1997 July: 36-40. (J)
- Tanaka, K., **Sugahara, K., Ohwaki, Y.** and Poh-Sze, C. (1998). C, N, P composition of suspended matter in Matang Mangrove Estuary, Malaysia. *Japan Agricultural Research Quarterly*, 32(2): 153-158.

- Tanaka, N., **Hamazaki, K.**, and Vacharangkura, T. (1998). Distribution, growth and site requirements of teak. *Japan Agricultural Research Quarterly*, 32(1): 65-77.
- **Tobita, S., Shono, M.** (1997). Salinity tolerance in rice plants as focused on its physiological and genetic mechanisms and breeding strategies. *Research Journal of Food and Agriculture*, 20(12): 29-34. (J)
- Tomooka, N., Chotechuen, S., Boonkerd, N., Taengsan, B., Nupplean, S., Vaughan, D.A., **Egawa, Y.**, Yokoyama, T. and Tateishi, Y. (1997). Collection of seed and nodule samples from wild subgenus *Ceratotropis species* (genus *Vigna*) in central and northern Thailand. *Annual Report of Plant Genetic Resources Exploration*, 13: 189-207. (J)
- Tsuruta, H., **Kanda, K.** and Hirose, T. (1997). Nitrous oxide emission from a rice paddy field in Japan. *Nutrient Cycling in Agroecosystems*, 49: 51-58.
- **Watanabe, T.**, Osada, T., Yoh, M. and Tsuruta, H. (1997). N₂O and NO emissions from grassland soils after the application of cattle and swine excreta. *Nutrient Cycling in Agroecosystems*, 49: 35-39.
- Winslow, M. D., **Okada, K.** and Correa-Victoria, F. (1997). Silicon deficiency and the adaptation of tropical rice ecotypes. *Plant and Soil*, 188: 239-248.
- Xiao, H., **Maoka, T.** and Luo, X. (1997). Investigation and identification of papaya ringspot virus and papaya leaf-distortion mosaic virus in South China. *Journal of the South China Agricultural University*, 18(4): 52-53. (C)
- **Yagi, K., Minami, K.** and Ogawa, Y. (1998). Effect of water percolation on methane emission from rice paddies: A lysimeter experiment. *Plant and Soil*, 198: 193-200.
- **Yagi, K.**, Tsuruta, H. and **Minami, K.** (1997). Possible options for mitigating methane emission from rice cultivation. *Nutrient Cycling in Agroecosystems*, 49: 213-220.
- **Yajima, M.** (1997). Potential productivity of rice plant estimated by crop model. *Nogyo-oyobi-Engei*, 72(5): 549-554. (J)
- **Yamada, R.** (199 ). A study of labour employment in irrigated rice-growing areas in Tanzania. *Nogyo Keiei Kenkyu* 35(3): 11-23. (J)
- **Yamada, Y.**, Panpruik, P., Piyasiranada, T. and Ingkapradit, W. (1997). Changes in agricultural production and the agro-environment in Thailand using GIS. *Journal of the Japan Society of Photogrammetry and Remote Sensing*, 1997. (J)
- **Yamada, R.** (1997). Classification of hilly and mountainous areas in Shikoku. *Journal of Agricultural Sciences*, 52(7): 16-20. (J)
- **Yamaguchi-Shinozaki, K.** (1997). Drought-stress tolerance and regulation of gene expression. *Research Journal of Food and Agriculture*, 20(12): 10-15. (J)
- **Yamamoto, Y.** (1998). Amenity of grassland and pasture. *Environmental Conservation and Agriculture*: 149-154. (J)
- **Yamamoto, Y.** (1998). Study of grassland evaluation and planning methods with geographic information systems. *Bulletin of the National Grassland Research Institute*, 56: 37-87. (J)
- Yang, H., Chang, Q., Du, M., **Minami, K.** and **Hatta, T.** (1998). Quantitative model of soil erosion rates using ¹³⁷C's for uncultivated soil. *Soil Science*, 163(3): 248-257.
- Yoh, M., Toda, H., **Kanda, K.** and Tsuruta, H. (1997). Diffusion analysis of N₂O cycling in fertilized soil. *Nutrient Cycling in Agroecosystems*, 49: 29-33.
- Yokoyama, T. and **Ando, S.** (1997). Genetic variation within soybean *bradyrhizobia*. *Soil Microorganisms*, 50: 31-44. (J)
- Yoneyama, T., Fujihara, S. and **Yagi, K.** (1998). Natural abundance of ¹⁵N in amino acids and polyamines from leguminous nodules unique ¹⁵N enrichment in homospermidine. *Journal of Experimental Botany*, 49: 521-526.
- Yoshiba, Y., Kiyosue, T., **Nakashima, K., Yamaguchi-Shinozaki, K.** and Shinozaki, K. (1997). Regulation of the level of proline as an osmolyte in plants under water stress. *Plant Cell Physiology*, 38: 1095-1102.



- Yoshiba, Y., Kiyosue, T., **Yamaguchi-Shinozaki, K.** and Shinozaki, K. (1997). Proline biosynthesis and water stress tolerance in plants. *Protein, Nucleic Acid and Enzyme*, 42: 842-855.
- **Yoshihashi, T.** and Ohtsubo, K. (1997). DNA extraction method from a single grain of milled rice. *In: Protocol for PCR-Related Research in the Plant Field*, Ed. Sasaki, T., Shujunsha: 63-66. (J)

[return to top](#)  
[back to main contents](#)

## ◎Published Proceedings and Conference Presentations

- Abe, H., **Urao, T.**, **Yamaguchi-Shinozaki, K.**, Iwasaki, T., Hosokawa, D. and Shinozaki, K. (1997). Novel cis- and trans-acting elements, myc and myb homologs, involved in ABA-responsive gene expression in *Arabidopsis* under water stress. 5th International Congress of Plant Molecular Biology, Singapore: 812.
- **Adachi, K.**, Chaitep, W. and Senboku, T. (1998). Promotive and inhibitory effects of rice straw and cellulose application on rice plant growth in pot and field experiments. Abstracts of the Annual Meeting, Japanese Society of Soil Science and Plant Nutrition, 44: 353. (J)
- **Ando, Y.**, Hayatsu, M. and Miyashita, K. (1997). Chitinases produced by the fungilytic bacterium *Flexibacter* sp. FL824A. *Annals of the Phytopathological Society of Japan*, 63(3): 253. (J)
- **Ando, Y.** and Miyashita, K. (1998). Molecular cloning of chitinase gene from *Flexibacter* sp. FL824A. *Nippon Nogeikagaku Kaishi*, 72(extra issue): 139. (J)
- Atmomarsono, M., **Wilder, M. N.**, Kawazoe, I. and Aida, K. (1997). Changes in vitellogenin composition during reproduction in the giant freshwater prawn, *Macrobrachium rosenbergii*. Annual Spring Meeting of the Japanese Society of Fisheries Science: 79.
- **Ban, T.** (1997). Genetic analysis of *Fusarium* head blight resistance using wheat doubled haploids. Eds. Dubin, H. J., Gilchrist, L., Reeves, J. and McNab, A, *Fusarium Head Scab: Global Status and Future Prospects*. Mexico City, CIMMYT: 71-78.
- **Ban, T.** and **Suenaga, K.** (1997). Genetic analysis of resistance to *Fusarium* head blight caused by *Fusarium graminearum* in wheat. *Ikushugaku Zasshi* 47 (Supplement 2): **131**. (J)
- **Ban, T.** and **Suenaga, K.** (1997). Inheritance of resistance to *Fusarium* head blight caused by *Fusarium graminearum* in wheat. *Cereal Research Communications* 25 (3): 727-728.
- Brown, L.R., Mitsuhashi, T., **Koyama, O.** and Matsubara, T. (1998). Food and resources problems in the 21st century - Will a sustainable global economy be possible? *Ritsumeikan Journal of International Relations and Area Studies*, 12: 3-41. (J)
- Chang, Q., **Hatta, T.**, Komuro, K. and **Minami, K.** (1997). Secondary minerals occurring at near earth surface in dry areas. Abstracts of the Japanese Society of Soil Science and Plant Nutrition, 43: 136.
- Dhillon, N.P.S. and **Ishiki, K.** (1998). Early prediction of genetic potential of yield on the basis of root traits in gynoeocious F1 (MMAcraCr) hybrids of cucumber. *Breeding Science*, 48 (Supplement 1): 249.
- **Hiraoka, H.** (1998). Direct sowing experiences from Japan and Malaysia. Workshop for International Technology for High Quality Rice Production, MARDI and CLRRRI, Vietnam: 10-21. (J)
- El-Khawas, H. and **Adachi, K.** (1997). Identification and quantification of auxins in culture medium of *Azospirillum* and *Klebsiella* and their effect on rice roots. *Soil Microorganisms*, 50: 70.
- **Fukamachi, H.**, Kawamitsu, Y., **Komori, S.** and **Hidaka, T.** (1997). Leaf photosynthesis in 'Irwin' mango as influenced by leaf age. *Journal of Japanese Society of Horticultural Science*, 66(2): 28-29. (J)
- **Fukuda, Y.** (1998). Surimi and kamaboko. Proceedings of the Sino-Japanese Workshop Advanced Food Technology,

Beijing, People's Republic of China: 34-38.

- **Goto, J.** (1997). Social experiment for an ecologically sustainable agriculture: The case of Australian Landcare. Proceedings of the Annual Conference of the Rural Planning Association: 229-232. (J)
- **Goto, J.** and Ouchi, M. (199x). The resilience and fragility of Japanese rural communities: Implications for other Asian countries. Geographical Perspectives on Sustainable Rural Systems, Proceedings of the Tsukuba International Conference on the Sustainability of Rural Systems, Eds. H. Sasaki et al. eds: 181-188.
- **Goto, J.,** Yamada, R. and Yokoyama, S. (1997). Problems and challenges for the farming systems research and extension today. Sub-symposium, Annual Conference of the Farm Management Society of Japan. (J)
- **Hatta, T.** and Kainuma, K. (1997). Electronic structure analysis of saccharides by high resolution XPS (ESCA). Journal of Applied Glycoscience, 44(3): 456. (J)
- **Hayase, S.** and Muhammad, F.H.H. (1997). Fish distribution and abundance in Matang/Merbok mangrove brackish waters on the west coast of Peninsular Malaysia (I): Preliminary results in 1995-1996. Proceedings of the 2nd Seminar on Results for 1995/96 Research Projects (Productivity and Sustainable Utilization of Brackish Water Mangrove Ecosystems), Kuala Lumpur, Malaysia: 42-83.
- **Hidaka, T., Komori, S.** and **Fukamachi, H.** (1997). Effects of IBA concentration on *in vitro* root formation of papaya. Journal of the Japanese Society for Horticultural Science, 66(2): 254-255. (J)
- **Hosen, Y.** (1998). Reports of activities and plans in Japan for 1998 (1): Experiment in an upland field. Proceedings of 1st Planning Workshop on Evaluation and Development of Methods for Sustainable Agriculture and Environmental Conservation, Tsukuba, Japan: 30.
- **Hosen, Y.,** Tsuruta, H. and **Minami, K.** (1997). Dynamics of NO and N₂O in soil: Constructing a basic mathematical simulation model. Abstracts of the Annual Meeting, Japanese Society of Soil Science and Plant Nutrition, 43: 236. (J)
- **Hosen, Y.,** Tsuruta, H. and **Minami, K.** (1997). Effects of soil depth producing nitric oxide and nitrous oxide on their emission: Measurement and analysis using a mathematical simulation model. Proceedings of the SCOPE Nitrogen Workshop on the Effects of Human Distribution on the Nitrogen Cycle in Asia, Nanjing, People's Republic of China: 14.
- **Hosen, Y.,** Tsuruta, H. and **Minami, K.** (1998). Dynamics of NO and N₂O in soil: Verification of the effects of deep fertilizer application on their concentration profiles in soil and their emission rates tested by a laboratory experiment. Abstracts of the Annual Meeting, Japanese Society of Soil Science and Plant Nutrition, 44: 215. (J)
- Imura, T., Kosaka, T. and **Sato, K.** (1997). Comparison of grazing adaptability between Japanese brown (Kochi) and Japanese black cows: Effects of age and body weight on daytime grazing behavior of breeding cows after weaning. Grassland Science, 43(supplement): 370-371. (J)
- **Inagaki, M.N.** and Mujeeb-Kazi, A. (1997). Production of polyhaploids of hexaploid wheat using stored pearl millet pollen. Proceedings of the 5th International Wheat Conference, Ankara, Turkey: 319-325.
- **Inagaki, M.N.** and Mujeeb-Kazi, A. (1997). Efficient techniques for polyhaploid production in hexaploid wheat using pearl millet crosses. Proceedings of the 3rd International Triticeae Symposium, Aleppo, Syria: 97-102.
- **Inagaki, M.N.** and Mujeeb-Kazi, A. (1997). Production of polyhaploids of hexaploid wheat using stored pearl millet pollen. Proceedings of the 5th International Wheat Conference, Ankara, Turkey: 319-325.
- **Ishikawa, T., Ito, O., Okada, K.** and **Minami, K.** (1997). Fluctuation of numbers of *Nitrosomonas* affected by root of a tropical rice grass. Abstracts of the Annual Meeting, Japanese Society of Soil Science and Plant Nutrition, 43: 44. (J)
- **Ishikawa, T., Matsumoto, N.** and **Kawashima, T.** (1998). Root distribution of several crops in the dry season in Northeast Thailand. Abstracts of the Annual Meeting, Japanese Society of Soil Science and Plant Nutrition, 44:108. (J)
- **Ishiki, K.,** Arellano, J. and Salgado, V. (1997). Chromosomal fragile site and karyotype of achira (*Canna edulis*) cultivated in South America. Resumenes del Primer Taller Internacional de Recursos Fitogeneticos del Noroeste Argentino: 76.

- **Ishiki, K.**, Arellano, J. and Salgado, V. (1997). Karyotype of achira (*Canna edulis*) cultivated in South America. Japanese Journal of Tropical Agriculture, 41(Extra issue 2): 3-4. (J)
- **Ishiki, K.**, Arellano, J. and Salgado, V. (1997). Yield of achira (*Canna edulis*) cultivated in South America. Japanese Journal of Tropical Agriculture, 42(Extra issue 1): 69-70. (J)
- **Ishiki, K.**, Salgado, V. and Arellano, J. (1997). Karyotype analysis of yacon (*Polymnia sonchifolia*). Breeding Science, 47 (Supplement 2): 294. (J)
- **Ishiki, K.**, Salgado, V. and Arellano, J. (1997). Karyotype of yacon (*Polymnia sonchifolia*) cultivated in South America. Japanese Journal of Tropical Agriculture, 41(Extra issue 2): 1-2. (J)
- **Ishiki, K.**, Salgado, V. and Arellano, J. (1997). Revision of chromosome number and karyotype of yacon (*Polymnia sonchifolia*) cultivated in South America. Resúmenes del Primer Taller Internacional de Recursos Fitogenéticos del Noroeste Argentino: 77.
- **Ishiki, K.**, Salgado, V. and Arellano, J. (1997). Yield of yacon (*Polymnia sonchifolia*) cultivated in South America. Japanese Journal of Tropical Agriculture, 42(Extra issue 1): 71-72. (J)
- **Ishiki, K.**, Salgado, V. and Arellano, J. (1998). Morphotype and yield of yacon (*Polymnia sonchifolia*). Breeding Science, 48(Supplement 1): 319.
- **Ito, O.**, Matsunaga, R., **Tobita, S.**, Adu-Gyamfi, J.J., Katayama, K., Rao, T.P., Gayatri, D. (1997). Nitrogen fertilizer management in pigeonpea/sorghum intercropping on an Alfisol in the semiarid tropics. *In: Plant Nutrition - For Sustainable Food Production and Environment*, Eds. Ando, T. et al., Kluwer Academic Publishers: 689-690.
- Ito, Y., Yoshioka, T., **Komori, S.** and Soejima, J. (1997). Adventitious shoot formation on excised leaves of *in vitro* grown shoots of several Japanese apple cultivars. Journal of the Japanese Society for Horticultural Science, 66(2): 96-97. (J)
- Iuchi, S., **Yamaguchi-Shinozaki, K.**, **Urao, T.** and Shinozaki, K. (1997). Characterization of cDNAs for drought-inducible genes in the highly drought-tolerant cowpea. 5th International Congress of Plant Molecular Biology, Singapore: 637.
- Kainoh, Y., Tanaka, C. and **Nakamura, S.** (1998). Behavioral response of the parasitoid fly, *Exorista japonica*, on foliage damaged by the common armyworm, *Mythimna separata*. Proceedings of the 42nd Congress of Japanese Society of Applied Entomology and Zoology, 42: 67. (J)
- **Kato, H** and Man, A. (1998). Yield of hybrids under low direct seeding rate conditions and their competitive ability to *Echinochloa* spp. Breeding Science, 48 (Supplement 1): 294. (J)
- **Kobayashi, H.** (1997). Trends in wagyu calf production and its characteristics in mountainous areas. Livestock Production in Mountainous Areas: 38-54. (J)
- **Kohgo, Y.**, Tamrakar, S.B. and Tang, H.G. (1997). Deformation and shear behavior of unsaturated soils sampled from Khon Kaen City. Proceedings of the 4th National Convention on Civil Engineering: 301-308.
- **Komori, S.**, **Fukamachi, H.** and **Hidaka, T.** (1998). Storage quality of 'Golden Pine' and other species. Japanese Journal of Tropical Agriculture, 42(1): 9-10. (J)
- **Komori, S.**, Ito, Y., Yoshikawa, M., Soejima, J., Abe, K. and Kotouda, N. (1997). Production of transgenic apple with  $\alpha$ -1,3-endoglucanase. Journal of the Japanese Society for Horticultural Science, 66(2): 10-11. (J)
- **Komori, S.**, Soejima, J., Abe, K., Kotouda, N., Itou, Y. and Bessho, H. (1997). Analysis of S-allele genotype of 'Indo' and some other apple cultivars. Journal of the Japanese Society for Horticultural Science, 66(1): 190-191. (J)
- **Komori, S.**, Soejima, J., Abe, K., Kudo, K. and Kyotani, H. (1997). Production of transgenic apple with  $\alpha$ -1,3-endoglucanase. Journal of the Japanese Society for Horticultural Science, 66(2): 100-101. (J)
- **Kondo, M.** and Aguilar, A. (1997). Architecture of rice root system as affected by tillering characteristics and nitrogen. Philippines Journal of Crop Science, 22(Supplement 1): 17.

- **Kondo, M.**, Agbisit, R. and Pablico, P. (1997). Dynamics of soil and applied N under upland rice culture. Philippines Journal of Crop Science, 22(Supplement 1): 33.
- Konohira, E., Yoh, H., **Yagi, K.** and Tsubota, J. (1997). Delta ¹⁵N of NH₄⁺ and NO₃-N dissolved in forest rain water. Abstracts of the Annual Meeting, Japanese Society of Hydrology and Water Resources, 39: 73. (J)
- Konohira, E., Yoh, M., **Yagi, K.**, Toda, H. and Tsubota, R. (1997). Delta ¹⁵N of NO₃-N in streamwater and denitrification processes in a forest soil. Abstracts of the Annual Meeting, Japanese Society of Limnology, 40: 60. (J)
- **Kosaka, K.**, Murakami, H., Yamazaki, M., Takemasa, M., Engku-Azhan, E.A. and Zainul-Alsumi, S. (1997). Development of adipose tissue in Malaysian meat type chicken. Proceedings of 19th Malaysian Society of Animal Production Conference: 104-105.
- **Koyama, O.** (1997). Outline of the USDA international agricultural baseline projection. Seifun Shinko, 370: 5-10. (J)
- **Koyama, O.** (1997). Projecting food balances in China using the world food model. Post Conference, Asian Agriculture Economic Association Annual Meeting, 1997: 1-13.
- **Koyama, O.** (1998). Asian food supply-demand situation from a global perspective. JIRCAS International Symposium Series, 6: 13-30.
- **Maoka, T.** and **Noda, C.** (1997). Nucleotide sequence of the capsid protein region of papaya leaf-distortion mosaic, *Potyvirus Cucurbitaceae* strain RNA. Annals of the Phytopathological Society of Japan, 63(6): 484. (J)
- **Maoka, T.** and **Noda, C.** (1997). The occurrence of a tentative potyvirus: Papaya leaf-distortion mosaic virus cucurbitaceae strain. Annals of the Phytopathological Society of Japan, 63(3): 194. (J)
- **Maoka, T.**, **Usugi, T.**, **Noda, C.**, Kashiwazaki, S., Tsuda S. and Hibino, H. (1997). Comparison of capsid protein genes between two kinds of potyviruses isolated from papaya in Japan. Conference Handbook and Abstracts of International Symposium on Biotechnology of Tropical and Subtropical Species, Brisbane, Australia: 132.
- **Minami, K.** and **Watanabe, T.** (1997). Effects of controlled release fertilizers on nitrous oxide emission from some Japanese fertilized soils. Abstracts of SCOPE Nitrogen Workshop on the Effects of Human Disturbance on the Nitrogen Cycle in Asia: 21.
- **Miyamoto, M.** (1998). Trends of a transmigration project in forest in Indonesia. Program and Abstracts, 109th Annual Japanese Forestry Society Meeting: 45. (J)
- **Moriya, S.** (1997). Apple snail problems and a national research project on apple snails in Japan. Abstracts of the International Workshop on Ecology and Management of the Golden Apple Snail in Rice Production in Asia, Phitsanulok, Thailand: 4.
- **Moriya, S.** (1997). The possibility of controlling the golden apple snail, *Pomacea canaliculata* (Mesogastropota: Pilidae), by exotic natural enemies in Japan. 18th Symposium of the Society of Population Ecology Abstracts: 76. (J)
- **Moriya, S.** (1998). Damages caused by apple snails and possible natural enemies in South East Asia. Abstracts of the 42nd Annual Meeting of the Japanese Society of Applied Entomology and Zoology: 82. (J)
- **Moriya, S.** and Dolsopon, S. (1997). Occurrence and ecology of the litchi fruit borer in Northern Thailand. Abstracts of the 57th Annual Meeting of the Japanese Society of Entomology: 45. (J)
- **Moriya, S.** and Shimizu, T. (1997). Effect of gamma irradiation on the locomotion activities of two sweet potato pests, *Cylas formicarius* and *Euscepes postfasciatus*, in Okinawa, Japan. Abstracts of the Third Asia-Pacific Conference of Entomology, Taichung, Taiwan: 249.
- Murai, M., **Ise, K.**, Sato, S. and Takamura, I. (1997). Utility of Ur-1 for developing F1 rice cultivars. Proceedings of the International Symposium on Two-line Heterosis Breeding in Crops. China National Hybrid Research and Development Center, Chansha, People's Republic of China: 246-251.
- **Nakamura, S.** (1996). Can parasitoid flies regulate their clutch size in response to host density? Proceedings of the 20th International Congress of Entomology, Firenze, Italy: 646.

- **Nakamura, S.** (1997). Interspecific competition between parasitoid flies having different oviposition habits. Proceedings of the 14th Entomophagous Insects Workshop, 14: 14. (J)
- **Nakamura, S.** (1997). Ovipositional strategy of the parasitoid fly, *Exorista japonica* (Diptera: Tachinidae): Effect of host deprivation on egg quality and parasitisation. Proceedings of the 41st Congress of Japanese Society of Applied Entomology and Zoology, 41: 17. (J)
- **Nakamura, S.** (1998). Oviposition preferences of a parasitoid fly: Host stage preferences. Proceedings of the 42nd Congress of Japanese Society of Applied Entomology and Zoology, 42: 51. (J)
- **Nakano, M., Liao, L., Wang, S., Meng, X. and Hayashi, T.** (1997). Soybean virus diseases in northeast China. Abstracts of Annual Phytopathological Society of Japan, 63(3): 259. (J)
- **Nakashima, K., Kiyosue, K., Yamaguchi-Shinzaki, K. and Shinozaki, K.** (1997). A nuclear gene encoding a chloroplast-targeted Clp protease regulatory subunit homolog is not only induced by water stress but also developmentally upregulated during senescence. 8th International Conference on *Arabidopsis* Research, Madison, Wisconsin, U.S.A.: 6-14.
- **Nakashima, K., Kiyosue, T., Yamaguchi-Shinozaki, K. and Shinozaki, K.** (1997). A nuclear gene encoding a chloroplast-targeted Clp protease regulatory subunit homolog is not only induced by water stress but also developmentally upregulated during senescence in *Arabidopsis thaliana*. 5th International Congress of Plant Molecular Biology, Singapore: 651.
- **Nakashima, K., Satoh, R., Kiyosue, K., Yamaguchi-Shinozaki, K. and Shinozaki, K.** (1997). Expression analysis of the *erd5* gene that encodes proline dehydrogenase in *Arabidopsis thaliana*. The 20th Annual Meeting of the Molecular Biology Society of Japan: 706. (J)
- **Nakayama S., Lee D.J. and Morita, H.** (19xx) Infestation with alien weeds in a paddy field surveyed by questionnaire. Journal of Weed Science and Technology, 42(Supplement): 200-201. (J)
- **Nakayama, S.** (1998). Naturalized weeds recently conspicuous in paddy fields. Annual Report of the Kanto Weed Science Society, 9: 5-10. (J)
- **Nanjo, T., Yoshiba, Y., Hayashi, H., Sanada, K., Wada, K., Kakubari, Y., Yamaguchi-Shinozaki, K. and Shinozaki, K.** (1997). Roles of proline in osmotic stress tolerance and growth in *Arabidopsis thaliana*. The 20th Annual Meeting of the Molecular Biology Society of Japan: 707. (J)
- **Nishimura, K., Krongyuti, P., Intramane, S., Senakase, U., Sukkasame, P. and Kawashima, T.** (1998). Mineral balance of beef cattle fed on Ruzi grass and supplementary feeds. JIRCAS Working Report, 10: 99-110.
- **Noda, C. and Maoka, T.** (1997). Potato virus Y (PVY) isolated from *Solanum seaforthianum*. Annals of the Phytopathological Society of Japan, 63(6): 483. (J)
- **Noda, C., Maoka, T. and Koyama, N.** (1997). Natural hosts of hibiscus viruses. Annals of the Phytopathological Society of Japan, 63(3): 258.
- **Ochiai, Y. and Sasaki, S.** (1997). Regeneration of seraya (*Shorea curtisii*) on the logging roads in a hill forest, Semangkok, Selangor, Peninsular Malaysia. Proceedings of the 4th Conference on Forestry and Forest Products Research (Malaysia).
- **Ohtsubo, K., Yoshihashi, T., Nakamura, S. and Kawasaki, S.** (1997). Cultivar identification from a single grain of milled rice. Japanese Journal of Breeding 47(supplement 2): 258. (J)
- **Ohwaki, Y.** (1998). Comparative studies on phosphorous and iron nutrition of tropical legumes. Abstracts of the Annual Meeting, Japanese Society of Soil Science and Plant Nutrition, 43: 244. (J)
- **Ohwaki, Y. and Sugahara, K.** (1998). Extrusion of protons and inhibition of nitrate absorption in response to iron deficiency by root of chickpea (*Cicer arietinum*). Abstracts of the Annual Meeting, Japanese Society of Soil Science and Plant Nutrition, 43: 66. (J)
- **Ohwaki, Y., Kraokaw, S., Chotechuen, S., Egawa, Y. and Sugahara, K.** (1997). Evaluation of mungbean cultivars for resistance to iron deficiency chlorosis in calcareous soil and water culture. Volume of Abstracts, 9th International Symposium on Iron Nutrition and Interaction in Plants Stuttgart, Germany: 61.

- **Okada, K.** and Fischer, A.J. (1998). Mechanisms of the adaptation of upland rice genotypes to highly weathered acid soils of savannas in South America. Abstract paper from the International Workshop on New Concepts of Plant Nutrient Acquisition, Tsukuba, Japan.
- **Okada, K.** and Fischer, A.J. (1997). Mechanisms of the adaptation of upland rice genotypes to highly weathered acid soils of savannas in South America. Volume of Abstracts. International Symposium on Plant Responses to Tonic Stress: Aluminum and Other Ions, Kurashiki, Japan: 23-24.
- **Okuda, S.,** Pasukaru, J., Utsugi, G. and Sato, A. (1998). Influences on under-planted seedlings of palosapis (*Anisoptera thurifera*) by thinning of the upper story (*Acacia auriculiformis*) in an acacia forest: A case in Pantabangan, Philippines. Program and Abstracts, 109th Annual Japanese Forestry Society Meeting: 140. (J)
- **Oshibe, A.** (1997). Processing of feed based on agro-byproducts in Malaysia. 299th meeting of the Society of International Agricultural Mechanization: 1. (J)
- **Oshibe, A.,** Ando, S. and Yamada, A. (1998). The effects of destruction of pancreatic² cells by alloxan administration on GH secretion in cattle. Proceedings of the 94th Annual Meeting of the Japanese Society of Zootechnical Science: 104. (J)
- **Sakagawa, M., Hatta, T., Minami, K. and Hamazaki, T.** (1998). The influence of dissolved heavy metals on the surfaces of clay minerals. Abstracts of the Japanese Society of Soil Science and Plant Nutrition, 44: 22. (J)
- Sakuma, Y., Riu, K., Abe, H., **Kasuga, M.,** Miura, S., **Yamaguchi-Shinozaki, K.** and Shinozaki, K. (1997). Molecular cloning of *Arabidopsis* cDNAs encoding DNA binding proteins that specifically bind to dehydration-responsive-element (DRE). The 20th Annual Meeting of the Molecular Biology Society of Japan: 387. (J)
- Sakuma, H. and **Suzuki, K.** (1997). Studies on hydroponic systems without requiring electricity. Japanese Journal of Tropical Agriculture, 41(Extra issue 1): 41-42. (J)
- **Sasaki, S., Ochiai, Y.,** Yamada, K. and Umeda, S. (1998). Problems related to selective cutting operations. Program and Abstracts, 109th Annual Japanese Forestry Society Meeting: 269. (J)
- **Sato K.** and Urazaliev E. (1997). How to develop ecological seeding methods in the collaborative research project between the Kazak Institute of Agriculture and JIRCAS. Ecology and Problems of Environmental Protection (Proceedings of International Congress in Russia): 99-100.
- Shamusudin, I., Chong, P., Ahmad, S., Ismail, H., **Sasaki, S.** and Appanah, L. (1997). Cable haulage to reduce logging damage in hill forests. Proceedings of the 4th Conference, Forestry and Forest Products Research (Malaysia).
- Shinozaki, K. and **Yamaguchi-Shinozaki, K.** (1997). Signal transduction in water stress response. The Plant Workshop: Leaves, La Colle-sur-Loup, France: 32.
- Shinozaki, K. and **Yamaguchi-Shinozaki, K.** (1997). Gene expression and signal transduction in water stress response. 5th International Congress of Plant Molecular Biology, Singapore: 80.
- Shinozaki, K., **Yamaguchi-Shinozaki, K.,** Mizoguchi, T., **Urao, T.,** Katagiri, T. and Hirayama, T. (1997). Role of MAP kinase and two component histidine kinase in water stress response. Protein Phosphorylation in Plants, Orsay, France: 25.
- **Sugahara, K., Ohwaki, Y.** and Katsuta, Y. (1998). Difference in soil erosion between sugarcane and pineapple fields. Abstracts of the Annual Meeting, Japanese Society of Soil Science and Plant Nutrition, 43: 131. (J)
- **Suzuki, K.** and Sakuma, H. (1997). Examination for morphological character of newly introduced crop *Raphanus sativus* cv. Pakkihood. Kyushu Agricultural Research, 59: 176. (J)
- **Suzuki, K., Takeda, H. and Egawa, Y.** (1998). Effect of change of nutrient solution on the incidence of blossom-end rot of tomato fruits at several growing stages. Journal of Japanese Society for Horticultural Science, 67 (Supplement 1): 182.
- **Suzuki, K.,** Sakuma, H., **Takeda, H. and Egawa, Y.** (1997). Morphological studies on the occurrence of blossom-end rot of tomato fruit. Journal of Japanese Society for Horticultural Science, 66 (Supplement 1): 288-289. (J)
- Taji, T., Seki, M., **Yamaguchi-Shinozaki, K.,** Giraudat, J. and Shinozaki, K. (1997). RFLP mapping of *Arabidopsis*

drought inducible genes, RD and ERD. The 20th Annual Meeting of the Molecular Biology Society of Japan: 707. (J)

- **Takahashi, K.** (1997). *Rhabdoscelus obscurus* in the Ogasawara Islands. Proceedings of Kanto Plant Protection Society, 44: 255-257. (J)
- **Takahashi, K.**, Kohno, K., Meneses, N., Tsukiboshi, T. and Kobayashi, M. (1998). *Ephelis* sp. found in Ishigaki Island and its effect on insect feeding. Proceedings of the Japanese Society of Applied Entomology and Zoology, 42: 22. (J)
- **Takeda, H.**, Hossain, M.M., Senboku, T., **Suzuki, K. and Egawa, Y.** (1998). Physiological studies of heat tolerance in *Brassica* crops: Study of thermostability in cell membrane. Journal of Japanese Society for Horticultural Science, 67 (Supplement 1): 197.
- **Tanaka, R.**, Hatakeyama, R. and Hatakeyama, H. (1997). Effect of thermal history on locust bean gum hydrogel formation by freezing-thawing. Polymer Preprints, Japan, 46(3): 409. (J)
- **Tanaka, R.**, Hatakeyama, R. and Hatakeyama, H. (1997). Junction zone formation of polysaccharide hydrogels induced by phase transition of water. Abstracts and Program. The 4th IUMRS International Conference in Asia (MRS-ICA-97), Makuhari, Chiba, Japan, 137.
- **Tanaka, R.**, Hatakeyama, R. and Hatakeyama, H. (1997). Viscoelastic studies on locust bean gum hydrogel prepared by freezing and thawing. Conference Program and Book of Abstracts. The 9th International Conference and Industrial Exhibition on Gums and Stabilizers for the Food Industry, Wexham, United Kingdom: 39
- Tomooka, N., Chotechuen, S., Boonkerd, N., Vaughan, D.A., **Egawa, Y.**, Yokoyama, T. and Tateishi, Y. (1997). Collection of root nodules from wild *Vigna* species (subgenus *Ceratotropis*) in Thailand. Japanese Journal of Tropical Agriculture, 41 (Extra issue 1): 93-94. (J)
- Tomooka, N., Rao, S.S., **Egawa Y.** and Vaughan, D.A. Intra-specific isozyme polymorphism of three Asian wild *Vigna* species (subgenus *Ceratotropis*). Japanese Journal of Tropical Agriculture, 42 (Extra issue 1): 59-60. (J)
- Tsukiboshi, T., **Takahashi, K.**, Uegaki, R. and Shimanuki, T. (1997). *Ephelis* sp. found on 13 species of grass in the field. Annals of the Phytopathological Society of Japan, 63(6): 496. (J)
- **Uchida, S.** (1997). Analysis of annual change of agricultural land use in the semi-arid tropics using a vegetation index. Proceedings of the Annual Conference of the Japan Society of Photogrammetry and Remote Sensing (Autumn): 187-192. (J)
- **Uchida, S.** (1997). Analysis of locational conditions for agricultural land in the semi-arid areas of India using IRS data. Proceedings of the Annual Conference of the Japan Society of Photogrammetry and Remote Sensing (Spring): 301-306. (J)
- **Uchida, S.** (1997). Temporal analysis of agricultural land use in the semi-arid tropics of India using IRS data. Proceedings of the 18th Asian Conference on Remote Sensing, Kuala Lumpur, Malaysia, A-7: 1-6.
- Uno, Y., **Yamaguchi-Shinozaki, K.** and Shinozaki, K. (1997). Identification of a cis-acting element involved in the dehydration and ABA-responsive expression of rd29B gene in *Arabidopsis thaliana*. The 20th Annual Meeting of the Molecular Biology Society of Japan: 700. (J)
- Uno, Y., **Yamaguchi-Shinozaki, K.** and Shinozaki, K. (1997). Analysis of dehydration-responsive rd29B gene promoter in transgenic plants. 5th International Congress of Plant Molecular Biology, Singapore: 825.
- **Urao, T., Yamaguchi-Shinozaki, K.**, Hirayama, T. and Shinozaki, K. (1997). Potential involvement of an *Arabidopsis* transmembrane histidine kinase in the osmosensing of plants. 8th International Congress of Arabidopsis Research, Madison, Wisconsin, U.S.A.: 7-52.
- **Urao, T.**, Miyata, S., **Yamaguchi-Shinozaki, K.**, Hirayama, T. and Shinozaki, K. (1997). Molecular analysis of two-component system in *Arabidopsis thaliana*. The 20th Annual Meeting of the Molecular Biology Society of Japan: 468. (J)
- **Urao, T., Yamaguchi-Shinozaki, K.**, Hirayama, T. and Shinozaki, K. (1997). Potential involvement of an *Arabidopsis* transmembrane histidine kinase in the osmosensing of plants. 5th International Congress of Plant Molecular Biology, Singapore: 808.
- Utsugi, G. and **Okuda, S.** (1998). Response of photo synthesis ratio for leaf-air vapor pressure difference with dipterocarp

seedlings in the Philippines. Program and Abstracts, 109th Annual Japanese Forestry Society Meeting: 140. (J)

● Wada, M., Kotoda, N. and **Komori, S.** (1997). Cloning and analysis of apple floricaula/leafy homologue gene. The Molecular Biology Society of Japan 20th Annual Meeting: 97. (J)

● Watanabe, M., **Noda, C., Maoka, T.**, Usugi, T. and Natsuaki, K. (1997). Occurrence of passiflora latent virus in Japan. Annals of the Phytopathological Society of Japan, 63(3): 194. (J)

● **Watanabe, T.** (1998). The mechanism of nitrous oxide emission from soils applied with some controlled availability fertilizers, fertilizer amended with nitrification inhibitor and urea: Analysis by laboratory incubation experimentation. Abstracts of 1st Planning Workshop on Evaluation and Development of Methods for Sustainable Agriculture and Environmental Conservation, Tsukuba, Japan.

● **Watanabe, T.** and **Minami, K.** (1998). Development of control technique of nitrous oxide emission: Application of controlled availability fertilizers. Abstracts of the Annual Meeting, Japanese Society of Soil Science and Plant Nutrition, 44: 216.

● **Watanabe, T.**, Chairroj, P., Tsuruta, H., Masarngsa, W., Cholitkul, W. and **Minami, K.** (1997). Measurement of nitrous oxide emission from fertilized maize fields in Thailand. Abstracts of SCOPE Nitrogen Workshop on the Effects of Human Disturbance on the Nitrogen Cycle in Asia: 31.

● **Wilder, M.N.**, Ikuta, K., Atmomarsono, M., Hatta, T. and Komuro, K. (1997). Salinity, methyl farnesoate titers, and osmotic and ionic regulation in *Macrobrachium rosenbergii*. Proceedings of the XIIIth International Congress of Comparative Endocrinology, Yokohama, Japan: 93-96.

● **Yagi, K.** (1997). Can we mitigate methane emission from paddy fields in the world? Abstracts of the Annual Meeting, Japanese Society of Soil Science and Plant Nutrition, 43: 231. (J)

● **Yagi, K.** and Akiyama, H. (1997). On-line analyses of stable isotope ratios of gases, soils, and plant materials by using Precon/GC/C/IRMS and EA/IRMS. Abstracts of the Annual Meeting of the ¹⁵N Field Application Society, 18: 5. (J)

● **Yagi, K.** and **Minami, K.** (1997). Preliminary estimation of global methane emission rate from paddy fields based on field flux measurements and soil properties. Abstracts of the International Symposium on Atmospheric Chemistry and the Future Global Environment, Nagoya, Japan: 4-7.

● **Yajima, M.** (1987). Agrometeorological review of rice and upland crop production in Asia: In the case of Sri Lanka and Philippines. Abstracts, the Symposium on Climatic Resources and Plant Production, Joint Meeting of the Societies of Agro-meteorology and Bio-environmental Control: 529-540. (J)

● Yamada, K., Endo, T., Sasaki, T., Ito, M. and **Sasaki, S.** (1998). Mobility of an articulated tracked vehicle: Effects of the addition of a floating suspension system and attitude control system. Program and Abstracts, 109th Annual Japanese Forestry Society Meeting: 261. (J)

● **Yamada, R.** Significance and direction of forest use in hilly and mountainous areas. Comprehensive Proceedings of the 47th Regional Agricultural Technology Meeting. (J)

● **Yamada, Y.**, Panpruik, P., Piyasiranada, T. and Ingkapradit, W., (1997). Construction of a GIS database in Northeast Thailand and evaluation of the potential of agricultural land use. Proceedings of the Annual Meeting of the Japanese Society of Irrigation, Drainage and Reclamation Engineering, 1997. (J)

● **Yamaguchi-Shinozaki K.** and Shinozaki K. (1997). Drought tolerance and regulation of gene expression. Japanese Journal of Crop Science, 66 (Extra issue 2): 367-372. (J)

● **Yamaguchi-Shinozaki, K.** and Shinozaki, K. (1998). Gene expression and signal transduction in *Arabidopsis* under water stress. The 40th NIBB Conference, Okazaki, Japan.

● **Yamaguchi-Shinozaki, K.**, Liu, Q., Abe, H., Miura, S., Sakuma, Y., **Kasuga, M.** and Shinozaki, K. (1997). Molecular cloning of *Arabidopsis* cDNAs encoding DNA binding proteins that specifically bind to dehydration-responsive element (DRE). 5th International Congress of Plant Molecular Biology, Singapore: 81.

● **Yamamoto, Y., Ohno, H., Watanabe, T.** and **Uchida, S.** (1997). Development of a method for assessing desert soil



stability and database transformation. Studies for Production of Fundamental Datasets for Earth Science and Technology Researches, JFY1996 Report for Study Results: 130-141. (In English and Japanese)

- Yang, H., **Hatta, T., Minami, K. and Hamazaki, T.** (1998). Changes in the chemical state on mineral surfaces by dissolution of granite forming minerals. Abstracts of Japanese Society of the Soil Science and Plant Nutrition, 44: 118. (J)
- **Yashima, S.** (19xx). Assessing water management performance in paddy fields using field water depth data. Japanese Journal of Tropical Agriculture, 42 (Extra 1): 15-16. (J)
- Yasuda, K. (1997). Immigration of rice planthoppers in Ishigaki Island, the most southern region of Japan. Proceedings of China-Japan Workshop on Migration and Management of Insect Pests of Rice in Monsoon Asia: 48-57.
- Yasuda, K., **Sogawa, K.** and Takahashi, A. (1998). 虫害. Proceeding of the Congress of Japanese Society of Applied Entomology and Zoology, 42:236. (J)
- Yonemura, S., **Yajima, M.** and Sakai, H. (1997). Estimating productivity of rice plants under elevated CO₂ levels and warming in Japan. Abstracts, Joint Meeting of the Societies of Agro-meteorology and Bio-environmental Control: 296-297. (J)
- Yoneyama, T., Fujihara, S. and **Yagi, K.** (1997). Analyses of delta ¹⁵N in amino acids and polyamines by using GC/C/MS. Abstracts of the Annual Symposium of Stable Isotopes in Science and Technology, 21: 26. (J)
- Yoshida, Y., **Yamaguchi-Shinozaki, K.,** Shinozaki, K. (1997). Tissue specific expression of the gene for proline synthetase (P5CS) in *Arabidopsis thaliana*. The 20th Annual Meeting of the Molecular Biology Society of Japan: 706.
- Yoshida, Y., Hanyuda, T., Bessho, H., Tsuchiya, S., Soejima, J., Masuda, T., **Komori, S.,** Sanada, T., Ito, Y., Sadamori, S. and Kashimura, Y. (1997). New dwarfing apple rootstock cultivars, 'JM1', 'JM7' and 'JM8'. Journal of the Japanese Society of Horticultural Science, 66(1): 184-185. (J)
- Yoshimura, A., **Okamoto, M.,** Nagamine, T. and Tsunematsu, H. (1998). QTL analysis of rice heading time under environmental conditions of Ishigaki. Breeding Science, 48(Supplement 1). (J)

[return to top](#)  
[back to main contents](#)

---

© Symbols: (J) Denotes articles written in Japanese; (C) denotes articles written in Chinese; **bold** lettering indicates authors who were staff members (see staff list) or STA post-doctoral fellows (see fellowship explanation) at JIRCAS during FY1997.

# Annual Report 1996

## CONTENTS

[Foreword - Message from the Director General](#)

[Highlights from 1996](#)

[JIRCAS and the Ministry of Agriculture, Forestry and Fisheries](#)

### **Research Overview**

[International research at JIRCAS](#)

JIRCAS Research Divisions

- [Research Information Division](#)
- [Biological Resources Division](#)
- [Environmental Resources Division](#)
- [Crop Production and Postharvest Technology Division](#)
- [Animal Production and Grassland Division](#)
- [Forestry Division](#)
- [Fisheries Division](#)
- [Okinawa Subtropical Station](#)

[Miscellaneous projects outline](#)

### **Training and invitation programs; information events**

[Fellowship Programs](#)

[Symposia and workshops](#)

### **APPENDIX**

[Official Publications / library holdings](#)

[Research staff activity](#)

# Message from the Director General

## Toward Global Partnership in Agricultural Research



*Director General*  
***Nobuyoshi Maeno***

On August 1, 1996, I became the second Director General of the Japan International Research Center for Agricultural Sciences (JIRCAS) after succeeding Dr. Keiji Kainuma who retired from the Ministry after a service of 37 years. Under the dynamic leadership of Dr. Kainuma, the former Tropical Agriculture Research Center was reorganized into JIRCAS and the difficult task of setting up a new structure was eventually accomplished.

During the three-year tenure of Dr. Kainuma, JIRCAS activities were re-oriented and re-defined along the lines of its new role as an international research center. New research facilities, including a biotechnology unit and fisheries science and Earth science laboratories (highlighted in Annual Report 1994), were constructed to enhance domestic research activities and to strengthen support for overseas activity. In early 1994, a new type of project, the “Integrative-type” Comprehensive Research Project was initiated; these projects, currently being implemented in Vietnam, Thailand, Malaysia, and Brazil (for more detail, see Research Overview section), aim to unite the activities of research scientists and experts in wide-ranging agricultural fields to achieve common objectives. In addition, the scope of specific research activity was expanded to include activities in regions which had not been previously targeted for research collaboration, such as Kazakhstan in Central Asia and the subtropical areas of Brazil. Finally, under Dr. Kainuma, the JIRCAS Visiting Research Fellowship Program at Tsukuba was inaugurated in the Fall of 1995, and close relations between JIRCAS and the Japan International Cooperation Agency (JICA) were further advanced.

At present, JIRCAS activities are being expanded and promoted according to a basic strategy developed during the past three years as described below.

[Fig.1 Research Collaboration with CGIAR centers](#) (83KB)

### **Expansion of areas targeted for research collaboration**

With the reorganization of TARC into JIRCAS, areas targeted for research collaboration were expanded beyond the tropical and subtropical areas focused on at TARC to include all developing regions. However, the tropics and sub-tropics remain important regions in which to work, and budgetary

constraints necessitated the establishment of priorities. Presently, research collaboration with Asian nations comprises 80% of total activity; this is partly based on geographical considerations and cultural similarities. Although current research activity in Africa and Latin America occurs mainly in collaboration with the Consultative Group on International Agricultural Research (CGIAR) centers, in the future, JIRCAS may expand relations with these countries to include other organizations.

### **Importance of research related to information systems and socio-economic aspects**

In selecting research themes relevant to the needs of the targeted countries and regions, it is necessary to comprehensively collect, process and analyze; only by considering agriculture, forestry and fisheries as a whole, is it possible to effectively implement projects. Moreover, it is essential to develop technology compatible with the socio-economic conditions of each region. To reach these objectives, it is important to promote information activities aimed at integrating social and natural sciences as they relate to agriculture, forestry and fisheries activity.

### **Multidisciplinary versus unidisciplinary approach**

Due to the complexity of the many agricultural ecosystems and societies in regions targeted by JIRCAS, it is urgent to adopt a systematic and integrated strategy for sustainable agricultural development rather than an isolated and fragmentary approach. Therefore, efforts should be made toward promoting comprehensive projects on a multidisciplinary basis in addition to pursuing specific, focused topics. Research on information science and socio-economic aspects of agricultural activity should be carried out in the context of the drafting and implementing of integrated projects.

### **Overseas research activity and domestic research**

TARC adopted a strategy of dispatching researchers abroad to carry out collaborative research in targeted areas. This system has been essentially maintained, but certain activities abroad require the support of advanced research and the use of sophisticated instruments. Often such research activity is most effectively performed domestically. In order to strengthen JIRCAS's capacity to carry out advanced studies, JIRCAS has established the new research facilities delineated above. JIRCAS researchers are also able to utilize equipment and facilities of other MAFF institutes located in the Tsukuba Institutional Complex. As overseas and domestic research become more closely linked, the development of such a cooperative system will help alleviate many of the difficulties associated with carrying out research in developing areas.

### **Development of human resources (training programs and fellowships)**

The development of sustainable agriculture in any region depends on the establishment of a pool of highly trained personnel. JIRCAS recognizes that there is a need to train researchers who can fulfill such requirements. JIRCAS currently sponsors two types of fellowships: the JIRCAS Visiting Research Fellowship Program at Tsukuba and the JIRCAS Visiting Research Fellowship Program at Okinawa. Under these programs, invited researchers are able to take advantage of advanced facilities in an environment conducive to research. These programs aim at enhancing the capabilities of the research fellows while promoting cooperative research with JIRCAS researchers. It is expected that upon returning to their respective countries, the fellows will become core counterparts for further research collaboration with JIRCAS.

## **Priorities for the future**

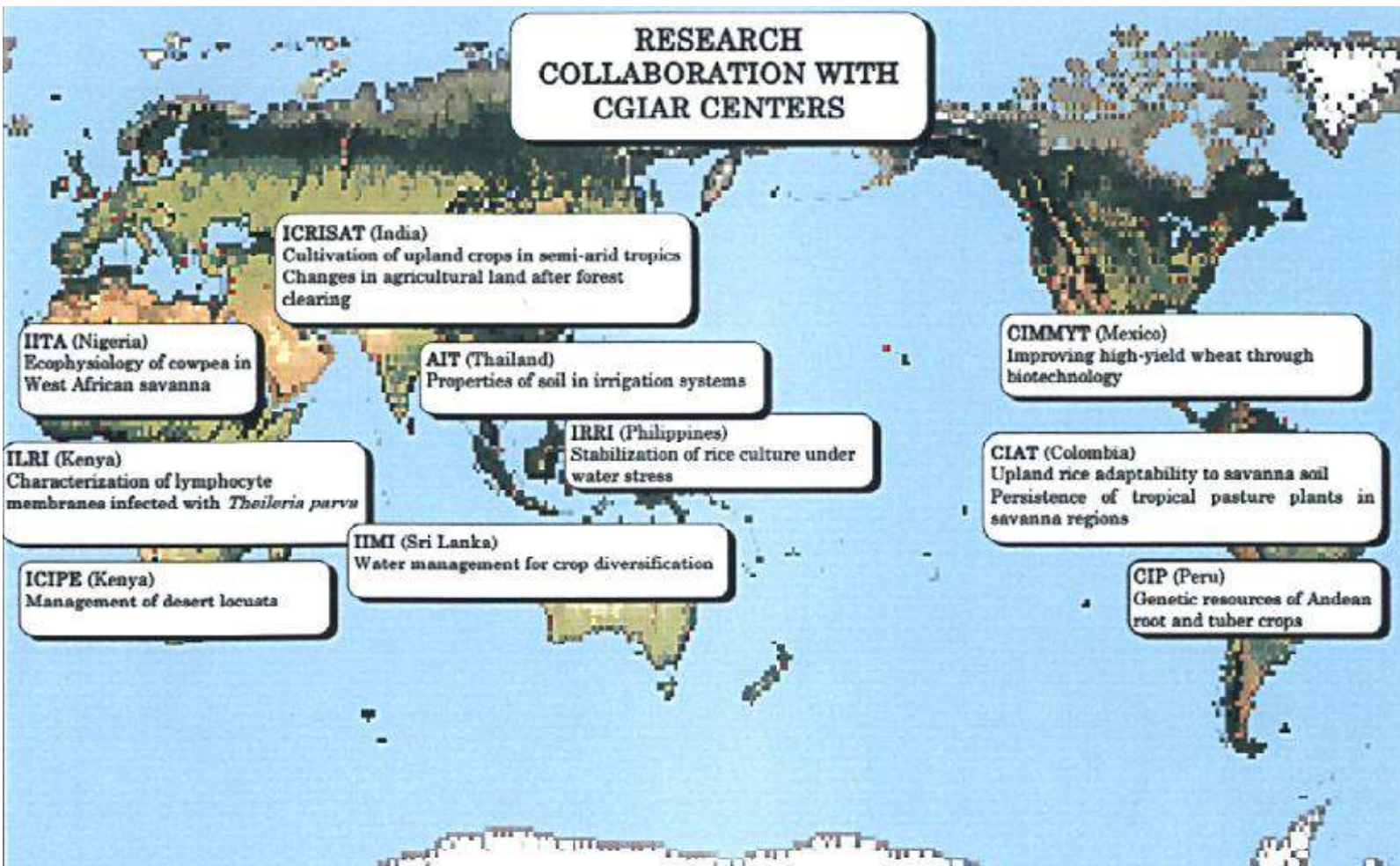
During the past three years, JIRCAS activities have become widely recognized within the international agricultural research community and numerous countries have requested JIRCAS to engage in joint research projects. Such collaboration based on partnerships with other MAFF institutes, CGIAR centers, and related research organs will help pave the way toward establishing a global partnership dedicated to the establishment of sustainable agriculture, productive forestry and fisheries activities and the preservation of the environment.

Yet in the future, staff size and budgetary constraints will limit, and in some ways determine, our activities. Therefore, it will be essential for JIRCAS to fully utilize its comparative advantages, establishing research priorities that make the best use of its human and technical resources while considering the capabilities and the needs of the target countries and regions.

## **Note about Annual Report 1996**

While including summaries of JIRCAS research activity around the globe, in continuation of last year's focus on projects in Latin America, Annual Report 1996 will highlight recent projects in Africa. In addition, however, 1996 marked the beginning of JIRCAS's first collaborative project in Central Asia, with the signing of a research agreement with Kazakhstan as is introduced in the Highlights section.

[Continue to Highlights from 1996](#)



# HIGHLIGHTS FROM 1996

This past year was marked not only with success in longstanding research activities but also by the establishment of several promising new projects. Important new studies will include research on soybeans in South America, food supply and demand in China, and shrimp viral disease in South East Asia and Oceania. In addition to these new projects in regions with a long history of collaboration with JIRCAS, however, 1996 also marked the intensification of research efforts in Africa and the beginning of joint projects with Central Asian countries.

## IMPORTANT NEW PROJECTS

### **(1) Comprehensive studies on soybean improvement, production and utilization in South America**

The soybean, *Glycine max*, is considered one of the four major crops essential for human life, especially as an oil resource for human consumption and as a protein resource for livestock feed. At present the increase of soybean production is important for the stabilization of the world food supply. However, there is no international research institute devoted to soybeans, although there are several international research institutes for other major crops such as wheat, maize, rice, coarse grain cereals and root crops under the Consultative Group on International Agricultural Research (CGIAR).

Soybean production in South America, mainly in the MERCOSUR (South American Common Market including Brazil, Argentina, Uruguay, and Paraguay) countries, amounts to approximately one third of the total world production. Thus the MERCOSUR nations play a major role as leading soybean export countries. However, soybean production in the MERCOSUR countries has been mostly carried out under environmentally vulnerable conditions such as in arid, acid soils with low-fertility level. In addition, the history of soybean production in these countries is relatively short since cultivation was initiated on a large scale only in the 1960s. Scientists anticipate that in the future, continuous cropping, outbreaks of diseases and pests and soil erosion will retard growth, adversely affecting soybean production in this area. Therefore, a comprehensive, multinational research project focused on the development of sustainable and more efficient systems of soybean production in the MERCOSUR countries is important to address these constraints.

The research project entitled “Soybean improvement, production and utilization in MERCOSUR countries of South America” places special emphasis on the following topics: (1) to strengthen the collaboration with JICA, and to utilize CETAPAR (Centro Tecnológico Agropecuario en Paraguay) as the main research site of the project (2) to carry out multidisciplinary studies on soybean improvement and development in the MERCOSUR countries by collaborating with researchers from Japan and South American countries.

Research areas for implementation are as follows: (1) genetics and breeding (2) soil management and pest control (3) crop management and production (4) postharvest technology (5) socioeconomic aspects.

This project is planned to last 10 years starting from April, 1997. During the first year (FY 1997), details of the project will be decided in consultation with counterpart organizations in MERCOSUR countries. A first seminar relating to the project will be held in early 1998.

[Photo1:Bird's eye view of JIRCAS.\(44KB\)](#)

[Photo2:World map showing JIRCAS international research activity in the lobby of the JIRCAS Main Building.\(17KB\)](#)

[Continue to Highlights](#)







## **(2) Comprehensive studies of China's future food production and demand**

The first comprehensive project with China is scheduled to be established on May 28, 1997, marking the beginning of JIRCAS's fifth comprehensive project. It will commence with joint signing among JIRCAS, the Agriculture, Forestry and Fisheries Research Council of the Ministry of Agriculture, and the People's Republic of China at the 16th meeting of the Japan-China Agricultural Science and Technology Exchange Group in Tokyo, and is scheduled to continue for seven years.

A report titled "Who Will Feed China? Wake-up Call for a Small Planet" (L. Brown: The World Watch Institute, 1995) triggered the heightened concerns over China's future food problems. Many Chinese and foreign researchers had made analyses and projections of China's food future, focusing most of their studies on the grain sector. However, the reports revealed little agreement on food production and its demand, most likely due to differences in assumptions, data and estimation approaches. Nevertheless, the following consensus materialized: food demand will increase continuously over the next three decades, and the supply will not meet the demand. Thus, an increase in import demand will accompany the increase in food demand.

Major factors influencing production in China include area of cultivated land, yield of grains, poor quality of farmland, weak response to fertilizer and small-scale farm structure. It is inevitable that more farm land will be used for non-farm uses in the process of rapid economic development. Newly reclaimed land and an increase in the crop index do not seem to have halted the continued tendency towards a decrease in cultivated land area. The crop yield in China is significantly lower than in advanced countries. On the other hand, major factors influencing food demand will include the population expansion, population structure changes due to rural-urban migration, income growth, price of agricultural products and poor infrastructure.

Consequently, due to population expansion and income improvement, the food demand in China will continue to rise. Agricultural production will not keep pace with increasing demand, due to inevitable resource shrinkage, and natural, structural, financial and economic constraints in the yield potentials.

In order to respond to the increasing expectations for a high-quality diet caused by the development of the Chinese economy and the increase of people's purchasing power, this project aims to develop the technologies for sustainable production and utilization of major food resources in China such as rice, soybean, corn and freshwater fishes. More specific objectives of this project are: 1) to establish an effective production and distribution system for agricultural produce in order to cope with the changing supply and demand structure of food, based on the following studies: `evaluation of the dissemination of new technologies in selected areas and their effects on rural and individual farmers' economy, a modeling of supply and demand of food in selected areas and the analysis of the structure of corresponding farming areas and agricultural products b design of a more sustainable and effective control system to improve supply and demand of major foods in selected areas; 2) development of technologies for sustainable and stable production of major food resources based on the following studies: `the evaluation of existing gene resources and the creation of new species from these, athe development and evaluation of environment-friendly agricultural technologies; 3) development of food technologies for improved utilization and distribution of major food resources based on the following studies; `the quality evaluation of major food resources and the development of new food ingredients from these, athe creation of improved preservation and distribution technologies for major food

resources.

The [topics of research subjects](#) to be pursued in this project are shown below and the counterpart research institutes ([Figure 1](#)) will participate in joint studies as necessary to promote the further progress of the projects:

[Click here to continue Highlights](#)

Figure 1: Counterpart research institutes which will participate in this project are shown geographically.



## **Development of technology for the diagnosis and prevention of shrimp viral disease**

Southeast Asia and Oceania are areas of great significance in world prawn culture production. The export of cultured shrimp and prawn provides these countries with substantial economic benefit. However, in recent years, the production of cultured shrimp has greatly decreased due to rapid disease outbreak. The increased severity of widespread viral infection is without a doubt the most significant threat to stable aquacultural production.

In Thailand, the Philippines and Australia, several species of viruses, white-spot baculovirus (WSBV), yellow-head virus (YHV), and penaeid haemocytic rod-shaped virus (PHRV), have been recently isolated from diseased prawns under intensive aquaculture. These types of viruses have caused and continue to pose significant problems for the shrimp aquaculture industry. The countries of Southeast Asia and Oceania are continually faced with the danger of viral intrusion because of the practice of large-scale import and export of larval shrimps among countries in order to supply seed for prawn farming operations. If the seed derives from a viral-infested area, pathogens are likely to be brought in with the seed into pathogen free areas.

Therefore, in order to ensure the stable production of cultured products, especially in the case of intensive culture, it is imperative to adopt preventive countermeasures against viral disease. At present, it is necessary to develop techniques for the accurate diagnosis of viral infection and identification of the source of the infection, as well as methods for viral inactivation. However, it is often the case that pathological and etiological characteristics of significant pathogens are insufficiently understood.

The aim of this new international project is the development of preventive techniques to protect against viral intrusion; the project is scheduled to commence in FY 1997. The techniques which will be developed will enable accurate and quick diagnosis of prevalent shrimp viruses as a basis for the selection of appropriate inactivation methods using disinfectants, ultraviolet radiation and other means.

Research will be executed according to a four-phase plan. First, field work will be conducted to examine the circumstances of disease occurrence, based on the collection of accurate etiological data. In the second phase, laboratory work will be carried out to purify and identify viral particles. In the third phase of this project, steps will be taken to develop virological, serological and genetic diagnoses for newly-classified diseases. In the final phase, trials will be conducted to establish effective disinfectant and control methods for major viral diseases.

The collaborating partner in this project will be the National Institute of Coastal Aquaculture (NICA), Songkhla, Thailand, which is an institute belonging to Thailand's Ministry of Agriculture and Cooperatives. Songkhla is a locality greatly affected by prawn disease outbreaks. The institute itself boasts a large fisheries disease section with an active fish pathology staff and laboratories which are sufficiently well-equipped to undertake the studies forming the backbone of this project. Furthermore, the location of NICA will enable the convenient collection of samples and research material because of its proximity to major shrimp culture farms. On the Japan side, the National Research Institute of Aquaculture of the Fisheries Agency will lend support to this project through the dispatch of various specialists.

As mentioned above, Southeast Asian countries are now faced with difficult problems relating to the

control of shrimp viral disease. This project will contribute to developing a rational means of prevention and control through basic and applied cooperative research.

[Continue to highlights](#)

## **START OF RESEARCH COLLABORATION WITH KAZAKHSTAN**

Central Asia is one of the new research areas which has been targeted for collaboration following the reorganization of TARC into JIRCAS. Central Asia, which stretches from the Tianshan and Pamir mountains in the east to the lower reaches of the Volga River and the Caspian Sea in the west, covers more than four million kilometers over a vast steppe and desert with a wide range of temperatures. The area consists of five independent republics formed after the division of the Soviet Union in 1991: Kazakhstan, Uzbekistan, Kirghizstan, Tajikstan, and Turkmenistan.

Traditional agriculture originally consisted of pastoralism and steppe and oasis agriculture in piedmont and desert areas. Currently, the following activities characterize agriculture in Central Asia: (1) settled cattle raising on grasslands (2) rainfed upland farming on the steppes of northern Kazakhstan (3) large-scale irrigation and oasis agriculture and (4) fish culture in river and lake basins.

The main difficulties confronting agriculture in this country include the deterioration of the steppes and arable land, environmental problems in the Aral Sea basin, and the erosion of genetic resources. To combat these problems, research priorities are as follows: 1) to develop methods of sustainable crop production (primarily wheat) which preserve soil fertility in rainfed uplands 2) to alleviate environmental problems in the Aral Basin including soil salinization caused by agricultural activities such as cotton cultivation based on large scale irrigation, and water pollution arising from the overuse of agricultural chemicals and fertilizers and to 3) develop methods to conserve agricultural resources, including fruits, vegetables, cereals and forage crops as well as animals and fish in inland seas.

### **MOU signing between JIRCAS and KIA**

In 1996, JIRCAS began collaboration with the Kazakh Institute of Agriculture (KIA) for a 5-year research project entitled, "Development of sustainable systems of grassland management and animal production in Central Asia." To initiate this joint project and as the last official mission of his tenure as Director General, in July of 1996 Dr. Keiji Kainuma, Director General of JIRCAS, visited Kazakhstan to sign a Memorandum of Understanding (MOU) between KIA and JIRCAS. Under this MOU, the first JIRCAS staff researcher, a pasture agronomist, joined the collaborative project at KIA, the first project implemented by JIRCAS in Central Asia.

[Photo:MOU-signing ceremony between JIRCAS and KIA. Dr.R.A.Urazaliev\(left\),KIA Director General and Dr.K.Kainuma\(right\),former Director General of JIRCAS.\(14KB\)](#)

[Continue to Highlights.](#)





# AFRICA SPOTLIGHT

International collaborative projects at JIRCAS encompass all the fields of agriculture, forestry and fisheries and are being carried out with counterpart institutions including international research institutions, national research centers and universities. As part of this year's feature on research activities in African regions, the following pages provide an introduction to collaborative projects with three international research centers in Africa: ICIPE (International Center of Insect Physiology and Ecology), ILRI (International Livestock Research Institute), and WARDA (West Africa Rice Development Association).

## Background

Until recently, JIRCAS had centered its efforts on Asia due to geographical and historical reasons. Asian regions attracted JIRCAS efforts because of their overly populated land areas with low farm investment and low level technologies. The share of Asia in the total JIRCAS collaboration still remains about 80 percent in terms of both researchers dispatched and project budget allocations. JIRCAS scientists have had little difficulty working with Asian agriculture because of similarity of Japanese agriculture with monsoon paddy farming in other Asian regions.

From its founding, JIRCAS has been little involved in the issues surrounding agricultural development in Africa. Africa may have simply been too far away to attract the interest of researchers. Extensive semi-dry farming of Sub-Sahara areas is still alien to many Japanese scientists, thus JIRCAS collaboration in Africa has been sporadic and confined to a few very specific research areas such as parasite-induced disease, desert locusts and drought resistant field crops.

Recently, however, food and environmental problems in Africa have come to look far more serious than we had once thought. With its annual population growth of 3 %, very poor infrastructure and political instabilities, Sub-Saharan Africa is likely to suffer from chronic food shortages and malnutrition. Environmental degradation including desertification and urbanization could aggravate the situation, hitting hardest the poor segments of their societies. It may be high time that JIRCAS place more attention on African agriculture issues.

Given its limited resources and experiences, JIRCAS set up a workshop in October 1996 to review the major issues at stake, learn lessons from the past projects and set priorities for future collaboration. The workshop held several meetings and issued an interim report as outlined later. Along with the workshop recommendations, JIRCAS plans to initiate collaborative research with WARDA while continuing valuable collaborative projects on specific subjects with broad applications.

[Soil sampling in a cowpea field at IITA Kano Station, Nigeria. \(19 KB\)](#)

[\(Photo : I. Watanabe\)](#)

## **(1) Collaborative Research Project with ICIPE on African Locusts**

The International Center of Insect Physiology and Ecology (ICIPE), which operates under an international charter, was established in 1970 in Nairobi, Kenya. Its mandate is to conduct research and development in the area of arthropod science with the objective of improving food security, alleviating

poverty, improving human health, contributing to conservation of biodiversity and helping build the capacity of institutions and people in the tropical world, especially in Africa. Currently ICIPE has three major research programs -- disease vector management, plant pest management and arthropod conservation and utilization -- supported by five departmental units: behavioral biology and chemical ecology, applied ecology, pathology and microbiology, molecular biology and biochemistry and social science.

[On the way home from shopping in Niger. \(30 KB\)](#)

[\(Photo : T.Terao\)](#)

ICIPE's work benefits developing countries in three major ways. First, through research and development, the technologies and improved practices that ICIPE develops contribute to improved human health and increased productivity in the agricultural and livestock sectors. In this respect, ICIPE's work with national agricultural research and extension systems in Kenya, Ethiopia, Zambia, Rwanda and Somalia has led to marked improvements in crops and/or livestock productivity in farmers' fields in these countries. Secondly, ICIPE makes a strong contribution to the development of human and institutional capacity in many developing countries, especially those in Africa. The capacity building programs are aimed at equipping scientists as well as front-line practitioners, including farmers, with the skills necessary to deal with pest and vector-related programs through the African Regional Postgraduate Program in Insect Science (ARPPIS), ICIPE collaborates with thirty African universities to train young scientists at the masters and doctoral levels. In addition, through the Practitioner Group Training courses, about 700 trainees from more than 50 countries have been trained since 1977. Finally, particularly in the last four years, ICIPE has helped farmers, especially women farmers, set up sericulture and apiculture based micro-enterprise projects. The objective here is to promote biodiversity conservation through profitable and sustainable utilization of silkmoths and honey bees

Migrant pests such as locusts and grasshoppers invade vast areas of Africa in explosive outbreaks, sometimes causing total devastation of crops and denuding the environment. Among these pests, the desert locust, *Schistocerca gregaria*, presents a special challenge in integrated pest management (IPM). Basic research on the desert locust's biology, behavioral and chemical ecology has provided new insights into crowding (gregarization) and suggested possible methods for controlling the swarming and migratory behavior of this important pest. Chemical ecology studies of the desert locusts in ICIPE provided several new pieces in the puzzle of locust behavior. Now scientists know that the pheromone system of the gregarious desert locust is a complex mixture of volatiles emitted by different developmental stages of the insects and their waste products. Phenylacetonitrile is the major component of the aggregation pheromone which keeps adult locusts in the gregarized phase. An interesting fact is that the adult aggregation pheromone plays a dual role as an aggregant for mature adults and as an accelerant of sexual maturation of immature adults. On the other hand, the nymphal aggregation pheromone retards maturation of the immature adult locusts.

A collaborative research project between ICIPE and JIRCAS entitled, "Locust Management in East and Northeast Africa: Development of Biological IPM", has been in progress since 1995 and has focused on the role of neuroendocrine factors in the sexual maturation of the desert locust. A juvenile hormone mimic prevented adult emergence and prolonged the nymphal stage, at the same time reducing feeding activity. It stimulated, however, precocious mating behavior in the fifth instar nymphs. These results will

be expected to contribute not only to the promotion of basic research on locust reproductive physiology but also to the establishment of new control methods of locusts by insect growth regulators. This project will also identify new uses of edible insects such as locusts, grasshoppers, flies, termites and wild silkmths in rural communities in East African countries. Research in the Maragoli area in Western Kenya has shown that villagers easily distinguish species and the emergence patterns of the termites. Cooked termites are sold not only in the local market but also in some open markets in Nairobi because they can be stored up to 4 days without spoilage. From preliminary surveys, termites play an important role in the daily food consumption in this area during the rainy season and during times of maize shortages. They may be especially valuable for children and pregnant women in need of high calories and enhanced nutrition.

[Continue to Africa Spotlight - \(2\) Collaborative Research at ILRI: Past and Present](#)





## (2) Collaborative Research at ILRI: Past and Present

### ***Merging of ILCA and ILRAD***

The International Livestock Research Institute (ILRI), sponsored by the Washington-based Consultative Group on International Agricultural Research (CGIAR), started its operation in January 1995. The Institute incorporates the resources, facilities and major research and outreach programs of two former CGIAR centers - the International Laboratory for Research on Animal Diseases (ILRAD, founded in 1973 in Nairobi, Kenya) and the International Livestock Center of Africa (ILCA, founded in 1974 in Addis Ababa, Ethiopia). The work programs of ILRAD and ILCA have been consolidated, streamlined and reoriented. They now support an expanded, global mandate to conduct research on biological, animal and social sciences to improve livestock productivity in sustainable agricultural systems of developing countries. The new Institute, whose headquarters are in Nairobi, will be directly responsible for about two-thirds of all CGIAR livestock and livestock-related research in developing regions. ILRI will also lead the development of a major CGIAR initiative - the Systemwide Livestock Research Programme (SLP) - and participate in other related inter-center initiatives supported by the CGIAR.

### ***TARC/JIRCAS and collaborative research with ILRI***

Cooperative research between TARC and the former ILCA was initiated in 1980 to examine the genetic and physiological characteristics of trypano-tolerant cattle. This project has since ended, but it aimed to increase genetic potential in indigenous cattle stocks and to identify strains particularly tolerant to environmental stresses and disease. JIRCAS's current project, entitled "Biochemical characterization of membranes of lymphocytes infected with *Theileria parva* schizonts" was initiated with ILRAD in 1994 and is now being conducted in cooperation with ILRI.

At ILRI's Nairobi campus, researchers are developing a new vaccine against East Coast Fever (ECF), a deadly disease of cattle caused by a single-celled organism, *Theileria parva*. This parasite, transmitted by ticks, costs farmers in Africa more than US\$ 170 million a year in direct losses. The potential of developing a vaccine using a protein referred to as p67, which is found on the surface of the sporozoite form of *T. parva*, has been intensely investigated. JIRCAS and ILRI researchers have found that p67 is a glycosylated protein and have inserted the p67 gene into *Salmonella* bacteria and vaccinia viruses along with a cytokine gene to enhance its effects. Inoculation of these harmless recombinant organisms into cattle has demonstrated that some cattle are protected against severe diseases after lethal challenge.

However, prior to the current project, collaborative background research between ILRAD and TARC had been carried out since 1980. This collaboration focused on the characterization of *Theileria* parasites to improve epidemiological knowledge about the disease, to improve methods of diagnosis, and to develop a "live" vaccine against ECF that is now in use. During this period, TARC/JIRCAS dispatched eight long-term and seven short-term visiting scientists for this program.

### [African cattle in Ethiopia.\(Photo:K.Togashi\) \(33KB\)](#)

The objective of the current cooperative study is to characterize the inflammatory reaction of the skin of cattle to the bite of the tick, which feeds on cattle blood and infects the animal with *T. parva* parasites. Since early interactions between the parasite and the bovine immune system have considerable bearing on the success of a vaccine based on "neutralizing" sporozoite parasite forms, a clear understanding of the environment into which sporozoites are delivered is important for the development of optimal vaccination strategies. JIRCAS and ILRI researchers have recently developed a means based on

immuno-histochemical methods of tracing the expression of *T. parva* antigens in tick salivary gland and have nearly completed an examination of this process. In addition, technology for the detection of parasite and bovine cytokine messenger RNA in the skin using non-radioactive *in situ* hybridization is being developed. These endeavors should allow researchers to further identify the mechanisms of *T. parva* infection. The above collaborative research is expected to deepen basic knowledge of the immunology of ECF and accelerate ILRI's development of a novel genetically engineered vaccine against ECF.

[Continue to Africa Spotlight - \(3\)Workshop on Africa agriculture and plans to initiate cooperation with WARDA](#)





### 3) Workshop on African Agriculture and its interim report

Because of their limited knowledge of African agricultural issues, JIRCAS and the Secretariat to the Agriculture, Forestry and Fisheries Research Council set up a workshop on African agriculture in October 1996. Its purpose was to review major issues in African agriculture, to learn lessons from the failures and successes of past research attempts, to establish research priorities for JIRCAS, and to examine possible collaborative projects. The workshop invited researchers, policy makers and aid agencies to participate in its discussions.

Since its inception the workshop has had four meetings. JIRCAS scientists as well as guest speakers made presentations on the basis of their own experiences and/or research results. The main themes discussed in each meeting are shown in the Table below.

1st meeting ( 31 October 1996)

- agricultural preconditions and research activities in Africa
- food supply-demand in Africa and its main determinants

2nd meeting (2 December 1996)

- special characteristics of agricultural technologies required for development assistance
- rural development efforts at preventing desertification in Mali

3rd meeting (17 January 1997)

- environmental and resource problems in Africa with particular reference to the State of the World report
- a proposal for developing African-type integrated paddy fields in small catchment areas
- major issues and solutions for African agriculture; experiences of Sasagawa Africa Association

4th meeting (4 April 1997)

- Expectations for contributions from JIRCAS and African researchers towards African development
- proposals for rice farming development in West Africa

After these meetings, the workshop issued an interim report intended to formulate a special research project for Africa. The report recommended that JIRCAS intensify its collaborative efforts in Africa because: (1) Aggravated by high population growth, poor economic performance, desertification, and urbanization, the food, environment and poverty situations in Africa are far more serious than any other region,; (2) Africa desperately needs its own version of “green revolution” to overcome the inherent problems of low productivity in agricultural production and marketing; (3) the international community increasingly wishes Japan to play much larger roles in addressing world poverty and environmental problems.

The interim report suggested that given the current resource limitations, JIRCAS's collaborative researches in Africa should take into account the following points. First, they should focus on the development and extension of the technologies that are relevant to the local socioeconomic conditions,

technological levels and farming practices. It would be premature to embark on research requiring high technologies and expenditures. Second, although water is one of the most critical elements, priority should be given to research on small-scale irrigation and increased water efficiency in upland cropping rather than on large-scale, modern irrigated farming.

Third, the recent trends in food balance and farmers' income in Sub Saharan Africa indicate that research aimed at increasing the production and income from major food crops should be given first priority. In this regard, research on rice would be the area in which Japanese scientists could contribute most effectively. Fourth, the recent success in the hybridization of *Oryza Sativa* and *Oryza Glaberrima* at WARDA (West Africa Rice Development Association) is worth noting. Fifth, JIRCAS should continue collaborative research on individual subjects such as desert locusts or animal vaccines if they have broad application possibilities.

On the basis of these suggestions JIRCAS planned to initiate collaborative research with WARDA from 1997 on the inter-specific hybridization of *O. Sativa* and *O. Glaberrima*. The workshop will continue its discussions envisaging the further expansion of JIRCAS activities in Africa.

[Continue to Highlights](#)

# ACADEMIC PRIZES AND AWARDS

JIRCAS is pleased to note that in the past few years, many of our staff, including our Director General and two of our Research Division Directors have been the recipients of academic prizes and awards from scientific societies and organs of the media. The following is a brief summary of these achievements which we are proud to include in the Highlights of the 1996 Annual Report.

**Mr. Naruo Matsumoto, Researcher in the Environmental Resources Division** received the 1997 Encouragement Prize for Soil Science and Plant Nutrition awarded by the Japanese Society of Soil Science and Plant Nutrition for "Nitrogen flow assessment of an agricultural district." The award is given to a rising, young researcher as the Society's recognition of the individual's achievement and promise.

**Dr. Yukio Toida, Senior Researcher Crop Production and Postharvest Technology Division** received the honorable award from His Majesty Prince Masahito, President of the Dainippon Silk Foundation on November 14, 1996. Dr. Toida has devoted his whole career to the study of the ecology and the protection of mulberry nematodes. In Thailand, he identified the nematode species attacking the Thai mulberry and described four new species of nematodes, including *Meloidogyne suginamiensis*.

[Continue to MAFF Research Structure](#)

# JIRCAS AND THE MINISTRY OF AGRICULTURE, FORESTRY AND FISHERIES

## MAFF Research Structure

The Japan International Research Center for Agricultural Sciences (JIRCAS) is one of 29 research institutes belonging to the Ministry of Agriculture, Forestry and Fisheries (MAFF), the Government of Japan. In this age, in which we have seen remarkable progress in advanced fields of science and technology including biotechnology, MAFF's research institutes are playing a key role in the development of new technologies to pave the way for further development of the food industry, and promotion of agriculture, forestry and fisheries activities in the 21st century. MAFF's institutes work in close collaboration with local governments, universities, and private research organizations and aim to contribute to the overall prosperity of Japan while making significant contributions to the international community.

Nineteen of the 29 institutes including JIRCAS are directly overseen by the Agriculture, Forestry and Fisheries Research Council (AFFRC), which is a special agency attached to MAFF. The main duties of the AFFRC are overall research planning and coordination, liaison and coordination between research and administration, administration and guidance of the institutes, and research assistance to prefectural organizations and the private sector. The AFFRC is headed by a chairman, and its advisory members consist of independent university faculty members and previous MAFF research institute directors ([Table 1](#)). The remaining 10 institutes, which include one institute devoted to forestry and nine fisheries research institutes, are also attached to the AFFRC. However, they are overseen by the Forestry Agency and the Fisheries Agency, M administrative agencies directly under MAFF. Overall MAFF research Structure is as shown in [Fig.1\(123KB\)](#).

JIRCAS is unique among the 29 research institutes in that it serves as an international research center but is at the same time part of the overall MAFF infrastructure. Thus, it is involved in active exchange and collaboration with the other 28 institutes. JIRCAS is located in the Tsukuba Science City which is about 50 km northeast of Tokyo [Fig.2\(74KB\)](#). Many other MAFF institutes are also located in Tsukuba, and the AFFRC secretariat maintains a Tsukuba office, forming the Tsukuba Institutional Complex. Tsukuba itself is home to numerous other research institutes and experimental facilities belonging to other ministries and agencies of the Japanese Government as well as to the private sector.

## Research structure at JIRCAS

JIRCAS has a current staff of 164 including research scientists and administrators. Forty-three staff are located out of Tsukuba at JIRCAS's Okinawa Subtropical Station. JIRCAS is headed by a Director General; the Research Planning and Coordination Division oversees the seven research divisions which are comprised of the Research Information Division, Biological Resources Division, Environmental Resources Division, Crop Production and Postharvest Technology Division, Animal Production and Grassland Division, Forestry Division, and the Fisheries Division as well as the Okinawa Subtropical Station. The Administration Division is responsible for general administrative affairs. Research structure at JIRCAS is delineated in [Fig.3.\(76KB\)](#)

## **Research Planning and Coordination Division**

The Research Planning and Coordination Division in itself does not act as a research division, but rather serves to oversee and support the activities of the Research Divisions and Subtropical Station. The Division consists of four sections which are the Research Planning Section, the Research Coordination Section, the International Relations Section, and the Publication and Documentation Section. In addition, a Research Information Officer is assigned to the Division.

In order to promote the implementation of research programs both overseas and in Japan, the first 3 sections are responsible for the overall planning of JIRCAS research projects, dispatching of researchers on long- or short-term basis, implementation of programs for the invitation of researchers and administrators, and liaison and coordination with international and domestic institutions and agencies. The Publication and Documentation Section is responsible for the collection, classification, and supply of bibliographic materials from both overseas and domestic sources, as well as the release of public relation materials. The Research Information Officer handles the coordination of collaborative activities with the Japan International Cooperation Agency (JICA) and related research institutions and deals with problems pertaining to the exchange of technical information. Additionally, the Division coordinates the organization of various meetings and workshops including JIRCAS's International Symposia.

## **Administration Division**

The Administration Division consists of three sections: the General Affairs Section, the Accounting Section, and the Overseas Support Section. The General Affairs Section is responsible for the management of official documents, personnel-related matters, and social affairs pertaining to JIRCAS staff. The Accounting section handles overall accounting, all budgeting, settlements and wage distribution. Lastly, the Overseas Support Section is in charge of all matters pertaining to JIRCAS's overseas operations, which includes general international affairs, overseas expenditures, and overseas shipments of equipment and materials.

## **Other**

The Okinawa Subtropical Station has its own General Affairs Section which is independent of the Administration Division. Additionally, JIRCAS has two field management sections which oversee JIRCAS's experimental fields. The Okinawa Section is directly under the Subtropical Station management and the Tsukuba Section is attached to the Crop Management and Postharvest Technology Division.

[Forward to International Research at JIRCAS](#)

[Back to Contents](#)

Table 1

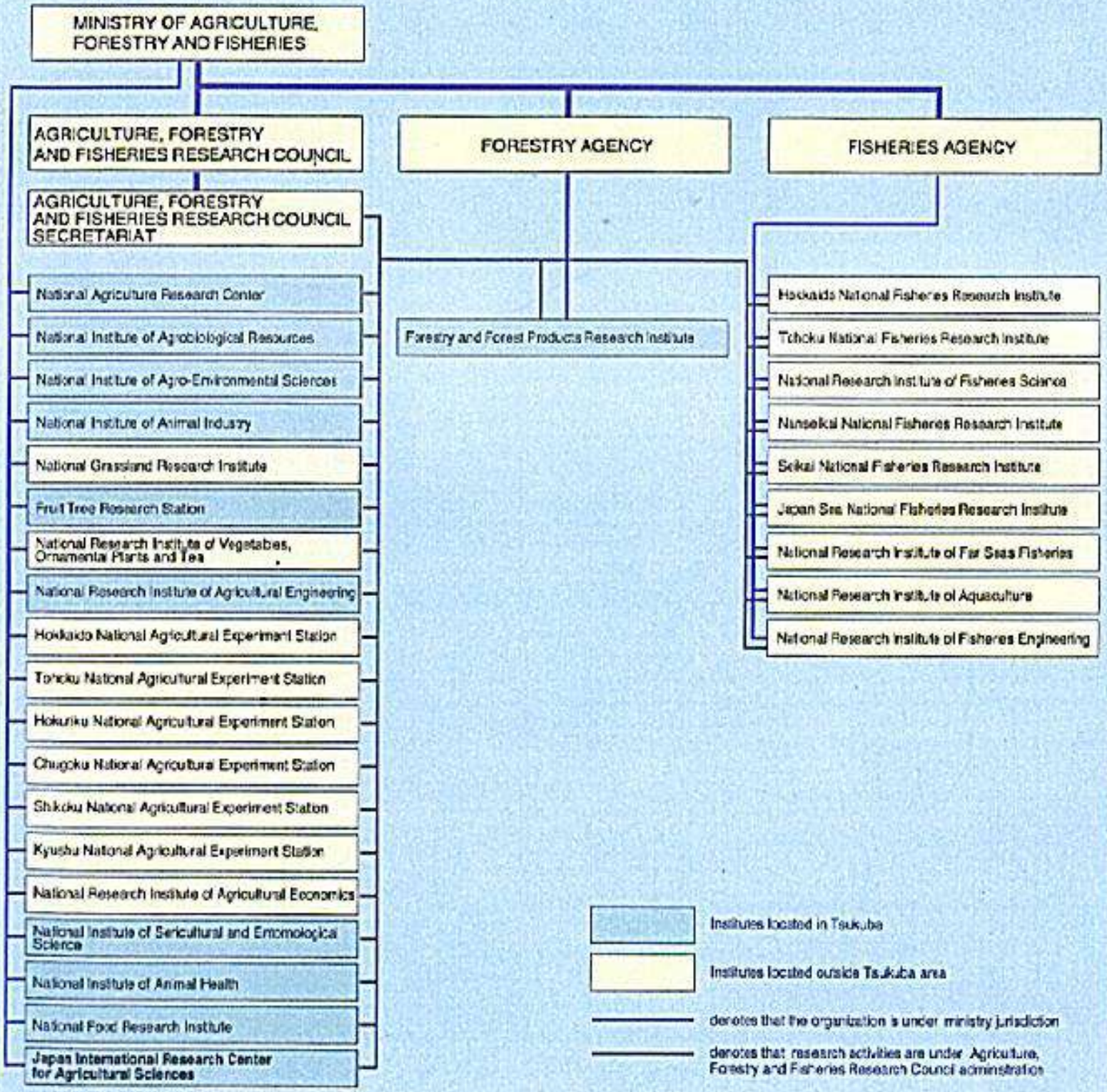
**Table 1**

Chairman	Sakue Matsumoto	Former Vice-Minister of the Ministry of Agriculture, Forestry and Fisheries
Advisory Members	Nobutaka Takahashi	Professor Emeritus, University of Tokyo(Agricultural Chemistry)
	Ryoichi Kawashima	Former Director General of the National Agriculture Research Center
	Tetsuo Iino	Professor, Waseda University (Genetics)
	Masatoshi Yoshino	Professor, Aichi University (Meteorology)
	Takenori Inoki	Professor, Osaka University(Economics)
	Kazuo Takahashi	Governor, Yamagata Prefecture

### General organization of the research institutes of the Ministry of Agriculture, Forestry and Fisheries

Fig. 1

Twenty-nine research organizations are affiliated to the Ministry of Agriculture, Forestry and Fisheries: 19 are directly overseen by the AFFRC; 1 forestry and 9 fisheries institutes are under the administration of the Forestry Agency and the Fisheries Agency, respectively.





## Organization

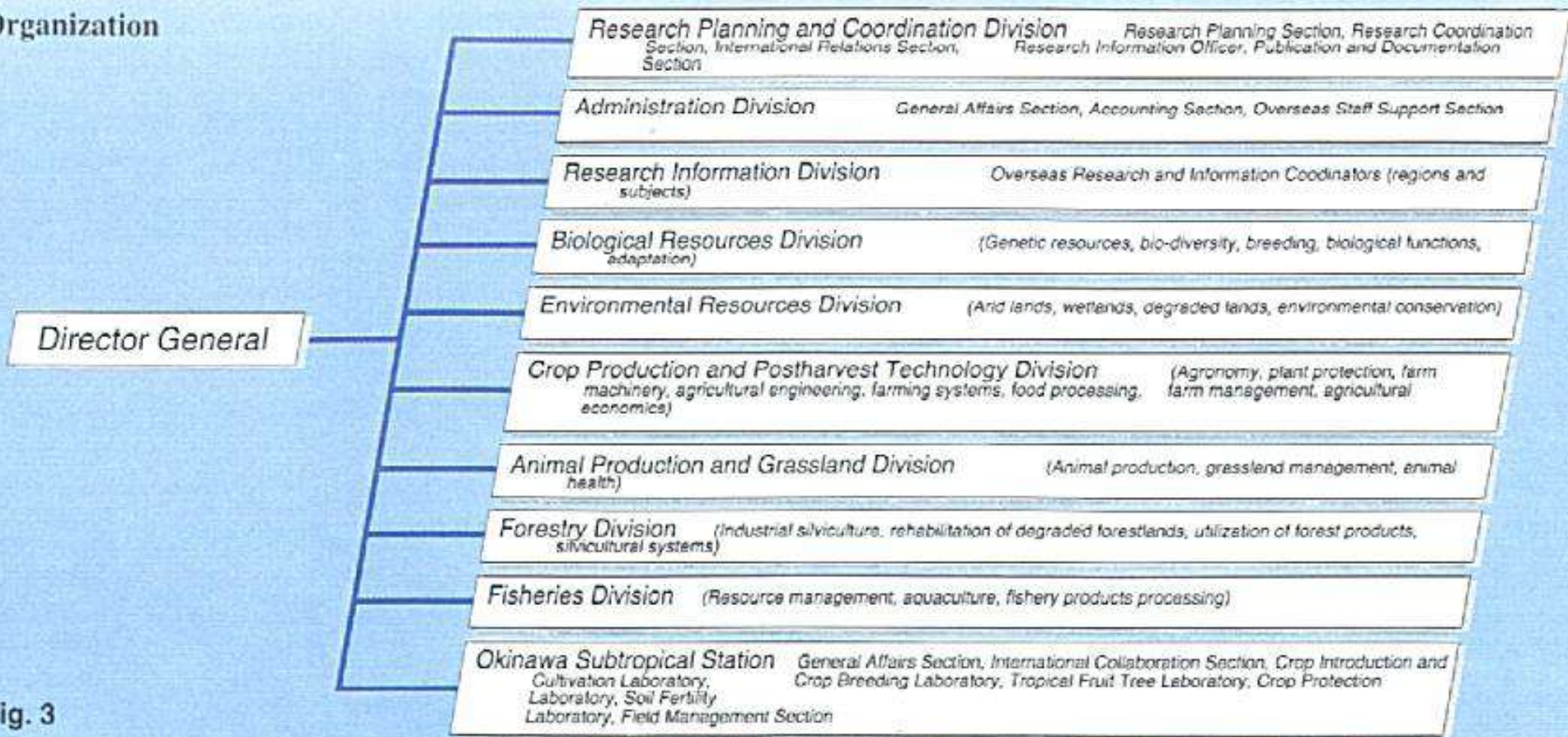


Fig. 3

# INTERNATIONAL RESEARCH AT JIRCAS

International collaborative projects at JIRCAS encompass all of the fields of agriculture, forestry, and fisheries and are being carried out in collaboration with counterpart institutions including international research centers, national research organizations and universities. The integrative type comprehensive project was initiated with the transformation of TARC into JIRCAS; there are currently four ongoing comprehensive projects in Vietnam, Thailand, Malaysia, and Brazil. In addition, JIRCAS continues to promote the specific, focused type of project carried out at TARC. Details of some of these projects can be found in the description of activities of the JIRCAS research divisions. A summary of all ongoing collaborative projects can be found at the end of this section.

## COMPREHENSIVE PROJECTS

In 1996, JIRCAS was involved in four key comprehensive projects in Vietnam, Thailand, Malaysia, and Brazil. These studies were part of the continuation of the comprehensive research system begun in 1995. Under this program, a research coordinator in the Research Information Division assumes the role of project leader, organizing and overseeing the collaboration among numerous research divisions and researchers. During the planning stages of these comprehensive projects, socio-economic studies are conducted to identify the research priorities of the counterpart countries.

- [VIETNAM: Farming systems in the Mekong Delta](#)
- [THAILAND: Sustainable agricultural systems in Northeast Thailand](#)
- [MALAYSIA: Productivity and sustainable utilization of tropical and subtropical brackish water mangrove ecosystems](#)
- [BRAZIL: Development of sustainable agropastoral systems in the subtropical area of Brazil](#)

[Forward to JIRCAS RESEARCH DIVISIONS](#)

## **VIETNAM : Farming Systems in the Mekong Delta**

Since its inception in 1994, the research program "Evaluation and Improvement of Farming Systems Combining Agriculture, Animal Husbandry, and Fisheries in the Mekong Delta" has been carried out for 3 years in cooperation with Canto University and Cuu Long Delta Rice Research Institute, Vietnam. In order to improve people's nutrition, increase farmers' income and develop rural communities, increased production of rice, livestock, fisheries, and horticultural commodities is necessary. The Mekong Delta possesses good farming systems which combine these various types of husbandry in each farm to maximize income.

[Surveying irrigation methods in the Mekong Delta.\(Photo:S.Matsui\)\(23KB\)](#)

[Livestock grazing in Vietnam.\(Photo:S.Matsui\)\(23KB\)](#)

This research project aimed to clarify the structure of the systems, to identify and develop necessary technology currently lacking in the systems and to specify the conditions for applying the systems to other regions. Currently, we are concentrating our research on developing new methods to grow high yielding rice, for better management of livestock and for aquaculture nurseries for prawn. Last year, we had a workshop in Canto University to review the project and concluded that more close cooperation is necessary.

Vietnam has become the world's second largest rice exporter, shipping out approximately 3.1 million tons last year. Improved irrigation and drainage, the introduction of modern varieties of rice and integrated management of rice production, and the development of a market-oriented economic policy called "Doi Moi" brought about the increased rice production in the Mekong Delta.

The example of the Mekong Delta is encouraging because it demonstrates that increased food production can keep up with population increases. The Mekong Delta possess good resources for agriculture including vast fertile land, huge amounts of river water, adequate temperature and sunshine and a well-educated, diligent labor force. However, they suffer from periodical flooding, large areas of waste land and the threat of salt water intrusion. This cooperative research is earnestly expected to develop technologies for sustainable growth in the area.

[Continue to Sustainable agricultural systems in Northeast Thailand](#)





## **THAILAND: Sustainable Agricultural Systems in Northeast Thailand**

Since the 1960s, large forest acreage has been cleared to make room for upland fields in Northeast Thailand, leading to a reduction in water-holding capacity and to salt accumulation due to the elevation of the groundwater table. In addition, the deforestation of sloping land has made the land highly vulnerable to soil erosion by wind and rainfall. Because of the inadequate application of fertilizer and organic material, soil fertility of the reclaimed fields, which was originally low, has further deteriorated after several years of cultivation. Moreover, precipitation is erratic and the dry season lasts for more than half a year in the area. These environmental constraints as well as the social problems facing Northeast Thailand have restricted agricultural development in the region.

To address these constraints and problems, in 1995 JIRCAS initiated a 7-year research project, "Comprehensive studies on sustainable agricultural systems in Northeast Thailand". This multidisciplinary research project includes soil, crop and livestock sciences as well as economic and social studies. The contents of the project are based on the knowledge gained in previous collaborative research activities undertaken by JIRCAS (formerly TARC) and JICA in Northeast Thailand during the past few decades. Research activities are currently being carried out at the Agricultural Development Research Center in Northeast Thailand (ADRC) and other Thai research institutes affiliated with the Department of Agriculture (DOA), Department of Land Development (LDD), Department of Livestock Development (DLD) and Asian Institute of Technology (AIT).

[Paddy field in the dry season in Khon Kaen, Thailand. \(Photo: M. Oka\) \(22KB\)](#)

The main objective of this project is to develop sustainable farming systems in Northeast Thailand by improving agricultural technologies for crop and livestock production that are readily transferable to local farmers. More specific subjects to be taken up include: 1) evaluation of environmental and biological resources in the area and development of more effective uses of those resources, 2) development of sustainable farming systems in lowland and upland fields, 3) improvement of forage crop management and livestock production with locally available feed resources, 4) development of postharvest technologies for local agricultural products, and 5) economic evaluation of mixed, multiple-cropping agricultural systems. At ADRC, two researchers are studying farming systems and groundwater salinization mechanisms; at the Khon Kaen Animal Nutrition Research Center, DLD, another scientist is studying the improvement of livestock nutrition through the use of sugarcane feeds. Additional JIRCAS researchers are scheduled to initiate studies on the evaluation and utilization of environmental and biological resources available in the region.

[Continue to MALAYSIA: Productivity and sustainable utilization of tropical and subtropical brackish water mangrove ecosystems](#)



## **MALAYSIA: Productivity and sustainable utilization of tropical and subtropical brackish water mangrove ecosystems**

JIRCAS has initiated an integrated research project entitled "Productivity and sustainable utilization of tropical and subtropical brackish water mangrove ecosystems" in collaboration with leading Malaysian scientists that includes the following four research topics: 1) production and decomposition processes in the brackish water mangrove ecosystems, 2) nutrient flux from rivers to the coastal ecosystems, 3) energy flow and carrying capacity in the brackish water mangrove ecosystems and 4) socio-economic evaluation of the brackish water mangrove ecosystems, covering a five year period from 1995-2000.

Among the various research activities of the project, collaborative studies in fisheries are being conducted with the Fisheries Research Institute (FRI) and the University of Malaya (UM). The Forest Research Institute Malaysia (FRIM) serves as a counterpart research organ to integrate the forest-related aspects of the project. The Matang Mangrove Forest Reserve in Perak State and the Merbok Estuary in Kedah State, West Coast of Peninsular Malaysia are serving as research sites. The Matang Mangrove Forest is especially important as a location for analysis of the role of mangrove ecosystems in fish production.

One senior researcher who specializes in the ecology of finfish and squid has been dispatched to the FRI, Penang since November 1995 as a long-term residing scientist. Other researchers specializing in larval fish ecology, life history of crustacea, and soil runoff have been dispatched short-term in supporting roles of one and half years from November 1995 to March 1997.

Since 1995, a seminar has been held annually in Malaysia as a part of the comprehensive project (see the JIRCAS Working Report No.4) to produce integrated, interdisciplinary results through the close collaboration of researchers in different fields.

[Oyster culture in Merbok mangrove estuary, Malaysia.\(Photo:K.Fukusho\)\(25 KB\)](#)

[Continue to BRAZIL: Development of sustainable agropastoral systems in the subtropical area of Brazil](#)





## **BRAZIL: Development of Sustainable Agropastoral Systems in the Subtropical Area of Brazil**

The research project entitled 'Comprehensive Studies of the Development of Sustainable Agro-pastoral Systems in the Subtropical Area of Brazil' emphasizes the development of sustainable farming systems with high productivity in environmentally degraded areas of subtropical Brazil. It focuses on land utilization in the crop-pasture rotation system.

[Wide area soybean cultivation in south central Brazil.\(Photo:H.Eguchi\)\(29 KB\)](#)

[Cattle grazing on agro-pastoral land in Campo Grande,Brazil.\(Photo:M.Kokubun\)\(13 KB\)](#)

To fulfill its research objectives, this project included the following topics: (1) to identify the use of forages for soil improvement and erosion control in addition to their value as pasture, fodder, soil cover and green manure, (2) to establish mixed, multiple-cropping patterns employing soybean as a main crop for the diversification of agricultural products in order to minimize the market risk and to profit local farmers, and (3) to improve the cattle production technologies with disease controls to promote crop-pasture rotation systems. Research studies will mainly be carried out in conjunction with EMBRAPA and JIRCAS, and necessary consultation with CIAT, for 7 years from 1996 to 2002.

In 1996, a pasture agronomist was sent to CNPGC, National Center for Research on Beef Cattle, of EMBRAPA as the first long-term scientist from JIRCAS. He engaged in studies on the introduction and management of forage legumes in mixed, multiple-cropping patterns for soil improvement. Also three short-term scientists of JIRCAS have stayed at CNPGC, CNPSo, National Center for Research on Soybean, and/or the headquarters of EMBRAPA for one to three months. They have investigated the dynamics of soil fertility and plant nutrition in crop-pasture rotation, and the development of a domestic food and agricultural policy simulation model.

[Forward to JIRCAS Research Divisions](#)

[Back to Contents](#)





# JIRCAS RESEARCH DIVISIONS

The following pages are an introduction of the activities of JIRCAS's seven research divisions and the Okinawa Subtropical Station. Each summary features an overall explanation of the research thrusts of the division along with a presentation of the highlights of FY 1996.

## RESEARCH INFORMATION DIVISION

The Research Information Division of JIRCAS has three main responsibilities relating to overall research operations of the Institute. The first is to collect and analyze information pertaining to the agricultural sciences and the related socioeconomic situation in developing countries. The second is to formulate and coordinate collaborative research projects with developing countries. The third is to develop and operate a computer-based information system in JIRCAS.

[Banjarmasin's Market, South Kalimantan, Indonesia.\(Photo:J.Goto\)\(25KB\)](#)

The Division's research coordinators and senior scientists undertake these tasks through two different approaches. The first is a region-oriented approach with focus on strategically important regions: China, other monsoon Asian regions, arid and semi-arid Asia, Africa, Latin America and developing countries. The second is an issue-oriented approach with emphasis on global problems concerning the environment, food security and rural development. Research coordinators conduct studies on agriculture in specific regions and investigate the need for collaborative studies. They design and coordinate both comprehensive and multi-national projects. Thus far, six projects have been formulated since JIRCAS was established.

In 1994 JIRCAS launched its first integrated-type comprehensive research project in Vietnam dealing with the improvement of combined farming systems in the Mekong Delta. This was followed by the initiation of two research projects in 1995 and one in 1996 on tropical brackish water ecosystems in Malaysia, sustainable agricultural technologies in northeast Thailand and agro-pastoral rotation systems in subtropical Brazil. In 1997, two new comprehensive projects will begin: sustainable production and processing of major food resources in China and technological development of soybean production and utilization in MERCOSUR countries.

The Research Information Division is also involved in analyzing global issues. A sophisticated world food model was developed by the Division in collaboration with MAFF headquarters, the FAO and other international agencies. It is being used to project world food supply and demand and to simulate policy, and the findings of collaborative research are often incorporated into its models. Currently, researchers are attempting to elaborate the model so that the impact of environmental changes can also be analyzed. Rural development strategies are also being studied by the Division with particular emphasis on farming systems research. The Division's social science researchers review recent rural development strategies and assist researchers in the natural sciences who are involved in integrated projects.

Another important task of the Division is to develop and operate the computer-based JIRCAS information system. In addition, the Division has constructed a database of bibliographic articles on tropical agriculture published in Japan which is available to JIRCAS researchers. The Division has developed a comprehensive information system including statistical data, documents and imagery data

base on PC windows and UNIX. JIRCAS researchers have access to this information as well as access to external sources through the Internet system.

In addition, the Division works as the secretariat for the JIRCAS international symposium held every year on a specific research issue. In 1996, a symposium entitled "The biosafety results of field tests of genetically modified plants and microorganisms" was held with 220 participants from 29 countries.

[Topic: A perspective of the rice market situation in Vietnam](#)



# BIOLOGICAL RESOURCES DIVISION

Environmental stresses such as drought, high and low temperature extremes, and pest and disease outbreak can result in the serious instability of a crop yield with devastating results, bringing about the starvation and malnutrition of a large number of people in a developing region. In addition, a rapidly growing population rapidly accelerates the deterioration of natural resources, especially in marginal lands, which may lead to further degradation of food production. We are now faced with the need to increase and stabilize agricultural production through methods compatible with the preservation of the environment. To achieve this objective, it is essential to develop agricultural technologies by optimizing the use of biological resources.

In light of the above, the first objective of the Biological Resources Division is to collect, evaluate and preserve germplasm accessions of under-utilized crops and wild relatives, taking into account the rapid genetic erosion occurring on a world-wide scale. In this regard, studies on Andean root and tuber crops are being carried out at the International Potato Center's (CIP) experimental station in Quito, with the assistance of National Agricultural Research Institute (INIAP). Yacon is one of the major natural sources of fructooligosaccharides, accounting for 90% of total sugar content. It was found that yacon has at least 2 different basic chromosome numbers. The normal cultivar is octaploid. This research may open up possibilities for increased utilization of this plant through hybridization breeding and ploidy manipulation as well as identify methods to increase fructan production.

[Local markets can also provide valuable plant genetic resources. Many kinds of wild and cultivated species are sold for medicinal use in Ecuador. \(Photo: K.Ishiki\)\(23KB\)](#)

Secondly, using biotechnological methods, the molecular biology group of the Division, including several visiting scientists, is studying molecular mechanisms of tolerance for environmental stresses in higher plants. The researchers in the Division isolated a number of genes that function in drought tolerance and using stress response from *Arabidopsis* and cowpea plants analyzed the regulatory factors of their genes. This group is studying how to use these genes and regulatory factors for the production of drought-tolerant transgenic crops. This research will contribute to the development of technologies which will help resolve problems relating to the food crisis and environmental degradation in developing countries.

Thirdly, using genetic resources and applying biotechnological procedures, we are implementing collaborative breeding projects in various countries in order to develop new varieties of rice, wheat, soybean, and vegetables characterized by high yield potential and resistance to various diseases and environmental stresses. These new varieties should contribute to the increase and stabilization of agricultural production with lower input in the developing regions. In 1996, soybean viral diseases and nematode pests were investigated for the breeding of resistant varieties in collaboration with the Soybean Institute of the Jilin Academy of Agricultural Sciences, People's Republic of China.

[Topic1.Development of new rice cultivars Hexi 34 and Hexi 35 in Yunnan Province"](#)

[Topic2.New disease resistant varieties of cucumbers and strawberries in China"](#)





**TOPIC 1: Development of new rice cultivars Hexi 34 and Hexi 35 in Yunnan Province of the People's Republic of China**

A collaborative research project for rice breeding using a wide diversity of genetic resources has been conducted in Yunnan Province of the People's Republic of China since 1982. The new rice cultivars developed through the joint project have been widely grown in and around the Province. In 1996, the total acreage of these cultivars covered more than 170,000 hectares, accounting for nearly 20% of the total rice-growing area in Yunnan.

In 1996, two rice cultivars, Hexi 34 and Hexi 35, were developed and newly released under the project; they will be officially registered by the Yunnan provincial government. Hexi 34 was developed from the cross Yunxi 2 / Dianyu 1, and Hexi 35 from the cross Hexi 15 / Hexi 4. The pedigree of these new cultivars can be traced to some Japanese rice genetic resources: a high-yielding cultivar Todorokiwase, a cool-weather resistant cultivar Narukaze, and blast resistant germplasm lines BL 1 and BL 6 among others.

The principal reason for releasing these two cultivars is that they display a higher yield ability than that of the current japonica rice cultivars grown in Yunnan, which is the most important factor in crop production in China. Hexi 34 and Hexi 35 performed very well in uniform trials conducted at twelve sites representative of the japonica rice growing areas in the central and northern part of Yunnan. In twenty-four tests across twelve locations during a two-year period, the average yield of Hexi 34 and Hexi 35 were 8.55 and 8.80 t ha⁻¹ respectively, compared with 7.10 t ha⁻¹ of the standard cultivar Yunkeng 9.

We conducted a statistical analysis of adaptation based on the data of the uniform trials using linear regression and principal component analysis. The regression coefficients of the mean yield of each environment of Hexi 34 and Hexi 35 were smaller than those of other tested cultivars. These findings indicate that these cultivars are well adapted to various kinds of environments in Yunnan. The results of principal component analysis also revealed the high-yielding characteristics and wide-adaptability of Hexi 34 and Hexi 35.

The cooking and processing qualities of Hexi 34 and Hexi 35 are superior to those of the standard cultivar Yunkeng 9 in Yunnan. Milled kernels of Hexi 34 and Hexi 35 are nonglutinous and nonaromatic; they are translucent in contrast to those of Yunkeng 9, which show a pronounced white belly. Taste panelists rated Hexi 34 and Hexi 35 as satisfactory in sensory tests of steamed rice. Recently, the standard of living in urban areas of China has been rapidly rising, resulting in a remarkable increase in the demand for rice of superior taste. These two new cultivars should meet the demand for good quality rice.

Finally, careful attention should be given to the shift in the frequency of the blast fungus races, because Hexi 34 and Hexi 35 exhibit a race-specific resistance to rice blast disease. These cultivars could be widely grown in and around Yunnan Province, because of their high-yielding ability and high grain quality as mentioned above. However, breakdown of the blast resistance is common in many rice-growing areas, often shortly after the release of cultivars with race-specific resistance. Rice blast is the most devastating disease in japonica rice growing areas. We should develop breeding strategies for durable resistance to reduce the impact of rice blast disease by using the abundant rice genetic resources of Yunnan Province and Japan.

**Table 1. Main agronomic characteristics of Hexi 34 and Hexi 35**

Character	Hexi 34	Hexi 35	Yunkeng 9(Standard)
Maturity	<b>Medium</b>	<b>Medium</b>	<b>Medium</b>
Plant height (cm)	<b>88</b>	<b>93</b>	<b>115</b>
Lodging resistance	<b>HR</b>	<b>HR</b>	<b>S</b>
Cool-weather resistance	<b>MR</b>	<b>MR</b>	<b>R</b>
Blast resistance	<b>HR</b>	<b>M</b>	<b>R</b>
Grain appearance	<b>Good</b>	<b>Good</b>	<b>Poor</b>
Eating quality	<b>Good</b>	<b>Good</b>	<b>Poor</b>
Yielding ability (%)	<b>112</b>	<b>121</b>	<b>100</b>

*HR, highly resistant; MR, moderately resistant; M, moderate; S, susceptible*

[Photo:Rice cultivation in a basin near Kunming City, Yunnan Province. Rice plants \(right\) are of a new cultivar Hexi 35. Mountainous regions account for about 84% of the total area in the province. Cultivation of japonica-rice for obtaining high yields is usually conducted in a small number of basins at an elevation of 1,500 to 2,000m. \(32 KB\)](#)

[Forward to Environmental Resources Division](#)



# ENVIRONMENTAL RESOURCES DIVISION

A recent estimate suggests that the world population could reach the 6.3 billion mark by the year 2000 and the 6.8 billion mark by 2025. To feed this ever-increasing population, existing agricultural land is likely to be subjected to a higher intensity of cultivation in populous areas, and farmland development is likely to be extended to areas only marginally suited for agriculture. Trade liberalization in recent years has led to a sharp increase in the importation of commercial crops and is encouraging increased production in exporting countries. This may result in excessive load to farmland soils as well as continuous single cropping and deforestation in many countries. Past experience has shown us that these practices accelerate farmland degradation and desertification on a global-scale. Such drastic changes in land use cause climatic transformation over extended regions and bring about unpredictable constraints to existing agricultural and forest ecosystems.

From the middle of this century, patterns of land utilization have been changing due to population expansion. These changes, along with a rapid increase in fossil fuel consumption, have had tremendous impact on the atmosphere through intensified emissions of carbon, nitrogen, and sulfur gases. The annual consumption of fossil fuel now exceeds 5 billion tons of carbon. If the present level of consumption continues, CO₂ concentration will increase by 0.5% per year and double by the middle of the next century. The 1995 IPCC report suggests that a two-fold increase in CO₂ concentrations could cause an increase in mean global surface temperature by about 2 by the year 2100.

Furthermore, research has shown that the atmospheric concentrations of other greenhouse gases such as methane, nitrous oxide and chlorofluorocarbons have also increased greatly within the past two decades. If the effects of these trace gases are taken into account, global warming is estimated to take place more rapidly than in the case where the effects of CO₂ are considered alone. These trace gases move from the troposphere to the stratosphere and participate in the destruction of the stratospheric ozone. The depletion of the ozone layer allows more ultraviolet rays to reach the Earth's surface where millions of species of organisms live without any means of protection from ultraviolet radiation.

To address these problems, this Division is organizing research to identify and develop technologies for the improvement of agricultural activities and the rehabilitation of degraded lands. The target technology must be compatible with the conservation of the environment and ecosystems such as arid lands, wetlands and sloped lands which have long been considered of little use for agriculture. Other projects aim at the development of technology for sustainable agriculture through analyzing mechanisms of nutrient cycling within arable land ecosystems. To conserve the global environment in harmony with agricultural activities, research on sustainable agriculture should be given foremost emphasis.

[Figure1:Protection against soil erosion by using rice terracing to preserve sustainable agriculture in Japan \(Noto Peninsula, Ishikawa Prefecture\)\(23KB\)](#)  
(Photo:K.Minami)

["Mechanism of uplifting saline-groundwater in the Phra Yune area, Northeast Thailand"](#)

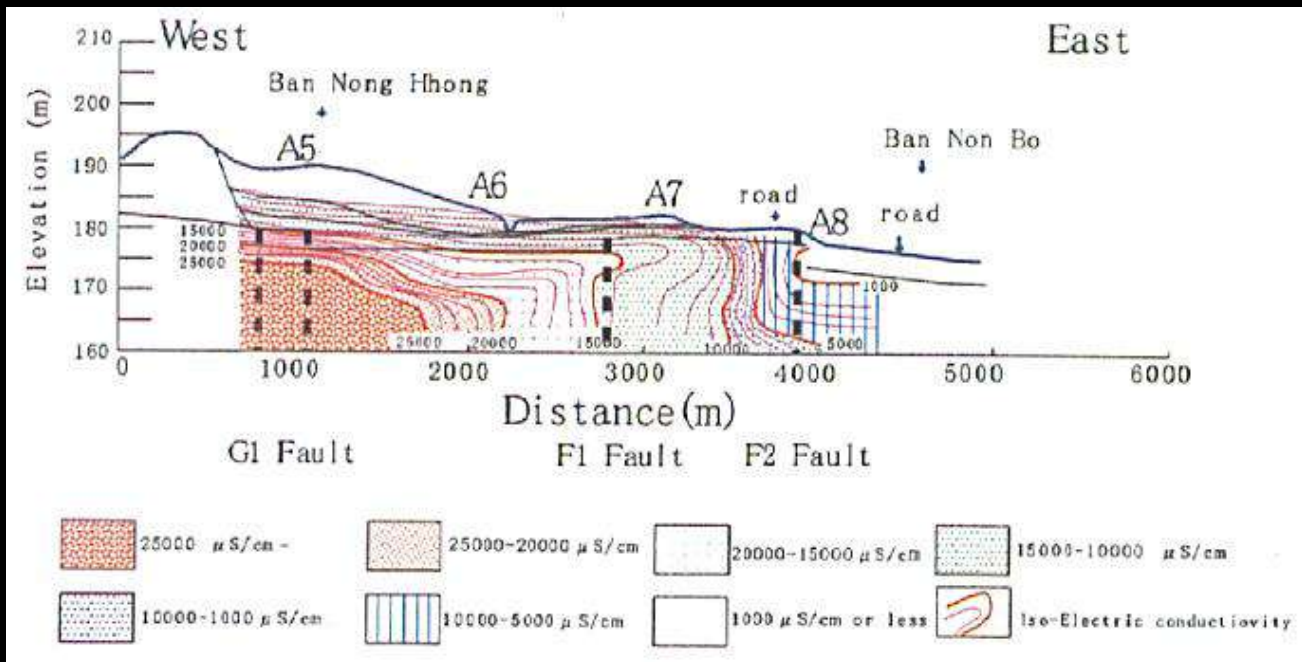
["The influence of physical properties and rock dissolution"](#)



## TOPIC 1: Mechanism of uplifting saline-groundwater in the Phra Yune area, Northeast Thailand

In Northeast Thailand, salt accumulation in soil is thought to derive principally from saline groundwater. Several theories have been proposed to explain this salinization. All of them agree that salinization is related mainly to the presence of a few rock salt strata of the Maharakham formation which underlies much of Northeast Thailand. One of the problems to be solved is how salt from the rock salt strata reaches the ground surface. An understanding of this mechanism of uplifting saline-groundwater should contribute to the development of technologies for the utilization of groundwater and the evaluation of water resources in Northeast Thailand.

The Phra Yuen region, which is a salt-affected area, was selected for studying the relationship between geological structure and groundwater flow. Piezometers were installed at every intersecting point of a regular 1 km grid. Intersecting points were set up at 16 stations (A1^A16). At each intersecting point, 3 investigation wells of 5, 10 and 15 meters in depth were set up for monitoring groundwater level (potential head), electric conductivity (EC), and temperature of the groundwater.



Lineament analysis and examination of the upper structure of the Maharakham Formation and distribution level of the gravel layer in the Quaternary laterite deposits revealed the presence of G1, F1, F2 and F3 faults. Saline groundwater at stations A1, A5, A9 and A13 was supplied from the G1 faults and that at station of A 11 from the F1 fault. However, not all of the faults were observed to be supply conduits for saline groundwater.

EC values increased rapidly when the groundwater level decreased below 187.4 meters above sea level (Dead Line) at A5. The equi-potential line of 187 meters in the vicinity of A5 was directed to the east side in April, 1995 so that the flux of the groundwater moved up. On the other hand, the equi-potential line of 189 meters was directed to the west in September, 1995. The flux of the groundwater there moved down. When the groundwater level decreases below the Dead Line, the flux of upward groundwater may reach the maximum volume. Saline groundwater may rise from the underground through the fault crack.

### [Topic2:The influence of physical properties and rock dissolution](#)

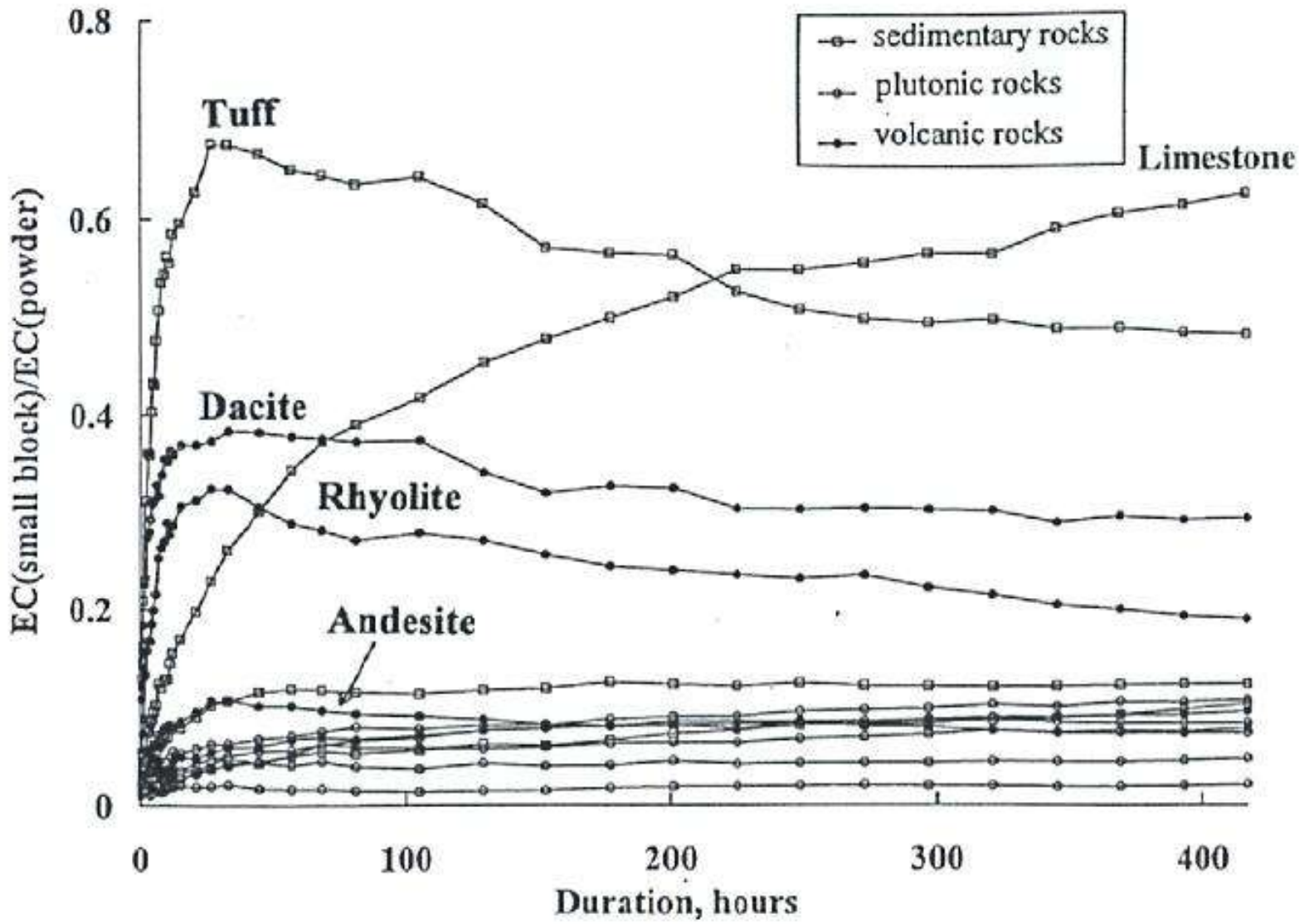
## TOPIC 2: The influence of physical properties and rock dissolution

Mechanisms of rock weathering are important in the study of soil genesis. This study dealt with the changes in chemical properties of rocks during experimental weathering. To define characteristics of the rock dissolution by examining the effects of physical properties on their dissolution characteristics, closed-system experiments were carried out using thirteen rock species, i.e., four types of sedimentary rock (limestone, chert, sandstone and tuff), five types of plutonic rock (dunite, gabbro, diorite, granodiorite and granite) and four types of volcanic rock (basalt, dacite, andesite and rhyolite). For each rock type, a clay-size powdered sample (1.000g in weight) and a small block sample ( $3.54 \times 3.54 \times 20 \text{mm}^3$ ) were treated with 50.0ml of distilled water. Electric conductivity of the aqueous solution, as an index of the concentration of dissolved materials, was measured at intervals of several hours over a total of 417 hours.

Results of the experiments using powdered samples indicated that the concentration of dissolved materials is larger in samples having a large amount of ingredient of alkalis, e.g., the mafic rocks dissolved in more abundance than did felsic rocks. On the other hand, this tendency was not recognized in results obtained from the experiments using small block samples. Experiments using small block samples also showed that the rocks with higher porosity have higher rates of dissolution, particularly in the initial phases of the water-rock interaction. In the case of rocks with higher porosity (such as tuff, dacite, andesite and rhyolite), the ratio of the concentration of dissolved materials of the powdered sample to that of the small block sample at the same elapsed time showed peaks with relatively larger values in the initial stages; these gradually lowered in the latter stages. In the case of other rocks with lower porosity, with the exception of limestone, ratios did not peak and showed small values until the final stages. This evidence shows that the concentration of dissolved materials is controlled by the porosity of the rocks.

[Fig.1 Changes in the ratio of electric conductivity of powdered samples to that of small block samples.\(39KB\)](#)

[Forward to Crop Production and Postharvest Technology Division](#)





# CROP PRODUCTION AND POST HARVEST TECHNOLOGY DIVISION

Due to the constant increase of the human population, it is urgent to improve crop production technology in order to deal with increasingly severe food shortages. As research demonstrates, food supply problems will become more serious as patterns of food consumption improve in developing countries; with higher incomes and societal development, people will require more meat, fruits, vegetables, and oil.

In the developing regions of today, self-reliance in food, rather than self-sufficiency, is an important objective. There are no definitive models for achieving this goal, but rather various methods to ensure self-sufficiency in context of the natural and environmental conditions of a particular country.

The Crop Production and Postharvest Technology Division conducts studies covering production to storage, as well as the marketing and processing of crop products. Our research activities encompass a variety of disciplines including agronomy, plant protection (insect pests, disease and weed control), agricultural mechanization, irrigation, drainage, cropping systems, food storage, postharvest technology, farm management and agricultural economics.

Because the world-wide total area of arable lands is limited, we believe that sustainable production of agricultural products can be achieved only by increasing overall productivity. For this purpose, various technological problems have to be resolved, but at the same time sustainable agriculture has to be compatible with the preservation of the natural environment. It is necessary to reduce as much as possible the amount of chemical inputs in agricultural endeavors. To achieve this, more research on biological or cultural control systems should be implemented, such as studies on the ecology of insect pests and their natural enemies and the development of methodologies for the prediction of outbreaks of insects and diseases. Thus, "integrated pest management" is strongly called for. Additionally, it is necessary to stress postharvest studies of agricultural products: quality improvement, including safety and the extension of shelf life as well as control of the presence of insects and microorganisms in foodstuffs, is one of the main objectives of this Division. Finally, sustainable production of agricultural commodities can only be supported by the development of sustainable markets. Technology for enhancing the value of agricultural products is being developed with the aim of increasing the incentive of the farmer to promote sustainable production. Economic studies are requisite in furthering the regional development of respective countries.

[Local delicacy in Khon Kaen, Northern Thailand. Som tum \(papaya salad\), kaw neeo \(sticky rice\) and Ka-ab moo \(fried pig fat\).](#)

[\(Photo:K.Kawasima\)\(18KB\)](#)

[Topic1:Distribution of 2,4D hebicide resistant biotype of *Fimbristylis miliacea* \(L.\) in the Muda area, Malaysia](#)

[Topic2:Leaf-cutting ants in Brazil and Paraguay](#)

[Topic3:The root-knot nematode *Meloidogyne* in Thailand](#)

[Tpoic4:Group farming in the Muda area, Malaysia](#)



## TOPIC 1: Distribution of a 2,4-D herbicide resistant biotype of *Fimbristylis miliacea* (L.) Vahl. in the Muda area, Malaysia, and its response to several herbicides

*Fimbristylis miliacea* (L.) Vahl. is one of the most common annual sedges in direct seeded rice fields in the Muda plain, the largest double cropping area in Peninsular Malaysia. In 1989, the 2,4-D resistant biotype was observed in a farmer's field in Kampung Gulau where 2,4-D had been seasonally applied since 1975.

Response of the resistant plants to several herbicides was compared to susceptible plants. Resistant plants recovered after the application of 2,4-D dimethylamine at rates up to 2.78 g a.i./m², equivalent to 32 times of the recommended rate, whereas the growth of susceptible plants was strongly affected at a rate of 0.087 g a.i./m², the recommended rate, and completely controlled at 0.17 g a.i./m² (two times of the recommended rate) or higher. LD₅₀ of 2,4-D dimethylamine to resistant plants was 1.89 g a.i./m², which was 29 times higher than the LD₅₀ to susceptible plants. Resistant plants were also resistant to other phenoxy herbicides, e.g. 2,4-D iso-butylester, 2,4-D ethylester, 2,4-D sodium salt and MCPA, but no difference was observed in reaction toward propanil, paraquat and glufosinate ammonium between biotypes. Resistant plants were not distinguishable from susceptible plants based on morphological characters such as panicle size, spikelet length and nut form.

Distribution of resistant plants, detected by treatment of 2,4-D dimethylamine at a rate of 0.17 g a.i./m², was investigated in 1993 using 100 rice fields which were heavily infested with *F. miliacea* in the Muda plain. Resistant plants were detected in five rice fields, but not in the other 95 fields. It was suggested that 2,4-D resistant *F. miliacea* had not dominated in the area. The proportion of resistant plants decreased from 85.6% in 1992 to 1.7% in 1994 in a monitored field where 2,4-D had not been applied since 1992. Other type of herbicides, replacing phenoxy compounds, could be used to control the 2,4-D resistant biotype based on the results of this study.

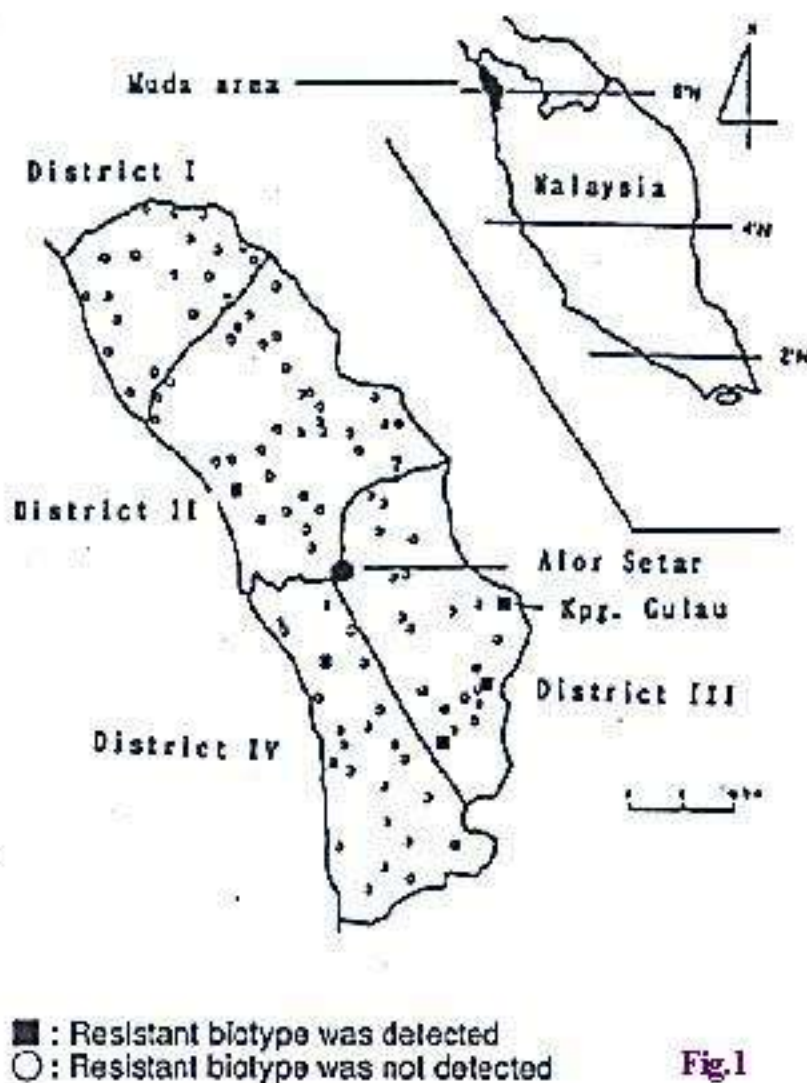


Fig.1: Distribution of 2,4-D resistant biotype of *Fimbristylis miliacea* in the Muda area.

## [Topic2: Leaf-cutting ants in Brazil and Paraguay](#)

## TOPIC 2: Possible occurrence of agricultural damage due to invasion of leaf-cutting ants into southern Brazil and Paraguay

The leaf-cutting ant, consisting of two genera *Acromyrmex* and *Atta*, is recognized as one of the most serious agricultural pests in Latin America. While not all species are important pests, it is not well known to what extent and in which localities respective species are serious pests. Farmers who live in ant-free regions of southern Brazil believe that there will be no problem with the ant in the future. To confirm whether or not there are really no leaf-cutting ants in their regions, we performed studies on the biogeographical distributions and densities of the ants in southern Brazil and Paraguay. The data obtained suggested that there was no place immune to invasion by leaf-cutting ants.

We drove by automobile on highways in southern Brazil and Paraguay from 1993 to 1996. We stopped about every 100 km (Fig. 1), where we counted nests of leaf-cutting ants in an agricultural grassy crop field by one of the following three methods: observation of areas marked by a 500 meter line, observation by naked-eye or with binoculars, and random walking. We surveyed from shorter distances at places reported to be located near margins of distribution limits of leaf-cutting ants. Using the number of nests counted, density of ant nests per hectare could be calculated for every survey site. Heterogeneity of method was inevitable due to the physical conditions of the field (area, location, and geography), time allowed for sampling, and/or biological conditions such as growth of vegetation and presence of domestic animals. This may have prevented us from making precise comparisons of density between sites. However, we consider this data to provide sufficient information concerning which species are distributed in certain locations and at what density. Furthermore, distribution and density of ants are varied between locations, even between neighboring ones. To reduce variation in density among survey sites, we divided the surveyed areas into nine regions and pooled data for each region: south-western region of the São Paulo state (SPSW), north-eastern Paraná (PANE), north-western Paraná (PANW), south-eastern Paraná (PASE), south-western Paraná (PASW), eastern Santa Catarina (STCE), western Santa Catarina (STCW), south-eastern Paraguay (PGSE), and south-western Paraguay (PGSW). We used the mean nest density of each species in each region for this study.

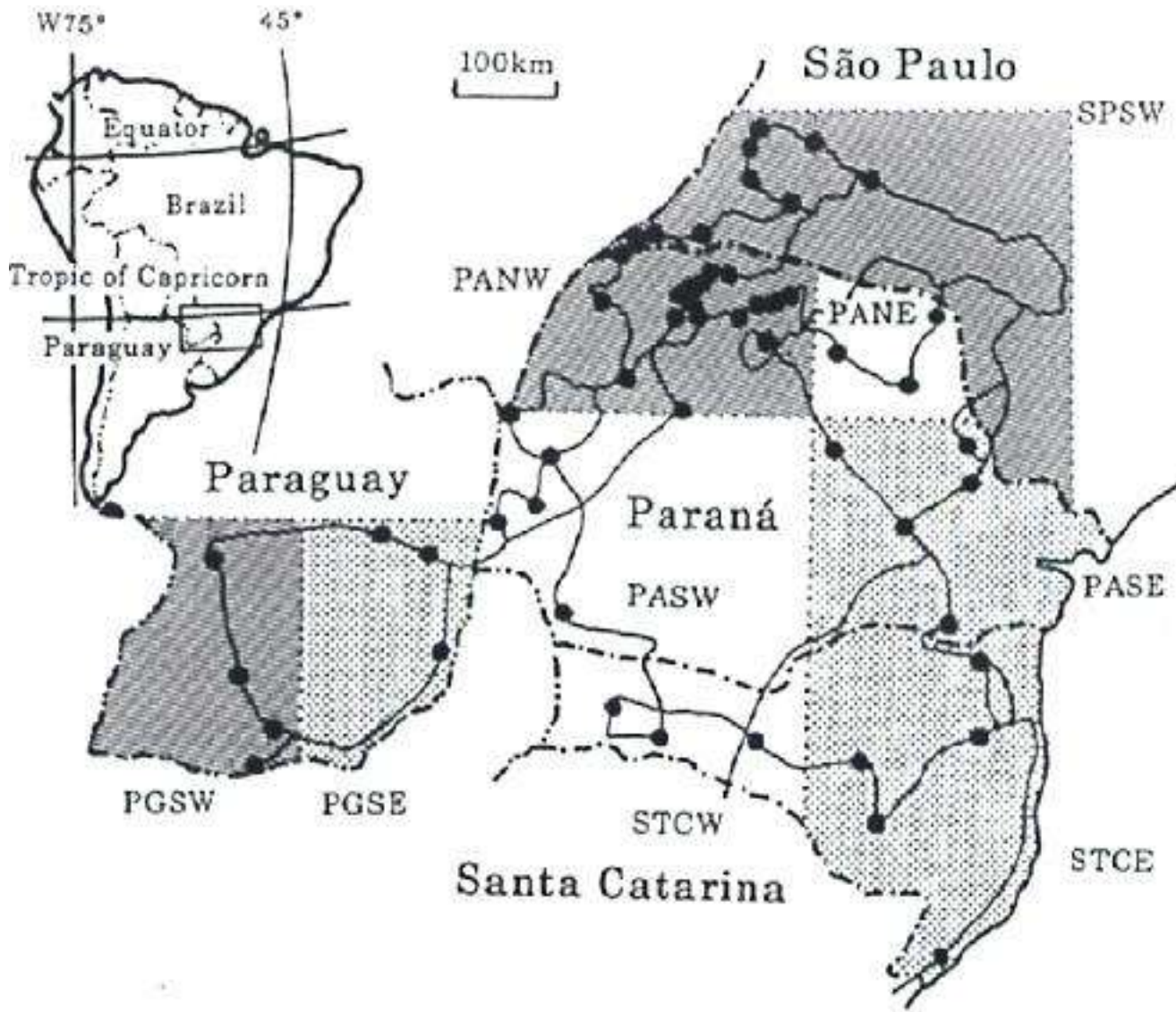
Three and four species of *Acromyrmex* and *Atta*, *Ac. balzani*, *Ac. fracticornis*, *Ac. heyeri*, *At. capiguara*, *At. laevigata*, *At. sexdens*, and *At. Vollenweideri*, were collected at a total of 54 survey sites. We calculated a mean nest density for each species in each region and estimated the degree of agricultural damage by the ants (Fig. 1). The maximal densities obtained for the two genera *Acromyrmex* and *Atta* were 667 (*Ac. balzani* in SPSW) and 48 (*At. capiguara* in PANW), respectively, while no or few nests were detected in PANE, PASW, or STCW. In other regions ants were distributed with intermediate densities between these two extreme values. We carried out cluster analysis using a centroid method with squared euclidian distances. The results revealed the existence of three groups: one group included PANE, PASW, STCW, and PGSE; the second was composed of PASE, PGSW, and STCE; and the third of SPSW and PANW. The first group was characterized as an ant-free or ant-scarce region, the second as regions where cool-climate preferring species, *Ac. fracticornis*, *Ac. heyeri*, and *At. vollenweideri*, were collectable, the third as regions where hotter-climate preferring species, *Ac. balzani*, *At. capiguara*, and *At. laevigata* were predominant. *At. sexdens* was throughout the surveyed areas, though the taxonomy of this species is still under debate.

Comparison of our data with those obtained in the past by other researchers allowed us to trace the possible routes of expansion of ant distribution and predict probable invasion of leaf-cutting ants in the

future. At least 10 years ago, distributions of *Ac. balzani*, *Ac. fracticornis*, and *At. capiguara* had not been reported or found in PANW. Although *At. vollenweideri* was known in PGSW in these years, our record of the ant in this region is new with the eastern -limit being in Paraguay. This indicates that distributions of these ants have expanded into these regions during this decade. Since the north-limit of the distribution of *At. vollenweideri* is northern Argentina, this ant may not invade into the surveyed regions of Brazil. Similarly *At. laevigata*, the south-limit of which was detected in PANE in this study, may not extend its distribution into more southern regions. On the other hand, the south-limits of both *Ac. balzani* and *At. capiguara* in PGSE and the north-limit of *Ac. fracticornis* in more northern regions in Brazil were reported within this decade. The geographical distribution patterns of these three species strongly suggest that these ants will invade into the ant-free or ant-scarce regions, PANE, PASW, SCTE, and SCTW in which farmers believe that their farmland is protected from invasion by the leaf-cutting ant. Because our results contradict the above, it is considered necessary to widely monitor changes in distributions of leaf-cutting ants in the immediate future.

[Fig.1:Upper left: a map of South America. The rectangle indicates the surveyed area. Lower right: a map of the surveyed area. Country and state boundaries are shown by two- and one-dotted chain lines, respectively. Solid lines indicate highways followed by automobile and surveyed sites are indicated by closed circles. Nine regions could be conveniently established and are distinguished by dotted lines. Regions which commonly have serious problem with ants are hatched, those where problems occur only locally are shadowed, and those where problems are negligible are not marked. All abbreviations for regions are explained in the text. \(45 KB\)](#)

[Topic3:The root-knot nematode Meloidogyne in Thailand](#)



### TOPIC 3: Identification of root-knot nematodes (*Meloidogyne*) including a new species based on enzyme phenotypes in Thailand

In Thailand eight species of *Meloidogyne* attacking crops have been recorded. They are *Meloidogyne arenaria*, *M. exigua*, *M. graminicola*, *M. hapla*, *M. incognita*, *M. javanica*, *M. microcephala* and *M. nassi*. Of these, *Meloidogyne incognita*, *M. javanica* and *M. arenaria* occur most commonly and cause serious damage to crops. *M. exigua*, *M. microcephala* and *M. nassi* have not been reported since they were first classified. They appear to be rare and not very significant agricultural pests. Reduction of crop yield caused by these nematodes is estimated to be as much as 5-10% by Thai nematologists. Therefore, development of control measures not only for insect pests but also for the pest nematode is required to increase crop yield in Thailand. Application of nematicides such as carbofuran and chloropicrin to the soil is remarkably effective in decreasing nematode density in the fields. However, concern exists over the disturbance of the ecosystem, causation of environmental pollution or disruption and harmful effects resulting to human beings and other living organisms that may stem from the continuous use of these chemicals.

It was shown in this research that cultural control including crop rotation and application of organic matter decreased the density of *M. javanica* attacking mungbean and increased crop yield. In cultural control of nematodes, accurate identification of species or race is indispensable because the propensity of the nematodes to attack crops varies for each species. Therefore, for the first time in Thailand, we identified *Meloidogyne* species based on enzyme phenotypes through electrophoresis; this is a more reliable method for identifying *Meloidogyne* species than is the observation of morphological characteristics. Esterase (Est) and malate dehydrogenase (Mdh) harbored by female root-knot nematodes were collected and their phenotypes were analyzed through electrophoresis by the Phast System.

In this experiment, one new species and four known species were identified, but two species thought to be new or unrecorded species in Thailand were not determined. *Meloidogyne arenaria* was identified by two distinct bands of Est(A2) and one or three bands of Mdh (N1,N3). Many of the species which had been regarded as *M. javanica* based on morphological characteristics of female perineal patterns in Thailand were identified as *M. arenaria* with two bands of Est. *M. graminicola* was easily determined by one clear broad band of Est(VS1).) *M. incognita* could be distinguished from other species by one band each of Est (I1) and Mdh (N1), and *M. javanica* was identified by three bands of Est (J3) and one band of Mdh(N1). The nematode population collected from weeds in Bangkok showed three bands of Est and two bands of Mdh. Other populations from tomato in Chiang Mai did not show any band pattern. Although these two populations could not be identified, their enzyme phenotypes suggested that they were likely to be new or unrecorded species in Thailand.

The population collected from mulberry in Udon Thani was identified as a new species on the basis of the specific phenotype of one band of Est and two bands of Mdh and the morphological character of female perineal patterns. This is the second recorded new species of the genus *Meloidogyne* in Thailand since the discovery of *M. microcephala* Cliff and Hirschmann, 1984. This new species occurred in large numbers in mulberry fields at the Udon Thani Sericulture Research Center and on some ornamental plants around this area as well as in mulberry fields at Chiang Mai. As sericulture is one of Thailand's important industries, it is urgently necessary to develop methods to prevent mulberry damage caused by this species.

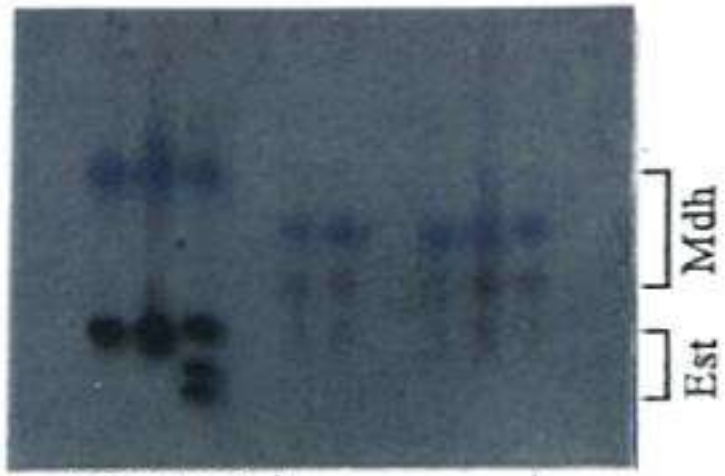
[Fig.1: Polyacrylamide gel \(Phast System\) showing esterase and malate dehydrogenase phenotypes of](#)



females of Meloidogyne.

Ma: M.arenaria, Mi: M.incognita, Mj: M.javanica, Ms1: new species, Ms2: unrecorded species in Thailand.(15 KB)

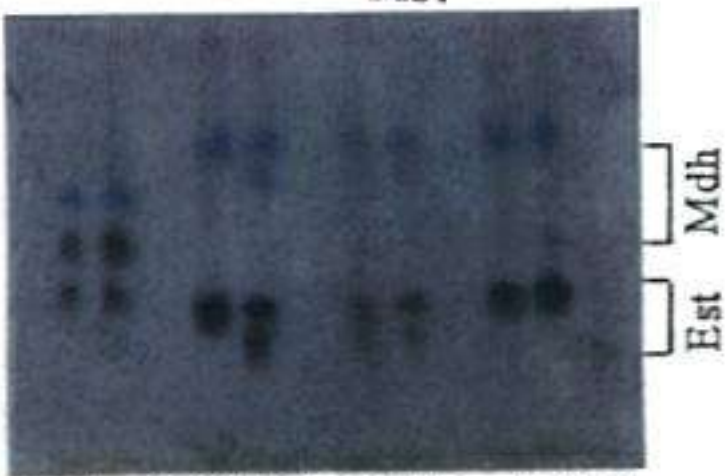
Tpoic4:Group farming in the Muda area, Malaysia



MiMiMj

Ms1

Mdh  
Est



Ms1 Mi Ms2 MaMa MiMi

Mdh  
Est

## **TOPIC 4: Advantages of and Problems in the Management of group farming projects in the Muda area, Malaysia**

The new National Agricultural Policy (1992) of Malaysia aims to promote smallholders to entrepreneur farmers through group farming projects. Encouraging farmers to organize into group farming is the one of the urgent issues in the Malaysian Paddy Policy. Especially in the Muda area, which is the largest rice production area of this nation, the Paddy Mini Estate Project (PSP) is considered to be the core farmers group for development. There are two types of group farming, Kelompok Tani and PSP. PSP is the most advanced of the group farming types in the area and its number increased from 16 to 129 during the period 1988- 1995. On the contrary, the number of the Kelompok Tani has not changed much within this seven year period.

Though both Kelompok Tani and PSP are types of group farming project, there are four main differences between them: 1) There is an agreement between PPK (Area Farmer's Association ) and PSP members in regard to the rice planting schedule and farming practices. Since PPK is in charge of the administration of government credit for the farmers, PSP members must follow the planting schedule to receive the seasonal credit and must send the yield to a specific mill to settle their debt; 2) PPK provides higher financial assistance to PSP members than to Kelompok Tani members, RM650*¹ and RM250 per relong*² per season, respectively; 3) PPK provides farm machinery and transportation for sending the yield to the mill for PSP member farmers. At the same time, PSP members can use the earnings from the sale of their harvest as capital for PSP activities; and 4)Both PSP and Kelompok Tani members can receive technical assistance from PPK. However, priority is granted to PSP members rather than to Kelompok Tani members. Overall both projects are supervised by PPK, but PSP has a higher commitment to PPK than others.

[Photo:Animal meeting between PSP members and a PPK Officer.\(20 KB\)](#)

One PSP (PSP Matang Pinang) in the Muda area was selected and the functions and characteristics of PSP were clarified. A comparative study between PSP member farmers and non-members was conducted. PSP Matang Pinang is located near the JIRCAS pilot so farmers are quite familiar and cooperative with interview surveys. The total number of respondents was 53: they consisted of 26 PSP member farmers and 27 non-members. There are no limitations on PSP membership. However, operational land size of the PSP members ( 3.5 relong or 1.0 ha) is slightly larger than non-members (2.4 relong or 0.7ha).The results of the comparison show the PSP members' advantages in farming. Since PSP members can apply for loans easily, they have easy access to fertilizer and chemicals. However, there is no significant difference in the cost of production between PSP members and non-members. PSP members' yield is higher than non-members. Overall PSP members have more resources such as land and farm machinery; as well, their income is higher than non-members . This clearly indicates that PSP activities bring benefit to the members.

The survey also showed, however, that PSP members faced management problems and have some complaints about the flow of information from PPK to them. After analyzing farmers' responses, we found that some of the complaints were the result of misunderstanding among members. The result clearly shows that two-way communication between PPK officers and members is very important to avoid misunderstanding and to create a clear vision of PSP in the future. Listening to the members' opinions is a suggested for resolving future problems.

In addition to the complaints mentioned by the members, we also realized the weakness of PSP. The observations in this survey show that members are highly dependent on the PSP committee members and/or PPK officer. If possible, it is better for all the members to join the meeting and participate in the decision-making process regarding PSP management issues.

At the same time, members are recommended to keep their own farming records to understand their farming condition under the PSP. Financial management, in particular, is controlled by PPX and it is difficult for the members to prepare farming plans and make decisions by themselves. Some of the members just followed what was written on the receipt and documents they received from PPK without examining or understanding them. Further research is needed to focus on how the credit scheme can affect the farmers' attitudes in carrying out their farm management activities.

*1: RM1=¥50, *2: 1relong = 0.298ha.

[Forward to Animal Production and Grassland Division](#)



# ANIMAL PRODUCTION AND GRASSLAND DIVISION

Animals in developing countries contribute to the betterment of people's lives in various ways. Animals not only produce meat, milk and hide, which are essential in daily life and are an important source of income, but also generate draft power for tillage and transportation, and produce wastes for use as fertilizer and as a source of fuel. Yet, production related to livestock rearing remains at low levels due to constraints such as the low genetic potential of animals, poor quality and quantity of feeds, prevalence of diseases, harsh climatic conditions, and inadequate management.

The Animal Production and Grassland Division carries out research to achieve a sustainable increase in animal production in harmony with the environment by enhancing the reproductive capacity of natural resources, managing grasslands to secure feed resources, making better use of agro-industrial by-products, controlling invasive animal diseases, and improving management practices.

Two research projects ended successfully in the fiscal year 1996. Those themes and the collaborative research organizations were as follows: (1) Investigation of the response to heat stress of the endocrinological functions in ruminant animals and their relation to milk secretion in tropical areas (Malaysian Agricultural Research and Development Institute). (2) Development of forage crop management in Northeast Thailand (Department of Livestock Development (DLD), Thailand). Currently, six research projects are being carried out abroad on long term assignments ( 25 years ): (1) Improvement of cattle production with locally-available feed resources in Northeast Thailand (DLD),( 2) Immunohistorical studies for the development of a vaccine against East Coast Fever (International Livestock Center for Africa (ILRI), Kenya), (3) Improvement of the rearing methods of small livestock (Malaysian Agricultural Research and Development Institute), (4) Improvement of animal production under farming systems combining agriculture, animal husbandry and fisheries in the Mekong Delta (Cantho University, Vietnam), (5) Grassland conservation and sustainable livestock production in Central Asia (KIA, Kazakhstan) and (6) Development of grassland utilization and management under sustainable agro-pastoral systems (CNPGC-EMBRAPA, Brazil). Commencing this year, the last project was initiated in place of the project "Eco-physiological studies on the persistence of tropical pastures in the Latin American Savanna" (CIAT, Colombia ).

The following studies were carried out by researchers on short-term assignments (1-3 months): (1) Comparative study of the accumulation of body fat in native Malaysian chickens (Malaysian Agricultural Research and Development Institute); (2) Control of meat quality and fat deposition in native Malaysian chickens (Malaysian Agricultural Research and Development Institute); (3) Studies of the eradication of animal parasitemia in Vietnam (Cantho University); (4) Evaluation of the feeding value of aquatic plants in the Mekong Delta (Cantho University); (5) Improvement of the nutritional condition of livestock under the farming systems in the Mekong Delta (Cantho University); (6) Genetic characteristics of indigenous breeds of cattle in the Philippines (University of Philippines at Los Banos) and (7) Elucidation of the role of the TNF- $\alpha$  gene in trypanosomiasis.

In order to address varied requests for collaborative research from developing countries, which includes incorporating biotechnological applications along with upgrading the overall level of research, the Division is now promoting basic research on the Tsukuba premises as support for overseas activities. At

present a project entitled "Identification of endophytic fungi in pasture plants in tropical regions and their utilization in plants via biotechnological methods" is the focus of domestic research.

[Topic1:Sugarcane as roughage for cattle feeding in the dry season](#)

[Topic2:Estimation of regional feed resources in a barley/rangeland zone in Northeastern Syria](#)

## TOPIC 1: Sugarcane as roughage for cattle feeding in the dry season

Dairy production has been well-developed in temperate and cool geographical zones. A feeding system established in these areas is primarily based on preserved feed such as hay and silage. This system requires large machinery with a large scale of operation. On the other hand, dairy activities have been newly introduced into monsoon and savanna zones in the tropics. Generally speaking, dairy production in this region is characterized by its small scale and reliance on man-power. In this system, hay or silage production is not yet practically operational. Farmers rely heavily on rice straw as roughage in the dry season and its poor nutritive value limits the further improvement of dairy production. An additional restraint is that the collection of rice straw is labor- and time-intensive work. On the other hand, sugarcane has unique characteristics. It has high bio-mass production and can remain standing until the end of dry season without withering, which allows farmers to cut it when they need it without processing or preservation. The use of sugarcane as a roughage for cattle feeding was examined in Northeast Thailand, where the number of dairy cattle are rapidly increasing.

A metabolic trial using Brahman cattle was carried out and the metabolizable energy content in sugarcane stalk was calculated to be 9.05 MJ/kg. It was estimated that sugarcane can produce metabolizable energy per hectare nearly 3 time more than that produced by ruzi grass which is the major grass produced in the region.

The feeding trial was carried out using dairy cows owned by a private dairy farm in order to examine the use of sugarcane as roughage for milking cows. Milking cows were given either only rice straw *ad libitum* or chopped sugarcane stalk plus rice straw *ad libitum* as roughage. In addition, both groups were given commercial concentrate feed, the amount of which was determined by the farmer based on body condition as well as the milk yield. In spite of the lower total DM consumption, the milk production of the cows given sugarcane stalk tended to be higher than that of those given only rice straw. Protein content in the milk of those cows was also significantly higher. It was concluded that the energy supply was increased by giving sugarcane stalk, which improved protein content in the milk, while energy supply was not sufficient when only rice straw was given to cows.

Sugarcane stalk can be divided into an easily soluble sugar fraction and a hardly degradable bagasse fraction. It appears that the latter remains in the rumen for a long period without degradation, which suppresses feed intake. Cattle can not consume enough sugarcane stalk to satisfy their energy requirements in spite of its high metabolizable energy content. Sugarcane stalk was proven to be a good quality roughage for cattle in the dry season, if cattle were provided with enough concentrate feed to satisfy not only protein but also energy requirements.

[Fig1:Chopped sugarcane stalk\(37KB\)](#)

[Fig2:Cattle are fond of chopped sugarcane stalk. However, it has to be supplemented with energy and protein sources.\(Photo:T.Kawasima\)\(35KB\)](#)

[Forward to Forestry Division](#)



# FORESTRY DIVISION

With the rapid exploitation of arable land because of high food demands, the degradation and devastation of natural forest areas are rapidly progressing, particularly in developing areas. This is bringing about serious economic and environmental problems not only at the local level but also on a global scale. Therefore, the rehabilitation and sustainable management of these forests are urgent issues. Establishment of forest production systems and post harvest technologies for local communities can be viewed as essential means for the reduction of forest devastation.

The Forestry Division covers a wide range of research in developing countries from production to end-use as related to forestry and forest products under the following two research categories: (1) silvicultural and forest management technology; and (2) processing technology of forest products. These projects necessitate disciplines such as silviculture, plant ecology and eco-physiology, soil science, entomology, mycology, forest mechanization, socio-economics, and wood technology.

Forest rehabilitation and the enrichment of devastated and degraded areas are the first steps in developing sustainable management of forest areas. To do so, silviculture, site evaluation and pest control technologies have to be developed in consideration of the conditions of the natural environment.

At present, forest products are a principal trading commodity in 33 developing countries. Sustainable production of these products should be achieved in natural forests and plantations. For such purposes, studies on species behavior, natural regeneration, enrichment planting, and harvesting systems are essential.

Another major reason for forest devastation is the shifting of cultivation by landless farmers. Hence, forest production and planning systems for stimulating the activities of local communities have to be developed. Various lesser-known tree species and forestry products may be in danger of extinction if rapid forest devastation continues. Evaluation studies should be urgently conducted and improvement of current wood processing technology should be given priority.

[A. mangium plantation in Rawang, Selangor, Malaysia.\(31KB\)](#)

[\(Photo:K.Yamamoto\)](#)

[Topic: Some wood properties of Acacia mangium in Peninsular Malaysia](#)



## TOPIC: Some wood properties of *Acacia mangium* grown in Peninsular Malaysia

Since it was introduced to Sabah, Malaysia from Australia as an exotic species in 1966, *Acacia mangium* Willd. has become one of the major fast-growing plantation species for timber and pulp production in Asia. Currently plantation area covers over 150,000 hectares world wide. In Indonesia, especially in East-Kalimantan and Sumatra, thousands of hectares are being planted each year with this species. In spite of its importance for sustainable timber resources in the future, until recently comprehensive characteristics of *A. mangium* wood were not fully understood. In order to identify the basic wood properties of *A. mangium*, collaborative research work has been conducted with the Unit of Wood, Paper, and Coating unit of the School of Industrial Technology, University of Science, Malaysia. Three *A. mangium* trees free from the heart rot disease were used in this study. The age of trees harvested were 9, 11 and 6 years in Byram Forest Reserve, Pulau Pinang, in Rawang, Selangor, in Bidor, Perak, Malaysia, respectively.

Several important wood characteristics of *A. mangium* have been found since the research project commenced in 1995. Wood near the pith has lower density and a shorter length of fibers than the outer surrounding wood ([Figure 1](#)). This indicates that *A. mangium* has juvenile wood near the pith. The existence of juvenile wood may be one of the reasons that the inner heartwood of *A. mangium* is subject to heart rot attack. In fact, the incidence of heart rot of *A. mangium*, aged two to nine years old, was reported to range from 0 to 50% in a recent survey at Sabah Forestry Development Authority, Sabah, Malaysia.

The inner heartwood of *A. mangium* sometimes has a higher moisture content than the adjacent outer heartwood or sapwood ([Figure 2](#)). An increase in moisture content in the heartwood region normally refers to wetwood which has been identified as an abnormal type of heartwood caused by decay or a wound. Existence of the wetwood in tropical wood species has not yet been reported. As close relationships between inorganic concentrations and moisture contents in wetwood have been described in the literature, radial distributions of 4 major elements from alkali metals and alkaline earth metals in *A. mangium* were examined by inductively coupled plasma optical emission spectroscopy. Concentrations of potassium (K) and magnesium (Mg) in *A. mangium* stem wood and sap showed a maximum value in the outermost sapwood and then decreased gradually toward the sapwood-heartwood boundary. There were no obvious variations within the heartwood ([Figure 3](#)). The changes from sapwood to heartwood indicated a close relationship between heartwood formation and inorganic elements. Radial distribution patterns of sodium (Na) and calcium (Ca) did not show a clear trend. All analyzed samples possessing wetwood (Rawang and Bidor sample trees) or even non-wetwood (Byran sample tree) generally retained lower inorganic contents in heartwood than in sapwood ([Figure 3](#)). The close relationship between inorganic concentrations and moisture contents, as reported in the wetwood of temperate species, was not recognized in *A. mangium*. The characteristics and origin of wetwood may differ from temperate species to tropical ones. The origin of water in the wetwood of *A. mangium* is an important scientific issue that remains to be clarified.

[Photo.1:Wetwood of *A. mangium* with higher moisture contents than surrounding wood showing dark color is located in the inner heartwood \(arrow\).\(13 KB\)](#)

[Figure.1:Radial variation of oven dry density of *A. mangium* stem \(Rawang sample tree\). Wood densityincreases from the pith to several centimeter outwards and then becomes almost constant. A.](#)

[mangium has juvenile wood near the pith. Dotted lines indicate the boundary between the sapwood and heartwood.\(94 KB\)](#)

[Figure.2:Radial variation of moisture content of A. mangium stem \(Rawang sample tree\) . Moisture content is highest in the inner region of heartwood. An increase in moisture content at the heartwood region normally refers to wetwood. Dotted lines indicate the boundary between sapwood and heartwood. The line with filled circles shows the calculated maximum moisture contents, and the line with filled diamonds shows the actual moisture contents. The wood is almost saturated with free water.](#)

[Figure.3: Radial distribution of potassium content of A. mangium stem from three different cites \(Byran, Bidor and Rawang\). Maximum values were found in the outermost sapwood and then decreased toward the sapwood-heartwood boundary. No obvious variations were observed in the heartwood. Arrows show the boundary between sapwood and heartwood.](#)

[Forward to Fisheries Division](#)



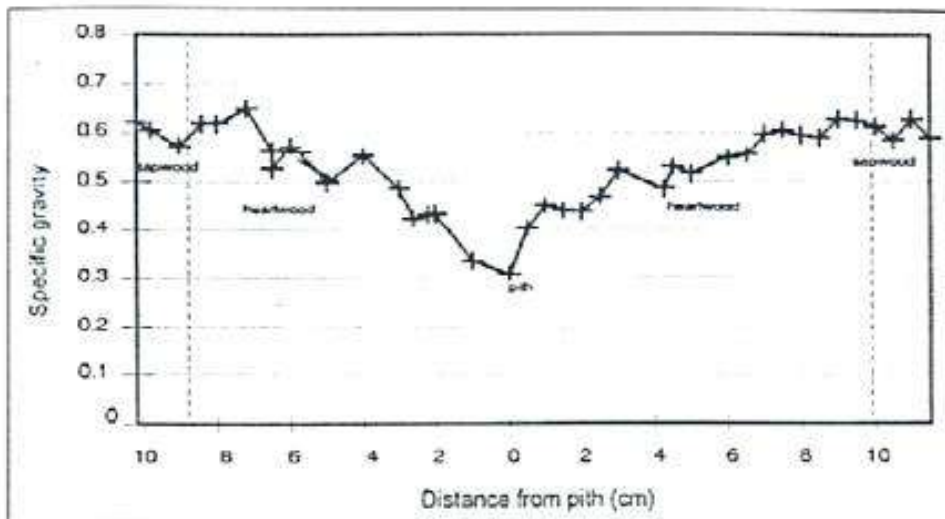


Fig. 1. Radial variation of oven dry density of *A. mangium* stem (Rawang sample tree). Wood density increases from the pith to several centimeter outwards and then becomes almost constant. *A. mangium* has juvenile wood near the pith. Dotted lines indicate the boundary between sapwood and heartwood.

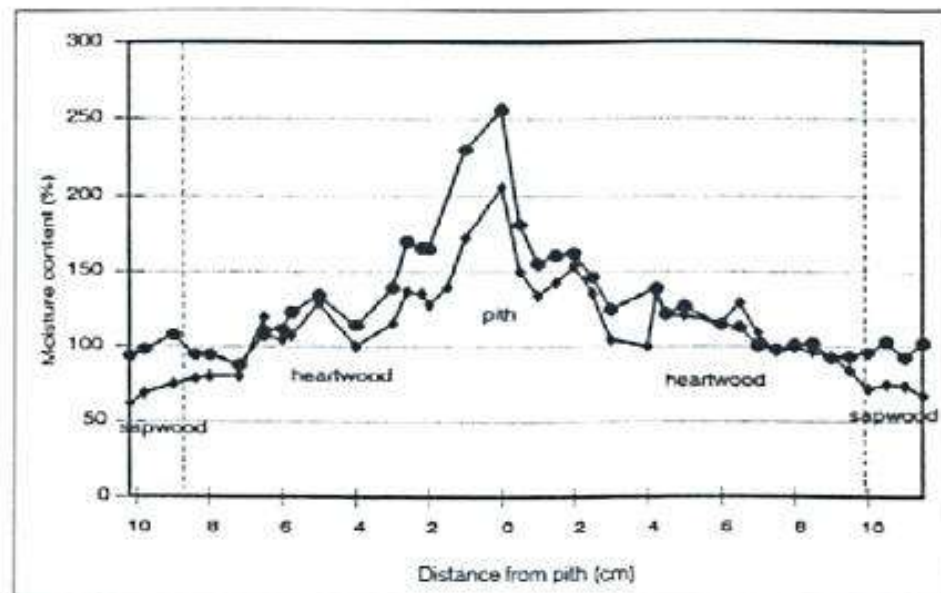


Fig. 2. Radial variation of moisture content of *A. mangium* stem (Rawang sample tree). Moisture content is highest in the inner region of heartwood. An increase in moisture content at the heartwood region normally refers to wetwood. Dotted lines indicate the boundary between sapwood and heartwood. The line with filled circles shows the calculated maximum moisture contents, and the line with filled diamonds shows the actual moisture contents. The wood is almost saturated with free water.

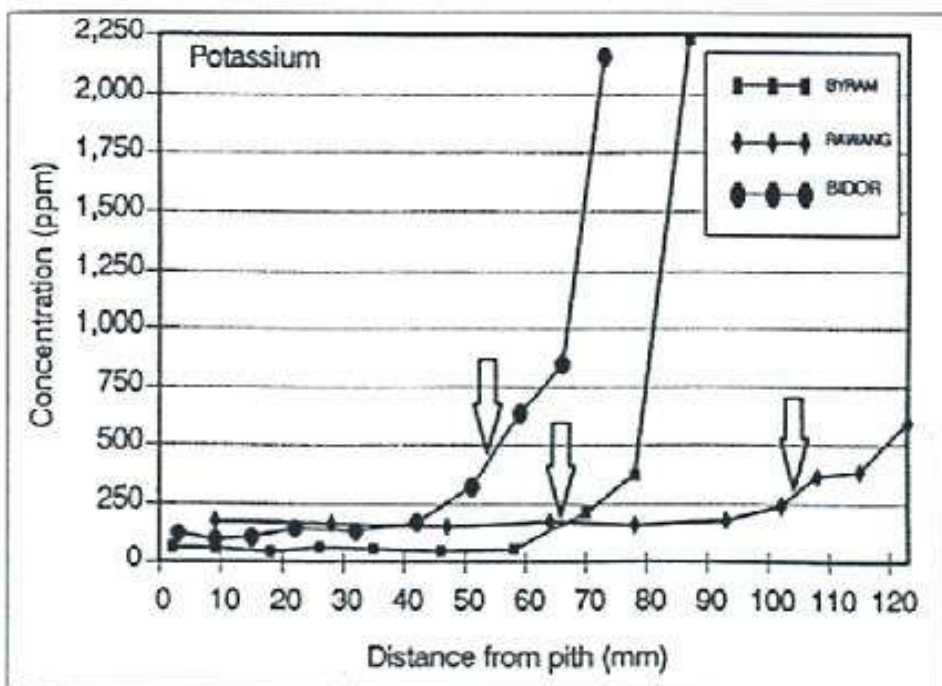


Fig. 3. Radial distribution of potassium content of *A. mangium* stem from three different sites (Byran, Bidor and Rawang). Maximum values were found in the outermost sapwood and then decreased toward the sapwood-heartwood boundary. No obvious variations were observed in the heartwood. Arrows show the boundary between sapwood and heartwood.

# FISHERIES DIVISION

As an initial phase (1994-1998) of international collaborative activity in the field of fisheries, the Fisheries Division has initiated five research projects in Asian countries, e.g., fisheries resources management in Malaysia and Indonesia, aquaculture in Thailand and Vietnam, and fisheries product processing in China. In addition to these studies, however, in 1996 the Division implemented a project for the development of technology to diagnose and prevent shrimp viral diseases. A summary of this project, scheduled to begin in 1997, can be found in the Highlights section.

As a first international collaborative research project on fisheries resource management, "Production and sustainable utilization of brackish water mangrove ecosystems" has been initiated with the Fisheries Research Institute (FRI) and the University of Malaya (UM). The project involves the integration of studies dealing with the brackish water mangrove and is conducted on a multidisciplinary basis including fields related to fisheries, forestry, agriculture, and socio-economics. One senior researcher has already been dispatched by JIRCAS to Penang to oversee the project, as a long-term residing scientist, and several short-term scientists specializing in fish larval ecology, crustacean ecology and marine chemistry have participated in this project. In addition to working with the above counterpart organizations, JIRCAS is receiving the active cooperation of the Marine Fisheries Resources Development and Management Department of the Southeast Asian Fisheries Development Center (SEAFDEC) regarding the fisheries aspects of the comprehensive project. Another project involving fisheries resources management, "Studies on the life history of major coastal fishes in Indonesia based on otolith analysis", has also been initiated with the Central Research Institute of fisheries (CRIFI), at the Research Institute for Coastal Fisheries (RICF), CRIFI, in Maros, South Sulawesi, Indonesia. The project aims to clarify ecology and life history of important coastal fishes for the establishment of methods of resources management. One researcher has been dispatched to Maros as long-term residing scientist.

In addition to the Division's earliest collaborative research project on aquaculture, "Development of sustainable aquaculture technology in Southeast Asia" with the Faculty of Fisheries, Kasetsart University, in Bangkok, Thailand, another project, "Evaluation and improvement of farming systems combining agriculture, animal husbandry, and fisheries in the Mekong Delta", has been initiated with the College of Agriculture, Cantho University in Cantho, Vietnam. The project involves the integration of studies dealing with square farming on a multidisciplinary basis including fields related to rice production, animal husbandry, freshwater aquaculture, and socio-economics. The fisheries aspects of this integrated project relate to freshwater aquaculture as follows: 1) fry production technology of fish and prawns, 2) disease prevention methodology for fish and prawns and 3) utilization of new feed resources for freshwater aquaculture. To oversee the fisheries aspects of the project, a JIRCAS researcher specializing in crustacean endocrinology and three short-term Fisheries Agency scientists specializing in fish disease and fisheries nutrition have been dispatched short-term to Cantho, Vietnam.

[JIRCAS staff and Cantho University counterparts at work in Vietnam.\(16 KB\)](#)

[\(Photo:M.Sano, Seikai National Fisheries Research Institute\)](#)

[An integrated farm in Omon,Cantho Province,Vietnam\(Photo:M.N Wilder, JIRCAS\)\(33KB\)](#)

Concerning fisheries product processing, a collaborative research project, "Study on post harvest and processing of freshwater fish in China", has been initiated with the Faculty of Food Science and

Technology, Shanghai Fisheries University. Two senior researchers have already been successively dispatched to Shanghai, and short-term scientists specializing in post harvest technology have visited to lend support to the project.

Intensive aquaculture has been well-developed in recent years and has become one of the most important industries in many countries, but self-contamination and fish disease in culture ponds have given rise to serious environmental and social problems. Therefore, fish disease protection has been given priority as a topic of collaboration under the JIRCAS Visiting Research Fellowship Program in which one scientist has been invited from the Central Research Institute of Fisheries, Indonesia to initiate cooperative studies in Tsukuba during a two-year period. Current and future Tsukuba Fellows are expected to become core scientists in JIRCAS's counterpart institutions and to contribute to the continued development of collaborative study.

[Topic1: Molting and reproduction in the giant freshwater prawn, *Macrobrachium rosenbergii*: Endocrinology and potential aquaculture applications](#)

[Topic2: Development of sustainable aquaculture technology in Southeast Asia](#)







## **TOPIC 1: Molting and reproduction in the giant freshwater prawn, *Macrobrachium rosenbergii*: Endocrinology and potential aquaculture applications**

Successful prawn culture depends on many factors and requires the integration of knowledge from diverse fields. Sound economic and environmental management are essential to the efficiency of operations while expertise in the engineering and design fields are almost always necessary to set-up and construct facilities. However, basic understanding of the biology and physiology of the animals being targeted remains fundamental and most significant in the establishment of sustainable aquacultural production. In shrimp culture today, inducing reproduction in captivity and controlling disease remain obstacles to successful culture. Solving these technological problems will depend greatly on basic laboratory research and field work.

The giant freshwater prawn, *Macrobrachium rosenbergii*, is a commercially important crustacean species cultured extensively throughout Southeast Asia. While wide-spread viral infection has been a problem of increasing magnitude in the culture of seawater species of the *Penaeus* genus, disease outbreak has not been of significant concern in freshwater species such as *M. rosenbergii*. Rather, in the case of species of the *Macrobrachium* genus, it is important to be able to effectively control maturation and reproduction under artificial conditions in order to produce the larval "seed" prawns which will be raised to market size by aquaculturists and fish farmers. In Vietnam, where JIRCAS is currently implementing a comprehensive project entitled "Evaluation and improvement of farming systems combining agriculture, animal husbandry and fisheries in the Mekong Delta", *M. rosenbergii* is considered an important target species by the Vietnamese Government, and its aquaculture is being actively promoted. Farmers have traditionally depended on wild sources to obtain seed for aquaculture but are now faced with dwindling resources and a shortage of natural spawners. It is therefore necessary to increasingly rely on artificial seed production in the Mekong Delta.

JIRCAS is currently implementing basic studies concerning the endocrinology of molting and reproduction in *M. rosenbergii* as part of the Mekong Delta project. Research is being conducted both at the project site, Cantho University's College of Agriculture, in Cantho Province, Vietnam in collaboration with Vietnamese counterparts, and on JIRCAS's Tsukuba premises. In addition, although not directly related to the project, some of these studies have been carried out under the JIRCAS Visiting Fellowship Program at Tsukuba.

In *M. rosenbergii* and most other species of decapod crustacea including crabs and lobsters, the physiological processes of molting and reproduction are inextricably linked and under the control of various hormones. Crustaceans, which are arthropods, bear much endocrinological similarity to insects, and differ greatly from vertebrate species. However, compared with insects, which have been studied more widely, little is known about endocrinological mechanisms in Crustacea.

It is well-established that ecdysteroids such as 20-hydroxyecdysone serve as "molting hormone" in Crustacea and are excreted from a tissue known as the Y-organ. On the other hand, peptides (molt-inhibiting hormone: MIH) originating in the sinus gland complex of the eyestalks exert negative influence on molting. In *M. rosenbergii*, molting occurs approximately once per month accompanied by growth of the animal. In females, reproduction occurs in synchronization with the molt cycle during which vitellogenin (yolk protein) is produced and ovaries develop and mature. This process is also under the inhibition of an eyestalk hormone: vitellogenesis-inhibiting hormone (VIH). In hatcheries and on

prawn farms, the technique of eyestalk ablation has long been employed to induce female maturation; the basis of this is the removal of the eyestalks and thus the removal of the source of these inhibitory hormones.

While much progress has been made regarding negative control of molting and reproduction, it is unclear whether positive control mechanisms exist. Regarding molting, it is still not known what causes ecdysteroid titers in the hemolymph (crustacean blood) to surge just before a molt. It is also not known how the negative effects of VIH are lifted, enabling the animal to produce vitellogenin for uptake into the ovaries. In insects, juvenile hormone (JH), which is a larval developmental hormone, also appears in the adult female to stimulate yolk protein production and uptake. At JIRCAS, we are interested in the functioning of juvenoid substances in *M. rosenbergii* and are attempting to determine whether such hormones exert similar influences in crustacean species. At present, we have detected a JH-precursor molecule, methyl farnesoate (MF) ([Figures 2a,b](#)), in the hemolymph of *M. rosenbergii*. It was expected that MF would be present in only females undergoing ovarian maturation, but it was detectable in both females and males without connection to reproductive events. MF was also seen to fluctuate during the molting cycle, suggesting involvement together with ecdysteroids in regulating molting.

We are also characterizing the nature of the vitellogenin molecule in *M. rosenbergii* and examining how it is produced. Vitellogenin initially appears in the hemolymph mid-way through the molt cycle and is then taken into the oocytes as vitellin. By analyzing vitellogenin electrophoretically, we found that it is composed of three polypeptide components of molecular weights 199, 102 and 92 kilodaltons. The 199 kilodalton component is always first to appear during the course of vitellogenin synthesis. We subsequently plan to examine the involvement of MF and putative ovarian factors in the control of this process.

Another research theme we are pursuing at JIRCAS is that of osmoregulatory control in relation to reproduction. While *M. rosenbergii* is primarily a freshwater species, it migrates to brackish water during times of spawning. The female broods eggs attached to the abdominal area for about three weeks until hatching. Newly-hatched larvae can not survive in freshwater and are required to spend about one month in low salinity before returning to fresh water areas. Adults have the ability to survive in both freshwater and brackish water, but larvae do not. We are interested in how this osmoregulatory ability develops and what physiological mechanisms govern this. We are currently examining the involvement of MF and whether juvenoid substances function to control the activity of ion regulatory enzymes such as Na/K-ATPase.

Finally, at Cantho University, we are conducting applied experiments to examine the effects of feed quality and level and stock origin on reproduction in female prawns under captive conditions. In Vietnam, there are presently four national freshwater prawn hatcheries. Production is usually achieved, but females often mature precociously. This inhibits overall growth, but more importantly, it leads to diminished egg batches and low survival rates of larvae. It is often difficult to obtain high-quality larvae. In the current experiments, we are monitoring growth, reproductive state, and vitellogenin levels in prawns of natural and artificial origin subjected to representative feeding regimens practiced by farmers in the Mekong Delta. These studies will be expanded later in order to examine the effects of various environmental factors such as water temperature, salinity levels, and daylength.

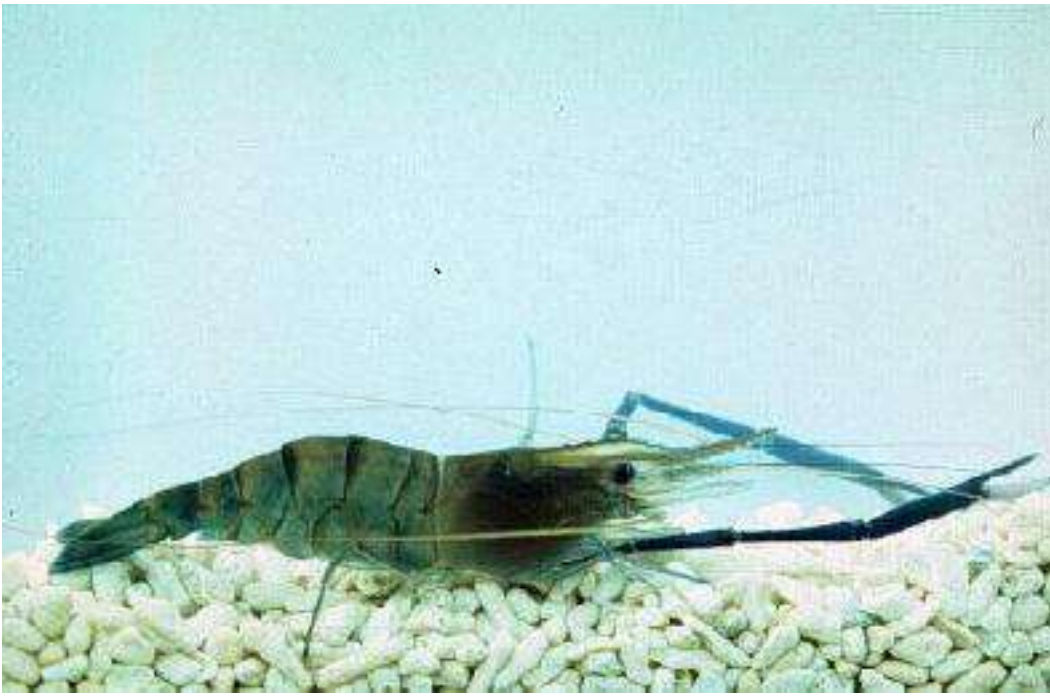
Up until the present, JIRCAS personnel accompanied by researchers from the Fisheries Agency's National Research Institute of Aquaculture and the Seikai National Fisheries Research Institute have traveled to Vietnam to work on the project, but in FY 1997, Vietnamese counterparts will spend several months at JIRCAS to conduct further analysis of samples and data and to promote overall cooperative research. These collaborative studies, both in Japan and in Vietnam are expected to contribute to current knowledge concerning the endocrinology of *M. rosenbergii* and to enhance potential for culture applications in context of the JIRCAS's Mekong Delta project.

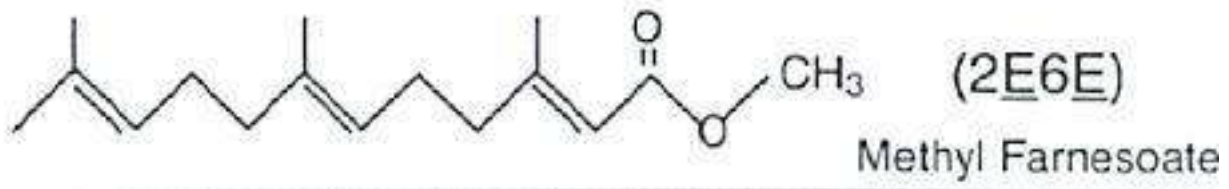
[Figure.1:M. rosenbergii being maintained at JIRCAS.\(16KB\)](#)

[Figure.2:\(a\) Structure of methyl farnesoate\(MF\).\(6KB\)](#)

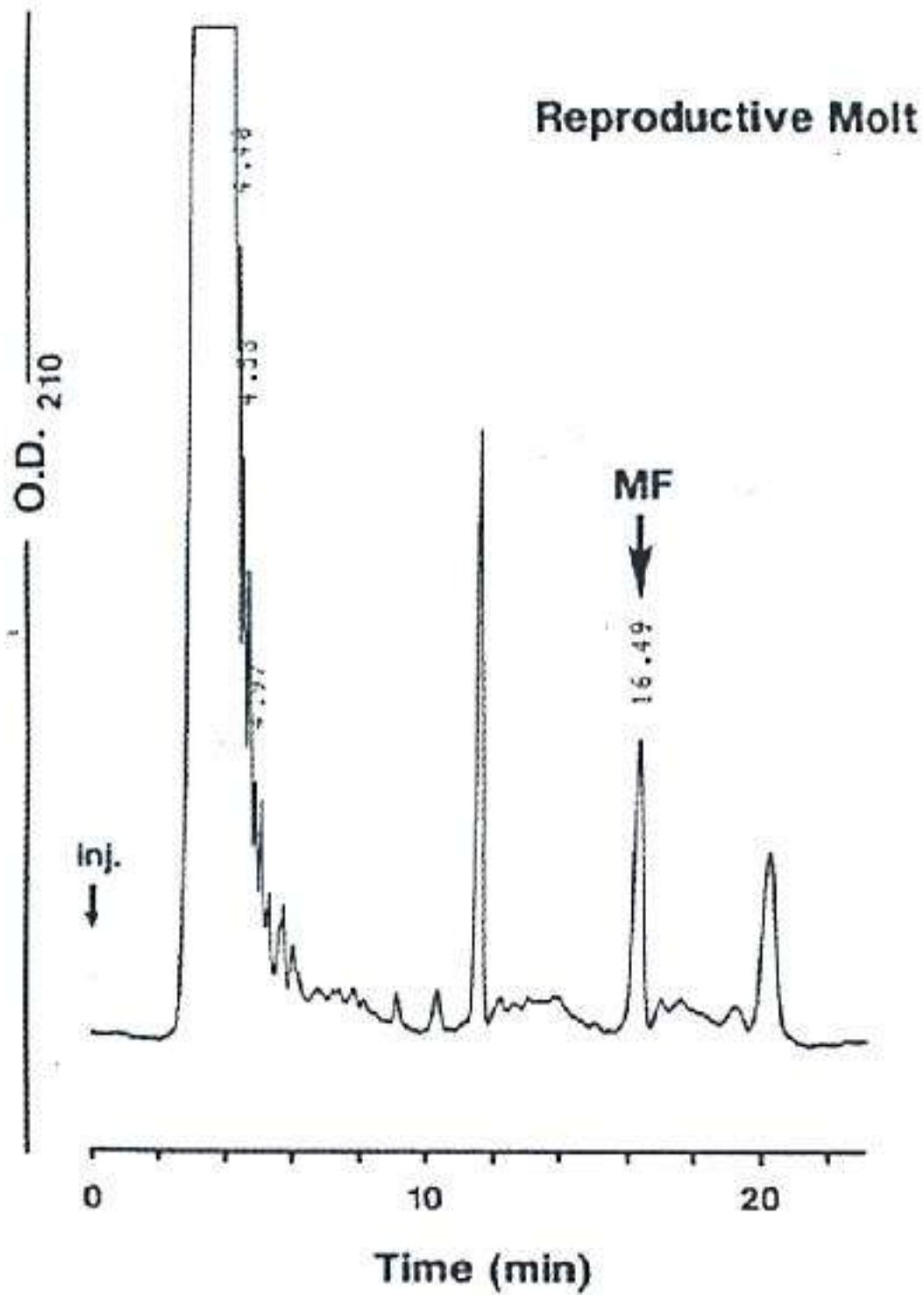
[Figure.2:\(b\) Detection of MF in female hemolymph by normal phase high performance liquid chromatography\(NP-HPLC\).\(20KB\)](#)

[Topic2:Development of sustainable aquaculture technology in Southeast Asia](#)





# NP-HPLC 1.5% Ether/n-Hexane (50% aqu. sat.)





## TOPIC 2: Development of sustainable aquaculture technology in Southeast Asia

In recent years, many Southeast Asian countries including Thailand have promoted an intensive form of aquaculture to increase product volume along with economic growth. As a result, aquacultural production, especially that of prawns and shrimps, has increased markedly in a short period of time ([Fig. 1](#)). However, in some countries and regions, intensive aquaculture practices have been reduced or discontinued because of the occurrence of severe outbreaks of disease affecting the animals under culture. Therefore, it has become apparent that certain difficulties exist in maintaining high productivity using intensive aquaculture. To achieve sustainable aquacultural production in Southeast Asia, basic studies relating to aquaculture sciences, such as genetics, physiology, pathology and nutrition of fish and prawns are required. JIRCAS believes that technology contributing to sustainable aquaculture can be developed through basic studies related to aquaculture sciences.

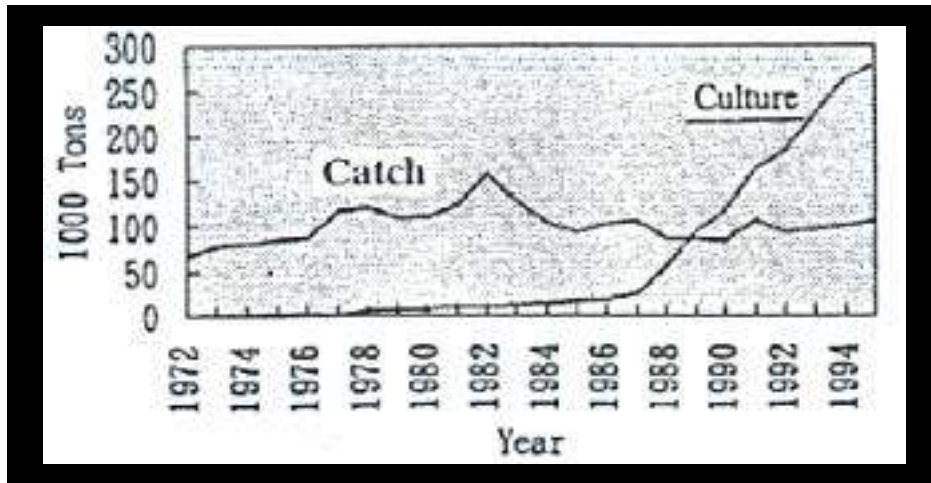
In 1994, collaborative studies covering a five-year period were initiated between the Japan International Research Center for Agricultural Sciences (JIRCAS) and the Faculty of Fisheries, Kasetsart University, Thailand. The first half of the research program emphasized genetic research to promote basic studies related to aquaculture sciences. At the outset, to develop methods for detecting genetic variability in breeding, a manual for isozymic analysis of 20 aquatic animal species economically important to Thailand fisheries was prepared. The manual describes how-to techniques for sample collection and preparation, starch-gel electrophoresis, and isozyme staining and contains instructions concerning how to use these techniques to discern isozymic loci, estimate genetic variability, and calculate genetic divergence. The genetic variability of wild populations of catfish (*Clarias macrocephalus*) was analyzed using this manual.

Wild populations of catfish collected from five localities indicated in [Fig. 2](#) were examined using genes at eleven loci controlling nine enzymes as markers. An isozymic analysis concluded that, because most of the pairs of five populations showed significant differences in all the allele frequencies at more than one locus, the populations examined were genetically independent of each other. Furthermore, based on the genetic distances among the six local populations of catfish, the dendrogram revealed that genetic relationships of the populations could be determined ([Fig. 3](#)). The relationships between the populations of Prachin Buri and Chachoeng Sao, or Pattani and Yala were very close genetically, whereas the relationship between the Chiang Rai and Pattani (or Yala) populations was genetically distant. A vertical dotted line was drawn across the dendrogram to delineate a group with a distance of 0.01. A genetic distance of 0.01 was considered to correspond to a local race level based on the results of analyses of many kinds of animals. Using this vertical dotted line, the five local populations were divided into two groups, which indicated the differentiation of local races into north/central and south groups. The distribution of this species was strongly related to geographical distance or geographical regions in Thailand. The country of Thailand consists of three regions: the central plains, northeastern plains and southern plains. In this research, these three wide regions could be differentiated as a whole with respect to catfish strain, which suggested the possibility of genetic segregation of wild populations. It is important to identify local strains for breeding in aquacultural applications, since hybridization among local races can lead to heterosis, enabling increased productivity.

The steady increase in world population requires that a sustainable and highly productive form of aquaculture be promoted as quickly as possible. Increased productivity based on selective breeding and

adoption of technologies adapted to the regions in which they are practiced is expected to contribute to the promotion of sustainable aquacultural production.

Fig. 1. Production of prawns, catches, and culture in Thailand.



[Fig. 2. Sampling sites of catfish and snake-head fish.\(29 KB\)](#)

Fig. 3. Dendrogram depicting the relationship among local populations of catfish Thailand.

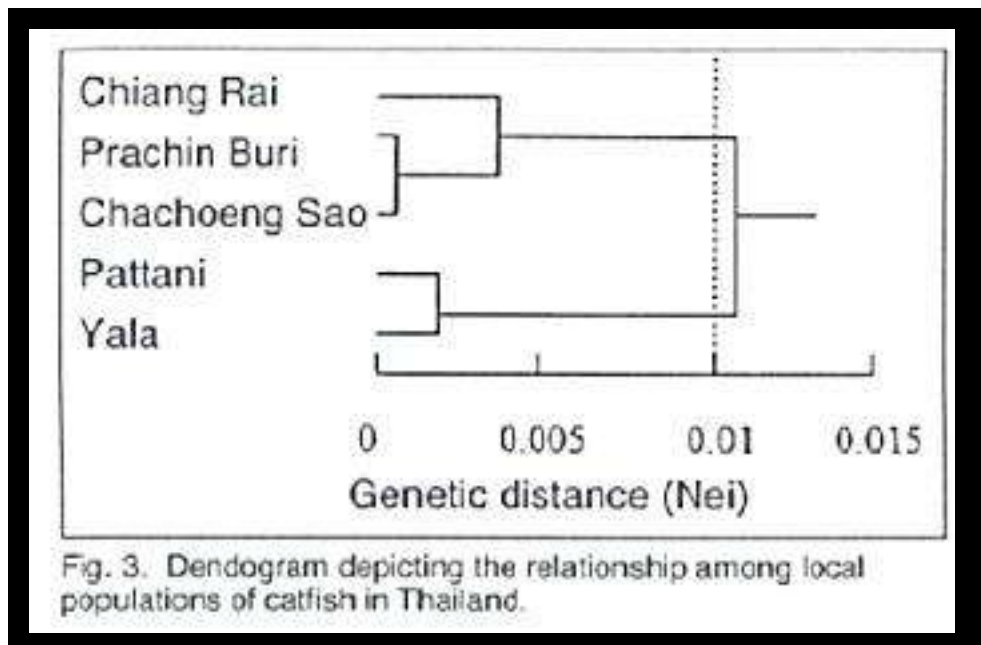


Fig. 3. Dendrogram depicting the relationship among local populations of catfish in Thailand.

[Forward to Okinawa Subtropical Station](#)

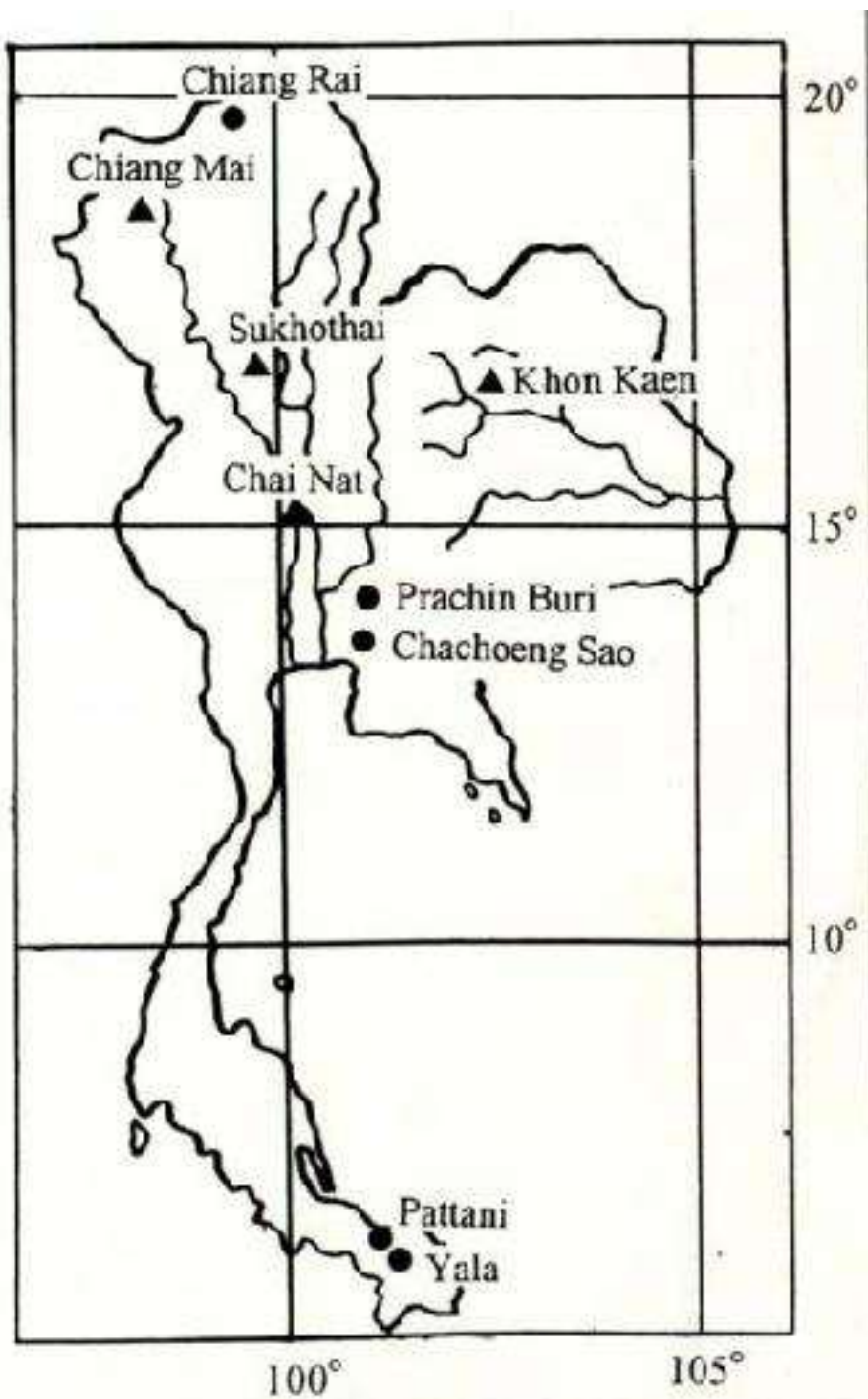


Fig. 2. Sampling sites of catfish (●) and snake-head fish (▲).

# OKINAWA SUBTROPICAL STATION

The Okinawa Subtropical Station is located in Japan's southernmost city, Ishigaki (2,100 km southwest from Tokyo). The station is the only national research organization carrying out agricultural research under subtropical conditions.

Research at the Station includes: (1) introduction, acclimatization and cultivation of tropical vegetables; (2) improvement of tropical crops and development of breeding methods; (3) introduction and cultivation of new cultivars of tropical fruits; (4) improvement of methods for rapid generation advance for hybrid populations of rice and wheat; (5) studies of viral diseases and insect pests of tropical plants; (6) utilization of soil microorganisms and genetic regulation of nutrition in tropical crops, and (7) international collaboration for the improvement of agricultural technology in the tropics. Under (7), researchers from developing countries are invited to undertake advanced studies at the International Collaboration Section of the Station. In 1996, ten researchers from eight countries participated in the Visiting Research Fellowship Program. In this program, emphasis is placed on studies for the optimum utilization of bio-resources for conservation of the environment and sustainable agricultural production in the tropics.

[JIRCAS host and Visiting Reserch Fellows at the Okinaw Subtropical Station.](#)

[\(Photo : S.Tobita.\)\(18 KB\)](#)

[Topic1:Large-scale production of lateral shot seedlings of sugarcane using hydroponic systems](#)

[Topic2:Cryopreservation of taro shoot tips \(*Colocasia esculenta* \(L.\) Schott\) by vitrification](#)

[Topic3:Detection of capsid antipain proteins of viruses in papaya using protease inhibitor](#)



## **TOPIC 1 : Large-scale production of lateral shot seedlings of sugarcane using hydroponic systems**

On the Nansei islands of Japan where typhoon and drought frequently occur, sugarcane is a major crop. However, production of sugarcane, especially at the time of planting and harvesting, requires so much labor that few farmers are interested in growing it. The harvesting of sugarcane has greatly improved through mechanization by sugar manufacturing companies, but the planting of rooted cuttings is still done one at a time using a planter. Although the rearing of high-nodal position tiller seedlings has already been developed through machine setting, this requires cultivation of the mother plant to the desired length of lateral shoots. The growth of the lateral shoots, however, is unstable. Thus sufficient production of high-nodal-position tiller seedlings cannot be guaranteed.

The JIRCAS Okinawa subtropical station developed low input hydroponics, allowing cultivation of sugarcane by the large-scale production of lateral shoot seedlings. In this system, sugarcane stem cuttings placed vertically in the nutrient solution were allowed to develop roots in the lowest node and in large portions of the first, second and third levels of lateral shoots. As observed in the field, lateral shoot production was found only in the upper three nodes, whereas in the hydroponic system, lateral shoots developed in almost all the nodal positions. Thus, we were able to show that using a hydroponic system, a great number of lateral shoots could be produced in just a small area. Also using this system, we examined the effects of various culture media on the elongation of lateral shoots. The results showed that Magic Soil and Jam Breaker, which are both made from chemical fibers, are the best media for lateral shoot production. Moreover, when this system was placed inside the pipe house, where the climate for sugarcane growth can be kept at optimum temperatures, production of lateral shoots was observed within a short period. Weeding and chemical application was also kept at a minimum so that nutrient deficiency problems could be avoided.

Since it is now possible to produce a large number of lateral shoot seedlings from a mother plant, the above research will contribute to the development of a stable, mechanized planting scheme.

[Figure1:Sugarcane greenhouse cultivation.\(21KB\)](#)

[Topic2:Cryopreservation of taro shoot tips \(*Colocasia esculenta* \(L.\) Schott\) by vitrification](#)



## TOPIC 2: Cryopreservation of taro shoot tips (*Colocasia esculenta* (L.) Schott) by vitrification

Through recent remarkable technical progress, cryopreservation is recognized as a practical and efficient tool for long-term storage of vegetatively-propagated plant germplasm. However, cryopreservation of tropical species still has been less extensively investigated than that of cold hardy species. Although cells and somatic embryos of about 30 tropical species have been well-preserved in liquid nitrogen (LN₂), information on the effective cryopreservation of shoot primordia of tropical species is still limited. This project aims to develop simple techniques for the efficient and stable cryopreservation of shoot tips of vegetatively propagated tropical crops.

Among different strategies for successful cryopreservation, the vitrification method was applied because the handling of explants by this method is relatively simple and the method has been reported to be successful with complex tissues such as meristems rather than cells. The principle of the vitrification method is to dehydrate a specimen by exposing it to a vitrification solution of a high osmolality, thus altering the condition of intracellular water. This also allows for the penetration of antifreeze substances in the vitrification solution so that the specimen is vitrified by rapid cooling in LN₂. A procedure for vitrification was successfully developed for shoot tips of taro, one of the common and most important tuber crops grown throughout the humid tropics and sub-tropics.

The conditions of the vitrification method were investigated in detail and optimized by using *Colocasia esculenta* (L.) Schott var. *antiquorum* cv. Eguimo as experimental material. We concluded the following concerning the successful cryopreservation of taro shoot tips: (1) conditioning culture with a high concentration of sucrose (120g/l) is very effective for raising and stabilizing post thaw survival compared with the shoot tips from the plants raised on the medium with 30g/l sucrose, a common condition for *in vitro* multiplication of taro, (2) proper size of shoot tips should be used, (3) preculture of dissected shoot tips with 0.3M sucrose prior to the cryogenic procedure improved post-thaw survival, and (4) loading is an essential procedure to improve tolerance to the dehydration by PVS2, a vitrification solution used in this study. The finalized protocol is summarized in Table 1.

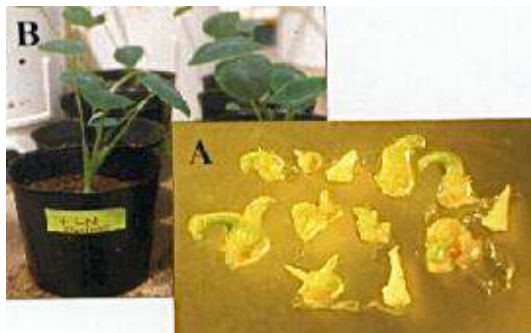
Shoot tips which successfully vitrified and warmed using this protocol resumed growth within 7 days and developed shoots directly without intermediate callus formation (Fig. 1a). Almost all the shoot tips that survived were successfully transferred to soil in pots (Fig. 1b). No morphological abnormalities were observed in plants developed from cryopreserved shoot tips.

The protocol developed was applied to different cultivars of triploid and diploid taro and post thaw survival rates of 67-100% were obtained for the different genotypes (Table 2). The protocol is considered valuable for the long-term preservation of taro germplasm and further studies are needed to expand the applicability of this procedure to other species belong to the family *Aracea*.

<b>Table 1.</b>	<b>Protocol developed for cryopreservation of taro shoot tips by vitrification</b>
<b>Step 1:</b>	<b>Culture the shoot tip donor plants on Murashige and Skoog medium(MS) supplemented with 120g/l sucrose for three weeks (conditioning culture)</b>
<b>Step2:</b>	<b>Dissect shoot tips shoot tips (0.5-0.8mm in length, apical dome + 1-2 leaf primordia)</b>
<b>Step3:</b>	<b>Preculture the shoot tips on MS containing 0.3M sucrose for 1 night at 25°C</b>
<b>Step4:</b>	<b>Treat the precultured shoot tips with a loading solution [2M glycerol + 0.4M sucrose] for 20min at 25°C</b>
<b>Step5:</b>	<b>Expose the loaded shoot tips to PVS2 [ 30%(w/v) glycerol + 15%(w/v) ethylene glycol +15%(w/v) DMSO + 0.4M sucrose ] for 10min at 25°C</b>



- Step6:** Directly plunge into liquid nitrogen (LN₂) and store
- Step7:** Rapidly rewarm the cryopreserved shoot tips in a 40°C-water bath
- Step8:** Soak the shoot tips into 1.2M sucrose for 10min at 25°C
- Step9:** Reculture the shoot tips on two layers of blotting paper over MS supplemented with 0.3M sucrose
- Step10:** Transfer the shoot tips to MS containing 0.1M sucrose for regrowth of plantlets



**Fig. 1. A) Taro shoots formed from cryopreserved shoot tips by vitrification. Dead shoot tips turned white whereas those which survived showed a green color. B) Taro plants developed from cryopreserved shoot tips by vitrification.**

**Table 2. Post-thaw survival of taro(*Colocasia esculenta*)shoot tips subjected to vitrification methods.**

Scientific names (2n)	Cultivars	Post thaw survival rate (%±SE)
<i>Colocasia esculenta</i>		
<i>var. antiquorum</i> (3x=42)	Eguimo	100.0±0.0
	Dodare	100.0±0.0
<i>var. esculenta</i> (2x=28)	Kabira	83.3±7.5
	Ginowan	95.3±3.2
	So	66.6±5.4
	Sap	75.0±4.2

*a: The shoot tips were treated as shown in Table 1.*

*b: Six shoot tips were tested for each of these*

[Forward to Miscellaneous Projects Outline](#)

[Back to Contents](#)

# MISCELLANEOUS PROJECTS OUTLINE

In addition to international collaborative projects, JIRCAS conducts a variety of miscellaneous projects: domestic projects, in cooperation with other MAFF institutes; commissioned research, principally in cooperation with universities; cross-ministry/agency projects currently with the Science and Technology Agency and the Environment Agency; and special allotment projects.

## DOMESTIC PROJECTS

**Collaborative operations pertaining to the Agriculture, Forestry and Fisheries Gene Bank**  
(Biological Resources Division and Okinawa Subtropical Station, 1989-ongoing)

**Comprehensive research on ordering mechanisms of agriculture, forestry and fisheries ecosystems and elucidation of optimal means of governance**  
(Animal Production and Grassland Division, 1995-1998)

**Development of methodology to forecast changes in the structure of the production and consumption of agricultural products in the context of internationalization**  
(Research Information Division, 1995-1997)

**The elucidation of endophyte functions to develop new forms and qualities**  
(Animal Production and Grassland Division, 1996-1998)

**Comprehensive research pertaining to trade and industry in the realm of agriculture, forestry and fisheries, resources, and the environment**  
(Crop Production and Postharvest Technology Division, 1996-2000)

**New usages for wheat crops: The development of high-quality field crops and their utilization technology**  
(Okinawa Subtropical Station, 1996-2005)

**Development of an agricultural information evaluation tool using GIS interface**  
(Research Information Division, 1997-2002)

**Studies on the improvement of crop adaptation to high temperature stress**  
(Okinawa Subtropical Station, 1997-2001)

## COMMISSIONED RESEARCH

**Distribution and ecology of *Vigna* species in tropical regions of Asia**  
(Biological Resources Division in cooperation with The University of the Ryukyus, 1994-1996)

**Desertification in cool, dry areas and accompanying changes in systems of agricultural dynamics**  
(Environmental Resources Division in cooperation with Nihon University, 1995-1997)

**Evaluation of salinity tolerance in wild species of rice and elucidation of tolerance mechanisms**  
(Okinawa Subtropical Station in cooperation with The University of the Ryukyus, 1996-1999)

## **RESEARCH PROJECTS WITH OTHER GOVERNMENT AGENCIES AND MINISTRIES**

### **In cooperation with the Science and Technology Agency**

**Oceanographic investigations: Fluctuations in tropical mangrove forests and evaluation of possible influences**  
(Forestry Division, 1990-1997)

**Global research network: set-up of data-base for changes in desertification**  
(Environmental Resources Division, 1994-1996)

**Study on endocrine responses of somatotropin in livestock animals in tropical environments**  
(Animal Production and Grassland Division, 1996)

**Biology of the asiatic palm weevil, *Rhabdoscelus lineaticollis*, a new sugarcane pest in Okinawa**  
(Okinawa Subtropical Station, 1996)

**Development of an integrated long term monitoring method for transpiration**  
(Environmental Resources Division, 1996)

### **In cooperation with the Environmental Agency**

**Research for the development of technology to inhibit the production and emission of methane and nitrous oxide from agricultural fields**  
(Environmental Resources Division, 1995-1997)

## **MAFF SPECIAL RESEARCH ALLOTMENTS**

**Stabilization of rice culture under water stress in the tropics utilizing a broader spectrum of genetic resources**  
(JIRCAS in cooperation with the International Rice Research Institute (IRRI), 1994 - 1999)

**Sustainable cultivation of upland crops in the semi-arid tropics**  
(JIRCAS in cooperation with International Crops Research Institute for the Semi-Arid Tropics)

[Forward to Training and invitation programs; information event](#)

[Back to Contents](#)

# INVITATION PROGRAMS AT JIRCAS

As part of JIRCAS's role as an international research center, we have implemented several systems for the invitation of foreign researchers and counterpart administrators. These programs serve to facilitate the exchange of information and opinion concerning agriculture, forestry and fisheries administration and to strengthen international research ties with scientists and administrators in other countries. Below is a description of two of our fellowship programs. Beginning in 1998, application materials will be available via the JIRCAS website.

## **JIRCAS Visiting Research Fellowship Program at Okinawa**

This program was initiated in FY 1992 before TARC was reorganized into JIRCAS. Post-doctoral level scientists are invited to conduct research for a period of one year at the Okinawa Subtropical Station. Research focuses on important topics related to tropical agriculture in developing countries. Research themes are divided into several major categories: 1) Development of techniques for environmental control by using plants and microorganisms specific to the tropics and subtropics; 2) Studies on mechanisms of heat-tolerance of tropical and subtropical crops; 3) Identification and evaluation of salt-tolerant crops; and 4) Evaluation and development of long-term conservation techniques of genetic resources of vegetatively propagated crops in the tropics and subtropics. Ten fellows are generally chosen every year and begin their term on October 1 ending September 30 of the following year. Recent activity is summarized below. More information on the Okinawa Fellowship Program can be obtained by contacting the International Relations Section, Japan International Research Center for Agricultural Sciences, 1-2, Ohwashi, Tsukuba, Ibaraki, 305-8686, Japan. (Tel.: 81-298-38-6335 Fax: 81-298-38-6337 Telex: 3652456 JIRCAS J)

[A list of the 1996 Okinawa Research Fellows](#)

[Photo:JIRCAS visiting research fellows and hosts outside the Okinawa Subtoropical Station.](#)

## **JIRCAS Visiting Research Fellowship Program at Tsukuba**

A program similar to the Okinawa Visiting Research Fellowship Program has been implemented on the Tsukuba premises since October 1995. The fellowship aims at the promotion of collaborative research to address various problems confronting countries in the developing regions. The program allows for the invitation of 6 researchers per year. Four persons are engaged in 2-year projects at JIRCAS and 2-3 scientists carry out short-term (5 months) projects at the National Institute of Agrobiological Resources (NIAR). More information on the Tsukuba Fellowship Program can be obtained by contacting the International Relation Section, Japan International Research Center for Agricultural Sciences, 1-2, Ohwashi, Tsukuba, Ibaraki, 305, Japan. (Tel.: 81-298-38-6335 Fax: 81-298-38-6337 Telex: 3652456 JIRCAS J)

[A list of the 1996 Tsukuba Research Fellows](#)

[Photo:JIRCAS visiting research fellows and staff examine reading from the ESCA \(Electron Spectroscopy for Chemical Analysis\).](#)

### **Other fellowships for visiting scientists**

The Government of Japan sponsors a post-doctoral fellowship program for both Japanese and foreign scientists through the Science and Technology Agency (STA). The program places post-doctoral fellows in national research institutes throughout Japan according to research theme and prior arrangement with a host for a term of generally 1-3 years. Fellowships can be undertaken in any of the ministries and many fellows are currently working at the various institutes of MAFF. At present, the following four visiting scientists are residing at JIRCAS: Dr. O.A. Welker (Germany), Biological Resources Division; Dr. B.A. Yakubov (Republic of Uzbekistan), Biological Resources Division, Dr. Chien Hsiaoping (People's Republic of China), Research Information Division, and Dr. Mingyuan Du (People's Republic of China), Environmental Resources Division. In addition, two Japanese fellows, Dr. N. Aoki and Dr. T. Urao, are also conducting research at JIRCAS.

[Forward to Symposia and Workshops](#)

[Back to Contents](#)

<b>Development of techniques for environmental control by using plants and microorganisms specific to the tropics and subtropics</b>		
Lukman Gunart	Central Research Institute for Food Crops, Indonesia	Mutagenesis of <i>Azospillum</i> exopolysaccharide production and IAA excretion and its effect on the growth of lowland rice
Dianou Dayeri	Institute d'Etudes et de Recherches Agricoles, Burkina Faso	Isolation and characterization of methanotrophic and methanogenic bacteria from a subtropical paddy field
<b>Studies on the mechanism of heat-tolerance of tropical and subtropical crops</b>		
Lin Baiqing	Institute of Vegetables and Flowers, China	The roles of Hydroxyproline-rich Glycoproteins (HRGPs, extensin) in susceptible and resistant genotypes of <i>Brassica pekinensis</i> Rupr. response to heat treatments
Harvinder Singh Talwar	ICRISAT, India	Studies on physiological basis of heat tolerance in groundnut ( <i>Arachis hypogaea</i> L.)
Padmanaban Annmalai	University of Madras, India	Development of PCR based marker for heat tolerance and cloning of its related genes in <i>Brassica oleracea</i> var. capitata L.
<b>Identification and evaluation of salt tolerance crops</b>		
Lin Hongxuan	China National Rice Research Institute	Genetic characterization of salinity tolerance in rice and its wild relatives, and introduction of salinity tolerance into rice germplasm mainly through biotechnological procedures
Armenia Mendoza	University of the Philippines	Physiological and biochemical mechanisms of genotype variability in response to salt stress in rice callus and somatic hybrids
Somsong Chotechuen	Chainat Field Crops Research Center, Thailand	Physiological responses of rice seedlings after solinization, and in vitro selection of EMS-treated cell suspension cultures of rice for salt tolerance
<b>Evaluation and development of long-term conservation techniques of genetic resources of vegetatively propagated crops in the tropics and subtropics</b>		
Nguyen Tien Thinh	Nuclear Research Institute, Vietnam	Development of techniques for in vitro conservation of tropical root crops
Pius Michael Kyesmu	University of Jos, Nigeria	Cyropreservation of the West African tuber crop Rizga ( <i>Plectranthus esculentus</i> N.E. Br.)
from October 1996 to September 1997		
<b>Development of techniques for environmental control by using plants and microorganisms specific to the tropics and subtropics</b>		
Dianou Dayeri	Institute d'Etudes et de Recherches Agricoles, Burkina Faso	Establishment of a model ecosystem in vitro of methane production and oxidation to elucidate the mechanism of methane emission from wetland paddy fields with reference to the development of techniques for environmental control
El-Khwas Hussein Moustafa	Cairo University, Egypt	Utilization of associative diazotrophic bacteria for promoting plant growth and saving fertilizer
<b>Studies on the mechanism of heat-tolerance of tropical and subtropical crops</b>		
Harvinder Singh Talwar	ICRISAT, India	Physiological basis of heat tolerance during flowering and pod development stages in peanut ( <i>Arachis hypogaea</i> L.)
Padmanaban Annmalai	University of Madras, India	Molecular study on the function of heat shock-responsive genes in cabbage
<b>Identification and evaluation of salt tolerance crops</b>		
Li Chengyun	Yunnan Academy of Agricultural Sciences, China	1. Studies on the relationship between salinity tolerance and cold tolerance at the booting stage of rice 2. Studies on the culture and regeneration of protoplasts from <i>Porteresia coarctata</i> , a wild relative of rice
Safdar Hussain Shah	Agriculture Research Station D-hodial, Pakistan	Salinity tolerance and the co-tolerance phenomenon in rice at the cellular and whole-plant levels
Maribel Dionisio-Sese	University of the Philippines	Effects of salinity stress on photosynthetic and antioxidative activities in rice at Los Banos
Qian Qian	China National Rice Research Institute, China	Mapping quantitative trait loci for salt tolerance and cloning of its related genes in rice
<b>Evaluation and development of long-term conservation techniques of genetic resources of vegetatively propagated crops in the tropics and subtropics</b>		

Development of techniques for environmental control by using plants and microorganisms specific to the tropics and subtropics

Nguyen Tien Thinh	Nuclear Research Institute, Vietnam	1. Cryopreservation of shoot tips of Banana ( <i>Musa spp.</i> ) germplasm 2. Effects of pre-conditioning on post-thaw survival of cryopreserved shoot tips of tropical crops
Pius Michael Kyesmu	University of Jos, Nigeria	1. Optimization of cryopreservation protocol of the West African tuber crop, <i>Plectranthus esculentus</i> N.E. Br. 2. Cryopreservation of yam shoot tips ( <i>Dioscorea spp.</i> ) by vitrification





<b>Long-term at JIRCAS from October 1995 to September 1997</b>		
Methods for optimum utilization of biological resources		
Lin Qiang	Guangxi Agricultural University, China	Analysis of plant responses to environmental stresses and gene expression
Zhu Weiming	Jiangsu Academy of Agricultural Sciences, Institute of Genetics, China	Development of a DNA based assay for indexing plant diseases
Muharijadi Atomomarsono	Research Institute of Coastal Fisheries, Inodonesia	Development of methods for the diagnosis and prevention of diseases affecting aquatic animals for fresh water and marine aquaculture
Chang Qing	Xinjiang Institute of Biology, Pedology, and Desert Research, China	Investigations of the process of rockweathering through the analysis of rock surfaces by electron spectroscopy
<b>Long-term at JIRCAS from October 1996 to September 1998</b>		
Methods for optimum utilization of biological resources		
Zabta Khan Shinwari	National Agriculture Research Center, Pakistan	Analysis of plant responses to environmental stresses and gene expression
Gassinee Trakoontivakorn	Kasetsart University, Thailand	Development of practical methods for the evaluation of the quality of indigenous crops and for the analysis of components and functionality of foods
Analysis and evaluation of the impact of climatic and anthropogenic factors on environmental resources		
Qian Minze	Qinghua University, China	Relation between climatic changes and biomass in agro-ecosystems
Yang Hao	Turangkexue Institute, China	Investigations of the process of rockweathering through the analysis of rock surfaces by electron spectroscopy
<b>Short-term at NIAR from August 1996 to January 1997</b>		
Baryah Sabita J.N.	Assam Agricultural University, India	Production of new biological resources thourhg the application of biotechnological procedures
<b>Short-term at NIAR from October 1996 to March 1997</b>		
Pjotr Strelchenko	N.I. Vavilov Institute of Plant Industry, Russia	Methods for the analysis and preparation of biodiversity
<b>Short-term at NIAR from January 1997 to March 1997</b>		
Rolando B. So	International Rice Research Institute, Philippines	Methods for the analysis and control of biological functions



# SYMPOSIA AND WORKSHOPS

- [Click here for a summary of the international symposium on the Biosafety Results of Field Tests of Genetically Modified Plants and Microorganisms](#)
- [Click here for a summary of the Japan-Korea seminar on direct seeded rice](#)
- [Click here for a summary of the seminar on the Brackish Water Project in Malaysia](#)
- [Click here for a summary of the Mekong Delta Farming Systems Research Project Workshop](#)
- [Click here for information on other symposia and workshops](#)

### **TOPIC 3: Detection of capsid antipain proteins of viruses in papaya plant using protease inhibitor**

The papaya leaf-distortion mosaic virus (PLDMV) and P strain of papaya ringspot virus (PRSV-P) cause serious diseases of papaya (*Carica papaya* L.), which have only been partially controlled by conventional methods. An alternative control method is to coat protein mediated protection through the transfer and expression of the viral capsid protein (CP) gene in papaya.

Western blotting is commonly used for the serological detection of CPs of viruses. Thus far, however, no CP band of papayas viruses has been detected by western blotting when they were extracted directly from papaya plants. Since it was presumed that CP was digested by papain (sulfhydryl protease) in papaya tissues during extraction, an attempt was made to detect them by inhibiting the enzyme activity of papain.

Antipain isolated from culture filtrates of *Actinomices* has been reported as a specific enzyme inhibitor of papain. It was found that CP was clearly detected when 0.1-1 mg/ml of antipain was added to the extraction buffer at the first step of western blotting procedure (Fig. 1), and modified western blotting for papaya's viruses was established. This method is expected to accelerate the transgenic papaya production.

[Fig.1 Procedure of western blotting for detecting papaya viruses.\(52 KB\)](#)

## **TOPIC 2: Estimation of regional edible feed resources in a barley/rangeland zone in Northeastern Syria**

Within the dry marginal lands in West Asia and North Africa which receive an annual precipitation between 200-300mm, barley cropping and rangeland grazing for small ruminant production are the main land use systems. In these systems, native plants in rangelands comprise the major feed resources during winter and spring, whereas barley stubbles after the harvest contribute during dry summer and autumn.

In such systems, rapid land degradation is being accelerated by overgrazing, fuel cutting and inappropriate cropping. Estimation of the feed resource distribution and the carrying capacity of livestock in a whole region are fundamentally important to avoid degradation problems through improved land use systems.

In the Abdul Aziz test zone of 95,000 ha, northeastern Syria, feed resources were classified into 8 groups using Landsat TM data assisted by a series of vegetation surveys to monitor changes in botanical composition and aerial biomass. As presented in figure 2, the classified feed resources are barley (yellow), fallow (brown), forests (green), and five native vegetations of various plant components (red, reddish brown, charcoal, blue and gray).

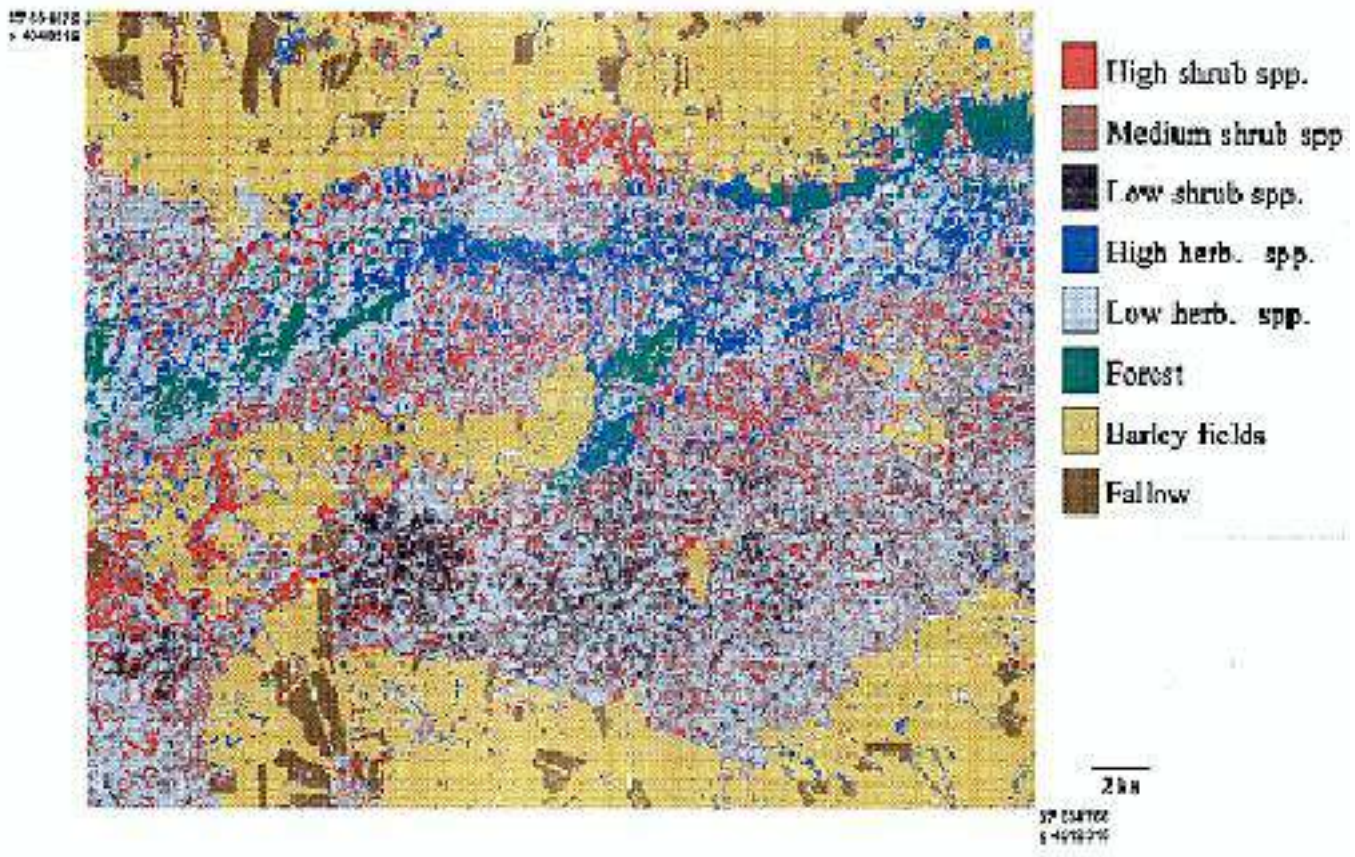
The total edible feed biomass is 63,000 tons per year, where barley cropping contributes 68% of the biomass from 32% of the total area. The natural plants, shrubs and herbaceous species on rangelands contribute 31% of the total biomass from 61% of the area.

This study revealed the regional distribution of feed resources and the quantitative assumption of edible biomass, which is the key information for setting a maximum number of small ruminants in the region without degradation risks. This method can be applied in similar arid environments to lead to sustainable livestock production and land use development.

[Figure 1: Stubble grazing after barley harvest in early May. Until the end of the dry season, local animals stay in villages for grazing in the fields. From September, animals will be moved to hilly rangelands where they graze on native plants grown mainly during the rainy season. \(October to April\). \(32 KB\)](#)

[Figure 2: Feed resources of eight classes in the Abdal Aziz test zone, Northeastern Syria. Local distribution of barley fields, fallow, forest and five classes of native vegetation on rangelands were classified by local surveys and Landstat TM data \(band 2, 3, 4\). \(60 KB\)](#)





## TOPIC 2: New disease resistant varieties of cucumbers and strawberries in China

The urban areas of China require a stable supply of fruits and vegetables because of recently increasing demand. Cucumber is one of the major vegetables cultivated in the Shanghai region, but it is susceptible in the field to *Fusarium* wilt and downy mildew. The cucumber varieties also tend to exhibit low yield and late maturity. Strawberries are a main fruit, and their demand is also increasing remarkably in Shanghai. However, varieties with strong disease resistance and high fruit quality in forcing culture are lacking.

Therefore, we attempted to develop new varieties of cucumbers and strawberries with good disease resistance, high-yield ability and high quality by using the genetic resources of Japan and China and adapting them to the Shanghai area.

**1) New cucumber variety Hu 116 and Hu 119.** Hu 116 is a F1 variety (Photo.1) which was derived from a cross between 0202-1-1 (progeny line of Rensei) and SK-11 (progeny line of Shinkoufushinari 11) and has early maturity. Hu 116 has been observed to have high resistance to *Fusarium oxysporum* sch.f.sp.cucumerinum and *Pseudoperonospora cubensis* Rostowzew in the results of an early testing method and in the field. Hu 116 has many female flowers and its yield is about 10 to 15% higher than Shinkoufushinari 11. The fruit length is about 21 to 24 cm. The skin color is deep green and has few nodules or spines.

Hu 119 is a F1 variety, which was derived from a cross between 0202-1-1 and 019-2 (progeny line of Chinese variety). Hu 119 has shown a similar degree of resistance to *F. oxysporum* and *P. cubensis* as Hu 116. Hu 119 has lower female flower bearing ability than Hu 116, but it produces steady harvesting during the growing period. Like Hu 116, the fruit quality is good. Hu 116 and Hu 119 are adapted to the semi-forcing culture found in the whole of the Shanghai area and the area of Jhejiang, Jiangsu, Shandong, and Sichuan.

**2) The new strawberry variety Shinkyoku 1 and Shinkyoku 2 .** The new strawberry varieties Shinkyoku 1 and Shinkyoku 2 were selected from hybrid seedlings crossed between Japanese strains. The total yield of Shinkyoku 1 continuing until April is higher than that of Toyonaka or Hokouwase. The fruit is large in size, about 11-14g, conic in shape and has a shiny scarlet skin color. The contents of soluble solids in the fruits were considerable, rating between 8 and 10 on the Brix scale. The flesh is firm and the skin is hard, so this new variety has good transportability. In Shanghai, strawberry anthracnose, which is caused mainly by *Colletotrichum acutatum* Simmonds, is also caused by *C. fragariae* Brooks. Shinkyoku 1 has higher resistance to the above anthracnose species than Hokouwase and also has resistance to gray mold.

The harvesting season of Shinkyoku Q' is earlier than that of Toyonoka. The yield within the year (from November to December) and the early yield from November to February is higher than Toyonok', thus this variety has many early fruits. The fruit is large, about 10-11g in the weight, conically shaped, and shiny scarlet in color. It is also very sweet, but moderately sour and very juicy, making it quite tasty. The fruit also has a high vitamin C content. Shinkyoku Q has higher resistance to *Colletotrichum acutatum*



Simmonds and *C. fragariae* Brooks than Hokouwase. Shinkyoku 1 and Shinkyoku 2 are well adapted to the forcing culture of the Shanghai area.

[Photo 1 : New disease resistant varieties of cucumbers under cultivation. \(22 KB\)](#)

[Photo 2 : New experimental varieties of strawberries. \(20 KB\)](#)





# PUBLISHING AT JIRCAS

## OFFICIAL JIRCAS PUBLICATIONS

### In English

1) JIRCAS Journal for Scientific Papers	No.4
2)JARQ (Japan Agricultural Research Quarterly)	Vol.30 - No.2, No.3 - No.4, Vol.31 - No.1
3) Annual Report	1995
4) JIRCAS Newsletter	No. 7, No.8, No.9, No10
5) JIRCAS International Symposium Series	No.4 Innovative Weed Management Strategy for sustainable Agriculture
6)JIRCAS Working Report	No.4 Sustainable Utilization Coastal Ecosystems
7)JIRCAS International Agriculture Series	No.3 Roots and Nitrogen in Cropping Systems of the Semi-Arid Tropics

### In Japanese

1)JIRCAS News	No.7, No.8, No.9, No.10
2)JIRCAS Working Report	No.3 Soil and Agriculture of Turpan, China No.5 Development of Sustainable Agricultural Systems in Northeast Thailand
3)JIRCAS International Agriculture Series	No.2 Traditional Food in Asia
4)JIRCAS Research Highlights	No.3

## LIBRARY HOLDINGS (April 1, 1996 - March 31, 1997)

Language	Books			Periodicals (titles)			Materials (Proceedings, maps and other)		
	Purchase	Gift	Total	Purchase	Gift	Total	Purchase	Gift	Total
Japanese	51 (3)	397 (4)	448 (7)	80 (33)	524 (77)	604 (110)	10	497	507
Foreign	33 (5)	461 (3)	494 (8)	155 (29)	311 (40)	466 (69)	12	208	220
<b>Total</b>	84 (8)	858 (7)	942 (15)	235 (62)	835 (117)	1070 (179)	22	705	727

( )Indicates separate holdings of the Okinawa Subtropical Station

[Research staff activity](#)

# RESEARCH STAFF ACTIVITY (1996-1997)

## Journal articles, book chapters, and monographs

- Adachi, K., Oyediran, G. and Senboku, T. (1996). Effect of application of rice straw and cellulose on methane emission and biological nitrogen fixation in a subtropical paddy field. II. Enumeration of population of methanogenic bacteria by the most probable number method and roll tube method. *Soil Science and Plant Nutrition* 42(4): 713-723.
- Adu-Gyamfi, J.J., Gayatri Devi, Rao, T.P., Katayama, K. and Ito, O. (1996). Estimation of soil nitrogen status in intercropping through soil solution. In "Roots and nitrogen in cropping systems of the semi-arid tropics" Eds. Ito, I., Johansen, C., Adu-Gyamfi, J.J., Katayama, K., Kumar Rao, J.V.D.K. and Rego, T.J. Japan International Research Center for Agricultural Sciences (JIRCAS), Ibaraki, Japan. JIRCAS International Agriculture Series, 3: 453-468
- Adu-Gyamifi, J.J., Gayatri Devi, Rao, T.P., Katayama, K. and Ito, O. (1996). Improvement of soil and fertilizer nitrogen use efficiency in sorghum/pigeonpea intercropping. In "Roots and nitrogen in cropping systems of the semi-arid tropics" Eds. Ito, I., Johansen, C., Adu-Gyamfi, J.J., Katayama, K., Kumar Rao, J.V.D.K. and Rego, T.J. Japan International Research Center for Agricultural Sciences (JIRCAS), Ibaraki, Japan. JIRCAS International Agriculture Series, 3: 493-506.
- Ahmad, H., Hayase, S. (1996). Structure of fish assemblages in Selangor/Matang Mangroves on the West Coast of Peninsular Malaysia. *JIRCAS Working Report* 4: 27-35.
- Akita, T., Yoshihara, S., Komatsu, M., Kato, H. (1996). Immunological characteristics in Mei-shang pigs: Complement fixation, C3 concentration, antibody production and skin structure. *Animal Science and Technology (Supplement)*: 92-9. (J)
- Ando, S., Yokoyama, T., Tomooka, N. and Murakami, T. (1996). Genetic diversity of mungbean bradyrhizobia isolated in Thailand. *JIRCAS Working Report No. 2 Mungbean Germplasm: Collection, Evaluation and Utilization for Breeding Program*. 49-51.
- Billore, S.K., Numata, S. and Minami, K. (1996). Nitrous oxide emission from grassland and forest soils through nitrification. *Current Science*, 70(11,12): 1010-1012.
- Bong, B.B., Tobita, S., Bermawie, N. and Senboku, T. (1996). Salt tolerance of cultivated rice varieties from Vietnam. *JIRCAS Journal*, 3: 75-83.
- Bujang, I., Egawa, Y., Tomooka N. and Bakar, A. (1996). Collection of wild *Vigna* germplasm in Malaysia and genetic diversity. *JIRCAS Working Report No.2: Mungbean Germplasmpp*. 25-30.
- Chapman, S.J., Kanda K., Tsuruta, H. and Minami, K. (1996). Influence of temperature and oxygen availability on the flux of methane and carbon dioxide from wetlands: A comparison of peat and paddy soils. *Soil Science & Plant Nutrition*, 42: 269-277.
- Cole, V., Cerri, C., Minami, K., Mosier, A., Roserberg, N. and Sauerbeck, D. (1996).

Chapter 23: Agricultural options for mitigation of greenhouse gas emission. Climate Change 1995, IPCC, Cambridge University Press, pp. 745-771.

Daido, H. and Minami, K. (1996). Agricultural characteristics and research situation in Central Asia, (4) Turkmenistan. Agriculture Former USSR & East Europe, 7: 14-21. (J)

Egawa, Y., Bujang, I. Chotechuen, S., Tomooka, N. and Tateishi, Y. (1996). Phylogenetic differentiation of tetraploid *Vigna* species, *V. glabrescens* and *V. reflexo-pilosa*. JIRCAS Journal, 3: 49-58.

Egawa, Y., Chotechuen, S., Tomooka, N., Lairubgreang, Nakeeraks, P., Thavarasook, C. and Kitbamroong, C. (1996). Collaborative research program on mungbean germplasm (subgenus *Ceratotropis* of the genus *Vigna*) between DOA, Thailand and JIRCAS, Japan. JIRCAS Working Report No. 2: Mungbean Germplasm: 1-9.

Fuentes, S., Mayo, M. A., Jolly, C.A., Nakano, M., Auerci, M. and Salazar, L.F. (1996). A novel luteovirus from sweet potato: Sweet potato leaf speckling virus. Annals of Applied Biology, 128(3): 491-504.

Fujii, Y., Azumi, Md., Watanabe, H. (1997). Screening of allelopathic plants for weed control in Malaysia. Weed Research, Japan, 42(Supplement): 9. (J)

Gayatri Devi, Rao, T.P., Adu-Gyamfi, J.J., Katayama, K. and Ito, O. (1996). Simulation of rooting profile using soil properties, crop characteristics, and climatic data. In: "Roots and nitrogen in cropping systems of the semi-arid tropics" Eds by Ito, I., Johansen, C., Adu-Gyamfi, J.J., Katayama, K., Kumar Rao, J.V.D.K. and Rego, T.J. Japan International Research Center for Agricultural Sciences (JIRCAS), Ibaraki, Japan. JIRCAS International Agriculture Series, 3: 573-584.

Hamdan, P., Mansor, M. and Watanabe, H. (1996) Yield component analysis of direct seeded rice under several densities of red sprangletop [*Leptochloa chinensis* (L.) Nees] in Peninsular Malaysia. Weed Research, Japan, 41(3): 216-224.

Hatta, T. and Kainuma, K. (1996). Surface analysis of polysaccharides by X-ray photoelectron spectroscopy, Journal of Applied Glycoscience, 43(3): 35.

Hatta, T. and Nemoto, S. (1996). ESCA (XPS) Introduction to analysis for geochemical samples: Analytical methods for soil components (IV). Hakuyusha: 109-132. (J)

Hatta, T. and Saito, N. (1996). An approach to study of the alteration and formation of minerals by X-ray photoelectron spectroscopy. Chikyu, 18(4): 236-240. (J)

Hayase, S. (1996). Methods for food-chain analysis in aquatic ecosystems. JIRCAS Working Report No. 4: 51-62.

Hisada, M., Moriguchi, T., Hidaka, T., Koltunow, A.M., Akihama, T. and Omura, M. (1996). Random sequencing of sweet orange (*Citrus sinensis* Osbeck) cDNA library derived from young seeds. Journal of the Japanese Society for Horticultural Science. 65(3): 487-495.

Hosen, Y. and Tsuruta, H. (1997). Effect of soil depth on the production of nitric oxide.

Research Reports of Division of Environmental Planning, NIAES, 13: 67-81. (J)

Igarashi, Y., Yoshiba, Y., Sanada, Y., Yamaguchi-Shinozaki, K., Wada, K. and Shinozaki, K. (1997). Characterization of the gene for D1-pyrroline-5-carboxylate synthetase and correlation between the expression of the gene and salt tolerance in *Oryza sativa* L. *Plant Molecular Biology*, 33: 857-865.

Imaizumi, M. (1996). Determination method for landslide slip surface locations in tertiary mudstone area by neutron moisture well logging. *Journal of Japan Landslide Society*, 32(4): 9-18. (J)

Imaizumi, M. (1996). Geochemical evolution of shallow groundwater on tertiary mudstone landslide slopes in Itakura, Niigata Prefecture. *Journal of the Japan Society of Engineering Geology*, 37(1): 2-18. (J)

Imaizumi, M., Okuyama, T., Komae, T. and Hamada, H. (1996). Study of the fault system within the Bandai-san explosion caldera of 1888 using the VLF-EM method and radioactivity prospecting. *Journal of the Japan Society of Engineering Geology*, 36(5): 322-338. (J)

Ishiki, K., Nakano, H. and Shirai, K. (1996). Root and tuber crops of the Incas (6). *Information for the Promotion of Root and Tuber Crops*, 47: 13-20. (J)

Ito, O., Katayama, K., Adu-Gyamfi, J.J., Gayatri Devi and Rao, T.P. (1996). Root activities and function in component crops for intercropping. In: *Roots and nitrogen in cropping systems of the semi-arid tropics*. Eds. Ito, I., Johansen, C., Adu-Gyamfi, J.J., Katayama, K., Kumar Rao, J.V.D.K. and Rego, T.J. Japan International Research Center for Agricultural Sciences (JIRCAS), Ibaraki, Japan. JIRCAS International Agriculture Series 3: 159-172.

Ito, O., Matsunaga, R., Katayama, K., Tobita, S., Adu-Gyamfi, J.J., Kashiwagi, J., Rao, T.P. and Gayatri Devi (1996). Dynamics of roots and nitrogen in cropping systems of the semi-arid tropics. *JIRCAS Journal*, 3: 33-48.

Iuchi, S., Yamaguchi-Shinozaki, K., Urao, T. and Shinozaki, K. (1996). Characterization of two cDNAs for novel drought-inducible genes in the highly drought-tolerant cowpea. *Journal of Plant Research*, 109: 415-424.

Iuchi, S., Yamaguchi-Shinozaki, K., Urao, T. and Shinozaki, K. (1996). Novel drought-inducible genes in the highly drought tolerant-cowpea: Cloning of cDNAs and analysis of the expression of the corresponding genes. *Plant Cell Physiology*, 37: 1073-1082.

Kaga, A., Tomooka, N., Egawa, Y., Hosaka, K. and Kamishima, O. (1996). Species relationships in the subgenus *Ceratotropis* (genus *Vigna*) as revealed by RAPD analysis. *Euphytica*, 88: 17-24.

Katayama, K., Adu-Gyamfi, J.J., Gayatri Devi, Rao, T.P. and Ito, O. (1996). Root system development of component crops in intercropping. In: *Roots and nitrogen in cropping systems of the semi-arid tropics*. Eds. Ito, I., Johansen, C., Adu-Gyamfi, J.J., Katayama, K., Kumar Rao, J.V.D.K. and Rego, T.J. Japan International Research Center for Agricultural



Sciences (JIRCAS), Ibaraki, Japan. JIRCAS International Agriculture Series, 3: pp. 199-210.

Katayama, K., Adu-Gyamfi, J.J., Gayatri Devi, Rao, T.P. and Ito, O. (1996). Balance sheet of nitrogen from atmosphere, fertilizer, and soil in pigeonpea-based intercrops. In: Roots and nitrogen in cropping systems of the semi-arid tropics. Eds. Ito, I., Johansen, C., Adu-Gyamfi, J.J., Katayama, K., Kumar Rao, J.V.D.K. and Rego, T.J. Japan International Research Center for Agricultural Sciences (JIRCAS), Ibaraki, Japan. JIRCAS International Agriculture Series, 3: 341-350.

Kawashima, T. Animal-Domestic animals. In: Dictionary of Southeast Asia: Natural features, ecology, environment, Volume 8, Kodansha, pp. 62-63.

Kawashima, T. Manufacturing technique: Animal Production. In: Dictionary of Southeast Asia: Natural features, ecology, environment, Volume 8, Kodansha, pp. 244-45.

Kifune, T. and Takahashi K. (1996). Sampling of *Strepsiptera* with a truck-mounted trap in Ishigaki Island. PULEX, 85: 459-460. (J)

Kiyosue, T., Yoshiba, Y., Yamaguchi-Shinozaki, K. and Shinozaki, K. (1996). Nuclear gene encoding mitochondrial proline dehydrogenase, an enzyme involved in proline metabolism, is upregulated by proline but downregulated by dehydration in *Arabidopsis*. Plant Cell, 8: 1323-1335.

Kobayashi, H., Kamarudin D., Nai-Kin Ho. and Abdul Rahman Abu Bakar (1996). Comparative studies on varietal performance and cultural practices under various direct seeding methods in the Muda area, Malaysia. Final report of MARDI/MADA/JIRCAS collaborative study, 1996: 1-103.

Komuro, K. and Hatta, T. (1996). The FeP 3/2 binding energy mapping around biotite in weathered granitic rocks. Annual Report of the Institute of Geoscience, the University of Tsukuba, 22: 53-57.

Kondo, M., Aragonés, D. and Aqsibit, R. (1996). Using controlled release fertilizer in an upland rice. The Philippine Journal of Crop Science, 21: 23.

Krishnamurthy, L., Johansen, C. and Ito, O. (1996). Genotypic variation in root system development and its implications for drought resistance in chickpea. In "Roots and nitrogen in cropping systems of the semi-arid tropics" Eds. Ito, I., Johansen, C., Adu-Gyamfi, J.J., Katayama, K., Kumar Rao, J.V.D.K. and Rego, T.J. Japan International Research Center for Agricultural Sciences (JIRCAS), Ibaraki, Japan. JIRCAS International Agriculture Series, 3: 235-250.

Kumar Rao, J.V.D.K., Johansen, C., Yoneyama, T., Tobita, S. and Ito, O. (1996). Estimation of nitrogen fixation by the natural ¹⁵N-abundance technique and nitrogen uptake by pigeonpea genotypes of different maturity groups grown in an inceptisol. Journal of Agronomy and Crop Science, 177: 129-238.

Li, C., Chen, Q., Chen, Z., Luo, C., Hayashi, C. and Ise, K. (1996). Distribution of the mating type in *Magnaporthe grisea* population pathogenic to rice in Yunnan Province.

Scientia Agricultura Sinica, 29(6): 60-64. (C)

Maoka, T., Prommintara, M., Kittipakorn, K., Doon, Y.B., Xiao, H., Usugi, T. and Noda, C. (1996). Characterization of several isolates of papaya ringspot virus (PRSV) collected from Asian countries. *Annals of the Phytopathological Society of Japan*, 62: 326.

Maoka, T., Usugi, T. and Noda, C. (1996). Modification of western blotting assay for detecting potyviruses in papaya plants. *Annals of the Phytopathological Society of Japan*, 62: 639.

Maoka, T. (1996). Studies on papaya ringspot virus. *Annals of the Phytopathological Society of Japan* 62: 220. (J)

Matsumoto, K., Santosa, S., Nazmulah and Ragil, S.B.I. (1966). Biology of the green lined albizzia longicorn, *Xystrocera globosa* Olivier (Coleoptera: Cerambycidae) from Sumatra, based on laboratory breeding. *Tropics*, 6: 79-89.

Matsumoto, K. and Woro, N. (1996). Establishment of *Papilio demoleus* L. (Papilionidae) in Java. *Journal of the Lepidopterists' Society*, 50: 139-140.

Matsumoto, N. (1996). Management of organic matter and nitrogen in local areas. Food production systems for future, *Norin-tokei-kyokai*: 91-102. (J)

Matsumoto, N., Mishima, S., Orita, K. and Hakamata, T. (1996). Nitrogen flow of organic matter resources in religion level. *Hokkaido-Dojohiryō-Tsushin*, 42: 47-54. (J)

Matsunaga, R., Ito, O., Tobita, T., Rao, T.P. and Johansen, C. (1996). Effects of transient waterlogging and nitrogen top-dressing on the root growth of short-duration pigeonpea. In "Roots and nitrogen in cropping systems of the semi-arid tropics" Eds. Ito, I., Johansen, C., Adu-Gyamfi, J.J., Katayama, K., Kumar Rao, J.V.D.K. and Rego, T.J. Japan International Research Center for Agricultural Sciences (JIRCAS), Ibaraki, Japan. *JIRCAS International Agriculture Series*. 3: pp. 273-284.

Minami, K. (1996). Agriculture, forestry and GAIA. *Globalnet*, 66: 2-3. (J)

Minami, K. (1996). The change of atmospheric CH₄ and N₂O, and livestock. The Report of Heisei 7 Chikusan Chousa Jigyo, 1-13. (J)

Minami, K. (1996). Food demand prediction and environment. *Food Policy Research*, 87: 62-118. (J)

Minami, K. (1996). GAIA, agriculture and fertilizer. *Fertilizer Science*, 75: 8-10. (J)

Minami, K. (1996). Global environment and desertification. *Farming Japan*, 30: 11-12.

Minami, K. (1996). A goal of sustainable agriculture (1). *Rakuno Journal*, 3: 52-55. (J)

Minami, K. (1996). Methane emission and its mitigation from the agro-environment. *Bio-Industry*, 9: 43-48. (J)

Minami, K. (1996). Sustainable agriculture and environmental conservation. *Techno Innovation*, 6(23): 22-27. (J)

Minami, K. (1997). A goal of sustainable agriculture (2). *Rakuno Journal*, 4: 54-57. (J)

Minami, K. (1997). Agricultural options for mitigation of greenhouse gas emissions. *Japanese Journal of Tropical Agriculture*, 41: 114-120. (J)

Minami, K. and Nikaido, T. (1996). Methane emission and its mitigation from agro-environment. *CMC-Bioindustry*, 1(4): 1-6. (J)

Miyamoto, M. (1996). Social impact of forest development upon indigenous people and the increase of wooden houses: A case study in East Kalimantan, Indonesia. *Transactions of the Japanese Forestry Society*, 107: 13-16. (J)

Mizoguchi, T., Yoshida, Y., Yamaguchi-Shinozaki, K. and Shinozaki, K. (1996). Water-stress induced genes in *Arabidopsis thaliana*. In: *Physical stress in plants: Genes and their propensity for tolerance*, Eds. Grillo, S. and Leoneeds, A. Springer, pp. 154-161.

Mosier, A.R., Duxbury, J.M., Freney, J.R., Heinemyer, O. and Minami, K. (1996). Nitrous oxide emissions from agricultural fields: Assessment, measurement and mitigation. *Plant and Soil*, 181: 95-108.

Nakashima, K. and Hayashi, T. (1997). Sequence analysis of extrachromosomal DNA of sugarcane white leaf phytoplasma. *Annals of the Phytopathological Society of Japan*, 63: pp. 32-25.

Nakashima, K., Prommintara, M., Ohtsu, Y., Kano, T., Imada, J. and Koizumi, M. (1996). Defection of 16S rDNA of the Thai isolate of bacterium-like organism associated with greening disease of citrus. *JIRCAS Journal*, 3: 1-8.

Ngampongsai, S., Pichitporn, S., Promkum, W., Egawa, Y. and Srinives, P. (1996). Interspecific hybridization of mungbean and related species using embryo rescue techniques. *JIRCAS Working Report No.2, Mungbean Germplasm*: 41-46.

Ohwaki, Y., Kraokaw S., Chotechuen S. and Egawa, Y. (1996). Physiological characteristics of mungbean varieties resistant to iron-deficient soils. *JIRCAS Working Report, No.2*: 60-66.

Oka, M. (1997) Agricultural characteristics and restraints of research collaboration in Central Asia. *Study Report of Central Asia, JOFCA*: 27-49. (J)

Oka, M. (1997) Comprehensive study on sustainable agricultural systems in Northeast Thailand. In: *Development of sustainable agricultural systems in Northeast Thailand*. Eds. Oka, M and Ando, S. *JIRCAS Working Report*, 5: 1-18. (J)

Oka, M. and Ando, S. (Eds.) (1997) *Development of sustainable agricultural systems in Northeast Thailand*. *JIRCAS Working Report*, 5: 1- 87. (J)

Oka, M. and Sato, M. (1995) Research activities of JIRCAS, MAFF. *AICF Bimonthly Bulletin*, 19(5): 1-14. (J)

Okada, K. (1996). Study on the mechanisms of acid-soil tolerance of upland rice in the savannas in South America. *JIRCAS Research Highlights*, 3: 9-10. (J)

Oyediran, G., Adachi, K. and Senboku, T. (1996). Effect of application of rice straw and cellulose on methane emission and biological nitrogen fixation in a subtropical paddy fields: I. Methane emission, soil-ARA, and rice plant growth. *Soil Science and Plant Nutrition*, 42(4): 701-711.

Rao, T.P., Adu-Gyamfi, J.J., Gayatri Devi, Katayama, K. and Ito, O. (1996). Characterization of uptake and translocation of nitrogen in component crops of intercropping systems. In: *Roots and nitrogen in cropping systems of the semi-arid tropics*. Eds. Ito, I., Johansen, C., Adu-Gyamfi, J.J., Katayama, K., Kumar Rao, J.V.D.K. and Rego, T.J. Japan International Research Center for Agricultural Sciences (JIRCAS), Ibaraki, Japan. *JIRCAS International Agriculture Series*, 3: 309-322.

Rego, T.J., Wani, S.P., Lee, K.K. and Ito, O. (1996). Nitrogen budget in soil under different cropping systems. In "Roots and nitrogen in cropping systems of the semi-arid tropics" Eds. Ito, I., Johansen, C., Adu-Gyamfi, J.J., Katayama, K., Kumar Rao, J.V.D.K. and Rego, T.J. Japan International Research Center for Agricultural Sciences (JIRCAS), Ibaraki, Japan. *JIRCAS International Agriculture Series*, 3: 481-492.

Saito, Y. and Kerridge, P. (1996). Adaptability of mixed seeding in tropical leguminous forage crops in South-American savannas. *Grassland Science*, 43 (Supplement): 3. (J)

Sasaki, S. (1996). Mobility tests with two forest tracked vehicles. *The Japan Forest Engineering Society*, 11: 45-54. (J)

Sato, K. and Urazaliev, E. (1997). Possibility of introduction of *Onobrychis* on steppes in Kazakstan. *Grassland Science* 43 (Supplement): 212-213. (J)

Shinogi, Y. and Anyoji, H. (1996). Studies of evapotranspiration and crop coefficient in relation to soil water suction and leaf area index. *Transactions of the Japanese Society of Irrigation, Drainage and Reclamation Engineering*, 187 (65,7): 739-746. (J)

Shinozaki, K. and Yamaguchi-Shinozaki, K. (1996). Molecular responses to drought and cold stress. *Current Opinion in Biotechnology*, 7: 161-167.

Sugahara, K. (1996). Soil losses from pineapple fields on Ishigaki Island. *JIRCAS Working Report*, 4: 37-42.

Sugahara, K., Ohwaki, Y., Banzai, K., Hasegawa, I., Kobayashi, M., Nakano, H. and Iwama, H. (1996). Soil erosion in pineapple fields and its control. *Research Highlights (JIRCAS)*, 3: 33-34. (J)

Suyama, S., Sakurai, Y. and Shimazaki, K. (1996) Maturation and age in days of Pacific saury *Cololabis saira* (Brevoort) in the centra North Pacific Ocean during the summer. *Nippon Suisan Gakkaishi*, 62(3): 361-369. (J)

Suzuki, K. and Sakuma, S. (1997). Examination for morphological character of the newly introduced crop *Raphanus sativus* cv. Pakkihood. *Kyushu Agricultural Research*, 59: 176. (J)

- Takagi, H. (1996). Cryopreservation of taro (*Colocasia esculenta* (L.) Schott) and papaya (*Carica papaya* L.) by vitrification. *Tissue Culture*, 22(9): 376-380.
- Takahashi, K. (1996). Studies on *Coccinella septempunctata brucki* mulsant as a biological agent for controlling alfalfa aphids. *Bulletin of the National Grassland Research Institute*, 54: 15-77. (J)
- Takaya, Y., Hatta, T. and Matsukura, Y. (1996). The influence of physical properties of sedimentary and igneous rocks on dissolution in closed-system experiments. *Transactions of the Japanese Geomorphological Union*, 17(3): 193-202. (J)
- Terauchi, T. (1996). Collection and research activities of sugarcane genetic resources and related grasses worldwide. *Japanese Journal of Tropical Agriculture*, 40(4): 237-240. (J)
- Tobita, T., Katayama, K., Matsunaga, R., Adu-Gyamfi, J.J., Rao, T. and Ito, O. (1996). Soil nitrogen as a limiting factor in the intercropping system of sorghum and pigeonpea. In "Roots and nitrogen in cropping systems of the semi-arid tropics" Eds. Ito, I., Johansen, C., Adu-Gyamfi, J.J., Katayama, K., Kumar Rao, J.V.D.K. and Rego, T.J. Japan International Research Center for Agricultural Sciences (JIRCAS), Ibaraki, Japan. JIRCAS International Agriculture Series, 3: 441-452.
- Tomooka, N., Chotechuen, S., Boonkerd, N., Vaughan, D., Egawa, Y., Yokoyama, T. and Tateishi, Y. (1996). Collection of root nodules from wild *Vigna* species (subgenus *Ceratotropis*) in Thailand, 41(Issue 1): 93-94. (J)
- Tomooka, N., Lairunreaang, C. and Egawa, Y. (1996). Taxonomic position of wild *Vigna* species collected in Thailand based on RAPD analysis. JIRCAS Working Report No.2, Mungbean Germplasm: 31-40.
- Uchida, S., Nakai, M., Ohno, M. and Watanabe, T. (1996). Development of a method for assessing desert soil stability and database transformation. *Studies for Production of Fundamental Datasets for Earth Science and Technology Research*: 138-143.
- Urao, T., Noji, M., Yanaguchi-Shinozaki, K. and Shinozaki, K. (1996). A transcriptional activation domain of ATMYB2, a drought-inducible *Arabidopsis* Myb-related protein. *Plant Journal*, 10: 1145-1148.
- Urao, T., Yamaguchi-Shinozaki, K., Mitsukawa, N., Shibata, D. and Shinozaki, K. (1996). Molecular cloning and characterization of a gene that encodes a MYC-related protein in *Arabidopsis*. *Plant Molecular Biology*, 32: 571-576.
- Watanabe, H. and Yamaguchi, H. (1996). Recent weed problems in irrigated rice areas of Malaysia. *Shokucho*, 30(10): 349-356. (J)
- Wong, F.Y., Yasunobu, K. & Husna, Sulaiman (1996). Profil Peladang Jaya di Semenanjung Malaysia. UPM/JIRCAS Joint Research Report, 8: 1-35. (M)
- Wong, F.Y., Yasunobu, K. & Husna, Sulaiman (1996). Projek Separa Perladangan (padi) di Kawasan Muda, Malaysia. UPM/JIRCAS Joint Research Report No. 7, 4: 1-35. (M)

- Yaegashi, T. and Toida, Y. (1996). *Meloidogyne javanica* with three bands of esterase phenotype from Honshu, the Main Island of Japan. *Japanese Journal of Nematology*, 26(1/2): 32-35.
- Yagi, S. (1996). Present and future research problems on locusts in Africa. *AICAF*. 19(3): 45-52. (J)
- Yagi, S. (1997). Edible insects in Africa. In: *Aera Mook*. 18: 111-114(J)
- Yagi, K., Tsuruta, H., Kanda, K. and Minami, K. (1996). Effect of water management on methane emission from a Japanese rice paddy field: Automated methane monitoring. *Global Biogeochemical Cycles*, 10: 255-267.
- Yakushido, K., Fukazawa, H., Hosokawa, H. and Sugahara, K. (1996). Technology for the affiliation of erosion hazards in sugarcane and pineapple fields. *New Technology for General Agriculture*, 9: 138-47. (J)
- Yamada, M., Hidaka, T. and Fukamachi, H. (1996). Heat tolerance in leaves of tropical fruit crops as measured by chlorophyll fluorescence. *Scientia Horticulture*, 67: 39-48.
- Yamaguchi, H., Nakai, S. and Watanabe, H. (1996). Diffusion of paraquat resistant gene by pollen flow in the natural and designed populations of *Erigeron philadelphicus* L. *Weed Research, Japan*. 41(3): 189-196.
- Yamaguchi-Shinozaki, K. and Shinozaki, K. (1996). Regulation of gene expression under drought and cold stress. *Cryobiology and Cryotechnology*, 40: 20-25. (J)
- Yamaguchi-Shinozaki, K., Urao, T. and Shinozaki, K. (1996). Drought stress and signal transduction, 30 (Special Issue): signal transduction in plants: 88-96. (J)
- Yamasaki, S., Murakami, H., Kosaka, K., Ismi, S.Z.A., Azahan, E.A.E. and Takemasa, M. (1996). Development of adipose tissue in abdominal cavity of Malaysian native chickens. *Japanese Poultry Science*, 34, 9. 3. (J)
- Yamazaki, R. (1996). Peasants in France (1). *Rural Life Research*, 40(2): 40-45. (J)
- Yamazaki R. (1996). Peasants in France (2). *Rural Life Research*, 40(3): 27-32. (J)
- Yamazaki, R. and Haseyama, T. (1996). Agricultural Cooperative Cooperations. In *The Course of Mountain Agriculture*, Eds. Tsukada, S. and Haseyama, T., Kawabe Shorin, pp. 8.
- Yang, Z., Kanda, K., Tsuruta, H. and Minami, K. (1996). Measurement of biogenic sulfur gas emission from Chinese and Japanese soil. *Atmospheric Environment*, 30: 2399-2405.
- Yashima, S. (1997). Data systematization for assessing irrigation performance: A case study of the Muda Irrigation Project on water utilization performance. *Rural and Environmental Engineering*, 32: 42-61.
- Yashima, S. (1997). Water use structure and irrigation performance assessment for a rice double cropping project. *Regional environment with Irrigation and Drainage (Agricultural Upland Development Association)*: 308-312. (J)

Yasunobu, K. (1996). Agricultural development and rural society with special reference to group farming. Recent Advances in Malaysia Rice Production Direct Seeding Culture in the Muda Area. Muda Agricultural Development Authority (MADA) and Japan International Research Center for Agricultural Sciences (JIRCAS), 8: 300-321.

Yasunobu, K., Husna, Sulaiman and Wong, F.Y. (1996). Farm management development and transformation under agricultural commercialization in Malaysia. UPM/JIRCAS Collaboration Study Report. Universiti Pertanian Malaysia: 1-112.

Yokota, A., Neda, H. and Sugung, S. (1996). Ectomycorrhizal fungi occurring in Dipterocarp artificial forests. Transactions of the Japanese Forestry Society, 107: 229-232. (J)

Yokoyama, T., Ando, S., Murakami, T. and Imai, H. (1996). Genetic variability of the common nod gene in soybean bradyrhizobia isolated in Thailand and Japan. Canadian Journal of Microbiology. 42: 1209-1218.

Zhang, Y.Z., Somantri, I.H., Tobita, S., Nagamine, T. and Senboku, T. (1996). Variation of salt tolerance at germination in cultivated rice (*Oryza sativa* L.) varieties. SABRAO Journal, 28(2): 15-23.

[Continue to Published proceedings and conference presentations](#)

# Annual Report 1995

## CONTENTS

[Foreword - Message from the Director General](#)

[Highlights from 1995](#)

[JIRCAS and the Ministry of Agriculture, Forestry and Fisheries](#)

## **Research Overview**

[International research at JIRCAS](#)

JIRCAS Research Divisions

- [Research Information Division](#)
- [Biological Resources Division](#)
- [Environmental Resources Division](#)
- [Crop Production and Postharvest Technology Division](#)
- [Animal Production and Grassland Division](#)
- [Forestry Division](#)
- [Fisheries Division](#)
- [Okinawa Subtropical Station](#)

[Miscellaneous Projects outline](#)

## **Training and invitation programs; information events**

[Invitation programs at JIRCAS](#)

[Fellowship Programs](#)

[Symposia and workshops](#)

## **Appendix**

[Publishing at JIRCAS](#)

[Official JIRCAS Publications/library holdings](#)

[Research Staff Activity](#)



# **JIRCAS 1995 ANNUAL REPORT**

## **Message from the Director General**



*Director General  
Keiji Kainuma*

### **Orientation of Research Activities at JIRCAS**

More than two years have passed since JIRCAS was established on October 1, 1993. During that time I have had the opportunity of visiting a large number of countries and organizations where JIRCAS staff are engaged in or plan to carry out collaborative research. I have held discussions with both researchers and administrators, signed memorandums of understanding with several institutions, and attended meetings organized by the CGIAR and its technical advisory committee. During these visits, I was able to observe agricultural activities in a wide range of environments where climatic conditions and infrastructure level differ greatly. As a result, I was able to renew my understanding of the significance of requests for cooperative research with JIRCAS on the part of many countries seeking to secure a sustainable production of food in order to cope with projected population increases and increased demand for diversified food products.

JIRCAS is currently engaged in worldwide comprehensive research activities covering all of the fields of agriculture, including animal husbandry, forestry and fisheries. At JIRCAS, the priorities and orientation of research are determined based on research requests from organizations in various foreign countries, detailed surveys conducted by JIRCAS staff members and other researchers from various institutes affiliated to the Ministry of Agriculture, Forestry and Fisheries, and discussion held during the JIRCAS Advisory Committee Meeting. Research themes are aimed to address urgent issues concerning international agriculture, including global environmental problems. The major aspects of our medium-range research plans (First term, until the year 2003) are outlined below.

### **Overseas activities**

One of the characteristics of JIRCAS research activities overseas is the undertaking of comprehensive and multidisciplinary projects in order to address problems on a large scale such as systems of agriculture or global environmental problems. Such collaborative projects for which a memorandum of understanding has been concluded with various research organizations are currently being implemented in Thailand, Malaysia and Vietnam or are being planned in Brazil as well as in China and other regions ([Table 1](#)). Needless to say, collaboration between researchers in the fields of natural sciences and socio-economics is essential for the formulation and execution of these projects.

In addition to our comprehensive projects, emphasis is being placed on projects for the solution of specific problems pertaining to agriculture, forestry and fisheries as well as on studies that could contribute to the generation of new projects. In 1995, more than 40 researchers were dispatched on long-term assignments to 15 countries to carry out collaborative research with national research institutes, universities, and centers affiliated to the CGIAR ([Table 2](#)). In addition, each year approximately 180 researchers and administrators visit a large number of countries with the objectives of carrying out research on a short-term basis, investigating the possibility of future research collaboration, and holding discussion about the initiation or promotion of collaborative research.

### **Importance of research carried out in Japan**

With the completion of new research facilities on our Tsukuba premises (highlighted in Annual Report 1994), we have become able to promote new research activity which had previously been carried out mainly at our Okinawa Subtropical Station. Presently, facilities include a plant biotechnology unit, and fisheries science and earth science laboratories, and equipment for remote sensing studies and econometric analyses. These facilities are enabling JIRCAS to address problems in agricultural research common to both foreign countries and Japan by providing a solid base for research overseas. In addition, we have recently implemented our JIRCAS Visiting Research Fellowship Program at Tsukuba in order to bring overseas researchers to Tsukuba for training and collaboration.

### **Role of the Okinawa Subtropical Station**

The Okinawa Subtropical Station is located on Ishigaki Island in the southernmost part of Japan and plays a major role in the promotion of JIRCAS's research activity related to tropical and subtropical agriculture. Studies on tropical and subtropical plant resources and investigations aimed at the introduction of new crops are being carried out, taking advantage of Okinawa's climatic conditions and location in the subtropical zone. At the same time, the station contributes significantly to the development of agriculture in the Okinawa area. In addition, the JIRCAS Visiting Research Fellowship Program at Okinawa, whereby 10 post-doctoral researchers are invited each year from overseas countries, is playing a role in the fostering and development of researchers in the developing regions and paving the way for future research collaboration with a large number of countries. The Okinawa Fellow Program was originally implemented under JIRCAS's forerunner, the Tropical Agriculture Research Center (TARC). The continued refinement of this program is one of JIRCAS's major goals.

### **Problems for the future**

JIRCAS is currently working out plans strategies to adopt up until the year 2003. In addition to actively promoting research collaboration, JIRCAS will have to meet the demand for the training of researchers through the implementation of the visiting research fellowship programs, strengthening of relations with various research organizations in the Asia Pacific Region, and the organization of workshops in collaboration with the CGIAR research centers. The effective utilization of limited human and material resources is a major challenge for JIRCAS in the coming years.

### **Note about Annual Report 1995**

Commencing with this year's issue of the JIRCAS Annual Report, while covering all of JIRCAS's

activities throughout the world, we will be featuring several close-up articles on research collaboration in a specific region or country. This year, we will be highlighting some of our activities in Latin America with an article on the implementation of a new "Integrative-type Comprehensive" project in Brazil in the "Highlights from 1995" section, and an introduction of "Research sites around Latin America" in the "International Research at JIRCAS" section to be found as part of our research overview.

**Table.1 Major collaborative research projects between national agricultural research organization and JIRCAS**

1.	Breeding of rice and vegetable resistant to diseases and environmental stresses (China)
2.	Development of technology for the evaluation of soybean genetic resources in Northeast China(China)
3.	Evaluation and improvement of farming systems combining agriculture, animal husbandry, and fisheries in the Mekong Delta(Vietnam)*
4.	Development of sustainable agricultural technology in Northeast Thailand*
5.	Development of sustainable aquaculture technology in Southeast Asia(Thailand)
6.	Productivity and sustainable utilization of tropical and subtropical brackish water mangrove ecosystems (Malaysia)*
7.	Development of methods of control of biotic agents injuring rice plants under direct seeding culture in Malaysia(Malaysia)
8.	Rehabilitation of secondary degraded (Malaysia)
9.	Methods of cultivation of soybean in cropping systems with low inputs in Indonesia(Indonesia)
10.	Evaluation of changes in agricultural production structure associated with economic development and clarification of agricultural development trends using model analysis
11.	Development of technology for sustainable management of grasslands in Central Asia (Kazakhstan)
12.	Comprehensive studies on the development of a sustainable agro-pastoral system in the subtropical zone of Brazil*

* Comprehensive projects

**Table 2. On-going collaborative research projects between CGIAR-International Research Centers, and JIRCAS**

IRRI(Philippines)	Stabilization of Rice Culture under Water Stress in the Tropics Utilizing a Broader Spectrum of Genetic Resources
ICRISAT (India)	Sustainable cultivation of upland crops in the semi-arid tropics Analysis of environmental changes in agricultural land after forest clearing in the tropics and development of sustainable land use systems
CIMMYT (Mexico)	Improvement of high-yielding wheat varieties through biotechnological procedures
IITA (Nigeria)	Studies on eco-physiological characteristics of cowpea in the savanna area of West Africa
CIP (Peru)	Characterization, evaluation and utilization of genetic resources of local Andean root and tuber crops
ILRI (Kenya)	Biochemical characterization of membranes of lymphocytes infected with <i>Theileria parva</i> schizonts
CIAT (Colombia)	Eco-physiological studies on upland rice roots in relation to adaptability to savanna soil in South America Eco-physiological studies on the persistency of tropical pasture plants in the savanna of Latin America
AIT	(Asian Institute of Technology, Thailand) Mechanical Properties of Typical Soils in Northeast Thailand for Construction of Irrigation Facilities
ICIPE	(International Center of Insect Physiology and Ecology, Kenya) Biorational approaches to long-term and Sustainable Management of desert locust

# HIGHLIGHTS FROM 1995

This past year was marked by JIRCAS's first external review since its reorganization from TARC on October 1, 1993, the implementation of the "integrative-type" comprehensive research project, and the initiation of the JIRCAS Visiting Research Fellowship Program at Tsukuba. In addition, Director General Dr. Kainuma was honored with the Alsberg-Schoch Memorial Award from the American Association of Cereal Chemists, and several other members of the staff were also the recipients of academic and scientific awards.

## **JIRCAS Research Review 1995**

In 1995, JIRCAS underwent an external research review for the first time after its reorganization from the former Tropical Agricultural Research Center (TARC) conducted according to the Implementation Plan of Research Review framed by the Agriculture, Forestry and Fisheries Research Council (AFFRC) Secretariat of the Ministry of Agriculture, Forestry and Fisheries (MAFF). The research review was performed within a one-year schedule covering the fiscal year from April 1995 to March 1996, with the objective of furthering international agricultural research on the Japan side. The review consisted of three segments with the first review being held within JIRCAS (April to October) followed by the second review conducted by members of the AFFRC (October 18-19), and the third and final review carried out based on the discussion and indications presented during the second review (until March 1996).

In the first research review, a review group consisting of JIRCAS staff members was organized to examine research issues in accordance with the AFFRC's Plan for International Research Promotion, and JIRCAS's Basic Research Plan of JIRCAS during the half-year phase and to debate the following: 1) research priorities, 2) situation and current status of research implementation, 3) cooperation and collaboration with related internal and external organizations, 4) internal research activities and 5) research manpower. The outcome of the first review was summarized, and a main report and supplementary documents were prepared for purposes of the second review.

The second review was held at JIRCAS in attendance of the review group of the AFFRC including three reviewers from universities and MAFF officials. The JIRCAS side presented an introduction of the present research situation especially focusing on the extension of overseas research sites following the reorganization of TARC into JIRCAS and the implementation of new collaborative research projects including comprehensive projects. In addition, JIRCAS outlined recent research highlights relating to information systems, biotechnology, and sustainable production. During the course of the review, the following major subjects were discussed: 1) future research priorities; 2) research promotion and 3) effective management of research.

For the third segment of the Research Review, JIRCAS submitted a report based on indications and comments of the second review in discussion with the review group of AFFRC. The JIRCAS Research Review was concluded with a final presentation of the overall processes and summary of the review at a meeting of the AFFRC held on March 19, 1996

Based on the investigations conducted during the Research Review, it was concluded that JIRCAS is fulfilling its role as a core institute in implementing international collaborative research, initiating cooperation and fostering connections among domestic and overseas research organs, and promoting the

exchange of information in the realm of international agricultural research. The investigation also highlighted JIRCAS's ongoing involvement in the cultivation of human talent, both domestically and overseas. Finally, regarding the future direction of agricultural research, giving consideration to issues concerning world food supply and global-scale environmental problems together with the many specific, regional problems facing world agriculture, it was deemed necessary for JIRCAS to place utmost importance on developing *comprehensive-type* research programs, encompassing all of the fields of agriculture, forestry and fisheries with emphasis placed on sustainable productivity.

[Photo:JIRCAS Main Building \(17KB\)](#)

[Photo:Schematic panorama of research activity at the Tsukuba Agriculture Research Hall,an agricultural museum maintained by MAFF.\(27KB\)](#)

[Initiation of the *integrative-type comprehensive* research project at JIRCAS with introduction of a new project to be implemented in Brazil](#)

[JIRCAS Visiting Research Fellowship Program at Tsukuba](#)

[Academic Prizes and Awards](#)







## Highlights 1995

### Initiation of the "integrative-type comprehensive" research project at JIRCAS with introduction of a new project to be implemented in Brazil



#### *Background*

The Tropical Agriculture Research Center (TARC) was reorganized into the Japan International Research Center for Agricultural Sciences (JIRCAS) on October 1, 1993, and since, JIRCAS has defined its goals as contributing to the promotion of the sustainable development of

agriculture, forestry and fisheries activities in the developing regions of the world. Through the implementation of a variety of collaborative research programs, JIRCAS continually aims to foster close relationships between overseas research organizations and Japanese domestic organizations.

JIRCAS continues to pursue the specific, focused research programs along the lines of those which were carried out at TARC, but as part of its new role as an international center, has also initiated a new type of project, the "Integrative-type Comprehensive Research Project". Three comprehensive projects have already commenced in Vietnam in the Mekong Delta, in Malaysia and in Northeast Thailand. The fourth comprehensive research project entitled "Comprehensive Studies on the Development of Sustainable Agro-pastoral Systems in the Subtropical Area of Brazil (Agro-pastoral)" is scheduled to be implemented in fiscal year 1996. In the planning of a comprehensive project, a research coordinator in the Research Information Division takes on the role of project leader to work in close collaboration with the directors of the relevant research divisions and the researchers who are involved in the project. During the planning stages of the project, socio-economic studies are undertaken to identify the research priorities of the counterpart countries.

#### *Focus on Brazil Project*

Details of the progression of the first three comprehensive projects can be found in the JIRCAS Research Divisions section, as relevant to the activities of each particular division. As one of this year's Annual Report's close-up feature articles on research activities in Latin America, the new program will be introduced below to provide an overview of the scheduled research activities and formulate an overall impression of the character of a JIRCAS Comprehensive Project.

#### *Research background, topics and counterparts*

The subtropical area of Brazil in the "Agro-pastoral" project has been recognized as one of the origins of modern agriculture in South America. This area, where the continuous cultivation of field crops has been carried out on a large scale in context of a major agriculture system with extensive cattle grazing, is extremely important to the food supply and economy of Brazil at present. This area encompasses about 400 thousands km² (approximately equal to Japan's total territory), and is a triangle of land connecting the cities of Londrina, Botucatu, Ribeirao Preto and Campo Grande. The area is additionally characterized by the settlement of hundreds of thousands of Japanese-Brazilian farmers who are mainly engaged in providing the essential food commodities designated for the megalopoli of Sao Paulo and Rio

de Janeiro.

In this subtropical area of the country, a large increase of agricultural products was achieved through the continuous extension of arable land and a high dependence on the net primary productivity of fertile land with minimum input. As a result, a great part of this area has become transformed into environmentally vulnerable land while the efficiency of production has remained unchanged at low levels without improvement of existing agricultural technology. Growth retardation due to continuous cropping, prevalence of disease, pest outbreak, and soil erosion inevitably threaten the agriculture in this area, serving as major constraints to agricultural sustainability and productivity.

This new comprehensive research project is thus focused on the development of sustainable farming systems with high productivity in environmentally-degraded areas in subtropical Brazil. Emphasis will be placed on land utilization based on a crop-pasture rotation system and research collaboration will be carried principally in conjunction with the Brazilian Agricultural Research Corporation (EMBRAPA). In addition, JIRCAS will hold consultation with the International Center for Tropical Agriculture (CIAT), drawing on the latter's extensive experience in crop-pasture system development in South American countries, and with the JATAK International Center of Agriculture Technology, the primary nongovernmental organization for Japanese-Brazilian farmers.

The following areas of research are to be implemented: (1) survey and evaluation of indigenous and traditional methods of agricultural land utilization, (2) multifaceted studies for the development of a sustainable crop-pasture rotation system [including *a*) mixed and multiple cropping agricultural systems employing soybean as a main crop for field crop diversification, *b*) introduction and management of forages in mixed, multiple-cropping patterns for soil improvement and erosion control, *c*) dynamics of soil fertility and plant nutrition under crop-pasture rotation *d*) control of deteriorative agents, e.g., pathogens, pests and weeds, under crop-pasture rotation *e*) management of grazing cattle under crop-pasture rotation), (3) Socioeconomic evaluation of crop-pasture rotation from the standpoint of a farming-systems approach, and lastly (4) on-farm participation research of the newly developed "agro-pastoral system". The expected duration of the project is 7 years, starting from April 1996 to March 2002.

## **JIRCAS Visiting Research Fellowship Program at Tsukuba**

On October 1, 1993, the Tropical Agriculture Research Center (TARC) was reorganized into JIRCAS. Since its establishment in 1970, TARC has been engaged in collaborative research activities consisting of the dispatching of researchers to various institutes located in tropical and subtropical areas to promote the development of agriculture, animal husbandry and forestry in these regions. Many substantial results were obtained.

However, there has been a recent growing awareness of the importance of conducting collaborative research while making use of the high level of research opportunities available in Japan. To achieve this objective, the Visiting Research Fellowship Program at Okinawa was implemented in 1992 to enable 10 outstanding doctorate-level researchers representing counterpart institutes located in tropical and subtropical countries to carry out collaborative research for a period of one year at the Okinawa Subtropical Station of the Center. Okinawa was selected in view of the similarity of the research priorities and climatic conditions to those in the tropical and subtropical regions.

With the transformation of TARC to JIRCAS, fisheries was added to the already-targeted research fields and international research activities were expanded to include the temperate and cooler regions in order to more comprehensively address the problems of food production and conservation of natural and environmental resources confronting developing countries. In this context, JIRCAS has additionally implemented the Visiting Research Fellowship Program at Tsukuba which commenced this past year in October, 1995. The program allows invited researchers and their JIRCAS hosts to take advantage of the research environment in the Tsukuba Science City, which in Japan serves as a strong base for scientific research and development in many basic disciplines. Promising, young researchers representing JIRCAS's counterpart institutes are the targets of this program, and there is much expectation that they will take initiative and leadership in developing collaborative research programs in order to address the agriculture, forestry and fisheries problems facing the developing areas.

Under the Fellowship Program, a total of 6 researchers will be invited per fiscal year to carry out research pertaining to one of several themes listed below ([Table 1](#)). Four researchers will undertake long-term projects for a period of 2 years and 2 researchers will be engaged in short-term projects for a period of 5 months. The long-term researchers will carry out collaborative research at JIRCAS, while the short-term fellows will conduct research at the National Institute of Agrobiological Resources (NIAR) at Tsukuba.

Table1**RESEARCH THEMES****Long - term projects***I.Methods for optimum utilization of biological resources*

- 1) Analysis of plant responses to environmental stresses and gene expression
- 2) Development of DNA-based assay for indexing plant diseases
- 3) Development of practical methods for the evaluation of the quality of indigenous crops and for the analysis of components and functionality of foods
- 4) Methods for the development of livestock breeds with high productivity through crossing with indigenous species
- 5) Development of methods for the diagnosis and prevention of diseases affecting aquatic for fresh water and marine aquaculture

*II.Analysis and evaluation of the impact of climatic and anthropogenic factors on environmental resources*

- 1) Relation between climatic change and biomass in agro-ecosystems
- 2) Investigation of the process of rock weathering through the analysis of rock surface by electron spectroscopy

**Short-term projects**

- 1) Methods for the analysis and preservation of *biodiversity*
- 2) Production of new biological resources through the application of biotechnological procedures
- 3) Methods for the analysis and control of biological functions

# ACADEMIC PRIZES AND AWARDS

JIRCAS is pleased to note that in the past few years, many of our staff, including our Director General and two of our Research Division Directors have been the recipients of academic prizes and awards from scientific societies and organs of the media. The following is a brief summary of these achievements which we are proud to include in the Highlights of Annual Report 1995.

## *DIRECTOR GENERAL AND DIRECTORS OF THE RESEARCH DIVISIONS*

**Dr. Keiji Kainuma, Director General of JIRCAS** was awarded the Alsberg-Schoch Memorial Award by the American Association of Cereal Chemists (AACC) on November, 6, 1995 for his outstanding contributions to starch science including molecular-level research on the starch molecule. Dr. Kainuma was invited to San Antonio, Texas to the annual convention of the AACC to deliver his award address entitled “The winding road to the double helix structure of the amylopectin molecule” in which he outlined an original approach adopted to assign a double helix structure to the amylopectin molecule leading to the first double helix model of a native carbohydrate as proposed by Kainuma and French in 1972.

**Dr. Katsuyuki Minami, Director of the Environmental Resources Division** and his research group were awarded the 5th Nikkei Excellence Prize for Global Environment Research sponsored by the Nihon-Keizai Shinbun (Japanese Economic Journal) for their exhaustive studies on the “Analysis of the mechanism of methane emission and its quantitative assessment from agro-ecological systems” on November 16, 1995. **Dr. Minami** also received the Prize for Agricultural Sciences in Japan, 1996 and the 33rd Yomiuri Prize sponsored by the Japan Society of Agricultural Sciences in conjunction with Yomiuri Press on April 5, 1996 for work entitled “Impact assessment of agro-systems on global change and its mitigation strategy” in recognition of outstanding scientific publication.

**Dr. Koji Kawashima, Director of the Crop Production and Postharvest Technology Division** and collaborators received the Science and Technology Agency’s 55th Award for Inventions of Distinction for “A method to preserve quality of agricultural products and food” on April 25, 1996. The new technology involves releasing high pressure carbon dioxide of agricultural products in sealed containers in order to eliminate adult insects, larvae, pupae and eggs.

## *JIRCAS RESEARCH STAFF ACCORDING TO RESEARCH DIVISION*

*Biological Resources Division*

**Kazuo Nakashima, Ph.D.** received the Young Scientist Award from the Phytopathological Society of Japan for “Characterization of phytoplasmas associated with rice yellow dwarf, sugarcane white leaf and sesame phyllody diseases” on April 2, 1996. The award is given to a rising, young researcher as the Society’s recognition of the individual’s achievement and promise. **Kazuko Yamaguchi-Shinozaki, Ph.D.** received the Botanical Society of Japan’s Young Scientist Award for “Gene suppression and signal transduction in plants under water-stress conditions” on Oct. 2, 1993, also in recognition of outstanding contribution as a rising scientist.

*Crop Production and Postharvest Technology Division*

**Yuji Kohgo, Ph.D.** received the Award of the Japanese Society of Soil Mechanics and Foundation Engineering for “Verification of a generalized elastoplastic model for unsaturated soils” on March 2, 1995. The award is given by the Society in recognition of outstanding scientific publication.

*Fisheries Division*

**Marcy N. Wilder, Ph.D.** received the Zoological Science Award from the Zoological Society of Japan for “Accumulation of ovarian ecdysteroids in synchronization with gonadal development in the giant freshwater prawn, *Macrobrachium rosenbergii*” on October 9, 1992. The award is given by the Society in recognition of outstanding scientific publication.

*Okinawa Subtropical Station*

**Yuhō Maetsu** received the Science and Technology Agency’s 37th Prize for Inventive Originality and Distinguished Service for the development of an improved soil sampler for the testing of negative water pressure on April 15, 1996. **Tetsu Maoka** received the Young Scientist Award from the Japanese Society of Plant Pathology for “Studies on the papaya ringspot virus” on April 2, 1996. The award is given to a rising, young researcher as the Society’s recognition of the individual’s achievement and promise. **Makoto Yamamori** received the Japanese Society of Breeding’s Young Scientist Award for “Production of waxy wheats” on April 2, 1996 also in recognition of outstanding contribution as a rising scientist.

# JIRCAS AND THE MINISTRY OF AGRICULTURE, FORESTRY AND FISHERIES

## MAFF Research Structure

The Japan International Research Center for Agricultural Sciences (JIRCAS) is one of 29 research institutes belonging to the Ministry of Agriculture, Forestry and Fisheries (MAFF), the Government of Japan. In this age, in which we have seen remarkable progress in advanced fields of science and technology including biotechnology, MAFF's research institutes are playing a key role in the development of new technologies to pave the way for further development of the food industry, and promotion of agriculture, forestry and fisheries activities in the 21st century. MAFF's institutes work in close collaboration with local governments, universities, and private research organizations and aim to contribute to the overall prosperity of Japan while making significant contributions to the international community.

Nineteen of the 29 institutes including JIRCAS are directly overseen by the Agriculture, Forestry and Fisheries Research Council (AFFRC), which is a special agency attached to MAFF. The main duties of the AFFRC are overall research planning and coordination, liaison and coordination between research and administration, administration and guidance of the institutes, and research assistance to prefectural organizations and the private sector. The AFFRC is headed by a chairman, and its advisory members consist of independent university faculty members and previous MAFF research institute directors ([Table 1](#)). The remaining 10 institutes, which include one institute devoted to forestry and nine fisheries research institutes, are also attached to the AFFRC. However, they are overseen by the Forestry Agency and the Fisheries Agency, M administrative agencies directly under MAFF. Overall MAFF research Structure is as shown in [Fig.1\(123KB\)](#).

JIRCAS is unique among the 29 research institutes in that it serves as an international research center but is at the same time part of the overall MAFF infrastructure. Thus, it is involved in active exchange and collaboration with the other 28 institutes. JIRCAS is located in the Tsukuba Science City which is about 50 km northeast of Tokyo [Fig.2\(74KB\)](#). Many other MAFF institutes are also located in Tsukuba, and the AFFRC secretariat maintains a Tsukuba office, forming the Tsukuba Institutional Complex. Tsukuba itself is home to numerous other research institutes and experimental facilities belonging to other ministries and agencies of the Japanese Government as well as to the private sector.

## Research structure at JIRCAS

JIRCAS has a current staff of 164 including research scientists and administrators. Forty-three staff are located out of Tsukuba at JIRCAS's Okinawa Subtropical Station. JIRCAS is headed by a Director General; the Research Planning and Coordination Division oversees the seven research divisions which are comprised of the Research Information Division, Biological Resources Division, Environmental Resources Division, Crop Production and Postharvest Technology Division, Animal Production and Grassland Division, Forestry Division, and the Fisheries Division as well as the Okinawa Subtropical Station. The Administration Division is responsible for general administrative affairs. Research structure at JIRCAS is delineated in [Fig.3.\(76KB\)](#)



## **Research Planning and Coordination Division**

The Research Planning and Coordination Division in itself does not act as a research division, but rather serves to oversee and support the activities of the Research Divisions and Subtropical Station. The Division consists of four sections which are the Research Planning Section, the Research Coordination Section, the International Relations Section, and the Publication and Documentation Section. In addition, a Research Information Officer is assigned to the Division.

In order to promote the implementation of research programs both overseas and in Japan, the first 3 sections are responsible for the overall planning of JIRCAS research projects, dispatching of researchers on long- or short-term basis, implementation of programs for the invitation of researchers and administrators, and liaison and coordination with international and domestic institutions and agencies. The Publication and Documentation Section is responsible for the collection, classification, and supply of bibliographic materials from both overseas and domestic sources, as well as the release of public relation materials. The Research Information Officer handles the coordination of collaborative activities with the Japan International Cooperation Agency (JICA) and related research institutions and deals with problems pertaining to the exchange of technical information. Additionally, the Division coordinates the organization of various meetings and workshops including JIRCAS's International Symposia.

## **Administration Division**

The Administration Division consists of three sections: the General Affairs Section, the Accounting Section, and the Overseas Support Section. The General Affairs Section is responsible for the management of official documents, personnel-related matters, and social affairs pertaining to JIRCAS staff. The Accounting section handles overall accounting, all budgeting, settlements and wage distribution. Lastly, the Overseas Support Section is in charge of all matters pertaining to JIRCAS's overseas operations, which includes general international affairs, overseas expenditures, and overseas shipments of equipment and materials.

## **Other**

The Okinawa Subtropical Station has its own General Affairs Section which is independent of the Administration Division. Additionally, JIRCAS has two field management sections which oversee JIRCAS's experimental fields. The Okinawa Section is directly under the Subtropical Station management and the Tsukuba Section is attached to the Crop Management and Postharvest Technology Division.

[Forward to International Research at JIRCAS](#)

[Back to Contents](#)

# INTERNATIONAL RESEARCH AT JIRCAS

International collaborative projects at JIRCAS encompass all of the fields of agriculture, forestry and fisheries and are being carried out in collaboration with counterpart institutions comprising international research centers including the CGIAR, national research organizations and universities. As detailed in the "Highlights" section, the integrative-type comprehensive project was initiated with the transformation of TARC into JIRCAS; there are currently 3 ongoing comprehensive projects in Thailand, Malaysia, and Vietnam, with the fourth destined to commence in fiscal year 1996 in Brazil. In addition, JIRCAS continues to promote the specific, focused type of project carried out at TARC; details of some of these projects can be found in the description of activities of the JIRCAS Research Divisions. As part of this year's feature on research activities in Latin America, the following pages provide an introduction of research activities at 3 international research centers: CIP, CIMMYT and CIAT. A summary of all ongoing collaborative projects can be found at the end of this section.

## RESEARCH SITES AROUND LATIN AMERICA

[For collaborative project with CIAT \(Upland rice research for sustainable development of Acid-soil savanna in South America\) click here](#)

[For collaborative research at CIP-Quito click here](#)

### **Collaborative Research Project with CIMMYT on Wheat Maize Crosses**

The International Maize and Wheat Improvement Center (CIMMYT) was established in 1966 in Mexico, following the implementation of a special research program sponsored by the Mexican Government and the Rockefeller Foundation. CIMMYT, with headquarters at E1 Batan, 45 km northeast of Mexico City, and with 15 regional offices in the developing countries, implements research and training programs related to the production of maize and wheat. Major activities include the development and worldwide distribution of improved varieties, the conservation of genetic resources, and the production of documentation related to new knowledge concerning these crops.

CIMMYT developed new wheat varieties in the 1960s characterized by stable stem rust resistance, photoperiod insensitivity and semi-dwarfness. These characters enabled the adaptation of these varieties far beyond Mexico to many other countries and developing areas. This resultant rapid growth in wheat production led to the so-called "green revolution." In the post-green revolution, breeding methodology is being continually refined, and breeding strategy is being carried out in terms of agroecological region.

At present, the use of haploids is of great interest to wheat breeders, since the production of haploid plants followed by chromosome doubling enables the creation of genetically homozygous lines. The successful production of doubled haploids provides the most rapid method for developing homozygous breeding lines with favorable uniformity in selection procedures, and complements conventional breeding programs. JIRCAS has been promoting the technical development of wheat haploid production

through wide crosses in collaboration with the International Center for Agricultural Research in the Dry Areas (ICARDA). It is possible to obtain, for example, wheat haploids from wide crosses using wheat as the female parent and a perennial species, *Hordeum bulbosum* L. as the pollen parent. After fertilization, the chromosomes of the pollen parent are eliminated from the hybrid zygote resulting in the production of wheat haploids. This method is limited since the success of haploid production depends strongly on the wheat genotypes used for crosses.

Recent reports have indicated that crosses of wheat with maize pollen result in the production of wheat haploids across diverse wheat genotypes. In addition to maize, selected species from the *Panicoides* subfamily, such as pearl millet and sorghum, also provide an alternative pollen source for wheat haploid production. A collaborative research project between CIMMYT and JIRCAS has been in progress since 1993 and has focused on the development of wheat — maize crosses for producing and utilizing wheat haploids for breeding purposes and genetical analyses. The current cooperative studies related to wheat haploids include the development of methods for long-term storage of maize pollen, genetic analysis of drought tolerance, and evaluation of various breeding schemes. Technical development for the efficient production of wheat haploids is expected to contribute to the promotion of basic research projects as well as conventional breeding programs.

## **Collaborative Project with CIAT: Upland Rice Research for Sustainable Development of Acid-soil Savanna in South America**

CIAT (Centro Internacional de Agricultura Tropical), based in Colombia, is one of the three international agriculture centers situated in Latin America. CIAT has conducted high-level scientific work and has contributed significantly to agricultural development world-wide for more than a quarter of a century by concentrating its efforts on 4 programs: bean, cassava, rice and tropical forages. In 1992, CIAT initiated three new programs, tropical lowlands, hillsides and land use in context of natural resources management in order to further promote research leading to sustainable agriculture development.

CIAT and JIRCAS (since TARC days) have enjoyed a long history of collaboration in research on tropical pastures since 1977 in which JIRCAS dispatched seven pasture scientists to the Tropical Forage Program of CIAT. Throughout this project, the development of highly productive pastures consisting of both legumes and grasses was been pursued. The development of seed-coated pellet fertilizer is one of the research highlights which arose from this project. At present, an ecophysiologicalist from JIRCAS is investigating the mechanism of legume persistence in pastures in order to develop suitable methods of management for the maintenance of legumes.

In addition, a new collaborative project on upland rice was initiated in January 1992. This project is also aiming at achieving sustainable development of the vast expanses of savanna covered with strongly acid soils seen in some parts of Latin America. The productivity of native pastures could be substantially increased through the introduction of improved pastures together with appropriate fertilizer application and soil management. However, the problem remain that improved pastures undergo degradation with time, and it is very difficult to renovate them because of the initial cost incurred by the farmers.

To address these problems, CIAT introduced a rice/pasture system in the late 1980s. In this system, the pasture is sown with upland rice and fertilizer is applied at the beginning of the rainy season. After 4 months, rice is harvested, and earnings can cover the initial cost of establishment, while the pasture grows well with organic matter derived from rice roots and stems as well as residual fertilizers. This system was implemented with the release of a new variety of upland rice which is high-yielding, has good grain quality, and is tolerant to acid soils. Breeding was initiated by CIAT in 1982, through crosses of indica rice (high-yielding variety with slender shape, good grain quality) with tropical japonica rice variety (tolerant to soil acidity). However, since the mechanism of tolerance of this variety has not yet been elucidated, the development of effective screening techniques for further improvement of similar types of tolerant varieties could not be realized.

JIRCAS initiated a collaborative project within the framework of CIAT's Rice Program and has dispatched a crop physiologist to pursue on-site research(?). The strategy of the research project is 1) to analyse changes in soil condition in fields of upland rice on acid savanna soils in relation to the growth of roots of upland rice, 2) to expose rice plants to soil-limiting factors prevailing in the area (high Al, or low pH, P, Ca, Mg) in order to reveal genotypic differences between tolerant and susceptible varieties, 3) to identify physiological and/or biochemical mechanisms controlling differences in tolerance (e.g. root exudates with chelating ability of elements) and 4) to develop rapid and accurate screening methods based on these mechanisms. Varieties were found to differ in Al tolerance as well as tolerance to low Ca and Mg contents of soils (see Research Divisions section). At present, the analysis of root exudates is also being pursued. A simple screening method based on Al tolerance is already in use in the selection of potential parents in the breeding program.

Savannas in Latin America cover vast areas which are under-populated and under-utilized. Although the soils tend to be acidic with low fertility levels and therefore must be used carefully, the topography is flat, precipitation is abundant and evenly distributed, temperature is high and the physical properties of the soils are adequate. It is anticipated that this collaborative project will contribute to the improvement of the management and utilization of these valuable natural resources for sustainable utilization.

## Collaborative Research at CIP-Quito

The International Potato Center (CIP) with headquarters in La Molina near Lima in Peru has recently celebrated its 25th anniversary. CIP started with a mandate to carry out research for potato food security which was subsequently expanded to include research on sweetpotato and Andean Root and Tuber Crops (ARTCs). In 1989, CIP established a research station in Ecuador within the site of the National Agricultural Research Institute (INIAP) on the outskirts of the capital city, Quito. CIP-Quito is located at an altitude of 3058 meters above sea level, and is the closest to the equator and second highest among CIP's worldwide network of research sites.

Ecuador, one of the world's richest countries in terms of biodiversity, is divided into three eco-regional areas. Mountainous highlands run in the center of the country from north to south, and tropical lowlands lie on the coastal plain and in the Amazon basin to the west and east of the mountains. Among its biodiversity, Ecuador provides a large number of plant species as food crops. The wide range of climatic conditions, from tropical rain forest on the east coast and the Amazon jungle to the cold zone in the highlands of the Andes, has resulted in the development of a broad variety of species.

In addition to the well-known potato, the Andes are home to nine other lesser-known root and tuber crops: achira (*Canna edulis*, Cannaceae), ahipa (*Pachyrhizus ahipa*, Leguminosae), arracacha (*Arracacia xanthorrhiza*, Umbelliferae), maca (*Lepidium meyenii*, Cruciferae), mashua (*Tropaeolum tuberosum*, Tropaeolaceae), mauka (*Mirabilis expansa*, Nyctaginaceae), oca (*Oxalis tuberosa*, Oxalidaceae), ulluco (*Ullucus tuberosus*, Basellaceae), and yacon (*Polymnia sonchifolia*, Compositae), but most of these crops are seldom cultivated today in the Andes. The ARTCs were lost from the scientific scope until recently in spite of their importance as high-yielding food crops on the Andean highlands and their potential for new food materials as well as for industrial and medicinal uses.

The lack of basic biological information on ARTCs has hindered their improvement as well as the management of these genetic resources. In order to gain basic biological and agronomical information and to help in improving and maintaining ARTCs, in 1993, the Japan International Research Center for Agricultural Sciences (JIRCAS) initiated a joint project entitled "Cytogenetical Characterization and Evaluation of Andean Root and Tuber Crops" with CIP, which is being carried out at CIP's experimental station in Quito, with the assistance of INIAP.

In the course of the research project, it was found that yacon has at least 2 different basic chromosome numbers, and the normal cultivar is octaploid. We also observed a decimodiploid cultivar which could be derived from an intervarietal hybrid between 2 morphological groups. Yacon is one of the major natural sources of fructooligosaccharides, accounting for about 90% of the total sugar content. This research may open up possibilities for increased utilization of this plant through hybridization breeding for ploidy manipulation and fructan production.

Another ARTC, achira, produces the largest starch granules among all plant species. Since the starch is highly digestible and has a low gelatinization temperature, it has much potential for food and industrial uses. We noted that achira has a fragile part on a single particular chromosome and observed broken chromosomes at the centromere in root tip cells of all varieties, which may account for the fact that many researchers have considered that there were aneuploid varieties. We also found that the rhizome position is very important for starch production regardless of polyploidy level. There are 3 rhizome positions; epigeal, endogeal and hypogeal. Cultivars with epigeal rhizomes always produce a large amount of total starch. This characteristic could be used as a breeding index for improving starch production. We are

currently attempting to promote triploid breeding for improving achira for purposes of starch production.

In addition to cytogenetic studies, research on the ecophysiological characteristics of these crops with emphasis placed on adaptation to various environmental conditions as well as studies on the biochemical composition of the crops are necessary to be promoted. We anticipate that the results obtained through this collaborative project should contribute to the conservation and better utilization of these valuable genetic resources, the ARTCs.

# RESEARCH INFORMATION DIVISION

The Research Information Division of JIRCAS has three main responsibilities relating to overall research operations of the institute. The first is to collect and analyze information pertaining to agricultural sciences and the related socio-economic situation in developing countries. The second is to formulate and coordinate collaborative research projects. The third is to develop and maintain a computer-based information system in JIRCAS.

Studies on agriculture, forestry and fisheries in developing countries are conducted by two groups of research coordinators and senior scientists. The first group takes a region-oriented approach by assigning themselves to five regions: monsoon Asia, arid and semi-arid Asia, Africa, Latin America and developed countries. The research coordinator in charge of developed countries looks at how these countries have applied research strategies to agriculture in developing countries as well as how international agricultural research institutes search for and conduct concerned collaborative research projects with developing countries.

The second group of research coordinators takes a problem-oriented approach by conducting studies involving three major topics: the environment, food problems, and rural development. The research coordinator handling environmental problems has been focusing on development of technology for the rehabilitation of soils with salt accumulation in the Central Asia. Another research coordinator and a senior research scientist are working on developing new world food models and making a long-term projection of the world food situation in collaboration with the Policy Planning Division of MAFF, the International Food Policy Research Institute (IFPRI), and the FAO. A research coordinator and a senior research scientist assigned to rural development have conducted an intensive study visit in various regions of Indonesia and India.

Research coordinators are committed to formulate and coordinate collaborative research projects based on their studies on regional agriculture or agriculture-related problems. In 1994, JIRCAS launched its first integrative research project "Evaluation and improvement of farming systems combining agriculture, animal husbandry, and fisheries in the Mekong Delta." One research coordinator serves as the project leader and chairs a working group consisting of the directors of the relevant Research Divisions and the involved researchers. In 1995, JIRCAS commenced the following two integrative projects: "Productivity and sustainable utilization of tropical and subtropical brackish water ecosystems" is a collaborative project with Malaysian research institutes and universities, and "Development of sustainable agricultural technology in Northeast Thailand" is follow-up of a project conducted by JICA which had been completed in 1994. A fourth integrative project "Development of a sustainable agro-pastoral system in the subtropical area of Brazil" will be commenced in collaboration with the Brazilian Agricultural Corporation (EMBRAPA).

The Research Information Division is also in charge of the development of computer information processing technologies such as data base management, geographic information system construction, local networking application of multi-media computer for promoting dissemination and utilization of research information. The Division is now developing a comprehensive information system including statistical data (JIRCAS-STAT), documents such as travel reports and imagery data (JIRCAS-INFO) based on PC windows and UNIX with the addition of social sciences as a new research field at JIRCAS.

The three responsibilities of Research Information Division remain in the course of development and



undergo constant revision and reorganization as our information system continues to develop.

[TOPIC: JIRCAS-STAT, A statistical database system for world agriculture, forestry and fisheries](#)

## **JIRCAS-STAT, A statistical database system for world agriculture, forestry and fisheries**

In order to facilitate analytical work for the planning of research projects and assistance of global research such as the world food demand-supply projections, the Division has constructed a statistical database system which enables the handling of a large variety of socio-economic time series data in an integrated manner.

Using this database system, the user can look up needed data simply by selecting the regions, items and years of interest. The user can arrange the data in various types of tables. In addition, using the combined software, a graphical display of the data and statistical /econometric analyses can also be carried out easily.

Most of relevant data published by international organizations dating up to present(?) have been stored in the database using a common format. The database covers yearly statistics related to the fields of agriculture, forestry and fisheries including general indicators such as population figures, GDP, and land usage values. In addition, the database includes data arranged according to products, with references to production, trade, food balance sheets and food aid.

### **Data Stored in the JIRCAS-STAT database**

<u>Contents</u>	<u>Number of time series(in thousands)</u>	<u>Storage Space(in MB)</u>
Population, Land use, Production (F.A.O)	200	50
Trade (F.A.O)	310	99
Food Balance Sheets (F.A.O)	540	128
Forestry Fisheries (F.A.O)	140	36
USDA. OECD. WB	130	113

The advantage of this system is its userfriendliness. As it is based on the Windows operating system which is currently the most widely-used system for personal computers, users do not need to learn any special commands. Because of the original approach employed in this system of transforming a modern relational database structure into a suitable structure for a statistical time series data, the database has advantage of great efficiency in terms of both processing speed and data storage space.

The system is being used in the preparatory work of the Division's econometric model analysis of the world food market. It has already been installed in several locations of the headquarters of the Ministry of Agriculture, Forestry and Forestry. Within a year it will also be available through an information network for remote users in the Ministry. In addition, a database system for documents and photographs is being constructed in the Division.

# BIOLOGICAL RESOURCES DIVISION

Environmental stresses such as drought, high and low temperature extremes, and pest and disease outbreak can result in the serious instability of a crop yield with devastating results, bringing about the starvation and malnutrition of a large number of people in a developing region. In addition, a rapidly growing population rapidly accelerates the deterioration of natural resources, especially in marginal lands, which may lead to further degradation of food production. We are now faced with the need to increase and stabilize agricultural production through methods compatible with the preservation of the environment. To achieve this objective, it is essential to develop agricultural technologies by optimizing the use of biological resources.

In light of the above, the first objective of the Biological Resources Division is to collect, evaluate and preserve germplasm accessions of under-utilized crops and wild relatives, taking into account the rapid genetic erosion occurring on a world-wide scale. In this regard, studies on mungbean germplasm, which had been carried out at the Chai Nat Field Crops Research Center in collaboration with the Department of Agriculture, Thailand, since 1987, were completed in 1995 and recent progress in this research field was reviewed during the workshop held in Bangkok, Thailand on August 17, 1995. The proceedings of the workshop were published as JIRCAS Working Report No.2.

Secondly, using biotechnological procedures, we are studying the mechanisms of tolerance to environmental stresses in higher plants at the molecular level. The molecular biology group of the Division including several visiting scientists is studying the molecular mechanisms of drought tolerance in *Arabidopsis thaliana*, *Vigna unguiculata* and other higher plants. These studies will be integrated with the overseas research activities of the Division, especially with a project involving drought-tolerant cowpeas, *Vigna unguiculata*, in the sub-Saharan regions conducted at the Kano Station of the International Institute of Tropical Agriculture.

Thirdly, using genetic resources and applying biotechnological procedures, we are implementing collaborative breeding projects in various countries in order to develop new varieties of rice, wheat, and vegetables characterized by high yield potential and resistance to various diseases and environmental stresses. These new varieties should contribute to the increase and stabilization of agricultural production with lower input in the developing regions. In 1995, a new research project on the use of soybean genetic resources for the implementation of a breeding program in northeastern China was initiated at Jilin, China, in collaboration with the Soybean Institute of the Jilin Academy of Agricultural Sciences.

[Photo:Exploration of plant genetic resources in Peru \(Photo:T.Nakanishi\)](#) 17KB

[TOPIC1:Use of stored pearl millet pollen in wheat haploid production](#)

[TOPIC2:Screening cowpea lines for drought tolerance and its expression in roots.](#)



## TOPIC 1: Use of stored pearl millet pollen in wheat haploid production

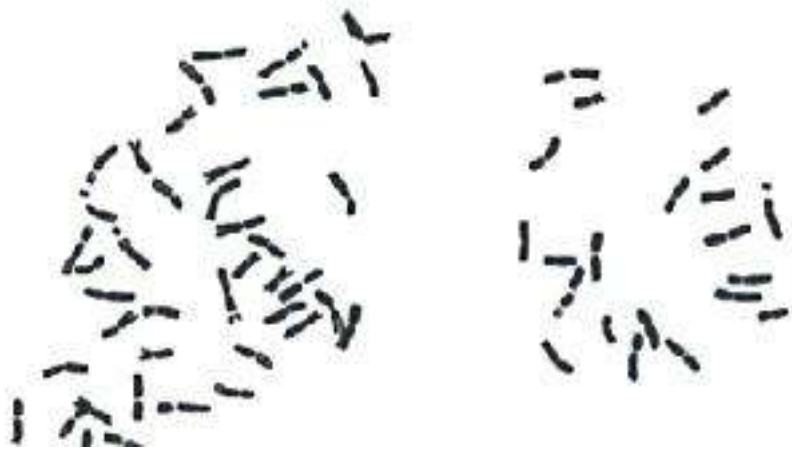
The use of haploids in plant breeding programs is of great interest to breeders, since the production of haploid plants followed by chromosome doubling enables the breeder to obtain genetically homozygous lines. The successful production of doubled haploids provides the most rapid means for developing recombinant lines with favorable uniformity in selection procedures, and serves as a complement for conventional breeding programs. JIRCAS (formerly TARC) has been promoting technical development of haploid production in wheat (*Triticum aestivum* L.) through wide crosses in collaboration with the International Center for Agricultural Research in the Dry Areas (ICARDA), Syria, and the International Maize and Wheat Improvement Center (CIMMYT), Mexico.

Up until the present, significant technical advances have been attributed to pollen selection from subfamilial species and application of plant growth regulators. However, this type of methodology always requires viable pollen at the time of pollination and restricts haploid production duration. An adequate pollen storage technique has the potential to resolve this disadvantage. In a previous study, maize (*Zea mays* L.) pollen stored at an ultra-low temperature produced haploid wheat embryos, but the frequencies were greatly reduced. Pearl millet (*Pennisetum glaucum* (L.) R. Br.) is an alternative pollen source for haploid production of wheat.

The effects of drying and freezing on the viability of pearl millet pollen and the crossabilities of wheat with stored pearl millet pollen were examined in this study. Freshly collected pollen of 40-50 % water content germinated at frequencies of 70-80 %. Dried pollen of 5-7 % water content after two hours of drying showed germination frequencies of 40-50 %, and also maintained similar germination frequencies after the freezing process. In crosses of wheat variety Norin 61 with the pearl millet pollen stored for one month, the embryo formation frequencies ranged from 17.4 to 27.5 % which were comparable the frequency obtained in a cross of fresh pollen (Fig. 1). After five months of storage, the frequencies still kept similar values at storage temperatures of -80 and -190°C, but were greatly decreased at -20°C. All of the plants regenerated from embryos were wheat haploids carrying a complement of 21 chromosomes (Fig. 2.). These results suggest that pearl millet pollen is more tolerant to drying and freezing than maize pollen, and that pearl millet pollen stored at ultra-low temperatures is an efficient haploid production source for wheat.

[Fig.1.Embryo formation in wheat, self-pollinated \(left\), and crossed with one-month stored pollen of pearl millet \(right\) 18 days after pollination. Bar indicates 2mm. 8KB](#)

[Fig.2.Somatic chromosomes of plants obtained from wheat, self-pollinated \(left, 2n=6x=42\), and crossed with five-month stored pollen of pearl millet \(right, 2n=3x=21\). Bars indicate 10 μm. 13KB](#)





## TOPIC 2: Screening cowpea lines for drought tolerance and its expression in roots.

Cowpea is a leguminous crop particularly important in savanna areas of West Africa and is well- adapted to semi-arid conditions. However, because of the risk of erratic rain fall and long dry spells, much higher drought tolerance is required in cowpea in order to utilized it as an effective crop.

Nine-hundred cowpea germplasm lines were screened in the field during the 1990-91 dry season. Selected lines were further screened using pots in which soil moisture content was maintained at 3% (w/wet weight) every day. Drought-tolerant as well as drought-susceptible varieties were further evaluated in the field during the dry season. Plants were sown after the last rain and were allowed to grow using only residual soil moisture. Drought-tolerant lines grew very vigorously and yielded about 1 ton per ha, although usually grown traditional and improved varieties yielded less than 500 kg per ha and susceptible lines less than 300 kg per ha ([Table 1](#)). These tolerant lines are expected to perform well and show more stable yields in drier areas. However, because the characteristics of these seeds are not preferred among local farmers, these lines are being considered for use as parent lines for drought-tolerant breeding.

Drought-tolerant lines are usually well-adapted in dry conditions, and therefore, are likely to have good root characteristics. In order to investigate the important root features for adaptation under dry conditions, the root distribution patterns of drought-tolerant and susceptible lines of cowpea were compared. Plants were grown in thin root boxes measuring 56cmW x 76cmH x 4cmD. Boxes were buried in soil to maintain soil temperature close to that of the natural soil. After growth of 12 days to 3 weeks, roots were fixed with on a pin board and soil was washed out with a gentle shower.

Clear differences were observed in root distribution in deeper zones between drought-tolerant and susceptible lines ([Fig. 1](#)). Drought-tolerant lines had a wider distribution of roots in the deeper zones of the root systems in comparison with drought-susceptible lines which had only tap roots penetrating deeply with less branching. It is considered that a wider distribution of roots in the deeper zone is important in concentrating scarce soil solutions in deeper soil layers.

[Fig. 1. Root distribution patterns of drought-tolerant and susceptible lines of cowpea.](#)(32 KB)

Drought tolerance and root character are two important, but independent factors complementing each other in developing adaptation ability to dry conditions. It is important to accumulate these factors in the cowpea which is an important agricultural crop. Efforts are being made to combine these factors with other characteristics such as early maturational ability, as well as diseases, insect pest and parasitic weed resistance to contribute to the stable production of cowpea in the Sahelian area.

**Table 1. Grain yields of drought-tolerant lines (upper 4 strains), traditional and IITA-released cultivars (middle 3 strains) and drought-susceptible lines (bottom 3 strains) of cowpea. Yields are shown per plant and per area.**

Strains	Grain yields(g/plant)	Grain yields(kg/ha)
TVU-11979	14.32	1007.0
TVU-11986	15.70	921.1



TVU-12348	13.60	910.9
TVU-12349	9.17	582.4
Dan llla	8.09	288.4
Kanannado	7.61	470.6
IT84S-2246-4	8.23	451.5
TVU-7778	4.01	267.4
TVU-8256	2.36	153.9
TVU-9357	4.58	272.1



## ENVIRONMENTAL RESOURCES DIVISION

A recent estimate suggests that the world human population will reach the 6.3 billion mark by the year 2000 and the 6.8 billion mark by 2025. To feed this ever-increasing population, existing agricultural land is likely to be subjected to a higher intensity of cultivation in populous areas, and farmland development to be extended to areas only marginally suited for agriculture. Trade liberalization in recent years has led to a sharp increase in import of commercial crops and is encouraging increased production in exporting countries; this may result in excessive load to farmland soils, continuous single cropping and deforestation in such countries. Past, unfortunate experiences have shown us that these practices have accelerated farmland degradation and desertification on a global-scale. Such drastic changes in land use cause climatic transformation over extended regions and bring about unpredictable constraints to existing agricultural and forest ecosystems.

From the second half of this century, patterns of land utilization have been changing due to population expansion. These changes, along with a rapid increase in fossil fuel consumption has tremendous impact on the atmosphere through intensified emissions of carbon, nitrogen, and sulfur gases. The annual consumption of fossil fuel now exceeds 5 billion tons of carbon. If the present level of consumption continues, CO₂ concentration will increase by 0.5% per year and double by the middle of the next century. The IPCC report (1990) suggests that a two-fold increase in CO₂ concentrations can potentially cause an increase in global mean surface temperature ranging from 1.5 to 4.5°C.

It has furthermore been shown that the atmospheric concentrations of other greenhouse gases such as methane, nitrous oxide and chlorofluorocarbons have also increased greatly within the past two decades. If the effects of these trace gases are taken into account, global warming is estimated to take place more rapidly than in the case where the effects of CO₂ are considered alone. These trace gases move from the troposphere to the stratosphere and participate in the destruction of the stratospheric ozone. The depletion of the ozone layer allows more ultraviolet rays to reach the earth surface where millions of species of organisms live without any means of protection from ultraviolet radiation.

To address these problems, research projects in this division are being organized to identify and develop technologies for the improvement of agricultural activities and rehabilitation of degraded lands. The target technology must be compatible with the conservation of the environment and ecosystem such as of arid lands, wetlands and sloped lands which have long been considered of little use for agriculture. Other projects aim at the development of technology for sustainable agriculture through analyzing mechanisms of nutrient cycling within arable land ecosystems. To conserve the global environment in harmony with agricultural activities, research on sustainable agriculture should be given foremost emphasis.

[Photo: Soil erosion in the Yangtze River area due to excess corn cultivation \(Photo:K.Minami\) 13KB](#)

[TOPIC 1: Distribution patterns and characteristics of Philippine lowland soils](#)

[TOPIC 2: Mechanisms of acid-soil tolerance of upland rice](#)

[TOPIC 3: Options for mitigating methane emission from tropical rice paddy fields](#)



## **TOPIC 1: Distribution patterns and characteristics of Philippine lowland soils**

In the Philippines, increases in rice production are very much needed, considering the rapid population increase in recent years. Thus, studies to clarify the fertility characteristics of the Philippine lowland soils in order to establish their real potential for rice production are highly required. The present study aimed to characterize the Philippine lowland soils from a pedological viewpoint in reference to factors such as parent material, climate, and topography.

The thirty-two major lowland soils from six lowland rice areas were selected in this study. Out of the soils examined, fifteen soils were considered to be irrigation water aquic, while the seven soils were regarded to be ground water aquic. Setting the dry month as <100 mm of rainfall, the ground water aquic soils were found only in the relatively humid areas with f4 dry months per year. In connection with the change in topography from natural levee to back swamp, in Central Luzon with >4 dry months per year, the increasing influence of irrigation water was obvious, while in Bicol with <2 dry months per year, the increasing influence of ground water was recognizable. Thus, the importance of rainfall and topographic conditions for profile development was verified.

Philippine lowland soils had high organic matter status, high base status, high clay and high available silica contents, as well as a high content of 14 + minerals, mostly smectite, compared with other tropical Asian lowland soils. However, there were some observed regional differences, e.g., with organic C and total N contents, reflecting the difference of rainfall condition among the regions.

This study shows that the various characteristics of the Philippine lowland soils are essentially controlled by the basic nature of the parent materials. In view of this, the Philippine lowland soils can be considered to have relatively high potentiality for rice production among the tropical Asian paddy soils. However, diversity of the soil characters is induced by two conditions, rainfall and topography, which may cause differences in soil fertility among regions and within a region, respectively. Thus, based on the knowledge obtained in this study, to develop proper soil management techniques leading to higher yield and sustainable rice cropping, is highly required.

[Photo:Photomicrograph of Fe coatings of a root channel \(tubular mottles\), typical in ground water aquic soils. 35KB](#)



## **TOPIC 2: Mechanisms of acid-soil tolerance of upland rice**

The savannas of South America (Cerrados and Llanos), which extend more than 2.4 million hectares, up until now, have been utilized only for extensive ranching due to their acidity and low fertility of soil. In this research, a new rice-pasture system was developed and introduced to these ecosystems as an alternative sustainable cropping system. In this cropping system, upland rice germplasm which has tolerance to soil acidity is a necessity. The physiological mechanisms of tolerance to soil acidity are, however, not well understood. Therefore, the mechanisms of acid tolerance were investigated by comparing tolerant and susceptible genotypes with the aim of obtaining basic information for the development of efficient screening methodology.

In field experiment on liming response, the susceptible genotypes yielded less at a liming rate lower than 300 kg/ha, whereas the tolerant ones showed no yield reduction even at 0 kg/ha liming. These results indicated a clear genotypic difference in terms of tolerance to soil acidity among upland rice germplasm. In actual farming practice, soil pH decreased to 4.3 and aluminum concentration in soil solution increased to the toxic level only at the middle and late growth stages, which showed that toxicity due to high aluminum may occur only at these stages. This acidification process was found to be enhanced by fertilization using KCl and urea.

The mechanisms of tolerance to aluminum can be distinguished as: 1) internal tolerance - aluminum is absorbed into the plant symplasm but is detoxified and 2) exclusion - the entry of aluminum into symplasm is in general blocked. In an enclosed pot experiment using savanna soils, the tolerant variety maintained higher soil pH in the pots and thus maintained lower aluminum concentration in soil solution. When the tissue concentration of aluminum was same in both varieties, growth was also the same. These results indicated that, as one of the exclusion mechanisms, the ability of maintaining higher soil pH around the roots is an important mechanism of aluminum tolerance in upland rice.

### TOPIC 3: Options for mitigating methane emission from tropical rice paddy fields

The atmospheric concentration of methane ( $\text{CH}_4$ ) has been noted to be increasing rapidly in recent years. Because it is a radiative trace gas (greenhouse gas) and takes part in atmospheric chemistry, this rapid increase could be of significant environmental consequence. Of the wide variety of the sources for atmospheric  $\text{CH}_4$ , rice cultivation is identified as one of the major sources of  $\text{CH}_4$  emission, and in particular, tropical rice paddy fields are significant because more than 70% of the world's rice acreage is located in this region. This research was aimed at measuring  $\text{CH}_4$  flux from rice paddy fields and at developing the options for mitigating  $\text{CH}_4$  emission from tropical rice paddy fields.

Field measurements performed at 9 sites in Thailand showed a large variation in  $\text{CH}_4$  emission rates among the sites. The average emission rates during the rice cultivation periods ranged from 1.1 to 23.0  $\text{mg m}^{-2} \text{hr}^{-1}$ . The results indicated that soil properties and agronomic practices including water and organic matter management affected  $\text{CH}_4$  emission rates from rice paddy fields.

Application of rice straw to paddy soils prior to flooding increased total  $\text{CH}_4$  emission 3.8- to 10.4-fold. The largest  $\text{CH}_4$  flux was observed in the early stage of cultivation at the rice straw- applied plot, whereas it was observed in the latter stage at the plot without rice straw application. Green manure application also increased  $\text{CH}_4$  emission significantly. On the other hand, some organic amendments such as palm oil wrung residue and complehumus did not affect  $\text{CH}_4$  emission rates significantly. The results suggest that promoting aerobic degradation of organic matter by composting or incorporation into soil during the off-season drained period decreases  $\text{CH}_4$  emission from tropical rice paddy fields.



Instrumentation for measuring  $\text{CH}_4$  flux in Thailand



## CROP PRODUCTION AND POSTHARVEST TECHNOLOGY DIVISION

Due to the constant increase of the human population, it is urgent to increase crop production in order to deal with increasingly severe food problems. The status of the food supply will become more serious as it is realized that patterns of food consumption are being improved in developing countries: people will require more meat, fruits, vegetables and oil in accordance with social development and achievement of higher incomes.

In the developing regions of today, self-reliance in food, rather than self-sufficiency is an important objective. There are no common models for achieving this goal, but it may be considered that there are various ways to go about this in context of the natural and environmental conditions of a particular country.

The Crop Production and Postharvest Technology Division is carrying out studies covering production to storage, as well as the marketing and processing of crop products, and our research activities encompass a variety of disciplines including agronomy, plant protection (insect pests, disease and weed control), agricultural mechanization, irrigation, drainage, cropping systems, food storage, postharvest technology, farm management and agricultural economics.

Because the world-wide total area of arable lands is limited, we view that sustainable production of agricultural products can be achieved only by increasing overall productivity. For this purpose, various technological problems have to be resolved, but not withstanding that sustainable agriculture has to be compatible with the preservation of the natural environment. It is deemed necessary to reduce as much as possible the amount of chemical inputs in agricultural endeavors, and to achieve this, more research on biological or cultural control systems should be implemented, such as studies on the ecology of insect pests and their natural enemies and development of methodology for the prediction of outbreaks of insects and diseases. Thus, "integrated pest management" is strongly called for. Additionally, it is necessary to stress postharvest studies of agricultural products; quality improvement including safety and the extension of shelf life as well as control of the presence of insects and microorganisms in foodstuffs is one of the main objectives of this division. Finally, sustainable production of agricultural commodities can only be supported by the development of sustainable markets. Technology for enhancing the value of agricultural products is being developed with the aim of increasing the incentive of the farmer to promote sustainable production. Economic studies are requisite in furthering the regional development of respective countries.

[Photo:Rambutan\(*Nephelium lappaceum* Linn.\)is one of the most popular of tropical fruits, but has a short shelf life.](#)

[The word "rambut" means hair in the Malay language. The photo was taken at an open air market in a suburb of Bangkok. \(Photo: K.Kawasima\) 22KB](#)

[TOPIC 1: Ecology of weedy rice \(*Oryza sativa* L.\) and its control strategy in direct seeded rice fields in Malaysia](#)

[TOPIC 2: Reproductive strategy of the parasitoid fly, *Exorista japonica* \(Diptera: Tachinidae\): clutch size regulation with host density](#)





## **TOPIC 1: Ecology of weedy rice (*Oryza sativa L.*) and its control strategy in direct seeded rice fields in Malaysia**

Weedy rice, which is locally known as padi angin in Malaysia, shows many undesirable traits such as easy grain shattering. The presence of weedy rice was initially reported in Projek Barat Laut Selangor in 1988, and thereafter, similar infestation problems were detected in the Muda rice area in 1990. Serious conditions became obvious in 1993, with a total of 168 ha becoming infested in this area. Weedy rice inflicts crop loss by reducing the yield and quality of commercial rice. The problem is now noted to occur frequently in direct seeded rice fields, and is apparently increasing with the spread of direct seeding rice culture in tropical Asia.

[Photo: Grain shattering of the rice crop before harvesting](#) (20KB)

In this research, it was found that weedy rice plants show continuous variation in morphology; although they showed many close similarities to modern rice cultivars, they differed from the latter in terms of culm length, leaf color, grain size, pericarp pigmentation, and awn and panicle form. Detailed survey of their morphologies showed that the majority (93%) of weedy rice plants had longer culms than modern cultivars, 34% had pigmented grains, and 39% had grains with long awns. DNA analysis using randomly amplified polymorphic DNA (RAPD) markers revealed that the genetic structure of weedy rice plants was also of close similarity to cultivated rice, indicating that the Malaysian weedy rice (padi angin) could have originated from cultivated rice.

Based on a survey we conducted by interviewing farmers in the Muda and Tanjung Karang rice areas, we found that weedy rice infestation was more serious in dry seeded rice fields and less so in wet seeded fields. Seedling establishment in dry seeded fields is more unstable because it is subject to the vagaries of uncertain rainfall. Poor establishment of such dry seeded rice was sometimes observed to be compensated by volunteer seedlings which emerged from shed seeds in the previous season. It was with this emergence of volunteer seedlings that weedy rice was found to occur. In the first season (off-season) of 1987, volunteer seedling culture was practiced in nearly 40% of total rice fields, where farmers depended on volunteer rice seedlings for the season crop. Volunteer seedling culture decreased in the off-seasons from 1988 to the early 1990's, when dry seedling culture was encouraged to save irrigation water because of an on-going shortage of water supply from irrigation dams. The practice of dry seeding culture associated with volunteer rice seedlings was therefore considered to be the most important factor causing infestation of weedy rice in Malaysia, although seed contamination too, was considered to be a factor exacerbating weedy rice problems in the above areas.

Weedy rice emerges earlier than dry seeded cultivated rice, resulting in its competitive advantages over cultivated rice. In seriously infested fields where weedy rice plants occupied 35% of total rice plants, the rice grain yield was reduced to 3.2 ton/ha, which was 50% to 60% of the rice yield in the absence of weedy rice infestation. Plants with pigmented and/or awned grain and colored pericarp will also reduce the quality of rice grains.

Weedy rice showed wide variation in seed shedding behavior. Seed shedding started at eight days after heading in the earliest shattering type, and earlier shattering resulted in a higher shattering rate. seeds were classified into several grades, i.e., hard threshing, easy threshing, easy shattering, very easy shattering and spontaneous shattering type. The result of a germination test using fresh dry seeds

immediately after shedding indicated that the degree of seed dormancy of the spontaneous shattering type was higher than that of the intermediate shattering type. However, seed dormancy was absent at three months after shedding, suggesting that Malaysian weedy rice required less than three months to overcome its seed dormancy. This trait may be desirable for weedy rice to emerge in the next season of double rice cropping in Malaysia.

Mimicry of cultivated rice, seed dormancy and tolerance to rice herbicides are qualities of weedy rice which cause difficulties in controlling it, and costs farmers in eliminating it. The results of this ecological study suggested that no single technique would have superior effectiveness in controlling weedy rice, and integrated control measures based on ecological methods should be applied in order to overcome these problems. Culture practices which would be effective in reducing weedy rice populations are as follows;

- (1) Land preparation: Repeated rotovation is effective to reduce weedy rice population in rice fields. Weedy rice seedlings which are promoted to emerge by the first or the second rotovation will be buried in the soil by the second or the third rotovation. Intensive land preparation is also effective in obtaining uniform seedling establishment of broadcasted rice as well as reducing weedy rice population.
- (2) Seed purity: Certified seeds are required to preventing contamination by weedy rice. However, the capacity of seed production of government seed suppliers is not sufficient for rice production in consideration of total rice cultivation areas. More than two-thirds of areas under cultivation are suspected to be planted using farmers' own seeds from the previous crop.
- (3) Seedling establishment: Uniform and rapid seedling establishment of seeded rice could have advantages over weedy rice in terms of stronger competitive ability. Tillage for mixing seeds with soil and pressing the soil surface with a roller after sowing are recommended for uniform seedling establishment.
- (4) Manual weeding: Many farmers have noted that manual weeding is the most effective practice for controlling weedy rice. However, it cost farmers physically and economically. Moreover, there are difficulties in walking in broadcasted rice fields and carrying out the identification of weedy rice. Making a narrow ditch to walk in the field, or doing row seeding or drill seeding would help farmers to practice manual weeding. Successful farmers could identify weedy rice by leaf sheath color at early to middle stage of rice cultivation.
- (5) Chemical control: Herbicide usage before land preparation is effective to reduce the seed population of weedy rice in the field. Paraquat, glufosinate and glyphosate are available, and rotovation after herbicide usage increases their effectiveness. Few herbicides are available for after seeding in rice fields. Breeding of rice highly tolerant to herbicide would aid in the chemical control of weedy rice. Weedy rice, however, will continue to evolve physiologically and metabolically similar to rice cultivars. Continuous usage of herbicide resistant cultivar would cause herbicide resistant weedy rice to develop, through crossing and natural selection in the rice fields. Information on mating performance of weedy rice, gene transfer between weedy rice and cultivated rice, and genetic structure in rice fields is necessary for further investigation of the evolution of weedy rice.



**TOPIC 2: Reproductive strategy of the parasitoid fly, *Exorista japonica* (Diptera: Tachinidae): clutch size regulation with host density**

The family of Tachinidae flies is considered to contain very important potential biological control agents. There have been, however, relatively few studies on the biology of tachinid flies as compared with their parasitoid counterparts, the parasitic wasps; one reason may be that the culture of tachinids has many difficulties. In order to employ the tachinid fly as a biological control agent, it is first essential to not only develop rearing techniques for these insects, but also to conduct fundamental studies on their biology.

*Exorista japonica*, the species which attacks the common armyworm *Mythimna separata*, is also an important natural enemy of the common cutworm *Spodoptera litura*, and the cabbage armyworm *Mamestra brassicae*. It has been reported that *E. japonica* sometimes deposits supernumerary eggs on a single host in the field. Unanswered questions such as relating to the optimal clutch size necessary for maximizing the reproductive success of the female fly or whether a female fly can regulate clutch size in response to host density need to be solved before introducing this parasitoid into the field.

A member of JIRCAS's research staff has already established a rearing procedure for *E. japonica* and predicted that the optimal clutch size of *E. japonica* parasitizing a last-instar larva of the common armyworm, will gain maximum fitness varying 1-10 in response to the rate of host encounter, host density per unit area (patch) and oviposition ability the time of host encounter. To verify this prediction required clarification of whether the flies really regulate clutch size according changes in these factors. Therefore, the effects of host encounter rate and host density per patch on the oviposition decisions of *E. japonica* females were studied in the laboratory.

To determine the effect of host encounter rate and host density per patch on oviposition, either 1, 2 or 5 host larvae were simultaneously presented to a female of *E. japonica* at the intervals of 1 min, 2 h or 24 h. Host presentation was repeated three times for the female at the same interval as the rate of host encounter. For each experiment, the number of eggs laid per oviposition bout, clutch size and time spent in a patch were recorded. Since it is sometimes very difficult to determine one bout from the series of oviposition behaviour, a bout of oviposition in this study was defined as oviposition during the time of entering the patch to leaving it.

As a result, a female fly decreased clutch size as the rate of host encounter and host density per patch increased (Fig. 1 (a), Tukey-Kramer's method,  $p < 0.05$ ), and also decreased the number of eggs per bout as the rate of host encounter increased and as host density per patch decreased (Fig.1 (b), Tukey-Kramer's method,  $p < 0.05$ ). Under the same host densities, the parasitoids tended to stay for shorter durations in a patch at the interval of 1 min than at those of 2 h and 24 h (Fig. 1 (c), Tukey-Kramer's method,  $p < 0.05$ ). On the other hand, time spent in a patch at an interval of 1 min increased with host density, although there was not significant difference among time in a patch at other intervals with increasing host density. Figure 1 (d) shows percentage of hosts oviposited with one or more than one egg (percentage parasitism). The flies parasitized 100 % of hosts at all intervals when given one host per patch. When given 2 or 5 hosts, percentage parasitism increased as the rate of host encounter decreased, but rapidly decreased as the result of flies leaving the patch with unparasitized hosts when host density increased ( $\chi^2$ -test,  $p < 0.05$ ).

In this study, hosts were provided to a female fly not only at different time intervals but also with different host densities, and flies laid more eggs in a bout as host density increased even at the same intervals in which hosts were encountered. When a parasitoid encounters a host in a short interval, there is the possibility that oviposition is limited by egg shortage, but not by the ability to recognize host density. However, the results of this investigation revealed that *E. japonica* regulated the number of ovipositions and left the patch with matured eggs that could still be oviposited. This study has indicated that flies are able to regulate the number of eggs in a bout because of having the ability to not only recognize host density according to the rate of host encounter, but also host density within a patch.

[Photo1.E.japonica female ovipositing on M.separata](#) (16KB)

Fig.1. Mean clutch size (calculated excepting unparasitized hosts) (a), mean number of eggs laid per bout (b), mean time in a patch during an oviposition bout (c) and percentage of host oviposited in a bout by *E. japonica* females (d), when hosts were given intervals of 1 min, 2 h and 24 h, with host densities of 1, 2 and 5 hosts per patch. Bars with the same letter among host densities in each interval (a-c) and among intervals of each host density (x-z) are not significantly different at the  $p=0.05$  level ((a), (b) and (c); multiple comparison test, based on Tukey-Kramer's method, (d);  $\chi^2$ -test).





## ANIMAL PRODUCTION AND GRASSLAND DIVISION

Animals in developing countries contribute to the betterment of people's lives in various ways. Animals not only produce the meat, milk, eggs and hide which are essential in daily life and are an important source of income, but also generate draft power for tillage and transportation, and produce wastes for use as fertilizers and source of fuel. Yet, production related to livestock rearing remains at low levels due to constraints such as low genetic potential of animals, poor feeds in terms of quality and quantity, prevalence of disease, harsh climatic conditions, and inadequate management.

The Division carries out research in order to achieve a sustainable increase of animal production in harmony with the natural resources of the environment by enhancing reproductive capacity, securing feed resources by improvement of grassland areas or better utilization of agro-industrial by-products, controlling invasive animal diseases and improving management practices.

Three research projects ended successfully in the fiscal year of 1995. The themes and the collaborative research organizations were as follows: 1) Development of genetic evaluation for trypano-tolerance and meat and milk production in African cattle with the International Livestock Research Institute (ILRI, Ethiopia); 2) Geographical information systems for characterization and analysis of rangelands in West Asia and North Africa with the International Center for Agricultural Research in Dry Areas (ICARDA); and 3) Mineral nutrition research in tropical ruminants with the Malaysian Agricultural Research and Development Institute (MARDI), Malaysia.

Currently, six projects are being carried out abroad on long-term assignments (2-5 years): 1) Immunohistorical studies for the development of vaccine against East Coast Fever with ILRI, Kenya; 2) Ecophysiological studies on the persistency of tropical pastures in the Latin American Savanna with the Centro Internacional de Agricultura Tropical (CIAT); 3) Development of technology for forage crop management in Northeast Thailand with the Department of Livestock Development (DLD), Thailand; 4) Improvement of cattle production with locally-available feed resources in Northeast Thailand with DLD; 5) Improvement of raising technology of small livestock in the tropics with MARDI; and 6) Utilization of by-products in pig feeding and utilization of livestock excreta as biogas and feed resources of fish with Cantho University, Vietnam. The last one was initiated from this year as part overall of JIRCAS's comprehensive project "Integrated research on farming systems combining agriculture, animal husbandry and fisheries in the Mekong Delta".

Additionally, the following studies were carried out by researchers on short-term assignments (1-3 months): 1) Genetic characteristics of indigenous breeds of pigs in the Philippines with University of the Philippines Los Banos (UPLB); 2) Manufacturing of good quality silage under tropical conditions (DLD); 3) Rumen characteristics and digestibility of feeds in ruminants (DLD); and 4) Control of body fat in chickens (MARDI).

In recent years, requests for collaborative research from developing countries have become diversified including incorporating applications in biotechnology along with upgrading the overall level of research. As a result, the Division is promoting basic research as a support for overseas activities at the Tsukuba campus on the following subjects: 1) identification of endophytic fungi in pasture plants in tropical regions and their utilization in plants via biotechnological methods; 2) investigation of endocrinological responses to heat stress in ruminant animals in relation to milk secretion.

[TOPIC 1: Processing of urea molasses blocks for ruminant animals in Malaysia](#)

[TOPIC 2: Utilization of oil palm frond silage as feed in the tropics](#)

[TOPIC 3: Analysis of association of dna markers and quantitative trait loci \(QTL\) effects](#)

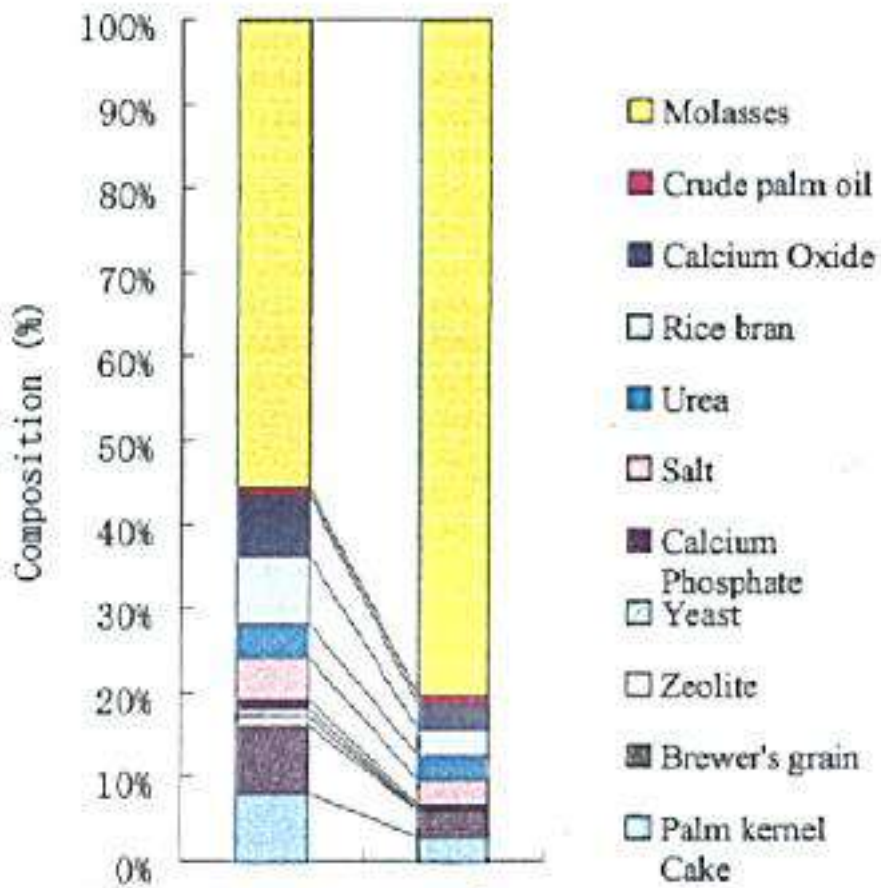
[TOPIC 4: Establishment of a long and accurate PCR \(LA-PCR\) method for mitochondrial dna rflp analysis in domesticated and wild pigs](#)

[TOPIC 5: Degradation hazard modelling and mapping of a small ruminant production systems in WANA](#)

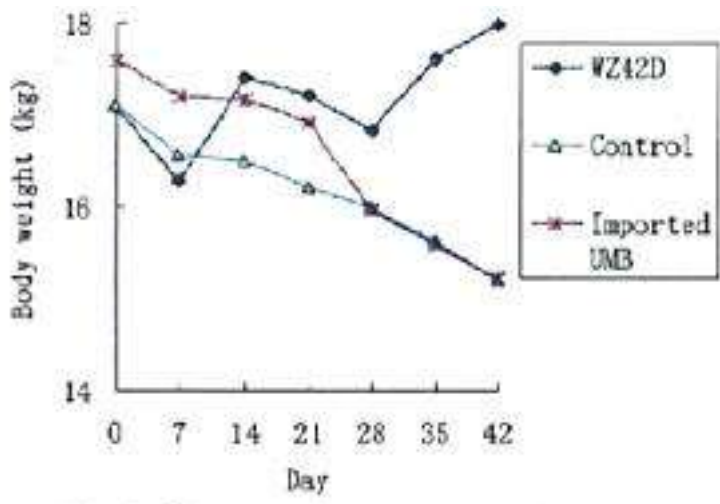
## **TOPIC 1: Processing of urea molasses blocks for ruminant animals in Malaysia**

Despite the abundance of agro-byproducts, Malaysia is still a net importer of feed by virtue of the basic and conventional ingredients used for animals. Malaysia imports maize, soy bean and fish meal to levels of more than M\$ 500 million annually. Molasses and palm kernel cake (PKC) are common agro-byproducts in the country and urea molasses block (UMB) is a promising feed supplement for ruminant animals. We have established processing methodology that can be utilized on a semi-commercial scale together with the Malaysian Agricultural Research and Development Institute (MARDI) in a collaborative research program.

We designed and set a processing line which consisted of a convey system, a semi-automatic weighing system, a cutter-mixer, a vertical mixer and a horizontal mixer in a building (approx. 100 m²) built at MARDI. More than fifty formulae of UMB were examined in terms of extent of mixing, solidification speed and palatability in animals. The best spectra of formulae that suits the processing line and shows good palatability performance is shown in [Figure 1](#)(9KB). The UMB which were processed based on the formulae were evaluated by animal field trials. Live weight in animals supplemented with UMB was significantly greater than in animals supplemented by imported UMB as verified in several of the trials [Figure 2](#)(20KB). The formulae and processing procedures were then applied to semi-commercial UMB production in Malaysia.



**Fig.1 Septra of formulae**



**Fig.2 Change in body weight**

## TOPIC 2: Utilization of oil palm frond silage as feed in the tropics

In Malaysia, self-sufficiency in beef, milk and mutton is low because of the shortage of feed resources for ruminants. However, the country leads the world in palm oil production and produces annually 1.7 million ton of oil palm frond (OPF) on a dry matter basis as by-products from the palm oil industry. At the present time, OPF is left discarded on the oil palm estates and not utilized. Given this situation, a collaborative study between the Tropical Agriculture Research Center (TARC), presently JIRCAS and the Malaysian Agricultural Research and Development Institute (MARDI) was initiated to develop uses of OPF as ruminant feed.

Firstly, a method for preserving OPF as silage was examined, and chemical analysis and digestion trials with Kedah-Kelantan bulls were conducted in order to evaluate the nutritive value of OPF silage. Secondly, two feeding trials were carried out to confirm the possibility of practical utilization of OPF silage for cattle feed. In the feeding trials with 24 Australian Commercial Cross fattening bulls, the effects of OPF level in the diet on feed intake, growth and meat production in the bulls was determined.

In feeding trials with 27 Sahiwahl-Friesian lactating dairy cows, feed intake and milk production were compared among three dietary treatments of 50% (on dry matter basis) tropical grass diet, 30% OPF diet and 50% OPF diet. Finally, the results of the collaborative study were announced at a press conference in MARDI to assist the transfer of the new technology to the livestock industry in Malaysia.

It was found that high quality silage could be prepared by packing OPF in a silo under anaerobic conditions. The nutritive value of OPF silage was found to be as high as rice straw. The concentrates: carcass ratio was reduced by increasing the OPF level in the diet, which indicated that dietary energy in OPF could be used for meat production by the bulls ([Table 1](#)). The efficiency of dietary energy utilization for milk production was higher in animals given 30 or 50% OPF diet treatment than in those on a 50% tropical grass diet treatment, which showed that the feeding value of OPF was not less than that of tropical grass ([Table 2](#)).

After the press conference, continuous visits and requests for information, demonstrations and training sessions on processings technique of OPF have been conducted by producers, farmers and extension agencies. Some farmers have already adopted the technology as shown in Plate 1. More than 100 units of the same chipper machine as examined in the collaborative study have been sold to farmers to chop OPF for feeding. The role that this research played in helping to develop the livestock industry in Malaysia was recognized by the awardance of a prize "The best research team in MARDI in 1992" to the research staff involved in the collaborative study

**Table 1. Effect of feeding oil palm frond on performance in Australian Commercial Cross bulls**

<b><u>Items</u></b>	<b><u>OPF level, DM%</u></b>		
	<b><u>10</u></b>	<b><u>30</u></b>	<b><u>50</u></b>
Number of bulls	6	6	6
Ingredient composition of diets, DM %			
Urea treated OPF silage	10	30	50
Concentrates	90	70	50
Feed intake and body weight gain			
Daily gain, kg/day	0.75 ^a	0.62 ^{ab}	0.45 ^c
Feed intake			
OPF, kg DM/day	0.70 ^c	1.83 ^b	2.74 ^a
Concentrates, kg DM/	6.32 ^a	4.26 ^b	2.74 ^c
Total diet, kg DM/day	7.02 ^a	6.10 ^{ab}	5.48 ^b
ME, MJ/day	73.0 ^a	54.9 ^b	45.4 ^{bc}
Carcass characteristics			
Carcass weight, kg	237.2 ^a	210.2 ^{ab}	189.0 ^b
Dressing percentage	60.6 ^a	58.2 ^{ab}	57.6 ^{ab}
Percentage in carcass			
Meat	53.6	58.2	57.2
Fat	31.6 ^a	27.6 ^{ab}	24.2 ^b
Bone	16.0	16.1	17.7
Concentrates: Carcass ratio	6.02 ^a	4.53 ^b	3.25 ^c

OPF : Oil palm frond, DM : Dry matter, ME:Metabolizable energy

¹Palm kernel cake based feed

a,b,c,dMeans with different superscript differ ( p<0.05 ).



**Table 2. Effect of feeding oil palm frond silage on performance in Sahiwal-Friesian lactating dairy cows**

<u>Items</u>	<u>Diet treatment</u>		
	<u>30%OPF</u>	<u>50%OPF</u>	<u>Grass</u>
Number of cows	9	9	9
Body weight, kg	417	451	450
Ingredient composition of diet, DM%			
OPF silage	30	50	
Tropical grass ¹	---	---	50
Concentrates	70	50	50
Feed intake and milk production			
DM intake, kg/day	6.46 ^b	5.86 ^c	8.28 ^a
Yield of 4% FCM, kg	6.93	5.73	6.48
4% FCM : ME intake ratio, kg/MJ	0.109 ^a	0.088 ^b	0.096 ^b

DM: Dry matter, OPF: Oil palm frond, FCM: Fat corrected milk,

ME: Metabolizable energy

¹Concentrates contained 24.0% crude protein and 11.28 MJ/kg of metabolizable energy.

a,b,c Means with different superscript differ ( p<0.05 )

### TOPIC 3: Analysis of association of dna markers and quantitative trait loci (QTL) effects

The genotype of QTL which affects trypanotolerance or milk yield has not been determined directly. However, it has become possible to identify QTL genotype directly using DNA markers linked closely to QTL. Many microsatellites have been detected in recent years. Thus, DNA markers such as microsatellites have widened the possibility to identify genotypes of QTL directly.

Simple association analysis procedures were developed for use in situations such as where the sire's marker and QTL's genotype are doubly heterozygous and observations for milk yield and the like are taken from the sire's offspring. As an example tested using the developed procedure, ninety QTL were assumed to be located equally among chromosomes, and flanking markers were assumed to be located surrounding a QTL. The relationship between true marker effects and estimated marker effects surged by limiting the number of markers. That is, the relationship surged when the top 30 largest markers were adopted instead of all markers. In addition, the influence of two combinations of heritability of 0.2 and 0.4 on the relationship was also compared.

The relationship was higher in the heritability of 0.4 than in that of 0.2. As a result, it has been shown that the effectiveness of using DNA markers to increase selection accuracy is justified when the effect of each QTL is genetically large in the case of limiting the number of markers in the order of size or higher heritability. Thus, it is indicated that QTL with large effects should be adopted in selection.

**Table 1. Correlation coefficients between true and estimated DNA**

#### Maker effects

<u>Heritability</u>	<u>All markers</u>	<u>Top largest 30 markers</u>
0.2	0.5089	0.6623
0.4	0.5909	0.7423

#### TOPIC 4: Establishment of a long and accurate PCR (LA-PCR) method for mitochondrial dna rflp analysis in domesticated and wild pigs

We established a simple method for the amplification of domesticated and wild pig mitochondrial DNA (mtDNA), which is 15.2kb in length, and for mtDNA RFLP analysis using the long-accurate PCR (LA-PCR) method with the "hot start" technique. Single primer sets (35-mer) were used to amplify mitochondrial DNA (mtDNA) of 15.2kb excepting the D-loop region. LA-PCR conditions were as follows: one cycle of 94°C, 30 cycles of 98°C (20 sec) and 68°C (20 min) followed by 10-min extension at 72°C. LA-PCR was carried out using the Takara LA PCR kit ver.2. Genomic DNA (about 500 ng) as the DNA template was extracted from peripheral white blood cells and hair roots. The usefulness of the present method for mtDNA amplification and mtDNA RFLP analysis was confirmed in Luzon native pig and Luzon wild pigs in the Philippines. We collected blood samples from seven native pigs (Bontoc: Mountain province and Banaue: fugaro province), and from six native pigs originating from Pangasinan and Batangas province. We have also collected hair samples from two Luzon wild pigs; Luzon warty pig (*Sus philippinensis*) and Palawan bearded pig (*Sus barbatus*). The mtDNA types of the two wild pigs were distinctly different from those of European and Chinese pigs and differed from each other as well. There were found two types of mtDNA in the Luzon native pigs. One of the mtDNA types may originate from Duroc or Berkshire breeds. The other type is similar to that of the Ryukyu wild pig.

**Table 1. Mitochondrial DNA patterns of several pig breeds and wild pigs.**

#### Restriction Enzymes

<u>Breeds</u>	<u>HincII</u>	<u>HaeIII</u>	<u>HinfI</u>	<u>ScaI</u>	<u>AatI</u>	<u>BglII</u>
Landrace	1	1	1	1	1	1
Large White (NIAI)	1	1	1	1	1	3
Duroc	1	2	2	3	2	2
Berkshire	1	2	2	3	2	2
Meishan	1	2	2	2	2	2
Japanese wild pig	1	2	3	3	3	2
Ryukyu wild pig	2	2	2	3	2	2
Luzon native pig I	1	2	4	4	3	3
Luzon native pig II	1	2	4	4	3	3
Luzon warty pig	3	3	2	5	1	2
Palawan earded pig	4	3	5	5	4	3

Identical numbers indicate the same digestion pattern.

NIAI: National Institute of Animal Industry (Japan).

## **TOPIC 5: Degradation hazard modelling and mapping of a small ruminant production systems in WANA**

In dry areas, the agriculturally marginal regions receive an annual rainfall between 200-300 mm and are significantly susceptible to land degradation, since both cropping and livestock production are often practiced in the same fragile environment. Geographical resource analyses in such an environment provide efficient assessment and mapping of land conditions, of hazardous areas for protection and conservation, and of potential areas for development.

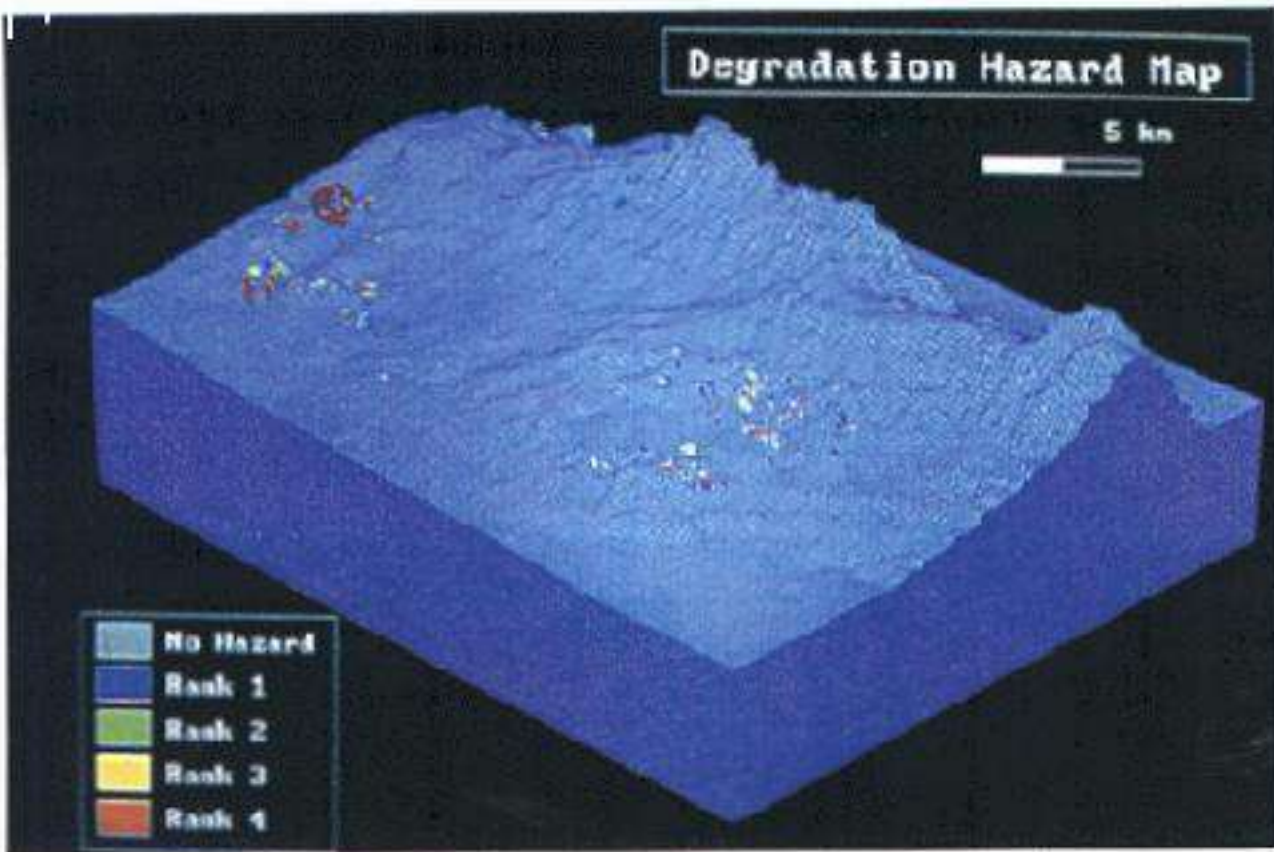
Within the framework of a collaborative program with ICARDA (International Center for Agricultural Research in the Dry Areas), a series of geographical resource studies was conducted during 1992-95 in the Abdal Aziz test zone (40°07'30"-30'E, 36°15'-30'N), northeastern Syria, typical of small ruminant production systems found widely in the marginal barley/rangeland zones of West Asia and North Africa (WANA). In this system, native plants on rangelands grown under the seasonal rains contribute to local animals as the main feed resource during winter and spring, whereas barley stubble in the harvested fields serve as a feed source during dry summer and autumn.

A resource map database of the test zone was compiled with the following parameters: 1) elevation, 2) slope, 3) direction of slope, 4) vegetation cover, 5) soil type, 6) degradation degree and 7) degradation extent (magnitude of terrain affected) within a GIS (Geographic Information System). Neural Network modelling (NEURO92) was applied, to estimate degradation variables using the resource map database.

Accuracy rates obtained by the modelling for the degree and extent of degradation were 86% and 79%, respectively. These two variables were mathematically multiplied to obtain "degradation hazard" as an evaluation index ([see Fig. 1](#)). The distribution of the high hazard evaluated areas was unique at the site of two stony soil types.

The evaluation was found valid by examination of the actual ground conditions in the northern foothill and plain areas, where many erosion gullies were identified. However, in very moderate southern slopes, severe degradation could not be identified as was evaluated by the modelling. It was considered that the local climate and resource utilization variables (grazing, cropping) should be included in the modelling.

[Fig. 1 Degradation hazard mapping \(rank 4 = hazardous areas\), a bird's-eye view from southeastern corner of test zone](#) (25KB)



# FORESTRY DIVISION



Mangrove forest area on the Malaysian Peninsula (Photo:

M. Oka)

With the rapid exploitation of arable land because of high food demands, the degradation and devastation of natural forest areas are rapidly progressing, particularly in developing areas. This is bringing about serious economic and environmental problems not only at the local level but also on a global scale. Therefore, the rehabilitation and sustainable management of these forests are urgent issues. Establishment of forest production systems and postharvest technologies for local communities can be viewed as essential means for the reduction of forest devastation.

The Forestry Division covers a wide range of research in developing countries from production to end-use as related to forestry and forest products under the following two research categories: 1) silvicultural and forest management technology; and 2) processing technology of forest products. These necessitate disciplines such as silviculture, plant ecology and eco-physiology, soil science, entomology, mycology, forest mechanization, socio-economics, and wood technology.

Forest rehabilitation and enrichment of devastated and degraded areas are the first steps in developing sustainable management of forest areas. To do so, silviculture, site evaluation and pest control technologies have to be developed in consideration of the conditions of the natural environment.

At present, forest products are a principal trading commodity in 33 developing countries. Sustainable production of these products should be achieved in natural forests and plantations. For such purposes, studies on species behavior, natural regeneration, enrichment planting, harvesting system, etc. are essential.

Another major reason for forest devastation is the shifting of cultivation by land-less farmers. Hence, forest production and planning systems for stimulating the activities of local communities have to be developed. Various lesser-known tree species and forestry products may face danger of disappearance from the Earth if rapid forest devastation continues. Evaluation studies should be urgently conducted and improvement of current wood processing technology should be given priority.

[TOPIC 1: Environmental performances of dipterocarps to environmental stress- special emphasis on water relation](#)

[TOPIC 2: Stimulation of growth of naturally regenerated seedlings in selectively logged-over secondary dipterocarp forests](#)

## TOPIC 1: Environmental performances of dipterocarps to environmental stress- special emphasis on water relation

Many studies have been carried out on the ecology and productivity of tropical tree species. However, much of these work has been descriptive and ecological in approach with very few studies on the ecophysiological characteristics of the species of interest. This research aimed to take into account such factors ... for several tropical tree species of ... importance.

According to the water relation parameters obtained in this study, the capacity for maintaining positive turgor appeared to be low in shaded and well-watered nursery seedlings of dipterocarps ([Fig. 1](#))12KB. On the other hand, leaves of the exposed trees had fully adapted to stress of water deficiency morphologically as well by maintaining positive turgor through osmotic adjustment.

Assimilation of CO₂ is essential for plant growth. The lower rate of net photosynthesis (P_n) observed in dipterocarps compared with fast growing species can explain slower growth of the former. However, *Hopea odorata* had a P_n equivalent to that of fast growing species and had very high water use efficiency (WUE). Decrease in P_n with increasing and decreasing temperature was relatively small in *H. odorata* and *Shorea platyclados*, suggesting that these species have high adaptability for changing temperature. From these photosynthetic characteristics, *H. odorata* and *S. platyclados* could be recommended as possible species for open planting.

Midday depression of G_w was observed in most of the species measured in this study. G_w started to decrease when leaves received full sunlight and/or when vapor pressure difference between leaf and ambient air reached above 10hPa. On the other hand, in *A. mangium* which is well known as a fast growing and drought tolerant species, G_w remained relatively constant even under full sunlight and VPD above 10hPa.

Since photosynthetic CO₂ uptake is strongly controlled by stomatal opening, P_n during daytime was reduced by the reduction of G_w. However, the reduction of transpiration rate (Tr) was relatively small because of increasing VPD, which stimulates evapotranspiration with increasing temperature and decreasing air humidity.

The leaf water potential ( $\psi_w$ ) was in accordance with the pattern of the transpiration rate (Tr), and was low during midday when Tr was high. In tall trees, difference in gravitational potential ( $\psi_g$ ) also caused a lowering of  $\psi_w$  of the upper canopy. In addition, low soil-to-leaf hydraulic conductance (L) in the tall trees limited water uptake from soil. Thus, minimum  $\psi_w$  was lower in the tall trees than in the small trees, resulting in severer water stress, and thus, in lower G_w and lower P_n in the former trees.

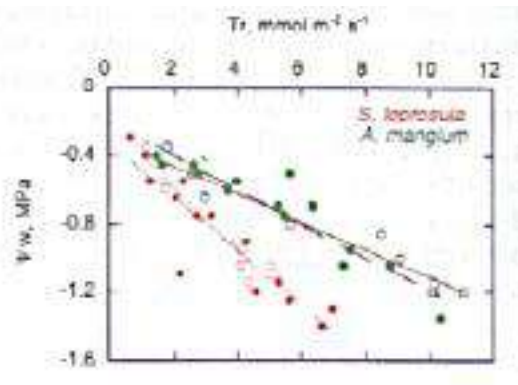
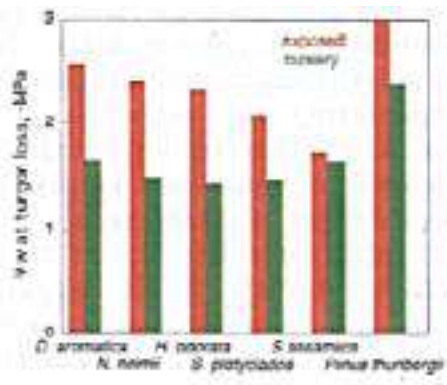
In *A. mangium*, soil-to-leaf hydraulic conductance (L) was remarkably high. High L enabled this species to keep  $\psi_w$  less negative for the same transpiration rate when compared to dipterocarps ([Fig 2](#))12KB. In this species, keeping water deficit low through high L resulted in maintaining high G_w during daytime when the transpiration rate was high.

From these results, it appears that low growth seen in dipterocarps may likely be caused by stomatal closure during daytime, which strongly reduces photosynthetic CO₂ uptake, as well as relatively lowers



net photosynthetic rate. In this study, low soil-to-leaf hydraulic conductance in dipterocarps limited water availability and thus, caused a lowering of leaf water potential especially in mature tall trees. Nursery grown seedlings of dipterocarps were susceptible to water stress because of their low ability for maintaining positive turgor. On the other hand, the leaves of the exposed trees had adapted to the stress of water deficiency morphologically and maintained positive turgor through osmotic adjustment.

In conclusion, when planting seedlings of dipterocarps, it is recommended to precondition prior to transplanting in order to enhance the capacity of the seedlings to cope with water stress. In addition, partial shading after transplanting can help maintain gaseous exchange through stomata, and is also advised in order to avoid turgor loss, which may cause mortality of seedlings.



## **TOPIC 2: Stimulation of growth of naturally regenerated seedlings in selectively logged-over secondary dipterocarp forests**

The hill forests of Peninsula Malaysia consisted of abundant commercial trees predominated by Dipterocarps. Almost all of these forests are under utilization for timber production. When the forests are harvested, loggers must follow the government's logging regulations known as the "Selective Management System (SMS)". Under this system for selective logging, only trees with trunks over 40 to 60 cm in diameter can be cut and other young trees must be left remaining.

However, the present logging methods are still not suitable to ensure the survival and growth of young trees, saplings and seedlings because logging roads are densely located on hill crests where useful seedlings such as *Shorea curtisii* and other dipterocarps are well-regenerated and heavy machines severely disturb the ground surface. In addition, surviving seedlings do not grow well after logging in spite of improvement of conditions of light via removal of canopy trees.

The purposes of this study were to answer two questions: 1) what causes retardation of seedling survival and growth after logging? and 2) how can the growth of surviving seedlings be stimulated? We selected one ha of a secondary forest 5 years after logging which was rich in *S. curtisii*. This area enclosed approximately 1,100 seedlings of this species (H<1.0m). The seedlings were continuously distributed on the hill crests and upper slopes, and the seedlings formed a distinct pattern similar to that seen in natural forests except for in locations directly on the logging roads. No seedlings were observed to have had survived and regenerated on the logging roads after commercial operations (Fig. ). Therefore, dense road networks appear to be one of the major causes of seedling disappearance where road areas occupy up to 10% of forest area.

Various types of ground floor vegetation grow on the hill forests. A stemless palm is one of these dominant undergrowths which covers 28% of the area and is associated with *S. curtisii*. The palm starts growing vigorously after logging because of improvement of light conditions due to the removal of canopy trees. The palm is therefore a strong competitor of *S. curtisii* seedlings and many of the latter die back because of shade brought about by growth of the overlaid palm. Removal of the palm seedlings would be an effective method for accelerating growth of *S. curtisii* seedlings and would enable convenient and low-cost methods of management in the field (Photos 1 and 2). The rate of canopy opening which is a parameter of light reflection value on the seedlings was greatly improved from 1.7% to 4.3%. As sapling growth rate was 4.5% at this point, seedlings would be freed from suppression of light deficiency by using these removal methods.

[Fig. Sapling distribution of *S. curtisii* over 1.0 m in height in a logged-over area and logging road network, Comp. 28, Semangkok State Forest Reserve, Selangor, Malaysia 20 KB](#)

[Photo:1 Stemless palms in a hill Dipterocarp forest. The palm and *S. Curtisii* occupy the same ecological niche. Two big stems of the trees are located in the center of the photo. 35 KB](#)

[Photo:2 The study site for acceleration of growth of *S. curtisii* seedlings. Stemless palm were removed. 35 KB](#)

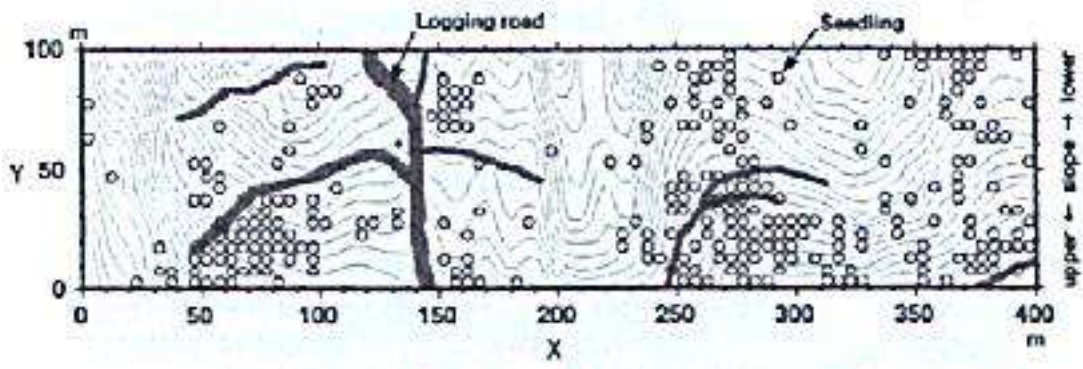




Photo 1. Stemless palms in a hill dipterocarp forest. The palm and *S. Curtisii* occupy the same ecological niche. Two big stems of the trees are located in the center of the photo.



Photo 2. The study site for acceleration of growth of *S. curtisii* seedlings. Stemless palm were removed.

# FISHERIES DIVISION

As an initial phase (1994-1998) of international collaborative activity in the field of fisheries, the Fisheries Division has initiated five research projects in Asian countries, eg., fisheries resources management in Malaysia and Indonesia, aquaculture in Thailand and Vietnam, and fisheries product processing in China.

An international collaborative research project on fisheries resource management “Production and sustainable utilization of brackish water mangrove ecosystems”, has been initiated with the Fisheries Research Institute (FRI) and the University of Malaya (UM). The project involves the integration of studies dealing with the brackish water mangrove and is conducted on multidisciplinary basis including fields related to fisheries, forestry, agriculture, and socio-economics. One senior researcher has already been dispatched by JIRCAS to Penang to oversee the project, as a long-term residing scientist, and three short-term scientists specializing in fish larva ecology, crustacean ecology, and marine chemistry have participated in this project. In addition to working with the above counterpart organizations, JIRCAS is receiving the active cooperation of the Marine Fisheries Resources Development and Management Department of the Southeast Asian Fisheries Development Center (SEAFDEC) regarding the fisheries aspects of the comprehensive project. Another project involving fisheries resources management, “Study on life history of coastal fish in Indonesia”, has also been initiated with the Central Research Institute of fisheries (CRIFI), at the Research Institute for Coastal Fisheries (RICF), CRIFI, in Maros, South Sulawesi, Indonesia. The project aims to clarify ecology and life history of important coastal fishes for the establishment of methods of resources management. One researcher has been dispatched to Maros as long-term residing scientist.

[Surveying mangrove forests in Malaysia \(Photo: K.Fukusho\)](#) (21 KB)

In addition to the Division’s earliest collaborative research project on aquaculture, “Development of sustainable aquaculture technology in Southeast Asia” with the Faculty of Fisheries, Kasetsart University, in Bangkok, Thailand (introduced in the JIRCAS Annual Report 1994), another project, “Evaluation and improvement of agro-forestry-animal husbandry-fisheries (AFAF) combined farming systems in the Mekong Delta”, has been initiated with the College of Agriculture, Cantho University in Cantho, Vietnam. The project involves the integration of studies dealing with square(?) farming on a multidisciplinary basis including fields related to rice production;, animal husbandary, freshwater aquaculture, and socio-economics. The fisheries aspects of this integrated project relate to freshwater aquaculture as follows: 1) fry production technology of fish and shrimp, 2) disease protection methodology for fish and shrimp (?) 3) utilization of new feed resources for freshwater aquaculture. To oversee the fisheries aspects of the project, two short-term scientists specializing in crustacean endocrinology and fish disease, respectively, have been dispatched to Cantho, Vietnam.

Concerning fisheries product processing, a collaborative research project, “Study on post harvest and processing of freshwater fish in China”, has been initiated with the Faculty of Food Science and Technology, Shanghai Fisheries University. One senior researcher has already been dispatched to Shanghai, and one short-term scientist specializing in post harvest of fish had visited to lend support to the project.

Intensive aquaculture has been well-developed in recent years and has become one of the most important industries in many countries, but self-contamination and fish disease in culture ponds has given rise to serious environmental and social problems. Therefore, fish disease protection has been given priority as a topic of collaboration under the JIRCAS Visiting Research Fellowship Program at Tsukuba in which one scientist has been invited from the Central Research Institute of Fisheries, Indonesia to initiate cooperative studies in Tsukuba during a two-year period. He is expected to become a core scientist as a representative of one of JIRCAS's counterpart institutions for the continual development of collaborative study.

[TOPIC: Productivity and sustainable utilization of brackish water mangrove ecosystems](#)





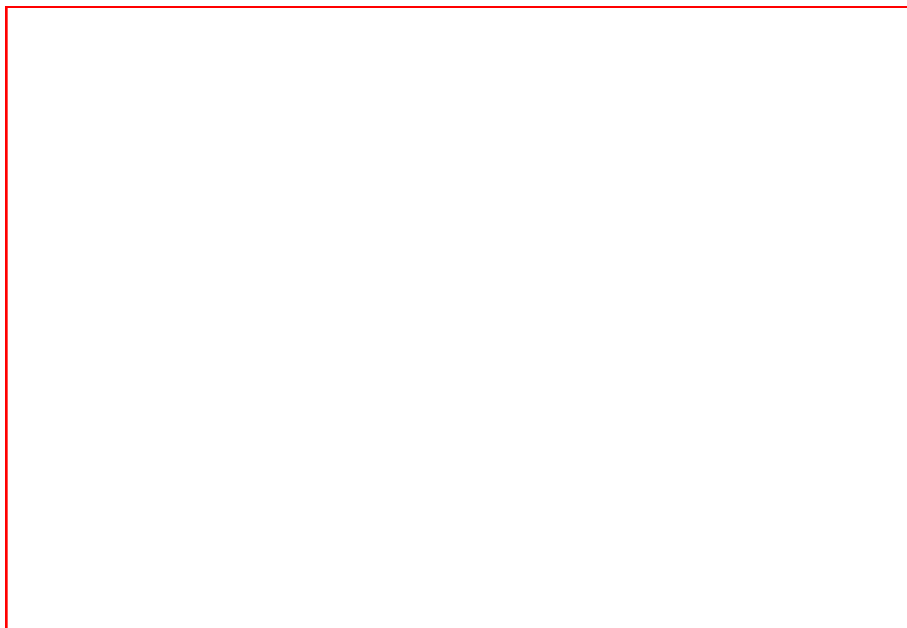
## **TOPIC: Productivity and sustainable utilization of brackish water mangrove ecosystems**

Tropical and sub-tropical mangrove forests serve as nursery grounds for fish, crab, sea shell, shrimps and other crustacea. However, urbanization, resort development, expansion of farmland, and construction of aquaculture ponds have destroyed the forests and resulted in ecological problems including pollution of surrounding waters, advanced soil erosion, and runoff of soil into the sea. The excessive utilization of brackish water area based on inadequate information about the production mechanisms of the ecosystems has resulted in the destruction of these mangrove ecosystems. It is required, therefore, to evaluate the biological productivity and carrying capacity of brackish water mangrove ecosystems with emphasis placed on the sustainable utilization of the mangrove forest. In this context, a new collaborative study, "Brackish water mangrove ecosystems" has been initiated in Malaysia where there are number of scientists interested in these problems, many well-managed research sites, and a large accumulation of knowledge.

The project is integrative and aims to evaluate the biological productivity of brackish water mangrove ecosystems in order to identify criteria for sustainable utilization of the areas from three viewpoints: aquatic production in mangrove areas, bank functioning and the prevention of soil erosion, and involvement and damaging aspects of hurricanes and cyclones. To achieve the fisheries-related objectives of this project, analyses of biological productivity, the food chain, energy flow, and carrying capacity in the brackish water mangrove ecosystems are necessitated. In addition, evaluating the effects of development in brackish water areas from a socio-economic is also considered important.

Among the various research activities of the project, collaborative studies in fisheries are being conducted with the University of Malaya and the Fisheries Research Institute. The Matang Mangrove Forest Reserve in Perak State and the Merbok Estuary in Kedah State are serving as research sites. The Matang Mangrove Forest is especially important as a location for the analysis of the role of mangrove ecosystems on fish production.

One senior researcher who specializes in larval ecology of finfish and squid, has already been dispatched to the FRI, Penang, Malaysia as a long-term residing scientist, and other researchers specializing in larval fish ecology, life history of crustacea and soil runoff have been dispatched short-term in supporting roles. Integrated studies like this project which are conducted in collaboration with research organizations belonging to several ministries and universities in Japan are still unusual and harbor many bureaucratic difficulties. Therefore, the success of this project has the possibility to stimulate the initiation of many other integrated studies encompassing a wide range of researchers representing varied fields of sciences in the future.



# OKINAWA SUBTROPICAL STATION



Main Entrance to the Okinawa Subtropical Station

The Okinawa Subtropical Station is located in Japan's southernmost city, Ishigaki (2100 Km southwest from Tokyo). The station is the only national research organization carrying out agricultural research under subtropical conditions.

Research at the Station includes: 1) introduction, acclimatization and cultivation of tropical vegetables; 2) improvement of tropical crops and development of breeding methods; 3) introduction and cultivation of new cultivars of tropical fruits; 4) improvement of methods for rapid generation advance for hybrid populations of rice and wheat; 5) viral diseases of tropical insects and plants; 6) utilization of soil microorganisms and genetic regulation of nutrition in tropical crops, and 7) international collaboration for the improvement of agricultural technology in the tropics. Under 7), researchers from developing countries are invited to undertake advanced studies at the International Collaboration Section of the Station. In 1995, ten researchers from nine countries participated in the Visiting Research Fellowship Program. In this program, emphasis is placed on studies for the optimum utilization of bio-resources for conservation of the environment and sustainable agricultural production in the tropics.

[TOPIC 1: Soil losses from pineapple fields and its control](#)

[TOPIC 2: Low input hydroponics](#)

**TOPIC 1: Soil losses from pineapple fields and its control**

[Photo: An example of rill erosion due to pineapple cultivation on Ishigaki Island, Okinawa](#) (12 KB)

For the last three decades, soil loading due to erosion in coastal marine environments has been serious in the Ryukyu Islands with coral reefs surrounding these islands being damaged by soil loading. Using LANDSAT TM data, great amounts of red soil accumulated near estuaries were detectable. Large-scale pineapple cultivation is one reason for the above soil loss. Pineapple fields receive an annual average rainfall of 2,100 mm with a slope ranging from 20 to 150 m in length and from 0 to 8 degrees in gradient. Since the growth of pineapple plant is very slow, fields are not covered for a long time, such that soil erosion in pineapple fields becomes a serious problem. Rill erosion occurs frequently along the road for agricultural practices, like spraying of chemicals and shipping of products (Fig. 1)??.

In order to alleviate erosion hazards, the effects of organic mulch, cover crops, and nontillage planting were investigated in field plots. Ground nut (*Arachis pintoi*) and weeping lovegrass (*Eragrostis curvula*) were selected as cover crops. Each of them was planted on the lower edge of a slope. The alleviation of soil losses in the plot with weeping lovegrass was 1/110 of the control plot, for 12 months after the planting of pineapple (Table 1). For investigation of the effects of nontillage planting, pigeonpea (*Cajanus cajan*) was cut down about four months after the seedling stage, and then pineapple was planted without plowing. The alleviation of soil losses in the plot of nontillage planting was 1/14 of the control plot for 8 months after the planting of pineapple (Table 2).

In conclusion, we recommend that farmers employ both cover crops and nontillage planting for the protection of soil surface. Organic mulch is less suitable because of the scarcity of labor and materials. Counter-measures for the alleviation of soil erosion should be undertaken urgently in the Ryukyu Islands.

**Table 1. Effect of cover crops on the alleviation of soil erosion in pineapple fields (1993-94)**

Plots	Cumulative soil losses (kg m ⁻² )		
	4 months	8 months	12 months
Control	0.00	1.12	7.48
Weeping lovegrass	0.01	0.02	0.07
<i>Arachis pintoi</i>	0.00	0.01	0.01
Organic much*	0.00	0.00	0.03

* Napiergrass was used.

**Table 2. Effect of nontillage planting on the alleviation of soil erosion in pineapple fields (1994-95)**

Plots	Cumulative soil losses (kg m ⁻² )		
	4 months	8 months	12 months
Control	0.82	1.01	1.80
Weeping lovegrass	0.02	0.07	0.61
<i>Arachis pintoi</i>	0.30	0.72	1.84
Organic mulch*	0.00	0.00	0.04

* Napiergrass was used.



## TOPIC 2: Low input hydroponics



Low input hydroponics system at the Subtropical Station

Areas under problem soils such as salinized, acid sulphatized, and sandy soil, are continually increasing world-wide. Hydroponics may be a suitable alternative for crop production in such regions. However, common hydroponics systems in our country are electron energy intensive, and operation of them is complicated and requiring chemical analysis of nutrition.

The JIRCAS Okinawa Subtropical Station is currently developing and testing hydroponic systems which do not require the consumption of electricity. This new hydroponics system is simple and easy to operate. The nutrient tank is positioned higher than cultural bed, such that nutrient solution flow to the bed occurs automatically via the action of gravity. Necessary amounts of nutrient solution in the canal under the bed are reserved by a floating bulb system. Supply of nutrient to upper side is achieved through capillary action by using a liquid absorbent sheet, root barrier sheet and polyvinyl alcohol material chips. In this system crops can absorb enough nutrient based on natural ability and there is no operation necessary to maintain complicated nutrient conditions. The operator only needs to prepare new nutrient solutions when the tank level decreases.

Melon, tomato, chinese cabbage, sweet potato and radish were cultured using this system at the JIRCAS Okinawa Subtropical Station. All crops grew normally. Melons required 90 days from seedling until harvest. Each melon plant totally absorbed 60 little nutrient solution. The yield was comparable with that obtained in usual ground culture.

# MISCELLANEOUS PROJECTS OUTLINE

In addition to international collaborative projects, JIRCAS conducts a variety of miscellaneous projects: domestic projects, in cooperation with other MAFF institutes; commissioned research, principally in cooperation with universities; cross-ministry/agency projects currently with the Science and Technology Agency and the Environment Agency; and special allotment projects.

## DOMESTIC PROJECTS

**Collaborative operations pertaining to the Agriculture, Forestry and Fisheries Gene Bank**(Biological Resources Division and Okinawa Subtropical Station, 1989-ongoing)

**Development of new genetic types of paddy crops for the enlargement of consumer demand**  
(Okinawa Subtropical Station and Biological Resources Division, 1989-1995)

**Comprehensive research on ordering mechanisms of agriculture, forestry and fisheries ecosystems and elucidation of optimal means of governance**  
(Animal Production and Grassland Division,1995-1998)

**Comprehensive research on the breeding of transgenic plants**  
(Biological Resources Division and Okinawa Subtropical Station,1989-1995)

**Development of methodology to forecast changes in the structure of the production and consumption of agricultural products in context of internationalization**  
(Research Information Division,1995-1997)

**The elucidation of endophyte functions to develop new forms and qualities**  
(Animal Production and Grassland Division,1996-1998)

**Comprehensive research pertaining to trade and industry and fisheries,resources,and the environment**  
(Crop Production and Postharvest Technology Division,1996-2000)

**New usages for wheat crops: The development of high-quality field crops and their utilization technology**  
(Okinawa Subtropical Station,1996-2005)

## COMMISSIONED RESEACH

**Useful plant species and evaluation of their functioning and potential usages**  
(Okinawa Subtropical Station in cooperation with Tokyo University of Agriculture,1992-1995)

**Distribution and ecology of Vigna species in tropical regions of Asia**

(Biological Resources Division in cooperation with the University of the Ryukyus,1994-1996)

**Desertification on cool,dry areas and accompanying changes in systems of agricultural dynamics**

(Environmental Resources Division in cooperation with Nihon University,1995-1977)

**Evaluation of salinity tolerance in wild species of rice and elucidation of tolerance mechanisms**

(Okinawa Subtropical Station in cooperation with the University of the Ryukyus,1996-1999)

[Click here continue to Research projects with other government agencies and ministries](#)



# **RESEARCHPROJECTS WITH OTHER GOVERNMENT AGENCIES AND MINISTRIES**

## **In cooperation with the science and Technology Agency**

**Oceanographic investigations: Fluctuations in tropical mangrove forests and evaluation of possible influences** (Forestry Division,1990-1997)

**Global research network: set-up of data-base for changes in desertification**  
(Environmental Resources Division,1994-1996)

**Evaluation of environmental adaptation of tropical fruit tree based on photosynthetic and photochemical activity** (Okinawa Subtropical Station,1995)

**Research on slope stability via groundwater monitoring and the development of methods for quantitative analysis**  
(Crop Production and Postharvest Technology Division,1995)

**Studies on molecular lineage in tropical species of Asian phytoplasmas**  
(Biological Resources Division,1995)

## **In cooperation with the Environmental Agency**

**Ecology and environments of tropical mangrove forests: structural analysis**  
(Forestry Division.1990-1994)

**Tropical tree species and facets of environmental adaptation**  
(Forestry Division,1990-1994)

**Generation of alluvial efflux, elucidation of mechanisms of occurrence,and development of prevention on the Nansei Islands of Okinawa**  
(Okinawa Subtropical Station,1991-1995)

Construction of an analytical model for climactic warming in the Asia-Pacific region (Research Information Division,1991-1996)

Research for the development of technology to inhibit the production and emission of methane and nitrous oxide from agricultural fields  
(Environmental Resources Division,1995-1997)

## **MAFF SPECIAL RESEARCH ALLOTMENTS**

**Stabilization of rice culture under water stress in the tropics utilizing a broader spectrum of genetic resources**

(JIRCAS in cooperation with the International Rice Research Institute (IRRI),1994-1999)

**Sustainable cultivation of upland crops in the semi-arid tropics**

(JIRCAS in cooperation with International Crops Research Insitute for the Semi-Arid Tropics (ICRISAT),1994-1999)

# INVITATION PROGRAMS AT JIRCAS

As part of JIRCAS's role as an international research center, we are implementing several systems for the invitation of foreign researchers and counterpart administrators. These programs serve to facilitate the exchange of information and opinion concerning agriculture, forestry and fisheries administration and to strengthen international research ties with those in other countries. Below is a description of our current programs.

## Administrative Invitation

Under this program, administrators in JIRCAS's counterpart organization are invited to the premises for purposes of holding discussion and conducting review of on-going research projects in order to ensure smooth running of collaborative projects.

Administrators are additionally introduced to related MAFF research organs. Finally, the program provides the opportunity for the exchange of information and opinion on the administrative level concerning policy-making, project design, etc., thereby contributing to a deeper mutual in the realm of international cooperation. Thirty-eight persons visited JIRCAS in FY 1995, including 12 international symposium invitees. Invited administrators are summarized below:

## Counterpart Researcher Invitation

This program provides for the invitation of a period for up to 6 months of a counterpart researcher engaged in collaborative work with a member of the JIRCAS research staff. The counterpart carries out in-depth research at JIRCAS or other MAFF research institute, or at a national university. The purpose of the program is to strengthen research activity being carried out abroad and to provide opportunity for exchange on the researcher to researcher level. Fifteen researchers were invited in FY 1995. Invited researchers and their activities are summarized below:

# JIRCAS Visiting Research Fellowship Program at Okinawa



Screening and evaluation of salt-tolerant rice strains at the Subtropical Station

This program was initiated in FY 1992 before TARC was reorganized into JIRCAS. Post-doctoral level scientists are invited to conduct research for a period of one year at the Okinawa Subtropical Station. Research focuses on topics of importance relating to tropical agriculture in respective developing countries. Research themes are divided into several major categories: 1) Development of techniques for environmental control by using plants and microorganisms specific to the tropics and subtropics; 2) Studies on mechanisms of heat-tolerance of tropical and subtropical crops; 3) Identification and evaluation of salt-tolerant crops; and 4) Evaluation and development of long-term conservation techniques of genetic resources of vegetatively propagated crops in the tropics and subtropics. Ten fellows are generally chosen every year and begin their term on October 1 ending September 30 of the following year. Recent activity is summarized below. More information on the Okinawa Fellowship Program can be obtained by contacting the [International Relation Section, Japan International Research Center for Agricultural Sciences, 1-2, Ohawasi, Tsukuba, Ibaraki, 305, Japan. (Tel: 81-298-38-6335 / Fax: 81-2987-38-6337 Telex: 3652456 JIRCAS J)]

## from October 1994 to September 1995

### Development of techniques for environmental control by using plants and microorganisms specific to the tropics and subtropics

Bayani-Espiritu	University of the Philippines	Enumeration of population, characterization, estimation of activity, and detection of methane-oxidizing bacteria in paddy soils
Lukman Gunart	Central Research Institute for Food Crops Indonesia	Study on <i>Azospirillum</i> inoculation and application to application of rice straw and methane emission under lowland conditions in subtropical paddy soil
Mbangu Olive Musoko	International Institute of Tropical Agriculture (IITA) Cameroon	Effectiveness of different populations of indigenous VAM fungi from acid and alkaline soil
Nampiah Sukano	Bogor Agricultural University Indonesia	Development and symbiotic function of indigenous VA mycorrhizal fungi in acid soil

### Studies on the mechanism of heat-tolerance of tropical and subtropical crops

Ancha Srinivasan	JIRCAS India	Mechanisms of heat tolerance during reproductive growth of chickpea and pigeonpea
Hassan Mohamed Rashad	Cairo University	Physiological studies on the mechanism of tolerance in some cabbage varieties

### Identification and evaluation of salt tolerance crops

Abdul Baset	Bangladesh Rice Research Institute (BRRI)	In vitro culture and screening some wild and cultivated rices for salt tolerance
-------------	-------------------------------------------	----------------------------------------------------------------------------------

Ningsheng Xu	Yunnan Academy Agricultural Sciences China	The physiological responses of some rice varieties from yunnan to salt stress
<b>Evaluation and development of long-term conservation techniques of genetic resources of vegetatively propagated crops in the tropics and subtropics</b>		
Nguyen Tien Thinh	Nucleat Research Institute Vietnam	Study on cryopreservation of tuber crop plants (taro and sweet potato)
Tie Gang Lu	Institute of Botany Academia Sinica China	Long term conservation and evaluation of yams
<b>from October 1995 to September 1996</b>		
<b>Development of techniques for environmental control by using plants and microorganisms specific to the tropics and subtropics</b>		
Lukman Gunart	Central Research Institute for Food Crops Indonesia	Mutagenesis of <i>Azospirillum</i> on exopolysaccharide production and IAA excretion and its effect on the growth of lowland rice
Dianou Deyeri	Institute d'Etudes et de Research Agricoles Burkina Faso	Isolation and characterization of methanotrophic and methanogenic bacterias from a subtropical paddy field
<b>Studies on the mechanism of heat-tolerance of tropical and subtropical crops</b>		
Lin Baiqing	Institute of Vegetables & Flowers China	The roles of hydroxyproline-rich glycoproteins (HRGPs, extensin) in susceptible and resistant genotypes of <i>Brassica pekinensis</i> Rupr. response to heat treatments
Harvinder Singh Talwar	ICRISAT India	Studies on physiological basis of heat tolerance in groundnut ( <i>Arachis hypogaea</i> L)
Padmanaban Annamalai	University of Madras India	Development of OCR based marker for heat tolerance and cloning of its related genes in <i>Brassica oleracea</i> var. capitata L.
<b>Identification and evaluation of salt tolerance crops</b>		
Lin Hongxuan	China National Rice Research Institute China	Genetic characterization of salinity tolerance in rice and its wild relatives, and introduction of salinity tolerance into rice germplasm mainly through biotechnological procedures
Armenia Mendoza	University of the Philippines The Philippines	Physiological and biochemical mechanisms of genotype variability in response to salt stress in rice callus and somatic hybrids
Somesong Chotechouen	Chinat Field Crops Research Center Thailand	Physiological responses of rice seedlings after solinization, and in vitro selection of EMS-treated cell suspension cultures of rice of salt tolerance
<b>Evaluation and development of long-term conservation techniques of genetic resources of vegetatively propagated crops in the tropics and subtropics</b>		
Nguyen Tien Thinh	Nuclear Research Institute Vietnam	Development of techniques for in vitro conservation of tropical root crops
Pius Michael Kyesmu	University of Jos Nigeria	Cryopreservation of the west African tuber crop "Rizga" ( <i>Plectranthus esculentus</i> N. E.Br.)

[Click here to continue JIRCAS Visiting Research Fellowship Program at Tsukuba](#)

# JIRCAS Visiting Research Fellowship Program at Tsukuba



Selection of experimental prawns for research on crustacean pathology and endocrinology at the Fisheries Division

A program similar to the Okinawa Visiting Research Fellowship Program has recently been implemented on the Tsukuba premises from October, 1995 (see Highlights 1995). The fellowship aims at the promotion of collaborative research to address various problems confronting countries in the developing regions. The program allows for the invitation of a total of 6 researchers per year. Four persons are engaged in 2-year projects at JIRCAS and 2 scientists carry out short-term (5-month) projects at the National Institute of Agrobiological Resources (NIAR). More information on the Tsukuba Fellowship Program can be obtained by contacting the [International Relation Section, Japan International Research Center for Agricultural Sciences, 1-2, Owashi, Tsukuba, Ibaraki, 305, Japan. (Tel: 81-298-6335 / Fax: 81-298-38-6337 / Telex: 3652456 JIRCAS J)]

## Long-term at JIRCAS from October 1995 to September 1997

### Methods for optimum utilization of biological resources

Lin Qiang	Guangxi Agricultural University, China	Analysis of plant responses to environmental stresses and gene expression
Zhu Weiming	Jiangsu Academy of Agricultural Sciences, Institute of Genetics, China	Development of a DNA based assay for indexing plant diseases
Muharijadi Atomomarsono	Research Institute of Coastal Fisheries, Indonesia	Development of methods for the diagnosis and prevention of diseases affecting aquatic animals for fresh water and marine aquaculture
Chang Qing	Xinjiang Institute of Biology, Pedology, and Desert Research, China	Investigations of the process of rock weathering through the analysis of rock surfaces by electron spectroscopy

## Short-term at NIAR from October 1995 to March 1996

### Production of new biological resources through the application of biotechnological procedures

Pallavolu Maheswaran Reddy	Soil Microbiology-ISWD International Rice Research Institute The Philippines
Ahmed Abou-Salha	Agricultural Genetic-Engineering Research Institute Egypt

## Other fellowships for visiting scientists

The Government of Japan sponsors a postdoctoral fellowship program for both Japanese and foreign scientists through the Science and Technology (STA). The program places post-doctoral fellows in national research institutes throughout Japan according to research theme and prior arrangement with a host scientist for a term of generally 1-3 years. Fellowships can be undertaken in any of the ministries and many fellows are currently working at the ministries and many fellows are currently working at the various institutes of MAFF. At JIRCAS, there are no Japanese fellows at present, but the following four visiting scientists are presently residing at JIRCAS: Dr. O.A. Welker (Germany), Biological Resources Division; Dr. B.A. Yakubov (Republic of Uzbekistan), Biological Resources Division; Dr. Chien Hsiaoping (People's Republic of China), Research Information Division; and Dr. Mingyuan Du (People's Republic of China), Environmental Resources Division.





# SIMPOSIA AND WORKSHOPS

## 1) INTERNATIONAL SYMPOSIA

Since 1967, TARC has sponsored an international symposium every year for purpose of promoting scientific exchange and accurately gauging and responding to the agriculture, forestry and fisheries needs of the world's developing areas. A theme of central importance is chosen and around ten researchers and administrators from concerned research institutes and international agencies are invited as speakers. The symposia are of ordinarily held in joint sponsor ship with a relevant scientific society. JIRCAS will continue to sponsor these symposia and held its first symposium in FY 1994 since its establishment from TARC into JIRCAS. The programs from FY 1995 is shown below:

### **INNOVATIVE WEED MANAGEMENT STRATEGY FOR SUSTAINABLE AGRICULTURE**

(Held July 24-28 in Tsukuba, Japan in conjunction with the Asian-Pacific Weed Science Society, the Weed Science of Japan Association for Advancement of Phyto-Regulators)

#### *Session I : Present Status of Weed Problems in Sustainable Agriculture*

##### **Opening Address**

Inaugural address by Keiji Kainuma, Director General, Japan International Research Center for Agricultural Sciences (JIRCAS)(Japan)

Welcome address by Toru Sato, Director General, Secretariat of the Agriculture, Forestry and Fisheries Research Council (Japan)

##### **Welcome Address**

Eitaro Miwa, Deputy Director General, Secretariat of Agriculture, Forestry and Fisheries Research Council (Japan)

##### **Technical Reports**

Noxious weeds in Asian tropics and their control. U. Suwunnamek, Department of Agronomy, Kasetsart University (Thailand )

The succession of noxious weeds in tropical Asian rice fields with emphasis on Malaysian rice ecosystems. M. Azmi and B. Baki, MARDI Rice Research Center (Malaysia)

Weedy rice problems in Southeast Asia and control strategy. H. Watanabe, JIRCAS (Japan)

Implementation of integrated weed management for sustainable rice Production. P. Vongsaoj, Botany and Weed Science Division, Department of Agriculture (Thailand)

Sustainability in rice weed management. Keith Moody, International Rice Research Institute (IRRI) (The Philippines)

The contribution of no-tillage crop production to sustainable agriculture. A. D. Worsham and G. G. Ngabhushana, Department of Crop Science, North Carolina State University (USA)

Weed management in rubber plantations with special reference to minimum tillage cultivation. S. Tjitrosemito, SEAMEO BIOTROP (Indonesia)

### **Closing Address**

Jiro Harada, Vice President, Asian-Pacific Weed Science Society (APWSS)

### ***Session II: Innovative Trends of Herbicide Use for Sustainable Agriculture***

### **Opening Address**

H. Hamaguchi, Elf ATO Chem. (Japan)

### **Technical Reports**

Current status of rice herbicide use in the tropics. N. K. MUDA Agricultural Development Authority (Malaysia)

Long term concepts of herbicide use in paddy fields in Korea. J. O. Guh, College of Agriculture, Chonnam National University (Korea)

Technical innovation in herbicide use. M. Kamo and K. Noritake, Research Institute of the Japan Association for the Advancement of Phyto-regulators (Japan)

Effectiveness and behaviors of soil-applied herbicides. Y. W. Kwon, Department of Agronomy, Seoul National University (Korea)

Allelopathic compounds as naturally occurring herbicides. C. H. Chou, Institute of Botany, Academia Sinica (Taiwan)

Herbicide safeners: Recent advances and biochemical aspects of their mode of action. K. Kreuz, S. Farago, S. Murakami and H. C. Steinruecken, Ciba Crop Protection, R&D Weed Control (Switzerland and Japan)

Current status of herbicide-resistant weeds and their management strategies. J. C. Cotterman, Dupont Agricultural Products (USA)

Current and future herbicide risk assessment in Europe and United States. W. L. Chen, Global regulatory, Toxicology and Environmental Chemistry, DowElanco (USA).

[Click here to continue \[Symposia And Workshops \(2\) Special Programs\]](#)

## 2) SPECEAL PROGRAMS



Group photo of participants in the "methance" international workshop

### **INTERNATIONAL WORKSHOP ON PADDY FIELDS: SUSTAINABLE AGRICULTURE AND CONTROL OF GREENHOUSE GAS EMISSIONS**

This international workshop was sponsored by the Office of Environment Policy Coordination (OEPC), JIRCAS, MAFF and the Mitsubishi Research Institute, Inc. and -was held at the Tsukuba Science City on March 7-8, 1996. The workshop reviewed the current status and future prospects for the role of rice cultivation in the promotion of sustainable agriculture and conservation of agro-ecosystems, and examined the current situation regarding the control of greenhouse gas emission from rice fields. The subject matter relating to greenhouse gas emission was highly evaluated by related researchers. The main objective of the workshop was to discuss how rice paddy fields serve in the promotion of sustainable agriculture and how measures can be undertaken for the mitigation of methane and nitrous oxide emissions from rice paddy fields. The workshop consisted of five introductory reports and overviews, eight country reports and twelve case study, reports. At the opening of the OEPC and Dr. K.Kainuma, Director General of JIRCAS, gave welcoming addresses.

#### **Introductory and overview reports**

The role of rice paddy fields in the promotion of sustainable agriculture and conservation of agro-ecosystems. K. Minami, JIRCAS (Japan)

Sustainable agriculture and the conservation of agro-ecosystems in Korea. W.G. Bae, Sustainable Agriculture Division, Ministry of Agriculture, Forestry and Fisheries (Korea)

Nitrous oxide emission from rice fields. J. R. Freney, CSIRO Division of Plant Industry (Australia)

A regional analysis of human alteration of nitrogen cycling: The role of agriculture. R. Howarth, Ecology and Systematics, Cornell University (USA)

Agricultural impact on soil consumption of atmospheric methane. A. R. Mosier, United States Department of Agriculture (USDA/ARS) (USA)

## **Country reports**

An option for reducing methane emission from rice fields in China. Z.Cai, Institute of Soil Science, Chinese Academy of Sciences (China)

Methane emission from rice fields in India. N. Sethunathan, Central Rice Research Institute, (India)

Classification of Philippines rice soils according to methane production potential. R. Wassmann, International Rice Research Institute(IRRI)(The Philippines)

Preliminary inventory of methane from flooded paddy field in Malaysia. M.Y. Yusoff, University Pertanian Malaysia (UPM-SERDANG)(Malaysia)

Research on methane emission from rice fields in Thailand. P. Chairoj, Department of Agriculture (Thailand)

Relationships between ambient methane concentration and flux from rice fields as affected by microclimate conditions. Y. A. Husin, Department of Forest Resources Conservation, Bogor Agricultural University (Indonesia)

Measurement of methane emission and mitigation options in Korean rice fields. Y. S. Lee, National Agricultural Science and Technology Institute (Korea)

Possible over estimation occurring in extrapolating methane emission rates from rice paddy fields. K. Yagi, National Institute of Agro-Environmental Sciences (Japan)

The twelve case study reports presented in the second session were concerned with methane and nitrous oxide emission and sink in rice paddy fields. In addition, a data book for sustainable agriculture in paddy fields was distributed to the participants with the following contents: environmental externalities of paddy field framing, sustainable agriculture and conservation of the agro-environment in Japan, and climate change and paddy field farming.

[Click here continue to JIRCAS International Seminar:](#)

# JIRCAS INTERNATIONAL SEMINAR: RESEARCH CAPACITY OF NEWLYSTRUCTURED ICIPE AND RELATED RESEARCH INVESTIGATIONS

In order to resolve many of the serious problems concerning food, supply, hunger and poverty alleviation that face north African countries, it is urgent to develop a means for elimination of the desert locust which causes severe damage to agricultural produce. Dr. Hans Herren, Director General of the International Centre of Insect Physiology and Ecology (ICIPE), other ICIPE staff, and related domestic researchers were invited JIRCAS to give lectures in a special international seminar on March 13, 1996.

- Greetings, K. Kainuma, JIRCAS Director General (Japan)
- The new ICIPE and its place in research and capacity: Building for sustainable development. Hans R. Herren, ICIPE Director General (Kenya)
- Roles of kairomones in host location behaviour of parasitic wasps. S. Takahashi, Kyoto University (Japan)
- Some aspects of the arthropod chemical ecology research at ICIPE. A . Hassanali, ICIPE Deputy Director General (Kenya)
- Role of pubescence in resistance of cassava to the cassava green mite, *Mononychellus tanajoa*. H. Kanno, Tohoku NAES (Japan)
- Testis development and imaginal diapause in lepidopteran insects. S. Hiroyoshi, Okinawa Prefectural Agricultural Experimental Station (Japan)
- Hormonal control of development and behavior in the desert locust associated with phase variation. S. Yagi, JIRCAS (Japan)

## SEMINAR ON SUSTAINABLE UTILIZATION OF COASTAL ECOSYSTEMS FOR AGRICULTURE, FORESTRY AND FISHERIES IN DEVELOPING REGIONS

Population increase and growth of the economy accelerate the development of coastal areas in tropical and sub-tropical areas; mangrove forests found along the sea coast can be particularly vulnerable. Urbanization, resort development, expansion of farmland, and aquaculture operations have in recent years contributed considerably to the destruction of mangroves, and have resulted in serious worldwide problems involving increased water pollution, soil erosion, soil run-off, and red tide occurrence. Thus, the excessive utilization of brackish water areas, based on inadequate information concerning mechanisms of renewal within these ecosystems, has brought about their destruction. JIRCAS's comprehensive research project, *Productivity and sustainable utilization of tropical and subtropical brackish water mangrove ecosystems* aims to clarify mechanisms of biological productivity in brackish

water ecosystems, with emphasis placed on sustainable utilization of these areas.

In order to review knowledge accumulated thus far on mangrove ecosystems, discuss the status of methodology for monitoring the ecosystems, and formulate overall project direction, this joint seminar was held in Malaysia with counterpart research organs, the University of Malaya (UM), the Fisheries Research Institute (FRI), and the Forestry Research of Malaysia (FRIM). The main seminar was held on December 12, 1995 at the Hotel Equatorial International in Kuala Lumpur, with a satellite symposium being held at the FRI in Penang. The program of speakers is shown below.

### *Main seminar*

## **Meiofauna and macrobenthos**

- Evaluation of the relationship between decomposed logging residues and biomass in logged-over mangroves at Matang, Peninsulare Malaysia. Shamusudin Ibarahim, FRI (Malaysia)
- Macrobenthos in mangrov shores. A. Sasekumar, UM (Malaysia).

## **Prawns and fish**

- The prawn-mangrove connection - facet or fallacy? Chong Ving-Ching, UM (Malaysia)
- Differences in the structure of fish assemblages in Matang and Merbok mangroves in the west coast of Peninsular Malaysia and their ecological significance. Ahamd Husin bin Alias, FRI (Malaysia)

## **Runoff of soil into brackish waters**

- Soil losses from pineapple fields in Ishigaki Island. K. Sugahara, JIRCAS (Japan)
- Effects of soil discharge on coastal marine environment. K. Tanaka, JIRCAS (Japan)

## **Food-chain, aquaculture and socio-economic aspects in mangrove areas**

- Analytical method for the food-chain in aquatic ecosystems. S. Hayase, JIRCAS (Japan)
- Development of aquaculture in mangrove habitats. Choo Poh Sze, FRI (Malaysia)
- Some socio-economic aspects of local communities near mangrove forest areas, Lim Hin Fui, FRIM (Malaysia)

### **Satellite Symposium**

- Opening address by Ibrahim bin Saleh, FRI (Malaysia)
- Current situation of Malaysia fisheries and research works. Chee Phail Ean, FRI (Malaysia)

Current situation of Japanese fisheries and research works, S. Kawahara, JIRCAS (Japan)

Current situation of Japanese mariculture and research works. K. Fukusho, JIRCAS (Japan)

- Closing address by K. Fukusho, JIRCAS (Japan)

[Click here continue to \[Symposia and workshops \(3\) JIRCAS Workshop Series:\]](#)



### 3) JIRCAS WORKSHOP SERIES: FACETS OF INTERNATIONAL AGRICULTURAL RESEARCH

In addition to the annual international symposia, JIRCAS additionally sponsors research workshops focusing on specific themes several times per year. Workshops are hosted by the relevant JIRCAS research divisions and are attended by JIRCAS staff, speakers invited from various government research institutes, private companies and universities. The following have been held at JIRCAS in the period covered by this annual report.

1) Jan. 26,1996	Current problems relating to livestock disease in Africa and prospects for future research collaboration <i>(Animal Production and Grasslands Division)</i>
2) Feb. 23,1996	Development in Asian villages: Current problems and concerns <i>(Research Information Division)</i>
3) Mar. 22.1996	Development of sustainable agriculture in Northeast Thailand: Current topics <i>(Biological Resources Division)</i>

[Click here continue to \[Symposia And Workshops \(4\) International Research Seminars\]](#)

## 4) INTERNATIONAL RESEARCH SEMINARS

International research seminars are held throughout the year informally, with 1 to 3 Japanese or foreign guests, or JIRCAS staff giving a presentation on some topic of interest to international agricultural research. Six seminars were held in FY 1995 as follows:

May. 8, 1995	Genetic resources in the <i>Vigna</i> genus <i>N. Egawa, JIRCAS (Japan)</i> <i>N. Tomooka, NAIR(Japan)</i> <i>Y. Takaishi, The University of the Ryukyus (Japan)</i>
Sep. 14, 1995	Applications of genetic engineering and molecular markers in potato breeding <i>K. Watanabe, CIP (Peru)</i>
Nov. 8, 1995	Research activity at WARDA (West Africa Rice Development Association) <i>R. Ishii, The University of Tokyo (Japan)</i>
Nov. 13, 1995	Applications of systems dynamics in agricultural research <i>M. Tsuiki, National Agriculture Research Center (NARC)(Japan)</i> <i>T. Monma, Tohoku National Agricultural Experiment Station (Japan)</i>
Nov. 15, 1995	Pest control in cotton fields in China <i>Y. Guo, Institute of Plant Protection (People's Republic of China)</i>
Nov. 30, 1995	Overview of world food demand <i>A. Womack, International Food Policy Research Institute (USA)</i> <i>G. Shuler, International Food Policy Research Institute (USA)</i>

## 5) ANNUAL MEETING FOR REVIEW AND PROMOTION OF RESEARCH

The 1995 Annual Meeting for Review and Promotion of Research for International Collaboration is held usually in February on JIRCAS premises, approaching the end of the fiscal year. The purpose of the meeting is to review and evaluate the year's activities in detail in preparation for the subsequent fiscal year period. All of JIRCAS's operations are outlined, and research achievements deemed of particular importance are highlighted (see Research Overview; Research Division). The meeting is held in the attendance of JIRCAS directors and invited representatives from the Agriculture, Forestry and Fisheries Research Council (AFFRC), the Forestry Agency, the Fisheries Agency, and various MAFF institutes. In this year's Meeting, emphasis was placed on environmental studies and the importance of furthering research activity aimed at the development of sustainable agriculture. In particular, discussion focused on how to further promote collaborative activities with the People's Republic of China as part of JIRCAS's overall research strategy until the year 2003.

## 6) JIRCAS RETURN SEMINARS

At JIRCAS, researchers returning abroad from overseas dispatches or research projects give an oral presentation accompanied by the preparation of a written summary of activities and report of research results to JIRCAS staff. These sessions termed "JIRCAS Return Seminars" and are given during the interim or upon the completion of research projects and dispatches. Such seminars are ordinarily held twice per month: in one year, approximately 50 scientists give presentations.

**PUBLISHING AT JIRCAS****OFFICIAL JIRCAS PUBLICATIONS**

<b>In English</b>	
1) JIRCAS Journal for Scientific Papers	No.2
2)JARQ (Japan Agricultural Research Quarterly)	Vol.29 No.2, No.3 No.4 Vol.30 No.1
3) Annual Report	1994
4) JIRCAS Newsletter	No. 4, No.5, No.6
5) JIRCAS Working Report	No.1 IFPSIM: International Food and Agricultural Policy Simulation Model(Use's Guide) No.2 Mungbean Germplasm: Collection, Evaluation and Utilization for Breeding Program
<b>In Japanese</b>	
1)JIRCAS News	No.4(Vol.3 No.1), No.5, No.6

2)JIRCAS Workshop Papers	No.4 Aquaculture: The status and outlook of international cooperative research
3)JIRCAS Research Documents	Report on the situation of animal husbandry, agriculture, and research activities in Mongolia and Inner Mongolia of the People's Republic of China
4)JIRCAS Research Highlights	No.2

### LIBRARY HOLDINGS (April 1, 1995 - March 31, 1996)

Language	Books			Periodicals (titles)			Materials (Proceedings, maps and other)		
	Purchase	Gift	Total	Purchase	Gift	Total	Purchase	Gift	Total
Japanese	45 (2)	45 (5)	90 (7)	87 (29)	507 (77)	594 (106)	10	552	562
Foreign	266 (4)	72 (3)	338 (7)	168 (30)	297 (40)	465 (70)	10	510	520
<b>Total</b>	311 (6)	117 (8)	428 (14)	255 (59)	804 (117)	1059 (176)	20	1062	1082

( )Indicates separate holdings of the Okinawa Subtropical Station

# RESEARCH STAFF ACTIVITY 1995-1996

## Journal articles, book chapters, and monographs

Arai, S., Hatta, T., Hayamizu, K., Kigoshi, K. and Ito, O. (1996). Characterization of the organic components of an Alfisol and a Vertisol in adjacent locations in Indian semi-arid tropics using optical spectroscopy,  $^{13}\text{C}$  NMR spectroscopy, and  $^{14}\text{C}$  dating. *Geoderma*, 69(1): 59-70.

Cai Zucong, Xu Hua, Yan Xiaoyuan, Tsuruta, H., Yagi, K. and Minami, K. (1995). Effect of nitrogen form on  $\text{CH}_4$  emission from rice paddy fields. *Acta Pedologica Sinica*, 32: 136-143.

Cai Zucong, Yan Xiaoyuan, Tsuruta, H., Yagi, K. and Minami, K. (1995). Special variation of methane emission from rice paddy fields in hilly areas. *Acta Pedologica Sinica*, 32: 151-159.

Du, M., Yoshino, M., Fujita, Y., Arizono, S., Maki, T. and Lei, J. (1996). Climate change and agricultural activities in the Taklimakan Desert, China in recent years. *Journal of Arid Land Studies*, 5(2): 173-183.

Fischer, A. and Okada, K. (1996). The characteristics of upland rice adapted to acid soil in South American Savanna. *Japanese Journal of Crop Science*, 65(1): 34-35. (J)

Fujisaki, K. (1995). Chicken leucocytozoonosis. In: *Veterinary infections diseases*, 4th edition. Eds, Shimizu, Y. et al., Kindai Shuppan pp. 309-310. (J)

Fujisaki, K. (1995). Parasitic arthropods. In: *Clinical parasite atlas of domestic animals*. Chikusan Syuppan, pp. 100-152. (J)

Fujisaki, K. (1995). Ticks, encepholitozoon. In: *New veterinary clinical parasitology - pet animals*. Buneido, pp. 152-153, 181-182. (J)

Fujisaki, K. (1995). Chewing lice, biting lice, ticks, northern fowl mites and red mites. In: *New veterinary clinical parasitology - domestic animals*. Buneido, pp. 197-209, 425-432. (J)

Fujisaki, K. (1995). Ectoparasitosis. In: *Color manual of chicken diseases*. Japanese Society of Avian Diseases, pp. 106-113. (J)

Fujita, H. (1996). Collaborative research in resources management with the International Center for Agricultural Research in the Dry Areas (ICARDA) - What's left behind. *International Agriculture and Cooperation Newsletter*, 18(4): 29-37. (J)

Fukuhara, T., Jun-Yong Pak, Ohwaki, Y., Tsujimura H. and Nitta, T. (1995). Tissue-specific expression of the gene for a dutative plasma membrane  $\text{H}^+$ -ATPase in a seagrass. *Plant Physiology*, 110(1): 35-42

Gayatri Devi, Ito, O., Matsunaga, R., Tobita, S., Rao, T.P., Vidyalakshmi, N. and Lee, K.K.

(1996). Simulating root system development of short-duration pigeonpea. *Experimental Agriculture*, 32: 343-350.

Goto, J. (1995). Income diversification in the farm household. *Niche Markets and Rural Development* (OECD), pp. 111-135.

Goto, J. (1995). The present conditions of predominantly rural and mountainous areas and the efforts of rural revitalization: Case study of Asuke-cho, Aichi Prefecture. *Journal of Rural Issues*, 41: 24-35. (J)

Hagino, Y., Kitamura, Y. and Murashima, K. (1995). The Asian drainage study. *Grid* (IPTRID Network Magazine), Issue 7: 8-9.

Hasan, S.M.Z. and Takagi, H. (1995). Alginate-coated nodal segments of yam (*Dioscorea* spp.) for germplasm exchange and distribution. *Plant Genetic Resources Newsletter*, 103: 32-35.

Hatta, T. and Nemoto, S. (1996). ESCA(XPS) - Basis on the analysis of geochemical samples: Analytical methods of soil forming components IV. *Hakuyusha*: 109-132. (J)

Hatta, T. and Saito, N. (1996). Analysis on the processes of alteration and formation of minerals by X-ray photoelectron spectroscopy. *Chikyu Monthly -Geochemical Spectroscopy*, 202: 236-240. (J)

Hayakawa, H. (1995). Seasonal appearance of dung beetles in the pasture on the outskirts of Morioka city in Iwate Prefecture. *Annual Report of the Society of Plant Protection of North Japan*, 46: 180-182. (J)

Hayakawa, H. (1995). Technology for control of insect pests (flies and others). *Encyclopedia for Countermeasures in the Animal Industry Environment*, pp. 41-46, 519-524. (J)

Hayakawa, H. (1995). Muscid flies, tabanid flies, and sanitation of dairy barns. *Zenraku-Shinpo*, pp. 1459. (J)

Hayakawa, H., Ikudome, S. and Yamashita, N. (1996). Release and establishment of introduced dung beetle *Onthophagus gazella* in the area of Okinawa Prefecture. *Bulletin of the Institute of Minami-Kyushu Regional Science, Kagoshima Women's Junior College*, 12: 1-7.

Hayakawa, H. and Kikuchi, T. (1995). Survey of tabanid flies infesting cattle in grazing forest at Nishine-Machi in Iwate Prefecture. *Annual Report of the Society of Plant Protection of North Japan*, 46: 183-184. (J)

Hayakawa, H. and Tanaka, K. (1995). Capturing tabanid flies at Yoshinotani-mura in Ishikawa Prefecture using a modified tabanid fly trap (dry type) developed by the Tohoku National Agriculture Experimental Station. *Annual Report of the Society of Plant Protection of North Japan*, 46: 185-186. (J)

Hidaka, T., Moriguchi, T., Motomura, T., Katagi, S. and Omura, M. (1995). Development of a new electrode chamber and its efficiency in protoplast fusion in *Citrus*. *Breeding Science*,

45(2): 237-239. (J)

Horino, T. and Okamoto, M. (1996). Measurement of Mg/K.N values. Rice Breeding Manual, pp. 79-88. (J)

Hossain, M. M., Takeda, H. and Senboku, T. (1995). Improved method of determination of membrane thermostability for screening heat-tolerant and sensitive varieties in *Brassica*. JIRCAS Journal, 2(1): 19-27.

Hossain, M.M., Takeda, H. and Senboku, T. (1995). Proline content in *Brassica* under high temperature stress. JIRCAS Journal, 2(1): 87-93.

Imaizumi, M. (1996). Geochemical evolution of shallow groundwater on a tertiary mudstone landslide slope in Itakura, Niigata Prefecture. Journal of the Japan Society of Engineering Geology, 37(1): 2-18. (J)

maizumi, M. (1996). A determination method for landslide slip surface locations in tertiary mudstone areas based on neutron moisture well logging. Journal of the Japan Landslide Society, 32(4): 9-18. (J)

Imaizumi, M., Okuyama, T. and Bizen, N. (1995). The relationship between hydrogeologic structure and groundwater vein-streams in the tertiary mudstone landslide slope in Niigata Prefecture. Journal of the Japanese Society of Engineering Geology, 36(4): 2-16. (J)

Imaizumi, M., Okuyama, T., Komae, T. and Hamada, H. (1995). Study on the fault system within the Bandai-san explosion caldera of the Year 1888 using the VLF-EM method and radioactivity prospecting. Journal of the Japan Society of Engineering Geology, 36(5): 2-18. (J)

Inagaki, M. and Mujeeb-Kazi, A. (1995). Comparison of polyhaploid production frequencies in crosses of hexaploid wheat with maize, pearl millet and sorghum. Breeding Science, 45(1): 157-161.

Iwasaki, T., Yamaguchi-Shinozaki, K. and Shinozaki, K. (1995). Identification of a cis-regulatory region of a gene in *Arabidopsis thaliana* whose induction by dehydration is mediated by abscisic acid and requires protein synthesis. Molecular & General Genetics, 147: 391-398.

Kaku, H., Hirayae, K., Ochiai, H., Kanematsu, S., Noda, T., Tsuchiya, K. and Hibi, T. (1996). Comparative RFLP profiles among representative strains of Japanese races of *Xanthomonas oryzae* pv. *Oryzae* using the repetitive DNA probe pJEL101. Annals of the Phytopathological Society of Japan, 62(1): 53-56.

Kaku, H., Ochiai, H. and Noda, T. (1995). Severe occurrence of bacterial leaf blight of rice caused by *Xanthomonas campestris* pv. *oryzae* with abnormal weather conditions. Plant Protection, 49(4): 27-29. (J)

Katayama, K., Ito, O., Matsunaga, R., Adu-Gyamfi, J.J., Rao, T.P. and Anders, M.M. (1995). Nitrogen balance and root behavior in four pigeonpea based intercropping systems. Fertilizer Research, 42: 315-319.



- Kawazu, S., Kamio, T., Sekizaki, T. and Fujisaki, K. (1995). *Theileria sergenti* and *T. buffeli*: Polymerase chain reaction-based marker system for differentiating the parasite species from infected cattle blood and infected tick salivary gland. *Experimental Parasitology*, 81(5): 430-435.
- Kawazu, S., Miyahara, T., Kamio, T. and Fujisaki, K. (1995). Immunization with synthetic peptide reduced the severe consequences of *Theileria sergenti* infection in cattle. *Bulletin de la Societe Franco-Japonaise des Sciences Veterinaires*, 6(2): 135-140.
- Kitamura, Y. (1995). Rice double cropping and field infrastructure in the Muda Irrigation Scheme, Peninsular Malaysia. In: *Paddy Fields in the World*. Eds. Tabuchi, T. and Hasegawa, S. The Japanese Society of Irrigation, Drainage and Reclamation Engineering (JSIDRE), pp. 147-166.
- Kitamura, Y. (1996). Activities of IPTRID and Japan's participation in the program: New R&D program on drainage in the humid tropics. *Journal of Irrigation Engineering and Rural Planning*, 30: 1-6.
- Kitamura, Y., Murashima, K., Hagino Y., and Smedema L. (1995). Research and development for drainage improvement in Asian monsoon region - Working paper for the workshop on Asia Drainage Study. IPTRID Workshop on Asia Drainage Study and China Drainage Program, Japan National Committee of ICID and Japanese Institute of Irrigation and Drainage (JIID), pp. 5-11.
- Kobayashi, N. (1995). Why radish yellows can not be found in the Miura radish-growing district. *Agriculture and Science*, 453: 1-6. (J)
- Kobayashi, N. (1995). Control of tomato bacterial wilt by plant rhizosphere environmental improvement. *High techniques in Agriculture II: Kagaku Kogyo Nipposha*, pp. 224-225. (J)
- Kobayashi, N. (1995). Plant diseases of Cucubitaceae. *Noyakugraph*, 134: 2-4. (J)
- Kobayashi, N. (1995). Fusarium wilt caused by *Fusarium oxysporum*. Method for isolation, cultivation, inoculation of plant pathogens. *Japanese Association of Plant Disease Protection*, pp. 295-298. (J)
- Kobayashi, N. (1995). Plant diseases of Solanaceal. *Noyakugraph*, 135: 2-4. (J)
- Kobayashi, N. (1995). West African countries with strong agricultural potential. *Agriculture, Forestry, Fisheries (AFF)*, 27(3): 54-56. (J)
- Kobayashi, N. (1995). Aggressiveness of anthracnose fungi of strawberry and cyclamen, and its behaviors in the early stages of infection. *Annals of the Phytopathological Society of Japan*, 61(3) : 241. (J)
- Kobayashi, N. (1996). An effective and stabilized technique for the control of soil-borne diseases by microbial organic amendment. *Outline of Agricultural Techniques, Soil Fertilizer Edition*. Nosangyoson Bunka Kyokai, 106(1): 21-29.
- Kohgo, Y. (1995). Development of a stability evaluation method for medium and small size

fill-type dams. Advanced Technologies of Management and Design Methods of Hydro-structures in Middle of Mountain Regions, Research Results, AFFRC, 303: 19-40. (J)

Koltunow, A.M., Hidata, T. and Robinson, S. (1996). Polyembryony in *citrus*; Accumulation of seed storage proteins in seeds and in embryos cultured in vitro. Plant Physiology, 110: 599-609.

Koyama, O. (1995). Agricultural situation of research in Hungary. Agriculture in Former USSR and East Europe, 7(4): 22-26. (J)

Maki, T., Pan, B., Du, M. and Samejima, R. (1995). Relation between desert climate and movement of sand dunes particularly in Turpan in Xinjiang of Northwestern China. Journal of Arid Land Studies, 4(2): 91-101. (J)

Maki, T., Pan, B., Huang, P., Samejima, R. and Du, M. (1995). Climatic improvement of multiple row forest windbreaks in the arid lands of Turpan of China. Journal of Agricultural Meteorology of Chugoku & Shikoku, 8: 1-6. (J)

Maki, T., Pan, B., Samejima, R. and Du, M. (1995). Micro-meteorological improvement for crop growth environment of cultivated fields by use of windbreaks in the arid land of Turpan in Xinjiang, China. Journal of Arid Land Studies, 5(1): 21-32. (J)

Maki, T., Pan, B., Samejima, R. and Du, M. (1995). Effects of forest and net windbreaks on climatic improvement and protection of sand movement in arid lands of Northwestern China. Journal of Arid Land Studies, 5(S): 107-110.

Maki, T., Pan, B., Samejima, R., Du, M. and Kawakata, T. (1995). Microclimatic improvement of agricultural fields using multiple row windbreaks comprised of mixed tree species in the arid Turpan region of China. Journal of Agricultural Meteorology, 51(3): 229-238. (J)

Maoka, T. (1995). Viral diseases of papaya in the Ryukyu islands. Kongetsu-no-Nogyo, 39(7): 96-100. (J)

Maoka, T., Kashiwazaki, S., Tsuda, S., Usugi, T. and Hibino, H. (1995). Nucleotide sequence of the 3-terminal region of papaya leaf-disformation mosaic potyvirus RNA. Annals of the Phytopathological Society of Japan, 61(3): 285. (J)

Maoka, T., Kashiwazaki, S., Tsuda, S., Usugi, T. and Hibino, H. (1996). Nucleotide sequence of the capsid protein gene of papaya leaf-disformation mosaic potyvirus. Archives of Virology, 141: 197-204. (J)

Matsune, H. and Fujita, H. (1996). Study on soil erosion in Jabal Abdal Aziz, NE Syria, under "Natural resource conservation and management in northeastern Syria (Jabal Abdal Aziz, Hassakeh)". Pasture, Forage and Livestock Program, Annual Report for 1994, International Center for Agricultural Research in the Dry Areas (ICARDA).

Minami, K. (1995). The effect of nitrogen fertilizer use and other practices on methane emission from flooded rice. Fertilizer Research, 40: 71-84.

- Minami, K. (1995). A goal to sustainable agriculture. NIAES, Research Series for the Agro-Environment, 9: 1-22. (J)
- Minami, K. (1995). Estimation of atmospheric greenhouse gases derived from agricultural activities. Journal of the Japanese Agricultural Systems Society, 11(2): 197-206. (J)
- Minami, K. (1995). Methane emission from rice paddy fields and its reduction strategy. Journal of Clean Technology, 5(6): 53-56. (J)
- Minami, K. (1995). UK-Japan Workshop: CH₄ and N cycles in agriculture. Techno Innovation, 5(2): 56-57. (J)
- Minami, K. (1995). GAIA and agriculture-forestry. In: Climate Change and Agriculture-Forestry. Ed. Minami, K. Asakura Publishers, pp. 1-44. (J)
- Minami, K. (Ed) (1995). Climate change and Agriculture-Forestry. Asakura Publishers. 176 pp. (J)
- Minami, K. and Ishikawa, T. (1996). The mechanisms of emission and sink of CO₂, CH₄ and N₂O and their control strategy. In: Conservation and Restoration of Soil Ecosystems for Planning of the Global Environment, pp. 99-109. (J)
- Mizoguchi, T., Hirayama, T., Hayashida, N., Yamaguchi-Shinozaki, K. and Shinozaki, K. (1996). A gene encoding a MAP kinase kinase kinase is induced simultaneously with genes for a MAP kinase and an S6 kinase by touch, cold and water stress in *Arabidopsis thaliana*. Proceedings of the National Academy of Science of the United States of America, 93: 765-769.
- Morooka, Y. (1995). Development process of rice-based agriculture undertechnical cooperation in Malaysia. Light and Shade of Development Assistance, Nosangyoson Bunka Kyokai, 11: 25-54. (J)
- Morooka, Y. (1995). Economic development and social equity in Indonesia. Light and Shade of Development Assistance, Nosangyoson Bunka Kyokai, 11: 55-80. (J)
- Morooka, Y. (1995). Local markets in transition in Indonesia - a perspective of changes in the "Pasar": The transformation of agricultural produce marketing systems - international comparison of wholesale markets for fruit and vegetables. Nosangyoson Bunka Kyokai, 20: 252-275. (J)
- Motomura, T., Hidaka, T., Moriguchi, T., Akihama, T. and Omura, M. (1995). Intergeneric somatic hybrids between *Citrus* and *Atalantia* or *Severinia* by electrofusion and recombination of mitochondrial genomes. Breeding Science, 45(3): 309-314.
- Mori, T., Miura, Y., Kusunoki, M., Togawa H. and Kobayashi, N. (1995). Biological control and combined benomyl effect of carnation wilt. Annals of the Phytopathological Society of Japan, 61(3): 268. (J)
- Murashima, K., Kitamura, Y. and Hagino, Y. (1995). Research and development needs for drainage improvement in Asian monsoon regions - Asia drainage study (I). Bulletin of

Ishikawa Agricultural College, 25: 19-26.

Nakagawa, M. (1995). Sustainability of food supply and demand. Eds. The Year 2050 Sustainability Group. "Sustainability Problems and Current Situation", Global Industrial and Social Progress Research Institute, pp. 116-137.

Nakagawa, M. (1995). Long term world agricultural commodity baseline projections. Nobiyuku Nogyo, No. 849. pp. 1-32. (J)

Nakagawa, M. (1995). Global environmental problems and world food market. In: "Will the World Starve?" Ed. M. Morishima. Nousongyoson Bunka Kyokai, pp. 176-200. (J)

Nakagawa, M. (1996). A projection of world safflower production. "Projection Report on World Oilseed Market: Cottonseeds and Safflower", Soybean Supply Stabilization Association, pp. 27-34. (J)

Nakagawa, M., Ohga, K. and Yanagishima, K. (1996). A projection of world cottonseeds market. "Projection Report on World Oilseed Market: Cottonseeds and Safflower", Soybean Supply Stabilization Association, pp. 1-26. (J)

Nakagawa, M., Otsuka, H., Yoshida, T. and Okada, M. (1996). A study on grain supply and demand in major countries: America. Report on Grain Supply and Demand in Major Countries, pp. 3-27. (J)

Nakagawa, M., Shimizu, K. and Tsubota, K. (1996). A perspective of the world livestock market. "Report of the Livestock Econometric Study Group" No. 4, Livestock Industry Promotion Cooperation, pp. 125-140. (J)

Nakamura, S. (1995). Optimal clutch size for maximizing reproductive success in a parasitoid fly, *Exorista japonica* (Diptera: Tachinidae). Applied Entomology and Zoology, 30(3): 425-431.

Nakamura, T., Yamaori, M., Hirano, H., Hidaka, M. and Nagamine, T. (1995). Production of waxy (amylose-free) wheats. Molecular and General Genetics, 248(3): 253-259.

Nakashima, K. and Hayashi, T. (1995). Extrachromosomal DNAs of rice yellow dwarf and sugarcane white leaf phytoplasmas. Annals of the Phytopathological Society of Japan, 61(5): 456-462.

Nakashima, K., Hayashi, T., Chaleeprom, W., Wongkaew, P. and Sirithorn, P. (1995). Complex phytoplasma flora associated with plant diseases in Northeast Thailand. Annals of the Phytopathological Society of Japan, 61(6): 610. (J)

Ohga, K. and Koyama, O. (1995). Future projections by the world food demand and supply model. In: "Will the World Starve?", M. Morishima, Ed. Nousongyoson Bunka Kyokai, pp. 120-175. (J)

Ohta, M., Kawazu, S., Tsuji, N., Terada, Y., Kamio, T. and Fujisaki, K. (1995). DNA probes for detection of *Babesia ovata* or the *Babesia sp.* 1, a newly isolated bovine *Babesia* parasite in Japan. Journal of Protozoology Research, 5(2): 58-65.

- Ohta, M., Tsuji, N., Tsuji, M. and Fujisaki, K. (1995). Morphological, serological and antigenic characteristics, and protein profile of newly isolated Japanese bovine *Babesia* parasite with particular reference to those of *B. ovata*. *Journal of Veterinary Medical Science*, 57(4): 671-675.
- Ohtsu, Y., Prommintara, M., Okuda, S., Nakazima, K., Koizumi, M. and Choopanya, D. (1995). Partial purification of citrus greening-causal bacteria-like organisms (Thai isolate) and production of the antiserum. *Annals of the Phytopathological Society of Japan*. 61(6): 610. (J)
- Ohtsu, Y., Prommintara, M., Gotou, T., Imada, J., Okuda, S. and Hoopanya, D.C. (1995). Conditions for symptom development in periwinkle infected with citrus greening-causal bacteria-like organisms (Thai isolate) and the distribution of organisms in the tissues. *Annals of the Phytopathological Society of Japan*. 61(6): 609-610. (J)
- Oka, M. (1995). Agricultural characteristics and situation of research in Kyrghyzstan. *Japan-Kyrghyzstan Friendship Association*, pp. 56-73. (J)
- Oka, M. (1995). Current situation of agriculture and constraints on its development in Uzbekistan. *Agriculture in Former USSR and East Europe*, 7(3): 14-30. (J)
- Oka, M. and Suzuki, M. (1995). Agricultural characteristics and recent research activities in Central Asia. *JIRCAS Research Highlights*, 2: 1-2.
- Oka, M., Tanabe, S., Suyama, T. and Ohwaki, Y. (1995). Agricultural characteristics and situation of research in Central Asia (3): Kyrghyzstan. *Agriculture in Former USSR and East Europe*, 7(1): 26-42. (J)
- Okada, K. (1996). Agricultural status in South America (3): Columbia. *Pesticides*, 43(1): 24-27. (J)
- Ono, H. (1995). Meteorological factors and snow melting coefficient and amounts of snow melting. *Meeting Report on Snow Melting*, 57(3): 297-298. (J)
- Oshibe, A., Gooden, J.M. and Wynn, P.C. (1995). Responses of mammary blood flow and milk secretion to bovine somatotropin infusion in lactating ewes, *Animal Science and Technology*, 66(12): 1002-1006.
- Oshibe, A., Hodate, K., Ando, S. and Oshio, S. (1995). The effect of intravenous insulin infusion on pre- and post-mean plasma growth hormone concentration in calves. *Journal of Animal Physiology and Animal Nutrition*, 73: 243-250.
- Oshibe, A., Yamada, A., Ando, S., Oshio, S. and Hodate, K. (1995). Responses of plasma insulin and growth hormone concentrations to intraruminal administration for different time duration of propionate in cattle. *Animal Science and Technology*, 66(5): 449-455.
- Saito, K., Kanayama, A., Hayakawa, H. and Uemoto, K. (1995). Studies of the ecology of blackflies (Diptera: Simuliidae) 29 - Fauna of the blackflies in Iwate Prefecture in spring. *Medical Entomology and Zoology*, 47(1): 87-96. (J)

- Sakuma, H. and Matsumoto, D. (1996). Low input hydroponics under field conditions. *Agriculture and Horticulture*, 71(4): 390-396. (J)
- Shinogi, Y. and Anyoji, H. (1996). Preliminary tests on eliminating kuroboku soil from irrigation water. *Transactions of the Japanese Society of Irrigation, Drainage and Reclamation Engineering*, pp. 181. (J)
- Sumi, A., Oka, M., Hakoyama, S., Agata, W. and Takeda, T. (1996). Analysis of plant characteristics determining ear weight increase during the ripening process in rice (*Oryza sativa* L.): I. Plant characteristics determining the sink capacity of spikelets. *Japanese Journal of Crop Science*, 65: 61-70. (J)
- Suyama, S. (1996). Age and growth of Pacific saury *Cololabis saira* (Brevoort) in the Western North Pacific Ocean estimated from daily otolith growth increments. *Fisheries Science*, 62(1): 1-7.
- Tada, M. and Morooka, Y. (1995). Supply and demand analysis for rice in Peninsular Malaysia with special reference to direct seeding in the Muda Area. *JIRCAS Journal*, 2: 1-11.
- Tanaka, K. (1995). Runoff loadings of soil phosphorus from rivers in Japan. *Japan Agricultural Research Quarterly (JARQ)*, 29(4): 215-222.
- Thurlow, M., Kanda, K., Tsuruta, H. and Minami, K. (1995). Methane uptake by upflooded paddy soils, the influence of soil temperature and atmospheric methane concentration. *Soil Science and Plant Nutrition*, 41: 371-374.
- Togashi, K. (1995). On living in Ethiopia. *Agriculture Forestry Fisheries (AFF)*, 95(6): 52-54. (J)
- Togashi, K. (1995). Simultaneous estimation procedure for production traits and herd life in African cattle. *JIRCAS Research Highlights*, 2: 21-22. (J)
- Togashi, K. (1995). African animal genetic conservation and utilization. *International Agriculture and Cooperation Newsletter*, 18(3): 51-57. (J)
- Uchida, S. (1995). Land degradation analysis of rainfed agricultural areas in Pakistan using remote sensing data. *JIRCAS Research Highlights*, 2: 7-8. (J)
- Uchida, S. (1996). Evaluation of desertification using remote sensing and geographic information systems (GIS). *Farming Japan*, 30(1): 30-37.
- Wilder, M.N. and Aida, K. (1995). Crustacean ecdysteroids and juvenoids: Chemistry and physiological roles in two species of prawn, *Macrobrachium rosenbergi* and *Penaeus japonicus*. *Israel Journal of Aquaculture - Bamidgeh*, 47: 129-236.
- Yagi, K., Tsuruta, H., Minami, K. and Kumagaya, K. (1995). Emission, production and oxidation of methane in a Japanese rice paddy fields. In: *Advances in Soil Science, Soil Management and Greenhouse Effect*. Eds. Lal, R., Kimble, J., Levine, E. and Stewart, B.A. Lewis Publishers, pp. 231-243.

- Yakushiji, H., Yamada, M., Yonemori, K., Sato, A. and Kimura, N. (1995). Staminate flower production on shoots of 'Fuyu' and 'Jiro' persimmon (*Diospyros kaki* Thurb.). *Journal of the Japanese Society for Horticultural Science*, 64(1): 41-46.
- Yamada, Y. (1995). Searching tools on the internet. *Journal of the Japanese Society of Irrigation, Drainage and Reclamation Engineering*, 63(9): 88. (J)
- Yamada, Y., Eguchi, H., Hayashi, T., Hirafuji, M. and Kiura, T. (1995). The state of academic research networks in South-Asia and Australia. *System Agricultural Science*, 12(1): 21-28. (J)
- Yamada, M., Fukamachi, H. and Hidaka, T. (1996). Photosynthesis in longan and mango as influenced by high temperatures under high irradiance. *Journal of the Japanese Society for Horticultural Science*. 64(4): 749-756.
- Yamada, M., Wang, R., Yamane, H., Sato, A. and Hirakawa, N. (1995). Variation in the performance of fruit maturing time, fruit weight, and soluble solids content in Oriental persimmon grown at Akitsu, Japan and Meixian, China. *Journal of the Japanese Society for Horticultural Science*, 64(2): 221-226.
- Yamada, M., Wang, R., Yamane, H., Sato, A. and Hirakawa, N. (1995). Comparisons in the variations in fruit maturing time, fruit weight, and soluble solids content of Oriental persimmon cultivars of Chinese and Japanese origin. *Journal of the Japanese Society for Horticultural Science*, 64(2): 227-233.
- Yamada, M., Yamane, H. and Ukai, Y. (1995). Genetic analysis of fruit ripening time in Japanese persimmon. *Journal of the American Society for Horticultural Science*, 120(6): 886-890.
- Yamaguchi-Shinozaki, K., Kiyosue, T. and Shinozaki, K. (1995). Regulation of gene expression by plant hormones. *Chemical Regulation of Plants*, 30(2):159-166. (J)
- Yamamori, M. and Nakamura, T. (1995). Waxy wheat - production of wheat containing a novel starch component. *Bei Baku Kairyo*, pp. 24-33. (J)
- Yamamori, M. and Nakamura, T. (1995). Production of waxy wheat. *Journal of Agricultural Science*, 50: 241-245. (J)
- Yamamori, M., Nakamura, T. and Nagamine, T. (1995). Inheritance of waxy endosperm character in a common wheat lacking three Wx proteins. *Breeding Science*, 45(3): 377-379.
- Yamamori, M., Nakamura, T. and Nagamine, T. (1995). Polymorphism of two waxy proteins in the emmer group of tetraploid wheat, *Triticum dicoccoides*, *T. dicoccum* and *T. durum*. *Plant Breeding*, 114: 215-218.
- Yamashita, N. and Hayakawa, H. (1995). Efficacy test of pyrethroid insecticides against *Vespa flaviceps lewisii*. *Annual Report of the Society of Plant Protection of North Japan*. 46: 187-189. (J)
- Yashima, S. (1996). Assessment of effective rainfall - A case study of the Muda Irrigation

Project, Malaysia. *Journal of Irrigation Engineering and Rural Planning*, 30: 62-80.

Yasunobu, K. and Morooka, Y. (1995). A contract system for rice farming work in the Muda Plain, Peninsular Malaysia. *Farming Japan*, 29(2): 25-33.

Yasunobu, K. and Sulaiman, H. (1995). Profile of leading farmers in Peninsular Malaysia - Experiences from Pelandang Jaya. UPM/JIRCAS Joint Research Report, No. 4, UPM (Universiti Pertanian Malaysia), pp. 1-83.

Yasunobu, K., Wong Foong Yee and Chia Yoke Sun. (1995). Comparison between Chinese and Malay Farmers in the Muda Area. UPM/JIRCAS Joint Research Report, No.5, UPM (Universiti Pertanian Malaysia), pp. 1-33.

Yokoyama, T. and Ando, S. (1995). Soybean bradyrhizobia in the tropics and the temperate regions are classified into four phylogenetic varieties. *Chemistry and Biology*, 33(6): 348-350. (J)

Yoshiba, Y., Kiyosue, T., Katagiri, T., Mizoguchi, T., Yamaguchi-Shinozaki, K. and Shinozaki, K. (1995). Correlation between the induction of a gene for ³¹pyrroline-5-carboxylate synthetase and the accumulation of proline in *Arabidopsis thaliana* under osmotic stress. *Plant Journal*, 7: 751-760.

Yoshiba, Y., Yamaguchi-Shinozaki, K. and Shinozaki, K. (1995). Characterization of a cDNA clone encoding 23 kDa polypeptide of the oxygen-evolving complex of photosystem II in rice. *Plant Cell Physiology*, 36: 1677-1682.

Yoshino, M., Fujita, Y., Arizono, S., Du, M. and Lei, J. (1995). Climate fluctuation, desertification and human activity (1): Agricultural land use and farmers' economy. *Literary Symposium (Bungaku Ronso)*, 110: 90-106. (J)

Yoshino, M., Fujita, Y., Arizono, S., Du, M. and Lei, J. (1996). Impact of agricultural landuse on desertification in the Taklimakan Desert. *Journal of Arid Land Studies*. 5(2):107-115. (J)

[Click here continue to Published proceedings and conference presentations](#)



# RESEARCH STAFF ACTIVITY 1995-1996

## Published proceedings and conference presentations

Abudullah, F.M., Wan Zahari, M., Oshibe, A. and Nor Ismail, M.S. (1995). Effect of supplementing urea molasses block on ewe-lamb production under an integrated oil palm system. Proceedings of the 17th Malaysian Society of Animal Production, Annual Conference, pp. 191-192.

Adachi, K., Oyediran, G. and Senboku, T. (1996). Effect of application of rice straw and cellulose on methane emission and biological nitrogen fixation in a subtropical paddy field (1): Methane emission, soil-ARA and fluctuation of methanogenic population. Abstracts of the Annual Meeting, Japanese Society of Soil Science and Plant Nutrition, 42: 45. (J)

Adu-Gyamfi, J.J., Katayama, K., Ito, O., Gayatri Devi and Rao, T.P. (1995). Nitrogen fixation in pigeonpea-based intercropping on alfisols of the semi-arid tropics. Proceedings of 10th International Congress on Nitrogen Fixation, St. Petersburg, Russia, p. 186.

Ando, S. and Yokoyama, T. (1995). Genetic ecology of tropical *Bradyrhizobium* strains based on RAPD analysis. Abstracts of the Annual Meeting, Soil Microbiological Society of Japan, pp. 1. (J)

Ando, S. and Yokoyama, T. (1995). Genetic diversity of indigenous soybean bradyrhizobia in tropical Asia. Abstract of the 5th Annual Meeting for Plant-Microbe Interactions, Kagoshima, Japan, 5: 36-38. (J)

Ando, S. and Yokoyama, T. (1995). Classification of tropical soybean brandrhizobia by sequencing of the partial 16S rRNA gene. Abstracts of the Annual Meeting, Japanese Society of Soil Science and Plant Nutrition, 42: 51. (J)

Asaga, K. and Minami, K. (1994). Effect of nitrification inhibitors on emission of nitrous oxide from fertilized soils. Proceedings of the Second Workshop on Material Cycling in the Pedosphere, Nanjing, China, pp. 21-30.

Azmi Man, Itoh, K. and Watanabe, H. (1995). Life cycle and seed longevity of *Echinochloa crus-galli* complex in direct seeded rice in Malaysia. Proceedings I of the 15th Asian-Pacific Weed Science Society Conference, Tsukuba, Japan, pp 506-511.

Banzai, K., Iwama, H., Fumoto, T., Sugahara, K. and Ohwaki, Y. (1995). Measurement of the kinetic energy of raindrops on Ishigaki Island using a distrometer. Abstracts of the 1995 Meeting, Japanese Society of Irrigation, Drainage and Reclamation Engineering, pp. 258-259. (J)

Bernawie, N., Tobita, S. and Senboku, T. (1995). Synthesis of salt stress-related proteins in tolerant and sensitive varieties of rice. Abstracts of the 2nd Asian Crop Science Conference, Fukui, Japan, p. 86.

- Blade, S.F., Shetty, S.V.R., Terao, T. and Singh, B.B. (1995). Recent developments in cropping systems research relevant to cowpea. *Cowpea Abstracts*, pp. 7.
- Bong, B.B., Tobita, S. and Senboku, T. (1995). Variation in salt tolerance of rice plants regenerated from salt-selected calli of a susceptible variety. *Abstracts of the Third International Rice Genetics Symposium, Manila, the Philippines*, p. 121.
- Bujang, I.B., Egawa, Y., Tomooka, N. and Quah, S.C. (1994). Wild *Vigna* (subgenus *Ceratotropis*) species in Peninsular Malaysia. *Proceedings of the 1st National Congress on Genetics, Malaysia*, pp. 198-200.
- Chien, H., Irie, N. and Nakagawa, M. (1996). A factor analysis of food supply and demand in China. *Proceedings for 1996 Annual Meeting of Japan Agricultural Economic Association*, pp. 1-12. (J)
- Daubenberger, C., Tsuji, N., Nandan, D. and McKeever, D. (1995). Identification, purification and partial characterization of hsp 70 kDa proteins expressed in *Theileria parva*-transformed cells. *ILRAD 1994 Annual Science Report*, pp. 34-35.
- Du, M. and Maki, T. (1995). Inter-relationship between oasis development and environment change. In: *Resources Exploitation, Global and Sustainable Development. The Resources and Environment Issue of the Proceedings of the Second Academic Conference of Young Scientists of China, the China Association for Science and Technology, China Science and Technology Press, Beijing*, pp. 85-91.
- Du, M. and Maki, T. (1995). Evapotranspiration around windbreak nets (II): Under different water conditions. *Proceedings of the Annual Conference of 1995 of the Society of Agricultural Meteorology of Japan*, pp. 356-357. (J)
- Du, M. and Maki, T. (1995). Effect of polyethylene windbreak nets on desertification and biometeorology. *Abstracts of the International Symposium on Environment and Biometeorology, July 20-22, 1995, Beijing*, p. 61.
- Du, M., Yoshino, M., Fujita, Y., Arizono, S., Lei, J. and Maki, T. (1995). Agricultural activity and climatic change in the Taklimakan Desert, Xinjiang, China, in recent years. *Abstracts of the 1995 Meeting, the Japanese Association for Arid Land Studies*, 6: 45-46. (J)
- Du, M., Yoshino, M., Fujita, Y., Arizono, S., Maki, T. and Lei, J. (1995). Some aspects of oasis development and environment change during the recent 43 years in the Taklimakan Desert, China. *Air pollution and Climate, Vol. 2 of the Proceedings of the International Congress on Modelling and Simulation, Nov. 27-30, 1995, the University of Newcastle. The Modelling and Simulation Society of Australia, Inc.*, pp. 265-268.
- Egawa, Y. and Bujang, I.B. (1995). Phylogenetic differentiation in plant with reference to subgenus *Ceratotropis* of the genus *Vigna*. Technical paper for "International Course on Underutilized Tropical Plant Genetic Resources, their Conservation and Utilization", Universiti Pertanian Malaysia, Malaysia.
- Egawa, Y., Chotechuen, S., Tomooka, N., Lairungreang, C., Thavarasoomk, C. and Kitbamboong, C. (1995). Mungbean germplasm research under the cooperative research

program between DOA, Thailand and JIRCAS, Japan (1995). Proceedings of the 6th National Mungbean Workshop, Thailand. pp. 18-24.

Fujita, H. (1996). Introduction and map database establishment for resource management, in "Natural resource conservation and management in Northeastern Syria (Jabal Abdal Aziz, Hassakeh)". Pasture, Forage and Livestock Program, Annual Report for 1994, International Center for Agricultural Research in the Dry Areas (ICARDA).

Fukamachi, H., Yamada, M. and Hidaka, T. (1995). Photosynthesis in 'Irwin' mango as influenced by leaf temperature. Journal of the Japanese Society for Horticultural Science, 64 (Suppl. 2): 18-181. (J)

Fukusho, K. (1995). Recent developments in aquaculture in Japan. In: Towards Sustainable Aquaculture in Southeast Asia and Japan. Eds. Bajarinao, T.U. and Flores, E.E.C.). Proceedings of the Seminar-Workshop on Aquaculture Development in Southeast Asia, Ilo Ilo City, the Philippines, pp. 117-124.

Fukusho, K. (1995). Mass larval rearing of marine finfish in Japan. Abstract paper of the International Larval Fish Conference, Sydney, Australia.

Fukusho, K. (1996). Present status and view of fry production technology for marine finfish in Japan. Abstract Paper of International Symposium "A New Paradigm for Aquaculture", Kobe, Japan, pp. 1-20.

Goto, J. and Ouchi, M. (1995). The resilience and fragility of Japanese rural communities: Implications for other Asian countries. The Tsukuba International Conference on the Sustainability of Rural Systems, pp. 1-10.

Hassan, O.A., Ishida, M. and Tajuddin, Z.A. (1995). Oil palm fronds (OPF) technology transfer and acceptance: A sustainable *in-situ* utilization for animal feeding. Proceedings of the 17th Malaysian Society of Animal Production, Annual Conference, pp. 134-135.

Hatta, T. (1995). Experimental study on "Physical weathering series of rocks". Abstracts with Programs. 1995 Joint Annual Meeting: The Society of Resource Geology, The Japanese Association of Mineralogists, Petrologists and Economic Geologists, and The Mineralogical Society of Japan, p. 99. (J)

Hayase, S. (1995). Methods for food-chain analysis in the aquatic ecosystems. Abstract Paper of International Seminar on Sustainable Utilization of Coastal Ecosystems for Agriculture, Forestry and Fisheries in Developing Regions, Kuala Lumpur, Malaysia (In press).

Hayashi, T., Nakashima, K., Wongkaew, P. and Sirithorn, P. (1996). Ecological studies on the occurrence of sesame phyllody phytoplasma: Identification of the vector leafhopper and its population dynamics. Abstracts of the Annual Meeting of the Phytopathological Society of Japan, p. 124. (J)

Hidaka, T., Yamada, M. and Fukamachi, H. (1995). Development of a simple particle gun for gene analysis and production of genetic transformants. Journal of the Japanese Society for Horticultural Science, 64 (Supple.2): 152-153. (J)

- Hidaka, T., Yamada, M. and Fukamachi, H. (1995). Delivery of foreign genes into citrus cells using a hand-made particle gun. *Breeding Science*, 45(Suppl. 2): 114. (J)
- Hirata, M. and Fujita, H. (1996). Changes in grazing areas and feed resources, under "Natural resource conservation and management in northeastern Syria (Jabal Abdal Aziz, Hassakeh)". Pasture, Forage and Livestock Program, Annual Report for 1994, International Center for Agricultural Research in the Dry Areas (ICARDA).
- Hisada, S., Hidaka, T., Moriguchi, T., Akihama, T. and Omura, M. (1995). Characterization of cDNA library from seeds of Valencia orange at early stages of embryogenesis. *Journal of the Japanese Society for Horticultural Science*, 64 (Suppl. 1): 136-137. (J)
- Igarashi, Y., Yoshida, Y., Sanada, Y., Yamaguchi-Shinozaki, K., Wada, K. and Shinozaki, K. (1996). Correlation between the induction of the gene for ³¹-pyrroline-5-carboxyline synthetase and salt tolerance in rice. Annual Meeting of the Japanese Society of Plant Physiologists, Kagoshima. (J)
- Imaizumi, M. (1996). The relationship between groundwater flow paths and the geochemistry of groundwater from a tertiary mudstone landslide slope in Niigata Prefecture, Japan. Proceedings of the International Symposium on Geology and Environment, Chiang Mai, Thailand, pp. 24-28.
- Imaizumi, M., Okuyama, T., Komae, T. and Hamada, H. (1995). Fault system in the Bandai-san explosion caldera. In: *Bandai Volcano - Recent progress on hazard prevention* (published by the Science and Technology Agency, Japan), pp. 57-68.
- Ishimura, I., Kojima, K. and Takabayashi, M. (1996). Ecological control methods in natural farming of the Sao Paulo state (I). *Japanese Journal of Tropical Agriculture*, 40(extra issue 1): 25-26. (J)
- Iuchi, T., Urao, T., Yamaguchi-Shinozaki, K. and Shinozaki, K. (1995). Analysis of genes that are responsive to dehydration stress in a highly drought-tolerant cowpea. Annual Meeting of the Japanese Society of Molecular Biology, Nagoya. (J)
- Kaku, H., Ochiai, H., Lu, C., Zhang, G. and Noda, T. (1995). Pathogenecity and genetic diversity of *Xanthomonas oryzae* pv. *Oryzae* strains collected in the Yellow River Basin, China. *Annals of the Phytopathological Society of Japan*, 61(6): 608. (J)
- Kaku, H., Yokoyama, T., Ochiai, H. and Noda, T. (1995). Purification of antibacterial compounds from rice leaves inoculated with an incompatible race of *Xanthomonas campestris* pv. *oryzae*. *Annals of the Phytopathological Society of Japan*, 61(3): 257. (J)
- Kashiwagi, J., Katayama, K., Adu-Gyamfi, J.J., Rao, T.P., Gayatri Devi and Ito, O. (1995). Characterization of root systems of pigeonpea in sole crop and intercrop with sorghum, pearl millet, groundnut and cowpea. Proceedings of the International Symposium on Dynamics of Physiological Processes in Woody Roots, Ithaca, New York, USA, p. 82.
- Katayama, K., Ito, O., Adu-Gyamfi, J.J., Gayatri Devi and Rao, T.P. (1995). Relationship between root length density and soil moisture content simultaneously measured with minirhizotron. Proceedings of the 2nd Asian Crop Science Conference, Fukui, Japan, p. 98.

- Katayama, K., Ito, O., Adu-Gyamfi, J.J., Rao, T.P., Gayatri Devi, Esperanza, V.D. and Yoneyama, T. (1996). Effects of continuous cultivation and fertilization on the growth of pigeonpea and sorghum. Proceedings of the Annual Meeting of the Japanese Society of Tropical Agriculture, pp. 19-20. (J)
- Katayama, K., Matsunaga, R., Adu-Gyamfi, J.J., Gayatri Devi, Rao, T.P. and Ito, O. (1996). Root dynamics of five crop species observed with minirhizotron. Proceedings of the Annual Meeting of the Japanese Society of Crop Science, pp. 33-34. (J)
- Kitamura, Y. (1996). Water use situation and its problems in the State of Rajasthan, India. Proceedings of the Annual Meeting of the Tropical Agriculture Research Association of Japan, pp. 1-2. (J)
- Kitamura, Y., Murashima, K., Hagino, Y. and Smedema, L. (1995). Drainage situation in South and Southeast Asian monsoon regions - Through IPTRID Asia drainage Study. Proceedings of the Tokyo Symposium on Sustainable Agriculture and Rural Development, the Japanese Institute of Irrigation and Drainage (JIID) and the United Nations University (UNU), pp. 421-432.
- Kitamura, Y., Murashima, K., Hagino, Y. and Smedema, L. (1996). Drainage situation and problems in monsoon Asia (I) Summary from five country survey. Proceedings of the Annual Meeting of the Japanese Society of Irrigation, Drainage and Reclamation Engineering, pp. 528-529. (J)
- Kobayashi, H., Kamaldin Dahuli, Ho Nai Kin and Abd. Rahman Abd. Bakar (1995). Survey on farmers' activities and their yield performance in the Muda Area. Paper of the 3rd Quarterly Meeting under MARDI/MADA/JIRCAS Joint Research Program.
- Kobayashi, M., Terauchi, T., Nakano, H., Ohwaki, Y. and Sugahara, K. (1995). Evaluation of forage or turf grass suitable for covercropping between pineapple rows. Japanese Journal of Tropical Agriculture, 39 (extra issue 1): 51-52. (J)
- Kobayashi, N. (1995). Biological and integrated control of tomato and egg plant bacterial wilt. Proceedings of the 18th Plant Bacterial Disease Workshop, Kyoto, Japan, pp. 24-31. (J)
- Kobayashi, N. (1995). Biological and integrated control of soil-borne diseases in Japan. Abstract of Japan International Cooperation Association (JICA) Lecture (Integrated pest management for plant protection), pp. 1-22.
- Kobayashi, N. (1996). Biological and integrated control of soil-borne diseases in Japan. Proceedings of Integrated Control of Main Diseases of Industrial Crops, Joint Seminar of the Research Institute for Spice and Medicinal Crops (RISMC) and Japan International Cooperation Association (JICA), Bogor, Indonesia, pp. 1-5.
- Koga, N. and Fujita, H. (1996). Historical background of Jabal Abdal Aziz, in "Natural resource conservation and management in northeastern Syria (Jabal Abdal Aziz, Hassakeh)". Pasture, Forage and Livestock Program, Annual Report for 1994, International Center for Agricultural Research in the Dry Areas (ICARDA).
- Kohama, Y., Fujimoto, K., Nakata, M., Hatta, T. and Honma, H. (1995). The dependence on

temperature and solute in plagioclase dissolution. 1995 Annual Meeting, Abstracts of the Mineralogical Society of Japan, p. 114. (J)

Kohgo Y. (1995). A consolidation analysis method for unsaturated soils coupled with an elastoplastic model. Proceedings of the 1st International Conference on Unsaturated Soils, Paris, France, p. 3.

Kohgo, Y. and Moriyama, H. (1995). On elastoplastic model for unsaturated soils. Proceedings of the 10th Asian Regional Conference on Soil Mechanics and Foundation on Engineering, Beijing, China, p. 1.

Kohgo, Y. and Moriyama, H. (1995). Seepage model tests of an unsaturated silt and their simulations. Proceedings of the National Conference of the Japanese Society of Irrigation Drainage and Reclamation Engineering, pp. 112-113. (J)

Kohgo, Y., Moriyama, H., Arakawa, M. and Hori, T. (1995). Triaxial compression tests of a sandy mixed soil and a silt under unsaturated conditions. Proceedings of the 30th Japan National Conference on Soil Mechanics and Foundation Engineering, 1: 625-628. (J)

Koitabashi, M. and Kobayashi, N. (1995). Growth inhibition of pathogenic fungi of fruit vegetables by a filamentous fungus which produces a volatile material. Proceedings of the Association for Plant Protection of Kyushu, 41: 24-27. (J)

Koyama, O., Suzuki, M., Kiura, T. and Oga, K. (1995). JIRCAS-STAT. The 4th Proceedings of the Norinsuisan Joho Kenkyukai, Japan, pp. 60-61. (J)

Maki T., Du, M., Kawakata, T. and Suta (1995). Rice growth in pots under low temperature and strong wind in a wind tunnel. Proceedings of the Annual Conference of the Society of Agricultural Meteorology of Japan, pp. 32-33. (J)

Maki, T., Pan, B., Du, M. and Samejima, R. (1995). Wind and sand dune movement in Xinjiang, China. Proceedings of the Spring Conference of 1995 of the Meteorological Society of Japan, 67: 292. (J)

Maki, T., Pan, B., Samejima, R. and Du, M. (1995). Variation from desert climate to oasis climate using multiple row windbreaks. Abstracts of the 1995 Meeting, the Japanese Association for Arid Land Studies, 6: 9-10. (J)

Maki, T., Pan, B., Samejima, R. and Du, M. (1995). Promotion of crop growth and improvement of climate by multiple windbreak forests. Proceedings of the Annual Conference of the Society of Agricultural Meteorology of Japan, pp. 130-131. (J)

Maki, T., Samejima, R. and Du, M. (1996). Improvement of hot and dry climate and promotion of crop growth by various windbreak forests. Proceedings of the 79th Conference of the Society of Tropical Agriculture of Japan, 40(S1): 13-14. (J)

Mao, G., Kurata, K., Du, M. and Maki, T. (1995). Change in net radiation of a colony of vegetable fields using row covers. Proceedings of the Annual Conference of the Society of Agricultural Meteorology of Japan, pp. 252-253. (J)

- Maoka, T., Noda, C. and Usugi, T. (1995). Occurrence and identification of the P strain of papaya ringspot virus and papaya leaf-distortion mosaic virus in Okinawa, Japan. Program and Abstracts of the International Symposium "Integrated Management of Insect-borne Virus Diseases of Tropical Fruits", Pingtung, Taiwan, p. 24. (J)
- Matsubara, Y., McKeever, D., MacHugh, N. and Mburu Young, A. (1995). Immunohistological analysis of the tick attachment site of *Rhipicephalus appendiculatus*. Abstract Paper of 4th International Veterinary Immunology Symposium, University of California at Davis, USA, pp. 138.
- Matsunaga, R., Terao, T. and Singh, B.B. (1995). Architectural analysis of cowpea root system. Cowpea Abstracts, pp. 9-10.
- Md. Zuki Ismail, Watanabe, H. and Ho Nai Kin (1995). Status and control of weedy rice in the Muda area. Proceedings I of the 15th Asian-Pacific Weed Science Society Conference, Tsukuba, Japan, pp. 827-829.
- Minami, K. (1994). Emission of biogenic sulfur gases from rice paddies. Proceedings of the Second Workshop on Material Cycling in the Pedosphere, Nanjing, China, pp. 42-53.
- Minami, K. (1995). Estimation of atmospheric greenhouse gases derived from agricultural activities. Symposium of the Spring Meeting of the Japanese Agricultural Systems Society, 11(Special ed. 1): 31-40. (J)
- Minami, K. (1995). Atmospheric methane and nitrous oxide: Source, sinks and strategies for reducing agricultural emissions. SCOPE, Tokyo, Abstract, pp. 1-4.
- Minami, K. (1995). Pedosphere and atmosphere; The role of the pedosphere in the conservation of global environment. The Proceedings of the Meeting of the Science Council of Japan, pp. 4-6. (J)
- Minami, K. (1995). The effect of agricultural practices on methane emission from flooded rice. Abstracts of the International Symposium on Soil-Source and Sink of Greenhouse Gases, Nanjing, China, pp. 24.
- Minami, K. (1995). Global estimates of potential mitigation of greenhouse gas emissions by agriculture. Abstracts of the International Symposium Soil-Source and Sink of Greenhouse Gases, Nanjing, China, pp. 43.
- Minami, K. (1996). Agro-ecosystems and global environment. The Proceedings of the 10th Conference on New Technology, Utsunomiya University, Japan, pp. 55-58. (J)
- Minami, K. (1996). The role of rice paddy fields in the promotion of sustainable agriculture and conservation of agro-ecosystems. Abstracts of the International Workshop on Paddy Fields Sustainable Agriculture and Control of Greenhouse Gas Emissions, Tsukuba, Japan, pp. 7-8.
- Minami, K. (1996). Anthropogenic impact on transport of N₂O from land surfaces to ground water. Abstracts of the International Workshop on NO_x Emission from soils and its Influence on Atmospheric Chemistry, Tsukuba, Japan, p. 25.

- Miura, K., Badayos, R.B., Miyazi, N., Taniyama, I. and Kato, K. (1996). The characterization of lowland soils in the Philippines (3): The characteristics of soil minerals in lowland soils on Luzon island. The Proceedings of the Annual Meeting of the Japanese Society of Soil Science and Plant Nutrition. 42: 133. (J)
- Mizoguchi, T., Hirayama, T., Hayashida, N., Yamaguchi-Shinozaki, K. and Shinozaki, K. (1995). ATMEKK1, a stress-ionduced MAPKKK in *Arabidopsis thaliana*. 6th International Conference on Arabidopsis Research, Wisconsin, USA.
- Mizoguchi, T., Yoshida, Y., Yamaguchi-Shinozaki, K and Shinozaki, K. (1995). Water-stress induced genes in *Arabidopsis thaliana*. ESF Network Workshop on Gene and their Products for Tolerance to Physical Stresses in Plants, Marates, Italy.
- Moriguchi, T., Motomura, T., Hidaka, T., Akihama, T. and Omura, M. (1995). Efficient production of *Citrus* cybrids by electrofusion and analyses of nuclear, mitochondrial, and chloroplast genomes. Journal of the Japanese Society for Horticultural Science, 64(Suppl. 2): 152-153. (J)
- Nabil, B. and Fujita, H. (1996) Analysis of vegetation by aerial photograph interpretation and vegetation mapping in northeastern Syria, in "Natural resource conservation and management in northeastern Syria (Jabal Abdal Aziz, Hassakeh)". Pasture, Forage and Livestock Program, Annual Report for 1994, International Center for Agricultural Research in the Dry Areas (ICARDA).
- Nakamura, S. (1995). Can parasitoid flies really not discriminate between parasitized and unparasitized hosts? Proceedings of the Entomophagous Insects Workshop, Nagoya, Japan, p.18 (J)
- Nakamura, S. (1995). Ovipositional behaviour of the parasitoid fly. *Exorista*: host searching time and oviposition. Abstracts of the 39th Annual Meeting of the Japanese Society of Applied Entomology and Zoology, p. 169. (J)
- Nakamura, S. (1996). Successive rearing of the parasitoid fly. *Exorista japonica*: Inbreeding and rotational breeding. Abstracts of the 40th Annual Meeting of the Japanese Society of Applied Entomology and Zoology, p. 203. (J)
- Nakashima, K. and Hayashi, T. (1995). Multiplication and distribution of rice yellow dwarf phytoplasma in infected tissues of rice and green rice leafhopper *Nephytettix cincticeps*. Annals of the Phytopathological Society of Japan, 61(5): 451-455.
- Nakashima, K., Hayashi, T., Chaleeprom, W., Wongkaew, P. and Sirithorn, P. (1995). Detection of DNA of phytoplasmas associated with phyllody disease of sesame in Thailand. Annals of the Phytopathological Society of Japan, 61(6): 519-528.
- Nakashima, K., Hayashi, T., Chaleeprom, W., Wonkaew, P. and Sirithorn, P. (1996). Complex phytoplasma flora in Northeast Thailand as revealed by 16S rDNA analysis. Annals of the Phytopathological Society of Japan, 62(1): 57-60.
- Nakashima, K., Kikuchi, Y. and Hayashi, T. (1995). Multiplication and distribution of rice



yellow dwarf phytoplasms in green rice leafhoppers. *Annals of the Phytopathological Society of Japan*, 61(3): 253. (J)

Nakashima, K., Kiyosue, T., Yamaguchi-Shinozaki, K. and Shinozaki, K. (1995). Analysis of expression of the *erdl* gene that encodes ClpA-like protein in *Arabidopsis thaliana*. Conference Presentations of the Annual Meeting of the Molecular Biology Society of Japan, pp. 452. (J)

Nakashima, K., Kiyosue, T., Yamaguchi-Shinozaki, K. and Shinozaki, K. (1996). Promoter analysis of the dehydration inducible *erd 1* gene that encodes ClpA-like protein in *Arabidopsis thaliana*. *Plant Cell Physiology*, 37 (Supplement): S68. (J)

Nakashima, K., Prommintara, M., Ohtsu, Y., Kano, T., Imada, J. and Koizumi, M. (1995). Detection of 16S rDNA of Thai isolates of bacterium-like organisms associated with greening disease of citrus. *Annals of the Phytopathological Society of Japan*, 61(6): 610. (J)

Nakashima, K., Tanaka, M., Hayashi, T., Wongkaew, P. and Sirithorn, P. (1996). Structural analysis of extrachromosomal DNA of sugarcane white leaf phytoplasma. Abstracts of the Annual Meeting of the Phytopathological Society of Japan, p. 120. (J)

Nguyen, T. T., Takagi, H. and Senboku, T. (1995). Cryopreservation of taro germplasm (*Colocasia esculenta* (L.) Shott): Preliminary investigations on different plant materials and cryopreservation methods. Proceedings of the 14th meeting of the Japanese Association for Plant Tissue Culture, p. 117. (J)

Nor Ismail, M.S., Wan Zahari, M., Oshibe, A. and Subramaniam, K. (1995). Liquid feeder as a method of supplementing nutrients for growing sheep. Proceedings of the 17th Malaysian Society of Animal Production, Annual Conference, pp. 187-189.

Ochiai, H., Kaku, H., Noda, T. and Tuyunashi, S. (1995). RFLP analysis of races and mutants of *Xanthomonas campestris* pv. *oryzae* (5): Analysis with an *avrXa10* Probe. *Annals of the Phytopathological Society of Japan*, 61(3): 256. (J)

Ohtsu, Y., Prommintara, M., Okuda, S., Nakashima, K., Koizumi, M. and Choopanya, D. (1995). Partial purification and antiserum production of Thai isolates of bacterium-like organisms (GO) associated with greening disease of citrus. *Annals of the phytopathological society of Japan*, 61(2): 610. (J)

Ohwaki, Y., Sugahara, K., Fukuhara, T. and Nitta, T. (1996). Physiological characteristics of H⁺ extrusion from roots of iron-deficient chickpea. Abstracts of the Annual Meeting, Japanese Society of Soil Science and Plant Nutrition, 42: 85. (J)

Okada, K., and Fischer, A. (1996). Problems of soil acidity of upland rice cultivation in South American Savanna. Abstracts of the Annual Meeting of the Japanese Society of Soil Science and Plant Nutrition, 42: 118. (J)

Oka, M. (1996). Agricultural characteristics and research situation in Central Asia. Third International Symposium on Land and Water Management for Sustainable Environment in the Aral Sea Basin. The Japanese Society of Irrigation, Drainage and Reclamation Engineering, pp. 73-78. (J)

- Okuyama, T., Imaizumi, M., Bizen, N. and Hamada, H. (1995). Ground temperature and groundwater flow paths. Proceedings of the Journal of the Japanese Society of Irrigation, Drainage and Reclamation Engineering, pp. 280-281. (J)
- Okuyama, T., Komae, T., Takeuchi, M. and Imaizumi, M. (1995). Underground temperature survey in the caldera of Bandai volcano. In: Bandai Volcano - Recent progress on hazard prevention (published by the Science and Technology Agency, Japan), pp. 51-56.
- Saito, Y., Rao, M. and Granobles, J.C. (1995). Legume establishment and persistence with different grasses. CIAT Biennial Report 1994-1995, p. 15.
- Simatupang, M.H., Rosamah, E. and Yamamoto, K. (1995). Importance of teak extractives to wood properties. Proceedings of the Third Conference on Forestry and Forest Products Research, Kuala Lumpur, Malaysia.
- Shinozaki, K., Yamaguchi-Shinozaki, K. and Urao, T. (1995). Analysis of ABA-inducible genes and their gene expression in *Arabidopsis thaliana* under drought conditions. 15th International Conference on Plant Growth Substances, Minneapolis, USA, July.
- Shinozaki, K., Yamaguchi-Shinozaki, K., Mizoguchi, T., Hirayama, T., Urao, T., Kiyosue, T., Katagiri, T. and Hayashida, N. (1995). Gene expression and signal transduction in *Arabidopsis* under drought stress. RIKEN Symposium "Survival Strategies of Plants", Woko, Japan, December.
- Shinozaki, K., Yamaguchi-Shinozaki, K., Urao, T., Mizoguchi, T., Hirayama, T., Kiyosue, T., Katagiri, T. and Noji, M. (1995). Gene expression and signal transduction in *Arabidopsis* plants under water stress. Japan-France Joint Workshop on Plant Physiology, Lyon, France.
- Shinozaki, K., Yamaguchi-Shinozaki, K., Urao, T., Mizoguchi, T., Hirayama, T., Kiyosue, T. and Noji, M. (1995). Gene expression and signal transduction in *Arabidopsis* plants under water stress. Proceedings of the Xth International Photosynthesis Congress, Vol. 1. pp. 363, Montpellier, France.
- Sugahara, K., Banzai, K., Ohwaki, Y. and Iwama, H. (1996). Soil losses from pineapple fields and its control on Ishigaki Island. Abstracts of the Annual Meeting, Japanese Society of Soil Science and Plant Nutrition, 42: 144. (J)
- Sugano, T., Miura, Y., Tsuruta, H. and Minami, K. (1995). Methane emission from Japanese rice paddy fields and soil characteristics. Abstracts of the International Symposium on Soil-Source and Sink of Greenhouse Gases, Nanjing, China, p. 30.
- Suzuki K. and Sakuma, H. (1995). Trials on development of low-energy consuming hydroponics. The 2nd Asian Crop Science Conference, Fukui, Japan.
- Suzuki, K. and Sakuma, H. (1995). Pod radish: a newly-introduced crop. Japanese Journal of Tropical Agriculture, 39(Extra issue 2): 39-40. (J)
- Takagi, H., Lu, T.G., Yasutomi, T. and Senboku, T. (1996). Cryopreservation of somatic embryos of papaya (*Carica papaya* L. ) by vitrification. Breeding Science, 46 (suppl. 1):

300. (J)

Takaya, Y., Hatta, T. and Matsukura, Y. (1995). Effects of physical and chemical properties in initial dissolution of rocks. Abstracts with Programs, 1995 Joint Annual Meeting: The Society of Resource Geology, The Japanese Association of Mineralogists, Petrologists and Economic Geologists, and The Mineralogical Society of Japan, p 98. (J)

Takeda, H., Srinivasan, A. and Senboku, T. (1995). Comparative evaluation of leaf tolerance to high temperatures in food legumes. Abstracts of the 2nd Asian Crop Science Conference, Fukui, Japan, p. 190.

Takeda, H., Srinivasan, A. and Senboku, T. (1995). Chlorophyll fluorescence as a screening tool for evaluating heat tolerance in pigeonpea. Japan Journal of Tropical Agriculture, 39(extra issue 2): 25-26. (J)

Tanaka, K. (1995). Effects of soil discharge on coastal marine environments. Abstract Paper of International Seminar on Sustainable Utilization of Coastal Ecosystems for Agriculture, Forestry and Fisheries in Developing Regions, Kuala Lumpur, Malaysia (In press).

Tanaka, M., Nakashima, K., Hayashi, T. and Shiomi, T. (1996). The nucleotide sequence of extrachromosomal DNA of rice yellow dwarf phytoplasma. Abstracts of the Annual Meeting of the Phytopathological Society of Japan, p. 119. (J)

Terao, T., Matsunaga, R. and Singh, B.B. (1995). Important root features of cowpea for the adaptation to drought condition. Agronomy Abstracts, 1995 Annual Meeting, St. Louis, Missouri, USA, p. 100.

Terao, T., Matsunaga, R. and Singh, B.B. (1996). Root characteristics of cowpea important for adaptation under dry conditions. Japanese Journal of Crop Science, 65(Extra issue 1): 228-229. (J)

Terao, T. and Singh, B.B. (1996). Eco-physiological analysis of cowpea cereal intercropping: 2) Root competition under cowpea-millet intercropping. Japanese Journal of Crop Science, 65(Extra issue 1): 64-65. (J)

Terao, T., Watanabe, I., Matsunaga, R., Hakoyama, S. and Singh, B.B. (1995). Analysis of agrophysiological constraints in intercropped cowpea. Cowpea Abstracts, p. 7-8.

Terao, T., Watanabe, I. and Singh, B.B. (1995). Branching: A significant factor for cowpea performance under intercropping. Agronomy Abstracts 1995, Annual Meeting, St. Louis, Missouri, USA, p. 101.

Terao, T., Watanabe, I. and Singh, B.B. (1996). Eco-physiological analysis of cowpea-cereal intercropping. 1) Branch numbers limit the yield of cowpea under intercropping. Japanese Journal of Crop Science, 65 (Extra issue 1): 62-63. (J)

Terao, T., Watanabe, I. and Singh, B.B. (1996). Drought tolerance of cowpea. Japanese Journal of Crop Science, 65(Extra issue 1): 230-231. (J)

Terauchi, T. (1996). Utilization of sugarcane genetic resources and research cooperation.

Japanese Journal of Tropical Agriculture, 40(Extra issue 1): 118-122. (J)

Terauchi, T., Matsuoka, M., Kobayashi, M. and Nakano, H. (1995). Relationships between growth and sugar accumulation of high sugar content varieties in sugarcane. Japanese Journal of Tropical Agriculture. 39(Extra issue 2) : 63-64. (J)

Tobita, S., Xu, N., Baset, A. and Senboku, T. (1996). Salt tolerance of rice varieties from Yunnan Province, P. R. China. Japanese Journal of Crop Science, 65 (Extra Issue 1): 234-235. (J)

Toida, Y. and Ekanayake, R. (1995). Comparison of population density of root-knot nematodes in vegetable fields cultivated with different cropping systems in Sri Lanka. Abstract of the 3rd Annual Meeting of the Japanese Nematological Society, p. 45. (J)

Toida, Y. and Ekanayake, R. (1995). Species of root-knot nematodes attacking crops and their distribution in Sri Lanka. Abstracts of the 39th Annual Meeting of the Japanese Society of Applied Entomology and Zoology, p. 228. (J)

Tomooka, N. and Egawa, Y. (1996). Crossability among cultivated and wild azuki bean related species in the genus *Vigna*. Japanese Journal of Tropical Agriculture, 40(Extra issue 1): 65-66. (J)

Tomooka, N., Lairungreang, C. and Egawa, Y. (1995). Molecular taxonomic relationships of the mungbean group species in the genus *Vigna* based on RAPD analysis. Japanese Journal of Tropical Agriculture, 39(Extra issue 2): 15-16.

Uchida, S. (1995). Diagnosis of land degradation in the semi-arid areas of Asia and Pacific regions using remote sensing data. Proceedings of the 16th Asian Conference on Remote Sensing. Proceedings of the 16th Asian Conference on Remote Sensing, Nakhon Ratchasima, Thailand.

Uno, U., Urao, T., Yamaguchi-Shinozaki, K., Shinozaki, K., Kanechi, T., Inagaki, N. and Maekawa, S. (1996). rd28-like genes induced by salt stress in Halophyte Sea Aster. Annual Meeting of the Japanese Society of Plant Physiologists. (J)

Urao, T., Yamaguchi-Shinozaki, K. and Shinozaki, K. (1995). Domain analysis of a transcription factor ATMYB2 in *Arabidopsis thaliana*. Annual Meeting of the Japanese Society of Molecular Biology, Nagoya, Japan. (J)

Vaughan, D.A., Watanabe, H., Abdullah Md. Zain and Okuno, K. (1995). Evolution and genetic diversity of Malaysian weedy rice. Proceedings I of the 15th Asian-Pacific Weed Science Society Conference, Tsukuba, Japan, pp. 461-466.

Velini, E.D., Kojima, K. and Takabayashi, M. (1996). Evaluation of allelopathic effects of leguminous species using leaf water extracts and soil solution. Weed Research, Japan, 41(supplement 1): 134-135.

Watanabe, H. (1995). Weedy rice problems in southeast Asia and control strategy. Proceedings I of the 15th Asian-Pacific Weed Science Society Conference, Tsukuba, Japan, pp. 68-80.

- Watanabe, I., Hakoyama, S., Terao, T., Matsunaga, R., Yamaguchi-Shinozaki, K. and Singh, B.B. (1995). Drought tolerance of cowpea, *Cowpea Abstracts*, p. 8.
- Watanabe, I., Terao, T. and Singh, B.B. (1995). Screening cowpea lines for drought tolerance. *Agronomy Abstracts*. 1995 Annual Meeting, St. Louis, Missouri, USA, pp. 101.
- Watanabe, T., Osada, T., Yoh, M. and Tsuruta, H. (1995). N₂O and NO emissions from grassland soils with the application of cattle and swine excreta. *Abstracts of the International Symposium on Soil-Source and Sink of Greenhouse Gases*, Nanjing, China, p. 20.
- Watanabe, T. and Tsuruta, H. (1996). Flux measurement of nitrous oxide and nitric oxide emitted from fertilized soil by automated flux monitoring system. *Abstracts of the International Workshop on NO_x Emission from Soils and its Influence on Atmospheric Chemistry*, Tsukuba, Japan, p. 46.
- Watanabe, T. and Tsuruta, H. (1996). NO and N₂O emission from fertilized soil (3): Automated flux monitoring from soil applied different types of nitrogen fertilizer: *Proceedings of the Japanese Society of Soil Science and Plant Nutrition*, 42: 225. (J)
- Yagi, K., Tsuruta, H., Kato, K., Minami, K., Cai, Z., Chairroj, P. and Cholitul, W. (1995). The determination of CH₄ fluxes from rice paddy fields in Japan, China and Thailand. *The Proceedings of Annual Meeting of the Geochemical Society of Japan*, p. 283. (J)
- Yagi, K., Tsuruta, H. and Minami, K. (1995). Possible options for mitigating methane emission from rice cultivation. *Abstracts of International Symposium Soil-Source and Sink of Greenhouse Gases*, Nanjing, China, pp. 62-63.
- Yagi, K., Tsuruta, H. and Minami, K. (1995). The effect of water management on the emission of methane from a Japanese rice paddy field. *IRRI-EPA-UNDP Meeting*, Chonburi, Thailand, p. 23.
- Yagi, S., M.M. Rai and Miyake, T. (1995). Procoxious mating behaviour caused by a juvenile hormone mimic in the desert locust, *Schistocerca gregaria*. *Abstracts of 39th Annual Meeting of Japanese Society of Applied Entomology and Zoology*, pp. 213. (J)
- Yagi, Y., Nene, V. and Musoke, A. (1995). Biochemical characterization of *Theileria parva* sporozoit proteins. *ILRAD 1994 Annual Science Report*, pp. 17-18.
- Yamada, M., Fukamachi, H. and Hidaka, T. (1995). Photosynthesis in longan and mango as influenced by high temperatures under high irradiance. *Journal of the Japanese Society for Horticultural Science*, 64 (Suppl. 1): 126-127. (J)
- Yamada, M., Fukamachi, H. and Hidaka, T. (1995). Chilling tolerance in tropical fruit tree crops as measured by chlorophyll fluorescence. *Journal of the Japanese Society for Horticultural Science*, 64 (Suppl. 2): 178-179. (J)
- Yamada, Y., Eguchi, H., Hayashi, T., Hirafuji, M. and Kiura, T. (1995). The state of the academic research network in Asia. *Proceedings of the Annual Meeting of the Japanese*

Society of Irrigation, Drainage and Reclamation Engineering, pp. 74-75. (J)

Yamada, Y., Suzuki, M. and Wapakorn Amorndham. (1995). Plan of the construction of GIS for Northeast Thailand. Proceedings of the 16th Asian Conference on Remote Sensing, Nakhon Ratchasima, Thailand.

Yamaguchi-Shinozaki, K. (1995). Regulation of gene expression under cold and drought condition. Annual Meeting of the Japanese Society of Cryotechnology, Sapporo, Japan. (J)

Yamaguchi-Shinozaki, K. (1995). Gene expression and signal transduction under drought stress. Kihara Institute Symposium. (J)

Yamamori, M., Hirano, H. and Endo, T. (1995). Variation of starch granule proteins in common wheat. *Breeding Science*, 45 (Suppl. 2): 225. (J)

Yamamoto, K. and Hong, L.T. (1995). Effects of extractives on natural durability of some Malaysian hardwood species. Proceedings of the Third Conference on Forestry and Forest Products Research, Kuala Lumpur, Malaysia.

Yamamoto, K. and Simatupang, M.H. (1995). Location of caoutchouc in teak. Proceedings of the Third Conference on Forestry and Forest Products Research, Kuala Lumpur, Malaysia.

Yamane, H., Yamada, M., Kurihara, A., Yoshinaga, K., Hirakawa, N., Sato, A., Matsumoto, R. and Iwanami, H. (1995). New Japanese persimmon cultivar 'Taishu'. *Journal of the Japanese Society for Horticultural Science*, 64(Supple. 2): 184-185. (J)

Yokoyama, T. and Ando, S. (1995). Characterization of nodulation genes of tropical *Bradyrhizobium japonicum* strains. Abstracts of the Japan Society for the Promotion of Science (JSPS)/national Science Foundation (NSF) Joint Seminar: Molecular, Physiological and Ecological Aspects of Symbiotic N₂ Fixation, p. 11.

Yoshihara, S. (1995). The role of animal husbandry in farming systems. National Symposium on Sustainable Livestock Production using Local Feed Resources (SAREC/FAO), Vietnam.

Yoshino, H., Fujii, H., Yuyama, Y., Kurita, Y. and Kitamura, Y. (1995). Water quality characteristics of water harvesting reservoirs. Proceeding of the Annual Meeting of the Japanese Society of Irrigation, Drainage and Reclamation Engineering, pp. 526-527. (J)

Yoshino, M., Fujita, Y., Arizono, S., Du, M. and Lei, J. (1995). Human activity and desertification at oases in the Taklimakan Desert. Abstracts of the 1995 Meeting, The Japanese Association for Arid Land Studies, 6: 49-50. (J)

Zhang, Y., Somantri, I.H., Tobita, S., Nagamine, T. and Senboku, T. (1995). Salt-tolerant variation in Asian cultivated rice (*Oryza sativa* L.) analyzed from taxonomic and geographical differences. Abstracts of the Third International Rice Genetics Symposium, Manila, the Philippines, p. 101.



## Effects of modification of culture conditions on varietal differences in rice cell culture

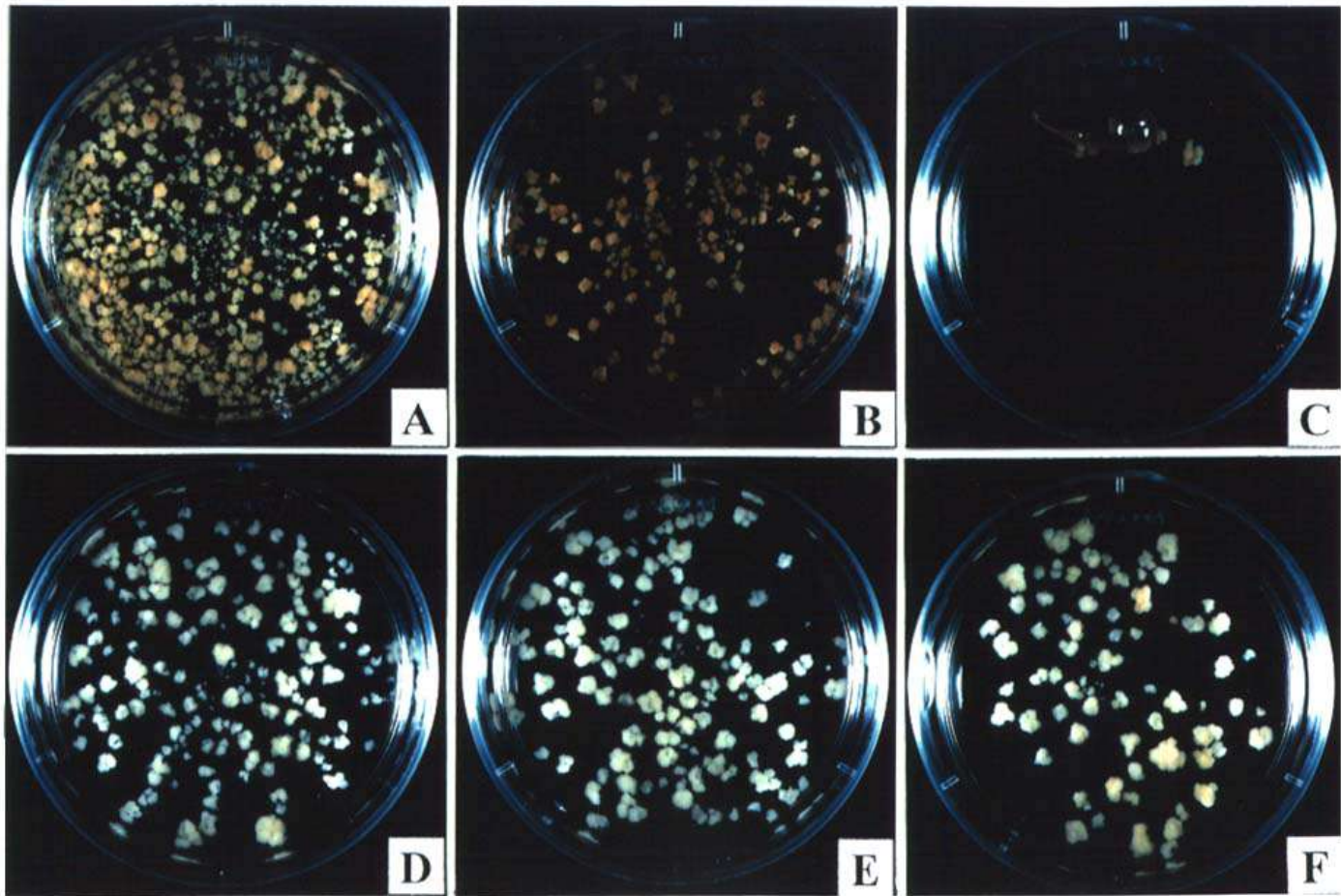
In a liquid culture for suspension culture, 2 kinds of basal media, N6⁵⁾ and R2¹⁵⁾, are widely used in combination with 2,4-D, sucrose, proline, etc. Both media were developed for cell culture of Japonica type rice in terms of promotion of cell proliferation and callus formation from explants, and the composition of the media was characterized by low levels of ammonium sulfate, 3.5 and 2.5 mM, respectively, as reduced nitrogen sources. [Fig. 1 A-C](#) shows a comparison of callus proliferation between 'Nipponbare', 'Koshihikari' and 'IR24', when the calluses derived from mature embryos were cultured in a liquid medium containing R2 basal medium, 1 mg/L 2,4-D and 30 g/L sucrose. Japonica type variety Nipponbare is one of the varieties most frequently used for biotechnological research. Nipponbare produced yellowish-white calluses and grew vigorously in this culture medium while Japonica type variety Koshihikari produced brown calluses and grew poorly. The scutellum of the embryo of the Indica type variety IR24 enlarged in the liquid medium but ceased to proliferate. In this study, 50 varieties from 4 varietal groups, Japonica type, Indica type, Javanica type and Indica-Japonica crossed varieties were classified into the 3 types described above in terms of callus proliferation in this medium as follows: Nipponbare type, Koshihikari type and IR24 type. [Fig. 2](#) shows that in the 50 varieties from the 4 varietal groups, the callus growth rate varied during the seven-day-culture period from 1.0 to 7.5 and that the Koshihikari and IR24 type varieties showed a lower level of growth. Based on these results, Koshihikari and IR24 were selected as recalcitrant varieties for improving the culture conditions.

In this study, it was assumed that specific constituents of the medium inhibited callus growth in some varieties, such as Koshihikari, IR24. To verify this hypothesis, experiments were conducted to remove the factors affecting varietal differences by modifying the medium composition. Improved composition by which the calluses of the 2 recalcitrant varieties and of Nipponbare could proliferate was eventually identified ([Fig. 1 D-F](#)). Ammonium sulfate and sucrose concentrations were considered to be the factors that inhibited the growth of the calluses of Koshihikari¹³⁾. The growth rate of the Koshihikari callus was almost identical with that of the Nipponbare callus, when alanine was added to the medium instead of ammonium sulfate as reduced nitrogen source and, in addition, the sucrose concentration decreased from 3 to 0.375%. In IR24, sucrose and medium pH were considered to be responsible for the poor response in culture. IR24 could be cultured in a liquid medium when the medium used for the Koshihikari varieties was improved with the following additional modifications: (1) Maltose replaced sucrose. (2) The pH of the medium decreased from 5.8 to 4.5. Furthermore, the addition of proline at a concentration of 10 mM promoted callus growth in the 3 varieties. The composition of the modified medium (Medium C) is shown in [Table 1](#) together with that of the initial medium (Medium A).

With the modified culture conditions, 50 varieties from 4 varietal groups were tested and the growth rates are shown in Fig 3. Koshihikari did not show any browning of calluses and all the tested IR24 varieties could be cultured under the modified conditions. The callus growth rates in the liquid medium ranged from 2.6 to 4.4. There were smaller differences in the callus growth rate compared to that under the initial conditions. These results indicated that the modified conditions developed in this study were applicable to a wider range of rice varieties.



NEXT



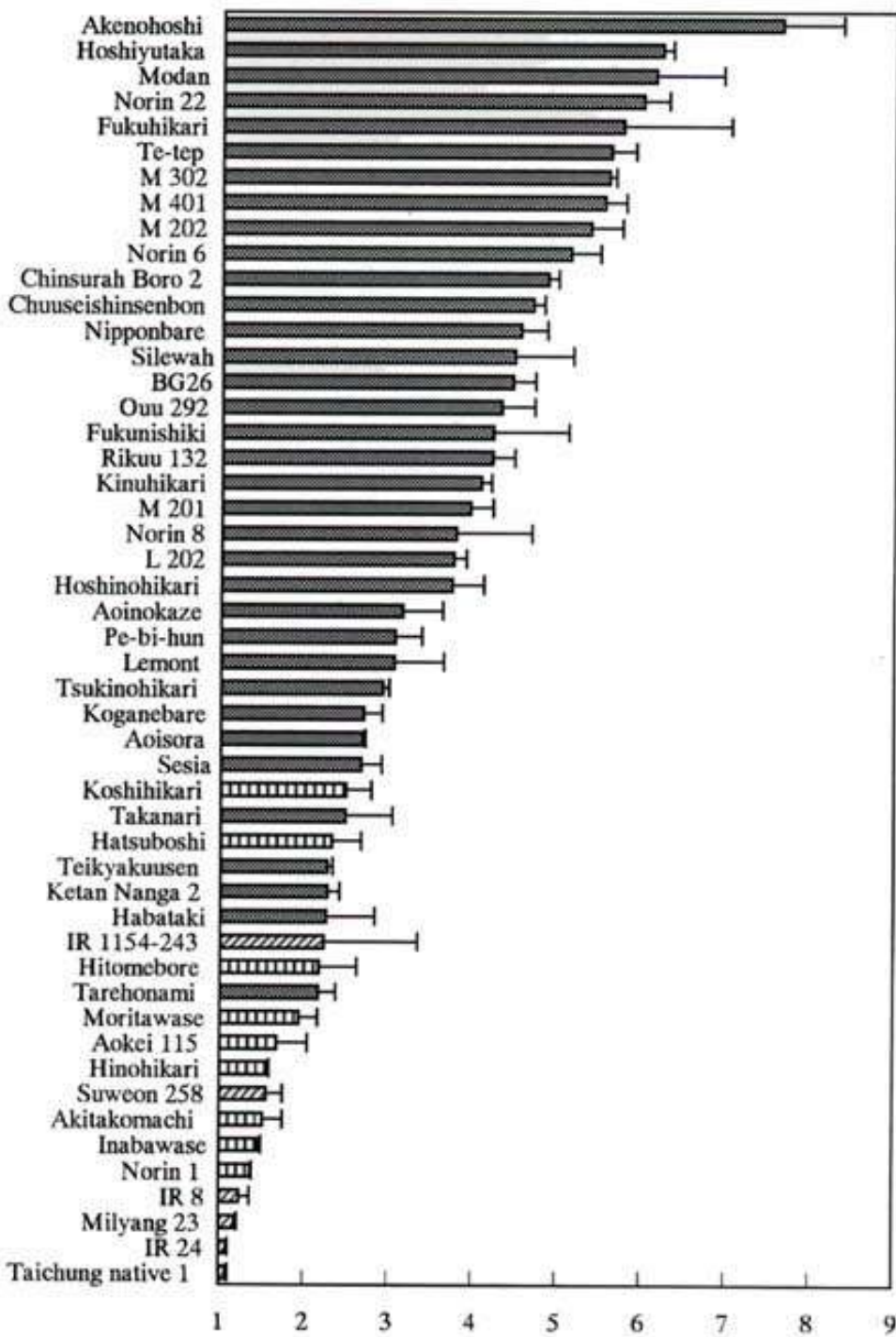
**Fig. 1. Effect of modification of culture conditions on callus proliferation of 3 varieties**

Variety : (A)(D) Nipponbare, (B)(E) Koshihikari, (C)(F) IR24.

Medium: (A)(B)(C) Media contain 40 mM  $\text{KNO}_3$  and 2.5 mM  $(\text{NH}_4)_2\text{SO}_4$  as nitrogen source and 30 g/L sucrose as carbon source. Medium pH is adjusted to 5.8. (Medium A)

(D)(E)(F) Media contain 20mM  $\text{KNO}_3$  and 5 mM alanine as nitrogen source, 3.75 g/L maltose as carbon source and 10 mM proline. Medium pH is adjusted to 4.5. (Medium C)

BACK



**Fig. 2. Varietal differences in callus growth rate under the initial conditions(Medium A) in liquid cell culture in rice**

- Nipponbare type varieties or lines
- Koshihikari type varieties or lines
- IR24 type varieties or lines

**Table 1. Medium composition**

Constituents	Medium A (Initial medium)	Medium B	(mg/L)
			Medium C (Modified medium)
Inorganic salts			
Macro-elements			
KNO ₃	4,040	2,020	2,020
(NH ₄ ) ₂ SO ₄	330	330	-
CaCl ₂ e2H ₂ O	147	147	147
MgSO ₄ e7H ₂ O	245	245	245
KH ₂ PO ₄	-	272	272
NaH ₂ PO ₄ e2H ₂ O	312	-	-
Micro-elements			
Fe-EDTA	19	19	19
MnSO ₄ e4H ₂ O	1.6	1.6	1.6
ZnSO ₄ e7H ₂ O	2.2	2.2	2.2
CuSO ₄ e5H ₂ O	0.20	0.20	0.20
Na ₂ MoO ₄ e2H ₂ O	0.13	0.13	0.13
H ₃ BO ₃	2.8	2.8	2.8
Vitamins			
Nicotinic acid	1.0	1.0	1.0
Thiamine-HCl	10.0	10.0	10.0
Pyridoxine-HCl	1.0	1.0	1.0
myo-Inositol	100.0	100.0	100.0
Amino acids			
Alanine	-	-	445
Proline	-	-	1,151
Carbon sources			
Sucrose	30,000	30,000	-
Maltose	-	-	3,750
pH	5.8	5.8	4.5

**BACK**

From **Narita International Airport** to **Tsukuba Center**:● By **Airport Bus** (100min)**2,540YEN**

Dep.	Arriv.	Dep.	Arriv.
07:20	09:00	16:15	17:55
09:05	10:45	17:20	19:00
10:35	12:15	18:40	20:20
12:50	14:30	20:00	21:40
14:35	16:15		

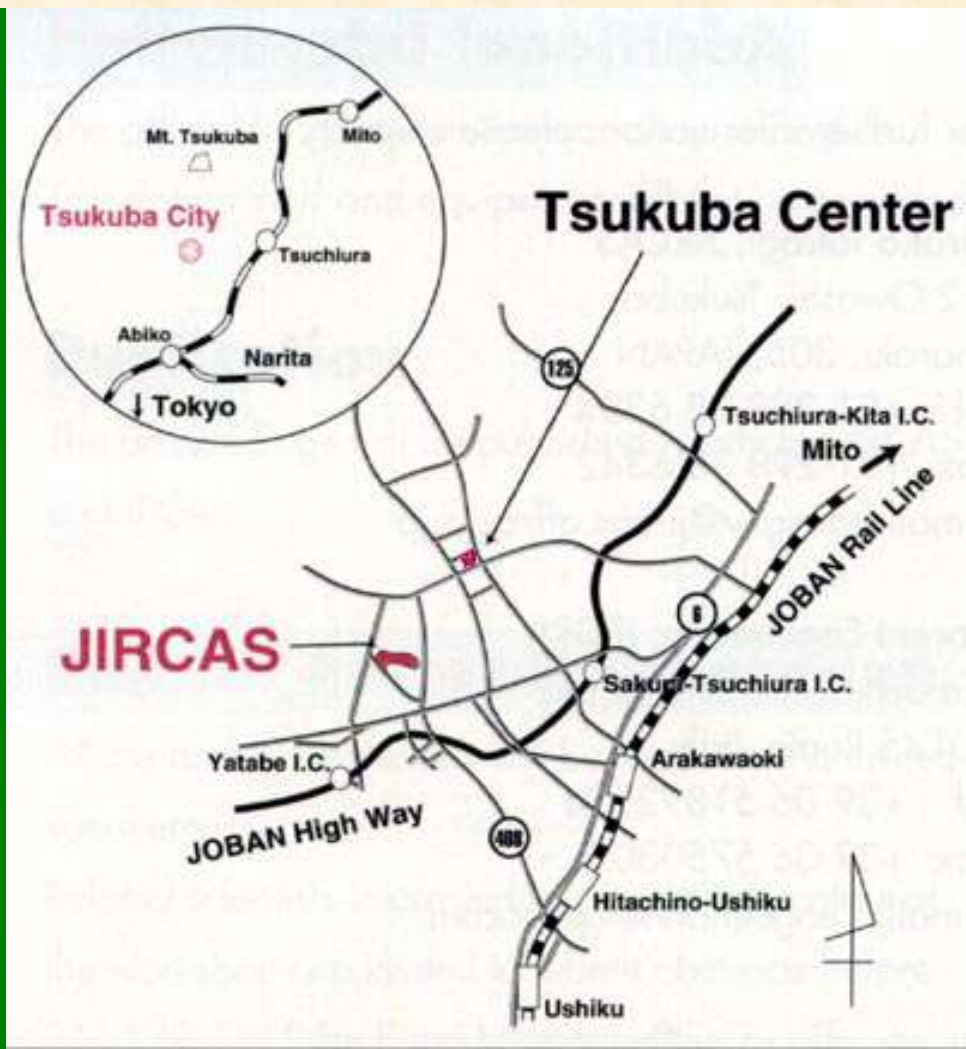
● To **JR Tokyo Station** by **Narita Express** / (60min) / **2,940YEN**From JR Tokyo Station (**Yaesu South Exit**) to **Tsukuba Center** by**JOBAN High Way Bus** / (60min) / **1,250YEN**▶ From **Tsukuba Center** to **JIRCAS** :By **Taxi** (15 min) /about **2,000YEN**

1-2 Ohwashi, Tsukuba, Ibaraki 305-8686 JAPAN

Tel: 0298-38-6313

Fax: 0298-38-6316

E-mail: [www@jircs.affrc.go.jp](mailto:www@jircs.affrc.go.jp)



[JIRCAS Home Page](#)



[What's New](#)

# Ministry of Agriculture, Forestry and Fisheries WWW servers.

Japanese version is [here](#).

- [National Research Institutes](#)
  - [AFF Research Council](#)
- 

## National Research Institutes

Some servers are still development.

More Information and clickable map is [here](#).

- [NARC](#):National Agriculture Research Center
- [ABR](#):National Institute of Agrobiological Resources
  - [DNA Information and Stock Center](#)
- [NIAES](#):National Institute of Agro-Environmental Sciences
- [NIAI](#):National Institute of Animal Industry
  - [Japan Animal Genome Database](#)
- [NGRI](#):National Grassland Research Institute
- [FRUIT](#):Fruit Tree Research Station
  - [AKT](#):Fruit Tree Research Station (Akitsu Branch)
  - [KCNT](#):Fruit Tree Research Station (Kuchinotsu Branch)
- [NIVOT](#):National Research Institute of Vegetables,Ornamental Plants and Tea
- [NKK](#):National Research Institute of Agricultural Engineering
- [CRYO](#):Hokkaido National Agricultural Experiment Station
  - [MMR](#):Hokkaido National Agricultural Experiment Station (Memuro Branch)
- [TNAES](#):Tohoku National Agricultural Experiment Station
  - [OMG](#):Tohoku National Agricultural Experiment Station (Omagari Branch)
- [INADA](#):Hokuriku National Agricultural Experiment Station
- [CGK](#):Chugoku National Agricultural Experiment Station
- [SKK](#):Shikoku National Agricultural Experiment Station
- [KNAES](#):Kyushu National Agricultural Experiment Station
  - [MYKZ](#):Kyushu National Agricultural Experiment Station (Miyakonojo Branch)

- [NRIAE](#):National Research Institute of Agricultural Economics
  - [NISES](#):National Institute of Sericultural and Entomological Science
  - [NIAH](#):National Institute of Animal Health
  - [NFRI](#):National Food Research Institute
  - [JIRCAS](#):Japan International Research Center for Agricultural Sciences
  - [FFPRI](#):Forestry and Forest Products Research Institute
    - [FSM](#):Forestry and Forest Products Research Institute (Kansai Branch)
  - [HNF](#):Hokkaido National Fisheries Research Institute
  - [MYG](#):Tohoku National Fisheries Research Institute
  - [NRIFS](#):National Research Institute of Fisheries Science
  - [NNF](#):Nansei National Fisheries Research Institute
  - [JSNF](#):Japan Sea National Fisheries Resaerch Institute
  - [ENYO](#):National Research Institute of Sea Fisheries
  - [NRIA](#):National Research Institute of Aquaculture
  - [NRIFE](#):National Research Institute of Fisheries Engineering
- 

## AFF Research Council

- [AFF Research Council Secretariat \(in Kasumigaseki\)](#)
    - [Tsukuba Office](#)
      - [Computer Center](#)
      - [Research Information Center](#)
      - [Tsukuba Bioscience Hall](#)
- 

tzhaya@cc.affrc.go.jp (Takanori Hayashi)



# Prediction of Pork Production Structure and Consumption in China

*Chien Hsiaoping*

*Research Information Division, JIRCAS*

Pork consumption in recent years has shown two main characteristics. The first one is that per capita pork consumption in the urban areas seems to have hit a peak already. The second one is that consumers' consumption preference has shown variations (from frozen meat to fresh meat, and from fat meat to lean meat, with a tendency to high quality consumption). These new trends have also resulted in changes in the production structure.

## 1 Pork production structure

### 1) Breeding scale

The main form of pork production is the family-scale hog raising. The average number of hogs raised in a farm is four per household (shipment + stock). Usually, one is for self-consumption. According to the data supplied by the Ministry of Agriculture, farms raising less than six hogs accounted for 94% of the total hog-raising farms in 1995. However, the number of farms raising more than six hogs has been increasing since 1986.

### 2) Production composition

Pork production in 1998 amounted to 38,840,000 tons, and the supply per capita was 31 kg. In the early 1980s, pork production accounted for more than 90% of the whole meat production, and now it accounts for 68%. This is partly due to the changes in consumers' preference in consumption, and partly influenced by the new policy of promoting the consumption of products derived from feed-saving-type stock raising in recent years, including herbivorous animal products (cow and sheep), poultry meat products that are produced with efficient feed-to-meat conversion rates, and marine products. At present, poultry meat and beef production accounts for 28%. However, the pork-predominant production structure will remain.

### 3) Regional distribution of production

A large proportion of pork production is carried out in the southern regions. In 1998, the production share of the southern regions was 65%, in contrast to the 35% share in the northern regions. In the past, pork production was heavily concentrated in Sichuan Province, but in the 1990s many provinces began to enhance their own self-supply capabilities. Among them, the northeastern region has taken the advantage of being a major grain production base and has markedly increased pork production in recent years. Also, as a result of the changes in consumers' consumption preference, it has become more difficult for Sichuan Province to adjust its production to meet the market demand, and the domestic pork production is facing a possible redistribution among provinces.

### 4) Feed in hog raising

The production structure based on the family-scale hog raising has resulted in a long breeding period and a low turnover rate. The low lean-meat rate characterizes the meat thus produced, since formula feed has not yet replaced the traditional feeding method. Nevertheless, as the commercial production is expanding, large-scale hog raising has begun to emerge, which in turn has stimulated the demand for feed. The formula feed production for hog raising had been increasing at an annual rate of 12% between 1991 and 1996 to 20,000,000 tons, accounting for 39% of the total formula feed production. Considering the large scale of pork production, however, the share of the formula feed for hog raising is still quite small. As the production moves rapidly to meet the needs of the commercial market, the demand for formula feed is expected to increase further.

## 2 Forecast for pork consumption

The future pork consumption per capita in the urban and rural areas has been analyzed, respectively. The simulation conducted from 1996 to 2010 covered a 15-year period in total, and the results are shown in Table 1. The base line of the analysis follows the average expansion rate in the past 16 years (1980 to 1995). The high and low predictions are obtained by moving the point up and down from the expansion rate of this base line. Compared with the urban areas, the income elasticity of demand in the rural areas is larger, indicating a possible future increase in pork consumption as the rural economy further develops. On the other hand, pork consumption in the rural areas is less influenced by price fluctuations, reflecting the self-supply and self-sufficiency conditions there.

Accordingly, pork consumption in the urban areas will only increase slightly, and the low prediction forecasts a decrease. The high prediction puts the amount of consumption per capita in the urban areas at 20 kg. On the other hand, a steady increase of pork consumption is predicted for the rural areas, with the amount of consumption per capita reaching 18 kg in 2010, about the same level as that in the urban areas. Taking into consideration the population trend to urbanization, the total amount of direct consumption is predicted to reach 3,540,000 tons (low prediction) or 37,000,000 tons (high prediction) in 2010, an increase of about 12,000,000 tons from 23,200,000 tons in 1996. As the population and income increase, the pork production and consumption will certainly expand further.



*Medium-scale hog raising in Sichuan*

**Table 1. Analytical results of prediction of per capita pork consumption (period 1996-2010)**

	Income elasticity	Price elasticity	R ²	D.W.
Urban	0.345	-0.133	0.92	2.24
(t value)	(6.62)	(-5.15)		
Rural	0.585	-0.051	0.95	1.93
(t value)	(10.07)	(-2.05)		

**NEXT**

**CONTENTS**

# JIRCAS International Symposium Series

---

No.1	Rehabilitation of Degraded Forest Lands in the Tropics - Technical Approach -	Mar. 1994
No.2	Plant Genetic Resource Management in the Tropics	Dec. 1994
No.3	Fruit Production in the Tropics and Sub-Tropics	Aug. 1995
No.4	Innovative Weed Management Strategy for Sustainable Agriculture	June 1996
No.5	The Bio-safety Results of Field Tests of Genetically Modified Plants and Microorganisms	Nov. 1997
No.6	Sustainable Agricultural Development Compatible with Environmental Conservation in Asia	Mar. 1998
No.7	Postharvest Technology in Asia - A step forward to stable supply of food products -	Mar. 1999
No.8	GIS Applications for Agro-Environmental Issues in Developing Regions	Mar. 2000
No.9	Agricultural Technology Research for Sustainable Development in Developing Regions	Aug. 2001
No.10	Water for Sustainable Agriculture in Developing Regions - More crop for every scarce drop -	Aug. 2002

---

*Japan International Research Center for Agricultural Sciences*



# JIRCAS Working Report

JIRCAS

No.	Žg—p CE¼CEê	<p>∧`è,` ,æ,Ñ•Ò`~ŽÒ</p>	”-Šš”NCEŽ
No.1	%op•@CEê	<p><b>IFPSIM INTERNATIONAL FOOD AND AGRICULTURAL POLICY SIMULATION MODEL (USER'S GUIDE)</b> by keiji Oga and Koji Yanagishima</p> <p>•čŠE•H—i••ôfVf~f...fCE•[fVf‡f“f„fffc•Ff†•[fU•[fKfCfh ‘â%œêCEŽi•A—ö“‡•GŽi•@”~</p>	1996”N3CEŽ
No.2	%op•@CEê	<p><b>Mungbean Germplasm:collection, Evaluation and Utilization for Breeding Program</b></p> <p>Edited by P. Srinives , C Kitbamroong and S .Miyazaki</p> <p>fŠf‡fNfgfE`â“Ž`CE!•FŽû•W•A•%œi,` ,æ,Ñ`çŽi—~p fsf%œfT•[fN•@fVf...fŠfj]fxfX•Af fff%œfX•@fLfbfof f•[f“•A {•è•@•@ŽŽ•@•Ö</p>	1996”N3CEŽ
No.3	“ú—{CEê	<p>’†••Efgf,ftf@f“~`n,İ“y•ë,Æ”~&lt;Æ ’†`ä•@•M•Aæâ•@•MŠC•Ažæ•@Ž©—\$•A`Ł•@—Ý“•@”~</p> <p><b>Soils and Agriculture of Turpan, China</b></p> <p>by Makoto Nakai, Guihai Zao, Zili Fffan and Leide Zhang</p>	1996”N10CEŽ
No.4	%op•@CEê	<p><b>Sustainable Utilization of Coastal EcosystemsProceedings of the Seminar on Sustainable Utilization of Coastal Ecosystems for Agriculture, Forestry and Fisheries in Developing Regions</b></p> <p>Edited by M. Suzuki, S. Hayase and S. Kawahara</p> <p>%œŠÝ•¶•ÔCEn,İŽ•±“I—~p•FŠJ”~“r•ā`n`æ,É,` ,é%œŠÝ”_—Ñ...ŽY•¶•ÔCEn,İŽ•±“İŠJ”—~p,ÉŠÖ, ,éfZf~fi•[,İcŽ~^ —é-Ø•³•A`•Ł—İ—Y•A•iCE`d•K•@•Ö</p>	1996”N10CEŽ
No.5	“ú—{CEê	<p>“CE~kf^fC,É,` ,éŽ•±“P”~&lt;Æ,Ö,İ%œÛ`è</p> <p>%œ•@ŽO“i•A`À“i•Û`¼Y•@•Ö</p> <p><b>Development of Sustainable Agricultural Systems in Northeast Thailand</b></p> <p>Edited by Mitsunori Oka and Shotaro Ando</p>	1997”N2CEŽ
No.6	“ú—{CEê	<p>’†•“y•ëCEn“œ•a—P•i•C’ù`Ä•j</p> <p>’†•%œÈŠw%œ@“i`ž“y•ëCEœ†•ŠŽâ•Ä ’†•%œÈŠw%œ@“i`ž“y•ëCEœ†CEn“œ•a—PCEœ†fOf•[fv•A ’†•“y•ëCEn“œ•a—P•œ“CEœ†fOf•[fv”~</p> <p><b>Chinese Soil Taxonomy (Revised proposal )</b></p> <p>by Chinese Soil Taxonomy Research Group, Institute of Soil Science, Academia Sinica &amp; Cooperative Research Group on Chinese Soil Taxonomy</p>	1997”N3CEŽ
No.7	“ú—{CEê	<p>“i•Ä,İ”~&lt;Æ,Æ`â“œ ,»,İCE»•ó,Æ•«—^</p> <p>••¶—q%œq•A“i`è•K`•@•Ö</p> <p><b>Agriculture and Soybean in South America</b></p> <p>Edited by Makie Kokubun and Kozo Fujisaki</p>	1997”N11CEŽ





# JIRCAS Working Report

JIRCAS “Ū”_<ÆCEα<†•î•ñ^ê——

No.	Žg—p CE¾CEê	·\`è,“,æ,Ñ•Ò~žÒ	”-šš”NCEž
No.11	%op•@CEê	<p><b>Comparative Studies on Phosphorus and Iron Nutrition of Tropical Legumes</b></p> <p>by Yoshinori Ohwaki</p> <p>”M’Ñf}f•%oÈ•i•,Ìfšf“„,æ,Ñ“S%och—{,ÉšÖ,.,é ”äšr•¶—•šw“ICEα† ‘ã~e—Ç•~•@”~</p>	1998”N3CEž
No.12	“ú—{CEê	<p>•...žYf fXfgfn•[fxfxfg••Ū&lt;α“CEα&lt;†,ÌCE»•ó,Æ“W—] •ÿ“c•@—T•A%oF—ižj~Y•@•Ò</p> <p>Current State and View of International Collaborative Research in Fisheries Postharvest technology Edietedd by Yutaka Fukuda and Shiro Uno</p>	1998”N12CEž
No.13	%op•@CEê	<p><b>No-Tillage cultivation of Soybean and Future Research Needs in South America</b></p> <p>Edited by Makie Kokubun</p> <p>‘i•Ä,É,“,.,é‘ã“α,Ì•s•k•N•Í”l,Æ•jCEã,Ì%oŪ‘è,ÉšÖ,.,éfZf~fi•[,Ì•ñ•••‘ •••ã—q%oα•@•Ò</p>	1998”N12CEž
No.14	%op•@CEê	<p><b>Proceedings of Workshop on Heat -Tolerance of Crops</b></p> <p>Edited by M. Yajima and T. Hayashi</p> <p>•i•,Ì•İ•&lt;•«,ÉšÖ,.,éf••[fnfvf‡fbfv —ĩ“‡•³•°•A—Ñ•@—žž•@•Ò</p>	1999”N3CEž
No.15	“ú—{CEê	<p>•,í,ã•,“,æ,Ñ“CE“ifAfWfA,ÌfpfpfCfAfEfBf&lt;fX•a •”-•¶•E•ã•z,È,ç,Ñ,É•aCE’fEfBf&lt;fX,Ì “~”è•E•f’f,ÆCEn“•ã—p\</p> <p>áÁ%oã•@“N•v•@”~</p>	1999”N12CEž

No.16	%op•@Œê	<p><b>Proceedings of the Seminar on High Value Timber Species for Plantation Establishment-Teak and Mahoganies,1-2 December 1998,Tawau, Sabahto</b></p> <p>Edited by Chan Hing Hon and Kazuma Matsumoto</p>	1999”N3ŒŽ
No.17	“ú-{ Œê	<p><i>Saccharum spp.</i></p> <p>Edited by Chan Hing Hon and Kazuma Matsumoto</p>	2000”N3ŒŽ
No.18	%opŒê	<p><b>Learning from the Farming Systems Research Experiences in Indonesia</b></p> <p>Edited by J.Goto and M.Mayrowani</p>	2000”N3ŒŽ
No.19	%opŒê	<p><b>Jircas/EMBRAPA Gado de Corte International Joint Workshop on Agropastoral System in South America</b></p> <p>Edited by Tsutomu Kanno and Manuel.C.Macedo</p>	2001”N1ŒŽ
No.20	%opŒê	<p><b>Development of Technology for Utilization and Processing of Freshwater Fisheries Resources</b></p> <p>Edited by Y.Fukuda,X.Wang,M.Yokoyama and M.Maeda</p>	2001”N1ŒŽ
No.21	“ú-{ Œê	<p><b>Genetic Engineering of Crop Plants for Abiotic Stress</b></p> <p>Edited by M.Iwanaga</p>	2001”N7ŒŽ
No.22	“ú-{ Œê	<p><b>Genetic Engineering of Crop Plants for Abiotic Stress</b></p> <p>Edited by M.Iwanaga</p>	2001”N12ŒŽ
No.23	%opŒê	<p><b>Genetic Engineering of Crop Plants for Abiotic Stress</b></p> <p>Compiled by M.Iwanaga</p>	2002”N2ŒŽ



# JIRCAS 国際農業技術センター

## 農業技術の国際交流と発展

### 国際農業技術センター

(ISSN 1341-3899)

‘æ12•† “ú–{Œê f}fŒ•[fVfAĩîŒo%oc,İ•V,µ,ç’S,çŽè  
Emergence of New Type of Rice Farmers in  
Malaysia

^À%oc,,@<v”ú”~

2002”N7ŒŽ

”-”,,Œ³•F  
“ú–{Œo•İ•]~ŽĐ  
TEL•F03-3230-1661  
4,200•{•Å

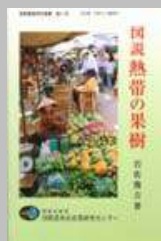
ISBN4-8188-1419-9



‘æ11•† “ú–{Œê }•à•@”M•Ñ,İ%oĒŽ÷  
Šâ²•r<g”~

2001”N1ŒŽ

”-”,,Œ³•F  
(Š”•j—{Œ«“°  
TEL:03(3814)0911  
6,000%oc~+•Å



‘æ10•† “ú–{Œê •İ–e,•,éƒ•fRf“ffƒ•f^  
•\ftf@•[f~f“fOfVfXfef,İ“WŠJ•  
•¼^ä•d—Y•Ò

2000”N12ŒŽ

”-”,,Œ³•F  
”_—Ñ“•Œv<‰oi  
TEL:03(3492)2987



‘æ9•† “ú–{Œê ftf@•[f~f“fOfVfXfefŒŒ•†  
•|—~_,ŒŽÀ•H•|

2000”N10ŒŽ

”ñ”,,•i

J.S.fR•[f<fhfEfFf•A  
%ociŽR–İŽ÷•AŒã“;•~Žq•@ŠÄ–ó





‘æ8•† %opCEê **Cryopreservation of tropical plant germplasm** 2000”N  
 ”ñ”,•i  
 Current research progress and application (ISBN92-9043-428-7)  
 Florent Engelmann and Hiroko Takagi, editors



•@  
 •|•Å<β, ÌCEα<†•ûCEü, Æ—~—p•|  
 F.fGf“fQf<f}f“•AH. •, -Ø•Ò

•@

‘æ7•† “ú—{CEê **“CE•E“CE‘îfAfWfA”_<Æ, Ì•V“WŠJ** 1999”N12CEŽ  
 ”-”,•E3  
 “_—Ñ“•CEv<!%öi  
 “†••AfCf“fhfVfA•Af^fC•Af}fCE{fVfA, Ì”ãŠrCEα<†•  
 —x“àv‘¾~Y•A•—Ñ•O-¾•@•Ò”  
 TEL:03(3492)2950  
 2,200%ö~+•Å



‘æ6•† “ú—{CEê **2020”N•çŠE•H—;Žù<<—\“^a** 1998”N10CEŽ  
 ”-”,•E3  
 “_—Ñ“•CEv<!%öi  
 “†••ûH—ç••ôfVf...f~fCE{fVf†f“f, fff<, ÌŠJ”-, Æ—~—p•|  
 “â%öêCEŽ;•@”  
 “ŽR<™“••||%ö><!%öi  
 TEL:03(3585)1141  
 2,476%ö~+•Å



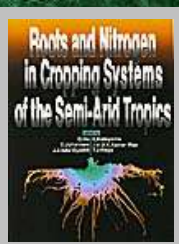
‘æ5•† “ú—{CEê **fAfWfA, Ì•©’ŽŽ‘CE¹** 1998”N9CEŽ  
 ”-”,•E3  
 “_—Ñ“•CEv<!%öi  
 “†••Ž‘CE!%ö>, Æ•||ŽY““, Ì—~—p•|  
 “¼••CEô•v•ACEI—Ñ—ÌŽ;•A  
 “~’JCE£“ñ•@”  
 TEL:03(3492)2987  
 2,100%ö~+•Å



‘æ4•† “ú—{CEê **”M•Ñ%oÊŽ÷, Æ, »; Ì—~—p** 1997”N9CEŽ  
 ”-”,•E3  
 “_—Ñ“•CEv<!%öi  
 “â“CE•@•G•@”  
 TEL:03(3492)2987  
 2,000%ö~+•Å



‘æ3•† %opCEê **”¼Š£‘†”M•Ñ, Ì•òt, -ÌCEn, É, “, -é^a, Æ’, ‘f, Ì“@•Ô** 1996”N10CEŽ  
 ”ñ”,•i  
 “É“;•@Ž;•AC.fWf†fZfnf“•AJ.J.fAfhfMfff“ftfB•A•ĐŽR•ÿ”V•AT.J.fCEfS•AJ.V.D.K.  
 fNf}f%öfI•@•Ò



‘æ2•† “ú—{CEê **fAfWfA, Ì““••H•i** 1996”N4CEŽ  
 ”-”,•E3  
 “_—Ñ“•CEv<!%öi  
 “†••CE‘îfAfWfA, δ’†•S, É•|  
 “→•è“1—Y•A“nÓ“Ä“ñ•A  
 “âŠp‘Žq•@”  
 TEL:03(3492)2987  
 1,553%ö~+•Å



‘æ1•†

“ú–{CEê

’†•‘,Ì–ì•Ø•|•ãŠC•Ò•|  
•X%œ°•!ŽO•A%œœ%œœ»•@ŠÄ•C

1995”N3CEŽ  
”ñ”„i



•@



••Ū”_—Ñ•...ŽY<ÆCEœ<†fZf“f^•[•@





# ••Ü”_<ÆCEΩ<†•¬%oË•î•ñ‘æ, V•† 1999•i•½•¬11”N“x•j

1. [•H—iŽù<<f,ffk<,đ—p,ç,½•H—i^À‘S•Û•á,ÌfVf~f...fCE•\[fVf‡f“•ª•Í](#)
2. [fxfgfif f•fRf“ffk<f^•Ý—^^î,Ìâ““‘I’½—l•«„Ì•l%oç,Æ‘İ%o—•«•iŽí,Ì‘I”²](#)
3. [“lŽÊ”²•β^â“Žq,đ—p,ç,½ŠÂ<<fXfgfCEfX‘İ•«•A•“,İšJ”-](#)
4. [’†•ŽR“CE•È—ÈCE§,É,“,-,é’n%o°•...•...Ži,Æ”_•k’n,Ì’,‘f•zŠÂ](#)
5. [•ªCEn•ª•z,©,ç,Ý,½”M‘ÑfAfWfA,Ì—□î,Ì...fXfgfCEfX•,ŠŽó•«](#)
6. [••,è•Ä’†,Ì••,è•¬ª,Ì’è—Ê—@](#)
7. [•,•Ä,©,ç,ÌfCf“ffBfJ•iŽí”»•Ê—@](#)
8. [f^fC•“CE-k”,É,“,-,é•Ý—”½ä%oœ’{,Ì•Á%o»“Á•«„ÆfGflf<fM•\[—v<•—Ê](#)
9. [“y•ë,Ö,Ì—L<@•“Y<<^—Í,©,ç,Ý,½”_—q—ÖŠ•fVfXfef,Ö,Ì“±“ü—D—ÇfCfl%oÈ•Ží](#)
10. [•ì•Æ“¹,É,“,-,éftf^fofKfL%oÈfZf%of,,Ì•X•V<Z•p](#)
11. [ftfBfŠfsf“,É,“,-,é}f%oÈ,“æ,Ñflf fmfL%oÈ—L—pŽ÷,İŽíŽq”-%oè‘£•i^—•<Z•p](#)
12. [fIfjfefifKfGfr,Ì—%o©f^f“fpfNfrfefŠf“,ÌfAf~fmŽ ”z—ñCE^è,“æ,Ñ•‡•¬•”Ê,Ì%ođ-¾](#)
13. [f}f“fOf••\[fu<D•...^æ•...^æ,É,“,-,é<>%oî—P•|ŽY<@’^,Ì%ođ-¾](#)
14. [fTf,,fCf“fQf“,Ì%oÔ²—«•«„É,æ,é‘İ•<«CEÿ’è](#)
15. [^ÿ”M‘Ñ’n^æ,Ì~%oJfGflf<fM•\[,“æ,Ñ%oJ“H—±CEa•ª•z,Ì‘Á•«](#)

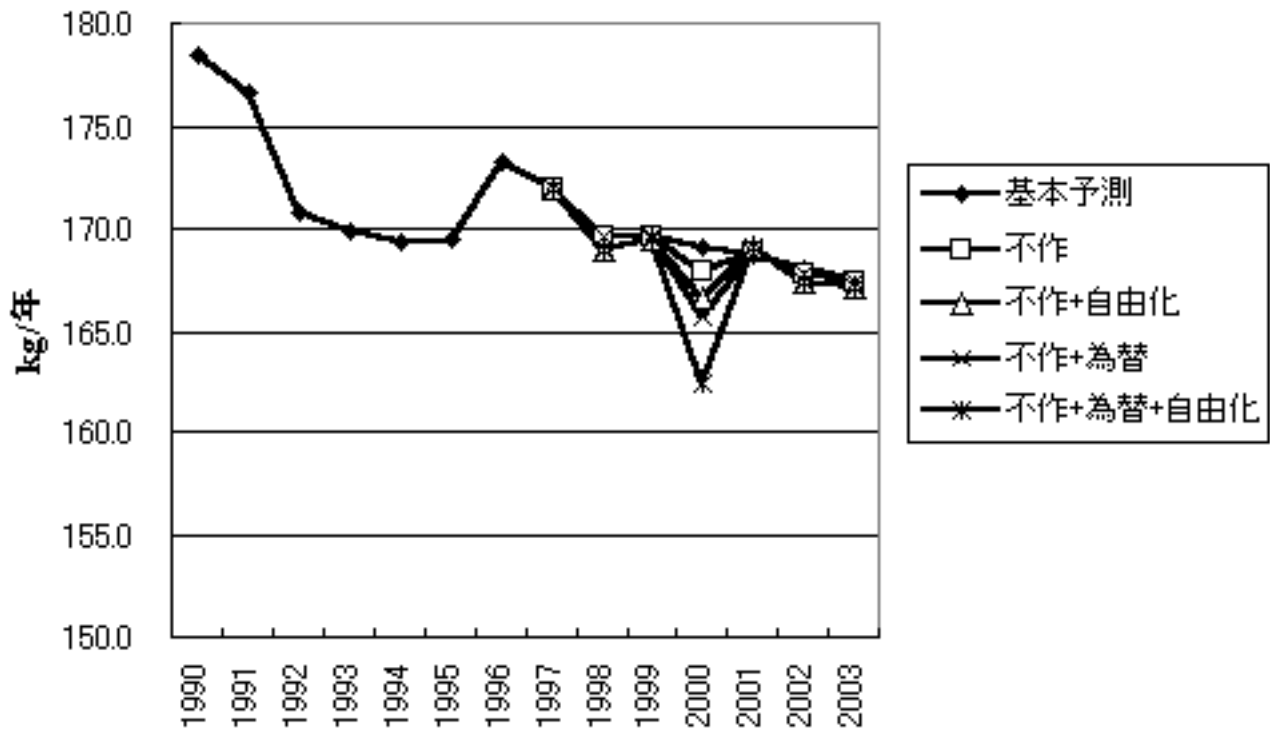




$fVfif\check{S}fI$	$-f\check{O}\check{Z}\textcircled{R}\%o\gg$ (fAfWfALIFDC)	$\cdot\check{i}\mu 2000''N$ ( $\check{Z}\check{a}-v-A\cdot o\cdot'$ )	$\wedge\times'\check{O}2000''N$ (fAfWfALIFDC)
$\check{S}\hat{i}-\{\text{---}\backslash^a$	50% $\%o_i$ $\check{S}\hat{i}^U\text{'}$ ]	$'\hat{E}\acute{i}$	$\hat{e}'\grave{e}$
$\cdot s\cdot\grave{i}$		$,R\check{S},,s\cdot\grave{i}$	$\hat{e}'\grave{e}$
$\cdot s\cdot\grave{i}+\wedge\times'\check{O}$		$,R\check{S},,s\cdot\grave{i}$	$,R\check{S},,\%o^\circ-\check{Z}$
$\cdot s\cdot\grave{i}+\check{Z}\textcircled{R}\%o\gg$	100% $\%o_i$ $\check{S}\hat{i}^U\text{'}$ ]	$,R\check{S},,s\cdot\grave{i}$	$\hat{e}'\grave{e}$
$\cdot s\cdot\grave{i}+\wedge\times'\check{O}+\check{Z}\textcircled{R}\%o\gg$		$,R\check{S},,s\cdot\grave{i}$	$,R\check{S},,\%o^\circ-\check{Z}$

$\cdot@ \cdot \backslash, P fVfif\check{S}fI, \hat{i}'g\cdot\ddagger, ^1$

もどる



基本予測、不作、不作+自由化、不作+為替、不作+為替+自由化  
 1990年、1991年、1992年、1993年、1994年、1995年、1996年、1997年、1998年、1999年、2000年、2001年、2002年、2003年

もどる





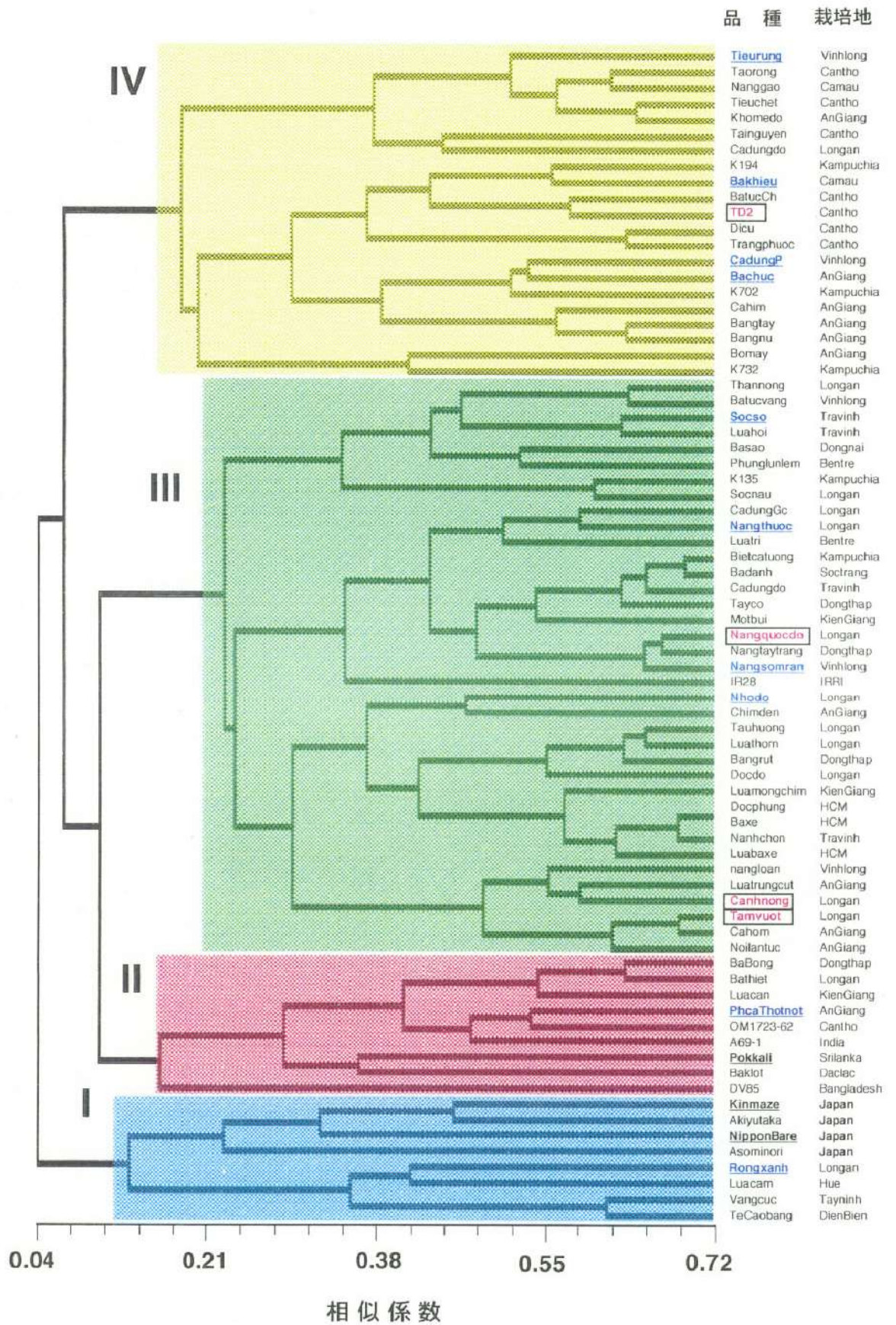
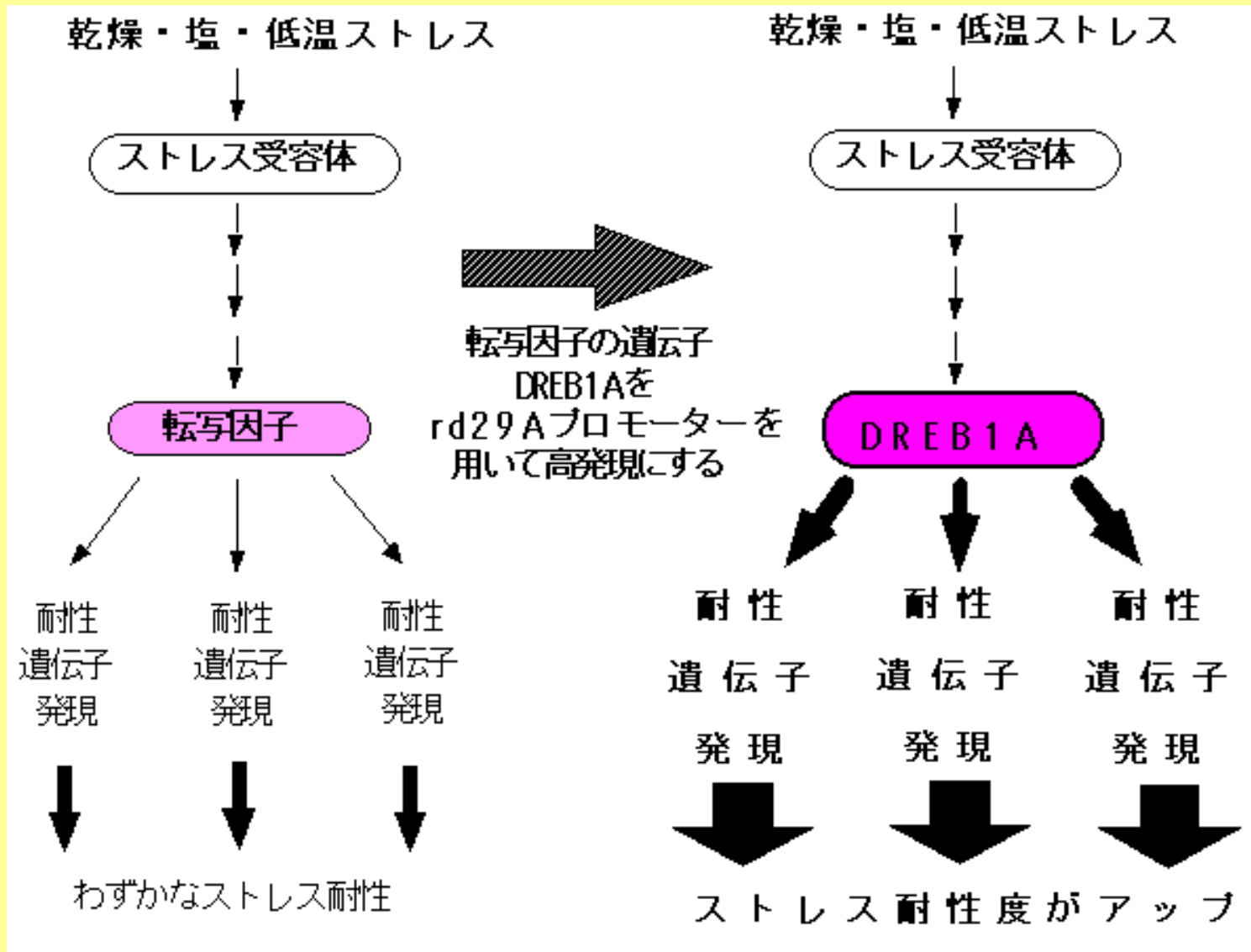


図1. 43個のマイクロサテライトマーカー多型を用いた完全連結法によるベトナムメコンデルタ在来稲の遺伝的変異（四角は高度耐塩性、下線は耐塩性品種）

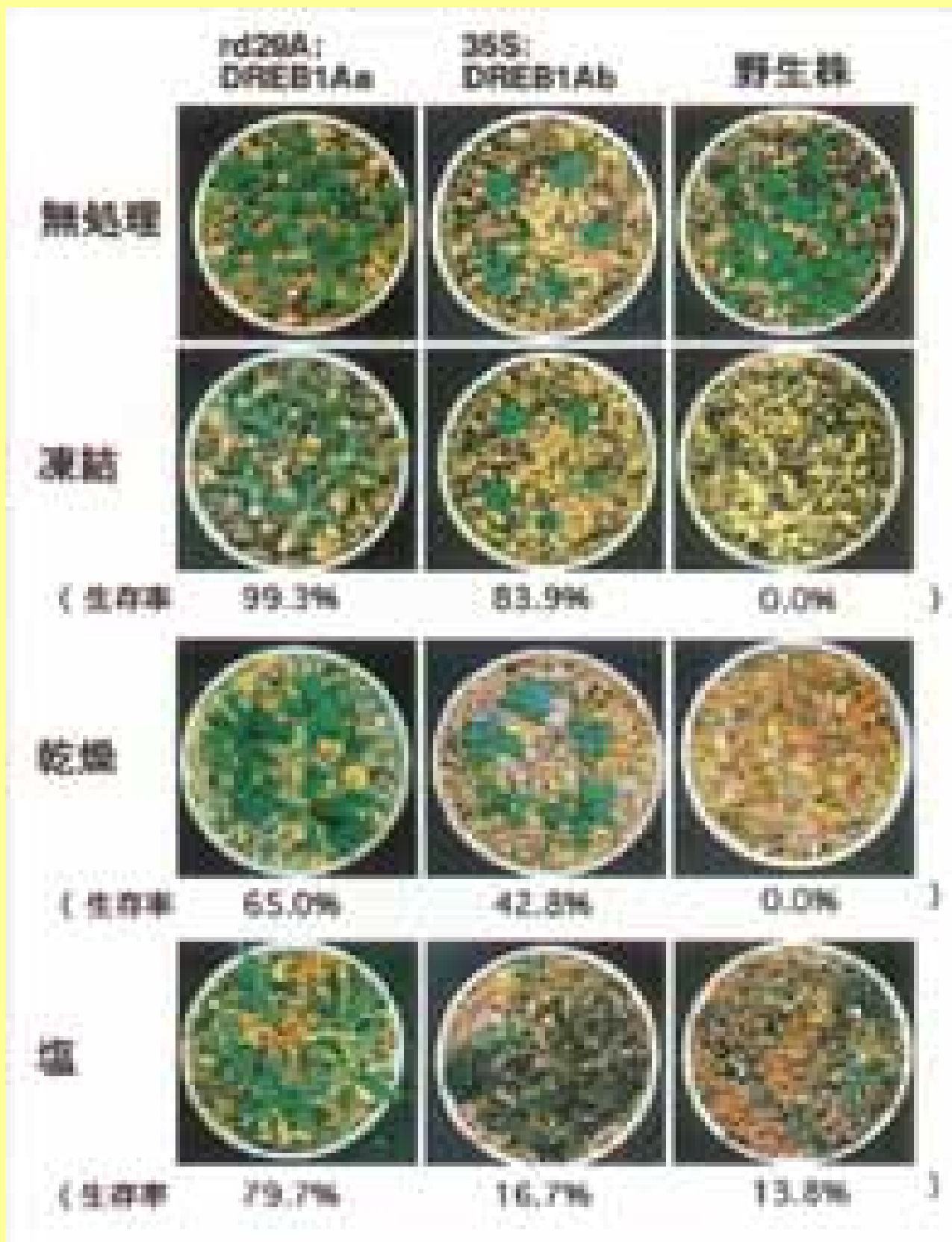
もどる





•},P•@ŠÂ««fXfgfŒfX‘İ•«‘•‘â,İf•fJfjfYf

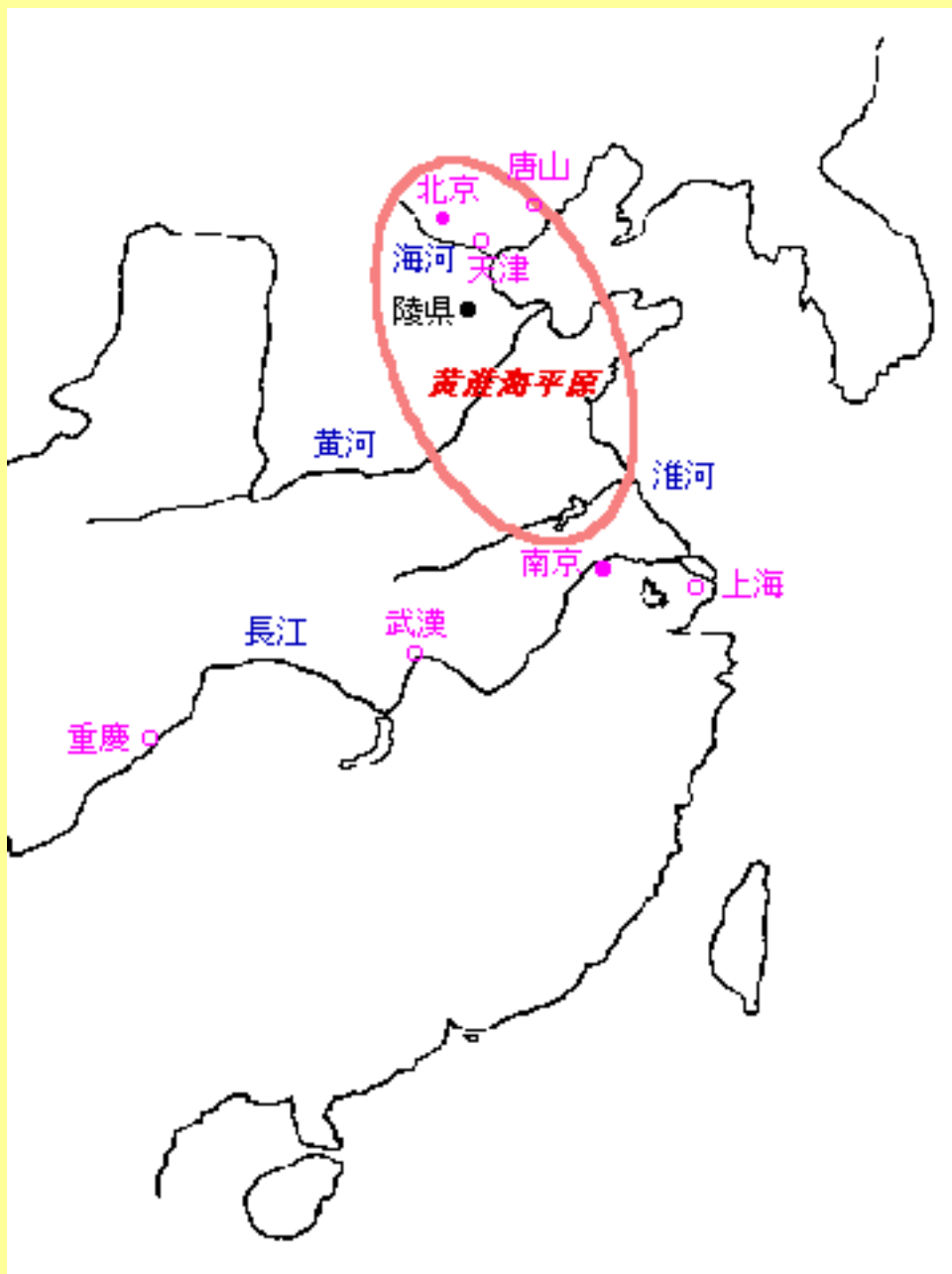
もどる



•},Q@Š£'‡•E“ CE<•E%oo-İ•«A•,İ•ì•o

もどる

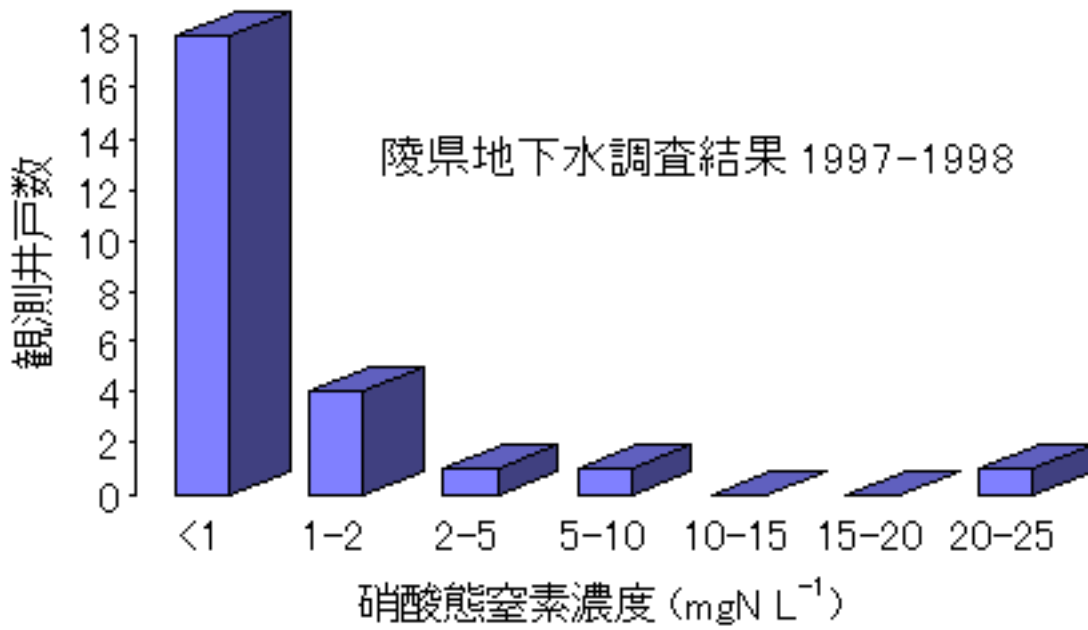




•}1•@'2•, 'î•Û'n^æ, îÊ'u

もどる

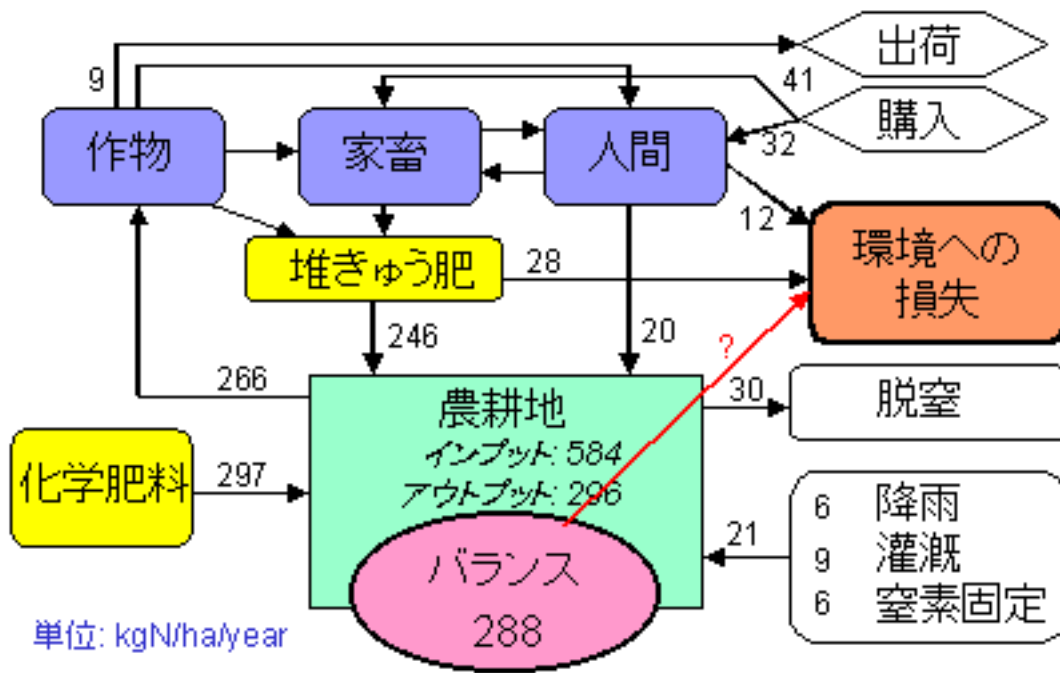




},Q•@—ËCE§,É,“,-,é^äCEË•...’†,ì•ÉŽ_‘Ô’,‘f’Z“‘x’²•,

CE<%oÊ•i’n%o°•...^Ê1.4`3.4 m•A•[,³2.1`13.3 m•j

もどる



•},R•@—ËCE§,É,,-,é',‘ftf••[,Ì.,,’è’l•i1997”N“x•j

もどる



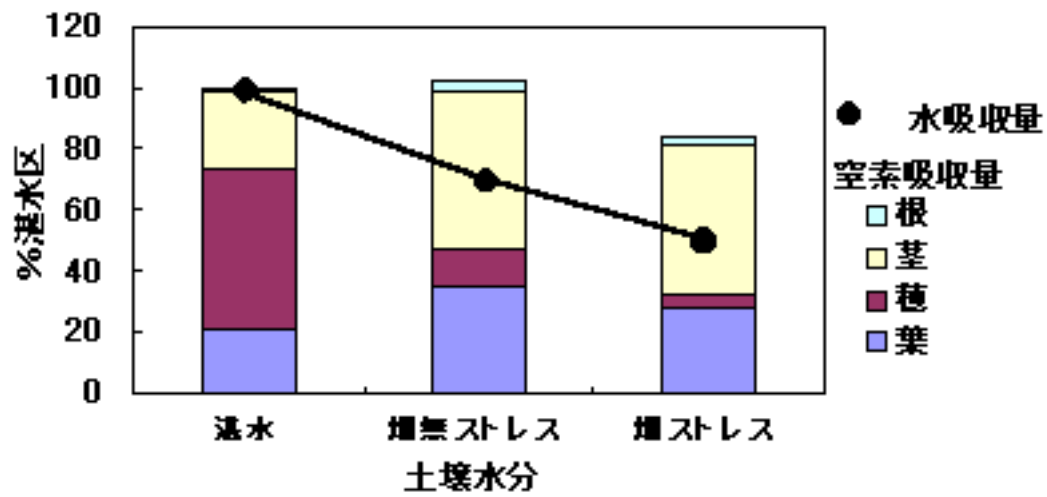
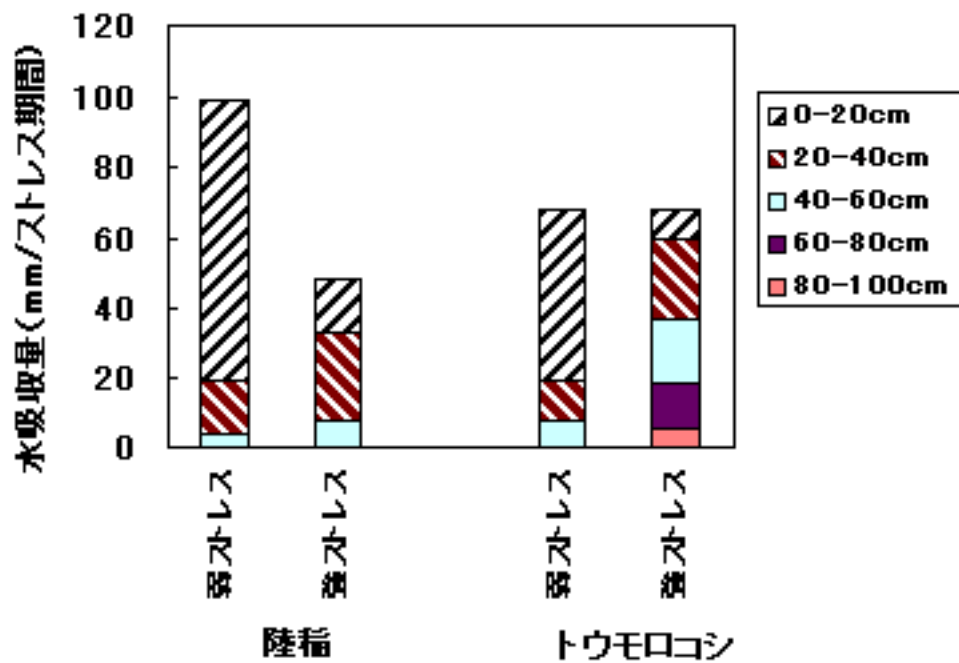


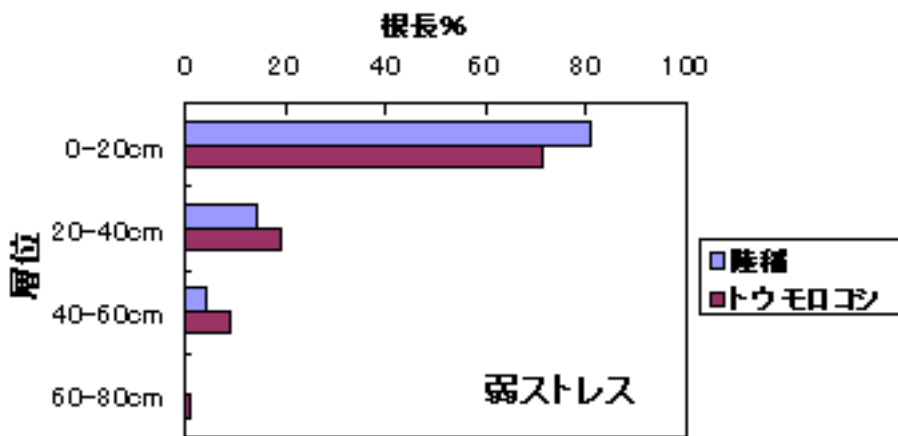
図1. 土壌水分が水吸収と植物体各部位への窒素吸収に及ぼす影響

もどる

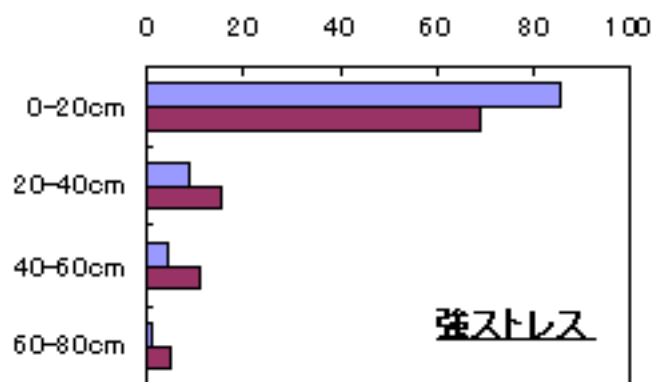


•},Q•@•...fXfgf⊕fX%°°,Å,Ì“y•ë‘w^Ê,©,ç,Ì•...<zŽû—Ê,É,“,̄,é—αî,ÆfgfEf,f•fRfV,Ì”äŠr  
 •i...<zŽû—Ê,Í“y•ë•...•^a,Ì•İ%o»—Ê,æ,è,,’è,μ,½•j

もどる

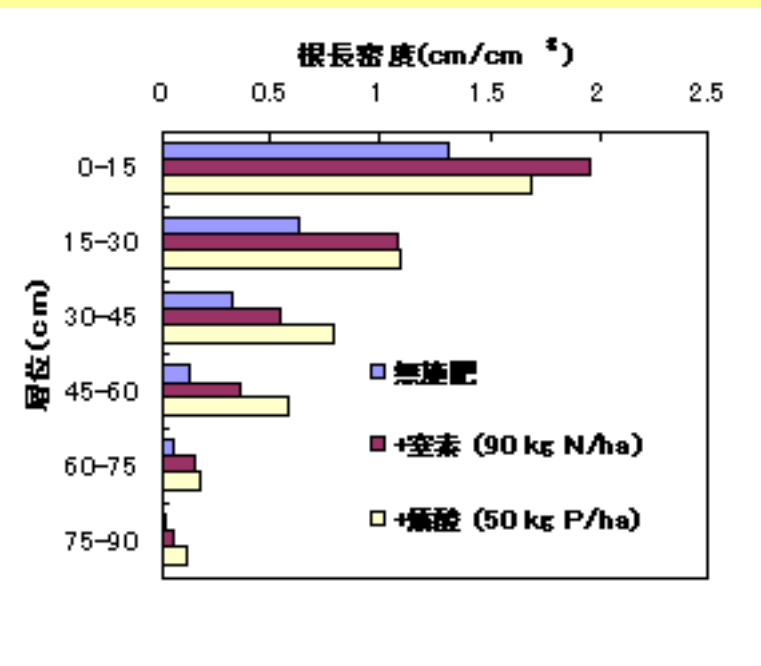


•@



•},R•@...fXfgfEfx,^a—αî,ÆfgfEf,f•fRfV,î‘y•ë‘w^Ê’†,î^a’•^a•z,É<y,Ú,•%œ<j

もどる



•},S•@Ž_•«“y,É,“,ç,Ä’,‘f•E—ÓŽ_Ž{”î,^a•^a’.–§“x,É<y,Ú,·%œ<j

もどる





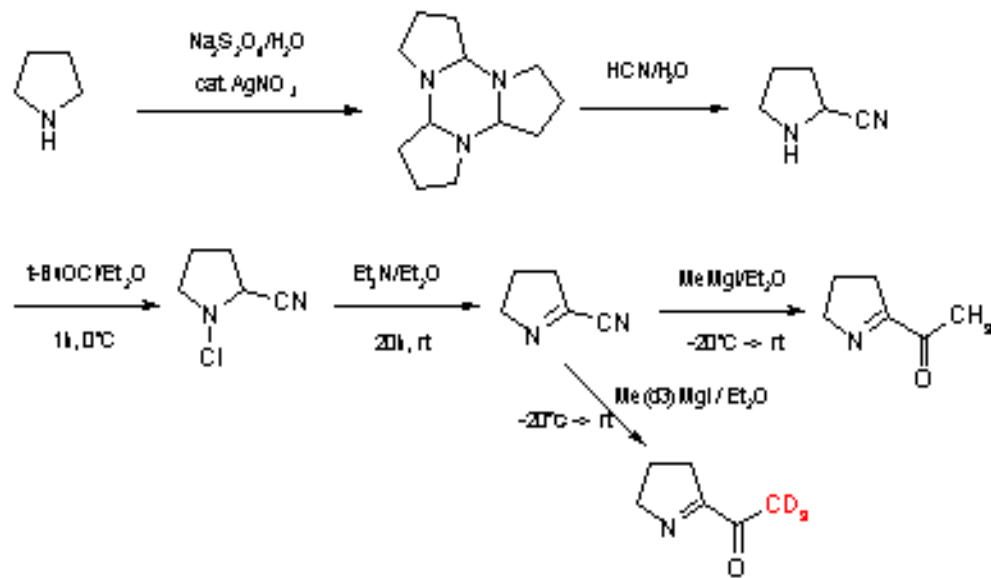


図1 2-アセチル-1-ピロリンの合成法

最後の合成反応時に重水素標識を行う場合、重水素標識Grignard試薬を使用する

例) タイ東北部ロイエト県産  
精米(平成10年度産)

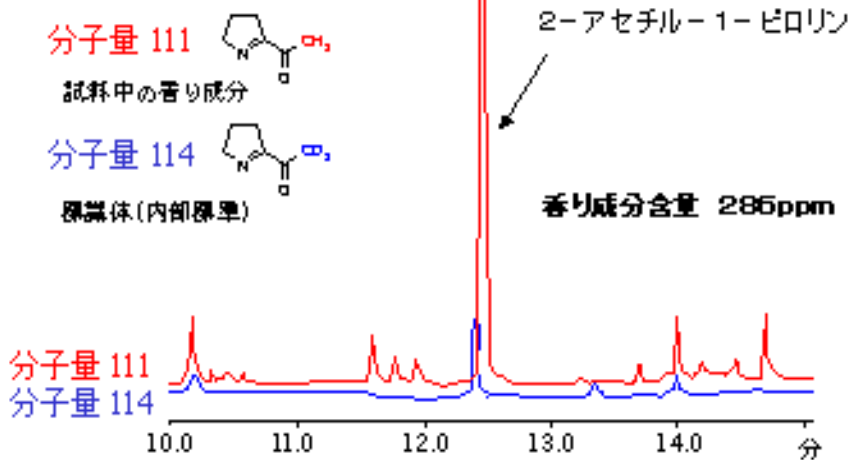


図2 香り米の香り成分の定量法

同位体希釈法による定量  
(重水素標識体を内部標準とする定量法)

試料 (50mg~)

熱抽出

エタノールまたは  
ジエチルエーテル  
(このとき、最終濃  
度200ppbになる  
よう、標識体を加  
える)

ガスクロマトグラフ質量分析  
単一イオンモニタリング



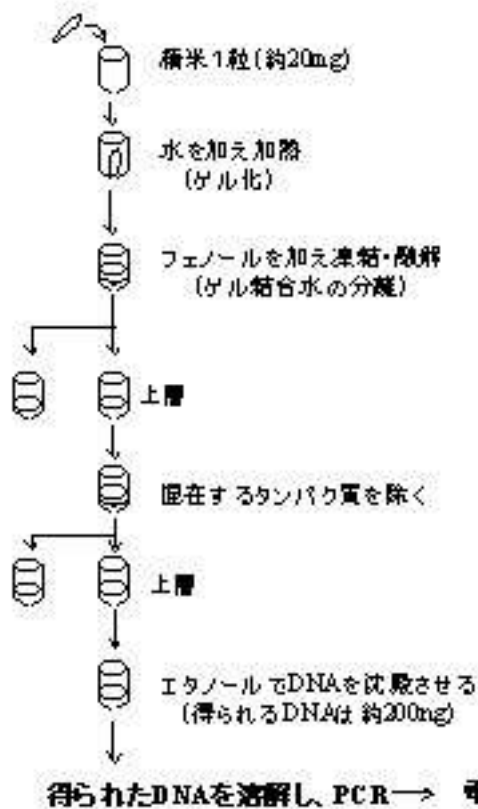


図1 新たに開発した簡易DNA抽出法

精米をゲル化し、そのゲルの結合水と共にDNAを効率よく抽出する。

もどる

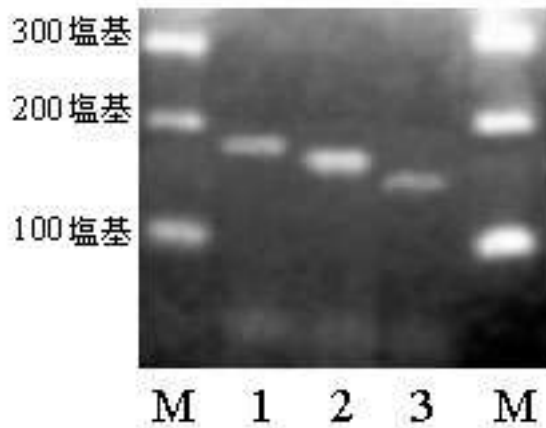


図2 カオドマリ105の混米用としてよく使われる品種とカオドマリ105の電気泳動パターン

1:RD7

2:カオドマリ105

3:チャイナー1

M:分子量マーカー

もどる

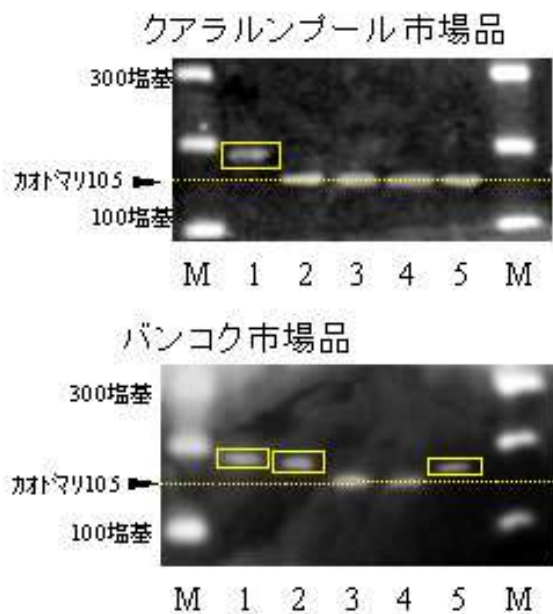


図3 カオマリ105市場品への適用

クアラルンプール市場品ではランダムに選んだ5粒のうち「1」が混米であることがわかった。

バンコク市場品でも同様に試験した結果、「1, 2, 5」が混米であることが判別できた。

もどる



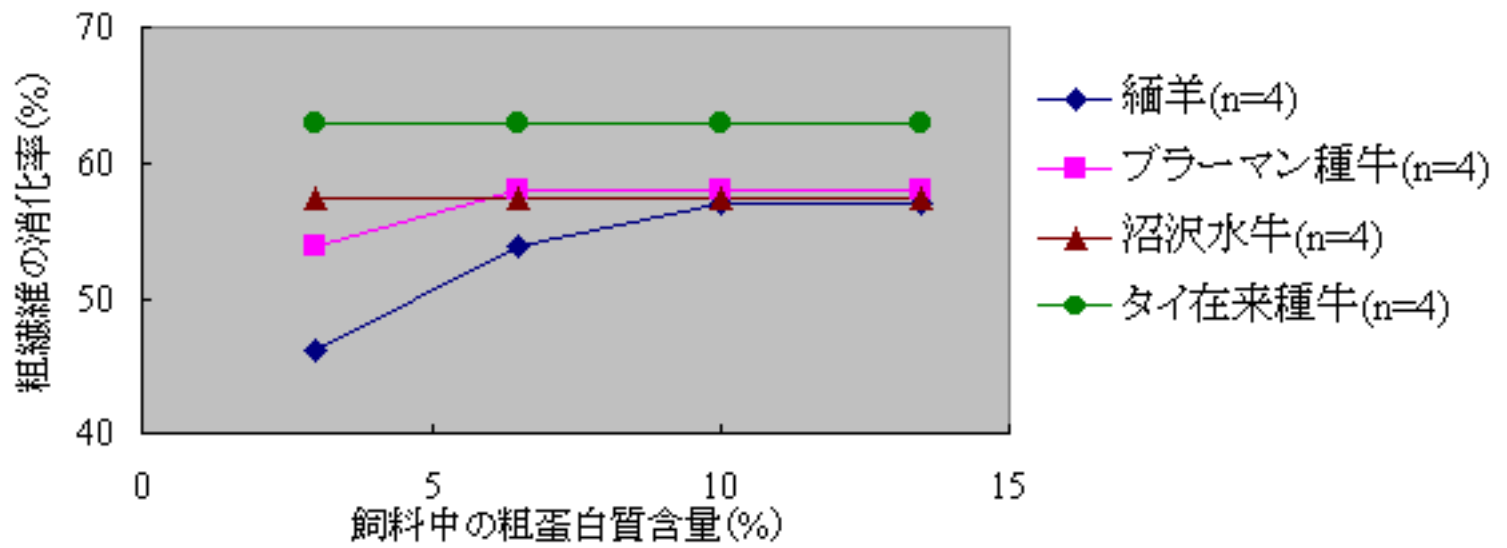


図1 大豆粕補給によるルジー乾草粗繊維消化率の変化の概念図

もどる

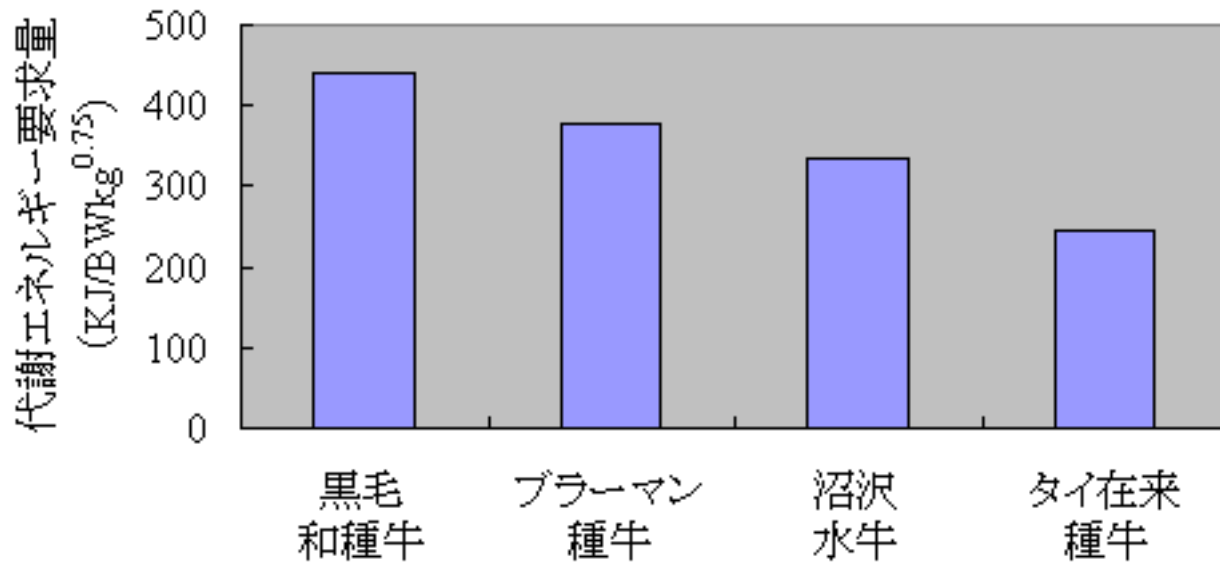


図2 維持のための代謝エネルギー要求量

もどる





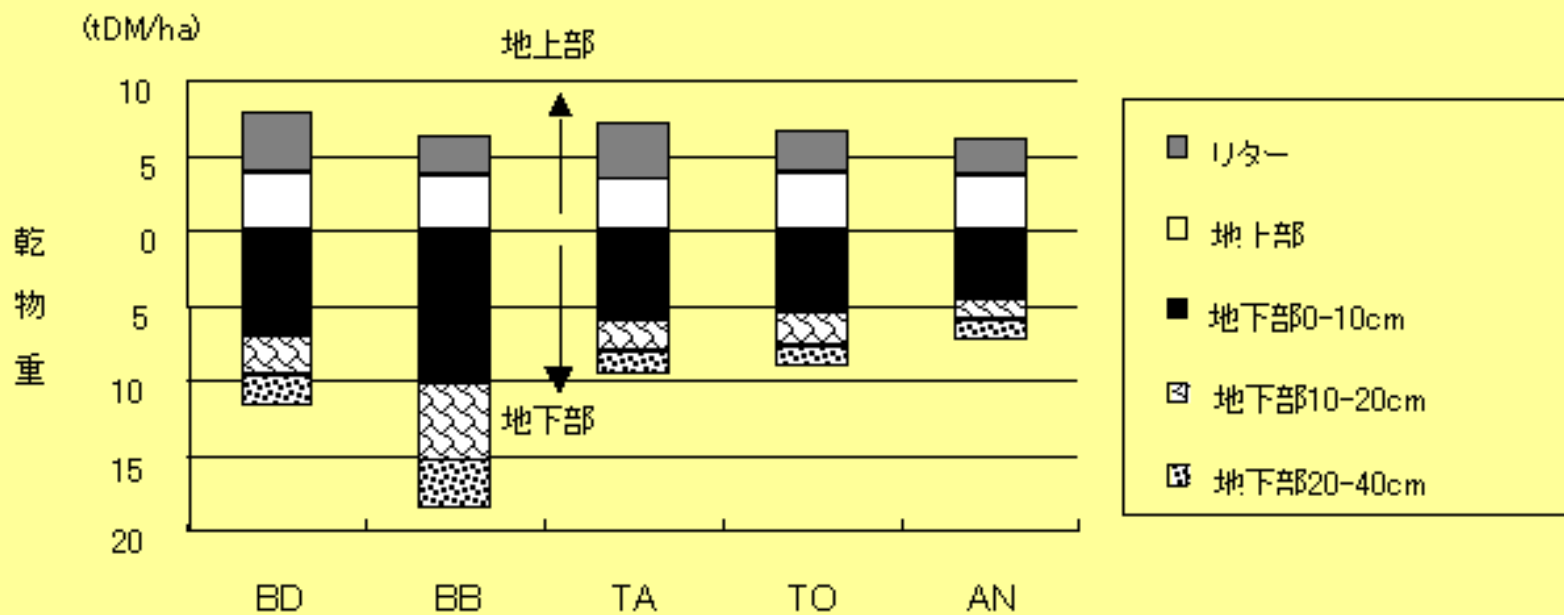


図1. *B. decumbens* (BD)、*B. brizantha* (BB)、*P. maximum* 品種 *Tanzania* (TA)、*P. maximum* 品種 *Tobata* (TO) 及び *Agaveanus* (AN) の造成3年目のバイオマス

注: 値は多肥区及び少肥区の平均値

もどる

、P・D・”い<y,N‘½”い%o°、I’n%o°”fofCfIf}}fX・@、Q・D‘½”い%o°、ISe‘w・E,I’n%o°”fofCfIf}}fX

‘Ží/iŽí・@・@’n%o°”fofCfIf}}fX・itDM/ha・j・@‘Ží/iŽí・@’n%o°”fofCfIf}}fX・itDM/ha・j

	<u>・”い%o°</u>	<u>‘½”い%o°</u>	<u>・½&lt;İ</u>		<u>0-10cm</u>	<u>10-20cm</u>	<u>20-40cm</u>
<i>B. decumbens</i>	9.6	13.7	11.7b	<i>B. decumbens</i>	8.56ab	2.59b	2.57ab
<i>B. brizantha</i>	16.2	21.9	18.7a	<i>B. brizantha</i>	11.63a	5.15a	4.30a
<i>P. maximum/TA</i>	8.6	10.4	9.5b	<i>P. maximum/TA</i>	6.35b	2.58b	1.49b
<i>P. maximum/TO</i>	7.9	10.1	9.0b	<i>P. maximum/TO</i>	6.29b	2.67b	1.10b
<i>A. gayanus</i>	6.4	8.2	7.3b	<i>A. gayanus</i>	4.95b	1.62c	1.63b

<u>・½&lt;İ</u>	<u>9.7</u>	<u>12.7</u>	<u>11.2</u>	<u>・½&lt;İ</u>	<u>7.56</u>	<u>2.92</u>	<u>2.22</u>
----------------	------------	-------------	-------------	----------------	-------------	-------------	-------------

’・F`Ù,È,é・||ŽšŠÔ,É,Í—L`Ó,È・,^a, ,é・@

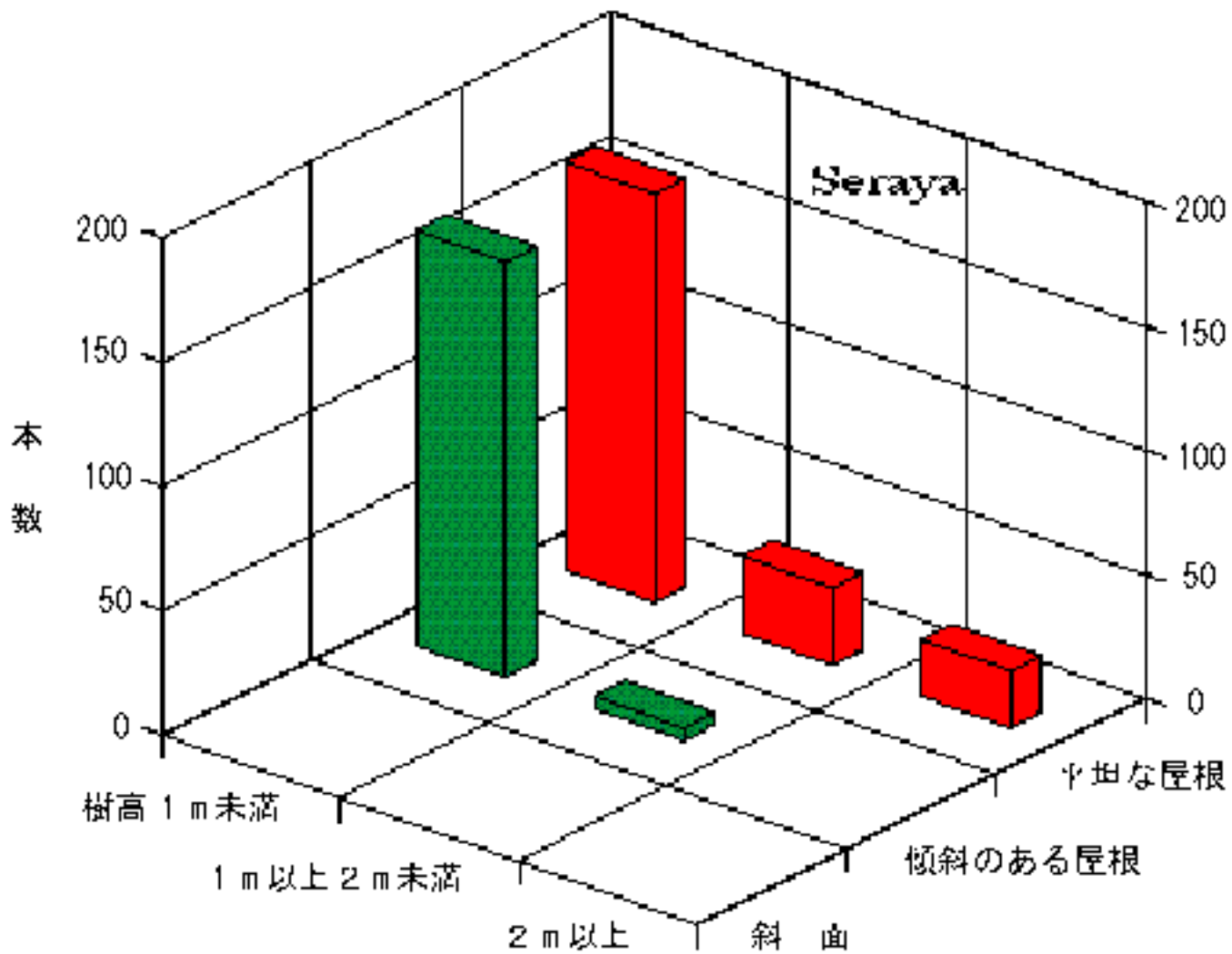
・@・@ (p<0.05)・B

’・F`Ù,È,é・||ŽšŠÔ,É,Í—L`Ó,È・,^a, ,é

・@・@ (p<0.05)・B

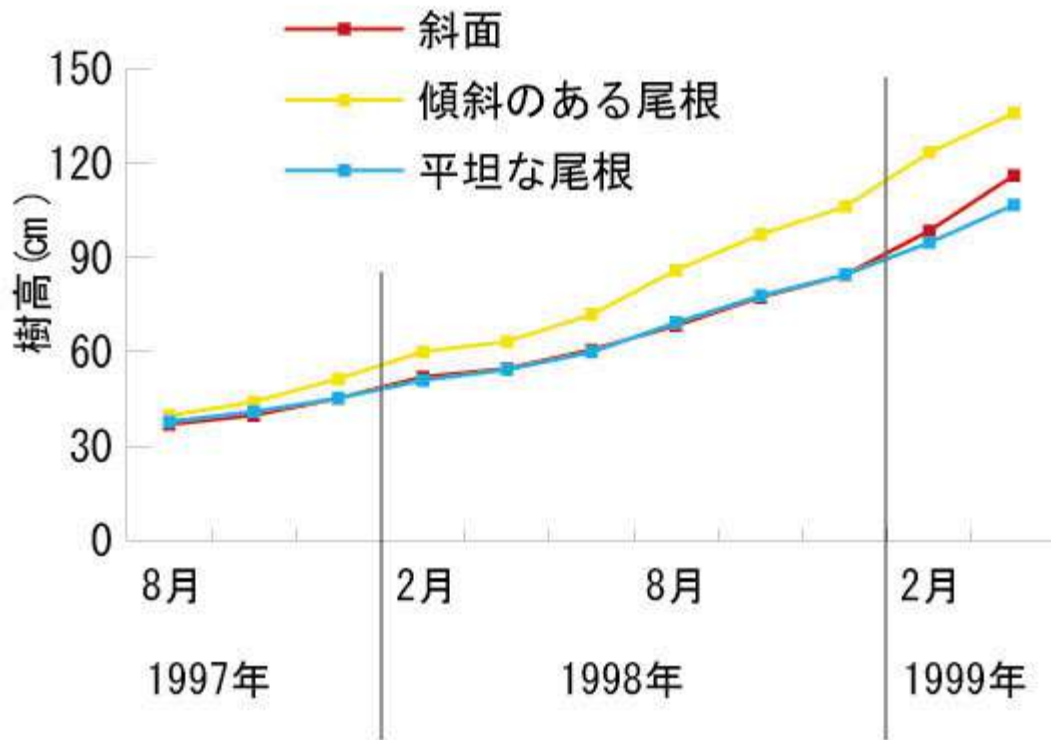
もどる





•},P•@`nCE`•Ê,İž÷•.,İ•p“x•^a•z

もどる



•},Q•@•ìkÆ“1,É•A•••Í,³,ê,½•c-Ø,İŽ÷•,•-’.

もどる

11. f/fB/Sfs*E,,dfj*%eE,*e,Nfj€fm/LeE-L—pZ-1ZZZq*%e*Ei*—Zp

m→v-0mF f/fB/Sfs*E,,dfj*%eE,*e,Nfj€fm/LeE-L—pZ-1ZZZq*%e*Ei*—Zp  
 mS→mF *U—N…ZY-ABE0:Zfj*%eE,*e,Nfj€fm/LeE-L—pZ-1ZZZq*%e*Ei*—Zp  
 mA→mF 0298386309  
 m*%m*F *U—,E  
 m*%m*F X—N*→  
 m*%m*F L—Z*  
 m*%m*F B*

m*%m*E.E.e.e.m

@/f/fB/Sfs*E,,dfj*%eE,*e,Nfj€fm/LeE-L—pZ-1ZZZq*%e*Ei*—Zp

1. S€1.E…A*%*%*%eE,*e,Nfj€fm/LeE-L—pZ-1ZZZq*%e*Ei*—Zp  
 2. %fj*%eE,*e,Nfj€fm/LeE-L—pZ-1ZZZq*%e*Ei*—Zp

m*%m*E.S—p.E.E—O*→m  
 1. f/fB/Sfs*E,,dfj*%eE,*e,Nfj€fm/LeE-L—pZ-1ZZZq*%e*Ei*—Zp  
 2. %fj*%eE,*e,Nfj€fm/LeE-L—pZ-1ZZZq*%e*Ei*—Zp

ΔP00/f/fB/Sfs*E,,dfj*%eE,*e,Nfj€fm/LeE-L—pZ-1ZZZq*%e*Ei*—Zp

ΔP00/%A*M*→E.e.€Leucam@f*%e*Ei*—Zp

m*%m*E.S—p.E.E—O*→m

@

Q0→%Q→%4 Y—L—pZ-1ZZZq*%e*Ei*—Zp

→ZZ.e*0000fmmY—L—pZ-1ZZZq*%e*Ei*—Zp

Q0→fS0→4 %fj*%eE,*e,Nfj€fm/LeE-L—pZ-1ZZZq*%e*Ei*—Zp

Q0→fS—Z0 *%m*E.Gascon, A. F



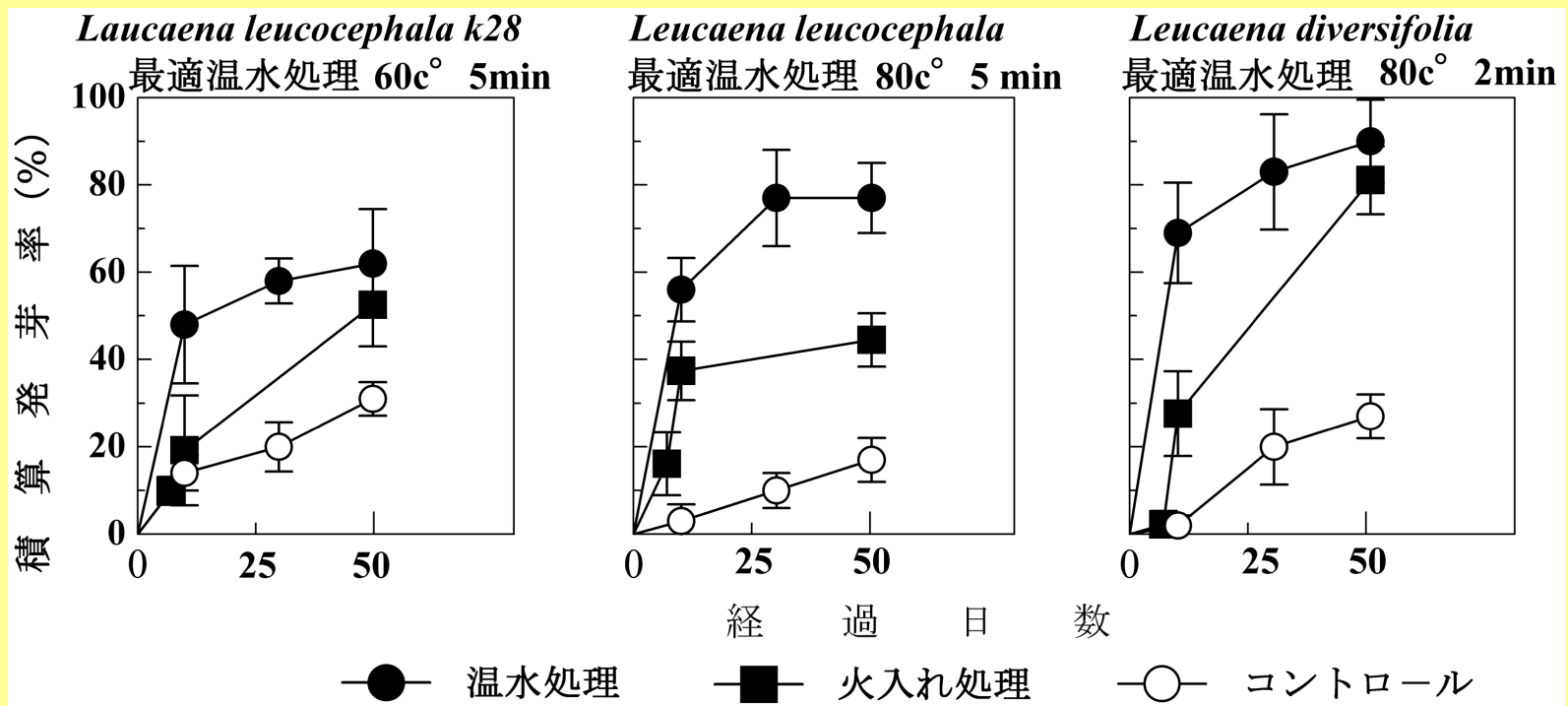
•@	•@	•@	”-%cè‘£•iCEø%oÊ,Ì—L ³		
CE»’n-¼	%oÊ-¼	Šw-¼	%cÁ••^—•	•Á“K%o•...•^—•	%cî“ü,é•^—•
Mangium	flf fmfL%oÊ	<i>Acacia mangium</i>	•	*	•
Rain Tree	flf fmfL%oÊ	<i>Albizia saman</i>	•	•	•
Kupang	flf fmfL%oÊ	<i>Parkia roxburghii</i>	•	•	•
Diversifolia	flf fmfL%oÊ	<i>Leucaena diversifolia</i>	•	**	*
Native Ipil-ipil	flf fmfL%oÊ	<i>Leucaena leucocephala</i>	•	**	*
Giant Ipil-ipil	flf fmfL%oÊ	<i>Leucaena leucocephala</i> K28	•	**	*
SmooH Narra	f}f%oÊ	<i>Pterocarpus indicus</i>	•	*	•
Prickly Narra	f}f%oÊ	<i>Pterocarpus indicus</i> <i>f.echinatus</i>	•	•	•

•@

•\•| f}f%oÊ,“æ,Ñflf fmfL%oÊ—L—pŽ÷,É‘Î,·,é”-%cè‘£•i•^—•,ÌCEø%oÊ  
 •@”-%cè‘£•iCEø%oÊ,Í•Á•I”-%cè—l,Á•]oö,µ•AMann-WhitneyCEÿ’è,É,æ,è”»’è,µ,½•i•—,ÍŠëCE—l 5•“—L^Ó•A•—•,Í  
 1•“—L^Ó,ðŽl,•j•B%oÁ•••^—•,ÍCEø%oÊ,³-•A%o•...•^—•,•Á,à—LCEø,Á, ,é,•A•Á“K,È•^—•%o“x•AŽžŠÔ,ÍŽ÷Ží,É,æ,è^Ù,È,é•B



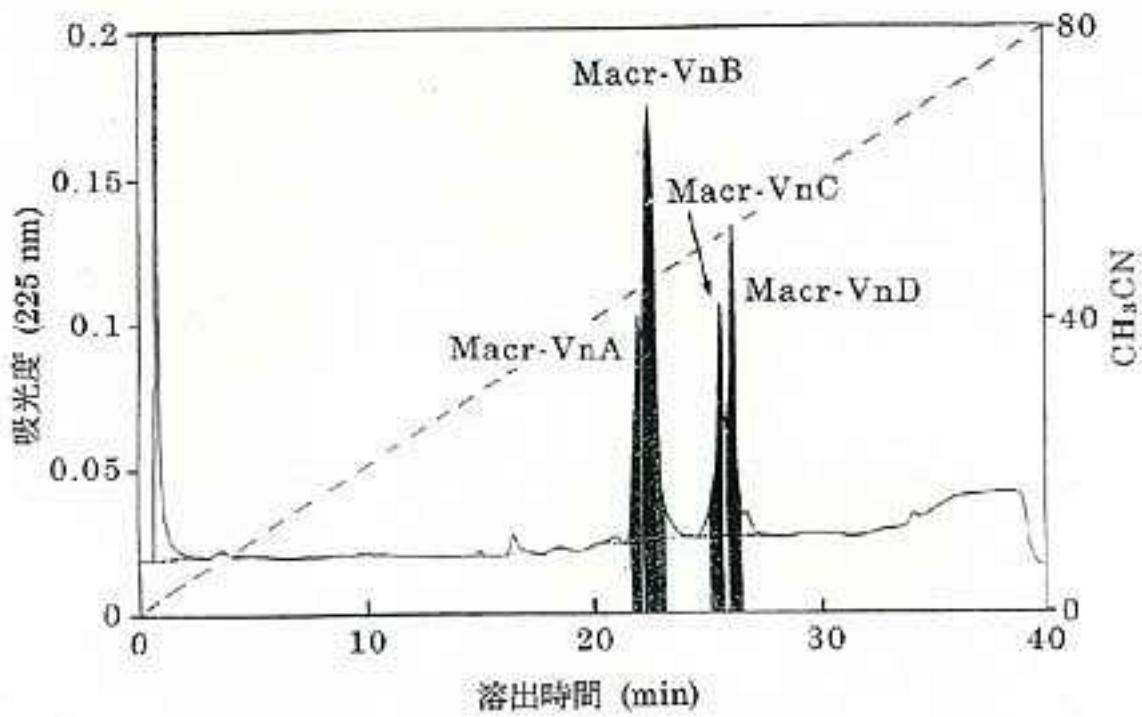




•@•}•l,P•@%oÁ”M•^—•,É,æ,éLeucaena‘®,’-‰oè‘£•iEø‰oÊ

もどる





•},P•@†ŠHPLC,É,æ,éfřefŠf“,Ì,•»

もどる

10                      20                      30                      40

**A-N:** APWPSGTNL?SKE?PVAGSPKLFYAAAEK??YSY?TG

AN-FP →                      ← AN-RP

AN-NFP →                      ← AN-NRP

**B-N:** SIDLRQISH?FDKLYENRHMOKADIYARIN?Q?MAFGS?G?NMKN

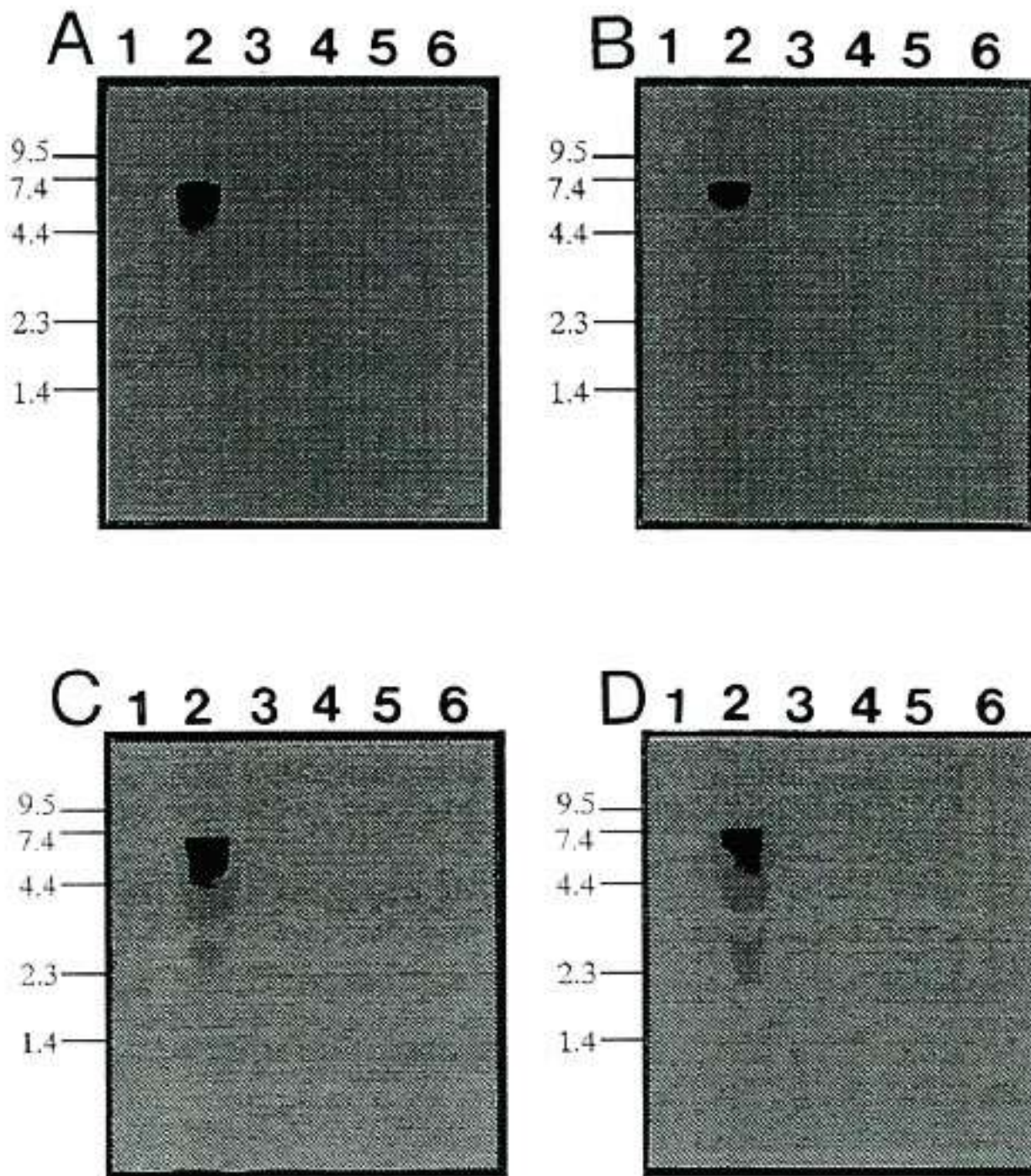
**C-N:** RREEQKVTGTVELDIFLRPEDKITGRLEILYARNTVI?EAKL?GK

**D-N:** RREEQKVTGTVELDIFLRPEDKITGRLEILYA

•},Q•@,m—'[fAf~fmŽ_”z—ñ•ª•Í,É,æ,è“‘è,³,ê,½fAf~fmŽ_”z—ñ

もどる





•},S•@Northern blot•^a•Í,É,æ,é—l•X,È‘g•D,É,“-,éfrfefŠf“mRNA,Ì”-Œ»

もどる



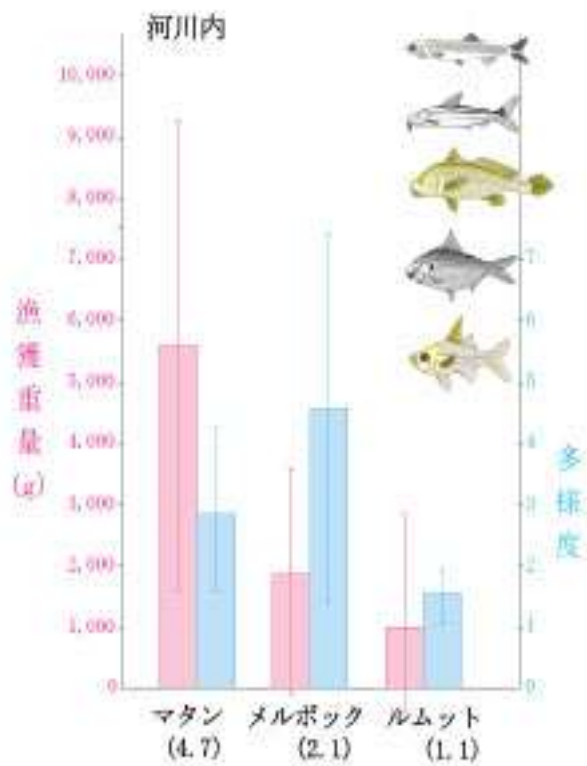


図1. マレーシア・マングローブ汽水域

もどる



- (A) マングローブ林面積/河川面積= 4.7  
 貝類数/全底生動物数 = 0.47  
 線虫数/全底生動物数 = 0.09



- (B) マングローブ林面積/河川面積= 1.1  
 貝類数/全底生動物数 = 0.10  
 線虫数/全底生動物数 = 0.46



図2. 異なるマングローブ汽水域の底

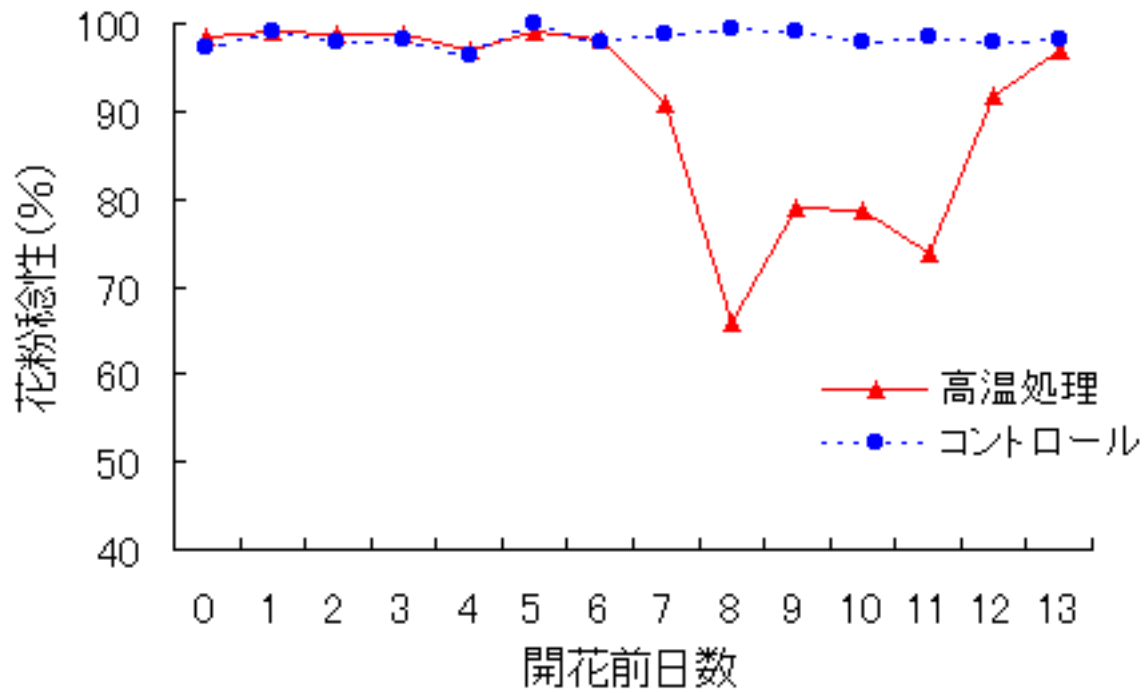
もどる



図3. マングローブ林の繁茂する湿地帯の役割

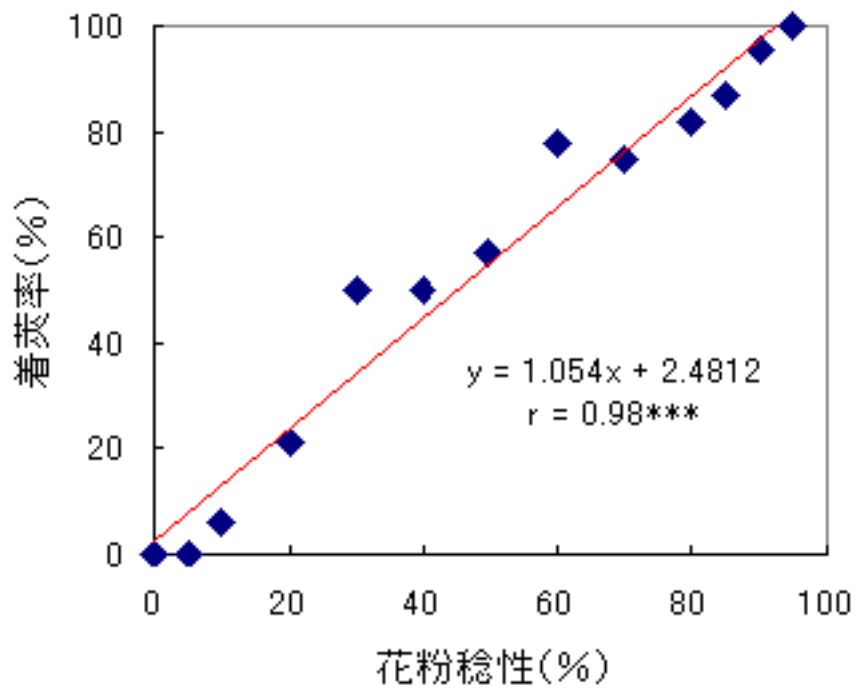
もどる





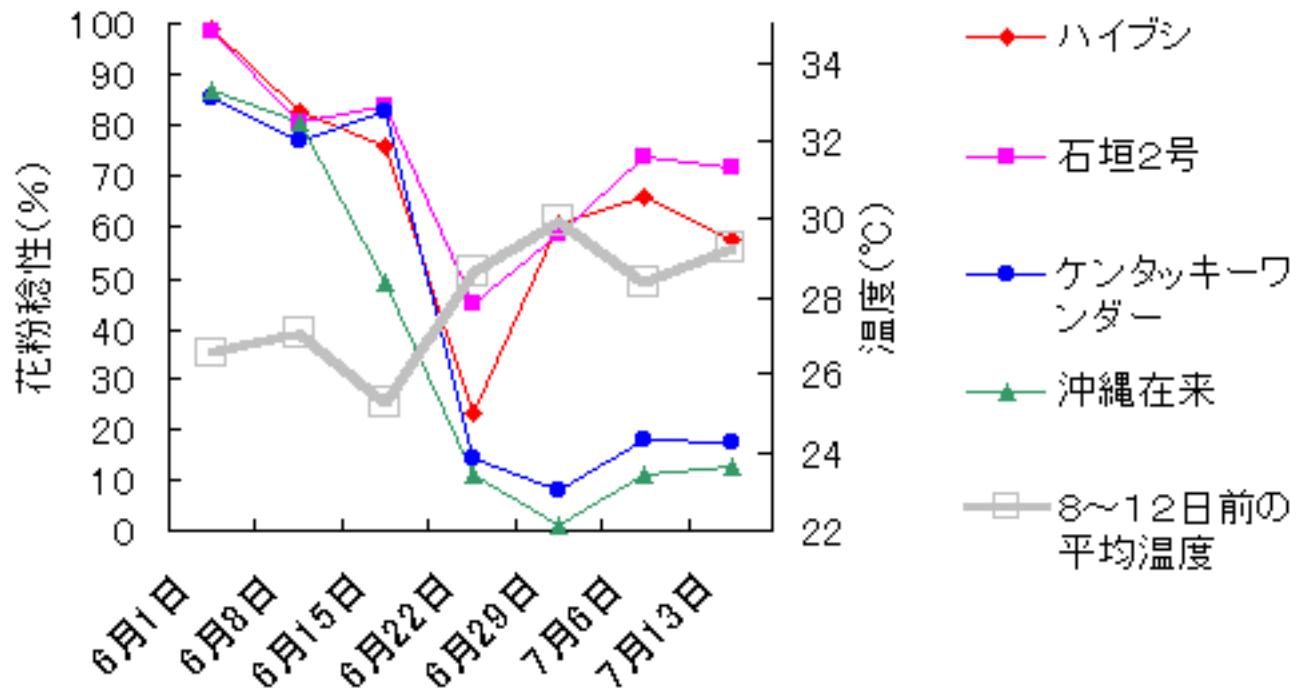
•},P•@ŠJ%ocÔ‘O,Ì•,%oc•^—•,%ocÔ•2—«•«„É<y,Ú,•%oc<j

もどる



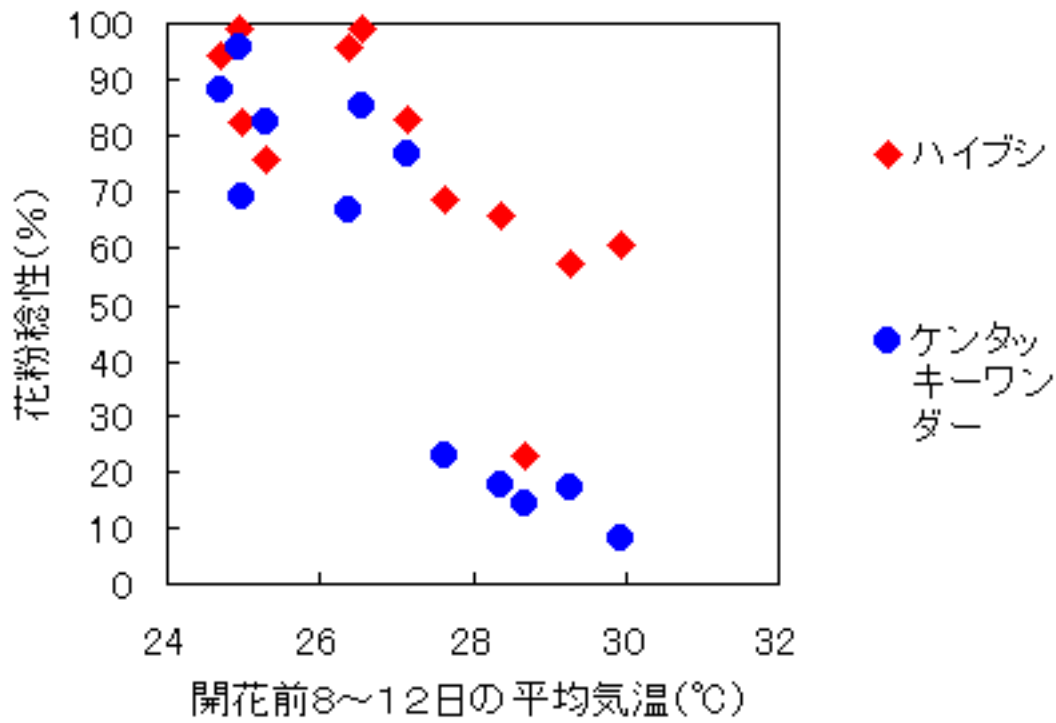
•},Q•@%oÔ•2-««„Æ'...ä°—!,İšÖEW•i***,Í0.1%•...• ,Å—L^Ó•j

もどる



•},R•@,Ù•ê•ðE•%o°,Å,İše•iŽí,ì%ooÔ•²-«•«,ì•İ%oo»

もどる

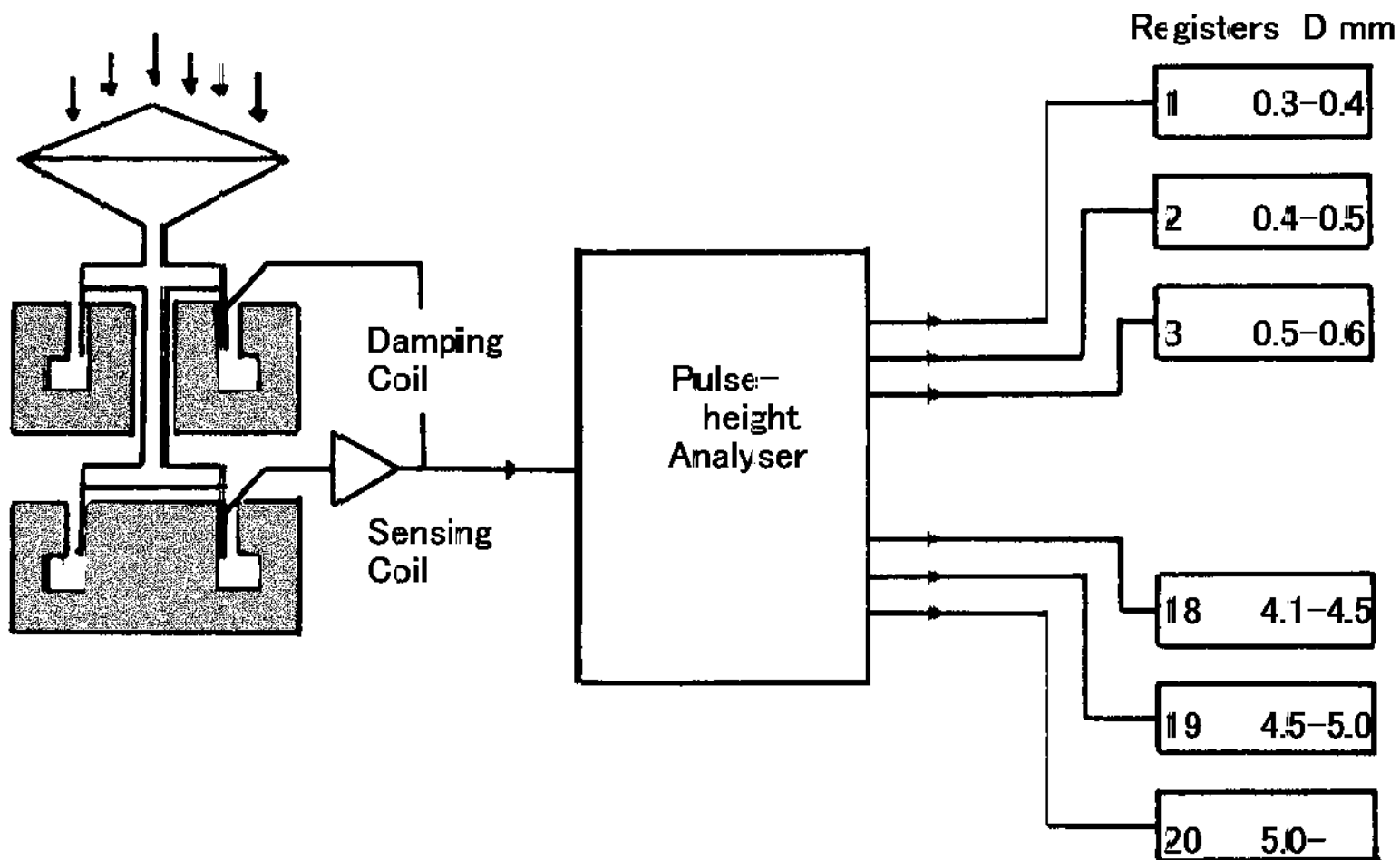


•},S•@ŠJ%ccÔ‘O,W•`12‘ú,Ì<C%cc,Æ%ccÔ•2-«•«,ÌŠÖCEW

もどる

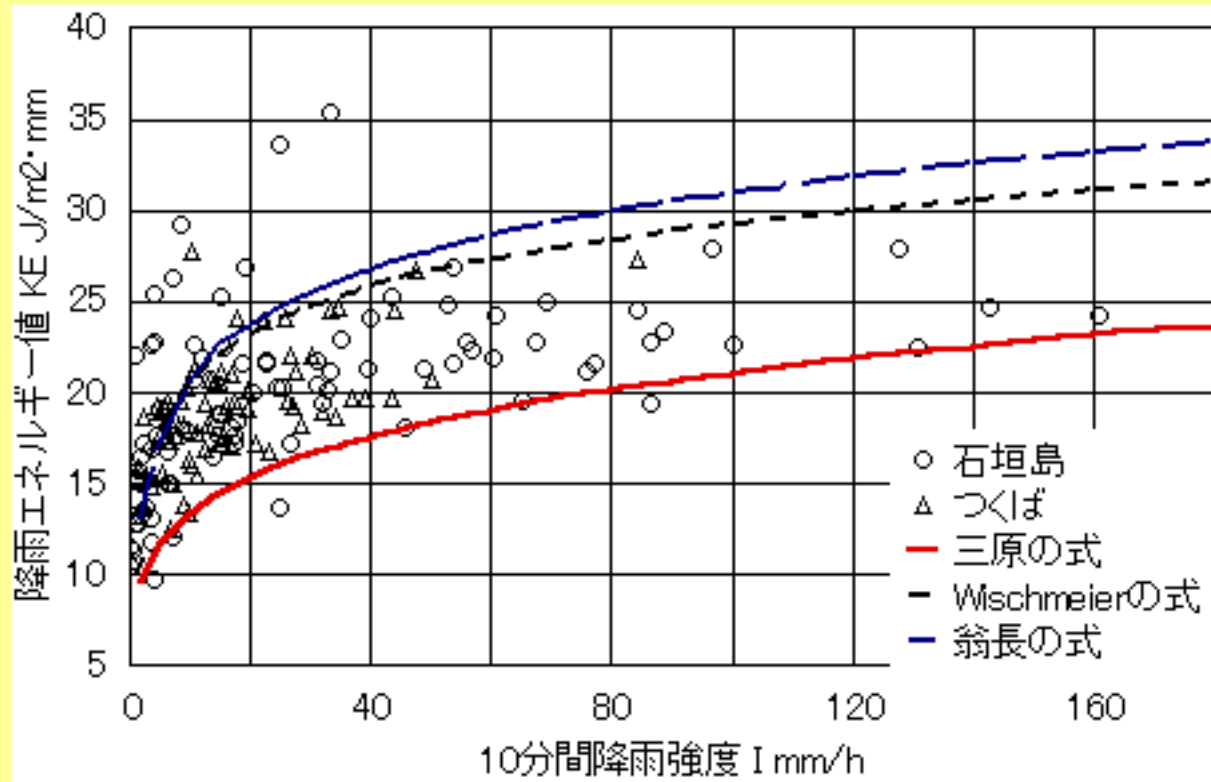






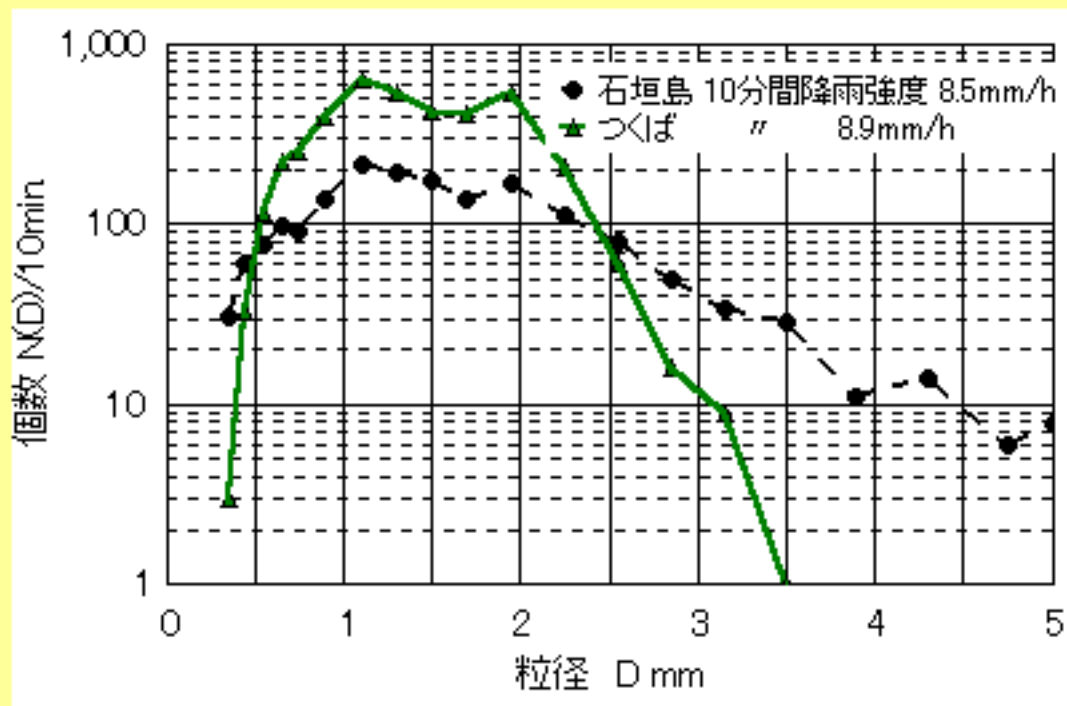
• } , P Disdrometer ( % ω J “ H — ± C E a • a • z ‘ a ’ è ‘ • ’ u ) , I • \ • -

もどる



・}, Q・~%oJ<-“x,Æ•~%oJfGf1f<fM•[’1,İšÖEW•i•Îš_“‡1995”N•C,Â,-,Î1994”N•j

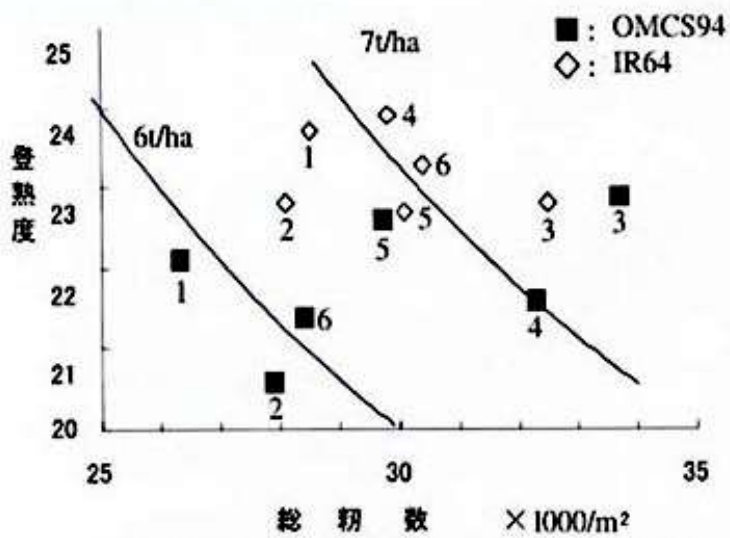
もどる



}, R \cdot \hat{I} _ " \ddagger, \mathcal{E}, \hat{A}, -, \hat{I}, \hat{A}, \hat{I} - \pm \mathcal{E} a \cdot \hat{z} " \hat{A} \cdot \ll

もどる





処理区の窒素使用時期と施用量 (Nkg/ha)

処理 番号	播種1 週間後	分けつ 始期	分けつ 盛期	穂孕 期	合計
1	40	40			80
2	40		40		80
3	40			40	80
4	40	40		40	120
5	40		40	40	120
6	40	40	40		120

注) P₂O₅ は 40kg/ha、K₂O は 30kg/ha 基肥施用

図1 窒素施肥法と収量構成要素 (1996/9 乾季)

注) 登熟度 = 登熟歩合 × 千粒重 (精粒) 図中の数字は表の処理区番号を示す

表 1 メコンデルタに分布するいもち病菌の病原性

判別品種	抵抗性遺伝子	病原性菌株割合
新 2 号	<i>Pik-s, Pish</i>	0.0 %
愛知旭	<i>Pia</i>	93.8
クサブエ	<i>Pik, Pi-sh</i>	0.0
ツユアケ	<i>Pik-m</i>	1.6
とりで 1 号	<i>Piz-t</i>	0.0
K60	<i>Pik-p</i>	0.0
K59	<i>Pit</i>	86.0
AA/S2-3	<i>Pish</i>	0.0
AA/S2-75	<i>Pik-s</i>	95.3

表 2 駆虫剤処理後の豚体重の推移 (kg)

豚群	No.	処理後期間 (週)				
		0	4	8	10	12
処* 理	1	40	52	70	82	89
	2	37	51	70	81	89
	3	39	51	68	80	90
無 処理	4	41	52	66	74	82
	5	39	50	64	72	81
	6	42	51	66	69	72

* テトラミゾール製剤の注射

表3 各階層の平均経営面積の変遷 (ha/戸)

農家階層	1974	1980	1988	1996	調査戸数
土地無し	0.2	0.2	0.2	0.0	10戸
1ha以下	0.4	0.5	0.6	0.7	25
1-2ha	1.8	0.8	1.2	1.4	17
2ha以上	1.4	1.1	1.2	3.3	18

注) 調査時点(96年)に在村する農家から聞き取ったもので、すでに流出した小農、土地なし農民は調査対象になっていない





図2 イネ、エビ、ココヤシなどの複合経営

•‘•Û”_<ÆCEα<†•→%oË•î•ñ‘æ6•† 1998•i•1/2•→10”N“x•j

-Ú •@•@Žÿ

1. [f•fRf“ff<f^,É,;, -,é”_’{•...•j•‡•Z•p’ÌCEn,Ì•}%oü,Æ%oü‘P](#)
2. [“r•ã•‘,ð’Î•Û,Æ,μ,1/2” <Æ,Ì••‡•CEα<†,É,;, -,é•‘•Û<α“- ,Ì,.,•i•û•ô](#)
3. [“î•Ä,É,;, -,é’ã‘α,Ì•s•k<N•Í”|<Z•p,Ì%oü‘P•û•Eü](#)
4. [fuf%ofWf<,Ì’ã“αŠÖ~AZÿ<Æ,ð’†•S,Æ,μ,1/2Žÿ<Æ~AŠÖ•a•Í](#)
5. [•→”ž•iŽÍ,Ì’ŠúŠJ”-,Ì,1/2,β,Ì”1/4•”’•Ì’i•oCEø—ì,Ì%oü‘P,Æ^çŽí<Z•p,Ì•}%oü](#)
6. [•É%oü»,ð—}•§,.,é”M’ÑfCfl%oË-q‘•](#)
7. [””n“y•ë,©,ç,Ì^êŽ %oü»,‘f,;,æ,Ñ^ÿŽ %oü»,‘f,Ì•ú•o,É<y,Ú,•Ž|”î\[‘x,Ì%oü<ç](#)
8. [Šł‘‡’n,Å•i••¶^ç,ð’ł•i,.,é•a’ê”dŽÍ](#)
9. [fxfgfif ,É•a•z,.,éfCfl,ç,à,ç,a•Û,;,æ,ÑfCfl”’—tCEÍ•a<Û,Ì•aCE’«](#)
10. [f^fCŽÿfVf‡fEfK%oË•H—p•A••,ÉŠÛ,Û,ê,é•R•Ï’ÛCE’•→•a,Ì’P—ł•E“—’è](#)
11. [—n<Û”÷•¶•“Flexibacter sp. FL824A,ÌfLf f“•a%oüð•y’f’â“Žq,Ì%oüð•Í](#)
12. [fxfgfif •Ef•fRf“ff<f^,É,;, -,é“Ø%oüñ’Ž,ÌŠ’•õ•ó<μ,Æ<i’Ž,ÌCEo•İCEø%oËË](#)
13. [fCf“fhflfVfA•EfXf}fgf%oü“‡,É,;, -,é’Ú•ZŽ-<ÆCEã,ÌfSf —Ñ’n,Ì•Š—LCE`‘Ô,Ì•İ%oü»](#)
14. [fIfCf<fp•\[f <ó%oËË-\[ ,ðCE’—ç,Æ,.,éfNf%oüftfgfpf<fv,Ì-3%oü-‘f•Y””](#)
15. [f}f“fOf••\[fu—Ñ,ÌfŠf^•\[—Ê](#)
16. [’†•Žÿ’W•...< ,ð—p,ç,1/2—â“ ,.,è•g,ÌŠJ”-](#)
17. [’Z“ú,É,æ,é“ú—{~î,Ì”•a•s—«,Ì”-•¶,Æ,»,Ì—v^ö](#)
18. [fAfYfL<β%oü-ì•¶ŽÍ,É,;, -,éfAfYfLf}f•f}fEf fV”i•R•«CEn“•,Ì”-CE©](#)
19. [Ž...•ó<Û,Ì^êŽÍ,ÉŠ’•õ,μ,1/2’g’nCE^fCfl%oË-q-ì’•,ÌŠQ’Ž,É’Î,.,é•Û•H’jŠQ•i—p](#)





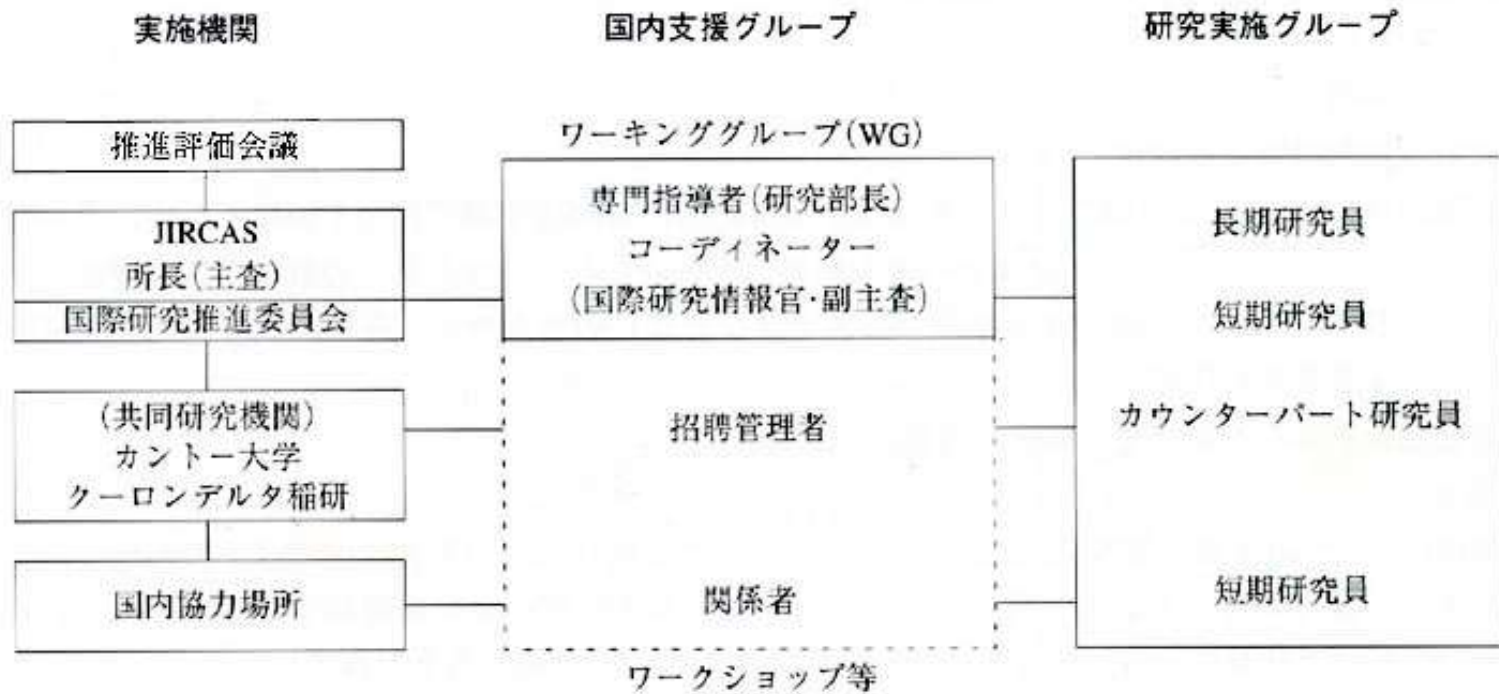


図1 「メコンデルタ」プロジェクトの推進体制

表1 メコンデルタプロジェクトにおける派遣及び招聘

研究分野	長期派遣		短期派遣					招聘				
	1期	2期	1994	1995	1996	1997	1998	1994	1995	1996	1997	1998
作物生産	95. 6-97. 6	97. 8-99. 12			1	1	1					
畜産	95. 10-97. 9				3	2	1					
作物保護	95. 11-98. 3				1	1	1					2
農業経済	96. 8-97. 8	97. 12-99. 12		2	2	1	3					
環境				1			1					
水産				2	3	2	2				2	1
流通加工						1	1					
管理調査			11	4	2	4	3	3	3	2	8	2
合計	4	2	11	9	12	12	13	3	3	2	10	5

表2 プロジェクトによる主要成果

1. メコンデルタ農業の自然、社会立地の特異性を明らかにした。
2. ファーミングシステムの主要な技術構造を解明した。
3. 個別技術の改善に向けた成果として、①稲の後期重点追肥技術、②主要病害抵抗性遺伝子解明、③寄生虫防除による養豚効率改善、④オニテナガエビの生長・脱皮・成熟に関わる内分泌の機構解明等
4. メコンデルタ農業経営の主要構造を明らかにした。
5. 今後のファーミングシステム発展の可能性を示すことができた。



表 1 不耕起栽培の普及面積の推移 (1,000ha)

国	1973/74	1983/84	1996/97
ブラジル	1	400	6,500
アルゼンチン	—	—	4,400
パラグアイ	—	—	500
ウルグアイ・ チリ・ボリビア	—	—	250
アメリカ	2,200	4,800	19,400
オーストラリア	100	400	1,000
世界合計			38,700

R. Derpsch(1998) による推定値。



表2 各技術分野における問題点と改善方向

技術分野	問題点	改善方向
土壌の物理性	土壌下層の緊密化	下層の透水性・通気性改良技術
土壌の化学性	土壌下層の養分不足	下層への施肥技術
病害	土壌伝染性病害の多発	土壌伝染性病害の防除技術
雑草	除草剤への依存度増大	耕種的防除法
作付け体系	大豆／小麦体系への偏り	作付け体系の多様化



```

m-v-8mF%e%eZG.8--p..e+2*6**b+o.lEa-1.fA%0%z11bA+0.8+1-1.A"E-0.f%0%z**1.ZpSjT.E.a.8Ea+u/3B**1Zz@-1--p.E.a.8A+1-.lEa+YZi@.E.a.A.A**%z.8Ea**E-C.G..e%Zb-EEa+8ZSd0.E+0%0A^A..e.z.E.8-3.c.0.E.u/3B
mS*-m+F*0--N...ZY.EEB5+fZ/f*+E4*Z(E)*
m'A---mF02983836305
m"%m+F*0--E*A+*+*_E
m%-8m+FYZi
m10m+F?--b
m%-1m+F(E5+

```

```

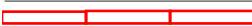
m"w(E)E.E.c.c.m
@+-72.fA+8SELE.fL.-11.bA+T.E.E.c.N-8%e/fjg**1MZY-E.NZi.-B..116**E+q*F**s-C$A-11%zSjT**+a.A*YZi).e.8B*0^N.A.lASjT**+d*.E..7.e1(E).fEBEa**%A.E.%z..e.1/3.B.H-E.1A^1.0.AZ*+*MZY.1*8dSm=0.*K+1.E.E.A.A.c.8-B+ZSjT..lSd0.8*0-0*1.E.Zk..e+@.E.u.A+8%e%eZG.8--p..e+2*6**114+o.Zp.f..A.E$M-3.f.E.A.c.8+9-2^N^y(Eb+1+0.E+0)+B-(Eb+1.A.fA**114+oEa-1.lEa+8*%z.8E+11%0A^11Ea+11%z.8+0.z.E.8-0^1.E.u/3B
m-%.E.f.3--eE^A^m
1.%e%eZG.8--p..e+2*6**11b+oEa-1.lEa+d
@+-72.11-11.u/3+0.8+8.E%aT..1.A"E-0.f%0%z11E/f.fjR/V.y.S/fjE/W.f/fjG.O*8Zm+u/6E%eE+A+0.8+1-1.fA**1.A.ZZm+u/6+1.E^u..x+2*6**11+o.lp%z.E%e%z.8y.0.1..A/fjE/W.f/fjG.10^%0*8Zg-p.u/3+1.E.8+V%0^11k+1.E**1.E.p%*..%z.83611B.u/3.A.A+0.8+1-1..E-0^%0^11g+1.E.a.A.A+*2.11M^YZiSd+4S.E$0.l.8.E..%110Ea-1.a.+0..e.z.E.A..e+B
2+-7Zi.E..7.e**11Zi@.11%z
@%e%eZG.8--p..u.A+*2ZS0jg+1ZGZi
F1.0.c+0.u.A^T**11.u/311%0A^11Ea**1A**1b+1..0.c+1-.lEa+YZi@.E.a.8^T**11.u/3Ea+.E^u..x.A.ZSd0+1b-1-1..0.c2fjN).AZb-E^u..8SjZm..e.z.E.%0A^A..e.0.A^T**+eO.A..e.z.E.011AZb-E.E$0.u.A.8+*1.E-C.G..e.z.E.-3.c.0.E.E.A.11211B.u/3.u.AEa+8%e%e.E.g+11b+1.E.f.Zb-EEa+1+0E+p%*%z.eEXEa.E..e.l.A.011B^A..e.8ME^..e.1/3.E+0..e11%0A^11Ea+*8*..0+A+0+11116**11e3.A^1120%0A^1A+p%*..8.e+K-+..7..e+B
[-%E.lS-p.EE-0*..]
@-1Zz@.fA+2*6**11b+o+@.E.u.A^8S^ISEO.A..e.l.A.ASjT**+a*.E..7.e.A/fjE/f.fjR/V.S/fjE/W.f/fjG.E.lE8ZG.8--p..u.A$A-+fX/fjE/fX^+ZP**1.SdSjT.E-1-p%0A^A..e.B.1/3.u.A/fj/fj-72.fjE/C-72.A.fA**11+o+p%*%z.eEXEa.E..e.E.1.8.A.c.8.l.A.A..e.8A^11..e.ZpSjT..y(Ea+K-+..A..e+B
m8111Mj**m
@
+1.S1%eZG.8--p.E.a.e+2*6**1b+o.lEa-1.E.a.U.+0.8+1-1.E%0%z11Ea+1Ea+1E
+11+-72.11m+1Zz@.A^T..8.lEa+
+12+-72.11m+1Zz@+DHj..e.NEa+YZi@+P5+1.E.a.8^T**11.u/3.e.8+1E.l10Ea+1Zb-E

```

```

m..A^1m
@
ED+1%0^34      "M^NSC^1n.E..7.e8SQ^R+*7-11^ZiZp.lSjT".
--ZZ.a+        +*0--E+8E^1^R+*7zj..a.NEa+
ED+18a-4        +6+9^N^x+6+4^N^9^N^xj
ED+1S+-Z0      'S..a^T.E--8Eh+1+..ZZj
^A^_A^TM      Inagaki,M.N.(1997)Technical advances in wheat haploid production using ultra-wide crosses. JIRCAS J.No.451-62.Inagaki,M.N.etal(1998)Comparison of bread wheat lines selected by doubled haploid, single-seed descent and pedigree selection methods. Theor. Appl. Genet.97:550-556@Apple. Genet.97:550-55

```





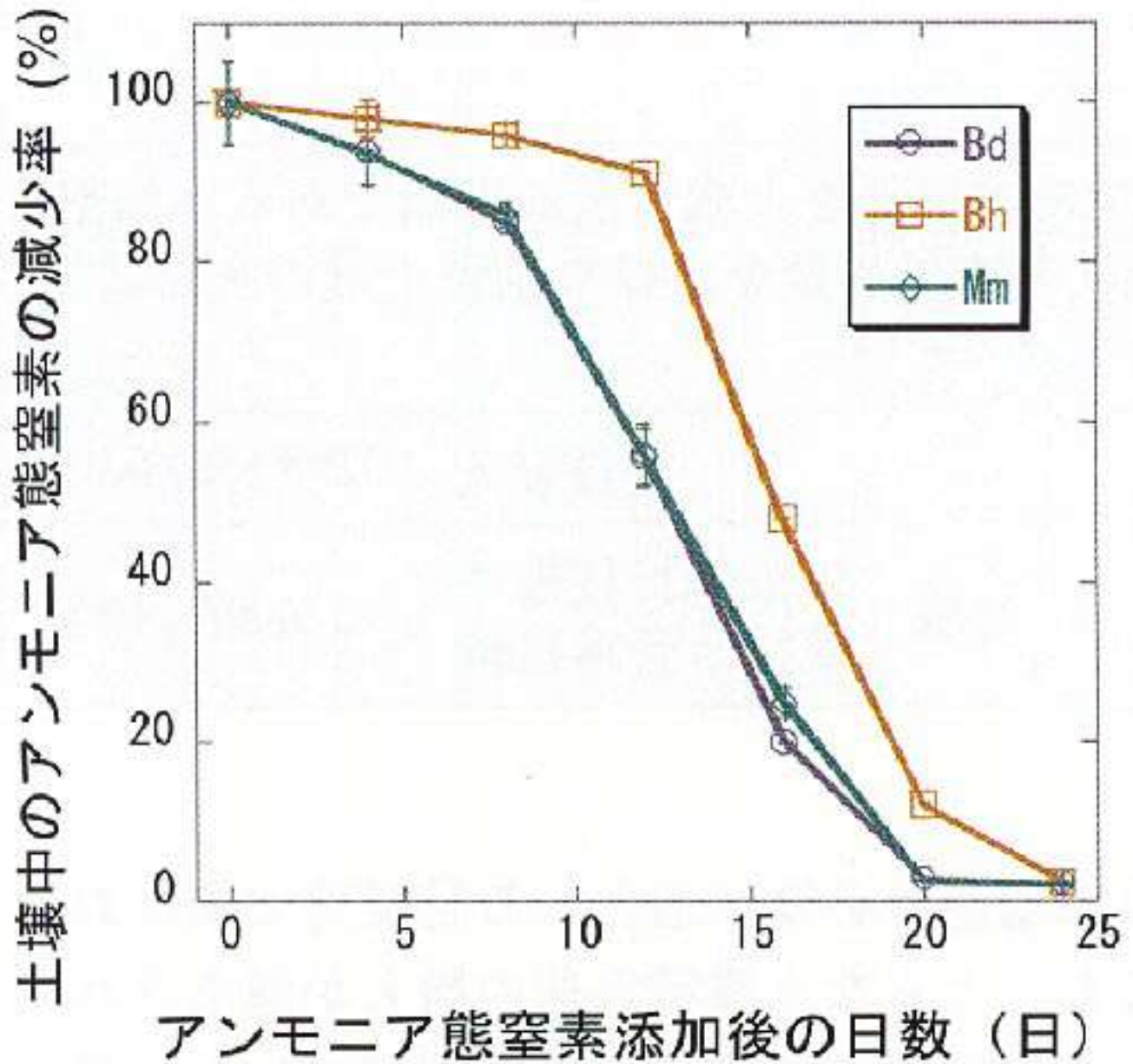


図 1 土壌中のアンモニア態窒素の変化  
0日目のアンモニア態窒素を100%として表した。

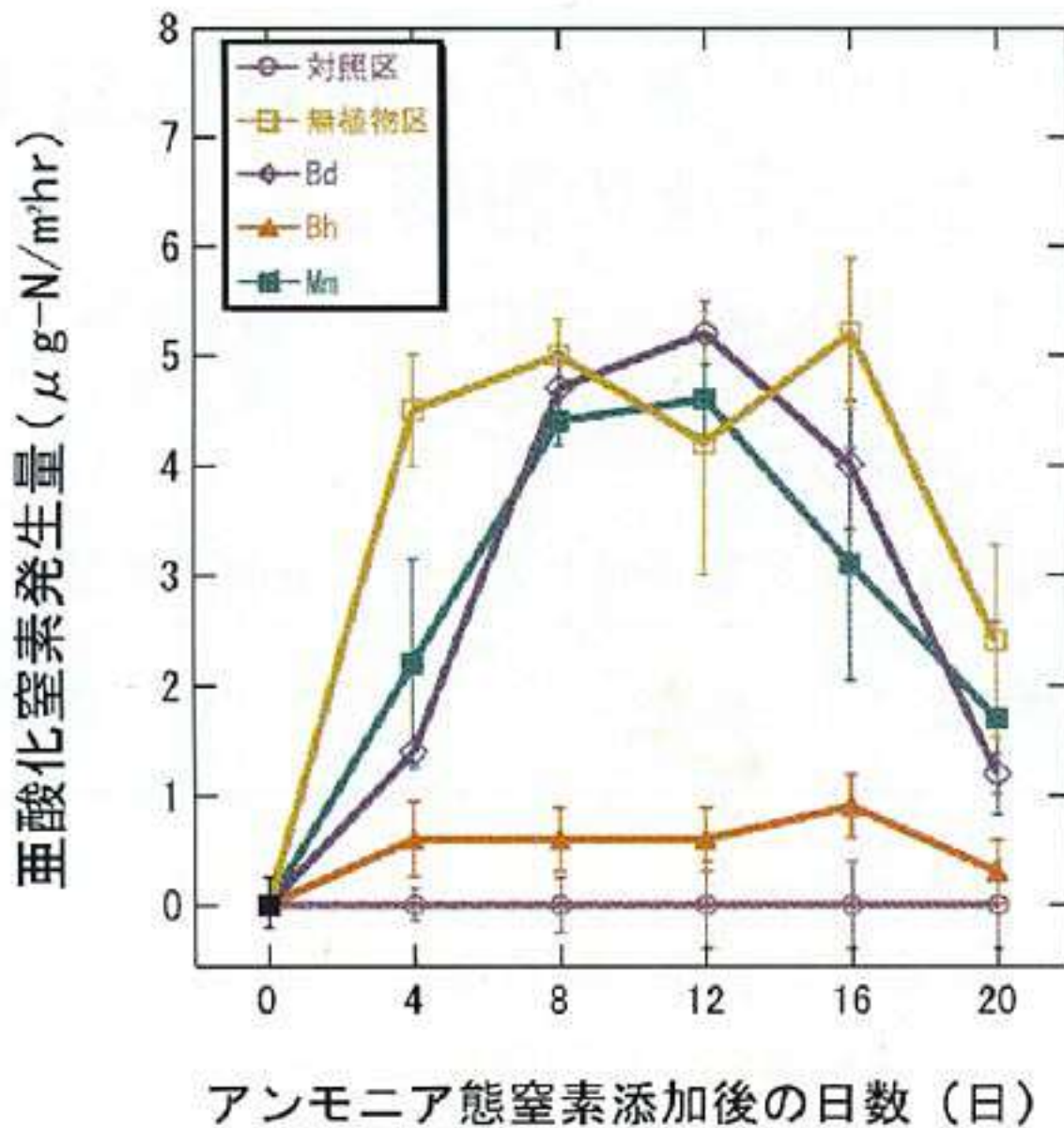


図2 土壤から発生する亜酸化窒素の変化  
植物を生育させなかった土壤で、窒素を与えない区を対照区、窒素を与えた区を無植物区とした。

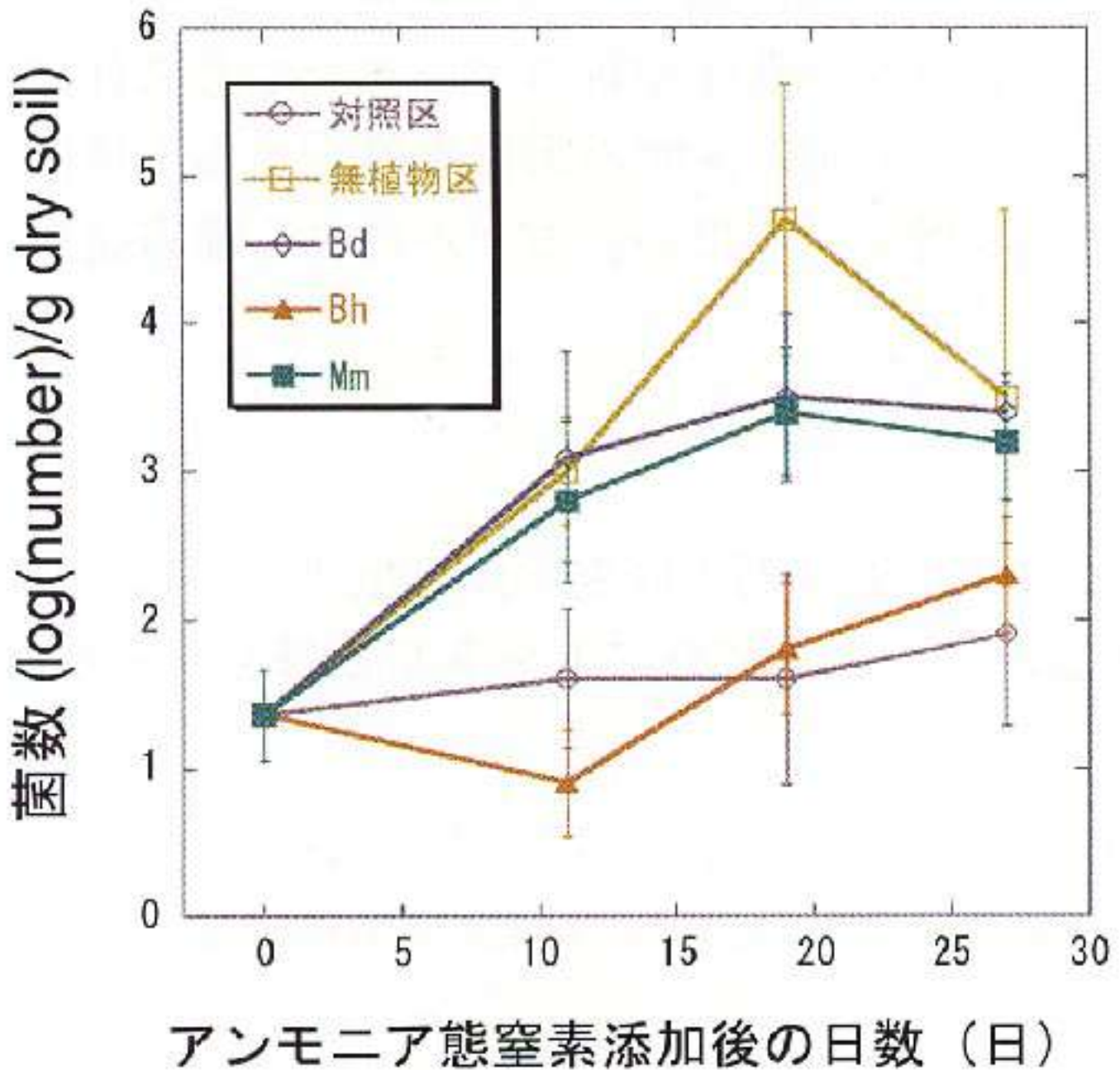


図 3 アンモニア酸化細菌数の変化  
窒素を与えず植物も無い区を対照区、窒素を与えたが植物のない区を無植物区とした。

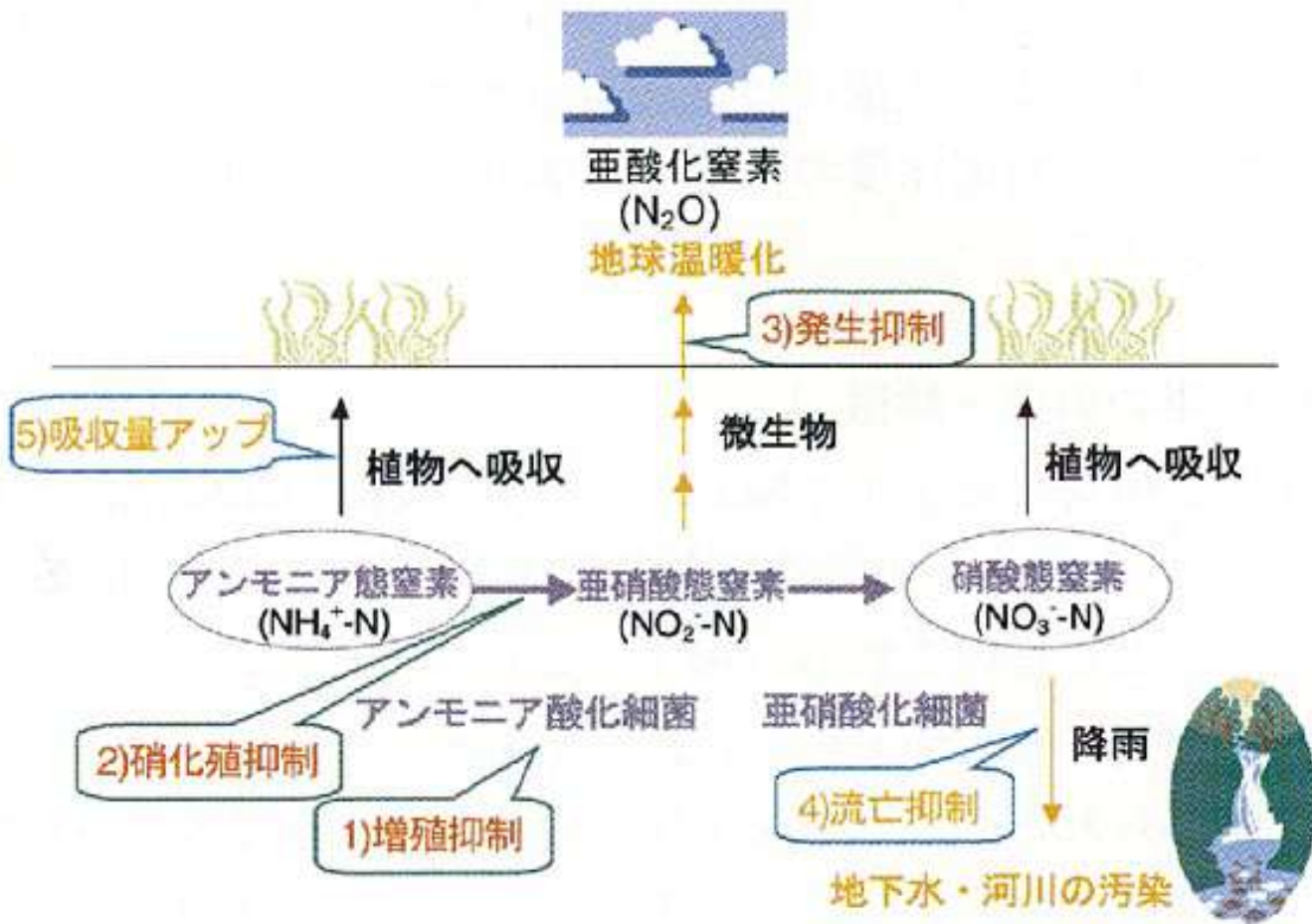


図 4 *B. humificans* による硝化抑制機構











11-n-U... Flexibacter sp.FL824A...

m-v-... Flexibacter sp.FL824A...
m-S...
m-A...
m...
m...
m...
m...

m"woE...
@-q...
D...
m...
1. Flexibacter...
2. [N]...
3. [N]...

Flexibacter sp.FL824A...
m...
1. Flexibacter...
2. [N]...
3. [N]...

1. Flexibacter sp.FL824A...

2. [N]...
3. [N]...

m...
E...
Z...
E...
S...
Z...
E...
B...

表 1 4-MU-*N*-Acetylchitooligosid を基質とした陽性クローンの酵素活性

クローン	酵素活性 ( $\mu$ Unit/ml) ¹⁾		活性比 (dimer/trimer)
	dimer ²⁾	trimer	
グループ A			
CHF2778	7.63	10.36	0.74
CHF2601	15.81	26.16	0.60
CHF1149	232.19	446.39	0.52
グループ B			
CHF1351	768.50	40.33	19.06

1) 1Unit は 37 °C で 1 分間に基質から 1  $\mu$  mol の 4-MU を生成する酵素量

2) dimer, 4-MU-(GlcNAc)₂; trimer, 4-MU-(GlcNAc)₃

*Flexibacter* sp. FL824A キチナーゼ



*Bacillus circulans* WL-12 キチナーゼ A1



*Bacillus circulans* WL-12 キチナーゼ D



*Aeromonas* sp. 10S-24 キチナーゼ II



図 1 *Flexibacter* sp. FL824 キチナーゼと他のキチナーゼのドメイン構造の比較

- ▨, ▩, ≡, 活性ドメイン； ≡, キチン吸着ドメイン；  
▨, フィブロネクチン・タイプⅢ様ドメイン；  
▨, □, 機能不明のドメイン















18. JAJY/L/8%~i4Z/E,":;AJY/L/J/J/J/E/J/V/R~E~I~

~E~I~AJY/L/8%~i4Z/E,":;AJY/L/J/J/J/E/J/V/R~E~I~  
 ~I~AJY/L/8%~i4Z/E,":;AJY/L/J/J/J/E/J/V/R~E~I~  
 ~I~AJY/L/8%~i4Z/E,":;AJY/L/J/J/J/E/J/V/R~E~I~  
 ~I~AJY/L/8%~i4Z/E,":;AJY/L/J/J/J/E/J/V/R~E~I~  
 ~I~AJY/L/8%~i4Z/E,":;AJY/L/J/J/J/E/J/V/R~E~I~  
 ~I~AJY/L/8%~i4Z/E,":;AJY/L/J/J/J/E/J/V/R~E~I~

~E~I~AJY/L/8%~i4Z/E,":;AJY/L/J/J/J/E/J/V/R~E~I~

~E~I~AJY/L/8%~i4Z/E,":;AJY/L/J/J/J/E/J/V/R~E~I~  
 ~I~AJY/L/8%~i4Z/E,":;AJY/L/J/J/J/E/J/V/R~E~I~  
 ~I~AJY/L/8%~i4Z/E,":;AJY/L/J/J/J/E/J/V/R~E~I~  
 ~I~AJY/L/8%~i4Z/E,":;AJY/L/J/J/J/E/J/V/R~E~I~  
 ~I~AJY/L/8%~i4Z/E,":;AJY/L/J/J/J/E/J/V/R~E~I~  
 ~I~AJY/L/8%~i4Z/E,":;AJY/L/J/J/J/E/J/V/R~E~I~

1. JAJY/L/8%~i4Z/E,":;AJY/L/J/J/J/E/J/V/R~E~I~
2. JAJY/L/8%~i4Z/E,":;AJY/L/J/J/J/E/J/V/R~E~I~
3. JAJY/L/8%~i4Z/E,":;AJY/L/J/J/J/E/J/V/R~E~I~
4. JAJY/L/8%~i4Z/E,":;AJY/L/J/J/J/E/J/V/R~E~I~

1. JAJY/L/8%~i4Z/E,":;AJY/L/J/J/J/E/J/V/R~E~I~
2. JAJY/L/8%~i4Z/E,":;AJY/L/J/J/J/E/J/V/R~E~I~

~E~I~AJY/L/8%~i4Z/E,":;AJY/L/J/J/J/E/J/V/R~E~I~

~E~I~AJY/L/8%~i4Z/E,":;AJY/L/J/J/J/E/J/V/R~E~I~

~E~I~AJY/L/8%~i4Z/E,":;AJY/L/J/J/J/E/J/V/R~E~I~

~E~I~AJY/L/8%~i4Z/E,":;AJY/L/J/J/J/E/J/V/R~E~I~

~E~I~AJY/L/8%~i4Z/E,":;AJY/L/J/J/J/E/J/V/R~E~I~

~E~I~AJY/L/8%~i4Z/E,":;AJY/L/J/J/J/E/J/V/R~E~I~

~E~I~AJY/L/8%~i4Z/E,":;AJY/L/J/J/J/E/J/V/R~E~I~

~E~I~AJY/L/8%~i4Z/E,":;AJY/L/J/J/J/E/J/V/R~E~I~

~E~I~AJY/L/8%~i4Z/E,":;AJY/L/J/J/J/E/J/V/R~E~I~  
 ~I~AJY/L/8%~i4Z/E,":;AJY/L/J/J/J/E/J/V/R~E~I~  
 ~I~AJY/L/8%~i4Z/E,":;AJY/L/J/J/J/E/J/V/R~E~I~  
 ~I~AJY/L/8%~i4Z/E,":;AJY/L/J/J/J/E/J/V/R~E~I~  
 ~I~AJY/L/8%~i4Z/E,":;AJY/L/J/J/J/E/J/V/R~E~I~  
 ~I~AJY/L/8%~i4Z/E,":;AJY/L/J/J/J/E/J/V/R~E~I~





# ••Û”_<ÆCEQ<†•¬%oË•î•ñ‘æ5•† 1997•i•½•¬9”N“x•j

1. [“ÆfAfWfAf,f“fX•\[f“n^æ,É,;,¬,éfcflfEf“fJ,ÌÚ“®ŽÀ‘Ô,Ì%oð-¾•@](#)
2. [fJf“fLfcfOfŠ•\[fjf“fO•a,Ì•RÆCE•’f f-@](#)
3. [f}f“fOf••\[fu<D•...^æ,É,;,¬,é’t—c<>,Ì•¶ŽY<@’\,Ì%oð-¾](#)
4. [fxfgfif •Ef•fRf“ff<f^,Ì...~îÍ”l,É,;,¬,é-â‘è“_,Æ%oü‘P•û•ô](#)
5. [fhfCf,fC•-•ô%o°,Ìfxfgfif •Ef•fRf“ff<f^,É,;,¬,é” <Æ\‘ç•İ“®](#)
6. [•A•,ÌŠ£‘‡‘İ•«ŠÖ—^â“ŽqCEQ,ð•§Æä,.,éflfC^â“Žq,Ì’P—£](#)
7. [fjf...•\[f%of<flfbfgf••\[fN,ð—p,ç,½•A•¶•İ“®•\]%oiŽè-@,ÌŠJ”-](#)
8. [%oq-ff•\[f^,É,æ,éfcf“fh•EfffJf“•,Æ”†%o>”’,É,;,¬,é” ’n—~—p“x”c^-Žè-@,ÌŠJ”-](#)
9. [f^fC,Ì””n“y•ë,©,ç,ÌŸŽ %o>’,‘f’-•¶—Ê,Ì,.,’è](#)
10. [fPffjA,Ì•H•¶Š^,É•è,ß,é•©’Ž•H,ÌŽÀ‘Ô](#)
11. [fRf%ofbfvfX“y,Ì—İŠw‘I“Á•«,Ì%oð-¾,Æ’è—Ê%o>Žè-@,ÌŠJ”-](#)
12. [f^fCfÆfŠfA•Efpf<foÆ’ŽŠ’õf fj,Ì•”ç•†•t’...•”Ê,É,;,¬,é-Æ%ou’S“-•x-E,Ì“®‘Ô](#)
13. [Æ’Ž•a,ÉŠÖ,.,é•fTfCfJfCf“mRNA ,Ì in situfnfCfufŠf_fCf\[•\[fVf‡f“-@,É,æ,éÆÿ•o](#)
14. [”M•ÑŽY•...ŽY•¶•,Ì“ú—î•,’è](#)
15. [fTfgfEflfr,Ì‘Šú•,“æ•«,ÆfVf‡“æ’~•İŠÖ~A•y‘f,ÌŠ^•«](#)
16. [fŠf‡fNfgfE,Ì“SÆ‡-R‘İ•«•iŽi,Ì“Á•«•\]%oi](#)
17. [2%oi“S,É,æ,é...~iŽiŽq-àŠk,©,ç,ÌfGf`fÆf“”-•¶,Ì‘£•i](#)
18. [f•\[fN•P,ÉŠÜ,Ü,ê,éJfEf`f...•\[fN,Ì‘İ<v•«,Ö,İŠÖ—^](#)
19. [f}fÆfCfvfA,É,;,¬,éfnfCfufŠf_bfhî,ÌŠJ”-,Æ,»,Ì—~—p](#)
20. [•...ÆnfÆfxf•...Ž‘Æ’ŠÇ—•ó<µ”c^-î,½,ß,ÌŠù‘¶ŸóŸòŠÇ—•ff•\[f^,Ì—LÆø—~—p-@](#)

•@ **BACK**





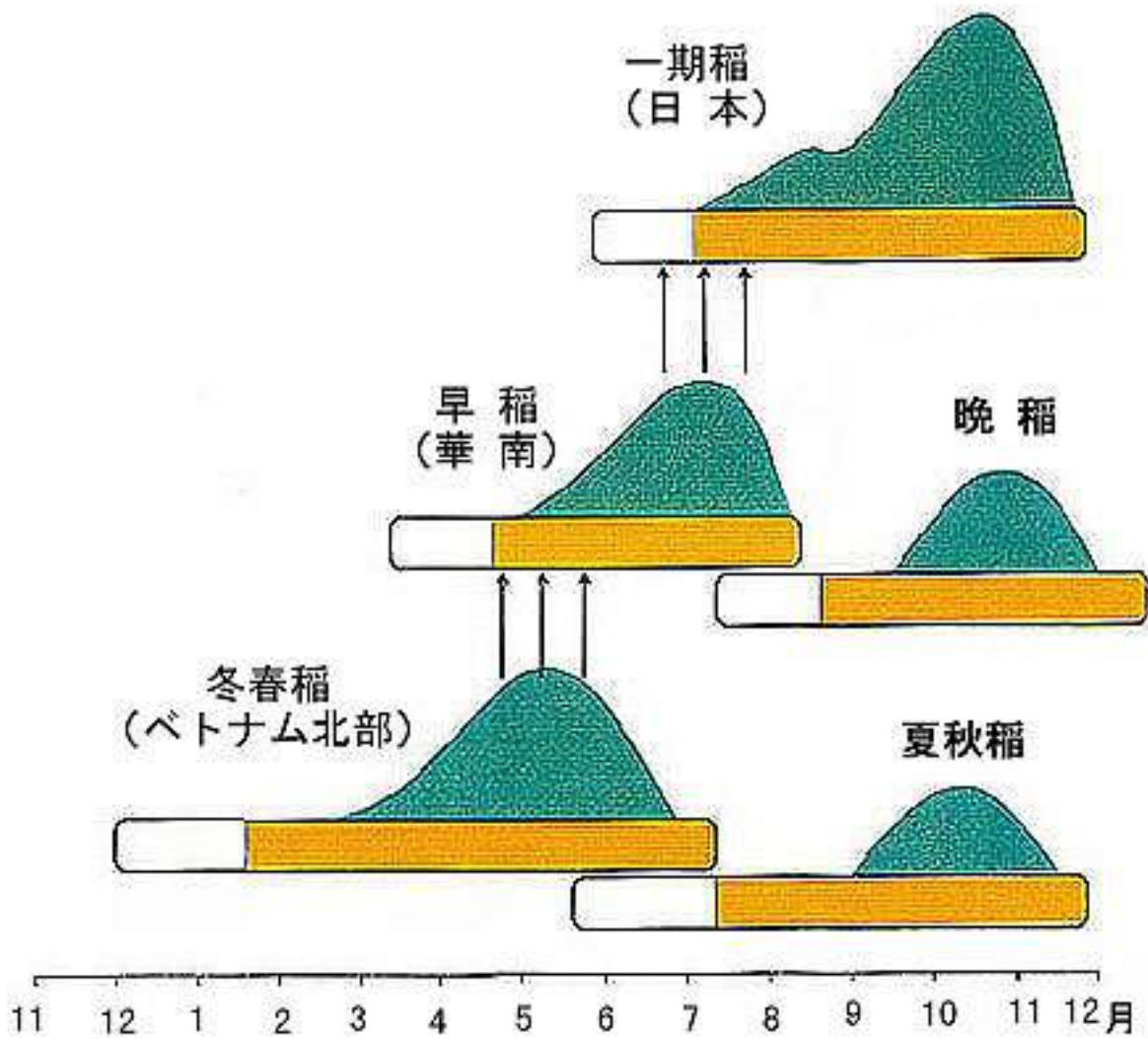


図1 ベトナム北部の冬春稲から華南の早稲をへて、わが国の一期作水稻に飛来するウンカの二段階移動の模式図。バーはイネの栽培期間、波型はウンカの発生パターンを示す。

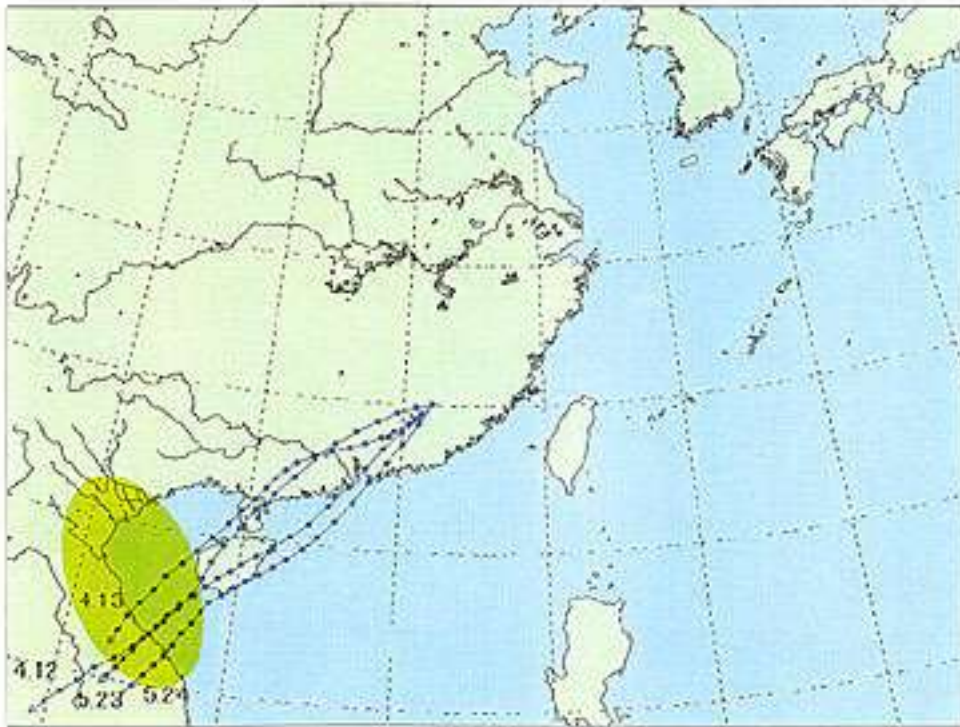


図2 ウンカがベトナム北部を移出した1991年4～5月に、華南東部を起点とする850hPa面の気流の48時間後退流跡線。黄色部分は移出域を示す。



図3 ウンカが華南から西日本に飛来した1991年7月初旬に、熊本を起点とする850hPa面の気流の48時間後退流跡線。黄色部分は移出域を示す。



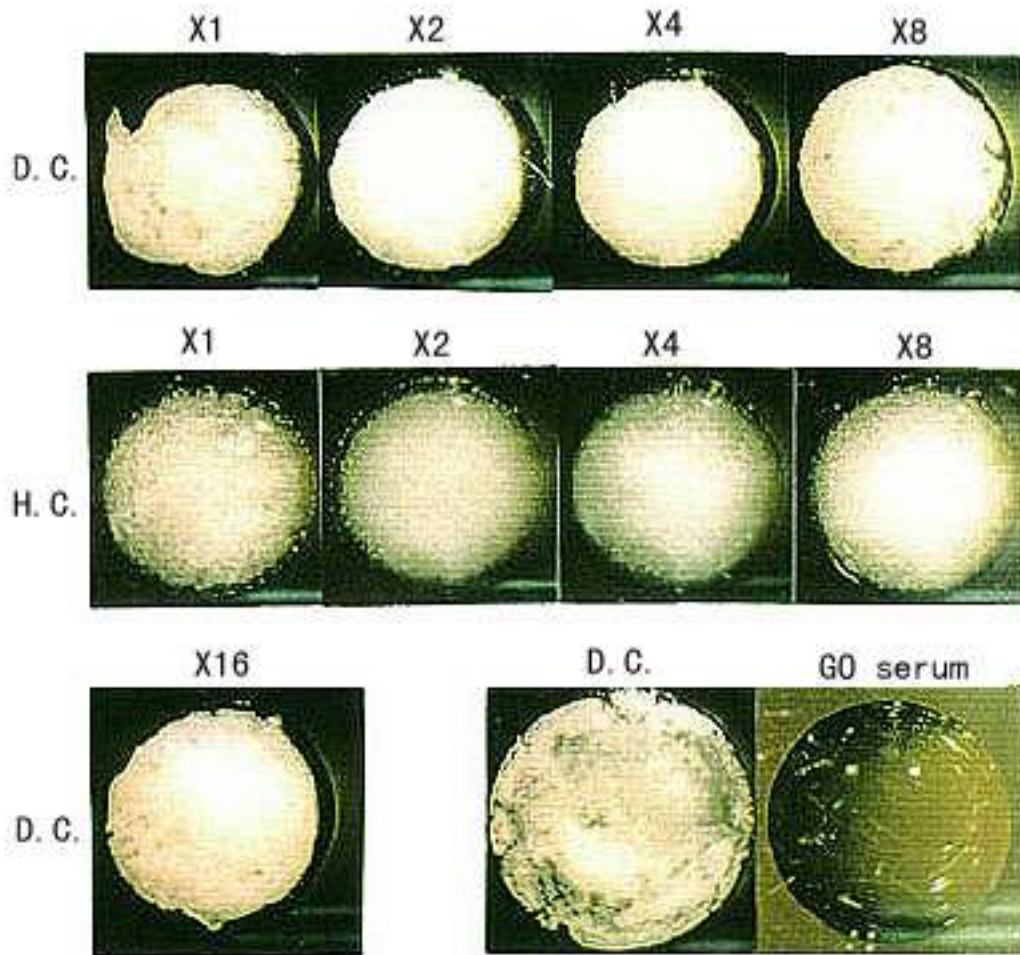


写真1 カンキツグリーンング病の微滴法による抗血清診断  
DC:罹病カンキツ葉篩部組織の磨砕・分画・懸濁液  
(抗血清の1~16倍希釈に滴下したものは陽性反応で  
外周が透明)  
HC:健全カンキツ葉篩部組織の磨砕・分画・懸濁液  
X1~X16:部分純化グリーンング病原体の抗血清希釈



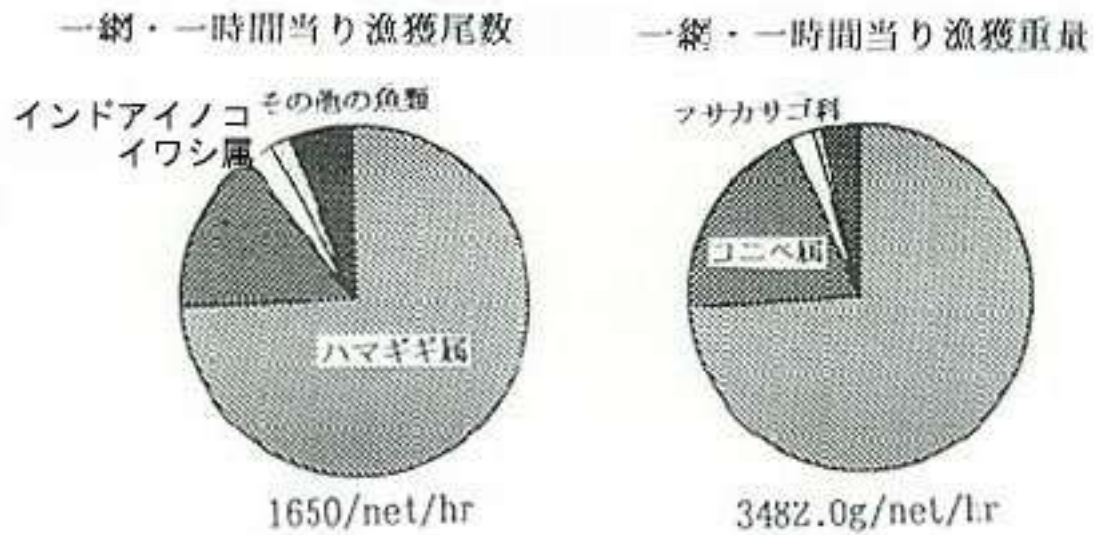


図1 マタンマングローブ汽水域（サンガ川）におけるバググネット試験操業の魚類 CPUE (1995年12月7日)



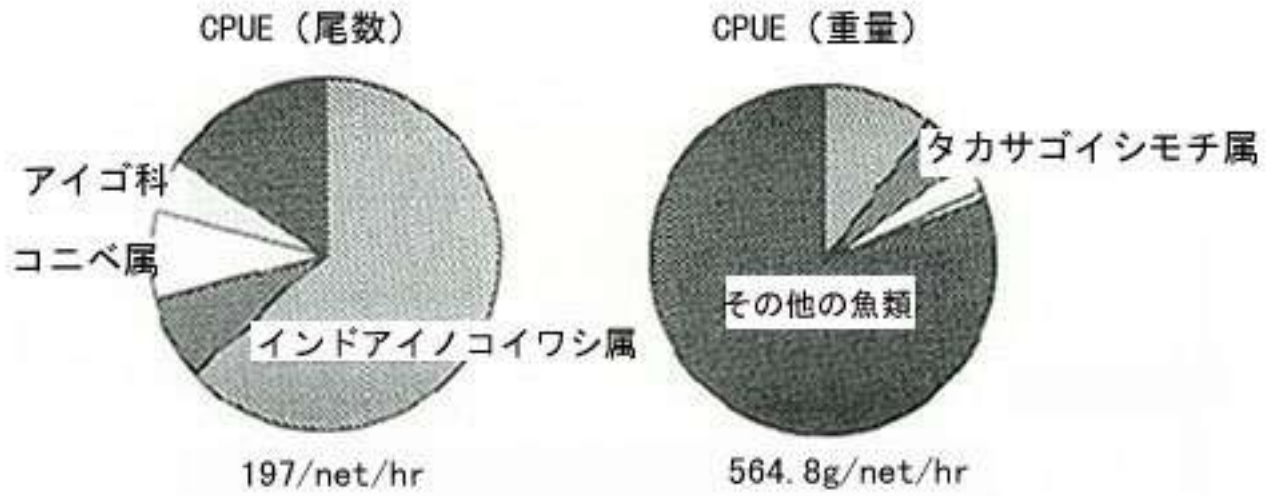


図2 メルボック川・マングローブ汽水域における  
バックネット試験操業の魚類  
CPUE (1995年12月4日)

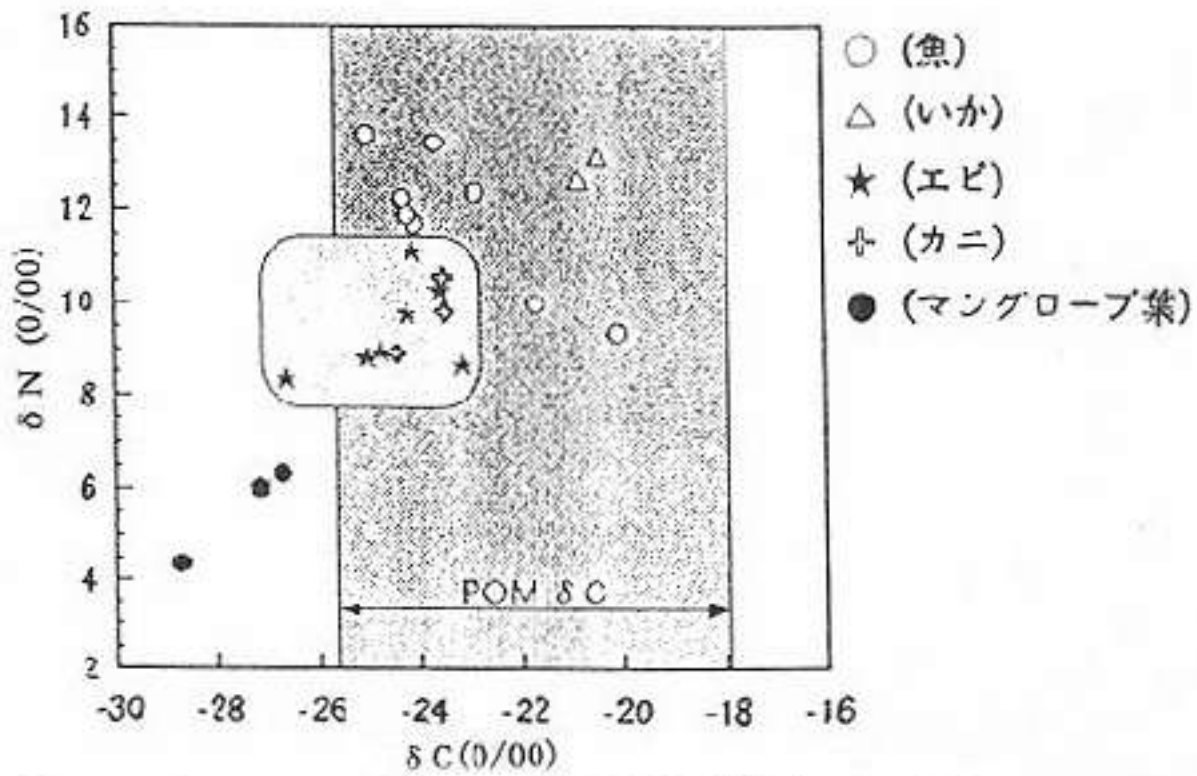
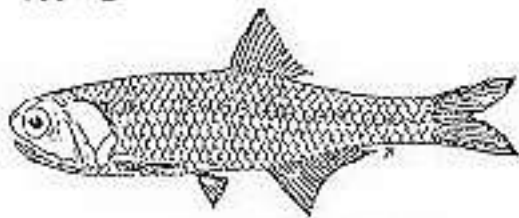
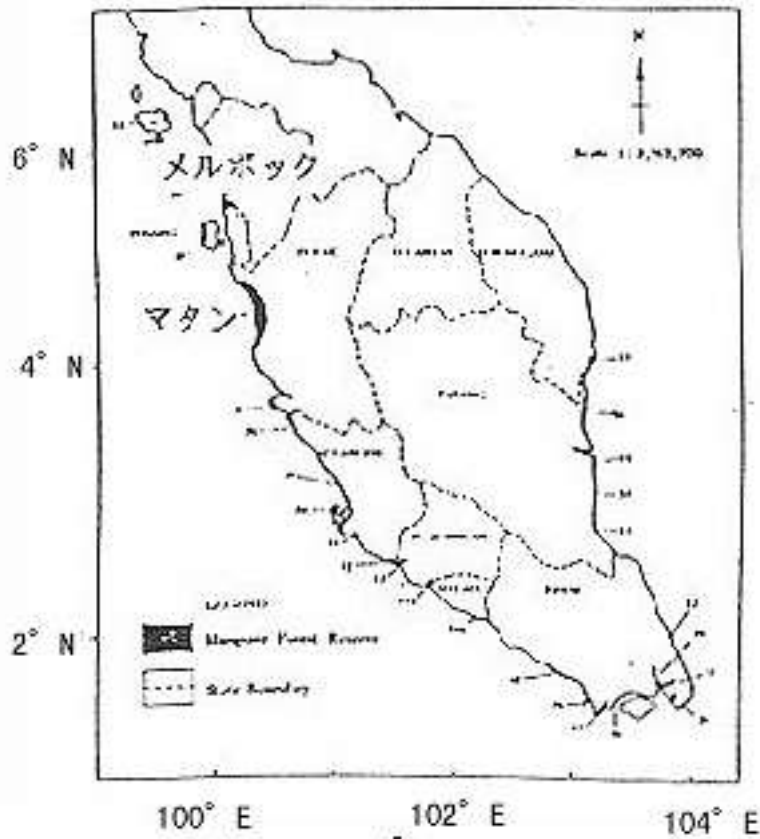


図3 マタン・マングローブ汽水域生態系における  $\delta^{13}\text{C}$ - $\delta^{15}\text{N}$  分布図



インドアイノコイワシ属

表1 マタンとメルボックのマングローブ汽水域に出現するインドアイノコイワシ属稚幼魚の分布密度・現存量・生産の比較

	Density (No./100m ³ )	Biomass (mg/100m ³ )	Production (mg/100m ³ )
Matang	32.6	3839.5	370.1
Merbok	21.3	883.1	82.4



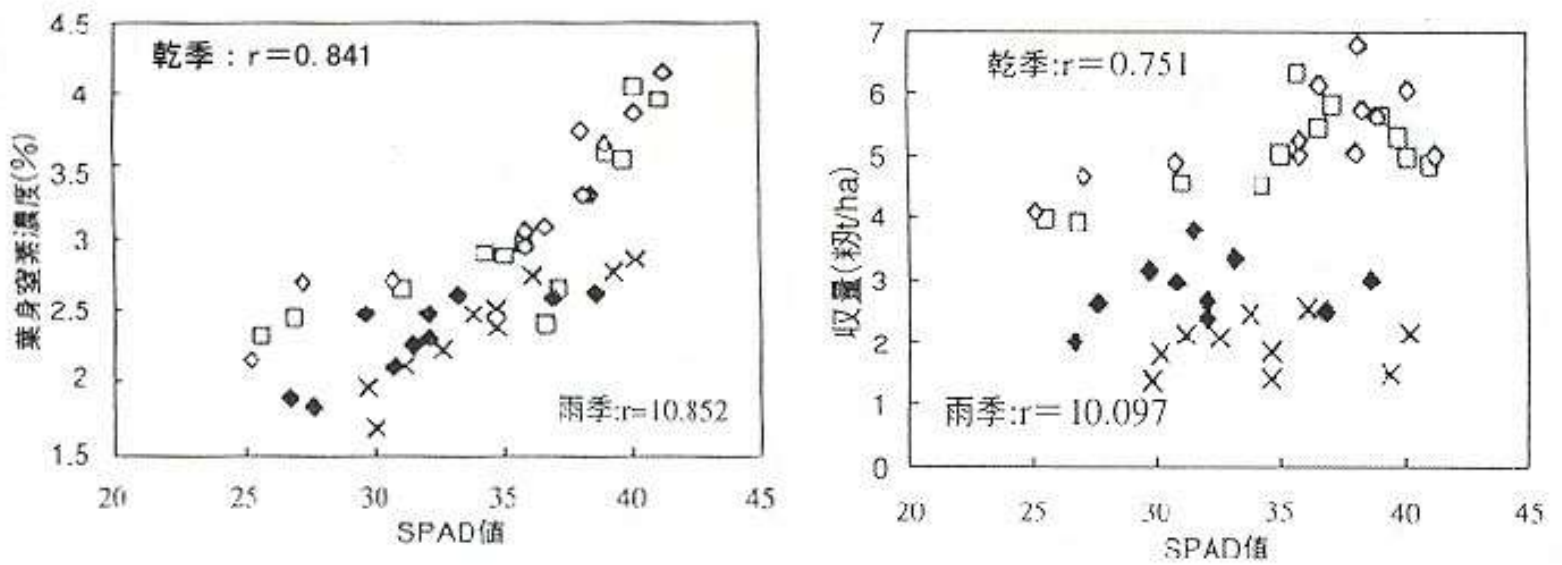


図1 幼穂形成期の葉色 (SPAD値) と葉身窒素濃度、収量との関係

品種 : 乾季 ◇IR64 □IR50404 雨期 ◆IR64 ×チヨニシキ

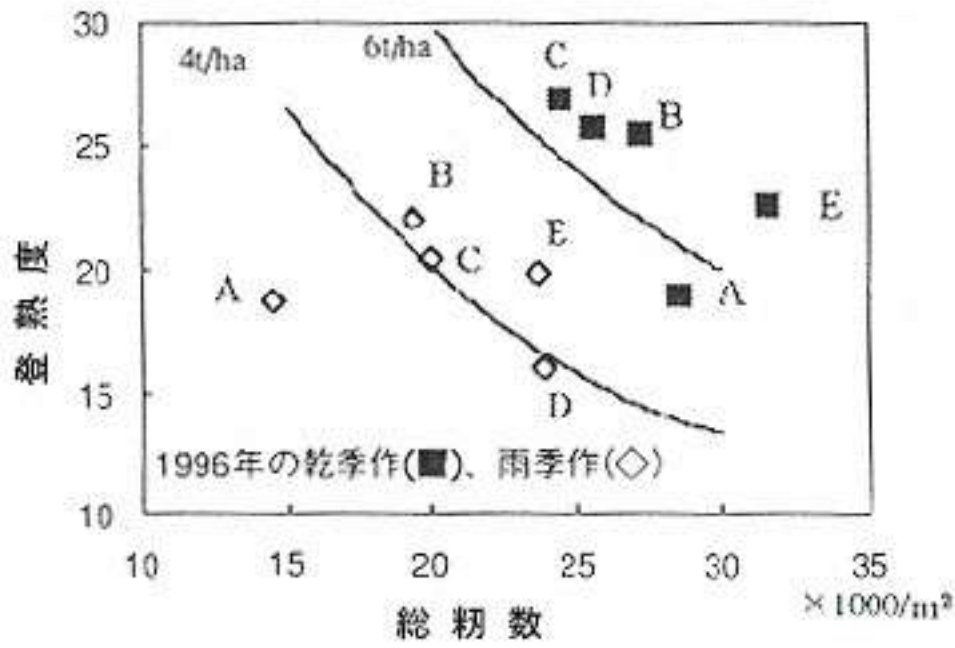


図3 ソンハウステートファーム5農家の収量構成要素  
注) 図中A-Eの文字は表2の農家を示す

表 1 処理区の窒素施用時期と施用量 (Nkg/ha)

処理 番号	播種1 週間後	分けつ 始期	分けつ 盛期	穂孕期	合計
1	40	40			80
2	40		40		80
3	40			40	80
4	40	40		40	120
5	40		40	40	120
6	40	40	40		120

注) P₂O₅は40kg/ha、K₂Oは30kg/ha。いずれも基肥施用

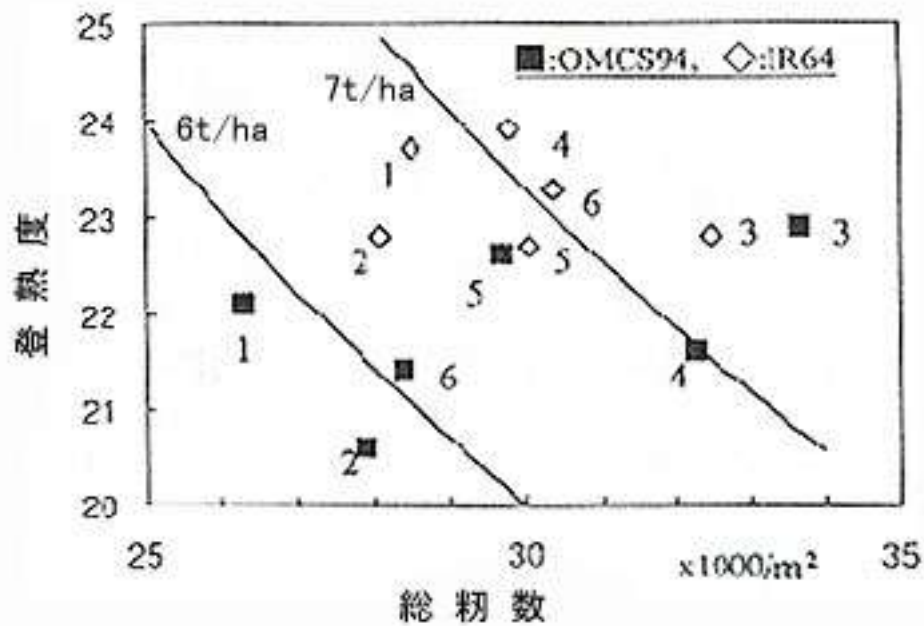


図2 窒素施肥法と収量構成要素 (1996/97 乾季)

注) 登熟度 = 登熟歩合  $\times$  千粒重 (精粒)

図中の数字は表1の処理区番号を示す



表2 ソンハウステートファーム水田の水深 (cm)

農家	1996年 月/日						
	4/28	5/12	5/26	6/9	6/23	7/7	7/21
A	8	23	25	29	26	6	---
B	—	10	13	24	20	20	0
C	8	1	8	18	21	9	0
D	8	13	15	18	21	9	0
E	—	0	2	9	3	0.5	0

注) 1996年雨季において異なる5農家の圃場を調査



表2 各階層の平均経営面積の変遷

(ha/戸)

農家階層	1974	1980	1988	1996
土地無し	0.2	0.2	0.2	0.0
1ha以下	0.4	0.5	0.6	0.7
1-2ha	1.8	0.8	1.2	1.4
2ha以上	1.4	1.1	1.2	3.3

注) 調査時点(96年)に在村する農家から聞き取ったもので、すでに流出した小農、土地無し農民は調査対象になっていないことに注意

表1 階層別農業所得の構成

(単位：百万ドン、%)

農家階層	稲作作期			畑作	畜産	養魚	合計
	合計	冬春	春夏				
土地無し	0.0	0.0	0.0	0.0	0.1(100)	0.0(0)	0.1(100)
1 ha 以下	7.8(65)	4.9	1.3	1.7	1.2(10)	2.2(18)	11.9(100)
1 - 2 ha	12.0(47)	8.3	2.4	1.3	3.0(12)	7.8(31)	25.5(100)
2 ha 以上	42.7(81)	26.3	9.0	7.4	4.8(9)	1.2(2)	52.4(100)

注1) 調査当時のレート：1USドル=11,000ドン

注2) 平均純農業所得に占める各部門の構成比率を示す。カッコ内はその構成比率で単位は%

注3) 冬春作は乾期作、春夏作、夏秋作は雨期作に相当する

表3 階層別水稻生産費（ドン/kg）および収量

農家階層	生産費（作期別）			水稻収量 （3期合計）
	冬春	春夏	夏秋	
1ha 以下	969	1,092	723	15.8t/ha
1 - 2ha	1,130	1,292	794	14.8
2ha 以上	720	958	663	15.9

注）機械、建造物の償却費は含まない



表1 タイの畑地土壌から発生する亜酸化窒素

	地域	土 壌	測定 期間 (日)	窒素施用区 N ₂ O-N発生量 N ₂ O-Nmg/m ²	窒素無施用区 N ₂ O-N発生量 N ₂ O-Nmg/m ²	(1)N--N)発生量	
						肥料-N a [*] (%)	b ^{**}
コンケン	東北	Oxic Paleustults	106	28.9	10.9	0.12	0.24
チェンマイ	北	Typic Ochraqualfs	78	19.6	11.9	0.08	0.16
ナコンサワン	中央	Typic Calcicustalfs	106	40.3	10.0	0.25	0.48
プラプフタバ	中央	Oxic Paleustults	110	35.1	12.2	0.19	0.37

*: 肥料を入れない畝間部については窒素肥料施用区と無施肥区とでN₂O発生量に差がないと仮定した場合

** : 畝間部についても畝上と同程度にN₂O発生量に差があると仮定した場合

参考: 温帯畑地における施肥窒素に対するN₂O放出比について、測定された46例の中央値が0.33%であった  
(八木一行 農業環境技術研究所 資源・生態管理科研究集録 (1997) より)。

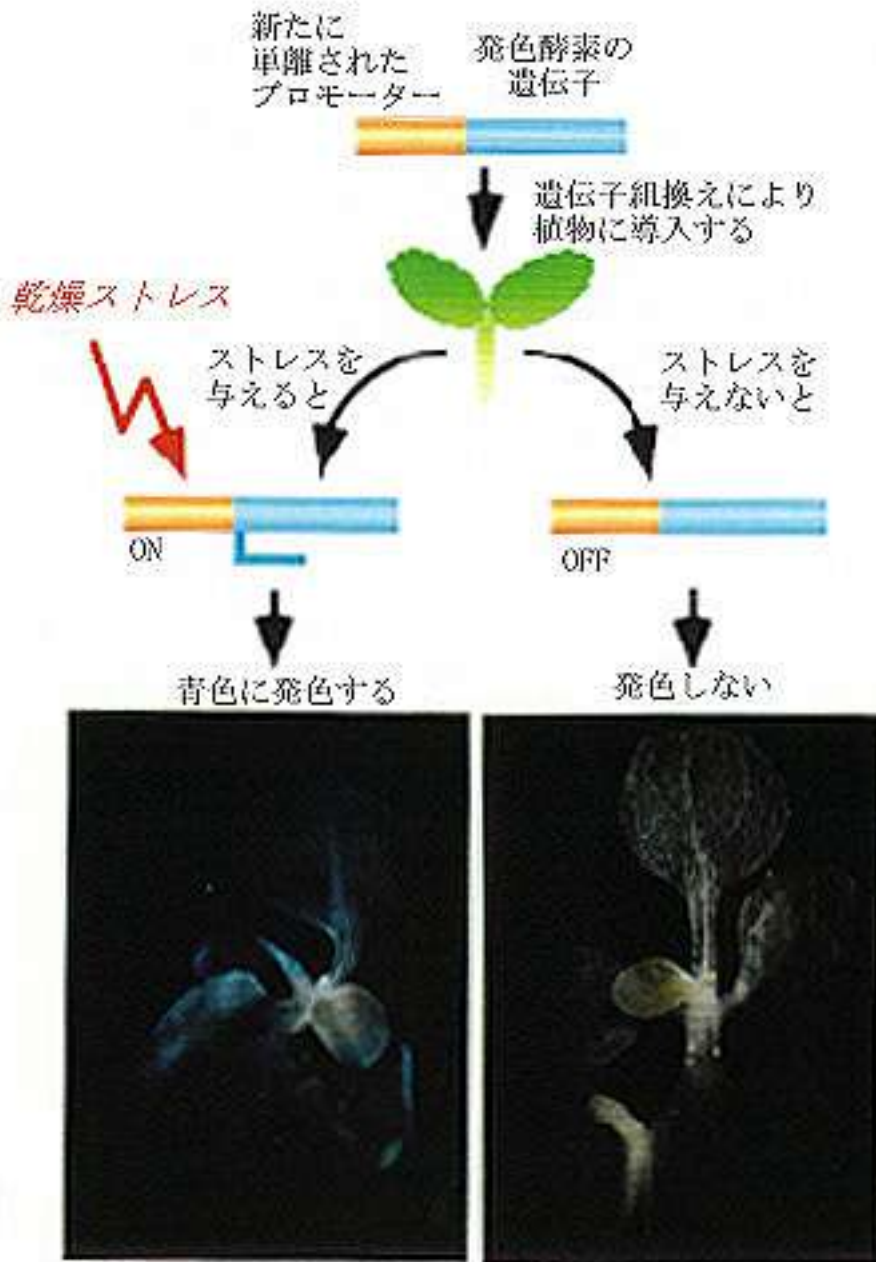


図2 乾燥ストレス誘導性プロモーターの働き

新たに単離した乾燥ストレス誘導性プロモーターを青い色素の合成酵素β-グルクロニダーゼの遺伝子と結合して植物に導入した。得られた形質転換体は乾燥ストレスを与えると青く染まった。





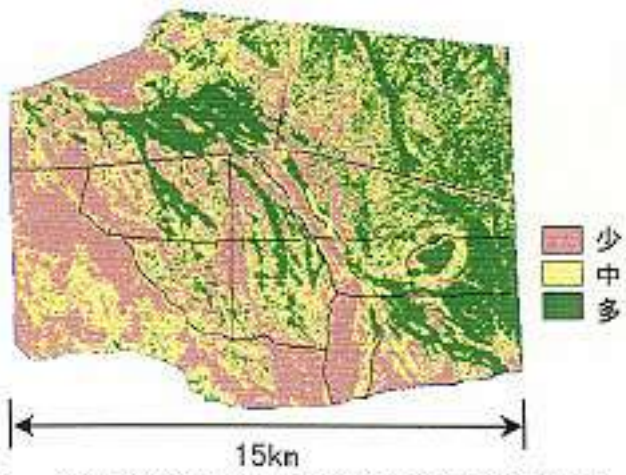


図1 植生指数PD54に基づく植生の多寡程度

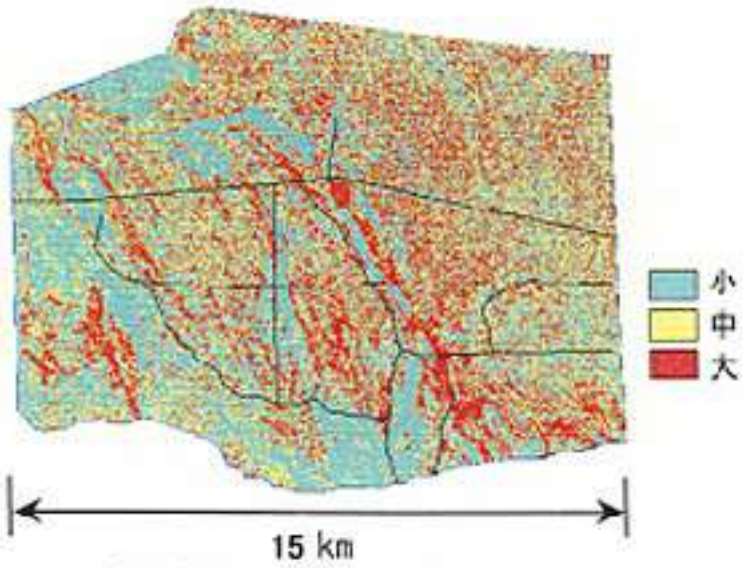


図 2 植生指数PD54に基づく植生の変動程度

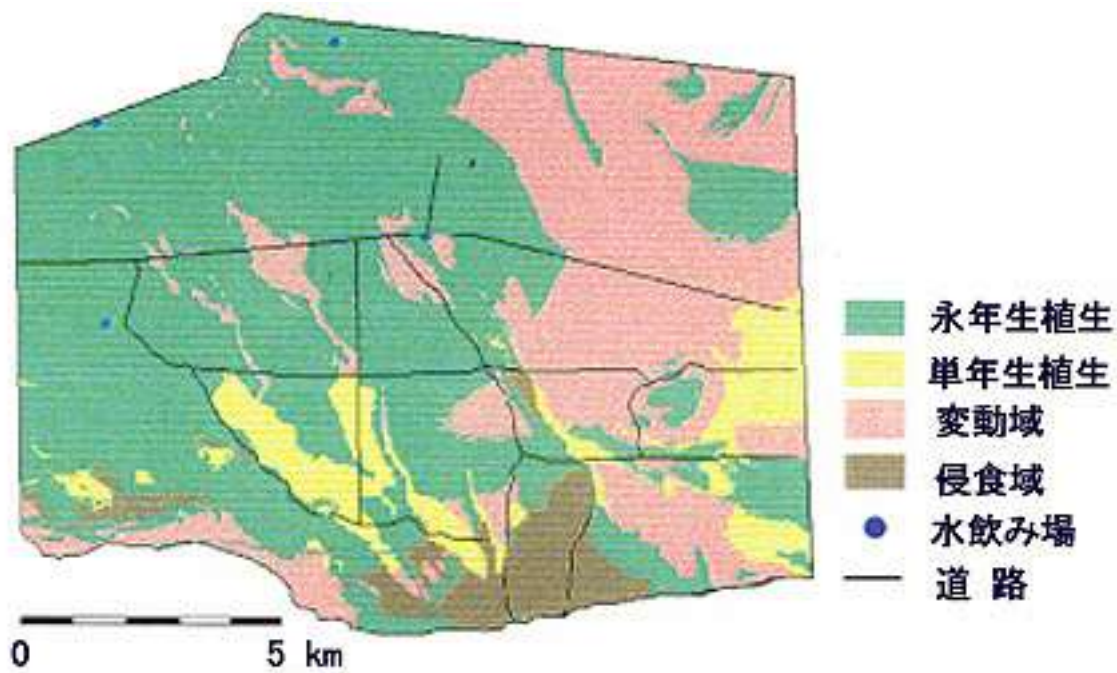


図3 ニューラルネットワークモデルによる植生変動評価

表 1 各要因を除いた場合の判別精度の変化

多寡	除外要因 判別精度 (%)	地 貌	水 系	土 壤	植 生	傾斜度	距 離 1	距 離 2
		67.90	69.00	67.90	69.74	71.59	59.04	70.85
変動	除外要因 判別精度 (%)	地 貌	水 系	土 壤	植 生	傾斜度	距 離 1	距 離 2
		67.90	69.00	67.90	69.74	71.59	59.04	70.85

距離 1 : 水飲み場からの距離、距離 2 : 稜線からの距離



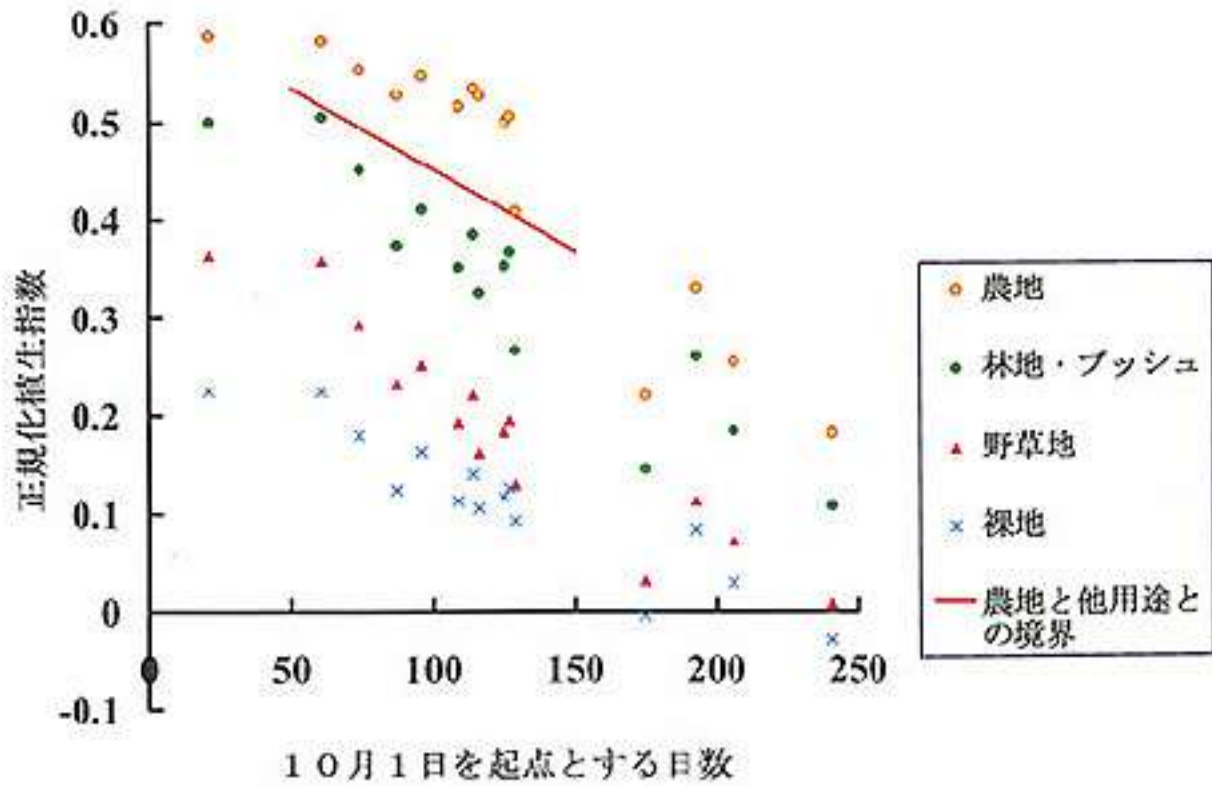


図1 土地利用毎の正規化植生指数時間プロファイルと農地判別境界線

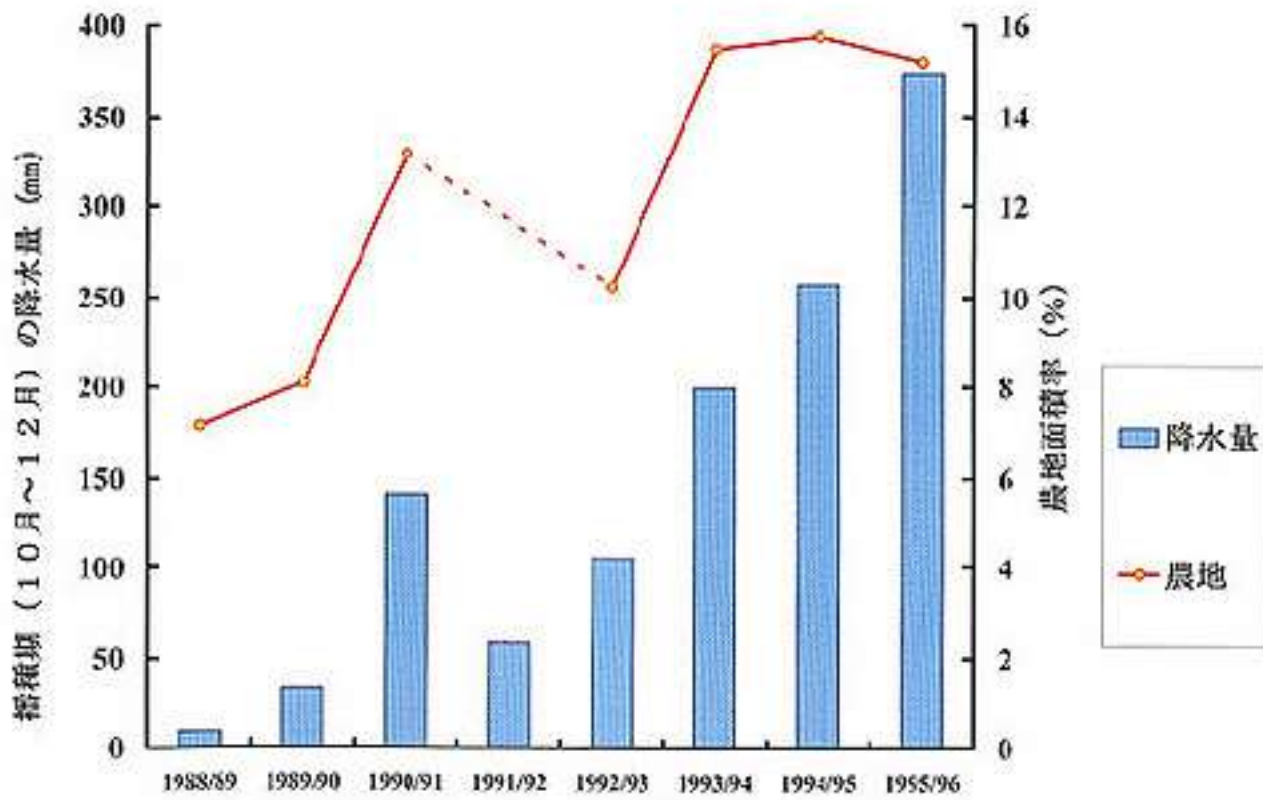


図2 推定されたラピー期農地面積率と播種期降水量の経年変化



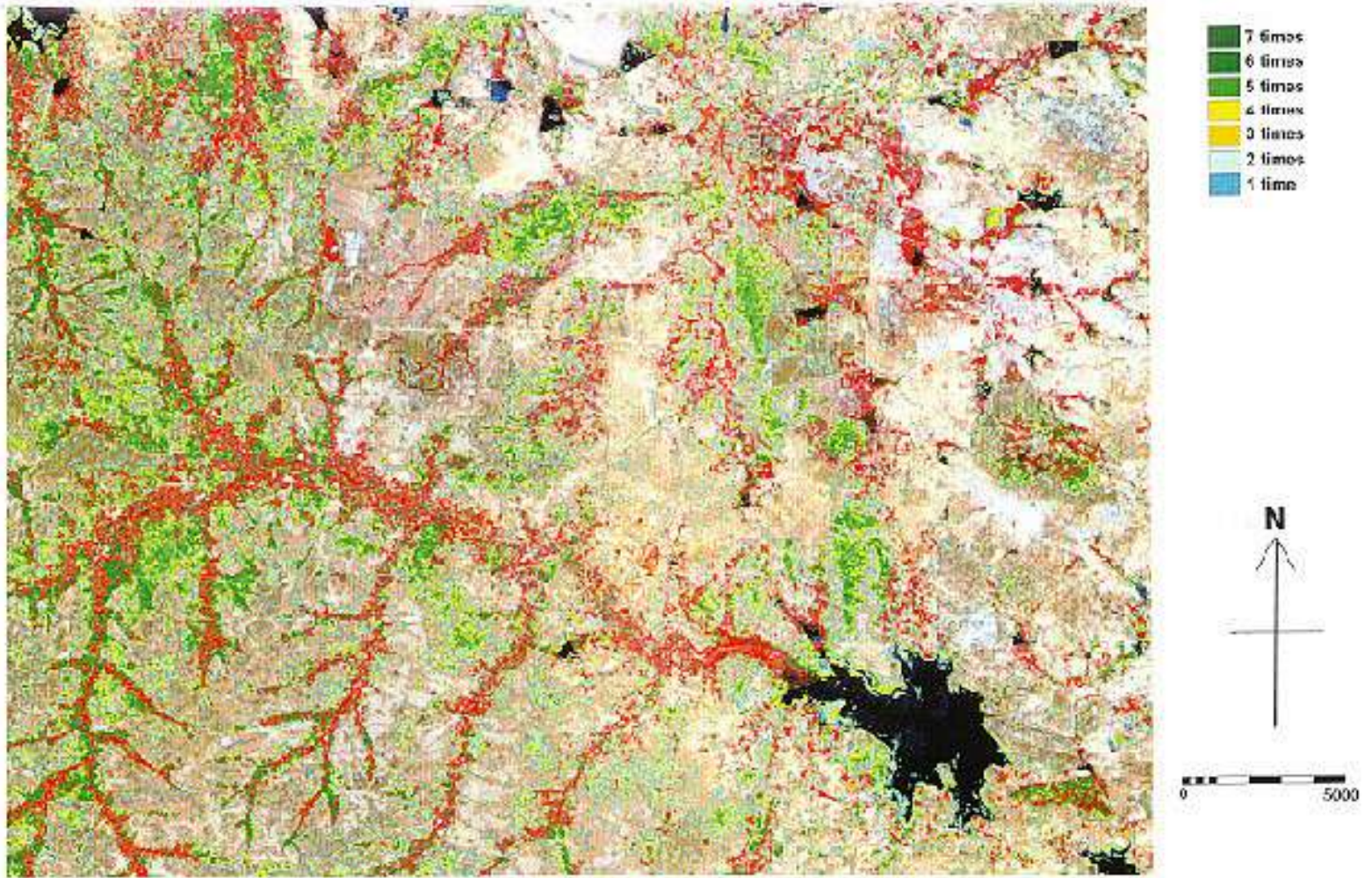


図3 1988/89年から1995/96年まで（1991/92年を除く）のラビー期耕作回数の分布



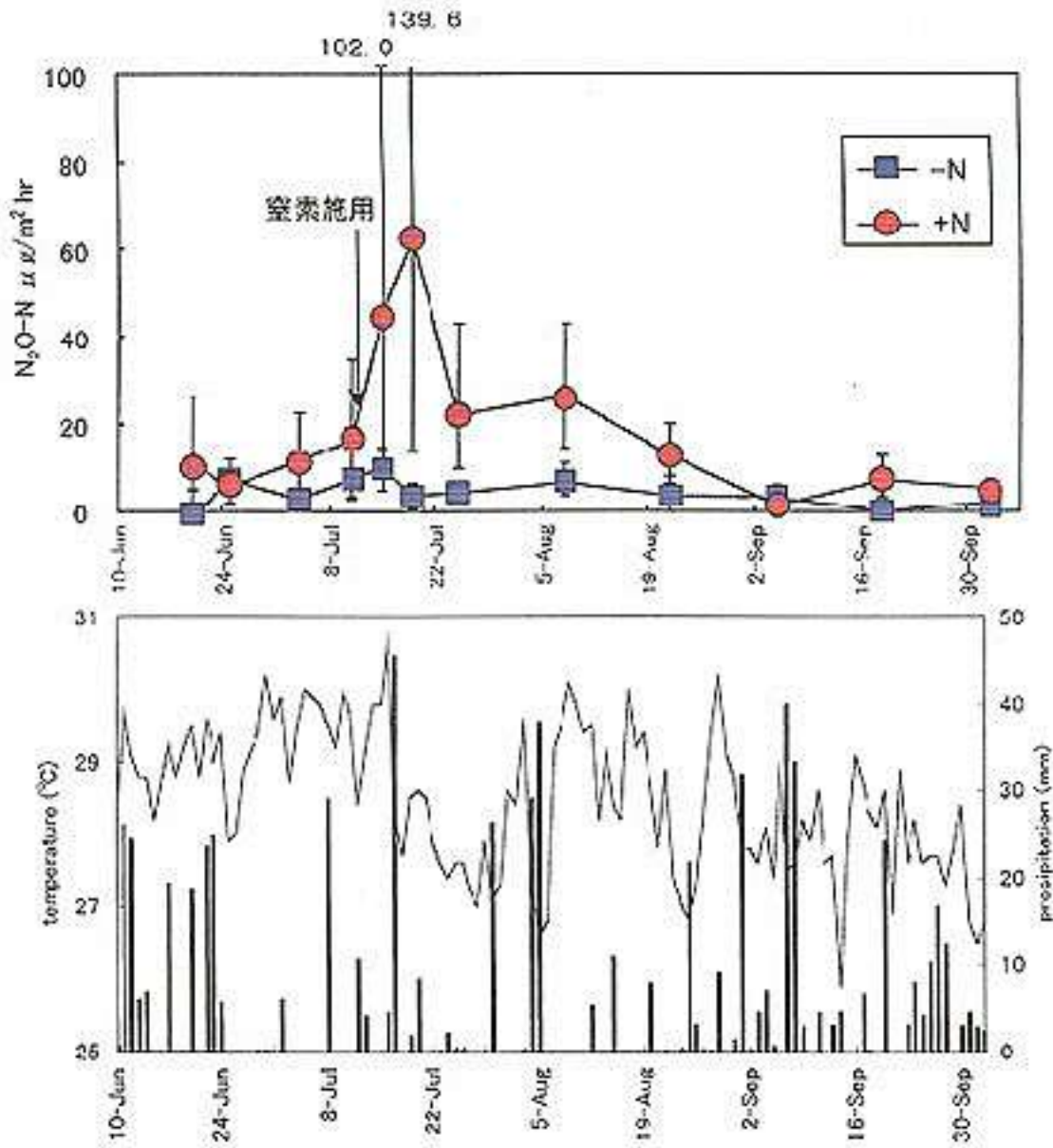


図1 ナコンサワンにおける亜酸化窒素フラックスの経時変化と日平均気温および日降水量

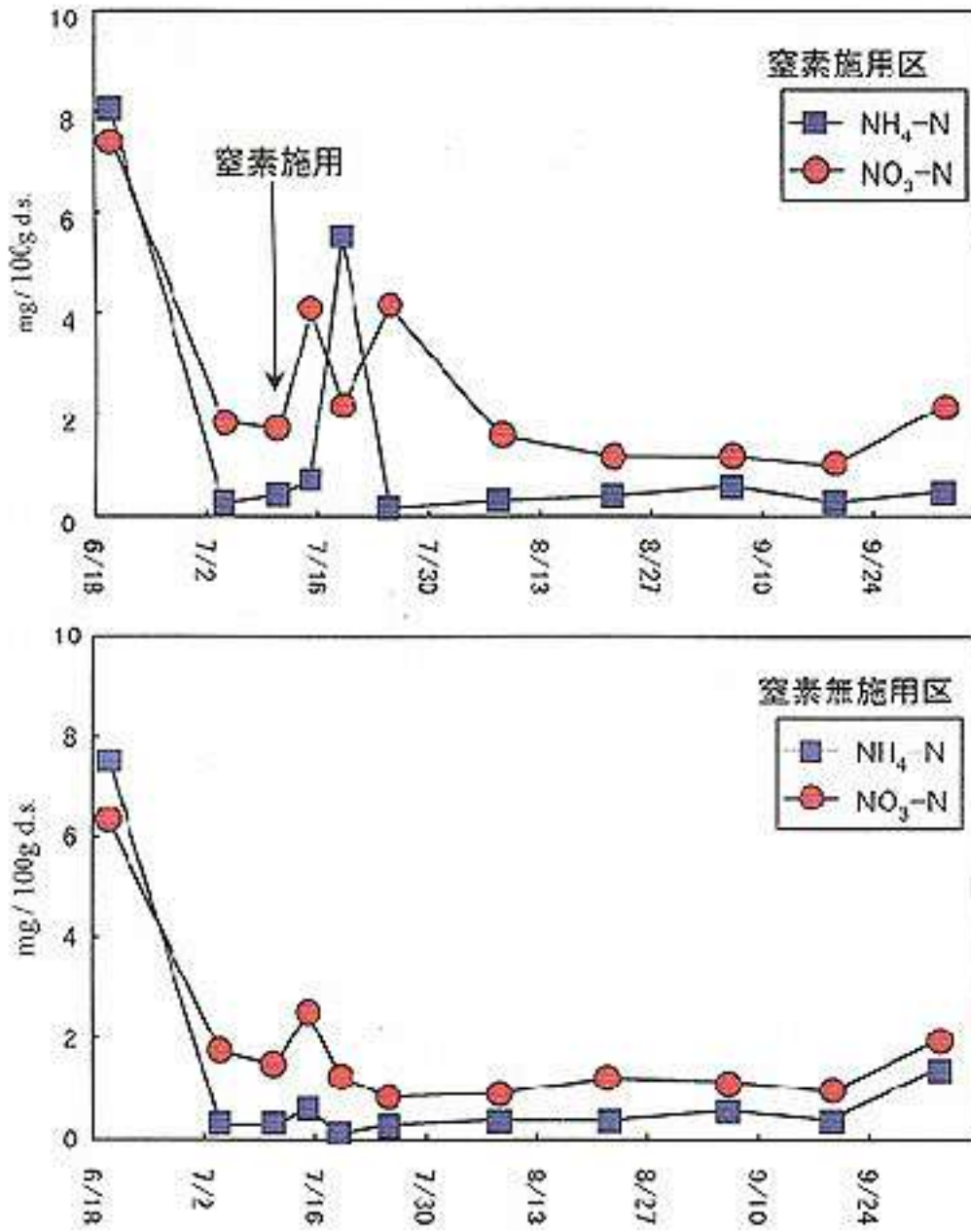


図2 土壤中の無機窒素の動態 (0-15cm)  
(ナコンサワン)





図1 シロアリの羽アリを捕らえるトラップ（エンザロ村）



図2 エンザロ村でのランチ。左手前の皿が水に少々塩を加えて料理したシロアリの羽アリ、その右の皿は主食であるトウモロコシ(白)とソルガム(褐色)のウガリ。

表1 エンザロ村におけるシロアリ（クンビクンビ）食の調査 *

	人 数	1日1人当たりのシロアリ摂取量（g）	
		範 囲	平 均
大 人	87	50-250	110
5 - 15才	51	25-150	61
5 才 以 下	24	20-125	53

*1995年11月からの4ヶ月間、村の約1割に当たる25戸での調査。なお、主食として大人は毎食300-500gのウガリ（図2参照）を食べている。





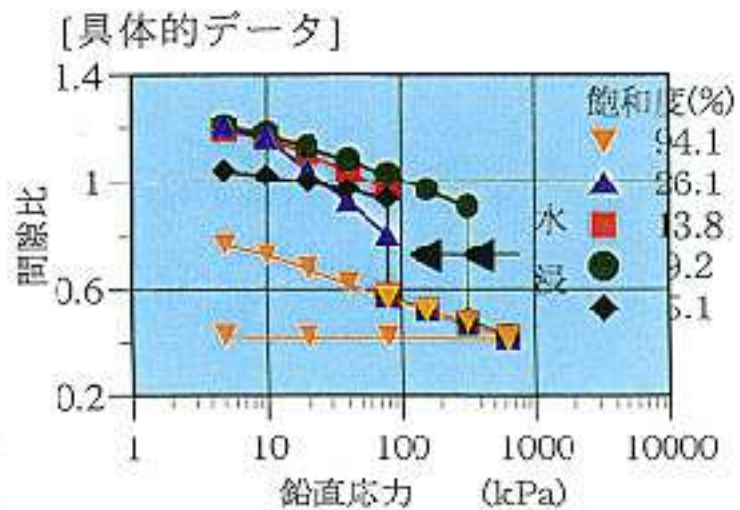


図1 圧密試験結果

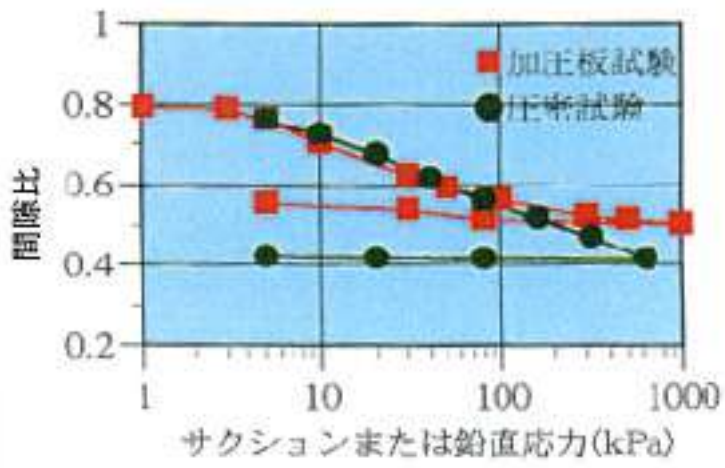


図2 加圧板試験結果

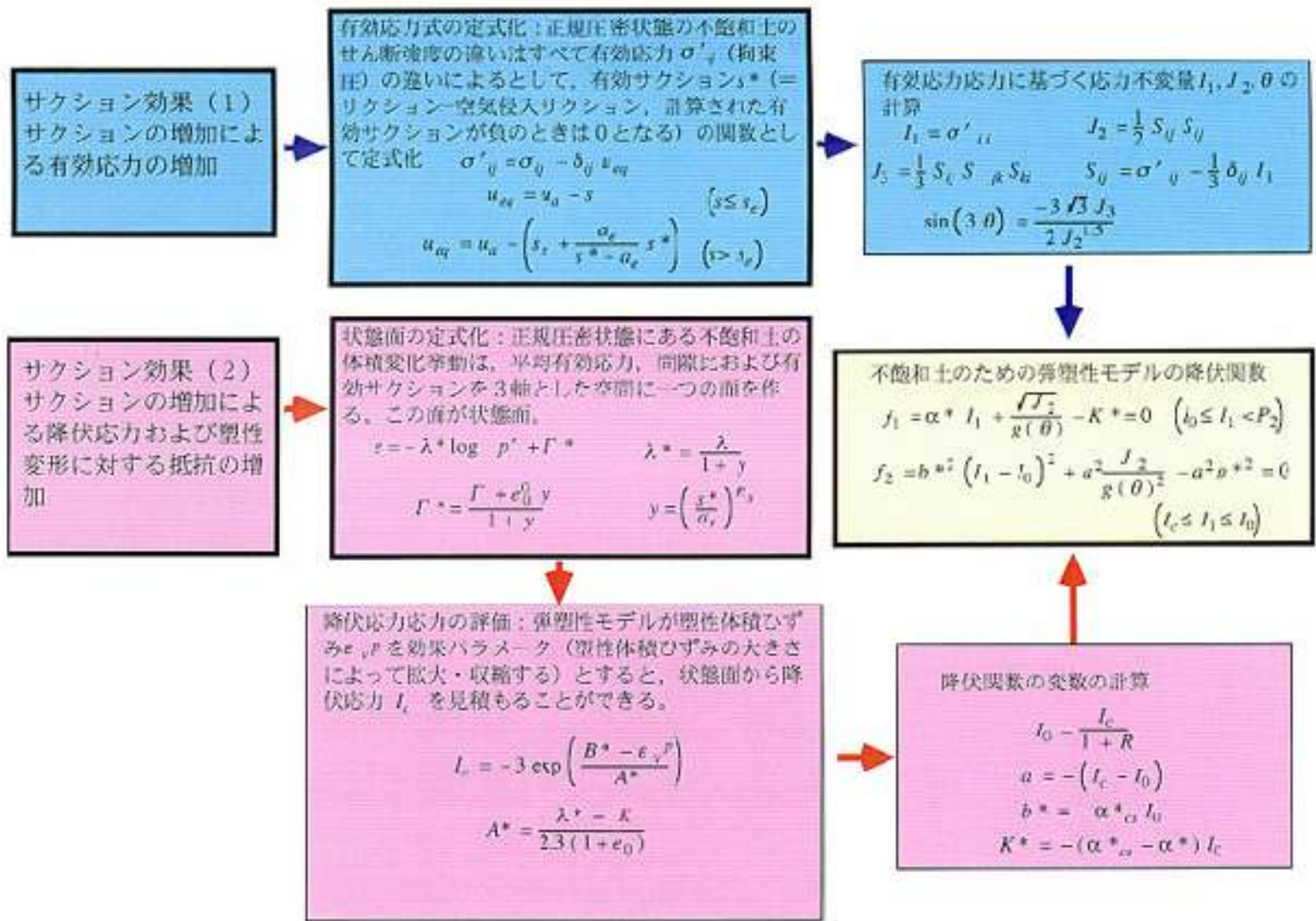


図3 サクシオン効果とその弾塑性モデルへの導入

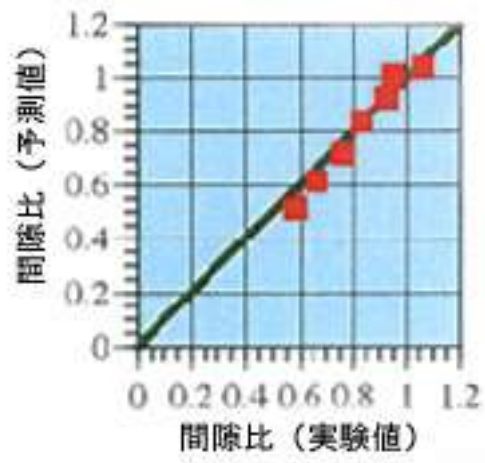


図4 間隙比の実験値と予測値の比較



表 1 牛白血球表面抗原に対するモノクローナル抗体の特異性

抗原	クローン	主な特異性
CD1	TH97A	胸腺皮質細胞、樹状細胞
CD4	IL-A12	ヘルパーT細胞
CD8	IL-A105	サイトキニックT細胞
CD11b	IL-A15	単球、顆粒球
WC1	CC15	成熟 $\gamma\delta$ T細胞
WC6	IL-A53	樹状細胞、顆粒球
class II MHC	R1	抗原提示細胞
IgM	IL-A30	B細胞

表2 ダニ免疫ポラン牛のタイレリア・パルバ感染ダニ付着部位における免疫担当細胞の動態

部位	付着後	CD4 ⁺ 細胞	CD8 ⁺ 細胞	WC1 ⁺ 細胞	MHC II ⁺ 細胞	CD1 ⁺ 細胞	CD11b ⁺ 細胞	WC6 ⁺ 細胞	IgM ⁺ 細胞
表皮	0日	±*	±	+	+	-	-	±	-
	2日	+	±	+	+	-	-	±	-
	4日	+	+	+	++	±	+	+	-
	6日	±	+	++	+++	±	+	++	-
真皮	0日	++	+	++	+++	+	+++	++	-
	2日	++	+	+-	+++	+	+++	++	-
	4日	++	+	+++	++++	++	++++	++	-
	6日	++	++	++++	++++	++	++++	++	±

*細胞数の半定量的評価：みられない（-）、大変少数（±）～大変多数（++++）。





、P <mRNA, ĪĒY•o, Ī, ½, B, Ī *in situ* fnfCfufŠf_fCf[•[fVf‡f“-@, Ē, ”, -, é‘O•^—••û-@, Ī”äŠr

fTfCfJfCf“	-3. ^ —•	0.02N%o-Ž_	0. 25% fgf%ofCfJfCf“	%o-Ž_•^—•Ēä fgf%ofCfJfCf“•^—•
TNF-fĭ	•{*	•{	•	•
IFN-fÁ	•{	•{	•{	•{
IL-2	•{	•{	•{	•
IL-4	•	•	•{	•
IL-6	•{	•{	•{	•{
IL-10	•{	•{	•{	•{
IL-12p35	•	•	•{	•

* •{•F—z•« •|•F%oA•«

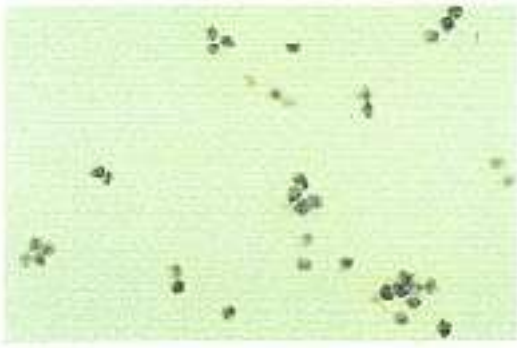


図 1 a CD11b陽性B細胞にみられた  
IL-10mRNAの発現

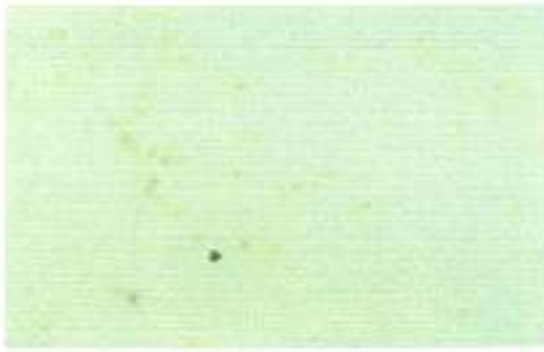


図1 b CD11b陰性B細胞ではIL-10mRNA  
の発現がみられない

Table with 1 column and 1 row. The cell contains a large block of garbled text, likely a corrupted document or a very low-quality scan of a page. The text is mostly illegible but appears to contain some header information and a main body of text.

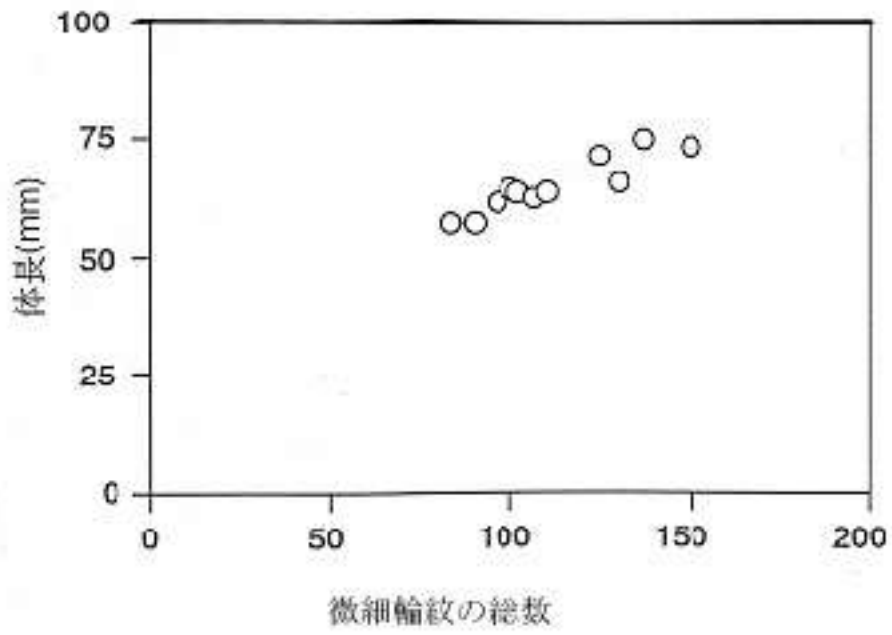


図1 ヤクシマイワシの耳石微細輪紋数と体長の関係

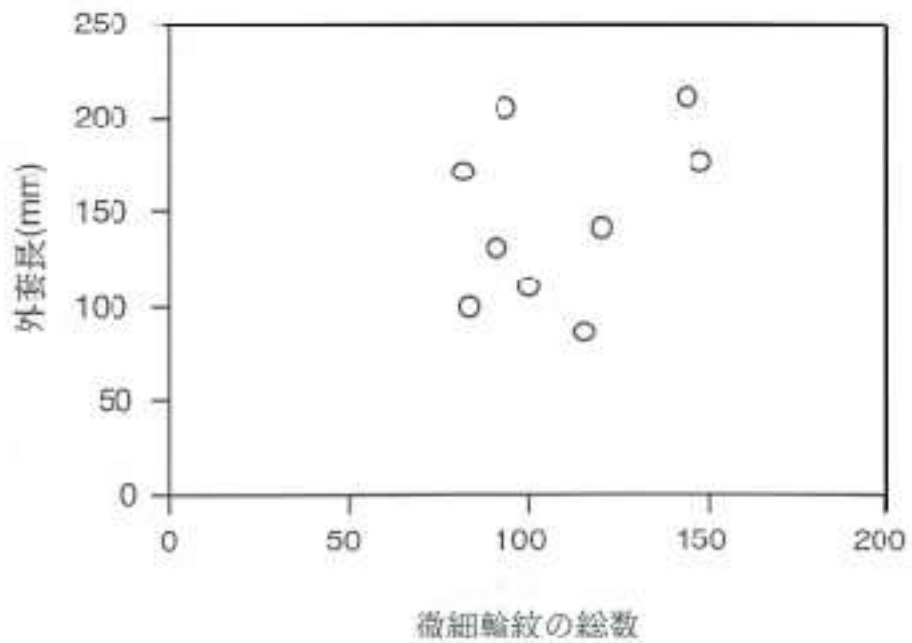


図2 アオリイカの平衡石微細輪紋数と外套長の関係

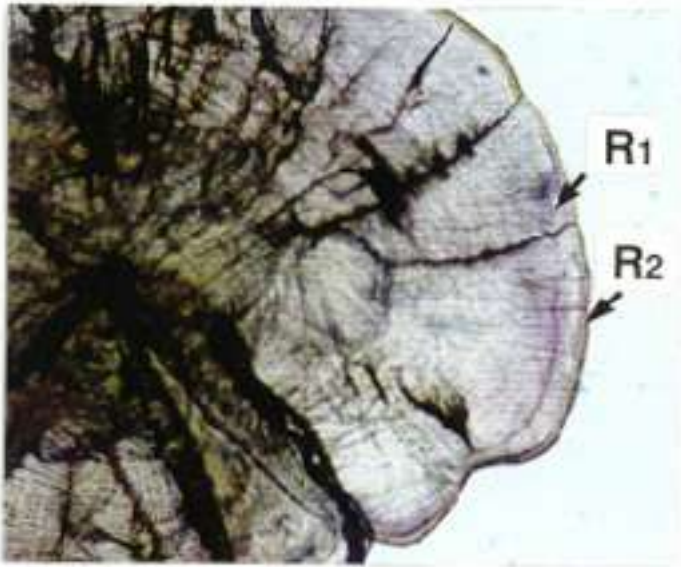


図3 ホソスジマンジュウイシモチの耳石  
(矢印はアリザリンコンプレクソン  
でマーキングされた部位)



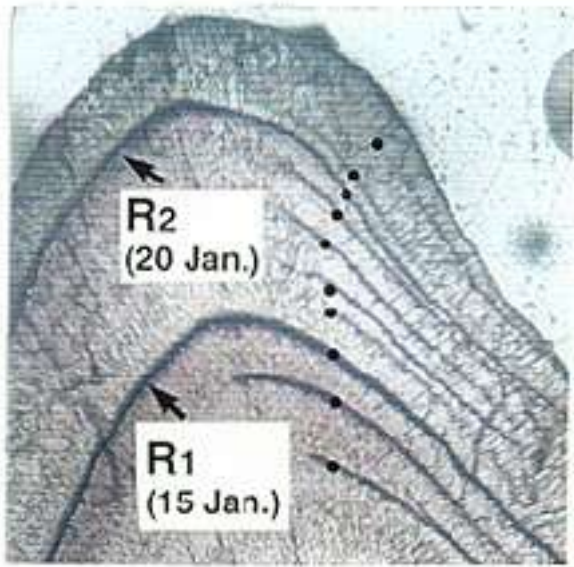


図4 ホソスジマンジュウイシモチの耳石微細輪紋 (矢印はアリザリンコンプレクソンでマーキングされた輪紋、●は日周輪を示す)



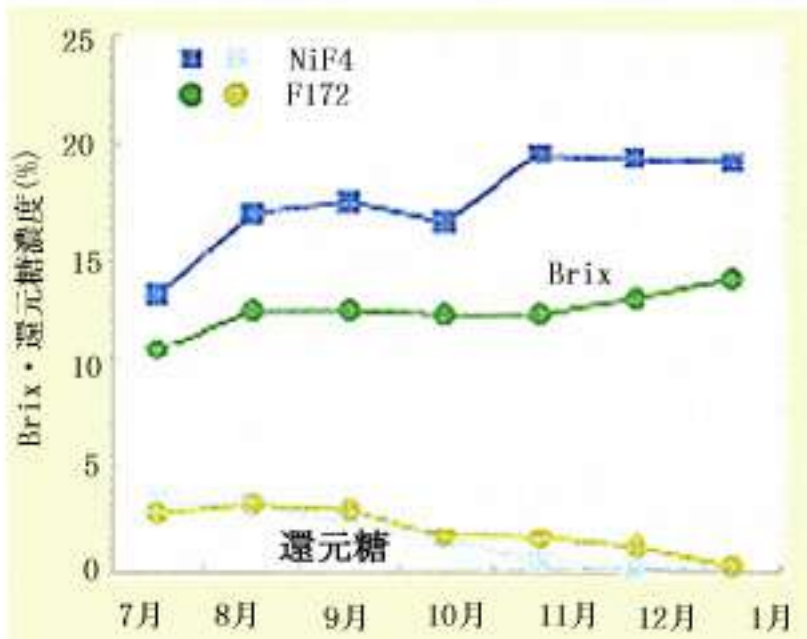


図1 春植サトウキビにおけるBrixおよび還元糖濃度の推移

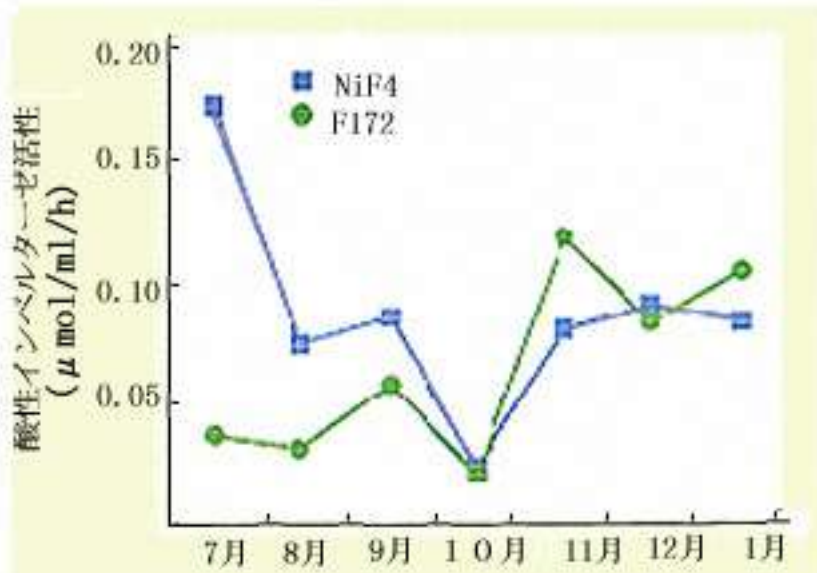


図2 春植サトウキビの貯蔵組織中の酸性インペルターゼ活性の推移

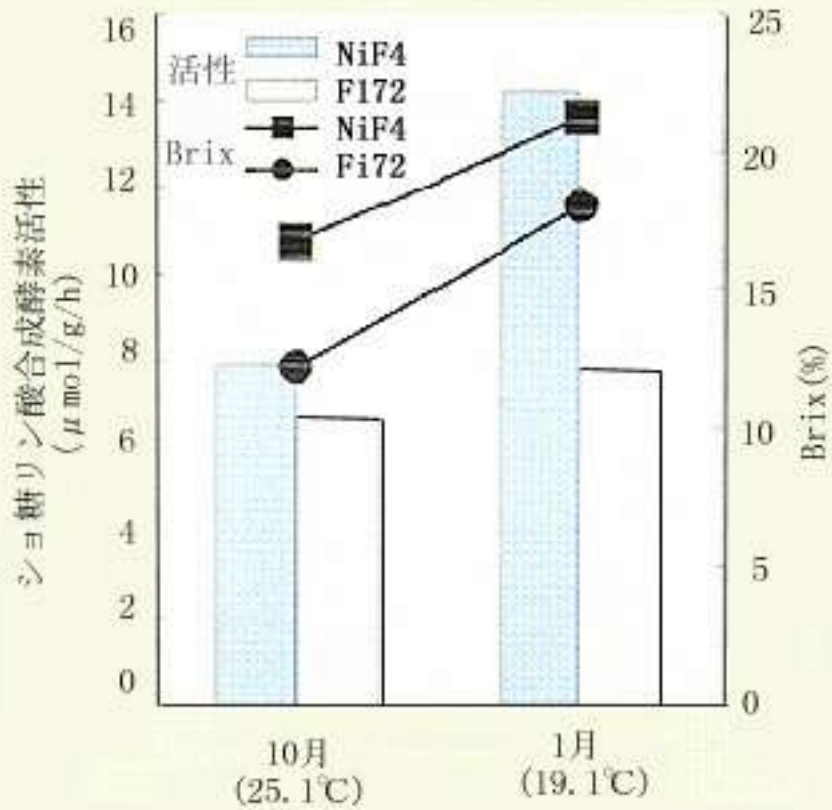


図3 秋季および冬季におけるサトウキビの Brix およびショ糖リン酸合成酵素活性

注：平均気温は測定月の平均気温を示す

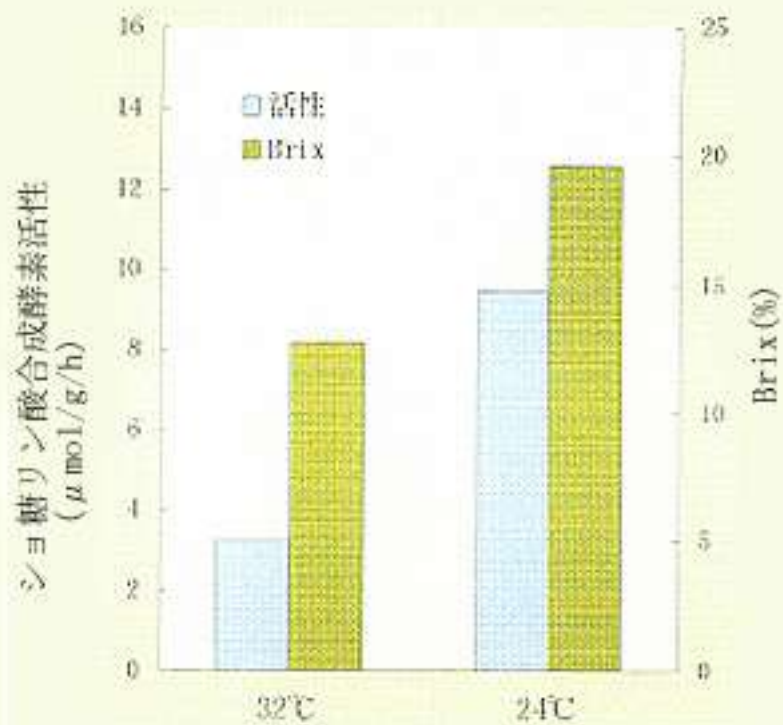


図4 温度処理が早期高糖性品種のNiF4のBrixおよびショ糖リン酸合成酵素活性に及ぼす影響





図1 アルカリ土壌に生育する鉄欠乏耐性品種 図1 アルカリ土壌に生育する鉄欠乏耐性品種(UT1、左) および感受性品種 (KPS2、右)



表1 アルカリ土壌で栽培したリョクトウ  
品種／系統の子実収量

品種／系統	クロロシス ¹⁾	収量 (Kg ha ⁻¹ )	
		対照区	鉄葉面散布
CNM8509B	—	860	861(100) ²⁾
CN36	—	697	671(96)
CN60	—	464	512(110)
UT1	—	358	387(108)
Pag-asal	+	299	428(143)
VC11538	+	535	673(126)
CNM-I	+	649	626(96)
PSU1	+	313	593(189)
KFS1	++	290	373(129)
KPS2	+++	58	178(308)

注1) 播種後25日目に評価、—、クロロシス無し；  
+、淡いクロロシス；++、明瞭なクロロシス；  
；+++激しいクロロシス

2) 対照区を100として表示

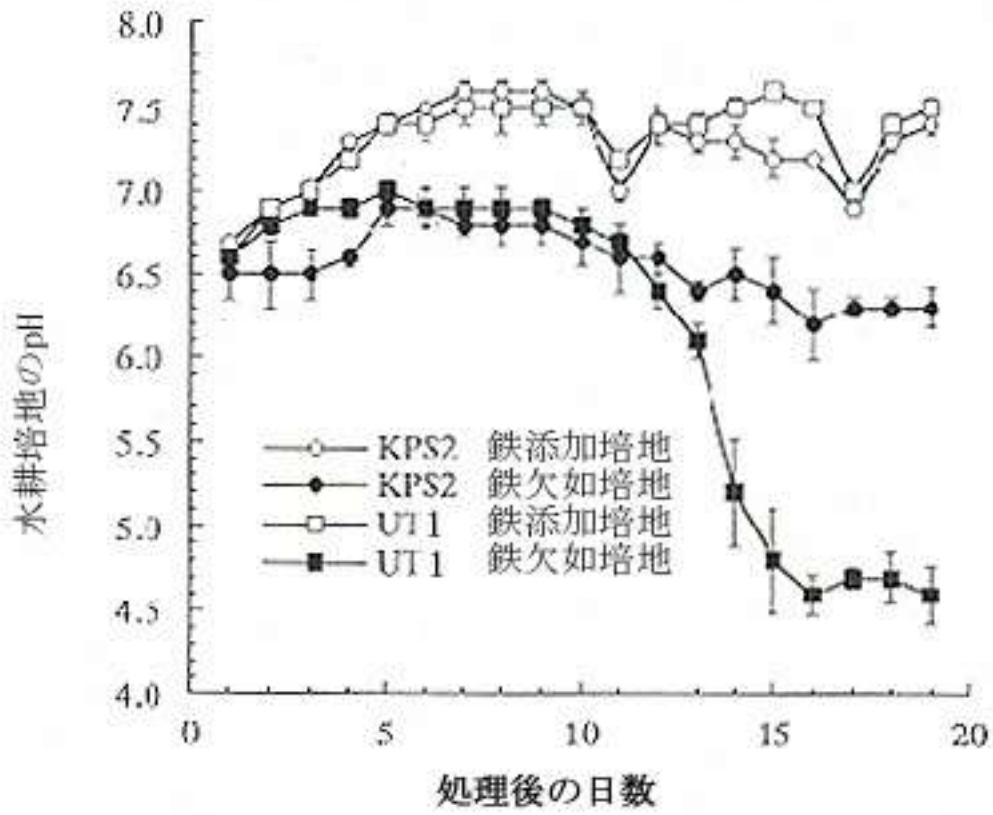


図2 鉄欠乏耐性を異にするリョクトウ2品種の水耕培地のpH変動



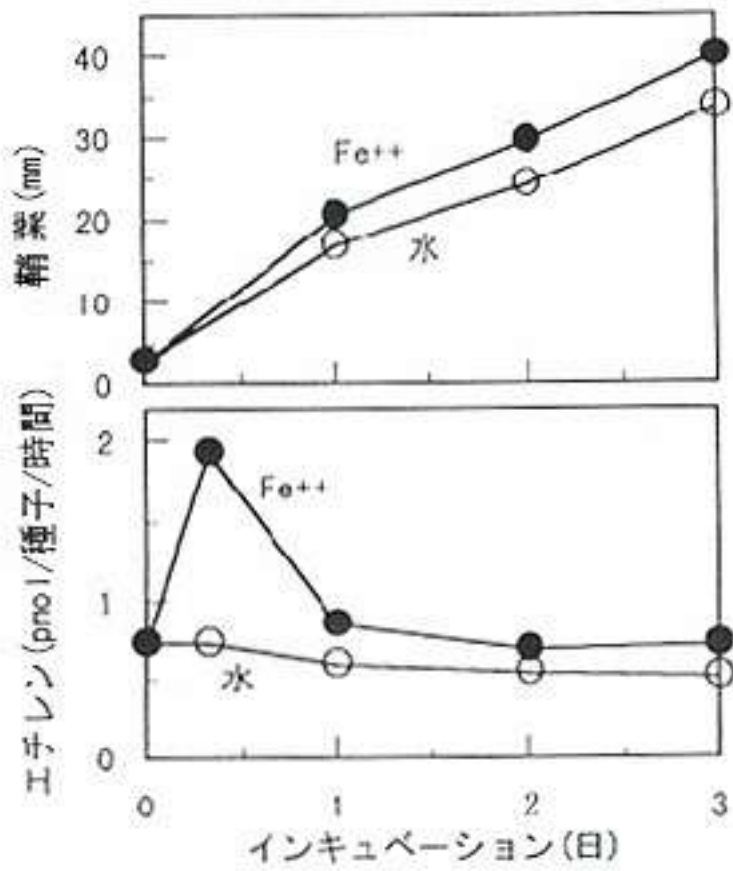


図1. 催芽種子においてFe⁺⁺が鞘葉の伸長とエチレンの生成に及ぼす影響

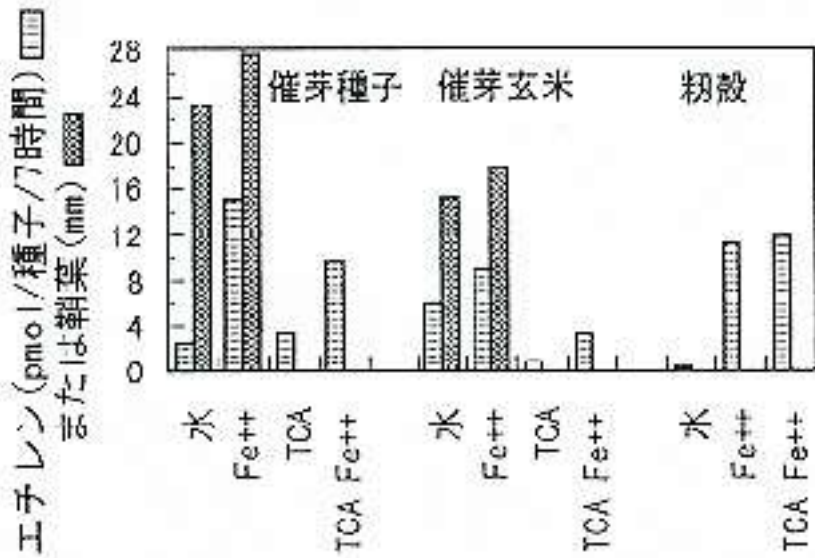


図2. 催芽種子、催芽玄米及び籾殻からのエチレン生成と鞘葉の伸長に及ぼすFe⁺⁺、トリクロル酢酸(TCA)の影響

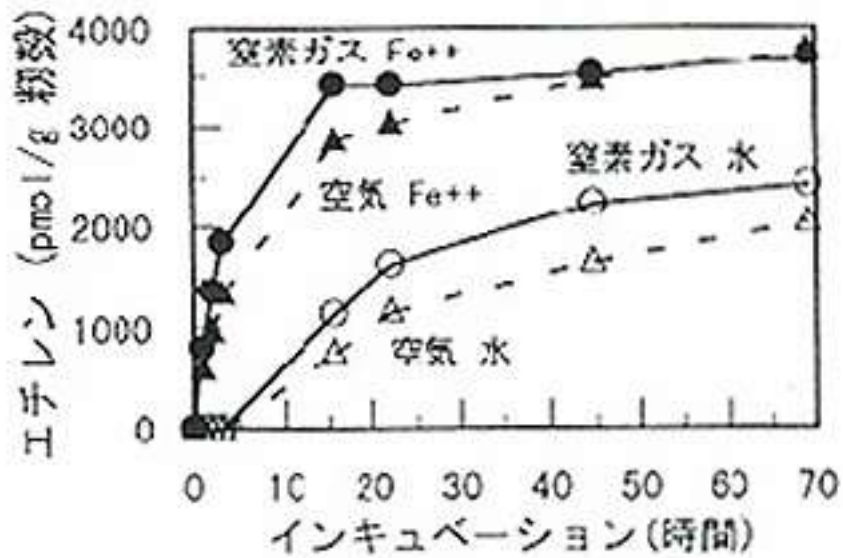


図3. 空气中及び窒素ガス中における籾殻からのエチレン生成に及ぼすFe++の効果

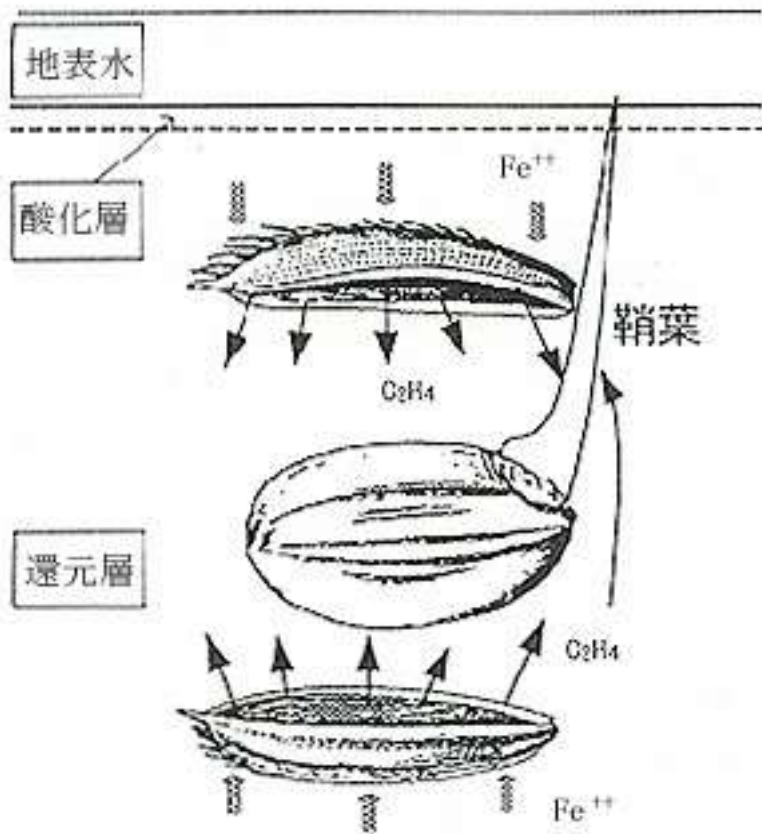


図4. 水稻の種子の湛水土壤中における出芽過程の模式図 (仮説)。2価鉄は粒殻と反応し、エチレンが生成され、鞘葉の伸長が促進される。

**m**—v—**ü****m****F** f *fjN,îS+*î,îZâ,Æ,µ,Ä+úZÊ*, *x—E,ÊSÜ,U,ê,êfJfEf f... *fjN+ifSf +Zç+j,îf +*fjN+P,î,*,e[†]v** ,î[†]CE*,ÊSÖ—^,µ,Ä,ê,ê+**B**fJfEf f... *fjN,î+P+Ê,î+*, *CE+â,¼,*,Ä,Ê,*,*A/Lf/m[†]—P,ð[†]+S,Æ,µ,½+S+*+*,Æ,î[†]S+æCE%ê,Ê,æ,êf *fjN+P,î[†]v** ,ð*,B,Ä,ê,ê,Æ+î,ç,ê,ê+B  
**m**^S+***n****F** +*Ü"—Ñ...ZY,ÆEð+†fZf[†]+*E—Ñ,*,Æ+*A/fjCE/CjVfA—%ê,âSw  
**m**^A—***n****F** 0298-38-6309  
**m**^{**}%**á****n****F** +*Ü"—Æ  
**m**^ê-**á****n****F** —ÑZY  
**m**[†]**Ü****n****F** [†]M[†]N[†]L—îZç  
**m**^{*}—**p****n****F** +*—

**m**^wCE+E,Ê,ç,*,**n**  
f *fjN+Tectona grandis+jP,Þëç,î,î,*,e[†]M[†]Ñ—L—pZçZi,î+â^,Ä, ,ê+*êSÊ[†],Ê,L,*,*ê—Ñ,*,ê,Ä,ê,ê+B,µ,©,µ+*,*,î[†]v** ,î+Zi,â+*[†]æ,Ê,æ,ê,â,*,*[†]@,*,ê+B,*,e[†]v**+*,CE+ ,î@^,ð-¼,ç,©,Ê,*,ê,±,Æ,Ê,æ,ê+A,æ,ê—D,ê,½+PZç,îf *fjN+P,ð[†]%,ê,½,B,î[†]çZi,â+ê—Ñ,îZw+W,ðZi,*,±,Æ,*,o—[†],ê+B  
**m**—%ê,î+â—eE[†]Ä[†]**n**

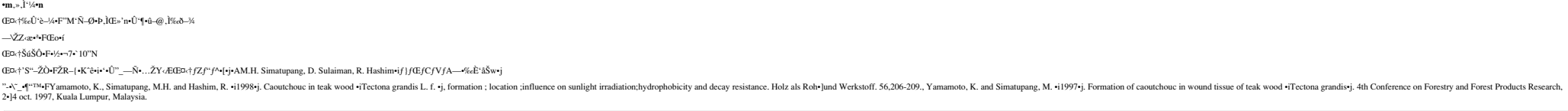
1.fJfEf f... *fjN,î+P,©,ç+S+P,ðSÑ, +úZÊ*[†],Ê+AZiZç%*fjXf—fEj* ,Ä+*SÊ+[†],Ê+ðF,*,ê,ê,*,CE,î—ð[†]H+*+Zç,Æ,µ,ÄCEðSWE[†]+*% ,ÄSîZ@,*,ê,ê+B,*,ê,î+A+Ó+PŠO[†],Ê,î[†]Y,*,*,A+Ó+P[†]æ*,©,ç[†]h[†],î+úZÊ_+*—E,ÄCE+*, ,êZn,B+A+Ó+S+P+*SÊ,Ä+*,â,µ,½+*+î+j+B  
2.**S**+*[†]ê[†]ðfA/fZfgf[†]S+o,µfJfEf f... *fjN,ðZç,*,Æf *fjN+P,î+*,*,*%CE+â,µ,½+B,*,Ê,î,*,A+P+^—Ê,Æ,...,Æ,î+Ü+GŠp,*,â,µ,½+*+î2+j+B—*,CE+âZçqCE[†]+*%SîZ@,Ä,îfJfEf f... *fjN,î+P+Ê,ðfjBfj f +ó,Ê+ç,Ä,Ä,ê,ê,±,Æ,*,î,©,ê+*+î2+j+B,*,îCE+ffEf f... *fjN,ðfNf+fjZf f ,Ä[†]S+o,*,ê,Æ+*,*,*,î[†]µ,*,%ê,µ,½+*+î2+j+B,±,ê,ç,îX+0CE+âZçq[†]CEð—@,Ê,æ,êC1+*†Y[†]f[†]Y[†]f[†],î,...†,ÆE+*+j,î+â—,î[†]@,©,ç,âS[†]m[†]F,Ä,*,½+*+î2+j+B  
3.—ç[†]S+o,îf *fjN+P,îfjJf%*ç[†]fP+Coriolus versicolor*+j,ÄJISA9201,Ê+*,ê,î2+TŠO+*,*,*,*,ê,Æ3,2%,îZç—ÊE,*,*—,ðZi,µ,½+BjGf[†]m+f,*,Ä+S+P+*+*,ðæ,ê,½+P,Ä,î14,2%+*+X,ÊfNf+fjZf f ,Ä,îfJfEf f... *fjN,ðæ,*,Æ16,3%,î+ð—ÊE,*,*—,ðZi,µ,½+BjJfEf f... *fjN,î+R+*,*,CE+0%ê,î,î,*,@,Ä, , ,ê+*,*,*,*,*,*,*,*,*,*+*+î2+j,Æ+S+P+*+*,î+R,Ü+*,Æ,î[†]S+æCE%ê,Ê,æ,êf *fjN,î,*,e[†]v** ,ðZi,*,E+î,ç,ê,ê+B  
**m**—%ê,îS[†]—p—ÊE—[†]Ö[†]—**n**

f *fjN+ç—Ñ,Ø,î[†]v** ,îZç+—+A[†]n[†]æ[†]TM,Ê,æ,ê+[†]@,*,â,*,*,e+BŠç+ ,î+ç—Ñ,Ø,î+S+P+*+—Ê,ÆfJfEf f... *fjN—Ê,ð[†],x,ê,±,Æ,Ê,æ,ê+ZiŠO+*+*[†]n[†]æŠO+*,Ê,ç,î[†]v** ,îZç+O+çç,îZw+W,ð,Ä,©,P,±,Æ,*,o—[†],ê,Ä, ,ê,ð+B[†]%,ê,½Zw+W,ð[†]çZi,â+ç—Ñ+0—@,Ê[†]q,©,*,±,Æ,*,K—v,Ä, ,ê+B  
**m**ç[†]î[†]fjNf[†]**n**

+|1:+úZÊ*,*x—E[†]†,îfjJf f... *fjN  
+|3:+úZÊ*,*x—E+Ø[†]†+^—Ê,ðfjBfj f +ó,Ê+ç,ðfJfEf f... *fjN  
+|2:f *fjN+P+^—Ê,î+*,*,*,î[†]S+o+—*,Ê,æ,ê+[†]æ+o  
+|1:f *fjN+P+^—Ê,îXPS C,P,çXfjJfJg f, ,îC1+AC2+AC3+AC4fj%*fNjVîj f[†]*,î[†]S+o+—*,Ê,æ,ê+[†]æ+o

**m**,*,*+***n**  
CE+†%ê,Ü+ç—¼+[†]F[†]M[†]Ñ—Ø+P,îE+[†]n[†]Ü[†]q+@—,î%ð—¼  
—ZZ,æ+*+[†]FE+†  
CE+†ŠüŠÖ+F+jç+—7*10[†]N

CE+†S[†]—ZÖ+[†]FZ[†]R—î[†]K[†]ç+*+Ü[†]—Ñ...ZY,ÆEð+†fZf[†]+*+j+AM.H,Simatupang, D. Sulaiman, R. Hashim+†fjCE/CjVfA—%ê,âSw+j  
[†]^,*,*[†]TM+[†]FYamamoto, K., Simatupang, M.H. and Hashim, R. +1998+j, Caoutchouc in teak wood +†Tectona grandis L. f. , formation ; location ;influence on sunlight irradiation;hydrophobicity and decay resistance. Holz als Roh+und Werkstoff. 56,206-209., Yamamoto, K. and Simatupang, M. +1997+j, Formation of caoutchouc in wound tissue of teak wood +†Tectona grandis+j, 4th Conference on Forestry and Forest Products Research, 2+14 oct. 1997, Kuala Lumpur, Malaysia.



[BACK](#)



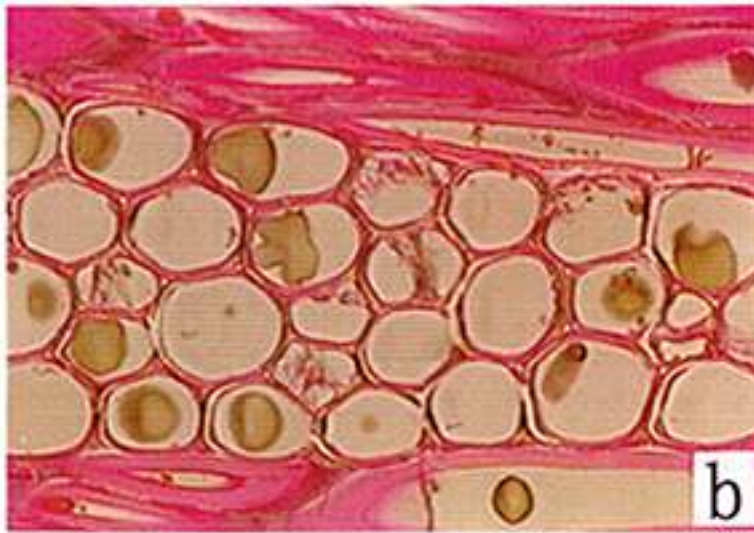
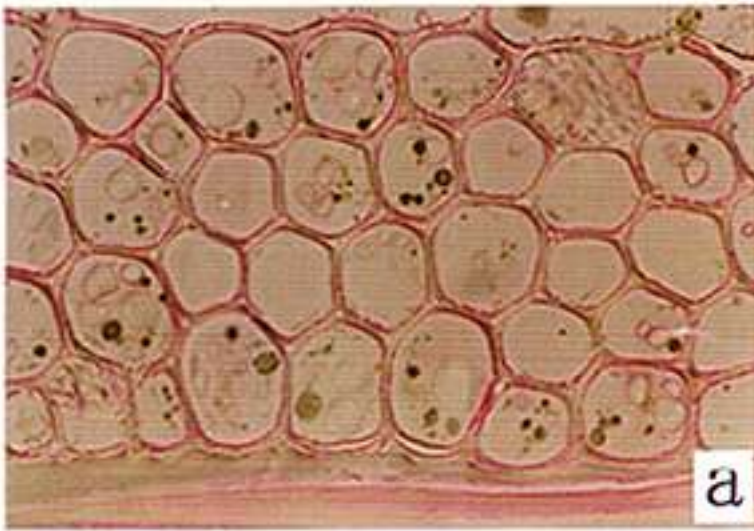


図1 放射柔細胞中のカウチューク  
a) 辺材中央部 b) 心材外部

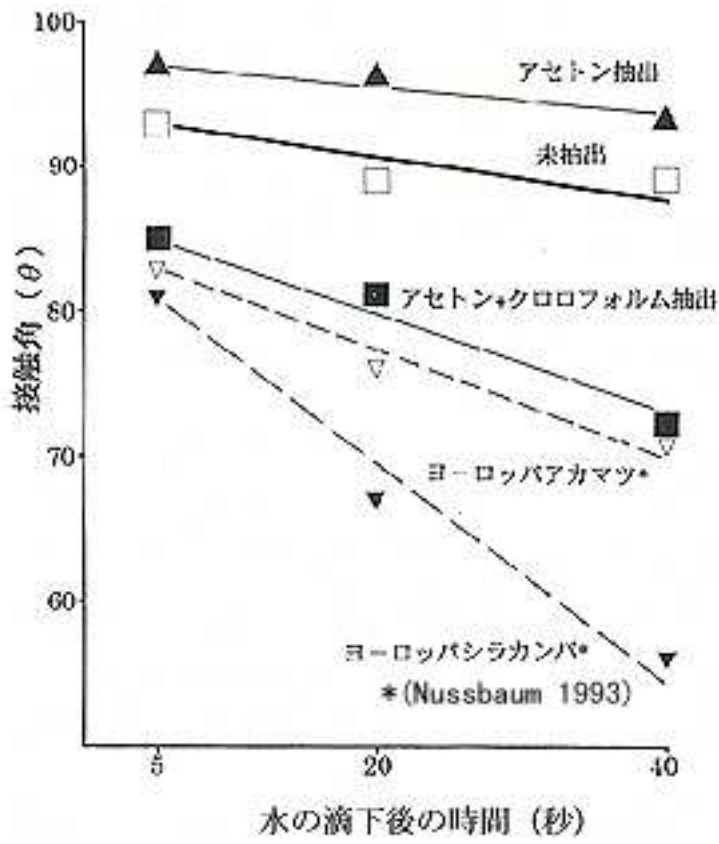


図2 チーク材表面の撥水性の抽出処理による変化

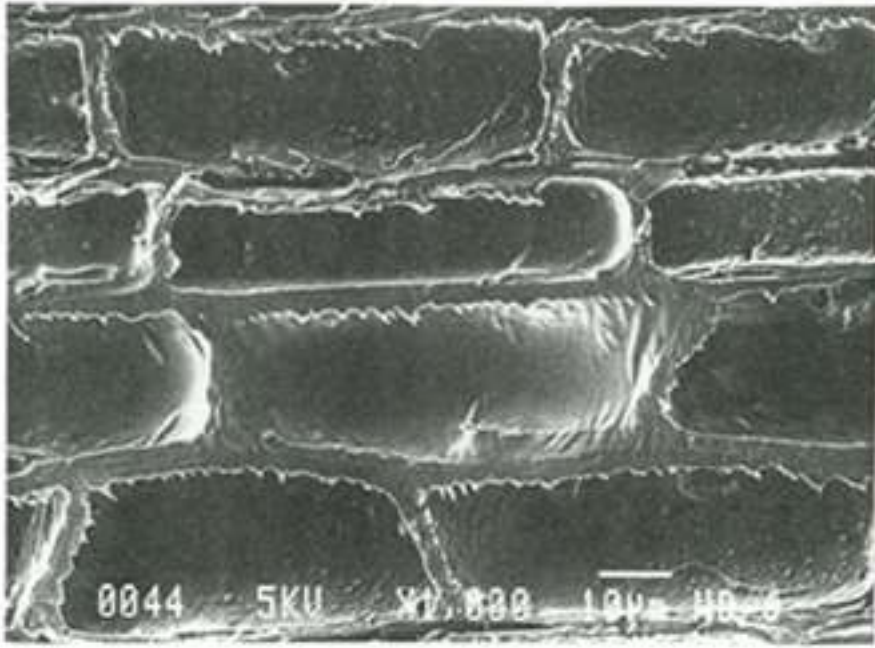


図3 放射柔細胞切断表面をフィルム状に覆うカウチューク

処理	O/C	C1s ピーク			
		C1	C2	C3	C4
未抽出	0.24	73	17	7	3
アセトン抽出	0.16	81	12	5	2
アセトン抽出後 クロロフォルム抽出	0.40	42	35	19	4

表1 チーク材表面のXPS C1sスペクトルの C1、C2、C3、C4フラクションの抽出処理による変化

- m—v—ñ•m•F f|f|E|C|V|A|.Á|n|C|u|Š|b|h“i.Š—~p.,e•i.Á.á.é.É.,é.Á.,,½•A•Zi.ÉZg,ø×EZç—Y•••••,1—••,1“}Š.,1—á.ø.ø•E•,µ,½•B.Û,½•A•.,éZá—É••.ŃZç.f|n|C|u|Š|b|h“i.g•i,i.,šEĐ.Á.,•µ,µ,½•B
- m“S“~•m•F••Û“~„Š~.,Z.Y.,EĐB•†|Z|F“•†E•••Z•E••“A•f|f|E|C|V|A“„,eŠ|F“•EĐ•†Š•MARD|j
- m“A—•µ•F•0298-38-6364
- m““%á•m•F••Û“~.,E
- m•é.á•m•F•çZi
- m•î•Û•m•F•T—•b
- m•“~„ß•m•F••••

•m“•w|E•E.,E.,ç,•m  
f|f|E|C|V|A|.f|R|•IZĐ••••,1—á•70%,Á•A•••••,f|f|C“™,Đ,ç,1—A“•u.É—Š.Á.á.é.é•B“•••É±••f|C“f|h.Á.á|n|C|u|Š|b|h“i.ZÁ—p|e••,†•A•f|f|E|C|V|A|.Á.á.á.,IZÁ—p|e••.É.1.,é.é—1“••,Û.Á.á.é.é•B.µ,ø,µ•A•f|n|C|u|Š|b|h“i.ZZq,1•Zi.ÉZç,Đ×EZç—Y•••••,%øÁ—%ø••,é.±.E.á•A“Û•A.,æ.á“•Zi—É.1½,ç““d.,“L.,••,i.é.Á.é.ç•“™,1—••••R.Á•EĐ•†,1•q“W.µ.á.é.é.É.É.½•B.,±.Á.—(EĐ•†.Á.†•A.±.é.ç,1—á.ø.ø•E•,µ•A•f|f|E|C|V|A|.„~1,14Z|Y~„,ŃE|e•á,µ“•,é|f|n|C|u|Š|b|h“i.šŠ|F“~„,é.±.E.Đ.B.,“µ,½•B

•m—%ø.É.1•á—e“E“Á•Y•m  
1.Šü—é•ŃE%ø.Á.1•×EZç—Y•••••,1—••,1“}Š.,1.N.±.ç.,•AZĐ•M|C|I,1—““™,šŠ“á.ç.µ,½.á.L.ÉZç,i.é.é•i.ç|1•µ•B|.Á.Á•A•f|f|E|C|V|A|.Á.á.š•µ“1•×EZç—Y•••••(E•“•.ŃZç.Á.½|f|n|C|u|Š|b|h“i,1•Zi.Đ.á.é.É.,••,Đ.±.E.“,Á.,•é.á•B  
2.400“~„Ń“•,é|f|n|C|u|Š|b|h“i.g•i,i.,É.Á.é.ÁZá—EZZE±,Đ••,ç•A•f|f|E|C|V|A|.IZá—•iZi.Á.,áMR84.æ.á•i.É20%••.,éZá—É.ŃZç.µ•A.µ.ø.á•q“šáŠÖ.1Z.e|R69690H.,E|R69690H.,MEĐ•ø.µ,½•B|f|f|E|C|V|A|.1•×EZç—Y•••••(E•“•,•E••Û“•EĐ•†Š,1—••••ó•ø•E•••,E.1|f|n|C|u|Š|b|h“i.g•i,i.,É.á—L—1.Á.,ç•i.ç|1•µ•B  
3.“““E““•Zi—É.Á.1|f|n|C|u|Š|b|h“i.IZá—É.á.,1•A—áE|e•,E“•ó.1½“~„É.æ.á•A“•A•ŃE%ø.É.á.×•A.é.Û.Ç••.,É.ø.Á.½•B|f|n|C|u|Š|b|h“i.1%šá“ç“~„D.á.á.é.±.E.“m.ç.á.Á.é.é.“Echincholœ“•,E.1•é“••““E“Zi.æ.á•Y.é.±.E.1.É.ø.Á.½•i.ç|1•µ•B|Á.Á•A•f|n|C|u|Š|b|h“i,1.,éZZq|R|X|g.Đ•i.Đ.½•B•A“Zi—É.ŃE,ç,µ,½““d.Đ•i.Đ.±.E.IZÁ—p“1.Á.É.ç.é•i.ç.é.½•B  
±.é.ç,1|f|n|C|u|Š|b|h“i.f““d.Á.f“K“).É.é.“A“••A.É.æ.áZÁ—p|e••%ø.Á“~„EZç“•).á,½•B  
•m—%ø.É.1Š“—p—É•E—“^Ó“~m  
f|n|C|u|Š|b|h“i.Š|F“~„,é.É.1•A••Û“•EĐ•†Š.,E,1—1|µ•,E|E•p±•i.ÉZá—EZZE±,Đ••,ç•A—D.é,½|f|n|C|u|Š|b|h“i.Đ.1““•,ç•K—••,1.,ç•B•IZi.1“~„E•É•ó•DO•A•q“™,Á••,ç•A•“Zi—É.ŃE,ç,µ,½,ø“•A.á.ø.ŃZç.Á.Á•f“1.,ç.1“•Á.á—e“Ó.É|f|n|C|u|Š|b|h“i,1—~p@.Á.,é.é•i.ç.é.é•B|f|f|E|C|V|A“„,eŠ|F“•EĐ•†Š•A•f|f“„,eŠ|F“•†MADA•µ•A“„,E•É.Đ.1•Û.,E.µ,½|f|n|C|u|Š|b|h“i•W““f|R•f|X•A•Z|f—f•f“™,Á“É•á,1•á—e.1|n“Á.Đ••,Á.½•i.ç|1•µ•B

- m•†|f|f|f|f“•m
- 1:Šü—é•ŃE%ø.Á•E|p•á|Zi.µ,½•×EZç—Y••••••
- 2:Zá—É.1.,ç“•A•f|n|C|u|Š|b|h“i
- 3:Echincholœ“•.IZZq,Đ••“d.µ,½|f|n|C|u|Š|b|h“i““d.,éZá—EZZE±
- 4:MARDI•AMADA•ADDA,Đ•Û.É.µ,½|f|n|C|u|Š|b|h“i•W““f|R•f|X

•m.,,1“}m  
EĐ•%ø.Û.é~½•f|f|E|C|V|A|.É.,,ç•••,74Z|Y~„šg.á,1½,ß,1|f|n|C|u|Š|b|h“i.Š|F“~  
—ZZ.æ•“F•E•ø†  
EĐ•†ŠšÖ•F““••,V•,X“N“x  
EĐ•†Š“~ZĐ•F““Á““@••

“~„ç“•““™FKato, H., Sobri, M. and Guok, H. P.,†1997“). Death of thermosensitive genic male sterile seedlings in Malaysian ricefields. IRN 22.6.,@Kato, H., Guok, H. P. and Azlan, S-Đ(1996ç). Hybrid rice breeding in Malaysia. Proceeding of the 2nd National Congress on Genetics:221-224•D



図 1 隔離条件下で継代採取した細胞質雄性不稔  
(可稔への転換は起こらない)



図2 収量の高い早生ハイブリッド稲



図 3 *Echinochloa* 属の種子を混播したハイブリッド  
稲直播き収量試験





図 4 MARDI、MADA、DOA を対象としたハイブリッド稲  
集中コース



•\ 1  
 •\ 1 f f _ 'n<æ, IYôYðŠÇ—•, E, ", , , é1•E2ZYff•[f^ •i'P^E•Fmm/97,000ha•j

ff•[f^¼	—•†	'æ1•i	'æ2•i	'Ê" N	2ŽŸff•[f^—U"±Ž®
f_f —"ü—Ê	DMIN	304	476	780	DMRL+ DMSP+ DMST
f_f 'TM—→Ê•İ%co—Ê	DMST	-232	113	-120	1ŽŸff•[f^
f_f -³CEø•ú—→Ê	DMSP	0	0	0	1ŽŸff•[f^
f_f —LEø•ú—→Ê	DMRL	536	364	899	1ŽŸff•[f^
"Žñ•H'n" _%cđ•i—→Ê	RVT	743	782	1524	RVIN+ DMRL+ DMSP
f_f Žc—→æ—→o—Ê	RVIN	207	418	625	1ŽŸff•[f^
%cđ•i—→Ê—LEø•~—p—Ê	RVE	56	134	190	@IF(IRIN-DMRL-DMSP>0,IRIN-DMRL-DMSP,0)
%cđ•i—→Ê—³CEø—%cđ—Ê	RVI	151	284	435	RVIN- RVE
•... "c" à••...—Ê	RF	1039	833	1872	1ŽŸff•[f^
—LEø•~—p%cđ—Ê	RFE	781	553	1334	WUF- IRDL- IRRC
-³CEø%cđ—Ê	RFI	258	280	537	RF- RFE
ŸôŸðŽæ•...—Ê	IRIN	592	498	1090	1ŽŸff•[f^
'—•... 'Ž,	IRLS	122	146	268	IRIN- IRDL
ŸôŸðfuf•fbfN"z•...—Ê	IRDL	470	352	822	1ŽŸff•[f^
ŠÖE³—~—p•...—Ê	IRRC	81	59	140	1ŽŸff•[f^
CEv%ææ•... "c—p•...—Ê	WR	1577	976	2553	1ŽŸff•[f^
•... "c—p•...—Ê	WUF	1331	964	2295	1ŽŸff•[f^
•... "c" ô" ŽU—Ê	ET	691	744	1434	1ŽŸff•[f^
•... "c" Z" §" R•...—Ê	SP	641	221	861	WUF- ET
"½•æ—~—p%cđ"•...—Ê	DR	763	366	1129	IRLS+ SP
•Å•I'næŠO—→o•...—Ê	DIS	1090	871	1962	DR- IRRC+ RVI+ RFI

•@

•2 •]‰iŽw•W

•2 •]‰oiŽw•W

Žw•WŽi•Ê	Žw•W -¼ •İ	ŽZ Ž®	'æ 1 •i	'æ 2 •i	'Ê "N
•→ÑŽw•W	—p•...['«—!	(RFE+IRDL+IRRC)/WR	0.84	0.99	0.90
%œ‰iŽw•W	f_f —r“ü—Ê—~—p—!	DMRC/DMIN	1.76	0.76	1.15
%œ‰iŽw•W	f_f Žc—r^æ—r•o—Ê—~—p—!	RVE/RVIN	0.27	0.32	0.30
%œ‰iŽw•W	—L(Æø‰œĴ—Ê—!	RFE/RF	0.75	0.66	0.71
%œ‰iŽw•W	‘—•...œø—!	IRDL/IRIN	0.79	0.71	0.75
%œ‰iŽw•W	”½•œ‰œĤ^“...—Ê—~—p—!	IRRC/DR	0.11	0.16	0.12

•@

# ••Ū”_<ÆCEα<†•→%ŌÊ•îñ‘æ,S•†•A1996•i•1/2•→,W”N“‘x•j

1. [fxfgfif,î.ĂŽù<<,î“W-\]](#)
2. [’†•%œ “î.È,É,“,“,é...î•V•iŽí•u•‡En34•†•v<y,Ñ•u•‡En35•†•v](#)
3. [’†••ãŠC’n^æ,É“K,•,éflf...fEfŠ•AfCf”fS,î.î.a•«—D—C•V•iŽí](#)
4. [“Œ-kf^fC,îfvf†f%œf“n^æ,É,“,“,é%œ-...’n%œ°•...,î•ã, <@•\,î%œđ-¾](#)
5. [ŠâÎ—n%œđ%œß’ö,É,“,“,éŠâÎ,î•—“I•«Ži,î%œ<ı](#)
6. [f}fœfCfVfA•E f f_’n^æ,É,“,“,é2,4-D’i•R•«Œ^fqffšfR,î•ã•z,Æ•œ‘••Ü,É•Î,•,é”½%œž](#)
7. [fu^œofWf<“î“Œ”•,É,“,“,éfnfLšfAfš,î•ã•z,Æ-š“x•@•”iŠQšg‘â,î%œÂ”\•«•`](#)
8. [f^fC,î•i•%œĂŠQflfRfufZf“f f...fE•VŽí,î•y‘f\Œ»Œ^,É,æ,é“~è](#)
9. [f}fœfCfVfA•E f f_î•i’ n^Ñ,É,“,“,éOf•\[fv•Eftf@•\[f~f“fO,î%œ^%œc,î—“_,Æ-â‘è“](#)
10. [ŠŁ•G,É,“,“,é“û•—pŽ”—i,Æ,µ,Ă,î,³,Æ,µ,«„Ñ,îŽ”—i%œi’1](#)
11. [fVfšfA-k“Œ”fIfIf fM•E-q-î’ n^Ñ,É,“,“,é%œÂ•HŽ”—iŽ‘Œ—Ê,î•L^æ•\]œi](#)
12. [fAfJfVfAf}f“fMfEf,É,“,“,é’½Ž¼•S•P,î”-Œ©,ÆŒ`•→-v^ö](#)
13. [“Œ“îfAfWfAŒŽYflfjfe fiKfGfr\(Macrobrachium rosenbergii\),î•→•n•EŽY—‘•E’E”ç%œß’ö,É,“,“,éfzf<f,f“,î%œđ-¾](#)
14. [“Œ“îfAfWfAŽY—L—p•%œî—P,î•â“•İ•ÙÈÿ•öf}fjf...fAf<,î•i•→](#)
15. [—{œ•Í”l‘•’u,đ—p,é,½fTfgfEfLfr‘đŽ}flfbfg•c,î•â—Ê‘••B](#)
16. [’•’á%œ•fKf%œofX%œ»-@,É,æ,éf^f•â“Ž‘Œ•Ū‘¶-@,İŠJ’-](#)
17. [fEfGfXf^f“fuf•fbfefBf“fO-@,î%œü—Ç,É,æ,éfpfpfCfA,îfEfCf<fXf^f“fpfN,îŒÿ•o](#)

@,‘-â,é•†,î,ı•æ•F•§305-8686•@~î•éCE§,Ă,-,İŽs’â,ı,µ,P•ı,P•@••Ū”_—Ñ...ŽY<ÆCEα<†fZf“f^•[•@Šé%œæ’²•®•”•@•î•ñŽ‘—i%œŪ  
 Tel : 0298-38-6340•@•@ Fax : 0298-38-6656•@•@ e-mail: ref@jircas.affrc.go.jp

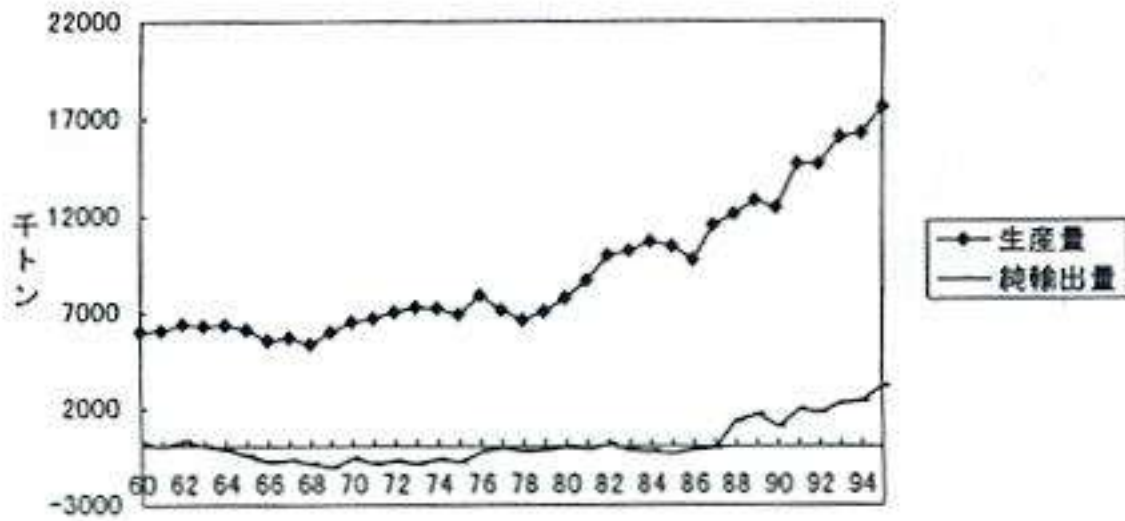


•@



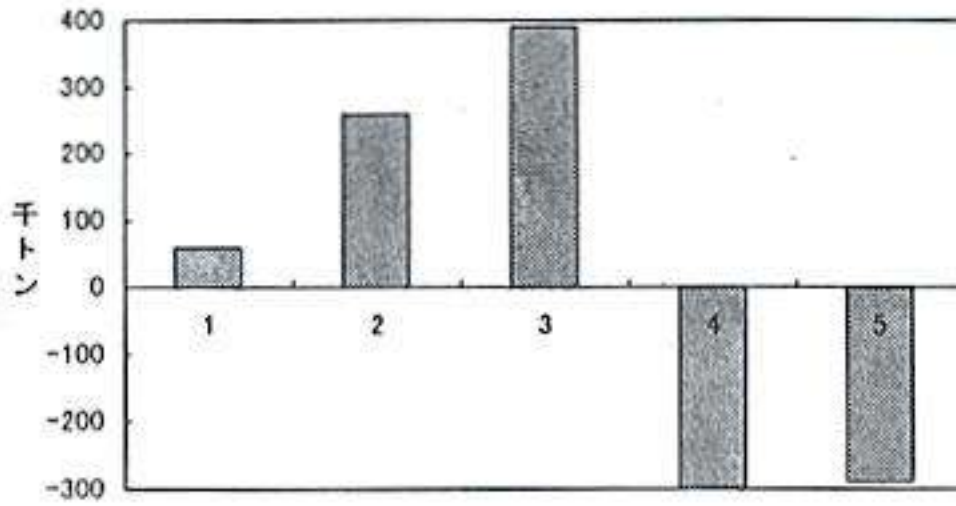
•@





資料: USDA, "PSD View : 1996".

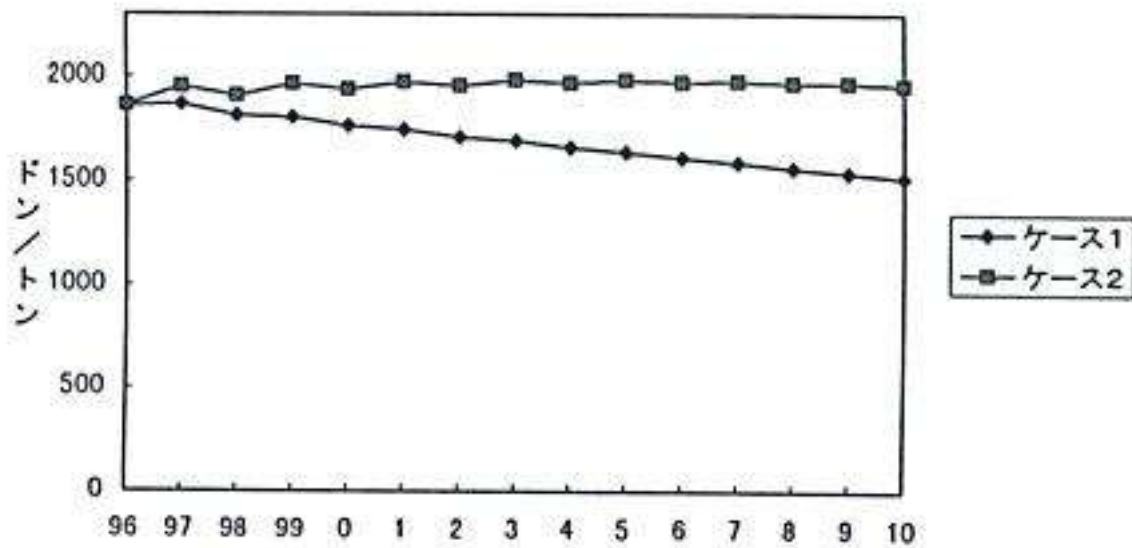
図1. ベトナムの米生産量と純輸出量の推移



注) 1:需給ギャップ、2:面積増加、3:単収上昇、4:1人当消費量増加  
5:人口増加

図2. 米需給ギャップの要因分析結果(1990～95年間平均)

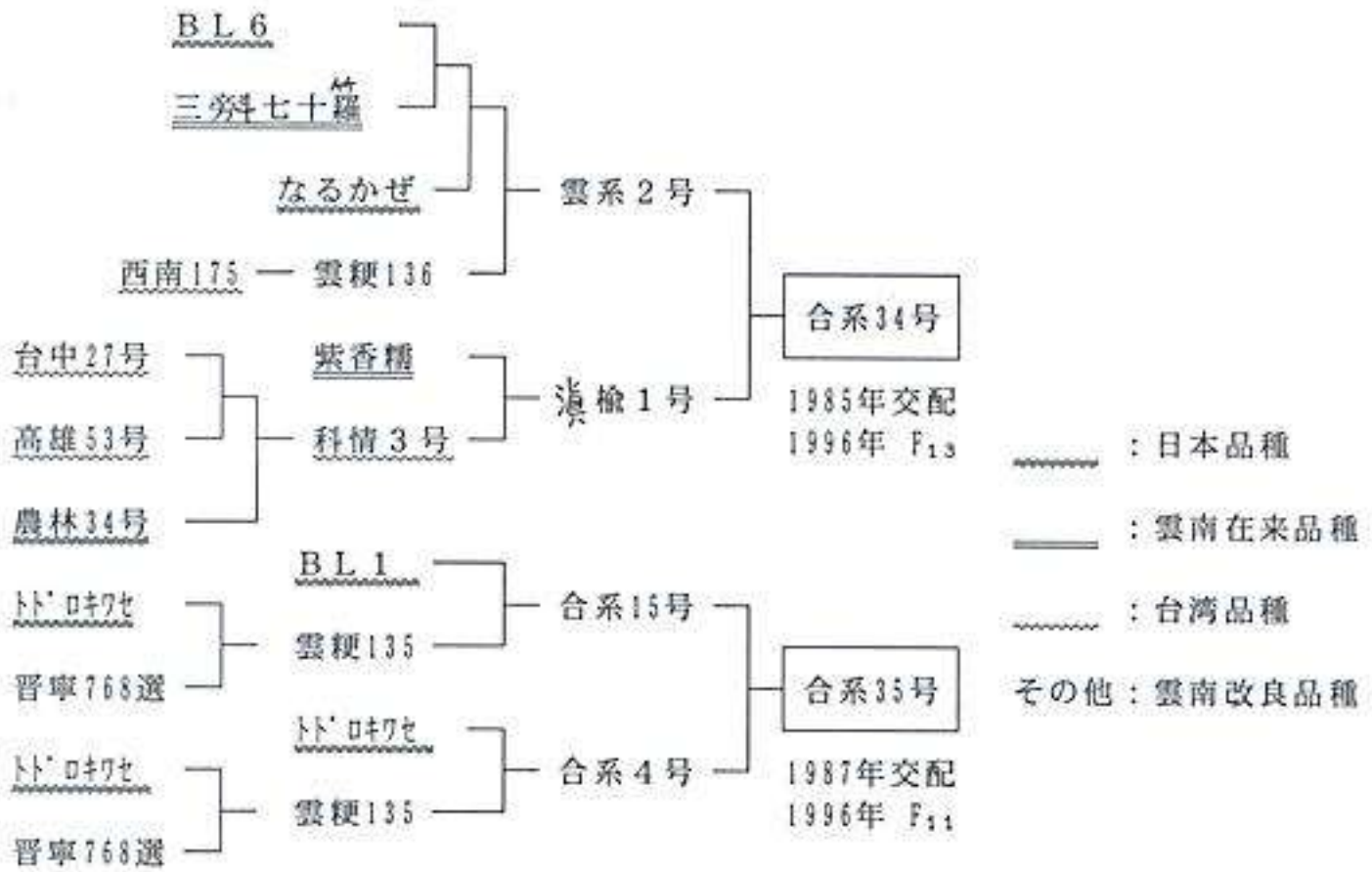




注) ケース1は、輸出規制数量を現行の320万トンで固定した場合。  
ケース2は、輸出規制数量を毎年20万トンずつ拡大した場合。

図3. 生産者米価の予測(籼ベース)





[具体的データ] 合系34号及び合系35号の主要特性

系統名：合系34号 組合せ：雲系2号/海檢1号

特性：長所 1. 多収 2. 良質

短所 1. 出穂揃い

系統名：合系35号 組合せ：合系15号/合系4号

特性：長所 1. 多収

短所 1. いもち病抵抗性

特性	合系34号	合系35号	雲梗9号(比較)
熟期	中生	中生	中生
草型	偏穂重型	穂重型	穂重型
出穂期(月.日)	8.04	8.01	8.03
成熟期(月.日)	9.19	9.12	9.16
稈長(cm)	69.2	76.1	99.1
穂長(cm)	18.3	17.3	15.8
穂数(本/m ² )	423	374	386
芒の多少・長短	無	無	無
ふ先色	黄白	褐	黄白
脱粒性	難	難	難
耐倒伏性	や強	や強	弱
耐冷性	や強	や強	強
いもち病抵抗性遺伝子型*	—	Pi-i	+
葉いもち	—	中	やや強
穂いもち	—	中	強
籾重(kg/a)	79.5	86.1	71.1
同上標準比(%)	112	121	(100)
籾千粒重(g)	24.8	25.9	22.9
玄米外観品質	上下	中中	中下
炊飯米食味	中中	中中	下中
調査地	雲南省農業科学院(昆明市桃園村、標高1916m)		
調査年次	1993~1994年(雲南省中北部区域試験)		

* 合系34号は未知の真性抵抗性遺伝子を保有している。遺伝子型「+」の雲梗9号は既知の抵抗性遺伝子を保有していない。



表1 キュウリ新品種の特性

育成系統 及び品種	雌花				1995年度			べと病 ^b 発病指数	つる割 ^c 発病指数
	着生率	1果重	果長	果径	早期収量 ^a		秀品率		
					kg/区	kg/区			
	%	g	cm	cm	kg/区	kg/区	%		
漣116号	74.0	150.8	24.0	2.9	16.9	47.8	85.8	35.0 39.3	
漣119号	47.0	146.5	22.9	3.3	11.9	45.4	85.3	45.0 32.0	
新光節成11号(期)	40.0	143.7	22.5	3.1	14.0	38.9	84.5	55.0 (62.0 ^d )	

a: 収穫開始後2週間(5/3~5/18) 1区:7.5m² b,c: 幼苗接種検定 (b: 葉に点滴接種10/30、調査11/4; c: 浸根接種9/19、調査10/8) d: 供試品種は「楊行」

表2 イチゴ新品種の特性

育成系統 及び品種	年内 収量 kg/株	早期 収量 ^a kg/株	全 収量 kg/株	商品 ^b 果率 %	1果 重 g	糖度 %	V.C.含量 mg/g	炭そ病萎凋・枯死株率	
								SC:1-1 ^c %	cf:5-2 ^d %
申旭1号	0.06	1.24	3.10	92.3	11.1	8.9	0.95	0.0	33.3
申旭2号	0.47	1.93	3.37	92.5	10.2	9.5	0.98	16.7	16.7
とよのか(廻)	0.21	1.34	2.20	86.5	10.6	9.5	1.09	(16.7 ^e )	(50.0 ^e )

a: 収穫始～2月末 b: 4g以上の秀品果 c: *C. acutatum* の菌株 d: *C. fragariae* の菌株 (c, d共に噴霧接種11/14、調査12/5) e: 「宝交早生」1区10株



図 1 : 漚116号(左)と漚119号(右)





図 2 : 申旭 1 号(上)と申旭 2 号(下)



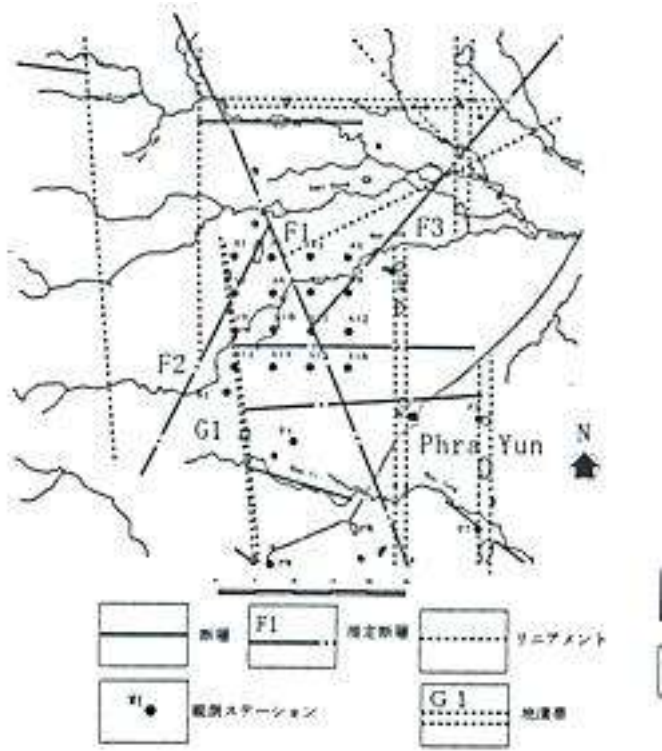


図1 断層分布図

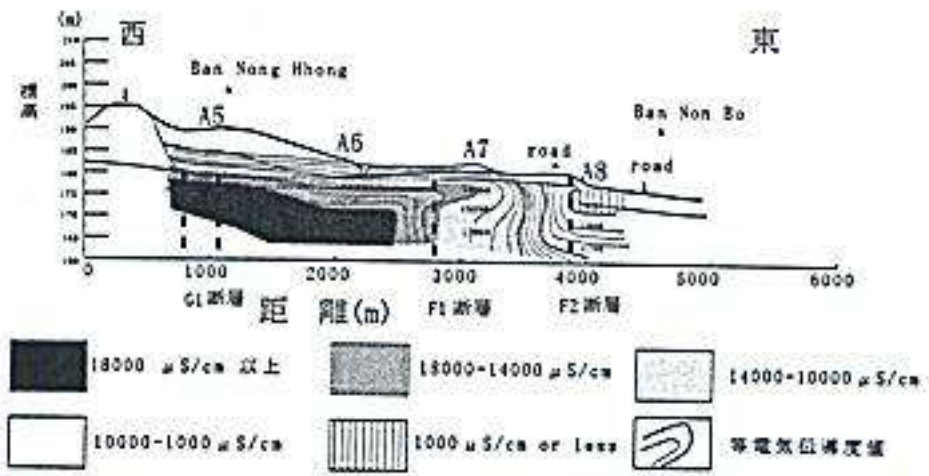
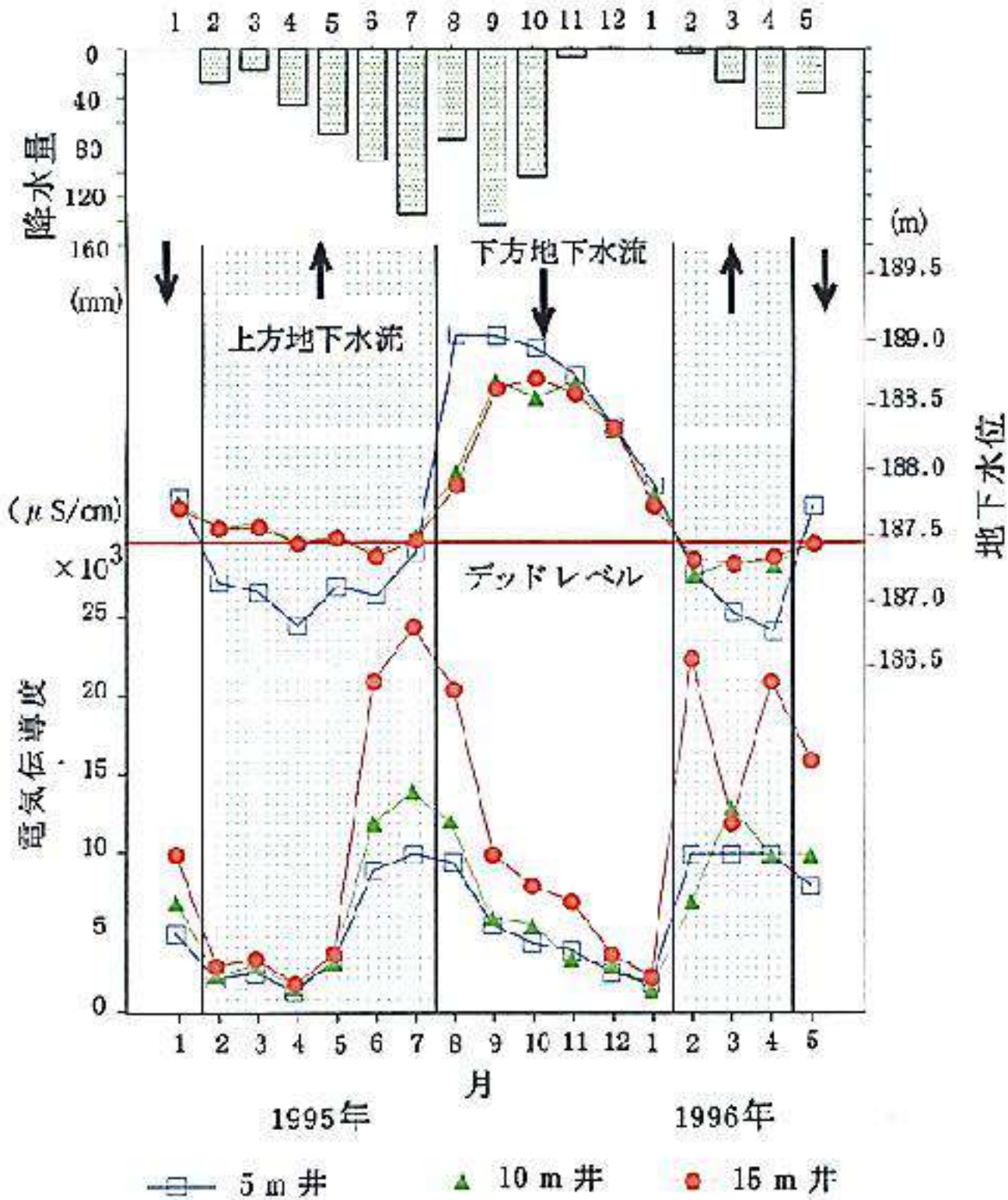


図2 1995年7月の電気伝導度分布図



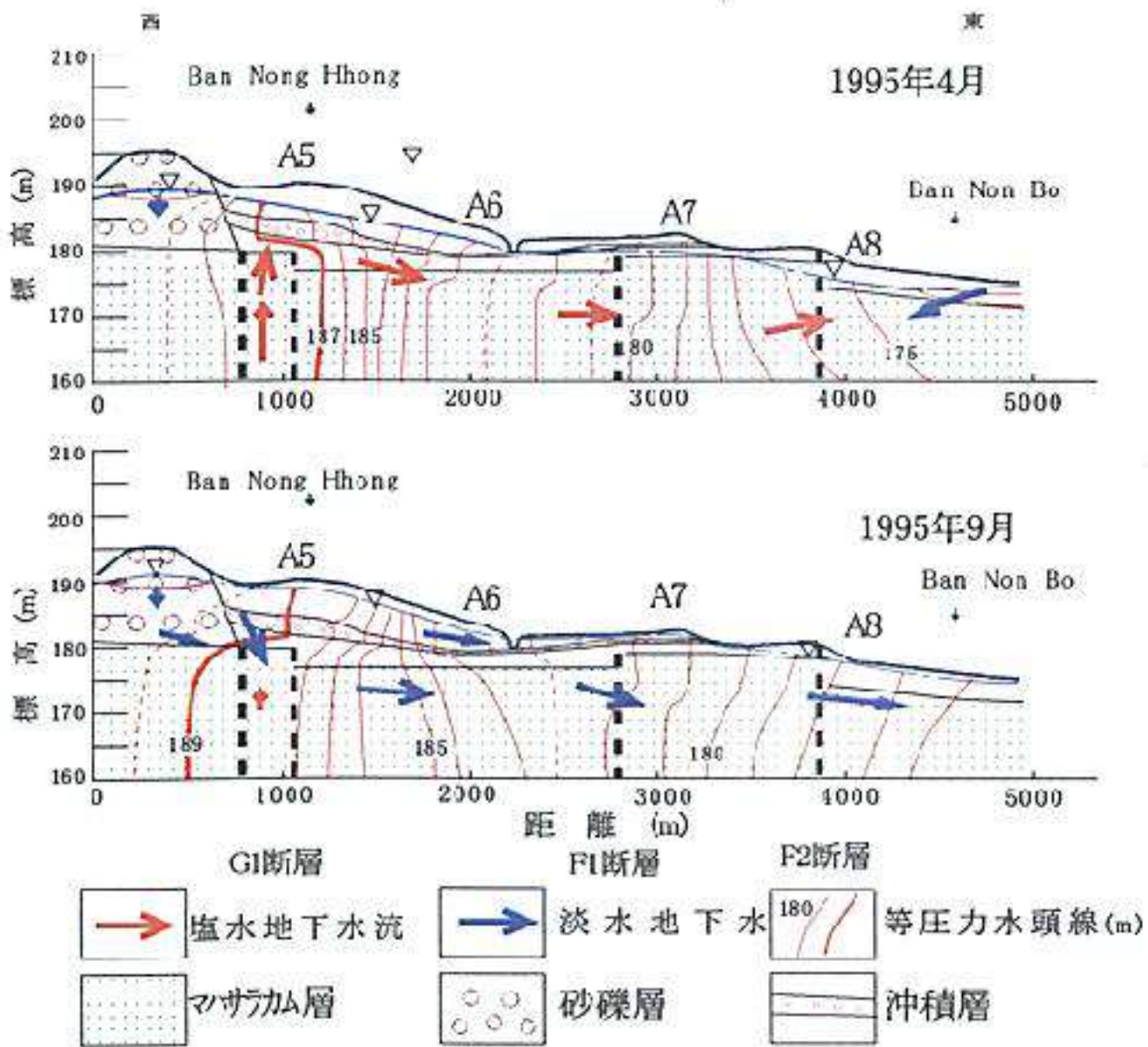




表 1 試料の物理的性質

Rock type	True specific gravity $\rho_{true}$ (-)	Bulk specific gravity $\rho_{bulk}$ (-)	Porosity $n$ (%)	Specific surface area $S$ ( $m^2/g$ )
石灰岩 (La)	2.78	2.69	3.3	1.6
チャート (Cb)	2.70	2.68	0.7	1.5
砂岩 (Sa)	2.65	2.55	3.5	4.1
凝灰岩 (Tr)	2.43	1.80	25.7	16.8
かんらん岩 (Da)	3.32	3.31	0.4	1.4
はんれい岩 (Gb)	3.00	2.97	1.0	1.4
閃緑岩 (Di)	2.78	2.69	3.0	1.4
かこう閃緑岩 (Gd)	2.75	2.67	2.9	1.3
かこう岩 (Gr)	2.65	2.61	1.7	0.8
玄武岩 (Ba)	2.86	2.78	2.9	3.2
安山岩 (Aa)	2.77	2.50	9.7	2.0
デイサイト (De)	2.64	2.42	8.4	2.3
炭酸岩 (Rb)	2.59	2.41	7.2	4.2



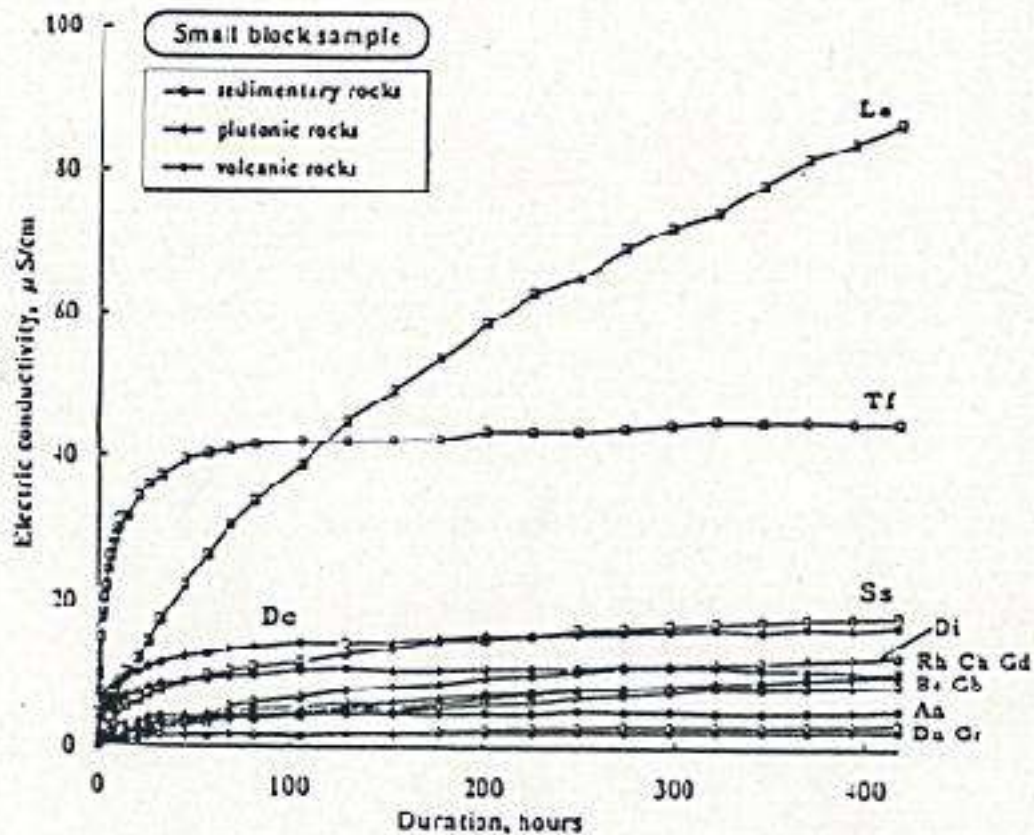


図 1 溶解実験における電気伝導度の変化(岩石試料)

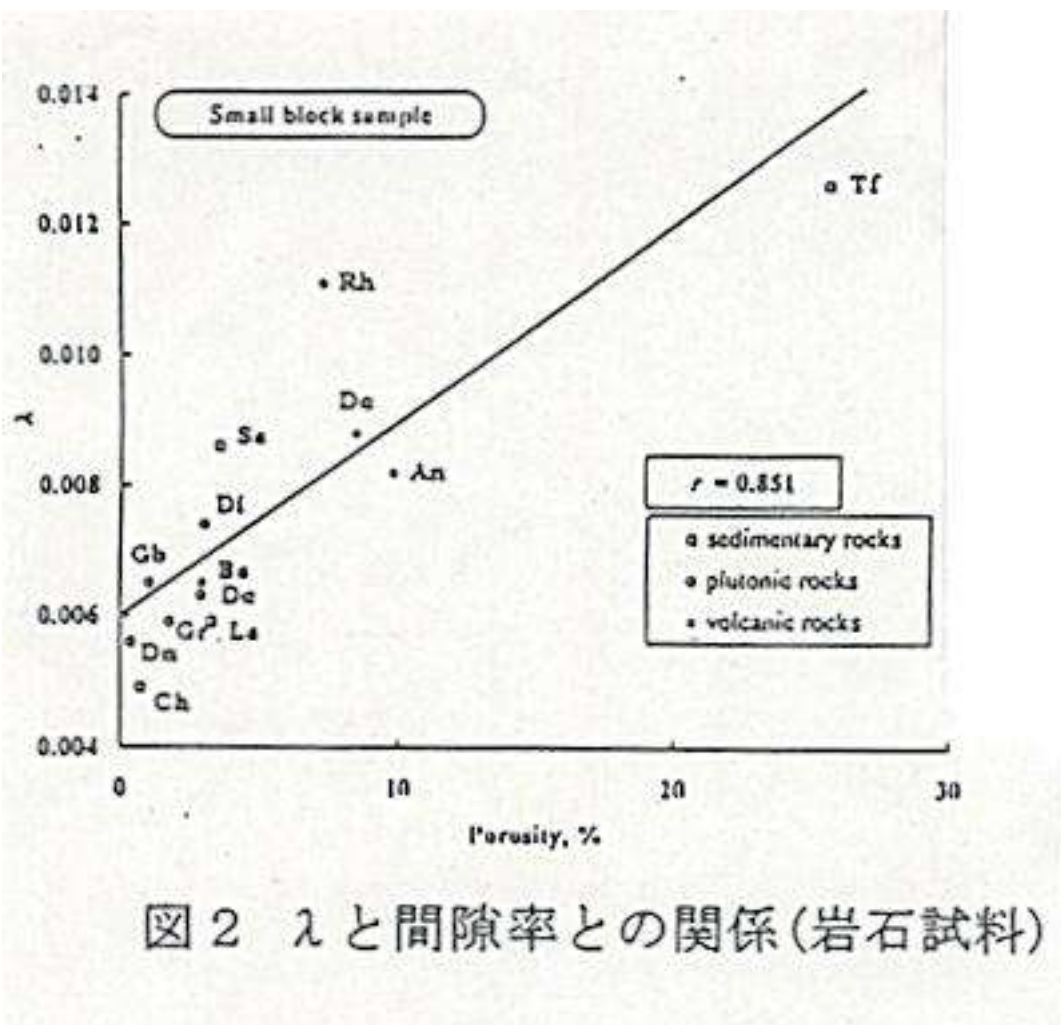


図2 λと間隙率との関係(岩石試料)

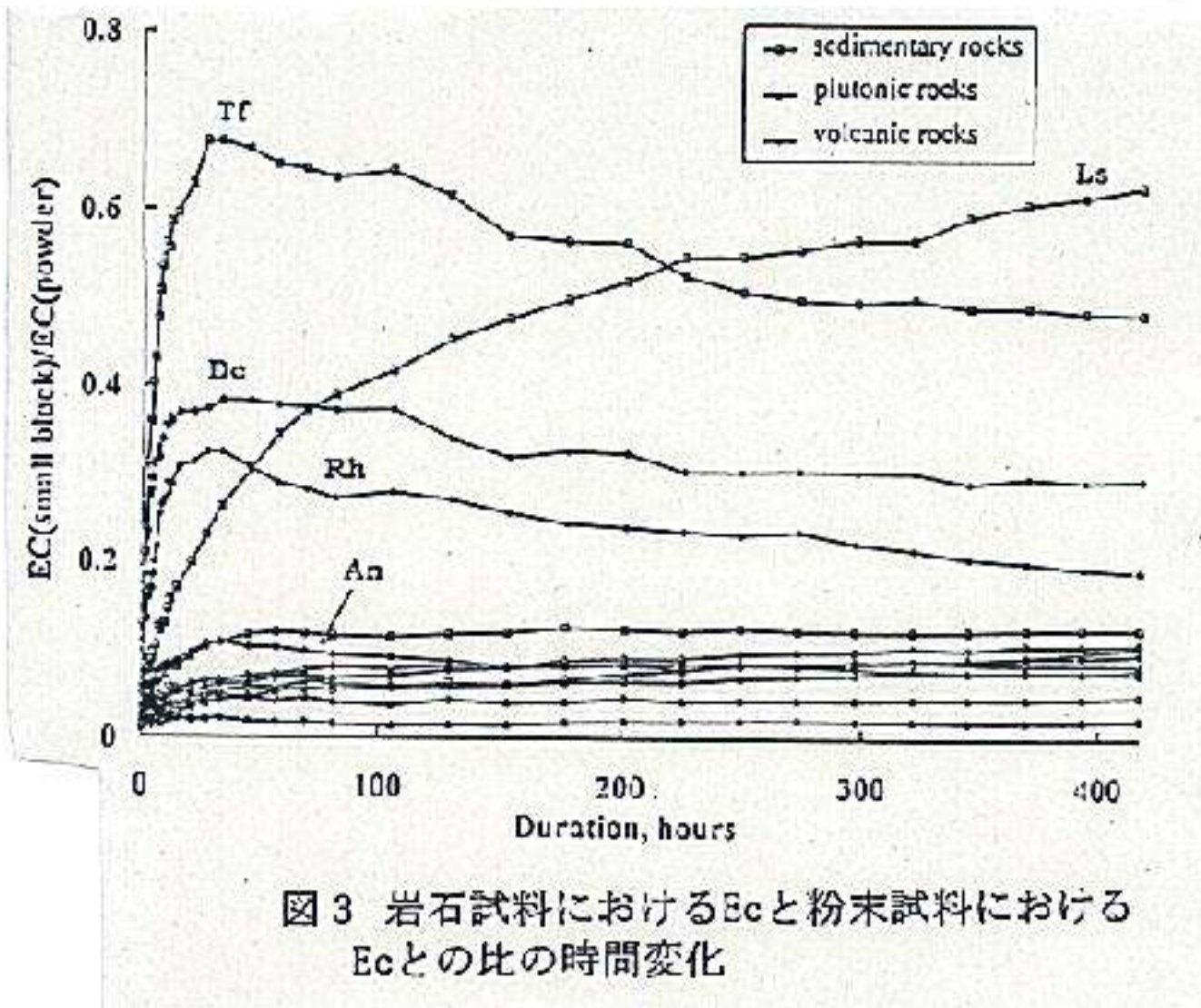


図3 岩石試料におけるEcと粉末試料におけるEcとの比の時間変化

6. f}fCEfCfVfA•Ef€f_n'æ,E,,-,é2,4-D'•R•«CE^f qffSfR,I°•z,Æ•œ'••U,E'I,•,é''½%ž

- m—v—ñ•n•F f}fCEfCfVfA.İf f_n'æ.Ä"•GE@,³,è,½2,4-D'•R•«CE^,İf qffSfR,İ•AŠ'Žó•«CE^,É"•ä,×,Ä29"İ,İ'•R•«,đŽ,.,•AŽg—p,.,é•œ'••Ü,đ,İ,İ,é,±,±,Æ,É,æ,Ä,Ä—e'Ö,É-h•œ,Ä,«A'ZŠúŠÓ,Ä'•R•«CE^,İ'••¶—,đ'á%œ²,³,İ,é,±,±,Æ,%œÄ"•,Ä, ,é•B
- m'S"•—•n•F••Ü...ŽY,ÆGEœ†fZf'f'•[•E•¶ŽY—'—p•"•A f f_n' _ÆŠJ'•; •iMADA•j•A f}fCEfCfVfA" _ÆŠJ'•GEœ†•Š•iMARDI•j
- m~A—•n•F 0298-38-6307
- m•"•%ö'İ•n•F••Ü" _Æ
- m•ê—â•n•F ŽG'•
- m'İ•Ü•n•F•...İ
- m•°—Đ•n•F•s••

•m"•wCEi•E,Ě,ç,ç•n

•@•L—t•y,ŇfJf.,fçfŠfOFT%œÈŽG'•İ•Ü•œ'••Ü,Æ,µ,Ä•A2,4-D,İf}fCEfCfVfA,İ'½"d... "c,Ä,Ä,Žg—p,³,è,Ä,ç,é•B,µ,©,µ•A2,4-D,ÄCEÍZE,Ä,«,È,çfJf.,fçfŠfOFT%œÈŽG'•f qffSfR(*Fimbristylis miliacea*(L.)Vahl),•A1989"N,Éf f_n'æ,İfOfœfE"•,İCE@,Ä,©,Ä,½•B,±,İ2,4-D'•R•«CE^f qffSfR,İ•AŠ'Žó•«CE^,É,æ,éŠ'Žó•«CE^,Æ,İŽ'•É,«,•A"•n'æ,Ä, İ°•zŠg'•ä,Æœ"O,³,è,Ä,ç,é•B•@

•@•,»,±,Ä•A•œ'••Ü'•R•«CE^ŽG'•,İ'••¶—,İ]•S@,đCEY"ç,.,é,½,ß,É•A2,4-D'•R•«CE^,İf qffSfR,İf f_n'æ,É,"•,éCE»ŽŽ" _ ,Ä,İ•°z,Æ•A•Ži•œ'••Ü, É'İ,.,é''½%œž,đCEY"ç,µ,½•B

•m•-%œĚ,İ'•ä—e•E'•Ä'Y•n

1. Š'Žó•«CE^f qffSfR,²2,4-DfWf•fçfA f~f'œt•Ü,İ'É•Žg—p—Ê(0.087g a.i./m²),İ•—,É,æ,Ä,ÄŽ—Ä,µ,½,İ,É'İ,µ,Ä•A'•R•«CE^,İ,»,İ32"İ,İ—đ—Ê(2.78 g a.i./m²),đ•—,µ,Ä,ä,»,İCEä%œİ•œ,µ,½,•İ•1•j•B"½•"•vŽ—đ—Ê(LD₅₀),Ä,İ•A—½CE^,İŠÓ,É29"İ,İ'•ä,ç,², ,Ä,½•B
2. '•R•«CE^,İ•A2,4-DfufççfGfXfçfœ... "a•Ü•A2,4-DfGfççfGfXfçfœ... "a•Ü•A2,4-DfifgçfŠfE f%œ...—n•Ü•AMCPAŠe•Ü,É'İ,µ,Ä,à'•R•«,Ä, ,Ä,½,•A f v f•p f j f•A f p f œ f R•[f g•A f O f•f t f H f j f•f C f g•E f A f•f, f j j f E f %œ,É'İ,µ,Ä,İCEđ•'•R,Æœ©,ç,è,È,©,Ä,½•i Δ]•j•B
3. 1993"N,És,Ä,½•°z'²•,İCE%œĚ•A f f_n'æ100•M,İf qffSfR'½"•... "c,İ,µ,ç,5•M,İ... "c,Ä'•R•«CE^Ä'İ,İ'••¶,Šm" F,³,è,½,•AŽc,è,İ95•M,İ... "c,Ä,İŠ'Žó•«CE^,İf qffSfR,²½"•,µ,Ä,ç,½,±,±,Æ,©,ç•A"•n'æ,Ä,İ'•R•«CE^,İ'••¶"X,İ'•ä,ç,Æ,İ,İ,ç,è,½•i•12]•j•B
4. '•R•«CE^,Æœ©,Ä,©,Ä,½fOfœfE"•,Ä,İ•A70•M,İ... "c,İ,µ,ç,69•M,İ... "c,Ä'•R•«CE^f qffSfR,İ'••¶,Šm" F,ß,ç,è,½•B'•R•«CE^Ä'İ,İŠ,•±,²,²86%,Ä, ,Ä,½... "c,Ä,»,İCEä2,4-D,đŽg—p,¹, fXfççfHfjççfE fCEfA CE n•œ'••Ü,đ—p,ç,½,Æ,±,è•A2"NSÓ,Ä'•R•«CE^,İŠ,•±,²,²1.7%,É,Ü,Ä'á%œ²,µ,½•B

•@•È•ä,İCE%œĚ,©,ç•A2,4-D'•R•«CE^f qffSfR,İŠ'Žó•«CE^,É"•ä,×,Ä29"İ,İ2,4-D'•R•«,đŽ,µ,½,•AŽg—p,.,é•œ'••Ü,đ,İ,İ,é,±,±,Æ,æ,Ä,Ä—e'Ö,É-h•œ,Ä,«,é,±,±,Æ•A'ZŠúŠÓ,Ä'•R•«CE^,İ'••¶—,đCE,ç,.,±,±,Æ,%œÄ"•,Ä, ,é,±,±,Æ,²•³,©,Ä,½•B

•m•-%œĚ,İŠ'—p—Ê•E—'Ö"•_n

•@—(CEœ†,İ•-%œĚ,Ä,İ•Aœ•Y,Ä,à2,4-D,đ'†•S,Æ,µ,½-h•œ'İCE n,²,Æ,ç,è,Ä,ç,é' n'æ,İ'İ,Ä,İŽG'•-h•œ—@,İ'đ'è,É—L—p,Ä, ,é•B,Ü,½—(CEœ†Žè—@,İ,İCEä"•CE",Æœ"O,³,è,Ä,ç,é fXfççfHfjççfE fCEfA•Ü,È,Ç'½,İ•œ'••Ü,É'İ,.,é'•R•«ŽG'•,İCEœ†,É,à—'—p,Ä,«,é•B

•@'A,µ•A•œ'••Ü,İi—p•œ,âŽG'•,İ•¶ç,İ'n'æ,É,æ,Ä,Ä'•ä,«,~Ü,É,è,±,±,Æ,—\z,³,è,é,İ,Ä•A—{•i•ñ,İ"K—p"Í'Í,Í" M'N'İ'İ'n'æ,ÉCEÄ,ç,è,é•B

•m,»,İ'½•n

CEœ†%œÜ'è—¼•@•F}fCEfCfVfA,İ'½"d... "İ'Í,É,"•,éŽä—v... "cŽG'•,İ•¶'Ö%œđ—¼,Æ•ŠCEä—@,İŠJ'—

—ŽZ,æ•²•@•@•F••Ü" _Æf v f• [•¶'•ŠQ—h•œ]

CEœ†ŠúŠÓ•@•@•F•½•—4•8"N

CEœ†Š'—ŽÓ•@•F'n•ÓŠ°—¼•i••Ü" _Ñ...ŽY,ÆGEœ†fZf'f'•j

Md . Zukı İsmail, Nai Kin Ho (MADA) , (MARDI)

"•.Ä' _•¶"™•@•F Watanabe, H et al.(1994) 2,4-D resistance of *Fimbristylis miliacea* in

direct seeded rice fields in the Muda area. Proceedings of the 4th

International Conference on Plant protection the Tropics, 353-356

•@Š Žó•«CE^fqffšfR,²,4-DfWf•f•fAf~f“%t•Ü,ÌÈ•íŽg—p—Ê(0



-ð—Ê•i%cc•j 7.0•~10⁻¹ _ 1.4 ____ 2.8 ____ 5.6 ____ 11.1 ____ ga.i/m²

-ð—Ê•i`•j 2.2•~10⁻² _ 4.4•~10⁻² 8.7•~10⁻¹ 1.7•~10⁻² 3.5•~10⁻¹ ga.i/m²

-ð—Ê•ižè‘O•j0 _____ 1.4•~10⁻³ 2.7•~10⁻³ 5.4•~10⁻³ 1.1•~10⁻² ga.i/m²

•},P: 2,4-D”i•R•«CE^•i•¶•j,y,ÑŠ Žó•«CE^•i%E•jfqffšfR,Ì,2,4-DfWf•f•fAf~f“%t•Ü,É‘Î,•,é”½%ž•i1992”N12CEŽ•j

表1 数種除草剤に対する抵抗性型と感受性型ヒデリコの反応

供試 除草剤	処理 薬量 g a.i./m ²	枯死率		
		抵抗性型 %	感受性型 %	
<b>実験1 (1993年1月)</b>				
2,4-D dimethylamine	0.087	10.6	100.0	**
	0.170	7.8	100.0	**
	0.700	4.3	100.0	**
2,4-D iso-butylester	0.068	0.0	81.3	**
	0.140	19.4	94.6	**
	0.540	15.6	100.0	**
propanil	0.350	58.7	39.9	N.S.
	0.700	65.5	83.5	N.S.
	2.800	91.9	100.0	N.S.
paraquat	0.032	32.7	26.2	N.S.
	0.064	77.7	73.3	N.S.
	0.260	100.0	100.0	N.S.
glufosinate ammonium	0.024	0.0	7.4	N.S.
	0.047	6.7	25.5	N.S.
	0.190	100.0	100.0	N.S.
<b>実験2 (1993年5月)</b>				
2,4-D dimethylamine	0.087	17.6	93.6	**
	0.170	37.6	89.0	**
	0.700	61.0	93.7	*
2,4-D ethylester	0.051	0.0	54.8	**
	0.102	5.6	39.8	*
	0.408	39.7	80.8	**
MCPA ethylester	0.042	0.0	66.2	**
	0.084	62.4	78.2	N.S.
	0.336	53.5	97.6	**
2,4-D sodium salt	0.062	21.6	97.3	**
	0.105	24.4	89.5	**
	0.418	32.9	92.0	**
MCPA sodium salt	0.043	27.4	92.8	**
	0.086	50.9	100.0	**
	0.343	100.0	100.0	N.S.

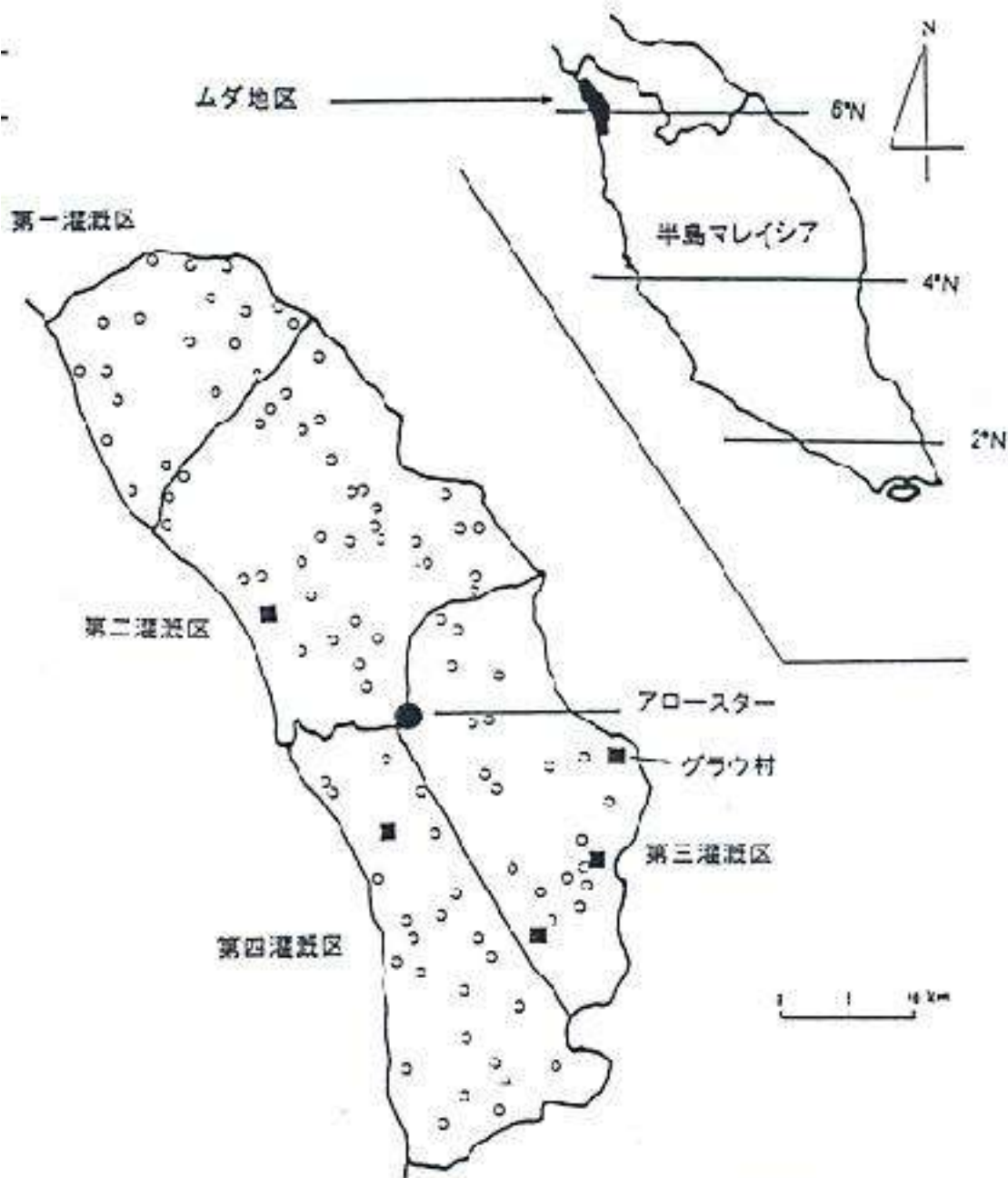


図2 ムダ地区における抵抗性型ヒデリコの分布(1993年乾期作)

- : 抵抗性型個体の発生が確認された場所
- : 抵抗性型個体の発生が確認されなかった場所







図1 ハキリアリによる食害を受けたユーカリの人工林。葉のない木は全て、ハキリアリにより、葉を切り取られている。



図2 本調査における主な経路図（細線）。太線は州境を示す。英字1文字で表された都市は、ボツカツ（B）、クリチーバ（C）、フロリアノーポリス（F）、ポルト・アレーグレ（P）。

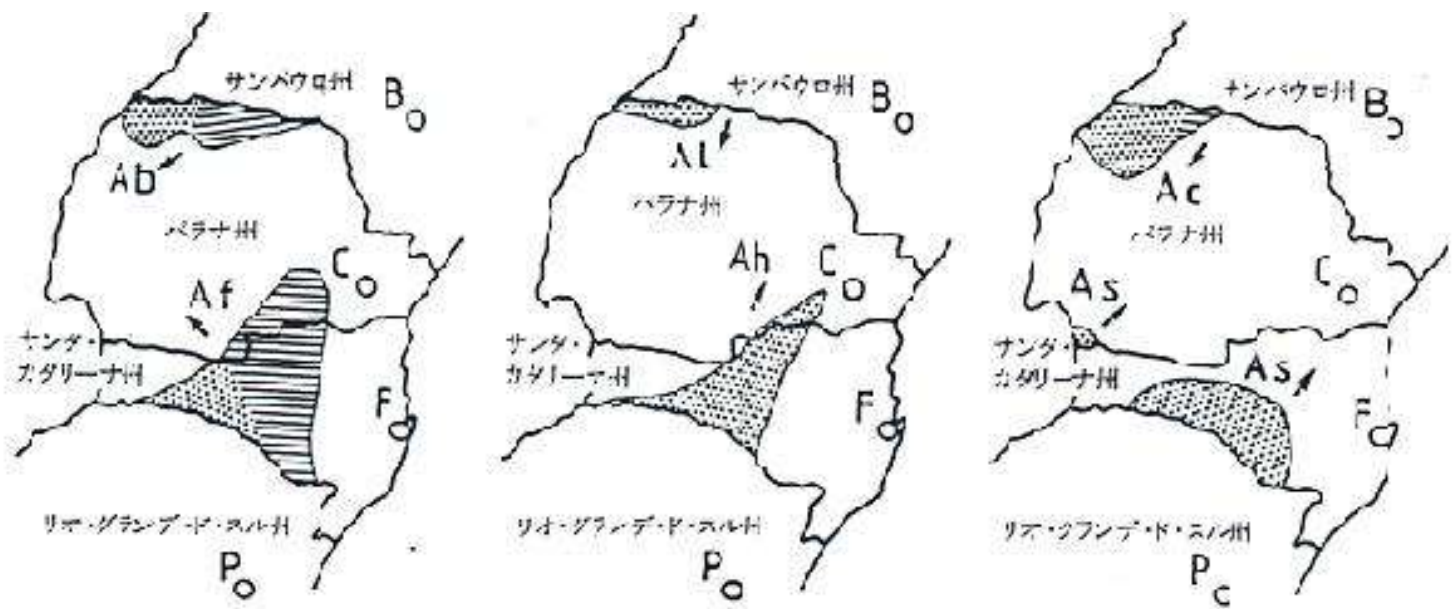


図3 今回の調査で明らかとなったハキリアリの分布地域。今回の調査と及び以前の調査でも分布が確認された地域は、斜線域で表示され、今回の調査で分布が新たに確認された地域は、点描域で示されている。矢印はこの10年間で分布が拡大された方向を示す。アリの種類は以下の通り。Acromyrmex halzani (上左図、Ab)、A. fracticornis (上左図、Af)、A. heveri (上中図、Ah)、Atta capiguara (上右図、Ac)、A. laevigata (上中図、Al)、A. sexdens (上右図、As)。英字1文字で表された都市は図2に同じ。図中のAsは、A. sexdens piriventrisという亜種に分類されている。



表1 タイのネコブセンチュウのエステラーゼ (Est) およびマレイトデヒドロゲナーゼ (Mdh) の電気泳動パターン

ネコブセンチュウ	宿主植物	バンドパターン(Phenotypes)	
		Est	Mdh
<i>M. arenaria</i>	キュウリ	A 2	N 3
	野草の一種	A 2	N 1
<i>M. incognita</i>	トマト	I 1	N 1
<i>M. javanica</i>	ナス	J 3	N 1
<i>M. graminicola</i>	オカボ	VS 1	未確認
<i>Meloidogyne</i> sp. (Ms1)	クワ	2 本	1 本
<i>Meloidogyne</i> sp. (Ms2)	野草の一種	3 本	2 本
<i>Meloidogyne</i> sp. (Ms3)	ジャスミンの一種	活性なし	活性なし
<i>Meloidogyne</i> sp. (Ms4)	トマト	活性なし	未確認

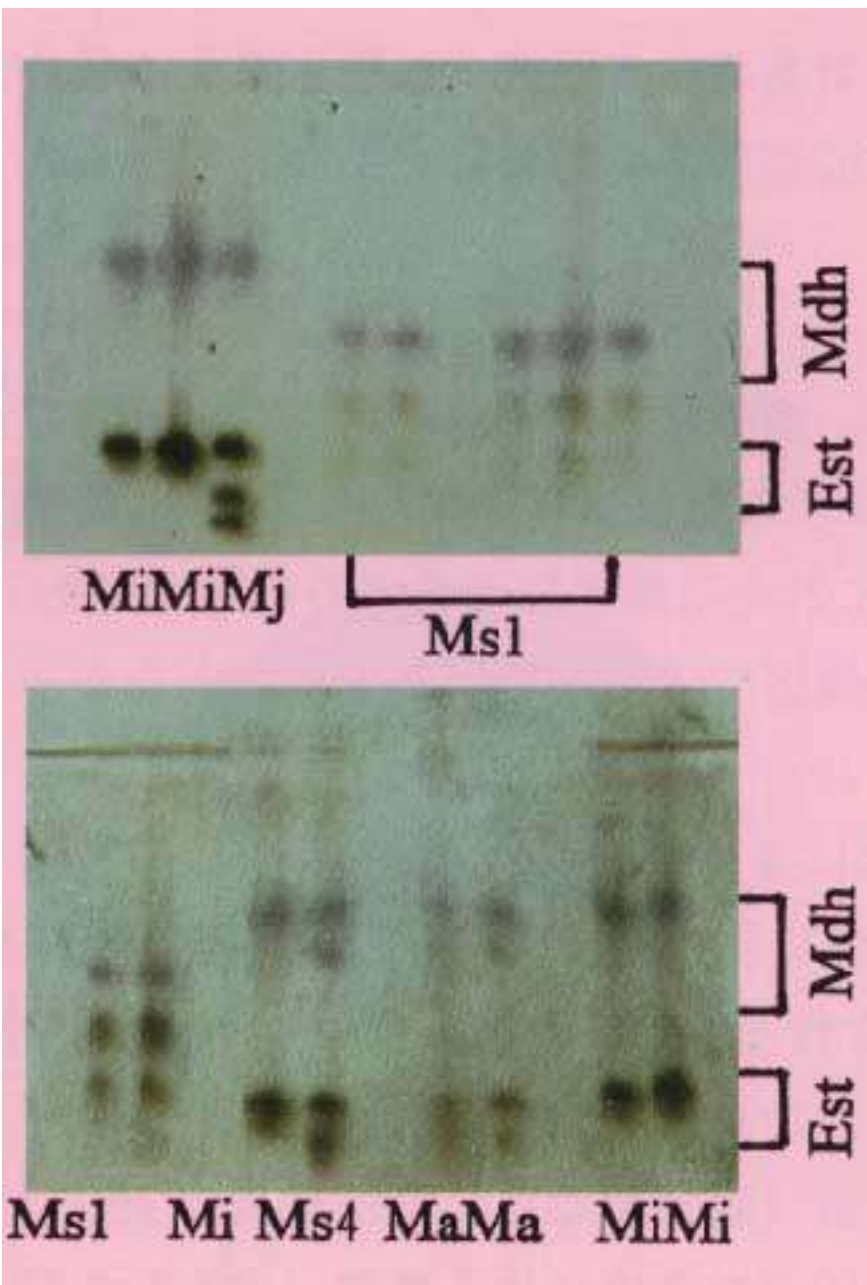


図2 ネコブセンチュウの酵素の電気泳動パターン

Mi: *M. incognita*,

Mj: *M. javanica*,

Ma: *M. arenaria*,

Msl, 4: 新種または未記録種





図3 ネコブセンチュウの新種  
の雌の会陰紋

A: ウドンタニ産

B: チェンマイ産





図1 新種のネコブセンチュウに加害された  
タイのクワの根



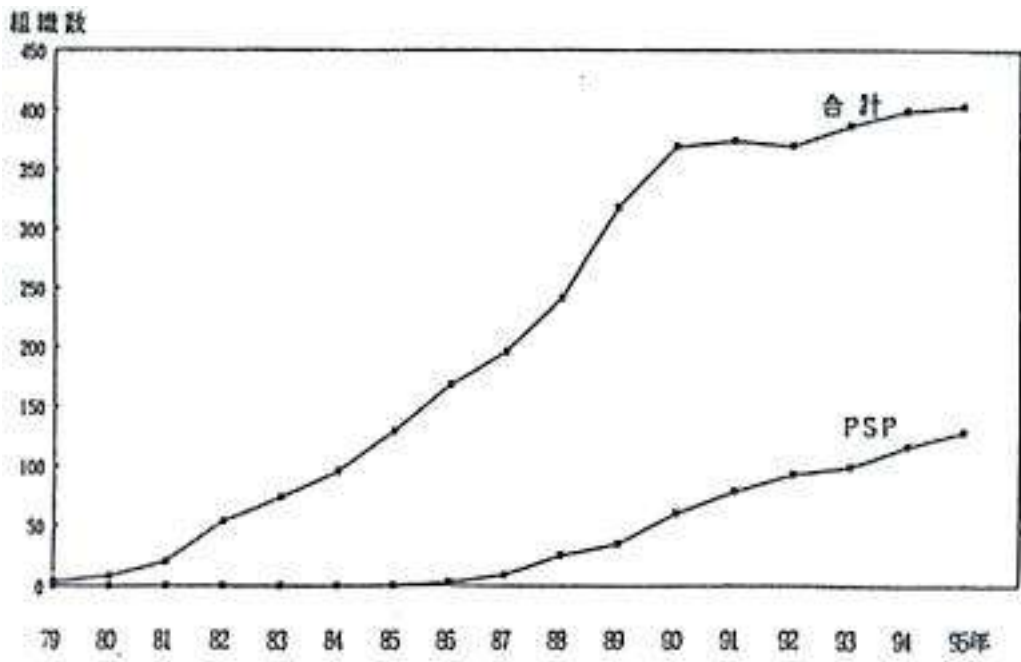


図1. ムダ地区におけるグループ・ファーム組織数の変遷

表1 P S P加入の利点と問題点 (加入農家 26 戸の複数回答)

	利 点	問 題 点
借入金	農業投入材用の借入金が可能 (77%) 非農業用途 (食費・教育費) 用の借入金が可能(27%)	借入金申請手続きが遅い (12%) 借り入れ返済の締め切りが厳しい(4%)
農業資材の入手	非農業用資材や委託料金が安く手にはいる (62%) 無料で農業が配布されることがある (4%)	資材価格が多くの小売店より高い (8%) 委託料金の設定が非加入農家と変わらない(8%)
行政との関連		農業関係機関との連携が非効率 (19%) 行政のコントロールが強い(4%)
技術情報	普及院から技術的指導を受けられる(27%) 他の加入農家を観察して知識が得られる(4%) 圃場で問題発生時、加入農家が相談にのってくれる(4%)	普及職員との討議が不足(4%) 普及員が圃場まで見回りにこない(4%)
農家間の関係	共同作業が時間や体力の節約になる(12%) 加入農家のための積立金がある(7%) 加入農家の親睦旅行がある(4%)  加入農家間で農業用具/機械の貸し借りができる(4%) 加入農家間の相互補助 (冠婚葬祭) がある(4%)	共同作業に従わない者がいる(15%) 借入金の返済をしない者がいる(4%) 借入金を飲食費に使ってしまう者がいる(15%)

表 2. 調査農家の概要と経営上の問題点

	加入農家(%)	非加入農家(%)
経営耕地面積(ha)	1.7	1.2
家族労働力数(人)	1.1	1.3
収穫量(kg/ha)	4934.3	450.5
経営問題(複数回答)		
問題あり	10(38.5)	18(60.0)
病虫害発生	4	9
農業技術情報の発生	2	6
低収量	1	3
雇用労働力不足	1	3
土地の高度	2	1
雑草繁茂	1	1
天候不順	1	1
農業機械の不足	1	0
経営者の高齢化	1	0
地代の高騰	1	0
経営費の増加	0	1
圃場管理の時間がない	1	0
何も問題はない	10(61.5)	9(36.0)
回答無し	0(0.0)	1(4.0)

図2 調査農家の経営費と稲作粗収益









図1 タイ東北部における作物の代謝エネルギー生産量  
(ギガジュール/ヘクタール/年)

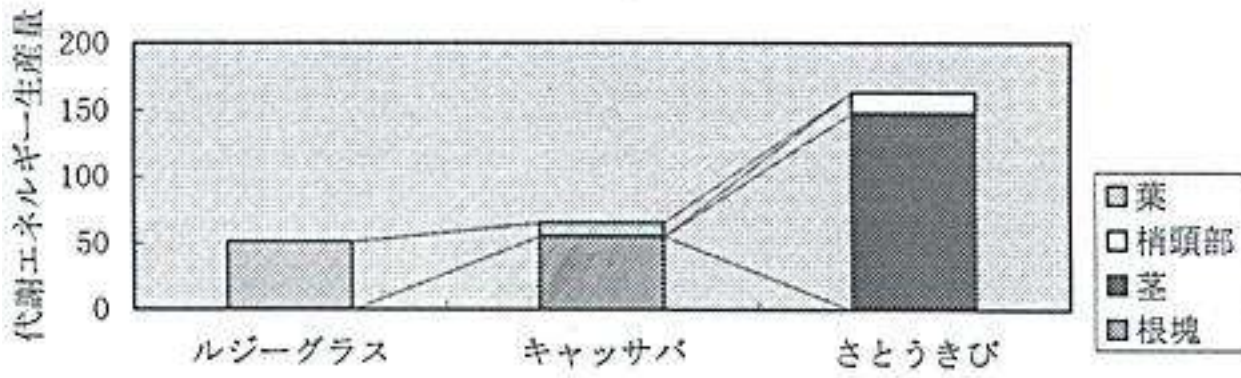
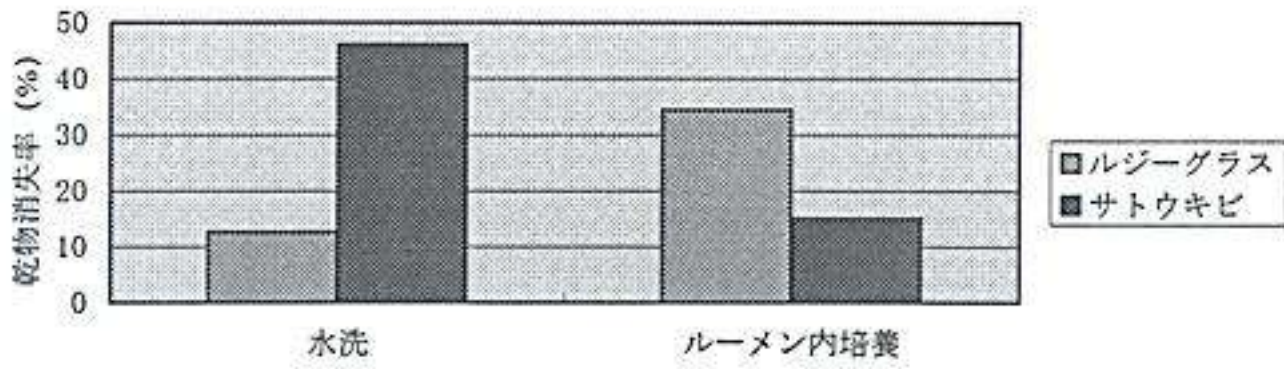


表1 さとうきび茎部の給与が乳牛の体重、乳量、乳質に及ぼす影響

処理	稲藁のみ給与	さとうきび茎部給与
さとうきび茎部の採食量(KgDM/day)	-	5.33
稲藁の採食量(KgDM/day)	6.69	1.00
配合飼料の採食量(KgDM/day)	6.50	5.88
体重の変化(Kg/3weeks)	7	9
乳量(Kg/day)	8.49	8.90
乳質(%)		
脂肪	4.57	4.79
蛋白質	3.45	3.73*
乳糖	4.14	4.15
全固形分	12.9	13.4
無脂固形分	8.29	8.58

*: p<0.05

図2 水洗とルーメン内培養（72時間）による乾物消失率





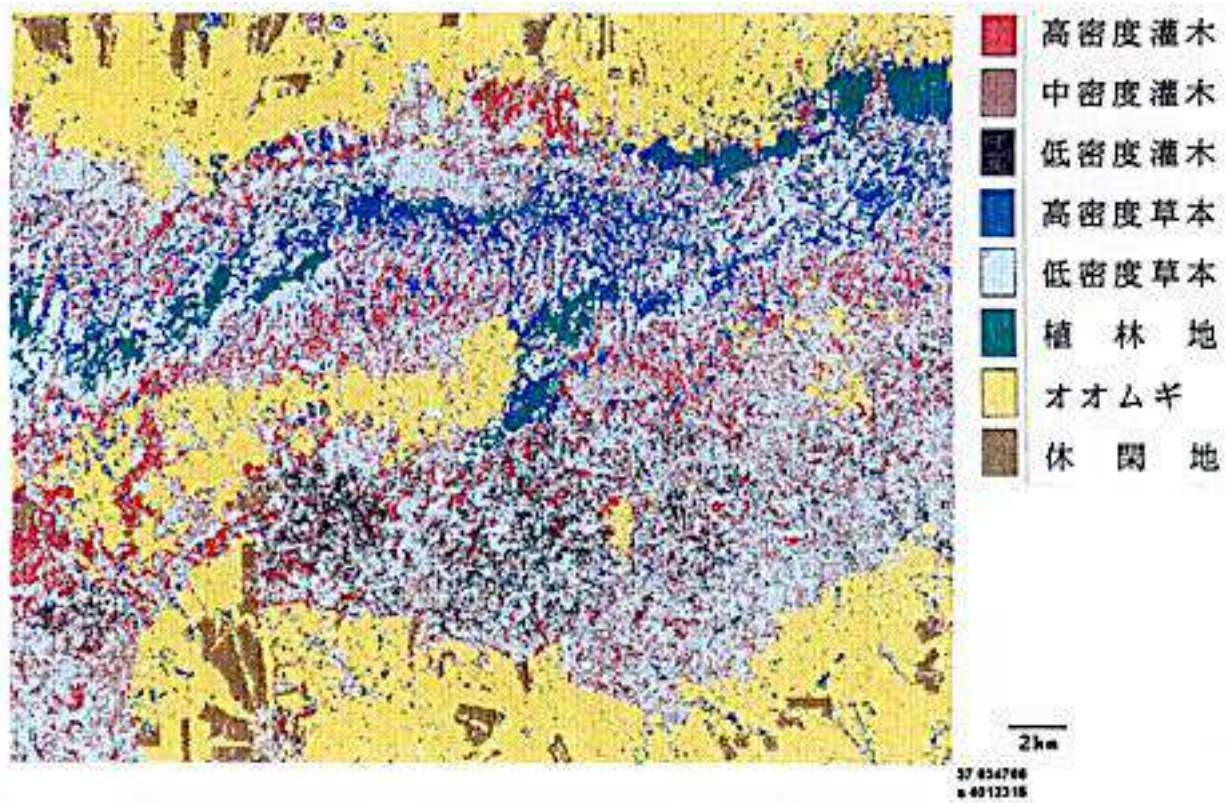


図1 北東シリア、アブダルアジズ試験地の飼料資源区分図

表1 各飼料資源の占有面積、地上バイオマス量および可食バイオマス量

飼料資源	占有面積		地上バイオマス量		可食バイオマス量	
	(ha)	(%)	(ト)	(%)	(ト)	(%)
高密度灌木	7767	(7.0)	4936	(7.0)	2842	(4.4)
中密度灌木	4724	(5.0)	2253	(3.2)	895	(1.4)
低密度灌木	5078	(5.3)	2247	(3.2)	726	(1.1)
高密度草本	6862	(7.2)	4392	(6.2)	4392	(6.9)
低密度草本	33348	(35.1)	10171	(14.3)	8487	(13.3)
植林地	2172	(2.3)	3328	(4.7)	2606	(4.1)
オオムギ	29965	(31.5)	43270	(61.0)	43270	(68.2)
休閑地	3048	(3.2)	334	(0.4)	213	(0.3)
未区分	2071	(2.2)	---	---	---	---
合計	95034	(100)	70931	(100)	63431	(100)



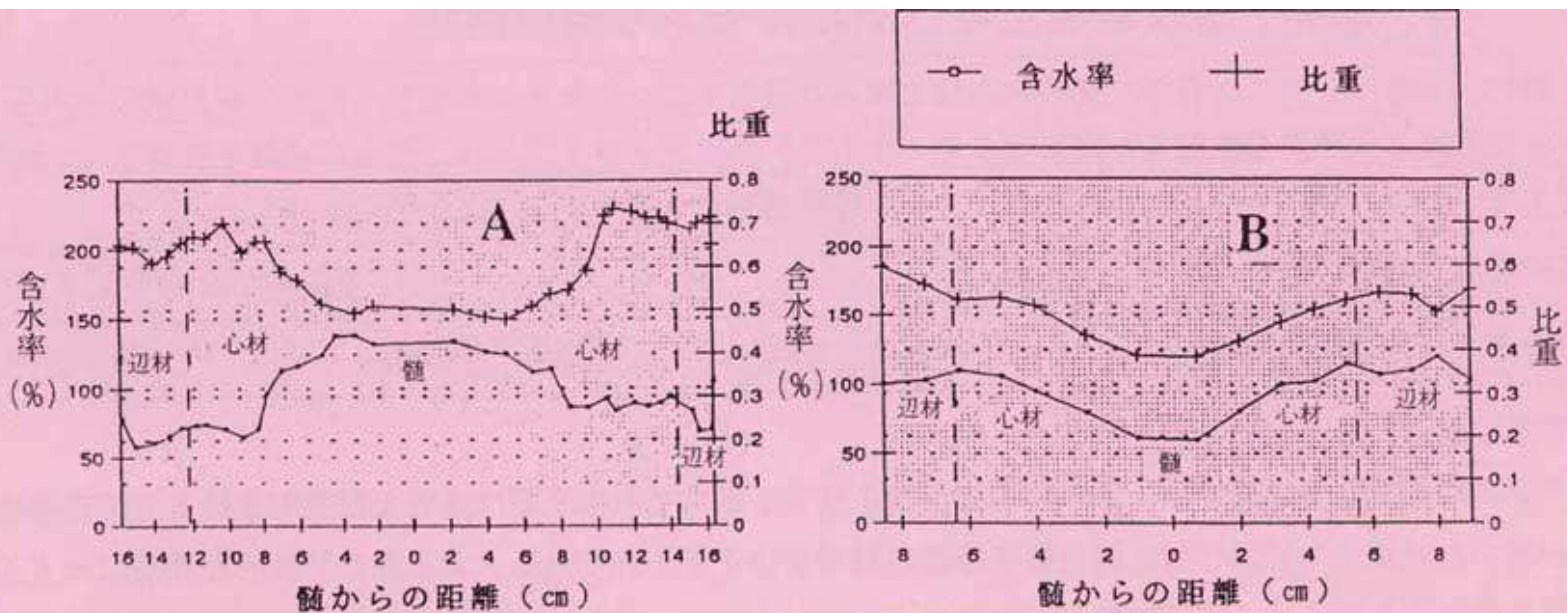


図1 樹幹横断面の生材含水率と比重分布。比重の低い心材中央部で含水率が高い個体 (A: 多湿心材を含む) と、低い個体 (B: 健全材)。



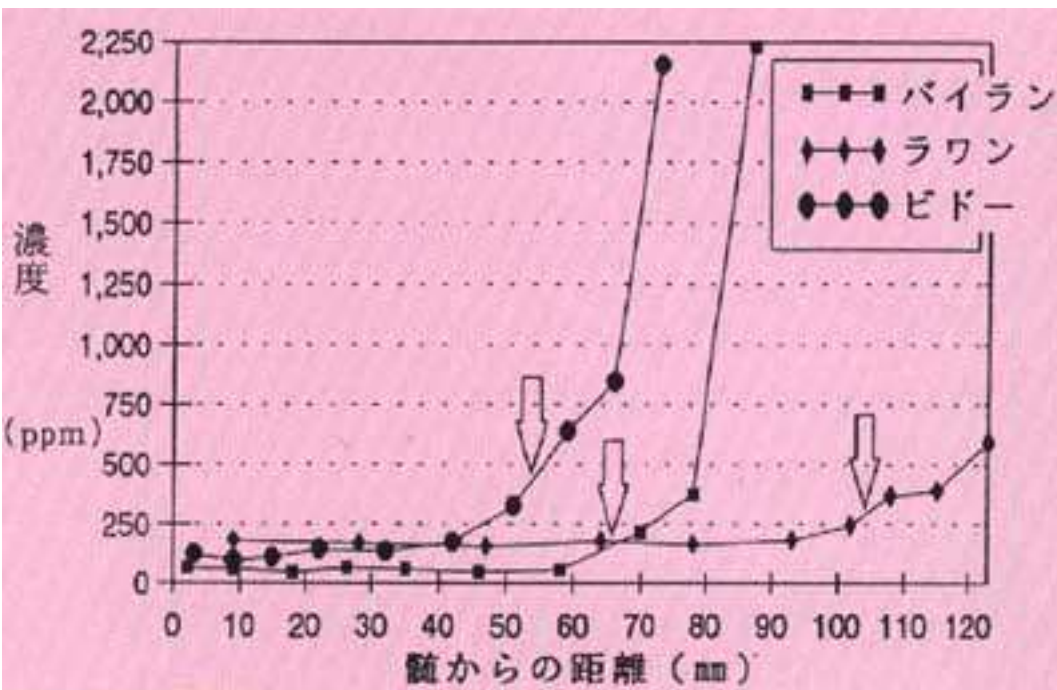


図2 3地点から採取した多湿心材を有する樹幹横断面のカリウムの分布。矢印は辺心材境界。一般に健全材では心材中央部が低く、辺材外部で高い値を示すが、多湿心材を有するものにおいてもその傾向は変わらなかった。

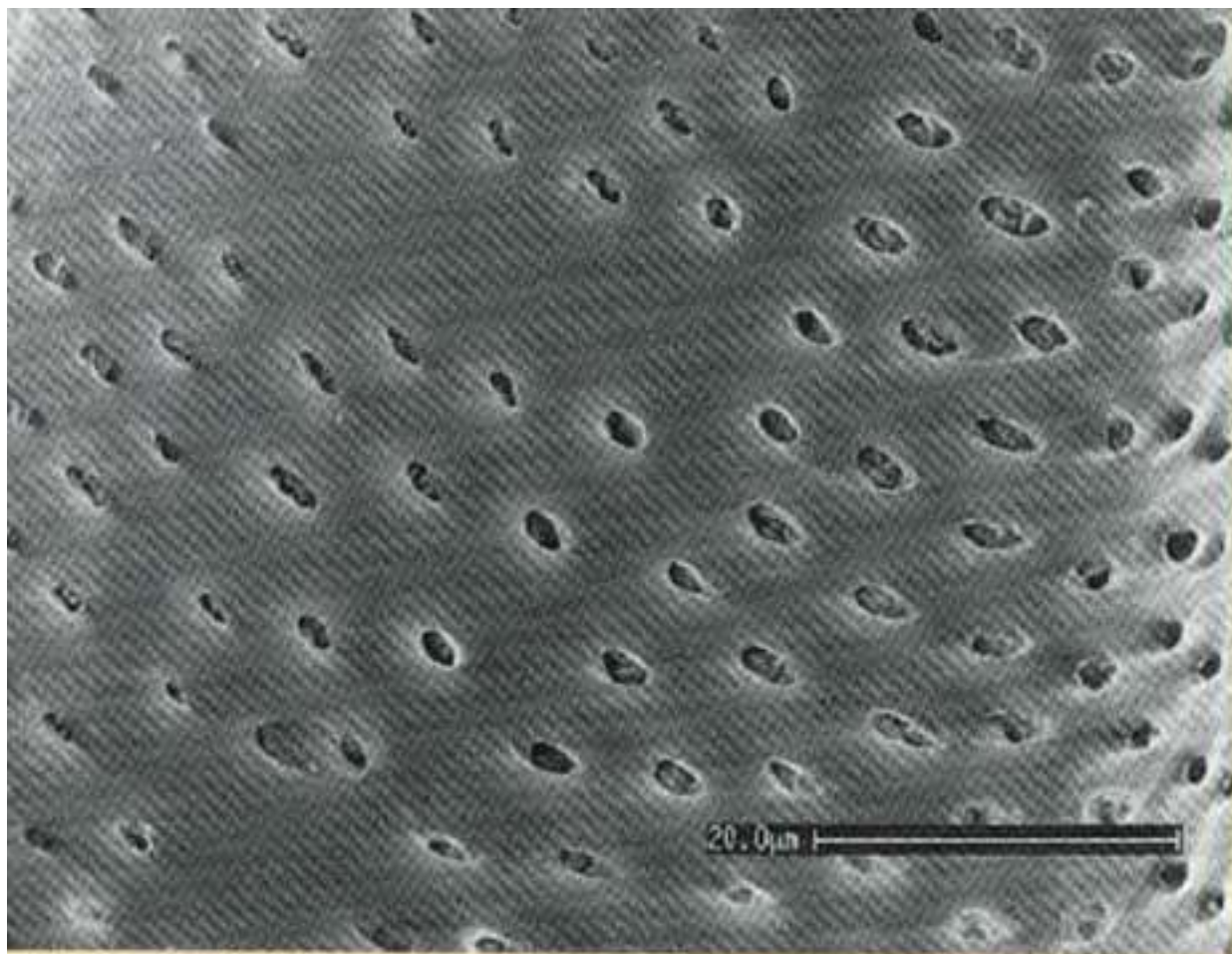


図3 道管内腔の走査電子顕微鏡写真。微生物の進入経路となると思われる道管内腔に微生物の存在は認められない。



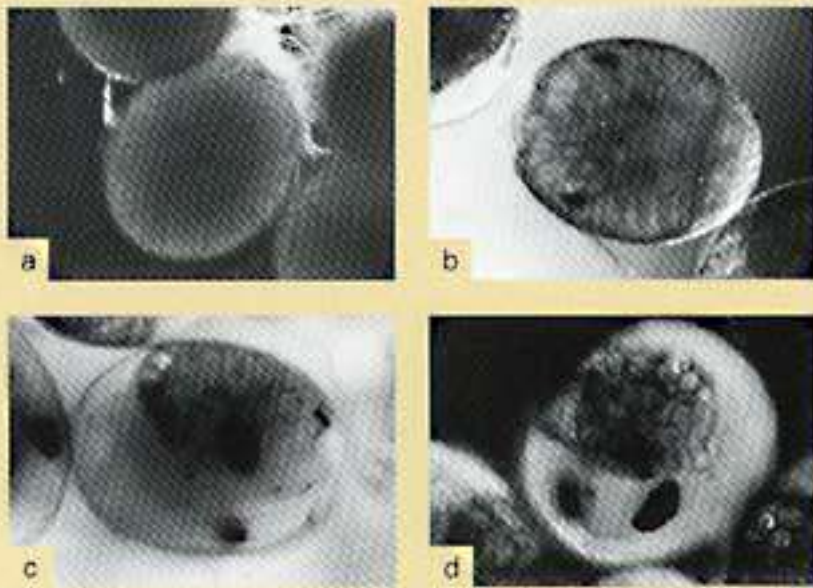


図1 抱卵したオニテナガエビ卵の発生段階

- |               |                |
|---------------|----------------|
| a) 卵割 -1 日目   | b) 複眼出現 -10 日目 |
| c) 体形成 -13 日目 | d) 孵化直前 -16 日目 |

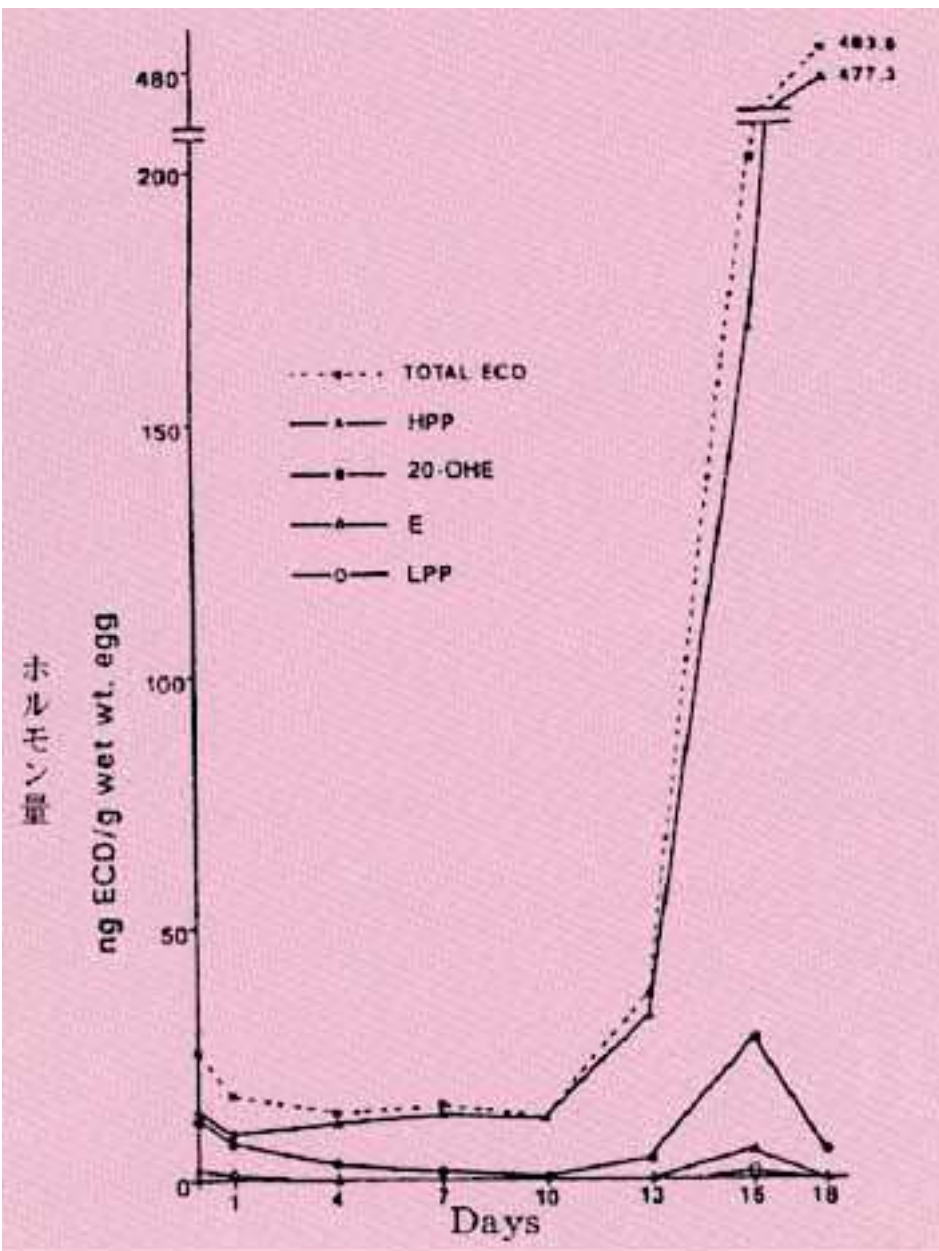


図2 胚発生に伴うエクジステロイドの変化

ECD: 総エクジステロイド

HPP: 高極性エクジステロイド

20-OHE: 20-ヒドロキシエクジソン

E: エクジソン

LPP: 低極性エクジステロイド

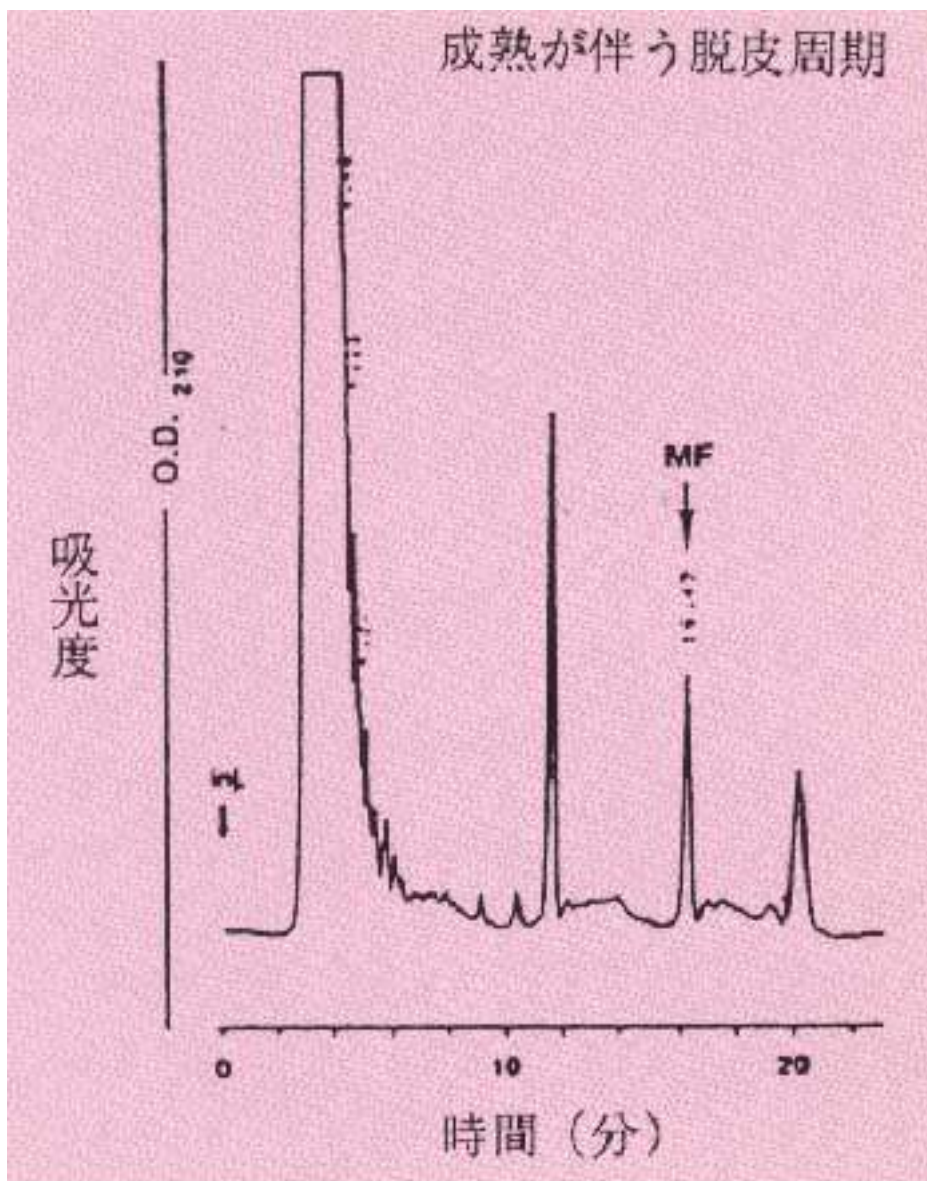


図3 REPRODUCTIVEMOLT  
(成熟が伴う脱皮周期)における  
メチルフェナーゼイト (MF) の検出



表1. アイソザイム分析マニュアルに記載した  
タイ産有用魚介類

- 
1. ナマズ (*Clarias macrocephalus*)
  2. アナバス (*Anabas testudineus*)
  3. スリースポットグラミー (*Tricogaster trichopterus*)
  4. スネックスイミングラミー (*Trichogaster pectoralis*)
  5. ライギョ (*Channa striatus*)
  6. ベタ (*Batta splendens*)
  7. ホソヒラアジ (*Selaroides leptolepis*)
  8. グルクマ (*Rastrelliger brachysoma*)
  9. アカメ (*Lates calcarifer*)
  10. オモンハタ (*Epinephelus areolatus*)
  11. チャイロマルハタ (*Epinephelus tauvina*)
  12. ヨコシマフエダ (*Lutjanus vitta*)
  13. ゴマフエダ (*Lutjanus argentimaculatus*)
  14. アナダラ (*Anadara granulosa*)
  15. ミドリイガイ (*Perna viridis*)
  16. アサリ (*Paphia undulata*)
  17. アオリイカ (*Sepistenthis lessoniana*)
  18. ウシエビ (*Penaeus monodon*)
  19. テンジクエビ (*Penaeus merguensis*)
  20. オニテナガエビ (*Macrobrachium rosenbergii*)
-



表2. ナマズのアイソザイム検出酵素

酵素	遺伝子座	組織	型
AAT	<i>Aat-1</i>	肝臓	単型
	<i>Aat-2</i>	肝臓	単型
ADH	<i>Adh-1</i>	肝臓	単型
	<i>Adh-2</i>	肝臓	単型
AK	<i>Ak</i>	筋肉	単型
FM	<i>Fm</i>	筋肉	単型
a GPD	<i>a GPD-</i>	筋肉	単型
G6PD	<i>G6PD</i>	肝臓	単型
GPI	<i>Gpi-1</i>	肝臓	単型
	<i>Gp-2</i>	筋肉	多型
	<i>Gpi-3</i>	筋肉	単型
IDH	<i>Idh-1</i>	肝臓	多型
	<i>Idh-2</i>	筋肉	単型
LDH	<i>Ldh</i>	筋肉	単型
ME	<i>Me-1</i>	筋肉	単型
	<i>Me-2</i>	筋肉	単型
	<i>Me-3</i>	筋肉	多型 *
MPI	<i>Mpi</i>	筋肉	多型
6MPG	<i>6Pgd</i>	筋肉	多型 *
PGM	<i>Pgm</i>	筋肉	多型

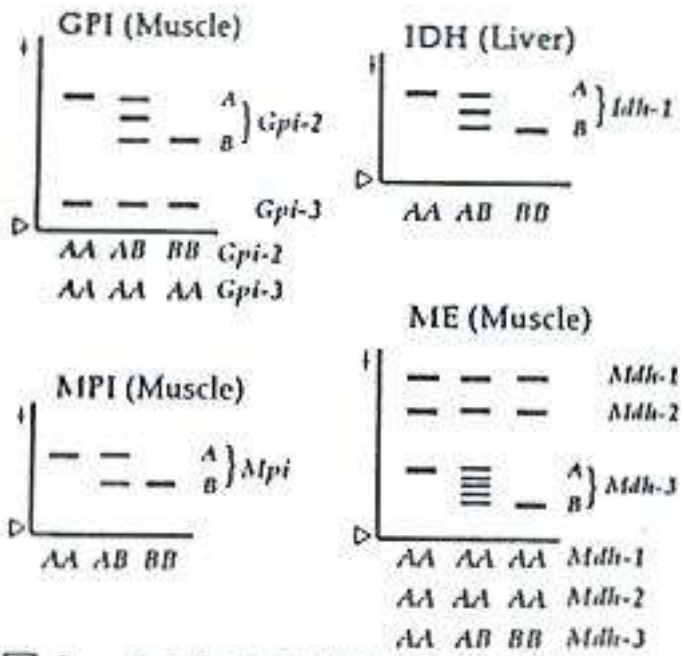


図 1. ナマス[®]の電気泳動パターンの一例

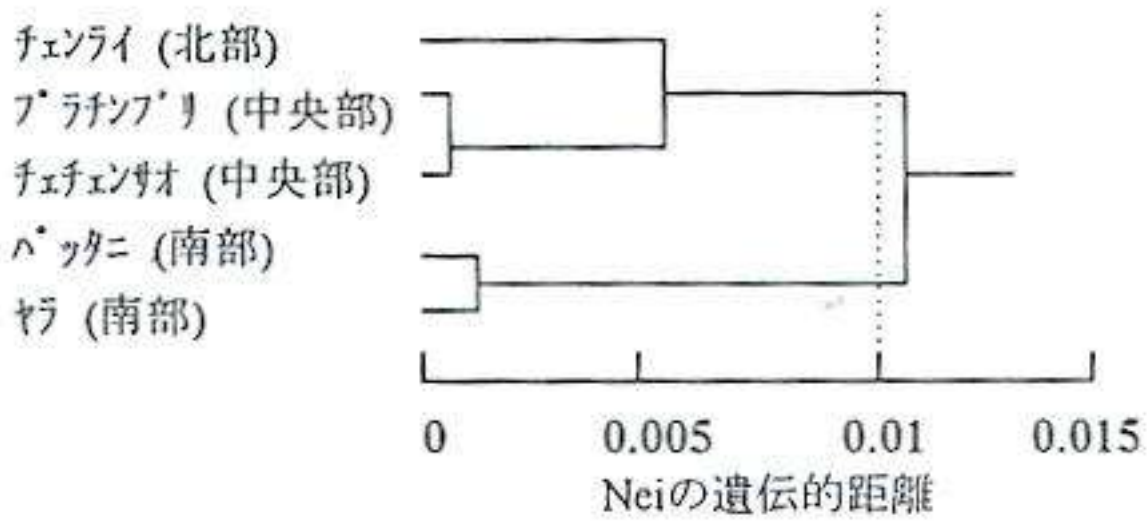


図2. ナマズ地域集団間の遺伝的類縁関係を示す枝分かれ図  
(遺伝的距離0.01が地方品種レベルでの遺伝的違いとされている)



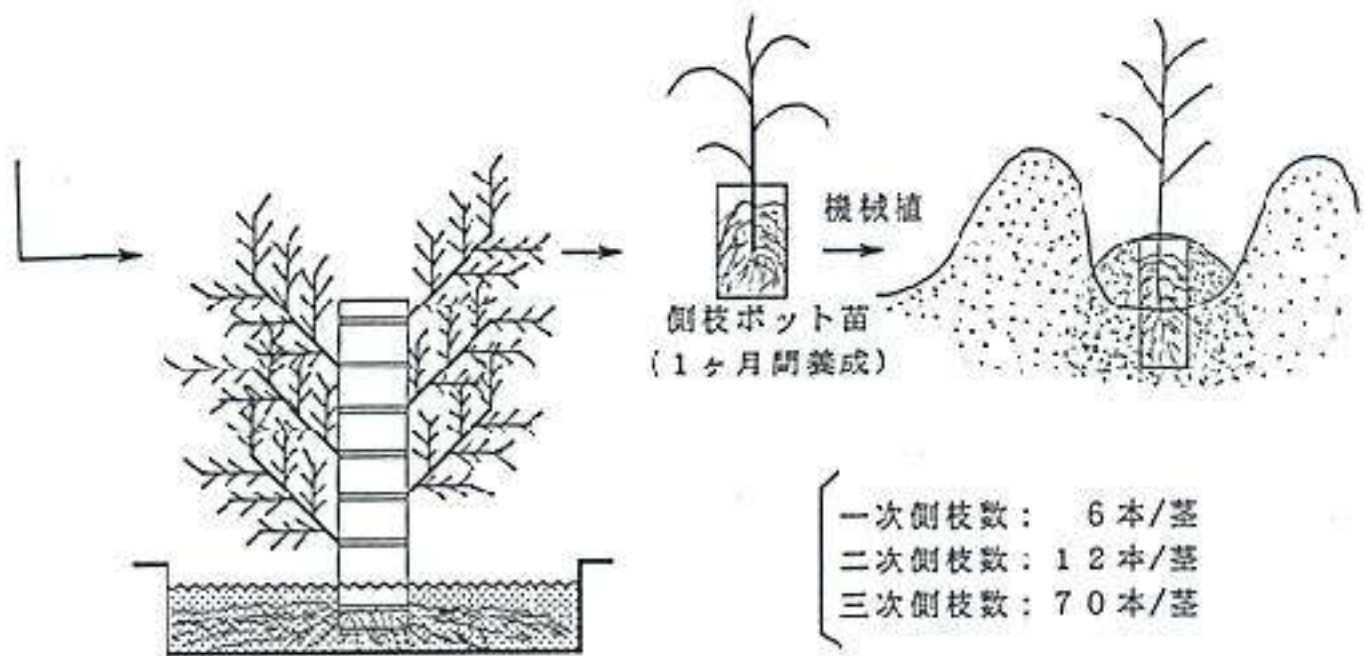
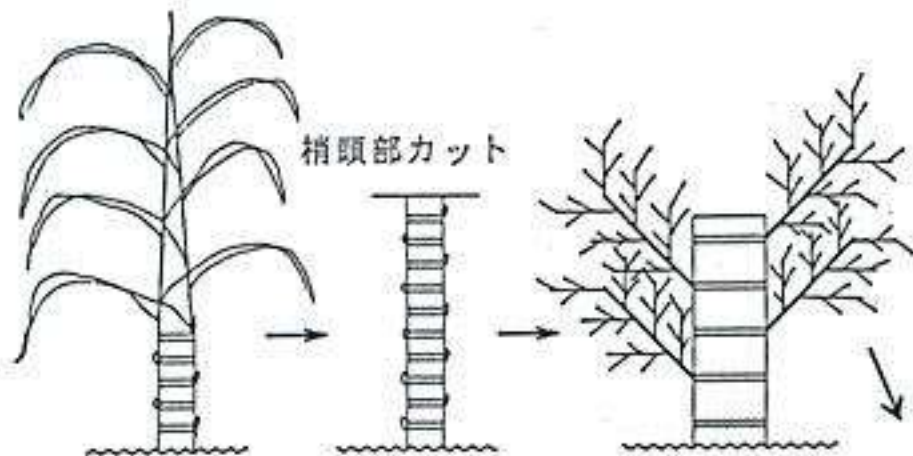


図3 養液栽培装置における側枝苗養成法



- 一次側枝数： 4本/茎
- 二次側枝数： 10本/茎
- 三次側枝数： 38本/茎

図2 圃場における側枝苗養成法

表1 養液栽培装置における植付100日後の2次側枝数(本/茎)

品 種	PVAチップ	マジックソイル	粒 状 綿	圃 場
F161	1.5	7.9	7.7	6.9
NiF8	6.3	9.2	5.7	6.0
Ni9	1.0	8.2	11.3	2.3



図1、 現行の蔗茎苗を用いた植付法





植物 の材 調料 整 ↓ ガ ラ ス 化 ↓ 融 再 解 培 ・ 養	①植物材料の増殖： 仔から得た幼芽を滅菌し、MS培地(3%糖30g/l)で増殖する。
	②コンタミネーション： 無菌培養した植物体(茎長2-3cm)を3%糖120g/lを含むMS培地に移植して1か月培養する。
	③茎頂の切り出し： 葉原基1-2枚を含む生長点(0.5-0.8mm)を切り出す。
	④茎頂の前培養： 0.3M%糖を含むMS培地で16時間培養する。
	⑤ローディング： 前培養した茎頂を2M%リセリン+0.4M%糖で20分間、25℃で処理する。
	⑥ガラス化処理： ローディングした茎頂をPVS2(30%リセリン+15%DMSO+15%エチレングリコール+0.4M%糖)で10分間、25℃で処理する。 液体窒素に直接浸漬する(手法の開発試験では1時間浸漬)。
	⑦融解： 40℃の温水中で急速融解する。
	⑧融解後の処理： 1.2M%糖に10分間浸漬後、滅菌した濾紙を敷いた0.3M%糖を含むMS培地上に1日静置する。
	⑨植物体の再生： 0.1M%糖を含むMS培地に移しかえ培養する。茎葉の再生を生存の指標とする。

図1. 本研究で確立したタロ茎頂の超低温ガラス化法による保存法の手順

表1. ショ糖によるコンディショニングが液体窒素中に保存したサトイモ科 (*Araceae*) 作物の茎頂の生存率に及ぼす影響

英名	種名	2n	系統名	原産国	液体窒素中に保存後の生存率 (% ^Y ± SE)	
					コンディショニング培地のショ糖濃度 ^X	
					30g/l	120g/l
Taro	<i>Colocasia esculenta</i> var. <i>antiquorum</i>	3x=42	Eguino Dodare	日本	65.7 ± 5.4	100.0 ± 0.0
				日本	60.0 ± 7.5	100.0 ± 0.0
Taro	<i>Colocasia esculenta</i> var. <i>esculenta</i>	2x=28	Kabira Ginowan So Sap	日本	73.3 ± 11.3	83.3 ± 2.7
				日本	61.1 ± 5.4	95.3 ± 3.2
				ベトナム	58.3 ± 10.9	66.6 ± 5.4
				ベトナム	67.5 ± 7.1	75.0 ± 4.2
Tanier	<i>Xanthosoma nigra</i>	2x=26	Mo	ベトナム	61.9 ± 8.3	42.8 ± 4.4
Tanier	<i>Xanthosoma sagittifolium</i>	2x=26	Alotau	パプアニューギニア	66.6 ± 6.4	40.0 ± 7.1

²: 超低温ガラス化法の諸条件は図1に示すとおり。^Y: 約6茎頂、3反復の平均、^X: 所定濃度のショ糖を含む培地で1カ月植物体を培養した(30g/lが通常の培養に使われるショ糖濃度)。



写真 右：液体窒素処理・融解後7日目のタロの茎頂. 生存した茎頂は緑色を帯び、生育を開始している. 白色の茎頂は生存しなかったもの(矢印).  
左：液体窒素中で保存した茎頂から得られた植物体.



HC C P P+A HP



図 1 アンチバインを用いたウエスタンブロッティング法  
によるババエア感染質からのPLOMVの検出

HC, 健全ツノニガウリ; C, 感染ツノニガウリ; P, 感染ババエア;  
P+A, 感染ババエア + 2.0 mg/ml アンチバイン; HP, 健全ババエア

0 0.1 0.5 1.0 2.0 (mg/ml)



図2 アンチバインの添加濃度  
(ババリア感染質からのPLD_{IV}の検出)



図 3 パパイア感染葉からのウェスタンブロットティングによる2種ウイルスの検出法



# •‘•Ū’_ <ÆCEα<†•¬%oÊ•î•ñ‘æ3•†•A1995•i•1/2•¬7’N‘‘x•j

1. [•‘•Ū’ —Ñ•...ŽY<Æ“•Eν•î•ñfVfXfef •iJIRCAS-STAT•j,İŠJ”- •k•s•-•l](#)
2. [fgfEfWf“frfG“ CE<•Ū‘¶%oÔ•²—~—p,É,æ,éfRf fM”¼•”‘İ,İ•ò•o •kCEα<†•l](#)
3. [Šł‘‡‘İ•<fJfEfs•\[CEn“•,İ‘I”² •kCEα<†•l](#)
4. [ftfBfŠfsf“á’n“y•ë,İ•ª•z—İŽ®,Æ“Á•«,İ%ođ-¾ •k•s•-•l](#)
5. [“î•ÄfTfof“fi,É,“,-,é—αî,İ“y•ë‘İ•«,İf•fJfjYf ,İ%ođ-¾ •kCEα<†•l](#)
6. [”M‘Ñ,É,“,-,é•...“c,©,ç,İf•f^f“”-•¶•§CEäZ•p,İŠJ”- •k•‘•Ū•l](#)
7. [%oß•ú-q,ªø,«<N,±,•»”TM%o»,İ”÷•C•ŪŠw“If•fJfjYf •kCEα<†•l](#)
8. [f}fCEfCfVfA,İ’¼”d...î•Í”l,É,“,-,éŽG‘fCfl•@•ipadi angin•j ,İ•¶‘Ô,Æ-h•œ •k•s•-•l](#)
9. [fuf%oof“fRf,,fhfŠfofG,İ”É•B•í—ª•@•Šñ•¶-§“x,ÆŽY—“²•ß• •kCEα<†•l](#)
10. [f}fCEfCfVfA,É,“,-,é”½ä%oÆ’ {—p”A‘f“œ—fuf•fbfN,İ‘g•¬,“æ,Ñ•»‘ç•û-@ •k•s•-•l](#)
11. [”M‘Ñ,É,“,-,éfAfuf%oof,,fVCEs—tftfCfCE•\[fW,İ—~—p •k•‘•Ū•l](#)
12. [DNAf}•\[fJ\[,đ—p,ç,½Ží’{,İâ““\—Í.,’è-@ •k•‘•Ū•l](#)
13. [fuf^,“æ,ÑfCfmfVfV,İf~fgfRf“fhfŠfADNAE^%ođ•Í,İ,½,ß,İLA-PCR-@,İŠm—! •kCEα<†•l](#)
14. [’n•|•î•ñ•^—•,É,æ,é“y’n•r”pŠëCE“x,İ•|%oiŽè-@ •k•‘•Ū•l](#)
15. [”M‘Ñ—Ñ”°•İCEã,İ•X—Ñ—đ%o»—v^ö,İ%ođ-¾ •kCEα<†•l](#)
16. [ftf^fofKfL%oÈŽ÷-Ø,İŠÂ<«“K%ož•«,İ%ođ-¾ •kCEα<†•l](#)
17. [fpfCf“fAfbfvf<”•,É,“,-,é•Ô%o©•F“y•N•H,İ”-•¶ŽÀ‘Ô,ÆEYCE,‘Î•ô •k•s•-•l](#)
18. [Tn•Ý’uCE^ÈfGflf<fM•\[—{%ot•Í”l‘•’u,İŠJ”- •k•‘•Ū•l](#)

•@,“-â,ç•‡,í,¹•æ  
 •F•§305-8686•@~i•éCE§,Â,-,İŽs‘â,í,µ,P•l,P•@•‘•Ū’_ —Ñ•...ŽY<ÆCEα<†fZf“f^•[•@Šé%oæ’²•®”•@•î•ñŽ‘—i%oŪ

Tel : 0298-38-6340•@•@ Fax : 0298-38-6656•@•@ e-mail: ref@jircas.affrc.go.jp



1. *U*_...N...ZY...E...M...V...X...Y...Z...C...A...I...R...C...A...S...T...A...T...I...S...T...*

... ..

... ..

... ..

... ..

... ..

... ..

... ..

... ..

... ..

... ..

... ..

... ..

... ..

... ..

... ..

... ..

... ..

... ..

... ..

... ..

... ..

... ..

... ..

... ..

... ..

... ..

... ..

... ..

... ..

... ..

... ..

... ..

... ..

... ..

... ..

... ..

... ..

... ..

... ..

... ..

... ..

... ..

... ..

... ..

... ..

... ..

... ..

... ..

... ..

... ..

... ..

... ..

... ..

... ..

... ..

... ..

... ..

... ..

... ..

... ..

... ..

... ..

... ..

... ..

... ..

... ..

... ..

... ..

... ..

... ..

... ..

... ..

... ..

... ..

... ..

... ..

... ..

... ..

... ..

... ..

... ..

表1 収容情報の種類と量

収容情報	時系列の件数	記憶容量
FAO人口・土地・生産	約20万件	50MB
FAO貿易	約31万件	99MB
FAO食料需給	約54万件	128MB
FAO林業・水産	約14万件	36MB
USDA・OECD・WB	約13万件	113MB



図1 メニュー画面 (一般利用者用)



図2 検索画面—品目グループと品目 (名称は英語でも表示)





[具体的データ]

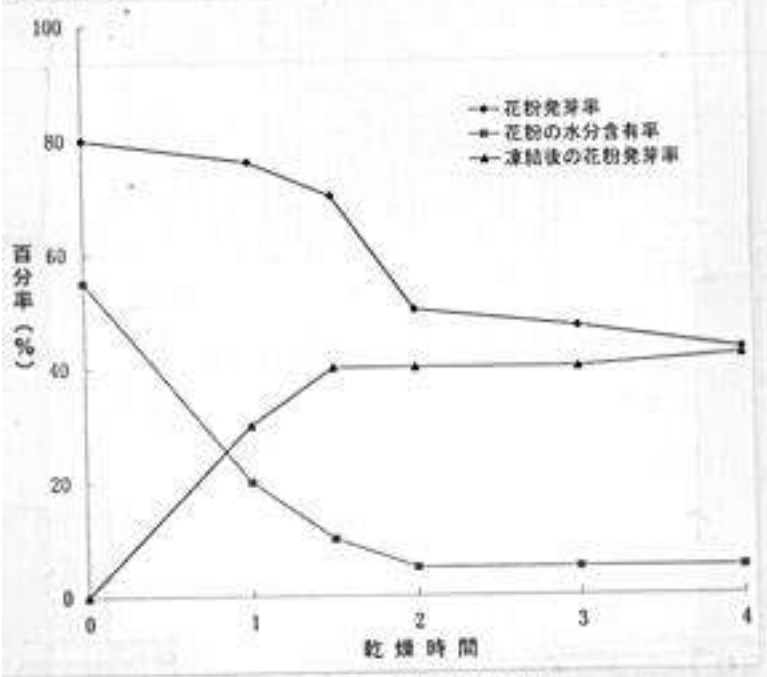


図1 トウジンビエ花粉の乾燥及び凍結後の発芽率

表1 トウジンビエ凍結保存花粉との交雑における  
小麦胚の形成頻度

水分含有率 (%)		貯蔵 温度 (°C)	貯蔵期間 (月数)		
新鮮	乾燥		0	1	3
36.8	—	—	27.6	—	—
54.7	6.6	-196	—	24.3	28.5
		-80	—	21.1	26.0
		-20	—	23.8	26.7
36.8	7.6	-196	—	25.4	29.1
		-80	—	22.1	26.4
		-20	—	17.4	14.2
22.0	5.7	-196	—	27.5	25.7
		-80	—	22.4	20.5
		-20	—	18.2	14.3



•},Q•@•¶•FŽ©•BŽiŽq•@%oE•FĚđŽGŽiŽq





•},R•@•¶•FŽ©•BŽíŽq•A%oE•FCEđŽGŽíŽq





•},P•@1993•`94”N,İŞ£Šú,ÉfifCfWfFfŠfA,İ-k•”fJfmfC,Å•Í”l,µ,½Š£‘‡‘İ•«„ÆŠ’Žó•«„İfJfEfs•[,İ•¶^ç  
 ’••j Š’Žó•«En“•TVu-9357•i%oE•j,ÍŠ£‘‡,İ,½,βCEÍ,ê,©,-,Ä,ç,é,ª•A’İ•«En“•TVu-11979•i•¶•j,Í%o••,È  
 •@ •@•¶^ç,đŽl,µ•AŠ£‘‡,İ%oçç,đ,Û,Æ,ñ,ÇŽó,-,Ä,ç,È,ç•B

表1: 1993-94年の乾期にカノで栽培したカウピーの  
子実と茎葉(乾物)の収量。¹⁾

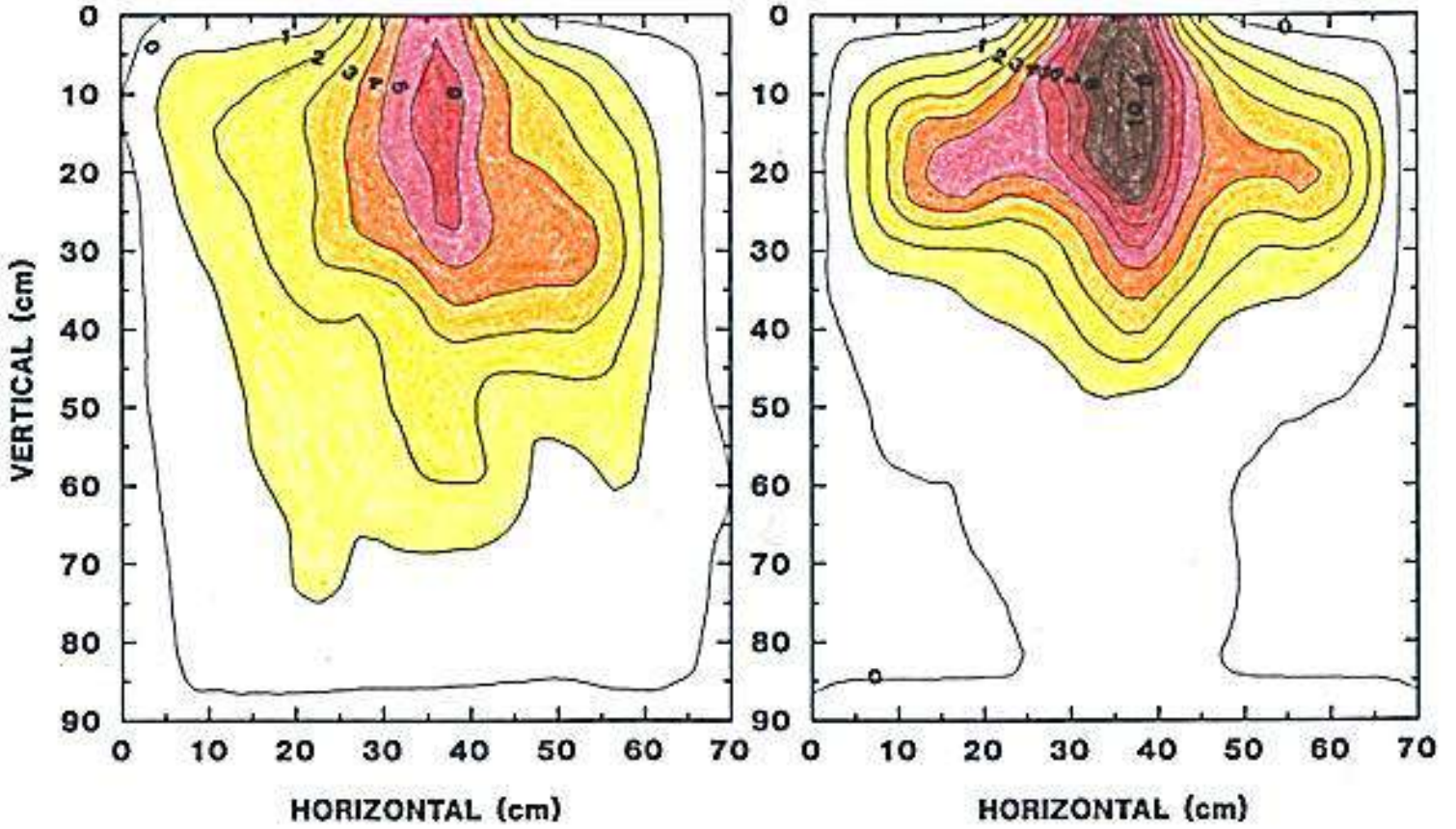
系統	乾燥耐性指数 ²⁾	子実収量 kg/ha	茎葉収量 kg/ha
TVu-11986	4.9	344.0	5,175
TVu-11979	4.8	916.7	4,735
TVu-7841	4.8	347.3	3,941
Suvita 2	4.6	202.0	1,713
TVu-7426	3.0	66.0	1,179
TVu-7368	2.8	108.0	1,337
TVu-8713	2.7	322.7	2,837
TVu-7778	1.5	344.0	1,959
TVu-8256	1.4	97.3	1,207
TVu-9357	1.3	68.0	1,070

注) 1) 面積12m²、1反復

2) ポット試験による乾燥耐性指数: 耐乾性(4.6以上)、  
中間型(2.7から3.0)、感受性(1.5以下)

TVU-11979

TVU-9357



•}2 •@ŠŔ‘‡‘Ñ•«CEn“••iTVu-11979•j,ÆŠ’Žó•«CEn“••iTVu-9357•j,Ì•ª,Ì•ª•z  
 ’••j•@••56cm,•[,³76cm,Œú,³4cm,Ì•ª” ,É,Ä2•TŠÔ•Í”l•B•}’†,Ì•”Žš,Í5cmŠp,đ’Ê%œß,µ,½•ª,Ì•”•B  
 •Å•%œ,ÉŠŔ“y•d—Êfx•[fX,Å20%,Ì•...,đŽ{,•B



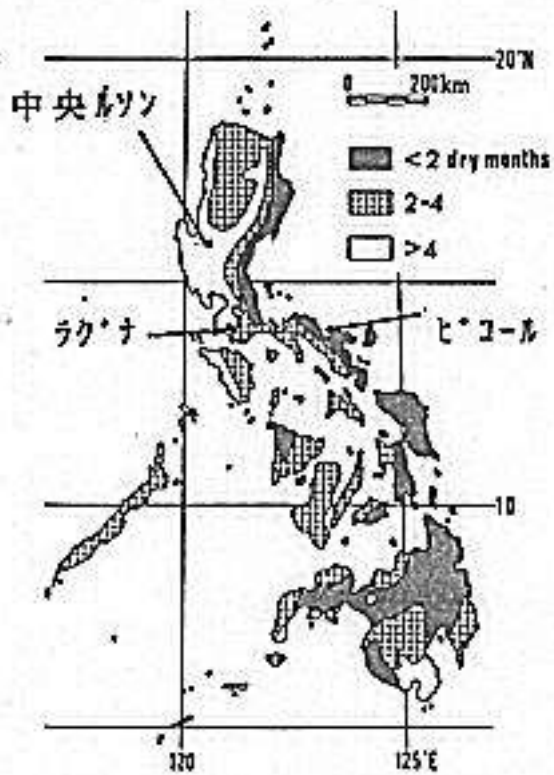


図1 乾燥月数によるフィリピンの気候区分図

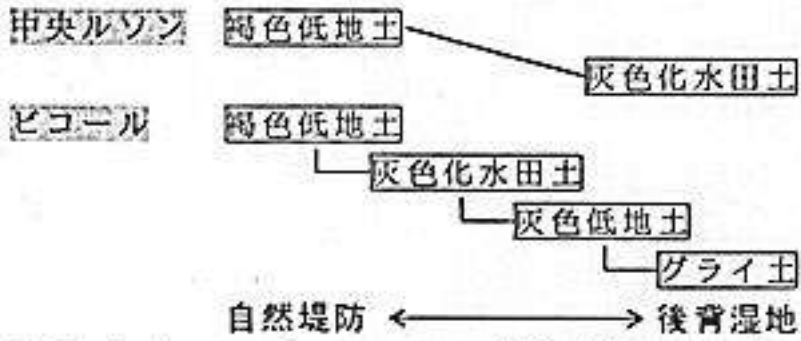


図2 中央ルゾンとピコールの低地土壌分布と地形条件

'†"f<f\j"•E'†%>f<f\j"n^æ,Æ"i" f<f\j"•EfrfR•[f<'n^æ,É,"-,é'á'n"y•ë•a•z,Æ'nœ`•ðœ•,]ŠÖœW

•i'••j•^a—P-¼,Í"ú-{|,Ì"•^ê"Í"y•ë•^a—P`ÌEn•ifyfhf•fWfXfg•§'k%öi•A1990•j,É,æ,é•B  
 •@•@•@ŠD•F%o»... "c"y,ÍYóYò•...Ž;•«•AŠD•F'á'n"y,ÆfOf%ofC"y,Í'n%o°•...Ž;•«•B



表1 フィリピンおよび熱帯アジア低地土壌表層部の  
主な特性の平均値と標準偏差値

	フィリピン(52点)		熱帯アジア(410点)*	
	Mean	S.D.	Mean	S.D.
有機態炭素 (%)	1.84	1.09	1.41	1.28
全窒素 (%)	0.17	0.11	0.13	0.11
pH (H ₂ O)	6.3	0.7	6.0	1.1
有効態ケイ酸 (mg/100g)	54.3	24.4	27.0	25.5
粘土 (%)	51.8	17.8	38.4	21.6

*

表2 中央ルソンとピコール低地土壌表層部の  
主な特性の地域別平均値と標準偏差値

地域	中央ルソン		ピコール	
	Mean	S.D.	Mean	S.D.
有機態炭素 (%)	1.17	0.59	3.05	1.01
全窒素 (%)	0.10	0.06	0.30	0.11
pH(H ₂ O)	6.6	0.6	6.0	0.4
CEC(pH7) (cmol(+) / kg)	30.7	9.6	44.7	10.9
交換性Ca (cmol(+) / kg)	22.1	6.4	31.5	9.2
交換性Mg (cmol(+) / kg)	9.1	5.1	11.7	3.6
交換性K (cmol(+) / kg)	0.3	0.2	0.4	0.3
有効態リン酸 (mg/100g)	3.4	3.1	2.2	2.2
有効態ケイ酸 (mg/100g)	46.0	19.3	59.3	15.7
粘土 (%)	43.6	17.8	70.2	13.3

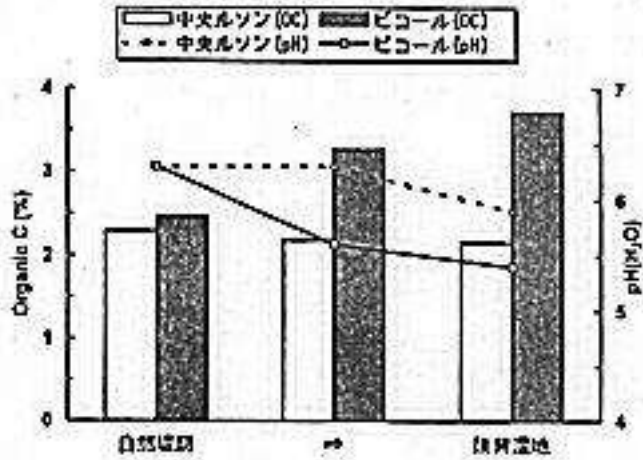


図3 中央ルソンとピコール低地  
土壌表層部の有機態炭素、  
pHと地形条件の関係



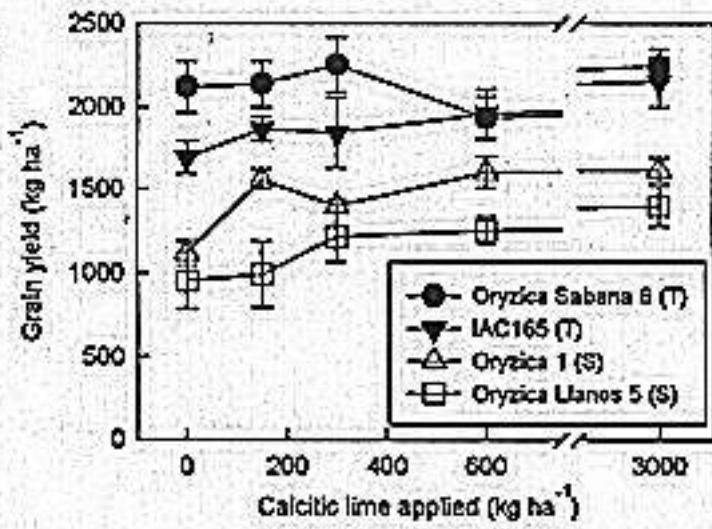


図 1. 圃場における酸性土壌耐性 (T) および感受性 (S) 陸稲品種の炭カル施用反応

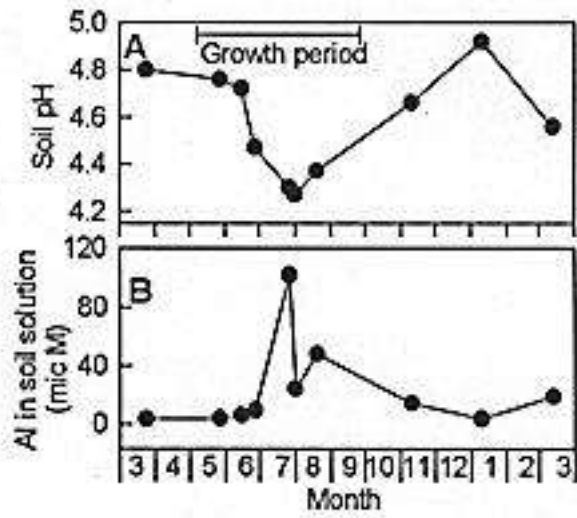


図2. 陸稲圃場の表層土壌の pH (A) および土壌溶液 Al (B) の季節的变化

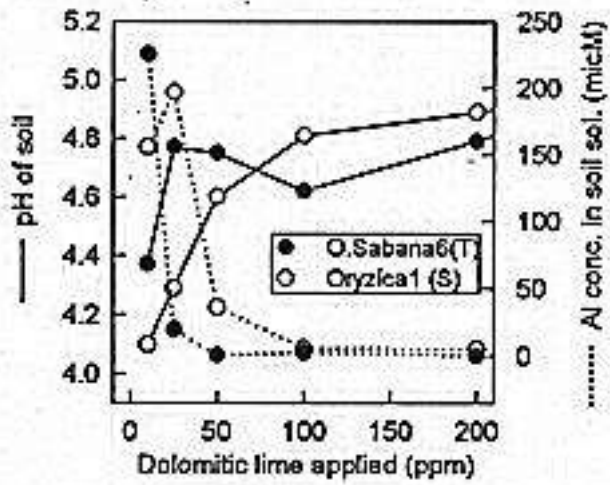


図3. 炭カル施用が酸性土壌耐性 (●) および感受性 (○) 品種の根圏土壌 pH および土壌溶液中 Al 濃度に及ぼす影響 (ポット試験)

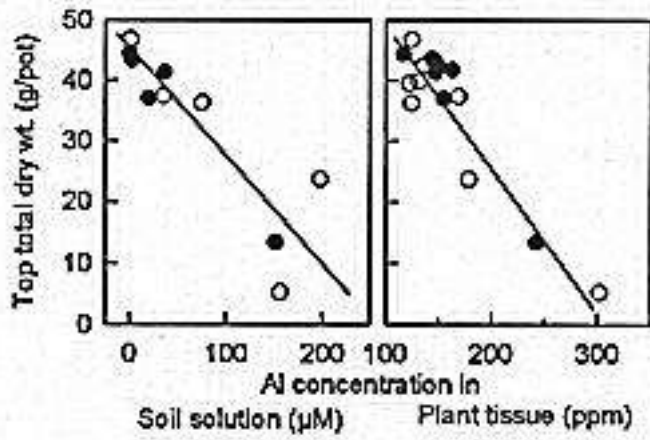


図4. 開花期における土壌溶液Alおよび作物体内Al濃度と、地上部生育との関係 (ポット試験, 凡例については前図を参照)





表1. タイの水田からのメタン発生量

地点	地域	土壌全炭素 (g/kg)	平均フラックス (mg/m ² hr)	湛水期間 (day)	全発生量 (g/m ² )
Bang Khen	中央	21.3	10.9±7.7	106-120	29±19
Chai Nat	中央	14.8	1.1	94	3
Khlong Luang	中央	17.5	3.1	83	6
Khon Kaen	東北	6.7	23.0	137	76
Phitsanulok	北	16.7	6.9±0.3	98-113	17±1
Phrae	北	ND	19.4±2.8	127-128	60±9
San Patong	北	13.4	13.3±2.9	101-103	33±7
Suphan Buri	中央	14.6	17.9±1.5	97-109	45±6
Surin	東北	6.3	13.3	129	41

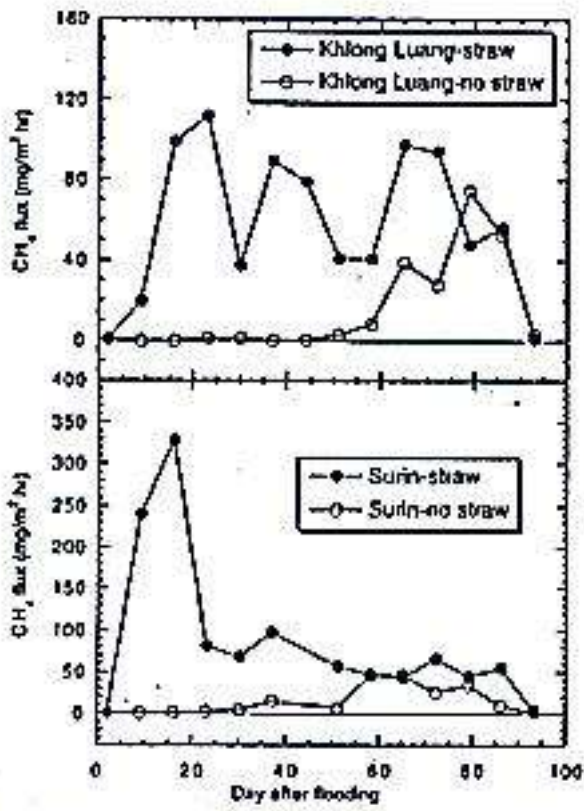


図1. 稲わらの施用がメタン発生に及ぼす影響 (タイ)

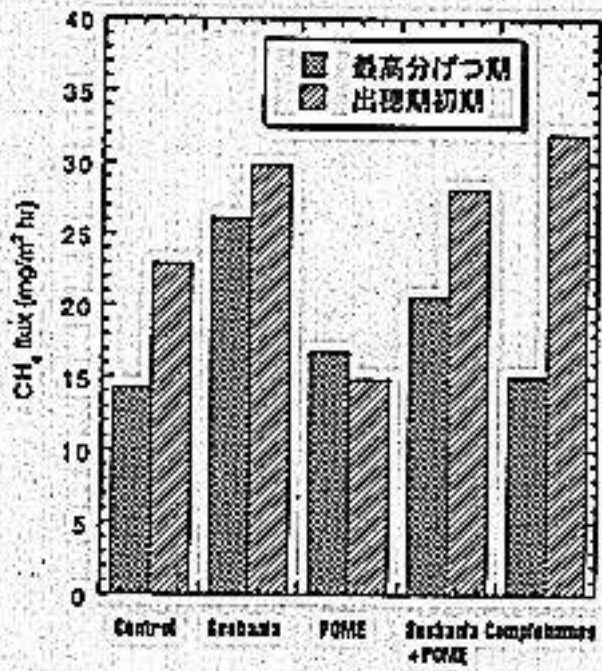


図 2. 緑肥と有機物資材の施用がメタン発生に及ぼす影響 (マレーシア)



表1 放牧試験における植生量の変化と土壌硬度の差異

	植生量 (1992-1994平均) (g/m ² )					土壌硬度 (kg/cm ² )
	5月下旬	6月下旬	7月下旬	8月下旬	9月下旬	
無放牧区	17.5	67.6	166.7	315.6	289.3	2.87
弱放牧区	22.2	37.7	88.7	115.3	115.3	3.50
中放牧区	15.3	37.0	66.4	99.0	54.1	5.57
強放牧区	11.9	12.9	25.7	30.8	18.1	8.66

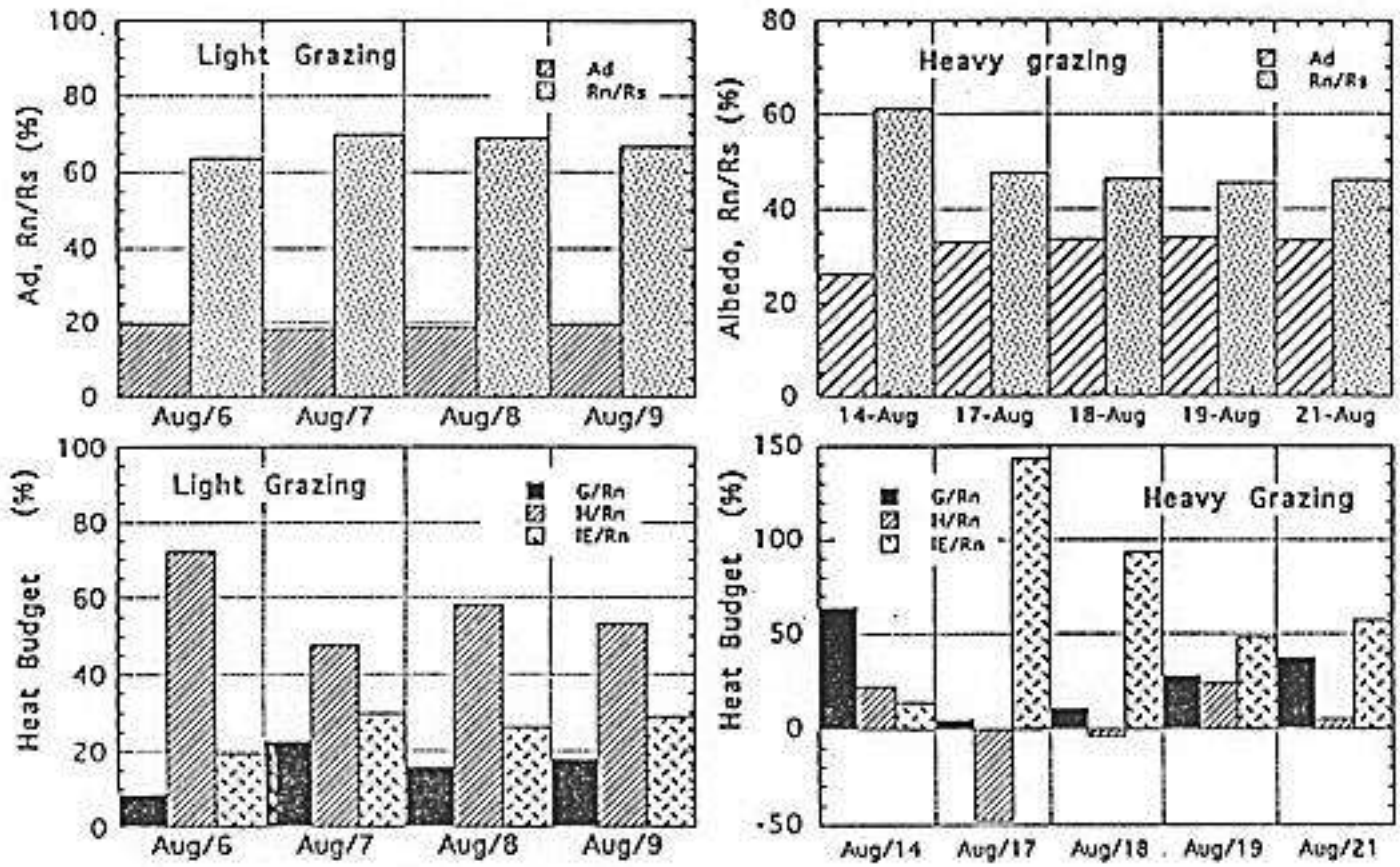


図.1 降雨後の弱放牧区(左)と強放牧区(右)の熱収支の変化  
 上段：アルベド, Adと日射と純放射との比率, 下段：熱収支配分, 純放射, Rn,  
 地中熱フラックス, G, 顕熱フラックス, H, 潜熱フラックス (蒸発散), IEの  
 Rnに占める比率.



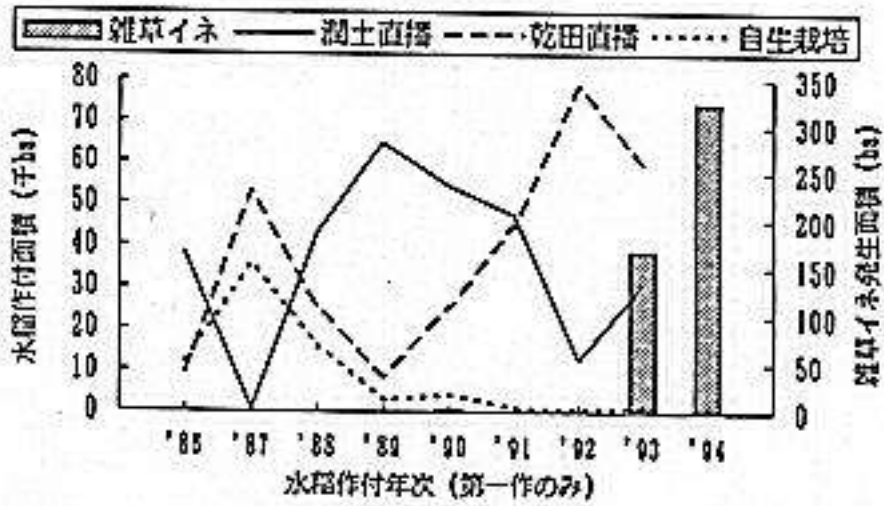


図1 マレーシア・ムダ地区の第一作における水稲栽培法の推移と雑草イネの発生面積



表1 ムダ地区に発生する雑草イネの形態と出穂期

形質	変異幅
稈長	51 cm ~ 188 cm
穂長	17 cm ~ 36 cm
一穂粒数	110 ~ 406
止葉長	15 cm ~ 57 cm
止葉幅	7 mm ~ 17 mm
籾長	6.8 mm ~ 10.3 mm
籾幅	2.0 mm ~ 3.1 mm
千粒重	9.6 g ~ 23.2 g
芒長	0 mm ~ 71 mm
出穂期	播種後 60 日 ~ 104 日

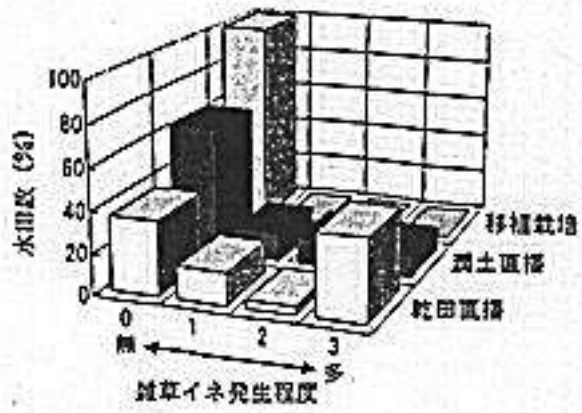


図2 農家水田における水稻栽培法と雑草イネの発生程度 (1993年, 1994年)

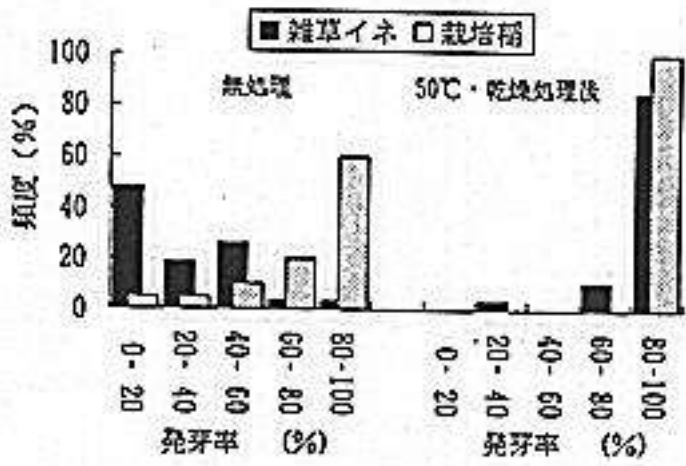


図3 農家水田から採取した雑草イネと栽培稲の種切の発芽率の比較



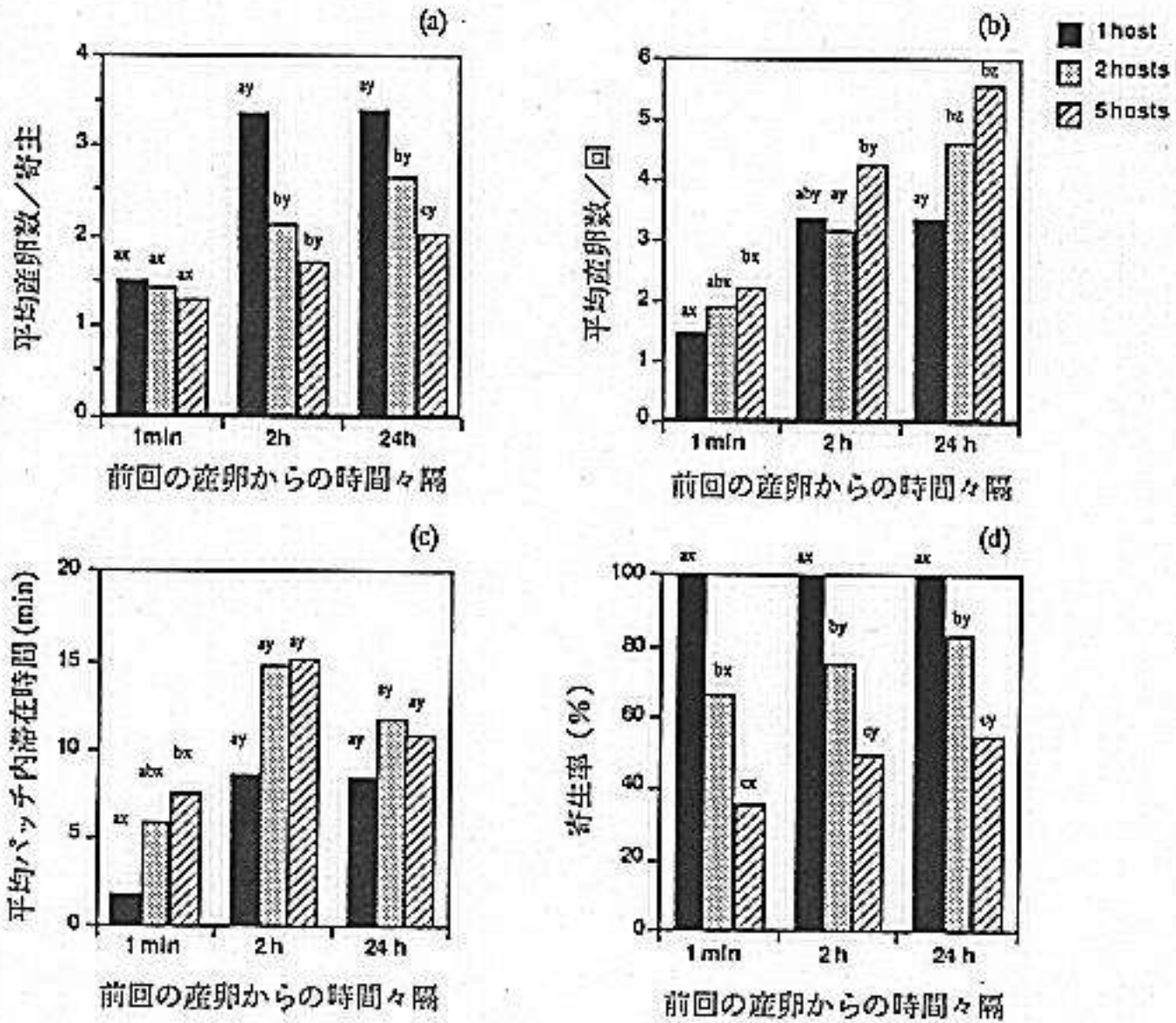


図1. 1, 2, 5頭の寄主をそれぞれ前回の産卵から1分, 2時間, 24時間々隔で1頭の*E. japonica* 雌成虫に与えたときの(a) 平均産卵数/寄主 (未寄生寄主を除いた場合), (b) 平均産卵数/回, (c) 平均パッチ内滞在時間/回, (d) 寄生率/回. 同一時間々隔(a-c), 同一寄主密度間(x-z)での同一アルファベット間には5%の危険率で有意差なし ((a), (b), (c); Tukey-Kramer法, (d);  $\chi^2$ -検定).



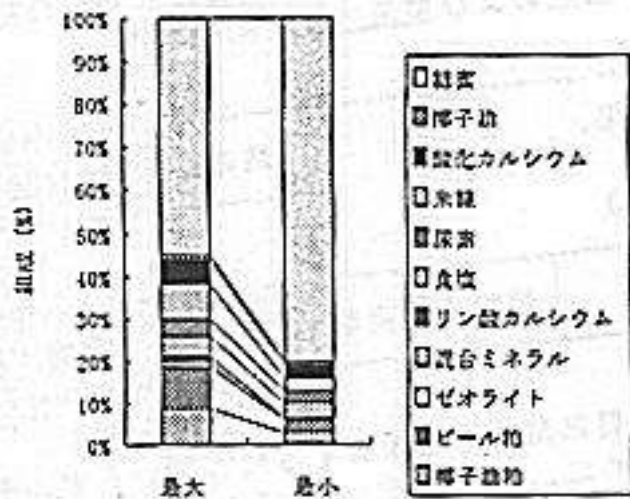


図 1 : LMB 組成の範囲

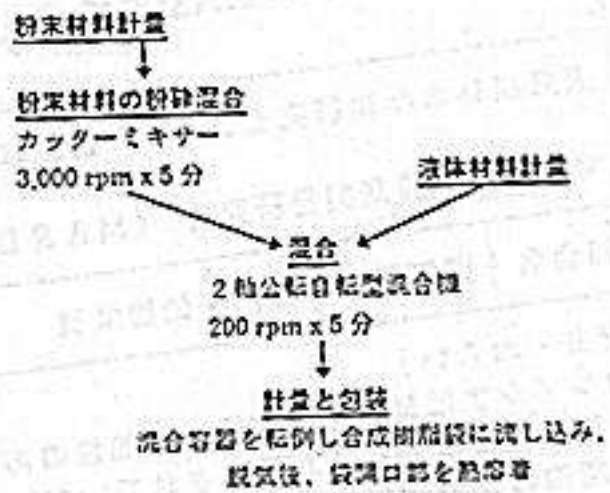


図2：製造方法



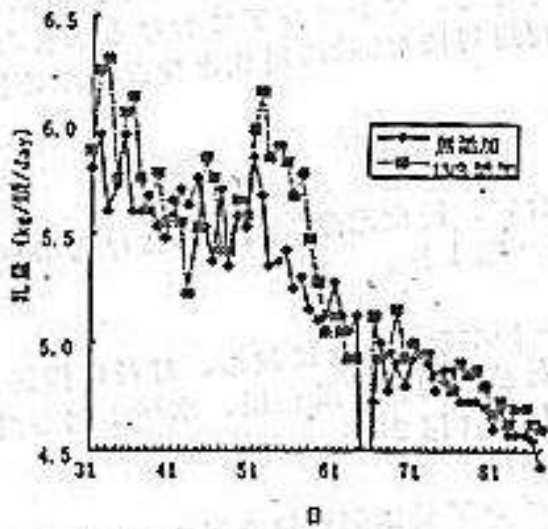


図3: LMB 添加が乳量に及ぼす効果  
ホルスタイン×ナヒワール雑種乳  
牛: 4頭/処理

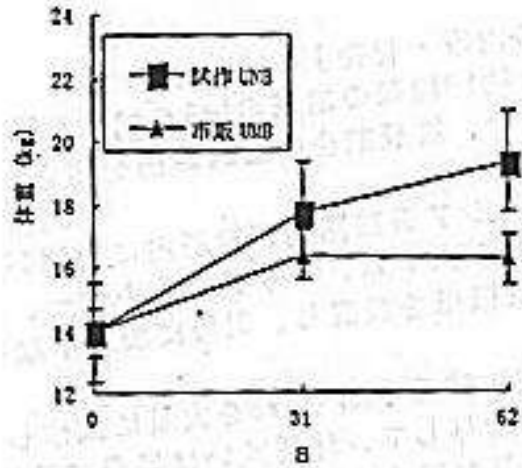


図4: LMB 添加が体重に及ぼす効果  
ドーセット×マリン雑種3歳処理

11. "M·N, E, ", "é fA fuf%of, fVCEs—t fTfCE+ fW, l—p

•m—v—ñ•n•F p f j f—úŽY•e•ŽY••, Ā, .é fA fuf%of, fVCEs—t, ĺŽ"—, ,E, .µ, Ā, ĺ%e' l, .δ—, ç, ©, É, ., é, .E, .E, .e, Ā, .e, .δ•M•N, ĺ•, ĺŽ"—, ,É"•z•f•A•←—, .é, ±, .E, .E, .e, Ā, . Ā••••, .E••••, .E••••, .δ•ŲŽY, Ā, ., é, ±, .E, .δŽĀ•O, .µ, ½•B

•m'S"•n•F•••Ū"—Ñ...ŽY•e•E•e•†fZ•f"•+•E' (ŽY••n"••A•f) fCEfVfA"—_e•EŠJ"—•E•e•†+MARDI

•m"A—•n•F 0298-38-6308

•m"•%ā•n•F•••Ū"—_e

•m•é—ā•n•F "•@•%•d—|

•m•Ī•Ū•n•F "•ü••E"•z—p••

•m••—p•n•F•••Ū

•m"•w•E+•E, Ē, ç, ••n

•@ f j fCEfVfA, Ā, Ī•Ž•CE l, ••, Ē, é, ½, .B•A•••z••A"••••, ĺŽ•@•—, ĺ, •, f, .B, Ā, ā, e•B"•e•ü•A•e•ŠE"•ē, ĺ p f j f—úŲŽY••, Ā, ., é••••, ĺ"—_e, Ī•A•fA fuf%of, fVCEs—t, ĺŽĀ•ŲŽY, É••, e'™"•ē, ½, é, é•E—t, ĪŠE"•Š•ŽŽ, Ā"•NSŌ1900—e f g f"•, É"•B, .µ, A"•pŠŪ, É••, oŠĀ•←•ā•ē, ā"•o, ••N, ±, .µ, Ā, ç, é•B, .µ, ±, Ā"•e"•N"•†•üŽē—e"•Ō, ĒŽ•CE l, Ā, ., é, Ā, .é fA fuf%of, fVCEs—t, .δŽ"—_ç%e•, .µ, Ā•, ĺŽ"—, ,E, .µ, ĀŠ"—p, .µ, e, .E, .µ, ½•B

•m"•%ē, ĺ"•à—e•E"•Á"•Yn

½•@•@ fA fuf%of, fVCEs—t, ĺŽ"—_ç ĺ f j f"•+ [, Ā•×, ©, •Ų"•l, .µ, Ā fTfCE f, É l, .B, é, ¾, ", Ā—ÇŽ, Ē fTfCE f fW, .E, Ē, é•B f j fCE fVfA•Ÿ—', ĺ p f j _E fP f%of"•f"•f"•Ži—Y••, É•←—^, .µ, ½•Ā%e•ŽŽE±, ©, ç•A fA fuf%of, fVCEs—t fTfCE f fW, ĺ%eĀ•Ā%e•%d—{•••—Ē, •ŠE"•†46%, Ā•A"•l, i, ç, É•C"•G, ., e%•d—| %e' l, ., é, ±, .E, .•"•>¾, .µ, ½•B

½•A•@ f ĺ fX f g %e fŠ fA ŽY"•z—p•E•δŽGŽi—Y••, .δ—p, e, ½32•TŠŌ, ĺŽ"—[ŽŽE±, ĺE%•ē+•i••@_P•j, ©, ç•A fA fuf%of, fVCEs—t fTfCE f fW, Ī•A, •, ē, .δ"•eŽ"—, ,E, .µ, ĀŽ"—_çŠE", ĺ30%'•o"•z•f•µ, Ā"•Ųç•, É•←—^, Ā, •, é, ±, .E, .•"•>¾, .µ, ½•B

½•B•@ fTf•f•q•+ f j •E f tŠ•+ fW fA f"•Ži"•ü••, .δ—p, e, ½27•TŠŌ, ĺŽ"—[ŽŽE±, ĺE%•ē+•i••@_Q•j, ©, ç•A fA fuf%of, fVCEs—t fTfCE f fW, ĺ"•ā"•ü••, ĺ"•eŽ"—, ,E, .µ, Ā"•M•N, ĺ—q"•, É•Ÿ, é, .E, .ā—, .δ, ç, É, e%e' l, .δ—L, ., é, ±, .E, .•"•>¾, .µ, ½•B

½•C•@—(E•e, †, ĺ—%eĒ, .δ•L•ñ, .µ, ½CE%ē•A••"•, ĺ"—_ç•e•E, Ā—|Z•p, Ž•e, .ā"•ü, ē, ç, ē, ½+ĪŽĒ•+•j•B

•m"•%ē, ĺŠ—p—Ē•E—"•Ō"••n

½•@•@ fA fuf%of, fVCEs—t, ĺ×, ©, •Ų"•l, ., é, ¾, ", Ā••, É•←—^, Ā, •, é, ĺ, Ā•A—|Z•p, .δ"—_e%e•B, ., ĺ"—_ç•e•E, .δ•Ī•Ū, .E, .µ, Ā•Ē—ĺ, Ā•E•e•Ī"•l, Ē•eŽ"—_ç"•üŽēŽē"•l, .E, .µ, Ā•••y, Ā, •, é•B, .µ, ©, .µ•A fA fuf%of, fVCEs—t, ¾, ", Ā, Ī•, .δŽ"—, .µ, ±, .E, .•, é, .e, ĺ, Ā•A f p f j •@•Šj"••, Ē, Ç, ĺ ĺ G f i f, fM•+ [, .ā"••Ži, ĺ•, •, e•ŽY••, E"•K•O, É•g, Ÿ•ç, ĺ, ĺ, Ā•←—^, ., é•@•K—v, ¾, ., é•B

½•A•@—|Z•p, ĺA fA fuf%of, fVĪ"•n•e, Ā, .é fA f jŠ fA•†"•+Ā•A"•E"•ĺA fWfA, Ē, Ç•A f j fCE fVfA"•ĒŠŌ, Ā, .ā••y, ĺ%eĀ"•••, ¾, é•B

½•B•@, ±, ĺE•e•†+•ē•Ē, ĺICA•Z•p•i—ĺ f v•f•W f jN f g•u f j fCE fVfA•←—pŽ"•E•Ž"—_ç%e•@•E•V%e•e•v, É"•Ū, ½, é, é—\•ē, Ā, ., é•B

•m, •, ĺ"•e•n

E•e, †%eĒ•Ū"•ē"•A•@•F"•M•N, É, ", ., é'•@"•Ū"•e•←—pŽ"•CE l, ĺŽ"—_ç%e•, ÉŠŌ, ., e•E•e•†

—_ŽŽ, e•••@•@•F•E•o•i

E•e, †ŠŪŠŌ•@•@•F+½•→7 "•N"•x+i+½•→2•4 "•N•j

E•e, †S"•—ŽŌ•@•@•FĪ"•c•E•F•E fA fuf•b fTf"••@ f ĺX f j f"•+ f j fCE fVfA"—_e•EŠJ"—•E•e•†•Š•j

"•••"•Ų"•M•F  
1. •Ī"•c•E•F•E fA fuf•b fTf"••E f ĺX f j f"•"•(1992). "M•N, Ā, ĺ f j fCE f p f j fCEs—t fTfCE f fW, ĺ•←—^, •"•z—p••, ĺŽ"—_ç, ĺ—p"••, .EŽY"•z—, ,E, y, Ū, %e•ç, •B"•e86%ā"•ū—|ŽYŠw%ā"•ā"•ū%e%e—vŽĺp76.

†A O.Abu Hassan, A.R.Azizan, M.Ishida and C.Abu Bakar (1993). Oil Palm frond silage as a roughage source for milk production in Sahiwal-Friesian cows. Proceedings 16th Malaysian Society of Animal Production Annual Conference, p.34-35. Pulau Langkawi, Malaysia.June 8-9.

½B New Straits Times (1992). Mardi finds commercial value in oil palm fronds. February 12. Malaysia. (•••••Ī"•).

[BACK](#)

表1 アブラヤシ茎葉給与肉用牛の発育と産肉量

項目	飼料処理区		
	10%茎葉区	30%茎葉区	50%茎葉区
飼料の配合割合	乾物%		
茎葉サイレージ	10	30	50
濃厚飼料	90	70	50
飼料摂取量(乾物kg/頭/日)			
茎葉サイレージ	0.70 ^a	1.83 ^b	2.71 ^a
濃厚飼料	6.32 ^a	4.26 ^a	2.71 ^a
日増体重(kg/頭/日)	0.75 ^a	0.62 ^{ab}	0.45 ^c
産肉量(kg/頭)			
赤肉	123.8	121.5	107.0
脂肪	76.4 ^a	58.1 ^{ab}	45.8 ^c

^{abc}: 処理間に有意な差のあることを示す(p<0.05)

表2 アブラヤシ茎葉給与泌乳牛の牛乳生産量

項目	飼料処理区		
	牧草区	30%茎葉区	50%茎葉区
飼料配合割合	——— 乾物% ———		
牧草	50	—	—
茎葉サイレージ	—	30	50
濃厚飼料	50	70	50
飼料摂取量(乾物kg/頭/日)	8.3 ^a	6.5 ^a	5.9 ^c
牛乳生産量(kg/頭/日)	6.5	6.9	5.7
飼料効率(牛乳量/摂取量)	0.78	1.06	0.97

^{abc}: 処理間に有意な差のあることを示す(p<0.05)



写真 飼料カッターでアブラヤシ茎葉を細切する肉用牛農家  
(マレーシア・パハン州)

後方に牛とアブラヤシが見える。

## 12. DNAf)•[fJ•[,ð—p,ç,é,½Zí' {,I'â'“”\—I•,,’è—@

•m—v—ñ•n•F %œE' {Z¼•a,â“û•¶ŽY,È,Ç,ì•¶ŽY«„É'í,.,é'â“”\—í,í,.,è.ÉDNAf)•[fJ•[,ð—p,ç,éŽè—@,ðŠJ”-,µ,½•BŠJ”-,µ,½Žè—@,ì—LCEø«„ð'â“”\—!•ACE`Žç,ÉŠÖ—^.,,é'â“”Žq””,æ,Ñ•,,è,É—p,ç,éDNAf)•[fJ•[•”,ð,à,Æ,É<á—j,µ,½•B

•m'S“—•n•F •••Ů”_—Ñ•...ŽY<Æœð†fzf“f^•[•E' {ŽY“•n”•A••Ů%œE' {œð†•Š(ILRI)

•m`A—•n•F 0298-38-6308

•m'“%ï•n•F •••Ů”_<Æ

•m•ê—â•n•F ' {ŽY

•m'î•Ů•n•F “û••E”÷—p•

•m•—P•n•F •••Ů

### •m'wœi•E,È,ç,ç•n

•@fgfšfpfmf)•[f],î'½—l,É.ï%œ»,.,é•ê—E””•A“û—Ê“™,ì•¶ŽYCE`Žç,ÉŠÖ—^.,,é'â“”Žq,ì%œð—¾,ì%œB'ö,É,.,ç,Ä•A^â“”Žq,É•B•Ů,µ,½DNAf)•[fJ•[•,Æ,µ,Äf)fcfNf•fTfef%œcfCfçDNA

,“”•(Eœ,³,è,Ä,«„½•B•],Ä,Ä•A^â“”Žq»,ì,à,ì,í“”è,Ä,«„È,-,Æ,àf)fcfNf•fTfef%œcfCfç“™,ìDNA•î•ñ,ð—p,µ,ÄDNAfEçfxfç,Ä'¼•Ů“l,Éfgfšfpfmf)•[f]•Ç,â“û•¶ŽY,Éy,Ů,“â“”l%œçç,ì'â,«„¾,âŽí {,ì'â“”\—í,ð•,,è,éŽè—@,ðŠJ”-,.,é•K—v,¾,.,é•B

### •m•-%œÈ,ì'â—e•E“Á•Y•n

‡@ DNAf)•[fJ•[•ÀÊ,¾fwfçf•,É,È,Ä,Ä,ç,éŽí—Y••,É,.,ç,Ä•ADNAf)•[fJ•[•fgfšfpfmf)•[f]•Ç,â“û•¶ŽY«„É—^,!,é'â“”l%œçç,ì'â,«„¾•iEø%œÊj,ð•,,è,.,é•@Žè—@,ðŠJ”-,µ,½•B

$$\begin{vmatrix} 1'R^{-1}1 & 1'R^{-1}Z \\ Z'R^{-1}1 & Z'R^{-1}Z+G^{-1} \end{vmatrix} \begin{vmatrix} u \\ s \end{vmatrix} = \begin{vmatrix} 1'R^{-1}Y \\ Z'R^{-1}Y \end{vmatrix}$$

1: 1を要素に持つ列ベクトル (N×1, Nは観測値数), R: 残差共分散行列 (N×N), Z: 各マーカー毎にMなら1, mなら-1を要素に持つ行列 (N×マーカー数, M, mはマーカー対立遺伝子), Y: 観測値列ベクトル (N×1), u: 平均値, s: DNA マーカー効果, G: DNA マーカー効果分散共分散行列。

l:1,ð—v'f,ÉŽ•,Â—ñfxfnfgfç•iN•~1, N,íŠí“”l””•j,R:Žç•œ•ŽŮ•s—ñ(N•~N),

Z,Šef)•[fJ•[•^,ÈM,È,ç1•Am,È,ç-1,ð—v'f,ÉŽ•,Â•s—ñ•iN•~f)•[fJ•[•”•AM,m•@ ,íf)•[fJ•[•í—š“”â“”Žqj,Y:Ší“”l—ñfxfnfgfç•iN•~1), u:½•í'l,•@s:DNAf) •[fJ•[(Eø%œÈ,G:DNAf) •[fJ•[(Eø%œÈ•ŽŮ•œ•ŽŮ•s—ñ•B

‡A•@ŠJ”-,µ,½Žè—@,ð,à,Æ,ÉCE`Žç,ì'â“”\—!•i0.2, 0.4),(E`Žç,ÉŠÖ—^.,,é'â“”Žw””•i60,90),.,è,É—v,µ,½DNAf)•[fJ•[•”•i’S””•A•ã^Ê30),ì,R,Ä,ì—v^ò,ð•Y,“ADNAf)•[fJ•[(Eø%œÈ,ì•^l,ÆŠJ”-,µ,½Žè—@,©,ç“¾,ç,è,½•,,è'l,Æ,ì'ŠŠÖCEW”•ð•,ß,½•j•\P•A•\Q•j•B.».ìCE%œÈ•A^â“”\—!,“”%œÄ,.,é,É,Ä,è,Ä'ŠŠÖCEW,ì,í,.,©,É•%œÄ,µ,½•B^è•û•ADNAf)•[fJ•[“S””,ð—p,ç,½•è•‡,ì'ŠŠÖCEW””,í0.5062^0.6667,Ä,.,Ä,½,¾•ADNAEø%œÈ,ì'â,«„ç30,íf)•[fJ•[•ð'l,ñ,Ä•,,è,µ,½•è•‡,ì'ŠŠÖCEW””,í0.6370^0.8177 ,Æ'â,«„“%œÄ,µ,½•B•],Ä,ÄDNAf)•[fJ•[•ð—p,ç,½•,,è,Ä,ìCEø%œÈ,ì'â,«„çf)•[fJ•[•ð'l,ñ,Ä^â“”\—í,ð•,,è,.,é,x,«„±,Æ,“”F,ß,ç,è,½•B

### •m•-%œÈ,ìŠ—p—Ê•E—“Ů“_•n

•@••Ů%œE' {œð†•Š•iILRI),Ä,í•Afgfšfpfmf)•[f]”•R•«“â“”Žq,É—x•Ů,.,éDNA,ð,.,Ä,É—¾,ç,©,É,µ,Ä,ç,é•B•],Ä,Ä•AZÄ•Ů,É•ñ••,¾,è,½DNAf)•[fJ•[•ð,à,Æ,É•A”•R•«“„ÆŠ`Žó«“„ðŽg,Ä,Ä—{Žè—@,ì“K—p,“œÄ“”\,Ä,.,é•B

### •m,»,ì'½•n

œð†%œŮ“è-½•@ •Ffgfšfpfmf)•[f]”•R•«“„ì'ç•-,ì,½,ß,ìŠt'b“Á•«„ìCEY”è

—ŽZ<æ•“•@•@ •F••Ůfvf•ifgfšfpfmf)•[f]•j

œð†šúŠÖ•@•@ •F•½•-,V”N“x•i•½•-,R•, V”N•j

œð†’S“—ŽÖ•@ •F•xŠ—œðŽç

”•^_•¶“™œ@ •F

An interactive procedure for analysing a combination of censored and uncensored traits in mixed models: Estimation of dispersion parameters. Genetic selection evolution (Submitted).

BACK

〔具体的データ〕

表1. 真のDNAマーカー効果値と推定DNAマーカー効果値との相関

遺伝率	娘牛数			
	500		1000	
	目的遺伝子数 60	目的遺伝子数 90	目的遺伝子数 60	目的遺伝子数 90
0.2	0.5928	0.5151	0.6812	0.5911
0.4	0.6649	0.5763	0.7276	0.6276

- 備考1：目的遺伝子数60の場合は1染色体内に2個の遺伝子があり、それを囲む3個のDNAマーカーがある（DNAマーカー間距離：0.5M）。  
 2：目的遺伝子数90の場合は1染色体内に3個の遺伝子があり、それを囲む4個のDNAマーカーがある（DNAマーカー間距離：0.33M）。

表2. 真のDNAマーカー効果値と推定DNAマーカー効果値との相関  
 （上位30のDNAマーカーを採用）

遺伝率	娘牛数			
	500		1000	
	目的遺伝子数 60	目的遺伝子数 90	目的遺伝子数 60	目的遺伝子数 90
0.2	0.7221	0.6741	0.7890	0.7639
0.4	0.7823	0.7316	0.8230	0.7961

〔その他〕

研究課題名：トリパノゾーマ抵抗性牛の育成のための基礎特性の検定

予算区分：国際プロ（トリパノゾーマ）

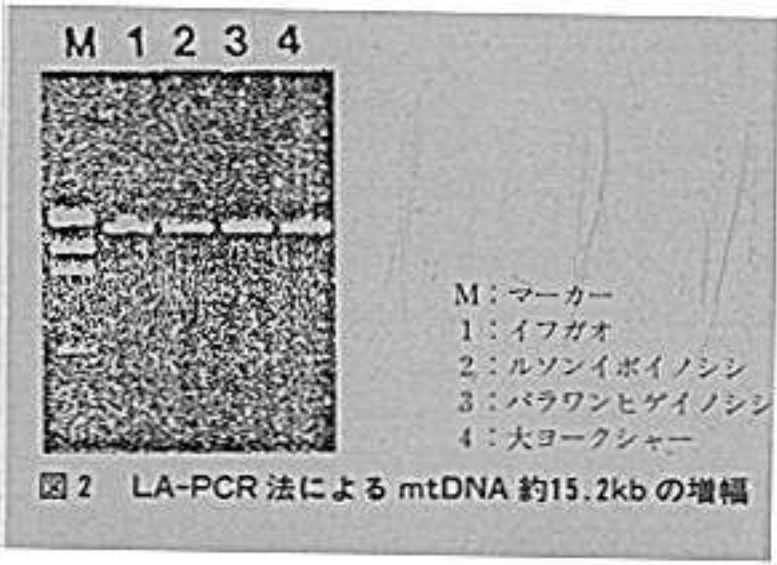
研究期間：平成7年度（平成3～7年）

研究担当者：富樫研治

発表論文等：Togashi, K. and J. E. O. Rege(1996). An interactive procedure for analysing a combination ofensored and uncensored traits in mixed models:Estimation of dispersion parameters. Genetic selection evolution (Submitted).







Lower Mix を分注	1サンプル 当 たり
10 × LA-PCR buffer	2 $\mu$ l
dNTP mixture (2.5mM)	8 $\mu$ l
Forward Primer (20pm/ $\mu$ l)	0.5 $\mu$ l
Reverse Primer (20pm/ $\mu$ l)	0.5 $\mu$ l
オートクレーブ済み蒸留水	9 $\mu$ l

↓  
ミネラルオイル 1滴 添加

↓  
94℃加温

Upper Mix 添加	1サンプル 当 たり
10 × LA-PCR buffer	3 $\mu$ l
Takara Ex Taq (2.5U/ml)	0.5 $\mu$ l
ゲノムDNA (500ng)	26.5 $\mu$ l
オートクレーブ済み蒸留水	

↓  
PCR

94℃	1分	1サイクル
98℃	20秒	30サイクル
68℃	20分	
72℃	10分	1サイクル

- ↓
- ・ 0.8%アガロースゲル電気泳動で増幅の確認
  - ・ 制限酵素による RFLP 解析  
(1%アガロースゲル電気泳動)

図1 LA-PCRの操作手順

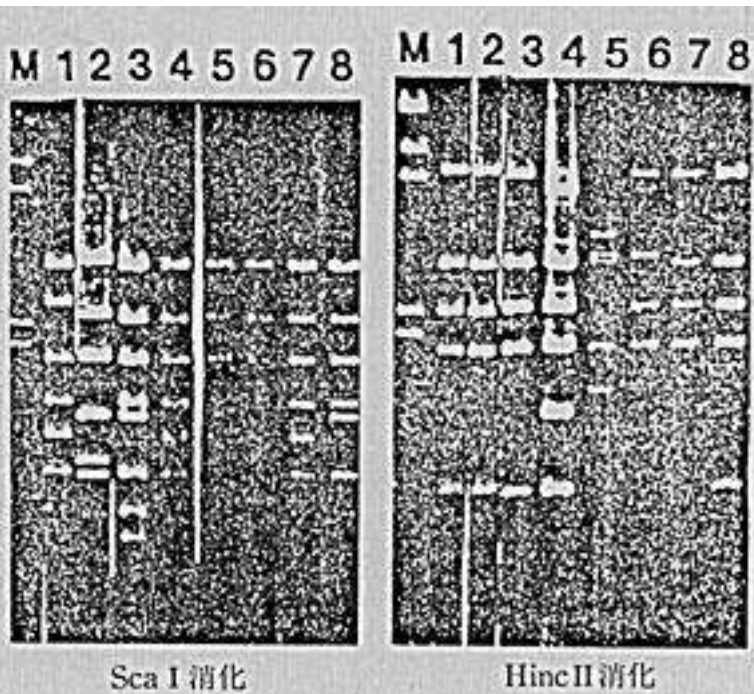


図3 フィリピン在来ブタ及びイノシシの mtDNA 型

- |               |                   |
|---------------|-------------------|
| M: マーカー       | 5: ルソンイボイノシシ      |
| 1: 大ヨークシャー    | 6: パラワンヒゲイノシシ     |
| 2: 梅山豚        | 7: イフガオブタ (IAS)   |
| 3: ニホンイノシシ    | 8: イフガオブタ (バナウエイ) |
| 4: リュウキュウイノシシ |                   |

14. 'n•}•i•ñ•^—•,E,æ,é'y'n•r"pSëCE"x,I•]%;Zè-@

•m—v-ñ•n•F Ž'CE'f}fbfvff•[f^fx•[fX,„.æ,Ñjff...[f%ef<flfbfgf•[fN,É,æ,è'y'n•r"p"òžq,đšw•K,.,é,f,ff<,đ^z,µ•A•r"pSëCE"x,đ'n•}•i•ñ.É,æ,è]%co<,µ,½•B

•m'S"~n•F ••Ů"~Ñ•...ŽY<ÆE□†fZf^f^•[•E' {ŽY'•n•"•A••ŮŠŁ'‡'n"~<ÆE□†fZf^f^•[iCARDa)

•m~A—•n•F 0298-38-6308

•m•%i•n•F ••Ů"~<Æ

•m•ê-â•n•F Ž'CE'ŠÇ—•

•m'Î•Ů•n•F •i•ñŠÇ—•

•m•—Đ•n•F ••Ů

•m''wCEi•E,Ě,ç,é•n

•@•A•(CEā'Đ•E'y•è•Z•H™™,l'y'n•r"p,đ%ēñ"đ,µ•AFTfXfefeifu<,È'y'n—~pCEv%æ•EŽ'CE'ŠÇ—•'Ī•đ,ÉŽ',.,é,½,•B•Ajjf...[f%ef<flfbfgf•[fN,É,æ,é'y'n•r"pSëCE"x,Ī•]%;Zè-@,đŠëCE"x,•,„é"~kCEÀŠEŠŁ'‡'n^æ.Ö%ēž—p,µ,½•B

•m•-%ōĚ,Ī"â—e•E"Á"Ÿ•n

‡@•@-k'CEVfšfA•EFAfuf_f.fAfwfYŽR'nžü•Ů'n^æ•uŽ'CE'f}fbfvff•[f^fx•[fX•v,•@•@,ç"CO,Ī214'n"~_É,,"~.é•u'y'n•r"p,Ī'đ"x•v•A•u•r"p,Ī%ce<ĭ,đŽđ,~,½•L,•@,è•v•W•,•AEXŽĪ•AŽĪ-Ē•Ű•Ē•A"y•è•A•A•¶,Īi•ñ,đ'Š•o,µ•A^è'è,ĪŠĪ'.É•),.Á,Á,KŠi%eo,µ,½ff•[f^fZfbfg,đ•i•~,µ,½•B  
‡A•@,„,è,½,è,Ī'n"~_..Éjff...[f%ef<flfbfgf•[fN•iNEUR092),ÉŠw•K,³,¹,é,±,Æ•@,É,æ,è•A•W•,•AEXŽĪ•AŽĪ-Ē•Ű•Ē•A"y•è,,"æ,Ñ•A•¶"x,•@,ç"y'n•r"p,Ī'u"đ"x•v,,"æ,Ñ•u•L,³,è•v,đ•,,"è,,"é,f,ff<,đ^z,µ,½•B•i•j,•P•j

‡B•@f,ff<,Ī•M—Š«•đCEŸ•Ŧ,µ,½CE%coĚ•A"y'n•r"p,Ī'u"đ"x•v,É,Ā,é,Ā,Ī86%•u•L,³,è•v,É,Ā,é,Ā,Ī79%,Ī"š—Ī,Ā,„,è,Ā,«,é,±,Æ,•Ži,³,è,½•B

‡C•@"y'n•r"p,Ī'u"đ"x•v,,"æ,Ñ•u•L,³,è•v,đ•"~%đ%žž,.,é,±,Æ,É,æ,è•u"y'n•r"@~p,ĪŠëCE"x•v,đ"¼,½•BŠëCE"x,³,„-•]%;co<,³,è,½'n•æ,Ī"•z"Á«•ĪāĪ,đ'½,ŠŮ•@,Đ"y•èCEĀ,É"Á"Ů,Ā,.,Ā,½,±,Æ,É,æ,è•AāĪ,ĪŠŮ—L—Ī,„y'n•r"p•A"Á,É•-%d,É,æ•@,é"y•è•Z•H,É%ce<ĭ,đy,Ů,.,Æ•„,³,è,½•B

‡D•@GPS,đ—p,é,½CE»nCEŸ•Ŧ,Ā,Ī•AŠëCE"x,³,„-•]%;co<,³,è,½ŽR'n,Ī-k"Đ"OŽR,•@,ç•@•½-Ī"•,É"Ůs,.,é'n•æ,Ā,Ī'S'æ,ÉfKfš[•Z•H,³,½,•oCE»,µ•A•]%;co<žè-@,Ī'Ā"~@•«,đŽi,µ,½,³•A"i"Đ,Ā,ĪŠëCE"x,Ī•„,³,đCE»•è,ĀŠm"Ŧ,.,é,±,Æ,•Ā,«,È,•@,Ā,½•B•i•j,•Q•j

‡E•@'n•}•i•ñ•^—•,Æfj...[f%ef<flfbfgf•[fN,đ—Z•‡,³,Ī,Ā"y'n•r"p,đ•]%;co<,„é%co,B,Ā,Īžè-@,Æ,É,Ā,½•B

•m•-%ōĚ,ĪŠ"~p-Ē•E—~Ů"•n

‡@•@f}fbfvff•[f^fx•[fX,ÉŠŮ,Ů,é,éŽ'CE'Ī,Ī—~p•i•ñ•i•ú-qAŽž-Ŧ"•Ī•A•k•i•j,đ•à-¾—v"đ,ÉŠŮ,B,é,±,Æ,É,æ,è•A,æ,èCE»ŽĀ,É•B,ęŠĀ«Ž'CE'•]%;co<,‰coĀ"~\,Æ,È,é•B

‡A•@Ž'CE'f}fbfvff•[f^fx•[fX,Ī•X•V•A.C•Ů•i•ñ,Ī"ü—Ī,³•K—v,Ā,.,é•B

•m,„,Ī"¼•n

CE□†%coŮ'è-¼•@•FfAftfšfj,ĪŠŁ'‡'E"~%ŠŁ'‡'n'Ñ,É,,"~.é•n,Īž'CE'•Ī"•@,Ī%cođ-¾,Æ•Ů'S•Z•p,ĪŠj"~

—ŽZ,æ•³•@•F••Ůfvf•i•n•Ů'S•j•EEo•í

CE□†šúŠŮ•@•F•½•~V"~N"x•i•½~CE³•,V"~N•j

CE□†S"~ŽŮ•@•FŽR-{—R'Ī'ā•E"i"~c"CE[•EGustav Gintzburger

"~.~_•¶™•@•F

Fujita, H., Yamamoto, Y. and Gintzburger, G.(1995),Establishment of a map database for@resources management and its application. Pasture, Forage and Livestock Program. Annual•@Report for 1995 (submitted). ICARDA.

BACK

### GIS：地図データベース

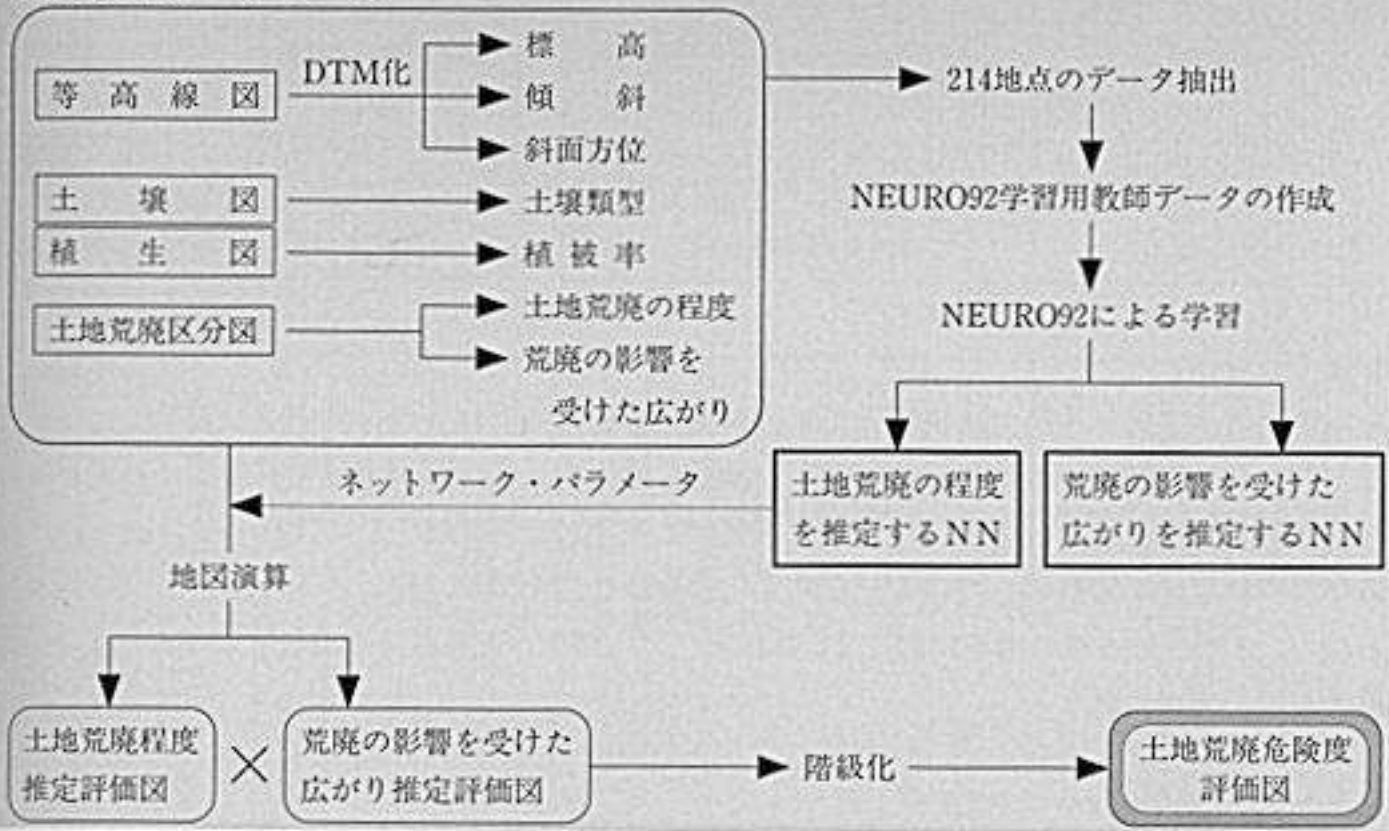
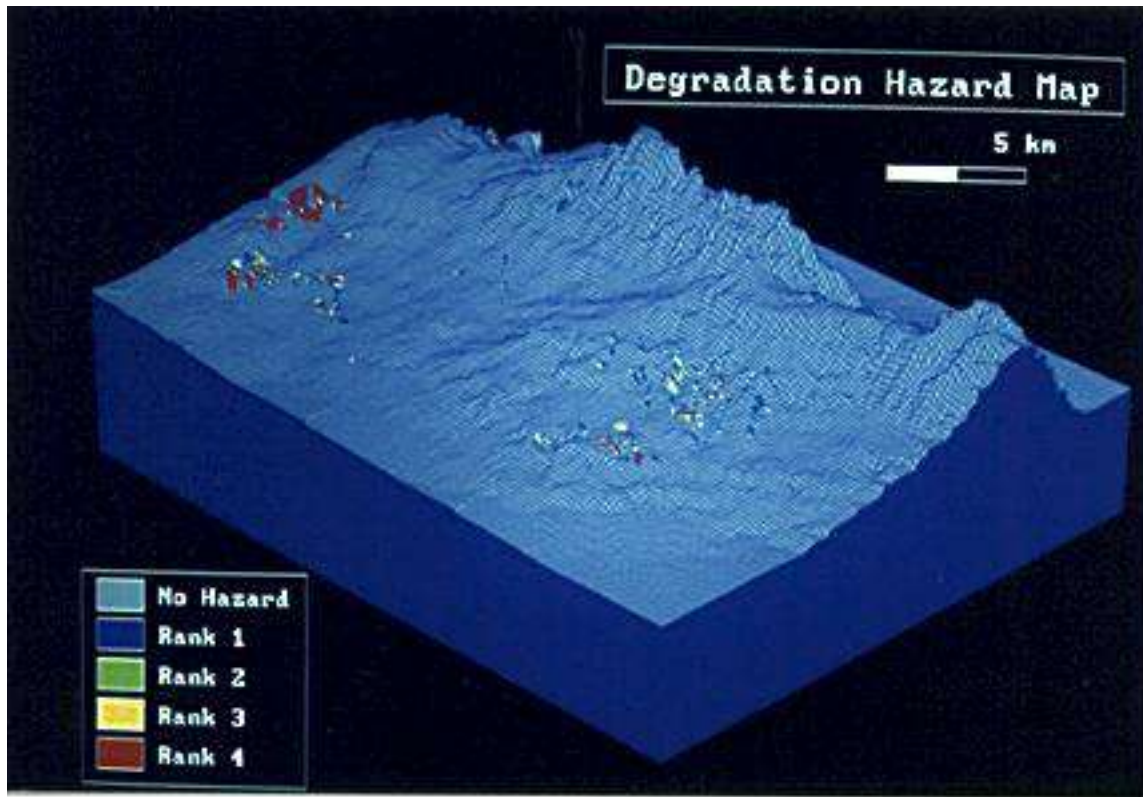


図1 土地荒廃危険度評価図作成の作業フロー







集・運材路

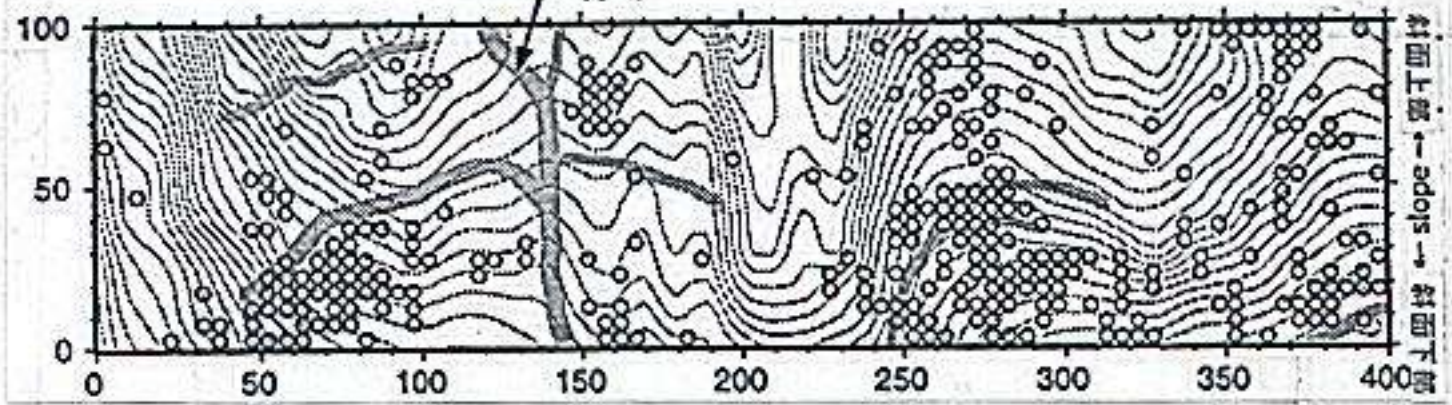


図1 択伐林における *Shorea curtisii* 種樹 (目 < 1.0a) の分布。  
集・運材路の内主線となる尾根筋には種樹が分布しない。

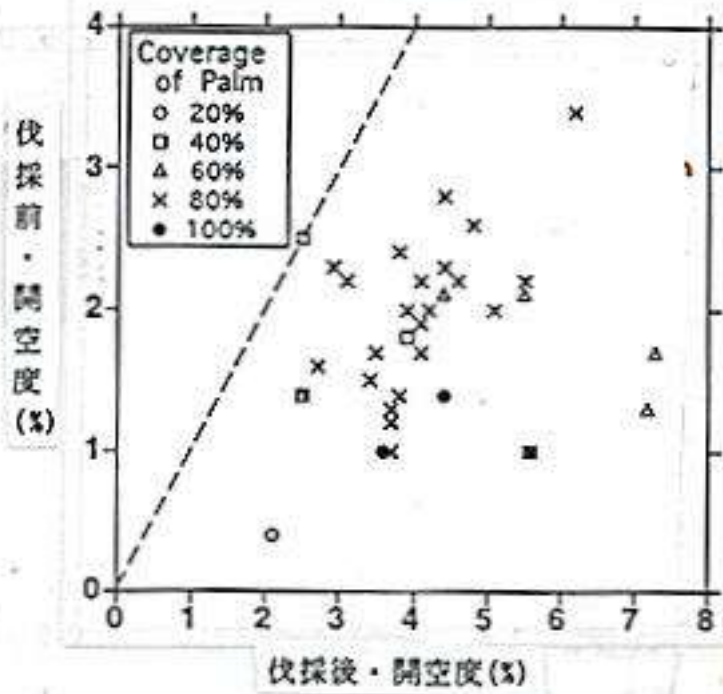


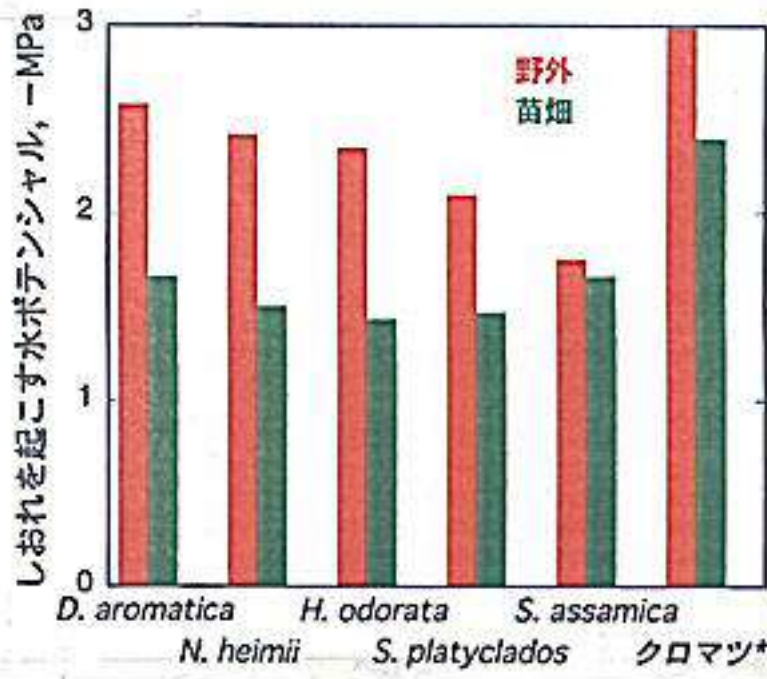
図2 叢生ヤシを除去する前後のShorea curtisii 稚樹上の林冠開空度の変化。ヤシの被度は除去前の稚樹位置での測定値を示す。

表 重度攪乱地の土壌の堅さと透水性

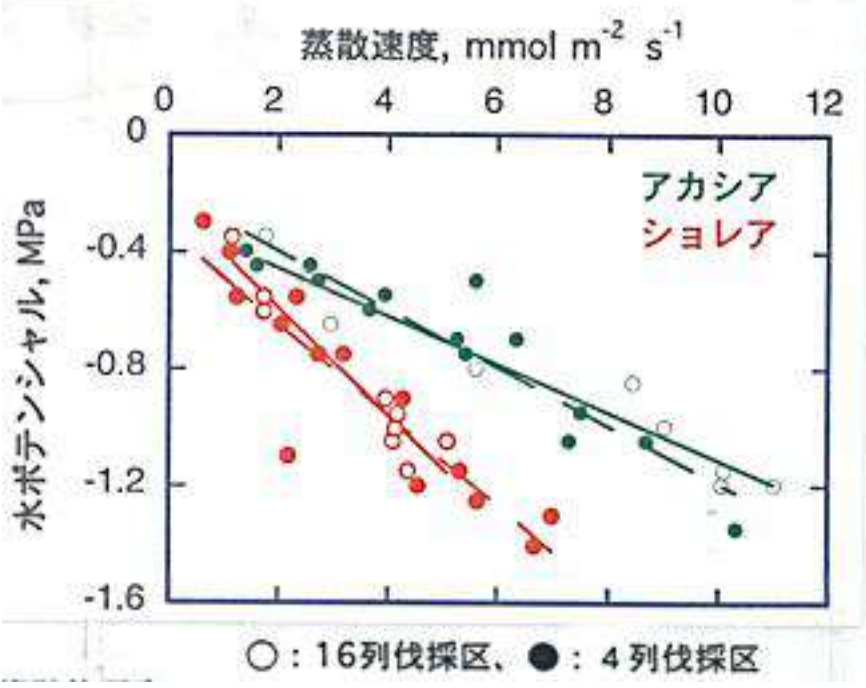
土壌の堅さ(mm)		透水性(ml/min)	
攪乱地	非攪乱地	攪乱地	非攪乱地
15.4	10.1	40.4	138.5

100地点の試料での解析値。





•},P•@•...f|fef“fVfff<,l•â“l,Í•,,ç,Ù,Ç,µ,;,”ê“i,-•A  
 Š£“‡“İ•<Ži,lfNf•f}fc,É”ä,x•Aftf^fofKfL,lfef“fVfff<,ª  
 ’á,ç•B



Q@ftf^fofKfL, ì•öŽU‘-“x, Í... flfef“fVfff<, ì’á%º, Æ, Æ, à, É< } ‘¬, ÉŒ, •-, µ•A  
 ’á, ç•... •ª’Ê“±•«„ ðŽì, •B^ê•û•AfAfJfVfA, Å, Í... flfef“fVfff<, ì<}Œf, ÈŒ»•Û, Í  
 , È, -... •ª’Ê“±•«„ •ª, ç, ±, Æ, •Ø-¾, ¾, ê, Ä, ç, é•B, Ü, ½•A•Æ“x, ì•, ç16—ñ”º•ì<æ, Æ  
 ’á, ç4—ñ<æ, Æ, ìŠÔ, É... •ª’Ê“±•«„ ì’á, «„ È^á, ç, í, È, -•ACEõ, ìŠÂ««K%öž•«„ É—^, !, é  
 %œ<ì, Í•¬, ¾, ç•B

17. • f p f C f f A f b f v f f . . . É . . . é O % • F y N H . l r . • ¶ Z A ° O . , E E y C E , l b 6

- m v - ñ n F f p f C f f A f b f v f f . . . Á . l A i a . E " H . É % . Á . Á Z l - É % • 0 . É E B . 0 . Á . Á y • e Z H . N . . . Á . e . é . ± . E . 8 - 3 / 4 . ç . 0 . É . µ . 1 / 2 . B . . . l E y C E : l b 6 . E . µ . Á . A • k • N % E B . a . e " - É . É f s f W f 3 f s [ . 8 • A Z l - É . l % 0 ] . É f E f B [ f s f f O • E f % e f u f O f % e f X . 8 • l µ . 1 / 2 . l . ç • A f s f W f 3 f f s [ . 8 S . e " µ . µ . Á • A f p f C f f A f b f v f . 8 • s k • N • e • A . . . é 0 - @ . 8 ' g . Y - § . Á . 1 / 2 • B
- m S " - n • F • • Ú " - N . . . Ž Y . E E 0 • † J Z f f • l • E % e " e Ž s • Š • E " n - † Ú Z • ( E 0 • † Ž
- m A - • n • F 09808-2-2306
- m " % ä n • F • • Ú " . E
- m é - ä n • F " y • e
- m f • Ú n • F " 1 / 4 . l % e É Z s - †
- m " - b n • F s s .

- m " w C E i • E . É . ç . e n
- @ • B " N • A % e " e - [ " 3 . 0 Z n . B . E . . . e " 1 / 4 " " ? . l % S Y Š C " e . É . " . e . Á • A • — É . l • Ó y . Š C - m . É — • 0 . µ • A f T f f J S • É . l • ¶ Ó E n . É • d • á . É % e e ç . 8 y . Ú . µ . Á . e . é • B . E . . . É • A f p f C f f A f b f v f . l • % Š ú ¶ " . " x . e . 1 / 2 . B . É • A f p f C f f A f b f v f " . l E f . µ . e • N • H . 8 Z 0 . " . á . . . • A • Ó y — • 0 . l E " 0 . É . È . Á . Á . e . é • B . ± . ± . Á . l • A . P y j E 0 " g Ž 0 " - É . @ Š B . 8 - p . e . Ā f p f C f f A f b f v f . . . É . " . . e y • e • N • H . l r • • ¶ Z Å ° 8 " c " - . . é . E . A . é . A . Q j Ž l - É " 11 m • E Z l - É Š p 3 " x . l E X Ž f g . 8 - p . e . Ā E y C E . l b 6 . 8 ' g . Y - § . Á . 1 / 2 • B
- m " - % É . l b 6 - e • E " Á Y n
- ‡ @ • " y • e Z • H . l r • • ¶ Z Å ° F E 0 " g Ž 0 " - É . @ Š B . 8 - p . e . Ā • A f p f C f f A f b f v f • e • A E B . P " N Š Ó . É . " . . e " y • e Z • H . l r • • ¶ Z Å ° 8 " . 1 / 2 E % • É • A " . É • b • e " a . l • i • e " H . É % . Á . Á Z l - É % • 0 . É E B . 0 . Á . Á • Z • H . i . n . Á . e . é . ± . E . 8 - 3 / 4 . ç . 0 . É . µ . 1 / 2 • i • l . P j • B
- ‡ A • Z l - É % 0 ] . l • H " l . l E 0 % e • F Ž l - É " 11 m • E E X Ž l Š p 3 " x . l Ž l - É % 0 ] • 1 m . É f E f B [ f s f f O • E f % e f u f O f % e f X . 8 • l µ . 1 / 2 • a . e . " . . . é . é f p f C f f A f b f v f • e • A E B . P " N Š Ó . l " y • e — • S - É ( 0 . 07 k g m • 0 ) . l • A • l • e • a . l " y • e — • S - É ( 7 . 48 k g m • 0 ) . l - 11 / 100 É % 0 . Á . . Á . 1 / 2 • i • l . P j • B
- ‡ B • @ • s k • N • f l . l E 0 % e • F Ž l - É " 11 m • E E X Ž l Š p 3 " x . l Ž l - É . É S E Z • a [ . 0 . ç 8 E Z % e " l . Ú • @ . Á f s f W f 3 f f s [ . 8 • l µ . 1 / 2 . l . ç . e " µ . µ • A 9 E Ž " † • l . É f p f C f f A f b f v f . 8 • s k • @ • N • e • A . µ . 1 / 2 • a . e . " . . . e " e • A 8 f - e Ž Š Ó . l " y • e — • S - É ( 0 . 07 k g m • 0 ) . l • A • l • e • a . l " y • e — • S - É ( 1 . 01 k g m • 0 ) . l - 11 / 14 É % 0 . Á . . Á . 1 / 2 • i • l . Q j • B
- ‡ C • " y • e Z • H . l E y C E . l b 6 • F 4 E Z . É k • N . µ . 1 / 2 l - É . l % 0 ] . É f E f B [ f s f f O • E f % e f u f O • @ f % e f X . 8 • A " - É . É f s f W f 3 f f s [ . 8 • l µ . 1 / 2 . l . ç • A 8 E Z . É f s f W f 3 f f s [ . 8 S . e " µ . µ . Á f p f C f f A f b f v f . 8 • s k • N • e • A . . . é 0 - @ . 8 ' g . Y - § . Á . 1 / 2 • B
- m " - % É . l Š - p - É • E - " Ó " . n
- ‡ @ • @ Š µ s . l Ž l " l . É . a . e . e • s k • N • f l . µ . 1 / 2 f p f C f f A f b f v f . l • % Š ú " - . l • l • E • a . e " a . x . Á Z a Š ± — 0 . é . • A Z u Š n Š ú . Ú . Á . É . l . Ú . Ú % a • e . µ . 1 / 2 • B
- ‡ A • @ • s k • N • f l . Á . á . e . é • è . E . É . e Ž G • 8 • b • a . e . . . é . 1 / 2 . B • É • A f p f C f f A f b f v f . l • e • A . P j - e Ž O . É f O f - f z f v f l [ f g • 0 . 8 • A • e • A . P j - e Ž E a y . N . Q j - e Ž E B . É D C M U • Ú . 8 Ž U • z . . . é . E . a . e • B
- m . • . l " 1 / 4 n
- ( E 0 • † % e Ú " è - 1 / 4 • @ • F f p f C f f A f b f v f . . . É . " . . e " y • w f V X f e f . l . Á . e . " y • s — • 0 . É y . Ú . % e e ç . l . l % 0 - 3 / 4
- Ž Z . a • A • @ • @ • F E 0 Š Q - h Ž - m • Ó " y — • 0 • n
- ( E 0 • † Š ú Š Ó • @ • @ • F • 1 / 2 • - . R • . V " N
- ( E 0 • † S " - Ž Ó • @ • F
- E " a • v • E " a • e — Ç • → E • i • e " ( E 0 " n • " . Š Á E 0 • j • E " J • i ( E • i • ( E • • Y • a • B " Ž Z j • E • — N • @ • A • E " † - i • @ Š " E Š Á Š Ó • G • e • i " . Š Á E 0 • j
- " . A " _ ¶ " 1 / 4 • @ • F
- E " a • v . " y • e — L • @ • " . l E " Ó . E • @ " \ " . E • Z • p l E n " y • e " l — . e • Ó • a . P Š " • i " . ¶ • j • Ç • a • e . U • † • A p . 48 . l 8 - 13 • @ ( 1995 ) .

BACK

[具体的データ]

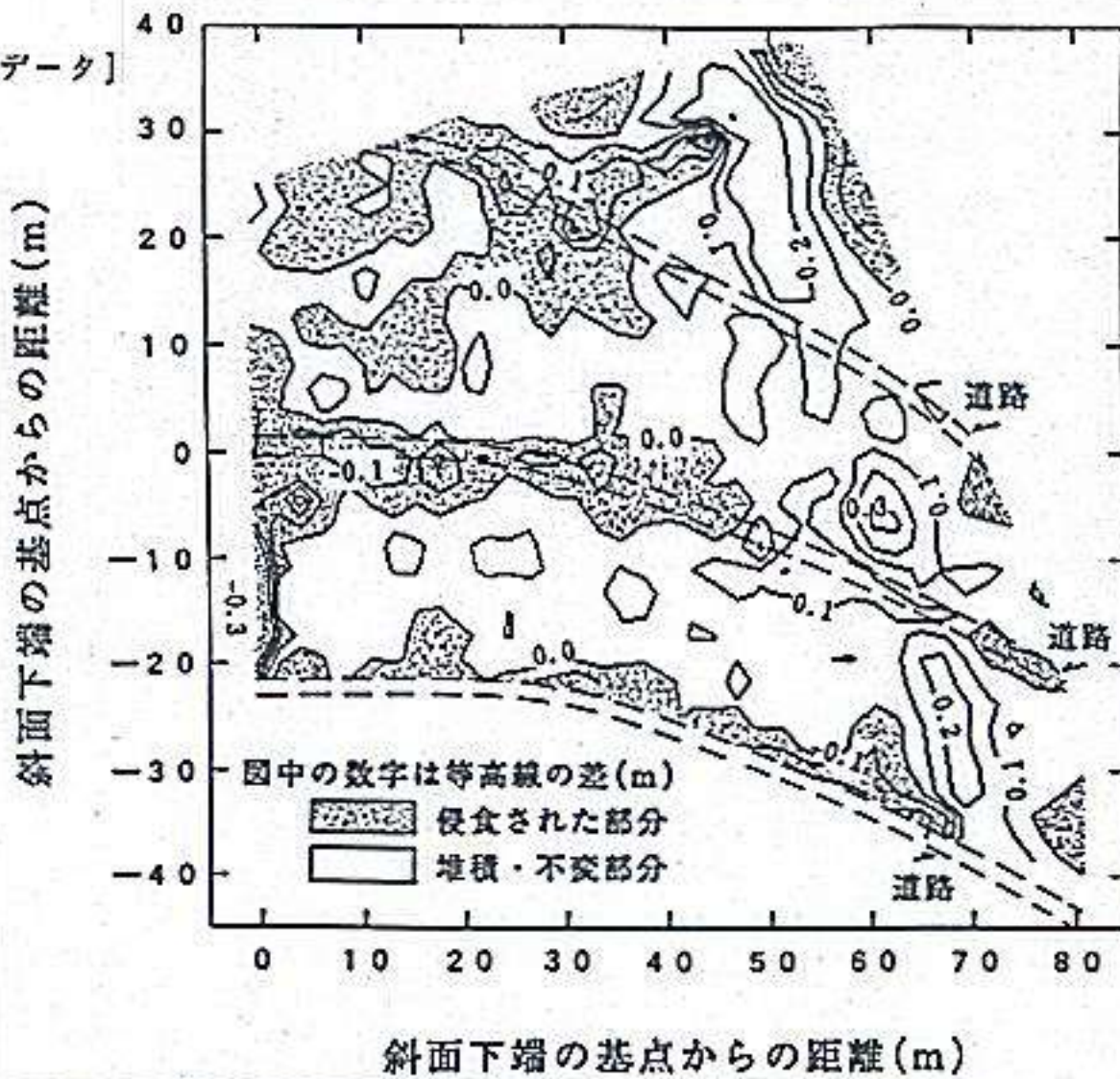


図1 光波式距離測定装置を用いた土壌侵食の実態(93~94年)



表1 土壌侵食に対する被覆作物の効果

処理区	積算土壌流亡量(kg m ⁻² )		
	4ヶ月	8ヶ月	12ヶ月
対照	0.00	1.12	7.48
ウイ・ビ・ンク・ラフ	0.01	0.02	0.07
アラキス・ビ・ンク	0.00	0.01	0.01
有機物マルチ	0.00	0.00	0.03

••@•P—¿,ÍfIfsfAfOf%.fX

表2 土壌侵食に対する不耕起栽培の効果

処理区	積算土壌流亡量(kg m ⁻² )		
	4ヶ月	8ヶ月	12ヶ月
対照	0.82	1.01	1.80
不耕起栽培	0.02	0.07	0.61
緑肥すき込み	0.30	0.72	1.84
有機物マルチ	0.00	0.00	0.04

••@•P—¿,ÍfIfsfAfOf%.fX

18. T n Y u (E ^ a E j G f j f M [ - { % t l ' u , i S l } ^ -

•m-y-ânoF %c- p, l w l ' y e , â p H ' y e , É ' a ' , é , é s - Ç Š Â c ' y e A ' p x ' n e , Á , l w % ^ . . . } k e - . . . % e o , â s ' n , É , Ç s ' , l ' l ' É , s ' K , É ' n e , Á A ' H ' n , É s ' Y ' u E ' d - l s - p E - { % a Š Ç - - , â s , l , , É ' l ' Á , e , é - { % t l ' u , i S l } ^ - , p , % B

•m'S^•mF +•Ü' _•N'... ŽY.ÉEÉ•tZf'f'•(Ék•c•Zš•S•@•i•'•a•u•f'KE•tZ'

•m'Á-•m'F 09808-2-2306

•m'•%ânoF +•Ü' _•E•A-â•A' }•E•A•â•B' _•E

•mô-ânoF +l'

•m'f•Ü•mF +â•D-â

•m'•-ânoF +•Ü

•m'w(ÉEÉ.É.Ç.e•n

•@%—p, l w l ' y e , â p H ' y e , É ' a ' , é , é s - Ç Š Â c ' y e A ' p x ' n e , Á , l w % ^ . . . } k e - . . . % e o , â s ' n , É , Ç s ' , l ' l ' É , s ' K , É ' n e , Á A ' H ' n , É s ' Y ' u E ' d - l s - p E - { % a Š Ç - - , â s , l , , É ' l ' Á , e , é - { % t l ' u , i S l } ^ - , p , % B , p , @ , p , l ' , ' , Á - p , e , Á , e , e l ' u , l ' a ' u - l , š ž , e ž l ' y ' a , É ' Y ' u , p A - { % t , l ' a ' ' a ' @ , â s , D K - y ' , , â A ' O ' l ' n ' e , Á , l } - - p , l ' y ' K , Á , é B , e , z , Á Š l ' ' y ' n ' e , Á A ' H ' n , É ' Y ' u , p % a d ' . . . â - - p j A ' d - l , â - p , e , ' A - { % a Š Ç - - t i ' y ' E ' , , j , â s , l , , É ' l ' Á , e , é - { % t l ' u , i S l } ^ - , p , % B

•m'•%É. l'â-•E'ÁYn

•@'•u, l f x f b j g i - @ , l ' i 60cm•A' ( ' l 5cm•A' , '6m•AŠT- - , š l l a š a š ) , É ž , p , % B

•@•@- { % t f ' f ' N • F l , e , â l ' f x f b j b F 2 , Ō , l - { % t Y ' , l A f ' f ' N , â l ' f x f b j b l @ [ , e , â , . . . i 20cm } , p A d - l , . . . E , p , Á f x f b j b , Ō , Á ' z , . % , â f f ' f ' v ' i ' d - l j , l @ s - y , Á , é B

•!A@ f x f b j b ' a , l - { % t - É , l A ' ' @ ' w • F 4 ' a , l j [ l f ' f ' f x f b j b • F 5 , É , e , â - { % t - É , ' ' É ' @ , É , É , é , e , p , É ' ' @ , ' , â - { % t , l f x f b j b ' e ' , l } Y ' o • F 6 , É , e , â f x f b j b - [ , Ō , Á @ ' z , @ , é , é B

•!B@ f x f b j b ' a , É ' u , Á , % a d ' . . . i T n Y ' u , l b • t j , l ' r , . . . • F 7 , É , e , â f x f b j b Š Ō , É @ ' y o , , é B

•!C@ f j b j f ' • F 8 , l f x f b j b , @ , ç , l - { % t , l R , é , â , h , - A ' ' s ' o ' Á • F 9 , l f x f b j b ' a , É ' u @ ' Á , % a d ' . . . â W , B , é i É , , z , E , l , Á , e , é j B

•!D@- { % t Y ' o j V [ f g • F 10 , l A , Y ' o • F 6 , @ , ç - { % t , â , z , e d , ' ' l ' n ' e ' , É ' Y ' o , p A @ - h ' j V [ f g • F 11 , l a ' , l ' , Y ' o • F 6 , É ' u , é , l , â , h , @ B

•!E@ ' T n F 12 , l a ž l ' e o z . . . • t p , l j X j f ' j W f j b j v , Á A - N • s Ç ( E • Ō , É , e , â - { % t @ , â l ' n ' e ' , e , â e , É , Ō , Á ' z , - B ' ' Ō Ž Ū - h Z - t • F 13 , l ' n , l ' Ō Ž Ū , â h Z - A A - É i @ ' ' - h Z - A % d ' . . . e • Z A ' l ' n , l , % e , Ō , % , l a , É , % e - h Z - É , Ç , l - Ū ' l , É % z , f , Á Ž ' • @ @ , Ž ž , e ' , , é B

•!F@- l ' ' u , â , Y Ž Z , p , Á f g l j g A f j f ' , É i d , e , ' A , ' Á , Ō , e , â A j j u • A f ' f ' Q ' l ' J ' C ' ' ' ' , F H n , Á ' l ' p , % , E , z , â A ' S , Á ' F ' % a ' ' A ' A ' y ' k , E ' a , x , Á , â ' • F , l , É , e , â , l , Ž Ō Š n , Á , e , % B

•m'•%É. lŠ - p - É E - ' Ō ' , n

•@ , . . . l , , é ' , â p H , â % - t w l , É , Ç s - Ç ' y e ' n ' e , â A ' l ' T ' y e , l , É , e ' p x ' n e , Á ' K - p % a ' ' , Á , é B , l ' y , Á , l A ' d ' c ' u , l , É , e , Ō , % e E ' e 0 % e , E , p , Á - - - p , A , e , é B Š e - t Ō , É ' l , , é A ' K - { % t ' z ' s ' A ' y ' e ' ' o s s Š Q , l ' l ' e @ • A ' l ' n ' a ž e ' e ' - - , l e @ • A ' l ' n ' e , É , } k e - - t w l e , ž i ž l ' y ' a ' Y ' u j , E , Ç , l E Y ' e B ' ' a y , Š ' Š Ō ' Á - , â v , p , % B

•m, s, l'•en

ÉE•%É.Ü'è-â•@-FŠÂc•"aÉ^•EjGfj fM[-{%t l' u, iŠ l}'

-ŽZ.e••@•@-F%É.Z' pE•F' Št b

ÉE•tŠúŠŌ•@•@-F•v•-, U'N

ÉE•t'S' -ŽŌ•@-F•v•ŠŌ•Á→E-é•Ō•Ž••E•v•(-'â•

'•A'•F'™@-F

Suzuki K., H.Sakuma(1995) Trials on development of low-energy consuming hydroponics 'aZ%âfAJfWfA• Šw%â•c. @•v•ŠŌ•Á→E•v•(-'â•(1996)@TnÉjGfj fM[ÉE—{%t l' u, iŠ l}'•E•y, Š% (E•A'•tŠ'•a•s•t(1996).

BACK

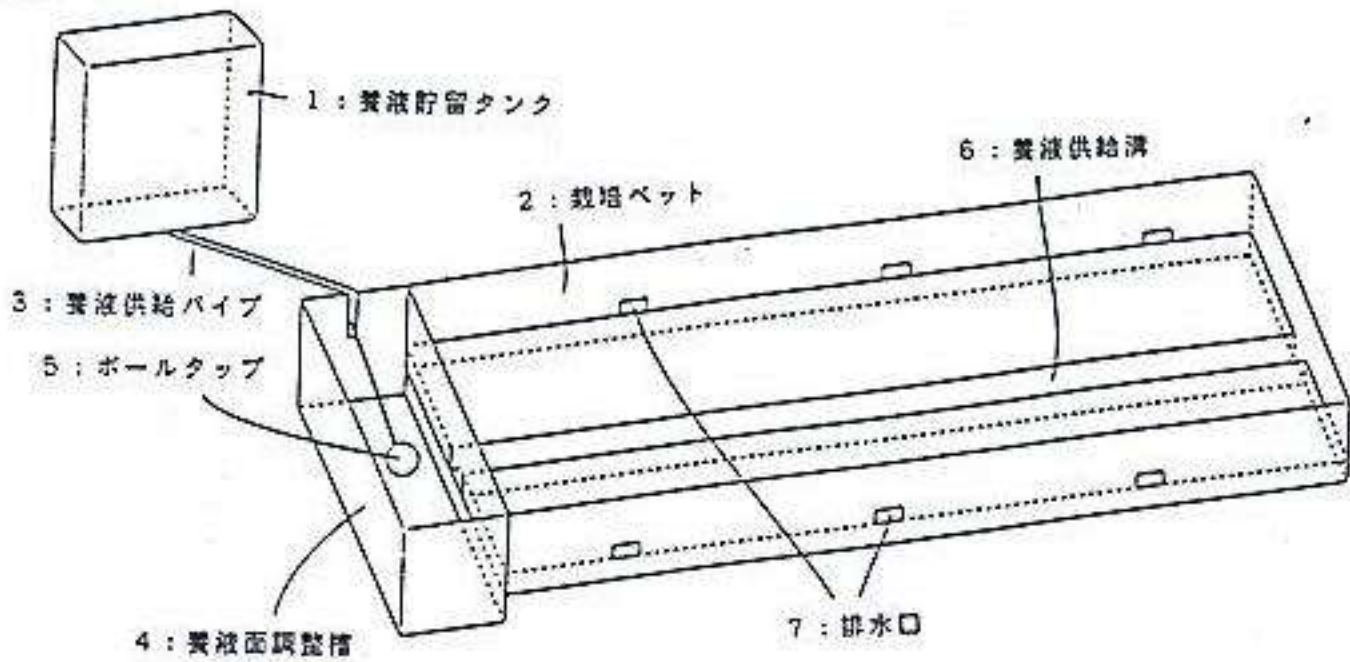


図1 装置概略図

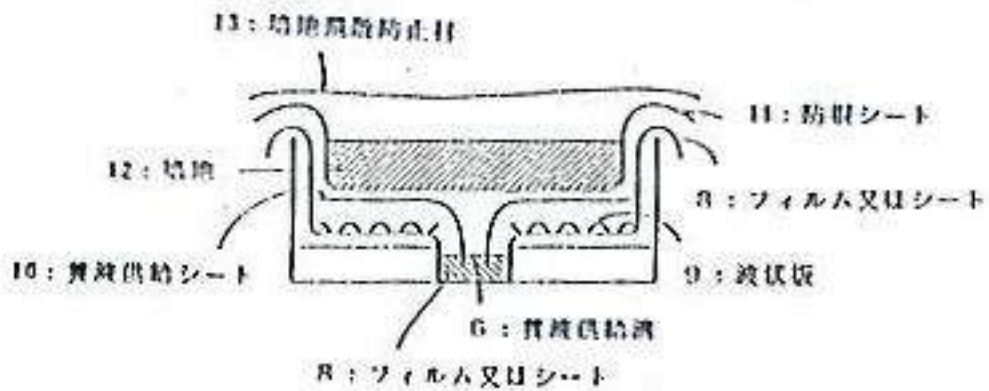


図2 ベット横断面

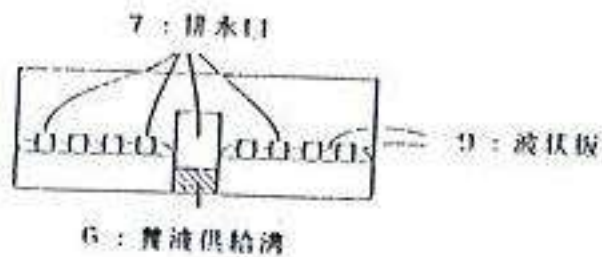



図3 ベット末端部

# •‘•Ū’_ <ÆCEα<†•¬%oÊ•î•ñ‘æ2•†•A1994•i•1/2•¬6’N‘‘x•j

1. [’†%o>fAfWfA’n^æ,Ì” —Ñ•...ŽY<Æ“Á•«<y,ÑCEα<†<Z•p“®CEü](#)
2. [fAfYfL^ÿ‘®,’S”{‘İ•dVigna glabrescens,Ì^â““I”wCEi](#)
3. [•,“TM•A•“,©,ç“¾,ç,ê,½Šf‘‡—U“±•«^â““ŽqCEQ,Ì\‘ç,Æ<@’\](#)
4. [fŠf,•\[fgfZf“fVf“fOff•\[f^,ð—p,ç,½“y•ë•N•HCE»•Ū,Ì%ođ•ÍŽè—@,ÌŠJ”-](#)
5. [Šf‘‡’n,É,“, -, é•j•” —ñ,Ì•¬CEđ-h• —Ñ•Ñ,É,æ,é”÷<C•Ū%oü—Ç,Æ•i•”](#)
6. [Ž{”îŽžŠú,³fLf}f•\[f<fKf ŠÔ•i•ÌEn,Ì•¶ŽY•«<y,Ñ’,‘f—~—pCEø—!,É<y,Ū, %oœ<j](#)
7. [”M‘Ñ,É,“, -, é•... î,Ì‘X•...“y•ë‘†’¼”d<Z•p,ÌŠJ”-](#)
8. [fuf%of“fRf,.,fhfŠfofG,Ì•l•HZ”^ç—@,ÌŠJ”-](#)
9. [”M‘Ñ,É,“, -, é—i•Ø,Ì•d—vŠQ’ŽfRfiK,Ì”-•¶•¶‘Ô](#)
10. [fXfŠf%of“fJ,Ì‘AŽi—’rŠÁÿðfVfXfef ,É,“, -, é•...ŽûŽx,Ì%ođ—¾,Æf,fff<oo>](#)
11. [fAftfŠfJŽ” —{<•,ÌŠÂ<<“K%ož•«,Æ•¶ŽY•«,Ì—¼^â““\—Í,ð“—Žž,É•.,’è,., éŽè—@](#)
12. [’n^æŽ‘CE¹ŠÇ—,Ì,½,B,Ìf}fbfvff•\[f^fx•\[fX\‘z,Æ,»,Ì”Ä—p•«](#)
13. [f}fCE•\[fVfAfIfXfWfJf~fLfŠ•iXystrocera festiva•j,Ì•¶‘Ô,Æ—h•œ](#)
14. [‘İ•«<Žáä°—pfCf“fQf“f}f•iŽí•u•ÎŠ ,P•†•v,Ì^ç•¬](#)



もどる



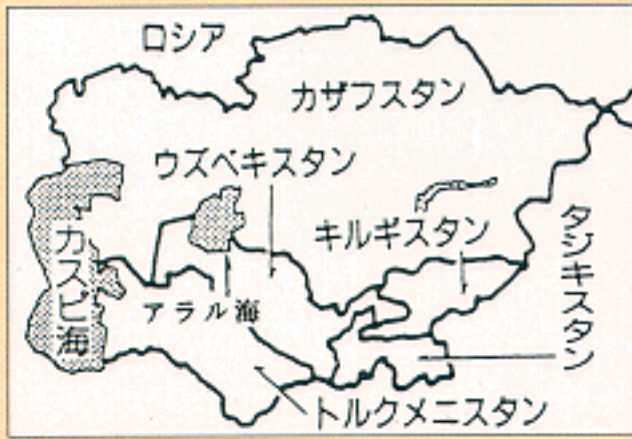


図 1 : 中央アジア諸国



写真1：ステップ草原の羊放牧



表 1 : 中央アジア諸国の国勢と農用地面積 (1989年)

共和国	国土面積 (千 km ² )	人口 (千人)	耕地面積 (100万 ha)	採草放牧地 (100万 ha)	作付面積 (千 ha)	
					コムギ	綿 花
カザフスタン	2,717	16,891	35.7	161.8	15,311	128
ウズベキスタン	447	20,322	4.5	21.6	466	2,108
キルギススタン	199	4,367	1.4	8.7	225	31
トルクメニスタン	488	3,622	1.2	32.6	66	633
タジキスタン	143	5,248	0.8	3.3	不明	不明

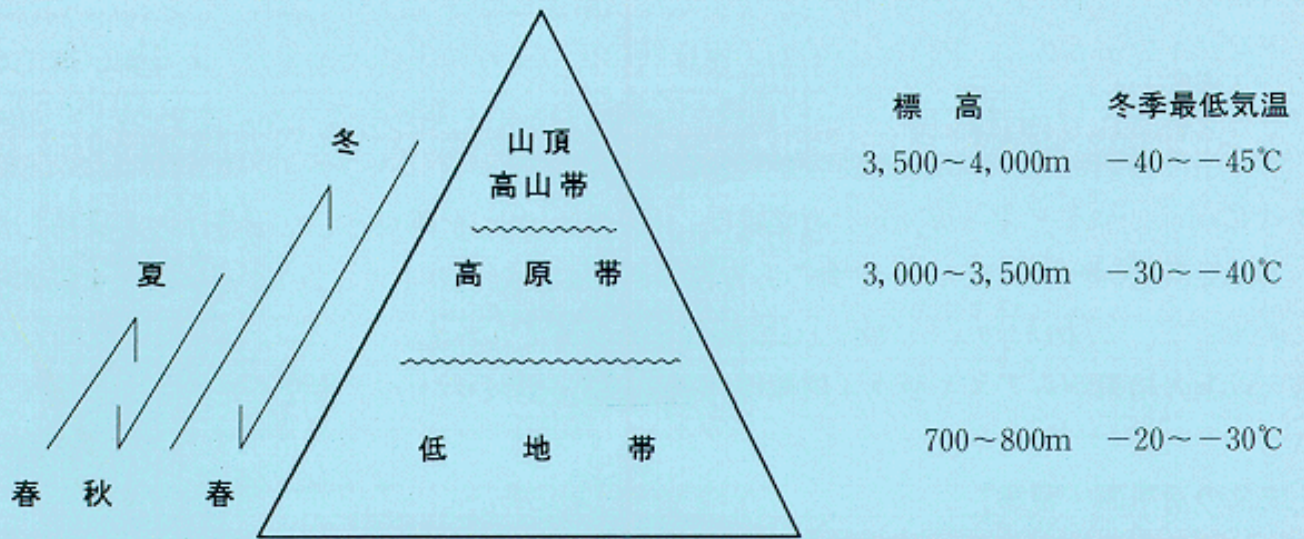


図 2 : キルギスの季節移動型羊放牧

注：草原の自然草種を対象に低地と高地の間を季節移動する。

冬季には、枯れ上がった草を求めて高山帯へ移動し、繁殖期を迎える。

<b>2. fAfYfL^Y'@,S'{'iZiVigna glabrescens,Îâ"l"WEi</b>										
•m—v—ñ•nŠfšfNfgfE,İZâ—v•aŠQ'Z,É'i•R•«„đŽi, .fAfYfL^Y'@4'{'İ'İ'Zi,İVigna glabrescens,İ•A4'{'İ—i•¶ZiV.reflexo-pilosa,İ'İ"lCE^,Ā, .è•A2'{'İ—i•¶Zi,IV.trinervia(Z'•e),ÆV.minima(%oÔ•2•e), ^a ,±,è,ç4'{'İ'Zi,İ—¼•eZi,Ā, .é,Æ•,,`è,³,è,½•B										
••Ū" —Ñ...ŽY<ÆCEα†fZf^f^•[•E•¶•Ž'CE'•]•C f^fC" <Æ•Çf fffCfi•[fg"•i•CEα†fZf^f^•[					•@~A—•æ		0298-38-6305			
•"‰i—¼		••Ū" <Æ		•è—ā		^â"Ž'CE'	İ'Ū	•@"α—p	• ^a —p	CEα†

[l'wEi•E,Ē,ç,ç]

•@"CE"ifAfWfA,Ā•i,β,ç,è,Ā,ç,éŠfšfNfgfE,İçZi,É•AfAfYfL^Y'@"à,İB%coŽi,đ—LCEø,É—~p,.,é,½,β,É,İ•A,»,è,ç,İ,à,Ā^â"~"I'½—I••AZiŠÖ,İ—P%coŠÖCEW,đ—¼,ç,©,É,.,é•K—v,^a, .é•B,S'{'İZiVigna glabrescens,İfŠfšfNfgfE,İZâ—v•aŠQ'Z,É'i•R•«„đŽi,.,^a•A,Q'{'İ,Ā, .éŠfšfNfgfE,Æ,İŽGŽi,İŠ@'S—«„Æ,È,èCEā'ā,^a¼,ç,è,É,ç•B,±,İ,½,B•AV. glabrescens,İfQfmf ••r,đ,Q'{'İfCEfxf<,Ā—¼,ç,©,É,.,é,±,Æ,É,æ,Ā,Ā•AfŠfšfNfgfE^çZi,İ,½,B,İ^â"Žq<CE',đŠg'ā,.,é•B

[•~‰oĒ,İ"à—e•E"Á"Ÿ]

•@f) fCE"l"¼"š,ĀfAfWfAŽYfTfTfQ'@—i•¶Zi,İ'T•đ,đ•s,ç•A,Q'{'İZiVigna trinervia•i70" .•jy,ŃV. minima•i,P" _j•A,S'{'İZiV. reflexo-pilosa•i16" _j,đŽû•W,µ,½•B,±,è,ç,İ—i•¶Zi<y,Ń,±,è,Û,Ā,ÉZû•W,µ,½•B%coŽi,İ"-%cèŽiŽq'Š•o" .,đ—p,ç,Ā" d.C%oj" @,đ•s,ç•AfAfCfUfUfCf,İfof" fhfpf^•[ f" ,ç•AV. trinervia,ÆV. minima,İ•A^Ūž;4" {'İV. glabrecens<y,ŃV. reflexo-pilosa,İ—¼•eZi,Ā, .é%coĀ"~"«„^a,.,ç,±,Æ,đ—¼,ç,©,É,µ,½•i•j•B

•@V. reflexo-pilosa•AV. glabrescens—¼ŽiŠÖ,İ³αCEđŽG,É,æ,è•A"-%cè—İ,İ, .éŽGŽiŽiŽq,^a—eÖ,É"¼,ç,è,½•i•j,±,Æ•A,Û,½•A,±,İ—¼Ži,^aCE"Ô"İ,É,à,æ,—PŽ—,µ,Ā,ç,é,±,Æ,ç•AV. glabrescens,İ—i•¶ZiV. reflexo-pilosa,İ'İ"lCE^,Ā, .é,Æ•,,`è,µ,½•B

•@V. trinervia,ÆV. minima,İCEđŽG,İ•AV. trinervia,đŽ"•e,Æ,µ,½•e•ç,É,İ,Ÿ—CE÷,µ,½•B'...â°—İ,İ3.5%,Æ'á,©,Ā,½,^a•A"-%cè—İ,İ, .éŽiŽq,^a¼,ç,è,½•i•P•j•B,±,İ,±,Æ,ç•A4'{'İZi,İ—¼—§,ÉŠÖ,µ,Ā•AV. trinervia,İZ"•e,Æ,µ,ĀŠÖ—^,µ,½,Æ•l,l,ç,è,é•B

•@^È•ā,İCE%oĒ,ç,fAfYfL^Y'@4'{'İZi,İCEn"••‰co»,đ•j2,İ,æ,ρ,É,,`è,µ,½•B

[•~‰oĒ,İŠ^—p—Ē•E—~Ó" _]

•@Žû•W,µ,½,Q'{'İ—i•¶ZiV. trinervia,İ•A^â"~"I,È•İ'Û,É•x,P,Æ,Æ,à,É•AfŠfšfNfgfE,İ—i•¶CE^V. radiata var. sublobata,Æ,İCEđŽG,Ā,à"-%cè—İ,İ, .éŽGŽiŽiŽq,^a¼,ç,è,é,±,Æ,ç•A,ŸfšfšfNfgfE^çZi,İ^â"Žq<CE',Æ,µ,Ā—L—],Æ•l,l,ç,è,é•B

[,»„İ'¼]

CEα†%oŪ"è—¼•F"CE"ifAfWfA,É•^az,.,éfAfYfL^B%co—i•¶Zi,İ^â"~"I'½—I•«

—ŽZ<æ•^a•@•FCEo'í

CEα†ŠúŠÖ•@•F•½•r,U"Ń"x•i•½•r,S•,V"Ń"x•j

"-•<_•¶"™•FPhylogenetic differentiation of Vigna species in Asia,

•@•@@•@•@•@•@•@JIRCAS International Symposium Series, 2, 112-120.



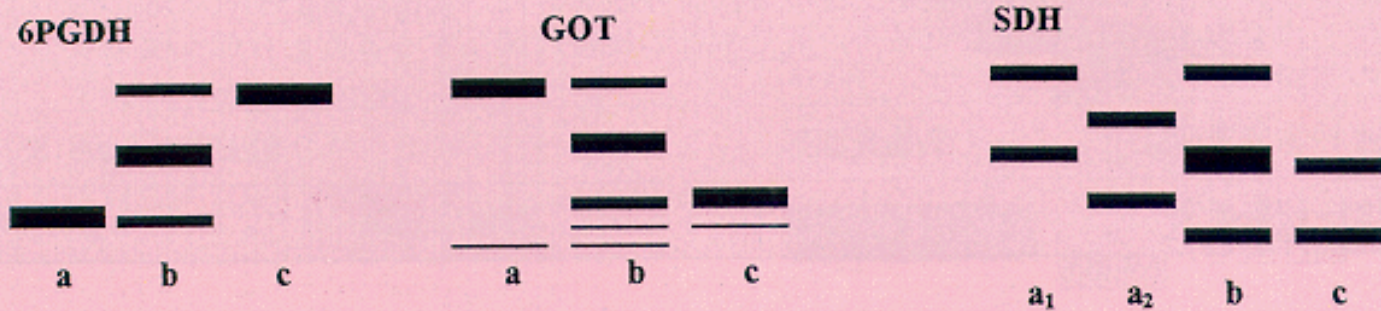


図 1 : アズキ亜属 4 倍体種とその近縁 2 倍体種にみられるアイソザイムの泳動型  
*V. trinervia* (a 型), *V. reflexo-pilosa* と *V. glabrescens* (b 型), *V. minima* (c 型)

表 1 : アズキ亜属 4 倍体種とその近縁 2 倍体種間の種間交雑結果

交配組み合わせ	交配花数	着莢数(%)	得られた雑種種子数
<i>V. minima</i> × <i>V. trinervia</i>	74	8(10.8)	0
<i>V. trinervia</i> × <i>V. minima</i>	144	5( 3.5)	21
<i>V. reflexo-pilosa</i> × <i>V. trinervia</i>	133	43(32.3)	0
<i>V. glabrescens</i> × <i>V. trinervia</i>	24	20(83.3)	0
<i>V. reflexo-pilosa</i> × <i>V. minima</i>	69	6( 8.7)	0
<i>V. glabrescens</i> × <i>V. reflexo-pilosa</i>	10	6(60.0)	18
<i>V. reflexo-pilosa</i> × <i>V. glabrescens</i>	13	2(15.4)	4

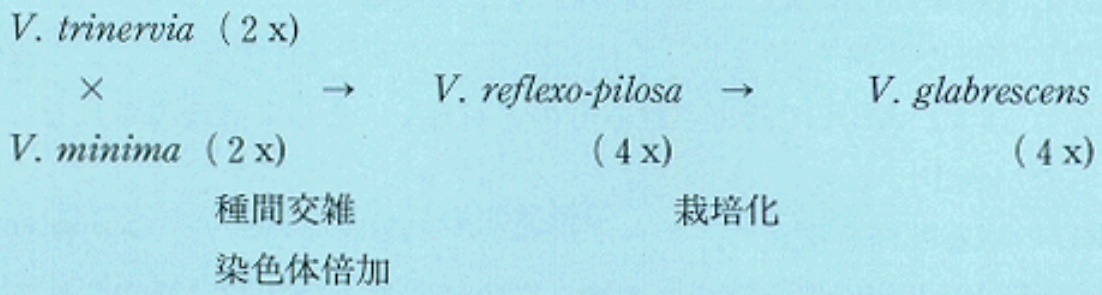


図 2 : アズキ亜属 4 倍体種の系統分化



図 1 : シロシヌナズナの乾燥  
によって誘導される遺  
伝子の機能

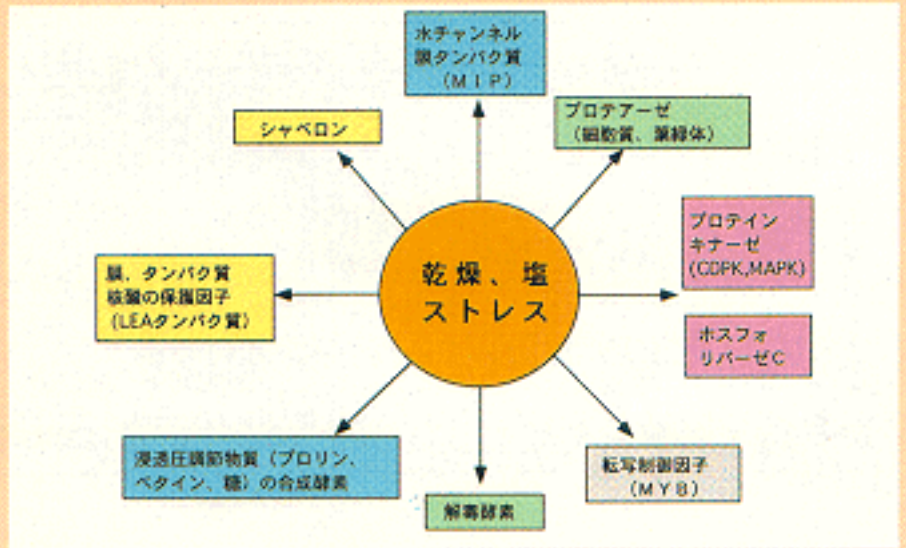


図 2 : カウピーの CPRD 遺伝子の乾燥による発現誘導のノーザン法による解析

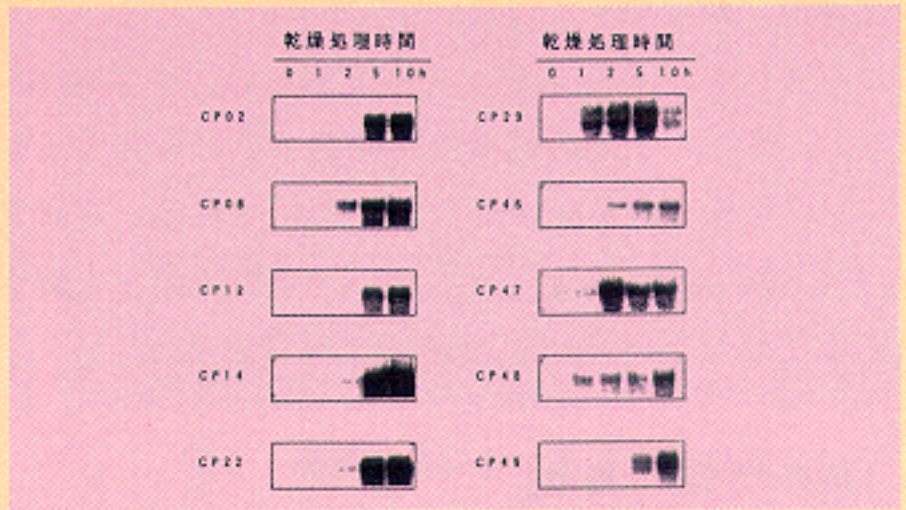




表1：ディファレンシャルスクリーニング法で得られたカウピーの乾燥誘導性の遺伝子

クローン名	インサート長 (bp)	個数 ¹⁾	相同性のあった遺伝子	各処理に対する誘導性			
				ABA	NaCl	Cold	
1	CP02	1684	8	berberine bridge enzyme	+	+	-
2	CP08	1515	1	old yellow enzyme	+	+	-
③	CP12	1082	1	alcohol dehydrogenase	+	+	-
④	CP14	1227	7	dihydroflavonol 4-reductase	+	+	-
⑤	CP22	1129	2	dehydrine	+	+	-
6	CP29	1808	1		-	-	-
7	CP46	2882	1	lipoxygenase	-	-	-
8	CP47	1343	1		-	-	-
9	CP48	647	1	B2 protein	+	+	-
10	CP49	666	1		-	-	-

1) 個数は今回のスクリーニングによって取られた数を示す。

2) ○はシロイヌナズナで得られたcDNAと相同性をもつ遺伝子。



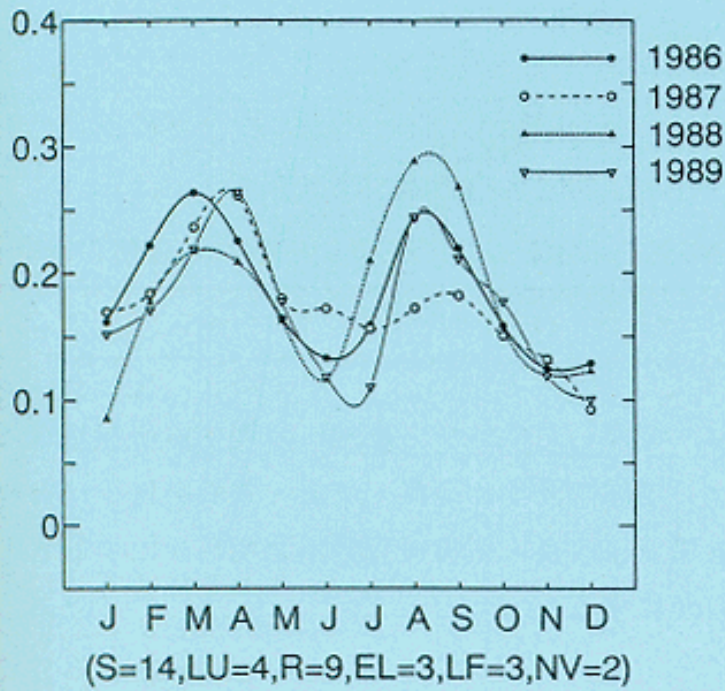


図 1 : 天水農地における GVI 値の変化

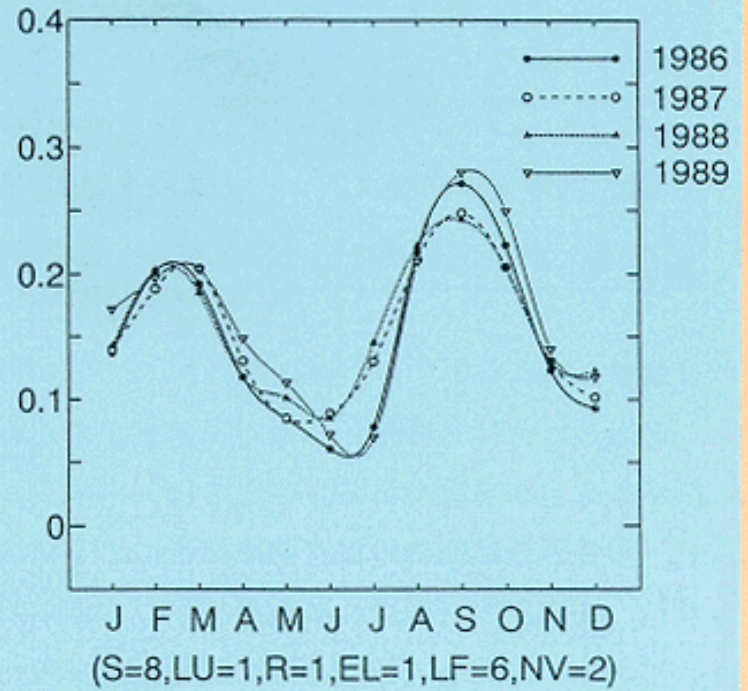


図 2 : 灌漑農地における GVI 値の変化

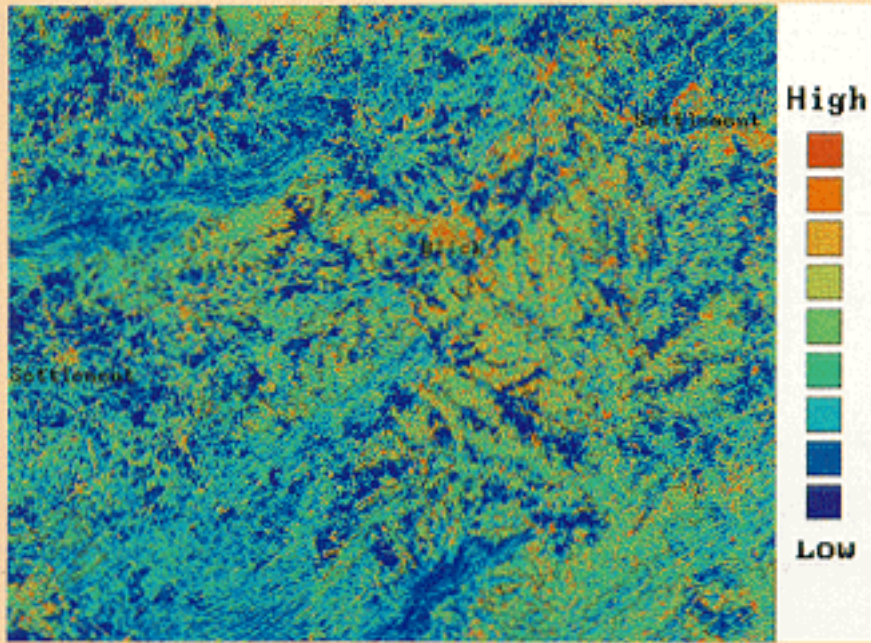


図 3 : SPOT データから推定した侵食度  
(黒線内が侵食の顕著な地域)

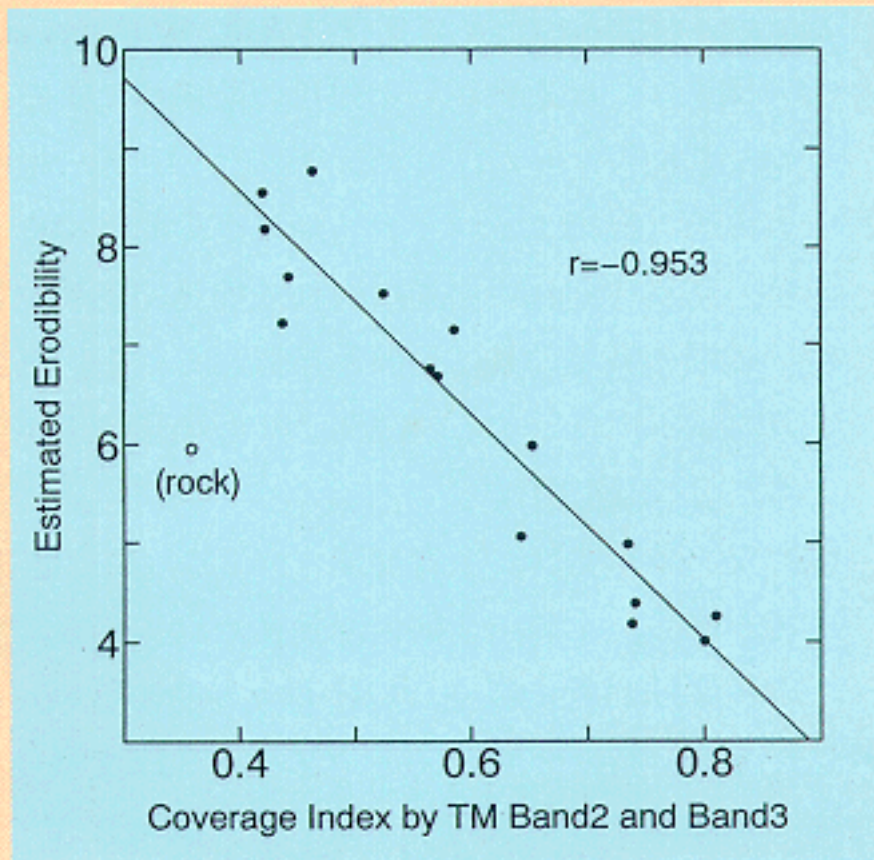


図 4 : 被覆度指数と侵食度との関係  
(各点はクラスタ分類された単位)



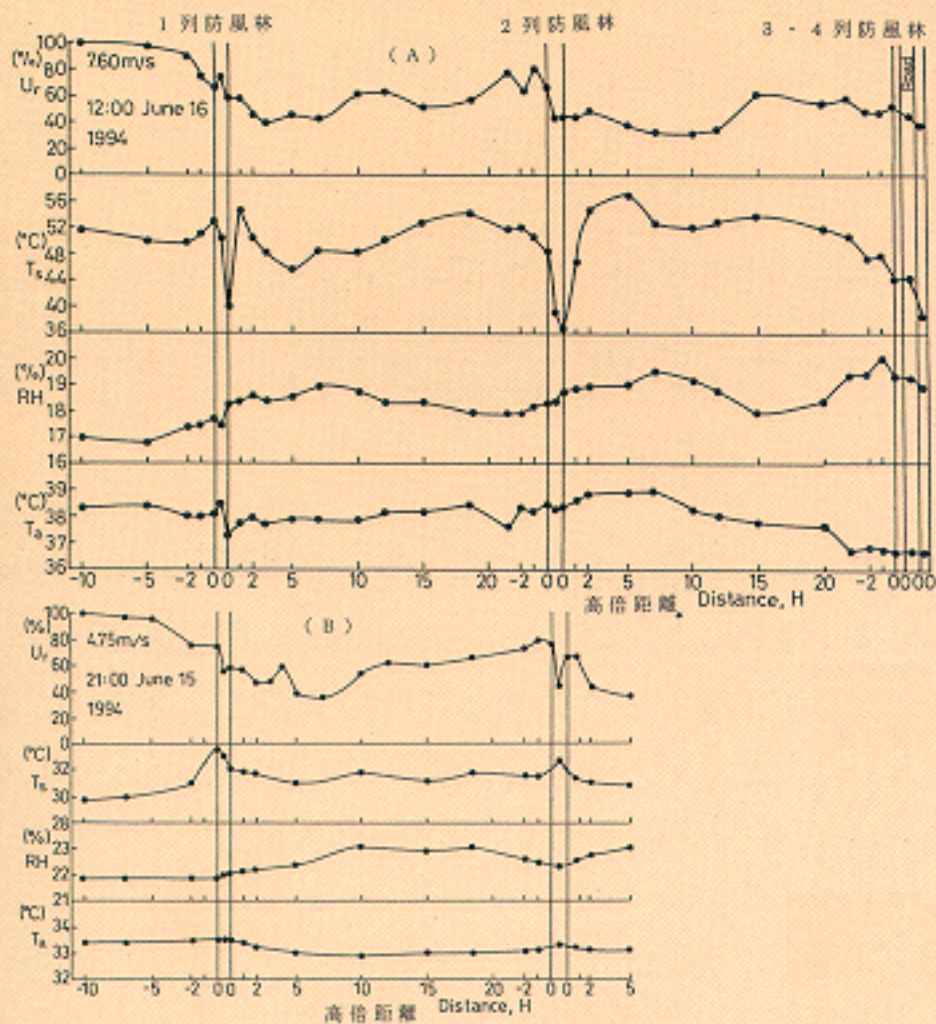


図1：シロニレ・スナナツメ・コヨウの混交防風林による昼夜の気象変化

注：高倍距離(nH)は防風林の高さ(H)の倍数(n)で表した距離，+は風下，-は風上

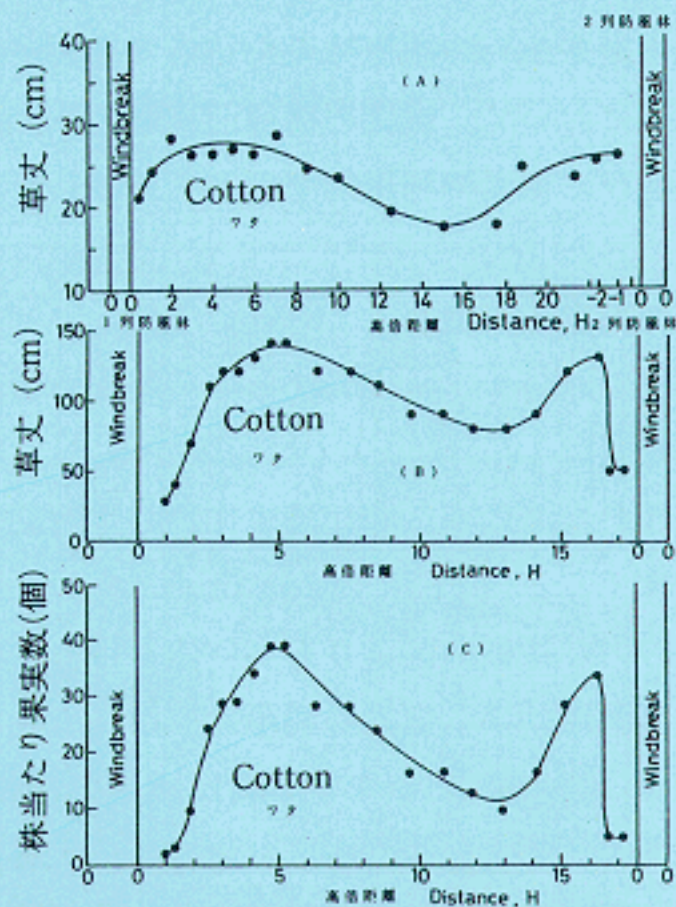


図 2 : シロニレ・スナナツメ・コ  
ヨウの混交防風林によるワ  
タの草丈と果実数の変化

(A) 生育初期, (B) 生育終期,  
(C) 株当たり果実数





写真1：シロニレ・スナナツメ・コヨウの  
混交防風林とオアシス内のワタ



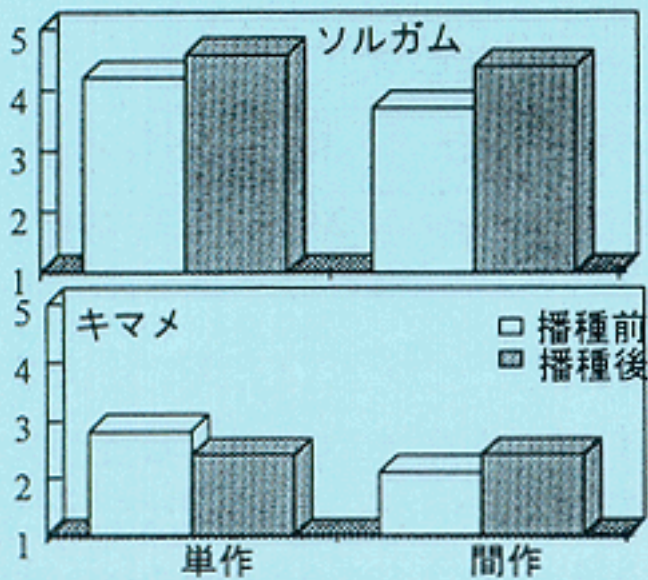


図1：子実収量(t/ha)

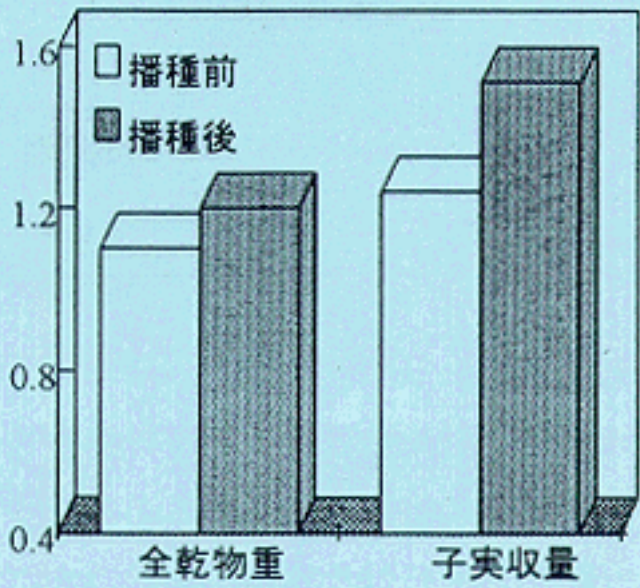


図 2 : 乾物重及び子実収量当たりの  
土地一時間生産効率

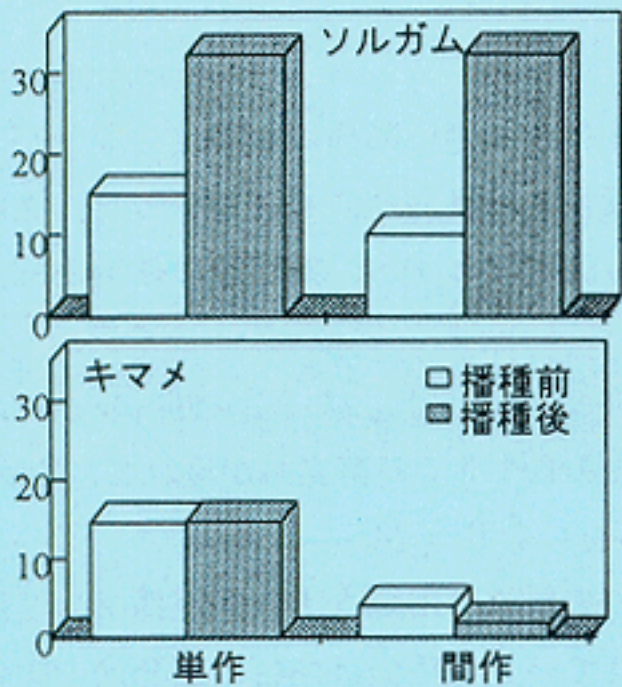


図 3 : 窒素利用効率 (%)

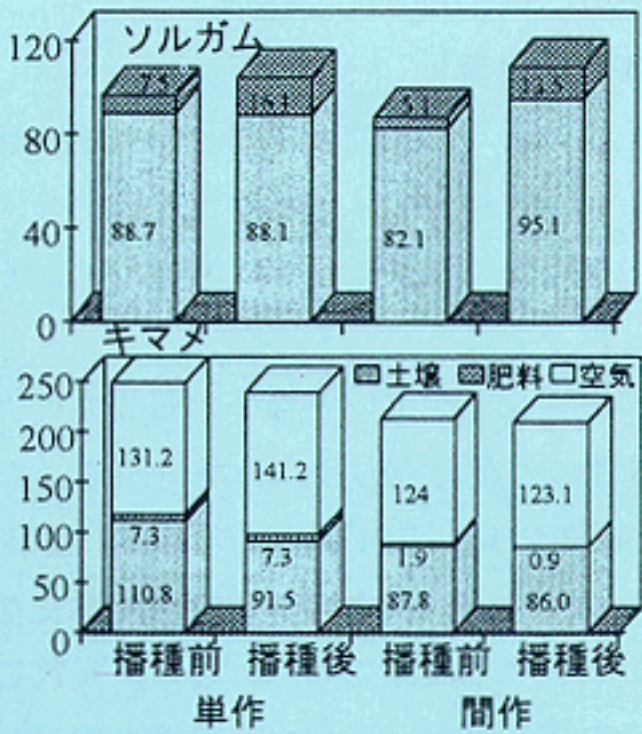


図 4 : 給源別窒素収量 (kg/ha)



表1：稲遺伝資源の湛水土壤中直播適応性の検索

遺伝資源、その入手先および アイソザイム型番号	検索品種数	選抜品種数	選抜率 (%)
IRGC			
1 (Major, Indica)	93	7	9
2 (Minor, Aus)	29	5	17
3 (Satellite, Deepwater)	5	3	60
4 (Satellite, Deepwater)	2	0	0
5 (Minor, Basmati)	31	0	0
6 (Major, Japonica)	90	5	6
Not classifiable	8	0	0
IRGC	分属なし	509	5
INGER	育種系統	404	8
育種部	Fハイブリット	61	1
IRGC	<i>Oryza glaberrima</i>	111	9
IRGC	Indica (登熟日数100日以下)	979	125
			13

IRGC=国際稲遺伝資源センター INGER=稲遺伝資源評価国際ネットワーク

表2：フィリピン2カ所における湛水土壤中直播適応品種（8-10品種平均）と対照品種（2品種平均）の苗立ちと収量。湛水土壤中直播機を使用し1993年乾期に実施。フィリピン国立稲研究所との共同研究。

調査項目	品種	Los Baños	Muñoz
苗立ち率(%)	適応	80.5 a	57.4 a
	対照	64.0 b	24.6 b
苗個体乾物重(mg)	適応	12.8 a	8.6 a
	対照	8.5 b	6.8 b
穂収量(kg/ha)	適応	7600 a	6600 a
	対照	7500 a	6270 b

平均値に付けた文字 (a, b 等) が異なる時は5%レベルで統計的に有意な差があることを示す。

表3：各種除草レベル下での湛水土壤中直播適応品種 IR41996-50-2-1-3と対照品種 PSBRC 4の穂収量と発生した雑草の乾物重。1993年乾期。

品種	除草レベル	穂収量(kg/ha)	雑草乾物重(kg/ha)
IR41996-50-2-1-3	完全	6000 a	241 c
	選択	6300 a	292 c
	無除草	5200 b	1536 b
PSBRC 4	完全	5000 b	671 c
	選択	5000 b	1550 b
	無除草	3100 c	3480 a

平均値に付けた文字 (a, b 等) が異なる時は5%レベルで統計的に有意な差があることを示す。





表1：ブランコヤドリバエの人工飼育*

培地の種類	供試卵数	発育した幼虫(%)		囲蛹殻形成 (%)	ファネル形成 (%)	成虫 (%)
		I 齢	III 齢			
IPL41・L	53	74	0	0	0	0
IPL41・L+FBS	46	85	7	0	9	0
IPL41・L+BMH	184	84	38	32	65	1
BMH	56	86	36	32	75	13

*IPL41・LとFBSあるいはBMHは1：1の割合で混入した。



→ 産みつけられた卵

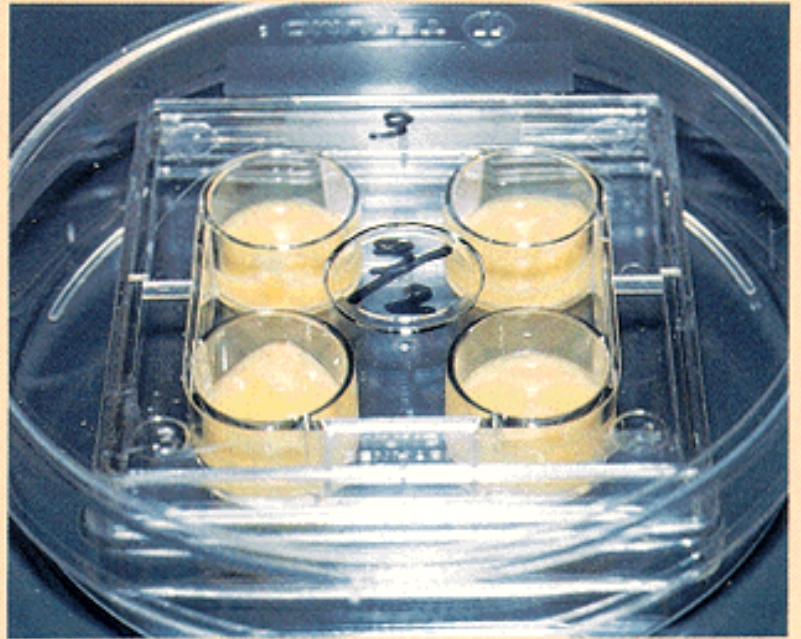


図1 (左上) : 寄主アワヨトウ幼虫に産卵されたブランコヤドリバエ卵

図2 (右下) : 人工飼育用のプラスチック製組織培養用容器 (4穴のウエル)

# "M"Ñ,É,"",é-ì•Ø,Ì•d—vŠQŽřRřifK,Ì"••¶•¶•Ô

9. "M"Ñ,É,"",é-ì•Ø,Ì•d—vŠQŽřRřifK,Ì"••¶•¶•Ô							
•m—v-ñ•n f^C' +". ÌYóYò'n'Ñ. ÌfAfu%ef%eÈ-ì•Ø. Û•é. Á. Í•A/RřifK. Ì%edJ•G•AŠE•G,•E,à,É•,•e'••Břifef'fVfAfç, ð—L,•µ•A•,-§"x. Á"••¶,•µ,•Á,•e,é,±,•E,ðŽ,µ,½•B, Û,½•A/RřifK, Ì•ÏE^, Í-•E^, Á•A,•, Ì"ÑŠř•, Û,•E,ñ, Ç-³,•e,±,•E,ð-¼,ç,©,•É,µ,½•B							
••Û" _—Ñ•... ŽY•E(EO•†řZř'f^†•E•¶ŽY—'—p"							
•"•%i-¼		••Û" _•E		•é-à		•j•"ŽŠQ	
				•İ•Û		•@•A—••re	
						0298-38-6359	
						•@•Ž—Đ	
						•"•Đ	
						EO•†	

["wCE†E,É,ç,€]  
 •@ f^fC,Á,Í•Á•B•A fAfu%ef%eÈ-ì•Ø,Ì•f"Ì-É•Ì,Šg'á,•E,•, ÌŽü"N•f"‰eo,•••y,µ•A/RřifK,³½"-,•é,æ,ø,É,É,Á,½•B,µ,©,µ•A/RřifK,Ì"••¶•Á",•áÏE^,Ì•G•B"Ì•"Û"™,Ì•¶•Ô,ÉŠÖ,•,é'mE@,Í,Û,•E,ñ,Ç"¼,ç,é,Á,é,É,é•B"™Ñ,ÌřRřifK,ÉŠÖ,•,é,±,é,ç,Ì'mE@,Í•A%e"Ñ,ÌřRřifK,Ì,•,é,ç,•E,Ì"äŠř•¶•Šw"ICE@'n,©,ç,à•d—v,Á,•é•B  
 ["•%É,Ì"à—e•E"Á"Y]  
 •@†•"•¼%€,ÌYóYò'n'Ñ,É,•,é2ř•Š,ÌfAfu%ef%eÈ-ì•Ø,Û•é.Éřřfřf•f"fgřf%efbřv,ð•Y'•u,µ•A2"ÑŠÖ,É•J,Á,Ä-•T•A—UŽE'Ž",ð"•,µ,½•B,Û,½•A%e"ÑE—,É,"",éřRřifK,Ì•ÏE^,ð"äŠř,•,é-Û"Ì,Á•A"èŠü"Ì,É—UŽE'Ž,Ì"OaÀ",ðCEv"•,µ•A•G•B•Ï"Û,Ì—L-³,ðCEY"ç,µ,½•B  
 •@ f^fC,Á,Í•É•†A%ed,É,ÌřRřifK,Ì-§"x,Í"š%ø,•,é,•E%¼,í,é,Á,é,é,•A" _—ðŽU•z•p"x,Ì"á,é•é•†•A•j•|1-A,ÌŽÄ•ü•j,•é,é,Í,•,é•é•†•j•|1-B,ÌŽÄ•ü•C"j•ü•j,•é,é,Í,•,é•é•†•j•|1-B,ÌŽÄ•ü•C"j•ü•j,Á,š%edJ•G•i,UEŽ•†11GEŽ•j•AŠE•G•i12•i,TGEŽ•j,•E,à,É—UŽE"•,Í½,•A•G•BŠÖ,Ì•"Û,Í"ř,•B,ç,é,É,©,Á,½•B,µ,½,•,Á,Á•A"ÑŠÖ,ð"É,¶,Á••Břifef'fVfAfç,Í•í,É,•,-"ÛŽ•,³,é,Á,é,½•B  
 •@•i•,ÌŽüŠnEä,É,Í—UŽE'Ž",Í,|CEf,ÉCE,•,µŽb,•%œ"ce,"F,•B,ç,é,É,é,±,•E,©,ç•A/RřifK—Y•"Ž,Ì"ðäÄ"Í"Í,Í,©,È,è•,ç,±,•E,%œM,Ì,½•B  
 •@—UŽE,³,é,½-¹Ž,Ì-•E^,Á•A"ü-(,Á,Ì%œAŠü,Ì"èŽžŠü,É,É,Ì,Ý—UŽE,³,é,é,•,é,É:Š"-,µ,Á,é,½•B,Û,½•A"OaÀ",Ì"ÑŠÖ,ð"É,¶,Á"è"è,µ,Á,"è•A•G•B•Ï"Û,Í"ř,•B,ç,é,É,é•B,±,é,Í•í,É,•,%œ,Á"ÑŠř•,Ì•,•,É,ç•C•Û•ðCE,ð"½%ef,µ,Á,é,é,•ECE"µ,½•i•|2•j•B  
 ["•%É,ÌŠ—p-É•E—"Ó"•]  
 •@-(EO•†,Á"¼,ç,é,½"-•¶•Á",•áE"Ô"™Á•«•É,Á,é,Á,Ì'mE@,ÌřRřifK,ð,Í,¶,•B•A"™ÑE—,É,"",éřRřifK,Ì•¶•ÔEO•†,à-h•ce,ð•l,í,é,ø,í,Á—L—p,•E•l,í,ç,é,é•B

[,»,Ì"¼]  
 EO•†%eÛ"è-¼•F"™Ñ,É,"",é-ì•Ø,Ì•d—vŠQŽřRřifK,Ì"••¶•¶•Ô,•E-h•ce  
 —ŽZ,œ••@•FCEo•í  
 EO•†ŠüŠÖ•@•F•½•-,R"Ñ•,™"N  
 "••¶,•¶"™•FPopulation dynamics and control of the diamondback moth, *Plutella*  
 •@•@•@•@•@•@xylostella, on vegetable crops in Thailand. Proc. Seminar on Thai-  
 •@•@•@•@•@•@JIRCAS. p.33-34.  
 •@

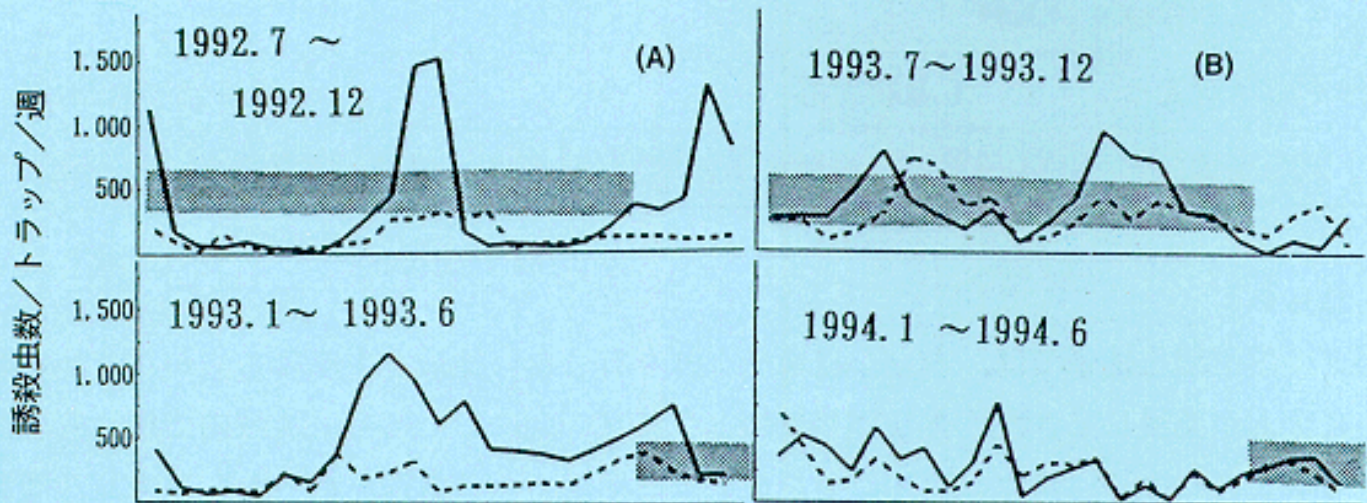


図1：パトニタニ県内 Bang Poon (実線) と Bang Po (破線) のアブラナ科野菜ほ場に設置したフェロモントラップにおけるコナガ誘殺虫数の推移

(A) Bang Poon 地区：農薬散布頻度：2～3週間に1回，Bang Po 地区：散布頻度：3～7日に1回，(B) 両地区ともに散布頻度：3～7日に1回 矢印は収穫期を，スリットは雨季を表す

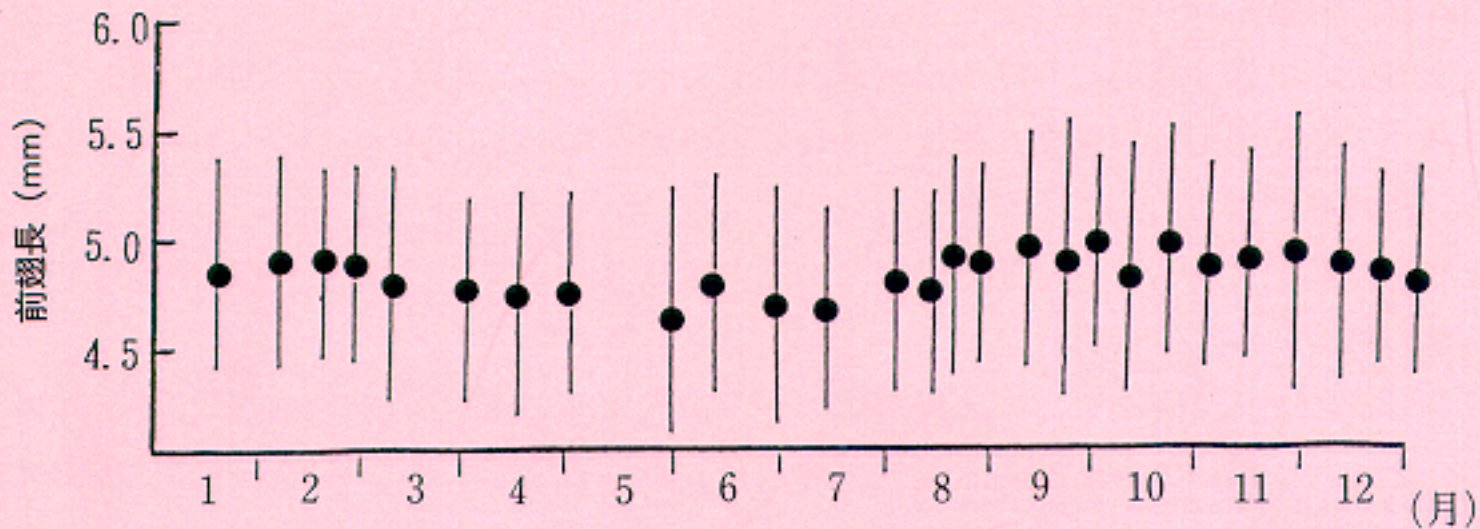


図 2 : フェロモントラップに誘殺されたコナガ雄成虫の前翅長の季節変異 (1993)



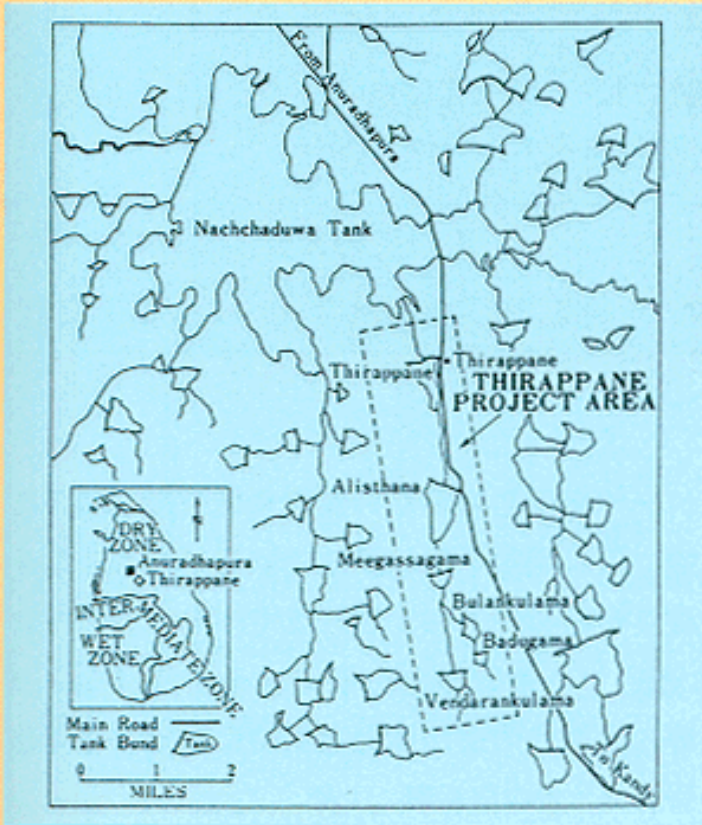


図 1 : 連珠溜池灌漑システムの分布状況

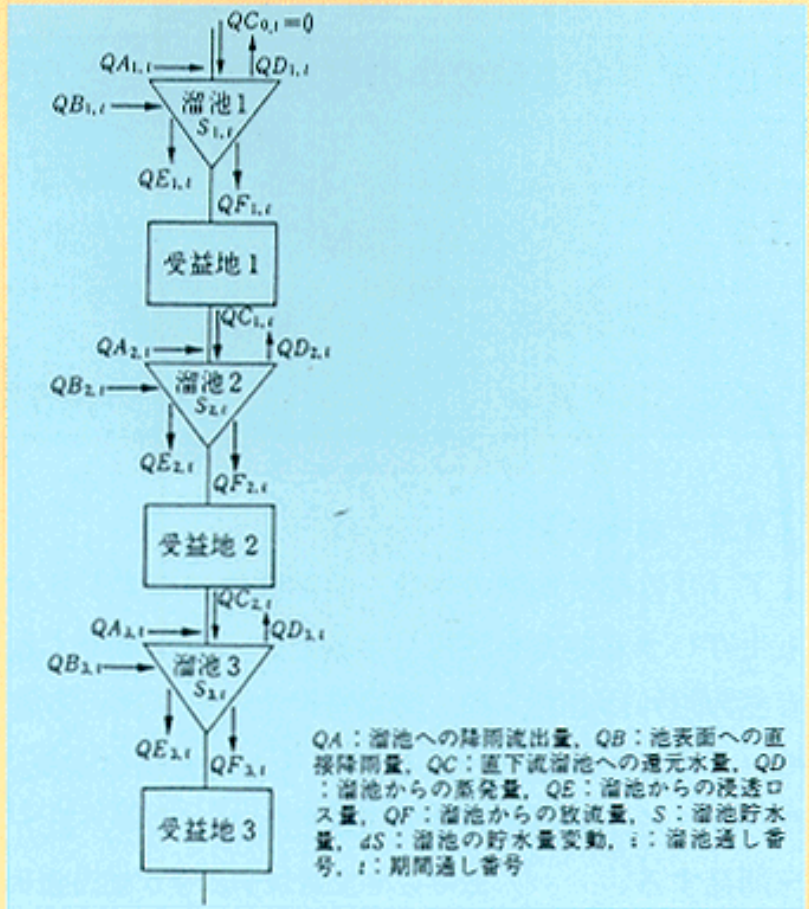


図 2 : 連珠システムの水収支基本構造



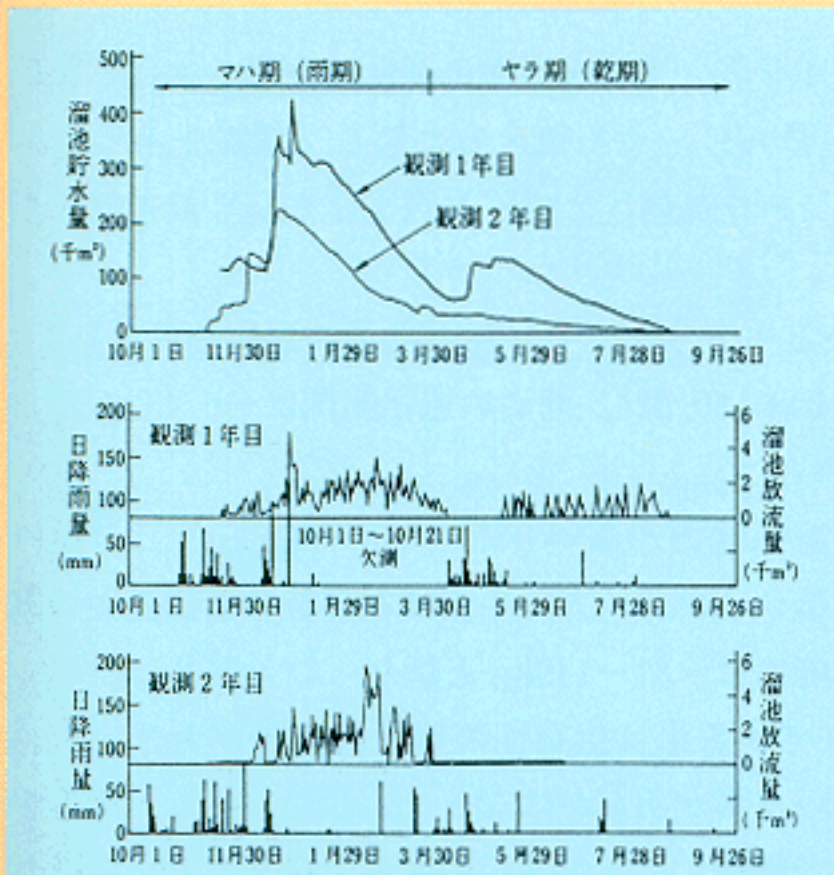


図3：溜池貯水量変動と降雨量・放流量分布の関係 (Meegassagame 池)

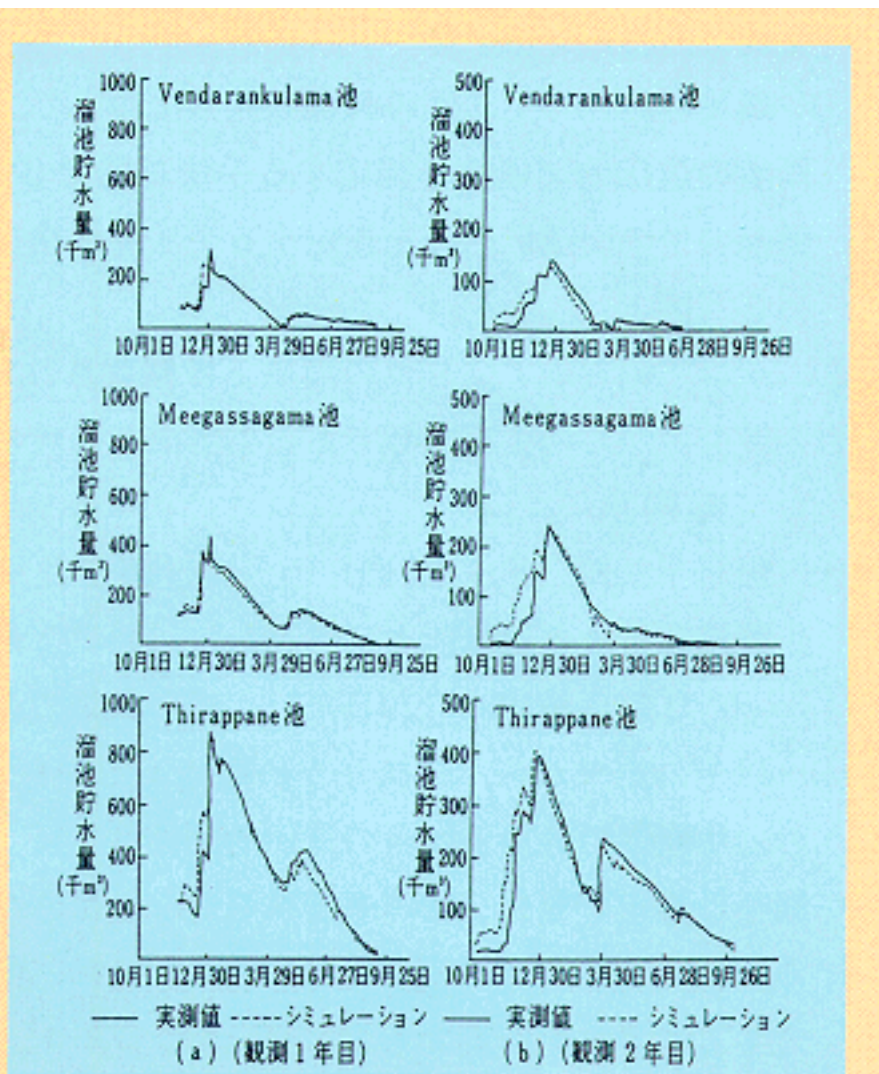


図4：現況シミュレーション

# fAftŠfjŽ” — {◁,}ŠÂ◁◁“K%ž•◁◁,Æ•¶žY◁◁,|—1/4^â“” — |,ð“Žž,É•,è,;éžè~@

H.fAftŠfjŽ” — {◁,}ŠÂ◁◁“K%ž•◁◁,Æ•¶žY◁◁, —1/4^â“” —  ,ð“Žž,É•,è,;éžè~@					
mm→4mAfjtŠfjŽ” — {◁,}fjŠfjfmfHfj)y,Š◁◁M^TM,É.1.,ŠŠĀ◁◁K%ž•◁◁,lžw◁W,Ā◁◁EQ◁Y◁◁◁,δ,Æ,è.,◁◁A.)ç,É◁◁TM,HžY◁◁,1ž” —  ,ð”žž,É•,è,;éžè~@.đŠf”•,μ)◁B					
◁◁Ů”_—Š◁...žY◁ÆB◁fjZf”y◁E1žY◁m◁					
◁◁šđ~ł	◁◁Ů”_◁E	◁◁â~đ	ž”~yšç→	◁◁Ů	“◁E”◁→p◁

ΓwGEÆ.E.Ĕ.ĕ.ĭ

@fAftŠfjŽ”M Š◁◁zł,1◁,1◁AZ@R””ž,11◁,fjgšfjfmfHfj)ç,1f,ð”◁,lž)◁◁ł)š%đ — |Š◁◁%ž,Ā,đ◁¶¶,μ,ð,ē — |đŠf”μ,Ā,◁)◁B”◁◁A””◁,◁Q◁◁A◁EB”◁Ā,ð◁zđ,◁.ĕ.É.fAftŠfj)◁,|¶¶¶” — fŠO,É,đ”◁A”◁◁A”◁”◁”TM,HžY”◁,ð,◁,ð,çžž%đ — Ç,“K — v.Ā, ◁◁B,±,ĕ,D,Ā◁AfjtŠfj)◁,É,Ā,ĕ,Ā,fjŠfjfmfHfj)y,ŠfAftŠfj,1 — v.,ÉŠĀ◁◁%ž,É”K%ž•◁◁,ē”ž” — |,ð,◁,è,;éžè~@.Í.É.ĉ,Ā,1)◁B,±,Ā◁ŠĀ◁◁“K%ž•◁◁,1ž” — |,É,Ā,ĕ,Ā,ĕ◁A”◁◁E”◁”TM,HžY”◁,1ž” — |,ð”žž,É•,è,;éžè~@.đŠf”◁,ðB

1~%š,1ž — ◁◁E”Ā”V

@ŠĀ◁◁“K%ž•◁◁,Æ•¶žY◁◁,|—1/4^â“” — |,É,Ā,ĕ,Ā◁AfjtCfWfj)FžŽ — đ,đ,Ā,É,É””HŮ.1)Ā,◁,ŷ,Š — žZ0.1ž” — ISO”◁◁,ð,◁,è,;éžè~@.đŠf”•,μ)◁B,1ç,É◁◁,◁,11,đ,Ā,ĕ,Ē,Ā,ž — Y◁,◁,ĕ,|ĒĒĀ◁X,1◁,|—1/4^â“” — |,ð,◁,è,;éžè~@.đŠf”•,μ)◁B — žŽ~@.Í.Ā,ĕ,Ā,É””%žž~@◁,ĕ,μ,Ā◁Ā◁P1,ð◁,É,◁◁,1)◁B

@PfjAž” — |,fAftŠfj,1ŠĀ◁◁%ž,Āž”ç,◁,Ā,ĕ,ĕ,fjŠfjfmfHfj)Fžž1ž — É.1ž” — |,0.172◁◁%žY◁◁Ů,ĉ,1¶¶¶”◁,Ā,◁◁EQ◁Y◁◁◁,1ž” — |,0.424◁◁ — žZ0.1ž” — ŠŠO,1)0.452,đž,μ,1)◁P◁B

@ž — Y◁,20””◁,◁◁12””◁,1)◁,Ā,◁◁◁ — É.1ž” — |,◁,◁,R””◁(98◁136kg),Ā,Ā,É◁EQ◁Y◁◁◁,1ž” — |,|◁(12””◁141””◁,Ē,Ā,Ā,Ā,ĉ,Ā,1)◁B””◁EQ◁Y◁◁◁,1ž” — |,◁,◁,Ā,1)◁(122◁179””◁),Ā,Ā,É◁É — É.1ž” — |,|◁81◁149kg,Ē,Ā,ĉ,Ā,1)◁P◁B

@É◁,|Ē.É.ĕ.ĕ,ĉ◁AfjtŠfj,1ŠĀ◁◁%ž,Āž”ç,◁,Ā,ĕ,ĕ~|¶¶¶”HŮ.”◁,◁,ĕ,đ,1)◁¶žY◁◁,1ž — É,É,|Ē◁,1ž” — ISO”◁◁,đž,Ā,Ā,ĕ,ēž,◁,ž,ĉ,ĉ,É,Ē,Ā,1)◁ — žZ0,ðÉ◁X,É,◁,ž,μ — D◁,Ē,ĒĀ,1)ž”◁,μ,1)◁,É,ĉ,1◁◁,1)◁,đŠf”μ,Ā,◁)◁B””HŮ.Ůž,◁,ž%Ā”◁,◁,ĕ◁B — žZ0.1ž” — |,ð,◁,ð,ĕ,1)◁ — žZ0,1ŠO”◁◁,đ,1,μ,É,ç”ž” — |,ð,◁,è,;éžè~@.” — |,Ē,Ē,Ā,◁,ðB

1~%š,É,Š — p.ðE — ”Ů”_]

@ — |žž~@.É.ĕ.Ā,Ā◁◁,1)◁,Ā◁◁Ā””Ā,Ā,1)AfjtŠfj)◁ — |,|žž” — |,|žž,đ,1)š,Ā,ĕ,ĕ,đB

.....

[◁,1]š

EĐ:1%Ůž — 1)¶fjgšfjfmfHfj)◁R◁◁◁,Γç”◁,1)š,Đ,Šf”Ā◁◁,|ĒE”ž

→žž:◁◁~@◁◁Ů”_fj)AfjtŠfjfmfHfj)j

EĐ:†ŠšŮ~@◁◁F)◁◁R”N◁, V”N

”◁_¶””FAn iterative procedure for analysing a combination of censored traits

@◁~@~@~@~@~@in sire and animal mixed models. Genetique selection evolution (Submitted).

@~@

.....

$$\begin{array}{c}
 \left( \begin{array}{cccc}
 X'X & 0 & X'Z & 0 \\
 & X'DX & 0 & X'DZ \\
 & & Z'Z & \\
 \text{sym.} & & +g_{11}A^{-1} & g_{12}A^{-1} \\
 & & & Z'DZ \\
 & & & +g_{22}A^{-1}
 \end{array} \right)
 \begin{array}{c}
 \left( \begin{array}{c}
 b1 \\
 b2 \\
 u1 \\
 u2
 \end{array} \right)
 =
 \begin{array}{c}
 \left( \begin{array}{c}
 X'Y \\
 X'DXb2+X'DZu2+X'h \\
 Z'Y \\
 Z'DXb2+Z'DZu2+Z'h
 \end{array} \right)
 \end{array}
 \end{array}$$

$$g_{ij} = [u'Au + \text{tr}(A^{-1}C_{ij})]$$

$$e_{22} = \Sigma h^2 / \Sigma d_i$$

X: 観測値の牛群に対する係数行列 Z: 観測値の種雄牛 (個々の牛) に対する係数行列  
 D: 対角行列 A: 血縁行列 Y: 乳量記録 h: 牛群滞在日数 (あるいは期待値) d_i: 個体毎の牛群滞在日数期待値の分散 b1: 乳量に及ぼす牛群効果 b2: 牛群滞在日数に及ぼす牛群効果 u1: 種雄牛 (個々の牛) の乳量に対する遺伝能力 u2: 種雄牛 (個々の牛) の牛群滞在日数に対する遺伝能力 g₁₁₍₂₂₎: 遺伝分散 (11は乳量, 22は牛群滞在日数) g₁₂: 遺伝共分散 e₂₂: 牛群滞在日数の残差分散

図 1 : 環境適応性と生産性の両遺伝能力を同時に推定する手法

表 1 : 遺傳的パラメータの推定値

	乳 量	牛群滞在日数
乳量	0.1718	-0.4516
牛群滞在日数	-0.1855	0.4239

対角線上は遺伝率，非対角線上は遺伝相関，非対角線下は表型相関

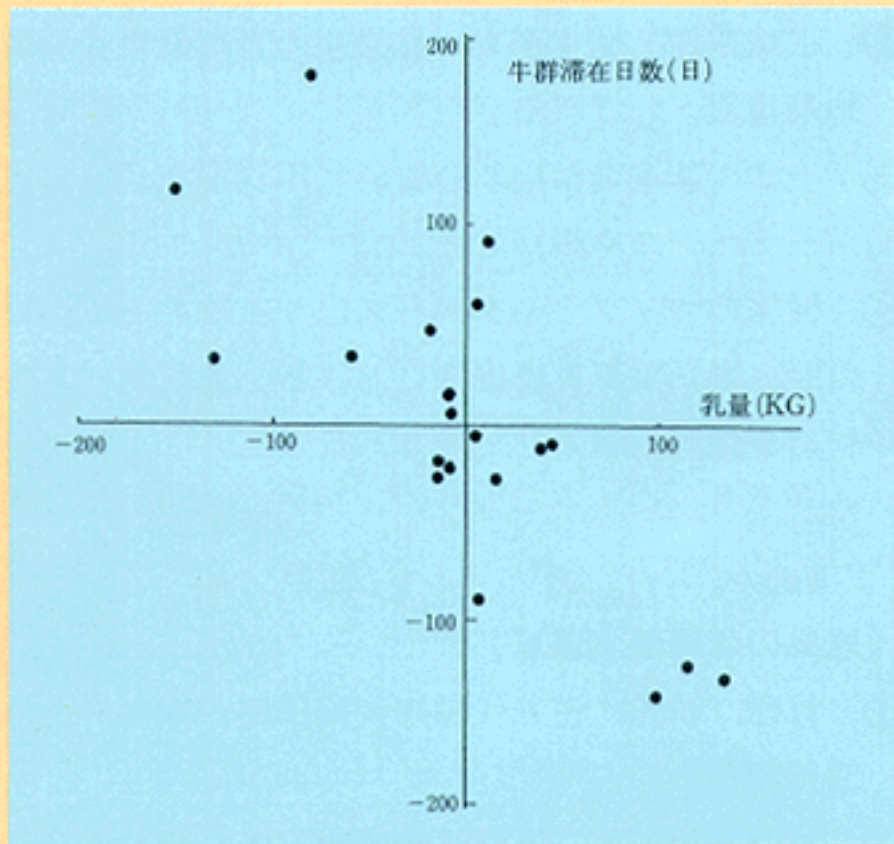


図 2 : 種雄牛の乳量・牛群滞在  
日数の育種価の分布

n'æŽ'CE'ŠÇ→,l,½,B,l}f}fbfvff•[f^fx•[fX•\z,Æ,»],l"Ä—p•«

12. n'æŽ'CE'ŠÇ→,l,½,B,l}f}fbfvff•[f^fx•[fX•\z,Æ,»],l"Ä—p•«							
•m—v—ñ•n'æf(Efxf,Ä,ž•X,l"y'nŽ'CE',,æ,Ñ,»,é,ç,ì—póµ,δ'n•)•iñ,Æ,µ,Äff•[f^fx•[fX%»,µ•A'y'n•r"p,ì—v'ð%δ•Í,â'n'æEv%æe"™,ÉŠˆ—p,Ä,«,é"Ä—p•«,δCEŸ"é,µ,½•B							
••Ū" _Ñ•...ŽY•Æ(Eδ†fZf"fvf"fo"™,É,æ,é"→•E•Ÿ"•T'n•)•iñ,žŽ•l,Ä, ,Ä,½,¾•A" _æÆÀŠEŠÉŁˆ‡n'æ,É," ,é"y'n•r"p,ìžž—v'ð,Æ•l,l,ç,é,é•ú-q•E•k•i•EŽž÷-Ø"•l•E•k•i•j,δ'n•)•iñ,Æ,µ,Ä"ž•Žü•W•Eft•[f^fx•[fX%»,µ•A'y'n•r"p,ìššCE"ˆx,¾,„,é"•kCEÀŠEŠÉŁˆ‡n'æ,Ä,žž'CE'ŠÇ→•Í•δ,ÉŠˆ—p,µ,ç,é"Ä—p•«,δCEŸ"é,„,é•B				•@~A—•æ		0298-38-6308	
•"‰î-¼	••Ū" _Æ	•é-â	Ž'CE'—-—p	Í•Ū	-q'•—P	•" —P	••Ū

["wEi•E,Ë,ç,é•n

@fvfšfA"CE-k",l}fAfwfYŽR'nžž•Ó,Ä•A'y'nCEÄ—L,žž'CE'i'nCE'•E"y•é•E•A•Ÿ"™•j,,æ,Ñ—póµ•i•ú-q•EŽž÷-Ø"•l•E•k•i•j,δ'n•)•iñ,Æ,µ,Ä"ž•Žü•W•Eft•[f^fx•[fX%»,µ•A'y'n•r"p,ìššCE"ˆx,¾,„,é"•kCEÀŠEŠÉŁˆ‡n'æ,Ä,žž'CE'ŠÇ→•Í•δ,ÉŠˆ—p,µ,ç,é"Ä—p•«,δCEŸ"é,„,é•B

[•-%‰Ë,ì"à—e•E"Á"Ÿ]

@-kfAftšfJ•E•¼fAfwfA,l" _kCEÀŠE'n'æ,ì"ã•Ä,Ä, ,éfvfYŽR'nžž•Ó'n,δ"t'è,µ•A"Ÿ•,•A•ó'†žžE•^—š"žž"»"Ç•ACE»'nCEŸ•Ø,É,æ,èšš-(Ž'CE'•)i'nCE Šw•)•E"y•é•)•E•A•Ÿ"•E"y'n•r"pCE»µ•)•EŠš-(•)•j,δ•i•r,µ,½•B

@•Lˆæš"b•E•A•Ÿ"ž•,ìCE%èÉ,ð,à,Æ,Éžž" _žž'CE"ž•, ,æ,ÑŸó-Ø"•l"ž•, ,ð•s,é•Ažž'CE'—-—póµ,δ'n→•iñ,Æ,µ,Äžž•W,µ,½•B

@•ã•L,žžš-(Ž'CE'•)•y,Ñžž'CE'—-—póµ,δGIS•i'n→•iñfvfXfef •j,É,æ,èffFBfvf"fo"™,µf}fbfvff•[f^fx•[fX,δ•\z,µ,½•B

@•) _-ˆ,l}f}fbfvff•[f^fx•[fX,ífššf,•[fgfZf"fvf"fo"™,É,æ,é"→•E•Ÿ"•T'n•)•iñ,žž•l,Ä, ,Ä,½,¾•A" _æÆÀŠEŠÉŁˆ‡n'æ,É," ,é"y'n•r"p,ìžž—v'ð,Æ•l,l,ç,é,é•ú-q•E•k•i•EŽž÷-Ø"•l"™,ì"l"×•i—p,δ'n•)•iñ,Æ,µ,Äžžæ,è"ü,é,é,±,Æ,É,æ,è•Ažž•X,ì—v'ð,δ"•žž"l,É%δ•Í, ,é,±,Æ,¾æÄ"ˆ,Æ,È,Ä,½•B

[•-%‰Ë,ìšž—p-É•E—-Ó" _]

@•ú-q•A•k•i•Ažž÷-Ø"•l"™•l"×•i—p,¾•A•Ÿ"•A"y'n•r"p,É•y,Ū, %ceçj,ð%δ-¼, ,é,½,B,ì—v'ð%δ•Í,ÉŠˆ—p,Ä,«,é•B

@•ú-q'n'æ"™'n•)•iñ,í" %æÆEÄ—L,ì,à,ì,Ä, ,è•A" _%æE,É,æ,Ä,Ä,Í•Ū-q'n'æ,à•ú-q,µ,Ä,ç,é,ì,Ä•Aft•[f^,ìžžg—p,í(CEδ†-Ū"l,É,ì,ŸCEÀ"è,„,é•B

•i•F"ž•,CEδ†ft••j

[,»],l"¼]

CEδ†%œŪ"è-¼•FfAftššfJ,ìššÉ"žž•E"l"ššÉ"žž•n'Ñ,É," ,é"•n,žž'CE'•í"•@,l%œδ-¼,Æ•Ū"•S:Z•p

•@•@•@•@•@•@•lššJ"•

—žžæ•¾•@•F••Ūfvf•i"•n•Ū"•S•j

CEδ†ššúŠÓ•@•F•½•-CE"•,U"•N

"••" _Ÿ"™•FRangeland resouce evaluation for conservation and manage-

•@•@•@•@•@•@•ment. Pasture,forage and livestock program. ICARDA Annual

•@•@•@•@•@•@•Report for 1992,p.238-246.

•@

# 調査研究フロー

広域基礎調査 (1992-3)

地形断面図

広域植生調査 (1993-4)

植生データ (75地点)

飼料資源調査 (1994-)

灌木伐採調査 (1994-)

肉食プロット試験 (1994-)

放牧地域等地図情報



空中写真 (1:45000)

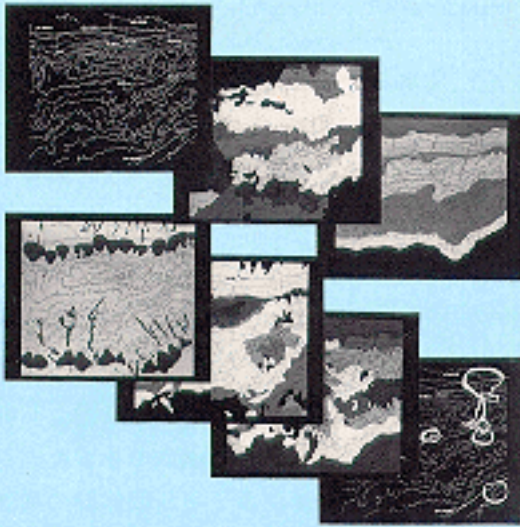
立体視判読

現地調査

基本資源図作成  
(1:50,000)  
地形学図  
土壌図  
植生図  
土地荒廃図  
基本図

地理座標現地検証

- 基本マップ
- 土壌マップ
- 地形型マップ
- 地形単位マップ
- 植生マップ
- 土地荒廃マップ
- 放牧地域マップ



マップデータベース構築

人間活動  
インパクトアセスメント

土壌侵食危険度  
予測図

土地利用  
リコメンデーション





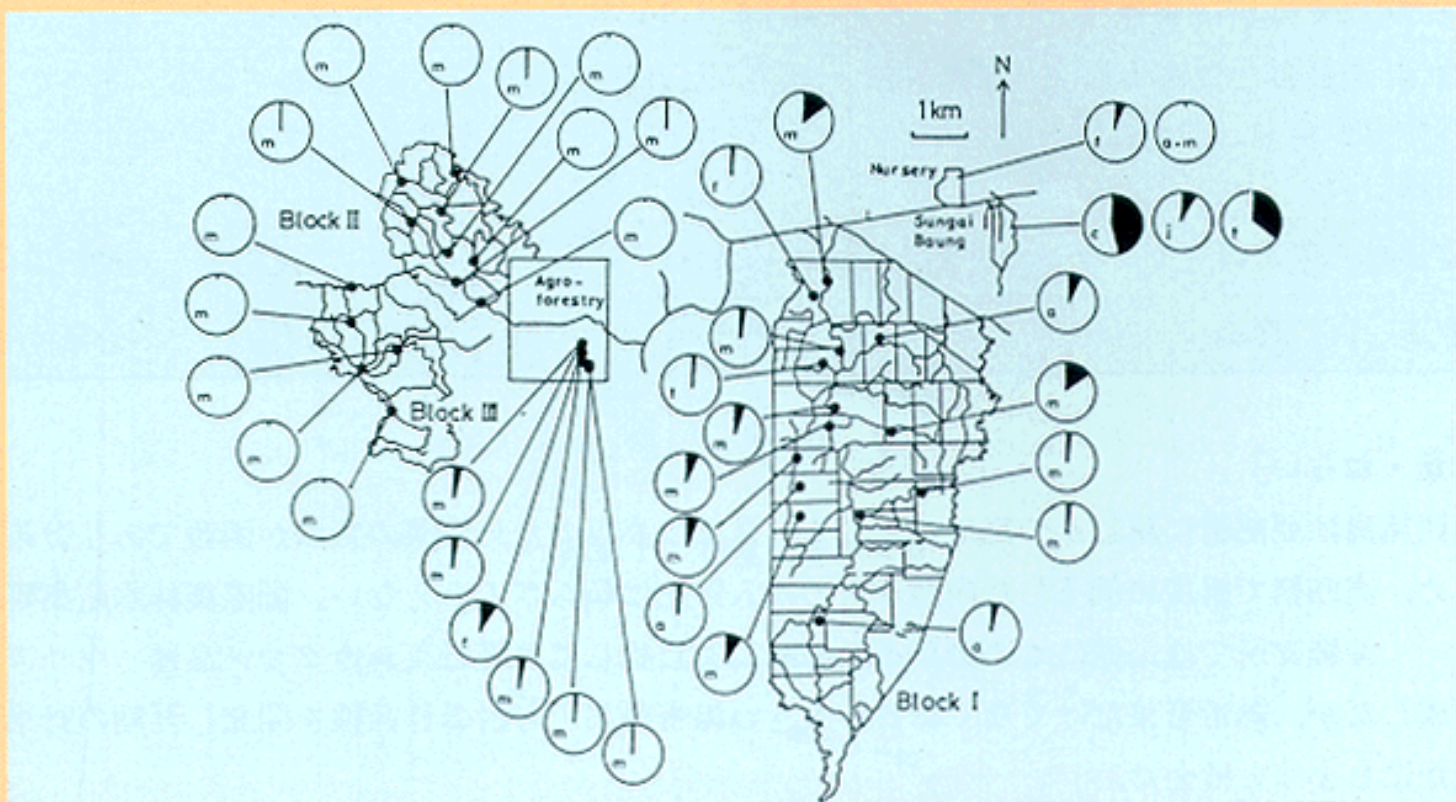


図 1 : ブナカットにおけるマレーアオスジカミキリの分布と植樹別被害率 (1992年 5 月)。

f: *Albizia falcataria*, c: *Albizia chinensis*, m: *Acacia mangium*,  
a: *Acacia auriculiformis*, j: *Pithecelobium jiringa*.

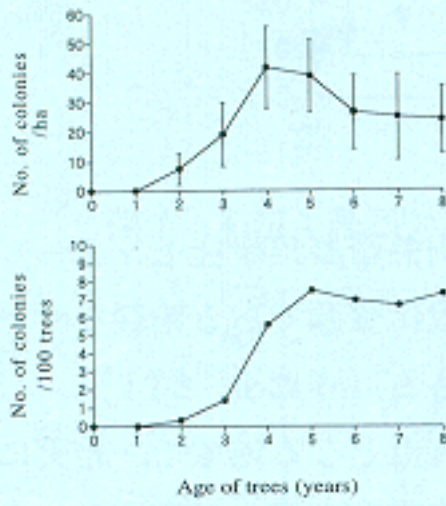


図 2 : クディリにおけるマレーアオスジ  
カミキリの林齢別個体群密度

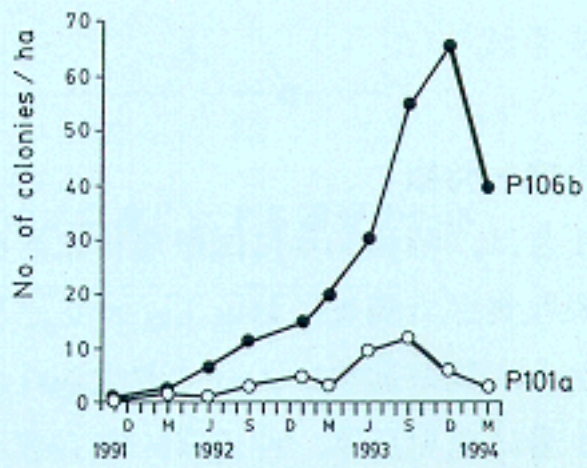


図 3 : クディリの1989年植林分におけるマレーアオスジカミキリの個体群レベル (ヘクタールあたりコロニー数) の変化  
● : コントロール区, ○ : 被害木除伐区



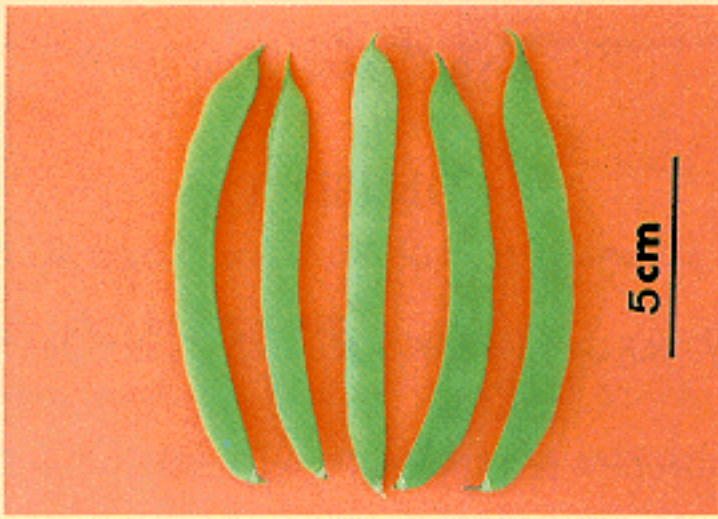


写真1. 石垣1号の若莢

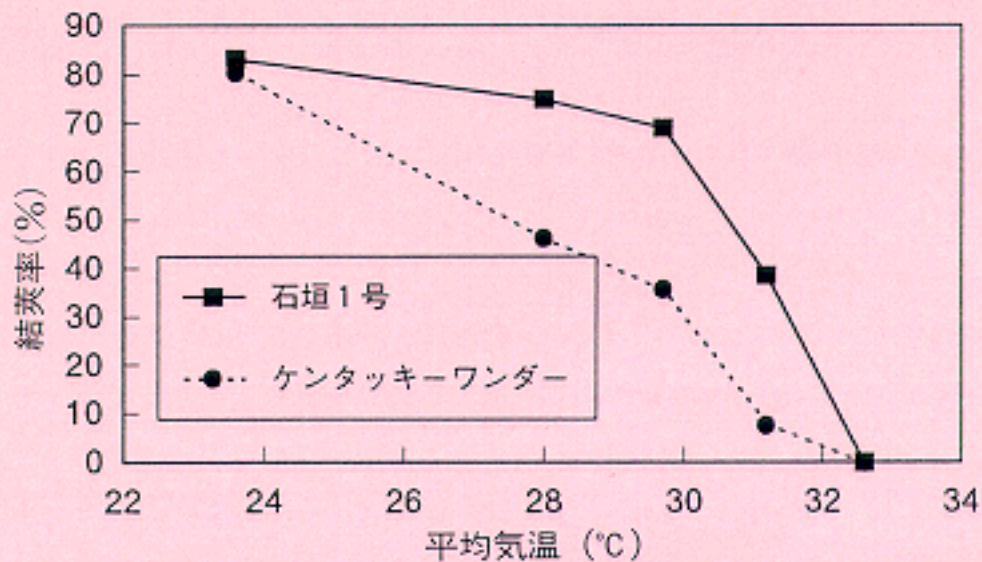


図1：石垣1号とケンタッキーワンダーの結莢率に対する温度の影響

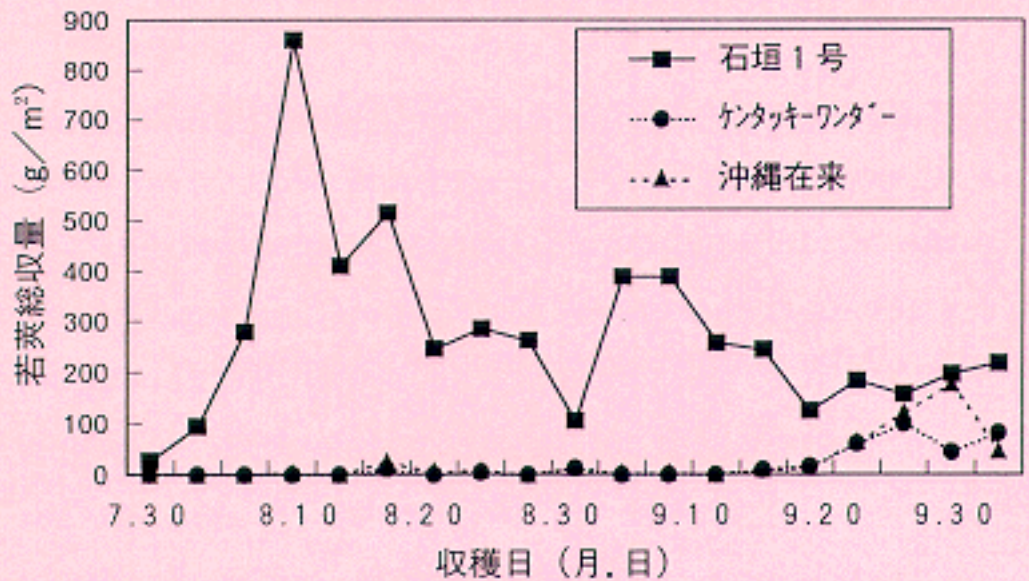


図 2 : 夏期栽培における収穫量 (沖縄県石垣島, 1992年)



# ••Ū”_<ÆCEα<†•¬%oÊ•î•ñ‘æ1•†•A1993•i•½•¬5”N“x•j

[English here](#)

1. [”M‘Ñ”_<ÆCEα<†•\[\(E£•î•ñff•\[f^fx•\[fX\(TROPIS\)](#)
2. [•,“™•A•”,İš£‘‡‘İ•«„ÉšÖ—^,.,é^â“Žq,İ’P—£,Æ”-CE»<@•\,İ%ođ•Í](#)
3. [“CE‘İfAfWfA,İf}fCfRfVf%ofYf}—l•aCE‘İ,İ,c,m,`CEÿ•o-@,İšJ”-](#)
4. [’†•%o “İ•È,É,“,̄,é•... ã•V•iŽiđ@âé34•`37•†](#)
5. [’†••E^ÿ”M‘Ñ’n^æ,É‘K,.,é‘½Žû•E•,•iŽ;‰ÄfLf...fEfš•iŽí,İ^ç•¬](#)
6. [f^fC,É,“,̄,éBradyrhizobium‘®•^a—±<Ū,İ^â““I’½—I•«](#)
7. [š£‘‡’n“y•ë,İ•¶•¬<@•\,Æ“Á•«„İ%ođ-¾](#)
8. [f^fC,É,“,̄,éfgfEfKf%ofV<y,ÑfEfš‰È-ì•ØfEfCf<fX•a,İžÀ‘Ô%ođ-¾,Æ•kŽí“I-h•œ-@,İšJ”-](#)
9. [”M‘Ñ”½,.,‰‰oÆ’{f<•\[f•f““à,İ‘@^Ū•‰‰ođ<Ū,İCEÿ•ō,Æ,»„İ‘Á•«](#)
10. [•VŽí,İžÀCE±“®•”,Æ,µ,Ä,İ•çšE•Å•¬”½,.,‰“®•”f}f•fWfJ,İž“à”É•B](#)
11. [â÷•¬”ž^ç•¬,đ‰‰oÂ’\,Æ,.,é,v,~f^f“fpfNž;„đCE‡ž,µ,½•İ^Ū‘ì,İ”-CE©](#)

BACK

# •qJIRCAS Research Highlight in 1993•r

---

1. [Tropical Agriculture Research Reference Information System\(TROPIS\)](#)
2. [Structure and Function of Genes Responsive to Dehydration in Higher Plants](#)
3. [DNA Probes for Detecting Pathogenic Mycoplasma-like Organisms in Plant Diseases in Southeast Asia](#)
4. [New Rice Varieties Registered in Yunnan Province, China](#)
5. [New Cucumber Varieties for Summer Season in Sub- tropical China](#)
6. [Genetic diversity of bradyrhizobia in Thailand](#)
7. [Soil properties in the desert region](#)
8. [Pepper and cucurbit virus incidence and control in Thailand](#)
9. [Laboratory breeding of the smallest ruminant, lesser mousedeer\(Tragulus javanicus\), as a new laboratory animal](#)
10. [Studies on cellulolytic bacteria in the rumen of tropical domestic ruminants and its characterization](#)
11. [Variants of wheat partially lacking Wx proteins for breeding waxy wheat](#)







tion of the expression of a desiccation-responsive rd29 gene of *Arabidopsis thaliana* and analysis of its promoter in transgenic plants. *Mol. Gene. Genet.* 236,331-340.

- (2) Yamaguchi-Shinozaki, K. and Shinozaki, K. (1994): Novel cis-acting element in an *Arabidopsis* gene is involved in responsiveness to drought, low temperature, or high-salt stress. *Plant Cell* 6,251-264.

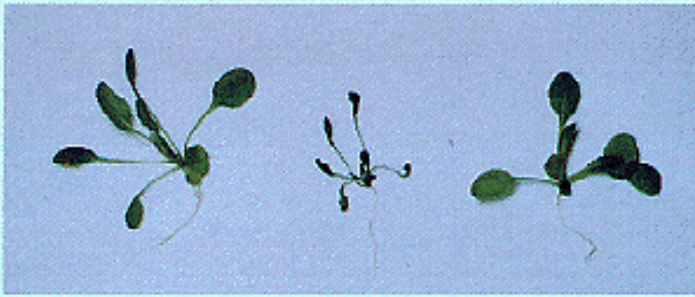


図 1 : 乾燥処理したシロイヌナズナ左は乾燥前, 中央は乾燥10時間, 右は乾燥後再び給水した状態を示す。

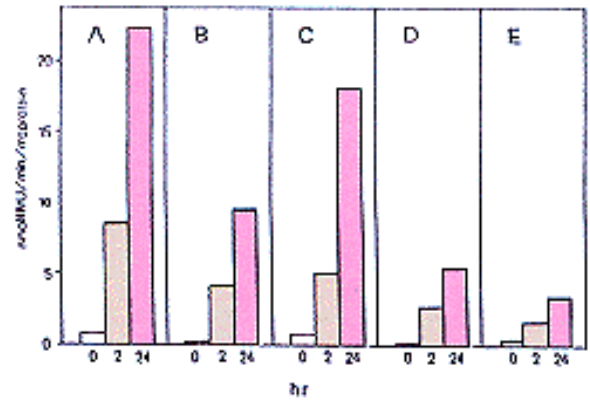
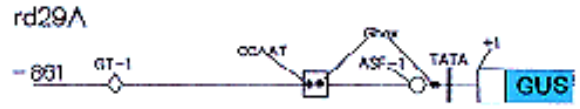


図 2 : rd29A 遺伝子のプロモーター領域とリポーターの GUS 遺伝子を結合したキメラ遺伝子の構造と (上) 5 個体の遺伝子導入タバコの乾燥による GUS 活性の上昇(下)

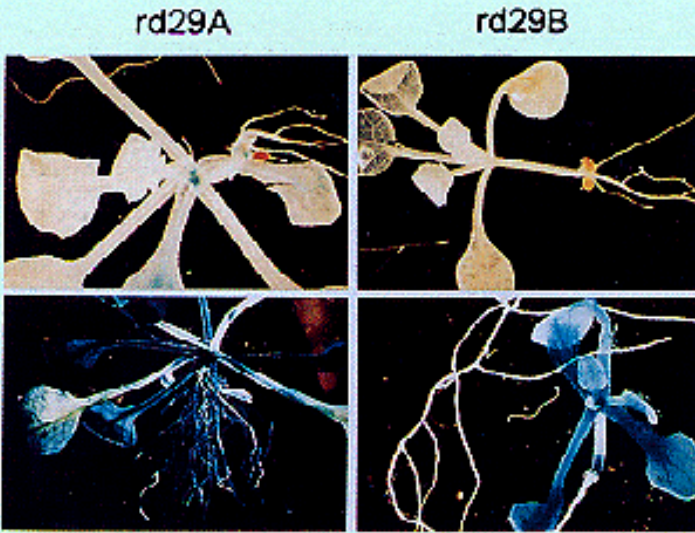


図 3 : rd29A と rd29B 遺伝子のプロモーター活性を示す GUS の組織化学  
GUS 活性は組織化学的に青に染色される。上は乾燥前の遺伝子導入シロイヌナズナ, 下は乾燥 8 時間を示す。rd29A はどの組織でも発現するが rd29B は根では発現しない。



図 4 : 西アフリカの乾燥地帯で栽培されているマメ科のカウピー







[具体的データ]



図1：ゴマフィロディー  
がく，花卉，雄蕊，雌蕊が葉化する



図2：サトウキビ白葉病  
葉が白色化・叢生し，茎が伸びない



図3：イネ黄萎病  
葉が黄化・叢生し，不稔になる

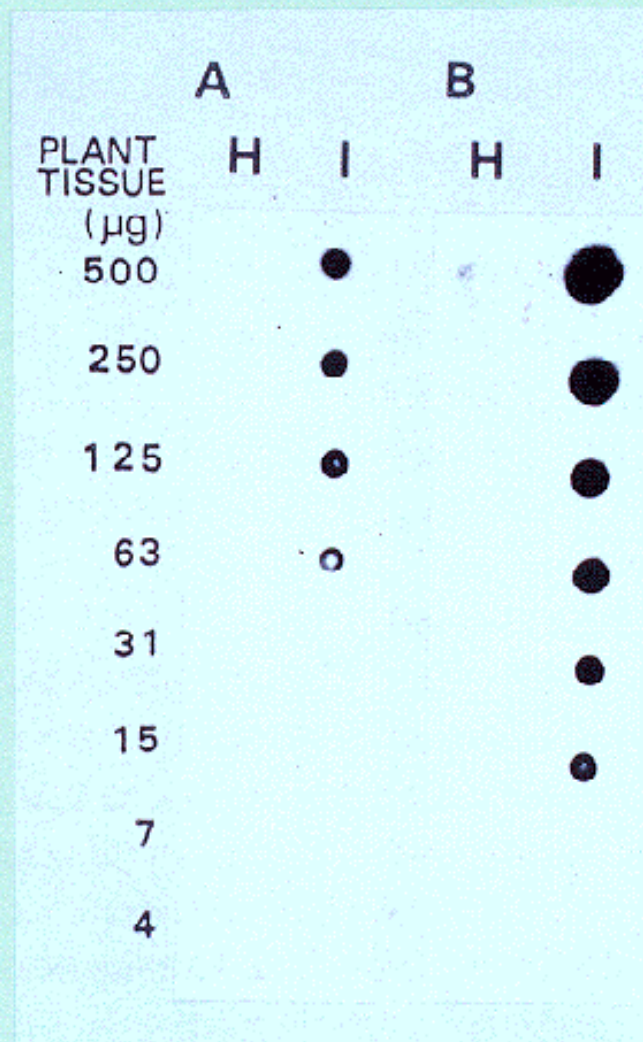


図4：イネ黄萎病ファイトプラズマの検出例  
健全なイネのDNA (カラムH) とイネ黄萎病ファイトプラズマが感染したイネのDNA (カラムI) を，濃度を変えてナイロン膜にスポットし，ファイトプラズマの染色体に由来するDNAプローブ(A)，または，ファイトプラズマの染色体外DNAに由来するDNAプローブ(B)と反応させた後，化学発光法により検出した。

Œα<†•¬%Ê•î•ñ-¼•F'†•\%_“ì•È,É,“,̄,̄,é...^î•V•iŽí,Ä,ñâé34•`37•†  
 [-v-ñ]•@•@•@•@•@•F'†•\%_“ì•È,Ì•W•, 1,500•`2,100m'n`Ñ,É`K%Ž,•,é`İ-â•«•A,ç,à,ç,a`i`R  
 •@•@•@•@•@•@•@•@•@•«•AŽû-Ê•«,É-D,ê,½,S,Â,Ì...^î•iŽí,ð^ç•¬,µ,½•B  
 'S“-•ê•Š•E•”•@•F•\•Û”_ -Ñ•...ŽY<ÆŒα<†fZf“f^•[•¶•“Ž`Œ¹•”•C%_“ì•È”_<Æ%ÊŠw%@,,  
 ~A•@•@•@•@•@•@•@•@•F0298-38-6305  
 •”•@•@•@•i•@•@•@•¼•F•\•Û”_<Æ  
 •ê•@•@•@•@•@•@•@•@•â•F^ç•@Ží  
 `î•@•@•@•@•@•@•Û•F^î•@-Ā  
 •â•@•@•@•@•@•@•@•@•F,P

[“wŒi•E,Ě,ç,ç]

'†•\%_“ì•È,Í•Í”|^î,Ì<Œ¹'n,Æ,Y,ç,ê•A`İ-â•«•A,ç,à,ç,a`i`R•«,Ì<- ,ç•Ý-^•iŽí,â`¶•Ý  
 ,•,é•B,±,ê,ç%_“ì•È,Ì^â`“Ž`Œ¹,Æ`Œ^“™,â%ü-ç,³,ê,Ä,ç,é`ú-{,Ì^â`“Ž`Œ¹,ð~p,µ,Ä•A%_  
 “ì•È,Ìâé^î•ifWfff|fjJŒ^•j'n`Ñ•A,Æ,-,É•W•, 1,500•`2,100m'n`Ñ,É`K%Ž,•,é`İ-â•E`İ•a•E  
 `½Žû•iŽí,ð^ç•¬,•,é•B,È,“•A`O`N`x,Û,Å,É,T,Â,Ì•†ŒŒ“•,â%_“ì•È,Ì-D-ç•iŽí,Æ,µ,Ä“o~^  
 ,³,ê,Ä,ç,é•B

[•¬%Ê,Ì“à-e•E`Á`¥]

,P•D•°~a58"N•`°~a61"N,É`ú`†^â`“Ž`Œ¹,ðŒð"z,µ•A,» ,ÌĚä`ä,©,ç^ç•¬,µ,½,S,Â,Ì•†ŒŒ“•  
 •@,â•A•½•¬,T"N,ŒĚ,É%_“ì•È,Ì-D-ç•iŽí,Æ,µ,Ä“o~^,³,ê,½•B  
 ,Q•D“o~^•iŽí,Ì•”“Á•«,Í•\,ÉŽ|,•,â•AŠT-v,Í^È%°,Ì`Ê,è,Å, ,é•B

@•(1) ð@âé34•†•iŒ“•-¼•F•†ŒŒ15•†•j•@,a,k,P•^%_âé 135•i•°~a58"NŒð"z•j,æ,è^ç•¬,³,ê  
 •@•@,½âéŽí•B`İ-â•«,Í<-•A,ç,à,ç,a•^•«`i`R•«^â`“Žq,ÍPi-b,ð,à,ç,âŠOŠİ•iŽç,Í'†•ã•A•H  
 •@•@-; ,Í'†††,Å•A`½Žû,Å, ,é•B%_“ì•È,Ì•W•, 1,900•`2,100m'n`Ñ,É••<y,âŒ•Ž,Û,ê,Ä,ç,é•B

(2) ð@âé35•†•iŒ“•-¼•F•†ŒŒ24•†•j•@fgfhf•fLf•fZ•^`^âé,S•†•i•°~a60"NŒð"z•j,É,æ,è  
 •@•@^ç•¬,³,ê,½âéŽí•B,ç,à,ç,a•B•ê`i`R•«,Í-t•A•ä,Æ,à<-•A`İ-â•«,Í,â,âŽă,Å•AŠOŠİ•iŽç  
 •@•@,Í'†††•A•H-; ,Í'†††,Å•A`½Žû,Å, ,é•B%_“ì•È,Ì•W•, 1,500•`1,800m'n`Ñ,É••<y,âŒ•Ž  
 •@•@,Û,ê,Ä,ç,é•B

(3) ð@âé36•†•iŒ“•-¼•F•†ŒŒ25•†•j•@83°81/fjJfVfJfŠ//%_Œ,R•†•i•°~a61"NŒð"z•j,É  
 •@•@,æ,è^ç•¬,³,ê,½âéŽí•B`İ-â•«,Í,â,â<-•`<-•A-ç`m,Ì,ç,à,ç,a•^•«`i`R•«^â`“Žq,ð,à,Â  
 •@•@,Æ•„`è,³,ê•AŠOŠİ•iŽç,Í'†•ã•A•H-; ,Í'†%°,Å•A`½Žû,Å, ,é•B%_“ì•È,Ì•W•, 1,800•`•@  
 •@•@2,000m'n`Ñ,É••<y,âŒ•Ž,Û,ê,Ä,ç,é•B

(4) ð@âé37•†•iŒ“•-¼•F•†ŒŒ30•†•j•@fgfhf•fLf•fZ•^`^âé,S•†•i•°~a60"NŒð"z•j,É,æ,è  
 •@•@^ç•¬,³,ê,½âéŽí•B,ç,à,ç,a•B•ê`i`R•«,Í-t•A•ä,Æ,à<-•A`İ-â•«,Í,â,âŽă,Å•AŠOŠİ•iŽç  
 •@•@,Í•ã%°•A•H-; ,Í'†•ã,Å•A`½Žû,Å, ,é•B%_“ì•È,Ì•W•, 1,500•`1,800m'n`Ñ,É••<y,âŒ•Ž  
 •@•@,Û,ê,Ä,ç,é•B

[•¬%Ê,ÌŠ^p-Ê•E-^ó”_]

•@•@ð@âé34•†,Í•°`Ê•A<È-ð•A•@-¼•A•ÛŽR'n<æ•Að@âé35•†,Í•@-¼•A<È-ð•A`^•Y•A<ÊĚk•A•g%Í  
 •@`n<æ•Að@âé36•†,Í•@-¼•A<È-ð•A•°`Ê'n<æ•Að@âé37•†,Í<ÊĚk•A•g%Í•A`â-`n<æ,ð`†•S,É••  
 •@<y,â•i,ß,ç,ê,é•B•½•¬,T"N,Ì%_“ì•È,É,“,̄,̄,é•†ŒŒ•iŽí,Ì•ì•t`•-Ê•İ,Í-ñ 8.2-æha,Å•A`İ  
 •@•Û'n`Ñ,Ì•...“c-Ê•İ,Ì-ñ25•”,ð,è,ß,½•B

[i`İ“If•[f^]



[,»,Ì`¼]

•@Œα<†%Û`è-¼•F'†•\,É,“,̄,̄,é^î^â`“Ž`Œ¹,Ì•]%;,Æ~p<Z•p,ÌŠJ”-  
 •@-\\ŽZ<æ•â•F•\•Ûfvf•i^î^â`“Ž`Œ¹•j  
 •@Œα<†ŠÛŠÔ•F•½•¬,T"N`x•i•½•¬,S•`,`W"N•j

•@Eα<†'S"-ŽŔ•F•tE'‰Ã•O•A•y"c•@Ej•A^À•"•M•s•A"i'°\xŽ÷•A"i"¢‰À•Ž•A^ä•ã•³•ÿ•A  
•@•@•@•@•@•@•@•@Šâ-î•³Eh•A•¼‰i~a<v•A-x--•@"o•A•X'J•''j•A"E•@•³•°•A•'•L'xŽj•A  
•@•@•@•@•@•@•@•@àŽR"c"ŽŽm•A-ŽR"c`PŽO•A•E•@"Ä•A•ÓŽu"•A‰‰‰i‰‰,Û,©16-¼  
•@"-•\~_•¶"™•F^â"Ž`E¹-~-p,É,æ,é...^î^çŽí•A`æ21‰ñ"M`Ñ" _<ÆEα<†•'•ÛfVf"f|fWfEf€~_•¶  
•@•@•@•@•@•@•@•@W,s,`,q,r No. 21•A1988•B

-

表：滇粳34号～37号の主要特性

品 種 名 系 統 名	滇粳34号 合系15号	雲粳9号 (比較)	滇粳36号 合系25号	雲粳9号 (比較)	滇粳35号 合系24号	滇粳37号 合系30号	楚粳3号 (比較)
熟 期 草 型	早生の晩 穂数型	中 生 穂 重 型	中生の早 偏穂重型	中 生 穂 重 型	中生の早 中 間 型	中生の早 穂数型	中生の早 穂数型
出穂期(月日)	7.28	8.3	8.1	8.2	7.19	7.18	7.18
成熟期(月日)	9.9	9.18	9.16	9.18	8.24	8.22	8.24
稈長 (cm)	82	99	77	102	87	85	88
穂長 (cm)	17.0	17.1	17.8	16.8	16.4	17.2	16.6
穂数(本/㎡)	564	423	447	406	453	541	538
芒の多少・長短 ふ 先 色 脱 粒 性 耐 倒 伏 性 耐 冷 性	稀・短 褐 難 やや強 強	無 黄 白 難 弱 強	無 黄 白 難 強 やや強～強	無 黄 白 難 弱 強	無 黄 白 易 強 やや弱	無 黄 白 易 やや強 やや弱	無 黄 白 易 中 中
いもち病真性 抵抗性遺伝子型	Pi-b	+	不 明	+	Pi-i, k ^m	Pi-i, k ^m	+
葉 い も ち	-	やや強	-	やや強	強	強	やや弱
穂 い も ち	-	強	-	強	強	強	弱
籾重 (kg/a)	77.8	58.9	84.8	65.9	115.9	112.0	94.2
同上標準比(%)	132	(100)	129	(100)	123	119	(100)
籾千粒重 (g)	23.8	20.8	25.2	20.9	26.3	23.3	24.0
玄 米 品 質 食 味	中上 中中	中下 下	中上 中下	中下 下	中中 中中	上下 中上	中中 中中
調 査 地	昆 明		昆 明		宜 良		
調 査 年 次	1989*~1990年		1989~1990年		1990~1991年		

注) 生産力検査本試験の成績である。但し *印は区域試験の成績

この資料は、本館の所蔵品です。詳しくは、本館のホームページをご覧ください。









•@•@•@•@•@•@•@19•A"Ⓔ-k`ãšw^â``•¶\`ÔⒺⓂ<†fZf`f^•[•ò

Æα<†•-‰Ê•î•ñ-¼•FŠf`†`n`y•ë, Ì•¶•-<@•\,Æ`Á•«•, Ì‰ð-¾  
•u-v-ñ•v•@•@•@•@•Ffgf<ftf@f`Šf`†`n`y•ë, Ì`ê`Ê, Ê•¶•-‰Šú`iŠK, Ê, , é•B-L<@•`ŠÛ-Ê, Ì`á, -•C  
•@•@•@•@•@•@•@•@•@-zfcfIf", a`½, ç, ±, Æ, a`Á`¥, Å, , é•B`y•ë•¶•-†, Ê, Ì`nÊ`, a<-,-ŠÖ-^, µ, Å, ç, é•B  
•@•@•@•@•@•@•@•@•@Šf`†`CÉó, Ì, ½, ß`y•ë`†, Ê... , Ì•ã•û, Ê`Ú`@, µ•C•\`-Ê, Ê‰-†, ð•W•Ï, , é•B, Æ, -  
•@•@•@•@•@•@•@•@•@, Ê`n‰°...`Ê, Ì, , ç, Æ, ±, ë, Å, Ì-e`Ö, Ê‰-†, a•W•Ï, , é•B  
`S"-•ê•Š•E•"•@•F•`•Û"-_Ñ...ŽY<ÆÆα<†fZf`f^•[  
~A•@•@-•@•@•@•@•F0298-38-6306•@`†•`‰ÊŠw‰@•Vád•¶•`"y•ë•»"™Æα<†•Š  
•"•@•@‰i•@•@-¼•F•`•Û"-_<Æ•E`••†"-_<Æ•E"-_<ÆŠÂ<«î†  
•ê•@•@•@•@•@-â•F`y•ë"ì-¿  
`î•@•@•@•@•@•Û•F•a•@-†

•u`wEi•E, Ê, ç, ç•v  
`n<...ã, ÌŠf`†`n`Ñ, Ì`S-α`n, Ìl/3, ð•è, ß, é•B, » , ÌŽ@`R•ðE, Ì•CŠf`†`C•-‰J•C<-•-•C‰Ä<G, Ì, ,  
‰•, Æ`~<G, Ì`á‰•, Ê, Ç`ñ•í, ÊEµ, µ, ç•B, Û, ½•C•lEû`‰Á, Ì`³-Ì, Ì‰ßŠJ"-•C‰ß•ú-q, Ê, Ç, Ê, æ, é•»"™‰»•C  
"y•ë, Ì‰-†‰» , ð`ø, «<N, •ŠEÊ`« , ð, , ß, Å, ç, é•B, ±, Ì, æ, α, Ê`n`æ, Ê, " , - , éŽ•`±`I"-_<ÆŠJ"- , ÌŠî`b  
"I`mE@, ð`¼, é, ½, ß•C"-_<Æ•¶ŽY, ÌŠî`Ö, Å, , é"y•ë, Ì•¶•-<@•\,Æ`Á•« , ð-¾, ç, ©, Ê, , é•B

•u•-‰Ê, Ì`à-e•E`Á`¥•v  
`†>fAfWfA, ÌŠf`†`n`æ, Ê`@, , é`†•`•Vád`n<æ, Ì•C‰Í•î, a~`n`à, Å•ÁŽ , , é•Á•½En, Ì`à•-†, Ì~  
`n, ©, ç, Ê, é•B, » , Ì`TE^, Å, , éfgf<ftf@f`n<æ, Ì`y•ë`²• , ð•s, ç`Ê‰° , Ì•-‰Ê, ð`¼, ½•B  
`nE` , Ì•CŽR`n, ©, ç~`n`†>•"•i•Á`á`n•j, ÊEû, ©, Á, Ä•C•^•î•-†•ó`n•\Š±ÿ¿ŽOŠp•B•\‰«•î•½E`  
•\ÊÏ, Æ, Ê, Á, Ä, ç, é•B, » , é, Ê‰Ž, ¶, Ä`y•ë, Ì•CŠE•F•»"™"y•\ÿóÿò•k•ì"y•\ÿóÿò‰«•î"y•\...•-†"y•\‰-  
-†"y•\‰-D, Æ•Ï‰» , , é•B`f-Ê"-B, ÌŽã, ç, à, Ì, a`½, -•C"y•ë•¶•-†‰ß`ö, Ì•‰Šú`iŠK, Ê, , é, Æ, ç, | , é•B  
•î`[•t<ß, ©, ç‰«•î`n, aŽâ, Ê"-_<Æ`n`Ñ, Å•C•l^x`y•ë, a•L, a , é•B  
"y•ë, Ì`½‰Ž, Ì`½, - , ÌpH8`9, Æ, , -•C...-n< , ÆðŠ•« , Ì‰-ŠîŠÛ-Ê, Ì50`200 me/100g, Æ• , -•C-L  
<@•`ŠÛ-Ê, Ì<ÿ<-Ê, a`á, -•a‰ð, a`-†, ç, ½, ß•\`w, Å, àl %<- , Æ`á, ç•B-³<@•A•"-{•a, Ì•\•a , , é, Æ, ç, |  
, é, a•C`Ê•í, Ì`½, , -†, Å•î`[•t<ß, â‰«•î•½E` , É, Ì‰-†"y, a•¶•-†, µ, Å, ç, é•B

‰-†"y, Ì•C<É`[ , ÊŠf`†, Ì, ½, ß`y•ë...•a , a•ã•û, Ê`Ú`@•ö"- , µ•C"y•ë•\`-Ê, Ê‰-•a , ðŽc, µ, ½, à, Ì, Å•C  
`n‰°...`Ê, a4`6  
m, æ, è•ó, ç, Æ‰-†‰» , ð<N, ± , •B‰Â-n•«- , ÌŽâ`Ì, Ì•C‰-‰»fifgfŠfEfE, Å , , é, a•C`ê  
•" , Ê, Ì"÷•¶•`Š`^`@, Ê, æ, é•ÉŽ_‰-`n`Ñ, à , , é•B

"y•« , Ì•î`a , Å, Ì•îâI, ©, ç, Ê, é , a`á`n, Û, Ç•x-†Ž¿ , Ê, Ê, è•Căk-s, ÅE~•d, Ê"y•ë, a`½, ç•B•B"y•ë•\`ç  
, Ì"-B, ÌŽã, -•C"S"y, Ì`Ú`@•W•Ï, Ì`f-Ê`²• , Å, Ì`F, ß, ç, é, Ê, ©, Á, ½•B


^êŽÿ•z• , Ì•îp, Æ•`•î, ðŽâ, Æ, , é , a•C•d•z• , àŠÛ, Û, é, Å, ç, é•B"S"y•z• , ÌfXf•fNf^fCfG, ð`†•S  
, Æ, µ, ½‰Á-‰»•«•z• , ð`½, -ŠÛ, ñ, Å, " , è•C•ö•Ý"ì-€"x, Ì, , ç, Æ, ç, | , é•B

^È•ã, Ì, æ, α, Ê•CfGf<ftf@f`n<æ, Ì`y•ë, Ì•-‰»•¶•-†, Ì•‰Šú`iŠK, Ê, , Á, Ä•ö•Ý"ì-€"x, a• , , -•C... , Ê  
, Ç, Ì`¼, Ì•ðE , a•@, | , Ì-Ç•D, Ê"-_k`n, Æ, Ê, é‰Á`\`« , a , , é•B, ½, ¼, µ•C‰-†‰» , â-•H, Ê, Ç, Ì`jŠQ-v`ö  
, à`½, -•C`••†"I, Ê`î•ó, a•K-v, Å , , é•B

•u•-‰Ê, ÌŠ^p-Ê•E-`^ó`_•v

Šf`†`n, Ì`y•ë, Ì•A•"-{•aŠÛ-Ê, a• , , ç , a•C, ±, é, ÌŠf`†`n`Á-L, Ì`y•ë...•a , a•ã•û, Ê`Ú`@, , é, Æ, ç, α  
"Á•« , Ì-•ó, µ, Å , , è•C"y•ë, Ì‰-†‰» , ÌŠEÊ` , Ì•í, Ê , , é•B, ±, é, Ì•s-p`ó, Êÿóÿò`r... , Ê, æ, Á, Ä, à<N, ±  
, é•B•] , Á, Ä•C‰-†‰» , Ì`ö"x, ÆŠEÊ`« , ð•í, Ê•l-¶ , , é•K-v, a , , é•B

•ufL•[f••[fh•v Šf`†`n`y•ë•C"y•ë•¶•-†•C"y•ë`Á•«•C"S"y•z•`  
[i`î`[ff•[f^]

`nE`Æ"y•ë`Á•«

•u,»,İ¼•v

Æα<†%Û'è-¼•FŠƒ'†'n,İ..."@'Ô•E"y•ë"Á•«,İ%đ-¼  
-\\ŽZ<æ•^a •FŠÂ<«Ž'Æ¹      Æα<†<@ŠÖ•F•½•¬, T"N"x.i.°~a,U,R"N•`•½•¬, S"N•j

Æα<†'S"-ŽÒ•F'†^ä •M•Cæâ<MŠC

"-•\~_•¶"™•F'†^ä •M (1991) '†•',İ»"™-â'è•C•\f^fNf%f}fJf"•»"™•\•C

'n<...ŠÂ<«,Æ"-Ñ<Æ•C-{Æ<"°•Cp.171-192

'†^ä •M•Eæâ<MŠC (1993) fgf<ftf@f" 'n<æ"y•ë,İ"S"y.z." "Á•«

'†<α"-Æα<†•¬%Ê"-•\•ñ••%i~_•¶•W•C"MEα•Cp.70-77

M. Nakai and Zhao Guihai (1993) Clay Mineralogy of Soils from Turfan, Proceedings of the International Workshop on Classification and Management of Arid-Desert Soils, pp.116-119

'†^ä •M (1993) '†•',İŠƒ'†'n"y•ë,Æ%--ƒ%»'Î•ô•C•»"™-Î%»,İ•Å'Ö•ü•C

•V"ú-{•o"Å•Cp.83-110



















# JIRCASfjf...•[fX

2002''N	<a href="#">No.28</a>	<a href="#">No.29</a>	<a href="#">No.30-31</a>			
2001''N	<a href="#">No.25</a>	<a href="#">No.26</a>	<a href="#">No.27</a>			
2000''N	<a href="#">No.19</a>	<a href="#">No.20</a>	<a href="#">No.21</a>	<a href="#">No.22</a>	<a href="#">No.23</a>	<a href="#">No.24</a>
1999''N	<a href="#">No.18</a>	•@	•@	•@	•@	•@
1998''N	<a href="#">No.14</a>	<a href="#">No.15</a>	<a href="#">No.16</a> <a href="#">No.16.pdf</a>	<a href="#">No.17</a> <a href="#">No.17.pdf</a>	•@	•@
1997''N	<a href="#">No.10</a>	<a href="#">No.11</a>	<a href="#">No.12</a>	<a href="#">No.13</a>	•@	•@
1996''N	<a href="#">No.6</a>	<a href="#">No.7</a>	<a href="#">No.8</a>	<a href="#">No.9</a>	•@	•@
1995''N	<a href="#">No.5</a>	•@	•@	•@	•@	•@

•@

;-â,c•†,í,¹æ •F

•••Ũ”_—Ñ•...ŽY<ÆCEκ†fZf“f^•[•@Šé%œ²•@•”•@•î•ñŽ‘—;‰Ũ

TEL:0298-38-6340

•@FAX:0298-38-6656•@E-mail: [ref@jircas.affrc.go.jp](mailto:ref@jircas.affrc.go.jp)

•§305-8686•@~•éCE§,Â,-,ÎŽs‘â,í,µ,P•l,Q

•@



ジルカスニュース

# JIRCAS NEWS

JAPAN INTERNATIONAL RESEARCH CENTER FOR AGRICULTURAL SCIENCES

独立行政法人国際農林水産業研究センター

2002 No. **28**

-Ú•@ŽŸ

•Ž†		1
Š ^u caE¾	<a href="#">JIRCAS,É,;,̄,éŠÄŽ-,Ì-ðŠ,,</a>	2
•-‰œÊ•îñ	<a href="#">••,è•Ä•iŽí,ð•,•Ä,©,ç”»•É,.,é</a>	3
Žó•Ü	<a href="#">•Ÿ•ufGfr—P,Ì•¶—•‰œ»Šwœœ†,Æ—{•B,Ö,Ì‰œž—p•v,³•‰œi,³,ê•A•u“ú—{•—•«‰œÈŠwŽÒ,Ì‰œi•v•§—ã•Ü,ðŽó•Ü</a>	4
	<a href="#">•Ÿ•uftfNf†f^fJ•v,È,Ç,Ì•â“œ•V•iŽí,Ì•ç•¬,Ä” —Ñ•...ŽŸ•â•b•\•²</a>	5
†ŠÔ•‰œi‰œc	<a href="#">•u“œ“ìfAfWfA,É,;,̄,é•’•,ÌflXfgfn•[fxXfgf•fX’áœ,çZ•p,ÌŠJ”-•v†ŠÔ•‰œi‰œy,Ñf•[fNfVf±fbfv</a>	6
fVf“flfWfEf •ñ••	<a href="#">‘æ,W‰œñJIRCAS•••ŸfVf“flfWfEf •ñ••</a>	7
œA••ñ•‰œi,ÌŠT—v		8
•l,Ì“@,«		8
•Ž†,ÌŽÊ•^•à-¾		8

ジルカスニュース

# JIRCAS NEWS

JAPAN INTERNATIONAL RESEARCH CENTER FOR AGRICULTURAL SCIENCES

独立行政法人国際農林水産業研究センター

2002 No. **28**

## 目次

### 巻頭言

JIRCASにおける  
監事の役割…………… 2

### 成果情報

香り米品種を精米から  
判別する…………… 3

### 受賞

- ◆「エビ類の生理化学研究と養殖への応用」が評価され、「日本女性科学者の会」奨励賞を受賞…………… 4
- ◆「フクユタカ」などの大豆新品種の育成で農林水産大臣表彰…………… 5

### 中間評価会議

「東南アジアにおける穀物のポストハーベストロス低減技術の開発」中間評価及びワークショップ…………… 6

### シンポジウム報告

第8回JIRCAS国際シンポジウム報告…………… 7

帰国報告会の概要…………… 8

人の動き…………… 8

表紙の写真説明…………… 8



# 巻頭言

## JIRCASにおける監事の役割



監事 加藤 邦彦

近年、会社などで金銭の使い込み等の違法行為が行われたとの報道がテレビ等でよく出てきます。そして、これらの報道のたびに「監事はいったい何をしていたのか？」というきびしい問いかけがあります。一方、独立行政法人における監事による監査は始まったばかりでこれまで手探り状態で進んできました。このため、監事の役割については理解されていない点が多々ありますので、以下に、JIRCASの業務との関連で監事の仕事について述べてみます。

### JIRCASの業務

JIRCASは5年ごとに業務運営に関する「中期目標」を農林水産大臣より指示され、これに基づいて「中期計画」を作成し、農林水産大臣に申請し、認可を受けます。さらに、「中期計画」に基づいた年度計画を作成し、農林水産大臣に届け出ます。そして、年度計画に従い業務を行った後、年度が終了したら、年度計画に定めた項目ごとにその実績を記入した年度報告書を独立行政法人評価委員会（以下「独法評価委員会」と略す。）に提出し、評価を受けます。

### 監査

監事は毎年定期監査を年度終了後に行いますが、これには上述の年度報告書が基になります。監査には業務監査と会計監査があり、業務監査ではセンターの業務がその目的を達成するために合理的かつ能率的に運営されているかどうかを監査し、会計監査はセンターの会計に関する事務処理が法令その他諸規程に従い適正に行われているかどうかを監査します。監事は監査結果をとりまとめ理事長に報告します。また、JIRCASが農林水産大臣に毎年提出する書類の内、財務諸表および決算報告書には監事の意見を付す必要があります。

### 監査の役割

通則法において、「独立行政法人は業務の内容を公表すること等を通じて、その組織および運営の状況を国民に明らかにするよう努めなければならない。」（第3条2）とされています。上述の独法評価委員会への年度報告書の提出もその例です。評価委員は報告書に基づいて評価を行うわけですから、もし、報告書の内容に間違いがあったり、実体とかけ離れていたりしたらJIRCASは正しい評価を受けられなくなります。そんなわけで、監査の第一の目的は報告書の内容に誤りがないか、実体にあったものであるかどうかを検証することにあります。JIRCASの業務内容は膨大ですから短期間の監査で内容のチェックを行うことは不可能です。そのため以下の日常業務を行っています。

### 監事の日常業務

#### 1 会計月次報告の検討

毎月一回監事室において会計月次報告を監査官が説明し、これについて常勤監事および非常勤監事が質問、コメント等を行い、回答を求めています。

#### 2 会議等への出席

役員会は3か月に1回、常任幹部会は毎週1回、運営会議は1か月に1回、各種委員会、帰国報告会等はその都度開かれ、常勤監事および非常勤監事が出席し内容を把握するとともに必要な時は意見を述べています。







## 成果情報

# 香り米品種を 精米から判別する



食料利用部 吉橋 忠

### タイの香り米 カオドマリ105

タイの東北部では、ポップコーンのような香りを持った香り米品種カオドマリ105 (Khao Dawk Mali 105; 英名 Jasmine) が、生産されています。我が国では香り米は「ねずみ米」などとも言われ、一般的な品種ではありませんが、国際的にはその香りが好まれるため、重要な品種です。香り米の需要は、東南アジア・東アジア地域の経済発展と共に、高まっていますが、このカオドマリ105を他の地域で栽培をしても、高品質な香り米を収穫することが出来ません。そのため、需要に供給が追いつかない状況が続き、タイ国内で生産される他の品種に比べ、高値で取り引きされています。

### 精米から品種を判別する

このため、香りのしない品種の米を混ぜる不正が発生していました。国家間で大口で取り引きされる香り米に対して、「香りがしない」との理由で受け取りが拒否されるなどの問題も発生しています。我が国では、米は玄米として流通していますが、国際的には嵩張らず、すぐに消費できる精米として流通しています。玄米では発芽させた後に、草型を見ることで、品種を判別することは比較的容易ですが、精米は発芽しませんので、粒径と粒長の比をもとに判別が行われていました。このため、粒形が同じような品種が混入された場合、従来の判別方法は無力でした。

### 米一粒から極微量のDNAを取り出す

品種は、遺伝子、つまりDNAの違いに起因しています。精米の中には極微量ではありますが、DNAが含まれています。このDNAを効率的に取りだし、違いを明らかにすることで、品種の判別を行うことが出来ます。このためには精米一粒一粒から、DNAを取り出さなければなりません。米の成分の

多くは澱粉で占められていて、この澱粉はDNAを取り出す際に邪魔になります。これを高野豆腐がスポンジ状になる原理を利用して、効率的に除くことを出来る方法を開発しました。(図1) この方法を利用することで、効率的にDNAを精米

から取り出すことが出来るようになりました。

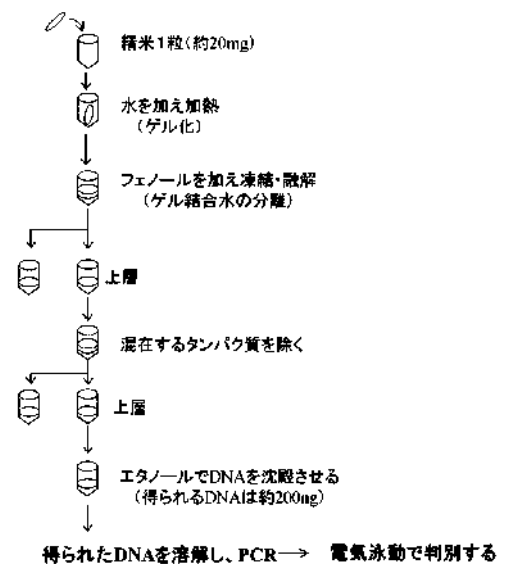


図1 新たに開発した簡易DNA抽出法  
精米をゲル化し、そのゲルの結合水と共にDNAを効率よく抽出する。

### 混米の検出

抽出されたDNAは、マイクロサテライト多型という、親子鑑定に使われる方法で品種を判別することが出来ます。図2に、実際に市場で入手した「カオドマリ105」として売られている精米を分析した例を示します。このように、一見ただけでは判らない混米を、高精度で判別することが出来ます。残念ながら、DNAを利用した品種の判別は、コストがかかりますので、一般的に利用することは出来ませんが、国家間大口取引の際には、有効な品質評価・保証法として利用することが出来ます。

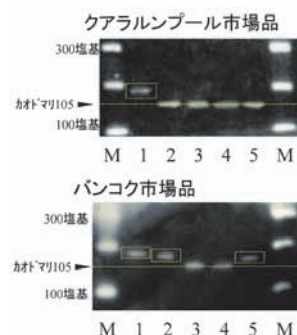


図2 カオドマリ105市場品への適用  
クアラルンプール市場品ではランダムに選んだ5粒のうち“1”が混米・バンコク市場品では“1, 2, 5”が混米であることが判別できた。



# 賞

## 「エビ類の生理化学研究と 養殖への応用」が評価され、 「日本女性科学者の会」奨励賞を受賞 水産部のマーシー・ワイルダーさん



水産部のマーシー・ニコル・ワイルダーさんは、「甲殻類の生理化学的基礎研究と養殖技術への応用」(JIRCASニュース23号)に関する研究業績が評価され、平成13年6月に第6回「日本女性科学者の会」(鈴木益子会長)の奨励賞を受賞しました。



ワイルダーさんは、ハーバード大学を卒業後、昭和62年に文部省の国費留学生として来日し、東京大学大学院で水産学を専攻し、東南アジアに多く生息する大型の淡水エビである「オニテナガエビ」を対象に、その脱皮・生殖・胚発生に関する基礎的研究を開始しました。平成5年にはこの研究で博士号を授与され、平成6年に国際農林水産業研究センターに入所し、現在もオニテナガエビの生理化学的研究を続けています。これまでの研究成果で特許も申請し、ベトナムとの国際共同研究の中で稚エビ生産技術として普及しつつあります。

理科系の女性研究者は、仕事を続けていく上で、結婚、出産、転職という大きなハードルに直面します。「日本女性科学者の会」は、理科系の研究者であった女性800名を対象にアンケート調査をした結果、仕事を辞めた理由のトップは出産・育児の33%で、次いで結婚の28%ということでした。勤続年数

では73%が10年以下で、3～4年が最も多く、歳をとり職場で昇任するに従って女性の比率が低くなるという現実も示されました。ワイルダーさんは大学を卒業して今年で14年で、JIRCASに入所してから8年目になりますが、その間、精力的に研究を推進し、一貫した基礎的研究とその応用技術の成果が認められ今回の受賞になりましたが、一方で、JIRCASでは外国のお客さんが多いため、英語が母国語のワイルダーさんは大変貴重な人材であり、いろいろな支援業務もお願いしてきました。平成7年に始まった英文のアンニュアルレポート作成では、企画調整部の一員として多大なる貢献をしています。また、明るい性格、他人への思いやりと責任感の人一倍強いワイルダーさんは、入所早々に研究所の人気者になり、職場を明るくするという「マーシー効果」の言葉も生まれました。

JIRCASの女性研究者はまだ1桁台で10%にも満たない数ですが、JIRCASのパートナーである開発途上国の研究所・大学には多くの女性研究者がいます。JIRCASの女性研究者の今後の活躍にエールを送ります。



(執筆：国際農林水産業研究センター 石谷孝佑)



# 受賞 「フクユタカ」などの大豆 新品種の育成で農林水産大臣表彰 生物資源部の異儀田和典さん



生物資源部の異儀田和典さんは、九州農業試験場（現：（独）農業技術研究機構・九州沖縄農業研究センター）時代に、永年にわたって大豆新品種の育成に取り組み、大品種の「フクユタカ」をはじめ、「アキシロメ」、「トヨシロメ」などの有力品種を次々と育成し、九州地方を中心とした暖地における大豆生産の安定化に大きく寄与しました。この業績により平成13年4月9日に、農林水産省において功績者表彰（農林水産大臣賞）を受賞しました。

異儀田さん達が育成した「フクユタカ」は、豆腐加工用の大豆として飛び抜けて高い品質をもっており、豆腐業界の評価が非常に高く、収量も多いことから、平成3年以降、全国1位の作付け面積を誇っており、平成11年の作付け占有率は18.5%にもなっています。異儀田さんは、この他にも中国・近畿地方を中心とした温暖地での栽培



に適し、豆腐加工に優れた品種「ニシムスメ」や、近畿・中国各県が一斉に奨励品種として採用の動きにある新品種「サチユタカ」の育成にも携わりました。

また、大豆特有の青臭みの原因となる脂質分解酵素・リポキシゲナーゼを全く含まない「いちひめ」、「エルスター」という品種を世界ではじめて育成し、世に出しました。この2種類は、新しいタイプの良質蛋白質を豊富に含んだ新しい食品素材として大いに期待されています。

さらに異儀田さんは、西日本ではじめての納豆用品種である「すずおとめ」の育成にも係りました。この納豆用品種は、九州産の大豆で作った納豆として熊本市のマルキン食品からデビューし、今年の3月10日から熊本県、福岡県を中心に本格的な販売に入っています。

こうした多彩な大豆品種を育成したことが、水田転作用の大豆作を発展させることにつながり、国の農業政策に対して多大な貢献をしたことが認められ、今回の受賞となりました。



(左) エルスター  
フクユタカから育成した子実中の青臭さをなくした新品種（リポキシゲナーゼ完全欠失品種）

(右) フクユタカ  
最近10年間、日本で最も広く栽培されている豆腐加工適性の高い安定多収品種

（執筆者：国際農林水産業研究センター 石谷孝佑）



## 中間評価会議

# 「東南アジアにおける穀類の ポストハーベストロス低減技術の開発 (収穫後損耗防止プロジェクト)」中間評価 及びワークショップ

食料利用部長 林 徹



標記プロジェクトは平成12年から5年間の計画で実施されているものであり、「主要穀類（主に米）収穫後の損耗調査及び品質劣化要因の解析」、「主要害虫・微生物種の周年動態及び被害発生・抑制機構の解析」、「資材低投入型乾燥技術、天敵・生理活性物質等を利用した生物的防除技術の開発」の3つの中課題で構成されている。

プロジェクトの中間評価会議及びワークショップが、平成13年11月29日にJIRCAS国際会議室において21名の参加のもと開催された。参加者の内訳は、評価委員3名、日本人研究者12名（北海道農業研究センター2名、食総研2名、JIRCAS8名）、タイ人カウンターパート6名であった。午前にはワークショップが開催され、「タイにおける害虫防除の現状」(Ms. Auranuj Kongkanjanaタイ農業局昆虫動物部長)、「タイにおける貯穀害虫防除の現状」(Ms. Porntip Visarathanonthタイ農業局貯穀害虫研究グループ長)、「天然物を用いた貯穀害虫の防除」(Dr. Gassinee Trakoontivakornカセサート大学食品開発研究所研究次長)、「農産物の品質評価の現状と課題」(Dr. Warunee Varanyanondカセサート大学食品開発研究所研究長)、「タイにおける穀物の乾燥技術」(Dr. Somchart Soponronnaritキングモンクット工科大学教授)の5課題の講演が行われた。

午後には開催された中間評価会議においては、日本人研究者により各実施課題ごとに研究成果が発表され、それぞれの成果について討議が行われ、評価がなされた。その結果、プロジェクトが開始されて実質1年余

りしか経過していないが、概ね順調に進捗しているとの評価がなされた。しかし、米の収穫後損耗の量的把握が不十分、害虫関係の担当者の変更に対する懸念、タイとの一層の連携強化の必要性の3点が指摘された。それに対して、翌11月30日に日本人研究者及びタイ人カウンターパートが参加してワーキンググループを開催し、パトンタニ稲研究所での貯蔵実験の設計の見直し、損耗実態調査地点の追加、害虫関係研究者の増強と必要に応じたタイへの派遣、プロジェクト責任者のタイへの派遣と現地での調整により対応することにした。また、具体的な成果として「タイ米、害虫、天敵鑑定の作成」、「簡易トラップによる害虫汚染実態の解明と天敵、植物を用いた制御システムの開発」、「天敵、天然物質、短時間高温乾燥(自然エネルギー利用)を組み合わせた技術の開発」、「簡易迅速乾燥・冷却技術とMA貯蔵を組み合わせた技術の提言」を目指してプロジェクトを推進することで合意した。



Workshop and Mid-term Evaluation Meeting of the Postharvest Project  
JIRCAS, 2001.11.29



## シンポジウム報告

# 第8回JIRCAS 国際シンポジウム報告



国際情報部 国際研究情報官 矢島 正晴

世界の発展途上地域では依然として人口増加と貧困が大きな問題となっており、人々は食料確保のために森や林の木を伐採し農地を開墾せざるを得ません。新たに開墾された農地では新たな水需要が増加し、伐採による森林の減少は大地の貯水能力をも衰えさせます。現在、このような水不足はアジア、アフリカなどの各地に広がっており、「水不足の圧力は世界人口の1/3に達し、2025年には3人のうち2人に及ぶ」と予測されています。

このように、発展途上地域の大部分を含む乾燥・半乾燥地帯や降雨の不安定な天水農業地帯では、持続的な農業生産を目指した水利用の向上に関する新たな研究の展開が必要とされています。

そこで、第8回JIRCAS国際シンポジウムでは、「発展途上地域における持続的農業と水問題 — 水利用の向上を目指して—」と題し、「水問題」を中心検討課題として、2001年11月27-28日に筑波国際会議場（エポカルつくば）において、内外から200名（海外より12カ国、25名）を超える国公立機関、大学、民間企業等の研究者、NGOの参加者を得て



開催されました。

シンポジウムでは16名の講演者により、世界の水資源の動向、食料・環境の安全確保と水、農業における水利用の変遷に関する基調講演と、①作物の遺伝・育種・生理生態的特性からみた耐乾性作物開発とその利用、②栽培管理技術からみた農耕地の水利用の現状と向上の可能性、③開発途上国における農業生産と生産安定化の可能性（天水農業および乾燥・半乾燥地農業における水管理の現状と生産安定化の可能性）について話題提供が行われました。さらに、ポスターセッションでは最近の成果を中心に24課題の報告が行われました。

総合討論では、2003年に日本で開催される第3回世界水フォーラム事務局から世界の水問題と同フォーラムの活動状況、さらにJIRCAS (TARC)の最近の水関連国際共同研究の報告に引き続き、今後の国際共同研究の展開方向について活発な意見交換が行われ、JIRCAS、国際研究機関、途上国研究機関、大学等の間で調和のとれた研究協力と連携の強化が確認されました。



# 人の動き

新	旧	氏名
平成 14 年 2 月 1 日付		
国際情報部主任研究官	選考採用	坂上 潤一
生物資源部	選考採用	山中 直樹

新	旧	氏名
平成 14 年 2 月 5 日付		
国際農林水産業研究センター付 (派遣職員 平成16年2月4日まで)	国際農林水産業研究センター 主任研究官	石谷 孝佑

## 帰国報告会の概要

平成13年4月から9月までにJIRCASで開催された帰国報告会の概要は以下の通りです。

年月日	演題	発表者	所属
H13.05.08	農牧輪換システムにおける熱帯牧草の特性	菅野 勉	JIRCAS畜産草地部
H13.05.08	ブラジル東北部の2種のセラード土壌におけるイオウおよび微量元素の可給度ーダイズの生育阻害要因としてのイオウおよびホウ素ー	檀田木世子	JIRCAS生産環境部
H13.05.08	大豆の干ばつ耐性検定法の開発	大矢 徹治	JIRCAS生産環境部
H13.06.28	インドネシア・西ジャワ高原の温帯野菜生産における技術的問題と現地適応技術の模索	山田 盾	JIRCAS生産環境部
H13.06.28	小農経営における温帯野菜作の社会経済的定着条件の解明	小杉 正	JIRCAS国際情報部
H13.07.09	大豆・米等を中心とする食品加工保全流通技術の開発	辰巳 英三	JIRCAS食料利用部
H13.07.25	道路建設と熱帯林減少：インドネシア・スマトラ島におけるゴム農村の事例	宮本 基枝	JIRCAS林業部
H13.07.25	熱帯産未利用木質資源の有効利用のための技術開発ーオイルパーム廃残物の利用研究ー	田中 良平	JIRCAS林業部
H13.07.25	熱帯天然林を対象とする低インパクト伐採技術の開発	佐々木尚三	JIRCAS林業部
H13.08.27	メコンデルタにおける窒素フローの評価と地域資源利用技術の開発	渡邊 武	JIRCAS生産環境部
H13.08.27	タイ東北部の畑作付け体系における深根性マメ科作物の導入が耕地生産力に及ぼす影響の解明	有原 丈二	農研機構・作物研究所
H13.09.03	タイ東北部における土壌保全型作物生産技術の開発	桜木 信幸	JIRCAS生産環境部
H13.09.03	タイにおける貯穀害虫とその天敵の発生状況	高橋 敬一	食品総合研究所
H13.09.25	アグロパストラルシステムにおける熱帯牧草の特性	菅野 勉	JIRCAS畜産草地部



### 表紙の写真説明

国際農林水産業研究センター 小坂 清巳

熱帯から温帯にまで広がるブラジルでは南米原産の果物はもちろんアフリカやアジアから伝わった果物も栽培されています。コーヒー（右上）はエチオピア辺が原産です。赤く熟した果実は乾燥して黒くなってから収穫していました。

レイシ（右下）は東南アジアでおなじみですが、ブラジルでは最近栽培されるようになったばかりなのでまだ珍しい高価な果物です。

クダモトケイソウ（果物時計草）（左下）はブラジル原産のつる草です。世界各地の亜熱帯地域や熱帯の涼しい高地でよく栽培されています。花は大きくて見事です。果実は熟すと黄色や赤紫になり、実の中には甘酸っぱいゼリーに包まれた種がたくさん入っています。このゼリーから、ジュースやアイスクリーム、ジャムを作ります。

カペロジーニャ（左上）はブラジル語で「毛の多い果物」という意味です。直径3cmくらいの黄色の甘い実の生る山の木を屋敷に植えているといった感じで栽培果物とはいえません。



JIRCASニュース No.28  
平成14年2月発行

発行 国際農林水産業研究センター  
編集 企画調整部国際研究広報官、情報資料課  
〒305-8686 茨城県つくば市大わし1-1  
TEL.0298(38)6340(情報資料課) FAX.0298(38)6316  
ホームページアドレス <http://www.jircas.affrc.go.jp/>



この印刷物は再生紙を使用しています。

ジルカスニュース

# JIRCAS NEWS

JAPAN INTERNATIONAL RESEARCH CENTER FOR AGRICULTURAL SCIENCES

独立行政法人国際農林水産業研究センター

2002 No. **29**

—Ú•@ŽŸ

<a href="#">•Ž†</a>		1
<a href="#">Š^a•a•E^{3/4}</a>	<a href="#">••ŪEα††—Í,Ö,Ïê,Â,Ïž&lt;“</a>	2
<a href="#">•-‰oÊ•î•ñ</a>	<a href="#">fpfpfCfAŠiE`—tf,fUfCfNfEfCf&lt;fX•iPLDMV),Ï’S‰-Ši”z—ñ</a>	3
<a href="#">•V&lt;K,fvf•fWfFfNfgEα†</a>	<a href="#">fCf“fhfVfi“V•...”&lt;Æ’n’Ñ,É,“,é•...Ž‘E!,ÏEø—!“I—~—p,ÆŽû‰ov•«,ÏEü•ã</a>	4
<a href="#">fvf•fWfFfNfgEα†</a>	<a href="#">••Ūfvf•fWfFfNfgEα†•@•½•-13”N“x,ÏžÀŽ •óμ</a>	5-7
<a href="#">&lt;A••ñ•‰ci</a>		8
<a href="#">•l,Ï“®,«</a>		8
<a href="#">•Ž†,ÏžÊ•^•à-¾</a>		8

ジルカスニュース

# JIRCAS NEWS

JAPAN INTERNATIONAL RESEARCH CENTER FOR AGRICULTURAL SCIENCES

独立行政法人国際農林水産業研究センター

2002 No. **29**

## 目次

### 巻頭言

国際研究協力への  
一つの視点…………… 2

### 成果情報

パパイヤ奇形葉モザイク  
ウイルス (PLDMV) の  
全塩基配列…………… 3

### 新規プロジェクト研究

インドシナ天水農業地帯  
における水資源の効率的  
利用と収益性の向上 …… 4

### プロジェクト研究

国際プロジェクト研究  
平成13年度の実施状況 …… 5

帰国報告会 …………… 8

人の動き …………… 8

表紙の写真説明 …………… 8



南米の花いろいろ



# 巻頭言

## 国際研究協力への一つの視点

企画調整部長 野口 明德



### 1. 国際協力の理念の変遷

この春に独立行政法人となったJIRCASはその役割に大きな変化は無いが、活動のあり方に変容が求められており、その概要は当ニュース26号の巻頭言として紹介されているので参照されたい。前者の役割は、「開発途上国との研究協力を通して、世界の食料・環境問題の解決に貢献することであり、もって開発途上地域における環境と調和した農林水産業の持続的発展に寄与し国際社会における責務を果たす」ことにある。この大きな役割の底流には、人道主義があると言えよう。(社)国際農林業協力協会が発行する「国際農林業協力」(第22巻、6・7号：通巻第100号記念特集号)において、紙谷 貢氏は日本の海外農業開発協力の理念の変遷に触れられており、その一部を筆者なりにまとめてみると、

～1960	開発途上地域の生産力の拡大と工業化の推進
1970代	人道主義+世界経済の安定化と反映に向けての国際協調 「最貧層の人々に設定すべきミニマムな生活水準」 Basic Human Needs：BHN（基礎生活分野）アプローチ
1980代	成長重視の開発戦略が再び脚光
1990代	開発途上国経済の開放体制化(構造調整プログラム) BHN+参加型開発戦略へ 地球環境問題、貧困問題への対処

のようになり、同様に紙谷氏が指摘されている課題を抜粋して筆者なりにまとめると、

- ・ 初期から現在も相手国の要請に応える→特定分野に関する技術移転が大多数
- ・ プロジェクト方式でもいくつかの技術的分野の集合体←PCM手法、PDMのより一層の浸透が望ましい
- ・ 参加型開発のプロジェクト形成への動きがもつと期待される
- ・ PRA（Participatory Rural Appraisal：参加型農村調査）などの手法に基づく農村生活総合調査（Baseline Survey）の必要性

のようになる。

### 2. 研究協力における課題

JIRCASは開発途上地域から多くの研究協力を求められているが、その特徴と課題として、①協力要請の分野が多様化しつつある、②各分野および複合分野に対応し得る人材が不足気味である、③人材を組織的、系統的に教育訓練する体制・規模を職員定員枠などから十分に構築しがたいなどが挙げられる。そして、独立行政法人化後の厳格な評価に応えるためには、④として、自己保全にむけて個別分野の研究協力に集中する可能性の高まりなどが挙げられよう。これらの課題をいかに乗り越えて行くかの構想をJIRCASは捻出しなければならないと考えている。日本のODAは世界トップの地位を得て久しい。しかし、研究協力が基本的に人材によるとすれば、この分野でもトップの地位をしめるとは残念ながら言い難い。両者が同等でなければならぬかどうかはともかく、より多くの研究協力参加者が輩出されて然るべきと考えるのは筆者ばかりではないだろう。

### 3. 人材育成・確保のプログラム

農林水産業分野で国際研究協力を推進し、開発途上地域の研究者などを育成しているのはJIRCASだけではなく、程度の差こそあれ、他の多くの研究機関も開発途上地域との研究交流を進めており、その過程の中で現地研究者の育成にも務めている。ここに着目すれば、人材育成・確保は日本内部からのみではなく、開発途上地域からもその視野を拡大し、それぞれでほぼ個別的に推進している人材育成・確保プログラムとも言えるものの大同団結があっても良いのではなかろうか。すなわち、こうした統合プログラムを通して、内外の優れた人材を育成し、各分野および複合分野に対応し得る人材を確保して行く構想である。同時に考えるべきは、育成した人材が、たとえば、現地リーダーあるいは現地での研究推進者として活躍できる環境を整えることが肝要と考えている。



# 成果情報

## パパイア奇形葉モザイクウイルス (PLDMV) の全塩基配列

沖縄支所 眞岡 哲夫

(現 農業技術研究機構北海道農業研究センター生産環境部ウイルス病研究室)



### パパイアのウイルス病

パパイアがウイルス病に感染すると、果実にリング状の病斑があらわれ、病徴が激しい場合には果実が奇形化する (写真)。このような果実はとうてい



商品にはなりえないので、農家は経済的な大打撃を被る。パパイアウイルス病は沖縄以南の熱帯アジア地域をはじめ世界中に発生しているが、その主な病原は、パパイア輪点ウイルスパパイア系統 (PRSV-P) とパパイア奇形葉モザイクウイルス (PLDMV) の2つである。このうち

PLDMVは、これまでわが国固有のウイルスとされてきたが、近年台湾各地にも発生していることがわかり、被害が東南アジア各国にまで広がる懸念されている。JIRCAS沖縄支所では、この病気を撲滅するため、病原ウイルスの遺伝子の解析を進めてきたが、このほど世界ではじめてPLDMVの全塩基配列を解読することに成功した。

### PLDMVの遺伝子構造

PLDMVは、10,153塩基の1本のRNAからなり、長大な読み取り枠 (ORF) が存在した。ORFは、3,269アミノ酸からなり、10種類のタンパク質がコードされていた (図1、表1)。各タンパク質のアミノ酸配列を、PRSV-Pや他のウイルスのタンパク質と比較したが相同性は低く、PLDMVが独立したウイルス種であることが判明した。

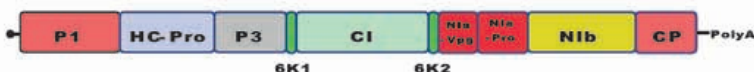


図1 PLDMVの遺伝子構造

### 解明したウイルス遺伝子の利用

近年、PRSV-Pの外被タンパク質 (CP) 遺伝子を組み込んだウイルス抵抗性パパイア品種「サンアップ」がハワイで育成された。この品種は、PRSV-Pに高い抵抗性を持ち、ウイルス病に悩んでいたハワイの栽培農家に急速に普及した。しかし著者らの実験では「サンアップ」は、ハワイのPRSV-Pには抵抗性を示すものの、PLDMVやアジアのPRSV-Pには抵抗性を持たなかった。そこで、アメリカ農務省・コーネル大学・JIRCASが協力し、今回明らかになったPLDMVの遺伝子と、アジアのPRSV-Pの遺伝子を組み合わせることで導入することにより、アジア地域のパパイアウイルスに対して広い抵抗性をもつ組換えパパイアの作出を行うことになった。1999年にコーネル大学で導入遺伝子の構築を行い、アメリカ農務省ハワイ農業試験場でパパイアカルスへ遺伝子を導入した。現在、JIRCAS沖縄支所で導入遺伝子を含むパパイアカルスから植物体を再分化しており、ウイルス抵抗性パパイアの作出に一条の光が見えてきた。この共同研究が実を結び、アジア地域からパパイアのウイルス病が撲滅される日が来ることを期待している。

表1 PLDMVのタンパク質と機能

名称	アミノ酸数	機能
P1	480	細胞間移行、プロテアーゼ
HC-Pro	458	アブラムシ伝搬、プロテアーゼ
P3	348	プロテアーゼ関連因子?
GK1	52	?
CI	635	ヘリカーゼ
GK2	52	?
NIa-Vpg	187	ゲノム結合タンパク
NIa-Pro	243	プロテアーゼ
NIb	521	ポリメラーゼ
CP	293	外被タンパク



# 新規プロジェクト 研究

## インドシナ天水農業 地帯における水資源の 効率的利用と収益性の向上

生産環境部長 伊藤 治



### 東南アジアでなぜ天水農業研究なのか？

東南アジア地域*は、熱帯多雨林及び熱帯季節林（熱帯モンスーン）地帯に属し、水資源には比較的恵まれている。また、大河の流域では灌漑施設の整備が進んでおり、潤沢な水資源を使った水田農業が主体となっている。

しかし、インドシナ半島の内陸部に位置する東北タイ地域は、乾期がきつく、台地状の地形であることから熱帯サバンナ気候に属し、水田と畑が錯綜する天水農業地帯である。この地帯では、インディカ種の稲作に畑作、畜産を加えた複合的な経営が行われているものの、乾期には全く降雨がないほか、雨期の始期、終期においても降雨が不安定なため、生産が安定せず、かつ生産性も低い。また、タイ東北部に隣接するラオスも天水農業地帯であるが、生産性が一層低い地域である。

この地帯での農業生産を安定させるためには、このように水の確保が不安定であることから、個別の農家レベルにおける丘陵地の土地の傾斜等地形をも考慮し、ため池の地理的分布や地下水の状況などを含めた集水域レベルでの水資源の効率的利用のための技術開発に取り組むことが必要である。また、これらの技術を適正化し現地に定着させるために、集水域内全域の農家の実証研究が必要である。

このため、タイ東北部及び隣接するラオスの天水農業地帯を対象に、平成14年度から平成20年度にわたって水資源の有効利用を核とした農畜産物生産に係わる技術開発と実証研究を行う。

なお、本プロジェクトで得られた成果は、南・西アジアやアフリカに広がるより条件の厳しい天水農業地帯を対象とした技術開発研究への波及効果も期待できる。

### 研究内容

- (1) 水資源の賦存量評価と利用率向上に向けた営農体系の制約要因の解明
  - ①地域内の水資源賦存量の評価
  - ②ため池、地下水の利用活性化条件の解明
  - ③水資源利用の高度化に向けた営農体系の制約要因（経営、水共同管理体制等）の解明

- (2) 水資源の利用効率向上技術の開発
  - ①不安定・分散型水資源の有効集配水技術の開発
  - ②水資源の効率的利用に向けた熱帯野菜・果実等の栽培技術の改良
  - ③耐乾性に優れた高収量飼料作物の育成と利用法の開発
- (3) 農民参加型研究手法による技術の実証・適正化
  - ①水の利用率と付加価値の高い営農体系に向けた受益者ニーズ認定と技術の共同試験
  - ②営農体系変革による小流域管理の効率化のガイドライン開発

### 年次計画

研究課題	14	15	16	17	18	19	20
(1)水資源の賦存量評価と利用率向上に向けた営農体系の制約要因の解明	←	←	←	←	←	←	←
①地域内の水資源賦存量の評価	←	←	←	←	←	←	←
②ため池、地下水の利用活性化条件の解明	←	←	←	←	←	←	←
③水資源利用の高度化に向けた営農体系の制約要因（経営、水共同管理体制等）の解明	←	←	←	←	←	←	←
(2)水資源の利用効率向上技術の開発							
①不安定・分散型水資源の有効集配水技術の開発							
②水資源の効率的利用に向けた熱帯野菜・果実等の栽培技術の改良							
③乾期での生育が優れた高耐乾性高収量飼料作物の育成と利用法の開発							
(3)農民参加型研究手法による技術の実証・適正化							
①水の利用率と付加価値の高い営農体系に向けた受益者ニーズ認定と技術の共同試験							
②営農体系変革による小流域管理の効率化のガイドライン開発							

### 研究実施機関

- [日本] 国際農林水産業研究センター（協力機関）農業技術研究機構、農業工学研究所
- [タイ] 農業局（土壌肥料部、国際農業開発トレーニングセンター、コンケン畑作センター）、畜産振興局（コンケン家畜栄養研究センター）、土地開発局、コンケン大学
- [ラオス] ラオス農林業研究所、県農業技術センター
- [国際機関] 国際稲研究所（IRRI）、国際熱帯農業研究センター（CIAT）

(*：ミャンマー以東の地域を指し、バングラデシュ、インド、パキスタン含まない。)



## プロジェクト 研究

# 国際プロジェクト研究 平成13年度の実施状況

### タイ東北部における持続的農業技術の 確立のための開発研究

本プロジェクトでは、タイ東北部において地域資源利活用促進による持続性のある農業の展開方向を提示するため、①環境資源と生物資源の特性評価及びその有効利用技術の開発、②水稲乾田直播や野菜飼料作物の導入を始めとする水の効率的利用と土壌の損耗防止を目的とした生産技術システムの確立、③経営安定化のための家畜飼養技術の確立等、ポストハーベストまで含めた、多角的・総合的な研究を推進し、多作物、有畜農業生産システムの構築を図り、地域の農地保全と農業振興に資することを目的に研究が進められてきた。本年度は7年間のプロジェクトの最終年に当たるが、長期在外研究員5名、短期派遣者27名、招へい者12名により、現地の関連研究組織との緊密な連携を保ちつつ研究推進を行った。本年度の主要研究成果としては、1) サトウキビやパイナップルは植物内生菌による窒素固定能を有し、適切な肥培管理により窒素施肥量の軽減が可能である、2) サトウキビの近縁種であるエリアンサスは耐湿性が高く、深い層にまで達する根系により脊薄で酸度の高い土壌条件に優れた適応力を有する、3) 東北タイの天水田地帯で、乾田直播栽培の導入が収数確保による増収の可能性が高く、また不耕起と組み合わせることによる一層の省力化が期待できる、4) サブソイル耕による硬盤層破碎で雨期作における透水性が向上し土壌流亡が軽減され、雨期作トウモロコシに対しては発芽促進や深根

機械による播種作業



化を促す、5) サブソイラーと施肥・植付機を結合した部分深耕同時施肥・植付機を開発し、これにより、サトウキビの耕起から植付けまでの作業工程を簡略化でき、耕起・植付作業の燃料消費量・作業時間を削減できる、等が挙げられる。

### ブラジル中南部における 持続的農牧輪換システムの開発

ブラジルは広大な可耕地を有する南米最大の国家である。ブラジルの農牧業は多大な発展の可能性を備えており、21世紀の世界の食料需給にも多大な貢献をなすことが期待されている。しかし、このような期待に応えるためには、現行の資源収奪型で環境破壊的な前近代的形態の農牧業から、高位安定型で持続的な特性を備えた体系の農牧業に変革することが不可欠と考えられる。このことから、本プロジェ



ブラジルで放牧されているネローレ種の牛

クトにおいては、技術研究と社経研究を総合しつつ、牧草地と農耕地を相互に輪換するシステムを確立することによって、牧草地の地力増進や耕地の土壌劣化防止を実現するとともに、牧草地への穀実・園芸作物の導入によって、作目の多様化を実現し、市場リスク回避を通じた日系農家等の中小農の経営安定にも貢献することなどを主要な目的とする総合研究を推進している。平成13年度は、農牧輪換条件下における窒素の動態の経時的・定量的把握、牧草の生



# プロジェクト研究

産性、牧草による窒素・リン酸吸収機構の解明などの研究を進めた。また、硝化抑制牧草の選択、GISを用いた牧草生産力の推定、農牧輪換システムの社会経済的評価及びブラジルの低湿地に適した牧草と草地造成方法などの研究を行った。

## 中国における主要食料資源の持続的生産及び高度利用技術の開発

中国は、改革開放政策と市場経済への移行により著しい経済発展を遂げつつある。人口増加と所得向上により、食料需要の増大と食料消費の質的・量的変化をもたらす一方、食料需給の地域バランスが乱れ、その安定化が中国農業の最大かつ緊急の課題となっている。そこで、社会経済研究を土台に、主要食料の持続的生産及びそれらの高度利用技術の開発を目的とする総合型プロジェクト研究を複数の研究機関との共同研究により実施する。研究開発の対象に水稻、大豆、トウモロコシ、淡水魚を選定し、技術開発に伴う農業経済への波及効果を検討しながら、生産性向上及び農林水産物の高度利用技術の開発を進める。

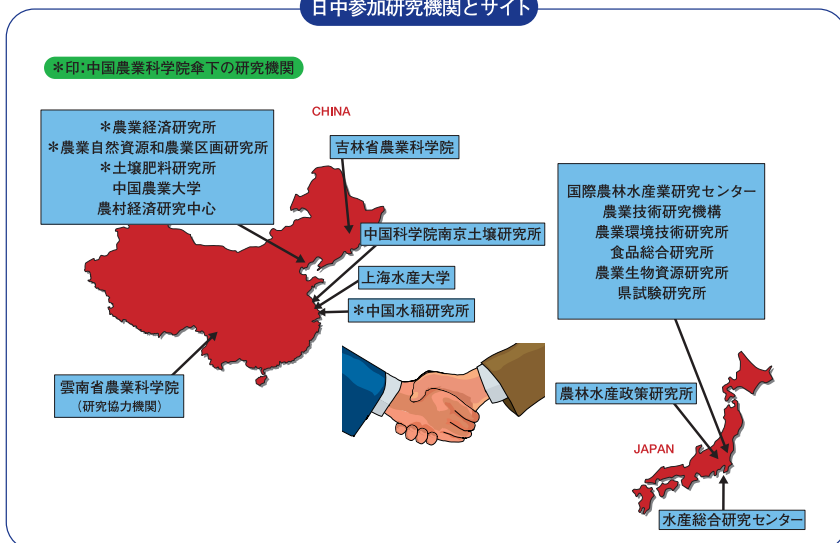
本年度は、昨年度末の中間推進評価会議の評価結

果を受けて、プロジェクトの研究課題について一部統合、延長、追加した。研究分野内及び分野間の一層の連携協力を進めてプロジェクト後期の研究計画の効率的な推進を図った。

長期派遣（4名）、短期派遣（のべ22名）及び研究管理者・共同研究者の招聘（9名）により、すべての研究課題について研究を実施した。中課題「食品加工流通技術の開発」から研究成果情報候補として3件を提出した。また、中課題「大豆遺伝資源の特性評価と利用及び新技術による大豆新品種素材の開発」では、吉林省農業科学院大豆研究所との共同研究により大豆新品種4系統が登録された。

プロジェクトの円滑な実施のため、第20回日中農業科学技術交流グループ会議（5月29～30日、東京）及び第6回日中農業研究連絡調整会議（5月31日、つくば）において、研究機材の免税措置と査証取得手続きの迅速化、日中共同研究の推進における中国側研究機関の人的及び財政的措置、日中共同研究の推進体制など、共同研究実施上の問題点や評価のあり方について協議した。今後、引き続き、各研究課題間の連携・協力を密にするとともに、他の技術協力案件との調整や中国側研究機関の再編、統合への対応を行う。

日中参加研究機関とサイト



## 南米諸国における大豆の高位生産・利用技術の総合的開発研究

大豆は、たんぱく、脂肪を多く含み、イネ、小麦とならぶ世界の重要作物である。大豆の生産量増大は世界の食料需給の安定化に不可欠の課題である。南米諸国は世界の大豆生産の1/3を占めさらに比重は増加すると見られている。しかし、南米諸国大豆はまだ歴史が浅く、不良環境下での栽培やシストセンチュウなどの蔓延など、解決すべき課題を抱えている。本プロジェクト



# プロジェクト 研究



パラグアイにおける大豆の不耕起栽培

トは持続可能な生産に関する課題にポストハーベストと社会経済分野の研究を加え、南米における大豆の総合的生産・利用技術開発を目指して実施している。研究推進に当たっては、多国間協力による研究実施と国際協力事業団との協力・連携を重視した。平成13年度は、大豆の種子成分の遺伝的改良、DNAマーカーの開発、持続的生産のための土壌管理、干ばつ耐性検定法、大豆主要病害の発生実態解明及び耐虫性育種などの研究を長期、短期派遣により実施するとともに、大豆の病害抵抗性遺伝子に関連するDNAマーカーの開発も実施した。さらに、干ばつストレス、大豆病害、耐病性育種部門については、招聘研究を行った。

さらに、平成13年3月22日には中間評価会議が国際農林水産業研究センターにて開催された。また、平成13年12月13日及び14日に南米大豆に関するワークショップがブラジルのパラナ州ロンドリーナ市のEMBRAPA大豆研究センターにて開催された。

## 西アフリカにおける米増産のための 稲種間交雑種の活用に関する研究

サハラ砂漠以南のアフリカ諸国では、農業生産の長期的な停滞や人口増加のため、慢性的な食糧不足

が続いている。この地域では、都市への人口の集中や生活形態の変化に伴って食料消費形態も変わり、米の消費が急速に伸び輸入が大幅に増大している。JIRCASは、西アフリカ地域における稲作の生産性および所得の向上に貢献することを目的とし、WARDAとの共同研究を行っている。

遺伝資源及び育種関連ではアジア・アフリカ稲を含む多様な遺伝資源（455品種/系統）の幼苗期の乾燥ストレス耐性をスクリーンハウス内で検定し、乾燥ストレス耐性の供与親として有望な7品種を選抜した。さらに、短期派遣の九州大学平尾助手



コートジボワールでの稲刈り

と共同で、アフリカ稲の生理学的形質の評価とそれを支配する遺伝子の座乗位置を推定するために、九州大学で育成された“アフリカ稲染色体部分置換系統”の栽培試験を行い、生理学的形質を評価した。

社会経済学関連の研究は2カ国を中心に行われている。コートジボワールでは、昨年度後半より開始した稲作農民調査を継続し、調査を完了した。現在、データの入力と分析を進めている。また、今年度は、稲作農民と地主の関係についてより詳細な調査を開始し、現在継続中である。ガーナでは、昨年度より開始した稲作農民調査について、補足調査を続けた。（次号に続く）

# 人の動き

新	旧	氏名
平成 14 年 3 月 1 日付		
水産部長	水産総合研究センター 中央水産研究所加工流通部長	福田 裕
宮崎大学教授 農学部生物環境科学科	水産部長	前田 昌調

新	旧	氏名
平成 14 年 3 月 15 日付		
畜産草地部主任研究官	畜産草地部付（派遣職員）	押部 明徳

## 帰国報告会の概要

平成13年10月から平成14年3月までにJIRCASで開催された帰国報告会の概要は以下の通りです。

年月日	演題	発表者	所属
H13.10.15	熱帯モンスーン地域における広域水田用水量を節減する配水管理手法の開発	堀川 直紀	JIRCAS生産環境部
H13.10.15	地表水と地下水の複合利用のための現地調査	濱田 浩正	JIRCAS企画調整部
H13.10.22	持続型農牧輪換システムにおける熱帯牧草および作物の養分吸収・利用特性の解明 — 熱帯牧草および作物の窒素吸収および利用 —	中村 卓司	JIRCAS生産環境部
H13.10.22	東北タイにおける畑作経営の現状と改善方向 — サトウキビ生産を中心に —	安藤 益夫	JIRCAS国際情報部
H13.10.29	メコンデルタ・ファームングシステムにおけるバイオダイジェスター技術の経営的評価	山田 隆一	JIRCAS国際情報部
H13.12.03	東北タイの農業生態系における養分循環の解明	松本 成夫	JIRCAS生産環境部
H13.12.03	東北タイにおける耕畜結合高度化のための畑作付体系の策定	松尾 和之	JIRCAS生産環境部
H13.12.03	東北タイ砂質土壌におけるサトウキビ作の耕起法改善のための作業機の開発	屋代 幹雄	農研機構・東北農研センター
H13.12.14	中国の食糧生産とWTO加盟	山下 憲弘	JIRCAS国際情報部
H13.12.21	遺伝子欠損マウス等を用いたトリパノソーマ感染抵抗性機構の解明	中村 義男	JIRCAS畜産草地部
H14.01.15	マングローブ域における自然浄化機能の解明	下田 徹	JIRCAS水産部
H14.01.15	淡水漁業資源の有効利用技術の開発	横山 雅仁	JIRCAS水産部
H14.02.21	コムギ倍加半数体集団を用いた耐病性のQTL解析	末永 一博	JIRCAS生物資源部
H14.02.21	ダイズ急性枯死症に対する抵抗性検定法の開発	本間 善久	JIRCAS生物資源部
H14.03.19	南米産大豆品種の種子成分の遺伝的改良	菊池 彰夫	JIRCAS生物資源部
H14.03.19	西アフリカにおけるイネ遺伝資源の特性評価と新品種素材の育成	常松 浩史	JIRCAS生物資源部



### 表紙の写真説明

国際農林水産業研究センター 小坂 清巳

ブラジル南部のロンドリーナでは9月ころになると春になり、いろいろな花が咲きます。  
 コーヒー（左下）：白い花が枝にびっしりと一斉に咲きます。コーヒー畑が良い香りに包まれるそうです。ロゼレ（右下）：オクラの花とよく似ています。未熟な果実は赤色の皮をしていて、酸っぱい味がします。ジャムやシロップを作りますが、ブラジルに移住した日本人は塩漬にしてウメボシの代用にしたので“はなうめ”と呼んでいました。火炎樹（右上）：熱帯の強い日差しに良く似合うオレンジ色かかった赤色の花です。花の後には莢豆がついてマメ科の特徴がわかります。街路樹としてよく植えられています。ラズベリー（左上）：木イチゴです。イチゴは熟すと黒紫色になります。ケーキ屋さんの裏庭に植えられていました。



JIRCASニュース No.29  
平成14年3月発行

発行 国際農林水産業研究センター  
 編集 企画調整部国際研究広報官、情報資料課  
 〒305-8686 茨城県つくば市大わし1-1  
 TEL.0298(38)6340(情報資料課) FAX.0298(38)6316  
 ホームページアドレス <http://www.jircas.affrc.go.jp/index.sjis.html>



この印刷物は再生紙を使用しています。

シルカスニュース

# JIRCAS NEWS

JAPAN INTERNATIONAL RESEARCH CENTER FOR AGRICULTURAL SCIENCES

独立行政法人国際農林水産業研究センター

2002 No. **30-31** 合併号

–Ú•@ŽŸ

<a href="#">•Ž†</a>		1
Š ^a “a”E ^{3/4}	<a href="#">•čŠE,ì...ŽY•H•i,ÆJIRCAS,İŠ“@</a>	2
•-%oÊ•î•ñ	<a href="#">—£“‡’n^æ,İfTfgfEflfr•¶ŽY,đ,ß,®,é“®Eü</a>	3
fvf•fWfFfNfgEα†	<a href="#">••Ûfvf•fWfFfNfgEα†•@•½•¬13”N“x,İŽÀŽ†•óμ</a>	4-6
Eα†•-%oÊ•î•ñ	<a href="#">•½•¬13”N“x••Û” —Ñ•...ŽY&lt;ÆEα†•-%oÊ•î•ñê—</a>	7-11
<a href="#">•l,İ“®,«</a>		12
<a href="#">•Ž†,İŽÊ•^•à-¾</a>		12



ジルカスニュース

# JIRCAS NEWS

JAPAN INTERNATIONAL RESEARCH CENTER FOR AGRICULTURAL SCIENCES

独立行政法人国際農林水産業研究センター

2002 No. **30-31** 合併号



南米の家畜

## 目次

巻頭言 .....	2
成果情報 離島地域のサトウキビ生産をめぐる動向 .....	3
プロジェクト研究 国際プロジェクト研究 平成13年度の実施状況 .....	4
研究成果情報 平成13年度国際農林水産業研究成果情報一覧 .....	7
人の動き .....	12
表紙の写真説明 .....	12

# 巻頭言

## 世界の水産食品と JIRCASの活動



水産部長 福田 裕

### 水圏の食料生産力

宇宙船から見ると青々と広がる地球上の水圏は、地球表面の7割を占め、しかも最も深い所は1万メートルを越えるので、生物が生息する場所は陸上を遙かにしのぐ容積を持っています。しかし、外洋は大きな容積を持つにも拘わらず、栄養塩が希薄であるため、生物生産能力はあまり高くなく、従って水圏全体でも陸上より低い生産能力しか持っておりません。食糧生産の場所としてみると、陸上では第一次生産物の穀類が主要な食糧となっているのに対して、水圏の一次生産物の植物プランクトン等は残念ながら食料として利用し難く、我々人類は高次生産物である魚介藻類を専ら食料として利用しています。

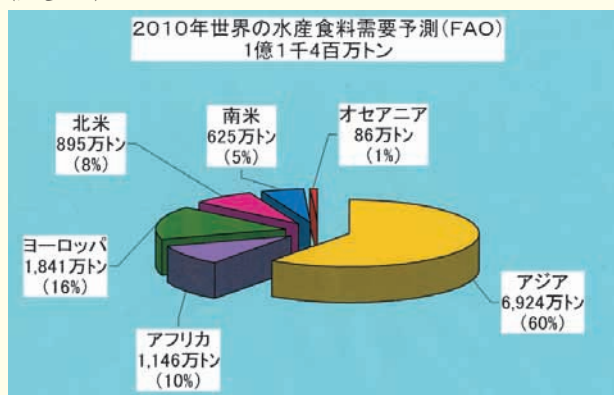
### 漁獲量の動向

1999年の世界の総漁獲量は1億3千7百万トン記録しました。穀物生産量が1990年代に入り横ばいの状態を続けているのに対して、水産物は1990年に比べて1.3倍と著しい増加を示しましたが、海洋の水産物供給量はそろそろ上限に近づきつつあるとの認識が一般的です。1999年について国別に漁獲量をみると、かつて世界一だった日本は1989年に中国に首位の座を奪われ、4位の661万トンとなりました。一方、中国は4750万トンと世界の生産量の約35%を占め圧倒的な首位に君臨しています。中国の漁獲統計に疑問を挟む経済学者もいますが、割り引いて考えても中国の漁獲量の伸びはめざましく、世界の漁業生産量を押し上げているのが中国です。中でも淡水養殖漁業生産量が大きな割合を占めており、世界の内水面地域が新しい漁業生産の場として期待されています。次いで、イワシ類を主漁業とする南米のペルーは844万トンで3位、チリは559万トンで5位と続きます。

### 2010年の水産物消費予測

2010年には、世界の人口は70億3千万人になると予想されており、1億トンから1億2千トンの水産食料が必要になるとFAOでは推計しています。漁獲量の約3割が非食用となることを考慮すると、1千万トンから4千万トンの不足が予想されます。しかも、世界的に消費の多い国は、日本を始め中国、イ

ンド、インドネシア、マレーシア、フィリピン、タイ等アジア諸国であります。ヨーロッパでは肉食が中心ですが、アジアのモンスーン地帯では米を主食としながら多様な魚食文化が育まれてきました。近年、この地域の所得の伸びが著しいことも考慮すると、2010年にはこの地域で6900万トンの水産食料が必要となります。つまり、世界中の水産食料の半分以上がアジア地域で消費されるることになります(図参照)。



### JIRCAS水産部の活動

以上の背景のもと、JIRCAS水産部ではアジア地域において水産食料の安定的供給のために、三つの国際共同研究に取り組んでいます。第一は、フィリピン、マレーシア、及びタイと協力して行われている「マングローブ汽水域における魚介類の持続的生産システムの開発」です。この共同研究は、荒廃劣化するマングローブ沿岸水域において、水産重要種の持続的漁業生産に向けた資源評価研究を行うとともに、マングローブ林の持っている自然の栄養成分や環境保全機能を活用して、低投入型の養殖技術の開発を目指します。第2の研究は「オニテナガエビの生殖機構の解明」です。この共同研究は、ベトナムメコンデルタの伝統的な複合的農業の一環として、稲作と組み合わせた淡水エビ養殖への応用技術として発展が期待されています。第3の研究は、「中国淡水漁業資源の利用技術の開発」です。この共同研究は、急増する中国淡水漁業資源の有効利用のため、淡水魚の冷凍すり身やフィッシュ・ミールの製造技術の開発を目的として行われており、多くの成果を上げてきました。



## 成果情報

# 離島地域のサトウキビ 生産をめぐる動向

海外情報部 銭小平



1世帯1ヶ月の砂糖消費支出は126円（平成12年5月～11月の全国平均）であり、うち大都市部（人口100万人以上）、中都市（人口15～100万人未満）、小都市（人口5～15万人未満）と人口5万人以下の小都市のそれぞれの消費支出は、106円、116円、127円、166円という順になり、都市の人口規模が大きくなると、砂糖の消費支出が少なくなる傾向がある。また、サトウキビの主産地である沖縄の消費支出が177円と最も多く支出している。都市別の小売価格（6ヶ月平均）を見ると、最も安い広島は177円/kgと比べ、那覇は246円/kgと高い。主産地でありながら、精製糖工場が本土にあるため、上白糖として戻って来ると逆に高くなった。砂糖を合理的な価格で安定的に供給し、需要の拡大を図るため、平成12年10月から新たな砂糖制度がスタートした。粗糖関税の撤廃、輸入糖調整金の減額など経営の合理化、市場原理の円滑な利用等が求められている。このような情勢の中で、今回生産現場を見る機会があった。

離島地域のサトウキビ生産が盛んに行われている。基幹作物でありながら、近年野菜を中心とする園芸作物、畜産の増加に伴い、サトウキビを取り巻く環境が変化している。種子島のサトウキビ農家は昭和49年から平成3年まで4500戸～4800戸で推移したが、近年では減少しつつあり、平成11年では3000戸となった。また平均栽培面積は0.8haで、平成5年の0.6haより上昇し、栽培面積が150a以上の農家数が増えている。石垣でも同じような傾向が見られた。農家にとって後継者の不足や担い手の高齢化、市場化への対応等の問題を抱えながら、経営の効率化を図ることが重要であり、その取り込みが始まっている。

経営の効率化を進めるには、栽培

技術の要因以外に、機械化の促進、複合経営への転換、間作、輪作による土地利用の高度化などが要求される。種子島ではサトウキビの総合利用の視点から飼料用キビの研究開発が進められ、全株の飼料利用を目指し、キビの生産と他の産業との連携を図っている。例えば、餌としての梢頭部、敷料としてのバガスと畜産農家の堆肥との交換、製糖過程で分離された糖蜜を飼料と混ぜることによって、牛の食欲を増進し、牛乳の風味も増すことで、キビの付加価値が高まり、島内で飼料を供給することは大きなメリットがある。石垣では21haのサトウキビを作っている大規模農家の話を聞くことができた。労働力は60才台の夫婦と後継者の次男の3人で、株出管理、定植、収穫など一貫して機械化し、側枝苗技術も導入して、将来3割まで側枝苗で作りたいとしている。以前パインナールも生産したが、加工工場の閉鎖によって、全部キビに転換し、大規模化を図った。短期間で見た限り、離島地域でのサトウキビの生産は他産業との連携を図りながら複合経営していくか、専業で大規模化するかは今後の大きな課題となるであろう。



大型機械による収穫作業（石垣）



## プロジェクト研究

# 国際プロジェクト研究 平成13年度の実施状況

### インドネシアにおける地域農業システムの評価と その総合的改善のための技術開発

インドネシアでは、その自然環境と開発の歴史に応じた多様な農林水産業が展開されており、農業・農村の発展はその農業形態とともに地域の多様な社会状況等に応じて大きく異なる。ジャワ島では、近年の急激な都市化と工業化の進展により、優良農地が減少し、都市と農村の地域間格差が拡大するなど、農村を取り巻く社会環境が大きく変化している。他方ジャワ島以外の島々では厳しい農業・生活環境や適正技術の開発の遅れが農業の発展を阻んでいる。このような状況の中で、地域の伝統的農法や農民の意向に配慮した適正技術の開発及び普及等により農業所得の向上や農村の発展を図ることが緊急の課題となっている。そこで、低地農業から傾斜地農業まで多様な農業形態が存在するジャワ島において、代表的な農業形態地域の農業システムなどについての特性評価を行うことにより、発展を阻んでいる社会経済的・技術的課題を解明し、地域農業システムの総合的改善に資する。

本研究は、平成12年3月の中間評価会議の結果をふまえ、ジャワ島中央部のレンバン周辺地域の温帯野菜を中心とするファームシステムに関する共同研究に重点を移してきている。本年度は、長期派遣研究者2名（野菜研究所及び農業社会経済開発研究所）のほか、各分野に短期で研究者を派遣し各課題を実施した。また、13年3月には、日本及びインドネシア双方の研究者及び研究管理者による会議をレンバンで開催し、各課題間の連携と円滑な実施に向けての討議を行った。温帯野菜生産技術分野では連作障害、特にネコブ病、混作の不適切な考え方、病虫害及び乾期の水不足と発芽不良などの重要な問題点を明確にした。これらをふまえ、現在、耕種的対策としての輪作や休耕、初期成育の保護による連作障害の軽減対策などを検討中

である。地理情報システム研究においては、調査対象地区について、自然条件（降水パターン、地形など）とともに土地利用・管理状況を考慮した土壌浸食危険度評価のためのモデル開発を行った。また、対象地域全体の土地利用現況と農家の作付け意向などについては、農民参加型による踏査



図1 西ジャワ州の高原地帯における野菜の段々畑

線手法により明らかにした。温帯野菜生産農家の経営及び流通構造については、各農家の作業体系や出荷体制、生産者組織などの役割に関するデータの情報収集・解析を行った。その中で、流通段階における価格決定のメカニズムなどが明らかとなった。さらに、混作を主体とした野菜ファームシステムの中での在来作物や果樹の民族植物学的調査を引き続き行い、その結果についてのデータベースを構築中である。

### メコンデルタにおける新技術の開発・導入と持続的 ファームシステムの実証

ベトナムは長い戦乱と経済混乱の末、新たな経済政策の下で米生産の急速な増強を達成し、現在は、中国と並び、高い経済成長率を誇っている。米生産の中心地メコンデルタ地帯では、持続的複合農業の一形態と言える、水稲作を基礎とした、園芸、畜産、水産を組み合わせた複合経営が展開されている。



図2 ベトナムメコンデルタの運河を行く

本プロジェクトの目的は、この持続的複合農業の技術的、経営的構造を解明し、複合経営各々の技術の改善方策の検討、技術の開発及び開発に伴う経営的・経済的評価、予測を行い、地域に適したより合理的な農林畜水複合技術体系を確立することである。

本年度は、昨年度に1名加えた、4名の長期在外研究者により経営的・経済的評価を行うと共に、技術体系の構造解明、技術の開発に当たった。これら4名の研究者でカバーできない研究分野は短期派遣により集中的に現地研究を実施した。また、管理者招聘、カウンターパート招聘により、相手側研究者を招き協力体制を強化した。さらに、ベトナム側と密接な協力体制を築くため、11月27～29日にかけてクーロンデルタ稲研究所において、ベトナム側研究者とJIRCAS側研究者とのワークショップを開催し、それぞれの課題の成果



## プロジェクト 研究

の検討及び本プロジェクトの今後の方向等について討議した。本年度の研究では、水稲では雑草防除法、播種量や施肥法、籾乾燥機の改善、豚では地域飼料の栄養価の評価や給餌の試み、衛生改善、果樹ではメコンデルタにおける苗供給システムの調査や洪水被害の実態調査、モデル圃場におけるIPMを利用した栽培法の開発、水産ではエビ稲ファームリングシステムの改良と種苗供給法の改善、最適養魚密度の決定、物質循環では村内窒素フローのさらなる調査推定、植物残渣堆肥の投入とその効果の推定、経営では投入技術の効果検定、各種果樹及び魚の流通実態の解明が行われるなど、それぞれの分野で新たな進展が認められた。

### 東南アジアにおける穀類のポストハーベストロス低減技術の開発

高温多湿な東南アジアにおいては、穀物の収穫後の損耗率は高く、少なく見積もっても、20~30%以上と推定され、こうした高い損耗は収穫直後の不十分な乾燥による品質劣化や貯蔵中の害虫



図3 精米所内に発生したコクゾウムシ

等に起因すると推定されている。また、これまで先進国で行われてきたような各種くん蒸剤の使用は、健康や環境への危害の問題、残留による穀物汚染の問題が指摘されている。そこで、自然エネルギー又は籾殻・稲藁等のローカルエネルギーを活用した資材低投入型乾燥保全技術の開発、並びに、天敵及び害虫抑制効果を有する生理活性物質等を利用した生物的防除技術の開発を目的にプロジェクトを実施している。

本年度は、一部課題の統合による効率化を図りながら、タイにおける米の収穫後損耗要因の解明、天敵の採集、害虫抑制効果のある天然活性物質の同定と作用機構の解明、タイの籾乾燥施設の問題点の把握と改善方法の明確化を行った。また、中間評価会議及びワークショップを開催した。評価結果は概ね良好であったが、収穫後損耗の量的把握が不十分との指摘、害虫関係の担当者の変更に対する懸念、タイとの一層の連携強化への要望が出された。

### 熱帯林再生のためのアグロフォレストリー技術の確立

開発途上地域においては森林の消失と劣化が急速に進み、その一方ではユーカリやアカシア等の外来早成樹種を用いた単純な人工林やオイルパーム、ゴム等のプランテーションが拡大しており、熱帯林のもつ生物多様性と持続性を低下させる大きな要因となってい

る。本研究では、これらすでにある早成樹人工林を多様性のある熱帯林へと再生させるため、地域住民の参加するアグロフォレストリーシステムを導入することにより、人工林の間伐跡等に生じた空間において成育が可能な熱帯果樹・薬用植物・野菜・キノコ等の弱光利用型作物を組み合わせた農林複合生産技術を開発する。さらに、天然林に近い人工林には好陰性の在来樹種を導入し、多様性豊かで経済的価値も備えた熱帯林へと回復させるシステムを開発する。

本年度はサバ州内の試験候補地での現況調査、試験地設定を進め、アグロフォレストリー生産環境に適した樹種として生育特性等が異なる8樹種を選定し、間伐試験地を設定した。試験地の現況調査からマンガウム林の下層には86種もの植物が生育していること、マンガウム人工林内には唐辛子や観葉植物等が自生しており、多様な植物を林内で育成できる可能性等を明らかにした。また、試験地内に植栽する作物として、果樹8種類、作物5種類、葉草5種類を有用性、耐陰性、市場性等を考慮して選定した。

荒廃草地を対象とするフィリピンでは、平成12年度に設定した2つの試験地において在来樹種6種、果樹5種の2年間の初期成長及び生残率を調査し、標高の異なる試験地での生残率、成長量で樹種による違いが明確に認められた。また、閉鎖林床においてもよく成長する果樹2種は、被陰を利用したアグロフォレストリーに適した果樹として期待できることがわかった。



図4 傾斜地における複数の作物栽培

### マングローブ汽水域における魚介類の持続的生産システムの開発

アジア地域では、沿岸域にマングローブ林が繁茂して高い魚介類の生産が得られているが、都市・農地開発等によるマングローブ林の伐採と共にマングローブ林の養殖池への転用による環境劣化・破壊、さらに疾病発生における薬剤の多投入等の問題が生じている。また魚肉蛋白質への需要及び高級魚への嗜好増大により、沿岸水域の水産重要魚種の資源量涸渇が危惧されている。

このため、本プロジェクトでは、沿岸水域における水産重要魚種の持続的漁業生産に向けた資源評価研究を行うとともに、本種の乱獲防止、資源保護及び漁民の収益向上のために、水産重要種の養殖システムを構築する。この養殖研究ではマングローブ林の自然循環機能を活かした低投入型の養殖技術を確立し、さらに収益性向上のためマングローブ水域に生息する比較的高価な新規及び



# プロジェクト 研究

在来魚介類の飼育生産技術を開発する。

これらを総合した持続的な生産システムを導入した場合の経営・経済便益等を明確化することにより、マングローブ汽水域における持続的な生産システムの普及・推進に資する。

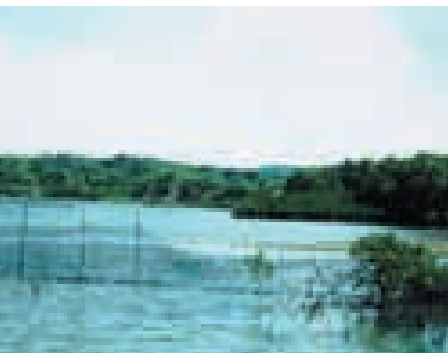


図5 汽水域のマングローブ林

研究の乏しいゴマフエダいの栄養特性に関して、①本種幼魚の飼料中至適タンパク質含量、至適タンパク質／エネルギー比を明らかにし、また本種は魚体に多量の脂肪を蓄積すること、肉食性だが飼料中の炭水化物を比較的有效に利用できることがわかった。一方、栄養塩を加えたマング

ローブ湿地では、アンモニアは6時間後には1/3の濃度となり、2日後には消失した。硝酸塩濃度は2日後に、リン酸塩濃度は9日後に0となった。クロロフィルa量は、添加したアンモニアが枯渇した2日後に最も高い値を示したが、その後大きく減少しており、アンモニアとの相関が示唆された。

フィリピンのマングローブ汽水域では、スネークヘッド、ナマズのEUS (Epizootic Ulcerative Syndrome)、ティラピア及びグルパーの体表及び咽頭寄生leech (蛭類)、グルパーの単生類寄生虫、ミルクフィッシュの外部寄生虫 (Amyloodinium)、ウシエビのウイルス性疾病 (MBV、HPV) 及び細菌性疾病 (Vibrio harveyi) が発生していた。大量死したグルパーの脳及び網膜組織ならびにCPEが観察されたSSN-1細胞培養上清についてウイルス性神経壊死症(VNN)特異的プライマーを用いてRT-PCRを行ったところVNN特異性のあるバンドが検出された。このグルパーから分離されたウイルスは、病理組織学的観察、SSN-1細胞によるウイルス分離、VNN特異的プライマーを用いたRT-PCR法による検出、電顕観察の結果から魚類ノダウイルスに属するVNN原因ウイルスであることが明らかとなった。本症例はフィリピンにおけるVNNの初記載となる。

半島マレーシアにおけるマングローブ汽水域の水産重要種フエダイ類の漁獲量は、この10年間平均6百トン／年で、養殖生産量は約1.7千トンであった。ハタ類漁獲量は1978年以降は平均3.3千トン／年とそれ以前の約1.7倍に増加した。マングローブ汽水域で操業されている漁具はバグネット、バリヤーネット、底刺網、かご網及びプッシュネットの5種類である。魚類消化管内容物では、フエダイ類は稚魚が橈脚類 (コペポダ) とアミ類、若齢魚はエビ類と魚類、ハタ類の若齢魚はカニ類を摂餌していた。

## 海外養殖エビ類ウイルス病の診断・防除技法の開発

東南アジアは世界で有数のエビ養殖が盛んな地域であり、これら養殖産業が地域経済の基盤を為している。しかし、エビ養殖場ではその規模の拡大に伴い著しい被害をもたらすホワイトスポットシンドロームウイルス(WSSV)等のウイルス病が発生し、深刻な問題となっている。現在、これら養殖エビのウイルス病に対する効果的な治療法はなく、疾病防除には広域的な防疫対策をとり疾病の蔓延を予防することが不可欠である。したがって、本課題ではこれらウイルス病のエビ養殖場における発生状況を調査し、正確かつ迅速な疾病の診断技法として血清学的診断法の開発を試みる為にWSSVに対する単クローン抗体の作製を行うと共に、消毒剤等を用いたエビ病原ウイルスの不活化手法を開発した。

マレーシアの半島部では、ウイルス病被害により多くのエビ養殖場が事業を断念して放置された状態であった。WSSV感染症が確認されたペナン州及びケダ州に於ける疾病の発生要因は、移入した種苗に病原体が付着していたことが示唆されている。

単クローン抗体の作成は、まず、健康エビへのウイルス感染試験、罹病エビからのウイルス回収、濃縮及び精製したウイルスを抗原としたマウスへの免疫、及びマウス脾細胞とミエローマ細胞との細胞融合を行う。次に融合細胞を培養し、コロニー形成後、ウイルスに特異的な抗体を産生している細胞を選択し、これらを限界希釈により純化させ培養する。その結果、細胞融合では90%以上と高い率での融合細胞のコロニー形成が認められ、これら細胞の中で268株に感染エビ抗原に対して抗体を産生した。さらに、この中で38株にウイルスに特異的な抗体の産生が示されているが、その後のサブクローニング及び培養過程で細胞株が減少し、最終的に単クローン抗体産生株として3株を得て保存している。ウイルスの不活化試験において、ホルマリンでは0.25%以上、次亜塩素酸ナトリウムの有効塩素濃度では0.5ppm以上、イソジンのポビドンヨードでは1.25ppm以上、エタノールでは30%以上の濃度でエビの死亡率が0%となり、次亜塩素酸ナトリウム及びイソジン等のハロゲン系消毒剤は低濃度でも非常に効果のあることが判明している。



図6 エビウイルス病による養殖ブラックタイガーの大量斃死



## 成果情報

# 平成13年度国際農林水産業研究成果情報一覧

成果情報名	自然立地的要因に基づく東北タイ・コンケン周辺地域の農業適地評価と土地利用現況の比較
担当	国際情報部 山本由紀代、Somsak Sukchan (タイ土地開発局)
分類	研究
要約	東北タイ・コンケン周辺地域を対象に、土壌図・地形図等の主題図を用いて自然立地的要因に基づく農業適地評価を行い、衛星データから判別される土地利用と比較することによって、土地利用の実態や適合性を面的・定量的に把握できる。

成果情報名	マイクロアレイを用いた高等植物の転写因子DREB1Aが制御する環境ストレス耐性遺伝子群の同定
担当	生物資源部 篠崎和子、春日美江、圓山恭之進、安部洋、関原明、篠崎一雄
分類	研究
要約	乾燥・塩・低温ストレス耐性が向上したDREB1A遺伝子組換えシロイヌナズナでは適合溶質合成酵素、解毒酵素、高分子の保護因子であるLEAタンパク質等多様な遺伝子が複合的に機能していることが、cDNAマイクロアレイを用いる解析により明らかになる。

成果情報名	ダイズリポキシゲナーゼアイソザイムの改良簡易迅速検出法
担当	生物資源部 菊池彰夫
分類	研究
要約	青臭み因子であるダイズリポキシゲナーゼアイソザイムの脱色反応利用選抜法を改良することによって、微量の同一検定試料と微量の検出溶液を用い、L-3検定後、L-1検定を続けて行い、全有、L-3欠失、L-1・L-2二重欠失および完全欠失個体を簡易、迅速に検出することが可能となる。

成果情報名	分子マーカーを利用した小麦赤さび病抵抗性遺伝子Lr34及びLr46の効率的な選抜法
担当	生物資源部 末永一博、坂智広
分類	研究
要約	小麦の倍加半数体系統群において、育種に広く利用されている赤さび病抵抗性遺伝子Lr34及びLr46に連鎖するマイクロサテライト(SSR)マーカーを組み合わせることで、両遺伝子を識別して赤さび病に対する抵抗性の効果を明らかにでき、赤さび病抵抗性系統を効率的に選抜できる。



# 成果情報

成果情報名	東北タイ砂質土壌での硬盤層破壊による土壌保全と作物根域拡大
担当	生物環境部 松尾和之、Chairoj Wongwiwatchai (コンケン畑作物研究センター)、屋代幹雄 (東北農研)
分類	研究
要約	東北タイの砂質土壌畑作地帯における主要作物のサトウキビの圃場では、大型トラクタによる頻繁な耕起によって一般に硬盤層が形成される。この硬盤層の一部をサブソイル耕で破壊すると、雨期中の透水性が向上するため土壌流亡が軽減され、土壌深部への根域の発達が促される。

成果情報名	エリアンサス属植物の飼料作物育種素材としての生育特性
担当	生産環境部 松尾和之、松本成夫、Taweesak C. (コンケン家畜栄養研究センター)
分類	研究
要約	エリアンサスは耐湿性が高く、深い層にまで達する根系により乾期の下層土壌水の利用が可能となり、植え付け2年目にはネピアグラスに匹敵する乾物生産能を示し、特に低窒素施肥条件や土壌pHが低い条件で生育が優れる傾向にある。

成果情報名	サトウキビの部分深耕同時施肥・植付機
担当	生産環境部 屋代幹雄 (東北農研)、松尾和之、Chairoj Wongwiwatchai (コンケン畑作物研究センター)
分類	国際
要約	東北タイの砂質土壌におけるサトウキビ栽培における低コスト・省エネルギー化を図るために、サブソイラーと施肥・植付機を結合した部分深耕同時施肥・植付機を開発した。これにより、サトウキビの耕起から植付けまでの作業工程を簡略化でき、耕起・植付作業の燃料消費量・作業時間を削減できる。

成果情報名	サトウキビにおける植物内生菌による窒素固定
担当	生産環境部 安藤象太郎、松本成夫、Sompong Meunchang (タイ農業局)、Praphan Prasertsak (タイ農業局)、Srisuda Thippayarugs (タイ農業局)、大脇良成 (中央農研)
分類	研究
要約	タイで栽培されているサトウキビは、植物体中全窒素の約2～3割の窒素を窒素固定によって獲得することができる。

成果情報名	東北タイの天水田稲作地帯における乾田直播栽培の適用性
担当	生産環境部 梶木信幸、田村治男、Uthai Arromratana (タイ農業局)、Tawachai Na Nagara (タイ農業局)
分類	国際
要約	東北タイ天水田稲作地帯において、乾田直播栽培の導入が移植労力の不足と 降雨の不安定性を克服する手段として効果的であり、移植稲並の収量を得ることができ、また不耕起と組み合わせることによる一層の省力化が期待できる。

成果情報名	東北タイ天水田における畦畔漏水防止技術
担当	生産環境部 藤森新作 (農工研)、小倉 力、梶木信幸
分類	国際
要約	東北タイ天水田地帯において土壌保水力を向上させるためには、止水シートの挿入、または土壌固化剤 (マグネシア系固化材) による畦畔造成が有効であり、土壌浸食防止・漏水抑制の効果が高い。





## 成果情報

成果情報名	東北タイ天水田土壌では含水比が20%であると水稲は出芽し、雑草は抑制される
担当	生産環境部 森田弘彦（九州沖縄農研）、椛木信幸
分類	国際
要約	砂質土壌の多い東北タイの天水田土壌で乾田直播を行う場合、土壌含水比が20%であると水稲カオドマリ-105の出芽には影響を与えずに、カヤツリグサ科雑草の発生を抑制できる。
成果情報名	広域灌漑地区における雨量計密度の評価
担当	生産環境部 堀川直紀
分類	行政
要約	少ない雨量観測点から降雨分布特性を推定する方法を用い、熱帯モンスーン地域の降雨分布例を示すとともにこれから雨量計密度を評価する方法を開発した。
成果情報名	アーバスキュラー菌根菌がブラジルサバンナにおける暖地型イネ科牧草の乾物生産量とリン吸収量に及ぼす影響
担当	畜産草地部 菅野勉（畜産草地研）、斎藤雅典（畜産草地研）、安藤康雄、中村卓司、M.C.Macedo（EMBRAPA肉牛研究センター）
分類	研究
要約	ブラジルサバンナに生育する暖地型イネ科牧草の乾物生産とリン吸収は、土着のアーバスキュラー菌根菌（AM菌）によって促進され、その効果は、土壌pHが低いほど大きい。また、牧草の中では、Brachiaria brizanthaとB.decumbensのAM菌依存度が高い。
成果情報名	ブラジルサバンナの低湿地に適した牧草と草地造成方法
担当	畜産草地部 菅野勉（畜産草地研）、川上隆治（全拓連）、吉村義則（畜産草地研）、魚住 順（東北農研）
分類	国際
要約	ブラジルサバンナに広がる低湿地の牧草地造成には、湛水中の生存が可能なBrachiaria humidicolaが最も適している。B. humidicola草地を播種造成する場合は雨季後半に低湿地の冠水が退いたのちトラクターによる作業が可能になる5月頃の播種が適している。
成果情報名	タイ東北部におけるホルスタイン種乾乳牛のエネルギー要求量
担当	畜産草地部 尾台昌治、川島知之（畜産草地研）、Pimpaporn Pholsen（コンケン畜産研究センター）、Witthaya Sumamal（コンケン畜産研究センター）、Taweesak Chuenprecha（コンケン畜産研究センター）
分類	研究
要約	タイ東北部のホルスタイン種乾乳牛では、エネルギー出納は大豆粕の給与（CP）水準が高くなるに従いエネルギー蓄積量が増加する。乾乳牛の維持に要する代謝エネルギー（ME）要求量は409KJ/BWK g0.75である。
成果情報名	電解水を用いた豆腐原料大豆の微生物制御技術
担当	食料利用部 辰巳英三、斎藤昌義、趙朝輝（中国農業大学）、李再貴（中国農業大学）、李里特（中国農業大学）
分類	研究
要約	大豆浸漬水として酸性電解水、又は、混合電解水を用いることにより、豆乳や豆腐の品質を損なうことなく、大豆由来の微生物を効果的に殺菌することが可能となる。



## 成果情報

成果情報名	中国における高品質ビーフンの加工法
担当	食料利用部 辰巳英三、成明華（中国農業大学）、李里特（中国農業大学）、李再貴（中国農業大学）、江正強（中国農業大学）
分類	研究
要約	異なるアミロース含量のジャポニカ・インディカ米の中で、アミロース含量20%以上のインディカ米を用いたビーフンの食味評価が高い。また、原料米を2時間浸漬後に水挽きすると湯溶けが少なく食感が向上する。河粉の食感向上のためには、原料の10%を予備糊化させ、残りの米粉スラリーと均一に混ぜた後蒸煮するとよい。

成果情報名	オイルパーム空果房からの高純度セルロースパルプの調製
担当	林業部 田中良平、Wan Rosli Wan Daud（マレーシア理科大学）
分類	研究
要約	オイルパーム空果房に対して環境負荷の少ない方法でパルプ化・漂白を行ない、既存の工業製品に近い性質を有する高純度セルロースパルプを調製し、熱帯産未利用木質資源からファインケミカルズ原料を製造することができる。

成果情報名	中国産淡水魚類筋肉の鮮度変化の特徴
担当	水産部 横山雅仁、陳舜勝（上海水産大学）
分類	研究
要約	中国において養殖生産量の多いハクレンおよび草魚は、官能検査による品質評価ならびにK-値の変化の特性から判断すると、即殺後の適切な温度管理により、鮮魚として3日間の流通が可能である。

成果情報名	養殖エビで発生しているウイルス病の単クローン抗体を用いる診断
担当	水産部 大迫典久（養殖研）
分類	研究
要約	養殖エビに深刻な被害を与えているホワイトスポットシンドロームウイルス(WSSV)は、単クローン抗体を用いる血清学的診断法によって検出できる。

成果情報名	遺伝分析に有用なサイインゲン細胞質雄性不稔系統
担当	沖縄支所 江川宜伸、塚口直史（生研機構）、鈴木克己、庄野真理子
分類	研究
要約	雄性不稔細胞質をもつサイインゲン品種「黒種衣笠」を1回親（種子親）とし、他の品種を反復親として戻交配を続けることにより細胞質雄性不稔系統を育成できる。これらの系統を用いれば、雑種を作出するのが極めて容易である。



## 成果情報

成果情報名	トマトのミトコンドリア型sHSPの高温ストレスに対する機能
担 当	沖 縄 支 所 庄野真理子、Jian Liu (Shandong Teachers University)、Jshwal Singh (Indian Institute of Sugarcane)、Jiral Ud Din (Land Resources Research Institute)、三宮一幸 (生研機構)、鈴木克己、塚口直史 (生研機構)、江川宣伸
分 類	研究
要 約	トマトのミトコンドリア型スモールヒートショックプロテイン (MT-sHSP) は、高温ストレスによる酵素の失活を防ぐ働き (分子シャペロン作用) がある。

成果情報名	サトウキビ初期生育促進のための選抜指標として重要な比葉面積
担 当	沖 縄 支 所 寺内方克、松岡誠、中川仁、中野寛
分 類	研究
要 約	葉面積の拡大が緩慢なサトウキビでは、長期間に及ぶ初期生育が収量を制限しており、比葉面積が小さいことがその原因となっている。比葉面積には遺伝的変異がみられることから、初期生育の速い品種の育成に比葉面積および葉の長さや厚さなどの関連形質を選抜指標として利用できる。

成果情報名	カンキツグリーニング病を媒介するミカンキジラミの分布はゲッキツの分布と一致する
担 当	沖 縄 支 所 河野勝行、中田唯文、高橋敬一、小西和彦 (農環研)、安田耕司 (農環研)、吉松慎一 (農環研)
分 類	研究
要 約	カンキツグリーニング病を媒介するミカンキジラミは、ミカン科のゲッキツが分布する奄美大島以南の南西諸島において恒常的に発生しているの、カンキツグリーニング病が未発生のこれらの島々では、本病の侵入に対する警戒が必要である。

成果情報名	アカホシカメムシの捕食性天敵ベニホシカメムシの生態的特性
担 当	沖 縄 支 所 河野勝行、高橋敬一
分 類	研究
要 約	ベニホシカメムシは、ワタ・オクラなどのアオイ科作物の重要害虫であるアカホシカメムシ類だけを捕食する狭食性の捕食者であり、高い増殖力を持ち、短日下でも非休眠であることから、アカホシカメムシ類に対する有力な捕食性天敵として位置付けられる。

成果情報名	水稻の登熟期におけるメタン発生と稲根圏のメタン酸化細菌数には稲品種間差がある
担 当	沖 縄 支 所 安達克樹、中村乾、B.Wang (沖縄招へい研究員)、D.Dianou (沖縄招へい研究員)、B.M.Espiritu (沖縄招へい研究員)、G.Oyediran (沖縄招へい研究員)、W.Chaitap (沖縄招へい研究員)、仙北俊弘
分 類	研究
要 約	亜熱帯水田の稲根圏にはメタン酸化細菌Methylosinus spp.が生息し、稲根圏の菌数は水田からのメタン発生量が多くなる出穂期から登熟期にかけて増加する。水稻の登熟期におけるこの菌数とメタン発生流量とは稲品種間で有意に差がある。

詳しくは、「国際農林水産業研究成果情報 第9号」2002年6月発行 ISSN 1341-5131を参照して下さい。

# 人の動き

新	旧	氏名
---	---	----

平成14年 3月31日付

定年退職	生物資源部主任研究官	異儀田和典
定年退職	生産環境部主任研究官	寒川 一成
定年退職	畜産草地部主任研究官	小坂 清巳
退職 生物系特定産業技術研究推進機構新技術開発部基礎研究課基礎研究企画係長	総務部会計課 (会計係)	木村 道人
退職 広島県立大学生物資源学部助教授	沖繩支所主任研究官 (島嶼環境管理研究室)	増田 泰三

平成14年 4月1日付

農業技術研究機構九州沖縄農業研究センター総務部長	総務部庶務課長	菊地 祝男
国際農林水産業研究センター付 (派遣職員)	国際農林水産業研究センター付 (派遣職員)	坪田 邦夫
企画調整部連絡調整科長	企画調整部研究交流科長	野田 孝人
企画調整部研究交流科長	食料利用部主任研究官	新國 佐幸
企画調整部国際研究調整官	国際情報部国際研究情報官	渡邊 洋子
企画調整部国際研究調整官	畜産草地部主任研究官	押部 明德
企画調整部情報資料課管理係長	企画調整部情報資料課 (管理係)	三浦 裕美
企画調整部	再任用	小坂 清巳
総務部庶務課長	農業技術研究機構作物研究所総務課長	堀口 昌宏
総務部庶務課専門職 (労務・人事)	総務部海外業務管理課海外服務専門官	栗原 輝貴
総務部庶務課 (庶務係) 専門職	農業技術研究機構中央農業総合研究センター総務部庶務課 (職員厚生係) 専門職	工藤 雅枝
総務部会計課課長補佐	農業生物資源研究所総務部管理課施設管理専門官	齊藤 良一
総務部会計課専門職 (監査) 併任	農業技術研究機構統括部付	大沼 善徳
総務部会計課 (用度係) 専門職	総務部庶務課庶務係主任	山本 直実
総務部海外業務管理課専門職 (海外服務)	総務部海外業務管理課海外前渡資金係長	田中 博
総務部海外業務管理課専門職 (海外業務)	総務部海外業務管理課海外業務専門官	福井 信治
総務部海外業務管理課海外前渡資金係長	農林水産技術会議事務局筑波事務所研究交流課業務係長	宮嶋 一夫

新	旧	氏名
---	---	----

総務部庶務課 (人事係)	総務部会計課 (用度係)	岡本 竜
総務部会計課 (会計係)	農業技術研究機構果樹研究所総務部興津総務分室 (用度係)	秋山 武志
国際情報部国際研究情報官	生産局農産振興課長	宮田 悟
国際情報部国際研究情報官	企画調整部連絡調整科長	小山 修
生物資源部併任 (平成15年3月31日まで)	農業生物資源研究所遺伝資源研究グループ主任研究官 (集団動態研究チーム)	友岡 憲彦
生産環境部主任研究官	企画調整部主任研究官 (研究交流科)	濱田 浩正
生産環境部	再任用	寒川 一成
畜産草地部主任研究官	農業技術研究機構畜産草地研究所家畜生理栄養部付	工藤 博
水産部主任研究官	水産総合研究センター研究推進部主任研究官	尾形 博
沖繩支所庶務課 (庶務係)	農業技術研究機構九州沖縄農業研究センター総務部会計課 (予算決算係)	廣瀬 修二
総合食料局国際部付	国際農林水産業研究センター付	坪田 邦夫
農林水産技術会議事務局技術政策課政策調整専門官	総務部庶務課管理官	薬師寺晴美
農業環境技術研究所総務部庶務課課長補佐	総務部会計課課長補佐	畦地日出男
農業技術研究機構動物衛生研究所総務部小平総務分室会計係長	総務部庶務課 (人事係)	菊地 寿輝
農業技術研究機構近畿中国四国農業研究センター作物開発部主任研究官 (大豆育種研究室)	生物資源部主任研究官	菊池 彰夫
農業技術研究機構中央農業総合研究センター企画調整部業務第1科長	生産環境部主任研究官	柁木 信幸
農業技術研究機構畜産草地研究所企画調整部情報資料第2課情報係長	沖繩支所庶務課 (庶務係)	少貳 年章
農林水産技術会議事務局研究調査官	沖繩支所主任研究官 (育種素材開発研究室)	寺内 方克

平成14年 5月1日付

文部科学省 (鹿児島大学多島園研究センター教授)	国際情報部国際研究情報官	日高 哲志
--------------------------	--------------	-------

平成14年 6月1日付

生物資源部長	農業技術研究機構作物研究所福研究部長	池田 良一
国際農林水産業研究センター主任研究官	生物資源部長	岩永 勝
農業技術研究機構東北農業研究センター地域基盤研究部長	国際情報部国際研究情報官	矢島 正晴



## 表紙の写真説明

カピバラ (左上)：乾季の放牧地 (右上)  
雨季の放牧地 (左下)：豚の放牧飼育 (右下)

カピバラ (ブラジル)：南米に住むネズミの仲間の野生動物です。普通のネズミのような長い尾はなく、体重は50Kg位になります。川や池の水辺に群れを作って住んでいて草を食べます。時には川辺の畑のトウモロコシを食べに出てくることがあるそうですが、人とのかわりは余りないようです。  
放牧地の牛 (ブラジル)：雨季 (夏) 放牧地と乾季 (冬) の放牧地の違いが良くわかる。雨の多い10月から3月頃は牧草の生育が良いので牛は太っているが、乾季になると牧草は枯れてえさ不足のため牛の成育は停滞する。  
放牧飼育している豚 (アルゼンチン)：家族経営の小規模農家で行われていたトウモロコシ、小麦、大豆、牧草の輪換畑作体系の中で、牧草地で豚の放牧をしていた。写真は母豚と小屋。



JIRCASニュース No.30-31  
平成14年 6月発行

発行 国際農林水産業研究センター  
編集 企画調整部国際研究広報官、情報資料課  
〒305-8686 茨城県つくば市大わし1-1  
TEL.0298(38)6340(情報資料課) FAX.0298(38)6316  
ホームページアドレス <http://www.jircas.affrc.go.jp/index.sjis.html>



この印刷物は再生紙を使用しています。

# JIRCAS

JAPAN INTERNATIONAL RESEARCH CENTER FOR AGRICULTURAL SCIENCES

# JN News

ジルカスニュース

ISSN 1342-1999

no. 25 2001

農林水産省  
国際農林水産業研究センター



シルクロードのバザール(ウズベキスタン・タシケントにて)(企画調整部 岡 三徳撮影)

## 目次

- 2 巻頭言 JIRCAS沖縄支所を熱帯・亜熱帯島嶼農業研究のメッカに
- 3 研究成果 荒廃した草山に熱帯林を復元する
- 4 研究成果 有害なカビを溶かす細菌の酵素
- 5 研究成果 地下水水質と農耕地の窒素循環:中国山東省陵県のケース
- 6 研究成果 中国雲南省イネ遺伝資源のアミロース含有率と脂質酸化酵素の遺伝変異
- 7 プロジェクト研究 西アフリカにおける米の増産を目指す品種の開発と技術普及
- 8 国際研究機関 アジア蔬菜研究開発センター(AVRDC)
- 9 国際研究 アジア太平洋高度ネットワーク
- 10 特別コーナー 麴(もたい)技術会議会長、中国に行く
- 11 特別コーナー TARC/JIRCAS創立30周年記念祝賀会・記念国際シンポジウム報告
- 12 人の動き  
所の動き 独立行政法人JIRCASの組織と期待される役割  
表紙の写真説明

ジルカスニュース

# JIRCAS NEWS

JAPAN INTERNATIONAL RESEARCH CENTER FOR AGRICULTURAL SCIENCES

独立行政法人国際農林水産業研究センター

2001 No. **26**

—Ú•@ŽŸ

<a href="#">•Ž†</a>		1
<a href="#">Š“aCE¾</a>	<a href="#">“Æ—§•s—@•l%o»,ÆCEα&lt;†,Ì•V“WŠJ</a>	2
<a href="#">“Á•ÊfR•[fi[</a>	<a href="#">“Æ—§•s—@•l••Ÿ” —Ñ•...ŽY&lt;ÆCEα&lt;†fZf“f^•[’†Šú-Ú•W</a>	3
<a href="#">•-%oÊ•î•ñ</a>	<a href="#">ŠCŠOfGfrfEfCf&lt;fX•a,Ì•f•E-h•œ&lt;Z•p,ÌŠJ”-</a>	6
<a href="#">fvf•fWfFfNfgCEα&lt;†</a>	<a href="#">•u’†••H—¿•vfvf•,Ìf••[fNfVf‡fbfv</a>	7
<a href="#">••ŸfVf“flfWfEf</a>	<a href="#">ŠJ”-“r•ã’n^æ,É,“,~,éŽ•±“T” &lt;Æ,Æ•...-â‘è</a> <a href="#">••...—~—p,ÌCEü•ã,đ,ß,´,μ,Ä•!</a>	8
<a href="#">‘g•D•}</a>		9
<a href="#">•l,Ì“®,«</a>		10
<a href="#">•Ž†,ÌŽÊ•^•à¾</a>		12

ジルカスニュース

# JIRCAS NEWS

JAPAN INTERNATIONAL RESEARCH CENTER FOR AGRICULTURAL SCIENCES

独立行政法人国際農林水産業研究センター

2001 No. **26**



野菜？ なんでもあるよ（ラオス、ビエンチャンのマーケットにて）

## 目次

巻頭言	独立行政法人化と研究の新展開	2
特別コーナー	独立行政法人国際農林水産業研究センター中期目標	3
成果情報	海外エビウイルス病の診断・防除技術の開発	6
プロジェクト研究	「中国食料」プロのワークショップ	7
国際シンポジウム	開発途上地域における持続的農業と水問題 －水利用の向上をめざして－	8
組織図		9
人の動き		10
表紙の写真説明		12

# 巻頭言

## 独立行政法人化と 研究の新展開



理事長 井上 隆弘

### 1. 国際農林水産業研究センター（JIRCAS）の独立行政法人化

1970年、農林省熱帯農業研究センター（TARC）として発足したJIRCAS（1993年改名）は、2001年4月1日をもって農林水産省から独立し、独立行政法人として再出発しました。これは、国が行う政策の企画立案部門とその実施部門のうち、実施部門を独立行政法人に行わせようという中央省庁再編の一環として実施されたものです。新しい法人は、国の制約の枠にとらわれることなく、法人の理事長が裁量権を持って最も効果的、効率的な方法で国民のための役割を果たす責務があり、その方法は法人の主体性に任されています。その代わりにその結果が的確であったかどうか厳格に評価されます。

### 2. JIRCASの役割

我が国の食料自給率は低く（熱量換算40%）、世界の主要先進国の中で最低です。日本国民は耕地面積の2倍以上を海外の土地に依存しながら生活を営んでいます。新しい食糧・農業・農村基本計画では、2010年度の食糧自給率の目標値を45%と決めました。我が国の農林水産情勢、食料消費の動向から見て、この目標の達成には相当の努力が必要です。一方、地球規模で見ると、とくに開発途上国を中心とし、人口の増加と環境の悪化が進み、今後、世界の食料生産が人口増加に追いつけるかどうか疑問視されています。こうした状況を考えると、我が国が国際協力を通して世界の食料生産、特に開発途上地域の食料生産の向上に寄与することはきわめて重要です。世界の食料・環境問題に対する国際貢献は、とりもなおさず我が国の食料・環境問題でもあります。

JIRCASの役割は、「開発途上国との研究協力を通して、世界の食料・環境問題の解決に貢献することであり、もって開発途上地域における環境と調和した農林水産業の持続的発展に寄与し国際社会における責務を果たす」ことです。この役割は、これまでと基本的には変わるものではありません。具体的には、

- ①世界の農林水産業の動向、国内外の研究開発動向及び技術開発の方向を明らかにしつつ、
- ②農林水産物の環境に調和した持続的生産技術、農

林水産物の品質評価・流通・加工技術、開発途上地域における遺伝資源及び生物機能の解明と利用技術、環境資源の特性評価と生物多様性の保全技術などの開発の研究等を行うことになりました。その際、我が国の農林水産業への波及と影響を考慮しつつ研究を実施することは言うまでもありません。

### 3. JIRCASの活動

JIRCASは農業、畜産業、林業、水産業、社会経済分野などに関する幅広い専門研究を総合的に展開するため、以下の活動を行います。

- ①研究者を海外に派遣し、開発途上国の要望を取り入れながら共同研究を行います。
- ②高度な施設や技術を必要とするため、海外での研究実施が困難な研究については、国内で研究を行います。
- ③開発途上国研究者の資質向上のため、途上国から研究者を招聘し、つくば及び沖縄で共同研究を実施します。
- ④世界の農林水産業の動向や関連研究情報の収集・分析・広報に力を入れ、インターネットの活用や使いやすい情報システムの開発などを行います。
- ⑤海外から著名な研究者を招き、国際シンポジウム・セミナー等を開催します。本年は国際シンポジウムとして、「開発途上地域における持続的農業と水問題」として11月27日～28日に開催を予定しています。
- ⑥国内の国際協力機関が行う開発途上国技術援助などに対し研究成果に基づいて支援します。
- ⑦開発途上地域を中心とする世界の食料・農業・環境の動向や重要問題について、継続的に調査・分析を行い、必要に応じて行政機関や国際援助機関等に対して提言を行います。

以上に述べたJIRCASの役割を着実に果たすためには、競争的かつ開放的な研究環境のもとで、創造的な研究を計画的・重点的に行い、しかもその結果が公正・透明となるような組織運営をすることが大切です。役職員が一体となって大きな成果を挙げるよう努力したいと思います。





## 特別コーナー

# 独立行政法人 国際農林水産業研究センター中期目標

### 第1 中期目標の期間

独立行政法人国際農林水産業研究センター（以下「センター」という。）の中期目標の期間は、平成13年4月1日から平成18年3月31日までの5年間とする。

### 第2 業務運営の効率化に関する事項

運営費交付金で行う事業については、中期目標の期間中、毎年度平均で、少なくとも前年度比1%の経費節減を行う。

#### 1 評価・点検の実施

独立行政法人評価委員会（評価委員会）の評価結果は、資源配分、業務運営等に適切に反映させる。評価委員会の評価の効率的かつ効果的な実施に資するため、センター自らにおいても、運営状況、研究成果について外部専門家・有識者等を活用しつつ、業務の点検を行う。また、研究職員については、公正さと透明性を確保した業績評価を行い、評価結果は研究資源配分等に反映させる。

#### 2 研究資源の効率的利用

外部資金の獲得、研究資源の充実・効率的利用、施設機械の有効利用等を図る。

#### 3 研究支援の効率化及び充実・高度化

研究業務の高度化に対応した高度な専門技術・知識を有する者を配置する等、研究支援業務の効率化、充実・強化を図る。また、必要に応じ、外部委託等の活用を図る。

#### 4 連携、協力の促進

他の独立行政法人との役割分担に留意しつつ、研究目標の共有、共同研究、人的交流の促進を行い、独立行政法人全体としての農林水産業等に関する研

究水準の向上を図る。また、研究の効率的な実施のため、国公立機関、大学、民間、海外機関、国際機関等との共同研究等の連携・協力及び研究者の交流を行う。

#### 5 管理事務業務の効率化

事務処理の迅速化、簡素化、文書資料の電子媒体化等による管理事務業務の効率化を行う。

#### 6 職員の資質向上

職員への研修、資格取得等の促進を通じた資質向上に努める。

#### 7 海外滞在職員等の安全と健康の確保

海外滞在職員等の安全及び健康の確保に努める。

### 第3 国民に対して提供するサービスその他の業務の質の向上に関する事項

#### 1 試験及び研究並びに調査

##### (1) 重点研究領域

平成11年7月に制定された「食料・農業・農村基本法」及びその理念や施策の基本方向を具体化した「食料・農業・農村基本計画」並びに平成11年11月に策定された「農林水産研究基本目標」に示された研究開発を推進するため、センターにおいては、「開発途上地域における農林水産物の環境に調和した持続的生産技術」、「開発途上地域における農林水産物の品質評価・流通・加工技術」、「開発途上地域における遺伝資源及び生物機能の解明と利用技術」、「開発途上地域における環境資源の特性評価と生物多様性の保全技術」等に関する研究を重点的に推進する。その際、経済活動や社会活動のグローバル化の進展を受けて、我が国の農林水産業への波及と影響についても考慮しつつ、国際的な連携・協力による国際共同研究を実施する。また、緊急に解決すべ



## 特別コーナー

き問題については、研究開発を積極的に推進する。

### (2) 研究の推進方向

研究に係る目標の作成に当たって、次のように定義した用語を主に使用して段階的な達成目標を示す。また、研究対象等を明示することにより、達成すべき目標を具体的に示す。

取り組む：新たな研究課題に着手して、試験及び研究を推進すること。

解明する：原理、現象を科学的に明らかにすること。

開発する：利用可能な技術を作り上げること。

確立する：技術を組み合わせて技術体系を作り上げること。

ア 開発途上地域の食料需給改善のための農林水産業の動向解析、国内外の研究開発動向の把握及び技術開発方向の解明

(ア) 世界の食料需給の動向解析と共同研究に係わる総合戦略の策定

a 内外の資料の収集、整理、分析等を迅速に行うため、主要な開発途上国、国際機関等との間で情報ネットワークの構築を図るとともに、国際共同研究の中期的な総合戦略を策定する。

b 中国主要省等について需給動向解析用モデルを開発し、世界の需給動向解析用モデルの精度を高める。

(イ) 開発途上地域における食料・環境に係わる地域特性及び発展方向の解明

インドネシア、ベトナム、西アフリカ等の総合プロジェクト実施地域を中心に、

a 農林水産業の発展阻害要因と技術的・経済的発展方向を解明する。

b 持続的なファーミングシステムの確立のための社会的・経済的・技術的視点を明確化し、問題点と展開方向を解明する。

イ 開発途上地域の農林水産業の持続的発展のための研究開発

(ア) 開発途上地域における農林水産物の環境に調和した持続的生産技術の改良・開発

タイ、マレーシア、ブラジル等の総合プロジェク

ト実施地域を中心に、

a 持続的生産を可能にするための窒素等の物質循環の解明と評価手法を開発する。

b 稲・畑作物の現地に適した省力・省資源的栽培技術を開発する。

c 稲・大豆等の現地における主要病害虫の発生生態を解明する。

d 農牧輪換システムに適したイネ科牧草の生理・生態学的特性を解明し、低利用飼料資源の栄養特性評価を行う。

e 現地における牛・豚等の生理学的特性と主要疾病の実態を解明する。

f 熱帯低質林への有用樹種の植込み等天然更新補助技術を開発する。

g 環境と調和した地域固有水産生物の増養殖技術を開発する。

(イ) 開発途上地域における農林水産物の品質評価・流通・加工技術の改良・開発

タイ、マレーシア、中国等の総合プロジェクト実施地域を中心に、

a 現地で生産されている米等の基本的な品質特性を解明する。

b 温湿度等の環境条件と連動した米・大豆等の品質劣化の簡易防止技術を開発する。

c 熱帯地域のオイルパーム廃材等低利用木質資源の高度利用技術を開発する。

d 淡水魚等低利用水産物のすり身等への有効利用技術を開発する。

(ウ) 開発途上地域における遺伝資源及び生物機能の解明と利用技術の開発

西アフリカ、中国等の総合プロジェクト実施地域を中心に、

a 乾燥耐性等の有用形質について、関連するプロモーターの単離等を行い、遺伝的特性を解明する。

b 稲等の病虫害抵抗性等の有用育種素材を開発する。

c 独立行政法人農業生物資源研究所が実施するジーンバンク事業のサブバンクとしてセンターバンク(独立行政法人農業生物資源研究所)と連携しつつ、遺伝資源の収集、評価及び保存を行う。



## 特別コーナー

### (エ) 開発途上地域における環境資源の特性評価と生物多様性の解明

タイ、インドネシア、マレーシア等の総合プロジェクト実施地域を中心に、

- a リモートセンシング技術を用いた環境資源の特性評価と土地利用の変動を解明する。
- b 熱帯林の持続性と再生のためのアグロフォレストリー技術の導入条件を解明する。
- c マングローブ汽水域の養殖を中心とした農林水産業の振興・活性化を図るための生物生産過程を解明する。

### (オ) 沖縄における研究

- a インゲンマメ、稲等を用いて耐暑性及び耐塩性のメカニズムを解明する。
- b アグロバクテリウム等を用いて、サトウキビ等の優れた特性を有する育種素材を開発する。
- c マンゴー、パパイヤ等の熱帯・亜熱帯果樹の特性を評価し、大量増殖に資する基盤技術を開発する。
- d 熱帯・亜熱帯に発生するカンキツグリーンング病等の重要病害虫の発生生態を解明する。
- e 熱帯・亜熱帯島嶼の生産不安定要因を解明し、節水・省肥栽培等の対策技術を開発する。
- f 稲等の世代促進における出穂特性等の変異固定技術を開発する。

## 2 専門研究分野を活かした社会貢献

### (1) 分析、鑑定

行政、各種団体、大学等の依頼に応じ、センターの有する高い専門知識が必要とされる分析、鑑定を実施する。

### (2) 講習、研修等の開催

講習会の開催、国公立機関、民間、大学、海外機関等外部機関からの研修生の受入れ等を行う。

### (3) 行政、国際機関、学会等への協力

行政、国際機関、学会等への専門家の派遣、行政等への技術情報の提供等を行う。

## 3 成果の公表、普及の促進

### (1) 成果の利活用の促進

研究成果はデータベース化やマニュアルの作成、共同研究等により積極的に開発途上地域等での利活用の促進を図る。

### (2) 成果の公表と広報

研究成果は、積極的に学術雑誌等への論文、学会での発表等により公表するとともに、主要な成果については各種手段を活用し、積極的に広報を行う。

### (3) 知的所有権等の取得と利活用の促進

重要な研究成果については、わが国の農林水産業等の振興に配慮しつつ、特許等の取得により権利の確保に努めるとともに、民間等における利用の促進を図る。また、育種研究成果については、国の命名登録制度を活用しつつ、優良品種の育成・普及に努める。

## 第4 財務内容の改善に関する事項

### 1 収支の均衡

適切な業務運営を行うことにより、収支の均衡を図る。

### 2 業務の効率化を反映した予算計画の策定と遵守

経費節減目標を踏まえた運営費交付金の交付を受けることを前提に中期計画の予算を作成し、当該予算による運営を行う。

## 第5 その他業務運営に関する重要事項

### 人事に関する計画

#### (1) 人員計画

期間中の人事に関する計画（人員及び人件費の効率化に関する目標を含む。）を定め、業務に支障を来すことなく、その実現に努める。

#### (2) 人材の確保

研究職員について、任期付任用制度の活用、職の公募等により、内外の優れた人材を確保する。



## 成果情報

# 海外エビウイルス病の 診断・防除技術の開発



水産部 主任研究官 大迫 典久

### 東南アジアエビ養殖の問題点

タイ、マレーシア、インドネシアといった東南アジアは、世界でも有数のエビ養殖が盛んな地域ですが、最近、エビ養殖場ではその規模の拡大に伴ってウイルスによる病気が発生し、重要な問題となってきています。現在、エビのウイルス病に対する治療法がないことから、病気を早期に発見して蔓延を予防することが強く望まれています。そこで、東南アジア地域で現在発生しているウイルス病の発生状況を調べ、病気の正確かつ迅速な診断が行える方法を開発するために“海外エビウイルス病の診断・防除技術の開発”プロジェクトを実施しています。

### エビ養殖場の現状

東南アジアのマレーシアにある国立水産研究所と共同研究が実施され、マレーシア各地のエビの養殖場を訪問して養殖場の環境や実際に発生している病気について調査しました。その結果、どの地域でもウイルス病による被害が深刻で、非常に多くの養殖場が事業を断念して養殖池を放置している状況であり、特にマレーシア半島の西海岸に位置するペナン州及びペラ州ではウシエビのウイルス性疾病であるホワイトスポット症による大量斃死を実際に確認しました。

これらの病気の発生を調べたところ、ウイルスが感染してきた経路は養殖池に入れた稚エビから持ち込まれたことが明らかとなり、稚エビについて病気の診断をすることが、病気の発生を防ぐことに重要であることがわかりました。



### エビウイルス病の診断方法

現在エビウイルス病の診断方法として、ウイルスの遺伝子の一部を増幅して調べるPCR法が一般的に行われています。マレーシアで発生したエビウイルス病もこの方法で診断が可能かどうかを調べ、その結果、十分診断が可能であることがわかりました。しかしながら、この方法では単価の安いエビに対して多額の検査費用が掛かってしまい、しかも診断には特定の装置や検査技師の訓練が必要な上、検査結果がでるまでに時間が掛かるなどの問題点があります。そこで、経費が掛からず養殖現場での応用が可能で、しかも正確かつ迅速に診断が行える手法として、ウイルスに対する単クローン抗体を用いた診断方法について検討しました。単クローン抗体の作成方法は、まず野外調査で採集したウイルスを健康なエビに接種して感染させ、増殖させたウイルスを回収した後、今度はこれをマウスに接種しました。こうしてエビウイルスに対する抗体をマウスに作らせ、抗体産生細胞を含むマウスの脾臓細胞とミエローマ細胞（マウスの癌細胞）とを融合させました。この様にして作成された一つの融合細胞は特定の抗体を産生する一つの細胞が癌細胞と融合したもので、やがて増殖して特定の抗体のみを持続的に産生するようになります。様々な抗体を産生する幾種類もの融合細胞が同時にできるので、その中からウイルスと特異的に反応する抗体を産生する細胞を選別し、選別された細胞を培養して得られた抗体を単クローン抗体としました。単クローン抗体の作成の結果、マウスの脾臓細胞とミエローマ細胞との融合は90%以上と高い率でのコロニー（細胞群集）形成が認められ、血リンパを用いた間接蛍光抗体によるスクリーニングでは感染と非感染との間に差が認められた株が36株ありました。その後培養及びサブクローニング（細胞株の純化）の過程を経て、現在までにウイルス特異反応を保持する3株の単クローン抗体が得られています。今後は、これらを高精度の診断薬として利用するために反応強度を増大させることが必要と考えています。なお、この研究でマレーシア水産局に於ける水産疾病の診断・防除の重要性が再認識され、水産防疫センターが国立水産研究所に隣接して建設されました。

マレーシアで発生したエビウイルス病（ホワイトスポットシンドローム）による養殖ブラックタイガーの大量斃死



# プロジェクト 研究

## 「中国食料」プロの ワークショップ



国際研究調整官 池田 良一

(現農業技術研究機構作物研究所稲研究部長)

総合型プロジェクト研究「中国における主要食料資源の持続的生産及び高度利用技術の開発」(略称「中国食料」プロ)では、今年度が研究期間(1997～2003年)の中間年に当たるので、中間推進評価会議を開催した。まず、会議の前日にワークショップを開いて、中国の共同研究機関から招聘した研究管理者等から中国における本プロジェクト研究の背景と重要性などの説明を受け、次いで翌日の中間推進評価会議では日本側研究担当者が中課題ごとの研究推進状況と今後の進め方を説明した上で、効果的な中間推進評価会議にしようと試みた。



ここでは、2月1日(木)に国際農林水産業研究センターで開催されたワークショップの概要を報告する。最初に、当センター井上隆弘所長、中国農業部国際合作司亜非処王維琴

副処長、国際研究課土屋正課長および中国農業科学院国際合作与産業発展局国家地区李淑雲処長の挨拶があった。続いて、本プロジェクトの立ち上がりから関わって来た野口生産利用部長が、これまでの経緯と全体像について概要を説明した。中国側の共同研究機関の研究管理者が発表した課題は以下のとおりである。発表は中国語か日本語で行われ、中国語の場合には、逐次通訳によった。

- 1) 中国の農業問題とその取り組み：①農村経済研究中心の劉志仁研究員、「中国農業の現状及び新世紀の政策的課題」、②農業自然資源和農業区画研究所の唐華俊所長、「中国における農業資源の現状及び主要農産物の供給課題」、③農業経済研究所の朱希剛前所長、「中国農業における新たな発展段階：農家収入の増加」。
- 2) 環境保全型農業研究から：

①土壤肥料研究所の黄鴻翔副所長、「中国における化学肥料の使用及び環境保全型農業技術発展の可能性」、②南京土壤研究所の朱建国研究員、「農業汚染が太湖水質に与える影響の評価・農業生態システムにおける主要要素循環の研究」。

- 3) 中国水稻研究所の張志涛副所長、「中国における稲作の発展と害虫防除」。
- 4) 大豆およびトウモロコシの研究から：①吉林省農業科学院の馮巍院長、「吉林省農業科学院における研究紹介」、②吉林省農業科学院大豆研究所の劉凱所長、「中国東北大豆遺伝資源の評価及び利用研究」。
- 5) 中国農業大学の李里特副校長、「中国農業及び農産物加工利用の概況」。
- 6) 上海水産大学の周応棋校長、「淡水漁業資源の有効利用に関する中日共同研究の展望」。

総合討論では、各発表に対する個別の質疑応答の後、中国政府の農業投資および中国農産物の品質について論議され、中国側から①中国政府は今後農村における道路、水資源、電気などインフラ整備に関する投資を進めると予想されること、②品質を高めるために市場システムの整備が必要であり、政府は農産物の加工も支持しているの、最近成果が見られること、さらには③WTO加入後には緑の政策実行も考えられるとの説明があった。

なお、中間推進評価会議の翌日(2月3日(土))には、日中友好協会つくば支部主催のカスミグループ食品流通システム見学会が催され、日中両国から合計20名が参加した。



「中国における主要食料資源の持続的生産及び高度利用技術の開発」  
ワークショップ 2001年2月1日



# 国際シンポジウム

## 第8回JIRCAS国際シンポジウム 開発途上地域における持続的農業と水問題 —水利用の向上をめざして—

国際情報部 国際研究情報官 矢島 正晴



### 世界規模での水問題

現在、60億人を突破した世界人口は、2025年には80億人に達すると予想され、「世界的な水不足」による干ばつや飢餓の拡大が危惧されています。すでに、世界人口の3分の1が水不足に見舞われており、2025年には全体の3分の2に達すると予想されています。生活水準の向上や生産体系の変化などに伴う水需要の増加、都市部と農村部での水利用の競合、地球の環境変動に伴う降水量やパターンの変化など、世界の水資源の需要と供給を巡る状況は、一層深刻化してきています。

### 持続的農業と水問題

農業においては、水不足の生じている地域に対して、ダムや水路等の建設を中心に施設整備が行われ、大きな成果をあげてきました。しかし、これらの大規模な施設整備は、建設や維持管理に多くの費用を必要とするばかりでなく、生態系など、環境への影響も懸念されるようになってきました。

このため、発展途上地域では、限られた水資源を有効に利用する工夫が従来にも増して必要とされ、農民自身により建設可能な溜池や簡易貯水槽の利用、土壌水分の効果的な利用と管理、さらに作物による水の利用率の向上を目指した節水栽培など、小規模ながらも効果的な技術開発が求められています。また、「水問題」を考える場合

に重要なことは、これらの技術が各地域の自然環境だけでなく、伝統や農村の習慣と強い結びつきを持っていることです。このことから、「水」に関わる技術開発を行う場合には、地域固有の伝統や習慣も踏まえたものでなければなりません。

「水問題」は単に乾燥地や半乾燥地の問題ではありません。降雨の不安定な天水農業地帯においても

同様の問題を抱えています。「水問題」の解決は持続的な農業生産や農村生活の安定に寄与するばかりでなく、バランスのとれた地球環境を維持していく上で、極めて重要な課題と言えるでしょう。



センターピボットによるサトウキビ畑の大規模灌漑

そこで、内外の識者を招聘し、世界の水資源や食料生産と水需要の動向、歴史的な水利用技術の系譜と水利慣行等に関する基調講演に引き続き、以下の課題について検討を行い、今後の研究方向を探ります。

1. 作物の遺伝・育種・生理生態的特性からみた耐乾性作物開発とその利用
2. 栽培管理技術からみた農耕地の水利用の現状と向上の可能性
3. 開発途上国における農業生産と生産安定化の可能性

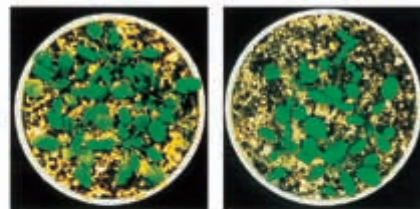
○日時：平成13年11月27日（火）及び28日（水）  
○場所：つくば国際会議場



サトウキビ畑における点滴チューブの設置作業。モーリシャスではサトウキビ畑の約7%で水利用効率の良い地中点滴灌漑が行われている

遺伝子組換え シロイヌナズナ      普通の シロイヌナズナ

普通に育てたとき



2週間 給水を止めたとき



遺伝子組換えによる植物の耐乾性増強。バイオテクノロジーを利用した、乾燥に強い作物の開発が期待されている



## 組織図

**理事長**

**理事**

**監事**

部を構成する組織または研究グループ

**企画調整部**

研究企画科、連絡調整科、研究交流科、情報資料課  
国際研究調整官、国際研究広報官

**総務部**

庶務課、会計課、海外業務管理課

**国際情報部**

国際研究情報官  
地域別動向、食料需給動向、ファーミングシステム、情報システム

**生物資源部**

遺伝資源利用、機能開発、育種法

**生産環境部**

栽培管理、病虫害防除、植物栄養生理、物質循環、水資源管理

**畜産草地部**

家畜生産、飼料資源開発、熱帯家畜疾病

**食料利用部**

品質評価、流通加工

**林業部**

森林施業、森林資源利用

**水産部**

水産増養殖、水産資源管理、沿岸環境保全

**沖縄支所**

上席研究官、国際共同研究科、庶務課、  
島嶼環境管理研究室、環境ストレス耐性研究室、  
育種素材開発研究室、熱帯果樹栽培利用研究室、  
総合防除研究室、業務科

# 人の動き

新	旧	氏名
平成 13 年 3 月 31 日付		
退職 (自己都合)	海外情報部主任研究官	池上 彰英
定年退職	生産利用部主任研究官	平岡 博幸
定年退職	生産利用部主任研究官	清水 啓
定年退職	生産利用部主任研究官	山本恵美子
平成 13 年 4 月 1 日付 (幹部人事)		
理事長	所長	井上 隆弘
理事	農業研究センター農業計画部長	諸岡 慶昇
監事	農業生物資源研究所遺伝資源第一部長	加藤 邦彦
監事 (非常勤)	東京農業大学国際食料情報学部教授兼東京農業大学国際交流センター所長	藤本 彰三
企画調整部長	生産利用部長	野口 明德
総務部長	北陸農業試験場総務部長	桐生 勝之
国際情報部長	海外情報部長	鶴見 和幸
生物資源部長	生物資源部長	岩永 勝
生産環境部長	環境資源部長	伊藤 治
畜産草地部長	畜産草地部長	谷口 稔明
食料利用部長	農林水産技術会議事務局研究管理官	林 徹
林業部長	森林総合研究所企画調整部海外研究情報調査科長	中島 清
水産部長	水産部長	前田 昌調
沖縄支所長	沖縄支所長	鈴木 正昭
国際農林水産産業研究センター主任研究官	企画調整部長	石谷 孝佑
(組織編成順)		
企画調整部研究企画科長	企画調整部研究企画科長	浅沼 修一
企画調整部主任研究官 (研究企画科)	企画調整部主任研究官 (研究企画科)	落合 幸仁
企画調整部主任研究官 (研究企画科)	企画調整部主任研究官 (研究企画科)	杉野 智英
企画調整部研究企画科	生産利用部	田村 治男
企画調整部研究企画科	生産利用部	小松 隆
企画調整部連絡調整科長	企画調整部連絡調整科長	小山 修
企画調整部主任研究官 (連絡調整科)	企画調整部主任研究官 (連絡調整科)	川杉 正一
企画調整部主任研究官 (連絡調整科)	企画調整部主任研究官 (連絡調整科)	伊勢 一男
企画調整部研究交流科長	企画調整部海外研究交流科長	野田 孝人
企画調整部主任研究官 (研究交流科)	企画調整部主任研究官 (海外研究交流科)	濱田 浩正
企画調整部国際研究調整官	生物資源部主任研究官	稲垣 正典
企画調整部国際研究広報官	企画調整部研究技術情報官	林 唯博
企画調整部情報資料課長	企画調整部情報資料課長	上野 信男
企画調整部情報資料課 (管理係)	農業研究センター研究情報部 (情報資料課広報係)	三浦 裕美
総務部庶務課長	総務部庶務課長	菊地 祝男
総務部庶務課課長補佐併任	独立行政法人農業技術研究機構統括部付	立谷 正男
総務部庶務課管理官	総務部庶務課課長補佐	薬師寺晴美
総務部庶務課庶務係長	総務部庶務課庶務係長	武田 岳
総務部庶務課庶務係主任	総務部庶務課人事係主任	山本 直実

新	旧	氏名
総務部庶務課人事係長	総務部庶務課人事係長	小野崎康裕
総務部庶務課 (人事係)	総務部庶務課 (人事係)	菊地 寿輝
総務部庶務課厚生係長	総務部庶務課厚生係長	松本 正幸
総務部会計課長	総務部会計課長	上村 久
総務部会計課課長補佐	総務部会計課課長補佐	畦地日出男
総務部会計課監査官併任	独立行政法人農業技術研究機構統括部付	大沼 善徳
総務部会計課主計係長	総務部会計課主計係長	高橋 功
総務部会計課 (主計係)	総務部会計課 (主計係)	篠塚 修央
総務部会計課会計係長	総務部会計課会計係長	和田 努
総務部会計課 (会計係)	総務部会計課 (会計係)	木村 道人
総務部会計課監査係長	総務部会計課監査係長	李澤 義彦
総務部会計課用度係長	総務部会計課用度係長	伊藤 宏次
総務部会計課 (用度係)	総務部会計課 (用度係)	岡本 竜
総務部会計課施設管理係長	総務部会計課施設管理係長	勝山 邦明
総務部会計課 (施設管理係)	農林水産技術会議事務局筑波事務所管理第2課 (建築係)	前野 智子
総務部海外業務管理課長	東北農業試験場総務部用度課長	松作 良一
総務部海外業務管理課海外服務専門官	総務部海外業務管理課海外服務専門官	栗原 輝貴
総務部海外業務管理課海外業務専門官	総務部海外業務管理課海外業務専門官	福井 信治
総務部海外業務管理課海外業務調整係長	総務部海外業務管理課海外業務調整係長	嶋田 秀子
総務部海外業務管理課海外前渡資金係長	総務部海外業務管理課海外前渡資金係長	田中 博
総務部海外業務管理課海外派遣係長	農林水産技術会議事務局筑波事務所管理第1課管理運営係長	柴垣 誠
総務部海外業務管理課海外物品係長	総務部海外業務管理課海外物品係長	田中 良穂
国際情報部国際研究情報官	海外情報部国際研究情報官	矢島 正晴
国際情報部国際研究情報官	海外情報部国際研究情報官	日高 哲志
国際情報部国際研究情報官	食品総合研究所素材利用部資源素材化研究室長	森 隆
国際情報部国際研究情報官	海外情報部国際研究情報官	渡邊 洋子
国際情報部国際研究情報官	海外情報部国際研究情報官	ジョン ス コルウェル
国際情報部主任研究官	海外情報部主任研究官	小杉 正
国際情報部主任研究官	海外情報部主任研究官	安藤 益夫
国際情報部主任研究官	海外情報部主任研究官	山田 康晴
国際情報部主任研究官	環境資源部主任研究官	内田 諭
国際情報部主任研究官	総合食料局国際部国際調整課課長補佐 (アジア大洋州班担当)	山下 憲博
国際情報部主任研究官	生産利用部主任研究官	山田 隆一
国際情報部主任研究官	海外情報部主任研究官	古家 淳
国際情報部主任研究官	環境資源部主任研究官	山本由紀代
国際情報部主任研究官	海外情報部主任研究官	櫻井 武司
国際情報部主任研究官	海外情報部主任研究官	銭 小平
生物資源部主任研究官	生物資源部主任研究官	異儀田和典
生物資源部主任研究官	生物資源部主任研究官	本間 善久
生物資源部主任研究官	生物資源部主任研究官	篠崎 和子
生物資源部主任研究官	生物資源部主任研究官	足立 大山
生物資源部主任研究官	生物資源部主任研究官	末永 一博



新	旧	氏名
生物資源部主任研究官	生物資源部主任研究官	佐藤 隆徳
生物資源部主任研究官	生物資源部主任研究官	坂 智広
生物資源部主任研究官	生物資源部主任研究官	菊池 彰夫
生物資源部主任研究官	生物資源部主任研究官	中島 一雄
生物資源部主任研究官	生物資源部主任研究官	浦尾 剛
生物資源部	生物資源部	春日 美江
生物資源部	生物資源部	常松 浩史
生産環境部主任研究官	生産利用部主任研究官	小林 廣美
生産環境部主任研究官	生産利用部主任研究官	山田 盾
生産環境部主任研究官	生産利用部主任研究官	寒川 一成
生産環境部主任研究官	生産利用部主任研究官	花木 信幸
生産環境部主任研究官	環境資源部主任研究官	小倉 力
生産環境部主任研究官	生産利用部主任研究官	松尾 和之
生産環境部主任研究官	環境資源部主任研究官	八田 珠郎
生産環境部主任研究官	海外情報部国際研究情報官	岡田 謙介
生産環境部主任研究官	環境資源部主任研究官	松本 成夫
生産環境部主任研究官	環境資源部主任研究官	飛田 哲
生産環境部主任研究官	環境資源部主任研究官	安藤象太郎
生産環境部主任研究官	生産利用部主任研究官	堀川 直紀
生産環境部主任研究官	環境資源部主任研究官	石川 隆之
生産環境部	生物資源部	中村 卓司
生産環境部	環境資源部	宝川 靖和
生産環境部	環境資源部	渡邊 武
生産環境部	農業研究センター作物生理品質部(稲栽培生理研究室)	藤本 寛
畜産草地部主任研究官	畜産草地部主任研究官	小坂 清巳
畜産草地部主任研究官	畜産草地部主任研究官	大桃 定洋
畜産草地部主任研究官	畜産草地部主任研究官	尾台 昌治
畜産草地部主任研究官	畜産草地部主任研究官	安藤 康雄
畜産草地部主任研究官	畜産草地部主任研究官	中村 義男
畜産草地部主任研究官	畜産草地部主任研究官	菅野 勉
畜産草地部主任研究官	生産局動物検疫所検疫部動物検疫課主任検疫官	鎌川 明美
畜産草地部	畜産草地部	山崎 正史
食料利用部主任研究官	生産利用部主任研究官	新國 佐幸
食料利用部主任研究官	生産利用部主任研究官	斎藤 昌義
食料利用部主任研究官	生産利用部主任研究官	中原 和彦
食料利用部	生産利用部	辰巳 英三
食料利用部	生産利用部	吉橋 忠
林業部主任研究官	林業部主任研究官	横田 明彦
林業部主任研究官	林業部主任研究官	田中 良平
林業部主任研究官	林業部主任研究官	高橋 和規
林業部主任研究官	林業部主任研究官	宮本 基枝
林業部主任研究官	森林総合研究所企画調整部主任研究官(海外森林環境変動研究チーム)	野口 正二
林業部	林業部	稲垣 昌宏

新	旧	氏名
林業部併任	独立行政法人森林総合研究所海外研究領域付	加茂 皓一
水産部主任研究官	水産部主任研究官	横山 雅仁
水産部主任研究官	瀬戸内海区水産研究所海区水産業研究部沿岸資源研究室長	小川 泰樹
水産部主任研究官	水産部主任研究官	前野 幸男
水産部主任研究官	水産部主任研究官	大迫 典久
水産部主任研究官	水産部主任研究官	マシコ ワカユキ
水産部主任研究官	水産部主任研究官	下田 徹
沖縄支所上席研究官	沖縄支所上席研究官	小沢 聖
沖縄支所国際共同研究科長	沖縄支所国際共同研究科長	野田千代一
沖縄支所庶務課長	沖縄支所庶務課長	初瀬 健一
沖縄支所庶務課庶務係長	沖縄支所庶務課庶務係長	川満 聡
沖縄支所庶務課(庶務係)	沖縄支所庶務課(庶務係)	少貳 年章
沖縄支所庶務課会計係長	中国農業試験場総務部大田総務分室用度係長	大賀 高生
沖縄支所庶務課(会計係)	沖縄支所庶務課(会計係)	西山 誠
沖縄支所庶務課(会計係)	沖縄支所庶務課(会計係)	関口 仁
沖縄支所島嶼環境管理研究室長	沖縄支所地力維持研究室長	坂西 研二
沖縄支所主任研究官(島嶼環境管理研究室)	沖縄支所主任研究官(地力維持研究室)	増田 泰三
沖縄支所島嶼環境管理研究室	沖縄支所(国際共同研究科)	中村 乾
沖縄支所環境ストレス耐性研究室長	沖縄支所作物導入栽培研究室長	江川 宜伸
沖縄支所主任研究官(環境ストレス耐性研究室)	沖縄支所主任研究官(国際共同研究科)	庄野真理子
沖縄支所主任研究官(環境ストレス耐性研究室)	沖縄支所主任研究官(作物導入栽培研究室)	鈴木 克己
沖縄支所育種素材開発研究室長	沖縄支所作物育種世代促進研究室長	松岡 誠
沖縄支所主任研究官(育種素材開発研究室)	沖縄支所主任研究官(国際共同研究科)	伊敷 弘俊
沖縄支所主任研究官(育種素材開発研究室)	沖縄支所主任研究官(作物育種世代促進研究室)	谷尾 昌彦
沖縄支所主任研究官(育種素材開発研究室)	沖縄支所主任研究官(国際共同研究科)	寺内 方克
沖縄支所主任研究官(育種素材開発研究室)	北陸農業試験場地域基盤研究部主任研究官(稲育種素材研究室)	田村 泰章
沖縄支所熱帯果樹栽培利用研究室長	沖縄支所熱帯果樹研究室長	小川 一紀
沖縄支所熱帯果樹栽培利用研究室	沖縄支所(熱帯果樹研究室)	深町 浩
沖縄支所熱帯果樹栽培利用研究室	果樹試験場リンゴ工場(育種研究室)	加藤 秀憲
沖縄支所総合防除研究室長	九州農業試験場地域基盤研究部主任研究官(病害遺伝子制御研究室)	大貫 正俊
沖縄支所主任研究官(総合防除研究室)	沖縄支所主任研究官(作物保護研究室)	河野 勝行
沖縄支所主任研究官(総合防除研究室)	沖縄支所主任研究官(作物保護研究室)	中田 唯文
沖縄支所総合防除研究室	沖縄支所(作物保護研究室)	河邊 邦正
沖縄支所業務科長	沖縄支所業務科長	勝田 義満
沖縄支所業務科	沖縄支所(業務科)	前津 有邦
沖縄支所業務科	沖縄支所(業務科)	大和 浩二
沖縄支所業務科	沖縄支所(業務科)	池間 浩千
沖縄支所業務科	沖縄支所(業務科)	鳥尻 勝人
沖縄支所業務科	沖縄支所(業務科)	平田 正和
沖縄支所業務科	沖縄支所(業務科)	桑田 将能
沖縄支所業務科	東北農業試験場企画連絡室(業務第1科)	小笠原 篤
沖縄支所業務科	沖縄支所(業務科)	吉田 真樹

→ 次号に続く



## 第8回JIRCAS国際シンポジウムのご案内 「開発途上地域における持続的農業と水問題」 －水利用の向上をめざして－

**日時：**平成13年11月27日（火）及び28日（水）  
**場所：**つくば国際会議場  
つくば市竹園2-20-3（電話：0298-61-0001）  
**申し込み：**第8回JIRCAS国際シンポジウム事務局  
FAX：0298-38-6342  
e-mail:symp8@ml.affrc.go.jp  
**問い合わせ：**国際農林水産業研究センター  
国際情報部 矢島 正晴  
電話：0298-38-6345

### プログラム

#### 27（火）

10：00 基調講演

1. 気候変動下における世界の水資源の動向  
虫明功臣（東京大学生産技術研究所）
2. 開発途上地域の水需要の動向と農林水産業  
Dr. David Molden（IWMI）
3. 世界の農業水利慣行の発展過程と今後の課題  
海田 能宏（京都大学東南アジア研究センター）

13：00 セッション1

作物の遺伝・育種・生理生態的特性からみた耐乾性作物開発とその利用

1. 作物の生理生態的特性・多様性利用による干害軽減の現状と可能性  
稲永 忍（鳥取大学乾燥地研究センター）
2. 耐乾性作物育種の現状と可能性  
Dr. Rodomiro Ortiz（IITA）
3. バイテク育種による耐乾性作物作出の現状と可能性  
篠崎和子（JIRCAS）

15：30 セッション2

栽培管理技術からみた農耕地の水利用の現状と向上の可能性

1. 耕地における水収支の現状と水利用効率の向上  
Dr. Rony Wallach（The Hebrew University of Jerusalem）
2. 土壌水分の利活用と生産安定化の可能性  
長谷川周一（北海道大学大学院農学研究科）
3. 作物の節水栽培法の現状と可能性  
Dr. Peter Thorburn（CSIRO Sustainable Ecosystems）

#### 28（水）

9：30 セッション3

開発途上国における農業生産と生産安定化の可能性

1. 天水農業における水管理の現状と生産安定化の可能性  
伊藤 治（JIRCAS）  
Dr. John S. Caldwell*（JIRCAS）  
凌 祥之*（農業工学研究所）  
Dr. Chayasit Aneksamphant*（タイ土地開発局）
2. 乾燥・半乾燥地農業における水管理の現状と生産安定化の可能性  
西牧隆壮（国際協力事業団）  
Prof. Ali A. Al-Jaloud*（KACST）  
狩野良昭*（国際協力事業団）

13：00～14：30 ポスターセッション

16：45 セッション4

総合討論

論点：今後必要とされる研究課題と連携協力

*コメンテーター



### 表紙の写真説明

現農業環境技術研究所 岡 三徳

ラオスとの共同研究の事前調査のため、タイのコンケンからメコン河畔のノンカイを越え、乾季のビエンチャンに入った。この町にも、タイやカンボジアと同じ町並みと人々の喧噪がある。カメラを向けた女性は、マーケットの一角でメコン河畔の畑でとれる多くの野菜を売っている。手前には、バナナの大きな花房、丸いナス、長ササゲ、ハヤトウリ、奥にはトマト、ショウガ、カボチャが並ぶ。マーケットに並ぶ野菜や多くの食材は、ビエンチャンの人々の豊かな暮らしの中に、長く育まれてきたものである。メコン河が南北に貫くラオスには、中南部の水田地帯から北部山岳部の畑地帯まで、多様な土地利用と農業が展開されている。タイ東北部とも隣接するラオスへの共同研究の拡大に向け、今後とも継続した調査が望まれる。



JIRCASニュース No.26

平成13年9月発行

発行 国際農林水産業研究センター

編集 企画調整部国際研究広報官、情報資料課

〒305-8686 茨城県つくば市大わし1-1

TEL.0298(38)6340(情報資料課) FAX.0298(38)6316

ホームページアドレス <http://www.jircas.affrc.go.jp/>



この印刷物は再生紙を使用しています。

ジルカスニュース

# JIRCAS NEWS

JAPAN INTERNATIONAL RESEARCH CENTER FOR AGRICULTURAL SCIENCES

独立行政法人国際農林水産業研究センター

2001 No. **27**

-Ú•@ŽŸ

<a href="#">•Ž†</a>		1
<a href="#">Š^a•a•E^{3/4}</a>	<a href="#">••Ū&lt;α“•Eα&lt;†,É&lt;•,β,ç,ê,é•V,½,ÈŽ&lt;•À</a>	2
<a href="#">•-‰œÊ•î•ñ</a>	<a href="#">‰œÔ²-«•«,É,æ,éfTf,,fCf“fQf“,Ì‘İ•&lt;•«•]‰œi</a>	3
<a href="#">••Ū&lt;@ŠÖ</a>	<a href="#">••Ū” &lt;ÆEα&lt;†&lt;kcfof&lt;•[fv•iCGIAR•j,İ•í—^a,Æ‘g•D‰œüŠv 21•φ&lt;I,Ö,İ•¶,«Žc,è,đ“q,-,Ä</a>	4
<a href="#">fvf•fWfFfNfgEα&lt;†</a>	<a href="#">••‡Eα&lt;†fvf•fWfFfNfg,É,“,̄,é•V,½,È&lt;Z•p‘I‘đŽè-@  f•fRf“fvf•fWfFfNfg,đŽ—á,Æ,μ,Ä• </a>	5
<a href="#">Eα&lt;†•-‰œÊ•î•ñ</a>	<a href="#">•½•-12”N“x••Ū” &lt;ÆEα&lt;†•-‰œÊ•î•ñê—</a>	6
<a href="#">•l,İ“@,«</a>		8
<a href="#">•Ž†,İŽÊ•^•à-¾</a>		8

ジルカスニュース

# JIRCAS NEWS

JAPAN INTERNATIONAL RESEARCH CENTER FOR AGRICULTURAL SCIENCES

独立行政法人国際農林水産業研究センター

2001 No. **27**

シルクロードのバザール（ウズベキスタン・タシケントにて）

## 目次

巻頭言	国際共同研究に求められる新たな視座 .....	2
成果情報	花粉稔性によるサヤインゲンの耐暑性評価 .....	3
国際機関	国際農業研究協議グループ（CGIAR）の戦略と組織改革 21世紀への生き残りを賭けて .....	4
プロジェクト研究	総合研究プロジェクトにおける新たな技術選択手法 —メコンプロジェクトを事例として— .....	5
研究成果情報	平成12年度国際農業研究成果情報一覧 .....	6
人の動き	.....	8
表紙の写真説明	.....	8

# 巻頭言

## 国際共同研究に 求められる新たな視座



理事 諸岡 慶昇

### 開発途上諸国の地域研究

この春から独立行政法人としてスタートしたJIRCASは、地球規模の食料・環境・エネルギー等の問題から見た研究の重要度や、わが国の食料安全保障への関わり方を視野に、開発途上諸国を対象とし概ね4地域に研究の重点化を図ることとしている。1つは膨大な人口を有し世界の食料需給の上できわめて重要な意味を持つ中国地域、2つは歴史的経済的にわが国との関係が深く農林水産業を基幹部門とする東南アジア地域、3つは世界の食料基地として多くの役割が期待される南米地域、4つはサブサハラを中心に多くの栄養不足の人口を抱え、基礎食料生産のための協力が求められるアフリカ地域である。

直近のOECD開発援助委員会(DAC)リストでは、152ヶ国が開発途上諸国で、先進国への移行国及び先進国を含めた世界のほぼ7割を占めている。当センターでは、そこから先の4地域の研究ニーズに沿う十ヶ国相当に拠点を置き、現地での実証研究と国内における基盤研究を連動させる地域研究(Area study)を進めている。こうした共同研究を中心とした研究の推進に当たっては、昨今の国際情勢の大きな変化を背景に、以下の見方に立つ新たな視座が重要と考えている。

### 共同研究の連携課題

1つは、ボーダーレス化を強める国際関係への対応視点である。農産物の対日輸出攻勢を契機に、開発途上諸国の経済開発に対する協力問題が大きな話題となっている。近接する諸国との交易摩擦はその代表例であるが、わが国と同様のモンスーン・アジアの農業は、その経済成長のテンポとは別に、相互の研究協力が不可欠なテーマを数多く含んでいる。

例えば大陸部の東南アジアで生まれ中国を経て日本へ飛来し、稲作に大きな被害を及ぼすトビイロウンカの研究は、問題を共有する複数国が互いに協力しあう方が研究に大きな弾みがつく。また、温暖化の広がりや資材投入型の集約農業が耕地や水質の急速な劣化を招いている環境問題は、わが国も深く関わり今後さらに増幅する傾向を強めている。

JIRCASではこうした研究の進展を先導的に担いつつ、何をなすべきかを主体的に捉えながら、中期計画の下で国民に対し説明責任を備えた研究と取り組む所存である。

### 技術と人のハーモニーを求めて

2つは、技術と文化の相互関係を読み解く視点である。科学技術の成果はそれぞれの国の受容の度合いに強く左右されるが、開発途上諸国を対象とした研究では、先端科学の導入と農林水産業の現場に近い技術研究の推進バランスを、どう調和させるかという問題にしばしば直面する。新たな技術を手に入れた途上諸国を訪ねると、村に漂うつましい社会関係に感動したり、さまざまな作物を植え込む伝統的な作付け体系に、多様性や持続性の点で学び教えられる場面によく出会う。先進国が成長の過程で見落としてきた文化や伝承技術が、共同研究に関与すると逆により鮮明に映し出されてくる。これからの半世紀は、暮らしや生きる価値観を求めて、科学と社会との関わりが重視される時代に向かうと予測される。ここでは、技術と人々の織りなすハーモニーが、共同研究を通し相互の理解を深める主要なテーマとなろう。

新生JIRCASの船出に当たって、異なる文化に対する国際共同研究の役割を改めて問い、謙虚に学び合う視座に立つことを心がけたいと思う。



## 成果情報

# 花粉稔性による サイインゲンの耐暑性評価

沖縄支所 鈴木克己

塚口直史 (生研機構、現新潟大学)

竹田博之 (現農研機構・近畿中国四国農業研究センター)・江川宜伸



高温期での作物の収量の低下は熱帯・亜熱帯地域では大きな問題で、耐暑性作物の開発が望まれています。沖縄支所では高温障害回避技術の開発や耐暑性作物作出を目的に、作物の高温障害及び耐暑性に関する研究を行っています。

サイインゲンはマメ科野菜の中では莢が美味しく世界的に人気があります。支所のある沖縄県では冬期県外移出品目として1位になる馴染みが深い野菜です。しかし平均気温28度以上の高温下では花が落ちてしまい莢を収穫することができないため、夏期になると県外から移入しなくてはなりません。

### 高温でサイインゲンの花が落ちる原因

それではなぜ高温によりサイインゲンの花は実をつけずに落ちてしまうのでしょうか。花のままおれて落ちた莢(子房)の内部を顕微鏡で観察してみると、胚ができておらず受精していないことが分かりました。また、花が咲くときの温度とその後の莢の着き方を詳しく調べてみますと、開花前日と開花8~11日前の時期が、花が特に、高温に悪影響を受けていることが判明しました。開花8~11日前の時期に高温にあうと、葯の中の発達途中の花粉に栄養を送る組織の細胞の機能が破壊されることによって、花粉の生育が阻害され、受精能力が失われます。また、開花当日に高温にあった場合はまだ明らかではありませんが、花粉発芽や花粉管伸長が阻害され受精がうまくいかず、莢を着けることができないものと考えられます。

### 耐暑性品種「ハイブシ」

以上のような高温による障害を克服する品種として沖縄支所では、東南アジアを中心に世界各国から集めたサイインゲンの遺伝資源の中から耐暑性サイインゲン品種「ハイブシ」を選抜育成しました。「ハイブシ」は、石垣島の初夏までなら収穫可能な品種として注目されています。

### 花粉稔性の調査

「ハイブシ」を含むサイインゲンの品種や、世界各国から集めた遺伝資源の収量と花粉稔性の関係を見てみました(図1)。花粉稔性は、開花1日前の蕾を用いて中から葯を取り出し、アセトカーミンと

いう赤色の染色液で花粉が染まるかどうかにより判別します。「ハイブシ」のような夏でも高い収量を得ることができる品種では花粉稔性が高い

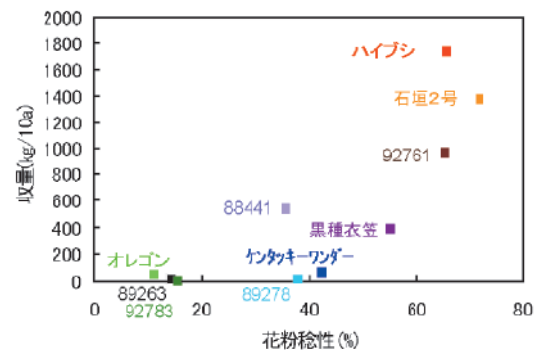


図1 サインゲンの花粉稔性(平成12年7月5日)と収量の関係  
番号はジーンバンクの保存番号

のに対し、収量が低い品種では一般に花粉稔性は低い傾向にありました(写真1)。前述のように花の落下は受精当日の温度にも影響されますので、花粉稔性のみではサイインゲンの耐暑性をすべて判断できませんが、すくなくとも高温下でも高い花粉稔性を示すことが高収量を得る上で重要であることが明らかとなりました。花粉稔性の調査は耐暑性の検定法の一つとして利用可能であると考えています。今回の調査では、「ハイブシ」や現在育成中である「石垣2号」よりも高い花粉稔性を示すものはありませんでしたが、将来、「石垣2号」や「ハイブシ」より高い値を示すものを探し出したいと思っています。また、耐暑性品種がなぜ高い花粉稔性を示すのかその生理メカニズムを解明し、作物全般での高温耐性の付与に役立てたいと思っています。



写真1 高温条件下でのサイインゲンの栽培。高温に弱い品種「ケンタッキーワンダー」(A)に多く見られる不稔花粉(a)と耐暑性品種「ハイブシ」(B)の正常花粉(b)



## 国際機関

# 国際農業研究協議グループ (CGIAR) の戦略と組織改革 21世紀への生き残りを賭けて

生物資源部長 岩永 勝



CGIAR傘下の16の国際研究機関は年間およそ350億円の予算の活動を行い、国際農業研究に関しては圧倒的な実績と高い評価がある。しかし「緑の革命」の成功体験が変革を妨げてしまい、21世紀の世界に適応出来ず恐竜のように滅亡にむかうのだろうか？

1992年にリオで開催された国連地球サミット会合で議長役を果たした世界的に著名なモーリス・ストロング氏がリーダーとなり、1998年にCGIAR全体のレビューが行われた。国際農林水産業研究は今後もその重要性が高まるが、大きく変化している世界の中であって今後も更なる活躍をするためにはCGIARが大きく変革するべきだとの強い指摘がなされた。これを受けてCGIAR内部で変革の具体化のための議論がなされて、2000年10月の年次総会で研究戦略と組織改革の具体的な案が採決される予定であったが・・・

1. 研究戦略に関しては、技術諮問委員会 (TAC) が主体になり研究内容の絞り込み、重点化等の議論を進めて来たが、2000年の年次総会で研究戦略提案を正式に提案した。主な変化としては：

- ① 科学技術の優秀性をCGIARの信条・基盤とする
- ② 地球的公共財 (International Public Goods) の生産に力点を置く
- ③ 貧困撲滅を大きな目標に掲げ、貧困層が集中するアフリカ、南アジアへ主力を注ぐ
- ④ 地域を枠組みとする研究課題の設定・実行システムを強化する
- ⑤ 科学技術だけでなく社会的制約・条件に目を向ける
- ⑥ 民間を含めた多くのパートナーとの連携協力を図る、等がある。先のドイツでの年次総会でかなり

の議論がなされていたため、TACの提案する戦略は満場一致の承認を受けた。研究現場でもこの研究戦略に対する強い支持がある。

2. 組織改革に関しては、新しい研究戦略を推進するための組織改革が2000年の年次総会の最も重要な議題であった。CGIARセンターの所長、理事長合同委員会より組織改革の提案が9月に出されていた。CGIAR全体をFederation (連邦・連合・連盟) に改変する事が骨格となっている。これは各センターの独自性を尊重しながらも組織として整合性と統一性のある力強い連合体に生まれ変わろうとの提案である。ヨーロッパのドナーを中心にこのFederation案に対し強い支持の発言があった。しかし他のドナーからはFederationの概念そして実際の運用に関し不明な点が多く、今回の総会で決断するのではなく、今後もFederation以外の選択肢も視野にいたした議論を続け、2001年5月の年次総会で正式に決断すべきとの慎重論が出た。コンセンサスが出来なかったため、ジョンソン新議長はこの慎重論を飲み決断を先送りするしかなかった。

ストロング・レポートが出されて既に2年が経っているのに大きな変革をするための決断が出来ない優柔不断さに対し研究センターから非常に強い不満が出された。変革出来ない組織への失望、変革を待ち続けた疲労感が明瞭である。CGIARの最大の弱点と言われた「意志決定システム」のなさが一番大切な時に露呈してしまった感がある。外部変化に適応し、あるいはその変化を先取りしたり、世界的変化の潮流を自ら作るぐらいの気概と組織力がないと21世紀は生きていけないと感じるのは現場の研究スタッフと幹部職員であり、雑多な目的を持って参画しているドナー等は異夢同船となり、ベクトルをそろえた方向へ跳躍する事は出来ないのだろうか？ 21世紀に生き延びるにはそれに通用する科学力と組織力が必要であり、変革をするための明確な意志決定システムを持つことの必要性はどの組織にも当てはまるだろう。





# プロジェクト 研究

## 総合研究プロジェクトに おける新たな技術選択手法 —メコンプロジェクトを事例として—

国際情報部 山田 隆一



### 1. 研究の背景

技術をいかにして開発するかということはもちろん重要なことだが、どのような技術を開発するかということもそれと同じくらい重要である。さらに重要な点は、こうした技術ニーズの把握が農家の問題意識にもとづくものでなければならないということである。そのためには医者が行う診察に相当するような診断を農家に対して行う必要がある。そして、その診断結果を技術開発に結びつけていかなければならない。そのためには一定の評価手法が求められる。

### 2. TN法とKJ法による診断

上記の診断に適した手法がTN法とKJ法である。TN法第1ステップは問題点などをリストアップし、当事者による得点化の後、各問題点ごとの平均得点や属性ごとの得点差などを把握するという手法である。我々は農家とのフリーディスカッションを繰り返す中で農家経営をめぐる技術的・経営的問題点をリストアップした。これに対して無作為に選ばれた約50戸の農家はその深刻度を3段階評価で得点化した。この結果、各問題点の深刻度順位が明らかとなった。それにもとづき一定以上の深刻度の問題点を抽出した上で、これについてKJ法を行い問題を集約し、その解決の基本方向を整理した。

### 3. AHP法による技術の事前評価と技術選択

次に、上記の方向性にもとづき技術開発課題のリストアップを行い、関係研究者にフィードバックし、メコンデルタプロジェクトチーム全体の議論の中でリストを確定した。このリストの中から最終的な技術選択を行うわけであるが、その判断材料を準備する必要がある。そのために行うのがAHP法による事前技術評価である。これは各技術をいくつかの基準によってそれぞれ一対評価を行い、総合的な評価値の大きさによってその優

先順位を決めるというものである。基準は①効果、②技術レベル、③農家の習得の容易性、④研究コストの4つである。図1はAHP法による事前技術評価結果の一部である。この例においては、最も総合評価値の高い地力維持向上対策が選択された。これは特に効果と技術レベルの面で優れていることが分かる。

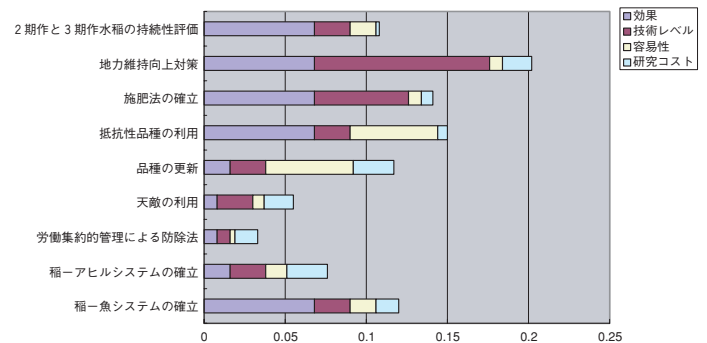


図1 AHP法による技術評価結果 (一部)

### 4. 今後の課題

以上の例と同様のプロセスを経てプロジェクトで取り扱うすべての技術が選択された。こうしたプロセスとそこで適用された手法が今後多くの総合研究プロジェクトで活用されるようにするために、さらに事例研究を重ね一定のマニュアル化を目指したい。

これまで、多くの技術開発プロジェクトの中で技術の事前評価が軽視されがちであった。その結果、時としてプロジェクトを軌道修正せざるを得なくなることもあり得た。

本稿では、メコンデルタのファーミングシステムを対象として、TN法・KJ法などの手法を組み合わせることで診断を行い、それをもとに技術開発課題をリストアップし、それに評価を加え優先順位をつけた上で技術選択を行うといった一連のプロセスを新たな技術選択手法(事前技術評価手法)として提起したい。

また、こうしたプロセスを可能とする条件はプロジェクトチームの確立による技術研究者と経営研究者の対話と協力である。この点を含めたプロジェクトマネジメントのあり方の検討が今後さらに必要であろう。







## 研究成果情報

# 平成12年度国際農業研究成果情報一覧

課題名	成果の分類
1. WTO加盟の中国農業への影響……………〔行政〕 国際農林水産業研究センター・海外情報部	10. インドネシアにおける大豆発酵調味液ケチャップ製造用麹菌の改良……………〔研究〕 国際農林水産業研究センター・生産利用部、食品総合研究所・食品機能部・健全性評価研究室、インドネシア豆類イモ類作物研究所
2. 日本在来小麦と中国育成小麦の赤かび病抵抗性遺伝子の比較と集積……………〔研究〕 国際農林水産業研究センター・生物資源部	11. 東北タイ緩斜面畑地におけるアレイクロッピング技術……………〔国際〕 国際農林水産業研究センター・生産利用部
3. プロリン代謝系酵素遺伝子操作による環境ストレス耐性植物の開発……………〔研究〕 国際農林水産業研究センター・生物資源部、理化学研究所	12. 下層土破碎処理による畑地土壌水分の有効利用技術……………〔国際〕 国際農林水産業研究センター・生産利用部
4. タイ国コンケン県における農業生産に関わる窒素循環……………〔行政〕 国際農林水産業研究センター・環境資源部	13. 東北タイ砂質畑地帯における不耕起栽培の適用性……………〔国際〕 国際農林水産業研究センター・生産利用部
5. ブラジルの草地およびダイズ畑における窒素収支……………〔研究〕 国際農林水産業研究センター・環境資源部	14. 東北タイ畑地優占雑草に対する機械除草の効果……………〔国際〕 国際農林水産業研究センター・生産利用部
6. CO ₂ 濃度増加にともなう水田からのメタン発生量増加……………〔研究〕 国際農林水産業研究センター・環境資源部	15. メコンデルタの水稲潤土直播栽培における収量性からみた最適播種量……………〔国際〕 国際農林水産業研究センター・生産利用部
7. 積雪深の分布と融解状況をリモートセンシングで知る手法……………〔研究〕 国際農林水産業研究センター・環境資源部	16. パラグアイの有害線虫抑制に有効なダイズ品種、輪作作物及び対抗植物……………〔国際〕 国際農林水産業研究センター・生産利用部、農業研究センター、北海道農業試験場、パラグアイ農牧省、国際協力事業団パラグアイ農業総合試験場
8. セジロウンカに対する中国ジャポニカ水稲‘春江-06’の品種抵抗性……………〔研究〕 国際農林水産業研究センター・生産利用部、中国水稲研究所	17. 脂肪細胞への分化抑制効果を示す大豆発酵食品中の生理機能性成分……………〔研究〕 国際農林水産業研究センター・生産利用部、食品総合研究所
9. インドネシア産大豆の豆腐・テンペへの加工適性……………〔研究〕 国際農林水産業研究センター・生産利用部、インドネシア豆類イモ類作物研究所	



## 研究成果情報

18. 腫瘍壊死因子 (TNF $\alpha$ ) はマウスのトリパノソーマ感染抵抗性に寄与している …… [研究]  
国際農林水産業研究センター・畜産草地部、国際畜産研究所 (ILRI)
19. カザフスタン産マメ科牧草エスパルツェトの種子は、地域の変異があり、強いアレロパシーを示す …… [研究]  
国際農林水産業研究センター・畜産草地部
20. 2種のアグロパストラルシステムにおける *Panicum maximum* 草地の乾物生産性と飼料価値の比較 …… [研究]  
国際農林水産業研究センター・畜産草地部、ブラジル農牧研究公社肉牛研究センター
21. ブラジル東北セラードのダイズ栽培におけるイオウの栄養診断基準 …… [研究]  
国際農林水産業研究センター・海外情報部、ブラジル農牧研究公社大豆研究所
22. 環境インパクトの小さい熱帯天然林の伐採技術 …… [研究]  
国際農林水産業研究センター・林業部、マレーシア森林研究所 (FRIM)
23. エビと二枚貝の混合養殖による有機汚濁物質の軽減 …… [国際]  
国際農林水産業研究センター・水産部
24. マングローブを利用した養殖排水の浄化 …… [国際]
25. 地中点滴装置を用いたかん水施肥によるハクサイ心腐れ症の軽減 …… [研究]  
国際農林水産業研究センター沖縄支所・地力維持研究室
26. パパイア奇形葉モザイクウイルス (PLDMV) の全塩基配列 …… [研究]  
国際農林水産業研究センター沖縄支所・作物保護研究室
27. 植物にも存在したナトリウム (排出) ポンプ (Na⁺-ATPase) …… [研究]  
国際農林水産業研究センター沖縄支所・国際共同研究科
28. 高温処理による生理的花粉不稔を利用したサヤインゲン簡易交配法 …… [研究]  
国際農林水産業研究センター沖縄支所・作物導入栽培研究室
29. サヤインゲン品種‘黒種衣笠’で見つかった細胞質雄性不稔 …… [研究]  
国際農林水産業研究センター沖縄支所・作物導入栽培研究室
30. サトウキビにおけるスクロースリン酸シターゼ (SPS) 遺伝子の識別法 …… [研究]  
国際農林水産業研究センター沖縄支所・作物育種世代促進研究室

成果情報の詳細は、「国際農業研究成果情報第8号」(2001年7月、国際農林水産業研究センター発行)を  
ご覧下さい。

問い合わせ先：情報資料課 Tel：0298-38-6341

ホームページアドレス：<http://www.jircas.affrc.go.jp/index.sjis.html>

# 人の動き

新	旧	氏名
平成 13 年 4 月 1 日付 (派遣職員)		
国際農林水産業研究センター付	国際農林水産業研究センター付	坪田 邦夫
企画調整部付	企画調整部付	佐藤 正仁
国際情報部付	海外情報部付	横山 繁樹
生物資源部付	生物資源部付	福田 善通
生産環境部付	環境資源部付	野副 卓人
生産環境部付	生産利用部付	中村 達
畜産草地部付	畜産草地部付	押部 明德
沖縄支所付	沖縄支所付	柳原 誠司
(転出者)		
独立行政法人農業技術研究機構総合情報管理部長	総務部長	水島 明
独立行政法人森林総合研究所企画調整部研究協力科長	林業部長	鈴木 皓史
独立行政法人農業技術研究機構作物研究所稲研究部長	企画調整部国際研究調整官	池田 良一
独立行政法人農業技術研究機構北海道農業研究センター北方農業研究官	生物資源部主任研究官	國廣 泰史
独立行政法人農業環境技術研究所生物環境安全全部植生研究グループ長	生物資源部主任研究官	岡 三徳
農林水産技術会議事務局国際研究課課長補佐(連絡調整班担当)	総務部海外業務管理課長	北 一義
独立行政法人農業技術研究機構統括部総務課(庶務係)	総務部会計課(用度係)	佐藤 光正
独立行政法人農業技術研究機構作物研究所稲研究部主任研究官(多用途稲育種研究室)	沖縄支所主任研究官(作物育種世代促進研究室)	出田 収
独立行政法人農業技術研究機構動物衛生研究所企画調整部情報資料課管理係長	情報資料課管理係長	橋本 霧子
独立行政法人農業技術研究機構東北農業研究センター企画調整部(業務第3科)	沖縄支所(業務科)	澤瀬 純一
独立行政法人農業技術研究機構近畿中国四国農業研究センター作物開発部(栽培生理研究室)	沖縄支所(作物導入栽培研究室)	竹田 博之
独立行政法人農業技術研究機構九州沖縄農業研究センター企画調整部研究交流科交流調整係長	沖縄支所庶務課会計係長	仲里 博幸

新	旧	氏名
独立行政法人農業環境技術研究所地球環境部主任研究官(温室効果ガステーム)	環境資源部主任研究官	八木 一行
独立行政法人農業環境技術研究所化学環境部主任研究官(栄養塩類研究グループ)	環境資源部主任研究官	神田 健一
独立行政法人森林総合研究所北海道支所実験林室長	林業部主任研究官	佐々木尚三
独立行政法人水産総合研究センター養殖研究所飼育環境技術部餌料生物研究室長	水産部主任研究官	日向野純也
岩手大学助教授農学部農業生命科学科	沖縄支所主任研究官(熱帯果樹研究室)	小森 貞男
平成 13 年 8 月 1 日付		
農業技術研究機構畜産草地研究所総務部会計課施設管理係長	総務部会計課(主計係)	篠塚 修央
平成 13 年 10 月 1 日付		
企画調整部国際研究調整官	沖縄支所国際共同研究科長	野田千代一
企画調整部主任研究官(研究企画科)	農業技術研究機構中央農業総合研究センター経営計画部主任研究官(耕種経営研究室)	安延 久美
総務部海外業務管理課海外物品係長	農林水産技術会議事務局技術政策課調査班調査第2係長	西野 重蔵
総務部会計課(主計係)	沖縄支所庶務課(会計係)	西山 誠
畜産草地部主任研究官	農業技術研究機構東北農業研究センター畜産草地部主任研究官(放牧管理研究室)	福田 栄紀
畜産草地部主任研究官	畜産草地部	山崎 正史
食料利用部主任研究官	食品総合研究所生物機能開発部主任研究官(細胞機能研究室)	伏見 力
林業部主任研究官	企画調整部主任研究官(研究企画科)	落合 幸仁
水産部併任(平成 14 年 3 月 31 日まで)	水産総合研究センター研究推進部主任研究官	尾形 博
沖縄支所庶務課(会計係)	農業技術研究機構畜産草地研究所総務部総務課(審査係)	星野谷善行
沖縄支所業務科	農業技術研究機構近畿中国四国農業研究センター企画調整部(業務第1科)	識名 安輝
農業生物資源研究所総務部松本総務分室会計係長	総務部海外業務管理課海外物品係長	田中 良穂
農業技術研究機構東北農業研究センター畜産草地部主任研究官(放牧管理研究室)	畜産草地部主任研究官	菅野 勉
水産総合研究センター養殖研究所病理部主任研究官(組織病理研究室)	水産部主任研究官	大迫 典久
農業技術研究機構近畿中国四国農業研究センター企画調整部(業務第1科)	沖縄支所業務科	桑田 将能



## 表紙の写真説明

農業環境技術研究所 岡 三徳撮影

収穫の季節を迎えたタシケントのバザールには、多くの秋の実りが並ぶ。近郊の人たちは、多くの果物、野菜、穀物、香辛料をバザールに持ち寄って売る。テントの下には干しブドウや杏、香辛料が並び、広場はスイカとメロンで占有される。スイカとメロンの種類が多いのも、この地域の特徴である。写真には、大玉で色の濃淡が異なるスイカや日本と同じ縞模様のも、黄色の丸いメロンやラクビーボールに似た大型のハミメロンが後方に写っている。男たちは布団を持ち込み、山積みしたスイカやメロンとともに、バザール広場で実りの季節を過ごす。

冷涼で乾燥したシルクロードのバザールでは、古くから短い夏に豊かに穫った農作物を喜び、自慢げに売る人たちの生活が続いている。



JIRCASニュース No.27

平成13年12月発行

発行 国際農林水産業研究センター

編集 企画調整部国際研究広報官、情報資料課

〒305-8686 茨城県つくば市大わし1-1

TEL.0298(38)6340(情報資料課) FAX.0298(38)6316

ホームページアドレス <http://www.jircas.affrc.go.jp/>



この印刷物は再生紙を使用しています。

# JIRCAS *ffj*...•[fX No.19 2000

JAPAN INTERNATIONAL RESEARCH CENTER FOR AGRICULTURAL SCIENCES



□.@ f•fRf“ff<f^,Î‘D,đ‘ ,é•w•l

## -Ú•@•@ ŽY

□.@ [Š“aCE¾](#)

• [,È,°K—v,©•AJIRCAS‘••žvf•fWfFfNfg](#)

•@

□.@ [CEα<†•~%oÊ](#)

• [Š£‘ž,É,àŠ!,³,É,àŠC•...É,à‘İ,!,éfx•\[fp•\[A•,İŠJ”-](#)

• [”-fKf“•Ži,İi—p,đ—},!,é^fC,İfVfžfEfK•~•ª](#)

•@

□.@ [•••Û<@ŠÖ](#)

• [•æ’\[<Z•p,É,æ,é•n•ç,İ•iCE,](#)

•@

□.@ [•••Û<@ŠÖ,İ“®,<<](#)

• [•V,µ,çî,İŠJ”-,đ’S,α••ÛîCEα<†•Š•iIRRI•j](#)

•@

□.@ [•Š,İ“®,<<](#)

• [•u•H—i•EŠÂ<<-â‘è,É,“,-,é••Û•vCE£•v,İ•í—ª,đ<c~](#)

•@





Navigation and search links including Home, About, News, and Search.

Navigation buttons: Home, About, News, Search









写真 タイのショウガ科野菜

•@•@•@ŽÊ•^•FftfBf“fK•[f<•[fg•i•ã•j,ÆfKf%of“fK•i%o°•j

もどる

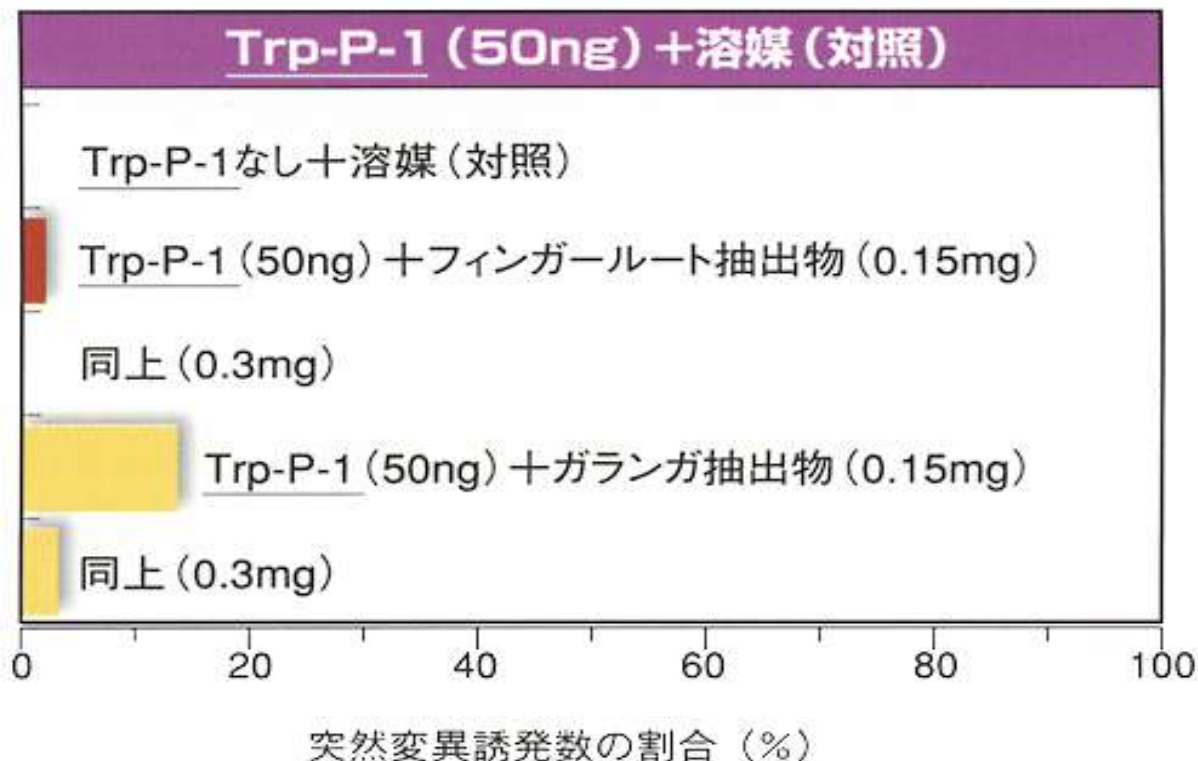


図1 タイのショウガ科野菜の抗変異原作用  
発ガン性物質として知られている Trp-P-1 は、強い変異原作用を示す。  
この実験では、寒天プレート1枚当たり、各野菜の80%メタノール抽出物を0.15mg及び0.3mg添加し、Trp-P-1 (50ng)の変異原作用がどの程度抑えられるかを測定した。

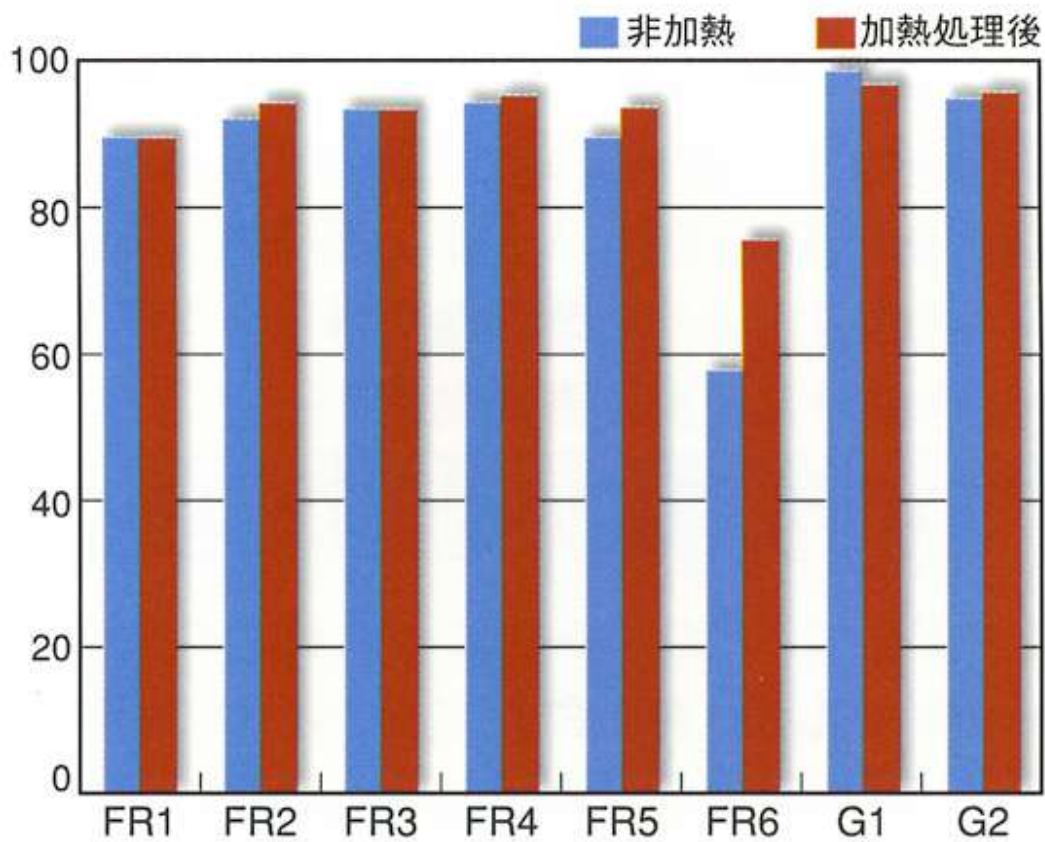


図2 各成分に対する加熱処理の影響

もどる





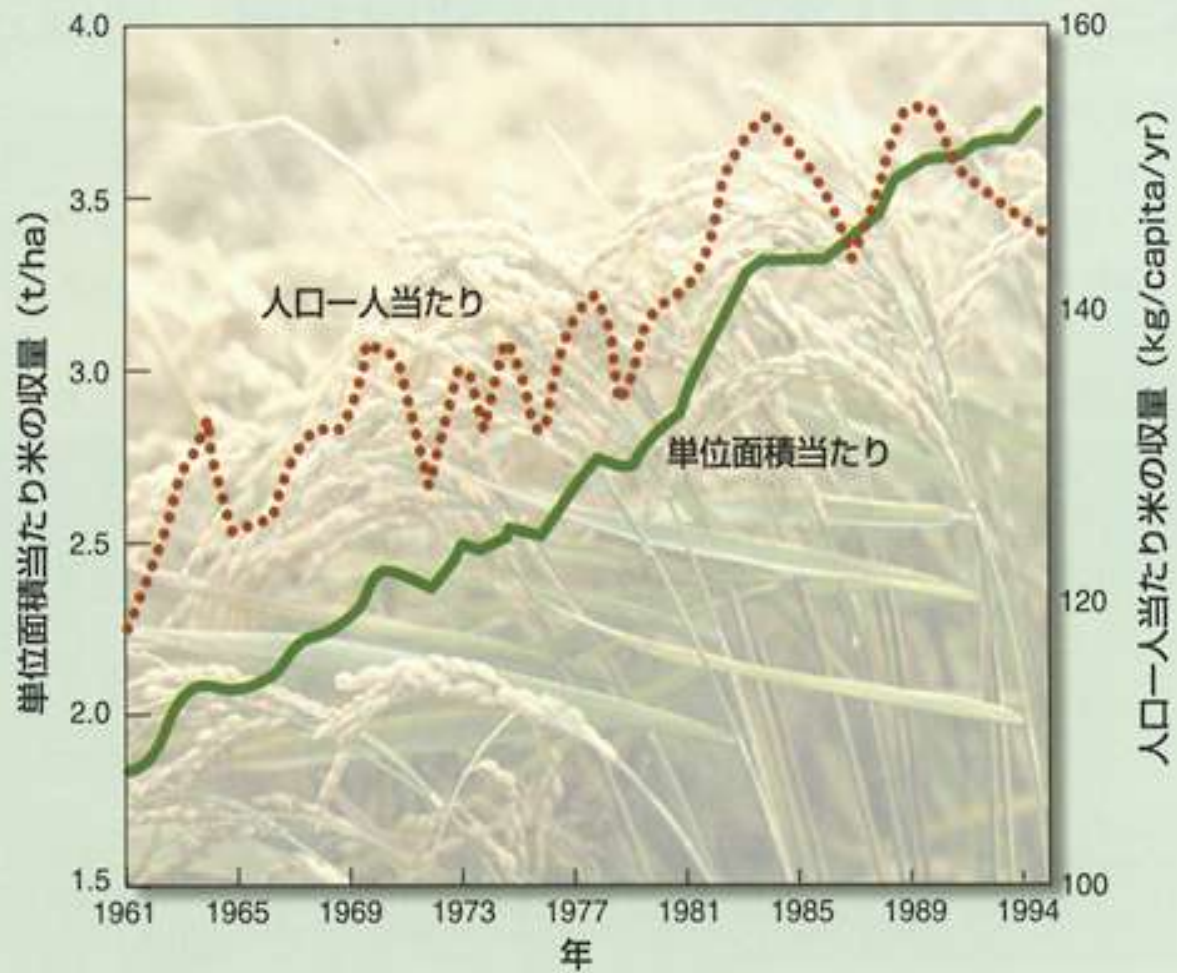


図1 単位面積当たり及び人口一人当たりの米生産量の年次推移： FAOSTAT DATA base より

もどる











# 特許情報

Žæ“¾,µ,½“Á←ê——			
¼ •İ	•oŠè•‘	“o~^“ú	”Ô •†
fXf f f x f “ -2-fJf f { f “ Ž_ A3-fnfCfhf • fL fV • A, » , İ • » ‘ ç - @ , “ , æ , Ñ , » , ê , ð — LÆø • - a , Æ , “ , é • œ “ • • Ü	“ú - {	H 8. 9.18	2090580
•ì••Í”l’•’u	“ú - {	H 9. 3.11	2615428
•ì••Í”l’•’u	fAf • fŠfJ	H 9. 7.22	5, 649, 387
•ì••Í”l’•’u	fCfMfŠfX	H 9.12.10	EP 0 699 383 B1 0699383
•ì••Í”l’•’u	fhfCfc	H 9.12.10	EP 0 699 383 B1 69501193.6
•ì••Í”l’•’u	ftf%of“fX	H 9.12.10	EP 0 699 383 B1 0699383
•ì••Í”l’•’u	fCf^fŠfA	H 9.12.10	EP 0 699 383 B1 19637BE/98
•ì••Í”l’•’u	Šø •	H10. 6. 2	149110
fpfpfCf, „ŠiÆ — tf, fUfCfNfEfCf fX, İŠO”r””Žç^â“Žq, İ%o-Ši”z—ñ	“ú - {	H11.10. 8	2987419
fpfpfCf, „ŠiÆ — tf, fUfCfNfEfCf fX, İŠO”r””Žç^â“Žq, İ%o-Ši”z—ñ	fAf • fŠfJ	H11. 1.12	5, 859, 224
fQf • ó%oÆ’ { — p • â • • Ž” — ç , Æ , » , İ • » ‘ ç • û — @	“ú - {	H10. 9. 4	2821574

•@

•iŽç“o~^ê——		
¼ •İ	“o~^“ú	”Ô •†
î • ... î • @ • @ • @ • @ • ... î ’ † ŠÔ • ê - { ” _ , X • †	S63.12.13	1807
, µ , © , - , Ü , B • @ • @ fEfŠfYf“	H 2. 8. 4	2342
fMfj fAfOf%ofX • @ ’ † ŠÔ • ê - { ” _ , P • †	H 5.10.13	3708
, ç , ñ , ° , ñ , Ü • @ • @ fnfCfufV	H10. 7.17	6624

•@

[目次へ](#)

[もどる](#)

[次ページへ](#)

[ホームへ](#)

•@



	-k-σ”_<ÆŽŽĀ±•ê•...“c-~—p•”i’ŽŠQĀα†Ž°j	•¶ŽY—~—p•”	•,<’-¾•F
	•¶•Ž’Ā!•”Žâ”CĀα†Š-	•V<K•ĭ—p	%oY”ö•@•,,
	•¶ŽY—~—p•”	•V<K•ĭ—p	’C-α%oqŽO
9.10.16	ŠCŠO•î•ñ”•••ŪĀα†î•ñŠ-	%o«“êŽx•ŠŽâ”CĀα†Š-•j••Ū•σ“-Āα†%oĒ•j	“nç²—mŽq

[目次へ](#)
[もどる](#)
[ホームへ](#)

•@



# JIRCAS *ffj*... [fX No.20 2000

JAPAN INTERNATIONAL RESEARCH CENTER FOR AGRICULTURAL SCIENCES



□ @ f^fC“i” , Å•o%öi, Á, ½“¬•—p, Ì<•, Æ’ {Žã

## -Ú•@•@ Žÿ

□ •@ Š^{a+ã}CE^¾

- @ [e’ {ŽY£, Å•, ß, éŠJ”-“rã•” <Æ, ÌŽ©‘R•zŠÂ<@’\](#)

•@

□ •@ CEα<†•-‰oÊ

- @ [“ú- {, Ì, ç, à, ç•a”i•R•<â“Žq, ã-ð, É—§, Âfxfgfif •Ef•fRf“ff<f^, Ì... ï, ç, à, ç•a](#)
- @ [’†•’, ÌfpfpfCfAfEfCf<fX, Í, Ç, ±, ©, ç, <, ½, ©](#)

•@

□ •@ f••[fNfVf‡fbfv

- @ [—{•^afXfgfCEfXŠÂ<<É, “, -, é•H—ç•¶ŽY, Ì^À`è%o»](#)

•@

□ •@ fZf~fi•[

- @ [••ÚCEα<†•W%öi•u”M’Ñ%oJ—Ñ, Ì”°•Ì, Æ•Ä•¶<Z•p•v](#)

•@

□ •@ fvf•fWfFfNfg

- @ [fuf%ofWf<, ÅŽ•±“I, É“÷<•, Æ•ã“o, ð•¶ŽY, ., éŽ•±CE^” -q—Ö“lfvfXfef, ÌŠJ”-](#)

•@

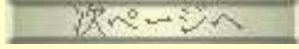


•@••ÚEα†

• •Ô,©,Ñ•a,É<,φ•¬”ž•iŽí,ð•ì,é

•@

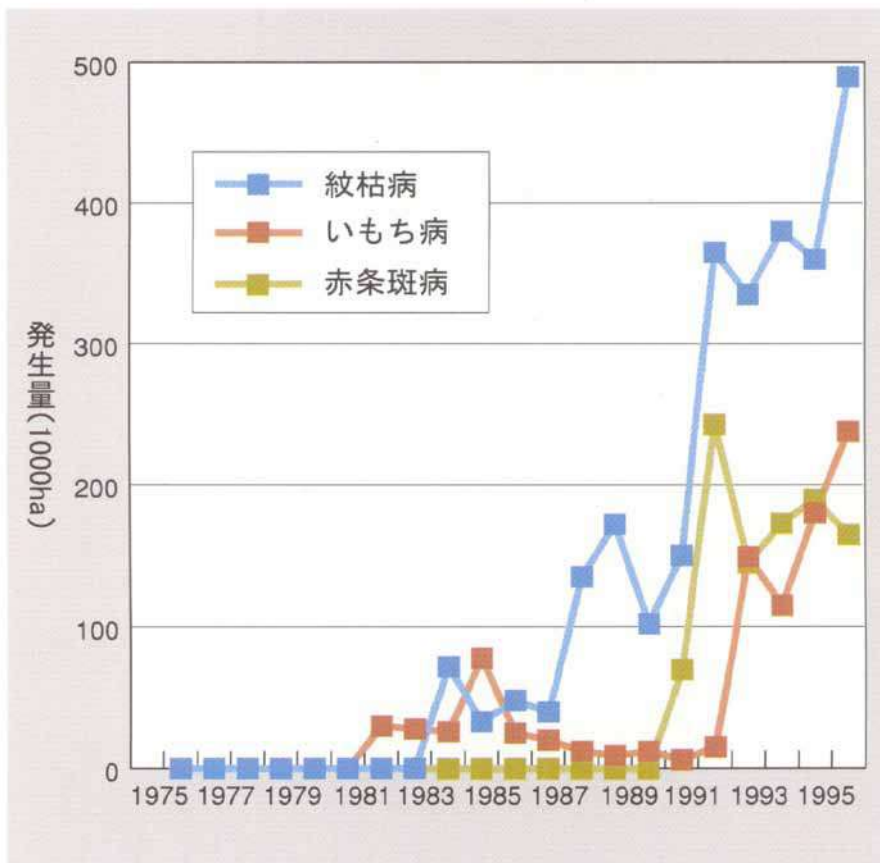
•@••l,î“®,<<



•@

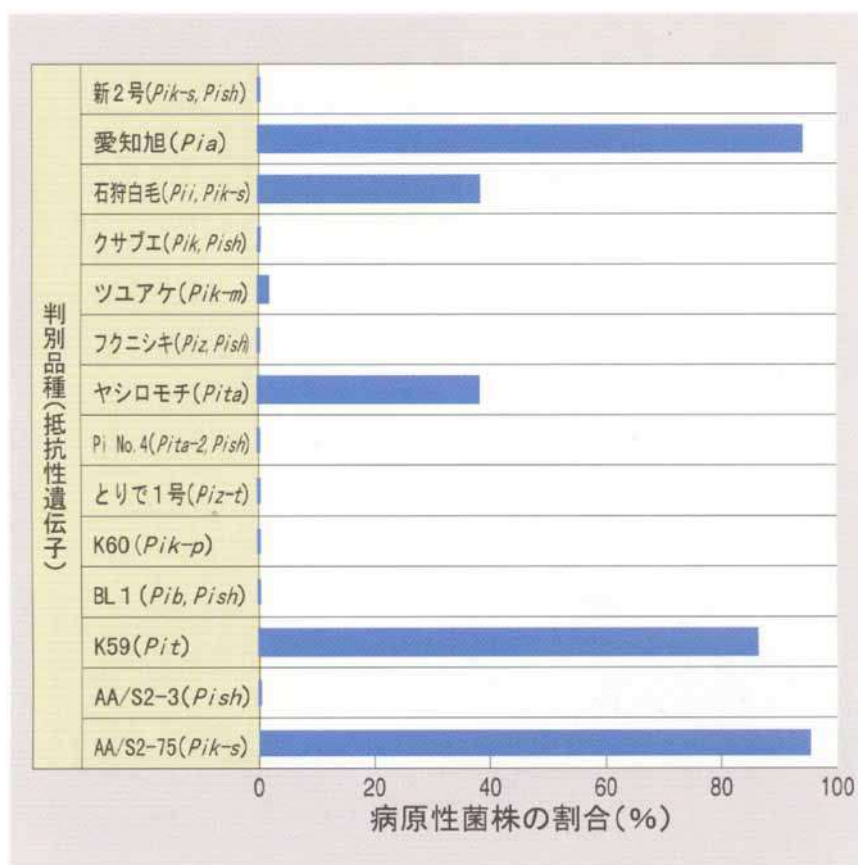






▲ 図1. メコンデルタにおける主要水稲病害の発生推移

もどる



▲ 図2. メコンデルタに分布するいもち病菌の病原性

もどる



研究結果

研究結果

研究結果

研究結果

研究結果

研究結果

研究結果

研究結果

研究結果

研究結果

研究結果

研究結果

研究結果

研究結果

研究結果

研究結果

研究結果

研究結果

研究結果

研究結果

研究結果

研究結果

研究結果

研究結果

研究結果

研究結果

研究結果

研究結果

研究結果

研究結果

研究結果

研究結果

研究結果

研究結果

研究結果

研究結果

研究結果

研究結果

研究結果

研究結果

研究結果

研究結果

研究結果

研究結果

研究結果

研究結果

研究結果

研究結果

研究結果

研究結果

研究結果

研究結果

研究結果

研究結果

研究結果

研究結果

研究結果

研究結果

研究結果

研究結果

研究結果

研究結果

研究結果

研究結果

研究結果

研究結果

研究結果

研究結果

研究結果

研究結果

研究結果

研究結果

研究結果

研究結果

研究結果

研究結果

研究結果

研究結果

研究結果

研究結果

研究結果

研究結果

研究結果











▲ 肉牛研究センターの農牧輪換試験圃場

もどる





もどる

# 人の動き

"NĚŽ'ú	^Ů•@“®•@Ěã	^Ů•@“®•@'O	-¼•@'O
10. 4.6	•¶•Ž'Ě!•"•t'hĚ-E^ō•j••Ů'ŷĚα†•Š•j	•¶•Ž'Ě!•"Žã"ĈĚα†Š-	%oÁ“;•@_
10. 6.1	%o«“êŽx•Š•Ž-±%oŮ%oiĚvĚW'.	<ã•B”_<ĚŽŽĚ±•ê'•-±”•Ž-±%oŮĈĚú•¶ĚW	'‡—Ě”Ž•K
	ŠCŠO•î•ñ”••ŮĈĚα†•î•ñŠ-	<ã•B”_<ĚŽŽĚ±•ê•¶ŽYŠĤ«“”“y•ë”÷•¶•ĈĚα†Ž°.	•ó•À•C^ê
	‘•nŽŽĚ±•ê'•-±”•Ž-±%oŮ•lŽ-‘æ,QĚW’.	%o«“êŽx•Š•Ž-±%oŮ%oiĚvĚW'.	“;—{••D
	'lŽæ'ãŠw”_Šw”<³Žö	ŠCŠO•î•ñ”••ŮĈĚα†•î•ñŠ-	-x“à<v'¼~Y
10. 8.1	<ã•B”_<ĚŽŽĚ±•ê'•n”Ž”_ĭ•¶ŽYŠÇ—•ĈĚα†Ž°.	'{ŽY'•n”Žã"ĈĚα†Š-	•²“;ĈĚŽY
10.8.16	'{ŽY'•n”.	%oĚ' {%oq•¶ŽŽĚ±•êŠé%oæ~A—Ž°Šé%oæĚW'.	•'...ŽĀŽk
	••Ů”_—Ñ...ŽY<ĚĈĚα†fZf“f^•[t'hĚ-E^ō	'{ŽY'•n”.	•j•ð%op'¼~Y
10. 9.1	“ĈĚ-k”_<ĚŽŽĚ±•êŽY'.	Šé%oæ'²•®”.	^ä•ã—²•O
	Šé%oæ'²•®”.	“ĈĚ-k”_<ĚŽŽĚ±•êŠé%oæ~A—Ž°.	•Î'J•F—C
	”_—Ñ...ŽY<Z•p%oi<cŽ—±<Ç' }”gŽ—±•Š'•-±%oŮ—p“xĚW'.	%o«“êŽx•Š•Ž-±%oŮ•Ž-±ĚW'.	•ó•À~a•b
	%o«“êŽx•Š•Ž-±%oŮ'.	%oĚ' {%oq•¶ŽŽĚ±•ê'•-±”•Ž-±%oŮ•Ž-±'æ,PĚW'.	‘•ĈĚ³•Y•G
	‘•-±”%oiĚv%oŮ—p“xĚW'.	‘•-±”%oiĚv%oŮ—p“xĚW	•²“;•PŽu
	Žl•”_<ĚŽŽĚ±•ê'•-±”%oiĚv%oŮ%oŮ'••â²	%o«“êŽx•Š•Ž-±%oŮ'.	Š•-i“N~Y
	%o«“êŽx•Š•Ž-±%oŮ•Ž-±ĚW'.	%o«“êŽx•Š•Ž-±%oŮ%oiĚvĚW	•ĂŽR•GŽ÷
	<ã•B”_<ĚŽŽĚ±•ê'•-±”•Ž-±%oŮ•Ž-±'æ,QĚW	%o«“êŽx•Š•Ž-±%oŮ•Ž-±ĚW	^É“;—F~ĚN
	%o«“êŽx•Š•Ž-±%oŮ•Ž-±ĚW	<ã•B”_<ĚŽŽĚ±•ê'•-±”ŽiŽq“‡'•-±•Ž°	•-æÇ”N•Í
	%o«“êŽx•Š•Ž-±%oŮ%oiĚvĚW	Žl•”_<ĚŽŽĚ±•ê'•-±”%oiĚv%oŮ—p“xĚW	•¼ŽR•@•½
	%o«“êŽx•ŠŽã"ĈĚα†Š'•i'n—ÍŮŽ•ĈĚα†Ž°•j	”_<ĚĈĚα†fZf“f^•[“y•ë”î—ĭ•”Žã"ĈĚα†Š'•i%oh—{•f'fĈĚα†Ž°•j	‘•“c“xŽO

10.10.1	—Ñ<Æ•”Žâ”CÆα†Š-	•X—Ñ‘••‡(Æα†•Š““Æ—kŽx•ŠŽâ”CÆα†Š-•i^ç—Ñ•”^ç—Ñ<Z•p(Æα†žŽ°j	•,<~a<K
	•...ŽY•”	’†%o•...ŽY(Æα†•ŠŠC—m•¶ŽY•”•Ži•zšÂ(Æα†žŽ°	%o“•c•@“O
	%o«“êŽx•š•i•^çŽi•φ‘ã‘£•i(Æα†žŽ°	<ã•B”_<ÆŽŽ(Æ±•ê•i•šJ”-•”^çŽi•Hšw(Æα†žŽ°	•o“c•@Žû
	•¶•Ž‘(Æ‘•”Žâ”CÆα†Š-	•¶ŽY—~—p•”Žâ”CÆα†Š-	^Û<V“c~a“T
	<ã•B”_<ÆŽŽ(Æ±•ê•...“c—~—p•”^çŽi(Æα†žŽ°’.	%o«“êŽx•š•i•^çŽi•φ‘ã‘£•i(Æα†žŽ°’.	%o^—{•³•O
	%o«“êŽx•š•i•^çŽi•φ‘ã‘£•i(Æα†žŽ°’.	%o«“êŽx•šžâ”CÆα†Š-•i••Û<α““Æα†%oÈ•j	•¼%o^•@•½
	%o«“êŽx•š••Û<α““Æα†%oÈ	šÉ%oæ’²•@•”šCšO(Æα†(Æđ—%oÈ	’†°•@šÉ
	%o«“êŽx•š••Û<α““Æα†%oÈ	%o«“êŽx•š•i•^çŽi•φ‘ã‘£•i(Æα†žŽ°	Ž,“à•û—°
	-kšC“‘”_<ÆŽŽ(Æ±•ê•”•i(Æα†fZf“f^•[•iŽi•§(Æä(Æα†f^•[f’.	•¶•Ž‘(Æ‘•”Žâ”CÆα†Š-	’†-i•@š°
	”_<Æ(Æα†fZf“f^•[“y•ë”i—i•”Žâ”CÆα†Š-•i%oh—{•f’f(Æα†žŽ°j	%o«“êŽx•šžâ”CÆα†Š-•i’n—ÍÛŽ•(Æα†žŽ°j	‘ã~e—Ç•¬
	<ã•B”_<ÆŽŽ(Æ±•ê•”’n—~—p•”Žâ”CÆα†Š-•i•¶ŽYšÇ—•(Æα†žŽ°j	%o«“êŽx•šžâ”CÆα†Š-•i••Û<α““Æα†%oÈ•j	^À’B•žž÷
	’†•”_<ÆŽŽ(Æ±•ê•’n^æšI”Ö(Æα†•”•ašQ(Æα†žŽ°	šÉ%oæ’²•@•”(Æα†šÉ%oæ%oÈ	^ä•ã”žšì
	“Æ—k<æ•...ŽY(Æα†•š”^a(ÆÈŽx•š	•...ŽY•”	‘fžR•@“N
	•X—Ñ‘••‡(Æα†•š•¶ŽY<Z•p•”^ç—Ñ<Z•p%oÈ•A•¶•§(Æä(Æα†žŽ°	—Ñ<Æ•”	%oæ“cžj~Y
šCšO•i•ñ•”	•V<K•İ—p	‘K•@•¬•½	
10.11.1	”_<Æ(Æα†fZf“f^•[“•-±•”•ž-±%oÛ’.	‘•-±•”•ž-±%oÛ’.	”~—{•r—Y
	‘•-±•”•ž-±%oÛ’.	’†•”_<ÆŽŽ(Æ±•ê•‘•-±•”%oi(ÆV%oÛ’.	<e’n•j’j
	”_<Æ(Æα†fZf“f^•[“•-±•”—p“x%oÛ”²’B(ÆW’.	‘•-±•”•ž-±%oÛ(Æú•¶(ÆW’.	•,¼<°
	‘•-±•”•ž-±%oÛ(Æú•¶(ÆW’.	‘•-±•”•ž-±%oÛ•ž-±(ÆW’.	âV“‘i<•_
‘•-±•”•ž-±%oÛ•ž-±(ÆW’.	•İ—p•i•¶•(Æn“Á”èŽY<Æ<Z•p(Æα†•,•i•@•\“•-±•”ž‘<àšÇ—•%oÛž‘<àšÇ—•,Q(ÆW’•j	•¼—{•³•K	
10.12.1	•¶ŽY—~—p•”Žâ”CÆα†Š-	”_<Æ(Æα†fZf“f^•[•k’n—~—p•”Žâ”CÆα†Š-•i•i•t•İ(Æn(Æα†žŽ°j	•¼“ö~a”V
	šÉ%oæ’²•@•”Žâ”CÆα†Š-•i(Æα†šÉ%oæ%oÈ•j	šÉ%oæ’²•@•”(Æα†šÉ%oæ%oÈ’.	%o^•@žO“i
	šÉ%oæ’²•@•”(Æα†šÉ%oæ%oÈ’.	•¶•Ž‘(Æ‘•”Žâ”CÆα†Š-	^iš_•³“T
	{žY‘•n•”Žâ”CÆα†Š-	šÉ%oæ’²•@•”Žâ”CÆα†Š-•i(Æα†šÉ%oæ%oÈ•j	%oÿ•”~¾“i

11. 1.1	•...ŽY'ı'ı'†%o>...ŽYŒα<†•Š•t'hŒ-E^ō•j	•...ŽY•”.	%oF-iŽj~Y
	•...ŽY•”.	'†%o>...ŽYŒα<†•Š•¶•<@'∧”.	'O'c•1'2
	•¶•Ž'Œ!•”Žâ”CŒα<†Š-	”_<Œ•¶•Ž'Œ!Œα<†•Š^â“Ž'Œ!‘æ“ñ•”^â“Ž'Œ!ŠÇ—•ı•ñ%oÈ’.	š œA'×Žj
11. 3.1	•¶•Ž'Œ!•”Žâ”CŒα<†Š-	“Œ-k”_<ŒŽŽŒ±•ê•ı•ŠJ”-•”Žâ”CŒα<†Š-ı•â“œ^çŽíŒα<†Ž°•j	‘«—š'ăŽR

[目次へ](#)
[もどる](#)
[ホームへ](#)

•@

# JIRCAS *fjf... [fX* No.2, P 2000

JAPAN INTERNATIONAL RESEARCH CENTER FOR AGRICULTURAL SCIENCES



@ [f•fRf“ff<f^,Å‘D,ð,±,®•w•l](#)

## -Ú•@•@ ŽŸ

@ [Š^a“a”E^{3/4}](#)

- [‘ã<f“Žž‘ã,ÆJIRCAS](#)

•@

@ [•-‰oÊ•î•ñ](#)

- [“î•Ä,É,“, -, é‘ã“o, ì•s•k•N•Í”](#)

•@

@ [fvf•fWfFfNfg](#)

- [fxfgfif •Ef•fRf“ff<f^,É,“, -, é•j•ž” <ÆCEo‰cc](#)

•@

@ [•V<Kfvf•fWfFfNfgEα<†](#)

- [•u“E“ifAfWfA,É,“, -, é•’—P,İŽûŠnEãf•fX,Ì‘áE, <Z•p,İŠJ”-•v,Ì”wEi,Æ‘ ,ç](#)

•@

@ [f•\[fNfVfžfbfv](#)

- [•u’†‰oØ—i—•,İ“S•lv,Æ•u“ú—{fJf}f{fRf••\[fJ•\[•v,Ì<£‰o‰o](#)


•@

@ [•••ÛEα<†<@ŠÖ,½,æ,è](#)

- [fAftfŠfJ,ì‰oE’{•—“y•a•ufgfŠfpfmf•\[f\]•Ç•v,ð‰oð—¾,•,é](#)

•@



 [@.1,1"®,<](#)



•@



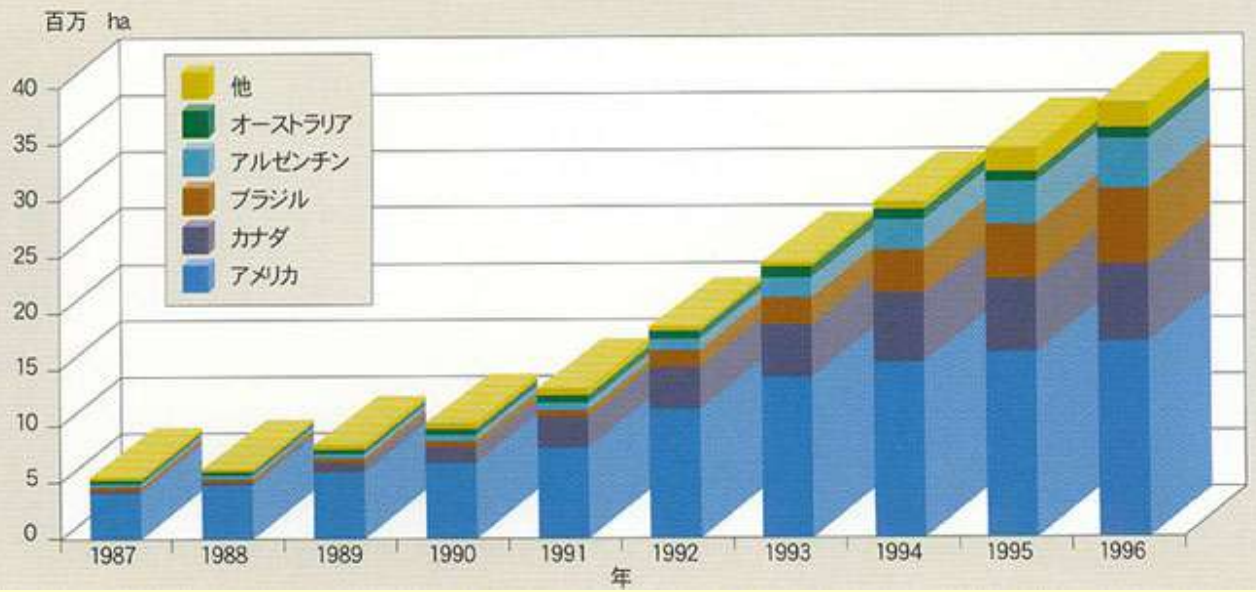




▲ 小麦あとの大豆栽培風景(パラグアイ・イグアス市近郊)

もどる

図 世界の主要国における  
不耕起栽培面積の増加  
(Derpsch, 1998)



もどる



IRRI  
INTERNATIONAL RICE RESEARCH INSTITUTE  
CIRAD-IRRI  
CIRAD-IRRI



IRRI





▲ 写真1 ベトナム・カントー市付近における籾の天日乾燥  
乾燥も不十分で、降雨により品質が低下する



▲ 写真2 コクゾウ虫の繁殖したインディカ米  
貯蔵害虫により、質的・量的に大きな被害が出る

もどる





写真  
1中華料理の鉄人が試作した  
すり身料理の例

◀ スープ入り  
フィッシュボール  
(ハクレン)

醤油風味賽子魚肉団子 ▶  
(ハクレン)

写真  
2日本の代表的メーカーが試作した  
練り製品の例

◀ カニ足カマボコ  
(草魚)

8 カニ足

8. 模擬蟹腿(草魚)

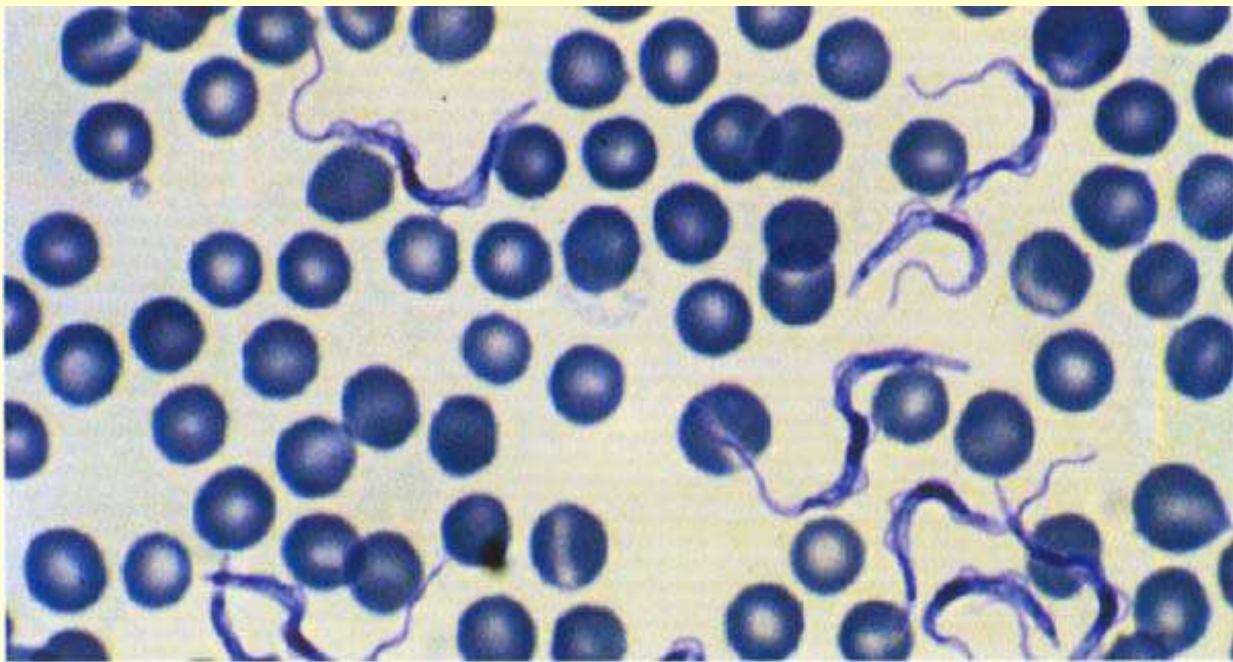
野菜てんぷら ▶  
(ハクレン)

5 ☆野菜てんぷら

5. 油炸蔬菜魚糕(白粉)

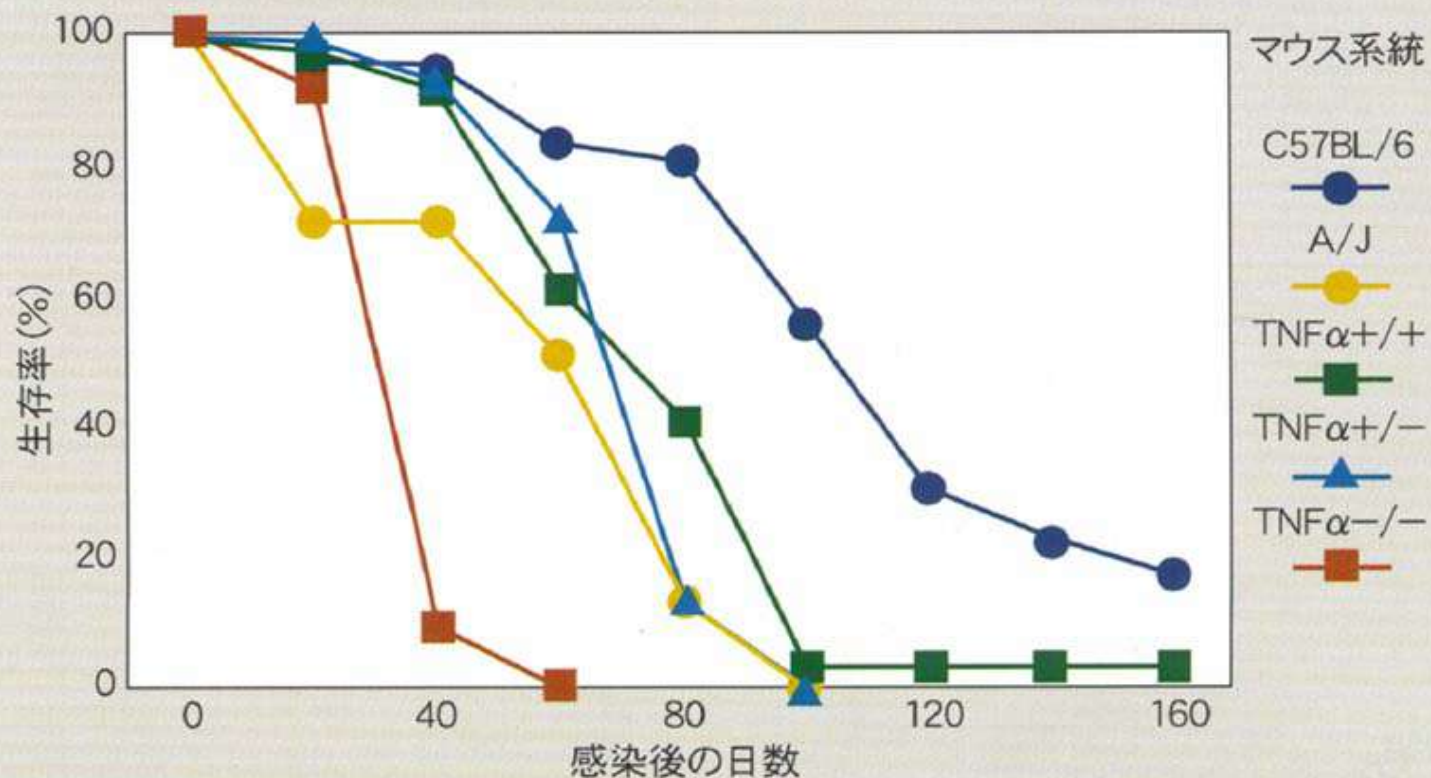
もどる





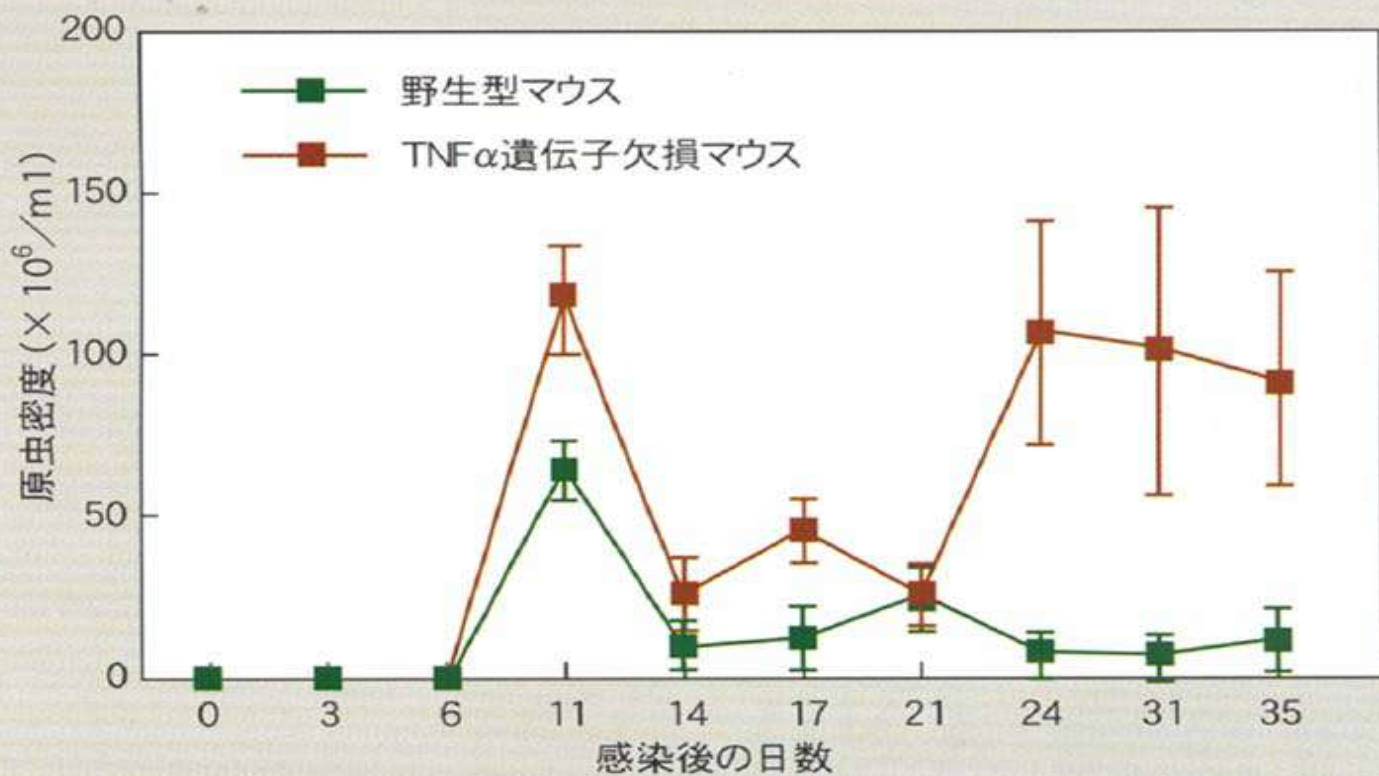
•@•£ŽÊ•^,P•@fgfŠfpfmf•[f}Œ`Ž,ìŒ°”÷<¾ŽÊ•^•i%oo~Œ` ,ÉŒ©,!,é,Ì,Í•ÔŒŒ<...•j

もどる



▲図1 トリパソノーマ症感受性におけるマウス系統差  
TNF  $\alpha$  遺伝子欠損マウス ( —■— ) は最も感受性が高い

もどる



▲図2 野生型およびTNF $\alpha$ 遺伝子欠損マウスの末梢血における原虫密度の比較

もどる

# 人の動き

”NĚŽ“ú	^Û•@“@•@Ěä	^Û•@“@•@‘O	-¼•@‘O
11. 3.15	’{ŽY‘•’n•’•t•i”hĚ-•E^ō•Ff}fĚfCfVfA•j	’{ŽY‘•’n•’Žâ”CĚα<†Š-	%oÿ”-¾¼“;̇
11. 3.31	‘P•E•i“È-ØĚ§”_<ÆŽŽĚ±•ê“È-Ø•ê“ñ•đ•â”ž•iŽ̇%öü“PŽw’èŽŽĚ±Žâ”C•j	%o«“èŽx•ŠŽâ”CĚα<†Š-•i•i•“çŽí•ç‘ã‘£•iĚα<†Ž°•j	•-“c•r%ôî
	‘P•E	%o«“èŽx•Š•Ž-±%oÛ	‘O’Ã••Ë
	ŠCŠO•î•ñ•”.	•İ—p•i••Û<†—ÍŽ-<Æ’c”_—Ñ•...ŽYŠJ”-’²•,•”’•j	’BĚ©~a•K
	’{ŽY‘•’n•”.	%oÆ’{%oq•¶ŽŽĚ±•ê•a‘ÔĚα<†•”•ã•ÈĚα<†Š-	’JĚû«-¾¼
	••Û”_—Ñ•...ŽY<ÆĚα<†fZf“f^•[•t•i”hĚ-•E^ō•FFAOfCf^fšfA•j	ŠCŠO•î•ñ•”.	’Ø“c-M•v
	<ã•B”_<ÆŽŽĚ±•ê•i•“ŠJ”-•”.	ŠCŠO•î•ñ•”••ÛĚα<†•î•ñŠ-	•¼^ã•d—Y
	%oÆ’{%oq•¶ŽŽĚ±•êšĚ%œ~A—Ž°’.	’{ŽY‘•’n•”.	••...ŽÀŽk
	‘•-±•”%oiĚv%oÛ’.	<ã•B”_<ÆŽŽĚ±•ê••-±•”%oiĚv%oÛ’.	•ã‘°•@<v
	šĚ%œ²•@•”•î•ñŽ’—;̇%oÛ’.	•H•i••‡Ěα<†•šĚ%œ~A—Ž°•î•ñŽ’—;̇%oÛ’.	•ã-î•M’j
	ŠCŠO•î•ñ•”Žâ”CĚα<†Š-	”_<Æ••‡Ěα<†•šŠCŠO•”Žâ”CĚα<†Š-•iŠJ”-<†—ÍĚα<†Ž°•j	ÿN^ã••Ži
	•¶•“Ž‘Ě¹•”Žâ”CĚα<†Š-	-kŠC“¹”_<ÆŽŽĚ±•ê”•iĚα<†fZf“f^•[šĤ««•šĚäĚα<†f•[f’.	-{šÔ‘P<v
	šĤ««Ž‘Ě¹•”Žâ”CĚα<†Š-	”_<Æ•HšwĚα<†•š’ñ^æŽ‘Ě¹•Hšw•”y’ñŽ‘Ě¹Ěα<†Ž°’.	•-“q•@—Í

11. 4. 1

%o«“êŽx•š’n—ÍŮŽ•œœ†ž°”.	”_<Æššâ<<<Z•pœœ†•ššâ<<<ž‘œ’•žâ”Cœœ†š•i...“@‘ôœœ†ž°j	•â¼œœ“ñ
%o«“êŽx•šžâ”Cœœ†š•i•i•“çŽi•ç‘ã‘£•iœœ†ž°j	”_<Æœœ†fZf“f^•[•i•“šJ”-•”žâ”Cœœ†š•i‘ã”ž^çŽiœœ†ž°j	’J”ö••F
‘•-±•”%oiœœ%ôššâ•œœ’.	žž...•E•©‘ž”_<Æ<Z•pœœ†•š‘•-±•”ž-±%ôššâ•ž-±‘æ,Qœœ’.	—>àV<•F
‘•-±•”šššœ<Æ-±šš—%ôššššœ•“iœœ’.	‘•-±•”%oiœœ%ôššâ•œœ’.	“c’†—ç•ã
‘•-±•”ž-±%ôššâ•ž-±œœ’C	‘•-±•”ž-±%ôššâ•ž-±œœ’	žR-{’¼žâ
‘•-±•”%oiœœ%ôššâ%oiœœœœ	”_<Æ•¶•“ž‘œ’œœ†•š‘•-±•”ž-±%ôššâ•ž-±‘æ,Qœœ	-Ø‘œ‘•i
ššœœœœ’••@•”œœ†ššœœœœœœ	•V<K•ĭ—p	•ùœœœœž÷
•¶•“ž‘œ’•”	•V<K•ĭ—p	’†‘œ‘žzi
‘•-±•”%oiœœ%ôššâ—p“xœœ	•V<K•ĭ—p	%o ^a -{•@— ³
•¶žY—~—p•”	•V<K•ĭ—p	<g‘c•^ž÷
-k—œ”_<Æžžœœ±•ê‘•-±•”ž-±%ôššâ’.	‘•-±•”%oiœœ%ôššâ’.	•ã-{‘•>%o
”_<Æœœ†fZf“f^•[ĭBŮ¼P ^a ,Ăœœ†‘æ,Pf•[f žâ”Cœœ†š-	•¶žY—~—p•”žâ”Cœœ†š-	’†žR‘s‘ê
”_<Æššâ<<<Z•pœœ†•ššâ<<<ž‘œ’•”y•ěšš—%ôššœœ“y•ěœœ»ššœœ†ž°’.	%o«“êŽx•š’n—ÍŮŽ•œœ†ž°”.	•œœ~a•v
”_<Æ•Hššœœœœ†•š‘ç•\•”‘çœœ†ž°’.	•¶žY—~—p•”žâ”Cœœ†š-	œœœœ—Y“ñ
-i•Ø•E’f<Æžžœœ±•êššœœœœ~A—•ž°•îñž‘—i%ôššâ’.	ššœœœœ’••@•”îñž‘—i%ôššâ’.	•œœ‘i’œœê



	”_<Æ•HŠw(Æα†•Š‘•–±•”%öi(Æv%öÛ—p“x(ÆW’.	‘•–±•”ŠCŠO<Æ–±ŠÇ—%öÛŠCŠO••i(ÆW’.	’r“c•ùŽ _i
	”_<Æ(Æα†fZf“f^•[‘•–±•”—p“x%öÛŽ{•ÝŠÇ—•(ÆW	‘•–±•”%öi(Æv%öÛ—p“x(ÆW	^êfm•£’m(Æ>
	‘P•E	‘•–±•”%öi(Æv%öÛ%öi(Æv(ÆW	<B“ _i •~Žq
	‘•–±•”ŠCŠO<Æ–±ŠÇ—%öÛ’.	%öÊŽ÷ŽŽ(Æ±•ê‘•–±•”Ž–±%öÛ%öÛ’•â ²	–k•@^ê<
	ŠCŠO•î•ñ•”••Û•î•ñ(Æα†Š ⁻	%ö«“êŽx•Š”M•Ñ%öÊŽ÷(Æα†Ž ^o ’.	“ú•,“NŽu
	ŠCŠO•î•ñ•”••Û•î•ñ(Æα†Š ⁻	Šé%öæ ² •®•”Žâ”C(Æα†Š ⁻	%ö ^a •@ŽO“ _i
	%ö«“êŽx•Š”M•Ñ%öÊŽ÷(Æα†Ž ^o ’.	%öÊŽ÷ŽŽ(Æ±•êfJf“fLfc•”Žâ”C(Æα†Š ⁻ •i•iŽ _i :%ö»Šw(Æα†Ž ^o •j	•→î^ê<I
11. 6. 1	Šé%öæ ² •®•”•t•i”h(Æ•E^ô•Ff~fff“f}•[•j	Šé%öæ ² •®•”Žâ”C(Æα†Š ⁻ •i(Æα†Šé%öæ%öÈ•j	%ö ^a “c(Æ ^a %öî
	‘•–±•”Ž–±%öÛ•lŽ–(ÆW	•H•i••‡(Æα†•Š‘•–±•”Ž–±%öÛ•lŽ–(ÆW	<e’nŽô<P
	%öÊŽ÷ŽŽ(Æ±•ê‘•–±•”Ž–±%öÛ’.	‘•–±•”ŠCŠO<Æ–±ŠÇ—%öÛ’.	“c’†—Ç“T
	•H•i••‡(Æα†•Š—→’Ê•Û‘S•”™• ŠQ’Ž(Æα†Ž ^o ’.	%ö«“êŽx•ŠŽâ”C(Æα†Š ⁻ •i•i••Û(Æi(Æα†Ž ^o •j	•, <’(Æh^ê
	–î•Ø•E’f<ÆŽŽ(Æ±•ê‘•–±•”à’J’•–±• ^a Ž ^o —p“x(ÆW’.	‘•–±•”Ž–±%öÛ•lŽ–(ÆW	—é–Ø•@•½
11. 7. 5	•H•i••‡(Æα†•Š ^a •Í•]•%ö _i •”.	ŠCŠO•î•ñ•”••Û•î•ñ(Æα†Š ⁻	–¼~a<•F
	•¶•Ž‘(Æ ¹ •”Žâ”C(Æα†Š ⁻	–k—α”_<ÆŽŽ(Æ±•êŠé%öæ~A—Ž ^o Žâ”C(Æα†Š ⁻ •iŠé%öæ%öÈ•j	•ÿ“c’P’Ê
	%ö«“êŽx•Š<Æ–±%öÈ	’†•”_<ÆŽŽ(Æ±•êŠé%öæ~A—Ž ^o •i<Æ–±%öÈ•j	(ÆK“c•«’\

11. 8. 1	-k—α”_<ÆŽŽŒ±•ê'n^æŠî”ŌŒα<†•”ŷçŽiŒα<†Ž°	Šé%œ”2•@•”Œα<†Šé%œ%È	•ùŒ’%pŽ÷
	’†•”_<ÆŽŽŒ±•êŠé%œ~A—•Ž°<Æ—±%È	%œ«“êŽx•Š<Æ—±%È	Ž-1/4^À<P
11. 9.30	‘P•E	‘•—±•”%œiŒv%œÛ%œiŒvŒW’.	ŒŽ-{{“1—Y

[目次へ](#)
[もどる](#)
[ホームへ](#)

•@

# JIRCAS *fjf...* [fX No.22 2000

JAPAN INTERNATIONAL RESEARCH CENTER FOR AGRICULTURAL SCIENCES



☐. @ f~fff“f}•[.İ•” ,,è,İŽq<Ÿ,½,ç•iŠé%œ’2•@•”•@%œ³•@ŽO“;ŽB%œ•j

## -Ú•@•@ ŽŸ

☐. @ Š^a“a”CE³/₄

• [ŠJ”-“rã•, ìflfXfgfn•\[fxfXfg•EfefNfmf•fW•\[](#)

•@

☐. @ CEα<†•-‰œÊ

• [flfCf<fp•\[f Ž‘CE¹, Ì—LCEø—~—p](#)

• [fTfgfEflfr, ÌŽ•±“I•|ŽY, ðŽx, l, é’, ‘fCEÁ’è](#)

• [•-”ž•iŽí, ð’ZZžŠÔ, ÅŠJ”-, , é•û—@, ð’T, é](#)

• [f}f“fOf••\[fu—Ñ, ÌfŠf^•\[—Ê, Ì, ,’è](#)

•@

☐. @ “Á•ÊfR•[fi•[

• [”MCEœ•EJIRCAS30Žü”N<L”OŽ—<Æ](#)

•@

☐. @ fv•fWfFfNfg

• [’†ŠÔ•|‰œç, ðCE}, l, é•u†••H—;Ž‘CE¹•vfvf•fWfFfNfg](#)

•@

@ • • Ů < @ Š Ö , ½ , æ , è

• [•uŸóŸò<Z•p,ÌCEĀ—ç•v fXfŠf%of“fJ,Ì~A‘±,½,B’r—~—p<Z•p](#)

•@

@ • Š , Ì “ ® , «

• [JIRCAS“Æ—§•s•—@•l%o»CEã,Ì•”—â‘è,ð~ <c](#)

•@

@ • l , Ì “ ® , «

, - â , ç • ‡ , l • æ • F

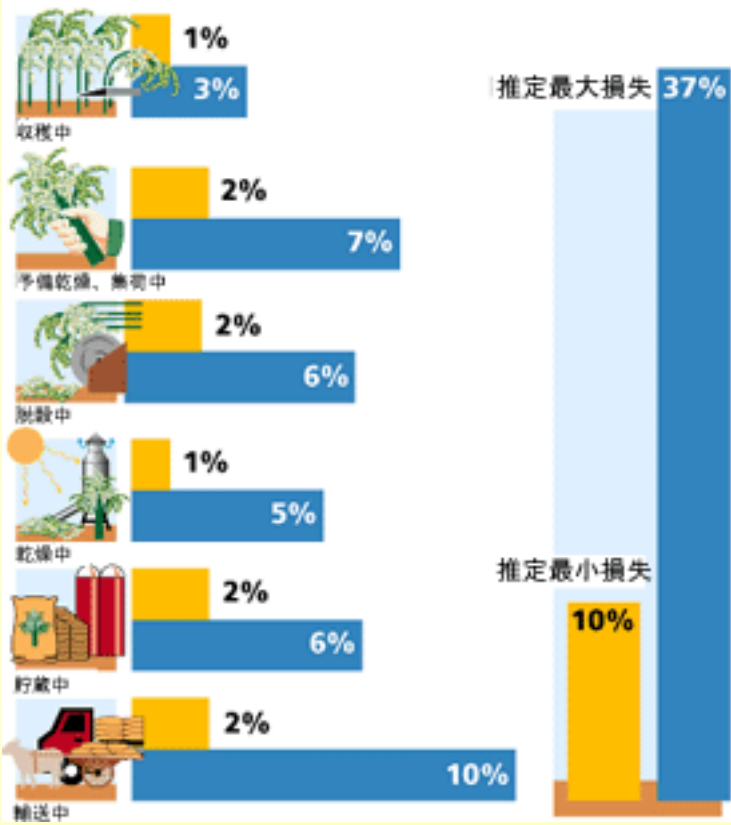
• • Ů ” _ — Ñ • ... Ž Y < Æ C E α < † f Z f “ f ^ • [ • @ • î • ñ Ž ‘ — ç % o Ů • @  
• Š • Ý ’ n • F • § 305-8686 ~ ĭ • é C E § , Ā , - , Ī Ž s ‘ ā , í , μ 1 - 2 • @

•@

TEL:0298-38-6341, FAX:0298-38-6656•@  
f••[f<fA,fhfCEfX•F[www@jircas.affrc.go.jp](http://www.jircas.affrc.go.jp)







•£•}•@“Ɖ“ifAfWfA,Å,Ì•Ä,Ì‘Ž,•iFAO•j

もどる



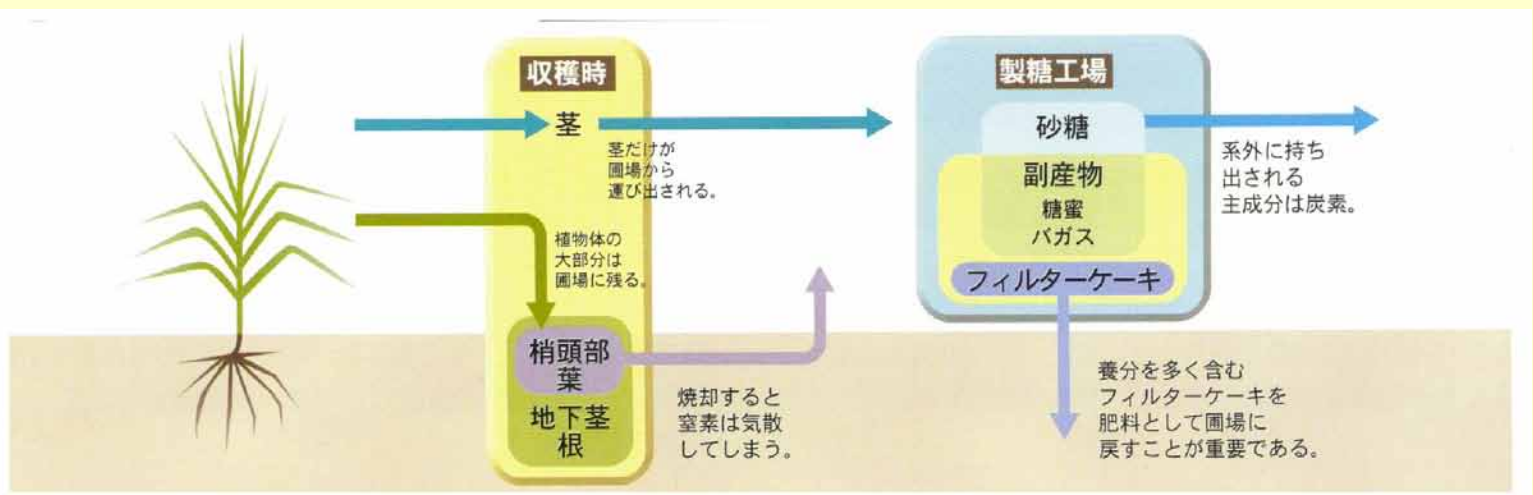


•£•@fIfCf<fp•[f •if}fŒfCfVfA—•%oÈ‘ăŠw•\“à•j

もどる







•@

•£•@fTfgfEflfrŽûŠnCEã,ì•Ž,ìÚ“®

もどる



←→Zi,0'ZŠuŠÖ,ÄŠJ',,éü-@,0'T,é  
+|'%"%eEÖZG,0-—p,,-é-''Z  
''g+''i,i+u|



4-2 研究員 左から：田中 浩二、佐藤 隆、佐藤 隆二

←→Zi,0'ZŠuŠÖ,ÄŠJ',,éü-@,0'T,é  
+|'%"%eEÖZG,0-—p,,-é-''Z  
''g+''i,i+u|

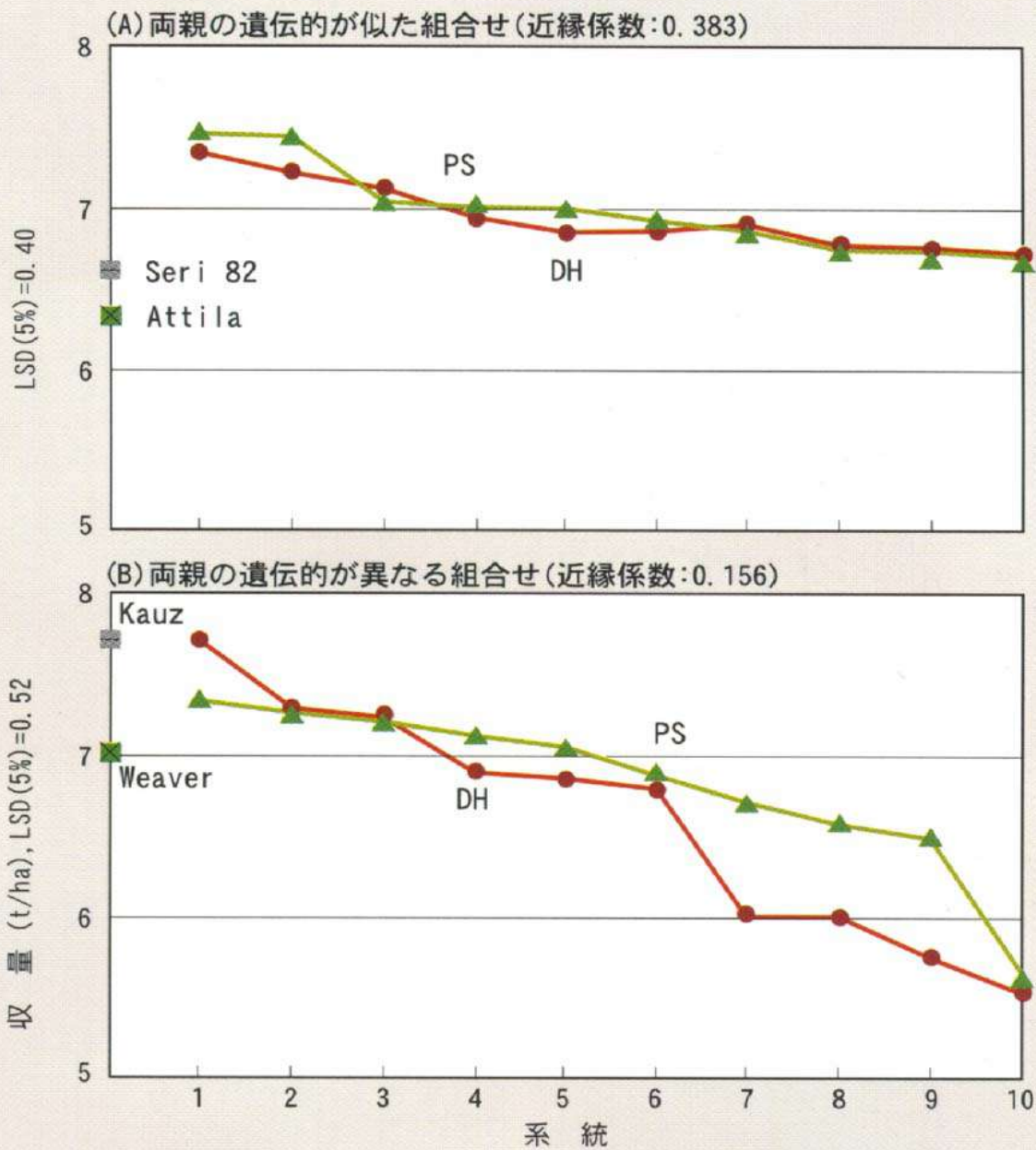
成果情報



•@

•£•@ŽÊ•^,P•@•¬”ž,Ì”¼•”‘İçŽí-@,Å•ì•o,³,ê,½Ĉen“•

もどる

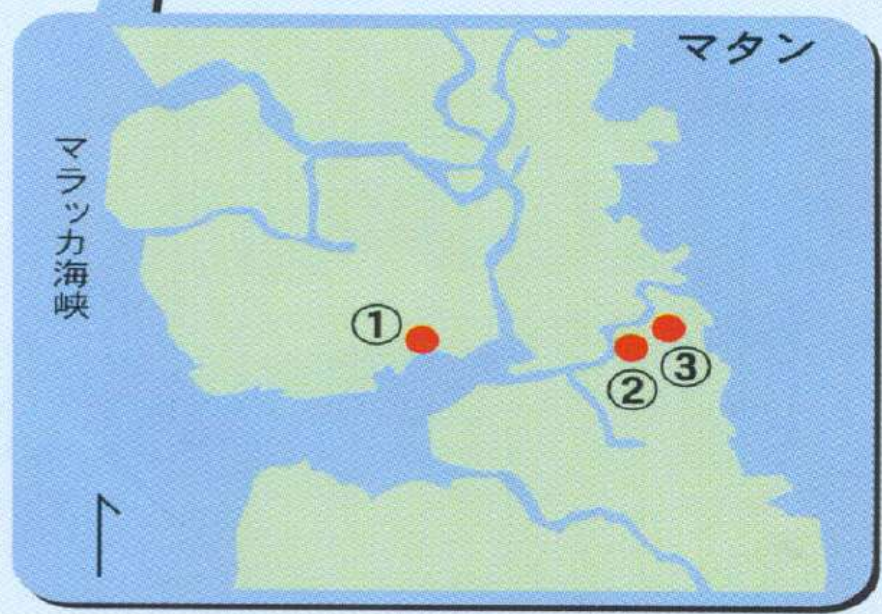
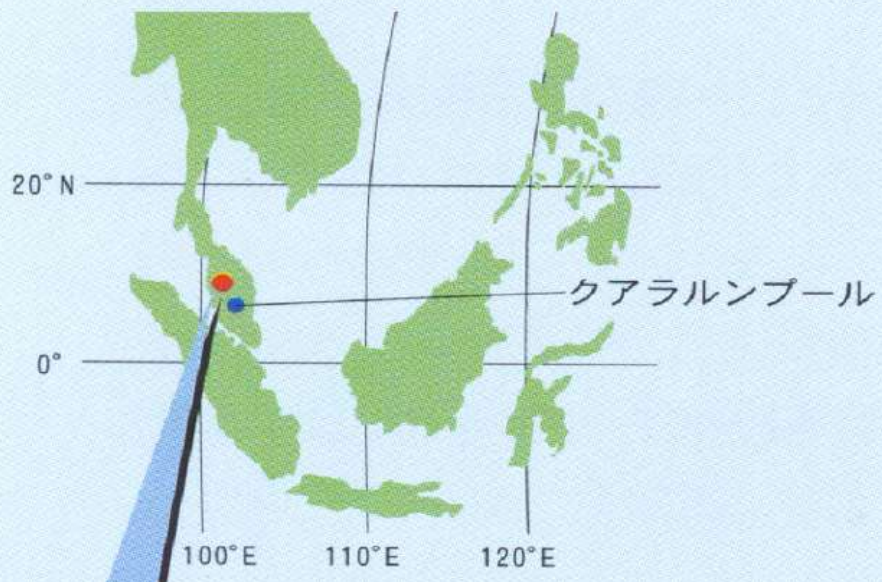


•@

•£•@•},P•@•-”ž,Ì”¼•”İçŽí-@(DH),”,æ,ÑĈEn“•^çŽí-@(PS),É,æ,è‘I”²,³,ê,½,»,ê,¼,ê•ã^Ê10ĈEn“•,İŽû—Ê

もどる





•@

•£•@•},P•@f}f^f“,îÊ’u

もどる

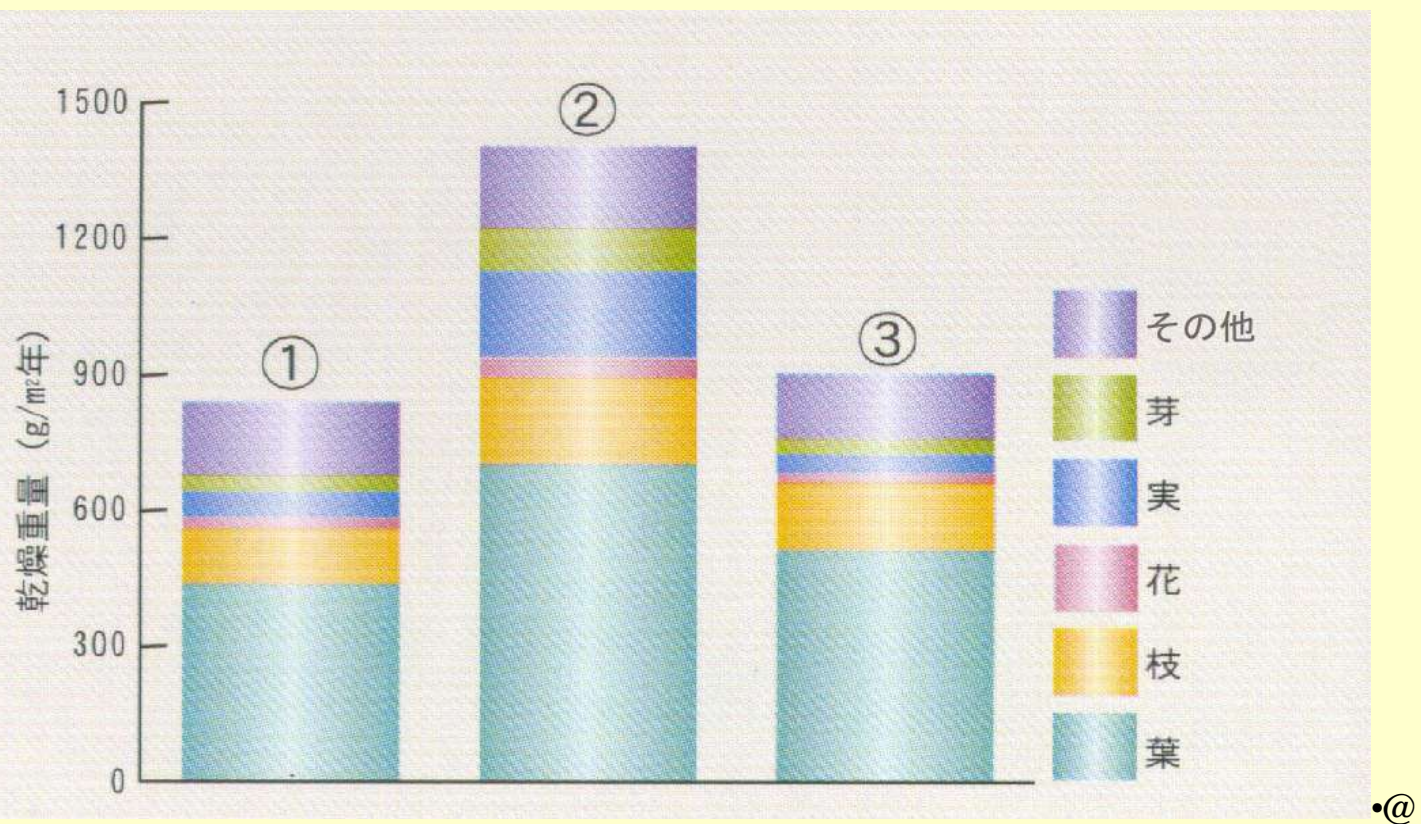


•@

•£•@ŽÊ•^•@fAfrfZfjfA‘®,Æf\lf%ofVfA‘®,Ì•¬•‡—Ñ,É•Ý’u,³,ê,½fŠf^•[fgf%ofbfv

もどる





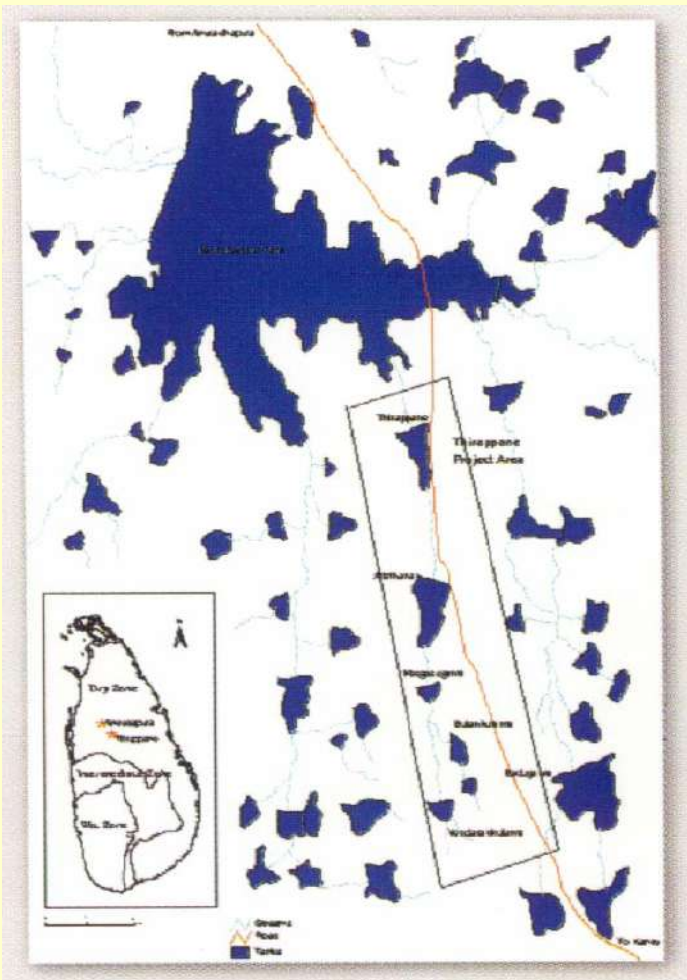
•£•@•},Q•@,R”NŠÔ,ìfšf^•[-Ê,Ì•½<ï

もどる









•@

•£•@fXfŠf%of“fJ-k•”,İ`A`±,½,B`rEQ•@•@•@•@•@•£•@,½,B`r,İE©,!,é•—Ei

もどる



# 人の動き

”NEŽ“ú	^Ù•@“@•@Eã	^Ù•@“@•@‘O	-¼•@‘O
11.10. 1	—Ñ<Æ•”.	•X—Ñ‘••‡CEα<†•ŠŠé%œ’2•@•”Žâ”CEα<†Š-	—é-Ø•iŽj
	ŠCŠO•î•ñ”•••ÛCEα<†•î•ñŠ-	ŠÂ<<Ž‘CE’•”•t(“hCE-•E^ô:•••ÛîCEα<†•Š)	^É“;•@Ži
	•¶ŽY—~—p•”Žâ”CEα<†Š-	”_—Ñ•...ŽY<Z•p%öi<cŽ—±<ÇCEα<†’2•,Š-	âV“;•i<
	•¶•”Ž‘CE’•”•t(“hCE-•E^ô:•••ÛîCEα<†•Š)	•¶•”Ž‘CE’•”Žâ”CEα<†Š-	•ÿ“c‘P’Ê
	‘•-±•”ŠCŠO<Æ-±ŠÇ—%œÛŠCŠO<Æ-±•ê-âŠ-	”_—Ñ•...ŽY<Z•p%öi<cŽ—±<Ç’}”gŽ—±•ŠŠÇ—•‘æ2%œÛ<Æ-±CEW’.	•ÿ“ä•MŽi
	‘•-±•”Ž-±%œÛ•lŽ-CEW’.	”_<ÆCEα<†fZf“f^•[‘•-±•”Ž-±%œÛ•lŽ-‘æ2CEW’.	•-i•è•N—T
	‘•-±•”%öiCEv%œÛ%öiCEvCEW’.	”_<Æ“••‡CEα<†•Š‘•-±•”Ž-±%œÛ•lŽ-±æ1CEW’.	~a“c•@“w
	•X—Ñ‘••‡CEα<†•ŠŠé%œ’2•@•”.	—Ñ<Æ•”.	“c’†•@CE%œ
	’{ŽYŽŽCE±•êŠé%œ’2•@•”Žâ”CEα<†Š-	’{ŽY‘••n•”Žâ”CEα<†Š-	•i“‡‘m”V
	”_—Ñ•...ŽY<Z•p%öi<cŽ—±<Ç’}”gŽ—±•ŠCEα<†CEđ—%œÛ%œÛ’•â	‘•-±•”ŠCŠO<Æ-±ŠÇ—%œÛŠCŠO<Æ-±•ê-âŠ-	ŠÚŽR~a•r
	”_<Æ•¶•”Ž‘CE’CEα<†•Š•úŽË•ú^çŽí•ê•Ž-±%œÛ%öiCEvCEW’.	‘•-±•”Ž-±%œÛ•lŽ-CEW’.	<v•Û•@CE’
11.12. 1	ŠÂ<<Ž‘CE’•”Žâ”CEα<†Š-	ŠÂ<<Ž‘CE’•”•t(“hCE-•E^ô:•••ÛîCEα<†•Š)	<B“;iŽn•F
	•¶•”Ž‘CE’•”Žâ”CEα<†Š-	•¶•”Ž‘CE’•”•t(“hCE-•E^ô:~•••ÛîCEα<†•Š)	%œÁ“;•@•_
12. 1. 1	Šé%œ’2•@•”CEα<†Šé%œ%œÈ	Šé%œ’2•@•”ŠCŠOCEα<†CEđ—%œÈ	•TM—i‘q%œp

	”_<ÆCEα†fZf^f^["y•ë"i—;•"Žâ"CEα†Š~(•...“c“y•ë”i—;_i(CEα†Ž ^o )	ŠÂ<<Ž‘Ā¹•”Žâ”CEα†Š~	<ß‘iŽn•F
	”_<ÆŠÂ<<<Z•p(CEα†•ŠŠé%œ²•®•”Žâ”CEα†Š~(‘n<...ŠÂ<<<CEα†f•[f	ŠÂ<<Ž‘Ā¹•”Žâ”CEα†Š~	‘â–i•G”V
12. 1.14	•¶ŽY—~—p•”•t(“hĒ•E^ō•F ICIPE)	•¶ŽY—~—p•”Žâ”CEα†Š~	’†•°•@’B
12. 2. 1	ŠÂ<<Ž‘Ā¹•”Žâ”CEα†Š~	”_<ÆŠÂ<<<Z•p(CEα†•ŠŽ•P“®•Ô•”(‘½—Ê—v‘f“®•Ô(CEα†Ž ^o )	–i>‘i
	“Ē–k”_<ÆŽŽĒ±•ê•...“c—~—p•”Žâ”CEα†Š~(‘çŽi(CEα†Ž ^o )	•¶•Ž‘Ā¹•”Žâ”CEα†Š~	%oÁ“i•@_
12. 3. 1	%o<<“êŽx•Š’.	Šé%œ²•®•”••Ū(CEα†²•®Š~	—é–Ø•³•°
	ŠCŠO•î•ñ•”••Ū(CEα†•î•ñŠ~	•Ī—p(“CŠú•t(CEα†î•ñ)	¼P®ÝS.°oÛÄP³aÛ
	ŠCŠO•î•ñ•”Žâ”CEα†Š~	”_<Æ••‡(CEα†•ŠCŠO•”ŠJ”-<—Í(CEα†Ž ^o ).	%oiŽR”ÉŽ÷
	%o<<“êŽx•ŠŽâ”CEα†Š~	%o<<“êŽx•Š•t(“hĒ•E^ō:fAf<f[f“f“f“)	%oF•TM•x—Y
	ŽO•d•âŠw•¶•”Ž‘Ā¹Šw•”•³Žö	%o<<“êŽx•Š’.	”a<<‡–Ī•v
	ŠÂ<<Ž‘Ā¹•”•t(“hĒ•E^ō••Ū(CEα†•Š)	ŠÂ<<Ž‘Ā¹•”Žâ”CEα†Š~	–i>‘i
12. 3.31	‘P•E	ŠCŠO•î•ñ•”Žâ”CEα†Š~	•––Ñ•O–¾
	‘P•E	%o<<“êŽx•Š’•Ū•d““CEα†%oÈ’.	—Ñ•@—²Ži
	•¶•”Ž‘Ā¹•”.	•Ī—p(••Ū•A•”â“Ž‘Ā¹(CEα†•Š•••Š’.)	Šâ%oi•@•ÿ
	ŠÂ<<Ž‘Ā¹•”.	ŠCŠO•î•ñ•”••Ū(CEα†•î•ñŠ~	^É“i•@Ži
	”_<ÆCEα†fZf^f^["i••¶—••iŽi•”.	•¶•”Ž‘Ā¹•”.	•––iŽÿ%oI



”_<ÆŠÂ««<Z•pŒα<†•ŠŠÂ««Ž‘Œ!•”.	ŠÂ««Ž‘Œ!•”.	•!•è’%o—Y
—{•BŒα<†•Š%ch—{‘ãŽÓ•”.	•...ŽY•”Žâ”CŒα<†Š-	•ÿ“c•@—T
Šé%œæ’2•@•”Žâ”CŒα<†Š-(Œα<†Šé%œæ%œÈ)	—Ñ<Æ•”Žâ”CŒα<†Š-	—Ž•‡•K•m
ŠCŠO•î•ñ•”•••ŪŒα<†•î•ñŠ-	%œ«“êŽx•Š•ã•ÈŒα<†Š-	-î“‡•3•°
ŠCŠO•î•ñ•”Žâ”CŒα<†Š-	“Œ-k”_<ÆŽŽŒ±•ê‘••‡Œα<†•””_‘°fVfXfef Œα<†Ž°.	^À“;%œv
•¶•”Ž‘Œ!•”Žâ”CŒα<†Š-	Šé%œæ’2•@•”•t(“hŒ-E•E^õ:f~fff“f}•D)	%œª•@ŽO“;_i
•¶•”Ž‘Œ!•”Žâ”CŒα<†Š-	-i•Ø•E’f<ÆŽŽŒ±•ê-i•Ø’çŽi•”Žâ”CŒα<†Š-(fifX%œÈ^çŽiŒα<†Ž°)	•2“;_•@—2
•¶ŽY—~—p•”Žâ”CŒα<†Š-	%œ«“êŽx•ŠŽâ”CŒα<†Š-	%œF•TM•x—Y
•¶ŽY—~—p•”Žâ”CŒα<†Š-	”_<ÆŒα<†fZf“f^•[k’n—~—p•”-i•Ø•¶ŽYŒα<†Ž°.	ŽR“c•@•,
’{ŽY‘•’n•”Žâ”CŒα<†Š-	’{ŽYŽŽŒ±•êŠé%œæ’2•@•”Žâ”CŒα<†Š-	”ö“ä•Ž;_i
%œ«“êŽx•Š•ã•ÈŒα<†Š-	“Œ-k”_<ÆŽŽŒ±•ê’ n^æŠî”ŌŒα<†•”<C•Ū•]œç;•šŒäŒα<†Ž°.	•-‘ò•@•1
%œ«“êŽx•Š••Ū•œ“Œα<†%œÈ’.	•¶ŽY—~—p•”Žâ”CŒα<†Š-	-i“c•F•l
Šé%œæ’2•@•”Žâ”CŒα<†Š-(ŠCŠOŒα<†Œð—%œÈ)	”_<Æ•HŠwŒα<†•Š’ n^æŽ‘Œ!•HŠw•”Žâ”CŒα<†Š-(’n%œ°...Ž‘Œ!Œα<†Ž°)	à“c•_•3
ŠCŠO•î•ñ•”Žâ”CŒα<†Š-	”_<ÆŒα<†fZf“f^•[Œœ%œçŠÇ—••”Žâ”CŒα<†Š-(Œœ%œç•ŸŒvŒα<†Ž°)	ŒÄ%œÆ•@•~
’{ŽY‘•’n•”Žâ”CŒα<†Š-	%œÆ’{œç¶¶ŽŽŒ±•ê‘••‡•f’fŒα<†•”Žâ”CŒα<†Š-(•ú-q•aŒα<†Ž°)	’†“°<’j
—Ñ<Æ•”Žâ”CŒα<†Š-	•X—Ñ‘••‡Œα<†•Š•¶ŽY<Z•p•”Žâ”CŒα<†Š-(‘ç—Ñ<Z•p%œÈ•X•V•@ŠBŒα<†Ž°)	<ã“‡•G“1

12. 4. 1

•...ŽY•”Žâ”CĚα<†Š ⁻	'†%o>•...ŽYĚα<†•Š—~—p%o>Šw•”'f•p%o>ŠwĚα<†Ž ^o '.	%oıŽR%oĉ•m
•...ŽY•”Žâ”CĚα<†Š ⁻	—{•BĚα<†•Š•a—••”Žâ”CĚα<†Š ⁻ (fEfCf<fXĚα<†Ž ^o )	'O~i•K'j
%o<<“êŽx•ŠŽâ”CĚα<†Š ⁻ (•i••ŮĚiĚα<†Ž ^o )	-kŠC“1”_<ĚŽŽĚ±•ê•¶ŽYŠÂ<<<”Žâ”CĚα<†Š ⁻ ('ŽŠQĚα<†Ž ^o )	'†“c—B•¶
'•-±•”%oıĚv%oŮ—p“xĚW'.	•İ—p(•¶“Ěn“Á'èŽY<ĚZ•pĚα<†•,•i@•\‘•-±•”‘•-±%oŮ•Ž-±ĚW'.)	^É“ı•GŽŸ
'•-±•”%oıĚv%oŮŽ{•ÝŠÇ—•ĚW'.	'â•bŠ ⁻ [Ěo—%oŮ'ı'ŽÉ%oĉ“U”Ç•hŽÉĚW'.	•ŸŽR—M— ³ / ₄
—Ň<Ě•”	•X—Ň'••‡Ěα<†•Š<â•BŽx•Š'Ç—Ň•”y•ëĚα<†Ž ^o	~iŠ_•1•G
%o<<“êŽx•Š•i••ŮĚiĚα<†Ž ^o	-kŠC“1”_<ĚŽŽĚ±•ê•¶ŽYŠÂ<<<”fEfCf<fX•aĚα<†Ž ^o	%oıĉ ² —M• ³
%o<<“êŽx•Š•Ž-±%oŮ%oıĚvĚW	”_<ĚĚα<†fZf“f^•[•-±•”%oıĚv%oŮŠÄ•,ĚW	ŠÖĚŮ•@•m
%o<<“êŽx•Š<Ě-±%oĚ	•¶ŽY—~—p•”	<g“c^Ž÷
”_<ĚĚα<†fZf“f^•[Ěo%oĉŠÇ—••”‘äšrĚo%oĉĚα<†Ž ^o .	ŠCŠO•i•ñ•”Žâ”CĚα<†Š ⁻	Ěä“ı•~Žq
%oĚ' { %oĉ•¶ŽŽĚ±•ê•¶'İ—hĚäĚα<†•”-Ě%oı•x—ĚĚα<†Ž ^o .	'{ŽY••n•”Žâ”CĚα<†Š ⁻	-Ø'J•@—T
”_<Ě•HŠwĚα<†•Š”_“o•@”“o•”“n,©,ñ,ª,¢Ěα<†Ž ^o .	•¶ŽY—~—p•”Žâ”CĚα<†Š ⁻	—1/2•@•Ě”V
-kŠC“1”_<ĚŽŽĚ±•ê•¶ŽYŠÂ<<<”Žâ”CĚα<†Š ⁻ (fEfCf<fX•aĚα<†Ž ^o )	%o<<“êŽx•ŠŽâ”CĚα<†Š ⁻ (•i••ŮĚiĚα<†Ž ^o )	áÁ%oĉ ² •N•v
•X—Ň'••‡Ěα<†•Š•¶ŽY<Z•p•”Žâ”CĚα<†Š ⁻ (^Ç—Ň<Z•p%oĚ•Žı•¶ŽYĚα<†Ž ^o )	—Ň<Ě•”Žâ”CĚα<†Š ⁻	•i•è'B~Y
•X—Ň'••‡Ěα<†•Š•1/2- •X—Ň%oĚŠw%o Žâ”CĚα<†Š ⁻ (•X—Ň•¶'Ěα<†Ž ^o )	—Ň<Ě•”Žâ”CĚα<†Š ⁻	•1/4-{~a”n
'{ŽY<Ç' {•ú%oŮ—\ŽZĚo—•”Ç—p“xĚW'.	'•-±•”%oıĚv%oŮŽ{•ÝŠÇ—•ĚW'.	^ĉ•”O“ñ

	ŠÖ“Ē”_•-ç‘•-±•”Ēú•¶%oÛ<Đ•Ī‘g•‡‘æ4ĒW’.	‘•-±•”%oïĒv%oÛ—p“xĒW’.	•2“j•PŽu
	<ã•B”_<ÆŽŽĒ±•ê‘•-±•”—p“x%oÛ•—L•ăŽYĒW	%o<<“êŽx•Š•Ž-±%oÛ%oïĒvĒW	”d-•@•®
	“Ē-k”_<ÆŽŽĒ±•êŠé%oæ~A—•Ž°<Æ-±‘æ^ê%oÈ	%o<<“êŽx•Š<Æ-±%oÈ	<g“c•²’j
	“Ē-k‘ăŠw‘ăŠw%o@”_ŠwĒ<†%oÈ<³Žö	ŠCŠO•î•ñ•”••ÛĒ<†•î•ñŠ-	š•ª-q%oq
	ŠCŠO•î•ñ•”•t(”hĒ-E•E^ö•FCGPRTfZf“f^•[]	ŠCŠO•î•ñ•”Žă”ĒĒ<†Š-	%oïŽR”ÉŽ÷
12. 6. 1	‘•-±•”•Ž-±%oÛ•Ž-±ĒW’.	-kŠC“1”_<ÆŽŽĒ±•ê‘•-±•”%oïĒv%oÛ%oïĒvĒW•ê	••“c•@Šx
	‘•-±•”%oÛĒú•¶ĒW’.	‘•-±•”•Ž-±%oÛ•Ž-±ĒW’.	•¼-{}•³•K
	”_—Ñ•...ŽY<Z•p%oï<cŽ—±<ç’}”gŽ—±•ŠĒú•¶%oÛ<Đ•Ī•ŸŽfĒW’.	‘•-±•”•Ž-±%oÛĒú•¶ĒW’.	ăV“j<’•_

[目次へ](#)
[もどる](#)
[ホームへ](#)

•@

# JIRCAS *fj*... [fX No.23 2000

JAPAN INTERNATIONAL RESEARCH CENTER FOR AGRICULTURAL SCIENCES



□ @ fgfEfKf%ofV, ìfWf... [f^f“ •if~fff“f} •[•Af}f“fOfŒ•[•½Œ´j

## -Ú•@•@ ŽŸ

□ •@ [Šac^{ca}Œ^{3/4}](#)

- [H—i, ì`À`è<Ÿ<<, Æ••Ű<—Í](#)

□ •@ [•-‰ŌÊ•îñ](#)

- [ŠQ`Ž, É•H, x, ç, ê, È, çfAfYfL](#)
- [•u•çŠE•H—iŽù<<f, fff•v, É, æ, é•H—i`À`S•Ű•á, ìfVf~f...fŒ•\[fVf‡f“•^a.Í](#)
- [•ufIfjfe fiKfGfr•v, ì`tfGfr•ŸŽY, ì, ½, B, ì•-•n•§Œä<Z•p, ÌŠJ`-](#)
- [”M`Ñ•Ý—‰ŌŒ`{, ð, Ç, Ì, æ, ų, ÉŽ”`ç, µ—~—p, ., é, ©](#)

□ •@ [fvf•fWfFfNfg](#)

- [`†•, É, , -, é““••H•iŽY<Æ, Ì<B`ã‰Ō»](#)

● [JIRCAS, ĩ±, pŪĭ«Ū½ÄØ°Œα†, ¢-ŪŽw, ·, à, ĩ](#)

● [@“•Ū<@ŠÖ,¾,æ,è](#)

● [“•Ū”M“Ñ” <ÆfZf“f^•\[CIAT\)](#)

● [•u¼fAftfŠfJîiŠJ”-<!%öiv\(WARDA\), ĩŒα†•E••<yŠ^“®,É,Â,ç,Ä](#)

● [fTfnf%œ»”™^È“i, ĩfAftfŠfJ, ĩ“y•ë, ĩi](#)

● [@“Á•ÊfR•\[fi•\[](#)

● [TARC-JIRCAS ‘n—§30Žü”N<L”O  
‘æ, V%œñJIRCAS•‘ŪfVf“flfWfEf •uŠJ”-“r•ã’n^æ, ĩŽ•‘±“T”-“W,ÉŒü, -,½” <Æ<Z•pŒα†•v](#)

, ¢-â, ç, ‡, ¤, æ•F

•‘Ū”_—Ñ•...ŽY<ŒŒα†fZf“f^•[•@•î•ñŽ‘—; %œŪ•@  
•Š•Ý’n•F•§305-8686 ~i•éŒ§, Á, -, ĩŽs‘â, í, µ1-2•@

•@ TEL:0298-38-6341, FAX:0298-38-6656•@  
f••[f<fAfhfŒfX•Fwww@jircas.affrc.go.jp









ŽÊ•^•FfAfYfLf}f•f]fEf fV,É,æ,é•HŠQ,đŽó,-,½fAfYfL

もどる

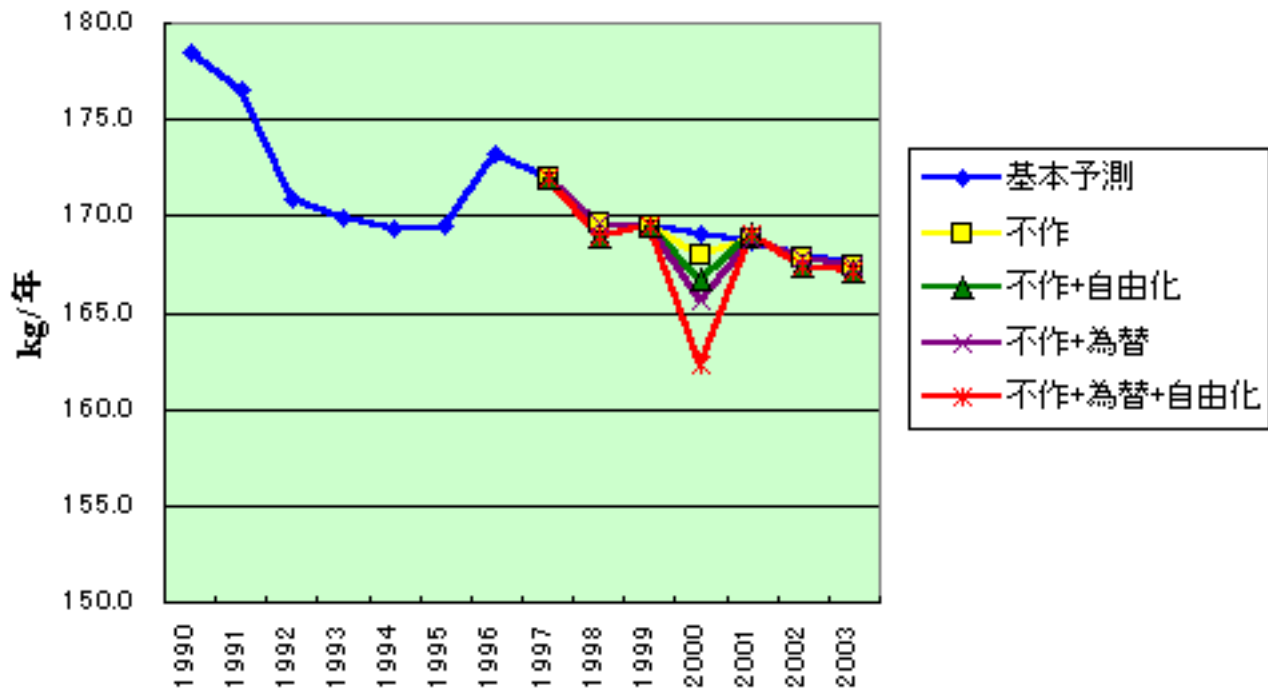




ŽÊ•^2:f}fŒfCfVfA,É,;,̄,éfA,fYfL<β%o•-ì•¶Ží,ÌŽûŠn•ifAfYfL,Æ“̄,¶%o©•F,ç%oÔ,ªŒ©,!,é•j

もどる



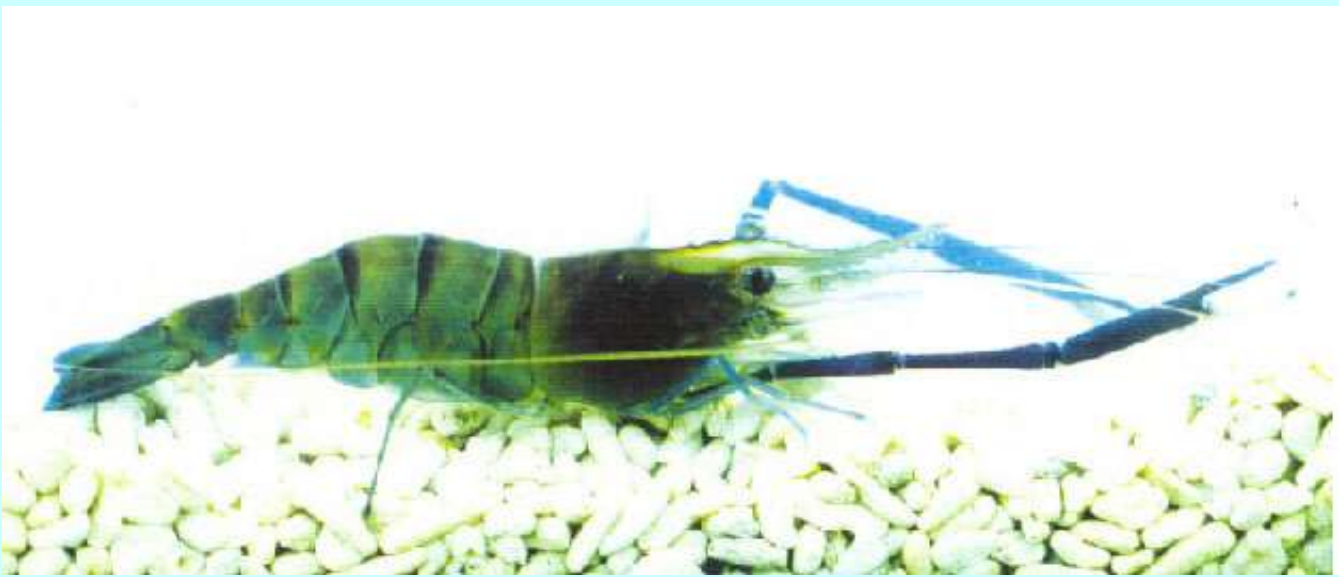


•@

•@

•},P fAfWfA'á•Š“¾•H—¿—A“ü•',ÌfVfiſŠfI•Ê^ê•l“-½,è•'••H—¿<ÿ<<—Ê





• } 1: Ćα†'Î•ŮŽí,Å, ,éfIfjfeifKfGfr•iŠw-¼•F*Macrobrachium rosenbergii*•j

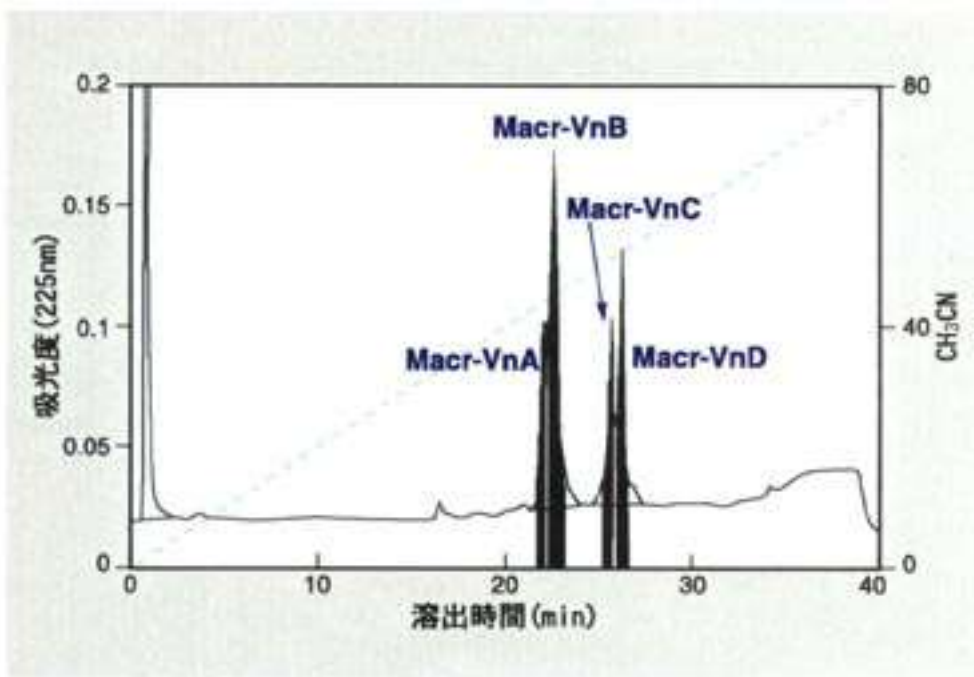
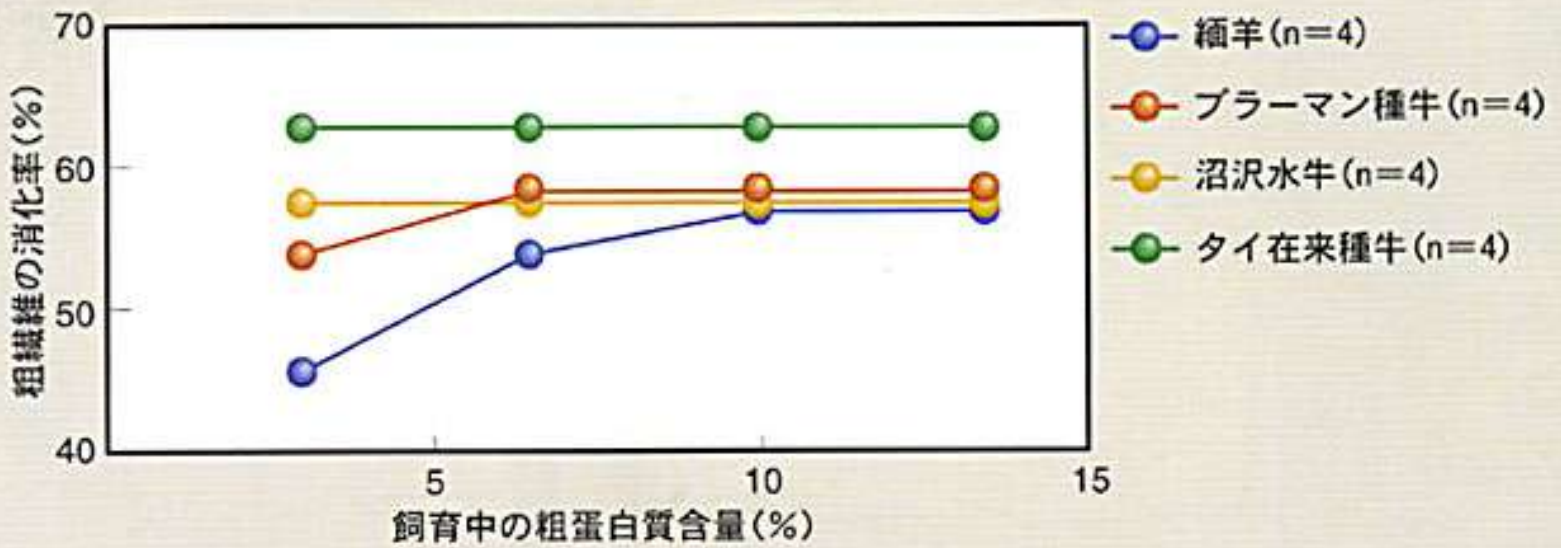


図2 HPLCによる卵黄タンパク質の精製



•@



•£•@•}•@•â“□””•â<<,É,æ,éf<fW•[Š£‘•‘e‘@^Ũ•Á%o»—!,Ì•İ%o»•iŠT”O•}•j

もどる





•@

•£•@ŽÊ•^•@f^fC•Ý—^Ži••i“Ē-kf^fC•j

もどる



久野 謙一

[トップページ](#)  
[お知らせ](#)  
[お知らせ](#)  
[お知らせ](#)



ZË•^1•F'¬'†,Ä•ì,ç,ê,Ä,ç,é'†•,Ì““•“□...



ŽÊ•^2•FJIRCASf••[fNfVf‡fbfv•u‘æ“ñ%oñ“ú’†•H•i•V<Z•p“ç~_%oï•v•i2000”N3ŒŽ•j



— S. E. — (10/2)

日本国際共同研究センター (JIRCAS) は、日本と海外の共同研究者が、地球環境問題の解決に貢献することを目的として設立された。本センターは、国際共同研究プロジェクトの推進、共同研究者の派遣・受け入れ、共同研究の成果の普及・啓蒙などを行っている。本センターの活動は、地球環境問題の解決に大きく貢献している。

本センターは、国際共同研究プロジェクトの推進、共同研究者の派遣・受け入れ、共同研究の成果の普及・啓蒙などを行っている。本センターの活動は、地球環境問題の解決に大きく貢献している。

本センターは、国際共同研究プロジェクトの推進、共同研究者の派遣・受け入れ、共同研究の成果の普及・啓蒙などを行っている。本センターの活動は、地球環境問題の解決に大きく貢献している。

# 熱帯林再生のためのアグロフォレストリー技術の確立



もどる



国際研究機関  
たより



国際研究機関



CIAT (International Center for Agricultural Sciences) - Tropic@CIAT

CIAT (International Center for Agricultural Sciences) - Tropic@CIAT







ftfnf%00>TM^È^i,lfAftfŠfJ,l^yë,Í;
•u••Ü^n—;ŠJ^fZf^f^•[vfaftfŠfJŽx•ŠE
••Ü^y•ë^n—E^xŠÇ—œæç†•Š
(IFDC-Africa)



ŠCS0667^••Ü0B66Š^q66^A^C^?

© 2000 IRCGS. All rights reserved.
This page is protected by the copyright law of the United States. Any reproduction or distribution of this page without the written permission of IRCGS is prohibited.
IRCGS is a non-profit organization. All proceeds from the sale of this page will be used to support the research and educational activities of the center.
For more information, please contact the center at the address below.
IRCGS, International Research Center for Global Studies, 1-1-1, Higashi, Chiyoda-ku, Tokyo 100-8385, Japan.
Tel: +81-3-5521-5000, Fax: +81-3-5521-5001, E-mail: irchg@irchg.ac.jp
Website: http://www.irchg.ac.jp





TARC-JIRCAS 'n—§30Žü"N·L'°O

æ7%õñJIRCAS·•ŪfVf“fJfWfEƒ€

•uŠJ”-“r•ã^ñ•æ,ÌŽ•±“T”-“W,ÉCEü,-½”_<Æ·Z·pCEɂ<†•v



ŠCSÖ•†ñ“••ŪCEð††ñŠ“•@-††ž••†

•æ•u—Í,Ìšv-½•v,Æ,Ä,É,TARC-JIRCAS30”N,Ì•à,Ý

•@•†•ç•d,Ì•ÄEä,Ì”N•A•½—2000”N,É•A••Ū”_—N...ZY•ÆCEð††Jf“f“f•†JIRCAS•A“O•g,Ì”M“N”_•ÆCEð††Jf“f“f•†•ATARC•j,Ì—n—§30Žü”N,öE|,Ì,Ū,•B,±,Ì•ç•d,Ì•B—Ū,É•AŠJ”-“rã“•É,“•,•é”_•EŠJ”-Ìiã,Æ•A•†(Eä,Ì”_•ÆCEð††,Ì%É,½•,•×,•øŠ,„,•ð•Ä•†,„,•é,±,Æ,Ì•A21•ç•d,ÌŠJ”-“rã^ñ•æ,ÌŽ•±“T”-“W,ÉCEü,-Ä,Ì”_<Æ·Z·pCEð††,ð•i,•B,ç•ã,Ä•A•É,•B,Ä“Ó•†,•ç,±,Æ,Ä,É,È,Ū,•B

JIRCAS,Ì“O•g,Ä,„,É,TARC,Ì•A1970”N•AŽž, ½,•@,ã•u—Í,Ìšv-½•v,„,„_•É”•B,„•æ,•ð,•Æ,•,•èŽžŠü,É•Ý—§,†,É,Ū,„½•B,„,Ì”_Žž•A•u—Í,Ìšv-½•v,Ì•AŠJ”-“rã“•A“Ä,É“CE”•E“JfJfWfJA““•É,“•,•é•••“†,É•H—Æs“•,Ì%ø•Ä,ÉCEü,-Ä,—Í,É,„•i,„,É•A,„,ÌCE%É•A“½,„,Ì•ÄŠi-Ì,É•H—ç,ÌŽ•@•,„%•Ä“N,Æ,É,è,Ū,„½•B

„,•@,„•µ•A•çŠE•Ä(Éü,•“%Ä,„,ç†,Ä•A•†(Eä“è“v,Ì•H—ç•†ŽY,ÌŠg“ã“••,•B,ç,è,Ä,é,Ū,•B,Ū,½•AŠJ”-“rã“•,Ì”_—Ì”%•É•ã,•“Z,„,é“n“æ“A”_Æ,Ì††,„çŠ†“Ö“@”•,“s“•“•,É•†ŽY•ðE,Ì“ç,é“n“æ,Ä,Ì•A•K,„,„ã•u—Í,Ìšv-½•v,ã,„,é,É,±“”_•ÆCEð††,Ì-%É,Ì%ç(Éb,ðŽö,„,Ä,„ç,„•AŽ•±“T”-“W,ÉCEü,-½•ŽY•Z•p,ÌŠJ”-Æ,ç•ð•ç“B→,Ì•ã“è,Žç,„è,Ä,é,Ū,•B

•æŠÄ««,Æ”“a,µ,½Žž•±“T”_<Æ,Æ•H—ç•¶ŽY

•@,±,è,ç,Ì•ã“è,Ì%øCE“É,Ì•A•f•o•f•C•f•f•e•f•N•f•m•f•f•W•f•ã•†•ñ•Z•p,ð,Ì,¶,„B,„E,„,éŠe“••i,Ì•V•Z•p,ÌŠJ”-ã—p,„s%ÄCEž,Ä,•B,Ū,½•A•CEÄ•É“•ã“†,É•Z•pCEð††,ð•†,•B,é,Ì,•@,è,Ä,Ì,É,„•AŽ•±“«„,Ì,„,ç•••ž“†,É•¶ŽY•EZ“CE†ŠC—→Z•p,ÌŠJ”,•K—v,Ä,„•B,„,ç,É,É,Ì•Z•pŠJ”,ã••y,Ö,Ì”_—ŽQ%éÄ,ãŠöCEWŠe•ñ—É,Æ,Ì•ACEg,Ì•%eo,ã•d—v,Ä,„•B

ŠJ”-“rã“•É,“•,•é•Ä•A”_Æ,Ì•É“R,Æ,„,µ,ÄŽD%ãCE•o††”-“W,ÌCE““—Í,Ä,„,è“±,„,ç,Ä,„µ,ã,ð•BŠÄ««Ū“S“†”_Æ,ÉŠÖ,„,çCEð††,†i,•p,±,Æ,É,æ,è•A21•ç•d,ÌŠJ”-“rã^ñ•æ,ÌŽ•±“T”-“W,ÉCEü,-Ä“ã,„•v•CE,Ä,„,ç,É,Ì,„Ä,•B

•@,„,±,Ä•AJIRCAS,ÌCEð††,É•Ä“_ð”-„,Ä,É,†,ç•AŠe“,ÌCEä“†@ŠÖ•A—ŠÖ““•ã•A,†,ç,É,“•ŪCEð††@ŠÖ,ÌCEð††ŽÖ,“è“•,É•W,ç•AŠJ”-“rã^ñ•æ,ÌŽ•±“T”-“W,ÉCEü,-½”_<Æ·Z·pCEð††,Ì,„è•á,É,Ä,ç,Ä•A“È%è,Ì4,Ä,Ì%éÜ“è,ð“†S,ÉCEY“ç,ð•s,ç,Ū,•B

©

- 1.†ŽY««“ã,ÉCEü,-½•Z•pŠJ”-É,“•,•é%øŽž,ÌCEð††-%éÉ•A•CE”•ð,Æ†(Eä,Ì%Ä““«
- 2.”_•Æ“†ÓCEñ,ÌŽ•±“«„,Ì,½,•B,ÌŠT“O•A•f•A•f•v•f“†J”
- 3.Z•pŠJ”-Æ••y,ÉCEü,-½•¶ŽYŽÖ•(CEð††ŽÖ•“•y“è“†—ŠÖSe““•ã,Æ,Ì•ACEg
- 4.Ž•±“†”_—N...ZY•ÆE,Ì”-“W,ÉCEü,-Ä,ÌIRCAS-y,ŠSÖ•A•CEð††@ŠÖ“TM,Ì•ã,Ý,Æ,†(Eä,Ì•òCEü

•@

# • @ JIRCAS f j f ... • [ f X No.24 2000

JAPAN INTERNATIONAL RESEARCH CENTER FOR AGRICULTURAL SCIENCES



• e , μ , ϕ ' † Š Ō • i f ~ f f f " f } • [ ' † • " • 1 / 2 C E ' , Ì • - , 3 , È ' - , É , Ä • j • i Š é % o æ ' 2 • @ " • " • @ % o ' a Ž O " , i Ž B % o e • j

## - Ú • @ • @ Ž Ÿ

• @ Š a c a C E 3 / 4

• Ž D % o i C E o • ĭ C E α † , É Š ú ' Ò , 3 , ê , é Z • p Š J " - , Ì • û C E ü • t , - , Æ f V f " f N f ^ f " f N < @ ' ^

• @ • - % o Ê • î ñ

• ^ Ÿ " M ' Ñ , Ì < - , ϕ % o J , a " y • ë , ð — - , μ < Ž , é

• @ C E α < † • - % o Ê

• • ... • s ' « , É Ž ā , ϕ — α ^ î , Ì " Á • « , ð % o ü ' P , , , é

• @ C E α < † • - % o Ê

• f J f r , a • A • " , ð Š Q ' Ž , © , ϕ Ž ϕ , é

• @ f v f • f W f F f N f g C E α < †

• < C • Ū • ĭ " @ — \ ' a , É , æ , é ' • " • ¶ Ž Ÿ , Ì f Š f X f N C E y C E





Šé%œæ"²•@•"•@%œŽO"¿

f~fff~f)•[.İŽq<Ÿ,½,¿,Í,x,-"••Bf)f~f_fE•(½CE"i•",İfCfGfWf""•,İŽq<Ÿ,½,¿,Í,A,"•ê,³,ñŽe•i,ê,İ'y•Ø,ð%••ä,É,İ,¹,Ä",,,Ä,Ä,ê,é•B"p,ç,Í,e,µ,e—V,Ŧ;ŠÔ,Ä, ,é•B••,ß,É—V,Ŧ,ð,ä,ß,Ä•A—[•é,é"O,Éf)•[fPfbfj,İ-T,ç,Ä"X,ð•o,•B"ú•Ä,"-hŽ-,İ,½,ß,É•A-Ø,İ••uf^fifj)•[•v,ðŠç,É,Ä,"½•→,³,eŽq<Ÿ,İŽp,³,Ù,Ù,İ,Ù,µ,é•B  
±,±fCfGfWf""•,É,Í•A f~fff~f)•[.İ"†%œ"_{E(œ:†•Š,â"_{E"•šw,•E,•E,ä,É•A"ú-[•³,İ—Í,µ,Ä,ê,é•A"••â"Ž'(E'(œ:†fZf~f"•[•³, ,è•A"çŽÉ,İ•u(œ:†Šw%œ"•v,É,É,Ä,Ä,ê,é•B f~fff~f)•["_{E,İ"•W,•E,±,İŽq<Ÿ,½,¿,İ-¾,é,e-e—,ð•F,è,½,é•B

もどる



ЈИРСАС





•@



ŽÊ•^•@•<%J,É,æ,é•Ô“y—•o

もどる

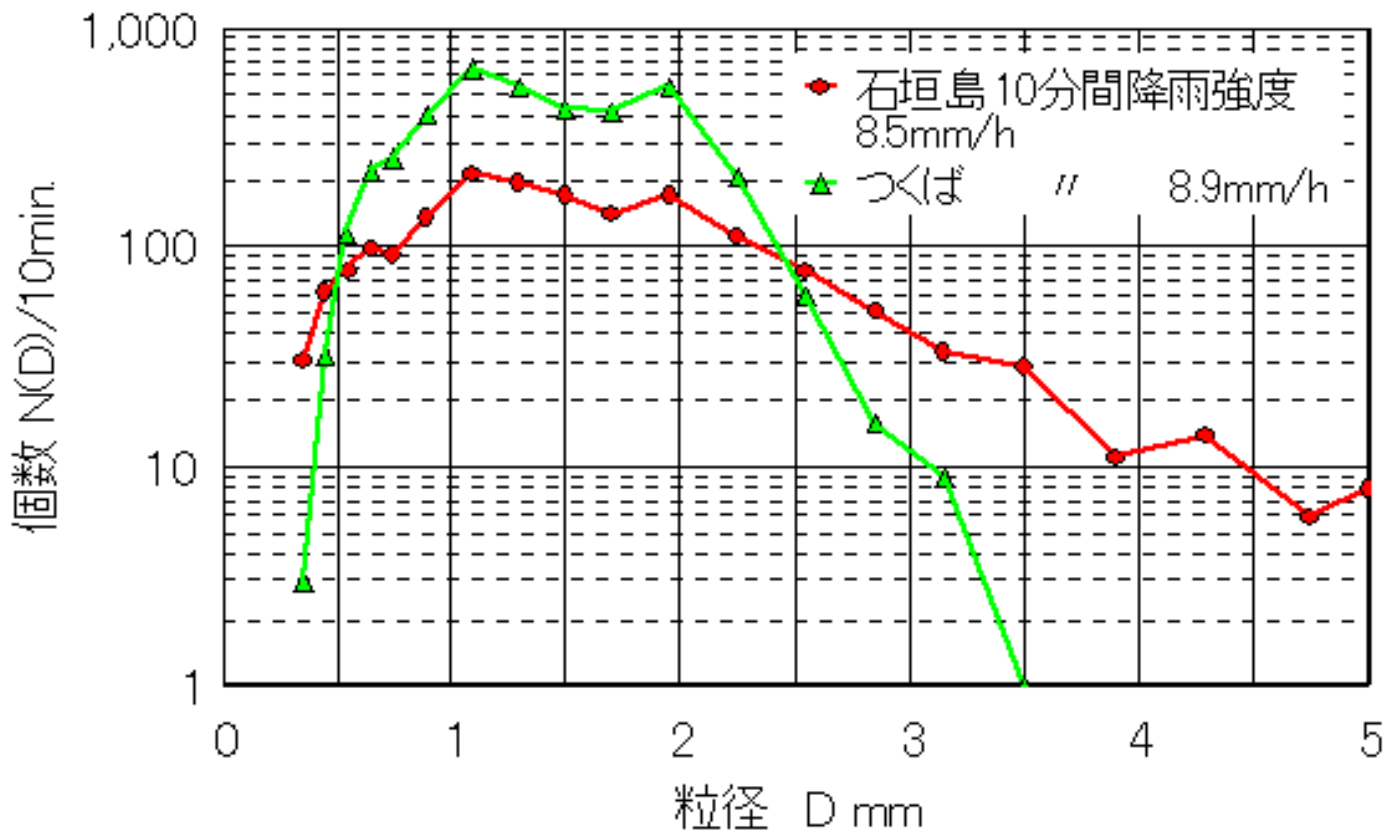


図 石垣島とつくばの粒径分布特性

もどる





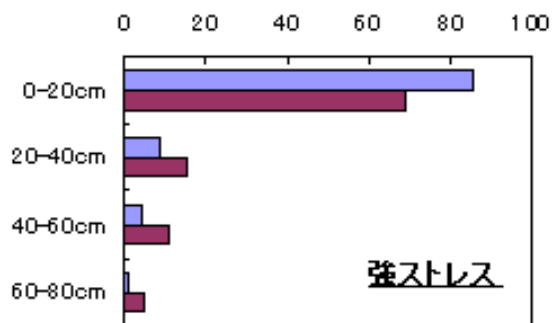
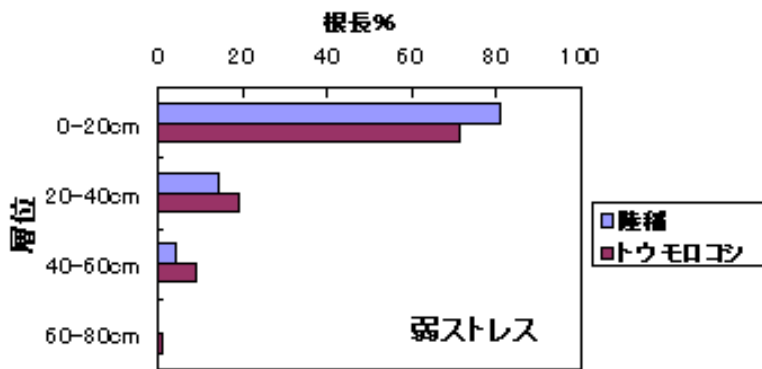
•@

ŽĚ•^ —σ̂, Ì•^aEn•@•^a” •F

•@ •¶ Moroberekan (•Ý—^—σ̂•iŽi)

•@ %oE UPLRi-5•i%öü—Ç—σ̂•iŽi•j

•@ もどる



•@

•}@•...fXfgfEfx,^a—αî•i•iŽiUPLRi-5•j,ÆfgfEf,f•fRfV,Ì“y•ë‘w^Ê’†,Ì•^a’•^a•z,É<y,Ú,%œ<ı

もどる



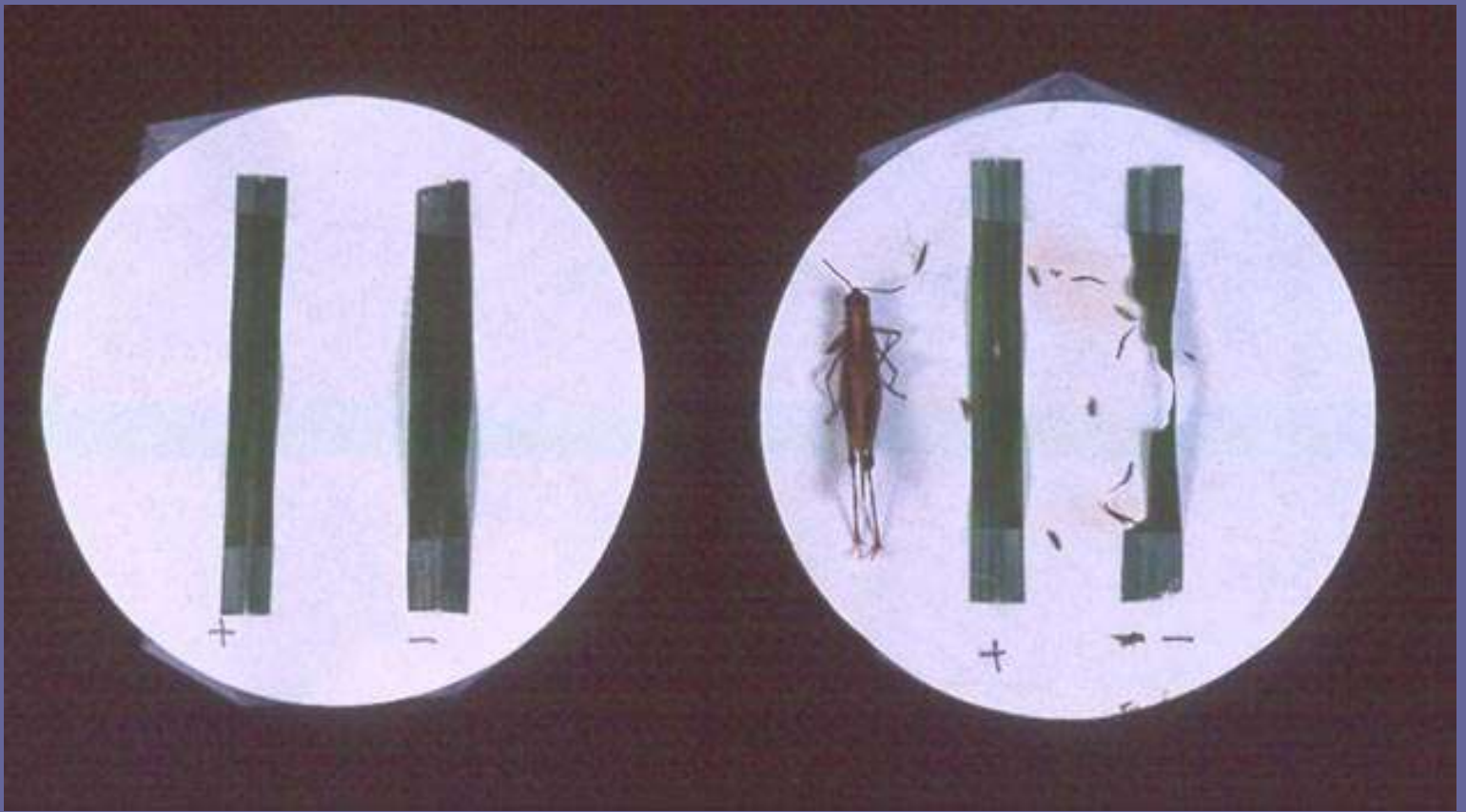




ŽĚ•^1 *Epelis japonica* ,ÌĶŮŽ... ,É•ϕ, í, ê, ½fpf“fSf%ofOf%ofX, Ì•ä

•@

もどる



ŽÊ•^2 f}f_f%ofofbf^,l•-i'Ž,ÍEphelis japonica ,lŠ'•ō,μ,½—t•i+•j,æ,è,à•AŠ'•ō,μ,Ä,ç,È,ç—t•i•|•j,l•û,ð,æ,è•D,ñ,Å•H,x,é

もどる



•@

•æ'[%œŠw,Æ''_-,Ì'mŽ~,ð•‡,í,¹,Ä-À,ç,ð%œðœ^,µ•A•H—ç•¶ŽY,Ì^À'è%œ»•A•n•ç,Ìœyœ,ðŽÀœ»

œ»ó

•EfAftfŠfJ,Ìn•ç,Æ•H—ç•s'«,Ì'wœi,É,é-â'è•F''_-,Ì-À,ç  
•E•s^À'è,È%œJ—Ê•FŽ'N,ÌŠ±,Î,Â,Ìœã•A<Ž'N%œJ—Ê,ð•M,¶,Ä'ì,ð•A,ì,Ä—Ç,ç,©''•ì,É,.,é,©  
•EŽù—v'•%œÁ,.,é•Ä•A•]—^,ÌŽâ•H,Ì''•iŽG'•,ð,Ç,œ'g,Ý•‡,í,¹•A,Ç,œ'ì,é,©

### 3-{ 'œ,Ì%œðœ^ -@

'æ1•|•|•|•|•|•|•|•|•|•|

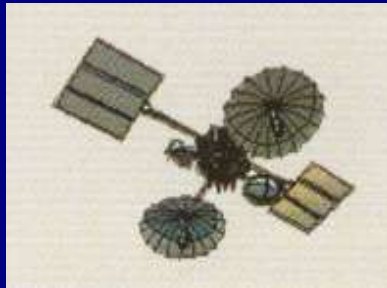
'æ,Q•|•|•|•|

''_—ŽQ%œÁ,Æ•æ'[<Z•p,ð•‡,í,¹,½•k'n—~—p,Æ•Í'l<Z•p,Ì'²•,

•ãŠÍ'³ff•[f^•A<C•Û%œq•^ff•[f^

<C•Û,É%œž,¶,½•'—P•¶ŽY'I'ð•s'«®,Ì%œð-¾

<C•Û—\^f,ff<,ÌŠJ'•-



'æ3•|•|•|•|•|

ÿ•i•E''•i,Ì'I'ð•E•Í'l<Z•p•A•i•t,~Ìœn,Ì,æ,è•³Sm,È'I'ðŠî•

fŠfXfNœyœ,•E•,Žù'ü•¶ŽYfVfXfe€€,Ì,±,œ'n<æ,Æ•î'ñ%œ»

•@

もどる



•@



ŽÊ•^ ‘O•û,É,Íž½Žq,ì-Ø,Æ•...“c•ACEã•û,É,Í%oÊŽ÷fhfŠfAf“,^aŽâ`ì,Æ,·,é—Ñ•ifAfOf•ftfHfŒfXfg•j,^a•L,^a,é

•@

もどる

•@



- ★ ICRAF Office
- Key research watershed
- Field site

•}@ICRAF“E“ifAfWfAZx•”,ìEα†fTfCfg

•@

もどる



# 人の動き

”NĚŽ“ú	˘Û•@“•@•@Ēã	˘Û•@“•@•@‘O	—¼•@‘O
12.8.1	”_<ÆĒœ<†fZf“f^•[•aŠQ”Ž—h•œ•”f}fCfRfVf%cfYf}•aŠQĒœ<†Žº’.	•¶ŽY—~—p”Žâ”CĒœ<†Š~	%œF•TM•x—Y
12.9.1	‘•—±•”’.	”_—Ñ•...ŽY<Z•p%œi<cŽ—±<Ç’}”gŽ—±•Š“dŽqĒvŽZ%œÛ’.	•...“‡•@—¾
•@	”_—Ñ•...ŽY<Z•p%œi<cŽ—±<Ç’•—±%œÛ•t	‘•—±•”’.	‘•ãĒ~Žj
•@	Šé%œæ’²•@•”••ÛĒœ<†’²•@Š~	”_<ÆĒœ<†fZf“f^•[Šé%œæ’²•@•”Ēœ<†Šé%œæ%œÈ’.	’r“c—Ç^ê
•@	Šé%œæ’²•@•”~A—•’²•@%œÈ’.	ŠCŠO•î•ñ•”••ÛĒœ<†î•ñŠ~	•—ŽR•@•C
•@	Šé%œæ’²•@•”ŠCŠOĒœ<†Ēœđ—%œÈ’.	%œœ“êŽx•Š•’Û•œ““Ēœ<†%œÈ’.	—i“c•F•l
•@	Šé%œæ’²•@•”Žâ”CĒœ<†Š~	Šé%œæ’²•@•”~A—•’²•@%œÈ’.	•²“j•³•m
•@	ŠCŠO•î•ñ•”Žâ”CĒœ<†Š~	Šé%œæ’²•@•”ŠCŠOĒœ<†Ēœđ—%œÈ’.	•—TM•@•³
•@	%œœ“êŽx•Š•’Û•œ““Ēœ<†%œÈ’.	%œœ“êŽx•Š•j•’ÛĒœiĒœ<†Žº’.	—i“c•ç“ã^ê
12.9.16	%œœ“êŽx•Š•Ž—±œW’.	”_<ÆŽÒ’ãŠw•Z•í—Î%œÈŽ±”_<ÆĒœ<C•ŠŠÇ—•œW’.	•i—ž•@‘•
•@	’†•”_<ÆŽŽĒœ±•ê‘•—±•”%œiĒœv%œÛ%œœ“UœW’.	%œœ“êŽx•Š•Ž—±%œÛœW’.	•ĂŽR•GŽ÷
12.10.1	%œœ“êŽx•Š•Ž—±%œÛ’.	”_—Ñ•...ŽY<Z•p%œi<cŽ—±<Ç’}”gŽ—±•Š“dŽqĒvŽZ%œÛŦVfXfef %œÛ’•ã²	•%œœfĒœ“^ê
•@	•@		•@
•@			
•@	’{ŽY•’n•”Žâ”CĒœ<†Š~	’{ŽYŽŽĒœ±•êŽâ”CĒœ<†Š~œ“’{ŽY•’n•”	‘ã“•’è—m
•@	•¶•Ž‘Ē¹•”	•V•K•Î—p	•í¼•_Žj
•@	’{ŽY•’n•”	•V•K•Î—p	ŽR•è•³Žj
•@	”_—Ñ•...ŽY<Z•p%œi<cŽ—±<Ç’}”gŽ—±•Š“dŽqĒvŽZ%œÛŦVfXfef %œÛ’•ã²	%œœ“êŽx•Š•Ž—±%œÛ’.	‘•Ē³•Ÿ•G
•@		•@	•@
•@			
•@	¼ŠC<æœ...ŽYĒœ<†•Š•ÎŠ_Žx•Š%œ^ŠŸŽ‘Ē¹Ēœ<†Žº’.	•...ŽY•”Žâ”CĒœ<†Š~	—Ø’j•Ž—T
	Šé%œæ’²•@•”•t•i”hĒœ•E^õ•FfCf“fhflVfA•”_<Æ•È•j	Šé%œæ’²•@•”Žâ”CĒœ<†Š~	•²“j•³•m
	%œœ“êŽx•Š•t•i”hĒœ•E^õ•F•’Û•îĒœ<†•Š•j	%œœ“êŽx•ŠŽâ”CĒœ<†Š~•i•’Û•œ““Ēœ<†%œÈ•j	—öĒœ’½Ži

もどる                      目次へ                      次ページへ

•@







➤ @ •ÔfgfEfKf%efV,âfof•f•E•f•f%œ,Æ,ç,í,ê,é•¬,³,ç•Ôf^f}f}fM,ÍfCf“fhflfVfA—i—•,î•KŽù•i•B`êŽŽ,Í%œiŠi,³,¹|“«,µ`â•Í•S”z,³,ê,½,³•A•Á•B,Í•,¹`À`è•BŽs•è,É,à•A—L•x,É•o%œñ,Á,Ä,ç,é•B(fCf“fhflfVfA•Af{fS•{f,Ìf})•[fPfbfg,É,ÄCEã“;•~ŽqŽB%œ)

## -Ú•@•@ Žÿ

•@ Š^{as}•E¼

•@ •E%œ“êŽx•Š,É,“;•é“ÿ”M•Ñfvf•fWfFNfgCEœ†

•@ Š,İ,İ•@,«

•E•u•H—i•EŠÁ««â`è.É,“;•é••Û•vCEf,İ•Ý.è•û•v,ÆJIRCAS“••žfvf•fWfFNfg,Ì,•,•i•û•ô.É,Á,ç,Ä“é•ç  
•@•½•10”N“x••Û” <EŽŽ(E†CEœ†•,•i%œç,³ŠJ•Ä,³,ê,é-

•@ •-%œÊ•i•ñ

•E••Û” <ÆCEœ†•-%œÊ•i•ñ%œÛ“è`è—

•@ fvf•fWfFNfg

•EfCf“fhflfVfA,É,“;•é•uftf@•f~f“fO•EfVfXfef CEœ†•v,İŠJñ  
•EfCf“fhflfVfA,É,“;•éftf@•f~f“fO•EfVfXfef CEœ†,İ—,è,ÆE»•ó

•@ ŠČŠOCEœ†

•EfCf“fhflfVfA,É,“;•é•œ“CEœ†  
•u“Û•ZŽ—ç,É,æ,é•X—Ñ•ÁŽ,“nCE“~,İ“y“n—~p,É—^,İ,½%œç;•v

•@ (CEœ†•-%œÊ

•E“ÿŽ, %œ”,“f,İ”-•¶—}•§•Z•p,İŠJ”-  
-“ñCEø”•BCE^”ñ—i,çy,Ñ•É%œ—}•§•Û,İ—~p-

•@ ŠČŠOfZf~fi•

•E•u•, %œ•bŽžŽifeB•[fN,Æf}fzfKfj•[,Ì`é—Ñ•v,ÉŠÖ,•,éfZf~fi••AfTfo,ÄŠJ•Ä

%ee"eZx+S.E,"",e"Y" M'N'f v f W f F f N f g B a r t



News: 11/18/99

News: 11/18/99

News: 11/18/99

News: 11/18/99

News: 11/18/99

News: 11/18/99

News: 11/18/99

News: 11/18/99

News: 11/18/99

News: 11/18/99



••Ů”_<ÆCEα<†•¬%ŮÊîñ^ê_____

No.	%Ů@ ‘è •@¼	•¬%ŮÊîñ—P•A 'ñ•o•êŠ
1.	f•fRf“ff<f^,É,“,“,é”_’{•...•;•‡<Z•p’ìEn,ì%öü‘P	(CEα<†•A•‘CEαfZ)
2.	“r•ã•,đ’î•Ů,Æ,μ,½”_<Æ,ì••‡CEα<†,É,“,“,é••Ů•α““,ì,,•i•û•ô	(CEα<†•A•‘CEαfZ)
3.	“î•Ä,É,“,“,é“â“α,ì•s•k<N•Í” <Z•p,ì%öü‘P•ûCEü	(CEα<†•A•‘CEαfZ)
4.	fuf%ofWf<,ì“â“öŠÖ~AZÿ<Æ,đ’†•S,Æ,μ,½Žÿ<ÆŠÖ~A•â•í	(•s•-•A”_CEαfZ)
5.	•¬“ž•iŽí,ì•ŠúŠJ”-,ì,½,β,ì”¼•“î•i•oCEø—ì,ì%öü‘P,Æ^çŽí<Z•p,ì]•%öü	(CEα<†•A•‘CEαfZ)
6.	•É%ö»,đ—}•§,•,é”M•ÑfCfì%öÊ-q•	(CEα<†•A•‘CEαfZ)
7.	””n“y•ë,©,ç,ìêŽ_%ö»’,‘f,“,æ,Ñ~ÿŽ_%ö»’,‘f,ì•ú•o,É<y,Ú,Ž’”î[“x,ì%öe<ü	(CEα<†•A•‘CEαfZ)
8.	Š£•‡’n,Á,ì•i•••¶^ç,đ’£•i,•,é•a•ê”dŽí	(CEα<†•A•‘CE-k”_ŽŽ)
9.	fxfgfif ,É•â•z,•,éfCfì,ç,à,ç,ì•a<Ů,“,æ,ÑfCfì”——tCEí•a<Ů,ì•aCE’•«	(CEα<†•A•‘CEαfZ)
10.	f^fCŽÿfVf‡fEfK%öÊ•H—p•A•“,ÉŠÜ,Ü,ê,é•R•İ^ÜCE’•¬•â,ì‘P—£•E““è	(CEα<†•A•‘CEαfZ)
11.	—n<Ů”÷•¶•“ Flexibacter sp.FL824A,ìfLf f“•â%öđ•y‘f^â“Žq,ì%öđ•í	(CEα<†•A•‘CEαfZ)
12.	fxfgfif •Ef•fRf“ff<f^,É,“,“,é“Ø%öñ’Ž,ìŠ’ô•ó<μ,Æ<ì’Ž,ìCEo•ìCEø%öÊ	(•s•-•A•‘CEαfZ)
13.	fCf“fhflfVfA•EfXf}fgf%ö“‡,É,“,“,é^Ů•ZŽ-<Æ,ìfSf —Ñ’n,ì•Š—LCE’Ô,ì•ì%ö»	(CEα<†•A•‘CEαfZ)
14.	fìfCf<fp•[f <ó%öÊ-[,đCE’—ç,Æ,•,éfNf%öftfgfpf<fv,ì-³%ö-‘f•Y”	(CEα<†•A•‘CEαfZ)
15.	f}f“fOf••[fu—Ñ,ìfŠf^[-Ê	(CEα<†•A•‘CEαfZ)
16.	’†•ŽY’W•...<,đ—p,ç,½—â“ ,•,è•g,ìŠJ”-	(••Ů•A•‘CEαfZ)
17.	’Z“ú,É,æ,é“ú-{î,ì”•â•s-<„ì”-•¶,Æ,»,ì—v^ö	(CEα<†•A•‘CEαfZ)
18.	fAfYfL•β%ö-ì•<Ží,É,“,“,éfAfYfLf}f•f]fEf fV”i•R•«(En“•,ì”-CE©	(CEα<†•A•‘CEαfZ)
19.	fGf“fhftf@fCfG,ÉŠ’ô•μ,½’g’nCE^fCfì%öÊ-q•,ìŠQ’Ž,É’î,•,é•Ů•H’jŠQ•i—p	(CEα<†•A•‘CEαfZ)

•@CEα<†•¬%ŮÊ,É,Á,ç,Ä•A••Ů”_<Æ”²•@•æ•â,Á,Í•A••Ů (<Z•p,ì•Ů“I,È•L,ª,è•A“K%öž•«)•ACEα<†  
(fV•[fY,Æ,μ,Ä,ì•d—v•«•AŠw•p“I”-“W,ì,½,β,ìŠñ—^)•A•s•- (•s•-<y,ÑŽÿ<ÆŠE,ì“ñ^êfY,É’î,•,é•vCE£)  
,ì•â-ì,É•],Á,Ä•¬%öÊ,đ•]•%öü,μ,Ä,ç,é•B

•@



1999-18/4
JIRCAS News
JIRCAS News

Table with 4 columns and 5 rows containing numerical data.

FAO Production Yearbook
JIRCAS News

Home





«UZZ»E.E.eX—SÁZ,"nD".l"y"n"—p.É—^,1/2wq»  
 «UZZ»E.E.eX—SÁZ,"nD".l"y"n"—p.É—^,1/2wq»  
 «UZZ»E.E.eX—SÁZ,"nD".l"y"n"—p.É—^,1/2wq»  
[http://www.jircas.go.jp/](#)

«UZZ»E.E.eX—SÁZ,"nD".l"y"n"—p.É—^,1/2wq»

種別	年	月	日	時	分	秒	分	秒	分	秒
1999	11	7	10:26:23	PM						

«UZZ»E.E.eX—SÁZ,"nD".l"y"n"—p.É—^,1/2wq»

«UZZ»E.E.eX—SÁZ,"nD".l"y"n"—p.É—^,1/2wq»  
 «UZZ»E.E.eX—SÁZ,"nD".l"y"n"—p.É—^,1/2wq»  
 «UZZ»E.E.eX—SÁZ,"nD".l"y"n"—p.É—^,1/2wq»  
 «UZZ»E.E.eX—SÁZ,"nD".l"y"n"—p.É—^,1/2wq»



ŽÊ•^•FfXf}fgf%o“‡fWfff“fr•Bf_fifI°‚Ì”_‰oÆ,³Œo‰cc,·,éfSf —Ñ

もどる





• } 1 : 1/2000af • fOf1f < flfbfg, É”i — ı, đŽ { — p, μ, Ä, ç, é, Æ, ±, ë

もどる



•}2:fgfEf,f•fRfV,^a•Í^l,³,ê,Ä,ç,é|fbfg,ÆN₂Oftf%ofbfNfX,ð^aè,·,é,½,B,Ìf`fff“fo•[

もどる

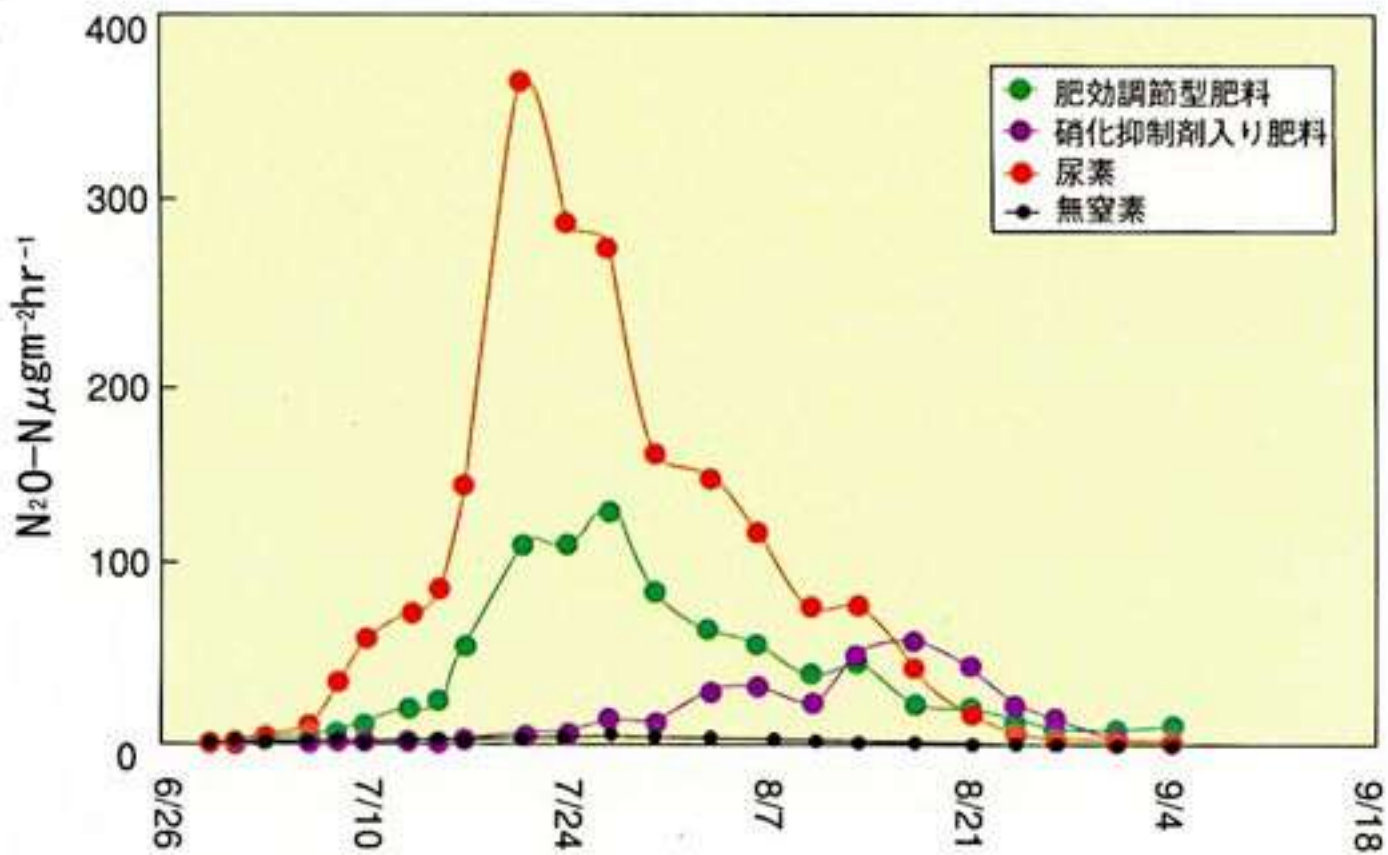


図3. 各窒素肥料を施用したポット土壌からのN₂Oフラックスの経日変化

もどる

• u • , % o • P Z : Ž i f e f B • [ f N , E f ] f z f K f j • , l ' e — N • v , E Š Ő , , é f z f - f i • [ • A f T f o , Á S J • Á

• @ • C E ' j A j W j A • ' • , É • , é Á l ' v R — N Z • C E l e i S % e E ' 6 — É • g p A ± é Ú Á % , , l ' e — N • w — [ , É , ' , é Á , , , ' , , • A , • , l ' + S , E , É , Á , Á , • , % l l , l • A j p f , v , B E y — p • P , E , g , Á — , p , ' , é , é • * Z ± Á , Á , % B , E , ± é • A j j C E j C j V j A , Á , l • Á , B , É , É , Á , Á , • , % • P Z : Ž i f e f B • [ f N , E f ] f z f K f j • — p l ' e — N , É l , é Š Ő S , • , Ú Á , Á , • , % B

Z E • • l • F T j o B , Á , Á , g E Á e f s f B i ( N l , e — N u ( l i O E C j V j A T j o B • A o • l ' , E )

• @ f T j o B , Á , ± l — 4 , É R , é , é , • A , E , , É • Ú , , • , • E X E i B , E , g , Á S — l — N , • E Š Ő E W Z Ő , % , , Á , É , • A j G j X j e [ j g f v f % • f • e [ j v f j ] , E e f e c Z Ő , á • E ' , , • , % • P Z : Ž i f e f B • [ f N , E f ] f z f K f j • — p l ' e — N , É f e f B [ j N ( T e c t o n a g r a n d i s ) i f ] f z f K f j • — p i s i w i e t i a m a c r o p h y l l a , , • , N k h a y a i v o r e n s i s j , • A , Z n , B , Á , é , é , ± , E , ' , ' , , , é , é , • B

• @ , • @ , g , e ' , e ' • n , É , , é Á l , ± é , é , l Z : Ž l ' e — N , l — N Z j l , ± é , Ú Á , Ú , E , a , C , E , • A , é • 4 l — N , • E Š Ő E W Z Ő , á Š Ő , B • A ' e • s • v • e — N • A • C E i A • — , p , E , C , É Š Ő , , é Z p • A ' m Z ' , • • Á , , é , E , E E % , e ' , , s • B

Z E • • 2 • E j A f i Š j j i f z K f j • , l ' e — N u ( T j o B , l , A , A • C • X — S j z f ' • j )

• @ , • , ± , Á • A j e f B • [ j N , E f ] f z f K f j • — p , E v e W , l , l , e • é • 4 % e E , E , e , e • u f e e , E ' , , c , y É , q , Á • + • l , l • + y , • • j , é , ± , E , é • Ú l , E , g , Á • A • • Ú ' , — N • , , Ž Y , E B • 2 j Z j ' • j • A j T j o E i Z D — N , • E ' • 4 i n n o p r i s e , @ S a h a b • F o u n d a t i o n • A j T j o — N , • E , C j S a h a b F o r e s t r y D e p a r t m e n t , l , o • Á , É , e , é j z f - f i • [ , Š S j • Á , g , % • B

Z E • • 3 • E • — S a ' e s , l z f h v f i • , Á l z , • , % • 2

• @ , • , ± l j z f - f i [ " H i g h - v a l u e T i m b e r S p e c i e s f o r P l a n t a t i o n E s t a b l i s h m e n t - T e a k a n d M a h o g a n i e s " , [ • j • 1 0 " N 1 2 E 2 1 - 2 " 0 , É Š Ő • Á , ' , é , % B i ' 6 , B j ( j • j • E • ) • Š Ő % e e s ( f T j o B j • j • E Z Ő ) , É , , é , Á • A d a n u k M u s a H a j j A m a n ( C h i e f E x e c u t i v e o f I n n o p r i s e ) • A ' • C ' i O E % ( J I R C A S — N • E • " ) • A H e r m a n A n j i n ( D e p u t y D i r e c t o r o f S a b a h F o r e s t r y D e p a r t m e n t ) Š e Z • l j X j e [ j , É , e , é Š j • a Z B • A d a t o D r S a l I e h M o h d , N o r ( E x e c u t i v e D i r e c t o r o f T R O P B I O R e s e a r c h ) , Š i Š ' • u f e e , É , Á , Á , • A • • u • — A j j f e j v j A • A j f i B j W • A j v j ' K j f i f o • A j f % • j X , l l 4 - 3 / 4 , l • é • 4 % E , É , e , e , 6 9 • , l • u f e e • A Z Ő • 6 , B j f v j E • i o • 6 • 1 0 0 k m , l j f A j v ' X — N j z j ' • j • ( L a u s o n g F o r e s t r y C e n t r e ) Z Z E • ± • — N • u , O l j f y B • [ f , f b j g Š j b j v , • , , l , j • B E i S j z j z f - f i • [ , E , g , % , % B • A — N • E • E — N S w • 1 , l • é • 4 % E , E e Á , , A • s q , l , e , e , E , • , % • P , É Š Ő S , B Z , Á j G j X j e [ j g f v f % • f • e [ j v f j ] , e , é , l z q % A Z Ő , 2 E 2 , g • A • u f e e , 0 , l z q % A Z Ő , l l 3 0 - 3 / 4 , s ' : A ' M • S , É Z e ' , % e 2 ' s , K E j , á • l , , é , é • B • U , % j f y B • [ f , f b j g Š j b j v , É , l 5 0 - 3 / 4 , B ' : , é Z q % A Z Ő , , Á , % B • , % e i , l j z f - f i • [ , l , 0 , , É Z z , B ' % , % Š e e , Á , , • A j j f e j v j A ' Á , É T j o B , l j e f B [ j N • A j j f z f K f j • ] e — N , l , e , i , É , é , e , É Š ũ — • , g , % , E , é , j , e , • B





ŽÊ•^1•FfTfo•B,Å•Å,àĒÃ,çfefB•[fN,ì‘ç—Ñ’n (f}fĒfCfVfAfTfo•B•Afof“f_fE)

もどる



ŽÊ•^2•FfAftfŠfJf}fzfKfj•[,Ì'¢—Ñ'n (fTfo•Af<fAf^f“•X—ÑfZf“f^•D

もどる



ŹÊ•^3•F'¢—Ñ•A^ç•c, ÌfZfbfVf‡f“, Å, ÌŽ¿<^%oŽ“š

もどる













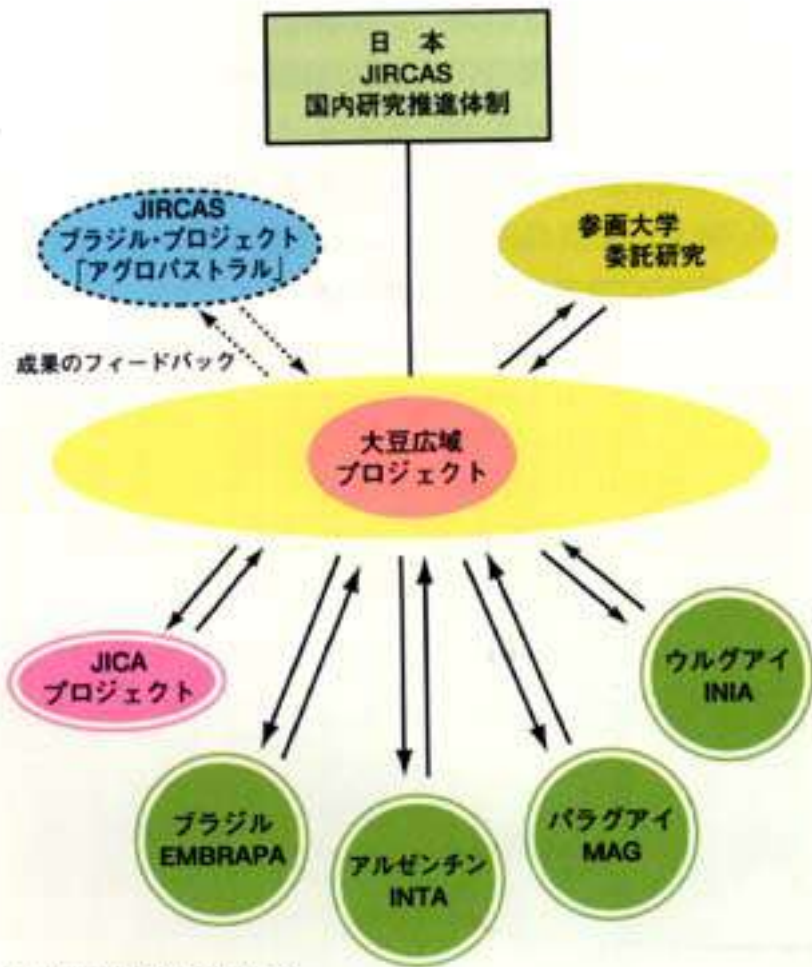


図1. プロジェクトの研究推進体制





### fCf“fhflfVfA“¼””,lfAf<frfWfA‘e—Ñ’n,É,“,e,Ä•H—tŠQ,ð̂ø,«<N,±,μ,Ä,e,éLl f f f E‘@•iEurema•j

•@

•X—ÑŽ@•R•ÚCE(=+fZf“f“@f%fMf•ES.B•EfCfŠfA f“fg

—Ñ•E““@“¼“f“n

fpfE f“fof““e—Ñ•ZpfZf“f“@fNfXfB•fE f€ššf.,ftfE

•@

@fAf fofWfAif,fbfj f f •GParaserianthes falcataria•j,İ“CE“fAfWfA,É•L,•A•Ü,è,Ä,e,é½—p“r,İ““žz,Ä, ,è•A,»İ“e—Ñ’n,Ä,İžz•ÜfL f f f E“@•iEurema•j,İ“èŽi,““žz“•“f,μ•Aef,μ,ε•H—tŠQ,ð̂ø,«<N,±,μ,Ä,e,é•BSY“—Ži,İ,±,è,Ü,ÄfL f f f E•iE.hacabe•j,É,è,½,èf f C f“f“fL f f f f E(E.blanda),É,è,½,è,μ,Ä,«½•B

@•MŽÖ,ç,žCf“fbfj f V f A“¼””,İfXf}fgf%•A f W f f““•A f J f f f“f“f“,İEv,T%Öš,İfAf<frfWfA‘e—Ñ’n,Ä““•f,μ,Ä,e,éLl f f f E“@,ð̂““,μ,½,•E,±,è•A f f C f“f“fL f f f E•A f L f f f E•A f A f Š f f“fL f f f E•iE.alita•j f T Š f f f E•iE.sari•j,İ.SŽi,““F,B,ç,è,½,è•A f f f r f W f A‘e—Ñ’n,É f L f f f E“@•S,İ,İEÄ“İ“,“““eÄ,μ,½,•E,«İ—DèŽi,İ“i,É f f C f“f“fL f f f E,Ä, ,Ä,½•B

@f f C f“f“fL f f f E,İEÄ“İ“,İ“E,““,μ,•AŠE•G,É,İ,•E,•A%edŠú,É““eÄ,μ•AŽž,É“e—Ñ’n“S“İ,İfAf<frfWfA,“Ü,ÜŠ@•S,É—t,ðž,““Ü,Ç,İ“““•f,•E,É,Ä,½•B

@“è•üfL f f f E,š f A f Š f“fL f f f E,İEÄ“İ“,İ“Š“T“á,efCEfX f ,Ä“è•μ,Ä,“,è•A,Ü,½ f T f Š f L f f f E,İ,“i,B,Ä•H,Ä•A,±,è,ç,İfAf<frfWfA,İ•H—tŠQ,ž,•E,μ,Ä,İ,“Ü,Ç,d—v,Ä,İ,É,•E,İ,İ,ç,è,½•B,±,è,Ü,Ä,d—v•H—tŠQ,ž,•E,μ,Ä,İ,“Ü,Ç,d—v,Ä,İ,É,•E,İ,İ,ç,è,½,İ,İ,“,«ç,•GE“““è,É,æ,é,ä,İ,Ä, ,è,ø•B

Ü,½,““eä,İ““,ÄŠm“E,è,½ f A f Š f“fL f f f E,İ•A•Ä•B,Ü,ÄfL f f f E,•E+““,è,Ä,«½Ži,Ä, ,è,“A f L f f f E,•E f A f Š f“fL f f f E,““Š“İ,É““•f,μ,Ä,e,é—4,İ,É,“@,Ä,½•B



ŽÉ•2, P•Df“fCf“f“fL f f f E,İ“““•“i1994“NS  
GEŽ•A“fXf}fgf%•Bfuf}fj f f E

ŽÉ•2, f“fCf“f“fL f f f E,İ•HŠQ,É,æ,ðš@•S  
É—t,ðž,““½ f A f f r f W f A‘e—Ñ’n  
“1994“NSGEŽ•A“fXf}fgf%•Bfuf}fj f f E

ŽÝfy•fW,Ö

@







検索

JIRCAS-k·žž—±•š, ĩšJ•Ýž®“T, ¢•s, ³, é, é

検索



検索



•@

# 5% JIRCAS • • • • •

fAfWfA,É,“,̄,é•H—; ,Ì’™‘ •E—→’Ê•E%Á•H<Z•p

•|•H—; -â‘è%đĈ^,Ö,Ì‘æŽO,Ì““•|

•@

fZfbfVf‡f“1•FfAfWfA,Ì•ø,!,é|fXfgfn•[fxfXfg<Z•p,Ì”-â‘è

fZfbfVf‡f“2•F”M•Ñ,É,“,̄,éŽûŠnĈě•’“ ,Ì’™‘ •Û‘¶<Z•p

fZfbfVf‡f“3•FfAfWfA,É,“,̄,é•H•iŽY<Æ,ÌŽÀ‘Ô,Æ•ûĈü

•@

•@Šú•@•@ŠÔ•@1998”N9ĈŽ9“ú•i...•jE10“ú•i-Ø•j

•@%öi•@•@•ê•@%öÈŠw<Z•p’;ĈĈ<ĈĈ—→fZf“f^•[i,Â,-,ÎŽs’l%o 2-20-5•j

•@

Žâ•@•@•@•Ă•@••Û”_—Ñ•...ŽY<ÆĈĈ<†fZf“f^•[iJIRCAS•j

◁•@•@•@—Í•@•H•i••‡ĈĈ<†•Š•A”_<ÆĈĈ<†fZf“f^•[•A

•@•@•@•@•@•@ft•[fh•EftfH•[f%of •E,Â,-,Î

-â,ç•‡,í,¹•æ•@JIRCAS•••ÛfVf“flfWfEf Ž—±<Ç

TEL 0298-38-6348•@FAX 0298-38-6342

e-mail:sympo@jircas.affrc.go.jp

Website:http://ss.jircas.affrc.go.jp/sympo5.htm

•@

•@Žÿfy•lfW,Ö

f••[fNfVf‡fbfv

•@

•½•-10"N"xJIRCAS/IPGRI•••Ã

••Ûf••[fNfVf‡fbfv

•@

”M‘Ñ•A••^â“Ž‘CE¹,Ì’”á%••Û‘¶<Z•p\CE••†,Æ%ž—p\

•@ fZfbfVf‡f“1•F’”á%••Û‘¶CE••†,ÉŠÖ,•,éŠî‘b‘T‘mCE©

•@ fZfbfVf‡f“2•F’”á%••Û‘¶<Z•p•i•×-E•AŽíŽqãó,Æ•s’èãó•ACEs’•j

•@ fZfbfVf‡f“3•FCE»•Ý•i•s’†,Ì’”á%••Û‘¶fvf•fWfFfNfg,ÌŽÀ•Û

•@

•Šú•@•@ŠÔ•@1998”N10CEŽ20“ú•i%ôÎ•j`23“ú•i•à•j

•%ö•@•@•ê•@••Û”_—Ñ•...ŽY<ÆCE••†fZf“f^•[-{ŠÛ

•@

-â,ç•‡,í,¹•æ•@JIRCAS/IPGRI•••Ã••Ûf••[fNfVf‡fbfvŽ—±•Ç

TEL 0298-38-6384•@FAX 0298-38-6342

e-mail:takagiw@jircas.affrc.go.jp

•@

•@Žÿfy•[fW,Ö











•¶Œ•@•\fvf•fWfFfNfgŒöšJfVf“f|fWfEf  
•¶Œ•@•\fvf•fWfFfNfgŒöšJfVf“f|fWfEf  
•@

# •A•,İfVfOfifšf“fo

•šÂ«ŽhŒf•EfXfgfŒfX%č“š,İ•žq<@•\



“úžž•F1998”N8Œž12“ú•i•...•j

%öi•ê•F••Ū”_—Ń•...žY<ŒŒ•†fZf“f^•[-{šÛ

<••Ť•F••Ū”_—Ń•...žY<ŒŒ•†fZf“f^•[•A—•%»šwŒ•†•š•A•¶Œ•@•\

•@šJ%öi

šJ%öi,İŸŽA

➤@•O-ì<x-¼•iJIRCAS•j

➤@šL•ÀŒ“ñ•i•¶Œ•@•\•j

•@“Á•Ê•u%ö%ö

•@•A•,İfVfOfif<“’B,İ•žq•¶•šw•E•â“šw•I%ö•İ•i•À’•FžÂ•è•ê—Y•j

➤@Nam-Hai Chua•if•fbfNftfFf%ö•[‘ššw•AUSA•j

•@fGf fŒf“fvfOfifšf“fo,Œ•¶•fXfgfŒfX%ž“š•i•À’•FžÂ•è•ažq•j

-Œ,©,çšj,Ö,İfGf fŒf“fKfXfvfOfifšf“fo

➤@Joe Ecker•ifyf“fvf<fofjfA‘ššw•AUSA•j

•A•fzf<f,f“fGf fŒf“É,æ,é•â“žq”-Œ»,İ²•B

➤@ižm•G-¾•i•¶-½•Hšw•H<Œ<Z•pŒ•†•š•j

f^fofRETHYLENE-INSENSITIVE3fzf,f•fo,İ“]žÊ^öžq,Œ,µ,Ä,İ<@’\

➤@•→™•r•ê•E‘â<—šžq•i”_<Œ•¶•ž•Œ•Œ•†•š•j



■•@ABAfvfOfifŠf“fO,Æ•...fXfgfŒfX%ž“š•i•À`•FJoe Ecker^Jerome Giraudat•j

fVf•fCfkfiYfi,É,“, ,éfAfuVfWf“Ž_fVfOfifŠf“fO,Îâ“ Šw“I%œđ•Í

➤•@Jerome Giraudat•iCNRS•Aftf%œf“fX•j

•...fXfgfŒfX%œž“š,É,“, ,é^â“Žq”-Œ»,ÆfVfOfif<“`B

➤•@ŽÂ•è~aŽq•iJIRCAS•j

fVf•fCfkfiYfi,É,“, ,é%œ-fXfgfŒfXfvfOfif<“`B,Îâ“ Šw“I%œđ•Í

➤•@Jian-Kang Zhu•ifAfŠf]fi`âŠw•AUSA•j

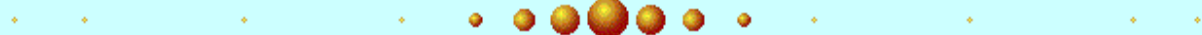
•œŠ`A•“,É,“, ,éŠ£`‡Žž,Îâ“Žq”-Œ»

➤•@Dorothea Bartels•if}fbfNfXfvf%œf“fNŒœ†•Š•AfhfCfc•j

fXfgfŒfX%œž“š,Æ`İ•œ,É,“, ,éŠ£`‡—U“±•œ^â“Žq,Î-đŠ,,

➤•@ŽÂ•è^ê—Y•i—•%œ»ŠwŒœ†•Š•j

●•@•Â%œi



—vŽl•W,È,Ç,Ì-â,œ•‡,í,•œ•F

••Ū”_—Ń•...ŽY<ŒŒœ†fZf“f^•[•@`†“‡^ê—Y•@Tel:•i0298•j38-6641 Fax:•i0298•j38-6643

E-mail•Fkazuid@jircas.affrc.go.jp

—•%œ»ŠwŒœ†•Š•@ ŽÂ•è^ê—Y•@Tel:•i0298•j36-4359 Fax:•i0298•j38-9060

E-mail•Fsinozaki@rtc.riken.go.jp

•@

•@ŽŸfy•|fW,Ö

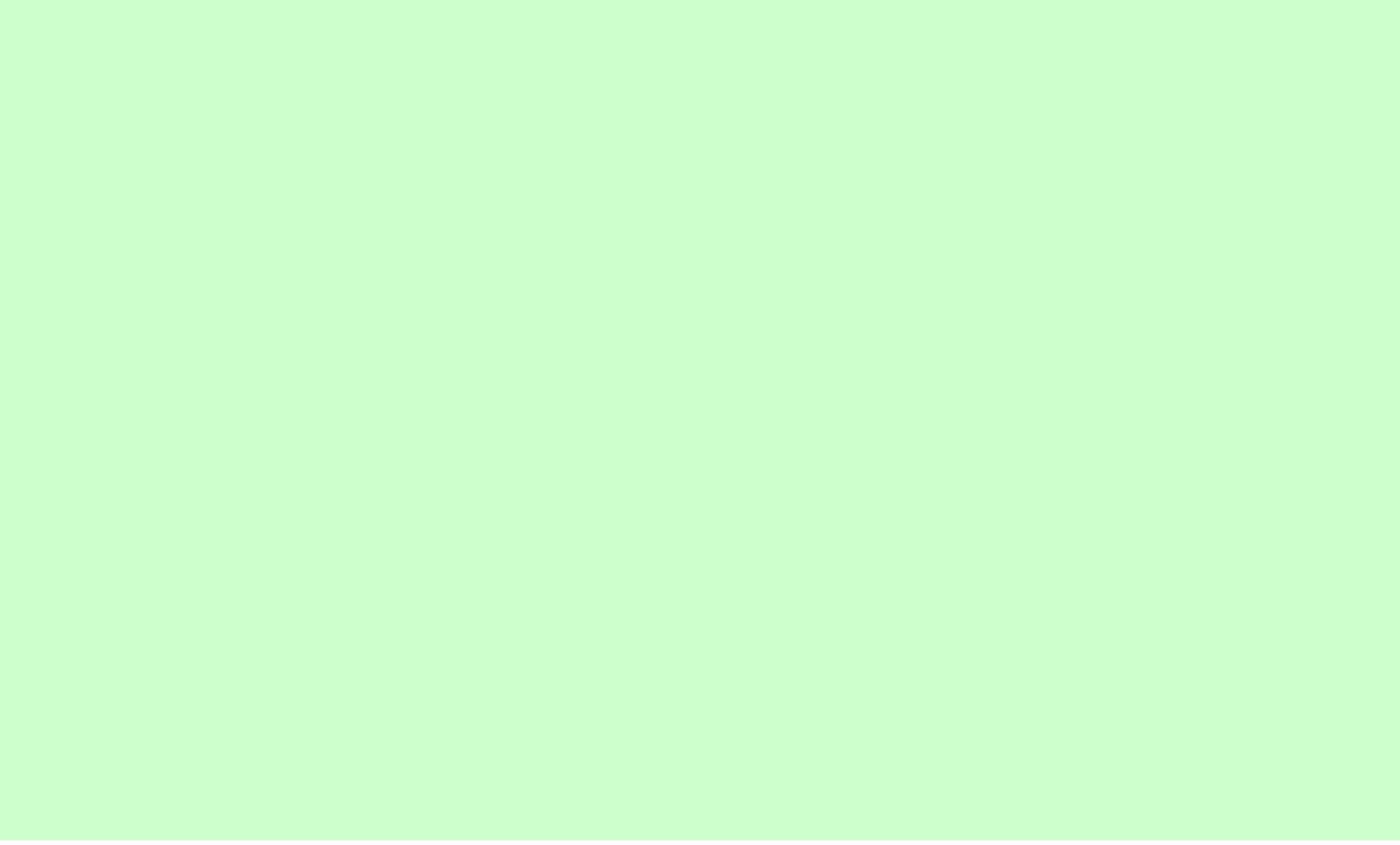
fRfFff"ff.f^,É,,;é•Ä,ì—îÊ,Æ•îŽ_ŠÇ—•Z•p,ìCE»•ó,Æ%•Ù'è

fRfFff"ff.f^,É,,;é•Ä,ì—îÊ,Æ•îŽ_ŠÇ—•Z•p,ìCE»•ó,Æ%•Ù'è



fRfFff"ff.f^,É,,;é•Ä,ì—îÊ,Æ•îŽ_ŠÇ—•Z•p,ìCE»•ó,Æ%•Ù'è

[fRfFff"ff.f^,É,,;é•Ä,ì—îÊ,Æ•îŽ_ŠÇ—•Z•p,ìCE»•ó,Æ%•Ù'è](#)



08/15/98

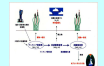
•É%»—}•§•i—p,ð,à,Â”M’ÑfCfI%È–q’•,}”-CE©

08/15/98 08:27:42 PM



08/15/98 08:27:42 PM

•É%»—}•§•i—p,ð,à,Â”M’ÑfCfI%È–q’•,}”-CE©



•É%»—}•§•i—p,ð,à,Â”M’ÑfCfI%È–q’•,}”-CE©



•É%»—}•§•i—p,ð,à,Â”M’ÑfCfI%È–q’•,}”-CE©

•É%»—}•§•i—p,ð,à,Â”M’ÑfCfI%È–q’•,}”-CE©

Navigation

ICRISAT's 10th Anniversary



Home

News

Publications

Services

Contact Us

Links

Privacy Policy

Site Map

Feedback

Help

Search

Advanced Search

Help

Home

News

Publications

Services

Contact Us

Links

Privacy Policy

Site Map

Feedback

Help

Search

Advanced Search

Help

Home

News

Publications

Services

Contact Us

Links

Privacy Policy

Site Map

Feedback

Help

Search

Advanced Search

Help

Home

News

Publications

Services

Contact Us

Links

Privacy Policy

Site Map

Feedback

Help

Search

Advanced Search

Help

Home

News

Publications

Services

Contact Us

Links

Privacy Policy

Site Map

Feedback

Help

Search

Advanced Search

Help

Home

News

Publications

Services

Contact Us

Links

Privacy Policy

Site Map

Feedback

Help

Search

Advanced Search

Help

Home

News

Publications

Services

Contact Us

Links

Privacy Policy

Site Map

Feedback

Help

Search

Advanced Search

Help

# •l ,İ “® ,«

## •Eˆo,İžó•Ü•E•\²

•@

•@1997”N“x“ú- {•á•XŠw%öi½“c•Ü

‘â-İ•G”V•iŠÂ«Ž‘Œ!•”•j •uŒú,ø•á•X‘İ,É,“,ˆ,é”M•E•...—A‘—,ÉŠÖ,.,éŒœ†•v  
•i“ú- {•á•XŠw%öi•@1997”N10ŒŽ13“ú•j

•@

•@“ú- {”M‘Ñ”_ <ŒŠw%öi•ÜŠw•p•Ü

“nç³•@Šp•i•Œ•“Ž‘Œ!•”•j •uŒTfTfQ,İ‘İŠŒ•«,İ•]‰œ, -@ ,ŒŒEn“•ŠŒ•,İ<@•i,ÉŠÖ,.,éŒœ†•v  
•i“ú- {”M‘Ñ”_ <ŒŠw%öi•@1998”N,RŒŽ27“ú•j

•@

•@‘æ16‰öñ“ú- {“y•ë”i—;Šw%öi•š—ã•Ü

‘ã•e—Ç•→i‰œœ“ëŽx•Š•j •uŒ}f•‰œÈ•i““,İ,è,ñ<y,Ñ“S‰œh— { ,ÉŠÖ,.,é”ãŠr•Œ—•Šw“İŒœ†•v  
•i“ú- {“y•ë”i—;Šw%öi•@1998”N,SŒŽ,R“ú•j

•@

•@



JIRCAS fjf... [fXNo.15

•Ö•W•E”•s ••Ū”_—Ñ•...ŽY<ŒŒœœ†fZf“f^•[

1998”N7ŒŽ”•s

•š305-8686 ,Â,-,İžs‘â,í,µ1-2

TEL.0298-38-8686(•i•ñŽ‘—;‰œŪ)

FAX.0298-38-6656

http://ss.jircas.afrc.go.jp

•@

[-úžÿ,ö](#)



►•@,Ç,±,©,ç,Æ,à,È,-Æ»,ê,½•-”N,½,ç•B”’Ç,ç,ð,μ,Ä,ç,½,Æ,ç,ϱ,±,Æ,¾,Á,½,³•A-Ú,ÌP,«,ÉŠ”•@•B  
•ufiCfWfFfŠfA•...“c•iOryza sativa),É,Ä•AŠČSO•î•ñ”•@•ó•Ä•C•ê•v

## -Ú•@•@•@•@ŽŸ

•@Š^aÆ¼

JIRCAS,ÌŠ”•@•û•j•E”W-]

•@Š,Ì”@,«

‘æ5%ñJIRCAS••ÛfVf“f|fWfEf€ŠJ,©,é

•@ÆöŠJfVf“f|fWfEf€

•u•A•”,ÌfVfOfifŠf“fO•vŠJ,©,é

•@‘••‡fVf•fWfFfNfg

’†•,É,“,“,éŠÁ«•Û”SCE^”_<Æ•¶ŽY<Z•p,Ì•]‰ç,ÆŠJ”-

•@fAfOf•fpfXfgf‰f<

Ž•±CE^”_—q—ÖŠ•fVfXfef€É“K,μ,½’•nŠÇ—•@,ÌŠJ”-

•@fVf•fWfEfNfgÆ‰†

‰—P•W•İ,Ì—\”Žè-@,ÌŠJ”-

•@μ,Ö,çÆ‰†

fCfl•aŠQ,ÉŠÖ,•,é‰“Æ‰†if•fRf“ff•f^fVf•fWfFfNfg•j







©1998-2002 JIRCAS. All rights reserved. This page is for internal use only. It is not to be distributed outside the organization. The information on this page is confidential and should not be disclosed to the public. If you have any questions, please contact the JIRCAS office.



### 窒素肥料消費量

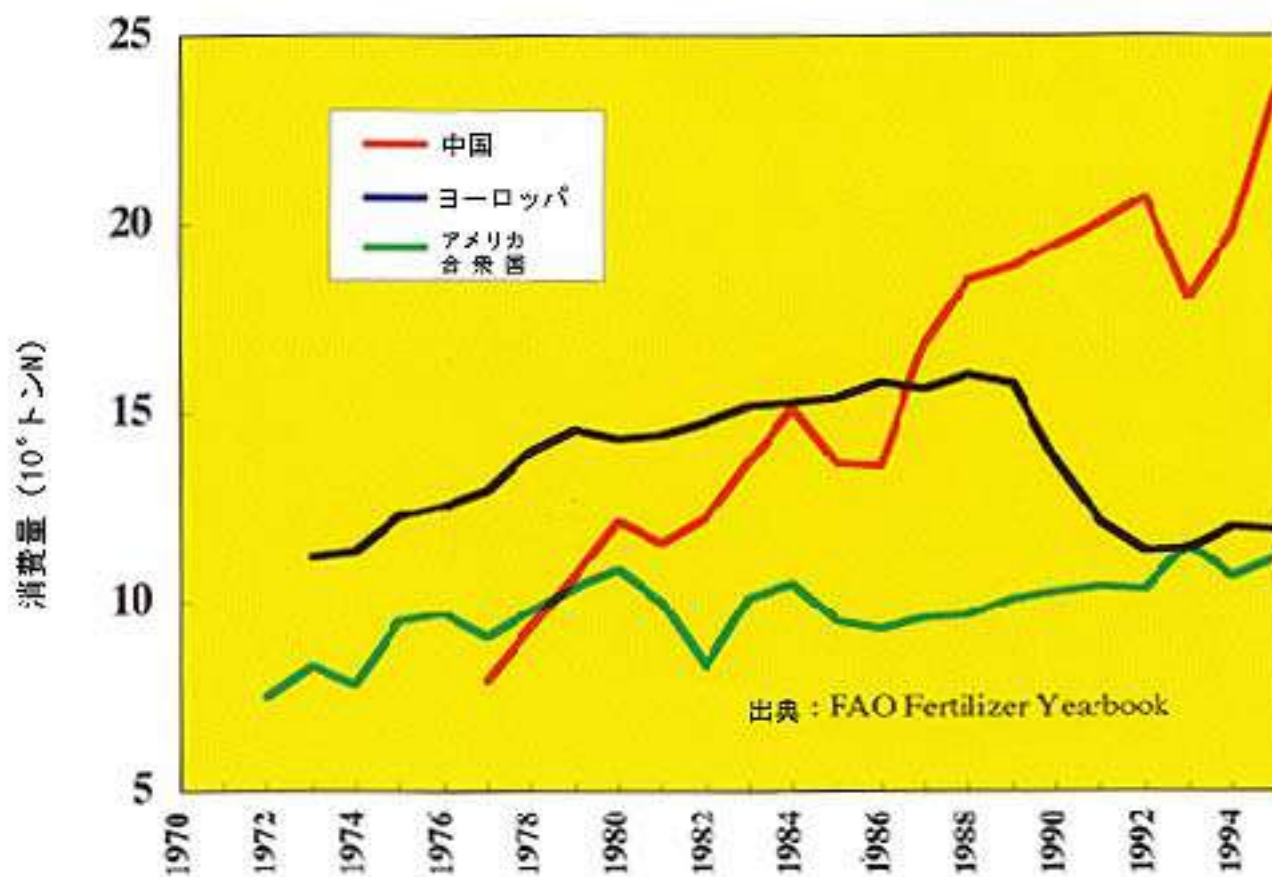


図1. 中国、ヨーロッパ、および、アメリカ合衆国の窒素肥料消費量の変化

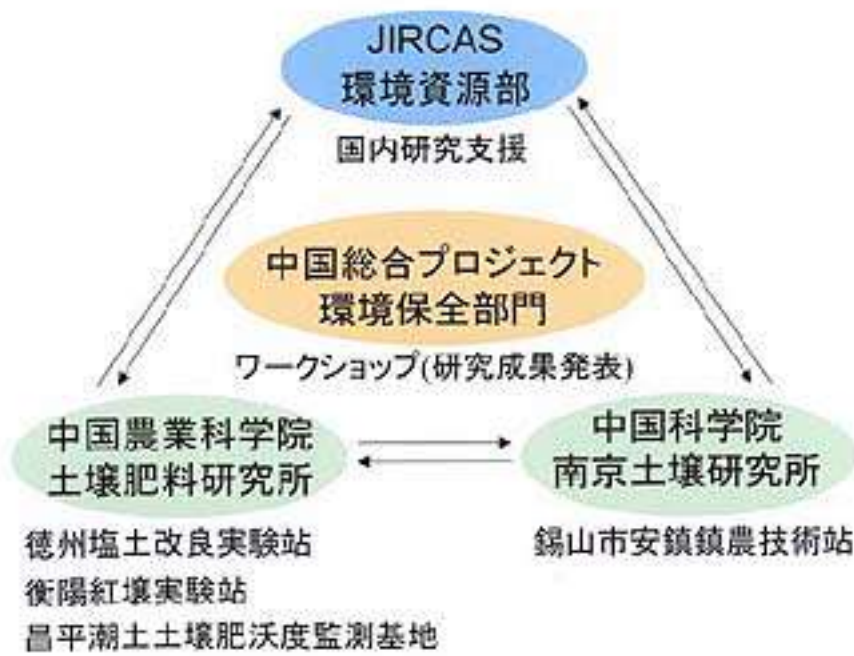


図2. 中国総合プロジェクト環境保全部門の研究推進体制

# 中国プロ環境保全部門関係地図

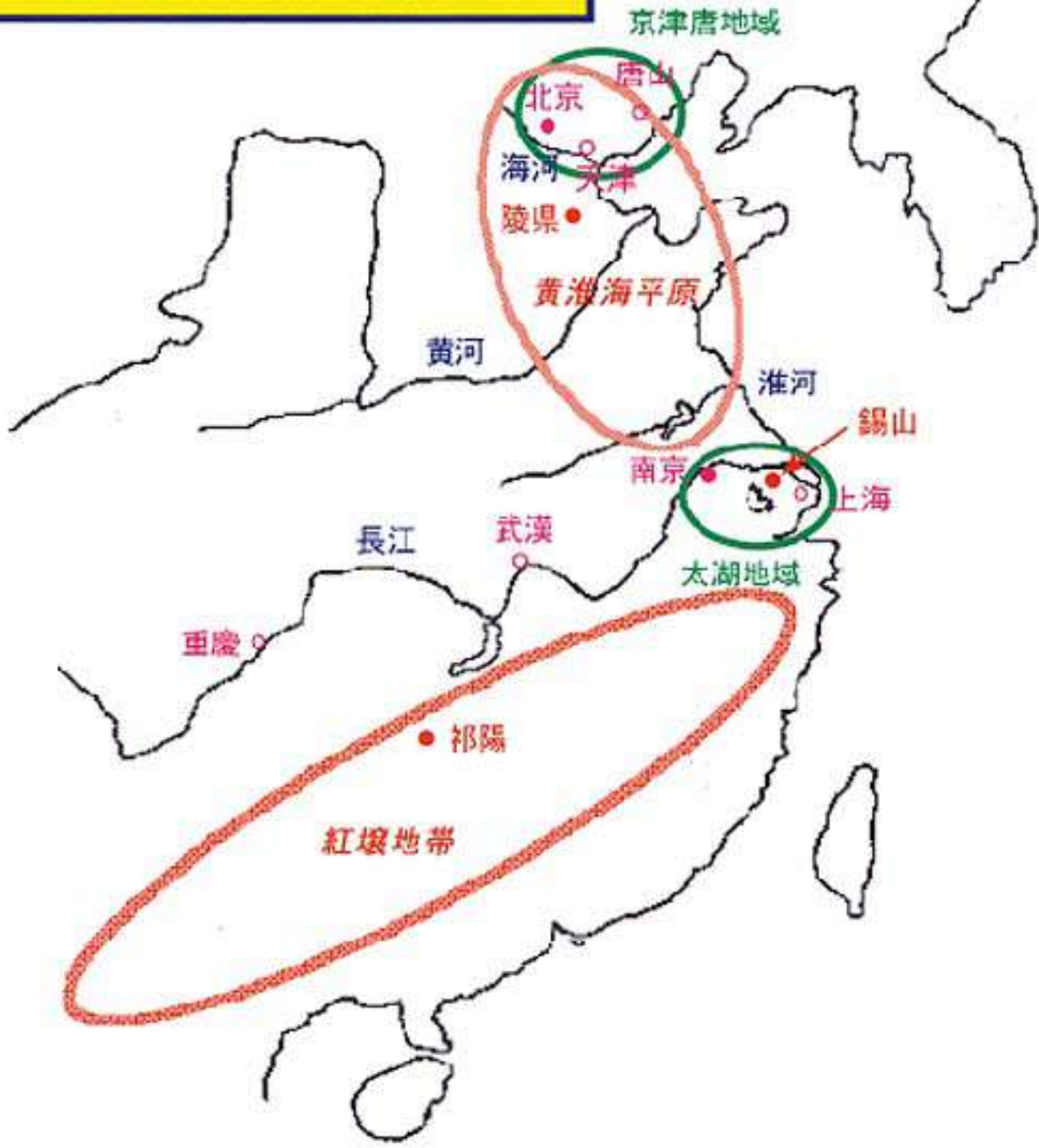


図 3. 中国総合プロジェクト環境保全部門関係地図





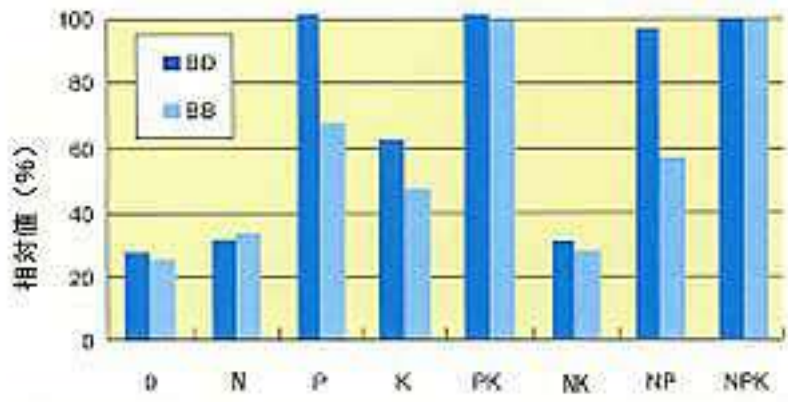


図1. 異なる施肥地区における *B. decumbens* (BD) 及び *B. brizantha* (BB) の乾物重の相対値 (播種4か月後の乾物重。N-P-K区を100とした。)



表 1. *B. decumbens* 及び *B. brizantha* の P 吸収・利用効率

草種	P吸収効率% (吸収Pg/施用Pg)	吸収Pの利用効率 (乾物g/吸収Pg)	P施用効率 (乾物g/施用Pg)
<i>E. decumbens</i>	28	3159	889
<i>B. brizantha</i>	23	4511	1057

試験では25kg/haのPを施用。

(P施用効率) = (P吸収効率/100) × (吸収Pの利用効率)







图1. 研究对象地区



図2. 地表に塩類が集積している研究圃場



图1：研究对象地区



图2：土地利用图 (Land Capability Map)

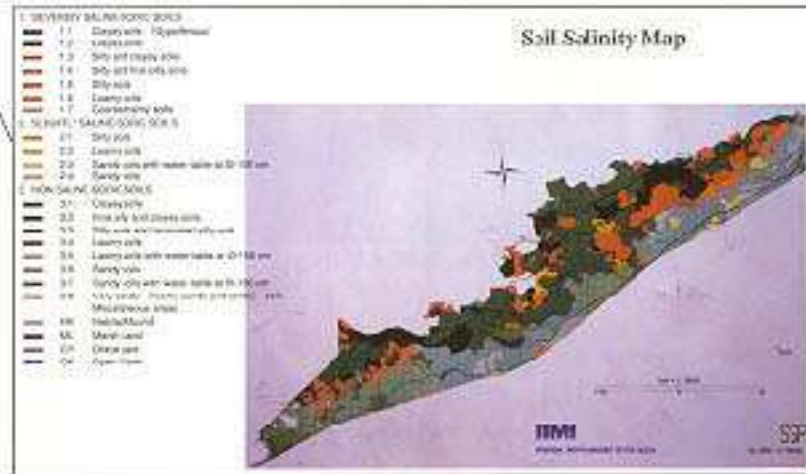


图3：土壤图 (Soil Salinity Map)



•@

fCfl•aŠQ,ÉŠÖ,·,é,œ“œœ†•if•fRf“ff•f^fvf•fWfFfNfg•j

•ZY—p“@—fœfœ

•@

•@fRf“ff•f^fvf•fWfFfNfg•j

fxfjff.Áœ“œœ†•AZÁZj.Á,é,šN(f•f•f•f^fvf•fWfFfNfg•j)•fRf“ff•f^fvf•fWfFfNfg•j.Á,é,šN(f•f•f•f^fvf•fWfFfNfg•j)•fRf“ff•f^fvf•fWfFfNfg•j.Á,é,šN(f•f•f•f^fvf•fWfFfNfg•j)•fRf“ff•f^fvf•fWfFfNfg•j.



Šœ—œZ.Á,é,šN(f•f•f•f^fvf•fWfFfNfg•j)•fRf“ff•f^fvf•fWfFfNfg•j.Á,é,šN(f•f•f•f^fvf•fWfFfNfg•j)•fRf“ff•f^fvf•fWfFfNfg•j.

•@fRf“ff•f^fvf•fWfFfNfg•j

f•fRf“ff•f^fvf•fWfFfNfg•j.Á,é,šN(f•f•f•f^fvf•fWfFfNfg•j)•fRf“ff•f^fvf•fWfFfNfg•j.Á,é,šN(f•f•f•f^fvf•fWfFfNfg•j)•fRf“ff•f^fvf•fWfFfNfg•j.

[Zêœœ†•if•fRf“ff•f^fvf•fWfFfNfg•j](#)

@.Á,é,šN(f•f•f•f^fvf•fWfFfNfg•j)•fRf“ff•f^fvf•fWfFfNfg•j.Á,é,šN(f•f•f•f^fvf•fWfFfNfg•j)•fRf“ff•f^fvf•fWfFfNfg•j.

•@fCf)•aŠQ,ÉŠÖ,·,é,œ“œœ†œœ

•aŠQ,ÉŠÖ,·,é,œ“œœ†œœ.Á,é,šN(f•f•f•f^fvf•fWfFfNfg•j)•fRf“ff•f^fvf•fWfFfNfg•j.Á,é,šN(f•f•f•f^fvf•fWfFfNfg•j)•fRf“ff•f^fvf•fWfFfNfg•j.

[Zêœœ†•if•fRf“ff•f^fvf•fWfFfNfg•j](#)

@.Á,é,šN(f•f•f•f^fvf•fWfFfNfg•j)•fRf“ff•f^fvf•fWfFfNfg•j.Á,é,šN(f•f•f•f^fvf•fWfFfNfg•j)•fRf“ff•f^fvf•fWfFfNfg•j.

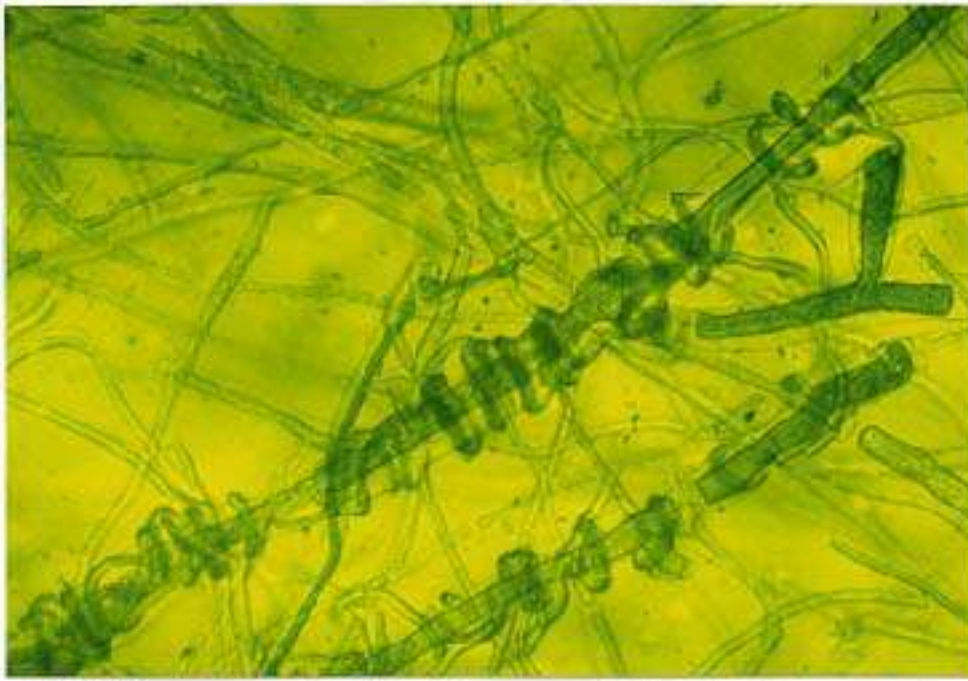
•@ZÁZœœ†•ZÖ,Á,é,šN

@•f•f•f•f^fvf•fWfFfNfg•j.Á,é,šN(f•f•f•f^fvf•fWfFfNfg•j)•fRf“ff•f^fvf•fWfFfNfg•j.Á,é,šN(f•f•f•f^fvf•fWfFfNfg•j)•fRf“ff•f^fvf•fWfFfNfg•j.



メコンデルタで多発している病原不明の赤条斑病の初期病徴





紋枯病菌にコイル条に巻き付き、その成長を阻害するトリコデルマ菌の一種（メコンデルタの土壌から分離）

# JIRCAS ニュース

JAPAN INTERNATIONAL RESEARCH CENTER FOR AGRICULTURAL SCIENCES

## 目 次

- ・ JIRCASの活動方針・展望 .....2
- ・ 第5回JIRCAS国際シンポジウム開かる .....3
- ・ 公開シンポジウム「植物のシグナリング」開かる .....3
- ・ 中国における環境保全型農業生産技術の評価と開発 .....4・5
- ・ 持続型農牧輪換システムに適した草地管理法の開発 .....6
- ・ 塩類集積の予測手法の開発 .....7
- ・ イネ病害に関する共同研究（メコンデルタプロジェクト）.....8



どこからともなく現われた少年たち。鳥追いをしていたということだったが、目の輝きに感動。[ナイジェリアの水田（*Oryza sativa*）にて、海外情報部 浅沼修一]

No. **16** 1998

農林水産省  
国際農林水産業研究センター

## JIRCASの活動方針・展望 - JIRCASのさらなる発展に期待する -



前 企画調整部長 井上隆弘  
(現 東北農業試験場次長)

平成10年10月1日をもって、JIRCASは発足後まる5年になる。当時の話は定かでないが、JIRCASはその前身TARCの長い経験と研究蓄積を活かしつつ、農林水産業における国際共同研究活動を通じて、地球規模での環境の保全、食料の安定的供給に貢献し、広く人類の生活、文化の向上等の国際社会の発展に貢献することをその使命とした。その際、政府資金援助、国際協力事業団による支援事業、技術協力等諸事業の効果を高めるため、技術面からの支援とそのための研究協力が一層重要になる。これを実践することによって、国の内外との組織的に幅広い活動を通して、国際的研究機関に育っていくものと信じる。

### 世界食料需給と地球環境問題を解く

基本問題調査会の食料部会では、農業分野における国際貢献をとくに取り上げ、今後我が国は、食料・農業分野において、その経済力や国際的地位に応じた国際貢献を従来以上に主体的・積極的に行っていく必要性を論じ、現在8.5億人以上の飢餓・栄養不足問題の解決のため、開発途上国自体の食料生産力を持続的に高めていく観点から、食料・農業分野における技術協力・資金協力の強化・充実の必要性を強調している。

一方、世界的な気象変動の不気味な動きに見られるように、人間の活動が地球環境の変動に深く関わっている。環境変動は農林水産業活動を制約し、今や、政策や経済はもとより地球環境問題を抜きにしては考えられない時代にある。世界中の研究者と手を繋いだ国際協力、21世紀はまさに農林水産業の時代である。

### Grobalで捉えLocalに解く

上記の問題の解決には、いろいろな方策があろう。政策的課題、経済的課題、国際協調的課題の解決もさることながら、自然科学、社会科学を含めた技術開発による問題解決も重要な要素である。その際、JIRCASが取り組むべき研究のスタンスは研究基本計画の中に見ることができる。まず、開発途上地域に存在する農林水産業問題の中から研究課題を抽出するこ

とから始まる。「研究問題Ⅰ：地域特性及び技術開発方向の解明」研究である。それらを受けて、研究問題Ⅱ～Ⅴ：農林水産業における生産・利用・加工技術の開発」研究がなされ、これらを総合化するために「研究問題Ⅳ：農林水産業の発展方向と総合的計画手法」の研究がある。

一人の研究者がすべてを解決することは不可能である。大切なことは、個々の立場を認識し、問題を地球規模(Grobal)で捉え、地域的・専門領域的(Local)に分析し、地球規模で解釈する心である。

### 総合的な研究の企画立案と実践

総合的研究への参画に躊躇の聲がたびたび聞かれる。総合研究とは何ぞやの論議は今さらでもないが敢えて発言したい。開発途上地域における農林水産業の問題の特定は、当該国の事情のみならず、全地球的問題でもあり、また、我が国の発展にとっても重要な問題であるという認識に立ち、海外情報解析研究が展開されており、こうして特定された農林水産業問題の中から優先度の高い問題が取り上げられている。

これらの中から、技術開発によって解決できる研究問題を全所的に(例えば、国際研究推進委員会において)論議し、多くの研究領域からなる研究課題にブレイクダウンする。これらのプロセスにおいて、研究に参画する相手国の状況、JIRCAS研究者の研究ステージを加味しながら、研究実施課題に組み立てられるのである。

総合研究に参画すると、焦点がぼけて何をやっていかわからない、研究論文が書けないという意見もあるがとんでもない。総合的研究だからこそ、個々の研究者の研究の位置づけが、研究目標が明確であり、たとえ、小さなパーツといえども、優れた論文として評価されるのである。

誕生後5年、ここらでもう一度JIRCASにおける研究組織のあり方を再点検し、世界をリードする国際的研究機関として、研究内容の一層の充実結びつこうにしたいものである。今が、そのチャンスである。

## 所の動き

## 第5回JIRCAS国際シンポジウム

「アジアにおける食料の貯蔵・流通・加工技術 食料問題解決の第三の道」  
初めてのポストハーベスト技術シンポジウム開催される

これまで、アジアの途上国では食料問題解決のため生産技術の向上に主たる努力が払われてきた。しかし、近年では、収穫後損失の軽減、貯蔵法の改善、安全性の向上、流通・加工による高付加価値化など収穫後における課題が重要視され始めている。また、食生活・ライフスタイルの変化に伴う食品需要形態の急速な変化に対応し、新加工食品製造のための技術開発への強いニーズが生まれており、途上国の実情に合った技術開発の取組みが求められている。

JIRCASでは現在、食料の利用・加工問題を通じて中国やインドネシア等の研究を支援しているが、今後は「ポストハーベスト技術」が途上国との共同研究において一層重要な課題になると予想される。

上記を背景に、9月9日～10日に研究交流センターで開催された本シンポジウムには、中国、インドネシア、韓国、ベトナム、台湾、フィリピン、タイ、インド、オーストラリア、日本からの計19名の招待講演者と、本省・技会事務局関係者、食糧庁、食総研、農研七、JIRCASほか国・公・民の食品関係者・団体、食品研究者、並びに留学生等、計230余名が参加し、時

宜を得た盛会なものとなった。

セッション 『アジアの抱えるポストハーベスト技術の諸問題』では、各国における背景・現状・問題点の分析・検討と将来展望を、[熱帯における収穫後穀物の貯蔵保存技術]では、食料問題緩和への技術開発の貢献、21世紀初頭に使用が禁じられる臭化メチルの代替え技術の確立と途上国への応用等を、『アジアにおける食品産業の実態と方向』では、食品製造業の技術開発実態・戦略の分析・検討、食品産業の方向と展望等を、各々議論した。

本シンポジウムが、アジアにおける「ポストハーベスト技術」開発研究の進展に役立つとともに、途上国における基本食料の確保と有効利用、農業所得の向上、ならびに食生活の改善に大きく貢献し、21世紀におけるアジアひいては世界の食料問題解決の道を拓くための一助とならんことを切に希望する。

なお、本シンポジウムでは、文字どおりの国際シンポジウムへの幕開けに向け、ビデオ・カンファレンス公開実験が同時に実施された。

(海外情報部 名和義彦)

## 公開シンポジウム

## 生研機構プロジェクトの公開国際シンポジウム開催される

## 「植物のシグナリング - 環境刺激・ストレス応答の分子機構」

生研機構プロジェクトの公開国際シンポジウムが8月12日にJIRCAS国際会議室で行われ、アメリカ、ヨーロッパなどの研究者を含む約200名が参加した。本シンポジウムは、生研機構予算によるプロジェクト研究「乾燥・塩ストレス耐性の分子機構の解明と分子育種への応用」の推進をはかるため、JIRCASと理化学研究所、生研機構の共催で開催された。今回のシンポジウムでは、これまでの私たちの研究成果を発表するとともに、植物における環境刺激・ストレス応答の分子機構に関する研究を世界的にリードしている研究者の方々に研究状況を紹介していただいた。

会議では前野所長による開会の挨拶および生研機構の貝沼理事による挨拶の後、以下のような講演が行われた。はじめにロックフェラー大学のChua博士により、植物の光認識・シグナル伝達に関する分子生物学・遺伝学的研究についての特別講演が行われた。続いて、「エチレンシグナリングと生物ストレス応答」と題し、植物のエチレン認識・シグナル伝達機構につ

いて3つの講演が行われた。さらに、「ABAシグナリングと水ストレス応答」と題して、ABAシグナル伝達機構、あるいはABAを介さない乾燥、塩ストレス、低温といった環境刺激のシグナル伝達について5つの講演が行われた。その中で私たちの研究グループでは、乾燥、塩、低温ストレス耐性のキーとなっている転写因子、および耐性に係わる多くの遺伝子の機能について発表した。この他にも植物のシグナル伝達機構について、6つのショート・トークが行われた。

今回の発表内容から、遺伝学的あるいは逆遺伝学的アプローチにより、植物の環境刺激・ストレスに対する応答・シグナル伝達、そしてストレス耐性において、キーとなっている遺伝子が明らかにされ始めていることが伺われた。これらの基盤的研究は、開発途上地域で問題となっている早魃、塩集積あるいは低温といった環境ストレスに対して耐性の作物を作出するために、非常に役立つことが期待される。

(生物資源部 中島一雄・篠崎和子)

## 総合プロジェクト

# 中国における環境保全型農業生産技術の評価と開発

## - 中国総合プロジェクト環境保全部門の開始 -

環境資源部 八木一行・宝川靖和

### 研究の背景

中国は世界最大の食糧の生産・消費国であるが、市場経済移行にともなう所得向上と継続する人口増加は、中国の食糧需要を増大させ、農業を質的にも量的にも大きく変化させている。「中国農業年鑑」によれば、米、小麦、トウモロコシ等の「穀物」に、豆類とイモ類を加えた「食糧」(中国語では「糧食」)生産量は、中国全体で、1980年代初頭には3億2,000万トン程度であったものが、1990年代に入り、4億5,000万トン前後を維持できるようになり、1996年には、ついに、5億トンに達している。

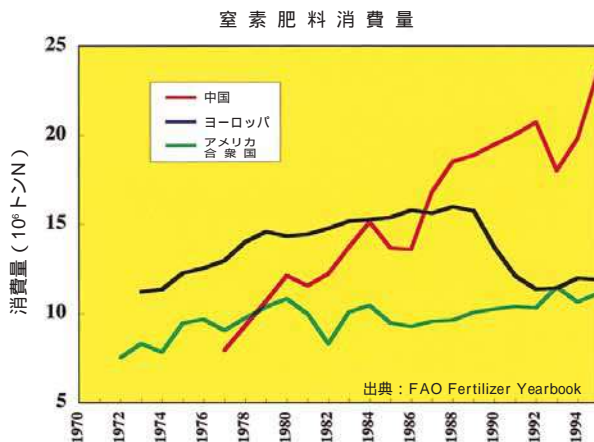


図1. 中国、ヨーロッパ、およびアメリカ合衆国の窒素肥料消費量の変化

このような急速な食糧増産は、何よりも、さまざまな農業技術の革新によるものであるが、特に、化学肥料投入量の増加の寄与が大きい。

図1に示すように、中国の窒素肥料消費量の増加は、食糧生産量の増加とほぼ並行している。そして、その消費量は、米国やヨーロッパ全体の消費量をはるかに上まわり、中国は、今や、世界最大の化学肥料消費国となっている。中国全土の推定耕地面積は約1億3,000万haであるから、1990年代以降の窒素肥料消費量2,000万トンNから、中国全体の単位面積当たりの平均窒素肥料投入量は、約150kgN/haと計算される。この値は、わが国や欧米先進国の値と同程度のものであるが、中国では、所得格差と同様に、地域による化学肥料消費量に著しい差があるものと思われる。したがって、沿岸部のような比較的豊かな地域では、この平均値よりもはるかに多量の窒素肥料が投入されているのが現状であろう。

このような過剰な化学肥料の投入は、各種の環境問

題を引き起こす。地下水や河川水の水質汚染、湖沼や内湾の富栄養化、発生するガスによる地球温暖化、成層圏オゾン破壊、光化学大気汚染、および酸性雨などの問題である。このような問題は、先進国ではすでに大きな社会問題となっており、化学肥料投入量は減少傾向にある。しかし、中国では、未だ化学肥料の投入量が高く、重要な飲料水源である地下水の水質、近年重要度を増している淡水魚介類生産に対する悪影響、そして、大気汚染の深刻化に結びつく問題である。一方、農業所得に対する化学肥料購入費用もけっして小さくなく、農家の経済的側面からも適切な化学肥料の投入が望まれる。

JIRCASでは、平成9年度より7年間の計画で、総合プロジェクト「中国における主要食料資源の持続的生産及び高度利用技術の開発」を開始したが、このなかの課題、「環境保全型農業生産技術の評価と開発」で、上記の問題に対し、適切な化学肥料の投入を中心とした、高い作物生産量を維持し、環境と調和した安定持続生産を可能とする技術開発の共同研究を行っている。

### 研究の目的

本共同研究の目的は、現在、中国の農業が直面している以下の重要な問題(キークエスチョン)に答えることである。

1. 中国の集約的な食糧生産システムは、環境にどのようなインパクトを与えているのか?
2. 現在、どのような変化が起きているのか?
3. 将来、どうなるのか?
4. そのインパクトを軽減するには、どうしたらよいのか?

しかし、環境問題や個々のインパクトは多様で、限られたプロジェクトのなかでそのすべてを網羅することは難しい。そこで、本共同研究では、上記のキークエスチョンの「切り口」として、「農業生態系の窒素循環とその環境影響」を取り上げる。

窒素は、作物にとって、最も重要な養分であると同時に、その環境影響は顕著で、かつ、重大である。したがって、上記のキークエスチョンに対する回答として、最も重要な「指針」が得られるものと思われる。

### 研究推進体制と研究課題

本共同研究は、JIRCASと中国側の2つの研究機関、すなわち、中国農業科学院土壤肥料研究所(所在地:北京)と中国科学院南京土壤研究所(同:南京)の連携のもとに行われている(図2)。

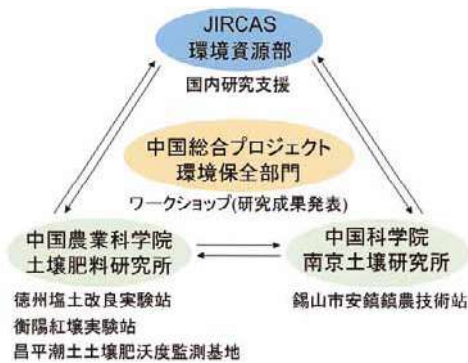


図2. 中国総合プロジェクト環境保全部門の研究推進体制

中国側の両研究所は、中国の土壌学の最高峰に位置しており、多くの優秀な研究者を有すると同時に、中国各地に独自の試験地を持ち、活発な研究活動を行っている。現在のところ、本共同研究に対しては、中国農業科学院土壌肥料研究所では、農業生態環境研究室、情報農業研究室、および紅壤試験站が、中国科学院南京土壌研究所では、土壌圈物質循環開放実験研究室および土壌環境保全研究室が参加している。

試験対象地域として、中国の典型的、かつ重要な4つの地域を選択し、圃場試験と広域の農業環境調査を計画している(図3)。



図3. 中国総合プロジェクト環境保全部門関係地図

第1に、トウモロコシ - 小麦栽培地域である黄淮海平原とその典型地である德州塩土改良実験站陵県試験区(山東省陵県)。

第2に、近年、きわめて集約的な都市近郊農業が盛んな、京津唐地域。

第3に、長江下流域の水稻 - 小麦栽培地域である太湖集水域地域とその中心部の無錫市に隣接した錫山市安鎮鎮農技站(江蘇省錫山市)。

第4に、中国南部の水稻二期作地域である紅壤地域とその典型地である衡陽紅壤実験站祁陽試験区(湖南省祁陽県)である。

これらの地域において、以下に示す課題を実施する計画である。

1. 黄淮海平原の農業生態系における主要元素の動態解明とその制御
  - 1-1 地域の有機物および窒素フローの分析
  - 1-2 集約的な農業システムからの環境負荷の定量とその抑制方策の開発
2. 京津唐地域の農業生態系における環境への窒素負荷の評価
  - 2-1 異なった施肥量と肥料タイプにおける窒素損失量の定量
  - 2-2 農業生態系における窒素施用が環境に及ぼす影響の総合的解析
3. 太湖の水質汚染に及ぼす面源負荷の影響評価
  - 3-1 集落スケールの評価
  - 3-2 集水域スケールの評価
4. 太湖地域の農業生態系における窒素循環の解明とその制御
  - 4-1 第1次実験
  - 4-2 第2次実験
5. 環境と調和した水田農業技術体系の開発
  - 5-1 物質循環を基にする環境保全型水稻栽培技術の開発
  - 5-2 水田の環境保全機能の有効利用

本共同研究の実施期間中、日中3研究機関での共同研究を円滑に推進し、その成果をよりよいものとするため、各年度の終わりに担当研究者とその他の専門家が集まり、研究成果と次年度以降の計画を検討するためのワークショップを開催することとしている。

初年度である平成9年度は、平成10年2月に、JIRCAS(つくば)にて、中国側研究者8名を招へいし、第1回のワークショップを開催した(写真1)。



写真1. 第1回ワークショップ参加者

本年度は、平成11年3月に北京で開催予定である。

現在、本共同研究は2年目に入り、山東省陵県、江蘇省錫山市、および湖南省祁陽県での圃場試験が開始され、本格的な広域調査も軌道に乗りつつある。中国の経済発展と食糧需給の問題は、世界的な注目を集めている。その、今後の発展のアキレス腱ともなりかねない農業環境問題の解決を目指した本研究の意義は、きわめて大きいものと考えている。

アグロパストラル

# 持続型農牧輪換システムに適した草地管理法の開発

畜産草地部 菅野 勉

ブラジルでは1970年代に*Brachiaria*属の牧草が導入された結果、熱帯サバナ（セラード）の開発が急速に進められた。しかしながら、これまでの草地管理が自然地力に依存したものであったため、現在、草地生産力の低下が顕在化してきている。このため、穀類生産と牧畜を組み合わせる地力維持とともに家畜生産力を向上させようとする農牧輪換システムの開発が期待されている。本研究では 農牧輪換システムに適した熱帯牧草を選定するとともに、農牧輪換システムに適した草地管理法を確立することを目的とする。

## 1 農牧輪換システムに適した熱帯牧草の選定

ブラジルでは従来から痩せ地には*Brachiaria decumbens*が、比較的肥沃な土壤には*Brachiaria brizantha*と*Panicum maximum*が適していることが経験的に知られていた。そこで、本研究では、最初に、これらの現象について生理、生態的観点から解析を加えることとした。

まず、圃場において*Brachiaria decumbens*（以下BD）と*Brachiaria brizantha*（以下BB）を供試しN、P₂O₅、K₂Oでそれぞれha当たり100kgを入れる、入れないの8通りの組み合わせ（無施肥区、Nのみ区、Pのみ区、Kのみ区、PK区、NK区、NP区、NPK完全区）を作って3要素圃場試験を実施した。その結果、セラードにおいてはPの施用効果が最も大きいことが示された（図1）。また、BD・BBともNの要求量が低いこと、BDはBBに比較しK欠乏条件下での生育が優れること等が示された。

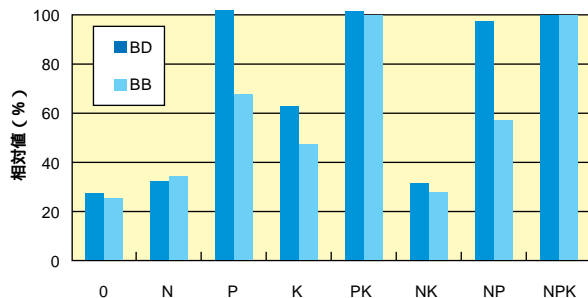


図1 . 異なる施肥区における*Brachiaria decumbens* (BD) 及び *Brachiaria brizantha* (BB) の乾物重の相対値 (播種4か月後の乾物重。N-P-K区を100とした。)

次に、セラードにおいて最も重要な要素であることが示されたPについて、ポット試験を行い、BDとBBのP吸収特性を比較した（表1）。P吸収効率はBDがBBよりも高く、BDはBBよりもPを吸い取る力が強い

表1 . *B. decumbens*及び*B. brizantha*のP吸収・利用効率

草種	P吸収効率% (吸収Pg / 施用Pg)	吸収Pの利用効率 (乾物g / 吸収Pg)	P施用効率 (乾物g / 施用Pg)
<i>B. decumbens</i>	28	3159	889
<i>B. brizantha</i>	23	4511	1057

試験では25kg / haのPを施用。  
(P施用効率) = (P吸収効率 / 100) × (吸収Pの利用効率)

草であることが示された。一方、吸収したPの利用効率（吸収したP 1g当たりの乾物生産量）をみるとBBがBDよりも高く、BBはBDよりも吸い取ったPをより効率的に利用する草であることが示された。そして、P吸収効率と吸収Pの利用効率の積であるP施用効率はBBの方が高かった。以上のように農牧輪換システムにおいて作物へ施用された肥料の残肥効果を期待する場合には、BDよりもBBの方が適していることが生理、生態的な側面から明らかとなった。

一方、農牧輪換システムのもう一つの目的である作物の連作障害回避のためには、牧草が後作の土壤へ十分な有機物を供給することが不可欠となる。そこで、有機物供給能力を評価するために*Brachiaria decumbens*、*Brachiaria brizantha*及び*Panicum maximum*の地下部バイオマスと比較した。その結果、BBは地下部バイオマスが大きく、かつより深くまで分布しており、有機物供給能力という観点からも農牧輪換システムにはBBが適していることが明らかとなった。

## 2 農牧輪換システムに適した草地管理法の確立

慣行無施肥栽培下の*Brachiaria*草地への施肥やマメ科牧草の導入効果を検討するとともに、それらの*Brachiaria*草地と穀類栽培後の*Panicum maximum*草地の生産力を比較する調査を開始した（写真1）。それらの調査結果をもとに、農牧輪換システムに適した草地管理法を明らかにする予定である。



写真1 : *Brachiaria decumbens* 草地における放牧試験。ケージ内外差法により乾物生産速度及び採食量を測定している。

プロジェクト研究

# 塩類集積の予測手法の開発

生産利用部 凌 祥之

## 1. 研究の背景

世界の灌漑農地の約24%において塩類集積で収量低下が起きていると報告されている。塩類集積は乾燥・半乾燥地で顕著な問題であり、不適切な水管理によって引き起こされた事例も多い。これらの地域では一般に生産性が低く貧困が深刻であり、持続的な生産性の向上が重要である。このように塩類集積地の改良は、事業投資の効率化の点からだけでなく人道的な見地からも重要な問題である。

本研究は農水省のプロジェクト研究「農林水産業及び農林水産貿易と環境・資源に関する総合研究」の一環として半乾燥地の塩類集積を予測する手法を策定する事を目的としている。

## 2. 研究目的

塩類集積は工学的な要因だけでなく自然科学的、営農的、組織的な要因からも引き起こされる複雑な問題である。一般に、塩類集積のメカニズムは灌漑水に含まれている塩分または本来土層に含まれている塩分が地下水位の増加に伴って毛管上昇し、土壌面蒸発によって塩類のみ地表に集積するものとされている。工学的には排水が最も効果的な改良手法と言われている。しかし、塩類集積が顕著なところ

では一般的に地表勾配が小さく、排水の勾配も充分に取れないために自然排水は難しく、また粘土質土壌で排水不良になりやすい。

また、塩類集積は地域性が高く、海水の遡上、海風による塩分輸送によっても現象が深刻化する場合もあり、これらの機構は複雑である。地域差がある塩類集積の主要因を特定する事は改良対策を特定するために重要である。

## 3. 研究手法

そこで塩類集積を引き起こす主要因を抽出することとした。対象とした地区はPakistan南部Chishtianである。当該地区の面積は67,000haであり、主要農産物は小麦と綿花である。当該地の平均年間降水量は260mm程度であり可能蒸発量は2,400mmを超える乾燥気候である。当該地で水文、気象、水管理などのデータ及び営農、作付け体系などのデータを収集した。これらのデータを元に統計解析手法を用いて塩類集積を引き起こす主要因を抽出し、最終的に当該地区の予測モデルを策定するものである。

これらの手法は当地のみならず塩類集積を被る他の地区に適用する事が可能であり、塩類集積地の予測が可能となる。



図1：研究対象地区

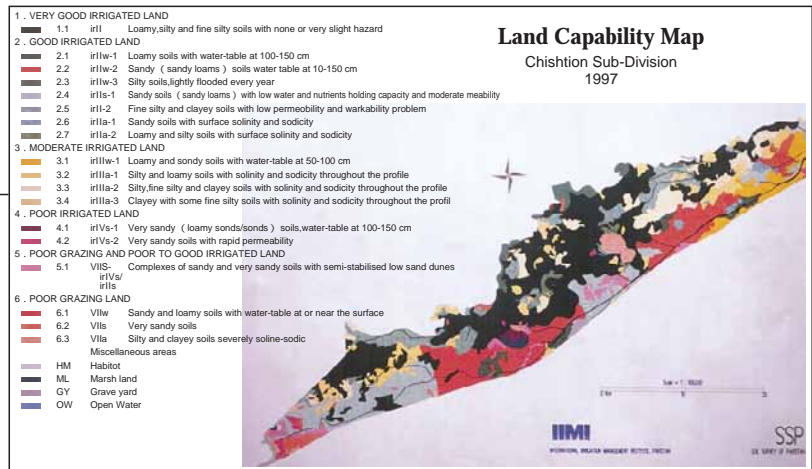


図3：土地利用図 (Land Capability Map)



図2：地表に塩類が集積している研究圃場

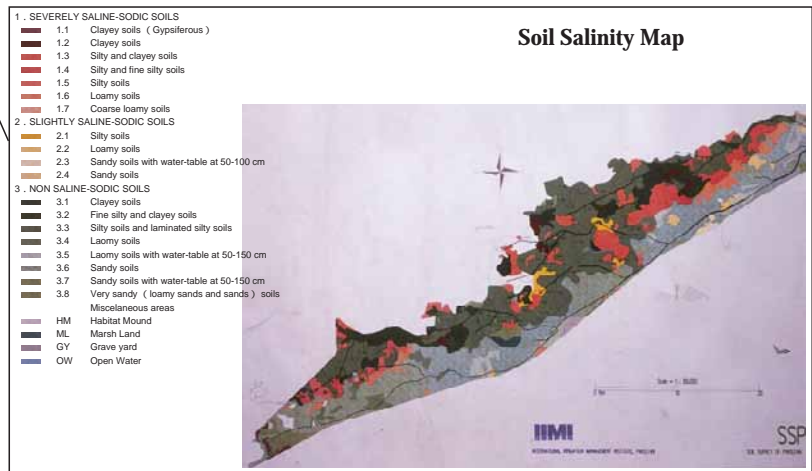


図4：土壌図 (Soil Salinity Map)



## 招へい研究

## イネ病害に関する共同研究（メコンデルタプロジェクト）

生産利用部 野田孝人

## カウンターパート招聘

ベトナムで共同研究を実施しているクーロンデルタ稲研究所（CLRRI）から2名のカウンターパートを招聘し、JIRCASで約2ヶ月半、イネ病害に関する共同研究を行った。来日したMr.Hoang Dinh DinhとMr.Lai Van Eの2名は、CLRRIの植物保護部に在籍しており、それぞれ現地におけるイネの主要病害であるいもち病と白葉枯病を中心に研究している。そこで、



隔離温室でのベトナム産いもち病菌の病原性検定  
(左からMr.Hoang Dinh Dinh、Mr.Lai Van E、筆者)

この機会にメコンデルタの稲作とイネ病害に関する共同研究についてその一端をご紹介します。

## メコンデルタの稲作

メコンデルタ農業の基幹作物は何と言っても稲であり、300万トンを超えるベトナムの米輸出量の大部分がメコンデルタで生産されたものである。米生産量がこのように増大した主な理由として、運河網の整備によって耕作面積が拡大したことに加えて、栽培品種が在来品種から国際稲研究所などから導入した新品種へ移行したことがあげられる。

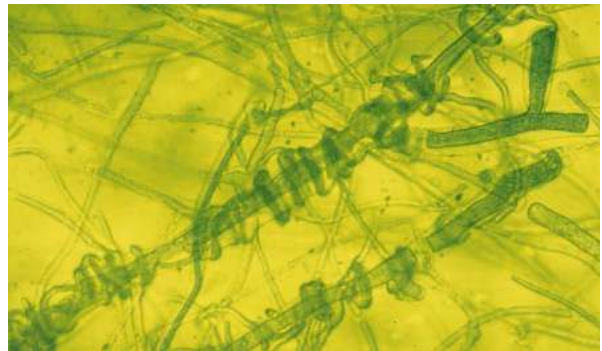


メコンデルタで多発している病原不明の赤条斑病の初期病徴

しかし、一方で新品種の普及はベトナムに分布する病原菌に対する抵抗性検定が十分でなかったこと、短幹で倒伏の心配がないため肥料を多投したこと、作期の短縮で年3作の周年栽培が可能になったこと、高密度直播が普及したこと、などによって病害の発生を増大させる結果になってしまった。

## イネ病害防除に関する共同研究

病害防除を行うための最善の方法は、抵抗性品種の育成・普及である。この方法は、極めて効果的、経済的、省力的、環境への影響がない等、究極の防除技術とすることができる。ただ、これには病原菌と品種との相互関係を解析して、現地に適合した抵抗性遺伝子を解明する研究が不可欠である。



紋枯病菌にコイル状に巻き付き、その成長を阻害するトリコデルマ菌の一種（メコンデルタの土壌から分離）

そこで、共同研究でメコンデルタに分布するいもち病菌と白葉枯病菌の各種イネ品種に対する病原性特性を詳細に検討した結果、それぞれに有効な抵抗性遺伝子を明らかにすることができた。今後、それらの抵抗性遺伝子を栽培品種へ導入して、普及に移すことが急務となっている。

## 若手研究者の招聘

今回、招聘した2名は正規のカウンターパートではなく、実際に私の研究助手として田圃を駆け回ってくれた若手研究員である。彼らの献身的な助力に対するお礼でもあり、今後のベトナムの発展を支える彼らに、設備の整ったJIRCASで新しい研究手法や考え方を学んで貰いたかったからでもある。現地の厳しい研究環境の中で、彼らが帰国してすぐに活用できる事は少なかつたかも知れないが、今回の招聘が若い彼らの貴重な経験として将来に役立つことを大いに期待している。



JIRCASニュース No.16

編集・発行 国際農林水産業研究センター  
1998年10月 発行

〒305-8686 つくば市大わし1 2

TEL. 0298(38)6340(情報資料課)

FAX. 0298(38)6656

インターネット・アドレス <http://ss.jircas.affrc.go.jp/>

# JIRCASfjf...[fX No.17 1998

JAPAN INTERNATIONAL RESEARCH CENTER FOR AGRICULTURAL SCIENCES



▶ @-0%eP,Á-à,ì'E•,δ,.,é•—«'B(•Û%cašCSŸ.σ'a••@f_fifl,É,Ä•AšCSŌ•i•ñ'•@•,-Ø—mŽqŽB%ce)

## -Ú •@•@ ŽŸ

•@Š^{ak}CE¼

•@

•@JIRCAS,¾,©,ç,Á,«,é

•@Š,ì“@,«

•E;|CEãJIRCAS,%cÊ,½,·,x,«-ðŠ,..ÆŽd'g,Ý,Í•H

•@

•@•@•½•-10"N"x•uJIRCASCEÚ-â%ci<c•v•AŠJ•Ä,³,ê,é

•EJIRCAS/IPGRI<•Äf••[fNfvf‡fbfvŠJ•Ä,³,ê,é

•@•u”M’Ñ•A•““â“Ž‘CE¹,ì’’á%o•Û‘¶\CEα<†,Æ%ož—p\•v

•@fvf•fwfFfNfg

•@

•¼fAftfŠfJ,É,“,“,é<σ“CEα<†,“Žn,Û,é•“iŽiŠÔCEðŽGŽi,ÌŠ^—p,ÉŠÖ,.,éCEα<†<†—Í\

•@CEα<†•-%cÊ

•@

”_k'n,©,ç,ìêŽ_%o»’,f,ìú•o,Í•§CEä,Á,«,é,©•H

∧“y•ë•ì’â<CSŌ,ìfK,fXCEðŠ•«<TM-@ •\

•@••Û•σ“CEα<†

•@

’W•...>,©,ç,.,è•g,ð•ì,é



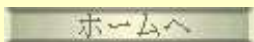
ŒD...^æ, Ì•¶-½, ðŽx, l, é•X—Ñ, Ì-ðŠ,,  
^f}fŒfCfVfA•Ef}f^f“ŒD...^æ, É, “, -, éf}f“fOf••[fu—Ñ, ÌŒœ<†^

•@

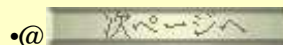
;-â, ç•†, í, l•æ •F••Ū”_—Ñ•...ŽY<ŒŒœ<†fZf“f^•[•@Šé%œæ’2•®•”•@•î•ñŽ‘—; %œŪ

TEL : 0298-38-6340•@FAX : 0298-38-6656•@E-mail: ref@jircas.affrc.go.jp

•§305-8686•@~i•éŒ§, Â, -, ÌŽs‘â, í, µ, P, l, Q



•@



•@



JIRCAS 3, 4, 5, 6



1998-17-1

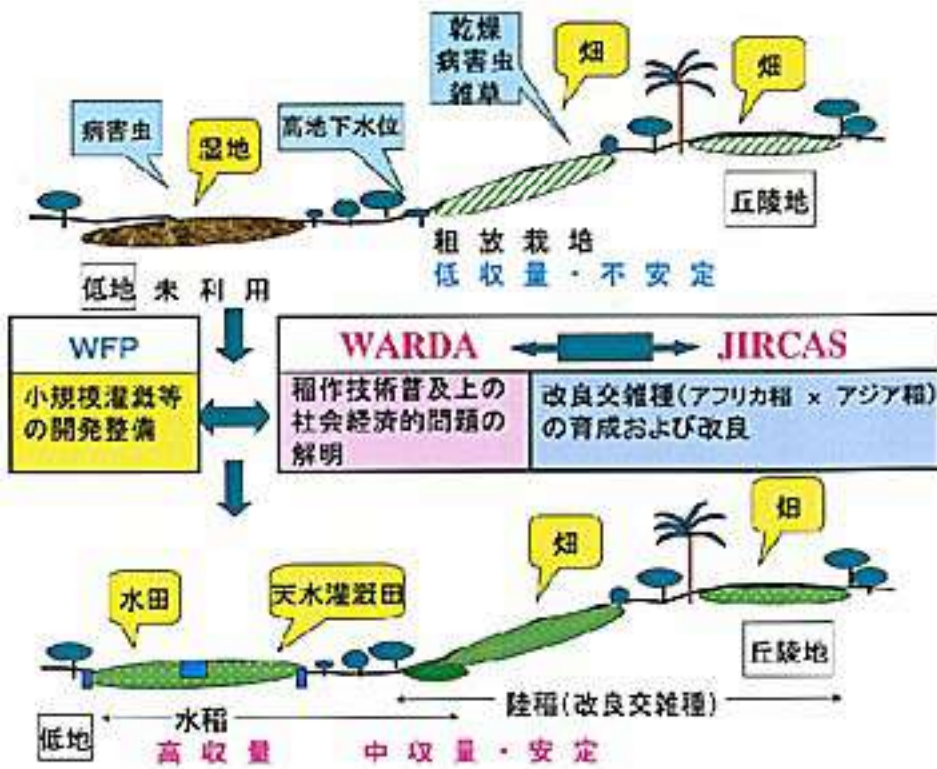
Main body of the page containing text, likely a news article or report, which is mostly illegible due to the image quality.











研究の背景

研究の内容

期待される成果



写真1. コンチナムの低湿地における水田風景(象牙海岸共和国)



写真2. WARDAで育成された  
種間雑種の有望系統

•¼fAftfŠfJ,É,“,̄,éJIRCAS,Ìæ“CEæ<†fvf•fWfFfNfg

•@

æ“CEæ<†, @ŠÖ	•Š•Ý’n	ŽÀŽ{ ŠúŠÖ	’Šú’h CE-ŽÖ•”	CEæ•@<†•@“à•@—e
••Ū%Æ’(CEæ<†•Š (ILRI)	fPjffA fifCf•fr	1980 • CE»•Ý	,X-¼	f g f Š f p f m f ] • [ f } i • R • « • , Ì ç • - , Ì , ½ , B , Ì Š i • b “ Á • « , Ì C E Ý ’ è f s f • f v f % o f Y f } • a , Ì f • f N f f “ Š J ” - , É Š Ö , , é C E æ < †
••Ū”M•Ñ”_<ÆCEæ<†•Š (IITA)	fifCfWfFfŠfA fJ fm	1990 • 1995	,Q-¼	•¼fAftfŠfJ”¼Š&“†’n,É,“,̄,éf}f•%ÈVigna‘@•A•”,ÌŠ&“†“K%ž•«CEü•ã
••Ū•©’Ž•¶—•¶ŌšwfZf“f^•[ (ICIPE)	fPjffA fifCf•fr	1994 • CE»•Ý	,Q-¼	-k,“,æ,Ñ“CEfAftfŠfJ,É,“,̄,éfofbf^—P,Ì•¶•†—•“İŠQ’ŽŠÇ—•-@,ÌŠJ”-

•@



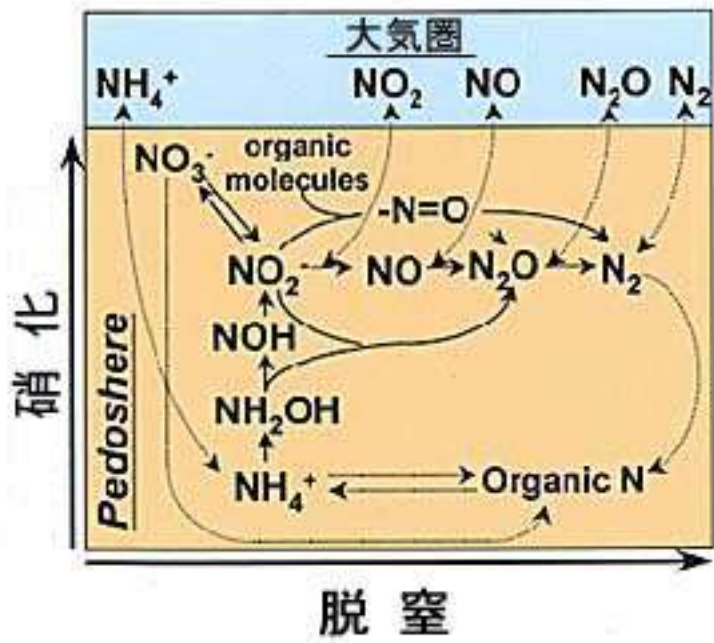


図1. 土壤圏－大気圏間の窒素動態

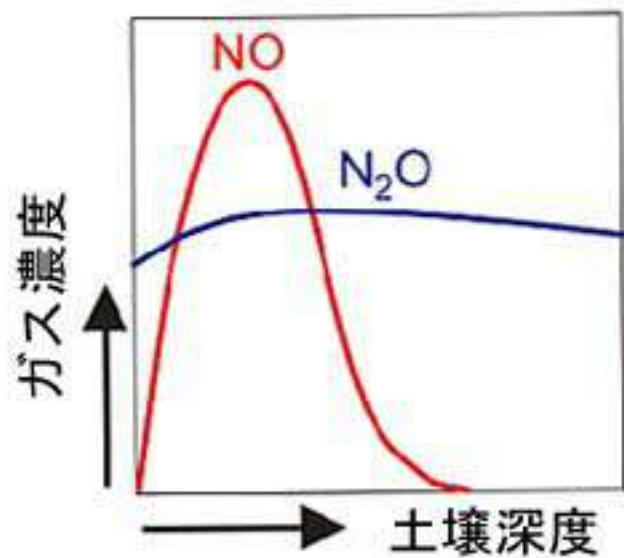


図2. NOおよびN₂Oの土壌中濃度プロファイルの特徴

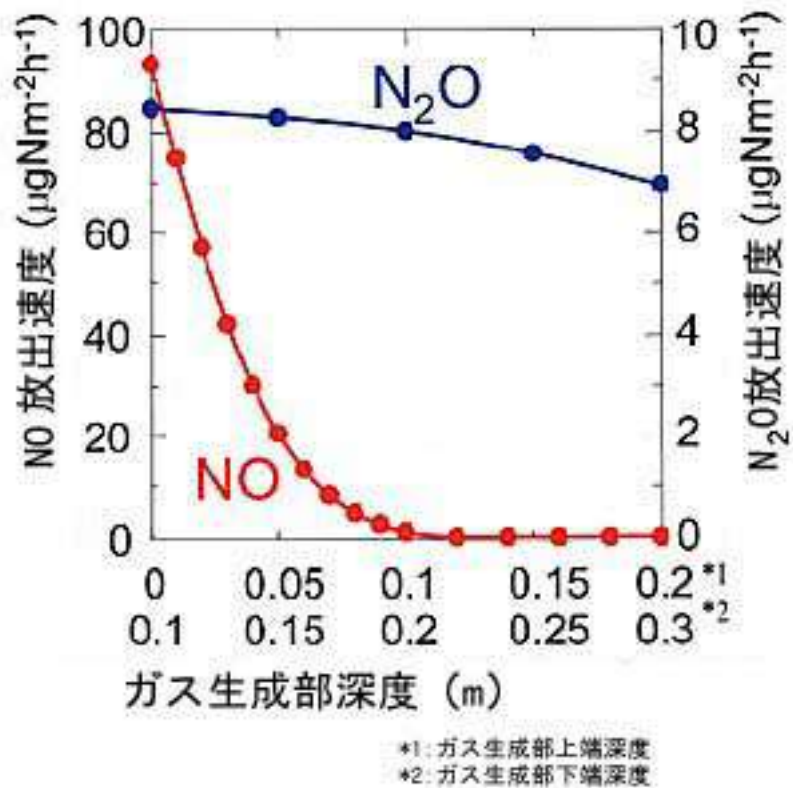


図3. ガス放出速度に及ぼす土壤中ガス生成部深度の影響(シミュレーションによる推定)



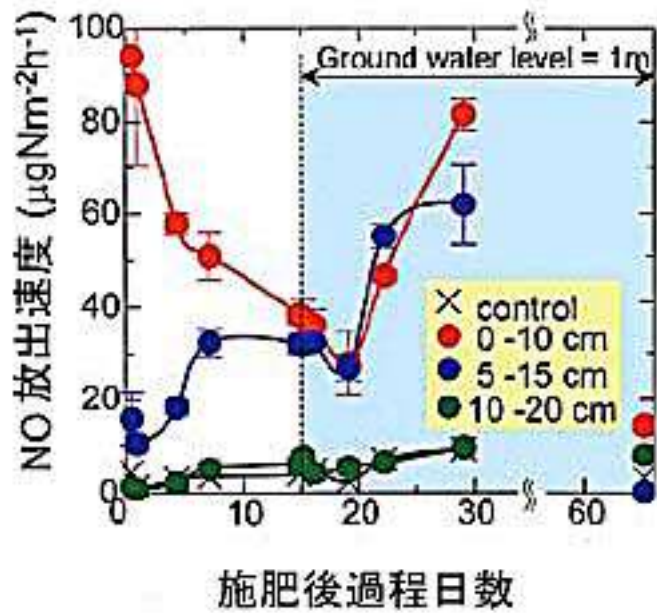


図4. NOの放出速度に及ぼす施肥深度の影響(室内実験の結果)  
● 施肥域深度0-10cm; ● 5-15cm;  
● 10-20cm; × 無施肥区

.....

.....



### 研究組織

### 支援組織

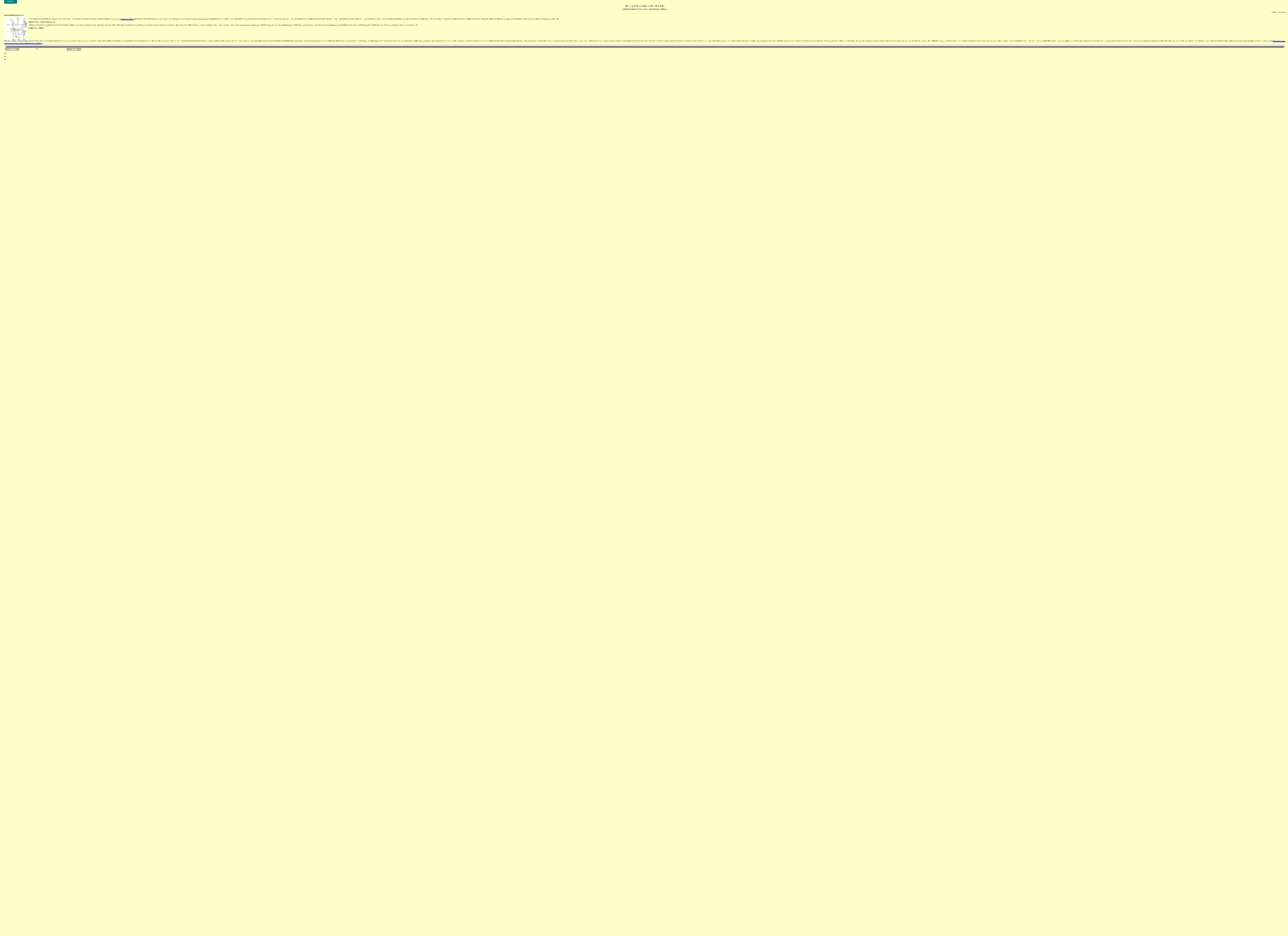
JIRCAS長期派遣研究員  
(カウンターパート)  
助教授1名、助手1名



(中日合作研究調協組)  
組長 大学学長  
副組長 相長 大学事務長、  
食品学部長  
免税事務担当者など他4名



大学院生2名  
4年目学生7名







# JIRCAS ニュース

JAPAN INTERNATIONAL RESEARCH CENTER FOR AGRICULTURAL SCIENCES

## 目 次

- ・ JIRCASだからできる .....2
- ・ 今後JIRCASが果たすべき役割と仕組みは？ .....3  
平成10年度「JIRCAS顧問会議」、開催される
- ・ JIRCAS / IPGRI共催ワークショップ開催される .....3  
「熱帯植物遺伝資源の超低温保存 研究と応用」
- ・ 西アフリカにおける共同研究が始まる 稲種間交雑種の活用に関する研究協力 .....4・5
- ・ 農耕地からの一酸化窒素の放出は制御できるか？ 土壌 大気間のガス交換制御法 .....6
- ・ 淡水魚からすり身を作る .....7
- ・ 汽水域の生命を支える森林の役割  
マレーシア・マタン汽水域におけるマングローブ林の研究 .....8



木臼で籾の脱穀をする女性達(象牙海岸共和国 ダナネにて 海外情報部 高木洋子撮影 本文4~5頁に関連記事)

No. **17** 1998

農林水産省  
国際農林水産業研究センター

## JIRCASだからできる



生物資源部長 星野次汪

ある予測では2050年に世界人口が100億人に達するという。そのためには、今の2倍の食料を確保しなければならない。各機関のシミュレーションでは、耕地の拡大はわずかしかなかった。単収の増加や不良耕地への作付け可能な品種開発に大きな期待が寄せられている。まさに生物資源研究の成果が待たれる。

### 1. 遺伝資源は今

かつて遺伝資源は、先進諸国の研究者が研究目的で滅び行く種の保存と未来の有効利用を意識しながら保存してきた。スローガン「遺伝資源は人類のために」は輝いていた。いつしか、巨大種子企業によって「種子を征する者は世界を征する」に変えられ、「遺伝資源 = 保有国の資（金）源」になってしまった。相手国の品種開発に利用する遺伝資源利用ですら思うに任せないこともある。JIRCASでさえ遺伝資源の収集・利用が困難になりつつある。

### 2. 玉を探し、玉を活かす

生物資源には直接利用可能な資源が多もあるが、遺伝資源は玉石混合である。いずれの資源も、玉石の中から目的に合った玉の資源を先端技術などを駆使して効率よく探し出し、時には原石を光輝く石に磨き上げなければならない。そして、その玉や石が多収を前提とした耐病虫性、障害抵抗性、機能性などの付加価値を付けた品種開発の素材となって初めて活きた資源となる。JIRCASには遺伝資源利用による具体的成果があるが、なお一層の地道な積み重ねが必要である。そうすれば遺伝資源保有国の理解が得られ、遺伝資源鎖国が開国へと向かうのではないかと。

### 3. 共同研究はお互いプラスに

JIRCASでは相手国に研究者を派遣し、時には招聘し、共同研究を展開している。最近は、「バイオ研究」に対する要望が強い。なかにはJIRCASでは手に余るような規模・研究水準の共同研究を提案してくることさえある。しかし、相手国には国の基幹産業としての農業があり、研究成果を待っている広大な現場あり、一所懸命な農民がいる。これらの現実を直視すれば、JIRCASの生物資源研究の方向は自ずと明らかになる。徹底した現場ニーズの把握と研究者の興味が前提となるが、「研究テーマは現場から」を心に刻み、手法開発や品種開発などを通して相手国に貢献する。と同時に、次期プロジェクトのシーズ醸成をも意識しながら、国際的な評価に耐えるような世界的水準の研究者を目指す。相手国研究者と二人三脚で基礎と応用、実験室と現場とを両立させることは、お互いにとって大きな財産となる。

### 4. 人口100億人時代に備えて

JIRCASでは開発途上国を中心に、イネ、コムギ、豆類などの品種開発や手法開発研究で大きな成果を上げ、信頼も得てきた。それなりに人的ネットワークができていく。情報も集まってくる。従来の延長線上では解決が困難な単収の飛躍的増加や不良耕地への作付け可能品種の開発が急がれる今、発想や手法で常識への挑戦が必要になってくる。これまでの成果と実績に最新の情報を加え、JIRCASだからできる研究分野「遺伝資源から生物資源、そして品種開発」を成功させ、すべての人々が心から豊作を祝い、満腹感に酔える喜びに貢献したい。



## 所の動き

## 今後JIRCASが果たすべき役割と仕組みは？ 平成10年度「JIRCAS顧問会議」、開催される

科学技術の振興にとって研究評価は非常に大切であり、技術開発研究への理解を国民と共有することが重要になっています。JIRCASでは、外部評価者（顧問）に、研究を進める基本的な方針や研究所の運営に対する助言を頂くため、毎年「顧問会議」を開催しています。

研究対象が途上国との共同研究であり、扱う問題も農・林・畜・水と広範なので、広く教育・研究、行政、国際協力、マスコミ、海外など様々な分野の著名な方々に顧問をお願いし、今年は、11月18日に、「今後JIRCASが果たすべき役割と仕組み」というテーマでご意見を伺いました。

現在JIRCASは、7つの機能で活動していますが、その具体的な内容を先ず紹介しました。活動の中心は、研究者の派遣を中心とした途上国との国際共同研究の推進です。それを支える、国内研究があり、海外から研究者を招いて行う招聘共同研究があります。また、これらの研究に役立てる、情報の収集・分析

と広報活動があり、シンポジウム・ワークショップ等の開催があります。さらに最近では、途上国技術援助等への支援にも参画し、シンクタンク機能の充実に努めています。

これらの活動を踏まえ、JIRCASは、得意な分野で重点的に共同研究を行い、農業生産だけでなく、6次産業的な発想で貧困の解決へ向けて取り組むことが重要であること、総合プロジェクトは良いが、必要以上に数を多くせず質を高めること、アフリカでは、地域を広く捉えて研究環境の整った拠点で共同研究を進めること、地域別に研究の重点化を図り、情報の収集・分析を深化させること、環境、バイオテック、遺伝資源、食料需給などのグローバルな問題への対応の仕方を考えること、途上国の研究者を活用し、第3国を含めた共同研究を推進することなど、新しい仕組みや、取組みを考える上で貴重なご意見をたくさん頂きました。（企画調整部長 石谷孝佑）

## JIRCAS / IPGRI共催 国際ワークショップ開催される 「熱帯植物遺伝資源の超低温保存 - 研究と応用 - 」

栄養繁殖性および難貯蔵性種子を持つ種の遺伝資源は従来圃場で保存されているが、自然災害や病害虫による消失の危険に加えて、その管理に莫大な労力と時間がかかることが問題となっている。省力的で安全な長期保存法の開発および実用化は遺伝資源活動のうちでも最優先分野とされている。植物遺伝資源の長期保存法として最も有望な超低温保存法（液体窒素中で細胞や組織を保存する）の研究は近年急速に発展し、保存できる植物種の数が増加してきたが、熱帯作物については、成功例も限られており、実用化に向けた開発研究の促進が強く望まれている。

上記の背景のもと、JIRCASでは国際招聘研究の一環として、栄養繁殖性熱帯作物の超低温保存の研究プロジェクトを進め、タロ・ヤム・バナナ等の超低温保

存法を確立した。今回のワークショップはJIRCASにおける研究成果を発表するとともに、熱帯性植物遺伝資源の長期保存研究の現状・問題点・実用化への展望を、内外の研究者が一同に会して討議することを目的に、10月20日～23日にJIRCAS国際会議室において開催された。熱帯地域の国々でも超低温保存への関心が高まり本格的な研究が始められつつあることから、国際農業研究機関（IPGRI, CIAT, CIP, IITA, INIBAP）の遺伝資源関係者をはじめ、29カ国から約100名の研究者が参加し、盛会なものとなった。会議では熱帯植物遺伝資源の超低温保存に関する研究の現状が報告され、今後研究が必要とされる分野、遺伝子銀行が超低温保存の導入に際して検討しなければならない問題点などについて活発な討議が展開された。

（海外情報部 国際情報研究官 高木洋子）

# プロジェクト 西アフリカにおける共同研究が始まる

## - 稲種間交雑種の活用に関する研究協力 -

海外情報部 国際研究情報官 高木洋子

### アフリカにおけるJIRCASの共同研究

アフリカは人口増加、砂漠化、環境劣化、および都市への人口集中等によって引き起こされる食料不足や貧困の問題がもっとも集約的にあらわれている地域であるといわれてきた。この地域における食料・農業問題の解決は、人類が21世紀に向けて取り組んでいかなければならない最重要課題のひとつとされている。

JIRCASのアフリカでの経験は、アジアでの活動に比べると、その規模や対象としている分野がかなり限られおり、表1に示す3つのプロジェクトが個別研究協力の形で進められてきたにすぎない。年々増えるアフリカからの研究支援の要請に応えるためには、アフリカの食料・農業問題に積極的に取り組み、より広い展望を持って組織としての経験を積み上げていくことが必要であるとの認識が、近年、JIRCAS内で強まってきた。平成9年度には、外部の有識者を交えた「アフリカ研究会」が開催され、基本的食料の増産につながる共同研究としてJIRCASが取り組むべき課題の検討がなされた。アフリカという「多様性」と「可能性」に富む地域への協力のあり方には、様々な方向性が示され討議も活発に行われたが、近年、アフリカにおける米の需要が急速に伸びていること、日本において研究・技術の蓄積が顕著であることから、「イネ」に関わる研究協力がアフリカにおける総合研究の第一歩として妥当であるとの結論に達した。

このような経緯を経て、西アフリカ稲開発協会（West Africa Rice Development Association: WARDA）との共同研究プロジェクト、「西アフリカ

における米増産のための稲種間交雑種の活用に関する研究」が平成10年4月に5年間のプロジェクトとして開始された。総合プロジェクトとはいえ、長期派遣研究員の数が僅か2名と小さく、将来的に総合化を目指すというのが実体であるが、WARDAとのMOUも締結され、第一歩がふみだされたので以下にその概要を紹介する。

### 西アフリカにおける米の需要

アフリカにおける主な稲作適地はギニア湾沿岸の湿潤及び半湿潤地帯であり、稲収穫面積の6割以上、約412万ヘクタールが西アフリカにある。西アフリカ地域では都市部に人口が集中するにつれ、従来のモロコシ・キビ・キャッサバ・ヤムといった伝統的作物に比べて、トウモロコシ・コメといった作物の需要が増加している。

特にコメの消費量は、生産量の伸びを大きく超えてこの30年間で3倍に増加し、輸入量が急増している。1970年代はじめには年間約60万トンであった輸入量が、90年代初めにおいて約280万トンにも達し、FAOの予測によれば、2000年には400万トン、800億USドルに及ぶという。コメの生産力向上および自給の達成は、西アフリカ諸国にとって極めて重要な課題となっているのである。

### WARDAの活動と種間交雑種の育成プロジェクト

WARDAはアフリカにおける米の需要が増大し始めた1970年代初頭に、稲作地帯を形成する西アフリカ諸国が相集い、FAOなどの支援を受けて、リベリアに設立された。設立当初は、栽培及び病害虫防除の技術開発や貯蔵・流通組織の改善を主たる活動としていたが、米の需要が増えるにつれ、地域のための品種育成や栽培法の研究に取り組む組織へと変化していった。1986年には、国際農業研究協議グループ（CGIAR）の傘下に入り、1988年にはその本部を象牙海岸共和国のボアケ市に移した。

WARDAは、国際研究機関であるが、西アフリカ地域の稲作を主な研究対象にしており、地域研究機関的な色彩が濃い。現在、WARDAには西アフリカ17カ国がメンバー国として加盟しており、各国の研究組織はWARDAと強い連携を保ちながら研究や技術移転を行っている。

WARDAは設立当初からアフリカの環境に適



図1 . JIRCAS西アフリカ稲作プロジェクトの概念図

研究の背景  
研究の内容  
期待される成果



写真1. コンチナムの低湿地における水田風景（象牙海岸共和国）

したイネの育種に精力的に取り組んでおり、とくに *Oryza glaberrima* Steud.（アフリカイネ）と *Oryza sativa* L.（アジアイネ）の雑種の利用に力をいれてきた。アフリカイネはニジェール川の内陸デルタ地域で栽培化されたと考えられており、この地域独特の生態・栽培環境に適応した系統を発達させ、いもち病、イネ黄斑ウイルス（RYMV）、タマバエ、メイ虫等の病虫害抵抗性や畑状態で問題となる雑草に対する競争力に優れた系統が多くある。また、コンチナムと呼ばれるこの地域独特な地形（丘陵から低湿地までなだらかな傾斜が繰り返し連なる）に見られる多様な土壌水分条件（畑状態 - 高地下水畑状態 - 湿润状態 - 湛水状態）（写真1）のそれぞれに適応した系統の分化も注目される。しかし一方で、アフリカイネは、易脱粒性、強い休眠性、易倒伏性などのため栽培しにくく、穂に2次枝梗がないため1穂あたりの粒数が少なく、潜在収量が低いという問題がある。

WARDAが目指したアジアイネの多収性と、アフリカイネの病虫害や不良環境に対する抵抗性を利用した品種改良の第一段階は、交雑率の低さや種間雑種F1の不稔性を克服することから始められた。胚培養・薬培養の利用や交配系統の組み合わせの検討により、効率良く雑種が作出されるようになった。種間雑種の特性については様々な観点からの調査・研究が進められているが、現在までの報告によると、アジアイネとアフリカイネの形質を併せ持った有望系統が作出され、農家圃場で試作されはじめている。（写真2）

#### 共同研究の方向性

WARDAの研究成果は、西アフリカ地域の環境や農業体系に適応したイネ品種の開発に新しい方向と可能性を示すものである。1997年1月からは、日本国政

府および国連開発計画の資金供給、技術援助を得て、種間交雑育種の推進と利用を目的としたアフリカ・アジア共同研究事業が開始された。この事業には日本・アメリカ・フランス・中国の大学や研究所、国際イネ研究所、国際熱帯農業センターおよびWARDAの加盟国の研究組織が参画し、WARDAの企画調整のもと、種間雑種の特性評価、種間交雑法の改良、分子マーカーの開発、各種抵抗性の遺伝分析等の研究、有望系統の収量試験、農家圃場における適応性の評価に取り組んでいる。

JIRCASもWARDAの育種プログラムに研究員を派遣し、不良環境に対する抵抗性とくに耐乾性と耐酸性土壌性に関する検定法の確立及び育種素材の評価に協力する形で共同研究を始めた。また、来年度からは、農業経済の研究者も加わってこの地域の稲作技術普及における社会経済的問題の解析に着手する計画になっている。

西アフリカは日本にとって遠い存在であると言われてきたが、最近では国際研究機関への拠出、国際協力事業団プロジェクト、食料増産援助、農林水産省の総合支援対策事業〔国連世界食糧計画（WFP）にトラストファンドを出資し、象牙海岸共和国において小規模灌漑等の開発整備を行う〕等が西アフリカで推進されるようになった。これらの協力事業の多くが、東南アジアからの大量輸入米に依存せざるを得ない状況の改善に力を入れており、各事業が密接な連携を持ちながら、総合的に地域開発に貢献していくことができればその成果もあがると考えられる。図1に示したように、JIRCASの共同研究プロジェクトは新品種の育成と稲作技術普及の現状・問題点の解析を行い、その成果が“WFPによって整備された地域の稲作普及活動”に“WARDAを通して”活かされていくことを当面の目標としていきたい。



写真2. WARDAで育成された種間雑種の有望系統

表1. アフリカにおけるJIRCASの共同研究プロジェクト

共同研究機関	所在地	実施期間	長期派遣者数	研究内容
国際家畜研究所 (ILRI)	ケニア ナイロビ	1980～現在	9名	トリパノゾーマ抵抗性牛の育成のための基礎特性の検定 ピロプラズマ病のワクチン開発に関する研究
国際熱帯農業研究所 (IITA)	ナイジェリア カノ	1990～1995	2名	西アフリカ半乾燥地におけるマメ科 <i>Vigna</i> 属植物の乾燥 適応性向上
国際昆虫生理生態学センター (ICIPE)	ケニア ナイロビ	1994～現在	2名	北および東アフリカにおけるバッタ類の生合理的害虫管 理法の開発

研究成果

# 農耕地からの一酸化窒素の放出は制御できるか？ 土壌 大気間のガス交換制御法

環境資源部 宝川靖和

## はじめに

環境問題は物質循環の問題であり、来世紀はこの物質循環をいかに管理していくかが大きな課題となるであろう。環境中で物質はその形態を変化させつつ同時に移動する。例えば、窒素の土壌圏内における形態変化および大気圏との交換反応を簡単に示すと図1のようになる。この中で農耕地土壌から大気への放出が顕著であり、また環境に大きな影響を及ぼすものとして一酸化窒素 (NO) と亜酸化窒素 (N₂O) が挙げられる。NOは光化学大気汚染や酸性雨、

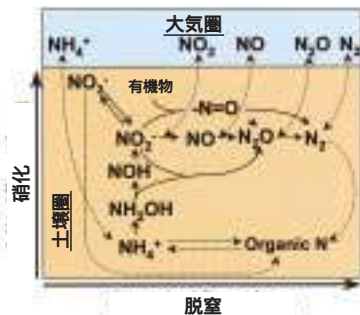


図1. 土壌圏 大気圏間の窒素動態

対流圏オゾン (温室効果ガス) の原因物質として、N₂Oは地球温暖化や成層圏オゾン層破壊の原因物質として知られている。これら窒素酸化物の動態を解明しその制御法を提案することが現在のトピックのひとつである。

## なぜNOとN₂Oで土壌中の濃度分布が異なるのか？

これまでに実測されてきたNOとN₂Oの土壌中での濃度分布は、面白いことに大体図2のような形を示す。この両者の違いは何を意味しているのであろうか？

## シミュレーション

これは土壌中での両者の消費速度の差異によるのではないのか？ NOはN₂Oに比較して土壌中での消費速度が高いために鋭い濃度ピークを持つのではないかとすれば、土壌中のNO生成部を土壌表面から遠ざけることでその大気への放出速度を削減できるのではないかと。このような推測が定性的に正しいかどうか、次の仮定の下に作成した数値解析モデルを用いて検証した。

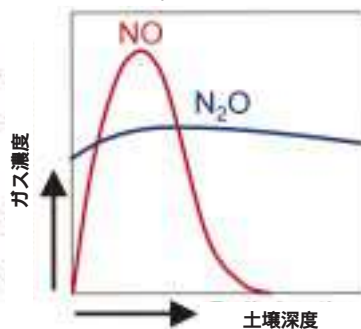


図2. NOおよびN₂Oの土壌中濃度プロファイルの特徴

- (1) ガスの生成速度は、施肥域 (土壌深度0-10cm) において一定であり、施肥域外で生成はない。
- (2) ガスの消費速度は、Michaelis-Menten式により表現可能であり、全土層において同一条件である。
- (3) 土壌中のガス移動は、Sallamら (1984) の提案したモデルによって表現可能である。

両ガスの生成・消費に関する未知の定数は、モデルによる計算結果が典型的な土壌中濃度分布の実測値と近似するよう設定した。この数値解析の結果、ガス生成域を土壌表

層から土壌深部へシフトすることで、NOの放出は図3のように削減可能であることが推定された。

## 室内実験

上記のシミュレーション結果はいくつかの仮定の下に自然現象を単純化して得られたものである。実際の土壌で同様のことが本当にいえるであろうか？ 高さ1m、内径約0.2mの土壌カラム (硫酸20gNm⁻²施肥) を用いて、NOの放出速度に及ぼす施肥深度の影響を検証した結果が図4である。NOの放出速度は、土壌環境の変化により変動するが、施肥深度の深層化に伴いNO放出速度は常時無施肥区と同程度の極めて低い値を維持した。

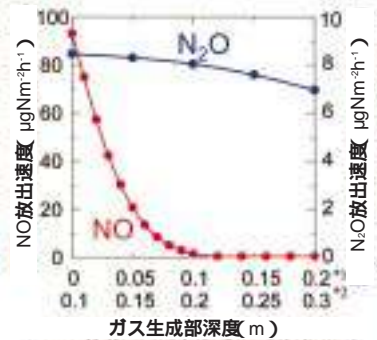


図3. ガス放出速度に及ぼす土壌中ガス生成部深度の影響 (シミュレーションによる推定)

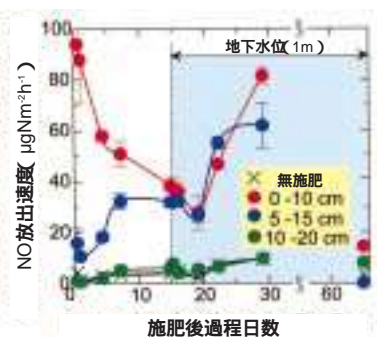


図4. NOの放出速度に及ぼす施肥深度の影響 (室内実験の結果)

## シンプルな技術・シンプルな社会

本研究は今後更なる検討が必要である。ガス生成・消費に及ぼす各土壌環境因子の影響を定量化していくことは重要であろう。また硝酸等による地下水汚染の影響も考慮する必要がある。

ただし今回の結果から少なくともいえることは、このような極めて簡単な方法によってNOの大気への放出をほぼバックグラウンドレベルにまで削減できたという事実である。

シンプルな技術はそれだけ現実性が高い。自然を上手に使ったシンプルな技術を用いて、物質循環そのものも、もっとシンプルで小さなスケールに立ち返らせる必要がある。我々の先達が限られた国土の中で実現していた効率的な物質循環のシステムは今の我々の生活からはほど遠いものとなってしまった。力でねじ伏せるようなシステムに変貌してしまった。こういった社会構造は長続きしない。現在の途上国において実用となるようなシンプルな技術こそが今後我々に必要とされるものではなからうか。環境問題を解く鍵はきっと我々の見落としてしまっている身近なものの中にあると思う。

## 国際共同研究

# 淡水魚からすり身を作る

水産部 福田 裕

### 【背景とねらい】

食料増産計画の中で、最も難しいのが動物タンパク質資源の拡大にあると言われている。

中国の淡水漁業資源は、1950年以前には100万トン以下であったが、市場経済制への転換後急速に増大し、1995年には1078万トン記録した。この量は世界の総漁獲量の約10%、中国の総漁獲量の約43%に相当する。20世紀の後半に新しい動物タンパク質資源が中国の淡水域に出現したと言うのは過言であろうか。ところが、淡水漁業資源の急増にもかかわらず、流通・貯蔵・加工に関する基盤整備が追いつかず、大半が活魚のまま流通されるため、貴重な動物タンパク質資源に量的質的な損失が顕在化して来た。こうした淡水漁業資源のポストハーベスト問題を改善するため上海水産大学と共同研究を1996年から開始し、1997年からは大型総合プロジェクト「中国における主要食料資源の持続的生産及び高度利用技術の開発」に参画し継続している。最初の研究目標として、淡水漁業資源の広域流通・長期安定貯蔵・多様な製品作りの三要素を同時に可能とする冷凍すり身型の中間原料素材の開発に着手した。

### 【研究の進捗状況】

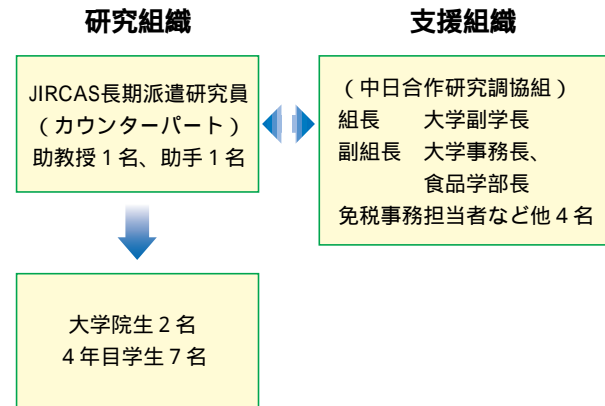
中国の主要な淡水魚類のすり身原料としての適性をスクリーニングした。ハクレンとコクレンは淡水漁獲量の40%以上を占める主要魚種であるが、味が劣るため消費者から次第に敬遠され、廉価である。しかし、そのゲル化特性は、世界のすり身原料の60%以上を占めている海産魚のスケトウダラと比較的似ており、実用性の高い中間原料素材として利用できる見通しを得た。次に、草魚はハクレン・コクレンに次ぎ約20%以上の漁獲量を占め、味もよく比較的人気の高い魚種である。そのゲル形成能力はハクレン・コクレンより劣るものの、広い加熱温度域でゲル化する特徴を有しており、加工しやすい中間原料素材として利用できる見通しを得た。

その他、タンパク質の架橋酵素、通電加熱法などを

利用したゲル形成能の向上技術の開発、および、タンパク質の利用効率を向上させるためのすり身の製造技術の改良に取り組み、成果を得ている。

### 【共同研究体制】

大学側と協議しながら試行錯誤を重ねて作り上げて



きた共同研究体制を図に示した。一つの重要なポイントは、研究に最も専心できる多くの学生と大学院生がこの共同研究に参加していることで、集中的に多くのテーマに挑戦できることにある。また、学生や大学院生の指導を通して大学へ貢献しており、協力を得るために大きな力となっている。もう一つは大学側の支援組織が出来たことにより、免税事務等の困難な問題に対しても組織的に対応していただいていることも重要と思われる。

### 【今後の研究戦略】

現在、日本型のすり身技術を中国の淡水魚肉へ応用する研究を展開しているが、この研究課題を成功させるには、魚肉の利用効率の改善、およびすり身を中国の消費者に受け入れてもらうための加工製品作りが必須である。その上に、常温流通できる中間原料素材の開発、さらに未・低利用部分の調味料、飼料等への転換によるゼロエミッションへの挑戦も課題である。



1. 先生、学生総出の魚体処理



2. 魚肉の水晒し



3. 魚肉の裏ごし



4. 冷凍変性防止剤を加えてハクレン冷凍すり身の完成

# 海外研究 汽水域の生命を支える森林の役割

## マレーシア・マタン汽水域におけるマングローブ林の研究

林業部 落合 幸仁

### 1. プロジェクトについて

半島マレーシアの西海岸にあるタイピンの近くのマタン汽水域では世界で唯一、マングローブ林の持続的な経営が行われている(図1)。熱帯・亜熱帯の潮間帯に棲息する植物の総称であるマングローブの中でもこの地方に多い*Rhizophora apiculata*が、植栽後30年で炭用に皆伐され、その後



図1. マタンの位置

後に次の伐採用に苗木が植栽される。このマタン汽水域を中心として、国際農林水産業研究センター(JIRCAS)は「熱帯・亜熱帯汽水域における生物生産機能の解明と持続的利用のための基準化」と題する総合プロジェクトを実施している。これには、日本側はJIRCASの水産部と林業部が中心となり、マレーシア側は水産研究所、マラヤ大学、森林研究所が参加している。ここでは、JIRCAS林業部の行っている研究を中心に述べることにする。

### 2. マタン汽水域のマングローブ林

熱帯雨林地域に属するマレーシアでは、一般的に森林の種多様性が非常に高い。つまり、森林の中を歩いても同じ種類の樹に会うことが極めて難しい。ところが、これに反してマングローブ林では、水位の高低によって同じ種が均一に分布することが多い。マタン汽水域においては、水位の高い方から、a) *Avicennia*や*Sonneratia*属の樹種が出現し、少し低くなるとb) *Rhizophora*属の樹種、そしてほとんど水のつかないところではc) *Bruguiera*属が主な種となる森林が多い。特に、a)の森林は海に近いだけ地盤がゆるく、体重が重いと歩くだけでも大変である(写真1)。

### 3. 研究内容の紹介

JIRCASの林業部では、上記の三つのタイプの森林にそれぞれ、リタートラップを置き、それぞれの森林から落ちてくる葉などの有機物(リターと言う)を回収している。このリターがマングローブの他の多くの生物の命を支えているのである。おかげで調査中に、

エビ、カニ、カワウソやサルだけではなく、コブラやウミヘビの様にあまりお近づきになりたくないものにも間近で出会うことになる。リターの回収結果から、a) b)およびc)の1平方メートルに落ちた一年間の全部のリターは、それぞれ、1.6、1.5および0.7kgであった。b)とc)はほぼ同じで、a)はその約半分であった。b)とc)は林冠が閉鎖してa)に比べてマングローブの本数が多いせいと思われる。落ちたリターの量には違いがみられたが、三つのタイプの森林とも、全リターに占める葉の割合はほとんど同じで、約6割程度であった。このことから、どの森林においても葉が重要なリターの構成員であることがわかる。

陸上の森林では、リターのほとんどが森林内の微生物によって分解される。しかし、マングローブ林では、大潮のときに入ってくる水によって海に持ち去られる葉が多い。a)では、ほとんどの葉が常に持ち去られるし、b)では大潮のときは100%持ち去られているが小潮のときは数%にとどまっている。地盤高が一番高いc)は大潮、小潮に関わらずほとんど持ち去られることがない。このことから、森林のタイプによって持ち去られる葉の量が異なり、そのため水産物の生産に対する影響力も異なることが予想される。

マングローブの中を、足をとられながら歩いていると、そこにはごみ、買物袋、蛍光灯や電球といったありとあらゆる人間の捨てたゴミが落ちている。ゴミだけではなく、マングローブは土砂なども止める働きをしている。陸上の森林も同じ様な働きはしているが、特に、マングローブは他の生物の生命を支えているだけではなく、巨大なゴミ箱、優秀なダムでもある。このため、持続的な森林経営をして、マングローブを守ることが重要なのである。



写真1. *Avicennia* と *Sonneratia* 属の森林で記念撮影(真ん中が筆者)



JIRCASニュース No.17

編集・発行 国際農林水産業研究センター  
1998年12月 発行

〒305-8686 つくば市大わし1 2  
TEL. 0298(38)6340(情報資料課)  
FAX. 0298(38)6656  
インターネット・アドレス <http://ss.jircas.affrc.go.jp/>  
表紙の下地は岩石の表面分析写真

# JIRCA S fjf...[fX•@•@No.,P,O•@ 1997

## -Ú•@•@•@•@ ÿ

•E•@JIRCAS,ì-Ši“l••Ū%»

•E•@‘O-ì•Š’•ftfBfŠfsf“•Ef^fC,ð-K-â

•E•@•½•-W”N“x JIRCASŒÚ-â%ïcŠT—vñ••

•E fuf%•fWf’†“i”•,É,“,é••‡fvf•fWfFfNfg•u”_—q—ÖŠ•fvfXfef ŠJ”-•v

•E•@fuf^,“,æ,ÑfCfmfVfV,ìf~fgfRf“fhfŠfADNACE^%•đ•í,½,β,ìLA-PCR-@,ìŠm—§

•E•@•ö”-Æ“ñ Ÿ%—P,ì•¶•-•»”™%»-h ~,Ö,ì’š•í\

•E•@-h— {•Ý,É,æ,é”_<ÆŠÂ««,ì%ü—Ç•E•Ū’S



•@•@•@

- —â—ÁfXfefbfv’•Œ’,É•¶,«,é%œÆ°
- ifJfUftfXf^f“,ìŽñ“sfAf<f}fCf g•xŠO,É,Ä•A’{ŽY‘•’n”•@••i”Ž•¶•j





'O-i•Š'·ftfBfŠšfsf"•Ef^fC,ð-K-â

### 'O-i•S'·ftfBfSfsf"•Ef^fC,ð-K-â

•@1996"N,18EŽ.ÉJRCAS,1'ae2'a-U•Š',.É•A"C,μ,½'O-i+Š',.1•A•½+~8"N12EŽ15"ú,©,ç24"ú,É,©,,"•A•Š',.E,È,Á,Ä,©,ç•%e,ß,ÄftfBfŠšfsf"•Ef^fC,ð-K-â,μ,Û,μ,½•B

•@ftfBfŠšfsf"•y,Ñ•A^fC•,•E,1'•N•A•σ"•CEð†,ðs,Á,Ä,«,Ä,"•è"...ŽÄ,È•~%eÉ,ð,°,Á,«,Û,μ,½•B

•@"Á,É•A^fC,É,"•e,Ä,1•A•½+~7"N"x,©,ç,1'•CE-kf^fC,1'•,•EŠJ"•,ÉCEW,é•V,½,È•+•šCE^CEð†fvf•fWfFfNfg•uf^fC"•CE-k",É,"•,éŽ•±CE"•_•E-Z•p,1Šm—§,1,½,ß,1ŠJ"•CEð†+v,ðŠJžn,μ,Á,e,é'•A•...ŽY•+•i,1CEð†,É,à"...Že,μ,½,•E,±,é,Ä,•è•A,»,1•~%eÉ,É'á,«,ÉŠó'Ò,!,©,"•ç,é,Ä,e,Û,••B

•@ŽÉ••F••Û"•CEð†+Š•iRR1•j,É,Ä•A•fXf"•fWfFfNfg•uf^fC"•CE-k",É,"•,éŽ•±CE"•_•E-Z•p,1Šm—§,1,½,ß,1ŠJ"•CEð†+v,ðŠJžn,μ,Á,e,é'•A•...ŽY•+•i,1CEð†,É,à"...Že,μ,½,•E,±,é,Ä,•è•A,»,1•~%eÉ,É'á,«,ÉŠó'Ò,!,©,"•ç,é,Ä,e,Û,••B

•@ŽÉ••F••F•fC"•,•E,C(DOA),É,Ä•A•fXf"•fWfFfNfg•uf^fC"•CE-k",É,"•,éŽ•±CE"•_•E-Z•p,1Šm—§,1,½,ß,1ŠJ"•CEð†+v,ðŠJžn,μ,Á,e,é'•A•...ŽY•+•i,1CEð†,É,à"...Že,μ,½,•E,±,é,Ä,•è•A,»,1•~%eÉ,É'á,«,ÉŠó'Ò,!,©,"•ç,é,Ä,e,Û,••B

•@,±,1,æ,ð,É•ó•μ,1†•A•fBfŠšfsf"•,1••Û"•CEð†+Š•iRR1•j•A•fC"•,•E,Ç•iDOA•j,ðŽn,ßŠÓCEW19@ŠÓ,ð-K-â,μ•A,Û,½•A•fC"•,•E,Ç,1,ç—1,É,æ,ð%αŽ"ŽRŠx"n"æfvf•fWfFfNfg,1Ž.Ž@•™,ðs,e,Û,μ,½•B

•@•j%eñ,1-K-â,Á,1•A•V•Š',.E,μ,Ä•ACE•»Y•+s†,1σ"•CEð†,1i"•ó•μ•y,Ñ•A'•šú•E'Zšú,É"•h(E-μ,Á,e,éCEð†ð,1CEð†ŠÄ«•,1"•c"•,ðs,e,Û,μ,½•B•X,É•AJRCAS,••jCEä,•E,âfOf••[f•f•f•p•[f•g•f•i•[1,1"•è"•ö,•E,μ,Ä-ðŠ,,ð%eÉ,½,μ,Ä,e,"•é,æ,ð•A,»,é,¼,é,1CEð†@ŠÓ,É,1,μJRCAS,1CEð†+i—•AZ-•E"à—e,É,Á,e,Ä•à-¼,.,é,•E,•E,à,É•A'ÓCE@CEðŠ,ðs,e,Û,μ,½•B

•iŠCSOE=†CEB—%•È•@"•iŠK"•@•FŽqj





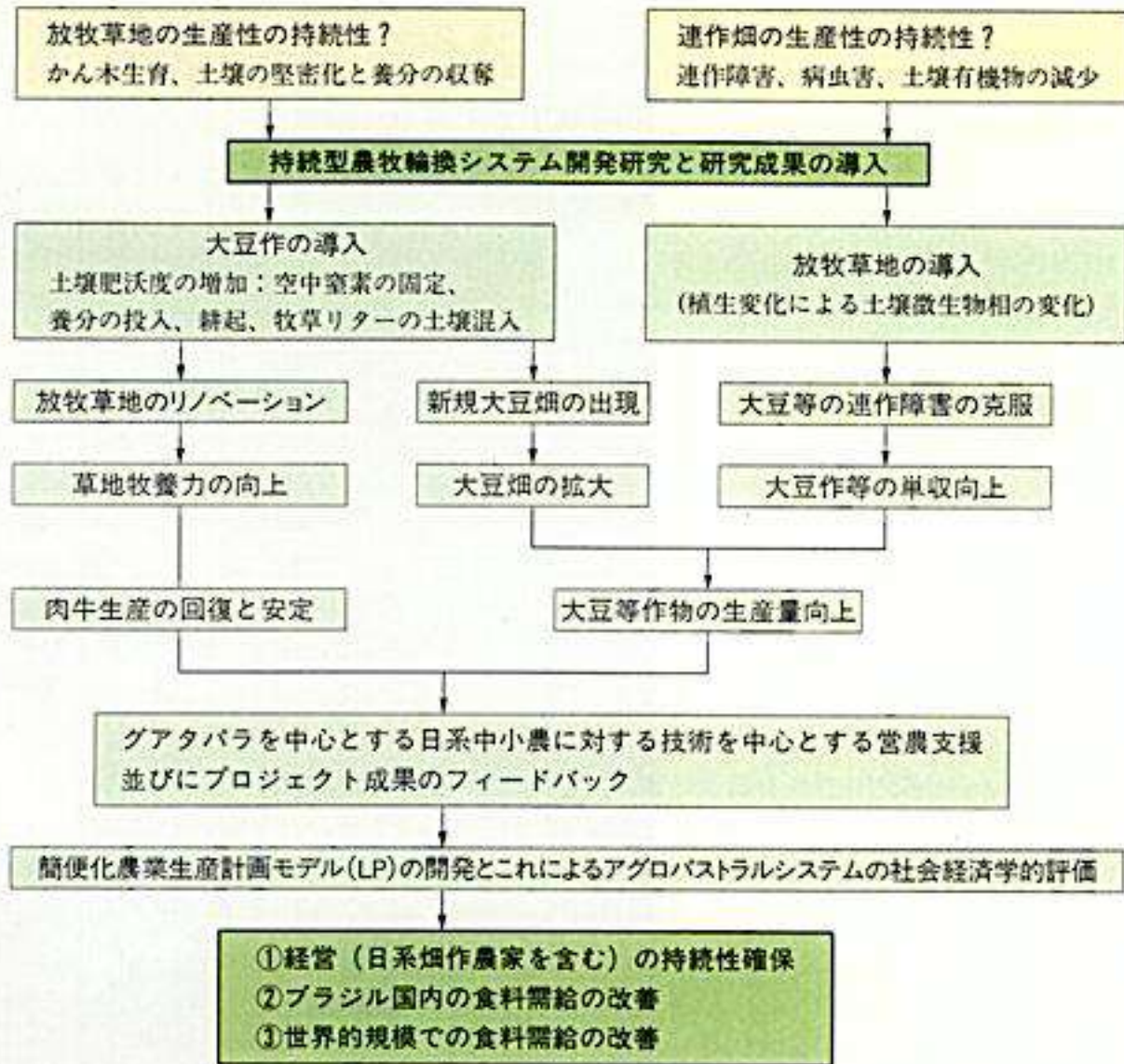






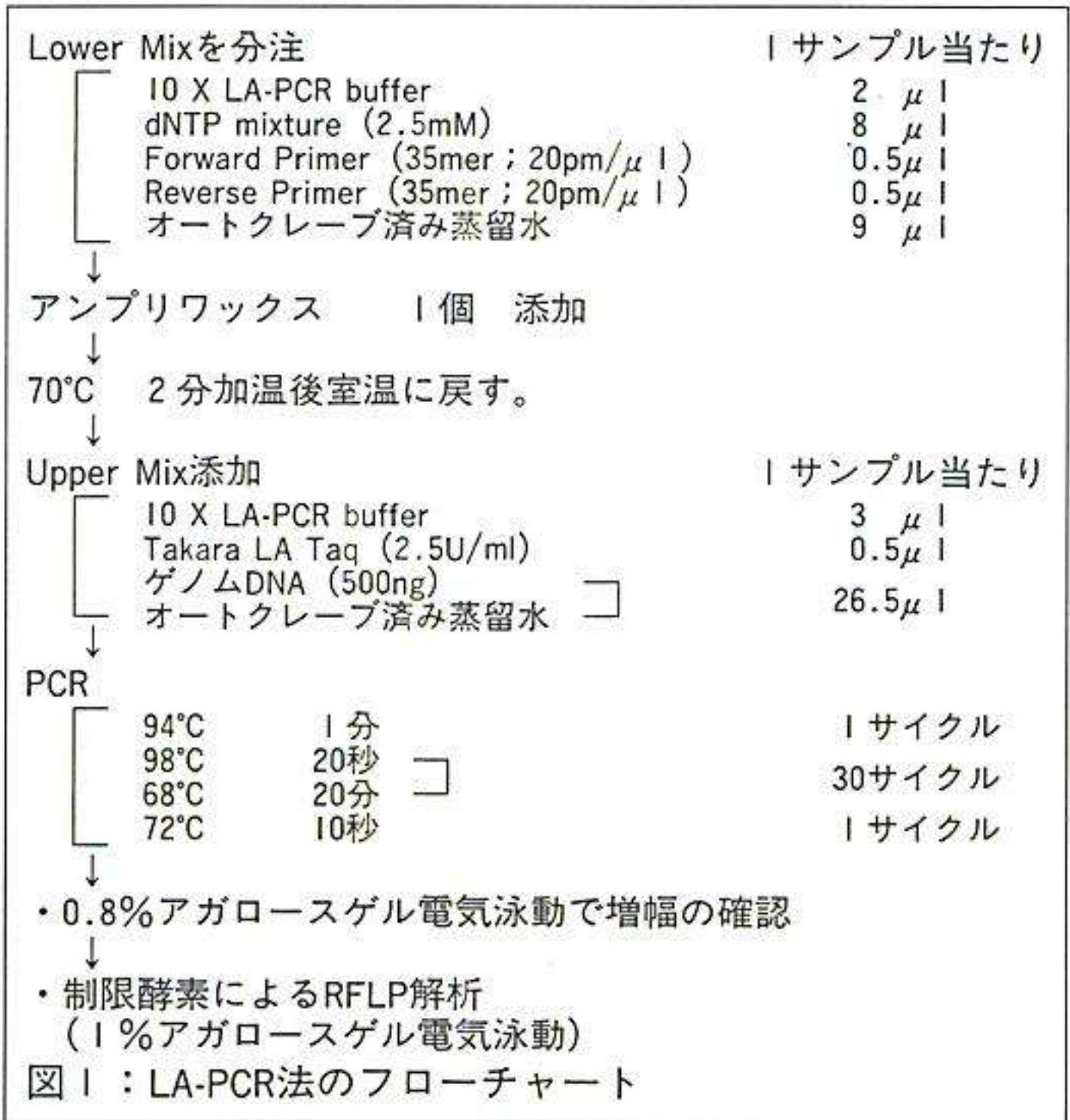


図：研究全体のフローチャート









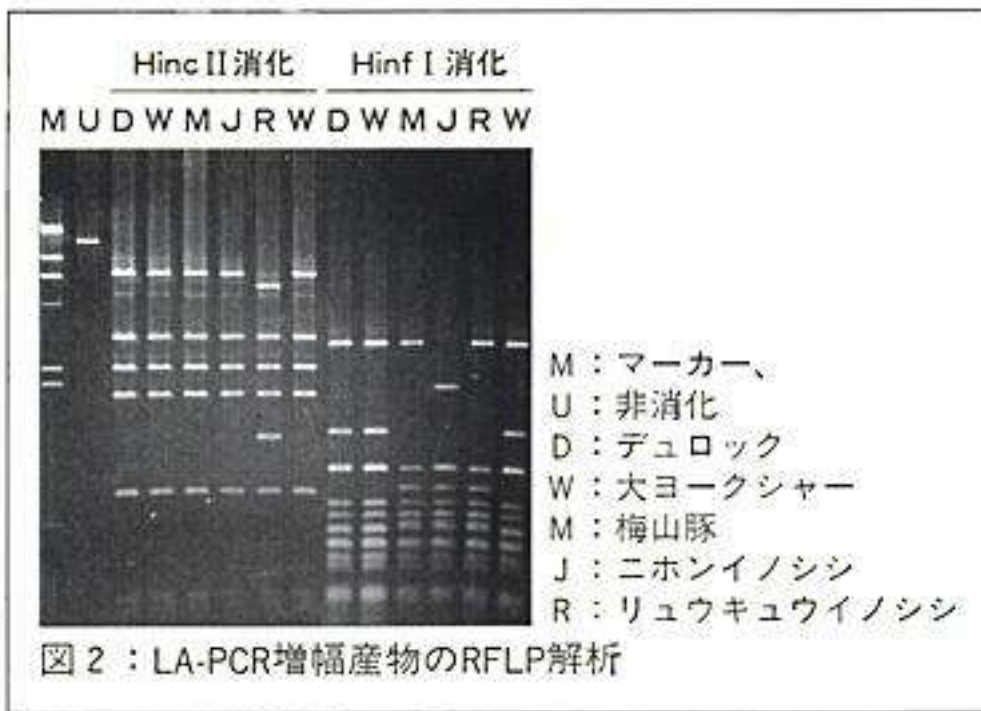


表1：各種ブタおよびイノシシのmtDNA型

ブタおよびイノシシ	制限酵素*					
	HincII	HaeIII	Hinf I	Sca I	Aat I	Bgl II
ランドレース	1	1	1	1	1	1
大ヨークシャー	1	1	1	1	1	3
デュロック	1	2	2	3	2	2
パークシャー	1	2	2	3	2	2
梅山豚	1	2	2	2	2	2
ニホンイノシシ	1	2	3	3	3	2
リュウキュウイノシシ	2	2	2	4	3	3
イフガオ (A型)	1	2	2	3	2	2
イフガオ (B型)	1	2	4	4	3	3
ルソンイボイノシシ	3	3	2	5	1	2
パラワンヒゲイノシシ	4	3	5	5	4	3

* 同じ数字は同じRFLP型を示す。





日本語・環境・社会・経済・文化・国際関係

日本語・環境・社会・経済・文化・国際関係

日本語・環境・社会・経済・文化・国際関係

## -Ú • @ • @ • @ Ž Ÿ

### • @

- —Ñ<Æ” ,É, ; , - , éŠCŠOĚα<†, Ì•Đ%ôì
- •½•-9”N“x•‘ŮfVf“flfWfEf •ufAfWfA,É, ; , - , éŽ•‘±“T” <Æ”-“W•v
- •½•-8”N“x[•‘Ů” <Æ|ŽŽĚ±Ěα<†•, •i%ôì<c•ñ••
- ’†•‘,É, ; , - , éŽâ—v•H—ÆŽ‘Ě¹, ÌŽ•‘±“I•¶ŽY<y, Ñ•, “x—~—p<Z•p, ÌŠJ”-
- ,³,Æ,ϱ,« , Ñ•“Ž} flfbfg•c, Ì‘â—Ê‘••B-@  
• ∖•ÈfGflf<fM•[Ě^—{ %ot•Í”l‘•’u, ð—~—p•[
- f^fC“Ě-k•” ,É, ; , - , é-q••EŽ” —; -∅, ÌŠĈ—•<Z•p



•£ŠĂ, cfVf•fbfv, ð, ©, -, Ä•H, x, é, “%oÙŽq  
 ••F(Xuong sau -” , ÍThach den)•A—Î•F(Xuong sam)•A”•F(Xuong sa-” , ÍThach trang)  
 ”•F, Ì, ÍŠĈ•‘, ðĚ’—; , Æ, •, é, ^a•A••F, Æ—Î•F, Ì, Ìfcfd f%oftfW%oĚ, Ì•A•, Ì—t, ðŽÌ•o, µ, Ä, ì, é•B  
 fxfgfif ^ÈŠO, Ì•, Ä, àĚ©, ©, -, é, ±, Æ, ^a•, Ä, «, é•B  
 •ifxfgfif •AfJf“fg•[Žs, É, Ä•A•¶ŽY—~—p”•@•ì“^•_“ñ•j









†•É,;,éŽâ—v•H—ÆŽ•Ĉ¹,İŽ•±“!•¶ŽY,y,Ń•,“x—p•Z•p,İŠJ”-

†•É,;,éŽâ—v•H—ÆŽ•Ĉ¹,İŽ•±“!•¶ŽY,y,Ń•,“x—p•Z•p,İŠJ”-

†•É,;,éŽâ—v•H—ÆŽ•Ĉ¹,İŽ•±“!•¶ŽY,y,Ń•,“x—p•Z•p,İŠJ”-

†•É,;,éŽâ—v•H—ÆŽ•Ĉ¹,İŽ•±“!•¶ŽY,y,Ń•,“x—p•Z•p,İŠJ”-

†•É,;,éŽâ—v•H—ÆŽ•Ĉ¹,İŽ•±“!•¶ŽY,y,Ń•,“x—p•Z•p,İŠJ”-

†•É,;,éŽâ—v•H—ÆŽ•Ĉ¹,İŽ•±“!•¶ŽY,y,Ń•,“x—p•Z•p,İŠJ”-

†•É,;,éŽâ—v•H—ÆŽ•Ĉ¹,İŽ•±“!•¶ŽY,y,Ń•,“x—p•Z•p,İŠJ”-

†•É,;,éŽâ—v•H—ÆŽ•Ĉ¹,İŽ•±“!•¶ŽY,y,Ń•,“x—p•Z•p,İŠJ”-

†•É,;,éŽâ—v•H—ÆŽ•Ĉ¹,İŽ•±“!•¶ŽY,y,Ń•,“x—p•Z•p,İŠJ”-

†•É,;,éŽâ—v•H—ÆŽ•Ĉ¹,İŽ•±“!•¶ŽY,y,Ń•,“x—p•Z•p,İŠJ”-

†•É,;,éŽâ—v•H—ÆŽ•Ĉ¹,İŽ•±“!•¶ŽY,y,Ń•,“x—p•Z•p,İŠJ”-

†•É,;,éŽâ—v•H—ÆŽ•Ĉ¹,İŽ•±“!•¶ŽY,y,Ń•,“x—p•Z•p,İŠJ”-

†•É,;,éŽâ—v•H—ÆŽ•Ĉ¹,İŽ•±“!•¶ŽY,y,Ń•,“x—p•Z•p,İŠJ”-

†•É,;,éŽâ—v•H—ÆŽ•Ĉ¹,İŽ•±“!•¶ŽY,y,Ń•,“x—p•Z•p,İŠJ”-

†•É,;,éŽâ—v•H—ÆŽ•Ĉ¹,İŽ•±“!•¶ŽY,y,Ń•,“x—p•Z•p,İŠJ”-

†•É,;,éŽâ—v•H—ÆŽ•Ĉ¹,İŽ•±“!•¶ŽY,y,Ń•,“x—p•Z•p,İŠJ”-

†•É,;,éŽâ—v•H—ÆŽ•Ĉ¹,İŽ•±“!•¶ŽY,y,Ń•,“x—p•Z•p,İŠJ”-

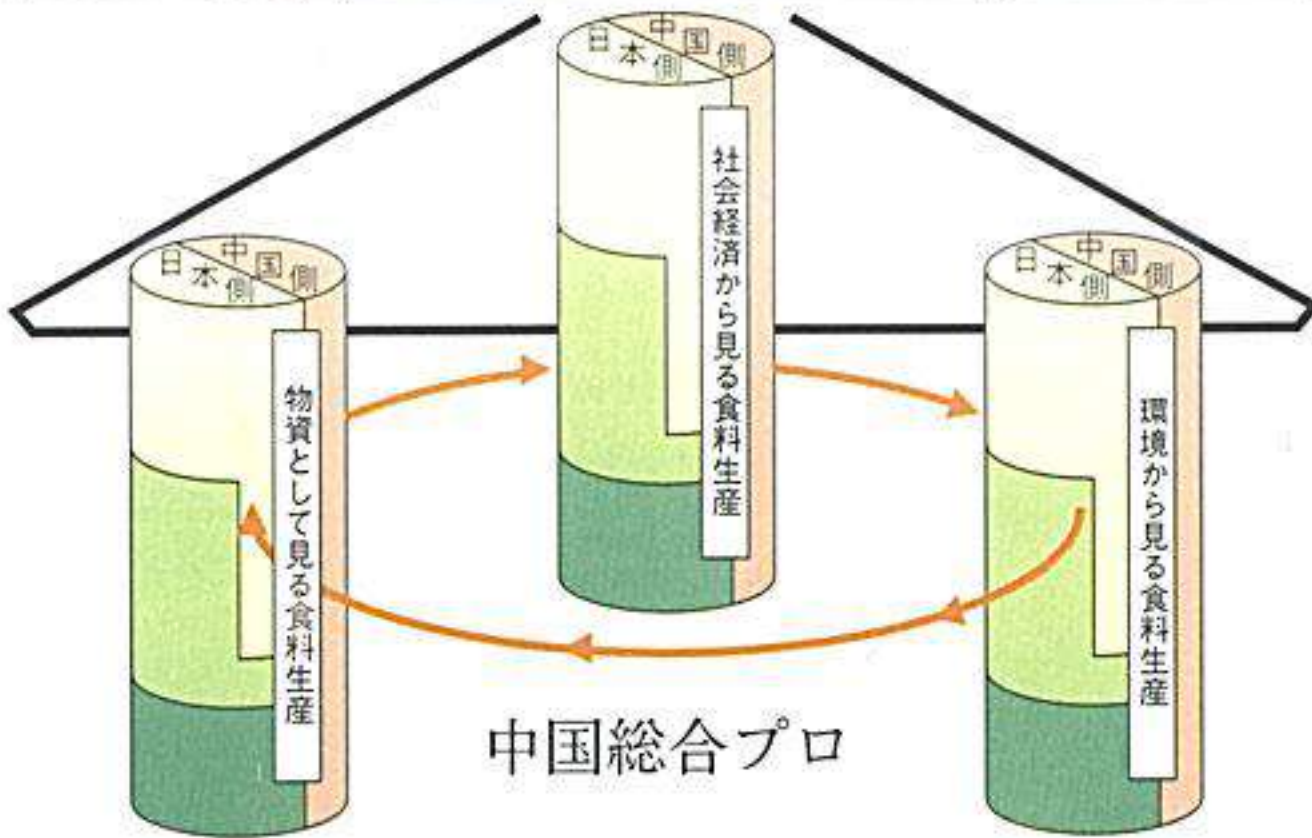
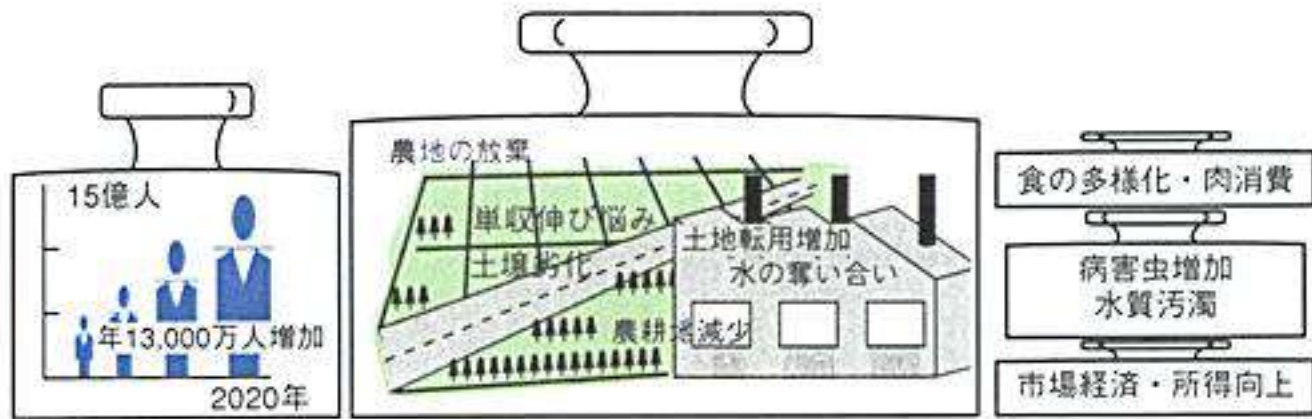
†•É,;,éŽâ—v•H—ÆŽ•Ĉ¹,İŽ•±“!•¶ŽY,y,Ń•,“x—p•Z•p,İŠJ”-

## 1995年の中国農村経済の実績

内 容	実 績	前年比増(%)	備 考	
国内生産総額	57,733億元	10.2	連続5年の2桁 農業の国内総生産比率19.7%	
内 第1次産業	11,365億元	4.5		
第2次産業	28,274億元	13.6		
第3次産業	18,094億元	8.0		
食糧総生産量	46,500万トン	4.5(史上最高)		
内 穀物	41,700万トン	5.9(史上最高)		
油料作物	2,250万トン	13.1(史上最高)		
果物	4,190万トン	19.7(史上最高)		
肉類総生産量	5,000万トン	11.0(史上最高)		連続10年以上の急伸 肉全体の約8割
内 豚牛羊肉	4,200万トン	13.7(史上最高)		
水産物総生産量	2,538万トン	18.4(史上最高)		
内 淡水養殖	1,161万トン			
農村人口年所得	1,578元	29.0(実績伸び率5.3%)		

郷鎮企業就労農民：1億2,350万人（農民4人に1人が郷鎮企業に就労）

郷鎮企業総生産額：農村社会総生産額の75%



プロジェクトのイメージ図



.,E,π,e,Œ:ž|f|f|f|g|c,l'ä—É'••B-@  
08FGHJIMN0P~123456789-.-,;:  
@#%&'()*+,-./:;<=>?@ABCD EFGHIJKL MNOPQRSTUVWXYZ[\]^_`a b c d e f g h i j k l m n o p q r s t u v w x y z { | } ~ ¡ ¢ £ ¤ ¥ ¦ § ¨ © ª « ¬ ® ¯ ° ± ² ³ ´ µ ¶ · ¸ ¹ º » ¼ ½ ¾ ¿ À Á Â Ã Ä Å Æ Ç È É Ê Ë Ì Í Î Ï Ñ Ò Ó Ô Õ Ö × Ø Ù Ú Û Ü Ý Þ ß à á â ã ä å æ ç è é ê ë ì í î ï ð ñ ò ó ô õ ö ÷ ø ù ú û ü ý þ ÿ

0

1. 08FGHJIMN0P~123456789-.-,;:  
@#%&'()*+,-./:;<=>?@ABCD EFGHIJKL MNOPQRSTUVWXYZ[\]^_`a b c d e f g h i j k l m n o p q r s t u v w x y z { | } ~ ¡ ¢ £ ¤ ¥ ¦ § ¨ © ª « ¬ ® ¯ ° ± ² ³ ´ µ ¶ · ¸ ¹ º » ¼ ½ ¾ ¿ À Á Â Ã Ä Å Æ Ç È É Ê Ë Ì Í Î Ï Ñ Ò Ó Ô Õ Ö × Ø Ù Ú Û Ü Ý Þ ß à á â ã ä å æ ç è é ê ë ì í î ï ð ñ ò ó ô õ ö ÷ ø ù ú û ü ý þ ÿ  
08FGHJIMN0P~123456789-.-,;:  
@#%&'()*+,-./:;<=>?@ABCD EFGHIJKL MNOPQRSTUVWXYZ[\]^_`a b c d e f g h i j k l m n o p q r s t u v w x y z { | } ~ ¡ ¢ £ ¤ ¥ ¦ § ¨ © ª « ¬ ® ¯ ° ± ² ³ ´ µ ¶ · ¸ ¹ º » ¼ ½ ¾ ¿ À Á Â Ã Ä Å Æ Ç È É Ê Ë Ì Í Î Ï Ñ Ò Ó Ô Õ Ö × Ø Ù Ú Û Ü Ý Þ ß à á â ã ä å æ ç è é ê ë ì í î ï ð ñ ò ó ô õ ö ÷ ø ù ú û ü ý þ ÿ

0

2. 08FGHJIMN0P~123456789-.-,;:  
@#%&'()*+,-./:;<=>?@ABCD EFGHIJKL MNOPQRSTUVWXYZ[\]^_`a b c d e f g h i j k l m n o p q r s t u v w x y z { | } ~ ¡ ¢ £ ¤ ¥ ¦ § ¨ © ª « ¬ ® ¯ ° ± ² ³ ´ µ ¶ · ¸ ¹ º » ¼ ½ ¾ ¿ À Á Â Ã Ä Å Æ Ç È É Ê Ë Ì Í Î Ï Ñ Ò Ó Ô Õ Ö × Ø Ù Ú Û Ü Ý Þ ß à á â ã ä å æ ç è é ê ë ì í î ï ð ñ ò ó ô õ ö ÷ ø ù ú û ü ý þ ÿ  
08FGHJIMN0P~123456789-.-,;:  
@#%&'()*+,-./:;<=>?@ABCD EFGHIJKL MNOPQRSTUVWXYZ[\]^_`a b c d e f g h i j k l m n o p q r s t u v w x y z { | } ~ ¡ ¢ £ ¤ ¥ ¦ § ¨ © ª « ¬ ® ¯ ° ± ² ³ ´ µ ¶ · ¸ ¹ º » ¼ ½ ¾ ¿ À Á Â Ã Ä Å Æ Ç È É Ê Ë Ì Í Î Ï Ñ Ò Ó Ô Õ Ö × Ø Ù Ú Û Ü Ý Þ ß à á â ã ä å æ ç è é ê ë ì í î ï ð ñ ò ó ô õ ö ÷ ø ù ú û ü ý þ ÿ  
08FGHJIMN0P~123456789-.-,;:  
@#%&'()*+,-./:;<=>?@ABCD EFGHIJKL MNOPQRSTUVWXYZ[\]^_`a b c d e f g h i j k l m n o p q r s t u v w x y z { | } ~ ¡ ¢ £ ¤ ¥ ¦ § ¨ © ª « ¬ ® ¯ ° ± ² ³ ´ µ ¶ · ¸ ¹ º » ¼ ½ ¾ ¿ À Á Â Ã Ä Å Æ Ç È É Ê Ë Ì Í Î Ï Ñ Ò Ó Ô Õ Ö × Ø Ù Ú Û Ü Ý Þ ß à á â ã ä å æ ç è é ê ë ì í î ï ð ñ ò ó ô õ ö ÷ ø ù ú û ü ý þ ÿ

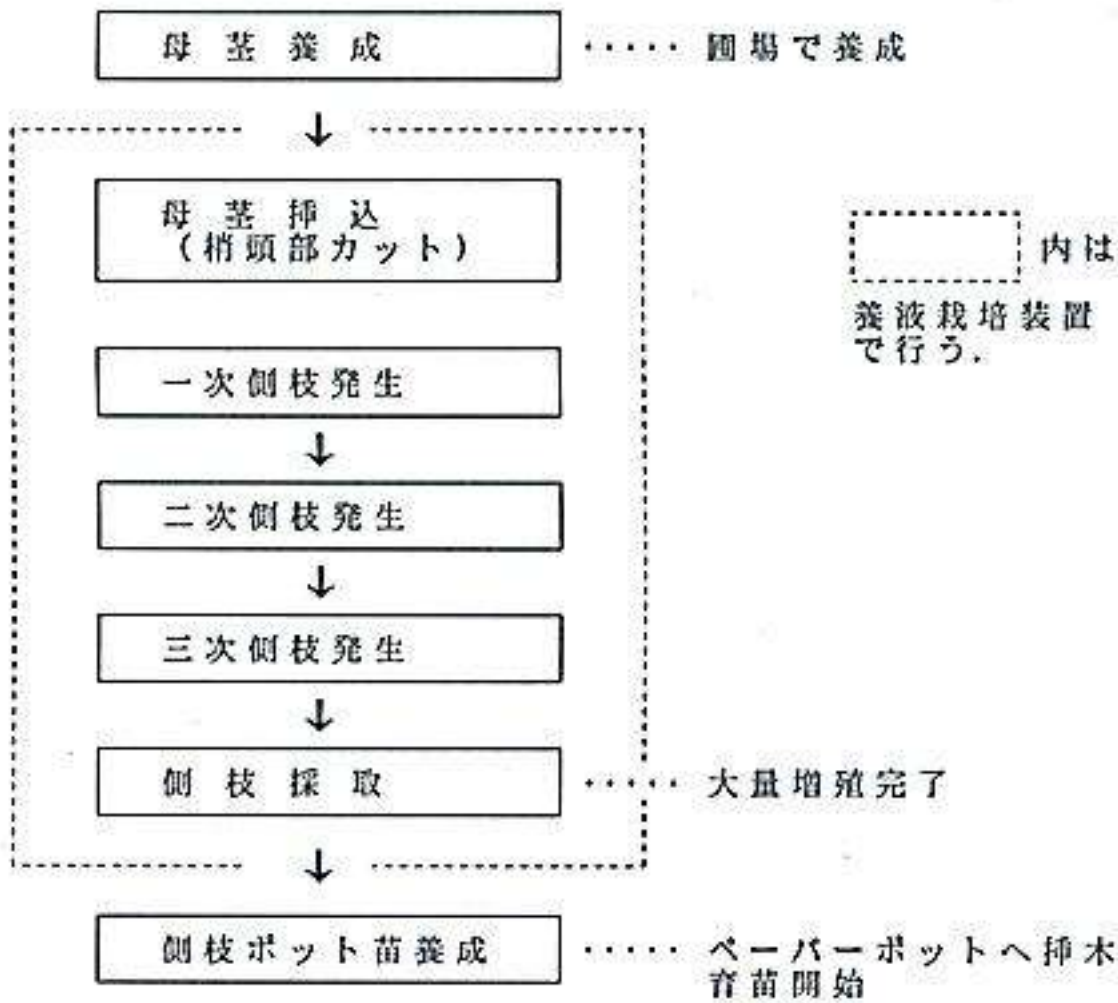


図 1. 側枝ポット苗大量増殖の流れ



ŽÊ•^1 —{‰t•Í”|•’u“à,Å,Ì‘řŽ}”-•¶•ó<µ



•@

ŽÊ•^1 —{‰t•Í”|•’u“à,Å,Ì‘řŽ}”-•¶•ó<µ



ŽÊ^ 2 •@<@ŠB,É,æ,é‘ǻŽ} flfbfg•c,Ì•A•t



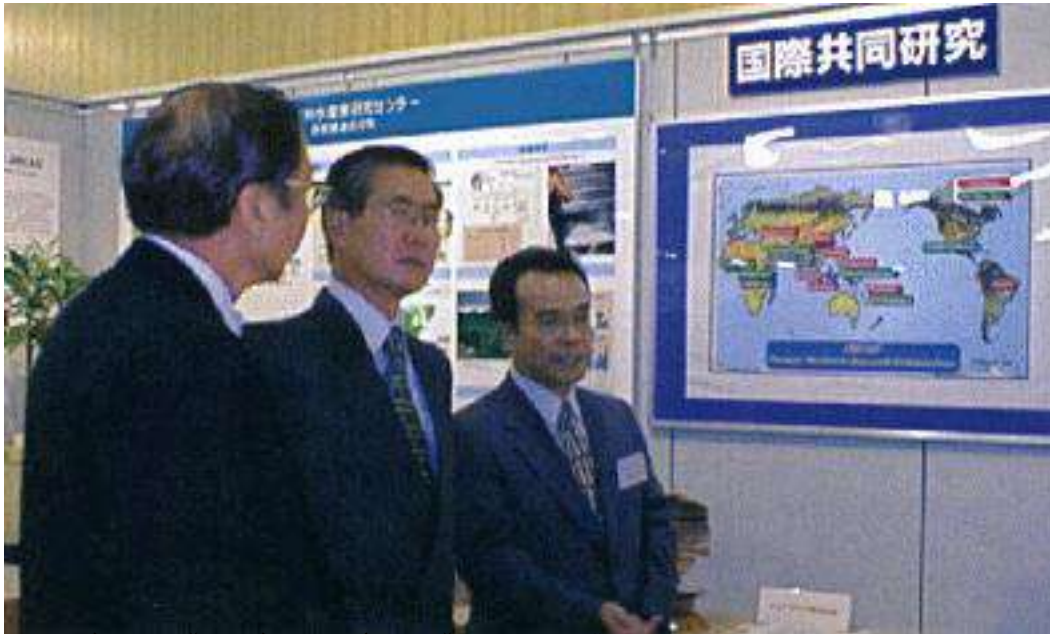




# JIRCAS fjf...[fX.@@@No.12.@1997

## -Ú •@•@•@ŽŸ

- [JIRCAS,É,;, -, é•¶•Ž‘Œ¹Œα<†, Ì-ðŠ,,](#)
- [‘•Ů” —Ñ...ŽŸ<Æfvf•fWfFfNfgŒŸ“ç%öï, Ì.ñ••](#)
- [‘O-ì•Š’•CGIAR”N%oo%öï•‡, É•o•È](#)
- [f}fŒfCfvfA•Efff_’n^æ,É,;, -, é%oØ•l^î” %ooÆ,Æf}fŒfC•l^î” %ooÆ, ÌŒo%oc”äŠr](#)
- [f^f••iColocasia esculenta•j^â“Ž‘Œ¹, Ì’” á%oo•Ů•¶](#)
- [fpcf“fAfbfvf<”•,É,;, -, é•Ô%o©•F“y•Z•H, Ì”-•¶ŽÀ‘Ô,ÆŒyŒ, ‘Î•ô](#)
- [f•fRf“ff<f^,É,;, -, é—{“Ø<Z•p, Ì%öü•P•l“V‘RŽ‘Œ¹, ÌŠ^—p,Æ•¶ŽŸ,É<y,Ú, ‘jŠQ—v^ö•l](#)



•Éfyf<•[.IftfWf, fS‘â“—l•i’†%oo•j, l•A, VŒZ, S“ú’}”g” —NŒα<†  
 ‘c’n, ð-K, é•AŠe<@ŠÖ, Ì.Ā•VŒα<†•%ooÈ, ð“WŽl, μ, Ā, ç, é•u, Ā, -, ÌfŠ  
 fT[f fMfff%ofŠ•[•v, âfofCfIfefNfmf•fW•[Œα<†, ÌŠÖ~AŽ{•Y, ðŽ<  
 Ž@, μ, ½•B•kfŠft•[f fMfff%ofŠ•[, É, Ā•A•Ů.α“Œα<†, ÌŒ»•ó, ð•à  
 -¾’†, Ì•O-ìJIRCAS•Š’.(%oE’l)•BŽB%oo•FŠé%ooæ”2•@•”•@—Ñ•@—B”Ž•l

•@







‘O-İŠ’CGIAR”N%o%šİ†,É•o•È

CGIAR’s Consultative Group on International Agricultural

Research (CGIAR) has convened a meeting of the International Agricultural Research Consultative Group (IARC) in Rome, Italy, on 12-13 December 2000. The meeting was held at the headquarters of the International Agricultural Research Consultative Group (IARC) in Rome, Italy, on 12-13 December 2000. The meeting was held at the headquarters of the International Agricultural Research Consultative Group (IARC) in Rome, Italy, on 12-13 December 2000.

The meeting was held at the headquarters of the International Agricultural Research Consultative Group (IARC) in Rome, Italy, on 12-13 December 2000. The meeting was held at the headquarters of the International Agricultural Research Consultative Group (IARC) in Rome, Italy, on 12-13 December 2000. The meeting was held at the headquarters of the International Agricultural Research Consultative Group (IARC) in Rome, Italy, on 12-13 December 2000.

The meeting was held at the headquarters of the International Agricultural Research Consultative Group (IARC) in Rome, Italy, on 12-13 December 2000. The meeting was held at the headquarters of the International Agricultural Research Consultative Group (IARC) in Rome, Italy, on 12-13 December 2000. The meeting was held at the headquarters of the International Agricultural Research Consultative Group (IARC) in Rome, Italy, on 12-13 December 2000.



CGIAR’s Consultative Group on International Agricultural Research (CGIAR) has convened a meeting of the International Agricultural Research Consultative Group (IARC) in Rome, Italy, on 12-13 December 2000.

The meeting was held at the headquarters of the International Agricultural Research Consultative Group (IARC) in Rome, Italy, on 12-13 December 2000. The meeting was held at the headquarters of the International Agricultural Research Consultative Group (IARC) in Rome, Italy, on 12-13 December 2000. The meeting was held at the headquarters of the International Agricultural Research Consultative Group (IARC) in Rome, Italy, on 12-13 December 2000.

The meeting was held at the headquarters of the International Agricultural Research Consultative Group (IARC) in Rome, Italy, on 12-13 December 2000. The meeting was held at the headquarters of the International Agricultural Research Consultative Group (IARC) in Rome, Italy, on 12-13 December 2000. The meeting was held at the headquarters of the International Agricultural Research Consultative Group (IARC) in Rome, Italy, on 12-13 December 2000.

The meeting was held at the headquarters of the International Agricultural Research Consultative Group (IARC) in Rome, Italy, on 12-13 December 2000. The meeting was held at the headquarters of the International Agricultural Research Consultative Group (IARC) in Rome, Italy, on 12-13 December 2000. The meeting was held at the headquarters of the International Agricultural Research Consultative Group (IARC) in Rome, Italy, on 12-13 December 2000.

CGIAR’s Consultative Group on International Agricultural Research (CGIAR) has convened a meeting of the International Agricultural Research Consultative Group (IARC) in Rome, Italy, on 12-13 December 2000.







表：マレイ人と華人農家の経営比較

	華人農家	マレイ人農家
調査農家数	21 (100%)	24 (100%)
専業農家	18 (86%)	20 (83%)
平均年齢	49.3	49.0
同居家族数	5.8	5.2
家族農業従事者数	1.3	2.0
経営耕地面積 (ha)	4.8	2.8
機械所有農家		
トラクタ	4 (19%)	2 (8%)
耕耘機	14 (67%)	12 (50%)
経営費 (RM/ha) *1	820.41	748.44
種子	10.03	63.32
肥料	62.63	3.11
農薬	193.77	85.47
雇用労賃	43.94	57.44
作業委託料金	322.49	384.77
機械修理費	57.79	13.15
減価償却費	15.57	29.76
運搬費	114.19	111.42
耕起回数		
第1作 (乾期作)	4-5	3
第2作 (雨期作)	3	3
品種	MR84+中国稻	MR84
粗収益 (RM/ha)	4043.94	2848.96

*1 経営費は現金支出分のみで、自給部分を計上していないので、投入物量の比較ではない。

1. 1997-12-5  
 2. 1997-12-5  
 3. 1997-12-5  
 4. 1997-12-5  
 5. 1997-12-5  
 6. 1997-12-5  
 7. 1997-12-5  
 8. 1997-12-5  
 9. 1997-12-5  
 10. 1997-12-5  
 11. 1997-12-5  
 12. 1997-12-5  
 13. 1997-12-5  
 14. 1997-12-5  
 15. 1997-12-5  
 16. 1997-12-5  
 17. 1997-12-5  
 18. 1997-12-5  
 19. 1997-12-5  
 20. 1997-12-5  
 21. 1997-12-5  
 22. 1997-12-5  
 23. 1997-12-5  
 24. 1997-12-5  
 25. 1997-12-5  
 26. 1997-12-5  
 27. 1997-12-5  
 28. 1997-12-5  
 29. 1997-12-5  
 30. 1997-12-5  
 31. 1997-12-5  
 32. 1997-12-5  
 33. 1997-12-5  
 34. 1997-12-5  
 35. 1997-12-5  
 36. 1997-12-5  
 37. 1997-12-5  
 38. 1997-12-5  
 39. 1997-12-5  
 40. 1997-12-5  
 41. 1997-12-5  
 42. 1997-12-5  
 43. 1997-12-5  
 44. 1997-12-5  
 45. 1997-12-5  
 46. 1997-12-5  
 47. 1997-12-5  
 48. 1997-12-5  
 49. 1997-12-5  
 50. 1997-12-5  
 51. 1997-12-5  
 52. 1997-12-5  
 53. 1997-12-5  
 54. 1997-12-5  
 55. 1997-12-5  
 56. 1997-12-5  
 57. 1997-12-5  
 58. 1997-12-5  
 59. 1997-12-5  
 60. 1997-12-5  
 61. 1997-12-5  
 62. 1997-12-5  
 63. 1997-12-5  
 64. 1997-12-5  
 65. 1997-12-5  
 66. 1997-12-5  
 67. 1997-12-5  
 68. 1997-12-5  
 69. 1997-12-5  
 70. 1997-12-5  
 71. 1997-12-5  
 72. 1997-12-5  
 73. 1997-12-5  
 74. 1997-12-5  
 75. 1997-12-5  
 76. 1997-12-5  
 77. 1997-12-5  
 78. 1997-12-5  
 79. 1997-12-5  
 80. 1997-12-5  
 81. 1997-12-5  
 82. 1997-12-5  
 83. 1997-12-5  
 84. 1997-12-5  
 85. 1997-12-5  
 86. 1997-12-5  
 87. 1997-12-5  
 88. 1997-12-5  
 89. 1997-12-5  
 90. 1997-12-5  
 91. 1997-12-5  
 92. 1997-12-5  
 93. 1997-12-5  
 94. 1997-12-5  
 95. 1997-12-5  
 96. 1997-12-5  
 97. 1997-12-5  
 98. 1997-12-5  
 99. 1997-12-5  
 100. 1997-12-5

植物材料の調整 ↓ ガラス化 ↓ 融解・再培養	①植物材料の増殖： イモから得た幼芽を滅菌し、MS培地（シヨ糖30g/l）で増殖する。
	②コンデショニング： 無菌培養した植物体（茎長2-3cm）をシヨ糖120g/lを含むMS培地に移植して1ヵ月培養する。
	③茎頂の切り出し： 葉原基1-2枚を含む成長点（0.5-0.8mm）を切り出す。
	④茎頂の前培養：0.3Mシヨ糖を含むMS培地で16時間培養する。
	⑤ローディング： 前培養した茎頂を2Mグリセリン+0.4Mシヨ糖で20分間、25℃で処理する。
	⑥ガラス化処理： ローディングした茎頂をPVS2（30%グリセリン+15%DMSO+15%エチレングリコール+0.4Mシヨ糖）で10分間25℃で処理する。液体窒素に直接浸漬する（手法の開発試験では1時間浸漬）。
	⑦融解：40℃の温水中で急速融解する。
	⑧融解後の処理：1.2Mシヨ糖に10分間浸漬後、滅菌した濾紙を敷いた0.3Mシヨ糖を含むMS培地上に1日静置する。
	⑨植物体の再生： 0.1Mシヨ糖を含むMS培地に移しかえ培養する。茎葉の再生を生存の指標とする。

図1. 本研究で確立したタロの茎頂の超低温ガラス化法による保存法の手順









表1 斜面下端の植被の効果 (93~94年)

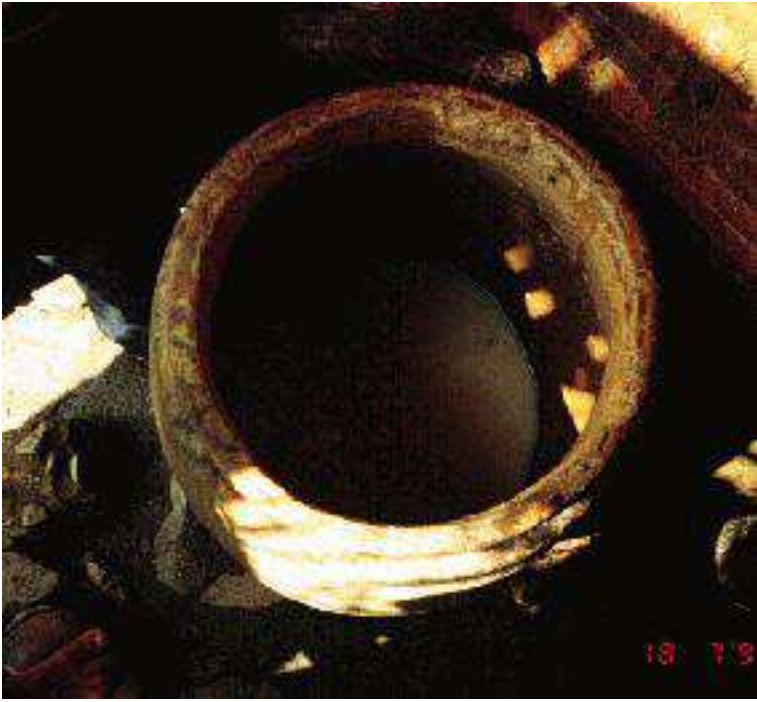
処理区	積算土壌流亡量 (kg m ⁻² )		
	4ヶ月	8ヶ月	12ヶ月
対照	0.00	1.12	7.48
ウィーピング・ラブ	0.01	0.02	0.07
アラキス・ピントイ	0.00	0.01	0.01
有機物マルチ	0.00	0.00	0.03

表2 不耕起栽培の効果 (94~95年)

処理区	積算土壌流亡量 (kg m ⁻² )		
	4ヶ月	8ヶ月	12ヶ月
対照	0.82	1.01	1.80
不耕起栽培	0.02	0.07	0.61
緑肥すき込み	0.30	0.72	1.84
有機物マルチ	0.00	0.00	0.04









# JIRCA S f j f . . . [ f X . @ . @ . @ N o . 1 3 . @ 1 9 9 7

- Ú . @ . @ . @ Ž Ÿ

[•EŠ^á“^aCE^{3/4}•@%^oÊ, 1/2, 1, é, ©, È•A” —ÑCE^α†, Æ•...ŽYCE^α†, Ì~ACEg](#)

[•E•u•,%^o•İ•«•v•f••\[fNfVf‡fbfv•@%^o«“êŽs•Š,É,ÄŠJ•Ã](#)

[•E•1/2•¬,X”N“x•i,P,X,X,V”N“x•j••Ûf••\[fNfVf‡fbfv](#)

[•Ef•fRf“ff<f^ftf@•\[f~f“fOfVfXfef ,É,“, ,éî•i<Z•p,İ%^oü‘P](#)

[•E“CE-kf^fC,İfvf†f%^of“n^æ,É,“, ,é•ó‘w’n%^o•... ,İ%^o—•...%^o»f•fJfjYf](#)

[•EfIfjefifKfGfr,Ì•¬•n•E’E”ç%^oÛ’ö,É,“, ,ézf<f,f“ ,Ì<@’\%^ođ-3/4](#)

[•EfCf“fhflfVfA,Ì’â“^o•H•i](#)



•fxfgfif€ ,İŽq<Ÿ’B•F%J•G,İ^o,İ^o...É•Z,Á,Ä,ç,1/2,³•AŽq<Ÿ’B,ÍCE³•C•B%^o^%^oİ,É,à...“c,É,à<°,³,ç,Á,İ,ç•BCEä,ë,ÉCE!, ,éŽIfcŽè•Ò,Ý,Á<°,ð,Æ,Á,ÄŽ%^oÆ—p,É•A,Û,1/2f}•[fPfbfg,É,à<°,•B—{•¶,S•,Tfy•[fW,ÉŠÖ~A<LŽ~•B

•@•ifxfgfif€•AfJf“fg•[ÈfgfbfgfmfbfgCESf f...f“fA,f““°•@•¶ŽY—~p•”•@<à@’%^o’j•j





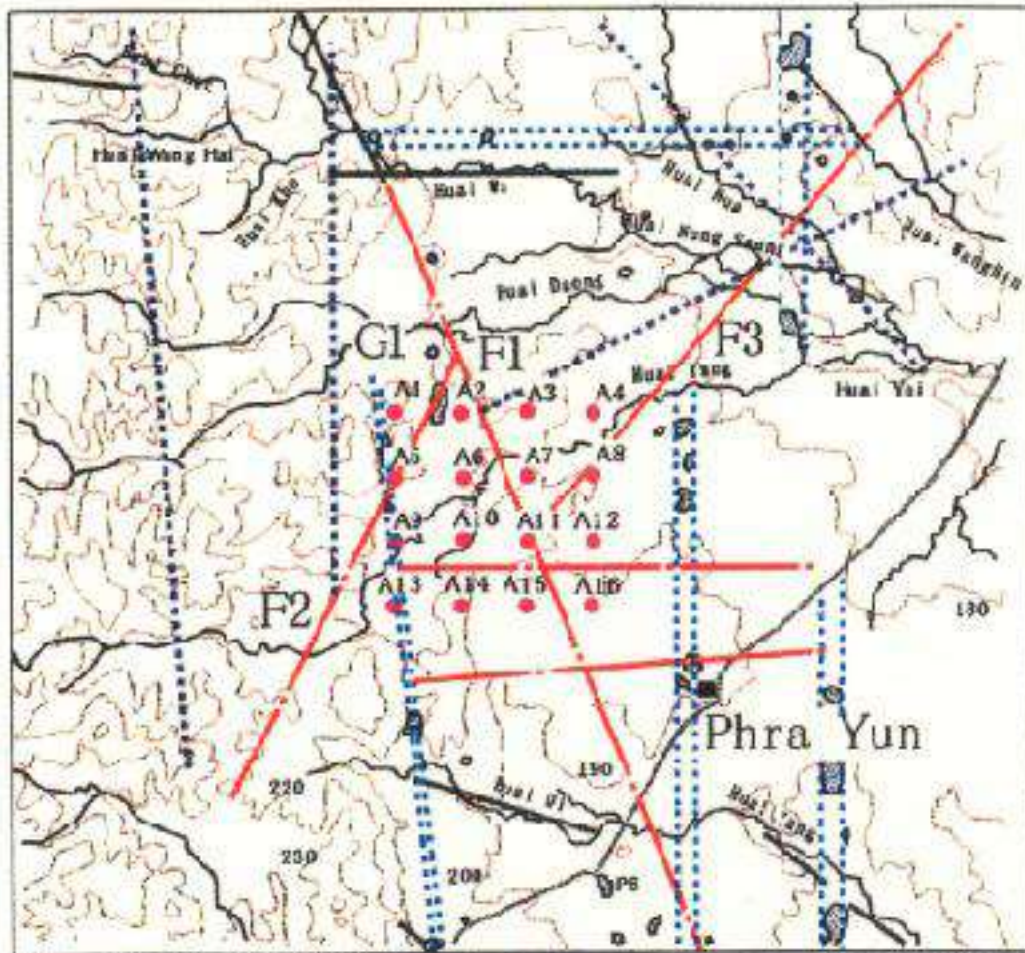




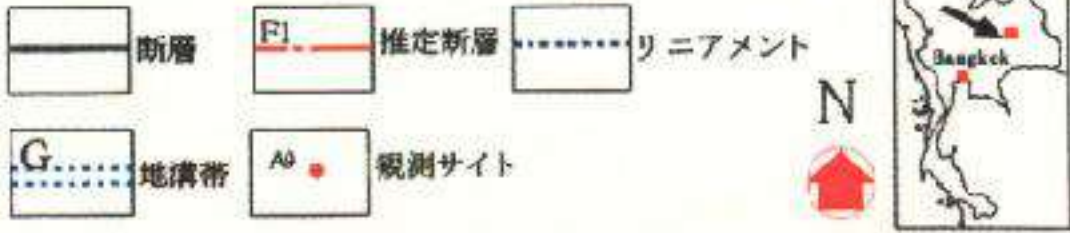


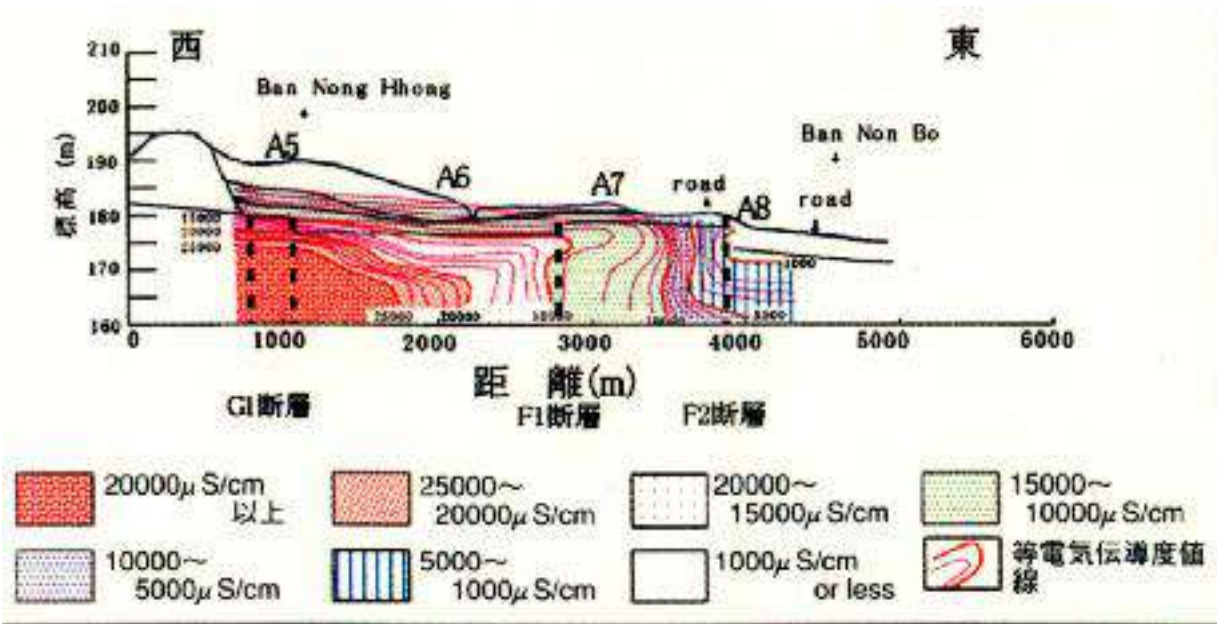




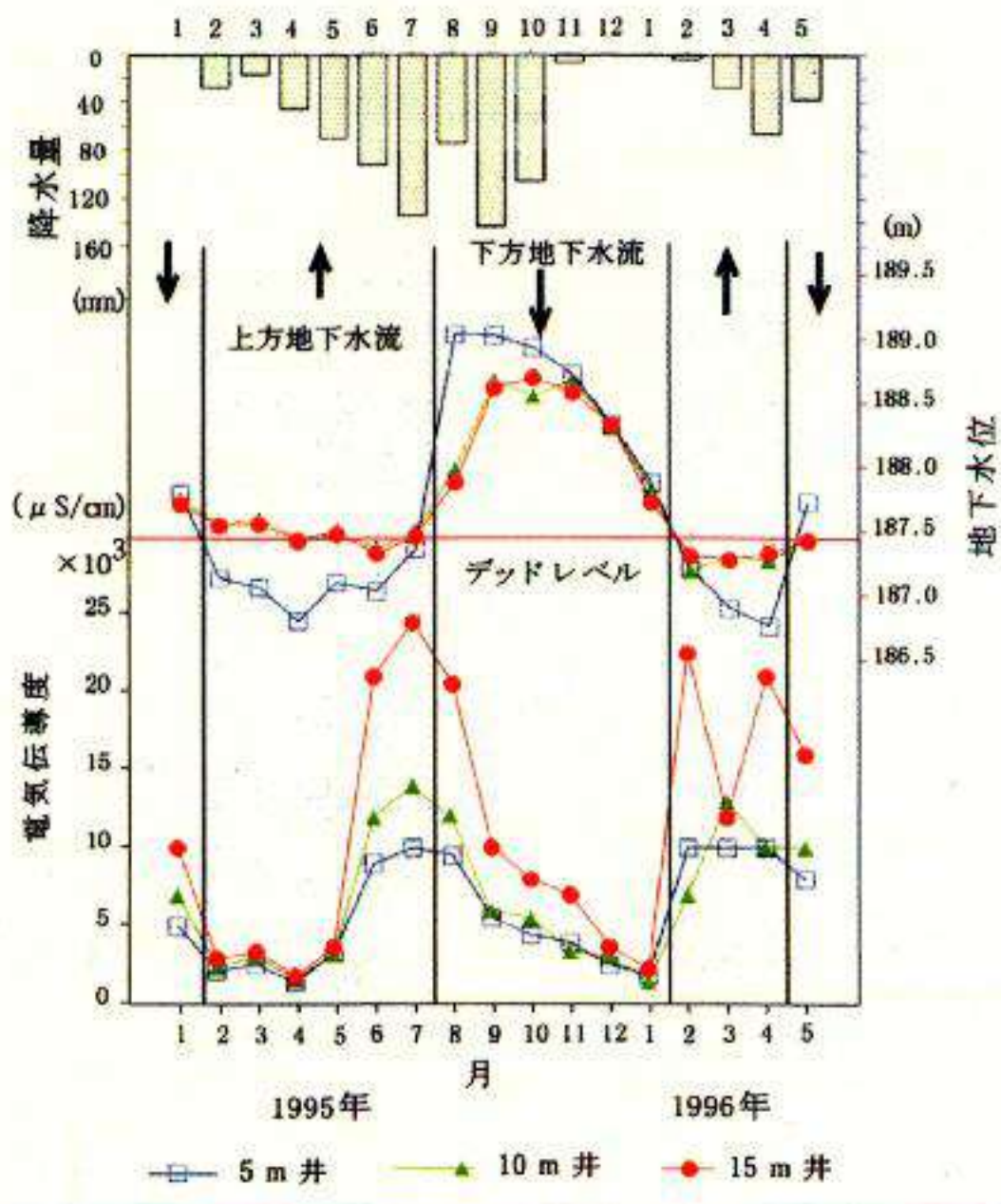


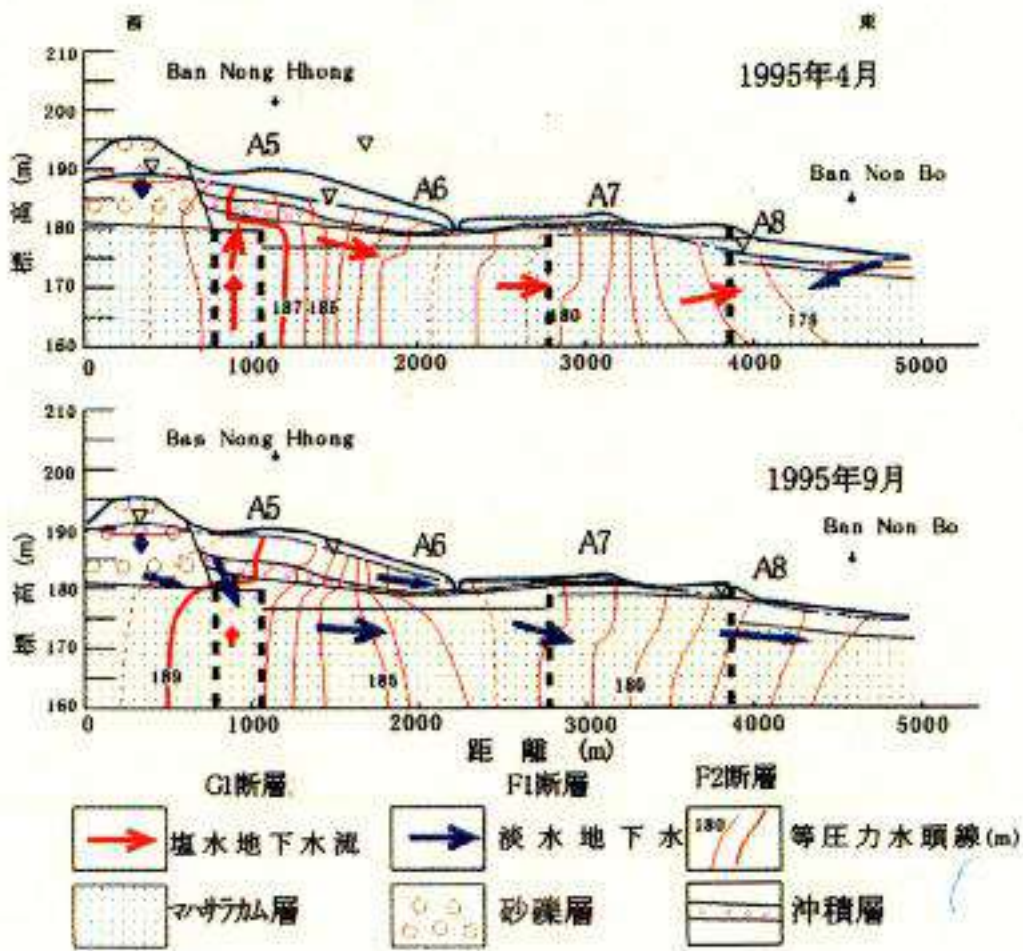
0 5 10 16 20 25 km

















•@

•@







n^æž'Ĉ'ŠÇ—•,½,B,lf}fbfvff•[f^fx•[fX•\z,Æ,»,l%ž—p

'wZ'Œ'ŒÇ—•,½,B,lf}fbfvff•[f^fx•[fX•\z,Æ,»,l%ž—p

© 2002 JIRCAS. All rights reserved.

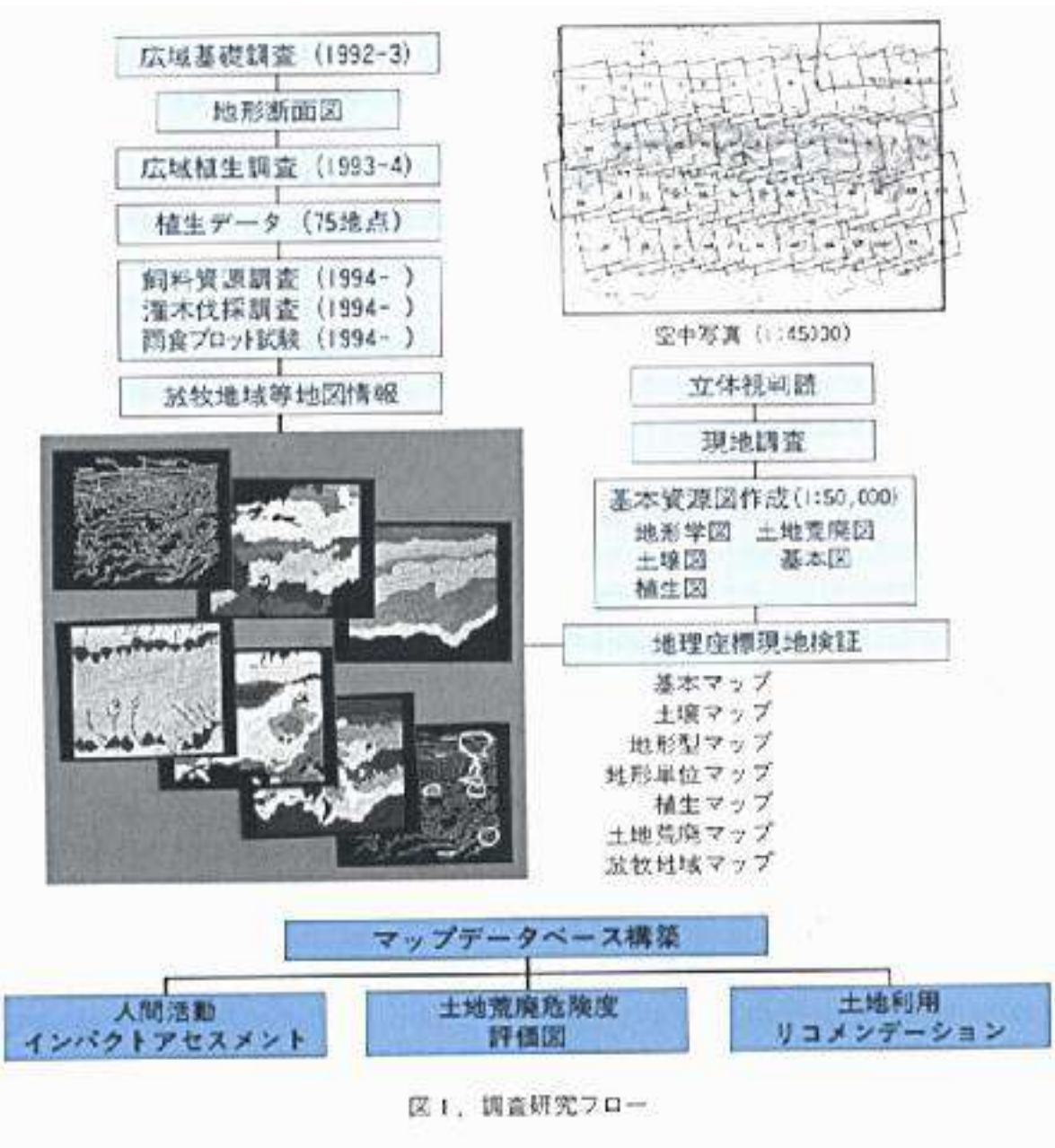


図1. 調査研究フロー

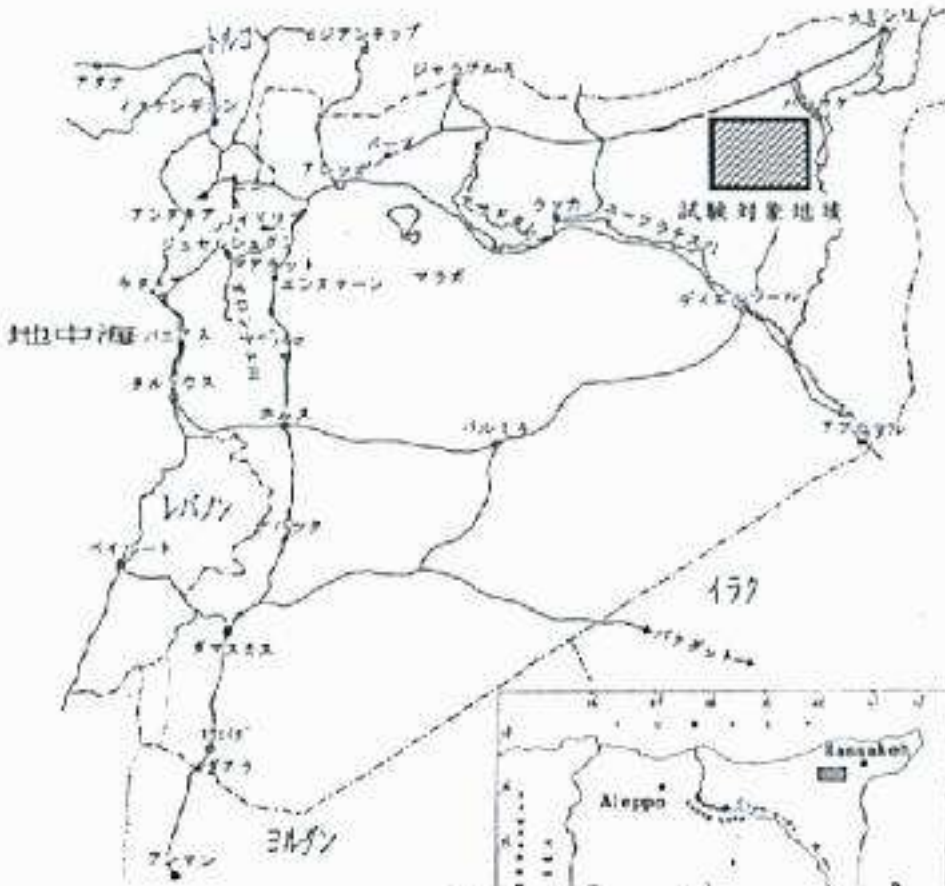


図 2. シリア概要図

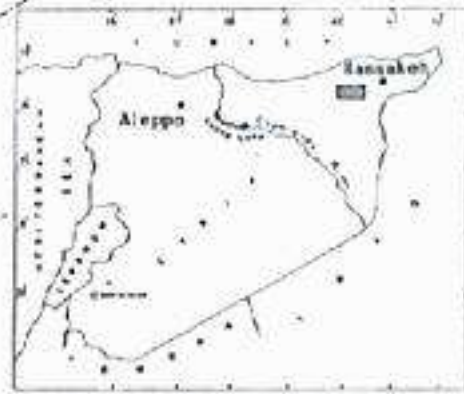


図 3. 試験対象地域

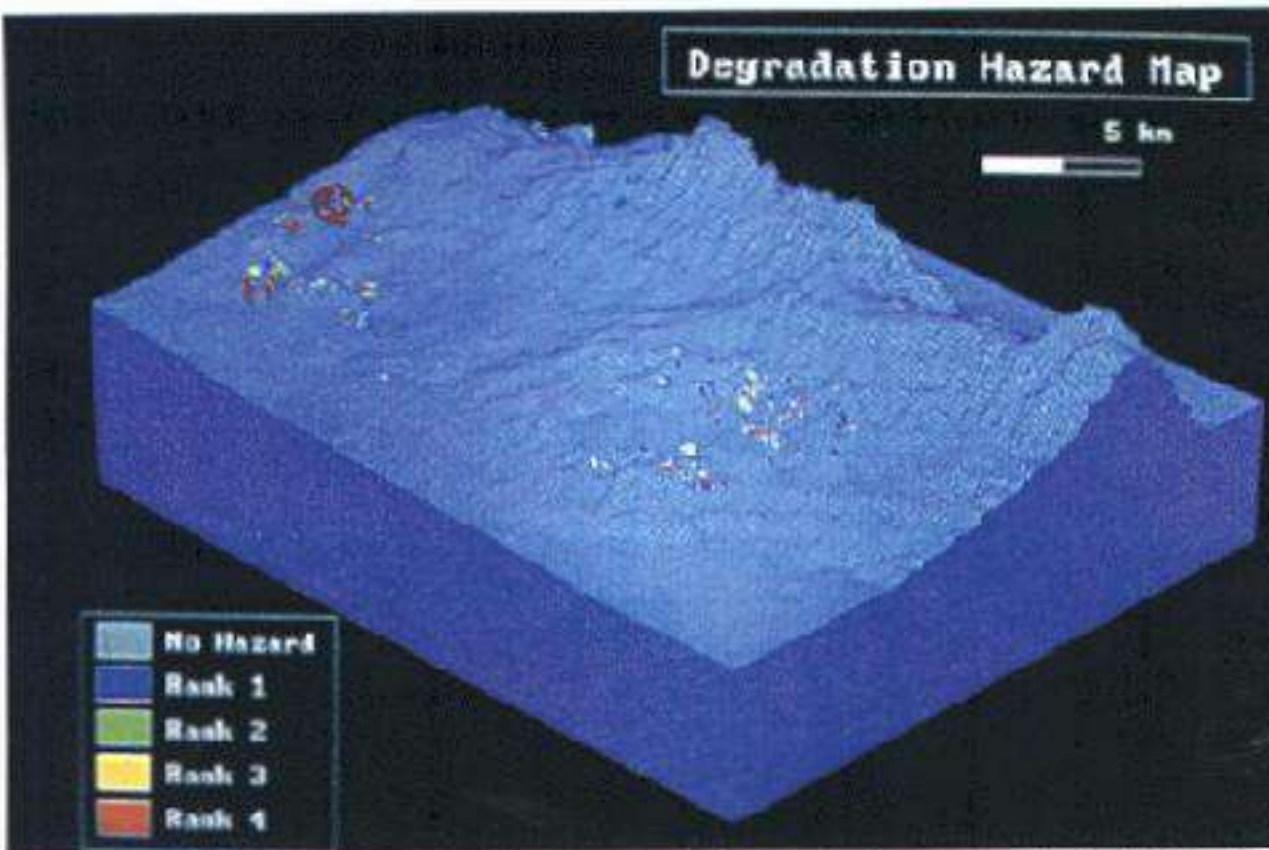


図4. 土地荒廃危険度評価図（ランク4＝危険度高、無ランク＝危険度低）対象地域北上空から山地を南に望む







ffBfSff"á"y"y,1"y—lŽ®,Æ"Á•«

ffBfSff"á"y"y,1"y—lŽ®,Æ"Á•«

ffBfSff"á"y"y,1"y—lŽ®,Æ"Á•«

ffBfSff"á"y"y,1"y—lŽ®,Æ"Á•«

ffBfSff"á"y"y,1"y—lŽ®,Æ"Á•«

ffBfSff"á"y"y,1"y—lŽ®,Æ"Á•«

ffBfSff"á"y"y,1"y—lŽ®,Æ"Á•«







fCf"fhflfVfA,É,";é••H'ø—Ñ'nŠQ'Ž,ÉŠÖ;:é•"œ▪†

ICP7ANVAE:7:44Rr-S'80Z280,ç•"0B•  
©1996-2002 JIRCAS

©1997 JIRCAS. All rights reserved. This page is for internal use only. It is not to be distributed outside the JIRCAS network. The JIRCAS logo is a registered trademark of JIRCAS. All rights reserved. The JIRCAS logo is a registered trademark of JIRCAS. All rights reserved.

1996-2002 JIRCAS. All rights reserved. This page is for internal use only. It is not to be distributed outside the JIRCAS network. The JIRCAS logo is a registered trademark of JIRCAS. All rights reserved. The JIRCAS logo is a registered trademark of JIRCAS. All rights reserved.







••Ûfzf~fi•,lžž{ó•µ

••Ufzf~fi•,lžž{ó•µ

•@

•½~v,v"n"x••Û"•_cE•ê-â•-j•ÊE•ç†%ã

•@

•æ,P%ã...žY•-j••Û•c•E•ç†•†•n•EY•e%ã

•½~8"N2Ež13"ú•A••ŽY"j,;æ,N•...žY•E•ç†•Š,É,"",éŠJ"-r•ã•"í%č•AJIRCAS,É,æ,••Û•c•E•ç†•,l•,•i•i•D•...žY••-†P•Efvf•fWfFfNfg•A2•DŠw•Û"†••çfvf•fWfFfNfgç@f•fRf•ff•f^çA•D•...æ,l•çžYçB"†••ç"•ç"•_cEj,É,Ā,ç,Ā"ÓE•E•ç†•,µ,Û,µ,½•B•i-â,ç•ç,í,l•æ•F•...žY•"••@•Y•Š-M•F•@TEL 0298-38-6370•j

•@

••Û"•_—Ñ•...žY•E•E•ç†•fZf"•f^•[,Ā,-,lžfz~fi•[

•½~8"N3Ež13"ú•A••Û•çŽ•ç—•ç"•ÓŠw•fZf"•f^•[(ICIPE)(fifCf•f•r),Æ•ç•Ā,Ā•A"•M"•N"•æ,É,"",éžā—vŠQž,l"•çžĀ"•Ā,»•,l•ç"•Ŏ,l%çδ-ç"™,ÉŠŎ,,éE•ç†•,l"•è"•w,l•i"•W,δ•],é,½,ß•uICIPE,l•E•ç†•i—•v,δfç[f],ÉfZf~fi•[,δŠj•Ā,µ,Û,µ,½•B•i-â,ç•ç,í,l•æ•F•çžY—p"••@•i"•ç@•_"•n•@TEL 0298-38-6307•A"•—Q•@•"É%ç@TEL 0298-38-6359•j

•è"•E•E•ç†•,l,"m,ç,"

•½~8"N"x%çÈŠw•çP•TŠŎ•i4/15•21•j,É"•,ç••Û"•_—Ñ•...žY•E•E•ç†•fZf"•f^•[,Ā,l"•_—ÑE•ç†•c"•n,l•E•ç†•J"•ú,É,•i,l,Ā4Ež16"ú•i%ç•j10:00•16:00•V••f•[f•v•f",µ,½"•Wžž",δ"†•S,É•Š"•à,δ"è"•E•E•ç†•,ç,½,µ,Û,•B(-â,ç•ç,í,l•æ•FŠç%ç"•ç"•i•nž"•—ç%çÛ•@TEL 0298-38-6340)

•½~8"N"x•æ3%ã••Ûfvf"•fjfwfE•€

•u'æ4%ã"•â"žq'g,Ý"Ŏ,l•A••E"•ç•ç"•lfofCfI•fZ•[f•f•e•fB•u••Ûfvf"•fjfwfE•f•i'æ3%ã••Û"•_—Ñ•...žY•E•E•ç†•fZf"•f^•[••Ûfvf"•fjfwfE•f•j•v,Æ,µ,Ā%ç•L,É,æ,èžĀž{,ç—\è,Ā,•B

fç[f]•F•u"•â"žq'g,Ý"Ŏ,l•A••E"•ç•ç"•lfofCfI•fZ•[f•f•e•fB••Ûfvf"•fjfwfE•f•v

"ú•@žž•F•½~8"N7Ež15"ú•i•Ež•j•17"ú•i•...j•A%ã@•ê•F,Ā,-,l'æ"èfzfefç

•i-â,ç•ç,í,l•æ•FŠçŎ•i•n"••@•ç%çç•@Ežj•@TEL 0298-38-6304•j

•@





























••Üf••[fNfVf‡fbfv•F•...“c”Z•±CE^”_<Æ,Æ%°Z°CEø%oÊfKfX,İ•§CEä•|

••Uf••[fNfVf‡fbfv•F•...“c”Z•±CE^”_<Æ,Æ%°Z°CEø%oEjKfX,İ•§CEä•|

•@

@'nc...K-İ.İŠÄ«-à'è,İ•A,e.Ü.ä'½,-,İ•X,İ.,µ.Ä'½,-,İ.D,Æ,Ñ,Æ,İ'd'ä.ÈŠÖ•SŽ-Æ.È.è•A,±.è.É™.Ä.Ä.e.½.é.Æ.±.è.Ä•A.»µ.Ä-İ•X.È•-İ.Ä••Ü°İ.È%ä+‡,ä.½.é.Ä.e.é•B'nc...ŠÄ««.İ•I°@.İCE±.ÉŠÖ.f.é'g•D.δ.,°,é.İ-‡.“.É.e.Æ.Ü.°,È.e.é•B.e.f.,+AIPCC.IGBP.SCOPE.UNEP.WMO.UNDP.UNESCO.GEF.ICSU.WCRP.GCOP.CACGP.ISSC.START.HDGECE.Ç.È.Ç•B

@•Ä•B,İ•A“Á.É”_<Æ•-İ.ÉŠÖ.f.é••Ü°İ.È%ä+‡.º½,é•B.»é.İ•°%Ä.µ.Ä.Ä.,é•İCEü.É•H-Æ.δ.Y<<.,é”_<ÆS™°@.»İ.ä.İ.°A'nc...ŠÄ««.É'ä.«.È%æç.δ-ı.İ.Ä.e.é.±.Æ.İ°L.“FŽ”°,é.é.ÉŽŠ.Ä.½.½.B.Ä.,é•B.±.é.ç.İ%ä+c.Ä.c”•ECEY”é.°,é.é-à'è.İ•A'äCSÄ««.İ•I°@.Æ'nc...K-İ.Ä.İ.CEö•I°@•A“Á.É%æ'g%æ.Æ.f/f/f”w.İ”%æö.ÉŠÖ.-.é.ä.İ.Ä.,é•B

@°%æÄ.µ.Ä.Ä.,é•İCEü.É'İ%ä.-.é.½.B•A“ŽY.µ.Ä.Ä.,é•...“c”_<Æ.Æ°%æÄ.µ.Ä.Ä.,é%æE'["••".İ•A%æ'g%æ»fKfX,İ.D,Æ,Ä.Ä.,é.f+f°f”İ”•(CE'Ä.,é.µ•A°%æÄ.µ.Ä.Ä.,é'Γ-ı-ı.Æ%æE'["r,İ•A•.İ•A.f/f/f”w”]f%æö.Æ%æ'g%æ.É%æç.δ.y.Ü.-YŽ%æ”'f.İ”•(CE'È.İ.Ä.,é•B

•@ZÈ••Ff••[fNfVf‡fbfv.İZQ%æÄZÖ:ıO—ñ¶.@.ç.R”Ö-Ü.°MZÖj

@~è•ü•A•...“c.İfAfwfA.Ä•ç”N.ä“ñ•ç”N.à'±.é.Ä.e.é•A.ÉŽ•±”I.È”_<Æ.Ä.,é•B•...“c.İ¶ŽY.İ.Y.È.ç.,+AŠÄ««δÜ°S.,é.°,Ü.“Ü.È@~\δ-L.µ.Ä.e.é•B.e.f.,+A•...@.ñ-ı-ı@~\°A”y•è•Z+H-hŽ-@~\°A%æ'ö•°•δ%æ»@~\°A¶”ŠÜ°S.@~\°A'ä.C•Ü°S.@~\È.Ç.È.Ç•B

±.İ.æ.ö.ÉŠ-µ•.,.é@~\δ-L.,.é•...“c.É•A“ŽZ.É-Ü.δCEü.”.Ä+s.ı.é.½••Üf••[fNfVf‡fbfv.İ•A,±.é.°eŠE.Ä.ä%æ.B.Ä.Ä.,é.ö•B

@.±.İf••[fNfVf‡fbfv.İ•A”_—Ñ•...ŽY•É'ä+bŠ-[ŠÄ««İ•öZ°•A••Ü°”_—Ñ•...ŽY.ÆCE±.fZf°f°[ı.æ.NZÖ+H”•+‡CE±+Š.İ.ö•Ä.İ.ä.Æ.É•A•½+•8”N3EŽ7”ü.”.æ.NŠ”ü.É”]”g.İ”_—ÑCEö—fZf°f°[.ÄŠJ•Ä.,é.½•B17•İ.İŠÖ•+İ.Æ40•İ.İ”ü-(ı.°ZQ%æÄ.µ•A—L%æv.È”e”_°s.f.é.½•B

- @ŠÄ««İ•öZ°İ.ñ•BZ”°.Æ••Ü°”_—Ñ•...ŽY.ÆCE±.fZf°f°[.İŠL•Ä•Š”.İ”YZA.É'±.é.Ä•A“ü-(+AŠÖ°•A.fA.f°f°f°[fXf.g.f°ç]ŠfA.©.ç5-½.İCE±.ZÖ.ŠT•ä.δ+s.e•A.»İCEä8f••.İ'ä^ı.»é.½.é.İ.İCE±.δ•D%æ.µ.½•B.°,ç.Éİ2-¼.İCE±.ZÖ.İı”İ.ÈCE±.+°æÉ.°D%æ.°,é.½•BZQ+İ.Ü.Ä.ÉŠT•ä.δ+s.Ä.½5+İ.İñ•ZÖ.İ^è.δ•D%æı.é•B
- The role of rice paddy fields in the promotion of sustainable agriculture and conservation of agro-ecosystems. K. Minami(Japan)
- Sustainable agriculture and the conservation of agro-ecosystems in Korea. W. G. Bae(Korea)
- Nitrous oxide emission from rice fields. J. R. Freney (Australia)
- A regional analysis of human alteration of nitrogen cycling: The role of agriculture. R. Howarth(USA)
- Agriculture impact on soil consumption of atmospheric methane. A. R. Mosier(USA)

(ŠÄ««Ž°CE'ı°”•@—Z°@••s)









































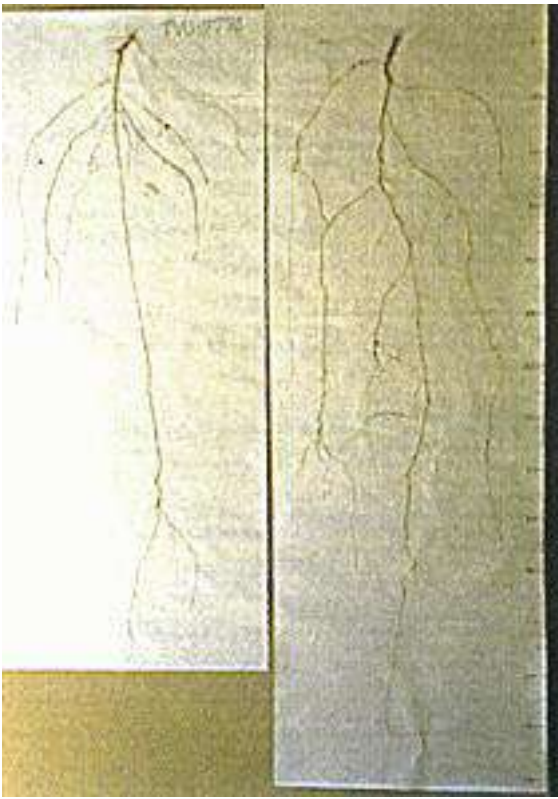


系統	子実収量 (g/plant)	子実収量 (kg/ha)
TVu-11979	14.32	1007.0
TVu-11986	15.70	921.1
TVu-12348	13.60	910.9
TVu-12349	9.17	582.4
-----		
Dan Illa	8.09	288.4
Kanannado	7.61	470.6
IT84s-2246-4	8.23	451.5
-----		
TVu-7778	4.01	267.4
TVu-8256	2.36	153.9
TVu-9357	4.58	272.1

上 4系統：乾燥耐性系統  
中 3系統：栽培品種  
下 3系統：乾燥感受性系統



























fn•[fŠ•[‘â%öi•—Œi  
 Žè‘O,©,ç,Q”Ô–Ú,ª•µ,Ö,çŠO•lf•[f•iŽB%œœ•FfL,fGfX,f•j





*****

*****

Jn4

*****

*****

*****

*****

*****

*****

*****

*****

*****

*****

*****

*****

*****

*****

*****

*****

*****

*****

*****

*****

*****

*****

*****

*****

*****

*****

*****

*****

*****

*****

*****

*****

*****

*****

*****

*****

*****

*****

*****

*****

*****

*****

*****

*****

*****

*****

*****

*****

*****

*****

*****

*****

*****

*****

*****

*****

*****

*****

*****

*****

*****

*****

*****

*****

*****

*****

*****

*****

*****

*****

*****

*****

*****

*****

*****

*****

*****

*****

*****

*****

*****

*****

*****

*****

*****

*****

*****

*****

*****

*****

*****

*****

*****

*****

*****

*****

*****

*****

*****

*****

*****

*****

*****

*****

*****

*****

*****

*****

*****

*****

*****

*****

*****

*****

*****

*****

*****

*****

*****

*****

*****

*****

*****

*****

*****

*****

*****

*****

*****

*****

*****

*****

*****











•¶%oo•F'á-ò—Ê•·%ooE•ã•F•,-ò—Ê



•¶%o°•F'á-ò—Ê•°E•ã•F•,-ò—Ê



写真5：  
農家水田で多発する雑  
草イネ（籾は既に脱落  
している）



写真6：  
雑草イネは幅広い形態  
変異を示す

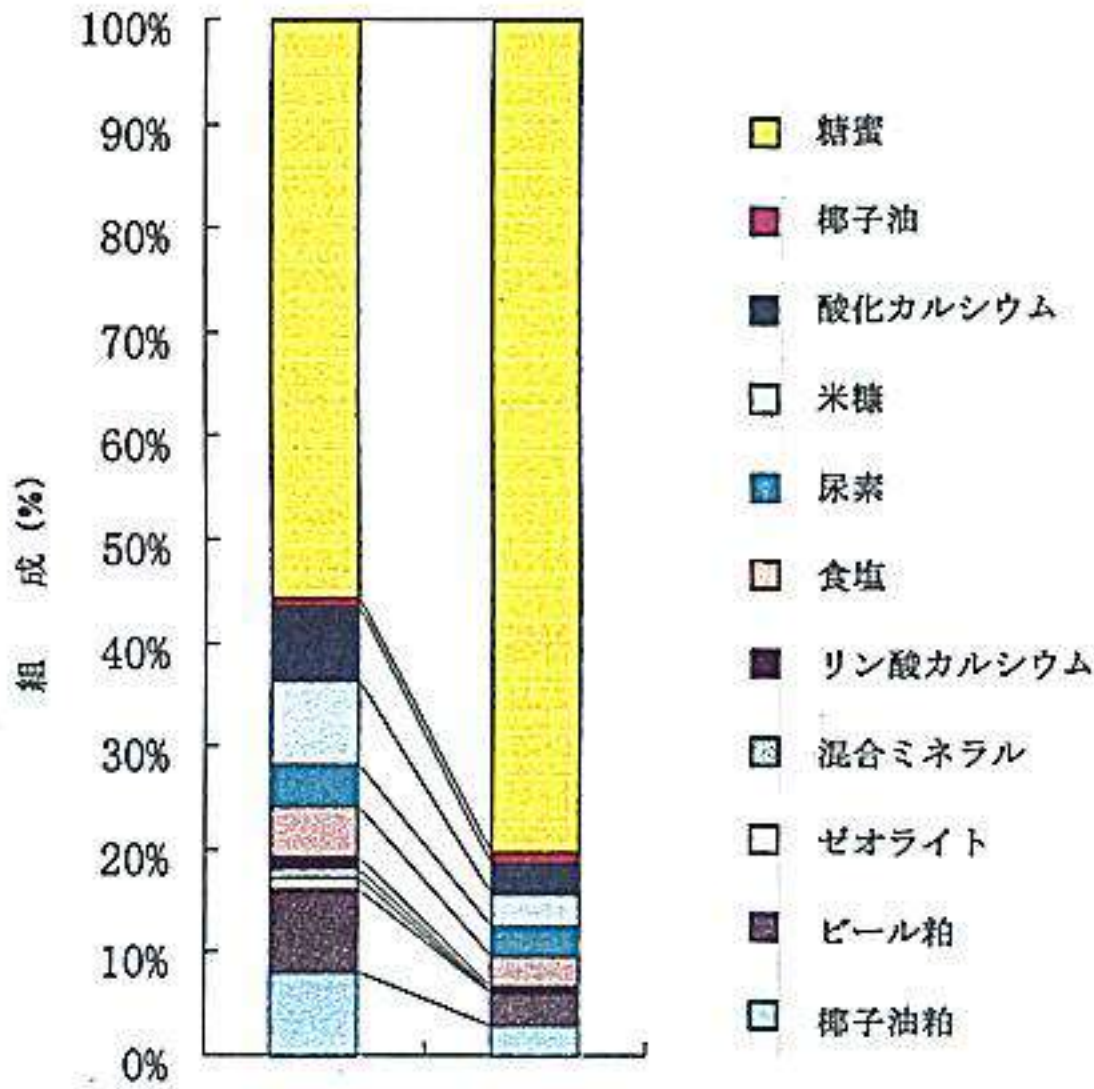


写真7：  
脱落種子は休眠性を有  
し、次作以降の発生源  
となる



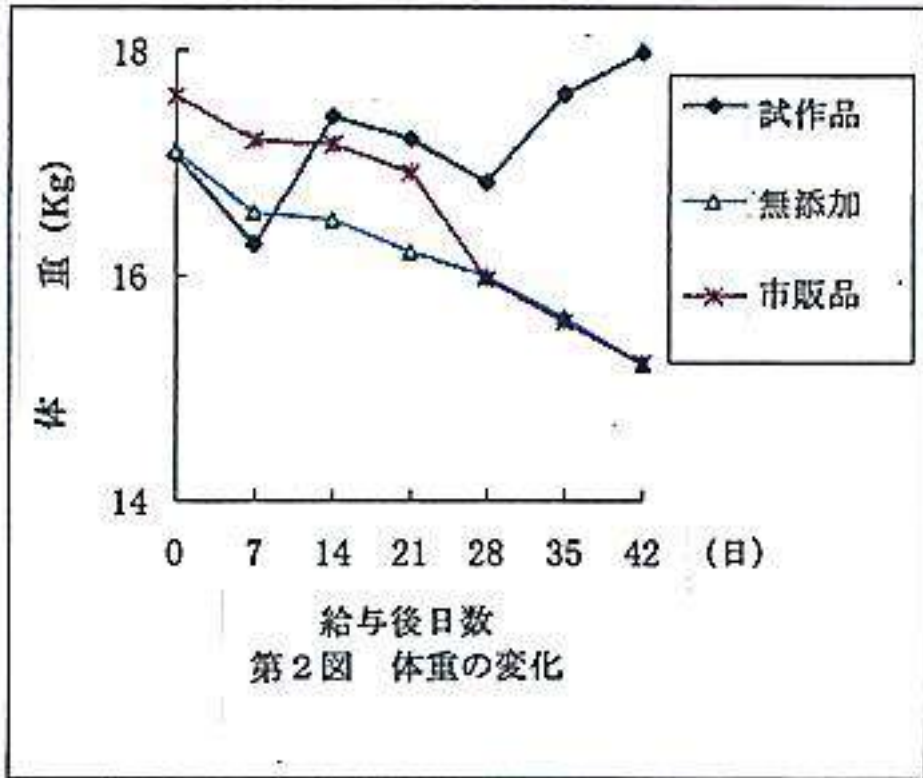






第1図 適正な組成の範囲









# JIRCAS fjf...[fX•@•@•@•@No.9•@ 1997

## -Ú•@•@•@•@ ÿ

- E•@ [fOf•\[fof<fp•\[fgfi•\[fVf‡fbfv,ì,à,Æ,Å](#)
- E•@ [f^fC-k¼•”,É,“,é”M’Ñ<G•β—Ñ,ì’ŠúŠī^{ia}](#)
- E•@ [fgfEfWf“frfG,ì“ Æ<Û“¶%Ô²,ð—~—p,.,é—” ”¼•”ì,ì•o](#)
- E•@ [”M’Ñ,É,“,é...“c,©,ç,ìf•f^f“”-•¶šÆä<Z•p,ìŠJ”-](#)
- E•@ [DNAf}•\[fJ•\[É,æ,é•,ì^â“”\—í•, ’è—@](#)
- E•@ [ftf^fofKfL%È,ì ÷ í“Á•«](#)
- E•@ [fCf“fhflfVfA”_<Æ•È”_<ÆÆα<†ŠJ”-’j•iAARD•j,Æ,ì<α““Æα<†,ì•,•i](#)
- E•@ [flfjfefifKfGfr,ìŠ@‘S—{•B•FJIRCAS,Å,ì,,,ìÆα<†,É,Â,ç,Ä](#)
- E•@ [fCf“fhflfVfA,É,“,éα““Æα<†•u—L—p%ˆŠÝ<—P,ì•¶Š^ j,ì%ð-¾•v,ìŠT—v](#)
- E•@ [¼fPffjA,É,“,é•@’ •H](#)



- Žl•ûŽR~b,đ,μ,È,ç-ì•Ø,đŽd•³,~,é•ê,Æ-º•@•i•¼fPffjA•AfGf“fUf•º,É,Ä•E-{-¶•A•¼fPffjA,É,“,é•©’Ž•H•A,ÉŠÖ~A<LŽ-•A•¶ŽY—~—p•”•@”ª-Ø”ÉŽÀ•j





•r”p’n,Å,İŽR%oİŽ-,İ—lŽq



•r”p’n,Å,İŽR%oİŽ-,İ—lŽq•@(1996”N2EŽ)



•-Œđ-Ž-t“V‘R-Ń,ì”ö•ã,ÉŠ®•-ı,μ,½•,³



•-Œđ-Ž-t“V‘R-Ń,ì”ö•ã,ÉŠ®•-ı,μ,½

•,³40m,Ìf^f••[









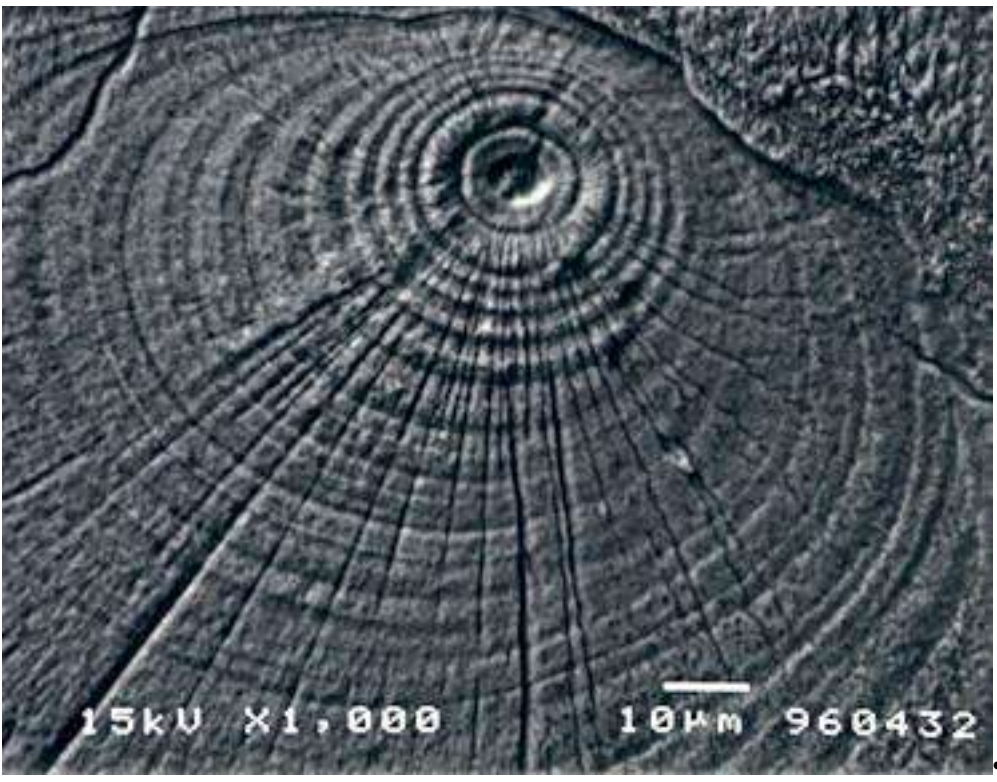








•@•@

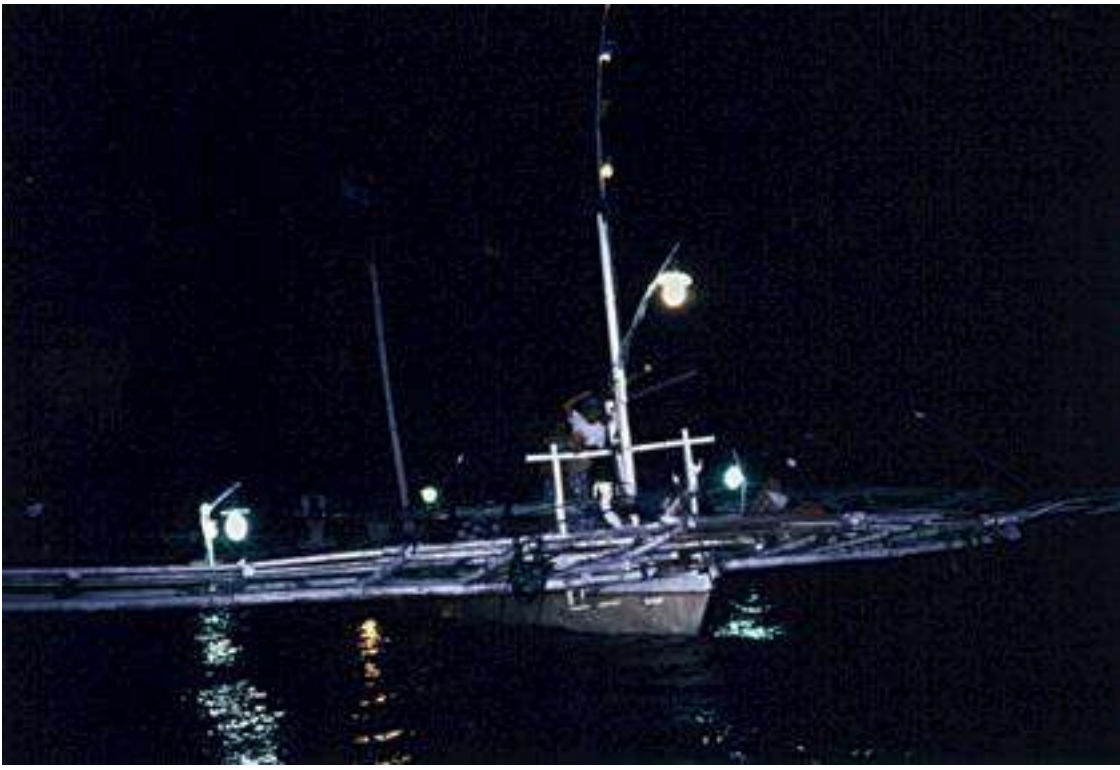


•@•@

•@•@•@•@•@Ž•Î“úŽü—Ö,Ì“dŽqCE°”÷<¾ŽÊ•^

•@•@•@•@•@•i<—Í•FŽŽ...•E•©’Ž”_<Æ<Z•pCEα†•Š•j







frf•,l—t,đ•HŠQ,•,éEmperor Moth,l`eŽi



ŽÊ^,P•F frf•,l—t,đ•HŠQ,•,é Emperor Moth ,l`eŽi

•@•@*Nudarelia guenzii*



ŽÊ•^,Q•F fEfYf%,ÅfEfYf%,đ•B,Ü,!,éŽdŠ|,~•B

•@•¼fPfjA•EfGf“fUf•°É,Ä•B

fGf“fUf•°Å,ì,²’y’–



ŽÊ•^,R •F fGf“fUf•°Å,ì,²’y’–



Žl•ûŽR~b,đ,μ,È,^aç-ì•Ø,đŽd•^a,-,.,é•ê,Æ-^o•i•¼fPffjA•AfGf“fUf•^o,É,Ä•j









fVf"flfWfEf •@'æ,Q%ñJIRCAS'•ÛfVf"flfWfEf ŠJ•Ã,³,è,é



▲ 進行役をつとめる大賀  
海外情報部長

← 一般討論





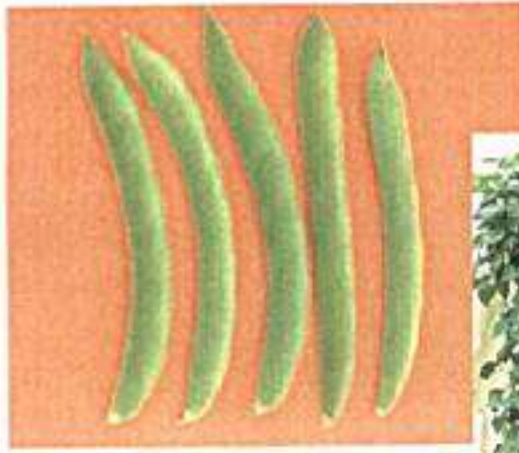












◀写真2：ハイブシの若莢  
▼写真3：ハイブシの草姿































- [•î•ñĀöŠJ•§“x,İŠT—v](#)
- [•‘Ū” —Ñ•...ŽY<ĀĀœ<†fZf“f^•\[•î•ñĀöŠJ‘<ĀĒ](#)
- [—@•l•¶•‘ftf@fCf<ŠÇ—••ë](#)
- [—@•l•¶•‘ŠJŽ!•i<••‘](#)
- [—@•l•¶•‘ŠÇ—•K’ö\(html\)](#)
- [•î•ñĀöŠJ,ÉŠÖ,.,é<K’ö](#)
- [ŠJŽ!Ā^’è“™•R•,Šî•](#)
- [•î•ñĀöŠJ—@‘æ22•đ,ÉŠî,Ã,—•î•ñ’ñ<ÿ\(html\)](#)
- [i“Ā—§•s•—@•l’Ê‘Ÿ—@•A•“%œĀĀö—±^õ—İ—•—@,ÉŠî,Ã,—•î•ñ’ñ<ÿ,đŠÛ,Ā•B•j](#)

* ‘•ó *

“Á,ÉŽw’è,Ì,È,¢ftf@fCf<,Í,.,x,ĀPDFftf@fCf<,Ā,•B,²—,İ•Ū,ÉAcrobat Reader,^aK—v,Ā,•B  
 Acrobat Reader f_fEf“f•[fh (—i•j

•‘Ū” —Ñ•...ŽY<ĀĀœ<†fZf“f^•[

# 情報公開制度の概要

## 開示請求権制度

何人も、当法人に対し、当法人の保有する法人文書の開示を請求することができます。

## 開示請求できる文書

役員又は職員が組織的に用いるものとして当法人が保有する文書、図画及び電磁的記録（フロッピーディスク等に記録された電子情報）が開示請求の対象となります。

ただし、書籍等の市販物等は除かれます。

## 開示請求

開示請求書に必要な事項を記載して、当法人等の情報公開窓口へ提出するか又は送付してください。

開示請求には開示請求手数料が必要です。

開示請求手数料及び開示実施手数料の額は行政機関の場合と同様となっています。

## 開示・非開示決定の通知

開示・不開示の決定は、原則として30日以内に行われ、書面で通知されます。個人に関する情報等の不開示情報が記録されている場合を除いて、法人文書を開示します。

## 開示の実施

開示決定の通知を受けた方は、文書又は図画の場合には閲覧又は写しの交付、電磁的記録の場合には別に定める方法により、開示の実施が受けられます。

開示の実施を受ける方は、通知のあった日から30日以内に、開示の実施方法を選択して、書面により申し出てください。

開示の実施を受けるには、開示実施手数料が必要となります。

写しの送付を希望する方は、手数料のほかに送料が必要となります。

手数料の納付の方法は、開示決定の通知において、開示実施手数料の額などの必要な事項、手続きが記載されていますので、これに沿って手続きを進めてください。

## 情報提供制度

法人文書の開示請求制度とは別に、当所の組織、業務、財務に関する基礎的な情報等を記録した文書等を作成し、適時に、かつ、備え付け及びインターネットのホームページにより情報の提供を行っています。

その他情報公開に関することは情報公開窓口にご相談ください。

独立行政法人国際農林水産業研究センター情報公開窓口

本所：総務部庶務課 〒 305-8686 茨城県つくば市大わし 1 - 1  
電話 0298-38-6313 FAX 0298-38-6316

支所：庶務課 〒 907-0002 沖縄県石垣市字真栄里川良原 1091-1  
電話 09808-2-2306 FAX 09808-2-0614

独立行政法人国際農林水産業研究センター法人文書ファイル管理簿

文書分類			法人文書ファイル名	作成者	作成(取得)時期	保存期間(年)	保存期間満了時期	媒体種別	保存場所	管理担当課 係	保存期間満了時の措置結果	備考
大分類	中分類	小分類										
共通	法規等	一般	(平成13年度)業務方法書	企画調整部研究企画科	2001年度	30	2031年度末	紙	企画書庫	企画調整部研究企画科		
共通	法規等	一般	(平成13年度)中期目標	企画調整部研究企画科	2001年度	30	2031年度末	紙	企画書庫	企画調整部研究企画科		
共通	法規等	一般	(平成13年度)中期計画	企画調整部研究企画科	2001年度	30	2031年度末	紙	企画書庫	企画調整部研究企画科		
共通	法規等	一般	(平成13年度)年度計画	企画調整部研究企画科	2001年度	10	2011年度末	紙	企画書庫	企画調整部研究企画科		
共通	法規等	一般	(平成12年度)法令等に基づく許可、認可、承認、届出、及び報告等に関する文書(重要なもの)	総務部庶務課庶務係	2000年度	30	2030年度末	紙	事務室	総務部庶務課庶務係		
共通	法規等	一般	(平成13年度)法令等に基づく許可、認可、承認、届出及び報告等に関する文書(重要なもの)	総務部庶務課課長補佐	2001年度	30	2031年度末	紙	事務室	総務部庶務課課長補佐		
共通	法規等	一般	(平成13年度)法令等に基づく許可、認可、承認、届出及び報告等に関する文書(重要なもの)	総務部庶務課庶務係	2001年度	30	2031年度末	紙	事務室	総務部庶務課庶務係		
共通	法規等	一般	(平成13年度)法令等に基づく許可、認可、承認、届出及び報告等に関する文書(重要なもの)	総務部庶務課厚生係	2001年度	30	2031年度末	紙	事務室	総務部庶務課厚生係		
共通	法規等	一般	(平成13年度)法令等に基づく許可、認可、承認、届出及び報告等に関する文書(重要なもの)	沖縄支所庶務課会計係	2001年度	30	2031年度末	紙	事務室	沖縄支所庶務課会計係		
共通	法規等	一般	(平成9年度)法令等に基づく許可、認可、承認、届出、及び報告等に関する文書(重要なもの以外)	総務部庶務課庶務係	1997年度	10	2007年度	紙	文書庫	総務部庶務課庶務係		
共通	法規等	一般	(平成13年度)法令等に基づく許可、認可、承認、届出及び報告等に関する文書(重要なもの以外)	総務部庶務課庶務係	2001年度	10	2011年度末	紙	事務室	総務部庶務課庶務係		
共通	法規等	一般	(平成13年度)法令又は規程等に関する通知、調査、照会、回答又は報告等に関する文書(重要なもの)	総務部庶務課庶務係	2001年度	10	2011年度末	紙	事務室	総務部庶務課庶務係		
共通	法規等	一般	(平成9年度)法令又は規程等に関する通知、調査、照会、回答又は報告等に関する文書(通常のもの)	総務部庶務課庶務係	1997年度	5	2002年度末	紙	文書庫	総務部庶務課庶務係		
共通	法規等	一般	(平成9年度)法令又は規程等に関する通知、調査、照会、回答又は報告等に関する文書(通常のもの)	総務部庶務課厚生係	1997年度	5	2002年度末	紙	文書庫	総務部庶務課厚生係		
共通	法規等	一般	(平成10年度)法令又は規程等に関する通知、調査、照会、回答又は報告等に関する文書(通常のもの)	総務部庶務課庶務係	1998年度	5	2003年度末	紙	文書庫	総務部庶務課庶務係		
共通	法規等	一般	(平成10年度)法令又は規程等に関する通知、調査、照会、回答又は報告等に関する文書(通常のもの)	総務部庶務課厚生係	1998年度	5	2003年度末	紙	文書庫	総務部庶務課厚生係		
共通	法規等	一般	(平成11年度)法令又は規程等に関する通知、調査、照会、回答又は報告等に関する文書(通常のもの)	総務部庶務課庶務係	1999年度	5	2004年度末	紙	文書庫	総務部庶務課庶務係		
共通	法規等	一般	(平成11年度)法令又は規程等に関する通知、調査、照会、回答又は報告等に関する文書(通常のもの)	総務部庶務課厚生係	1999年度	5	2004年度末	紙	文書庫	総務部庶務課厚生係		
共通	法規等	一般	(平成12年度)法令又は規程等に関する通知、調査、照会、回答又は報告等に関する文書(通常のもの)	総務部庶務課庶務係	2000年度	5	2005年度末	紙	事務室	総務部庶務課庶務係		
共通	法規等	一般	(平成12年度)法令又は規程等に関する通知、調査、照会、回答又は報告等に関する文書(通常のもの)	総務部庶務課厚生係	2000年度	5	2005年度末	紙	文書庫	総務部庶務課厚生係		
共通	法規等	一般	(平成13年度)法令又は規程等に関する通知、調査、照会、回答又は報告等に関する文書(通常のもの)	総務部庶務課庶務係	2001年度	5	2006年度末	紙	事務室	総務部庶務課庶務係		

独立行政法人国際農林水産業研究センター法人文書ファイル管理簿

文書分類			法人文書ファイル名	作成者	作成(取得)時期	保存期間(年)	保存期間満了時期	媒体種別	保存場所	管理担当課 係	保存期間満了時の措置結果	備考
大分類	中分類	小分類										
共通	法規等	一般	(平成13年度)法令又は規程等に関する通知、調査、照会、回答又は報告等に関する文書(通常のもの)	総務部庶務課厚生係	2001年度	5	2006年度末	紙	事務室	総務部庶務課厚生係		
共通	法規等	一般	(平成13年度)法令又は規程等に関する通知、調査、照会、回答又は報告等に関する文書(軽微なもの)	総務部庶務課庶務係	2001年度	1	2002年度末	紙	事務室	総務部庶務課庶務係		
共通	法規等	一般	(平成13年度)法令又は規程等に関する通知、調査、照会、回答又は報告等に関する文書(軽微なもの)	沖縄支所庶務課庶務係	2001年度	1	2002年度末	紙	事務室	沖縄支所庶務課庶務係		
共通	法規等	評価	(平成13年度)法人の評価に関する文書	企画調整部研究企画科	2001年度	30	2031年度末	紙	企画書庫	企画調整部研究企画科		
共通	法規等	内部規程	(昭和47年度)内部規程の制定又は改廃に関する文書	総務部庶務課庶務係	1972年度	30	2002年度末	紙	文書庫	総務部庶務課庶務係		
共通	法規等	内部規程	(昭和48年度)内部規程の制定又は改廃に関する文書	総務部庶務課庶務係	1973年度	30	2003年度末	紙	文書庫	総務部庶務課庶務係		
共通	法規等	内部規程	(昭和49年度)内部規程の制定又は改廃に関する文書	総務部庶務課庶務係	1974年度	30	2003年度末	紙	文書庫	総務部庶務課庶務係		
共通	法規等	内部規程	(昭和50年度)内部規程の制定又は改廃に関する文書	総務部庶務課庶務係	1975年度	30	2005年度末	紙	文書庫	総務部庶務課庶務係		
共通	法規等	内部規程	(昭和51年度)内部規程の制定又は改廃に関する文書	総務部庶務課庶務係	1976年度	30	2006年度末	紙	文書庫	総務部庶務課庶務係		
共通	法規等	内部規程	(昭和53年度)内部規程の制定又は改廃に関する文書	総務部庶務課庶務係	1978年度	30	2008年度末	紙	文書庫	総務部庶務課庶務係		
共通	法規等	内部規程	(昭和54年度)内部規程の制定又は改廃に関する文書	総務部庶務課庶務係	1979年度	30	2009年度末	紙	文書庫	総務部庶務課庶務係		
共通	法規等	内部規程	(昭和55年度)内部規程の制定又は改廃に関する文書	総務部庶務課庶務係	1980年度	30	2010年度末	紙	文書庫	総務部庶務課庶務係		
共通	法規等	内部規程	(昭和56年度)内部規程の制定又は改廃に関する文書	総務部庶務課庶務係	1981年度	30	2011年度末	紙	文書庫	総務部庶務課庶務係		
共通	法規等	内部規程	(昭和57年度)内部規程の制定又は改廃に関する文書	総務部庶務課庶務係	1982年度	30	2012年度末	紙	文書庫	総務部庶務課庶務係		
共通	法規等	内部規程	(昭和60年度)内部規程の制定又は改廃に関する文書	総務部庶務課庶務係	1985年度	30	2015年度末	紙	文書庫	総務部庶務課庶務係		
共通	法規等	内部規程	(平成3年度)内部規程の制定又は改廃に関する文書	総務部庶務課庶務係	1991年度	30	2021年度末	紙	文書庫	総務部庶務課庶務係		
共通	法規等	内部規程	(平成4年度)内部規程の制定又は改廃に関する文書	総務部庶務課庶務係	1992年度	30	2022年度末	紙	文書庫	総務部庶務課庶務係		
共通	法規等	内部規程	(平成4年度)内部規程の制定又は改廃に関する文書	沖縄支所庶務課庶務係	1992年度	30	2022年度末	紙	事務室	沖縄支所庶務課庶務係		
共通	法規等	内部規程	(平成5年度)内部規程の制定又は改廃に関する文書	総務部庶務課庶務係	1993年度	30	2023年度末	紙	文書庫	総務部庶務課庶務係		
共通	法規等	内部規程	(平成5年度)内部規程の制定又は改廃に関する文書	沖縄支所庶務課庶務係	1993年度	30	2023年度末	紙	事務室	沖縄支所庶務課庶務係		
共通	法規等	内部規程	(平成6年度)内部規程の制定又は改廃に関する文書	総務部庶務課庶務係	1994年度	30	2024年度末	紙	文書庫	総務部庶務課庶務係		

独立行政法人国際農林水産業研究センター法人文書ファイル管理簿

文書分類			法人文書ファイル名	作成者	作成(取得)時期	保存期間(年)	保存期間満了時期	媒体種別	保存場所	管理担当課 係	保存期間満了時の措置結果	備考
大分類	中分類	小分類										
共通	法規等	内部規程	(平成 7年度)内部規程の制定又は改廃に関する文書	総務部庶務課庶務係	1995年度	30	2025年度末	紙	文書庫	総務部庶務課庶務係		
共通	法規等	内部規程	(平成 8年度)内部規程の制定又は改廃に関する文書	総務部庶務課庶務係	1996年度	30	2026年度末	紙	文書庫	総務部庶務課庶務係		
共通	法規等	内部規程	(平成 9年度)内部規程の制定又は改廃に関する文書	総務部庶務課庶務係	1997年度	30	2027年度末	紙	文書庫	総務部庶務課庶務係		
共通	法規等	内部規程	(平成 10年度)内部規程の制定又は改廃に関する文書	企画調整部研究企画科	1998年度	30	2028年度末	紙	企画書庫	企画調整部研究企画科		
共通	法規等	内部規程	(平成 10年度)内部規程の制定又は改廃に関する文書	総務部庶務課庶務係	1998年度	30	2028年度末	紙	文書庫	総務部庶務課庶務係		
共通	法規等	内部規程	(平成 10年度)内部規程の制定又は改廃に関する文書	沖縄支所庶務課庶務係	1998年度	30	2028年度末	紙	事務室	沖縄支所庶務課庶務係		
共通	法規等	内部規程	(平成 11年度)内部規程の制定又は改廃に関する文書	企画調整部研究企画科	1999年度	30	2029年度末	紙	企画書庫	企画調整部研究企画科		
共通	法規等	内部規程	(平成 11年度)内部規程の制定又は改廃に関する文書	総務部庶務課庶務係	1999年度	30	2029年度末	紙	文書庫	総務部庶務課庶務係		
共通	法規等	内部規程	(平成 12年度)内部規程の制定又は改廃に関する文書	企画調整部研究企画科	2000年度	30	2030年度末	紙	企画書庫	企画調整部研究企画科		
共通	法規等	内部規程	(平成 13年度)内部規程の制定又は改廃に関する文書	企画調整部研究企画科	2001年度	30	2031年度末	紙	企画書庫	企画調整部研究企画科		
共通	法規等	内部規程	(平成 13年度)内部規程の制定又は改廃に関する文書	企画調整部連絡調整科	2001年度	30	2031年度末	紙	事務室	企画調整部連絡調整科		
共通	法規等	内部規程	(平成 13年度)内部規程の制定又は改廃に関する文書	企画調整部研究交流科	2001年度	30	2031年度末	紙	事務室	企画調整部研究交流科		
共通	法規等	内部規程	(平成 13年度)内部規程の制定又は改廃に関する文書	企画調整部情報資料課長	2001年度	30	2031年度末	紙	事務室	企画調整部情報資料課長		
共通	法規等	内部規程	(平成 13年度)内部規程の制定又は改廃に関する文書	総務部庶務課課長補佐	2001年度	30	2031年度末	紙	事務室	総務部庶務課課長補佐		
共通	法規等	内部規程	(平成 13年度)内部規程の制定又は改廃に関する文書	総務部庶務課庶務係	2001年度	30	2031年度末	紙	事務室	総務部庶務課庶務係		
共通	法規等	内部規程	(平成 13年度)内部規程の制定又は改廃に関する文書	総務部庶務課人事係	2001年度	30	2031年度末	紙	事務室	総務部庶務課人事係		
共通	法規等	内部規定	(平成 13年度)内部規定の制定又は改廃に関する文書	総務部庶務課厚生係	2001年度	30	2031年度末	紙	事務室	総務部庶務課厚生係		
共通	法規等	内部規定	(平成 13年度)内部規程の制定又は改廃に関する文書	総務部会計課課長補佐	2001年度	30	2031年度末	紙	事務室	総務部会計課課長補佐		
共通	法規等	内部規定	(平成 13年度)内部規程の制定又は改廃に関する文書	総務部会計課専門職(監査)	2001年度	30	2031年度末	紙	事務室	総務部会計課課長補佐		
共通	法規等	内部規定	(平成 13年度)内部規程の制定又は改廃に関する文書	総務部会計課会計係	2001年度	30	2031年度末	紙	事務室	総務部会計課会計係		
共通	法規等	内部規定	(平成 13年度)内部規程の制定又は改廃に関する文書	総務部会計課監査係	2001年度	30	2031年度末	紙	事務室	総務部会計課監査係		

独立行政法人国際農林水産業研究センター法人文書ファイル管理簿

文書分類			法人文書ファイル名	作成者	作成(取得)時期	保存期間(年)	保存期間満了時期	媒体種別	保存場所	管理担当課 係	保存期間満了時の措置結果	備考
大分類	中分類	小分類										
共通	法規等	内部規定	(平成13年度)内部規程の制定又は改廃に関する文書	総務部会計課用度係	2001年度	30	2031年度末	紙	事務室	総務部会計課用度係		
共通	法規等	内部規定	(平成13年度)内部規程の制定又は改廃に関する文書	海外業務管理課専門職(海外服務)	2001年度	30	2031年度末	紙	事務室	海外業務管理課専門職(海外服務)		
共通	法規等	内部規定	(平成13年度)内部規程の制定又は改廃に関する文書	海外業務管理課海外業務調整係	2001年度	30	2031年度末	紙	事務室	海外業務管理課海外業務調整係		
共通	法規等	内部規定	(平成13年度)内部規程の制定又は改廃に関する文書	沖縄支所庶務課庶務係	2001年度	30	2031年度末	紙	事務室	沖縄支所庶務課庶務係		
共通	訴訟等	訴訟	(平成13年度)不服申立及び訴訟に関する文書	総務部庶務課庶務係	2001年度	30	2031年度末	紙	事務室	総務部庶務課庶務係		
共通	監査	監査	(平成13年度)監事監査に関する文書	企画調整部研究企画科	2001年度	10	2011年度末	紙	企画書庫	企画調整部研究企画科		
共通	監査	監査	(平成13年度)監事監査に関する文書	総務部庶務課課長補佐	2001年度	10	2011年度末	紙	事務室	総務部庶務課課長補佐		
共通	会議	会議	(平成9年度)諸会議等の開催に関する文書(重要なもの)	企画調整部研究企画科	1997年度	5	2002年度末	紙	企画書庫	企画調整部研究企画科		
共通	会議	会議	(平成9年度)諸会議等の開催に関する文書(重要なもの)	総務部庶務課庶務係	1997年度	5	2002年度末	紙	文書庫	総務部庶務課庶務係		
共通	会議	会議	(平成10年度)諸会議等の開催に関する文書(重要なもの)	企画調整部研究企画科	1998年度	5	2003年度末	紙	企画書庫	企画調整部研究企画科		
共通	会議	会議	(平成10年度)諸会議等の開催に関する文書(重要なもの)	総務部庶務課庶務係	1998年度	5	2003年度末	紙	文書庫	総務部庶務課庶務係		
共通	会議	会議	(平成11年度)諸会議等の開催に関する文書(重要なもの)	企画調整部研究企画科	1999年度	5	2004年度末	紙	企画書庫	企画調整部研究企画科		
共通	会議	会議	(平成11年度)諸会議等の開催に関する文書(重要なもの)	総務部庶務課庶務係	1999年度	5	2004年度末	紙	文書庫	総務部庶務課庶務係		
共通	会議	会議	(平成12年度)諸会議等の開催に関する文書(重要なもの)	企画調整部研究企画科	2000年度	5	2005年度末	紙	企画書庫	企画調整部研究企画科		
共通	会議	会議	(平成12年度)諸会議等の開催に関する文書(重要なもの)	総務部庶務課庶務係	2000年度	5	2005年度末	紙	事務室	総務部庶務課庶務係		
共通	会議	会議	(平成13年度)諸会議等の開催に関する文書(重要なもの)	企画調整部研究企画科	2001年度	5	2006年度末	紙	企画書庫	企画調整部研究企画科		
共通	会議	会議	(平成13年度)諸会議等の開催に関する文書(重要なもの)	総務部庶務課庶務係	2001年度	5	2006年度末	紙	事務室	総務部庶務課庶務係		
共通	会議	会議	(平成13年度)諸会議等の開催に関する文書(重要なもの以外)	企画調整部研究企画科	2001年度	1	2002年度末	紙	企画書庫	企画調整部研究企画科		
共通	会議	会議	(平成13年度)諸会議等の開催に関する文書(重要なもの以外)	沖縄支所庶務課庶務係	2001年度	1	2002年度末	紙	事務室	沖縄支所庶務課庶務係		
共通	会議	会議	(平成13年度)諸会議等の開催に関する文書(重要なもの以外)	沖縄支所庶務課開会係	2001年度	1	2002年度末	紙	事務室	沖縄支所庶務課開会係		
共通	一般	その他	(平成10年度)他に該当しない事務及び事業に関する文書(重要なもの)	沖縄支所庶務課庶務係	1998年度	5	2003年度末	紙	事務室	沖縄支所庶務課庶務係		

独立行政法人国際農林水産業研究センター法人文書ファイル管理簿

文書分類			法人文書ファイル名	作成者	作成(取得)時期	保存期間(年)	保存期間満了時期	媒体種別	保存場所	管理担当課 係	保存期間満了時の措置結果	備考
大分類	中分類	小分類										
共通	一般	その他	(平成11年度)他に該当しない事務及び事業に関する文書(重要なもの)	沖縄支所庶務課庶務係	1999年度	5	2004年度末	紙	事務室	沖縄支所庶務課庶務係		
共通	一般	その他	(平成12年度)他に該当しない事務及び事業に関する文書(重要なもの)	沖縄支所庶務課会計係	2000年度	5	2005年度末	紙	事務室	沖縄支所庶務課会計係		
共通	一般	その他	(平成12年度)他に該当しない事務及び事業に関する文書(重要なもの)	沖縄支所庶務課庶務係	2000年度	5	2005年度末	紙	事務室	沖縄支所庶務課庶務係		
共通	一般	その他	(平成13年度)他に該当しない事務及び事業に関する文書(重要なもの)	総務部庶務課庶務係	2001年度	1	2002年度末	紙	事務室	総務部庶務課庶務係		
共通	一般	その他	(平成13年度)他に該当しない事務及び事業に関する文書(重要なもの)	沖縄支所庶務課庶務係	2001年度	5	2006年度末	紙	事務室	沖縄支所庶務課庶務係		
共通	一般	その他	(平成13年度)他に該当しない事務及び事業に関する文書(重要なもの以外)	沖縄支所庶務課庶務係	2001年度	1	2002年度末	紙	事務室	沖縄支所庶務課庶務係		



独立行政法人国際農林水産業研究センター法人文書ファイル管理簿

文書分類			法人文書ファイル名	作成者	作成(取得)時期	保存期間(年)	保存期間満了時期	媒体種別	保存場所	管理担当課 係	保存期間満了時の措置結果	備考
大分類	中分類	小分類										
調査及び研究	企画調整	一般	(平成9年度)企画調整に関する通知、照会、回答、依頼、報告等に関する文書(重要なもの)	企画調整部研究企画科	1997年度	5	2002年度末	紙	企画書庫	企画調整部研究企画科		
調査及び研究	企画調整	一般	(平成10年度)企画調整に関する通知、照会、回答、依頼、報告等に関する文書(重要なもの)	企画調整部研究企画科	1998年度	5	2003年度末	紙	企画書庫	企画調整部研究企画科		
調査及び研究	企画調整	一般	(平成11年度)企画調整に関する通知、照会、回答、依頼、報告等に関する文書(重要なもの)	企画調整部研究企画科	1999年度	5	2004年度末	紙	企画書庫	企画調整部研究企画科		
調査及び研究	企画調整	一般	(平成12年度)企画調整に関する通知、照会、回答、依頼、報告等に関する文書(重要なもの)	企画調整部研究企画科	2000年度	5	2005年度末	紙	企画書庫	企画調整部研究企画科		
調査及び研究	企画調整	一般	(平成13年度)企画調整に関する通知、照会、回答、依頼、報告等に関する文書(重要なもの)	企画調整部研究企画科	2001年度	5	2006年度末	紙	企画書庫	企画調整部研究企画科		
調査及び研究	企画調整	一般	(平成13年度)企画調整に関する通知、照会、回答、依頼、報告等に関する文書(重要なもの以外)	企画調整部研究企画科	2001年度	1	2002年度末	紙	企画書庫	企画調整部研究企画科		
調査及び研究	企画調整	委員会	(平成11年度)研究に係る各種委員会に関する文書	企画調整部研究企画科	1999年度	3	2002年度末	紙	企画書庫	企画調整部研究企画科		
調査及び研究	企画調整	委員会	(平成12年度)研究に係る各種委員会に関する文書	企画調整部研究企画科	2000年度	3	2003年度末	紙	企画書庫	企画調整部研究企画科		
調査及び研究	企画調整	委員会	(平成13年度)研究に係る各種委員会に関する文書	企画調整部研究企画科	2001年度	3	2004年度末	紙	企画書庫	企画調整部研究企画科		
調査及び研究	企画調整	委員会	(平成13年度)研究に係る各種委員会に関する文書	沖繩支所庶務課庶務係	2001年度	3	2004年度末	紙	事務室	沖繩支所庶務課庶務係		
調査及び研究	企画調整	評価	(平成13年度)業績評価に関する文書	企画調整部研究企画科	2001年度	5	2006年度末	紙	企画書庫	企画調整部研究企画科		
調査及び研究	企画調整	研究業務報告	(平成9年度)外国出張報告に関する文書	企画調整部連絡調整科	1997年度	5	2002年度末	紙	企画書庫	企画調整部連絡調整科		
調査及び研究	企画調整	研究業務報告	(平成10年度)外国出張報告に関する文書	企画調整部連絡調整科	1998年度	5	2003年度末	紙	企画書庫	企画調整部連絡調整科		
調査及び研究	企画調整	研究業務報告	(平成11年度)外国出張報告に関する文書	企画調整部連絡調整科	1999年度	5	2004年度末	紙	企画書庫	企画調整部連絡調整科		
調査及び研究	企画調整	研究業務報告	(平成12年度)外国出張報告に関する文書	企画調整部連絡調整科	2000年度	5	2005年度末	紙	企画書庫	企画調整部連絡調整科		
調査及び研究	企画調整	研究業務報告	(平成13年度)外国出張報告に関する文書	企画調整部連絡調整科	2001年度	5	2006年度末	紙	企画書庫	企画調整部連絡調整科		
調査及び研究	企画調整	研究業務報告	(平成9年度)研究業務の報告に関する文書	企画調整部研究企画科	1997年度	5	2002年度末	紙	企画書庫	企画調整部研究企画科		
調査及び研究	企画調整	研究業務報告	(平成10年度)研究業務の報告に関する文書	企画調整部研究企画科	1998年度	5	2003年度末	紙	企画書庫	企画調整部研究企画科		
調査及び研究	企画調整	研究業務報告	(平成11年度)研究業務の報告に関する文書	企画調整部研究企画科	1999年度	5	2004年度末	紙	企画書庫	企画調整部研究企画科		
調査及び研究	企画調整	研究業務報告	(平成12年度)研究業務の報告に関する文書	企画調整部研究企画科	2000年度	5	2005年度末	紙	企画書庫	企画調整部研究企画科		
調査及び研究	企画調整	研究業務報告	(平成13年度)研究業務の報告に関する文書	企画調整部研究企画科	2001年度	5	2006年度末	紙	企画書庫	企画調整部研究企画科		
調査及び研究	企画調整	原子力利用	(平成9年度)国際規制物質に関する文書	企画調整部研究企画科	1997年度	10	2002年度末	紙	企画書庫	企画調整部研究企画科		

独立行政法人国際農林水産業研究センター法人文書ファイル管理簿

文書分類			法人文書ファイル名	作成者	作成(取得)時期	保存期間(年)	保存期間満了時期	媒体種別	保存場所	管理担当課 係	保存期間満了時の措置結果	備考
大分類	中分類	小分類										
調査及び研究	企画調整	原子力利用	(平成10年度)国際規制物質に関する文書	企画調整部研究企画科	1998年度	10	2003年度末	紙	企画書庫	企画調整部研究企画科		
調査及び研究	企画調整	原子力利用	(平成11年度)国際規制物質に関する文書	企画調整部研究企画科	1999年度	10	2004年度末	紙	企画書庫	企画調整部研究企画科		
調査及び研究	企画調整	原子力利用	(平成12年度)国際規制物質に関する文書	企画調整部研究企画科	2000年度	10	2005年度末	紙	企画書庫	企画調整部研究企画科		
調査及び研究	企画調整	原子力利用	(平成13年度)国際規制物質に関する文書	企画調整部研究企画科	2001年度	10	2006年度末	紙	企画書庫	企画調整部研究企画科		
調査及び研究	企画調整	原子力利用	(平成6年度)法令等に基づく許可申請並びに届出及び変更等に関する文書	企画調整部研究企画科	1994年度	30	2024年度末	紙	企画書庫	企画調整部研究企画科		
調査及び研究	企画調整	原子力利用	(平成7年度)法令等に基づく許可申請並びに届出及び変更等に関する文書	企画調整部研究企画科	1995年度	30	2025年度末	紙	企画書庫	企画調整部研究企画科		
調査及び研究	企画調整	原子力利用	(平成8年度)法令等に基づく許可申請並びに届出及び変更等に関する文書	企画調整部研究企画科	1996年度	30	2026年度末	紙	企画書庫	企画調整部研究企画科		
調査及び研究	企画調整	原子力利用	(平成9年度)法令等に基づく許可申請並びに届出及び変更等に関する文書	企画調整部研究企画科	1997年度	30	2027年度末	紙	企画書庫	企画調整部研究企画科		
調査及び研究	企画調整	原子力利用	(平成10年度)法令等に基づく許可申請並びに届出及び変更等に関する文書	企画調整部研究企画科	1998年度	30	2028年度末	紙	企画書庫	企画調整部研究企画科		
調査及び研究	企画調整	原子力利用	(平成11年度)法令等に基づく許可申請並びに届出及び変更等に関する文書	企画調整部研究企画科	1999年度	30	2029年度末	紙	企画書庫	企画調整部研究企画科		
調査及び研究	企画調整	原子力利用	(平成12年度)法令等に基づく許可申請並びに届出及び変更等に関する文書	企画調整部研究企画科	2000年度	30	2030年度末	紙	企画書庫	企画調整部研究企画科		
調査及び研究	企画調整	原子力利用	(平成13年度)法令等に基づく許可申請並びに届出及び変更等に関する文書	企画調整部研究企画科	2001年度	30	2031年度末	紙	企画書庫	企画調整部研究企画科		
調査及び研究	企画調整	原子力利用	(平成9年度)法令等に基づく報告等に関する文書	企画調整部研究企画科	1997年度	5	2002年度末	紙	企画書庫	企画調整部研究企画科		
調査及び研究	企画調整	原子力利用	(平成10年度)法令等に基づく報告等に関する文書	企画調整部研究企画科	1998年度	5	2003年度末	紙	企画書庫	企画調整部研究企画科		
調査及び研究	企画調整	原子力利用	(平成11年度)法令等に基づく報告等に関する文書	企画調整部研究企画科	1999年度	5	2004年度末	紙	企画書庫	企画調整部研究企画科		
調査及び研究	企画調整	原子力利用	(平成12年度)法令等に基づく報告等に関する文書	企画調整部研究企画科	2000年度	5	2005年度末	紙	企画書庫	企画調整部研究企画科		
調査及び研究	企画調整	原子力利用	(平成13年度)法令等に基づく報告等に関する文書	企画調整部研究企画科	2001年度	5	2006年度末	紙	企画書庫	企画調整部研究企画科		
調査及び研究	企画調整	原子力利用	(平成5年度)アイソトープの利用に関する文書	企画調整部研究企画科	1993年度	10	2003年度末	紙	企画書庫	企画調整部研究企画科		
調査及び研究	企画調整	原子力利用	(平成6年度)アイソトープの利用に関する文書	企画調整部研究企画科	1994年度	10	2004年度末	紙	企画書庫	企画調整部研究企画科		
調査及び研究	企画調整	原子力利用	(平成7年度)アイソトープの利用に関する文書	企画調整部研究企画科	1995年度	10	2005年度末	紙	企画書庫	企画調整部研究企画科		
調査及び研究	企画調整	原子力利用	(平成8年度)アイソトープの利用に関する文書	企画調整部研究企画科	1996年度	10	2006年度末	紙	企画書庫	企画調整部研究企画科		
調査及び研究	企画調整	原子力利用	(平成9年度)アイソトープの利用に関する文書	企画調整部研究企画科	1997年度	10	2007年度末	紙	企画書庫	企画調整部研究企画科		

独立行政法人国際農林水産業研究センター法人文書ファイル管理簿

文書分類			法人文書ファイル名	作成者	作成(取得)時期	保存期間(年)	保存期間満了時期	媒体種別	保存場所	管理担当課 係	保存期間満了時の措置結果	備考
大分類	中分類	小分類										
調査及び研究	企画調整	原子力利用	(平成10年度)アイソトープの利用に関する文書	企画調整部研究企画科	1998年度	10	2008年度末	紙	企画書庫	企画調整部研究企画科		
調査及び研究	企画調整	原子力利用	(平成11年度)アイソトープの利用に関する文書	企画調整部研究企画科	1999年度	10	2009年度末	紙	企画書庫	企画調整部研究企画科		
調査及び研究	企画調整	原子力利用	(平成12年度)アイソトープの利用に関する文書	企画調整部研究企画科	2000年度	10	2010年度末	紙	企画書庫	企画調整部研究企画科		
調査及び研究	企画調整	原子力利用	(平成13年度)アイソトープの利用に関する文書	企画調整部研究企画科	2001年度	10	2011年度末	紙	企画書庫	企画調整部研究企画科		
調査及び研究	企画調整	組換えDNA	(平成4年度)組換えDNA、組換え体に関する文書	企画調整部研究企画科	1992年度	10	2002年度末	紙	企画書庫	企画調整部研究企画科		
調査及び研究	企画調整	組換えDNA	(平成5年度)組換えDNA、組換え体に関する文書	企画調整部研究企画科	1993年度	10	2003年度末	紙	企画書庫	企画調整部研究企画科		
調査及び研究	企画調整	組換えDNA	(平成6年度)組換えDNA、組換え体に関する文書	企画調整部研究企画科	1994年度	10	2004年度末	紙	企画書庫	企画調整部研究企画科		
調査及び研究	企画調整	組換えDNA	(平成7年度)組換えDNA、組換え体に関する文書	企画調整部研究企画科	1995年度	10	2005年度末	紙	企画書庫	企画調整部研究企画科		
調査及び研究	企画調整	組換えDNA	(平成8年度)組換えDNA、組換え体に関する文書	企画調整部研究企画科	1996年度	10	2006年度末	紙	企画書庫	企画調整部研究企画科		
調査及び研究	企画調整	組換えDNA	(平成9年度)組換えDNA、組換え体に関する文書	企画調整部研究企画科	1997年度	10	2007年度末	紙	企画書庫	企画調整部研究企画科		
調査及び研究	企画調整	組換えDNA	(平成10年度)組換えDNA、組換え体に関する文書	企画調整部研究企画科	1998年度	10	2008年度末	紙	企画書庫	企画調整部研究企画科		
調査及び研究	企画調整	組換えDNA	(平成11年度)組換えDNA、組換え体に関する文書	企画調整部研究企画科	1999年度	10	2009年度末	紙	企画書庫	企画調整部研究企画科		
調査及び研究	企画調整	組換えDNA	(平成12年度)組換えDNA、組換え体に関する文書	企画調整部研究企画科	2000年度	10	2010年度末	紙	企画書庫	企画調整部研究企画科		
調査及び研究	企画調整	組換えDNA	(平成13年度)組換えDNA、組換え体に関する文書	企画調整部研究企画科	2001年度	10	2011年度末	紙	企画書庫	企画調整部研究企画科		
調査及び研究	企画調整	ほ場管理	(平成11年度)ほ場管理等業務の運営に関する文書	企画調整部研究企画科	1999年度	3	2002年度末	紙	企画書庫	企画調整部研究企画科		
調査及び研究	企画調整	ほ場管理	(平成12年度)ほ場管理等業務の運営に関する文書	企画調整部研究企画科	2000年度	3	2003年度末	紙	企画書庫	企画調整部研究企画科		
調査及び研究	企画調整	ほ場管理	(平成13年度)ほ場管理等業務の運営に関する文書	企画調整部研究企画科	2001年度	3	2004年度末	紙	企画書庫	企画調整部研究企画科		
調査及び研究	企画調整	研究予算	(平成9年度)研究予算の配分及び執行管理に関する文書	企画調整部研究企画科	1997年度	5	2002年度末	紙	企画書庫	企画調整部研究企画科		
調査及び研究	企画調整	研究予算	(平成10年度)研究予算の配分及び執行管理に関する文書	企画調整部研究企画科	1998年度	5	2003年度末	紙	企画書庫	企画調整部研究企画科		
調査及び研究	企画調整	研究予算	(平成11年度)研究予算の配分及び執行管理に関する文書	企画調整部研究企画科	1999年度	5	2004年度末	紙	企画書庫	企画調整部研究企画科		
調査及び研究	企画調整	研究予算	(平成12年度)研究予算の配分及び執行管理に関する文書	企画調整部研究企画科	2000年度	5	2005年度末	紙	企画書庫	企画調整部研究企画科		
調査及び研究	企画調整	研究予算	(平成13年度)研究予算の配分及び執行管理に関する文書	企画調整部研究企画科	2001年度	5	2006年度末	紙	企画書庫	企画調整部研究企画科		

独立行政法人国際農林水産業研究センター法人文書ファイル管理簿

文書分類			法人文書ファイル名	作成者	作成(取得)時期	保存期間(年)	保存期間満了時期	媒体種別	保存場所	管理担当課 係	保存期間満了時の措置結果	備考
大分類	中分類	小分類										
調査及び研究	企画調整	研修 講習等	(平成 12年度) 研究員等の資質向上、技術研修等に関する文書	企画調整部研究企画科	2000年度	3	2003年度末	紙	企画書庫	企画調整部研究企画科		
調査及び研究	企画調整	知的所有権	(昭和 54年度) 知的所有権に関する文書	沖縄支所庶務課庶務係	1979年度	30	2009年度末	紙	事務室	沖縄支所庶務課庶務係		
調査及び研究	企画調整	知的所有権	(昭和 55年度) 知的所有権に関する文書	沖縄支所庶務課庶務係	1980年度	30	2010年度末	紙	事務室	沖縄支所庶務課庶務係		
調査及び研究	研究成果	知的所有権	(平成 2年度) 知的所有権に関する文書	企画調整部研究企画科	1990年度	30	2020年度末	紙	企画書庫	企画調整部研究企画科		
調査及び研究	研究成果	知的所有権	(平成 3年度) 知的所有権に関する文書	企画調整部研究企画科	1991年度	30	2021年度末	紙	企画書庫	企画調整部研究企画科		
調査及び研究	企画調整	知的所有権	(平成 3年度) 知的所有権に関する文書	沖縄支所庶務課庶務係	1991年度	30	2021年度末	紙	事務室	沖縄支所庶務課庶務係		
調査及び研究	研究成果	知的所有権	(平成 4年度) 知的所有権に関する文書	企画調整部研究企画科	1992年度	30	2022年度末	紙	企画書庫	企画調整部研究企画科		
調査及び研究	研究成果	知的所有権	(平成 5年度) 知的所有権に関する文書	企画調整部研究企画科	1993年度	30	2023年度末	紙	企画書庫	企画調整部研究企画科		
調査及び研究	研究成果	知的所有権	(平成 6年度) 知的所有権に関する文書	企画調整部研究企画科	1994年度	30	2024年度末	紙	企画書庫	企画調整部研究企画科		
調査及び研究	企画調整	知的所有権	(平成 6年度) 知的所有権に関する文書	沖縄支所庶務課庶務係	1994年度	30	2024年度末	紙	事務室	沖縄支所庶務課庶務係		
調査及び研究	研究成果	知的所有権	(平成 7年度) 知的所有権に関する文書	企画調整部研究企画科	1995年度	30	2025年度末	紙	企画書庫	企画調整部研究企画科		
調査及び研究	研究成果	知的所有権	(平成 8年度) 知的所有権に関する文書	企画調整部研究企画科	1996年度	30	2026年度末	紙	企画書庫	企画調整部研究企画科		
調査及び研究	研究成果	知的所有権	(平成 9年度) 知的所有権に関する文書	企画調整部研究企画科	1997年度	30	2027年度末	紙	企画書庫	企画調整部研究企画科		
調査及び研究	研究成果	知的所有権	(平成 10年度) 知的所有権に関する文書	企画調整部研究企画科	1998年度	30	2028年度末	紙	企画書庫	企画調整部研究企画科		
調査及び研究	研究成果	知的所有権	(平成 11年度) 知的所有権に関する文書	企画調整部研究企画科	1999年度	30	2029年度末	紙	企画書庫	企画調整部研究企画科		
調査及び研究	研究成果	知的所有権	(平成 12年度) 知的所有権に関する文書	企画調整部研究企画科	2000年度	30	2030年度末	紙	企画書庫	企画調整部研究企画科		
調査及び研究	研究成果	知的所有権	(平成 13年度) 知的所有権に関する文書	企画調整部研究企画科	2001年度	30	2031年度末	紙	企画書庫	企画調整部研究企画科		
調査及び研究	研究交流	一般	(平成 12年度) 研究交流に関する通知、照会、回答、依頼、報告等に関する文書	沖縄支所庶務課庶務係	2000年度	3	2003年度末	紙	事務室	沖縄支所庶務課庶務係		
調査及び研究	研究交流	一般	(平成 13年度) 研究交流に関する通知、照会、回答、依頼、報告等に関する文書	企画調整部研究企画科	2001年度	3	2004年度末	紙	企画書庫	企画調整部研究企画科		
調査及び研究	研究交流	一般	(平成 13年度) 研究交流に関する通知、照会、回答、依頼、報告等に関する文書	沖縄支所庶務課庶務係	2001年度	3	2004年度末	紙	事務室	沖縄支所庶務課庶務係		
調査及び研究	研究交流	研究員受入	(平成 9年度) 科学技術特別研究員、客員研究員、講習生等の受入に関する文書	企画調整部研究企画科	1997年度	5	2002年度末	紙	企画書庫	企画調整部研究企画科		
調査及び研究	研究交流	研究員受入	(平成 10年度) 科学技術特別研究員、客員研究員、講習生等の受入に関する文書	企画調整部研究企画科	1998年度	5	2003年度末	紙	企画書庫	企画調整部研究企画科		

独立行政法人国際農林水産業研究センター法人文書ファイル管理簿

文書分類			法人文書ファイル名	作成者	作成(取得)時期	保存期間(年)	保存期間満了時期	媒体種別	保存場所	管理担当課 係	保存期間満了時の措置結果	備考
大分類	中分類	小分類										
調査及び研究	研究交流	研究員受入	(平成11年度)科学技術特別研究員、客員研究員、講習生等の受入に関する文書	企画調整部研究企画科	1999年度	5	2004年度末	紙	企画書庫	企画調整部研究企画科		
調査及び研究	研究交流	研究員受入	(平成12年度)科学技術特別研究員、客員研究員、講習生等の受入に関する文書	企画調整部研究企画科	2000年度	5	2005年度末	紙	企画書庫	企画調整部研究企画科		
調査及び研究	研究交流	研究員受入	(平成13年度)科学技術特別研究員、客員研究員、講習生等の受入に関する文書	企画調整部研究企画科	2001年度	5	2006年度末	紙	企画書庫	企画調整部研究企画科		
調査及び研究	研究交流	研究員受入	(平成13年度)科学技術特別研究員、客員研究員、講習生等の受け入れに関する文書	沖縄支所庶務課庶務係	2001年度	5	2006年度末	紙	事務室	沖縄支所庶務課庶務係		
調査及び研究	研究交流	共同研究	(平成9年度)共同研究に関する文書	企画調整部研究企画科	1997年度	5	2002年度末	紙	企画書庫	企画調整部研究企画科		
調査及び研究	研究交流	共同研究	(平成10年度)共同研究に関する文書	企画調整部研究企画科	1998年度	5	2003年度末	紙	企画書庫	企画調整部研究企画科		
調査及び研究	研究交流	共同研究	(平成11年度)共同研究に関する文書	企画調整部研究企画科	1999年度	5	2004年度末	紙	企画書庫	企画調整部研究企画科		
調査及び研究	研究交流	共同研究	(平成12年度)共同研究に関する文書	企画調整部研究企画科	2000年度	5	2005年度末	紙	企画書庫	企画調整部研究企画科		
調査及び研究	研究交流	共同研究	(平成13年度)共同研究に関する文書	企画調整部研究企画科	2001年度	5	2006年度末	紙	企画書庫	企画調整部研究企画科		
調査及び研究	研究交流	受託研究	(平成13年度)受託研究に関する文書	企画調整部研究企画科	2001年度	5	2006年度末	紙	企画書庫	企画調整部研究企画科		
調査及び研究	研究交流	受託研究	(平成13年度)受託研究に関する文書	沖縄支所庶務課庶務係	2001年度	5	2006年度末	紙	事務室	沖縄支所庶務課庶務係		
調査及び研究	研究交流	受託出張	(平成13年度)受託出張に関する文書	企画調整部研究企画科	2001年度	1	2002年度末	紙	企画書庫	企画調整部研究企画科		
調査及び研究	研究交流	受託出張	(平成13年度)受託外国出張に関する文書	企画調整部連絡調整科	2001年度	1	2002年度末	紙	企画書庫	企画調整部連絡調整科		
調査及び研究	研究交流	受託出張	(平成13年度)受託出張に関する文書	沖縄支所庶務課庶務係	2001年度	1	2002年度末	紙	事務室	沖縄支所庶務課庶務係		
調査及び研究	研究交流	依頼出張	(平成13年度)依頼出張に関する文書	企画調整部研究企画科	2001年度	1	2002年度末	紙	企画書庫	企画調整部研究企画科		
調査及び研究	研究交流	委託研究	(平成10年度)委託研究に関する文書	総務部会計課監査係	1998年度	5	2003年度末	紙	文書庫	総務部会計課監査係		
調査及び研究	研究交流	委託研究	(平成11年度)委託研究に関する文書	総務部会計課監査係	1999年度	5	2004年度末	紙	文書庫	総務部会計課監査係		
調査及び研究	研究交流	委託研究	(平成12年度)委託研究に関する文書	総務部会計課監査係	2000年度	5	2005年度末	紙	文書庫	総務部会計課監査係		
調査及び研究	研究交流	委託研究	(平成13年度)委託研究に関する文書	総務部会計課監査係	2001年度	5	2006年度末	紙	文書庫	総務部会計課監査係		
調査及び研究	国際研究協力	一般	(平成3年度)国際共同研究及び技術協力に関する文書のうち重要なもの	企画調整部研究企画科	1991年度	30	2021年度末	紙	企画書庫	企画調整部研究企画科		
調査及び研究	国際研究協力	一般	(平成4年度)国際共同研究及び技術協力に関する文書のうち重要なもの	企画調整部研究企画科	1992年度	30	2022年度末	紙	企画書庫	企画調整部研究企画科		
調査及び研究	国際研究協力	一般	(平成5年度)国際共同研究及び技術協力に関する文書のうち重要なもの	企画調整部研究企画科	1993年度	30	2023年度末	紙	企画書庫	企画調整部研究企画科		

独立行政法人国際農林水産業研究センター法人文書ファイル管理簿

文書分類			法人文書ファイル名	作成者	作成(取得)時期	保存期間(年)	保存期間満了時期	媒体種別	保存場所	管理担当課 係	保存期間満了時の措置結果	備考
大分類	中分類	小分類										
調査及び研究	国際研究協力	一般	(平成 6年度)国際共同研究及び技術協力に関する文書のうち重要なもの	企画調整部研究企画科	1994年度	30	2024年度末	紙	企画書庫	企画調整部研究企画科		
調査及び研究	国際研究協力	一般	(平成 7年度)国際共同研究及び技術協力に関する文書のうち重要なもの	企画調整部研究企画科	1995年度	30	2025年度末	紙	企画書庫	企画調整部研究企画科		
調査及び研究	国際研究協力	一般	(平成 8年度)国際共同研究及び技術協力に関する文書のうち重要なもの	企画調整部研究企画科	1996年度	30	2026年度末	紙	企画書庫	企画調整部研究企画科		
調査及び研究	国際研究協力	一般	(平成 9年度)国際共同研究及び技術協力に関する文書のうち重要なもの	企画調整部研究企画科	1997年度	30	2027年度末	紙	企画書庫	企画調整部研究企画科		
調査及び研究	国際研究協力	一般	(平成 10年度)国際共同研究及び技術協力に関する文書のうち重要なもの	企画調整部研究企画科	1998年度	30	2028年度末	紙	企画書庫	企画調整部研究企画科		
調査及び研究	国際研究協力	一般	(平成 12年度)国際共同研究及び技術協力に関する文書のうち重要なもの	企画調整部研究企画科	2000年度	30	2030年度末	紙	企画書庫	企画調整部研究企画科		
調査及び研究	国際研究協力	一般	(平成 13年度)国際共同研究及び技術協力に関する文書のうち重要なもの	企画調整部研究企画科	2001年度	30	2031年度末	紙	企画書庫	企画調整部研究企画科		
調査及び研究	国際研究協力	一般	(平成 10年度)国際共同研究及び技術協力に関する文書(重要なもの以外)	企画調整部研究企画科	1998年度	5	2003年度末	紙	企画書庫	企画調整部研究企画科		
調査及び研究	国際研究協力	一般	(平成 11年度)国際共同研究及び技術協力に関する文書(重要なもの以外)	企画調整部研究企画科	1999年度	5	2004年度末	紙	企画書庫	企画調整部研究企画科		
調査及び研究	国際研究協力	一般	(平成 12年度)国際共同研究及び技術協力に関する文書(重要なもの以外)	企画調整部研究企画科	2000年度	5	2005年度末	紙	企画書庫	企画調整部研究企画科		
調査及び研究	国際研究協力	一般	(平成 13年度)国際共同研究及び技術協力に関する文書(重要なもの以外)	企画調整部研究企画科	2001年度	5	2006年度末	紙	企画書庫	企画調整部研究企画科		
調査及び研究	国際研究協力	一般	(平成 13年度)二国間協定に関する文書	企画調整部研究企画科	2001年度	30	2031年度末	紙	企画書庫	企画調整部研究企画科		
調査及び研究	国際研究協力	招へい	(平成 9年度)共同研究員の招へいに関する文書	企画調整部研究交流科	1997年度	5	2002年度末	紙	事務室	企画調整部研究交流科		
調査及び研究	国際研究協力	招へい	(平成 9年度)研究管理者の招へいに関する文書	企画調整部研究交流科	1997年度	5	2002年度末	紙	事務室	企画調整部研究交流科		
調査及び研究	国際研究協力	招へい	(平成 9年度)国際招へい事業(沖縄招へい)に関する文書	企画調整部研究交流科	1997年度	5	2002年度末	紙	事務室	企画調整部研究交流科		
調査及び研究	国際研究協力	招へい	(平成 9年度)国際招へい事業(つば長期)に関する文書	企画調整部研究交流科	1997年度	5	2002年度末	紙	事務室	企画調整部研究交流科		
調査及び研究	国際研究協力	招へい	(平成 9年度)国際招へい事業(つば短期)に関する文書	企画調整部研究交流科	1997年度	5	2002年度末	紙	事務室	企画調整部研究交流科		
調査及び研究	国際研究協力	招へい	(平成 10年度)共同研究員の招へいに関する文書	企画調整部研究交流科	1998年度	5	2003年度末	紙	事務室	企画調整部研究交流科		
調査及び研究	国際研究協力	招へい	(平成 10年度)研究管理者の招へいに関する文書	企画調整部研究交流科	1998年度	5	2003年度末	紙	事務室	企画調整部研究交流科		
調査及び研究	国際研究協力	招へい	(平成 10年度)国際招へい事業(沖縄招へい)に関する文書	企画調整部研究交流科	1998年度	5	2003年度末	紙	事務室	企画調整部研究交流科		
調査及び研究	国際研究協力	招へい	(平成 10年度)国際招へい事業(つば長期)に関する文書	企画調整部研究交流科	1998年度	5	2003年度末	紙	事務室	企画調整部研究交流科		
調査及び研究	国際研究協力	招へい	(平成 10年度)国際招へい事業(つば短期)に関する文書	企画調整部研究交流科	1998年度	5	2003年度末	紙	事務室	企画調整部研究交流科		

独立行政法人国際農林水産業研究センター法人文書ファイル管理簿

文書分類			法人文書ファイル名	作成者	作成(取得)時期	保存期間(年)	保存期間満了時期	媒体種別	保存場所	管理担当課 係	保存期間満了時の措置結果	備考
大分類	中分類	小分類										
調査及び研究	国際研究協力	招へい	(平成11年度)共同研究員の招へいに関する文書	企画調整部研究交流科	1999年度	5	2004年度末	紙	事務室	企画調整部研究交流科		
調査及び研究	国際研究協力	招へい	(平成11年度)研究管理者の招へいに関する文書	企画調整部研究交流科	1999年度	5	2004年度末	紙	事務室	企画調整部研究交流科		
調査及び研究	国際研究協力	招へい	(平成11年度)国際招へい事業(沖縄招へい)に関する文書	企画調整部研究交流科	1999年度	5	2004年度末	紙	事務室	企画調整部研究交流科		
調査及び研究	国際研究協力	招へい	(平成11年度)国際招へい事業(つば長期)に関する文書	企画調整部研究交流科	1999年度	5	2004年度末	紙	事務室	企画調整部研究交流科		
調査及び研究	国際研究協力	招へい	(平成11年度)国際招へい事業(つば短期)に関する文書	企画調整部研究交流科	1999年度	5	2004年度末	紙	事務室	企画調整部研究交流科		
調査及び研究	国際研究協力	招へい	(平成12年度)共同研究員の招へいに関する文書	企画調整部研究交流科	2000年度	5	2005年度末	紙	事務室	企画調整部研究交流科		
調査及び研究	国際研究協力	招へい	(平成12年度)研究管理者の招へいに関する文書	企画調整部研究交流科	2000年度	5	2005年度末	紙	事務室	企画調整部研究交流科		
調査及び研究	国際研究協力	招へい	(平成12年度)国際招へい事業(沖縄招へい)に関する文書	企画調整部研究交流科	2000年度	5	2005年度末	紙	事務室	企画調整部研究交流科		
調査及び研究	国際研究協力	招へい	(平成12年度)国際招へい事業(つば長期)に関する文書	企画調整部研究交流科	2000年度	5	2005年度末	紙	事務室	企画調整部研究交流科		
調査及び研究	国際研究協力	招へい	(平成12年度)国際招へい事業(つば短期)に関する文書	企画調整部研究交流科	2000年度	5	2005年度末	紙	事務室	企画調整部研究交流科		
調査及び研究	国際研究協力	招へい	(平成13年度)共同研究員の招へいに関する文書	企画調整部研究交流科	2001年度	5	2006年度末	紙	事務室	企画調整部研究交流科		
調査及び研究	国際研究協力	招へい	(平成13年度)研究管理者の招へいに関する文書	企画調整部研究交流科	2001年度	5	2006年度末	紙	事務室	企画調整部研究交流科		
調査及び研究	国際研究協力	招へい	(平成13年度)国際招へい事業(沖縄招へい)に関する文書	企画調整部研究交流科	2001年度	5	2006年度末	紙	事務室	企画調整部研究交流科		
調査及び研究	国際研究協力	招へい	(平成13年度)国際招へい事業(つば長期)に関する文書	企画調整部研究交流科	2001年度	5	2006年度末	紙	事務室	企画調整部研究交流科		
調査及び研究	国際研究協力	招へい	(平成13年度)国際招へい事業(つば短期)に関する文書	企画調整部研究交流科	2001年度	5	2006年度末	紙	事務室	企画調整部研究交流科		

独立行政法人国際農林水産業研究センター法人文書ファイル管理簿

文書分類			法人文書ファイル名	作成者	作成(取得)時期	保存期間(年)	保存期間満了時期	媒体種別	保存場所	管理担当課 係	保存期間満了時の措置結果	備考
大分類	中分類	小分類										
調査及び研究	国際研究協力	招へい	(平成13年度)海外の共同研究員、研究管理者及び海外研究員の招へい、受入に関する文書	企画調整部研究企画科	2001年度	5	2006年度末	紙	企画書庫	企画調整部研究企画科		
調査及び研究	国際研究協力	派遣	(平成9年度)海外派遣に関する文書	企画調整部研究企画科	1997年度	5	2002年度末	紙	企画書庫	企画調整部研究企画科		
調査及び研究	国際研究協力	派遣	(平成9年度)海外派遣に関する通知、依頼、報告等に関する文書	企画調整部連絡調整科	1997年度	5	2002年度末	紙	企画書庫	企画調整部連絡調整科		
調査及び研究	国際研究協力	派遣	(平成10年度)海外派遣に関する文書	企画調整部研究企画科	1998年度	5	2003年度末	紙	企画書庫	企画調整部研究企画科		
調査及び研究	国際研究協力	派遣	(平成10年度)海外派遣に関する通知、依頼、報告等に関する文書	企画調整部連絡調整科	1998年度	5	2003年度末	紙	企画書庫	企画調整部連絡調整科		
調査及び研究	国際研究協力	派遣	(平成11年度)海外派遣に関する文書	企画調整部研究企画科	1999年度	5	2004年度末	紙	企画書庫	企画調整部研究企画科		
調査及び研究	国際研究協力	派遣	(平成11年度)海外派遣に関する通知、依頼、報告等に関する文書	企画調整部連絡調整科	1999年度	5	2004年度末	紙	企画書庫	企画調整部連絡調整科		
調査及び研究	国際研究協力	派遣	(平成12年度)海外派遣に関する文書	企画調整部研究企画科	2000年度	5	2005年度末	紙	企画書庫	企画調整部研究企画科		
調査及び研究	国際研究協力	派遣	(平成12年度)海外派遣に関する通知、依頼、報告等に関する文書	企画調整部連絡調整科	2000年度	5	2005年度末	紙	企画書庫	企画調整部連絡調整科		
調査及び研究	国際研究協力	派遣	(平成13年度)海外派遣に関する通知、依頼、報告等に関する文書	企画調整部連絡調整科	2001年度	5	2006年度末	紙	企画書庫	企画調整部連絡調整科		
調査及び研究	国際研究協力	会議	(平成11年度)JIRCAS国際シンポジウムに関する文書	企画調整部研究交流科	1999年度	3	2002年度末	紙	事務室	企画調整部研究交流科		
調査及び研究	国際研究協力	会議	(平成12年度)JIRCAS国際シンポジウムに関する文書	企画調整部研究交流科	2000年度	3	2003年度末	紙	事務室	企画調整部研究交流科		
調査及び研究	国際研究協力	会議	(平成13年度)JIRCAS国際シンポジウムに関する文書	企画調整部研究交流科	2001年度	3	2004年度末	紙	事務室	企画調整部研究交流科		
調査及び研究	研究情報	利用管理	(平成13年度)情報システムの利用 管理に関する文書	企画調整部情報資料課管理係	2001年度	3	2004年度末	紙	事務室	企画調整部情報資料課管理係		
調査及び研究	広報	一般	(平成11年度)見学 一般公開 新聞報道等に関する文書	沖縄支所庶務課庶務係	1999年度	3	2002年度末	紙	事務室	沖縄支所庶務課庶務係		
調査及び研究	広報	一般	(平成12年度)見学 一般公開 新聞報道等に関する文書	沖縄支所庶務課庶務係	2000年度	3	2003年度末	紙	事務室	沖縄支所庶務課庶務係		
調査及び研究	広報	一般	(平成13年度)見学 一般公開 新聞報道等に関する文書	沖縄支所庶務課庶務係	2001年度	3	2004年度末	紙	事務室	沖縄支所庶務課庶務係		
調査及び研究	図書管理	一般	(平成13年度)図書 資料に関する通知 照会 回答 依頼 報告等に関する文書	企画調整部情報資料課管理係	2001年度	3	2004年度末	紙	事務室	企画調整部情報資料課管理係		
調査及び研究	図書管理	管理	(平成13年度)図書 資料の利用等に関する文書	企画調整部情報資料課管理係	2001年度	3	2004年度末	紙	事務室	企画調整部情報資料課管理係		
調査及び研究	研究	研究	(平成13年度)調査及び研究に関する文書のうち重要なもの	企画調整部研究企画科	2001年度	5	2006年度末	紙	企画書庫	企画調整部研究企画科		
調査及び研究	研究	研究	(平成13年度)調査及び研究に関する文書のうち重要なもの以外	企画調整部研究企画科	2001年度	1	2002年度末	紙	企画書庫	企画調整部研究企画科		
調査及び研究	研究	研究	(平成13年度)調査及び研究に関する文書(重要な物以外)	沖縄支所庶務課庶務係	2001年度	1	2002年度末	紙	事務室	沖縄支所庶務課庶務係		



独立行政法人国際農林水産業研究センター法人文書ファイル管理簿

文書分類			法人文書ファイル名	作成者	作成(取得)時期	保存期間(年)	保存期間満了時期	媒体種別	保存場所	管理担当課・係	保存期間満了時の措置結果	備考
大分類	中分類	小分類										
総務	一般	証明書	(平成13年度)各種証明書の発行に関する文書	総務部庶務課庶務係	2001年度	1	2002年度末	紙	事務室	総務部庶務課庶務係		
総務	一般	証明書	(平成13年度)各種証明書の発行に関する文書	沖縄支所庶務課庶務係	2001年度	1	2002年度末	紙	事務室	沖縄支所庶務課庶務係		
総務	一般	電報	(平成13年度)電報の打電に関する文書	総務部庶務課庶務係	2001年度	1	2002年度末	紙	事務室	総務部庶務課庶務係		
総務	一般	電報	(平成13年度)電報の打電に関する文書	沖縄支所庶務課庶務係	2001年度	1	2002年度末	紙	事務室	沖縄支所庶務課庶務係		
総務	一般	職員名簿	(平成13年度)役職員の名簿等の作成に関する文書	総務部庶務課庶務係	2001年度	1	2002年度末	紙	事務室	総務部庶務課庶務係		
総務	一般	登記	(平成13年度)登記に関する文書	総務部庶務課庶務係	2001年度	30	2031年度末	紙	事務室	総務部庶務課庶務係		
総務	一般	公印	(昭和48年度)公印の作成、改刻及び廃止に関する文書	総務部庶務課庶務係	1973年度	30	2003年度末	紙	文書庫	総務部庶務課庶務係		
総務	一般	公印	(平成8年度)公印の作成、改刻及び廃止に関する文書	総務部庶務課庶務係	1996年度	30	2026年度末	紙	文書庫	総務部庶務課庶務係		
総務	一般	公印	(平成9年度)公印の作成、改刻及び廃止に関する文書	総務部庶務課庶務係	1997年度	30	2027年度末	紙	文書庫	総務部庶務課庶務係		
総務	一般	公印	(平成12年度)公印の作成、改刻及び廃止に関する文書	総務部庶務課庶務係	2000年度	30	2030年度末	紙	事務室	総務部庶務課庶務係		
総務	文書	帳票帳簿類	昭和47年 文書原簿	総務部庶務課庶務係	1972年	30	2002年末	紙	文書庫	総務部庶務課庶務係		
総務	文書	帳票帳簿類	昭和47年 文書原簿	沖縄支所庶務課庶務係	1972年	30	2002年末	紙	事務室	沖縄支所庶務課庶務係		
総務	文書	帳票帳簿類	昭和48年 文書原簿	総務部庶務課庶務係	1973年	30	2003年末	紙	文書庫	総務部庶務課庶務係		
総務	文書	帳票帳簿類	昭和48年 文書原簿	沖縄支所庶務課庶務係	1973年	30	2003年末	紙	事務室	沖縄支所庶務課庶務係		
総務	文書	帳票帳簿類	昭和49年 文書原簿	総務部庶務課庶務係	1974年	30	2004年末	紙	文書庫	総務部庶務課庶務係		
総務	文書	帳票帳簿類	昭和49年 文書原簿	沖縄支所庶務課庶務係	1974年	30	2004年末	紙	事務室	沖縄支所庶務課庶務係		
総務	文書	帳票帳簿類	昭和50年 文書原簿	総務部庶務課庶務係	1975年	30	2005年末	紙	文書庫	総務部庶務課庶務係		
総務	文書	帳票帳簿類	昭和50年 文書原簿	沖縄支所庶務課庶務係	1975年	30	2005年末	紙	事務室	沖縄支所庶務課庶務係		
総務	文書	帳票帳簿類	昭和51年 文書原簿	総務部庶務課庶務係	1976年	30	2006年末	紙	文書庫	総務部庶務課庶務係		
総務	文書	帳票帳簿類	昭和51年 文書原簿	沖縄支所庶務課庶務係	1976年	30	2006年末	紙	事務室	沖縄支所庶務課庶務係		

独立行政法人国際農林水産業研究センター法人文書ファイル管理簿

文書分類			法人文書ファイル名	作成者	作成(取得)時期	保存期間(年)	保存期間満了時期	媒体種別	保存場所	管理担当課・係	保存期間満了時の措置結果	備考
大分類	中分類	小分類										
総務	文書	帳票帳簿類	昭和52年 文書原簿	総務部庶務課庶務係	1977年	30	2007年末	紙	文書庫	総務部庶務課庶務係		
総務	文書	帳票帳簿類	昭和52年 文書原簿	沖縄支所庶務課庶務係	1977年	30	2007年末	紙	事務室	沖縄支所庶務課庶務係		
総務	文書	帳票帳簿類	昭和53年 文書原簿	総務部庶務課庶務係	1978年	30	2008年末	紙	文書庫	総務部庶務課庶務係		
総務	文書	帳票帳簿類	昭和53年 文書原簿	沖縄支所庶務課庶務係	1978年	30	2008年末	紙	事務室	沖縄支所庶務課庶務係		
総務	文書	帳票帳簿類	昭和54年 文書原簿	総務部庶務課庶務係	1979年	30	2009年末	紙	文書庫	総務部庶務課庶務係		
総務	文書	帳票帳簿類	昭和54年 文書原簿	沖縄支所庶務課庶務係	1979年	30	2009年末	紙	事務室	沖縄支所庶務課庶務係		
総務	文書	帳票帳簿類	昭和55年 文書原簿	総務部庶務課庶務係	1980年	30	2010年末	紙	文書庫	総務部庶務課庶務係		
総務	文書	帳票帳簿類	昭和55年 文書原簿	沖縄支所庶務課庶務係	1980年	30	2010年末	紙	事務室	沖縄支所庶務課庶務係		
総務	文書	帳票帳簿類	昭和56年 文書原簿	総務部庶務課庶務係	1981年	30	2011年末	紙	文書庫	総務部庶務課庶務係		
総務	文書	帳票帳簿類	昭和56年 文書原簿	沖縄支所庶務課庶務係	1981年	30	2011年末	紙	事務室	沖縄支所庶務課庶務係		
総務	文書	帳票帳簿類	昭和57年 文書原簿	総務部庶務課庶務係	1982年	30	2012年末	紙	文書庫	総務部庶務課庶務係		
総務	文書	帳票帳簿類	昭和57年 文書原簿	沖縄支所庶務課庶務係	1982年	30	2012年末	紙	事務室	沖縄支所庶務課庶務係		
総務	文書	帳票帳簿類	昭和58年 文書原簿	総務部庶務課庶務係	1983年	30	2013年末	紙	文書庫	総務部庶務課庶務係		
総務	文書	帳票帳簿類	昭和58年 文書原簿	沖縄支所庶務課庶務係	1983年	30	2013年末	紙	事務室	沖縄支所庶務課庶務係		
総務	文書	帳票帳簿類	昭和59年 文書原簿	総務部庶務課庶務係	1984年	30	2014年末	紙	文書庫	総務部庶務課庶務係		
総務	文書	帳票帳簿類	昭和59年 文書原簿	沖縄支所庶務課庶務係	1984年	30	2014年末	紙	事務室	沖縄支所庶務課庶務係		
総務	文書	帳票帳簿類	昭和60年 文書原簿	総務部庶務課庶務係	1985年	30	2015年末	紙	文書庫	総務部庶務課庶務係		
総務	文書	帳票帳簿類	昭和60年 文書原簿	沖縄支所庶務課庶務係	1985年	30	2015年末	紙	事務室	沖縄支所庶務課庶務係		
総務	文書	帳票帳簿類	昭和61年 文書原簿	総務部庶務課庶務係	1986年	30	2016年末	紙	文書庫	総務部庶務課庶務係		
総務	文書	帳票帳簿類	昭和61年 文書原簿	沖縄支所庶務課庶務係	1986年	30	2016年末	紙	事務室	沖縄支所庶務課庶務係		

独立行政法人国際農林水産業研究センター法人文書ファイル管理簿

文書分類			法人文書ファイル名	作成者	作成(取得)時期	保存期間(年)	保存期間満了時期	媒体種別	保存場所	管理担当課・係	保存期間満了時の措置結果	備考
大分類	中分類	小分類										
総務	文書	帳票帳簿類	(昭和62年)文書原簿	総務部庶務課庶務係	1987年	30	2017年末	紙	文書庫	総務部庶務課庶務係		
総務	文書	帳票帳簿類	(昭和62年)文書原簿	沖縄支所庶務課庶務係	1987年	30	2017年末	紙	事務室	沖縄支所庶務課庶務係		
総務	文書	帳票帳簿類	(昭和63年)文書原簿	総務部庶務課庶務係	1988年	30	2018年末	紙	文書庫	総務部庶務課庶務係		
総務	文書	帳票帳簿類	(昭和63年)文書原簿	沖縄支所庶務課庶務係	1988年	30	2018年末	紙	事務室	沖縄支所庶務課庶務係		
総務	文書	帳票帳簿類	(平成元年)文書原簿	総務部庶務課庶務係	1989年	30	2019年末	紙	文書庫	総務部庶務課庶務係		
総務	文書	帳票帳簿類	(平成元年)文書原簿	沖縄支所庶務課庶務係	1989年	30	2019年末	紙	事務室	沖縄支所庶務課庶務係		
総務	文書	帳票帳簿類	(平成2年)文書原簿	総務部庶務課庶務係	1990年	30	2020年末	紙	文書庫	総務部庶務課庶務係		
総務	文書	帳票帳簿類	(平成2年)文書原簿	沖縄支所庶務課庶務係	1990年	30	2020年末	紙	事務室	沖縄支所庶務課庶務係		
総務	文書	帳票帳簿類	(平成3年)文書原簿	総務部庶務課庶務係	1991年	30	2021年末	紙	文書庫	総務部庶務課庶務係		
総務	文書	帳票帳簿類	(平成3年)文書原簿	沖縄支所庶務課庶務係	1991年	30	2021年末	紙	事務室	沖縄支所庶務課庶務係		
総務	文書	帳票帳簿類	(平成4年)文書原簿	総務部庶務課庶務係	1992年	30	2022年末	紙	文書庫	総務部庶務課庶務係		
総務	文書	帳票帳簿類	(平成4年)文書原簿	沖縄支所庶務課庶務係	1992年	30	2022年末	紙	事務室	沖縄支所庶務課庶務係		
総務	文書	帳票帳簿類	(平成5年)文書原簿	総務部庶務課庶務係	1993年	30	2023年末	紙	文書庫	総務部庶務課庶務係		
総務	文書	帳票帳簿類	(平成5年)文書原簿	沖縄支所庶務課庶務係	1993年	30	2023年末	紙	事務室	沖縄支所庶務課庶務係		
総務	文書	帳票帳簿類	(平成6年)文書原簿	総務部庶務課庶務係	1994年	30	2024年末	紙	文書庫	総務部庶務課庶務係		
総務	文書	帳票帳簿類	(平成6年)文書原簿	沖縄支所庶務課庶務係	1994年	30	2024年末	紙	事務室	沖縄支所庶務課庶務係		
総務	文書	帳票帳簿類	(平成7年)文書原簿	総務部庶務課庶務係	1995年	30	2025年末	紙	文書庫	総務部庶務課庶務係		
総務	文書	帳票帳簿類	(平成7年)文書原簿	沖縄支所庶務課庶務係	1995年	30	2025年末	紙	事務室	沖縄支所庶務課庶務係		
総務	文書	帳票帳簿類	(平成8年)文書原簿	総務部庶務課庶務係	1996年	30	2026年末	紙	文書庫	総務部庶務課庶務係		
総務	文書	帳票帳簿類	(平成8年)文書原簿	沖縄支所庶務課庶務係	1996年	30	2026年末	紙	事務室	沖縄支所庶務課庶務係		

独立行政法人国際農林水産業研究センター法人文書ファイル管理簿

文書分類			法人文書ファイル名	作成者	作成(取得)時期	保存期間(年)	保存期間満了時期	媒体種別	保存場所	管理担当課・係	保存期間満了時の措置結果	備考
大分類	中分類	小分類										
総務	文書	帳票帳簿類	(平成9年)文書原簿	総務部庶務課庶務係	1997年	30	2027年末	紙	文書庫	総務部庶務課庶務係		
総務	文書	帳票帳簿類	(平成9年)文書原簿	沖縄支所庶務課庶務係	1997年	30	2027年末	紙	事務室	沖縄支所庶務課庶務係		
総務	文書	帳票帳簿類	(平成10年)文書原簿	総務部庶務課庶務係	1998年	30	2028年末	紙	文書庫	総務部庶務課庶務係		
総務	文書	帳票帳簿類	(平成10年)文書原簿	沖縄支所庶務課庶務係	1998年	30	2028年末	紙	事務室	沖縄支所庶務課庶務係		
総務	文書	帳票帳簿類	(平成11年)文書原簿	総務部庶務課庶務係	1999年	30	2029年末	紙	文書庫	総務部庶務課庶務係		
総務	文書	帳票帳簿類	(平成11年)文書原簿	沖縄支所庶務課庶務係	1999年	30	2029年末	紙	事務室	沖縄支所庶務課庶務係		
総務	文書	帳票帳簿類	(平成12年)文書原簿	総務部庶務課庶務係	2000年	30	2030年末	紙	文書庫	総務部庶務課庶務係		
総務	文書	帳票帳簿類	(平成12年)文書原簿	沖縄支所庶務課庶務係	2000年	30	2030年末	紙	事務室	沖縄支所庶務課庶務係		
総務	文書	帳票帳簿類	(平成13年)文書原簿	総務部庶務課庶務係	2001年	30	2031年末	紙	文書庫	総務部庶務課庶務係		
総務	文書	帳票帳簿類	(平成13年)文書原簿	沖縄支所庶務課庶務係	2001年	30	2031年末	紙	事務室	沖縄支所庶務課庶務係		
総務	文書	帳票帳簿類	(平成13年度)文書原簿	総務部庶務課庶務係	2001年度	30	2031年末	紙	事務室	総務部庶務課庶務係		
総務	文書	帳票帳簿類	(平成13年度)文書原簿	沖縄支所庶務課庶務係	2001年度	30	2031年度末	紙	事務室	沖縄支所庶務課庶務係		
総務	文書	引継・廃棄	(平成11年度)保存文書の引継、移管及び廃棄に関する文書	総務部庶務課庶務係	1999年度	5	2004年度末	紙	文書庫	総務部庶務課庶務係		
総務	勤務時間	帳票帳簿類	(平成9年)出勤簿	総務部庶務課庶務係	1997年	5	2002年末	紙	文書庫	総務部庶務課庶務係		
総務	勤務時間	帳票帳簿類	(平成9年)出勤簿	沖縄支所庶務課庶務係	1997年	5	2002年末	紙	事務室	沖縄支所庶務課庶務係		
総務	勤務時間	帳票帳簿類	(平成10年)出勤簿	総務部庶務課庶務係	1998年	5	2003年末	紙	文書庫	総務部庶務課庶務係		
総務	勤務時間	帳票帳簿類	(平成10年)出勤簿	沖縄支所庶務課庶務係	1998年	5	2003年末	紙	事務室	沖縄支所庶務課庶務係		
総務	勤務時間	帳票帳簿類	(平成11年)出勤簿	総務部庶務課庶務係	1999年	5	2004年末	紙	文書庫	総務部庶務課庶務係		
総務	勤務時間	帳票帳簿類	(平成11年)出勤簿	沖縄支所庶務課庶務係	1999年	5	2004年末	紙	事務室	沖縄支所庶務課庶務係		
総務	勤務時間	帳票帳簿類	(平成12年)出勤簿	総務部庶務課庶務係	2000年	5	2005年末	紙	文書庫	総務部庶務課庶務係		

独立行政法人国際農林水産業研究センター法人文書ファイル管理簿

文書分類			法人文書ファイル名	作成者	作成(取得)時期	保存期間(年)	保存期間満了時期	媒体種別	保存場所	管理担当課・係	保存期間満了時の措置結果	備考
大分類	中分類	小分類										
総務	勤務時間	帳票帳簿類	(平成12年)出勤簿	沖縄支所庶務課庶務係	2000年	5	2005年末	紙	事務室	沖縄支所庶務課庶務係		
総務	勤務時間	帳票帳簿類	(平成13年)出勤簿	総務部庶務課庶務係	2001年	5	2006年末	紙	文書庫	総務部庶務課庶務係		
総務	勤務時間	帳票帳簿類	(平成13年)出勤簿	沖縄支所庶務課庶務係	2001年	5	2006年末	紙	事務室	沖縄支所庶務課庶務係		
総務	勤務時間	帳票帳簿類	(平成9年度)出勤簿	総務部庶務課庶務係	1997年度	5	2002年度末	紙	文書庫	総務部庶務課庶務係		
総務	勤務時間	帳票帳簿類	(平成9年度)出勤簿	沖縄支所庶務課庶務係	1997年度	5	2002年度末	紙	事務室	沖縄支所庶務課庶務係		
総務	勤務時間	帳票帳簿類	(平成10年度)出勤簿	総務部庶務課庶務係	1998年度	5	2003年度末	紙	文書庫	総務部庶務課庶務係		
総務	勤務時間	帳票帳簿類	(平成10年度)出勤簿	沖縄支所庶務課庶務係	1998年度	5	2003年度末	紙	事務室	沖縄支所庶務課庶務係		
総務	勤務時間	帳票帳簿類	(平成11年度)出勤簿	総務部庶務課庶務係	1999年度	5	2004年度末	紙	文書庫	総務部庶務課庶務係		
総務	勤務時間	帳票帳簿類	(平成11年度)出勤簿	沖縄支所庶務課庶務係	1999年度	5	2004年度末	紙	事務室	沖縄支所庶務課庶務係		
総務	勤務時間	帳票帳簿類	(平成12年度)出勤簿	総務部庶務課庶務係	2000年度	5	2005年度末	紙	文書庫	総務部庶務課庶務係		
総務	勤務時間	帳票帳簿類	(平成12年度)出勤簿	沖縄支所庶務課庶務係	2000年度	5	2005年度末	紙	事務室	沖縄支所庶務課庶務係		
総務	勤務時間	帳票帳簿類	(平成13年度)出勤簿	総務部庶務課庶務係	2001年度	5	2006年度末	紙	文書庫	総務部庶務課庶務係		
総務	勤務時間	帳票帳簿類	(平成13年度)出勤簿	沖縄支所庶務課庶務係	2001年度	5	2006年度末	紙	事務室	沖縄支所庶務課庶務係		
総務	勤務時間	帳票帳簿類	(平成9年度)超過勤務命令簿	総務部庶務課庶務係	1997年度	5	2002年度末	紙	文書庫	総務部庶務課庶務係		
総務	勤務時間	帳票帳簿類	(平成9年度)超過勤務命令簿	沖縄支所庶務課庶務係	1997年度	5	2002年度末	紙	事務室	沖縄支所庶務課庶務係		
総務	勤務時間	帳票帳簿類	(平成10年度)超過勤務命令簿	総務部庶務課庶務係	1998年度	5	2003年度末	紙	文書庫	総務部庶務課庶務係		
総務	勤務時間	帳票帳簿類	(平成10年度)超過勤務命令簿	沖縄支所庶務課庶務係	1998年度	5	2003年度末	紙	事務室	沖縄支所庶務課庶務係		
総務	勤務時間	帳票帳簿類	(平成11年度)超過勤務命令簿	総務部庶務課庶務係	1999年度	5	2004年度末	紙	文書庫	総務部庶務課庶務係		
総務	勤務時間	帳票帳簿類	(平成11年度)超過勤務命令簿	沖縄支所庶務課庶務係	1999年度	5	2004年度末	紙	事務室	沖縄支所庶務課庶務係		
総務	勤務時間	帳票帳簿類	(平成12年度)超過勤務命令簿	総務部庶務課庶務係	2000年度	5	2005年度末	紙	文書庫	総務部庶務課庶務係		

独立行政法人国際農林水産業研究センター法人文書ファイル管理簿

文書分類			法人文書ファイル名	作成者	作成(取得)時期	保存期間(年)	保存期間満了時期	媒体種別	保存場所	管理担当課・係	保存期間満了時の措置結果	備考
大分類	中分類	小分類										
総務	勤務時間	帳票帳簿類	(平成12年度)超過勤務命令簿	沖縄支所庶務課庶務係	2000年度	5	2005年度末	紙	事務室	沖縄支所庶務課庶務係		
総務	勤務時間	帳票帳簿類	(平成13年度)超過勤務命令簿	総務部庶務課庶務係	2001年度	5	2006年度末	紙	文書庫	総務部庶務課庶務係		
総務	勤務時間	帳票帳簿類	(平成13年度)超過勤務命令簿	沖縄支所庶務課庶務係	2001年度	5	2006年度末	紙	事務室	沖縄支所庶務課庶務係		
総務	勤務時間	帳票帳簿類	(平成11年)休暇簿	総務部庶務課庶務係	1999年	3	2002年末	紙	文書庫	総務部庶務課庶務係		
総務	勤務時間	帳票帳簿類	(平成11年)休暇簿	沖縄支所庶務課庶務係	1999年	3	2002年末	紙	事務室	沖縄支所庶務課庶務係		
総務	勤務時間	帳票帳簿類	(平成12年)休暇簿	総務部庶務課庶務係	2000年	3	2003年末	紙	文書庫	総務部庶務課庶務係		
総務	勤務時間	帳票帳簿類	(平成12年)休暇簿	沖縄支所庶務課庶務係	2000年	3	2003年末	紙	事務室	沖縄支所庶務課庶務係		
総務	勤務時間	帳票帳簿類	(平成13年)休暇簿	総務部庶務課庶務係	2001年	3	2004年末	紙	文書庫	総務部庶務課庶務係		
総務	勤務時間	帳票帳簿類	(平成13年)休暇簿	沖縄支所庶務課庶務係	2001年	3	2004年末	紙	事務室	沖縄支所庶務課庶務係		
総務	勤務時間	帳票帳簿類	(平成11年度)休暇簿	総務部庶務課庶務係	1999年度	3	2002年度末	紙	文書庫	総務部庶務課庶務係		
総務	勤務時間	帳票帳簿類	(平成11年度)休暇簿	沖縄支所庶務課庶務係	1999年度	3	2002年度末	紙	事務室	沖縄支所庶務課庶務係		
総務	勤務時間	帳票帳簿類	(平成12年度)休暇簿	総務部庶務課庶務係	2000年度	3	2003年度末	紙	文書庫	総務部庶務課庶務係		
総務	勤務時間	帳票帳簿類	(平成12年度)休暇簿	沖縄支所庶務課庶務係	2000年度	3	2003年度末	紙	事務室	沖縄支所庶務課庶務係		
総務	勤務時間	帳票帳簿類	(平成13年度)休暇簿	総務部庶務課庶務係	2001年度	3	2004年度末	紙	文書庫	総務部庶務課庶務係		
総務	勤務時間	帳票帳簿類	(平成13年度)休暇簿	沖縄支所庶務課庶務係	2001年度	3	2004年度末	紙	事務室	沖縄支所庶務課庶務係		
総務	勤務時間	帳票帳簿類	(平成11年度)勤務時間に関するその他の帳票帳簿類	総務部庶務課庶務係	1999年度	3	2002年度末	紙	文書庫	総務部庶務課庶務係		
総務	勤務時間	帳票帳簿類	(平成11年度)勤務時間に関するその他の帳票帳簿類	沖縄支所庶務課庶務係	1999年度	3	2002年度末	紙	事務室	沖縄支所庶務課庶務係		
総務	勤務時間	帳票帳簿類	(平成12年度)勤務時間に関するその他の帳票帳簿類	総務部庶務課庶務係	2000年度	3	2003年度末	紙	文書庫	総務部庶務課庶務係		
総務	勤務時間	帳票帳簿類	(平成12年度)勤務時間に関するその他の帳票帳簿類	沖縄支所庶務課庶務係	2000年度	3	2003年度末	紙	事務室	沖縄支所庶務課庶務係		
総務	勤務時間	帳票帳簿類	(平成13年度)勤務時間に関するその他の帳票帳簿類	総務部庶務課庶務係	2001年度	3	2004年度末	紙	文書庫	総務部庶務課庶務係		

独立行政法人国際農林水産業研究センター法人文書ファイル管理簿

文書分類			法人文書ファイル名	作成者	作成(取得)時期	保存期間(年)	保存期間満了時期	媒体種別	保存場所	管理担当課・係	保存期間満了時の措置結果	備考
大分類	中分類	小分類										
総務	勤務時間	帳票帳簿類	(平成13年度)勤務時間に関するその他の帳票帳簿類	沖縄支所庶務課庶務係	2001年度	3	2004年度末	紙	事務局	沖縄支所庶務課庶務係		
総務	勤務時間	通知・回答等	(平成13年度)勤務時間及び休暇に関する通知、照会、回答又は報告等に関する文書	総務部庶務課庶務係	2001年度	1	2002年度末	紙	事務局	総務部庶務課庶務係		
総務	勤務時間	通知・回答等	(平成13年度)勤務時間及び休暇に関する通知、照会、回答又は報告等に関する文書	沖縄支所庶務課庶務係	2001年度	1	2002年度末	紙	事務局	沖縄支所庶務課庶務係		
総務	人事	任免	(昭和47年度)役職員の任免に関する文書	総務部庶務課人事係	1972年度	30	2002年度末	紙	文書庫	総務部庶務課人事係		
総務	人事	任免	(昭和48年度)役職員の任免に関する文書	総務部庶務課人事係	1973年度	30	2003年度末	紙	文書庫	総務部庶務課人事係		
総務	人事	任免	(昭和49年度)役職員の任免に関する文書	総務部庶務課人事係	1974年度	30	2004年度末	紙	文書庫	総務部庶務課人事係		
総務	人事	任免	(昭和50年度)役職員の任免に関する文書	総務部庶務課人事係	1975年度	30	2005年度末	紙	文書庫	総務部庶務課人事係		
総務	人事	任免	(昭和51年)度役職員の任免に関する文書	総務部庶務課人事係	1976年度	30	2006年度末	紙	文書庫	総務部庶務課人事係		
総務	人事	任免	(昭和52年度)役職員の任免に関する文書	総務部庶務課人事係	1977年度	30	2007年度末	紙	文書庫	総務部庶務課人事係		
総務	人事	任免	(昭和53年度)役職員の任免に関する文書	総務部庶務課人事係	1978年度	30	2008年度末	紙	文書庫	総務部庶務課人事係		
総務	人事	任免	(昭和54年度)役職員の任免に関する文書	総務部庶務課人事係	1979年度	30	2009年度末	紙	文書庫	総務部庶務課人事係		
総務	人事	任免	(昭和55年度)役職員の任免に関する文書	総務部庶務課人事係	1980年度	30	2010年度末	紙	文書庫	総務部庶務課人事係		
総務	人事	任免	(昭和56年度)役職員の任免に関する文書	総務部庶務課人事係	1981年度	30	2011年度末	紙	文書庫	総務部庶務課人事係		
総務	人事	任免	(昭和57年度)役職員の任免に関する文書	総務部庶務課人事係	1982年度	30	2012年度末	紙	文書庫	総務部庶務課人事係		
総務	人事	任免	(昭和58年度)役職員の任免に関する文書	総務部庶務課人事係	1983年度	30	2013年度末	紙	文書庫	総務部庶務課人事係		
総務	人事	任免	(昭和59年度)役職員の任免に関する文書	総務部庶務課人事係	1984年度	30	2014年度末	紙	文書庫	総務部庶務課人事係		
総務	人事	任免	(昭和60年度)役職員の任免に関する文書	総務部庶務課人事係	1985年度	30	2015年度末	紙	文書庫	総務部庶務課人事係		
総務	人事	任免	(昭和61年度)役職員の任免に関する文書	総務部庶務課人事係	1986年度	30	2016年度末	紙	文書庫	総務部庶務課人事係		
総務	人事	任免	(昭和62年度)役職員の任免に関する文書	総務部庶務課人事係	1987年度	30	2017年度末	紙	文書庫	総務部庶務課人事係		
総務	人事	任免	(昭和63年度)役職員の任免に関する文書	総務部庶務課人事係	1988年度	30	2018年度末	紙	文書庫	総務部庶務課人事係		

独立行政法人国際農林水産業研究センター法人文書ファイル管理簿

文書分類			法人文書ファイル名	作成者	作成(取得)時期	保存期間(年)	保存期間満了時期	媒体種別	保存場所	管理担当課・係	保存期間満了時の措置結果	備考
大分類	中分類	小分類										
総務	人事	任免	(平成元年度) 役職員の任免に関する文書	総務部庶務課人事係	1989年度	30	2019年度末	紙	文書庫	総務部庶務課人事係		
総務	人事	任免	(平成2年度) 役職員の任免に関する文書	総務部庶務課人事係	1990年度	30	2020年度末	紙	文書庫	総務部庶務課人事係		
総務	人事	任免	(平成3年度) 役職員の任免に関する文書	総務部庶務課人事係	1991年度	30	2021年度末	紙	文書庫	総務部庶務課人事係		
総務	人事	任免	(平成4年度) 役職員の任免に関する文書	総務部庶務課人事係	1992年度	30	2022年度末	紙	文書庫	総務部庶務課人事係		
総務	人事	任免	(平成5年度) 役職員の任免に関する文書	総務部庶務課人事係	1993年度	30	2023年度末	紙	文書庫	総務部庶務課人事係		
総務	人事	任免	(平成6年度) 役職員の任免に関する文書	総務部庶務課人事係	1994年度	30	2024年度末	紙	文書庫	総務部庶務課人事係		
総務	人事	任免	(平成7年度) 役職員の任免に関する文書	総務部庶務課人事係	1995年度	30	2025年度末	紙	文書庫	総務部庶務課人事係		
総務	人事	任免	(平成8年度) 役職員の任免に関する文書	総務部庶務課人事係	1996年度	30	2026年度末	紙	文書庫	総務部庶務課人事係		
総務	人事	任免	(平成9年度) 役職員の任免に関する文書	総務部庶務課人事係	1997年度	30	2027年度末	紙	文書庫	総務部庶務課人事係		
総務	人事	任免	(平成10年度) 役職員の任免に関する文書	総務部庶務課人事係	1998年度	30	2028年度末	紙	文書庫	総務部庶務課人事係		
総務	人事	任免	(平成11年度) 役職員の任免に関する文書	総務部庶務課人事係	1999年度	30	2029年度末	紙	文書庫	総務部庶務課人事係		
総務	人事	任免	(平成12年度) 役職員の任免に関する文書	総務部庶務課人事係	2001年度	30	2030年度末	紙	文書庫	総務部庶務課人事係		
総務	人事	任免	(平成13年度) 役職員の任免に関する文書	総務部庶務課人事係	2001年度	30	2031年度末	紙	事務室	総務部庶務課人事係		
総務	人事	任免	(昭和47年度) 国際機関等への派遣職員に関する文書	総務部庶務課人事係	1972年度	30	2002年度末	紙	文書庫	総務部庶務課人事係		
総務	人事	任免	(昭和48年度) 国際機関等への派遣職員に関する文書	総務部庶務課人事係	1973年度	30	2003年度末	紙	文書庫	総務部庶務課人事係		
総務	人事	任免	(昭和49年度) 国際機関等への派遣職員に関する文書	総務部庶務課人事係	1974年度	30	2004年度末	紙	文書庫	総務部庶務課人事係		
総務	人事	任免	(昭和50年度) 国際機関等への派遣職員に関する文書	総務部庶務課人事係	1975年度	30	2005年度末	紙	文書庫	総務部庶務課人事係		
総務	人事	任免	(昭和51年度) 国際機関等への派遣職員に関する文書	総務部庶務課人事係	1976年度	30	2006年度末	紙	文書庫	総務部庶務課人事係		
総務	人事	任免	(昭和52年度) 国際機関等への派遣職員に関する文書	総務部庶務課人事係	1977年度	30	2007年度末	紙	文書庫	総務部庶務課人事係		
総務	人事	任免	(昭和53年度) 国際機関等への派遣職員に関する文書	総務部庶務課人事係	1978年度	30	2008年度末	紙	文書庫	総務部庶務課人事係		



独立行政法人国際農林水産業研究センター法人文書ファイル管理簿

文書分類			法人文書ファイル名	作成者	作成(取得)時期	保存期間(年)	保存期間満了時期	媒体種別	保存場所	管理担当課・係	保存期間満了時の措置結果	備考
大分類	中分類	小分類										
総務	人事	任免	(昭和54年度)国際機関等への派遣職員に関する文書	総務部庶務課人事係	1979年度	30	2009年度末	紙	文書庫	総務部庶務課人事係		
総務	人事	任免	(昭和55年度)国際機関等への派遣職員に関する文書	総務部庶務課人事係	1980年度	30	2010年度末	紙	文書庫	総務部庶務課人事係		
総務	人事	任免	(昭和56年度)国際機関等への派遣職員に関する文書	総務部庶務課人事係	1981年度	30	2011年度末	紙	文書庫	総務部庶務課人事係		
総務	人事	任免	(昭和57年度)国際機関等への派遣職員に関する文書	総務部庶務課人事係	1982年度	30	2012年度末	紙	文書庫	総務部庶務課人事係		
総務	人事	任免	(昭和58年度)国際機関等への派遣職員に関する文書	総務部庶務課人事係	1983年度	30	2013年度末	紙	文書庫	総務部庶務課人事係		
総務	人事	任免	(昭和59年度)国際機関等への派遣職員に関する文書	総務部庶務課人事係	1984年度	30	2014年度末	紙	文書庫	総務部庶務課人事係		
総務	人事	任免	(昭和60年度)国際機関等への派遣職員に関する文書	総務部庶務課人事係	1985年度	30	2015年度末	紙	文書庫	総務部庶務課人事係		
総務	人事	任免	(昭和61年度)国際機関等への派遣職員に関する文書	総務部庶務課人事係	1986年度	30	2016年度末	紙	文書庫	総務部庶務課人事係		
総務	人事	任免	(昭和62年度)国際機関等への派遣職員に関する文書	総務部庶務課人事係	1987年度	30	2017年度末	紙	文書庫	総務部庶務課人事係		
総務	人事	任免	(昭和63年度)国際機関等への派遣職員に関する文書	総務部庶務課人事係	1988年度	30	2018年度末	紙	文書庫	総務部庶務課人事係		
総務	人事	任免	(平成元年度)国際機関等への派遣職員に関する文書	総務部庶務課人事係	1989年度	30	2019年度末	紙	文書庫	総務部庶務課人事係		
総務	人事	任免	(平成2年度)国際機関等への派遣職員に関する文書	総務部庶務課人事係	1990年度	30	2020年度末	紙	文書庫	総務部庶務課人事係		
総務	人事	任免	(平成3年度)国際機関等への派遣職員に関する文書	総務部庶務課人事係	1991年度	30	2021年度末	紙	文書庫	総務部庶務課人事係		
総務	人事	任免	(平成4年度)国際機関等への派遣職員に関する文書	総務部庶務課人事係	1992年度	30	2022年度末	紙	文書庫	総務部庶務課人事係		
総務	人事	任免	(平成5年度)国際機関等への派遣職員に関する文書	総務部庶務課人事係	1993年度	30	2023年度末	紙	文書庫	総務部庶務課人事係		
総務	人事	任免	(平成6年度)国際機関等への派遣職員に関する文書	総務部庶務課人事係	1994年度	30	2024年度末	紙	文書庫	総務部庶務課人事係		
総務	人事	任免	(平成7年度)国際機関等への派遣職員に関する文書	総務部庶務課人事係	1995年度	30	2025年度末	紙	文書庫	総務部庶務課人事係		
総務	人事	任免	(平成8年度)国際機関等への派遣職員に関する文書	総務部庶務課人事係	1996年度	30	2026年度末	紙	文書庫	総務部庶務課人事係		
総務	人事	任免	(平成9年度)国際機関等への派遣職員に関する文書	総務部庶務課人事係	1997年度	30	2027年度末	紙	文書庫	総務部庶務課人事係		
総務	人事	任免	(平成10年度)国際機関等への派遣職員に関する文書	総務部庶務課人事係	1998年度	30	2028年度末	紙	文書庫	総務部庶務課人事係		

独立行政法人国際農林水産業研究センター法人文書ファイル管理簿

文書分類			法人文書ファイル名	作成者	作成(取得)時期	保存期間(年)	保存期間満了時期	媒体種別	保存場所	管理担当課・係	保存期間満了時の措置結果	備考
大分類	中分類	小分類										
総務	人事	任免	(平成11年度)国際機関等への派遣職員に関する文書	総務部庶務課人事係	1999年度	30	2029年度末	紙	文書庫	総務部庶務課人事係		
総務	人事	任免	(平成12年度)国際機関等への派遣職員に関する文書	総務部庶務課人事係	2000年度	30	2030年度末	紙	文書庫	総務部庶務課人事係		
総務	人事	任免	(平成13年度)国際機関等への派遣職員に関する文書	総務部庶務課人事係	2001年度	30	2031年度末	紙	事務室	総務部庶務課人事係		
総務	人事	任免	(平成9年度)女性職員の登用拡大計画に関する文書	総務部庶務課人事係	1997年度	5	2002年度末	紙	文書庫	総務部庶務課人事係		
総務	人事	任免	(平成10年度)女性職員の登用拡大計画に関する文書	総務部庶務課人事係	1998年度	5	2003年度末	紙	文書庫	総務部庶務課人事係		
総務	人事	任免	(平成11年度)女性職員の登用拡大計画に関する文書	総務部庶務課人事係	1999年度	5	2004年度末	紙	文書庫	総務部庶務課人事係		
総務	人事	任免	(平成12年度)女性職員の登用拡大計画に関する文書	総務部庶務課人事係	2000年度	5	2005年度末	紙	文書庫	総務部庶務課人事係		
総務	人事	任免	(平成13年度)女性職員の登用拡大計画に関する文書	総務部庶務課人事係	2001年度	5	2006年度末	紙	事務室	総務部庶務課人事係		
総務	人事	任免	(平成9年度)非常勤職員の雇用等に関する文書	総務部庶務課人事係	1997年度	5	2002年度末	紙	文書庫	総務部庶務課人事係		
総務	人事	任免	(平成9年度)非常勤職員の雇用等に関する文書	沖縄支所庶務課庶務係	1997年度	5	2002年度末	紙	事務室	沖縄支所庶務課庶務係		
総務	人事	任免	(平成10年度)非常勤職員の雇用等に関する文書	総務部庶務課人事係	1998年度	5	2003年度末	紙	文書庫	総務部庶務課人事係		
総務	人事	任免	(平成10年度)非常勤職員の雇用等に関する文書	沖縄支所庶務課庶務係	1998年度	5	2003年度末	紙	事務室	沖縄支所庶務課庶務係		
総務	人事	任免	(平成11年度)非常勤職員の雇用等に関する文書	総務部庶務課人事係	1999年度	5	2004年度末	紙	文書庫	総務部庶務課人事係		
総務	人事	任免	(平成11年度)非常勤職員の雇用等に関する文書	沖縄支所庶務課庶務係	1999年度	5	2004年度末	紙	事務室	沖縄支所庶務課庶務係		
総務	人事	任免	(平成12年度)非常勤職員の雇用等に関する文書	総務部庶務課人事係	2000年度	5	2005年度末	紙	文書庫	総務部庶務課人事係		
総務	人事	任免	(平成12年度)非常勤職員の雇用等に関する文書	沖縄支所庶務課庶務係	2000年度	5	2005年度末	紙	事務室	沖縄支所庶務課庶務係		
総務	人事	任免	(平成13年度)非常勤職員の雇用等に関する文書	総務部庶務課人事係	2001年度	5	2006年度末	紙	事務室	総務部庶務課人事係		
総務	人事	任免	(平成13年度)非常勤職員の雇用等に関する文書	沖縄支所庶務課庶務係	2001年度	5	2006年度末	紙	事務室	沖縄支所庶務課庶務係		
総務	人事	給与	(平成9年度)級別定数改定に関する文書	総務部庶務課人事係	1997年度	5	2002年度末	紙	文書庫	総務部庶務課人事係		
総務	人事	給与	(平成10年度)級別定数改定に関する文書	総務部庶務課人事係	1998年度	5	2003年度末	紙	文書庫	総務部庶務課人事係		

独立行政法人国際農林水産業研究センター法人文書ファイル管理簿

文書分類			法人文書ファイル名	作成者	作成(取得)時期	保存期間(年)	保存期間満了時期	媒体種別	保存場所	管理担当課・係	保存期間満了時の措置結果	備考
大分類	中分類	小分類										
総務	人事	給与	(平成11年度)級別定数改定に関する文書	総務部庶務課人事係	1999年度	5	2004年度末	紙	文書庫	総務部庶務課人事係		
総務	人事	給与	(平成12年度)級別定数改定に関する文書	総務部庶務課人事係	2000年度	5	2005年度末	紙	文書庫	総務部庶務課人事係		
総務	人事	給与	(平成13年度)級別定数改定に関する文書	総務部庶務課人事係	2001年度	5	2006年度末	紙	事務室	総務部庶務課人事係		
総務	人事	給与	(昭和47年度)昇給、昇格等に関する文書	総務部庶務課人事係	1972年度	30	2002年度末	紙	文書庫	総務部庶務課人事係		
総務	人事	給与	(昭和47年度)昇給、昇格等に関する文書	沖縄支所庶務課庶務係	1972年度	30	2002年度末	紙	事務室	沖縄支所庶務課庶務係		
総務	人事	給与	(昭和48年度)昇給、昇格等に関する文書	総務部庶務課人事係	1973年度	30	2003年度末	紙	文書庫	総務部庶務課人事係		
総務	人事	給与	(昭和48年度)昇給、昇格等に関する文書	沖縄支所庶務課庶務係	1973年度	30	2003年度末	紙	事務室	沖縄支所庶務課庶務係		
総務	人事	給与	(昭和49年度)昇給、昇格等に関する文書	総務部庶務課人事係	1974年度	30	2004年度末	紙	文書庫	総務部庶務課人事係		
総務	人事	給与	(昭和49年度)昇給、昇格等に関する文書	沖縄支所庶務課庶務係	1974年度	30	2004年度末	紙	事務室	沖縄支所庶務課庶務係		
総務	人事	給与	(昭和50年度)昇給、昇格等に関する文書	総務部庶務課人事係	1975年度	30	2005年度末	紙	文書庫	総務部庶務課人事係		
総務	人事	給与	(昭和50年度)昇給、昇格等に関する文書	沖縄支所庶務課庶務係	1975年度	30	2005年度末	紙	事務室	沖縄支所庶務課庶務係		
総務	人事	給与	(昭和51年度)昇給、昇格等に関する文書	総務部庶務課人事係	1976年度	30	2006年度末	紙	文書庫	総務部庶務課人事係		
総務	人事	給与	(昭和51年度)昇給、昇格等に関する文書	沖縄支所庶務課庶務係	1976年度	30	2006年度末	紙	事務室	沖縄支所庶務課庶務係		
総務	人事	給与	(昭和52年度)昇給、昇格等に関する文書	総務部庶務課人事係	1977年度	30	2007年度末	紙	文書庫	総務部庶務課人事係		
総務	人事	給与	(昭和52年度)昇給、昇格等に関する文書	沖縄支所庶務課庶務係	1977年度	30	2007年度末	紙	事務室	沖縄支所庶務課庶務係		
総務	人事	給与	(昭和53年度)昇給、昇格等に関する文書	総務部庶務課人事係	1978年度	30	2008年度末	紙	文書庫	総務部庶務課人事係		
総務	人事	給与	(昭和53年度)昇給、昇格等に関する文書	沖縄支所庶務課庶務係	1978年度	30	2008年度末	紙	事務室	沖縄支所庶務課庶務係		
総務	人事	給与	(昭和54年度)昇給、昇格等に関する文書	総務部庶務課人事係	1979年度	30	2009年度末	紙	文書庫	総務部庶務課人事係		
総務	人事	給与	(昭和54年度)昇給、昇格等に関する文書	沖縄支所庶務課庶務係	1979年度	30	2009年度末	紙	事務室	沖縄支所庶務課庶務係		
総務	人事	給与	(昭和55年度)昇給、昇格等に関する文書	総務部庶務課人事係	1980年度	30	2010年度末	紙	文書庫	総務部庶務課人事係		

独立行政法人国際農林水産業研究センター法人文書ファイル管理簿

文書分類			法人文書ファイル名	作成者	作成(取得)時期	保存期間(年)	保存期間満了時期	媒体種別	保存場所	管理担当課・係	保存期間満了時の措置結果	備考
大分類	中分類	小分類										
総務	人事	給与	(昭和55年度)昇給、昇格等に関する文書	沖縄支所庶務課庶務係	1980年度	30	2010年度末	紙	事務室	沖縄支所庶務課庶務係		
総務	人事	給与	(昭和56年度)昇給、昇格等に関する文書	総務部庶務課人事係	1981年度	30	2011年度末	紙	文書庫	総務部庶務課人事係		
総務	人事	給与	(昭和56年度)昇給、昇格等に関する文書	沖縄支所庶務課庶務係	1981年度	30	2011年度末	紙	事務室	沖縄支所庶務課庶務係		
総務	人事	給与	(昭和57年度)昇給、昇格等に関する文書	総務部庶務課人事係	1982年度	30	2012年度末	紙	文書庫	総務部庶務課人事係		
総務	人事	給与	(昭和57年度)昇給、昇格等に関する文書	沖縄支所庶務課庶務係	1982年度	30	2012年度末	紙	事務室	沖縄支所庶務課庶務係		
総務	人事	給与	(昭和58年度)昇給、昇格等に関する文書	総務部庶務課人事係	1983年度	30	2013年度末	紙	文書庫	総務部庶務課人事係		
総務	人事	給与	(昭和58年度)昇給、昇格等に関する文書	沖縄支所庶務課庶務係	1983年度	30	2013年度末	紙	事務室	沖縄支所庶務課庶務係		
総務	人事	給与	(昭和59年度)昇給、昇格等に関する文書	総務部庶務課人事係	1984年度	30	2014年度末	紙	文書庫	総務部庶務課人事係		
総務	人事	給与	(昭和59年度)昇給、昇格等に関する文書	沖縄支所庶務課庶務係	1984年度	30	2014年度末	紙	事務室	沖縄支所庶務課庶務係		
総務	人事	給与	(昭和60年度)昇給、昇格等に関する文書	総務部庶務課人事係	1985年度	30	2015年度末	紙	文書庫	総務部庶務課人事係		
総務	人事	給与	(昭和60年度)昇給、昇格等に関する文書	沖縄支所庶務課庶務係	1985年度	30	2015年度末	紙	事務室	沖縄支所庶務課庶務係		
総務	人事	給与	(昭和61年度)昇給、昇格等に関する文書	総務部庶務課人事係	1986年度	30	2016年度末	紙	文書庫	総務部庶務課人事係		
総務	人事	給与	(昭和61年度)昇給、昇格等に関する文書	沖縄支所庶務課庶務係	1986年度	30	2016年度末	紙	事務室	沖縄支所庶務課庶務係		
総務	人事	給与	(昭和62年度)昇給、昇格等に関する文書	総務部庶務課人事係	1987年度	30	2017年度末	紙	文書庫	総務部庶務課人事係		
総務	人事	給与	(昭和62年度)昇給、昇格等に関する文書	沖縄支所庶務課庶務係	1987年度	30	2017年度末	紙	事務室	沖縄支所庶務課庶務係		
総務	人事	給与	(昭和63年度)昇給、昇格等に関する文書	総務部庶務課人事係	1988年度	30	2018年度末	紙	文書庫	総務部庶務課人事係		
総務	人事	給与	(昭和63年度)昇給、昇格等に関する文書	沖縄支所庶務課庶務係	1988年度	30	2018年度末	紙	事務室	沖縄支所庶務課庶務係		
総務	人事	給与	(平成元年度)昇給、昇格等に関する文書	総務部庶務課人事係	1989年度	30	2019年度末	紙	文書庫	総務部庶務課人事係		
総務	人事	給与	(平成元年度)昇給、昇格等に関する文書	沖縄支所庶務課庶務係	1989年度	30	2019年度末	紙	事務室	沖縄支所庶務課庶務係		
総務	人事	給与	(平成2年度)昇給、昇格等に関する文書	総務部庶務課人事係	1990年度	30	2020年度末	紙	文書庫	総務部庶務課人事係		

独立行政法人国際農林水産業研究センター法人文書ファイル管理簿

文書分類			法人文書ファイル名	作成者	作成(取得)時期	保存期間(年)	保存期間満了時期	媒体種別	保存場所	管理担当課・係	保存期間満了時の措置結果	備考
大分類	中分類	小分類										
総務	人事	給与	(平成2年度)昇給、昇格等に関する文書	沖縄支所庶務課庶務係	1990年度	30	2020年度末	紙	事務室	沖縄支所庶務課庶務係		
総務	人事	給与	(平成3年度)昇給、昇格等に関する文書	総務部庶務課人事係	1991年度	30	2021年度末	紙	文書庫	総務部庶務課人事係		
総務	人事	給与	(平成3年度)昇給、昇格等に関する文書	沖縄支所庶務課庶務係	1991年度	30	2021年度末	紙	事務室	沖縄支所庶務課庶務係		
総務	人事	給与	(平成4年度)昇給、昇格等に関する文書	総務部庶務課人事係	1992年度	30	2022年度末	紙	文書庫	総務部庶務課人事係		
総務	人事	給与	(平成4年度)昇給、昇格等に関する文書	沖縄支所庶務課庶務係	1992年度	30	2022年度末	紙	事務室	沖縄支所庶務課庶務係		
総務	人事	給与	(平成5年度)昇給、昇格等に関する文書	総務部庶務課人事係	1993年度	30	2023年度末	紙	文書庫	総務部庶務課人事係		
総務	人事	給与	(平成5年度)昇給、昇格等に関する文書	沖縄支所庶務課庶務係	1993年度	30	2023年度末	紙	事務室	沖縄支所庶務課庶務係		
総務	人事	給与	(平成6年度)昇給、昇格等に関する文書	総務部庶務課人事係	1994年度	30	2024年度末	紙	文書庫	総務部庶務課人事係		
総務	人事	給与	(平成6年度)昇給、昇格等に関する文書	沖縄支所庶務課庶務係	1994年度	30	2024年度末	紙	事務室	沖縄支所庶務課庶務係		
総務	人事	給与	(平成7年度)昇給、昇格等に関する文書	総務部庶務課人事係	1995年度	30	2025年度末	紙	文書庫	総務部庶務課人事係		
総務	人事	給与	(平成7年度)昇給、昇格等に関する文書	沖縄支所庶務課庶務係	1995年度	30	2025年度末	紙	事務室	沖縄支所庶務課庶務係		
総務	人事	給与	(平成8年度)昇給、昇格等に関する文書	総務部庶務課人事係	1996年度	30	2026年度末	紙	文書庫	総務部庶務課人事係		
総務	人事	給与	(平成8年度)昇給、昇格等に関する文書	沖縄支所庶務課庶務係	1996年度	30	2026年度末	紙	事務室	沖縄支所庶務課庶務係		
総務	人事	給与	(平成9年度)昇給、昇格等に関する文書	総務部庶務課人事係	1997年度	30	2027年度末	紙	文書庫	総務部庶務課人事係		
総務	人事	給与	(平成9年度)昇給、昇格等に関する文書	沖縄支所庶務課庶務係	1997年度	30	2027年度末	紙	事務室	沖縄支所庶務課庶務係		
総務	人事	給与	(平成10年度)昇給、昇格等に関する文書	総務部庶務課人事係	1998年度	30	2028年度末	紙	文書庫	総務部庶務課人事係		
総務	人事	給与	(平成10年度)昇給、昇格等に関する文書	沖縄支所庶務課庶務係	1998年度	30	2028年度末	紙	事務室	沖縄支所庶務課庶務係		
総務	人事	給与	(平成11年度)昇給、昇格等に関する文書	総務部庶務課人事係	1999年度	30	2029年度末	紙	文書庫	総務部庶務課人事係		
総務	人事	給与	(平成11年度)昇給、昇格等に関する文書	沖縄支所庶務課庶務係	1999年度	30	2029年度末	紙	事務室	沖縄支所庶務課庶務係		
総務	人事	給与	(平成12年度)昇給、昇格等に関する文書	総務部庶務課人事係	2000年度	30	2030年度末	紙	文書庫	総務部庶務課人事係		

独立行政法人国際農林水産業研究センター法人文書ファイル管理簿

文書分類			法人文書ファイル名	作成者	作成(取得)時期	保存期間(年)	保存期間満了時期	媒体種別	保存場所	管理担当課・係	保存期間満了時の措置結果	備考
大分類	中分類	小分類										
総務	人事	給与	(平成12年度)昇給、昇格等に関する文書	沖縄支所庶務課庶務係	2000年度	30	2030年度末	紙	事務局	沖縄支所庶務課庶務係		
総務	人事	給与	(平成13年度)昇給、昇格等に関する文書	総務部庶務課人事係	2001年度	30	2031年度末	紙	事務局	総務部庶務課人事係		
総務	人事	給与	(平成13年度)昇給、昇格等に関する文書	沖縄支所庶務課庶務係	2001年度	30	2031年度末	紙	事務局	沖縄支所庶務課庶務係		
総務	人事	給与	(平成11年度)国家公務員給与実態調査に関する文書	総務部庶務課人事係	1999年度	3	2002年度末	紙	文書庫	総務部庶務課人事係		
総務	人事	給与	(平成12年度)国家公務員給与実態調査に関する文書	総務部庶務課人事係	2000年度	3	2003年度末	紙	文書庫	総務部庶務課人事係		
総務	人事	給与	(平成13年度)国家公務員給与実態調査に関する文書	総務部庶務課人事係	2001年度	3	2004年度末	紙	事務局	総務部庶務課人事係		
総務	人事	給与	(昭和47年度)給与の決定等に関する文書	総務部庶務課人事係	1972年度	30	2002年度末	紙	文書庫	総務部庶務課人事係		
総務	人事	給与	(昭和48年度)給与の決定等に関する文書	総務部庶務課人事係	1973年度	30	2003年度末	紙	文書庫	総務部庶務課人事係		
総務	人事	給与	(昭和49年度)給与の決定等に関する文書	総務部庶務課人事係	1974年度	30	2004年度末	紙	文書庫	総務部庶務課人事係		
総務	人事	給与	(昭和50年度)給与の決定等に関する文書	総務部庶務課人事係	1975年度	30	2005年度末	紙	文書庫	総務部庶務課人事係		
総務	人事	給与	(昭和51年度)給与の決定等に関する文書	総務部庶務課人事係	1976年度	30	2006年度末	紙	文書庫	総務部庶務課人事係		
総務	人事	給与	(昭和52年度)給与の決定等に関する文書	総務部庶務課人事係	1977年度	30	2007年度末	紙	文書庫	総務部庶務課人事係		
総務	人事	給与	(昭和53年度)給与の決定等に関する文書	総務部庶務課人事係	1978年度	30	2008年度末	紙	文書庫	総務部庶務課人事係		
総務	人事	給与	(昭和54年度)給与の決定等に関する文書	総務部庶務課人事係	1979年度	30	2009年度末	紙	文書庫	総務部庶務課人事係		
総務	人事	給与	(昭和55年度)給与の決定等に関する文書	総務部庶務課人事係	1980年度	30	2010年度末	紙	文書庫	総務部庶務課人事係		
総務	人事	給与	(昭和56年度)給与の決定等に関する文書	総務部庶務課人事係	1981年度	30	2011年度末	紙	文書庫	総務部庶務課人事係		
総務	人事	給与	(昭和57年度)給与の決定等に関する文書	総務部庶務課人事係	1982年度	30	2012年度末	紙	文書庫	総務部庶務課人事係		
総務	人事	給与	(昭和58年度)給与の決定等に関する文書	総務部庶務課人事係	1983年度	30	2013年度末	紙	文書庫	総務部庶務課人事係		
総務	人事	給与	(昭和59年度)給与の決定等に関する文書	総務部庶務課人事係	1984年度	30	2014年度末	紙	文書庫	総務部庶務課人事係		
総務	人事	給与	(昭和60年度)給与の決定等に関する文書	総務部庶務課人事係	1985年度	30	2015年度末	紙	文書庫	総務部庶務課人事係		

独立行政法人国際農林水産業研究センター法人文書ファイル管理簿

文書分類			法人文書ファイル名	作成者	作成(取得)時期	保存期間(年)	保存期間満了時期	媒体種別	保存場所	管理担当課・係	保存期間満了時の措置結果	備考
大分類	中分類	小分類										
総務	人事	給与	昭和61年度 給与の決定等に関する文書	総務部庶務課人事係	1986年度	30	2016年度末	紙	文書庫	総務部庶務課人事係		
総務	人事	給与	昭和62年度 給与の決定等に関する文書	総務部庶務課人事係	1987年度	30	2017年度末	紙	文書庫	総務部庶務課人事係		
総務	人事	給与	昭和63年度 給与の決定等に関する文書	総務部庶務課人事係	1988年度	30	2018年度末	紙	文書庫	総務部庶務課人事係		
総務	人事	給与	平成元年度 給与の決定等に関する文書	総務部庶務課人事係	1989年度	30	2019年度末	紙	文書庫	総務部庶務課人事係		
総務	人事	給与	平成2年度 給与の決定等に関する文書	総務部庶務課人事係	1990年度	30	2020年度末	紙	文書庫	総務部庶務課人事係		
総務	人事	給与	平成3年度 給与の決定等に関する文書	総務部庶務課人事係	1991年度	30	2021年度末	紙	文書庫	総務部庶務課人事係		
総務	人事	給与	平成4年度 給与の決定等に関する文書	総務部庶務課人事係	1992年度	30	2022年度末	紙	文書庫	総務部庶務課人事係		
総務	人事	給与	平成5年度 給与の決定等に関する文書	総務部庶務課人事係	1993年度	30	2023年度末	紙	文書庫	総務部庶務課人事係		
総務	人事	給与	平成6年度 給与の決定等に関する文書	総務部庶務課人事係	1994年度	30	2024年度末	紙	文書庫	総務部庶務課人事係		
総務	人事	給与	平成7年度 給与の決定等に関する文書	総務部庶務課人事係	1995年度	30	2025年度末	紙	文書庫	総務部庶務課人事係		
総務	人事	給与	平成8年度 給与の決定等に関する文書	総務部庶務課人事係	1996年度	30	2026年度末	紙	文書庫	総務部庶務課人事係		
総務	人事	給与	平成9年度 給与の決定等に関する文書	総務部庶務課人事係	1997年度	30	2027年度末	紙	文書庫	総務部庶務課人事係		
総務	人事	給与	平成10年度 給与の決定等に関する文書	総務部庶務課人事係	1998年度	30	2028年度末	紙	文書庫	総務部庶務課人事係		
総務	人事	給与	平成11年度 給与の決定等に関する文書	総務部庶務課人事係	1999年度	30	2029年度末	紙	文書庫	総務部庶務課人事係		
総務	人事	給与	平成12年度 給与の決定等に関する文書	総務部庶務課人事係	2000年度	30	2030年度末	紙	文書庫	総務部庶務課人事係		
総務	人事	給与	平成13年度 給与の決定等に関する文書	総務部庶務課人事係	2001年度	30	2031年度末	紙	事務室	総務部庶務課人事係		
総務	人事	給与	平成9年度 人件費に関する文書	総務部庶務課人事係	1997年度	5	2002年度末	紙	文書庫	総務部庶務課人事係		
総務	人事	給与	平成10年度 人件費に関する文書	総務部庶務課人事係	1998年度	5	2003年度末	紙	文書庫	総務部庶務課人事係		
総務	人事	給与	平成11年度 人件費に関する文書	総務部庶務課人事係	1999年度	5	2004年度末	紙	文書庫	総務部庶務課人事係		
総務	人事	給与	平成12年度 人件費に関する文書	総務部庶務課人事係	2000年度	5	2005年度末	紙	文書庫	総務部庶務課人事係		

独立行政法人国際農林水産業研究センター法人文書ファイル管理簿

文書分類			法人文書ファイル名	作成者	作成(取得)時期	保存期間(年)	保存期間満了時期	媒体種別	保存場所	管理担当課・係	保存期間満了時の措置結果	備考
大分類	中分類	小分類										
総務	人事	給与	(平成13年度)人件費に関する文書	総務部庶務課人事係	2001年度	5	2006年度末	紙	事務室	総務部庶務課人事係		
総務	人事	手当	(平成9年度)諸手当に関する文書	総務部庶務課人事係	1997年度	5	2002年度末	紙	文書庫	総務部庶務課人事係		
総務	人事	手当	(平成9年度)諸手当に関する文書	沖縄支所庶務課庶務係	1997年度	5	2002年度末	紙	事務室	沖縄支所庶務課庶務係		
総務	人事	手当	(平成10年度)諸手当に関する文書	総務部庶務課人事係	1998年度	5	2003年度末	紙	文書庫	総務部庶務課人事係		
総務	人事	手当	(平成10年度)諸手当に関する文書	沖縄支所庶務課庶務係	1998年度	5	2003年度末	紙	事務室	沖縄支所庶務課庶務係		
総務	人事	手当	(平成11年度)諸手当に関する文書	総務部庶務課人事係	1999年度	5	2004年度末	紙	文書庫	総務部庶務課人事係		
総務	人事	手当	(平成11年度)諸手当に関する文書	沖縄支所庶務課庶務係	1999年度	5	2004年度末	紙	事務室	沖縄支所庶務課庶務係		
総務	人事	手当	(平成12年度)諸手当に関する文書	総務部庶務課人事係	2000年度	5	2005年度末	紙	文書庫	総務部庶務課人事係		
総務	人事	手当	(平成12年度)諸手当に関する文書	沖縄支所庶務課庶務係	2000年度	5	2005年度末	紙	事務室	沖縄支所庶務課庶務係		
総務	人事	手当	(平成13年度)諸手当に関する文書	総務部庶務課人事係	2001年度	5	2006年度末	紙	事務室	総務部庶務課人事係		
総務	人事	手当	(平成13年度)諸手当に関する文書	沖縄支所庶務課庶務係	2001年度	5	2006年度末	紙	事務室	沖縄支所庶務課庶務係		
総務	人事	手当	(平成9年度)退職手当に関する文書	総務部庶務課人事係	1997年度	5	2002年度末	紙	文書庫	総務部庶務課人事係		
総務	人事	手当	(平成10年度)退職手当に関する文書	総務部庶務課人事係	1998年度	5	2003年度末	紙	文書庫	総務部庶務課人事係		
総務	人事	手当	(平成11年度)退職手当に関する文書	総務部庶務課人事係	1999年度	5	2004年度末	紙	文書庫	総務部庶務課人事係		
総務	人事	手当	(平成12年度)退職手当に関する文書	総務部庶務課人事係	2000年度	5	2005年度末	紙	文書庫	総務部庶務課人事係		
総務	人事	手当	(平成13年度)退職手当に関する文書	総務部庶務課人事係	2001年度	5	2006年度末	紙	事務室	総務部庶務課人事係		
総務	人事	人事記録	(昭和47年度)人事記録及びその付属書類	総務部庶務課人事係	1972年度	30	2002年度末	紙	文書庫	総務部庶務課人事係		
総務	人事	人事記録	(昭和48年度)人事記録及びその付属書類	総務部庶務課人事係	1973年度	30	2003年度末	紙	文書庫	総務部庶務課人事係		
総務	人事	人事記録	(昭和49年度)人事記録及びその付属書類	総務部庶務課人事係	1974年度	30	2004年度末	紙	文書庫	総務部庶務課人事係		
総務	人事	人事記録	(昭和50年度)人事記録及びその付属書類	総務部庶務課人事係	1975年度	30	2005年度末	紙	文書庫	総務部庶務課人事係		



独立行政法人国際農林水産業研究センター法人文書ファイル管理簿

文書分類			法人文書ファイル名	作成者	作成(取得)時期	保存期間(年)	保存期間満了時期	媒体種別	保存場所	管理担当課・係	保存期間満了時の措置結果	備考
大分類	中分類	小分類										
総務	人事	人事記録	(昭和51年度)人事記録及びその付属書類	総務部庶務課人事係	1976年度	30	2006年度末	紙	文書庫	総務部庶務課人事係		
総務	人事	人事記録	(昭和51年度)人事記録及びその付属書類	沖縄支所庶務課庶務係	1976年度	30	2006年度末	紙	事務室	沖縄支所庶務課庶務係		
総務	人事	人事記録	(昭和52年度)人事記録及びその付属書類	総務部庶務課人事係	1977年度	30	2007年度末	紙	文書庫	総務部庶務課人事係		
総務	人事	人事記録	(昭和53年度)人事記録及びその付属書類	総務部庶務課人事係	1978年度	30	2008年度末	紙	文書庫	総務部庶務課人事係		
総務	人事	人事記録	(昭和54年度)人事記録及びその付属書類	総務部庶務課人事係	1979年度	30	2009年度末	紙	文書庫	総務部庶務課人事係		
総務	人事	人事記録	(昭和55年度)人事記録及びその付属書類	総務部庶務課人事係	1980年度	30	2010年度末	紙	文書庫	総務部庶務課人事係		
総務	人事	人事記録	(昭和55年度)人事記録及びその付属書類	沖縄支所庶務課庶務係	1980年度	30	2010年度末	紙	事務室	沖縄支所庶務課庶務係		
総務	人事	人事記録	(昭和56年度)人事記録及びその付属書類	総務部庶務課人事係	1981年度	30	2011年度末	紙	文書庫	総務部庶務課人事係		
総務	人事	人事記録	(昭和57年度)人事記録及びその付属書類	総務部庶務課人事係	1982年度	30	2012年度末	紙	文書庫	総務部庶務課人事係		
総務	人事	人事記録	(昭和57年度)人事記録及びその付属書類	沖縄支所庶務課庶務係	1982年度	30	2012年度末	紙	事務室	沖縄支所庶務課庶務係		
総務	人事	人事記録	(昭和58年度)人事記録及びその付属書類	総務部庶務課人事係	1983年度	30	2013年度末	紙	文書庫	総務部庶務課人事係		
総務	人事	人事記録	(昭和58年度)人事記録及びその付属書類	沖縄支所庶務課庶務係	1983年度	30	2013年度末	紙	事務室	沖縄支所庶務課庶務係		
総務	人事	人事記録	(昭和59年度)人事記録及びその付属書類	総務部庶務課人事係	1984年度	30	2014年度末	紙	文書庫	総務部庶務課人事係		
総務	人事	人事記録	(昭和59年度)人事記録及びその付属書類	沖縄支所庶務課庶務係	1984年度	30	2014年度末	紙	事務室	沖縄支所庶務課庶務係		
総務	人事	人事記録	(昭和60年度)人事記録及びその付属書類	総務部庶務課人事係	1985年度	30	2015年度末	紙	文書庫	総務部庶務課人事係		
総務	人事	人事記録	(昭和60年度)人事記録及びその付属書類	沖縄支所庶務課庶務係	1985年度	30	2015年度末	紙	事務室	沖縄支所庶務課庶務係		
総務	人事	人事記録	(昭和61年度)人事記録及びその付属書類	総務部庶務課人事係	1986年度	30	2016年度末	紙	文書庫	総務部庶務課人事係		
総務	人事	人事記録	(昭和62年度)人事記録及びその付属書類	総務部庶務課人事係	1987年度	30	2017年度末	紙	文書庫	総務部庶務課人事係		
総務	人事	人事記録	(昭和62年度)人事記録及びその付属書類	沖縄支所庶務課庶務係	1987年度	30	2017年度末	紙	事務室	沖縄支所庶務課庶務係		
総務	人事	人事記録	(昭和63年度)人事記録及びその付属書類	総務部庶務課人事係	1988年度	30	2018年度末	紙	文書庫	総務部庶務課人事係		

独立行政法人国際農林水産業研究センター法人文書ファイル管理簿

文書分類			法人文書ファイル名	作成者	作成(取得)時期	保存期間(年)	保存期間満了時期	媒体種別	保存場所	管理担当課・係	保存期間満了時の措置結果	備考
大分類	中分類	小分類										
総務	人事	人事記録	(平成元年度)人事記録及びその付属書類	総務部庶務課人事係	1989年度	30	2019年度末	紙	文書庫	総務部庶務課人事係		
総務	人事	人事記録	(平成2年度)人事記録及びその付属書類	総務部庶務課人事係	1990年度	30	2020年度末	紙	文書庫	総務部庶務課人事係		
総務	人事	人事記録	(平成3年度)人事記録及びその付属書類	総務部庶務課人事係	1991年度	30	2021年度末	紙	文書庫	総務部庶務課人事係		
総務	人事	人事記録	(平成3年度)人事記録及びその付属書類	沖縄支所庶務課庶務係	1991年度	30	2021年度末	紙	事務室	沖縄支所庶務課庶務係		
総務	人事	人事記録	(平成4年度)人事記録及びその付属書類	総務部庶務課人事係	1992年度	30	2022年度末	紙	文書庫	総務部庶務課人事係		
総務	人事	人事記録	(平成5年度)人事記録及びその付属書類	総務部庶務課人事係	1993年度	30	2023年度末	紙	文書庫	総務部庶務課人事係		
総務	人事	人事記録	(平成5年度)人事記録及びその付属書類	沖縄支所庶務課庶務係	1993年度	30	2023年度末	紙	事務室	沖縄支所庶務課庶務係		
総務	人事	人事記録	(平成6年度)人事記録及びその付属書類	総務部庶務課人事係	1994年度	30	2024年度末	紙	文書庫	総務部庶務課人事係		
総務	人事	人事記録	(平成6年度)人事記録及びその付属書類	沖縄支所庶務課庶務係	1994年度	30	2024年度末	紙	事務室	沖縄支所庶務課庶務係		
総務	人事	人事記録	(平成7年度)人事記録及びその付属書類	総務部庶務課人事係	1995年度	30	2025年度末	紙	文書庫	総務部庶務課人事係		
総務	人事	人事記録	(平成7年度)人事記録及びその付属書類	沖縄支所庶務課庶務係	1995年度	30	2025年度末	紙	事務室	沖縄支所庶務課庶務係		
総務	人事	人事記録	(平成8年度)人事記録及びその付属書類	総務部庶務課人事係	1996年度	30	2026年度末	紙	文書庫	総務部庶務課人事係		
総務	人事	人事記録	(平成9年度)人事記録及びその付属書類	総務部庶務課人事係	1997年度	30	2027年度末	紙	文書庫	総務部庶務課人事係		
総務	人事	人事記録	(平成9年度)人事記録及びその付属書類	沖縄支所庶務課庶務係	1997年度	30	2027年度末	紙	事務室	沖縄支所庶務課庶務係		
総務	人事	人事記録	(平成10年度)人事記録及びその付属書類	総務部庶務課人事係	1998年度	30	2028年度末	紙	文書庫	総務部庶務課人事係		
総務	人事	人事記録	(平成11年度)人事記録及びその付属書類	総務部庶務課人事係	1999年度	30	2029年度末	紙	文書庫	総務部庶務課人事係		
総務	人事	人事記録	(平成11年度)人事記録及びその付属書類	沖縄支所庶務課庶務係	1999年度	30	2029年度末	紙	事務室	沖縄支所庶務課庶務係		
総務	人事	人事記録	(平成12年度)人事記録及びその付属書類	総務部庶務課人事係	2000年度	30	2030年度末	紙	文書庫	総務部庶務課人事係		
総務	人事	人事記録	(平成12年度)人事記録及びその付属書類	沖縄支所庶務課庶務係	2000年度	30	2030年度末	紙	事務室	沖縄支所庶務課庶務係		
総務	人事	人事記録	(平成13年度)人事記録及びその付属書類	総務部庶務課人事係	2001年度	30	2031年度末	紙	事務室	総務部庶務課人事係		

独立行政法人国際農林水産業研究センター法人文書ファイル管理簿

文書分類			法人文書ファイル名	作成者	作成(取得)時期	保存期間(年)	保存期間満了時期	媒体種別	保存場所	管理担当課・係	保存期間満了時の措置結果	備考
大分類	中分類	小分類										
総務	人事	人事記録	(平成13年度)人事記録及びその付属書類	沖縄支所庶務課庶務係	2001年度	30	2031年度末	紙	事務局	沖縄支所庶務課庶務係		
総務	人事	人事記録	(平成11年度)履歴事項の証明に関する文書	総務部庶務課人事係	1999年度	3	2002年度末	紙	文書庫	総務部庶務課人事係		
総務	人事	人事記録	(平成12年度)履歴事項の証明に関する文書	総務部庶務課人事係	2000年度	3	2003年度末	紙	文書庫	総務部庶務課人事係		
総務	人事	人事記録	(平成13年度)履歴事項の証明に関する文書	総務部庶務課人事係	2001年度	3	2004年度末	紙	事務局	総務部庶務課人事係		
総務	人事	組織・定員	(昭和47年度)組織・定員に関する文書	総務部庶務課人事係	1972年度	30	2002年度末	紙	文書庫	総務部庶務課人事係		
総務	人事	組織・定員	(昭和48年度)組織・定員に関する文書	総務部庶務課人事係	1973年度	30	2003年度末	紙	文書庫	総務部庶務課人事係		
総務	人事	組織・定員	(昭和49年度)組織・定員に関する文書	総務部庶務課人事係	1974年度	30	2004年度末	紙	文書庫	総務部庶務課人事係		
総務	人事	組織・定員	(昭和50年度)組織・定員に関する文書	総務部庶務課人事係	1975年度	30	2005年度末	紙	文書庫	総務部庶務課人事係		
総務	人事	組織・定員	(昭和51年度)組織・定員に関する文書	総務部庶務課人事係	1976年度	30	2006年度末	紙	文書庫	総務部庶務課人事係		
総務	人事	組織・定員	(昭和52年度)組織・定員に関する文書	総務部庶務課人事係	1977年度	30	2007年度末	紙	文書庫	総務部庶務課人事係		
総務	人事	組織・定員	(昭和53年度)組織・定員に関する文書	総務部庶務課人事係	1978年度	30	2008年度末	紙	文書庫	総務部庶務課人事係		
総務	人事	組織・定員	(昭和54年度)組織・定員に関する文書	総務部庶務課人事係	1979年度	30	2009年度末	紙	文書庫	総務部庶務課人事係		
総務	人事	組織・定員	(昭和55年度)組織・定員に関する文書	総務部庶務課人事係	1980年度	30	2010年度末	紙	文書庫	総務部庶務課人事係		
総務	人事	組織・定員	(昭和56年度)組織・定員に関する文書	総務部庶務課人事係	1981年度	30	2011年度末	紙	文書庫	総務部庶務課人事係		
総務	人事	組織・定員	(昭和57年度)組織・定員に関する文書	総務部庶務課人事係	1982年度	30	2012年度末	紙	文書庫	総務部庶務課人事係		
総務	人事	組織・定員	(昭和58年度)組織・定員に関する文書	総務部庶務課人事係	1983年度	30	2013年度末	紙	文書庫	総務部庶務課人事係		
総務	人事	組織・定員	(昭和59年度)組織・定員に関する文書	総務部庶務課人事係	1984年度	30	2014年度末	紙	文書庫	総務部庶務課人事係		
総務	人事	組織・定員	(昭和60年度)組織・定員に関する文書	総務部庶務課人事係	1985年度	30	2015年度末	紙	文書庫	総務部庶務課人事係		
総務	人事	組織・定員	(昭和61年度)組織・定員に関する文書	総務部庶務課人事係	1986年度	30	2016年度末	紙	文書庫	総務部庶務課人事係		
総務	人事	組織・定員	(昭和62年度)組織・定員に関する文書	総務部庶務課人事係	1987年度	30	2017年度末	紙	文書庫	総務部庶務課人事係		

独立行政法人国際農林水産業研究センター法人文書ファイル管理簿

文書分類			法人文書ファイル名	作成者	作成(取得)時期	保存期間(年)	保存期間満了時期	媒体種別	保存場所	管理担当課・係	保存期間満了時の措置結果	備考
大分類	中分類	小分類										
総務	人事	組織・定員	(昭和63年度)組織・定員に関する文書	総務部庶務課人事係	1988年度	30	2018年度末	紙	文書庫	総務部庶務課人事係		
総務	人事	組織・定員	(平成元年度)組織・定員に関する文書	総務部庶務課人事係	1989年度	30	2019年度末	紙	文書庫	総務部庶務課人事係		
総務	人事	組織・定員	(平成2年度)組織・定員に関する文書	総務部庶務課人事係	1990年度	30	2020年度末	紙	文書庫	総務部庶務課人事係		
総務	人事	組織・定員	(平成3年度)組織・定員に関する文書	総務部庶務課人事係	1991年度	30	2021年度末	紙	文書庫	総務部庶務課人事係		
総務	人事	組織・定員	(平成4年度)組織・定員に関する文書	総務部庶務課人事係	1992年度	30	2022年度末	紙	文書庫	総務部庶務課人事係		
総務	人事	組織・定員	(平成5年度)組織・定員に関する文書	総務部庶務課人事係	1993年度	30	2023年度末	紙	文書庫	総務部庶務課人事係		
総務	人事	組織・定員	(平成6年度)組織・定員に関する文書	総務部庶務課人事係	1994年度	30	2024年度末	紙	文書庫	総務部庶務課人事係		
総務	人事	組織・定員	(平成7年度)組織・定員に関する文書	総務部庶務課人事係	1995年度	30	2025年度末	紙	文書庫	総務部庶務課人事係		
総務	人事	組織・定員	(平成8年度)組織・定員に関する文書	総務部庶務課人事係	1996年度	30	2026年度末	紙	文書庫	総務部庶務課人事係		
総務	人事	組織・定員	(平成9年度)組織・定員に関する文書	総務部庶務課人事係	1997年度	30	2027年度末	紙	文書庫	総務部庶務課人事係		
総務	人事	組織・定員	(平成10年度)組織・定員に関する文書	総務部庶務課人事係	1998年度	30	2028年度末	紙	文書庫	総務部庶務課人事係		
総務	人事	組織・定員	(平成11年度)組織・定員に関する文書	総務部庶務課人事係	1999年度	30	2029年度末	紙	文書庫	総務部庶務課人事係		
総務	人事	組織・定員	(平成12年度)組織・定員に関する文書	総務部庶務課人事係	2000年度	30	2030年度末	紙	文書庫	総務部庶務課人事係		
総務	人事	組織・定員	(平成13年度)組織・定員に関する文書	総務部庶務課人事係	2001年度	30	2031年度末	紙	事務室	総務部庶務課人事係		
総務	人事	分限懲戒	(昭和47年度)分限及び懲戒に関する文書	総務部庶務課人事係	1972年度	30	2002年度末	紙	文書庫	総務部庶務課人事係		
総務	人事	分限懲戒	(昭和48年度)分限及び懲戒に関する文書	総務部庶務課人事係	1973年度	30	2003年度末	紙	文書庫	総務部庶務課人事係		
総務	人事	分限懲戒	(昭和49年度)分限及び懲戒に関する文書	総務部庶務課人事係	1974年度	30	2004年度末	紙	文書庫	総務部庶務課人事係		
総務	人事	分限懲戒	(昭和50年度)分限及び懲戒に関する文書	総務部庶務課人事係	1975年度	30	2005年度末	紙	文書庫	総務部庶務課人事係		
総務	人事	分限懲戒	(昭和51年度)分限及び懲戒に関する文書	総務部庶務課人事係	1976年度	30	2006年度末	紙	文書庫	総務部庶務課人事係		
総務	人事	分限懲戒	(昭和52年度)分限及び懲戒に関する文書	総務部庶務課人事係	1977年度	30	2007年度末	紙	文書庫	総務部庶務課人事係		

独立行政法人国際農林水産業研究センター法人文書ファイル管理簿

文書分類			法人文書ファイル名	作成者	作成(取得)時期	保存期間(年)	保存期間満了時期	媒体種別	保存場所	管理担当課・係	保存期間満了時の措置結果	備考
大分類	中分類	小分類										
総務	人事	分限懲戒	(昭和53年度)分限及び懲戒に関する文書	総務部庶務課人事係	1978年度	30	2008年度末	紙	文書庫	総務部庶務課人事係		
総務	人事	分限懲戒	(昭和54年度)分限及び懲戒に関する文書	総務部庶務課人事係	1979年度	30	2009年度末	紙	文書庫	総務部庶務課人事係		
総務	人事	分限懲戒	(昭和55年度)分限及び懲戒に関する文書	総務部庶務課人事係	1980年度	30	2010年度末	紙	文書庫	総務部庶務課人事係		
総務	人事	分限懲戒	(昭和56年度)分限及び懲戒に関する文書	総務部庶務課人事係	1981年度	30	2011年度末	紙	文書庫	総務部庶務課人事係		
総務	人事	分限懲戒	(昭和57年度)分限及び懲戒に関する文書	総務部庶務課人事係	1982年度	30	2012年度末	紙	文書庫	総務部庶務課人事係		
総務	人事	分限懲戒	(昭和58年度)分限及び懲戒に関する文書	総務部庶務課人事係	1983年度	30	2013年度末	紙	文書庫	総務部庶務課人事係		
総務	人事	分限懲戒	(昭和59年度)分限及び懲戒に関する文書	総務部庶務課人事係	1984年度	30	2014年度末	紙	文書庫	総務部庶務課人事係		
総務	人事	分限懲戒	(昭和60年度)分限及び懲戒に関する文書	総務部庶務課人事係	1985年度	30	2015年度末	紙	文書庫	総務部庶務課人事係		
総務	人事	分限懲戒	(昭和61年度)分限及び懲戒に関する文書	総務部庶務課人事係	1986年度	30	2016年度末	紙	文書庫	総務部庶務課人事係		
総務	人事	分限懲戒	(昭和62年度)分限及び懲戒に関する文書	総務部庶務課人事係	1987年度	30	2017年度末	紙	文書庫	総務部庶務課人事係		
総務	人事	分限懲戒	(昭和63年度)分限及び懲戒に関する文書	総務部庶務課人事係	1988年度	30	2018年度末	紙	文書庫	総務部庶務課人事係		
総務	人事	分限懲戒	(平成元年度)分限及び懲戒に関する文書	総務部庶務課人事係	1989年度	30	2019年度末	紙	文書庫	総務部庶務課人事係		
総務	人事	分限懲戒	(平成2年度)分限及び懲戒に関する文書	総務部庶務課人事係	1990年度	30	2020年度末	紙	文書庫	総務部庶務課人事係		
総務	人事	分限懲戒	(平成3年度)分限及び懲戒に関する文書	総務部庶務課人事係	1991年度	30	2021年度末	紙	文書庫	総務部庶務課人事係		
総務	人事	分限懲戒	(平成4年度)分限及び懲戒に関する文書	総務部庶務課人事係	1992年度	30	2022年度末	紙	文書庫	総務部庶務課人事係		
総務	人事	分限懲戒	(平成5年度)分限及び懲戒に関する文書	総務部庶務課人事係	1993年度	30	2023年度末	紙	文書庫	総務部庶務課人事係		
総務	人事	分限懲戒	(平成6年度)分限及び懲戒に関する文書	総務部庶務課人事係	1994年度	30	2024年度末	紙	文書庫	総務部庶務課人事係		
総務	人事	分限懲戒	(平成7年度)分限及び懲戒に関する文書	総務部庶務課人事係	1995年度	30	2025年度末	紙	文書庫	総務部庶務課人事係		
総務	人事	分限懲戒	(平成8年度)分限及び懲戒に関する文書	総務部庶務課人事係	1996年度	30	2026年度末	紙	文書庫	総務部庶務課人事係		
総務	人事	分限懲戒	(平成9年度)分限及び懲戒に関する文書	総務部庶務課人事係	1997年度	30	2027年度末	紙	文書庫	総務部庶務課人事係		

独立行政法人国際農林水産業研究センター法人文書ファイル管理簿

文書分類			法人文書ファイル名	作成者	作成(取得)時期	保存期間(年)	保存期間満了時期	媒体種別	保存場所	管理担当課・係	保存期間満了時の措置結果	備考
大分類	中分類	小分類										
総務	人事	分限懲戒	(平成10年度)分限及び懲戒に関する文書	総務部庶務課人事係	1998年度	30	2028年度末	紙	文書庫	総務部庶務課人事係		
総務	人事	分限懲戒	(平成11年度)分限及び懲戒に関する文書	総務部庶務課人事係	1999年度	30	2029年度末	紙	文書庫	総務部庶務課人事係		
総務	人事	分限懲戒	(平成12年度)分限及び懲戒に関する文書	総務部庶務課人事係	2000年度	30	2030年度末	紙	文書庫	総務部庶務課人事係		
総務	人事	分限懲戒	(平成13年度)分限及び懲戒に関する文書	総務部庶務課人事係	2001年度	30	2031年度末	紙	事務室	総務部庶務課人事係		
総務	人事	人事統計	(平成11年度)人事統計報告に関する文書	総務部庶務課人事係	1999年度	3	2002年度末	紙	文書庫	総務部庶務課人事係		
総務	人事	人事統計	(平成12年度)人事統計報告に関する文書	総務部庶務課人事係	2000年度	3	2003年度末	紙	文書庫	総務部庶務課人事係		
総務	人事	人事統計	(平成13年度)人事統計報告に関する文書	総務部庶務課人事係	2001年度	3	2004年度末	紙	事務室	総務部庶務課人事係		
総務	人事	旧姓使用	(平成9年度)旧姓使用に関する文書	総務部庶務課人事係	1997年度	5	2002年度末	紙	文書庫	総務部庶務課人事係		
総務	人事	旧姓使用	(平成10年度)旧姓使用に関する文書	総務部庶務課人事係	1998年度	5	2003年度末	紙	文書庫	総務部庶務課人事係		
総務	人事	旧姓使用	(平成11年度)旧姓使用に関する文書	総務部庶務課人事係	1999年度	5	2004年度末	紙	文書庫	総務部庶務課人事係		
総務	人事	旧姓使用	(平成12年度)旧姓使用に関する文書	総務部庶務課人事係	2000年度	5	2005年度末	紙	文書庫	総務部庶務課人事係		
総務	人事	旧姓使用	(平成13年度)旧姓使用に関する文書	総務部庶務課人事係	2001年度	5	2006年度末	紙	事務室	総務部庶務課人事係		
総務	人事	通知・回答等	(平成11年度)人事一般に関する通知、照会、回答又は報告等に関する文書	総務部庶務課人事係	1999年度	3	2002年度末	紙	文書庫	総務部庶務課人事係		
総務	人事	通知・回答等	(平成11年度)人事一般に関する通知、照会、回答又は報告等に関する文書	沖縄支所庶務課庶務係	1999年度	3	2002年度末	紙	事務室	沖縄支所庶務課庶務係		
総務	人事	通知・回答等	(平成12年度)人事一般に関する通知、照会、回答又は報告等に関する文書	総務部庶務課人事係	2000年度	3	2003年度末	紙	文書庫	総務部庶務課人事係		
総務	人事	通知・回答等	(平成12年度)人事一般に関する通知、照会、回答又は報告等に関する文書	沖縄支所庶務課庶務係	2000年度	3	2003年度末	紙	事務室	沖縄支所庶務課庶務係		
総務	人事	通知・回答等	(平成13年度)人事一般に関する通知、照会、回答又は報告等に関する文書	総務部庶務課人事係	2001年度	3	2004年度末	紙	事務室	総務部庶務課人事係		
総務	人事	通知・回答等	(平成13年度)人事一般に関する通知、照会、回答又は報告等に関する文書	沖縄支所庶務課庶務係	2001年度	3	2004年度末	紙	事務室	沖縄支所庶務課庶務係		
総務	職員管理	一般	(平成11年度)各種調査に関する文書	総務部庶務課人事係	1999年度	3	2002年度末	紙	文書庫	総務部庶務課人事係		
総務	職員管理	一般	(平成12年度)各種調査に関する文書	総務部庶務課人事係	2000年度	3	2003年度末	紙	文書庫	総務部庶務課人事係		

独立行政法人国際農林水産業研究センター法人文書ファイル管理簿

文書分類			法人文書ファイル名	作成者	作成(取得)時期	保存期間(年)	保存期間満了時期	媒体種別	保存場所	管理担当課・係	保存期間満了時の措置結果	備考
大分類	中分類	小分類										
総務	職員管理	一般	(平成13年度)各種調査に関する文書	総務部庶務課人事係	2001年度	3	2004年度末	紙	事務室	総務部庶務課人事係		
総務	職員管理	服務	(平成9年度)営利企業への就職に関する文書	総務部庶務課人事係	1997年度	5	2002年度末	紙	文書庫	総務部庶務課人事係		
総務	職員管理	服務	(平成10年度)営利企業への就職に関する文書	総務部庶務課人事係	1998年度	5	2003年度末	紙	文書庫	総務部庶務課人事係		
総務	職員管理	服務	(平成11年度)営利企業への就職に関する文書	総務部庶務課人事係	1999年度	5	2004年度末	紙	文書庫	総務部庶務課人事係		
総務	職員管理	服務	(平成12年度)営利企業への就職に関する文書	総務部庶務課人事係	2000年度	5	2005年度末	紙	文書庫	総務部庶務課人事係		
総務	職員管理	服務	(平成13年度)営利企業への就職に関する文書	総務部庶務課人事係	2001年度	5	2006年度末	紙	事務室	総務部庶務課人事係		
総務	職員管理	服務	(平成9年度)委嘱又は応嘱に関する文書	総務部庶務課人事係	1997年度	5	2002年度末	紙	文書庫	総務部庶務課人事係		
総務	職員管理	服務	(平成10年度)委嘱又は応嘱に関する文書	企画調整部研究企画科	1998年度	5	2003年度末	紙	企画書庫	企画調整部研究企画科		
総務	職員管理	服務	(平成10年度)委嘱又は応嘱に関する文書	総務部庶務課人事係	1998年度	5	2003年度末	紙	文書庫	総務部庶務課人事係		
総務	職員管理	服務	(平成11年度)委嘱又は応嘱に関する文書	企画調整部研究企画科	1999年度	5	2004年度末	紙	企画書庫	企画調整部研究企画科		
総務	職員管理	服務	(平成11年度)委嘱又は応嘱に関する文書	総務部庶務課人事係	1999年度	5	2004年度末	紙	文書庫	総務部庶務課人事係		
総務	職員管理	服務	(平成11年度)委嘱又は応嘱に関する文書	沖縄支所庶務課庶務係	1999年度	5	2004年度末	紙	事務室	沖縄支所庶務課庶務係		
総務	職員管理	服務	(平成12年度)委嘱又は応嘱に関する文書	企画調整部研究企画科	2000年度	5	2005年度末	紙	企画書庫	企画調整部研究企画科		
総務	職員管理	服務	(平成12年度)委嘱又は応嘱に関する文書	総務部庶務課人事係	2000年度	5	2005年度末	紙	文書庫	総務部庶務課人事係		
総務	職員管理	服務	(平成12年度)委嘱又は応嘱に関する文書	沖縄支所庶務課庶務係	2000年度	5	2005年度末	紙	事務室	沖縄支所庶務課庶務係		
総務	職員管理	服務	(平成13年度)委嘱又は応嘱に関する文書	企画調整部研究企画科	2001年度	5	2006年度末	紙	企画書庫	企画調整部研究企画科		
総務	職員管理	服務	(平成13年度)委嘱又は応嘱に関する文書	総務部庶務課人事係	2001年度	5	2006年度末	紙	事務室	総務部庶務課人事係		
総務	職員管理	服務	(平成13年度)委嘱又は応嘱に関する文書	沖縄支所庶務課庶務係	2001年度	5	2006年度末	紙	事務室	沖縄支所庶務課庶務係		
総務	職員管理	服務	(平成9年度)兼業の許可に関する文書	総務部庶務課人事係	1997年度	5	2002年度末	紙	文書庫	総務部庶務課人事係		
総務	職員管理	服務	(平成10年度)兼業の許可に関する文書	総務部庶務課人事係	1998年度	5	2003年度末	紙	文書庫	総務部庶務課人事係		

独立行政法人国際農林水産業研究センター法人文書ファイル管理簿

文書分類			法人文書ファイル名	作成者	作成(取得)時期	保存期間(年)	保存期間満了時期	媒体種別	保存場所	管理担当課・係	保存期間満了時の措置結果	備考
大分類	中分類	小分類										
総務	職員管理	服務	(平成11年度)兼業の許可に関する文書	総務部庶務課人事係	1999年度	5	2004年度末	紙	文書庫	総務部庶務課人事係		
総務	職員管理	服務	(平成12年度)兼業の許可に関する文書	総務部庶務課人事係	2000年度	5	2005年度末	紙	文書庫	総務部庶務課人事係		
総務	職員管理	服務	(平成13年度)兼業の許可に関する文書	総務部庶務課人事係	2001年度	5	2006年度末	紙	事務室	総務部庶務課人事係		
総務	職員管理	服務	(平成9年度)専従許可に関する文書	総務部庶務課人事係	1997年度	5	2002年度末	紙	文書庫	総務部庶務課人事係		
総務	職員管理	服務	(平成10年度)専従許可に関する文書	総務部庶務課人事係	1998年度	5	2003年度末	紙	文書庫	総務部庶務課人事係		
総務	職員管理	服務	(平成11年度)専従許可に関する文書	総務部庶務課人事係	1999年度	5	2004年度末	紙	文書庫	総務部庶務課人事係		
総務	職員管理	服務	(平成12年度)専従許可に関する文書	総務部庶務課人事係	2000年度	5	2005年度末	紙	文書庫	総務部庶務課人事係		
総務	職員管理	服務	(平成13年度)専従許可に関する文書	総務部庶務課人事係	2001年度	5	2006年度末	紙	事務室	総務部庶務課人事係		
総務	職員管理	勤務評定	(平成11年度)勤務評定に関する文書	総務部庶務課人事係	1999年度	3	2002年度末	紙	文書庫	総務部庶務課人事係		
総務	職員管理	勤務評定	(平成12年度)勤務評定に関する文書	総務部庶務課人事係	2000年度	3	2003年度末	紙	文書庫	総務部庶務課人事係		
総務	職員管理	勤務評定	(平成13年度)勤務評定に関する文書	総務部庶務課人事係	2001年度	3	2004年度末	紙	事務室	総務部庶務課人事係		
総務	職員管理	海外渡航等	(平成13年度)海外渡航承認書、研究集会参加承認書	総務部庶務課人事係	2001年度	1	2002年度末	紙	事務室	総務部庶務課人事係		
総務	職員管理	倫理	(平成9年度)倫理に関する文書	総務部庶務課人事係	1997年度	5	2002年度末	紙	文書庫	総務部庶務課人事係		
総務	職員管理	倫理	(平成10年度)倫理に関する文書	総務部庶務課人事係	1998年度	5	2003年度末	紙	文書庫	総務部庶務課人事係		
総務	職員管理	倫理	(平成11年度)倫理に関する文書	総務部庶務課人事係	1999年度	5	2004年度末	紙	文書庫	総務部庶務課人事係		
総務	職員管理	倫理	(平成12年度)倫理に関する文書	総務部庶務課人事係	2000年度	5	2005年度末	紙	文書庫	総務部庶務課人事係		
総務	職員管理	倫理	(平成12年度)倫理に関する文書	総務部庶務課課長補佐	2000年度	5	2005年度末	紙	事務室	総務部庶務課課長補佐		
総務	職員管理	倫理	(平成13年度)倫理に関する文書	総務部庶務課人事係	2001年度	5	2006年度末	紙	事務室	総務部庶務課人事係		
総務	職員管理	倫理	(平成13年度)倫理に関する文書	総務部庶務課課長補佐	2001年度	5	2006年度末	紙	事務室	総務部庶務課課長補佐		
総務	職員管理	研修	(平成11年度)研修に関する文書	総務部庶務課人事係	1999年度	3	2002年度末	紙	文書庫	総務部庶務課人事係		



独立行政法人国際農林水産業研究センター法人文書ファイル管理簿

文書分類			法人文書ファイル名	作成者	作成(取得)時期	保存期間(年)	保存期間満了時期	媒体種別	保存場所	管理担当課・係	保存期間満了時の措置結果	備考
大分類	中分類	小分類										
総務	職員管理	研修	(平成12年度)研修に関する文書	総務部庶務課人事係	2000年度	3	2003年度末	紙	文書庫	総務部庶務課人事係		
総務	職員管理	研修	(平成12年度)研修に関する文書	沖縄支所庶務課庶務係	2000年度	3	2003年度末	紙	事務室	沖縄支所庶務課庶務係		
総務	職員管理	研修	(平成13年度)研修に関する文書	総務部庶務課人事係	2001年度	3	2004年度末	紙	事務室	総務部庶務課人事係		
総務	職員管理	表彰	(平成11年度)表彰に関する文書(重要なもの以外)	総務部庶務課人事係	1999年度	3	2002年度末	紙	文書庫	総務部庶務課人事係		
総務	職員管理	表彰	(平成12年度)表彰に関する文書(重要なもの以外)	総務部庶務課人事係	2000年度	3	2003年度末	紙	文書庫	総務部庶務課人事係		
総務	職員管理	表彰	(平成13年度)表彰に関する文書(重要なもの以外)	総務部庶務課人事係	2001年度	3	2004年度末	紙	事務室	総務部庶務課人事係		
総務	職員管理	叙勲	(昭和47年度)叙位、叙勲、褒賞に関する文書(表彰に関する重要なもの)	総務部庶務課人事係	1972年度	30	2002年度末	紙	文書庫	総務部庶務課人事係		
総務	職員管理	叙勲	(昭和48年度)叙位、叙勲、褒賞に関する文書(表彰に関する重要なもの)	総務部庶務課人事係	1973年度	30	2003年度末	紙	文書庫	総務部庶務課人事係		
総務	職員管理	叙勲	(昭和49年度)叙位、叙勲、褒賞に関する文書(表彰に関する重要なもの)	総務部庶務課人事係	1974年度	30	2004年度末	紙	文書庫	総務部庶務課人事係		
総務	職員管理	叙勲	(昭和50年度)叙位、叙勲、褒賞に関する文書(表彰に関する重要なもの)	総務部庶務課人事係	1975年度	30	2005年度末	紙	文書庫	総務部庶務課人事係		
総務	職員管理	叙勲	(昭和51年度)叙位、叙勲、褒賞に関する文書(表彰に関する重要なもの)	総務部庶務課人事係	1976年度	30	2006年度末	紙	文書庫	総務部庶務課人事係		
総務	職員管理	叙勲	(昭和52年度)叙位、叙勲、褒賞に関する文書(表彰に関する重要なもの)	総務部庶務課人事係	1977年度	30	2007年度末	紙	文書庫	総務部庶務課人事係		
総務	職員管理	叙勲	(昭和53年度)叙位、叙勲、褒賞に関する文書(表彰に関する重要なもの)	総務部庶務課人事係	1978年度	30	2008年度末	紙	文書庫	総務部庶務課人事係		
総務	職員管理	叙勲	(昭和54年度)叙位、叙勲、褒賞に関する文書(表彰に関する重要なもの)	総務部庶務課人事係	1979年度	30	2009年度末	紙	文書庫	総務部庶務課人事係		
総務	職員管理	叙勲	(昭和55年度)叙位、叙勲、褒賞に関する文書(表彰に関する重要なもの)	総務部庶務課人事係	1980年度	30	2010年度末	紙	文書庫	総務部庶務課人事係		
総務	職員管理	叙勲	(昭和56年度)叙位、叙勲、褒賞に関する文書(表彰に関する重要なもの)	総務部庶務課人事係	1981年度	30	2011年度末	紙	文書庫	総務部庶務課人事係		
総務	職員管理	叙勲	(昭和57年度)叙位、叙勲、褒賞に関する文書(表彰に関する重要なもの)	総務部庶務課人事係	1982年度	30	2012年度末	紙	文書庫	総務部庶務課人事係		
総務	職員管理	叙勲	(昭和58年度)叙位、叙勲、褒賞に関する文書(表彰に関する重要なもの)	総務部庶務課人事係	1983年度	30	2013年度末	紙	文書庫	総務部庶務課人事係		
総務	職員管理	叙勲	(昭和59年度)叙位、叙勲、褒賞に関する文書(表彰に関する重要なもの)	総務部庶務課人事係	1984年度	30	2014年度末	紙	文書庫	総務部庶務課人事係		
総務	職員管理	叙勲	(昭和60年度)叙位、叙勲、褒賞に関する文書(表彰に関する重要なもの)	総務部庶務課人事係	1985年度	30	2015年度末	紙	文書庫	総務部庶務課人事係		

独立行政法人国際農林水産業研究センター法人文書ファイル管理簿

文書分類			法人文書ファイル名	作成者	作成(取得)時期	保存期間(年)	保存期間満了時期	媒体種別	保存場所	管理担当課・係	保存期間満了時の措置結果	備考
大分類	中分類	小分類										
総務	職員管理	叙勲	(昭和61年度)叙位、叙勲、褒賞に関する文書(表彰に関する重要なもの)	総務部庶務課人事係	1986年度	30	2016年度末	紙	文書庫	総務部庶務課人事係		
総務	職員管理	叙勲	(昭和62年度)叙位、叙勲、褒賞に関する文書(表彰に関する重要なもの)	総務部庶務課人事係	1987年度	30	2017年度末	紙	文書庫	総務部庶務課人事係		
総務	職員管理	叙勲	(昭和63年度)叙位、叙勲、褒賞に関する文書(表彰に関する重要なもの)	総務部庶務課人事係	1988年度	30	2018年度末	紙	文書庫	総務部庶務課人事係		
総務	職員管理	叙勲	(平成元年度)叙位、叙勲、褒賞に関する文書(表彰に関する重要なもの)	総務部庶務課人事係	1989年度	30	2019年度末	紙	文書庫	総務部庶務課人事係		
総務	職員管理	叙勲	(平成2年度)叙位、叙勲、褒賞に関する文書(表彰に関する重要なもの)	総務部庶務課人事係	1990年度	30	2020年度末	紙	文書庫	総務部庶務課人事係		
総務	職員管理	叙勲	(平成3年度)叙位、叙勲、褒賞に関する文書(表彰に関する重要なもの)	総務部庶務課人事係	1991年度	30	2021年度末	紙	文書庫	総務部庶務課人事係		
総務	職員管理	叙勲	(平成4年度)叙位、叙勲、褒賞に関する文書(表彰に関する重要なもの)	総務部庶務課人事係	1992年度	30	2022年度末	紙	文書庫	総務部庶務課人事係		
総務	職員管理	叙勲	(平成5年度)叙位、叙勲、褒賞に関する文書(表彰に関する重要なもの)	総務部庶務課人事係	1993年度	30	2023年度末	紙	文書庫	総務部庶務課人事係		
総務	職員管理	叙勲	(平成6年度)叙位、叙勲、褒賞に関する文書(表彰に関する重要なもの)	総務部庶務課人事係	1994年度	30	2024年度末	紙	文書庫	総務部庶務課人事係		
総務	職員管理	叙勲	(平成7年度)叙位、叙勲、褒賞に関する文書(表彰に関する重要なもの)	総務部庶務課人事係	1995年度	30	2025年度末	紙	文書庫	総務部庶務課人事係		
総務	職員管理	叙勲	(平成8年度)叙位、叙勲、褒賞に関する文書(表彰に関する重要なもの)	総務部庶務課人事係	1996年度	30	2026年度末	紙	文書庫	総務部庶務課人事係		
総務	職員管理	叙勲	(平成9年度)叙位、叙勲、褒賞に関する文書(表彰に関する重要なもの)	総務部庶務課人事係	1997年度	30	2027年度末	紙	文書庫	総務部庶務課人事係		
総務	職員管理	叙勲	(平成10年度)叙位、叙勲、褒賞に関する文書(表彰に関する重要なもの)	総務部庶務課人事係	1998年度	30	2028年度末	紙	文書庫	総務部庶務課人事係		
総務	職員管理	叙勲	(平成11年度)叙位、叙勲、褒賞に関する文書(表彰に関する重要なもの)	総務部庶務課人事係	1999年度	30	2029年度末	紙	文書庫	総務部庶務課人事係		
総務	職員管理	叙勲	(平成12年度)叙位、叙勲、褒賞に関する文書(表彰に関する重要なもの)	総務部庶務課人事係	2000年度	30	2030年度末	紙	文書庫	総務部庶務課人事係		
総務	職員管理	叙勲	(平成13年度)叙位、叙勲、褒賞に関する文書(表彰に関する重要なもの)	総務部庶務課人事係	2001年度	30	2031年度末	紙	事務室	総務部庶務課人事係		
総務	職員管理	陳情・要望等	(平成12年度)陳情・要望等に関する文書	総務部庶務課課長補佐	2000年度	5	2005年度末	紙	事務室	総務部庶務課課長補佐		
総務	職員管理	陳情・要望等	(平成13年度)陳情・要望等に関する文書	総務部庶務課課長補佐	2001年度	5	2006年度末	紙	事務室	総務部庶務課課長補佐		
総務	職員管理	労務	(平成13年度)労働組合との協定協約に関する文書	総務部庶務課専門職(労務・人事)	2001年度	30	2031年度末	紙	事務室	総務部庶務課専門職(労務・人事)		
総務	職員管理	労務	(平成13年度)労働組合との協定協約に関する文書	総務部庶務課人事係	2001年度	30	2031年度末	紙	事務室	総務部庶務課人事係		

独立行政法人国際農林水産業研究センター法人文書ファイル管理簿

文書分類			法人文書ファイル名	作成者	作成(取得)時期	保存期間(年)	保存期間満了時期	媒体種別	保存場所	管理担当課・係	保存期間満了時の措置結果	備考
大分類	中分類	小分類										
総務	職員管理	労務	(平成13年度)労務に係る事項の監督官庁への届出等に関する文書	総務部庶務課専門職(労務・人事)	2001年度	30	2031年度末	紙	事務室	総務部庶務課専門職(労務・人事)		
総務	職員管理	労務	(平成13年度)労務に係る事項の監督官庁への届出等に関する文書	総務部庶務課人事係	2001年度	30	2031年度末	紙	事務室	総務部庶務課人事係		
総務	職員管理	労務	(平成13年度)団体交渉、労使懇談会等に関する文書	総務部庶務課人事係	2001年度	10	2011年度末	紙	事務室	総務部庶務課人事係		
総務	職員管理	労務	(平成13年度)労務に関するその他の文書	総務部庶務課人事係	2001年度	5	2006年度末	紙	事務室	総務部庶務課人事係		
総務	職員管理	通知・回答等	(平成11年度)職員管理に関する通知、照会、回答又は報告等に関する文書	総務部庶務課人事係	1999年度	3	2002年度末	紙	文書庫	総務部庶務課人事係		
総務	職員管理	通知・回答等	(平成12年度)職員管理に関する通知、照会、回答又は報告等に関する文書	総務部庶務課人事係	2000年度	3	2003年度末	紙	文書庫	総務部庶務課人事係		
総務	職員管理	通知・回答等	(平成12年度)職員管理に関する通知、照会、回答、又は報告等に関する文書	沖縄支所庶務課庶務係	2000年度	3	2003年度末	紙	事務室	沖縄支所庶務課庶務係		
総務	職員管理	通知・回答等	(平成13年度)職員管理に関する通知、照会、回答又は報告等に関する文書	総務部庶務課人事係	2001年度	3	2004年度末	紙	事務室	総務部庶務課人事係		
総務	職員管理	通知・回答等	(平成13年度)職員管理に関する通知、照会、回答、又は報告等に関する文書	沖縄支所庶務課庶務係	2001年度	3	2004年度末	紙	事務室	沖縄支所庶務課庶務係		
総務	厚生	共済組合	(平成9年度)共済組合の長期給付に関する文書	総務部庶務課厚生係	1997年度	5	2002年度末	紙	文書庫	総務部庶務課厚生係		
総務	厚生	共済組合	(平成10年度)共済組合の長期給付に関する文書	総務部庶務課厚生係	1998年度	5	2003年度末	紙	文書庫	総務部庶務課厚生係		
総務	厚生	共済組合	(平成11年度)共済組合の長期給付に関する文書	総務部庶務課厚生係	1999年度	5	2004年度末	紙	文書庫	総務部庶務課厚生係		
総務	厚生	共済組合	(平成11年度)共済組合の長期給付に関する文書	沖縄支所庶務課庶務係	1999年度	5	2004年度末	紙	事務室	沖縄支所庶務課庶務係		
総務	厚生	共済組合	(平成12年度)共済組合の長期給付に関する文書	総務部庶務課厚生係	2000年度	5	2005年度末	紙	事務室	総務部庶務課厚生係		
総務	厚生	共済組合	(平成12年度)共済組合の長期給付に関する文書	沖縄支所庶務課庶務係	2000年度	5	2005年度末	紙	事務室	沖縄支所庶務課庶務係		
総務	厚生	共済組合	(平成13年度)共済組合の長期給付に関する文書	総務部庶務課厚生係	2001年度	5	2006年度末	紙	事務室	総務部庶務課厚生係		
総務	厚生	共済組合	(平成13年度)共済組合の長期給付に関する文書	共済組合沖縄支部長	2001年度	5	2006年度末	紙	事務室	共済組合沖縄支部長		
総務	厚生	共済組合	(平成11年度)共済組合の短期給付に関する文書	総務部庶務課厚生係	1999年度	3	2002年度末	紙	文書庫	総務部庶務課厚生係		
総務	厚生	共済組合	(平成11年度)共済組合短期給付に関する文書	沖縄支所庶務課庶務係	1999年度	3	2002年度末	紙	事務室	沖縄支所庶務課庶務係		
総務	厚生	共済組合	(平成12年度)共済組合の短期給付に関する文書	総務部庶務課厚生係	2000年度	3	2003年度末	紙	文書庫	総務部庶務課厚生係		

独立行政法人国際農林水産業研究センター法人文書ファイル管理簿

文書分類			法人文書ファイル名	作成者	作成(取得)時期	保存期間(年)	保存期間満了時期	媒体種別	保存場所	管理担当課・係	保存期間満了時の措置結果	備考
大分類	中分類	小分類										
総務	厚生	共済組合	(平成12年度)共済組合短期給付に関する文書	沖縄支所庶務課庶務係	2000年度	3	2003年度末	紙	事務室	沖縄支所庶務課庶務係		
総務	厚生	共済組合	(平成13年度)共済組合の短期給付に関する文書	総務部庶務課厚生係	2001年度	3	2004年度末	紙	文書庫	総務部庶務課厚生係		
総務	厚生	共済組合	(平成13年度)共済組合短期給付に関する文書	沖縄支所庶務課庶務係	2001年度	3	2004年度末	紙	事務室	沖縄支所庶務課庶務係		
総務	厚生	共済組合	(平成11年度)共済組合の貸付金に関する文書	総務部庶務課厚生係	1999年度	3	2002年度末	紙	文書庫	総務部庶務課厚生係		
総務	厚生	共済組合	(平成11年度)共済組合の貸付金に関する文書	沖縄支所庶務課庶務係	1999年度	3	2002年度末	紙	事務室	沖縄支所庶務課庶務係		
総務	厚生	共済組合	(平成12年度)共済組合の貸付金に関する文書	総務部庶務課厚生係	2000年度	3	2003年度末	紙	事務室	総務部庶務課厚生係		
総務	厚生	共済組合	(平成12年度)共済組合の貸付金に関する文書	沖縄支所庶務課庶務係	2000年度	3	2003年度末	紙	事務室	沖縄支所庶務課庶務係		
総務	厚生	共済組合	(平成13年度)共済組合の貸付金に関する文書	総務部庶務課厚生係	2001年度	3	2004年度末	紙	事務室	総務部庶務課厚生係		
総務	厚生	共済組合	(平成13年度)共済組合の貸付金に関する文書	沖縄支所庶務課庶務係	2001年度	3	2004年度末	紙	事務室	沖縄支所庶務課庶務係		
総務	厚生	共済組合	(平成11年度)共済組合の掛金払込に関する文書	総務部庶務課厚生係	1999年度	3	2002年度末	紙	文書庫	総務部庶務課厚生係		
総務	厚生	共済組合	(平成12年度)共済組合の掛金払込に関する文書	総務部庶務課厚生係	2000年度	3	2003年度末	紙	事務室	総務部庶務課厚生係		
総務	厚生	共済組合	(平成13年度)共済組合の掛金払込に関する文書	総務部庶務課厚生係	2001年度	3	2004年度末	紙	事務室	総務部庶務課厚生係		
総務	厚生	共済組合	(平成11年度)標準報酬に関する文書	総務部庶務課厚生係	1999年度	3	2002年度末	紙	文書庫	総務部庶務課厚生係		
総務	厚生	共済組合	(平成11年度)標準報酬に関する文書	沖縄支所庶務課庶務係	1999年度	3	2002年度末	紙	事務室	沖縄支所庶務課庶務係		
総務	厚生	共済組合	(平成12年度)標準報酬に関する文書	総務部庶務課厚生係	2000年度	3	2003年度末	紙	事務室	総務部庶務課厚生係		
総務	厚生	共済組合	(平成12年度)標準報酬に関する文書	沖縄支所庶務課庶務係	2000年度	3	2003年度末	紙	事務室	沖縄支所庶務課庶務係		
総務	厚生	共済組合	(平成13年度)標準報酬に関する文書	総務部庶務課厚生係	2001年度	3	2004年度末	紙	事務室	総務部庶務課厚生係		
総務	厚生	共済組合	(平成13年度)標準報酬に関する文書	沖縄支所庶務課庶務係	2001年度	3	2004年度末	紙	事務室	沖縄支所庶務課庶務係		
総務	厚生	共済組合	(平成11年度)組合員の異動報告書に関する文書	総務部庶務課厚生係	1999年度	3	2002年度末	紙	文書庫	総務部庶務課厚生係		
総務	厚生	共済組合	(平成11年度)組合員の異動報告に関する文書	沖縄支所庶務課庶務係	1999年度	3	2002年度末	紙	事務室	沖縄支所庶務課庶務係		

独立行政法人国際農林水産業研究センター法人文書ファイル管理簿

文書分類			法人文書ファイル名	作成者	作成(取得)時期	保存期間(年)	保存期間満了時期	媒体種別	保存場所	管理担当課・係	保存期間満了時の措置結果	備考
大分類	中分類	小分類										
総務	厚生	共済組合	(平成12年度)組合員の異動報告書に関する文書	総務部庶務課厚生係	2000年度	3	2003年度末	紙	事務室	総務部庶務課厚生係		
総務	厚生	共済組合	(平成12年度)組合員の異動報告に関する文書	沖縄支所庶務課庶務係	2000年度	3	2003年度末	紙	事務室	沖縄支所庶務課庶務係		
総務	厚生	共済組合	(平成13年度)組合員の異動報告に関する文書	総務部庶務課厚生係	2001年度	3	2004年度末	紙	事務室	総務部庶務課厚生係		
総務	厚生	共済組合	(平成13年度)組合員の異動報告に関する文書	沖縄支所庶務課庶務係	2001年度	3	2004年度末	紙	事務室	沖縄支所庶務課庶務係		
総務	厚生	共済組合	(平成11年度)任意継続組合員に関する文書	総務部庶務課厚生係	1999年度	3	2002年度末	紙	文書庫	総務部庶務課厚生係		
総務	厚生	共済組合	(平成11年度)任意継続組合員に関する文書	沖縄支所庶務課庶務係	1999年度	3	2002年度末	紙	事務室	沖縄支所庶務課庶務係		
総務	厚生	共済組合	(平成12年度)任意継続組合員に関する文書	総務部庶務課厚生係	2000年度	3	2003年度末	紙	事務室	総務部庶務課厚生係		
総務	厚生	共済組合	(平成13年度)任意継続組合員に関する文書	総務部庶務課厚生係	2001年度	3	2004年度末	紙	事務室	総務部庶務課厚生係		
総務	厚生	共済組合	共済組合員証整理簿	総務部庶務課厚生係	2000年度	5	2005年度末	紙	事務室	総務部庶務課厚生係		
総務	厚生	公務災害	(昭和48年度)公務災害の認定及び補償額の決定・支出に関する文書	沖縄支所庶務課庶務係	1973年度	30	2003年度末	紙	事務室	沖縄支所庶務課庶務係		
総務	厚生	公務災害	(昭和50年度)公務災害の認定及び補償額の決定・支出に関する文書	沖縄支所庶務課庶務係	1975年度	30	2005年度末	紙	事務室	沖縄支所庶務課庶務係		
総務	厚生	公務災害	(昭和57年度)公務災害の認定及び補償額の決定・支出に関する文書	沖縄支所庶務課庶務係	1982年度	30	2012年度末	紙	事務室	沖縄支所庶務課庶務係		
総務	厚生	公務災害	(昭和58年度)公務 通勤災害の認定及び補償額の決定・支出に関する文書	総務部庶務課厚生係	1983年度	30	2013年度末	紙	作業室	総務部庶務課厚生係		
総務	厚生	公務災害	(昭和63年度)公務 通勤災害の認定及び補償額の決定・支出に関する文書	総務部庶務課厚生係	1988年度	30	2018年度末	紙	作業室	総務部庶務課厚生係		
総務	厚生	公務災害	(昭和63年度)公務災害の認定及び補償額の決定・支出に関する文書	沖縄支所庶務課庶務係	1988年度	30	2018年度末	紙	事務室	沖縄支所庶務課庶務係		
総務	厚生	公務災害	(平成6年度)公務 通勤災害の認定及び補償額の決定・支出に関する文書	総務部庶務課厚生係	1994年度	30	2024年度末	紙	作業室	総務部庶務課厚生係		
総務	厚生	公務災害	(平成6年度)公務災害の認定及び補償額の決定・支出に関する文書	沖縄支所庶務課庶務係	1994年度	30	2024年度末	紙	事務室	沖縄支所庶務課庶務係		
総務	厚生	公務災害	(平成11年度)公務 通勤災害の認定及び補償額の決定・支出に関する文書	総務部庶務課厚生係	1999年度	30	2029年度末	紙	事務室	総務部庶務課厚生係		
総務	厚生	公務災害	(平成12年度)公務 通勤災害の認定及び補償額の決定・支出に関する文書	総務部庶務課厚生係	2000年度	30	2030年度末	紙	事務室	総務部庶務課厚生係		
総務	厚生	公務災害	(平成13年度)公務 通勤災害の認定及び補償額の決定・支出に関する文書	総務部庶務課厚生係	2001年度	30	2031年度末	紙	事務室	総務部庶務課厚生係		

独立行政法人国際農林水産業研究センター法人文書ファイル管理簿

文書分類			法人文書ファイル名	作成者	作成(取得)時期	保存期間(年)	保存期間満了時期	媒体種別	保存場所	管理担当課・係	保存期間満了時の措置結果	備考
大分類	中分類	小分類										
総務	厚生	公務員宿舎	(平成11年度)公務員宿舎に関する文書	総務部庶務課厚生係	1999年度	3	2002年度末	紙	文書庫	総務部庶務課厚生係		
総務	厚生	公務員宿舎	(平成11年度)公務員宿舎に関する文書	沖縄支所庶務課庶務係	1999年度	3	2002年度末	紙	事務室	沖縄支所庶務課庶務係		
総務	厚生	公務員宿舎	(平成12年度)公務員宿舎に関する文書	総務部庶務課厚生係	2000年度	3	2003年度末	紙	文書庫	総務部庶務課厚生係		
総務	厚生	公務員宿舎	(平成12年度)公務員宿舎に関する文書	沖縄支所庶務課庶務係	2000年度	3	2003年度末	紙	事務室	沖縄支所庶務課庶務係		
総務	厚生	公務員宿舎	(平成13年度)公務員宿舎に関する文書	総務部庶務課厚生係	2001年度	3	2004年度末	紙	事務室	総務部庶務課厚生係		
総務	厚生	公務員宿舎	(平成13年度)公務員宿舎に関する文書	沖縄支所庶務課庶務係	2001年度	3	2004年度末	紙	事務室	沖縄支所庶務課庶務係		
総務	厚生	公務員宿舎	(平成12年度)国家公務員住宅事情調査に関する文書	総務部庶務課厚生係	2000年度	3	2003年度末	紙	文書庫	総務部庶務課厚生係		
総務	厚生	公務員宿舎	(平成13年度)国家公務員住宅事情調査に関する文書	総務部庶務課厚生係	2001年度	3	2004年度末	紙	事務室	総務部庶務課厚生係		
総務	厚生	財産形成貯蓄	(平成11年度)財産形成貯蓄に関する文書	総務部庶務課厚生係	1999年度	3	2002年度末	紙	文書庫	総務部庶務課厚生係		
総務	厚生	財産形成貯蓄	(平成12年度)財産形成貯蓄に関する文書	総務部庶務課厚生係	2000年度	3	2003年度末	紙	事務室	総務部庶務課厚生係		
総務	厚生	財産形成貯蓄	(平成13年度)財産形成貯蓄に関する文書	総務部庶務課厚生係	2001年度	3	2004年度末	紙	事務室	総務部庶務課厚生係		
総務	厚生	財産形成貯蓄	(平成13年度)財産形成貯蓄に関する文書	沖縄支所庶務課庶務係	2001年度	3	2004年度末	紙	事務室	沖縄支所庶務課庶務係		
総務	厚生	健康管理	(平成11年度)健康診断に関する文書	総務部庶務課厚生係	1999年度	3	2002年度末	紙	文書庫	総務部庶務課厚生係		
総務	厚生	健康管理	(平成11年度)健康診断に関する文書	沖縄支所庶務課庶務係	1999年度	3	2002年度末	紙	事務室	沖縄支所庶務課庶務係		
総務	厚生	健康管理	(平成12年度)健康診断に関する文書	総務部庶務課厚生係	2000年度	3	2003年度末	紙	文書庫	総務部庶務課厚生係		
総務	厚生	健康管理	(平成12年度)健康診断に関する文書	沖縄支所庶務課庶務係	2000年度	3	2003年度末	紙	事務室	沖縄支所庶務課庶務係		
総務	厚生	健康管理	(平成13年度)健康診断に関する文書	総務部庶務課厚生係	2001年度	3	2004年度末	紙	文書庫	総務部庶務課厚生係		
総務	厚生	健康管理	(平成13年度)健康診断に関する文書	沖縄支所庶務課庶務係	2001年度	3	2004年度末	紙	事務室	沖縄支所庶務課庶務係		
総務	厚生	健康管理	(平成11年度)健康管理に関する文書	総務部庶務課厚生係	1999年度	3	2002年度末	紙	文書庫	総務部庶務課厚生係		
総務	厚生	健康管理	(平成12年度)健康管理に関する文書	総務部庶務課厚生係	2000年度	3	2003年度末	紙	文書庫	総務部庶務課厚生係		

独立行政法人国際農林水産業研究センター法人文書ファイル管理簿

文書分類			法人文書ファイル名	作成者	作成(取得)時期	保存期間(年)	保存期間満了時期	媒体種別	保存場所	管理担当課・係	保存期間満了時の措置結果	備考
大分類	中分類	小分類										
総務	厚生	健康管理	(平成13年度)健康管理に関する文書	総務部庶務課厚生係	2001年度	3	2004年度末	紙	文書庫	総務部庶務課厚生係		
総務	厚生	衛生管理	(平成13年度)衛生管理に係る事項の監督官庁への届出に関する文書	総務部庶務課厚生係	2001年度	5	2006年度末	紙	事務室	総務部庶務課厚生係		
総務	厚生	衛生管理	(平成13年度)衛生管理に係る事項の監督官庁への届け出等に関する文書	沖縄支所庶務課庶務係	2001年度	5	2006年度末	紙	事務室	沖縄支所庶務課庶務係		
総務	厚生	衛生管理	(平成13年度)安全衛生委員会等に関する文書	総務部庶務課厚生係	2001年度	3	2006年度末	紙	事務室	総務部庶務課厚生係		
総務	厚生	社会保険	(平成11年度)社会保険(雇用保険含む)の資格の取得及び喪失に関する文書	総務部庶務課厚生係	1999年度	3	2002年度末	紙	文書庫	総務部庶務課厚生係		
総務	厚生	社会保険	(平成11年度)社会保険(雇用保険を含む。)の資格取得及び喪失に関する文書	沖縄支所庶務課庶務係	1999年度	3	2002年度末	紙	事務室	沖縄支所庶務課庶務係		
総務	厚生	社会保険	(平成12年度)社会保険(雇用保険含む)の資格の取得及び喪失に関する文書	総務部庶務課厚生係	2000年度	3	2003年度末	紙	文書庫	総務部庶務課厚生係		
総務	厚生	社会保険	(平成12年度)社会保険(雇用保険を含む。)の資格取得及び喪失に関する文書	沖縄支所庶務課庶務係	2000年度	3	2003年度末	紙	事務室	沖縄支所庶務課庶務係		
総務	厚生	社会保険	(平成13年度)社会保険(雇用保険含む)の資格の取得及び喪失に関する文書	総務部庶務課厚生係	2001年度	3	2004年度末	紙	文書庫	総務部庶務課厚生係		
総務	厚生	社会保険	(平成13年度)社会保険(雇用保険を含む。)の資格取得及び喪失に関する文書	沖縄支所庶務課庶務係	2001年度	3	2004年度末	紙	事務室	沖縄支所庶務課庶務係		
総務	厚生	社会保険	(平成11年度)社会保険に係る標準報酬に関する文書	総務部庶務課厚生係	1999年度	3	2002年度末	紙	文書庫	総務部庶務課厚生係		
総務	厚生	社会保険	(平成12年度)社会保険に係る標準報酬に関する文書	総務部庶務課厚生係	2000年度	3	2003年度末	紙	文書庫	総務部庶務課厚生係		
総務	厚生	社会保険	(平成13年度)社会保険に係る標準報酬に関する文書	総務部庶務課厚生係	2001年度	3	2004年度末	紙	事務室	総務部庶務課厚生係		
総務	厚生	社会保険	(平成11年度)高齢者給付 継続給付に関する文書	総務部庶務課厚生係	1999年度	3	2002年度末	紙	文書庫	総務部庶務課厚生係		
総務	厚生	社会保険	(平成12年度)高齢者給付 継続給付に関する文書	総務部庶務課厚生係	2000年度	3	2003年度末	紙	文書庫	総務部庶務課厚生係		
総務	厚生	社会保険	(平成13年度)高齢者給付 継続給付に関する文書	総務部庶務課厚生係	2001年度	3	2004年度末	紙	事務室	総務部庶務課厚生係		
総務	厚生	社会保険	(平成11年度)社会保険に関するその他の文書	総務部庶務課厚生係	1999年度	3	2002年度末	紙	文書庫	総務部庶務課厚生係		
総務	厚生	社会保険	(平成12年度)社会保険に関するその他の文書	総務部庶務課厚生係	2000年度	3	2003年度末	紙	事務室	総務部庶務課厚生係		
総務	厚生	社会保険	(平成13年度)社会保険に関するその他の文書	総務部庶務課厚生係	2001年度	3	2004年度末	紙	事務室	総務部庶務課厚生係		
総務	厚生	通知・回答等	(平成13年度)厚生に関する通知、照会、回答又は報告等に関する文書	沖縄支所庶務課庶務係	2001年度	1	2002年度末	紙	事務室	沖縄支所庶務課庶務係		

独立行政法人国際農林水産業研究センター法人文書ファイル管理簿

文書分類			法人文書ファイル名	作成者	作成(取得)時期	保存期間(年)	保存期間満了時期	媒体種別	保存場所	管理担当課・係	保存期間満了時の措置結果	備考
大分類	中分類	小分類										
総務	会計一般	通知・回答等	(平成13年度)保存期間を満了する計算書及び証拠書類について	総務部会計課監査係	2001年度	1	2002年度末	紙	文書庫	総務部会計課監査係		
総務	会計一般	通知・回答等	(平成13年度)他に属さない会計関係に係る通知、調査、照会、回答又は報告等に関する文書	沖縄支所庶務課会計係	2001年度	1	2002年度末	紙	事務室	沖縄支所庶務課会計係		
総務	会計一般	検査	(平成10年度)会計事務監査等の実施について	総務部会計課監査係	1998年度	10	2008年度末	紙	事務室	総務部会計課監査係		
総務	会計一般	計算証明	(平成4年度)計算証明書類の提出について	総務部会計課会計係	1992年度	10	2002年度末	紙	文書庫	総務部会計課会計係		
総務	会計一般	計算証明	(平成4年度)支出計算書、証拠書類等の提出に関する文書	総務部会計課監査係	1992年度	10	2002年度末	紙	文書庫	総務部会計課監査係		
総務	会計一般	計算証明	(平成4年度)計算証明に関する文書	沖縄支所庶務課会計係	1992年度	10	2002年度末	紙	事務室	沖縄支所庶務課会計係		
総務	会計一般	計算証明	(平成5年度)計算証明書類の提出について	総務部会計課会計係	1993年度	10	2003年度末	紙	文書庫	総務部会計課会計係		
総務	会計一般	計算証明	(平成5年度)支出計算書、証拠書類等の提出に関する文書	総務部会計課監査係	1993年度	10	2003年度末	紙	文書庫	総務部会計課監査係		
総務	会計一般	計算証明	(平成5年度)計算証明に関する文書	沖縄支所庶務課会計係	1993年度	10	2003年度末	紙	事務室	沖縄支所庶務課会計係		
総務	会計一般	計算証明	(平成6年度)計算証明書類の提出について	総務部会計課会計係	1994年度	10	2004年度末	紙	文書庫	総務部会計課会計係		
総務	会計一般	計算証明	(平成6年度)支出計算書、証拠書類等の提出に関する文書	総務部会計課監査係	1994年度	10	2004年度末	紙	文書庫	総務部会計課監査係		
総務	会計一般	計算証明	(平成6年度)計算証明に関する文書	沖縄支所庶務課会計係	1994年度	10	2004年度末	紙	事務室	沖縄支所庶務課会計係		
総務	会計一般	計算証明	(平成7年度)計算証明書類の提出について	総務部会計課会計係	1995年度	10	2005年度末	紙	文書庫	総務部会計課会計係		
総務	会計一般	計算証明	(平成7年度)支出計算書、証拠書類等の提出に関する文書	総務部会計課監査係	1995年度	10	2005年度末	紙	文書庫	総務部会計課監査係		
総務	会計一般	計算証明	(平成7年度)計算証明に関する文書	沖縄支所庶務課会計係	1995年度	10	2005年度末	紙	事務室	沖縄支所庶務課会計係		
総務	会計一般	計算証明	(平成8年度)計算証明書類の提出について	総務部会計課会計係	1996年度	10	2006年度末	紙	文書庫	総務部会計課会計係		
総務	会計一般	計算証明	(平成8年度)支出計算書、証拠書類等の提出に関する文書	総務部会計課監査係	1996年度	10	2006年度末	紙	文書庫	総務部会計課監査係		
総務	会計一般	計算証明	(平成8年度)計算証明に関する文書	沖縄支所庶務課会計係	1996年度	10	2006年度末	紙	事務室	沖縄支所庶務課会計係		
総務	会計一般	計算証明	(平成9年度)計算証明書類の提出について	総務部会計課会計係	1997年度	10	2007年度末	紙	文書庫	総務部会計課会計係		
総務	会計一般	計算証明	(平成9年度)支出計算書、証拠書類等の提出に関する文書	総務部会計課監査係	1997年度	10	2007年度末	紙	文書庫	総務部会計課監査係		



独立行政法人国際農林水産業研究センター法人文書ファイル管理簿

文書分類			法人文書ファイル名	作成者	作成(取得)時期	保存期間(年)	保存期間満了時期	媒体種別	保存場所	管理担当課・係	保存期間満了時の措置結果	備考
大分類	中分類	小分類										
総務	会計一般	計算証明	(平成9年度)計算証明書類の提出について	総務部海外業務管理課海外前渡資金係	1997年度	10	2007年度末	紙	文書庫	総務部海外業務管理課海外前渡資金係		
総務	会計一般	計算証明	(平成9年度)計算証明に関する文書	沖縄支所庶務課会計係	1997年度	10	2007年度末	紙	事務室	沖縄支所庶務課会計係		
総務	会計一般	計算証明	(平成10年度)計算証明書類の提出について	総務部会計課会計係	1998年度	10	2008年度末	紙	文書庫	総務部会計課会計係		
総務	会計一般	計算証明	(平成10年度)支出計算書,証拠書類等の提出に関する文書	総務部会計課監査係	1998年度	10	2008年度末	紙	文書庫	総務部会計課監査係		
総務	会計一般	計算証明	(平成10年度)計算証明書類の提出について	総務部海外業務管理課海外前渡資金係	1998年度	10	2008年度末	紙	文書庫	総務部海外業務管理課海外前渡資金係		
総務	会計一般	計算証明	(平成10年度)計算証明に関する文書	沖縄支所庶務課会計係	1998年度	10	2008年度末	紙	事務室	沖縄支所庶務課会計係		
総務	会計一般	計算証明	(平成11年度)計算証明書類の提出について	総務部会計課会計係	1999年度	10	2009年度末	紙	文書庫	総務部会計課会計係		
総務	会計一般	計算証明	(平成11年度)支出計算書,証拠書類等の提出に関する文書	総務部会計課監査係	1999年度	10	2009年度末	紙	文書庫	総務部会計課監査係		
総務	会計一般	計算証明	(平成11年度)計算証明書類の提出について	総務部海外業務管理課海外前渡資金係	1999年度	10	2009年度末	紙	文書庫	総務部海外業務管理課海外前渡資金係		
総務	会計一般	計算証明	(平成11年度)計算証明に関する文書	沖縄支所庶務課会計係	1999年度	10	2009年度末	紙	事務室	沖縄支所庶務課会計係		
総務	会計一般	計算証明	(平成12年度)計算証明書類の提出について	総務部会計課会計係	2000年度	10	2010年度末	紙	文書庫	総務部会計課会計係		
総務	会計一般	計算証明	(平成12年度)支出計算書,証拠書類等の提出に関する文書	総務部会計課監査係	2000年度	10	2010年度末	紙	文書庫	総務部会計課監査係		
総務	会計一般	計算証明	(平成12年度)計算証明書類の提出について	総務部海外業務管理課海外前渡資金係	2000年度	10	2010年度末	紙	文書庫	総務部海外業務管理課海外前渡資金係		
総務	会計一般	計算証明	(平成12年度)計算証明に関する文書	沖縄支所庶務課会計係	2000年度	10	2010年度末	紙	事務室	沖縄支所庶務課会計係		
総務	会計一般	計算証明	(平成13年度)合計残高試算表等の提出について	総務部会計課監査係	2001年度	10	2011年度末	紙	事務室	総務部会計課監査係		
総務	会計一般	計算証明	(平成13年度)計算証明に関する文書	沖縄支所庶務課会計係	2001年度	10	2011年度末	紙	事務室	沖縄支所庶務課会計係		
総務	会計一般	監査	(平成13年度)会計監査法人の監査に関する文書	沖縄支所庶務課会計係	2001年度	10	2011年度末	紙	事務室	沖縄支所庶務課会計係		
総務	会計一般	特許権	スチルベン-2-カルボン酸、3-ハイドロキシ、5-メオキシ、その製造法及びそれを有効成分とする除草剤	総務部会計課課長補佐	1996年度	30	2026年度末	紙	事務室	総務部会計課課長補佐		
総務	会計一般	特許権	作物栽培装置(日本国)	総務部会計課課長補佐	1996年度	30	2026年度末	紙	事務室	総務部会計課課長補佐		
総務	会計一般	特許権	作物栽培装置(米国、英国、独国、仏蘭西、伊国、韓国)	総務部会計課課長補佐	1997年度	30	2027年度末	紙	事務室	総務部会計課課長補佐		

独立行政法人国際農林水産業研究センター法人文書ファイル管理簿

文書分類			法人文書ファイル名	作成者	作成(取得)時期	保存期間(年)	保存期間満了時期	媒体種別	保存場所	管理担当課・係	保存期間満了時の措置結果	備考
大分類	中分類	小分類										
総務	会計一般	特許権	ハ'イヤ奇形葉モザイクウイルスの外皮蛋白質の塩基配列(米国)	総務部会計課課長補佐	1998年度	30	2028年度末	紙	事務室	総務部会計課課長補佐		
総務	会計一般	特許権	ゲル状家畜用補助飼料とその製造法	総務部会計課課長補佐	1998年度	30	2028年度末	紙	事務室	総務部会計課課長補佐		
総務	会計一般	特許権	育成者権(稲、しかくまめ、キニアグラス、インゲンマメ)	総務部会計課課長補佐	1998年度	30	2028年度末	紙	事務室	総務部会計課課長補佐		
総務	会計一般	特許権	育成者権(インゲンマメ)に係る実施許諾	総務部会計課課長補佐	1998年度	30	2028年度末	紙	事務室	総務部会計課課長補佐		
総務	会計一般	特許権	ハ'イヤ奇形葉モザイクウイルスの外皮蛋白質の塩基配列(日本国)	総務部会計課課長補佐	1999年度	30	2029年度末	紙	事務室	総務部会計課課長補佐		
総務	会計一般	特許権	ハ'イヤ奇形葉モザイクウイルスの外皮蛋白質の塩基配列(台湾)	総務部会計課課長補佐	2000年度	30	2030年度末	紙	事務室	総務部会計課課長補佐		
総務	会計一般	特許権	植物の転写因子をコードする遺伝子	総務部会計課課長補佐	2001年度	30	2031年度末	紙	事務室	総務部会計課課長補佐		
総務	会計一般	特許権	環境ストレス耐性植物	総務部会計課課長補佐	2001年度	30	2031年度末	紙	事務室	総務部会計課課長補佐		
総務	会計一般	特許権	Na ⁺ -ATPアーゼ遺伝子	総務部会計課課長補佐	2001年度	30	2031年度末	紙	事務室	総務部会計課課長補佐		
総務	会計一般	出資金	設立事務引継書(国有財産の現物出資について)	総務部会計課主計係	2001年	30	2031年末	紙		総務部会計課施設管理係		
総務	会計一般	資金管理	農林畜水産業関係無利子貸付金基本要綱の一部改正等に関する文書	総務部会計課主計係	2002年	5	2007年末	紙	事務室	総務部会計課主計係		
総務	会計一般	資金管理	(平成13年度)施設整備事業無利子貸付金の貸付契約の承諾決定通知について	総務部会計課主計係	2002年	5	2007年末	紙	事務室	総務部会計課主計係		
総務	会計一般	資金管理	(平成13年度)独立行政法人施設整備事業の繰越承認について	総務部会計課主計係	2002年	5	2007年末	紙	事務室	総務部会計課主計係		
総務	会計一般	資金管理	(平成13年度)独立行政法人国際農林水産業研究センター運営費交付金の交付に関する文書	総務部会計課主計係	2001年	5	2006年末	紙	事務室	総務部会計課主計係		
総務	会計一般	収入	(平成9年度)歳入金証拠書	総務部会計課主計係	1997年度	5	2002年度末	紙	文書庫	総務部会計課主計係		
総務	会計一般	収入	(平成10年度)歳入金証拠書	総務部会計課主計係	1998年度	5	2003年度末	紙	文書庫	総務部会計課主計係		
総務	会計一般	収入	(平成11年度)歳入金証拠書	総務部会計課主計係	1999年度	5	2004年度末	紙	文書庫	総務部会計課主計係		
総務	会計一般	収入	(平成12年度)歳入金証拠書	総務部会計課主計係	2000年度	5	2005年度末	紙	文書庫	総務部会計課主計係		
総務	会計一般	収入	(平成13年度)受託研究契約(政府受託1)	総務部会計課主計係	2001年度	5	2006年度末	紙	事務室	総務部会計課主計係		
総務	会計一般	収入	(平成13年度)受託研究契約(政府受託2)	総務部会計課主計係	2001年度	5	2006年度末	紙	事務室	総務部会計課主計係		

独立行政法人国際農林水産業研究センター法人文書ファイル管理簿

文書分類			法人文書ファイル名	作成者	作成(取得)時期	保存期間(年)	保存期間満了時期	媒体種別	保存場所	管理担当課・係	保存期間満了時の措置結果	備考
大分類	中分類	小分類										
総務	会計一般	収入	(平成13年度)受託研究契約(政府受託3)	総務部会計課主計係	2001年度	5	2006年度末	紙	事務室	総務部会計課主計係		
総務	会計一般	収入	(平成13年度)受託研究契約(政府受託4)	総務部会計課主計係	2001年度	5	2006年度末	紙	事務室	総務部会計課主計係		
総務	会計一般	収入	(平成13年度)受託研究契約(政府外受託)	総務部会計課主計係	2001年度	5	2006年度末	紙	事務室	総務部会計課主計係		
総務	予算・決算	予算	(平成10年度)予算概算要求書	総務部会計課主計係	1997年度	5	2002年度末	紙	事務室	総務部会計課主計係		
総務	予算・決算	予算	(平成11年度)予算概算要求書	総務部会計課主計係	1998年度	5	2003年度末	紙	事務室	総務部会計課主計係		
総務	予算・決算	予算	(平成12年度)予算概算要求書	総務部会計課主計係	1999年度	5	2004年度末	紙	事務室	総務部会計課主計係		
総務	予算・決算	予算	(平成13年度)運営費交付金要求書	総務部会計課主計係	2000年度	5	2005年度末	紙	事務室	総務部会計課主計係		
総務	予算・決算	予算	(平成14年度)運営費交付金要求書	総務部会計課主計係	2001年度	5	2006年度末	紙	事務室	総務部会計課主計係		
総務	予算・決算	予算	(平成9年度)歳出予算説明参考書	総務部会計課主計係	1997年度	5	2002年度末	紙	文書庫	総務部会計課主計係		
総務	予算・決算	予算	(平成10年度)歳出予算説明参考書	総務部会計課主計係	1998年度	5	2003年度末	紙	文書庫	総務部会計課主計係		
総務	予算・決算	予算	(平成11年度)歳出予算説明参考書	総務部会計課主計係	1999年度	5	2004年度末	紙	文書庫	総務部会計課主計係		
総務	予算・決算	予算	(平成12年度)歳出予算説明参考書	総務部会計課主計係	2000年度	5	2005年度末	紙	文書庫	総務部会計課主計係		
総務	予算・決算	予算	(平成13年度)歳出予算説明参考書	総務部会計課主計係	2001年度	5	2006年度末	紙	文書庫	総務部会計課主計係		
総務	予算・決算	予算	(平成9年度)予算配分書	総務部会計課主計係	1997年度	5	2002年度末	紙	事務室	総務部会計課主計係		
総務	予算・決算	予算	(平成10年度)予算配分書	総務部会計課主計係	1998年度	5	2003年度末	紙	事務室	総務部会計課主計係		
総務	予算・決算	予算	(平成11年度)予算配分書	総務部会計課主計係	1999年度	5	2004年度末	紙	事務室	総務部会計課主計係		
総務	予算・決算	予算	(平成12年度)予算配分書	総務部会計課主計係	2000年度	5	2005年度末	紙	事務室	総務部会計課主計係		
総務	予算・決算	予算	(平成13年度)予算配分書	総務部会計課主計係	2001年度	5	2006年度末	紙	事務室	総務部会計課主計係		
総務	予算・決算	予算	(平成9年度)支出負担行為計画示達	総務部会計課主計係	1997年度	5	2002年度末	紙	文書庫	総務部会計課主計係		
総務	予算・決算	予算	(平成10年度)支出負担行為計画示達	総務部会計課主計係	1998年度	5	2003年度末	紙	文書庫	総務部会計課主計係		

独立行政法人国際農林水産業研究センター法人文書ファイル管理簿

文書分類			法人文書ファイル名	作成者	作成(取得)時期	保存期間(年)	保存期間満了時期	媒体種別	保存場所	管理担当課・係	保存期間満了時の措置結果	備考
大分類	中分類	小分類										
総務	予算・決算	予算	(平成11年度)支出負担行為計画示達	総務部会計課主計係	1999年度	5	2004年度末	紙	文書庫	総務部会計課主計係		
総務	予算・決算	予算	(平成12年度)支出負担行為計画示達	総務部会計課主計係	2000年度	5	2005年度末	紙	文書庫	総務部会計課主計係		
総務	予算・決算	予算	(平成9年度)支払計画示達	総務部会計課主計係	1997年度	5	2002年度末	紙	文書庫	総務部会計課主計係		
総務	予算・決算	予算	(平成10年度)支払計画示達	総務部会計課主計係	1998年度	5	2003年度末	紙	文書庫	総務部会計課主計係		
総務	予算・決算	予算	(平成11年度)支払計画示達	総務部会計課主計係	1999年度	5	2004年度末	紙	文書庫	総務部会計課主計係		
総務	予算・決算	予算	(平成12年度)支払計画示達	総務部会計課主計係	2000年度	5	2005年度末	紙	文書庫	総務部会計課主計係		
総務	予算・決算	予算	(平成13年度)独立行政法人国際農林水産業研究センター資金計画	総務部会計課主計係	2001年度	5	2006年度末	紙	事務室	総務部会計課主計係		
総務	予算・決算	予算	二法人間負担金に関する文書	総務部会計課主計係	2001年	1	2002年末	紙	事務室	総務部会計課主計係		
総務	予算・決算	予算	(平成13年度)補助金等事務予定表の提示について	総務部会計課主計係	2001年	1	2002年末	紙	事務室	総務部会計課主計係		
総務	予算・決算	決算	合計残高試算表(月次)	総務部会計課主計係	2001年度	10	2011年度末	紙	事務室	総務部会計課主計係		
総務	予算・決算	帳簿	事業予算執行状況一覧表(月次)	総務部会計課主計係	2001年度	10	2011年度末	紙	事務室	総務部会計課主計係		
総務	予算・決算	決算	(平成12年度)県民経済計算に必要な資料について	総務部会計課主計係	2001年度	1	2002年度末	紙	事務室	総務部会計課主計係		
総務	経理	債権	(平成9年度)債権管理簿・徴収簿	総務部会計課主計係	1997年度	5	2002年度末	紙	文書庫	総務部会計課主計係		
総務	経理	債権	(平成10年度)債権管理簿・徴収簿	総務部会計課主計係	1998年度	5	2003年度末	紙	文書庫	総務部会計課主計係		
総務	経理	債権	(平成11年度)債権管理簿・徴収簿	総務部会計課主計係	1999年度	5	2004年度末	紙	文書庫	総務部会計課主計係		
総務	経理	債権	(平成12年度)債権管理簿・徴収簿	総務部会計課主計係	2000年度	5	2005年度末	紙	文書庫	総務部会計課主計係		
総務	経理	債権	(平成9年度)債権管理計算書	総務部会計課主計係	1997年度	5	2002年度末	紙	文書庫	総務部会計課主計係		
総務	経理	債権	(平成10年度)債権管理計算書	総務部会計課主計係	1998年度	5	2003年度末	紙	文書庫	総務部会計課主計係		
総務	経理	債権	(平成11年度)債権管理計算書	総務部会計課主計係	1999年度	5	2004年度末	紙	文書庫	総務部会計課主計係		
総務	経理	債権	(平成12年度)債権管理計算書	総務部会計課主計係	2000年度	5	2005年度末	紙	文書庫	総務部会計課主計係		

独立行政法人国際農林水産業研究センター法人文書ファイル管理簿

文書分類			法人文書ファイル名	作成者	作成(取得)時期	保存期間(年)	保存期間満了時期	媒体種別	保存場所	管理担当課・係	保存期間満了時の措置結果	備考
大分類	中分類	小分類										
総務	経理	一般	独立行政法人国際農林水産業研究センターにおける取引金融機関の内定について	総務部会計課主計係	2001年	10	2011年末	紙	事務室	総務部会計課主計係		
総務	経理	一般	(平成13年度)旅替伝票	総務部会計課監査係	2001年度	10	2011年度末	紙	事務室	総務部会計課監査係		
総務	経理	一般	(平成13年度)旅替伝票	沖縄支所庶務課会計係	2001年度	10	2011年度末	紙	事務室	沖縄支所庶務課会計係		
総務	経理	一般	(平成11年度)勤務時間報告書	総務部庶務課庶務係	1999年度	3	2002年度末	紙	文書庫	総務部会計課会計係		
総務	経理	一般	(平成11年度)勤務時間報告書	沖縄支所庶務課庶務係	1999年度	3	2002年度末	紙	事務室	沖縄支所庶務課庶務係		
総務	経理	一般	(平成12年度)勤務時間報告書	総務部庶務課庶務係	2000年度	3	2003年度末	紙	文書庫	総務部会計課会計係		
総務	経理	一般	(平成12年度)勤務時間報告書	沖縄支所庶務課庶務係	2000年度	3	2003年度末	紙	事務室	沖縄支所庶務課庶務係		
総務	経理	一般	(平成13年度)勤務時間報告書	総務部庶務課庶務係	2001年度	3	2004年度末	紙	文書庫	総務部会計課会計係		
総務	経理	一般	(平成13年度)勤務時間報告書	沖縄支所庶務課庶務係	2001年度	3	2004年度末	紙	事務室	沖縄支所庶務課庶務係		
総務	経理	海外支払	(平成9年度)契約担当官及び資金前渡官吏の任命について	総務部海外業務管理課海外前渡資金係	1997年度	5	2002年度末	紙	文書庫	総務部海外業務管理課海外前渡資金係		
総務	経理	海外支払	(平成9年度)契約担当官及び資金前渡官吏の解任について	総務部海外業務管理課海外前渡資金係	1997年度	5	2002年度末	紙	文書庫	総務部海外業務管理課海外前渡資金係		
総務	経理	海外支払	(平成9年度)資金前渡官吏の帳簿金庫の検査における検査員の任命について	総務部海外業務管理課海外前渡資金係	1997年度	5	2002年度末	紙	文書庫	総務部海外業務管理課海外前渡資金係		
総務	経理	海外支払	(平成10年度)契約担当官及び資金前渡官吏の任命について	総務部海外業務管理課海外前渡資金係	1998年度	5	2003年度末	紙	文書庫	総務部海外業務管理課海外前渡資金係		
総務	経理	海外支払	(平成10年度)契約担当官及び資金前渡官吏の解任について	総務部海外業務管理課海外前渡資金係	1998年度	5	2003年度末	紙	文書庫	総務部海外業務管理課海外前渡資金係		
総務	経理	海外支払	(平成10年度)資金前渡官吏の帳簿金庫の検査における検査員の任命について	総務部海外業務管理課海外前渡資金係	1998年度	5	2003年度末	紙	文書庫	総務部海外業務管理課海外前渡資金係		
総務	経理	海外支払	(平成10年度)契約担当官及び資金前渡官吏の事務の範囲の追加について	総務部海外業務管理課海外前渡資金係	1998年度	5	2003年度末	紙	文書庫	総務部海外業務管理課海外前渡資金係		
総務	経理	海外支払	(平成11年度)契約担当官及び資金前渡官吏の任命について	総務部海外業務管理課海外前渡資金係	1999年度	5	2004年度末	紙	文書庫	総務部海外業務管理課海外前渡資金係		
総務	経理	海外支払	(平成11年度)契約担当官及び資金前渡官吏の解任について	総務部海外業務管理課海外前渡資金係	1999年度	5	2004年度末	紙	文書庫	総務部海外業務管理課海外前渡資金係		
総務	経理	海外支払	(平成11年度)資金前渡官吏の帳簿金庫の検査における検査員の任命について	総務部海外業務管理課海外前渡資金係	1999年度	5	2004年度末	紙	文書庫	総務部海外業務管理課海外前渡資金係		
総務	経理	海外支払	(平成12年度)契約担当官及び資金前渡官吏の任命について	総務部海外業務管理課海外前渡資金係	2000年度	5	2005年度末	紙	文書庫	総務部海外業務管理課海外前渡資金係		

独立行政法人国際農林水産業研究センター法人文書ファイル管理簿

文書分類			法人文書ファイル名	作成者	作成(取得)時期	保存期間(年)	保存期間満了時期	媒体種別	保存場所	管理担当課・係	保存期間満了時の措置結果	備考
大分類	中分類	小分類										
総務	経理	海外支払	(平成12年度)契約担当官及び資金前渡官吏の解任について	総務部海外業務管理課海外前渡資金係	2000年度	5	2005年度末	紙	文書庫	総務部海外業務管理課海外前渡資金係		
総務	経理	海外支払	(平成12年度)資金前渡官吏の帳簿金庫の検査における検査員の任命について	総務部海外業務管理課海外前渡資金係	2000年度	5	2005年度末	紙	文書庫	総務部海外業務管理課海外前渡資金係		
総務	経理	海外支払	(平成13年度)健康診断等の実施について(立替払)	総務部海外業務管理課専門職	2001年度	5	2006年度末	紙	事務室	総務部海外業務管理課専門職		
総務	経理	海外支払	(平成13年度)出納員等の任命について	総務部海外業務管理課海外前渡資金係	2001年度	5	2006年度末	紙	事務室	総務部海外業務管理課海外前渡資金係		
総務	経理	海外支払	(平成13年度)出納員等の解任について	総務部海外業務管理課海外前渡資金係	2001年度	5	2006年度末	紙	事務室	総務部海外業務管理課海外前渡資金係		
総務	経理	海外支払	(平成13年度)出納員の事務の範囲の追加について	総務部海外業務管理課海外前渡資金係	2001年度	5	2006年度末	紙	事務室	総務部海外業務管理課海外前渡資金係		
総務	経理	報酬 給与	(平成9年)基準給与簿	総務部会計課会計係	1997年	5	2002年末	紙	文書庫	総務部会計課会計係		
総務	経理	報酬 給与	(平成9年)基準給与簿	沖縄支所庶務課庶務係	1997年	5	2002年末	紙	事務室	沖縄支所庶務課庶務係		
総務	経理	報酬 給与	(平成9年)職員別給与簿	総務部会計課会計係	1997年	5	2002年末	紙	文書庫	総務部会計課会計係		
総務	経理	報酬 給与	(平成9年)職員別給与簿	沖縄支所庶務課庶務係	1997年	5	2002年末	紙	事務室	沖縄支所庶務課庶務係		
総務	経理	報酬 給与	(平成10年)基準給与簿	総務部会計課会計係	1998年	5	2003年末	紙	文書庫	総務部会計課会計係		
総務	経理	報酬 給与	(平成10年)基準給与簿	沖縄支所庶務課庶務係	1998年	5	2003年末	紙	事務室	沖縄支所庶務課庶務係		
総務	経理	報酬 給与	(平成10年)職員別給与簿	総務部会計課会計係	1998年	5	2003年末	紙	文書庫	総務部会計課会計係		
総務	経理	報酬 給与	(平成10年)職員別給与簿	沖縄支所庶務課庶務係	1998年	5	2003年末	紙	事務室	沖縄支所庶務課庶務係		
総務	経理	報酬 給与	(平成11年)基準給与簿	総務部会計課会計係	1999年	5	2004年末	紙	文書庫	総務部会計課会計係		
総務	経理	報酬 給与	(平成11年)基準給与簿	沖縄支所庶務課庶務係	1999年	5	2004年末	紙	事務室	沖縄支所庶務課庶務係		
総務	経理	報酬 給与	(平成11年)職員別給与簿	総務部会計課会計係	1999年	5	2004年末	紙	文書庫	総務部会計課会計係		
総務	経理	報酬 給与	(平成11年)職員別給与簿	沖縄支所庶務課庶務係	1999年	5	2004年末	紙	事務室	沖縄支所庶務課庶務係		
総務	経理	報酬 給与	(平成12年)基準給与簿	総務部会計課会計係	2000年	5	2005年末	紙	文書庫	総務部会計課会計係		
総務	経理	報酬 給与	(平成12年)基準給与簿	沖縄支所庶務課庶務係	2000年	5	2005年末	紙	事務室	沖縄支所庶務課庶務係		

独立行政法人国際農林水産業研究センター法人文書ファイル管理簿

文書分類			法人文書ファイル名	作成者	作成(取得)時期	保存期間(年)	保存期間満了時期	媒体種別	保存場所	管理担当課・係	保存期間満了時の措置結果	備考
大分類	中分類	小分類										
総務	経理	報酬 給与	(平成12年)職員別給与簿	総務部会計課 会計係	2000年	5	2005年末	紙	文書庫	総務部会計課 会計係		
総務	経理	報酬 給与	(平成12年)職員別給与簿	沖縄支所庶務 課庶務係	2000年	5	2005年末	紙	事務室	沖縄支所庶務 課庶務係		
総務	経理	報酬 給与	(平成13年)基準給与簿	総務部会計課 会計係	2001年	5	2006年末	紙	文書庫	総務部会計課 会計係		
総務	経理	報酬 給与	(平成13年)基準給与簿	沖縄支所庶務 課庶務係	2001年	5	2006年末	紙	事務室	沖縄支所庶務 課庶務係		
総務	経理	報酬 給与	(平成13年)職員別給与簿	総務部会計課 会計係	2001年	5	2006年末	紙	文書庫	総務部会計課 会計係		
総務	経理	報酬 給与	(平成13年)職員別給与簿	沖縄支所庶務 課庶務係	2001年	5	2006年末	紙	事務室	沖縄支所庶務 課庶務係		
総務	経理	旅費	(平成9年度)旅行命令 依頼簿	総務部会計課 会計係	1997年度	5	2002年度末	紙	文書庫	総務部会計課 会計係		
総務	経理	旅費	(平成9年度)旅費支給に伴う格付けについて	総務部会計課 会計係	1997年度	5	2002年度末	紙	文書庫	総務部会計課 会計係		
総務	経理	旅費	(平成9年度)旅費に関する文書	沖縄支所庶務 課会計係	1997年度	5	2002年度末	紙	事務室	沖縄支所庶務 課会計係		
総務	経理	旅費	(平成10年度)旅行命令 依頼簿	総務部会計課 会計係	1998年度	5	2003年度末	紙	文書庫	総務部会計課 会計係		
総務	経理	旅費	(平成10年度)旅費支給に伴う格付けについて	総務部会計課 会計係	1998年度	5	2003年度末	紙	文書庫	総務部会計課 会計係		
総務	経理	旅費	(平成10年度)旅費に関する文書	沖縄支所庶務 課会計係	1998年度	5	2003年度末	紙	事務室	沖縄支所庶務 課会計係		
総務	経理	旅費	(平成11年度)旅行命令 依頼簿	総務部会計課 会計係	1999年度	5	2004年度末	紙	文書庫	総務部会計課 会計係		
総務	経理	旅費	(平成11年度)旅費支給に伴う格付けについて	総務部会計課 会計係	1999年度	5	2004年度末	紙	文書庫	総務部会計課 会計係		
総務	経理	旅費	(平成11年度)旅費に関する文書	沖縄支所庶務 課会計係	1999年度	5	2004年度末	紙	事務室	沖縄支所庶務 課会計係		
総務	経理	旅費	(平成12年度)旅行命令 依頼簿	総務部会計課 会計係	2000年度	5	2005年度末	紙	文書庫	総務部会計課 会計係		
総務	経理	旅費	(平成12年度)旅費支給に伴う格付けについて	総務部会計課 会計係	2000年度	5	2005年度末	紙	文書庫	総務部会計課 会計係		
総務	経理	旅費	(平成12年度)旅費に関する文書	沖縄支所庶務 課会計係	2000年度	5	2005年度末	紙	事務室	沖縄支所庶務 課会計係		
総務	経理	旅費	(平成13年度)出張命令伺	総務部会計課 会計係	2001年度	5	2006年度末	紙	文書庫	総務部会計課 会計係		
総務	経理	旅費	(平成13年度)旅費支給に伴う格付けについて	総務部海外業務管 理課海外派遣係	2001年度	5	2006年度末	紙	事務室	総務部海外業務管 理課海外派遣係		

独立行政法人国際農林水産業研究センター法人文書ファイル管理簿

文書分類			法人文書ファイル名	作成者	作成(取得)時期	保存期間(年)	保存期間満了時期	媒体種別	保存場所	管理担当課・係	保存期間満了時の措置結果	備考
大分類	中分類	小分類										
総務	経理	公租公課	(平成9年)平成8年分給与所得の源泉徴収票等の提出について	総務部会計課 会計係	1997年	5	2002年末	紙	文書庫	総務部会計課 会計係		
総務	経理	公租公課	(平成9年)平成9年度給与支払報告書の提出について	総務部会計課 会計係	1997年	5	2002年末	紙	文書庫	総務部会計課 会計係		
総務	経理	公租公課	(平成9年)海外出張者にかかる証明書の提出について	総務部会計課 会計係	1997年	5	2002年末	紙	文書庫	総務部会計課 会計係		
総務	経理	公租公課	(平成10年)平成9年分給与所得の源泉徴収票等の提出について	総務部会計課 会計係	1998年	5	2003年末	紙	文書庫	総務部会計課 会計係		
総務	経理	公租公課	(平成10年)平成10年度給与支払報告書の提出について	総務部会計課 会計係	1998年	5	2003年末	紙	文書庫	総務部会計課 会計係		
総務	経理	公租公課	(平成10年)海外出張者にかかる証明書の提出について	総務部会計課 会計係	1998年	5	2003年末	紙	文書庫	総務部会計課 会計係		
総務	経理	公租公課	(平成11年)平成10年分給与所得の源泉徴収票等の提出について	総務部会計課 会計係	1999年	5	2004年末	紙	文書庫	総務部会計課 会計係		
総務	経理	公租公課	(平成11年)平成11年度給与支払報告書の提出について	総務部会計課 会計係	1999年	5	2004年末	紙	文書庫	総務部会計課 会計係		
総務	経理	公租公課	(平成11年)海外出張者にかかる証明書の提出について	総務部会計課 会計係	1999年	5	2004年末	紙	文書庫	総務部会計課 会計係		
総務	経理	公租公課	(平成12年)平成11年分給与所得の源泉徴収票等の提出について	総務部会計課 会計係	2000年	5	2005年末	紙	文書庫	総務部会計課 会計係		
総務	経理	公租公課	(平成12年)平成12年度給与支払報告書の提出について	総務部会計課 会計係	2000年	5	2005年末	紙	文書庫	総務部会計課 会計係		
総務	経理	公租公課	(平成12年)海外出張者にかかる証明書の提出について	総務部会計課 会計係	2000年	5	2005年末	紙	文書庫	総務部会計課 会計係		
総務	経理	公租公課	(平成13年)平成12年分給与所得の源泉徴収票等の提出について	総務部会計課 会計係	2001年	5	2006年末	紙	文書庫	総務部会計課 会計係		
総務	経理	公租公課	(平成13年)平成13年度給与支払報告書の提出について	総務部会計課 会計係	2001年	5	2006年末	紙	文書庫	総務部会計課 会計係		
総務	経理	公租公課	(平成13年)海外出張者にかかる証明書の提出について	総務部会計課 会計係	2001年	5	2006年末	紙	文書庫	総務部会計課 会計係		
総務	経理	公租公課	(平成14年)平成13年分給与所得の源泉徴収票等の提出について	総務部会計課 会計係	2002年	5	2007年末	紙	文書庫	総務部会計課 会計係		
総務	経理	帳簿	(平成13年度)総勘定元帳	総務部会計課 監査係	2001年度	30	2031年度末	紙	事務室	総務部会計課 監査係		
総務	経理	帳簿	(平成4年度)現金出納簿等	総務部会計課 会計係	1992年度	10	2002年度末	紙	文書庫	総務部会計課 会計係		
総務	経理	帳簿	(平成4年度)資金前渡官吏に係る帳簿類	沖縄支所庶務 課会計係	1992年度	10	2002年度末	紙	事務室	沖縄支所庶務 課会計係		
総務	経理	帳簿	(平成5年度)現金出納簿等	総務部会計課 会計係	1993年度	10	2003年度末	紙	文書庫	総務部会計課 会計係		



独立行政法人国際農林水産業研究センター法人文書ファイル管理簿

文書分類			法人文書ファイル名	作成者	作成(取得)時期	保存期間(年)	保存期間満了時期	媒体種別	保存場所	管理担当課・係	保存期間満了時の措置結果	備考
大分類	中分類	小分類										
総務	経理	帳簿	(平成5年度)資金前渡官吏に係る帳簿類	沖縄支所庶務課会計係	1993年度	10	2003年度末	紙	事務室	沖縄支所庶務課会計係		
総務	経理	帳簿	(平成6年度)現金出納簿等	総務部会計課会計係	1994年度	10	2004年度末	紙	文書庫	総務部会計課会計係		
総務	経理	帳簿	(平成6年度)資金前渡官吏に係る帳簿類	沖縄支所庶務課会計係	1994年度	10	2004年度末	紙	事務室	沖縄支所庶務課会計係		
総務	経理	帳簿	(平成7年度)現金出納簿等	総務部会計課会計係	1995年度	10	2005年度末	紙	文書庫	総務部会計課会計係		
総務	経理	帳簿	(平成7年度)資金前渡官吏に係る帳簿類	沖縄支所庶務課会計係	1995年度	10	2005年度末	紙	事務室	沖縄支所庶務課会計係		
総務	経理	帳簿	(平成8年度)現金出納簿等	総務部会計課会計係	1996年度	10	2006年度末	紙	文書庫	総務部会計課会計係		
総務	経理	帳簿	(平成8年度)資金前渡官吏に係る帳簿類	沖縄支所庶務課会計係	1996年度	10	2006年度末	紙	事務室	沖縄支所庶務課会計係		
総務	経理	帳簿	(平成9年度)現金出納簿等	総務部会計課会計係	1997年度	10	2007年度末	紙	文書庫	総務部会計課会計係		
総務	経理	帳簿	(平成9年度)資金前渡官吏に係る帳簿類	沖縄支所庶務課会計係	1997年度	10	2007年度末	紙	事務室	沖縄支所庶務課会計係		
総務	経理	帳簿	(平成10年度)現金出納簿等	総務部会計課会計係	1998年度	10	2008年度末	紙	文書庫	総務部会計課会計係		
総務	経理	帳簿	(平成10年度)資金前渡官吏に係る帳簿類	沖縄支所庶務課会計係	1998年度	10	2008年度末	紙	事務室	沖縄支所庶務課会計係		
総務	経理	帳簿	(平成11年度)現金出納簿等	総務部会計課会計係	1999年度	10	2009年度末	紙	文書庫	総務部会計課会計係		
総務	経理	帳簿	(平成11年度)資金前渡官吏に係る帳簿類	沖縄支所庶務課会計係	1999年度	10	2009年度末	紙	事務室	沖縄支所庶務課会計係		
総務	経理	帳簿	(平成12年度)現金出納簿等	総務部会計課会計係	2000年度	10	2010年度末	紙	文書庫	総務部会計課会計係		
総務	経理	帳簿	(平成12年度)資金前渡官吏に係る帳簿類	沖縄支所庶務課会計係	2000年度	10	2010年度末	紙	事務室	沖縄支所庶務課会計係		
総務	経理	帳簿	(平成13年度)現金出納帳	総務部会計課会計係	2001年度	10	2011年度末	紙	文書庫	総務部会計課会計係		
総務	経理	帳簿	(平成13年度)預金出納帳	総務部会計課会計係	2001年度	10	2011年度末	紙	文書庫	総務部会計課会計係		
総務	経理	帳簿	(平成13年度)銀行勘定帳	総務部会計課会計係	2001年度	10	2011年度末	紙	文書庫	総務部会計課会計係		
総務	経理	帳簿	(平成13年度)資金前渡官吏に係る帳簿類	沖縄支所庶務課会計係	2001年度	10	2011年度末	紙	事務室	沖縄支所庶務課会計係		
総務	経理	通知・回答	(平成13年度)経理に係る通知、調査、照会、回答又は報告等に関する文書	総務部海外業務管理課専門職	2001年度	1	2002年度末	紙	事務室	総務部海外業務管理課専門職		

独立行政法人国際農林水産業研究センター法人文書ファイル管理簿

文書分類			法人文書ファイル名	作成者	作成(取得)時期	保存期間(年)	保存期間満了時期	媒体種別	保存場所	管理担当課・係	保存期間満了時の措置結果	備考
大分類	中分類	小分類										
総務	契約	一般	(平成11年度)契約に関する文書(売買契約書、請負契約書、賃貸借契約書、等の契約書含む。)	沖縄支所庶務課会計係	1999年度	5	2004年度末	紙	事務室	沖縄支所庶務課会計係		
総務	契約	一般	(平成12年度)契約に関する文書(売買契約書、請負契約書、賃貸借契約書、等の契約書含む。)	沖縄支所庶務課会計係	2000年度	5	2005年度末	紙	事務室	沖縄支所庶務課会計係		
総務	契約	一般	(平成13年度)契約に関する文書	総務部海外業務管理課専門職	2001年度	5	2006年度末	紙	事務室	総務部海外業務管理課専門職		
総務	契約	一般	(平成13年度)契約に関する文書(売買契約書、請負契約書、賃貸借契約書、等の契約書含む。)	沖縄支所庶務課会計係	2001年度	5	2006年度末	紙	事務室	沖縄支所庶務課会計係		
総務	契約	通知・回答等	(平成13年度)契約に係る通知、調査、照会、回答又は報告等に関する文書	沖縄支所庶務課会計係	2001年度	1	2002年度末	紙	事務室	沖縄支所庶務課会計係		
総務	契約	検査・監督	(平成4年度)監督職員、検査職員、契約担当官等の補助者の任命及び報告に関する文書	総務部会計課監査係	1992年度	10	2002年度末	紙	文書庫	総務部会計課監査係		
総務	契約	検査・監督	(平成5年度)監督職員、検査職員、契約担当官等の補助者の任命及び報告に関する文書	総務部会計課監査係	1993年度	10	2003年度末	紙	文書庫	総務部会計課監査係		
総務	契約	検査・監督	(平成6年度)監督職員、検査職員、契約担当官等の補助者の任命及び報告に関する文書	総務部会計課監査係	1994年度	10	2004年度末	紙	文書庫	総務部会計課監査係		
総務	契約	検査・監督	(平成7年度)監督職員、検査職員、契約担当官等の補助者の任命及び報告に関する文書	総務部会計課監査係	1995年度	10	2005年度末	紙	文書庫	総務部会計課監査係		
総務	契約	検査・監督	(平成8年度)監督職員、検査職員、契約担当官等の補助者の任命及び報告に関する文書	総務部会計課監査係	1996年度	10	2006年度末	紙	文書庫	総務部会計課監査係		
総務	契約	検査・監督	(平成9年度)監督職員、検査職員、契約担当官等の補助者の任命及び報告に関する文書	総務部会計課監査係	1997年度	10	2007年度末	紙	文書庫	総務部会計課監査係		
総務	契約	検査・監督	(平成10年度)監督職員、検査職員、契約担当官等の補助者の任命及び報告に関する文書	総務部会計課監査係	1998年度	10	2008年度末	紙	文書庫	総務部会計課監査係		
総務	契約	検査・監督	(平成11年度)監督職員、検査職員、契約担当官等の補助者の任命及び報告に関する文書	総務部会計課監査係	1999年度	10	2009年度末	紙	文書庫	総務部会計課監査係		
総務	契約	検査・監督	(平成12年度)監督職員、検査職員、契約担当官等の補助者の任命及び報告に関する文書	総務部会計課監査係	2000年度	10	2010年度末	紙	文書庫	総務部会計課監査係		
総務	管理運営	建物等管理	(平成13年度)建物等の管理運営等に関する文書	総務部会計課施設管理係	2001年度	3	2004年度末	紙	文書庫	総務部会計課施設管理係		
総務	資産管理	一般	(平成13年度)固定資産の出資及び引継等に関する文書	総務部会計課施設管理係	2001年度	30	2031年度末	紙	文書庫	総務部会計課施設管理係		
総務	資産管理	一般	(平成13年度)独立行政法人化に伴う物品の引継について	総務部海外業務管理課海外物品係	2001年度	30	2031年度末	紙	事務室	総務部海外業務管理課海外物品係		
総務	資産管理	登記	(平成13年度)不動産の登記に関する文書	総務部会計課施設管理係	2001年度	30	2031年度末	紙	文書庫	総務部会計課施設管理係		
総務	資産管理	帳簿	(平成13年度)不動産台帳	総務部会計課施設管理係	2001年度	30	2031年度末	紙	文書庫	総務部会計課施設管理係		
総務	資産管理	帳簿	(平成13年度)固定資産台帳	総務部会計課施設管理係	2001年度	30	2031年度末	紙	文書庫	総務部会計課施設管理係		

独立行政法人国際農林水産業研究センター法人文書ファイル管理簿

文書分類			法人文書ファイル名	作成者	作成(取得)時期	保存期間(年)	保存期間満了時期	媒体種別	保存場所	管理担当課・係	保存期間満了時の措置結果	備考
大分類	中分類	小分類										
総務	資産管理	帳簿	物品等管理簿(平成13年度購入分)	総務部海外業務管理課海外物品係	2001年度	10	2011年度末	紙	事務室	総務部海外業務管理課海外物品係		
総務	資産管理	不動産管理	(平成13年度)不動産の取得及び処分に関する文書(重要なもの)	総務部会計課施設管理係	2001年度	30	2031年度末	紙	文書庫	総務部会計課施設管理係		
総務	資産管理	不動産管理	(平成13年度)不動産の取得及び処分に関する文書(重要なもの以外)	総務部会計課施設管理係	2001年度	10	2011年度末	紙	文書庫	総務部会計課施設管理係		
総務	資産管理	不動産管理	(平成13年度)不動産の種目変更・移築及び改築に関する文書	総務部会計課施設管理係	2001年度	10	2011年度末	紙	文書庫	総務部会計課施設管理係		
総務	資産管理	不動産管理	(平成13年度)不動産の貸付・借受に関する文書	総務部会計課施設管理係	2001年度	10	2011年度末	紙	文書庫	総務部会計課施設管理係		
総務	資産管理	不動産管理	(平成13年度)不動産の寄附・譲受に関する文書	総務部会計課施設管理係	2001年度	10	2011年度末	紙	文書庫	総務部会計課施設管理係		
総務	資産管理	取得	(平成13年度)不動産以外の固定資産の取得に関する文書	総務部会計課施設管理係	2001年度	5	2006年度末	紙	文書庫	総務部会計課施設管理係		
総務	資産管理	処分	(平成10年度)不動産以外の固定資産の処分に関する文書	沖縄支所庶務課会計係	1998年度	5	2003年度末	紙	事務室	沖縄支所庶務課会計係		
総務	資産管理	処分	(平成11年度)不動産以外の固定資産の処分に関する文書	沖縄支所庶務課会計係	1999年度	5	2004年度末	紙	事務室	沖縄支所庶務課会計係		
総務	資産管理	処分	(平成12年度)不動産以外の固定資産の処分に関する文書	沖縄支所庶務課会計係	2000年度	5	2005年度末	紙	事務室	沖縄支所庶務課会計係		
総務	資産管理	処分	(平成13年度)不動産以外の固定資産の処分に関する文書	総務部会計課施設管理係	2001年度	5	2006年度末	紙	文書庫	総務部会計課施設管理係		
総務	資産管理	貸付・借受	(平成13年度)不動産以外の固定資産の貸付・借受に関する文書	総務部会計課施設管理係	2001年度	5	2006年度末	紙	文書庫	総務部会計課施設管理係		
総務	資産管理	寄附・譲受等	(平成13年度)不動産以外の固定資産の寄附・譲受等に関する文書	総務部会計課施設管理係	2001年度	5	2006年度末	紙	文書庫	総務部会計課施設管理係		
総務	資産管理	滅失・毀損等	(平成13年度)固定資産の滅失又は毀損並びに亡失・損傷に関する文書	総務部会計課施設管理係	2001年度	5	2006年度末	紙	文書庫	総務部会計課施設管理係		
総務	資産管理	評価	(平成12年度)固定資産の評価に関する文書	総務部会計課施設管理係	2001年度	5	2006年度末	紙	文書庫	総務部会計課施設管理係		
総務	資産管理	減価償却	(平成13年度)固定資産の減価償却に関する文書	総務部会計課施設管理係	2001年度	5	2006年度末	紙	文書庫	総務部会計課施設管理係		
総務	資産管理	保守管理	(平成13年度)固定資産の保守管理、営繕に関する文書	総務部会計課施設管理係	2001年度	3	2004年度末	紙	文書庫	総務部会計課施設管理係		
総務	資産管理	通知・回答等	(平成13年度)資産管理に係る通知、調査、照会、回答又は報告等に関する文書	総務部会計課施設管理係	2001年度	1	2002年度末	紙	文書庫	総務部会計課施設管理係		
総務	資産管理	海外輸送	(平成13年度)物品送付に関する証明書について	総務部海外業務管理課海外物品係	2001年度	5	2006年度末	紙	事務室	総務部海外業務管理課海外物品係		
総務	資産管理	輸入禁止品	(平成9年度)輸入禁止品に関する文書	総務部海外業務管理課専門職	1997年度	5	2002年度末	紙	事務室	総務部海外業務管理課専門職		

独立行政法人国際農林水産業研究センター法人文書ファイル管理簿

文書分類			法人文書ファイル名	作成者	作成(取得)時期	保存期間(年)	保存期間満了時期	媒体種別	保存場所	管理担当課・係	保存期間満了時の措置結果	備考
大分類	中分類	小分類										
総務	資産管理	輸入禁止品	(平成 9年度)輸入禁止品に関する文書	沖縄支所庶務課会計係	1997年度	5	2002年度末	紙	事務室	沖縄支所庶務課会計係		
総務	資産管理	輸入禁止品	(平成 10年度)輸入禁止品に関する文書	総務部海外業務管理課専門職	1998年度	5	2003年度末	紙	事務室	総務部海外業務管理課専門職		
総務	資産管理	輸入禁止品	(平成 10年度)輸入禁止品に関する文書	沖縄支所庶務課会計係	1998年度	5	2003年度末	紙	事務室	沖縄支所庶務課会計係		
総務	資産管理	輸入禁止品	(平成 11年度)輸入禁止品に関する文書	総務部海外業務管理課専門職	1999年度	5	2004年度末	紙	事務室	総務部海外業務管理課専門職		
総務	資産管理	輸入禁止品	(平成 12年度)輸入禁止品に関する文書	総務部海外業務管理課専門職	2000年度	5	2005年度末	紙	事務室	総務部海外業務管理課専門職		
総務	資産管理	輸入禁止品	(平成 12年度)輸入禁止品に関する文書	沖縄支所庶務課会計係	2000年度	5	2005年度末	紙	事務室	沖縄支所庶務課会計係		
総務	資産管理	輸入禁止品	(平成 13年度)輸入禁止品に関する文書	総務部海外業務管理課専門職	2001年度	5	2006年度末	紙	事務室	総務部海外業務管理課専門職		
総務	資産管理	輸入禁止品	(平成 13年度)輸入禁止品に関する文書	沖縄支所庶務課会計係	2001年度	5	2006年度末	紙	事務室	沖縄支所庶務課会計係		
総務	資産管理	通知・回答等	(平成 13年度)資産管理に係る通知、調査、照会、回答又は報告等に関する文書	沖縄支所庶務課会計係	2001年度	1	2002年度末	紙	事務室	沖縄支所庶務課会計係		
総務	海外業務	貿易登録	(平成 13年度)日本輸出入者標準コードの変更登録について、署名届(変更用)の提出について	総務部海外業務管理課海外物品係	2001年度	5	2006年度末	紙	事務室	総務部海外業務管理課海外物品係		
総務	海外業務	一般	(平成 13年度)海外業務管理に関する文書(重要なもの)	総務部海外業務管理課専門職	2001年度	5	2006年度末	紙	事務室	総務部海外業務管理課専門職		

# 法人文書開示請求書

平成 年 月 日

独立行政法人国際農林水産業研究センター理事長 殿

(法人その他の団体にあつてはその名称及び代表者氏名)

氏名又は名称：

(法人その他の団体にあつては主たる事務所の所在地)

住所又は居所：〒

TEL

( )

(連絡先が上記の本人以外の場合は、連絡担当者の住所・氏名・電話番号)

連絡先：

独立行政法人等の保有する情報の公開に関する法律第 4 条第 1 項の規定に基づき、下記のとおり法人文書の開示を請求します。

## 記

### 1 請求する法人文書の名称等

(請求する法人文書が特定できるよう、法人文書の名称、請求する文書の内容等をできるだけ具体的に記載してください。)

### 2 求める開示の実施の方法等 (本欄の記載は任意です。)

ア又はイに 印を付してください。アを選択された場合は、その具体的な方法を記載してください。

ア 事務所における開示の実施を希望する。

<実施の方法> 閲覧 写しの交付 その他 ( )

<実施の希望日>

イ 写しの送付を希望する。

開示請求手数料 (1件300円)	納入方法は次のいずれかに をつけて下さい	(受付印)
	1. 銀行振込 2. 郵便為替 3. 現金	

銀行振込の場合は振込を証明する用紙を同封してください。

銀行振込口座名 銀行 支店 普通口座

口座番号

別紙の注意事項をお読みください。

*この欄は記入しないでください。

担当課	
備考	

## 「法人文書開示請求書」(別紙)

### <記載に当たっての注意事項>

#### 1 「氏名又は名称」「住所又は居所」

個人で開示請求をする場合は、あなたの氏名、住所又は居所を、法人その他の団体の場合には、その名称と代表者の氏名及び所在地を記載してください。

ここに記載された住所及び氏名により、開示決定通知等を行うこととなりますので、正確に記入願います。

連絡等を行う際に必要となりますので、電話番号も記載してください。

#### 2 「連絡先」

連絡等を行う場合に、「氏名又は名称」欄に記載された本人と異なる方に行う必要があるときは、連絡担当者の氏名、住所及び電話番号を記載してください。

#### 3 「請求する法人文書の名称等」

開示を請求する法人文書について、その名称、お知りになりたい情報の内容等をできる限り具体的に記載してください。

#### 4 「求める開示の実施の方法等」

請求される法人文書について開示決定がされた場合に、開示の実施の方法、事務所における開示を希望される場合の希望日についてご希望がありましたら、記載してください。

なお、開示の実施の方法等については、開示決定後に提出していただく「法人文書の開示の実施の方法等申出書」により申し出ることができます。

### <開示請求手数料の納付について>

開示請求を行う場合には、1件の法人文書について300円を納付していただくこととなっています。

# –@•l•¶•‘ŠÇ—•<K’ö

•X•V“ú•F2002.10.1

• –@•l•¶•‘ŠÇ—•<K’ö•i•ð•¶•j

• –@•l•¶•‘ŠÇ—•<K’ö•i—lŽ®•W•j

–lŽ®‘æ1•†•@•@•¶•‘Æ’•ë

–lŽ®‘æ2•†•@•@–@•¶•‘•^a—PŠi••\

–lŽ®‘æ3•†•@•@•ÚŽó^ó

–lŽ®‘æ4•†•@•@•¶•‘”Ô•†•VŽi^ó

–lŽ®‘æ5•†•@•@<N^Ä—pŽ†•i•b•j

–lŽ®‘æ6•†•@•@<N^Ä—pŽ†•i%^{c3}•j

–lŽ®‘æ7•†•@

–lŽ®‘æ8•†•@•@Æ_ ^ó

–lŽ®‘æ9•†•@•@Žæ^μ’•^Ó•¶•‘•VŽi^ó

–lŽ®‘æ10•†•@•Û•¶•ë—pŽ†

–lŽ®‘æ11•†

–lŽ®‘æ12•†•@–@•l•¶•‘ftf@fCf<ŠÇ—••ë

–lŽ®‘æ13•†•@–@•l•¶•‘‘Ý•o•[

–lŽ®‘æ14•†•@•¶•‘•Ž_‘Í

•Ê\‘æ1•i‘æ11•ðŠÖÆW•j•@–@•l•¶•‘•Û•¶•ŠúŠÔŠi•

•Ê\‘æ2•i‘æ32•ðŠÖÆW•j•@^İ”CŽ–•

•Ê\‘æ3•i‘æ35•ðŠÖÆW•j•@‘ãÆ^ŽÒ

–lŽ®‘æ5•†•@•@<N^Ä—pŽ†•i•b•j•@<N^Ä—á

–lŽ®‘æ6•†•@•@<N^Ä—pŽ†•i%^{c3}•j•@<N^Ä—á

Ž{•s•¶•‘—á

•‘•Ū”_—Ñ•...ŽY<ÆCEα<†fZf“f^•[



# 独立行政法人国際農林水産業研究センター法人文書管理規程

14国研セ第8-65号  
平成14年8月22日

## 第1章 総則

### (目的)

第1条 この規程は、独立行政法人国際農林水産業研究センター（以下「センター」という。）における法人文書の管理について必要な事項を定めることにより、事務の適正かつ能率的な遂行に資することを目的とする。

### (定義)

第2条 この規程において、次の各号に掲げる用語の意義は、それぞれ当該各号に定めるところによる。

- (1) 法 独立行政法人等の保有する情報の公開に関する法律（平成13年法律第140号）をいう。
- (2) 法人文書 法第2条第2項に規定するものをいう。
- (3) 部課 独立行政法人国際農林水産業研究センターの組織に関する規程（13国研セ第4-25号。以下「組織規程」という。）に規定する部、科、課（庶務課を除く。）及び室をいう。
- (4) 支所 組織規程第49条に規定する沖縄支所をいう。
- (5) 庶務課 組織規程第15条及び第50条に規定する庶務課をいう。
- (6) 主管部課 法人文書の内容たる事案を主管する部課をいう。

### (法人文書の作成の原則)

第3条 センターとしての意思決定並びに事務及び事業の実績については、次に掲げる場合を除き、文書（図画及び電磁的記録を含む。以下この条において同じ。）を作成することを原則とする。ただし、第1号の場合においては、事後に文書を作成しなければならない。

- (1) 意思決定と同時に文書を作成することが困難である場合
- (2) 処理に係る事案が軽微なものである場合

### (法人文書の処理の原則)

第4条 法人文書の処理は、确实かつ迅速に行わなければならない。

### (統括文書管理者)

第5条 センターに統括文書管理者を置く。

- 2 統括文書管理者は、総務部長をもって充てる。
- 3 統括文書管理者は、センターにおける次に掲げる事務を行う。
  - (1) 法人文書管理規程その他の法人文書の管理に関する規程類の整備に関すること。
  - (2) 法人文書分類基準表及び法人文書ファイル管理簿の整備に関すること。
  - (3) 法人文書の管理に関する事務の指導監督等に関すること。

### (文書管理者)

第6条 センターに文書管理者を置く。

- 2 文書管理者は、庶務課の課長（支所にあっては支所長）をもって充てる。
- 3 文書管理者は、センターにおける次に掲げる事務を行う。
  - (1) 法人文書分類基準表及び法人文書ファイル管理簿の作成に関すること。
  - (2) 法人文書の保存期間の延長、独立行政法人国立公文書館（以下「国立公文書館」という。）への移管又は廃棄の実施に関すること。
  - (3) センターが保有する法人文書の管理の徹底を図ること。

（文書管理担当者）

第7条 庶務課に文書管理担当者を置く。

- 2 文書管理担当者は、庶務課の課長補佐（支所にあっては課長）をもって充てる。
- 3 文書管理担当者は、前条第3項各号の事務について、文書管理者を補佐する。
- 4 文書管理担当者は、庶務系の職員に前項に掲げる事務の全部又は一部を行わせることができる。

（帳簿）

第8条 庶務課に、次に掲げる帳簿を備える。

- (1) 文書原簿
- (2) 文書補助簿
- 2 文書補助簿は、文書原簿の補助簿とし、同一事案に関し文書の施行又は受付が繰り返され、又は同一事案に関する回答文書若しくは報告文書が多数のため、文書原簿の記載が困難なときに用いる。
- 3 前2項に規定する帳簿の様式は、別記様式第1号による。

（電磁的記録による帳簿等の作成）

第9条 前条に規定する帳簿については、パーソナルコンピュータ（以下「パソコン」という。）を使用して、電磁的記録により作成することができる。

（文書記号及び文書番号）

第10条 文書原簿に登録を要する法人文書には、文書記号及び文書番号を付するものとする。

- 2 文書記号は「国研セ」とする。ただし、支所においては「国研セ沖」とする。
- 3 文書番号は、毎年4月1日をもって更新することとし、各月ごとの区分番号と、月別の受付順による一連番号を併記したものとする。

例 14国研セ第4〔各月ごとの区分番号〕-1〔月別の受付順による一連番号〕

- 4 外国（日本駐在の外国出先機関を含む。以下同じ。）あてに施行する文書の文書番号については、前項の規定にかかわらず原則として次のとおりとし、文書管理担当者は施行された文書について文書原簿の記事欄に当該番号を記載するものとする。

J C ' X X〔西暦の下2桁〕/ Y Y〔月〕/ Z Z〔月別の受付順による一連番号〕

例 J C ' 0 2 / 7 / 6 5

- 5 同一の事案により第1項の法人文書の接受又は施行が繰り返される場合には、当該事案に係る最初に登録した文書記号及び文書番号を用いるものとする。ただし、文書管理者が、当該事案の処理を行うに当たって新たに登録することが適当と認めたときは、この限りでない。

(法人文書の保存期間)

- 第11条 法人文書の保存期間は、法律又は法律に基づく命令において保存期間が定められているものを除き、30年、10年、5年、3年、1年又は1年未満とする。
- 2 法人文書の保存期間の基準は、別表第1のとおりとする。

(保存期間の起算)

- 第12条 保存期間の起算は、完結した年度(4月1日から翌年の3月31日までの間をいう。以下同じ。)の翌年度の4月1日とする。

(法人文書の分類)

- 第13条 保存期間が1年以上の法人文書について、系統的かつ体系的に管理するため、大分類、中分類及び小分類に区分する。
- 2 前項に規定する分類により法人文書を分類するときは、次に定めるところにより行うものとする。
- (1) 大分類 共通、調査及び研究並びに総務の単位で整理する。
  - (2) 中分類 センターの所掌する事務及び事業の種類又は内容に基づき整理する。
  - (3) 小分類 中分類を更に細分化して整理する。

(法人文書分類基準表の作成等)

- 第14条 文書管理者は、センターの所掌する事務に係る法人文書の適切な分類及び保存に資するため、法人文書分類基準表(別記様式第2号)を、パソコンを使用して電磁的記録により作成しなければならない。
- 2 文書管理者は、法人文書分類基準表について、毎年定期的に、又は時宜に応じて見直しを行うものとする。

## 第2章 接受及び配布

(法人文書の接受)

- 第15条 法人文書の接受は、庶務課において行う。ただし、主管部課の担当職員が直接受け取った場合は、速やかに庶務課に回付し接受の手続きを取らなければならない。

(電子文書の接受)

- 第16条 電子文書(電子メールにより送受信された電磁的記録をいう。以下同じ。)の接受は、その相手方たる職員が接受する。
- 2 電子文書を接受した職員は、速やかに当該電子文書を紙に出力する。ただし、保存期間が1年未満のものについては、紙に出力することを省略することができる。
- 3 前項の規定により電子文書の内容が出力された紙は、接受した法人文書とみなし、次条に規定するところにより、速やかに接受の手続きをとらなければならない。

(接受した法人文書の配布)

- 第17条 庶務課において接受した法人文書(担当職員が直接接受したものを除く。)は、直ちに、主管部課の担当職員に配布する。
- 2 前項に規定する法人文書の担当職員への配布は、当該法人文書を接受した日のうちに完了しなければならない。

(接受印の押印)

第18条 担当職員は、直接法人文書を接受したとき又は前条第1項の規定により法人文書の配布を受けたときは、速やかに庶務課において当該法人文書（第16条第2項ただし書の規定により紙に出力することを省略するものを除く。）に接受印（別記様式第3号）を受けるものとする。

2 電子文書の接受年月日は、電子文書が当該システムに到達した日とする。

（接受した法人文書の登録）

第19条 接受した法人文書（保存期間が1年未満のもの及び主管部課の長が決裁（供覧を含む。以下同じ。）を要しないと認めたものを除く。）については、速やかに登録を行い、起案その他の必要な処理を行わなければならない。

2 前項の登録は、文書管理担当者が文書原簿に、当該法人文書の件名、差出人、接受年月日、登録年月日その他必要な事項を記載して行う。

3 前項の文書管理担当者は、法人文書の登録を行ったときは、当該法人文書に文書番号表示印（別記様式第4号）を押す。

### 第3章 法人文書の作成

（書式等）

第20条 法人文書の作成は、次に掲げるものを除くほか、左横書きとする。

（1）法令等の規定により縦書きと定められているもの

（2）賞状、表彰状、祝辞その他これらに類するものであって、縦書きが適当と認められるもの

（記述の原則）

第21条 法人文書は、的確かつ簡潔に記載する。

2 文書の作成は、特別の場合を除き、漢字仮名まじりとし、句読点をつける。

3 文体は口語体とし、原則として、文字は常用漢字及び平仮名を用い、現代仮名遣いとし、数字は算用数字を用いる。

（起案）

第22条 決裁を行う法人文書については、事案ごとに起案を行う。

2 接受した2以上の法人文書で相互に関連のあるものについては、1の事案とみなして、合併処理をして起案することができる。

3 接受した1の法人文書で、その内容が異なる2以上の事案について起案する場合には、その写しを作成し、分割処理をして起案することができる。この場合には、当該法人文書の写しを必要部数だけ作成し、それぞれについて、第19条の規定による登録を行う。

（合併処理の起案）

第23条 前条第2項の規定により合併処理を行う場合には、当該文書番号のうち適宜のものを代表文書番号として起案用紙の文書番号欄に記載し、その他の文書番号は、起案用紙の記事欄に記載し、かつ合併処理の表示をする。

2 前項の場合には、代表文書番号の文書が登録された文書原簿の記事欄に代表文書番号以外の文書番号を、代表文書番号以外の文書が登録された文書原簿の記事欄に当該代表文書番号を記載し、かつ、合併処理の記載をする。

(分割処理の起案)

第24条 第22条第3項の規定により分割処理を行う場合には、原本の起案用紙の記事欄に当該写しの文書番号を、写しの起案用紙の記事欄に原本の文書番号を記載し、かつ分割処理の記載を行う。

2 前項の場合には、原本が登録された文書原簿の記事欄に当該写しの文書番号を、写しが登録された文書原簿の記事欄に原本の文書番号を記載し、かつ、分割処理の記載をする。

(起案文書の作成)

第25条 法人文書の起案は、起案用紙(別記様式第5号及び第6号)を用いるものとする。ただし、接受した法人文書に基づいて起案する場合で内容が軽微なものについては、別記様式第7号により、これを起案用紙に代えて起案することができる。

2 起案者は、起案用紙に必要な事項を記載して、起案しなければならない。ただしパソコンを使用して起案するときは、起案用紙の様式に必要な事項を入力し、紙に出力したものを原議とする。

3 法人文書を起案する場合は、次に掲げるところによるものとする。

(1) 法人文書の起案は、別記の起案文書の書式例に準拠して行い、起案用紙の接受年月日欄に、接受印に記載された年月日を、登録年月日欄に、文書原簿に登録した年月日を、起案年月日欄に、起案文書を作成した年月日を記載する。

(2) 起案用紙の分類番号欄及び保存期間欄に、法人文書分類基準表の該当欄に記載された分類番号及び保存期間を記載する。

(3) 当該起案に係る事案が第32条の規定により各委任者が処理することができるものであるときは、起案用紙の委任事項番号欄に次の記載例の形式により、当該委任事項に係る別表第3に規定する事項番号を記載する。

記載例(別表第3の事項番号第8項の場合)

3 - 8

4 起案文書には、事案が定例的又は軽微なものを除き、起案の趣旨及び事案の概要等を記載するとともに、必要に応じて、参照条文、新旧対照表その他参考資料を添付する。

5 起案文書をつづる場合は、原則として、つづりひも、ホッチキス等により容易に分離しないようにとじなければならない。

6 外国語による接受文書又は外国語により施行する文書を起案する場合は、必要に応じて日本語による訳文又は要旨文を添付しなければならない。

7 電報により発信する文書案は、電報文により作成する。

(起案の特例)

第26条 接受した法人文書に基づき起案する場合であって、当該法人文書の事案の内容又は性質により、当該法人文書に記載された名あて人以外の者が、最終決裁者及び発信名義人となるのが適当であると主管部課長が認めるときは、法令等に定めのある場合を除き、名あて人以外の者を最終決裁者及び発信名義人として起案することができる。

(文書管理担当者による点検)

第27条 法人文書を起案したときは、その起案について文書管理担当者の点検を受けなければならない。

- 2 文書管理担当者は、前項の規定により起案文書を点検したときは、当該起案用紙の文書管理担当者欄に署名又は押印をする。

(起案により作成する法人文書)

第28条 起案により法人文書を作成するときは、法令等の規定に基づき施行する場合を除き、次に掲げる者の職名・氏名を発信名義人として表示する。

- (1) 理事長
- (2) 支所長
- 2 庶務課長が認めるときは、前項の規定にかかわらず、次に掲げる者の職名・氏名を発信名義人として表示することができる。
  - (1) 理事
  - (2) 企画調整部長
  - (3) 総務部長
- 3 センターの組織の名称を表示する法人文書であって、次に掲げるものについては、起案により作成するものとする。
  - (1) 独立行政法人国際農林水産業研究センター公印取扱規程(13国研セ第4-12号。以下「公印規程」という。)に規定された公印の押印を要するもの(第45条第4項及び第5項により公印の押印を省略することができるものを含む。)
  - (2) 主管部課長又はその上司が決裁を要すると認めたもの

(起案によらないで作成する法人文書)

第29条 前条第1項に規定する発信名義人を表示する法人文書のうち、次に掲げるものを施行するときは、起案によらないで作成することができる。

- (1) 主管部課長又はその上司が起案することを要しないと認めたもの
- (2) 起案によらないで作成することが通例となっているもの
- 2 起案によらないで発信名義人を表示する法人文書を作成するときは、当該発信名義人の了解を得なければならない。
- 3 起案によらないで、前条第1項又は第2項に規定する者以外の職名等を発信名義人としてセンター外に発信する法人文書を作成するときは、上司又は責任ある者の了解を得なければならない。
- 4 起案によらないで組織名を表示して法人文書を作成するときは、上司又は責任ある者の了解を得なければならない
- 5 起案によらないで法人文書を作成するときは、当該法人文書の作成年月日、作成者の主管部課名(発信名義人を表示しない場合に限る。)等必要な事項を当該法人文書の見やすい箇所に記載する。

(発議文書の登録)

第30条 発議により起案した法人文書で、主管部課長の決裁を受けたものについては、速やかに登録を行わなければならない。

- 2 前項の登録は、文書管理担当者が文書原簿に、当該法人文書の件名、起案年月日その他必要な事項を記載して行う。

第4章 決裁  
(決裁の方法)

- 第31条 起案文書の決裁は、発信名義人（施行を伴わないものにあつては名あて人。次項において同じ。）が最終の決裁者となることを原則とする。
- 2 前項の規定にかかわらず、主管部課長が必要と認めるときは、当該発信名義人の上位の者の決裁を求めることができる。
  - 3 決裁の順序は、原則として主管部課から開始し、組織規程に定める部課等の順序の逆順序とする。ただし、総務部において起案した法人文書を除き、総務部長を各部課長の最終の決裁者とする。
  - 4 理事長の決裁を受ける法人文書は、総務部長の決裁を経なければならない。
  - 5 総務部長の決裁を受ける法人文書は、庶務課長の決裁を経なければならない。
  - 6 支所長の決裁を受ける法人文書は、支所の庶務課長の決裁を経なければならない。
  - 7 決裁は、起案文書の決裁欄に署名又は押印をすることにより行うものとする。
  - 8 部課において起案文書に署名又は押印をすることができる者は、当該起案文書の内容に直接関係ある者とする。

（文書の委任処理）

- 第32条 別表第2の委任事項欄に掲げる事項に係る法人文書の起案は、事の異例に属するものを除き、この表の委任者欄に掲げる者が決裁することができる。この場合には、同表の合議者欄に掲げる者に合議しなければならない。

（他の部課への合議）

- 第33条 起案文書の事案が他の部課に関係する場合は、事前の協議等により合議することを省略することができるものを除き、当該関係する部課に合議しなければならない。

（持ち回り）

- 第34条 起案文書で緊急に処理を要するもの又は詳細な説明を要するものは、当該起案文書の起案者又はその説明を行うことができる職員が携行して決裁を受けることができる。

（代決）

- 第35条 起案文書は、次の各号に掲げる要件のすべてに適合する場合に限り、代決することができる。
- （1） 決裁者が出張、休暇その他やむを得ない事情により不在であること。
  - （2） 緊急に処理しなければならない理由があること。
  - （3） 決裁者から代決してはならないものとして、あらかじめ指定された事項に関するもの又は異例なものでないこと。
- 2 前項の規定による代決は、別表第3の決裁者欄に掲げるものについては、同表の代決者欄に掲げる者でなければならない。
  - 3 起案文書の代決をする場合には、その決裁が代決であることを示すため、決裁欄の右上に「代」と表示する。
  - 4 重要な事案に関する起案文書を代決した者は、事後速やかに代決として処理された決裁者にその旨を報告しなければならない。

（後伺い）

- 第36条 決裁者及び代決者が不在であつて、かつ、緊急やむを得ない場合には、最終

の決裁者を除き、当該決裁者の決裁を後伺いとして処理することができる。

- 2 前項の規定により後伺いとして処理するときは、起案文書の決裁欄に「後伺い」と記載し、次の決裁者に回付するとともに、事後速やかに後伺いとして処理された決裁者の決裁を受けなければならない。

（起案文書の回付に係る事案の検討）

- 第37条 決裁のため起案文書の回付を受けた者は、直ちに、当該事案を検討し、異議があるときは、その旨を速やかに起案者に連絡する。
- 2 起案文書の内容の訂正を行うときは、軽微な訂正を行う場合を除き、起案者又はその上司の了解を得るものとする。

（決裁月日の記載）

- 第38条 文書管理担当者又は起案者は、起案文書の決裁が完了したときは、当該起案文書の決裁年月日欄に、決裁が完了した年月日を記載する。
- 2 文書管理担当者は、法人文書の施行を伴わない起案文書の決裁が完了したときは、当該法人文書を登録した文書原簿の該当欄に決裁を完了した年月日を記載する。

（廃案）

- 第39条 起案文書で施行前に廃案の処理を行う場合は、新たにその旨を起案し、当該施行を取りやめた起案文書を添えて、既決裁者の決裁を受けるものとする。
- 2 前項の規定により廃案の処理のために新たに起案する文書に記載する文書番号及び文書記号は、施行を取りやめた起案文書に付した文書記号及び文書番号を用いるものとする。
- 3 第1項の規定により既決裁者の決裁を受けるときは、決裁した者全員の決裁を受ける必要はなく、部課においては部課長の決裁があればよいものとする。
- 4 廃案に係る決裁が終了したときは、当該起案文書を登録した文書原簿に、その旨及び当該処理年月日を記載する。

## 第5章 法人文書の施行

（浄書）

- 第40条 決裁済みの起案文書で施行を要するものは、浄書を行う。
- 2 前項の規定により浄書を行うときは、照会その他の便宜に資するため、必要に応じて当該浄書文書の末尾に、担当職員の所属、職名、氏名、電話番号等を記載することができる。
- 3 第1項の浄書文書には、法令等に定めのあるものを除き、当該起案用紙の文書記号番号欄に記載する文書記号及び文書番号を付するものとする。
- 4 決裁済みの起案文書により作成した浄書文書のうち次に掲げるものについては、前項の規定にかかわらず、文書記号及び文書番号を付すことを省略する。
  - (1) 賞状、表彰状、人事異動通知書、祝辞類
  - (2) 主管部課長が文書記号及び文書番号を付すことを要しないと認めたもの
- 5 浄書文書に記載した事項を訂正するときは、当該訂正箇所当該浄書文書の発信名義人の公印を押す。

（施行年月日）

- 第41条 法人文書の施行年月日は、当該法人文書の発送又は発信の日とする。ただし、



次の各号に掲げるものについては、それぞれ当該各号に定める日とする。

- (1) 交付 交付した日
  - (2) 発令 発令した日
  - (3) ホームページ等への登載 登載した日
  - (4) 官報、公報等への掲載 掲載した日
  - (5) 刊行物の発行 発行した日
  - (6) 掲示 掲示した日
  - (7) 公表 公表した日
  - (8) 配布 当該法人文書を作成した日
  - (9) 縦覧 縦覧に供した日
- 2 浄書文書に付する日は、前項に規定する施行年月日とすることを原則とする。ただし、特別な事情があると認めるときは、前項に規定する施行年月日と異なる日を浄書文書に付することができる。

(浄書文書の日付の特例)

第42条 前条第2項ただし書きの規定により浄書文書に付する日を同条第1項に規定する日と異なる日とするときは、起案文書の伺い文に当該理由を明記するとともに、記事欄に「指定日施行」と表示し、かつ、当該指定する年月日を記載する。

2 前項の場合には、次に掲げる浄書文書の区分に応じて、それぞれ当該各号に定める者の決裁を受けなければならない。

- (1) 第28条第1項に規定する発信名義人による浄書文書 総務部長（支所にあつては庶務課長）
- (2) 第28条第2項に規定する発信名義人による浄書文書 庶務課長

(契印の押印)

第43条 浄書文書に記載した発信名義人が第28条第1項及び第2項に規定するものであるときは、契印（別記様式第8号）を当該浄書文書と起案文書にわたって押す。

第44条 前条の規定にかかわらず、次に掲げる浄書文書については、契印の押印を省略する。

- (1) 賞状、表彰状、通知書、祝辞類
- (2) 掲示により施行する法人文書

(公印の押印)

第45条 浄書文書の発信名義人が公印規程の規定により公印の作成及び使用を認められている者である場合には、公印規程第7条第3項ただし書きの規定によりあらかじめ公印を押印した用紙を使用する場合を除き、当該発信名義人の公印を保管する課において当該公印を当該浄書文書に押すものとする。

2 前項の規定による浄書文書への公印の押印は、当該浄書文書の発信名義人の末字に半分かけて押す。ただし、次に掲げるものに押印する場合にあつては、発信名義人の末字にかからないように押す。

- (1) 賞状、表彰状類
  - (2) 通知書
- 3 公印規程第7条第3項ただし書きの規定によりあらかじめ公印を押印した用紙を使用する場合は、公印にかからないように発信名義人を記載することができる。

4 第1項の規定にかかわらず、次の各号に掲げる法人文書については、公印の押印を省略することができる。この場合は、当該浄書文書の公印の押印位置に公印省略の表示をする。

(1) 農林水産省所管の試験研究独立行政法人あてに施行する文書のうち内容が軽微なもの及び総務部長が認めるもの

(2) センターの内部組織あてに施行する法人文書

5 前4項の規定にかかわらず、外国に対して施行する浄書文書については、発信名義人の自筆の署名をもって公印の押印に代えることができる。

(割印)

第46条 浄書文書の各葉に割印を押す場合には、当該法人文書の発信名義人の公印を用いるものとする。

(取扱注意文書の取扱い)

第47条 主管部課長は、取扱いについて注意を要すると認める法人文書については、当該法人文書を取扱注意文書として指定するものとする。

2 前項の規定により取扱注意文書として指定するときは、起案文書については記事欄に、その他の法人文書については、当該法人文書の見やすい箇所に別記様式第9号による表示印を押し、取扱いに注意を要する期限を記載する。

(施行の方法)

第48条 法人文書を施行するときは、次に定める方法によるものとする。

(1) 郵送 庶務課において行い、郵送する文書の内容により、文書管理担当者が必要があると認めるときは、小包郵便物とすること又は速達、書留その他の特殊扱いとすることを指定することができる。

(2) 使送 庶務課において当該法人文書を使送人に交付し、これを当該法人文書の名あて人又はその名あて人に代わって、当該法人文書を受領する権限を有する者に直接送達させるものとする。この場合において、使送人は、センターの職員又はこれに代わるべき者(センターとの契約により使送事務を行う者。)とする。

(3) 直接の交付 施行する法人文書を本人等に手渡す場合とし、この場合、必要に応じ本人等の受領の署名又は押印を受けるものとする。

(4) 発令 人事異動等の辞令を発する

(5) 電子メール 保存期間が1年未満の法人文書をパソコンから発信する。

(6) ファクシミリ 保存期間が1年未満の法人文書を当該装置を使用して施行する

(7) 電報 電報により法人文書を発信するときは、当該法人文書に発信者の氏名及び発信した日時等を記載する。

(8) ホームページ等への登載 センターのホームページへ法人文書を登載する。

(9) 官報、公報等への掲載又は刊行物の発行 法人文書を官報、公報等へ掲載し、又は刊行物を発行する。

(10) 掲示 独立行政法人国際農林水産業研究センター構内等管理規程(14国研セ第4-73号)に規定する手続に従い掲示する。

(11) 縦覧 広く国民一般に見せるため、法人文書を一定の場所に備え置く。

(12) 公表又は配布 パンフレットその他国民一般に情報提供するために作成さ

れた法人文書を公表又は配布する。

( 1 3 ) その他総務部長が認める方法

( 施行年月日の記載 )

第 4 9 条 文書管理担当者は起案に基づき法人文書を施行したときは、当該起案用紙に施行した年月日 ( 第 4 1 条第 2 項ただし書きの規定により同条第 1 項に規定する日と異なる日を浄書文書に付した場合にあっては当該異なる日 ) を記載する。

2 起案によらないで作成した法人文書の施行年月日は、原則として当該法人文書を作成した日とする。

## 第 6 章 法人文書の完結及び保存

( 完結 )

第 5 0 条 法人文書の完結は、当該法人文書に係る事案の処理が終了したときとする。

ただし、当該事案について、さらに継続して照会、回答その他文書の往復を要するときは、その最後の処理を終了したときとすることができる。

2 文書管理担当者は、起案文書が完結したときは、当該起案文書の完結年月日欄に完結した年月日を記載するとともに、当該法人文書を登録した文書原簿に完結の旨その他必要な事項を記載する。

3 起案によらないで作成した法人文書 ( 保存期間が 1 年以上のものに限る。 ) の完結年月日が、当該法人文書を作成した日と異なるときは、完結した年月日を当該法人文書に記載する。

( 法人文書の保存方法 )

第 5 1 条 文書管理者は、完結した法人文書について、保存期間が満了する日まで、適正かつ確実に利用できる方法で保存しなければならない。

2 法人文書 ( 保存期間が 1 年以上のものに限る。 ) を保存するときは、法人文書ファイル ( 能率的な事務又は事業の処理及び法人文書の適切な保存の目的を達成するためにまとめられた、相互に密接な関連を有する法人文書 ( 当該保存期間を同じくすることが適当であるものに限る。 ) の集合物をいう。以下同じ。 ) 単位又は法人文書 ( 単独で管理することが適当なものに限る。 ) ごとに、管理が適切に行える場所に保存しなければならない。

3 前項に規定する管理が適正に行える場所は、次に掲げるものについては、それぞれ当該各号に定める場所とする。

( 1 ) 文書及び図面 事務室及び書庫の書棚

( 2 ) 電磁的記録 ( 電子情報に限る。 ) 共用の保管庫 ( フレキシブルディスク等の場合に限る。 ) ホストコンピュータで管理されている磁気媒体又はサーバの共有部分

4 複数の法人文書をもって法人文書ファイルを設定した場合の保存期間は、当該法人文書のうち保存期間の満了する日がもっとも遅いものに合わせるものとする。

5 同一の法人文書が複数存在する場合又は原本のほかに写しが法人文書として存在する場合における正本または原本として管理されているもの以外の法人文書の保存期間は、正本又は原本の保存期間より短い保存期間を設定することができる。

6 法人文書は法人文書ファイル単位で編集するものとし、簿冊ごとに保存簿用紙 ( 別記様式第 1 0 号 ) に完結年度、廃棄年度、法人文書ファイル名、保存期間、分類番号等必要な事項を記載し、当該法人文書と合わせてつづり込むとともに、その背表紙 ( 別

記様式第 1 1 号)に基づき、分類番号、法人文書ファイル名等必要な事項を記載する。

(法人文書ファイルの設定)

第 5 2 条 前条第 2 項に規定する法人文書ファイルの設定方法は、次に掲げるところによるものとする。

- ( 1 ) 内容(主題)別 法人文書に書かれている内容(主題)ごとにまとめる方法  
(例: 会議議事録ファイル等)
- ( 2 ) 形式別 法人文書の内容や相手方と関係なくその形式をとらえてまとめる方法  
(例: 関係照会・回答ファイル等)
- ( 3 ) 様式・標題別 帳票類、伝票類等、法人文書の標題をそのままファイル名としてまとめる方法  
(例: 申請書ファイル等)
- ( 4 ) 案件(一件)別 工事の計画から完了までの法人文書等、一つの案件に係る法人文書を順序立ててまとめる方法  
(例: 工事一件ファイル等)
- ( 5 ) 相手方別 法人文書に係る提供者、提出先等ごとにまとめる方法  
(例: 説明資料ファイル等)
- ( 6 ) 時期別 同種の内容の法人文書を一定の期間ごとにまとめる方法  
(例: 年月支払い書ファイル等)

(法人文書の保存)

第 5 3 条 起案文書で保存期間が 3 0 年以上の法人文書は、主管部課において 5 年間保存し、その後庶務課において保存する。

- 2 保存期間が 3 0 年未満のもの及び起案によらない法人文書は、主管部課において保存する。

(法人文書の引継ぎ)

第 5 4 条 主管部課において前条第 1 項の規定により、庶務課において保存する法人文書があるときは、当該法人文書の目録を作成の上、引き継ぐものとする。

- 2 前項の引継目録は、第 5 1 条第 6 項の規定により必要な事項を記載した保存簿用紙を用いるものとする。

(法人文書ファイル管理簿の作成)

第 5 5 条 文書管理者は、法人文書ファイル及び法人文書(単独で管理することが適当なものであって、保存期間が 1 年以上のものに限る。)の管理を適切に行うため、法人文書ファイル管理簿(別記様式第 1 2 号)を、パソコンを使用して電磁的記録により作成しなければならない。

- 2 文書管理者は、法人文書ファイル管理簿について、毎年 1 回以上定期的に、又は時宜に応じて見直しを行うものとする。

(法人文書の利用)

第 5 6 条 職員から保存する法人文書の利用の申込みがあったときは、当該職員に法人文書を閲覧させ、又は貸し出すことができる。

- 2 公表その他の方法により国民に情報提供される法人文書については、何人に対しても閲覧させ、又は配布するものとする。ただし、1 人当たりの配布部数を制限することができる。

( 職員の法人文書の利用 )

第 5 7 条 主管部課以外の職員が主管部課で保存する法人文書の貸出しを受けようとするときは、法人文書貸出票（別記様式第 1 3 号）に必要な事項を記載して、当該法人文書の主管部課長（庶務課にあっては第 7 条第 1 項に規定する文書管理担当者）に提出し、承認を受けなければならない。

( 職員への貸出期間 )

第 5 8 条 前条の法人文書の貸出期間は、1 週間以内とする。ただし、当該法人文書の主管部課長又はその上司（第 5 4 条の規定により引継ぎを受けた法人文書であるときは、当該法人文書を保存する庶務課長又はその上司）が認めたときは、この限りでない。

( 貸出文書等の取扱い )

第 5 9 条 職員は、閲覧し、又は貸出しを受けた法人文書を、切取り、つづりかえ又は転貸してはならない。

2 貸出しを受けた法人文書は、センター外に持ち出してはならない。ただし、当該法人文書の主管部課長又はその上司（第 5 4 条の規定により引継ぎを受けた法人文書であるときは、当該法人文書を保存する庶務課長又はその上司）が認めたときは、この限りでない。

( 貸出文書の返還 )

第 6 0 条 法人文書の貸出を受けた職員は、次の各号に掲げる事由が生じたときは、速やかに当該文書を返還しなければならない。

- ( 1 ) その必要がなくなったとき。
- ( 2 ) 貸出期間が終了したとき。
- ( 3 ) 職員でなくなったとき。
- ( 4 ) 退職を命じられたとき。
- ( 5 ) 長期にわたり出張、休暇又は欠勤するとき。
- ( 6 ) 主管部課長が返還を請求したとき。

( 職員以外の者への閲覧等 )

第 6 1 条 第 5 6 条第 2 項の規定により国民に情報提供される法人文書の閲覧又は配布は、原則として主管部課において行うものとする。

- 2 前項の閲覧又は配布の対象となる法人文書は、パンフレットその他国民一般に情報提供するために作成された法人文書とする。
- 3 前項の法人文書は、配布予定数に達した場合には配布を終了し、閲覧又は写しの交付のみを行う。
- 4 法人文書の情報提供を開始した日から 1 年を経過した場合は、法第 4 条第 1 項の規定に基づく開示請求手続により閲覧又は写しの交付を行うものとする。ただし、配布を継続している場合は、この限りではない。

( 保存期間が満了した法人文書の取扱い )

第 6 2 条 保存期間が満了した法人文書は、保存期間を延長し、又は国立公文書館へ移管するものを除き、廃棄する。

- 2 前項に規定する処理は、法人文書ファイル単位ごとに行う。

(保存期間が1年未満の法人文書の取扱い)

第63条 保存期間が1年未満の法人文書については、当該法人文書が現用に供しなくなったときに保存期間が満了したものとする。

(保存期間の延長)

第64条 文書管理者は、保存期間が満了した法人文書について、職務遂行上必要があると認めるときは、一定の期間を定めて当該保存期間を延長することができる。当該延長に係る保存期間が満了した後に、これを更に延長しようとするときも同様とする。

2 前項により保存期間を延長する場合における一定の期間は、当該法人文書の保存期間以下の期間(保存期間が1年未満の法人文書にあっては1年間)とする。

3 次に掲げる法人文書については、保存期間が満了した後においても、その区分に応じてそれぞれ次に定める期間が経過する日までの間、保存期間を延長する。この場合において、1の区分に該当する法人文書が他の区分にも該当するときは、それぞれの期間が経過する日のいずれか遅い日までの間保存する。

(1) 現に監査、検査等の対象になっているもの 当該監査、検査等が終了するまでの間

(2) 現に係属している訴訟における手続上の行為をするために必要とされるもの 当該訴訟が終結するまでの間

(3) 現に係属している不服申立てにおける手続上の行為をするために必要とされるもの 当該不服申立てに対する裁決又は決定の日の翌日から起算して1年間

(4) 開示請求があったもの 法第9条各項の決定の日の翌日から起算して1年間

4 前3項の規定により保存期間を延長するときは、当該法人文書の目録及び延長の理由を作成し、文書管理者の承認を受けなければならない。

5 法人文書の保存期間を延長するときは、当該法人文書ファイルの背表紙等にその旨を記載するなどして、保存期間を延長していることを明らかにしておくものとする。

(国立公文書館への移管)

第65条 文書管理者は、保存期間(延長された場合にあっては、延長後の保存期間)が満了した法人文書について、国立公文書館で保存することが適当と認められる歴史資料がある場合には、国立公文書館に移管する。

2 文書管理者は、前項の規定により法人文書を国立公文書館に移管するときは、当該法人文書及び当該法人文書の目録を統括文書管理者に提出する。

3 統括文書管理者は、前項の規定により法人文書及び目録の提出を受けたときは、当該法人文書及び目録の内容を確認の上、国立公文書館に移管する。

(法人文書の廃棄)

第66条 保存期間が満了した法人文書(保存期間が1年以上のものに限る。以下第68条まで同じ。)を廃棄するときは、当該法人文書の目録を作成し、文書管理者の承認を受けなければならない。

2 文書管理者は、保存期間が満了する前に廃棄しなければならない法人文書があるときは、当該法人文書の目録及び廃棄の理由を統括文書管理者に提出し、その承認を受けなければならない。

3 文書管理者は、前項の承認を受けて法人文書を廃棄したときは、当該法人文書の目録、廃棄の理由及び廃棄年月日を記載した記録を作成するとともに、文書原簿の記事欄にその旨を記載する。

( 廃棄方法 )

第 6 7 条 前条の規定により法人文書を廃棄するときは、庶務課において一括して廃棄する。

2 法人文書を廃棄するときは、煮つぶし、焼却その他適当と認められる方法により行う。

( 法人文書の紛失 )

第 6 8 条 保存する法人文書を紛失した者は、速やかに紛失届 ( 別記様式第 1 4 号 ) を当該法人文書の主管部課長に提出しなければならない。

2 主管部課長は、前項の届出があったときは、文書管理者に報告しなければならない。

3 保存する法人文書を紛失した者又は当該法人文書の主管部課長は、当該法人文書の写し等をもって復元に努めなければならない。

4 提出された紛失届は、紛失した法人文書に替えて、当該法人文書ファイルにつづり込んで保存する。

第 7 章 雑則

( 会計に関する法人文書の取扱いの特例 )

第 6 9 条 会計に関する法人文書であって、この規程の規定により取り扱った場合、事務処理に支障を生ずると認められるものについては、次に掲げるところにより取り扱うものとする。

( 1 ) 接受した法人文書の欄外余白が少なく接受印を押印した場合、当該法人文書に記載されている文字が汚損されるおそれがあるときは、接受印の押印を省略することができる。

( 2 ) 接受した法人文書を会計に関する帳簿に登載すること等によりその処理が終了するものは、文書原簿への登録を省略することができる。

( 3 ) 法令等の規定により起案用紙以外の用紙を用いて起案したものは、文書原簿への登録、文書管理担当者の点検及び第 3 1 条第 5 項に規定する決裁を省略することができる。

( 4 ) 浄書文書で整理番号を付したものは、文書記号及び文書番号の表示を省略することができる。

( 5 ) 浄書文書が伝票に類するものであるときは、契印の押印を省略することができる。

( 法人文書の管理に関する細部事項 )

第 7 0 条 この規程に定めるもののほか、法人文書の管理に関し、必要な事項は別に定める。

附 則

1 この規程は、平成 1 4 年 9 月 1 日から施行する。

2 独立行政法人国際農林水産業研究センター文書管理規程 ( 1 3 国研セ第 4 - 1 号。以下「旧文書管理規程」という。 ) 及び外国文書の取扱いについて ( 1 3 国研セ第 1 - 1 号 ) は、廃止する。

3 この規程の施行の前日に旧文書管理規程の規定により起案した法人文書であって、

この規程の施行の際未だ施行されていないものについては、この規程の規定により起案した法人文書として取り扱うことができる。

- 4 この規程の施行の際現に存する起案用紙は、当分の間これを使用することができる。この場合、起案用紙の文書管理責任者は文書管理担当者と読み替えて使用する。



様式第 1 号

1 文書原簿

文書番号	登録年月日	受付年月日	差出人 (発議)	受付文書 番号	件名	主管課	処理経過	記事	完結	分類番号	保存期間 (年)

備考 用紙の大きさは、日本工業規格 A 4 とする。

2 文書補助簿

文書番号		文書番号	
差出人(発議)	受付月日	差出人(発議)	受付月日

備考 用紙の大きさは、日本工業規格 A 4 とする。

様式第2号  
 法人文書分類基準表

分類番号	文 書 分 類			標準法人文書ファイル名	保存 期間 (年)	備 考
	大分類	中分類	小分類			

備考 用紙の大きさは、日本工業規格A4とする。

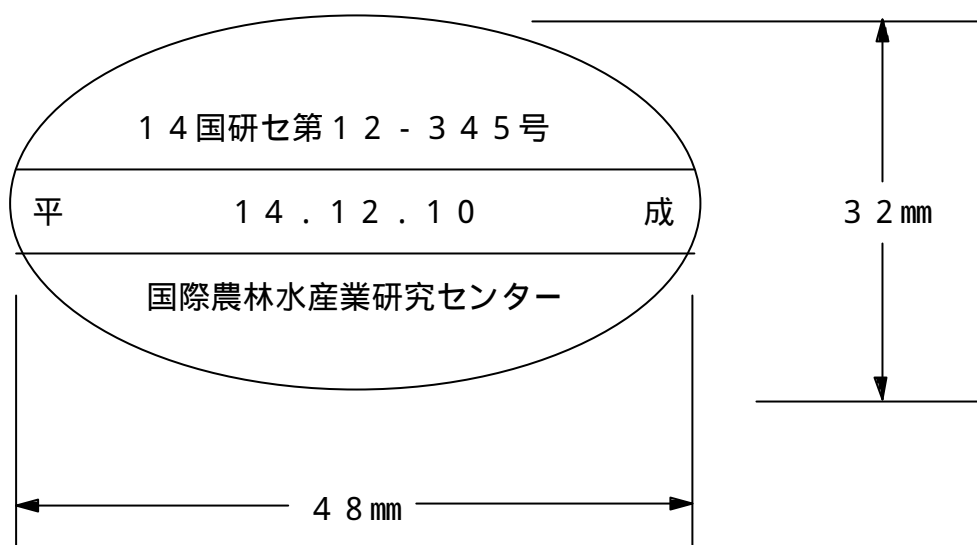
様式第3号  
 接受印



備考

- 1 受付印の直径は30mmとする。
- 2 支所にあつては「国際農林水産業研究センター」の下に「沖縄支所」と表示すること。

様式第4号  
文書番号表示印



備考

- 1 支所にあつては、上段の「国研セ」を「国研セ沖」に、下段の「国際農林水産業研究センター」の下に「沖縄支所」と表示する。
- 2 「平」と「成」との間には、法人文書の登録年月日を入れる。





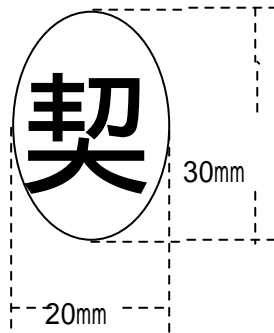
様式第7号

			起案者		
決裁	平成	年 月 日	文書管理 担当者	分類番号	完 結
起案	平成	年 月 日		保存期間	
記事					

備考 上覧には決裁者名を入れること。

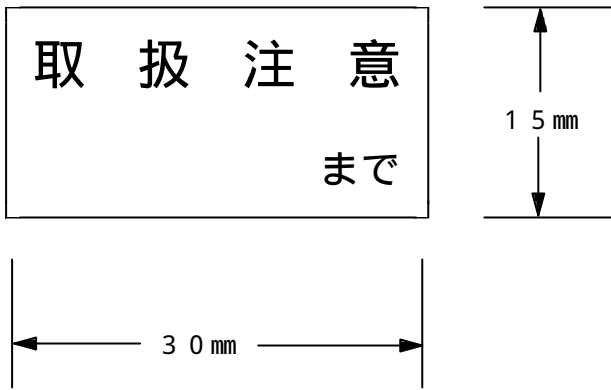
様式第8号

契印



様式第9号

取扱注意文書表示印



様式第10号  
保存簿用紙

部・支所				課・科・室		書架番号
完結 平成	年度	廃棄 平成	年度	保存期間 年	分類番号	分冊番号
法人文書ファイル名						
綴り 順序	文書番号 完結月日	件 名				備考
	第 号	-----				
	年 月 日					
	第 号	-----				
	年 月 日					
	第 号	-----				
	年 月 日					
	第 号	-----				
	年 月 日					
	第 号	-----				
	年 月 日					
	第 号	-----				
	年 月 日					
	第 号	-----				
	年 月 日					
	第 号	-----				
	年 月 日					
	第 号	-----				
	年 月 日					

備考 用紙の大きさは、日本工業規格A4とする。



様式第 1 1 号

分類番号
法人文書ファイル名
作成者
管理担当課・係
作成（取得）時期
保存期間
年
保存期間満了時期
分冊番号
書架番号

230mm

13 ~ 30mm

The diagram shows a vertical rectangular form with a height of 230mm and a width of 13 to 30mm. The form is divided into 15 horizontal sections. The sections are labeled as follows from top to bottom: 1. 分類番号 (Classification Number), 2. (Empty), 3. 法人文書ファイル名 (Corporate Document File Name), 4. (Empty), 5. (Empty), 6. 作成者 (Creator), 7. (Empty), 8. 管理担当課・係 (Management Department/Division), 9. (Empty), 10. 作成（取得）時期 (Creation/Acquisition Date), 11. (Empty), 12. 保存期間 (Retention Period), 13. 年 (Year), 14. 保存期間満了時期 (Retention Period Expiry Date), 15. (Empty), 16. 分冊番号 (Volume Number), 17. (Empty), 18. 書架番号 (Shelf Number), 19. (Empty). A vertical dimension line on the right indicates the total height of 230mm. A horizontal dimension line at the bottom indicates the width of 13 to 30mm.

様式第 1 2 号

法人文書ファイル管理簿

文書分類			法人文書ファイル名	作成者	作成 (取得) 時期	保存期間	保存期間 満了時期	媒体の種別	保存場所	管理担当課・係	保存期間 満了時の 措置結果	備 考
大分類	中分類	小分類										

備考

- 1 「作成者」欄は、課・係単位で記載し、取得したものであるときは例えば「申請者」、「届出者」等と記載する。作成者が多数の場合は、代表者と考えられる者を適宜記載する。
- 2 「作成（取得）時期」欄は、法人文書ファイルにまとめられた法人文書のうち、作成（取得）された時期が古いものの時期（暦年、年度、年月日等）を記載する。
- 3 「保存期間」欄は、作成（取得）時期から法人文書ファイルにまとめられていた法人文書のうち、保存期間の満了する日が最も遅い時期までの期間を記載する。
- 4 「保存期間満了時期」欄は、法人文書ファイルにまとめられた法人文書のうち、保存期間の満了する日がもっとも遅いものの時期を記載する。
- 5 「保存場所」欄は、法人文書検索の目安となる程度に、事務室、書庫等の別を記載する。
- 6 「備考」欄は、適宜参考となる事項を記載することとする。例えば、法人文書ファイルの統合・分割、媒体変換の予定時期や、法人文書ファイルの中に未公表著作物がある場合の開示に関する著作者の意思表示の有無等、管理及び開示事務への対応を進めていく上で参考となる事項等が考えられる。

様式第 1 3 号  
 法人文書貸出票

法人文書貸出票			
主管部課	部・支所	課・科・室	
法人文書ファイル名	完結年度	分類番号	主管部課長
-----	-----	-----	文書管理 担当者
-----	-----	-----	
-----	-----	-----	
所属	部・支所 課・科・室	内線	貸出期間
氏名			平成 年 月 日 まで
貸出	平成 年 月 日	返還	平成 年 月 日
備考			

備考

用紙の大きさは、日本工業規格 A 4 とする。

様式第14号  
文書紛失届

		文書管理者	文書管理 担当者	主管部課長
<h1>文 書 紛 失 届</h1>				
平成 年 月 日				
主管部課長 殿				
所属部課				
氏 名				
印				
下記の文書を紛失しましたので、お届けいたします。				
文書記号番号		件 名		
分類番号		保存期間	年	
紛失理由				

備考

- 1 用紙の大きさは、日本工業規格A4とする。
- 2 分類番号及び保存期間は、紛失した文書の分類番号及び保存期間を記入し、紛失した文書に替えて保存する。

別表第1（第11条関係）  
法人文書保存期間基準

保存期間	法人文書の区分	該当する法人文書の類型
30年	1 法人の登記に関する文書	<ul style="list-style-type: none"> <li>・設立の登記</li> <li>・変更等の登記</li> <li>・不動産の登記</li> </ul>
	2 業務方法書に関する文書	<ul style="list-style-type: none"> <li>・業務方法書の作成・認可・変更の決裁文書</li> </ul>
	3 中期目標に関する文書	<ul style="list-style-type: none"> <li>・中期目標に関する指示文書</li> </ul>
	4 中期計画に関する文書	<ul style="list-style-type: none"> <li>・中期計画の作成・認可・変更の決裁文書</li> </ul>
	5 法人の評価に関する文書	
	6 法人を当事者とする訴訟の判決書	<ul style="list-style-type: none"> <li>・判決書（正本）</li> </ul>
	7 決裁文書の管理を行うための帳簿	<ul style="list-style-type: none"> <li>・文書原簿</li> </ul>
	8 法第23条第2項に規定する帳簿	<ul style="list-style-type: none"> <li>・法人文書ファイル管理簿</li> </ul>
	9 公印の作成、改刻又は廃止を行うための決裁文書	
	10 内部規程の制定又は改廃に関する文書	
	11 人事に関する文書	<ul style="list-style-type: none"> <li>・任免</li> <li>・昇級、昇格</li> <li>・人事記録及びその他附属書類</li> <li>・組織・定員</li> <li>・分限及び懲戒</li> <li>・給与の決定</li> <li>・国際機関等への派遣</li> </ul>
	12 公務災害等に関する文書	<ul style="list-style-type: none"> <li>・公務、通勤災害の認定</li> <li>・補償額の決定、支出</li> </ul>
	13 決算、経理に関する文書	<ul style="list-style-type: none"> <li>・財務諸表、決算報告書</li> <li>・総勘定元帳</li> <li>・出資金</li> </ul>
	14 法令等に基づく許可申請、届け出及び変更等に関する文書で重要なもの	<ul style="list-style-type: none"> <li>・消防設備、電気設備、建築関係の届出</li> <li>・原子力利用許可申請等の届出</li> </ul>
	15 知的所有権に関する文書	<ul style="list-style-type: none"> <li>・特許権等の管理及び実施許諾</li> </ul>

別表第1（第11条関係）

保存期間	法人文書の区分	該当する法人文書の類型
30年	16 国際共同研究及び技術協力に関する文書のうち重要なもの	<ul style="list-style-type: none"> <li>・共同研究機関等との覚書、交換公文</li> <li>・二国間協定</li> </ul>
	17 栄典又は表彰を行うための決裁文書	<ul style="list-style-type: none"> <li>・叙位、叙勲、褒章に関する文書</li> </ul>
	18 労務に関する文書のうち重要なもの	<ul style="list-style-type: none"> <li>・労働組合との協定・協約に関する文書</li> <li>・監督官庁への届出等に関する文書</li> </ul>
	19 資産管理に関する文書のうち重要なもの	<ul style="list-style-type: none"> <li>・固定資産の出資及び引継等に関する文書</li> <li>・不動産台帳</li> <li>・固定資産台帳</li> </ul>
	20 1から19までに掲げるもののほか、理事長がこれらの法人文書と同程度の保存期間が必要であると認めたもの	<ul style="list-style-type: none"> <li>・契約に関する文書でその契約期間が特に長期にわたるもの</li> </ul>
10年	1 年度計画に関する文書	<ul style="list-style-type: none"> <li>・年度計画の作成・届出・変更の決裁文書</li> </ul>
	2 監査及び検査等に関する文書	<ul style="list-style-type: none"> <li>・監事監査</li> <li>・会計検査院の検査</li> <li>・会計監査法人の監査</li> </ul>
	3 法令の解釈又は運用についての通達、照会又は回答に関する文書	
	4 原子力利用に関する文書	<ul style="list-style-type: none"> <li>・国際規制物質</li> <li>・アイソトープ利用</li> </ul>
	5 資産管理に関する文書	<ul style="list-style-type: none"> <li>・不動産の取得及び処分（重要なものを除く。）</li> <li>・不動産の種目変更・移築及び改築</li> </ul>
	6 取引銀行の指定等に関する文書	
	7 労務に関する文書	<ul style="list-style-type: none"> <li>・団体交渉、労使懇談会等に関する文書</li> </ul>
	8 会計に関する文書で、法令等により保存期間が定められている文書	<ul style="list-style-type: none"> <li>・計算証明書類</li> <li>・月次決算、年度末決算</li> <li>・消費税簿</li> <li>・預金出納簿</li> <li>・銀行勘定簿</li> </ul>

別表第1（第11条関係）

保存期間	法人文書の区分	該当する法人文書の類型
10年	9 1から8までに掲げるもののほか、理事長がこれらの法人文書と同程度の保存期間が必要であると認めるもの（30年保存に該当するものを除く。）	<ul style="list-style-type: none"> <li>・組換えDNA、組換え体に関する文書</li> </ul>
5年	1 法令又は規程等に関する通知等文書	
	2 国際共同研究及び技術協力に関する文書	<ul style="list-style-type: none"> <li>・外国からの研究者の招へい、受入</li> </ul>
	3 諸会議等の開催に関する文書で重要なもの	<ul style="list-style-type: none"> <li>・独立行政法人代表者会議</li> <li>・運営評価会議</li> <li>・試験研究推進会議</li> <li>・国際プロジェクト会議</li> <li>・成果検討会</li> <li>・顧問会議</li> <li>・総務部長会議</li> </ul>
	4 人事に関する文書	<ul style="list-style-type: none"> <li>・人事異動情報</li> <li>・各審査委員会等に関する文書</li> <li>・級別定数改定</li> <li>・非常勤職員の雇用等に関する文書</li> </ul>
	5 人件費等に関する文書	<ul style="list-style-type: none"> <li>・諸手当に関する文書（当該認定に係る要件を具備しなくなってから5年）</li> <li>・退職手当に関する文書</li> </ul>
	6 服務に関する文書	<ul style="list-style-type: none"> <li>・営利企業への就職に関する文書</li> <li>・委嘱又は応嘱に関する文書</li> <li>・兼業の許可に関する文書</li> <li>・専従許可に関する文書</li> </ul>
	7 研究員の受入に関する文書	<ul style="list-style-type: none"> <li>・科学技術特別研究員</li> <li>・客員研究員</li> <li>・講習生</li> </ul>
	8 倫理に関する文書	<ul style="list-style-type: none"> <li>・贈与等報告書</li> </ul>
	9 検査・監督に関する文書	<ul style="list-style-type: none"> <li>・工事、請負及び買入等の検査、監督に関する文書</li> </ul>
	10 予算要求、配分及び執行管理を行うための文書	
	11 取得した文書の管理を行うための	<ul style="list-style-type: none"> <li>・廃棄目録</li> </ul>

別表第1（第11条関係）

保存期間	法人文書の区分	該当する法人文書の類型
5年	帳簿又は文書の廃棄若しくは移管の状況が記録された帳簿等	<ul style="list-style-type: none"> <li>・ 移管目録</li> </ul>
	12 1から11までに掲げるもののほか、理事長がこれらの法人文書と同程度の保存期間が必要であると認めるもの（30年保存又は10年保存に該当するものを除く。）	<ul style="list-style-type: none"> <li>・ 業績評価に関する文書</li> <li>・ 研究業務の報告に関する文書（通則法に基づくもの以外）</li> <li>・ 出勤簿、超過勤務命令簿</li> <li>・ 共済組合貸付金台帳、共済組合組合員証整理簿、長期給付に関する文書、健康診断個人票、財産形成貯蓄等台帳</li> <li>・ 共同研究、受託研究、委託研究</li> <li>・ 銀行等との約定等</li> <li>・ 資金の管理運用</li> <li>・ 衛生管理に係る事項の監督官庁への届出</li> <li>・ 有資格者名簿</li> </ul>
3年	1 定型的な事務に係る意思決定を行うための決裁文書（1年保存に該当するものを除く。）	<ul style="list-style-type: none"> <li>・ 通知、照会、回答、依頼及び報告等</li> <li>・ 情報システムに関する文書</li> <li>・ ほ場管理等業務の運営に関する文書</li> <li>・ 各種委員会に関する文書</li> <li>・ 図書管理、刊行に関する文書</li> <li>・ 勤務評定に関する文書</li> <li>・ 研修に関する文書</li> <li>・ 共済組合に関する文書</li> <li>・ 公務員宿舎に関する文書</li> <li>・ 健康管理に関する文書</li> <li>・ 衛生管理に関する文書</li> <li>・ 社会保険、雇用保険等に関する文書</li> <li>・ 財産形成貯蓄に関する文書</li> <li>・ 建物等の管理運営等に関する文書</li> <li>・ 特定調達、契約競争参加資格審査に関する文書</li> </ul>
	2 調査又は研究の結果が記録されたもの	<ul style="list-style-type: none"> <li>・ 中期計画に反映させるために実施した調査又は研究の結果報告書</li> </ul>
	3 3に掲げるもののほか、法人に係る方針の決定又は業務遂行上参考とした事項が記録されたもの	<ul style="list-style-type: none"> <li>・ 予算要求説明資料</li> <li>・ 業務上の参考としたデータ</li> <li>・ 法人運営上の懇談会の検討結果</li> </ul>
	4 職員の勤務の状況が記録されたもの	<ul style="list-style-type: none"> <li>・ 職員の出張に関する文書</li> </ul>
	5 1から4までに掲げるもののほか、理事長がこれらの法人文書と同程度	



別表第1（第11条関係）

保存期間	法人文書の区分	該当する法人文書の類型
5年	の保存期間が必要であると認めるもの（30年保存、10年保存又は5年保存に該当するものを除く。）	
1年	1 法人の軽易な事項に係る意思決定を行うための決裁文書	<ul style="list-style-type: none"> <li>・ 受領証明書（図書）</li> <li>・ 各種証明書の発行</li> <li>・ 会議開催通知書</li> <li>・ 講師依頼書</li> <li>・ 資料送付書</li> <li>・ 式辞、祝辞</li> </ul>
	2 通知、照会等に関する文書	
	3 所定の手続により作成又は取得することとされているもの	<ul style="list-style-type: none"> <li>・ 物品請求書等</li> </ul>
	4 1から3までに掲げるもののほか、理事長がこれらの文書と同程度の保存期間が必要であると認めるもの所管行政に係る確認を行うための決裁文書（30年保存、10年保存、5年保存又は3年保存に該当するものを除く。）	
事務処理上必要な1年未満の期間	その他の法人文書	<ul style="list-style-type: none"> <li>・ 週間、月間予定表</li> <li>・ 随時発生し、短期に廃棄するもの</li> <li>・ 1年以上の保存を要しないもの</li> </ul>

- （注）1 上記の保存期間は、最低保存期間の基準であり、必要に応じて延長することを妨げるものではない。
- 2 法律及びこれに基づく命令の規定により、文書の保存期間について特別の定めが設けられている場合にあつては、当該事項については、当該法律及びこれに基づく命令の定めるところによるものとする。

## 別表第2（第32条関係）

## 委任事項

事項 番号	主 管 部 課	委 任 事 項	委 任 者	合 議 者	備 考
1	企 画 調 整 部	試験研究施設等の一般見学者の受入れに 関すること。	企画調整 部 長	総務部長 関係部長	
2	同 上	受託研究、共同研究、受託調査等の実施 報告に関すること。	同 上	同 上	
3	同 上	科学技術特別研究員制度に係る実施報告 書に関すること。	同 上	同 上	
4	同 上	重点支援協力員制度に係る実施報告書に 関すること。	同 上	同 上	
5	同 上	農林水産研究計算センター利用承認に関 すること。	同 上	同 上	
6	同 上	依頼分析・鑑定の結果書発行に関すること。 。	同 上	総務部長	
7	総 務 部 庶 務 課	職員に対する各種証明書の発行に関する こと(特に重要なものを除く。)	総務部長		
8	同 上	依頼研究員その他国際農林水産業研究セ ンターにおいて研修を受ける者に対する 各種証明書の発行に関すること。	同 上		
9	同 上	職員録等の原稿提出に関すること。	同 上		
10	同 上	人事院規則8-13第3条の規定による 職員の任用結果の通知に関すること。	同 上		
11	同 上	国家公務員等共済組合法施行規則（昭和 33年大蔵省令第54号。以下この表に おいて「共済組合法施行規則」という。） 第87条の2第1項若しくは第3項の規 定により長期組合員が提出すべき前歴報 告書又は同規則に定める長期組合員若し くはその者の遺族が提出すべき長期給付 に関する請求書等に添付する同規則別紙 様式第33号の3による履歴書の証明に 関すること。	同 上		

別表第2（第32条関係）

事項 番号	主 管 部 課	委 任 事 項	委 任 者	合 議 者	備 考
12	総務部 庶務課	共済組合法施行規則第88条、第90条第1項、第91条第1項及び第3項、第93条並びに第95条第1項及び第3項の規定による組合員からの申告、申請及び返納の処理に関すること。	総務部長		農林水産省共済組合運営規則第8条、第9条及び第10条
13	同 上	共済組合法施行規則第99条から第113条の2までの規定による短期給付の請求の処理に関すること。	同 上		農林水産省共済組合運営規則第17条及び第18条
14	同 上	共済組合法施行規則第114条から第114条の37までの規定による長期給付の請求の処理に関すること。	同 上		農林水産省共済組合運営規則第22条
15	同 上	農林水産省共済組合運営規則第8条の規定による組合員の異動報告に関すること。	同 上		
16	同 上	農林水産省共済組合運営規則第47条第1項の規定による組合員等月例報告及び会計別標準報酬月額等報告に関すること。	同 上		
17	同 上	農林水産省共済組合貸付規程第9条の規定による貸付に関すること。	同 上		
18	同 上	健康保険法施行規則（大正15年内務省令第36号）第3条及び第4条の規定による報酬月額の届出及び標準報酬改定に該当する場合の届出に関すること。	同 上		
19	同 上	健康保険法施行規則第10条の2及び第10条の3の規定による被保険者資格の取得又は被保険者資格の喪失の届出に関すること。	同 上		
20	同 上	厚生年金保険法施行規則（昭和29年厚生省令第37号）第15条及び第22条の規定による被保険者資格の取得又は被保険者資格の喪失の届出に関すること。	同 上 同 上		

別表第2（第32条関係）

事項 番号	主 管 部 課	委 任 事 項	委 任 者	合 議 者	備 考
2 1	総 務 部 庶 務 課	厚生年金保険法施行規則第18条及び第19条の規定による報酬月額及び報酬月額変更の届出に関する事。	総務部長		
2 2	同 上	雇用保険法施行規則（昭和50年労働省令第3号）第6条及び第7条による被保険者となったことの届出及び被保険者でなくなったことの届出に関する事。	同 上		
2 3	同 上	レクリエーション実施に関する事。	同 上		
2 4	同 上	農林水産省共済組合財形持家融資規程第8条の規定による貸付に関する事。	同 上		
2 5	同 上	勤労者財産形成貯蓄等実施要領（13国研セ第4-60号）第4の規定による手続きに関する事。	同 上		
2 6	同 上	非常勤職員の雇用に関する事。	同 上		
2 7	企 画 調整部 各 部	職員の出張（当該職員の代理として出張した場合及び重要会議の出席に係るものを除く。）の復命に関する事。	同 上		
2 8	同 上	陳情文書、照会文書、報告書その他これらに関する文書（会計機関が発行するものを除く。）でその内容が軽微なものの処理に関する事。	同 上		

別表第3（第35条関係）

代 決 者

決 裁 者	代 決 者
理 事 長	理 事 (理事が不在の場合は監事)
企画調整部長	研究企画科長
総 務 部 長	庶 務 課 長
支 所 長	庶 務 課 長 上席研究官

様式第5号  
起案用紙(甲) 起案例

文書番号	平成	年	国研セ	第	-	号	分類番号	-
接受	平成	年	月	日	文書管理 担当者印	照合者印	保存期間	年
登録	平成	年	月	日			委任事項番号	
起案	平成	年	月	日	記 事			
決裁	平成	年	月	日				
施行	平成	年	月	日				
完結	平成	年	月	日				
件 名 について								
理事長								
理事								
部長								
総務部長								
課長				課長補佐				
係長								
課長				課長補佐				
係長								
伺 い								
よろしいか。								
担当係			起案者			内線		
係								

国際農林水産業研究センター起案用紙(甲)



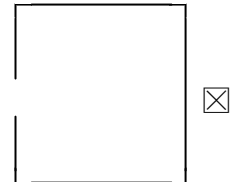
# 【施行文書例】

「☒」は、1文字あきを示す。

14国研セ第 - 号☒☒  
平成14年 月 日☒☒

☒ 殿又は様  
【団体名・役職名・氏名の順】

独立行政法人  
国際農林水産業研究センター理事長



☒☒☒ 件名 ☒☒  
☒☒☒ について（依頼、報告、回答等）

☒ 本文 、 、  
☒ なお、 。

記

- 1 ☒
- ☒
- 2 ☒
- ☒(1)☒
- ☒(2)☒
- ☒☒ア☒
- ☒☒イ☒

原則として漢数字は用いない。



様式第 1 号

1 文書原簿

文書番号	登録年月日	受付年月日	差出人 (発議)	受付文書 番号	件名	主管課	処理経過	記事	完結	分類番号	保存期間 (年)

備考 用紙の大きさは、日本工業規格 A 4 とする。

2 文書補助簿

文書番号		文書番号	
差出人(発議)	受付月日	差出人(発議)	受付月日

備考 用紙の大きさは、日本工業規格 A 4 とする。

様式第2号  
 法人文書分類基準表

分類番号	文 書 分 類			標準法人文書ファイル名	保存 期間 (年)	備 考
	大分類	中分類	小分類			

備考 用紙の大きさは、日本工業規格A4とする。

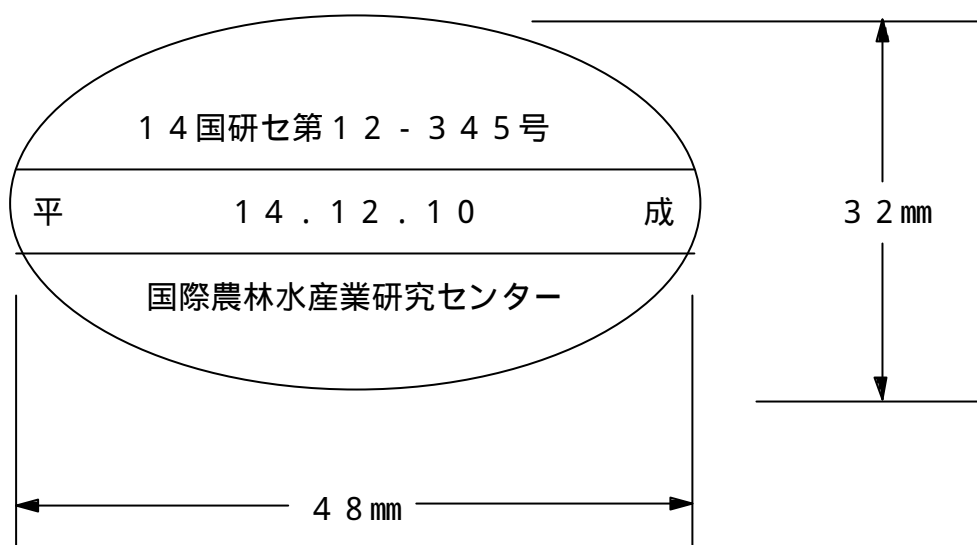
様式第3号  
 接受印



備考

- 1 受付印の直径は30mmとする。
- 2 支所にあつては「国際農林水産業研究センター」の下に「沖縄支所」と表示すること。

様式第4号  
文書番号表示印



備考

- 1 支所にあつては、上段の「国研セ」を「国研セ沖」に、下段の「国際農林水産業研究センター」の下に「沖縄支所」と表示する。
- 2 「平」と「成」との間には、法人文書の登録年月日を入れる。





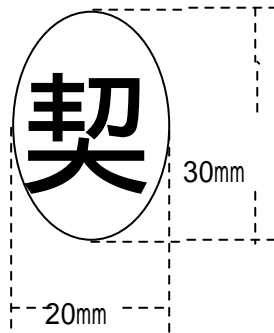
様式第7号

			起案者		
決裁	平成	年 月 日	文書管理 担当者	分類番号	完 結
起案	平成	年 月 日		保存期間	
記事					

備考 上覧には決裁者名を入れること。

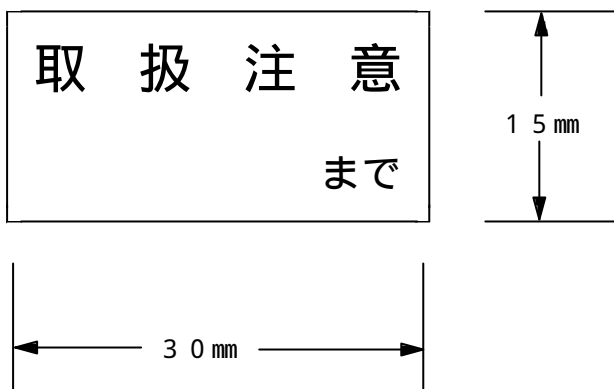
様式第8号

契印



様式第9号

取扱注意文書表示印



様式第10号  
保存簿用紙

部・支所				課・科・室		書架番号
完結 平成	年度	廃棄 平成	年度	保存期間 年	分類番号	分冊番号
法人文書ファイル名						
綴り 順序	文書番号 完結月日	件名				備考
	第 号	-----				
	年 月 日					
	第 号	-----				
	年 月 日					
	第 号	-----				
	年 月 日					
	第 号	-----				
	年 月 日					
	第 号	-----				
	年 月 日					
	第 号	-----				
	年 月 日					
	第 号	-----				
	年 月 日					
	第 号	-----				
	年 月 日					
	第 号	-----				
	年 月 日					

備考 用紙の大きさは、日本工業規格A4とする。



様式第 1 1 号

分類番号
法人文書ファイル名
作成者
管理担当課・係
作成（取得）時期
保存期間
年
保存期間満了時期
分冊番号
書架番号

230mm

13 ~ 30mm

The diagram shows a vertical rectangular form with a height of 230mm and a width of 13 to 30mm. The form is divided into 15 horizontal sections. The sections are labeled as follows from top to bottom: 1. 分類番号 (Classification Number), 2. (empty), 3. 法人文書ファイル名 (Corporate Document File Name), 4. (empty), 5. (empty), 6. 作成者 (Creator), 7. (empty), 8. 管理担当課・係 (Management Department/Division), 9. (empty), 10. 作成（取得）時期 (Creation/Acquisition Date), 11. (empty), 12. 保存期間 (Retention Period), 13. 年 (Year), 14. 保存期間満了時期 (Retention Period Expiry Date), 15. (empty), 16. 分冊番号 (Volume Number), 17. (empty), 18. 書架番号 (Shelf Number), 19. (empty). A vertical dimension line on the right indicates the total height of 230mm. A horizontal dimension line at the bottom indicates the width of 13 to 30mm.

様式第12号

法人文書ファイル管理簿

文書分類			法人文書ファイル名	作成者	作成 (取得) 時期	保存期間	保存期間 満了時期	媒体の種類別	保存場所	管理担当課・係	保存期間 満了時の 措置結果	備 考	
大分類	中分類	小分類											

備考

- 1 「作成者」欄は、課・係単位で記載し、取得したものであるときは例えば「申請者」、「届出者」等と記載する。作成者が多数の場合は、代表者と考えられる者を適宜記載する。
- 2 「作成（取得）時期」欄は、法人文書ファイルにまとめられた法人文書のうち、作成（取得）された時期が古いものの時期（暦年、年度、年月日等）を記載する。
- 3 「保存期間」欄は、作成（取得）時期から法人文書ファイルにまとめられていた法人文書のうち、保存期間の満了する日が最も遅い時期までの期間を記載する。
- 4 「保存期間満了時期」欄は、法人文書ファイルにまとめられた法人文書のうち、保存期間の満了する日がもっとも遅いものの時期を記載する。
- 5 「保存場所」欄は、法人文書検索の目安となる程度に、事務室、書庫等の別を記載する。
- 6 「備考」欄は、適宜参考となる事項を記載することとする。例えば、法人文書ファイルの統合・分割、媒体変換の予定時期や、法人文書ファイルの中に未公表著作物がある場合の開示に関する著作者の意思表示の有無等、管理及び開示事務への対応を進めていく上で参考となる事項等が考えられる。

様式第 1 3 号  
 法人文書貸出票

法人文書貸出票			
主管部課	部・支所	課・科・室	
法人文書ファイル名	完結年度	分類番号	主管部課長
-----	-----	-----	
-----	-----	-----	
-----	-----	-----	
-----	-----	-----	文書管理 担当者
-----	-----	-----	
-----	-----	-----	
所属	部・支所 課・科・室	内線	貸出期間
			平成 年
氏名			月 日 まで
貸出	平成 年 月 日	返還	平成 年 月 日
備考			

備考

用紙の大きさは、日本工業規格 A 4 とする。

様式第14号  
文書紛失届

		文書管理者	文書管理 担当者	主管部課長
<h2>文 書 紛 失 届</h2>				
平成 年 月 日				
主管部課長 殿				
所属部課				
氏 名				
印				
下記の文書を紛失しましたので、お届けいたします。				
文書記号番号		件 名		
分類番号		保存期間	年	
紛失理由				

備考

- 1 用紙の大きさは、日本工業規格A4とする。
- 2 分類番号及び保存期間は、紛失した文書の分類番号及び保存期間を記入し、紛失した文書に替えて保存する。

別表第1（第11条関係）  
法人文書保存期間基準

保存期間	法人文書の区分	該当する法人文書の類型
30年	1 法人の登記に関する文書	<ul style="list-style-type: none"> <li>・設立の登記</li> <li>・変更等の登記</li> <li>・不動産の登記</li> </ul>
	2 業務方法書に関する文書	<ul style="list-style-type: none"> <li>・業務方法書の作成・認可・変更の決裁文書</li> </ul>
	3 中期目標に関する文書	<ul style="list-style-type: none"> <li>・中期目標に関する指示文書</li> </ul>
	4 中期計画に関する文書	<ul style="list-style-type: none"> <li>・中期計画の作成・認可・変更の決裁文書</li> </ul>
	5 法人の評価に関する文書	
	6 法人を当事者とする訴訟の判決書	<ul style="list-style-type: none"> <li>・判決書（正本）</li> </ul>
	7 決裁文書の管理を行うための帳簿	<ul style="list-style-type: none"> <li>・文書原簿</li> </ul>
	8 法第23条第2項に規定する帳簿	<ul style="list-style-type: none"> <li>・法人文書ファイル管理簿</li> </ul>
	9 公印の作成、改刻又は廃止を行うための決裁文書	
	10 内部規程の制定又は改廃に関する文書	
	11 人事に関する文書	<ul style="list-style-type: none"> <li>・任免</li> <li>・昇級、昇格</li> <li>・人事記録及びその他附属書類</li> <li>・組織・定員</li> <li>・分限及び懲戒</li> <li>・給与の決定</li> <li>・国際機関等への派遣</li> </ul>
	12 公務災害等に関する文書	<ul style="list-style-type: none"> <li>・公務、通勤災害の認定</li> <li>・補償額の決定、支出</li> </ul>
	13 決算、経理に関する文書	<ul style="list-style-type: none"> <li>・財務諸表、決算報告書</li> <li>・総勘定元帳</li> <li>・出資金</li> </ul>
	14 法令等に基づく許可申請、届け出及び変更等に関する文書で重要なもの	<ul style="list-style-type: none"> <li>・消防設備、電気設備、建築関係の届出</li> <li>・原子力利用許可申請等の届出</li> </ul>
	15 知的所有権に関する文書	<ul style="list-style-type: none"> <li>・特許権等の管理及び実施許諾</li> </ul>

別表第1（第11条関係）

保存期間	法人文書の区分	該当する法人文書の類型
30年	16 国際共同研究及び技術協力に関する文書のうち重要なもの	<ul style="list-style-type: none"> <li>・共同研究機関等との覚書、交換公文</li> <li>・二国間協定</li> </ul>
	17 栄典又は表彰を行うための決裁文書	<ul style="list-style-type: none"> <li>・叙位、叙勲、褒章に関する文書</li> </ul>
	18 労務に関する文書のうち重要なもの	<ul style="list-style-type: none"> <li>・労働組合との協定・協約に関する文書</li> <li>・監督官庁への届出等に関する文書</li> </ul>
	19 資産管理に関する文書のうち重要なもの	<ul style="list-style-type: none"> <li>・固定資産の出資及び引継等に関する文書</li> <li>・不動産台帳</li> <li>・固定資産台帳</li> </ul>
	20 1から19までに掲げるもののほか、理事長がこれらの法人文書と同程度の保存期間が必要であると認めたもの	<ul style="list-style-type: none"> <li>・契約に関する文書でその契約期間が特に長期にわたるもの</li> </ul>
10年	1 年度計画に関する文書	<ul style="list-style-type: none"> <li>・年度計画の作成・届出・変更の決裁文書</li> </ul>
	2 監査及び検査等に関する文書	<ul style="list-style-type: none"> <li>・監事監査</li> <li>・会計検査院の検査</li> <li>・会計監査法人の監査</li> </ul>
	3 法令の解釈又は運用についての通達、照会又は回答に関する文書	
	4 原子力利用に関する文書	<ul style="list-style-type: none"> <li>・国際規制物質</li> <li>・アイソトープ利用</li> </ul>
	5 資産管理に関する文書	<ul style="list-style-type: none"> <li>・不動産の取得及び処分（重要なものを除く。）</li> <li>・不動産の種目変更・移築及び改築</li> </ul>
	6 取引銀行の指定等に関する文書	
	7 労務に関する文書	<ul style="list-style-type: none"> <li>・団体交渉、労使懇談会等に関する文書</li> </ul>
	8 会計に関する文書で、法令等により保存期間が定められている文書	<ul style="list-style-type: none"> <li>・計算証明書類</li> <li>・月次決算、年度末決算</li> <li>・消費税簿</li> <li>・預金出納簿</li> <li>・銀行勘定簿</li> </ul>

別表第1（第11条関係）

保存期間	法人文書の区分	該当する法人文書の類型
10年	9 1から8までに掲げるもののほか、理事長がこれらの法人文書と同程度の保存期間が必要であると認めるもの（30年保存に該当するものを除く。）	<ul style="list-style-type: none"> <li>・組換えDNA、組換え体に関する文書</li> </ul>
5年	1 法令又は規程等に関する通知等文書	
	2 国際共同研究及び技術協力に関する文書	<ul style="list-style-type: none"> <li>・外国からの研究者の招へい、受入</li> </ul>
	3 諸会議等の開催に関する文書で重要なもの	<ul style="list-style-type: none"> <li>・独立行政法人代表者会議</li> <li>・運営評価会議</li> <li>・試験研究推進会議</li> <li>・国際プロジェクト会議</li> <li>・成果検討会</li> <li>・顧問会議</li> <li>・総務部長会議</li> </ul>
	4 人事に関する文書	<ul style="list-style-type: none"> <li>・人事異動情報</li> <li>・各審査委員会等に関する文書</li> <li>・級別定数改定</li> <li>・非常勤職員の雇用等に関する文書</li> </ul>
	5 人件費等に関する文書	<ul style="list-style-type: none"> <li>・諸手当に関する文書（当該認定に係る要件を具備しなくなってから5年）</li> <li>・退職手当に関する文書</li> </ul>
	6 服務に関する文書	<ul style="list-style-type: none"> <li>・営利企業への就職に関する文書</li> <li>・委嘱又は応嘱に関する文書</li> <li>・兼業の許可に関する文書</li> <li>・専従許可に関する文書</li> </ul>
	7 研究員の受入に関する文書	<ul style="list-style-type: none"> <li>・科学技術特別研究員</li> <li>・客員研究員</li> <li>・講習生</li> </ul>
	8 倫理に関する文書	<ul style="list-style-type: none"> <li>・贈与等報告書</li> </ul>
	9 検査・監督に関する文書	<ul style="list-style-type: none"> <li>・工事、請負及び買入等の検査、監督に関する文書</li> </ul>
	10 予算要求、配分及び執行管理を行うための文書	
	11 取得した文書の管理を行うための	<ul style="list-style-type: none"> <li>・廃棄目録</li> </ul>

別表第1（第11条関係）

保存期間	法人文書の区分	該当する法人文書の類型
5年	帳簿又は文書の廃棄若しくは移管の状況が記録された帳簿等	<ul style="list-style-type: none"> <li>・ 移管目録</li> </ul>
	12 1から11までに掲げるもののほか、理事長がこれらの法人文書と同程度の保存期間が必要であると認めるもの（30年保存又は10年保存に該当するものを除く。）	<ul style="list-style-type: none"> <li>・ 業績評価に関する文書</li> <li>・ 研究業務の報告に関する文書（通則法に基づくもの以外）</li> <li>・ 出勤簿、超過勤務命令簿</li> <li>・ 共済組合貸付金台帳、共済組合組合員証整理簿、長期給付に関する文書、健康診断個人票、財産形成貯蓄等台帳</li> <li>・ 共同研究、受託研究、委託研究</li> <li>・ 銀行等との約定等</li> <li>・ 資金の管理運用</li> <li>・ 衛生管理に係る事項の監督官庁への届出</li> <li>・ 有資格者名簿</li> </ul>
3年	1 定型的な事務に係る意思決定を行うための決裁文書（1年保存に該当するものを除く。）	<ul style="list-style-type: none"> <li>・ 通知、照会、回答、依頼及び報告等</li> <li>・ 情報システムに関する文書</li> <li>・ ほ場管理等業務の運営に関する文書</li> <li>・ 各種委員会に関する文書</li> <li>・ 図書管理、刊行に関する文書</li> <li>・ 勤務評定に関する文書</li> <li>・ 研修に関する文書</li> <li>・ 共済組合に関する文書</li> <li>・ 公務員宿舎に関する文書</li> <li>・ 健康管理に関する文書</li> <li>・ 衛生管理に関する文書</li> <li>・ 社会保険、雇用保険等に関する文書</li> <li>・ 財産形成貯蓄に関する文書</li> <li>・ 建物等の管理運営等に関する文書</li> <li>・ 特定調達、契約競争参加資格審査に関する文書</li> </ul>
	2 調査又は研究の結果が記録されたもの	<ul style="list-style-type: none"> <li>・ 中期計画に反映させるために実施した調査又は研究の結果報告書</li> </ul>
	3 3に掲げるもののほか、法人に係る方針の決定又は業務遂行上参考とした事項が記録されたもの	<ul style="list-style-type: none"> <li>・ 予算要求説明資料</li> <li>・ 業務上の参考としたデータ</li> <li>・ 法人運営上の懇談会の検討結果</li> </ul>
	4 職員の勤務の状況が記録されたもの	<ul style="list-style-type: none"> <li>・ 職員の出張に関する文書</li> </ul>
	5 1から4までに掲げるもののほか、理事長がこれらの法人文書と同程度	



別表第1（第11条関係）

保存期間	法人文書の区分	該当する法人文書の類型
5年	の保存期間が必要であると認めるもの（30年保存、10年保存又は5年保存に該当するものを除く。）	
1年	1 法人の軽易な事項に係る意思決定を行うための決裁文書	<ul style="list-style-type: none"> <li>・ 受領証明書（図書）</li> <li>・ 各種証明書の発行</li> <li>・ 会議開催通知書</li> <li>・ 講師依頼書</li> <li>・ 資料送付書</li> <li>・ 式辞、祝辞</li> </ul>
	2 通知、照会等に関する文書	
	3 所定の手続により作成又は取得することとされているもの	<ul style="list-style-type: none"> <li>・ 物品請求書等</li> </ul>
	4 1から3までに掲げるもののほか、理事長がこれらの文書と同程度の保存期間が必要であると認めるもの所管行政に係る確認を行うための決裁文書（30年保存、10年保存、5年保存又は3年保存に該当するものを除く。）	
事務処理上必要な1年未満の期間	その他の法人文書	<ul style="list-style-type: none"> <li>・ 週間、月間予定表</li> <li>・ 随時発生し、短期に廃棄するもの</li> <li>・ 1年以上の保存を要しないもの</li> </ul>

- （注）1 上記の保存期間は、最低保存期間の基準であり、必要に応じて延長することを妨げるものではない。
- 2 法律及びこれに基づく命令の規定により、文書の保存期間について特別の定めが設けられている場合にあつては、当該事項については、当該法律及びこれに基づく命令の定めるところによるものとする。

## 別表第2（第32条関係）

## 委任事項

事項 番号	主管 部 課	委任事項	委任者	合議者	備 考
1	企画 調整部	試験研究施設等の一般見学者の受入れに 関すること。	企画調整 部 長	総務部長 関係部長	
2	同 上	受託研究、共同研究、受託調査等の実施 報告に関すること。	同 上	同 上	
3	同 上	科学技術特別研究員制度に係る実施報告 書に関すること。	同 上	同 上	
4	同 上	重点支援協力員制度に係る実施報告書に 関すること。	同 上	同 上	
5	同 上	農林水産研究計算センター利用承認に関 すること。	同 上	同 上	
6	同 上	依頼分析・鑑定の結果書発行に関すること。 。	同 上	総務部長	
7	総務部 庶務課	職員に対する各種証明書の発行に関する こと(特に重要なものを除く。)	総務部長		
8	同 上	依頼研究員その他国際農林水産業研究セ ンターにおいて研修を受ける者に対する 各種証明書の発行に関すること。	同 上		
9	同 上	職員録等の原稿提出に関すること。	同 上		
10	同 上	人事院規則8-13第3条の規定による 職員の任用結果の通知に関すること。	同 上		
11	同 上	国家公務員等共済組合法施行規則（昭和 33年大蔵省令第54号。以下この表に おいて「共済組合法施行規則」という。） 第87条の2第1項若しくは第3項の規 定により長期組合員が提出すべき前歴報 告書又は同規則に定める長期組合員若し くはその者の遺族が提出すべき長期給付 に関する請求書等に添付する同規則別紙 様式第33号の3による履歴書の証明に 関すること。	同 上		

別表第2（第32条関係）

事項 番号	主 管 部 課	委 任 事 項	委 任 者	合 議 者	備 考
12	総務部 庶務課	共済組合法施行規則第88条、第90条第1項、第91条第1項及び第3項、第93条並びに第95条第1項及び第3項の規定による組合員からの申告、申請及び返納の処理に関すること。	総務部長		農林水産省共済組合運営規則第8条、第9条及び第10条
13	同 上	共済組合法施行規則第99条から第113条の2までの規定による短期給付の請求の処理に関すること。	同 上		農林水産省共済組合運営規則第17条及び第18条
14	同 上	共済組合法施行規則第114条から第114条の37までの規定による長期給付の請求の処理に関すること。	同 上		農林水産省共済組合運営規則第22条
15	同 上	農林水産省共済組合運営規則第8条の規定による組合員の異動報告に関すること。	同 上		
16	同 上	農林水産省共済組合運営規則第47条第1項の規定による組合員等月例報告及び会計別標準報酬月額等報告に関すること。	同 上		
17	同 上	農林水産省共済組合貸付規程第9条の規定による貸付に関すること。	同 上		
18	同 上	健康保険法施行規則（大正15年内務省令第36号）第3条及び第4条の規定による報酬月額の届出及び標準報酬改定に該当する場合の届出に関すること。	同 上		
19	同 上	健康保険法施行規則第10条の2及び第10条の3の規定による被保険者資格の取得又は被保険者資格の喪失の届出に関すること。	同 上		
20	同 上	厚生年金保険法施行規則（昭和29年厚生省令第37号）第15条及び第22条の規定による被保険者資格の取得又は被保険者資格の喪失の届出に関すること。	同 上 同 上		

別表第2（第32条関係）

事項 番号	主 管 部 課	委 任 事 項	委 任 者	合 議 者	備 考
2 1	総 務 部 庶 務 課	厚生年金保険法施行規則第18条及び第19条の規定による報酬月額及び報酬月額変更の届出に関する事。	総務部長		
2 2	同 上	雇用保険法施行規則（昭和50年労働省令第3号）第6条及び第7条による被保険者となったことの届出及び被保険者でなくなったことの届出に関する事。	同 上		
2 3	同 上	レクリエーション実施に関する事。	同 上		
2 4	同 上	農林水産省共済組合財形持家融資規程第8条の規定による貸付に関する事。	同 上		
2 5	同 上	勤労者財産形成貯蓄等実施要領（13国研セ第4-60号）第4の規定による手続きに関する事。	同 上		
2 6	同 上	非常勤職員の雇用に関する事。	同 上		
2 7	企 画 調整部 各 部	職員の出張（当該職員の代理として出張した場合及び重要会議の出席に係るものを除く。）の復命に関する事。	同 上		
2 8	同 上	陳情文書、照会文書、報告書その他これらに関する文書（会計機関が発行するものを除く。）でその内容が軽微なものの処理に関する事。	同 上		

別表第3（第35条関係）

代 決 者

決 裁 者	代 決 者
理 事 長	理 事 (理事が不在の場合は監事)
企画調整部長	研究企画科長
総 務 部 長	庶 務 課 長
支 所 長	庶 務 課 長 上席研究官

様式第5号  
起案用紙(甲) 起案例

文書番号	平成	年	国研セ	第	-	号	分類番号	-
接受	平成	年	月	日	文書管理 担当者印	照合者印	保存期間	年
登録	平成	年	月	日			委任事項番号	
起案	平成	年	月	日	記 事			
決裁	平成	年	月	日				
施行	平成	年	月	日				
完結	平成	年	月	日				
件 名 について								
理事長								
理事								
部長								
総務部長								
課長				課長補佐				
係長								
課長				課長補佐				
係長								
伺 い								
よろしいか。								
担当係			起案者			内線		
係								

国際農林水産業研究センター起案用紙(甲)



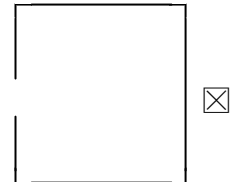
## 【施行文書例】

「☒」は、1文字あきを示す。

14国研セ第 - 号☒☒  
平成14年 月 日☒☒

☒ 殿又は様  
【団体名・役職名・氏名の順】

独立行政法人  
国際農林水産業研究センター理事長



☒☒☒ 件名 ☒☒  
☒☒☒ について（依頼、報告、回答等）

☒ 本文 、 、  
☒ なお、 。

記

1 ☒  
☒  
2 ☒  
☒(1)☒  
☒(2)☒  
☒☒ア☒  
☒☒イ☒

原則として漢数字は用いない。



# 独立行政法人国際農林水産業研究センターにおける情報公開に関する規程

14国研セ第9-120号  
平成14年9月20日

## 第1章 総則

### (趣旨)

第1条 独立行政法人国際農林水産業研究センター（以下「センター」という。）における情報公開については、独立行政法人等の保有する情報の公開に関する法律（平成13年法律第140号。以下「法」という。）に定めるもののほか、この規程に定めるところによる。

### (定義)

第2条 この規程において、次の各号に掲げる用語の意義は、当該各号に定めるところによる。

- (1) 法人文書 法第2条第2項に規定する文書をいう。
- (2) 本所 茨城県つくば市に所在するセンターをいう。
- (3) 支所 独立行政法人国際農林水産業研究センターの組織に関する規程（13国研セ第4-25号。以下「組織規程」という。）第49条に規定する沖縄支所をいう。
- (4) 主管部課 独立行政法人国際農林水産業研究センター法人文書管理規程（14国研セ第8-65号。以下「法人文書管理規程」という。）第2条第6号に規定する部課をいう。
- (5) 他の独立行政法人等 センター以外の法第2条第1項に規定する独立行政法人等をいう。
- (6) 行政機関 行政機関の保有する情報の公開に関する法律（平成11年法律第42号。以下「行政機関情報公開法」という。）第2条第1項に規定する行政機関をいう。
- (7) 第三者 法第14条第1項に規定する第三者をいう。

## 第2章 情報公開の事務分掌

### (情報公開窓口で行う事務)

第3条 本所に、センターにおける情報公開の窓口として情報公開窓口を置く。

- 2 情報公開窓口は、総務部庶務課とし、当該窓口においては次の各号に掲げる事務を行う。
  - (1) センターにおける情報公開に係る相談及び案内に関すること。
  - (2) センターにおける情報公開事務に係る総合的な連絡及び調整に関すること。
  - (3) センターにおける開示請求事案等の進行管理に関すること。
  - (4) センターにおける法の施行状況の取りまとめに関すること。
  - (5) 開示請求書の受付及び受理に関すること。
  - (6) 開示請求書の不備に係る補正の求めに関すること。
  - (7) 開示請求に係る法人文書を特定するための分掌窓口及び主管部課との連絡及び調整に関すること。
  - (8) 開示請求に係る主管部課の法人文書の検索及び特定に関すること。
  - (9) 開示請求に係る開示の実施方法等の申し出に係る書面及び更なる開示の申し出に係る書面の受付及び受理に関すること。
  - (10) 開示請求手数料又は開示実施手数料の徴収に関すること。
  - (11) 開示請求に係る文書の主管部課の法人文書に係る開示の実施に関すること。
  - (12) 法人文書の閲覧等を行う場所の提供に関すること。

( 1 3 ) 異議申立てに係る開示請求者への指導並びに異議申立てに係る連絡及び調整に関すること。

( 分掌窓口で行う事務 )

第 4 条 支所に、情報公開に係る事務を行う分掌窓口を置く。

2 分掌窓口は、支所の庶務課とし、分掌窓口においては、次の各号に掲げる事務を行う。

- ( 1 ) 情報公開に係る相談及び案内に関すること。
- ( 2 ) 開示請求書の受付及び受理に関すること。
- ( 3 ) 開示請求書の不備に係る補正の求めに関すること。
- ( 4 ) 開示請求に係る所管する主管部課の法人文書の検索及び特定に関すること。
- ( 5 ) 開示請求に係る開示の実施方法等の申し出に係る書面及び更なる開示の申し出に係る書面の受付及び受理に関すること。
- ( 6 ) 開示請求手数料又は開示実施手数料の徴収に関すること。
- ( 7 ) 所管する主管部課の法人文書に係る開示の実施に関すること。
- ( 8 ) 法人文書の閲覧等を行う場所の提供に関すること。
- ( 9 ) 異議申立てに係る開示請求者への指導等に関すること。

### 第 3 章 開示請求の受理等

( 相談及び案内 )

第 5 条 情報公開窓口及び分掌窓口(以下「受付窓口」という。)は、情報公開を求める者の相談に応ずるとともに、情報公開制度の内容及び手続等について適切に説明するものとする。

2 受付窓口は、情報公開を求める者が必要としている情報の内容を確認するとともに、当該情報が次の各号に掲げるものである場合には当該各号に定めるところにより当該者に案内するものとする。

- ( 1 ) 官報、白書、新聞、雑誌、書籍その他不特定多数の者に販売することを目的として発行されているものである場合 その旨
- ( 2 ) 独立行政法人国立公文書館等(法第 2 条第 2 項に定める政令で定める公文書館その他の施設をいう。)において歴史的若しくは文化的な資料又は学術研究用資料として特別の管理がされているものである場合 その旨及びその連絡先
- ( 3 ) 法第 2 2 条第 1 項の規定に基づき提供される情報で対処できる場合 その旨及び主管部課
- ( 4 ) 法第 2 2 条第 1 項の規定に基づき提供される情報で対処できない場合 その旨及び開示請求手続

3 主管部課は、前項第 3 号に規定する提供できる情報については、極力情報の提供を行うものとする。なお、この場合においては、開示請求手数料又は開示実施手数料は徴収しないものとする。

( 開示請求書の受付等 )

第 6 条 受付窓口における開示請求書の受付時間は、午前 9 時から正午まで及び午後 1 時から午後 4 時 3 0 分までとする。

2 開示請求書の様式は、別紙様式 1 のとおりとする。なお、別紙様式 1 によらないもので開示請求がなされた場合であって、当該開示請求の書面に記載された内容が次条に定める確認事項が確認できるものである場合には、有効な請求として受け付けるものとする。

( 開示請求書の記載事項の確認 )

第7条 受付窓口は、受け付けた開示請求書について、次の各号に掲げる事項を確認するものとする。

- (1) あて先が正しく記載されていること。
- (2) 開示請求をする者の氏名又は名称及び住所又は居所並びに法人その他の団体にあつては代表者の氏名及び連絡先が記載されていること。
- (3) 請求する法人文書の名称等欄は、開示請求の対象となる法人文書を特定し、主管部課が特定できる程度に具体的な記載であること。
- (4) 求める開示の実施の方法等欄の記載がある場合にあっては、次に掲げる事項を確認する。
  - ア センターにおける開示の実施又は写しの送付のいずれかであるかの選択の有無
  - イ センターにおける開示の実施を希望する場合にあっては、実施の方法及び実施を希望する日

(開示請求書の補正等)

第8条 受付窓口は、前条に定める確認の結果、開示請求書に不備があつた場合で、当該不備が必要事項の記載漏れ、不鮮明又は不明確な記載その他形式上の不備であるときには、開示請求をする者に対して、直ちにその箇所を訂正し、又は補正するよう求めるものとする。この場合において、受付窓口は開示請求をする者に対し、訂正又は補正の参考となる情報を提供するよう努めるものとする。

- 2 受付窓口は、前条に定める確認の結果、開示請求書に不備があつた場合で、当該不備があて先の記載に係るもののみであるときには、前項の規定にかかわらず、職権をもって当該不備を補正することができる。この場合において、受付窓口は、開示請求をする者に対して、その旨を通知するものとする。

(開示請求手数料)

第9条 開示請求をする者は、開示請求手数料として、開示請求に係る法人文書1件につき300円をセンターに納めなければならない。ただし、開示請求をする者が、次の各号のいずれかに該当する複数の法人文書の開示請求を一の開示請求書によつて行う場合は、当該複数の法人文書を1件の法人文書とみなす。

- (1) 一の法人文書ファイル(法人文書管理規程第51条第2項に規定するものをいう。)にまとめられた複数の法人文書
  - (2) 前号に掲げるもののほか、相互に密接な関連を有する複数の法人文書
- 2 開示請求をする者は、前項の開示請求手数料を納付する場合には、銀行振込、郵便為替又は現金で納付するものとし、原則として、次の各号に掲げるとおり手続きを取らなければならない。
    - (1) 銀行振込で納付する場合 振込の事実を証明できる書類の写しを開示請求書とともに郵送し、又は直接受付窓口を持参する。
    - (2) 郵便為替で納付する場合 郵便為替を開示請求書とともに郵送し、又は直接受付窓口を持参する。
    - (3) 現金で納付する場合 開示請求書とともに直接受付窓口を持参する。

- 3 受付窓口は、開示請求手数料が未納又は不足している場合には、開示請求をする者に対し、納付又は追納を求めるものとする。
- 4 開示請求者が開示請求手数料を納付後、6か月以上経過して開示請求を行わない場合は支払に要する費用を除き、開示請求者に開示請求手数料同等額を支払うものとする。

(開示請求書の受理)

第10条 受付窓口は、第7条に定める開示請求書の確認（第8条に定める訂正又は補正後の確認を含む。）及び開示請求手数料の納付の完了の確認を行った後は、当該開示請求書に別紙様式2の受付印を押印し受理するとともに、次の各号に定める処理を行うものとする。

- (1) 受理した開示請求書の写しを、直接又は郵送により開示請求者に交付するとともに、受付窓口で保管する。
- (2) 受付窓口が分掌窓口である場合にあっては、情報公開窓口当該受理した開示請求書の写しを送付する。
- (3) 情報公開窓口においては、センターにおける開示請求事案の進行管理のため、別紙様式3の法人文書開示請求等処理簿を備え、必要事項を記載する。

（開示請求があった日の取扱い）

第11条 法第10条第1項及び第11条に定める開示請求があった日は、前条の規定により受理した日とするものとする。

#### 第4章 開示決定等

（法人文書の特定及び情報の審査等）

第12条 情報公開窓口は、開示請求書（第10条第2号の規定により分掌窓口から送付を受けた開示請求書の写しを含む。）を受理した後、速やかに、開示請求に係る法人文書を検索し、及び特定するものとする。この場合において、情報公開窓口は、必要に応じて、当該検索及び特定を分掌窓口に行わせることができる。

2 理事長は、法人文書の特定後、直ちに、当該法人文書に記載された情報が法第5条各号に掲げる情報（以下「不開示情報」という。）又は第7条若しくは第8条に掲げる情報に該当するかについて、審査を行うものとする。なお、理事長は、不開示情報が記載されている場合にあっては、部分開示についての検討も併せて行うものとする。

（第三者に対する意見書提出の機会の付与等）

第13条 理事長は、前条第1項の規定により特定した法人文書に、第三者に関する情報（以下「第三者情報」という。）が記録されている場合のうち、当該第三者情報が個人に関する情報又は法人その他の団体（国、独立行政法人等及び地方公共団体を除く。）に関する情報ではあるが、人の生命若しくは健康等を保護するために開示することが必要であると認める場合又は不開示情報が記録されている法人文書ではあるが、開示することに特に公益上必要があると認められる場合には、開示決定等をするに当たって、当該第三者に対し、別紙様式4の意見照会書により通知して、意見を提出する機会を与えなければならない。ただし、第三者の所在が判明しない場合には、この限りでない。

第14条 理事長は、第12条第1項の規定により特定した法人文書に、第三者情報が記録されている場合のうち、前条に掲げる場合以外の場合には、開示決定等をするに当たって、必要に応じ、当該第三者に対し、別紙様式5の意見照会書により通知して、別紙様式第6の法人文書の開示に関する意見書により意見を提出する機会を与えることができる。ただし、第三者情報が不開示情報に該当すること又は不開示情報に該当しないことが明らかであるときは、この限りでない。

（開示決定等の通知）

第15条 理事長は、法第10条第2項又は法第11条に該当する場合を除き、法第10条第1項に定める期間（以下「開示決定等期間」という。）内のできるだけ早

い時期に開示決定をするよう努めるものとし、開示決定等をした場合には、速やかに、別紙様式7の法人文書開示決定通知書又は別紙様式8の法人文書不開示決定通知書により開示請求者に通知するものとする。なお、法人文書開示決定通知書を送付する場合にあっては、別紙様式9（開示請求者の求める開示の実施の方法等欄を記載している場合）にあっては、別紙様式10）の法人文書の開示の実施方法等申出書を併せて送付するものとする。

- 2 情報公開窓口は、分掌窓口が受理した開示請求書に係る開示決定等については、前項の通知書の写しを当該分掌窓口へ送付するものとする。

（開示決定等の期間を延長する場合の手続等）

第16条 理事長は、法第10条第2項の規定により事務処理上の困難その他の正当な理由から開示決定等の期間を延長する場合には、別紙様式11の開示決定等の期の延長通知書により開示決定期間内に開示請求者に通知するものとする。

- 2 前条各項の規定は、前項の規定により延長した期間内に行う開示決定等に係る通知等について準用する。

（大量請求による期限の特例を適用する場合の手続等）

第17条 理事長は、大量請求のため事務の遂行に著しい支障が生ずるおそれがあると認める理由から法第11条に規定する開示決定等の期間の特例を適用する場合には、別紙様式12の開示決定等の期限の特例規定の適用通知書により開示決定期間内に開示請求者に通知するものとする。この場合において、理事長は、開示請求のあった日から60日以内に相当部分について開示決定等を行い、開示の実施までの処理を行うものとする。

- 2 第15条各項の規定は、前項の規定により開示請求のあった日から60日以内に行う開示決定等及び残りの法人文書の開示決定等に係る通知等について準用する。

（第三者への開示決定の通知等）

第18条 理事長は、第13条又は第14条の規定により意見書の提出の機会を与えた第三者が反対意見書を提出した場合において開示決定をしたときは、直ちに当該第三者に対し、別紙様式13の法人文書の開示決定通知書により通知するものとする。

- 2 理事長は、第13条又は第14条の規定により意見書の提出の機会を与えた第三者が反対意見書を提出した場合において開示を実施するときは、開示決定をした日と開示を実施する日との間を少なくとも2週間を置かなければならない。

## 第5章 開示の実施等

（申出書の受理）

第19条 受付窓口は、開示請求者から法人文書の開示の実施方法等申出書又は第23条に定める法人文書の更なる開示の申出書（以下「申出書」という。）の提出があった場合には、法人文書管理規程第18条第1項に規定する接受印を押印し受理するものとする。

- 2 受付窓口が分掌窓口である場合にあっては、情報公開窓口へ当該受理した申出書の写しを送付するものとする。

（開示実施手数料）

第20条 開示請求者は、開示実施手数料として、開示を受ける法人文書1件につき、別表の左欄に掲げる法人文書の種別ごとに、同表の中欄に掲げる開示の実施の方法に応じ、それぞれ同表の右欄に定める額（複数の実施の方法により開示を受ける場合にあっては、その合計額。以下「基本額」という。）をセンターに納めなければ

ならない。ただし、基本額（第23条第1項の規定により更に開示を受ける場合にあっては、当該開示を受ける場合の基本額に、すでに開示を求めた際の基本額を加えた額）が300円に達するまでは無料とし、300円を超えるとき（同項の規定により更に開示を受ける場合であって、既に開示の実施を求めた際の基本額が300円を超えるときを除く。）は当該基本額から300円を減じた額とする。

- 2 開示請求者が、第9条第1項各号のいずれかに該当する複数の法人文書の開示請求を一の開示請求書によって行った場合で、かつ、当該複数である法人文書の開示を受ける場合における前項ただし書の規定の適用については、当該複数である法人文書に係る基本額に、先に開示の実施を求めた当該複数の法人文書である他の法人文書に係る基本額に順次加えた額を基本額とみなす。
- 3 開示請求者は、法人文書の写しの送付により開示を受ける場合には、前項の開示実施手数料のほか、送付に要する費用をセンターに納めなければならない。
- 4 開示請求者は、第1項の開示実施手数料及び前項の送付に要する費用（以下「開示実施手数料等」という。）を納付する場合には、銀行振込、郵便為替又は現金で納付するものとし、原則として、次の各号に掲げるとおり手続きを取らなければならない。
  - (1) 銀行振込で納付する場合 振込の事実を証明できる書類の写しを法人文書の開示の実施方法書等申出書とともに郵送し、又は直接受付窓口に持参する
  - (2) 郵便為替で納付する場合 郵便為替を法人文書の開示の実施方法書等申出書とともに郵送し、又は直接受付窓口に持参する
  - (3) 現金で納付する場合 法人文書の開示の実施方法書等申出書とともに直接受付窓口に持参する
- 5 受付窓口は、開示実施手数料等が未納又は不足している場合には、開示請求者に対し、納付又は追納を求めるものとする。

（開示実施手数料の免除）

- 第21条 理事長は、開示請求者が別紙様式14の開示実施手数料の減額（免除）申請書に次の各号のいずれかの書面を添付して申請した場合には、2,000円を限度として、開示実施手数料を減額し、又は免除することができる。なお、この場合において、理事長は、減額し、又は免除する場合にあっては法人文書開示決定通知書を再度送付するとともに、別紙様式15の開示実施手数料の減額（免除）決定通知書を併せて送付するものとし、減額せず、又は免除しない場合にあっては別紙様式16の開示実施手数料の減額（免除）非承認通知書を送付するものとする。
- (1) 生活保護法（昭和25年法律第144号）による扶助を受けている事実を証明する書面
  - (2) 同一の世帯に属する者のすべてが市町村民税が非課税である旨を明らかにできる書面
  - (3) らい予防法の廃止に関する法律（平成8年法律第28号）第6条による援護を受けていることを明らかにできる書面

（開示の実施）

- 第22条 情報公開窓口は、開示請求者から提出された法人文書の開示の実施方法等申出書による申し出のとおり開示の実施を行うものとする。ただし、法人文書の開示の実施方法等申出書による申し出が開示請求者が法人文書開示決定通知書を受け取った日から30日以内になされなかった場合（当該期間内に当該申し出をすることができないことにつき正当な理由があるときを除く。）は、開示の実施を行う必要はないものとする。
- 2 情報公開窓口は、分掌窓口の所管する主管部課に係る法人文書の開示の実施を当

該分掌窓口に行わせる場合には、法人文書開示決定通知書及び法人文書の開示の実施方法等申出書の写しを送付するものとする。ただし、分掌窓口で開示請求書を受理している場合又は法人文書の開示の実施方法等申出書を受理している場合には、当該通知書又は申出書の写しの送付は要しないものとする。

(更なる開示の実施)

- 第23条 情報公開窓口は、開示決定に基づき法人文書の開示を受けた者から、最初に開示を受けた日(写しの送付の方法による場合には、当該写しが開示請求者に到達した日)から30日以内に別紙様式17の法人文書の更なる開示の申出書によりさらに開示を受ける旨の申し出があった場合には、開示を実施しなければならない。
- 2 前条第2項の規定は、前項の更なる開示の実施を分掌窓口に行わせる場合について準用する。この場合において、前条第2項中「法人文書の開示の実施方法等申出書」とあるのは「法人文書の更なる開示の申出書」と読み替えるものとする。

(開示の立会い等)

- 第24条 情報公開窓口(第22条第2項又は前条第2項の規定により分掌窓口に行わせる場合にあっては、分掌窓口。第26条において同じ。)は、開示請求のあった法人文書の開示を実施する場合にあっては、当該法人文書の主管部課の職員(主管部課の職員の立会いが困難である場合にあっては、これに代わる職員)に次の各号に掲げる事務を行わせるものとする。

- (1) 開示の場所に、開示に係る法人文書又は交付する法人文書の写しを持参し、開示に立ち会うこと。
- (2) 開示請求者の求めに応じて必要な説明を行うこと。

(開示の方法)

- 第25条 法人文書の開示の方法は、次の各号に掲げるとおりとし、当該各号に定めるところにより行うものとする。

- (1) 文書等の閲覧 文書、図面及び写真は、原本を閲覧に供するものとする。ただし、次に掲げる場合には、その写しを閲覧に供するものとする。
- ア 原本を閲覧に供することにより、原本の保存に支障が生ずるおそれがあるとき。
- イ 日常業務に使用している帳票等を閲覧に供することにより、業務に支障が生ずるとき。
- ウ 法人文書の一部を開示する場合で、必要と認めるとき。
- エ その他正当な理由があるとき。
- (2) 電磁的記録の閲覧 記録された情報を通常の方法により印字装置を用いて紙に出力したものを閲覧に供するものとする。
- (3) 視聴 録音テープ又は録画テープ等は、再生機器等により視聴に供するものとする。
- (4) 写しの交付 主管部課において法人文書の写しを作成し、交付するものとする。

(部分開示の方法)

- 第26条 情報公開窓口は、法人文書の部分開示をする場合においては、次の各号に定めるところにより行うものとする。

- (1) 開示する部分は、有意の情報が記録されており、かつ、当該部分を開示することにより当該法人文書の理解に誤解を生じさせない範囲で、できる限り多く開示するものとする。
- (2) 開示部分と不開示部分が別の頁に記録されているときは、当該不開示部分が記録されている頁を取り外す、袋をかけるその他の方法により区分し、開示部分を

閲覧に供するものとする。

- (3) 開示部分と不開示部分が同一の頁に記録されているときは、当該法人文書全体を複写し、その複写したものの不開示部分を黒塗りし、それを再度複写するなどにより、不開示情報の判読が不可能となったものを閲覧に供するものとする。
- (4) 録音テープ及び録画テープ等の部分開示は、不開示部分のみを除去することが困難な場合は、容易に区分して除くことができる範囲で部分開示を行うものとする。

## 第6章 事案の移送等

(事案の移送の単位)

第27条 法第12条第1項又は法第13条第1項の規定により事案を移送する場合の移送の単位は、原則として、法人文書を単位として行うものとする。

(事案の移送の協議)

第28条 理事長は、開示請求書(第10条第2号の規定により分掌窓口から送付を受けた開示請求書の写しを含む。次条において同じ。)が次の各号に掲げる場合には、当該各号に掲げる機関に対し、事案の移送に関する協議を行うものとする。

- (1) 開示請求に係る法人文書が他の独立行政法人等又は行政機関(以下「他の機関」という。)により作成されたものである場合 当該他の機関
- (2) 開示請求に係る法人文書が他の機関と共同で作成されたものである場合 当該他の機関
- (3) 開示請求に係る法人文書に記載されている情報を公にすることにより、国の安全が害されるおそれ、他国若しくは国際機関との信頼関係が損なわれるおそれ又は他国若しくは国際機関との交渉上不利益を被るおそれがあると認める場合 当該情報に係る行政機関の長
- (4) 開示請求に係る法人文書に記載されている情報を公にすることにより、犯罪の予防、鎮圧又は捜査その他の公共安全と秩序の維持に支障を及ぼすおそれがあると認める場合 当該情報に係る行政機関の長
- (5) 開示請求に係る法人文書に記載されている情報の重要な部分が他の機関の事務又は事業に係るもの(開示請求に係る法人文書に記載されている情報が、既に公にされ、又は公にする予定が明らかであると認めるものを除く。)である場合 当該他の機関
- (6) その他、他の機関において開示決定することにつき正当な理由がある場合 当該他の機関

2 開示請求に係る法人文書が複数であって、かつ、それぞれが複数の機関により作成されたものである場合には、記録されている情報の内容により他の機関が開示決定等の判断を行うことが適当な場合には、当該複数の法人文書のうち一部について事案の移送に関する協議を行うものとする。

(協議の期間)

第29条 事案の移送に関する協議は、開示請求書を受理した後速やかに開始し、原則として1週間以内に終了するよう努めるものとする。

(事案の移送)

第30条 理事長は、事案の移送に関する協議の結果、他の機関に対して事案を移送する場合には、別紙様式18の書面に次の各号に掲げる資料等を添付して行うものとする。なお、複数の他の機関に対して事案を移送する場合には、その旨を当該書面に記載するものとする。



( 1 ) 開示請求書

( 2 ) 移送前にした行為があれば、その経過を記載した書面

2 情報公開窓口は、前項の規定により事案が移送される場合には、当該開示請求書の写しを作成し、保管するものとする。

( 開示請求者への通知 )

第 3 1 条 理事長は、事案の移送に関する協議の結果、他の機関に対して事案を移送した場合には、別紙様式 1 9 の書面により開示請求者にその旨を直ちに通知するとともに、当該事面の写しを事案を移送した他の機関に送付するものとする。

( 移送された事案に係る協力等 )

第 3 2 条 情報公開窓口は、第 3 0 条第 1 項の規定により移送した事案が開示決定された場合には、次の各号に掲げる協力を行うものとする。

( 1 ) 移送前にした行為の記録及び提供

( 2 ) 開示請求書及び事案を移送した旨の書面の写しの提供

( 3 ) 開示決定をした他の機関が開示請求に係る法人文書を保有していない場合には、開示請求に係る法人文書の写しの提供又は原本の貸与

( 4 ) 原本を閲覧する方法による開示の実施のための法人文書の貸与又は開示の場所の提供

( 事案の移送を受けた場合の措置結果の報告 )

第 3 3 条 理事長は、他の機関から事案の移送を受けた場合で開示決定等を行った場合には、速やかに当該事案の移送を行った他の機関に対し、開示決定等の結果の報告を行うものとする。

( 移送が行われた場合の開示実施手数料 )

第 3 4 条 開示請求に係る法人文書が複数である場合であって、複数の他の機関に事案の移送が行われ、かつ、他の機関及び自らも開示決定をする場合には、次の各号に定めるところにより開示実施手数料に係る第 2 0 条第 1 項ただし書きの控除措置（以下「控除措置」という。）を取るものとする。この場合において、情報公開窓口は、当該複数の他の機関と協議して行うものとする。

( 1 ) 自らの開示決定が複数の他の機関より早く行われた場合 控除措置を取るものとする。

( 2 ) 他の機関の開示決定が自らの開示決定より早く行われた場合 次に定めるところにより控除措置を取るものとする。

ア 自らの開示決定より早く開示決定をした他の機関すべてにおいて開示実施手数料に係る控除が行われない場合 控除措置を取るものとする。

イ 自らの開示決定より早く開示決定をした他の機関において開示実施手数料の控除が行われた場合 当該控除が行われた開示決定が自らの開示決定とみなして第 2 0 条第 1 項ただし書きの規定を適用して得られる控除可能な残額を控除するものとする。

2 他の機関から移送された場合の開示実施手数料は、他の機関の開示請求に係る手数料の額に相当する額により控除措置を取るものとする。

## 第 7 章 異議申立て等

( 異議申立書の審査及び受理等 )

第 3 5 条 法人文書の開示決定等に対する行政不服審査法（昭和 3 7 年法律第 1 6 0 号）の規定に基づく異議申立ての受付及び受理は、情報公開窓口において行うものとする。

2 情報公開窓口は、開示請求者から口頭で異議申立てがあった場合には、行政不服審査法第9条第1項の規定により次の各号に掲げる事項を記載した書面（以下「異議申立書」という。）によることを要する旨を指導するものとする。

- (1) あて名
- (2) 異議申立人の氏名及び年齢又は名称並びに住所（法人その他の団体である場合にあっては、名称及び所在地）
- (3) 異議申立てに係る処分
- (4) 異議申立てに係る処分（以下「原処分」という。）のあったことを知った年月日
- (5) 異議申立ての趣旨及びその理由
- (6) 処分庁の教示の有無及びその内容
- (7) 異議申立年月日
- (8) 異議申立人が法人その他の団体であるとき、総代を互選したとき又は代理人によって異議申立てをするとき、その代表者若しくは管理人、総代又は代理人の氏名及び住所
- (9) 異議申立人（異議申立人が法人その他の団体であるときはその代表者又は管理人、総代を互選したときは総代、代理人によって異議申立てをするとき代理人）の押印

3 情報公開窓口は、開示請求者から異議申立書の提出があった場合には、前項各号に掲げる記載事項の審査を行った後、記載事項に誤りがない場合又は不適法ではあるが補正することができる場合には法人文書管理規程第18条第1項に規定する接受印を押印し受理するとともに、次の各号に掲げる事務を行うものとする。なお、この場合において、異議申立書が不適法ではあるが補正できる場合においては、2週間程度の期間を定めて、その補正を命ずるものとする。

- (1) 当該異議申立書の写しを異議申立人に交付するとともに、情報公開窓口で保管する。
  - (2) 処理経過を把握できるよう、法人文書開示請求等処理簿を備え、必要事項を記載する。
- 4 分掌窓口は、開示請求者から異議申立てがあった場合は、異議申立書の提出先が情報公開窓口である旨を指導するものとする。

（異議申立ての却下の決定）

第36条 理事長は、異議申立てが次の各号のいずれかに該当する場合は、当該異議申立てを却下する決定をするとともに、決定書を異議申立人に送付するものとする。

- (1) 異議申立てが異議申立期間（原則として「処分があったことを知った日の翌日から起算して60日以内」。）の経過後にされたものであるとき。
- (2) 異議申立てをすべき処分機関を誤ったものであるとき。
- (3) 異議申立適格のない者からの異議申立てであるとき。
- (4) 存在しない開示決定等についての異議申立てであるとき。
- (5) 異議申立書記載の不備等について、補正を命じたにもかかわらず、異議申立人が補正を行わないため、形式的不備である異議申立てであるとき。

（異議申立てを容認する決定）

第37条 理事長は、原処分について再検討を行い、その結果、異議申立てを容認し、全部を開示しようとするときは、次の各号に定めるところにより処理するものとする。ただし、第三者が反対意見書を提出していない場合に限る。

- (1) 決定により原処分を変更し、全部を開示する旨の決定をする。
- (2) 法人文書開示決定通知書及び決定書を異議申立人に送付する。この場合において

て、法人文書開示決定通知書の備考欄には、法人文書開示異議申立て容認による再決定である旨記載する。

(情報公開審査会への諮問)

第38条 理事長は、当該異議申立てを第36条の規定に基づき却下する場合及び前条の規定に基づき容認する場合を除き、遅滞なく、情報公開審査会(法第18条第2項に規定するものをいう。以下「審査会」という。)に対し、別紙様式20の諮問書に次の各号に掲げる書類を添えて諮問するものとする。

- (1) 開示請求書
- (2) 法人文書開示決定通知書等及び異議申立書の写し
- (3) 処分機関としての考え方とその理由を記載した理由説明書
- (4) その他必要と認める書類

2 理事長は、審査会に諮問したときは、遅滞なく、別紙様式21の法人文書審査諮問通知書により次の各号に掲げる者に通知するものとする。

- (1) 異議申立人及び参加人
- (2) 開示請求者(開示請求者が異議申立人又は参加人である場合を除く。)
- (3) 当該原処分についての反対意見書を提出した第三者(当該第三者が異議申立人又は参加者である場合を除く。)

(異議申立てに対する決定)

第39条 理事長は、前条第1項の規定により審査会に諮問した異議申立てについて、審査会から答申があったときには、速やかに異議申立てに対する決定を行い、前条第2項各号に掲げる者に決定書を送付するものとする。

(第三者からの異議申立てを棄却する場合等の手続)

第40条 第18条第2項の規定は、次の各号のいずれかに該当する決定をする場合において準用する。

- (1) 開示決定に対する第三者からの異議申立てを却下し、又は棄却する決定をする場合
- (2) 原処分を変更し、当該原処分に係る法人文書を開示する旨の決定(第三者である参加人が当該法人文書の開示に反対の意思を表示している場合に限る。)をする場合

(異議申立てに対する情報公開窓口の連絡及び調整)

第41条 情報公開窓口は、開示決定等に係る異議申立てに関する事務が円滑に遂行できるよう、分掌窓口又は主管部課等との連絡および調整を行うものとする。

## 第8章 雑則

(公開窓口における掲示等)

第42条 公開窓口は、開示請求をしようとする者の便宜を図るため、わかりやすい場所に次の各号に掲げる事項を掲示しておくよう努めるものとする。

- (1) 受付時間に関する事項
- (2) 開示請求手数料に関する事項
- (3) 開示実施手数料及び当該手数料の減額又は免除に関する事項

(その他)

第43条 この規程に定めるもののほか、センターにおける情報公開の実施に関し必要な事項は、理事長が別に定める。

附 則  
この規程は、平成14年10月1日から施行する。

別表（第20条第1項関係）

法人文書の種類	開示の実施の方法	開示実施手数料の額
1 文書又は図面 (2の項から4の項まで又は8の項に該当するものを除く。)	ア 閲覧	100枚までごとにつき100円
	イ 撮影した写真フィルムを印画紙に印画したものの閲覧	1枚につき100円に12枚までごとに750円を加えた額
	ウ 複写機により複写したものの交付	用紙1枚につき20円(A2判については60円、A1判については110円)
	エ 撮影した写真フィルムを印画紙に印画したものの交付	1枚につき130円(縦203ミリメートル、横254ミリメートルのものについては、530円)に12枚までごとに750円を加えた額
2 マイクロフィルム	ア 用紙に印刷したものの閲覧	用紙1枚につき10円
	イ 専用機器により映写したものの閲覧	1巻につき300円
	ウ 用紙に印刷したものの交付	用紙1枚につき70円(A3判については130円、A2判については250円、A1判については510円)
3 写真フィルム	ア 印画紙に印画したものの閲覧	用紙1枚につき10円
	イ 印画紙に印画したものの交付	1枚につき30円(縦203ミリメートル、横254ミリメートルのものについては、440円)
4 スライド(9の項に該当するものを除く。)	ア 専用機器により映写したものの閲覧	1巻につき400円
	イ 印画紙に印	1枚につき120円(縦203ミリ

	画したものの 交付	メートル、横 254 ミリメートル のものについては、1,500 円)
5 録音テープ( 9 の項に該当する ものを除く。)又 は録音ディスク	ア 専用機器に より再生した ものの聴取	1 巻につき 300 円
	イ 録音カセッ トテープに複 写したものの 交付	1 巻につき 600 円
6 ビデオテープ 又はビデオディ スク	ア 専用機器に より再生した ものの視聴	1 巻につき 300 円
	イ 録画カセッ トテープに複 写したものの 交付	1 巻につき 700 円
7 電磁的記録( 5 の項、 6 の項又 は 8 の項に該当 するものを除 く。)	ア 用紙に出力 したものの閲 覧	用紙 100 枚までごとに 200 円
	イ 専用機器に より再生した ものの閲覧又 は視聴	0.5 メガバイトまでごとに つき 550 円
	ウ 用紙に出力 したものの交 付	用紙 1 枚につき 20 円
	エ フレキシブ ルカートリッ ジに複写した ものの交付	1 枚につき 80 円に 0.5 メガバ イトまでごとに 220 円を加えた額
	オ 光ディスク に複写したも のの交付	1 枚につき 200 円に 0.5 メガバ イトまでごとに 220 円を加えた 額
	カ 幅 12 . 7 ミリメートル のオープンリ ールテープに 複写したもの の交付	1 巻につき 4,000 円に 1 メガバ イトまでごとに 220 円を加えた 額

	キ 幅 12.7 ミリメートル の磁気テープ カートリッジ に複写したも のの交付	1巻につき 1,900 円（日本工業規格 X 6135 に適合するものについては 2,800 円、国際規格 14833、15895 又は 15307 に適合するものについてはそれぞれ 7,200 円、9,800 円又は 16,800 円）に 1 メガバイトまでごとに 220 円を加えた額
	ク 幅 8 ミリメ ートルの磁気 テープカート リッジに複写 したものの交 付	1巻につき 1,250 円（日本工業規格 X 6142 に適合するものについては 2,450 円、国際規格 15757 に適合するものについては 13,400 円）に 1 メガバイトまでごとに 220 円を加えた額
	ケ 幅 3.81 ミリメートル の磁気テープ カートリッジ に複写したも のの交付	1巻につき 980 円（日本工業規格 X 6129,6130 又は 6137 に適合するものについてはそれぞれ 2,000 円、4,150 円又は 6,000 円）に 1 メガバイトまでごとに 220 円を加えた額
8 映画フィルム	ア 専用機器に より映写した ものの視聴	1巻につき 400 円
	ケ ビデオカセ ットテープに 複写したも のの交付	3,300 円（16 ミリメートル映画フィルムについては 12,300 円、35 ミリメートル映画フィルムについては 14,000 円）に記録時間 10 分までごとに 1,550 円（16 ミリメートル映画フィルムについては 3,650 円、35 ミリメートル映画フィルムについては 4,450 円）を加えた額
9 スライド及び 録音テープ（ス ライド及び当該 スライドの内容 に関する音声を 録音した録音テ ープを同時に開 示する場合に限 る。）	ア 専用機器に より再生した ものの視聴	1巻につき 700 円
	イ ビデオカセ ットテープに 複写したも のの交付	5,200 円（スライド 20 枚を超える場合にあっては、5,200 円にその超える枚数 1 枚につき 110 円を加えた額）

備考 1 項のウ若しくはエ又は 7 項のウの場合において、両面印刷の用紙を用いるときは、片面を 1 枚として額を算出する。

# 法人文書開示請求書

平成 年 月 日

独立行政法人国際農林水産業研究センター理事長 殿

(法人その他の団体にあつてはその名称及び代表者氏名)

氏名又は名称:

(法人その他の団体にあつては主たる事務所の所在地)

住所又は居所: 〒

TEL

( )

(連絡先が上記の本人以外の場合は、連絡担当者の住所・氏名・電話番号)

連絡先:

独立行政法人等の保有する情報の公開に関する法律第 4 条第 1 項の規定に基づき、下記のとおり法人文書の開示を請求します。

## 記

### 1 請求する法人文書の名称等

(請求する法人文書が特定できるよう、法人文書の名称、請求する文書の内容等をできるだけ具体的に記載してください。)

### 2 求める開示の実施の方法等 (本欄の記載は任意です。)

ア又はイに 印を付してください。アを選択された場合は、その具体的な方法を記載してください。

ア 事務所における開示の実施を希望する。

<実施の方法> 閲覧 写しの交付 その他 ( )

<実施の希望日>

イ 写しの送付を希望する。

開示請求手数料 (1 件 3 0 0 円)	納入方法は次のいずれかに をつけて下さい	( 受付印 )
	1. 銀行振込 2. 郵便為替 3. 現金	

銀行振込の場合は振込を証明する用紙を同封してください。

銀行振込口座名 銀行 支店 普通口座

口座番号

別紙の注意事項をお読みください。

*この欄は記入しないでください。

担当課	
備考	



## 「法人文書開示請求書」(別紙)

### <記載に当たっての注意事項>

#### 1 「氏名又は名称」「住所又は居所」

個人で開示請求をする場合は、あなたの氏名、住所又は居所を、法人その他の団体の場合には、その名称と代表者の氏名及び所在地を記載してください。

ここに記載された住所及び氏名により、開示決定通知等を行うこととなりますので、正確に記入願います。

連絡等を行う際に必要となりますので、電話番号も記載してください。

#### 2 「連絡先」

連絡等を行う場合に、「氏名又は名称」欄に記載された本人と異なる方に行う必要があるときは、連絡担当者の氏名、住所及び電話番号を記載してください。

#### 3 「請求する法人文書の名称等」

開示を請求する法人文書について、その名称、お知りになりたい情報の内容等をできる限り具体的に記載してください。

#### 4 「求める開示の実施の方法等」

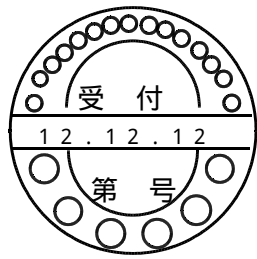
請求される法人文書について開示決定がされた場合に、開示の実施の方法、事務所における開示を希望される場合の希望日についてご希望がありましたら、記載してください。

なお、開示の実施の方法等については、開示決定後に提出していただく「法人文書の開示の実施の方法等申出書」により申し出ることができます。

### <開示請求手数料の納付について>

開示請求を行う場合には、1件の法人文書について300円を納付していただくこととなっています。

別紙様式2（第10条関係）



径 30 mm

- 備考 1 上部の            には「独立行政法人国際農林水産業研究センター」及び  
「独立行政法人国際農林水産業研究センター沖縄支所」を入れる。  
下部の            には「情報公開窓口」の文字を入れる。
- 2 日付は、回転式とする。

別紙様式 3 ( 第 1 0 条第 3 号関係 )

法人文書開示請求等処理簿

受付 番号	受付月日	開示請求者氏名	法人文書名又は内容	開示請求 手数料 ( 円 )	主管部課

開示決定期限	延長期限	開示決定日	開示決定の内容	開示実施日	開示実施 手数料 ( 円 )

異議申立の内容	異議申立日	審査会 諮問日	審査会 開催日	審査会 答申日	審査会答申の内容

決定又は 決裁日	決定又は裁決の内容

備考 用紙の大きさは日本工業規格 A 3 版とする。

## 意見照会書

（第三者） 様

独立行政法人  
国際農林水産業研究センター理事長 印

（あなた、貴社等）に関する情報が記録されている下記の法人文書について、独立行政法人等の保有する情報の公開に関する法律第4条の規定による開示請求があり、開示決定を行いたいと考えています。

つきましては、同法第14条第2項に基づき、御意見を伺いますので、当該法人文書を開示することについて御意見がある場合は、同封の「法人文書の開示に関する意見書」を御提出いただきますようお願いいたします。

なお、提出期限までに同意見書の御提出がない場合には、特に御意見がないものとして取り扱わせていただきます。

### 記

- 1 開示請求のあった法人文書の名称
  - 2 開示請求の年月日
  - 3 法第14条第2項第1号又は第2号の規定の適用区分及び当該規定を適用する理由
  - 4 上記法人文書に記録されている（あなた、貴社等）に関する情報の内容
  - 5 意見書の提出先
  - 6 意見書の提出期限  
月 日（ ）
- * 担当課等

## 意見照会書

(第三者) 様

独立行政法人  
国際農林水産業研究センター理事長 印

(あなた、貴社等) に関する情報が記録されている下記の法人文書について、独立行政法人等の保有する情報の公開に関する法律第 4 条の規定による開示請求があり、当該法人文書について開示決定等を行う際の参考とするため、同法第 14 条第 1 項の規定に基づき、御意見を伺うこととしました。

つきましては、当該法人文書を開示することにつき御意見があるときは、同封の「法人文書の開示に関する意見書」を御提出いただきますようお願いいたします。

なお、提出期限までに同意見書の御提出がない場合には、特に御意見がないものとして取り扱わせていただきます。

### 記

- 1 開示請求のあった法人文書の名称
  - 2 開示請求の年月日
  - 3 上記法人文書に記録されている(あなた、貴社等)に関する情報の内容
  - 4 意見書の提出先
  - 5 意見書の提出期限  
月 日( )
- * 担当課等

## 法人文書の開示に関する意見書

独立行政法人国際農林水産業研究センター理事長 殿

氏名又は名称  
住所又は居所  
連絡先電話番号

平成 年 月 日付けで照会のあった下記の法人文書の開示について、次のとおり意見を提出します。

### 記

- 1 照会のあった法人文書の名称
  
- 2 意見
  - (1) 上記法人文書の開示による支障（不利益）の有無
  
  - (2) 支障（不利益）の具体的内容

* 担当課等

## 法人文書開示決定通知書

( 開示請求者 ) 様

独立行政法人  
国際農林水産業研究センター理事長 印

平成 年 月 日付けで請求のありました法人文書の開示について、独立行政法人等の保有する情報の公開に関する法律第 9 条第 1 項の規定に基づき、下記のとおり、開示することとしましたので通知します。

### 記

- 1 開示する法人文書の名称
- 2 不開示とした部分とその理由

* この決定に不服がある場合は、行政不服審査法(昭和 37 年法律第 160 号)第 5 条(第 6 条)の規定により、この決定があったことを知った日の翌日から起算して 60 日以内に、理事長に対して審査請求(異議申立て)をすることができます。

- 3 開示の実施の方法等  
( 1 ) 開示の実施の方法等

* 別紙の説明事項をお読み下さい。

法人文書の種類・数量等	開示の実施の方法	開示実施手数料の額	法人文書全体について開示の実施を受けた場合の基本額

( 2 ) 事務所における開示を実施することができる日時、場所

( 3 ) 写しの送付を希望する場合の準備日数、送付に要する費用(見込み額)

納入方法は次のいずれかに つけて下さい

- 1 . 銀行振込
- 2 . 郵便為替
- 3 . 現金

銀行振込の場合は振込を証明する用紙を同封してください。

銀行振込口座名 三井住友銀行牛久支店 普通口座  
口座番号 3949093

* 担当課等

## 法人文書の開示決定通知書（別紙）

### < 説明事項 >

#### 1 「開示の実施の方法等」の選択について

開示の実施の方法等については、この通知書を受け取った日から30日以内に、同封した「法人文書の開示の実施方法等申出書」に所要の開示実施手数料を納付して、申出を行ってください。開示の実施の方法は、3(1)「開示の実施の方法等」に記載されている方法から自由に選択できます。必要な部分のみの開示を受けること（例えば、100頁ある文書について冒頭の10頁のみ閲覧する等）や部分ごとに異なる方法を選択すること（冒頭の10頁は「写しの交付」を受け、残りは閲覧する等）もできます。一旦、閲覧をした上で、後に必要な部分の写しの交付を受けることもできます（ただし、その場合は、最初に閲覧を受けた日から30日以内に、別途「法人文書の更なる開示の申出書」を提出していただく必要があります。）。

事務所における開示の実施を選択される場合は、3(2)「事務所における開示を実施することができる日時、場所」に記載されている日時から、御希望の日時を選択してください。記載された日時に都合がよいものがない場合は、お手数ですが、「4 担当課等」に記載した担当までご連絡ください。なお、開示の実施の準備を行う必要がありますので、「法人文書の開示の実施方法等申出書」は開示を受ける希望日の3日前には、当方に届くように御提出願います。

また、写しの送付を希望される場合は、「法人文書の開示の実施方法等申出書」にその旨を記載してください。

なお、この場合は、開示実施手数料のほかに、送付に要する費用が必要になります。

#### 2 開示実施手数料の算定について

##### (1) 手数料額の計算方法

開示実施手数料は、選択された開示の実施の方法に応じて、定められた算定方法に従って基本額（複数の実施の方法を選択した場合はそれぞれの合算額）を計算し、その額が300円までは無料、300円を超える場合は当該額から300円を差し引いた額となります。

（例）

150頁ある法人文書を閲覧する場合：

100枚までごとにつき100円      基本額200円      手数料は無料

150頁ある法人文書の写しの交付を受ける場合：

用紙1枚につき20円      基本額3,000円      手数料は2,700円

150頁ある法人文書のうち100頁を閲覧し、10頁について写しの交付を受ける場合（残りの40頁は開示を受けない）：

閲覧に係る基本額100円 + 写しの交付に係る基本額200円 = 計300円

手数料は無料

##### (2) 手数料の減免

生活保護を受けているなど経済的困難により手数料を納付する資力がないと認められる方については、開示請求1件につき2,000円を限度として、手数料の減額又は免除を受けることができます。減額又は免除を受けたい方は、「開示実施手数料の減額（免除）申請書」を御提出してください。

#### 3 不開示部分に係る不服申立て等

開示しないこととされた部分について、不服がある場合には、行政不服審査法（昭和37年法律第160号）第5条（第6条）の規定により、この決定があったことを知った日の翌日から起算して60日以内に、独立行政法人国際農林水産業研究センターに対して審査請求（異議申立て）をすることができます。

#### 4 開示の実施について

事務所における開示の実施を選択され、その旨「法人文書の開示の実施方法等申出書」により申し出られた場合は、開示を受ける当日、事務所に来られる際に、本通知書をご持参ください。

#### 5 担当課等

開示の実施の方法等、開示実施手数料の算定・納付方法、不服申立ての方法等について、ご不明な点等がございましたら、本欄に記載した担当までお問い合わせください。



(文 書 番 号)  
平成 年 月 日

## 法人文書不開示決定通知書

(開示請求者) 様

独立行政法人  
国際農林水産業研究センター理事長 印

平成 年 月 日付けの法人文書の開示請求について、独立行政法人等の保有する情報の公開に関する法律第 9 条第 2 項の規定に基づき、下記のとおり、開示しないことと決定しましたので通知します。

### 記

- 1 不開示決定した法人文書の名称
- 2 不開示とした理由

* この決定について不服があるときは、行政不服審査法(昭和 37 年法律第 160 号)第 5 条(第 6 条)の規定により、この決定があったことを知った日の翌日から起算して 60 日以内に、理事長に対し審査請求(異議申立て)をすることができます。

* 担当課等

## 法人文書の開示の実施方法等申出書

独立行政法人国際農林水産業研究センター理事長 殿

氏名又は名称  
住所又は居所  
連絡先電話番号

独立行政法人等の保有する情報の公開に関する法律第 15 条第 3 項の規定に基づき、下記のとおり申出をします。

記

1 法人文書開示決定通知書の番号等

* 日 付  
文書番号

2 求める開示の実施の方法

下表から実施の方法を選択し、該当するものに 印を付してください。

* 法人文書の名称	種類・量	実施の方法	
		1	全部 一部 ( )
		2	全部 一部 ( )
		3	全部 一部 ( )

3 開示の実施を希望する日

4 「写しの送付」の希望の有無

( 有  
無

開示実施手数料 _____ 円      うち送付に要する費用      円	( 接受印 )
-------------------------------------------	---------

納入方法は次のいずれかに つけて下さい

- 1 . 銀行振込
- 2 . 郵便為替
- 3 . 現金

銀行振込の場合は振込を証明する用紙を同封してください。

銀行振込口座名      三井住友銀行牛久支店 普通口座  
口座番号      3 9 4 9 0 9 3

* 担当課等

## 法人文書の開示の実施方法等申出書

独立行政法人国際農林水産業研究センター理事長 殿

氏名又は名称  
住所又は居所  
連絡先電話番号

法人文書開示決定通知書(平成 年 月 日付け第 号)により通知のありました法人文書について、既報のとおり開示を受けるので、独立行政法人等の保有する情報の公開に関する法律第 15 条第 3 項及び同施行令第 9 条第 2 項の規定に基づき、申出をします。

開示実施手数料

開示実施手数料 _____ 円	うち送付に要する費用 _____ 円	( 接受印 )
--------------------	--------------------	---------

納入方法は次のいずれかに つけて下さい

1. 銀行振込
2. 郵便為替
3. 現金

銀行振込の場合は振込を証明する用紙を同封してください。

銀行振込口座名 三井住友銀行牛久支店 普通口座  
口座番号 3949093

* 担当課等

## 開示決定等の期限の延長通知書

(開示請求者) 様

独立行政法人  
国際農林水産業研究センター理事長 印

平成 年 月 日付けの法人文書の開示請求については、下記のとおり、独立行政法人等の保有する情報の公開に関する法律第 1 0 条第 2 項の規定に基づき、開示決定等の期限を延長することとしましたので通知します。

### 記

- 1 開示請求のあった法人文書の名称
  
  - 2 延長後の期間
  
  - 3 延長の理由
- * 担当課等

## 開示決定等の期限の特例規定の適用通知書

(開示請求者) 様

独立行政法人  
国際農林水産業研究センター理事長 印

平成 年 月 日付けの法人文書の開示請求については、下記のとおり、独立行政法人等の保有する情報の公開に関する法律第 11 条の規定(開示決定等の期限の特例)を適用することとしたので通知します。

### 記

- 1 開示請求のあった法人文書の名称
- 2 法第 11 条の規定(開示決定等の期限の特例)を適用することとした理由
- 3 開示決定等する期限  
( 月 日までに可能な部分について開示決定を行い、残りの部分については、次に記載する時期までに開示決定等する予定です。)  
月 日( )

* 担当課等

(文 書 番 号)  
平成 年 月 日

## 法人文書の開示決定通知書

(反対意見書を提出した第三者)様

独立行政法人  
国際農林水産業研究センター理事長 印

(あなた、貴社等) から平成 年 月 日付けで「法人文書の開示に関する意見書」の提出がありました法人文書については、下記のとおり開示決定しましたので、独立行政法人等の保有する情報の公開に関する法律第 14 条第 3 項の規定に基づき通知します。

### 記

- 1 開示決定した法人文書の名称
  - 2 開示することとした理由
  - 3 開示を実施する日
- * 担当課等

この決定に不服があるときは、行政不服審査法(昭和 37 年法律第 160 号)第 5 条(第 6 条)に基づき、この決定があったことを知った日の翌日から起算して 60 日以内に理事長に対して審査請求(異議申立て)をすることができます。

## 開示実施手数料の減額(免除)申請書

独立行政法人国際農林水産業研究センター理事長 殿

氏名又は名称  
住所又は居所  
連絡先電話番号

独立行政法人等の保有する情報の公開に関する法律第 1 7 条第 3 項の規定に基づき、下記のとおり、法人文書の開示実施手数料の減額(免除)を申請します。

### 記

1 開示決定のあった法人文書の名称等

(開示決定通知書の日付・番号: )

2 減額(免除)を求める額

3 減額(免除)を求める理由

生活保護法(昭和 2 5 年法律第 1 4 4 号)第 1 1 条第 1 項第 号に掲げる扶助を受けており、手数料を納付する資力がないため。

その他

(注) 又は のいずれかに 印を付してください。

に を付した場合は、当該扶助を受けていることを証明する書面を添付してください。

に を付した場合は、その理由を具体的に記載するとともに、その事実を証明する書面を添付してください。

## 開示実施手数料の減額（免除）決定通知書

(開示請求者) 様

独立行政法人  
国際農林水産業研究センター理事長 印

平成 年 月 日付けで請求のありました開示実施手数料の減額（免除）申請について、独立行政法人等の保有する情報の公開に関する法律第 17 条第 3 項の規定に基づき、下記のとおり、減額（免除）することとしたので通知します。

### 記

1 対象となる法人文書の名称とその開示の実施方法

法人文書の名称：

開示の実施方法：

2 開示実施手数料を減額（免除）する額



## 開示実施手数料の減額（免除）非承認通知書

(開示請求者) 様

独立行政法人  
国際農林水産業研究センター理事長 印

平成 年 月 日付けの開示実施手数料の減額（免除）申請については、独立行政法人等の保有する情報の公開に関する法律に規定する減額（免除）理由に該当しませんので通知します。

### 記

1 対象となる法人文書と、その開示の実施方法

法人文書の名称：

開示の実施方法：

2 減額（免除）を求める開示実施手数料の額

3 減額（免除）が認められない理由等

(注 1)

開示の実施を受ける場合には、上記 2 の開示実施手数料の追納が必要です。

(注 2)

この決定に不服があるときは、行政不服審査法(昭和 37 年法律第 160 号)第 5 条(第 6 条)に基づき、この決定があったことを知った日から起算して 60 日以内に、理事長に対して審査請求(異議申立て)をすることができます。

## 法人文書の更なる開示の申出書

独立行政法人国際農林水産業研究センター理事長 殿

氏名又は名称  
住所又は居所  
連絡先電話番号

独立行政法人等の保有する情報の公開に関する法律第 15 条第 5 項の規定に基づき、下記のとおり申出をします。

### 記

- 1 更なる開示を求める法人文書の名称
- 2 開示決定通知書の日付及び文書番号  
平成 年 月 日付け 第 号
- 3 最初に開示を受けた日
- 4 更なる開示の実施の方法等

(事務所における開示の実施を受ける場合、その希望日)

(写しの送付を希望する場合は、その旨)

* 法人文書の同じ部分について、最初に開示を受けた開示の実施の方法と同じ開示の実施の方法を受けることはできません。

開示実施手数料  _____ 円	うち送付に要する費用 円	( 接受印 )
------------------------	--------------	---------

納入方法は次のいずれかに つけて下さい

- 1 . 銀行振込
- 2 . 郵便為替
- 3 . 現金

銀行振込の場合は振込を証明する用紙を同封してください。

銀行振込口座名 銀行 支店 普通口座  
口座番号

(文 書 番 号)  
平成 年 月 日

(他の機関の長) 殿

独立行政法人  
国際農林水産業研究センター理事長

印

開示請求に係る事案の移送について

平成 年 月 日付けで開示請求のあった事案については、独立行政法人等の保有する情報の公開に関する法律第12条第1項(第13条第1項)の規定により、下記のとおり移送します。  
記

開示請求に係る 法人文書名	開示請求書に記載されている法人文書の名称等 (一部を移送する場合には、開示請求のあった事案のうち、 、 及び に係る法人文書)
請求者名等	氏名： 住所：  電話番号
添付資料等名	・開示請求書 ・移送前に行った行為の概要記録 ・ ・
備 考	(複数の他の機関に移送する場合には、その旨)

《連絡先》  
独立行政法人国際農林水産業研究センター  
(所属部課名)  
(担当者氏名)  
TEL:  
FAX:  
E-mail:

( 文 書 番 号 )  
平成 年 月 日

( 開示請求者 ) 様

独立行政法人  
国際農林水産業研究センター理事長

印

開示請求に係る事案の移送について ( 通知 )

平成 年 月 日付けで開示請求のありました事案について、下記のとおり移送しましたので、独立行政法人等の保有する情報の公開に関する法律第 12 条第 1 項 ( 第 13 条第 1 項 ) の規定により、通知します。

記

開示請求に係る 法人文書名	開示請求書に記載されている法人文書の名称等 (一部を移送する場合には、開示請求のあった事案のうち、 、及び に係る法人文書)
移送年月日	平成 年 月 日
移送先の他の機関 長	他の機関の長  (連絡先) 担当部課室名： 担当者名：  所在地： 電話番号：
移送の理由	
備 考	1 標記の移送した事案に係る開示決定等及び開示の実施は、 移送先の他の機関の長が行うこととなります。 2 複数の他の機関に移送が行われた場合 ( 自らも開示決定等 を行う場合を含む。 ) には、開示実施手数料からの 300 円 ( 独立行政法人等の場合は開示請求手数料相当額 ) の控除措置 については、開示決定等が早く行われた法人文書又は行政文 書に係る開示実施手数料から順次控除措置を取る旨を記載す る。

担当課：

# 諮 問 書

(文 書 番 号)  
平成 年 月 日

情報公開審査会 殿

独立行政法人  
国際農林水産業研究センター理事長 印

独立行政法人等の保有する情報の公開に関する法律第 9 条の規定に基づく開示決定等について、別紙のとおり、異議申立てがあったので、同法第 18 条の規定に基づき諮問します。

(別紙)

1 異議申立てに係る法人文書の名称	
2 異議申立てに係る開示決定等 (開示決定等の種類) 開示決定 部分開示決定 (該当不開示条項)  不開示決定 (該当不開示条項)	(1) 開示決定等の日付、記号番号 (2) 開示決定等した者 (3) 決定の概要
3 異議申立て (異議申立ての種類) 審査請求 異議申立て	(1) 異議申立日 (2) 異議申立人 (3) 異議申立ての趣旨
4 諮問の理由	
5 参加人等	
6 添付書類等	法人文書開示請求書(写し) 法人文書開示決定等通知書(写し) 異議申立書(写し) 理由説明書 その他参考資料(第三者からの反対意見書等)

注1) 2の(開示決定等の種類)については、該当する開示決定等の をチェックすること。また、部分開示決定又は不開示決定の場合は、当該不開示条項(法第5条各号、第8条又は文書不存在)を記載すること。

注2) 3の(異議申立ての種類)については、該当する異議申立ての をチェックすること。

注3) 4の(諮問の理由)については、例えば、「原処分維持が適切と考えるため」、「全部開示とすることが適切と考えるが、第三者の反対意見書が提出されているため。」など、諮問を必要とする理由を簡潔に記述すること。

## 法人文書審査諮問通知書

( 異議申立人 ) 様

独立行政法人  
国際農林水産業研究センター所理事長 印

独立行政法人等の保有する情報の公開に関する法律第 9 条の規定に基づく開示決定等に対する次の異議申立てについて、同法第 1 8 条の規定により情報公開審査会に諮問したので、同法第 1 9 条の規定により通知します。

1 異議申立てに係る法人文書の名称	
2 異議申立てに係る開示決定等	
3 異議申立て ( 異議申立ての種類 ) 審査請求 異議申立て	( 1 ) 異議申立日  ( 2 ) 異議申立ての趣旨
4 諮問日・諮問番号	平成 年 月 日・平成 年諮問第 号

担当課等：  
〒

注 1 ) 「 2 異議申立てに係る開示決定等」の欄については、開示決定等の日付・記号番号、開示決定等した者、開示決定等の種類 ( 開示決定、部分開示決定又は不開示決定 ) を記載すること。

注 2 ) 3 の ( 異議申立ての種類 ) については、該当する異議申立ての をチェックすること。

注 3 ) 4 の「諮問番号」は、情報公開審査会が付す番号である。

# 国際農林水産業研究センター文書開示決定等審査基準

14国研セ第9-121号

平成14年9月20日

## 1 第5条第1号（個人に関する情報）関係

1 個人に関する情報（事業を営む個人の当該事業に関する情報を除く。）であって、当該情報に含まれる氏名、生年月日その他の記述等により特定の個人を識別することができるもの（他の情報と照合することにより、特定の個人を識別することができることとなるものを含む。）又は特定の個人を識別することはできないが、公にすることにより、なお個人の権利利益を害するおそれがあるもの。ただし、次に掲げる情報を除く。

イ 法令の規定により又は慣行として公にされ、又は公にすることが予定されている情報  
ロ 人の生命、健康、生活又は財産を保護するため、公にすることが必要であると認められる情報

ハ 当該個人が公務員等（国家公務員法（昭和22年法律第120号）第2条第1項に規定する国家公務員（独立行政法人通則法第2条第2項に規定する特定独立行政法人の役員及び職員を除く。）、独立行政法人等（独立行政法人等の保有する情報の公開に関する法律（平成13年法律第140号。以下「独立行政法人等情報公開法」という。）第2条第1項に規定する独立行政法人等をいう。以下同じ。）の役員及び職員並びに地方公務員法（昭和25年法律第261号）第2条に規定する地方公務員をいう。）である場合において、当該情報がその職務の遂行に係る情報であるときは、当該情報のうち、当該公務員等の職及び当該職務遂行の内容に係る部分

### 【趣旨】

本号は、個人に関する情報の不開示情報としての要件を定めるものである。

### 【解説】

地方公共団体の情報公開条例や諸外国の情報公開法制の中には、個人に関する情報のうち、個人のプライバシー等の権利利益を害するおそれがあるものに限って不開示情報とする方式（プライバシー保護型）を採用しているものもあるが、我が国では、いわゆるプライバシーの概念は、法的にも社会通念上も必ずしも確立したものではないことから、本法では、個人の権利利益の十分な保護を図るため、特定の個人を識別できる情報は、原則として不開示とする方式（個人識別型）を採用している。ただし、個人識別型を採用した結果、本来保護する必要性のない情報も含まれることになることから、公知の情報等個人に関する情報の不開示情報から除かれるべきものを限定列挙している。

## 1 特定の個人を識別することができる情報（本文）

### (1) 「個人に関する情報」

「個人に関する情報」（以下「個人情報」という。）とは、個人の内心、身体、身分、地位その他個人に関する一切の事項について的事实、判断、評価等のすべての情報が含まれるものであり、個人に関連する情報全般を意味する。したがって、個人の属性、人格や私生活に関する情報に限らず、個人の知的創作物に関する情報、組織体の構成員としての個人の活動に関する情報も含まれる。

個人の権利利益を十全に保護するため、個人識別性のある情報を一般的に不開示とし、個人情報の判断に当たり、原則として、公務員に関する情報と非公務員に関する情報とを区別していない。ただし、前者については、特に不開示とすべきでない情報を八において除外している。

「個人」には、生存する個人のほか、死亡した個人も含まれる。生前に本号により不開示で



あった情報が、個人が死亡したことをもって開示されることとなるのは不適當である。

(2) 「(事業を営む個人の当該事業に関する情報を除く。)」

「事業を営む個人の当該事業に関する情報」は、個人情報の意味する範囲に含まれるが、当該事業に関する情報であるので、法人等に関する情報と同様の要件により不開示情報該当性を判断することが適當であることから、本号の個人情報からは除外している。

(3) 「当該情報に含まれる氏名、生年月日その他の記述等により特定の個人を識別することができるもの」

「特定の個人を識別することができるもの」の範囲は、当該情報に係る個人が誰であるかを識別させることとなる氏名その他の記述の部分だけでなく、氏名その他の記述等により識別される特定の個人情報の全体である。

「その他の記述等」としては、例えば、住所、電話番号、役職名、個人別に付された記号、番号(振込口座番号、試験の受験番号、保険証の記号番号等)等が挙げられる。氏名以外の記述等単独では、必ずしも特定の個人を識別することができない場合もあるが、当該情報に含まれるいくつかの記述等が組み合わされることにより、特定の個人を識別することができることとなる場合が多いと考えられる。

(4) 「(他の情報と照合することにより、特定の個人を識別することができることとなるものを含む。)」

当該情報単独では特定の個人を識別することができないが、他の情報と照合することにより特定の個人を識別することができるものについても、個人識別情報として不開示情報となる趣旨である。

照合の対象となる「他の情報」としては、公知の情報や、図書館等の公共施設で一般に入手可能なものなど一般人が通常入手し得る情報が含まれる。また、何人も開示請求できることから、仮に当該個人の近親者、地域住民等であれば保有している又は入手可能であると通常考えられる情報も含まれると解する。他方、特別の調査をすれば入手し得るかも知れないような情報については、一般的には、「他の情報」に含めて考える必要はないものと考えられる。

照合の対象となる「他の情報」の範囲については、当該個人情報の性質や内容等に応じて、個別に適切に判断することが必要となる。

また、識別可能性の判断に当たっては、厳密には特定の個人を識別することができる情報ではないが、特定の集団に属する者に関する情報を開示すると、当該集団に属する個人に不利益を及ぼすおそれがある場合があり得る。このように、当該情報の性質、集団の性格、規模等により、個人の権利利益の十全な保護を図る観点から、個人識別性を認めるべき場合があり得る。

(5) 「特定の個人を識別することができないが、公にすることにより、なお、個人の権利利益を害するおそれがあるもの」

独立行政法人が保有する個人情報の大部分は、特定の個人を識別することができる情報であり、これを不開示情報とすることで、個人の権利利益の保護は基本的には十分確保されることが考えられる。

しかしながら、中には、匿名の作文や、無記名の個人の著作物のように、個人の人格と密接に関連したり、公にすれば財産権その他の個人の正当な権利利益を害するおそれがあると認められるものがあることから、特定の個人を識別できない個人情報であっても、公にすることにより、なお、個人の権利利益を害するおそれがある場合について、補充的に不開示情報として規定したものである。

2 「法令の規定により又は慣行として公にされ、又は公にすることが予定されている情報」(ただし書イ)

個人識別情報であっても、一般に公にされている情報については、あえて不開示情報として

保護する必要性に乏しいものと考えられることから、ただし書により、本号の不開示情報から除くこととしたものである。

(1) 「法令の規定により」

「法令の規定」は、何人に対しても等しく当該情報を公開することを定めている規定に限られる。公開を求める者又は公開を求める理由によっては公開を拒否する場合が定められていれば、当該情報は、「公にされている情報」には該当しない。

(2) 「慣行として」

公にすることが慣習として行われていることを意味するが、慣習法としての法規範的な根拠を要するものではなく、事実上の慣習として公にされていること又は公にすることが予定されていることで足りる。

当該情報と同種の情報が公にされた事例があったとしても、それが個別的な事例にとどまる限り、「慣行として」には当たらない。

(3) 「公にされ」

当該情報が、現に公衆が知り得る状態に置かれていれば足り、現に公知（周知）の事実である必要はない。過去に公にされたものであっても、時の経過により、開示請求の時点では公にされているとは見られない場合があり得る。

(4) 「公にすることが予定されている情報」

将来的に公にする予定（具体的に公表が予定されている場合に限らず、求めがあれば何人にも提供することを予定しているものも含む。）の下に保有されている情報をいう。ある情報と同種の情報が公にされている場合に、当該情報のみ公にしないとする合理的な理由がないなど、当該情報の性質上通例公にされるものも含む。

3 「人の生命、健康、生活又は財産を保護するため、公にすることが必要であると認められる情報」（ただし書ロ）

人の生命、健康その他の基本的な権利利益を保護することは、独立行政法人の基本的な責務である。

不開示情報該当性の判断に当たっては、開示することの利益と開示されないことの利益との調和を図ることが重要であり、個人情報についても、公にすることにより害されるおそれがある当該情報に係る個人の権利利益よりも、人の生命、健康等の保護の必要性が上回る場合には、当該個人情報を開示する必要性と正当性が認められることから、当該情報を開示しなければならないこととするものである。現実には、人の生命、健康等に被害が発生している場合に限らず、将来これらが侵害される蓋然性が高い場合も含まれる。

この比較衡量に当たっては、個人の権利利益にも様々なものがあり、また、人の生命、健康、生活又は財産の保護にも、保護すべき権利利益の程度に差があることから、個別の事案に応じた慎重な検討が必要である。

なお、人の生命、健康等の基本的な権利利益の保護以外の公益との調整は、公益上の理由による裁量的開示の規定（法第7条）により図られる。

4 「当該個人が公務員である場合において、当該情報とその職務の遂行に係る情報であるときは、当該情報のうち、当該公務員の職及び当該職務遂行の内容に係る部分」（ただし書ハ）

法人文書には、業務遂行の主体である公務員の職務活動の過程又は結果が記録されているものが多いが、政府の諸活動を説明する責務が全うされるようにするという観点からは、これらの情報を公にする意義は大きい。一方で、公務員についても、個人としての権利利益は、十分に保護する必要がある。

この両者の要請の調和を図る観点から、どのような地位、立場にある者（「職」）がどのように職務を遂行しているか（「職務遂行の内容」）については、たとえ、特定の公務員が識別される結果となとしても、個人に関する情報としては不開示とはしないこととする趣旨であ

る。

(1) 「当該個人が公務員である場合において」

個人情報のうち、当該個人が「公務員」である場合である。

「公務員」の職務遂行に係る情報が職務遂行の相手方等公務員以外の個人情報である場合がある。このように一つの情報が複数の個人情報である場合には、各個人ごとに不開示情報該当性を判断する必要がある。すなわち、当該公務員にとっての不開示情報該当性と他の個人にとっての不開示情報該当性が別個に検討され、そのいずれかに該当すれば、当該部分是不開示とされることになる。

「公務員」とは、広く公務遂行を担当する者を含むものであり、一般職か特別職か、常勤か非常勤かを問わず、国及び地方公共団体の職員のほか、国務大臣、国会議員、裁判官等を含む。また、公務員であった者が当然に含まれるものではないが、公務員であった当時の情報については、本規定は適用される。

(2) 「当該情報がその職務の遂行に係る情報であるとき」

「職務の遂行に係る情報」とは、公務員が独立行政法人及び行政機関その他の国の機関又は地方公共団体の機関の一員として、その担任する職務を遂行する場合における当該活動についての情報を意味する。例えば、行政処分その他の公権力の行使に係る情報、職務としての会議への出席、発言その他の事実行為に関する情報がこれに含まれる。

また、本規定は、具体的な職務の遂行との直接の関連を有する情報を対象とし、例えば、公務員の情報であっても、職員の人事管理上保有する健康情報、休暇情報等は管理される職員の個人情報として保護される必要があり、本規定の対象となる情報ではない。

(3) 「当該情報のうち、当該公務員の職及び当該職務遂行の内容に係る部分」

公務員の職務の遂行に係る情報には、当該公務員の氏名、職名及び職務遂行の内容によって構成されるものが少なくない。このうち、前述のとおり、政府の諸活動を説明する責務が全うされるようにする観点から、公務員の氏名を除き、その職名と職務遂行の内容については、当該公務員の個人に関する情報としては不開示とはしないという意味である。

(4) 公務員の職務遂行に係る情報に含まれる当該公務員の氏名の取扱い

公務員の職務遂行に係る情報に含まれる当該公務員の氏名については、公にした場合、公務員の私生活等に影響を及ぼすおそれがあり得ることから、私人の場合と同様に個人情報として保護に値すると位置付けた上で、ただし書イに該当する場合には例外的に開示することとするものである。

すなわち、当該公務員の職及び氏名が、法令の規定により又は慣行として公にされ、又は公にすることが予定されている場合には、職務の遂行に係る情報について、本号の八とともに、イが重疊的に適用され、個人情報としては不開示とはならないことになる。慣行として公にされているかどうかの判断に当たっては、人事異動の官報への掲載その他独立行政法人により職名と氏名とを公表する慣行がある場合、独立行政法人により作成され、又は独立行政法人が公にする意思をもって（あるいは公にされることを前提に）提供した情報を基に作成され、現に一般に販売されている職員録に職と氏名とが掲載されている場合には、その職にある者の氏名を一般に明らかにしようとする趣旨であると考えられ、慣行として公にされ、又は公にすることが予定されていると解される。

## 5 本人からの開示請求

本法の開示請求権制度は、何人に対しても、請求の目的の如何を問わず請求を認めていることから、本人から、本人に関する情報の開示請求があった場合にも、開示請求者が誰であるかは考慮されない。したがって、特定の個人が識別される情報であれば、本号のイから八又は公益上の理由による裁量的開示（第7条）に該当しない限り、不開示となる。

なお、行政機関が保有する電子計算機処理に係る個人情報については、行政機関が保有する電子計算機処理に係る個人情報の保護に関する法律により、一定の個人情報ファイルに記録さ

れている自己情報の開示が認められている。

## 2 第5条第2号（法人等に関する情報）関係

2 法人その他の団体（国、独立行政法人等及び地方公共団体を除く。以下「法人等」という。）に関する情報又は事業を営む個人の当該事業に関する情報であって、次に掲げるもの。ただし、人の生命、健康、生活又は財産を保護するため、公にすることが必要であると認められる情報を除く。

イ 公にすることにより、当該法人等又は当該個人の権利、競争上の地位その他正当な利益を害するおそれがあるもの

ロ 独立行政法人等の要請を受けて、公にしないとの条件で任意に提供されたものであって、法人等又は個人における通例として公にしないこととされているものその他の当該条件を付することが当該情報の性質、当時の状況等に照らして合理的であると認められるもの

### 【趣旨】

本号は、法人等に関する情報の不開示情報又は事業を営む個人の当該事業に関する情報の不開示情報としての要件を定めるものである。

### 【解説】

1 「法人その他の団体（国、独立行政法人等及び地方公共団体を除く。以下「法人等」という。）」（本文）

(1) 「法人その他の団体（国、独立行政法人等及び地方公共団体を除く。）に関する情報」

株式会社等の商法上の会社、財団法人、社団法人、学校法人、宗教法人等の民間の法人のほか、特殊法人及び認可法人、政治団体、外国法人や法人ではないが権利能力なき社団等も含まれる。

一方、国、独立行政法人等及び地方公共団体については、その公的性格にかんがみ、法人等とは異なる開示・不開示の基準を適用すべきであるので、本号から除き、その事務又は事業に係る不開示情報は、第4号等において規定している。

「法人その他の団体に関する情報」は、法人等の組織や事業に関する情報のほか、法人等の権利利益に関する情報等法人等と何らかの関連性を有する情報を指す。

なお、法人等の構成員に関する情報は、法人等に関する情報であると同時に、構成員各個人に関する情報でもある。

(2) 「事業を営む個人の当該事業に関する情報」

「事業を営む個人の当該事業に関する情報」は、事業に関する情報であるので、(1)に掲げた法人等に関する情報と同様の要件により、事業を営む上での正当な利益等について不開示情報該当性を判断することが適当であることから、本号で規定しているものである。

(3) 「ただし、人の生命、健康、生活又は財産を保護するため、公にすることが必要であると認められる情報を除く。」

本号のただし書は、第1号口と同様に、当該情報を公にすることにより保護される人の生命、健康等の利益と、これを公にしないことにより保護される法人等又は事業を営む個人の権利利益とを比較衡量し、前者の利益を保護することの必要性が上回るときには、当該情報を開示しなければならないとするものである。

現実には人の生命、健康等に被害が発生している場合に限らず、将来これらが侵害される蓋然性が高い場合も含まれる。なお、法人等又は事業を営む個人の事業活動と人の生命、健康等に対する危害等との明確な因果関係が確認されなくても、現実には人の生命、健康等に対する被害等の発生が予想される場合もあり得る。

2 「公にすることにより、当該法人等又は当該個人の権利、競争上の地位その他正当な利益を害するおそれがあるもの」(イ)

(1) 「権利」

信教の自由、集会・結社の自由、学問の自由、財産権等、法的保護に値する権利一切を指す。

(2) 「競争上の地位」

法人等又は事業を営む個人の公正な競争関係における地位を指す。

(3) 「その他正当な利益」

ノウハウ、信用等法人等又は事業を営む個人の運営上の地位を広く含むものである。

(4) 「害するおそれ」

「害するおそれ」があるかどうかの判断に当たっては、法人等又は事業を営む個人には様々な種類、性格のものがあり、その権利利益にも様々なものがあるので、法人等又は事業を営む個人の性格や権利利益の内容、性質等に応じ、当該法人等又は事業を営む個人の憲法上の権利(信教の自由、学問の自由等)の保護の必要性、当該法人等又は事業を営む個人と行政との関係等を十分考慮して適切に判断する必要がある。なお、この「おそれ」の判断に当たっては、単なる確率的な可能性ではなく、法的保護に値する蓋然性が求められる。

3 「独立行政法人等の要請を受けて、公にしないとの条件で任意に提供されたものであって、法人等又は個人における通例として公にしないこととされているものその他の当該条件を付することが当該情報の性質、当時の状況等に照らして合理的であると認められるもの」(ロ)

本号は、法人等又は事業を営む個人から公にしないとの条件の下に任意に提供された情報については、当該条件が合理的なものと認められる限り、不開示情報として保護しようとするものであり、情報提供者の信頼と期待を基本的に保護しようとするものである。なお、独立行政法人等の情報収集能力の保護は、別途、第4号等の不開示情報の規定によって判断されることとなる。

(1) 「独立行政法人等の要請を受けて、公にしないとの条件で任意に提供されたもの」

独立行政法人等の要請を受けずに、法人等又は事業を営む個人から提供された情報は含まれない。ただし、独立行政法人等の要請を受けずに法人等又は事業を営む個人から提供申出があった情報であっても、提供に先立ち、法人等又は事業を営む個人の側から非公開の条件が提示され、独立行政法人等が合理的理由があるとしてこれを受諾した上で提供を受けた場合には、含まれ得ると解する。

「要請」には、法令に基づく報告又は提出の命令は含まれないが、独立行政法人等が報告徴収権限を有する場合でも、当該権限を行使することなく、任意に提出を求めた場合は含まれる。

「公にしない」とは、本法に基づく開示請求に対して開示しないことはもちろんであるが、第三者に対して当該情報を提供しない意味である。また、特定の行政目的以外の目的には使用しないとの条件で情報の提供を受ける場合も通常含まれる。

「条件」については、独立行政法人等の側から公にしないとの条件で情報を提供してほしいと申し入れる場合も、法人等又は事業を営む個人の側から独立行政法人等の要請があったので情報は提供するが公にしないでほしいと申し出る場合も含まれるが、いずれにしても双方の合意により成立するものである。

また、条件を設ける方法については、黙示的なものを排除する趣旨ではない。

(2) 「法人等又は個人における通例として公にしないこととされているものその他の当該条件を付することが当該情報の性質、当時の状況等に照らして合理的であると認められるもの」

「法人等又は個人における通例」とは、当該法人等又は個人の個別具体的な事情ではなく、当該法人等又は個人が属する業界における通常の取扱いを意味し、当該法人等において公にしていなくてもいいことだけでは足りない。

公にしないとの条件を付すことの合理性の判断に当たっては、情報の性質に応じ、当該情報の提供当時の諸般の事情を考慮して判断するが、必要に応じ、その後の変化も考慮する趣旨である。公にしないとの条件が付されていても、現に当該情報が公にされている場合には、本号には当たらない。

### 3 第5条第3号（審議、検討等情報）関係

3 国の機関、独立行政法人等及び地方公共団体の内部又は相互間における審議、検討又は協議に関する情報であって、公にすることにより、率直な意見の交換若しくは意思決定の中立性が不当に損なわれるおそれ、不当に国民の間に混乱を生じさせるおそれ又は特定の者に不当に利益を与え若しくは不利益を及ぼすおそれがあるもの

#### 【趣旨】

本号は、審議、検討等情報の不開示情報としての要件を定めるものである。

#### 【解説】

開示請求の対象となる法人文書は、判決、供覧等の手続を終了したものに限られないことから、国の機関、独立行政法人等及び地方公共団体の内部又は相互間における意思決定前の審議、検討又は協議の段階において作成又は取得された文書であっても、組織的に用いるものとして現に保有していれば、対象文書となる。

このように、開示請求の対象となる法人文書の中には、独立行政法人等としての最終的な決定前の事項に関する情報が少なからず含まれることになるため、これらの情報を開示することによってその意思決定が損なわれないようにする必要がある。しかしながら、事項的に意思決定前の情報をすべて不開示とすることは、独立行政法人等がその諸活動を説明する責務を全うするという観点からは、適当ではない。そこで、個別具体的に、開示することによって独立行政法人等の適正な意思決定に支障を及ぼすおそれの有無及び程度を考慮し、不開示とされる情報の範囲を画したものである。

#### 1 「国の機関、独立行政法人等及び地方公共団体の内部又は相互間」

「国の機関」とは、国会、内閣、裁判所及び会計検査院（これらに属する機関を含む。）を指し、これらの機関、独立行政法人等及び地方公共団体について、それぞれの機関の内部又は他の機関との相互間の意味である。

#### 2 「審議、検討又は協議に関する情報」

国の機関、独立行政法人等又は地方公共団体の事務及び事業について意思決定が行われる場合に、その決定に至るまでの過程においては、例えば、具体的な意思決定の前段階としての政策等の選択肢に関する自由討議のようなものから、一定の責任者の段階での意思統一を図るための協議や打合せ、判決を前提とした説明や検討、審議会等又は独立行政法人等が開催する有識者、関係法人等を交えた研究会等における審議や検討など、様々な審議、検討及び協議が行われており、これら各段階において行われる審議、検討又は協議に関連して作成され、又は取得された情報をいう。

#### 3 「率直な意見の交換若しくは意思決定の中立性が不当に損なわれるおそれ」

公にすることにより、外部からの圧力や干渉等の影響を受けることなどにより、率直な意見の交換若しくは意思決定の中立性が不当に損なわれるおそれがある場合を想定したもので、適正な意思決定手続の確保を保護利益とするものである。

例えば、審議、検討等の場における発言内容が公になると、発言者やその家族に対して危害が及ぶおそれがある場合には、第4号等の他の不開示情報に該当する可能性もあるが、「率直な意見の交換が不当に損なわれるおそれ」が生じたり、また、独立行政法人内部の施策の検討がまだ十分でない情報が公になり、外部からの圧力により当該施策に不当な影響を受けるおそれがあり、「意思決定の中立性が不当に損なわれるおそれ」が生じたりすることのないようにする趣旨である。

#### 4 「不当に国民の間に混乱を生じさせるおそれ」

未成熟な情報や事実関係の確認が不十分な情報などを公にすることにより、国民の誤解や憶測を招き、不当に国民の間に混乱を生じさせるおそれがある場合をいう。適正な意思決定を行うことそのものを保護するのではなく、情報が公にされることによる国民への不当な影響が生じないようにする趣旨である。

例えば、特定の物資が将来不足することが見込まれることから、政府として取引の規制が検討されている段階で、その検討情報を公にすれば、買い占め、売り惜しみ等が起こるおそれがある場合に、「国民の間に不当な混乱」を生じさせたりすることのないようにする趣旨である。

#### 5 「特定の者に不当に利益を与え若しくは不利益を及ぼすおそれ」

尚早な時期に情報や事実関係の確認が不十分な情報などを公にすることにより、投機を助長するなどして、特定の者に不当に利益を与え又は不利益を及ぼす場合を想定したもので、4と同様に、事務及び事業の公正な遂行を図るとともに、国民への不当な影響が生じないようにする趣旨である。

例えば、施設等の建設計画の検討状況に関する情報が開示されたために、土地の買い占めが行われて土地が高騰し、開示を受けた者等が不当な利益を得たり、違法行為の事実関係についての調査中の情報が開示されたために、結果的に違法・不当な行為を行っていなかった者が不利益を被ったりしないようにする趣旨である。

#### 6 「不当に」

上記3、4及び5のおそれの「不当に」とは、審議、検討等途中の段階の情報を公にすることの公益性を考慮してもなお、適正な意思決定の確保等への支障が看過し得ない程度のものを意味する。予想される支障が「不当」なものかどうかの判断は、当該情報の性質に照らし、公にすることによる利益と不開示にすることによる利益とを比較衡量した上で判断される。

#### 7 意思決定後の取扱い等

審議、検討等に関する情報については、独立行政法人等としての意思決定が行われた後は、一般的には、当該意思決定そのものに影響が及ぶことはなくなることから、本号の不開示情報に該当する場合は少なくなるものと考えられるが、当該意思決定が政策決定の一部の構成要素であったり、当該意思決定を前提として次の意思決定が行われる等審議、検討等の過程が重層的、連続的な場合には、当該意思決定後であっても、政策全体の意思決定又は次の意思決定に関して本号に該当するかどうかの検討が行われるものであることに注意が必要である。また、当該審議、検討等に関する情報が公になると、審議、検討等が終了し意思決定が行われた後であっても、国民の間に混乱を生じさせたり、将来予定されている同種の審議、検討等に係る意思決定に不当な影響を与えるおそれがある場合等があれば、本号に該当し得る。

なお、審議、検討等に関する情報の中に、調査データ等で特定の事実を記録した情報があった場合、例えば、当該情報が専門的な検討を経た調査データ等の客観的、科学的事実やこれに基づく分析等を記録したものであれば、一般的に本号に該当する可能性が低いものと考えられる。



#### 4 第5条第4号(事務又は事業に関する情報)関係

- 4 国の機関、独立行政法人等又は地方公共団体が行う事務又は事業に関する情報であって、公にすることにより、次に掲げるおそれその他当該事務又は事業の性質上、当該事務又は事業の適正な遂行に支障を及ぼすおそれがあるもの
- イ 国の安全が害されるおそれ、他国若しくは国際機関との信頼関係が損なわれるおそれ又は他国若しくは国際機関との交渉上不利益を被るおそれ
  - ロ 犯罪の予防、鎮圧又は捜査、その他の公共の安全と秩序の維持に支障を及ぼすおそれ
  - ハ 監査、検査、取締り又は試験に係る事務に関し、正確な事実の把握を困難にするおそれ又は違法若しくは不当な行為を容易にし、若しくはその発見を困難にするおそれ
  - ニ 契約、交渉又は争訟に係る事務に関し、国、独立行政法人等又は地方公共団体の財産上の利益又は当事者としての地位を不当に害するおそれ
  - ホ 調査研究に係る事務に関し、その公正かつ能率的な遂行を不当に阻害するおそれ
  - ヘ 人事管理に係る事務に関し、公正かつ円滑な人事の確保に支障を及ぼすおそれ
  - ト 国若しくは地方公共団体が経営する企業又は独立行政法人等に係る事業に関し、その企業経営上の正当な利益を害するおそれ

#### 【趣旨】

本号は、事務又は事業に関する情報の不開示情報としての要件を定めるものである。

#### 【解説】

国の機関、独立行政法人等又は地方公共団体が行う事務又は事業は、公共の利益のために行われるものであり、公にすることによりその適正な遂行に支障を及ぼすおそれがある情報については、不開示とする合理的な理由がある。

国の機関、独立行政法人等又は地方公共団体が行う事務又は事業は広範かつ多種多様であり、公にすることによりその適正な遂行に支障を及ぼすおそれのある事務又は事業の情報を事後的にすべて列挙することは技術的に困難であり、実益も乏しい。そのため、各機関共通的に見られる事務又は事業に関する情報であって、公にすることによりその適正な遂行に支障を及ぼすおそれがある情報を含むことが容易に想定されるものを「次に掲げるおそれ」としてイからトまで例示的に掲げた上で、これらのおそれ以外については、「その他当該事務又は事業の性質上、当該事務又は事業の適正な遂行に支障を及ぼすおそれがあるもの」として包括的に規定している。

- 1 「次に掲げるおそれその他当該事務又は事業の性質上、当該事務又は事業の適正な遂行に支障を及ぼすおそれがあるもの」(第4号本文)

(1) 「次に掲げるおそれ」

「次に掲げるおそれ」としてイからトまでに掲げたものは、各機関共通的に見られる事務又は事業に関する情報であって、その性質上、公にすることにより、その適正な遂行に支障を及ぼすおそれがあると考えられる典型的な支障を挙げたものである。これらの事務又は事業の外にも、同種のもので反復されるような性質の事務又は事業であって、ある個別の事務又は事業に関する情報を開示すると、将来の同種の事務又は事業の適正な遂行に支障を及ぼすおそれがあるもの等、「その他当該事務又は事業の性質上、当該事務又は事業の適正な遂行に支障を及ぼすおそれ」があり得る。

(2) 「当該事務又は事業の性質上」

当該事務又は事業の本質的な性格、具体的には、当該事務又は事業の目的、その目的達成のための手法等に照らして、その適正な遂行に支障を及ぼすおそれがあるかどうかを判断する趣旨である。

(3) 「適正な遂行に支障を及ぼすおそれ」

本規定は、独立行政法人等に広範な裁量権限を与える趣旨ではなく、各規定の要件の該当性を客観的に判断する必要がある、また、事務又は事業がその根拠となる規定・趣旨に照らし、公益的な開示の必要性等の種々の利益を衡量した上での「適正な遂行」と言えるものであることが求められる。

「支障」の程度は名目的なものでは足りず実質的なものが要求され、「おそれ」の程度も単なる確率的な可能性ではなく、法的保護に値する蓋然性が要求される。

2 「国の安全が害されるおそれ、他国若しくは国際機関との信頼関係が損なわれるおそれ又は他国若しくは国際機関との交渉上不利益を被るおそれ」(第4号イ)

(1) 「国の安全が害されるおそれ」

「国の安全」とは、国家の構成要素である国土、国民及び統治体制が害されることなく平和で平穏な状態に保たれていること、すなわち、国としての基本的な秩序が平穏に維持されている状態をいう。具体的には、直接侵略及び間接侵略に対し、独立と平和が守られていること、国民の生命が国外からの脅威等から保護されていること、国の存立基盤としての基本的な政治方式及び経済・社会秩序の安定が保たれていることなどが考えられる。

「国の安全が害されるおそれ」とは、これらの国の重大な利益に対する侵害のおそれ(当該重大な利益を維持するための手段の有効性を阻害され、国の安全が害されるおそれがあると考えられる場合を含む。)をいう。

(2) 「他国若しくは国際機関との信頼関係が損なわれるおそれ」

「他国若しくは国際機関」(我が国が承認していない地域、政府機関その他これに準ずるもの(各国の中央銀行等)、外国の地方政府又は国際会議その他国際協調の枠組みに係る組織(アジア太平洋経済協力、国際刑事警察機構等)の事務局等を含む。以下「他国等」という。)との間で、相互の信頼に基づき保たれている正常な関係に支障を及ぼすようなおそれをいう。例えば、公にすることにより、他国等との取決め又は国際慣行に反することとなる、他国等の意思に一方的に反することとなる、他国等に不当に不利益を与えることとなるなど、我が国との関係に悪影響を及ぼすおそれがある情報が該当すると考えられる。

(3) 「他国若しくは国際機関との交渉上不利益を被るおそれ」

他国等との現在進行中の又は将来予想される交渉において、我が国が望むような交渉成果が得られなくなる、我が国の交渉上の地位が低下するなどのおそれをいう。例えば、交渉(過去のものを含む。)に関する情報であって、公にすることにより、現在進行中の又は将来予想される交渉に関して我が国が執ろうとしている立場が明らかにされ、又は具体的に推測されることになり、交渉上の不利益を被るおそれがある情報が該当すると考えられる。

3 「犯罪の予防、鎮圧又は捜査その他の公共の安全と秩序の維持」

(第4号ロ)

(1) 「犯罪の予防、鎮圧又は捜査」は、「公共の安全と秩序の維持」の例示である。

「犯罪の予防」とは、犯罪の発生を未然に防止することをいう。なお、国民の防犯意識の啓発、防犯資機材の普及等、一般に公にしても犯罪を誘発し、又は犯罪の実行を容易にするおそれがない防犯活動に関する情報については、本号に該当しない。

「犯罪の鎮圧」とは、犯罪が正に発生しようとするのを未然に防止したり、犯罪が発生した後において、その拡大を防止し、若しくは終息させることをいう。

「犯罪の捜査」とは、捜査機関が犯罪があると思料するときに、公訴の提起などのために犯人及び証拠を発見・収集・保全することをいう。犯罪捜査の権限を有する者は、刑事訴訟法によれば、検察官、検察事務官及び司法警察職員であり、司法警察職員には、一般司法警察職員と特別司法警察職員とがある。

(2) ここでいう「公共の安全と秩序の維持」とは、犯罪の予防、鎮圧又は捜査に代表される刑事法の執行を中心としたものを意味する。

刑事訴訟法以外の特別法により、臨検・捜索・差押え、告発等が規定され、犯罪の予防・捜査とも関連し、刑事司法手続に準ずるものと考えられる犯則事件の調査、独占禁止法違反の調査等や、犯罪の予防・捜査に密接に関連する破壊的団体（無差別大量殺人行為を行った団体を含む。）の規制、暴力団員による不当な行為の防止、つきまとい等の規制、強制退去手続に関する情報であって、公にすることにより、公共の安全と秩序の維持に支障を及ぼすおそれがあるものは、本号に含まれる。

また、公にすることにより、テロ等の人の生命、身体、財産等への不法な侵害や、特定の建造物又はシステムへの不法な侵入・破壊を招くおそれがあるなど、犯罪を誘発し、又は犯罪の実行を容易にするおそれがある情報や被疑者・被告人の留置・勾留に関する施設保安に支障を生ずるおそれのある情報も、本号に含まれる。

4 「監査、検査、取締り又は試験に係る事務に関し、正確な事実の把握を困難にするおそれ又は違法若しくは不当な行為を容易にし、若しくはその発見を困難にするおそれ」（第4号八）

(1) 「監査」とは、主として監察的見地から、事務又は事業の執行又は財産の状況の正否を調べることをいう。

「検査」とは、法令の執行確保、会計経理の適正確保、物資の規格、等級の証明等のために帳簿書類その他の物件等を調べることをいう。

「取締り」とは、行政上の目的による一定の行為の禁止、又は制限について適法、適正な状態を確保することをいう。

「試験」とは、人の知識、能力等又は物の性能等を試すことをいう。

(2) 「正確な事実の把握を困難にするおそれ又は違法若しくは不当な行為を容易にし、若しくはその発見を困難にするおそれ」

上記の監査等は、いずれも事実を正確に把握し、その事実に基づいて評価、判断を加えて、一定の決定を伴うことがある事務である。

これらの事務に関する情報の中には、例えば、監査等の対象、実施時期、調査事項等の詳細な情報や、試験問題等のように、事前に公にすれば、適正かつ公正な評価や判断の前提となる事実の把握が困難となったり、行政客体における法令違反行為又は法令違反に至らないまでも妥当性を欠く行為を助長したり、巧妙に行うことにより隠蔽をするなどのおそれがあるものがあり、このような情報については、不開示とするものである。また、事後であっても、例えば、違反事例等の詳細についてこれを公にすると他の行政客体に法規制を免れる方法を示唆するようなものは該当し得ると考えられる。

5 「契約、交渉又は争訟に係る事務に関し、国、独立行政法人等又は地方公共団体の財産上の利益又は当事者としての地位を不当に害するおそれ」（第4号二）

(1) 「契約、交渉又は争訟」

「契約」とは、相手方との意思表示の合致により法律行為を成立させることをいう。

「交渉」とは、当事者が、対等の立場において相互の利害関係事項に関し一定の結論を得るために協議、調整などの折衝を行うことをいう。

「争訟」とは、訴えを起こして争うことをいう。訴訟、行政不服審査法に基づく不服申立てその他の法令に基づく不服申立てがある。

(2) 「国、独立行政法人等又は地方公共団体の財産上の利益又は当事者としての地位を不当に害するおそれ」

国、独立行政法人等又は地方公共団体が一方の当事者となる上記の契約等においては、自己の意思により又は訴訟手続上、相手方と対等な立場で遂行する必要があり、当事者としての利益を保護する必要がある。

これらの契約等に関する情報の中には、例えば、入札予定価格等を公にすることにより公正な競争により形成されるべき適正な額での契約が困難になり財産上の利益が損なわれた

り、交渉や争訟等の対処方針等を公にすることにより、当事者として認められるべき地位を不当に害するおそれがあるものがあり、このような情報については、不開示とするものである。

6 「調査研究に係る事務に関し、その公正かつ能率的な遂行を不当に阻害するおそれ」(第4号ホ)

国の機関、独立行政法人等又は地方公共団体が行う調査研究(ある事柄を調べ、真理を探究すること)の成果については、社会、国民等にあまねく還元することが原則であるが、成果を上げるためには、従事する職員が、その発想、創意工夫等を最大限に発揮できるようにすることも重要である。

調査研究に係る事務に関する情報の中には、例えば、知的所有権に関する情報、調査研究の途中段階の情報などで、一定の期日以前に公にすることにより成果を適正に広く国民に提供する目的を損ね、特定の者に不当な利益や不利益を及ぼすおそれがあるもの、試行錯誤の段階のものについて、公にすることにより、自由な発想、創意工夫や研究意欲が不当に妨げられ、減退するなど、能率的な遂行を不当に阻害するおそれがある場合があり、このような情報を不開示とするものである。

7 「人事管理に係る事務に関し、公正かつ円滑な人事の確保に支障を及ぼすおそれ」(第4号ヘ)

国の機関、独立行政法人等又は地方公共団体が行う人事管理(職員の任免、懲戒、給与、研修その他職員の身分や能力等の管理に関すること)に係る事務については、当該機関の組織としての維持の観点から行われる一定の範囲で当該組織の独自性を有するものである。

人事管理に係る事務に関する情報の中には、例えば、勤務評価や、人事異動、昇格等の人事構想等を公にすることにより、公正かつ円滑な人事の確保が困難になるおそれがあるものがあり、このような情報を不開示とするものである。

8 「国若しくは地方公共団体が経営する企業又は独立行政法人等に係る事業に関し、その企業経営上の正当な利益を害するおそれ」(第4号ト)

国若しくは地方公共団体が経営する企業(国営企業及び特定独立行政法人の労働関係に関する法律第2条第1号の国営企業及び地方公営企業法第2条の適用を受ける企業をいう。)又は独立行政法人等に係る事業については、企業経営という事業の性質上、第2号の法人等に関する情報と同様な考え方で、その正当な利益を保護する必要がある、これを害するおそれがあるものを不開示とするものである。ただし、正当な利益の内容については、経営主体、事業の性格、内容等に応じて判断する必要がある、その開示の範囲は第2号の法人等とでは当然異なり、国又は地方公共団体が経営する企業又は独立行政法人等に係る事業に関する情報の不開示の範囲は、より狭いものとなる場合があり得る。

## 5 第6条（部分開示）関係

第6条 独立行政法人等は、開示請求に係る法人文書の一部に不開示情報が記録されている場合において、不開示情報が記録されている部分を容易に区分して除くことができるときは、開示請求者に対し、当該部分を除いた部分につき開示しなければならない。ただし、当該部分を除いた部分に有意の情報が記録されていないと認められるときは、この限りでない。

2 開示請求に係る法人文書に前条第1号の情報（特定の個人を識別することができるものに限る。）が記録されている場合において、当該情報のうち、氏名、生年月日その他の特定の個人を識別することができることとなる記述等の部分を除くことにより、公にしても個人の権利利益が害されるおそれがないと認められるときは、当該部分を除いた部分は、同号の情報に含まれないものとみなして、前項の規定を適用する。

### 【趣旨】

本条第1項は、法人文書の一部に不開示情報が記録されている場合における独立行政法人等の部分開示の義務の内容及びその要件を明らかにするものである。

第2項は、開示請求に係る法人文書に個人識別情報（不開示情報）が記録されている場合に、個人識別性のある部分を除くことによる部分開示について定めるものである。

### 【解説】

1 不開示情報が記録されている場合の部分開示（第1項）

(1) 「開示請求に係る法人文書の一部に不開示情報が記録されている場合」

一件の法人文書に複数の情報が記録されている場合に、各情報ごとに、第5条各号に規定する不開示情報に該当するかどうかを審査した結果、不開示情報に該当する情報がある場合を意味する。

開示請求は、法人文書単位に行われるものであるため、第5条では法人文書に全く不開示情報が記録されていない場合の開示義務を定めているが、本項の規定により、独立行政法人等は、開示請求に係る法人文書に不開示情報が記録されている場合に、部分的に開示できるか否かの判断を行わなければならないことになる。

(2) 「容易に区分して除くことができるとき」

ア 当該法人文書のどの部分に不開示情報が記載されているかという記載部分の区分けが困難な場合だけではなく、区分けは容易であるがその部分の分離が技術的に困難な場合も部分開示の義務がないことを明らかにしたものである。

「区分」とは、不開示情報が記録されている部分とそれ以外の部分とを概念上区分けすることを意味し、「除く」とは、不開示情報が記録されている部分を、当該部分の内容が分からないように墨塗り、被覆等を行い、法人文書から物理的に除去することを意味する。

例えば、文章として記録されている内容そのものには不開示情報は含まれないが、特徴のある筆跡により特定の個人を識別することができる場合には、識別性のある部分を区分して除くことは困難である。また、録音されている発言内容自体には不開示情報が含まれていないとしても声により特定の個人を識別できる場合も同様である。

イ 文書の記載の一部を除くことは、コピー機で作成したその複写物に墨を塗り再複写するなどして行うことができ、一般的には容易であると考えられる。なお、部分開示の作業に多くの時間・労力を要することは、直ちに、区分し、分離することが困難であるということにはならない。

一方、録音、録画、磁気ディスクに記録されたデータベース等の電磁的記録については、区分して除くことの容易性が問題となる。例えば、複数の人の発言が同時に録音されているがそのうち一部の発言内容のみに不開示情報が含まれている場合や、録画されている映

像中に不開示情報が含まれている場合などでは、不開示情報部分のみを除去することが容易ではないことがあり得る。このような場合には、容易に区分して除くことができる範囲で、開示すべき部分を決定することになる。

なお、電磁的記録について、不開示部分と開示部分の分離が既存のプログラムでは行えない場合は、「容易に区分して除くことができない場合」に該当する。

(3) 「当該部分を除いた部分につき開示しなければならない。」

ア 部分的に削除すべき範囲は、文書であれば、一般的には、文、段落等、表であれば個々の欄等を単位として判断することをもって足りる。

イ 本項は、義務的に開示すべき範囲を定めているものであり、部分開示の実施に当たり、具体的な記述をどのように削除するかについては、独立行政法人等の本法の目的に沿った合目的な裁量に委ねられている。すなわち、不開示情報の記録部分の全体を完全に黒く塗るか、文字が判読できない程度に被覆するか、当該記録中の主要な部分だけ塗りつぶすかなどの方法の選択は、不開示情報を開示した結果とならない範囲内において、当該方法を講ずることの容易さ等を考慮して判断することとなる。その結果、観念的にはひとまとまりの不開示情報を構成する一部が開示されることになるとしても、実質的に不開示情報が開示されたと認められないのであれば、独立行政法人等の不開示義務に反するものではない。

(4) 「有意の情報が記録されていないと認められるときは、この限りではない。」

ア 「有意の情報が記録されていないと認められるとき」とは、説明責任が全うされるようにするとの観点から、不開示情報が記録されている部分を除いた残りの部分に記載されている情報の内容が、開示をしても意味がないと認められる場合を意味する。例えば、残りの部分に記載されている内容が、無意味な文字、数字等の羅列となる場合等である。

この「有意」性の判断に当たっては、同時に開示される他の情報があればこれも併せて判断されるべきである。

イ また、「有意」性の判断は、請求の趣旨を損なうか否か、すなわち、開示請求者が知りたいと考える事柄との関連によって判断すべきものではなく、本条では、個々の請求者の意図によらず、客観的に決めるべきものとしている。

## 2 個人識別情報が記録されている場合の部分開示（第2項）

(1) 「開示請求に係る法人文書に前条第1号の情報（特定の個人を識別することができるものに限る。）が記録されている場合」

ア 第1項の規定は、法人文書に記録されている情報のうち、不開示情報ではない情報の記載部分の開示義務を規定しているが、ひとまとまりの不開示情報のうちの一部を削除した残りの部分を開示することの根拠条項とはならない。

個人識別情報は、通常、個人を識別させる部分（例えば、氏名）とその他の部分（例えば、当該個人の行動記録）とから成り立っており、その全体が一つの不開示情報を構成するものである。他の不開示情報の類型は各号に定められた「おそれ」を生じさせる範囲で不開示情報の大きさをとらえることができるのとは、その範囲のとらえ方を異にするものである。

このため、第1項の規定だけでは、個人識別情報については全体として不開示となることから、氏名等の部分だけを削除して残りの部分を開示しても個人の権利利益保護の観点から支障が生じないときには、部分開示とするよう、個人識別情報についての特例規定を設けたものである。

イ 「特定の個人を識別することができるものに限る。」こととしているのは、「特定の個人を識別することはできないが、公にすることにより、なお個人の権利利益を害するおそれがあるもの」（第5条第1号本文の後半部分）については、特定の個人を識別することとなる記述等の部分を除くことにはならないので、他の不開示情報の類型と同様に不開示情報が記録されている部分を除いた部分につき開示することとなるためである。

- (2) 「当該情報のうち、氏名、生年月日その他の特定の個人を識別することができることとなる記述等の部分を除くことにより、公にしても、個人の権利利益が害されるおそれがないと認められるとき」

個人を識別させる要素を除去することにより誰の情報であるかが分からなくなれば、残りの部分については、通常、個人情報としての保護の必要性は乏しくなるが、個人識別性のある部分を除いても、開示することが不相当であると認められるものもある。例えば、カルテ、作文などの個人の人格と密接に関連する情報や、個人の未公表の研究論文等開示すると個人の権利利益を害するおそれがあるものである。

このため、個人を識別させる部分を除いた部分について、公にしても、個人の権利利益を害するおそれがないものに限り、部分開示の規定を適用することとしている。

- (3) 「当該部分を除いた部分は、同号の情報に含まれないものとみなして、前項の規定を適用する。」

第1項の規定により、部分開示の範囲を決定するに当たっては、個人識別情報のうち、特定の個人を識別することができることとなる記述等以外の部分は、個人の権利利益を害するおそれがない限り、第5条第1号に規定する不開示情報ではないものとして取り扱うことになる。したがって、他の不開示情報の規定に該当しない限り、当該部分は開示されることになる。

また、第1項の規定を適用するに当たっては、容易に区分して除くことができるかどうか要件となるので、個人を識別させる要素とそれ以外の部分とを容易に区分して除くことができない場合には、当該個人に関する情報は全体として不開示となることになる。

なお、個人を識別することができる要素は、第5条第1号イ～ハのいずれかに該当しない限り、部分開示の対象とならない。

## 6 第7条（公益上の理由による裁量的開示）関係

第7条 独立行政法人等は、開示請求に係る法人文書に不開示情報が記録されている場合であっても、公益上特に必要があると認めるときは、開示請求者に対し、当該法人文書を開示することができる。

### 【趣旨】

本条は、開示請求に係る法人文書に不開示情報が記録されていても、開示請求者に対し、当該法人文書を開示することができる場合について規定するものである。

### 【解説】

#### 1 「公益上特に必要があると認めるとき」

第5条各号の不開示情報の規定に該当する情報であるが、独立行政法人等の高度の行政的な判断により、公にすることに、当該保護すべき利益を上回る公益上の必要性があると認められる場合を意味する。

第5条各号の不開示情報該当性の判断に当たっては、個人に関する情報（同条第1号）及び法人等に関する情報（同条第2号）のように、個人を識別できる情報や法人の正当な利益を害するおそれがあっても、人の生命、健康、生活又は財産を保護するため、公にすることが必要である場合には、開示をしなければならない（個人に関する情報については第1号ただし書き口、法人等に関する情報については第2号ただし書き参照）。このほか、審議検討等情報（同条第3号）においては、「不当に損なうおそれ」とし、例えば、率直な意見交換を損なうおそれがあるとしても、不当に損なうものでなければ、開示することとなり、事務・事業情報（同条第4号）についても、その遂行に支障を及ぼすおそれがあっても「適正な遂行」でなければ、開示することとなる。

以上のように、第5条各号においても、当該規定により保護する利益と当該情報を公にすることの公益上の必要性との比較衡量が行われる場合があるが、本条では、第5条の規定を適用した場合に不開示となる場合であっても、なお公にすることに公益上の必要性があると認められる場合には、開示することができるとするものである。

#### 2 「当該法人文書を開示することができる。」

本条の適用に関しては、公益上特に必要と認めたとにかかわらず法人文書を開示しないことは想定できないが、その規定振り（「公益上特に必要があると認めるとき」）からも、処分の性質（不開示情報を開示すること）からも明らかとなっており、公益上の必要性の認定についての独立行政法人等の要件裁量を認める規定である。なお、この趣旨を明確化するため、見出しは「公益上の理由による裁量的開示」としている。



## 7 第8条（法人文書の存否に関する情報）関係

第8条 開示請求に対し、当該開示請求に係る法人文書が存在しているか否かを答えるだけで、不開示情報を開示することとなるときは、独立行政法人等は、当該法人文書の存否を明らかにしないで、当該開示請求を拒否することができる。

### 【趣旨】

本条は、開示請求の拒否処分の一態様として、一定の場合に、独立行政法人等は、法人文書の存否自体を明らかにしないで、拒否することができることを定めるものである。

### 【解説】

独立行政法人等は、開示請求に係る法人文書が存在していれば、開示決定又は不開示決定を行い、存在していなければ不開示決定を行うことになる。したがって、法人文書の不存在を理由とする不開示決定の場合以外の決定では、原則として法人文書の存在が前提となっている。

しかしながら、開示請求に係る法人文書の存否を明らかにするだけで、第5条各号の不開示情報を開示することとなる場合があり、この場合には、法人文書の存否を明らかにしないで開示請求を拒否できることとするものである。

#### 1 「開示請求に係る法人文書が存在しているか否かを答えるだけで、不開示情報を開示することとなるとき」

開示請求に係る法人文書が具体的にあるかないかにかかわらず、開示請求された法人文書の存否について回答すれば、不開示情報を開示することとなる場合をいう。開示請求に含まれる情報と不開示情報該当性が結合することにより、当該法人文書の存否を回答できない場合もある。例えば、特定の個人の名を挙げて、その病歴情報が記録された文書の開示請求があった場合、当該法人文書に記録されている情報は不開示情報に該当するので、不開示であると答えるだけで、当該個人の病歴の存在が明らかになってしまう。このような特定の者又は特定の事項を名指しした探索的請求は、第5条各号の不開示情報の類型すべてについて生じ得ると考えられる。

具体的には、次のような例が考えられる。

特定の個人の病歴に関する情報（第1号）

先端技術に関する特定企業の設備投資計画に関する情報（第2号）

買い占めを招くなど国民生活に重大な影響を及ぼすおそれのある特定の物質に関する政策決定の検討状況の情報（第3号）

情報交換の存在を明らかにしない約束で他国等との間で交換された情報（第4号イ）

犯罪の内偵捜査に関する情報（第4号ロ）

特定分野に限定しての試験問題の出題予定に関する情報（第4号ハ）

#### 2 「当該法人文書の存否を明らかにしないで、当該開示請求を拒否することができる」

法人文書の存否を明らかにしないで、開示請求を拒否する決定も、申請に対する処分であることから、行政手続法第8条に基づき、処分の理由を示す必要がある。提示すべき理由の程度としては、開示請求者が拒否の理由を明確に認識し得るものであることが必要であると考えられる。また、個別具体的な理由提示の程度については、当該情報の性質、内容、開示請求書の記載内容等を踏まえ、請求のあった法人文書の存否を答えることにより、どのような不開示情報を開示することになるかをできる限り具体的に提示することになる。

また、存否を明らかにしないで拒否することが必要な類型の情報については、常に存否を明らかにしないで拒否することが必要であり、例えば、法人文書が存在しない場合に不存在と答

えて、法人文書が存在する場合にのみ存否を明らかにしないで拒否したのでは、開示請求者に当該法人文書の存在を類推させることになる。

(参考)

行政手続法(抄)

(理由の提示)

第8条 行政庁は、申請により求められた許認可等を拒否する処分をする場合は、申請者に対し、同時に、当該処分を理由を示さなければならない。ただし、法令に定められた許認可等の要件又は公にされた審査基準が数量的指標その他の客観的指標により明確に定められている場合であって、当該申請がこれらに適合しないことが申請書の記載又は添付書類から明らかであるときは、申請者の求めがあったときにこれを示せば足りる。

2 前項本文に規定する処分を書面でするときは、同項の理由は、書面により示さなければならない。

# •î•ñŒöŠJ–@™,ÉŠî,Ā,-'ñ<Ÿ•î•ñ

•X•V“ú•F2002.10.1

- [“Æ—§•s•--@•l'Ê'Ÿ—@](#)
- [<Æ–±•û–@•‘ \( \[html\]\(#\) \)](#)
- [•‘•Ū”_—Ñ•...ŽY<ÆŒœ<†fZf“f^•\[–@](#)
- [‘g•D,ÉŠÖ,.,é<K’ö](#)
- [‘g•D•}](#)
- [–đ^õŒo—đ•‘](#)
- [–đ^õ<<—^<K’ö](#)
- [–đ^õ‘P•EŽè“–<K’ö](#)
- [•E^õ<<—^<K’ö](#)
- [Ž–<Æ•ñ•••‘](#)
- [’†Šú–Ú•W \( \[html\]\(#\) \)](#)
- [’†ŠúŒv%ooæ \( \[html\]\(#\) \)](#)
- [•½•¬14”N“x”N“xŒv%ooæ \( \[html\]\(#\) \)](#)

• ŠÄŽ-ŠÄ•,Î^ÓŒ©

• Ā-±ŽžŠÔĀK'ö

• -{•È%ooŪ'•â•²<%oo^È•ã,Ì•E^õ<y,ÑŽw'è•E^È•ã,Ì•E^õ,Ì"ÍÍ

---

• ‘•Ū” _—Ñ•...ŽY<ÆŒœœ<†fZf“f^•[

# 独立行政法人通則法

平成11年法律第103号

平成11年7月16日

## 目次

### 第1章 総則

第1節 通則（第1条～第11条）

第2節 独立行政法人評価委員会（第12条）

第3節 設立（第13条～第17条）

第2章 役員及び職員（第18条～第26条）

### 第3章 業務運営

第1節 業務（第27条・第28条）

第2節 中期目標等（第29条～第35条）

第4章 財務及び会計（第36条～第50条）

### 第5章 人事管理

第1節 特定独立行政法人（第51条～第60条）

第2節 特定独立行政法人以外の独立行政法人（第61条～第63条）

第6章 雑則（第64条～第68条）

第7章 罰則（第69条～第72条）

## 附則

### 第1章 総則

#### 第1節 通則

（目的等）

第1条 この法律は、独立行政法人の運営の基本その他の制度の基本となる共通の事項を定め、各独立行政法人の名称、目的、業務の範囲等に関する事項を定める法律（以下「個別法」という。）と相まって、独立行政法人制度の確立並びに独立行政法人が公共上の見地から行う事務及び事業の確実な実施を図り、もって国民生活の安定及び社会経済の健全な発展に資することを目的とする。

2 各独立行政法人の組織、運営及び管理については、個別法に定めるもののほか、この法律の定めるところによる。

（定義）

第2条 この法律において「独立行政法人」とは、国民生活及び社会経済の安定等の公共上の見地から確実に実施されることが必要な事務及び事業であって、国が自ら主体となって直接に実施する必要のないもののうち、民間の主体にゆだねた場合には必ずしも実施されないおそれがあるもの又は一の主体に独占して行わせることが必要であるものを効率的かつ効果的に行わせることを目的として、この法律及び個別法の定めるところにより設立される法人をいう。

2 この法律において「特定独立行政法人」とは、独立行政法人のうち、その業務の停滞が国民生活又は社会経済の安定に直接かつ著しい支障を及ぼすと認められるものその他当該独立行政法人の目的、業務の性質等を総合的に勘案して、その役員及び職員

に国家公務員の身分を与えることが必要と認められるものとして個別法で定めるものをいう。

(業務の公共性、透明性及び自主性)

第3条 独立行政法人は、その行う事務及び事業が国民生活及び社会経済の安定等の公共上の見地から確実に実施されることが必要なものであることにかんがみ、適正かつ効率的にその業務を運営するよう努めなければならない。

2 独立行政法人は、この法律の定めるところによりその業務の内容を公表すること等を通じて、その組織及び運営の状況を国民に明らかにするよう努めなければならない。

3 この法律及び個別法の運用に当たっては、独立行政法人の業務運営における自主性は、十分配慮されなければならない。

(名称)

第4条 各独立行政法人の名称は、個別法で定める。

(目的)

第5条 各独立行政法人の目的は、第2条第1項の目的の範囲内で、個別法で定める。

(法人格)

第6条 独立行政法人は、法人とする。

(事務所)

第7条 各独立行政法人は、主たる事務所を個別法で定める地に置く。

2 独立行政法人は、必要な地に従たる事務所を置くことができる。

(財産的基礎)

第8条 独立行政法人は、その業務を確実に実施するために必要な資本金その他の財産的基礎を有しなければならない。

2 政府は、その業務を確実に実施させるために必要があると認めるときは、個別法で定めるところにより、各独立行政法人に出資することができる。

(登記)

第9条 独立行政法人は、政令で定めるところにより、登記しなければならない。

2 前項の規定により登記しなければならない事項は、登記の後でなければ、これをもって第三者に対抗することができない。

(名称の使用制限)

第10条 独立行政法人でない者は、その名称中に、独立行政法人という文字を用いてはならない。

(民法の準用)

第11条 民法(明治29年法律第89号)第44条及び第50条の規定は、独立行政法人について準用する。

## 第2節 独立行政法人評価委員会

(独立行政法人評価委員会)

第12条 独立行政法人の主務省(当該独立行政法人を所管する内閣府又は各省をいう。以下同じ。)に、その所管に係る独立行政法人に関する事務を処理させるため、独立行政法人評価委員会(以下「評価委員会」という。)を置く。

2 評価委員会は、次に掲げる事務をつかさどる。

(1) 独立行政法人の業務の実績に関する評価に関すること。

(2) その他この法律又は個別法によりその権限に属させられた事項を処理すること。

3 前項に定めるもののほか、評価委員会の組織、所掌事務及び委員その他の職員その他評価委員会に関し必要な事項については、政令で定める。

### 第3節 設立

(設立の手續)

第13条 各独立行政法人の設立に関する手續については、個別法に特別の定めがある場合を除くほか、この節の定めるところによる。

(法人の長及び監事となるべき者)

第14条 主務大臣は、独立行政法人の長(以下「法人の長」という。)となるべき者及び監事となるべき者を指名する。

2 前項の規定により指名された法人の長又は監事となるべき者は、独立行政法人の成立の時に於いて、この法律の規定により、それぞれ法人の長又は監事に任命されたものとする。

3 第20条第1項の規定は、第1項の法人の長となるべき者の指名について準用する。

(設立委員)

第15条 主務大臣は、設立委員を命じて、独立行政法人の設立に関する事務を処理させる。

2 設立委員は、独立行政法人の設立の準備を完了したときは、遅滞なく、その旨を主務大臣に届け出るとともに、その事務を前条第1項の規定により指名された法人の長となるべき者に引き継がなければならない。

(設立の登記)

第16条 第14条第1項の規定により指名された法人の長となるべき者は、前条第2項の規定による事務の引継ぎを受けたときは、遅滞なく、政令で定めるところにより、設立の登記をしなければならない。

第17条 独立行政法人は、設立の登記をすることによって成立する。

### 第2章 役員及び職員

(役員)

第18条 各独立行政法人に、個別法で定めるところにより、役員として、法人の長1人及び監事を置く。

2 各独立行政法人には、前項に規定する役員のほか、個別法で定めるところにより、他の役員を置くことができる。

3 各独立行政法人の法人の長の名称、前項に規定する役員の名称及び定数並びに監事

の定数は、個別法で定める。

( 役員の職務及び権限 )

第 19 条 法人の長は、独立行政法人を代表し、その業務を総理する。

- 2 個別法で定める役員（法人の長を除く。）は、法人の長の定めるところにより、法人の長に事故があるときはその職務を代理し、法人の長が欠員のときはその職務を行う。
- 3 前条第 2 項の規定により置かれる役員の職務及び権限は、個別法で定める。
- 4 監事は、独立行政法人の業務を監査する。
- 5 監事は、監査の結果に基づき、必要があると認めるときは、法人の長又は主務大臣に意見を提出することができる。

( 役員の任命 )

第 20 条 法人の長は、次に掲げる者のうちから、主務大臣が任命する。

- ( 1 ) 当該独立行政法人が行う事務及び事業に関して高度な知識及び経験を有する者
- ( 2 ) 前号に掲げる者のほか、当該独立行政法人が行う事務及び事業を適正かつ効率的に運営することができる者
- 2 監事は、主務大臣が任命する。
- 3 第 18 条第 2 項の規定により置かれる役員は、第 1 項各号に掲げる者のうちから、法人の長が任命する。
- 4 法人の長は、前項の規定により役員を任命したときは、遅滞なく、主務大臣に届け出るとともに、これを公表しなければならない。

( 役員の任期 )

第 21 条 役員の任期は、個別法で定める。ただし、補欠の役員の任期は、前任者の残任期間とする。

- 2 役員は、再任されることができる。

( 役員の欠格条項 )

第 22 条 政府又は地方公共団体の職員（非常勤の者を除く。）は、役員となることができない。

( 役員の解任 )

第 23 条 主務大臣又は法人の長は、それぞれその任命に係る役員が前条の規定により役員となることができない者に該当するに至ったときは、その役員を解任しなければならない。

- 2 主務大臣又は法人の長は、それぞれその任命に係る役員が次の各号の一に該当するとき、その他役員たるに適しないと認めるときは、その役員を解任することができる。
  - ( 1 ) 心身の故障のため職務の遂行に堪えないと認められるとき。
  - ( 2 ) 職務上の義務違反があるとき。
- 3 前項に規定するもののほか、主務大臣又は法人の長は、それぞれその任命に係る役員（監事を除く。）の職務の執行が適当でないため当該独立行政法人の業務の実績が悪化した場合であって、その役員に引き続き当該職務を行わせることが適切でないとして認めるときは、その役員を解任することができる。
- 4 法人の長は、前二項の規定によりその任命に係る役員を解任したときは、遅滞なく、



主務大臣に届け出るとともに、これを公表しなければならない。

(代表権の制限)

第24条 独立行政法人と法人の長その他の代表権を有する役員との利益が相反する事項については、これらの者は、代表権を有しない。この場合には、監事が当該独立行政法人を代表する。

(代理人の選任)

第25条 法人の長その他の代表権を有する役員は、当該独立行政法人の代表権を有しない役員又は職員のうちから、当該独立行政法人の業務の一部に関し一切の裁判上又は裁判外の行為をする権限を有する代理人を選任することができる。

(職員の任命)

第26条 独立行政法人の職員は、法人の長が任命する。

### 第3章 業務運営

#### 第1節 業務

(業務の範囲)

第27条 各独立行政法人の業務の範囲は、個別法で定める。

(業務方法書)

第28条 独立行政法人は、業務開始の際、業務方法書を作成し、主務大臣の認可を受けなければならない。これを変更しようとするときも、同様とする。

- 2 前項の業務方法書に記載すべき事項は、主務省令(当該独立行政法人を所管する内閣府又は各省の内閣府令又は省令をいう。以下同じ。)で定める。
- 3 主務大臣は、第1項の認可をしようとするときは、あらかじめ、評価委員会の意見を聴かななければならない。
- 4 独立行政法人は、第1項の認可を受けたときは、遅滞なく、その業務方法書を公表しなければならない。

#### 第2節 中期目標等

(中期目標)

第29条 主務大臣は、3年以上5年以下の期間において独立行政法人が達成すべき業務運営に関する目標(以下「中期目標」という。)を定め、これを当該独立行政法人に指示するとともに、公表しなければならない。これを変更したときも、同様とする。

- 2 中期目標においては、次に掲げる事項について定めるものとする。
  - (1) 中期目標の期間(前項の期間の範囲内で主務大臣が定める期間をいう。以下同じ。)
  - (2) 業務運営の効率化に関する事項
  - (3) 国民に対して提供するサービスその他の業務の質の向上に関する事項
  - (4) 財務内容の改善に関する事項
  - (5) その他業務運営に関する重要事項
- 3 主務大臣は、中期目標を定め、又はこれを変更しようとするときは、あらかじめ、評価委員会の意見を聴かななければならない。

(中期計画)

第30条 独立行政法人は、前条第1項の指示を受けたときは、中期目標に基づき、主務省令で定めるところにより、当該中期目標を達成するための計画(以下「中期計画」という。)を作成し、主務大臣の認可を受けなければならない。これを変更しようとするときも、同様とする。

2 中期計画においては、次に掲げる事項を定めるものとする。

(1) 業務運営の効率化に関する目標を達成するためとるべき措置

(2) 国民に対して提供するサービスその他の業務の質の向上に関する目標を達成するためとるべき措置

(3) 予算(人件費の見積りを含む。) 収支計画及び資金計画

(4) 短期借入金の限度額

(5) 重要な財産を譲渡し、又は担保に供しようとするときは、その計画

(6) 剰余金の使途

(7) その他主務省令で定める業務運営に関する事項

3 主務大臣は、第1項の認可をしようとするときは、あらかじめ、評価委員会の意見を聴かなければならない。

4 主務大臣は、第1項の認可をした中期計画が前条第2項第2号から第5号までに掲げる事項の適正かつ確実な実施上不適当となったと認めるときは、その中期計画を変更すべきことを命ずることができる。

5 独立行政法人は、第1項の認可を受けたときは、遅滞なく、その中期計画を公表しなければならない。

(年度計画)

第31条 独立行政法人は、毎事業年度の開始前に、前条第1項の認可を受けた中期計画に基づき、主務省令で定めるところにより、その事業年度の業務運営に関する計画(次項において「年度計画」という。)を定め、これを主務大臣に届け出るとともに、公表しなければならない。これを変更したときも、同様とする。

2 独立行政法人の最初の事業年度の年度計画については、前項中「毎事業年度の開始前に、前条第1項の認可を受けた」とあるのは、「その成立後最初の中期計画について前条第1項の認可を受けた後遅滞なく、その」とする。

(各事業年度に係る業務の実績に関する評価)

第32条 独立行政法人は、主務省令で定めるところにより、各事業年度における業務の実績について、評価委員会の評価を受けなければならない。

2 前項の評価は、当該事業年度における中期計画の実施状況の調査をし、及び分析をし、並びにこれらの調査及び分析の結果を考慮して当該事業年度における業務の実績の全体について総合的な評定をして、行わなければならない。

3 評価委員会は、第一項の評価を行ったときは、遅滞なく、当該独立行政法人及び政令で定める審議会(以下「審議会」という。)に対して、その評価の結果を通知しなければならない。この場合において、評価委員会は、必要があると認めるときは、当該独立行政法人に対し、業務運営の改善その他の勧告をすることができる。

4 評価委員会は、前項の規定による通知を行ったときは、遅滞なく、その通知に係る事項(同項後段の規定による勧告をした場合にあっては、その通知に係る事項及びその勧告の内容)を公表しなければならない。

5 審議会は、第3項の規定により通知された評価の結果について、必要があると認め

るときは、当該評価委員会に対し、意見を述べることができる。

(中期目標に係る事業報告書)

第33条 独立行政法人は、中期目標の期間の終了後3月以内に、主務省令で定めるところにより、当該中期目標に係る事業報告書を主務大臣に提出するとともに、これを公表しなければならない。

(中期目標に係る業務の実績に関する評価)

第34条 独立行政法人は、主務省令で定めるところにより、中期目標の期間における業務の実績について、評価委員会の評価を受けなければならない。

- 2 前項の評価は、当該中期目標の期間における中期目標の達成状況の調査をし、及び分析をし、並びにこれらの調査及び分析の結果を考慮して当該中期目標の期間における業務の実績の全体について総合的な評定をして、行わなければならない。
- 3 第32条第3項から第5項までの規定は、第1項の評価について準用する。

(中期目標の期間の終了時の検討)

第35条 主務大臣は、独立行政法人の中期目標の期間の終了時において、当該独立行政法人の業務を継続させる必要性、組織の在り方その他その組織及び業務の全般にわたる検討を行い、その結果に基づき、所要の措置を講ずるものとする。

- 2 主務大臣は、前項の規定による検討を行うに当たっては、評価委員会の意見を聴かななければならない。
- 3 審議会は、独立行政法人の中期目標の期間の終了時において、当該独立行政法人の主要な事務及び事業の改廃に関し、主務大臣に勧告することができる。

## 第4章 財務及び会計

(事業年度)

第36条 独立行政法人の事業年度は、毎年4月1日に始まり、翌年3月31日に終わる。

- 2 独立行政法人の最初の事業年度は、前項の規定にかかわらず、その成立の日に始まり、翌年の3月31日(1月1日から3月31日までの間に成立した独立行政法人にあっては、その年の3月31日)に終わるものとする。

(企業会計原則)

第37条 独立行政法人の会計は、主務省令で定めるところにより、原則として企業会計原則によるものとする。

(財務諸表等)

第38条 独立行政法人は、毎事業年度、貸借対照表、損益計算書、利益の処分又は損失の処理に関する書類その他主務省令で定める書類及びこれらの附属明細書(以下「財務諸表」という。)を作成し、当該事業年度の終了後3月以内に主務大臣に提出し、その承認を受けなければならない。

- 2 独立行政法人は、前項の規定により財務諸表を主務大臣に提出するときは、これに当該事業年度の事業報告書及び予算の区分に従い作成した決算報告書を添え、並びに財務諸表及び決算報告書に関する監事の意見(次条の規定により会計監査人の監査を

受けなければならない独立行政法人にあっては、監事及び会計監査人の意見。以下同じ。)を付けなければならない。

- 3 主務大臣は、第1項の規定により財務諸表を承認しようとするときは、あらかじめ、評価委員会の意見を聴かなければならない。
- 4 独立行政法人は、第1項の規定による主務大臣の承認を受けたときは、遅滞なく、財務諸表を官報に公告し、かつ、財務諸表並びに第2項の事業報告書、決算報告書及び監事の意見を記載した書面を、各事務所に備えて置き、主務省令で定める期間、一般の閲覧に供しなければならない。

(会計監査人の監査)

第39条 独立行政法人(その資本の額その他の経営の規模が政令で定める基準に達しない独立行政法人を除く。)は、財務諸表、事業報告書(会計に関する部分に限る。)及び決算報告書について、監事の監査のほか、会計監査人の監査を受けなければならない。

(会計監査人の選任)

第40条 会計監査人は、主務大臣が選任する。

(会計監査人の資格)

第41条 株式会社の監査等に関する商法の特例に関する法律(昭和49年法律第22号)第4条(第2項第2号を除く。)の規定は、第39条の会計監査人について準用する。この場合において、同法第4条第2項第1号中「第2条」とあるのは、「独立行政法人通則法第39条」と読み替えるものとする。

(会計監査人の任期)

第42条 会計監査人の任期は、その選任の日以後最初に終了する事業年度の財務諸表についての主務大臣の第38条第1項の承認の時までとする。

(会計監査人の解任)

第43条 主務大臣は、会計監査人が次の各号の一に該当するときは、その会計監査人を解任することができる。

- (1) 職務上の義務に違反し、又は職務を怠ったとき。
- (2) 会計監査人たるにふさわしくない非行があったとき。
- (3) 心身の故障のため、職務の遂行に支障があり、又はこれに堪えないとき。

(利益及び損失の処理)

第44条 独立行政法人は、毎事業年度、損益計算において利益を生じたときは、前事業年度から繰り越した損失をうめ、なお残余があるときは、その残余の額は、積立金として整理しなければならない。ただし、第3項の規定により同項の用途に充てる場合は、この限りでない。

- 2 独立行政法人は、毎事業年度、損益計算において損失を生じたときは、前項の規定による積立金を減額して整理し、なお不足があるときは、その不足額は、繰越欠損金として整理しなければならない。
- 3 独立行政法人は、第1項に規定する残余があるときは、主務大臣の承認を受けて、その残余の額の全部又は一部を第30条第1項の認可を受けた中期計画(同項後段の規

定による変更の認可を受けたときは、その変更後のもの。以下単に「中期計画」という。)の同条第2項第6号の剰余金の使途に充てることができる。

- 4 主務大臣は、前項の規定による承認をしようとするときは、あらかじめ、評価委員会の意見を聴かなければならない。
- 5 第1項の規定による積立金の処分については、個別法で定める。

#### (借入金等)

第45条 独立行政法人は、中期計画の第30条第2項第4号の短期借入金の限度額の範囲内で、短期借入金をすることができる。ただし、やむを得ない事由があるものとして主務大臣の認可を受けた場合は、当該限度額を超えて短期借入金をすることができる。

- 2 前項の規定による短期借入金は、当該事業年度内に償還しなければならない。ただし、資金の不足のため償還することができないときは、その償還することができない金額に限り、主務大臣の認可を受けて、これを借り換えることができる。
- 3 前項ただし書の規定により借り換えた短期借入金は、1年以内に償還しなければならない。
- 4 主務大臣は、第1項ただし書又は第2項ただし書の規定による認可をしようとするときは、あらかじめ、評価委員会の意見を聴かなければならない。
- 5 独立行政法人は、個別法に別段の定めがある場合を除くほか、長期借入金及び債券発行をすることができない。

#### (財源措置)

第46条 政府は、予算の範囲内において、独立行政法人に対し、その業務の財源に充てるために必要な金額の全部又は一部に相当する金額を交付することができる。

#### (余裕金の運用)

第47条 独立行政法人は、次の方法による場合を除くほか、業務上の余裕金を運用してはならない。

- (1) 国債、地方債、政府保証債(その元本の償還及び利息の支払について政府が保証する債券をいう。)その他主務大臣の指定する有価証券の取得
- (2) 銀行その他主務大臣の指定する金融機関への預金又は郵便貯金
- (3) 信託業務を営む銀行又は信託会社への金銭信託

#### (財産の処分等の制限)

第48条 独立行政法人は、主務省令で定める重要な財産を譲渡し、又は担保に供しようとするときは、主務大臣の認可を受けなければならない。ただし、中期計画において第30条第2項第5号の計画を定めた場合であって、その計画に従って当該重要な財産を譲渡し、又は担保に供するときは、この限りでない。

- 2 主務大臣は、前項の規定による認可をしようとするときは、あらかじめ、評価委員会の意見を聴かなければならない。

#### (会計規程)

第49条 独立行政法人は、業務開始の際、会計に関する事項について規程を定め、これを主務大臣に届け出なければならない。これを変更したときも、同様とする。

(主務省令への委任)

第50条 この法律及びこれに基づく政令に規定するもののほか、独立行政法人の財務及び会計に関し必要な事項は、主務省令で定める。

## 第5章 人事管理

### 第1節 特定独立行政法人

(役員及び職員の身分)

第51条 特定独立行政法人の役員及び職員は、国家公務員とする。

(役員の報酬等)

第52条 特定独立行政法人の役員に対する報酬及び退職手当(以下「報酬等」という。)は、その役員の業績が考慮されるものでなければならない。

- 2 特定独立行政法人は、その役員に対する報酬等の支給の基準を定め、これを主務大臣に届け出るとともに、公表しなければならない。これを変更したときも、同様とする。
- 3 前項の報酬等の支給の基準は、国家公務員の給与、民間企業の役員の報酬等、当該特定独立行政法人の業務の実績及び中期計画の第30条第2項第3号の人件費の見積りその他の事情を考慮して定められなければならない。

(評価委員会の意見の申出)

第53条 主務大臣は、前条第2項の規定による届出があったときは、その届出に係る報酬等の支給の基準を評価委員会に通知するものとする。

- 2 評価委員会は、前項の規定による通知を受けたときは、その通知に係る報酬等の支給の基準が社会一般の情勢に適合したものであるかどうかについて、主務大臣に対し、意見を申し出ることができる。

(役員の服務)

第54条 特定独立行政法人の役員(以下この条から第56条までにおいて単に「役員」という。)は、職務上知ることのできた秘密を漏らしてはならない。その職を退いた後も、同様とする。

- 2 役員は、在任中、政党その他の政治的団体の役員となり、又は積極的に政治運動をしてはならない。
- 3 役員(非常勤の者を除く。次項において同じ。)は、在任中、任命権者の承認のある場合を除くほか、報酬を得て他の職務に従事し、又は営利事業を営み、その他金銭上の利益を目的とする業務を行ってはならない。
- 4 役員は、離職後2年間は、商業、工業又は金融業その他営利を目的とする私企業(以下「営利企業」という。)の地位で、その離職前5年間に在職していた特定独立行政法人又は人事院規則で定める国の機関と密接な関係にあるものに就くことを承諾し、又は就いてはならない。ただし、人事院規則の定めるところにより、任命権者の申出により人事院の承認を得た場合は、この限りでない。

(役員の災害補償)

第55条 役員の公務上の災害又は通勤による災害に対する補償及び公務上の災害又は

通勤による災害を受けた役員に対する福祉事業については、特定独立行政法人の職員の例による。

(役員に係る労働者災害補償保険法の適用除外)

第56条 労働者災害補償保険法(昭和22年法律第50号)の規定は、役員には適用しない。

(職員の給与)

第57条 特定独立行政法人の職員の給与は、その職務の内容と責任に応ずるものであり、かつ、職員が発揮した能率が考慮されるものでなければならない。

2 特定独立行政法人は、その職員の給与の支給の基準を定め、これを主務大臣に届け出るとともに、公表しなければならない。これを変更したときも、同様とする。

3 前項の給与の支給の基準は、一般職の職員の給与に関する法律(昭和25年法律第95号)の適用を受ける国家公務員の給与、民間企業の従業員の給与、当該特定独立行政法人の業務の実績及び中期計画の第30条第2項第3号の人件費の見積りその他の事情を考慮して定められなければならない。

(職員の勤務時間等)

第58条 特定独立行政法人は、その職員の勤務時間、休憩、休日及び休暇について規程を定め、これを主務大臣に届け出るとともに、公表しなければならない。これを変更したときも、同様とする。

2 前項の規程は、一般職の職員の勤務時間、休暇等に関する法律(平成6年法律第33号)の適用を受ける国家公務員の勤務条件その他の事情を考慮したものでなければならない。

(職員に係る他の法律の適用除外等)

第59条 次に掲げる法律の規定は、特定独立行政法人の職員(以下この条において単に「職員」という。)には適用しない。

(1) 労働者災害補償保険法

(2) 国家公務員法(昭和22年法律第120号)第18条、第28条(第1項前段を除く。)、第29条から第32条まで、第62条から第70条まで、第72条第2項及び第3項、第75条第2項並びに第106条の規定

(3) 国家公務員の寒冷地手当に関する法律(昭和24年法律第200号)の規定

(4) 一般職の職員の給与に関する法律の規定

(5) 国家公務員の職階制に関する法律(昭和25年法律第180号)の規定

(6) 国家公務員の育児休業等に関する法律(平成3年法律第109号)第5条第2項、第8条及び第11条の規定

(7) 一般職の職員の勤務時間、休暇等に関する法律の規定

2 職員に関する国家公務員法の適用については、同法第2条第6項中「政府」とあるのは「独立行政法人通則法第2条第2項に規定する特定独立行政法人(以下「特定独立行政法人」という。)」と、同条第7項中「政府又はその機関」とあるのは「特定独立行政法人」と、同法第60条第1項中「場合には、人事院の承認を得て」とあるのは「場合には」と、「により人事院の承認を得て」とあるのは「により」と、同法第72条第1項中「その所轄庁の長」とあるのは「当該職員の勤務する特定独立行政法人の長」と、同法第78条第4号中「官制」とあるのは「組織」と、同法第80条第

4 項中「給与準則」とあるのは「独立行政法人通則法第 57 条第 2 項に規定する給与の支給の基準」と、同法第 81 条の 2 第 2 項各号中「人事院規則で」とあるのは「特定独立行政法人の長が」と、同法第 81 条の 3 第 2 項中「ときは、人事院の承認を得て」とあるのは「ときは」と、同法第 100 条第 2 項中「、所轄庁の長」とあるのは「、当該職員の勤務する特定独立行政法人の長」と、「の所轄庁の長」とあるのは「の属する特定独立行政法人の長」と、同法第 101 条第 1 項中「政府」とあるのは「当該職員の勤務する特定独立行政法人」と、同条第 2 項中「官庁」とあるのは「特定独立行政法人」と、同法第 103 条第 3 項中「所轄庁の長」とあるのは「当該職員の勤務し、又は勤務していた特定独立行政法人の長」と、同法第 104 条中「内閣総理大臣及びその職員の所轄庁の長」とあるのは「当該職員の勤務する特定独立行政法人の長」とする。

- 3 職員に関する国際機関等に派遣される一般職の国家公務員の処遇等に関する法律（昭和 45 年法律第 117 号）第 5 条及び第 6 条第 3 項の規定の適用については、同法第 5 条第 1 項中「俸給、扶養手当、調整手当、研究員調整手当、住居手当、期末手当及び期末特別手当のそれぞれ 100 分の 100 以内」とあるのは「給与」と、同条第 2 項中「人事院規則（派遣職員が検察官の俸給等に関する法律（昭和 23 年法律第 76 号）の適用を受ける職員である場合にあつては、同法第 3 条第 1 項に規定する準則）」とあるのは「独立行政法人通則法第 57 条第 2 項に規定する給与の支給の基準」と、同法第 6 条第 3 項中「国は」とあるのは「独立行政法人通則法第 2 条第 2 項に規定する特定独立行政法人は」とする。
- 4 職員に関する労働基準法（昭和 22 年法律第 49 号）第 12 条第 3 項第 4 号及び第 39 条第 7 項の規定の適用については、同法第 12 条第 3 項第 4 号中「育児休業、介護休業等育児又は家族介護を行う労働者の福祉に関する法律（平成 3 年法律第 76 号）第 2 条第 1 号」とあるのは「国家公務員の育児休業等に関する法律（平成 3 年法律第 109 号）第 3 条第 1 項」と、「同条第 2 号」とあるのは「育児休業、介護休業等育児又は家族介護を行う労働者の福祉に関する法律（平成 3 年法律第 76 号）第 2 条第 2 号」と、同法第 39 条第 7 項中「育児休業、介護休業等育児又は家族介護を行う労働者の福祉に関する法律第 2 条第 1 号」とあるのは「国家公務員の育児休業等に関する法律第 3 条第 1 項」と、「同条第 2 号」とあるのは「育児休業、介護休業等育児又は家族介護を行う労働者の福祉に関する法律第 2 条第 2 号」とする。
- 5 職員に関する船員法（昭和 22 年法律第 100 号）第 74 条第 4 項の規定の適用については、同項中「育児休業、介護休業等育児又は家族介護を行う労働者の福祉に関する法律（平成 3 年法律第 76 号）第 2 条第 1 号」とあるのは「国家公務員の育児休業等に関する法律（平成 3 年法律第 109 号）第 3 条第 1 項」と、「同条第 2 号」とあるのは「育児休業、介護休業等育児又は家族介護を行う労働者の福祉に関する法律（平成 3 年法律第 76 号）第 2 条第 2 号」とする。

（国会への報告等）

- 第 60 条 特定独立行政法人は、政令で定めるところにより、毎事業年度、常時勤務に服することを要するその職員（国家公務員法第 79 条又は第 82 条の規定による休職又は停職の処分を受けた者、法令の規定により職務に専念する義務を免除された者その他の常時勤務に服することを要しない職員で政令で定めるものを含む。次項において「常勤職員」という。）の数を主務大臣に報告しなければならない。
- 2 政府は、毎年、国会に対し、特定独立行政法人の常勤職員の数を報告しなければならない。



## 第2節 特定独立行政法人以外の独立行政法人

### ( 役員の兼職禁止 )

第61条 特定独立行政法人以外の独立行政法人の役員（非常勤の者を除く。）は、在任中、任命権者の承認のある場合を除くほか、営利を目的とする団体の役員となり、又は自ら営利事業に従事してはならない。

### ( 準用 )

第62条 第52条及び第53条の規定は、特定独立行政法人以外の独立行政法人の役員の報酬等について準用する。この場合において、第52条第3項中「実績及び中期計画の第30条第2項第3号の人件費の見積り」とあるのは、「実績」と読み替えるものとする。

### ( 職員の給与等 )

第63条 特定独立行政法人以外の独立行政法人の職員の給与は、その職員の勤務成績が考慮されるものでなければならない。

- 2 特定独立行政法人以外の独立行政法人は、その職員の給与及び退職手当の支給の基準を定め、これを主務大臣に届け出るとともに、公表しなければならない。これを変更したときも、同様とする。
- 3 前項の給与及び退職手当の支給の基準は、当該独立行政法人の業務の実績を考慮し、かつ、社会一般の情勢に適合したものとなるように定められなければならない。

## 第6章 雑則

### ( 報告及び検査 )

第64条 主務大臣は、この法律を施行するため必要があると認めるときは、独立行政法人に対し、その業務並びに資産及び債務の状況に関し報告をさせ、又はその職員に、独立行政法人の事務所に立ち入り、業務の状況若しくは帳簿、書類その他の必要な物件を検査させることができる。

- 2 前項の規定により職員が立入検査をする場合には、その身分を示す証明書を携帯し、関係人にこれを提示しなければならない。
- 3 第1項の規定による立入検査の権限は、犯罪捜査のために認められたものと解してはならない。

### ( 違法行為等の是正 )

第65条 主務大臣は、独立行政法人又はその役員若しくは職員の行為がこの法律、個別法若しくは他の法令に違反し、又は違反するおそれがあると認めるときは、当該独立行政法人に対し、当該行為の是正のため必要な措置を講ずることを求めることができる。

- 2 独立行政法人は、前項の規定による主務大臣の求めがあったときは、速やかに当該行為の是正その他の必要と認める措置を講ずるとともに、当該措置の内容を主務大臣に報告しなければならない。

### ( 解散 )

第66条 独立行政法人の解散については、別に法律で定める。

(財務大臣との協議)

第67条 主務大臣は、次の場合には、財務大臣に協議しなければならない。

- (1) 第29条第1項の規定により中期目標を定め、又は変更しようとするとき。
- (2) 第30条第1項、第45条第1項ただし書若しくは第2項ただし書又は第48条第1項の規定による認可をしようとするとき。
- (3) 第44条第3項の規定による承認をしようとするとき。
- (4) 第47条第1号又は第2号の規定による指定をしようとするとき。

(主務大臣等)

第68条 この法律における主務大臣、主務省及び主務省令は、個別法で定める。

## 第7章 罰則

第69条 次の各号の一に該当する者は、1年以下の懲役又は50万円以下の罰金に処する。

- (1) 第54条第1項の規定に違反して秘密を漏らした者
- (2) 第54条第4項の規定に違反して営利企業の地位に就いた者

第70条 第64条第1項の規定による報告をせず、若しくは虚偽の報告をし、又は同項の規定による検査を拒み、妨げ、若しくは忌避した場合には、その違反行為をした独立行政法人の役員又は職員は、20万円以下の罰金に処する。

第71条 次の各号の一に該当する場合には、その違反行為をした独立行政法人の役員は、20万円以下の過料に処する。

- (1) この法律の規定により主務大臣の認可又は承認を受けなければならない場合において、その認可又は承認を受けなかったとき。
- (2) この法律の規定により主務大臣に届出をしなければならない場合において、その届出をせず、又は虚偽の届出をしたとき。
- (3) この法律の規定により公表をしなければならない場合において、その公表をせず、又は虚偽の公表をしたとき。
- (4) 第9条第1項の規定による政令に違反して登記することを怠ったとき。
- (5) 第30条第4項の規定による主務大臣の命令に違反したとき。
- (6) 第33条の規定による事業報告書の提出をせず、又は事業報告書に記載すべき事項を記載せず、若しくは虚偽の記載をして事業報告書を提出したとき。
- (7) 第38条第4項の規定に違反して財務諸表、事業報告書、決算報告書若しくは監事の意見を記載した書面を備え置かず、又は閲覧に供しなかったとき。
- (8) 第47条の規定に違反して業務上の余裕金を運用したとき。
- (9) 第60条第1項又は第65条第2項の規定による報告をせず、又は虚偽の報告をしたとき。

第72条 第10条の規定に違反した者は、10万円以下の過料に処する。

## 附 則

(施行期日)

第1条 この法律は、内閣法の一部を改正する法律(平成11年法律第88号)の施行

の日から施行する。

（名称の使用制限に関する経過措置）

第2条 この法律の施行の際現にその名称中に独立行政法人という文字を用いている者については、第10条の規定は、この法律の施行後6月間は、適用しない。

（政令への委任）

第3条 前条に定めるもののほか、この法律の施行に関し必要な経過措置は、政令で定める。

# 独立行政法人国際農林水産業研究センター業務方法書

## 目次

第1章 総則（第1条 - 第2条）

第2章 業務に関する事項（第3条 - 第12条）

第3章 業務委託の基準（第13条 - 第14条）

第4章 競争入札その他契約に関する基本的事項（第15条 - 第17条）

第5章 雑則（第18条 - 第19条）

附則

## 第1章 総則

### （目的）

第1条 この業務方法書は、独立行政法人通則法（平成11年法律第103号）第28条第1項及び独立行政法人国際農林水産業研究センターの業務運営並びに財務及び会計に関する省令（平成13年農林水産省令第47号）第1条の規定に基づき、独立行政法人国際農林水産業研究センター法（平成11年法律第197号。以下「法」という。）第10条に規定する独立行政法人国際農林水産業研究センター（以下「センター」という。）の行う業務の方法について基本的な事項を定め、もってその業務の適正な運営に資することを目的とする。

### （業務運営の基本的方針）

第2条 センターは、法に定められたその設置の目的及び業務内容の重要性にかんがみ、関係機関と緊密な連携を図り、もってその業務の適正かつ効率的な運営を期するものとする。

## 第2章 業務に関する事項

### （中期計画）

第3条 センターは、法第10条各号に掲げる業務を農林水産大臣の認可を受けた中期計画に従って実施するものとする。

### （試験及び研究並びに調査）

第4条 センターは、法第10条第1号に掲げる試験及び研究並びに調査の実施に当たっては、研究所が有する各種の研究資源の効率的な活用を図るとともに、他の独立行政法人、都道府県、大学や民間の試験研究機関その他関

係機関との連携の確保に留意するものとする。

(分析、鑑定)

第5条 センターは、法第10条第1号に掲げる分析及び鑑定については、依頼に応じて、センターが有する高度な専門知識を必要とするものについて実施する。

2 センターは、前項の業務を実施するときは、別に定めるところより、所要の対価を徴収することができるものとする。

(資料の収集、整理及び提供)

第6条 センターは法第10条第2号に掲げる資料の収集、整理及び提供については、開発途上国等における農林水産業研究の中核機関としての機能を活用し、関係機関の協力も得つつ、業務の充実を図るものとする。

(受託による業務の実施)

第7条 センターは、法第10条第1号に掲げる試験及び研究並びに調査の業務の実施に支障のない範囲内で、依頼に応じて、受託による業務を実施することができる。

(受託契約)

第8条 センターは、前条の規定による受託をしようとするときは、委託しようとする者と受託に関する契約を締結するものとする。

2 前項の契約においては、次の事項を定める。

- (1) 受託により実施する業務(以下「受託業務」という。)の課題
- (2) 受託業務の内容に関する事項
- (3) 受託業務を実施する場所及び方法に関する事項
- (4) 受託契約の期間及びその解除に関する事項
- (5) 受託業務の結果の報告に関する事項
- (6) 受託費の額並びに支払いの時期及び方法に関する事項
- (7) 受託業務の実施の結果の取扱方法及びその結果が知的所有権の対象となったときのその帰属に関する事項
- (8) その他必要な事項

(共同研究)

第9条 センターは、試験及び研究並びに調査を効率的に実施するために必要な場合には、他の者と試験及び研究並びに調査を分担し、技術及び知識を交換し、並びにその費用を分担して行う試験及び研究並びに調査(次条におい

て「共同研究」という。)を行うことができる。

(共同研究等契約)

第10条 センターは、共同研究を実施しようとするときは、共同研究を行おうとする者と共同研究契約を締結するものとする。

2 前項の契約においては、次に掲げる事項を定める。

- (1) 共同研究の課題
- (2) 共同研究の内容に関する事項
- (3) 共同研究に係る業務を実施する場所及び方法に関する事項
- (4) 共同研究の期間及びその解除に関する事項
- (5) 共同研究に要する費用の分担に関する事項
- (6) 共同研究の結果の取扱の方法に関する事項
- (7) 共同研究の結果が知的所有権の対象となったときのその帰属に関する事項
- (8) その他必要な事項

(成果の普及)

第11条 センターは、次の各号に掲げる方法により、成果の公表、普及を図るものとする。

- (1) 成果に関する発表会を開催すること
- (2) 成果に関する報告書等を作成し、これを頒布すること
- (3) 成果を研究所のホームページに掲載して、提供すること
- (4) その他事例に応じて最も適当と認められる方法

(知的所有権)

第12条 センターは、重要な研究成果については、積極的に国内外において知的所有権を取得するとともに、民間等に対し、その実施を許諾する等により、研究成果の普及を推進するものとする。

2 センターは、知的所有権の実施の許諾等については、我が国の農林水産業等の振興に支障を来すことのないよう考慮の上、決定するものとする。

### 第3章 業務委託の基準

(業務の委託)

第13条 センターは、その業務の効率的かつ効果的な運営に資すると認めるときは、法第10条に掲げる業務について、センター以外の者に委託することができる。

(委託契約)

第14条 センターは、前条の規定により業務を委託しようとするときは、当該委託業務に関し、受託者と契約を締結するものとする。

2 前項の契約においては、次の事項を定める。

- (1) 委託業務の課題
- (2) 委託業務の内容に関する事項
- (3) 委託に係る業務を実施する場所及び方法に関する事項
- (4) 委託契約の期間及びその解除に関する事項
- (5) 委託に係る業務の結果の報告に関する事項
- (6) 委託費の額並びに支払いの時期及び方法に関する事項
- (7) 委託業務の実施の結果の取扱方法及びその結果が知的所有権の対象となったときのその帰属に関する事項
- (8) その他必要な事項

第4章 競争入札その他契約に関する基本的事項

(契約の方法)

第15条 センターにおける売買、賃貸、請負その他の契約は、すべて一般競争契約の方法によるものとし、当該契約の目的に従い、最高又は最低の価格による入札者と締結するものとする。ただし、次の各号に掲げる場合には、指名競争契約又は随意契約に付することができるものとする。

- (1) 契約の性質又は目的から一般競争に付することが適当でないとき又は一般競争に付し得ないとき。
- (2) 災害その他緊急を要するために一般競争に付し得ないとき。
- (3) 予定価格が少額であるとき。
- (4) その他一般競争に付することが不利と認められるとき。

(政府調達に関する協定に係る物品等の契約手続き)

第16条 政府調達に関する協定(平成7年条約第23号)に係る物品等の調達手続きについては、同協定の規定に則してこれを行うものとする。

(会計規程への委任)

第17条 この章に定めるもののほか、センターが行う契約に関して必要な事項は、通則法第49条の会計規程で定める。

## 第5章 雑 則

### (施設等の貸与)

第18条 センターは、センターの業務運営に支障のない範囲において、センターの施設・設備の一部を他の者に貸与することができるものとする。

2 センターは、前項により貸与を実施するときは、別に定めるところより、所要の対価を徴収することができるものとする。

### (その他の業務の方法)

第19条 この業務方法書に定めるもののほか、業務に関し必要な事項については、理事長が別に定める。

## 附 則

この業務方法書は、農林水産大臣の認可のあった日から施行する。



-0ZY

æ.Pb@••Yc••PbS••QbZj

æ.Qb@••E••EŠO_•Z••r••RbS••a|ZbJ

æ.Rb@••E••EŠO_•E••T••bŠ••r••a|ZbS••a|ZbJ

æ.Sb@••r••ZD_•|••Œ••_•EŠO_•EŠ••|•Z•••r••a|ZbS••a|ZbJ

æ.Tf@••ZG••v••a|ZbS••a|ZbJ

æ.Y

æ.P•f@••r•Y

æ.Ū

æ.Q•b@••E••EŠO_•E••Z••C

æ.R•b@••|ŠbŒ••Œ

æ.S•b@••ZZE••y••N•b••t••A••N••E••

æ.T•b@••v••b••AŠ••Œ

æ.W•b@••Z••b••Œ••E••E••Z••A••Z

æ.X•b@••Œ••Œ••E••E••Z••A••Z

æ.Y•b@••E••EŠO_•E••Z••C

æ.Z•b@••E••EŠO_•E••Z••C

æ.Œ•b@••E••EŠO_•E••Z••C

æ.Œ•b@••E••EŠO_•E••Z••C

æ.Œ•b@••E••EŠO_•E••Z••C

æ.Œ•b@••E••EŠO_•E••Z••C

æ.Œ•b@••E••EŠO_•E••Z••C

æ.Œ•b@••E••EŠO_•E••Z••C

æ.Œ•b@••E••EŠO_•E••Z••C

æ.Œ•b@••E••EŠO_•E••Z••C

æ.Œ•b@••E••EŠO_•E••Z••C

æ.Œ•b@••E••EŠO_•E••Z••C

æ.Œ•b@••E••EŠO_•E••Z••C

æ.Œ•b@••E••EŠO_•E••Z••C

æ.Œ•b@••E••EŠO_•E••Z••C

æ.Œ•b@••E••EŠO_•E••Z••C

æ.Œ•b@••E••EŠO_•E••Z••C

æ.Œ•b@••E••EŠO_•E••Z••C

æ.Œ•b@••E••EŠO_•E••Z••C

æ.Œ•b@••E••EŠO_•E••Z••C

æ.Œ•b@••E••EŠO_•E••Z••C

æ.Œ•b@••E••EŠO_•E••Z••C

æ.Œ•b@••E••EŠO_•E••Z••C

æ.Œ•b@••E••EŠO_•E••Z••C

æ.Œ•b@••E••EŠO_•E••Z••C

æ.Œ•b@••E••EŠO_•E••Z••C

æ.Œ•b@••E••EŠO_•E••Z••C

æ.Œ•b@••E••EŠO_•E••Z••C

æ.Œ•b@••E••EŠO_•E••Z••C

æ.Œ•b@••E••EŠO_•E••Z••C

æ.Œ•b@••E••EŠO_•E••Z••C

æ.Œ•b@••E••EŠO_•E••Z••C

æ.Œ•b@••E••EŠO_•E••Z••C

æ.Œ•b@••E••EŠO_•E••Z••C

æ.Œ•b@••E••EŠO_•E••Z••C

æ.Œ•b@••E••EŠO_•E••Z••C

æ.Œ•b@••E••EŠO_•E••Z••C

æ.Œ•b@••E••EŠO_•E••Z••C

æ.Œ•b@••E••EŠO_•E••Z••C

æ.Œ•b@••E••EŠO_•E••Z••C

æ.Œ•b@••E••EŠO_•E••Z••C

æ.Œ•b@••E••EŠO_•E••Z••C

æ.Œ•b@••E••EŠO_•E••Z••C

æ.Œ•b@••E••EŠO_•E••Z••C

æ.Œ•b@••E••EŠO_•E••Z••C

æ.Œ•b@••E••EŠO_•E••Z••C

æ.Œ•b@••E••EŠO_•E••Z••C

æ.Œ•b@••E••EŠO_•E••Z••C

æ.Œ•b@••E••EŠO_•E••Z••C

æ.Œ•b@••E••EŠO_•E••Z••C

æ.Œ•b@••E••EŠO_•E••Z••C

æ.Œ•b@••E••EŠO_•E••Z••C

æ.Œ•b@••E••EŠO_•E••Z••C

æ.Œ•b@••E••EŠO_•E••Z••C

æ.Œ•b@••E••EŠO_•E••Z••C

æ.Œ•b@••E••EŠO_•E••Z••C

æ.Œ•b@••E••EŠO_•E••Z••C

æ.Œ•b@••E••EŠO_•E••Z••C

æ.Œ•b@••E••EŠO_•E••Z••C

æ.Œ•b@••E••EŠO_•E••Z••C

æ.Œ•b@••E••EŠO_•E••Z••C

æ.Œ•b@••E••EŠO_•E••Z••C

æ.Œ•b@••E••EŠO_•E••Z••C

æ.Œ•b@••E••EŠO_•E••Z••C

æ.Œ•b@••E••EŠO_•E••Z••C

æ.Œ•b@••E••EŠO_•E••Z••C

æ.Œ•b@••E••EŠO_•E••Z••C

æ.Œ•b@••E••EŠO_•E••Z••C

æ.Œ•b@••E••EŠO_•E••Z••C

æ.Œ•b@••E••EŠO_•E••Z••C

æ.Œ•b@••E••EŠO_•E••Z••C

# •î•ñŒöŠJ-@“™,ÉŠî,Ä,-’ñ<ÿ•î•ñ

•X•V“ú•F2002.10.1

- <Æ-±•û-@•‘ ( [html](#) )
- ••Û”_—Ñ•...ŽY<ÆŒœ<†fZf“f^•[-@
- ‘g•D,ÉŠÖ,.,é<K’ö
- ‘g•D•}
- -đ^õŒo—đ•‘
- -đ^õ<<—^<K’ö
- -đ^õ‘P•EŽè“-<K’ö
- Ž-<Æ•ñ•••‘
- ’†Šú-Ú•W
- ’†ŠúŒv%ooæ
- •½•¬14”N“x”N“xŒv%ooæ
- ŠÄŽ-ŠÄ•,ÌÓŒ©

<Æ-±•û-@•‘ ( [html](#) )  
 ••Û”_—Ñ•...ŽY<ÆŒœ<†fZf“f^•[-@  
 ‘g•D,ÉŠÖ,.,é<K’ö  
 ‘g•D•}  
 -đ^õŒo—đ•‘  
 -đ^õ<<—^<K’ö  
 -đ^õ‘P•EŽè“-<K’ö  
 •E^õ<<—^<K’ö  
 Ž-<Æ•ñ•••‘

[’†Šú–Ú•W•@ \(html\)](#)

[’†ŠúŒv%œ•@ \(html\)](#)

[•½•–14”N“x”N“xŒv%œ \(html\)](#)

ŠÄŽ–ŠÄ•, ÌÓŒ©

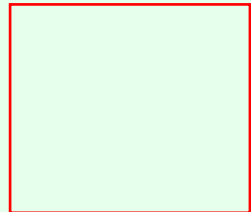
[–đ^õ<<—^<K’ö](#)

[–đ^õ‘P•EŽè“–<K’ö](#)

[•E^õ<<—^<K’ö](#)

•‘•Ū” _—Ñ•...ŽY<ÆŒœœ<†fZf“f^•[(JIRCAS)

•‘•Ū” _—Ñ•...ŽY<ÆŒœœ<†fZf“f^•[(JIRCAS)



[JIRCAS Homepage,Ö](#)

# 独立行政法人国際農林水産業研究センター法

平成11年法律第197号

平成11年12月22日

## 目次

- 第1章 総則（第1条～第6条）
- 第2章 役員（第7条～第9条）
- 第3章 業務等（第10条・第11条）
- 第4章 雑則（第12条）
- 第5章 罰則（第13条）
- 附則

## 第1章 総則

### （目的）

第1条 この法律は、独立行政法人国際農林水産業研究センターの名称、目的、業務の範囲等に関する事項を定めることを目的とする。

### （名称）

第2条 この法律及び独立行政法人通則法（平成11年法律第103号。以下「通則法」という。）の定めるところにより設立される通則法第2条第1項に規定する独立行政法人の名称は、独立行政法人国際農林水産業研究センターとする。

### （センターの目的）

第3条 独立行政法人国際農林水産業研究センター（以下「センター」という。）は、熱帯又は亜熱帯に属する地域その他開発途上にある海外の地域における農林水産業に関する技術上の試験及び研究等を行うことにより、これらの地域における農林水産業に関する技術の向上に寄与することを目的とする。

### （特定独立行政法人）

第4条 センターは、通則法第2条第2項に規定する特定独立行政法人とする。

### （事務所）

第5条 センターは、主たる事務所を茨城県に置く。

### （資本金）

第6条 センターの資本金は、附則第5条第2項の規定により政府から出資があつたものとされた金額とする。

- 2 政府は、必要があると認めるときは、予算で定める金額の範囲内において、センターに追加して出資することができる。
- 3 センターは、前項の規定による政府の出資があつたときは、その出資額により資本金を増加するものとする。

## 第2章 役員

(役員)

第7条 センターに、役員として、その長である理事長及び監事2人を置く。

2 センターに、役員として、理事1人を置くことができる。

(理事の職務及び権限等)

第8条 理事は、理事長の定めるところにより、理事長を補佐してセンターの業務を掌理する。

2 通則法第19条第2項の個別法で定める役員は、理事とする。ただし、理事が置かれていないときは、監事とする。

3 前項ただし書の場合において、通則法第19条第2項の規定により理事長の職務を代理し又はその職務を行う監事は、その間、監事の職務を行ってはならない。

(役員任期)

第9条 理事長の任期は4年とし、理事及び監事の任期は2年とする。

### 第3章 業務等

(業務の範囲)

第10条 センターは、第3条の目的を達成するため、次の業務を行う。

(1) 熱帯又は亜熱帯に属する地域その他開発途上にある海外の地域における農林水産業に関する技術上の試験及び研究、調査、分析、鑑定並びに講習を行うこと。

(2) 前号の地域における農林水産業に関する内外の資料の収集、整理及び提供を行うこと。

(3) 前二号の業務に附帯する業務を行うこと。

(積立金の処分)

第11条 センターは、通則法第29条第2項第1号に規定する中期目標の期間(以下この項において「中期目標の期間」という。)の最後の事業年度に係る通則法第44条第1項又は第2項の規定による整理を行った後、同条第1項の規定による積立金があるときは、その額に相当する金額のうち農林水産大臣の承認を受けた金額を、当該中期目標の期間の次の中期目標の期間に係る通則法第30条第1項の認可を受けた中期計画(同項後段の規定による変更の認可を受けたときは、その変更後のもの)の定めるところにより、当該次の中期目標の期間における前条に規定する業務の財源に充てることができる。

2 農林水産大臣は、前項の規定による承認をしようとするときは、あらかじめ、農林水産省の独立行政法人評価委員会の意見を聴くとともに、財務大臣に協議しなければならない。

3 センターは、第1項に規定する積立金の額に相当する金額から同項の規定による承認を受けた金額を控除してなお残余があるときは、その残余の額を国庫に納付しなければならない。

4 前三項に定めるもののほか、納付金の納付の手續その他積立金の処分に関し必要な事項は、政令で定める。

### 第4章 雑則

(主務大臣等)

第12条 センターに係る通則法における主務大臣、主務省及び主務省令は、それぞれ農林水産大臣、農林水産省及び農林水産省令とする。

## 第5章 罰則

第13条 次の各号のいずれかに該当する場合には、その違反行為をしたセンターの役員は、20万円以下の過料に処する。

(1) 第10条に規定する業務以外の業務を行ったとき。

(2) 第11条第1項の規定により農林水産大臣の承認を受けなければならない場合において、その承認を受けなかつたとき。

## 附 則

(施行期日)

第1条 この法律は、平成13年1月6日から施行する。ただし、附則第7条の規定は、同日から起算して6月を超えない範囲内において政令で定める日から施行する。

(職員の引継ぎ等)

第2条 センターの成立の際現に農林水産省の部局又は機関で政令で定めるものの職員である者は、別に辞令を発せられない限り、センターの成立の日において、センターの相当の職員となるものとする。

第3条 センターの成立の際現に前条に規定する政令で定める部局又は機関の職員である者のうち、センターの成立の日において引き続きセンターの職員となつたもの(次条において「引継職員」という。)であつて、センターの成立の日の前日において農林水産大臣又はその委任を受けた者から児童手当法(昭和46年法律第73号)第7条第1項(同法附則第6条第2項において準用する場合を含む。以下この条において同じ。)の規定による認定を受けているものが、センターの成立の日において児童手当又は同法附則第6条第1項の給付(以下この条において「特例給付」という。)の支給要件に該当するときは、その者に対する児童手当又は特例給付の支給に関しては、センターの成立の日において同法第7条第1項の規定による市町村長(特別区の区長を含む。)の認定があつたものとみなす。この場合において、その認定があつたものとみなされた児童手当又は特例給付の支給は、同法第8条第2項(同法附則第6条第2項において準用する場合を含む。)の規定にかかわらず、センターの成立の日の前日の属する月の翌月から始める。

(センターの職員となる者の職員団体についての経過措置)

第4条 センターの成立の際現に存する国家公務員法(昭和22年法律第120号)第108条の2第1項に規定する職員団体であつて、その構成員の過半数が引継職員であるものは、センターの成立の際国営企業及び特定独立行政法人の労働関係に関する法律(昭和23年法律第257号)の適用を受ける労働組合となるものとする。この場合において、当該職員団体が法人であるときは、法人である労働組合となるものとする。

2 前項の規定により法人である労働組合となつたものは、センターの成立の日から起算して60日を経過する日までに、労働組合法(昭和24年法律第174号)第2条及び第5条第2項の規定に適合する旨の労働委員会の証明を受け、かつ、その主たる事務所の所在地において登記しなければ、その日の経過により解散するものとする。

3 第1項の規定により労働組合となつたものについては、センターの成立の日から起算して60日を経過する日までは、労働組合法第2条ただし書（第1号に係る部分に限る。）の規定は、適用しない。

（権利義務の承継等）

第5条 センターの成立の際、第10条に規定する業務に関し、現に国が有する権利及び義務のうち政令で定めるものは、センターの成立の時に於いてセンターが承継する。

2 前項の規定によりセンターが国の有する権利及び義務を承継したときは、その承継の際、承継される権利に係る土地、建物その他の財産で政令で定めるものの価額の合計額に相当する金額は、政府からセンターに対し出資されたものとする。

3 前項の規定により政府から出資があつたものとされる同項の財産の価額は、センターの成立の日現在における時価を基準として評価委員が評価した価額とする。

4 前項の評価委員その他評価に関し必要な事項は、政令で定める。

（政令への委任）

第6条 附則第2条から前条までに定めるもののほか、センターの設立に伴い必要な経過措置その他この法律の施行に関し必要な経過措置は、政令で定める。

（農林水産省設置法の一部改正）

第7条 農林水産省設置法（平成11年法律第98号）の一部を次のように改正する。

第13条第5号の2に次のように加える。

へ 独立行政法人国際農林水産業研究センター

第13条第9号を削る。

13国研セ第4 - 25号

独立行政法人国際農林水産業研究センターの組織に関する規程を次のように定める。

平成13年4月2日

独立行政法人国際農林水産業研究センター理事長

## 独立行政法人国際農林水産業研究センターの組織に関する規程

### 目次

- 第1章 総則(第1条・第2条)
- 第2章 企画調整部(第3条～第13条)
- 第3章 総務部(第14条～第39条)
- 第4章 国際情報部(第40条～第42条)
- 第5章 生物資源部(第43条)
- 第6章 生産環境部(第44条)
- 第7章 畜産草地部(第45条)
- 第8章 食料利用部(第46条)
- 第9章 林業部(第47条)
- 第10章 水産部(第48条)
- 第11章 支所(第49条～第59条)
- 第12章 主任研究官及び専門職(第60条・第60条の2)
- 第13章 特例(第61条・第62条)
- 附則



## 第1章 総則

(目的)

第1条 この規程は、独立行政法人国際農林水産業研究センター（以下「センター」という。）の円滑な運営を図るため組織及び所掌事務を定めることを目的とする。

(センターに置く部及び支所)

第2条 センターに、次の9部及び支所を置く。

企画調整部  
総務部  
国際情報部  
生物資源部  
生産環境部  
畜産草地部  
食料利用部  
林業部  
水産部

## 第2章 企画調整部

(企画調整部の所掌事務)

第3条 企画調整部は、次に掲げる事務をつかさどる。

- (1) 試験及び研究並びに調査の総合的な企画及び立案並びに調整に関すること。
- (2) 試験及び研究並びに調査に関する連絡調整に関すること。
- (3) 試験及び研究並びに調査に関する情報の収集、整理、分析及び広報を行うこと（国際情報部の所掌に属するものを除く。）。
- (4) 試験及び研究に供するほ場及び植物の管理に関すること。

(企画調整部の内部組織)

第4条 企画調整部に、国際研究調整官及び国際研究広報官のほか、次の3科及び1課を置く。

研究企画科  
連絡調整科  
研究交流科  
情報資料課

(研究企画科の所掌事務)

第5条 研究企画科においては、次の事務をつかさどる。

- (1) 試験及び研究並びに調査の総合的な企画及び立案並びに調整に関すること。
- (2) 試験及び研究並びに調査の成果の取りまとめに関すること。
- (3) 試験及び研究に供するほ場及び植物の管理に関すること。

(連絡調整科の所掌事務)

第6条 連絡調整科においては、試験及び研究並びに調査に関し海外及び国内の関係

機関及び海外滞在職員との連絡調整に関する事務をつかさどる。

( 研究交流科の所掌事務 )

第 7 条 研究交流科においては、海外及び国内における研究交流の推進に係る会議の運営及び海外の管理者、研究者等の受入れに関する事務をつかさどる。

( 国際研究調整官の所掌事務 )

第 8 条 国際研究調整官は、命を受けて、国際共同研究の推進に係る重要事項に関する総合調整を行い、関係事務を総括する。

( 国際研究広報官の所掌事務 )

第 9 条 国際研究広報官は、試験及び研究並びに調査の広報に関する専門的事項についての企画及び連絡調整に関する事務をつかさどる。

( 情報資料課の所掌事務 )

第 10 条 情報資料課においては、次の事務をつかさどる。

- ( 1 ) 試験及び研究並びに調査に関する情報の収集、整理及び提供を行うこと ( 国際情報部の所掌に属することを除く。 )。
- ( 2 ) 試験及び研究並びに調査に関する図書資料の刊行及び配布を行うこと。

( 情報資料課の内部組織 )

第 11 条 情報資料課に管理係及び広報係を置く。

( 管理係の所掌事務 )

第 12 条 管理係においては、試験及び研究並びに調査に関する図書資料その他情報の収集、整理及び管理を行う事務をつかさどる ( 国際情報部の所掌に属することを除く。 )。

( 広報係の所掌事務 )

第 13 条 広報係においては、試験研究及び調査に関する図書資料の刊行及び配布その他情報の提供を行う事務をつかさどる。

### 第 3 章 総務部

( 総務部の所掌事務 )

第 14 条 総務部は、次に掲げる事務をつかさどる。

- ( 1 ) 理事長の印及びセンター印の保管に関すること。
- ( 2 ) 労務及び職員の人事に関すること。
- ( 3 ) 公文書類の接受、発送、編集及び保存に関すること。
- ( 4 ) 予算、決算及び会計に関すること。
- ( 5 ) 土地、建物、工作物及び物品の管理に関すること。
- ( 6 ) 構内の管理に関すること。
- ( 7 ) 前各号に掲げるもののほか、センターの所掌事務で他の所掌に属しないものに関すること。

( 総務部の内部組織 )

第 1 5 条 総務部に、次の 3 課を置く。

庶務課

会計課

海外業務管理課

( 庶務課の所掌事務 )

第 1 6 条 庶務課は、次に掲げる事務をつかさどる。

( 1 ) 理事長の印及びセンター印の保管に関する事。

( 2 ) 労務及び職員の人事に関する事。

( 3 ) 公文書類の接受、発送、編集及び保存に関する事。

( 4 ) 前各号に掲げるもののほか、センターの所掌事務で他の所掌に属しないものに関する事。

( 庶務課の内部組織 )

第 1 7 条 庶務課に、課長補佐のほか、次の 3 係を置く。

庶務係

人事係

厚生係

( 課長補佐の所掌事務 )

第 1 8 条 課長補佐は、命を受けて、庶務課の所掌事務の一部を総括整理する。

第 1 9 条 削除

( 庶務係の所掌事務 )

第 2 0 条 庶務係においては、次の事務をつかさどる。

( 1 ) 公文書類の接受、発送、編集及び保存に関する事。

( 2 ) 理事長の印及びセンター印を管守する事。

( 3 ) 職員の勤務時間及び休暇に関する事。

( 4 ) 各種証明書の発行に関する事。

( 5 ) 前各号に掲げるもののほか、他の所掌に属しない事務に関する事。

( 人事係の所掌事務 )

第 2 1 条 人事係においては、次の事務をつかさどる。

( 1 ) 職員の任免、分限及び懲戒に関する事。

( 2 ) 職員の服務に関する事 ( 勤務時間及び休暇に関する事及び海外業務管理課の所掌に属することを除く。 ) 。

( 3 ) 職員の勤務成績の評定に関する事。

( 4 ) 職員の人事記録に関する事。

( 5 ) 職員の初任給、昇格及び昇給に関する事。

( 6 ) 退職手当に関する事。

( 7 ) 職員の研修及び資質の向上に関する事。

( 8 ) 表彰に関する事。

( 9 ) 前各号に掲げるもののほか、人事に関する事で他の所掌に属しない事務に関する事。

( 厚生係の所掌事務 )

第 2 2 条 厚生係においては、次の事務をつかさどる。

- ( 1 ) 共済組合に関する事。
- ( 2 ) 職員の災害補償に関する事 ( 海外業務管理課の所掌に属することを除く。 )。
- ( 3 ) 宿舍の運営に関する事。
- ( 4 ) 職員の健康の管理に関する事 ( 海外業務管理課の所掌に属することを除く。 )。
- ( 5 ) 前各号に掲げるもののほか、職員の福利厚生に関する事 ( 海外業務管理課の所掌に属することを除く。 )。

( 会計課の所掌事務 )

第 2 3 条 会計課は、次に掲げる事務をつかさどる。

- ( 1 ) 独立行政法人の適正な会計処理の確保に関する事。
- ( 2 ) 予算、決算及び会計に関する事 ( 海外業務管理課の所掌に属するものを除く。 )。
- ( 3 ) 土地、建物、工作物及び物品の管理に関する事 ( 海外業務管理課の所掌に属するものを除く。 )。
- ( 4 ) 構内の管理に関する事。

( 会計課の内部組織 )

第 2 4 条 会計課に、課長補佐のほか、次の 5 係を置く。

主計係  
会計係  
監査係  
用度係  
施設管理係

( 課長補佐の所掌事務 )

第 2 5 条 課長補佐は、命を受けて、会計課の所掌事務の一部を総括整理する。

第 2 6 条 削除

( 主計係の所掌事務 )

第 2 7 条 主計係においては、次の事務をつかさどる。

- ( 1 ) 予算の要求、交付申請及び配分に関する事。
- ( 2 ) 支出及び収入の決算に関する事。
- ( 3 ) 資金の運用計画に関する事。

( 会計係の所掌事務 )

第 2 8 条 会計係においては、次の事務をつかさどる。

- ( 1 ) 収入及び支出に関する事。

- ( 2 ) 給与、賃金及び旅費の支払いに関する事。
- ( 3 ) 債権の管理に関する事。
- ( 4 ) 計算証明に関する事( 海外業務管理課の所掌に属することを除く。 )。
- ( 5 ) 前各号に掲げるもののほか、会計課の所掌事務で他の所掌に属しない事務に関する事。

( 監査係の所掌事務 )

第 2 9 条 監査係においては、次の事務をつかさどる。

- ( 1 ) 契約決議書及び振替伝票の審査に関する事。
- ( 2 ) 経費の執行管理に関する事( 海外業務管理課の所掌に属することを除く。 )。
- ( 3 ) 受託及び委託の契約に関する事。
- ( 4 ) 製造委託及び買入れに係る物件の検収に関する事。

( 用度係の所掌事務 )

第 3 0 条 用度係においては、次の事務をつかさどる。

- ( 1 ) 物品の製造委託及び買入れ並びに役務の調達に関する事。
- ( 2 ) 物品の管理に関する事( 海外業務管理課の所掌に属することを除く。 )。
- ( 3 ) 構内取締りに関する事。
- ( 4 ) 職員の安全保持に関する事。
- ( 5 ) 官公需についての中小企業者の受注の機会の確保に関する事に関する事。

( 施設管理係の所掌事務 )

第 3 1 条 施設管理係においては、次の事務をつかさどる。

- ( 1 ) 固定資産の管理に関する事。( 物品の管理に関する事を除く。 )
- ( 2 ) 建物及び工作物の営繕に関する事。
- ( 3 ) 特許権等の出願及び実施許諾に関する事。

( 海外業務管理課の所掌事務 )

第 3 2 条 海外業務管理課は、次に掲げる事務をつかさどる。

- ( 1 ) 決算及び会計に関する事( 海外における経費の会計に関するものに限る。 )。
- ( 2 ) 外国出張旅費並びに海外からの招へい者の旅費及び滞在費の支払いに関する事。
- ( 3 ) 海外における物品の管理に関する事。
- ( 4 ) 前 3 号に掲げるもののほか、センターの所掌事務のうち海外における事務に関するもので他の所掌に属しないものに関する事。

( 海外業務管理課の内部組織 )

第 3 3 条 海外業務管理課に、次の 4 係を置く。

- 海外業務調整係
- 海外前渡資金係
- 海外派遣係
- 海外物品係

第 3 4 条 削除

### 第35条 削除

(海外業務調整係の所掌事務)

第36条 海外業務調整係においては、次の事務をつかさどる。

- (1) 海外における事務の調整及び指導に関すること。
- (2) 海外滞在職員への海外における事務情報の提供に関すること。
- (3) 海外における経費の執行管理に関すること。
- (4) 前各号に掲げるもののほか、海外業務管理課の所掌事務で他の所掌に属しない事務に関すること。

(海外前渡資金係の所掌事務)

第37条 海外前渡資金係においては、次の事務をつかさどる。

- (1) 海外経費に係る契約及び支出を担当する者の任免に関すること。
- (2) 海外における経費の送金に関すること。
- (3) 海外における経費の計算証明に関すること。

(海外派遣係の所掌事務)

第38条 海外派遣係においては、次の事務をつかさどる。

- (1) 外国出張旅費の支払い及びその他外国出張者の手続きに関すること。
- (2) 海外からの招へい者の旅費及び滞在費の支払いに関すること。

(海外物品係の所掌事務)

第39条 海外物品係においては、次の事務をつかさどる。

- (1) 海外物品の管理に関すること。
- (2) 海外物品の発送に関すること。

## 第4章 国際情報部

(国際情報部の所掌事務)

第40条 国際情報部は、次に掲げる事務をつかさどる。

- (1) 試験及び研究並びに調査に関する海外の情報の収集、整理、分析及び提供を行うこと。
- (2) 熱帯又は亜熱帯に属する地域その他開発途上にある海外の地域(以下「熱帯地域等」という。)における農林水産業に関する調査を行うこと。

(国際情報部の内部組織)

第41条 国際情報部に、国際研究情報官を置く。

(国際研究情報官の所掌事務)

第42条 国際研究情報官は、命を受けて、熱帯地域等における農林水産業に関する調査研究並びに情報の収集、整理、分析及び提供を行う事務をつかさどる。

## 第5章 生物資源部

(生物資源部の所掌事務)

第43条 生物資源部は、熱帯地域等における生物資源の農業上の開発及び利用に関する試験及び研究を行う事務をつかさどる。

## 第6章 生産環境部

(生産環境部の所掌事務)

第44条 生産環境部は、熱帯地域等における農産物の生産技術及び生産の対象となる生物の生育環境に関する試験及び研究を行う事務をつかさどる。

## 第7章 畜産草地部

(畜産草地部の所掌事務)

第45条 畜産草地部は、熱帯地域等における畜産、草地及び飼料作物並びに家畜衛生に関する試験及び研究を行う事務をつかさどる。

## 第8章 食料利用部

(食料利用部の所掌事務)

第46条 食料利用部は、熱帯地域等における農産物の品質の評価及び保全並びに加工利用に関する試験及び研究を行う事務をつかさどる。

## 第9章 林業部

(林業部の所掌事務)

第47条 林業部は、熱帯地域等における林業に関する試験及び研究を行う事務をつかさどる。

## 第10章 水産部

(水産部の所掌事務)

第48条 水産部は、熱帯地域等における水産業に関する試験及び研究を行う事務をつかさどる。

## 第11章 支所

(支所の名称及び位置)

第49条 センターの支所の名称及び位置は、次のとおりとする。

国際農林水産業研究センター沖縄支所 石垣市

(沖縄支所の内部組織)

第50条 沖縄支所に、上席研究官のほか、次の1課、2科及び5研究室を置く。

国際共同研究科

庶務課

島嶼環境管理研究室

環境ストレス耐性研究室

育種素材開発研究室  
熱帯果樹栽培利用研究室  
総合防除研究室  
業務科

( 上席研究官の所掌事務 )

第 5 1 条 上席研究官は、命を受けて、第 5 4 条から第 5 8 条までに規定する事務に参画し、及び総括する。

( 国際共同研究科の所掌事務 )

第 5 2 条 国際共同研究科においては、農林水産業技術に関する国際招へい共同研究を行う事務をつかさどる。

( 庶務課の内部組織及び所掌事務 )

第 5 3 条 庶務課に、次表の左欄に掲げる 2 係を置き、その所掌事務の範囲は、それぞれ、相当右欄に掲げる事務をつかさどる。

名 称	所 掌 事 務
庶 務 係	第 2 0 条、第 2 1 条及び第 2 2 条に掲げる事務(ただし、第 2 0 条第 2 号中「理事長の印及びセンター印」とあるのは「支所長の印及び支所印」とする。)
会 計 係	第 2 8 条(第 3 号に掲げる事務を除く。)、第 2 9 条(第 3 号に掲げる事務を除く。)、第 3 0 条及び第 3 1 条(第 1 号及び第 3 号に掲げる事務を除く。)に掲げる事務

( 島嶼環境管理研究室の所掌事務 )

第 5 4 条 島嶼環境管理研究室においては、熱帯地域等の島嶼における水利用及び環境保全に関する試験研究を行う事務をつかさどる。

( 環境ストレス耐性研究室の所掌事務 )

第 5 5 条 環境ストレス耐性研究室においては、熱帯地域等における作物の環境ストレス耐性機構の解明とその利用に関する試験研究を行う事務をつかさどる。

( 育種素材開発研究室の所掌事務 )

第 5 6 条 育種素材開発研究室においては、熱帯地域等の作物の育種及び亜熱帯条件を利用した作物の世代促進に関する試験研究を行う事務をつかさどる。

( 熱帯果樹栽培利用研究室の所掌事務 )

第 5 7 条 熱帯果樹栽培利用研究室においては、熱帯地域等の果樹の導入じゅん化及び亜熱帯における果樹の栽培及び利用に関する試験研究を行う事務をつかさどる。

( 総合防除研究室の所掌事務 )

第 5 8 条 総合防除研究室においては、熱帯地域等における作物の病害虫の生態及び防除その他作物保護に関する試験研究を行う事務をつかさどる。



(業務科の所掌事務)

第59条 業務科においては、試験及び研究に供するほ場及び植物の管理に関する業務並びにこれに必要な試験及び調査を行う事務をつかさどる。

## 第12章 主任研究官及び専門職

(主任研究官)

第60条 センターに主任研究官を置く。

2 主任研究官は、命を受けて、特定の研究課題について研究の指導及び管理を行う事務をつかさどる。

(専門職)

第60条の2 センターに専門職を置く。

2 専門職は、命を受けて、課又は係における特定の事務をつかさどる。

## 第13章 特例

(特例)

第61条 前各条の規定にかかわらず、科(研究企画科及び業務科を除き、情報資料課を含む。以下同じ。)、係又は研究室においては、当該科、係又は研究室の属する部(総務部を除き、支所(庶務課及び業務科を除く。))を含む。)又は課(情報資料課を除き、研究企画科及び業務科を含む。)の長が特に必要があると認めて命じた業務又は事務を行う。

第62条 理事長は、試験研究を効率的に推進するため、特に相互の密接な連けいを確保する必要があると認めた場合は、複数の研究部等を指定して、試験研究を共同して行わせることができるものとする。

附 則

この規程は、平成13年4月1日から施行する。

附 則

この規程は、平成14年4月1日から施行する。

## 役 員 一 覧

役職	氏 名	就任日	経 歴
理事長	井上 隆弘	平成13年4月1日（任期4年）	1942年生まれ。農学博士 1999年 農林水産省東北農業試験場長 2001年 農林水産省国際農林水産業研究センター所長
理事	諸岡 慶昇	平成13年4月1日（任期2年）	1944年生まれ。農学博士 1997年 農林水産省東北農業試験場総合研究部長 2000年 農林水産省農業研究センター農業計画部長
監事	加藤 邦彦	平成13年4月1日（任期2年）	1943年生まれ。農学博士 1995年 農林水産省農業生物資源研究所遺伝資源第一部長
監事 (非常勤)	藤本 彰三	平成13年4月1日（任期2年）	1950年生まれ。Ph.D 2000年 東京農業大学国際食料情報学部教授 兼 東京農業大学国際交流センター所長(現任)

## 独立行政法人国際農林水産業研究センター役員給与規程

13国研セ第4-23号  
平成13年4月2日

### (目的)

第1条 この規程は、独立行政法人国際農林水産業研究センター（以下「センター」という。）の役員給与に関する事項を定めることを目的とする。

### (給与の種類)

第2条 役員給与は、常勤役員については俸給、調整手当、通勤手当及び期末特別手当とし、非常勤役員については非常勤役員手当とする。

### (給与の支給)

第3条 常勤役員給与（期末特別手当を除く。）は、その月の16日（その日が独立行政法人国際農林水産業研究センター職員の勤務時間、休憩、休日、休暇等に関する規程（13国研セ第4-28号）第11条に規定する休日にあたる時は、その月の15日以降の日のうち、その日に最も近い休日でない日）に、法令及び理事長が別に定めるところにより、給与から控除すべきものの金額を控除し、その残額を現金で直接常勤役員に支給する。

### (俸給)

第4条 常勤役員俸給の月額、次のとおりとする。

- (1) 理事長 937,000円
- (2) 理事 810,000円
- (3) 監事 658,000円

2 前項の常勤役員俸給の月額は、その役員の業績を考慮して定めるものとする。

3 新たに常勤役員となった者には、その日から俸給を支給する。

4 常勤役員が離職したときは、その日まで俸給を支給する。

5 常勤役員が死亡したときは、その死亡の日の属する月の俸給の全額を支給する。

6 第3項及び第4項の規定により俸給を支給する場合であって、月の初日から支給するとき以外のとき、又はその月の末日まで支給するとき以外のときは、その俸給の額は、その月の現日数から日曜日及び土曜日の日数を差し引いた日数を基礎として、日割りによって計算する。

### (調整手当)

第5条 調整手当は、物価及び生計費等が特に高い茨城県つくば市に所在するセンター本所に在勤する常勤役員に支給する。

2 調整手当の月額は、俸給の月額に100分の3を乗じて得た額とする。

3 調整手当の支給方法は、前条第3項から第6項までの規定を準用する。この場合において、同条第3項から第6項までの規定中「俸給」とあるのは「調整手当」と読み替えるものとする。

### (通勤手当)

第6条 通勤手当は、次に掲げる常勤役員に支給する。

- (1) 通勤のため交通機関又は有料の道路（以下「交通機関等」という。）を利用してその運賃又は料金（以下「運賃等」という。）を負担することを常例とする常勤役員（交通機関等を利用しなければ通勤することが著しく困難である常勤役員以外の常勤役員であって交通機関等を利用しないで徒歩により通勤するものとした場合の通勤距離が片道2キロメートル未満であるもの及び第3号に掲げる常勤役員を除く。）
- (2) 通勤のため自動車、自転車その他の交通の用具（以下「自動車等」という。）を使用することを常例とする常勤役員（自動車等を使用しなければ通勤することが著しく困難である常勤役員以外の常勤役員であって自動車等を使用しないで徒歩により通勤するものとした場合の通勤距離が片道2キロメートル未満であるもの及び次号に掲げる常勤役員を除く。）
- (3) 通勤のため交通機関等を利用してその運賃等を負担し、かつ、自動車等を使用することを常例とする常勤役員（交通機関等を利用し、又は自動車等を使用しなければ通勤することが著しく困難である常勤役員以外の常勤役員であって、交通機関等を利用せず、かつ、自動車等を使用しないで徒歩により通勤するものとした場合の通勤距離が2キロメートル未満であるものを除く。）
- 2 通勤手当の月額、次の各号に掲げる常勤役員の区分に応じて、当該各号に掲げる額とする。
- (1) 前項第1号に掲げる常勤役員 その者の1箇月の通勤に要する運賃等の額に相当する額（その額が45,000円を超えるときは、その額と45,000円との差額の2分の1（その差額の2分の1が5,000円を超えるときは、5,000円）を45,000円に加算した額。（以下「運賃等相当額」という。）
- (2) 前項第2号に掲げる常勤役員 次に掲げる常勤役員の区分に応じて、それぞれ次に掲げる額
- イ 自動車等の使用距離（以下この号において「使用距離」という。）が片道5キロメートル未満である者 2,000円
  - ロ 使用距離が片道5キロメートル以上10キロメートル未満である者 4,100円
  - ハ 使用距離が片道10キロメートル以上15キロメートル未満である者 6,500円
  - ニ 使用距離が片道15キロメートル以上20キロメートル未満である者 8,900円
  - ホ 使用距離が片道20キロメートル以上25キロメートル未満である者 11,300円
  - ヘ 使用距離が片道25キロメートル以上30キロメートル未満である者 13,700円
  - ト 使用距離が片道30キロメートル以上35キロメートル未満である者 16,100円
  - チ 使用距離が片道35キロメートル以上40キロメートル未満である者 18,500円
  - リ 使用距離が片道40キロメートル以上である者 20,900円
- (3) 前項第3号に掲げる常勤役員 交通機関等を利用せず、かつ、自動車等を使用しないで徒歩により通勤するものとした場合の通勤距離、交通機関等の利用距離、自動車等の使用距離等の事情を考慮して、運賃等相当額及び前号に掲げる額の合計額（その額が45,000円を超えるときは、その額と45,000円との差額の2

分の1（その差額の2分の1が5,000円を超えるときは、5,000円）を45,000円に加算した額）第1号に掲げる額又は前号に掲げる額

- 3 前2項に規定するもののほか、通勤の実情の変更に伴う支給額の改定その他通勤手当の支給に関し必要な事項は、理事長が別に定める。

（期末特別手当）

第7条 期末特別手当は、3月1日、6月1日及び12月1日（以下この条から第9条までにおいて、これらの日を「基準日」という。）にそれぞれ在職する常勤役員に対して、それぞれ3月15日、6月30日及び12月10日（これらの日が休日に当たるときは、その直前の休日でない日。以下「支給日」という。）に支給する。これら基準日前1箇月以内に退職し、又は死亡した常勤役員についても同様とする。

- 2 期末特別手当の額は、それぞれその基準日現在（退職し、又は死亡した常勤役員にあっては、退職し、又は死亡した日現在）において常勤役員が受けるべき俸給及び調整手当の月額、俸給の月額に100分の25を乗じて得た額並びに俸給及び調整手当の月額に100分の20を乗じて得た額の合計額に、3月に支給する場合には100分の55、6月に支給する場合には100分の145、12月に支給する場合には100分の155を乗じて得た額を基礎として、基準日以前3箇月以内（基準日が12月1日であるときは6箇月以内）の期間におけるその者の在職期間の区分に応じて、理事長が別に定める割合を乗じて得た額とする。ただし、理事長はその者の業績を考慮し、これを増額し、又は減額することができる。

第8条 次の各号のいずれかに該当する者には、前条第1項の規定にかかわらず、当該各号の基準日に係る期末特別手当（第2号に掲げる者にあつては、その支給を一時差し止めた期末特別手当）は、支給しない。

- (1) 基準日から当該基準日に対応する支給日の前日までの間に独立行政法人通則法（平成11年法律第103号）第23条の規定により解任された常勤役員（同条第1項及び第2項第1号に該当し解任された場合を除く。）
- (2) 基準日前1箇月以内又は基準日から当該基準日に対応する支給日の前日までの間に離職した常勤役員（前号に掲げる者を除く。）で、その離職した日から当該支給日の前日までの間に禁錮以上の刑に処せられたもの
- (3) 次条第1項の規定により期末特別手当の支給を一時差し止める処分を受けた常勤役員（当該処分を取り消された者を除く。）で、その者の在職期間中の行為に係る刑事事件に関し禁錮以上の刑に処せられたもの

第9条 理事長は、支給日に期末特別手当を支給することとされていた常勤役員で当該支給日の前日までに離職したものが次の各号のいずれかに該当する場合は、当該期末特別手当の支給を一時差し止めることができる。

- (1) 離職した日から当該支給日の前日までの間に、その者の在職期間中の行為に係る刑事事件に関して、その者が起訴（当該起訴に係る犯罪について禁錮以上の刑が定められているものに限り、刑事訴訟法（昭和23年法律第131号）第6編に規定する略式手続によるものを除く。次項において同じ。）をされ、その判決が確定していない場合
- (2) 離職した日から当該支給日の前日までの間に、その者の在職期間中の行為に係る刑事事件に関して、その者が逮捕された場合又はその者から聴取した事項若しくは調査により判明した事実に基づきその者に犯罪があると思料するに至った場合であ

って、その者に対し期末特別手当を支給することが、センターの公共上の見地から行う事務及び事業に対する国民の信頼を確保し、期末特別手当の支給に関し、その適正かつ円滑な実施を維持する上で重大な支障を生ずると認めるとき。

- 2 理事長は、前項の規定による期末特別手当の支給を一時差し止める処分（以下「一時差止処分」という。）について、次の各号のいずれかに該当するに至った場合には、速やかに一時差止処分を取り消さなければならない。ただし、第3号に該当する場合において、一時差止処分を受けた者がその者の在職期間中の行為に係る刑事事件に関し現に逮捕されているときその他これを取り消すことが一時差止処分の目的に明らかに反すると認めるときは、この限りでない。
  - (1) 一時差止処分を受けた者が当該一時差止処分の理由となった行為に係る刑事事件に関し禁錮以上の刑に処せられなかった場合
  - (2) 一時差止処分を受けた者について、当該一時差止処分の理由となった行為に係る刑事事件につき公訴を提起しない処分があった場合
  - (3) 一時差止処分を受けた者がその者の在職期間中の行為に係る刑事事件に関し起訴されることなく当該一時差止処分に係る期末特別手当の基準日から起算して1年を経過した場合
- 3 前項の規定は、理事長が、一時差止処分後に判明した事実又は生じた事情に基づき、期末特別手当の支給を差し止める必要がなくなったとして当該一時差止処分を取り消すことを妨げるものではない。
- 4 理事長は、一時差止処分を行う場合は、当該一時差止処分を受けるべき者に対し、当該一時差止処分の際、一時差止処分の事由を記載した説明書を交付しなければならない。
- 5 前各項に規定するもののほか、一時差止処分に関し必要な事項は、理事長が別に定める。

#### （非常勤役員手当）

第10条 非常勤役員手当は、日額27,200円とする。

- 2 非常勤役員手当の支給については、理事長が別に定める。

#### （実施細則）

第11条 役員の給与の支給手続きその他この規程の実施に関し必要な事項については、理事長が別に定める。

#### 附 則

この規程は、平成13年4月1日から施行する。

#### 附 則

- 1 この規程は、平成13年11月30日から施行し、平成13年4月1日から適用する。

# 独立行政法人国際農林水産業研究センター役員退職手当規程

13国研セ第4 - 24号

平成13年4月2日

## (趣旨)

第1条 独立行政法人国際農林水産業研究センター(以下「センター」という。)の常勤の役員(以下「役員」という。)の退職手当の支給に関する事項は、この規程に定めるところによる。

## (退職手当の支給)

第2条 退職手当は、役員が退職した場合に、その者(死亡による退職の場合には、その遺族)に支給する。ただし、役員が独立行政法人通則法(平成11年法律第103号)第23条の規定により解任された場合(同条第1項及び第2項第1号に該当し解任された場合を除く。)は、当該役員には退職手当は支給しない。

## (支給額)

第3条 退職手当の額は、その者の退職した日における俸給月額に、在職期間1月につき100分の28の割合(以下「支給割合」という。)を乗じて得た額とする。ただし、役員が任期満了の日以前又はその翌日に役職を異にする役員に任命され、引き続き在職した後退職した場合の退職手当の額は、それぞれ退職した日における当該異なる役職ごとの俸給月額に、当該異なる役職ごとの在職期間(以下「役職別期間」という。)1月につき支給割合を乗じて得たそれぞれの額の合計額とする。

2 前項の規定による退職手当の額は、その者の職務実績に応じ、これを増額し、又は減額することができる。

## (在職期間の計算)

第4条 在職期間及び役職別期間の月数の計算については、任命された日から起算して、暦に従って計算するものとする。この場合において、1月に満たない端数(以下「端数」という。)を生じたときは、これを1月とするものとする。

2 前条第1項ただし書に規定する場合において、各役職別期間の月数の合計が、同一の役職に在職したものとみなした場合に前項の規定により得られる在職期間の月数を超えるときは、同項の規定により1月とした端数の少ない役職別期間の月数から当該超える月数に達するまで順次1月を減ずるものとし、この場合において端数が等しいときは、後の役職別期間の月数から同様に1月を減ずるものとする。

(退職手当の支給制限)

第5条 役員が任期満了となり退職する場合において、その者がその日の翌日に再び同一の役職の役員に任命されたときは、その退職については、退職手当を支給しない。役員が任期満了の日以前又はその翌日に役職を異にする役員に任命されたときも、同様とする。

(遺族の範囲及び順位)

第6条 第2条に規定する遺族の範囲及びこれらの者が退職手当を受ける順位については、国家公務員退職手当法(昭和28年法律第182号)第11条の規定を準用する。この場合において、同条第1項中「職員」とあるのは「役員」と読み替えるものとする。

(遺族からの排除)

第7条 遺族からの排除については、国家公務員退職手当法第11条の2の規定を準用する。この場合において、同条中「職員」とあるのは「役員」と読み替えるものとする。

(起訴中に退職した場合等の退職手当の取扱い)

第8条 役員が刑事事件に関し起訴(当該起訴に係る犯罪について禁錮以上の刑が定められているものに限り、刑事訴訟法(昭和23年法律第131号)第6編に規定する略式手続きによるものを除く。次項及び次条第2項において同じ。)をされた場合において、その判決の確定前に退職したときは、退職手当は支給しない。ただし、禁錮以上の刑に処せられなかったときは、この限りでない。

2 前項の規定は、退職した者に対しまだ退職手当が支払われていない場合において、その者が在職期間(その退職手当の支給の基礎となる期間をいう。次条及び第10条において同じ。)中の行為に係る刑事事件に関し起訴をされたときについて準用する。

(退職手当の支給の一時差止め)

第9条 理事長は、退職した役員に対しまだ退職手当が支払われていない場合において、その者の在職期間中の行為に係る刑事事件に関して、その者が逮捕されたとき又はその者から聴取した事項若しくは調査により判明した事実に基づきその者に犯罪があると思料するに至ったときであって、その者に対し退職手当を支給することが、公共上の見地から行うセンターの事務及び事業に対する国民の信頼を確保し、退職手当の支給に関し、その適正かつ円滑な実施を維持する上で重大な支障を生ずると認めるときは、退職手当の支給を一時差し止めることができる。

2 理事長は、前項の規定による退職手当の支給を一時差し止める処分(以下「一時差止め処分」という。)について、次の各号のいずれかに該当するに至った場合には、速



やかに当該一時差止処分を取り消さなければならない。ただし、第2号に該当する場合において、一時差止処分を受けた者がその者の在職期間中の行為に係る刑事事件に関し現に逮捕されているときその他これを取り消すことが、一時差止処分の目的に明らかに反すると認められるときは、この限りでない。

- (1) 一時差止処分を受けた者について、当該一時差止処分の理由となった行為に係る刑事事件につき公訴を提起しない処分があった場合
- (2) 一時差止処分を受けた者がその者の在職期間中の行為に係る刑事事件に関し起訴されることなくその者の退職の日から起算して1年を経過した場合
- 3 前項の規定は、理事長が一時差止処分後に判明した事実又は生じた事情に基づき、退職手当の支給を差し止める必要がなくなったとして当該一時差止処分を取り消すことを妨げるものではない。
- 4 理事長は、一時差止処分を行う場合は、当該一時差止処分を受けるべき者に対し、当該一時差止処分の際、一時差止処分の事由を記載した説明書を交付しなければならない。
- 5 前各項に規定するもののほか、一時差止処分に関し必要な事項は、理事長が別に定める。

#### (退職手当の返納)

第10条 理事長は、退職した役員に対し退職手当を支給した後において、その者が在職期間中に係る刑事事件に関し禁錮以上の刑に処せられたときは、その支給した退職手当の全部又は一部を返納させることができる。

#### (実施細則)

第11条 退職手当の支給手続きその他この規程の実施に関し必要な事項については、理事長が別に定める。

#### 附 則

- 1 この規程は、平成13年4月1日から施行する。

#### 附 則(平成14.3.29 13国研セ第3-145号)

- 1 この規程は、平成14年4月1日から施行する。
- 2 平成14年4月1日(以下「基準日」という。)の前日に現に在職する役員が引き続き在職した後基準日以降に退職した場合における退職手当の額は、第3条の規定にかかわらず、基準日の前日における俸給月額に任命された日から基準日の前日までの在職期間1月につき100分の36を乗じて得た額と当該退職の日における俸給月額

に基準日から退職した日までの在職期間 1 月につき 1 0 0 分の 2 8 を乗じて得た額の合計額とする。

- 3 前項の場合において、各在職期間の月数の計算については、暦に従って計算するものとし、端数を生じたときは、これを 1 月とするものとする。ただし、各在職期間の月数の合計が、第 4 条第 1 項の規定により得られる在職期間の月数を超えるときは、1 月とした端数の少ない在職期間の月数から 1 月を減ずるものとし、この場合において端数が等しいときには後の在職期間の月数から 1 月を減ずるものとする。
- 4 基準日の前日に現に在職する役員が任期満了の日以前又はその翌日に役職を異にする役員に任命された場合における前 2 項の規定の適用については、附則第 2 項中「基準日の前日における」とあるのは「それぞれ退職した日（基準日以降も同一の役職に引き続いて在職している場合にあっては、基準日の前日）における」と、「任命された日から基準日の前日までの在職期間」とあるのは「各役職別期間（基準日以降も同一の役職に引き続いて在職している場合にあっては、基準日の前日までの役職別期間）」と、「当該退職の日」とあるのは「それぞれ退職した日」と、「基準日から退職した日までの在職期間」とあるのは「各役職別期間（基準日の前日から引き続き同一の役職に在職している場合にあっては、基準日からの役職別期間）」と、附則第 3 項中「在職期間」とあるのは「役職別期間」と、「第 4 条第 1 項の規定により得られる在職期間」とあるのは「同一の役職に在職したものとみなした場合に第 4 条第 1 項の規定により得られる在職期間」と読み替えるものとする。

# 平成13年度に係る業務実績報告書概要版

平成14年6月

独立行政法人 国際農林水産業研究センター

## 第 章 国際農林水産業研究センターの概要

### 1 業務内容

#### 1) 目的

熱帯又は亜熱帯に属する地域その他開発途上にある海外の地域における農林水産業に関する技術上の試験及び研究等を行うことにより、これらの地域における農林水産業に関する技術の向上に寄与することを目的とする。

(独立行政法人国際農林水産業研究センター法第3条)

#### 2) 業務の範囲

(1) 熱帯又は亜熱帯に属する地域その他開発途上にある海外の地域における農林水産業に関する技術上の試験及び研究、調査、分析、鑑定並びに講習を行うこと。

(2) 前号の地域における農林水産業に関する内外の資料の収集、整理及び提供を行うこと。

(3) 前二号の業務に付帯する業務を行うこと。

(独立行政法人国際農林水産業研究センター法第10条)

### 2 事務所の所在地

(本所) 〒 305-8686 茨城県つくば市大わし 1-1

電話 0298-38-6313 (代表)

ファックス 0298-38-6316

ホームページ <http://www.jircas.affrc.go.jp/index.sjis.html>

(支所) 〒 907-0002 沖縄県石垣市字真栄里川良原 1091-1

電話 09808-2-2306 (代表)

ファックス 09808-2-0614

### 3 資本金の状況

平成 13 年 4 月 1 日に、独立行政法人国際農林水産業研究センター法附則第 5 条に基づき、国から資本金として 8,470,154,319 円相当の土地・建物等の現物出資を受けた。平成 13 年度末の資本金の額は同じく 8,470,154,319 円で、増減はない。

### 4 役員の状況

独立行政法人国際農林水産業研究センター法第 7 条に基づき、理事長、理事 1 名、監事 2 名 (内 1 名は非常勤) の 4 名の役員を置いている。

理事長 井上 隆弘 (昭和 17 年 9 月 28 日生)

任期：平成 13 年 4 月 1 日～平成 17 年 3 月 31 日

理事 諸岡 慶昇 (昭和 19 年 10 月 1 日生)

任期：平成 13 年 4 月 1 日～平成 15 年 3 月 31 日

監事 加藤 邦彦 (昭和 18 年 11 月 10 日生)

任期：平成 13 年 4 月 1 日～平成 15 年 3 月 31 日

監 事 藤本 彰三（昭和 25 年 1 月 27 日生）

（非常勤）

任期：平成 13 年 4 月 1 日～平成 15 年 3 月 31 日

## 5 職員の状況

平成 14 年 1 月 1 日現在の常勤職員の現在員数は 162 名、この内一般職員 34 名、技術専門職員 10 名、研究職員 118 名である。

## 6 設立の根拠となる法律名

独立行政法人国際農林水産業研究センター法（平成 11 年法律第 197 号）

## 7 主務大臣

農林水産大臣

## 8 沿革

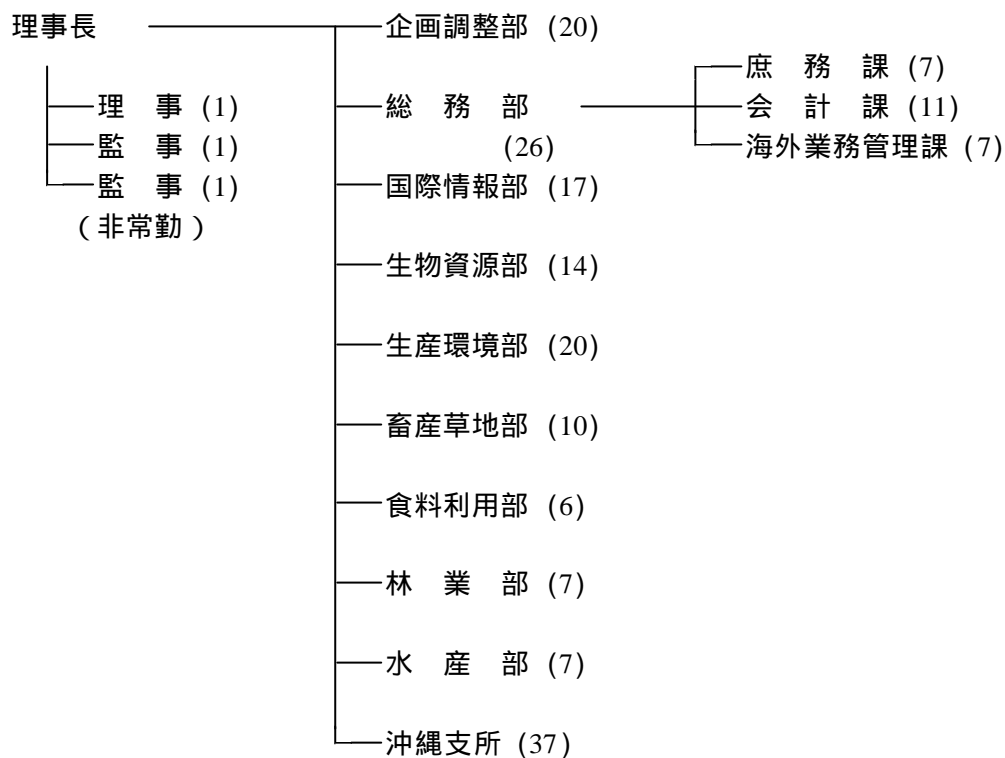
昭和 45 年 6 月、農林省熱帯農業研究センターとして発足した。その目的は、a) 開発途上国（その大部分が熱帯または亜熱帯に位置する）の食糧増産等の農業振興に必要な技術を開発する、b) 我が国の試験研究領域の拡大と研究水準の向上に資する（国内農業技術の開発のために必要な研究を熱帯現地で行う）であった。このため、主たる研究の場を海外におき、研究者を長期派遣して研究に従事させた。

昭和 52 年 6 月の農林省設置法の一部改正により熱帯農業研究センターは茨城県に置かれ、昭和 53 年 7 月の国家行政組織の一部改正に伴って、農林水産省熱帯農業研究センターとなった。昭和 58 年 12 月に、研究技術情報官（現在の国際研究情報官）が設置され、昭和 60 年 4 月に調査情報部（現在の国際情報部）が新設された。これは我が国の ODA の伸び、研究対象や対象国の拡大など、国際環境の中での我が国の役割が変化し、研究の深化と拡大がもたらされてきたことが背景にある。昭和 62 年 5 月には基盤技術研究部、昭和 63 年 10 月には環境資源部が創設された。

農林水産業をとりまく世界情勢の変化や旧ソ連や東欧、モンゴルなどの熱帯・亜熱帯以外の開発途上地域からの研究協力要請の増大等の背景をふまえ、平成 5 年 10 月に、新たに水産業研究を包摂し、熱帯又は亜熱帯に属する地域及びその他開発途上にある海外の地域における食料・資源・環境問題等に総合的に対応することを目的とし、熱帯農業研究センターは農林水産省国際農林水産業研究センターに改組されることとなった。

そして、平成 11 年 4 月中央省庁等改革推進本部で決定された「中央省庁等改革の推進に関する方針」のうち閣議決定された「国の行政組織等の減量、効率化等に関する基本計画」により、平成 13 年 4 月に独立行政法人国際農林水産業研究センターに移行した。

## 9 組織図



独立行政法人化に伴い、開発途上国・地域の情報を重点的に収集・解析し、研究戦略の構築を行うため、海外情報部を改組して国際情報部として強化した。また、開発途上地域において農産物の流通・利用・消費までを視野に入れた一貫した研究体制を強化するため、また、農作物の生産に関わる研究を総合的に推進するため、生産利用部と環境資源部を改組して食料利用部と生産環境部として整備した。さらに、沖縄支所を亜熱帯・島嶼農業の研究拠点として整備した。各部署の所掌は組織規程に定めた。

## 第 章 平成 13 年度に係わる業務の実績

業務運営の効率化に関する目標を達成するためにとるべき措置

### 1 評価・点検の実施

#### 「運営評価会議」の開催

平成 13 年度業務実績の自己評価を実施するため、平成 14 年 3 月 26 日～27 日に運営評価会議を開催した。センターが内部評価資料に基づいて年度計画の各事項を説明し、評価委員に評価をお願いした。9 名の評価委員の総合評価所見を代表委員がとりまとめて理事長に提出し、センターの自己評価とした。

#### 「研究計画・成果検討会」の開催

平成 13 年度の研究計画や成果等の検討及び評価を行うため、研究計画・成果検討会を実施した。部・支所検討会では実施課題、新規課題、研究成果情報について検討し、平成 14 年 2 月 1 日の全所検討会では、それらに加えて、年度計画各事項の具体的達成状況について内部評価を行った。内部評価結果は運営評価会議の資料とした。

#### 「国際農林水産業試験研究推進会議」の開催

センターが行う事業の適切かつ円滑な推進を図るため、平成 14 年 2 月 19 日に、農林水産業関係試験研究機関等の協力及び行政部局との連携のもとに国際農林水産業試験研究推進会議を開催した。国際農林水産業における国際共同研究の戦略、国内農業研究との共栄及び研究成果情報の審査を行った。

#### 「顧問会議」の開催要領

センターの試験研究の基本方向や運営に関して長期的な観点から検討するため顧問会議を設置した。理事長が 3 名の顧問を委嘱したが、平成 13 年度は開催には至らず、次年度早々開催することとした。

#### 「国際プロジェクト研究推進評価」の実施

センターは、中期計画の効率的な達成のためプロジェクト態勢で研究を遂行している。国際プロジェクト研究毎に外部評価委員を委嘱し、評価を行うこととした。平成 13 年度は、「海外養殖エビ類ウイルス病の診断・防除技法の開発（9～13 年度）」と「タイ東北部における持続的農業技術の確立のための開発研究（7～13 年度）」について事後評価を、「インドシナ天水農業地帯における水資源の効率的利用と収益性の向上（14～20 年度）」について事前評価を、また、「東南アジアにおける穀類のポストハーベストロス低減技術の開発（12～16 年度）」について中間評価を実施した。他の 7 プロジェクト研究については毎年度評価を実施する。

#### 「研究職員業績評価委員会」の開催

研究職員の研究業績並びに前年度の研究成果及び業務内容等をもとに、研究職員業績評価委員会で評価・審査した。農業への貢献度、科学上の貢献度及び研究推進に対する貢献度等の視点から客観的評価を行うとともに、総合判断をも加え理事長に答申した。理事長、人件費予算の状況等をも総合的に勘案しつつ精査を行い、昇格者及び研究業績に基づく特別昇給者を選考し発令した。

なお、新たな業績評価システムは、平成 14 年度からの導入を目指し現在策定中である。

## 2 研究資源の効率的利用

### 競争的資金への応募

運営費交付金に加えて研究費をさらに充実させるため、平成 13 年度は文部科学省、環境省、農林水産省、生物系特定産業技術研究推進機構、民間財団などの競争的資金に 16 件応募し、5 件（合計 41,640 千円）及び第 2 次補正予算（958,480 千円）を獲得した。

### 研究費の重点的な配分

独法化に伴う研究体制整備の一環として、専門研究領域を 27 グループに絞り込み、個々の専門研究グループを研究推進の重要な単位として位置づけた。そして、運営費交付金による研究費を重点的に配分するため、専門研究グループとして応募することができる所内プロジェクト「法人プロ」を開始し、採択された 17 課題に 83,000 千円配分した。

### 高額機器の効率的な利用

「高分解能 X 線光電子分光分析装置 (ESCA)」及び「エネルギー分散形走査型分析電子顕微鏡 (SEM-EDS)」（本所）と「作物環境評価検定施設」（沖縄支所）を共同利用機器等として選定し、「共同利用機器等管理要領」を作成した。当面、共同利用の範囲を原則として所内、独法間及び国の研究機関とした。

### 圃場の効率的な利用

国際農林水産業研究センターのほ場は本所（つくば市）と沖縄支所（石垣市）の 2 カ所にあることから、ほ場の管理運営事項の一元的な把握・調整を図るためほ場委員会を設けた。また各所在地において迅速かつ効率的な業務運営や調整等を行うため、各所在地に小委員会を設け、それぞれの所在地で運営する態勢を整えた。

## 3 研究支援の効率化及び充実・高度化

### 特許、品種登録等の知的所有権の取得・移転のための事務的な支援態勢等の強化

事務的な支援を行う担当を決めて態勢を強化し、ホームページで公表した。先行特許の検索方法の紹介や農林水産技術情報協会が提供する公開特許情報等を利用して、関連研究分野の特許出願等に関する情報を提供した。また、当所ホームページへ保有特許等の一覧及び担当窓口等を掲載し、実施許諾を行った特許権（作物栽培装置）の実施状況及び実施料を把握した。職務発明審査会を 4 回開催し、特許出願のための所内審査を行った。

### 計算情報センター 2000 年システムの活用

平成 13 年 11 月に開催した国際農林水産業研究センターでの講習会で、計算情報センター 2000 年システムに関するセミナーの開催予定を紹介し、当所ホームページからリンクできるようにした。

（計算情報センターのホームページ <http://www.affrc.go.jp/ja/info/tebiki/index.html>）

### アジア太平洋高度ネットワーク (APAN) 関連セミナー

国際農林水産業研究センターで平成 13 年 9 月 7 日にセミナーを開催し、APAN に関わる日本人研究者の活動の周知を図るとともに今後の方向について議論し、当面は研究者レベルで進めていくこととした。



### **JIRCAS/STAT（国際農林水産業統計情報システム）の拡充**

開発途上地域を中心とする世界の食料需給に関する計量分析研究を推進するため、13年度は、中国の農業、畜産業、林業、水産業関連時系列データと、31省の農業、畜産業、農業資源の変化等クロスセクションデータを含むデータベースを作成し、JIRCAS/STATの更新拡充を図った。

### **図書資料管理システムや文献情報検索システムの活用に向けた説明会**

新図書資料管理システムや文献情報検索システムの内容及び活用方法の理解を図るため、平成13年11月に講習会を開催し、所員への周知を図った。

### **庁舎、研究棟、熱帯温室の保守管理の外部委託**

本所では庁舎、海外実験棟、バイテク棟、隔離温室のセキュリティー及び庁舎の保守管理（空調・清掃等）の外部委託を実施し、また沖縄支所では特殊設備、空調設備について外注により保守管理を行っている。

### **技術専門職員等による海外現地における研究職員の研究業務等の支援**

平成13年11月に作物栽培管理における省力・機械化技術の開発のため（タイ、21日間、1名）、14年1月に節水節肥栽培技術導入及び実験ほ場の整備のため（タイ、19日間、1名）それぞれ技術職員を派遣した。11月派遣では、相手国の関係機関の研究者や研究管理者及び多数の農民の参加のもとに農業機械によるほ場作業や機械メンテナンスのデモンストレーションを行い、高い評価を得た。

## **4 連携、協力の促進**

### **（1）他の独立行政法人との連携、協力**

#### **国際農林水産業研究に関する中核的研究センターとしての機能の整備**

国際プロジェクト研究は海外長期滞在研究員による研究と短期滞在研究を組み合わせ実施している。年間約200件の短期派遣を実施しており、農林水産省所管の試験研究に係わる独立行政法人の協力が必須である。そのため、これらの独立行政法人との間で「独立行政法人国際農林水産業研究センターが海外において行う国際共同研究の実施についての協約書」を平成13年9月に締結して連携・協力システムを構築し、国際農林水産業研究に関する中核的研究センターとしての機能を整備した。

### **（2）開発途上地域の試験研究機関等との連携、協力**

#### **新規国際プロジェクト研究の開始**

東南アジア漁業開発センター（SEAFDEC）（フィリピン）、マレーシア中央水産研究所及びカセサート大学（タイ）に長期滞在研究員を各1名、短期滞在研究員を8名派遣して、「マングローブ汽水域における魚介類の持続的生産システムの開発（13～17年度）」のプロジェクト研究を開始した。

#### **国際共同研究の相手機関等との覚書の見直し**

ブラジル農牧研究公社（EMBRAPA）と2つの国際共同研究を実施している。平成13年度に覚書の見直しを行い、知的所有権を共有する場合の手続き、共有しない場合の補償、秘密保持、係争解決方法（第三者の調停）等を新たに規定した。マレーシア・サバ州林業局森林研究センターとの間で、複数回の覚書案の見直しを行い、知的所有権に係わる両機関の同等の権利を保障する覚書を平成13年12月に締結した。平成14年1月にベトナムのクーロンデルタ稲研究

所及び南部果樹研究所と新たに覚書を締結した。

国際農林水産業研究センター、農業技術研究機構、農業生物資源研究所及び農業環境技術研究所を代表して、国際稲研究所（IRRI）（フィリピン）と国際共同研究に係わる覚書を平成 14 年 3 月に締結した。

#### **開発途上地域の研究者、研究管理者等の招聘による国際共同研究の推進**

「国際招へい共同研究事業実施要綱」及び関連規程など独立行政法人化後の招へい事業の実施体制を整備した。平成 13 年度は JIRCAS 国際シンポジウム 8 名、研究管理者 45 名、共同研究員 28 名、招へい共同研究者（フェロー、継続含む）37 名、アジアバイテク招へい者 3 名、計 121 名を招へいし、国際共同研究を推進した。

### **（3）産学官の連携、協力**

#### **国内外の研究機関等との連携・協力の推進**

「共同研究規程」を作成し、それに基づいて、生物系特定産業技術研究推進機構との間で、「環境ストレス耐性遺伝子組換え作物の開発」に関する共同研究を実施している。法人間の研究協力が研究部長（相当職を含む。）間の文書の交換によって実施できるように、平成 14 年 1 月に、8 法人間で協約書を締結した。また、平成 13 年 4 月に、東京大学大学院農学生命科学研究科との間で教育研究指導等への協力に関する協定書を締結し、研究員 2 名を併任教授及び助教授として、学生の指導に当たった。

#### **共同利用可能な施設・機器等のホームページ等での公表**

「高分解能 X 線光電子分光分析装置（ESCA）」及び「エネルギー分散形走査型分析電子顕微鏡（SEM-EDS）」（本所）と「作物環境評価検定施設」（沖縄支所）を共同利用機器等として選定し、そのデータベース化を図り、ホームページで公表した。

#### **国内外の研究機関等との産学官の共同研究の推進**

「客員研究員受入れ規程」を作成し、受入基準、成果の取り扱い等を明確化した。また、平成 14 年 2 月 19 日に国際農林水産業試験研究推進会議を開催した（既述）。

## **5 管理事務業務の効率化**

### **会計事務の効率化**

支払い業務のためにファームバンキングを導入して、会計事務の効率化を図った。

### **総務担当職員による海外長期滞在研究員の事務処理の支援**

海外長期滞在研究員は共同研究の他に事務的な仕事の責任も負い、負担が大きい。負担をできるだけ軽くするため、現在、タイ国に海外業務専門官 1 名を派遣しタイ、マレーシアの海外滞在研究員に係わる事務処理の支援を行っている。

## **6 職員の資質向上**

### **各種研修等の開催通知の迅速化**

所外からの研修案内等は所内 LAN を活用して直ちに職員に周知している。平成 13 年度は、97 件の募集を行い、希望又は必要な研修 14 件については全て受講させた。また、所内においては本・支所合同で「会計システム決算等説明会」を開催した。なお、業務遂行に必要な資格取得は、第一種衛生管理者が 1 名である。

### 各種制度による海外での研究実施の支援

センターは若手研究者の育成と競争的資金の活用の観点から各種制度による海外での研究実施を支援している。平成 13 年度は、科学技術振興事業団の「若手研究者海外派遣」制度に応募した（補欠合格）。また、環境省及び文部科学省の予算による下記の海外研究を実施した。

#### 環境省

- ・アジア地域における環境安全保障の評価手法の開発と適用に関する研究（中国、タイ）(11～13年度)
- ・環境インパクトの少ない木材搬出手法に関する調査研究（マレーシア）(11～13年度)

#### 文部科学省

- ・西アフリカの気象変動予測の高度化による穀物生産リスク軽減技術の開発（マリ）(12～14年度)
- ・バイオ肥料へのアイソトープ技術応用に関する調査（タイ）(13年度)

### 研究員の博士号取得の奨励と指導

主に海外での共同研究を実施しているセンターにとって、研究者の育成、学位取得は研究実施上も重要な意味を有する。平成 13 年度の博士号の取得状況は、在職者 120 名中 73 名（全体の 60%強）であり、年度内には、研究部長等の適切な指導もあり、5 名の増加（現任者：3 名、新規採用者：2 名）があった。

## 7 海外滞在職員等の安全と健康の確保

### 「安全衛生委員会」を設置と職員等の安全と健康の確保

本・支所毎に安全衛生委員会を設置し、規程類、健康診断等の実施方法及びその他の安全・衛生に関する事項について、衛生管理者及び産業医の巡視結果等も踏まえて調査審議した。

### 海外滞在職員等の安全確保と海外情報や危険・医療情報等の海外出張中職員への連絡体制の確保

海外滞在職員及びその家族の安全と健康の確保は非常に重要であるため、緊急時に速やかに対応できる態勢を整えた。また、外務省や国際協力事業団との連携を図り、最新海外情報や危険・医療情報等を収集し、必要に応じ職員に周知し注意を喚起した。さらに、「緊急時の情報伝達フロー」、「海外滞在派遣職員名簿」を作成し配付した。また、緊急脱出のため「コーポレート・セキュリティ・アクセスプログラム契約」を締結した。他に、E メールリストの作成（随時）、国内外の携帯電話の利用により連絡体制を確保した。

### 海外に出張する者への「出張の手引き」の整備

海外に出張する者への安全と健康並びに事務手続きの円滑化等を図るため「外国出張の手引き」を整備した。また、短期出張者向けの安全対策マニュアルを作成し、さらに、出発前に安全情報、研究内容等の連絡が遺漏のないよう個票を作成するなどガイダンス実施方法を改善した。

国民に対して提供するサービスその他の業務の質の向上に関する目標を達成するためとるべき措置

## 1 試験及び研究並びに調査

A 開発途上地域の食料需給改善のための農林水産業の動向解析、国内外の研究開発動向の把握及び技術開発方向の解明

### 1) 世界の食料需給の動向解析と共同研究に係わる総合戦略の策定

#### (1) 主要な開発途上国の研究動向の解明及び中期的国際共同研究戦略の策定

先進諸国の主要な研究成果の中から、米国などの有する木材需給モデルの内容・特徴を分析し、世界林産物需給に関する独自のプロトタイプモデルを開発した。

また、FAO等の土壌関係データなどを含む情報データベースへのアクセスを容易にするためのシステム開発を進めるとともに、気象データの内挿補間処理システムを開発した。

さらに、東北タイのため池や天水田の現地測量結果をGISデータ化したほか、大規模水害の状況把握のため衛星データの解析手法を検討した。

#### (2) 中国主要省等の食料需給動向の解析等による世界の食料需給モデルの改良

中国山東省及び貴州省について、食糧生産や農業収益と肥料投入との関係を明らかにした。また、農業生産の機械化と兼業化の進展における中国の主要地域間の格差、穀物の生産・流通のインテグレーションの動向などを明らかにした。

一方、将来の食料需給動向分析に不可欠な中長期の予測モデルについては、世界の主要国際研究機関のモデルのパラメータ自体の変化のメカニズムを明らかにした。

また、中国山東省を対象に計量モデルによる要因分析を行い、今後干ばつ被害がさらに大きくなる可能性が高いことを明らかにした。

### 2) 開発途上地域における食料・環境に係わる地域特性及び発展方向の解明

#### (1) インドネシア、西アフリカ等における農林水産業の発展阻害要因と技術的・経済的発展方向の解明

(論文数：3)

インドネシアに関しては、温帯野菜の流通構造と生産農家の出荷体制や取り組み方とともに、野菜や熱帯果樹の在来種の栽培の背景やその技術の実態などを把握・分析した。また、タイの水稻直播技術や酪農経営の動向のほか、中国、東南アジア各国の農業生産・流通の現状と問題点を把握した。

一方、西アフリカにおいては、穀物生産などの土地利用状況や気象パターン、農家の具体的作付け体系と作目選択基準などを明らかにした。特に、低湿地の稲作灌漑施設の所有権・利用権とこれらの施設への追加投資の動向、作物選択の考え方、さらに経営改善に向けての対応方向などについて分析した。

B 開発途上地域の農林水産業の持続的発展のための研究開発

### 1) 開発途上地域における農林水産物の環境に調和した持続的生産技術の改良・開発

#### (1) 多様な耕地生態系における窒素等の物質循環の評価と土壌改良技術の改善

(論文数：3)

中国山東省陵県、東北タイコンケン県、メコンデルタカントー県という3つの異なる農業生態系に代表される行政単位内の農耕地を中心とした窒素循環の定性的並びに定量的評価を終了し、持続的発展へ向けての窒素循環の適正化方向を提示した。

中国においては、肥効調節型窒素肥料の環境負荷軽減効果が確認された。モデル系内での塩類集積制御に効果を持つ物質が確認された。

## (2) タイ、ベトナム等における稲・畑作物の省力・省資源的生産技術の開発

(論文数：2、成果情報：8)

水稻栽培においては、メコンデルタの集約栽培地域における直播体系内での適正播種量と施肥法に関して、また東北タイの天水田地域で機械化と雑草管理に関して、それぞれ農家圃場を使った現地実証試験により新技術の有効性を確かめた。

畑栽培においては、東北タイの砂質土壌地帯でサブソイラーを利用した硬盤管理体系を提案し、施肥・植付機を結合した部分深耕同時施肥・植付機を開発した。窒素の効率的な利用に関して作物の硝酸化成抑制作用と有機態窒素利用の作物間差に関する知見が得られた。

大規模灌漑水田地帯の農業用水消費を削減するために、雨量観測、用水量の推定、灌漑時期について問題点を明らかにし、対応策を導き出すモデルを構築した。

## (3) 東南アジア、南米等における稲・大豆等の主要病害虫の発生実態の解明

中国のハイブリッド水稻栽培ではウンカ多発が問題となっているが、その多発化現象は、不稔系統珍汕 97A の核遺伝子に支配された著しい感受性に原因し、F1 ハイブリッド汕優 63 の乾物生産に発現されるヘテロシスがウンカの多産を支持する形質として作用する結果と考察できた。

また、中国粳稻(ジャポニカ)品種“春江 06”のセジロウンカ抵抗性の由来を家系分析し、セジロウンカ抵抗性のうち、殺卵抵抗性は家系内の品種間で連続的変異を示すので特定品種に由来する形質ではないが、吸汁抑制抵抗性は特定の品種群に帰属していることが分かった。半数体倍加系統群を用いて殺卵抵抗性および吸汁抵抗性を QTL 解析し、前者に関わる QTL を第 6 染色体と第 11 染色体に、後者を第 11 染色体に検出した。

## (4) 農牧輪換システム等に適したイネ科牧草及びトウモロコシ茎葉等の地域低利用飼料資源の特性の解明

(論文数：8、成果情報：2)

農牧輪換システムでは、作付体系の選択が重要で、中でも *Panicum maximum* が高い牧草生産性を得る作付体系であるが、その生産性低下要因となる土壌窒素の損耗防止策を講じる必要があること、また、*Brachiaria humidicola* は低窒素環境下での養分吸収が優れているなどの興味深い知見が得られた。ほかに、ブラジルサバンナの低湿地に適した牧草種を明らかにした。

中国で調製されたトウモロコシ茎葉サイレージの飼料特性を有機酸分析等により明らかにし、タイで調製されたサイレージの微生物相を明らかにした。

## (5) タイ、ベトナム等における牛・豚等の生理学的特性の解明と主要家畜疾病の実態の解明

(論文数：4、成果情報：1)

熱帯地域ではこれまでほとんど知見がなかったので、タイ東北部において、泌乳牛の維持エネルギー要求量を解明し、産乳に対する利用効率を推定した。

トリパノソーマ感染した腫瘍壊死因子(TNF)- $\alpha$  欠損マウスや C57 マウスでは、感染後血清中のフェリチン濃度が低下し、鉄欠乏性貧血を起こすが、その病態にはマウス間で相違があり、感染動物体内では TNF $\alpha$  の間接的な作用により原虫増殖が抑制されることなどが示唆された。

## (6) 熱帯低質林におけるフタバガキ等有用樹種の天然更新補助技術の開発

熱帯森林における集材路の作設に伴う土砂流出や表土劣化等の因果関係を調査し、集材路の

作設方法により森林環境、特に集材道路面の表面侵食が大きく影響を受けることを明らかにした。

標高の異なる試験地に植栽した在来樹種 6 種、果樹 5 種の初期成長量及び生残率等の調査・解析を行い、植栽地の標高及び樹種により成長特性が明確に異なること、3 樹種は乾燥の激しい山地造林樹種としての特性を備えていること等を明らかにするなど、熱帯樹種についての生理生態的基礎データを集積した。

## (7) 水産生物の環境と調和した養殖方法の開発

(論文数：6、成果情報：1)

閉鎖領域内に人工的なマングローブモデル林を作り、窒素成分等の消長に及ぼす各種要因の解明を進めた。

汽水域での養殖業を阻害している疾病発生の実態を明らかにし、養殖魚の大量斃死の原因となっている一部原因ウイルスの特定を行った。新規有用養殖対象魚として、ゴマフエダイ等の産卵と孵化の特性解明が進捗し、栄養改善効果の研究を開始した。

オニテナガエビの卵黄タンパク質の研究では、判定が難しかったエビ類の成熟判定法の開発に成功した。

## 2) 開発途上地域における農林水産物の品質評価・流通・加工技術の改良・開発

### (1) 東南アジアにおける米等の食料資源の形状・香り等の品質特性の解明

(論文数：6)

香り米における 2-アセチル-1-ピロリンには 2 種類の形態があり、開花後の水分ストレスが 2-アセチル-1-ピロリン含量を増加させることを明らかにした。また、オオバンガジュツを主要ポリフェノール成分の含量比率によりパターン化し、さらに、いくつかのタイ産植物に含まれる抗変異原物質、抗酸化物質、抗菌活性物質等を単離、精製、同定した。

タイ産野菜中の有用物質については、特許出願している。

### (2) 温湿度等の環境条件と連動した香り米等の品質劣化の簡易防止技術の開発と加工技術の改良・開発

(論文数：9、成果情報：2)

切り妻型乾燥機を改良し、ベトナムの農民の求める性能を超える乾燥能力を有する機械を開発した。また、タイの乾燥施設の問題点を明らかにするとともに、籾の簡易乾燥法としてのブロードダクトの有効性を明らかにした。

米の損耗要因として害虫、鳥、鼠のいずれも重要であり、主要害虫はバクガ(もみ)、コクゾウムシ類(もみ、精米)、ガイマイツヅリガ(精米)の 3 種であることを明らかにし、貯穀害虫の天敵を多数採集した。ポメロの果皮中の d-リモネンが米貯蔵庫における害虫防除に利用できる可能性を示した。

加熱絞り豆乳に二段階加熱を適用した豆腐製造技術を確立し、発酵米がビーフン製造に適していること、及び、酸性水または混合電解水が豆腐用大豆の殺菌に有効なことを明らかにし、白色孢子変異株を用いたケチャップ用種麹の調製に成功した。

### (3) オイルパーム廃材等の低利用木質資源の利用技術の開発

未利用資源であるオイルパーム空果房(EFB)の有効利用を図るため、環境への影響を抑えた酸を用いない高品質溶解パルプの調整を可能にした。EFB 含有のポリマーコンポジット調整法については、マレーシア理科大学(USM)と協力して、パームオイル主成分に反応が起こりやすい置換基を導入する反応経路を検討し、その実証に向け、反応条件等を決定するための

生成物の検出法（定性テスト）や定量方法等の予備試験を行った。

#### **（４）中国における淡水魚等低利用水産資源のすり身等への利用技術の開発**

（論文数：７、成果情報：１）

淡水漁業資源の完全利用技術の確立を目標に、すり身加工残滓等の養殖魚用飼料化技術の開発のため、飼料製造行程中の問題点の把握及び製造された飼料の有用性評価等を行い、全魚体を利用した場合に比べて、加工残滓を原料とした場合には、タンパク質含量が著しく減少するなどの問題点を抽出した。

### **３）開発途上地域における遺伝資源及び生物機能の解明と利用技術の開発**

#### **（１）乾燥等の環境ストレスに対する耐性機構の解明と組換え体作出技術の開発**

（論文数：８、成果情報：１）

モデル植物であるシロイヌナズナを使って解明された環境ストレス耐性に関与する遺伝子や知見を使い、双子葉植物であるタバコでもシロイヌナズナと同じようなストレス応答の遺伝子発現がみられる事を解明した。さらに単子葉植物であるイネにおいても DREB 類似遺伝子を単離し、その発現様式が似ている事を証明した。これにより環境ストレス耐性作物の開発のための基礎的知見が植物種を越えて広く応用できることが示された。

環境ストレス応答に関与する遺伝子発現様式を一層解明していくため、浸透圧センサーの解明、マイクロアレイ手法の確立、ABA シグナル伝達異常変異体の作出等の研究を実施した。

#### **（２）稲、小麦等における病虫害抵抗性等の評価技術の開発と育種素材の育成**

（論文数：３、成果情報：１）

中国原産およびブラジルの大豆遺伝資源の中から高脂肪含有率等の有用な形質を持つ品種を選抜した。また、大豆製品の豆臭や青臭み発生の原因となるダイズリポキシゲナーゼの簡易迅速選抜法を改良した。

稲いもち病の判別系統、小麦の赤さび、赤かび病抵抗性育種のための有用な育種素材が開発された。小麦の赤さび病、赤かび病では分子マーカーを使い起源が異なる抵抗性遺伝子を効率的に選抜集積が出来ることを示した。中国水稻研と共同でイネ紋枯病の検定法として注射器接種法を開発した。

熱帯・亜熱帯地域の高温・多湿時期においても生育が旺盛な土着野菜（葉菜）である、ヒユナ、ツルムラサキ、モロヘイヤ、ヨウサイにおいて抗酸化活性やビタミン含量等で多くの変異がみつきり、有望な系統が選抜された。

#### **（３）熱帯・亜熱帯等の野菜・果樹等の遺伝資源収集、評価並びに保存**

外国から導入した稲 200 系統を亜熱帯条件下で栽培し、植物遺伝資源調査マニュアルに従って、一次及び二次特性（葉いもち病抵抗性、耐倒伏性）を調査し、また種子の増殖を行った。

国内外から導入したサトウキビ及び近縁属植物の育種素材化を進めるため一次特性から必須 11 項目と選択項目の出穂早晩性を調査しデータベース化した。さらにインドネシアより 5 品種・系統を導入した。

微生物では、イネ科植物から分離したキチナーゼ生産細菌 3 菌株と窒素固定細菌 7 菌株の合計 10 菌株、及びマメ科植物から分離した根粒菌 1 2 菌株をベースコレクションとして登録した。また、大豆発酵食品の改良・開発を目的として、糸状菌スターター及び乳酸菌の特性を調べるためにそれぞれワーキングコレクションを収集した。

#### **４）開発途上地域における環境資源の特性評価と生物多様性の解明**

### (1) 農業生産に関する環境資源の特性評価と土地利用の変動機構の解明

(成果情報：1)

東北タイの衛星データの解析等を通じて、土壌条件及び水利用可能性の点から作物別栽培適地と実際の土地利用との関係进行分析し、特に水利用可能性の評価手法を改良した。

インドネシアにおいては、USLE 式を用いて土壌浸食量を推定するとともに、土地利用変動など動的要因も考慮した改良手法を適用し、土壌浸食危険度を明らかにした。

中国においては土地利用区分と衛星データ値の季節変化と特性进行分析し、動的要因の評価において適用すべき手法の概要を明らかにした。

ブラジルにおいては植生調査を通じた現況観察図の作成、多時期の衛星データ解析による草地の季節変化を把握した。さらに、草地植生の不均一性の定量的把握や耕地面積変化の長期モニタリングに有効な解析手法を示した。

### (2) マレーシア等における熱帯林の再生技術及び持続的利用技術の導入条件の解明

サバ州政府との間で知的所有権の帰属が問題となり、MOU 締結が 12 月まで延びたため、予定していた長・短期出張者の派遣及び研究の開始が大幅に遅れた。

試験地の現況調査から 13 年生マンギウム林の下層には唐辛子や観葉植物等、86 種もの多様な植物が確認された。アグロフォレストリー生産環境に適した樹種として生育特性等が異なる 8 樹種を、栽培作物として果樹 8 種、作物 5 種、薬草 5 種類をそれぞれ有用性、耐陰性、市場性等を考慮して選定し、林内での栽培野菜としてスーパセルリ、ヒユナ等の葉茎菜類を選定した。

現地林分調査により人工林地下部での強い溶脱環境の存在や、植栽樹種からのリター供給量と分解速度、土壌化学性との密接な関連性等についての知見が得られた。

### (3) 東南アジアにおける沿岸、マングローブ汽水域生態系の水産重要魚種資源の変動過程の解明

マングローブ汽水域の開発に伴う水産資源減少の対策として、環境保全に配慮した資源管理型漁業の確立が急務となっている。そのための基礎調査として資源動向、漁具漁法、養殖実態等に関する情報が集積された。フエダイ、ハタ類等重要魚種の生活環の解明が進められおり、フエダイ類の消化管内容物調査の結果から食性を明らかにした。

## 5) 沖縄における研究

### (1) サヤインゲン、稲等の耐暑性・耐塩性の特性評価と利用

(論文数：3、成果情報：2)

サヤインゲンでは、高温による花粉の活力低下が原因で、花粉管の発芽や伸長過程が影響を受けるため結莢不良となることを明らかにした。また、耐暑性品種では蒸散能が高く、葉温が低く維持されることが判明した。

耐暑性作物作出のための候補遺伝子としてトマトのミトコンドリア型スモールヒートショックプロテイン遺伝子を単離し、E. coli 発現系を用いた組換え MT-sHSP の特性を明らかにした。有用育種素材としてサヤインゲン「黒種衣笠」を用いて、耐暑性サヤインゲン標準品種の雄性不稔系統シリーズの作出した。

耐塩性バクテリア *Bacillus coagulans* の持つ耐塩性遺伝子の探索とクローニングを行い、また、藻類の持つナトリウムイオン輸送遺伝子のイーストへの導入に成功した。

### (2) サトウキビ、イモ類等の特性評価及び利用技術の開発 (論文数：1, 成果情報：1)

サツマイモのアントシアニン転写活性化遺伝子の特異的 DNA 断片として 200bp 断片、230bp



断片、380bp断片及び500bpを単離したが、塩基配列を決定した380bp断片と230bp断片の相同性は低かった。アントシアニン合成酵素遺伝子を完全に含む2.3kbpDNA断片を単離し塩基配列を決定した。

サトウキビの初期生長には比葉面積の影響が大きいことを明らかにし、サトウキビ品種NiF8（農林8号）の茎から3.5kbpのスクロースリン酸シンターゼ(SPS)遺伝子と考えられる遺伝子を単離した。

サトウキビで、アグロバクテリウム、バイナリーベクターを用いて形質転換体と推測されるカルスおよびシュートを多数得ることに成功した。これらのシュートからはPCR-サザン法によりハイグロマイシン耐性遺伝子の存在を示唆するバンドが検出された。

### **(3)マンゴー、パパイア等熱帯果樹の樹形制御・食味等の特性評価及び大量増殖技術等の基盤技術の開発**

(論文数：6)

石垣島内の自生パパイアを調査収集し、実生のうち雄株を除いた559個体について1次調査を行い、矮性と考えられるパパイア約30個体を選抜した。12月以降は果実の収穫期となるので、年度内に食味調査を行う。

3地域で栽培されたマンゴー(品種アーウィン)のカロチノイド含有量には地域間で大きな差があり、また冬期の加温によりカロチノイド含有量に差が認められる地域もあるなど、環境条件により品質特性が異なることが示唆された。

パインアップルの果実品質の劣化要因となる果実の倒伏に関して品種群ごとの特徴を調査し、樹体が傾斜する要因を究明した。また、数種のパパイア品種を用い、アグロバクテリウム法によるウイルス外被タンパク導入手法を開発し、形質転換した不定胚と不定芽を得ることに成功した。

### **(4)熱帯・亜熱帯に発生するカンキツグリーニング病等の重要病害虫の発生生態の解明**

(論文数：3, 成果情報：2)

石垣島内では、ミカンキジラミに寄生する2種の寄生蜂が発見されたが、寄生率自体は低かった。ミカンキジラミの分布はゲッキツの分布と一致し、奄美大島以南の南西諸島の総ての島で分布が確認され、1種もしくは2種の寄生蜂の発生が確認された。また、これら寄生蜂の飼育系も確立した。

ミカンキジラミ成虫を用いたカンキツグリーニング病の伝搬試験は一部成功したものの、安定的な伝搬条件を見出すには至らなかった。同病検出には新たに作出したモノクローナル抗体は不完全だったが、ポリクローナル抗体は有望だった。Nested-PCRの利用は感染樹からの病原検出精度向上に有用であった。

アオイ科作物の重要害虫であるアカホシカメムシを捕食するベニホシカメムシは狭食性で、短日による休眠反応は認められず高い増殖力を持つことが判明した。

### **(5)熱帯・亜熱帯島嶼における気象・土壌等に関わる生産不安定化要因の解明と節水・省肥栽培等対策技術の開発**

(論文数：2, 成果情報：1)

地中点滴灌水により慣行の60%窒素量を液肥で施用した場合のサトウキビの生育量は、慣行の無灌水に比べ良好となり、窒素4割の節肥効果があった。また、耕盤はサトウキビ根の伸長阻害、土壌中の蓄積水の利用抑制、地表面流亡の助長、土壌通気性抑制、茎数減少等による収量低下等を招いた。

養液栽培の灌水位置は浅根性のキャベツなどでは地表灌水が窒素経済面でも適しており、サ

トウキビ春植え栽培では、側枝ポット苗培地へ肥効調節型肥料を用いると慣行施肥量の4割減が可能であった。

夏期における高温強日射が作物の生育に及ぼす影響が大きいと、野菜生産における効率的な遮光を検討し、一日の時刻別にその効果を解明した。

河川での実態調査に基づく年負荷総量や養分収支及び宮良川のゲート開閉に伴う流量変化を解明するとともに、手持ちの濁度計の値を浮遊物質濃度に変換する回帰式を完成し、純農業地域の河川の窒素汚濁の進行を明らかにした。

## **(6) 稲等の世代促進における出穂特性等の変異固定技術の開発**

(論文数：1)

稲では、2期作型は北海道農研センター等226集団、3期作型は北海道農研センター等35集団延べ261集団の世代促進栽培を行った。また、本年の本圃場における穂いもち病の発病程度を明らかにした。

小麦では、育成地の計40集団について1または2世代の世代促進を計画どおり実施した。農林59号×TD(F)(春化反応性の遺伝分析系統)のF2分析では春化反応性遺伝子Vrn4と硬軟質性遺伝子の間に2.5%水準で有意な連鎖が認められたが、その組換え価は大きかった。ゼンコウジコムギ×農林67号の組合せにおいて、種子休眠性について成熟月の差異による有意差は認められないことから、世代促進において硬軟質性と種子休眠性に関して成熟期選抜に大きな効果はないと考えられる。

## **2 専門研究分野を活かした社会貢献**

### **(1) 分析、鑑定**

#### **依頼分析・鑑定の体制整備**

当面の分析・鑑定の対象として「高分解能 X 線光電子分光分析装置 (ESCA)」及び「エネルギー分散形走査型分析電子顕微鏡 (SEM-EDS)」を選定し、「依頼分析・鑑定規程」を作成して態勢を整えた。

### **(2) 講習、研修等の開催**

#### **タイにおけるバイオテクノロジーに関する研修会の開催**

アジアにおけるバイオテクノロジー技術の研修及び普及を図るため、平成13年9月に、アジア太平洋経済協力会議 (APEC) との共催による「農業バイオテクノロジー国際シンポジウム」をバンコクにて、引き続き、JIRCAS ワークショップ「バイオテク利用による環境ストレス耐性作物」を同所にて開催した。

#### **国際シンポジウム・ワークショップ・セミナー等の開催**

国内外の大学、国際農業研究機関、国際協力事業団等の協力を得て、毎年 JIRCAS 国際シンポジウムを開催している。平成13年度は、11月に開催し、持続的農業との係わりにおける水問題に関する最近の成果と問題点及び今後の展開方向について情報交換を行った。また、平成14年3月に、参加型手法によるファームシステム研究に関するトレーニングコースをつくばにおいて開催した。このほか、国際プロジェクト研究の相手国機関からの招へい管理者25回、来訪研究者5回のセミナーを開催した。

#### **研修生の受入れ**

「独立行政法人国際農林水産業研究センター講習規程」を整備し、規程に基づいて、JICA 研修で来日した2名の研究員を受入れ、バイオテク研究の指導を行った。

### **国等の委託による国際共同研究に従事する研究者等の研修・育成**

国際共同研究や農業技術協力への従事予定研究者等の研修もセンターの重要な社会貢献の一つであるとの認識から、平成 13 年度は、国際農林業協力協会（AICAF）の依頼を受けて、受託契約を締結し、4 名の国際協力専門要員を受入れ、沖縄支所で 40 日間の技術補完研修を実施した。

### **（ 3 ） 行政、国際機関、学会等への協力**

#### **行政、国際機関、学会等の委員会、会議等への職員の派遣**

新規事業として、国際共同研究従事希望者の人材データベースを作成し、国際機関における共同研究実施状況に関して派遣調査を実施した。また、タイにおいてバイオテクノロジーに関する研修会を主催し、6 名の講演者等を派遣した。このほかの平成 13 年度における派遣状況は、行政・国際機関等の委員会：56 件、学会等の委員会：40 件、講師・講演依頼等への対応：38 件、以上国内合計 134 件で、所外からの依頼等による国際会合への派遣者数は 10 件で延べ 12 人である。

#### **国際協力事業団等の委託による技術協力のための職員の派遣、研修員の受入れ**

国際協力事業団(JICA)、国際農林業協力協会（AICAF）等の委託を受けて、研修員の受入れ並びに研修会等に職員を講師として派遣するとともに、海外からの来訪者を積極的に受入れ、海外との技術協力の推進を支援した。〔JICA 委託：17 件、AICAF 委託：9 件、その他の委託：34 件〕〔JICA、AICAF 等の外国人研修員受入れ：246 人〕

#### **行政、生産者、消費者等からの技術相談**

行政、生産者、消費者等からの技術相談窓口（国際研究広報官）を当所のホームページに公表し、対応の態勢を整えた。その結果、当所の研究成果、JIRCAS ニュース記事の詳細などについての問い合わせが増加し、また、マスコミ（テレビ局）からの取材の相談などがあつた。

## **3 成果の公表、普及の促進**

### **（ 1 ） 成果の利活用の促進**

#### **研究成果情報(15 件以上)の公表**

研究成果情報のホームページでの公表は平成 5 年度から行っており、平成 13 年度の 26 件の情報名と要約はすでに公表した。

#### **"JIRCAS Newsletter"及び"JIRCAS ニュース"への研究成果情報の掲載**

平成 12 年度の研究成果情報の中からより重要な情報と考えられるものを 4 回に分けて JIRCAS Newsletter(No.27 ~ 30)及び JIRCAS ニュース(No.26 ~ 29)で公表し、利活用の促進に努めた。

#### **不定期刊行物(JIRCAS Working Report Series 等)を通じての研究成果の公表**

種々の不定期刊行物を通じて研究成果を随時公表しており、平成 13 年度は、Annual Report 2000 (April 2000 ~ March 2001)を平成 13 年 10 月に発行した。(JIRCAS Working Report Series は - 3 - ( 2 ) - の項に記載)

#### **研究成果情報のデータベースを作成し、ホームページへ公開する。**

上記 参照。

## (2) 成果の公表と広報

### [ 成果の公表 ]

#### 学術雑誌、機関誌等への論文(108報以上)の発表

「情報発信届」によって研究職員の成果の公表を把握している。平成13年度は、研究成果情報：16、特許・品種登録：12、機関誌：72(審査有20、審査無52)、原著論文：86(学会誌登録団体雑誌及び国際誌74、その他12)、国内学会発表：164、国際学会発表：111、公刊図書(単行本)：19、調査報告資料：22、総説：15、雑誌等：49、その他：3、合計569報である。なお、平成13年度に、日本土壌肥料学会賞、文部科学省研究功績者表彰、日本水産学会奨励賞をそれぞれ受賞し、また、日本女性科学者の会奨励賞(日本水産学会奨励賞受賞者と同一人)を受賞した。

#### JIRCAS Journal の発行

平成13年7月にJIRCAS Journal No.9を発行した。なお、No.1～No.8までの論文題目リストは当所のホームページで公表済みである。

#### JIRCAS 国際シンポジウムの開催

平成13年11月に開催した第8回JIRCAS国際シンポジウムにおいて、当所から、バイオテクノロジーによる乾燥ストレス耐性作物の開発、天水農業地帯における水資源の効率的利用及び国際農林水産業研究センターにおける水利用に係わる最近の研究成果について紹介し、今後の研究方向についての議論を深めた。

#### 研究成果公表のためのJIRCASワークショップ(5回以上)の開催

国際プロジェクト研究では、研究成果の公表と検討を行うため、共同研究相手国やつくば本所において随時ワークショップを開催している。平成13年度は中国で3回、ブラジルとベトナムで各1回、つくばで5回(うち1回FFTCと共催)開催した。

#### JIRCAS International Symposium Series の発行

平成12年度に開催した第7回JIRCAS国際シンポジウムのプロシーディングをJIRCAS International Symposium Series No.9「TARC-JIRCAS 30th Anniversary, The 7th JIRCAS International Symposium: Agricultural Technology Research for Sustainable Development in Developing Regions」として平成13年8月に発行し、国内外の関係機関に配布した。

#### JIRCAS Working Report Series(5冊以上)、国際農業研究叢書(2冊)、JARQ(4回)の発行

JIRCAS Working Report Seriesとして3冊発行し、国際農業研究叢書として、現在、1冊印刷原稿作成中である。JARQは、わが国における農業研究の現状を開発途上地域の研究機関に広く紹介する役割を担っており、独法化後も、農林水産省所管の試験研究に係わる独立行政法人、大学の協力を得て刊行を継続することとした。平成13年度は4回(Vol.35(3)～Vol.36(2))発行した。

### [ 成果の広報 ]

#### 研究成果に関する情報のデータベースの作成とホームページへの公開

農林水産研究情報センターの「研究課題情報データベース」とリンクできるようにして、研究成果の概要をホームページで公開した。( <http://kiss.aris.affrc.go.jp/> )

## 各種の定期・不定期刊行物を通じての研究計画、業務報告、成果情報等の公開とホームページへの公開

独立行政法人国際農林水産業研究センター中期目標（JIRCAS ニュース No.26（平成 13 年 9 月発行））及び平成 12 年度国際農業研究成果情報（JIRCAS ニュース No.27（平成 13 年 12 月発行））を掲載した。また、シンポジウム、ワークショップ等の報告はその都度掲載し、データベースを作成してホームページへ公開した。

### JIRCAS ギャラリーの拡充と一般公開や来客に対する情報公開

これまで別棟にあった JIRCAS ギャラリーを研究本館ロビーに拡充整備し、新たにパネル・写真が設置出来るようにして、研究成果等の既存及び新規パネルや写真・世界地図等を展示して、来客が自由に観覧できるようにした。

### 成果情報の記者クラブ（2 回）への提供

平成 12 年度国際農業研究成果情報及びエビウイルス・プロジェクトの成果である WSSV（ホワイトスポットシンドロームウイルス）感染診断用抗体作成について提供した。

## （3）知的所有権等の取得と利活用の促進

### 国内外への特許等（4 件以上）の出願

独法化後、知的所有権の取得・移転に関する事務的な支援態勢を強化し、特許等の取得について研究職員の積極的な取り組みを喚起した。平成 13 年度は新たに 5 件の国内特許出願を行い、この内 2 件については延べ 8 カ国にも外国特許を出願した。

### 研究者の知的所有権への理解を促す説明会、会議等の開催

「研究成果の管理に関する規程」の作成の経緯と概要について、平成 14 年 3 月に所内説明を行い、周知徹底を図った。また、弁理士相談会に職員（職務発明申請希望職員及び支援職員）が 2 回参加した。

### 知的所有権のデータベース作成とホームページへの公開

センターが所有する特許権及び育成者権等の名称及び概要を記載したデータベースを作成し、ホームページで公開した。また、平成 13 年 9 月にブルネイで開催されたアセアン科学技術週間において、センターの特許である作物栽培装置を展示し、利活用の促進に努めた。

予算（人件費の見積りを含む。）、収支計画及び資金計画（別紙 1）

- 1 予算 平成13年度予算
- 2 収支計画 平成13年度収支計画
- 3 資金計画 平成13年度資金計画

短期借入金の限度額

実績なし。

重要な財産を譲渡し、又は担保に供しようとするときは、その計画計画なし。

### 剰余金の使途

平成 13 年度の剰余金は積立金とする。

### その他農林水産省令で定める業務運営に関する事項

#### 1 施設及び設備に関する計画（別紙 2）

病害ガラス室の改修（沖縄支所）が平成 14 年 1 月に竣工し、輸入植物病原体の維持・増殖が可能となったので、研究の加速が期待できる状況となった。

#### 2 人事に関する計画（人員及び人件費の効率化に関する目標を含む。）

##### 1）人員計画

##### （1）方針

##### 本支所間の支払い等の会計事務の合理化

つくば本所と沖縄支所の 2 カ所に事業所を所有しているため、支払い等の会計事務の一元化のため平成 15 年 4 月の実現に向けて検討を開始したが、平成 14 年度も引き続き具体的な移行方法及び措置の検討が必要である。

##### 国際総合プロジェクト研究の推進における重点化

農業生産技術が未熟な地域であるタイ東北部及びラオスの天水農業地帯における農業生産の安定と向上及び収益向上のための技術開発が重要であるため、平成 14 年度から新規国際プロジェクトを開始する。また、当面する環境及び食料問題の緊急性と重要性に鑑みてアフリカが重要であるため、西アフリカの半乾燥熱帯地域における土壌肥沃度の維持管理手法の開発に関するプロジェクトの平成 15 年度実施開始に向けて、重点的に検討を行った。人材については、国及び他法人との人事交流を行いつつ要員の確保と調整を図っているが、人材が僅少な研究分野については独自に選考採用を行うことなどにより、将来の国際農林水産業研究を担う人材の確保と養成を行う。

##### （2）人員に係る指標

常勤職員の現在員数は、平成 14 年 1 月 1 日現在 162 名であった。

##### 2）人材の確保

##### 選考採用による研究者（2 名）の確保

平成 13 年 10 月 1 日付採用及び平成 14 年 2 月 1 日付採用として選考採用を 2 回行った。前者では、「アフリカ（西アフリカ）における地域動向の分析と効率的な研究戦略の企画・立案」を行おうとする人材 1 名を公募して応募者 4 名を得たが、審査の結果、該当者無しとして採用を見送った。後者では、「開発途上地域（特にアフリカ）における地域開発、食料・環境問題についての研究」を行おうとする人材 1 名及び「作物（特に大豆）の分子マーカーを利用した遺伝資源及び遺伝育種の研究」を行おうとする人材 1 名を公募し、それぞれ 7 名、6 名の応募者から書類・

面接審査を経て、能力・経験・人格等が十分と判断し得る人材各 1 名を選出・採用した。

#### **科学技術特別研究員の受入れによる研究業務の加速化**

平成 14 年 1 月から新たに 2 名（国際情報部、生産環境部）を科学技術特別研究員として受入れ、現在の受入れ総数は 8 名である。JIRCAS の研究業務の活性化に大きく貢献しているので、次年度も受入れたい。

(別紙1)

予算、収支計画及び資金計画に対する実績

1 予算

平成13年度予算及び決算

(単位:百万円)

区 分	予 算 額	決 算 額
収入		
運営費交付金	3,439	3,439
施設整備費補助金	78	78
受託収入	234	190
諸収入	0	3
試験場製品等売払代	0	3
その他収入	0	0
計	3,751	3,710
支出		
業務経費	1,307	1,173
施設整備費	78	78
受託経費	234	188
試験研究費	212	173
管理諸費	22	15
一般管理費	371	502
研究管理費	31	116
管理諸費	340	386
人件費	1,761	1,735
計	3,751	3,676



## 2 収支計画

### 平成13年度収支計画及び実績

(単位:百万円)

区 分	計 画 額	決 算 額
費用の部	3,566	4,088
經常費用	3,566	4,088
人件費	1,761	1,912
業務経費	1,077	1,674
受託経費	226	174
一般管理費	371	157
減価償却費	131	171
財務費用	0	0
臨時損失	0	0
収益の部	3,566	4,271
運営費交付金収益	3,209	3,219
諸収入	0	691
受託収入	226	190
資産見返負債戻入	23	7
資産見返物品受贈額戻入	108	164
臨時利益	0	0
純利益	0	183
目的積立金取崩額	0	0
総利益	0	183

### 3 資金計画

#### 平成13年度資金計画及び実績

(単位:百万円)

区 分	計 画 額	決 算 額
資金支出	3,751	3,710
業務活動による支出	3,435	3,153
投資活動による支出	316	258
財務活動による支出	0	0
翌年度への繰越金	0	299
資金収入	3,751	3,710
業務活動による収入	3,673	3,632
運営費交付金による収入	3,439	3,439
受託収入	234	190
その他の収入	0	3
投資活動による収入	78	78
施設整備費補助金による収入	78	78
その他の収入	0	0
財務活動による収入	0	0

(別紙2)

その他農林水産省令で定める業務運営に関する事項

1 施設及び設備に関する計画

平成13年度施設、設備に関する計画及び実績

(単位:百万円)

施設・設備の内容	計 画 額	決算額	財 源
病害ガラス室改修	78	78	施設整備費補助金

# 財務諸表及び決算報告書に関する意見書

独立行政法人国際農林水産業研究センターの平成13年度における財務諸表及び決算報告書について監査をしたところ、いずれも適正であることを認める。

平成14年 6月 18日

独立行政法人 国際農林水産業研究センター

監 事

加 藤 邦 彦



監 事

藤 本 彰 三



# 独立行政法人国際農林水産業研究センター中期目標

## 第1 中期目標の期間

独立行政法人国際農林水産業研究センター（以下「センター」という。）の中期目標の期間は、平成13年4月1日から平成18年3月31日までの5年間とする。

## 第2 業務運営の効率化に関する事項

運営費交付金で行う事業については、中期目標の期間中、毎年度平均で、少なくとも前年度比1%の経費節減を行う。

### 1 評価・点検の実施

独立行政法人評価委員会（評価委員会）の評価結果は、資源配分、業務運営等に適切に反映させる。評価委員会の評価の効率的かつ効果的な実施に資するため、センター自らにおいても、運営状況、研究成果について外部専門家・有識者等を活用しつつ、業務の点検を行う。また、研究職員については、公正さと透明性を確保した業績評価を行い、評価結果は研究資源配分等に反映させる。

### 2 研究資源の効率的利用

外部資金の獲得、研究資源の充実・効率的利用、施設機械の有効利用等を図る。

### 3 研究支援の効率化及び充実・高度化

研究業務の高度化に対応した高度な専門技術・知識を有する者を配置する等、研究支援業務の効率化、充実・強化を図る。また、必要に応じ、外部委託等の活用を図る。

### 4 連携、協力の促進

他の独立行政法人との役割分担に留意しつつ、研究目標の共有、共同研究、人的交流の促進を行い、独立行政法人全体としての農林水産業等に関する研究水準の向上を図る。また、研究の効率的な実施のため、国公立機関、大学、民間、海外機関、国際機関等との共同研究等の連携・協力及び研究者の交流を行う。

### 5 管理事務業務の効率化

事務処理の迅速化、簡素化、文書資料の電子媒体化等による管理事務業務の効率化を行う。

### 6 職員の資質向上

職員への研修、資格取得等の促進を通じた資質向上に努める。

- 7 海外滞在職員等の安全と健康の確保  
海外滞在職員等の安全及び健康の確保に努める。

### 第3 国民に対して提供するサービスその他の業務の質の向上に関する事項

#### 1 試験及び研究並びに調査

##### (1) 重点研究領域

平成11年7月に制定された「食料・農業・農村基本法」及びその理念や施策の基本方向を具体化した「食料・農業・農村基本計画」並びに平成11年11月に策定された「農林水産研究基本目標」に示された研究開発を推進するため、センターにおいては、「開発途上地域における農林水産物の環境に調和した持続的生産技術」、「開発途上地域における農林水産物の品質評価・流通・加工技術」、「開発途上地域における遺伝資源及び生物機能の解明と利用技術」、「開発途上地域における環境資源の特性評価と生物多様性の保全技術」等に関する研究を重点的に推進する。その際、経済活動や社会活動のグローバル化の進展を受けて、我が国の農林水産業への波及と影響についても考慮しつつ、国際的な連携・協力による国際共同研究を実施する。また、緊急に解決すべき問題については、研究開発を積極的に推進する。

##### (2) 研究の推進方向

研究に係る目標の作成に当たって、次のように定義した用語を主に使用して段階的な達成目標を示す。また、研究対象等を明示することにより、達成すべき目標を具体的に示す。

取り組む：新たな研究課題に着手して、試験及び研究を推進すること。

解明する：原理、現象を科学的に明らかにすること。

開発する：利用可能な技術を作り上げること。

確立する：技術を組み合わせて技術体系を作り上げること。

#### ア 開発途上地域の食料需給改善のための農林水産業の動向解析、国内外の研究開発動向の把握及び技術開発方向の解明

##### (ア) 世界の食料需給の動向解析と共同研究に係わる総合戦略の策定

- a 内外の資料の収集、整理、分析等を迅速に行うため、主要な開発途上国、国際機関等との間で情報ネットワークの構築を図るとともに、国際共同研究の中期的な総合戦略を策定する。
- b 中国主要省等について需給動向解析用モデルを開発し、世界の需給動向解析用モデルの精度を高める。

(イ) 開発途上地域における食料・環境に係わる地域特性及び発展方向の解明

インドネシア、ベトナム、西アフリカ等の総合プロジェクト実施地域を中心に、

- a 農林水産業の発展阻害要因と技術的・経済的発展方向を解明する。
- b 持続的なファームリングシステムの確立のための社会的・経済的・技術的視点を明確化し、問題点と展開方向を解明する。

イ 開発途上地域の農林水産業の持続的発展のための研究開発

(ア) 開発途上地域における農林水産物の環境に調和した持続的生産技術の改良・開発

タイ、マレーシア、ブラジル等の総合プロジェクト実施地域を中心に、

- a 持続的生産を可能にするための窒素等の物質循環の解明と評価手法を開発する。
- b 稲・畑作物の現地に適した省力・省資源的栽培技術を開発する。
- c 稲・大豆等の現地における主要病害虫の発生生態を解明する。
- d 農牧輪換システムに適したイネ科牧草の生理・生態学的特性を解明し、低利用飼料資源の栄養特性評価を行う。
- e 現地における牛・豚等の生理学的特性と主要疾病の実態を解明する。
- f 熱帯低質林への有用樹種の植込み等天然更新補助技術を開発する。
- g 環境と調和した地域固有水産生物の増養殖技術を開発する。

(イ) 開発途上地域における農林水産物の品質評価・流通・加工技術の改良・開発

タイ、マレーシア、中国等の総合プロジェクト実施地域を中心に、

- a 現地で生産されている米等の基本的な品質特性を解明する。
- b 温湿度等の環境条件と連動した米・大豆等の品質劣化の簡易防止技術を開発する。
- c 熱帯地域のオイルパーム廃材等低利用木質資源の高度利用技術を開発する。
- d 淡水魚等低利用水産物のすり身等への有効利用技術を開発する。

(ウ) 開発途上地域における遺伝資源及び生物機能の解明と利用技術の開発

西アフリカ、中国等の総合プロジェクト実施地域を中心に、

- a 乾燥耐性等の有用形質について、関連するプロモーターの単離等を行い、遺伝的特性を解明する。
- b 稲等の病虫害抵抗性等の有用育種素材を開発する。
- c 独立行政法人農業生物資源研究所が実施するジーンバンク事業のサブバンクとしてセンターバンク（独立行政法人農業生物資源研究所）と連携しつつ、遺伝資源の収集、評価及び保存を行う。

(エ) 開発途上地域における環境資源の特性評価と生物多様性の解明

タイ、インドネシア、マレーシア等の総合プロジェクト実施地域を中心に、

- a リモートセンシング技術を用いた環境資源の特性評価と土地利用の変動を解明する。
- b 熱帯林の持続性と再生のためのアグロフォレストリー技術の導入条件を解明する。

- c マングローブ汽水域の養殖を中心とした農林水産業の振興・活性化を図るための生物生産過程を解明する。

#### (オ) 沖縄における研究

- a インゲンマメ、稲等を用いて耐暑性及び耐塩性のメカニズムを解明する。
- b アグロバクテリウム等を用いて、サトウキビ等の優れた特性を有する育種素材を開発する。
- c マンゴー、パパイヤ等の熱帯・亜熱帯果樹の特性を評価し、大量増殖に資する基盤技術を開発する。
- d 熱帯・亜熱帯に発生するカンキツグリーンング病等の重要病害虫の発生生態を解明する。
- e 熱帯・亜熱帯島嶼の生産不安定要因を解明し、節水・省肥栽培等の対策技術を開発する。
- f 稲等の世代促進における出穂特性等の変異固定技術を開発する。

### 2 専門研究分野を活かした社会貢献

#### (1) 分析、鑑定

行政、各種団体、大学等の依頼に応じ、センターの有する高い専門知識が必要とされる分析、鑑定を実施する。

#### (2) 講習、研修等の開催

講習会の開催、国公立機関、民間、大学、海外機関等外部機関からの研修生の受入れ等を行う。

#### (3) 行政、国際機関、学会等への協力

行政、国際機関、学会等への専門家の派遣、行政等への技術情報の提供等を行う。

### 3 成果の公表、普及の促進

#### (1) 成果の利活用の促進

研究成果はデータベース化やマニュアルの作成、共同研究等により積極的に開発途上地域等での利活用の促進を図る。

#### (2) 成果の公表と広報

研究成果は、積極的に学術雑誌等への論文、学会での発表等により公表するとともに、主要な成果については各種手段を活用し、積極的に広報を行う。

#### (3) 知的所有権等の取得と利活用の促進

重要な研究成果については、わが国の農林水産業等の振興に配慮しつつ、特許等の取得により権利の確保に努めるとともに、民間等における利用の促進を図る。また、育種研究成果については、国の命名登録制度を活用しつつ、優良品種の育成・普及に努める。



## 第4 財務内容の改善に関する事項

### 1 収支の均衡

適切な業務運営を行うことにより、収支の均衡を図る。

### 2 業務の効率化を反映した予算計画の策定と遵守

経費節減目標を踏まえた運営費交付金の交付を受けることを前提に中期計画の予算を作成し、当該予算による運営を行う。

## 第5 その他業務運営に関する重要事項

### 人事に関する計画

#### (1) 人員計画

期間中の人事に関する計画（人員及び人件費の効率化に関する目標を含む。）を定め、業務に支障を来すことなく、その実現に努める。

#### (2) 人材の確保

研究職員について、任期付任用制度の活用、職の公募等により、内外の優れた人材を確保する。



# 独立行政法人国際農林水産業研究センター中期計画

## 業務運営の効率化に関する目標を達成するためとるべき措置

運営費交付金で行う事業については、中期目標の期間中、毎年度平均で、少なくとも前年度比1%の経費節減を行う。

### 1 評価・点検の実施

外部専門家・有識者等を活用し、毎年度の報告に先立ち、自ら点検を行う。

主要な研究については、研究の推進方策・計画及び進捗状況の点検を行うとともに、外部専門家・有識者等の意見を聞いて成果の評価を行い、その結果は研究資源の配分に反映させるとともに公表する。

評価項目、評価基準を定める等公正さを確保しつつ、研究職員の業績評価を行い、その結果は処遇、研究資源の配分に反映させる。

### 2 研究資源の効率的利用

中期目標達成に有効な競争的資金には積極的に応募し、研究資源の充実を図る。

研究資源の効率的・重点的な配分を行う。

施設・機械の有効利用を図るため、共同利用に努めるとともに、共用等が可能な機械については、その情報をインターネットを介して広く公開する等、有効かつ効率的利用に努める。

### 3 研究支援の効率化及び充実・高度化

特許、品種登録等の知的所有権の取得・移転に係る支援態勢を強化する。

農林水産省研究ネットワーク等を活用して、研究情報収集・提供業務の効率化、充実・強化を図る。

施設、機械等の保守管理については、業務の性格に応じて外部委託に努める。

海外長期滞在研究員の所在地に、長期・短期に事務職員を出張させ、現地における会計事務等を支援する。

### 4 連携、協力の促進

#### (1) 他の独立行政法人との連携、協力

他の独立行政法人との役割分担に留意しつつ、研究目標の共有、共同研究、人事交流を含めた連携、協力を積極的に行う。また、独立行政法人農業技術研究機構が行う多様な専門知識を融合した総合研究に必要なに応じて協力する。

( 2 ) 開発途上地域の試験研究機関等との連携、協力

開発途上地域における研究問題解決のため、海外の農林水産業研究機関等との共同研究を実施する。

開発途上地域の農林水産業研究機関等から研究管理者等を招へいし、共同研究の推進方向について協議して、連携と協力を強化する。

開発途上地域における研究機関等の研究員を招へいし、共同研究を実施する。

( 3 ) 産学官の連携、協力

国公立機関、大学、民間、海外機関、国際機関、国際協力事業団等との共同研究及び研究者の交流等を積極的に推進する。

研究を効率的に推進するため、行政との連携を図る。

科学技術協力に関する政府間協定等を活用し、先進国等との共同研究を推進する。

国の助成により公立機関等が実施する研究等への協力を行う。

毎年定期的に、関係独立行政法人、行政部局、都道府県等の参加を求めて、研究推進のための会議を開催し、相互の連携・協力のあり方等につき意見交換等を行う。

5 管理事務業務の効率化

事務の簡素化と迅速化を図るため、LAN等を有効に利用するとともに、会計処理、発注業務の電子化を進め、事務処理に係わる新たなソフトウェア等の導入を行う。

光熱水の節約等により、管理経費の節減を図る。

6 職員の資質向上

業務上必要な各種の研修に職員を積極的に参加させるほか、必要な研修を実施し、職員の資質向上に努める。また、業務上必要な資格取得を支援する。

各種制度を積極的に活用し、職員の在外研究の機会の増加に努める。

博士号の取得を奨励し、適切な指導を行う。

7 海外滞在職員等の安全と健康の確保

海外滞在職員等の安全を確保するため、外務省や国際協力事業団との連携を密にし、常時、海外情報や危険・医療情報等の収集及び海外派遣中の職員への連絡態勢を確保する。また、緊急時には速やかな危機管理対策をとる態勢を確保する。

## 国民に対して提供するサービスその他の業務の質の向上に関する目標を達成するためとるべき措置

### 1 試験及び研究並びに調査

#### A 開発途上地域の食料需給改善のための農林水産業の動向解析、国内外の研究開発動向の把握及び技術開発方向の解明

##### 1) 世界の食料需給の動向解析と共同研究に係わる総合戦略の策定

###### (1) 主要な開発途上国の研究動向の解明及び中期的国際共同研究戦略の策定

主要な開発途上国及び国際研究機関等の研究問題設定の背景・目的、研究動向等を解析するとともに、情報収集に必要な情報ネットワークの構築を進める。また、それらの解析結果や国内外のニーズを踏まえ、我が国としての中期的国際共同研究戦略を策定する。

###### (2) 中国主要省等の食料需給動向の解析等による世界の食料需給モデルの改良

中長期の世界の食料需給動向を明らかにするため、中国主要省等の食料需給動向を解析するとともに、農林水産業関連の政策や経済環境、土地・水等の自然環境の変動を解明し、世界食料需給モデルを改良する。

##### 2) 開発途上地域における食料・環境に係わる地域特性及び発展方向の解明

###### (1) インドネシア、西アフリカ等における農林水産業の発展阻害要因と技術的・経済的発展方向の解明

農林水産業の研究協力では、各地域・国の自然条件、歴史、習慣等の社会条件や技術水準等に対応した多様な内容が求められていることからその効率的実施のため、地域の特性を的確に把握する。インドネシアや西アフリカ地域等について、農林水産業の特徴とその歴史的背景をふまえ、これまでの発展を阻害してきた要因と今後の技術的・経済的発展方向を解明する。

###### (2) インドネシア、ベトナム等における持続的ファーミングシステムの展開方向の解明

開発された農林水産業関連の技術が普及・定着するためには、持続的ファーミングシステムを構築することが必要であることから、地域の条件に応じたファーミングシステムの展開方向を明確化する。インドネシアやベトナム等についてのファーミングシステムの現状と問題点をふまえ、その展開方向を解明する。

## B 開発途上地域の農林水産業の持続的発展のための研究開発

### 1) 開発途上地域における農林水産物の環境に調和した持続的生産技術の改良・開発

#### (1) 多様な耕地生態系における窒素等の物質循環の評価と土壌改良技術の改善

持続的な生産を可能にし、環境負荷を軽減する耕地生態系管理技術及び土壌管理技術を開発するため、窒素、リン、有機物等の物質循環を評価する手法を開発し、研究対象地域におけるこれらの物質循環を評価する。

#### (2) タイ、ベトナム等における稲・畑作物の省力・省資源的生産技術の開発

限られた天然資源の有効利用と環境保全を考慮し、稲（香り米等の現地品種）及び畑作物の生産力を向上させるため、有機物投入による土壌管理・栽培法を改善するとともに、高品質・多収技術及び水管理技術を開発する。

#### (3) 東南アジア、南米等における稲・大豆等の主要病害虫の発生実態の解明

持続的な農業生産に寄与する総合防除を中心とした病害虫防除技術の開発を目指して、主要病原菌、害虫等の発生実態を解明する。

#### (4) 農牧輪換システム等に適したイネ科牧草及びトウモロコシ茎葉等の地域低利用飼料資源の特性の解明

農牧輪換システム等の持続型家畜生産に適したイネ科牧草の生理生態学的特性を明らかにするとともに、トウモロコシ茎葉等の農業副産物等の調製法及び飼料栄養特性を解明する。

#### (5) タイ、ベトナム等における牛・豚等の生理学的特性の解明と主要家畜疾病の実態の解明

牛・豚等の栄養代謝等の生理学的特性を解明し、環境と調和した飼養技術の開発に資するとともに、家畜の生産性を低下させるトリパノソーマ症等の主要な家畜疾病の実態を解明する。

#### (6) 熱帯低質林におけるフタバガキ等有用樹種の天然更新補助技術の開発

東南アジアにおける持続可能な森林経営を達成するための伐採・育林技術を開発する。特に、択伐後の林内におけるフタバガキ科樹種の天然更新補助技術を開発する。また、荒廃草地からの森林回復に効果的なギンネム等による造林技術を開発する。

#### (7) 水産生物の環境と調和した養殖方法の開発

水産上の重要な地域固有の魚種の成熟・産卵過程の解明、稚仔魚の摂餌生態、餌料生物の選定・培養、人工配合飼料の検討・実用化等の研究を行うとともに、養殖排水の浄化及びマングローブ林等に多量に生息する天然餌料の利用等の自然循環機能の利用による低投餌、低投薬（疾病防除型）養殖方法を開発する。

### 2) 開発途上地域における農林水産物の品質評価・流通・加工技術の改良・開発

#### (1) 東南アジアにおける米等の食料資源の形状・香り等の品質特性の解明

簡易で廉価な機器又は資材の組合せによる現地適合型評価手法を開発し、収穫前後及び流通加工過程における食料資源の基本特性（形状、香り、加工性等）を評価するとともに、変動要因を解明する。

(2) 温湿度等の環境条件と連動した香り米等の品質劣化の簡易防止技術の開発と加工技術の改良・開発

高温・高湿度の環境条件と劣悪な保全設備による収穫後の急速な品質劣化、及び害虫による量的・質的損耗の低減を図るため、低資材投入型の簡易な乾燥・保全技術を開発する。付加価値向上を図るため、現地加工技術を改良・開発する。

(3) オイルパーム廃材等の低利用木質資源の利用技術の開発

熱帯地域に豊富な未・低利用の低質木質資源の有効利用を図るため、オイルパーム廃材等の原料特性を解明し、木質製品への加工技術を開発する。

(4) 中国における淡水魚等低利用水産資源のすり身等への利用技術の開発

中国の生産、流通、消費の実状に合致したすり身等の水産物利用技術を開発するとともに、不明の点が多い淡水魚介類の特性に関する基礎的知見を蓄積する。また、未低利用部位の完全利用を目標に、資源の有効利用及び自然環境に配慮した利用技術を開発する。

3) 開発途上地域における遺伝資源及び生物機能の解明と利用技術の開発

(1) 乾燥等の環境ストレスに対する耐性機構の解明と組換え体作出技術の開発

モデル植物を用いて乾燥等の環境ストレス耐性機構を分子レベルで解明し、環境ストレス耐性に関する有用遺伝子やプロモーター等を作物へ導入して、環境ストレス耐性を持つ遺伝子組換え体を作成する。

(2) 稲、小麦等における病虫害抵抗性等の評価技術の開発と育種素材の育成

稲、小麦、大豆等の作物遺伝資源について特性評価を行う。これにより、環境ストレス耐性、病虫害抵抗性、収量性、品質成分等の有用形質に係る特性を明らかにし、これらの遺伝資源を利用して有用な育種素材を開発する。さらに、開発途上地域での育種事業の効率化を図るため、複合形質の効率の選抜のための育種法を開発・発展させる。

(3) 熱帯・亜熱帯等の野菜・果樹等の遺伝資源収集、評価及び保存

独立行政法人農業生物資源研究所が実施するジーンバンク事業のサブバンクとしてセンターバンク（独立行政法人農業生物資源研究所）と連携しつつ、熱帯・亜熱帯等の作物及び微生物遺伝資源について、収集・評価及び保存を行う。また、適当であると認められた遺伝資源については、随時、センターバンクに移管する。

4) 開発途上地域における環境資源の特性評価と生物多様性の解明

(1) 農業生産に関する環境資源の特性評価と土地利用の変動機構の解明

環境資源を有効に活用した農業生産システムを確立するため、リモートセンシング等による環境資源の特性評価技術を開発するとともに、土地利用変動と環境資源との関係を解明する。

(2) マレーシア等における熱帯林の再生技術及び持続的利用技術の導入条件の解明

熱帯早成樹人工林等を適切に管理・活用しながら多様性・持続性のある熱帯林へ再生させる方策を解明する。特に、環境保全を考慮したアグロフォレストリー生産環境の造成条件、及び間伐後に生じた空間において栽培が可能な果樹・野菜等の弱光利用型作物を組み合わせたアグロフォレストリー技術の導入条件を解明する。

( 3 ) 東南アジアにおける沿岸、マングローブ汽水域生態系の水産重要魚種資源の変動過程の解明

熱帯・亜熱帯地域におけるマングローブ汽水域は、生産の場としての経済的価値が高いばかりでなく、環境及び生物多様性の保全に果たす役割も大きい。本地域における環境の保全に配慮した水産業の持続的な活性化を図るため、沿岸域開発下における水産重要魚種資源の変動過程を解明する。

5 ) 沖縄における研究

( 1 ) サヤインゲン、稲等の耐暑性・耐塩性の特性評価と利用

サヤインゲン等野菜類の高温ストレス耐性に関する特性評価を行い、有用な育種素材を探索し、育種利用を図る。また、耐塩性を向上させた稲を開発するため、耐塩性の主要因であるナトリウムイオンの制御に関する遺伝子の機能を解明する。

( 2 ) サトウキビ、イモ類等の特性評価及び利用技術の開発

サトウキビ、イモ類等、熱帯・亜熱帯の栄養繁殖性作物がもつ有用形質について特性評価を行うとともに、生物工学的手法等を活用して優れた特性を持つ育種素材を開発する。

( 3 ) マンゴー、パパイア等熱帯果樹の樹形制御・食味等の特性評価及び大量増殖技術等の基盤技術の開発

マンゴー等の熱帯・亜熱帯果樹の樹形・着果制御等に必要物質生産・開花特性を解明する。また、パパイア等の食味等に関する品質特性を評価し、高品質果樹の大量増殖技術等の基盤技術を開発する。

( 4 ) 熱帯・亜熱帯に発生するカンキツグリーンング病等の重要病害虫の発生生態の解明

カンキツに壊滅的被害を及ぼすカンキツグリーンング病等の熱帯・亜熱帯地方の作物に発生する重要な病害及び害虫、天敵生物等の生理生態的特性を解明する。

( 5 ) 熱帯・亜熱帯島嶼における気象・土壌等に関わる生産不安定化要因の解明と節水・省肥栽培等対策技術の開発

気象、土壌等の環境が作物等の反応、土壌・肥料等の動態に及ぼす影響を解明し、節水・省肥栽培等対策技術を開発する。

( 6 ) 稲等の世代促進における出穂特性等の変異固定技術の開発

亜熱帯気候という地理的環境を活用して実施する稲及び麦類の世代促進において、出穂特性等の効率的な変異固定技術を開発する。



## 2 専門研究分野を活かした社会貢献

### (1) 分析、鑑定

行政、各種団体、大学等の依頼に応じ、高度な専門的知識が必要とされ、他の機関では実施が困難な分析、鑑定を実施する。

### (2) 講習、研修等の開催

講習会、講演会等を積極的に開催するとともに、国や団体等が主催する講習会等に積極的に協力する。

他の独立行政法人、大学、国公立機関、民間等の研修生を積極的に受け入れ、人材育成、技術水準の向上、技術情報の移転を図る。また、海外からの研修生を積極的に受け入れる。

国等の委託を受け、国際研究機関や技術協力に通ずる国際農林水産業研究に従事する研究者の確保・育成を推進する。

外部に対する技術相談窓口を設置し対応する。

### (3) 行政、国際機関、学会等への協力

わが国を代表する国際農林水産業に関わる研究機関として、行政、国際機関、学会等の委員会・会議等に職員を派遣するとともに、政府の行う科学技術に関する国際協力・交流に協力する。また、行政等の要請に応じて、国内外の技術情報を適切に提供する。

## 3 成果の公表、普及の促進

### (1) 成果の利活用の促進

行政、生産者、開発途上地域等が利用可能な各種のマニュアル、データベース等を作成するとともに、農林水産省研究ネットワーク、国際共同研究等を活用して、成果の開発途上地域等での普及、利活用の促進に努める。

### (2) 成果の公表と広報

研究成果は国内外の学会、シンポジウム等で発表するとともに、中期目標の期間内に540報以上の論文を学術雑誌、機関誌等に公表する。

研究成果については、その内容をインターネットや「つくばリサーチギャラリー」の展示等を通じて公開に努めるとともに、重要な成果に関しては、適宜マスコミに情報を提供する。また、パブリックアクセプタンスの確保に努める。

### (3) 知的所有権等の取得と利活用の促進

知的所有権の取得に努め、中期目標の期間内に20件以上の国内特許等を出願する。また、海外で利用される可能性、我が国の農林水産業等への影響を配慮して、特許等の外国出願を行う。

育種研究成果については、積極的に種苗法に基づく品種登録を行うとともに、海外で利用される可能性、我が国の農林水産業等への影響を配慮して、外国出願を行う。また、育種研究成果の普及及び利用促進を図るため、農林水産省の命名登録制度を活用する。

補償金の充実等により、知的所有権取得のインセンティブを与える。

取得した知的所有権に係る情報提供はインターネットを通じて行うとともに研究成果移転促進事業等を活用し、知的所有権の利活用を促進する。この場合、知的所有権の実施の許諾等については、我が国の農林水産業等の振興に支障を来すことのないよう考慮の上、決定する。

## 予算（人件費の見積りを含む。） 収支計画及び資金計画

### 1 予算

平成13年度～平成17年度予算

（単位：百万円）

区 分	金 額
収入	
運営費交付金	17,118
施設整備費補助金	943
無利子借入金	958
受託収入	1,162
諸収入	2
試験場製品等売払代	2
その他の収入	0
計	20,183
支出	
業務経費	6,408
施設整備費	1,262
受託経費	1,162
試験研究費	1,051
管理諸費	111
借入償還金	639
一般管理費	1,817
試験研究費	153
管理諸費	1,664
人件費	8,895
計	20,183

[ 人件費の見積り ]

期間中総額 7,483 百万円を支出する。

但し、上記の額は、役員報酬並びに職員基本給、職員諸手当、超過勤務手当、休職者給与及び国際機関派遣職員給与に相当する範囲の費用である。

[ 運営費交付金算定のルール ]

1. 平成 13 年度については、積み上げ方式とする。
2. 平成 14 年度以降については、次の算定ルールを用いる。

$$\begin{aligned} \text{運営費交付金} &= (\text{業務経費} + \text{一般管理費}) \times \times + \text{人件費} \\ &\quad - \text{諸収入} \pm \\ &\quad : \text{消費者物価指数} \\ &\quad : \text{効率化係数} \\ &\quad : \text{各年度の業務の状況に応じて増減する経費} \end{aligned}$$

$$\begin{aligned} \text{人件費} &= \text{基本給等} + \text{退職手当} + \text{休職者・派遣者給与} + \text{公務災害補償費} \\ &\quad + \text{児童手当拠出金} + \text{共済組合負担金} \end{aligned}$$

$$\text{基本給等} = \text{前年度の} (\text{基本給} + \text{諸手当} + \text{超過勤務手当}) \times (1 + \text{給与改定率})$$

(注) 1. 運営費交付金額には、中期目標の期間中の常勤職員数の効率化減員分を反映させる。

2. 消費者物価指数及び給与改定率については、運営状況等を勘案した伸び率とする。ただし、運営状況等によっては、措置を行わないことも排除されない。

[ 注記 ] 前提条件

1. 期間中の効率化係数を年 99% と推定
2. 給与改定率及び消費者物価指数についての伸び率を、ともに 0% と推定

## 2 収支計画

### 平成13年度～平成17年度収支計画

(単位：百万円)

区 分	金 額
費用の部	17,973
經常費用	17,973
人件費	8,895
業務経費	5,263
受託経費	1,162
一般管理費	1,817
減価償却費	836
財務費用	0
臨時損失	0
収益の部	17,973
運営費交付金収益	15,973
諸収入	2
受託収入	1,162
資産見返運営費交付金戻入	499
資産見返物品受贈額戻入	337
臨時利益	0
純利益	0
目的積立金取崩額	0
総利益	0

#### [ 注記 ]

1. 収支計画は予算ベースで作成した。
2. 当法人における退職手当については、役員退職手当支給基準及び国家公務員退職手当法に基づいて支給することとなるが、その全額について、運営費交付金を財源とするものと想定している。
3. 「受託収入」は、農林水産省及び他省庁の委託プロジェクト費を計上した。

### 3 資金計画

#### 平成13年度～平成17年度資金計画

(単位：百万円)

区 分	金 額
資金支出	20,183
業務活動による支出	17,137
投資活動による支出	2,407
財務活動による支出	639
次期中期目標の期間への繰越金	0
資金収入	20,183
業務活動による収入	18,282
運営費交付金による収入	17,118
受託収入	1,162
その他の収入	2
投資活動による収入	943
施設整備費補助金による収入	943
その他の収入	0
財務活動による収入	958
無利子借入金による収入	958
その他の収入	0

#### [注記]

1. 資金計画は予算ベースで作成した。
2. 「受託収入」は、農林水産省及び他省庁の委託プロジェクト費を計上した。
3. 「業務活動による収入」の「その他の収入」は、諸収入額を記載した。

#### 短期借入金の限度額

中期目標の期間中の各年度の短期借入金は3億円を限度とする。

想定される理由：運営費交付金の受け入れの遅延

重要な財産を譲渡し、又は担保に供しようとするときは、その計画計画なし。

#### 剰余金の使途

開発途上地域の農林水産業を対象とする研究戦略策定のための調査、情報技術利用高度化のための機器の整備、広報の充実、研究用機器の更新・購入に使用する。

その他農林水産省令で定める業務運営に関する事項

1 施設及び設備に関する計画

業務の適切かつ効率的な実施の確保のため、業務実施上の必要性及び既存の施設、設備の老朽化等に伴う施設及び設備の整備改修等計画的に行う。

平成13年度～平成17年度施設、設備に関する計画

(単位：百万円)

施設・設備の内容	予定額	財 源
病害ガラス室改修		施設整備費補助金
遺伝子組換え体発現制御実験棟改修		〃
網室改修		〃
海外食品素材調整実験室改修		〃
小 計	304 ±	
島嶼環境技術開発棟新築		無利子借入金
小 計	958	
合 計	1,262 ±	

(注) : 各年度増減する施設、設備の整備等に要する経費

2 人事に関する計画(人員及び人件費の効率化に関する目標を含む。)

1) 人員計画

(1) 方針

管理業務の効率化に伴う適切な職員の配置に努める。また、重点研究領域への職員の重点配置等を行うことにより、研究業務の効率的、効果的な推進を行う。

(2) 人員に係る指標

期末の常勤職員数は期初を上回らないものとする。

(参考：移行職員相当数164名、期末の常勤職員数161名)

(参考：中期目標の期間中の人件費総額見込み7,483百万円

但し、上記の額は、役員報酬並びに職員基本給、職員諸手当、超過勤務手当、休職者給与及び国際機関派遣職員給与に相当する範囲の費用である。)

## 2) 人材の確保

職員の新規採用については、国家公務員採用試験の活用及び選考採用により行う。研究職員については任期付任用の拡大を図る。また、中期目標達成に必要な人材を確保するため、ポストドクター等の派遣制度を活用する。

広く人材を求めるため、研究を行う職については公募の導入を図る。













## 独立行政法人国際農林水産業研究センター平成14年度年度計画

### 業務運営の効率化に関する目標を達成するためにとるべき措置

#### 1 評価・点検の実施

独立行政法人評価委員会農業技術分科会への報告に先立ち、自己点検評価の一環として、理事長が委嘱した評価委員による評価を行う。

主要な研究について、研究の推進方策、進捗状況の点検及び成果の評価のため、「研究計画・成果検討会」、「国際農林水産業試験研究推進会議」及び「運営評価会議」を開催する。

試験研究の基本方向や運営に関して長期的な観点から検討するため「顧問会議」を開催する。

新たな業績評価システムを策定し、それに基づき研究職員の業績評価を実施する。

#### 2 研究資源の効率的利用

中期計画達成に有効な競争的資金に積極的に応募する。

研究費の重点的な配分方法に関する新たな仕組みを作成し、これに基づき研究費を配分する。

「高分解能X線光電子分光分析装置(ESCA)」及び「エネルギー分散形走査型分析電子顕微鏡(SEM-EDS)」（本所）と「作物環境評価検定施設」（沖縄支所）については、引き続きその効率的利用を図る。また、平成14年度末に完成予定の「島嶼環境技術開発棟」（沖縄支所）の効率的利用を図るために産官学共同利用の方策を検討する。

ほ場委員会の本・支所小委員会はそれぞれ年間利用計画の作成、利用の調整を行い、ほ場の効率的な利用を図る。また、ほ場の管理運営事項の一元的な把握・調整を図るためほ場委員会を開催する。

#### 3 研究支援の効率化及び充実・高度化

特許、品種登録等の知的所有権の取得・移転に関し、事務的な支援態勢を継続して実施する。

計算情報センター 2000年システムの活用を進めるため、セミナーに職員を参加させる。

アジア太平洋高度ネットワーク（APAN）に関連するワークショップ等に協力する。新図書資料管理システムや文献情報検索システムの内容及び活用方法の理解を図るため、講習会を開催する。

庁舎、研究棟、熱帯温室等の保守管理の外部委託を継続して実施すると共に、効率化のために、部分委託の活用を努める。

海外滞在研究員の所在地に、高度な専門技能を有する技術専門職員及び総務職員を出張させ、現地の研究職員の研究業務及び会計業務等を効率的に支援する。

#### 4 連携、協力の促進

##### (1) 他の独立行政法人との連携、協力

「独立行政法人国際農林水産業研究センターが海外において行う国際共同研究の実施についての協約書」に基づき、海外における共同研究の実施課題の分担等について他の独立行政法人との積極的な連携・協力を図る。また、国際協力事業団等との連携・協力を積極的に行う。

##### (2) 開発途上地域の試験研究機関等との連携、協力

これまでの国際共同研究を継続するとともに、新たにタイ農業局・畜産振興局・土地開発局及びコンケン大学並びにラオス農林業研究所と共同して、「インドシナ天水農業地帯における水資源の効率的利用と収益性の向上」のプロジェクト研究を開始する。国際共同研究の相手機関等と必要に応じて覚書の締結または見直しを行う。開発途上地域等の研究者、研究管理者等を招聘し、積極的に共同研究を推進する。

##### (3) 産学官の連携、協力

国内外の研究機関等との連携・協力を積極的に推進する。国際農業研究機関へ管理職として人材を派遣する。また、国際共同研究課題の円滑な実施を図るため、大学、民間等の研究者を海外派遣するなど外部人材の活用を図る。

平成13年度の公表に加えて、新たに共同利用可能な施設・機器等が整備された場合には、ホームページ等で公表する。

文部科学省の内地研究員及び日本学術振興会の外国人特別研究員等を積極的に受入れ、産学官の共同研究を推進する。また、科学技術特別研究員を客員研究員として受け入れる。

農林水産省農林水産技術会議が平成13年4月に定めた国際研究・技術開発戦略の実施状況に関する調査等、農林水産省が行う政策評価に協力する。

独立行政法人農業技術研究機構九州沖縄農業研究センターとの連携を介して沖縄県及び鹿児島県の公立研究機関が実施する研究に協力する。

国際農林水産業試験研究推進会議を開催し、関係独立行政法人、行政部局、大学、民間、NGO等の参加を求めて、相互の連携・協力のあり方等について意見交換等を行う。

#### 5 管理事務業務の効率化

ペーパーレス化の更なる促進及び事務の簡素化・効率化を図るため、データの共有が可能で入力しやすいグループウェアソフトを導入する。

独立行政法人会計システムの本支所間連結を図り、円滑なシステムの運用を図る。

#### 6 職員の資質向上

各種研修等の開催を迅速に通知し、職員の積極的な参加を促す。また、平成14年2月1日付けで採用した研究職員2名について3ヶ月間の業務研修を行う。なお、業務遂行に必要な資格については、積極的に研修及び講習等を受講させ、取得促進に努める。

国際共同研究との連携を図りつつ各種制度による海外での研究実施を支援する。また、国際学会等への参加を積極的に支援する。

研究員の博士号取得を奨励し、適切に指導する。

#### 7 海外滞在職員等の安全と健康の確保

「安全衛生委員会」を毎月開催し、職員の安全と健康の確保に努める。

緊急時対策委員会の開催等により、海外滞在職員の安全確保のための速やかな対応をとるとともに、外務省や国際協力事業団との連携を密にし、海外情報や危険・医療情報等の収集及び海外出張中の職員への連絡態勢の確保を図る。また、「海外安全対策マニュアル」を整備し、出張者の安全の確保に資する。さらに、海外滞在職員等が居住する住居の安全を確保するため、必要な防犯機器を配布する。

海外に出張する者へ「外国出張の手引き」の利用等により事前ガイダンスを実施するとともに、健康診断等を確実に実施し、出張者の安全と健康の確保に努める。

国民に対して提供するサービスその他の業務の質の向上に関する目標を達成するためとるべき措置

#### 1 試験及び研究並びに調査

A 開発途上地域の食料需給改善のための農林水産業の動向解析、国内外の研究開発動向の把握及び技術開発方向の解明

##### 1) 世界の食料需給の動向解析と共同研究に係わる総合戦略の策定

###### (1) 主要な開発途上国の研究動向の解明及び中期的国際共同研究戦略の策定

開発途上国や国際研究機関との国際共同研究戦略の策定

担当：国際情報部

研究計画：中国、アジア、アフリカ等及び国際農林水産業研究機関の研究体制・戦略等を調査・分析する。

アジア太平洋地域等の情報収集・解析・戦略策定のための情報ネットワーク及び地理情報システム等の利用技術の開発

担当：国際情報部

研究計画：衛星データの洪水等による農地被害推定への利活用法等についての検討を行う。

###### (2) 中国主要省等の食料需給動向の解析等による世界の食料需給モデルの改良

中国主要省等における食料需給動向解析

担当：国際情報部

研究計画：中国の沿海部の主要消費省等での食料需給及び農村経済の動向等を調査・解析する。

#### 中長期的世界食料需給モデルの改良

担当：国際情報部

研究計画：地球環境変化や経済変動等に対応した中長期動向の分析のため、世界食料需給モデルの需要セクターを検討・改良する。

### 2) 開発途上地域における食料・環境に係わる地域特性及び発展方向の解明

(1) インドネシア、西アフリカ等における農林水産業の発展阻害要因と技術的・経済的発展方向の解明

インドネシア、タイ等における生産・流通技術の評価と発展制約要因の解明

担当：国際情報部、食料利用部、生産環境部

研究計画：インドネシア、タイ等における農産物の生産流通システムを社会経済的視点から評価する。また、アジア等における効率的水利用への対応方向等について調査・分析を行う。

西アフリカ、ベトナム等における稲作を中心とする栽培管理及び経営技術の問題点の解明

担当：国際情報部

研究計画：西アフリカ等の稲作普及の地域的な差異及び各作目の導入・作付要因等を検討する。

(2) インドネシア、ベトナム等における持続的ファーミングシステムの展開方向の解明  
インドネシア、ベトナム等における新技術の導入条件と持続的ファーミングシステムの展開方向の解明

担当：国際情報部、生産環境部、畜産草地部、林業部、水産部

研究計画：インドネシア、ベトナム等における農家レベルの新技術の導入可能性や中高標高地の作物等のファーミングシステムの改善方向等の検討を行う。

## B 開発途上地域の農林水産業の持続的発展のための研究開発

### 1) 開発途上地域における農林水産物の環境に調和した持続的生産技術の改良・開発

(1) 多様な耕地生態系における窒素等の物質循環の評価と土壌改良技術の改善

中国、東北タイ等における窒素等の物質循環の解明

担当：生産環境部

研究計画：研究対象サイトにおいて、環境負荷が高い集約的農業体系が窒素等の循環に及ぼす影響の実態を解明する。



乾燥地における塩類土壌等の特性解明と天然資源を活用した土壌改良技術の開発

担当：生産環境部

研究計画：塩類析出過程における鉛直方向の濃度変化を調べるとともに、土壌改良資材を挟在させた場合の効果を実験系において明らかにする。

(2) タイ、ベトナム等における稲・畑作物の省力・省資源的生産技術の開発

省力化を目指した乾田直播・生育診断等に基づく稲栽培技術の開発

担当：生産環境部

研究計画：試験圃場並びに研究対象サイトにおいて、播種法、施肥法、作付け時期等に関する改良点を現行法と比較評価する。

東北タイ等における持続的畑作体系構築のための土壌管理等による栽培技術の開発

担当：生産環境部

研究計画：集約栽培における病害虫抑制に適した短期作付体系を検討する。

南米、アフリカ等の不良土壌における作物の適応機能の解明と栽培技術の開発

担当：生産環境部

研究計画：不良環境適応機能の品種間差異を調査し、各作物の生理的評価基準にしたがって、耐性・感受性品種を同定する。

効率的な水資源利用のための配水管理技術の開発及び小規模灌漑システムの評価

担当：生産環境部

研究計画：天水依存小流域における水循環解明のための調査技術を検討する。

(3) 東南アジア、南米等における稲・大豆等の主要病害虫の発生実態の解明

中国・東南アジア等におけるウンカ等の稲病害虫の発生実態の解明

担当：生産環境部

研究計画：抵抗性品種の耕種的活用を中心としたウンカの防除技術を開発する。

中国・南米等における大豆作等の主要病害虫等の発生実態の解明

担当：生産環境部

研究計画：アフリカにおける移動性バッタ類の、低コスト・均一実験個体を供給するための人工飼料による飼育の可能性を探る。

(4) 農牧輪換システム等に適したイネ科牧草及びトウモロコシ茎葉等の地域低利用飼料資源の特性の解明

農牧輪換システム等に適したイネ科牧草等の生理生態学的特性の解明・評価

担当：畜産草地部、生産環境部

研究計画：農牧輪換システムに適したイネ科牧草種の窒素等の吸収特性や生育反応を解明するとともに、草地生産性を評価する。

タイ、中国等における低利用飼料資源等の栄養特性評価と調製法の開発

担当：畜産草地部

研究計画：タイのサイレージ等から分離される有用細菌の特性を評価するとともに、中国で調製した茎葉サイレージなどの飼料成分の分析や肥育効果を明らかにする。

(5) タイ、ベトナム等における牛・豚等の生理学的特性の解明と主要家畜疾病の実態の解明

タイ、ベトナム等における牛・豚等の栄養生理学的特性の解明

担当：畜産草地部

研究計画：タイの乾期にも生育旺盛な地域飼料作物等の牛での消化特性やベトナムにおいて豚に対する米ぬかの飼料摂取特性などを明らかにする。

牛のトリパノソーマ症等の感染・発病機構の解明

担当：畜産草地部

研究計画：トリパノソーマ感染マウスの炎症性応答や主要臓器における遺伝子発現状況をDNAチップ等を用いて明らかにする。

(6) 熱帯低質林におけるフタバガキ等有用樹種の天然更新補助技術の開発

伐採インパクトの低減と森林の更新機構の解明

担当：林業部

研究計画：集材作業技術の改善のための作業体系の検討及び技術改善による環境インパクト変動を把握する。

在来有用樹種の成長を促すカバーフォレスト造成技術の開発

担当：林業部

研究計画：有用樹植栽稚樹の耐乾燥性や草本に対する競争耐性、施肥効果等を生理的側面から明らかにする。

(7) 水産生物の環境と調和した養殖方法の開発

フィリピン、タイ等における環境向上機能を利用した増養殖技術の開発

担当：水産部

研究計画：栄養素が養殖親魚の卵質及び孵化仔魚の活性等に及ぼす影響を検討し、また、マングローブ植林閉鎖系内の栄養成分や養殖排水投入時の窒素とリンの収支を明らかにする。

ベトナム等におけるオニテナガエビ成熟過程で産生される卵黄タンパク質の動態解明

担当：水産部

研究計画：オニテナガエビの生殖に關与する卵黄タンパク質の全アミノ酸配列の解析を行う。

フィリピン等における養殖魚介類の新規疾病診断技術の開発

担当：水産部

研究計画：組織培養系を用いてフィリピン等における養殖ハタ、シーバス類稚仔魚の病原ウイルスの分離同定を行う。

2) 開発途上地域における農林水産物の品質評価・流通・加工技術の改良・開発

(1) 東南アジアにおける米等の食料資源の形状・香り等の品質特性の解明

米等の嗜好特性の評価とその変動要因の解明

担当：食料利用部

研究計画：香り米における香り成分含量と貯蔵条件の関係を解明するとともに、香り成分の生成部位を特定する。

根茎菜類等の機能成分の検索と作用機作の解明

担当：食料利用部

研究計画：新たに見出された有望根茎菜類からの生理的機能成分の単離・同定を行う。

(2) 温湿度等の環境条件と連動した香り米等の品質劣化の簡易防止技術の開発と加工技術の改良・開発

太陽熱等を利用した米等の資材低投入型簡易乾燥技術の開発

担当：食料利用部

研究計画：簡易籾乾燥機器の構造改良を検討し、試作機の製作に取り組む。

天敵・天然物質による米等の保全技術の開発

担当：食料利用部

研究計画：米貯穀害虫の天然物による防除効果を明らかにするとともに、主要天敵の飼育法の確立と寄主の解明を行う。

中国等における豆腐等の食品素材化技術の改良・開発

担当：食料利用部

研究計画：中国等における大豆・米の中国豆腐・ビーフン（米線及び河粉）等への加工特性を解明するとともに、伝統的加工技術の改良を行う。

(3) オイルパーム廃材等の低利用木質資源の利用技術の開発

未低利用木質資源の高度利用のための技術開発

担当：林業部

研究計画：パーム類等の熱帯産植物由来のリグノセルロース資源の特性解明と既存技術への応用性を検討する。

(4) 中国における淡水魚等低利用水産資源のすり身等への利用技術の開発

中国淡水魚体及び加工残滓からの魚粉作製と栄養成分の解析

担当：水産部

研究計画：淡水魚を原料とする魚粉の遊離アミノ酸組成を定量し、淡水魚によるその消化性と摂取性を評価する。

### 3) 開発途上地域における遺伝資源及び生物機能の解明と利用技術の開発

#### (1) 乾燥等の環境ストレスに対する耐性機構の解明と組換え体作出技術の開発

シロイヌナズナ等における乾燥等の環境ストレス応答及び耐性の分子機構の解明

担当：生物資源部

研究計画：酵母での浸透圧受容分子であるヒスチジンキナーゼの高等植物における機能の有無を形質転換植物を用いて解明し、高等植物での環境ストレスのシグナル伝達機構を明らかにする。

稲等における乾燥等の環境ストレス耐性遺伝子組換え体の作出法の開発

担当：生物資源部

研究計画：稲細胞内での転写因子タンパク質の発現活性化機構を解析し、調節を受ける有用遺伝子群をマイクロアレイ法等を用いて特定する。

#### (2) 稲、小麦等における病虫害抵抗性等の評価技術の開発と育種素材の育成

中国等の稲の遺伝資源のイモチ病抵抗性及び多収性等の評価と育種素材の育成

担当：生物資源部、生産環境部

研究計画：稲紋枯れ病抵抗性の簡易検定法を開発し、中国在来遺伝資源の評価を開始する。

中国等の小麦の遺伝資源の赤さび病抵抗性等の評価と育種素材の育成

担当：生物資源部

研究計画：赤かび病、さび病抵抗性に関与する遺伝子について分子マーカーを用いてゲノム上の位置を特定する。

南米等の大豆の遺伝資源の線虫、茎疫病抵抗性及び子実成分等の評価と育種素材の育成

担当：生産環境部、生物資源部

研究計画：核酸増殖法(PCR法)による大豆急性枯死症(SDS)の病原性検定法を開発する。

東南アジア在来葉菜類等の遺伝資源の栄養・機能特性等の有用形質の評価及び育種素材の育成

担当：生物資源部

研究計画：500点以上の収集遺伝資源の栄養性、生理的機能特性等を評価する。

#### (3) 熱帯・亜熱帯等の野菜・果樹等の遺伝資源収集、評価並びに保存

熱帯、亜熱帯等の作物及び微生物遺伝資源のサブバンク業務

担当：生物資源部、沖縄支所、畜産草地部、生産環境部、食料利用部

研究計画：生物研により導入された熱帯・亜熱帯稲の特性評価並びに種子増殖を行うとともに、未評価のサトウキビ遺伝資源の一次特性及び他の有用形質について特性を評価する。

#### 4) 開発途上地域における環境資源の特性評価と生物多様性の解明

##### (1) 農業生産に関する環境資源の特性評価と土地利用の変動機構の解明

タイ、インドネシア等における時系列・空間解析技術を用いた環境資源及び社会経済要因の特性評価

担当：国際情報部

研究計画：土地利用変動、植生変動、土地劣化等において特徴的な地域を対象とする衛星データ等を用いた解析技術の高度化を行う。

##### (2) マレーシア等における熱帯林の再生技術及び持続的利用技術の導入条件の解明

マレーシア等におけるアグロフォレストリー生産環境造成技術の開発

担当：林業部

研究計画：各種間伐に伴う早成樹林、荒廃二次林等の林内環境特性、生産力、養分循環の動態等を解明する。

マレーシア等におけるカバーフォレストを活用した農林複合技術の開発

担当：林業部、沖縄支所

研究計画：林内の伐開地に植栽する果菜類の適正品目を選定し、条件別生育特性を解明する。併せて、オイル パーム空果房等各種農林産廃物を培地に使用した熱帯産キノコ栽培試験及び食用キノコ種菌の収集を行う。

##### (3) 東南アジアにおける沿岸、マングローブ汽水域生態系の水産重要魚種資源の変動過程の解明

東南アジアの沿岸、マングローブ汽水域生態系における水産重要魚種資源の変動過程の解明

担当：水産部、林業部

研究計画：ミナミフエダイ等のマングローブ汽水域における滞留様式と食性の関係を調べ、生活環を解明する。

#### 5) 沖縄における研究

##### (1) サヤインゲン、稲等の耐暑性・耐塩性の特性評価と利用

サヤインゲン等の高温ストレス耐性に関する生理生化学的的特性評価

担当：沖縄支所

研究計画：サヤインゲンについて、開花当日の高温に対する耐暑性の品種間差異を調べるとともに、雄性不稔細胞質に対する稔性回復システムを探索する。また、アズキ近縁野生種を

利用した耐暑性の雑種後代にアズキの戻し交配と選抜を行う。さらに、小胞体型スモールヒートショックプロテイン遺伝子の機能をタバコ細胞を用いて invitro で解析する。

ナトリウム塩排除機能等の耐塩性関連遺伝子の稲への導入と評価

担当：沖縄支所

研究計画：藻類からクローニングしたナトリウムイオン輸送遺伝子産物をイーストで発現させるための新たな導入法を試みる。また、バクテリアの耐塩性機構を解析する。

(2) サトウキビ、イモ類等の特性評価及び利用技術の開発

サトウキビ、イモ類等遺伝資源の有用特性評価及び利用技術の開発

担当：沖縄支所

研究計画：サツマイモの cDNA ライブラリーを作成し、アントシアニン合成制御遺伝子断片を単離して塩基配列を決定する。また、サトウキビのアグロバクテリウム法による効率的な遺伝子導入条件を検討する。

(3) マンゴー、パパイア等熱帯果樹の樹形制御・食味等の特性評価及び大量増殖技術等の基盤技術の開発

マンゴー、パパイア等熱帯果樹の物質生産・開花・食味等の特性評価及び高品質系統の大量増殖等に関する基盤技術の開発

担当：沖縄支所

研究計画：熱帯果樹について、遮光・水分状態等が物質生産や生育に及ぼす影響の解析、栽培特性や食味・機能性成分特性に基づく高品質系統の評価及びアグロバクテリウム法によるパパイア形質転換系の確立のための手法開発を行う。

(4) 熱帯・亜熱帯に発生するカンキツグリーンング病等の重要病害虫の発生生態の解明  
ミカンキジラミ等及びそれらの天敵生物の生理生態的特性の解明

担当：沖縄支所

研究計画：石垣島に自生・植栽のゲッキツを対象に、ミカンキジラミとその天敵の発生動態を解析するとともに、ミカンキジラミの移動能力を予測するための調査法を検討する。また、アカホシカメムシの餌となる各種寄主植物の好適性を比較する。

カンキツグリーンング病等の生理生態的特性の解明

担当：沖縄支所

研究計画：高力価の抗血清作製のため、カンキツグリーンング病病原体の効率的純化法を検討するとともに、核酸増殖法 (PCR 法) による媒介虫からの病原検出法の改良を図る。

(5) 熱帯・亜熱帯島嶼における気象・土壌等に関わる生産不安定化要因の解明と節水・省肥栽培等対策技術の開発

熱帯・亜熱帯島嶼の気象・土壌等に関わる生産不安定化要因の解明と節水栽培等対策技術の開発

担当：沖縄支所

研究計画：地表面の形状等が地温、土壌水分、作物反応等に及ぼす影響を解明するとともに、耕盤の破砕等が根の伸長と吸水に及ぼす影響を解明する。また、サトウキビ栽培における資材の地中埋設方法について検討する。

サトウキビ等栽培環境における施肥窒素等の有効利用技術の開発と土砂・養分の動態解明

担当：沖縄支所

研究計画：河川流域での懸濁土量，窒素，リンの年間負荷量の算定や既存資料，農家調査による資材等投入量の推定を行うとともに、灌水位置の違いが下層土からの水供給に及ぼす影響を解析する。また、農家圃場においてサトウキビの窒素節減の実証栽培試験を行う。

#### (6) 稲等の世代促進における出穂特性等の変異固定技術の開発

地理的環境を利用した稲及び麦類の世代促進における出穂特性等の変異固定技術の開発  
担当：沖縄支所

研究計画：石垣島の亜熱帯気候環境で稲の世代促進における穂いもち病選抜が可能な栽培条件を検討する。また、小麦品種の出穂早晚性の変動要因を解明するため出穂特性に係る遺伝的特性を調査する。

### 2 専門研究分野を活かした社会貢献

#### (1) 分析、鑑定

依頼分析を引き受ける場合の手数料を決め、依頼分析・鑑定の円滑な運営を図る。

#### (2) 講習、研修等の開催

国際シンポジウム・ワークショップ・セミナー等を積極的に開催する。

国内外の研修生を積極的に受け入れる。

国等の委託を受け、国際共同研究に従事する研究者等の研修・育成を推進する。

広報等を担当する専門官を通じて行政、生産者、消費者等からの技術相談に対応する。

#### (3) 行政、国際機関、学会等への協力

行政、国際機関、学会等の要請に応じて、委員会、会議等に職員を派遣する。また、農林水産省委託事業である「国際共同研究人材育成推進事業」及び「バイオテクノロジーに関する途上国研究者の能力構築事業」を実施する。

国際協力事業団等の委託を受け、技術協力のために職員の派遣、研修員の受入れを行う。

### 3 成果の公表、普及の促進

#### (1) 成果の利活用の促進

研究成果情報を15件以上ホームページで公表する。

平成13年度の研究成果情報を"JIRCAS Newsletter"(No.31 ~ No.34)及び"JIRCAS ニュース"(No.30 ~ No.33)に掲載し、普及、利活用の促進に努める。

研究成果を不定期刊行物(JIRCAS Working Report Series 等)を通じて公表する。

平成13年度の研究成果情報(26報)をすでに作成済みの研究成果情報データベース(144報)に加えてホームページで公開し、検索の便宜を図る。

## (2) 成果の公表と広報

### [成果の公表]

学術雑誌、機関誌等に108報以上の論文を発表する。

平成14年度からJIRCAS JournalとJapan Agricultural Research Quarterly (JARQ)を合併し、JARQとして刊行する。

JIRCAS 国際シンポジウム「農林水産物および農林水産加工品の付加価値向上(仮題)」を開催する。

研究成果の公表を目的としたJIRCAS ワークショップを5回以上開催する。

平成13年度開催の第8回 JIRCAS 国際シンポジウムのプロシーディングを JIRCAS International Symposium Series No.10 "Water for Sustainable Agriculture in Developing Regions - More crop for every scarce drop" として発行する。

JIRCAS Working Report Series を5冊以上、国際農業研究叢書2冊、JARQを4回発行する。

### [成果の広報]

研究の成果に関する情報を農林水産研究情報センターの「研究課題情報データベース (<http://kiss.aris.affrc.go.jp/>) とリンクして公開する。

JIRCAS ニュース等各種の定期・不定期刊行物を通じて、研究計画、業務報告、成果情報等を公開し、またデータベースを作成してホームページへ公開する。

本館ロビーの JIRCAS ギャラリーにおいて、研究成果等の既存及び新規パネル等を活用して、一般公開や来客に情報公開を行う。

成果情報を記者クラブへ2回以上提供する。

## (3) 知的所有権等の取得と利活用の促進

国内外へ特許等を4件以上出願する。

研究者の知的所有権への理解を促す説明会、会議等を2回以上開催する。

新たに取得した知的所有権がある場合には、迅速に情報を追加し、データベースを充実させて利活用の促進を図る。



## 予算、収支計画及び資金計画

(別紙1)

- 1 予算
- 2 収支計画
- 3 資金計画

## その他農林水産省令で定める業務運営に関する事項

- 1 施設及び設備に関する計画  
島嶼環境技術開発棟を新築する(沖縄支所)(平成13年度第2次補正予算)

(別紙2)

- 2 人事に関する計画(人員及び人件費の効率化に関する目標を含む。)

### 1) 人員計画

#### (1) 方針

独立行政法人会計システムの本支所間の連結を図ると共に、支払い関係事務の統合を行うことによって、平成15年度以降の要員配置の適切化・効率化を目指す。  
国際総合プロジェクト研究の推進において重点化を図る。

#### (2) 人員に係る指標

常勤職員数は、年度当初164名、年度末164名とする。

### 2) 人材の確保

任期付任用制及び公募制による研究職員の採用の計画を策定し、2名の研究者の確保を図る。

科学技術特別研究員を積極的に受け入れ、受け入れた特別研究員は客員研究員として扱う。

(別紙1)

予算、収支計画及び資金計画

1 予算

平成14年度予算

(単位：百万円)

区 分	金 額
収入	
運営費交付金	3,530
施設整備費補助金	0
無利子借入金	958
受託収入	233
諸収入	0
試験場製品等売払代	0
その他の収入	0
計	4,721
支出	
業務経費	1,507
施設整備費	958
受託経費	233
試験研究費	210
管理諸費	23
借入償還金	0
一般管理費	160
研究管理費	30
管理諸費	130
人件費	1,863
計	4,721

## 2 収支計画

### 平成14年度収支計画

(単位：百万円)

区 分	金 額
費用の部	3,674
經常費用	3,674
人件費	1,863
業務経費	1,275
受託経費	225
一般管理費	160
減価償却費	151
財務費用	0
臨時損失	0
収益の部	3,674
運営費交付金収益	3,298
諸収入	0
受託収入	225
資産見返負債戻入	62
資産見返物品受贈額戻入	89
臨時利益	0
純利益	0
目的積立金取崩額	0
総利益	0

#### [ 注記 ]

1. 収支計画は予算ベースで作成した。
2. 当法人における退職手当については、役員退職手当支給基準及び国家公務員退職手当法に基づいて支給することとなるが、その全額について、運営費交付金を財源とするものと想定している。
3. 「受託収入」は、農林水産省及び他省庁の委託プロジェクト費を計上した。

### 3 資金計画

#### 平成14年度資金計画

(単位：百万円)

区 分	金 額
資金支出	4,721
業務活動による支出	3,523
投資活動による支出	1,198
財務活動による支出	0
翌年度への繰越金	0
資金収入	4,721
業務活動による収入	3,763
運営費交付金による収入	3,530
受託収入	233
その他の収入	0
投資活動による収入	0
施設整備費補助金による収入	0
その他の収入	0
財務活動による収入	958
無利子借入金による収入	958

#### [注記]

1. 資金計画は予算ベースで作成した。
2. 「受託収入」は、農林水産省及び他省庁の委託プロジェクト費を計上した。

(別紙2)

その他農林水産省令で定める業務運営に関する事項

1 施設及び設備に関する計画

業務の適切かつ効率的な実施の確保のため、業務実施上の必要性及び既存の施設、設備の老朽化等に伴う施設及び設備の整備改修等を計画的に行う。

平成14年度施設、設備に関する計画

(単位：百万円)

施設・設備の内容	予定額	財源
島嶼環境技術開発棟新築	958	無利子借入金







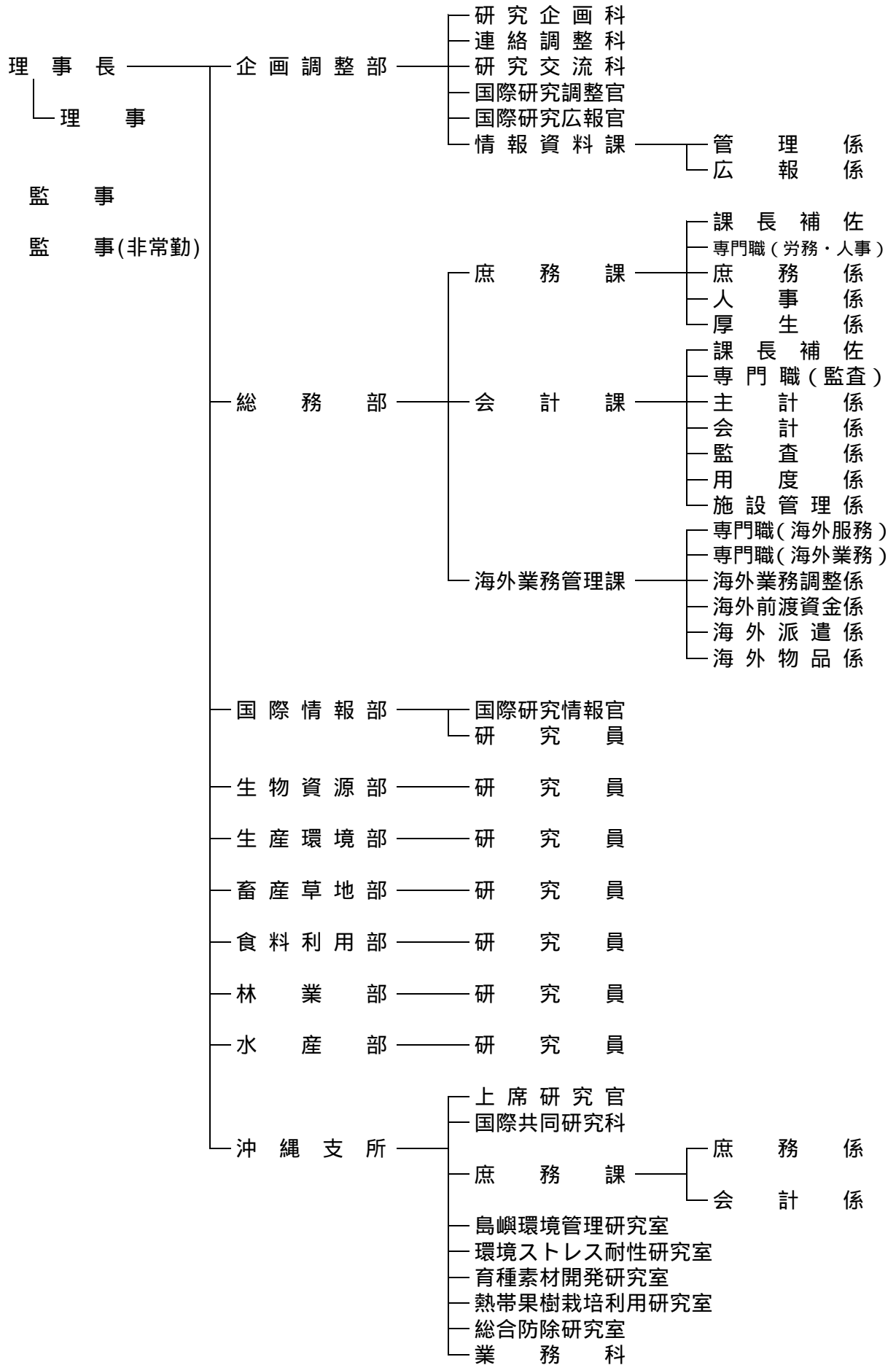








独立行政法人国際農林水産業研究センター組織図



## 独立行政法人国際農林水産業研究センター職員給与規程

13国研セ第4-31号

平成13年4月2日

### (目的)

第1条 この規程は、独立行政法人国際農林水産業研究センター（以下「センター」という。）職員（国家公務員法（昭和22年法律第120号。以下「国公法」という。）第2条に規定する一般職に属する職員のうち、一般職の任期付研究員の採用、給与及び勤務時間の特例に関する法律（平成9年法律第65号）第3条及び一般職の任期付職員の採用及び給与の特例に関する法律（平成12年法律第125号）第3条第1項の規定により任期を定めて採用された職員及び独立行政法人国際農林水産業研究センター非常勤職員就業規則（13国研セ第4-27号）の適用を受ける職員を除く。以下同じ。）の給与に関する事項を定めることを目的とする。

### (給与の支給)

第2条 職員の給与は、法令及び労使協定に定めるところにより、職員の給与から控除すべきものの金額を控除し、その残額を現金で直接職員に支給する。

2 前項に規定するもののほか、給与の支給に関し必要な事項は、理事長が別に定める。

### (俸給)

第3条 各職員の受ける俸給は、その職務の複雑、困難及び責任の度に基づき、かつ、勤労の強度、勤務時間、勤労環境その他の勤務条件を考慮したものでなければならない。

第4条 俸給は、独立行政法人国際農林水産業研究センター職員の勤務時間、休憩、休日、休暇等に関する規程（13国研セ第4-28号。以下「勤務時間規程」という。）第3条、第4条第2項、第5条及び第6条の規定する正規の勤務時間（以下「正規の勤務時間」という。）による勤務に対する報酬であって、この規程に定める俸給の特別調整額、扶養手当、調整手当、研究員調整手当、住居手当、通勤手当、単身赴任手当、特勤勤務手当、超過勤務手当、休日給、管理職員特別勤務手当、期末手当及び勤勉手当を除いた全額とする。

第5条 俸給表の種類は、次に掲げるとおりとし、各俸給表の適用範囲は、それぞれ当該俸給表に定めるところによる。

- (1) 一般職員俸給表（別表第1）
- (2) 技術専門職員俸給表（別表第2）
- (3) 研究職員俸給表（別表第3）

2 職員の職務は、その複雑、困難及び責任の度に基づきこれを俸給表に定める職務の級に分類するものとし、その分類の基準となるべき標準的な職務の内容は、理事長が別に定める。

第6条 理事長は、第5条第2項の規定に基づく分類の基準に適合するように、かつ、予算の範囲内で、職務の級の定数を設定し、又は改定することができる。

2 職員の職務の級は、前項の職員の職務の級ごとの定数の範囲内で、かつ、理事長が別に定める基準に従い決定する。

3 新たに俸給表の適用を受ける職員となった者の号俸は、理事長が別に定める初任給の基準に従い決定する。

4 職員が一の職務の級から他の職務の級に移った場合又は一の官職から同じ職務の級の初任給の基準を異にする他の官職に移った場合における号俸は、理事長が別に定めるところにより決定する。

5 前2項の規定により号俸を決定する場合において、他の職員との権衡上必要と認めるときは、理事長が別に定めるところにより、その者の属する職務の級における最高の号俸を超えて俸給月額を決定することができる。

6 職員が現に受けている号俸を受けるに至った時から、12月を下らない期間を良好な成績で勤務したときは、1号俸上位の号俸に昇給させることができる。ただし、第3項又は第4項の規定により号俸が決定された場合において、他の職員との権衡上必要と認めるときは、理事長が別に定めるところにより、当該期間を短縮することができる。

7 職員の勤務成績が特に良好である場合においては、前項の規定にかかわらず、同項に規定する期間を短縮し、若しくはその現に受ける号俸より2号俸以上上位の号俸まで昇給させ、又はそのいずれをも併せ行うことができる。

8 職員の俸給月額がその属する職務の級における俸給の幅の最高額である場合又は最高額を超えている場合には、その者が同一の職務の級にある間は、昇給しない。ただし、それらの俸給月額を受けている職員で、その俸給月額を受けるに至った時から24月（その俸給月額が職務の級における俸給の幅の最高額である場合にあっては、18月）を下らない期間を良好な成績で勤務したものの、勤務成績が特に良好であるもの等については、その職員の属する職務の級における俸給の幅の最高額を超えて、理事長が別に定めるところにより、昇給させることができる。

9 55歳（ただし、技術専門職員俸給表の適用を受ける職員にあっては、57歳）を超える職員は、第6項、第7項及び前項ただし書の規定にかかわらず、昇給しない。ただし、当該職員で勤務成績が特に良好であるものについては、理事長が別に定めるところにより、昇給させることができる。

10 第6項から前項までに規定する昇給は、予算の範囲内で行わなければならない。

11 国公法第81条の4第1項又は第81条の5第1項の規定により採用された職員（以下「再任用職員」という。）の俸給月額は、その者に適用される俸給

表の再任用職員の欄に掲げる俸給月額のうち、その者の属する職務の級に応じた額とする。

第7条 国公法第81条の5第1項に規定する短時間勤務の官職を占める職員（以下「再任用短時間勤務職員」という。）の俸給月額は、第5条第2項及び前条第11項の規定にかかわらず、これらの規定による俸給月額に、理事長が別に定めた勤務時間で除して得た数を乗じて得た額とする。

（俸給の支給）

第8条 俸給は、毎月16日（その日が土曜日、日曜日及び勤務時間規程第11条に規定する休日（以下「休日」という。）にあたる時は、その月の15日以降の日のうち、その日に最も近い土曜日、日曜日及び休日でない日）にその月の全額を支給する。ただし、理事長が別に定めるところにより、特に必要と認められる場合には、月の初日から15日まで及び月の16日から末日までの各期間内の日に、その月の月額の半額ずつを支給することができる。

第9条 新たに職員となった者には、その日から俸給を支給し、昇給、降給等により俸給額に異動を生じた者には、その日から新たに定められた俸給を支給する。ただし、離職した職員が即日職員になったときは、その日の翌日から俸給を支給する。

2 職員が離職したときは、その日まで俸給を支給する。

3 職員が死亡したときは、その月まで俸給を支給する。

4 第1項又は第2項の規定により俸給を支給する場合であって、月若しくは前条ただし書に規定する各期間（以下この項において「期間」という。）の初日から支給するとき以外のとき、又はその期間の末日まで支給するとき以外のときは、その俸給額は、その期間の現日数から勤務時間規程第4条第1項及び第6条に規定する週休日（以下「週休日」という。）の日数を差し引いた日数を基礎として日割りによって計算する。

（俸給の特別調整額）

第10条 理事長は、別に定める官職を占める職員に対して、その職務の特殊性に基づき、俸給月額につき適正な俸給の特別調整額を支給する。

2 前項に規定するもののほか、俸給の特別調整額の支給に関し必要な事項は、理事長が別に定める。

（扶養手当）

第11条 扶養手当は、扶養親族のある職員に対して支給する。

2 扶養手当の支給については、次に掲げる者で他に生計の途がなく主としてその職員の扶養を受けているものを扶養親族とする。

（1）配偶者（届出をしないが事実上婚姻関係と同様の事情にある者を含む。以

下同じ。)

- (2) 満22歳に達する日以後の最初の3月31日までの間にある子及び孫
- (3) 満60歳以上の父母及び祖父母
- (4) 満22歳に達する日以後の最初の3月31日までの間にある弟妹
- (5) 重度心身障害者

3 扶養手当の月額は、前項第1号に該当する扶養親族については16,000円、同項第2号から第5号までの扶養親族(次項において「扶養親族たる子、父母等」という。)のうち二人までについてはそれぞれ6,000円(職員に扶養親族でない配偶者がある場合にあってはそのうち一人については6,500円、職員に配偶者がいない場合にあってはそのうち一人については11,000円)、その他の扶養親族については一人につき3,000円とする。

4 扶養親族たる子のうちに満15歳に達する日以後の最初の4月1日から満22歳に達する日以後の最初の3月31日までの間(以下「特定期間」という。)にある子がいる場合における扶養手当の月額は、前項の規定にかかわらず、5,000円に特定期間にある当該扶養親族たる子の数を乗じて得た額を同項の規定による額に加算した額とする。

5 新たに職員となった者に扶養親族がある場合又は職員に次の各号の一に該当する事実が生じた場合においては、その職員は、理事長が定める様式の扶養親族届により、直ちにその旨(新たに職員となった者に扶養親族がある場合又は職員に第1号に該当する事実が生じた場合において、その職員に配偶者がいないときは、その旨を含む。)を理事長又はその委任を受けた者に届け出なければならない。

- (1) 新たに扶養親族たる要件を具備するに至った者がある場合
- (2) 扶養親族たる要件を欠くに至った者がある場合(第2項第2号又は第4号に該当する扶養親族が、満22歳に達した日以後の最初の3月31日の経過により、扶養親族たる要件を欠くに至った場合を除く。)
- (3) 扶養親族たる子、父母等がある職員が配偶者のない職員となった場合(前号に該当する場合を除く。)
- (4) 扶養親族たる子、父母等がある職員が配偶者を有するに至った場合(第1号に該当する場合を除く。)

6 扶養手当の支給は、新たに職員となった者に扶養親族がある場合においてはその者が職員となった日、扶養親族がない職員に前項第1号に掲げる事実が生じた場合においてはその事実が生じた日の属する月の翌月(これらの日が月の初日であるときは、その日の属する月)から開始し、扶養手当を受けている職員が離職し、又は死亡した場合においてはそれぞれその者が離職し、又は死亡した日、扶養手当を受けている職員の扶養親族で同項の規定による届出に係るもののすべてが扶養親族たる要件を欠くに至った場合においてはその事実が生じた日の属する月(これらの日が月の初日であるときは、その日の属する月の前月)をもって終わる。ただし、扶養手当の支給の開始については、同項の規定による届出が、これに係る事実の生じた日から15日を経過した後に行われた



ときは、その届出を受理した日の属する月の翌月（その日が月の初日であるときは、その日の属する月）から行うものとする。

- 7 扶養手当は、これを受けている職員に更に第5項第1号に掲げる事実が生じた場合、扶養手当を受けている職員の扶養親族で同項の規定による届出に係るものの一部が扶養親族たる要件を欠くに至った場合、扶養手当を受けている職員について同項第3号若しくは第4号に掲げる事実が生じた場合又は職員の扶養親族たる子で同項の規定による届出に係るもののうち特定期間にある子でなかった者が特定期間にある子となった場合においては、これらの事実が生じた日の属する月の翌月（これらの日が月の初日であるときは、その日の属する月）からその支給額を改定する。前項ただし書の規定は、扶養手当を受けている職員に更に第5項第1号に掲げる事実が生じた場合における扶養手当の支給額の改定（扶養親族たる子、父母等で同項の規定による届出に係るものがある職員で扶養親族たる配偶者のないものが扶養親族たる配偶者を有するに至った場合における当該扶養親族たる子、父母等に係る扶養手当の支給額の改定を除く。）及び扶養手当を受けている職員のうち扶養親族たる子、父母等で同項の規定による届出に係るものがある職員について当該職員の配偶者が扶養親族たる要件を欠くに至った場合又は同項第3号に掲げる事実が生じた場合における当該扶養親族たる子、父母等に係る扶養手当の支給額の改定について準用する。
- 8 前7項に規定するもののほか、扶養手当の支給に関し必要な事項は、理事長が別に定める。

（調整手当）

- 第12条 調整手当は、物価及び生計費等が特に高い茨城県つくば市に所在するセンター本所（以下「本所」という。）に在勤する職員に調整手当を支給する。
- 2 調整手当の月額、俸給、俸給の特別調整額及び扶養手当の月額の合計額に、100分の3を乗じて得た額とする。
- 3 本所に在勤する職員が調整手当を支給されない沖縄県石垣市に所在するセンター沖縄支所（以下「支所」という。）に異動したときは、第1項の規定にかかわらず、当該異動の日から3年を経過するまでの間、前2項の規定により支給されることとなる調整手当を支給する。
- 4 国公法第2条に規定する一般職及び特別職の国家公務員、国の経営する企業に勤務する職員の給与等に関する特例法（昭和29年法律第141号）の適用を受ける職員、独立行政法人通則法第2条第2項に規定する特定独立行政法人、地方公共団体及び理事長が別に定める法人から引き続き人事交流等により職員となった者のうち、異動又は採用の日の前日に人事院規則9-49（調整手当）に規定する地域に所在する官署若しくは機関又は同規則に規定する官署（以下「支給官署等」という。）に在勤していた者で異動後の本所に係る調整手当の支給割合がこれらの支給官署等に在勤するものとした場合に一般職の職員の給与に関する法律（昭和25年法律第95号。以下「給与法」という。）及び同規則の規定を適用して得られる支給割合（以下「給与法による支給割合」とい

う。)に達しないときは、第2項の規定にかかわらず、当該異動の日又は採用の日から3年を経過するまでの間、給与法による支給割合をもって調整手当を支給する。

- 5 前4項に規定するもののほか、調整手当の支給に関し必要な事項は、理事長が別に定める。

( 研究員調整手当 )

第13条 研究活動の状況、研究員(研究職員俸給表の適用を受ける職員(1級の職員を除く。))をいう。以下同じ)の採用状況等からみて人材の確保等を図るため、本所に勤務する研究員に研究員調整手当を支給する。

- 2 研究員調整手当の月額、俸給、俸給の特別調整額及び扶養手当の月額の合計額に100分の10(調整手当が支給される職員にあっては、その割合から前条第2項に掲げる支給割合を減じた割合)を乗じて得た額とする。

- 3 第1項の規定により研究員調整手当が支給される職員のうち、前条第3項及び第4項の規定により調整手当が支給されることとなる者の当該調整手当の支給割合は、これらの規定により支給されることとなる調整手当の支給割合の区分に応じ、それぞれ当該各号に定める支給割合に調整する。この場合において、当該割合が0となる職員には、当該調整手当は支給しない。

(1) 100分の10を超える支給割合 当該支給割合から研究員調整手当の支給割合を減じた割合

(2) 100分の10以下の支給割合 100分の10から研究員調整手当の支給割合を減じた割合

- 4 前3項に規定するもののほか、研究員調整手当の支給に関し必要な事項は、理事長が別に定める。

( 住居手当 )

第14条 住居手当は、次の各号のいずれかに該当する職員に支給する。

(1) 自ら居住するため住宅(貸間を含む。第3号において同じ。)を借り受け、月額12,000円を超える家賃(使用料を含む。以下同じ。)を支払っている職員

(2) その所有する住宅又は理事長が定めるこれに準ずる住宅に居住している世帯主である職員

(3) 第16条第1項又は第3項の規定により単身赴任手当を支給される職員で、配偶者が居住するための住宅(理事長が別に定める住宅を除く。)を借り受け、月額12,000円を超える家賃を支払っているもの又はこれらのものとの権衡上必要があると認められるものとして理事長が別に定めるもの

- 2 住居手当の月額は、次の各号に掲げる職員の区分に応じ、当該各号に掲げる額(第1号又は第2号に掲げる職員のうち第3号に掲げる職員でもあるものについては、第1号又は第2号に掲げる額及び第3号に掲げる額の合計額)とする。

- ( 1 ) 第 1 項第 1 号に掲げる職員 次に掲げる職員の区分に応じて、それぞれ次に掲げる額（その額に 1 0 0 円未満の端数を生じたときは、これを切り捨てた額）に相当する額
- イ 月額 2 3 , 0 0 0 円以下の家賃を支払っている職員 家賃の月額から 1 2 , 0 0 0 円を控除した額
  - ロ 月額 2 3 , 0 0 0 円を超える家賃を支払っている職員 家賃の月額から 2 3 , 0 0 0 円を控除した額の 2 分の 1（その控除した額の 2 分の 1 が 1 6 , 0 0 0 円を超えるときは、1 6 , 0 0 0 円）を 1 1 , 0 0 0 円に加算した額
- ( 2 ) 第 1 項第 2 号に掲げる職員 1 , 0 0 0 円（当該住宅が当該職員その他理事長が定める者によって新築され、又は購入されたものである場合にあっては、当該新築又は購入がなされた日から起算して 5 年を経過するまでの間は 2 , 5 0 0 円）
- ( 3 ) 第 1 項第 3 号に掲げる職員 第 1 号の規定の例により算出した額の 2 分の 1 に相当する額（その額に 1 0 0 円未満の端数を生じたときは、これを切り捨てた額）
- 3 職員は、新たに第 1 項の職員たる要件を具備するに至った場合には、当該要件を具備していることを証明する書類を添付して、理事長が定める様式の住居届により、その居住の実情、住宅の所有関係等を速やかに理事長又はその委任を受けた者に届け出なければならない。住居手当を受けている職員の居住する住宅、家賃の額、住宅の所有関係等に変更があった場合についても、同様とする。
- 4 住居手当の支給は、職員が新たに第 1 項の職員たる要件を具備するに至った日の属する月の翌月（その日が月の初日であるときは、その日の属する月）から開始し、職員が同項に規定する要件を欠くに至った日の属する月（その日が月の初日であるときは、その日の属する月の前月）をもって終わる。ただし、住居手当の支給の開始については、前項の規定による届出がこれに係る事実の生じた日から 1 5 日を経過した後にはされたときは、その届出を受理した日の属する月の翌月（その日が月の初日であるときは、その日の属する月）から行うものとする。
- 5 住居手当を受けている職員にその月額を変更すべき事実が生じたとき、又は職員が第 3 項第 2 号に規定する場合に係る住居手当を受けている場合において同号に規定する当該新築又は購入がなされた日から起算して 5 年を経過したときは、それぞれの事実の生じた日又は 5 年を経過した日の属する月の翌月（それらの日が月の初日であるときは、その日の属する月）から支給額を改定する。前項ただし書の規定は、住居手当の月額を増額して改定する場合について準用する。
- 6 前 5 項に規定するもののほか、住居手当の支給に関し必要な事項は、理事長が別に定める。

(通勤手当)

第15条 通勤手当は、次に掲げる職員に対して支給する。

- (1) 通勤のため交通機関又は有料の道路(以下「交通機関等」という。)を利用してその運賃又は料金(以下「運賃等」という。)を負担することを常例とする職員(交通機関等を利用しなければ通勤することが著しく困難である職員以外の職員であって交通機関等を利用しないで徒歩により通勤するものとした場合の通勤距離が片道2キロメートル未満であるもの及び第3号に掲げる職員を除く。)
- (2) 通勤のため自動車その他の交通の用具で理事長が別に定めるもの(以下「自動車等」という。)を使用することを常例とする職員(自動車等を使用しなければ通勤することが著しく困難である職員以外の職員であって自動車等を使用しないで徒歩により通勤するものとした場合の通勤距離が片道2キロメートル未満であるもの及び次号に掲げる職員を除く。)
- (3) 通勤のため交通機関等を利用してその運賃等を負担し、かつ、自動車等を使用することを常例とする職員(交通機関等を利用し、又は自動車等を使用しなければ通勤することが著しく困難である職員以外の職員であって、交通機関等を利用せず、かつ、自動車等を使用しないで徒歩により通勤するものとした場合の通勤距離が片道2キロメートル未満であるものを除く。)

2 通勤手当の月額は、次の各号に掲げる職員の区分に応じて、当該各号に掲げる額とする。

- (1) 前項第1号に掲げる職員 理事長が別に定めるところにより算出したその者の1箇月の通勤に要する運賃等の額に相当する額(以下「運賃等相当額」という。)(その額が45,000円を超えるときは、その額と45,000円との差額の2分の1(その差額の2分の1が5,000円を超えるときは、5,000円)を45,000円に加算した額)
- (2) 前項第2号に掲げる職員 次に掲げる職員の区分に応じて、それぞれ次に掲げる額(再任用短時間勤務職員のうち、1箇月当たり通勤回数が10回に満たない職員にあっては、その額から、その額に100分の50を乗じて得た額を減じた額)
- イ 自動車等の使用距離(以下この号において「使用距離」という。)が片道5キロメートル未満である職員 2,000円
- ロ 使用距離が片道5キロメートル以上10キロメートル未満である職員 4,100円
- ハ 使用距離が片道10キロメートル以上15キロメートル未満である職員 6,500円
- ニ 使用距離が片道15キロメートル以上20キロメートル未満である職員 8,900円
- ホ 使用距離が片道20キロメートル以上25キロメートル未満である職員 11,300円
- ヘ 使用距離が片道25キロメートル以上30キロメートル未満である職員

13,700円

ト 使用距離が片道30キロメートル以上35キロメートル未満である職員  
16,100円

チ 使用距離が片道35キロメートル以上40キロメートル未満である職員  
18,500円

リ 使用距離が片道40キロメートル以上である職員 20,900円

- (3) 前項第3号に掲げる職員 交通機関等を利用せず、かつ、自動車等を使用しないで徒歩により通勤するものとした場合の通勤距離、交通機関等の利用距離、自動車等の使用距離等の事情を考慮して理事長が別に定める区分に応じ、運賃等相当額及び前号に掲げる額の合計額(その額が45,000円を超えるときは、その額と45,000円との差額の2分の1(その差額の2分の1が5,000円を超えるときは、5,000円)を45,000円に加算した額)、第1号に掲げる額又は前号に掲げる額

- 3 国公法第2条に規定する一般職及び特別職の国家公務員、国の経営する企業に勤務する職員の給与等に関する特例法(昭和29年法律第141号)の適用を受ける職員、独立行政法人通則法第2条第2項に規定する特定独立行政法人、地方公共団体及び理事長が別に定める法人から引き続き人事交流等により職員となった者のうち、第1項第1号又は第3号に掲げる職員で、当該人事交流等により職員となった直前の住居(当該住居に相当するものとして理事長が別に定める住居を含む。)からの通勤のため、新幹線鉄道等の特別急行列車、高速自動車国道その他の交通機関等(以下「新幹線鉄道等」という。)でその利用が理事長が別に定める基準に照らして通勤事情の改善に相当程度資するものであると認められるものを利用し、その利用に係る特別料金等(その理由に係る運賃等の額から運賃等相当額の算出の基礎となる運賃等に相当する額を減じた額をいう。)を負担することを常例とするもの(任用の事情等を考慮して理事長が別に定める職員に限る。)の通勤手当の月額、前項の規定にかかわらず、理事長が別に定めるところにより算出したその者の1箇月の通勤に要する特別料金等の額の2分の1に相当する額(その額が20,000円を超えるときは、20,000円)及び同項の規定による額の合計額とする。その他前段の通勤手当を支給される職員との権衡上必要があると認められるものとして理事長が別に定める職員の通勤手当の月額について準用する。

- 4 職員は、新たに第1項の職員たる要件を具備するに至った場合には、理事長が定める様式の通勤届により、その通勤の実情を速やかに理事長又はその委任を受けた者に届け出なければならない。同項の職員が次の各号の一に該当する場合についても、同様とする。

(1) 本所、支所間で異動した場合

(2) 住居、通勤経路若しくは通勤方法を変更し、又は通勤のため負担する運賃等の額に変更があった場合

- 5 通勤手当の支給は、職員が新たに第1項の要件を具備するに至った場合においてはその日の属する月の翌月(その日が月の初日であるときは、その日の属

する月)から開始し、通勤手当を支給されている職員が離職し、又は死亡した場合においてはそれぞれの者が離職し、又は死亡した日、通勤手当を支給されている職員が同項の職員たる要件を欠くに至った場合においてはその事実の生じた日の属する月(これらの日が月の初日であるときは、その日の属する月の前月)をもって終わる。ただし、通勤手当の支給の開始については、前項の規定による届出がこれに係る事実の生じた日から15日を経過した後にされたときは、その届出を受理した日の属する月の翌月(その日が月の初日であるときは、その日の属する月)から行うものとする。

- 6 通勤手当を受けている職員にその月額を変更すべき事実が生じたときは、その事実の生じた日の属する月の翌月(その日が月の初日であるときは、その日の属する月)から支給額を改定する。前項ただし書の規定は、通勤手当の月額を増額して改定する場合について準用する。
- 7 第1項の職員が、出張、休暇、欠勤、その他の事由により、月の初日から末日までの期間の全日数にわたって通勤しないこととなるときは、その月の通勤手当は支給しない。
- 8 前7項に規定するもののほか、通勤の実情の変更に伴う支給額の改定その他通勤手当の支給に関し必要な事項は、理事長が別に定める。

#### ( 単身赴任手当 )

- 第16条 本所、支所間の異動に伴い、住居を移転し、父母の疾病その他の理事長が別に定めるやむを得ない事情により、同居していた配偶者と別居することとなった職員で、当該異動の直前の住居から当該異動の直後に在勤する本所又は支所に通勤することが通勤距離等を考慮して理事長が別に定める基準に照らして困難であると認められるもののうち単身で生活することを常況とする職員には、単身赴任手当を支給する。ただし、配偶者の住居から在勤する本所又は支所に通勤することが、通勤距離等を考慮して理事長が別に定める基準に照らして困難であると認められない場合は、この限りでない。
- 2 単身赴任手当の月額は、23,000円(理事長が別に定めるところにより算定した職員の住居と配偶者の住居との間の交通距離(以下単に「交通距離」という。)が理事長が別に定める距離以上である職員にあっては、その額に、45,000円を超えない範囲内で交通距離の区分に応じて理事長が別に定める額を加算した額)とする。
  - 3 国公法第2条に規定する一般職及び特別職の国家公務員、国の経営する企業に勤務する職員の給与等に関する特例法(昭和29年法律第141号)の適用を受ける職員、独立行政法人通則法第2条第2項に規定する特定独立行政法人、地方公共団体及び理事長が別に定める法人から人事交流等により引き続き職員となり、これに伴い、住居を移転し、父母の疾病その他の理事長が別に定めるやむを得ない事情により、同居していた配偶者と別居することとなった職員で、当該人事交流等により職員となった直前の住居から通勤することが通勤距離等を考慮して理事長が別に定める基準に照らして困難であると認められるものの

うち、単身で生活することを常況とする職員（任用の事情等を考慮して理事長が別に定める職員に限る。）その他第1項の規定による単身赴任手当を支給される職員との権衡上必要があると認められるものとして理事長が別に定める職員には、前2項の規定に準じて、単身赴任手当を支給する。

- 4 職員は、新たに第1項又は前項の職員たる要件を具備するに至った場合には、当該要件を具備していることを証明する書類を添付して、理事長が定める様式の単身赴任届により、配偶者等との別居の状況等を速やかに理事長又はその委任を受けた者に届け出なければならない。単身赴任手当を受けている職員の住居、同居者、配偶者等の住居等に変更があった場合についても、同様とする。
- 5 単身赴任手当の支給の始期及び終期については、第15条第5項及び第6項の規定を準用する。この場合において、同条第5項及び第6項中、「通勤手当」とあるのは「単身赴任手当」と、「第1項」とあるのは「第16条第1項及び第3項」と、「前項」とあるのは「第16条第4項」と読み替えるものとする。
- 6 前5項に規定するもののほか、単身赴任手当の支給の調整に関する事項その他単身赴任手当の支給に関し必要な事項は、理事長が別に定める。

#### （特地勤務手当）

- 第17条 離島その他の生活の著しく不便な地である支所に在勤する職員には、特地勤務手当を支給する。
- 2 国公法第2条に規定する一般職及び特別職の国家公務員、国の経営する企業に勤務する職員の給与等に関する特例法（昭和29年法律第141号）の適用を受ける職員、独立行政法人通則法第2条第2項に規定する特定独立行政法人、地方公共団体及び理事長が別に定める法人から引き続き人事交流等によりセンターの職員となって特地事務所又は理事長が指定するこれらに準ずる事務所（以下「準特地事務所」という。）に在勤することとなったことに伴って住居を移転した職員（任用の事情等を考慮して理事長が別に定める職員に限る。）、新たに特地事務所又は準特地事務所に該当することとなった事務所に在勤する職員でその特地事務所又は準特地事務所に該当することとなった日前3年以内に当該事務所に異動し、当該異動に伴って住居を移転したもののその他権衡上必要があるものとして理事長が別に定める職員には、特地勤務手当に準ずる手当を支給する。
  - 3 特地勤務手当の月額、職員が支所に勤務することとなった日の俸給及び扶養手当の月額の合計額の2分の1の額に現に受ける職員俸給及び扶養手当の2分の1の額を加えた額に100分の12を乗じて得た額とする。
  - 4 支所に勤務する職員のうち、支所に異動となり当該異動に伴って住居を移転した職員には、異動となった日から6年に達するまでの間、異動となった日に受けていた俸給及び扶養手当の月額の合計額に、次に掲げる異動の日からの期間の区分に応じ、それぞれに掲げる割合を乗じて得た額を月額として加算する。ただし、その期間内において職員が支所以外に異動した場合には、その異動の日の前日まで支給する。

- ( 1 ) 異動となった日から起算して4年に達するまでの期間 100分の6
  - ( 2 ) 異動となった日から起算して4年に達した後から5年に達するまでの期間 100分の4
  - ( 3 ) 異動となった日から起算して5年に達した後から6年に達するまでの期間 100分の2
- 5 前4項に規定するもののほか、特地勤務手当の支給に関し必要な事項は、理事長が別に定める。

( 給与の減額 )

第18条 職員が勤務しないときは、勤務時間規程第11条第1号に規定する祝日法による休日(勤務時間規程第12条第1項の規定により代休日を指定されて、当該休日に割り振られた勤務時間の全部を勤務した職員にあっては、当該休日に代わる代休日。以下「祝日法による休日等」という。)又は勤務時間規程第11条第2号に規定する年末年始の休日(勤務時間規程第12条第1項の規定により代休日を指定されて、当該休日に割り振られた勤務時間の全部を勤務した職員にあっては、当該休日に代わる代休日。以下「年末年始の休日等」という。)である場合、休暇による場合その他その勤務しないことにつき特に承認のあった場合を除き、その勤務しない1時間につき、第23条に規定する勤務1時間当たりの給与額を減額して給与を支給する。

( 給与の半減 )

- 第19条 職員が負傷(公務上の負傷及び通勤(国家公務員災害補償法(昭和26年法律第191号)第1条の2に規定する通勤をいう。以下同じ。)による負傷を除く。)若しくは疾病(公務上の疾病及び通勤による疾病を除く。以下この項及び第29条において同じ。)に係る療養のため、又は疾病に係る就業禁止の措置により、当該療養のため病気休暇又は当該措置の開始の日から起算して90日(結核性疾患の場合にあっては1年)を超えて引き続き勤務しないときは、その期間の経過後の当該病気休暇又は当該措置に係る日につき俸給の半額を減ずる。
- 2 前項に規定するもののほか、同項の勤務しない期間の範囲、俸給の計算その他俸給の半減に関し必要な事項は、理事長が別に定める。

( 超過勤務手当 )

第20条 正規の勤務時間を超えて勤務することを命ぜられた職員には、正規の勤務時間を超えて勤務した全時間に対して、勤務1時間につき、第23条に規定する勤務1時間当たりの給与額に正規の勤務時間を超えてした次に掲げる勤務の区分に応じてそれぞれ100分の125から100分の150までの範囲内で理事長が別に定める割合(その勤務が午後10時から翌日の午前5時までの間である場合は、その割合に100分の25を加算した割合、勤務時間規程第6条第2項の規定により週休日の再振替又は再割振り変更(当該再振替又は



再割振り変更により週休日に勤務しなかった場合に限る。)を行った勤務(勤務時間規程第6条第1項に規定する勤務を命ずる必要がある日の属する週内の正規の勤務時間(勤務時間規程第11条に定める勤務することを要しない勤務時間を除く。)が40時間以内となるように週休日の再振替又は再割振り変更を行った勤務を除く。)については、100分の35)を乗じて得た額を超過勤務手当として支給する。

(1) 正規の勤務時間が割り振られた日(次条の規定により正規の勤務時間中に勤務した職員に休日給が支給されることとなる日を除く。次項において同じ。)における勤務

(2) 前号に掲げる勤務以外の勤務

2 再任用短時間勤務職員が、正規の勤務時間が割り振られた日において、正規の勤務時間を超えてした勤務のうち、その勤務の時間とその勤務をした日における正規の勤務時間との合計が8時間に達するまでの間の勤務に対する前項の規定の適用については、同項中「正規の勤務時間を超えてした次に掲げる勤務の区分に応じてそれぞれ100分の125から100分の150までの範囲内で理事長が別に定める割合」とあるのは「100分の100」とする。

(休日給)

第21条 祝日法による休日等及び年末年始の休日等において、正規の勤務時間中に勤務することを命ぜられた職員には、正規の勤務時間中に勤務した全時間に対して、勤務1時間につき、第23条に規定する勤務1時間当たりの給与額に100分の125から100分の150までの範囲内で、理事長が別に定める割合を乗じて得た額を休日給として支給する。これらの日に準ずるものとして理事長が別に定める日において勤務した職員についても、同様とする。

(端数計算)

第22条 第18条に規定する勤務1時間当たりの給与額及び前2条の規定により勤務1時間につき支給する超過勤務手当及び休日給の額を算定する場合において、当該額に、50銭未満の端数を生じたときはこれを切り捨て、50銭以上1円未満の端数を生じたときはこれを1円に切り上げるものとする。

(勤務1時間当たりの給与額の算出)

第23条 第18条、第20条及び第21条に規定する勤務1時間当たりの給与額は、俸給月額並びにこれに対する調整手当及び研究員調整手当の月額の合計額に12を乗じ、その額を1週間当たりの勤務時間に52を乗じたもので除して得た額とする。

(管理職員特別勤務手当)

第24条 第10条第1項の規定に基づく理事長が別に定める職員のうち管理又は監督の複雑、困難及び責任の度が高い職員として理事長が別に定める職員(以

下「特定管理職員」という。)が、臨時又は緊急の必要その他の業務の運営の必要により週休日又は祝日法による休日等若しくは年末年始の休日等に勤務した場合は、当該職員には、管理職員特別勤務手当を支給する。

- 2 管理職員特別勤務手当の額は、前項の規定による勤務1回につき、特定管理職員にあっては12,000円を超えない範囲内において理事長が別に定める額とする。ただし、同項の規定による勤務に従事する時間等を考慮して理事長が別に定める勤務にあっては、それぞれその額に100分の150を乗じて得た額とする。
- 3 前2項に定めるもののほか、管理職員特別勤務手当の支給に関し必要な事項は、理事長が別に定める。

( 期末手当 )

第25条 期末手当は、3月1日、6月1日及び12月1日(以下この条から第27条までにおいてこれらの日を「基準日」という。)にそれぞれ在職する職員に対して、それぞれ3月15日、6月30日及び12月10日(これらの日が週休日に当たるときは、その直前の週休日でない日。以下この条から第27条までにおいて「支給日」という。)に支給する。これらの基準日前1箇月以内に退職し、若しくは国公法第38条第1号に該当して同法第76条の規定により失職し、又は死亡した職員(同法第39条第6項の規定の適用を受ける職員及び理事長が別に定める職員を除く。)についても、同様とする。

- 2 期末手当の額は、期末手当基礎額に、3月に支給する場合においては100分の55、6月に支給する場合においては100分の145、12月に支給する場合においては100分の155を乗じて得た額(理事長が別に定める特定幹部職員(第28条において「特定幹部職員」という。)にあっては、3月に支給する場合においては100分の55、6月に支給する場合においては100分の125、12月に支給する場合においては100分の135を乗じて得た額)に、基準日以前3箇月以内(基準日が12月1日であるときは、6箇月以内)の期間におけるその者の在職期間の区分に応じて、次の表に定める割合を乗じて得た額とする。

在 職 期 間		割 合
基準日が3月1日又は6月1日である場合	基準日が12月1日である場合	
3箇月	6箇月	100分の100
2箇月15日以上3箇月未満	5箇月以上6箇月未満	100分の80
1箇月15日以上2箇月15日未満	3箇月以上5箇月未満	100分の60
1箇月15日未満	3箇月未満	100分の30

- 3 再任用職員に対する前項の規定の適用については、前項中「100分の55」とあるのは「100分の30」と、「100分の145」とあるのは「100分の70」と、「100分の155」とあるのは「100分の90」と、「100分の125」とあるのは「100分の60」と、「100分の135」とあるのは「100分の80」とする。
- 4 第2項の期末手当基礎額は、それぞれその基準日現在（退職し、若しくは失職し、又は死亡した職員にあっては、退職し、若しくは失職し、又は死亡した日現在）において職員が受けるべき俸給及び扶養手当の月額並びにこれらに対する調整手当及び研究員調整手当の月額の合計額とする。
- 5 一般職員俸給表の適用を受ける職員で、その職務の級が4級以上であるもの並びに同表以外の各俸給表の適用を受ける職員で職務の複雑、困難及び責任の度等を考慮してこれに相当する職員として理事長が別に定める職員については、前項の規定にかかわらず、同項に規定する合計額に、俸給の月額並びにこれに対する調整手当及び研究員調整手当の月額の合計額に、理事長が別に定める職員の区分に応じて100分の20を超えない範囲内で理事長が別に定める割合を乗じて得た額（別に定める管理又は監督の地位にある職員にあっては、その額に俸給月額の100分の25を超えない範囲内で理事長が別に定める割合を乗じて得た額を加算した額）を加算した額を第2項の期末手当基礎額とする。
- 6 国公法第2条に規定する一般職及び特別職の国家公務員、国の経営する企業に勤務する職員の給与等に関する特例法（昭和29年法律第141号）の適用を受ける職員、独立行政法人通則法第2条第2項に規定する特定独立行政法人、地方公共団体及び理事長が別に定める法人から人事交流等により異動又は採用となった職員の第2項に掲げる在職期間の区分は、当該異動又は採用前の機関に在職していた期間を職員として在職していた期間とみなした場合に得られる区分とする。
- 7 前6項及び次条に規定するもののほか、期末手当の支給に関し必要な事項は、理事長が別に定める。

第26条 次の各号のいずれかに該当する者には、前条第1項の規定にかかわらず、当該各号の基準日に係る期末手当（第4号に掲げる者にあつては、その支給を一時差し止めた期末手当）は、支給しない。

- (1) 基準日から当該基準日に対応する支給日の前日までの間に国公法第82条の規定による懲戒免職の処分を受けた職員
- (2) 基準日から当該基準日に対応する支給日の前日までの間に国公法第76条の規定により失職した職員（同法第38条第1号に該当して失職した職員を除く。）
- (3) 基準日前1箇月以内又は基準日から当該基準日に対応する支給日の前日までの間に離職した職員（前2号に掲げる者を除く。）で、その離職した日から当該支給日の前日までの間に禁錮以上の刑に処せられたもの

- (4) 次条第1項の規定により期末手当の支給を一時差し止める処分を受けた者（当該処分を取り消された者を除く。）で、その者の在職期間中の行為に係る刑事事件に関し禁錮以上の刑に処せられたもの

第27条 理事長又はその委任を受けた者は、支給日に期末手当を支給することとされていた職員で当該支給日の前日までに離職したものが次の各号のいずれかに該当する場合は、当該期末手当の支給を一時差し止めることができる。

- (1) 離職した日から当該支給日の前日までの間に、その者の在職期間中の行為に係る刑事事件に関して、その者が起訴（当該起訴に係る犯罪について禁錮以上の刑が定められているものに限り、刑事訴訟法（昭和23年法律第131号）第6編に規定する略式手続によるものを除く。第3項において同じ。）をされ、その判決が確定していない場合
- (2) 離職した日から当該支給日の前日までの間に、その者の在職期間中の行為に係る刑事事件に関して、その者が逮捕された場合又はその者から聴取した事項若しくは調査により判明した事実に基づきその者に犯罪があると思料するに至った場合であって、その者に対し期末手当を支給することが、公務に対する国民の信頼を確保し、期末手当に関する制度の適正かつ円滑な実施を維持する上で重大な支障を生ずると認めるとき。

2 前項の規定による期末手当の支給を一時差し止める処分（以下「一時差止処分」という。）を受けた者は、国公法第90条の2に規定する処分説明書を受領した日から起算すべき期間が経過した後においては、当該一時差止処分後の事情の変化を理由に、理事長に対し、その取消しを申し立てることができる。

3 理事長又はその委任を受けた者は、一時差止処分について、次の各号のいずれかに該当するに至った場合には、速やかに当該一時差止処分を取り消さなければならない。ただし、第3号に該当する場合において、一時差止処分を受けた者がその者の在職期間中の行為に係る刑事事件に関し現に逮捕されているときその他これを取り消すことが一時差止処分の目的に明らかに反すると認めるときは、この限りでない。

- (1) 一時差止処分を受けた者が当該一時差止処分の理由となった行為に係る刑事事件に関し禁錮以上の刑に処せられなかった場合
- (2) 一時差止処分を受けた者について、当該一時差止処分の理由となった行為に係る刑事事件につき公訴を提起しない処分があった場合
- (3) 一時差止処分を受けた者がその者の在職期間中の行為に係る刑事事件に関し起訴をされることなく当該一時差止処分に係る期末手当の基準日から起算して1年を経過した場合

4 前項の規定は、理事長又はその委任を受けた者が一時差止処分後に判明した事実又は生じた事情に基づき、期末手当の支給を差し止める必要がなくなったとして当該一時差止処分を取り消すことを妨げるものではない。

5 理事長又はその委任を受けた者は、一時差止処分を行う場合は、当該一時差止処分を受けるべき者に対し、当該一時差止処分の際、一時差止処分の事由を

記載した説明書を交付しなければならない。

- 6 一時差止処分に対する行政不服審査法（昭和37年法律第160号）による不服申立てについては、一時差止処分は国公法第89条第1項に規定する処分と、一時差止処分を受けた者は同法第90条第1項に規定する職員と、前項の説明書は同法第90条の2の処分説明書とそれぞれみなして、同法第90条から第92条の2までの規定を適用する。
- 7 前6項に規定するもののほか、一時差止処分に関し必要な事項は、理事長が別に定める。

（勤勉手当）

第28条 勤勉手当は、6月1日及び12月1日（以下この条においてこれらの日を「基準日」という。）にそれぞれ在職する職員に対し、基準日以前6箇月以内の期間におけるその者の勤務成績に応じて、それぞれ6月30日及び12月10日（これらの日が週休日に当たるときは、その直前の週休日でない日。以下この条において「支給日」という。）に支給する。これらの基準日前1箇月以内に退職し、若しくは国公法第38条第1号に該当して同法第76条の規定により失職し、又は死亡した職員（理事長が別に定める職員を除く。）についても同様とする。

2 勤勉手当の額は、勤勉手当基礎額に、理事長が別に定める基準に従って得られる割合を乗じて得た額に、基準日以前6箇月以内の期間におけるその者の勤務期間の区分に応じて、理事長が別に定める割合を乗じて得た額とする。この場合において、センターにおいて支給する勤勉手当の額の、その者の属する次の各号に掲げる職員の区分ごとの総額は、それぞれの当該各号に掲げる額を超えないものとする。

（1）前項の職員のうち再任用職員以外の職員

当該職員の勤勉手当基礎額に当該職員がそれぞれの基準日現在（退職し、若しくは失職し、又は死亡した職員にあっては、退職し、若しくは失職し、又は死亡した日現在。次項において同じ。）において受けるべき扶養手当の月額並びにこれに対する調整手当及び研究員調整手当の月額の合計額を加算した額に、6月に支給する場合においては100分の60（特定幹部職員にあっては、100分の80）、12月に支給する場合においては100分の55（特定幹部職員にあっては、100分の75）を乗じて得た額の総額

（2）前項の職員のうち再任用職員

当該再任用職員の勤勉手当基礎額に100分の30（特定幹部職員にあっては、100分の40）を乗じて得た額の総額

3 前項の勤勉手当基礎額は、それぞれその基準日現在において職員が受けるべき俸給の月額並びにこれに対する調整手当及び研究員調整手当の月額の合計額とする。

4 第25条第5項の規定は、第2項の勤勉手当基礎額について準用する。この場合において、同条第5項中「前項」とあるのは、「第28条第3項」と読み

替えるものとする。

- 5 国公法第2条に規定する一般職及び特別職の国家公務員、国の経営する企業に勤務する職員の給与等に関する特例法（昭和29年法律第141号）の適用を受ける職員、独立行政法人通則法第2条第2項に規定する特定独立行政法人、地方公共団体及び理事長が別に定める法人から人事交流等により異動又は採用となった職員の第2項に掲げる勤務期間の区分は、当該異動又は採用前の機関に勤務していた期間を職員として勤務していた期間とみなした場合に得られる区分とする。
- 6 前2条の規定は、第1項の規定による勤勉手当の支給について準用する。この場合において、第26条中「前条第1項」とあるのは「第28条1項」と、同条第1号中「基準日から」とあるのは「基準日（第28条第1項に規定する基準日をいう。以下この条及び次条において同じ。）から」と「支給日」とあるのは「支給日（同項に規定する支給日をいう。以下この条及び次条において同じ。）」と読み替えるものとする。
- 7 前6項に規定するもののほか、勤勉手当の支給に関し必要な事項は、理事長が別に定める。

（特定の職員についての適用除外）

第29条 第20条及び21条の規定は、特定管理職員には適用しない。

- 2 第11条、第12条第3項から同条第4項まで、第13条、第14条、第16条及び第17条の規定は、再任用職員には適用しない。

（非常勤職員の給与）

第30条 委員、顧問若しくは参与の職にある者又は理事長の指定するこれらに準ずる職にある者で、常勤を要しない職員（再任用短時間勤務職員を除く。次項において同じ。）については、勤務1日につき、理事長が別に定める額を超えない範囲内において、手当を支給することができる。

- 2 前項に定める職員以外の常勤を要しない職員については、理事長は、常勤の職員の給与との権衡を考慮し、予算の範囲内で、給与を支給する。
- 3 前2項の常勤を要しない職員には、別段の定めがない限り、これらの項に定める給与を除く外、他のいかなる給与も支給しない。

（休職者の給与）

第31条 職員が公務上負傷し、若しくは疾病にかかり、又は通勤により負傷し、若しくは疾病にかかり、国公法第79条第1号に掲げる事由に該当して休職にされたときは、その休職の期間中、これに給与の全額を支給する。

- 2 職員が結核性疾患にかかり国公法第79条第1号に掲げる事由に該当して休職にされたときは、その休職の期間が満2年に達するまでは、これに俸給、扶養手当、調整手当、研究員調整手当、住居手当及び期末手当のそれぞれ100分の80を支給することができる。

- 3 職員が前2項以外の心身の故障により国公法第79条第1号に掲げる事由に該当して休職にされたときは、その休職の期間が満1年に達するまではこれに俸給、扶養手当、調整手当、研究員調整手当、住居手当及び期末手当のそれぞれ100分の80を支給することができる。
- 4 職員が国公法第79条第2号に掲げる事由に該当して休職にされたときは、その休職の期間中、これに俸給、扶養手当、調整手当、研究員調整手当及び住居手当のそれぞれ100分の60以内を支給することができる。
- 5 職員が国公法第79条に基づく人事院規則で定める場合のいずれかに該当して休職にされたときは、その休職の期間中、理事長が別に定めるところにより、これに俸給、扶養手当、調整手当、研究員調整手当、住居手当及び期末手当のそれぞれ100分の100以内を支給することができる。
- 6 第2項、第3項又は第5項に規定する職員が、当該各項に規定する期間内で第25条第1項に規定する基準日前1箇月以内に退職し、若しくは国公法第38条第1号に該当して同法第76条の規定により失職し、又は死亡したときは、同項の規定により理事長が別に定める日に、当該各項の例による額の期末手当を支給することができる。ただし、理事長が別に定める職員については、この限りでない。
- 7 前項の規定の適用を受ける職員の期末手当の支給については、第26条及び第27条の規定を準用する。この場合において、第26条中「前条第1項」とあるのは、「第31条第6項」と読み替えるものとする。

(育児休業等職員の給与)

- 第32条 職員が、理事長から国家公務員の育児休業等に関する法律(平成3年法律第109号)第3条の規定に基づき育児休業の承認を受けている期間は給与を支給しない。
- 2 職員が勤務時間規程第20条第1項に基づく育児部分休業をしている場合の給与は、第18条の規定にかかわらず、その勤務しない1時間につき、第23条に規定する勤務1時間当たりの給与額を減額して給与を支給する。
  - 3 第25条第1項に規定するそれぞれの基準日に育児休業をしている職員のうち、基準日以前3箇月以内(基準日が12月1日であるときは6箇月以内)の期間において勤務した期間がある職員には第1項の規定にかかわらず、当該基準日に係る期末手当を支給する。
  - 4 第28条第1項に規定するそれぞれの基準日に育児休業をしている職員のうち、基準日以前6箇月以内の期間において勤務した期間がある職員には、第1項の規定にかかわらず、当該基準日に係る勤勉手当を支給する。
  - 5 前4項に定めるほか、必要な事項は理事長が別に定める。

(介護休暇職員の給与)

- 第33条 職員が、理事長から介護休暇の承認を受けて勤務しない場合は、第18条の規定にかかわらず、その勤務しない1時間につき、第23条に規定する

勤務 1 時間当たりの給与額を減額して給与を支給する。

2 前項に定めるほか、必要な事項は理事長が別に定める。

( 派遣職員の給与 )

第 3 4 条 国際機関等に派遣される一般職の国家公務員の処遇等に関する法律 ( 昭和 4 5 年法律第 1 1 7 号 ) 第 3 条に規定する派遣職員には、その派遣の期間中、俸給、扶養手当、研究員調整手当、住居手当及び期末手当のそれぞれの 1 0 0 分の 1 0 0 以内を支給することができる。

2 前項に定めるほか、給与の支給に関し必要な事項は、理事長が別に定める。

( 交流派遣職員の給与 )

第 3 5 条 職員が交流派遣されたときは、その交流派遣の期間中給与を支給しない。

( 給与の非常時支給 )

第 3 6 条 職員が、職員又はその収入によって生計を維持する者の出産、疾病、災害、婚礼、葬儀その他これに準ずる非常の費用に充てるために給与を請求した場合には、俸給の支給日前であっても、請求の日までの給与を日割り計算により支給する。

( 雑則 )

第 3 7 条 この規程に定めるもののほか、職員の給与に関し必要な事項は、理事長が別に定める。

附 則

この規程は、平成 1 3 年 4 月 1 日から施行する。

附 則

1 この規程は、平成 1 3 年 1 1 月 3 0 日から施行し、平成 1 3 年 4 月 1 日から適用する。

2 当分の間、国及び民間における賃金との均衡を考慮して講ずる措置として、各年度 ( 4 月 1 日から翌年 3 月 3 1 日までをいう。以下この項及び次項第 1 号において同じ。 ) において、当該各年度の 3 月 1 日 ( 以下この項から附則第 4 項までにおいて「基準日という。 ) に在職する職員 ( 独立行政法人国際農林水産業研究センター任期付研究員及び特定任期付職員給与規程 ( 1 3 国研セ第 4 - 3 3 号 ) の適用を受ける職員を除く。以下同じ。 ) に対し、基準日の属する月の理事長が別に定める日において、特例一時金を支給する。



- 3 特例一時金の額は、3,756円とする。ただし、次の各号に掲げる職員については、当該各号に定める額とする。
- (1) 基準日の属する年度の4月1日から基準日までの期間（次号及び次項において「基準期間」という。）において俸給を支給しないこととされていた期間（在職しなかった期間を含む。以下この項及び次項において「無給期間」という。）がある職員（次号に掲げる者を除く。） 3,756円を超えない範囲内で無給期間を考慮して理事長が別に定める額
  - (2) 基準日において第7条又は第19条の規定の適用を受ける職員である者 3,756円（基準期間において無給期間がある者については、前号の規定の例により得られる額）を超えない範囲内で理事長が別に定める額
- 4 基準日に国家公務員の育児休業等に関する法律第3条第1項の規定により育児休業をしている職員については、第32条第1項の規定にかかわらず、特例一時金を支給する。ただし、当該職員で基準期間の全期間が無給期間であるものについては、この限りでない。
- 5 職員に特例一時金が支給される間、第4条中「及び勤勉手当」とあるのは「、勤勉手当及び特例一時金」と、第31条第2項、第3項及び第5項並びに第34条第1項中「及び期末手当」とあるのは「、期末手当及び特例一時金」と、第31条第4項中「及び住居手当」とあるのは「、住居手当及び特例一時金」とする。

独立行政法人国際農林水産業研究センター職員の勤務時間、休憩、休日、  
休暇等に関する規程

13国研セ第4 - 28号  
平成13年4月2日

第1章 総則

(趣旨)

第1条 この規程は、別に法令で定めるもののほか、独立行政法人国際農林水産業研究センター(以下「センター」という。)に勤務する国家公務員法(昭和22年法律第120号。以下「国公法」という。)第2条第2項に規定する一般職の職員(常時勤務に服することを要しない職員(国公法第81条の5第1項に規定する短時間勤務の官職を占める職員(以下「再任用短時間勤務職員」という。))を除く。))を除く。以下「職員」という。)の勤務時間、休憩、休日、休暇、育児部分休業等に関する事項について定めるものとする。

(理事長の責務等)

第2条 理事長は、勤務時間、休憩、休日、休暇、育児部分休業等に関する事務の実施に当たっては、業務の円滑な運営に配慮するとともに、職員の健康及び福祉を考慮することにより、職員の適正な勤務条件の確保に努めるものとする。

2 理事長は、この規程による権限の一部をセンター内の別に定める職員(以下「勤務管理者」という。)に委任することができる。

第2章 正規の勤務時間等

(1週間の勤務時間)

第3条 職員の勤務時間は、1週間当たり40時間とする。

2 国公法第81条の5第1項に規定する短時間勤務の官職を占める職員(以下「再任用短時間勤務職員」という。)の勤務時間は、前項の規定にかかわらず、1週間当たり16時間から32時間までの範囲内で理事長が別に定める。

(週休日及び勤務時間の割振り)

第4条 職員の週休日(勤務時間を割り振らない日をいう。以下同じ。)は、土曜日及び日曜日とする。ただし、再任用短時間勤務職員にあっては、理事長は、これらの日に加えて、月曜日から金曜日までの5日間において、週休日を設けることができる。

2 理事長は、月曜日から金曜日までの5日間において、1日につき8時間の勤務時間を割り振るものとする。ただし、再任用短時間勤務職員にあっては、1週間ごとの期間について、1日につき8時間を超えない範囲内で勤務時間を割り振るものとする。

(フレックスタイム制による勤務時間の割振り)

第5条 理事長は、始業及び終業の時刻について、試験研究に関する業務に従事する職員(理事長が別に定める職員に限る。)の申告を考慮して当該職員の勤務時間を割り振ることがセンターの業務の能率の向上に資すると認める場合には、前条第2項の規定にかかわらず、理事長が別に定めるところにより、職員の申告を経て、清算期間(毎月の初

日から末日までの期間をいう。)につき第3条に規定する勤務時間となるように当該職員の勤務時間を割り振ることができる。

- 2 前項の規定により勤務時間の割振りを定める場合には、月曜日から金曜日までの5日間において、午前10時から午後0時までの共通する勤務時間を設けるものとする。
- 3 第1項の規定により勤務時間の割振りを定める場合には、始業の時刻は午前7時以後に、終業の時刻は午後10時以前に設定するものとする。

(週休日の振替等)

- 第6条 勤務管理者は、職員に第4条第1項の規定により週休日とされた日において特に勤務することを命ずる必要がある場合には、第4条第2項、又は前条の規定により勤務時間が割り振られた日(以下この条において「勤務日」という。)のうち当該勤務を命ずる必要がある日の属する週(週の起算日は土曜日とする。以下この条において同じ。)内にある勤務日を週休日に変更して、当該勤務日に割り振られた勤務時間を当該勤務することを命ずる必要がある日に割り振り、又は当該勤務を命ずる必要がある日の属する週内にある勤務日(4時間の勤務時間のみが割り振られている日を除く。以下この条において同じ。)の勤務時間のうち4時間を当該勤務日に割り振ることをやめて当該4時間の勤務時間を当該勤務することを命ずる必要がある日に割り振ること(以下この条において「半日勤務時間の割振り変更」という。)ができる。
- 2 前項の週休日の振替及び半日勤務時間の割振り変更については、勤務管理者が業務上必要があると認める場合には、別に定める期間内に再振替又は再割振り変更を行うことができる。
  - 3 週休日の振替等の手続きに関し必要な事項は、理事長が別に定める。

(休憩時間)

- 第7条 職員の休憩時間は、1日の勤務時間が8時間以下の場合には45分、8時間を超える場合には1時間とする。
- 2 理事長は、業務のため必要と認めるときは、前項の規定にかかわらず休憩時間の時刻を変更することができる。ただし、休憩時間は勤務時間の途中に置くものとする。
  - 3 職員は、休憩時間を自由に利用することができる。

(休息时间)

- 第8条 職員の休息時間は、勤務時間のおおむね4時間につき15分をその勤務時間中に置くものとする。ただし、業務の必要によりやむを得ない場合には、この限りでない。
- 2 休息時間は、前項ただし書きの場合においても、繰り越さないものとする。
  - 3 休息時間が休憩時間にかかる場合には、職員は、その時間を自由に利用することができる。

(通常の勤務場所を離れて勤務する職員の勤務)

- 第9条 第4条第2項、第5条及び第6条の規定により勤務時間が割り振られた日(第12条において「勤務日等」という。)に通常の勤務場所を離れる勤務について、勤務時間を算定し難いときは、通常の勤務時間を勤務したものとみなす。

### 第3章 時間外勤務

(時間外勤務)

第10条 勤務管理者は、第3条、第4条第2項、第5条及び第6条の規定による勤務時間（以下「正規の勤務時間」という。）以外の時間において、労働基準法（昭和22年法律第49号。以下「労基法」という。）第36条の規定に基づき、職員に勤務を命ずることができる。

2 勤務管理者は、災害その他避けることのできない事由のため緊急の必要がある場合には、正規の勤務時間以外の時間において、職員に前項に規定する勤務以外の勤務を命ずることができる。

## 第4章 休日

（休日）

第11条 職員の休日は、次に掲げる日とし、当該休日においては、特に勤務することを命ぜられる者を除き、正規の勤務時間においても勤務することを要しない。

（1）国民の祝日に関する法律（昭和23年法律第178号）に規定する休日（以下「祝日法による休日」という。）

（2）12月29日から翌年の1月3日までの日（祝日法による休日を除く。以下「年末年始の休日」という。）

（3）その他理事長が別に定める日

（代休日の指定）

第12条 勤務管理者は、職員に休日である勤務日等に割り振られた勤務時間の全部（第3項において「休日の全勤務時間」という。）について特に勤務することを命じた場合には、当該休日前に、当該休日に代わる日（以下この条において「代休日」という。）として、当該休日後の別に定める期間内にある当該休日に割り振られた勤務時間と同一の時間数の勤務時間が割り振られた勤務日等（休日を除く。）を指定することができる。

2 勤務管理者は、前項の代休日に業務上やむを得ず勤務することを命じた場合には、当該代休日前に、当該代休日に代わる日（以下この条において「再代休日」という。）として、前項の休日後の別に定める期間内にある当該代休日に割り振られた勤務時間と同一の時間数の勤務時間が割り振られた勤務日等（休日を除く。）を指定することができる。

3 第1項の規定により代休日（前項の規定により再代休日指定された場合にあつては、再代休日を含む。以下この項において同じ。）を指定された職員は、勤務を命ぜられた休日の全勤務時間を勤務した場合において、当該代休日には、特に勤務することを命ぜられるときを除き、正規の勤務時間においても勤務することを要しない。

4 代休日又は再代休日の指定の手續きに関し必要な事項は、理事長が別に定める。

## 第5章 任期付研究員の特例

（職員の裁量による勤務）

第13条 理事長は、一般職の任期付研究員の採用、給与及び勤務時間の特例に関する法律（平成9年法律第65号）第3条第1項第1号の規定により任期を定めて採用された職員（以下「第1号任期付研究員」という。）の職務につき、その職務の性質上時間配分の決定その他の職務遂行の方法を大幅に当該第1号任期付研究員の裁量に委ねることが当該第1号任期付研究員に係る研究業務の能率的な遂行のため必要であると認める場

合には、当該第1号任期付研究員を、理事長が別に定めるところによりこの規程の規定による勤務時間の割振りを行わないで、その職務に従事させることができる。

## 第6章 休暇

### (休暇の種類)

第14条 職員の休暇は、年次休暇、病気休暇、特別休暇及び介護休暇とする。

### (年次休暇)

第15条 職員(再任用短時間勤務職員を除く。以下この項において同じ。)の年次休暇は1の年ごとにおける休暇とし、その日数は、1の年において、20日とする。ただし、当該年の中途において新たに職員となった者(第3項に定める者を除く。)又は任期が満了することにより退職する者については、別表第1の左欄の在職期間に応じ、それぞれ同表の右欄に掲げる日数とする。

2 再任用短時間勤務職員の年次休暇は1の年ごとにおける休暇とし、その日数は、1の年において、次の各号に掲げる再任用短時間勤務職員の区分に応じ、当該各号に定める日数とする。

(1) 同一勤務型職員(再任用短時間勤務職員のうち、1週間ごとの勤務日の日数及び勤務日ごとの勤務時間の時間数が同一である職員をいう。以下同じ。) 20日に1週間の勤務日数を5日で除して得た数を乗じた日数。ただし、当該年の途中において新たに同一勤務型職員となった者(次項に定める者を除く。)又は任期が満了することにより退職する者にあつては、その者の当該年における在職期間に応じ、別表第2の下欄に掲げる1週間の勤務日の日数の区分ごとに定める日数。

(2) 非同一勤務型職員(再任用短時間勤務職員のうち、1週間ごとの勤務日の日数又は勤務日ごとの勤務時間の時間数が同一でない職員をいう。以下同じ。) 160時間に第3条の規定に基づき定められた当該職員の1週間当たりの勤務時間を40時間で除して得た数を乗じて得た時間数を、8時間を1日として日に換算して得た日数(1日未満の端数があるときは、これを四捨五入して得た日数)。ただし、当該年の途中において新たに非同一勤務型職員となった者(次項に定める者を除く。)又は任期が満了することにより退職する者にあつては、その者の当該年における在職期間に応じ、別表第3の下欄に掲げる1週間当たりの勤務時間の区分ごとに定める日数。

3 国公法第2条第2項に規定する一般職及び同条第3項に規定する特別職に属する国家公務員、地方公務員法(昭和26年法律第261号)第3条第2項に規定する一般職及び同条第3項に規定する特別職に属する地方公務員又は公庫の予算及び決算に関する法律(昭和26年法律第99号)第1条に規定する公庫その他その業務がセンターの事務又は事業と密接な関連を有する法人のうち理事長が別に定めるものの職員(常時勤務に服することを要しない職員を除く。以下「他の国家公務員等」という。)であつた者であつて引き続き職員となった者その他理事長が別に定める者の年次休暇の日数は、次の各号に掲げる職員の区分に応じ、当該各号に定める日数から職員となった日の前日までの間に使用した年次休暇に相当する休暇又は年次休暇の日数を減じて得た日数とする。

(1) 次号に掲げる職員以外の職員 20日に当該年の前年における年次休暇に相当する休暇又は年次休暇の残日数(当該日数が20日を超える場合にあっては、20日)を加えた日数(再任用短時間勤務職員にあつては、その者の勤務時間等を考慮して、理事長が別に定める日数)

(2) 当該年の中途において新たに他の国家公務員等となり引き続き職員となった者 他

の国家公務員等となった日において職員となったものとみなして第1項ただし書の規定を適用した場合に得られる日数（再任用短時間勤務職員にあっては、その者の勤務時間等を考慮して、理事長が別に定める日数）

- 4 年次休暇は、1の年における年次休暇の20日を超えない範囲内の残日数（1日未満の端数があるときはこれを切り捨てた日数）を限度として、当該年の翌年に繰り越すことができる。
- 5 年次休暇については、その時季につき、あらかじめ休暇簿に記入して勤務管理者に請求しなければならない。この場合において、勤務管理者は、業務の正常な運営に支障がある場合は、他の時季にこれを変更することができる。
- 6 病気、災害その他やむを得ない事由によりあらかじめ前項の請求ができなかった場合には、その事由を休暇簿に付して事後において提出することができる。

#### （病気休暇）

- 第16条 病気休暇は、職員が負傷又は疾病のため療養する必要があり、その勤務しないことがやむを得ないと認められる場合における休暇とする。
- 2 病気休暇の期間は、療養のため勤務しないことがやむを得ないと認められる必要最小限の期間とする。
  - 3 勤務管理者は、生理日の就業が著しく困難な女性職員が第1項の休暇を請求した場合には、その者を生理日に勤務させてはならない。
  - 4 病気休暇の承認を受けようとする職員は、あらかじめ休暇簿に記入して勤務管理者に請求しなければならない。ただし、病気、災害その他やむを得ない事由によりあらかじめ請求できなかった場合には、その事由を付して事後において承認を求めることができる。
  - 5 勤務管理者は病気休暇の請求について、第1項に掲げる場合に該当すると認めるときは、これを承認するものとする。ただし、業務の運営に支障があり、他の時期においても当該休暇の目的を達することができるものと認められる場合においては、この限りでない。
  - 6 勤務管理者は、病気休暇について、その事由を確認する必要があると認めるときは、証明書類の提出を求めることができる。

#### （特別休暇）

- 第17条 特別休暇は、次の各号に掲げる場合における休暇とし、その期間は、次の各号に掲げる場合の区分に応じて、当該各号に掲げる期間とする。
- （1）職員が選挙権その他公民としての権利を行使する場合で、その勤務しないことがやむを得ないと認められるとき 必要と認められる期間
  - （2）職員が証人、鑑定人、参考人等として国会、裁判所、地方公共団体の議会その他官公署へ出頭する場合でその勤務しないことがやむを得ないと認められるとき 必要と認められる期間
  - （3）職員が骨髄移植のための骨髄液の提供希望者としてその登録を実施する者に対して登録の申出を行い、又は骨髄移植のため配偶者、父母、子及び兄弟姉妹以外の者に骨髄液を提供する場合で、当該申出又は提供に伴い必要な検査、入院等のため勤務しないことがやむを得ないと認められるとき 必要と認められる期間
  - （4）職員が自発的に、かつ、報酬を得ないで次に掲げる社会に貢献する活動（専ら親族に対する支援となる活動を除く。）を行う場合でその勤務しないことが相当であると認められるとき 1暦年において5暦日の範囲内の期間

- ア 地震、暴風雨、噴火等により相当規模の災害が発生した被災地又はその周辺の地域における生活関連物資の配布その他の被災者を支援する活動
- イ 身体障害者療護施設、特別養護老人ホームその他の主として身体上若しくは精神上的の障害がある者又は負傷し、若しくは疾病にかかった者に対して必要な措置を講ずることを目的とする施設であって理事長が別に定めるものにおける活動
- ウ ア及びイに掲げる活動のほか、身体上若しくは精神上的の障害、負傷又は疾病により常態として日常生活を営むのに支障がある者の介護その他の日常生活を支援する活動
- (5) 職員が結婚する場合で結婚式、旅行その他の結婚に伴い必要と認められる行事等のため勤務しないことが相当であると認められるとき 結婚の日の5日前から当該結婚の日後1月を経過する日までの間に連続する5暦日の範囲内の期間
- (6) 6週間(多胎妊娠の場合にあっては、14週間)以内に出産する予定である女性職員が申し出た場合 出産の日までの申し出た期間
- (7) 女性職員が出産した場合 出産の日の翌日から8週間を経過する日までの期間(産後6週間を経過した女性職員が就業を申し出た場合において、医師が支障がないと認めた業務に就く期間を除く。)
- (8) 生後1年に達しない子を育てる職員が、その子の保育のために必要と認められる授乳等を行う場合 1日2回それぞれ30分以内の期間(男性職員にあっては、その子の当該職員以外の親が当該職員がこの号の休暇を使用しようとする日におけるこの号の休暇(これに相当する休暇を含む。)を承認され、又は労基法第67条の規定により同日における育児時間を請求した場合は1日2回それぞれ30分から当該承認又は請求に係る各回ごとの期間を差し引いた期間を超えない期間)
- (9) 職員の妻(届出をしないが事実上婚姻関係と同様の事情にある者を含む。)が出産する場合で職員が妻の出産に伴い必要と認められる入院の付添い等のため勤務しないことが相当であると認められるとき 妻が出産するため病院に入院する等の日から当該出産後の2週間を経過する日までの間に2日の範囲内の期間
- (10) 小学校就学の始期に達するまでの子(配偶者の子を含む。)を養育する職員が、その子の看護(負傷し、又は疾病にかかったその子の世話をを行うことをいう。)のため勤務しないことが相当であると認められる場合 1暦年において5暦日の範囲内の期間
- (11) 次に掲げる職員の親族が死亡した場合で職員が葬儀、服喪その他の親族の死亡に伴い必要と認められる行事等のため勤務しないことが相当であると認められるとき 次の各号に掲げる区分に応じて、当該各号に掲げる連続する日数(葬儀のため遠隔の地に赴く場合にあっては、往復に要する日数を加えた日数)の範囲内の期間とし、暦日によるものとする。
- ア 配偶者又は父母 7日
- イ 子 5日
- ウ 祖父母 3日(職員が代襲相続し、かつ、祭具等の承継を受ける場合、又は、理事長が類似の慣習と認める場合にあっては、7日)
- エ 孫 1日
- オ 兄弟姉妹 3日
- カ おじ又はおば 1日(職員が代襲相続し、かつ、祭具等の承継を受ける場合、又は、理事長が類似の慣習と認める場合にあっては、7日)
- キ 父母の配偶者又は配偶者の父母 3日(職員と生計を一にしていた場合にあっては、7日)

- ク 子の配偶者又は配偶者の子 1日（職員と生計を一にしていた場合にあっては、5日）
- ケ 祖父母の配偶者又は配偶者の祖父母、兄弟姉妹の配偶者又は配偶者の兄弟姉妹 1日（職員と生計を一にしていた場合にあっては、3日）
- コ おじ又はおばの配偶者 1日
- (12) 職員が父母追悼のため特別な行事（父母の死亡後15年以内に行われるものに限る。）のため勤務しないことが相当であると認められる場合 1日の範囲内の期間
- (13) 職員が夏季における諸行事、心身の健康の維持及び増進又は家庭生活の充実のため勤務しないことが相当であると認められる場合 1の年の7月から9月までの期間内における、週休日、休日及び代休日を除いて、原則として連続する3日の範囲内の期間
- (14) 地震、水害、火災その他の災害により職員の現住居が滅失し、又は、損壊した場合で職員が当該住居の復旧作業等のため勤務しないことが相当であると認められるとき原則として連続する7暦日の範囲内の期間
- (15) 地震、水害、火災その他の災害又は交通機関の事故等により出勤することが著しく困難であると認められる場合 必要と認められる期間
- (16) 地震、水害、火災その他の災害時において、職員が退勤途上における身体の危険を回避するため、勤務しないことがやむを得ないと認められる場合 必要と認められる期間
- 2 特別休暇の承認を受けようとする職員は、あらかじめ休暇簿に記入して勤務管理者に請求しなければならない。ただし、病気、災害その他やむを得ない事由によりあらかじめ請求できなかった場合には、その事由を付して事後において承認を求めることができる。
- 3 第1項第7号に掲げる場合に該当することとなった女性職員は、その旨を速やかに勤務管理者に届け出るものとする。
- 4 勤務管理者は、特別休暇の請求について、第1項各号に掲げる場合に該当すると認めるときは、これを承認するものとする。ただし、業務の運営に支障があり、他の時季においても当該休暇の目的を達することができるものと認められる場合には、この限りでない。
- 5 勤務管理者は、特別休暇について、その事由を確認する必要があると認めるときは、証明書類の提出を求めることができる。

（介護休暇）

- 第18条 介護休暇は、職員が次に掲げる者（第2号及び第3号に掲げる者にあっては、職員と同居しているものとする。）で負傷、疾病、老齢又は身体上若しくは精神上の障害により2週間以上の期間にわたり日常生活を営むのに支障がある者（以下「要介護者」という。）の介護をするため、勤務しないことが相当であると認められる場合における休暇とする。
- (1) 配偶者（届出をしないが事実上婚姻関係と同様の事情にある者を含む。以下この条において同じ。）、父母、子、配偶者の父母
  - (2) 祖父母、孫及び兄弟姉妹
  - (3) 職員又は配偶者との間において事実上父母と同様の関係にあると認められる者及び職員との間において事実上子と同様の関係にあると認められる次の者
    - ア 父母の配偶者
    - イ 配偶者の父母の配偶者



ウ 子の配偶者  
エ 配偶者の子

- 2 介護休暇の期間は、前項に規定する者の各々が同項に規定する介護を必要とする1の継続する状態ごとに、連続する6月の期間内において必要と認められる期間とする。
- 3 介護休暇の承認を受けようとする職員は、当該休暇の承認を受けようとする期間の始まる日の前日から起算して1週間前の日までに休暇簿に記入して勤務管理者に請求しなければならない。
- 4 前項の場合において、第2項に規定する介護を必要とする1の継続する状態について初めて介護休暇の承認を受けようとするときは、2週間以上の期間について一括して請求しなければならない。
- 5 勤務管理者は介護休暇の請求について、第1項に掲げる場合に該当すると認めるときは、これを承認するものとする。ただし、当該請求に係る期間のうち業務の運営に支障がある日又は時間については、この限りでない。
- 6 第3項の請求があった場合において、勤務管理者は速やかに承認するかどうかを決定し、当該請求を行った職員に対して当該決定を通知するものとする。
- 7 勤務管理者は、介護休暇について、その事由を確認する必要があると認めるときは、証明書類の提出を求めることができる。
- 8 勤務管理者は、介護休暇の承認をした後に当該職員からその事由を添えて撤回の申請があった場合には、この申請を承認するものとする。
- 9 前8項に定めるほか、介護休暇について必要な事項は理事長が別に定める。

( 休暇簿 )

第19条 休暇簿に関し必要な事項は、理事長が別に定める

第7章 育児部分休業

( 育児部分休業 )

- 第20条 育児部分休業は、職員がその3歳に満たない子を養育するため1日の勤務時間の一部について勤務しないことが相当であると認められる場合における休業とする。
- 2 次に掲げる職員は育児部分休業の申請を行うことができない
    - (1) 常時勤務を要しない職員(再任用短時間勤務職員を除く。)
    - (2) 育児部分休業により養育しようとする子について、配偶者が育児休業、介護休業等育児又は家族介護を行う労働者の福祉に関する法律(平成3年法律第76号)その他の法律により育児休業をしている職員
    - (3) 前号に掲げる職員のほか、育児部分休業を取得しようとする時間において、育児部分休業により養育しようとする子を職員以外の当該子の親が養育することができる場合における当該職員
  - 3 育児部分休業の承認は、正規の勤務時間の始め又は終わりにおいて、1日を通じて2時間(保育時間を承認されている職員については、2時間から当該保育時間を減じた時間)を超えない範囲内で、職員の託児の態様、通勤の状況等から必要とされる時間について30分を単位として行うものとする。
  - 4 育児部分休業の承認を受けようとする職員は、あらかじめその期間等を育児部分休業承認請求書に記入して勤務管理者に請求しなければならない。
  - 5 前項の請求があった場合において、勤務管理者は、業務の運営に支障がないと認めるときは承認するものとし、当該請求を行った職員に対して速やかに承認又は非承認の決

定を通知するものとする。

- 6 勤務管理者は、育児部分休業の承認の請求について、その事由を確認する必要があると認めるときは、証明書類の提出を求めることができる。
- 7 勤務管理者は、育児部分休業の承認をした後当該職員からその事由を添えて撤回の申請があった場合には、この申請を承認するものとする。
- 8 育児部分休業の承認は、次の各号に掲げる場合には、その効力を失うものとする。
  - (1) 職員が産前の休業を始め、又は出産（妊娠満12週以後の分べん（死産を含む。）をいう。）した場合
  - (2) 職員が休職又は停職の処分を受けた場合
  - (3) 当該育児部分休業に係る子が死亡した場合
  - (4) 当該育児部分休業に係る子が次に掲げる事由により当該職員の子でなくなった場合
    - ア 職員と育児部分休業に係る子とが離縁した場合
    - イ 職員と育児部分休業に係る子との養子縁組が取り消された場合
    - ウ 職員と育児部分休業に係る子との親族関係が民法（明治29年法律第89号）第817条の2に規定する特別養子縁組により終了した場合
- 9 勤務管理者は、育児部分休業をしている職員が次の各号に掲げる事由により当該部分休業に係る子を養育しなくなった場合、又は育児部分休業に係る子を職員以外の当該子の親が常態として養育することができることとなった場合には、当該育児部分休業の承認を取り消すものとする。
  - (1) 職員と育児部分休業に係る子とが同居しないこととなった場合
  - (2) 職員が、負傷、疾病又は精神若しくは身体の障害により、育児部分休業の期間中、当該育児部分休業に係る子の日常生活上の世話をすることができない状態になった場合
  - (3) 職員が常態的に当該子の日常生活上の世話に専念しないこととなった場合
- 10 前2項の場合において、職員は遅滞なく、第8項各号又は前項各号に掲げる事由が生じた旨を勤務管理者に届け出なければならない。
- 11 前10項に定めるほか、育児部分休業に必要な事項は理事長が別に定める。

## 第8章 育児又は介護を行う職員の深夜勤務及び時間外勤務の制限

（育児を行う職員の深夜勤務の制限）

第21条 勤務管理者は、小学校就学の始期に達するまでの子のある職員（職員の配偶者で当該子の親であるものが、深夜（午後10時から翌日の午前5時までの間をいう。以下同じ。）において常態として当該子を養育することができるものとして別に定める者に該当する場合における当該職員を除く。）が当該子を養育するために請求した場合には、業務の運営に支障がある場合を除き、深夜における勤務（以下「深夜勤務」という。）をさせないものとする。

（育児を行う職員の深夜勤務の制限の請求手続等）

第22条 職員は、深夜勤務制限請求書により、深夜勤務の制限を請求する1の期間（6月以内の期間に限る。以下「深夜勤務制限期間」という。）について、その初日（以下「深夜勤務制限開始日」という。）及び末日（以下「深夜勤務制限終了日」という。）とする日を明らかにして、深夜勤務制限開始日の1月前までに前条の規定による請求を行うものとする。

2 前条の規定による請求があった場合においては、勤務管理者は、業務の運営の支障の

有無について、速やかに当該請求をした職員に対し通知しなければならない。当該通知後において、業務の運営に支障が生じる日があることが明らかとなった場合にあっては、勤務管理者は、当該日の前日までに、当該請求をした職員に対しその旨を通知するものとする。

- 3 勤務管理者は、前条の請求に係る事由について確認する必要があると認めるときは、証明書類の提出を求めることができる。

第23条 第21条の規定による請求がされた後深夜勤務制限開始日とされた日の前日までに、次の各号に掲げるいずれかの事由が生じた場合には、当該請求はされなかったものとみなす。

- (1) 当該請求に係る子が死亡した場合
  - (2) 当該請求に係る子が離縁又は養子縁組の取消により当該請求をした職員の子でなくなった場合
  - (3) 当該請求をした職員が当該請求に係る子と同居しないこととなった場合
  - (4) 当該請求をした職員の配偶者で当該請求に係る子の親であるものが、深夜において常態として当該子を養育することができるものとして別に定める者に該当することとなった場合
- 2 深夜勤務制限開始日以後深夜勤務制限終了日とされた日の前日までに、前項各号に掲げるいずれかの事由が生じた場合には、第21条の規定による請求は、当該事由が生じた日を深夜勤務制限期間の末日とする請求であったものとみなす。
  - 3 前2項の場合において、職員は遅滞なく、第1項各号に掲げる事由が生じた旨を勤務管理者に届け出なければならない。
  - 4 前条第3項の規定は、前項の届出について準用する。

(介護を行う職員の深夜勤務の制限)

第24条 第21条から前条まで(同条第1項第4号を除く。)の規定は、第18条第1項に規定する要介護者を介護する職員について準用する。この場合において、第21条中「小学校就学の始期に達するまでの子のある職員(職員の配偶者で当該子の親であるものが、深夜(午後10時から翌日の午前5時までの間をいう。以下同じ。))において常態として当該子を養育することができるものとして別に定める者に該当する場合における当該職員を除く。)が当該子を養育」とあるのは「要介護者のある職員が当該要介護者を介護」と、前条第1項第1号中「子」とあるのは「要介護者」と、同項第2号中「子が離縁又は養子縁組の取消により当該請求をした職員の子でなくなった」とあるのは「要介護者と当該請求をした職員との親族関係が消滅した」と、同項第3号中「子」とあるのは「要介護者」と読み替えるものとする。

(育児を行う職員の時間外勤務の制限)

第25条 勤務管理者は、小学校就学の始期に達するまでの子のある職員(職員の配偶者で当該子の親であるものが、常態として当該子を養育することができるものとして別に定める者に該当する場合における当該職員を除く。)が当該子を養育するために請求した場合には、当該請求をした職員の業務を処理するための措置を講ずることが著しく困難である場合を除き、1月について24時間、1年について150時間を超えて、正規の勤務時間以外の時間における勤務(第10条第2項に規定する勤務を除く。以下「時間外勤務」という。)をさせないものとする。

( 育児を行う職員の時間外勤務の制限の請求手続等 )

第 26 条 職員は、時間外勤務制限請求書により、時間外勤務の制限を請求する 1 の期間について、その初日 ( 以下「時間外勤務制限開始日」という。 ) 及び期間 ( 1 年又は 1 年に満たない月を単位とする期間に限る。 ) を明らかにして、時間外勤務制限開始日の前日までに前条の規定による請求を行わなければならない。

- 2 前条の規定による請求があった場合においては、勤務管理者は、前条に規定する措置を講ずることが著しく困難であるかどうかについて、速やかに当該請求をした職員に対し通知するものとする。
- 3 勤務管理者は、前条の規定による請求が、当該請求があった日の翌日から起算して 1 週間を経過する日 ( 以下「1 週間経過日」という。 ) 前の日を時間外勤務制限開始日とする請求であった場合で、前条に規定する措置を講ずるために必要があると認めるときは、当該時間外勤務制限開始日から 1 週間経過日までの間のいずれかの日に時間外勤務制限開始日を変更することができる。
- 4 勤務管理者は、前項の規定により時間外勤務制限開始日を変更した場合においては、当該時間外勤務制限開始日を当該変更前の時間外勤務制限開始日の前日までに当該請求をした職員に対し通知するものとする。
- 5 勤務管理者は、前条の請求に係る事由について確認する必要があると認めるときは、証明書類の提出を求めることができる。

第 27 条 第 25 条の規定による請求がされた後、時間外勤務制限開始日の前日までに、次の各号に掲げるいずれかの事由が生じた場合には、当該請求はされなかったものとみなす。

- ( 1 ) 当該請求に係る子が死亡した場合
- ( 2 ) 当該請求に係る子が離縁又は養子縁組の取消により当該請求をした職員の子でなくなった場合
- ( 3 ) 当該請求をした職員が当該請求に係る子と同居しないこととなった場合
- ( 4 ) 当該請求をした職員の配偶者で当該請求に係る子の親であるものが、を常態として当該子を養育することができるものとして別に定める者に該当することとなった場合

2 時間外勤務制限開始日から起算して第 25 条の規定による請求に係る期間を経過する日の前日までの間に、次の各号に掲げるいずれかの事由が生じた場合には、同条の規定による請求は、時間外勤務制限開始日から当該事由が生じた日までの期間についての請求であったものとみなす。

- ( 1 ) 前項各号に掲げるいずれかの事由が生じた場合
- ( 2 ) 当該請求に係る子が小学校就学の始期に達した場合

3 前 2 項の場合において、職員は遅滞なく、第 1 項各号に掲げる事由が生じた旨を勤務管理者に届け出なければならない。

4 前条第 5 項の規定は、前項の届出について準用する。

( 介護を行う職員の時間外勤務の制限 )

第 28 条 第 25 条から前条まで ( 同条第 1 項第 4 号並びに第 2 項第 1 号及び第 2 号を除く。 ) の規定は、要介護者を介護する職員について準用する。この場合において、第 25 条中「小学校就学の始期に達するまでの子のある職員 ( 職員の配偶者で当該子の親であるものが、常態として当該子を養育することができるものとして別に定める者に該当する場合における当該職員を除く。 ) が当該子を養育」とあるのは「要介護者のある職

員が当該要介護者を介護」と、前条第1項第1号中「子」とあるのは「要介護者」と、同項第2号中「子が離縁又は養子縁組の取消により当該請求をした職員の子でなくなった」とあるのは「要介護者と当該請求をした職員との親族関係が消滅した」と、同項第3号中「子」とあるのは「要介護者」と、同条第2項中「次の各号」とあるのは「前項第1号から第3号まで」と読み替えるものとする。

## 第9章 妊産婦である女性職員に対する措置

(妊産婦である女性職員の深夜勤務等の制限)

第29条 勤務管理者は、妊娠中の女性職員及び産後1年を経過しない女性職員（以下「妊産婦である女性職員」という。）が請求した場合には、深夜勤務又は時間外勤務をさせないものとする。

(妊産婦である女性職員の健康診査及び保健指導)

第30条 勤務管理者は、妊産婦である女性職員が請求した場合には、その者が母子保健法（昭和40年法律第141号）第10条に規定する保健指導又は同法第13条に規定する健康診査を受けるため勤務しないことを承認するものとする。

2 前項の健康診査及び保健指導のため勤務しないことを承認しなければならない時間は、妊娠満23週までは4週間に1回、妊娠満24週から満35週までは2週間に1回、妊娠満36週から出産までは1週間に1回、産後1年まではその間に1回（医師等の特別の指示があった場合には、いずれの期間についてもその指示された回数）について、それぞれ1日の正規の勤務時間の範囲内で必要と認められる時間とする。

(妊産婦である女性職員の業務軽減等)

第31条 勤務管理者は、妊産婦である女性職員が請求した場合には、その者の業務を軽減し、又は他の軽易な業務に就かせるものとする。

2 勤務管理者は、妊産婦である女性職員が請求した場合において、その者の業務が母体又は胎児の健康保持に影響があると認めるときは、当該職員が適宜休息し、又は補食するために必要な時間、勤務しないことを承認することができる。

(妊産婦である女性職員の通勤緩和)

第32条 勤務管理者は、妊産婦である女性職員が請求した場合において、その者が通勤に利用する交通機関の混雑の程度が母体又は胎児の健康保持に影響があると認めるときは、正規の勤務時間の始め又は終わりにおいて、別に定める時間、勤務しないことを承認するものとする。

## 第10章 就業禁止等

(就業禁止)

第33条 理事長は、法令又は他の規程等の定めに基づき、やむを得ないと認める場合には、職員に業務に就くことを禁止することができる。

(職務専念義務の免除)

第34条 理事長は、法令又は他の規程等の定めに基づき、この規程に定めるもののほか、職務に専念する義務を免除することができる。

## 第 1 1 章 雑則

(勤務時間の割振り等の規定についての別段の定め)

第 3 5 条 理事長は、業務若しくは勤務条件の特殊性又は地域的若しくは季節的事情により、この規程の規定によると、能率を甚だしく阻害し、又は職員の健康若しくは安全に有害な影響を及ぼす場合には、週休日、勤務時間の割振り、週休日の振替等、休憩時間、休息时间又は代休日の指定について別段の定めをすることができる。

(非常勤職員の勤務時間及び休暇)

第 3 6 条 常時勤務を要しない職員(再任用短時間勤務職員を除く。)の勤務時間及び休暇に関する事項については、その職務の性質等を考慮して別に定める。

### 附 則

- 1 この規程は、平成 1 3 年 4 月 1 日から施行する。
- 2 勤務管理者は、平成 1 4 年 3 月 3 1 日までの間、小学校就学の始期に達するまでの子を養育し、又は要介護状態にある家族を介護する労基法第 1 3 3 条に規定する特定労働者に該当する女性職員が申し出た場合、当該職員の時間外勤務は、4 週間について 3 6 時間、1 年間にについて 1 5 0 時間を超えない範囲とする。ただし、部課等の業務の遂行を指揮命令する職制上の地位にある女性職員については適用しない。
- 3 センター設立の前日において、農林水産省の国際農林水産業研究センターの職員であった者が引き続きセンターの職員(以下「引継職員」という。)となった場合において、一般職の職員の勤務時間、休暇等に関する法律(平成 6 年法律第 3 3 号)第 6 条第 3 項又は第 7 条の規定に基づき、勤務時間の割振りがなされていた職員については、センターの成立の前日まで過不足なく同法第 6 条第 1 項に掲げる勤務時間を勤務したものとみなす。
- 4 引継職員となった場合におけるセンター設立の年における年次休暇の算定については、第 1 5 条第 1 項第 3 号を準用する。
- 5 引継職員となった場合において、センターの設立の日の前日までに受けていた設立の日以後に係る病気休暇、特別休暇、介護休暇及び育児部分休業に相当する休暇又は休業は、この規程に基づく理事長の承認があったものとみなす。
- 6 この附則に定めのない事項については、理事長が定めるものとする。

附 則(平成 1 3 . 1 2 . 2 8 1 3 国研セ第 1 2 - 7 6 号)

(施行期日)

- 1 この規程は、平成 1 4 年 1 月 1 日から施行する。ただし、第 1 8 条第 2 項及び第 2 0 条第 1 項の改正規定並びに附則第 2 項及び附則第 3 項の規定は、同年 4 月 1 日から施行する。

(経過措置)

- 2 この規程による改正後の独立行政法人国際農林水産業研究センター職員の勤務時間、休憩、休日、休暇等に関する規程(以下「新勤務時間規程」という。)第 1 8 条の規定は、この規程による改正前の独立行政法人国際農林水産業研究センター職員の勤務時間、休憩、休日、休暇等に関する規程(以下「旧勤務時間規程」という。)第 1 8 条第 5 項の規定により介護休暇の承認を受けた職員でこの規程の施行の日(以下「施行日」という。)において当該承認に係る介護を必要とする 1 の継続する状態についての介護休暇の初日から起算して 3 月を経過しているもの(当該介護休暇の初日から起算して 6

月を経過する日までの間にある職員に限る。)についても適用する。この場合において、新勤務時間規程第18条第2項中「連続する6月の期間内」とあるのは、「平成14年4月1日から、当該状態についての介護休暇の初日から起算して6月を経過するまでの間」とする。

- 3 旧勤務時間規程第18条第5項の規定により介護休暇の承認を受け、施行日において当該承認に係る介護を必要とする一の継続する状態についての介護休暇の初日から起算して3月を経過していない職員の介護休暇の期間については、新勤務時間法第18条第2項中「連続する6月の期間内」とあるのは、「当該状態についての介護休暇の初日から起算して6月を経過するまでの間」とする。
- 4 新勤務時間規程第25条(第28条の規定により読み替えて準用する場合を含む。)の規定は、この規程の施行の日以後にする請求から適用し、同日前にした請求による時間外勤務の制限については、なお従前の例による。

附 則(平成14.4.1 14国研セ第4-22号)  
(施行期日)

この規程は、平成14年4月1日から施行する。

別表第1 職員の在職期間別年次休暇付与日数（第15条第1項関係）

在 職 期 間	日 数
1月に達するまでの期間	2日
1月を超え2月に達するまでの期間	3日
2月を超え3月に達するまでの期間	5日
3月を超え4月に達するまでの期間	7日
4月を超え5月に達するまでの期間	8日
5月を超え6月に達するまでの期間	10日
6月を超え7月に達するまでの期間	12日
7月を超え8月に達するまでの期間	13日
8月を超え9月に達するまでの期間	15日
9月を超え10月に達するまでの期間	17日
10月を超え11月に達するまでの期間	18日
11月を超え1年未満の期間	20日



別表第2 再任用短時間勤務職員（同一勤務型職員）の在職期間別年次休暇付与日数（第15条第2項第1号関係）

在職期間		1月に達するまでの期間	1月を超え2月に達するまでの期間	2月を超え3月に達するまでの期間	3月を超え4月に達するまでの期間	4月を超え5月に達するまでの期間	5月を超え6月に達するまでの期間	6月を超え7月に達するまでの期間	7月を超え8月に達するまでの期間	8月を超え9月に達するまでの期間	9月を超え10月に達するまでの期間	10月を超え11月に達するまでの期間	11月を超え1年未満の期間
1週間の勤務日の日数	5日	2日	3日	5日	7日	8日	10日	12日	13日	15日	17日	18日	20日
	4日	1日	3日	4日	5日	7日	8日	9日	11日	12日	13日	15日	16日
	3日	1日	2日	3日	4日	5日	6日	7日	8日	9日	10日	11日	12日
	2日	1日	1日	2日	3日	3日	4日	5日	5日	6日	7日	7日	8日

別表第3 再任用短時間勤務職員（非同勤型職員）の在職期間別年次休暇付与日数（第15条第2項第2号関係）

在職期間		1月に達するまでの期間	1月を超え2月に達するまでの期間	2月を超え3月に達するまでの期間	3月を超え4月に達するまでの期間	4月を超え5月に達するまでの期間	5月を超え6月に達するまでの期間	6月を超え7月に達するまでの期間	7月を超え8月に達するまでの期間	8月を超え9月に達するまでの期間	9月を超え10月に達するまでの期間	10月を超え11月に達するまでの期間	11月を超え1年未満の期間
1 週 当 た り の 勤 務 時 間	31時間を超え32時間以下	1日	3日	4日	5日	7日	8日	9日	11日	12日	13日	15日	16日
	30時間を超え31時間以下	1日	3日	4日	5日	6日	8日	9日	10日	12日	13日	14日	16日
	29時間を超え30時間以下	1日	3日	4日	5日	6日	8日	9日	10日	11日	13日	14日	15日
	28時間を超え29時間以下	1日	2日	4日	5日	6日	7日	8日	10日	11日	12日	13日	15日
	27時間を超え28時間以下	1日	2日	4日	5日	6日	7日	8日	9日	11日	12日	13日	14日
	26時間を超え27時間以下	1日	2日	3日	5日	6日	7日	8日	9日	10日	11日	12日	14日
	25時間を超え26時間以下	1日	2日	3日	4日	5日	7日	8日	9日	10日	11日	12日	13日
	24時間を超え25時間以下	1日	2日	3日	4日	5日	6日	7日	8日	9日	10日	11日	13日
	23時間を超え24時間以下	1日	2日	3日	4日	5日	6日	7日	8日	9日	10日	11日	12日
	22時間を超え23時間以下	1日	2日	3日	4日	5日	6日	7日	8日	9日	10日	11日	12日
	21時間を超え22時間以下	1日	2日	3日	4日	5日	6日	6日	7日	8日	9日	10日	11日
	20時間を超え21時間以下	1日	2日	3日	4日	4日	5日	6日	7日	8日	9日	10日	11日
	19時間を超え20時間以下	1日	2日	3日	3日	4日	5日	6日	7日	8日	8日	9日	10日
	18時間を超え19時間以下	1日	2日	2日	3日	4日	5日	6日	6日	7日	8日	9日	10日
17時間を超え18時間以下	1日	2日	2日	3日	4日	5日	5日	6日	7日	8日	8日	9日	
16時間を超え17時間以下	1日	1日	2日	3日	4日	4日	5日	6日	6日	7日	8日	9日	
16時間	1日	1日	2日	3日	3日	4日	5日	5日	6日	7日	7日	8日	

国家公務員倫理法（平成 11 年法律第 129 号）第 2 条第 7 項の規定に基づ  
く本省課長補佐級以上の職員及び指定職以上の職員の範囲の公表

1．本省課長補佐級以上の職員

- (1) 独立行政法人国際農林水産業研究センター職員給与規程別表第 1 一般職員俸給表の職務の級 7 級以上の職員
- (2) 独立行政法人国際農林水産業研究センター職員給与規程別表第 3 研究職員俸給表の職務の級 4 級以上の職員
- (3) 一般職の任期付研究員の採用、給与及び勤務時間の特例に関する法律（平成 9 年法律第 65 号）第 3 条第 1 項第 1 号の規定により任期を定めて採用された職員

2．指定職以上の職員

独立行政法人国際農林水産業研究センター任期付研究員及び特定任期付職員給与規程で定める任期付研究員俸給表の 4 号俸以上の俸給を受ける職員



••Ū<α“~Æα<†•l•P^ç•¬•,•iŽ-Æ(JIREC)  
JIRCAS International REsearch Career Network

•^1. Ž-ÆŠT—v•^2. Ž-Æ“à—e•^3. JIRECfÆfl•[fg•^4. This is CGIAR•^

•y2. Ž-Æ“à—e•z

•i” —Ñ•...ŽY<Æ•^a—i,İ••Ū<α“~Æα<†•l•Pff•[f^fx•[fX•iJIRECff•[f^fx•[fX•j

” —Ñ•...ŽY<Æ•^a—i,İ••Ū<α“~Æα<†,É^Ó—~“l,ÉŽæ,è‘g,ñ,Å,ç,½,¾,¯,é•û•X,İ•l•Pff•[f^fx•[fX,ð\’z,.,é,à,Ì,Å,•B  
ff•[f^fx•[fX,É“o~^,ç,½,¾,ç,½•û,É,Í•A•uJIRECfÆfl•[fg•v•A•uThis is  
CGIAR•v,İ”z•M,ð,Í,¶,ß•A••Ū<α“~Æα<†,ÉŠÖ,.,é—l•X,È•î•ñ’ñ<ÿ,ð•s,α—\`è,Å,•B  
,±,ê,Û,Å,É•A800—¼,ð’’,i,éÆα<†ŽÖ,İ•û,•A•ff•[f^fx•[fX,É“o~^,ð•s,Á,Ä,ç,Û,•B  
” —Ñ•...ŽY<Æ•^a—i,İ••Ū<α“~Æα<†,É.]Ž—,.,é^ÓŽu,ð—L,.,é•û,İ•A•İ•É“l,È,2“o~^,ð,“Ò,ç,μ,Ä,ç,Û,•B  
•ff•[f^fx•[fX“o~^ftfH•[f,Í,±,ç,ç•B

•^1. Ž-ÆŠT—v•^2. Ž-Æ“à—e•^3. JIRECfÆfl•[fg•^4. This is CGIAR•^

JIREC—â,ç,ç,í,¹•æ•F“Æ—§•s•—@•l•@••Ū” —Ñ•...ŽY<ÆÆα<†fZf“f^•[•iJIRCAS•j  
Šé%œ’²•®”•@••Ū<α“~Æα<†•l•P^ç•¬•,•iŽ-ÆÆW jinzai@ml.affrc.go.jp

••Ū<α“CEα<†•l•P^ç•→•,,iŽ—<Æ(JIREC)  
JIRCAS International REsearch Career Network  
•^1. Ž—<ÆŠT—v•^2. Ž—<Æ“à—e•^3. JIRECf(ef)l(fg•^4. This is CGIAR•^

•y3. JIRECf(ef)l(fg•z

•@••Ū<@ŠÖ,â•A•æ•i••,İ••ŪCEα<†•l—Í’S“—<@ŠÖ,É,“;—,éα“CEα<†,İŽÀŽ{,İŽd’g,Ý•EŽÀŽ{•ó•μ,É,Â,ç,Ä•AJIRCAS,İCEα<†^ö,“CE”n’2•,đŽÀŽ{,μ•AŽû•W,μ,½•î•ñ,đ•@—••E•â•Í,μ,½•ñ••••,Ä,••B  
•½•→,P,R”N“x,Í•A^È%°,İ<@ŠÖ,ÉŠÖ,•,é’2•,đŽÀŽ{,μ,Û,μ,½•B

1. IRRI	••Ū^iCEα<†•Š
2. ADB	fAfwfAŠJ”-â•s
3. ACIAR	fI•[fXfgf%ofŠfA••Ū”_<ÆCEα<†fZf“f^•[
4. CSIRO	fI•[fXfgf%ofŠfA%ÈŠwŽY<ÆCEα<†<@•\

•ff•[f^fx•[fX“o^ftfH•[f,Í,±,ı,ç•B

••uThis is CGIAR•v,İ•Ū×,Í,±,ı,ç•B

•^1. Ž—<ÆŠT—v•^2. Ž—<Æ“à—e•^3. JIRECf(ef)l(fg•^4. This is CGIAR•^

JIREC—â,ç•‡,í,ı•æ•F“Æ—§•s—@•l•@••Ū”_—Ń...ŽY<ÆCEα<†fZf“f^•[•iJIRCAS•j  
Šé%œ’2•@”•@••Ū<α“CEα<†•l•P^ç•→•,,iŽ—<ÆCEW [jinzai@ml.affrc.go.jp](mailto:jinzai@ml.affrc.go.jp)



---

•^1. Ž-ĀŠT-v•^2. Ž-Ā“à—e•^3. JIRECfĀfl•[fg•^4. This is CGIAR•^

---

JIREC-â,ç•ž,í,í,•æ•F“Ā—š•s•—@•!•@•••Ū” —Ñ•...ŽYĀĀĀ†fZf“f^•[•JIRCAS•j  
Šé%æ’2•@•”•@••Ū,Ā“ĀĀ†•!•P^ç•—•,•iŽ-ĀĀEW [jinzai@ml.affrc.go.jp](mailto:jinzai@ml.affrc.go.jp)















国際共同研究 共同研究員	国際共同研究 共同研究員	国際共同研究 共同研究員
国際共同研究 共同研究員	国際共同研究 共同研究員	国際共同研究 共同研究員
国際共同研究 共同研究員	国際共同研究 共同研究員	国際共同研究 共同研究員
国際共同研究 共同研究員	国際共同研究 共同研究員	国際共同研究 共同研究員
国際共同研究 共同研究員	国際共同研究 共同研究員	国際共同研究 共同研究員

国際共同研究  
共同研究員

CIP, E.I

CIP, E.I: 国際共同研究  
共同研究員

国際共同研究  
共同研究員

国際共同研究  
共同研究員

国際共同研究  
共同研究員

国際共同研究  
共同研究員

国際共同研究  
共同研究員

国際共同研究  
共同研究員

国際共同研究  
共同研究員

国際共同研究  
共同研究員

国際共同研究  
共同研究員

国際共同研究  
共同研究員

国際共同研究  
共同研究員

国際共同研究  
共同研究員

国際共同研究  
共同研究員

国際共同研究  
共同研究員

国際共同研究  
共同研究員

国際共同研究  
共同研究員

国際共同研究  
共同研究員

国際共同研究  
共同研究員

国際共同研究  
共同研究員

国際共同研究  
共同研究員

国際共同研究  
共同研究員

国際共同研究  
共同研究員

国際共同研究  
共同研究員

国際共同研究  
共同研究員





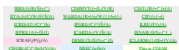












国際共同研究センターネットワーク  
International Research Center network

ICRAF 简介

ICRAF 国际农业研究中心 (International Research Center for Cereals and Rice) 是国际农业研究中心 (JIRCAS) 的组成部分。ICRAF 的主要研究领域是粮食安全和营养。ICRAF 的研究项目包括：  
• 水稻生产系统  
• 旱地农业系统  
• 畜牧业系统  
• 渔业和水产养殖系统  
• 农村生计和农村发展  
ICRAF 的研究项目旨在提高粮食安全和营养，并改善农村生计和农村发展。ICRAF 的研究项目包括：  
• 水稻生产系统  
• 旱地农业系统  
• 畜牧业系统  
• 渔业和水产养殖系统  
• 农村生计和农村发展

ICRAF 的使命

ICRAF 的使命是改善粮食安全和营养，并改善农村生计和农村发展。ICRAF 的研究项目包括：  
• 水稻生产系统  
• 旱地农业系统  
• 畜牧业系统  
• 渔业和水产养殖系统  
• 农村生计和农村发展  
ICRAF 的研究项目旨在提高粮食安全和营养，并改善农村生计和农村发展。ICRAF 的研究项目包括：  
• 水稻生产系统  
• 旱地农业系统  
• 畜牧业系统  
• 渔业和水产养殖系统  
• 农村生计和农村发展

ICRAF 的成就

ICRAF 的成就包括：  
• 提高了粮食安全和营养  
• 改善了农村生计和农村发展  
• 提高了农民的收入  
• 提高了农民的生活水平  
ICRAF 的成就包括：  
• 提高了粮食安全和营养  
• 改善了农村生计和农村发展  
• 提高了农民的收入  
• 提高了农民的生活水平

ICRAF 的合作伙伴

ICRAF 的合作伙伴包括：  
• 日本政府  
• 国际农业研究中心 (JIRCAS)  
• 国际水稻研究所 (IRRI)  
• 国际旱地农业研究中心 (ICRISAT)  
• 国际畜牧业研究中心 (ILRI)  
• 国际渔业和水产养殖研究中心 (IITA)  
• 国际农村生计和农村发展研究中心 (ILRI)  
ICRAF 的合作伙伴包括：  
• 日本政府  
• 国际农业研究中心 (JIRCAS)  
• 国际水稻研究所 (IRRI)  
• 国际旱地农业研究中心 (ICRISAT)  
• 国际畜牧业研究中心 (ILRI)  
• 国际渔业和水产养殖研究中心 (IITA)  
• 国际农村生计和农村发展研究中心 (ILRI)

国際共同研究センターネットワーク  
International Research Center network



ICLARM	ICLARM	ICLARM
ICLARM	ICLARM	ICLARM
ICLARM	ICLARM	ICLARM
ICLARM	ICLARM	ICLARM
ICLARM	ICLARM	ICLARM

ICLARM

ICLARM, E.I

ICLARM

ICLARM

ICLARM

ICLARM

ICLARM, I-6

ICLARM

ICLARM

ICLARM

ICLARM

ICLARM

ICLARM

ICLARM

ICLARM

ICLARM

ICLARM

ICLARM

ICLARM

ICLARM

ICLARM

ICLARM

ICLARM

ICLARM

ICLARM

JIREC





農林水産業分野の国際共同研究人材データベース構築のためのアンケートのお願い

#### アンケート実施の背景

技術開発は競争と協調の時代に入っており、バイオテクノロジー等先端的な技術に端的に見られるように、世界各国が研究開発にしのぎを削る一方、最新の知見・情報を持ち寄っての国際共同研究は、効率的な研究に必須となっています。

一方、今日の世界は、人口の増加とこれに伴う食料問題・環境問題等、地球規模で取り組むべき諸問題に直面しており、その解決に向けて技術開発の一層の加速と効率化を図っていくため、対開発途上国も含めて我が国の一層の貢献が求められており、この観点から、国際研究機関に対して、また国際共同研究に対して一層の人的貢献が求められています。

このため、国際共同研究に従事する意志と必要な資質を有する人材を把握し、その方々に対し、適切な国際研究参加の機会を提供させていただくことを企画しました。

独立行政法人国際農林水産業研究センター（JIRCAS）では、以上のような背景に基づき、全国の農林水産業分野の試験研究機関を中心として、国際共同研究に意欲的に取り組んでいただける方々の人材データベースの構築を、農林水産省の委託事業として実施することになりました。

本データベースに登録された方には、次の1～5のような国際共同研究参加機会等に関する情報提供を行う予定です。

1. JIRCAS が実施している国際共同研究プロジェクトへの研究者としての派遣
2. 上記プロジェクトに関する開発途上地域からの招へい研究者の受入れ
3. 国際協力事業団(JICA)が行っている研究協力事業への専門家としての派遣
4. 国際研究機関における研究実施状況
5. 先進国の国際研究協力機関の紹介

本アンケートは、国際共同研究人材の基礎データを得るためのものであり、ご本人の意に反して義務を課されることは一切ありません。また、当センターが、本データベースに登録された方に就職のあっせんを目的とするものではありません。この点をご考慮のうえ、ご回答いただきますよう、よろしくお願い申し上げます。

本アンケートの返送先・問い合わせ先

独立行政法人国際農林水産業研究センター企画調整部研究企画科（担当：杉野）

〒305-8686 茨城県つくば市大わし 1-1

電話：(0298)38-6331

FAX：(0298)38-6337

e-mail:jinzai@ml.affrc.go.jp

< 調査票 >

回答方法：空欄に必要事項を記入するか、該当する番号に 印をつけてください。記入欄が不足した場合は、別紙を添付していただいても結構です。

1. 記入年月日 西暦 年 月 日
2. 氏名 (姓) (名)
3. 氏名のローマ字表記 (surname) (given name)
4. 性別 男・女
5. 生年月日 西暦 年 月 日
6. 所属先 機関名  
研究部等 研究科等  
研究室等
7. 職名 1. 部長 2. 科長・課長 3. 室長 4. 主任研究官 5. 研究員  
6. その他 ( )
8. 勤務先住所 〒 - :
9. 勤務先電話番号 ( ) -
10. 勤務先 Fax 番号 ( ) -
11. 現住所 〒 - :  
電話番号 ( ) - Fax 番号 ( ) -
12. 電子メールアドレス @
13. 取得学位 1. 博士 2. 修士 3. 学士 4. その他 ( )

< あなたの研究経験について >

14. あなたの専門に近い専門分野のキーワード番号を専門・分科コード表より 3 つ以内で選んで下さい。

番号 ( , , )

15. あなたの最近の研究テーマをお答え下さい。(記述式)

---

---

---

---

16. 開発途上地域に関する研究(開発途上地域を対象とした研究のほか、開発途上地域で利活用できそうな研究も含む)の経験がありますか? 1. ある 2. なし

具体的にはどのような研究ですか?(記述式)

---

---

---

---

17. 外国語の会話能力についてお答えください。また、取得している資格（英検、TOEIC等）があれば、記入してください。）

- 1 ) 英語 (1.堪能 2.普通 3.日常会話程度 4.不可) 資格( )
- 2 ) フランス語 (1.堪能 2.普通 3.日常会話程度 4.不可) 資格( )
- 3 ) スペイン語 (1.堪能 2.普通 3.日常会話程度 4.不可) 資格( )
- 4 ) 中国語 (1.堪能 2.普通 3.日常会話程度 4.不可) 資格( )
- 5 ) ロシア語 (1.堪能 2.普通 3.日常会話程度 4.不可) 資格( )
- 6 ) ドイツ語 (1.堪能 2.普通 3.日常会話程度 4.不可) 資格( )
- 7 ) アラビア語 (1.堪能 2.普通 3.日常会話程度 4.不可) 資格( )
- 8 ) その他( ) (1.堪能 2.普通 3.日常会話程度) 資格( )

18. 開発途上地域における研究以外の目的で、海外で3ヶ月以上の滞在経験があれば、国名、期間、目的をお答えください。

- 1 ) 国名： 滞在期間：西暦 年 月 ~ 年 月  
目的： _____
- 2 ) 国名： 滞在期間：西暦 年 月 ~ 年 月  
目的： _____

19. CGIAR 等海外の国際研究機関(IRRI、FAO 等)における勤務経験がありますか？

1. ある 2. ない

[ある]と答えた方は、具体的な機関名及び滞在期間(例:1999年4月-2000年3月)をご記入ください。

---

---

<開発途上地域における研究活動について>

20. 開発途上地域へ研究を目的として派遣された経験がありますか？1. はい 2. いいえ  
([はい]と答えた方は21以降に進んでください。[いいえ]と答えた方は22以降に進んで下さい。)

21. 研究を目的として何回派遣されたか、お答えください。 ( )回

そのうちで主要なものに関して、派遣された開発途上地域の国名、滞在期間、派遣元機関、目的をお答え下さい。

- 1 ) 国名： 滞在期間：西暦 年 月 ~ 年 月  
派遣元機関：1. 農林水産省(国際農林水産業研究センターを含む) 2. JICA
3. 文部科学省 4. その他( )

目的： _____

2) 国名：_____ 滞在期間：西暦 _____ 年 _____ 月 ~ _____ 年 _____ 月

派遣元機関：1. 農林水産省（国際農林水産業研究センターを含む） 2. JICA

3. 文部科学省 4. その他（_____）

目的：_____

3) 国名：_____ 滞在期間：西暦 _____ 年 _____ 月 ~ _____ 年 _____ 月

派遣元機関：1. 農林水産省（国際農林水産業研究センターを含む） 2. JICA

3. 文部科学省 4. その他（_____）

目的：_____

(21 の続き)

さらに、開発途上地域へ研究者として派遣された時に主に研究した事柄に近いキーワード番号を専門・分科コード表より選択してください。(複数回答可)

番号(_____, _____, _____)

22. 開発途上地域へ農林水産分野の研究者として派遣依頼があった場合、お受けいただけますか？下の1~4より選択してください？

1.可能 2. 状況による 3. 将来的には可能 4.不可能

1) [可能]、[状況による]、[将来的には可能]と答えた方は、どういう分野であれば協力可能であるのか、キーワード番号を専門・分科コード表より選択してください。

当てはまるものがなければ、記述式でお答えください。(複数回答可)

番号(_____, _____, _____)

その他(_____)

2) [可能]、[状況による]、[将来的には可能]と答えた方は、派遣先、派遣期間についてご希望がありましたらお書き下さい。(複数回答可)

地域：1.アジア 2. 中近東 3. アフリカ 4. 中南米 5. 大洋州 6. 東欧

7.その他(_____) 8. どこでもよい

国名：1.(_____) 2. どこでもよい

期間：(_____)日間 (_____)週間 (_____)ヶ月間 (_____)年間

3) [将来的には可能]と答えた方は、いつ頃から可能であるか、具体的にお書き下さい。

いつ頃から：(_____)年後に (_____)ヶ月後に

<外国人招へい研究員・外国人研修員受け入れについて>

23. 外国人招へい研究員・研修員との共同研究・研修を行った経験がありますか？

1. ある

内容はどのようなものでしたか？以下より選択してください。(複数回答可)

1. 講義 2. 室内実験指導 3. 野外実習指導 4. 施設見学案内 5. 研究指導

6.その他(_____)

2. ない

24. 現在、外国人招へい研究員・研修員受入れ事業への協力が可能ですか?

1. 可能 2. 状況による 3. 将来的には可能 4. 不可能

([可能][状況による]と答えた方は、25 以降に進んでください。[将来的には可能]と答えた方は 27 以降、[不可能]と答えた方は<同意書><ご意見・ご要望>の欄に進んでください。)

25. どのような内容の受け入れが可能か、以下より選択してください。(複数回答可)

1. 講義 2. 室内実験指導 3. 野外実習指導 4. 施設見学案内 5. 研究指導  
6. その他( )

26. 相手側開発途上地域、受け入れ可能な分野、期間について希望がありましたらお書き下さい。分野については専門・分科コード表より選択してください。

当てはまるものがない場合はその他の欄に記述してください。

地域：1. アジア 2. 中近東 3. アフリカ 4. 中南米 5. 大洋州 6. 東欧

7. その他( ) 8. どこでもよい

国名：1.( ) 2. どこでもよい

分野：番号( , , )

その他( )

受入れ可能期間：( )日間 ( )週間 ( )ヶ月間 ( )年間

27. [将来的には可能]と答えた方は、いつからどのくらいの期間、可能であるか、具体的にお書き下さい。

いつから：( )年後に ( )ヶ月後に

期間：( )日間 ( )週間 ( )ヶ月間 ( )年間

*****

1 から 27 までの事項について、国際協力関係機関から情報提供の要請があった場合、ご回答いただいた情報を農林水産省や国際農林水産業研究センターが提供することに同意していただけますか？(情報提供については慎重に検討した上で行います。また、提供された情報が原因で義務を課されるようなことは一切ありません。)

1. はい 2. いいえ ([はい]と答えた方は、下に署名(自署)をお願いします。)

_____  
年 月 日

*****

当センター、あるいは農林水産業分野での国際共同研究に関して、ご意見、ご要望がありましたらご記入ください。

ご協力ありがとうございました。

### 専門・分科コード表

登録用紙には分科コード欄の番号を記入してください。

当てはまるものがない場合は<その他>の番号を選択してください。

専門	農学		農業工学		林学・林産学		畜産学・獣医学		水産学	
専門コード	1		2		3		4		5	
分科コード	植物遺伝育種学	11	農業土木学	21	森林生物学	31	畜産学/	41	水圏生物学	51
	作物学	12	農業機械学	22	森林環境学	32	家畜飼育学		水圏経済学	52
	園芸学	13	農業環境工学	23	森林計画学・経	33	草地学	42	水圏環境学	53
	植物病理/防疫学	14	農村計画学	24	済学		飼料学	43	増養殖・漁業学	54
	蚕糸学	15			森林生産学	34	外科学/内科学	44	水産学一般	55
	応用昆虫学	16			森林水文学/	35	繁殖学	45		
	造園学	17			砂防工学		病理学	46		
					森林利用学/	36	生理学/薬理学	47		
					林業工学		微生物学/	48		
					木材組織・	37	寄生虫学	49		
				物理学		家畜衛生学/疫学				
				木材加工学	38					
				林産化学	39					
	その他	10	その他	20	その他	30	その他	40	その他	50

専門	農芸化学		食品科学・生物工学		農業経済学		地域農学		その他	
専門コード	6		7		8		9		0	
分科コード	土壌学	61	食品化学	71	農業経済学	81	地域農学/	91	自然保護	01
	肥料・植物栄養学	62	食品工学	72	農業経営学	82	農村社会学		遺伝資源学	02
		63	食品機能学	73	農業政策学	83	農業普及科学	92	環境科学	03
	栄養化学	64	酵素工学	74	農業協同組合	84	生活科学	93	バイオマス・自然	04
	微生物学	65	農産物利用学	75	学		地域資源管理学	94	エネルギー利用	
	生物化学	66	生物工学	76	農産物流通学	85	国際農業関係論	95	学	
	遺伝子工学	67	家政学	77			総合農学	96	GIS・リモート	05
	有機化学	68							センシング	
	天然物化学	69								
	分析化学									
	その他	60	その他	70	その他	80	その他	90	その他	00

このコード表は、日本学術会議第 6 部の分類をもとに国際協力の目的に見合うように修正したものです。





平成14年4月1日現在

## 共同利用機器等のリスト

国際農林水産業研究センター

機 器 等	型 式 等	使 用 責 任 者 等		
		研 究 部 等	責 任 者 名	電 話 番 号 ・ E メ ー ル ア ド レ ス
電 子 顕 微 鏡	日本電子 JSM-5600LV	生産環境部	八田 珠郎	0298-38-6634 esca@jircas.affrc.go.jp
高分解能X線光電子分光分析装置	E S C A - 3 0 0	生産環境部	八田 珠郎	0298-38-6634 esca@jircas.affrc.go.jp
作物環境評価検定施設	ビニ - ル張り S 1 階 8 7 0 m ²	熱帯果樹栽培 利用研究室	小川一紀	09808-3-6110 kazunori@jircas.affrc.go.jp

〔 手続き等の問い合わせ先  
総務部会計課（齊藤）  
0298-38-6321  
riyouiti@jircas.affrc.go.jp 〕

## 共同利用機器等使用申込書

平成 年 月 日

独立行政法人  
国際農林水産業研究センター  
使用責任者 殿

機関名  
所 属

(申込者)  
代表者

印

独立行政法人国際農林水産業研究センター共同利用機器等管理要領第 8 条の  
規定により、下記のとおり使用を申し込みます。

記

使用機械・施設名	
使用目的	
使用期間	平成 年 月 日 ~ 平成 年 月 日
その他	

## 共同利用機器等使用承認伺

平成 年 月 日

管理責任者 殿  
( 総務部長又は沖縄支所長 )

使用責任者

印

独立行政法人国際農林水産業研究センター共同利用機器等管理要領第 8 条の規定により、別添使用申込書のとおり申し込みがあったので承認してよろしいか。

上記機械・施設の使用を承認する。

平成 年 月 日

管理責任者

印

担 当 係

## 共同利用機器等使用許可書

平成 年 月 日

機関名  
所 属  
使用者

殿

独立行政法人  
国際農林水産業研究センター  
使用責任者

印

独立行政法人国際農林水産業研究センター共同利用機器等管理要領第 9 条の  
規定により、下記のとおり許可します。

記

使用機械・施設名	
使用目的	
使用期間	平成 年 月 日 ~ 平成 年 月 日
その他	





# 海外出張の手続き。



© 2002 JIRCAS. All rights reserved.

## 1041

1041

1041

1041

1041

1041

1041



[1041](#)



[1041](#)



[1041](#)



f••[f<—•M,É,Í•A,±,±,đfNfŠfbfN,μ,Ä,-,¾,³,¢•B







•@•@•@•@ŠCSO•o•EEV%æñ+~.lŽè+‡

@•••Ů" _Ň•...ŽY•QEBQ†fZf•f•[i,i,h,q,b,"r,j,Ā,Ī•A•ñ,S,O•l,Ī Šů•ŸSOEB††ôA%œ„x•ñ,Q,O,O•l,Ī ZŠů•ŸSOEB††ô„đ•""NŠCSO,É"ñE•,µ,Ā,ē,Ů,•B„»•l•o•EEV%œe,Ī•A,i,h,q,b,"r,fCSŠ•"%ā,Ā•"F,đ•%ē,±,E,•K—v,Ā,•B

,P•D•o•EŠOEW•—P,Ī,ŋ,ž•u•o•EEV%œe+•v,•E•u•Ů"Ů•ñ•Ā•j•v,đ•...—j•Ů,ĪEB•O,P,OŽŽ,Ů,Ā,É•ñ•o,µ•ē•‡,Ī•A•—,•TEŽŽ—j•Ů,Ī•"CSŠ•"%ā,Ā•EEV%œe,Ī"ñ—e,•QEY"ē,±,ē,Ů,•B,½,¾,µ•A•—P,É•s•Ů,"½,ē•ē•‡,É,Ç,Ī•A•"CSŠ•"%ā,Ů,Ī•ñ•o,"x,ē,ē,±,E,ā, ,ē,Ů,.,Ī,Ā•ACEĪ—†•,•¾,‡,ē•B

,Q•D•u•o•EEV%œe+•v•y,Ň•u•Ů"Ů•ñ•Ā•j•v,Ī•ñ•oŠŮEĀ,Ī•ACE"Y,•E,µ,ĀZŸ,Ī,•E," ,ē,Ā,•B

@•i,P•j•Eš—p—CE",Ů,½,Īf•f•U,ĪŽe""%đ•K—v,•E,.,ē•o•É,Ī•ē•‡,Ī•A•o"—\•Ů"Ů,Ī,Q,•CEŽ"Ů"Ā•O,É•EĪ"ñ•o,.,•¾,‡,ē•B

@•i,Q•j•Eš—p—CE",.,æ,Ň•f•f•U,ĪŽe""%đ•K—v,•E,µ,Ī,ē•o•É,Ī•ē•‡,Ī•A•o"—\•Ů"Ů,Ī,P,•CEŽ"Ů"Ā•O,É•EĪ"ñ•o,.,•¾,‡,ē•B

@•i,R•j•¼•@•i"™,Ī•E"Ů,Ī•o•É,É,Ā,Ī•A•o•EEV%œe+"FCEĀ,É•A•Š"•@•ŠŮ,Ī,Ī,•E,đŽš,.,ē•K—v,†, ,ē,Ů,•B„»•Ī,½,B•A•ā•L,Ī•ñ•oŠŮEĀ,æ,ē•A,‡,ē,É,P,O•Ů"Ů•ē•Ā,Ī—|—T,đ,Y,Ā,.,•¾,‡,ē•B

R•D•"CSŠ•"%ā,Ā•o•EEV%œe,+•"F,‡,ē,½•EĀ•A%•L,Ī,•—P"™,đ•EĪ"ñ•o,.,•¾,‡,ē•B

@•i,P•j•SO•"•o•EŽŮ•@•—+|

@•i,Q•j•SO•"•o•É,Ī,½,B,Ī•A•—+•E"É—S•Eš"™,"—Šš,ē

@•i,R•j•Ž•E•"•@•i•Eš—p—CE",.,ē,ē,Īf•f•U,ĪŽe""%đ•K—v,É•ē•‡•j

@•i,S•j•š•SO•@•i%ā•E•VŽ—±•"—+•P•AZš"Ī,ĪŠŮ••"Ů"•x,Ī,Ī,j

@•É,•A"ŠŮ•o•EŽŮ,Ī•A•ā•L,Ī,Ů,•@,É•A•u•EB††E•V%œe+•A•u—š—đ•"•v•y,Ň•u•ŽĀ—v_"Ų,ĪŠf•f•Xf•g•v,đ%œp"Ų,Ā•ñ+~,µ,Ā•EĪ"ñ•o,.,•¾,‡,ē•B,½,¾,µ•A"Ů"•o•EŽŮ,Ī•A"•a"Ų,Ā•E•"•Ā,•B

,S•D•o•EŠOEW•—P,Ī—ĪŽŮ,É,Ī•AZŸ,Ī•ñ,Ā•f•f•@fCf,.,†, ,ē,Ů,•B„»•ē,½,ē,ĪÉ"u,Ā•f•Nšf•b•f•N,.,ē,Ī•A•f•f•@fCf,đf_•E•f"•f•[f•h,Ā,«•Ů,•B,É,"•A•ñ+~CE@—[f•f•@fCf,Ī•AMS-WORD,Ā•ñ+~†,ē,Ā,ē,Ů,•B

@•@•@•Ī,†,v,.,.,.,f•f•@fCf,

@•@•@•E"Y•f•f•@fCf,

@•@•@•@•+~•CE@—[f•f•@fCf,•@•i%œ,B,Ā•ñ+~,.,ē•ē•‡,Ī•A,±,Īf•f•@fCf,đŽQ•Ī,É,µ,Ā,.,•¾,‡,ē•B•j

@•Še•—P,Īf•f•@fCf,Ī•A,k,y,ē•EŽŮ,Ā"•k,‡,ē,Ā"ē,Ā,Īf•f•@fCf,É,É,Ā,Ā,ē,Ů,•BCE",Īf•f•@fCf,É•B,.,½,B,É,Ī•A•f_•E•f"•f•[f•h•EĀ•A„»•Īf•f•@fCf,đf_•f•u•f•Nšf•b•f•N,µ,Ā,.,•¾,‡,ē•B,i,h,q,b,"r,•E,ē,Ůf•f•Hf•f_•[,ŽŮ•"•@•"Ī,É•ñ+~†,ē•A„»•Ī†,ÉŠe•—P,Īf•f•@fCf,•Ů"Ų,‡,ē,Ů,•B

@•@•@

,T•D,i,h,q,b,"r,Ā,Ī•A"•E"É—CE",ĪŽg—pŠg"ā,đ•Ī,Ā,Ā,ē,Ů,•BCE"Y,•E,µ,Ā•f"•C•A"Ů"•+~•f•f•@fCf•f•A•y,N•f•f•B•f•š•f•š,Ů,Ů,ĪZŠŮ"•o•É,É,Ā,ē,Ā,Ī•A"•E"É—CE",Ā,•E•±—p•f•f•U,đŽe""%đ,µ,ĀZĀŽ{,µ,Ů,•B,Ů,½•A•ā•L"ÉSO,Ī•,Ů,Ī•o•É,É,Ā,ē,Ā,ā•A"•Ā"i,Ī•ā"ē,‡,É,ē•EĀ,ē•A•o•EŽŮ,ĪŠŮ—Ī,É,æ,ē•E"É—CE",ĀZĀŽ{,µ,Ů,•BCEĀ—%đ,Ā•EĪ"ñ•o—Ī,đ,Šš,ē,ē,½,µ,Ů,•B



Īf•f•b•f•v•f•f•W,Ů,ā,C,ē





20	H13.12.03	"E-kj/CJ",.E"OEm.E,,.e- *sSA,Reδ-3	*/- @**v	JIRCAS4ZYSA**
21	H13.12.03	"E-kj/C.E,,".ek"(E*+,"%co,1/3.B.1"i"lEm,10é	*/-o@*u"V	JIRCAS4ZYSA**
22	H13.12.03	"E-kj/C*Z,"ys.E,,".s/fTg/E/LJr*1,ksN-@%P.1/3.B,1/3.E@.ISJ"	%@*@S*-Y	"_E@*sE"Q-k" _E@ZJ"/"i
23	H13.12.14	"*,"H—E(ZY,EWTO%A_	ZR%*@E+O	JIRCAS*U*ri*
24	H13.12.21	3" ZqE"/j/BJX"18,δ—p,s/3fg/SJp/m/j/S" s0*rk**@*A,Reδ-3	"*+@*"]	JIRCAS"IZY*in*
25	H14.01.15	fJ"/Oj*Jm.e.E,,".Z0"R*0*co@*_Reδ-3	%*+@*O	JIRCAS...ZY*
26	H14.01.15	"W*...%EZQ"1—LRe—p,Zp"	%ZR@%e*ni	JIRCAS...ZY*
27	H14.02.21	f JCY)1+eHZ*Ç.E'L, s*pk+QY"s-@.ISJ"	-ISO@*P*o	JIRCAS4*Z*E**
28	H14.02.21	[Rf JM]"%*%*"+W*c.A—p.e.s/3q**1,p.s.k%δd	-s*é"Z	JIRCAS4*Z*E**
29	H14.03.19	"*AZY*+0ZLIZZq**13""E@—Ç.E.A.e.A	ce**v	JIRCAS4*Z*E**
30	H14.03.19	*sJA/r/SJ,E,,".sJCPi3"Z:Q.EJ*A**%e_,"E*v+ZC*P.E.JÇ**	*/*_Zj	JIRCAS4*Z*E**



•@•@•@•@•@•@ŠCŠO•o'£,ì,;-ð—š,¿fšf“fN•W

•@•@ŠCŠO•A,Æ,-,ÉŠJ”-“r•ā'n^æ,ÉŠÖ,.,é,±,Æ,Í•A—çŠm”F,ì•î•ñ,“è•è•à,«,μ,Ä,ç,½,è•A“à—e,“•—•,μ,Ä,ç,é•è•ç,à, ,è,Ü,••B^ê,Â,Ì•î•ñE¹,É—Š,é,±,Æ,E,È,-•A,Â,«,é,¾,“•j•”,Ìfz•[f fy•[fW,È,Ç,ÂEäŠm”F,-,¾,³,ç•B

•o'£“ú'ö•î•→,Ì,½,B,Ì•î•ñ

•@•@•→“c<ó••@•@•@•@•@•@•@ŠÖ•¼••Û•ó•`

•@•@•çŠE,ì•,ì“V.C

•@•@“ú—[.É•æ,è“ü,è,Ä,ç,é•q<ó%āŽDfšf“fN•W

•@•@“ú—[•q<ó•i••Û•ü•j•@•@•@•@

•@•@•@•@•@•@•@•@•@•@•@•@•@

•@•@“S“ú<ó•i••Û•ü•j

•@

•@•@fG•[f<Eftf%cf“fX

•@•@fLffzfC•EfpfVftfBfbfN•q<ó

•@•@f|fE•[fVfA•q<ó

•@•@ftfBfšfšf“•q<ó

•@•@f^fC••Û•q<ó

•@•@,o,d,w,i•³•KŠ,^ø•j•q<óE”

•@•@'n<...,ì•à,«•û•@•@•@•@•@•@•@•@“ú—[—•s<E<%ā

•@•@“ú—[fNfEfwfbfj•[fh<%ā

•@•@^x^Ö•E,s^,b•E—•s•Û•E^-i“E<žŽO•H<â•sf%cfxf<fR•[fi•[•j

ŠCŠO“n•q•A—E”•A•,•Ø•ifrfU•j,ÉŠÖ,.,é^è”E“I,È•î•ñ

•@•@ŠO—±•È“n•qŠÖ^A•î•ñ

•@•@~i•éEšfpfXfl•[fgfZf“f^•[

”-“W“r•ā'n^æ,È,Ç,ì••È•î•ñ

•@•@••Û•ç—fŽ<Æ^c,ì••È•î•ñ

•@•@ŠO—±•È,ì^žgšÛ•E—ž—šÛ,ì••È•î•ñ

•@•@Še•,ì•Ý“ú^žgšÛ•EŠÍEö•Çšfšf“fN•W

•@•@ “ú-|fuf<flfC—F•D<‰œï

•@•@“ú-|fCf“fh—F•D<‰œï

•@•@“ú-|fu•|f^f“—F•D<‰œï

•@•@“ú-|fuf<fLfi ftf@^—F•D<‰œï

•@•@“ú’†—F•D<‰œï•i“ŒŽ“s~A•‡‰œï•j

•@•@f^fC.ì•—š“ášw^ê—

•@•@f^fC“Œ-k•”Œ©••L

—\h•ÚŽi•A^ã—Ã•AŒÿ%œu,È,Ç,ÉŠÖ,•,é•î•ñ

•@•@ŠCŠO“n•qŽÖ.ì.½,B.ìŠ’•ø•Ç•i•ñ•iŒú•f^J“-•ÈŒÿ%œu•Š•j

•@•@ŠCŠO“n•qŽÖ.ì.½,B.ìã—Ã•î•ñfT•|frfX

•@•@ŠCŠO—•s,ŒŒE’•N•iWHO_2001•@•F“ú-|Œê-ó•j

# •••Ů<@ŠÖ

1. [CGIAR](#) [~a•\[fy•fW](#) •••Ů”_<ÆCEα<†<|<c|fOf•[fv(Consultative Group on International Agricultural Research)
2. [IRRI](#) [~a•\[fy•fW](#) •••Ů”îCEα<†•Š•@(1960:ftfBfŠšfsf“)
3. [CIMMYT](#) [~a•\[fy•fW](#) •••Ů”Æ,α,à,ë,±,μ•E•→”ž%öü—ÇfZf“f^•[•@(1966:f•fL,fVfR)
4. [CIAT](#) [~a•\[fy•fW](#) •••Ů”M•Ñ”_<ÆfZf“f^•[•@(1968:frf•f“frfA)
5. [ITA](#) [~a•\[fy•fW](#) •••Ů”M•Ñ”_<ÆCEα<†•Š•@(1968:fifCfW,fFfŠfA)
6. [WARDA](#) [~a•\[fy•fW](#) •¼fA,ftfŠfJ”îŠJ”-<|%ö (1971:fr•[fgfWf{fA•[f<)
7. [CIP](#) [~a•\[fy•fW](#) •••ŮfCf,—pCEα<†fZf“f^•[•@(1971:fyf<•D)
8. [ICRISAT](#) [~a•\[fy•fW](#) •••Ů”¼ŠÉ’•‡”M•Ñ”î•”CEα<†•Š•@(1972:fcf“fh)
9. [IPGRI](#) [~a•\[fy•fW](#) •••Ů•A•””â””Ž’CE’CEα<†•Š•@(1974:fcf^fŠfA)
10. [ILRI](#) [~a•\[fy•fW](#) •••Ů’{ŽYCEα<†•Š•@(1974/95:fpfjfA)
11. [IFPRI](#) [~a•\[fy•fW](#) •••Ů•H—ž•••ôCEα<†•Š•@(1974:fA,f•fŠfJ)
12. [ICARDA](#) [~a•\[fy•fW](#) •••ŮŠÉ’•‡’n”_<ÆCEα<†fZf“f^•[•@(1976:fvfŠfA)
13. [ISNAR](#) [~a•\[fy•fW](#) ”_<ÆCEα<†••ŮfT•[frfX•@(1976:fIf%cf“f_)
14. [ICRAF](#) [~a•\[fy•fW](#) •••ŮfAfof•ftfHfÆfXfgfŠ[CEα<†fZf“f^•[•@(1978:fpfjfA)
15. [IWMI](#) [~a•\[fy•fW](#) •••ŮÿöÿðŠÇ—•CEα<†fZf“f^•[ (1983:fx,fŠf%cf“fJ)
16. [ICLARM](#) [~a•\[fy•fW](#) •••Ů•...žYŽ’CE’ŠÇ—•fZf“f^•[•@(1973:f}fCE•[fvfA)
17. [CIFOR](#) [~a•\[fy•fW](#) •••Ů•X—Ñ•E—Ñ<ÆCEα<†fZf“f^•[•@(1993:fcf“fhflfvfA)

•@

•@

•@

ホームへ

•@

•@













# WARDA(•¼fAfJfšfJiŠJ”-«!%ö)

WARDA(•¼fAfJfšfJiŠJ”-«!%ö)  
WARDA(•¼fAfJfšfJiŠJ”-«!%ö)  
WARDA(•¼fAfJfšfJiŠJ”-«!%ö)  
WARDA(•¼fAfJfšfJiŠJ”-«!%ö)  
WARDA(•¼fAfJfšfJiŠJ”-«!%ö)

WARDA(•¼fAfJfšfJiŠJ”-«!%ö)  
WARDA(•¼fAfJfšfJiŠJ”-«!%ö)  
WARDA(•¼fAfJfšfJiŠJ”-«!%ö)  
WARDA(•¼fAfJfšfJiŠJ”-«!%ö)  
WARDA(•¼fAfJfšfJiŠJ”-«!%ö)

WARDA(•¼fAfJfšfJiŠJ”-«!%ö)  
WARDA(•¼fAfJfšfJiŠJ”-«!%ö)  
WARDA(•¼fAfJfšfJiŠJ”-«!%ö)  
WARDA(•¼fAfJfšfJiŠJ”-«!%ö)

WARDA(•¼fAfJfšfJiŠJ”-«!%ö)  
WARDA(•¼fAfJfšfJiŠJ”-«!%ö)  
WARDA(•¼fAfJfšfJiŠJ”-«!%ö)  
WARDA(•¼fAfJfšfJiŠJ”-«!%ö)

WARDA(•¼fAfJfšfJiŠJ”-«!%ö)  
WARDA(•¼fAfJfšfJiŠJ”-«!%ö)

WARDA(•¼fAfJfšfJiŠJ”-«!%ö)  
WARDA(•¼fAfJfšfJiŠJ”-«!%ö)  
WARDA(•¼fAfJfšfJiŠJ”-«!%ö)

WARDA(•¼fAfJfšfJiŠJ”-«!%ö)  
WARDA(•¼fAfJfšfJiŠJ”-«!%ö)  
WARDA(•¼fAfJfšfJiŠJ”-«!%ö)  
WARDA(•¼fAfJfšfJiŠJ”-«!%ö)

WARDA(•¼fAfJfšfJiŠJ”-«!%ö)  
WARDA(•¼fAfJfšfJiŠJ”-«!%ö)  
WARDA(•¼fAfJfšfJiŠJ”-«!%ö)  
WARDA(•¼fAfJfšfJiŠJ”-«!%ö)

WARDA(•¼fAfJfšfJiŠJ”-«!%ö)  
WARDA(•¼fAfJfšfJiŠJ”-«!%ö)  
WARDA(•¼fAfJfšfJiŠJ”-«!%ö)  
WARDA(•¼fAfJfšfJiŠJ”-«!%ö)

WARDA(•¼fAfJfšfJiŠJ”-«!%ö)  
WARDA(•¼fAfJfšfJiŠJ”-«!%ö)  
WARDA(•¼fAfJfšfJiŠJ”-«!%ö)

WARDA(•¼fAfJfšfJiŠJ”-«!%ö)  
WARDA(•¼fAfJfšfJiŠJ”-«!%ö)  
WARDA(•¼fAfJfšfJiŠJ”-«!%ö)





























# ⟨Z•p‘Š’k‘⟨Œû

•‘Ű”_—Ñ•...ŽY⟨ŒŒα†,ÉŠÖ,.,é⟨Z•p‘Š’k‘⟨Œû,đ•Ý,¯,Û,μ,½•B⟨ŒEy,É‘Š’k,μ,Ä,-,¾,³,¢•B

’S“—•FŠé%œ’²•®•”•‘ŰŒα†•L•ñŠ•@Tel.: 0298-38-6708 email:[pubj@ml.affrc.go.jp](mailto:pubj@ml.affrc.go.jp)





# fofX%o^•sžž••\

‡@•-“có•`

‡A%oH“có•`

‡B•r“Ö•,‘-fofX

‡C”_—Ñ’c’n•,,%oñfofX

‡D~H•üfofX

•@  
•@

‡B•@•r“Ö•,‘-fofX

“Á<},Á,-,İŽR•†•@•ã,è•A%o°,è

%o^’À•\

•@

➤•@%oÊŽ÷ŽŽ(Ě±•è•@•Ě•@“Ěž%ow

6:22      8:27      10:42      12:42      14:37      16:22      18:07      19:57

➤•@,Á,-,İfZf“f^•[•Ě•@“Ěž%ow

5:15      5:30      5:45      6:00-20:00(12•šŌš•u)      20:00-21:30•i15•šŌš•u•j

➤•@“Ěž%ow•@•Ě•@’}”gŽR•û-Ê

7:15      9:05      11:05      12:50      14:45      16:35      18:35      20:20

➤•@“Ěž%ow•@•Ě•@,Á,-,İfZf“f^•[

6:00      6:30      7:00      7:30      7:45

8:00-11:00•y,Ñ15:00-17:00 (12•šŌš•u)

11:00-15:00,İŠŌ•i15•šŌš•u•j

17:00-23:00 (10•šŌš•u)

‡C•@”_—Ñ’c’n•,,%oñfofX

’}”gŽ—±•š•İ JIRCAS fR•[fX

’}”gŽ—±•š•@•İ•@•X—Ñ••‡Ě•†•š•@fR•[fX

’}”gŽ—±•š•@•Ě•@JIRCAS

’}”gŽ—±•š•@•Ě•@•X—ÑĚ•

Ž—±•š•“%oÊŽ÷ŽŽ•Ží•cfZ•Ž•@Ě•“JIRCAS

Ž—±•š•”_šĀĚ•“{ŽŽ•“X—ÑĚ•

Ž—±•š      8:30      16:37

Ž—±•š      8:51      16:15

%oÊŽ÷ŽŽ      8:36      16:43

”_šĀĚ•      8:54      16:18

Ží•cfZ      8:37      16:44

{ŽŽ      8:57      16:21

Ž•@Ě•      8:38      16:45

•X—ÑĚ•      9:01      16:25

JIRCAS      8:39      16:46

•@

JIRCAS •@•Ě•@Ž—±•š

•X—ÑĚ•@ •Ě•@Ž—±•š•@

JIRCAS•Ž•@Ě•“Ží•cfZ•“%oÊŽ÷ŽŽ•Ž—±•š

•X—ÑĚ•“{ŽŽ•”_šĀĚ•“Ž—±•š

JIRCAS      8:40      16:47

•X—ÑĚ•      9:02      16:26

Ž•@Ě•      8:41      16:48

{ŽŽ      9:06      16:30

Ží•cfZ      8:42      16:49

”_šĀĚ•      9:09      16:33

%oÊŽ÷ŽŽ      8:43      16:50

Ž—±•š      9:12      16:33

ž—±•š

8:49

16:56

•@

•@

‡D•@~H•üfofX

•@

➤•@ž\•©E•Ě •<v%ow•i,©,Á,±“à,í“ž’...žžšŎ•j

7:56(8:45)

8:55(9:24)

17:20(17:49)

18:04(18:40)

➤•@<v%ow•Ě ž\•©E•i,©,Á,±“à,í“ž’...žžšŎ•j

8:00(8:26)

14:35(15:01)

18:55(19:21)

19:30(19:56)

➤•@ž\•©E•Ě ’}’g’âšw•a%o@•@

15:01

17:18

19:21

19:56

➤•@’}’g’âšw•a%o@•Ě ž\•©E•i,©,Á,±“à,í“ž’...žžšŎ•j

7:35(7:56)

•@17:50(18:04)

•@

•½•~12”N2Ež29“ú•X•V

;-â,ç•‡,í,!•Fwww@jircas.affrc.go.jp

ホームへ



2-1-n, í•E•E-1-n•š, Á, ŠÖ•SSw%o fT•[frfXfZf“f^•[ TEL:0298-52-5666 %oc<ÆŽžŠÖ/8:30`19:00

•@ •-“c<ó•`s, <Á—\—ñ•š, Á, ••B  
 •@ , 2—\—ñ, Í, Pf—ĈŽ‘O, ©, çŽó, -t, -A•æŽÔĈ” , Í•æŽÔ“ú, Ì, R“ú‘O, Ü, Á, É, “<•, ß, -, ¾, ¾, ç•B  
 •@ •-“c<ó•` , ©, çŠe•û—Ê, Ö, Ì•æŽÔĈ” , Í—“ú, “<•, ß, -, ¾, ¾, ç•B

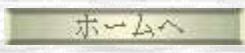
•@%o^•sŽž••\•@

<p>•-“c&lt;ó•`•o”-f•fr•[, Ö                  •E•-“c&lt;ó•` , Á, ÌFž•-fJfEf“f^•[ , É, Áf fPfbfg, ð, “&lt;•, ß, -, ¾, ¾, ç</p> <p>•-“c&lt;ó•`•æ1f^•[f~fif&lt;                  •-“c&lt;ó•`•æ2f^•[f~fif&lt;</p>	<p>“y%oY“ĈĈê, ©, ç</p>	120 ^a	‘â•I•Đ“12,540%o~
	<p>, Á, -, ÎfZf“f^•[ , ©, ç</p>	100 ^a	‘â•I•Đ“12,540%o~
	<p>, Đ, ½, ç, ì, ð, µ, -%ow, ©, ç</p>	80 ^a	‘â•I•Đ“12,150%o~
	<p>•V—~•a’ , ©, ç</p>	50 ^a	‘â•I•Đ“1,300%o~

•@

•æŽÔĈ”””-” , •š, ÆTEL•iŠÖ“Ĉ“S““•j			
“y%oY%ow‘OfJfEf“f^•[	0298-21-5240	fGfXfJ•[fh<•v	0298-74-2475
-{ŽĐ	0298-22-3724	, Đ, ½, ç, ì<•v	0298-30-7811
•...ĈĈ%oc<Æ•š	029-247-5111	, µ, ñ, Æ, ĈCOM	0297-60-6152
’}”g-k%oc<Æ•š	0298-66-0510	•@	•@
’}”g’+%o%oc<Æ•š	0298-36-1145	••—\—ñfZf“f^•[ •iŠw%o fT•[frfXfZf“f^•[•j	0298-52-5666

•@



%^sZz...

%^sZz...

“y%Y|•”“c

“y%Y%w”“CEÉû	,Â,-,Î fZf“f^•[	,Ð,½,¿-ì ,α,μ,-%w	•V—~•’~	•“c<ó•`æ1—<qf^•[f~fif<
				•“c<ó•`æ2—<qf^•[f~fif<

•@

“y%Y%w”-					•“c<ó•`”-				
土浦駅 発	つくば センター 発	ひたち野 うしく駅 発	新利根町 発	成田空港 着	成田空港 発	新利根町 着	ひたち野 うしく駅 着	つくば センター 着	土浦駅 着
6:00	6:20	6:40	7:10	8:00	7:20	8:10	8:40	9:00	9:20
7:00	7:20	7:40	8:10	9:00	9:05	9:55	10:25	10:45	11:05
8:30	8:50	9:10	9:40	10:30	10:35	11:25	11:55	12:15	12:35
10:00	10:20	10:40	11:10	12:00	12:50	13:40	14:10	14:30	14:50
11:35	11:55	12:15	12:45	13:35	14:35	15:25	15:55	16:15	16:35
13:05	13:25	13:45	14:15	15:05	16:15	17:05	17:35	17:55	18:15
14:15	14:35	14:55	15:25	16:15	17:20	18:10	18:40	19:00	19:20
15:30	15:50	16:10	16:40	17:30	18:40	19:30	20:00	20:20	20:40
17:15	17:35	17:55	18:25	19:15	20:00	20:50	21:20	21:40	22:00

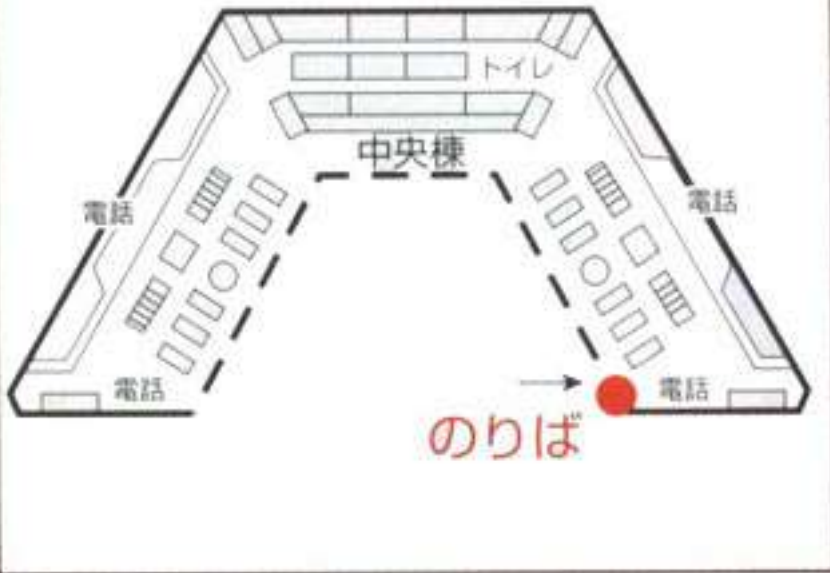
•@

もどる



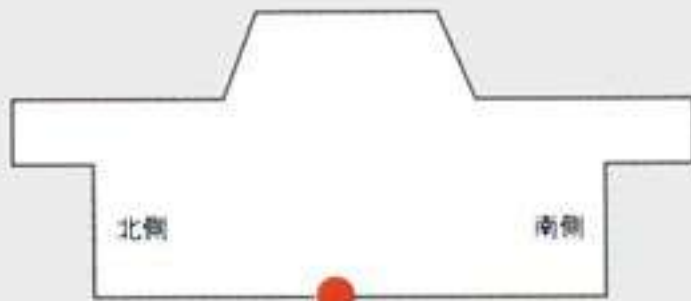
# 成田空港/第1ターミナル

乗車場1階到着ロビー①番のりば



# 成田空港/第2ターミナル

乗車場 1階到着ロビー ⑫番のりば

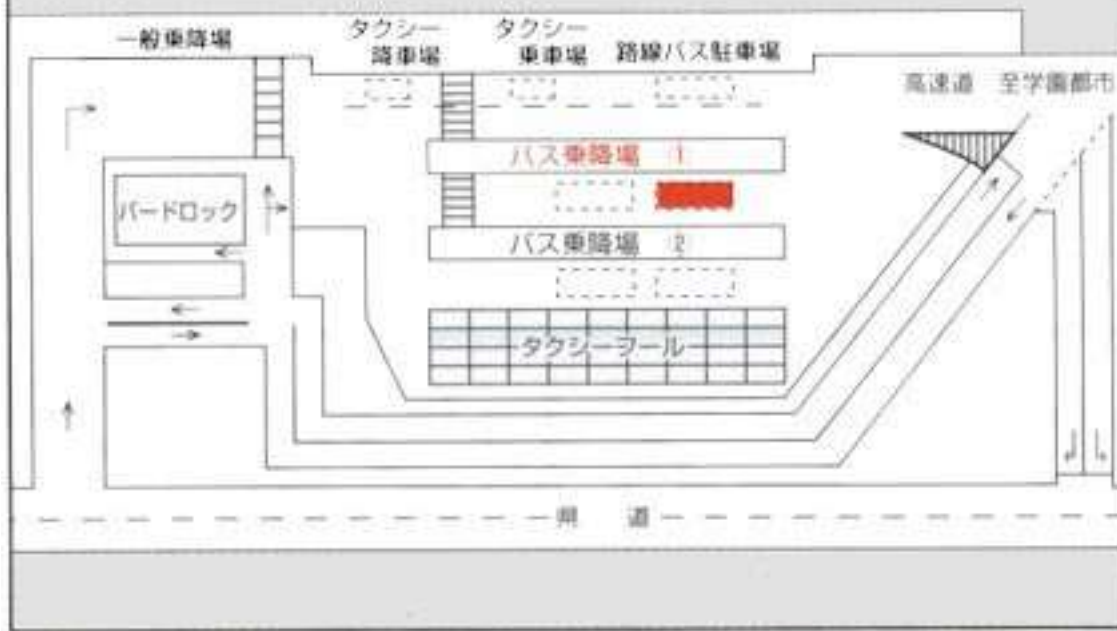


のりば

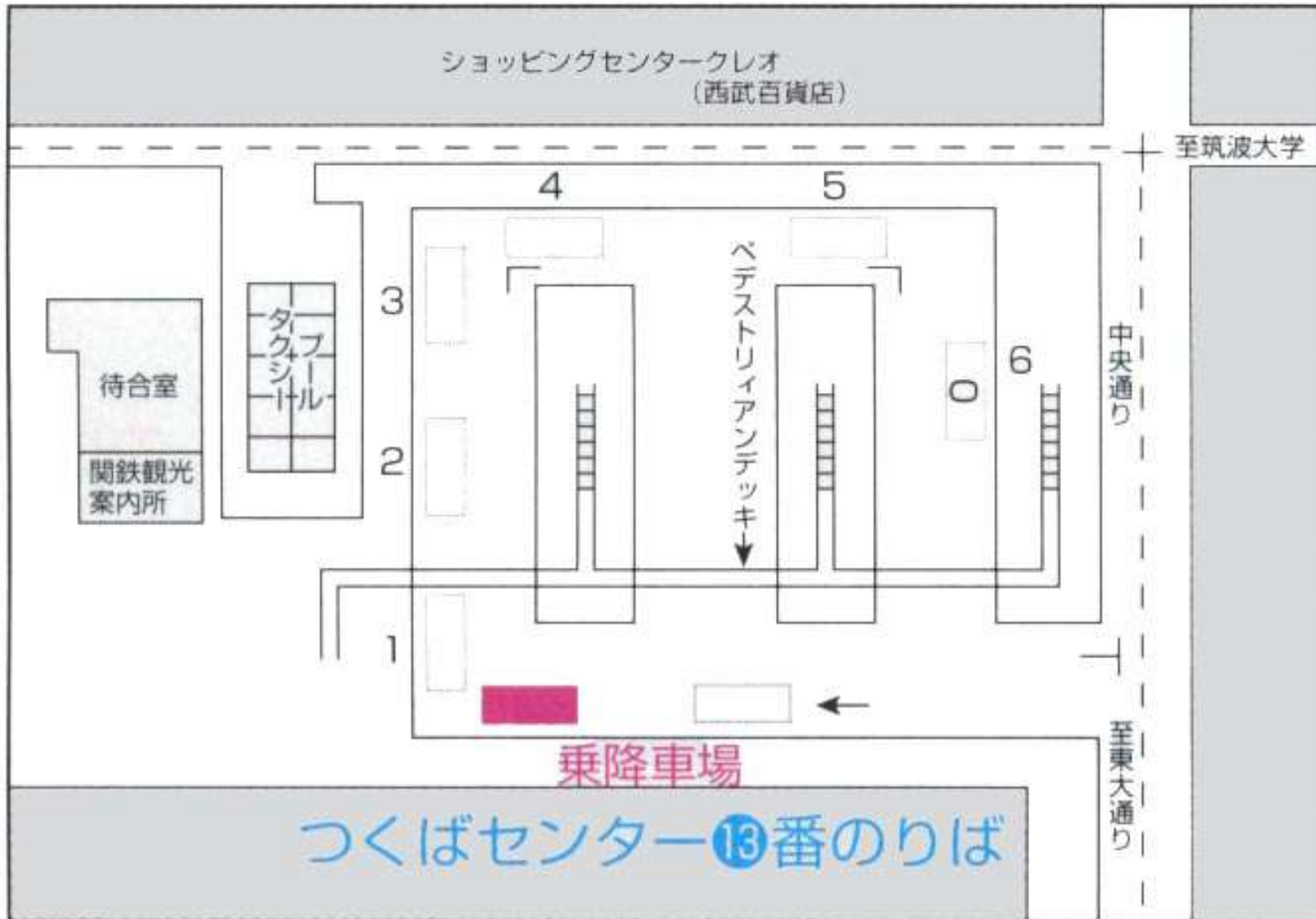
JR京成空港第2ビル駅

# 土浦駅東口

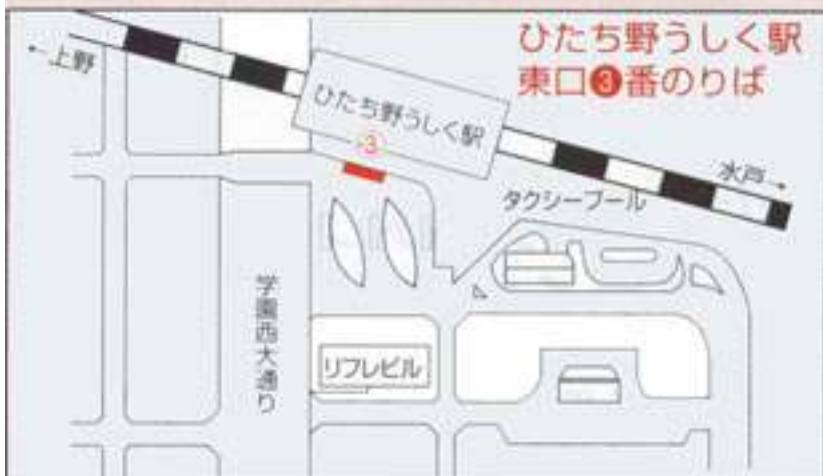
## 土浦駅東口①番のりば



# つくばセンター乗り場略図



# ひたち野うしく駅



# 新 利 根 町

至潮来

ショッピングセンター  
しんとねCOM

至成田空港

至電ヶ崎



‰H“c•üŽž•••\

;-â,ç•‡,í,•æ  
ŠÖ“SŠw‰ fT•[frfXfZf“f^•[  
TEL:0298-52-6666  
‰cc<ÆŽžŠÔ/8:30•`19:00

‰^•@’À

‘â•11,800‰~  
Žq<Ÿ•@900‰~

•ã,è		‰°è	
,Â,-,Î fZf“f^•[”-	‰H“c <ó•`”...	‰H“c <ó•`”-	,Â,-,Î fZf“f^•[’...
5:30	7:10	8:40	10:30
6:20	8:20	9:30	11:20
7:00	9:00	10:35	12:25
8:00	10:00	11:35	13:25
9:30	11:30	13:00	14:50
11:40	13:40	14:20	16:10
13:00	14:40	15:20	17:10
14:00	15:40	16:30	18:20
15:00	16:40	17:55	19:45
16:00	17:40	19:20	20:50
16:40	18:20	20:20	21:40
17:00	19:10	21:20	22:40

•E“ž’...Žž•â,Í•A“~H•ó<µ,É,æ,è’x,è,é•è•‡,à, ,è,Û,••B  
•E’S“ú•i“y•E“ú•j“ú,đŠÛ,Ÿ,Û,••j

•@



# 羽田線時刻表

つくばセンター→  
羽田空港

羽田空港→  
つくばセンター

上り

下り

つくば  
センター発

羽田  
空港着

羽田  
空港発

つくば  
センター着

5:30

7:10

8:40

10:30

6:20

8:20

9:30

11:20

7:00

9:00

10:35

12:25

8:00

10:00

11:35

13:25

9:30

11:30

13:00

14:50

11:40

13:40

14:20

16:10

13:00

14:40

15:20

17:10

14:00

15:40

16:30

18:20

15:00

16:40

17:55

19:45

16:00

17:40

19:20

20:50

16:40

18:20

20:20

21:40

17:40

19:10

21:20

22:40

到着時分は道  
路状況により遅  
れる場合もあり  
ますので、ご了  
承下さい。

全日(土・日祝日を含  
む)

運賃 大人 1,800円

小人 900円

お問い合わせ先

関鉄学園サービスセンター

0298(52)5666



•,‘-f of X • u “A < } , Ä , - , Ī Ž R • † • v • ã , è • i ’ } ” g Ž R • • i ’ Ö Ž © “ @ Ž Ö “ 1 • • “ Ć : ž % ow • j

• i • ã , è • j • : ½ “ ú , ĩ • ã , è , Ì , Ý • ã - i % ow Ć eo — R • @ • @ • ½ • - 1 1 ” N 10 Ć Ž Ī “ ú ž ž • • % ü • 3 • A • X • V “ ú • F 2000.2.29

'S“-f of X % i ž Ď	ŠÖ•@“S	ŠÖ•@“S	J•@R	J•@R	ŠÖ•@“S	ŠÖ•@“S	J•@R	J•@R
'j”g Ž R”-	5:50	7:45	10:00	12:00	14:05	15:50	17:25	19:15
•i—o—k•ð”-	5:55	7:50	10:05	12:05	14:10	15:55	17:30	19:20
-k•”•H:Æ’c’n “üĆÉú”-	6:00	7:57	10:12	12:12	14:17	16:02	17:37	19:27
•,fGfIf<fM•[ Ćo:†•Š”-	6:01	7:58	10:13	12:13	14:18	16:03	17:38	19:28
‘ã•ãžx•š”-	6:03	8:01	10:16	12:16	14:21	16:06	17:41	19:31
“y—ØĆo:†•š”-	6:05	8:04	10:19	12:19	14:24	16:09	17:44	19:34
•“y’n—%o@”-	6:08	8:07	10:22	12:22	14:27	16:12	17:47	19:37
“ĆĆĆö“ãĆo:†•c’n”-	6:13	8:14	10:29	12:29	14:34	16:19	17:54	19:44
Žö“@ŽöĆo:†•š”-	6:16	8:17	10:32	12:32	14:37	16:22	17:57	19:47
•¼•ã,S’š—Ú”-	6:19	8:23	10:38	12:38	14:43	16:28	18:03	19:53
%eÈžž:žžĆe±•è“üĆÉú”-	6:22	8:27	10:42	12:42	14:47	16:32	18:07	19:57
”_—Ñ’c’n’†%o”-	6:26	8:31	10:46	12:46	14:51	16:36	18:11	20:01
’J“c•”%oçÆ•š”-	6:28	8:33	10:48	12:48	14:53	16:38	18:13	20:03
’J“c•””-	6:31	8:37	10:52	12:52	14:57	16:42	18:17	20:07
•ã-i%ow’...	8:00	9:55	12:10	14:10	16:05	17:50	19:25	21:15
“Ć:ž%ow’...	8:20	10:15	12:30	14:30	16:25	18:10	19:45	21:35

•y“ú•j“ú•z•ã,è%o°,è,Æ,àžn”-žž••,Í“- ,¶,Ä,•B•š—vžžšö,Í•ã,è,Ì,Ý120•ã,Ä,•B•i%o°,è,Í•½“ú,Æ“- ,¶,Ä,•j

,Ä,-,Í-k%oçÆ•šž,.,F0298-66-0510

•, ‘-fofX•u“Á<},Ä,-,ĪŽR•†•v%°°,è(“Ĉ<ž%ow••í”ÖŽ©“@ŽÔ“•‘}”gŽR)

•i%°°,èj••½“ú•A•ã,è,Ī,Ý•ã-ì%owĈeo—R•@•½•-11”N10ĈEŽ1“úŽž••%oü•³•A•X•V“ú•F2000.2.29

'S“-fofX%ıŽD	J•@R	J•@R	ŠÖ•@“S	ŠÖ•@“S	J•@R	J•@R	ŠÖ•@“S	ŠÖ•@“S
“Ĉ<ž%ow”-	7:20	9:10	11:10	12:50	14:50	16:40	18:40	20:20
’J“c•”...	8:13	10:03	12:03	13:43	15:43	17:33	19:33	21:13
’J“c•”%oc<Ĉ•Š’...	8:16	10:06	12:06	13:46	15:46	17:36	19:36	21:16
”_—Ń“c’n’†%o’...	8:18	10:08	12:08	13:48	15:48	17:38	19:38	21:18
%cĈŽž:ŽžĈ±•è“üĈĕ’...	8:22	10:12	12:12	13:52	15:52	17:42	19:42	21:22
¼“ãŽl’š—Ú’...	8:25	10:15	12:15•@	13:55•@	15:55	17:45•@	19:45•@	21:25•@
Ž©“@ŽÔĈo<†•Š’...	8:29	10:19•@	12:19•@	13:59•@	15:59•@	17:49•@	19:49•@	21:29•@
“ĈĈĕō“äĈo<†•c’n’...	8:32	10:22•@	12:22•@	14:02•@	16:02•@	17:52•@	19:52•@	21:32•@
•“y’n—%c@’...	8:38	10:28•@	12:28•@	14:08•@	16:08•@	17:58•@	19:58•@	21:38•@
“y—ŲĈo<†•Š’...	8:42	10:32•@	12:32•@	14:12•@	16:12•@	18:02•@	20:02•@	21:42•@
‘ã•ãŽx•Š’...	8:44	10:34•@	12:34•@	14:14•@	16:14•@	18:04•@	20:04•@	21:44•@
•,fGflf<fM•[ Ĉo<†•Š’...	•@8:46	10:36•@	12:36•@	14:16•@	16:16•@	18:06•@	20:06•@	21:46•@
-k•”H<Ĉ’c’n “üĈĕ’...	•@8:48	10:38•@	12:38	14:18•@	16:18•@	18:08•@	20:08•@	21:48•@
•f—o-k•đ’...	•@8:54	10:44•@	12:44	14:24•@	16:24•@	18:14•@	20:14•@	21:54•@
’}”gŽR’...	•@9:00•@	10:50•@	12:50	14:30•@	16:30•@•@	18:20•@	20:20•@	22:00•@

•y“ú•j“ú•Z•ã,è•A%°°,è,Ĉ,ãŽn”-Žž•,Ī“•,Ī,Ä,•B•Š—vžžŠÔ,Īã,è,Ī,Ý120•,Ä,•B•i%°°,è,Ī•½“ú,Ĉ“•,Ī,Ä,•j

„Ä, -, Ī-k%oc<Ĉ•Šž,„F0298-66-0510

### fofX%o^'A

•E•i' }”gŽR••í—□—k•đ•j•““Ě<ž%owšŎ	\1,730
•E•i—k•”•H<Æ'c'n“üĚû•““ĚĚđ“äĚ□†'c'n•j•““Ě<ž%owšŎ	\1,470
•E•iž@“@žŎĚ□†•š•'J“c•”•j•““Ě<ž%owšŎ	\1,250

•@

### %oñ•”•æžŎĚ”

•æ•@•@žŎ•@•@<æ•@•@šŎ	5—ž'Ŏ,è	%oñ•”Ě”,P—ž“—,½,è	š.,^ø—!
•E•i' }”gŽR••í—□—k•đ•j•““Ě<ž%owšŎ	\7,100	\1,420	17.9%
•E•i—k•”•H<Æ'c'n“üĚû•““ĚĚđ“äĚ□†'c'n•j•““Ě<ž%owšŎ	\6,100	\1,220	17.0%
•E•iž@“@žŎĚ□†•š•'J“c•”•j•““Ě<ž%owšŎ	\5,200	\1,040	16.8%

•@ (•½—9”N4Ěž1“ú %o^'À%oü•³)•@ž—ž'ñ<Ÿ•F•,‘¬fofX’}”g—k%cc<Æ•š•@ž,,,0298-66-0510

•X•V“ú•F2000.2.29

,”—â,ç•ž,!•æ•F [www@jircas.affrc.go.jp](http://www@jircas.affrc.go.jp)

•@

•@

# 常磐高速バス「つくば号」時刻表

## Tokyo Sta → Tsukuba Center

平成11年10月1日改正

### 下り(東京駅、八重洲南口発)

6	00	30									
7	00	20	40	50							
8	平	00	10	30	40	50	日	00	10	30	40
9	平	00	10	30	40	50	日	00	10	30	40
10	平	00	10	30	40	50	日	00	10	30	40
11	平	00	10	30	40	50	日	00	10	30	40
12	平	00	10	30	40	50	日	00	10	30	40
13	00	10	30	40							
14	00	10	30	40							
15	00	10	30	40	50						
16	00	10	20	30	40	50					
17	00	10	20	30	40	50					
18	00	10	20	30	40	50					
19	00	10	20	30	40	50					
20	00	10	20	30	40	50					
21	00	10	20	30	40	50					
22	00	10	20	30	40	50					
23	00										

※上・下便、つくば市内でのバス停  
 竹園二丁目、千現一丁目、並木一丁目、並木大橋  
 平印-平日運行    日印-日祝日運行

# 常磐高速バス「つくば号」時刻表

## Tsukuba Center → Tokyo Sta

平成11年10月1日改正

上り(つくばセンター発)						
5	15	30	45			
6	00	12	24	36	48	
7	00	12	24	36	48	
8	平 00	12	24	36	48	日 00 10 20 30 40 50
9	00	10	20	30	40	50
10	00	10	20	30	40	50
11	平 00	12	24	36	48	日 00 10 20 30 40 50
12	00	12	24	36	48	
13	00	12	24	36	48	
14	平 00	10	20	30	40	50 日 00 12 24 36 48
15	平 00	10	20	30	40	50 日 00 12 24 36 48
16	平 00	10	20	30	40	50 日 00 12 24 36 48
17	平 00	10	20	30	40	50 日 00 12 24 36 48
18	00	12	24	36	48	
19	00	12	24	36	48	
20	00	15	30	45		
21	00	15	30			

※平日の上りのみ、上野駅経由。 運賃 大人1,250円  
 平印-平日運行 日印-日祝日運行 小人 630円

••Ů”_—Ñ•...ŽY<ÆCEα<†fZf“f^•[<β•Ó,ìfzfef<

fz•@•@fe•@•@f•@-¼	•š•@•ý•@'n•@•i,â,-,îžs•j•@•@•@	,s•@,d•@,k (0298)
fEfbffBfzfef<fXf•	•ã%oj•ê436-7	36-7123
fzfef<fXf•	Žè‘ã-Ø302	36-4011
^@%•@fzfef<•Ešw%•€‘X	“ñ,ì<{3-24-14	55-0311
šw%•€•÷^äfzfef<	“CE•V^ä8-7	51-3011
frfWflfXfzfef<¼“†	•¬-ì•è35	56-1191
,â,-,îfXfJfCfzfef<	•¬-ì•è283-1	51-0008
fzfef<fOf%of“fh“CE%_	•¬-ì•è—O^ä488-1	56-2211
fzfef<fjf†•[‘é	”~%o 2-1-19	51-4788
’}’g‘æ^êfzfef<	CEá•È,P’s-Ú	52-1112
’}’g‘æ^êfzfef<fGfJfJf<	’l%o 2-,Q0-1	60-7700
fzfef<fjf...[,½,©,Í,μ’l%•€	’l%o 2-10-3	51-2255
ffCfš•[fCf“	•çCE»1-12-4	51-0003
fzfef<fTf“f•[fg,â,-,î	%oÔŽ³1154-1	52-1151
fzfef<“CECEõ	“CECEõ‘ä3-7-7	47-1113
fgfCEf,f“fgfzfef<	“V<v•Ů3-19-9	51-8711
fA•[fof“fzfef<	‘â’]•³3840	77-1444

••Ů”_—Ñ•...ŽY<ÆCEα<†fZf“f^•[<β•Ó,ìf^fNfV•[

f^•@fN•@fV•@•[•@%iŽD-¼	•š•ý’n•i,â,-,îžs•j	TEL(0298)	ftfš•[f_fCf,,f<
’†%•>f^fNfV•[	•ã%oj•ê2573-126	36-0184	0120-390184
,³,Æ,αf^fNfV•[•i-{ŽD•j	’J“c•”2014	38-1288	0120-011288
•V•išw%•€%•c•j	•¬-ì•è177-3	52-6688	0120-016688
“V•if^fNfV•[šw%•€•À-Ø•i%•c•j	‘âšp“²2010-69	51-6500	•@-----

—~p.É., ½.Á.Á	%e!•@—	˘Y•o•E•Ö•p	fRfs•fT•ftrfX
fE ftf@fCEf'fX	•iñfT•ftrfX	SÜ"à"z'u	SO—ZÖ, l•ü, l

•E—~p,É., ½.Á.Á•E•E•E•E"é"É.İ•ü,É.àCEšSJ

- "•%eÁ.,é"~Ñ...ZY•E.É.İ.,éŠ"~"rã",©,ç,İEö+†~İ—vç,É%zç,é,½,B•AŽA.É•A"™•Ñ•E"™•M•Ñ,İ"~EŠÖEW,đ†+S,•E.,,é+)*,İŽ•W•E•@→E"ñ•Y,đ,µ,Á,ç,Ü,•B
- "•~Š•E"š"ÉŠÖ,İ•ü,İ•A"•üSÜ.É•Ü,µfJfEf'f"•f,É.Á•A•uSO—ZÖ—~p•é•v,É•L"ü,µ,Á%e",ç•B

•E %o{•@—

- SÜ"à,İ%e|—,İZ•R,Á,•B
- SÜ"à,É,İ•A%e|—Š+•A%e|—fe|fufç,đ~p"Ö,µ,Á.,à,Ü,•B
- —~p,µ,½*)•Ž'~ç,İ•A,à,•E,İ•é•Š,É•B,µ,Á%e",ç•B~B,•é•Š,•e,©,ç,É,ç•é•ç,İ•A fJfE f'f"•f,É"İ.,Á%e",ç•B

•E •*)•ŠÜ"à,İ"z'u

- •*)•ŠÜ"à,İ"z'u,İ•A,±,ç,đ,ž—,•,¾,ž,ç•B

•E fRfs•fT•ftrfX

- "•~Š•E"š"ÉŠÖ,İ•ü,Á•f(EE,İfRfs•f,•K—v,É•é•ç,İ•A fJfE f'f"•f,É.,~•µ,ø%e",ç•B

•E ˘Y•o•E•Ö•p

(1)˘Y•o

E"™•Y,•E,µ,Á•ASÖ",İ•ü,İ•Y,µ•o,µ,İ,µ,Á,"•é,Ü,İ,ñ•B•*)•ŠÜŠÖ,İŠEYç~İ,İ[s,Á,Á,"•é,Ü,İ,İ•A,ž•A→,•,¾,ž,ç•B  
 ˘Y•o•ü•@,İ•A"Ps•,İ•A•*)•,É•"š,µ,Á.,,éY•o fJfR,É•AZGŽ•EŽ'~ç"™,İY•o•f,É•K—vŽ→,đ•L"ü,µ•A fJfE f'f"•f,İ•uY•o fJfR[ñ•ü,é•v,É•ü,é,Á%e",ç•B,Ü,½*)•Ž'~ç,İfRf'fX•fX%e",É"™,ç•A"è" fJfRf(CEfX•üŽ•đ,•E,Á,Á,"•é,Ü,•B•Y•o fJfR,•"š,é,Á,ç,É,ç"Ps•,É,Á,ç,Á,İ,Ž•",Á.,,•AZGŽ•EŽ'~ç,•E"™~İ,ÉY•o•f,Á,İ%ež,đ,Šè,ç,µ,Ü,•B

˘Y•oŠüŠÖ

"Ps•"	,Pf~EŽ"É"à
Ž'~ç•EŽGŽ•+•V'...•e.,•j	,P•TŠÖ"É"à
•V'...ŽGŽ•	~ÉŠÖ"Y•o,İ,Ÿ

(2)Ö•p

fJfE f'f"•f+•i•ö,µ,ş,Ö,~Ö,µ%e",ç•B

•E fE ftf@fCEf'fXfT•ftrfX

- •*)•,ÉŠÖ,•é•s~¾,ÉZ••,ž,é•é•ç,É,İ•A,"~CEy,É,"½.,,É%e",ç•B•K—v,ÉŽ'~ç,ã•ñ,đ,Ÿ,Á,"•é,"Žè",ç,đ,µ,Ü,•B

•EŠÖ—~ŽÖ,İ•ü,İ•E•E

- •K,•A fJfE f'f"•f,Ö,~µ,µ•o,İ•ä•A,ž~p%e",ç,ç,ç•A,žç~İ,đ,Šè,ç,µ,Ü,•B,Ü,½•A,•,İ•Ü,É•A—~p•Ö"™,đ,Ž'~ç,İ,İñŽ%e",ç•B,ç,ç,µ,~žç~İ,đ,Šè,ç,µ,Ü,•B

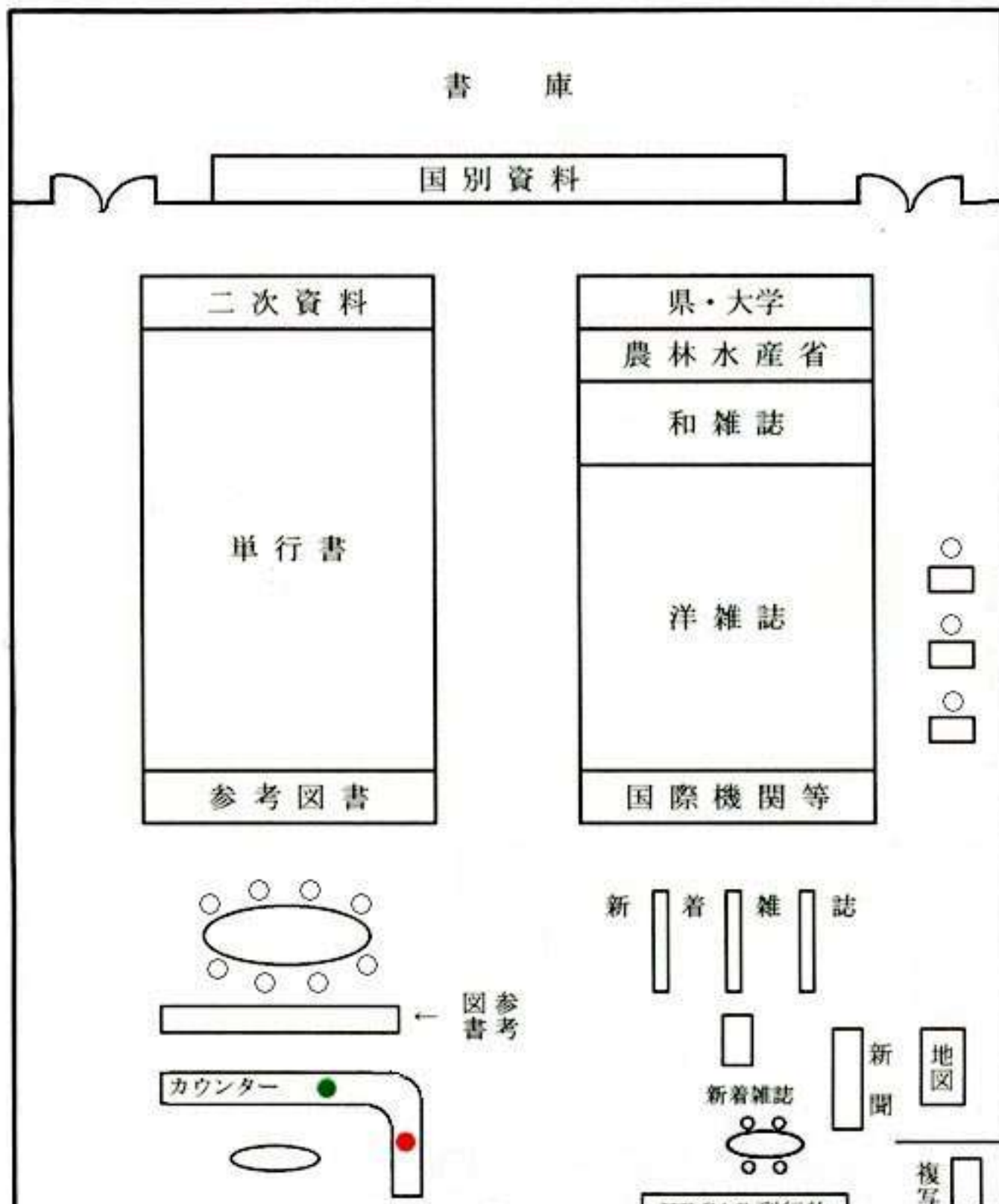
# •î•ñfT•[frfX,Ö,İfŠf“fN

•X•V“ú•F2001.9.6

- 
- [” —Ñ•...ŽY•ÈŽŽĀ±Āα†<@ŠÖ••‡-Ú~^\(Web-Opac\)](#)
  - [” Šw•î•ñŽ‘Ā!fVfXfef](#)
  - [•“à•åŠw•}•ŠÛ“™OPAC•i” —Ñ•...ŽYĀα†•î•ñfZf“f^•\[•j](#)
  - [•“à•}•ŠÛWebfy•\[fW‘S•\[Āÿ•õfVfXfef](#)  
[•i” —Ñ•...ŽYĀα†•î•ñfZf“f^•\[•j](#)
  - [Šw•p•î•ñfZf“f^•\[••‡-Ú~^ff•\[f^fx•\[fX•@NACISIS Webcat](#)
  - [••Û~Āα†•Š Library and Documentation Service](#)
  - [••Û<|—ÍŽ-<Ā‘c•}•ŠÛ•Š‘ Āÿ•õ](#)
  - [•‘—§•%oi•}•ŠÛ](#)
  - [The British Library Online Public Access Catalogue](#)
  - [Welcome to the National Agricultural Library's \(NAL\)](#)
  - [” <Ā•î•ñ•\[Ā£ff•\[f^fx•\[fX•i” <Ā•î•ñ—~—pĀα†%oi•j](#)
  - [” <Ā•HŠwĀnŽGŽ•Āÿ•õfT•\[frfX](#)
  - [%o Ā|Šw%oi•\[Ā£ff•\[f^fx•\[fXĀÿ•õ](#)
-



# 図書館の配置図



● : 外来者利用簿

● : 返 却



入口

もどる



•@•}•ŠÛ,Ì,²^Ä“à

---

^Ê'u

ŠÛ“à,Ì'z'u

•}•ŠÛ,ÌŠT—v

---

•@

ホームへ

目次へ

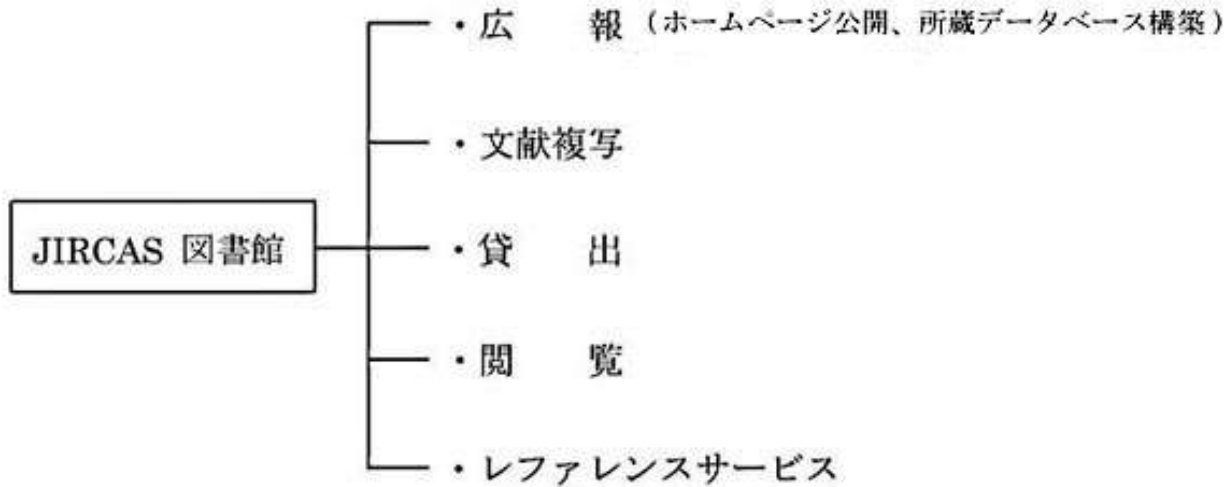
•@

# •‘•Ū’_—Ñ•...ŽY<ÆCEα<†fZf“f^•[•]•‘ŠÛ,ÌŠT—v

## [•]•‘ŠÛ,Í•c]

- ‘%oÁ,.,é”_—Ñ•...ŽY<Æ,É,Í,.,éŠJ”-“r•ã•,©,ç,ÌCEα<††—Í—v•,É%ož,!,é,½,β•A•‘Ū’_—Ñ•...ŽY<ÆCEα<†fZf“f^•[,Í•A1993”N10CEŽ,É•Ý—§,³,ê,Û,μ,½•B
- Žã,É•A”M‘Ñ•E^Ý”M‘Ñ,Ì”_<ÆŠÖCEW,ð†•S,Æ,.,é•]•,ÌŽû•W•E•@—•E’ñ<ÿ,ð,μ,Ä,ç,Û,•B

## [,“,μ,²,Æ]



## [‘••’]•@•@

•@	~a•	—m•	•‡ CEv
’P•@•s•@•‘	7,475	10,538	18,013

’€ŽŸš•s•‘	4,306	6,936	11,242
-----------	-------	-------	--------

’PÊ•F•û•i•½•¬10”N3ĈŽ31“úĈ»•Ý•j



,æ,ǻ,±,»

# ••Ū”_—Ñ•...ŽY<ÆŒǻ<†fZf“f^•[•]•ŠÛ,Ö

Japan International Research Center for Agricultural Sciences Library



•@

•§305-8686

•@ ũi•éŒ§,Â,-,ÎŽs‘â,í,µ 1-2

TEL: 0298-38-6340

•@ [ref@ml.affrc.go.jp](mailto:ref@ml.affrc.go.jp)



[•\]•ŠÛ,ì,²^Ä“à](#)



[•\]•ŠÛ}—~—pfKfCfh](#)

ホームへ

••Ū”_—Ñ•...ŽY<ÆŒǻ<†fZf“f^•[fz•[f fy•[fW,Ö

# •}•ŠŮ—~—pfKfCfh

1. —~—p,É, ,½,Á,Ä

2. ŠJŠŮŽžŠŌ•E<xŠŮ“ú

3. %o{——•Efrfs•[fT•[frfX

4. ‘Ý•o•E•Ō<p

5. fŒftf@fŒf“fXfT•[frfX

1. —~—p,É, ,½,Á,Ä•E•E•E•E^ê”Ê,Ì•û,É,àŒöŠJ

○ “Á,ÉŠJ”-“rã•,â”M’Ñ•E^Ÿ”M’Ñ’n^æ,Ì”_<Æ,É<»-j,Ì, ,é•û•B

•Ÿ”ñ,²—^ŠŮ,ð•I

○ “üŠŮ,É•Ů,µ,Ä,Í•AfJfEf“f^•[É,Ä•A•uŠŌ—^ŽŌ—~—p•ë•v,ÉL“ü,µ,Ä%o^o,³,ç•B

[•Ä•%o,É-B,é](#)

## 2. ŠJŠŮŽžŠŌ•E<xŠŮ“ú

[ŠJŠŮŽžŠŌ]

ŒŽ—j“ú•`<à—j“ú

9:00•`17:00

[<x ŠŮ “ú]

“y•A“ú—j“ú•A•j•E•Ō“ú•A”N—”NŽn

•@

[•Ä•%o,É-B,é](#)

## 3. %o{——•Efrfs•[fT•[frfX

[%o{——]

○ ŠŮ“à,ì%o{——,ÍŽ©—R,Á,•B

○ ŠŮ“à,É,Í•A%o{——Š÷•A%o{——fe•[fuf<,ð—p^Ó,µ,Ä, ,è,Û,•B

○ —~—p,µ,½•}•Ž—ç,Í•A,à,Æ,Ì•ê•Š,É-B,µ,Ä%o^o,³,ç•B

○ -ß,•ê•Š,^a,^a,©,ç,È,ç•ê•‡,Í•AfJfEf“f^•[É“Í, -,Ä%o^o,³,ç•B

[ŠŮ“à”z’u]

○ •}•ŠŮ“à,Ì”z’u,Í•A,±,ç,ð,²——,-,³/₄,³,ç•B

[frfs•[fT•[frfX]

○ •[ŒŒ,Ìfrfs•[^a•K—v,È•ê•‡,Í•AfJfEf“f^•[É,“\,µ•o%o^o,³,ç•B

[•Ä•%o,É-B,é](#)

## 4. ‘Ý•o•E•Ō<p

(1) ‘Ý•o

○ Œ‘Ÿ,Æ,µ,Ä•AŠŌ•”,Ì•û,Ì‘Ý,µ•o,µ,Í,µ,Ä,“è,Û,¹,ñ•B

○ •}•ŠŮ“—Žm,Ì‘ŠŒÉŸ<|—Í,Í•s,Á,Ä,“è,Û,•Ì,Ä•A,²A—•,-,³/₄,³,ç•B

## [‘Ý•oŠúŠÖ]

- ’P•s•‘ •F 1f–ĀŽ`È“à
- Ž‘—¿•AŽGŽ• •F 1•TŠÔ`È“à
- •V ’... ŽG Ž• •F –éŠÔ`Ý•o•i—,“ú•Ô<p•j

## [‘Ý•oŽè‘±,«]

- ’P•s•,Í•A•}•,É‘•”õ,µ,Ä, ,é‘Ý•ofJ•[fh,É•AŽGŽ••EŽ‘—¿“™,Í  
‘Ý•o•[,É•K—vŽ–• ,ð<L“ü,µ•AfJfEf“f^•[,Ì•u‘Ý•ofJ•[fh•[“ü,ê•v  
,É“ü,ê,Ä%o°,³,ç•B

## (,Q) •Ô&lt;p

- fJfEf“f^•[•i•Ô<p•j,Ö,“•Ô,µ%o°,³,ç•B

[•Ä%o,É–B,é](#)**5. fĀftf@fĀf“fXfT•[frfX**

## [²,×,à,Ì,â•A,í,©,ç,È,ç,±,Æ,Í•c]

- ,“<CĀy,É,“½,„,È%o°,³,ç•B
- •K—v,ÈŽ‘—¿,â•î•ñ,ð,Ý,Â,¯,é,“Žè““ ,ç,ð,µ,Û,•B

[•Ä%o,É–B,é](#)



# ^ê”Ě<£“^“üZDCEö•••E—ŽŽDCEöŽ!

”Ô•†	Ži•Ě	”2”BCE•-¼	Ĉef•Ú“ú	—ŽŽD“ú
1	“ ^a —Ě•EĈš•ÝfRf“fTf<f^f“fg	“‡>×ŠĀ<<<Z•pŠJ”-“•V’z•HŽ-•ÝĈv<Ā-±	02/03/08	02/03/29
		<a href="#">“üZDCEö••</a> <a href="#">—ŽŽDŽÒ“™ĈöŽ!</a>		
2	Ĉš•Ý•HŽ-	“‡>×ŠĀ<<<Z•pŠJ”-“•Ĉš’z•HŽ-	02/07/17	02/08/20
		<a href="#">“üZDCEö••</a> <a href="#">—ŽŽDŽÒ“™ĈöŽ!</a>		
3	Ĉš•Ý•HŽ-	“‡>×ŠĀ<<<Z•pŠJ”-“•“d•C•Ý”ö•HŽ-	02/07/24	02/08/27
		<a href="#">“üZDCEö••</a> <a href="#">—ŽŽDŽÒ“™ĈöŽ!</a>		
4	Ĉš•Ý•HŽ-	“‡>×ŠĀ<<<Z•pŠJ”-“•@ŠB•Ý”ö•HŽ-	02/08/07	02/09/10
		<a href="#">“üZDCEö••</a> <a href="#">—ŽŽDŽÒ“™ĈöŽ!</a>		
5	•••i•w“ü	“”-û•i%o”¼Šú•j	02/09/09	02/09/30
		<a href="#">“üZDCEö••</a> <a href="#">—ŽŽDŽÒ“™ĈöŽ!</a>		
6	•••i•w“ü	%o»Šw”-ĈöĈÿ•o•’u	02/09/26	---
		<a href="#">“üZDCEö••</a> <a href="#">—ŽŽDŽÒ“™ĈöŽ!</a>		

“Ā—§•s•--@•l••Ū”_—Ñ•...ŽY<ĀĈĈα<†fZf“f^•[

# 入札公告

次のとおり一般競争入札に付します。

平成14年3月8日

独立行政法人国際農林水産業研究センター  
理事長 井上 隆 弘

## 1. 競争に付す事項

- (1) 業務名 島嶼環境技術開発棟新築工事設計業務
- (2) 業務内容 詳細は入札説明書による。
- (3) 履行期限 平成14年6月28日
- (4) 入札方法

入札金額は、業務の総価とする。

なお、落札決定に当たっては、入札書に記載された金額に当該金額の100分の5に相当する金額を加算した金額（当該金額に1円未満の端数があるときは、その端数金額を切り捨てた金額とする。）をもって落札価格とするので、入札者は、消費税及び地方消費税に係る課税事業者であるか免税事業者であるかを問わず、見積もった契約金額の105分の100に相当する金額を記載した入札書を提出しなければならない。

## 2. 競争参加資格

- (1) 独立行政法人国際農林水産業研究センター契約事務取扱規程（以下の項において「契約規程」という。）第8条及び第9条の規定に該当しない者であること。なお、未青年者、被保佐人又は被補助人であって、契約締結のために必要な同意を得ている者は、同条中、特別の事由がある場合に該当する。
- (2) 平成13・14年度農林水産本省又は農林水産技術会議事務局筑波事務所の競争契約の参加資格における「測量・建設コンサルタント等契約」の業種区分のうち「建築士事務所」において、「A」の等級に格付けされている者であること。
- (3) 平成4年度以降に研究施設等の設計業務において実績を有する者であること。

## 3. 入札手続等

- (1) 担当部局

〒305 - 8686 茨城県つくば市大わし1 - 1

独立行政法人国際農林水産業研究センター  
総務部会計課用度係

電話 0298-38-6236、FAX0298-38-6328

- (2) 入札説明書の交付期間、場所及び交付方法

本公告の日から、平成14年3月20日（水）までの土曜日及び日曜日を除く毎日午前9時から午後5時まで、上記(1)の交付場所にて交付する。

なお、次に掲げる場所においても交付する。

〒907 - 0002 沖縄県石垣市字真栄里川良原1091-1

独立行政法人国際農林水産業研究センター沖縄支所  
庶務課会計係

電話 09808-2-2306、FAX09808-2-0614

(3) 入札説明会の日時及び場所

平成14年3月22日(金) 11:00

茨城県つくば市大わし1-1

独立行政法人国際農林水産業研究センター  
国際研究本館 1階 総務作業室

(4) 入札・開札の日時及び場所

平成14年3月29日(金) 11:00

茨城県つくば市大わし1-1

独立行政法人国際農林水産業研究センター  
国際研究本館 1階 総務作業室

#### 4. その他

(1) 契約手続において使用する言語及び通貨 日本語及び日本国通貨

(2) 入札保証金及び契約保証金 免除

(3) 入札者に要求される事項

この一般競争に参加を希望する者は、本入札説明書2.(2)の競争参加資格を有することを証明する「資格確認通知書」又は「資格審査決定通知書」の写し、2.(3)の実績が確認できる書類(例えば契約書及び仕様書の写し等)を添付し、入札説明会までに3.(1)の場所まで提出しなければならない。

開札日の前日までの間において、担当者から上記の書類等に関し説明を求められた場合には、それに応じなければならない。

(4) 入札の無効

本公告に示した競争参加資格のない者、入札条件に違反した者又は入札者に求められる義務を履行しなかった者の提出した入札書は無効とする。

(5) 契約書の作成の要否 要

(6) 落札者の決定方法

本公告に示した競争参加資格等の要件を全て満たし、当該入札者の入札価格が契約規程第29条の規定に基づいて作成された予定価格の制限の範囲内であり、かつ、最低価格をもって有効な入札を行った者を落札者とする。

(7) その他 詳細は入札説明書による。

# 落札者等の公示

次のとおり落札者について公示します。

平成14年4月1日

独立行政法人  
国際農林水産業研究センター  
理事長 井上隆弘  
(茨城県つくば市大わし1-1)

1. 件名 島嶼環境技術開発棟新築工事設計業務
2. 契約方式 一般競争
3. 落札決定日 平成14年3月29日
4. 落札者の氏名 株式会社安井建築設計事務所東京事務所  
及び住所 常務取締役  
東京事務所長 北村正信  
東京都千代田区平河町一丁目3番14号
5. 落札価格 27,300,000円
6. 入札公告日 平成14年3月8日
7. 落札方式 最低価格

# 入札公告（建設工事）

次のとおり一般競争入札に付します。

平成14年 7月17日

独立行政法人国際農林水産業研究センター  
理事長 井上 隆弘

## 1. 工事概要等

- (1) 工事名 島嶼環境技術開発棟建築工事
- (2) 工事場所 沖縄県石垣市字真栄里川良原 1091-1  
国際農林水産業研究センター沖縄支所構内
- (3) 工事内容 島嶼環境技術開発棟建築工事  
鉄筋コンクリート造 2階建 延べ面積 778.56㎡  
屋内ライシメーター 1式  
屋外ライシメーター 1式  
当該工事は、「建設工事に係る資材の再資源化等に関する法律」に基づく分別解体等及び特定建設資材廃棄物の再資源化等の実施が義務づけられた工事である。
- (4) 工期 平成15年3月10日まで 約8か月

## 2. 競争参加資格

次に掲げる条件を全て満たしている者であること。

- (1) 独立行政法人国際農林水産業研究センター契約事務取扱規程（以下「契約規程」という）第8条の規定に該当しない者であること。なお、未成年者、被保佐人又は被補助人であつて、契約締結のために必要な同意を得ている者は、同条中、特別の理由がある場合に該当する。
- (2) 契約規程第9条の規定に該当しない者であること。
- (3) 平成13・14年度農林水産本省又は農林水産技術会議事務局筑波事務所の競争契約の参加資格における「建設工事契約」の業種区分のうち、「建築一式工事」において、「A」の等級に格付けされている者であること（会社更生法（昭和27年法律第172号）に基づき更生手続開始の申立てがされている者及び民事再生法（平成11年法律第225号）に基づき再生手続開始の申立てがされている者について手続開始の決定後、農林水産本省又は農林水産技術会議事務局筑波事務所が別に定める手続開始に基づく一般競争参加資格の再確認を受けていること。）
- (4) 会社更生法に基づき更生手続開始の申立てをしている者及び民事再生法に基づき再生手続開始の申立てをされている者（上記（3）の再確認を受けた者を除く。）でないこと。
- (5) 平成4年度以降に、元請けとして完成・引渡し完了した鉄筋コンクリート造2階建以上で延べ面積1,000㎡以上の試験研究施設を施工した実績を有すること（共同企業体の構成員としての実績は、出資率が20%以上の場合のものに限る。）
- (6) 次に掲げる基準を満たす主任技術者又は監理技術者を当該工事に専任できること。
  - 1) 1級建築施工管理技士又はこれと同等以上の資格を有する者であること。
  - 2) 平成4年度以降に、上記（5）に掲げる工事を施工した経験を有する者であること。
  - 3) 監理技術者にあつては、監理技術者資格者証を有する者であること。
- (7) 農林水産本省営繕工事請負契約指名停止等措置要領」に基づく指名停止を受けている期間中でないこと。

- (8) 上記 1 に示した工事に係る設計業務等の受託者又は当該受託者と資本若しくは人事面において一定の関連がある建設業者でないこと。

### 3. 入札手続等

#### (1) 担当部局

〒 305 - 8686 茨城県つくば市大わし1 - 1  
独立行政法人国際農林水産業研究センター 総務部会計課用度係  
TEL 0298-38-6326

#### (2) 入札説明書の交付期間、場所及び方法

本公告日から平成 14 年 7 月 31 日 (水) までの土曜日、日曜日及び休日を除く毎日午前 9 時から午後 4 時まで上記 (1) において交付する。

#### (3) 競争参加資格確認申請書 (以下「申請書」という。) 及び競争参加資格確認資料 (以下「資料」という。) の提出方法、場所及び方法

平成 14 年 7 月 18 日 (木) から平成 14 年 7 月 29 日 (月) までの土曜日、日曜日及び休日を除く毎日午前 9 時から午後 4 時まで上記 (1) に持参するか、又は郵送により提出すること。

#### (4) 入札及び開札の日時、場所並びに方法

平成 14 年 8 月 20 日 (火) 午前 11 時 00 分 国際農林水産業研究センター国際研究本館 1 階 総務作業室に持参すること。

### 4. その他

#### (1) 契約の手続において使用する言語及び通貨

日本語及び日本国通貨に限る。

#### (2) 入札保証金及び契約保証金

1) 入札保証金 免除

2) 契約保証金 履行保証保険契約の締結又は公共工事履行保証証券による保証を付することにより、契約保証金を免除する。

#### (3) 入札の無効

本公告に示した競争参加資格のない者のした入札、申請書又は資料に虚偽の記載を行った者のした入札及び入札に関する条件に違反した入札は無効とする。

#### (4) 落札者の決定方法

契約規程第 29 条の規定に基づいて作成された予定価格の範囲内で、最低の価格をもって有効な入札を行った入札者を落札者とする。ただし、落札者となるべき者の入札価格によっては、その者により当該契約の内容に適合した履行がなされない恐れがあると認められるとき、又はその者と契約を締結することが公正な取引の秩序を乱すこととなる恐れが著しく不適当であると認められるときは、予定価格の制限の範囲内の価格をもって入札した他の者のうち最低の価格をもって入札した者を落札者とする可能性がある。

#### (5) 契約書作成の要否

要

#### (6) 一般競争参加資格を有していない者の参加

上記 2 (3) に掲げる一般競争参加資格を有していない者も上記 3 (3) により申請書及び資料を提出することができるが、競争に参加するためには、開札の時に、当該資格の認定を受け、かつ、競争参加資格の確認を受けていなければならない。

#### (7) その他

詳細は入札説明書による。

## 落札者等の公示

次のとおり落札者について公示します。

平成14年8月28日

独立行政法人  
国際農林水産業研究センター  
理事長 井上 隆 弘  
(茨城県つくば市大わし1-1)

1. 件 名 島嶼環境技術開発棟建築工事
2. 契約方式 一般競争
3. 落札決定日 平成14年8月20日
4. 落札者の氏名 佐藤工業株式会社  
及び住所 管財人 梶谷 剛  
  
東京都中央区日本橋本町四丁目12番20号  
(登記上の本店 富山市桜木町1番11号)
5. 落札価格 343,350,000円
6. 入札公告日 平成14年7月17日
7. 落札方式 最低価格

# 入札公告（建設工事）

次のとおり一般競争入札に付します。

平成14年 7月24日

独立行政法人国際農林水産業研究センター  
理事長 井上 隆弘

## 1. 工事概要等

- (1) 工事名 島嶼環境技術開発棟電気設備工事
- (2) 工事場所 沖縄県石垣市字真栄里川良原 1091-1  
国際農林水産業研究センター沖縄支所構内
- (3) 工事内容 以下建物等の電気設備工事一式  
島嶼環境技術開発棟 鉄筋コンクリート造 2階建 延べ面積 778.56㎡  
屋内ライシメーター 1式  
屋外ライシメーター 1式  
当該工事は、「建設工事に係る資材の再資源化等に関する法律」に基づく分別解体等及び特定建設資材廃棄物の再資源化等の実施が義務づけられた工事である。
- (4) 工期 平成15年3月10日まで 約7か月

## 2. 競争参加資格

次に掲げる条件を全て満たしている者であること。

- (1) 独立行政法人国際農林水産業研究センター契約事務取扱規程（以下「契約規程」という）第8条の規定に該当しない者であること。なお、未成年者、被保佐人又は被補助人であつて、契約締結のために必要な同意を得ている者は、同条中、特別の理由がある場合に該当する。
- (2) 契約規程第9条の規定に該当しない者であること。
- (3) 平成13・14年度農林水産本省又は農林水産技術会議事務局筑波事務所の競争契約の参加資格における「建設工事契約」の業種区分のうち、「電気工事」において、「A」の等級に格付けされている者であること（会社更生法（昭和27年法律第172号）に基づき更生手続開始の申立てがされている者及び民事再生法（平成11年法律第225号）に基づき再生手続開始の申立てがされている者について手続開始の決定後、農林水産本省又は農林水産技術会議事務局筑波事務所が別に定める手続開始に基づく一般競争参加資格の再確認を受けていること。）
- (4) 会社更生法に基づき更生手続開始の申立てをしている者及び民事再生法に基づき再生手続開始の申立てをされている者（上記（3）の再確認を受けた者を除く。）でないこと。
- (5) 平成4年度以降に、元請けとして完成・引渡し完了した鉄筋コンクリート造2階建以上で延べ面積1,000㎡以上の試験研究施設における電気設備工事を施工した実績を有すること（共同企業体の構成員としての実績は、出資率が20%以上の場合のものに限る。）
- (6) 次に掲げる基準を満たす主任技術者又は監理技術者を当該工事に専任できること。
  - 1) 1級電気工事施工管理技士又はこれと同等以上の資格を有する者であること。
  - 2) 平成4年度以降に、上記（5）に掲げる工事を施工した経験を有する者であること。
  - 3) 監理技術者にあつては、監理技術者資格者証を有する者であること。
- (7) 「農林水産本省営繕工事請負契約指名停止等措置要領」に基づく指名停止を受けている期間中でないこと。



- (8) 上記 1 に示した工事に係る設計業務等の受託者又は当該受託者と資本若しくは人事面において一定の関連がある建設業者でないこと。

### 3.入札手続等

#### (1)担当部局

〒 305 - 8686 茨城県つくば市大わし1 - 1

独立行政法人国際農林水産業研究センター総務部会計課用度係

TEL 0298-38-6326

#### (2) 入札説明書の交付期間、場所及び方法

本公告日から平成 14 年 8 月 7 日 (水)までの土曜日、日曜日及び休日を除く毎日午前 9時から午後 4時まで上記 (1)において交付する。

#### (3) 競争参加資格確認申請書 (以下「申請書」という。)及び競争参加資格確認資料 (以下「資料」という。)の提出方法、場所及び方法

平成 14 年 7 月 25 日 (木)から平成 14 年 8 月 5 日 (月)までの土曜日、日曜日及び休日を除く毎日午前 9時から午後 4時まで上記 (1)に持参するか、又は郵送により提出すること。

#### (4) 入札及び開札の日時、場所並びに方法

平成 14 年 8 月 27 日 (火) 午前 11時 00分 国際農林水産業研究センター国際研究本館 1階総務作業室に持参すること。

### 4.そ の 他

#### (1)契約の手続において使用する言語及び通貨

日本語及び日本国通貨に限る。

#### (2)入札保証金及び契約保証金

1)入札保証金 免除

2)契約保証金 履行保証保険契約の締結又は公共工事履行保証証券による保証を付することにより、契約保証金を免除する。

#### (3)入札の無効

本公告に示した競争参加資格のない者のした入札、申請書又は資料に虚偽の記載を行った者のした入札及び入札に関する条件に違反した入札は無効とする。

#### (4)落札者の決定方法

契約規程第29条の規定に基づいて作成された予定価格の範囲内で、最低の価格をもって有効な入札を行った入札者を落札者とする。ただし、落札者となるべき者の入札価格によっては、その者により当該契約の内容に適合した履行がなされない恐れがあると認められるとき、又はその者と契約を締結することが公正な取引の秩序を乱すこととなる恐れが著しく不適当であると認められるときは、予定価格の制限の範囲内の価格をもって入札した他の者のうち最低の価格をもって入札した者を落札者とすることがある。

#### (5)契約書作成の要否

要

#### (6)一般競争参加資格を有していない者の参加

上記 2 (3)に掲げる一般競争参加資格を有していない者も上記 3 (3)により申請書及び資料を提出することができるが、競争に参加するためには、開札の時に、当該資格の認定を受け、かつ、競争参加資格の確認を受けていなければならない。

#### (7)その他

詳細は入札説明書による。

## 落札者等の公示

次のとおり落札者について公示します。

平成14年9月3日

独立行政法人  
国際農林水産業研究センター  
理事長 井上隆弘  
(茨城県つくば市大わし1-1)

1. 件名 島嶼環境技術開発棟電気設備工事
2. 契約方式 随意契約
3. 落札決定日 平成14年8月27日
4. 落札者の氏名 株式会社東電通  
及び住所 取締役社長 島津佳夫  
東京都港区東新橋二丁目12番7号
5. 落札価格 117,600,000円
6. 入札公告日 平成14年7月24日
7. 落札方式 一般競争入札不調に伴う最低価格入札者との  
随意契約

# 入札公告（建設工事）

次のとおり一般競争入札に付します。

平成14年 8月 7日

独立行政法人国際農林水産業研究センター  
理事長 井上 隆弘

## 1. 工事概要等

- (1) 工事名 島嶼環境技術開発棟機械設備工事
- (2) 工事場所 沖縄県石垣市字真栄里川良原 1091-1  
国際農林水産業研究センター沖縄支所構内
- (3) 工事内容 以下建物等の空気調和設備及び給排水 衛生設備工事一式  
島嶼環境技術開発棟 鉄筋コンクリート造 2階建 延べ面積 778.56㎡  
屋内ライシメーター 1式  
屋外ライシメーター 1式  
当該工事は、「建設工事に係る資材の再資源化等に関する法律」に基づく分別解体等及び特定建設資材廃棄物の再資源化等の実施が義務づけられた工事である。
- (4) 工期 平成15年3月10日まで 約7か月

## 2. 競争参加資格

次に掲げる条件を全て満たしている者であること。

- (1) 独立行政法人国際農林水産業研究センター契約事務取扱規程（以下「契約規程」という）第8条の規定に該当しない者であること。なお、未成年者、被保佐人又は被補助人であつて、契約締結のために必要な同意を得ている者は、同条中、特別の理由がある場合に該当する。
- (2) 契約規程第9条の規定に該当しない者であること。
- (3) 平成13・14年度農林水産本省又は農林水産技術会議事務局筑波事務所の競争契約の参加資格における「建設工事契約」の業種区分のうち、「管工事」において、「A」の等級に格付けされている者であること（会社更生法（昭和27年法律第172号）に基づき更生手続開始の申立てがされている者及び民事再生法（平成11年法律第225号）に基づき再生手続開始の申立てがされている者について手続開始の決定後、農林水産本省又は農林水産技術会議事務局筑波事務所が別に定める手続開始に基づく一般競争参加資格の再確認を受けていること。）
- (4) 会社更生法に基づき更生手続開始の申立てをしている者及び民事再生法に基づき再生手続開始の申立てをされている者（上記（3）の再確認を受けた者を除く。）でないこと。
- (5) 平成4年度以降に、元請けとして完成・引渡し完了した鉄筋コンクリート造2階建以上で延べ面積1,000㎡以上の試験研究施設における空気調和設備及び給排水 衛生設備工事を施工した実績を有すること（共同企業体の構成員としての実績は、出資率が20%以上の場合のものに限る。）
- (6) 次に掲げる基準を満たす主任技術者又は監理技術者を当該工事に専任できること。
  - 1) 1級管工事施工管理技士又はこれと同等以上の資格を有する者であること。
  - 2) 平成4年度以降に、上記（5）に掲げる工事を施工した経験を有する者であること。
  - 3) 監理技術者にあつては、監理技術者資格者証を有する者であること。
- (7) 「農林水産本省営繕工事請負契約指名停止等措置要領」に基づく指名停止を受けている期間中でないこと。

- (8) 上記 1 に示した工事に係る設計業務等の受託者又は当該受託者と資本若しくは人事面において一定の関連がある建設業者でないこと。

### 3.入札手続等

#### (1)担当部局

〒 305 - 8686 茨城県つくば市大わし1 - 1  
独立行政法人国際農林水産業研究センター総務部会計課用度係  
TEL 0298-38-6326

#### (2) 入札説明書の交付期間、場所及び方法

本公告日から平成 14 年 8 月 21 日 (水) までの土曜日、日曜日及び休日を除く毎日午前 9 時から午後 4 時まで上記 (1) において交付する。

#### (3) 競争参加資格確認申請書 (以下「申請書」という。) 及び競争参加資格確認資料 (以下「資料」という。) の提出方法、場所及び方法

平成 14 年 8 月 8 日 (木) から平成 14 年 8 月 19 日 (月) までの土曜日、日曜日及び休日を除く毎日午前 9 時から午後 4 時まで上記 (1) に持参するか、又は郵送により提出すること。

#### (4) 入札及び開札の日時、場所並びに方法

平成 14 年 9 月 10 日 (火) 午前 11 時 00 分 国際農林水産業研究センター国際研究本館 1 階  
総務作業室に持参すること。

### 4.その他

#### (1) 契約の手続において使用する言語及び通貨

日本語及び日本国通貨に限る。

#### (2) 入札保証金及び契約保証金

1) 入札保証金 免除

2) 契約保証金 履行保証保険契約の締結又は公共工事履行保証証券による保証を付することにより、契約保証金を免除する。

#### (3) 入札の無効

本公告に示した競争参加資格のない者のした入札、申請書又は資料に虚偽の記載を行った者のした入札及び入札に関する条件に違反した入札は無効とする。

#### (4) 落札者の決定方法

契約規程第 29 条の規定に基づいて作成された予定価格の範囲内で、最低の価格をもって有効な入札を行った入札者を落札者とする。ただし、落札者となるべき者の入札価格によっては、その者により当該契約の内容に適合した履行がなされない恐れがあると認められるとき、又はその者と契約を締結することが公正な取引の秩序を乱すこととなる恐れが著しく不適当であると認められるときは、予定価格の制限の範囲内の価格をもって入札した他の者のうち最低の価格をもって入札した者を落札者とする可能性がある。

#### (5) 契約書作成の要否

要

#### (6) 一般競争参加資格を有していない者の参加

上記 2 (3) に掲げる一般競争参加資格を有していない者も上記 3 (3) により申請書及び資料を提出することができるが、競争に参加するためには、開札の時に、当該資格の認定を受け、かつ、競争参加資格の確認を受けていなければならない。

#### (7) その他

詳細は入札説明書による。

## 落札者等の公示

次のとおり落札者について公示します。

平成14年9月18日

独立行政法人  
国際農林水産業研究センター  
理事長 井上 隆 弘  
(茨城県つくば市大わし1-1)

1. 件 名 島嶼環境技術開発棟機械設備工事
2. 契約方式 随意契約
3. 落札決定日 平成14年9月10日
4. 落札者の氏名 株式会社朝日工業社  
及び住所 代表取締役 高 須 康 有  
東京都港区浜松町1丁目25番7号
5. 落札価格 304,500,000円
6. 入札公告日 平成14年8月7日
7. 落札方式 一般競争入札不調に伴う最低価格入札者との  
随意契約

# 入 札 公 告

次のとおり一般競争入札に付します。

平成14年 9 月 6 日

独立行政法人国際農林水産業研究センター  
理 事 長 井 上 隆 弘

## 1 調達内容

- ( 1 ) 燃 料 灯油 J I S 1号
- ( 2 ) 予定数量 下半期 160KL
- ( 3 ) 納入期間 平成14年10月 1 日～平成15年 3 月31日
- ( 4 ) 納入場所
  - 〒305-8686 茨城県つくば市大わし1 - 1
  - 独立行政法人国際農林水産業研究センター 隔離温室
  - ” ” 育苗温室
  - ” ” 熱帯作物棟
  - ” ” 海外生物学実験棟
- ( 5 ) 納入方法 独立行政法人国際農林水産業研究センターが指定した日時に、指定した数量を石油元売業者が給油口に封印したタンクローリー車等で納品すること。  
その他詳細は別紙仕様書による
- ( 6 ) 入札方法 上記1(1)の物品1L当たりの単価を記入すること。また、落札決定に当たっては、入札書に記載された金額に当該金額の5パーセントに相当する額を加算した金額(当該金額に1円未満の端数があるときは、その端数金額を切り捨てるものとする。)をもって落札価格とするので、入札者は、消費税に係る課税事業者であるか免税事業者であるかを問わず、見積った契約金額の105分の100に相当する金額を入札書に記載すること。

## 2 競争参加資格

- ( 1 ) 平成13・14・15年度の一般競争(指名競争)参加資格(全省庁統一資格)の「燃料類」において「B」、「C」又は「D」の等級に格付けされている者であること。

- ( 2 ) 1 ( 1 ) の物品を独立行政法人国際農林水産業研究センターが指定する日時、場所に確実に納品できる者であること。

### 3 入札書の提出場所等

- ( 1 ) 入札説明書の交付場所及び問い合わせ先  
〒305-8686 茨城県つくば市大わし1 - 1  
独立行政法人 国際農林水産業研究センター  
総務部会計課用度係  
TEL.0298-38-6326 FAX.0298-38-6328

- ( 2 ) 入札説明書の交付方法  
本公告の日より3 ( 1 ) の交付場所にて随時無料交付する。

- ( 3 ) 入札日時及び場所  
平成14年9月30日(月) 11:00 ~  
国際研究本館 1F 総務作業室

### 4 その他

- ( 1 ) 契約手続きにおいて使用する言語及び通貨  
日本語及び日本国通貨に限る。
- ( 2 ) 入札者に求められている義務  
この一般競争に参加を希望するものは、封印した入札書を入札日時に入札場所まで持参しなければならない。
- ( 3 ) 入札保証金及び契約保証金  
免除
- ( 4 ) 入札の無効  
本公告に示した競争参加資格のない者がした入札及び入札に関する条件に違反した入札。
- ( 5 ) 契約書作成の要否  
要
- ( 6 ) 落札者の決定方法  
独立行政法人国際農林水産業研究センター契約事務取扱規程第29条の規定に基づいて作成された予定価格の制限の範囲内で、かつ、最低価格をもって有効な入札を行った者を落札者とする。
- ( 7 ) 支払条件  
灯油の代金は、毎月1回支払う。供給者は灯油納入の翌月に前月納入した数量に契約単価を乗じて得た額を請求するものとする。
- ( 8 ) 入札説明会  
本入札に係る入札説明会は行わない。

## 落札者等の公示

次のとおり落札者について公示します。

平成14年10月1日

独立行政法人  
国際農林水産業研究センター  
理事長 井上隆弘  
(茨城県つくば市大わし1-1)

1. 件名 灯油(下半期)単価契約
2. 契約方式 一般競争
3. 落札決定日 平成14年9月30日
4. 落札者の氏名 株式会社稲葉燃料  
及び住所 代表取締役 稲葉 茂  
茨城県結城郡石下町大字若宮戸字井戸田664番地
5. 落札価格 33.3375円/L
6. 入札公告日 平成14年9月6日
7. 落札方式 最低価格



# 入札公告

次のとおり一般競争入札に付します。

平成14年9月26日

独立行政法人国際農林水産業研究センター  
理事長 井上隆弘

## 1 調達内容

- (1) 購入件名及び数量 化学発光検出装置 1台
- (2) 購入件名の規格等 米国アルファイノテック社製  
イメージアナライザー FluorChem IS-8800-5SU  
詳細は仕様書による
- (3) 納入期限 平成14年11月29日
- (4) 納入場所 独立行政法人国際農林水産業研究センター  
海外生物学実験棟
- (5) 入札方法 落札決定に当たっては、入札書に記載された金額に当該金額の5%に相当する額を加算した金額(当該金額に1円未満の端数があるときは、その端数金額を切り捨てるものとする。)をもって落札価格とするので、入札者は、消費税及び地方消費税に係る課税事業者であるか免税事業者であるかを問わず、見積った契約金額の105分の100に相当する金額を入札書に記載すること。

## 2 競争参加資格

- (1) 平成13・14・15年度の一般競争(指名競争)参加資格(全省庁統一資格)における「物品販売」の業種区分「精密機器類」において「A」、「B」又は「C」の等級に格付けされている者であること。
- (2) 当該装置を確実に納品できる代理店等であり、販売物品に係る迅速なアフターサービス・メンテナンスの体制が整備されていることを証明した者であること。

### 3 入札書の提出場所等

- ( 1 ) 入札説明書の交付場所及び問い合わせ先  
〒305-8686 茨城県つくば市大わし1 - 1  
独立行政法人 国際農林水産業研究センター  
総務部会計課用度係  
TEL.0298-38-6326 FAX.0298-38-6328
- ( 2 ) 入札説明書の交付方法  
本公告の日より3 ( 1 ) の交付場所にて随時無料交付する。
- ( 3 ) 入札及び開札の日時及び場所  
平成14年10月18日(金) 11:00 ~  
国際研究本館 1F 総務作業室

### 4 その他

- ( 1 ) 契約手続きにおいて使用する言語及び通貨  
日本語及び日本国通貨に限る。
- ( 2 ) 入札者に求められている義務  
この一般競争に参加を希望するものは、封印した入札書を入札日時に入札場所まで持参しなければならない。
- ( 3 ) 入札保証金及び契約保証金  
免除
- ( 4 ) 入札の無効  
本公告に示した競争参加資格のない者がした入札及び入札に関する条件に違反した入札。
- ( 5 ) 契約書作成の要否  
要
- ( 6 ) 落札者の決定方法  
独立行政法人国際農林水産業研究センター契約事務取扱規程第29条の規定に基づいて作成された予定価格の制限の範囲内で、かつ、最低価格をもって有効な入札を行った者を落札者とする。
- ( 7 ) その他  
詳細は入札説明書による。

CEα<†•E^õ(ŽáŽè^ç~CE^”CŠú•tCEα<†^õ)•â•W—v—Ī

•@“Æ—§•s—@•l••Ů”_—Ñ•...ŽY<ÆCEα<†fZf“f^•[ ,Á,Í•A•W<LCEα<†•E^õ,Ī•â•W,ð•s,Á,Ä,“;è,Û,•B  
 ”CŠú•tCEα<†^õ,Ī•Ī—p,Í•ACEα<†Š^“@,Ī^è‘w,Ī•,•i•y,Ñ”_—Ñ•...ŽY•â—i,É,“; ,é—D•G,ÉŽáŽèCEα  
 <†ŽŮ,Ī^ç•~•,ð•},éŠĪ“_•,©,çŽÁŽ{ ,•,é,à,Ī,Á•A•j%oñ,Ī•Ī—p—\`èf|fXfg•A•â•W•ðCE•A‘I•lŽŽCE±  
 —v—Ī,Í%o<L,Ī’É,è,Á,•B

<L

- 1    Ī—p—\`è,ĪCEα<†•”                    ‘{ŽY••’n•”  
      CEα<†<Æ—±“à—e                        ‘ĪŠ£•«Ž”—ĪŽ‘CE¹,ð—~—p,μ,½“û—p<Ž”—{<Z•p,ĪŠJ”-  
      CEα<†—ĪæfL•[f••[fh                    %ooÆ’{(•)•%oh—{‘ãŽÓ•AŽ”—Ī•]•%oi•AŽ”—{•W••AŽ”—{ŠÇ—••A—”_  
      ”C—pŠúŠŮ                                    •½•~14”N10CEŽ1“ú,©,ç•½•~19”N9CEŽ30“ú,Û,Á(5”N  
      [ŠŮ—,•,é•l•P](#)
  
- 2    %oç•â•ðCE•                                ‡@”ŽŽm%oŮ‘ö•C—ĪŽŮ—”,Í,±,è,Æ“~“TM,ĪŽ‘Ši,ð—L,•,éŽŮ,Á•ACE‘¥,Æ,μ,Ä35•Ī—ç—ž,ĪŽŮ•B  
      ‡AŽŽCE±CEα<†•E^õ,Æ,μ,Ä“Á•É,È‘mŽ~A’\—Ī—”,Í<Z•p,ð—L,•,éŽŮ
  
- 3    ‘ñ•o•‘—P                                    ‡@—š—ð•‘iŽs”Ī,Ī,` ,S”Á—pŽ†,ÉŽè•‘,« ,μ•AŽĚ•^,ð“Y•t,•,é,±,Æ•j  
      ‡ACEĀ•l’2•‘(•ÉŽ†,Ī—ĪŽ®•qPDF•r,É•],Á,Ä<L•Ú,Ī,±,Æ;•j  
      ‡BCEα<†<Æ•Ñ•i•ÉŽ†,Ī—ĪŽ®,É•],Á,Ä<L•Ú,Ī,±,Æ;•j  
      ‡CŽdŽ—,É‘Ī,•,é•ø%ooi,` ,S”Á,P—‡•B•Ž®Ž©—R•j  
      ‡D•Ô•M—p—t•‘i•‘—PŽó—•‘Ě‘m—p•A^¶—¼<L•Ú,Ī,±,Æ•j,Û,½,Ī E-mail fAfhfCEfX
  
- 4    •‘—P’ñ•o•æ•@                                •§,R,O,T•l,W,U,W,U  
      •@•@•@~i•éCE§,Á,-,ĪŽs‘â,í,μ,P•l,P  
      •@•@•@“Æ—§•s—@•l•@••Ů”_—Ñ•...ŽY<ÆCEα<†fZf“f^•[  
      •@•@•@Šé%oæ’2•®•”•@  
      •@•@•@~iCEû —¾“;̣
  
- 5    %oç•â’÷•Ø                                    •½•~•,P,S”N,XCEŽ,P,O“ú•i%oĪ•j•@•i’÷•Ø“úCEμŽç•E“—“ú•Á^ó—LCEø•j
  
- 6    ‘I•l•Ī—pŽŽCE±                                ‡@•‘—P•R•,•@•½•~•,P,R”N,XCEŽ’†•{  
      ‡A—Ě•ÚŽŽCE±•@•½•~•,P,R”N,XCEŽ’†•{
  
- 7    •Ī—pŽŽŠú                                    •½•~•,P,S”N,P,OCEŽ,P“ú•t(—\`è)
  
- 8    —â,ç•‡,í,¹•æ                                —iCEû —¾“;̣  
      •@•@•@Tel•F 0298-38-6302 •@•@•@E-mail•F [nog@jircas.affrc.go.jp](mailto:nog@jircas.affrc.go.jp)

## 希望する人材（畜産草地部）

### 1. 予定される活動

近い将来では、現在進行中のJIRCASの天水農業プロジェクトでの「耐乾性飼料資源を利用した乳用牛飼養技術の開発」の中で、家畜の生産性、飼料の栄養評価、家畜の栄養代謝、飼養管理、酪農生産などの長期在外研究を推進。

将来的には家畜生産グループの中核的役割を果たし、中国、アフリカ等の小雨量地域での家畜飼養、家畜の排出するメタン等の低減化による温暖化防止等の研究を担う。

### 2. 必須な、あるいは好ましい経験、資質

#### 必須

- 牛栄養学関連の分野での博士課程レベルの教育を受けていること。
- 牛の代謝機能、飼料評価、ガス測定、飼養標準についての研究活動。
- 日本語に堪能であること。
- 英語の読み書き及び会話ができる。
- 現在所属している組織から JIRCAS への異動に同意を得られること。

#### 好ましい

- 乳牛のみならず、肉牛や在来反芻家畜の生理的特異性を解明しうる素養。
- 技術普及研究の経験。
- 飼料作物学関連の研究活動。
- スペイン語、フランス語、ドイツ語等の主要言語の経験。
- 海外での勉学、研究の経験。
- 外国人パートナーとの連携研究に積極的であること。
- チームワークでの活動に熱心である。
- 開発途上国の農業・環境問題への関心。

## 応募者個人調書

履 歴 書				
ふりがな 氏 名		男・女	本籍地 又は国籍	東京都
生年月日 (年齢)	19 年 月 日生 ( 歳)		自 宅 住 所 電話/Fax	〒305-0044 茨城県つくば市 123 0298 - -
所属機関名 部 門 名 機 関 住 所  電話/Fax E-mail	〒			写 真
担当(関与)の 分野				
学 歴				
年 月	事 項			
19 年.4	大学 学部 学科入学			
19 年.3	同上 卒業			
19 年.4	東京工業大学理学部化学科大学院博士課程入学			
19 年.3	同上 修了			
19 年.3	博士( 学 )学位授与( 大学 )			
職 歴				
年 月	事 項			
19 年.4	農林水産省 食品総合研究所 食品工学部 資源利用工学研究室 研究員			
19 年.4	農林水産省 食品総合研究所 食品理化学部 蛋白質研究室 研究員			
19 年.4	農林水産省 食品総合研究所 食品理化学部 蛋白質研究室 主任研究官			
19 年.4				
19 年.4				
19 年.4				
19 年.4				
2000年.4				
2001年.4				
2002年.4	現在に至る			

学会及び社会における活動等	
年 月	事 項
19 年.1	茨城大学農学部助手(食品工学、19 年 3月まで)
19 年.4	筑波大学農林工学系助手(食品素材開発工学、19 年 3月まで)
賞 罰	
年 月	事 項
19 年.4	学会研究奨励賞( に関する研究)
19 年.5	賞(研究功績者、 の研究)
資 格	
年 月	事 項
19 年.4	英検 級取得
19 年.5	TOEIC 点
19 年.6	TOEFL 点
所 属 学 会	
19 年--	日本油化学会
上記の通り相違ありません。	
2002年 月 日	<u>Signature</u> _____ または 氏 名 印

研 究 業 績

2002 年 月 日現在  
氏名：

(学術論文：審査有)  
2002

Myllymäki, O., Eerikäinen, T., Suortti, T., Forssell, P., Linko, P. and Poutanen, K.,

Depolymerization of barley starch during extrusion in water-glycerol mixtures. Lebensmittel-Wissenschaft & Technologie (submitted)

Jääskeläinen, S., Wu, X.-Y., Linko, S., Wang, Y., Linko, Y.-Y., Teleman, O. and Linko, P.,

Production, characterization and molecular modelling of lipases for esterification. Annals of the New York Academy of Sciences (in press).

2001

Karowski, M., Venelampi, O., Linko, P. and Mattila-Sandholm, T.,

A staining procedure for viability assesment of starter culture cells. Food Biotechnology 6 (2001) 21-29.

Siimes, T., Holmberg, A., Pokkinen, M. and Linko, P.,

Flexible computer-aided design, monitoring and data management system for biocatalyst production. Bioprocess Engineering 4 (2001) 141-146.

Siimes, T. and Linko, P.,

Real-time fuzzy knowledge-based control of baker's yeast production. Biotechnology and Bioengineering 3 (2001) 135-143.

2000

1999

(学会等プロシーディング)

2002

2001

Eerikäinen, T. and Linko, P.,

Neural network based food extrusion cooker control. In Proceedings, EANN'95, Engineering Applications of Artificial neural Networks (A. B. Bulsari and S. Kallio, eds), 21.-23. August, 2001, Finnish Artificial Intelligence Society, Espoo, Finland, pp. 473-476.

2000

1999

(学会等アブストラクト)

2002

Linko, S., Haapala, R., Parkkinen, E., Suominen, P. and Linko, P.,

Immobilized biocatalyst system for cellulase and xylanase production. Abstracts, XIII Enzyme Engineering Conference, 15.-20. July, 2002, San Diego, CA.

2001

2000

1999

(Books)

2002

2001

2000

1999

(Patents)

Lämsä, M., Linko, Y. -Y., Linko, P. and Uosukainen, E.,

An enzymatic process for preparing a synthetic ester from a vegetable oil. Patent SF 95 395/1995 (1995).

(Other Artcles)

2002

Aarts, R. J., Suviranta, A., Rauman-Aalto, P. and Linko, P.,

An expert system in enzyme production control. Food Biotechnology 4 (2002) 301-315.

2001

2000

1999



代表委員による総合評価所見(平成13年度)

代表委員： 稲垣 春郎

年度計画の達成状況に関する総合所見

(1) 業務運営の効率化に関する目標を達成するためにとるべき措置について

法人化の初年目にあつて、所内のおよび対外的な各種規定・協約等必要な体制が整備され、機関運営が順調に進められたことは高く評価される。さらに研究者のインセンティブを高め、JIRCASの国際性が発揮されるような効率的な機関運営に努められたい。

(2) 試験及び研究並びに調査について

国内外における広範・多岐にわたる試験研究が活発に実施され、大部分の課題で計画が達成されたことは高く評価される。一方、海外における一部の共同研究で見られた予期せぬ事態や人事配置の困難性等による研究の遅れについては、その問題点を明らかにし、計画変更も含めた臨機な対応が望まれる。また、発展途上国との共同研究の課題選定に当たっては、これら諸国への研究支援がJIRCASの役割であり、共同研究の基本理念であるとの認識に立って、課題の重点化に努める必要がある。

(3) 専門研究分野を活かした社会貢献について

JIRCASは持てる能力を最大限に活用して、国際シンポジウム、研修、講習等、多様な形での社会的・国際的貢献を果たしている。地域共同研究の理念や手法を明らかにしつつ、さらに国際貢献を進めていくためには、移転すべき研究成果・技術のニーズ把握を的確かつタイムリーに行うことの出来る研究マネジメントが重要である。

(4) 成果の公表、普及の促進について

研究成果等の公表は十分に行われている。公表形態については、JIRCASとしての性格付け・位置付けを明らかにし、機関誌およびメディアの多様化と共に権威付けを図ることが望まれる。研究成果等情報の伝達に当たっては、海外志向を強化し、JIRCASのみならず国内他機関の成果も積極的に取り上げてゆくことが重要である。

(5) その他農林水産省令で定める業務運営に関する事項について

諸規定・規則等がよく整備され、適正に業務運営されている。

(6) 全体を通して

限られた人的・経済的資源の中で、JIRCAS としての目標達成のために多大な努力がはらわれたことを高く評価する。技術開発研究と基礎科学研究が共存する JIRCAS の機関運営上の問題については、他機関との関連を含めて、今後十分検討していくべきであろう。同時に、JIRCAS に期待される役割を果たしていくための人材確保については、JIRCAS 独自の人材育成と他機関との協力関係のあり方について、長期的な検討と対応が必要である。JIRCAS としては特に、発展途上国における研究ニーズの的確な把握とプロジェクトの効果的な実施を可能にする研究マネジメントの重要性が強調されるべきである。

#### その他ご意見（次年度に向けての意見も含む。）

JIRCAS がさらに国際貢献を進めていくためには、国内各機関との安定的な支持・協力関係ならびに海外関連機関との日常的な意思疎通が極めて重要である。同時に、海外研究と国内研究のマッチング、発展途上国に役立つ研究成果・技術等の情報発信機能の強化が肝要である。

次年度の運営評価会議においては、資料や会議準備に費やす研究職員の労力と時間を最小限にする工夫をしつつ、資料等の更なる合理化と会議の効率的運営に努められたい。また、JIRCAS が実施する総合プロジェクトについては、個別プロジェクトとはちがった評価方法を案出するべきではないか。さらに、「中期目標」と「中期計画」の記述には工夫が必要で、「中期目標」は研究戦略を中心に記述するべきであろう。評価表 1 - 1（業務運営の効率化に関する目標を達成するためにとるべき措置、専門研究分野を活かした社会貢献、成果の公表、普及の促進及びその他農林水産省令で定める業務運営に関する事項）については、研究推進上の問題点にもう少しスペースをさき、評価表 1 - 2（試験及び研究並びに調査）では、研究の進捗度を評価する観点から、研究期間、年次計画、人員、予算等を加えたほうがよい。

‘æ,X%ñ,i,h,q,b,`,r•‘ÜfVf“f|fWfEf€  
 ’n^æŽs•ê,ÉŒü,-,1/2”_—Ñ•...ŽY•,İ•t%Á%ı;’lŒü•ã  
 •|ŠJ”-“r•ã’n^æ,É,;,é”_—Š“¾Œü•ã,Æ”_“Š^•«%»„İ,1/2,ß,É•|

“ú•@Žž•F•½•-14”N10ŒŽ16“ú•A17“ú  
 •ê•@•Š•F,Â,-,Î•‘Ü%öı<c•ê•EfGf|fJf<,Â,-,Î  
 Žâ•@•Ã•F“Æ—§•s•—@•l•@•‘Ü”_—Ñ•...ŽY<ÆŒü<†fZf“f^•[  
 Œã•@%œ•F“Æ—§•s•—@•l•@”_<Æ<Z•pŒü<†<@•\  
 “Æ—§•s•—@•l•@•H•i••†Œü<†•Š  
 “Æ—§•s•—@•l•@•...ŽY‘••†Œü<†fZf“f^•[  
 PhAction  
 ft•[fh•EftfHf%œf•E,Â,-,Î

**fvf•fOf%of€ŠT—v•@•@*ú•x,Í%œpŒê”Å,İfz•[f fy•[fW,đ,²—%œ°,³,ç•B**

1“ú-Ü•i10ŒŽ16“ú•j	
Šİ²•u%œœ	f fXfgfn•[fxfXfgŒü<†ŠJ”-,İŒ»•ó,Æ”_“Œo•İŠ^•«%»„É,Î,•,é•t%Á%ı;’lŒü•ã<Z•p,İ-đŠ,,(Geoffrey Mrema, FAO•j
	”_-,đf}•[fPfbfg,ÉŒ<,Ñ,Â,-,é,½,ß,É•PhAction fCfjfvfAfefCfu (Guy Poulter, Chair of PhAction, NRI, UK)
fZfbfVf†f“1	”_“Œo•İ,İŽÀ‘Ô,Æ”_—Š“¾Œü•ã•E”_“Š^•«%»„İ,½,ß,İŽæ,è‘g,Ý•@•ifJf“fgfŠ•[fŒfl•[fg•j
fZfbfVf†f“2	•iŽıŒü•ã•E^À‘S•«Šm•Û,İ,½,ß,İ•û•ô
2“ú-Ü•i10ŒŽ17“ú•j	
fZfbfVf†f“3	•,•t%Á%ı;’l%œ»<Z•p,İŠJ”-
f fXf^•[fZfbfVf†f“	
fZfbfVf†f“4	ŠJ”-“r•ã’n^æ,İ•n,µ,ç”_—,İ,½,ß,Éf fXfgfn•[fxfXfgŒü<†,Í%œ½,đ,•,x,«,<,©
••†“ç~_	f fXfgfn•[fxfXfgŒü<†,İ•V,½,È•ûŒü•ı^1-Ō-hŽ~,©,ç•t%Á%ı;’lŒü•ã,Ö

<p><b>f fXf^•[”-•\•\,µ•ž,ÝŽó,-•t,-’†•I</b>                  •i’÷,ß•Ø,è•F8ŒŽ15“ú•j</p>	
<p><a href="#">fAfufXfgf%œfNfg,İ•Ž@™</a></p>	<p><a href="#">•ì-—á</a></p>

ŽQ%Á”ı•F            -3—ı  
 ŽQ%Á•\,µ•ž,Ý•F    ,±,ı,ç,İftfH•[f •iWord•APDF•j,đ,“—,è%œ°,³,ç•B  
 ’÷,ß•Ø,è•F            9ŒŽ30“ú  
 — •u%œœŒ¾Œü,Í%œpŒê,Å,•B

English

## Call for Posters

The 9th JIRCAS International Symposium will be hosted under the title of “Value–Addition to Agricultural Products—towards increase of farmers’ income and vitalization of rural economy”. Posters that contribute to information exchange related to the symposium subject will be welcomed for Poster Session.

1. Panel: One panel is available per subject. The size of each panel is 100 cm wide and 210 cm high. The official language is English.
2. Period for display: Poster panels will be displayed during the duration of the Symposium from October 16 to 17. Posters should be mounted by noon on October 16 in the designated location, and removed after the poster session by the presenters. Presenters are expected to be by their posters during the poster session (12:30-14:30, October 17).
3. Presentation site: Epochal Tsukuba (3F Foyer)
4. Abstracts: All participants who will present a poster are required to submit an abstract. These will be the basis for the abstract book which will be distributed at the beginning of the symposium. An example of the required format is shown below.

### (Abstract Format)

- Abstracts must be in English
- Type on A4 (210 x 297 mm) paper within an area of 160 mm (width) and 240 mm (length), centered on the page, using Time New Roman Letters (12 point font except for title and names) with 1 line-spacing.
- Give the title first (14 pt. bold) followed by the names (14 pt.) and affiliations of the authors (12 pt.). Underline the presenter.
- Give full postal addresses of all authors with numeric superscripts if needed.
- Leave one line blank, indent 4 spaces, and begin first paragraph.
- Abstracts should be approximately 200 words.
- Give the name and e-mail address of the presenter for contacts at the bottom of paper.
- Save abstracts in MS-Word or DOS text format.

Please submit abstracts through e-mail as attached files, or on 3.5 inch diskettes to:

Yutaka Mori  
Secretariat of the Organizing Committee  
for the 9th JIRCAS International Symposium  
Japan International Research Center  
for Agricultural Sciences  
Tsukuba, Ibaraki 305-8686, Japan  
E-mail: sympo9@ml.affrc.go.jp

5. Deadline: The deadline for receipt of abstracts is August 15, 2002. In case you do not receive a confirmation e-mail, please contact the office by telephone or ordinary mail

*9th JIRCAS International Symposium*  
**“Value-Addition to Agricultural Products”**  
**-Towards increase of farmers’ income and vitalization of rural economy-**

**REGISTRATION FORM**

**Please type or print**

Name :

( Prof./ Dr. / Mr. / Ms. ) First name                      Middle initial                      Family name

Affiliation :

Address :

Phone:

Fax:

E-mail:

**Please check off the sessions you will participate in:**

Keynote address	(free of charge)	October 16	morning
Sessions 1-2	(free of charge)	October 16	afternoon
Sessions 3-4	(free of charge)	October 17	full day
Reception	(5,000yen)	October 16	evening

Note: The Symposium Reception will be held from 6:00 to 8:00 p.m. Wednesday, October 16 , in the restaurant Espoir in Epochal Tsukuba. The fee for participation in the reception is ¥5,000, and may be paid at the door

**Deadline for receipt of registration : September 30, 2002.**

Please submit this form by fax or E-mail to:


**Yutaka Mori**

Secretariat of the Organizing Committee for the 9th JIRCAS International Symposium  
Japan International Research Center for Agricultural Sciences  
1-1 Ohwashi, Tsukuba, Ibaraki 305-8686, JAPAN

Fax: +81-298-38-6342                      Tel: +81-298-38-6343

E-mail: [sympo9@ml.affrc.go.jp](mailto:sympo9@ml.affrc.go.jp)

*9th JIRCAS International Symposium***Value-Addition to Agricultural Products****- Towards increase of farmers' income and vitalization of rural economy -**

Date	October 16 and 17 , 2002	
Venue	<a href="#">Tsukuba International Center:EPOCHAL TSUKUBA</a> 2-20-3, Takezono, Tsukuba, Ibaraki,305-0032, Japan TEL : +81-298-61-0001,Fax:+81-298-61-1209	
<a href="#">Background and Objectives</a>		
<a href="#">Program</a>		
<b>Call for Posters</b>	( <a href="#">Abstract Format etc.</a> , <a href="#">Sample</a> )	
Registration ( <a href="#">Word</a> , <a href="#">PDF</a> )		
Reception	The Symposium Reception will be held from 6:00 to 8:00 p.m. Wednesday, October 16, in the restrand Espoir in Epochal Tsukuba. The fee for participation in the reception is ¥5,000 , and may be paid at the door.	
Hotel	Please see <a href="#">Hotel list</a> .	
<a href="#">Site Map</a>		

Organized by •F

Japan International Research Center for Agricultural Science(JIRCAS)

In Cooperation with •F

National Agricultural Research Organization(NARO),

National Food Research Institute(NFRI),

Fisheries Research Agency (FRA),

PhAction,

Food Forum Tsukuba

Secretariat •F

Yutaka Mori , Development Resarch Coordinator

Japan International Research Center for Agricultural Sciences

1-1 Ohwashi, Tsukuba, Ibaraki 305-8686, JAPAN

TEL : +81-298-38-6343 Fax: +81-298-38-6342

E-mail: [sympo9@ml.affrc.go.jp](mailto:sympo9@ml.affrc.go.jp)[Japanese](#)

# 9th JIRCAS International Symposium

Value-Addition to Agricultural Products

-Towards increase of farmers' income and vitalization of rural economy-

## Background and Objectives

The current world population is about 6 billion and it is anticipated that the population will reach 7.5 billion and 8.0 billion by years 2020 and 2030, respectively, according to United Nations' World Population Prospects. Global food production should be increased so as to meet the demands of the rapidly increasing population, with the limited water resources and arable land. Therefore, the roles of rural areas where agriculture and food industry greatly contribute to the production of agricultural produce and products will be more important, from the point of food security. Agriculture is still the largest sector of rural economies, and a majority of the rural population is engaged in agriculture, in developing countries. The incomes of rural people are much lower than the urban ones, and the population has been shifting from the rural to the urban areas seeking better incomes and convenient daily-life. These trends will lead to the reduction of rural potential as a base for food supply and the increase of the poorest in slums in big cities. On the other hand, it is difficult for small-scale rural food companies to compete with big companies of the urban and developed countries. In considering these facts, we have to make efforts to give rural people and enterprises tools to increase their income through value-adding to the commodities, in order that they may stay in the rural areas and continue to be engaged in agriculture and food production.

Changes in urban lifestyle as a result of the increased income and the increasing number of working women have resulted in increased consumers' demand for a more diversified diet, for processed and convenience foods and for animal products. When people overcome hunger, they become concerned about the quality and safety of what they eat. For example, they want to avoid foods with contaminants such as pathogens, mycotoxins and pesticides, and prefer foods with physiological functions such as anti-carcinogenicity and anti-hypertension. It is important for rural farmers and enterprises to market products that meet the demands of urban consumers.

We dealt with postharvest losses of grains in the 5th JIRCAS Symposium in 1998, and then started a research project to reduce postharvest losses of grains in Southeast Asia. It is worthwhile to review the demands of urban consumers, the role of rural food industry and the related research activities in developing countries. For this purpose, we will invite distinguished experts from Japan and overseas, to discuss problems associated with ensuring high quality/safety of, and adding value to agricultural produce and products, and explore directions for research on these topics in developing countries.

[BACK](#)



# 9th JIRCAS International Symposium

## Value-Addition to Agricultural Products

-Towards increase of farmers•f income and vitalization of rural economy-

### Program

Day 1 (Wednesday, October 16)	
Opening Session (9:30-10:00)	Opening address and welcome remarks
Keynote addresses (10:00-11:00)	1. Status of postharvest development and the potential future contribution of value addition to rural economy (Geoffrey Mrema, FAO)
	2. Linking farmers to markets - PhAction Initiative (Guy Poulter, Chair of PhAction, NRI, UK)
Session 1 (11:15-15:20)	Current status of rural economy and measures for increasing farmers•f income and vitalization of rural economy
	1. China (Li Suoping, CAAS, China) 2. The Philippines (Nerlita M.Manalili, SEARCA, The Philippines) 3. Vietnam (Le Van To, Post Harvest Technology Center, Vietnam) 4. Indonesia (Made S. Mahendra, UNUD, Indonesia) 5. South Asia (Andrew Hall, CPHP, India) 6. Latin America (Bernard Ospina, GLAYUCA, Colombia) 7. Africa (Shaun Ferris, IITA, Uganda)
Session 2 (15:35-17:55)	System for ensuring high quality and safety
	1. Codex standards and food safety (Yukiko Yamada, NFRI, Japan) 2. Systems for ensuring production quality and safety for small rural agro-enterprises-the way forward (Linda Nicolaidis, NRI, UK) 3. Grain Quality-storage to market (Joseph Rickman, IRRI, The Philippines) 4. Safety of feed and animal products (Andrew Speedy, FAO, Italy) 5. Extension of fish pre-rigor state by enhancing mitochondrial ATP synthesis (Shugo Watabe, Univ.Tokyo, Japan)
Day 2 (Thursday, October 17)	
	Research on value-addition and novel utilization

<p>Session 3 (9:00-12:30)</p>	<ol style="list-style-type: none"> <li>1. Application of value adding technologies in Thailand (Warunee Varanyanond, IFRPD-KU, Thailand)</li> <li>2. Adding value of milk and milk products (Jean-Paul Ramet, Ensaia, France)</li> <li>3. Present status and problems of traditional fish products in Southeast Asia (Tan Sen Min, SEAFDEC, Singapore)</li> <li>4. Development of intermediate foodstuff from freshwater fish in China (Wang Xi Chang, SFU, China)</li> <li>5. Inventory of indigenous plants and minor crops in Thailand based on bioactivities (Kazuhiko Nakahara, JIRCAS, Japan)</li> <li>6. Functionalities of traditional foods in China (Li Lite, CAU, China)</li> <li>7. Functionalities of foods and their utilization in Japan (Makoto Shimidzu, Univ.Tokyo, Japan)</li> </ol>
<p>Poster Session (12:30-14:30)</p>	
<p>Session 4 (15:00-16:30)</p>	<p>General Discussion</p> <ol style="list-style-type: none"> <li>1. What needs to be done to make postharvest research and development serve the needs of the poor farmers in their efforts to find markets for their products? (Chair: Geoffrey Mrema, FAO)</li> <li>2. Changing focus of postharvest research - from postharvest losses towards value- addition - --re-evaluation of indigenous products and traditional foods(Chair: Toru Hayashi, JIRCAS)</li> </ol>
<p>Closing Address (16:30-16:45)</p>	

[BACK](#)

# Hotel List

Hotels	Address(Tsukuba City)	Tel: (+81-298)
<a href="#"><u>OKURA FRONTIER HOTEL TSUKUBA EPOCHAL</u></a>	2-20-1, Takezono	60-7700
<a href="#"><u>OKURA FRONTIER HOTEL TSUKUBA</u></a>	1, Azuma	52-1112
<a href="#"><u>Hotel Gland Shinonome</u></a>	488-1, Wakui, Onozaki	56-2211
<a href="#"><u>Gakuen Sakurai Hotel</u></a>	8-7, Higashiarai	51-3011
<a href="#"><u>Tsukuba Sky Hotel</u></a>	283-1, Onozaki	51-0008
<a href="#"><u>Business Hotel Matsusima</u></a>	35, Onozaki	56-1191
<a href="#"><u>Hotel New Takahashi Takezono</u></a>	2-10-3, Takezono	51-2255

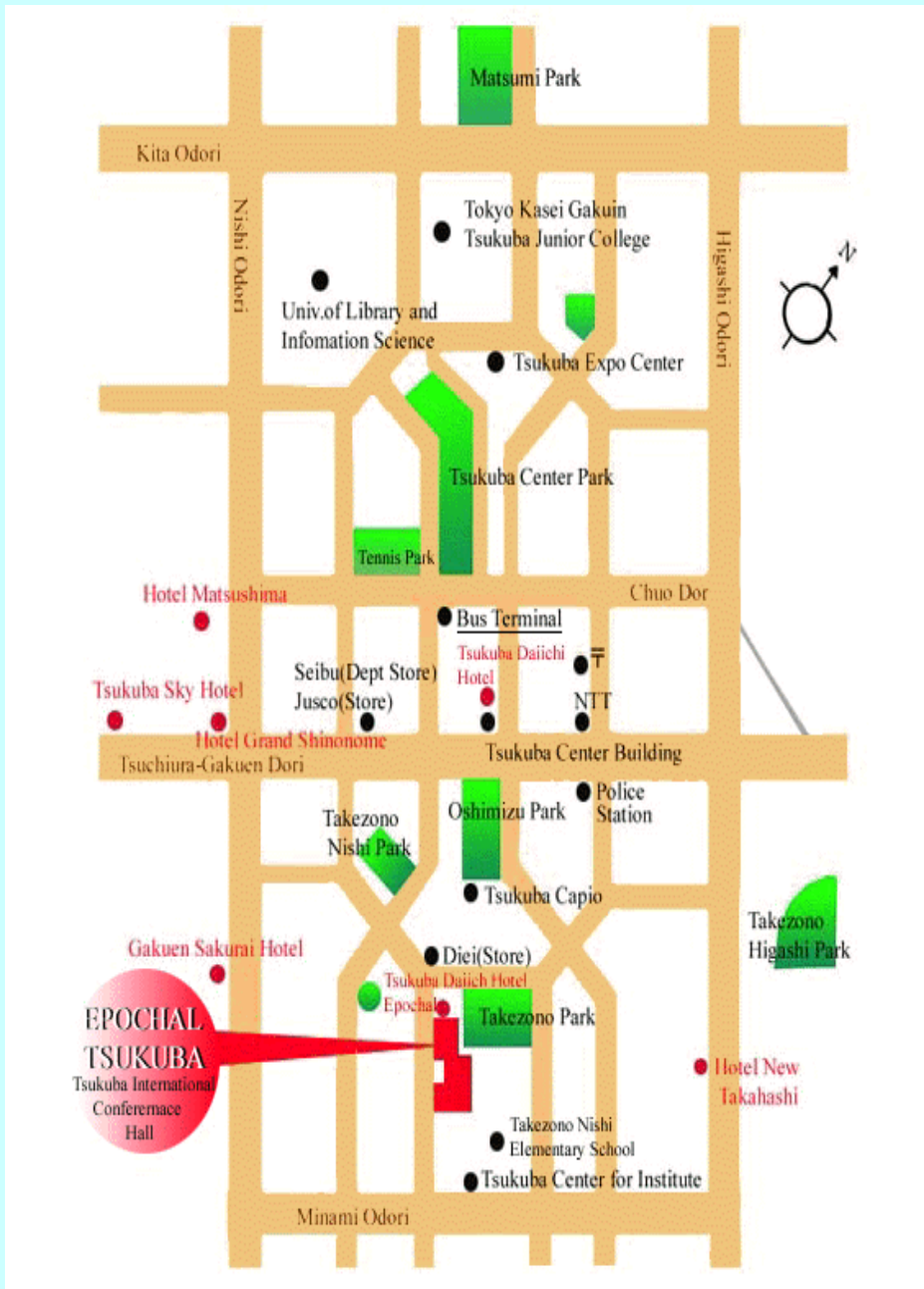
Rate: Single room with service charge and tax (JPY)

## Taxi

Taxi	Address(Tsukuba City)	Tel(+81-298)	Free Dial
<b>Chyuo Taxi</b>	2573-126, kamiyokoba	36-0184	0120-390184
<b>Sato Taxi</b> (head office)	2014, Yatabe	38-1288	0120-011288
<b>Sato Taxi</b> (gakuen branch)	177-3, Onozaki	52-6688	0120-016688
<b>Amakawa Taxi Gakuen Namiki</b>	2010-69, Sasagi	51-6500	-----

[BACK](#)

# Site Map



Tsukuba International Conference Hall,  
[EPOCHAL TSUKUBA](http://www.epochal-tokyo.com)  
 2-20-3 Takezono, Tsukuba, Ibaragi  
 Tel : 81-298-61-0001  
 Fax : 81-298-61-1209

## Transportation Guide

### From Tokyo

**1. JR-Ueno Station (Joban Line)-JR-Tsuchiura Station (Bus)-Epochal Tsukuba (about 60 min)**

**2. JR-Tokyo Station, Yaesu South Exit-(Joban High Way Bus)-Tsukuba Center - (Taxi)- Epochal Tsukuba (about 65 min)**

### From Narita International Airport

**1. Narita. IAP-(Taxi)-Epochal Tsukuba (about 60 min)**

**2. Narita.IAP-(Airport Bus)-Tsukuba Center-(Taxi)-Epochal Tsukuba**

**for further information:**  
[EPOCHALTSUKUBA](http://www.epochal-tokyo.com)

[BACK](#)



fO•@fŠ•@•[•@f“•@•w•@“ü•@–@•@,É•@,Ä•@,ç•@,Ä

•@

“Æ—§•s•—@•l•‘•Û”_—Ñ•...ŽY<ÆCEα<†fZf“f^•[,Í•A’n<...ŠÂ««É”z—¶,μ,Ä••i,ð’2’B,μ,Û,•B

“Æ—§•s•—@•l•‘•Û”_—Ñ•...ŽY<ÆCEα<†fZf“f^•[,Í•AŠÂ««•%o%oX,Ì•-,È,çŽ•‘±%oÄ’\,ÈŽĐ%oi,Ì•\’z,ÉŠñ—^,•,é,½,β•A

•½•¬,P,R”N“x,æ,è•uŠÂ««••i,Ì’2’B,Ì•,,i“TM,ð•},é,½,β,Ì•û•j•v,ÉŠî,Ä,ç,Ä••i,Ì’2’B,ð•,,i,μ,Û,•B

•@

[ŠÂ««••i“TM,Ì’2’B,Ì•,,i“TM,ð•},é,½,β,Ì•û•j\(PDF\)](#)

•@

“Á’è’2’B•i–Ú’2’BŽÀ•ÑŽæ,è,Û,Æ,β\

<a href="#"><u>•½•¬,P3”N“x</u></a>	<a href="#"><u>•iPDF•j</u></a>
<a href="#"><u>•½•¬14”N“x</u></a>	<a href="#"><u>•iPDF•j</u></a>

# SA«~••i~TM,I'2'B,I,•,•i~TM,ð•},é,1/2,ß,I•û•j

“E—\$•s•—@•I•@  
••Ü”_—Ñ•...ZY•AECEçfZf~f~•[

•@~“TM,É,æ,èŠÄ«~••i~TM,Ì'2'B,Ì,•,•i~TM,ÉŠÖ,•,é—@—Ÿ•i•½~••,P,Q”N—@—Ÿ~æ,P,O,O•t•B`È%ø•u—@•v,Æ,ç,•B•j~æ,V•ð~æ,P, Ì•K`è,ÉŠi,Ä,«•A•½~••,P,S”N”x,É,“,”,èŠÄ«~••i~TM,Ì'2'B,Ì,•,•i,ð•},é,½,ß,Ì•û•j•i`È%ø•u'2'B•û•j•v,Æ,ç,•B•j,ð`è,ß,½,Ì,Ä•A~“•ð,R•, Ì•K`è,ÉŠi,Ä,«•ACEø••,•éB  
‡T~Ä`è'2'B•i~TM,Ì•½~••,P,S”N”x,É,“,”,é'2'B,Ì—Ü•W  
•@•½~••,P,S”N”x,É,“,”,èCEÄ•É,Ì'Ä`è'2'B••i~TM,Ì'2'B—Ü•W,Ì•A`È%ø•Ì,Æ,“,”,è,Æ,•,é•B  
È,“•ASÄ«~••i~TM,Ì'2'B,Ì,•,•i,ÉŠÖ,•,éŠi—[•û•j•i•½~••,P,R”N,QEŽ,Q`úŠtccE”•èj,É•K`è,ç,é,½”»f,ÌŠi•,Í•A, •,Ü,Ä,à'2'B,Ì,•,•i,É~•,½,Ä,Ä,Ì`è,Ä,Ì—Ü`à,ðŽÌ,•,à,Ì,Ä, é,½,ß•ASÄ«~••i~TM,Ì'2'B,É~•,½,Ä,Ä,Í•A,Ä,«çCEÄ,èŠÄ«ç,Ö,Ì%ø%øç,Ì•,È,ç••i~TM,Ì'2'B,É~w,ß,é,±,Æ,Æ,•,é•B  
P•@Ž~•@—P

•i~ñ—pŽ† •i~fRfs•[—pŽ†•CftfH•[f —pŽ†•j •@	•@'2'B,ðŽÀŽÌ[•,•é•è•ç,Í•Afcf~fNfWfFfbfg•ûŽ@,ÌfvfŠf~f~f~[—pŽ†•AfJf%ø•[•;ŽÈ.@—pŽ†•y,ÑftfH•[f —pŽ†,ð•æ,«•A'2'B—Ü•W,Í,V,O•“,Æ,•,é•B
•óü—pŽ† •@	•@'2'B,ðŽÀŽÌ[•,•é•è•ç,Í•AflfXf^•[,âfpf~fufCEfbfg—p,ÌŽÈ•^•óü,ðŽà,Æ,•,é—pŽ†•y,Ñ•F•ãŽçŽ†,ð•æ,«•A'2'B—Ü•W,Í,V,O•“,Æ,•,é•B
%øç¶—pŽ†•ifgfcfCEfbfgfy•[fp•[j •@	•@'2'B,ðŽÀŽÌ[•,•é•è•ç,Í•A'2'B—Ü•W,Í,P,O,O•“,Æ,•,é•B •@

,Q•@”l“ü“óü•“  
flfXf^•[y,Ñfpf~fufCEfbfg—p,ÌŽà,Æ,µ,ÄŽÈ•^•óü,Æ,È,é,à,Ì,ð•æ,“l“ü“óü•“•Ä, ,Ä,Ä•A,»l”l“ü“óü•“,l“è“,ÉŽÈ•^•óü,«ü,Ä,Ä,à•A,»,l,Ü,Æ,ñ,Ç,“”»f,ÌŠi•,ð~ž`«•,é,à,Ì,ð'2'B,•,é,à,Ì,Æ,µ•A,»,l”l“ü“óü•“,l'2'B,ðŽÀŽÌ[•,•é•è•ç,Í•A'2'B—Ü•W,Í,V,O•“,Æ,•,é•B

R•@•¶•í—P

fVff•[fvfyf~fvfç fvff•[fvfyf~fvfç•Öç f[çfçfyf~ f[çflfç~fOfyf~ %ø•M fXf^f~fv~ä Žé~± •ó[çfbfg `è•K fgfCE•[ •A,µfSf fXfe•[fvf%øç[ ~AZÈŽ@fNfŠfbfv Ž—±—p•C•ç•i•fe•[fv•j Ž—±—p•C•ç•i•%øç•ó•j fNf%øçfvgfe•[fv fufbfNfXf^f~fh ,Í,³,Y f]fOf]fbfg•i•É•j f]fOf]fbfg•ifó•[j fe•[fvfjfbf^•[ fpf~f f,çfgfP•[fX %ø•M•f .n,`fNfŠ•[fi•[•iEfbfbfgf^fCfv•j.n,`fNfŠ•[fi•[•i%øçf^fCfv•j fCEf^•[fP•[fX f]fEfbfbfbfh fjfbf^•[fiçft .n,g,oftfBfçf ŠG,Ìä —n• ,Ì,è•i%øç•ó•j ,Ì,è•i“b”•,Ì,è•j ,Ì,è•iCEÄCE•j ,Ì,è•ife•[fv•j ftf@fcfç fofcfç~f_ç[ fj•[fhfP•[fX f ffbfbN•tP•[fX Ž—±—p•••••iž~•»•j ~çŽ†•E;N`Ä—pŽ† fm•[fg fCf~fçfbNfX •tä`Ž† fSf~” fŠfTfCfNfçf]fbfNfX ~½ŽD•iŠ~•ä—p•j	•@'2'B,ðŽÀŽÌ[•,•é•è•ç,Í•A'2'B—Ü•W,Í,X,O•“,Æ,•,é•B •@.È,“•ASø”•M•AfufbfNfXf^f~fh•Afl[fbfP•[fX•Afsf~”çy,Ñ~½ŽD•iŠ~•ä—p•j,É,Ä,ç,Ä,Í•ASÖ””•P,È,Ç,Ì—Ø•P,ðŽg—p,µ,½~»•i,ð—D•æ“l,É`l`ð,•,é•B
------------------------------------------------------------------------------------------------------------------------------------------------------------------------------------------------------------------------------------------------------------------------------------------------------------------------------------------------------------------------------------------------------------------------------------------------------------------------------------------------------------------------------------------------------------------------------------------------------------------------------------------------------------------------------------------------------------------------------------------------------------------------------------------------	----------------------------------------------------------------------------------------------------------------------------------------------------------------------------------------

.S•@•@Ší—P

,ç, Šž 'l Žâ"l—p•YŠí:īTÈŠOf•[fp•[fçfBfvfžf“•j ÇfZ“:Ä ••”Ä fzf•fCfçf{•[fh•@	•@’”2”B,ðŽÀŽ{,.,é•é•ž•í•A’2”B—Ú•W,Í,R,O“.,Æ,.,é•B •@,È,“•ASÖ”“•P,È,Ç,Ì—Ø•P,ðŽg—p,μ,½“»•i,ð—D•æ“l,É’l’ð,.,é•B
----------------------------------------------------------------------------------------------	-----------------------------------------------------------------------------------------------------------------

.T•@,n,`•@Ší

fRfs•l(@ “dZqEvZZ,•@ fv fŠf“f^y,Nfv fŠf“f^Eftf@fNfvf~fŠCE“—p•@ ftf@fNfvf~fŠ fXfLfffi ŽY.CftfBfXfN“•u •@	•@’”2”B,ðŽÀŽ{,.,é•é•ž•i’O”N“x’È’O,©,çfŠ•[fX,âfCEf“f^fç,ÌCE_ñ,ð’÷CE,μ•A•½“~r,P,S”N“x,É,“ç,Ä,àCEp±,μ,ÄŽg—p,.,é•@Ží,ð•æ,~•B•j,Í•A’2”B—Ú•W,Í,T,O“.,Æ,.,é•B  •@
---------------------------------------------------------------------------------------------------------------------------	------------------------------------------------------------------------------------------------------------------------------------------------------------------

•@

.U•@%çÆ“d•»•i

“d.C—â’ ÇEÉ•i—â’ ÇEÉ•A—â“ ÇEÉ•A—â“ —â’ ÇEÉ•j fGfAfRf“ffBfvfžfi• ççfCEftrfWfžf“Žó•M•@ frftrfçç•[fvfCEfR•[f_• •@	•@’”2”B,ðŽÀŽ{,.,é•é•ž•i’O”N“x’È’O,©,çfŠ•[fX,âfCEf“f^fç,ÌCE_ñ,ð’÷CE,μ•A•½“~r,P,S”N“x,É,“ç,Ä,àCEp±,μ,ÄŽg—p,.,é•@Ží,ð•æ,~•B•j,Í•A’2”B—Ú•W,Í,P,O,O“.,Æ,.,é•B  •@
----------------------------------------------------------------------------------------------------------------------------	--------------------------------------------------------------------------------------------------------------------------------------------------------------------

.V•@•E•@—¼

(EuCEö”“•Æ—¼Šíç (EuCEöŠÇ •@	•@’”2”B,ðŽÀŽ{,.,é•é•ž•iŠíç,ÌCE’ó,É,æ,è•A•s%çÄ“È•é•ž•,ð•æ,~•B•j,Í•A’2”B—Ú•W,Í,P,O,O“.,Æ,.,é•B  •@
-----------------------------------	--------------------------------------------------------------------------------------------------------

.W•@Ž©“@ŽÖ•i••ÈŽ©“@ŽÖ•A•—ÇEŽ©“@ŽÖ•y,NÇeyŽ©“@ŽÖ,Æ,μ•A“ñ—ÖŽÖ•y,N•d—ÈŽÖ,ð•æ,~•B•j

‘áÇEöŠQŽÖ	•@’”2”B,Ì—\è,Í,È,ç•B
‘áÇEöŠQŽÖ^ÈŠO,ÌŽ©“@ŽÖ •@	•@’”2”B,Ì—\è,Í,È,ç•B •@

.X•@•Š•ž•E•iç•Æ•ž •@•@  
”2”B,ðŽÀŽ{,.,é•é•ž•í•A’2”B—Ú•W,Í,T,O“.,Æ,.,é•B

.P,O•@fCf“fçfŠfA•E•Q•

fJ•[fçf“	•@’”2”B,ðŽÀŽ{,.,é•é•ž•í•A’2”B—Ú•W,Í,X,O“.,Æ,.,é•B
fJ•[fyfBfg•i•D,¶,ã,ð,½,ñ•Afj•[fhfçpçf“f fJ•[fyfBfg•j —N“z •@	•@’”2”B,Ì—\è,Í,È,ç•B  •@

.P,P•@•iç•Æ—pŽè’Ü •@•@•@  
”2”B,ðŽÀŽ{,.,é•é•ž•i—h—lŽè’Ü•y,N—h—UŽè’Ü,ð•æ,~•B•j,Í•A’2”B—Ú•W,Í,S,O“.,Æ,.,é•B

.P,Q•@•Ý•@”ö

¼—zÇEö”“•dfVfXfçf ¼—z”M—“—pfVfXfçf ”R—ç“d’r •@	•@’”2”B,Ì—\è,Í,È,ç•B  •@
---------------------------------------------------------	--------------------------------

.P,R•@ÇEö•HŽ—  
•@•@ÇEö•HŽ—,Ì†,Ä•AŠí—[•ú•j,É’É’u•t,“ç,è,½Ž“•P•ACEŠ•Ý•@ŠB,ðŽg—p,.,é•é•ž•í•ACE“¥,Æ,μ,Ä•A””f,ÌŠí,ð—ž’ç,.,é,à,Ì,ðŽg—p,.,é,à,Ì,Æ,.,é•B •@ •@



# fOfŠ•[f“•w“ü,É,Â,Ç,Ä

.P.S•@-δ•@-±•@•i•EfgfI•f“f-δ-±•j •@•@’2’B,I-∨`è,I,E,ç•B •@ •@

‡U•@“Á`è’2’B••i“TM“ÈŠÖ,İ½↯,P,S”N“x,É’2’B,ð•,•i,•,éŠÁ««•i“TM“y,Ñ,»„İ’2’B,İ-Ú•W  
•@ ,P•@ŠÁ««•i“TM,İ’T’δ,É“-½,Á,Ä,İ•AfgfRf}•[fN,İ”F’è,δZó,˘,Á,ç,é•»•i,Ü,½,İ,±,é,Æ““TM,İ,à,İ,δ’2’B,•,é,æ,ϱ,É“w,ß,é•B  
•@ ,Q•@,n,`<Ši•A%æE“d•»•i,İ’2’B,É•Ü,µ,Ä,İ•A,æ,è•Á”T“d—Í,•↯,³,••A,©,Ä•Ä•¶•P,δ’½,•Žg—p,µ,Ä,ç,é,à,İ,δ’T’δ,•,é•B

‡V•@,»„İ¼ŠÁ««•i“TM,İ’2’B•,•i,ÉŠÖ,•,éŽ-•€  
•@ ,P•@,±,İ’2’B•ü•j,İ“Æ—§•s-@•l••Ü” —Ñ•...ŽY<ÆEϱ<†fZf“f^•[%ææ“éŽx•Š,à’İ•Ü,Æ,•,é•B  
•@ ,Q•@’2’B,İŽÄ•Ñ,İ•ASç•i-Ú-˘,ÉŽæ,è,Ü,Æ,ß•A••Ü” —Ñ•...ŽY<ÆEϱ<†fZf“f^•[İfz•[f fy•[fW,ÄEö•\,•é•B  
•@ ,R•@’2’B,•,é•i-Ü,Éæç,¶,Ä•AfgfRf}•[fN“TM,İŠù•¶,İ•i•ñ,δŠ˘—p,•,é,±,Æ,É,æ,è•A”»’fŠi• ,δ-ž,½,˘,±,Æ,É,Æ,Ç,Ü,ç,•,•A,Ä,«,éEÄ,èŠÁ««%ßæx,İ•,È,ç••i,İ’2’B,É“w,ß,é•B  
•@ ,S•@-{’2’B•ü•j,ÉŠi,Ä,-’2’B’S“-˘<Eü,İ•A˘•±•”%äE%æÜ—p“xGEW,Æ,•,é•B

## 環境物品等の調達を推進等を図るための方針

独立行政法人

国際農林水産業研究センター

国等による環境物品等の調達の推進等に関する法律（平成12年法律第100号。以下「法」という。）第7条第1項の規定に基づき、平成14年度における環境物品等の調達の推進を図るための方針（以下「調達方針」という。）を定めたので、同条3項の規定に基づき、公表する。

### 特定調達品等の平成14年度における調達の目標

平成14年度における個別の特定調達物品等の調達目標は、以下のとおりとする。

なお、環境物品等の調達の推進に関する基本方針（平成13年2月2日閣議決定）に規定された判断の基準は、あくまでも調達の推進に当たっての一つの目安を示すものであるため、環境物品等の調達に当たっては、できる限り環境への負荷の少ない物品等の調達に努めることとする。

### 1 紙 類

情報用紙 (コピー用紙, フォーム用紙)	調達を実施する場合は、インクジェット方式のプリンター用紙、カラー複写機用紙及びフォーム用紙を除き、調達目標は70%とする。
印刷用紙	調達を実施する場合は、ポスターやパンフレット用の写真印刷を主とする用紙及び色上質紙を除き、調達目標は70%とする。
衛生用紙(トイレトペーパー)	調達を実施する場合は、調達目標は100%とする。

### 2 納入印刷物

ポスター及びパンフレット類の主として写真印刷となるものを除く納入印刷物であって、その納入印刷物の一部に写真印刷が入っても、そのほとんどが判断の基準を満足するものを調達するものとし、その納入印刷物の調達を実施する場合は、調達目標は70%とする。

### 3 文具類

シャープペンシル シャープペンシル替芯 ボールペン マーキングペン	調達を実施する場合は、調達目標は90%とする。 なお、鉛筆、ブックスタンド、カードケース、ゴミ箱及び名札(机上用)については、間伐材などの木材を使用した製品を優先的に選択する。
--------------------------------------------	---------------------------------------------------------------------------------------------

鉛筆  
スタンプ台  
朱肉  
印章セット  
定規  
トレー  
消しゴム  
ステープラー  
連射式クリップ  
事務用修正具（テープ）  
事務用修正具（液状）  
クラフトテープ  
ブックスタンド  
はさみ  
マグネット（玉）  
マグネット（バー）  
テープカッター  
パンチ  
モルトケース  
鉛筆削  
OAクリーナー（ウェットタイプ）  
OAクリーナー（液タイプ）  
レターケース  
マウスパッド  
カッターナイフ  
OHPフィルム  
絵の具  
墨汁  
のり（液状）  
のり（澱粉のり）  
のり（固形）  
のり（テープ）  
ファイル  
バインダー  
カードケース  
チャック付ケース  
事務用封筒（紙製）  
けい紙・起案用紙  
ノート  
インデックス

付箋紙 ゴミ箱 リサイクルボックス 名札（机上用）	
------------------------------------	--

#### 4 機器類

いす 机 棚 収納用什器（棚以外ローパーティション） 掲示板 黒板 ホワイトボード	調達を実施する場合は、調達目標は30%とする。 なお、間伐材などの木材を使用した製品を優先的に選択する。
-------------------------------------------------------------	---------------------------------------------------------

#### 5 OA機器

コピー機 電子計算機 プリンタ及びプリンタ・ファクシミリ兼用機 ファクシミリ スキャナ 磁気ディスク装置	調達を実施する場合（前年度以前からリースやレンタルの契約を締結し、平成14年度においても継続して使用する機種を除く。）は、調達目標は50%とする。
---------------------------------------------------------------------	---------------------------------------------------------------------------

#### 6 家電製品

電気冷蔵庫（冷蔵庫、冷凍庫、冷凍冷蔵庫） エアコンディショナー テレビジョン受信機 ビデオテープレコーダー	調達を実施する場合（前年度以前からリースやレンタルの契約を締結し、平成14年度においても継続して使用する機種を除く。）は、調達目標は100%とする。
----------------------------------------------------------------	----------------------------------------------------------------------------

## 7 照 明

蛍光灯照明器具 蛍光管	調達を実施する場合（器具の形状により、不可能な場合を除く。）は、調達目標は100%とする。
----------------	-----------------------------------------------

## 8 自動車（普通自動車、小型自動車及び軽自動車とし、二輪車及び重量車を除く。）

低公害車	調達の予定はない。
低公害車以外の自動車	調達の予定はない。

## 9 制服・作業服

調達を実施する場合は、調達目標は50%とする。

## 10 インテリア・寝装

カーテン	調達を実施する場合は、調達目標は90%とする。
カーペット（織じゅうたん、ニードルパンチカーペット） 毛布	調達の予定はない。

## 11 作業用手袋

調達を実施する場合（防蜂手袋及び防振手袋を除く。）は、調達目標は40%とする。

## 12 設 備

太陽光発電システム 太陽熱利用システム 燃料電池	調達の予定はない。
--------------------------------	-----------

## 13 公共工事

公共工事の中で、基本方針に位置付けられた資材、建設機械を使用する場合は、原則として、判断の基準を満足するものを使用するものとする。

#### 1 4 役 務 （省エネ診断役務）

調達の手定はない。

特定調達物品等以外の平成14年度に調達を推進する環境物品等及びその調達の目標

- 1 環境物品等の選択に当たっては、エコマークの認定を受けている製品またはこれと同等のものを調達するように努める。
- 2 OA機器、家電製品の調達に際しては、より消費電力が小さく、かつ再生材を多く使用しているものを選択する。

その他環境物品等の調達推進に関する事項

- 1 この調達方針は独立行政法人国際農林水産業研究センター沖縄支所も対象とする。
- 2 調達の実績は、各品目毎に取りまとめ、国際農林水産業研究センターのホームページで公表する。
- 3 調達する品目に応じて、エコマーク等の既存の情報を活用することにより、判断基準を満たすことにとどまらず、できる限り環境負荷の少ない物品の調達に努める。
- 4 本調達方針に基づく調達担当窓口は、総務部会計課用度係とする。

“Æ—§•s•—@•|•••Ů”_—Ñ•...ŽY<ÆEα<†fZf“f^•[

•½•→,P,R”N“x“Á`è`2`B•i—Ú`2`BŽÀ•ÑŽæ,è,Û,Æ,B∧

••@•@•@-i	•i•@•@•@•@-Ú	-Ú•W`1	‘•`2`B—Ê	“Á`è`••i`2`B—Ê	ŽÀ•Ñ`1	”»`fŠi` ,ÉŠÖ,` ,é“Á•LŽ-•	”õ•@•@•@•@•@•1
Ž†—P•i,S•j	fRfs•[—pŽ†	70%	9022.896	9022.896	143%•@	•@	
•@	ftfH•[f —pŽ†	70%	0	0	0%•@	•@	
•@	^ó•ü—pŽ†	70%	10.825	10.825	143%•@	•@	
•@	%cq•¶[—pŽ†•ifgfcfEfbfgy•[fp•[•j	100%	459	459	100%•@	•@	
”[“ü^ó•ü••i,P•j	”[“ü^ó•ü••	70%	12	12	143%•@	•@	
•¶•i—P•i,S,X•j	fVff•[fvfyf“fvf<	90%	325	325	111%•@	•@	
•@	fVff•[fvfyf“fvf<Ö•c	90%	33	23	77%•@	•@	
•@	f{•[f<fyf“	90%	490	453	103%•@	•@	
•@	f}•[Lf“fOfyf“	90%	622	557	99%•@	•@	
•@	%o”•M	90%	682	562	92%•@	•@	
•@	fXf^f“fv`ä	90%	12	12	111%•@	•@	
•@	Žé“÷	90%	10	10	111%•@	•@	
•@	^ó•ÍfZfbfg	90%	2	1	56%•@	•@	
•@	`è•K	90%	21	16	85%•@	•@	
•@	fgfE•[	90%	76	48	70%•@	•@	
•@	•Á,µfSf	90%	195	195	111%•@	•@	
•@	fXfe•[fvf%o•[	90%	4	4	111%•@	•@	
•@	~AZĚfNfŠfbfv	90%	920	460	56%•@	•@	
•@	Ž—±—p•C•³•i•%ct•ó•j	90%	49	44	100%•@	•@	
•@	Ž—±—p•C•³•i•ife•[fv•j	90%	5	5	111%•@	•@	
•@	fNf%ctfJfge•[fv	90%	182	106	65%•@	•@	
•@	fufbfNfXf^f“fh	90%	4	4	111%•@	•@	
•@	fnfTf~	90%	50	50	111%•@	•@	
•@	f}fOfLfbfg•Ê	90%	10	10	111%•@	•@	
•@	f}fOfLfbfgfo•[	90%	0	0	0%•@	•@	
•@	fe•[fvfJfbf^•[	90%	6	4	74%•@	•@	
•@	fpf“f	90%	25	22	98%•@	•@	
•@	f,f<fgfP•[fX	90%	0	0	0%•@	•@	
•@	%o”•M•í	90%	8	6	83%•@	•@	
•@	,n,`fNfŠ•[fi•[•ifeJfbfgf^fCfv•j	90%	33	33	111%•@	•@	
•@	,n,`fNfŠ•[fi•[•ifeJfbfgf^fCfv•j	90%	5	5	111%•@	•@	
•@	fE^f^•[fP•[fX	90%	0	0	0%•@	•@	
•@	f}fEfXfpfbfh	90%	21	16	85%•@	•@	
•@	fJfbf^•[fiCft	90%	47	47	111%•@	•@	
•@	,n,g,oftfBf<f	90%	3701	2911	87%•@	•@	
•@	ŠG,İi	90%	0	0	0%•@	•@	
•@	-n`	90%	0	0	0%•@	•@	
•@	,İ,è•i%ct•ó•j	90%	5	5	111%•@	•@	
•@	,İ,è•iEÁE`•j	90%	258	253	109%•@	•@	
•@	,İ,è•ife•[fv•j	90%	3	2	74%•@	•@	
•@	,İ,è•i“b²,İ,è•j	90%	0	0	0%•@	•@	
•@	ftf@fCf<	90%	5834	5733	109%•@	•@	
•@	fofCf“f_•[	90%	169	168	110%•@	•@	

•@	fJ•[fhfP•[fX	90%	167	161	107%•@	•@
•@	f fffbfN•tfP•[fX	90%	0	0	0%•@	•@
•@	Ž—±—p••“>	90%	88550	88550	111%•@	•@
•@	, , eŽ†•E•NˆÄ—pŽ†	90%	0	0	0%•@	•@
•@	fm•[fg	90%	267	267	111%•@	•@
•@	fCf“fffbfNfX	90%	25	25	111%•@	•@
•@	•tâ³Ž†	90%	20	20	111%•@	•@
•@	fSf~”	90%	17	12	78%•@	•@
•@	fŠfTfCfNf<f{fbfNfX	90%	4	4	111%•@	•@
•@	-¼ŽD•iŠ÷•ã—p•j	90%	209	209	111%•@	•@
<@Ší—P•i,W•j	,e,.	30%	51	49	320%•@	•@
•@	Š÷	30%	16	12	250%•@	•@
•@	’I	30%	13	10	256%•@	•@
•@	Žâ”[—p•YŠí	30%	21	12	190%•@	•@
•@	f••[fp•[fefBfVf‡f“	30%	0	0	0%•@	•@
•@	ŒfŽ”Ā	30%	0	0	0%•@	•@
•@	••”Ā	30%	0	0	0%•@	•@
•@	fzf•fCfGf{•[fh	30%	0	0	0%•@	•@
%œĀ“d•»•i,U•j	—âˆ’ ŒÉ	100%	2	2	100%•@	•@
•@	—â“ ŒÉ	100%	0	0	0%•@	•@
•@	—â“ —âˆ’ ŒÉ	100%	0	0	0%•@	•@
•@	fGfA,fRf“	100%	6	6	100%•@	•@
•@	fefŒf†ŽóˆœŠí	100%	5	5	100%•@	•@
•@	,u,s,q	100%	3	3	100%•@	•@
,n,`<@Šíi,V•j	fRfs*[<@	50%	1	1	200%•@	•@
•@	fRf“fsf...[f^•[	50%	133	133	200%•@	•@
•@	fvfŠf“f^	50%	41	41	200%•@	•@
•@	fvfŠf“f^•E,e,`,wŒ“—p<@	50%	0	0	0%•@	•@
•@	,e,`,w	50%	6	6	200%•@	•@
•@	fXfLfffi•[	50%	18	18	200%•@	•@
•@	Ž×<CfffbfXfNˆ•’u	50%	42	21	100%•@	•@
•Ā→¼•i,Q•j	ŒuŒö•“Šíi	100%	10	7	70%•@	•@
•@	ŒuŒöf%œf“fv	100%	1344	1042	78%•@	•@
Ž©“®ŽÔ•i,Q•j	’áŒöŠQŽÔ	-	2	2-	•@	•@
•@	Ž©“®ŽÔ	-	0	0-	•@	•@
•š•ž•E•i<Ā•ž•i,Q•j	•š•ž	50%	0	0	0%•@	•@
•@	•i<Ā•ž	50%	114	80	140%•@	•@
fCf“fefŠfA•E•Qˆ•i,S•j•D,ŕ,ã,œ,½,ñ	-	-	0	0-	•@	•@
•@	fj•[fhf<fpf“f fJ•[fyfbfg	-	0	0-	•@	•@
•@	fJ•[fef“	90%	0	0	0%•@	•@
•@	-Ñ•z	-	0	0-	•@	•@
•i<Ā—pŽèˆÜ•i,P•j	•i<Ā—pŽèˆÜ	40%	95	95	250%•@	•@
•Ý”ô•i,R•j	‘¾—zŒö”-“dfVfXfef	-	0	0-	•@	•@
•@	f•[f%œ[fVfXfef	-	0	0-	•@	•@
•@	”R—i“d’r	-	0	0-	•@	•@
Œö•œ•HŽ—i,P,P•j	fP•[fefBfNf<f{•[fh	-	-	-	•@	•@
•@	’@ˆÜ”Ā	-	-	-	•@	•@
•@	-ØŽi(EnfZf•f“fg”Ā	-	-	-	•@	•@



•@	“©ŽŸŠiŽj,f^fCf<	-	-	-	-	•@	•@
•@	•,~FfZf•f“fg	-	-	-	-	•@	•@
•@	ftf%cofCfAfbfVf...fZf•f“fg	-	-	-	-	•@	•@
•@	•Ä•¶%oÄ”MfAfXftf@f<fg•→•‡•	-	-	-	-	•@	•@
•@	•Ä•¶•œ•P—i	-	-	-	-	•@	•@
•@	ŠÔ”°•p	-	-	-	-	•@	•@
•@	”r•o,fKfX’Î•ôŒ^ŒŸ•Ý<@ŠB	-	-	-	-	•@	•@
•@	’á’>%oŒŒ^ŒŸ•Ý<@ŠB	-	-	-	-	•@	•@
-ð-±i,P•j	•ÈfGflf<fM•[•f’f	-	-	-	-	•@	•@

独立行政法人国際農林水産業研究センター  
平成13年度特定調達品目調達実績取りまとめ表

分野	品目	目標値	総調達量	特定物品調達量	実績値	判断基準に関する特記事項	備考
紙類(4)	コピー用紙	70%	9022.896	9022.896	143%		
	フォーム用紙	70%	0	0	0%		
	印刷用紙	70%	10.825	10.825	143%		
	衛生用紙(トイレトペーパー)	100%	459	459	100%		
納入印刷物(1)	納入印刷物	70%	12	12	143%		
文具類(49)	シャープペンシル	90%	325	325	111%		
	シャープペンシル替芯	90%	33	23	77%		
	ボールペン	90%	490	453	103%		
	マーキングペン	90%	622	557	99%		
	鉛筆	90%	682	562	92%		
	スタンプ台	90%	12	12	111%		
	朱肉	90%	10	10	111%		
	印章セット	90%	2	1	56%		
	定規	90%	21	16	85%		
	トレイ	90%	76	48	70%		
	消しゴム	90%	195	195	111%		
	ステープラー	90%	4	4	111%		
	連射クリップ	90%	920	460	56%		
	事務用修正具(液状)	90%	49	44	100%		
	事務用修正具(テープ)	90%	5	5	111%		
	クラフトテープ	90%	182	106	65%		
	ブックスタンド	90%	4	4	111%		
	ハサミ	90%	50	50	111%		
	マグネット玉	90%	10	10	111%		
	マグネットバー	90%	0	0	0%		
	テープカッター	90%	6	4	74%		
	パンチ	90%	25	22	98%		
	モルタケース	90%	0	0	0%		
	鉛筆削	90%	8	6	83%		
	OAクリーナー(ウェットタイプ)	90%	33	33	111%		
	OAクリーナー(液タイプ)	90%	5	5	111%		
	レターケース	90%	0	0	0%		
マウスパッド	90%	21	16	85%			
カッターナイフ	90%	47	47	111%			
OHPフィルム	90%	3701	2911	87%			
絵の具	90%	0	0	0%			
墨汁	90%	0	0	0%			

	のり(液状)	90%	5	5	111%	
	のり(固形)	90%	258	253	109%	
	のり(テープ)	90%	3	2	74%	
	のり(澱粉のり)	90%	0	0	0%	
	ファイル	90%	5834	5733	109%	
	バインダー	90%	169	168	110%	
	カードケース	90%	167	161	107%	
	チャック付ケース	90%	0	0	0%	
	事務用封筒	90%	88550	88550	111%	
	けい紙 起案用紙	90%	0	0	0%	
	ノート	90%	267	267	111%	
	インデックス	90%	25	25	111%	
	付箋紙	90%	20	20	111%	
	ゴミ箱	90%	17	12	78%	
	リサイクルボックス	90%	4	4	111%	
	名札(机上用)	90%	209	209	111%	
機器類(8)	いす	30%	51	49	320%	
	机	30%	16	12	250%	
	棚	30%	13	10	256%	
	収納用什器	30%	21	12	190%	
	ローパーティション	30%	0	0	0%	
	掲示板	30%	0	0	0%	
	黒板	30%	0	0	0%	
	ホワイトボード	30%	0	0	0%	
家電製品(6)	冷蔵庫	100%	2	2	100%	
	冷凍庫	100%	0	0	0%	
	冷凍冷蔵庫	100%	0	0	0%	
	エアコン	100%	6	6	100%	
	テレビ受像器	100%	5	5	100%	
	VTR	100%	3	3	100%	
OA機器(7)	コピー機	50%	1	1	200%	
	コンピューター	50%	133	133	200%	
	プリンタ	50%	41	41	200%	
	プリンタ・FAX兼用機	50%	0	0	0%	
	FAX	50%	6	6	200%	
	スキャナー	50%	18	18	200%	
	磁気ディスク装置	50%	42	21	100%	
照明(2)	蛍光灯器具	100%	10	7	70%	
	蛍光灯ランプ	100%	1344	1042	78%	
自動車(2)	低公害車	-	2	2	-	
	自動車	-	0	0	-	

制服 作業服 (2)	制服	50%	0	0	0%	
	作業服	50%	114	80	140%	
インテリア 寝装 (4)	織じゅうたん	-	0	0	-	
	ニードルパンチカーペット	-	0	0	-	
	カーテン	90%	0	0	0%	
	毛布	-	0	0	-	
作業用手袋 (1)	作業用手袋	40%	95	95	250%	
設備 (3)	太陽光発電システム	-	0	0	-	
	ソーラーシステム	-	0	0	-	
	燃料電池	-	0	0	-	
公共工事 (11)	パーティクルボード	-	-	-	-	
	繊維板	-	-	-	-	
	木質系セメント板	-	-	-	-	
	陶磁器質タイル	-	-	-	-	
	高炉セメント	-	-	-	-	
	フライアッシュセメント	-	-	-	-	
	再生加熱アスファルト混合物	-	-	-	-	
	再生骨材料	-	-	-	-	
	間伐材	-	-	-	-	
	排出ガス対策型建設機械	-	-	-	-	
低騒音型建設機械	-	-	-	-		
役務 (1)	省エネルギー診断	-	-	-	-	

“Æ—§•s•—@•]••Ů”_—Ñ•...ŽY<ÆĖα<†fZf“f^•[

•½•¬,P,S”N“x“Á’è’2’B•i—Ú’2’BŽÀ•ÑŽæ,è,Û,Æ,β\

• ³ •@•@•@-i	•i•@•@•@•@-Ú	-Ú•W’1	‘•’2’B—Ê	“Á’è’•’i’2’B—Ê	ŽÀ•Ñ’1	”»’fŠi•,ÉŠÖ,•,é“Á•LŽ-•	”õ•@•@•@•@•@-1
Ž†—P•i,S•j	fRfs•[-pŽ†	70%	•@	•@	•@	•@	•@
•@	ftfH•[f—pŽ†	70%	•@	•@	•@	•@	•@
•@	ˆó•ü—pŽ†	70%	•@	•@	•@	•@	•@
•@	%cq•¶[-pŽ†•ifgfcfĖfbfgy•[fp•[•j	100%	•@	•@	•@	•@	•@
”[“üˆó•ü••i,P•j	”[“üˆó•ü••	70%	•@	•@	•@	•@	•@
•¶•i—P•i,S,X•j	fVff•[fvfyf“fVf<	90%	•@	•@	•@	•@	•@
•@	fVff•[fvfyf“fVf<Ö•c	90%	•@	•@	•@	•@	•@
•@	f{[f<fyf“	90%	•@	•@	•@	•@	•@
•@	f}[fLf“fOfyf“	90%	•@	•@	•@	•@	•@
•@	%c”•M	90%	•@	•@	•@	•@	•@
•@	fXf^f“fv•ä	90%	•@	•@	•@	•@	•@
•@	Žé“÷	90%	•@	•@	•@	•@	•@
•@	ˆó•ÍfZfbfg	90%	•@	•@	•@	•@	•@
•@	’è•K	90%	•@	•@	•@	•@	•@
•@	f g f Ė [	90%	•@	•@	•@	•@	•@
•@	•Á,µfSf	90%	•@	•@	•@	•@	•@
•@	fXfe•[fvf%c•[	90%	•@	•@	•@	•@	•@
•@	ˆAZĖfNfŠfbfv	90%	•@	•@	•@	•@	•@
•@	Ž—±—p•C• ³ •i•i%ct•ó•j	90%	•@	•@	•@	•@	•@
•@	Ž—±—p•C• ³ •i•ife•[fv•j	90%	•@	•@	•@	•@	•@
•@	fNf%ctf g f e•[fv	90%	•@	•@	•@	•@	•@
•@	fufbfNfXf^f“fh	90%	•@	•@	•@	•@	•@
•@	fnfTf~	90%	•@	•@	•@	•@	•@
•@	f}fOfLfbfg•Ê	90%	•@	•@	•@	•@	•@
•@	f}fOfLfbfgfo•[	90%	•@	•@	•@	•@	•@
•@	fe•[fvfJfbf^•[	90%	•@	•@	•@	•@	•@
•@	fpf“f	90%	•@	•@	•@	•@	•@
•@	f,f<fgfP•[fX	90%	•@	•@	•@	•@	•@
•@	%c”•M•i	90%	•@	•@	•@	•@	•@
•@	,n,`fNfŠ•[fi•[•ifeJfbfgf^fCfv•j	90%	•@	•@	•@	•@	•@
•@	,n,`fNfŠ•[fi•[•i%ctf^fCfv•j	90%	•@	•@	•@	•@	•@
•@	fĖf^•[fP•[fX	90%	•@	•@	•@	•@	•@
•@	f}fEfXf p f b f h	90%	•@	•@	•@	•@	•@
•@	fJfbf^•[fi f C f t	90%	•@	•@	•@	•@	•@
•@	,n,g,oftfBf<f	90%	•@	•@	•@	•@	•@
•@	ŠG,İi	90%	•@	•@	•@	•@	•@
•@	-n•`	90%	•@	•@	•@	•@	•@
•@	,İ,è•i%ct•ó•j	90%	•@	•@	•@	•@	•@
•@	,İ,è•iĖĀĖ•j	90%	•@	•@	•@	•@	•@
•@	,İ,è•ife•[fv•j	90%	•@	•@	•@	•@	•@
•@	,İ,è•i“b• ² ,İ,è•j	90%	•@	•@	•@	•@	•@
•@	ftf@fCf<	90%	•@	•@	•@	•@	•@
•@	f of C f “ f _ • [	90%	•@	•@	•@	•@	•@

•@	fJ•[fhfP•[fX	90%	•@	•@	•@	•@
•@	f f f f b f N • t f P • [f X	90%	•@	•@	•@	•@
•@	Ž—±—p••“>	90%	•@	•@	•@	•@
•@	, , e Ž † • E • N ^ Ä — p Ž †	90%	•@	•@	•@	•@
•@	f m • [f g	90%	•@	•@	•@	•@
•@	f C f “ f f i b f N f X	90%	•@	•@	•@	•@
•@	•tâ³Ž†	90%	•@	•@	•@	•@
•@	f S f ~”	90%	•@	•@	•@	•@
•@	f Š f T f C f N f < f { f b f N f X	90%	•@	•@	•@	•@
•@	-¼ŽD•iŠ÷•ä—p•j	90%	•@	•@	•@	•@
<@Ší—P•i,W•j	,ç,·	30%	•@	•@	•@	•@
•@	Š÷	30%	•@	•@	•@	•@
•@	’I	30%	•@	•@	•@	•@
•@	Žâ”[—p•YŠí	30%	•@	•@	•@	•@
•@	f••[fp•[fefBfvfžf“	30%	•@	•@	•@	•@
•@	ŒfŽ”Á	30%	•@	•@	•@	•@
•@	••”Á	30%	•@	•@	•@	•@
•@	f z f • f C f g f { • [f h	30%	•@	•@	•@	•@
%œÆ“d•»•i,U•j	—âˆ’ ŒÉ	100%	•@	•@	•@	•@
•@	—â“ ŒÉ	100%	•@	•@	•@	•@
•@	—â“ —âˆ’ ŒÉ	100%	•@	•@	•@	•@
•@	f G f A f R f “	100%	•@	•@	•@	•@
•@	f e f Œ f i Ž ó ‘ œ Š í	100%	•@	•@	•@	•@
•@	,u,s,q	100%	•@	•@	•@	•@
,n,`<@Šíi,V•j	f R f s • [ < @	50%	•@	•@	•@	•@
•@	f R f “ f s f … • [f ^ • [	50%	•@	•@	•@	•@
•@	f v f Š f “ f ^	50%	•@	•@	•@	•@
•@	f v f Š f “ f ^ • E , e , ` , w Œ “ — p < @	50%	•@	•@	•@	•@
•@	,e,`,w	50%	•@	•@	•@	•@
•@	f X f L f f f i • [	50%	•@	•@	•@	•@
•@	Ž×<CffBfXfN••’u	50%	•@	•@	•@	•@
•Æ→¼•i,Q•j	ŒuŒö““Šíi	100%	•@	•@	•@	•@
•@	ŒuŒöf%œf“fv	100%	•@	•@	•@	•@
Ž©“@ŽÔ•i,Q•j	’áŒöŠQŽÔ	-	•@	•@	•@	•@
•@	Ž©“@ŽÔ	-	•@	•@	•@	•@
•š•ž•E•i<Æ•ž•i,Q•j	•š•ž	50%	•@	•@	•@	•@
•@	•i<Æ•ž	50%	•@	•@	•@	•@
f C f “ f e f Š f A • E • Q ‘ • i , S • j • D , ¶ , ā , ð , ½ , ñ		-	•@	•@	•@	•@
•@	f j • [f h f < f p f “ f f J • [f y f b f g	-	•@	•@	•@	•@
•@	f J • [f e f “	90%	•@	•@	•@	•@
•@	-Ñ•z	-	•@	•@	•@	•@
•i<Æ—pŽèˆÜ•i,P•j	•i<Æ—pŽèˆÜ	40%	•@	•@	•@	•@
•Ý”ô•i,R•j	‘¾—zŒö”-“dfVfXfef	-	•@	•@	•@	•@
•@	f•[f%œ•[fVfXfef	-	•@	•@	•@	•@
•@	”R—ç“d’r	-	•@	•@	•@	•@
Œö•œ•HŽ—i,P,P•j	f p • [f e f B f N f < f { • [f h	-	•@	•@	•@	•@
•@	‘@ˆÚ”Á	-	•@	•@	•@	•@
•@	-ØŽç(EnfZf•f“fg”Á	-	•@	•@	•@	•@

•@	“©ŽŸŠiŽj,f^fCf<	-	•@	•@	•@	•@
•@	•,~FfZf•f“fg	-	•@	•@	•@	•@
•@	ftf%cfCfAfbfVf...fZf•f“fg	-	•@	•@	•@	•@
•@	•Ă•¶%ooĂ”MfAfXftf@f<fg•~•‡•	-	•@	•@	•@	•@
•@	•Ă•¶•œ•P—i	-	•@	•@	•@	•@
•@	ŠÔ”°•p	-	•@	•@	•@	•@
•@	”r•ofKfX‘Î•ôŒ^ŒŸ•Ý<@ŠB	-	•@	•@	•@	•@
•@	’á’>%oŒŒ^ŒŸ•Ý<@ŠB	-	•@	•@	•@	•@
-ð-±•i,P•j	•ÈfGflf,fM•[•f’f	-	•@	•@	•@	•@

独立行政法人国際農林水産業研究センター  
平成14年度特定調達品目調達実績取りまとめ表

分野	品目	目標値	総調達量	特定物品調達量	実績値	判断基準に関する特記事項	備考
紙類 (4)	コピー用紙	70%					
	フォーム用紙	70%					
	印刷用紙	70%					
	衛生用紙 (トイレトペーパー)	100%					
納入印刷物 (1)	納入印刷物	70%					
文具類 (49)	シャープペンシル	90%					
	シャープペンシル替芯	90%					
	ボールペン	90%					
	マーキングペン	90%					
	鉛筆	90%					
	スタンプ台	90%					
	朱肉	90%					
	印章セット	90%					
	定規	90%					
	トレ	90%					
	消しゴム	90%					
	ステープラー	90%					
	連射クリップ	90%					
	事務用修正具 (液状)	90%					
	事務用修正具 (テープ)	90%					
	クラフトテープ	90%					
	ブックスタンド	90%					
	ハサミ	90%					
	マグネット玉	90%					
	マグネットバー	90%					
	テープカッター	90%					
	パンチ	90%					
	モルトケース	90%					
	鉛筆削	90%					
	OAクリーナー (ウェットタイプ)	90%					
	OAクリーナー (液タイプ)	90%					
レターケース	90%						
マウスパッド	90%						



	カッターナイフ	90%				
	OHPフィルム	90%				
	絵の具	90%				
	墨汁	90%				
	のり(液状)	90%				
	のり(固形)	90%				
	のり(テープ)	90%				
	のり(澱粉のり)	90%				
	ファイル	90%				
	バインダー	90%				
	カードケース	90%				
	チャック付ケース	90%				
	事務用封筒	90%				
	けい紙 起案用紙	90%				
	ノート	90%				
	インデックス	90%				
	付箋紙	90%				
	ゴミ箱	90%				
	リサイクルボックス	90%				
	名札(机上用)	90%				
機器類(8)	いす	30%				
	机	30%				
	棚	30%				
	収納用什器	30%				
	ローパーティション	30%				
	掲示板	30%				
	黒板	30%				
	ホワイトボード	30%				
家電製品(6)	冷蔵庫	100%				
	冷凍庫	100%				
	冷凍冷蔵庫	100%				
	エアコン	100%				
	テレビ受像器	100%				
	VTR	100%				
OA機器(7)	コピー機	50%				
	コンピューター	50%				
	プリンタ	50%				

	プリンタ・FAX兼用機	50%					
	FAX	50%					
	スキャナー	50%					
	磁気ディスク装置	50%					
照明 (2)	蛍光灯器具	100%					
	蛍光ランプ	100%					
自動車 (2)	低公害車	-					
	自動車	-					
制服 作業服 (2)	制服	50%					
	作業服	50%					
インテリア 寝装 (4)	織じゅうたん	-					
	ニードルパンチカーペット	-					
	カーテン	90%					
	毛布	-					
作業用手袋 (1)	作業用手袋	40%					
設備 (3)	太陽光発電システム	-					
	ソーラーシステム	-					
	燃料電池	-					
公共工事 (11)	パーティクルボード	-					
	繊維板	-					
	木質系セメント板	-					
	陶磁器質タイル	-					
	高炉セメント	-					
	フライアッシュセメント	-					
	再生加熱アスファルト混合物	-					
	再生骨材料	-					
	間伐材	-					
	排出ガス対策型建設機械	-					
	低騒音型建設機械	-					
役務 (1)	省エネルギー診断	-					

## 独立行政法人国際農林水産業研究センター役員退職手当規程

13国研セ第4 - 24号

平成13年4月2日

### (趣旨)

第1条 独立行政法人国際農林水産業研究センター(以下「センター」という。)の常勤の役員(以下「役員」という。)の退職手当の支給に関する事項は、この規程に定めるところによる。

### (退職手当の支給)

第2条 退職手当は、役員が退職した場合に、その者(死亡による退職の場合には、その遺族)に支給する。ただし、役員が独立行政法人通則法(平成11年法律第103号)第23条の規定により解任された場合(同条第1項及び第2項第1号に該当し解任された場合を除く。)は、当該役員には退職手当は支給しない。

### (支給額)

第3条 退職手当の額は、その者の退職した日における俸給月額に、在職期間1月につき100分の28の割合(以下「支給割合」という。)を乗じて得た額とする。ただし、役員が任期満了の日以前又はその翌日に役職を異にする役員に任命され、引き続き在職した後退職した場合の退職手当の額は、それぞれ退職した日における当該異なる役職ごとの俸給月額に、当該異なる役職ごとの在職期間(以下「役職別期間」という。)1月につき支給割合を乗じて得たそれぞれの額の合計額とする。

2 前項の規定による退職手当の額は、その者の職務実績に応じ、これを増額し、又は減額することができる。

### (在職期間の計算)

第4条 在職期間及び役職別期間の月数の計算については、任命された日から起算して、暦に従って計算するものとする。この場合において、1月に満たない端数(以下「端数」という。)を生じたときは、これを1月とするものとする。

2 前条第1項ただし書に規定する場合において、各役職別期間の月数の合計が、同一の役職に在職したものとみなした場合に前項の規定により得られる在職期間の月数を超えるときは、同項の規定により1月とした端数の少ない役職別期間の月数から当該超える月数に達するまで順次1月を減ずるものとし、この場合において端数が等しいときは、後の役職別期間の月数から同様に1月を減ずるものとする。

(退職手当の支給制限)

第5条 役員が任期満了となり退職する場合において、その者がその日の翌日に再び同一の役職の役員に任命されたときは、その退職については、退職手当を支給しない。役員が任期満了の日以前又はその翌日に役職を異にする役員に任命されたときも、同様とする。

(遺族の範囲及び順位)

第6条 第2条に規定する遺族の範囲及びこれらの者が退職手当を受ける順位については、国家公務員退職手当法(昭和28年法律第182号)第11条の規定を準用する。この場合において、同条第1項中「職員」とあるのは「役員」と読み替えるものとする。

(遺族からの排除)

第7条 遺族からの排除については、国家公務員退職手当法第11条の2の規定を準用する。この場合において、同条中「職員」とあるのは「役員」と読み替えるものとする。

(起訴中に退職した場合等の退職手当の取扱い)

第8条 役員が刑事事件に関し起訴(当該起訴に係る犯罪について禁錮以上の刑が定められているものに限り、刑事訴訟法(昭和23年法律第131号)第6編に規定する略式手続きによるものを除く。次項及び次条第2項において同じ。)をされた場合において、その判決の確定前に退職したときは、退職手当は支給しない。ただし、禁錮以上の刑に処せられなかったときは、この限りでない。

2 前項の規定は、退職した者に対しまだ退職手当が支払われていない場合において、その者が在職期間(その退職手当の支給の基礎となる期間をいう。次条及び第10条において同じ。)中の行為に係る刑事事件に関し起訴をされたときについて準用する。

(退職手当の支給の一時差止め)

第9条 理事長は、退職した役員に対しまだ退職手当が支払われていない場合において、その者の在職期間中の行為に係る刑事事件に関して、その者が逮捕されたとき又はその者から聴取した事項若しくは調査により判明した事実に基づきその者に犯罪があると思料するに至ったときであって、その者に対し退職手当を支給することが、公共上の見地から行うセンターの事務及び事業に対する国民の信頼を確保し、退職手当の支給に関し、その適正かつ円滑な実施を維持する上で重大な支障を生ずると認めるときは、退職手当の支給を一時差し止めることができる。

2 理事長は、前項の規定による退職手当の支給を一時差し止める処分(以下「一時差止め処分」という。)について、次の各号のいずれかに該当するに至った場合には、速

やかに当該一時差止処分を取り消さなければならない。ただし、第2号に該当する場合において、一時差止処分を受けた者がその者の在職期間中の行為に係る刑事事件に関し現に逮捕されているときその他これを取り消すことが、一時差止処分の目的に明らかに反すると認められるときは、この限りでない。

- (1) 一時差止処分を受けた者について、当該一時差止処分の理由となった行為に係る刑事事件につき公訴を提起しない処分があった場合
  - (2) 一時差止処分を受けた者がその者の在職期間中の行為に係る刑事事件に関し起訴されることなくその者の退職の日から起算して1年を経過した場合
- 3 前項の規定は、理事長が一時差止処分後に判明した事実又は生じた事情に基づき、退職手当の支給を差し止める必要がなくなったとして当該一時差止処分を取り消すことを妨げるものではない。
- 4 理事長は、一時差止処分を行う場合は、当該一時差止処分を受けるべき者に対し、当該一時差止処分の際、一時差止処分の事由を記載した説明書を交付しなければならない。
- 5 前各項に規定するもののほか、一時差止処分に関し必要な事項は、理事長が別に定める。

#### (退職手当の返納)

第10条 理事長は、退職した役員に対し退職手当を支給した後において、その者が在職期間中に係る刑事事件に関し禁錮以上の刑に処せられたときは、その支給した退職手当の全部又は一部を返納させることができる。

#### (実施細則)

第11条 退職手当の支給手続きその他この規程の実施に関し必要な事項については、理事長が別に定める。

#### 附 則

- 1 この規程は、平成13年4月1日から施行する。

#### 附 則(平成14.3.29 13国研セ第3-145号)

- 1 この規程は、平成14年4月1日から施行する。
- 2 平成14年4月1日(以下「基準日」という。)の前日に現に在職する役員が引き続き在職した後基準日以降に退職した場合における退職手当の額は、第3条の規定にかかわらず、基準日の前日における俸給月額に任命された日から基準日の前日までの在職期間1月につき100分の36を乗じて得た額と当該退職の日における俸給月額

に基準日から退職した日までの在職期間 1 月につき 1 0 0 分の 2 8 を乗じて得た額の合計額とする。

- 3 前項の場合において、各在職期間の月数の計算については、暦に従って計算するものとし、端数を生じたときは、これを 1 月とするものとする。ただし、各在職期間の月数の合計が、第 4 条第 1 項の規定により得られる在職期間の月数を超えるときは、1 月とした端数の少ない在職期間の月数から 1 月を減ずるものとし、この場合において端数が等しいときには後の在職期間の月数から 1 月を減ずるものとする。
- 4 基準日の前日に現に在職する役員が任期満了の日以前又はその翌日に役職を異にする役員に任命された場合における前 2 項の規定の適用については、附則第 2 項中「基準日の前日における」とあるのは「それぞれ退職した日（基準日以降も同一の役職に引き続いて在職している場合にあっては、基準日の前日）における」と、「任命された日から基準日の前日までの在職期間」とあるのは「各役職別期間（基準日以降も同一の役職に引き続いて在職している場合にあっては、基準日の前日までの役職別期間）」と、「当該退職の日」とあるのは「それぞれ退職した日」と、「基準日から退職した日までの在職期間」とあるのは「各役職別期間（基準日の前日から引き続き同一の役職に在職している場合にあっては、基準日からの役職別期間）」と、附則第 3 項中「在職期間」とあるのは「役職別期間」と、「第 4 条第 1 項の規定により得られる在職期間」とあるのは「同一の役職に在職したものとみなした場合に第 4 条第 1 項の規定により得られる在職期間」と読み替えるものとする。

# Impact of Depreciated Currency on Agriculture in Thailand

**Minoru TADA***

Research Information Division, Japan International Research Center for Agricultural Sciences (JIRCAS) (Tsukuba, Ibaraki, 305-8686 Japan)

These studies were carried out within the framework of the Thailand-Japan joint project entitled "Econometric Model Building of Agriculture in Thailand" sponsored and coordinated by JICA and JIRCAS, and conducted at the Office of Agricultural Economics, Ministry of Agriculture and Cooperatives in Thailand.

Present address:

*Fisheries Management and Economy Division, National Research Institute of Fisheries Science (Fukuura 2-12-4, Yokohama, 236-8648 Japan)

## ---Abstract-----

In this paper, the impact of currency depreciation that took place on July 2, 1997 in Thailand, on agriculture especially on prices and production was analyzed by estimating and constructing demand-supply models for the main agricultural commodities. As a result, it was found that the most favored commodities were upland crops which compete in the world market and for which dollar prices are given, and the broiler meat export sector which has a significant market share in Japan, although the contraction in the domestic market exceeded the expansion in export. The next favored commodity was rice in the rainy season for which few imported input materials are used and the output price depends on export. Domestic commodities such as pork and eggs were worst off because of the contraction of the domestic market. If we consider the recent economic recession in Thailand, the impact of the factors indicated above is amplified, although the increase in the number of migrants from urban to rural areas may lead to the decrease in farmers' income per capita.

**Discipline:** Agricultural economics

**Additional key words:** demand, supply, price, economic growth

[1....7\):References](#)

(Received for publication, December 4, 1998)

## ---Introduction-----

The purpose of this report is to analyze the impact of the currency depreciation that took place on July 2, 1997 in Thailand on agriculture, especially on prices and production by estimating and constructing demand-supply models for the main agricultural commodities.

In the latter half of 1997, the "Baht", the currency of Thailand, depreciated nearly 100% against the US dollar and other major currencies. This is because the Baht had been strongly pegged to the dollar and overvalued in spite of continuous inflation and wage hikes in Thailand, and the current account balance recorded almost 338 billion Baht which accounted for 8% in the GDP ([Fig. 1\(34KB\)](#)).

There are direct and indirect effects of currency depreciation on agriculture. The direct one is that some agricultural commodities gain competitiveness in the world market in spite of the rise in input prices such as fertilizer price. The indirect one is through changes in the domestic demand for agricultural products caused by the economic recession, especially in the commercial sectors such as real estate development, banking and retail companies which do not face international competition. The economic crisis of these sectors is caused by the loss of the purchasing power of urban people and increased debt payment of the sector accelerated by the currency depreciation.

Thailand experienced an economic boom after 1987 caused by direct and indirect foreign capital inflow with the appreciation of the Japanese "yen". During this period, the Baht was overvalued against the US dollar, and the impact was opposite to the recent case. Martin and Warr demonstrated the importance of the impact of capital accumulation in the manufacturing sector that reduced the agricultural share in the GDP of Thailand³).

In light of the macroeconomic linkages with agriculture, Schuh was the first to show the importance of exchange rates in determining agricultural competitiveness⁵). Subsequently, McCalla emphasized the role of monetary policy that affects agricultural trade through changes in the exchange rates⁴). Chambers and Just developed these concepts into an empirical model, and the importance of real exchange rates was verified²). In the case of Japan, Tada pointed out the key role of monetary policy in determining the agricultural income of upland crop commodities⁶). Thraen, Hwang and Larson could not find a clear relation between US monetary expansion and soybean exports, where the role of the exchange rate was still significant⁷). For the macroeconomic impact on agriculture in developing countries, Bautista pointed out that realistic and competitive real exchange rates in the 1980s promoted the growth of the agricultural sector¹).

## ---Method-----

In the context of introductory economics that assumes a "small country" case, industries of tradable goods become better off through the depreciation of currency. In the case of Thailand, however, exported rice has a significant market share in the world and the assumption of "small country" can not be applied. Additionally Thai broiler meat competes with US, Chinese and Brazilian products in the Japanese market, and each share is substantial. This means that the balance between the positive influence of the improvement in price competitiveness and the negative effect of the rise in input prices is important to evaluate the impact of the depreciated Baht. Therefore, we constructed an econometric model of Thai agriculture comprising rice, wheat, maize, sugarcane, cassava, broiler, pork and egg commodities, where the sub-models of US rice and Japanese broiler meat were also included.

After constructing the model, we compared the results of simulations as of 1995/96 under the actual exchange rate which was 26 BT/\$ in 1996 and the alternative 40 BT/\$, which was stable as of April 1998 and corresponds to the Purchasing Power Parity exchange rate. The period of simulation ranged from 1989/90 to 95/96, because it takes several years for planted areas and prices to be adjusted to new economic conditions. Therefore, the differences in the simulated results under the alternative conditions of exchange rates demonstrate the long-term impact when the exchange rate changes from 26 to 40 BT/\$ under conditions where other exogenous variables such as GDP and dollar prices of fertilizer and feed remain constant.



## ---Framework of the model-----

The model is composed of 8 sub-models for rice, wheat, maize, cassava, sugarcane, broiler meat, pork meat and eggs, and these commodities account for nearly 60% of the value of the agricultural production. The model also includes the agricultural labor supply reflecting the subsistence characteristic of rice farming. Exchange rate, national income, population, CIF prices of fertilizer and feed given in dollar are the important exogenous variables influencing agriculture ([Fig. 2\(65KB\)](#)).

The rice model shows the following characteristics: price, production, consumption and trade depend on each other, where Thailand and USA are main players. FOB price for Thai rice is determined by the export of Thailand, by the aggregated export of USA and Australia, by the aggregated export of Vietnam, India, Myanmar and Pakistan, by the import of Japan, by the aggregated import of China, Indonesia and Iran, by the inflation ratio, implying that the demand for assets shifts from monetary to real assets during the period of inflation. The FOB price is transmitted into the wholesale price, thereby into retail and farm gate prices. Since it takes several years for the FOB price to be transmitted, we adopted partial adjustment lags for equations of wholesale, retail and farm gate price determinations. Production is defined as the planted area multiplied by yield, and the export is defined as production minus domestic consumption minus change in ending stock, where ending stock is an exogenous variable.

Supply of small livestock such as broilers, pigs and hen layers can respond to price changes quickly, because Thailand imports parent stock from the USA and European countries. Therefore, we assume horizontal supply curves for them, implying that they are produced under a constant return to scale. The prices depend on the price of feed which is the main component of the cost of production. In the broiler meat sector, the demand is represented by the aggregation of domestic and foreign market, where the Japanese market is the most important. The import of Japan from Thailand depends on the Japanese demand and the relative price of Thai to US and Chinese products.

Demand for maize is derived from livestock production, and the difference between production and domestic consumption is exported or imported. The price is transmitted into the domestic market through the exchange rate from USA Chicago market. Broken rice is also a major component of feed, and the price is determined based on wholesale prices of maize and rice.

For the cassava and sugarcane commodities, the raw outputs are processed into various kinds of final goods, and it is difficult to estimate the domestic consumption. Therefore, we built models for forecasting price and production. Yields are exogenous, because the yield functions estimated did not fit well. Domestic markets for these products are not linked to the world market perfectly, and the domestic prices are influenced by domestic production as well as world prices.

In estimating supply functions composed of planted area and yield functions and demand functions, we adopted single equation regressions such as OLS and ridge regressions rather than system estimations. In addition, the planted area and price in the previous year were selected in the explanatory variables of the planted area functions, where these two variables are components of the partial adjustment lag and adaptive price expectation. In all the equations, prices are deflated by the CPI of the country.

The reasons for this approach are as follows: (a) the presence of significant differences in profitability and labor productivity among industries and the fact that optimum conditions such as profit

maximization and zero profit are not satisfied in the Thai economy, (b) the problem of data accuracy in using sophisticated estimating methods such as the seemingly unrelated regression (SUR), and (c) existing equations estimated by single equation regressions that can be readily replaced by new equations when data are updated.



[Estimated impact of depreciation](#)



[Contents](#)

## ---Estimated impact of depreciation-----

The explanation below shows the difference in endogenous variables when the exchange rate changes from 26 to 40 BT/\$. [Table 1\(80KB\)](#) presents a summary of the impact. Since the simulation was conducted during the 6-year period after 1989/90, the estimated impact of the devaluation is considered to be a long-term one. In the short-term, the rise in prices of imported materials such as fertilizer and feed may not be fully transmitted to the domestic prices, or farmers change their planted area gradually, and as a result the impact will be less appreciable than the impact in the long-term.

### 1)Rice

Planted area and yield decrease by 4.4 and 2.6%, respectively, because the impact of the rise in fertilizer price exceeds that of the rise in rice price. In total, production decreases by 7.0%. Domestic consumption increases by 1.8% in spite of the 8.8% rise in retail price, because substitutive foods such as meats and wheat products become expensive relative to rice.

Farm gate price rises by 9.8%. One reason is the leftward shift of the supply curve (=cost push), and the other is the increase in the domestic and foreign demand for Thai rice due to the decrease in US production that responds to the fall in the dollar rice price.

Consequently, the gross revenue of farmers from rice production increases slightly, and farmers' income increases especially from the main crop (rainy season). This is because the cost of imported inputs in the total cost accounts for 10-12% for the main crop and 16-23% for the second crop, respectively. Therefore, production cost per unit increases by 5.0-7.0%, and is slightly lower than the price rise for the main crop.

### 2)Maize

Wholesale price and farm gate price rise by 49.0 and 40.0%, respectively due to the depreciation. For the supply side, planted area remains almost constant because of the substitution between maize, cassava and sugarcane. Yield and production increase by 15.5% due to the rise in output price, which means that more intensive production is promoted. Consequently, farmers' gross revenue increases by 65.5%. The cost of imported inputs accounts for about 10% (max. 25%) of the total cost, and the production cost per unit of maize is estimated to increased by 5.4% (max. 13.5%). Therefore, farmers' income from maize production increases significantly.

For the demand side, the use of maize is discouraged because of the contraction of livestock production. Thus, domestic consumption decreases by 18.0% and the export increases by 1,470,000 ton. Therefore, Thailand becomes a net exporter of maize again, and exports nearly 510,000 ton. For this estimation, it must be noted that the climatic conditions of the northeastern area of Thailand have become unsuitable for maize production, and that the expansion of production seems impossible. If this interpretation is correct, the production of other upland crops and perennial crops such as sugarcane, cassava, and kenaf is likely to increase.

### 3)Broiler

Feed price and retail price rise by 22.1 and 16.1%, respectively, and domestic consumption decreases by 16.0%. However, Thai broiler meat recovers its price competitiveness in the Japanese market, although it becomes expensive in the domestic market. Thus, the export to Japan increases by 20.0%. Under the

assumption that exports to countries other than Japan remain constant, the total export increases by 16.1% and the total demand for broiler and the production decline by 8.9%.

#### **4)Pork and eggs**

Feed prices for producing pork and eggs rise by 21.9 and 13.1%, respectively. Consequently, farm gate price and retail price increase as well. As a result, domestic consumption and production of pork and eggs decrease by 2.7 and 5.3%, respectively.

#### **5) Cassava and sugarcane**

Farm gate prices for these commodities rise by 40.0 and 48.1%, respectively. However, planted areas remain constant because of the substitution between these commodities, maize and other upland crops. Since the yield functions could not be estimated for these commodities, the yields are assumed to be constant in the simulation, although they are considered to respond to the prices of products and fertilizer. Thus, gross revenue exceeds price increase.

### **---Economic growth and prospects for agriculture-----**

The drastic depreciation of the exchange rate which occurred in 1997 had 2 effects: (a) agricultural products recovered their price competitiveness, and (b) the cost of production increased, especially for the commodities for which imported materials are intensively used. These effects offset each other, and the effect of the former was dominant for the commodity which competes internationally.

According to the results of simulation, the most favored commodities are upland crops such as maize, cassava and sugarcane for which world dollar prices are given, and broiler meat for export. The next favored commodity is rice in the rainy season. On the other hand, pork and egg commodities which are domestically consumed, are worst off because of the contraction of the domestic market.

The current balance account of Thailand has improved remarkably and been in the black since the end of 1997, implying that the international competitiveness of exporting industries has recovered substantially. Therefore, the predictions of our econometric model seem to be qualitatively satisfactory, although they should be revised by updating the data.

The analysis above is limited to the impact of the currency depreciation, and does not include the impact of economic growth. The recent economic recession in Thailand is very severe, and the economic growth rate is forecasted to be -3.0 to -8.0% for the year 1998. If this situation continues for some years, the impact may become very significant both on the demand and supply of agriculture, though it is not significant in only one year.

The persistent economic recession affects agriculture as follows. Demand for livestock products and maize decreases, while the demand for rice increases under the negative economic growth. The production of livestock shrinks and exports of upland crops expand due to the changes in the demand side. If the economic growth rate recovers to a 3.0% value or higher, our model shows that the situation after the depreciation will return to that before the depreciation in some years. However, under the assumption that the growth rate remains at less than 1% even after 1999, similar situation of agriculture is forecasted to continue.

These effects of the economic recession amplify the impact of devaluation. However, if the economic recession continues for many years, many laborers in the urban sector will migrate to rural areas. Under

this scenario, labor migration may reduce the agricultural income per capita.

Finally, there are 2 alternative strategies for the recovery of the Thai economy: (1) to promote the introduction of advanced technology and enhance the industrial structure through the improvement of human capital, thereby discontinuing the export-oriented growth depending on assembly plants such as current automobile industries, and (2) to enhance the domestic industrial linkages, thereby expanding the labor-intensive industries that are less dependent on foreign capital and technology.

For the development of agriculture in Thailand, the latter alternative is preferable whereby the currency weakens and the export of agricultural and processed products is promoted. Consequently, the opportunities for employment in the rural areas are also expanded.

### ---References-----



[Back to the first page](#)

- 1) Bautista, R. M. (1993): Trade and agricultural development in the 1980s and the challenges for the 1990s; *Asia. Agric. Econ.*, **8**, 345-375.
- 2) Chambers, R. G. & Just, E. J. (1982): An investigation of the effect of monetary factors on agriculture. *J. Monetary Econ.*, **9**, 235-247.
- 3) Martin, J. W. & Warr, G. P. (1994): Determinants of agriculture's relative decline; Thailand. *Agric. Econ.*, **11**, 219-235.
- 4) McCalla, A. F. (1982): Impact of macroeconomic policies upon agricultural trade and international agricultural development. *Am. J. Agric. Econ.*, **64**, 861-868.
- 5) Schuh, G.E. (1974): The exchange rate and U.S. agriculture. *Am. J. Agric. Econ.*, **56**, 1-13.
- 6) Tada, M. (1991): Effect of foreign exchange rate on Japanese agricultural income. *Bull. Natl. Agric. Res. Cent.*, **20**, 73-91 [In Japanese].
- 7) Thraen, C. S., Hwang, T. C. & Larson, D. W. (1992): Linking of U.S. monetary policy and exchange rates to world soybean markets. *Agric. Econ.*, **6**, 365-384.



[Forward to:-Preliminary Report on Stable Isotope Ratio Analysis for Samples from Matang Mangrove Brackish Water Ecosystems](#)



[Contents](#)



[JIRCASD Home Page](#)

Table 1. Estimated impact of the depreciation on agriculture

	1995/96	1995/96 (Simulation)		
	Actual value	Actual exchange rate (a)	40 BT/\$ (b)	Impact of depreciation (b)/(a)(%)
<b>Rice</b>				
Planted area (million rai ^{a)} )	63.35	61.32	58.60	▼ 4.4
Yield (kg/rai)	347	336	327	▼ 2.6
Production (1,000 t)	22,015	20,622	19,183	▼ 7.0
Farm gate price (BT/t)	5,182	5,127	6,030	△17.6
FOB price (BT/t)	9,229	9,298	11,561	△24.3
Retail price (BT/t)	10,970	11,711	12,741	△ 8.8
Demand per capita (kg)	140	136	138	△ 1.8
Domestic consumption (1,000 t)	13,009	12,352	12,577	△ 1.8
Export (1,000 t)	5,619	5,131	4,033	▼21.4
Broken rice price (BT/t)	5,290	5,586	7,004	△25.4
USA export (1,000 t)	2,624	2,757	2,219	▼19.5
<b>Wheat</b>				
Import (1,000 t)	694	653	588	▼10.0
<b>Maize</b>				
Planted area (1,000 rai)	8,346	9,218	9,219	△ 0.0
Yield (kg/rai)	498	420	485	△15.5
Production (1,000 t)	4,155	3,874	4,476	△15.5
Farm gate price (BT/t)	4,350	4,021	5,630	△40.0
Wholesale price (BT/t)	4,950	4,776	7,114	△49.0
Net export (1,000 t)	-582	-963	510	(△1,473)
Domestic consumption (1,000 t)	4,512	4,836	3,965	▼18.0
<b>Broiler^{b)}</b>				
Production (million head)	705	772	703	▼ 8.9
Retail price (BT/kg)	42.8	39.1	45.4	△16.1
Export (1,000 t)	137	190	221	△16.1
Domestic consumption (1,000 t)	661	684	575	▼16.0
Feed price (BT/kg)	8.38	9.27	11.32	△22.1
Japanese import (1,000 t)	548	588	595	△ 1.2
<b>Pork^{b)}</b>				
Production (head)	9,993	9,647	9,387	▼ 2.7
Retail price (BT/kg)	78.0	79.3	86.2	△ 8.7
Farm gate price (BT/kg)	40.6	37.5	42.0	△12.0
Feed price (BT/kg)	7.18	7.16	8.73	△21.9
<b>Eggs^{b)}</b>				
Production (million eggs)	8,599	9,017	8,541	▼ 5.3
Retail price (BT/egg)	1.83	1.77	1.91	△ 8.0
Feed price (BT/kg)	6.22	6.57	7.43	△13.1
<b>Cassava</b>				
Planted area (1,000 ha)	1,200	1,366	1,365	▼ 0.0
Production (1,000 t)	16,000	18,205	18,197	▼ 0.0
Farm gate price (BT/t)	1,207 ^{c)}	813	1,138	△40.0
<b>Sugarcane</b>				
Planted area (1,000 rai)	6,279 ^{c)}	5,398	5,422	△ 0.4
Production (1,000 t)	57,974 ^{c)}	48,581	48,794	△ 0.4
Farm gate price (BT/t)	386 ^{c)}	356	526	△48.1

a): 1 rai = 0.16 ha.

b): Since the data of livestock production are derived from estimations from the import of parent stock rather than from the survey, there are serial correlations for errors between actual and forecasted values.

c): The data refer to those of 1994/95.



[Back](#)

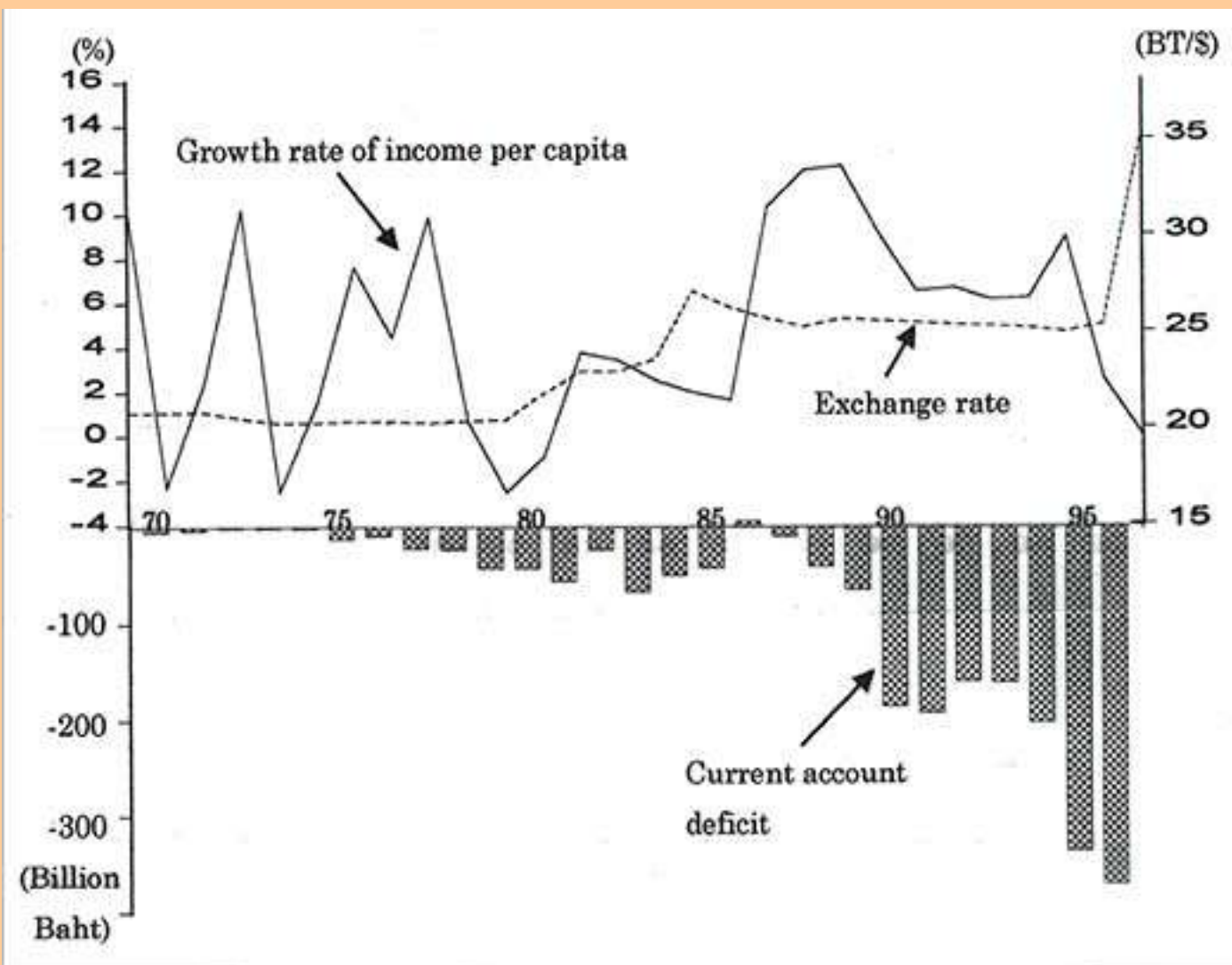


Fig.1. Main economic indicators of Thailand



[Back](#)

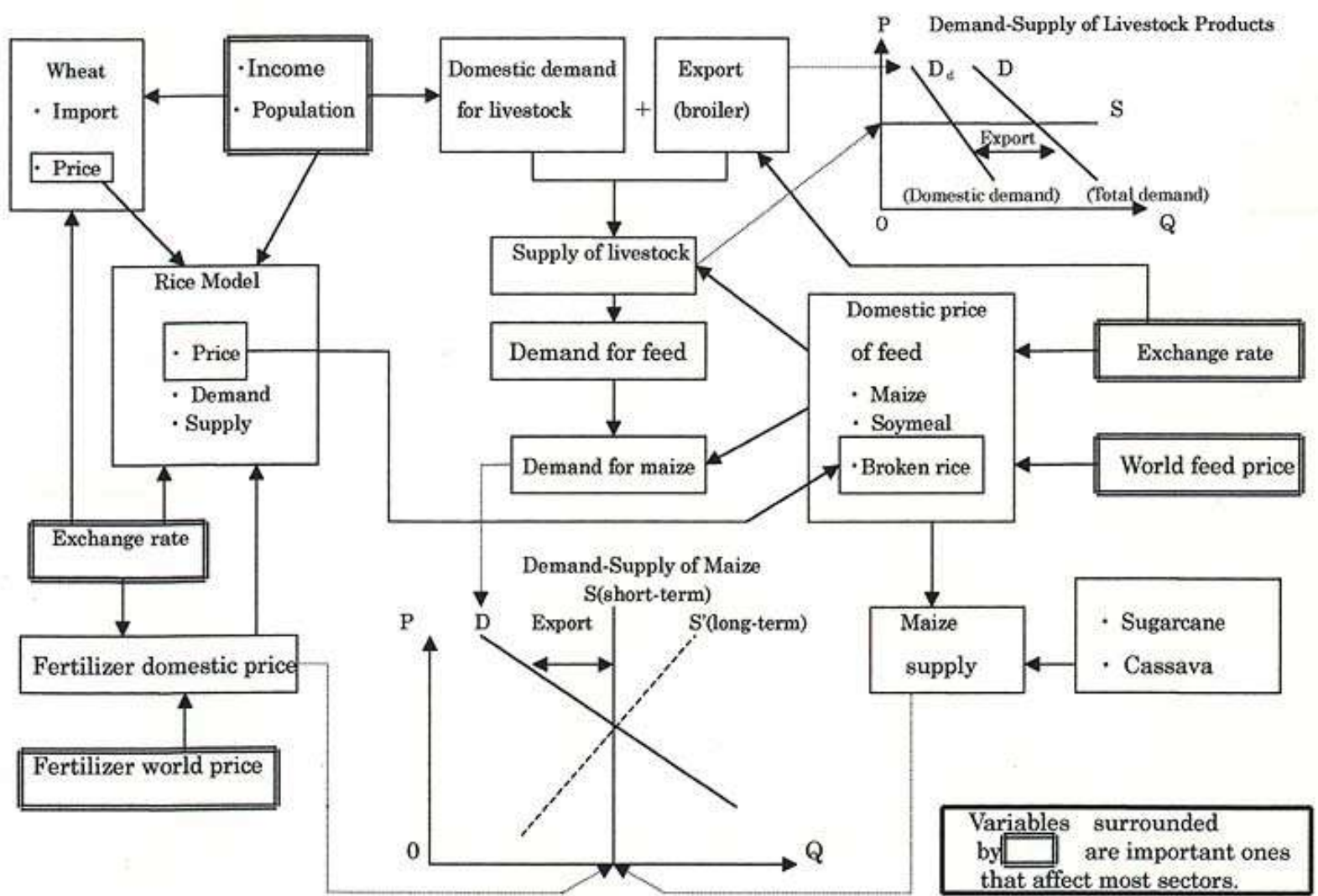


Fig.2. Structure of the econometric model of Thai agriculture



[Back](#)



# Preliminary Report on Stable Isotope Ratio Analysis for Samples from Matang Mangrove Brackish Water Ecosystem

Shigeo HAYASE*¹, Tadafumi ICHIKAWA *² and Katsuhisa TANAKA*²

*¹ Fisheries Division, Japan International Research Center for Agricultural Sciences (JIRCAS) (Tsukuba, Ibaraki, 305-8686 Japan)

*² Marine Productivity Division, National Research Institute of Fisheries Science (Kanazawa, Yokohama, 236-8648 Japan)

This report was written within the framework of the integrated project entitled "Productivity and Sustainable Utilization of Brackish Water Mangrove Ecosystems" in collaboration with Fisheries Research Institute, University of Malaya, Forestry Research Institute of Malaysia and JIRCAS, during the period of 1995 to 2000.

Present address:

*¹ East China Sea Fisheries Oceanography Division, Seikai National Fisheries Research Institute (Kokubu, Nagasaki, 850-0951 Japan)

## ---Abstract-----

The stable carbon and nitrogen isotope ratios of mangrove leaves, particulate organic matter (POM), shrimps and crabs, squids and fishes were studied for tracing the actual food web structure in the Matang mangrove brackish water ecosystems. Carbon isotope ratio of POM showed a positive correlation with the level of salinity, suggesting that POM around the mouth to mudflat areas of the river may consist of phytoplankton-derived detritus from the sea, whereas POM from mid- to upstream areas of the river may consist of mangrove-derived detritus. ¹³C-¹⁵N map showed a C-N isotope ratio gradient with the lowest value with mean (±SD) of ¹³C (-28.74±0.031‰) and ¹⁵N (4.36±0.15‰) for a mangrove leaf (*Rhizophora apiculata*), the highest value of ¹³C (-20.45±0.026‰) for a squid (*Loligo duvaucelii*) and of ¹⁵N (13.63±0.021‰) for a fish (*Stolephorus commersonii*). Penaeid shrimps (*Penaeus merguensis*, *Metapenaeus brevicornis* and *M. ensis*) and mangrove crabs (*Scylla serrata*) showed intermediate C-N values between those of mangrove leaves and fish/squid.

**Discipline:** Fisheries resources

**Additional key words:** mangrove litter, food-chain, energy flow

[1...18](#); [References](#)

## ---Introduction-----

Brackish waters form where sea water and freshwater mix, usually within regions characterized by flat topography stretching between rivers and seas. In tropical and subtropical areas, brackish water coastlines often play host to mangrove forests, which serve as nursery grounds for fish and prawns while playing critical roles in protecting coasts from the threat of hurricanes and erosion. Humans also utilize mangrove trees for fuel, charcoal, chips, timber and medicinal products.

Matang Mangrove Forest Reserve in Perak State, reputed to be the world's best managed forest. This reserve consisting of some 40,711 hectares of mainly *Rhizophora apiculata* mangroves situated on the north-western coast of Peninsular Malaysia. It is the largest tract of mangrove forest in Peninsular Malaysia and has been under sustainable yield management since the early century, consisting of many islands and adjacent numerous waterways (rivers, channels, inlets and streams). Among of those waterways, Selinsing river (Sungai Selinsing in Malay language) is the most undisturbed river, and Sangga river (Sungai Sangga) is a main ships course of otter-trawlers and particularly in around the mouth area of the river, a Chinese fishing village and many rafts for cage culture of finfish (mainly giant sea-bass and mangrove snapper) have been engaged. We collected samples from above 2 rivers in Matang, and tried to analyze the trophic relations in mangrove brackish water ecosystems.

Measurements of natural ¹³C/¹²C and ¹⁵N/¹⁴N isotope ratios are useful for determining sources of nutrition for consumers and trophic relationships among organisms and have often been used in studies of lake, river and marine food webs^{2,4,6,11,14,16-18}). It is generally recognized that ¹³C measurements primarily indicate the main sources of carbon for consumers, and ¹⁵N values indicate the trophic distance of consumers from the food base⁵). The simultaneous use of ¹³C and ¹⁵N values therefore enables to analyze the trophic relationships in food webs³).

Measurements of ¹³C and ¹⁵N values in mangrove brackish water ecosystems have been carried out by many researchers^{1,3,7-10,12,13,15}) who reported the presence of a ¹³C gradient at the higher trophic levels.

## ---Materials and methods-----

### 1) Sampling and processing

Samples for isotope analysis were collected from Sungai Selinsing and Sangga Matang, November 1996 and February 1997 ([Fig. 1\(105KB\)](#)). Five species of shrimps, 4 mangrove crabs and 8 squids with different body sizes, and 7 species of fishes were collected from Sungai Selinsing. Leaves from 2 species of mangrove and 7 bottles of surface water for the isotope analysis of particulate organic matter at different stations from mouth/mudflat to upstream areas of the river were also sampled from Sungai Sangga ([Table 1\(114KB\)](#)). The length and weight were measured for each sample, then fat/gut were removed and gut contents were investigated in fish samples. Thereafter, each sample was dried at 60 for about half to one day. At least 4 whole individuals of fish and shrimp were pooled and muscle tissues were carefully excised from each specimen with a clean scalpel, and only muscle tissue was used for isotope analysis. Particulate organic carbon (POC) samples were collected with precombusted (450) Whatman GF/F glass-fiber filters and dried at 60. In each analysis, dried samples were pretreated with concentrated hydrochloric acid (HCl) for removing carbonates since carbonates are known to interfere with C signatures. Dry animal tissues, particulate organic matter and leaf tissues were ground to a fine powder using a mortar and pestle, then subjected to combustion.

### 2) Isotope analysis

The organic matters were converted into CO₂ and N₂ gases with the sealed quartz tube combustion method⁵). CO₂ and N₂ gases were separated and purified cryogenically with liquid nitrogen and dry ice ethanol slush. Purified gases were introduced into isotope ratio mass spectrometer (Finnigan Mat, MAT 252). A graphite reference material was used as a standard for carbon isotope ratio measurements. ¹³C values are expressed relative to the VPDB (Vienna Peedee Belemnite) standard. High purity tank nitrogen gas was used as a working standard for the nitrogen isotope ratio measurements. This working standard was calibrated against N₁ and N₂ ammonium sulfate. ¹⁵N values are reported relative to nitrogen in air. Stable carbon and nitrogen isotope ratios are represented by the following  $\delta$  values:

$$\delta^{13}\text{C}, \delta^{15}\text{N} (\text{‰}) = \left[ \frac{R_{\text{sample}}}{R_{\text{standard}}} - 1 \right] \times 1,000, \text{ where } R = {}^{13}\text{C}/{}^{12}\text{C} \text{ or } {}^{15}\text{N}/{}^{14}\text{N}.$$

## ---Results and discussion-----

Carbon isotope ratio of POM showed a positive correlation with the level of salinity (n=7, p<0.05) ([Fig. 2\(49KB\)](#)). Carbon isotope ratio of POM without 2 stations (Sts. 7 and 8 in Fig. 1) also showed a positive correlation with the total carbon content (n=5, p<0.05) ([Fig. 3\(49KB\)](#)), suggesting that an area with higher salinity contains a higher total carbon content with a higher POM ¹³C. The content of phytoplankton carbon calculated from chlorophyll-a was almost stable (about 15-25% of total carbon), regardless of the POM ¹³C level ([Fig. 4\(49KB\)](#)). These findings indicate that the phytoplankton-derived carbon contains about 15-25% of total carbon, and major parts of remaining carbon may consist of detritus carbon throughout the river to the estuary of Sungai Sangga. In other words, the results shown in Figs. 2-4 suggesting that the POM around the mouth to mudflat areas of the river (higher POM ¹³C) may consist of phytoplankton-derived detritus from the sea, whereas POM from mid- to upstream areas of the river (lower POM ¹³C areas) may consist of mangrove-derived detritus. ¹³C and ¹⁵N of mangrove leaves showed the lowest values without a range of POM ¹³C in Sungai Sangga.

While in Sungai Selinsing, squid showed the highest value of ¹³C and tropical anchovy (*Stolephorus commersonii*) showed the highest value of ¹⁵N ([Table 1](#)). ¹³C-¹⁵N map showed that there was a C-N isotope ratio gradient from the Matang mangrove brackish water ecosystem with the lowest value with mean (SD) of ¹³C (-28.74 x 0.031_‰) and ¹⁵N (4.36 x 0.15_‰) for a mangrove leaf (*Rhizophora apiculata*), the highest value of ¹³C (-20.45 x 0.026_‰) for a squid (*Loligo duvaucelii*) and of ¹⁵N (13.63 x 0.021_‰) for a fish (*S. commersonii*). Except for one fish, *Anodontostoma chacunda*, all fishes showed higher ¹⁵N values suggesting with a higher trophic level. Penaeid shrimps (*Penaeus merguensis*, *Metapenaeus brevicornis* and *M. ensis*) and mangrove crab (*Scylla serrata*) showed on intermediate C-N value between those of mangrove leaves and fish/squid. The range of the ¹³C values for POM in Sungai Sangga overlapped the ¹³C signal range for fishes, squids, shrimps and crabs in Sungai Selinsing ([Fig. 5\(47KB\)](#)). Thus a clear C-N isotope ratio gradient in the Matang mangrove brackish water ecosystem could be detected.

Natural Environment Research Center⁷), which conducted the isotope studies of mangrove leaves, land and aquatic animals, mangrove and marine mud sediments collected in the northern portion (around Kuala Gula area) of the Matang mangrove ecosystem during the period 1992-1994, concluded the following: (1) there is a mangrove leaf-based organic matter flux in the water, running into the sea through the river, (2) some of the organic materials accumulated in the mud sediment and were utilized by mangrove/aquatic mollusks, and (3) fishes showed the highest values of ¹³C and ¹⁵N, and also a clear C-N isotope ratio gradient from mangrove leaves up to fishes in the Matang mangrove brackish water ecosystem ([Fig. 6\(28KB\)](#)).

The present results also suggest that there is a food pathway from the mangrove leaf-based detritus to carnivorous fishes and squids through herbivorous shrimps and crabs.



[Contents](#)



[First page of JARQ](#)



[JIRCAS Home Page](#)



**Japan International Research Center for Agricultural Sciences**  
**Ministry of Agriculture, Forestry, and Fisheries**  
**1-2 Ohwashi, Tsukuba, Ibaraki 305-8686 JAPAN**  
**Telephone 0298-38-6304**  
**published on July 15, 1999**

## ---References-----

[Back](#)

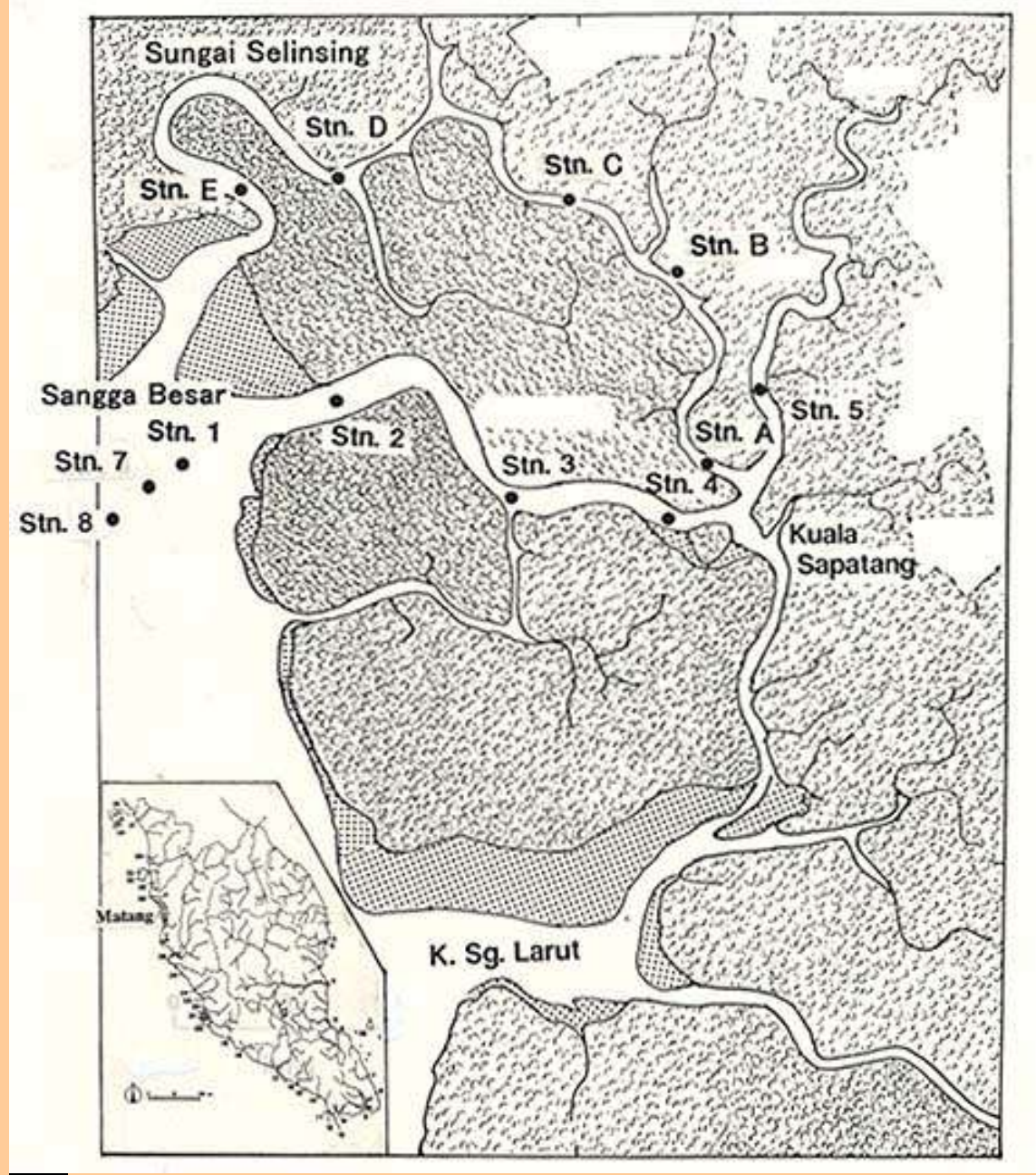
- 1) Hemminga, M. A. et al. (1994): Carbon outwelling from a mangrove forest with adjacent seagrass beds and coral reefs (Gazi Bay, Kenya). *Mar. Ecol. Prog. Ser.*, **106**, 291-301.
- 2) Lindsay, D. J. (1995): Stable isotopic features of the food web in Sagami Bay in relation to Shirasu (*Engraulis japonicus* larvae). Thesis submitted in partial fulfillment of the requirements for the Degree of Master of Science (Agriculture) to the University of Tokyo, pp. 56.
- 3) Marguillier, S. et al. (1997): Trophic relationships in an interlinked mangrove-seagrass ecosystem as traced by  $^{13}\text{C}$  and  $^{15}\text{N}$ . *Mar. Ecol. Prog. Ser.*, **151**, 115-121.
- 4) Matsuura, Y. & Wada, E. (1994): Carbon and nitrogen stable isotope ratios in marine organic matters of the coastal ecosystem in Ubatuba, southern Brazil. *Ciencia e Cultura* (J. Brazil. Assoc. Adv. Sci.), **46** (3), 141-146.
- 5) Minagawa, M. & Wada, E. (1984): Stepwise enrichment of  $^{15}\text{N}$  along food chains; further evidence and the relation between  $^{15}\text{N}$  and animal age. *Geochim. Cosmochim. Acta*, **48**, 1135-1140.
- 6) Nakamoto, N. (1991): Primary production by diurnal variation method. *Res. Bull. Shinsyu Univ.*, **7**, 91-97.
- 7) Natural Environment Research Center (1995): Studies on conservation of biological diversity in the Asian tropical wetlands. pp. 248 [In Japanese].
- 8) Newell, R. I. E. et al. (1995): Relative importance of benthic microalgae, phytoplankton, and mangroves as source of nutrition for penaeid prawns and other coastal invertebrates from Malaysia. *Mar. Biol.*, **123**, 595-606.
- 9) Primavera, J. H. (1996): Stable carbon and nitrogen isotope ratios of penaeid juveniles and primary producers in a riverine mangrove in Guimaras, Philippines. *Bull. Mar. Sci.*, **58** (2), pp. 21.
- 10) Rao, R. G. et al. (1994): Carbon, nitrogen contents and stable carbon isotope abundance in mangrove leaves from an East African coastal lagoon (Kenya). *Aquat. Bot.*, **47**, 175-183.
- 11) Rau, G. H. et al. (1992):  $^{15}\text{N}/^{14}\text{N}$  and  $^{13}\text{C}/^{12}\text{C}$  in Weddell Sea birds, seals, and fish; implications for diel and trophic structure. *Mar. Ecol. Prog. Ser.*, **84**, 1-8.
- 12) Rodelli, M. R. et al. (1984): Stable isotope ratio as a tracer of mangrove carbon in Malaysian ecosystems. *Oecologia (Berlin)*, **61**, 326-333.
- 13) Stoner, A. W. & Zimmerman, R. J. (1988): Food pathways associated with penaeid shrimps in a mangrove-fringed estuary. *Fish. Bull.*, **86** (3), 543-550.

- 14) Takahashi, K. et al. (1990): Temporal variations in carbon isotope ratio of phytoplankton in a eutrophic lake. *J. Plankton Res.*, **12**, 799-808.
- 15) Tan F. C., Cai, D. L. & Edmond, J. M. (1991): Carbon isotope geochemistry of the Changjiang estuary. *Estuarine, Coastal & Shelf Sci.*, **32**, 395-403.
- 16) Wada, E. et al. (1984): Carbon and nitrogen isotopic composition as tracers of transport of organic matter along the Otsuchi watershed. *Geochim. Cosmochim. Acta*, **18**, 89-98 [In Japanese].
- 17) Welch, D. W. & Parsons, T. R. (1993):  $^{13}\text{C}$ - $^{15}\text{N}$  values as indicators of trophic position and competitive overlap for Pacific salmon (*Oncorhynchus* spp.). *Fish. Oceanogr.*, **2** (1), 11-23.
- 18) Yoshioka, T., Wada, E. & Saijo, Y. (1988): Isotopic characterization of Lake Kizaki and Lake Suwa. *Jpn. J. Limnol.*, **49**, 119-128.



[Back](#)

Fig.1. Sampling stations for stable isotope analysis in Sungai Selinsing and Sangga Besar, Matang



 [Back](#)

Table 1. Sample specimens for stable isotope ratio analysis in the Matang mangrove brackish water ecosystem

## 1) Sungai Selinsing, Matang

Animal group	Japanese name	Date	Station	No.	Range (cm)	Range (g)	$\delta^{15}\text{N}$ (‰)	SD (‰)	$\delta^{13}\text{C}$ (‰)	SD (‰)	Remarks
<b>Shrimps</b>											
					<b>CL^{e)}</b>	<b>BW^{g)}</b>					
<i>Penaeus merguensis</i> (L) ^{a)}	Tenjikuturumaebi	Feb. 6, '97	Stas. A-E	5	2.4-2.8	5.48-8.51	8.910	0.023	-24.777	0.038	
<i>P. merguensis</i> (M) ^{b)}	Tenjikuturumaebi	Feb. 6, '97	Stas. A-E	5	2.0-2.3	4.32-5.38	8.640	0.048	-23.165	0.015	
<i>P. merguensis</i> (S) ^{c)}	Tenjikuturumaebi	Feb. 6, '97	Stas. A-E	5	1.2-1.8	1.22-1.92	9.765	0.025	-24.223	0.045	
<i>Metapenaeus brevicornis</i>	Yoshiebi zoku	Feb. 6, '97	Stas. A-E	7	1.2-1.6	0.95-1.77	8.359	0.033	-26.613	0.030	
<i>M. ensis</i>	Yoshiebi	Feb. 6, '97	Stas. A-E	7	1.5-1.9	1.51-2.38	8.778	0.023	-25.032	0.031	
<i>Echippolysmata ensirostris</i>	Not available	Feb. 6, '97	Stas. A-E	8	0.8-1.2	0.36-0.86	10.284	0.034	-23.580	0.019	
<i>Macrobrachium rosenbergii</i>	Onitenagaebi	Feb. 6, '97	Stas. A-E	1	2.0	4.20	11.109	0.027	-24.111	0.034	
<b>Mangrove crab</b>											
					<b>CL</b>	<b>BW</b>					
<i>Scylla serrata</i> (L)	Nokogirigazami	Feb. 6, '97	Stas. A-E	1	10.2	290	10.563	0.033	-23.527	0.031	
<i>S. serrata</i> (M)	Nokogirigazami	Feb. 6, '97	Stas. A-E	1	8.1	110	9.800	0.017	-23.505	0.026	
<i>S. serrata</i> (S)	Nokogirigazami	Feb. 6, '97	Stas. A-E	2	6.8-7.1	60-80	8.891	0.240	-24.476	0.022	
<b>Squid</b>											
					<b>ML^{e)}</b>	<b>BW</b>					
<i>Loligo duvaucelii</i> (L)	Ajiajindouika	Feb. 6, '97	Stas. A-E	3	4.6-4.9	7.29-10.51	12.673	0.030	-20.855	0.010	
<i>L. duvaucelii</i> (S)	Ajiajindouika	Feb. 6, '97	Stas. A-E	5	2.8-4.0	2.01-4.61	13.182	0.016	-20.446	0.026	
<b>Fishes</b>											
					<b>SL^{f)}</b>	<b>BW</b>					<b>Gut contents</b>
<i>Ambassis gymnocephalus</i>	Takasagoishimochi zoku	Nov. 16, '96	Sta. D	9	2.2-4.3	0.18-1.88	11.738	0.020	-24.057	0.022	Polychaeta
<i>Anodontostoma chacunda</i>	Nanyoukonoshiro	Nov. 16, '96	Stas. D-E	19	3.3-6.6	0.54-3.95	9.727	0.022	-21.014	0.017	Diatom
<i>Panchax melostigma</i>	Not available	Nov. 16, '96	Sta. D	10	2.0-2.4	0.08-0.18	12.256	0.022	-24.305	0.026	Phytoplankton
<i>Stolephorus commersonii</i>	Indoainokoiwashu zoku	Nov. 16, '96	Sta. E	10	4.8-6.3	0.95-2.15	13.633	0.021	-25.008	0.026	Mysis
<i>S. insularis</i>	Indoainokoiwashu zoku	Nov. 16, '96	Sta. E	6	4.9-6.8	0.98-2.90	13.454	0.025	-23.656	0.025	Mysis
<i>Johnius vogleri</i>	Konibe zoku	Nov. 16, '96	Sta. E	4	11.1-11.9	24.9-35.3	12.377	0.015	-22.864	0.014	Mys., Shr., Fish
<i>Lutjanus vitta</i>	Tatefuedai	Nov. 16, '96	Sta. E	1	11.1	30.6	11.897	0.017	-24.207	0.038	Shrimp

a): L; Large size. b): M; Middle size. c): S; Small size. d): CL; Carapace length. e): ML; Mantle length. f): SL; Standard length. g): BW; Body weight.

## 2) Sungai Sangga Besar, Matang

Leaves and POM	Japanese name	Date	Station	No.	Range (g)	$\delta^{15}\text{N}$ (‰)	SD (‰)	$\delta^{13}\text{C}$ (‰)	SD (‰)	Salinity
<b>Mangrove leaves</b>										
<i>Rhizophora apiculata</i> (L) ^{a)}	Futabanahirugi	Feb. '97		13	0.17 ~ 1.21	4.356	0.150	-28.738	0.031	
<i>R. apiculata</i> (S) ^{b)}	Futabanahirugi	Feb. '97		23	0.44 ~ 1.33	6.343	0.150	-26.705	0.016	
<i>Brugiera</i> sp.	Ohirugi zoku	Feb. '97		45	0.26 ~ 0.65	7.977	0.066	-27.040	0.023	
<b>Particulate organic matter (POM)</b>										
POM at 0 m	Suityuu kendakubutu	Nov. 18, '96	Stn. 8					-17.934	0.026	28.34
POM at 0 m	Suityuu kendakubutu	Nov. 18, '96	Stn. 7					-18.106	0.037	28.09
POM at 0 m	Suityuu kendakubutu	Nov. 18, '96	Stn. 1					-19.848	0.045	25.86
POM at 0 m	Suityuu kendakubutu	Nov. 18, '96	Stn. 2					-21.955	0.010	21.93
POM at 0 m	Suityuu kendakubutu	Nov. 18, '96	Stn. 3					-22.941	0.023	18.37
POM at 0 m	Suityuu kendakubutu	Nov. 18, '96	Stn. 4					-23.532	0.023	16.28
POM at 0 m	Suityuu kendakubutu	Nov. 18, '96	Stn. 5					-25.610	0.034	9.26

a): L; Large size. b): S; Small size.



Back

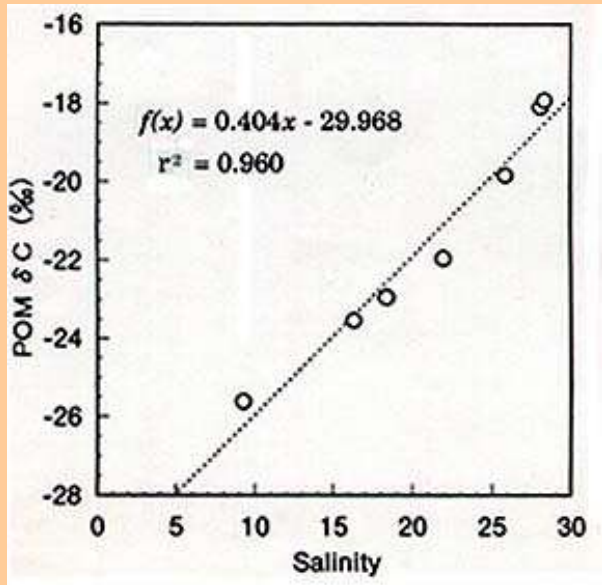


Fig.2.  
Plot of carbon isotope ratio of particulate organic matter (POM) against the salinity at each sampling in Sangga Besar, Matang

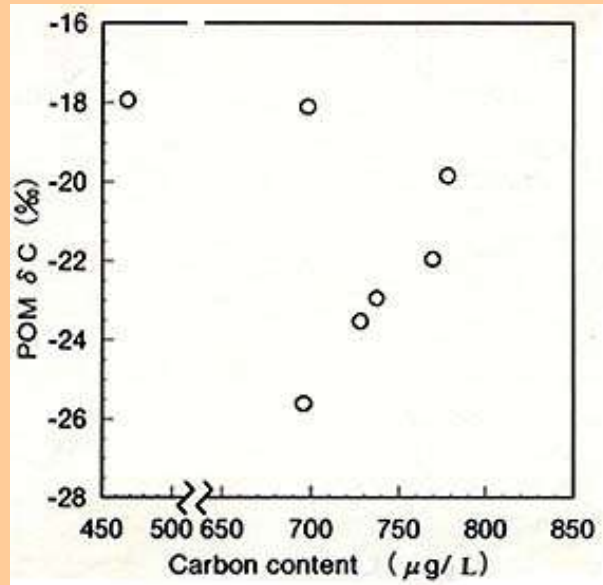


Fig.3.  
Plot of carbon isotope ratio of POM against total carbon content at each sampling station in Sangga Besar, Matang

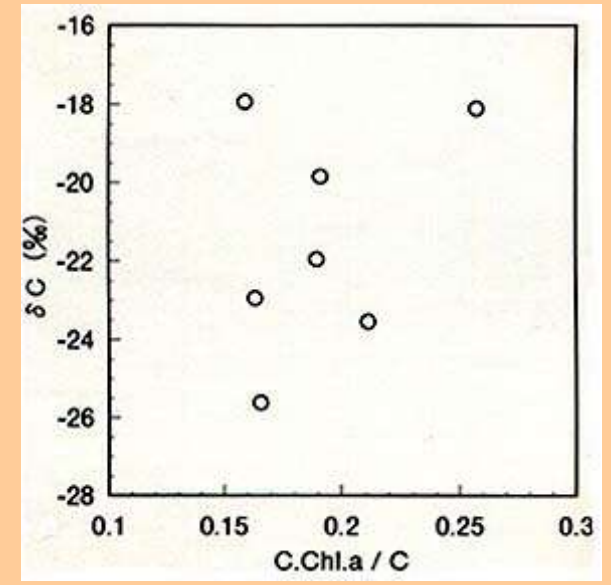


Fig.4.  
Plot of carbon isotope ratio of POM against chlorophyll-a carbon content (total carbon basis) at the sampling station of Sangga Besar, Matang



[Back](#)



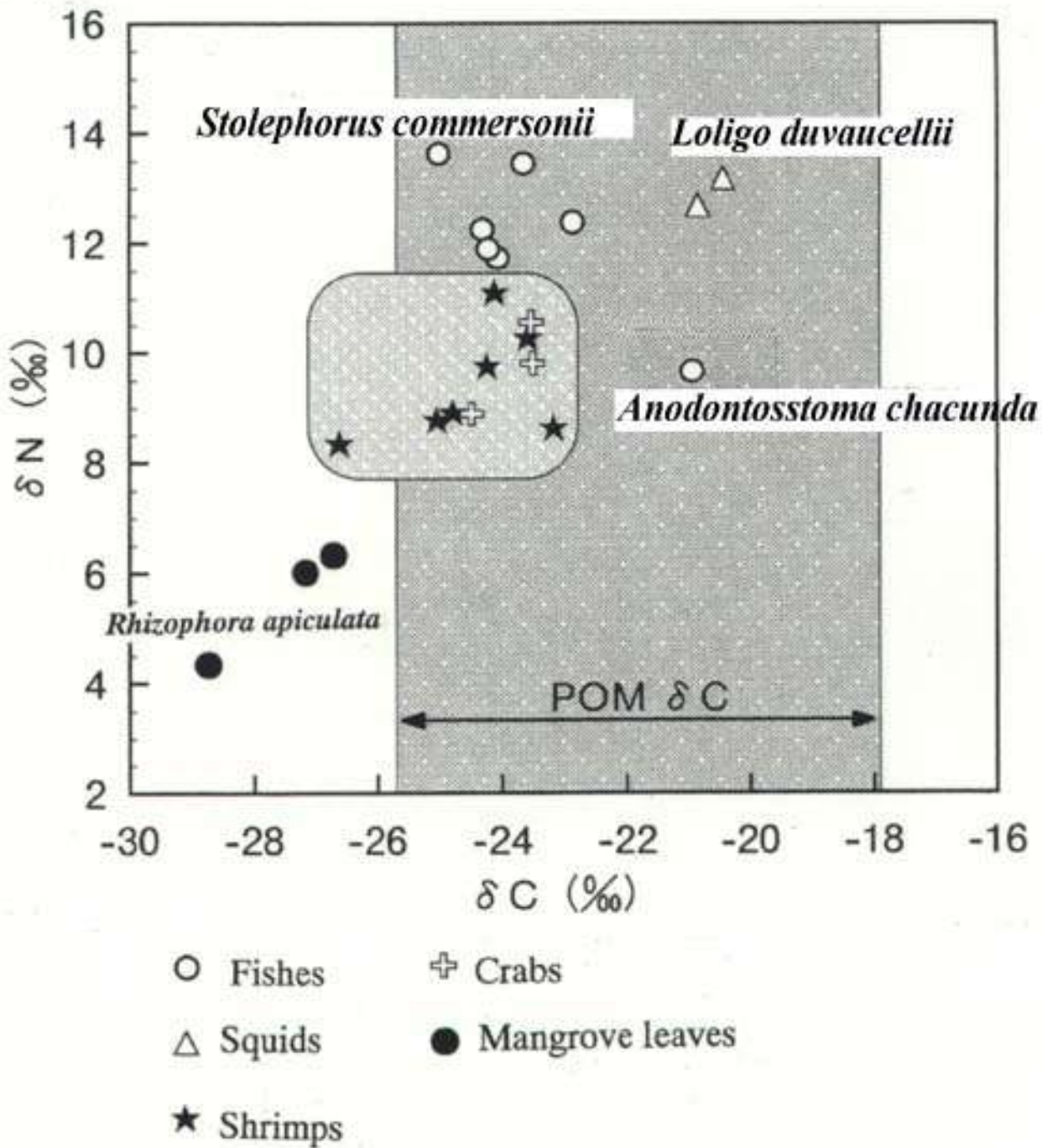


Fig. 5.  $\delta^{13}C$ - $\delta^{15}N$  map of mangrove leaves, animals and POM in the Matang mangrove brackish water ecosystem



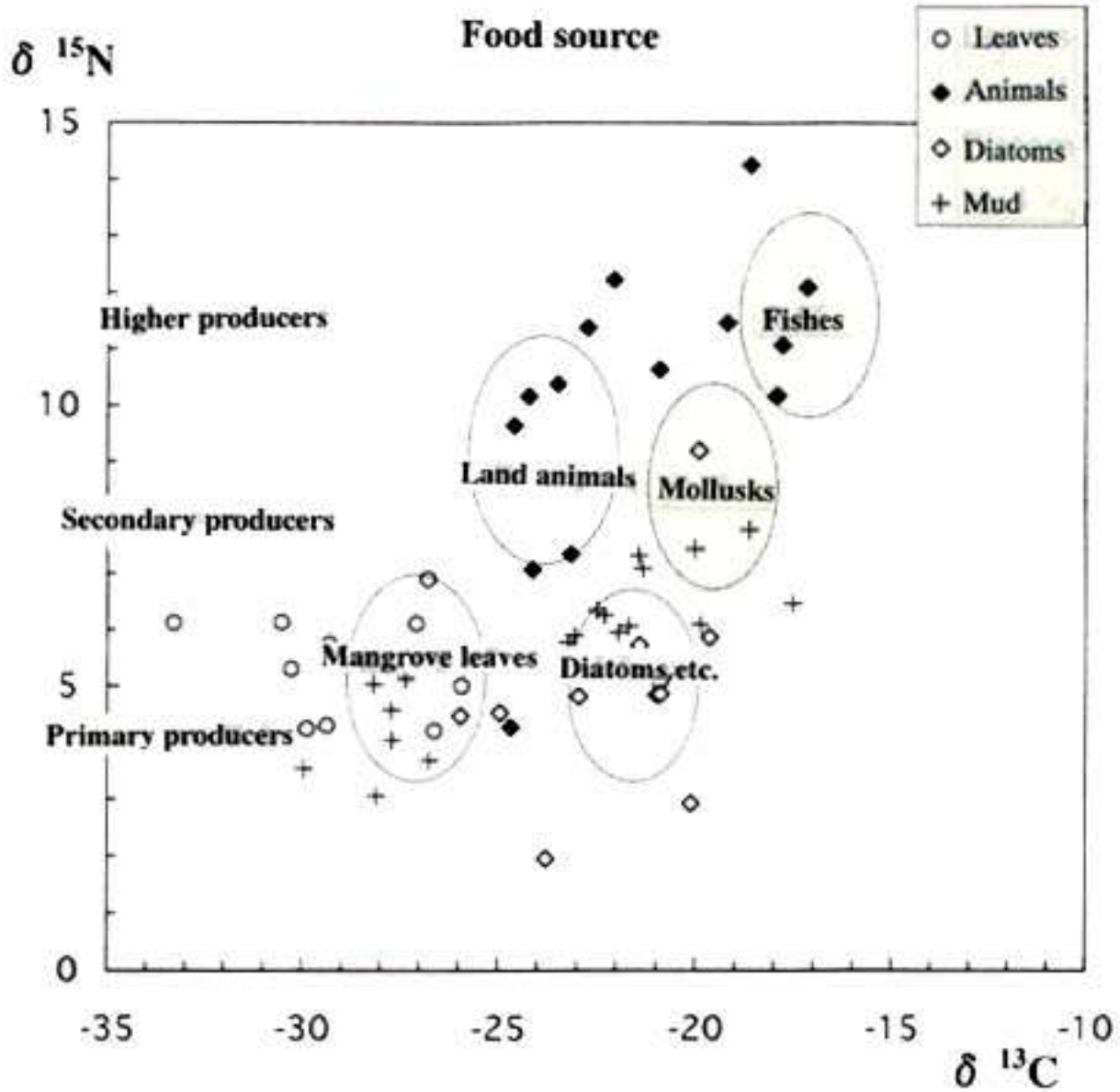


Fig. 6.  $^{13}\text{C}$ - $^{15}\text{N}$  plot and schematic map in the Matang (Sg. Gula) mangrove brackish water ecosystem (from Natural Environment Research Center⁷⁾)



[Back](#)