

# **AT** MICROFICHE REFERENCE LIBRARY

A project of Volunteers in Asia

Anti-Pollution Lab: Elementary Research,  
Experiments and Science Projects on Air, Water and  
Solid Pollution in Your Community

by: Elliott Blaustein

Published by:  
Arco Publishing, Inc.  
215 Park Avenue South  
New York, NY 10003 USA

Paper copies are \$ 3.00.

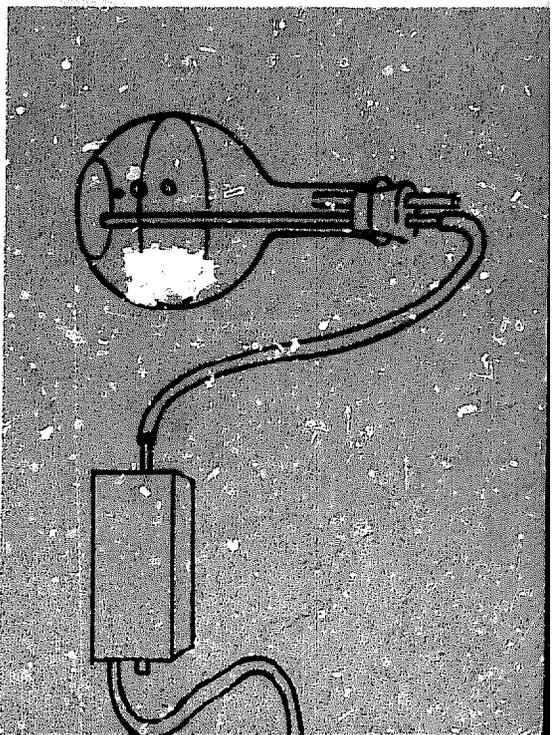
Available from:  
Arco Publishing, Inc.  
215 Park Avenue South  
New York, NY 10003 USA

Reproduced by permission of Arco Publishing, Inc.

Reproduction of this microfiche document in any form is subject to the same restrictions as those of the original document.

ARCO

# Anti-



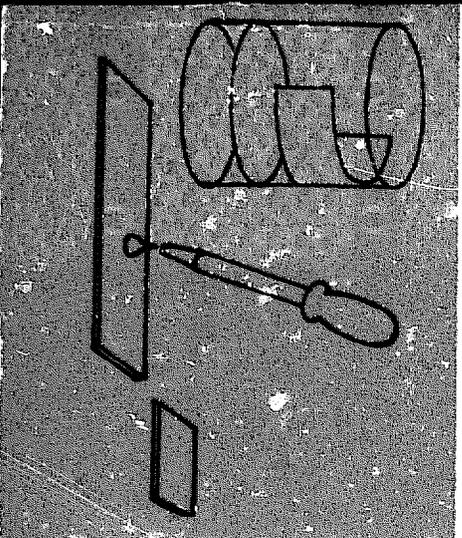
# pollution LAB

Elementary research,  
experiments and  
science projects  
on air, water and  
soil pollution in  
your community.

**Elliot H. Blaustein**

Preface by René Duinos

\$2.25



# **anti- pollution lab**

**Elementary research,  
experiments and  
science projects  
on air, water and  
solid pollution in  
your community.**

**Elliott H. Blaustein**

**Preface by René Dubos.**

**ARCO PUBLISHING COMPANY, INC.**

219 Park Avenue South, New York, N.Y. 10003

**Acknowledgment by the Author**

To Peter Greenleaf for his very helpful advice and encouragement, and to Michael Barr for designing the electronic circuits.

To Vincent C. Golpe and Louis Sackman for their excellent suggestions and dedicated efforts without which this book could not have been written.

**Acknowledgment by the Publisher:**

To Staten Island Museum of Arts and Sciences for their assistance in compiling lists of organizations involved in the struggle against pollution.

Drawings by Louis Sackman

First Arco Printing, 1975

Published by Arco Publishing Company, Inc.  
219 Park Avenue South, New York, N.Y. 10003

Copyright © 1972 by Elliot H. Blaustein

All rights reserved. No part of this book may be reproduced in any form without written permission from the publisher, except by a reviewer.

Library of Congress Catalog Card Number 74-32559  
ISBN 0-668-03234-0

Printed in the United States of America

**This book is dedicated  
to Rose with sincere  
appreciation.**

## CONTENTS

<b>Preface by René Dubos</b> .....	<b>9</b>
<b>Introduction</b> .....	<b>11</b>
<b>1. How Air Pollution Affects Living Things</b> .....	<b>13</b>
The deadly smog. How air pollution affects the weak, the healthy and the elderly. Air pollution and respiratory diseases. How to check for lung damage. How age and height affects breathing (lung power). The effects of emphysema, asthma and bronchitis on the lungs. Pollution from natural sources. How man's respiratory system tries to protect him against air pollution. How air pollution affects the respiratory system. How deadly is sulfur dioxide? How harmful are air pollutants?	
<b>Special projects:</b> How to measure vital capacity. How age, height and the community affects vital capacity. How to measure maximum breath pressure. How age and type of community affects maximum breath pressure. How to prepare solutions for testing ciliary action. Testing reaction of chemicals on the respiratory cilia. How to perform bioassay on live brine shrimp. How to make serial dilutions of acid solutions. How sulfur dioxide affects living things.	
<b>2. How to Detect, Identify and Measure Air Pollutants</b> .....	<b>33</b>
The problem of air pollution. Chemical analysis of air pollution. Detecting sulfur dioxide in air we breathe. Calculating the mass of molecules. Reducing volume of sulfur dioxide in air. How fall-out of solid particles originates. How to measure fall-out. Automobiles and photochemical smog. Temperature inversions. Why ozone is both helpful and harmful. How the otherwise almost harmless carbon dioxide can destroy cities. How carbon monoxide can become a painless poison. Why pollutants affect visibility.	
<b>Special projects:</b> How to identify sulfur dioxide. How to measure the amount of sulfur dioxide in the air. How to build and use a photometer to measure fall-out. How to detect air pollution in your community. How to make and use an electrical thermometer. How to test for ozone. How to measure the amount of carbon dioxide in the air. How to estimate the production of carbon monoxide in your community. How to measure visibility. How to measure ceiling.	

<b>3. Water Pollution</b> .....	<b>68</b>
<p>Water, a joy or a blight? How water pollution menaces all forms of life. "Dead" rivers and lakes. Causes of water pollution. Algae, the killers of lakes and aquatic life. How algae feed on detergents. How to limit the growth of algae. Foaming rivers and foaming faucets. The meaning of turbidity. Thermal pollution. How salts get into the water. Effect of salts on water and aquatic life. Oil, the deadly tide. How oil spills affect the ecology. The fight against oil spillage.</p> <p><b>Special projects:</b> How to measure water turbidity with a homemade device. Using the photometer to measure water turbidity. How to measure the concentration of solid particles. How to prepare nutrient solutions for the growth and study of algae. How the absence or variation of a nutrient affects the growth of algae. Foam from detergents. How to measure detergent concentrations in water. How to test for thermal pollution in water. How to make and calibrate a salinity meter to measure salts in water. How oil damages plant life.</p>	
<b>4. Solid Pollution</b> .....	<b>94</b>
<p>Solid pollution, the ever-present enigma. How you, your family and the community contribute towards solid pollution. Garbage dumps, a health hazard. Problems of solid pollution disposal: sanitary landfills, incineration and recycling. How pollution has been reduced. How you can help reduce air, water and solid pollution.</p> <p><b>Special projects:</b> How much solid waste does your family produce per day? How much litter is scattered on your street? How do bacteria and fungi affect waste foods? How burning garbage reduces the requirement for landfill space. Air pollution from burning paper. How to compare the rate of disintegration of steel to that of aluminum. How to determine which kinds of fibers are most resistant to decay. How to identify different kinds of fibers under a microscope. Recycling: How to make new paper from old. Extracting pure lead from lead oxide. How to obtain pure copper from scrap copper by electroplating.</p>	
<b>Test Your Knowledge of Pollution</b> .....	<b>118</b>
<b>Bibliography</b> .....	<b>121</b>
<b>Organizations Engaged in Combatting Pollution</b> .....	<b>124</b>
<b>Index</b> .....	<b>126</b>

### **Preface**

**MOST OF US** live in environments which are so constantly polluted that we tend to forget how brilliant the sky can be, how fragrant the air, how clean tasting the water. We become progressively tolerant of pollution and come to accept it as a matter of course.

This tolerance is helpful since it allows us to function in a more or less normal way despite environmental pollution, but it can be very dangerous in the long run. Levels of pollutants which are so low as not to cause obvious and immediate effects may elicit undesirable and even grave body reactions on prolonged exposure. The increase in the incidence of chronic pulmonary diseases and of certain forms of cancer, for example, can almost certainly be traced to the ubiquitous presence of pollutants in industrial and urban environments.

We have no instinct to warn us of the dangers posed by modern pollutants, and most of them indeed are not even detected by our senses. We absorb lead, asbestos, pesticides, and thousands of other potentially toxic chemicals without being aware of their presence. The only possible approach to the control of pollution, therefore, is to develop practical scientific methods of detection so as to make up for the lack of warning instincts and of sensual perception of pollutants. This is precisely what Elliott Blaustein has done in his book **ANTIPOLLUTION LAB**. He has shown that practical and inexpensive methods are now available for the detection of many different kinds of environmental pollutants.

It is certain, on the other hand, that the modern environment contains many potentially toxic substances which have not yet been recognized, or identified. For example, it is only during the past few years that we have become aware of the damage done to the body by minute amounts of the asbestos used for insulation or of the nitrogen oxides produced by motor cars. We must therefore learn to detect

disorders of the body caused by pollution, even though we do not yet know the nature of the pollutants which are responsible for these disorders. Here again, Elliott Blaustein serves as a useful guide by describing practical methods for the measurement of abnormalities and deficiencies in body processes caused by pollutants, known or unknown.

Environmental pollution is so ubiquitous and diversified, its effects so vast and ill-defined, that the complexity of the problem tends to discourage social action. As already mentioned, we have no instinct to warn us of the presence of pollutants or to guide us in the development of control measures against them.

The great merit of Elliott Blaustein's book is to demonstrate that we can use simple and practical scientific techniques to detect pollutants as well as their effects on the body, and also to develop action programs which will once more render our environment healthy and pleasurable.

René Dubos  
The Rockefeller University  
New York, New York 10021

## INTRODUCTION

EVERYBODY TALKS about pollution, but now *you* can do something about it. Newspapers, television and radio repeatedly tell us how badly polluted our world is becoming. If you live in or near a town or city, or an industrial area, you will undoubtedly find that pollution is fairly heavy in your own community. While you may not be able to solve the pollution problems of the world, you can help to solve this problem in your community.

This book helps you to understand how pollution affects your well-being and your very life. It provides the techniques and procedures to *locate* the pollution sources in your community, to *measure how much* pollution exists there, to *examine the nature* of some of the pollutants, and finally, to gather information that will be useful to the people in your community who are fighting pollution in the social and political arena. In addition, we are going to look into the problem of how to *reduce* pollution in our community.

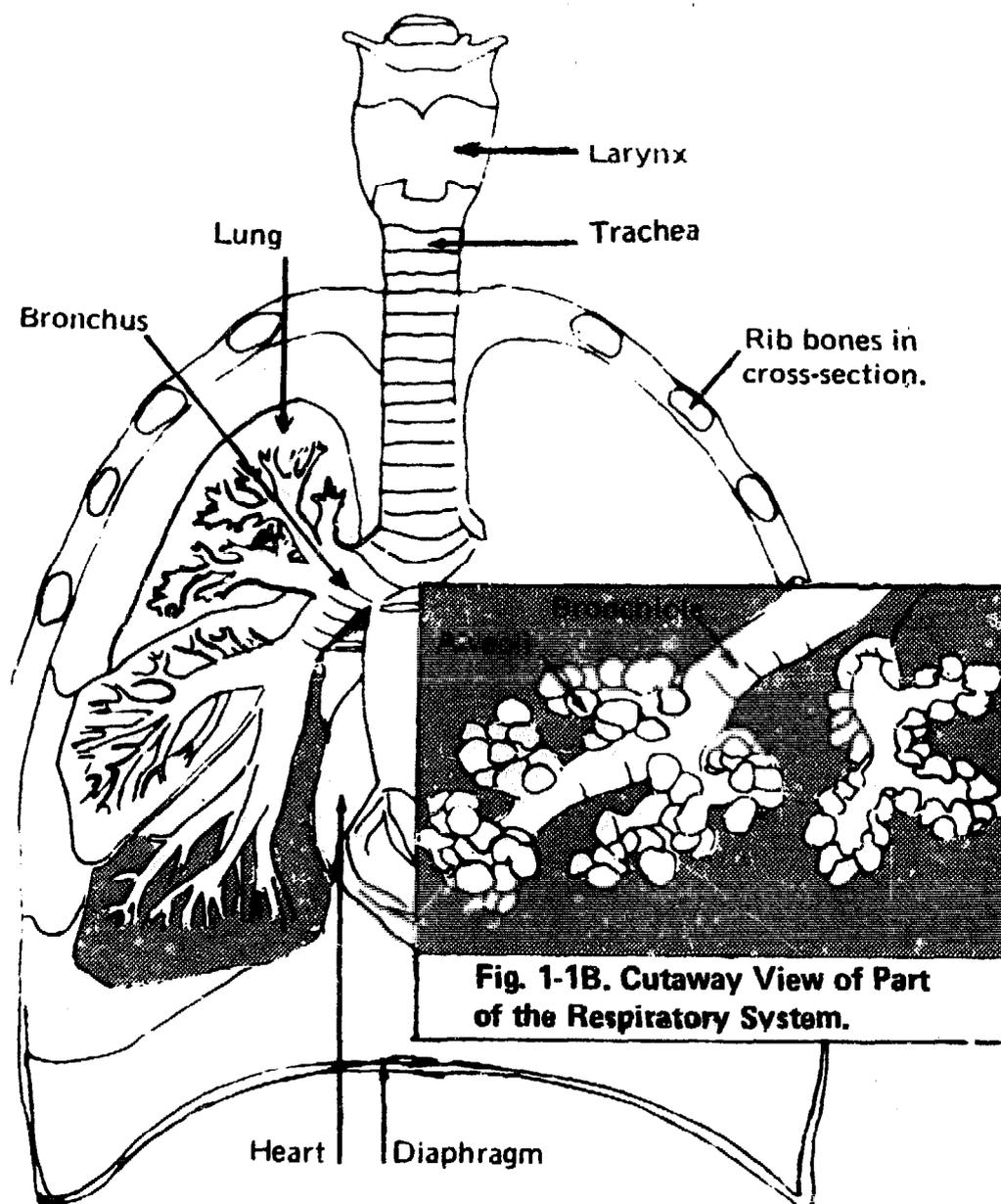
Pollution can be studied on many different levels. The highly trained scientist will make faster and more accurate measurements than we can. However, with the procedures offered here, we can gather valuable and necessary data that will contribute to the fight against pollution.

### How To Use This Book

This book is divided into three sections: *air*, *water* and *solid* pollution. While noise pollution is an important part of the problem, it is not included here because of space limitations. Each section opens with simple investigations that you can do. Certain procedures in each section are more advanced than others. However, if you cannot complete some of the more advanced projects, pass over them to the next section; those projects you *do* complete will be valuable in furthering your understanding of pollution. Some of the projects require more than one person; several will require people in different parts of the community, and even in different parts of the country. If you need help, consult your science teachers or possibly some of the environmental groups in your community who are fighting pollution.

At the end of each investigation you will find questions and suggestions that will help you to apply the data you have gathered to

local pollution conditions. There are rarely any cut and dried answers to these questions because the problems have not been completely solved. But, in the process of seeking answers, you and those working with you will better understand the dimensions of the problem, and you will better understand in which directions the solutions must be sought.



**Fig. 1-1A. How Man's Respiratory System Works. (Adapted From Scientific American's The Mechanism of Breathing.)**

## CHAPTER ONE

### HOW AIR POLLUTION AFFECTS LIVING THINGS

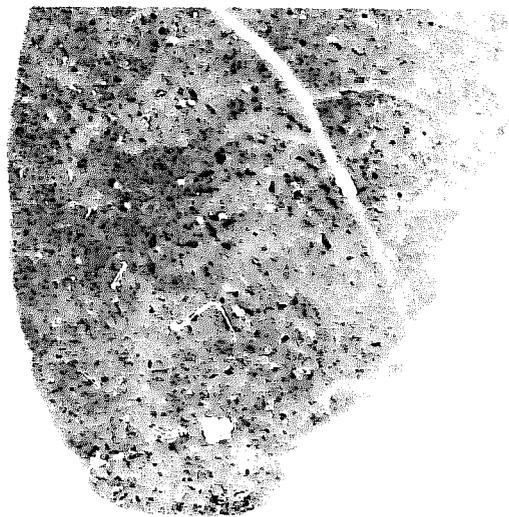
ON DECEMBER 5, 1952 an unusually heavy fog settled over the city of London. Chimney smoke mixed with the fog; automobile exhausts added poisonous pollutants to the air mixture. People soon realized that this was no ordinary fog. It had in fact become a deadly *smog* (combination of smoke and fog). Many people were stricken and died during the four day smog. Others died from its effects within a few weeks. As many as 4,000 deaths were caused by that London smog.

People in American cities and towns were also subjected to similar terrifying experiences. In October 1948, air pollution killed 20 persons in Donora, Pennsylvania. During the few days that the smog lasted, 5,900 people in Donora and nearby towns became ill. Almost half of the population in that area suffered from the smog.

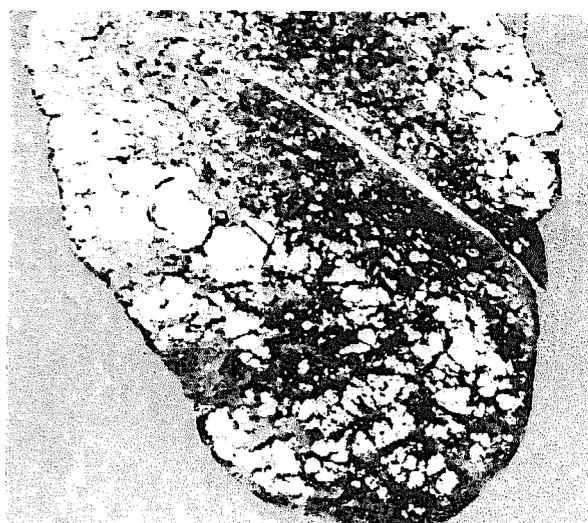
What caused these disasters? What will happen to those who become ill but survive a smog attack? How safe are we from the present air pollution which can seriously damage our lungs?

#### Pollution and Emphysema

Some diseases like cancer, which may be caused by air pollution, take years to develop. Emphysema, although not as well known as lung cancer, is just as deadly. It also develops slowly as a result of continual exposure to air pollution. A lung (see Fig. 1-1A) is made of small air sacs called *alveoli* (see Fig. 1-1B). How does the air get into the *alveoli*? The air we breathe passes through our nose and mouth into the *trachea*, or windpipe in our throat. The lower part of the *trachea* forms two branches called *bronchi* (see Fig. 1-1A), or bronchial tubes. These tubes branch again and again until they become the very small tubes that lead to the air sacs (*alveoli*). The smallest tubes are called *bronchioles* (see Fig. 1-1B). Emphysema results when the walls between the *alveoli* break down because of the



**Fig. 1-2A. Photo of a Section of Healthy Lung.**



**Fig. 1-2B. Photo of a Section of Lung Ravaged by Emphysema.**

**Courtesy Dr. Oscar Auerbach, Veterans Administration Hospital, East Orange, N.J.**

toxic chemicals breathed in with the polluted air. Then the lung becomes filled with large holes in place of the many small air sacs. The emphysema victim is "short of breath." His breathing capacity is much less than that of a healthy person (see Figs. 1-2A and 1-2B), and his life span is shortened.

Air pollution may also cause some lung damage even in people who appear to be quite healthy. One way to find out if, and to what extent air pollution may have harmed your lungs is to measure your vital capacity as in Project 1-1. A person's vital capacity is the volume of air that he or she can exhale in one breath.

Having learned to measure vital capacity in Project 1-1, you might try to find out the vital capacity of people of different ages living in the same community. This is described in Project 1-2. This same method may be used in determining the effects of air pollution on the lungs of people in badly polluted areas.

Poor vital capacity indicates that only a small volume of the person's lungs can actually be used in breathing. This reduces the lung's ability to absorb oxygen and to get rid of carbon dioxide and water vapor. Since oxygen is needed for energy production, a person with a very small vital capacity caused by emphysema becomes increasingly feeble. The breakdown of the alveoli destroys capillaries (the smallest blood vessels) in the lungs. This makes it more difficult for the heart to pump blood through the lungs. When death occurs, it is usually caused by the failure of the overworked and weakened heart.

### Project 1-1. How to Measure Vital Capacity.

**You will need:** two 1-gallon glass jugs, a 2-hole rubber stopper to fit the opening of one of the jugs, 2 pieces of glass tubing to fit the holes in the stopper (one piece about 3" long, the other long enough to reach from 1" above the top of the stopper to the bottom of the jug), 2 pieces of rubber tubing (each 1' long), a graduated cylinder (100-ml or larger), a bunsen burner, a cloth towel or 2 pot holders, liquid detergent, an asbestos pad and a triangular file.

1. To cut the 2 pieces of glass tubing to proper length draw an edge of the triangular file firmly across glass tube at place where you wish to cut it (Fig. 1-3A).

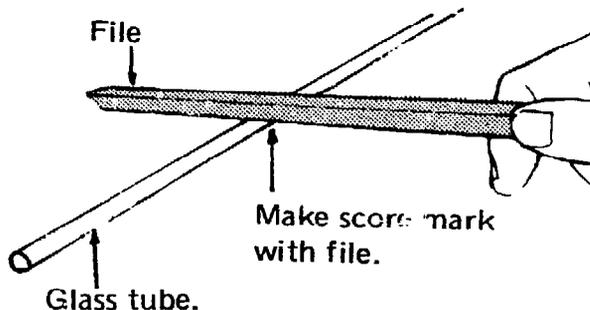
2. Protect both your hands with the towel or pot holders. Hold the score mark on the tube away from you. Press with both protected thumbs *opposite* the score mark, then push the tube away from you (see Fig. 1-3B). The tube will break at the score mark.

3. Fire polish the rough ends of each tube by holding the rough end of the glass tube in the hottest part of the bunsen burner's flame, just above the flame's inner blue cone (see Fig. 1-3C). Rotate tube in flame until its rough edges are rounded. Then put the tube on the asbestos pad until glass is cool.

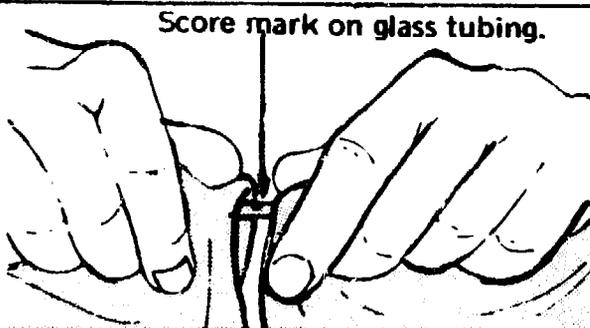
4. Moisten one end of each glass tube with liquid detergent. Protecting hands with the pot holders or towel, gently insert moist ends of glass tubes into the rubber stopper with a twisting motion as shown in Fig. 1-3D, and complete as in Fig. 1-3E.

5. Moisten one end of each rubber tube with liquid detergent. Slip a rubber tube onto the upper part of each glass tube.

6. Completely fill a gallon jug with water. Insert the rubber stopper with the tubes into the opening of this jug (see Fig. 1-3F).

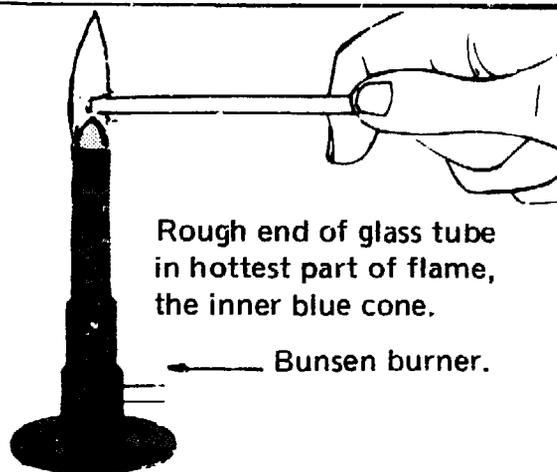


**Fig. 1-3A. How to Cut Glass Tubing.**

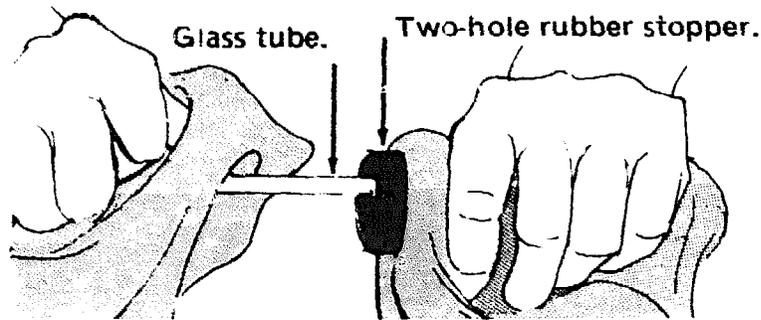


Hands protected by pot holders or towel.

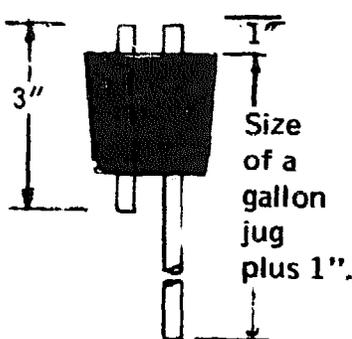
**Fig. 1-3B. How to Break Glass Tubing at Score Mark.**



**Fig. 1-3C. How to Fire Polish Glass Tubing.**



**Fig. 1-3D. How to Insert Glass Tubing Into Rubber Stopper.**



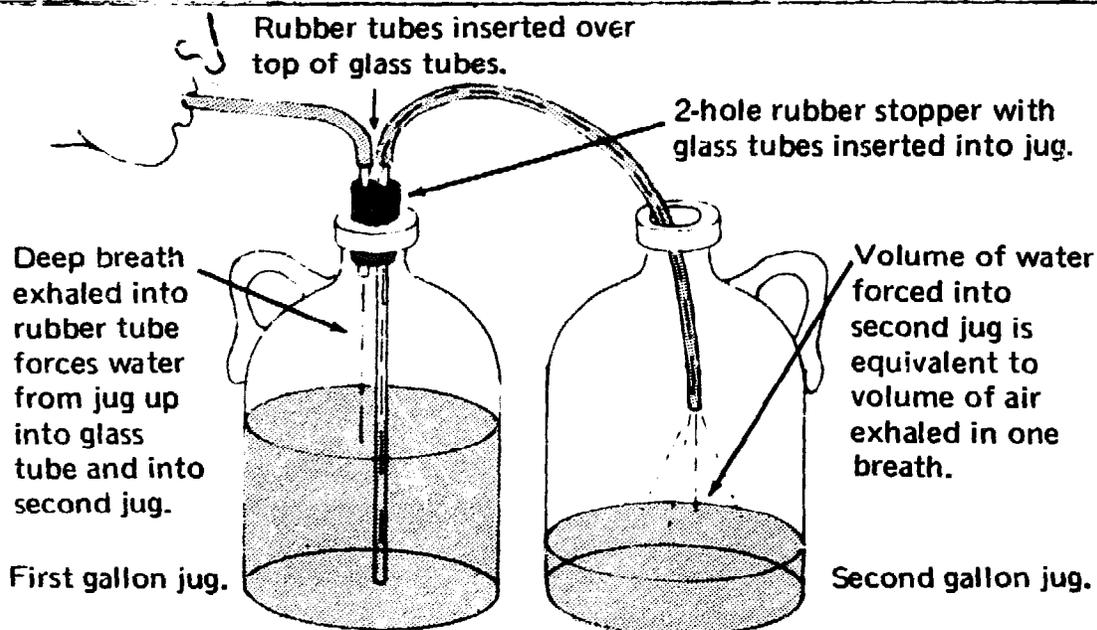
**Fig. 1-3E. Hidden view of Glass Tubing In Rubber Stopper.**

7. Into the second jug, put the free end of the rubber tube which is attached to the longer glass tube. Now you are ready to test your vital capacity.

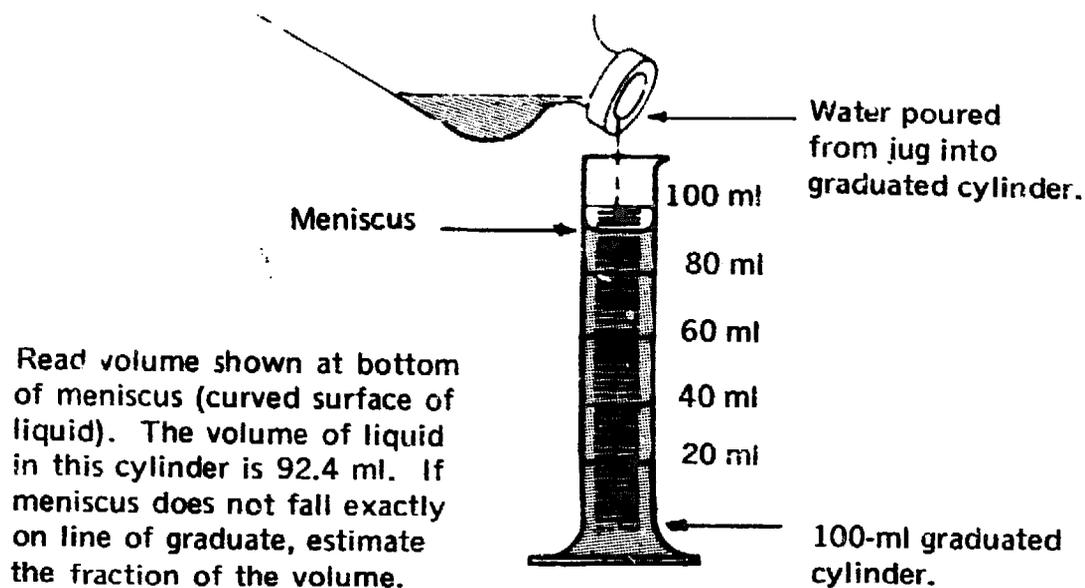
8. Take a deep breath, hold your nose with one hand and blow into the rubber tube connected to the shorter glass tube until you are out of breath. As you do so, water pours from the other rubber tube into the second glass jug (see Fig. 1-3F).

9. To measure the volume of air exhaled in one breath, pour the water from the second jug into the

graduated cylinder as shown in Fig. 1-3G. If your vital capacity is large, the graduate may have to be filled several times to measure the total volume of water in the jug. If so, don't pour water into the graduate past its 100-ml top line. Read and record the volume in the cylinder each time you fill it. Then add all the recorded volumes to get the total volume. The amount of air that you can exhale with one breath is your "vital capacity." This amount of air is equal to the amount of water you forced from the first jug into the second jug.



**Fig. 1-3F. Set-up to Test Vital Capacity.**



**Fig. 1-3G. How to Read Volume in Graduated Cylinder.**

**Project 1-2. How Age Affects Vital Capacity.**

**You will need:** the equipment used in Project 1-1, graph paper, a pencil and a pen.

1. As in Steps 8-9, Project 1-1, measure the vital capacities of people of different ages in your community or your family.

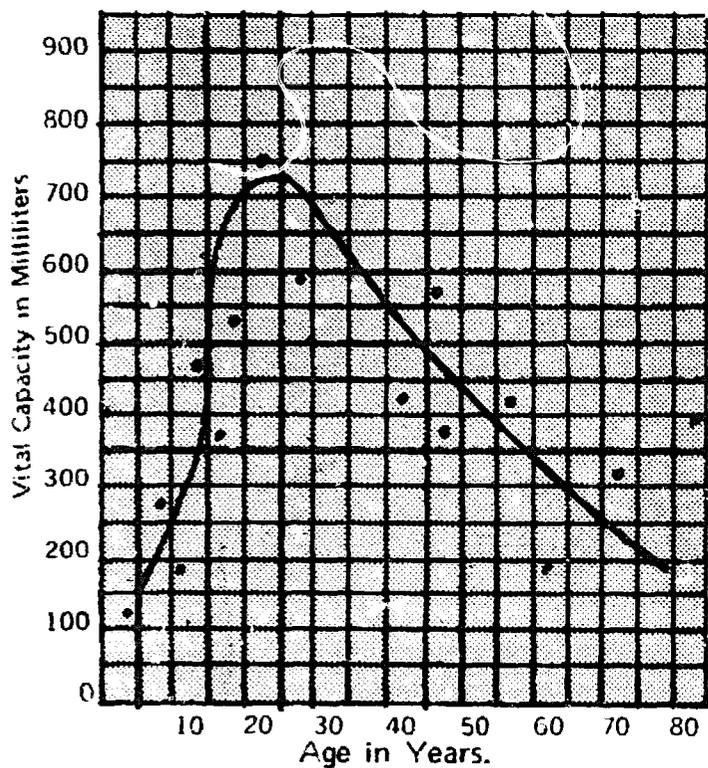
2. Record each person's name and sex, age, height and vital capacity as in Table 1-1.

3. Make graphs using the information you have gathered.

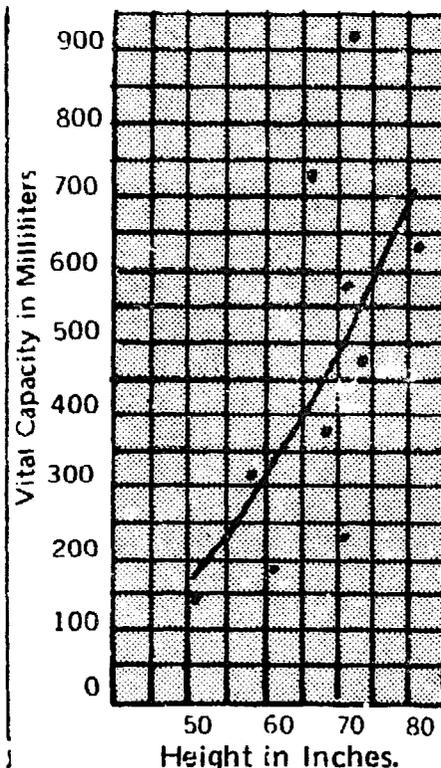
One graph might show how vital capacity is related to the age of the people (see Fig. 1-4A). Because older people have been breathing polluted air for a longer time than young people, your graph might show the effect of air pollution on the vital capacity of the older people. Another graph might show the effect, if any, height has on vital capacity (see Fig. 1-4B).

**Table 1-1. How Age Affects Vital Capacity.**

NAME	SEX	AGE IN YEARS	HEIGHT IN INCHES	VITAL CAPACITY IN MILLILITERS
Susan Cipolla	Female	11	54	148
Stuart Langer	Male	36	67	735
John Costas	Male	17	71	920
May Lindley	Female	62	61	176



**Fig. 1-4A. Graph Showing How Vital Capacity Is Related to Age.**



**Fig. 1-4B. Graph Showing How Height Affects Vital Capacity.**

Is there any difference in the vital capacity of people of the same age, living in different kinds of localities? If we can find the answers to this essential question, it can be important to us when we decide what kind of locality is least dangerous to our health. Project 1-3 shows how this can be done.

#### How Asthma Damages Our Lungs

Asthma is another disease that may be caused by air pollution. Doctors believe that many asthma cases are the result of allergies. Allergies cause inflammations of certain parts of the body. Some people are sensitive to pollen grains from certain flowers, fungus spores and many kinds of dust. Medical research has shown that such substances can cause allergies that affect the lungs.

A lung allergy may cause a swelling of the walls of the bronchioles (the tubes that lead to the alveoli). As the walls swell, the openings inside the tubes become narrower. This makes it hard for the person to breathe. He may even "wheeze" because the air whistles as it is forced through the bronchioles (see Fig. 1-1B).

Asthma is like lung allergy, but more serious. An asthmatic attack may kill someone because it can prevent breathing. Asthma has, in fact, been listed as the cause of many deaths in the 1952 London smog disaster.

### **Project 1-3. How the Type of Community Affects Vital Capacity.**

**You will need:** the cooperation of students or teachers in other communities (small towns, suburbs, industrial areas, etc.)

1. Select schools in a rural community, a ghetto community, a middle class community, a suburban community, and any other kind of community you can think of.
2. Write to the principal or to the chairmen of the science departments of the schools in these communities, explaining the project. They will provide you with the names of volunteer students

willing to undertake this experiment. Ask the students to perform the vital capacity experiment at about the same time as you do yours.

3. Compare the results of your experiments with theirs. The vital capacities might be quite different for people living in or near ghettos of large cities, in industrial areas, in the suburbs, in small towns or in the country.

**Explanation:** While this experiment may not give a totally accurate account or picture of vital capacity, it will show that differences in vital capacities, in different localities, do exist. Thus, if the people in your community generally show a lower vital capacity than those of other communities, you may reasonably suspect that pollution is more severe in your community and is a factor that contributes to the decreased vital capacity.

---

### **The Effect of Bronchitis on Our Lungs**

Bronchitis is an irritation of the bronchioles. Sometimes it results from infection, but it may also be caused by certain gases and other chemicals that pollute the air. Bronchitis makes breathing difficult. The bronchitis victim may wheeze because the walls of his bronchioles become thicker and the narrow openings in the bronchioles' tubes fill with heavy mucus. When these conditions persist for a long time, the person is said to suffer from chronic bronchitis.

Special clinics have been established in London for the relief of chronic bronchitis. In one of their most effective treatments, the bronchitis victim lies face down, with head, neck and chest lower than the abdomen. This helps drain the mucus from the lungs.

People who suffer from bronchitis, asthma, emphysema and other respiratory ailments cannot exert as great a pressure with their breath as healthy people. However, breath pressure varies even among people who appear to be quite healthy. Project 1-1 helps us to find out how well a person breathes by measuring his vital capacity. Another method of learning how well a person breathes is to measure the pressure of the air he breathes out. Project 1-4 described this method. Projects 1-5 and 1-6 show how maximum breath pressure is related to age and affected by the type of community.

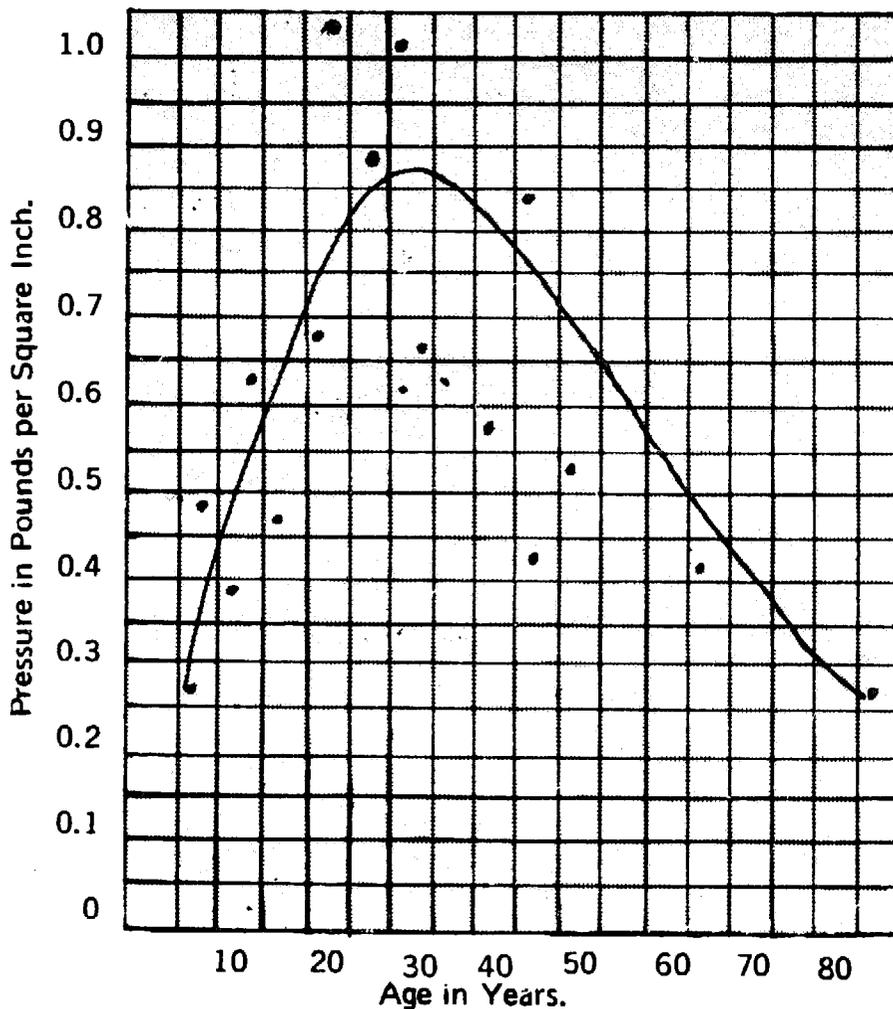
**Table 1-II. How to Convert Inches-of-Water to Pressure-in-Pounds per Square Inch.**

Height of water in inches.	1	2	3	4	5	6	7	8	9	10	11	12	13	14	15	16	17	18	19	20
Pressure in pounds per square inch.	0.036	0.072	0.108	0.144	0.180	0.216	0.252	0.288	0.324	0.360	0.396	0.432	0.468	0.504	0.540	0.576	0.612	0.648	0.684	0.720

**Project 1-5. How Age is Related to Maximum Breath Pressure.**

**You will need:** the equipment used in Project 1-4, graph paper, pencil and pen.

1. Measure the maximum breath pressure of people of different ages in your community.
2. Record each person's age and maximum breath pressure.
3. Make a graph showing the relationship of maximum breath pressure to age (see Fig. 1-5B).
4. Study your graph. *Does your graph indicate a difference in the breath pressure of the various age groups?*



**Fig. 1-5B. Graph Showing Relationship of Maximum Breath Pressure to Age.**

## **Project 1-6. How Maximum Breath Pressure Is Affected by the Type of Community.**

**You will need:** the cooperation of students or teachers in other communities (small towns, suburbs, industrial areas, etc.).

1. Follow the procedures in Steps 1-2 of Project 1-3.
2. Ask the people in the communities selected to carry out Projects 1-4 and 1-5.
3. Compare your results with those of other communities. *Is there a difference in maximum breath pressure? What would you attribute the difference to?*

---

### **Pollution From Natural Sources**

Air pollution existed long before man first made fires to cook his food and keep himself warm. The pollen grains from flowers and the spores of fungi are considered to be pollutants. They existed many millions of years ago, as did other kinds of dust that floated in the air. Lightning started forest fires whose smoke darkened the ancient sky. Sulfur dioxide belched forth into the air from volcanos. Millions of years ago, long before man made his appearance, the ancestors of man developed their own protection against such natural air pollution. While man-made air pollution is far worse than natural air pollution, man's respiratory system still protects him as it did his ancient ancestors.

#### **Man's Respiratory System Protects Him Against Air Pollution**

The insides of the tubes in your respiratory system are lined with mucous membrane. This membrane or tissue continually produces mucus, a sticky fluid that traps dust and germs in the respiratory system. When the mucous membrane is irritated, the rate at which it forms mucus increases as a protection against the pollutants or germs that cause the irritation. This is quite noticeable when you have a cold.

#### **How Air Pollution Affects the Cilia**

Your respiratory system has an efficient method of clearing dust and germs together with mucus out of the bronchioles and other respiratory tubes. The mucous membrane lining those passageways is covered with millions of *cilia*. These are microscopic, hairlike projections which beat continuously in an up-and-down direction.

Since the upward stroke is faster and more powerful than the downward stroke, the cilia send the mucus up the respiratory tubes. Eventually the mucus reaches your mouth, where you swallow it without even realizing that you are doing so. When it gets to your stomach and intestines, the mucus is digested. Any germs that the mucus has trapped are killed and also digested. This is how mucus and cilia work together to rid your respiratory system of germs and dust.

Certain chemicals found in polluted air however, slow down or even stop the beating action of the cilia. When the cilia stop beating, mucus remains in the bronchioles. This prevents air from getting into or out of the alveoli (air sacs in the lungs). Thus, the lungs cannot absorb oxygen from the air as rapidly as they should, and the person is "short of breath."

When the bronchioles are clogged with mucus, the person coughs to clear the respiratory tubes. Sometimes he coughs purposely, but often he cannot help coughing. The cough is a reflex reaction caused by the mucus in his bronchioles. When someone coughs, the pressure of the air in his lungs increases greatly. Sometimes the pressure is high enough to damage the alveoli. Emphysema results when many alveoli have been destroyed. Large spaces replace the destroyed alveoli. The ability of the lungs to absorb oxygen is reduced, making the emphysema victim feeble because he cannot produce energy rapidly enough.

Many cases of emphysema result from ordinary air pollution, and considerably more are caused by cigarette smoking. Tobacco smoke pollutes the air both for the smoker and for the people around him.

Scientists can observe the action of respiratory cilia in humans. They have even been able to take motion pictures showing how different chemicals affect the beating of the cilia. This requires very special equipment and is quite difficult for us to do. While we cannot observe the beating of cilia in humans, we can test the effects of chemicals on the beating of cilia on lower forms of life such as clams, mussels or snails. This is described in Project 1-10. Before these tests can be made, you must first prepare a 1% solution of calcium chloride (Project 1-7), a 0.9% solution of potassium chloride (Project 1-8), and Ringer's solution (Project 1-9). All of these solutions will be used in Project 1-10, to test their effect on the action of cilia.

### Project 1-7. Preparing a One Per Cent Solution of Calcium Chloride.

**You will need:** 100 ml of distilled water, a 250-ml beaker, a graduated cylinder (100-ml or larger), a stirring rod, a sensitive balance scale and masses, a 250-ml bottle with a stopper, weighing paper, calcium chloride ( $\text{CaCl}_2$ ), a pen and a label.

1. Measure 99 ml of distilled water in graduated cylinder and pour it into the beaker.
2. Measure 1 gm calcium chloride on the sensitive balance using the weighing paper, and pour it into the

water. Stir until the calcium chloride has dissolved.

3. Pour this solution into a bottle and stopper it. Label the bottle "1% Calcium Chloride," and set it aside for use in Project 1-10.

**Explanation:** To make a solution with a particular percentage of solid by mass, such as 1 gm calcium chloride, subtract the percent of solid (1%) from 100. The difference is the number of milliliters of water that should be used for the solution. One milliliter (ml) of water has a mass of one gram (gm). The percentage of the solid is the number of grams of solid (in this case, 1 gm of calcium chloride), that should be added to the water (99 ml in this case). The total mass of the solution will be almost exactly 100 grams.

---

### Project 1-8. Preparing a 0.9 Per Cent Solution of Potassium Chloride.

**You will need:** potassium chloride (KCl) and the same equipment as in Project 1-7.

1. Using the information given in Project 1-7 as a reference, prepare a 0.9% solution of potassium chloride. (This consists of 0.9 gm of

potassium chloride and 99.1 ml of water.)

2. Set solution aside for use in Project 1-10.

---

### Project 1-9. Preparing Ringer's Solution.

**You will need:** one liter (1000 ml) of distilled water, potassium chloride (KCl), sodium chloride (NaCl), calcium chloride ( $\text{CaCl}_2$ ), sodium bicarbonate ( $\text{NaHCO}_3$ ), a graduated cylinder (100-ml or larger), a 2-liter beaker, a glass stirring rod, a sensitive balance and masses, a 250-ml bottle with a stopper, weighing paper, a pen and a label.

1. Using the graduated cylinder, measure one liter (1000 ml) of distilled water and pour it into the beaker.
2. Measure the following chemicals on the scale, using a separate piece of weighing paper for each:
  - 0.14 gm potassium chloride
  - 6.50 gm sodium chloride
  - 0.12 gm calcium chloride

0.20 gm sodium bicarbonate

3. Add these chemicals to the distilled water. Stir with glass rod until the chemicals have completely dissolved.

4. Pour the solution into the bottle and stopper the bottle. Label the bottle "Ringer's Solution." Set aside for use in Project 1-10.

### Project 1-10. How Do Some Chemicals Affect the Action of Cilia?

**You will need:** a live clam (available at tropical fish shops). The clam should be kept in cool, fresh water to keep it alive. You will also need a medicine dropper, forceps, a small hammer, a microscope, a watch glass, Ringer's solution, methylene blue, 0.9% potassium chloride solution, 1% calcium chloride solution, a cigarette, distilled water, a 400-ml beaker, a 250-ml graduated cylinder, a pen and note paper.

1. Pour some Ringer's solution into the watch glass.
2. Gently crack open the shell of the clam with the hammer. Using the forceps, pick off a small piece of the mantle or gill as shown in Fig. 1-6. This tissue is covered with cilia.
3. Place this tissue into the watch glass. With medicine dropper, add a few drops of methylene blue to stain the cilia and make them easier to see.
4. Place watch glass on stage of microscope. Using the low power of the microscope, observe the action of the cilia. The tissue is still alive although the animal may not be alive. Note the speed at which the cilia beat. Record your findings.
5. Repeat steps 2-4, using 0.9% potassium chloride solution instead of Ringer's solution. *Do the cilia beat faster or slower than in Step 4?* Record your observations.
6. Repeat Steps 2-4, using 1% calcium chloride solution instead of Ringer's solution. *Do the cilia beat faster or slower than in Step 4?* Record your findings.

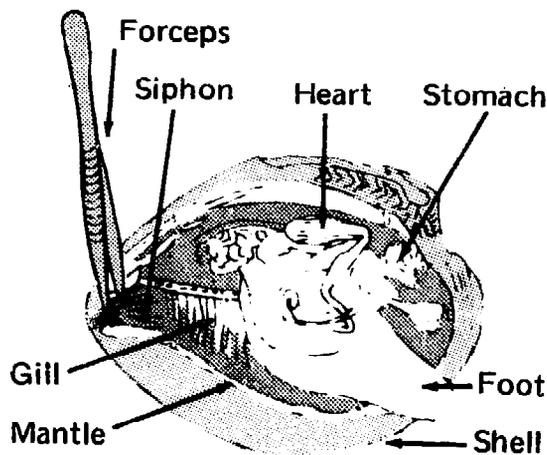
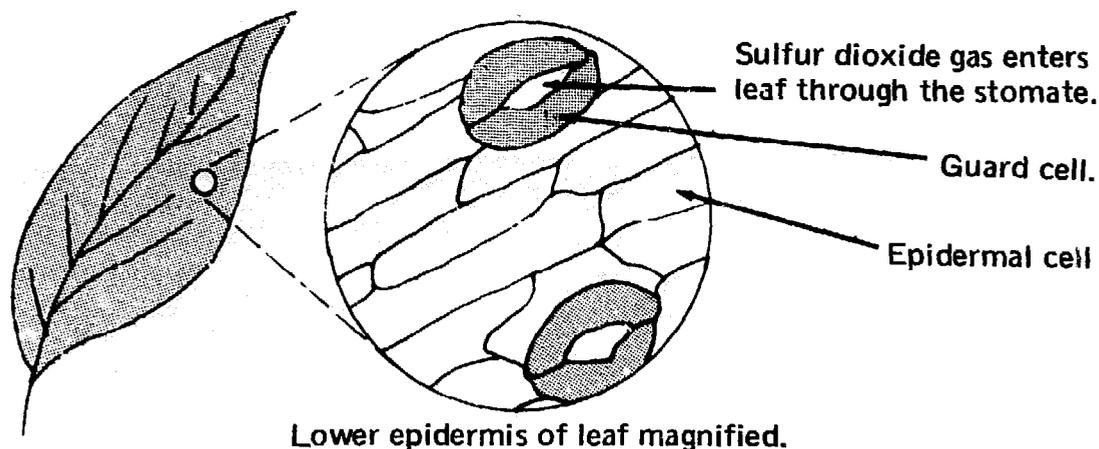


Fig. 1-6. Anatomy of a Clam.

7. Soak a cigarette for one day in a beaker containing 200 ml of distilled water.
8. Repeat steps 2-4, but in place of Ringer's solution, use some of the tobacco solution made in Step 7. *Do the cilia beat faster or slower than in Step 4? Do certain chemicals and tobacco solutions affect the cilia? The beating action? If the cilia in our respiratory passages, which protect our lungs, react the same way, how do these chemicals and tobacco solutions affect our lungs?*

### How Deadly is Sulfur Dioxide?

Most of the 4,000 deaths caused by the London smog of 1952, are believed to have resulted from lung diseases such as bronchitis and pneumonia. In a "London-type smog," the pollutants are produced mainly by burning coal and other fuels in furnaces. One of the pollutants, sulfur dioxide gas ( $\text{SO}_2$ ), is sent into the air when sulfur (S) in the fuel combines with oxygen ( $\text{O}_2$ ). Doctors believe that sulfur dioxide gas was responsible for many of these deaths.



**Fig. 1-7. How Sulfur Dioxide In the Air Enters a Leaf.**

When sulfur dioxide gas dissolves in water, sulfurous acid results. This acid may also be formed from sulfur dioxide gas when very little water is present. For example, if sulfur dioxide gas is released into humid air, moisture in the air condenses into droplets which dissolve some of the sulfur dioxide creating a sulfurous acid solution. In badly polluted air, such droplets of sulfurous acid solution form part of the smog, and are responsible for much of the damage done to both living and non-living things such as metals and rocks. Sulfur dioxide gas can also dissolve in the film of moisture that covers the eyes and the inside of the nose, throat and lungs. The resulting solution is a strong acid which can cause damage to these organs. Plants also may be hurt if much sulfur dioxide gas from the air enters their leaves through the pores called *stomates*, and combines with the water in the leaves (see Fig. 1-7). Droplets of sulfurous acid suspended in a smog are so small that they too can enter the stomates almost as easily as sulfur dioxide gas, and cause the same kind of damage as the gas.

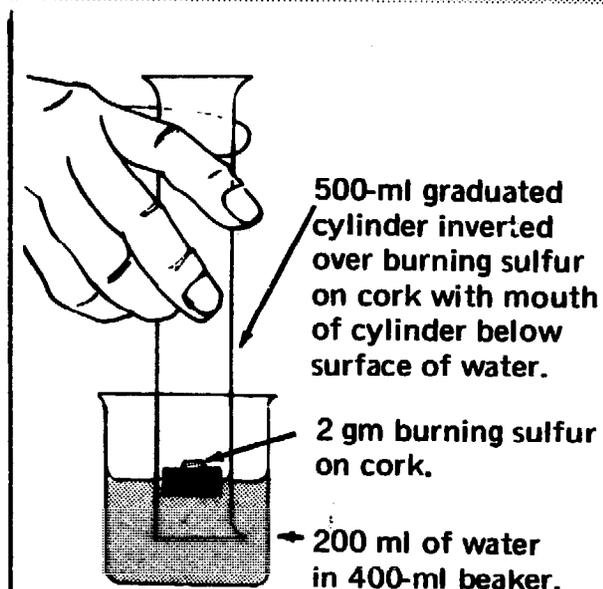
#### **How Harmful are Pollutants?**

While we know that pollutants can injure our health, we must also know *how much* of a given pollutant can be harmful. In this way we can determine how great a pollutant concentration living things can tolerate, and at what point the concentration of the pollutant reaches a dangerous level. One way of finding out how harmful a pollutant may be to living things is to perform a test, called a *bioassay*. In Project 1-11 we will hatch brine shrimp (see Fig. 1-10) for use in performing a bioassay, and we will prepare a sulfurous acid solution to act as a pollutant. The brine shrimp will be exposed to various concentrations of this pollutant.

### Project 1-11. Preparing For Bioassay on Live Brine Shrimp.

**You will need:** brine shrimp eggs, salts for hatching brine shrimp, powdered sulfur, a flat cork, matches, a 500-ml graduated cylinder, a 400-ml beaker, a medicine dropper, a bottle with stopper, a sensitive balance with masses, labels, weighing paper, a pen and note paper.

1. Prepare the solution you will need for hatching the brine shrimp. Instructions for this usually come with the purchase of brine shrimp eggs and the salts for the solution.
2. Place brine shrimp eggs in the solution and let it stand until the brine shrimp hatch from the eggs. This should take about 3 days. While waiting for the brine shrimp to hatch, perform Steps 3 through 8.
3. Measure 200 ml of cold water in the 500-ml graduated cylinder and pour it into the 400-ml beaker.
4. Using the sensitive balance and weighing paper, measure a mass of 2 grams of powdered sulfur and put it on the flat cork. Float the cork on the water in the beaker.
5. Light the sulfur with a match. Invert the 500-ml cylinder over the cork and hold it so that the mouth of the cylinder is below the surface of the water (see Fig. 1-8).
6. After the sulfur has stopped burning, continue to hold the cylinder and allow a few minutes for the air in the cylinder to cool down to room temperature. The cylinder now contains some  $\text{SO}_2$  gas. Record on paper the level to which the water has risen in the cylinder. Then, remove the cylinder and cork from the beaker.
7. The beaker now contains a solution of sulfurous acid which forms when  $\text{SO}_2$  gas dissolves in water. Pour it into a bottle. Stopper the bottle and label it "Sulfurous



**Fig. 1-8. How to Make a Sulfurous Acid Solution.**

acid solution, original concentration." Set it aside for use as a pollutant in Step 1, Project 1-11A. Rinse out the beaker.

8. To calculate the amount of oxygen used in making the sulfur dioxide (which became sulfurous acid), do the following:

Completely fill to the lip the 500-ml graduated cylinder with water (see Fig. 1-9, A). Then, pour some of the water from the graduate into the 400-ml beaker until less than 500 ml of water remains in the graduated cylinder (Fig. 1-9, B). Record the amount of water left in the cylinder (Fig. 1-9, B), then discard the water. Now pour the water from the 400-ml beaker back into the empty graduated cylinder and record the amount of water (Fig. 1-9, C).

500-ml graduate completely filled to lip with water.



Remainder of water from 400-ml beaker poured back into empty 500-ml graduate.

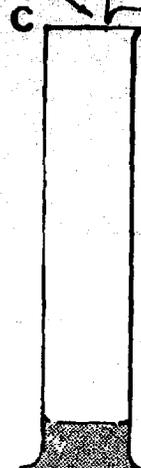
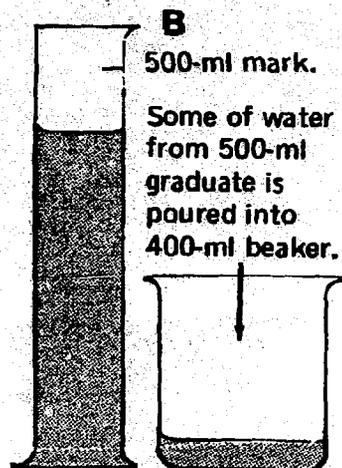
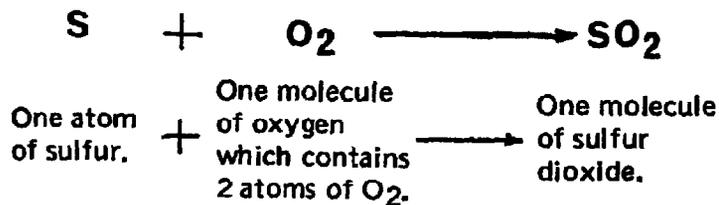


Fig. 1-9. How to Calculate Amount of Oxygen Needed to Make a Sulfurous Acid Solution.

Add the two amounts recorded in B and C, to find the total volume of water that the completely filled 500-ml graduated cylinder (Fig. 1-9, A) holds. Now, to find the volume (in ml) of oxygen in the graduated cylinder that was used to burn the sulfur (Steps 5 and 6),

subtract the measurement you recorded in Step 6 from the volume of water of the completely filled cylinder (Fig. 1-9, A).

What happened when the sulfur burned is described in the following equation:



**Explanation:** The oxygen gas in the air is in the form of molecules. When one molecule of oxygen combines with one atom of sulfur, one molecule of sulfur dioxide is formed. Thus a molecule of sulfur dioxide is produced for each molecule of oxygen that is used in the reaction.

In Project 1-11A we will prepare serial dilutions of this pollutant for the tests. The tests help us find the minimum concentration of a pollutant that will cause a certain amount of damage to living things. For example, you may want to know the percentage of DDT that will kill 50% of the house flies exposed to it under controlled conditions. Once this percentage has been determined, the bioassay method can be used to find out the percentage of DDT that is present in a solution.

---

**Project 1-11A. How to Make Serial Dilutions of the Original Sulfurous Acid Solution.**

**You will need:** the original sulfurous acid solution prepared in Step 6, Project 1-11, a sensitive balance with masses, a 500-ml graduated cylinder, 5 bottles with stoppers, a 400-ml beaker, distilled water, a stirring rod, 5 labels, pen and note paper.

1. Measure 100 ml of the original 200 ml sulfurous acid solution in the graduated cylinder. Then, pour it into a bottle and stopper the bottle. Label this first bottle "Sulfurous acid solution, 1 gm SO<sub>2</sub> per liter" (or whatever the original concentration happens to be). Set aside for use in bioassay. Remember, the concentration of your original sulfurous acid solution will probably *not* be 1 gm SO<sub>2</sub> per liter.

2. Pour the remaining 100 ml of the original solution into the 400-ml beaker. Add 100 ml of distilled water to this solution, stirring it thoroughly with the stirring rod. Measure 100 ml of this diluted solution in the cylinder and then pour it into a bottle. Stopper and label this second bottle "Sulfurous acid solution, 0.5 gm SO<sub>2</sub> per liter"

(one-half the original concentration).

3. To the 100 ml of solution remaining in the 400-ml beaker add 100 ml of distilled water and stir. Measure 100 ml of this diluted solution and pour it into a bottle. Stopper and label this third bottle "Sulfurous acid solution, 0.25 gm SO<sub>2</sub> per liter" (one-quarter the strength of original concentration).

4. Repeat Step 3 with the 100 ml solution remaining in the beaker. This fourth bottle will contain one-eighth the strength of the original SO<sub>2</sub> concentration.

5. Repeat Step 4, using the 100 ml solution remaining in the beaker from Step 3. This fifth bottle will contain a one-sixteenth strength solution. We are now ready to perform the bioassay as described in Project 1-11B.

---

Project 1-11B shows how to perform the bioassay, using the brine shrimp (see Fig. 1-10) for the tests. When you have completed these three related projects, you will understand how to use this procedure to determine the percentage of a pollutant present in a solution.

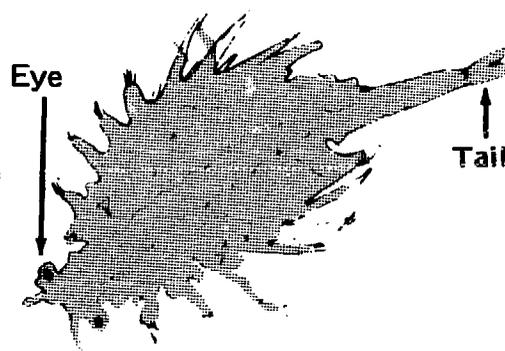
## Project 1-11B. How Sulfur Dioxide Affects Living Things – Performing the Bioassay.

**You will need:** the hatched brine shrimp (Step 2, Project 1-11), 5 wide-mouth jars, a 25-ml graduated cylinder, a 500-ml graduated cylinder, a 1-liter beaker, a 400-ml beaker, a medicine dropper, distilled water, a stirring rod, and the 5 bottles of sulfurous acid solution prepared in Project 1-11A.

1. In the 1-liter beaker, prepare one liter of double strength salt solution by following the directions that come with the brine shrimp salts, however, use only one-half the recommended amount of water. to give a double strength salt solution.

2. Using the 500-ml cylinder, measure and pour 100 ml of this double strength salt solution into each of the 5 jars.

3. Pour the original sulfurous acid solution (bottle No. 1, Step 1, Project 1-11A) into one jar and stir thoroughly with the stirring rod. The original concentration of sulfurous acid solution has now become one-half its original value because it was added to 100 ml of salt solution. Meanwhile, the double strength solution has become the required strength for maintaining the brine shrimp because the water in the sulfurous acid solution has diluted the salt solution. Label this first jar "Sulfurous acid solution, 0.5 gm  $\text{SO}_2$  per liter" (or whatever its actual concentration is). Then, with medicine dropper pick up 50 hatched, live brine shrimp and put them into the 25-ml graduated cylinder. Note and record the number of milliliters of salt solution that you have added to the cylinder along with the shrimp. Now, pour into the 25-ml cylinder as much sulfurous acid solution (from bottle No. 1) as the number of ml of salt solution put into the cylinder with the brine shrimp.



**Fig. 1-10. Brine Shrimp As Seen Under the Microscope.**

Pour the contents of the graduated cylinder into the first jar of sulfurous acid solution. If any brine shrimp remain in the cylinder, wash them out and into the jar with some of the sulfurous acid solution from the jar.

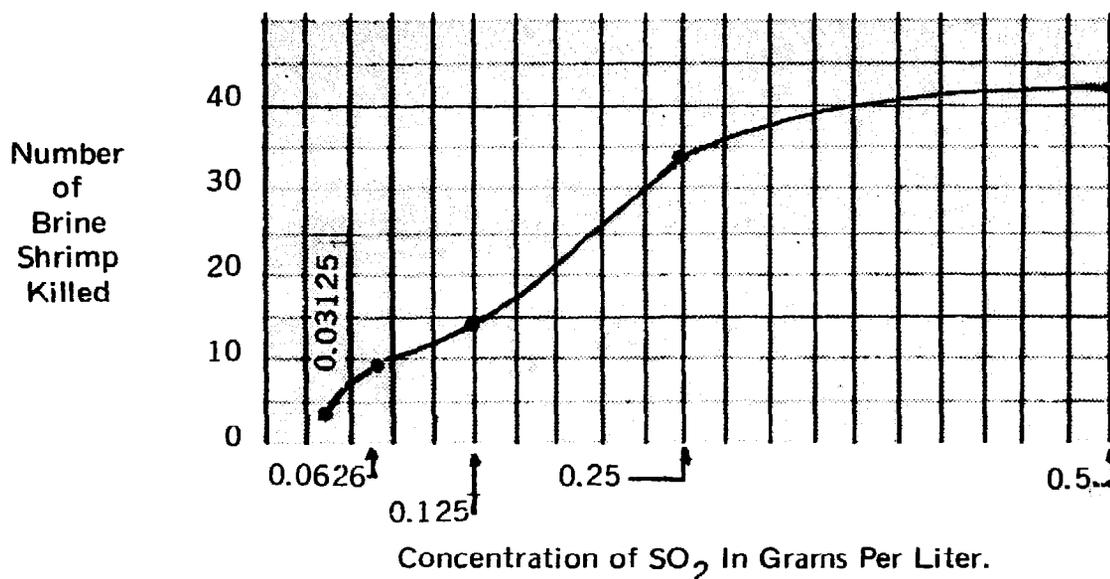
4. Observe the brine shrimp in the jar to see if any die. If any die (live brine shrimp will swim if they are disturbed), remove them with the medicine dropper and put them into the 400-ml beaker. Continue to do this for 15 minutes. Record the total number of brine shrimp that have died in 15 minutes. Then, rinse the 400-ml beaker with tap water. Rinse the medicine dropper and the 25-ml graduate cylinder first with tap water and then with distilled water.

5. Repeat Steps 3-4 with each of the other four bottles of sulfurous acid solution prepared in Project 1-11A, and the jars prepared in Step 2 of this project. In each experiment using these four bottles

and jars, the concentration of sulfurous acid solution is further diluted in the jar. For example, if bottle No. 2 contents was 0.5 gm  $\text{SO}_2$  per liter, it is now 0.25 gm  $\text{SO}_2$  per liter in the jar. Bottle No. 3 would become diluted in the jar from 0.25 to 0.125, bottle No. 4 from 0.125 to 0.0625 and bottle

No. 5 from 0.0625 to 0.03125.

6. Make a graph as in Fig. 1-11, showing the number of brine shrimp killed by each concentration of sulfurous acid solution. The graph can be used to determine the amount of  $\text{SO}_2$  in water. Project 1-11C suggests a method of doing this.



**Fig. 1-11. Graph Showing Number of Brine Shrimp Killed by Various Concentrations of Sulfur Dioxide.**

If the temperature and air pressure are constant (steady), 1 ml of any gas contains the same number of molecules as 1 ml of any other gas. For example, 1 ml of sulfur dioxide gas has the same number of molecules as 1 ml of oxygen. Therefore, 1 ml of sulfur dioxide is produced when 1 ml of oxygen combines with sulfur. The volume of sulfur dioxide produced in the reaction is equal to the volume of oxygen used. Since you have just calculated the volume of oxygen used in burning the sulfur (Step 8, Project 1-11), you now know the volume of sulfur dioxide that was produced.

#### How to Calculate the Mass of a Volume of Sulfur Dioxide

One ml of sulfur dioxide gas has a mass of about 0.0025 gm at average room temperature and air pressure. To find the mass of the sulfur dioxide produced when you burned the sulfur, multiply the number of ml of sulfur dioxide produced in Project 1-11 by 0.0025. For example, if 80 ml of sulfur dioxide were produced, its mass would be 80 ml x 0.0025 gm, or 0.20 gm. (A gram is a mass with a weight of about 1/450 of a pound.)

### How to Calculate the Concentration of Sulfur Dioxide in Grams Per Liter

In Step 6, Project 1-11, the sulfur dioxide produced is dissolved in 200 ml of water, creating a sulfurous acid solution. Concentrations are often expressed as grams per liter. A liter is 1000 ml. To calculate the concentration per liter of the sulfur dioxide produced, set up the following kind of proportion (assuming that 0.20 gm of sulfur dioxide was produced and dissolved in 200 ml of water):

$$\frac{x \text{ gm}}{1000 \text{ ml}} = \frac{0.20 \text{ gm}}{200 \text{ ml}}$$

$x \text{ gm}$  = the concentration of  $\text{SO}_2$  in gm per liter.

0.20 gm = amount of  $\text{SO}_2$  produced in Step 6, Project 1-11.

200 ml = amount of water  $\text{SO}_2$  was dissolved in.

By applying simple algebra, we can restate the equation as follows:

$$x \text{ gm} = \frac{(1000 \text{ ml})(0.20 \text{ gm})}{200 \text{ ml}}$$

$$x \text{ gm} = \frac{5}{\cancel{200 \text{ ml}}} (\cancel{1000 \text{ ml}}) (0.20 \text{ gm})$$

$$x \text{ gm} = (5) (0.20 \text{ gm})$$

$$x = 1 \text{ gm}$$

The concentration of  $\text{SO}_2$  is 1 gm per liter.

Of course, the concentration of  $\text{SO}_2$  produced when you burned the sulfur will probably *not* be exactly 1 gm per liter.

To obtain precious information on which our very health may depend, the scientist must work accurately. When he establishes an accurate standard, only then is it possible to measure the pollution in the community to determine whether or not it is safe for us. That is why the scientist is often interested in knowing the weakest concentration of a chemical which will kill certain living things. To obtain this information, he prepares a series of solutions of varying concentration by a method called *serial dilution* (see Project 1-11A). Once the minimum lethal concentration of a chemical is known, we assume that this concentration and any stronger concentration will be deadly to the animals in question.

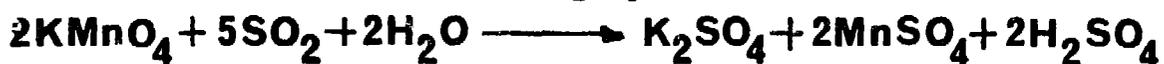
Now that we have learned something about how air pollution affects some living things, let's also learn to detect, identify and measure air pollutants. In addition, we will study how air temperature can prolong pollutants, which, in turn, affect visibility

## CHAPTER TWO

### HOW TO DETECT, IDENTIFY AND MEASURE AIR POLLUTANTS

AIR POLLUTION has already become a serious problem and is getting worse with each passing year. Sometimes there is so much sulfur dioxide in the air, especially in cities, that you can smell its sharp, stinging odor.

If you burn a bit of sulfur and carefully sniff the gas that is given off, you will smell the distinctive odor of sulfur dioxide. Although a chemist may use his nose to help him identify a chemical, he usually relies on chemical analysis which is a more accurate method of testing. Some of these chemical analysis methods depend on color changes. Project 2-1 describes one way to identify sulfur dioxide ( $\text{SO}_2$ ) by observing the color change it produces in a potassium permanganate ( $\text{KMnO}_4$ ) solution. A solution of potassium permanganate is purple. It becomes almost colorless when sulfur dioxide is added. This happens because potassium permanganate combines with sulfur dioxide forming manganous sulfate ( $\text{MnSO}_4$ ), which is so light pink that it is almost colorless. Potassium sulfate ( $\text{K}_2\text{SO}_4$ ) and sulfuric acid ( $\text{H}_2\text{SO}_4$ ) are also produced in this reaction, as shown in the following equation:



This reaction will take place only if the potassium permanganate solution is slightly acid. For that reason, a drop of dilute hydrochloric acid ( $\text{HCl}$ ) is added. The hydrochloric acid does not take part in the reaction.

#### How Much $\text{SO}_2$ Is In the Air We Breathe?

Scientists keep a careful and constant check on the percentage of sulfur dioxide in the air. This helps them to find out if their efforts to control air pollution are producing good results. It is not enough to be able to detect the presence of sulfur dioxide. It is also necessary to be able to measure the amount of sulfur dioxide in the air. You can do this by following the same procedure used in Projects 2-1 and 2-2 with some changes.

## Project 2-1. How to Identify Sulfur Dioxide.

**You will need:** powdered sulfur (S), potassium permanganate ( $\text{KMnO}_4$ ), a sensitive balance with masses, weighing paper, a 100-ml graduated cylinder, a 1-ml pipette, a 250-ml Florence flask, a 250-ml beaker, a stirring rod, a 2-hole rubber stopper to fit the flask, a 1-foot piece of glass tubing to fit the holes in the stopper, one foot of rubber tubing into which the glass tubing fits, a bunsen burner, 2 tubing clamps, a tripod, wire gauze, asbestos pad, triangular file, two 6-inch test tubes and test tube rack, distilled water, barium chloride, dilute hydrochloric acid, litmus paper, two bottles with stoppers, labels and a pen.

1. Make a 0.99% solution of potassium permanganate as follows:

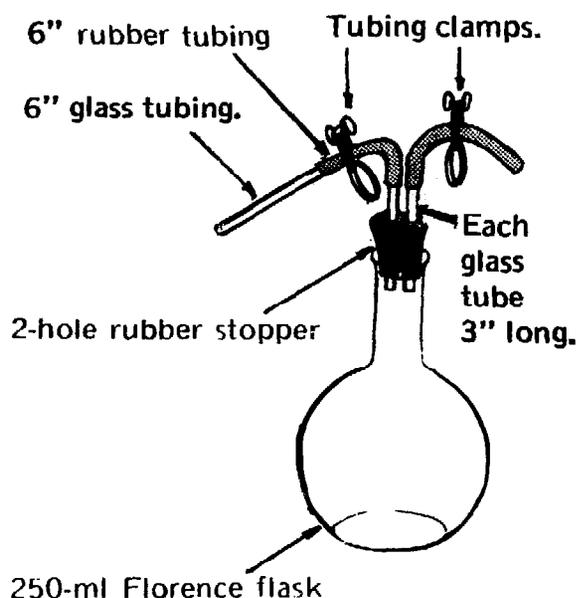
(a) Place weighing paper on the balance and measure 0.99 gm of potassium permanganate, then pour into the 250-ml beaker.

(b) Pour 50 ml of distilled water into the beaker and stir with stirring rod until the potassium permanganate dissolves.

(c) Pour the resulting approximately 50 ml of potassium permanganate solution into the 100-ml graduated cylinder. Add distilled water until the total volume of solution in the cylinder is 100 ml. Note the purple color of this solution.

(d) Pour the solution from the cylinder into the bottle. *Stopper the bottle tightly* and label it "Potassium permanganate solution, 0.99%." The 0.99% means that there is 0.99 gm of potassium permanganate in 100 ml of solution. Set aside for use in Step 5 and in Project 2-2.

**Note:** Only a small amount of  $\text{KMnO}_4$  solution (100 ml) should be made at one time because it can be spoiled by chemicals in the air, which react with it. That is why the solution *must* be kept in a tightly stoppered bottle.



**Fig. 2-1. Set-up for Making Sulfur Dioxide.**

2. Dissolve 0.1 gm of barium chloride in 100 ml of distilled water. Pour the solution into a bottle. Stopper the bottle and label it "Barium chloride solution, dilute." Set aside for use in Step 6.

3. Prepare a set-up as in Fig. 2-1. See Steps 1-5, Project 1-1, for this procedure. Then, slip on a clamp over each rubber tube.

4. Unstopper the flask in the set-up. Pour 0.1 gm of powdered sulfur into the flask. Stopper the flask and close the rubber tubes with the clamps (see Fig. 2-1). Place set-up on the tripod and heat the flask over the bunsen burner (see Fig. 2-2) until the sulfur burns. When the burning stops, shut off the bunsen burner flame. The air in the flask now contains sulfur dioxide. Let the flask cool, then remove set-up from tripod.

5. Pour 10 ml of distilled water into one of the 2 test tubes in the test tube rack. Then, with the pipette, add a drop of 0.99% potassium permanganate solution and a drop of dilute hydrochloric acid to the distilled water in the test tube. Remove clamps on the set-up. Put the glass tube from the set-up into the test tube so that its end is near the bottom of the test tube (see Fig. 2-3). Blow through the rubber tube, forcing sulfur dioxide from the flask through the potassium permanganate solution in the test tube (see Fig. 2-3). Be sure to blow *out* the  $\text{SO}_2$  — *do not breathe in*. The sulfur dioxide will make the purple potassium permanganate solution colorless. Discard contents of the test tube.

**Note:** The decolorization of  $\text{KMnO}_4$  is often used to identify sulfur dioxide. However, other chemicals such as hydrogen peroxide can also decolorize potassium permanganate. That is why the barium chloride test, described in Step 6, is needed to make the identification of sulfur dioxide positive.

6. Pour 10 ml of dilute barium chloride solution into another test tube. Blow sulfur dioxide from the flask through the solution as in Step 5. The white precipitate that

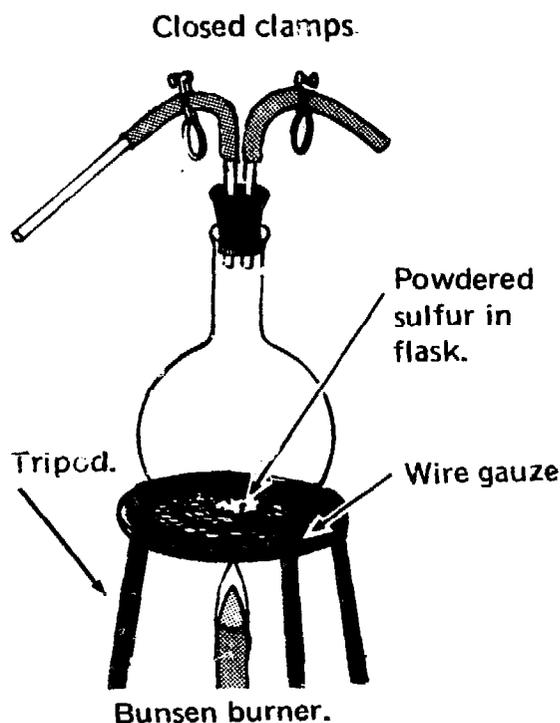


Fig. 2-2. Making Sulfur Dioxide.

Potassium permanganate solution with dilute hydrochloric acid and distilled water in test tube.

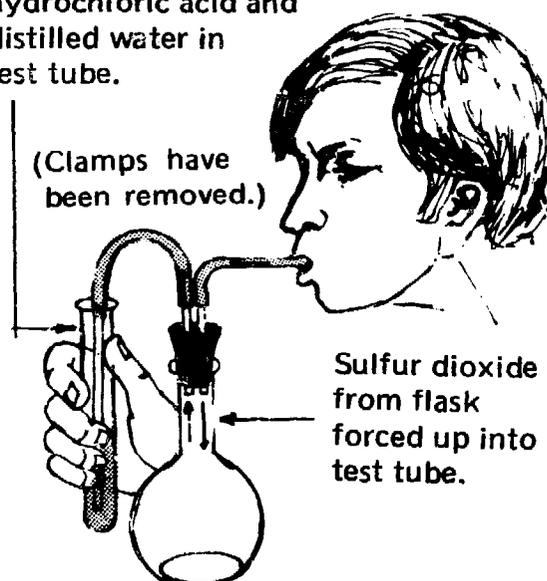


Fig. 2-3. Forcing Sulfur Dioxide Into Test Tube.

forms in the test tube is barium sulfite. Now drop a piece of blue litmus paper into the test tube. With the 1-ml pipette add dilute hydrochloric acid to the test tube until the solution is acidic enough to turn the blue litmus paper red. The hydrochloric acid dissolves the white barium sulfite precipitate, leaving the solution clear. This shows that the precipitate cannot be barium sulfate, which would not

be dissolved by hydrochloric acid. Discard test tube contents.

**Note:** While other chemicals form precipitates with barium chloride solution, they do not also decolorize potassium permanganate solution. That is why a gas which can decolorize potassium permanganate and also form a precipitate with barium chloride, can be identified positively as sulfur dioxide ( $\text{SO}_2$ ).

### Project 2-2. Measuring the Amount of Sulfur Dioxide in the Air.

**You will need:** the 0.99% potassium permanganate ( $\text{KMnO}_4$ ) solution prepared in Project 2-1, a 1-ml pipette, dilute hydrochloric acid ( $\text{HCl}$ ), a 250-ml graduated cylinder, a battery jar, a small air pump with rubber hose such as an aquarium aerator, a 250-ml flask, a 2-hole rubber stopper to fit the flask, 18" of glass tubing to fit the holes in the rubber stopper, distilled water, asbestos pad, triangular file and a bunsen burner.

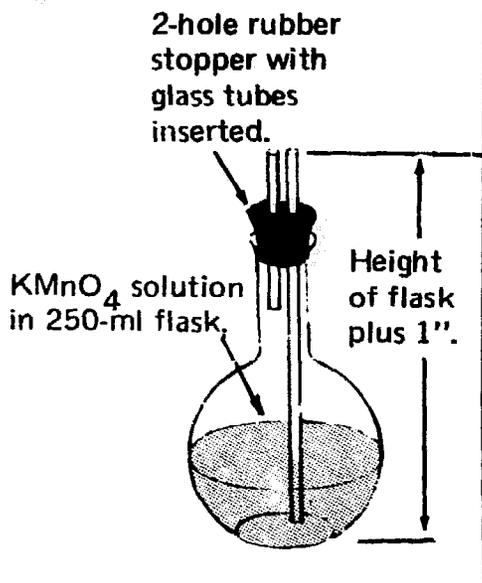
1. Follow instructions in Project 1-1, Steps 1-4, to set up equipment as shown in Fig. 2-4.
2. Remove stopper from flask and pour 100 ml of distilled water into flask. With pipette add 1 ml of 0.99%  $\text{KMnO}_4$  solution and 1 ml of the dilute  $\text{HCl}$ . Replace stopper on flask.
3. Connect the rubber hose of the pump to upper end of the longer glass tube that leads into the flask (see Fig. 2-5). Insert air pump plug into wall outlet and turn on the air pump. Allow the pump to work until the  $\text{KMnO}_4$  in the flask turns colorless. Note the length of time it takes. In some cases, this may take several hours. Disconnect the air pump.
4. Test the air pump to find out how much air it pumps per minute. Fig. 2-6 shows how to do this.
5. To calculate the *volume* of air pumped through the  $\text{KMnO}_4$  solution to decolorize it, multiply the number of minutes that pump

worked (Step 3) by its pumping capacity in liters of air per minute (Fig 2-6).

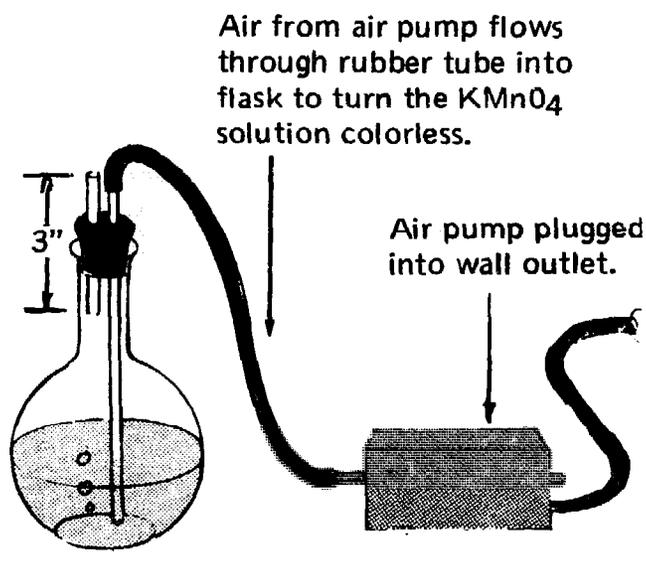
6. One liter of air has a mass of about 1.3 grams. To calculate the *mass* of air pumped through the  $\text{KMnO}_4$  solution, multiply the volume of air in liters (obtained in Step 5) by 1.3 grams.

7. The 0.99%  $\text{KMnO}_4$  solution used in this project contains 0.99 gram of  $\text{KMnO}_4$  per 100 ml of solution. Thus, 1 ml of the solution contains 0.0099 gram of  $\text{KMnO}_4$ . We already know that 1 gram of  $\text{SO}_2$  is required to decolorize 0.99 gram of  $\text{KMnO}_4$  (see page 35). Therefore, it will take 0.01 gram of  $\text{SO}_2$  to decolorize 0.0099 gram of  $\text{KMnO}_4$ . Since 1 ml of 0.99%  $\text{KMnO}_4$  solution (Step 2) was decolorized when air was pumped through the solution in the flask (Step 3), we can conclude that there was 0.01 gram of  $\text{SO}_2$  in the air.

8. Let us assume, for example, that 250 liters of air from the air pump



**Fig. 2-4. Set-up for Measuring Sulfur Dioxide.**



**Fig. 2-5. Measuring Sulfur Dioxide.**

Fill graduated cylinder with water, cover with glass plate and then quickly place it upside down halfway into water in battery jar. Remove glass plate. Slightly tilt cylinder and insert glass tube connected to end of air pump's rubber hose. Turn on air pump. Note and record the number of seconds required to fill the graduated cylinder with air (air displaces water in cylinder) to the

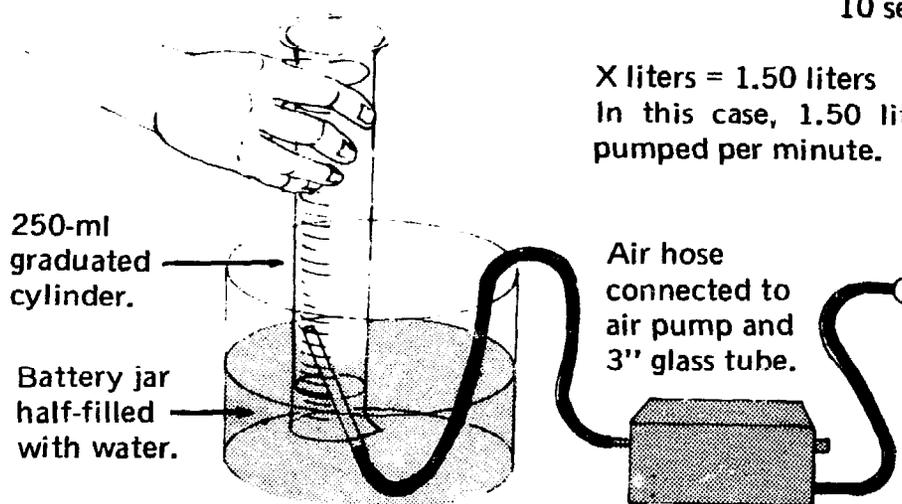
250-ml mark (nearest its lip). Let us say that 10 seconds are required. Since 1000 ml equal 1 liter, then 250 ml equal 0.250 liter. To calculate the volume that the air pump can pump per minute, set up a ratio like this:

$$\frac{X \text{ liters}}{60 \text{ seconds}} = \frac{0.250 \text{ liters}}{10 \text{ seconds}}$$

$$X \text{ liters} = \frac{(60 \text{ seconds}) (0.25 \text{ liters})}{10 \text{ seconds}}$$

$$X \text{ liters} = 1.50 \text{ liters}$$

In this case, 1.50 liters of air are pumped per minute.



**Fig. 2-6. How to Calculate the Mass and Volume of Air Discharged from Air Pump Per Minute.**

were needed to decolorize 1 ml of 0.99%  $\text{KMnO}_4$ . The 250 liters of air have a mass of (250) (1.3 gm), or 325 gm. This 250 liters of air contained a mass of 0.01 gram of

sulfur dioxide. This is enough to decolorize the 0.0099 gram of  $\text{KMnO}_4$  that 1 ml of 0.99%  $\text{KMnO}_4$  solution contains.

**Note:** With this information you can calculate the number of parts of sulfur dioxide per million parts of air. You can set up this proportion:

$$\begin{aligned} \frac{x \text{ gm of SO}_2}{1,000,000 \text{ gm of air}} &= \frac{0.01 \text{ gm of SO}_2}{325 \text{ gm of air}} \\ x \text{ gm of SO}_2 &= \frac{0.01 \text{ gm of SO}_2(1,000,000)}{325} \\ x \text{ gm of SO}_2 &= 30.77 \text{ gm of SO}_2 \end{aligned}$$

Thus, you can conclude that the sample of air that you tested in this project contained 30.77 parts of sulfur dioxide per million parts of air. The results in this project may be inaccurate because dust also decolorizes  $\text{KMnO}_4$  and interferes with the analysis. However, this project does indicate a type of chemical analysis done more accurately in air pollution control laboratories to determine  $\text{SO}_2$  concentration in the air.

The reaction between potassium permanganate and sulfur dioxide is expressed in the chemical equation shown on page 33, which tells us that 5 molecules of  $\text{SO}_2$  are changed when 2 molecules of  $\text{KMnO}_4$  become colorless. Scientists use this equation to measure the amount of  $\text{SO}_2$  in a sample of air or water. The equation enables the scientist to determine exactly how much  $\text{KMnO}_4$  solution is decolorized by 1 gm of  $\text{SO}_2$  and thus measure the amount of  $\text{SO}_2$  in the air. To do this, the scientist must calculate the mass of a  $\text{KMnO}_4$  molecule and the mass of an  $\text{SO}_2$  molecule.

#### Calculating the Mass of a Molecule

Chemists have a way of calculating the mass of a molecule. The mass of each kind of atom is known. The mass of each atom is given in *Atomic Mass Units* (abbreviated: AMU). Adding the masses of all the atoms in a molecule gives the mass of the molecule. Tables 2-I and 2-II show how this method is used to find the mass of a  $\text{KMnO}_4$  molecule and of the  $\text{SO}_2$  molecule.

You can convert the masses of these molecules to gram molecular masses by changing AMU (Atomic Mass Unit) to grams. A gram is a mass with a weight of about 1/450 of a pound. One gram molecular mass of potassium permanganate is 158.04 grams and one gram molecular mass of sulfur dioxide is 64.06 grams (see Tables 2-I, 2-II).

<b>Table 2-I. How to Calculate the Mass of the Potassium Permanganate Molecule.</b>			
ATOM	MASS	NUMBER OF ATOMS IN THE MOLECULE	TOTAL MASS
K	39.10 AMU	1	39.10 AMU
Mn	54.94 AMU	1	54.94 AMU
O	16.00 AMU	4	64.00 AMU
Mass of a molecule of $\text{KMnO}_4$ : 158.04 AMU			

Just as 2 molecules of  $\text{KMnO}_4$  combine with 5 molecules of  $\text{SO}_2$  as shown in equation on page 33, so do 2 gram molecular masses of  $\text{KMnO}_4$  combine with 5 gram molecular masses of  $\text{SO}_2$ . You can round off the gram molecular masses shown in Tables 2-I and 2-II to the nearest whole numbers, making the gram molecular mass of potassium permanganate 158 grams and the gram molecular mass of sulfur dioxide 64 grams. Thus 2(158) grams of potassium permanganate combine with 5(64) grams of sulfur dioxide. This means that 316 grams of potassium permanganate combine with 320 grams of sulfur dioxide. Almost exactly one gram of sulfur dioxide combines when 0.99 gram of potassium permanganate changes color.

By using a potassium permanganate solution of just the right strength, 0.99%, you can easily measure the amount of sulfur dioxide in a sample of air or water. Project 2-2 tells how to do this.

### Can We Reduce the Harmful $\text{SO}_2$ ?

Thus far we have learned to detect and measure  $\text{SO}_2$  in the atmosphere, and we have observed how it destroys life. If heavier concentrations of this poisonous substance continue to pour into our atmosphere, the harm that it does will increase to deadly proportions unless we learn how to eliminate or reduce  $\text{SO}_2$ . Already something is being done about this.

<b>Table 2-II. How to Calculate the Mass of a Sulfur Dioxide Molecule.</b>			
ATOM	MASS	NUMBER OF ATOMS IN THE MOLECULE	TOTAL MASS
S	32.06 AMU	1	32.06 AMU
O	16.00 AMU	2	32.00 AMU
Mass of a molecule of $\text{SO}_2$ : 64.06 AMU			

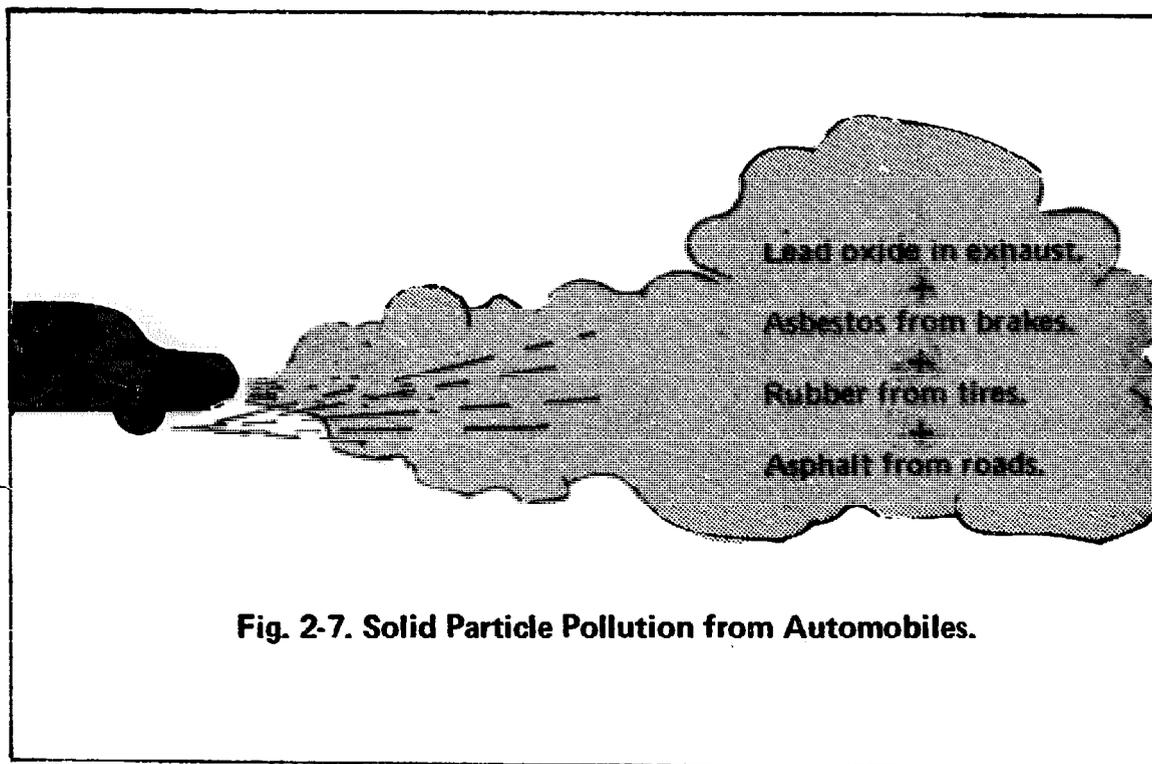
Fuels which produce large quantities of  $\text{SO}_2$  are being replaced with fuels that do not produce as much  $\text{SO}_2$ . But we must be sure that the new fuels do not produce other equally dangerous pollutants. It may be possible to change the  $\text{SO}_2$  at the point of emission, so that it is harmless when it reaches our atmosphere. Another possible solution is to "recycle" the  $\text{SO}_2$  so that the sulfur can be extracted from the  $\text{SO}_2$ , and re-used again. Think of all the sulfur that could be saved for future generations if this can be done. Recycling is a complicated procedure and can be done only by competent chemists with sophisticated equipment. However, part of the cost of recycling is covered by the value of the sulfur that is recovered.

### **Fall-out of Solid Particles**

All year long, solid particles fall through the air. They settle on the soil, on window sills, on clean clothing and even on furniture inside houses. People sweep, dust and wash to remove this airborne dirt, which is one of the most annoying components of air pollution. Fighting the damage done by the fall-out of solid particles from the air takes much work and expense.

Solid particles in the air we breathe can be harmful to our health. Clouds of lead oxide particles are thrown into the air by automobile exhausts because most gasoline contains lead compounds. Lead oxide is dangerous because it can cause lead poisoning, damaging the brain and other vital parts of the body. As automobile brake linings gradually wear away, the asbestos of which they are made floats into the air as extremely small, but dangerous particles which are known to cause cancer of the lungs. Heavy automotive traffic rapidly turns the rubber from tires and the asphalt from roads to dust (see Fig. 2-7). The chimneys of incinerators and the furnaces of homes and factories send large amounts of tar, silicate, arsenic and beryllium particles as well as many other substances into the air. Chemicals such as these are suspected of causing lung cancer and other diseases.

In large cities, an almost unbelievable amount of solid matter falls from the air. Each square mile in New York City receives an average of about 90 tons of such dirt per month. That amounts to 36,000 tons per month on the 400 square miles of the city's area. In fact, the solids that fall from polluted air on all of New York City would fill one ten-ton truck every 12 minutes.



**Fig. 2-7. Solid Particle Pollution from Automobiles.**

### **How To Measure Solid Fall-out**

The problem is worse in some locations than in others. Where is there a greater fall of solid particles? How can you measure the amount that falls? There are some simple methods for finding the answers.

One method of comparing amounts of solid particle fall-out is to place white pieces of paper (typing paper is suitable) in a horizontal position in different locations for the same number of days. If the paper is protected from draft and wind (as within small, open-top cartons) the solids that gather will remain on the paper. By observing the darkness of the layer on each piece of paper, you can then make a rough comparison of amounts of particulate matter that fall in different locations. A more accurate measure can be made with an instrument called a photometer (see Figs. 2-8 and 2-9). With it you can measure the amount of light that can pass through the dust on a sheet of paper (see Fig. 2-10). The paper with the darkest layer would show that the heaviest fall occurred in that locality. A similar method is used at air pollution stations. Air is pulled through a fiberglass filter by a vacuum pump for 24 hours. The amount of dust deposited on the filter is then measured with a photometer. Project 2-3 shows how to build and use a photometer.

### Project 2-3. How to Build and Use a Photometer to Measure Fall-out.

You will need: an ammeter (0-1 milliampere), two terminals, a 5000-ohm potentiometer, a 9-volt transistor radio battery, a GE-A33 photoconductive cell, 6 feet of No. 20 insulated wire, rosin-core solder, a soldering iron, an X-acto knife, diagonal pliers, several small cardboard cartons to collect fall-out, a 10-gallon aquarium tank, a lamp, several sheets of white typing paper, a pen, labels and note paper.

1. First, connect the ammeter, potentiometer and battery to each other with the wire as shown in the pictorial diagram of Fig. 2-8, and schematic diagram of Fig. 2-9. Use diagonal pliers to cut the wire. The connections to the terminals, to the potentiometer lugs and to the battery contacts must be soldered.
2. Connect the photoconductive cell to the terminals as shown in

Fig. 2-8 by tightening the terminal nuts onto the wire leads. Fig. 2-8 shows how the parts of the photometer can be mounted in the cardboard box in which the ammeter is packed. Use the X-acto knife to cut a hole (in the top of the cardboard box) into which you can fit the round case of the ammeter. The face of the ammeter should be on the outside of the

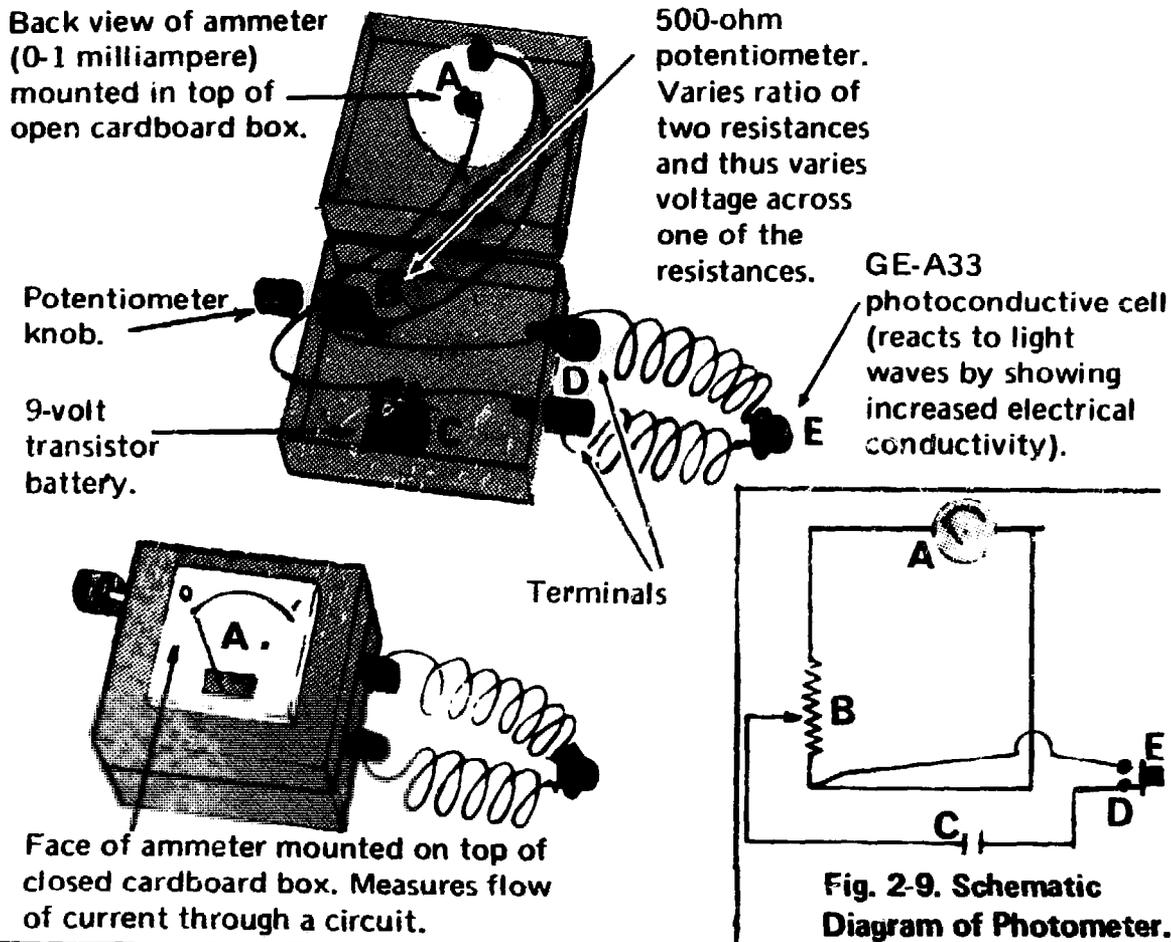


Fig. 2-8. Pictorial Diagram: How to Assemble a Photometer.

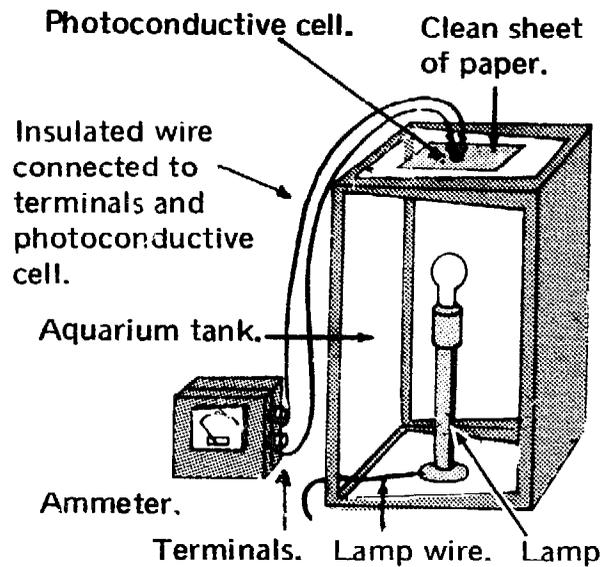
box. Punch holes on the sides of the box for the shafts of the potentiometer and the terminals.

3. Now, calibrate the photometer by standing the 10-gallon aquarium tank on one end. Put the lamp inside the aquarium tank and turn the lamp on (see Fig. 2-10). Put a clean piece of typing paper on top of the upper end of the aquarium tank so that the light from below is transmitted through the paper. The clean paper acts as a control against which to compare the fall-out samples you have collected. Hold the photoconductive cell one inch above the paper and turn the potentiometer knob until the ammeter reads full scale, which is 1 milliampere. See Fig. 2-10.

4. Then, carefully lift up the photoconductive cell and remove the sheet of clean paper. Turn the lamp off. Do not change the potentiometer setting while you perform any of the following steps.

5. Cut off and discard the tops of the cardboard cartons. Put a sheet of white typing paper in the bottom of each carton and leave the cartons for a few days in locations where you wish to sample the fall-out of solid particles (also called dust-fall). You might want to collect dust-fall samples in your school yard, in your classroom, in your own home, etc.. When you retrieve these samplings, label each with its location, type of locality (residential, industrial, or a main street), dates, length of time and weather conditions.

6. From your collected samples, carefully lift a dust-covered sheet of paper out of its carton and place it



**Fig. 2-10. How to Calibrate the Photometer.**

on top of the upper end of the aquarium tank, as in Fig. 2-10. Turn the lamp on. With the photoconductive cell held one inch above the paper, read the ammeter. *Is there a difference between this reading and the reading with the clean paper used in Step 3?* The layer of fall-out on the paper will interfere with the transmission of light from the lamp and cause a lower photometer reading.

7. Repeat Step 6 for each exposed sheet of paper. Now, record your observations. *In what location was the dust fall-out heaviest? What might cause differences in the heaviness of the dust-fall? Does it seem that heavy traffic, smoke from furnaces or dust from building construction affect the amount of dust-fall? How could dust-fall be decreased?* Another method of gathering some samplings of solid particles fall-out is described in Project 2-4.

### **Project 2-4. Where is Air Pollution Heaviest in Your Community?**

**You will need:** 3 blocks of wood, about 3" x 3" x 3/4", a roll of cellophane tape, a 100-power microscope, 10 slides, 10 cover slips, lens paper, forceps, an X-acto knife, a pen and note paper.

1. Wrap cellophane tape around a block of wood, sticky side out, overlapping the ends for about 1". With X-acto knife cut the tape ends and stick them together. Stand block on end so that exposed part of tape does not touch anything. See Fig. 2-11 (A).

2. Stick a piece of paper, about 3" x 3", to the cellophane tape, on the side of the block where the ends of the tape overlap (B). Place the block on a horizontal surface with the paper down, so that no part of the exposed cellophane tape touches any other surface (C). Prepare two more wood blocks as in Steps 1-2.

3. On a clear day expose the three blocks, with the cellophane tape facing up, for 24 hours in different locations such as a shelf inside your home, on the outside window sill of a room facing a street with heavy traffic, etc.. Examine each block after this 24-hour period. Fall-out will have settled on the sticky side of the cellophane tape.

4. Carefully clean a microscope slide with lens paper and examine it through the microscope to make certain that there is no dust on the slide.

5. Take one of the blocks and with the X-acto knife, cut across the exposed tape at two places, at least

2" apart, as in Fig. 2-12 (A). With forceps, carefully remove the 2" strip of tape without touching the sticky surface except at its ends (B). Place this strip on the slide, sticky side up. Fasten each end of the tape to the slide with small pieces of cellophane tape (C). Put a clean cover slip on the tape to prevent the lens of the microscope from touching the tape.

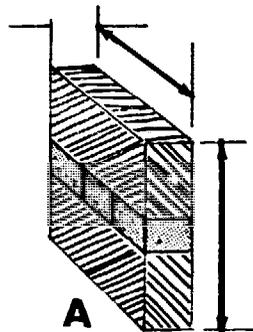
6. Now, examine the slide under 100-power magnification with the microscope. Be careful not to move the slide. Count the number of visible particles, in the field that you see through the microscope. Record this number on paper, including the location where you exposed the strip of tape, the dates and hours of the beginning and end of the exposure, and also any additional information that you may think is important.

7. Repeat the procedures in Steps 4-6 with cellophane tape strips cut from each of the other two blocks that you exposed for 24 hours. *Was there a difference in the number of particles counted on the slides of the tapes from the three blocks exposed in different locations? Which location showed the heaviest density of fall-out? Can you explain the reason for this difference?*

---

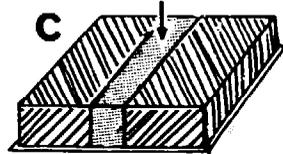
In project 2-4 we learn how to collect and determine the number or quantity of particles in a fall-out. We find that there are more dirt particles in the air in some locations than in others. While the dirt particles will soil our clothing, dirty our houses and even clog our lungs, another serious question comes to mind: Do any of these

Wood block rests on end to prevent cellophane tape from touching anything.

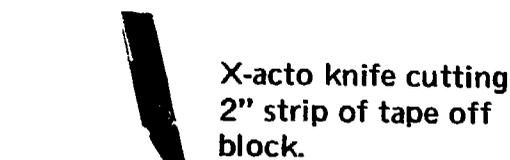
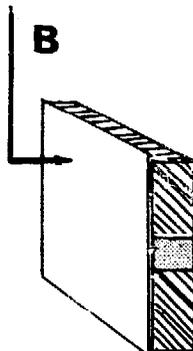


Sticky side of tape faces up.

Wood block resting on paper.



Paper placed against block where tape overlaps.



X-acto knife cutting 2" strip of tape off block.



Exposed tape being removed with forceps.



Exposed tape placed on glass slide.



Cellophane tape holding down exposed tape.

**Fig. 2-11. How to Prepare Wood Blocks to Collect Solid Fallout Particles from the Air.**

**Fig. 2-12. How to Remove Exposed Tape from Wood Blocks to Examine Solid Particle Fallout.**

particles contain chemicals that will injure our health? The answers can be found by examining the particles *chemically*. Delicate chemical analyses performed in air pollution control stations and in research laboratories reveal the nature and actual amounts of pollutants in the dust. Such substances as lead, arsenic, beryllium, silicon, asbestos and asphalt are readily identified and their quantities are accurately measured. Although Project 2-4 is not as accurate, it does help us to find out where in our community the heaviest fall-out originates, and if we could perform the sophisticated chemical analysis that is required, it would also tell us what the fall-out contains that may make it even more dangerous. If our findings are accurate, we can provide our community with valuable information to help make it aware of and possibly help eliminate this pollution.

### Temperature Inversions

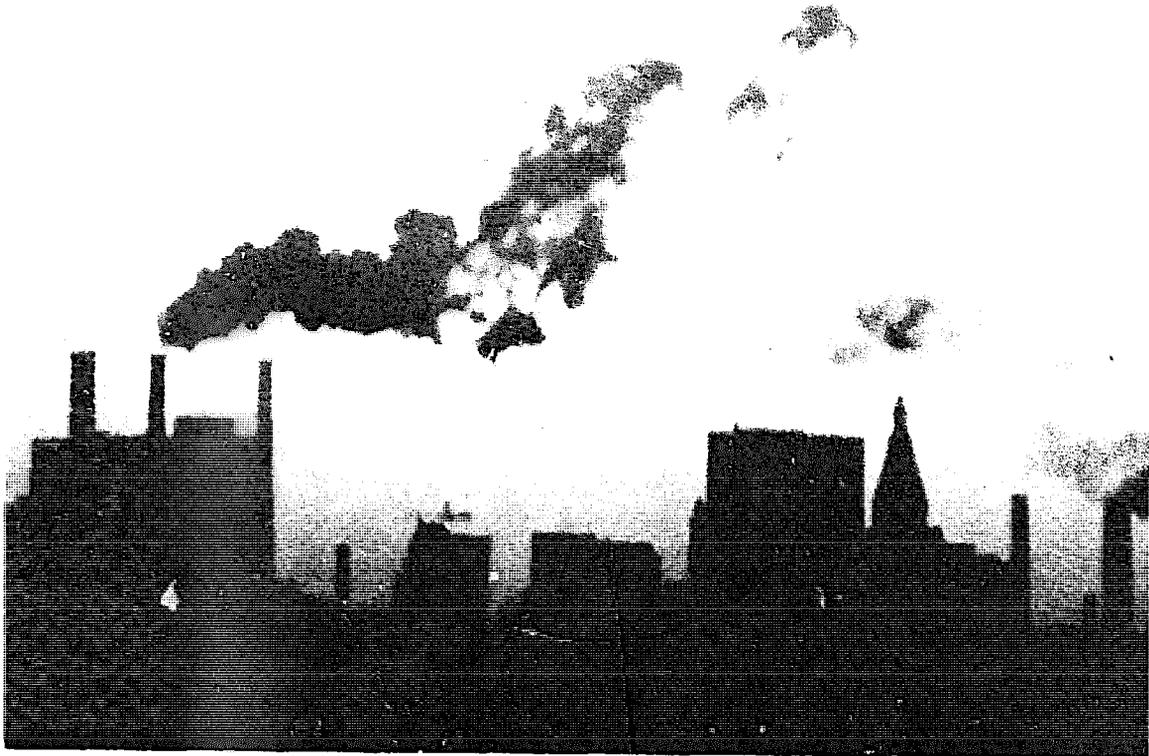
Los Angeles has an average of 260 days of smog a year (see photo Fig. 2-13). This smog irritates people's eyes and makes breathing



**Fig. 2-13. Smoggy Day in Los Angeles. (Photo courtesy of Environmental Protection Agency.)**

difficult. Although much has been done to ease the problem, its main cause, temperature inversion, has not been changed. When there is a temperature inversion, air near the ground begins to rise but cannot reach heights of more than a few hundred feet. As a result, pollutants poured into the air by automobiles and chimneys are trapped close to the ground (see photo Fig. 2-14). The pollution condition becomes progressively worse as long as the inversion lasts.

To understand how a temperature inversion acts, we must first know what happens when there is no inversion. In the usual normal distribution of air temperatures, the air closest to the ground is warmest and the temperature gradually decreases (the air becomes cooler) as the height becomes greater (see Fig. 2-15). Warm air is less dense than cold air. Therefore, a volume of warm air weighs less than an equal volume of cold air. For this reason, warm air is pushed upward by the pressure of the denser cold air that surrounds it. Warm air moving up from the ground will continue to rise as long as it remains warmer than the air around it. As the warm air rises, it moves through air that gradually becomes colder with increasing height. However, the rising warm air also becomes cooler (see Fig. 2-16) because it expands as it moves upward into heights where the



**Fig. 2-14. Pollutants Poured Into Air by Chimneys Aggravate Smog Condition During Temperature Inversion. (Photo courtesy of Bell Telephone Magazine.)**

air pressure becomes progressively lower. When there is no temperature inversion, the rising warm air cools off less rapidly than the surrounding air as the height increases. Therefore, as long as the temperature of the rising warm air is always higher than that of the surrounding air, it will continue to rise (see Fig. 2-16). It is this rising warm air which carries the air pollutants up into the atmosphere and away from the community, allowing us to breathe fresher air. But what happens when there is a temperature inversion?

A temperature inversion results when the air near the ground is colder than a layer of air some distance above it (see Fig. 2-17). In this instance, the warm air can rise through the cold air that is near the ground but will stop rising when it reaches the layer of air which is warmer than the air near the ground and which may be only a few hundred feet above the ground. The warm air that has been rising from the ground has slowly been cooling by expansion. Now it may be cooler and therefore more dense than the layer of warm air above it. And, being more dense than the air above it, it can no longer rise (see Fig. 2-18). In a temperature inversion the warm layer of air (possibly a few hundred feet above the ground) acts like a lid on a pot. It stops the upward movement of the warm air currents which

Height	Temperature
5,000 Ft.	52.5°
4,000 Ft.	56.0°
3,000 Ft.	59.5°
2,000 Ft.	63.0°
1,000 Ft.	66.5°
0 Ft.	70.0°

**Fig. 2-15. A Normal Distribution of Air Temperature.**

Height	Rising Air	Temperature
5000 Ft.	52.5°	52.5°F
4000 Ft.	58.°	56°F
3000 Ft.	63.5°	59.5°F
2000 Ft.	69.°	63°F
1000 Ft.	74.5°	66.5°F
0 Ft.	80.°	70°F

**Fig. 2-16. Warm Air Rising In a Normal Temperature Distribution.**

carry away the pollutants, with the result that these pollutants remain concentrated close to the ground. When this occurs, you have the makings of a smog condition.

Temperature inversion may form in several ways. In the Los Angeles area, two main actions combine to create the inversions. West winds sweep cold air from the Pacific Ocean across the surface of the ground. This makes the lower layers of air in the Los Angeles area colder than the air that is higher up. In addition, the air over Los Angeles generally has high barometric pressure and therefore tends to sink rather than rise. As this air sinks, it becomes warmer because it is being compressed by the increasing weight of the air above it (see Fig. 2-19). The temperature of the sinking air increases until it descends to a height where its temperature now is warmer than the air below it. At that height, which is usually a few hundred feet above the ground, the air stops falling. As a result, there is a layer of warm air above the colder air near the ground. The lid is on! A temperature inversion has formed (see Figs. 2-17 and 2-18).

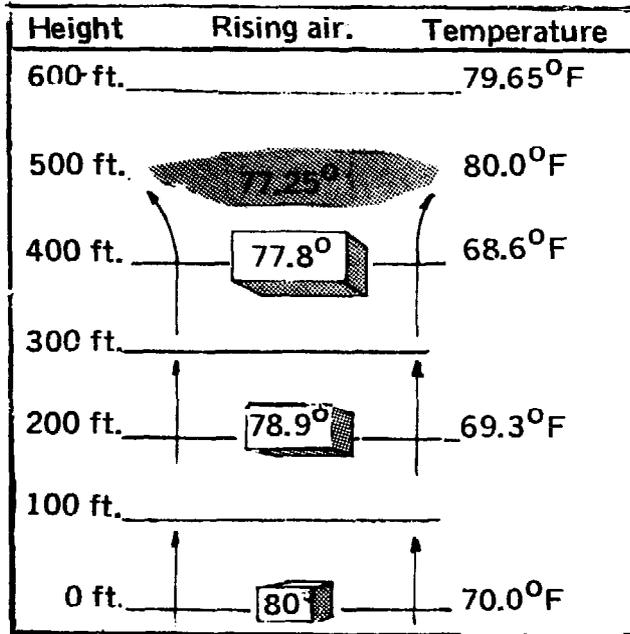
To find out whether there is a temperature inversion in your community, you must measure the temperature of the air at

Fig. 2-18 shows that at 500 feet the rising air is  $77.25^{\circ}$  ( $2.75^{\circ}$  cooler than surrounding air at  $80^{\circ}$ ). At this temperature the rising air cannot continue upward and the rising pollutants in the air are

trapped. The longer this condition remains the more pollutants accumulate, creating a smog condition which can become a health hazard as it progresses.

Height	Temperature
600 Ft.	$79.65^{\circ}\text{F}$
500 Ft.	$80^{\circ}\text{F}$
400 Ft.	$68.6^{\circ}\text{F}$
300 Ft.	
200 Ft.	$69.3^{\circ}\text{F}$
100 Ft.	
0 Ft.	$70^{\circ}\text{F}$

**Fig. 2-17. Temperature Inversion at 500 Feet Above Ground.**



**Fig. 2-18. Warm Air Rising In Temperature Inversion.**

Air above Los Angeles tends to sink because it has high barometric pressure. As it drops, it is being compressed by the increasing weight of the air above it.

West winds sweep cold air from the Pacific Ocean across the surface of the ground.

Lower layers of air are colder than the air higher up.

Cold winds.

West.



East.

The temperature of the sinking air increases until it descends to a height where its temperature, by compression, now is warmer than the air below it. At this height, usually a few hundred feet above the ground, the air stops falling.

**Fig. 2-19. How Temperature Inversion Is Created In Los Angeles.**

different heights. Project 2-5 shows how to make and use an electrical thermometer that can measure temperatures hundreds of feet above the ground.

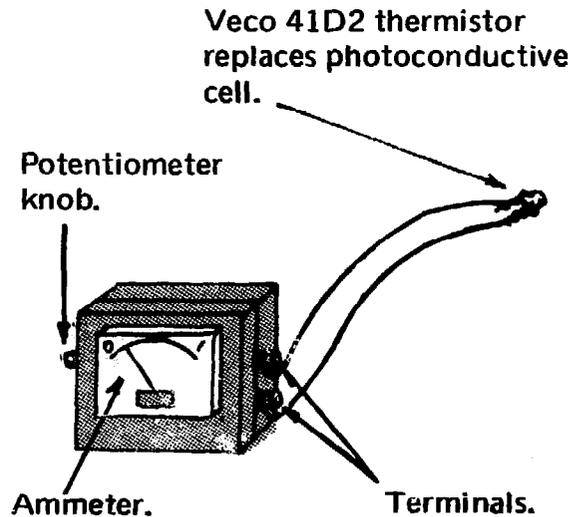
### Project 2-5. How to Make and Use the Electrical Thermometer.

**You will need:** the photometer made in Project 2-3, a Veco 41D2 thermistor, two 500-foot lengths of Litz wire, a helium-filled balloon, 500 feet of thin, nylon fishing line, ice, water, a 400-ml beaker, a stove or hot plate, an ordinary mercury or alcohol thermometer that measures from about 20°F to about 110°F, one red and one black waterproof marking pen, tape measure or ruler, note paper, graph paper, a pen and pencil.

1. Remove the photoconductive cell and its connecting wires from the photometer terminals, and replace it with the thermistor (see Fig. 2-20). This converts the photometer into an electrical thermometer.

2. On the hot plate or stove heat some water in the beaker to 100°F. Use the ordinary thermometer to measure the 100°F temperature. Remove the beaker from the hot plate or stove. Now, put the thermistor of the electrical thermometer into the water. While the water is still at 100°F (as shown by the ordinary thermometer), turn the knob of the potentiometer until the ammeter reads 1 milliampere. When this adjustment has been made, the 1 milliampere reading on the ammeter equals the 100°F reading on the ordinary thermometer (see Fig. 2-21). Dispose of hot water in beaker. Note: Do not turn the potentiometer knob during any of the following steps.

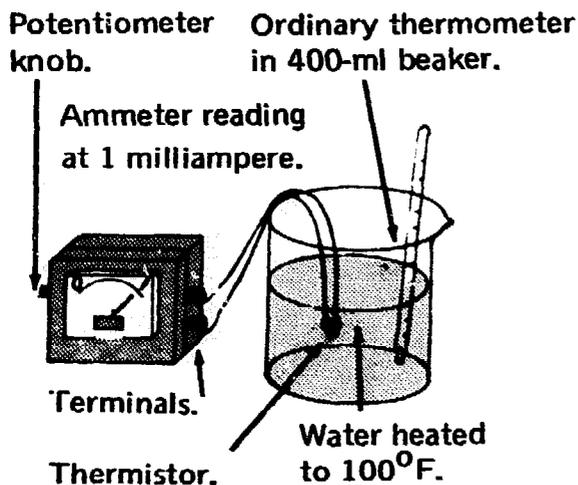
3. Place the thermistor and the ordinary thermometer into the beaker containing a mixture of ice and water. The temperature reading should be about 32°F on the ordinary thermometer. Now check the reading on the ammeter.



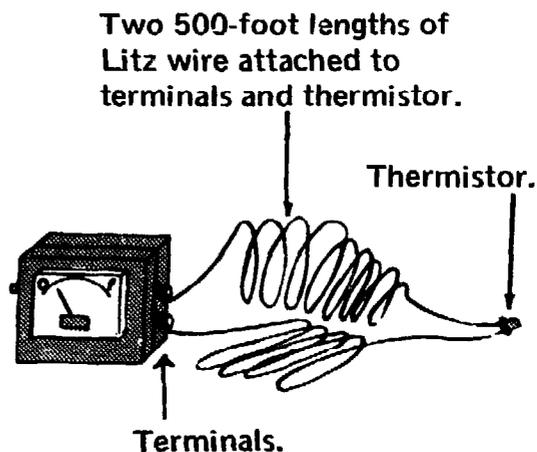
**Fig. 2-20. How to Assemble Electric Thermometer.**

Note: This reading on the ammeter corresponds to the 32°F reading on the ordinary thermometer. Make a record of this reading, so that you will know where 32°F is on the ammeter.

4. With both the thermistor and the ordinary thermometer still in the cold water, heat the water slowly on the stove or hot plate until it reaches 100°F. As the water temperature rises, record the ammeter readings at 40°F, 50°F and every 10 degrees until you reach 100°F. You have now fully calibrated your electrical thermometer from 32°F to 100°F, and know the temperature that corresponds to each meter reading.



**Fig. 2-21. How to Calibrate Electric Thermometer.**

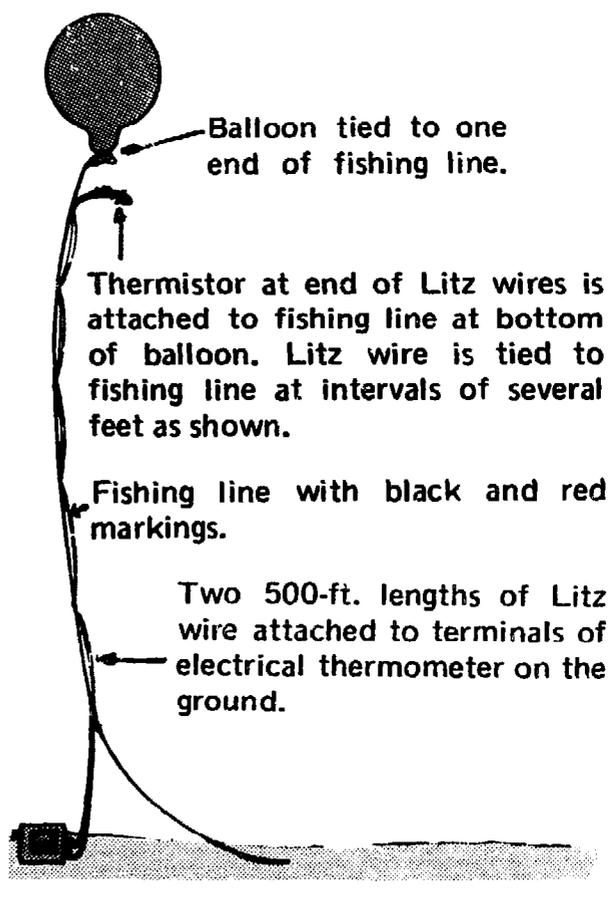


**Fig. 2-22. How to Convert the Electric Thermometer to Record Temperature Above Ground.**

5. Mark the 500-foot fishing line every 10 feet with the black marking pen. Mark every 100 feet with the red marking pen.

6. Now, let's convert the electrical thermometer so we can record temperatures above ground level. Disconnect the thermistor leads from the terminals of the electrical thermometer. Scrape one inch of insulation from each end of the Litz wire. Attach the short wire leads of the thermistor to the two 500-foot lengths of Litz wire by twisting one end of each piece of Litz wire around each thermistor lead. Then, attach the free ends of the Litz wires to the terminals of the electrical thermometer as shown in Fig. 2-22. Now, check your electrical thermometer as in Step 4 to see that it still works correctly.

7. Go outdoors, to an open area. Tie one end of the fishing line to the helium-filled balloon. Then, using a short piece of the nylon



**Fig. 2-23. How to Record Atmospheric Temperatures.**

fishing line, tie the thermistor-ends of the Litz wires to the fishing line, close to where the fishing line is attached to the balloon (see Fig. 2-23). Now, with short pieces of fishing line, tie the Litz wire to the fishing line every few feet, so that the line supports the weight of the wire. While holding the fishing line securely, allow the balloon and thermistor to rise (100 feet at a time), pulling the Litz wire with it. Make a record of the ammeter reading (as in Fig. 2-24) for every 100 feet that the balloon rises, using the red and black marks on the fishing line to guide your height count.

8. Now, make a graph of your

**Note:** If a temperature inversion does exist in your community, there will tend to be a higher concentration of pollutants such as sulfur dioxide, asbestos, lead oxide, nitric acid, etc. in the atmosphere. All of these are highly dangerous to our health, and the community, guiding itself to some extent by your findings, should demand official action to eliminate this condition.

observations showing the temperature on the horizontal axis and the height above the ground on the vertical axis as shown in Fig. 2-25, which shows a typical graph for a day when there is no temperature inversion. Fig. 2-26 is a graph made on a day when there was a temperature inversion.

9. Compare your graph with Figs. 2-25 and 2-26. *Does your graph indicate that there is a temperature inversion?* Your results will show that you have learned how to measure atmospheric temperature. Now, using the procedure in this Project, you can find out when there is a temperature inversion in your community.

600 Ft.	57.3°
500 Ft.	57.7°
400 Ft.	58.1°
300 Ft.	58.6°
200 Ft.	59.2°
100 Ft.	59.7°
0 Ft.	60.0°

Fig. 2-24. Record of Temperature and Height Recorded Above Ground.

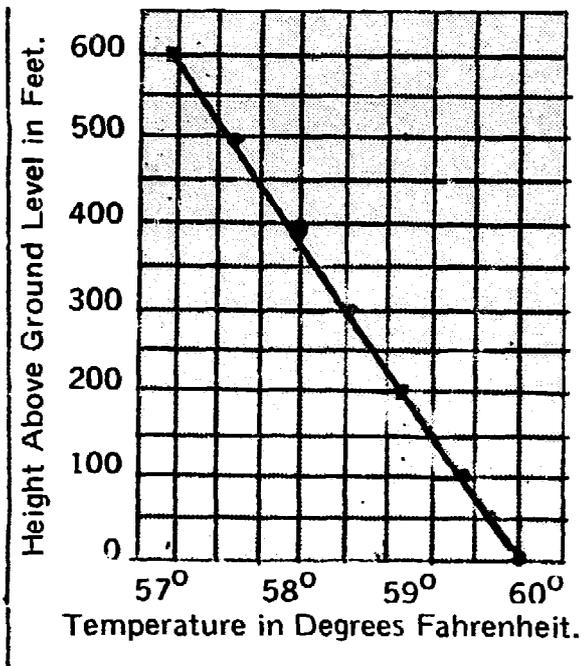
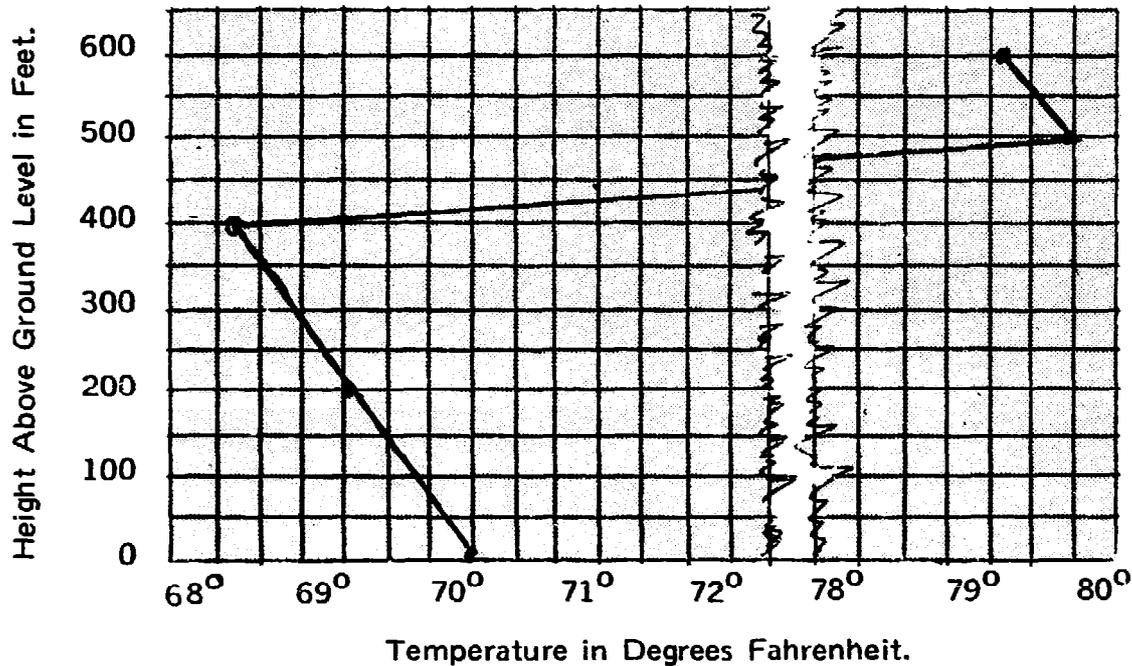


Fig. 2-25. Typical Graph of Day With No Temperature Inversion.

Note how the temperature in Fig. 2-26 gradually drops as the air rises. It continues to drop until the air reaches the altitude of 400

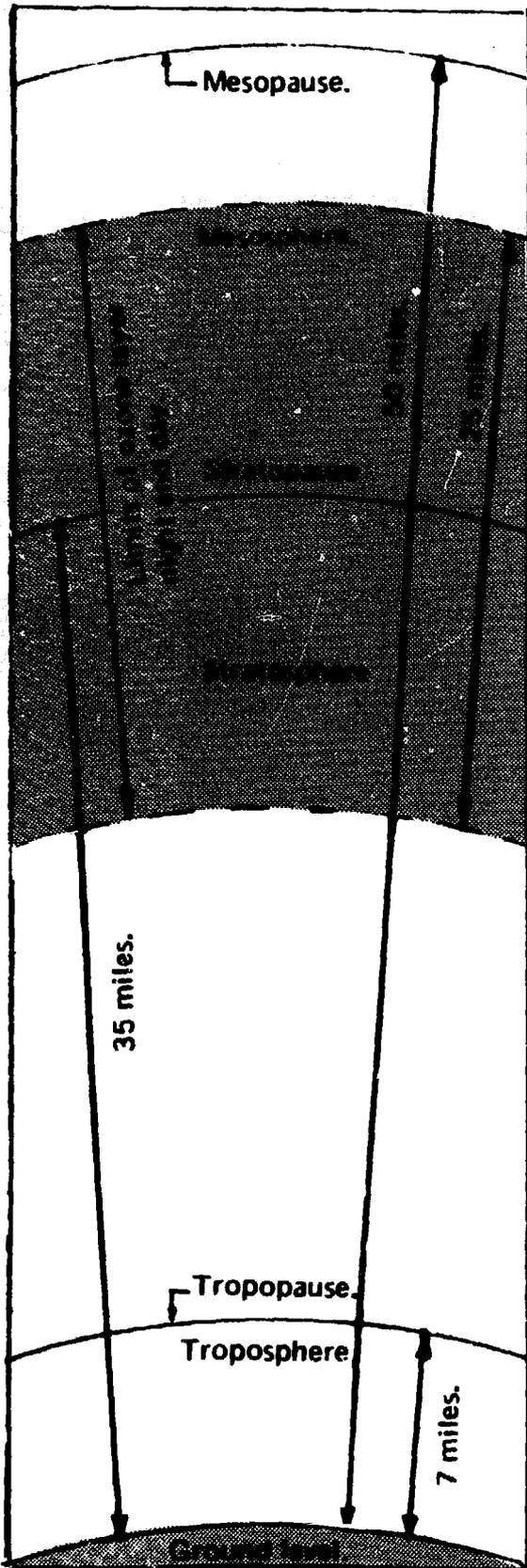
feet, at which height the temperature then begins to rise sharply.



**Fig. 2-26. Typical Graph of Day With Temperature Inversion.**

### Ozone, the More Active Oxygen

Ozone ( $O_3$ ), a form of oxygen, is both helpful and harmful. If there were no ozone in the atmosphere, powerful ultraviolet rays from the sun would reach the earth's surface and destroy most, if not all of life. A layer of ozone high above the earth absorbs almost all of the strong ultraviolet rays. The height of this ozone layer changes from about 25 miles above the earth's surface during the day to 50 miles during the night (see Fig. 2-27). The ozone concentration is greatest higher up where the ultraviolet rays from the sun first encounter dense concentrations of oxygen and changes the oxygen ( $O_2$ ) to ozone ( $O_3$ ). When the oxygen changes to ozone, the strong ultraviolet rays are absorbed and cannot travel further down toward the earth's surface. Ultraviolet radiation not only forms ozone, it also breaks up existing ozone, changing it back to oxygen. That is why



Ozone layer here absorbs almost all of the strong ultraviolet rays from the sun and prevents them from penetrating to the earth.

Ozone layer changes from about 50 miles above the earth at night to about 25 miles above the earth during the day. There are about eight parts of ozone to a million parts of air in the ozone layer above the earth.

Ozone concentrations near earth's surface is usually less than one tenth of a part to a million parts of air.

**Fig. 2-27. Location of the Ozone Layer in the Atmosphere.**

the concentration of ozone in the ozone layer high above the earth does not increase to much more than 8 parts of ozone in a million parts of air. Although this may appear to be a small concentration, it is still about 100 times greater than the average concentration of ozone near the earth's surface.

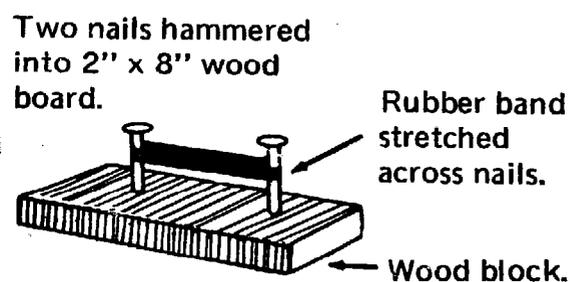
When a layer of ozone has formed in the upper layers of the atmosphere, it prevents the strong ultraviolet radiation from penetrating further and changing the oxygen closer to the ground to ozone. Although the ozone layer miles above the earth, in the upper atmosphere, is essential if life is to continue on the earth, ozone itself is highly poisonous. As little as one-half part of ozone in one million parts of air indicates a severe air pollution condition and is considered to be quite dangerous to human health. Within an hour, such a concentration of ozone can cause serious damage to plants and animals. Ozone destroys organic matter, both living and dead. If we can devise a method for detecting ozone, we can take steps to reduce its concentration before it destroys plant and animal life. Scientists have found that ozone deteriorates and cracks rubber. Thus, we can test rubber deterioration to detect the presence of ozone. Project 2-6 describes a way of estimating ozone concentrations near the earth's surface, based on the cracking of rubber.

#### Project 2-6. Testing for Ozone.

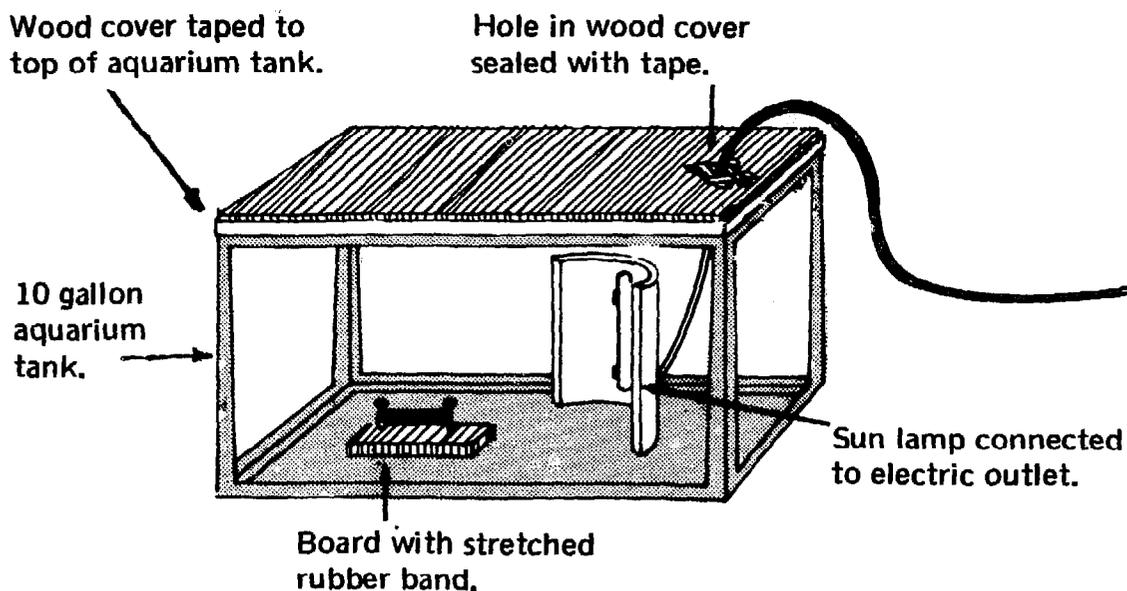
**You will need:** six rubber bands, six 2" x 8" wooden boards, 12 nails, a hammer, a 10-gallon aquarium tank, a board to cover the aquarium tank, a drill, a sun lamp or other ultraviolet lamp, a large cardboard carton and cellophane tape.

1. Hammer two nails into one of the boards, far enough apart to stretch a rubber band tightly over them as in Fig. 2-28. Then prepare 5 more such boards.

2. Place one board in each of five locations (indoors or outdoors) where you wish to test the ozone concentration. Since the electric motors often produce quite a bit of ozone, you might test the ozone concentration near an appliance



**Fig. 2-28. Stretching Rubber Band to Test for Ozone.**



**Fig. 2-29. How to Test Ozone Production by a Sun Lamp.**

with an electric motor which is used for long periods of time, such as a refrigerator, an air conditioner, electric fan, etc. Check periodically, and note how long it takes for the rubber band to crack and break.

**Note:** In areas where the ozone concentration is high, it will take less time for the rubber to crack. It may take weeks or months for the rubber to crack in some locations, depending on the amount of ozone concentration.

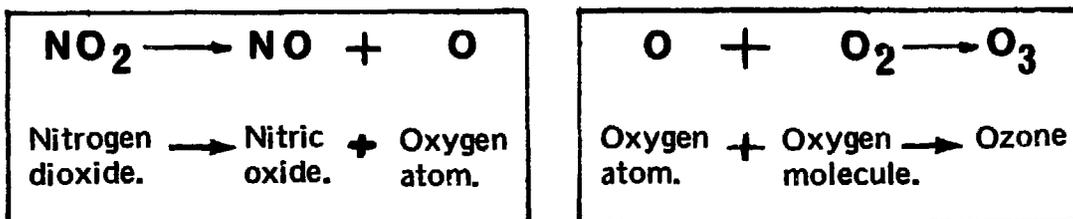
3. Place the sun lamp in the aquarium tank together with the unused sixth prepared board. Drill a hole at one end of the aquarium cover board and push the electric cord from the sun lamp through it. Cover the aquarium tank with the wooden board and seal the edges

and the area around the hole on the board with cellophane tape (see Fig. 2-29). Then invert the cardboard carton completely over the aquarium tank to absorb the harmful ultraviolet rays from the sun lamp. Turn on the sun lamp for a few minutes, then turn it off. Remove the carton, but do not take the wooden cover off. Note how long it takes the rubber band to crack. *Does this show that ozone is produced by an ultraviolet lamp?*

4. Check the other 5 locations. Record how long it takes for the rubber band to crack in each location. *Since the rubber band will crack sooner in locations with the highest ozone concentrations, what conclusions can you draw from this experiment?*

**Note:** Large concentrations of ozone are produced by the action of sunlight on automobile exhaust. Therefore, highways and heavily traveled streets in your community should be tested for ozone. Power company substations are good locations to check since the generators are likely to produce much ozone. The location with the lowest ozone concentration (Step 4) may be used as a control.

The ozone concentration near the earth's surface is generally less than one-tenth of a part per million parts of air. Some of this ozone is brought down from the ozone layer by the extremely slow vertical currents that mix the atmosphere. However, most of the ozone found in badly polluted air does not come from higher altitudes. Some ozone is made by lightning, and by ultraviolet lamps and other electrical equipment. Most ozone is formed near the earth's surface when nitrogen dioxide forms nitric oxide, releasing an oxygen atom. The oxygen atom then combines with an oxygen molecule, producing ozone. The equations for these reactions are:



These reactions take place when nitrogen dioxide is exposed to sunlight in the presence of hydrocarbons. Much of the nitrogen dioxide and hydrocarbons come from automobile exhausts. This is another way that the automobile adds to the air pollution problem.

While ozone is forming, the reaction of nitrogen oxides and hydrocarbons also produces chemicals called peracyl nitrates and formaldehyde. These are irritating to the eyes and cause the eyes to smart when we are riding in heavy automobile traffic. Since sunlight supplies the energy that starts this set of reaction, the resulting pollution is called photochemical smog (see Fig. 2-30). Photo, which means light, refers to the light that triggers the reactions.

### Carbon Dioxide

Although carbon dioxide is considered to be a normal and very useful part of the air, it could conceivably destroy heavily populated cities if its concentration were to increase greatly. Although its concentration in our atmosphere is quite small, only 300 parts per million parts of air, carbon dioxide is essential for food and oxygen production (photosynthesis) by plants. Carbon dioxide also stimulates the breathing center in the brains of animals. About the only harm carbon dioxide does at present is to react with limestone. When carbon dioxide dissolves in water, it forms carbonic acid, which slowly dissolves the limestone.

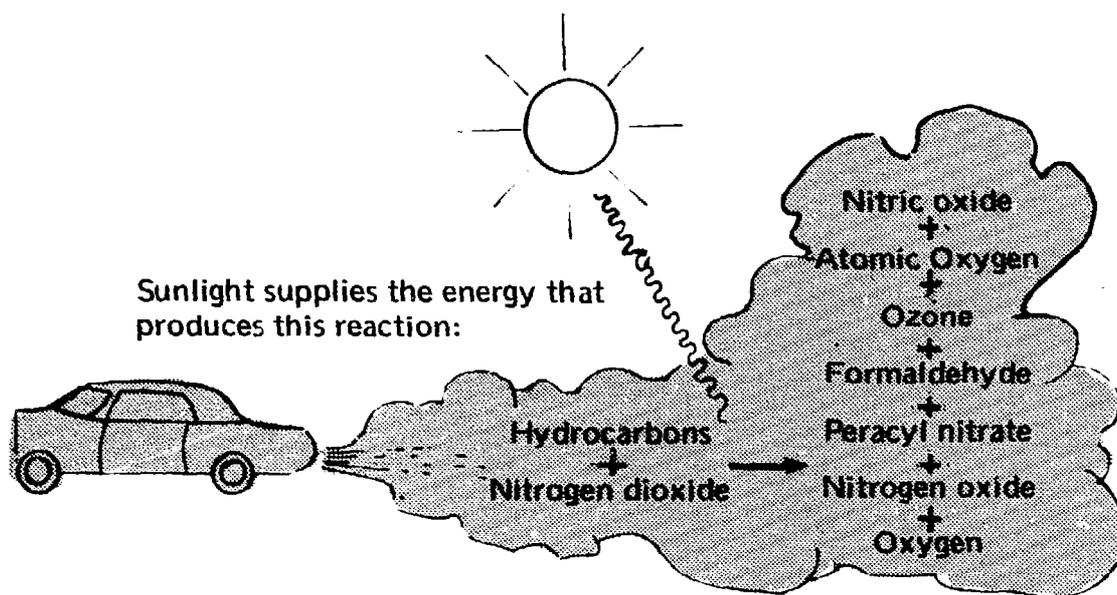
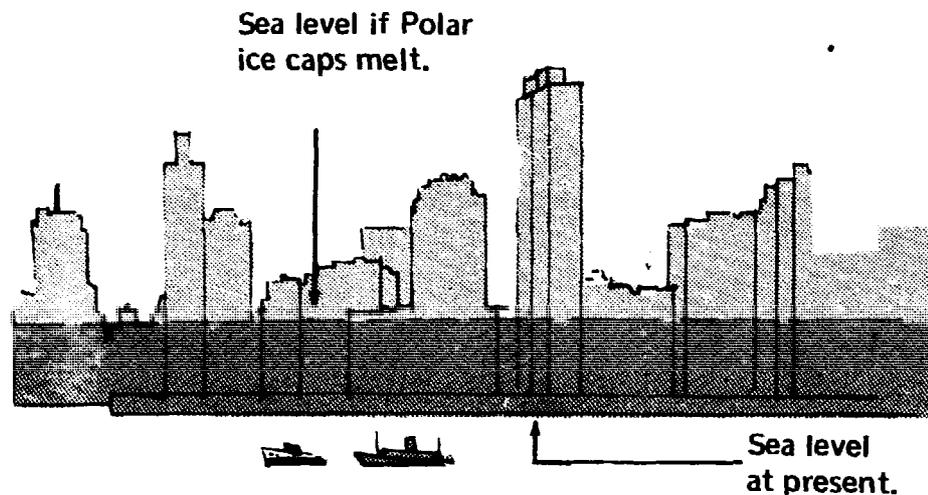


Fig. 2-30. How Photochemical Smog Forms.

If carbon dioxide seems almost harmless, how could it destroy cities? This possibility is being created because we are producing considerably larger quantities of carbon dioxide now than in the past by burning more coal, oil and gasoline. Green plants, which remove carbon dioxide from the air for use in photosynthesis are no longer able to remove it as rapidly as we pour it into the air. The result is that the carbon dioxide concentration in the air has increased about 5% in the last 50 years. In 500 years this rate of increase would add 50% more carbon dioxide to the air. The carbon dioxide concentration would then be about 450 parts per million parts of air instead of the 300 parts we now have. As a result, the average temperature of the earth would rise about 7 degrees Fahrenheit. This would be enough to melt the polar icecaps, releasing enough water to raise the ocean levels about 150 feet. All the coastal cities in the world would be under many feet of water (see Fig. 2-31). Low-lying cities deep inland would also be flooded. How high is your house above the sea level?

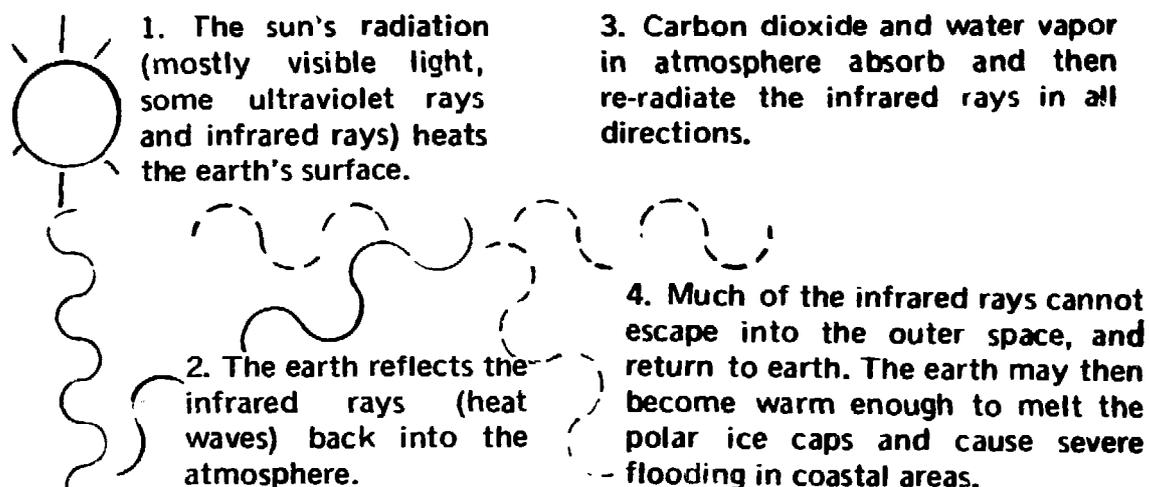
Carbon dioxide in the atmosphere helps make the earth warmer because it permits the visible light and some weak ultraviolet rays from the sun to pass through it and heat the earth. However, carbon dioxide in the atmosphere absorbs infrared rays from the earth and re-radiates it back to the earth, creating a hothouse effect (see Fig. 2-32). Energy from the sun can easily reach the earth, but energy



**Fig. 2-31. How Melting Polar Icecaps Might Flood Coastal Cities.**

from the earth cannot radiate out into space as easily. At present, the balance between warming and cooling of the earth is maintained by a steady concentration of carbon dioxide, and all is well. However, a large increase in the concentration of carbon dioxide will upset this balance and cause disastrous floods. Future scientific advances may make it practical to convert carbon dioxide into other compounds (for example, calcium carbonate) fast enough to prevent an excess of the gas from accumulating in the atmosphere. Also, new regulations limiting the use of such fuels as oil and coal will probably help to diminish the quantities of carbon dioxide now poured into the air. Measures such as these may help avoid the catastrophe that might result from the hothouse effect.

Project 2-7 shows how to measure the carbon dioxide concentration in the air.



**Fig. 2-32. How Carbon Dioxide Causes the "Hothouse" Effect.**

## Project 2-7. How to Measure the Amount of Carbon Dioxide In the Air.

**You will need:** calcium hydroxide, phenolphthalein solution, distilled water, a sensitive balance with masses, weighing paper, a 250-ml flask, a 2-hole rubber stopper to fit the flask, glass tubing, rubber tubing, an air pump, a 1-ml pipette, a medicine dropper, a 250-ml graduated cylinder, a 1-liter beaker, a stirring rod, a triangular file, an asbestos pad, a pair of scissors, note paper, a pen, a bottle with stopper, and a label.

1. Prepare the same set-up used in Fig. 2-4, Project 2-2, following the procedures in Steps 1-5, Project 1-1.

2. Using weighing paper and the sensitive balance, measure a mass of 1.68 grams of calcium hydroxide. Set aside for use in Step 3.

3. Pour 1 liter of distilled water into the 1-liter beaker. Add the calcium hydroxide and stir with stirring rod until it is dissolved. Pour some of the calcium hydroxide into the bottle. Stopper the bottle tightly and label it "Calcium hydroxide solution." Discard the rest of the calcium hydroxide solution that is left in the beaker.

4. Pour 100 ml of distilled water into the 250-ml flask. With the pipette, add 1 ml of the calcium hydroxide solution from the bottle. Now, add two drops of the phenolphthalein solution with the medicine dropper. The solution will turn bright pink. Set aside for use in Step 6.

5. Test the air pump to find out how many liters of air it pumps per minute. Follow procedure used in Fig. 2-6, Project 2-2.

6. Connect the air pump to the glass

tube of the flask as in Fig. 2-5, Project 2-2 (Step 3). Allow the pump to work until the solution in the flask becomes colorless.

7. Calculate the volume of air that passed through the solution by multiplying the liters-per-minute capacity of the air pump by the number of minutes it took to turn the solution colorless.

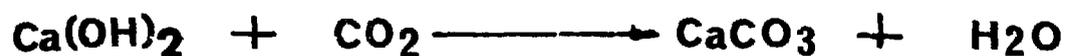
**Note:** 1 liter of air has a mass of about 1.3 grams. Calculate the number of grams of air that have passed through the solution.

8. It takes 0.001 gram of carbon dioxide to make the solution colorless. Use the results of your experiment (the number of grams of air) to calculate the number of parts-per-million of carbon dioxide in the air. Use the method explained in Project 2-2.

9. Measure the carbon dioxide content of the air in various locations. For example, *what difference in carbon dioxide concentration can you find near a block or a street that has very heavy traffic as compared to a block or a street with very light traffic? What is the carbon dioxide concentration in a kitchen where a gas stove is being used for cooking a meal?*

**Explanation:** Phenolphthalein is a dye that is bright pink in a basic solution, but is colorless in a neutral or acid solution. Since calcium hydroxide is a base, phenolphthalein is pink when it is in a calcium hydroxide solution. Carbon dioxide combines with calcium hydroxide, forming calcium carbonate, which is an insoluble precipitate. When all the calcium hydroxide has combined, the phenolphthalein becomes

colorless because the solution is no longer basic. The equation for the reaction is:



(Phenolphthalein is pink)

(Phenolphthalein is colorless)

In words, this equation states that one gram molecular mass of calcium hydroxide combines with one gram molecular mass of carbon dioxide. One gram molecular mass of calcium hydroxide,  $\text{Ca(OH)}_2$ , may be calculated this way:

One gram atomic mass of calcium (Ca) = 40.1 gm

One gram atomic mass of oxygen (O) = 16 gm

One gram atomic mass of hydrogen (H) = 1 gm

One gram molecular mass of calcium hydroxide,  $\text{Ca(OH)}_2$ , is composed of one gram atomic mass of calcium, 2 gram atomic masses of oxygen and two gram atomic masses of hydrogen. Thus, one gram molecular mass of calcium hydroxide

$$\begin{aligned} &= 40.1 \text{ gm} + 2 (16 \text{ gm}) + 2 (1 \text{ gm}) \\ &= 40.1 \text{ gm} + 32 \text{ gm} + 2 \text{ gm} \\ &= 74.1 \text{ gm} \end{aligned}$$

You can use the same method to calculate one gram molecular mass of carbon dioxide ( $\text{CO}_2$ ):

One gram atomic mass of carbon = 12 gm

One gram atomic mass of oxygen = 16 gm

One gram molecular mass of carbon dioxide ( $\text{CO}_2$ ) is composed of one gram atomic mass of carbon and two gram atomic masses of oxygen. Thus, one gram molecular mass of carbon dioxide

$$\begin{aligned} &= 12 \text{ gm} + 2 (16 \text{ gm}) \\ &= 12 \text{ gm} + 32 \text{ gm} \\ &= 44 \text{ gm} \end{aligned}$$

Then, since 44 grams of carbon dioxide combine with 74.1 grams of calcium hydroxide

$$\frac{74.1 \text{ gm of Ca(OH)}_2}{44 \text{ gm of CO}_2} = \frac{1.68 \text{ gm Ca(OH)}_2}{1.00 \text{ gm CO}_2}$$

or one gram of  $\text{CO}_2$  combines with 1.68 grams of  $\text{Ca(OH)}_2$ .

In Step 2, Project 2-7, we measured a mass of 1.68 grams of calcium hydroxide and dissolved it in a liter of distilled water. We now know that 1 gram of carbon dioxide combines with 1.68 grams of calcium hydroxide. However, in Step 4, we used only 1 milliliter (0.001 liter) of the calcium hydroxide solution. One milliliter of the calcium hydroxide solution contains 0.00168 gram of calcium hydroxide. Only 0.001 gram of carbon dioxide combines with 0.00168 gram of calcium hydroxide. The solution used in Step 8 contains 0.00168 gram of calcium hydroxide. When the solution has become neutral and the phenolphthalein has become colorless, 0.001 gram of carbon dioxide has combined. From this we know that the amount of air that was pumped through the solution contained 0.001 gram of carbon dioxide. We can now calculate the number of parts of carbon dioxide per-million-parts of air.

Extremely careful calculations of this sort could help you keep track of the rise in concentration of carbon dioxide in the local community's atmosphere. In the future, scientists will probably attempt to slow down that rise or even decrease the quantity of carbon dioxide in the atmosphere. Chemical analyses and calculations will be used by scientists to tell whether we are getting the results we want.

### **Carbon Monoxide: Painless Poison**

Carbon monoxide is so treacherous an air pollutant that its victims may die without sensing that anything is wrong in the atmosphere around them. Carbon monoxide cannot be seen because it is colorless. Its lack of odor makes it impossible to smell, and carbon monoxide is not irritating, so that it cannot be felt. Air that contains deadly concentrations of carbon monoxide appears to be the same as air that is practically free of it.

One of the functions of our blood is to carry oxygen to all parts of our body. Carbon monoxide kills by destroying this ability of the blood to carry oxygen. Hemoglobin, the chemical that gives red blood cells their color, combines with oxygen in the lungs and releases it in parts of the body where the oxygen is needed. The presence of hemoglobin makes it possible for the blood to supply sufficient oxygen to all body tissues. Unfortunately, hemoglobin attracts carbon monoxide even more strongly than it attracts oxygen. When a hemoglobin molecule has combined with a carbon monoxide molecule, it does not release the carbon monoxide. The altered

hemoglobin molecule can no longer attract oxygen. If too much hemoglobin has combined with carbon monoxide, the blood cannot combine with enough oxygen in the lungs, and release it in other parts of the body. Thus, the blood is unable to satisfy the vital demands of the body for oxygen and death occurs.

The brain is the first organ affected by a lack of oxygen. First there is a feeling of drowsiness and confusion, followed by loss of consciousness. Breathing stops if the activity of the brain falls to a still lower level. The victim of carbon monoxide poisoning dies after becoming unconscious.

The sources of carbon monoxide are many and varied. Some cooking gases have high percentages of carbon monoxide. Almost any fire gives off carbon monoxide. The highest concentrations of carbon monoxide are produced when the supply of oxygen is insufficient for complete burning of the fuel. For example, a smoldering pile of newspapers gives off a great deal of carbon monoxide because air cannot easily get between the pages of the newspaper. The automobile, however, is the major source of the greatest amount of carbon monoxide. Exhaust gases from automobiles contain as much as 5% carbon monoxide. If we are to rid ourselves of this dangerous pollutant or reduce it to an acceptable level, we must first know where the carbon monoxide concentrations occur, how much is present, and what the safe levels are. Project 2-8 suggests one way to estimate the amount of this deadly pollutant that automobile traffic produces in your locality. Before we begin this project there are certain facts we must understand. Since the methods of measuring carbon monoxide concentrations are expensive and complicated, we will study the extent of carbon monoxide by basing our research on certain known estimates:

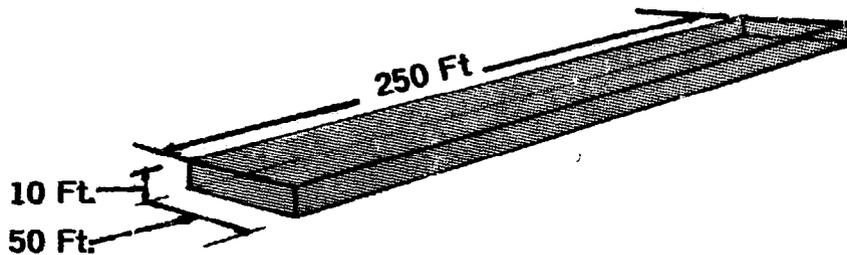
About 2.7 pounds of carbon monoxide are produced by the average automobile when it uses up one gallon of gasoline. The average car travels 15 miles on a gallon. Therefore, an average automobile traveling one mile uses  $1/15$  of a gallon. Since one gallon of gasoline produces 2.7 pounds of carbon monoxide,  $1/15$  of a gallon produces  $\frac{2.7}{15}$  pounds of carbon monoxide, or 0.18 pounds of carbon monoxide.

The average city block is about  $1/20$  of a mile long. To estimate the amount of carbon monoxide produced by one car traveling one city block we multiply 0.18 pounds of carbon monoxide by  $1/20$  of

a mile (one city block). The result is 0.009 pounds of carbon monoxide. With these facts in mind, we are now ready to undertake our study.

**Project 2-8. How to Estimate the Production of Carbon Monoxide in Your Community.**

**You will need: a watch, a pen and note paper.**



**Fig. 2-33. The Carbon Monoxide Danger Level on a Typical City Block.**

1. Station yourself at one point on a city block or a street. Count the number of automobiles that pass this point in 10 minutes. Record your observations. Now, try several 10-minute periods to arrive at an average number of automobiles that pass this point.

2. Multiply the average number of automobiles by 0.009. This will give you the number of pounds of carbon monoxide released into the air by the automobiles that pass through that block or street in 10 minutes. For example, if an average

of 111 automobiles pass through the block or street, multiply 111 x 0.009. The answer is "one pound of carbon monoxide (CO)."

3. Perform the same test on different blocks or streets in your locality, where traffic is heavy, to arrive at an overall average. Assume that 111 automobiles pass through one city block or street in 10 minutes, producing one pound of carbon monoxide. This amount of carbon monoxide can make a surprisingly large volume of air poisonous to breathe.

**Explanation:** If your city block is 250 feet long (slightly shorter than 1/20 mile) and 50 feet wide, then a 10-foot depth of this block would contain 125,000 cubic feet of air (see Fig. 2-33). This volume of air has a weight of about 10,000 pounds. If 111 automobiles ride through the block, they give off one pound of carbon monoxide (CO) into the air. One pound of carbon monoxide in 10,000 pounds of air is equal to a concentration of 100 parts of carbon monoxide per million parts of air. This is expressed in the following equation:

$$\frac{1 \text{ lb. of CO}}{10,000 \text{ lbs. of air}} = \frac{100 \text{ lbs. of CO}}{1,000,000 \text{ lbs. of air}}$$

Therefore, if 111 automobiles ride through the block they give off

enough carbon monoxide to raise the concentration in that large volume of air to 100 parts per million. In moderately heavy traffic, 111 automobiles may ride through the block in 10 minutes or less. If the air is stationary for even a short period of time, the carbon monoxide level may become high enough to justify the first alert. Fortunately, however, the air currents on the street ordinarily move the carbon monoxide upwards and sideways and out of the street, thus carrying off the deadly gas.

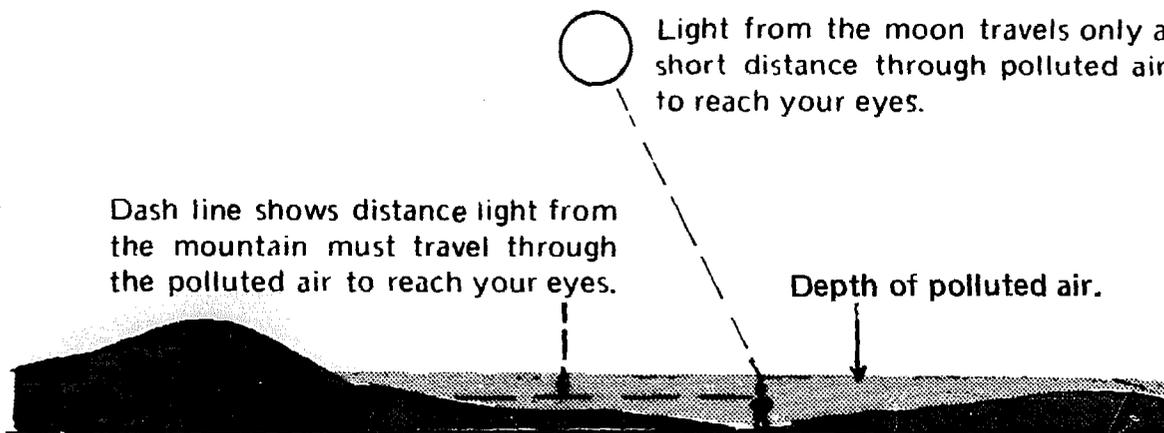
---

In Los Angeles, if and when the carbon monoxide concentration reaches as much as 100 parts per million parts of air, a first alert against air pollution will be declared. A first alert means that the carbon monoxide concentration is high enough to be a serious threat to health. When a first alert is declared, certain procedures are followed to decrease the carbon monoxide level. All automobile traffic (except for emergency vehicles) in the city may be prohibited. Only absolutely essential furnace fires may be permitted. Second and third alerts would be declared at higher carbon monoxide levels and the control measures would be even stricter.

### **How Pollutants Affect Visibility**

How far can you see on a clear day in a large city? If you could see anything that is as much as 10 miles away, you would think that the visibility is excellent. Even in rural areas, where visibility is generally much better than in cities, mountains usually cannot be seen from a distance of more than 15 or 20 miles. Yet, have you ever wondered why you can see the moon clearly during the daytime, even in a city, although it is about a quarter of a million miles away? Fig. 2-34 shows what causes the difference in visibility.

When you look along the surface of the earth in a horizontal direction, light reflected from a distant object must travel toward your eyes through miles of air filled with particles of dust and droplets of liquid. If there is a heavy concentration of these pollutants, almost all the light from the distant object is scattered and absorbed by the pollutants before it reaches your eyes and, therefore, you cannot see the distant object. On the other hand, light reflected from the moon travels mainly through the clean, near-vacuum of outer space. Only when the moonlight gets very close to the earth must it pass through badly polluted air containing a large concentration of suspended particles. However, the light can usually get to your eyes because it travels only a relatively short distance through polluted air (see Fig. 2-34). As a result, you can see the moon clearly, although you may not be able to see the mountain.



**Fig. 2-34. How Pollutants Affect Visibility.**

Airports especially are interested in visibility and ceiling because aircraft takeoffs and landings are far safer when visibility is good and the ceiling is high. Visibility is the distance you can see on a line close to horizontal. The ceiling is the greatest vertical height which you can see above the earth's surface. The ceiling is usually the bottom of thick layers of clouds.

Since poor visibility can mean air pollution, and air pollution indicates unhealthy conditions, we can sometimes roughly measure air pollution by measuring visibility. Project 2-9 gives methods of measuring visibility. Project 2-10 suggests a way of determining the ceiling, provided it is not too high above the earth's surface.

### **Project 2-9. Measuring Visibility.**

**You will need:** street maps, road maps or topographic maps, a pen and note paper. Street maps and road maps can be obtained from a gasoline station. Topographic maps of your area can be obtained from the Chief of Distribution, U.S. Geological Survey, Washington, D. C. 20025.

1. Using the scales on the map find out how far your home is from tall buildings, bridges, hills or other landmarks that you can see on a very clear day. Then, record these landmarks and their distance.

2. Find out which of the recorded

landmarks you can see on each of several days. Keep a record of your observations and note the type of weather (cloudy, hazy, rainy, etc.) and the distance. This will help you to determine the visibility, in miles, on both inclement and clear days.

### **Project 2-10. Measuring the Ceiling.**

**You will need:** a helium-filled balloon, 2000 feet of thin, white nylon string, a black and a red magic marker, a pen and note paper.

1. Mark the nylon string every 10 feet with the black magic marker and every 100 feet with the red magic marker. Tie one end of the string to the balloon.
  2. On a day with very low-lying clouds, let the balloon rise until you cannot see it. At that point, the balloon has reached the ceiling.
  3. Measure the height of the ceiling by lowering the balloon and counting the number of 100-foot
- and 10-foot marks on the length of string that the balloon pulled up with it. Make certain you count all marks from the ground to the point where the balloon was no longer visible.
4. Measure the ceiling several times within a short period of time, on the same day. Keep a record of your observations. *Do your notes indicate that the ceiling changes rapidly? What conditions may cause rapid changes in the ceiling?*

---

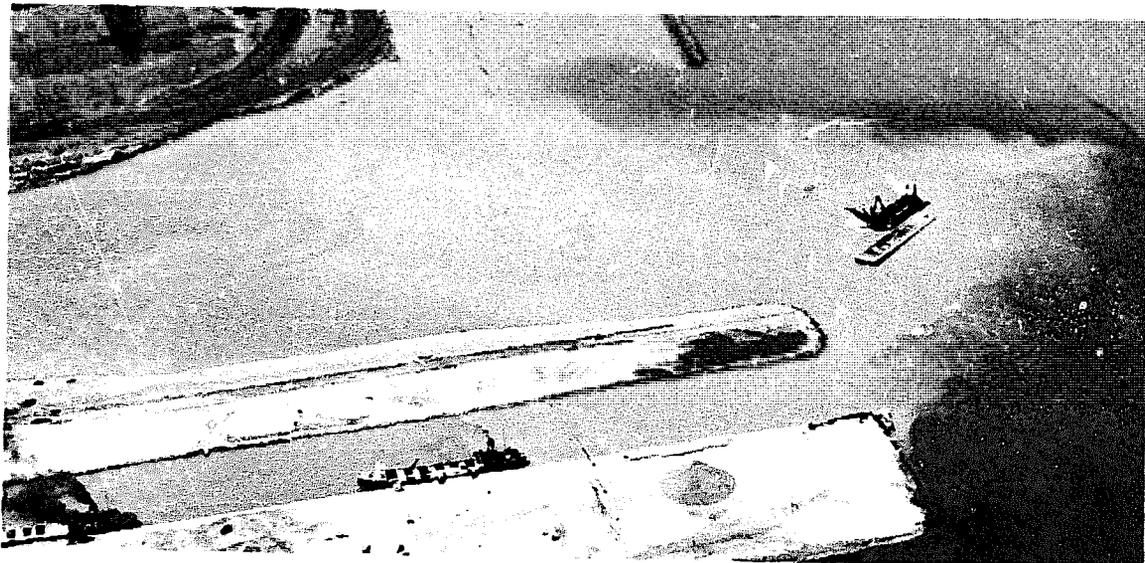
We have examined several aspects of air pollution and how to reduce it. In the following chapter, we will look into the problem of water pollution.

## CHAPTER THREE

### WATER POLLUTION

**WATER CAN** be wonderful. You can really enjoy it, and it is one of life's necessities. A pure river, lake or bay is a place where you can swim or fish without danger or fear of infection. However, when water is polluted, those pleasures become impossible, the polluted bodies of water become eyesores and worse yet, their odor is often more than you can stand. See photo Fig. 3-1.

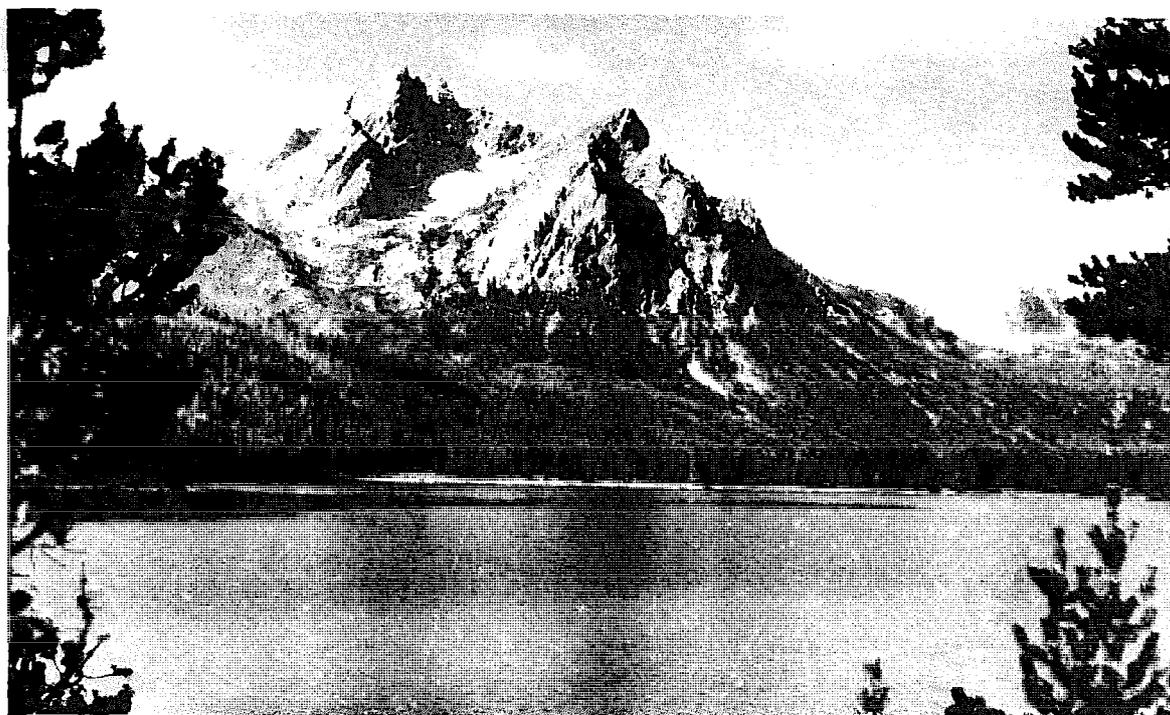
Water pollution is a menace to all forms of life, and when it has reached a dangerous level of concentration, only the hardiest plants and animals can continue to exist there. The rivers and lakes that have reached these dangerous levels are considered to be "dead." Lake Michigan is an example of a lake that is practically dead. See Fig. 3-2. Its water is muddy and coated with algae that are among the few pollution resistant plants still living in the lake. All the lake's fish have disappeared except for a few kinds that have little food value.



**Fig. 3-1. Typical View of a Polluted Body of Water.**  
(Photo courtesy Environmental Protection Agency.)



**Fig. 3-2. Vast Expanse of Dead Algae Contributes to the Pollution of Lake Michigan. (Photo courtesy of Environmental Protection Agency.)**



**Fig. 3-3. Scenic View of a Clean Water Lake. (Photo courtesy of Environmental Protection Agency.)**

There are many causes of water pollution and many ways in which water may be polluted. If we live in or near a city or industrial area, the nearby waters are probably polluted. Since this does affect our well-being in many ways, we are going to examine the problems of local water pollution and we will try to find out what the pollution sources are, the nature of the pollution, and how to reduce or eliminate it in the community.

## How Clear Is the Water?

Some water is so clear that you can see down into it for many feet. This is true of Stanley Lake in Idaho. (See photo Fig. 3-3). Such clear water is quite pure and unpolluted. On the other hand, turbidity or "cloudiness" usually indicates water pollution. Badly polluted water may be so turbid that you cannot see through it more than a few inches. Projects 3-1 and 3-2 provide two methods of judging the degree of water pollution by measuring its turbidity.

### Project 3-1. How to Measure Water Turbidity.

**You will need:** a top cut out of a tin can, a hammer, a nail, a flat piece of wood, 50 feet of nylon fishing line, a lead sinker, white and black airplane model paint, 2 paint brushes, a waterproof red magic marker, a tape measure, scissors, a pen and note paper.

1. Place tin can top on the piece of wood. With the hammer and nail, punch three holes through the can top as shown in Fig. 3-4.

2. Paint one side of can top white. When this layer of paint has dried, paint a black X on the white paint as in Fig. 3-5.

3. With scissors cut seven 6" pieces of line and tie the line and sinker to the can top as in Fig. 3-5. With the magic marker, accurately mark one foot from tin can top to line, and an additional mark at each foot of the line's length.

4. From a boat, dock or pier, lower the tin can disc into the water until you can no longer see the X on it. Of course, if the disc touches bottom before the X becomes invisible, try again in deeper water.

5. Measure and record the depth to which the disc must be lowered before the X disappears. The red markings on the line will indicate the depth reached.

**Note:** If the disc must be lowered to a greater depth before it becomes invisible, the turbidity is less.

Three holes punched through tin can top.

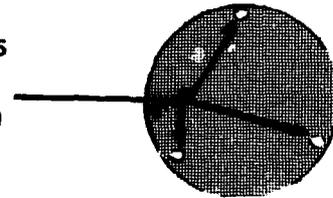


Fig. 3-4. Preparing the Tin Can Top.

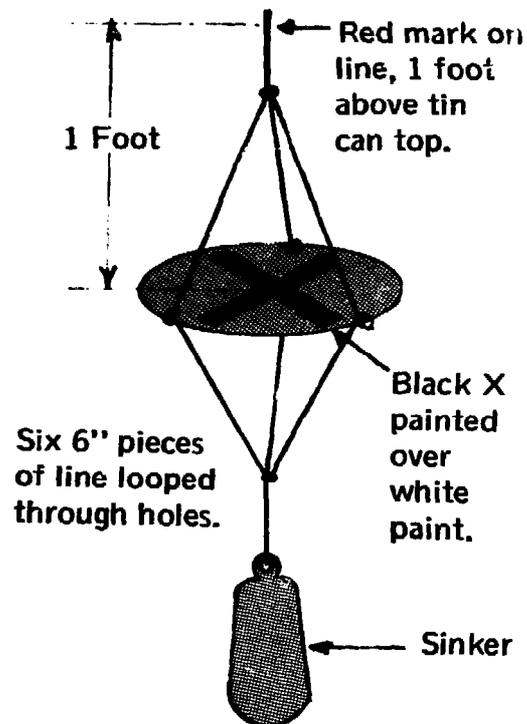


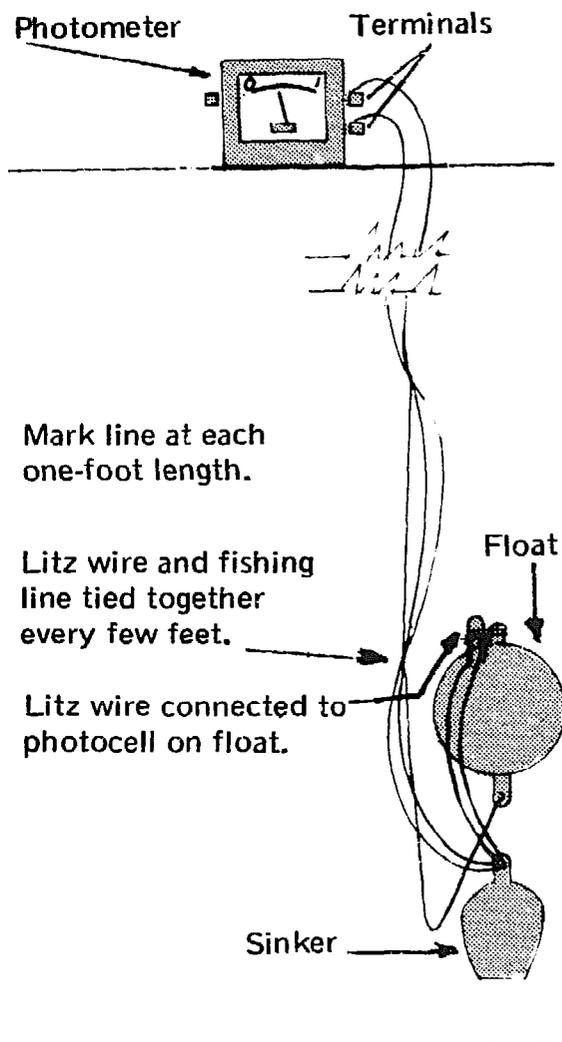
Fig. 3-5. Assembled Device to Measure Water Turbidity.

**Explanation:** Turbidity can be expressed as 100 divided by the number of feet to which the disc must be lowered before it cannot be seen. The resulting number may be called the *turbidity index*. If the disc disappears at a depth of 2 feet in the water, the turbidity index is 100 divided by 2, or 50. If the disc disappears at a depth of 25 feet, the turbidity index is 4. Since there is a fairly direct relationship between turbidity and pollution, we may say that water with a higher turbidity index (such as 50) is more polluted than water with a lower turbidity index (such as 4).

**Project 3-2. How to Measure Water Turbidity With a Photometer.**

**You will need:** the photometer from Project 2-3, 100 feet of Litz wire, 50 feet of nylon fishing line, a red waterproof magic marker, a tape measure, a fishing float, a sinker, a pen and note paper.

1. Tie the sinker, the float and the photoconductive cell to each other with the fishing line as in Fig. 3-6. The photoconductive cell itself is to be disconnected from the insulated wire and then reconnected to the rest of the photometer with two 50-foot pieces of Litz wire. Attach the 50-foot fishing line to the sinker and float as shown. The sinker must be heavy enough to pull the float and the attached photoconductive cell down under the water. The float is needed to keep the photoconductive cell pointed vertically upward at all times.
2. Tie the Litz wire to the fishing line every few feet, then, with the magic marker, mark the fishing line at each foot length.
3. Calibrate the photometer by lowering the photoconductive cell four feet into the water of a lake or stream (from a boat, dock or pier) and set the ammeter reading at 0.5 milliampere by turning the potentiometer knob. The turbidity of the water at this location acts as a standard against which you compare the turbidity of water in other locations. Therefore, do not turn the potentiometer knob as you continue this project.



**Fig. 3-6. Set-up to Measure Water Turbidity With a Photometer.**

4. At other places in streams and lakes, lower the photoconductive cell as deep as necessary until the

meter reads 0.5 milliamperere. Record the depth in each case.

**Explanation:** The turbidity of the water can be expressed as a turbidity index by dividing 100 by the depth in feet at which you get the 0.5 milliamperere reading. Turbidity index =  $\frac{100}{\text{Depth in feet}}$ . If a 0.5 milliamperere reading is obtained at a 4 feet depth, the turbidity index is 100/4 or 25. This is the turbidity of the water used as a standard in Step 3. If the ammeter reads 0.5 milliamperere at 2 feet, the turbidity index is 100/2 or 50. Note that these turbidity indexes are *not* necessarily the same as the ones you would obtain by the method used in Project 3-1. However, just as in Project 3-1, a higher turbidity index indicates greater water pollution.

---

Use these methods in different locations in various bodies of water and on different days. In that way, you may be able to determine the extent of water pollution in your community and endeavor to discover some of the causes of the pollution.

### Why the Water Isn't Clear

If water is turbid, it cannot be pure because turbidity is caused mostly by pollutants in the form of solid particles in the water. Project 3-3 shows how to find the concentration of solid particles in the water. When you have completed this project, you will readily understand how solid particles affect the turbidity of water.

The measuring method described in Project 3-3 can be used to measure the concentration of solid particles in the water of nearby streams, ponds, lakes, rivers, bays, etc. Most solid particles (such as chemical wastes from factories, human wastes from sewage systems and solid particles washed into the water from farmers' fields) generally are pollutants. Some turbidity is caused, not by pollutants, but by one-celled algae and other minute living organisms in the water.

Since turbidity prevents light from penetrating deep into water, plants cannot grow far below the surface of turbid water. Thus, the depths of turbid lakes and rivers have little of the oxygen and food that plants would supply. This limits the amount of food fish that can live in turbid water. Because of its pollutants, turbid water may harm people who swim in it, or drink it or eat fish from this water. Since turbidity greatly decreases the value to people of bodies of water, the sources of the pollutants that cause turbidity should be discovered and action should be taken to reduce the quantity of pollutants.

### Project 3-3. Measuring the Concentration of Solid Particles.

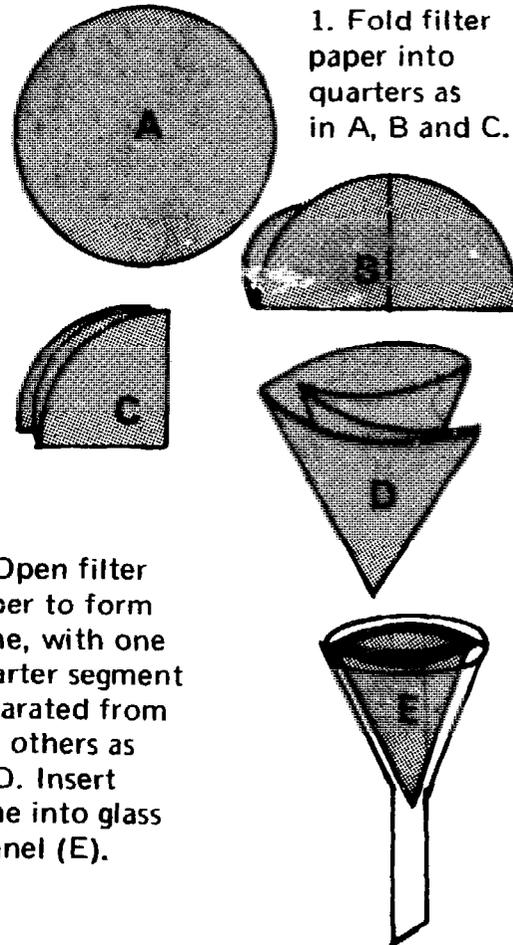
**You will need:** collecting jars (gallon-size), a 250-ml graduated cylinder, a large glass funnel, filter paper, a sensitive balance with masses, an oven or other device for drying wet filter paper, a 400-ml beaker, a pen and note paper.

1. Fill your collecting jars with several gallons of water from one pond or lake.

2. Using the sensitive balance, measure the mass of a piece of filter paper. Then place the filter paper in the oven and keep it there for about 10 minutes at a temperature of about 200°F. Measure the mass of the filter paper again. If the mass has not changed, it shows that the filter paper did not contain excess moisture and you may proceed with Step 3. If the mass changed, repeat Step 2 with the same piece of filter paper until the mass is constant.

3. Prepare a filter by folding the piece of filter paper into a cone as in Fig. 3-7, and placing it in the funnel. Insert tube of funnel into the 400-ml beaker.

4. Using the 250-ml graduated cylinder, measure 200 ml of the water you have collected and filter it, permitting the filtrate to flow into the beaker. Record the number of ml of water filtered. Discard the filtrate (water) in the beaker. Continue this procedure until you have filtered one liter (1000 ml) of water. If you can easily see a layer of sediment on the filter paper, proceed with Step 5. If there is very little sediment on the filter paper, filter several more liters of water until more sediment is visible on the filter paper. Record the number of liters of water filtered to obtain easily visible sediment.



1. Fold filter paper into quarters as in A, B and C.

2. Open filter paper to form cone, with one quarter segment separated from the others as in D. Insert cone into glass funnel (E).

**Fig. 3-7. How to Make a Filter.**

5. Put the filter paper cone with the sediment in the oven at a temperature of about 200°F. At this temperature, the paper will become dry, but will not char or burn. After one hour, remove the filter paper cone from the oven. Measure and record the mass of the paper and sediment. Be careful not to let any of the sediment fall out of the paper cone.

6. Put the paper cone and sediment back in the oven for 10 more minutes. Remove and measure its mass once again. If the mass remains the same as in Step 5, proceed to Step 7. If the mass is not the same, repeat Step 6 until the mass remains constant, showing that all the moisture has been dried out of the paper cone and sediment.

7. Subtract the mass of the filter paper (which you measured in Step 2) from the combined mass of the filter cone and sediment (which

you measured in Step 6). The result is the mass of the sediment.

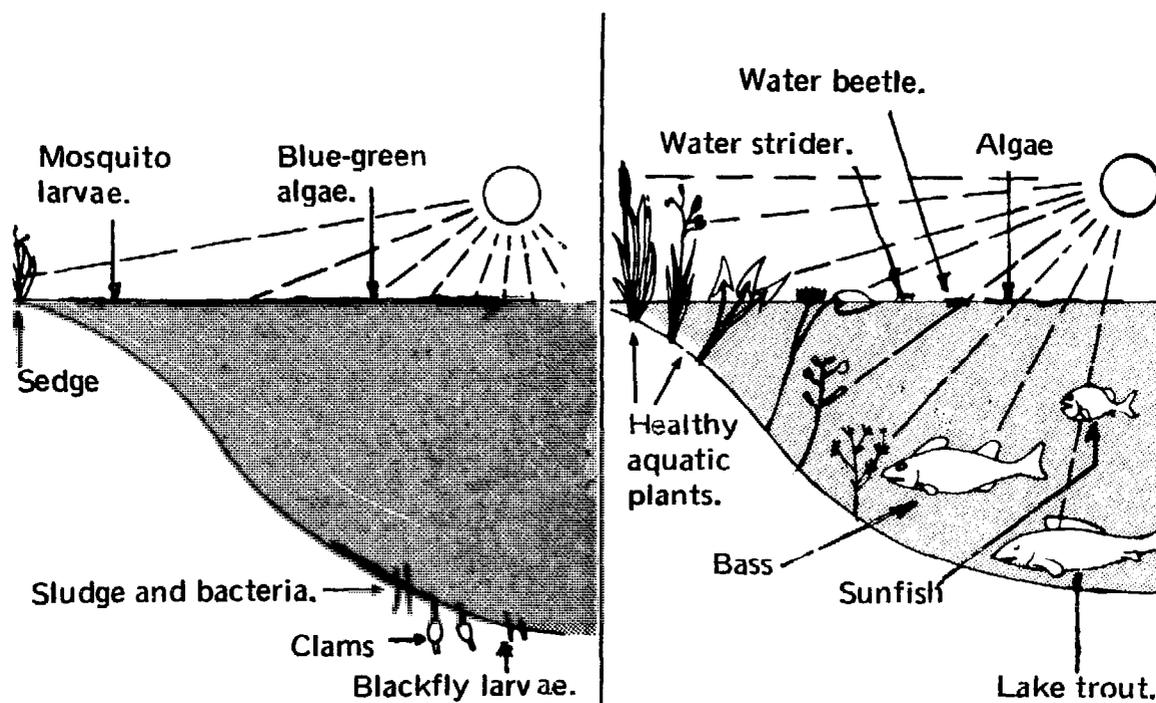
8. Divide the mass of the sediment by the number of liters of water filtered. This gives the number of grams of solid particles per liter of water. For example, if you used 2 liters of water to obtain 0.6 gram of sediment, there would be an average of 0.3 gram of sediment per liter of water. This gives us a known density concentration of solid particles in this water. This concentration is expressed as "0.3 gram per liter."

---

### Don't Overfeed the Algae!

Algae, the simplest green plants, have no true leaves, stems, roots or flowers. Algae may be single cells or groups of cells in the form of spheres, threads, sheets or more complicated shapes. When thick masses of algae cover the surface of a lake, the lake is said to be dying (see Fig. 3-8). The water in such a lake may appear to be dark green because of the large numbers of algae floating in it. You might think that a plentiful growth of algae would prove helpful by providing food and oxygen for the fish and other animals that live in the lake. However, that is not the case. The algae which cover the lake's surface absorb the sunlight and prevent it from penetrating deep into the lake. As a result, few plants can grow below the top few feet of water. The oxygen produced by the algae tends to remain at the surface, leaving the lower parts of the lake poor in oxygen. In addition, as algae at the lake's surface die, they sink toward the bottom. There, they decay as bacteria use them as food. The decay bacteria that feed on the dead algae remove oxygen from the water for their own use in respiration. This further reduces the oxygen concentration in the lake bottom so that fish cannot live there. A few species of insect larvae and clams are the usual animals that exist in such a polluted location (see Fig. 3-8).

Fish are greatly affected by variations in the concentration of dissolved oxygen in the water and by water temperature. Lake trout and coho salmon, two excellent food fish, require cold water with a high concentration of oxygen. They live and reproduce far below the surface of the lake where the water is cold. However, if there is a



**Fig. 3-8. Plant and Animal Distribution in Dying Lake.**

**Fig. 3-9. Plant and Animal Distribution in Clear Lake.**

heavy growth of algae at the surface of the lake, the cold, deep water cannot contain enough oxygen. Therefore, if lake trout and salmon are to live there, a lake must have very few algae. Other species of fish, such as bass, perch and sunfish, do not need such cold water (see Fig. 3-9). Yet, even they cannot live in a lake that is choked by algae, because its water does not contain enough oxygen to sustain them.

During the last few years, the amount of algae in lakes has increased greatly. The two main reasons for this change are (1) the use of detergents for washing clothes and dishes, and (2) the increased use of chemical fertilizers on farms. Huge quantities of detergent, dissolved in waste water, flow through sewers and into lakes. Detergents which contain phosphate act as a nutrient for the algae and speed-up their growth. Fertilizers are as efficient at making algae grow as they are at improving the growth of farm plants. Never before have the algae in lakes been as well supplied with nutrients as they are now. But, as a result, other forms of life in the lakes such as food fish are suffering. This, in turn, reduces the food supply for human beings. The lakes are dying, because algae are being overfed.

Before we look into the problems created by overfed algae, we must first find out how detergents affect the growth of algae. Projects 3-4, 3-4A and 3-4B show how this can be done.

### Project 3-4. Preparing Nutrient Solutions for Growing Algae.

**You will need:** potassium nitrate, magnesium sulfate, dipotassium hydrogen phosphate, calcium sulfate, distilled water, a sensitive balance with masses, weighing paper, and a 250-ml graduated cylinder, a 400-ml beaker, 4 bottles with stoppers, a stirring rod, 4 labels and a pen.

1. Use the graduated cylinder to measure 200 ml of distilled water into the 400-ml beaker.
2. Using weighing paper, measure a 0.2-gram mass of potassium nitrate on the sensitive balance. Then, pour the potassium nitrate into the water in the beaker and stir with the stirring rod until the potassium nitrate is completely dissolved. Pour the solution into a bottle. Label the solution "0.1% potassium nitrate solution." Set it aside for later use in Project 3-4A. Now, thoroughly clean the 250-ml graduate, the 400-ml beaker and the stirring rod in preparation for Step 3.
3. Repeat the procedures in Steps 1 and 2 to make 0.1% solutions of magnesium sulfate, dipotassium hydrogen phosphate, and calcium sulfate. You should have a total of four separate bottled and labeled solutions. See Fig. 3-10.

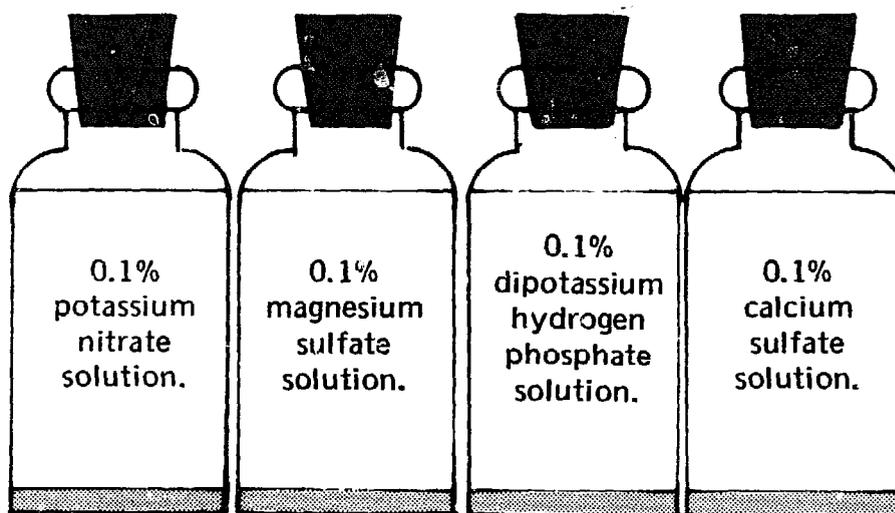


Fig. 3-10. How to Prepare Nutrient Solutions to Grow Algae.

### Project 3-4A. How Does Absence of a Nutrient Affect the Growth of Algae in Water?

**You will need:** the 4 bottles of solutions prepared in Project 3-4, distilled water, water from a nearby pond or from an aquarium, a 50-ml graduated cylinder, 3 wide-mouth jars, the photometer used in Project 3-2, a lamp with light bulb, a microscope (at least 100x magnification), 3 microscope slides with cover slips, lens cleaning paper, 3 medicine droppers, a 1-ml pipette, 3 stirring rods, labels and a pen.

1. Into a clean, wide-mouth jar pour 20 ml each of potassium nitrate, calcium sulfate, dipotassium hydrogen phosphate and magnesium sulfate solutions. Add 20 ml distilled water. Stir well, label it Jar No. 1 and note contents on label (see Fig. 3-11).

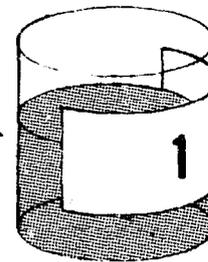
**Note:** This is a complete nutrient solution for many kinds of algae. It can act as the control solution. You can compare the growth of algae in other solutions with their growth in this solution.

2. Make a solution to test the effect of a lack of *phosphate* on the growth of algae, as follows: using the graduated cylinder, measure and pour into a clean, wide-mouth jar 20 ml each of calcium sulfate, potassium nitrate and magnesium sulfate solutions. Rinse the graduate cylinder after each use here, and in Step 3. Add 20 ml distilled water. *Do not add dipotassium hydrogen phosphate solution.* Stir well with clean stirring rod, label it Jar No. 2, and note contents on label.

3. Make a solution to test the effect of a lack of *nitrate* on the growth of algae, as follows: Into another clean, wide-mouth jar pour 20 ml each of dipotassium hydrogen phosphate, calcium sulfate and magnesium sulfate solutions. Add 20 ml distilled water. *Do not add potassium nitrate solution.* Stir well with clean stirring rod, label it Jar No. 3, and note contents on label.

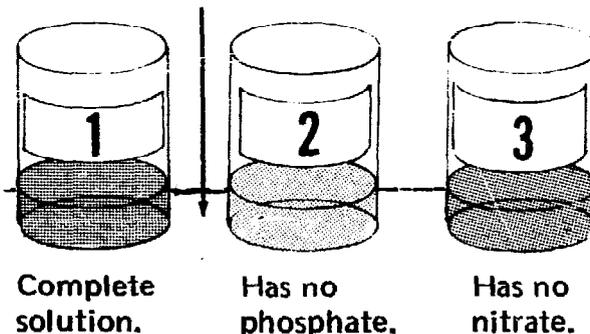
4. With pipette, add one ml of water from pond or aquarium to each of Jars No. 1, No. 2 and No. 3. Place jars near a window that faces north. Leave the jars there for two weeks or longer. See Fig. 3-12.

Solution containing 20 ml each of calcium sulfate, potassium nitrate, dipotassium hydrogen phosphate and magnesium sulfate.



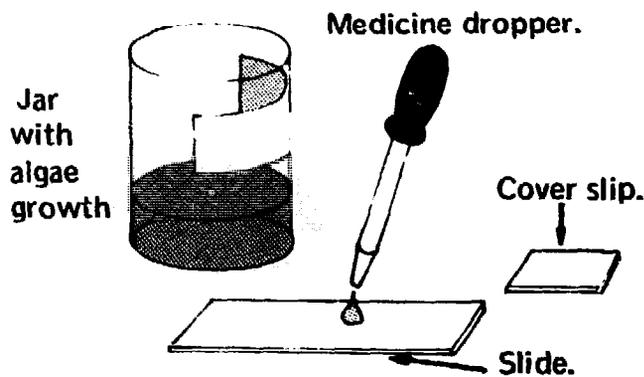
**Fig. 3-11. A Complete Nutrient Solution to Grow Algae.**

Window sill.

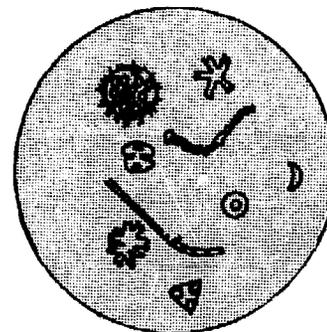


**Fig. 3-12. Comparing Algae Growth in Different Nutrient Solutions.**

5. Compare the growth of algae in the three jars each day by simply looking at them, and then by measuring the turbidity of the water in the jars with the same photometer used in Project 3-2. Place a lamp on one side of Jar No. 1 and the photoconductive cell on the opposite side, facing the light bulb. Set the ammeter to read 0.5 milliamperes by turning the potentiometer knob. Once you have calibrated the photometer in this way, be sure not to turn the potentiometer knob as you continue the project. Record the turbidity index for Jar No. 1 as 0.5. Test the turbidity of the water in Jars No. 2 and No. 3 with the same procedure. The jar with the greatest turbidity (and therefore the least



**Fig. 3-13. Preparing for Algae Count.**



**Fig. 3-14. Algae Growth Examined Under Microscope.**

transmitted light and the lowest ammeter reading) has the heaviest growth of algae. *Do the photometer tests agree with your own visual observations?*

6. For more accurate counts of the algae, stir the water in each jar using a separate, clean stirring rod for each jar. Then draw up one drop of water from each jar, using a separate, clean medicine dropper for each jar, and place each drop on a separate, clean slide and cover each slide with a clean cover slip.

See Fig. 3-13. Use the lens paper to clean the slides and cover slips.

7. Place each slide, in turn, under the microscope and focus so that you can see the algae clearly (see Fig. 3-14). Count and record the number of algae in one field of each slide as you look at it through the microscope. This procedure enables you to compare the growth rate of the algae in different solutions under the same controlled conditions. Thus, you can determine the effects of nitrate and phosphate on the growth of algae.

### **Project 3-4B. How Is the Growth of Algae Affected by Varying Percentages of Nutrients In the Solutions?**

**You will need:** the same equipment as in Project 3-4A, and three additional wide-mouth jars.

1. Into a clean, wide-mouth jar pour 20 ml each of calcium sulfate, potassium nitrate and magnesium sulfate solutions. Add 5 ml dipotassium hydrogen phosphate solution and 35 ml distilled water. Stir well, label it Jar No. 4 and note contents on label.

2. Into a clean, wide-mouth jar pour 20 ml each of calcium sulfate, potassium nitrate and magnesium

sulfate solutions. Add 1 ml dipotassium hydrogen phosphate solution and 39 ml distilled water. Stir well, label it Jar No. 5 and note contents on label.

3. Into a clean, wide-mouth jar pour 20 ml each of calcium sulfate, potassium nitrate and magnesium sulfate solutions. Add 40 ml dipotassium hydrogen phosphate solution. Stir well, label it Jar No. 6 and note contents on label.

4. With pipette add 1 ml of water from pond or aquarium to each of Jars No. 4, No. 5 and No. 6. Place jars near a window that faces north. Leave the jars there for two weeks or longer.
5. Compare the growth of algae and

the turbidity of the water in these 3 jars by following the same procedure as in Step 5, Project 3-4A.

6. For more accurate counts of the algae, follow the same procedure as in Steps 6-7, Project 3-4A.

**Explanation:** With this procedure, you can determine how the growth rate of algae is affected by a decrease or increase of the phosphate percentage (in dipotassium hydrogen phosphate) in the solution. You could also vary the percentage of potassium nitrate in the solution while keeping the percentages of the other chemicals constant, thus determining the effects of changes in the percentage of nitrate. Experiments to determine the effects of calcium, potassium and magnesium can be designed in a similar manner.

---

Most detergents contain large percentages of phosphates. The fertilizers that farmers use on their fields contain nitrates in addition to phosphates. How would algae respond if large amounts of detergents and fertilizers are allowed to mix with the water in which they are growing? What can be done to limit the growth of the algae?

### Foaming Rivers

Something new has been added to the landscape. Detergents used in washing dishes and clothes flow with waste water into sewers which often lead into streams. There, the motion of the stream whips the detergent into clouds of foam. From the streams, the thick masses of foam flow into many of our rivers, and the term "foaming rivers" has been added to our vocabulary.

A few years ago, the only kinds of detergents anyone could buy were "persistent." That is, they did not break down into simpler compounds, but could remain in the water as foam-producing detergents for months. In areas where there are no sewers, waste water drains into cesspools and then into the ground. As this water seeps through the soil, it carries the dissolved detergent with it. Therefore, water pumped from wells in such localities contained enough detergent to produce a foam. In such cases, a glass of water from a faucet would have a layer of foam on it. This foamy water is not very appetizing, and could be quite harmful to a person's health.

Recently, "biodegradable" detergents have been developed and are being sold in place of the persistent detergents. These biodegradable detergents are broken down in the water when they are used as food by certain harmless bacteria in the water. As a result, such detergents do not last long after they get into the waste water and the problem

of foaming water is somewhat lessened. But a great deal of improvement is still needed. The biodegradable detergents cannot completely solve the foam problem because it takes time for bacteria to break down all the detergent. Where large amounts of detergent are continuously entering the water supply, there still remains enough unchanged detergent to produce some foam on the water that flows from faucets.

To solve the detergent problem, we must first find a method for measuring the amount of detergent present in the water in your community, so that you can determine just how bad the situation is and keep track of the progress made toward solving the detergent problem. Perhaps we must replace our present detergents with other materials. Or, we can develop more effective ways to destroy detergents in waste water. Whatever the answer is, the first step toward a solution of the problem is to measure the amount of detergent in the local water supply. Projects 3-5 and 3-5A show how to do this. Project 3-5 sets up a standard — the smallest concentration of detergent in water that will produce foam. In Project 3-5A, the concentration of detergent in the water supply is measured by comparing it to the standard established in Project 3-5.

### **Project 3-5. Foam from Detergents.**

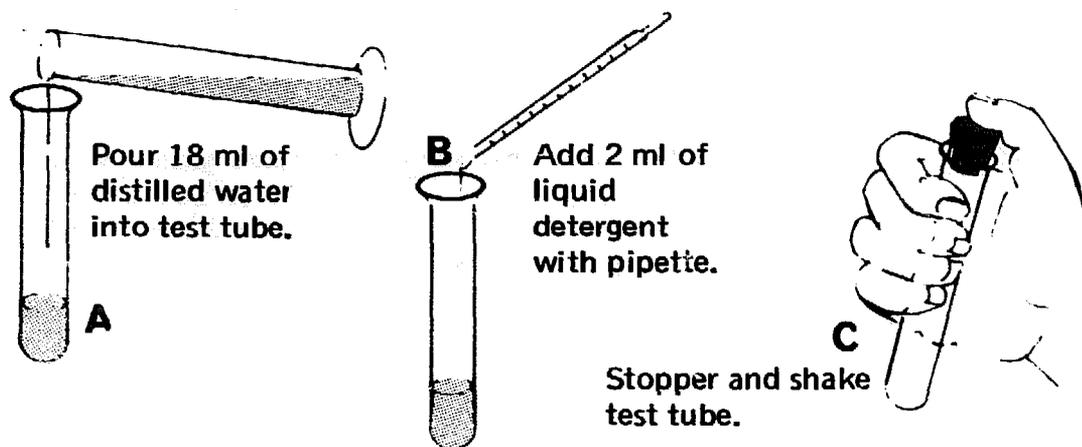
**You will need:** distilled water, a container of liquid detergent, a 25-ml graduated cylinder, a 5-ml pipette, 10 test tubes with clean, solid rubber stoppers, 2 test tube racks, labels, a pen and note paper.

1. Measure 18 ml of distilled water in the graduated cylinder and pour it into a clean test tube (see Fig. 3-15, A). Add 2 ml of liquid detergent with the pipette (see Fig. 3-15, B). Stopper the test tube and shake it (see Fig. 3-15, C). *What do you see?* Label this test tube No. 1 and set it in the test tube rack. Record test tube number and contents on note paper. Now, rinse the pipette thoroughly, first with tap water, then with distilled water. The pipette must be cleaned and emptied completely after each use.

2. As in Step 1, pour 18 ml of distilled water into a second clean test tube. Add 2 ml of the solution

from test tube No. 1. Stopper the test tube and shake it. *Does a layer of foam still form on the water in the test tube?* Label this test tube No. 2 and set it in the test tube rack. Record number and contents on note paper.

3. Pour 18 ml of distilled water into test tube No. 3. Add 2 ml of solution from test tube No. 2. Continue repeating this procedure with the other test tubes, adding 2 ml of solution from test tube No. 3 into No. 4, 2 ml from No. 4 into No. 5, etc., until you no longer see foam on the surface of the water in a test tube. Record the number of the last test tube in which foam forms.



**Fig. 3-15. How to Prepare Serial Dilutions of a Detergent.**

**Explanation:** This procedure has produced a set of serial dilutions of detergent. In test tube No. 1 (2 ml detergent plus 18 ml distilled water) the concentration, calculated as *volume of detergent* divided by *volume of solution*, is expressed as:

$$\text{Concentration in test tube No. 1} = \frac{2 \text{ ml detergent}}{20 \text{ ml solution}}$$

$$\text{Concentration in test tube No. 1} = 1/10$$

Concentrations of pollutants (such as detergents) are often expressed as parts per million (p.p.m.). To change a fraction to parts per million, multiply the fraction by 1,000,000:

$$\text{Concentration in test tube No. 1} = (1/10)(1,000,000)$$

$$\text{Concentration in test tube No. 1} = 100,000 \text{ p.p.m.}$$

In test tube No. 2, two ml of solution from test tube No. 1 was added to 18 ml of distilled water. There is only 0.2 ml of detergent in 2 ml of test tube No. 1 solution. Therefore, the concentration of test tube No. 2 solution is calculated as:

$$\text{Concentration in test tube No. 2} = \frac{0.2 \text{ ml detergent}}{20 \text{ ml solution}}$$

$$\text{Concentration in test tube No. 2} = 1/100$$

$$\text{Concentration in test tube No. 2} = (1/100)(1,000,000)$$

$$\text{Concentration in test tube No. 2} = 10,000 \text{ p.p.m.}$$

Each time you repeat the procedures in Step 2, you divide the concentration of the solution in each test tube by 10 (see Table 3-1).

If, for example, the last test tube in which foam is produced was test tube No. 4, the concentration of detergent in this test tube is 100 p.p.m. (see Table 3-1). In this example, the first concentration that did *not* produce foam is 10 p.p.m., in test tube No. 5. Therefore, the smallest concentration of detergent and water that will produce foam is somewhere between 10 p.p.m. (test tube No. 5) and 100 p.p.m. (test tube No. 4). By using the solution in test tube No. 4 to make another set of serial dilutions as shown in Project 3-5A), you can determine

more accurately the *smallest* foam-producing concentration. Of course, when you carry out Project 3-5, your results may not agree with the example we have given here. Perhaps tube No. 6 will be the last one that produces foam instead of tube No. 4. In that case, you will have to perform Project 3-5A with the solution from tube No. 6.

TEST TUBE	CONCENTRATION IN PARTS PER MILLION
No. 1	100,000
No. 2	10,000
No. 3	1,000
No. 4	100
No. 5	10
No. 6	1
No. 7	0.1
No. 8	0.01
No. 9	0.001
No. 10	0.0001

### **Project 3-5A. How to Refine the Measurement of Detergent Concentrations.**

**You will need:** 8 test tubes with clean, solid rubber stoppers, a test tube rack, distilled water, a 5-ml graduated pipette, labels and a pen.

1. Measure 1 ml of distilled water with the 5-ml pipette and put it into a clean test tube. Then, use the 5-ml pipette twice to add 9 ml of the last solution that produced foam in Project 3-5. Stopper the test tube and shake it. Label this test tube No. 11 and place it in the test tube rack. Now, rinse the pipette thoroughly, first with tap water, then with distilled water. The pipette must be cleaned and emptied completely after each use.

2. Repeat Step 1, using 2 ml of distilled water and 8 ml of

detergent solution. Label this test tube No. 12.

3. Continue repeating Step 1, using the following proportions of distilled water and detergent solution: test tube No. 13, 3 ml distilled water and 7 ml solution; test tube No. 14, 4 ml distilled water and 6 ml solution; test tube No. 15, 5 ml distilled water and 5 ml solution; test tube No. 16, 6 ml distilled water and 4 ml solution; test tube No. 17, 7 ml distilled water and 3 ml solution; test tube No. 18, 8 ml distilled water and 2 ml solution.

**Explanation:** Test tube No. 11 contains 1 ml of distilled water and 9 ml of the last solution that produced foam. If, for example, that solution is in test tube No. 4 from Project 3-5, then its concentration would be

**Table 3-II. Concentrations of Detergent Solutions Produced by a Second Set of Serial Dilutions**

TEST TUBE	CONCENTRATION IN PARTS PER MILLION
No. 11	90
No. 12	80
No. 13	70
No. 14	60
No. 15	50
No. 16	40
No. 17	30
No. 18	20

100 parts per million, or  $\frac{100}{1,000,000}$ . The volume of detergent in 9 ml of solution can be calculated by multiplying the volume of solution by its concentration:

$$\text{Volume of detergent} = \frac{(9 \text{ ml})(100)}{1,000,000}$$

$$\text{Volume of detergent} = \frac{900 \text{ ml}}{1,000,000}$$

$$\text{Volume of detergent} = 0.0009 \text{ ml}$$

The concentration of the detergent solution in test tube No. 11 is:

$$\text{Concentration of detergent solution} = \frac{0.0009 \text{ ml detergent}}{10 \text{ ml solution}}$$

$$\text{Concentration of detergent solution} = \frac{90}{1,000,000}$$

$$\text{Concentration of detergent solution} = 90 \text{ p.p.m.}$$

In same way, you can calculate the concentration of detergent solution in test tube No. 12. Assume that the detergent solution in test tube No. 12 is also in test tube No. 4 (Project 3-5). Then, the 8 ml of solution from test tube No. 4 contains 0.008 ml of detergent, so that the concentration of the solution in test tube No. 12 is 80 p.p.m. (see Table 3-II). The concentrations in the other test tubes can be calculated in this same way (see Table 3-II).

Decide which is the last test tube in this series of dilutions (test tubes No. 1-No. 18) that has foam. That test tube contains the solution with the minimum concentration of detergent that will produce foam. It is the *standard* against which you can compare a sample of water that has an unknown concentration of detergent in it.

Now that you know the minimum concentration of detergent solution that will produce foam, you can use this information to find out if tap water from your sink contains detergent, and how much it contains. Project 3-5B tells how to measure the concentration of detergent in a sample of tap water, also water from streams and lakes.

### Project 3-5B. How to Measure Concentration of Detergent in Water Samples.

**You will need:** a 25-ml graduated cylinder, a 5-ml graduated pipette, 18 6-inch test tubes with clean, solid rubber stoppers, a test tube rack, distilled water, labels and a pen. Obtain foaming water from the kitchen sink or nearby lakes or streams; if you cannot, have someone make a solution of detergent in water, using the pipette to add a given amount of detergent to a given amount of distilled water. Have him record the concentration of the solution, but be sure you do *not* look at his record until you have completed this project.

1. Using the graduated cylinder, measure 18 ml of distilled water and pour it into a clean test tube. Then with pipette, add 2 ml of the sample of foaming water. Stopper the test tube and shake it. Label this test tube No. 1 and set it in the test tube rack. If there is foam in this test tube, perform Step 2. If there is no foam, go to Step 3, using the sample of foaming water in Step 3. Remember to clean the pipette with each use.

2. As in Step 1, pour 18 ml of distilled water into test tube No. 2. Add 2 ml of solution from test tube No. 1. Stopper the test tube and shake it. Label this test tube No. 2 and place it in the test tube rack. Continue this procedure until you no longer see foam on the surface of water in a test tube. You may need only 1 or 2 test tubes to perform this step. However, 10 test tubes are available for use if you should need that many. That is why the test tube resulting from Step 3 is labeled No. 11.

3. Using the pipette, measure 1 ml

of distilled water and put it into a clean test tube. Use the pipette twice to add 9 ml of the *last* solution that produced foam. If there is no foam in test tube No. 1 (from Step 1), perform this Step 3 with 1 ml of distilled water and 9 ml of the sample of foaming water. Stopper the test tube and shake it. Label this test tube No. 11 and place it in the test tube rack.

4. Repeat Step 3, using 2 ml of distilled water and 8 ml of the same solution used in Step 3. Label this test tube No. 12.

5. Continue repeating Step 3, using the following proportions of distilled water and the same solution used in Step 3: Test tube No. 13, 3 ml distilled water and 7 ml solution; test tube No. 14, 4 ml distilled water and 6 ml solution; test tube No. 15, 5 ml distilled water and 5 ml solution; test tube No. 16, 6 ml distilled water and 4 ml solution; test tube No. 17, 7 ml distilled water and 3 ml solution; test tube No. 18, 8 ml distilled water and 2 ml solution.

**Explanation:** When you add 2 ml of solution to 18 ml of distilled water, you dilute the solution to 1/10 of its original concentration. Thus, the solution in test tube No. 1 has 1/10 the concentration of the sample; the solution in test tube No. 2 has 1/100 the concentration in the sample, and so on (see Table 3-III).

Let us assume that the last solution that produced foam was in test tube No. 2. Its concentration is 1/100 that of the sample of foaming

Table 3-III. Results of Serial Dilutions of a Sample.		
TEST TUBE	CONCENTRATION	COM-PARED TO SAMPLE
No. 1	1/10	
No. 2	1/100	
No. 3	1/1000	
No. 4	1/10,000	
No. 5	1/100,000	
No. 6	1/1,000,000	
No. 7	1/10,000,000	
No. 8	1/100,000,000	
No. 9	1/1,000,000,000	
No. 10	1/10,000,000,000	

Table 3-IV. Results of a Second Set of Serial Dilutions of a Sample.		
TEST TUBE	CONCENTRATION	COM-PARED TO SAMPLE
No. 11	9/1000	
No. 12	8/1000	
No. 13	7/1000	
No. 14	6/1000	
No. 15	5/1000	
No. 16	4/1000	
No. 17	3/1000	
No. 18	2/1000	

water. If 9 ml of the solution from test tube No. 2 is added to 1 ml of distilled water in test tube No. 11, the concentration of the new solution is 9/10 of the concentration in test tube No. 2. The new concentration can be calculated as:

$$\frac{(9)(1)}{(10)(100)} = \frac{9 \text{ of the concentration of the original sample.}}{1000}$$

In a similar way, if 8 ml of solution from test tube No. 2 is added to 2 ml of distilled water in test tube No. 12, the concentration of the new solution is 8/10 of the concentration in test tube No. 2 or:

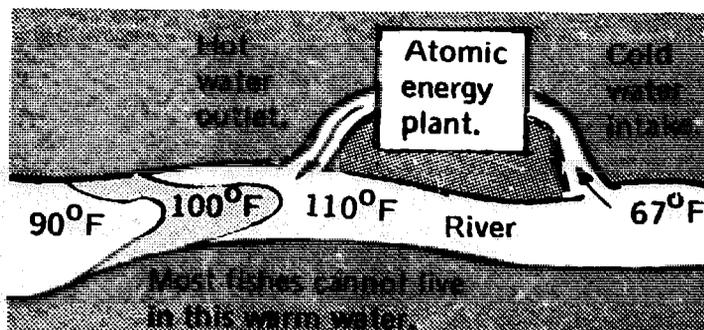
$$\frac{(8)(1)}{(10)(100)} = \frac{8 \text{ of the concentration of the original sample.}}{1000}$$

By using this procedure you can quite accurately calculate the concentration of the last solution to produce foam as compared to the concentration of the sample (see Table 3-IV).

Let us assume that the last solution to produce foam has 4/100 the concentration of the sample of foaming water. Now, let us also assume that in Project 3-5, you found that the minimum concentration of detergent that produced foam was 60 parts per million. Then, 60 parts per million of detergent in water is the standard against which we measure the concentration of detergent in foaming water. Thus, the 4/100 of the concentration of your sample of foaming water is 60 parts per million of detergent. You can calculate the concentration of the sample as follows:

$$\begin{aligned} 4/100 \text{ (concentration of sample)} &= 60 \text{ p.p.m.} \\ \text{(concentration of sample)} &= \frac{(100)(60) \text{ p.p.m.}}{(4)} \\ \text{(concentration of sample)} &= 1500 \text{ p.p.m.} \end{aligned}$$

Having completed this project, you have learned how to determine the detergent concentration in your local water supply. This is the first step toward solving the problem of detergent pollution.



**Fig. 3-16. Thermal Pollution from Atomic Energy Plant.**



**Fig. 3-17. Dead Fish from Polluted Water. (Photo courtesy EPA.)**

### Thermal Pollution

Some industrial buildings do not release any waste materials into the water but they still pollute the water badly. An atomic energy plant, for instance, may not pour any pollutant materials into the water. Nevertheless, it does pollute the water by raising its temperature. This is an example of “thermal” or heat pollution. Atomic energy plants draw huge amounts of water from rivers. The water is used to cool and condense steam that passes through the turbines that convert atomic energy to electricity. As the water cools the steam, the water gets hot. When it is poured back into the river, the water may be just as pure as before, but it is much hotter. Because an atomic energy plant may use billions of gallons of water each day for cooling purposes, the temperature of a river may be raised considerably for miles from the plant. When that happens, certain fish can no longer live in that part of the river. See Fig. 3-16 and photo Fig. 3-17. In fact, there is a complete change in the kinds of plants and animals that live there, when the temperature of the water changes. Thermal pollution can be as harmful as any other kind of water pollution.

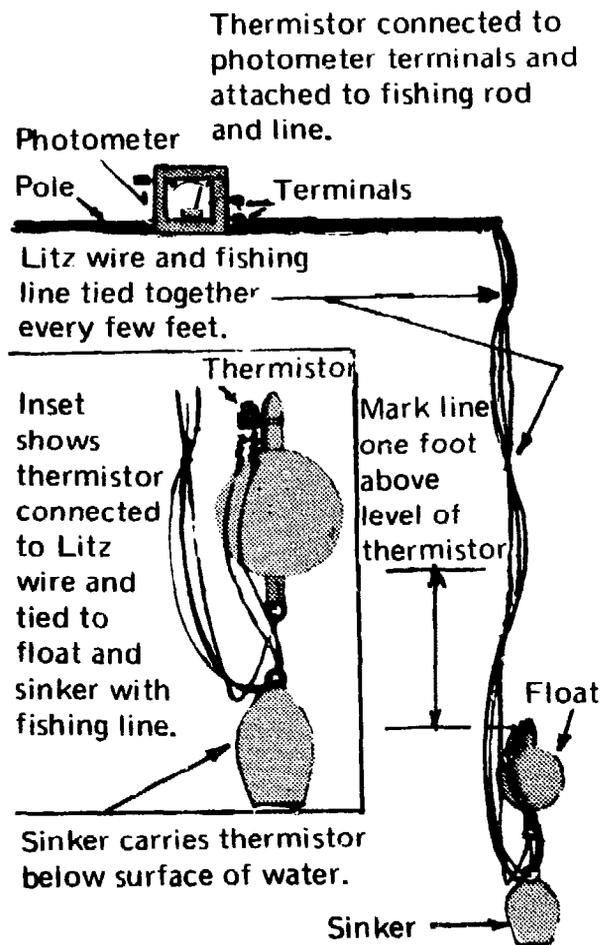
What can be done about thermal pollution? How can thermal pollution be reduced to tolerable levels or eliminated? We must first learn such facts about thermal pollution as: (1) where it exists in our community, (2) where it originates, (3) to what extent it destroys water animals and plants and (4), how this destruction affects our health and well-being. When this valuable data has been presented to the local authorities, they will be ready to take the next important steps to fight thermal pollution.

The first thing *we* can do to help, is to learn *where* thermal pollution exists in nearby water. Project 3-6 provides one method for tracking down thermal pollution.

### Project 3-6. How to Test for Thermal Pollution in Water.

**You will need:** the electrical thermometer from Project 2-5 (Step 1, Fig. 2-20), 30 feet of Litz wire, a broomstick or long rod or a fishing pole, 25 feet of fishing line, a red, waterproof magic marker, a map of the river or lake you are studying, a fishing float, a sinker heavy enough to pull the float under the water, a pen and note paper.

1. Attach the thermistor to the two terminals of the electrical thermometer with two 15-foot lengths of Litz wire.
2. Now, calibrate the electrical thermometer in degrees according to the directions in Project 2-5, Steps 2-4.
3. Allow 5 feet of fishing line (with the sinker and the float at the 5-foot end) to hang securely from the tip of the fishing pole. Tie the thermistor to top of float. Then, tie a part of the Litz wire to the fishing line and to the pole at several places (see Fig. 3-18). With the magic marker, make a mark on the fishing line one foot above the level of the thermistor.
4. Hold the fishing pole so that the thermistor hangs one foot below the surface of the water. The weight of the heavy sinker will pull the thermistor and float down below the surface of the water. Read and record the measurement on the ammeter, converting this reading to temperature in degrees.
5. Measure the water temperature at different points along a nearby river or lake with the electrical thermometer. If local factories discharge waste water into the river or lake, measure the water temperature near these factories.
6. Record the water temperatures on the map at the places where the



**Fig. 3-18. Testing for Thermal Pollution.**

measurements are made. *Are the temperatures different near the factories as compared to other locations along the water? Can you distinguish between the normal water temperature of the water and that of the thermally polluted water?* Your readings will supply this answer.

**Note:** If your measurements show higher temperatures downstream from a factory than upstream, the downstream water is thermally polluted. This probably has caused serious changes in the aquatic life downstream from the factory.

## Salts in the Water

Ocean water that is considered to be pure and not polluted, generally contains about 3.5% of salts. The types of organisms that usually live in the ocean require this 3.5% concentration of salts to survive. When ocean water is diluted by fresh water flowing into it from rivers, it becomes brackish (semi-salt) water and typical ocean fish cannot exist, but are replaced by fish that can live in brackish water. On the other hand, fresh water may be considered not pure, but polluted if it has a far smaller percentage of salts than ocean water. As noted earlier, phosphates and nitrates from industrial plants and from most detergents especially may pollute lakes and ruin them by encouraging the growth of algae. Such lakes may be considered badly polluted even though their total concentration of salts is low compared to that in sea water. This pollution exists because the salts make conditions in the lake so bad that only the hardiest forms of life can survive.

A high concentration of salts spoils water for certain uses. People prefer to drink water that tastes pure because it has only a very small percentage of salt. When larger quantities are present, the water is brackish or hard. Some kinds of salts, such as borates, can even make the water poisonous. Aside from the fact that some salts are poisonous even in fairly small concentrations, salts in water may be objectionable in other ways. Even a low concentration of salt in drinking water gives it a bad taste. People with heart trouble cannot tolerate sodium chloride. Salts precipitate out of water when it is boiled and clog the tubes of steam engines, steam turbines and other such devices. Water containing too high a salt concentration cannot be used for irrigating fields, because the plants would be damaged or killed by the salts. In addition, the salts tend to accumulate in the soil, so that even if the plants do not suffer at first, they are injured after a few years of irrigation. Salty water entering streams and lakes kills the fresh water fish living there.

Salt gets into water in a number of ways. Sometimes wells are unknowingly drilled through underground layers of salts that were precipitated when inland seas evaporated. Wells drilled in locations near the sea may also provide salt water instead of fresh water, if water is pumped out of them too rapidly. The inorganic fertilizers that are spread on fields are salts. They filter through the ground and may eventually get into wells or bodies of formerly fresh water.

By measuring the salinity of fresh water in different locations, you can determine whether the water is being contaminated with salts.

You may even be able to pinpoint the source of the pollution, and thereby be instrumental in helping to correct the trouble. However, the presence of salt does not necessarily mean that fresh water is polluted. Only the most carefully distilled water has no salts at all. Rivers, lakes and ponds all have certain amounts of salts. It is only when fresh water contains the wrong kinds of salt or too high a salt concentration that bodies of fresh water are considered to be polluted by the salts. Project 3-7 tells how you can determine the salinity or percentage of salt in water.

### Project 3-7. How to Make and Calibrate a Salinity Meter.

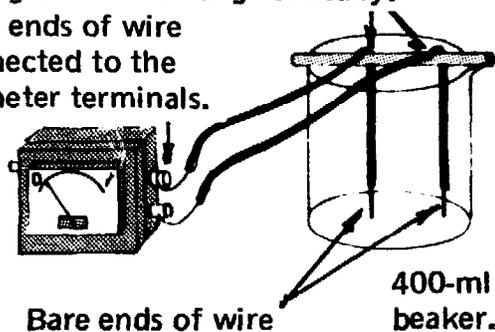
**You will need:** the photometer from Project 2-3, two 1-foot lengths of insulated wire, two 6" glass stirring rods, two 400-ml beakers, a 600-ml beaker, a 500-ml graduated cylinder, a 100-ml graduated cylinder, twenty 500-ml bottles with stoppers, distilled water, sodium chloride, a sensitive balance with masses, weighing paper, an X-acto knife, cellophane tape, labels, a pen and note paper.

1. First, remove photoconductive cell from photometer's terminals. Remove 1" of insulation from each end of each of the two lengths of wire. Place one of the glass stirring rods across the top of an empty 400-ml beaker (see Fig. 3-19). Bend the two wires over the glass rod so that the wires hang vertically with their free ends about  $\frac{1}{4}$ " above the bottom of the beaker. Keep the ends of the wire exactly 2" apart. Tape the two wires to the glass rod, keeping the wires in position as you do so. Now, connect the other end of each wire to a terminal of the ammeter. You have completed the construction of the salinity meter. **CAUTION: DO NOT EVER ALLOW THE BARE ENDS OF THE WIRES TO TOUCH EACH OTHER. THE AMMETER MAY BURN OUT IF THEY TOUCH.**

2. Pour ordinary tap water into the 400-ml beaker that is part of the salinity meter. Now, turn the potentiometer knob clockwise; the ammeter needle should swing to the

Insulated wires bent and taped over glass rod to hang vertically.

Bare ends of wire connected to the ammeter terminals.



**Fig. 3-19. How to Make and Calibrate a Salinity Meter.**

right, showing an increase in the current. Then, turn the knob counterclockwise as far as it will go; the ammeter needle should swing to zero. Your potentiometer knob may already be marked "O" in this extreme counterclockwise position. If it is not, mark this position by scratching a vertical line at the top of the knob with X-acto knife, to indicate the "O" position. **THE KNOB MUST BE SET AT THIS ZERO POSITION AT ALL TIMES BEFORE YOU BEGIN**

**CALIBRATING THE SALINITY METER TO TAKE READINGS. FAILURE TO DO SO MAY BURN OUT THE AMMETER.** Discard the tap water in the beaker.

3. Measure 350 ml of distilled water in the 500-ml graduated cylinder, and pour it into the 600-ml beaker. Using weighing paper, measure a mass of 20 gm of sodium chloride on the balance and pour it into the water in the 600-ml beaker. Stir with a stirring rod until the sodium chloride is completely dissolved. Pour *all* the resulting sodium chloride solution back into the 500-ml graduated cylinder. Then, add enough distilled water to increase the volume of the sodium chloride solution to 400 ml. Now, pour the solution from the graduated cylinder back into the 600-ml beaker. Stir the solution thoroughly with the stirring rod. This is a 5% sodium chloride solution (20 gm sodium chloride in 400 ml of solution).

4. Set the potentiometer knob of the salinity meter at "O" position. Measure 200 ml of the 5% sodium chloride solution into the 500-ml graduated cylinder, and pour it into the salinity meter's 400-ml beaker. Now, you very slowly turn the potentiometer knob clockwise until the ammeter reads exactly 0.8 milliampere. This is the first step in calibrating the salinity meter. Record the fact that 5% sodium chloride solution corresponds to a 0.8 milliampere reading when the potentiometer is kept in the position at which you set it. Do not change the setting of the knob during Steps 6-8.

5. Remove the wires of the salinity meter from the 400-ml beaker,

using the glass rod as a handle. Rinse the wires thoroughly, first in tap water and then in distilled water. Place the glass rod across the top of the second (empty) 400-ml beaker, so that the wires hang inside the empty beaker. This is done to prevent extreme bending or damage to the wires. Now pour the 5% sodium chloride solution from the 400-ml beaker and from the 600-ml beaker into a bottle. Stopper the bottle and label it "5% Sodium Chloride Solution." Thoroughly wash all glassware used in this and previous steps; rinse with distilled water and dry it. The procedures in this Step 5 must be followed each time the apparatus is used, to save the solutions and especially to avoid contaminating the solution to be prepared in the following steps.

**Note:** After you have used each of the solutions in Steps 6-10 (which follow) to further calibrate the meter, save the labeled bottles of solution for use as standards for setting the potentiometer before measuring the salinity of samples of brackish, salty or fresh water. This is important, because it will enable you to make your measurements quickly without the bother of making up the standard solutions each time.

6. Measure 40 ml of the 5% sodium chloride solution into the 100-ml graduated cylinder and pour it into a clean 400-ml beaker. Add to this beaker 160 ml of distilled water and stir thoroughly. This makes a 1% sodium chloride solution. Now, lift the glass rod of the salinity meter from the beaker on which it was stored and place it across the top of the beaker with the 1% solution, so that the wires hang

inside the beaker, and in the solution. Record the reading in milliamperes. **Note:** This reading corresponds to a 1% solution of sodium chloride. Now, follow the same procedures as in Step 5.

7. Repeat Step 6, using 80 ml of the 5% sodium chloride solution and 120 ml of distilled water. This gives the meter reading for a 2% sodium chloride solution.

8. Repeat Step 6, using the proper quantities of 5% sodium chloride solution and distilled water to find the readings for 3% and 4% sodium chloride solutions. To do these two steps, requires a bit of figuring on your part.

**Note:** The salinity meter has now been calibrated from 0-5% sodium chloride solution. It may now be used to measure the salinity of sea water or brackish water. To further calibrate the meter, continue with Steps 9-10.

9. First, reset the potentiometer of the salinity meter so that the ammeter reads 0 milliamperes. This must be done each time before you begin calibrating the salinity meter. Then, as in Step 3, make a 1% solution of sodium chloride by dissolving 4 gm sodium chloride in enough distilled water to make 400 ml of solution. Now, follow the procedure outlined in Steps 4-8, but this time calibrate the meter to read from 0-1% salinity. This range is useful for measuring the salinity of brackish water.

10. Pour 40 ml of the 1% solution from Step 9 into a clean beaker, add 360 ml of distilled water and stir thoroughly. This makes a 0.1% sodium chloride solution. Calibrate the salinity meter from 0-0.1%. Repeat this procedure to calibrate the meter from 0-0.01% and from 0-0.001%. These ranges are useful for measuring the salinity of fresh water.

**Note:** By following the procedures in Step 10, you have calibrated the salinity meter for such widely different ranges of salinity, that you can measure the salinity of fresh water from lakes, rivers or faucets. Find out how the salinity varies in different localities.

---

### **Oil: The Deadly Tide**

When large amounts of petroleum oil are suddenly released into the water, spectacular and disastrous water pollution occurs. We have read about such accidents at Santa Barbara in California, at beaches along the English Channel and at Coney Island in New York City. Similar catastrophes have taken place throughout the world. No ocean, river or large lake seems to be immune to the awful effects of the oil.

The damage done by oil takes many forms. Generally, the spill consists of crude oil, a dark, viscous, thick fluid that clings tightly to and fouls everything it touches. A clean, white sandy beach becomes repulsively filthy when its sands are contaminated with crude oil. Bad as this is, the damage to the sand is one of our less important problems. Crude oil and the liquid products derived from it are

poisonous to most forms of life. The plight of water birds is especially pitiful. With their feathers coated by oil, the birds can no longer fly. They lose most of their buoyancy and may even sink and drown. When the birds attempt to clean the oil from their feathers with their bills, they may be killed by the poisonous oil that they swallow. Fish die by the millions as a result of oil spills. Plankton, the smaller organisms on which most fish feed, are also devastated. When water plants (including algae) are killed, the fish and other organisms lose their main source of oxygen. As a result, many fish die. To continue to dump more oil into the water will further cut additional food fish out of the human diet. This, in turn, aggravates the problem of a shrinking food supply for an exploding human population on our planet Earth. Some ecologists believe that, if algae are killed off in sufficient numbers, the resulting reduction in oxygen may even threaten human life.

#### **How Oil Spills Occur**

Some oil spills are accidental, but others are deliberate. Off-shore oil wells sometimes leak large quantities of oil in the ocean. Oil tankers near the shore sometimes collide or are wrecked in other ways, releasing their cargoes of oil. Occasionally a valve is opened in error, and oil pours into the water. Much damage is done, however, when crews wash out the insides of oil tankers as part of their work and flush the oily waste into the ocean to create a highly dangerous condition of water pollution.

Whether the damage done by oil spills is accidental or purposeful, most of it can be avoided. Procedures have been developed by governmental agencies to prevent oil spills or to minimize their damage. International laws have been passed requiring the use of such procedures. But these laws are not always obeyed and governmental agencies may not always strictly apply these rules. Therefore, we who have the most to lose by this oil spillage, must see to it that the waters are kept free of oil pollution. We must insist that all people who produce, transport and deal in petroleum follow practices that will protect our beaches and the aquatic organisms that are of vital importance to all other forms of life, including man.

#### **How Oil Affects Aquatic Plant Life**

An essential part of the water environment for human beings is the aquatic plant organism. Since it is too difficult for us to examine the effect of oil spillage on aquatic plants, we must find a land plant that

will react to oil in a way similar to an aquatic plant such as algae. Land grass is like algae because both carry on the process of photosynthesis to produce the food and oxygen so essential to all forms of life. Therefore, in Project 3-8 we can study how oil affects grass, and we can reasonably conclude that oil spillage would have a similar effect on aquatic forms of life such as algae. This project will also give you some idea of the harm oil can do to other organisms.

---

### **Project 3-8. How Oil Damages Plants.**

**You will need:** two flower pots, enough fertile topsoil to fill the two flower pots, one ounce of grass seed, water, a 100-ml graduated cylinder and 100 ml of lubricating oil (oil for automobiles is suitable).

1. Fill the two flower pots with fertile topsoil. Plant enough grass seed on the soil to provide a thick growth of grass. The seed need merely be sprinkled on the surface of the soil.

2. Keep the flower pots in a sunny location. Water every second day until the grass is about two inches tall. This should take about three weeks.

3. Sprinkle 100 ml of lubricating oil

on the grass in one of the flower pots, using the graduated cylinder to measure the oil. (The other flower pot will act as a control.)

4. Continue watering the pots every second day. *What happens to the grass in each of the two flower pots? Can you explain how the oil damaged the grass in one of the flower pots? How does this experiment illustrate what might happen to aquatic algae if an oil spill occurred in an ocean?*

---

Here, we have examined various kinds of water pollution and we have also considered methods of reducing this menace. In the following chapter, we will look into the problem of solid pollution.

## CHAPTER FOUR

### SOLID POLLUTION

**WHENEVER YOU** eat or drink, solid waste materials in the form of cans, bottles, cartons, bones and so forth almost always remain. After you finish reading a newspaper, the newspaper itself is not finished. The solid material, paper, still exists as waste. Some other objects such as automobiles become solid wastes much more slowly. Ten, fifteen years or more may elapse before an automobile becomes useless as a means of transportation. At that time, it becomes a mass of solid waste.

Did you ever stop to consider how much solid waste matter *your* family contributes (unintentionally) to this problem? If you can answer this question, and if you were to multiply this answer by all the families on your street (assuming that your family is average size, about 4 people) and if you multiply this total by 365 days of the year, you will understand the enormity of the problem on your street and on all of the "streets" in the world. A good starting point for this investigation is described in Project 4-1.

If you know the population total in your community, Project 4-1 should help you answer the following questions:

1. About how many cubic feet of solid waste does the community produce each day? Each year?
2. If we assume that the metals and glass cannot be burned, how many tons of such unburnable materials does the community generate each day? Each year? How many cubic feet does this amount to per day if the volume of the unburnable material is not reduced by crushing or melting? How many cubic feet per year?

## Project 4-1. How Much Solid Waste Does Your Family Produce Per Day?

You will need: a quart-size jar, a spring balance with a maximum capacity of 10 pounds, strong twine, pen, paper labels and a notebook.

1. Empty all the waste baskets and garbage pails in your house and dispose of the rubbish in the usual way. Using strong twine, make a handle for each empty waste basket and garbage pail, as shown in Fig. 4-1. Put a label on each waste container, number all the containers on the label to identify them, and write the kind of waste to be put into each container.
2. Weigh each waste container on the balance, and record its weight on the label and in a notebook. Then, find the volume of each empty waste container by filling it with water. Use the quart-size jar to measure the volume of the water (4 quarts equals 1 gallon). As a rough estimate, 8 gallons of water equals 1 cubic foot.
3. Begin collecting waste. Put the same kind of waste into the same container. For example, put tin cans into one container; bottles and glass jars into another; paper into a separate container; plastic material into another and organic wastes into another, etc. Only food scraps may be thrown into the garbage pail. Get the members of your family to cooperate.
4. At the same time each day for one week, calculate the *volume* of the waste. Compact the waste in each container and fill it to the top. Record the volume in each full container. If a container is not completely filled, estimate and record the volume of the waste in it.
5. Before waste is discarded, weigh each waste container and its

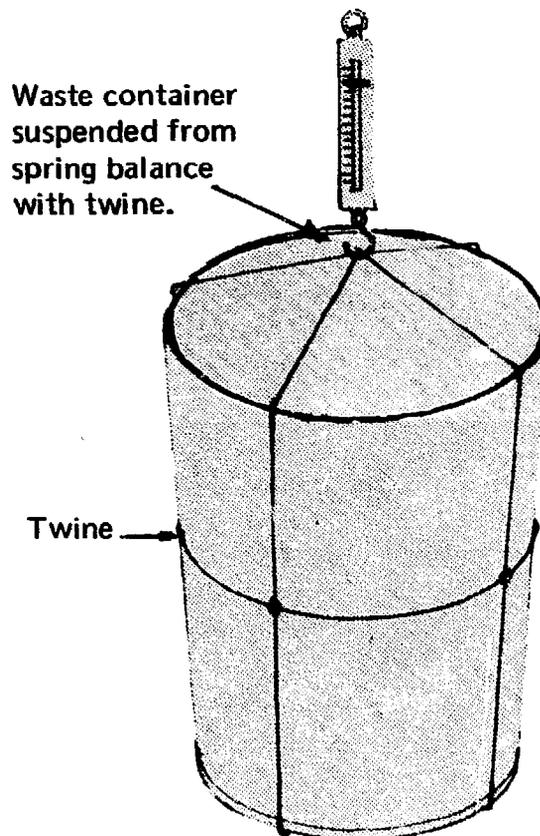


Fig. 4-1. How to Weigh a Waste Container.

contents. Record the weight of the empty waste container to calculate the *weight* of the refuse only. Now, record the weight of the refuse. Remember, you can weigh only 10 pounds at a time. Find the total weight of the refuse per day, then discard the refuse. Calculate the weight of solid waste per person by dividing the total weight by the number of persons in the family. In the same way, calculate the volume of solid waste per person. Then, determine the percentage of each kind of waste.



**Fig. 4-2. Scattered Debris in a Street.**  
(Photo courtesy of Bell Telephone Magazine.)

3. If we assume that a 10-foot deep layer of unburned garbage can be piled on a sanitary landfill, how many square feet of landfill surface would the unburned garbage produced by the community cover in one year?

4. If the refuse is incinerated before being dumped in a 10-foot deep layer, how many square feet would be covered per year by the unburnable refuse from the community? Assume that the volume of the unburnable material is not reduced by crushing or melting.

Disposing of solid waste materials presents a variety of problems. If they are simply left where they are or carelessly discarded, the scattered solid wastes ruin the appearance of large areas of the community. Old papers, bottles, cans, worn-out furniture and rusting

remains of cars can make any scene look depressing (see photo Fig. 4-2). This blight is partially remedied by concentrating such solid wastes at garbage dumps and junkyards. Thus, the ugliness of solid waste is confined to a relatively small area and most of the community remains clean. It is certainly better for a beer can to end up on a garbage dump than floating in a lake or resting on your street.

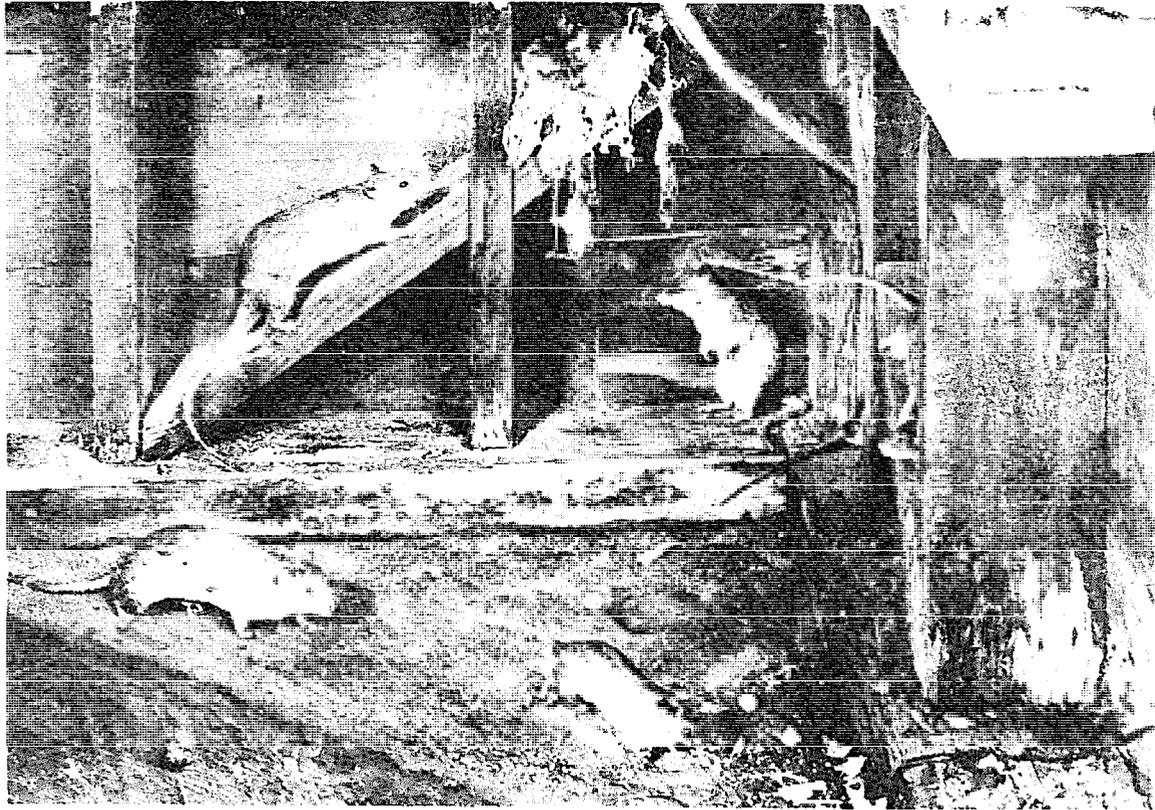
Is *your* street plagued by scattered debris? Do you live on or near a street littered with solid waste? If you do, your community is faced with the problem of having this debris removed and disposed of properly. Project 4-2 suggests an effective way of learning how much and what kind of litter there is on one block. If the block is typical, you can multiply the result you get by the number of blocks in your community and arrive at the total amount of litter. With the data obtained from Project 4-2, you and the other members of your community can do much to clean up the area and to prevent littering in the future.

---

#### **Project 4-2 How Much Litter Is Scattered On Your Street?**

**You will need:** a plastic bucket, tongs, a strong magnet, a spring balance with a maximum capacity of 5 pounds, note paper, a pen, a broom and dustpan. (It is best if several people cooperate on this project since it involves a good deal of work.)

1. Select an area to study. The area need not be especially dirty. It may be a whole block, part of a block or several blocks. A few hundred feet of a road would also be suitable.
2. Collect all the litter in the block, street or road. Anything weighing more than 5 pounds can be considered too large to be a piece of litter. (You might, however, make a separate list of all the heavier refuse such as abandoned automobiles, refrigerators or even furniture.) The tongs, broom and pan will be useful for handling the trash. Small pieces of iron and steel (nails, screws, etc.) may be picked up with the magnet.
3. Use the plastic bucket and spring balance as in Project 4-1. Weigh the total amount of trash and record the weight. Be sure to subtract the weight of the bucket from the total (or gross) weight of the bucket plus trash.
4. Separate the trash into different categories such as paper, glass, wood, steel (including "tin" cans), other metals, rubber, etc. Weigh each kind of refuse separately, subtract the weight of the container, and record the weight of the refuse.
5. Count and record the number of collected soda bottles, tin cans, cigarette packages, candy wrappers and so forth.
6. Repeat Steps 1-5 in the same area each day for a week if possible, to calculate the average amount of solid waste that is scattered in the area per day.



**Fig. 4-3. Rats from Nearby Garbage Dumps Can Invade Homes.**  
(Photo courtesy of the American Museum of Natural History.)

If different groups of researchers in different communities perform the same study, each group will be able to arrive at a rough *average* of solid waste produced on one street. If your count is accurate and if your records are complete, they will have provided valuable data to the community for the eventual solution of this problem of solid waste. The data should be presented to organizations interested in improving local community conditions. They can use it to get prompt, effective action from the local government. Your neighbors on your street can also help, by being careful not to litter. Such cooperation may not completely solve the litter problem; therefore, the local government must be asked to help.

If we merely haul refuse to a dump and leave it there, we may be creating more problems than we started with. Mixed in with paper, bottles, cans and other kinds of solid wastes are scraps of food. When this food is left on the surface of the dump it will not only create a foul odor, but it will attract and nourish rats, insects and bacteria. Project 4-3 tells how you can investigate the adverse conditions created by rotting organic matter.

### Project 4-3. How Do Bacteria and Fungi Affect Waste Foods?

**You will need:** a Petri dish with cover, a piece of meat about 1" in diameter and ¼" thick, a chlorine bleach, a pail or other large container, tap water, liquid detergent and a test tube brush.

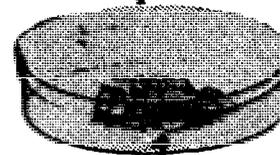
1. Put the meat into the Petri dish. Allow the dish to remain open for about 10 minutes, then cover it (see Fig. 4-4).

2. Leave the covered Petri dish in a warm place for one week or more to allow the meat to decay. Check each day to note whether any fungus or colonies of bacteria are growing on the meat. Fungus will usually look like a tangled mass of fine threads. Bacteria colonies are usually round, almost flat and may be white, pink or various other colors.

3. Remove the Petri dish cover each day and note the odor, and whether any liquid has oozed from the meat. If you note an odor or oozing, decay has begun. Meat which has been discarded on a garbage dump decays in a similar way.

4. Kill the bacteria and fungi before you clean the Petri dish. Put the Petri dish and cover, open side up, into a pail or large container. Fill the Petri dish and cover with full-strength chlorine bleach and allow it to remain for at least one hour. Then, pour water slowly into

Covered Petri dish.



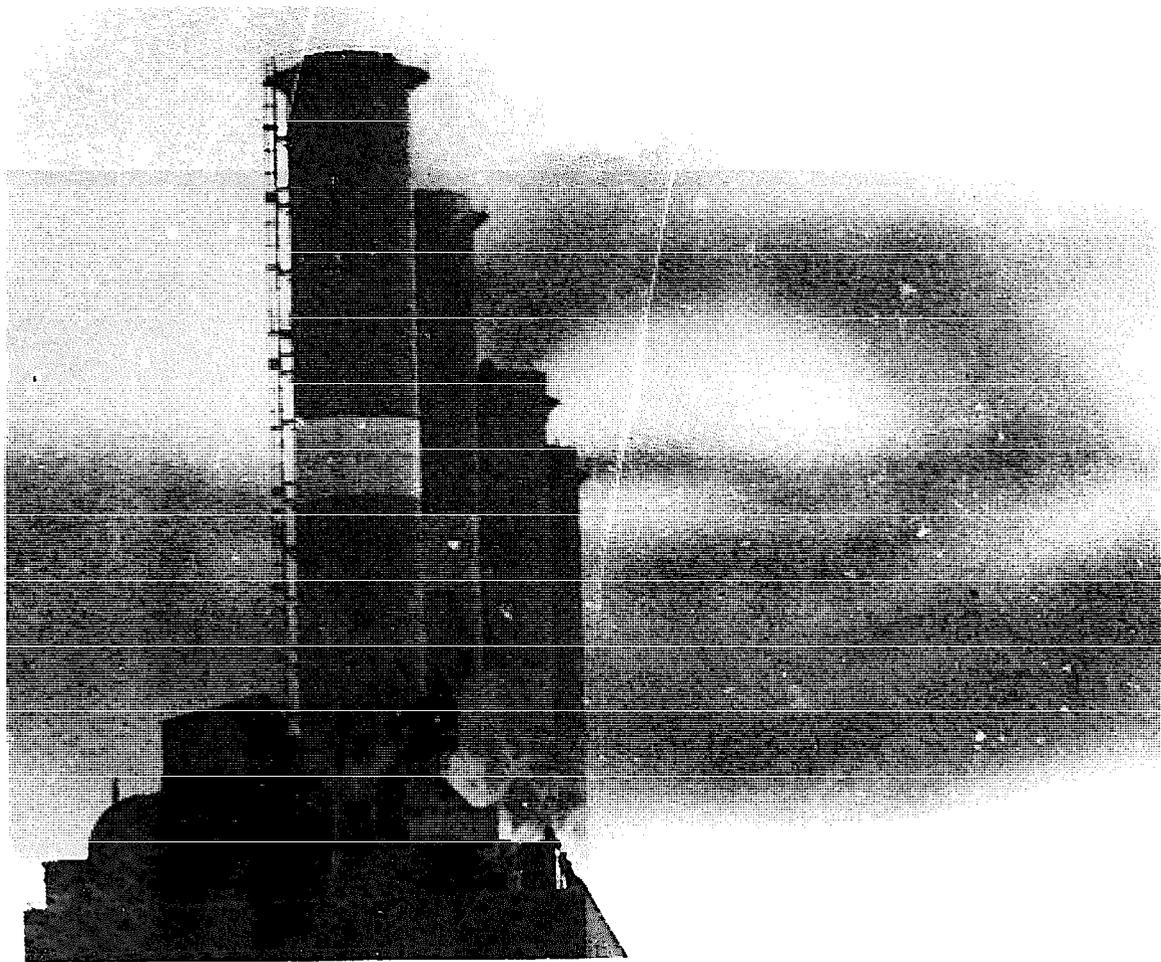
Colonies of bacteria on decaying meat.

**Fig. 4-4. Covered Petri Dish with Decaying Meat.**

the container until it is about half-full. This will dilute the bleach so that it can be safely poured out. (Handle chlorine bleach very carefully because it can damage objects that it spills on.) Now, you can clean the Petri dish and cover by scrubbing it with the test tube brush in a solution of liquid detergent in water. Carefully rinse the Petri dish with tap water and let it dry.

5. Repeat this experiment using scraps of foods other than meat. Observe the differences in the odor and in the color of the bacteria. Record the results.

Although you perform a safe experiment under carefully controlled conditions in Project 4-3, what would happen if large areas in the community were exposed to decaying meat? While the odor of decay is unpleasant to us, it attracts rats and flies which carry dangerous bacteria such as those that produce typhoid and dysentery, two potentially deadly diseases. These bacteria, as well as other types, can thrive and multiply on garbage. Therefore, if the



**Fig. 4-5. Incinerators Add to Air Pollution.**  
**(Photo courtesy of Bell Telephone Magazine.)**

location of a garbage dump is not carefully selected, the disease bacteria may be washed into the local water supply and cause epidemics. This has happened frequently in the past. Rats and flies that feed and breed on garbage dumps are also known to invade homes (see photo Fig. 4-3), carrying with them many kinds of deadly diseases, in addition to typhoid and dysentery. In the middle ages, fleas living as parasites on infected rats transmitted bubonic plague which wiped out entire populations in Europe and Asia.

By burning or burying garbage so that rats and insects cannot reach it, we can remove the danger of certain kinds of epidemics, and avoid unpleasant odors. Burning garbage also reduces its mass and volume, so that the unburnable remains (mostly glass and metals) do not occupy as much space on the dump as unburned garbage. Project 4-4 demonstrates how the mass of meat and other substances in garbage is reduced by burning.

#### Project 4-4. How Burning Garbage Reduces Landfill Space.

**You will need:** a porcelain crucible with cover, crucible tongs, a clay triangle, a tripod, a bunsen burner, a small piece of meat (about one cubic inch), a sensitive balance with masses for the balance, paper, pen and weighing paper.

1. Using the balance, measure on weighing paper the mass of the meat before burning, and record it.

2. Measure and record the mass of the crucible.

3. Place the meat in the crucible held by the clay triangle on the tripod. Cover the crucible and heat the meat with a hot bunsen burner flame (see Fig. 4-6). With tongs, remove cover and note the odor of the burning meat. The odor produced is similar to that created when garbage is burned on a dump or in an incinerator. This indicates that some additional, foul-smelling pollutants are being added to the air.

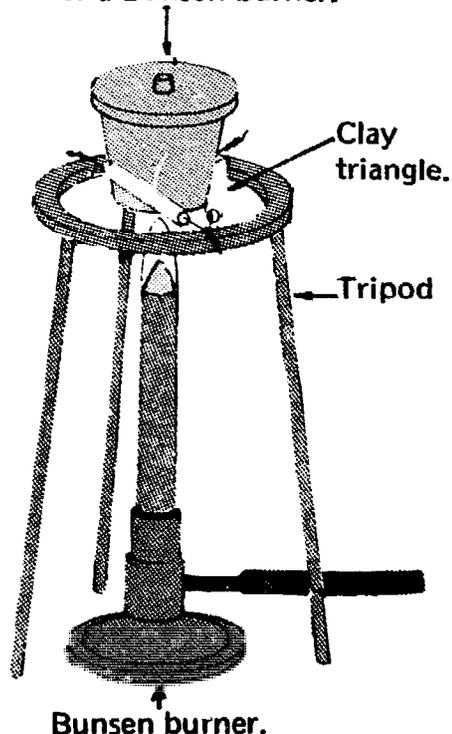
4. Continue heating the meat until it becomes black. This shows that carbon is one of meat's component elements. Continue heating until the meat finally is reduced to a white ash. This will require heating for at least 15 minutes over a very hot flame.

5. Allow the crucible and its contents to cool. Measure the mass of the crucible plus the ashes in it, then from this total mass subtract the mass of the crucible (see Step 2) to find the mass of the ashes.

6. *What percentage of the original mass of the meat does the mass of the ashes represent?*

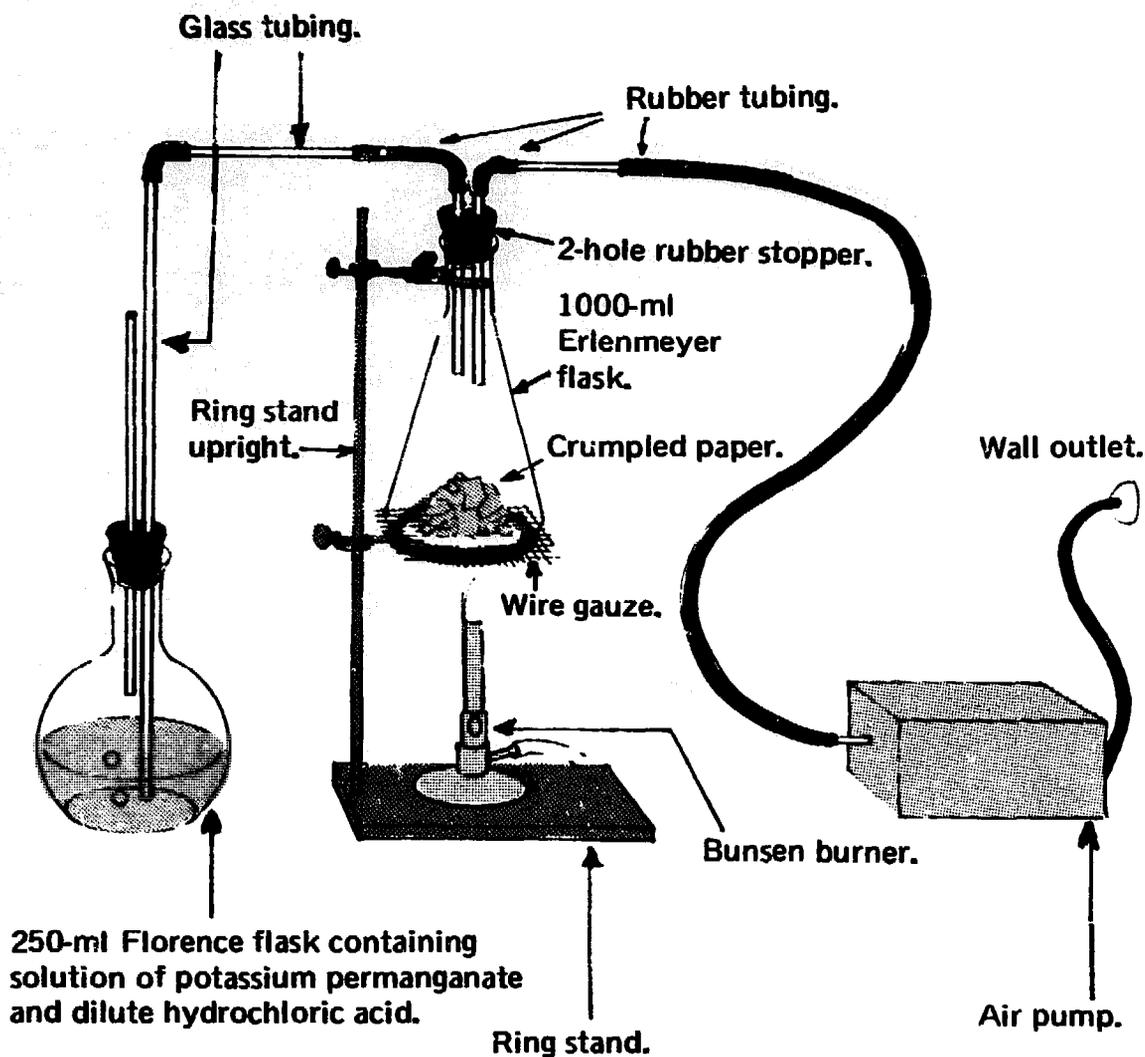
7. Repeat this experiment with other kinds of foods, as well as with paper or wood.

Covered porcelain crucible containing meat, held by clay triangle on tripod over a Bunsen burner.



**Fig. 4-6. How to Heat Meat in Porcelain Crucible.**

8. *Having shown that burning greatly reduces the mass and also the volume of the meat or other materials, can you calculate what percentage of the space at a dump can be saved by burning the garbage? (Assume that the volume is directly proportional to the mass.)*



**Fig. 4-7. Set-up for Identifying and Measuring Pollutants Produced by Burning Paper.**

Although burning garbage reduces its mass and volume and destroys its food value for rats and insects, most communities have discontinued burning refuse on open dumps because it greatly increases air pollution. In many areas, large incinerators are used to burn the refuse, but they are expensive to construct and operate. Costly oil or gas must be burned in the incinerator to produce a fire hot enough to cause complete combustion. Even then, incinerators add to air pollution. The dark smoke that pours out of an incinerator stack (see photo Fig. 4-5) contains many kinds of pollutants. Even the simple process of burning paper will add pollutants to the atmosphere. Project 4-5 shows how to identify and measure two of the pollutants produced by burning paper.

### **Project 4-5. Air Pollution From Burning Paper.**

**You will need:** the equipment and chemicals required for detecting and measuring the amount of sulfur dioxide (see Project 2-2), the equipment and chemicals needed for detecting and measuring the amount of carbon dioxide (see Project 2-7), 2 sheets of paper, a 1000-ml Erlenmeyer flask with a 2-hole rubber stopper, a ring stand, a ring clamp, asbestos-centered wire gauze, 3 feet of glass tubing, 3 feet of rubber tubing and a bunsen burner.

1. Set up the equipment as shown in Fig. 4-7.
2. Heat the bottom of the flask to make the paper burn.
3. Follow the directions given in Project 2-2 to determine the amount of sulfur dioxide produced by the burning paper. Record your results.
4. Repeat Steps 1-2. This time, follow the directions given in Project 2-7 (Steps 2 thru 9), to determine the amount of carbon

dioxide produced by the burning paper.

5. Record the time required to make the solution colorless. Record the results.

*6. Having measured the amounts of sulfur dioxide and carbon dioxide given off by one sheet of burning paper which weighs about 1/8 ounce, can you calculate how much of these pollutants would be produced when a ton of paper is burned?*

**Note:** In addition to sulfur dioxide and carbon dioxide, you can see dark tar, another pollutant, sticking to the inside of the flask. The burning paper also produced carbon monoxide, wood alcohol, acetic acid, mineral salts, carbon particles and other chemical pollutants. Since mercury is used in the manufacture of paper, mercury vapor also enters the atmosphere. This is an indication of the many pollutants in addition to sulfur dioxide and carbon dioxide that pour into the air from incinerators. Therefore, to reduce air pollution, we must use other methods of garbage disposal instead of burning.

---

### **Sanitary Landfills**

Since it makes little sense to increase air pollution during the process of decreasing solid pollution, most communities bury their garbage in what are called sanitary landfills. This is an expensive process since huge volumes of soil must be moved as trenches are dug and the refuse is covered (see photo Fig. 4-8). One serious fault in this method of garbage disposal is the large area of land required. A big city will quickly fill up one sanitary landfill and soon must establish another. Some cities are running out of nearby locations suitable for landfills. A sanitary landfill can be used for a longer period of time if the refuse rapidly disintegrates by rotting, rusting or by other chemical and biological action. Materials such as plastics,



**Fig. 4-8. Sanitary Landfill—the Garbage Graveyard.**

---

glass and aluminum that are resistant to rapid disintegration make the landfill useless in a short time because they cause landfills to fill up quickly.

If the sanitary landfill is to be used more efficiently, we must find out which materials will rust and decay (thus taking up less space), and which materials will resist decay, and remain in their original solid state. The resistant materials could be separated and perhaps re-used as raw materials in manufacturing. The remaining materials, which would decay or corrode quickly, could be buried in the landfill. Projects 4-6 and 4-7 demonstrate methods for determining the resistance of different kinds of waste materials.

### **Project 4-6. How To Compare The Rate of Disintegration of Steel To That of Aluminum When Both Are Buried In Moist Soil.**

**You will need:** a recently opened, empty "tin" can and an aluminum can, a can opener, a flower pot filled with soil, water, a sensitive balance with masses, graph paper, writing paper and a pen. Note: A "tin" can is made of steel with a thin coat of tin.

1. Remove the undamaged top or bottom of the opened "tin" can and aluminum can with the can opener. Keep the tops and discard the cans.
2. Find the masses of the can tops and record the mass of each.
3. Bury the can tops in the soil of the flower pot. Record the date on which you bury them. Water the soil thoroughly to simulate rain.
4. After one week, remove the can tops from the soil. Rinse away any clinging soil and corroded material, but do not rub the can tops hard enough to remove any of the metal. Look for signs of corrosion on each can top. Record the date when you notice the first signs of corrosion on either top, and record the mass of each can top together with the

date. *Has there been any change in appearance? Any change in the mass?* Record your observations for each can top separately.

5. Replace the can tops in the soil and again water the soil thoroughly.
6. Repeat Steps 4-5 each week until one of the can tops has completely disintegrated. Note: Even in moist soil, complete disintegration will take many weeks. Do not expect fast results.

7. Carefully consult your record of observations and make a graph showing the mass of each can top on the vertical axis, against time in weeks indicated on the horizontal axis. After this project has been completed, you should be able to answer the following questions by consulting the graph:

*(a) Which kind of can, a "tin" can or an aluminum can, disintegrates more rapidly when it is buried?*

*(b) Does the can that disintegrates more rapidly lose mass at a steady rate? Consult your graph for this answer. (A graph showing a straight line indicates a steady rate of change).*

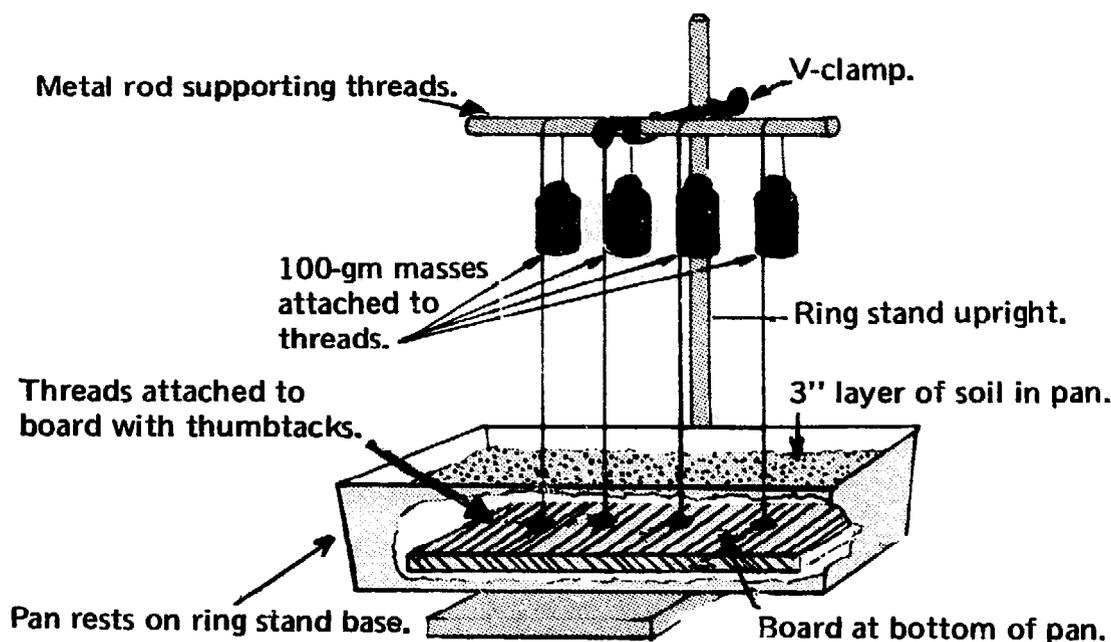
*(c) How long does it take for the can to disintegrate completely?*

*(d) If the only metals you want to put into a landfill are those that corrode rapidly, would you put steel, aluminum, both metals or neither into the landfill?*

*(e) What can be done with those metals which cannot be used for landfills? Can they be collected and recycled? Note: If it is profitable to recycle them, it may occur to you that it might be possible to collect them as a means of earning a little extra money in addition to combatting pollution.*

### Project 4-7. How To Determine Which Kinds of Fibers Are Most Resistant to Decay.

**You will need:** one spool each of No. 30 cotton thread, nylon thread, rayon thread, silk thread, a pan (about 10" x 6" x 4"), a board (about 8" x 4" x 1/2"), 4 thumbtacks, soil, water, a metal rod (1/4" diameter, 10" long), ring stand, a V-clamp, four 100-gm masses, note paper and a pen.



**Fig. 4-9. How to Test the Resistance of Fibers to Decay.**

1. Set up the ring stand, V-clamp and metal rod as shown in Fig. 4-9. Cut a 15" piece of thread from each spool. Attach each thread to the board with a thumbtack, spacing the threads as shown. Put the board into the bottom of the pan.

2. Set the pan on the base of the ringstand and bring the threads about 5" over the metal rod, and at that point attach the 100-gm masses to the ends of the threads as shown in Fig. 4-9.

3. Pour soil into the pan until it is

about 3" deep. Water the soil thoroughly at the beginning of the experiment and then again every 3 days as long as the experiment lasts. Record the date of the beginning of the project.

4. Observe the set-up at least once a day. Record the date on which each thread breaks. This may take several weeks. *Why do the different threads break at different times? Which threads are more resistant to disintegration? Which kinds of fibers would probably last the longest in a sanitary landfill?*

## Recycling Waste Materials

There are serious faults with the disposal of garbage on ordinary dumps, sanitary landfills, or with open-burning and incineration. To attempt to avoid these problems, some communities load garbage onto barges and dump it out at sea. This method is harmful and must not be continued because it causes water pollution. Valuable fishing grounds near New York City have been destroyed by such pollution. Floating garbage has been seen near bathing beaches as well as many hundreds of miles from any shore. The oceans are not limitless. They too can become "dead seas" and thus remove a source of food for the humans. The oceans must be protected against pollution.

None of our present methods for the disposal of solid wastes is truly satisfactory. Other procedures must be developed. A completely different approach to solving this problem is to consider the solid wastes as valuable raw materials for the manufacture of new products. This is the basis of "recycling," which is simply the disposal of wastes by re-using them rather than attempting to destroy or hide them. The idea is far from new, but up to this time it has been applied only in a limited way with a few select waste materials. For example, new paper is manufactured from waste paper, glass makers include a certain percentage of old broken glass in their new glass, and some metals such as aluminum, copper and iron are salvaged for re-use. Projects 4-8, 4-9, 4-10 and 4-11 describe some of the techniques of recycling.

If we are to explore the possibilities for recycling, we should know something about the nature of the materials to be recycled. Since waste fabrics are already used in recycling, let us begin by examining the appearance and structure of some of these fabrics as in Project 4-8.

Paper is often made of fibers previously used in other paper or in cotton or linen cloth. Silk, wool and other fibers from discarded garments can also be recycled into new cloth once again. Thus, recycling waste materials avoids the solid pollution and air pollution that would result if the wastes were simply discarded and destroyed. In Project 4-9, we will make new paper from old. Then, we will extract lead from lead oxide in Project 4-10 and in Project 4-11 we will obtain pure copper from scrap copper.

## Project 4-8. How to Identify Different Kinds of Fibers Under a Microscope.

**You will need:** a microscope, a microscope illuminating lamp, prepared slides containing samples of cotton, wool, rayon, silk, nylon and other fibers, 7 clean slides with cover slips, forceps, medicine droppers, dissecting needles, water, stains (such as eosin, methylene blue or gentian violet), small pieces of cloth such as wool, silk, cotton, rayon, nylon and dacron, a piece of facial tissue paper, note paper and a pencil.

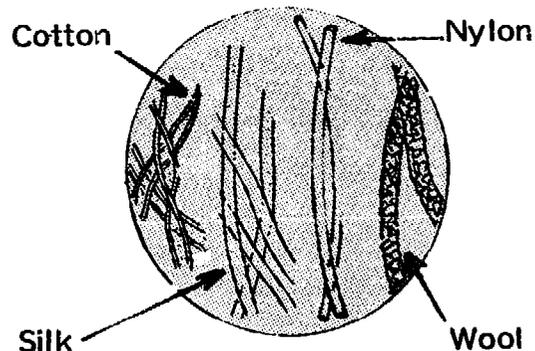
1. With the aid of the microscope illuminating lamp, examine the prepared slides of sample fibers under the microscope. Then, make drawings of the different kinds of fibers you examine. Your drawings may look somewhat like those in Fig. 4-10.

2. Carefully pull a few fibers from the piece of wool cloth with the dissecting needles and forceps. Put the fibers on a clean slide. With a clean medicine dropper, add a drop of water and a drop of stain. Cover the slide with a cover slip. Examine the fibers with the microscope and compare them to the wool fibers on the prepared slide. *Are they similar in appearance? Do they resemble your drawing of a wool fiber?*

3. Repeat Step 2 using each of the other pieces of cloth.

4. When you have become familiar with the microscopic appearance of the different kinds of fibers, you will be able to readily identify the fibers used in any piece of cloth.

5. Snip off some loose fibers from any piece of castoff wearing apparel and examine them under the



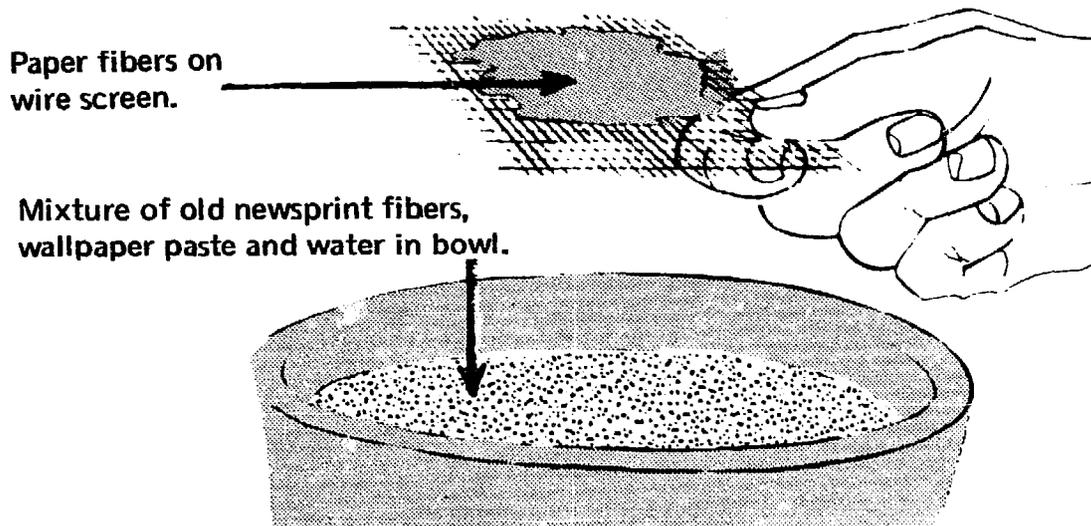
**Fig. 4-10. Typical Fibers Seen Under a Microscope.**

microscope. Then, compare what you see with your drawings of fibers. *Can you identify the fibers used in the castoff apparel?*

6. Prepare a slide of facial tissue paper. First, tear off a piece of paper smaller than a cover slip. Then, place the paper on a clean slide. With a clean medicine dropper, add a drop of water and a drop of stain. Examine the paper with the microscope. (Most paper, including facial tissue, is made of wood fibers which are quite similar to cotton fibers in appearance.) Under the microscope, the paper looks very much like a tangle of fibers running in every direction.

### Project 4-9. Recycling: How To Make New Paper From Old.

**You will need:** an old newspaper, an egg beater or electric mixer, a mixing bowl, a 3" square piece of window screen, a 3" square block of wood, a 3" square sheet of polyethylene plastic (this can be cut from a plastic bag), 2 heaping tablespoonfuls of wallpaper paste (or starch), water and a stirring rod.



**Fig. 4-11. Recycling: Making New Paper from Old.**

1. Tear one square foot of newspaper into small pieces. Put the pieces into bowl,  $\frac{1}{4}$ -full of water, and let them soak for at least one hour.

2. Beat the paper and water with eggbeater or electric mixer until the paper breaks apart into separate fibers and gives the water a creamy appearance. (There may be a good deal of spattering at this time, so work in a place that you can easily clean up.)

3. Now, dissolve two heaping tablespoonfuls of wallpaper paste (or starch) in a pint of water and add it to the water-and-paper fiber mixture in the mixing bowl. Stir well with the stirring rod.

4. Dip the piece of window screen into the mixture. Holding the piece of window screen horizontally, lift it out of the bowl as in Fig. 4-11. There should be a layer of fibers on the screen. Stir the contents of the

mixing bowl again and carefully repeat this step until the layer of fibers on the screen is at least  $\frac{1}{16}$ " thick.

5. Put the rest of the newspaper on a table, then place the window screen on the newspaper with the fibers facing upward. Put the sheet of plastic over the layer of fibers and the block of wood on top of the plastic. Squeeze down on the wooden block, gently at first, and then harder. Most of the water should be squeezed out of the fibers, through the screen and onto the newspaper underneath.

6. Allow the fibers to dry on the screen until the next day or until they are thoroughly dry. Then peel the paper from the screen. You have recycled waste paper! Paper mills recycle waste paper in a similar way to make cardboard, pasteboard or new paper.

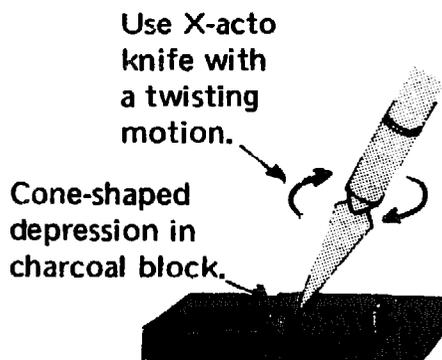
### Project 4-10. Recycling: Extracting Pure Lead From Lead Oxide.

**You will need:** red lead oxide, a charcoal block (a piece of ordinary charcoal will do), an X-acto knife, a brass blowpipe, a bunsen burner.

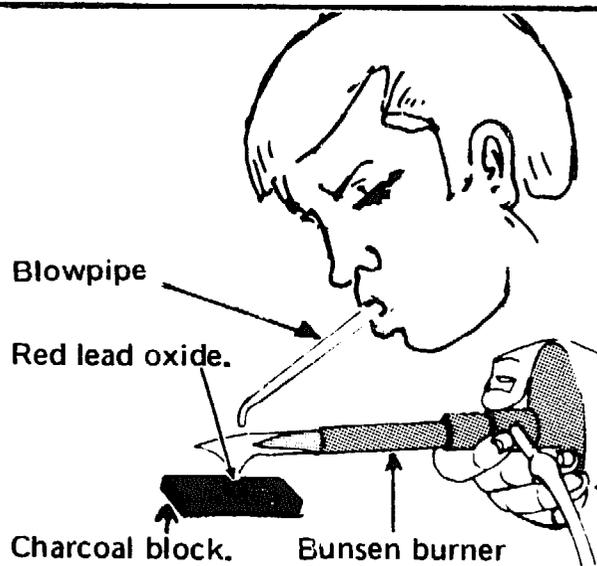
1. Make a cone-shaped depression about  $\frac{1}{4}$ " deep in the charcoal block using the X-acto knife with a twisting motion (see Fig. 4-12).

2. Fill the depression in the charcoal block with red lead oxide. Holding the bunsen burner and blowpipe as shown in Fig. 4-13, blow through the blowpipe so that the Bunsen burner flame is directed at the lead oxide. Do not blow hard enough to blow away the lead oxide powder. However, blow forcefully enough so that the flame makes the lead oxide and a small area of charcoal around it hot enough to glow.

3. Continue to blow until you see droplets of molten metal in the depression. Allow the charcoal block and its contents to become cool. The droplets of molten metal will cool and become metal spheres. Remove some of the metal spheres and try to cut them with the X-acto knife to test their hardness. You have just extracted pure lead from lead oxide! (A different kind of lead oxide can be salvaged from storage batteries.) *How did this happen?*

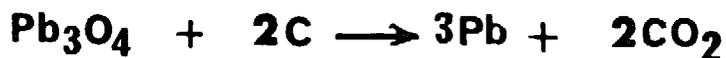


**Fig. 4-12. Cutting Cone-Shaped Depression in Charcoal Block.**



**Fig. 4-13. Recycling: Extracting Pure Lead from Lead Oxide**

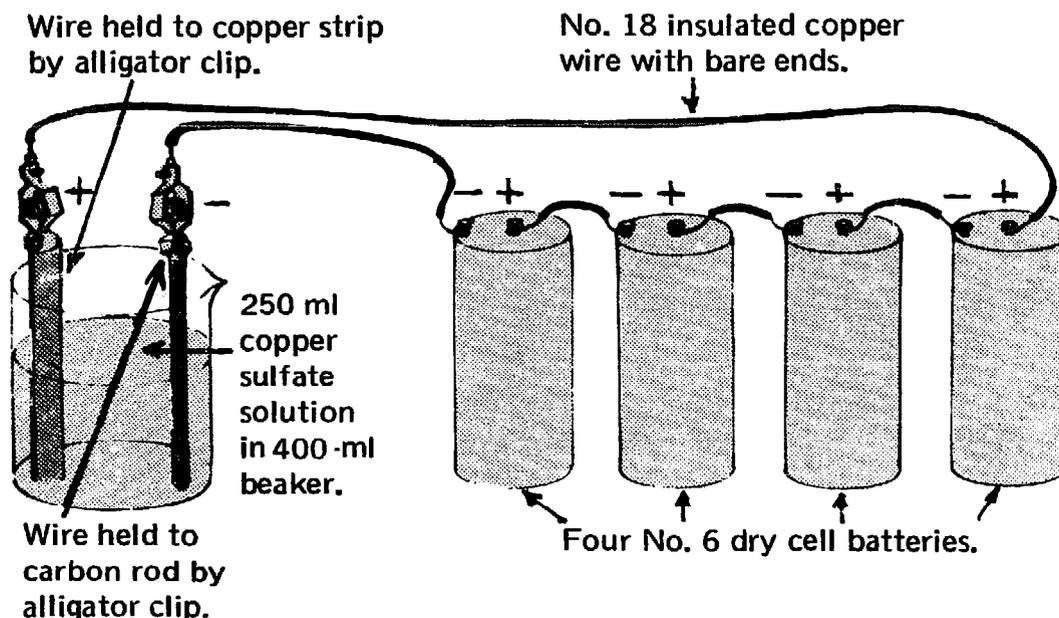
**Explanation:** Heating lead oxide with carbon reduces the lead oxide to metallic lead. At the same time, the carbon is oxidized to carbon dioxide. The equation for this reaction is as follows:



This kind of chemical reaction is often used to extract metals from their oxides. Lead, iron and most other metal become oxides when they corrode. When waste metals are recycled, they are usually heated with a form of charcoal (coke) in a process similar to the one in this project.

### Project 4-11. Recycling: How To Obtain Pure Copper From Scrap Copper by Electroplating.

**You will need:** a copper strip, a carbon rod (remove from old dry cell and clean with sandpaper), powdered copper sulfate ( $\text{CuSO}_4$ ), two 400-ml beakers, water, 6 feet of No. 18 insulated copper wire, 2 alligator clips, four size No. 6 dry cells, an X-acto knife, a 250-ml graduated cylinder, a balance with masses, a stirring rod and weighing paper.



**Fig. 4-14. Recycling: Purifying Copper by Electroplating.**

1. Assemble the apparatus as in Fig. 4-14. Then remove about 1" of insulation from the wire at each connection. Use the X-acto knife to cut through the insulation.

2. Using the graduated cylinder, measure 250 ml of water and pour it into the unused beaker. On weighing paper, measure a mass of 20 gm of copper sulfate with the balance. Pour the copper sulfate into the water in the beaker. Stir

with the stirring rod until the copper sulfate dissolves.

3. Pour the copper sulfate solution into the beaker being used as part of the apparatus assembled in Step 1. This will cause an electric current to begin flowing. Stop the flow of electricity after about 5 minutes by lifting the carbon rod out of the solution. Observe the carbon rod. Note that it is now coated with brownish copper.

4. Disconnect the apparatus and discard the copper sulfate solution.

**Explanation:** You have electroplated copper onto the carbon rod. When the current of electricity flows through the copper sulfate solution, copper comes out of the copper sulfate solution and is deposited as pure copper on the carbon rod. Meanwhile, copper goes into the copper

sulfate solution from the copper strip, keeping the concentration of the copper sulfate solution constant. Thus, copper goes from the copper strip to the copper sulfate solution and then to the carbon rod. The copper strip gradually becomes thinner, showing that the copper deposited on the carbon rod actually comes from the copper strip.

Electroplating is generally used commercially for refining and purifying impure copper. After impure waste copper has been melted and allowed to solidify as a preliminary part of the recycling process, it is then purified by electroplating.

---

A major goal in solving the pollution problem should be to make recycling universal, re-using all material whenever they have lost their original usefulness. However, a number of serious obstacles stand in the way. It is often less expensive to mine and refine new metals than to re-use junk metal. Other products, such as paper and cloth may also be cheaper when produced from virgin materials. The cost of collecting and processing junk may make it too expensive for industries to re-use as a raw material. That is one reason that so many old cars are left to rust instead of being salvaged for their large amounts of steel, copper and other metals. (See photo Fig. 4-15.)

But, there is only a limited amount of raw materials in the world, and it is growing less every day. Perhaps, when new materials become much scarcer and more expensive than they are now, it will be cheaper to recycle the refuse than to obtain new materials. When the time comes that the entire underground supply of certain raw metals and minerals has been used up, recycling may be the only way of obtaining those substances.

If more waste materials are to be recycled, new and more economical methods must replace those used at present to recycle a few select substances, such as steel and paper. New methods must be developed for separating each kind of substance in the refuse. These would include paper, glass, wood, various plastics, bones, meat, fat, vegetables, plaster, brick, all kinds of metals and minerals. After the materials are separated, they can be refined and used once again.

Recycling of all wastes will considerably reduce, if not eliminate, the problem of waste disposal. Moreover, it will reduce pollution of air and water, and eliminate solid pollution.



**Fig. 4-15. Discarded Cars. (Photo courtesy of Bell Telephone Magazine.)**

### **How Pollution Has Already Been Reduced**

Pollution is threatening our civilization. As the world's population grows larger and as our technology – the machines and methods we use – becomes more complicated, we produce an increasing amount of pollution. Many scientists feel that pollution might become so bad that man could not continue to exist. We must not let that happen and we will not let it happen. **Pollution can be controlled and reduced.**

For the past few years, governments, industries and some of the general public have been fighting pollution. These efforts have indeed decreased pollution in many communities. Now the air over London is much less polluted than it was previously. Up to 20 years ago, London homes were heated by burning soft coal in open fireplaces. As a result, sulfur dioxide and solid particles poured into the atmosphere. Now, London homes have central heating systems burning oil in closed furnaces. The result is much less pollution

because the oil contains less sulfur than soft coal, it also produces considerably smaller amounts of solid particles, and the burning is more complete in a furnace than in a fireplace. Air pollution in Los Angeles has also decreased in recent years. There, some benefit has resulted from local regulations requiring improvements in the ways that automobile engines burn gasoline. But, the greatest decrease in air pollution was brought about by a law prohibiting burning garbage in open back-yard incinerators. At one time, over a million back-yard incinerators in Los Angeles poured dangerous, foul smelling pollutants into the air. Prohibiting the operation of these incinerators was a most important step in the fight against pollution.

The problem of water pollution was also attacked vigorously. The Suffolk County water supply in New York State had become so badly contaminated that detergent foam flowed from faucets along with the water. To solve this problem, the Suffolk County authorities banned the sale of all detergents (except those used in automatic dishwashers). Drilling of offshore oil wells and shipping oil in tankers are now regulated by Federal laws designed to prevent the kinds of oil spillages that have killed so much sea life and spoiled so many beaches. Factories are being fined as much as \$10,000 per day for releasing pollutants into rivers, lakes and bays. With such vigorous action, we should begin to make progress in our fight against pollution. Each person, however, must help in some way to control pollution.

### **How You Can Help Reduce Air Pollution**

Here are some ways in which you, personally, can help reduce air pollution:

1. Don't burn anything (leaves, rubbish and fuel for barbecues) outdoors; discourage others from doing so.
2. Have the furnace at home tested to make certain that it is working properly. The company supplying fuel may make the test without charging a fee.
3. If you or some member of your family drive a car, have a mechanic check it to determine whether it is producing too much carbon monoxide and hydrocarbons. Frequently, a minor adjustment will reduce the output of carbon monoxide or unburned hydrocarbons that the engine gives off. Sometimes, the spark plugs, distributor points or other parts should be replaced to further reduce pollution.

4. Decreasing the total amount of driving reduces air pollution. When two people travel in the same car instead of using individual cars, the amount of pollution has been cut at least in half. A car pool, involving four or five people, is even more effective. Sharing a car means fewer cars on the roads, less traffic congestion and all the cars can move faster. A rapidly moving car produces much less pollution per mile than a car moving slowly or idling.

5. Use gasoline that does not contain lead. If you don't drive, try to convince others to use gasoline without lead.

6. Jack-rabbit starts and "panic" stops quickly wear rubber off the tires, asbestos off the brakes and concrete or asphalt off the road. All these materials add to air pollution. A driver should avoid accelerating or stopping suddenly.

7. You can help your local pollution control agency by reporting sources of pollution. Dark smoke pouring from a chimney is an evidence of pollution, as is a strong odor of any sort.

### **How You Can Help Reduce Water Pollution**

The control of water pollution is, generally, a problem that either a government agency or a large industrial establishment must handle. One individual person cannot do much to improve the disposal of sewage or industrial wastes, other than by locating the source of pollution and making the community aware of it. You can, however, help reduce water pollution in certain important ways. Here are some suggestions:

1. Use detergents that contain the lowest percentages of phosphates. Low phosphate detergents help to lessen the problem of algae growth in rivers and lakes.

2. Do not throw any kind of waste material, liquid or solid, into rivers, lakes or other bodies of water. Aside from detracting from the appearance of the water, any kind of refuse may pollute the water by decaying, rusting or rotting.

3. Motorboats pollute the water of lakes and bays with the exhaust and oil leakage from their gasoline engines. An electric motor will prevent such pollution. Oars, paddles or sails to propel a boat are even better and — you also benefit from the exercise. The trip may be slower, but you will probably find it to be more fun.

## **How You Can Help Reduce Solid Pollution**

Here are some suggestions for reducing solid pollution:

1. Buy soft drinks in deposit bottles that you can return to the store.
2. Buy canned goods in "tin" cans, which are made of tin-plated steel that rusts and crumbles.
3. If some of the foods and drinks are in aluminum cans (they do not rust and crumble), flatten and save the cans; give them to an organization that will sell them back to the aluminum manufacturer.
4. Save old newspapers and magazines to sell to junkmen. This cuts down on solid pollution and allows the paper to be recycled and used once again.
5. Above all, do not litter. Bottles, cans and paper which are scattered about are the worst form of solid pollution. It is much simpler to cope with solid pollutants when they are gathered together neatly. This prevents them from polluting large areas.

### **Conclusion — But Only the Beginning**

We have investigated several of the many aspects of air, water and solid pollution. We have learned to locate, identify and measure different forms of pollution. We have learned something about the acceptable or "safe" levels of pollutants. In a word, we now have acquired some of the "know-how" to combat this menace in our community. This is the first step, and for us, a most important beginning. Now, we can help provide the community with data they will need to spark a campaign to get rid of or to restrict local pollution sources.

Having recognized and been made aware of the seriousness of this problem, we may wonder why so few people in our community are involved in attempting to solve it. The solution is complex. Some of the necessary changes may require moving complete industries from our community, resulting in unemployment, which in turn may force some residents to move from the community. Changing or restricting the electrical power sources may bring about increased rates for electrical power and possibly higher taxes, or less power for consumer use. It will be necessary to redesign automobile engines and change automobile fuels. There may be a need to relocate airports and heavy traffic arteries. The government may, for one

reason or another, be unable to put together effective legislation rapidly enough to remove already existing pollution.

The environment young people have inherited is markedly unhealthier than that of the older generation. Although this condition originated and evolved long before the new generation came upon the scene, nevertheless, the problem remains and affects us all. Where does the solution really lie? Any concerned scientist will not merely do scientific investigations in the laboratory and field. He will also seek the social and economic causes of the pollution dilemma. While an understanding of the social and economic factors is not the goal of this book, these two factors are a vital part of the solution. Young people should investigate the social and economic practices which are the main causes of pollution. Armed with this knowledge, young people might then feel that they must become part of the community struggle against pollution because the future world is *their* world, one in which *they* must live.

## **Test Your Knowledge of Pollution**

The following questions can serve to test your understanding of the problems of pollution. How many of them can you answer?

### **Chapter 1**

1. How is emphysema caused?
2. Why is it difficult for a victim of emphysema to obtain all the oxygen he needs?
3. How is bronchitis related to emphysema?
4. How do parts of your respiratory system prevent pollutants from entering your alveoli?
5. How does the normal action of respiratory cilia help maintain the health of the respiratory system?
6. How do air pollutants affect the action of respiratory cilia?
7. What are some ways in which sulfur dioxide harms living organisms?
8. Why are maximum breath pressure and vital capacity important indicators of the health of the respiratory system?
9. How can you make a set of serial dilutions of sulfurous acid?

### **Chapter 2**

1. What are some important characteristics of sulfur dioxide?
2. How can sulfur dioxide be identified chemically?
3. What can a photometer be used to measure?
4. Why is it possible to use rubber bands to measure the concentration of ozone in the air?
5. Why might an increase in carbon dioxide concentration cause a large rise in the sea level?
6. What is the main way that carbon monoxide damages a person's health?

7. What is the difference between *visibility* and *ceiling*? Why are both important to us?
8. How does a temperature inversion differ from a normal vertical temperature distribution?
9. Why is ozone considered to be both helpful and harmful?

### Chapter 3

1. How does a heavy growth of algae decrease the concentration of oxygen in a lake?
2. What is the main way that detergents make lakes and rivers more turbid?
3. How are aquatic animals affected by thermal pollution?
4. What harm may be done by excess salts in fresh water?
5. What are some ways that excess salts may get into drinking water?
6. How does turbidity affect the depth to which you can see through water?
7. What are the chemical elements that are included in a complete nutrient solution for algae?
8. How does a *biodegradable* detergent differ from a *persistent* detergent?
9. How can an oil spill reduce the concentration of oxygen in water?
10. Why is petroleum oil sometimes purposely poured into the ocean from tankers?

### Chapter 4

1. The solid pollution produced by a typical family includes glass, paper, food scraps, aluminum cans, tin cans, fabrics and plastics. Which can be burned?
2. How do bacteria and fungi help in the disposal of solid wastes?

3. What are some dangers that may be caused by the bacteria and fungi that help dispose of solid wastes?
4. What are some of the advantages and disadvantages of disposing of solid wastes by burning them?
5. Why may aluminum cans cause more waste disposal problems than tin cans?
6. What are the advantages of recycling wastes rather than disposing of them in other ways?
7. What are some problems that may make recycling difficult or impractical?
8. How is pure lead formed when lead oxide reacts with carbon?
9. What are some of the advantages and disadvantages of using sanitary landfills for waste disposal?
10. What can you personally do to help solve the problems of pollution?
11. Why is it important to cooperate with organizations that are attempting to reduce the pollution problem?
12. What are the names and addresses of organizations in your community which are attempting to solve the problems of pollution?
13. How can you help the local antipollution organizations in their fight against pollution? What kind of data on pollution can you gather that would be of help to these organizations?
14. In our efforts to reduce pollution, what is the comparative worth of these two procedures: (1) to gather all litter and clean up your local community and (2) compel large industrial organizations to employ methods that will decrease the amount of pollution they produce?

## Bibliography

For the reader who wishes to explore the problems of pollution in greater depth, the following books are suggested. This is not a complete list of books by any means. Nevertheless it will serve as an introduction to the available material on this subject.

Aylesworth, Thomas.

"Our Polluted World." American Education Publications, Education Center, Columbus, Ohio 43216.

Battan, Louis.

"The Unclean Sky." Doubleday and Co., Inc., Garden City, New York 11530.

Commoner, B.

"Science and Survival." The Viking Press, Inc., 625 Madison Ave., New York City 10022.

Corman, Rena.

"Air Pollution Primer." National Tuberculosis and Respiratory Disease Association, 1740 Broadway, New York City 10019.

De Bell, Garrett.

"The Environmental Handbook." Ballantine Books, Inc., 101 Fifth Ave., New York City 10003.

Dubos, René.

"So Human an Animal." Charles Scribner's Sons, 597 Fifth Ave., New York City 10017.

Ehrlich, Paul.

"The Population Bomb." Ballantine Books, Inc., 101 Fifth Ave., New York City 10003.

Esposito, John.

"Vanishing Air." Grossman Publishers, Inc., 125A East 19th St., New York City 10003.

Kormondy, E.

"Concepts of Ecology." Prentice-Hall, Inc., Englewood Cliffs, New Jersey 07632.

Lewis, Alfred.

"Clean the Air." McGraw-Hill, Inc., 330 West 42nd St., New York City 10036.

Marx, W.

"The Frail Ocean." Ballantine Books, inc., 101 Fifth Ave., New York City 10003.

Odum, E.

"Ecology." Holt, Rinehart & Winston, Inc., 383 Madison Ave., New York City 10017.

United Steelworkers of America.

"Poison in Our Air." United Steelworkers of America, 1001 Connecticut Ave., N.W., Washington, D.C. 20036.

Weaver, Elbert.

"Environmental Pollution." Holt, Rinehart and Winston, Inc., 383 Madison Ave., New York City 10017.

The reader will find the following books helpful for learning laboratory techniques in connection with performing the investigations offered by "Antipollution Lab."

Berman, William.

"Experimental Biology." Sentinel Books Publishers, Inc., 17-21 East 22nd St., New York City 10010.

Berman, William.

"Beginning Biochemistry." Sentinel Books Publishers, Inc.

Johnson and Bleifeld.

"Hunting with the Microscope." Sentinel Books Publishers, Inc.

Feifer, Nathan.

"Let's Explore Chemistry." Sentinel Books Publishers, Inc.

### **Periodicals**

If you wish to keep up with new material that is constantly being published on pollution, ecology and the environment, following are some of the periodicals that offer articles on these subjects:

**"Audubon."** National Audubon Society, 1130 Fifth Ave., New York City 10028.

**"Eco-News."** Environmental Action Coalition, 235 East 49th St., New York City 10017.

**"Environmental News."** Environmental Protection Agency, 1129 20th St., N.W., Washington, D.C. 20013.

**"Natural History."** The American Museum of Natural History, Central Park West and 79th St., New York City 10024.

**"Right Now."** Sierra Club Atlantic Chapter, 250 West 57th St., New York City 10019.

**"Scientific American."** Scientific American, 415 Madison Ave., New York City 10017.

## **Organizations Engaged in Combatting Pollution**

For the antipollution activist, following are some of the many groups that battle against pollution. If you want to become part of this movement, you may wish to write to the one nearest you.

American Camping Association, Inc., Bradford Woods, Martinsville, Indiana 46151.

American Forest Institute, 1835 K St., N.W., Washington, D.C. 20006.

American Forestry Association, 919 17th St., N.W., Washington, D.C. 20006.

Appalachian Mountain Club, 5 Joy St., Boston, Massachusetts 02108.

American Museum of Natural History, Central Park West at 79th St., New York City 10024.

Boy Scouts of America, 25 West 43rd St., New York City 10036.

Camp Fire Club of America, 19 Rector St., New York City 10006.

Conservation Foundation, 1717 Massachusetts Ave., N.W., Washington, D.C. 20036.

Environmental Action, Inc., 2000 P St., N.W., Washington, D.C. 20036.

Environmental Protection Agency, 1129 20th St., N.W., Washington, D.C. 20013.

Friends of the Earth, 30 East 42nd St., New York City 10017.

Garden Club of America, 598 Madison Ave., New York City 10022.

Girl Scouts of the U.S.A., 830 Third Ave., New York City 10022.

Izaak Walton League of America, 1326 Waukegan Rd., Glenview, Illinois 60025.

League of Women Voters of the U.S., 1730 M St.,  
N.W., Washington, D.C. 20036.

Muir Institute for Environmental Studies, 451  
Pacific Ave., San Francisco, California 94133.

National Audubon Society, 1130 Fifth Ave., New  
York City 10028.

National Museum of Natural History, Smithsonian  
Institution, 1000 Jefferson Dr., S.W., Washington,  
D.C. 20560.

National Parks Association, 1701 18th St., N.W.,  
Washington, D.C. 20009.

National Wildlife Federation, 1412 16th St., N.W.,  
Washington, D.C. 20036.

Nature Conservancy, 1522 K St., N.W.,  
Washington, D.C. 20005.

Scientists' Institute for Public Information, 30 East  
68th St., New York City 10021.

Sierra Club, 1050 Mills Tower, San Francisco,  
California 94104.

Student Conservation Association, Inc., Olympic  
View Dr., Route 1, Box 573A, Vashon,  
Washington 98070.

Wilderness Society, 729 15th St., N.W.,  
Washington, D.C. 20005.

World Health Organization, Palais des Nations,  
Geneva, Switzerland.

## Index

- Air pollution, 13-67, 101, 103  
  from natural sources, 22  
  its effect on age groups, 14-15  
  its effect on cilia, 22-23  
  its effect on living things, 26  
  its effect on localities, 18, 44  
  its effect on lungs, 13-14, 23, 26  
  its effect on plants, 26  
Air pump, 36-37, 60  
Algae, 68-69, 72, 74, 78, 92, 115  
  its effect on aquatic life, 74-75  
  its effect on plant life, 74-75  
  its effect on water, 68-69, 74, 115  
  its growth rate, 76-79, 88  
Allergies, 18  
Alveoli, 12-13, 23  
Ammeter, 42-43, 50, 52, 71-72,  
  77, 87, 89, 91  
Aquarium tank, 42-43, 55-56  
Asbestos, 40, 52  
Asthma, 18-19  
Atomic Mass Units (AMU), 38-39  
Automobile pollution, 13-40, 46-47,  
  56-57, 63-64
- Bacteria, 74, 98-99  
Balance scale with masses 24, 27, 29,  
  34, 60, 73, 101, 105, 111  
Barium chloride, 34-36  
Barometric pressure, 49  
Battery jar, 36-37  
Beakers, 24-25, 27, 29-30, 34, 50-51,  
  60, 73, 76, 111  
Bibliography, 121-122  
Bioassay, 26-27, 29  
Biodegradable detergents, 79-80  
Blowpipe (brass), 110  
Bottles (glass), 24, 27, 34, 60  
Bottles with stoppers, 27, 29, 76, 60  
Brackish water, 88  
Breath pressure (maximum), 19-21  
  effect of age on, 20-21  
  effect of community on, 22  
  measuring, 20  
Brine shrimp, 26-27, 29-30  
  preparing hatching solution for, 27  
Bronchi (bronchial tubes), 12-13
- Bronchioles, 12-13, 18-19, 22-23  
Bronchitis, 19, 25
- Calcium chloride, 23, 25  
  preparing solution of, 24  
Calcium hydroxide, 60-62  
  preparing solution of, 60  
Calcium sulfate, 76-78  
Capillaries, 14  
Carbon dioxide, 57-58, 62  
  dangers of, 58-59, 64  
  measuring, 60, 62, 103  
  usefulness of, 57-58  
Carbon monoxide, 62-65, 114  
  measuring 63-65  
Carbonic acid, 57  
Ceiling, 66  
  measuring, 67  
Chemical analysis, 33, 45, 62  
Chemical pollutants, 19, 23, 40, 45,  
  103  
Chimney smoke pollution, 25, 39-40,  
  46, 58  
Cigarette smoking, 23  
Cilia, 22-23  
  action of the, 23  
  effect of chemicals on, 25  
Clam (anatomy of), 25  
Clay triangle, 101  
Collecting jars, 73  
Copper sulfate (powdered), 111  
Crucible (porcelain), 101  
  cover for, 101
- Detergent pollution, 75, 79-80, 114  
  measuring, 80-85  
Dipotassium hydrogen phosphate,  
  76, 78  
Dissecting needles, 108
- Electrical thermometer, 49  
  how to make an, 50  
  how to use an, 50, 87  
Electroplating, 111-112  
Emphysema, 13-14, 19, 23  
Erlenmeyer flask, 103

- Fall-out, 40, 43, 45
  - collecting, 41, 43-44
  - measuring, 41-44
- Filter paper, 73
- Flasks (glass), 20, 36, 60
- Florence flask, 34-35, 37
- "Foaming rivers," 79-80
- Fog, 13
- Forceps, 25, 44, 108
- Formaldehyde, 57
- Fungus, 99
  
- Garbage dumps, 97-101
  - dangers of, 98-100
  - disease hazards of, 99-100
  - burning in, 100-102
- Glass tubing, 15, 20, 34, 36, 60, 103
  - cutting, 15
  - fire polishing, 15
  - inserting, 15-16
- Graduated cylinders, 15-17, 24-25, 24-30, 34, 36-37, 60, 73, 76, 80, 84, 111
- Gram mass, 31, 38-39
  
- Hemoglobin, 62-63
- "Hothouse" effect, 58-59
- Hydrocarbons, 57-58, 114
- Hydrochloric acid (dilute), 33-34,
  
- Incinerator pollution,
  - 40, 101-103, 107, 114
  
- Lakes ("Dead"), 68
- Lead oxide, 40, 52, 110
- Lens paper, 44, 76, 78
- Liter, 32
- Litmus paper, 34
- Littering, 96-97
- Litz wire, 50-52, 71, 87
- Lung, 12-14, 18, 23
- Lung allergy, 18
- Lung cancer, 40
- Lung damage, 14, 40, 44
- Lung power, 20
  
- Magic markers, 67, 70-71, 87
- Magnesium sulfate, 76, 78
  
- Manganous sulfate, 33
- Medicine droppers, 25, 27, 30, 60, 76, 78, 108
- Methylene blue, 25, 108
- Microscope, 25, 44, 76, 78, 108
  - cover slips, 44, 76, 78, 108
  - illuminating lamp, 108
  - slides, 44, 76, 78, 108
- Milliliter, 24, 62
  
- Nitric oxide, 52, 57
- Nitrogen dioxide, 57
- Noise pollution, 11
- Nutrient solutions, 76-78
  - for growing algae, 75-79
  
- Ocean dumping, 107
  - effect on beaches, 107
  - effect on fishing grounds, 107
- Oil pollution, 91-93, 114
  - effect on beaches, 91
  - effect on fish, 92
  - effect on plants, 92-93
  - effect on wildlife, 92
- Organizations against pollution, 124-125
- Oxygen, 14-23, 25, 31, 53, 55-57, 62-63, 74-75
- Oxygen atom, 57
- Ozone, 53-57
  - concentrations of, 53-55, 57
  - detecting, 55
  - how it forms, 57
  
- Peracetyl nitrates, 57
- Periodicals on pollution, 123
- Petri dish, 99
- Phenolphthalein, 60-62
- Phosphate pollution, 75, 79, 88
  
- Photochemical smog, 57-58
- Photoconductive cell, 42, 71-72, 77
- Photometer, 41-43, 50, 71, 76
- Photosynthesis, 57
- Pipette, 34, 36, 60, 76, 79-82, 84
- Pneumonia, 25
- Poisonous pollutants, 13, 26
- Polar ice caps, 58-59

- Potassium chloride, 23, 25  
 preparing solution of, 24
- Potassium nitrate, 76, 78  
 preparing solution of, 76
- Potassium permanganate, 33-34, 36, 38  
 preparing solution of, 34
- Potassium sulfate, 34
- Potentiometer, 42, 77, 90-91
- Questions to test your knowledge of  
 pollution, 118-120
- Rats, 98, 100
- Recycling, 40, 104-105, 107,  
 109-112,  
 disadvantages of, 112  
 techniques of, 109-112
- Reducing pollution, 113-116
- Respiratory ailments, 19
- Respiratory system, 22-23
- Ring clamp, 103
- Ring stand, 20, 103, 106
- Ringer's solution, 23, 25
- Rubber stoppers, 15, 20, 34, 36,  
 60, 80-82, 84, 103
- Salinity meter, 89-91  
 how to calibrate a, 89-91  
 how to make a, 89
- Salt pollution, 88  
 effect on fish, 88  
 effect on fresh water, 88  
 effect on plants, 88  
 salinity tests, 88-89
- Sanitary landfills, 96, 103-104  
 disadvantages, 103-104
- Serial dilutions, 27, 29, 32, 81-83,  
 85
- Smog, 13, 18, 25-26, 45-56, 49
- Sodium chloride, 89-91
- Solid pollution, 94-112  
 bacteria, fungi and, 99  
 burning and, 101, 103  
 how to determine, 94-96, 99  
 rate of disintegration and, 104-106  
 unburnable solids and, 94-96,  
 103, 105
- Spring balance, 95, 97
- Stirring rod, 24, 29-30, 34, 60, 76,  
 89-91, 109, 111
- Stomates, 26
- Sulfur, 25, 31-33
- Sulfur dioxide, 22, 25-26, 30-40, 113  
 measuring, 36-38, 103
- Sulfur (powdered), 34
- Sulfuric acid, 33
- Sulfurous acid, 26, 29, 32  
 serial solution of, 29-31
- Sun lamp, 55-56
- Temperature inversion, 45-49,  
 52-53, 55
- Test tube, 33-34, 80-82, 84  
 brush, 99  
 rack, 34, 80, 82, 84
- Thermal pollution, 86  
 effect on aquatic life, 86  
 testing for, 87  
 tracking down, 86
- Thermistor, 50-51, 87
- Thermometer, 50-51
- Trachea, 12-13
- Tripod, 34-35, 101
- Tubing clamps, 34
- Turbidity index, 71-72, 77-78
- Ultraviolet lamp, 55
- Ultraviolet radiation, 53
- Visibility, 65-66  
 measuring, 66
- Vital capacity, 14-19  
 how age affects, 17-18, 21  
 how height affects, 17  
 how localities affect, 18-19
- Watch glass, 25
- Water pollution, 68-89  
 effect on bodies of water, 68, 72  
 effect on fish, 68, 72  
 effect on humans, 69, 72  
 effect on plant life, 68, 72  
 how to detect, 70, 72  
 how to measure, 72-73
- Water turbidity, 70-71  
 measuring, 70-72



**ANTIPOLLUTION LAB** provides young people with the "know-how" to begin approaching the problem of pollution scientifically. Dr. René Dubos, of Rockefeller University says, "The great merit of Elliott Blaustein's book is to demonstrate that we can use simple and practical techniques to detect pollutants as well as their effects on the body, and also to develop programs which will once more render our environment healthy and pleasurable."



**The author, Elliott H. Blaustein, is active in pollution research. He has taught science in New York City Schools and he has lectured at Brooklyn College.**

*Printed in U.S.A.*

668-03234-0