



This is a digital copy of a book that was preserved for generations on library shelves before it was carefully scanned by Google as part of a project to make the world's books discoverable online.

It has survived long enough for the copyright to expire and the book to enter the public domain. A public domain book is one that was never subject to copyright or whose legal copyright term has expired. Whether a book is in the public domain may vary country to country. Public domain books are our gateways to the past, representing a wealth of history, culture and knowledge that's often difficult to discover.

Marks, notations and other marginalia present in the original volume will appear in this file - a reminder of this book's long journey from the publisher to a library and finally to you.

Usage guidelines

Google is proud to partner with libraries to digitize public domain materials and make them widely accessible. Public domain books belong to the public and we are merely their custodians. Nevertheless, this work is expensive, so in order to keep providing this resource, we have taken steps to prevent abuse by commercial parties, including placing technical restrictions on automated querying.

We also ask that you:

- + *Make non-commercial use of the files* We designed Google Book Search for use by individuals, and we request that you use these files for personal, non-commercial purposes.
- + *Refrain from automated querying* Do not send automated queries of any sort to Google's system: If you are conducting research on machine translation, optical character recognition or other areas where access to a large amount of text is helpful, please contact us. We encourage the use of public domain materials for these purposes and may be able to help.
- + *Maintain attribution* The Google "watermark" you see on each file is essential for informing people about this project and helping them find additional materials through Google Book Search. Please do not remove it.
- + *Keep it legal* Whatever your use, remember that you are responsible for ensuring that what you are doing is legal. Do not assume that just because we believe a book is in the public domain for users in the United States, that the work is also in the public domain for users in other countries. Whether a book is still in copyright varies from country to country, and we can't offer guidance on whether any specific use of any specific book is allowed. Please do not assume that a book's appearance in Google Book Search means it can be used in any manner anywhere in the world. Copyright infringement liability can be quite severe.

About Google Book Search

Google's mission is to organize the world's information and to make it universally accessible and useful. Google Book Search helps readers discover the world's books while helping authors and publishers reach new audiences. You can search through the full text of this book on the web at <http://books.google.com/>

NYPL RESEARCH LIBRARIES



3 3433 00672936 6

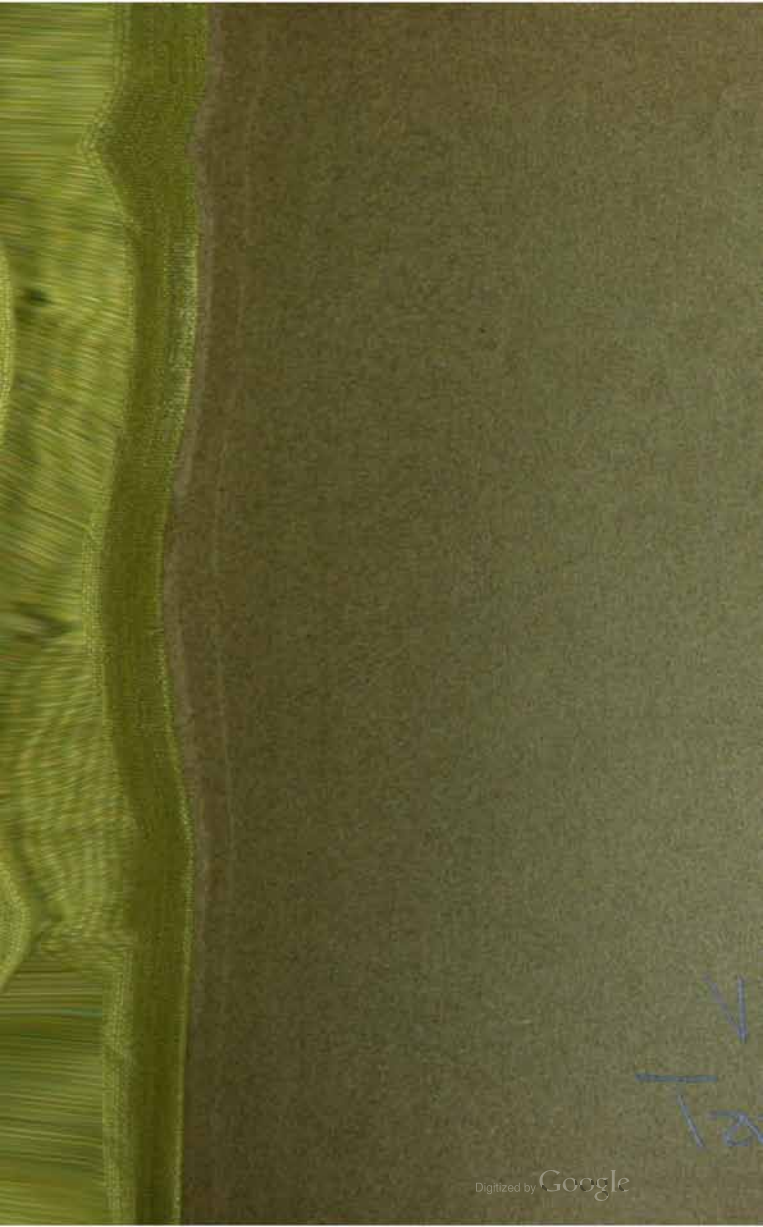

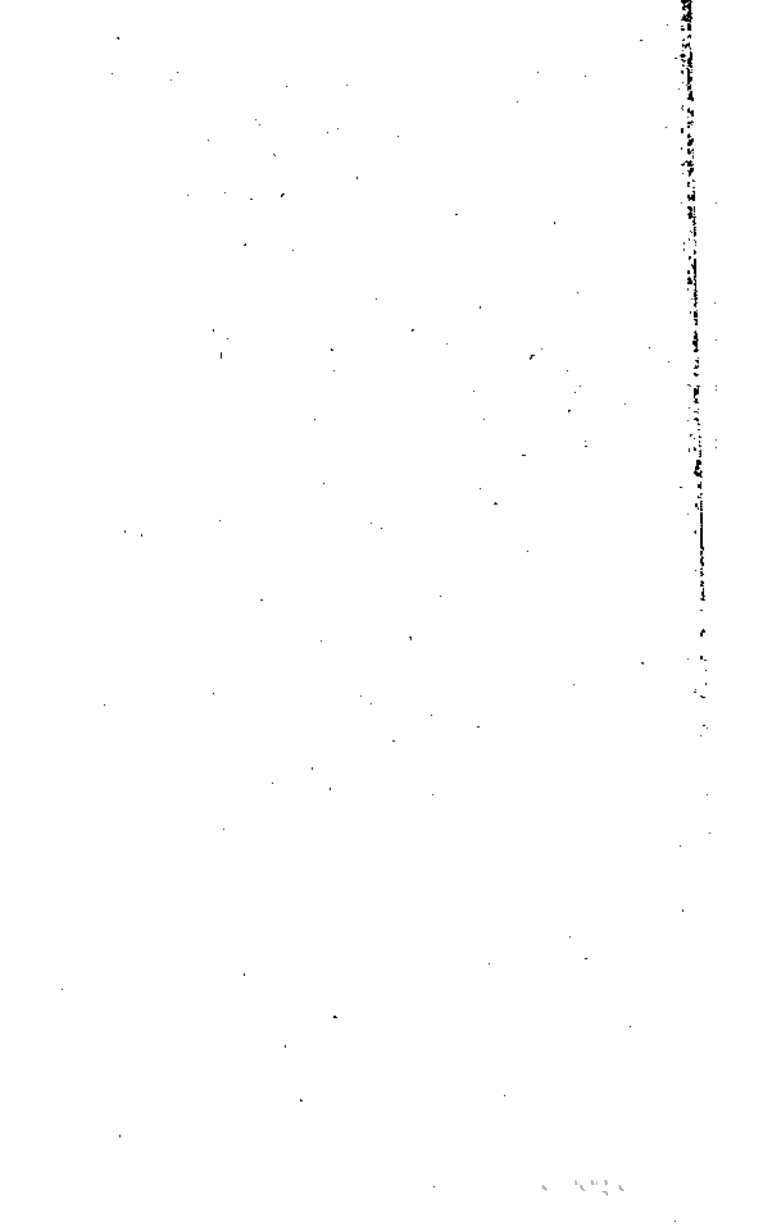

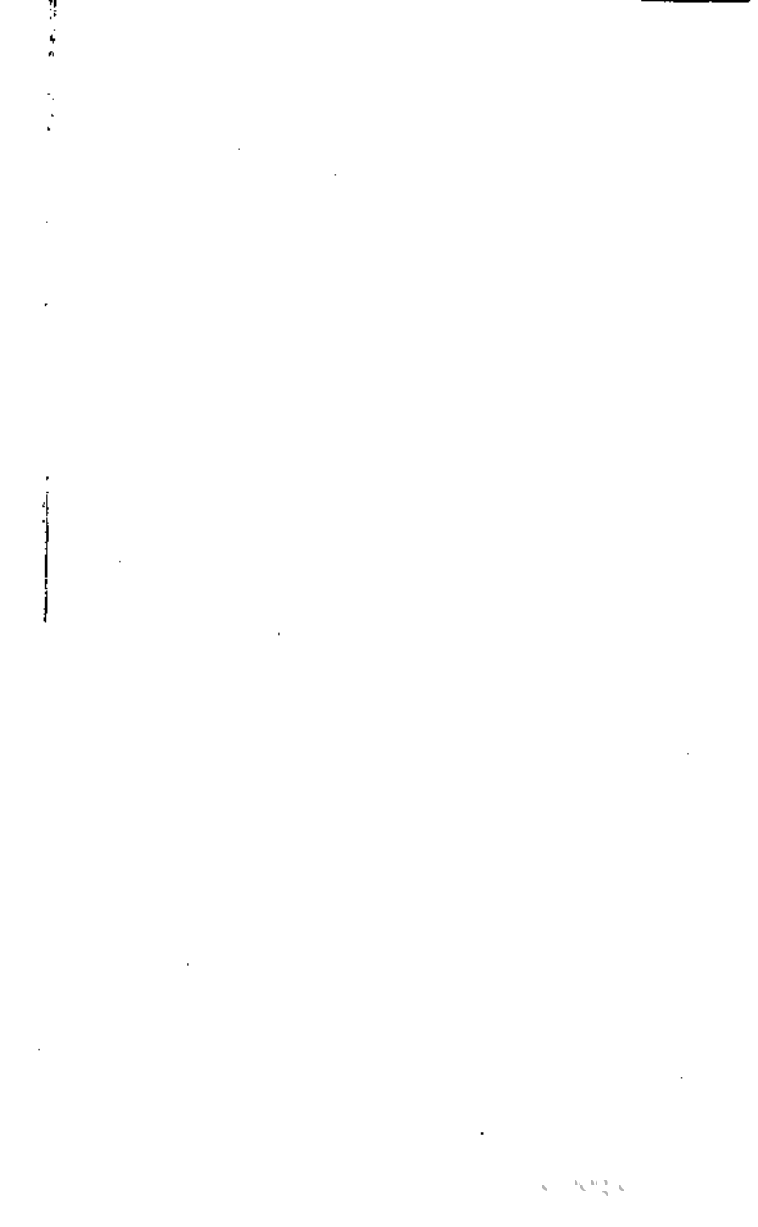

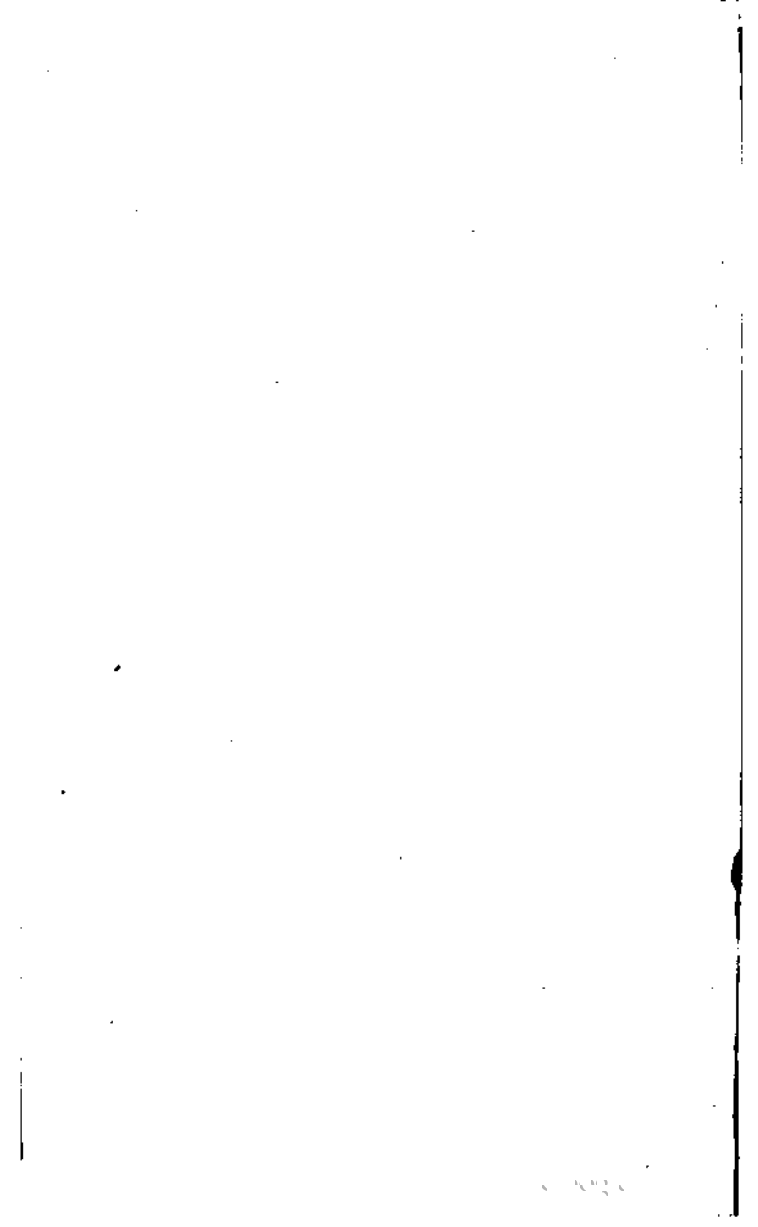

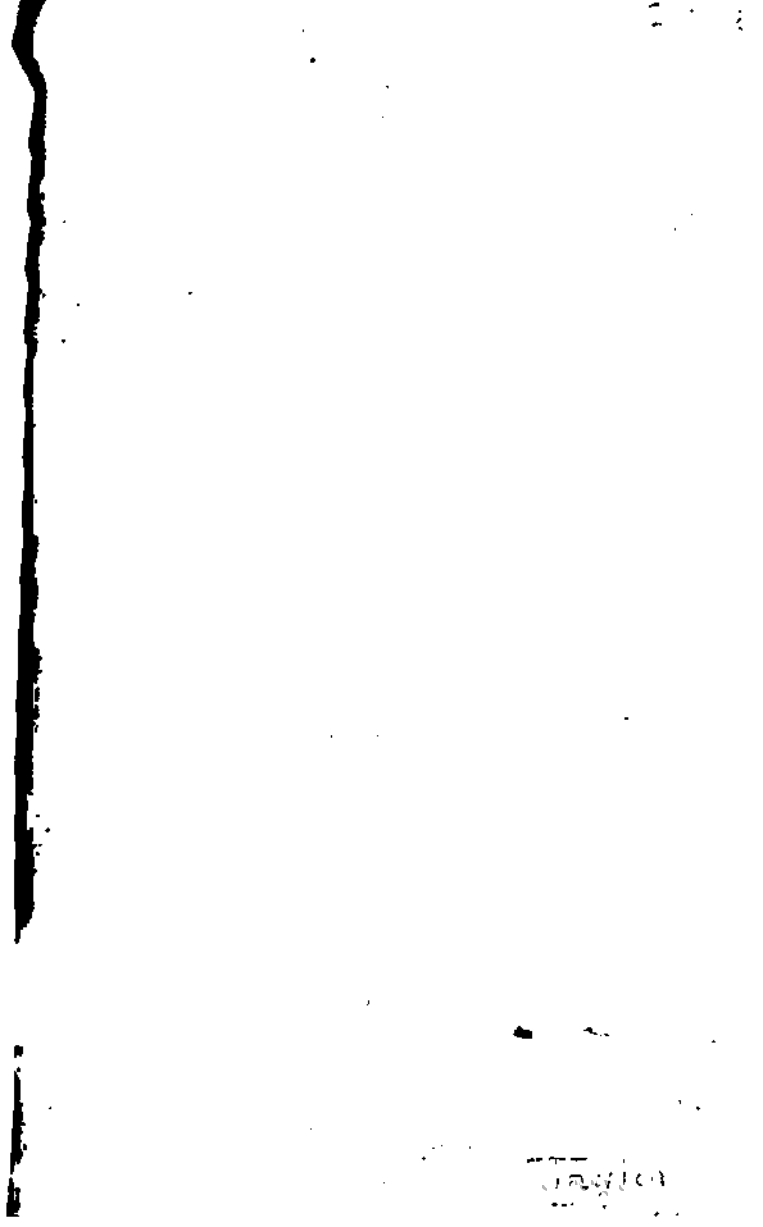



HANDBOOK
FOR
RANGERS & WOODSMEN

***BY**
JAY L. B. TAYLOR
FOREST RANGER
UNITED STATES FOREST SERVICE

FIRST EDITION
FIRST THOUSAND

NEW YORK
JOHN WILEY & SONS, INC.
LONDON: CHAPMAN & HALL, LIMITED

1917

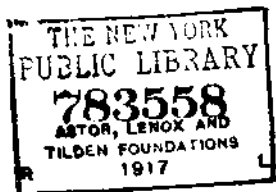

Copyright, 1916, by

JAY E. B. TAYLOR

PREFACE

(1) *Object.*—The object of this volume is to serve as a guide for inexperienced men in woods work. While in its preparation, the author had primarily in mind the problems which confront a forest ranger, in Government, State, or private employ, and especially rangers on National Forests, yet the suggestions offered may be of use to others whose work or recreation takes them into rough and unsettled regions. The book is not intended and should not be considered in any way as an official or even a semi-official publication the use of which is obligatory upon National Forest Rangers. It has been prepared, however, by permission of the Secretary of Agriculture, whose criticisms have been carefully considered and at whose request certain revisions have been made, and is strictly in the nature of a private publication prepared after eight years of experience in field work of the United States Forest Service.

It is not placed before the public with any intention or desire on the part of the author to insist that opinions of inexperienced persons must coincide with the ones expressed here before satisfactory results may be obtained. On the contrary, the absolute necessity for exercising ingenuity and originality of thought, in so far as this is practicable, is thoroughly appreciated and is suggested as the most effective means of extrication from all difficulties encountered, especially those the solution of which cannot be touched upon here.

(2) *Brevity.*—Recognition of the fact that volume after volume might still fail to cover in detail any one of the subjects discussed here makes it at once apparent that only the most essential points can be covered in a book of this size. Consequently only such problems as have been found to be especially difficult for the inexperienced woodsman are considered.

(3) *Technical Terms.*—These have been avoided so far as such a course seemed practical, and all unusual trade or professional terms with which the beginner can not be expected to be familiar have been defined in the Glossary.

(4) *Cost Data.*—It is assumed as general knowledge that costs increase as western sections are reached, and that tabu-

lated lists of costs covering each article and applicable to each section would require work and research of a nature not justified by or compatible with the nature of this book. Therefore the costs given range from the minimum for the cheaper grades to the maximum for the better grades of articles mentioned.

Finally, it is sincerely hoped that beginners will not be content to accept the following suggestions as the only possible or the most effective solutions of the problems involved, but that they will be continually on the alert to discover other and more effective solutions which they may transmit to their successors.

Sincerest thanks are extended to the Secretary of Agriculture, Chief Forester Graves, District Forester Ringland, and Forest Supervisors Kiefer and Hinderer for assistance rendered; to Forest Ranger Russell, who spent some fourteen years as a soldier and Forest Officer in the Philippine Islands and who contributed the article on "Field Work in the Philippine Islands"; to Forest Ranger Perry, Special Detail on Telephone Construction, Carson National Forest, for valuable suggestions offered on the subject of "Telephone Construction"; to Assistant Forest Ranger Warner, Prescott National Forest, for the timely suggestions he has offered on the subject of "Identification of Live Stock"; to ex-Forest Guard Highfill, Arkansas National Forest, for practical assistance extended in compiling the article on "Care of Horses"; to R. C. Bryant, Professor of Lumbering, and S. J. Record, both of the Yale Forest School, for their continued assistance and interest in this work; to the Moline Plow Company for illustrations and assistance furnished on the subject of "Wagons"; to the Lufkin Rule Company for illustrations and for the Doyle log rule and the table showing comparisons of various log rules; to the Pratt Food Company for advice concerning "Diseases of Live Stock"; to the Western Electric Company for their assistance and continued interest in the subject of "Telephone Construction"; to the Du Pont Powder Company for illustrations and data on "Blasting"; to the Simmons Hardware Company for illustrations and information supplied; to the International Harvester Company for information contributed; to Swift & Company and Armour & Company for courtesies extended; to the late N. H. C. Taylor, formerly of the Signal Corps, United States Army, for data supplied; to O. St. John, M. D., for assistance rendered in the compilation of the subject "Ailments"; to H. T. Southworth,

M. D., City Health Officer of Prescott, Arizona, for valuable suggestions concerning the subject of "Poisoning"; to the Southwestern Portland Cement Company for advice on the subject of "Concrete Work"; to C. C. Queen, practical blacksmith and shoer, for assistance rendered in the compilation of the subject relating to horseshoeing; to E. G. Bosserman, practical painter and paper-hanger for advice on the subject of "Painting"; to J. A. Richards, sawmill operator, for advice on the subject of "Woods Work"; to N. H. Getchell, mine operator, for suggestions concerning "Blasting"; to J. E. Bacon, packer, for assistance in the work of compiling the article on "Packing"; and to Chas. B. Weil, whose practical suggestions, offered from the view-point of an experienced camper, have proven of inestimable value in the work of assembling and preparing the subjects covered here.

J. L. B. T.

Groom Creek, Arizona,
December 1, 1916.

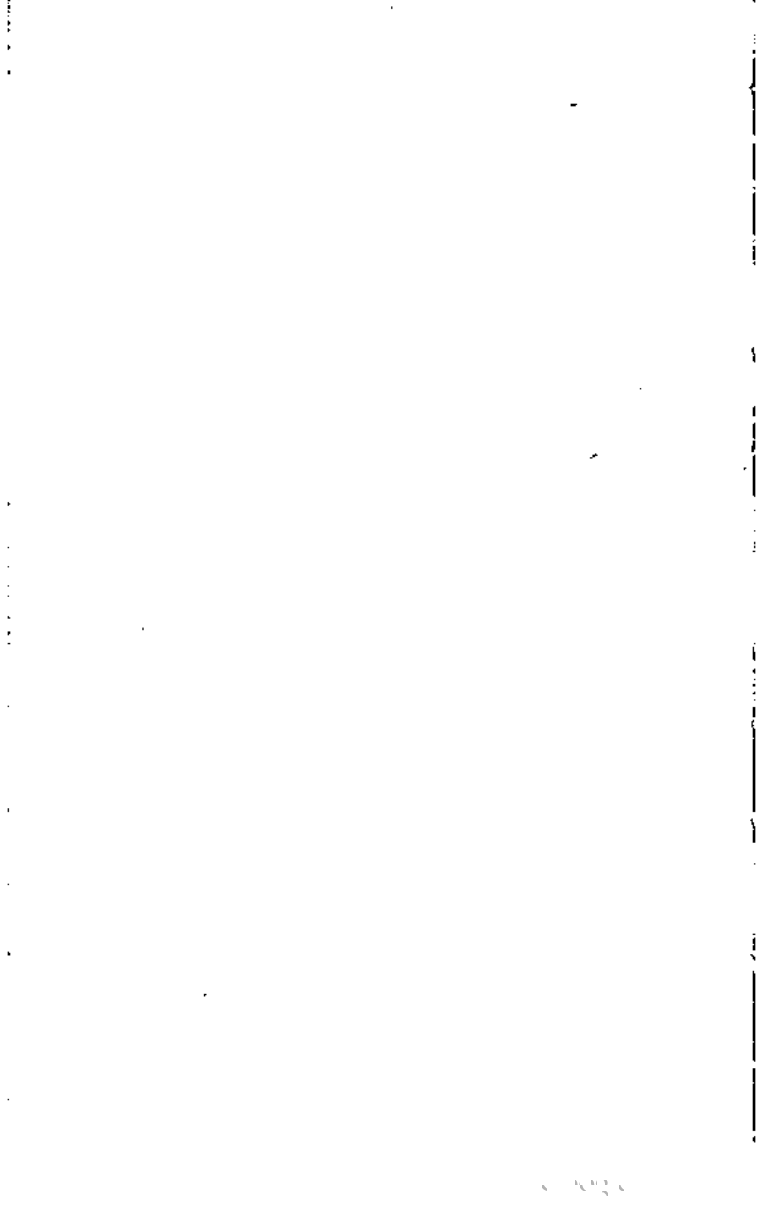

CONTENTS

	PAGE
PREFACE	iii
EQUIPMENT	1
Personal	1
Riding	10
Packing	20
Animal	24
Cooking	28
Provisions	30
CONSTRUCTION WORK	31
Telephone Lines	31
Telephones	49
Telephone Troubles	51
Trails	52
Rock Drilling	72
Blasting	74
Buildings	85
Concrete Work	99
Painting	105
Fences	107
Carpenter's Kit	119
Carpenter's Square	127
Shears	137
GENERAL FIELD WORK	139
Riding	139
Packing	147
Wagons	153
Driving	167
Woods Work	170
Estimating Timber	180
Felling Timber	183
Bucking Logs	186
Log Scaling	188
Land Surveys	199

GENERAL FIELD WORK (<i>Continued</i>)	PAGE
Surveying Crews and Their Work	198
Standard Forest Service Compass	200
Variation	203
Traverse Tables	204
Fire Fighting	205
Field Cooking	210
Care of Field Cooking Utensils	224
Butchering	225
 LIVE STOCK	 227
Care of Horses	227
Shoeing	231
Hobbling	238
Diseases of Horses, Cattle, Sheep, and Hogs	240
Administering Medicines	266
Subjugating Horses	267
Purchasing a Saddle Horse	272
Identification of Stock	279
Brands	280
Ear-Marks	291
Ear Buttons	294
Ear Loops	294
Ear Tags	294
Dewlaps	294
Ages of Cattle	295
 MISCELLANEOUS	 296
Ailments and Injuries	296
Treatments	296
Poisons	310
Reptiles	315
Location of Camp Sites	319
Confusion of Directions	322
Fastenings	325
Field Work in the Philippine Islands	338
 APPENDIX	 341
Administrative Districts	341
Forest Supervisors' Headquarters	341
Lands Acquired Under the Weeks Law	346
Weights	346

APPENDIX (Continued)	PAGE
Measures	347
Weights and Measurements of Hay, Grain, Seed, and Vegetables	349
Per Cent. Measurement of Grades	351
Miscellaneous Weights	352
Relation of Degrees and Per Cent	354
To Ascertain Grades without a Gradometer	354
Sag Tables	355
To Ascertain Distant Elevations	356
Traverse Table	357
Preservative Treatment of Telephone Poles	358
Size and Number of Nails per Pound	359
Materials Required in Concrete	362
Blasting Charges	369
Government Formula for Whitewash	369
Log Rules	369
Comparison of Log Rules	377
GLOSSARY	379
INDEX	407

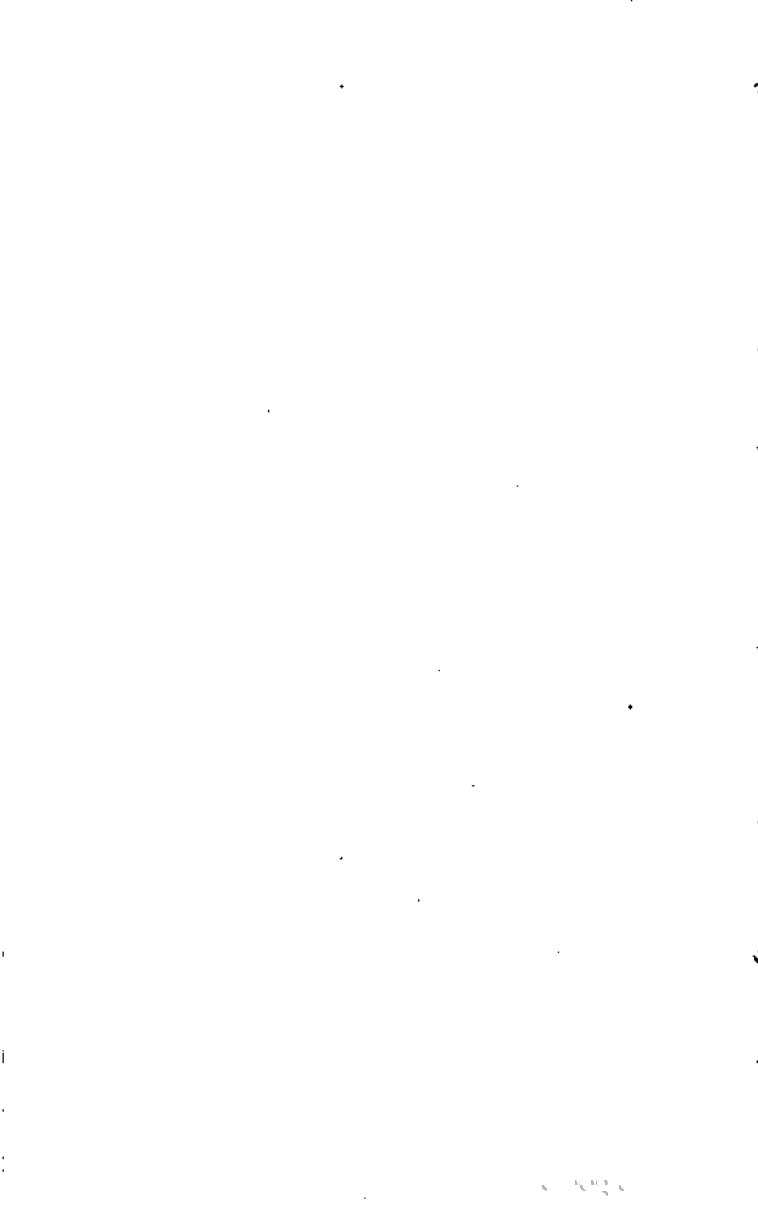

Handbook for Rangers and Woodsmen

EQUIPMENT

PERSONAL

CLOTHING

ALTITUDE, latitude, and season must of course be carefully considered before field clothing is purchased, and if personal experience has taught the purchaser that garments of different weight or texture than those hereafter described will prove more comfortable in his individual case he should by all means secure them. In case of doubt he will find the following suggestions of more or less assistance until such time as actual field experience will have shown him just what articles are best suited to his personal tastes.

Official efforts have been and are still being made to popularize the use of Forest Service uniforms, the wearing of which may possibly become general, if not compulsory, within the near future. The two principal varieties of proposed uniform goods are a whipcord of serge and a cloth closely approximating this in nature and being especially strong and durable. Officers who favor the use of uniforms base their opinion on the necessity for two things, viz., the neatness of appearance of the officer as compared with his appearance in ordinary civilian clothing, and the beneficial educational effect on the general public, and upon transients in particular.

The following suggestions, therefore, are applicable chiefly to campers in general, and if followed by Forest officers should be so modified, so far as purchases are concerned, as to meet with official approval upon the particular Forests to which such officers are to be assigned.

Hat.—A hat for general field wear should be of the best grade obtainable, since the cheaper grades soon lose their shape, become limp and uncomfortable, and are eventually more costly than

the better grades. A \$5.00, thirty-ounce hat will give the best all-round service. The crown should be $4\frac{1}{2}$ or 5 inches high (a low crown is uncomfortably warm in summer) and the brim should be flexible and 3 or $3\frac{1}{4}$ inches wide. A stiff brim is to be avoided, especially where the hat is to be worn in thick underbrush or during very windy weather. In color a nutria tan is preferable. A black hat is uncomfortably warm in summer, and when wet invariably stains the wearer's forehead and face. Much less difficulty will be experienced in keeping the hat on in brush or during windy weather if the leather sweat-band is removed.

To Use a Hat as a Drinking-Cup.—The brim is folded upward against the sides of the crown and held there with one hand across the crown.

The end of the brim nearest the thumb and forefinger is then dipped into the water and the other end submerged later, allowing the brim to fill. The water is taken from the end most convenient, usually the one first dipped into the water.

If it becomes necessary to water a horse from a pool or stream to which the animal is unable to gain access a hat may be used in lieu of a bucket. In such a case the animal takes the water from the inverted crown.

Cap.—The most serviceable cap is leather-covered, wool-lined, fitted with ear tabs and forehead and neck protector, and costs from \$1.25 to \$10.00, according to style and finish. Its use is not recommended, however, unless the weather is so extremely cold that comfort can not be secured by wearing a hat.

Coat.—A coat will be found of little or no practical value except for use in lounging about camp. The heavy ready-made work-coats are not constructed in a way that allows a field man as much freedom of motion as his work requires, and if one is to be used it should be at least two sizes larger than that usually worn. A common "denim" jumper will give much better satisfaction and wear better than a coat. It is made with from two to five pockets, is short-bodied, buttons close up under the chin, and is almost indestructible. The cost varies from 80 cents to \$1.50.

Coat Sweater.—This is not recommended for use in brushy country. However, if one is to be worn it should be of the best grade, made with two pockets, a roll collar, and to button to the top. The cost is about \$5.00.

Slicker.—A cheap slicker is to be avoided. The best grade weighs but little more and will give much greater satisfaction. For general field use the yellow pommel slicker, made with adjustable wristlets, re-enforced shoulders, throat latch, and one outside pocket, and weighing about six and one-half pounds, is recommended. The cost varies from \$2.50 to \$3.50.

Shirt.—A shirt for both summer and winter wear should be of the regular medium weight, army woolen variety, with double back, two pockets, and wide collar. It will cost from \$2.50 to \$5.00.

Trousers.—Common "denim" overalls are recommended for general rough field work. They should be well riveted, bibless, with top front pockets, watch pocket, and two hip pickets. They cost from sixty cents to \$1.50 per pair.

Corduroy is extremely heavy and stiff when wet, and except in the very best grades the nap soon wears off and breaks appear at wrinkles. The cloth is easily torn and is otherwise unsatisfactory as trousers material. A good grade of whipcord will give much better satisfaction than corduroy.

Underwear.—Medium weight, full length, woolen underwear for both summer and winter wear will be found generally more comfortable than other varieties. Cotton wear is cold and clammy when wet, and if the wearer stops exercising when warm he is quite liable to take cold. Woolen wear does not possess this disadvantage. The wearer may even plunge into water, and if he wrings his underwear thoroughly upon emerging may replace it and feel no ill effects later. Fleece-lined wear is not recommended. Suits vary in price from \$1.50 to \$5.00.

FOOTWEAR

Here again personal experience must dictate what purchases should be made, and the following remarks on the subject of footwear are offered only as a general guide for the field man who has never before encountered the question of comfortable footwear in outdoor work.

Work Shoes.—If considerable walking is to be done, such as in surveying or timber cruising, shoes should have wide, roomy toes and low, flat heels. They should be made to lace rather than to buckle or button. Low-cut styles allow snags and brush to injure the ankles and insteps; moreover, the entrance of leaves,

twigs, gravel, etc., soon requires their removal. A pair of forty- or fifty-ounce elkskin, full-vamped, heavy-soled, screw-fastened, seamless shoes, costing from \$2.50 to \$5.00 will give general satisfaction. They may be ordered with or without hob-nails.

Shoe Strings.—Cloth shoe strings should not be included in the camp equipment; they are too easily frayed, worn through, or broken to prove satisfactory. The best material from which shoe strings can be made is buckskin, whang leather, or lace leather, such strings costing from five to fifteen cents per pair. Eelskin also makes very strong, durable strings.

Hob-Nails.—These are short heavy nails fitted with large heads and designed for the protection of shoe soles and heels. Common hob-nails have large round, smooth heads, Bulgarian nails have extra large serrated heads, and Swiss and English edging nails have large pyramidal heads fitted with lips which extend upward outside of and act as protection to the sole edges. Lengths vary from $\frac{1}{4}$ inch to $1\frac{1}{4}$ inches. The points are not symmetrically fashioned like those of common wire nails, but are cut long at one side in order to lead the shank of the nail in any desired direction. Therefore, in driving hob-nails near the edge of the sole, this long side of the point is set toward the center of the sole, and thus prevents the point from emerging outside of the upper leather. Nails long enough to reach completely through the sole should not be used. They are excellent conductors and will prove very uncomfortable in extreme weather.

Soles should be nailed only along the edges with possibly one or two rows of nails through the center. Too many nails are detrimental rather than beneficial, this being due to the fact that a sole driven full of nails burns, breaks, or weakens sooner than one carrying only a few nails. Moreover, the wearer's progress is retarded rather than assisted if large numbers of nails are used, the reason for this being that so many nail-heads set close together present an almost even iron surface to the ground, and thus cause slipping.

Shoe Calks.—These are screws fitted with sharp heads and are used to prevent slipping when the shoe shank is set against a log. They are inserted in the shank by means of a short wrench which works against the squared shoulders. The points soon become dull and blunt when used in rocky country, and for this reason calks are not recommended for field use.

Heel Plates.—These are flat iron plates shaped like horse-

shoes and punched for attachment to the shoe heels. Their use is much more likely to cause slipping on flat stones or logs than if they are not used. A row of hob-nails driven along the outer edge of the heel is much more effective than a heel plate.

Bootees.—Many field men prefer these to shoes for general outdoor use and contend that the extra weight involved is more than offset by the increased protection afforded the ankles and shins. However, bootees should not exceed 15 inches in height nor sixty ounces in weight. The 15-inch, bellows-tongue, full-vamp, screw-fastened, double-sole, toe-capped variety, costing from \$5.00 to \$7.00, will give general satisfaction. Side gussets at the top or ankle hang in brush and weeds, and impede progress in traveling. Moccasin bootees, not having toe caps, allow stumps, logs, and stones to bruise the wearer's toes. Eyelets are preferable to hooks. The latter hang in brush, the laces are torn out, and the wearer must be continually relacing them. Eyelets require a little more time in lacing and unlacing, but during a day's tramp the extra time involved is more than compensated by the avoidance of constantly relacing hooks. Side buckles at the top are not only unnecessary, but they also present an added means of annoyance in thick brush. Outside counters soon rip loose.

Riding Boots.—The boots known as "stockmen's riding boots" should not be worn if much walking is to be done. The heels are too high and the toes are too narrow to prove comfortable in such work, and their use in general field work is not recommended. Another style of boot, however, having low flat heels and wider toes, is a general favorite among officers whose work involves both riding and walking. If these are worn it is suggested that they be made to order and a good fit secured. The cost should not exceed \$10.00.

The regulation stockman's boot, used so extensively in the West, usually has a fancy stitched 17-inch top, stitched sole, 1½- or 2-inch heel, and a pair weighs from sixty to eighty ounces. The cost per pair varies from \$4.00 to as high as \$30.00 or \$40.00, according to style and finish.

Other officers prefer ordinary shoes and spiral cloth leggings. Contrary to a general belief, these leggings are not uncomfortably warm. They originated among the natives of East India and were subsequently adopted by the British Army. Incidentally, where walking must be done, they prove excellent protection

against snake bites, experiments having shown that the poison of a rattlesnake will not penetrate two thicknesses of ordinary blotting paper. The cost per pair should not exceed \$1.50.

Moccasins.—Except in the north woods of Maine, Wisconsin, and Minnesota, or in other localities where conditions render them a suitable form of footwear, these should be supplied only for camp use. They are too soft and offer too little protection to the feet to prove comfortable in general field use, and they are especially uncomfortable when used in riding. They may be low cut, ankle high or even higher, but for camp use the low-cut variety is recommended. The tan-colored, twenty-ounce, single-tie style costs from seventy-five cents to \$3.00 per pair.

Rubber Boots.—In order to be water-proof these must necessarily be air-proof, and for that reason cannot be recommended for field use. If he must work in water the field man will find common leather shoes preferable to rubber boots, this being especially true of such work in warm weather.

The best style for occasional wear about camp has rubberized duck vamps, rolled sole, weighs about sixty-four ounces per pair, and costs from \$3.00 to \$6.00. Hip- or thigh-boots weigh but little more and cost from \$4.75 to \$7.50 per pair.

Storm Rubbers.—Ordinarily the field man has neither room in his pack nor use in his work for storm rubbers. They are only useless burdens and should not be included in the list of footwear.

Socks.—Medium-weight woolen socks are recommended for both summer and winter wear, and for the same reasons that woolen underwear is recommended. It not infrequently happens, however, that such footwear proves especially unsatisfactory in individual cases, and in such event the field man should of course procure whatever style of socks he has found most satisfactory. Woolen socks vary in price from twenty-five cents to \$1.00.

Hose Supporters.—Supporters which encircle the leg at or near the calf should be avoided if continued walking is to be done. Their chief disadvantage lies in the fact that they must be drawn so close about the leg that circulation is impeded when it should be especially free and regular. The small two-ended clip, costing ten cents, is recommended for general use. If these cannot be secured the socks may be pinned to the drawer legs.

HANDKERCHIEFS

Nothing in this line is better for field use than a common five- or ten-cent bandana. Red will be found preferable to blue, as the latter fades when wet, the stain being removed from the user's skin only with difficulty.

BEDDING

Quilts, comforters, sheets, and pillows are unnecessary articles of bedding for field use. The first two are bulky and heavy, are no warmer than blankets and dry very slowly when wet; furthermore they seem to attract moisture and always feel clammy and damp. Sheets soon become grimy, are easily torn, and do not add materially to the comfort of a camp bed. A coat, sweater, or other clothing may be rolled up and used for a pillow.

A very comfortable, durable, and easily packed bed may be had by the use of one four-pound and two six-pound double woolen blankets 72 by 84 inches in size. These cost from \$4.00 to \$6.00 and \$6.50 to \$9.00, respectively. If it is felt that such bedding is too expensive for camp use horse blankets may be used as a substitute and will prove very comfortable. A five-pound blanket 76 by 80 inches in size costs about \$2.00; one 84 by 90 inches, weighing eight pounds, costs about \$3.00; and a ten-pound blanket 90 by 96 inches costs about \$3.50. One of each should be secured, dark colors being preferred.

TARPAULINS

A tarpaulin is used as protection to bedding when the latter is rolled into a pack or made down on the ground. The best size is 11 by 15 feet, or the same size as a regulation wagon "sheet" or "cover." It should be of not less than eight-ounce duck, would weigh approximately ten pounds and would cost about \$4.00. Ten-ounce material, same size, costs about \$5.25, and twelve-ounce about \$6.50. No water-proof blanket need be included in the bedding if a good grade of tarpaulin is used. A 30-foot $\frac{1}{2}$ -inch manila rope is long enough to tie the bed for packing and costs from thirty to fifty cents.

DUFFLE BAGS

Trunks, suit cases, grips, or satchels should never be taken on extended camping trips; the rough usage incident to packing or to other forms of transportation will soon destroy them and call

for the purchase of new articles. Aside from this fact they are very inconvenient to handle, especially if packing is to be the means of transportation.

Extra clothing and other personal equipment can best be carried in a heavy canvas bag known as a "duffle" bag, which can be purchased from any firm handling sporting goods. Such a bag is fitted with a canvas loop or handle at one end and with another at the side; the top has an inside hood supposed to be water-proof, and the bag is fastened shut with a drawstring or bar lock passed through the eyelets at the open end. As a matter of fact, however, these bags are usually constructed in such a manner that they are too long and narrow to prove satisfactory either in packing or unpacking them.

One which has been used in the field for more than six years, and which has withstood the roughest usage and given complete satisfaction in every respect, was made to order for \$3.50. It is of extra heavy canvas, 34 inches deep, 22 inches wide, and has an extra heavy leather bottom riveted through the canvas into a heavy leather inside collar. The top is fitted with a pliant 2-inch leather band bearing sixteen $\frac{3}{4}$ -inch eyelets. A $\frac{3}{16}$ -inch forged D-ring is attached to a leather re-enforcement on one side of the bag 6 inches below the top, and a second similar ring is likewise attached to the leather bottom.

A 2-inch leather strap, fitted with a heavy harness snap at either end, is attached to the two rings and has proven very convenient in carrying the bag or attaching it to a pack-saddle. Except at the open end, which has no inside hood, the bag is absolutely water-proof, although it has been run over by wagons, kicked about by fractious pack-animals, and otherwise been given the most severe treatment. It is fastened shut by means of a buckskin thong passing through the eyelets.

In filling, or packing, duffle bags, care must be taken not to place hard or sharp articles immediately against the canvas sides, or the canvas will be cut or worn through.

Small articles may be confined in smaller canvas bags and the latter finally packed in the big bag. One of the small bags may hold pins, needles, thread, thimble, and similar articles; another may be used for packing tobacco, pipes, matches, or match cases; and a small medicine kit may be carried in still another. These small bags should be fitted with leather drawstrings and kept closed when packed in the duffle bag.

CANTINAS

These are leather bags supplied to field men who are to do considerable riding. They are made in pairs and are designed to be carried at the saddle horn or fork. Each large bag is fitted with a smaller outer bag 5 inches wide, 8 inches long, and 1 inch deep. The large bags are $8\frac{1}{2}$ inches wide, 11 inches long, and $3\frac{1}{4}$ inches deep, made bellows fashion and equipped with 10-inch flaps which cover both the large and small bag and which are made to buckle down. At the upper edge of the flap a $\frac{3}{4}$ -inch strap 14 inches long buckles across into the flap of the other bag of a pair and serves as a handle by which the bags may be carried when they are to be used otherwise than on horseback. Two 6-inch straps, set $1\frac{1}{2}$ inches apart, also connect the two bags and hold them to the saddle horn.

EQUIPMENT FOR A FIELD TRIP

Clothing.—The greatest problem involved in providing clothing for a field trip is not so much what to include but what to exclude from the baggage. The inexperienced person invariably burdens himself with a large amount of excess baggage which he finds later is of no use to him. Meanwhile, he suffers more or less inconvenience in transporting it about from place to place.

It is of course utterly impractical to compile a list of clothing and then declare that such articles are sufficient and that no others are necessary for any field trip and regardless of all conditions.

It is possible, however, to compile a list suitable for given conditions and to use such a list as a basis for determining approximately what equipment may be needed to meet other conditions and it is with this idea in view that the following lists are supplied. It is assumed that the work to be done is timber cruising, that the country to be covered varies in altitude from one thousand to six or seven thousand feet and lies approximately in latitude 40° north and that the work is to be done during the period from May to August. Normal climatic conditions incident to such work would justify the field man in providing himself with about the following clothing:

Underwear.—Four suits, medium weight, woolen, full length, to be changed often.

Shirts.—Four, medium weight, woolen, good grade.

Trousers.—Three pairs of denim overalls.

Socks.—Twelve pairs, medium weight, woolen, to be changed often and kept in good repair.

Shoes.—Two pairs, low, flat heels, roomy toes, high tops, capped, hob-nailed sole and heel edges, to lace.

Hat.—Soft felt, 3- or 3¼-inch flexible brim, 4- or 5-inch crown.

Coat.—Denim jumper.

Other equipment that may be included with the above is:

Handkerchiefs.—Three bandanas, preferably red.

Shoe Laces.—Two extra pairs, buckakin or lace leather.

Shoes.—One pair, low cut, soft, for camp wear.

Housewife.—Carrying pins, needles, thread, small scissors, bachelor buttons, yarn for darning.

Stationery.—Stamped envelopes and paper for all personal correspondence. Official correspondence is on official stationery and is covered under frank. Paper and envelopes are supplied.

The toilet set should include:

Shaving Outfit.

Pocket Comb.

Pocket Mirror.

Six Bars Toilet Soap.

Two Towels.

Tooth Brush and Dentifrice.

One Extra Pocket Knife.

It may seem that the foregoing lists are rather limited, but under present-day conditions the field man is seldom stationed so far from country stores or post-offices that he is unable to purchase or order any extra supplies he may need.

For a list of camp bedding, see page 7. Cots are not recommended for winter use. They permit such free circulation of air beneath the bed that practically twice as much bedding is required to assure comfort.

Camp supplies are listed on page 30, and cooking utensils on page 28.

RIDING

The following remarks on the subject of riding equipment are not offered as suggestions to experienced horsemen; their sole aim is to furnish inexperienced field men with a general idea of what equipment they may depend upon for practical results until their own experience will enable them to select equipment more in accord with their individual tastes.

Bridle.—This should be light but strong, and fancy conchas,

heavy rosettes and heavy nose pieces and superfluous straps and buckles should be avoided. Such impedimenta are uncomfortable in extreme weather, and, contrary to a general idea among a certain class of horsemen, do not add to the real value of nor contribute favorably to the appearance of a bridle. The bridle may or may not be fitted with a brow band and throat latch, although these pieces are recommended for use on animals that have developed the habit of "rubbing the bridle," i.e., removing it by rubbing against a tree, post, or similar object. One form

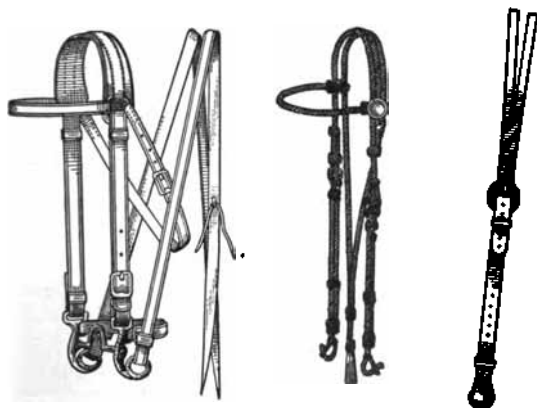

FIG. 1.—Bridles.

of bridle is fitted with ear holes instead of a brow band, but in most cases does not prove as comfortable or effective as one with a brow band.

The bridle shown at the left of Fig. 1 has $\frac{1}{8}$ -inch double cheeks, $\frac{5}{8}$ -inch throat latch, brow band and curb strap, wide layer crown piece, bar buckles, sewn-in rings, and $\frac{1}{8}$ -inch reins 6 feet long. It weighs approximately thirty-six ounces and can be bought for \$2.00 or \$2.50.

The one shown at the center of the same figure is made of clarified rawhide, plaited in four strands, and has no buckles or rings, the cheek pieces being regulated by adjustment of the side loops. It weighs ten ounces and costs from \$1.50 to \$2.00, without the reins or bit. It is so subject to stretching when wet and shrinking as it dries that it will not give satisfaction.

A side view of an ear bridle is shown at the right in the same

figure. It has $\frac{1}{8}$ -inch cheeks and 1-inch split crown, weighs about ten ounces, and costs \$1.00 without the reins or bit.

Horsehair reins and headstalls are not recommended because the loose hair ends of the former are uncomfortably rough to the rider's bare hands and of the latter irritate an animal's skin.

Bit.—The best all-round riding bit, and one that can safely be recommended for general field work, is the regulation military

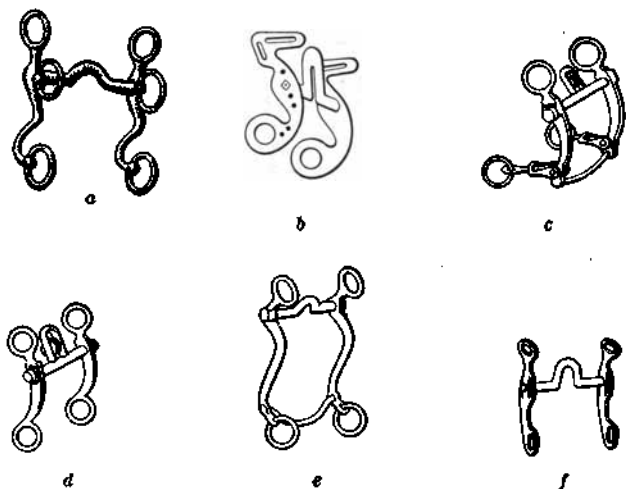

FIG. 2.—Bits.

curb bit shown at *a* in Fig. 2. It weighs sixteen ounces and costs from \$1.75 to \$2.00. Other styles of bit are the blued Mexican curb, shown at *b* in the same figure, weighing eleven ounces and costing from fifteen to twenty-five cents; the swivel ring-bar bit, shown at *c*, weighing seventeen ounces and costing \$1.00; the low port bit, shown at *d*, bearing a roller, weighing fourteen ounces and costing seventy-five cents; and the Kentucky bar braced racking bit, shown at *e*, weighing thirteen ounces and costing fifty cents. It is especially constructed for very light work. The wrought port mule bit, shown at *f*, is designed for extra hard usage, weighs fifteen ounces and costs from fifteen to twenty-five cents.

Silver-mounted or engraved bits are not recommended. They

are usually too heavy and expose an animal's mouth to too much heat or frost to give general satisfaction.

Hackamore.—This is merely a variety of light, strong halter used chiefly in breaking, training, or controlling saddle animals. It may also be used to advantage when injuries to an animal's mouth prohibit the use of a bit. In using it it is simply hung on an animal's head, and a rope which has been tied about the animal's neck is then passed through the bozal, indicated at *a* in Fig. 3, and upward to the rider's hand. If the animal is to be trained to turn to the left the rope may be pulled steadily, or, if a double rein is being used, the right rein is held against the neck and the left rein is pulled. In turning to the right the left rein is drawn tightly against the left side of the neck, while the right rein is pulled. In this way an animal is soon taught to "neck rein," and after the bit is used no pressure against it is required in turning the animal. The hackamore shown in Fig. 3 is of rawhide with a double-looped bozal, over plaited nose piece, flat double-plaited cheeks and brow band and adjustable crown piece. No brow band is necessary in most instances. Such a hackamore weighs approximately twelve ounces and costs from \$3.50 to \$5.00.

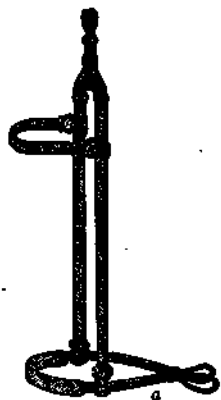

FIG. 3.—Hackamore.

Saddle Blanket.—The most satisfactory blanket that can be obtained for steady riding is one made of three or four thicknesses of tow or "gunny" sacks carefully cleaned of all knots, bunches, and other uneven surfaces and sewn together around the edges. Such a blanket should be about 1 inch longer and wider than the under surface of the saddle skirts. When wet with perspiration or water it should be dried in the shade and care must be taken to see that burrs, twigs, etc., are not allowed to stick to either side.

Thickly padded, air-tight, bunched, or ribbed blankets should not be used. A very thin blanket is sufficient under a properly fitting saddle, and if the saddle fits so poorly that numerous

extra thicknesses of blanket are necessary it should either be discarded or rebuilt.

Saddle.—This is a question upon which few horsemen agree, and the inexperienced person who seeks advice from them may expect to receive as many different suggestions as the number of men he interviews.

However, a saddle having about the following specifications will give general satisfaction for all-round field work until the new man

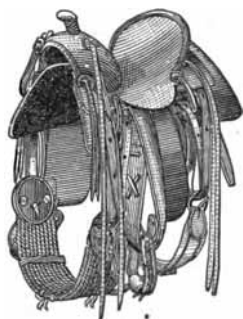

Stock saddle.



Military saddle.

FIG. 4.

learns enough about the subject to select something more to his own taste:

Tree.—15-inch, 14-inch swelled steel fork, leather-covered steel horn.



FIG. 5.—Saddle-tree.

Seat.—In one piece with the jockeys and not too erect in the cantle.

Skirts.—Wool-lined, from 26 to 28 inches by 12 to 14 inches, round corners, laced to tree.

Rig.—Double. (This particular point furnishes more ground for contention among riders than any other single one, some declaring in favor of a double rig, some preferring a single rig,



Front

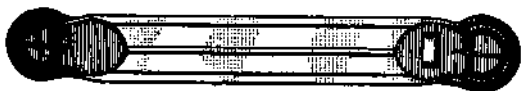

Rear

FIG. 6.—Cinches.

others advocating a three-quarters rig, and still others asserting that a five-eighths rig is best.)

Cinches.—Twenty strand Angora, front; 3½-inch belt web, rear; both fitted with leather chafes.

Latigoes.—Off side: 1¾ inches wide, 20 inches long, double

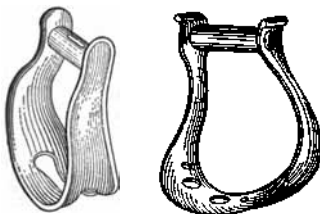

FIG. 7.—Iron stirrups.

to loop through ring of rig; near side: 1¾ inches wide, 7 feet long, punched to buckle into cinch ring or cinch buckle.

Stirrup Straps.—2¾ inches wide, to buckle.

Stirrups.—Steel, leather-covered and lined.

Fenders.—9 by 16 inches.

Tapaderas.—Short, "monkey nose," one piece.

Finish.—Plain.

Weight.—Thirty pounds.

Cost.—From \$30.00 to \$40.00.

Swelled forks are preferable to straight forks on account of the extra thigh grip they afford. A wide flat seat will prove

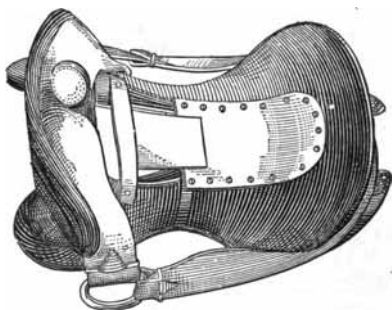

FIG. 8.—Single rig seat plate.

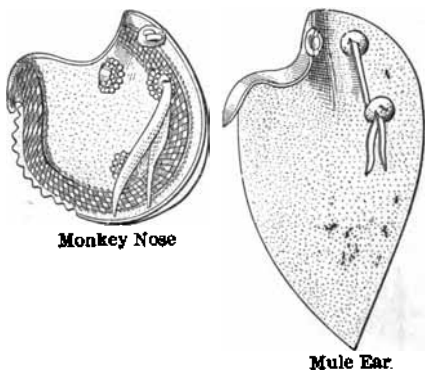

FIG. 9.—Tapaderas.



FIG. 10.—Saddle horns.

much more comfortable than a high narrow one. Steel stirrups are practically indestructible, will outlast any ordinary saddle,

and when lined with leather are not appreciably hotter or colder than wooden stirrups. Long "mule-ear" tapaderas are not only a source of useless and extra weight, but are even troublesome in thick underbrush, and, contrary to a prevalent idea, cannot be thrust forward at such times to protect a horse's forelegs. Cinch buckles facilitate fastening and unfastening the cinch and, opinions of some horsemen to the contrary notwithstanding, do not break any oftener than latigos and cinch rings. In attaching them to the latigo the latter is run through the upper slit from the rear, back through the ring in the rig from the front, then down through the lower slit of the buckle from the rear. The loose end of the latigo is then hung up in the loop provided for it under the fork or just back of the cantle edge at the rear.



FIG. 11. — Cinch buckle with chafe attached.

Single and three-quarter rigs will not prove satisfactory for all-round work; they are designed for certain forms of horseback work and can seldom be used successfully otherwise. The rear cinch of a double rig seldom need be used, the chief advantage of such a rig being the location of the front ring.

Deeply engraved or hand-carved trimmings are to be avoided. They increase the cost of a saddle without adding to its practical value and render cleaning and oiling more difficult.

Spurs.—These are almost indispensable when western-trained horses are to be ridden, but are otherwise an unnecessary part of the riding equipment. Three general styles are shown in Fig. 12. The one indicated at *a* is best suited to general field work. The fork or counterpiece should be at least $\frac{1}{2}$ -inch wide, the shank should be not less than 2 inches long, and the rowel should have a diameter of at least $1\frac{1}{2}$ inches. Heavy silver ornaments, such as large buttons, bells, knobs, and chains, not only fail to increase the practical value of a spur but also render it uncomfortably heavy and unnecessarily expensive. A pair of spurs similar to those described above can be purchased for \$1.50 or \$2.00.

Spur straps should be wide enough at the center to cover the entire instep. If laced shoes are worn narrow straps will allow the chaparejo cuffs to cut the laces, and if boots are worn the cuffs will eventually cut through the insteps.

Other spurs, very seldom used in field work, are shown in the same figure. A "heel" spur is shown at *b* and is designed

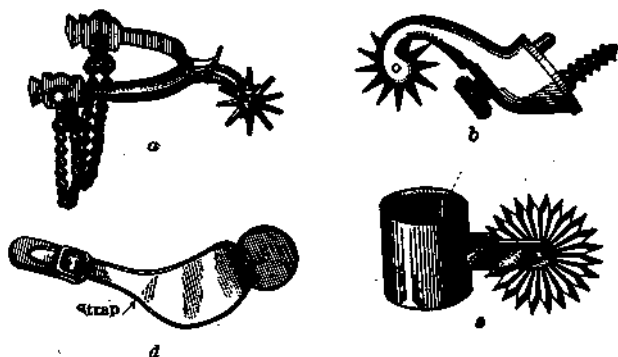

FIG. 12.—Spurs.

to be screwed into the boot heel, where it is made fast by means of a small set screw beneath the rowel.

The "whip" spur, shown at *c*, is fitted with a flat band through which the whip butt is thrust. A spur strap is shown at *d*.

Quirt.—Ordinarily the field man need not burden himself with a quirt, but if an unusually vicious animal is to be ridden and can not be well controlled with the reins and spurs a quirt may



FIG. 13.—Quirts.

prove of considerable advantage. Two styles of quirt are shown in Fig. 13. The upper one is of plaited rawhide with loaded butt, weighs from twelve to sixteen ounces, and costs from sixty to seventy-five cents. The lower one is of sewn leather, shot-loaded, and costs about fifty cents.

Chaparejos.—These are commonly known as "shaps" and are indispensable in brushy country, where a rider's legs and trousers

require continual protection. Three general styles are shown in Fig. 14. For all-round work the ones shown at *a*, known as "Texas," or "bat-" or "buzzard-wings," are recommended. They are fitted with a series of rings and snaps which hold the legs shut. By reason of the fact that these shaps need not be

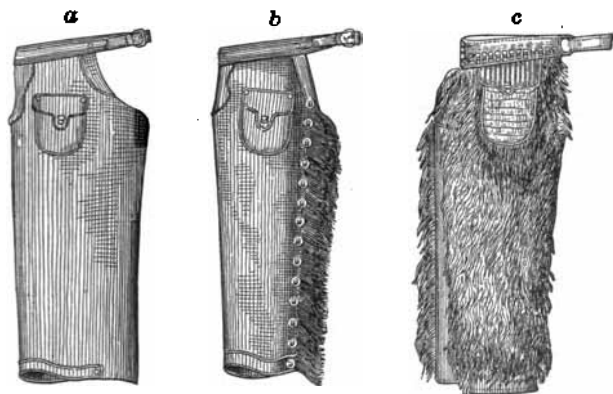

FIG. 14.—Chaparejos.

drawn on and off over the feet but may be unsnapped at the sides, they are much more convenient than the closed leg varieties. Furthermore, if spurs are worn, these need not be removed if the shaps are to be laid aside temporarily. Such shaps should be of oiled leather with side extensions not wider than 5 inches. Five rings and snaps are preferable to a larger number. The weight should not exceed five or six pounds and the cost varies from \$13.00 to \$15.00, plain finish.

A heavier variety of these shaps is made for use in extra brushy country and for corral work, where the rider's thighs and hips are subjected to constant pressure of the rope. The belt is extra wide and thick and the legs fasten shut from the inside with loops and leather buttons. The leather is extra heavy and stiff and the price runs from \$18.00 to \$25.00, plain finish.

The closed leg variety, shown at *b*, costs from \$15.00 to as much as the purchaser wishes to pay for extra fancy style and finish.

The hair front variety, shown at c, can not be recommended for any kind of field work. They are not only heavier than the plain leather varieties, but are also very unsatisfactory in brushy country, where the hair is continually hanging and being torn out. Moreover, in stormy weather, the hair catches and holds rain, snow, or sleet and the shaps soon become too heavy for comfort. The cost runs from \$15.00 to as high as the purchaser wishes to pay for finish.

PACKING

In most parts of the West, where travel facilities are usually more or less limited, supplies and equipment must often be transported from place to place by means of pack-animals, but throughout the greater part of the South and Southeast transportation is by means of wagons. It is therefore advisable for the camper or woodsman to ascertain previously whether or not he will have use for a pack outfit in the section he expects to enter.

PACK-SADDLE

Muley.—This style of pack-saddle derives its name from the construction of its forks, illustrated in Fig. 15. They are rounded off at the top, and ropes or other fastenings are passed through under the bow.



FIG. 15.—Fork of "muley" pack-saddle.

Mexican packers of the Southwest, who often construct their own pack-saddles, hew these forks from the crotches of limbs of some tough wood such as Gambel oak (*Quercus Gambelli*) or Arizona white-oak (*Q. Arizonica*). These are then nailed or bolted securely to the saddle-bars and the

whole is usually, though not always, covered with rawhide.

Cross-Tree.—This saddle has forks made as shown in Fig. 16, although the rounded opening beneath the cross may not appear in some varieties. Ropes may be passed around or through such forks, and in either case will not work off unless loosened. The cross-tree saddle is recommended for field work.

Combination.—Another form of tree seldom used in packing is a combination pack and riding tree, but this is not recommended for any field use whatever. The cross-tree affords much better facilities for fastening the pack to the saddle, weighs only about

six pounds, and can be bought for \$1.50; the combination tree weighs twelve pounds and costs \$3.50. For illustration of pack-saddle parts (cross-tree) see Fig. 18.

Parts.—In order to present a more definite idea of what the

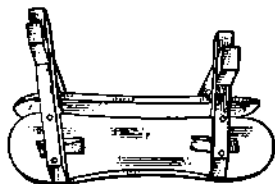

Cross tree pack saddle.

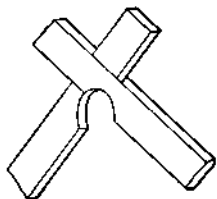

Fork of cross tree pack saddle.

FIG. 16.

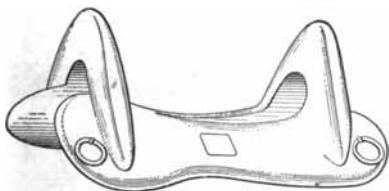

FIG. 17.—Combination pack and riding saddle-tree.

best form of pack-saddle should be, specifications of each part are given as follows:

Breeching.—This should be of ordinary 3-inch back-band web with $1\frac{1}{8}$ -inch side and hip straps. To be most effective both the latter should be lengthened till the breeching works below the points of the hips rather than close up under the root of the tail. Such breeching costs about \$1.00.

Breast Collar.—The body of the breast collar should also be of 3-inch back-band web and fitted with $1\frac{1}{4}$ -inch leather side straps. If the latter are left long enough to allow the collar to fall too far below the points of the shoulders the animal will experience more or less difficulty in traveling. If allowed to work above the shoulder points it may cause the animal to choke down when steep grades are ascended. Proper regulation will allow it to work just below the points of the shoulders. If necessary a strap may be fastened from one side strap over the

animal's neck to the other. The cost of such a collar is about \$1.00.

Cinches.—The best cinches for all-round work are of 4-inch

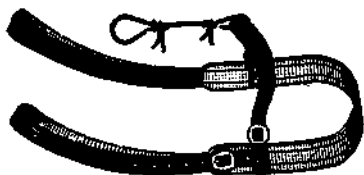

Breeching.

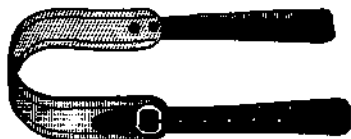

Breast collar.



Cinch.

FIG. 18.—Pack-saddle parts.

folded canvas fitted with a forged ring in each end. If rear cinches are to be used they should be made of the same material. The cost is about sixty-five cents.

Latigoes.—These may be known as “tie straps” and are used in connecting the cinches to the rigging. They should be not less than $3\frac{1}{2}$ feet long and $1\frac{1}{4}$ inches wide, and should be made to tie rather than buckle. They cost about twenty-five cents each.

Rig.—The rigging of any saddle is that part into which the cinches are fastened by means of the latigoes. They may be either single or double in pack-saddles, the one providing for only one cinch, the other for two. They should be well looped about

the forks and securely nailed to the saddle bars. The single rig costs seventy-five cents, the double \$1.25.

Full-Rigged Saddle.—A single rig, cross-tree pack-saddle, burro size, with $1\frac{1}{8}$ -inch rig, wrapped about the forks and nailed to the bars, $1\frac{1}{4}$ -inch latigoes, 3-inch back-band web, breeching of the same material with $1\frac{1}{8}$ - or $1\frac{1}{4}$ -inch leather

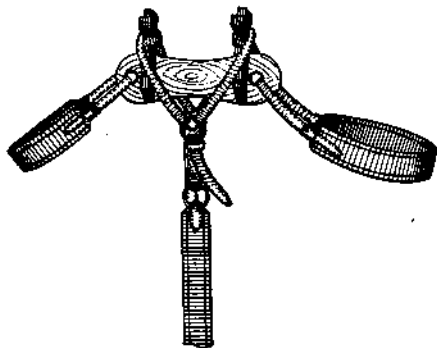

FIG. 19.—Full-rigged pack-saddle. (Single rig.)

side straps, and 4-inch folded canvas cinches, weighs approximately nine pounds and can be purchased for from \$4.50 to \$6.00; double-rigged it weighs ten pounds and costs about \$6.00 to \$7.00; horse size, double rig, costs about \$8.00.

Lash Rope and Cinch.—These are used in fastening the top pack to the saddle. The cinch should be of 4-inch folded canvas fitted at one end with a forged ring and at the other with an iron lash hook. Together with 30 feet of $\frac{1}{2}$ -inch manila rope it can be purchased for about \$1.75.



FIG. 20.—Lash hook.

Panniers.—These are heavy canvas bags equipped with leather loops to hang over the saddle forks. They are convenient receptacles in which to pack small loose articles, but are by no means absolutely essential to a pack outfit and are not recommended for general field use. The loops soon wear out or break, the canvas tears or wears through, and continual repairing soon becomes necessary. Ordinary "gunny" sacks or

heavy flour or feed sacks will serve the purpose as well, and when badly worn or damaged may be discarded without loss. Instead of being attached to the saddle by means of loops these are fastened with a grain hitch. (See Packing, p. 147.)

ANIMAL

Halters.—These should be supplied for work- and saddle-animals if the nature of the field work requires them to stand tied for extended intervals. They may be of leather or rope or may consist simply of a tie rope.

Leather.—The best halter for field use is made of $1\frac{1}{4}$ -inch flat leather, fitted with squares where the cheeks support the

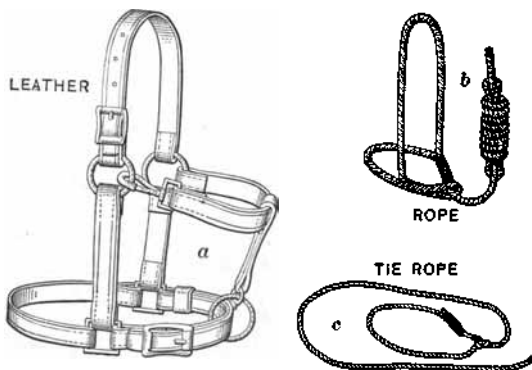

FIG. 21.—Halters.

nose piece and bozal and with rings where the crown and cheeks meet. One end of the throat latch is sewed into the off ring and the other end is fitted with a snap to hook into the near ring. The crown and bozal have buckles to permit lengthening or shortening or opening or closing the head-stall, while the cheeks and the off end of the crown piece are sewed into the rings which carry the throat latch. One end of the tie rope should be fitted with a substantial snap to hook into the chin ring, and the other end should be tightly wrapped with fine wire or heavy cord. Such a halter, together with the tie rope, costs about \$1.25. See *a* in Fig. 21.

Rope.—A ready-made halter of jute, cotton, or hemp can be bought for fifty cents. The crown and cheeks are in one piece, while the nose piece, bozal, and tie rope are in another. Such a halter is light, strong, and serviceable, provided the animal to be tied is fairly gentle and well trained. Its chief disadvantage lies in the fact that it can be easily slipped if accidentally hung over a post, snag, or similar object.

If a rope halter must be made in the field, a $\frac{1}{2}$ -inch cotton rope 12 feet long should be used. An eye splice is made in one end of this and the other end is passed through it to form the nose piece and bozal. The cheek and crown piece should be cut long enough to reach from back of the animal's ears down either side of the head to a point about 2 inches above the mouth. Ordinarily it will be from 28 to 36 inches long after it is spliced into the other rope, one end being spliced in about 6 inches from the eye splice and the other some 6 or 8 inches farther along. The material required for such a halter costs about twenty-five cents. See *b* in Fig. 21. For splices, see p. 335.

Tie Rope.—This should be of $\frac{1}{2}$ -inch cotton rope, 10 feet long, and fitted with a harness snap spliced into one end, the other end being wrapped with fine wire or heavy cord or else knotted in a Turk's head. See *Knots*, p. 325. An iron band, bearing an eye-screw, and especially designed for the purpose, is then fitted to the rope at a point far enough from the snap to allow the snap to be hooked into the eye after the rope has been placed about the animal's neck. The rope will cost ten cents and the iron band as much more. See *c*, Fig. 21.

Hobbles.—A single hobble, sometimes known as a "picket" hobble, and a pair of double hobbles are illustrated in Fig. 22. They are for use in tying an animal's legs together, and thus prevent it from straying too far from camp. All should be of $1\frac{1}{2}$ -inch leather with 2-inch single strap lining and equipped with chains and swivels. A picket hobble weighs about one pound and costs \$1.00 or \$1.25; double hobbles weigh approximately thirty ounces and cost the same as picket hobbles.

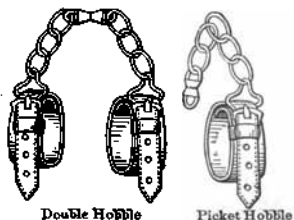

FIG. 22.

Picket Pin and Rope.—When neither halter nor hobbles are available an animal may be "picketed" out to graze. The

picket pin and rope shown in Fig. 23 cost about \$1.00. For general purposes the rope should be not less than 30 feet long and fitted with a strong snap at either end to facilitate fastening it into and removing it from the pin or hobble. The pin should be 15 inches long, and equipped with a swivel link at the upper end.

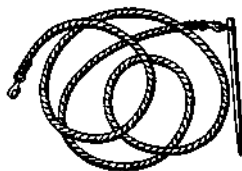

FIG. 23.—Picket pin and rope.

Feed Bags.—These are known as "morrals" in the West and Southwest, where the camp equipment is not complete without them. They are fitted with a crown piece, and after the grain is placed in them are suspended from the animal's head. It soon learns to lower its head and allow the bag to rest on the ground so that the grain may be reached.

Only the best grades should be used. These are of heavy cotton duck or canvas, are double sewed and riveted, have

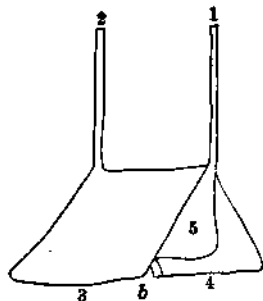
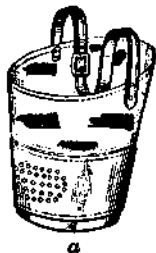

FIG. 24.—Morrals.

heavy leather bottoms, lower walls and ventilators, and the crown piece is of leather. They weigh approximately thirty ounces and cost about \$1.50 each. See *a* in Fig. 24. An improvised morral made from a gunny sack is shown at *b*. This can best be made by seizing one upper corner of the sack, stand-

ing on the corresponding lower corner, thrusting a knife-blade through both sides of the sack and ripping them out to the end. The blade should be thrust through the sack at a point about 2 inches in from the edge, as the sack is flattened, and 14 inches from the bottom. The bag is shown at 5, the pieces 1 and 2 are tied together and serve as a crown piece, and the pieces 3 and 4 are tied together snugly about the animal's jaws or thrust under the cheek pieces to prevent loss of grain by spilling if the animal tosses its head in an attempt to secure the grain.

Bells.—Animals should be belled when turned out to graze at night or during times when they are not to be used. Some of them stray to a considerable distance from camp even when hobbled, and unless bells are provided more or less trouble will be had in finding them.

The best camp bells are the small ordinary cow bells generally known as "horse" bells. Size No. 5 is $3\frac{3}{8}$ inches high and has a mouth $2\frac{1}{4}$ by 3 inches. It costs twenty cents. Black leather bell collars 2 inches wide cost about forty cents. Usually one bell to every three or four animals will prove sufficient.

Combs and Brushes.—These should always be included in the field equipment if horses are to be worked or ridden. Two styles

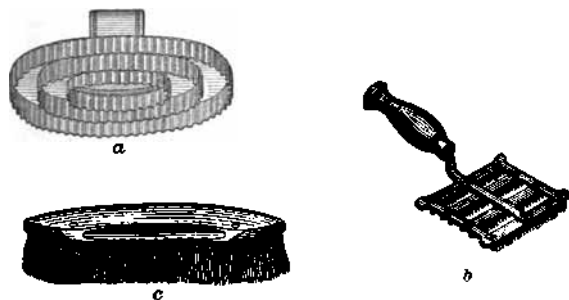

FIG. 25.—Curry-combs and brush.

of combs are shown in Fig. 25. The one shown at *a* is recommended for general field use. It is circular, of spring steel, and bears three complete circles which work independently on each other and which are attached to an iron back by a hinge joint. The handle may be of wood or leather. It is strong and com-

fact, will stand the hardest kind of treatment, and costs about twenty-five cents.

The comb shown at *b* is especially unsatisfactory for field use. The bars and teeth soon become bent, the handle takes up as much room as the comb and may soon work loose or break, and the shank may be bent, broken, or otherwise damaged in packing. The cost is ten cents. The brush shown at *c* has a heavy wooden back 3 inches wide and 8 inches long with India fiber brush $1\frac{1}{2}$ inches long. It costs twenty-five cents and should be included in the field equipment even if there is no room for the comb.

COOKING

For Stations.—For permanent stations or camps, the following cooking equipment will be found very convenient. The list is rather elaborate for field work, but where the field man need not pack his kit about from place to place he will find too many utensils preferable to too few; furthermore, he may have occasion to prepare meals for visitors or for local residents who may call on business:

Article	Capacity	Approximate Cost
1 Dishpan.....	18 quarts	\$0.50
1 Coffee-pot.....	4 quarts	.50
1 Tea-kettle.....	6 quarts	.40
1 Double boiler.....	$1\frac{1}{2}$ quarts	.40
1 Water pail.....	12 quarts	.40
3 Straight kettles.....	7 quarts	2.80
2 Pudding pans.....	$3\frac{1}{2}$ quarts	.50
2 Bake pans.....	4 quarts	.35
1 Cup.....	1 quart	.15
1 Ladle.....	$\frac{1}{4}$ quart	.05
1 Dipper.....	$\frac{1}{2}$ quart	.05
1 Bread-raiser.....	8 quarts	.80
1 Colander.....	4 quarts	.25
1 Frying pan.....		.35
Total.....		\$7.50

His dinner set should include:

4 Cups and saucers.....	\$0.50
6 Plates.....	.75
3 Bowls, 8-inch.....	.45
6 Knives and forks, iron handles.....	.75
6 Teaspoons.....	.15

Article	Approximate Cost
3 Tablespoons.....	\$0.15
1 Soup spoon.....	.15
1 Sugar bowl.....	.40
1 Salt and pepper shaker.....	.35
1 Meat platter.....	.50
1 Vegetable dish.....	.60
Total.....	\$4.75

Other utensils to be used about the kitchen should be:

1 Garbage bucket.....	18 quarts	\$1.25
1 Wash basin.....		.25
1 Soap dish and grate.....		.10
3 Glass jars.....	2 quarts	.30
1 Bread box, 8 by 10 by 20 inches..		.25
1 Butcher knife.....		.25
1 Can opener.....		.15
Total.....		\$2.55
Total cost of cooking outfit.....		\$14.80

All dishes should be of granite or enamelware; the cook stove should be No. 8, four holes, iron top, and wood or coal grate, and is generally furnished upon requisition. Costs given are for enamelware.

For Temporary Camp.—Two men on a camping trip should provide themselves with the following cooking utensils:

1 Dutch oven with lid.	2 Tablespoons.
1 Bucket, galvanized, 18 quarts	1 Kettle, straight, 10 quarts.
1 Bucket, galvanized, 14 quarts.	1 Kettle, straight, 6 quarts.
1 Cup, 1 quart.	1 Canteen, gallon.
2 Cups, 1 pint.	1 Combination can and bottle opener.
4 Plates.	1 Frying pan.
1 Butcher knife.	
2 Table knives and forks.	

The Dutch oven is a low, flat, heavy iron kettle for use over camp fires or live coals. The average size is about 10 inches in diameter and from 2 to 3 inches deep. It is fitted with three substantial legs and a short, heavy handle. The lid is fitted with a raised edge or rim designed to hold live coals and supply heat from the top. Other vessels of the kit should be granite or enamelware; knives and forks should have iron handles and spoons should be of tin.

Such a kit weighs about twenty-five pounds and costs about \$5.00. It can be most conveniently packed by dividing it into

three parts: The plates, knives, forks, and spoons are carried in the Dutch oven, the smaller bucket and the kettles and cups are carried in the large bucket, and the frying pan is carried separately.

PROVISIONS

While the following lists of provisions, compiled for one man for thirty days, must be accepted as including only approximate amounts, they will be of assistance to the new man when he must lay in a supply of such articles. It should be borne in mind also that a variety of food which appeals to one person may not suit another and that personal tastes must therefore be considered in making out a bill of supplies based on these lists:

For Stations

Baking powder.....	1 pound	Pickles.....	2 quarts
Beans.....	5 pounds	Potatoes.....	25 pounds
Butter.....	3 pounds	Rice.....	2 pounds
Canned fruit.....	10 quarts	Salt.....	2 pounds
Catsup.....	1 quart	Soda.....	8 ounces
Cereals.....	4 pounds	Spices.....	1 pound
Coffee.....	3 pounds	Sugar.....	10 pounds
Dried fruit.....	5 pounds	Tea.....	8 ounces
Eggs.....	3 dozen		
Flour.....	30 pounds		
Lard.....	5 pounds		
Meal.....	2 pounds		
Meat, salt.....	8 pounds		
Milk, canned.....	10 quarts		
Pepper.....	2 ounces		

MISCELLANEOUS

Matches, 1 box, 1,000	
Soap, laundry.....	2 bars
Soap, toilet.....	2 bars
Tobacco	

For Temporary Camps.—Two men expecting to be in camp for fifteen days should provide themselves with the following:

Baking powder.....	1 pound	Meat, salt.....	10 pounds
Beans.....	10 pounds	Milk, canned.....	8 quarts
Butter.....	2 pounds	Pepper.....	4 ounces
Canned fruit.....	8 quarts	Potatoes.....	20 pounds
Coffee.....	4 pounds	Rice.....	2 pounds
Dried fruit.....	3 pounds	Salt.....	2 pounds
Flour.....	35 pounds	Sugar.....	8 pounds
Lard.....	10 pounds		

It is also well to include ten or a dozen candles in this list. This supply of provisions, together with the cooking outfit, hobbles, picket ropes, or extra pack ropes, and bedding for two men, can be carried on one pack-animal.

CONSTRUCTION WORK

TELEPHONE LINES

General.—Telephone lines are built and maintained by the Forest Service chiefly as a means of quicker communication between different officers' headquarters or between such headquarters and lookout points. The actual work of construction and maintenance, invariably affected by local conditions, is carried on under specific instructions from the proper office and for that reason cannot be discussed in detail here. A few general rules of construction are given, however, merely as guides for inexperienced men engaged in this work.

Costs.—Local conditions affect this problem to such a degree that it is impossible to offer any definite suggestions concerning cost estimates. Such items as the nature of the ground to be worked over, local sources of supply, transportation facilities, the number of "poles in place," the ease or difficulty with which other poles may be secured and set, the amount of swamping to be done, and the best camp sites available, all affect the question of costs. Lines have been built, where no swinging insulators were used, for as low as \$20.00 per mile. A general statement of costs in such cases is about as follows:¹

No. 9 wire.....	\$11.00
Insulators, pony, glass.....	1.05
Brackets.....	.60
Spikes.....	.25
Labor.....	7.10
Total.....	\$20.00

Preliminary Survey.—This is made before actual construction begins. The proposed route to be followed should be marked with stakes set at points where poles are to be set, and these stakes should bear any information required by the workmen for proper setting of the poles. It may not be advisable to follow this survey in all instances, and deviations are permissible if circumstances demand them.

¹Supplied by Forest Ranger Perry, Special Detail on Telephone Construction, Carson National Forest.

Location.—Location of telephone lines should be determined by the following factors:

- (1) The shortest and most direct route practicable.
- (2) Possibilities of following roads or trails in order that first cost of construction and subsequent cost of maintenance may be kept at a minimum.
- (3) Best points for connection with desired points not on the main line or with points of possible future importance.
- (4) Avoidance of canyons and streams exceeding 500 feet in width; also of power transmission or electric light lines. Telephone lines should not parallel high-power transmission lines nearer than $\frac{1}{2}$ mile.
- (5) The accessibility of detours necessary to avoid bad country or scarcity of pole material.
- (6) The advantage, if any, of increased expense for material over one route as compared with increased cost of labor over another.
- (7) Possibilities of future patrol of the line as affected by present or proposed bridle trails the entire length of the line.
- (8) Possibility of securing rights-of-way across private lands.¹

Equipment.—Equipment for the lineman consists of a pair of 8-inch side-cutting pliers, a pair of reversible connectors, a light ax with a 16-inch handle, a safety belt and strap, a pair of hooks or climbers, and two Buffalo grips with 24 feet of $\frac{1}{2}$ -inch rope. Swampers should carry 4-pound double-bitted axes, whetstones, and 8-inch files. If required to do any climbing, they should be supplied with hooks and safety belt and strap.

Transportation.—This is not a serious problem if wagons can be used, but is more difficult if pack-animals are required. No. 9 galvanized iron wire, which is the standard wire used by the Forest Service, is put up in $\frac{1}{2}$ -mile coils weighing one hundred and sixty pounds each. If it is to be packed all the ties except one are cut, and this one is re-enforced, the coil is opened in half, and two men can then drop it down over a pack-saddle, one-half on either side. It should be tied securely to the saddle and not allowed to work loose. Insulators and spikes may be packed in feed sacks or panniers. Brackets may be strung on

¹ Verbal permission will not suffice. The concession must be drawn up in regular form on blanks supplied for the purpose.

wires, about twenty-five to a wire, each bundle weighing approximately sixteen pounds. These may be tied to the saddle without difficulty.

Two pack-animals are required in packing poles. The regular size poles may be packed in pairs and should be fastened high up on the saddle, the animals working tandem fashion one at either end of and between the poles. Short sharp curves must be avoided, as the animals will not be able to pass around them. Extra long heavy poles must be packed separately and should be securely fastened to the tops of the saddles. Burros will be found preferable to horses for packing, since the latter usually carry their heads too high and are much more likely to become excited in case of accidents.

Right-of-Way Clearance.—Rights-of-way through timber or brush should be wide enough to provide free access of mounted patrolmen over the entire length of the line. Dead or leaning timber that may fall across the line and all branches which may touch or hang close to the wire should be removed. Rubbish and slash resulting from such removal should be carefully disposed of in order to lessen the fire danger.

POLES

Material.—The best poles obtainable are of cedar, such as red cedar (*Juniperus Virginiana*), Western red cedar (*J. occidentalis*), one-seed juniper (*J. monosperma*), rock cedar or mountain juniper (*J. sabinoides*), California juniper (*J. Californica*), and Utah juniper (*J. Utahensis*), although the last named seldom reaches a height sufficient for standard poles. Alligator or checkered bark juniper (*J. pachyphlœa*) is widely used in the Southwest for fence posts, and is also frequently used for telephone poles when it is found tall and straight enough for this purpose. However, it is too light and brittle to make durable poles.

Red Douglas fir (*Pseudotsuga taxifolia*), also known as Douglas spruce, is also quite durable and as a rule can be easily obtained throughout most parts of the Rocky Mountain regions. Fire-killed poles of sugar pine (*Pinus Lambertiana*), obtainable in nearly all parts of the Northwest, and of Rocky Mountain white pine or limber pine (*P. flexilis*), found on the eastern slope of the Rocky Mountains, are almost as durable as cedar, and generally possess the advantage of being already peeled and sea-

soned at the time they are cut. Bald cypress (*Taxodium distichum*), also known as deciduous cypress, sassafras (*Sassafras sassafras*), locust (*Robinia pseudacacia*), white oak (*Quercus alba*), post oak (*Q. minor*), chinquapin (*Q. acuminata*), and black walnut (*Juglans nigra*), all common to the South and Southeast, are likewise durable and make good poles. Redwood (*Sequoia sempervirens*), occurring near the Pacific Coast in southwestern Oregon and northwestern California, also makes durable poles.¹

Dimensions.—The following table shows the dimensions that have proven the most satisfactory:

Length, in Feet.....	18	22 ²	25	30	35	40	45
Top Diameter, Inches.....	5	5	5.5	6	6	6.5	7

² Length of standard Forest Service pole.

It is not always possible to obtain poles having exactly these dimensions, but the table will serve as a general guide and should be followed as closely as possible.



FIG. 26.

Preparation.—Only the straightest timber should be selected, and if dead must be perfectly sound. Poles that are to be used in supporting extra long heavy spans of wire or which may otherwise be subjected to severe strain should be of the very best quality of material obtainable. The best time for cutting is when the sap is "down" or during the winter months, the poles being peeled as soon as cut and all large knots, splinters, and chips being hewn away. The upper ends or tops are "roofed" or beveled as shown in Fig. 26. The lower ends or butts are cut square across. After the poles have been peeled and roofed and otherwise properly shaped they are placed where they

will season, and may be piled in tiers not nearer to each other than 6 inches in the same or in different tiers, the lowest tier being propped up at least 6 inches above the ground. If

¹ See following Forest Service publications:

Bul. 88, Properties and Uses of Douglas Fir, pp. 60 and 62; Bul. 95, Uses of Commercial Woods of the United States (Cedars, Cypresses, and Sequoias), pp. 15, 18, 27, 39, 46, and 49; Bul. 99, Uses of Commercial Woods of the United States (Pines), pp. 56, 72, 75, 82, 87, and 92.

they have been cut here and there, one or two in a place, they should be propped well up off the ground and left in such a position that as they season they will not twist, warp, or rot. Seasoning should cover a period of two or three months.

Preservative treatment may be applied after they are thoroughly seasoned, while they are perfectly dry, and at times when they are free of frost. See page 358, Appendix.

Poles in Place.—These are simply trees growing at convenient points for the location of poles along the line and are trimmed and topped at the proper height and left standing. When treated in this manner some varieties of timber last better than when not. Chief among the more durable ones are Douglass fir, white pine (*Pinus albicaulis*), and white oak. White fir (*Abies concolor*) and piñon (*Pinus edulis*) soon rot and do not make satisfactory poles in place. Yellow pine (*Pinus ponderosa*) usually rots within a year or eighteen months, unless the pole is very large. Aspen (*Populus tremuloides*) may sprout and stay green if topped in the spring, as will also most of the oaks. The sprouts appear at the point of topping and must be removed before they reach a size or length that will allow them to rub against the wire and impair communication. Poles in place should have a minimum top diameter of 4 inches and should have all branches removed.

Use of Different Lengths.—Standard Forest Service poles are used in all cases except:

(1) When a line crosses a railroad; the wire must be not less than 26 feet above the track.¹

(2) When a line crosses a wagon road; the wire must be not less than 14 feet above the road.¹

(3) When a line crosses other lines; the wire should be not less than 18 inches above the other line.

(4) When lines are run across country where brush exceeds 10 feet in height; the wire should be held at least 4 feet above the tops of the brush.

(5) When lines cross country where snow may drift higher than 10 feet; the wire should be held at least 2 feet above the tops of probable drifts.

(6) When spans exceed 500 feet in length; poles must be sufficiently high and heavy to support the extra weight.

¹ Higher if the State laws require it.

(7) Where poles must be set at such points that extra long spans demand unusual sag; the lowest part of the wire should be held high enough to allow uninterrupted passage of travelers and stock beneath it.

Utilization.—In order to secure the greatest stability and efficiency of a line, care must be taken to distribute the poles where different lengths will do the most good. The largest and strongest ones should be used at points where the strain of the wire is greatest, such as at corners, along curves, under long spans and at terminals and switching points. Lighter and weaker poles should be set at points where they will be subjected to only moderate strain.

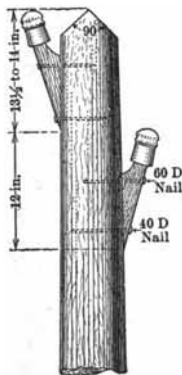

FIG. 27.

Spaces.—Under ordinary circumstances straight lines should have thirty poles to the mile, thus making the average pole space or length of span 176 feet. If the line makes a turn at right angles the spaces at either side of the turn should not exceed 100 feet in length. This same length of span is also used in spans

adjoining one from 300 to 500 feet in length. It is likewise used in short, sharp curves.

Attaching Brackets and Insulators.—Brackets are attached to the poles at right angles to the ridge of the roof and before the poles are raised. A 60-D spike is used in the upper hole and a 40-D in the lower, knots, thick rough bark, and other irregularities being hewn away if the brackets are to be attached to trees. Brackets are always so attached that after the poles are set they will be on the outer side of curves, but when the poles carry two lines then the brackets are placed on exactly opposite sides of the poles. They are fitted with the insulators before the poles are raised. See Fig. 27.

Holes.—Except where conditions render it impossible or inadvisable these should have about the following depths:

Length of pole, in feet . . .	18	22	25	30	35	40	45
Depth of hole, { Earth . . .	3.5	4.0	4.5	5.0	6.0	6.5	6.5
in feet { Rock . . .	3.0	3.0	3.5	4.0	4.5	5.0	5.0

Holes along curves or in loose soil should be at least 6 inches deeper than shown above, and should have a diameter about 6 inches greater than that of the pole to be set. If poles must be set in solid rock, it usually proves more economical to drill 2- or 3-inch holes and use pipe for poles.

Setting.—In setting poles they are turned so the ridge of the roof will be parallel with the line wire, care having been taken to roof the crooked poles so the crooks will face the next pole in the line when the ridge of the roof is parallel with the line. All poles in straight lines are set as nearly perpendicularly as possible, but in curves are given a certain amount of rake which is about as follows:

Pull, in feet	5	10	15	20	25	30	(See Fig. 28)
Rake, in inches	10	16	24	33	42	..	(See Fig. 29)

The pole must be braced or guyed if the rake exceeds 42 inches.

No attempt should be made to adhere strictly to these figures regardless of all conditions; neither should they be totally disregarded.

Tamping.—Some heavy iron instrument, such as a crowbar, having a beveled point will be found preferable for this use to one having a broad, flat-tamping surface. Fine dirt should be well



FIG. 28.

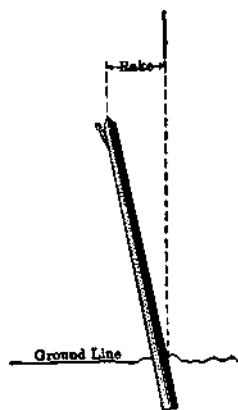

FIG. 29.

tamped about the base of the pole first, and care must be taken to see that it is firmly packed on all sides of the poles. Alternate filling and tamping of coarser material then follow till the hole is filled. After this has been done, dirt is tamped about the pole above the ground level, and serves as a watershed which will drain surface water away from rather than

allow it to seep down about the base of the pole. Such a watershed should be not less than 6 inches high at the pole, and should extend outward from the pole to a distance somewhat past the edges of the hole.

Methods of Strengthening.—It not infrequently happens that poles may be of such material or may be so placed that in themselves they are not of sufficient strength to withstand the strain imposed upon them by the line wire, and in such instances it of course becomes necessary to re-enforce them in such a manner that efficiency of the line will not be impaired.

Guys.—These are of twisted wire and are usually cheaper than braces. They consist of at least two wires (of the same gauge as the line wire) twisted together and are of a length sufficient to reach from the bracket to a point on the ground at a distance from the pole equal to the pole's height above ground. See Fig. 30. An anchor block, or "dead man," is buried at a depth of 3 feet, which allows the eye of an ordinary anchor rod to extend above the surface of the ground. After the upper end of the guy wire has been made fast to the pole by two turns about it just below the bracket and twisted not less than six times about itself, the lower end is brought to the anchor rod by means of the Buffalo grips, which regulate the tension, and is then passed through the eye and back on and twisted about itself in not fewer than six turns.

Braces.—Brace poles should have a minimum butt diameter of 8 inches. They should be set at least $3\frac{1}{2}$ feet below the surface of the ground, against a solid bottom, and at a point from the pole equal in distance to one-half the pole's length. See Fig. 31. When so set the upper end should strike the pole three-fourths of the way up. Hewing, for the purpose of making a tight joint where the brace strikes the pole, should always be done on the brace and never on the pole. A $\frac{1}{2}$ -inch galvanized bolt is passed through both timbers just above the lower edge of the braces and serves to hold the two together.

Use of Guys and Braces.—These are used on the first and last poles of a line, at approaches to crossings, at the ends of spans from 300 to 500 feet long, and on poles set in very steep hillsides or along curves where the pull exceeds 30 feet. They may be used at other points as circumstances demand.

Re-enforcements.—Poles may be re-enforced as shown in Fig. 32. This method of bracing is used when conditions prohibit

the use of guys or braces or when poles have become weakened through decay. Stubs should be of cedar, although other dur-

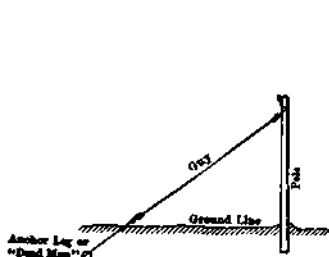

FIG. 30.—Guy for telephone pole.

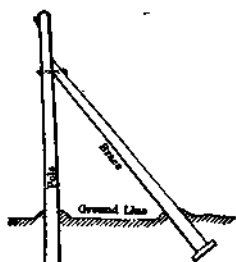

FIG. 31.—Brace for telephone pole.

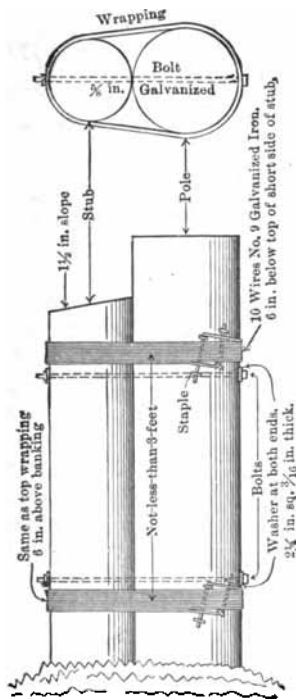

FIG. 32.—Re-enforcement with stub.

able woods may be used when this is not available, and should have the following approximate dimensions:

Length of pole, in feet.....	18	22	25	30
Length of stub, in feet.....	9	9	9.5	10
Top diameter of stub, in inches.....	7	7	8	8.5

They should be set as deep as the pole and on the side where line strain will tend to pull the pole toward rather than away from them.

Methods of construction are explained in the figure.

Stubs—These are used where a guy crosses a road or trail and are shown in Fig. 33. They are guyed the same as a pole.

LAYING WIRE

No more wire than can be hung in one day should be laid out at one time. It should be cut at points where the line is to cross a road, trail, or other path of travel and the loose ends should be fastened back out of the way. Unless this is done the wire should be suspended in such a manner that vehicles or travelers may pass beneath it without difficulty. Care must be taken to see that all short kinks are either straightened or cut out and the wire spliced

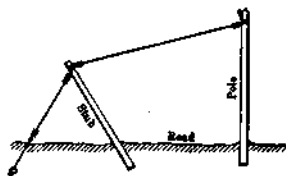

FIG. 33.—Stub for telephone pole.

before it is stretched, this being especially true of hard drawn copper wire. Deep nicks, stretches of rust, and all other especially weak spots should be cut out, but at the same time care must be taken to keep the number of splices at a minimum if efficient service of the line is to be secured.

The coil of wire to be laid out should be placed on the reel in such a way that the loose end will run from the outside and a few rounds should be run off in order to ascertain definitely whether this end of the wire has been loosened. If the topography and travel facilities of the country permit, the reel may then be placed in the rear of a wagon and hauled over the right-of-way after the loose end has been tied to some stationary object. Otherwise two men may carry the reel and lay out the wire after the same manner. If neither of these methods is practicable then the reel may be firmly set and the wire laid out with a horse. This can be done by tying a 12- or 14-foot rope to the end of the wire and "dallying" the other end at the saddle horn. The practice of looping the wire itself about the horn is one to be avoided; in case of accident the wire can not be released in time to avert injury either to the horse or the rider.

Animals not trained to pull under the saddle may be worked

in harness, the wire being looped into the center clip of a single tree and laid out quickly and easily. It is always advisable, however, for one man to remain at the reel to see that no tangles occur as the wire is run off. It invariably happens that without some means of regulating the speed at which the reel revolves several turns of wire are thrown off at once and the consequent tangle necessitates numerous splices or else total loss of all the turns so tangled. It is also advisable, and even necessary, that a prearranged system of signals be agreed upon by the man at the reel and the one paying out the wire.

Care must be taken, also, to see that the wire is laid on the proper side of poles if extra work in the way of replacing or cutting and splicing is to be avoided.

After the wire has been laid it may be hung over the brackets, ready for stretching and tying, by means of either a slender pole, to the ends of which a horseshoe has been attached so that when the pole is erect the heels will point upward, or by using a long slender forked pole.

CLIMBING

The climbers or hooks are strapped securely to the legs just below the knees and again at the ankles with the loose ends of the straps projecting to the rear as shown in Fig. 34. The safety belt is buckled about the waist comfortably tight and all the tools to be used in tying or otherwise working on the wire at the insulator are placed in their respective loops. One end of the safety strap is snapped into the ring at the left side of the belt and the other is allowed to hang loose until the climber reaches the desired height on the pole. This is usually when the chin is about on a level with the insulator if tying is to be done. In using the hooks no attempt should be made to grip the pole with the knees, as this will force the hooks out of the wood and cause the climber to slide suddenly downward.¹ The knees must be bent outward away from the pole and care



FIG. 34.—Method of attaching climbers or "hooks" to the legs and feet.

¹ Known in the lineman's vernacular as "burning the pole."

must be taken to fix each hook firmly into the pole before another step is attempted. This is done by a sharp, vigorous thrust with the foot directed diagonally downward at the pole. The body is kept well away from the pole and parallel with it from the waist up. Crooked or leaning poles are climbed on the upper side of the crook. When the desired height has been reached both hooks are struck into the pole at about the same level and the pole is securely grasped with the right hand and arm. The safety strap is passed around the pole with the left hand and caught with the fingers of the right. The left hand and arm then grasp the pole, and the safety strap is hooked into the right side of the belt with the right hand. The lineman then settles his weight backward against the belt and downward on the hooks, keeping his body rigid and well away from the pole. In this position he is able to make a tie without difficulty.

POLE STEPS

These are used in poles over 35 feet in length. Beginning at a point 6 feet above the ground they are set alternately along

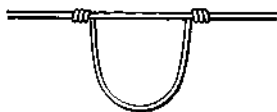

FIG. 35.—Horseshoe tie for iron wire.

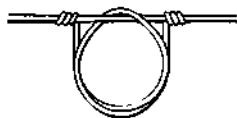

FIG. 36.—Figure 8 tie for iron wire.

opposite sides of a pole and are spaced 3 feet apart, making steps 18 inches high. As a general rule they are screwed into the pole before the latter is raised. The most convenient method of inserting them is to start holes $\frac{1}{16}$ -inch less in diameter than the screws. They may then be screwed or driven in without difficulty. If they are to be used in large trees they should be placed at about right angles to each other rather than on exactly opposite sides of the tree.

TIES

Horseshoe.—This tie is illustrated in Fig. 35. It is the most common tie used, and is especially convenient in rural and secondary lines. The tie wire is of the same gauge as the line wire and is cut 10 inches long. Each end is given not less than three



FIG. 37.—Figure 8 tie for hard-drawn copper wire.

close turns about the line wire and the projecting ends are then clipped off short in order to avoid weakened transmission as the result of "leakage." Such ties are for use on iron wire and are not adapted to tying hard-drawn copper wire.

Figure 8.—The wire for this tie is also of the same gauge as that of the line wire, but is cut from 24 to 30 inches long. When used on iron wire, it is constructed as shown in Fig. 36, but if hard-drawn copper wire is to be tied it is made as shown in Fig. 37.

A variation of this tie is shown in Fig. 38, but is not used as extensively as either of the preceding ones. However, it may be used to good advantage in tying hard-drawn copper wire, and in such a case the ends are disposed of as shown in Fig. 37. The tie wire is cut 18 inches long.

Swinging.—These ties are constructed as shown in Fig. 39 and are for use in lines hung from swinging insulators. They are attached to the line wire not nearer than 6 inches to the insulator and are cut about 20 inches long.

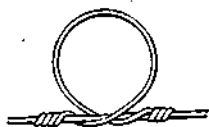

FIG. 38.—Tie for iron wire.
(Seldom used.)

SAG

This term has reference to the distance below the horizontal to which a line wire should reach at or near the center of the span. The table of sag necessary to allow for galvanized

iron wire, hard-drawn copper wire, and for lines hung on trees, will be found on page 355, Appendix. The object of sag is to permit regulation of the tension of the wire during hot or cold

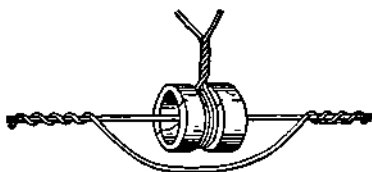

FIG. 39.—Swinging insulator.

weather. In no case should it be less than that given in the table.

SPLICES

In Galvanized Iron Wire.—If a splice is to give the best service it must be as tight as possible and projecting ends must be cut away close up. Otherwise the transmitting efficiency of the line will be weakened through "leakage" and communication



Hook.



Western Electric joint. For iron wire.

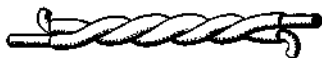

Hard-drawn copper wire spliced by use of sleeve.

FIG. 40.—Splices.

will be greatly impaired. The process followed in constructing a splice for this variety of wire is illustrated in Fig. 40, and is known as the "Western Electric" joint. The wire ends are

run through the connectors from opposite sides and are then given five turns about each other. Another method is to use two pairs of connectors and turn them in opposite directions or else hold one stationary and turn the other.

In Hard-Drawn Copper Wire.—Splices in this wire are made as shown in Fig. 40. The wire ends are inserted in the sleeves from opposite sides and ends and are then given not less than

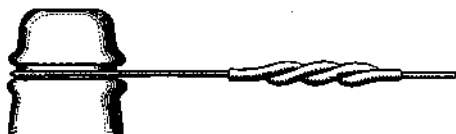
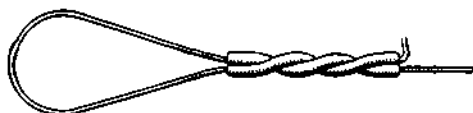

For hard-drawn copper wire.

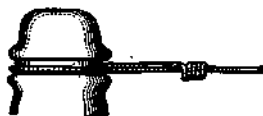
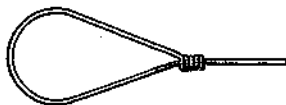

For iron wire.

FIG. 41.—Dead ends.

three nor more than four turns. The projecting ends, which should not exceed 1 inch in length, are turned back upon themselves. The sleeves should not be used in making splices in galvanized iron wire, as corrosion will result and weaken the wire.

The Hook Splice.—This splice, also shown in Fig. 40, is the very poorest sort of makeshift and should not be used under

any circumstances. Two or three of them in a line will so weaken the transmitting powers as to render communication almost impossible.

DEAD-ENDS

These are used at the terminals of lines, on poles next to railway or underground crossings, and at the junctions of switch lines with main lines. They are constructed as shown in Fig. 41. If hard-drawn copper wire is to be dead-ended the method is the same as shown in Fig. 41, where a half-length sleeve is given one and one-half turns.

APPROACHES AND CROSSINGS

Forest Service lines approaching other lines for the purpose of crossing them are dead-ended at either side. This is especially important if the crossing span is to be very long, in which case it is also dead-ended and connected to the main line as shown in Fig. 42. Such crossings are to be over other lines, unless the latter will be kept in good repair, and not allowed to fall across the Forest Service line. Power-transmission lines or electric-light lines are crossed underground, the nearest poles being set not less than 150 feet from them. These crossings should be taken up in detail with the proper office and specific instructions obtained as to the proper method of construction.

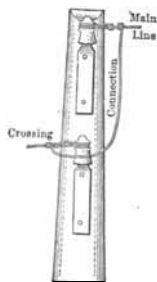

FIG. 42.—Dead-ends at crossing.

Spans crossing railroads must be suspended from poles set far enough back from the track so they will not reach it in case they fall. Ordinarily they should be braced or guyed from a direction that will prevent them from falling toward the track. The line wire is dead-ended at either side and two insulators are used, as shown in Fig. 42.

Spans crossing wagon roads must be suspended at a height that will permit the passage of traffic beneath them.

All approaches to crossings are at right angles to the line or road to be crossed; unless the ends of the crossing spans are dead-ended they are tied with the figure 8 tie; and if the spans are to be 500 feet or more in length, specific instructions as to the proper method of crossing should be obtained.

CONNECTIONS

Branch lines connecting with Forest Service lines are dead-ended on a separate insulator. They are left long enough to supply the connection wire, as shown in Fig. 43, and this is given at least seven turns about the main line if galvanized iron wire is used. Hard-drawn copper-wire connections are made as shown in Fig. 44.

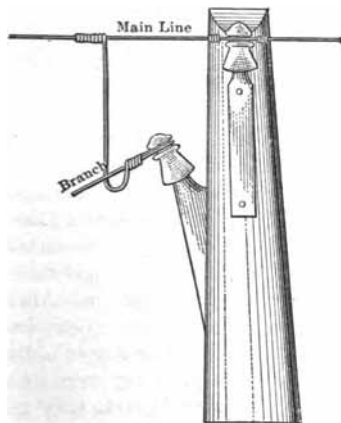

FIG. 43.—Branch-line connection.
Iron wire.

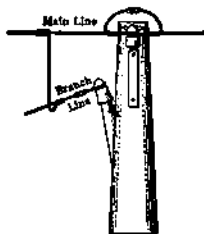

FIG. 44.—Branch-line
connection.
Hard-drawn copper wire.

LIGHTNING RODS

These are of the same gauge wire as the line wire and are attached to the poles before the latter are set. They are cut $3\frac{1}{2}$ feet longer than the pole to which they are to be stapled and a 6-inch length is allowed to project beyond the upper end, or past the ridge of the pole roof. This is then bent back and twisted about itself, leaving a 3-inch extension above the pole. The extra 3-foot length is coiled or wound about in the shape of a clock spring and is stapled to the squared-off butt of the pole. The wire is then stapled along the pole one-quarter of the way around from the insulator. It must not be allowed to come in contact with the line wire or grounding will be the result. Ordinarily one should be attached to every tenth pole, but if the line follows a route which is greatly exposed to atmospheric disturbances one should be supplied at every fifth pole.

OTHER LINES

Forest Service lines hung on the same poles with other lines should be fastened at least 2 feet above the latter. They should never under any circumstances be hung on poles carrying power lines or other wires heavily charged with electricity.

TREE LINES

Where trees are used in lieu of poles the line is hung to them by means of swinging insulators, as shown in Fig. 39. These consist of two duplicate pieces of porcelain which when properly fitted together resemble an ordinary "spool" or "knob" insulator, except that the groove passes around the center instead of at one end. Each piece is fitted with a shallow hole at one corner and with a short tenon at the corner diagonally opposite. These prevent lateral displacement of the halves. Each half is also fitted with a semicircular, well-glazed, lengthwise groove through which the line wire passes when the halves are fastened together. After they have been fastened about the line wire they are suspended from long tie wires in such a way that they may swing to a distance of from 8 to 24 inches, farther if necessary. They were originally designed as a means of allowing the wire to slide through its support and not be broken by the swaying of the tree. However, the line wire seldom slides through them, but finally causes the tie wire to break at or near the tree as the result of continuous bending backward and forward. This trouble may be overcome by attaching a wire ring to the tree and fastening the tie wire into it. This ring may be made by twisting a piece of wire about a hammer- or hatchet-handle. Another objection to the use of such insulators is the fact that when the line wire does slide through them it becomes worn at that point and finally breaks. It is assumed that when they are used, trees falling across the line will not break it, but that the sag from several spans will accumulate at that place and allow the wire to be borne to the ground. This is exactly what occurs if the line is properly hung. Such lines are tied at about every seventh pole or tree by being fastened to an insulator on a bracket. These ties are of No. 12 gauge wire instead of No. 9, the difference in gauge allowing the tie wire to break before the line wire does. The same gauge is also used in tying every third swinging insulator. Other ties are of No. 18 gauge seizing strand.

TELEPHONES

Ohms Resistance of Ringer Coils.—The standard telephone used by the Forest Service is of 2,500 ohms resistance, but when Forest Service lines are connected with other lines the ringer coils in both the telephones and extension bells should have the same resistance as those on the line connected with. In some instances it may therefore be necessary to use instruments having 1,600 ohm ringers.

Protection.—The protector adopted as standard by the Forest Service is known as No. 60-E and is used where there is no exposure to high-tension circuits, such as power or electric-light lines. If exposure to lightning is especially great a No. 47-A line fuse is used in addition to the No. 60-E protector, but should be so placed that the wire nearest the line may fall away when the fuse is blown.

The same combination protection is used where there may be exposure to lines of high-tension voltage except in cases where the voltage may exceed 1,800. In that event specific instructions are to be obtained as to what method of protection should be used.

INSTALLATION¹

Dead-Ending the Line Wire.—The dead-end bracket should be attached to the side of the building at a point as near the proposed location of the telephone as possible. In attaching the line wire to the dead-end insulator it is left long enough after dead-ending to be bent back on itself for a distance of at least 2 feet and is then run down to and connected with the fuse as shown in Fig. 45. The fuse should be suspended at a point low enough to allow easy access to it when replacement becomes necessary.

Connection of Fuse with Set.—This connection is shown at 1 in Fig. 45 and should be of No. 14 Brown & Sharp gauge wire weather-proofed. The insulator shown at 2 is the regular No. 4½ porcelain knob attached to the wall with a No. 18, 3-inch, flat-headed iron screw. The tie wire should be insulated.

¹ For installation of sets on metallic circuits, wiring, and installation of outside sets, and other information, see Forest Service manual, "Instructions for the Building and Maintenance of Telephone Lines on the National Forests."

Drip Loops.—These are made as shown at 3 and are provided in order that water may not follow along the wire into the tube, shown at 4. Such loops should be at least 2 inches deep.

Tubes.—These are also of porcelain and are of different lengths and diameters. They are used as conveyances for wires which are to be passed through walls and they also act as extra insulation for such wires. In outside walls they should be set with the inner end higher than the outer end. This prevents

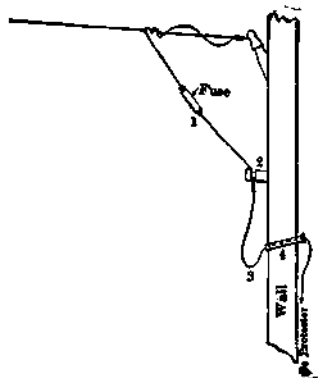

FIG. 45.

water from following along the wire into the building. They may be set horizontally in interior walls.

Connections at Protector.

—Usually the protector is attached to the inside of the wall at a point directly over the telephone. The line wire connects at the upper side and the line terminal in the set connects at the lower side.

Connections in the Set.

As a general rule all telephone sets come ready wired and the terminals in the ones used by the Forest Service

are lettered "Line 1" and "Line 2." The line wire is connected with the former and the ground wire with the latter.

Ground Rods.—The standard ground rod used by the Forest Service is a $\frac{1}{2}$ -inch iron rod 5 feet long fitted with a copper wire for connection with the ground wire of the set. When possible to do so this rod should be driven its full length into the ground. At any rate, it must be driven to moist earth if good grounding is secured. It need not necessarily be driven immediately next to the building but may be set at a point several rods away. If the character of the ground is such that no suitable place can be found for the ground rod, a 50-foot length of wire may be closely coiled and buried at a depth which will insure its contact with permanently moist earth. One end of this wire is then connected with the ground wire of the set. The hole in which the wire is buried should be filled with charcoal or very fine dirt.

Joints and Splices.—All joints and splices, both inside and

outside of the telephone, should be wrapped with tape, except those at the terminals in the set. If this is done they need not be soldered.

Connection of Batteries.—Ordinarily all telephones are fitted with dry batteries which are connected with each other, as shown in Fig. 46. They are connected before being placed in

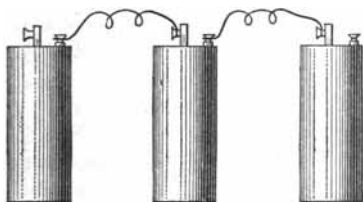

FIG. 46.—Connection of batteries.

the box. If the latter is wide enough to accommodate three batteries this number should be used in preference to two.

To Test Dry Batteries.—The easiest method of ascertaining whether or not a battery is exhausted or "dead" is to press the heel of a knife-blade firmly against the binding post at the edge of the battery and the point of the blade against that portion of the battery in which the other binding post is fastened. If the portion touched with the point of the blade "fries," sparkles, or smokes the battery is still "alive." If the application of the knife-blade has no perceptible effect on it, then the battery is too weak to give good service and should be replaced with a new one. Another effective test is to place the binding posts of one battery against opposite posts of another. A spark will result if the batteries are alive.

TELEPHONE TROUBLES

The following "troubles" occur most frequently and as a general rule may be immediately remedied by making the necessary repairs or adjustments:

(1) Rings and communication received but not transmitted: Loose connections or broken wires in batteries or transmitter or both.

(2) Rings not received: Broken wires or loose connections in ringer or improper adjustment of clapper between bells.

(3) Rings transmitted but not received: Loose connections

or broken wires at connection of line wire with set, ground rod or protector, contact of line with trees, or other grounding agents.

(4) Crank turns hard and rings are inaudible and not transmitted: Usually due to crossed wires.

(5) Crank turns easily, rings audible but not transmitted: Broken or poor ground connections, loose connections of outside with inside wiring, broken line wire, poor connection at terminals or protector.

(6) Indistinct transmission and receiving: Loose connections, improper joints or splices, worn-out batteries, or faulty grounding.

(7) Difficult ringing, transmission, and receiving: Poor joints, faulty ground, line wire of too light a gauge, too many telephones on the line, too many receivers down, contact of line with trees, branches, or poles.

(8) Good transmission, poor receiving: Loose connection or broken wires in induction coil or receiver hook, broken wires in receiver or receiver cord, damaged or dusty diaphragm.

(9) No transmission or receiving: Broken or disconnected line wire, crossed or broken wires in the set, no ground connection, improper terminal connections.

(10) Intermittent transmission and receiving: Loose line connections, intermittent contact of line wire with grounding agents.

DAMAGE TO OR DESTRUCTION OF TELEPHONE LINES

Section 60 of the Act of March 4, 1909, as quoted on page 31, U. S., 1915, provides as follows:

"Whoever shall willfully or maliciously injure or destroy any of the works, property, or material of any telegraph, telephone, or cable line or system, operated or controlled by the United States, whether constructed or in process of construction, or shall willfully or maliciously interfere in any way with the working or use of any such line or system, or shall willfully or maliciously obstruct, hinder, or delay the transmission of any communication over any such line or system, shall be fined not more than \$1,000 or imprisoned not more than three years, or both."

TRAILS

Local conditions so completely govern the work of trail construction as to make a set of definite rules impracticable, but

nevertheless certain general rules can always be followed with more or less success, and it is felt that a few suggestions concerning the actual work in the field will not be out of place.¹

Purpose.—Trails are constructed in National Forests for three general purposes, viz.: (1) Transportation facilities; (2) travel facilities; (3) protection facilities. The first is constructed between points where more or less traffic in the shape of supplies and other commodities passes in transportation by pack-animals. Such a trail would correspond to a class A trail as designated in the Forest Service and would usually follow some natural line of travel, such as a main valley, where eventually it could be widened into a road with little further expense. It would have a maximum grade of 15% with a standard grade of 6%. The second would be constructed chiefly as a means of access from one secondary point to others, would not exceed a 20% grade, maximum, with a standard grade of 12%, would not be built in anticipation of its future reconstruction as a road, and would correspond to what is known in the Forest Service as a class B trail.

A trail leading to some isolated point not of sufficient importance to justify heavy expenditures in trail construction or to demand frequent visits or quick access would be a class C trail, and might have a grade as much in excess of 20% as could be negotiated by pack- or saddle-animals, the standard grade, however, being 18%.

All trails, in addition to facilitating transportation and travel, may also serve as means of fire protection by providing stretches of ground free from inflammable material.

Preliminary Survey.—The three features of greatest importance in the preliminary survey for a trail are: (1) Directness of route; (2) uniformity of grade; and (3) cost of construction as compared with the economic value of the completed trail. Obviously the adoption of an indirect route between termini when a more direct and just as good a route is possible cannot be justified, nor are numerous and unnecessary descents justifiable when ascent is the objective. Cost estimates must be held to a limit compatible with the importance of the trail, i. e., ex-

¹ See Trail Manual, 1913, Preliminary Draft, by F. A. Silcox, District Forester, District No. 1. See also the manual, Trail Construction on the National Forests, 1915.

penditures sufficient for construction of a class A trail should not be contemplated in construction of a trail to be of minor importance when completed. On the other hand, however, proper construction of a trail intended to be used chiefly for transportation purposes should not be neglected to an extent that will leave the trail in no better condition when completed than a class B or C trail. Cost of construction is necessarily determined by the nature of the route to be covered, the amount of blasting and grading to be done, the number and sizes of bridges, culverts, drain ditches, retaining walls, and switchbacks required and the amount of swamping to be done. It also includes the cost of the preliminary survey, which, under ordinary conditions, should not exceed 5% of the entire cost of actual construction.

Locating the Route.—In most instances where a trail must cross hilly or mountainous country the work of locating the route should begin at the high points and proceed down-hill, this method of operation facilitating advance observations and obviating extra work often incident to up-hill surveys. The preliminary route or routes should be marked only at points sufficient to indicate the line for possible future reference in the final survey, blazes being very light and not cut through the bark, and stakes being small and only temporary in nature. Later, after all trail lines have been run and the final survey has been made, this should be marked plainly with blazes cut through the bark or with strong durable stakes set firmly in the ground at frequent intervals.

Such blazes or stakes may be scribed or otherwise marked with any information the construction crew may require for proper grading or other work, care being taken of course to see that the foreman will readily understand what is meant by certain locations of or data on stakes or blazes.

Grade.—To determine the grade of a trail between objective points the rise, or difference in elevation, between those points is divided by the corresponding length of trail minus the total length of the level stretches it may cover. Thus, letting R represent the rise, T the length of trail, L the total length of levels, and G the per cent of grade, the formula for such a calculation would be

$$\frac{R}{T - L} = G.$$

Therefore, assuming that a trail $\frac{1}{2}$ mile, or 2,640 feet, in length ascends 375 feet and covers levels aggregating 140 feet in length, the per cent of the grade is found thus:

$$\frac{375}{2,640 - 140} = 15\%.$$

Clearing.—Trees, brush, and saplings should be cut out to a distance far enough back on either side of the trail to allow uninterrupted progress of pack- and saddle-animals. Limbs overhanging the trail should be removed till at least an 8-foot vertical clearance is secured. These should not be merely "bobbed" or "dehorned" so that long stubs are left projecting toward the trail, but should be cut away close up to the tree trunk. Stumps growing along the lower edge of a side-hill trail frequently may be utilized as braces in retaining walls of minor importance but should not be relied upon to form parts of heavy walls that can be repaired only with difficulty. If they are to be left along other portions of the trail they should be cut low enough to allow plenty of room for stirrups to pass above them. Large trees growing directly in the route chosen for the trail to follow should, in all ordinary circumstances, be passed around rather than felled. If they are felled the stumps must be either passed around anyhow or else grubbed out, and in this case there always arises the question whether or not grubbing is more economical than deviation of the trail.

Large roots or small stumps uncovered in grading and left projecting above ground or from the upper bank should be cut out in such a way that remaining portions cannot possibly interfere with travel.

Disposal of Débris.—A fixed rule in the Forest Service is either to burn all refuse resulting from clearing and grading or else pile it and have it ready for burning at a later date if circumstances prohibit burning at the time the trail is constructed.

GRADING

Blasting.—A discussion of this subject will be found on pages 74 to 85, inclusive.

Tools Required.—The number of tools required in building a trail depends upon the number of men to be employed and the nature of the ground to be worked over, and about the only

general rule that can be followed in outfitting a crew is to see that each man is provided with at least one tool. In addition to such a list it is also well to supply at least one extra tool, or accessories, of each variety to be used most and which will be most liable to damage. This is especially true of handles if suitable material for improvised handles cannot be secured along the trail.

Plows.—Only in rare cases can trail grading be done by means of teams.

Occasionally, however, one horse, hitched to a light plow, can be used to advantage in breaking ground which can later be raked or shoveled out or placed as desired. The most suitable plow for such work is what is known in the South, and, in fact, in most other sections, as a "bull tongue" or "Georgia stock," and which consists merely of a straight beam frame carrying a straight leg fitted with a 4-inch steel shovel from 8 to 16 inches long. A lighter variation of the bull tongue is known as the "calf tongue," which is only about 2 inches wide and which is designed for use on a bent leg. Another suitable form of shovel for such a frame is known as a "twister." This is about 6 inches wide by 12 long and bears a 3- or 4-inch wing which serves the same purpose as the mould board on a turning plow. The wing may be either right or left turning.

The best 2-horse turning plow for trail work is what is commonly known as a "side-hill" or "hillside" plow. The land-side and mould board are so constructed that either may be used as the other simply by reversing their positions. They are released by raising a lock that holds them in position for plowing and can easily be turned by allowing the team to tip the plow as the turn is made for cutting the next furrow. The lock is fastened before the furrow is started. Constructed in this manner, the plow may be used to throw dirt down-hill in plowing in either direction along the trail.

If a side-hill plow is not available, then an Oliver chilled No. 13 turning plow is recommended. This will cut a clean 8-inch strip without difficulty, is light, and can be easily handled on steep hillsides, and will be found preferable to heavier plows cutting wider furrows. It is especially suitable for work in ground full of stones and roots. The share fastens to the frog with only one bolt, and this is threaded in such a way that the tap must be turned to the left to be tightened. Being threaded

in this manner the tap is tightened rather than loosened if it accidentally slides along on rough ground. Another advantage of this plow is that when dull, the share, being chilled, may be sharpened by chipping it with a hammer, the blows being directed against the edge in line with the upper surface, thus breaking the chips from the upper side and beveling the share so it will feed into rather than out of the ground. If the chips are knocked from the under side of the share the bevel will be reversed and the plow will jump or feed upward. The share cannot be heated and beaten out to a thin edge.

Another form of 2-horse plow very suitable for rough work, and especially effective in breaking out roots and small boulders, is known as a "coultter." It consists simply of a pointed steel leg, square, round, or shaped like a knife-blade, thrust through the beam and used in breaking ground. It is designed only for breaking hard or rough ground and cannot be used in moving dirt.

In using any form of plow in ground where roots or stones may be encountered frequently the plowman must exercise great care in avoiding broken root ends as they snap back from the plow. Carelessness in this respect may result in severe injuries to or even fractures of the legs. He should also walk behind rather than between the handles, since these are often forced suddenly sidewise or upward or downward as the plow-point strikes stones or slips over or under roots, and at such times may inflict painful or even dangerous injuries on the body. He should also remember that a bull tongue, twister, or coultter is so constructed that it is lowered into the ground by downward pressure on the handles and is released by raising the handles, while a turning plow, being fitted with a long point, landside, and share, can be forced into the ground with much less difficulty if the handles are gradually forced slightly upward or toward the side on which the landside works, which, in a regulation turning plow is to the plowman's left. The plow can be released quickly and easily by sudden downward pressure on the handles or by turning the plow sidewise and downward on the share side. The latter operation can be performed without difficulty by seizing the left handle with both hands and thrusting the plow to the right.

The lateral direction and the depth to which a turning plow may be made to run in rough ground is regulated to a certain extent by means of the double clevis fitted to the end of the

beam and supplied as a means of attachment for the double tree. This is known as an "end clevis" or a "plow clevis." On steel-beam plows the part attached to the beam is in two pieces, one piece fitting to each side of the beam. For a wooden beam it is made in one piece and to fit over the end of the beam. At the forward and perpendicular end a number of holes, one below the other, provide means for attaching that part of the clevis which fastens to the double tree, and it is by means of these holes that depth is gauged. Hitching into the lowest hole serves to raise the point of the plow and thus permits shallow plowing, while hitching into the upper hole forces the point downward and allows deeper plowing. Intermediate depths are provided for by the other holes. Lateral direction may be gauged by attaching the double tree to the horizontal part of the end clevis. Hitching into the hole farthest to the left forces the plow to the right and causes it to "cut narrow." Using the hole farthest to the right makes the plow "take to land" and cut wide, or "cut and cover," this term applying to work in which a narrow strip of uncut ground is left between furrows and covered over with fresh dirt.

In making the turn at the end of a furrow preparatory to cutting the next furrow, a turning plow should not be slid along on the edge of the share. If it must be slid at all it should either be slid on the heel of the landside, which is made extra heavy for this use, or else thrown completely over on its left side and dragged. Dragged in this manner it is always in such a position that it may be easily set upright by seizing the upper or right handle with the right hand and raising the other handle to the left hand.

A bull tongue, twister, or coulter, having no long horizontal point, share, or landside, may be turned about on the point as on a pivot.

In turning any plow sufficient downward pressure should be applied to the handles to raise the end of the beam to a point where it will hold the double and single trees high enough to prevent the animals from stepping over or entangling themselves in the traces. Turning may also be facilitated by tipping the beam away from the team after it has been raised.

Weights placed on a turning plow to assist in holding it in rough ground should be attached near the end of the beam rather than over the leg. When they are placed on bull tongues,

twisters, or coulter they should be fastened immediately over the leg.

Plowing in very rough ground will be found much easier if one man drives while the other holds the plow. The driver should keep his animals under complete control, should hold them to a slow, steady walk, avoid exciting them, and before starting them again should give them ample time in which to regain their footing and equilibrium after the plow has been brought to a standstill by contact with a root or boulder. The sudden violent jars transmitted to the animals when the plow suddenly strikes a stationary object is not only severely painful and nerve-wracking, but may even so irritate a team that proper management is a difficult matter. It is therefore imperative that the collars fit properly, that all parts of the harness are substantial and properly adjusted, and that careful horsemanship be observed in all respects. Excited or irritated animals should be given a complete rest while the driver and plowman turn their attention to other lines of work, such as removing roots, stones, or brush.

Graders.—Trails are so seldom constructed in country where graders can be used that these implements will not be discussed here.

Picks.—Common "railroad" picks, weighing about five or six pounds, fitted with 34-inch handles, and costing from fifty cents to a dollar each, including cost of the handle, will be found very effective in loosening dirt, but cannot be used to advantage in removing it. Care should be taken to supply several extra handles for the crew, many members of which are often found to exercise little or no judgment in their use of a tool or tools. Handles cost from fifteen to twenty-five cents.

Mattocks.—These should have 16-inch blades with 6- or 8-inch axes and should never be used in extremely hard or stony ground. They are designed primarily for dirt-moving rather than loosening. They weigh and cost about the same as picks.

They will be found especially suitable for grubbing out roots, cutting brush beneath the ground surface, and taking out roots and stumps along the bank.

Combined Picks and Mattocks.—As their name indicates, these are so constructed as to provide a pick and mattock in one tool, and if limited funds demand strict economy in the

purchase of tools their use is recommended in preference either to picks or mattocks. They can be used with equal success as either, are strong and durable, and weigh and cost about the same as picks.



Railroad pick.



Mattock.



Combined pick and mattock.



Pick or mattock handle.



Grubbing hoe handle.



Planter's hoe handle.

FIG. 47.

Grubbing Hoes.—A heavy grubbing hoe may also be used effectively in cutting roots and brush and moving loose material. They are heavier and more durable than mattocks and can be used to better advantage in hard or stony ground. They should weigh not less than three and one-half pounds, should be of forged steel, fitted with an adze eye and a 36-inch bent handle, and should cut $3\frac{1}{2}$ inches. Their cost, including that of the handle, is about the same as that of a pick.

A light variety, having a thinner but much wider blade, and known variously as "planter's," "cotton," "hazel," and "eye"

hoe, made for use on a 4-, 5-, or 6-foot handle, will be found very effective for cutting grass roots and fine brush or in leveling



Grubbing.



Planter's.

FIG. 48.—Hoes.

uneven ground. They cost somewhat less than the heavier grubbing hoes.

Shovels.—Shovels for general use should be fitted with long handles and should not exceed five pounds in weight. Blades

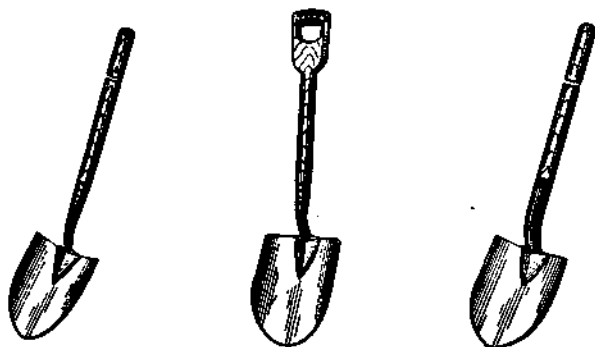

Socket shank.

D-handled shovel.
(Socket shank.)

Strap shank.

FIG. 49.—Long-handled shovels.

should be about 9 by 12 inches in size and should bear socket shanks in preference to strap shanks, new handles being fitted in the former with much less difficulty than in the latter. The cost is slightly more than for strap shanks, but such shovels prove much more economical in the long run. The cost varies from sixty-five cents to \$1.25.

At least one short D-handled shovel should be provided each crew for work in close quarters where a long handle cannot be used to advantage, such as in work about stumps or boulders or along ditches and banks. It weighs somewhat less than the long-handled variety, but the size and cost are about the same. A socket shank is recommended.

Pinch Bars.—These implements, if fitted with wedge points, are known as "crow" bars, but if beveled only on one side of the point have "pinch" points and are known as "pinch" bars. The pinch point renders them more effective than a wedge point in forcing them under and prying up heavy boulders, and they



Crowbar.



Pinch bar.

FIG. 50.

will be found more generally satisfactory than crowbars. They should be 5 or 5½ feet long and should weigh about twenty pounds. The cost varies from seventy-five cents to \$1.25.

Rakes.—These will be found very useful in leveling the tread and in removing gravel and fine brush from the trail. Asphalt rakes, which have extra long shanks fitted into heavy handles, will be found most suitable for rough trail work. They weigh approximately four pounds and cost from fifty cents to one dollar.

Axes.—A description of the best axes for general trail work will be found on page 170.

Bush Hooks.—These should be about 12 inches long over all, should have 2-inch blades and 6-inch cutting edges, and should be made to attach to regulation bush snathes. They will be found very effective for use in cutting out tangles of briars, dense thickets, and other growths not easily reached with the ax. Made of



FIG. 51.—Bush hook.

a good quality of tempered steel, they weigh about one pound and cost from fifty cents to one dollar.

Brush Forks.—Ordinary hay forks, or “pitch” forks, will prove very satisfactory in removing or piling fine brush, such as brambles, sage brush, buck brush, and small seedlings. They should have 5-foot handles, three 12-inch tines, and substantial ferrules fitted over the sockets. They weigh about three pounds and cost from fifty cents to one dollar.

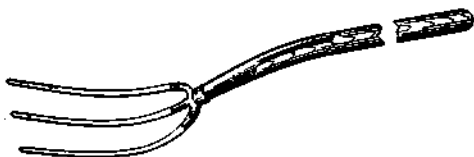

FIG. 52.—Brush fork.

Use of Picks, Mattocks, and Other Tools.—About the first request made of a new man in any large construction gang employed in grading work where men must work close abreast of each other is to refrain from swinging the tool he is using, and thereby avoid the possibility of inflicting injuries on his fellow workmen. Picks, mattocks, grubbing hoes, axes, sledges, and all other tools ordinarily swung to one side in using, must, in crowded work, be raised straight up and dropped without any swing whatever. The practice of delivering a long, violent, swinging blow at hard or stony earth is to be avoided at any time. It is not only wearing on the workman, but in the majority of cases does not prove more effective than shorter and lighter blows. Such tools are not made for work that requires them to be used with such force, and if the foreman allows his men to use them in a manner not provided for in their construction he will soon find his repair bill out of all proportion to other expenses.

In average hard ground the workman will find that from twelve to fifteen blows per minute with a pick, mattock, or hoe will constitute a reasonable rate of speed in labor for him to maintain throughout an eight-hour day.

Shovels should not be thrust violently against boulders or into extremely hard ground, nor should they be used as a pinch bar or pick. They are not intended for such use, are not built to withstand such treatment, and may be quite easily battered, bent, or broken.

The easiest method of using them is to rest the lower hand against the upper side of the corresponding thigh as the knee is slightly bent, bring the other hand close in against the right hip, and thrust them into loose dirt by inclining the body side-wise and slightly forward. This relieves the back and arms of unnecessary strain by providing a fulcrum, through the medium of the thigh first mentioned, against which the loaded shovel may be operated.

A workman of average strength and endurance shoveling in this manner can remove on an average of ten shovelfuls per minute and throw or scatter the dirt to a distance of from 6 to 12 feet. If the dirt must be thrown upward to about the same distance the rate must be lowered to about eight or nine shovelfuls per minute.

Care of Tools.—Each man should be required to take his tool or tools into camp with him at the end of the day's work and to see that they are in proper repair for use the next day, this rule not applying, of course, to plows and scrapers if these are used.

One man should also be detailed to carry in the extra tools, his own tools being taken care of by one of the other men if the extras are so numerous or heavy as to make this arrangement desirable. By following such a plan of caring for his tools the foreman or Forest officer in charge will suffer fewer losses through theft, carelessness, and forgetfulness than if the tools are not so taken care of.

A grindstone, whetstone, files, and a portable forge should be supplied for sharpening purposes. The first two may be used in sharpening axes, bush hooks, and other keen-edged tools; blunt-edged tools may be filed; and the forge may be used in heating picks, drills, and other tempered tools for sharpening.

A plow to be left unused for considerable periods should never be left sticking in the ground, nor should it be removed and carelessly thrown on its side in such a position that men or animals may accidentally injure themselves on the point, the heel of the share, or the ends of the handles. It should be set up squarely and securely and all exposed cutting or turning portions should be well smeared with wagon-grease to prevent rusting. This precaution often obviates the necessity for preliminary plowing through sand or gravel before the plow will "scour." All taps used on it, especially the one that secures the

share to the frog of an Oliver chilled plow, should be kept tight and not allowed to work loose. Single and double trees when not in use should be laid near the plow or kept attached to it.

The brush fork, when not in use, should be set securely on the tine points, and in such a place that in their work men or animals will not accidentally displace it, and thus provide possible means of injury to themselves.

Rakes should either be set away in a safe place or laid teeth downward where men and animals need not pass over them in going about their regular work.

Bed.—The larger, coarser stones removed in grading and not needed in retaining walls are thrown into the bed first and are firmly settled and packed with loose dirt before filling progresses further. Smaller stones, coming from farther up on the bank, are then thrown in and likewise settled. By using this material at such a time it is not only removed from a point from which it might otherwise slide into the trail, but it is also utilized in making a substantial bed. Finally, all loose material is removed from the upper side and used to complete the bed and provide capping. Care must be taken to see that brush, stumps, and old logs are not made a part of the bed. If buried in the bed they will soon rot and leave the bed full of "sink" holes or otherwise in bad condition.

Retaining Walls.—Instances may occur where the nature of the ground to be worked over is such that stone for retaining walls cannot be secured from cuts or grades, but must be ob-

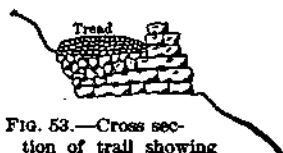

FIG. 53.—Cross section of trail showing construction of retaining walls.

tained elsewhere. In that event the man in charge must determine whether or not such material can be procured and put in place with less expense than would be required in grading out an extra wide bed which would require no retaining walls.

In any case, however, retaining walls should be of stone and should be constructed in a manner similar to that shown in Fig. 53.

The larger, heavier stones are placed on a firm foundation along the lower side of the trail, the lighter stones being used to complete the upper portions of the walls.

Walls should be drawn in slightly toward the trail as they are completed, and larger stones from the grade are then drawn down against them. They are thus built up with the bed in such a way that long stones may be used in tying them securely together, thereby allowing each to brace the other. Loose dirt is thrown in as the walls are built up, and is not, as may be supposed, kept till the last and then used as a cap.

Retaining walls may also be required along the upper side of a trail constructed through loose slides of broken rock.

Logs and brush should not be used for wall material unless it is absolutely impossible to secure stone. They are subject to decay and to destruction by fire, and their use invariably results in increased cost of maintenance.

Switchbacks.—These are short zigzag lengths of trail provided as a means of maintaining as nearly as possible a uniform grade up steep slopes and long sloping ridges known as "hog-backs," serving much the same purpose as landings in a flight of stairs where horizontal distance is so limited that uniform continuation of the flight in the same direction is impossible. They should be made as flat as possible in the turn, which should have a minimum width of 4 feet, and which should be protected by a log or a guard-rail so placed as to prevent short cuts across the turn by pack- or saddle-animals. The practice of building them around trees or high stumps is to be avoided. Under ordinary conditions their frequent use is unnecessary if proper care has been taken in determining the grade at which the trail is to ascend. Their construction materially increases the total cost of a trail and their presence renders travel more difficult than when a uniform grade is maintained.

Bridges and Culverts.—Since their construction adds materially to the first cost of trail construction and subsequent cost of its maintenance, these are to be avoided when possible. Deep cañons may be crossed by dropping the trail to the stream at a point suitable for a ford and ascending the opposite bank, thus doing away with the need of a bridge.

However, if a bridge must be built, care must be taken to see that it is erected on a substantial foundation that water will not weaken or remove. If the field man understands masonry,

and proper material and sufficient funds are available, he should by all means construct the piers and abutments either of stone or concrete. (For Concrete Construction, see pages 99 to 105, inclusive.)

Less permanent, though very reliable, piers and abutments may be made by laying up triangular log pens, pinning or otherwise locking the corners securely together, and filling the pens with loose rock or heavy boulders. Corner pins may be of iron or wood, but if the latter is used it should be of some tough variety, such as seasoned hickory or oak, that will not decay quickly. Pier pens should be placed in such a position with reference to the stream flow that the current may act directly against a corner rather than full against one side.

Bridges not to exceed 20 or 24 feet may be constructed as shown in Fig. 54. Over this length and of complicated design

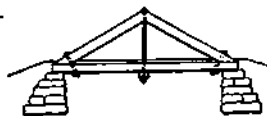

FIG. 54.—Short bridge.

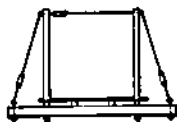

FIG. 55.—Method of guying bridge "rafters."
(End elevation.)

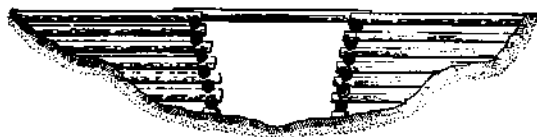

FIG. 56.—Log Bridge.

their construction should be left to an experienced bridge builder and will not be discussed here. Side braces or "rafters" may be tied together, as shown in Fig. 55, the tie being far enough above the floor, of course, to allow the free passage of vehicles beneath it.

Bridges to be built across permanent streams having long sloping banks may be constructed as shown in Fig. 56. None of the logs should be less than 10 inches in diameter at the small

end and all should be perfectly sound. Abutments should have substantial rock foundations that water will not undermine or wash out and the logs should be notched into each other preferably in the same manner in which house logs are notched. See Fig. 85. The sides flare outward toward the rear, and when filled with rock and earth serve as approaches. If the sides next the stream are gradually drawn in as the top is reached there will be much less danger of their collapsing if the foundations are disturbed.

Culverts should always be of stone when such material is available and may be constructed as shown in Fig. 57. Other



Box.



Stone.



Corduroy.

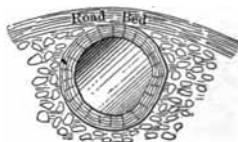

Hollow log.



Corduroy over bog.

FIG. 57.—Culverts.

forms of culverts, only temporary in nature, are of poles, boxes, or hollow logs, and are also illustrated in the same figure. Poles of seasoned aspen or quaking asp (*Populus tremuloides*), or any of the cedars or junipers having a top diameter of not less than 8 inches, will be found quite durable, but most of the pines may be used in cases of emergency. Such structures are usually only for temporary use and do not justify heavy expenditures for material.

If circumstances prohibit the use of poles a very good substitute may be had by the use of puncheons. These are merely portions of split logs laid flat side upward and used in lieu of planks or heavy timbers. They should be notched till they fit securely against the stringers.

Box culverts should be of seasoned white oak (*Quercus alba*) or creosoted pine, and should be not less than 8 by 12 inches inside, thus requiring the use of four 2 by 12s. A stronger box will be the result if the top, or floor, plank is nailed to the upper edges of the side planks. It is also advisable, especially when a poor grade of lumber must be used, to cut in at least two 2 x 4s crosswise of the box and under those portions of the floor plank which will be subjected to the greatest pressure. Set edgewise under the floor, these will reduce the net inside dimensions to 8 by 8 inches, but this size will be found sufficiently large to carry any ordinary amount of drainage. If an unusually large amount of drainage is to be carried, then six 2 by 12s should be used and a box 12 by 20 inches made. Such a culvert, of course, requires crosspieces under the floor planks, but in a box, say 6 feet long, three 2 by 4s laid flatwise will be of sufficient strength to support all ordinary traffic.

Laid in this manner, the crosspieces reduce the net inside dimensions to 10 by 20 instead of only 8 by 20 inches.

Hollow log culverts of sycamore or buttonwood (*Platanus occidentalis*) and black gum or tupelo (*Nyssa sylvatica*) are widely used in the South and Southeast, being placed not only in trails but in many of the country roads as well. The material is quite durable, and such culverts often remain in good repair for ten or fifteen years or more. However, this timber is not available in most parts of the West.

Corrugated iron piping, or terra cotta tiling used for culverts, should be at least 8 inches in diameter inside. The most widely used size is only 6 inches, but such pipes clog too easily to prove satisfactory for culverts.

Corduroy.—This is a form of artificial bed provided as a means of crossing bog-holes in a trail, and is also one form of construction used in culverts or small bridges of minor importance. Used across bogs, it consists merely of numerous small logs or large poles laid crosswise of the trail and capped usually with dirt or gravel. For deep bogs it may be made more substantial by first placing heavy logs, even 12 or 16 inches in

diameter, at the bottom, lighter logs being laid at right angles across these. If necessary a third tier is placed at right angles across the second.

Frequently only two or three stringer logs will be found necessary for the foundation, corduroy being placed on these to serve as a bed. Ordinarily, if capping is to be from 4 to 8 inches thick, no other fastenings will be required to hold the corduroy in place. If necessary, however, it may be pinned to the stringers with wooden pins or toe-nailed with 60-D spikes.

Drain Ditches.—Ditches of adequate size to prevent the tread being flooded should be provided at all points along important trails where flooding is likely to occur. They may be cut into the bank above or into the ground alongside the trail, or, in case only a limited amount of drainage is to be carried, may be cut directly against the upper side of the trail.

If drainage is to be conveyed across the trail, side ditches should be continued to points suitable as locations for culverts or water bars, the latter being merely logs of sufficient length and size to direct the flow across the trail after they have been set into the ground diagonally to the line of travel.

Proper drainage is absolutely essential to economical maintenance of a trail, and carelessness in construction in this respect may later prove responsible for complete abandonment of the trail. Continued travel tends to settle and otherwise displace the capping material until, if proper drainage facilities have not been provided, water flows directly down the middle of the tread and soon cuts an impassable ditch.¹

Tread.—The tread of a trail is that portion of it which is exposed to travel, and upon its width depends the greater portion of the cost of construction and maintenance. Its proper consideration in the preliminary survey is, therefore, of the greatest importance and must be given close attention.

In any trail, regardless of its classification, per cent of grade, or any other particularly important characteristic, costs in construction and maintenance will be materially reduced if the

¹ In all parts of the country, and especially in the rural districts or in sparsely settled regions, will be found roads and trails which have been "set over" time after time as each new route has been allowed to wash out and become impassable, the final result being a series of parallel ditches none of which can be used as a path of travel.

width of the tread is kept at a minimum, this point in construction applying with equal force to trails in classes A, B, and C.

Quite naturally it would seem to the inexperienced trail-builder that a class A trail, which might have a uniform grade as low as 6 per cent, and which eventually might be reconstructed into an unusually good wagon road, should have an extra wide tread. The mere fact, however, that it has the low grade is sufficient justification for a narrow tread, because the disadvantages of a narrow tread are offset by the low grade; and as for being rebuilt as a road, he should remember that the way is a trail first and may possibly be a road later.

The maximum tread seldom need exceed 3 feet, and except in short switchbacks can usually be much less. The minimum for trails of little importance should be about 15 inches.

Capping.—This term refers to the material used on the surface of a trail or road and is known in many localities as the "crown," "top," or "top dressing." It should be hard and compact, free from large stones, and of a nature that prevents its ready removal by traffic.

For instance: Very dry adobe forms a fine dust which may be kicked or blown from the trail in large quantities. When thoroughly wet it forms a stiff mud, through which progress can be made only with the greatest difficulty, and holes or ruts made by pack- or saddle-animals do not fill in but remain as such, and after the adobe begins to dry out present a surface even more difficult to travel than one full of large stones. Obviously, such material is unfit for capping. Loam is but little better—as, in fact, are most other loose soils, the yellow clay common to the South and Southeast being especially unsatisfactory in wet weather.

The best capping is of coarse sand or fine gravel, disintegrated granite being exceptionally suitable. Crushed rock, slag, and cinders are also good, and sawdust or rotten wood can be used to good advantage over permanently wet stretches of trail.

Whatever material is used for capping should be thick enough to present a substantial surface for travel and should be graded enough higher in the center than at the sides to allow ample slope for drainage of all rain or snow that may fall upon it.

Blazes.—The standard blaze used by the Forest Service in marking trails is not less than 8 inches long, is cut through the bark into the sapwood, and is accompanied by a horizontal

notch cut directly above it. These blazes are made in trees growing at such points along a trail that at least one blaze is always visible to the traveler as he proceeds in either direction. Ordinarily trees along both sides of a completed trail are blazed both fore and aft; but if limited time for construction renders such blazing impractical, they are often blazed on one side only and in such a manner that in proceeding along the trail in either direction the traveler always observes the blazes to his right. Later, other blazes are made as required.

The foreman or officer in charge of construction should see that large, ragged, unsightly blazes are avoided. Where a trail crosses open country with little or no grading, he should also see that its course is plainly marked either by means of rock monuments or by guide-posts and boards. Intersecting or branch trails should be indicated by guide-boards showing directions and distances to important points. Specifications for such boards will be furnished field men upon application to the proper office.

ROCK DRILLING

Effective rock drilling is possible only when properly sharpened and tempered drills are used. However, volumes might be written on the subjects of sharpening and tempering steel, and still the inexperienced person would not secure sufficiently definite information to justify him in attempting the operations. Therefore, they will not be discussed here. It is suggested, however, that where considerable drilling must be done the field officer in charge of the work should secure the services of a man familiar with the work of sharpening and tempering. Even if such a person demands a higher rate of pay than other members of the crew, his services will prove proportionately more valuable.

Single Jacking.—This method of drilling is employed when shallow holes are to be bored. One man performs both operations of holding and striking the drill and otherwise sees that the hole is properly sunk. A single jack should not weigh more than three and one-half or four pounds.

Double Jacking.—Two men are employed in this work, one holding the drill in position while the other strikes it with a sledge known as a "double jack," and which usually weighs from six to twelve pounds or, in some instances, more. In order to get the best results, either man should be experienced both

in holding and in striking the drill. Such men, however, are not always available, and it may be found necessary on such occasions to teach certain members of the crew how these operations are performed.

The one who is to hold the drill should seat himself in such a manner as to bring the drill between his knees, where, by the use of both hands, he can hold it in the required position. It need not be gripped more tightly than is necessary to hold it in position unless it is of such light material that blows from the double jack produce violent lateral vibrations in it. In such a case a tighter grip is necessary in order to avoid the severe jars which otherwise result to the hands.

Immediately after a blow has been delivered, and while the double jack is being raised for another, the drill should be raised slightly, turned part way around, and then settled back against the bottom of the bore-hole. If it has been unevenly dressed or, instead of being turned on the center, is merely moved at one corner of the bit, a triangular rather than a round hole will be the result, and cutting will be retarded as the result of extra labor imposed upon the striker in cutting the three corners. Ordinarily, such holes are the result of an attempt by the man holding the drill to avoid the labor incident to raising, turning, and settling the drill, but the advantages gained in this respect are more than offset by the striker's extra labor.

By turning the drill after each blow of the double jack the edge of the bit is brought diagonally across the last groove cut and the shoulders of this are chipped away, thus facilitating sinking.

The man holding the drill should keep his hat-brim pulled well down over his eyes, should keep his face turned downward, and should never watch the drill-head. Blows from the double jack may cause this to splinter or splinter, and fragments of steel are often thrown off as if shot from a gun. The striker, however, whose face and hands are above the drill-head, is not subjected to this danger and should watch the drill-head continuously. This permits him to observe any sudden change of the drill's location and to manage the double jack accordingly.

If for any reason the drill sticks or hangs and can not be turned between blows of the double jack, the man holding it should make this fact known to the striker immediately. Meanwhile he should not attempt to loosen the drill by moving or

shaking it about in the bore-hole until he has assured himself that the striker knows he must stop striking. This is usually done with the interjection "Mud!" which all experienced drillers understand to mean that operations are to be temporarily suspended.

Water poured into the bore-hole will not only serve to prevent the drill bit from heating, but will also facilitate cutting. The man holding the drill may protect himself from spattering by placing an old grain sack loosely about the drill at the top of the bore-hole.

Churn Drilling.—This operation is performed by means of a long drill, used, in most cases, by two men and heavy enough to obviate the necessity for using a sledge. It is simply raised and then forced violently against the bottom of the bore-hole, cutting the same as if driven with a sledge. It is especially convenient in drilling into upright faces of rock.

Removing the Cuttings.—Cuttings are removed from the bore-hole with a long, slender tool known as a "spoon." However, if no spoon is available the cuttings may be "swabbed out" by means of a stick, preferably of some hard, tough wood, beaten into splinters at one end. This end is thrust into the cuttings and twisted about till the brush is filled. After removing it from the bore-hole the stick is rapped sharply against the drill or a stone, and is thus relieved of the cuttings.

BLASTING

The construction of permanent improvements, such as roads, trails, and telephone lines, often requires the use of explosives, and unless the new field man has had previous experience in their use he should place a competent man in charge of blasting operations until such time as he himself may have become sufficiently familiar with the work to carry it on with a minimum possibility of accidents.

The two chief forms of explosives used in general field work are dynamite and blasting powder, but since the latter is used less frequently than the former it will not be discussed here. Electric firing of blasts is seldom practised except in ditching through loose dry dirt or gravel and occasionally in controlling severe forest fires. The inexperienced man is seldom required to handle such work, however, and for that reason only cap-

and fuse-firing will be considered. If electric firing must be done, the field man should consult some reliable authority on the subject.¹

Dynamite.—*Composition.*—This is composed of nitro-glycerin mixed with sawdust, nitrate of soda, and other explosive or absorbent ingredients, and is packed into cylindrical paper shells forming what are known as "sticks" or "cartridges." These are 8 inches long and of different diameters, the standard diameter, however, being $1\frac{1}{4}$ inches. They are shipped in cases of twenty-five and fifty pounds.

Strength.—The strength of dynamite is expressed in per cent, according to the strength of the explosive regardless of the per cent of nitro-glycerin present, and is known as "20%," "30%," or whatever the strength may be. Straight dynamite is made in strengths from 20% to 60%, gelatin from 35% to 75%, and blasting gelatin 100% only.

Use of Different Strengths.—The required strength of dynamite for different uses may be determined about as follows: For shell rock, hard clay, frozen earth, log splitting, ditching, grading, or other light work, 20%, 25%, 30%, or possibly 40%; for quarry use where stone is to be split but not shattered, 30%, 33%, and 40%; for stumps; tree-felling, ice, and medium hard stone, 40% and 50%; and for extremely hard stone, or iron or steel, 60% straight or 75% gelatin.

Blasting powder, aside from the greater inconvenience encountered in using it, is hardly strong enough in satisfactorily small quantities to produce the desired results when used in the work just mentioned. It may be used to convenience, however, when logs are to be split into comparatively regular sections, such as for cordwood, corral timbers, rails, and posts. Blasting powder for such work should be of FF, FFF, or FFFF granulation.

Caps.—These are small metal tubes closed at one end and designed for the purpose of detonating dynamite. The closed end carries a small quantity of fulminate of mercury, which explodes by ignition, the concussion thus produced detonating the dynamite.

¹ See "The Farmer's Handbook," published by the E. I. du Pont de Nemours Powder Company, Wilmington, Delaware.

See also "Handbook of Mining Details," published by McGraw-Hill Book Company, 239 West 39th St., New York, N. Y.

mite. They are classed as No. 6, No. 7, or No. 8, according to the amount of fulminate of mercury they carry.

Fuse.—This is flexible tape-, cotton-, hemp-, or jute-covered tubing carrying powder used to convey a flame to the fulminate charge in the cap. The different grades are: Plain hemp for very dry work; single tape for damp work; double tape for wet work; and triple-tape or gutta-percha covered for use in water. It comes in double rolls each 50 feet long, one fitting closely inside the other. Ordinarily it burns at the rate of about 2 feet per minute, but if much abraded or if under pressure, as in a tightly tamped bore-hole, the rate of burning will be increased and may even reach 4 feet per minute. It should be stored in a cool, dry place where it will neither become dry and brittle nor have the varnish melted off.

Preparing the Charge.—*Attaching the Cap to the Fuse.*—The required length of fuse, long enough to allow the shot-firer to retire to a safe distance after the fuse has been lighted and before the charge explodes, is cut squarely off from the roll. An inch or two should be cut from the end of the roll first and discarded, as the fuse is constructed of such material that the exposed end always attracts moisture. If in cutting the fuse from the roll the fuse end is flattened it should be rolled round between the thumb and finger, care being taken, however, to see that none of the powder is allowed to escape. This end is then held in a vertical position and the cap is fitted down over it as shown in Fig. 58 until the fulminate charge rests firmly against the end of the fuse. In doing this the cap must not be twisted or rotated about the fuse, as the charge is very

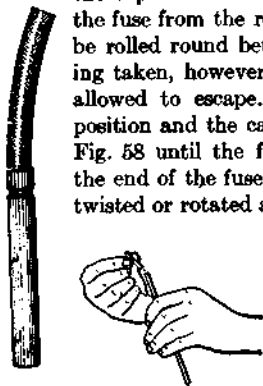

FIG. 58.

sensitive and friction against it may result in an explosion. The final operation is known as "crimping" the cap, and consists in crimping or creasing it about the fuse in such a way that the two are held securely together. The crimp is made near the open end of the cap as shown in the

same figure. A specially designed combination crimper, fuse cutter, and punch is manufactured for this purpose and is used as shown in Fig. 59. Many blasters crimp with a piece of hard

sharp-edged wood, with a knife-blade, or with their teeth, but none of these methods should be followed unless a crimper is not



Crimper.

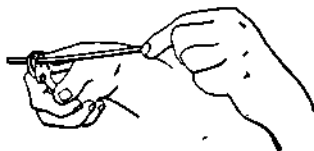

Using the crimper.

FIG. 59.

available. In any event crimping with the teeth is a practice to be avoided.

Attaching the Cap to the Cartridge.—Opinions differ as to whether the cap should be inserted at the end or in the side of the cartridge. The latter method, however, is a much safer one by reason of the fact that it not only leaves the entire end of the cartridge exposed for tamping, but also provides a cushion of dynamite between the cap and the end of the tamping stick.



FIG. 60.—Inserting cap in cartridge.

An opening is made in the cartridge by means of the round handle of the crimper, or, if no crimper is available, a smooth round stick of the required diameter may be used. Nails, wire, and small bolts should never be used for this purpose. When the hole has been completed the cap is inserted therein as shown in Fig. 60.

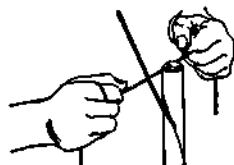

FIG. 61.—Cord about fuse.

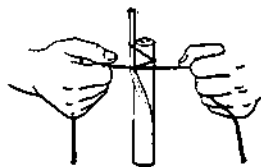

FIG. 62.—Tying the fuse into the cartridge.

A strong heavy thread or light cord is then tied about the fuse as in Fig. 61, and finally the fuse is tied securely to the cartridge as shown in Fig. 62.

If the cap is to be inserted in the end of the cartridge the paper wrapping is unfolded and opened at that end, the hole is punched and the cap inserted, and the wrapping is then closed and securely tied about the fuse.

If the charge is to be placed in water or very wet earth the connection of the fuse and cap with the cartridge should be well covered with grease. This should not be of an oily nature or it may pass through the tape and into the filling of the fuse.

Loading.—This operation, which is also known as "charging," consists in placing the cartridge in the bore-hole or drill-hole. If several cartridges are to be used in the same hole the one bearing the cap, which is known as the "primer," should be placed next to the top or last one and pressed down firmly. The others must also be firmly settled into the hole, and this can be done much more satisfactorily if their wrappers are slit through lengthwise once or twice. This allows them to spread out and fill the hole more closely. Care must be taken to see that each cartridge is pressed firmly against the one before it and that no vacant spaces are left between them.

Another method of loading where only one cartridge is to be used in a hole is to cut the cartridge in half, lower the primed half to the bottom of the hole, press it down firmly, and then tamp the broken-up remaining half in above it. Still another method is to lower the capped fuse into the hole till the cap is at or near the bottom and then tamp the broken-up cartridge about it.

The last method is especially satisfactory where bore-holes are so small that cartridges can not enter readily. They should never be forced into a bore-hole. The chief disadvantage of loading in this manner is the possibility of igniting the dynamite.

Tamping.—Iron tamping rods should never be used when dynamite is to be tamped. The safest method of tamping is by means of a wooden stick cut square at the large end and of a diameter small enough to allow it to enter the bore-hole easily beside the fuse. Fine dry dirt should be used for tamping and should be firmly tamped as filling progresses. The first 5 to 6 inches of dirt should be pressed down firmly but gently. After that greater pressure may be used with little danger, but it should not be greater than that made possible by hand. The hole should be tamped full to the surface. If plenty of grease has been smeared about the connection of the cap and fuse

with the cartridge, water will also make fair tamping, but the charge must be fired before the water can soak into it.

Firing.—In order to save time and facilitate operations the foreman should have other members of his crew remove tools and other equipment to a safe distance while the shot-firer is loading and preparing the charge for firing.

The fuse end should be split back through the center for a distance of $\frac{1}{2}$ inch in order to expose the powder and allow the flame of the match to reach it without delay. Ignition of the powder will be indicated by a sudden hissing spurt of sparks and flame, and the shot-firer should not leave it till this has occurred. He then warns other members of the crew of this fact usually by calling, "Fire in the hole!" and immediately retires to a safe distance. Protection from flying débris should be sought behind large trees or boulders where the bore-hole may be watched and where an unobstructed view of falling earth and stone may be had. Such positions should if possible be selected so the sun and wind will be to the watchers' backs.

Misfires.—These may occur as the result of broken, defective, or improperly prepared fuse, defective caps, or separation of the fuse and cap. They should not be investigated nor worked near for at least an hour after they should have exploded, and if conditions are such that they may be avoided till the next day the safety is so much the greater.

The practice of "picking out" or removing an unexploded cartridge from a bore-hole with intent to reload and fire it is not safe, although in many instances it is more convenient to remove the tamping and reprime than to drill and charge a new hole. If the "missed" hole is shallow enough to permit the charge being seen when it is reached there is little danger of an accident. In such a case a half-cartridge may be primed and loaded in above the first charge, and both may then be exploded.

A wise precaution to observe in loading shallow holes is to tamp a crumpled wad of paper down directly against the charge. If this is done and a misfire occurs the tamping may be picked out of the hole with little danger of picking into the charge.

Holes so deep, however, that such a wad of paper could not be seen should not be picked, but another hole should be drilled at a safe distance and another charge fired. In removing the broken-out material a close watch should be kept for any unexploded dynamite that was placed in the first hole. In most cases

the detonation of the second charge will also result in the explosion of the first.

Blasting Out Boulders.—One of the largest items in the cost of construction of roads and trails is the removal of large boulders from the bed. These are often of such a shape and nature as to prevent their removal by means of teams, bars, or sledges, and they must therefore be broken up with explosives. This involves operations that are not at first sight apparent to the novice, and unless he is careful to adopt the most effective measures he may have little better success than if he had used a sledge.

The first important thing to do in breaking out a boulder is to obtain a general knowledge of its size and shape and the depth to which it may be imbedded. This can be done by shoveling away the dirt at the edges of the boulder or by probing around or under it with a bar. The nature of the ground in which it is imbedded also plays an important part in the work of its removal and must be carefully considered before any charges are placed.

The three chief methods used in breaking out boulders follow:

Mudcapping.—This is also known as “blistering.” A dynamite cartridge is stripped of its wrapping and is then pulverized

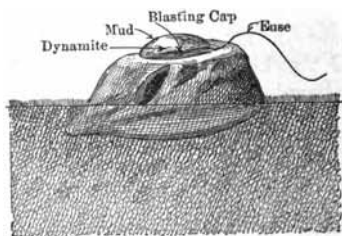

FIG. 63.—Mudcapping.

and laid on top of the boulder in a compact pile. The cap is placed at or near the center of the charge and the whole is then covered with 6 or 8 inches of very damp sand or stiff, wet clay. This is pressed tightly down over the charge and serves as tamping. The method is illustrated in Fig. 63.

Blockholing.—This method of breaking out a boulder is shown in Fig. 64, and is also known as “splitting.” Its chief disadvantage lies in the necessity for drilling one or more holes

in the boulder, but this is more than offset by the much more effective results obtained. In order to concentrate the charge as much as possible the cartridge should be broken up and

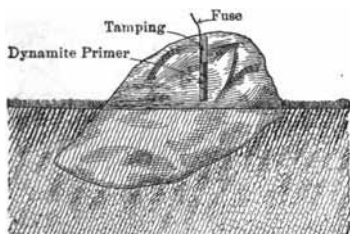

FIG. 64.—Blockholing.

tamped in about the cap. Later, if fragments too large to handle remain, they may be mudcapped.

Snakeholing.—For small boulders that can be easily removed after having been broken from their bed, this method, also known as "gophering," is very effective. The charge should be placed



FIG. 65.—Snakeholing.

directly against and at or near the exact center of the under side. It must be well tamped and care must be taken to see that it is not placed at a point where wet or soft dirt may allow the force to be expended downward rather than upward and against the boulder. See Fig. 65. (For Table of Blasting Charges, see page 361, Appendix.)

Blasting Out Trees and Stumps.—The chief trouble in this operation usually lies either in the fact that the charge is placed at the bottom of a hole drilled too straight down and not under

the center of the tree or else it is placed in a hole in such a way that it is carried beyond or to one side of the tap root. For the correct location of a charge expected to affect the tap root directly see Fig. 66.

Fig. 67 shows a charge improperly placed at one side of the center of a tree having no large tap root. The charge should

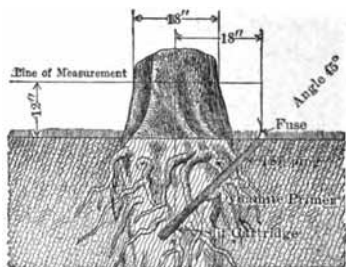

FIG. 66.—Correct location of charge in tap root.

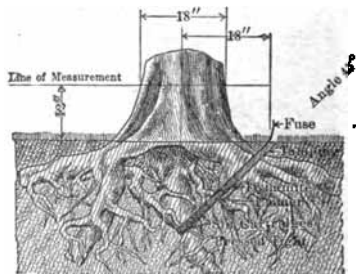

FIG. 67.—Incorrect location of charge in stump having no tap root.

be placed as shown in Fig. 68. Unless it is placed well down under the roots a "blow out" at one side of the tree will be the result. A charge placed too near the surface of the ground is shown in Fig. 69. A similarly placed charge under a stump only serves to split it without removing the roots from the ground. (See Fig. 70.)

If a concentrated charge is desired it may be provided for as shown in Fig. 71, where the lower end of the bore-hole has

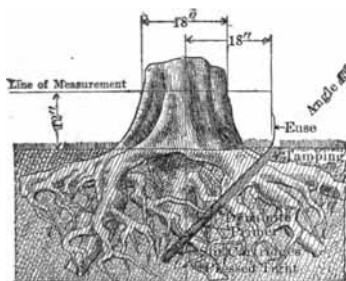

FIG. 68.—Correct location of charge in stump having no tap root.

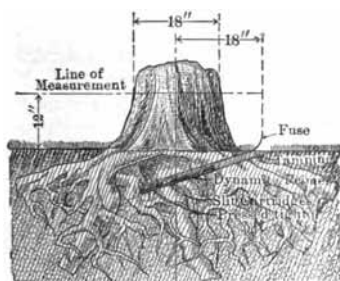

FIG. 69.—Charge placed too near surface.

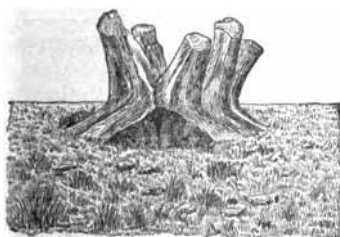

FIG. 70.—Bore-hole too shallow. Stump split, but roots not removed.

been enlarged or "chambered" by exploding a quarter-cartridge in it. Such a chamber should be allowed to cool an hour before the final charge is placed in it, unless fired in wet ground.

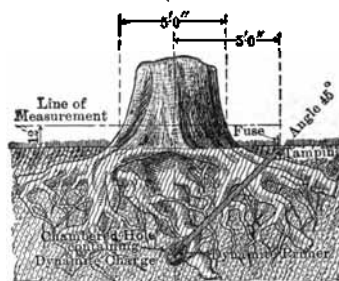

FIG. 71.—"Chambered" or "sprung" bore-hole.

Mistakes to be Avoided.—Allowing priming to be done in or near a magazine.

Allowing stock access to explosives.

Crimping a cap with the teeth.

Cutting a frozen dynamite cartridge.

Cutting fuse too short in an effort to economize.

Disturbing the fulminate charge in a cap.

Drilling or charging a new hole less than 2 feet from a "missed" one.

Exploding a charge before all the workmen have retired to a safe distance or before other explosives have been protected from falling débris.

Forcing a primer into a bore-hole.

Handling dynamite with bare hands unless immune to "dynamite headache." Use gloves.

Immediately reloading a "chambered" bore-hole.

Investigating a misfire in less than an hour after it should have exploded.

Keeping dynamite in a blacksmith shop or near a forge.

Leaving explosives in wet, damp, cold, unlocked places.

"Picking out" a misfire unless the bore-hole is shallow enough to allow the charge to be seen as soon as it is reached.

Removing caps from the box with a nail or wire.

Smoking while preparing or otherwise handling explosives.

Storing explosives in or near a residence.

Storing fuse in a hot, dry place.

Tamping with an iron bar.

Thawing dynamite except in a receptacle especially designed for that purpose.

Transporting or storing caps with dynamite.

Using frozen or chilled dynamite. Most of it freezes at 50° F.

BUILDINGS

Ordinarily, the field man is not required to construct buildings of more elaborate or complicated design than that involved in cabins, barns, sheds, and other buildings of a similar character. Otherwise expert carpenter work is secured and the field man, if he is engaged in the work at all, usually acts as assistant to the carpenter in charge. Consequently, only rudimentary rules of construction will be considered here.

Foundations.—Properly constructed foundations constitute the most important factor in a substantially built house. Stones or blocks comprising foundations should not be set merely on the surface of the earth, but should be firmly bedded on solid rock or earth, and dirt or fine stone then tamped closely about them. This not only provides a much firmer base on which to build, but also prevents water from undermining the blocks or piers. All points of a foundation must be level with each other and secured in such a manner that the process of erection will not displace them. Construction proper should not begin until the foundations have been allowed to settle securely, after which, if necessary, the upper surfaces may be finally leveled. Block foundations, or foundations made of lengths of tree-trunks, can not be recommended for use under any building, whatever its size or use, and especially if it is to be of a permanent nature. The best materials for foundations are concrete, stone, and pressed brick.

Materials.—The materials commonly used in the construction of Forest Service buildings are lumber and logs, although in localities remote from such supplies stone or concrete may be and frequently is used. Corrugated iron roofing may also be used for walls as well as for roofing. As a matter of fact, however, the average field man will seldom find it necessary to use other material than lumber and logs.

Classifications.—Buildings made of the materials mentioned above may be classed as frame, half-frame, box, and log. The first have full frames of studding and joists, are usually built for permanency, and are so constructed as to support great weight in the upper portions.

Half-frames are fitted with fewer studding and joists, may or may not be permanent structures, and will not support as great weight above as full frames.

Box frames have a few or no studding, are ribbed, are more or less temporary in nature, and are seldom more than one story high.

Log frames have neither studding nor ribs, may or may not be built for permanency, and will support heavy upper parts in proportion to the crushing resistance of the wall logs.

Full Frames.—Studding in these are usually spaced at from 18 to 24 inches. Ribs may be fitted into the studding if the walls are to be boxed, but braces may take the place of ribs if regular siding is to be used. Sills may be of solid timbers or they may be constructed by spiking two timbers together in a V-shape or "hog trough" as shown in Fig. 72. Many carpenters insist that the vertical timber of

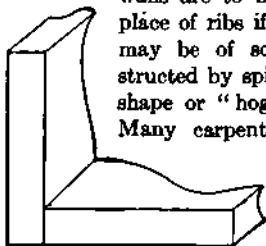

FIG. 72.—"Hog-trough" sill.

a hog-trough sill should project downward outside of the horizontal timber in order to prevent water from entering the joint, but since this joint is protected, or at least should be protected,

by the boxing or siding this point of construction is of minor importance.

Floor joists or "sleepers" are spiked into hog-trough sills as shown at the left in Fig. 73. They are secured to solid sills as shown at the right in the same figure. Studding are fastened to hog-trough sills as shown in Fig. 74, this method being used when the walls are to be boxed. If the walls are to be sided then the studding are notched and set as shown at the right of the same figure. Corner studding for siding are set on the upper surface of the end sleeper, one side and one edge being flush with the outer side of the sleeper and sill, respectively, as shown in Fig. 75. In the same figure is also shown the method used in setting corner studding when the walls are

to be ribbed and boxed. If ribs are to be set into the studding rather than nailed against them, then all studding for box walls are set the same as for siding. Methods of attaching ribs to studding for boxing or for siding are shown in Fig. 76.

To Estimate Lumber for Building.—There are so many styles

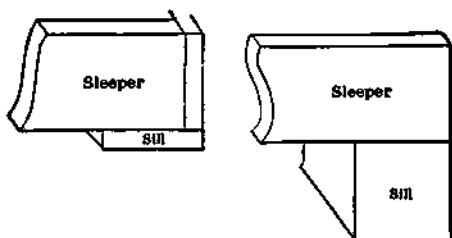

FIG. 73.—Attachment of sleepers.

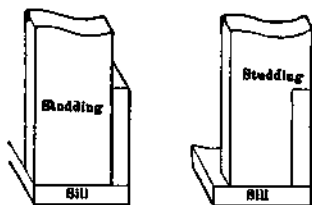

FIG. 74.—Attachment of studding.

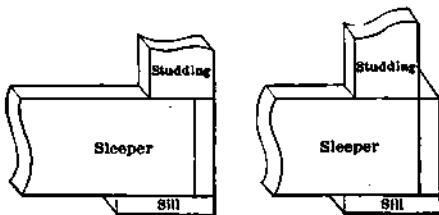

FIG. 75.—Attachment of corner studding.

and varieties of buildings that a comprehensive treatise covering estimates on all would be almost impossible, but a general idea of estimates for the simplest forms of construction may be obtained from the following plan. It is assumed that the field

man is required to estimate the material required for the construction of a cabin 14 by 16 feet in size, with 8-foot walls, rough floor and ceiling, 12-inch eaves and overhangs, no cornice, one rough door, and three shutter windows. The estimate follows:

Sills, Hog-Trough.....	4 pieces	2 x 6 x 16.....	64 feet
" Plain.....	2	2 x 6 x 14.....	28 "
		2 x 6 x 16.....	32 "
Sleepers, 2-foot spaces.....	7	2 x 6 x 14.....	98 "
Ribs.....	2	2 x 4 x 14.....	20 "
		2 x 4 x 16.....	22 "
Plates.....	2	2 x 4 x 16.....	22 "
Joists, 2-foot spaces.....	9	2 x 4 x 14.....	85 "
Rafters, 2-foot spaces.....	18	2 x 4 x 12.....	144 "
Sheeting, 26-inch shakes to be laid 21 inches to the weather, board fashion, twelve courses	14	1 x 4 x 18.....	84 "
Sheeting, shingles to be laid 4 inches to the weather, thirty-four courses.....	34	1 x 4 x 18.....	204 "
Shakes.....	1300		
Shingles.....	4000		
Saddle board, shake roof.....		none required	
" " shingle roof.....	2 pieces	1 x 6 x 18.....	18 "
Floor.....	14	1 x 12 x 16.....	224 "
Walls.....	30	1 x 12 x 16.....	480 "
Ceiling.....	14	1 x 12 x 16.....	224 "
Gables.....	7	1 x 12 x 16.....	112 "
Nails.....	6 pounds	20-d	
".....	20	8-d	
".....	9	6-d for shakes	
".....	7	3-d for shingles, 1 nail	
".....	15	3-d for shingles, 2 nails	

Add one pound of 20s if hog-trough sills are used.

Thirty-five pounds of 8s will be required if three nails are used at each point of contact on the boxing, floor, and ceiling, and also used in nailing on shakes.

Hinges, 4 pairs, 6-inch strap, for door and shutter windows.

Plates, which are those timbers at the top of a wall and upon which the rafters rest, are spiked to the upper ends of the studding as shown in Fig. 77. Eave ribs are attached when 'boxing is to be used. Studding braces, generally used in walls to be sided, are fitted into the studding in three different ways as shown in Fig. 78. Upper joists, or "stringers," are laid on the plates as in Fig. 79. Rafters are set on the plates, usually

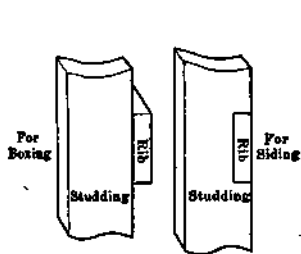

FIG. 76.—Attachment of ribs to studding.

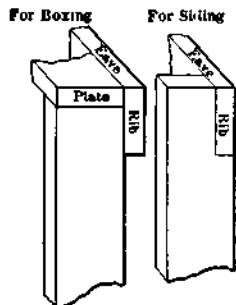

FIG. 77.—Attachment of plates.

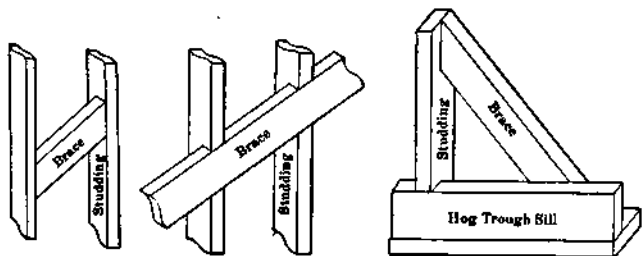

FIG. 78.—Studding braces.

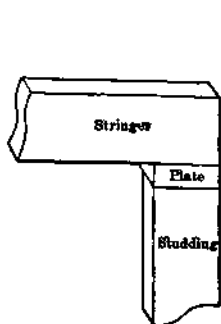

FIG. 79.—Attachment of stringer to plate

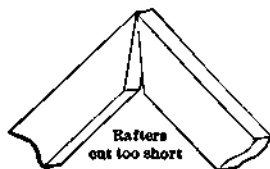

FIG. 80.

against the joists, and spiked to both. If they are cut too long they will not meet at the extreme upper points but will gap as shown in Fig. 80. If cut too short the gap will appear at the under side. They may be tied with "wind" beams or "wind collars" or "collar beams" as shown in Fig. 81. Fig. 82 shows a self-supporting roof. This method of construction prevents

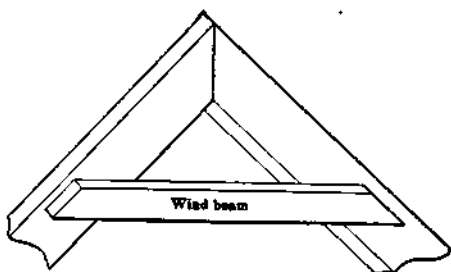

FIG. 81

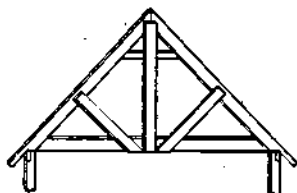

FIG. 82.—Self-supporting roof.

the rafters from sagging and makes a very strong roof. It is frequently used in roofs having long rafters and is very effective where a large amount of snow may remain on a roof for a considerable period. It is not a satisfactory form of roof for barns the upper parts of which are to be filled with hay or other feed. A self-supporting shed roof may be constructed as shown in Fig. 83.

This is known as a "truss" roof. Its chief disadvantage is the extra cost of material and labor required in its construction. Furthermore, the presence of the lower truss beam causes the loss of more or less space beneath the roof.

Half-frames.—This method of construction is similar to that used in erecting frame buildings, the only difference being in

the number of studding and other frame timbers used. Such frames are used chiefly where the walls are to be boxed.

Box Frames.—These have either no studding at all, or at the most only a few. Like the half-frames they are used where

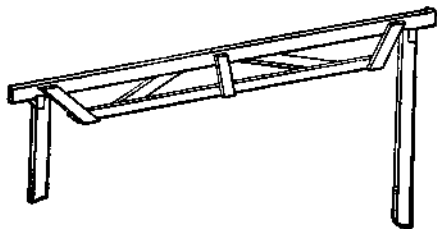

FIG. 83.—Truss roof.

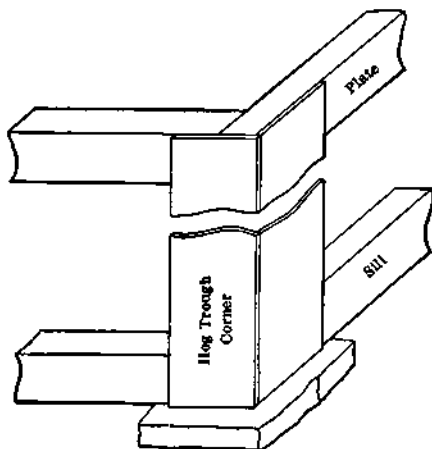

FIG. 84.—“Hog-trough” corner.

little or no pressure will be brought to bear on the plates. Ribs are used occasionally, but these are supported by and serve to increase the rigidity of the boxing. The four hog-trough corners are first set up as shown in Fig. 84 and boxing is then nailed to the sills and plates. Ribs may be put in as soon as the

corners are erected or they may be supplied after all the boxing has been attached.

Log Frames.—Logs to be used in walls should be notched, preferably as shown in Fig. 85. These notches are made after the sides of the logs have been hewn flat from the ends back to a distance of from 12 to 24 inches. Such hewing brings the logs to the required thickness for the wall and leaves the corners of the building in a finished condition if the entire sides of the logs are to be hewn flat later. Ground logs are not fitted with notch No. 1, but are hewn flat on the under side and fitted with notch No. 2. Notch No. 1 in the next log above fits down over notch No. 2 of the ground log. This process of fitting the logs together is followed on up the wall to the top log. This log, which is known as the "plate" log, has notch No. 1, but is not fitted with

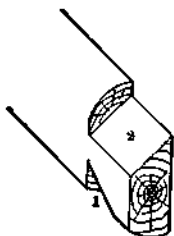

FIG. 85.—Notches for wall logs.

notch No. 2. Its entire upper surface is hewn flat and supports the rafters. Many log buildings have the top two or three logs pinned through the corners to each other, but this is seldom necessary if the logs are notched as shown in the illustration.

LAYING THE ROOF

Cornice.—This is very commonly though erroneously referred to as the "cornish" or "carnish." In the very roughest forms of construction no cornice is attached, the lookouts and sheeting ends being left uncovered and the openings between, on the plates and rafters, filled with short lengths of board or left open as the builder prefers. A very simple and effective form of cornice and one that completely covers all exposed lookouts and sheeting ends is known as the "box" cornice. It consists of the "facia," which is nailed against the ends of the lookouts and sheeting ends, the "plencia," nailed against the lower edges of the lookouts, and the "frieze," nailed against the walls and close up under the inner edge of the plencia. Ordinarily, the plencia is attached first, the frieze next, and the facia last, although many carpenters prefer to follow other methods of construction. The outer or lower edge of the plencia should come

out flush with the ends of the lookouts and the fascia should be cut wide enough to reach from the upper edge of the sheeting to the lower edge of the plencia. A square "box" is recommended for all ordinary buildings, its chief advantage being the fact that it requires less skill in construction than a cornice having a perpendicular fascia or a fascia set at other than right angles to the plencia.

Sheeting.—The work of laying sheeting begins at the outer face of the cornice where the first sheeting board is nailed out flush with the edge of the fascia. As he lays succeeding courses of sheeting the carpenter uses the lower courses as a means of support both for himself and for any extra tools or material that he may need close at hand.

Each course should be nailed to every rafter it crosses and care must be taken to see that joints do not all fall on the same rafter. Unless joints are distributed over the entire set of rafters a weak roof will be the result. The last course, at the apex or the "comb" of the roof, should be nailed securely to the corresponding course on the opposite side. Sheeting for shingles is usually of 1 by 4 lumber laid with 4-inch spaces. Sheeting for shakes that are to be laid "shake fashion" must be spaced wide enough to provide firm support for each end of the shakes. If shakes are to be laid shingle fashion, then of course sheeting is spaced the same as for shingles.

Shingling.—Shingling also begins at the lower edge of the roof. The old practice of cutting shingles for the first course in half in order to avoid a "humped" roof is seldom followed by modern carpenters. This course is simply doubled and full-length shingles are used. In order to keep the lower ends of the first course of shingles even, a shingle is nailed at either end of the roof, a small nail is driven up into the end of each, and a chalk line is then stretched from one to the other. A third shingle should be used at the center of a long roof. When the first course has been laid the end shingles are marked at a point where the lower ends of the next course will reach, the line is well chalked, stretched tightly across the lower course from one end mark to the other, raised, and then allowed to snap down against the shingles, thus leaving a distinct line of chalk against which to set the next course of shingles. These should always cover the joints between shingles in the course below and should be nailed to the sheeting at a point just above where the butts

in the next course above will fall. By nailing them in this manner all nail-heads are hidden and a much neater looking and more durable roof is the result. The last, or top, course of shingles on the side first covered should be sawed off flush with the top sheeting board on the opposite side, while those on the opposite side should be sawed off flush with the upper surfaces of the top course on the first side.

The nails used in fastening the shingles to the sheeting should not be driven so deeply that the heads will split the shingles.¹

Shingles Required.—The number of shingles required to cover a roof of given size may be obtained by either of two methods, viz.: (1) by ascertaining the number of squares contained in the surface of the roof, including eaves and "overhangs," and multiplying this by the number of shingles required to cover one square; (2) by ascertaining the number of square feet in the roof and multiplying this by the number of shingles required for one square foot. For example: Given a 24-foot roof (plate measure) with 12-foot rafters, 12-inch eaves or lookouts, and 12-inch overhangs, to find the number of shingles required. The two overhangs added to the plate measure make a total roof length of 26 feet, while the 12-inch eave makes the roof, or this particular half of it, 13 feet wide. This makes an area of 338 square feet, or 3.38 squares. The entire roof will of course contain twice this number of square feet. Assuming that the shingles average 4 inches in width and that they are to be laid 4 inches to the weather, it follows that nine shingles are required to cover a square foot or that nine hundred are required for a square. However, carpenters usually estimate that a roof of this sort requires one thousand shingles per square, the extra one hundred shingles being used in the double course at the eave or being discarded as damaged or cull. Very wide shingles do not make a satisfactory roof because of their tendency to swell or shrink and to buckle or split.

Number of Nails for a Shingle Roof.—In all ordinary shingling not more than one nail per shingle is necessary, although many carpenters insist that all shingles, and especially the very wide ones, should be nailed near both edges. However, in single

¹ A common expression among shinglers: "When you lay shingles don't strike the nails a last lick."

nailing, the nail may be driven, for instance, near the left edge of the shingle and far enough above the butt to allow the butt of the shingle in the next course above to cover the nail-head. The other edge of the shingle will be made secure when the next succeeding course is laid, and the shingle will also be further secured by nails which pass through other shingles above. Two nails per shingle will of course make a much more substantial and weatherproof roof. The nails most widely used for sawed shingles are known as "No. 3 Common," and are approximately $1\frac{1}{4}$ inches long.

Shakes.—This term, typically Southern, applies to clap boards split or hewn from timbers. Ordinarily shakes are made about 4 inches wide and from 18 to 36 inches long, frequently longer if to be used in special construction, such as for walls or for narrow roofs where one course will cover the rafters. They may be laid the same as shingles, but as a general rule are laid in "board fashion," *i. e.*, laid in double courses in such a way as to break joints and at the same time overlap the next lower course by from 2 to 4 inches. When laid in this manner the butts are held even by means of a straight edge tacked to the course below. As each course is finished the straight edge is removed and then tacked to the last course laid. The method of nailing shakes in board fashion differs from that followed in laying them shingle fashion. In the first course a pair of shakes, or "boards," is laid side by side on the sheeting and a third board is laid on top of and parallel with these in such a way that the joint between the lower boards falls immediately beneath it. A nail is then driven through a lower corner of the top board, through the board beneath it and into the sheeting. The nail driven through the opposite corner secures the other board of the pair. The next board is laid beside one of the pair and a second board is placed over the joint and beside the top board first laid, nailing to be done after the manner just described. The upper ends are left unnailed for the time being, but are finally fastened to the sheeting when the next course above is laid. By nailing them in this manner, where nails passing through the course above also pass through the upper ends of the course below, considerable time is saved and the number of nails required is much less than when each board is nailed separately. In view of the extra thickness of most boards, however, it is often found necessary to use much larger

nails than are required for sawed or cut shingles and in very thick or rough boards it may even be necessary to use 8ds. Occasionally, if twisted or warped boards are being laid, it may also be found necessary to use extra nails at the other corners.

Shakes Required.—Estimates for shake roofs, shakes to be laid "shingle fashion," are the same as for shingle roofs. If the shakes are to be laid "board fashion," then a different method of estimating must be followed. Assuming that the shakes are 32 inches long and that they are to be laid 28 inches to the weather, the 13-foot rafters will carry about four and one-half courses, or, as is usually estimated, five whole courses. If the shakes average 4 inches in width, then each course in a 26-foot roof will contain seventy-eight shakes, but since the shakes are to be laid "board fashion" each course must be doubled. This requires one hundred and fifty-six shakes for each of the ten courses necessary to cover the entire roof.

Number of Nails for a Shake Roof.—If shakes are to be laid shingle fashion the same number of nails must be used as for a shingle roof. If they are to be laid board fashion two nails will be required for each shake in the top tier of each course, and in addition thereto an extra row of nails will be required at the comb. The number of nails required for such a roof will therefore be equal to the number of shakes used, plus the extra number required at the comb. Ordinarily 6-penny commons can be used, although it may be found necessary to use 8-penny commons in extra thick or rough shakes.

Saddle Boards.—This completes the roof, and consists of two boards nailed together hog-trough fashion and extending the entire length of the roof along the comb. It provides an inverted V-shaped covering at the comb, and not only serves to hold the last course of shingles more securely, but also prevents the entrance of rain and snow. It should be nailed securely through the shingles and into the sheeting.

A saddle board is seldom used on a shake roof. As a means of protection against snow and rain the last course of boards laid on the side first covered is sawed off flush with the opposite sheeting board, while the last course on the opposite side is not sawed off but is allowed to project upward over the sawed-off ends of the corresponding course on the first side. This is a very common form of roof throughout the South.

LAYING THE FLOOR

Ordinarily the roof is first completed in order to provide shelter for workmen during the completion of a building in bad weather, and after this comes the laying of the floor, which will present an even and substantial surface upon which to work while the door and window casings and other parts are being made and fitted.

Unmatched Flooring.—This is plain, dressed or undressed planks, but if properly laid makes a tight and comparatively even floor. In nailing it to the sleepers the nails must be driven directly through it and into the sleepers, and all nail-heads should be well sunk beneath the surface of the planks if a smooth floor is desired. Crooked planks should be drawn close up against adjoining planks by beginning at one end and nailing to successive sleepers as the planks are forced over. If planks are so crooked or warped that they cannot be forced sidewise, then they may be ripped or planed straight, or, if crooks make even this procedure impractical, they may be sawed half-way through, and thus weakened until they can be bent. Care must be taken in such sawing, however, to see that the point of sawing will fall on a sleeper. Unseasoned flooring should not be used unless battens are placed beneath the joints. At least two nails should be used in each sleeper.

Matched Flooring.—Planks in matched flooring are fitted with a tongue at one edge and with a groove at the other, thus providing for a closed joint between them. The nails used in fastening down the floor should be of a small-headed variety, such as casing nails, and should be driven diagonally through the planks immediately at the rear of the tongue, care being taken not to bruise or batter the shoulder above the tongue. Nailed in this manner the groove of one plank covers the nail-head in the one beside it, and no nail-heads protrude above the surface of the finished floor. No nail is required on the side next to the groove, the tongue of the adjoining plank being sufficiently strong to serve the purpose of a nail.

WALLS

The rules suggested for laying floors apply equally well to walls, except that when boxing is used it is customarily set vertically rather than horizontally, like siding, and battens are nailed

to the outside.¹ Matched or "drop" siding, to be attached horizontally to studding or boxing, bears a tongue at either edge, but these are diagonally opposite each other, thus allowing the lower of one plank to fall outside the upper of the one below. Such a manner of construction presents a shingle effect which prevents the entrance of rain or snow.

Plain siding, or "shiplap," made thicker at one edge than at the other, is laid shingle fashion against the studding or boxing

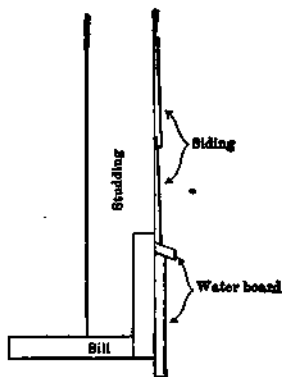

FIG. 86.

with the thin edge up. Most carpenters allow the lower edge to cover the upper edge of the plank below with a lap of about $\frac{1}{2}$ inch. The work of attaching such siding must of course begin at the bottom of the wall.

Water Board.—This may also be known as a "water shed." It is placed at the bottom of a wall which is to be sided and is nailed directly against the sill. It is designed primarily as a protection to the sill, but also tends to give a building a much neater and more fully completed appearance if a box cornice is used and completed with a

frieze. Water boards are seldom used on walls to be boxed. Fig. 86 shows an end view of such a board.

Door and Window Casings and Other Inside Work.—The proper construction and fitting of door and window casings and inside finishing require skill and tools that the average layman does not possess. Therefore, in view of these facts, together with the improbability of a field man being required to do such work, no suggestions on the subject will be offered here. The most practical procedure that can be followed is to secure the services of a professional carpenter who possesses the

¹ Boxing is set horizontally in most tent houses. The reason for this form of construction lies in the fact that set in this manner a minimum of labor and waste of material is secured. Moreover, a tent house is usually only temporary in nature and is seldom designed as a complete protection against extreme weather.

necessary knowledge of and proper tools for finishing such work.

CONCRETE WORK

Concrete.—This form of artificial stone is continually meeting with greater favor among builders, and although the average field man seldom is required to use such material he may nevertheless find occasional need for a knowledge of its general nature. The chief reasons why concrete is in such universal demand are its superior strength as compared with masonry involving the use of lime mortar, the cheapness, ease, and simplicity with which it may be made, the complete success which attends its use in nearly all forms of construction, and the permanency in construction which it affords.

Cement.—This bears the same relation to concrete that ordinary lime mortar bears to other forms of masonry, but differs from lime in its capacity for hardening, or "setting," under water, while lime hardens only when exposed to air. It is obvious that this particular characteristic of cement, which gives it the name of "hydraulic" cement, renders it preferable to lime for general use.

There are a number of different cements manufactured, but Portland and natural cements are most widely used and are the only ones that can be considered in detail here. Rosendale, formerly applying only to the Ulster County, N. Y., natural cements, is a name now given to practically all natural cements of this country. Another variety, known as "Puzzolan," is made by grinding slaked lime and slag together. Silica cement consists of a ground mixture of cement and quartz sand.

Natural Cement.—This is produced by burning certain clay-bearing limestone, or calcareous clay, after it has been quarried and broken in fragments of a size most convenient to handle, the quarrying, breaking, and burning being done in a manner similar to that employed in preparing lime. Later the burned stone is crushed or ground to a fine powder. Natural cement sets quicker than Portland cement, but is considerably inferior in strength.

Portland Cement.—The production of Portland cement consists in grinding the different materials together in desired proportions, after which they are burned, at a temperature higher than that allowed in burning natural cements, and are then

ground again until a fine powder is produced. By reason of the fact that this method of preparation permits absolute control of quantity and quality of ingredients Portland cement is far superior to natural cements, and is therefore more widely used than the latter.

Proportions.—Concrete consists of three principal materials mixed together in water, viz., cement, sand, and aggregate. These are mixed together in proportions previously determined by the nature of the use to which the concrete is to be put, the efficiency of the concrete depending chiefly upon the amount of each material used. The following table of mixtures is in sufficient detail to cover any concrete mixing the field man will be required to do:

PROPORTIONS TO 1 PART CEMENT		
Sand	Aggregate	
2	4	For great strength; to resist water.
2½	5	For moderate strength, such as in cellars, walls of small buildings, steps, curbs, etc.
3	6	For ordinary work where a minimum of strength is required, such as in walks, small retaining walls, floors, etc.

Sand.—The three principal varieties of sand are known as "Pit," "River," and "Sea" sand, these names being derived, of course, from the location from which the respective varieties are obtained.

Better results may be obtained in concrete work if coarse and fine-grained sands are mixed together. Such a mixture reduces the total void, and therefore requires less cement for filling. Any sand used must be screened, if leaves, twigs, dirt, or other foreign materials are present. Voids in sand vary from 25% to 40%, according to the degree of coarseness or fineness.

Pit Sand.—This usually has sharp angular grains and will be found most satisfactory for general use. The chief disadvantage often encountered in securing it is the presence of clay pockets, occasionally so extensive as to make it necessary either

to wash the sand or else mix the clay into it. Clay has no perceptible detrimental effect on rich mortar, and is even desirable in lean mortar when it is thoroughly mixed with the sand.

River Sand.—In nearly all localities river sand has smooth, round grains, made so by constant friction against each other when disturbed by water, and although it is not as desirable as pit sand it may be used with satisfactory results in all ordinary concrete work. As with pit sand, however, care must be taken to see that all foreign material is removed.

Sea Sand.—In addition to the undesirable rounded grains, sea sand may also carry ocean salts, which, unless they are removed by washing, may cause trouble by attracting moisture to concrete which should be kept perfectly dry. Such salts occur, however, in quantities too small to warrant rejection of sea sand when it is needed for other work.

Aggregate.—This constitutes the main body of concrete, the same as brick or stone constitutes the body of other masonry, and is responsible to a corresponding degree for the efficiency of the concrete. Sand, which acts to a certain extent as a filler, is provided chiefly as an aid to proper distribution of and some assistance to the binding quality of cement. The three principal forms of aggregate are: Crushed stone, gravel, and cinders.

Crushed Stone.—This should be angular, sharp-edged fragments of some hard stone, such as granite, trap, gneiss, or quartz, having an average maximum edge length of not more than 3 inches for use in walls or other work from 4 to 6 inches thick. The edge length should not exceed 2 inches for lighter work. Voids vary from 30% to 50%, depending upon the size of the fragments. Crushed stone will prove more generally effective than gravel.

Gravel.—This is inferior to crushed stone in its lack of sharp edges and corners and its softer composition. It should be free from a clay coating and of a size similar to that of crushed stone heretofore mentioned. It does not make as strong concrete as crushed stone, but is nevertheless used extensively and with fairly satisfactory results.

Voids are slightly less than in crushed stone.

Cinders.—This form of aggregate makes much weaker concrete than crushed stone or gravel and is never used except in work where nails are to be driven into the concrete. The cinders must be very hard and care must be taken in ramming not

to crush them. They, therefore, make a thin mixture imperative in order that filling may progress properly with a minimum of ramming.

Water.—Warm water is often used in concrete to prevent it from freezing, and salt water in the proportion of five pounds of salt to one hundred gallons of water is used for a similar purpose when there is no objection to the resultant crystalline deposits which invariably appear during or immediately after setting. However, cold water may be used in freezing weather with no perceptible ill effects on the strength of the concrete.

Re-enforcement.—This is provided as a means of binding concrete so effectively that portions of the concrete can not fall out if cracks or breaks appear. Woven stock wire, barbed wire, mine rails, iron pipe, old wagon tires, or any similar material can be used to good advantage. Re-enforcement material need not be galvanized, as concrete will not rust plain iron. It is especially necessary to re-enforce thin walls, steps, floors, etc., and even in thick, heavy work much more satisfactory results may be obtained if some form of re-enforcement is used.

Mixing.—Thorough mixing and proper proportions of all materials used are absolutely essential in any concrete construction. Dry cement has no binding force. Coarse aggregate used at one time and finer aggregate used at another cause lack of uniformity in strength, or too much of one material or too little of another may so impair the quality of construction as to render the work worthless.

A mechanical mixer is recommended only for use when large quantities of concrete are to be used; otherwise economy demands mixing by hand.

This can best be done by placing proper proportions of sand and cement on a tight-bottomed platform (side and end walls on the platform are unnecessary) and turning the two together with a shovel until the mixture acquires a uniform color. A concavity is then made in the top of the pile and water is poured into this as needed, the mixture of sand and cement being taken gradually from the rim of the crater thus produced. Aggregate, previously wetted down, is then mixed into the "mud," and if necessary more water is added until the concrete is thin enough to pour readily and settle uniformly in the forms. If Portland cement is to be mixed during freezing weather, a minimum of

water should be used or else heated. For table of estimates, see page 359, Appendix.

Forms.—It is always advisable to lay form lumber in water and let it swell to its greatest capacity before it is built into forms; otherwise water from the concrete may soak into and swell it to an extent that will cause it to buckle as it expands and thus present an uneven surface against which to place the concrete.

Forms to be removed and re-erected at frequent intervals should be scraped clean of all large accumulations of concrete after each removal. Except when the nature of the work to be done demands them, sharp corners should be avoided. This may be done by placing a triangular strip in the corner of the form where a corner of the concrete will be exposed. Inside corners require little or no attention in this respect. Nothing definite can be offered on the subject of construction of forms; the work to be done always determines the style of form to be used.

Filling Forms.—If the workman has reason to believe that the nature of the material used for forms is such that the concrete may stick and chip away when the forms are removed he should avoid such trouble by lining the forms with paper each time they are erected. Under ordinary conditions, however, sticking may be prevented by wetting the forms before they are filled.

If concrete is to be dropped more than 4 or 5 feet it should be re-mixed before ramming begins; otherwise the heavier materials may be deposited at the bottom rather than uniformly throughout the mass. Thin mixtures do not require as much ramming as thick ones, and the latter should be thoroughly rammed as filling progresses. Ramming can best be done in narrow walls with a 5-foot length of 1-inch pipe. A heavier implement, preferably a 4- or 5-foot wooden ram having a 4-inch face and shod with iron, will be found more effective for heavier work. Thorough ramming adds about 50% to the strength of concrete and consolidates it from 4% to 6%.

Layers to be built on later should be left rough on the exposed surface and then carefully cleaned and well wetted before the work of filling is resumed.

Setting.—The length of time required for concrete to set depends upon the character and kind of cement used, the amount of water used in mixing, the degree of thoroughness in ramming.

and the temperature of the air. Slow setting will be found preferable to quick setting concrete in practically all ordinary work, and the minimum length of time allowed to elapse before the forms are removed should not in any case be less than forty-eight hours. Even then it is always advisable to protect the work from sudden jars or strains while the new forms are being erected. All concrete grows harder with age.¹

Cement Finish.—Surfaces to be finished, top-dressed, or plastered with cement should be rough, clean, and well wetted. The plaster, consisting of one part cement to two parts sand, must be thoroughly mixed but with only enough water to leave it plastic. If made too thin it will fail to adhere closely to the concrete. It must be kept well moistened while it hardens. Neat or even very rich cement mortar frequently cracks in setting and is not, therefore, as good for plaster as the mortar carrying the per cent of sand heretofore mentioned. Natural cement plaster should not be used on concrete made with Portland cement nor should Portland cement plaster be used on concrete made with natural cement. Plaster made of equal parts of both may be used on concrete made with the same mixture, but separation of the plaster and concrete frequently occurs when the two are made with different cements. Top dressing on walks, steps, floors, etc., should keep pace with the work of laying the concrete; otherwise the concrete and dressing will not set together.

Concrete Blocks.—The method of construction followed in making these, *i.e.*, leaving them hollow, constitutes their chief advantage in many respects. The spaces left in the structures made with blocks reduce the first cost of construction by a corresponding decrease in the amount of material required; they

¹In recent years numerous prominent architects, builders, and scientists declare that the pyramids of Egypt are of concrete construction, but whether or not such a theory merits serious consideration can not be discussed here. It is a well-established fact, however, that the use of concrete was for centuries practically a lost art, conclusive proof to this effect being provided by the existence at the present time of buildings erected in the Orient in the third and fourth centuries and known definitely to have been constructed of concrete. A prominent architect of Milwaukee, recently returned from a tour of inspection of ancient structures in that locality, states that upon one occasion, when he attempted to chip away fragments of concrete from a bridge, the most vigorous chiseling resulted only in a stream of sparks and failed utterly to chip the concrete.

may serve as passages for flues, wiring, or plumbing, and they prevent sudden changes of temperature within buildings having hollow block walls. Moreover, walls made of hollow blocks may be erected and completed in less time than stone or brick walls and do not require near as much mortar in laying. In strength they are equal to brick walls and in their capacity for resistance to fire are far superior.

Successful block construction, however, requires the use of a block machine, but this expense will prove disproportionate to other expenses unless the proposed structure will require a very large number of blocks. The minimum cost of a reliable machine equipped with enough different moulds for all ordinary work is about \$50.00. It will be seen from this that forms of lumber are much cheaper for limited construction.

One of the chief disadvantages of hollow-block walls is their tendency to split when improper proportions are used in the concrete, when careless mixing has been allowed, or when the blocks are laid before they are firmly set. Some medical authorities also contend that residences having hollow-block walls are unsanitary, because such walls attract and retain moisture. In the majority of cases, however, this is due to improper construction.

The general consensus of opinion among builders seems to be in favor of re-enforced solid walls for residences and hollow block walls for other buildings.

PAINING

Object.—Paint is used for two principal purposes, viz.: (1) To protect iron or wood building material from weathering, and (2) to secure a more pleasing external appearance of buildings and other structures. Used on iron it prevents rust and on wood it prevents the entrance of moisture, which would eventually cause more or less damage through rotting the material.

Composition.—Most paints used in all ordinary outside and inside work consist chiefly of white lead or zinc oxide ground in raw linseed oil and having the coloring matter added to the mixture before it leaves the factory. Body matter invariably settles to the bottom when the paint is left standing for any considerable length of time, and must, therefore, be stirred and forced to mix with the oil before it can be used.

Ready-made paints are usually mixed thicker than is neces-

sary or even desirable, but this trouble may be overcome by adding boiled oil in quantities which reduce the paint to the desired thinness. Thinning with raw oil necessitates the addition of a drier if the work being done requires prompt hardening. Commercial driers are carried in stock by practically all dealers in paint, but if the work is remote from such a source of supply then sulphate of zinc, litharge, or sugar of lead may be used in the proportion of two teaspoonfuls to five pounds of prepared paint of any color. Many painters prefer what is known as "Japan varnish," but if this is used in excess it will cause the paint to crack as it hardens. Turpentine is also frequently used for thinning, except in the first coat. It is cheaper than oil and causes the paint to flow more readily and uniformly from the brush. It may be used in inside work with good results, but reduces the firmness of paint to a degree that renders it unfit for outside work.

In emergencies kerosene (coal oil) may also be used as a thinner, but can be used with better success in stains than in paints. If wax is melted and thoroughly mixed into a stain thinned with coal oil it will produce a smooth, glossy finish.

Colors.—Ready mixed coloring matter may be secured from any paint dealer. Like paint, it should be well stirred before it is added, and finally should be stirred into the paint till the whole mass assumes a uniform color.

Coats.—From three to five coats are applied in all high-grade painting, but in all common work three coats will be found sufficient. Surfaces to be painted must be perfectly clean and dry, and if of lumber, must be thoroughly seasoned. The first coat, known as the "primer" or "priming," should not carry too much oil or turpentine, since these may sink into woodwork and leave a large per cent of the paint body unevenly distributed over the surface, where it will eventually peel away. Very thin paint will not "stand," or adhere well, if used on an iron surface. The second coat should not be applied before the primer is thoroughly hardened. The last coat, in which the coloring matter is placed, may be finished "dull" or in "gloss." Dull or dead finish results from the use of turpentine alone as a thinner; a gloss finish may be secured by using equal parts of oil and turpentine for thinning. Two coats are usually sufficient on iron surfaces, but the paint used in this work should have a body composed of one of the oxides of iron, since white lead, in

common use in paint for woodwork, will not stand on iron and must therefore be renewed at frequent intervals. The red paint known to laymen as "railroad" paint can be used with equally good results on either wood or iron. It carries a large per cent of drier, is cheap and quite generally effective.

Amount of Paint Required for One Square.—For primer work more paint per square is of course necessary than for succeeding coats, this being due to the fact that the open pores of the surface to be painted must be filled before an even surface of paint can be obtained. Usually, on dressed lumber, from five to six pounds of thin keg paint per square will be found sufficient for the primer. If the lumber is undressed and very rough then this amount must be increased even as much occasionally as 50% or 75%.

After a firm primer has been secured the first coat will require approximately four pounds of keg paint per square, while the second and succeeding courses should not require more than two and one-half or three pounds.

Care of Paint Brushes.—These should be thoroughly cleaned and dried after using and before they are stored away. Cleaning can best be done by alternate soaking in coal oil, turpentine, gasoline, or linseed oil and pressing or kneading to remove paint. When free from all paint the bristles may be worked dry with paper or cloth. If the paint is not to be removed, then the brushes should be stored in oil to prevent hardening.

Brushes having the bristles set in rubber or cement should never be boiled: boiling will dissolve the binding and the bristles will be released.

FENCES

On some of the National Forests, especially in the West, where corrals and drift fences must be provided for the proper handling of stock, the field man may find it necessary to devote a large portion of his time to the inspection, repair, or even construction of fences.

These may be of stone, logs, rails, brush, plank, wire, or pickets, depending upon the supply of material available and the permanent or temporary nature of the fence to be built. Plank and wire are the most widely used materials, and fences constructed of these will be found in all parts of the country.

Stone.—A very important item in the construction of a stone

fence, or "wall," is the substantiality of the side walls. If these are to be 4 or 5 feet high the base of the wall should be at least 3 feet thick. Side walls are built up separately with the larger stones at the bottom and are drawn in toward each other as the



FIG. 87.—Cross-section of a stone fence.

top is reached, until at the very top the fence has about the same thickness as one side wall. The space between the side walls is kept filled with smaller stones, filling keeping pace with the growth of the walls. Tie stones are used after the side walls have been brought together. A cross section of a stone fence is shown in Fig. 87.

Logs.—Log fences may be constructed as shown in Fig. 88. The short cross logs need not exceed 4 feet in length, and are fitted with notches into which the long logs are sunk. These are also notched on the upper side immediately over the cross logs and the next cross logs above are dropped into the notches. Proper construction of log fences requires them to be built up

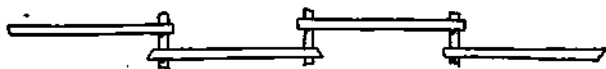

Log fence.

FIG. 88.—Method of laying ground logs.

perpendicularly in order to prevent the logs from slipping. This method of construction is especially necessary along steep hill-sides.

Rails.—There are two principal methods of constructing rail fences, although a third method is the same as that employed in building log fences. The most widely used style of rail fence, and one that is common to all parts of the South and to many parts of the West and middle West, is known as the "worm" fence, and derives its name from the manner in which the rails are laid. The first rails, or the "ground" rails, are laid as

shown in Fig. 89. Succeeding tiers must be placed firmly on these and the corners or "locks" must be built up exactly per-

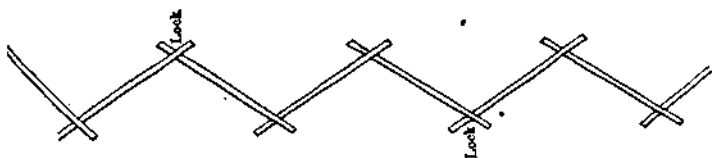
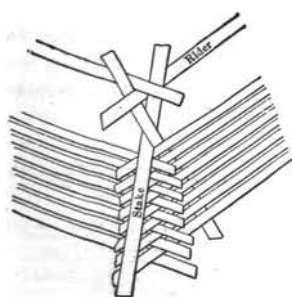
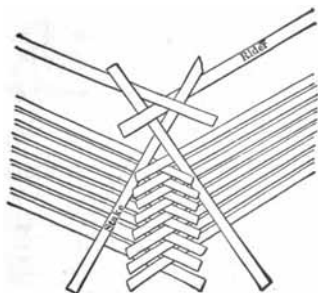

FIG. 89.—Worm rail fence. Method of laying ground rails.

pendicular. The latter may be fastened by means of "stake" rails set as shown in Fig. 90, and these are then held in place by the "riders." Such a fence is known as a "staked and ridered worm" fence. The method of "cross" staking the



Cross stakes at a lock.



Side stakes at a lock.

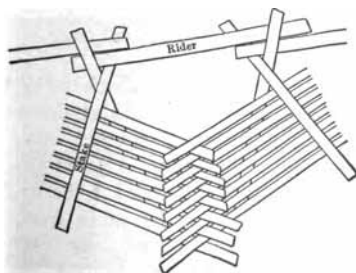

Panel stakes.

FIG. 90.

locks is shown at the top of the figure. Its chief disadvantage lies in the fact that the stake rails take up considerable ground along either side of the fence. However, the method is about the most common one used.

The second method shown, where the crosses of the stake rails are at right angles to the line of fence, is also widely used. A variation of this method requires the foot of either stake to be set close against the ground rail at the next lock.

A third method of staking is also shown in this figure and provides for the staking of each panel at or near its center. Heavy poles, sometimes long enough to cover six or eight panels, may be used for riders.

Worm fences for corrals should not have short sharp corners.

These present excellent opportunities for viciously inclined animals to "hem" or "corner" the weaker ones and punish them severely.

A second general style of rail fence, known as a "post and rail" fence, is illustrated in Fig. 91. Such fences may be built of long poles, and are therefore especially adapted for corrals

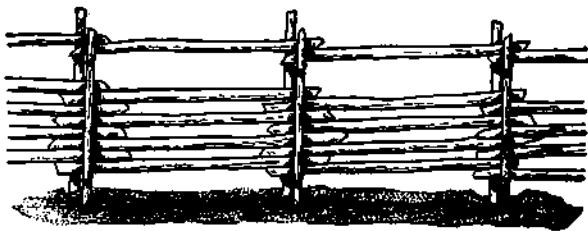

FIG. 91.—Post and rail fence.

and other small enclosures where stock is to be confined for short periods. Posts are set in pairs at desired intervals and are wired or otherwise fastened together, once at or near the ground and again near the tops. A third tie at or near the middle of the posts may also be used if the fence is to be 8 or 10 feet high. This prevents the posts from spreading and allowing displacement of the rails or poles. Where long, heavy poles are to be used and it is not considered necessary to start the fence at the ground, blocks may be cut the desired length and set endwise under the ends of the lower poles. Top poles

may be laid on the top ties, thus serving to bind the posts together more securely. Corral fences of this kind should have rounded corners.

Pickets.—These are known in many localities as “palings,” although the latter term is generally applied to the split variety of pickets which are so widely used in fences in the South and Southeast. The construction of a picket fence consists merely in setting the posts at required intervals, connecting them with “stringers,” usually two in number, and nailing the pickets to the stringers. The pickets should be set perpendicularly rather than at right angles to the stringers, this rule of construction holding good even when the fence ascends or descends steep slopes. The common idea that more pickets are required in fencing through hilly country than across level country is erroneous, as may be seen by observing Fig. 92.

In this figure it is assumed that the pickets are set perpendicularly. The line 1 indicates a length of fence built across a hill,

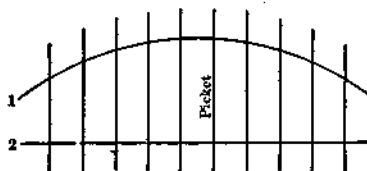

FIG. 92.

while line 2 represents the horizontal length. More posts will be required in line 1 than in line 2 if the stringer lengths are to be the same, and in any case the amount of stringer material must be increased, but the number of pickets will be the same in both lines.

Split pickets, or palings, which are usually too thick and irregular to be nailed to stringers, may be fastened upright by means of wires attached to the posts and woven about the palings as indicated in Fig. 93. The wires are stapled securely to the first post but loosely to the second until the panel has been filled with palings. They are then drawn as tight as possible and securely stapled to the next post. Succeeding panels are constructed in a similar manner. Not less than No. 12 gauge wire should be used, and No. 9 will be found much better.

Plank.—The construction of a plank fence is so simple that little need be said on the subject. If care is taken to trim or set the posts in such a way that a flat surface is presented to the planks,

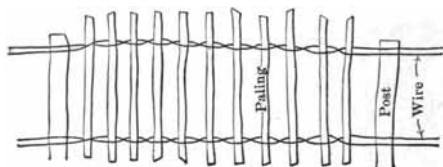

FIG. 93.—Picket or "paling" fence.

and if the latter are sound and securely nailed to the posts, a substantial fence will be the result. Red oak (*Quercus rubra*), Spanish oak (*Q. digitata*), blackjack (*Q. marilandica*), and sycamore (*Platanus occidentalis*) are especially liable to warp, crack, twist, or split and should never be used in a plank fence. The chief disadvantage of any plank fence is its susceptibility to fire and to climatic conditions.

Brush.—A brush fence consists merely of a row of brush piled high enough to prevent stock from passing over it. It is the very poorest form of a fence and should never be used if other material is available. It is very susceptible to fire, takes up a large amount of ground, is unsightly, soon rots and settles and requires constant repairing.

Barbed Wire.—Well-set corner posts and proper tension and attachment of wires are the most important points to consider



2-point or "cattle" wire.



4-point or "hog" wire.

FIG. 94.

in building barbed wire fence. After the fence row has been brushed out and the posts set the lower wire should be laid first, since trouble will be had in separating them if all the wires are laid at once. The common practice of carrying the

spool or reel of wire along the fence row is to be avoided if this is at all possible. It is not only tedious work, but it is also a dangerous practice if the wire is not properly wound on the spool. The best method of laying wire is to bore a 2-inch hole through a heavy plank, place the plank flat on the ground, set the spool endwise on it and hold it there by means of a crowbar thrust through the spool and plank into the ground. The wire may then be laid out with a saddle horse, the rider securing the wire to the saddle horn with two or three turns of a 12- or 14-foot rope tied into the wire and holding the loose end of the rope in his hand. When fastened to the horn in this manner the rope may be released instantly if this becomes necessary. The wire itself should never be looped or tied to the horn. The other man remains at the spool and holds the upper end of the crowbar. Friction of the spool against the plank prevents it from revolving too rapidly and little trouble with tangles need be expected. Spools carry from 80 to 110 rods of wire weighing approximately one pound per rod, and such a length of wire may be laid out with an average size animal trained to pull under the saddle. If not so trained, harness must be used.

However, this method of laying wire can be followed only with difficulty if the wire is to be hung to trees growing along the fence line. Hanging it in this manner necessitates cutting and splicing if the wire is to pass on different sides of trees.

Tension of wires crossing hills and hollows should be tested at the highest and lowest points. This should not be done by seizing the wire with the hands, but should be accomplished by means of a heavy pole or crowbar placed across the wire and forced downward or upward. Defective wires, or even sound wires under great tension, may suddenly break, and when this occurs the ends recoil with a spiral twisting motion that may result in serious injuries to the workmen standing near.

Staples should be set with the points in a line diagonally across the grain of the posts. If driven in this manner they are much less likely to split the wood and always hold the wire more securely. One-inch staples should be used in hardwood, $1\frac{1}{4}$ inch in medium hardwood, and $1\frac{1}{2}$ inch in softwood.

The stretcher must be operated with steady, regular movements and must be so attached to the wire that it will not slip.

The best splice for barbed wire is the same as that used in

splicing telephone wire and which is known as the Western Electric joint. See Fig. 40.

If gloves are to be worn they should be of hard, stiff leather and should fit loosely in order that they may be removed instantly if the barbs hang in them. Soft cloth gloves should never be worn. They not only allow the barbs to injure the hands, but they may become so badly entangled on the barbs that in case the wire breaks or other accidents occur the workman may suffer serious injuries.

Woven Wire.—This is hung with the narrow meshes at the bottom, and, like barbed wire, must be tightly stretched and securely stapled to well-set posts if a substantial fence is desired.

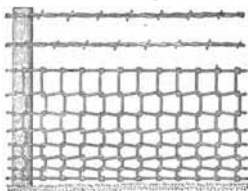

General stock fence.

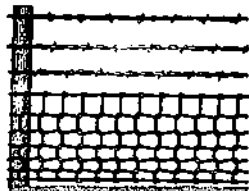

Sheep and hog fence.

FIG. 95.

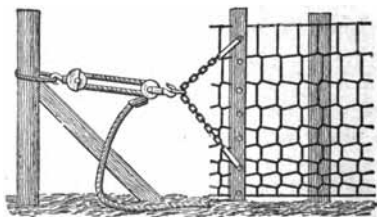

FIG. 96.—Block and tackle stretcher for woven wire fencing.

Its construction prevents it from being laid out from a stationary reel, and the roll or spool must therefore be revolved along the cleared fence row after the loose end has been made fast to some stationary object. The heavy top and bottom wires should be securely stapled to each post, but, except in rare cases, it is not necessary to staple all the intermediate wires so often. The

perpendicular stay wires are not stapled. No trouble will be experienced with buckling line wires stretched across ridges and hollows if the fence is hung so the stay wires set perpendicularly. Splices in woven wire are made the same as in barbed wire, each line wire in one length being spliced to the corresponding wire in the other. Stretchers used on woven wire consist of a pair of heavy wooden clamps which are bolted together through the meshes and which are drawn in by means of a double set of claws working on a chain attached to a tree or heavy post. Another style of stretcher is operated by means of a team hitched to a block and tackle.

Corner Posts.—For ordinary smooth or barbed wire these need be no larger than the line posts, but should be from 12 to 18 inches longer and set deeper in the ground. Woven wire, by reason of the increased strain it imposes on a corner post while stretching is in progress, requires heavier corner posts. They should be not less than 8 inches in top diameter and should be at least 9 feet long. Being of this size they are too large and heavy to be driven with a post maul and must therefore be set. They should either be roofed like a telephone pole or rounded off at the upper end and painted or smeared with tar to prevent the entrance of water.

Setting and Bracing.—The best method of setting and bracing a corner post is shown in Fig. 97, the same method with lighter material also being effective for corner posts to which smooth or barbed wire is to be hung.

For woven wire the post should be set not less than 3 feet, preferably 4 feet, in the ground, and should be firmly tamped. The brace should be cut long enough to allow the lower end to rest on a flat stone, shown at 1, set at least 12 feet from the foot of the post and directly in line with the fence. The upper end of the brace is fitted into a notch cut about 8 inches below the upper end of the post and is fastened there with a 20-d or 60-d spike, which will prevent its lateral displacement. Six or eight strands of not less than No. 12 gauge smooth or barbed wire are then wrapped about the lower end of the brace and

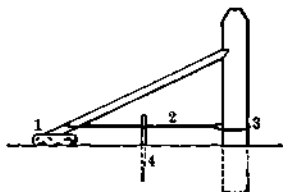

FIG. 97.—Brace for corner post.

corner post as shown in the figure and are twisted together with an iron rod or a stick. If a stick is used it should have one end nailed to the brace after the wires have been twisted tight. An iron rod may be driven into the ground.

Line Posts.—The most durable woods for any fence posts are white oak (*Quercus alba*), post oak (*Q. minor*), black locust (*Robinia pseudacacia*), sassafras (*Sassafras sassafras*), red mulberry (*Morus rubra*), any of the cedars or junipers, and dead heart-pine, which carries a large amount of pitch. All posts should be thoroughly seasoned before they are set.

Line posts need not exceed 4 or 5 inches in diameter nor 6½ or 7 feet in length. If they are to be driven, the upper ends should be rounded off to prevent splitting or battering when the maul is used. The points should not be drawn out fine, but should be at least ½ inch across the tip and not less than 16 inches long. Shoulders should be tapering rather than blunt. Posts to be set do not of course require sharpening. The practice of burning or charring the points is not recommended, since posts so treated seem to attract and hold moisture more than when not. For an illustration of a sharpening rack see Fig. 98.

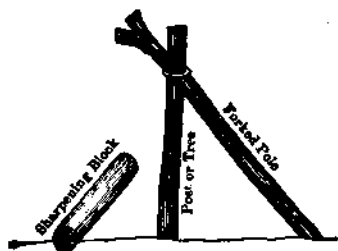

FIG. 98.—Rack for sharpening posts.

Setting or Driving.—Line posts should always be driven rather than set if this is at all practicable. A heavy, sharp-pointed instrument, known throughout the South as a "spud," may be used in starting a hole, or a crowbar may be used for the same purpose. The sharpened post is placed in the hole and is then settled firmly with an iron maul weighing from twelve to twenty pounds. This not only makes a more substantial fence but also eliminates the extra labor that would be required in digging

the holes and afterward tamping the posts, items of labor which involve greater expense than sharpening and driving the posts.

If hard or stony ground prohibits driving, posts may be set into holes, large end downward, and firmly tamped. The holes should not have a greater diameter than is absolutely necessary for removal of the dirt and insertion of the posts. Fine dry dirt should be firmly packed about the posts and a watershed at least 3 inches high should be left above the ground. Mud, or even very damp dirt, does not make satisfactory tamping material. As it dries it will settle away from and allow the post to work loose.

Holes should be from 14 to 20 inches deep. Post spaces for woven wire should not exceed one rod, but in smooth or barbed wire fences where stays are to be used may be as long as 3 or 4 rods.

Lightning Rods.—These are provided as a means of carrying electricity from the wires into the ground. The simplest form is made of ordinary smooth wire, preferably of No. 12 gauge, which is stapled downward along the post, the lower end being placed in permanently moist earth. To insure its contact with such earth the wire should be attached before the post is set. Later it is wrapped closely about each wire in the fence. One such wire should be attached to every fourth or fifth post along fences where stock congregate for water or for protection against extreme weather. Otherwise one wire to every ten posts will be found sufficient.

Gates.—Two very common varieties of fence gates are shown in Fig. 99, one being known as a "sliding" gate and the other

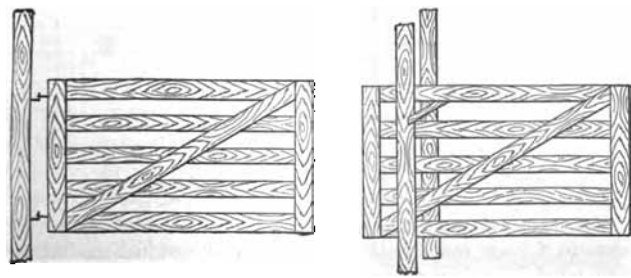

Swinging.

Sliding.

FIG. 99.—Gates.

as a "swinging" gate. Properly constructed and firmly hung swinging gates are preferable to any style of sliding gate, but with the greater first cost of construction the cost of maintenance is also greater. Moreover, owing to a general impression on the part of the traveling public that such gates lock automatically when slammed shut, the danger of their being left open is much greater than that involved in the use of a sliding gate.

Hinges for swinging gates should be so constructed that the gates may swing out of the fence line in either direction, and the style of hinge shown in Fig. 100 is recommended as being the most satisfactory in this respect.



FIG. 100.—Gate hinge.

Another convenient and durable style of hinge, which may be made from an old wagon tire or from other discarded iron of the same strength, is not fitted with the lag screw which fastens into the post, but consists merely of a heavy staple, into which a bent strap is fitted.

Any swinging gate should be securely braced from the lower hinge to the corner diagonally opposite, and when possible should also be guyed to the gate post as shown in Fig. 101. Both gate

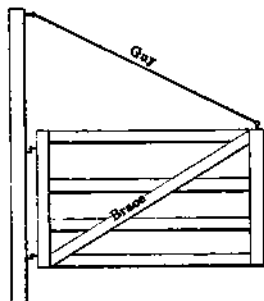

FIG. 101.—Gate guy.

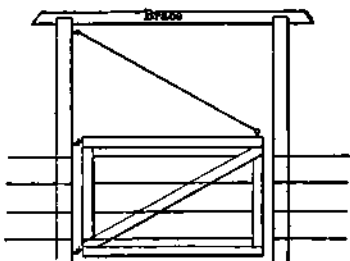

FIG. 102.—Gate tie.

posts in a fence may be tied together as shown in Fig. 102, but care must be taken to see that such ties are high enough to permit the passage of loaded vehicles beneath them.

CARPENTER'S KIT

For ordinary rough work about a station a carpenter's kit should include the following tools:

1 Handsaw, cross cut	1 Plane, block
1 Handsaw, rip	4 Chisels, $\frac{3}{8}$ -, $\frac{1}{2}$ -, 1- and 1 $\frac{1}{2}$ -inch
1 Saw, keyhole, or compass	1 Level-plumb
1 Square	1 Calliper
1 Brace	1 Compass
2 Bits, augur, in $\frac{1}{16}$ -inch sizes from $\frac{4}{16}$ - to 1-inch, inclusive	1 Rule, calliper
3 Bits, gimlet, $\frac{3}{8}$ -, $\frac{5}{16}$ - and $\frac{1}{4}$ -inch	1 Wrench, monkey
4 Bits, drill, brace, $\frac{1}{4}$ -, $\frac{5}{16}$ -, $\frac{3}{8}$ - and $\frac{7}{16}$ -inch	1 Hammer, claw
1 Plane, jack	3 Files, saw, assorted sizes
	1 Grindstone
	1 Whetstone

Fine work requires a much more elaborate set, but it is assumed that a professional carpenter will be employed when such work is to be done and that he will furnish his own tools. It is obviously impracticable for every field man to have access to a kit even as limited as that listed above, but in most instances he will gradually acquire many such tools for his own personal use. Handsaws, squares, hammers, and grindstones may be secured by requisition, as may also numerous other tools if the nature of the work to be done demands them. At any rate, if he feels that his personal needs demand the purchase of carpenter tools the field man will do well to confine his purchases to such tools as are described below. A complete kit of high-grade tools includes from fifty to one hundred pieces, together with the chest weighs from seventy-five to two hundred pounds and costs from \$25.00 to \$150.00, or even more.

Handsaws.—Cross-Cut.—The two flat surfaces of this are known as the "face" and the "back," the former being the side next the carpenter as he holds the handle of the saw in his right hand, the latter being the opposite side. The end of the cutting edge next the handle is the "heel," the other end the "point." Handsaws are made in various sizes, each of which may be expressed in a different manner by different carpenters. Thus one carpenter may designate a saw as No. 16 because it is made of what is known as "16 spring steel"; another carpenter may refer to the same saw as a No. 11 because it has eleven teeth to the inch. Spring steel numbers are usually indicated on the face along with the manufacturer's name or trade-mark; tooth numbers are stamped on the face near the

heel. Larger numbers of the spring steel indicate greater toughness and flexibility of the blade; larger tooth numbers indicate more teeth per inch and consequently a finer cutting edge. Teeth are frequently known as "points," and a saw may be designated as a "six-point" or "eight-point" saw. A nine-point saw of 12 spring steel will be found most satisfactory for



5½ points to the inch. 6 points to the inch. 9 points to the inch.

FIG. 103.—Handsaw teeth.

general field work, as it may be used with equally good results in hard or soft lumber. It should have a 24- or 26-inch blade with a straight back rather than a skew back.

The straight-back variety may be used as a straight edge in case nothing else longer than a foot-rule is available. The cost is about \$1.25 or \$1.50.

Filing Handsaws.—A thoroughly practical knowledge of handsaw filing can be acquired only by experience, and the beginner may expect to damage more or less the first few saws he attempts to file. He should bear in mind that unless some teeth have been completely broken out, or at least so badly dulled that the entire set must be filed down, he need not exert severe pressure on his file. Any good sharp file will cut away the teeth faster than he at first realizes, and unless he exercises great caution he is more than likely to find that he has caused himself considerable extra work in the final "jointing up."

The saw should be held firmly in a clamp manufactured especially for this purpose, or, if no such clamp is available, the improvised article may be made from two boards about the length of the saw-blade. These should have their upper outer edges beveled in order to afford the file free access to the saw-teeth. The blade is placed between the boards and the latter are then fastened in a vise. After the blade has been made secure the filer should begin, preferably at the heel of the saw, and file all teeth cutting on one side of the blade before he begins on the others. Assuming that he stands at the vise in such a position that the heel of the upturned blade is to his left, he places his file horizontally across the blade, then moves the file handle

toward his left until the file drops squarely down before the first tooth that cuts on the side opposite him, in this case the back of the saw, and files the forward edge of that tooth. The next tooth on that side is then filed and this operation is repeated on down to the point of the blade. The saw is then reversed in the clamp, or vise, and the remaining teeth are filed in a similar manner. After all the points have been sharpened it then becomes necessary to joint the saw, that is, see that no long or short points are left. Long points cause a saw to jump, hang, feed to one side, or push hard. Short points can not cut, and the only remedy in such a case is to file the other points down even with the short ones. Thus it is that too much emphasis can not be placed on the admonition to be careful and not bear too heavily on the file. Unevenness may be detected by placing the edge of a carpenter's rule along the points.

The whole secret of good saw filing is to keep the teeth as nearly as possible in their original shape.

Setting Handsaws.—Unlike the larger two-man cross-cut saws, most handsaws have such fine teeth and are used in so much finer work that it is next to impossible to set them with anything except a regular saw set. This tool is made in such a way that it can be regulated for different work. Hardwoods require the least set in a saw, seasoned timber requiring not more than $\frac{1}{80}$ inch, or just enough to allow the blade to follow through without binding. Softwoods, by reason of the fact that they cut faster and usually are more or less spongy, require greater set, depending entirely upon their firmness.

Rip.—This should be 26 inches long with a straight back and should have five and one-half or six teeth to the inch. It costs from \$1.50 to \$2.00.

Keyhole.—This is used in cutting circles or curves and may be known as a "compass" saw. For general use it should have a 12-inch blade. Care must be taken not to kink, crack, or bend it short, since the blade is necessarily very narrow, and therefore easily damaged. The cost, including that of two or three extra blades, varies from twenty-five to forty cents. The uses to which a keyhole saw is put subject it to severe strain that frequently results in a broken or otherwise

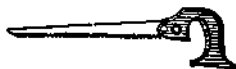

FIG. 104.—Keyhole or "compass" saw.

damaged blade, and this of course demands the purchase of new blades. Manufacturers recognize the impracticability of using high-grade steel in such blades, and therefore supply them in lower grades that can be produced at much less expense than better grades used in other saws.

Square.—See pages 127 to 137, inclusive.

Brace.—This should be of the ratchet variety, which permits boring holes in corners or at other points where complete revolutions of the sweep are impossible. It consists of the top or knob or head, the sweep (including the handle), the ratchet, the chucks which hold the bit, and the sleeve which screws down over and forces the chucks against the shoulders of the bit. It should have at least a 10-inch sweep, which makes the crook that carries the handle 5 inches deep. The plain finish is most satisfactory for general station work. The cost varies from \$1.50, plain finish, to \$5.00, nickel finish.

Bits.—*Auger.*—These consist of the shank, the threads, the knives, the lips, and the screw. The shank is the smooth, round part the squared head of which fits into the chucks of the brace; the threads, or twists, are the spiral wings which remove the borings; the knives cut the borings loose; the lips cut vertically ahead of the knives; and the screw is the threaded lower tip that feeds the knives into the timber. If the screw, knives, and lips are in good condition, no pressure on the brace will be required to make the bit cut.

Bits carrying only one thread or wing are known as "solid center" bits, but they may carry two knives and lips. They cost from \$1.25 to \$2.00, while those with double threads cost from seventy-five cents to \$1.00 per set, depending upon the number in the set, usually thirteen. Most manufacturers stamp the size of each bit, either on the shank or on the squared head, the size number being indicated in $\frac{1}{16}$ -inch. Thus a bit stamped "14" is known to have a cutting diameter of $\frac{14}{16}$ - or $\frac{7}{8}$ -inch, while one stamped "5" cuts a $\frac{5}{16}$ -inch hole.

Car.—These are for use in boring heavy timbers and may be either single or double threaded. They seldom are equipped with a lip. They vary from $\frac{5}{16}$ - to $1\frac{1}{4}$ -inches in diameter and cost from thirty-five to seventy-five cents each.

Expansive.—These have no twist, but are fitted with a movable knife bearing a lip, the screw usually bearing a second lip.

They vary in price from \$1.20 to \$2.00 each, depending upon the size.

Drill.—These are for use in iron or in hard, close-grained



Brace.

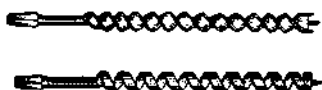

Car bits.



Brace drill.



Gimlet bit.

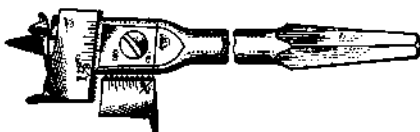

Expansive bit.

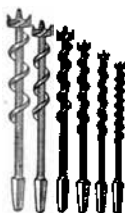

Solid center.

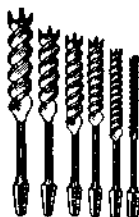

Auger.

FIG. 105.—Bits.

wood, and are especially adapted to boring timbers that may be full of nails or other metals or in boring holes that must be started near or through iron. Instead of having knives and

lips like auger bits the lower ends of the threads are cut back at an angle of about forty-five degrees or less and are ground flat, the sharp edges thus produced forming the peculiarly constructed knives necessary in boring iron or hardwoods. These bits are made in $\frac{1}{16}$ -inch sizes and cost from ten to thirty-five cents each.

Gimlet.—Gimlet bits are shaped about the same as drill bits, except that the knives are longer in proportion to the rest of the bit and the material of which they are constructed is not as durable as that of drill bits. They are for use in boring small holes through very soft wood and cost from five to ten cents each.

Planes.—*Jack.*—For general use about a station this plane should have an iron frame 15 inches long and wide enough to carry a 2-inch bit. Lateral regulation of the blade or bit is



Jack plane.

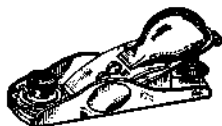

Block plane.

FIG. 106.

provided for by means of a thumb lever immediately before and at the upper end of the handle. It may be set to cut deep or shallow by revolving a circular milled nut which raises or lowers it through the medium of a flanged tumbler located parallel with the frame beneath the upper part of the blade. The cost is \$1.00 or \$1.50.

Block.—A block plane is especially adapted for cutting across the grain of wood. The blade is raised or lowered by means of a small horizontal screw wheel located immediately beneath the palm piece. Its rim works in a Y-lever fitted at the forward end with a vertical elbow joint the end of which fits into grooves in the lower side of the blade. To release the blade the screw bolt near its center must be loosened until the blade can be slid along to where the hole at the end of the slot coincides with the bolt. This plane should have about a 6- or 7-inch frame and should carry an inch or an inch-and-a-half blade. The cost varies from seventy-five cents to \$1.50.

Chisels.—These consist of the wooden handle, the handle socket, the shank, the blade, and the bit. The last has a single

bevel at the rear and the corners are square. Ordinarily a set includes eight pieces, but for all common work about a station four chisels will be found sufficient. These should be $\frac{1}{2}$ -, $\frac{3}{4}$ -,



FIG. 107.—Chisels.

1- and $1\frac{1}{4}$ -inches in size. The four cost from seventy-five cents to \$1.50.

Level-Plumb.—In view of the fact that many inferior instruments are placed on the market, this tool should be tested before it is purchased. An easy yet accurate test is to place it on a smooth, straight plank and then block the plank up till the instrument indicates that it is level. This will be when the bubble remains stationary immediately under the mark found on the glass or the glass guard. If the bubble assumes the same position when the instrument is reversed the level is reliable. The plumb is tested in a similar manner except that the instrument is placed in a vertical position against an object known to be plumb. The bubble will rest immediately under



FIG. 108.—Level-plumb.

the plumb mark regardless of whether the face or the back is placed against the object.

The best instrument for rough work has a 20-inch iron frame and costs from seventy-five cents to \$1.50.

Caliper.—A caliper is for use in securing diameters, and the best style for all-round work has flat legs that may be pushed past each other so the instrument may be used in securing inside as well as outside diameters. The cost is from ten to twenty-five cents.

Compass.—This is used in laying off circles or curves. It should be of the 8-inch extension variety, which inscribes a

41-inch circle and which costs from seventy-five cents to \$1.25.

Caliper Rule.—This should be of the fourfold variety, full brass bound, boxwood, $\frac{1}{2}$ -inch wide, spaced in $\frac{1}{8}$ -, $\frac{1}{10}$ - and



Caliper.



Compass or dividers.

FIG. 109.

$\frac{1}{12}$ -inches with drafting scale. The caliper, which works in the end of one joint, will be found very convenient in ascertaining outside diameters of bolts, pins, etc. The cost is about fifty cents.

Monkey-Wrench.—This tool should be about 10 inches long with a heavy wrought bar and head and a deeply milled screw. It costs forty or fifty cents.

Claw-Hammer.—A square-faced hammer is sufficient for all rough work, but finer work requires a round face that will not bruise the wood if this is struck either intentionally or through

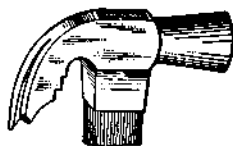

Claw-hammer.



Monkey-wrench.

FIG. 110.

accident. The hammer shown in Fig. 110 may also be used as a wrench, but too great leverage must not be attempted or the handle will be cracked or broken. It weighs about eighteen ounces, including the handle's weight, and costs from fifty cents to \$1.00. A claw-hatchet should weigh thirty or thirty-two ounces and can be bought for from forty to seventy-five cents.

Files.—*Saw.*—These should be triangular and 7 inches long. They cost from \$1.00 to \$1.50 per dozen.

Wood.—A 14-inch half-round rasp will be found very convenient for all rough work and costs from fifty to seventy-five cents.

Grindstone.—This is almost an absolute necessity at every station where edged tools are used and is usually supplied upon requisition if the nature of the work to be done seems to justify such an expenditure. It should have a take-down tubular iron

frame fitted with seat and pedals for use by one man. It should also be equipped with ball bearings, water cup, and guard. The stone should be 20 or 22 inches in diameter, of Berea grit and 2 or 2½ inches thick. It weighs about sixty pounds, making the weight of the entire

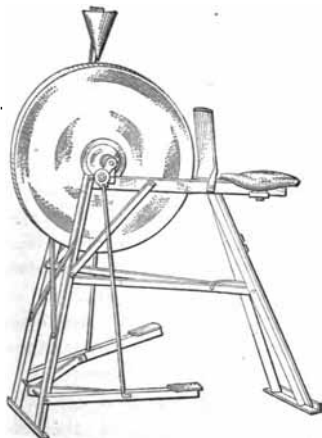

FIG. 111.—Grindstone.



FIG. 112.—Oilstone mounted in block.

implement approximately eighty-five pounds. The cost is about \$5.00.

Whetstone.—This is to be used in finishing the sharpening of tools and should be of the tough, fine grit known as an oil stone. It should weigh about one pound and should be set in a block fitted with a cover. The cost is about fifty cents.

The Carpenter's Square.—A carpenter's square means no more to a man not versed in its use than an instrument whereby he may lay off straight lines, erect perpendiculars to them, and measure distances in feet and inches. As a matter of fact, these three uses of the square are the simplest to which it can be put. Therefore, in order to assist the beginner in mastering a knowledge of the more important uses of the square a few of these will be explained here. The most reliable style of square for general use is that known as the "No. 100," which costs from \$1.50 to \$2.00.

Parts.—These are the "blade," or the 2-foot length, 2 inches

wide; the "tongue," or the narrow arm, 14, 16. or 18 inches in length; the "face," or the upper surface of the square as the carpenter holds the blade in his left hand and the tongue in his right; the "back," or the reverse side; and the "heel," or the outer angle formed by the junction of the blade and tongue.

Graduations.—The outer edge of the face of the blade is graduated in $\frac{1}{16}$ -inches, the inner edge in $\frac{1}{8}$ -inches, the outer edge of the back in $\frac{1}{12}$ -inches, and the inner edge of the back in $\frac{1}{32}$ -inches.

Graduations on the tongue are the same as on the corresponding parts of the blade except that on some styles of the No. 100 the inner edge of the back of the tongue is graduated in $\frac{1}{10}$ inches.

Tables and Scales.—The following tables and scales will be found in some form on any No. 100 square and the discussions covering them have reference only to that style of square:

Diagonal Scale.—This scale is a square inch divided diagonally as shown in Fig. 113 and is provided for the determination of $\frac{1}{100}$ -inches. It is found on the face of the square at the junction of the blade and the tongue. Primary divisions are

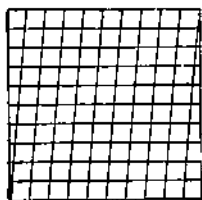

FIG. 113.—Diagonal scale.

made by intersections of the diagonal with the parallel lines, such intersections being $\frac{1}{10}$ -inch apart on the latter. The diagonal line starting at the lower left-hand corner of the rectangle strikes the upper edge of this figure $\frac{1}{10}$ -inch to the right of the perpendicular left-hand edge of the rectangle. In other words, after crossing the square inch it has departed $\frac{1}{10}$ -inch from the perpendicular.

Thus the first interior parallel line from the bottom is crossed at a point equal to one-tenth of one-tenth, or $\frac{1}{100}$ -inch, from the perpendicular line. The sixth parallel line from the bottom is crossed at a point equal to six-tenths of $\frac{1}{10}$ -inch, or $\frac{6}{100}$ -inch from the perpendicular.

Assuming that the carpenter wishes to ascertain a measure of $\frac{73}{100}$ -inch, he places one leg of his compass on the intersection of the eighth diagonal line from the left with the third interior parallel line from the bottom, the other leg of the compass being placed on the point where the third parallel line strikes the per-

pendicular left side of the diagram. Thus the compass covers $\frac{7}{10}$ -inch plus $\frac{3}{100}$ -inch or $\frac{73}{100}$ -inch.

$\frac{1}{100}$ -Inch Scale.—Like the diagonal scale, this scale is provided as a means of ascertaining a measure as small as $\frac{1}{100}$ -inch and is found on certain styles of the No. 100. It consists merely of an inch line divided into quarters, these into fifths and these again into fifths, and is found usually at the inner side of the angle on the back of the blade. Owing to the necessarily small fine markings and the possibility of their being obliterated by rust or bruises, this scale is not as satisfactory as the diagonal scale.

Board Scale.—On the back of the blade on some styles of the No. 100 will be found a series of figures which indicate the

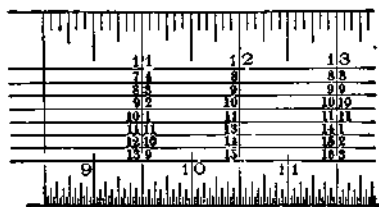

FIG. 114.—Board Scale.

number of board feet contained in a 1-inch plank of given length and width. This table includes lengths of 8, 9, 10, 11, 13, 14, and 15 feet, which are found in the column under the 12-inch measure at the outer edge of the blade. The 12-foot length is omitted because it is evident at once that the contents of any inch plank 12 inches wide are equal to the plank's length in feet. Other inch measures along the same edge of the blade serve as plank widths, the figures in the columns directly beneath them indicating the contents, in board feet, of different-sized planks.

Thus the contents of a plank 6 inches wide and 10 feet long are indicated by the figures found where the 10-foot length line, under 12, crosses the 6-inch width column, under 6, the number of board feet in such a plank being five. If the plank is 2 inches thick, then five must be multiplied by two; if 6 inches thick, then by six, etc.

In view of the fact that a large per cent of lumber is cut 16 feet long, this board scale would be much more convenient if it included a 16-foot length. However, the number of board feet in a plank exceeding 15 feet in length may be secured by doubling the contents of a plank half as long. Thus a 16-foot plank 9 inches wide contains double the number of board feet found in an 8-foot plank of the same width, or twelve board feet.

Rafter Table.—On one style of the No. 100 this table is found along the center of the back of the tongue, the various groups of figures representing the "run" and "rise" and the length of the rafter from the comb to the outer edge of the plate. Thus the group $\frac{60}{60}$ 84.85 indicates a run of 60 feet, or inches, a rise of the same and a rafter length of 84.85 feet, or inches. At first glance it may appear to the inexperienced that since only fourteen groups are given (on most squares) these provide only for fourteen different rafter lengths.

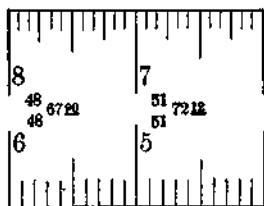

FIG. 115.—Rafter table.

However, close observation of the first thirteen groups, reading toward the right from the end of the tongue, will reveal the fact that they are arranged in increasing and finite arithmetical progressions. Two of these progressions represent run and rise,

and, being equal, are therefore applicable only to rafters which are to be cut for a half-pitch roof, which, by the way, is the most widely used pitch for roofs. The first term is 24, the constant difference is 3, and the last term is 60. The third progression, composed of the numbers found to the right and midway between the numbers representing run and rise, indicates the length of rafters which are to cover the length of run and rise shown. The first term is 33.95, the constant difference is approximately 4.24 and the last term is 84.85. These numbers may be used to indicate inches, feet, yards, rods, or any other units of length.

Other lengths than those given may be determined by using this table as a basis of computations and dividing or multiplying a group according to whether the proposed rafter is to be longer or shorter than that indicated in the group. Thus, given a run

and rise of 6 feet, to determine the rafter length: The first group may be used to best advantage; $\frac{24}{6} = 4$; $\frac{33.95}{4} = 8.49$, the length required.

Or, given a run and rise of 90, to find the rafter length: Examination of the various groups shows the eighth to be most convenient; $\frac{90}{45} = 2$; $2 \times 63.64 = 127.28$, the length required. It will be seen from this that instead of covering only thirteen different rafter lengths these thirteen groups cover the subject of rafter lengths for equal run and rise in a very complete manner.

The fourteenth group, $\frac{18}{24}$ 30, applies to other pitches. Assuming 24 as run and 18 as rise, the roof will be $\frac{3}{8}$ -pitch, and, like the half-pitch, is a favorite among builders. Reversing the relations makes a rise of 24 and a run of 18, or a $\frac{2}{3}$ -pitch, which is seldom used.

Other rafter lengths covering run and rise of the same relative proportions may be obtained in a manner similar to that employed and previously described in the matter of rafters to be cut for half-pitch roofs.

It is well to remember that the use of this table is not confined exclusively to rafter and brace lengths. It may be applied with equal facility to land measurements and to other work involving hypotenuses.

Pitch Table.—Some styles of the No. 100 bear a table on the back of the blade which shows the pitch of rafters or braces after the run and rise have been determined.

Pitch is determined by dividing the rise by twice the run.

$$\text{Formula: } \frac{R}{2 \text{ Run}} = p.$$

For example: Given a 10-foot rise and a 15-foot run, to determine the pitch. The solution follows: $\frac{10}{2 \times 15} = \frac{1}{3}$ pitch.

Ordinarily 12 is assumed as the run and other numbers as the rise, thus: 12-4, 12-6, 12-8, etc., these combinations appearing in the first double column of the table shown in Fig. 116. Pitch is indicated in the second column as $\frac{1}{6}$, $\frac{1}{4}$, $\frac{1}{3}$, etc. Run

may be taken at each inch mark along the outer edge of the blade.

Thus, in a quarter-pitch roof having a run of 4 feet, the rafter length is found in the quarter-pitch line under 4, and is 4 feet, $5\frac{1}{2}$ inches. In a half-pitch roof (in which the run and rise are always equal) if the run is 3 feet, then the rafter length appears in the half-pitch line under 3, and is 4 feet, $2\frac{1}{2}$ inches. No provision is made for lookout lengths.

Rise for different pitches may be determined by simple operations in proportion. For example: In a sixth-pitch roof the

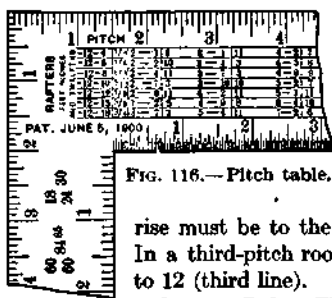

FIG. 116.—Pitch table.

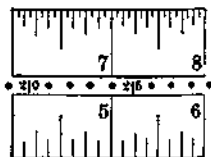

FIG. 117.—Octagon rule.

rise must be to the run as 4 is to 12 (first line). In a third-pitch roof it must be to the run as 8 is to 12 (third line).

Octagon Rule.—This is found along the center of the face of the tongue and is supplied as a means for laying off gauge-lines on a square timber that is to be dressed down to an octagon. Assuming that such a timber is 12 inches square, lines are drawn across the ends of the timber exactly through the center and at right angles to each other, so that each end is marked off into four 6-inch squares. The carpenter then sets off on either side of each center line, where it strikes the edge of the timber, a number of spaces on the octagon rule equal to the timber's width in inches, in this case 12. The points thus determined indicate the proper place from which to stretch the chalk- or gauge-line. If the timber is 16 inches square then sixteen spaces of the octagon rule are used.

Other Uses.—*To Lay off Rafters.*—Assuming that a run is 12 feet and a rise 8 feet and that the rafter length has been determined, let the 12-inch mark on the back of the blade represent the run and the 8-inch mark on the tongue the rise. As the carpenter stands on the proposed long side of the rafter holding the blade in his left hand and the tongue in his right, he

places the 12-inch mark at the point decided upon for the long side or upper edge of the rafter foot. The 8-inch mark is then placed directly over the long edge of the timber and the latter is marked along the edge of the blade, this line indicating the proper angle at which the foot is to be cut. In laying off the upper angle the 8-inch mark is placed immediately over the point decided upon as the upper end of the rafter. The 12-inch mark on the blade is then brought out flush with the upper edge of the rafter and the timber is marked along the edge of the tongue. This mark indicates the angle at which the upper end of the rafter is to be cut.

A second method of laying off rafters and at the same time marking their length follows: Assuming that the run is 12 feet and the rise 8 feet, place the square on the timber so the 12-inch mark on the blade and the 8-inch mark on the tongue fall di-

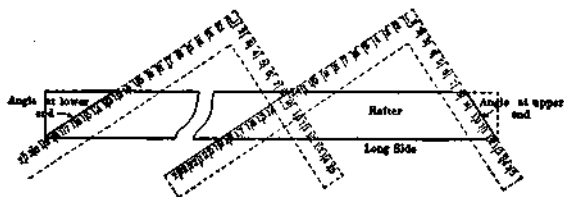

FIG. 118.—Method of applying square in obtaining length of rafter.

rectly over the proposed long side of the rafter. A mark along the edge of the blade indicates where the timber must be cut to form the rafter foot. The 12-inch mark is then moved along the timber to where the 8-inch mark first rested, and this operation is repeated as often as is necessary in running the length of the rafter, in this case twelve times. A mark made along the edge of the tongue at the last application of the square to the timber will indicate the angle at which the upper end of the rafter is to be cut. The work of laying off the rafter length in this particular case may be shortened by using the figures 24 and 16 on the blade and tongue, respectively, thus requiring only six applications of the square to the timber. The one rule to remember in laying off rafters in this manner is to find first how many times the distance used as run on the square is contained in the total run of the roof, and then to apply the square this number of times to the timber. It is hardly necessary

to say that if the figures at first determined upon as representing run and rise on the square are later changed, they must be kept relatively the same as the originals.

To Lay Off a Lookout.—This is merely an extension of the rafter and is intended to project over and protect the plate.

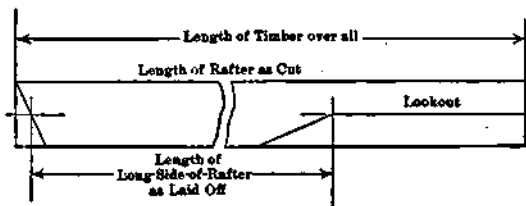

FIG. 119.—To cut rafter lookouts.

The rafter should be cut the same as any other except that instead of cutting clear through the timber it is cut from the under side only to the intersection of the lines marking the angle and the under side of the lookout. Thus, if the lookout is to be 2 inches thick the angle should be drawn from a point exactly 2 inches in from the long edge. Likewise, the point which marks the upper end of the rafter must be set in 2 inches from the long edge and the angle drawn through it. (See Fig. 119.)

To Lay Off Stair Strings.—The run, or the horizontal distance from the foot to a point directly beneath the head of the stairs,

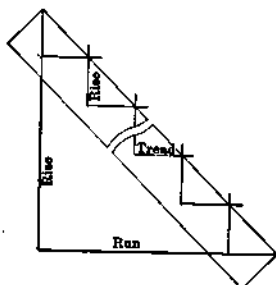

FIG. 120.—Stair string.

is first obtained. (See Fig. 120.) After the rise of each step has been decided upon, the number of steps required for the entire string is obtained by dividing the total rise by the rise

of one step. Tread of each step is obtained by dividing the run of the string by the number of steps. The square is used the same as in laying off rafters or braces.

To Lay Off Octagons When No Octagon Rule Is Available.—Lay the square on the face of the timber, as shown in Fig. 121, with the heel flush with one edge of the face and the outer corner of the

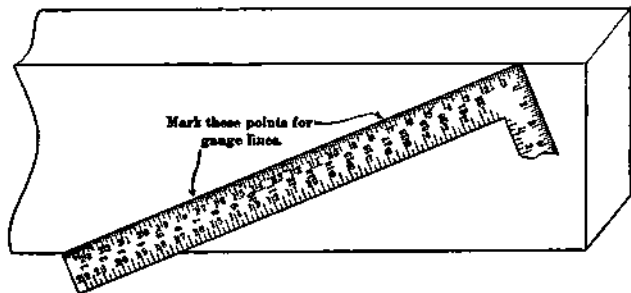

FIG. 121.—Octagon rule.

blade flush with the opposite edge. Mark the timber where the figures 7 and 17 fall and repeat this operation at the other end of the timber. Gauge-lines drawn between respective points thus marked near the ends of the timber will indicate the depth to which the timber must be dressed, the rule holding good on any size timber and being sufficiently accurate for any rough work. A 2-foot rule may be used in a similar manner if no square is available.

To Obtain the Center of a Circle.—Apply the square to the circle

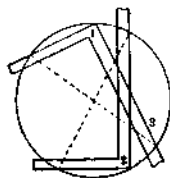

FIG. 122.—To obtain the center of a circle.

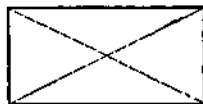
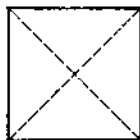

FIG. 123.—To obtain the center of a rectangle.

twice as shown in Fig. 122. The circumference is marked where the blade and tongue cross it and the pairs of marks are then connected as shown in the figure. The intersection of the con-

necting lines indicates the center. Care must be taken to see that the figures used are the same in both applications of the square to the circle.

To Obtain the Center of a Rectangle.—Draw connecting lines between diagonally opposite corners as shown in Fig. 123. The point of intersection between the two lines indicates the center of the rectangle.

To Erect a Perpendicular without a Square.—It not infrequently happens that an odd job of carpenter work about a station requires the erection of a perpendicular when no square is available. This may be done by means of a compass or a string and pencil as shown in Fig. 124, wherein the point 3 indicates the place at which the perpendicular is to be erected.

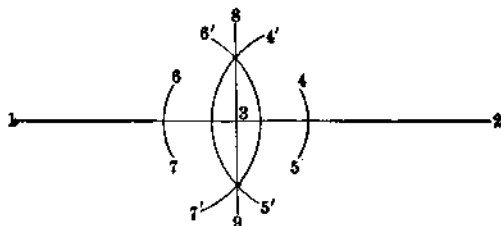

FIG. 124.—To erect a perpendicular without a square.

With 3 as a center the arcs 4-5 and 6-7 are laid off, being, of course, arcs of the same circle. Their points of intersection with the line 1-2 are used as centers from which to lay off 4'-5' and 6'-7'. The line 8-9 drawn through the points of intersection of these two arcs is perpendicular to the line 1-2.

To Bisect an Angle without a Square.—If this must be done and no square is at hand, the compass or string and pencil must be used again. Assuming that the angle 2 in Fig. 125 is to be bisected, it is used as a center from which to lay off the arc 4-5, and the points of intersection of this arc with the lines 1-2 and 3-2 are used as centers from which to lay off arcs 8-9 and 6-7. The line 2-10, passing through the intersection of arcs 6-7 and 8-9, bisects the angle 2.

Improvised Square.—A very satisfactory substitute for a square is illustrated in Fig. 126. Its construction, however, calls for the use of a foot-rule, yardstick, or other similar instru-

ment whereby lengths may be laid off. Unless such an instrument is available it will be almost impossible to fasten the two parts together exactly at right angles to each other, and if the substitute is to be reliable it is very necessary that this point of construction be carefully observed.

The principle involved in securing perfect right angles between the two parts is based on the well-known 47th problem of Euclid.

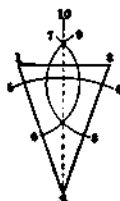

FIG. 125.—To bisect an angle without a square.

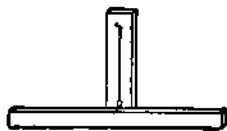

FIG. 126.—Substitute for level-plumb.

Thus, after a certain length, say 6 inches, has been laid off on each arm of the instrument, the measurements being taken of course from the same point, the square of the hypotenuse of the triangle formed must equal the sum of the squares of the lengths of the two sides. An easier method is to lay off 6 inches on one arm and 8 on the other, after which the two parts are so arranged that the hypotenuse is 10 inches. This instrument may also be used as a level-plumb if a plumb-bob is attached as shown.

SHEARS

These are used in the erection of long, heavy timbers when the draft is to be from a point at the ground. Their function is to raise the direction of draft, which would otherwise be almost parallel with the long dimension of the timber to be erected. They should be half as long as the timber to be erected and of a diameter that will prevent buckling under endwise strain. They are first laid with the upper ends crossed on the timber, the lower ends being placed one on either side of the timber, and at a distance from it sufficient to present a suitable base as the timber is raised. Shallow holes are dug as receptacles for the lower ends and are supplied for the purpose of preventing the shears from "kicking out" at the bottom when the

draft is applied. The upper ends are fastened securely together at a point about 12 inches down. At or near the upper end, of the timber a cable is attached and then brought down to where the shears cross each other. Here it is securely fastened to the shears at a point on the cable far enough from the end of the timber to allow the shears to rise at an angle of about 45 degrees before any draft is applied to the timber. Tackle ropes will not work through the cross of the shears and the

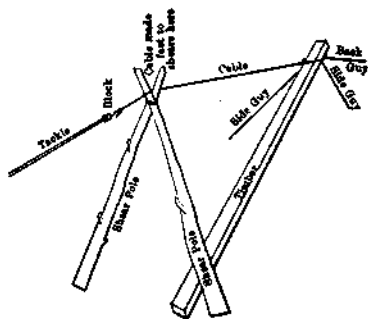

FIG. 127.—Erection of timber with shears.

cable must therefore be supplied with an eye for the reception of the hook in the block. A back guy and two side guys are then attached to the upper end of the timber, the back guy being snubbed about a post and paid out as the timber is raised, but the side guys being fastened securely to posts set in line with the foot of the timber and at right angles to the line of draft. Posts for the side guys must be set at a distance from the foot of the timber equal to the distance from the foot to where the guys are fastened to the timber. The tackle is taken in by means of a crab.

GENERAL FIELD WORK

RIDING

Since good saddle animals cost from \$80.00 to \$125.00 per head, it is quite to the advantage of an inexperienced man to know what constitutes proper and improper riding.

One important fact he should bear in mind is that it never pays, in any circumstance, to purchase vicious, diseased, crippled, partially blind, or otherwise defective animals. Since a large part of his time must be spent in the saddle he will find that even the best horses are none too satisfactory, and the use of inferior animals will only tend to make his work more unpleasant.

SADDLING

Adjusting the Blanket.—Without doubt, one of the most common causes of a saddle animal's sore back is an improperly constructed or badly adjusted saddle blanket. The first thing to be done in securing a proper adjustment of the blanket is to see that both the top and under sides are free from burrs, twigs, leaves, and other similar articles that may abrade the animal's back or cause sitfasts or galls. (See page 255.) After this precaution has been observed, the blanket should be placed so it will fit squarely and evenly under the saddle, allowing as nearly as possible an equal pressure along either side of the animal's backbone downward to a distance somewhat below the edge of the saddle bars or even to the lower edges of the skirts. If the blanket is one that must be folded several times care must be taken to see that the edges of the folds do not come where great pressure of the saddle will occur. These folds should be made to fall below or to the front or rear of the saddle skirts. Heavily ribbed blankets require special attention in being so placed as to bring the ribs parallel with the skirts. Any blanket that has been wet and then allowed to dry quickly and become stiff should be worked pliant and scraped clean of all incrustations of dirt and sweat.

Placing the Saddle.—After the blanket has been properly adjusted, seize the saddle horn or fork with the right hand, and

the lower front corner of the near skirt with the left, then swing the saddle upward over the animal's back to a height that will permit it to be lowered squarely on the blanket. This operation is performed from the near side of the animal. The saddle should not be lowered to the blanket with violence nor should it be swung in such a manner as to cause the off stirrup or the loose end of the cinch to strike the animal a severe blow on the leg or side. If saddling is done in this manner, any horse will soon acquire the habit of shying out from under the saddle as it descends. If the saddle has been properly placed, the off skirt and stirrup and the cinch will fall into their proper positions, and the saddle is then ready to be cinched.

Tightening the Cinch.—The front cinch of a double-rigged saddle is fastened first. To do this, the left hand is thrust beneath the animal's body, the cinch is secured and brought up to the near side, and the latigo is then threaded through the cinch ring from the inner side with the right hand. Afterward, the latigo is passed upward and through the ring in the rig from the outer side, downward again through the cinch ring from the inner side, then upward and tied into the rig, as shown in Fig. 228. If the latigo is made to buckle, the buckle-tongue is thrust through it, and the loose end is then disposed of by hanging it in the loop provided for that purpose, just under the near side of the fork. Care must be taken to see that all slack in the latigo between the rig and the cinch has been taken up, or the buckle-tongue may work loose and allow the saddle to slip.

After the front cinch has been fastened the rear cinch is treated in a similar manner except that it is not drawn as tightly. If a cinch fastener (see Fig. 11) is used, the latigo must be drawn tightly enough to force the lower end of the fastener lever outward against the lip of the loop. Unless this is done the cinch ring may slip from the loop and thus leave the saddle without any fastening whatever.

Neither cinch of a double rig should be fastened too loosely. As a general rule, the front cinch may be given an extra tightening after the animal has been ridden 300 or 400 yards. By that time the blanket is firmly settled and the animal, if he is a "sweller," has resumed his normal girth, so the saddle may be fastened for a long ride. The cinch should not be drawn up close against the animal's elbow joints but should rest to the rear of them at a distance of from 1 to 2 inches.

It is seldom necessary to draw the rear cinch very tight. When this is done the animal suffers more or less inconvenience and discomfort in breathing and will in most instances object strenuously to such treatment. This cinch should be drawn snugly against the body, however, and not left loose enough to rub against the ends of the hair and produce a tickling sensation.

Removing the Saddle.—The rear cinch is loosened first and the latigo end is either thrown upward across the saddle or else hung in the loop provided for it. When this has been done the front cinch is loosened and the latigo is disposed of in a similar manner. This disposition of the latigos obviates the possibility of their becoming entangled in brush or about the horseman's legs as he moves away from the horse.

In removing the saddle the horn or fork is seized with the right hand and the blanket is caught by the left. By thus securing the blanket it is kept from the ground, where it might accumulate dirt or burrs. When a firm hold has been secured at the fork the saddle is dragged from the animal's back by pulling it toward the near side. It is then laid on its side or stood on end, fork downward. If thrown flat down on the skirts the latter soon lose their shape and curl in or out or otherwise become twisted and wrinkled. Moreover, the skirt linings may pick up twigs or burrs or become damp or dusty. The blanket should be thrown, sweaty side downward, across the saddle. Both blanket and saddle should be placed in the shade during hot, dry weather.

Mounting.—This operation should always be conducted from the near side and only from the off side when circumstances absolutely demand it. Nothing indicates a man's inexperience with horses or emphasizes it more strongly than his attempt to mount from the off side, which usually results in disaster when western horses are to be ridden. They are seldom trained to expect such handling, and are naturally more or less puzzled or surprised when the inexperienced man introduces the novelty. Practically all of the saddle animals found on the farms of the East and South, and in many parts of the North, may be mounted with equal facility from either side, but they are so trained merely as a matter of convenience and the rule should never be assumed as a general one. It is well to learn to mount from either side in order to be prepared for emergencies, but it is never advisable to try experiments with strange horses.

Various styles of mounting prevail in different localities, and each has its advantages and disadvantages according to the animal to be ridden and to the manner in which it has been trained or "broken."

Cheeking.—This method is common to all parts of the West and is the safest method by which a fractious or viciously inclined animal may be mounted. The horseman secures a firm grip of the near bridle cheek with his left hand and with the right then turns the near stirrup forward until he can insert his left foot in it as he stands facing almost rearward. When his left foot has been firmly placed in the stirrup he releases the latter and then grasps the reins and saddle horn with the same hand; in some cases the reins are held with the bridle cheek in the left hand. He hoists himself into the saddle by a muscular effort of the right arm and left leg. If the animal attempts to pitch while it is being mounted it is prevented from doing so by the reins held at the saddle horn, or drawn in with the left hand. These should be drawn in short enough to hold the animal's head well up. No horse can pitch until he can lower his head.

If it makes a sudden lunge the grip on the bridle cheek serves automatically to hold the horseman near the animal and pull it under him rather than allow it to move in an opposite direction. This method of mounting also keeps the horseman well to the front and out of the danger zone if the animal kicks. If it is impatient and attempts to start unmounted, it is forced to travel in a circle about the horseman, and the latter is thus materially assisted in his efforts to mount.

Another method of mounting common to the West is to seize the mane with the left hand. Except for this difference the method is the same as cheeking.

Vaulting.—This method of mounting is used chiefly on moving animals. The rider secures a firm grip of the saddle horn with one or both hands, uses his elbows as a fulcrum against the horse's side or the side of the saddle, and thus assists himself in springing high enough to pass his right leg over the cantle and to alight squarely in the saddle seat.

This is the quickest method of mounting that can be used, and it may be employed to great advantage when a swiftly moving animal is to be mounted. In such a case, if the grip at the horn is secure, the momentum of the horse will almost

throw the horseman into his seat if he exerts only the slightest effort in springing upward from the ground. Care must be taken, however, not to spring too forcibly or the horseman will invariably throw himself completely over the horse. Such an accident may appear quite improbable, but as a matter of fact the novice will throw himself too far rather than not far enough, and unless the saddle is well cinched and his grip at the horn is very secure he may experience a serious fall.

"Climbing On."—Throughout the East, in some portions of the South, and in many parts of the North and central West, a very common method of mounting is to insert the left foot in the proper stirrup, seize the reins and the saddle horn with the left hand and the cantle with the right, and then "climb on" a horse. This method of mounting is perfectly safe when a well-trained animal is to be ridden, but should never be attempted on a spirited or half-trained horse.

Position.—The inexperienced rider invariably assumes an unnecessarily stiff and unnatural position in the saddle, and this results in his extreme lameness for several days. Moreover, such a method of riding, by reason of the resultant unyielding seat, has a tendency to tire a horse and may even have serious effects upon one so ridden. The only muscles in the rider's body that must be held in a reasonably prolonged degree of intensity are those which enable him to maintain a thigh grip against the sides of the saddles. This grip is necessary in order to prevent him from being unseated in case his mount shies suddenly or unexpectedly, or whirls or makes a sudden swerve from the general direction of travel. It also assists him in maintaining his seat at other times and prevents, to a great extent, the unpleasant sensation of "bouncing" when a horse travels otherwise than at a walk. The action of this set of muscles soon becomes involuntary and requires no attention on the part of the rider.¹

The English style of riding, known as "posting," where the rider raises his body from the saddle at regular intervals throughout an animal's progress, is to be avoided. It is tiresome to the rider, injurious to his mount, and can not be justified by any

¹ Frequent instances have occurred where greatly fatigued or sleep-worn cavalymen, and others whose duties require continual riding, have been known to fall sound asleep and in this condition maintain their seats throughout miles of travel.

rule of practice or elegance. Aside from these facts, it is even dangerous in fast riding over rough country or in brush.

Another common practice among a certain class of careless riders is to "ride the stirrups," *i.e.*, stand in them in such a way as to remove the weight of the body from the saddle seat. It is never employed by the best riders, except occasionally in very rough traveling, such as fast downhill trotting or over uneven ground where an animal may be expected to fall and in doing so compel instant dismounting.

Another practice to be avoided is "riding one stirrup." In doing this the rider removes one foot from the stirrup, raises the corresponding thigh into the saddle seat, and rests practically all of the weight of his body on the foot in the other stirrup. On long, hard rides an occasional change to this position for short intervals is restful to both the rider and his mount, but when maintained for extended periods it usually results in injuries to the animal's back. This is due, of course, to unequal pressure of the saddle. For the same reason the practice of crooking one knee about the saddle horn and riding sidewise for long intervals is likewise bad.

The easiest position, and one that produces a minimum of discomfort for both horse and rider, is a firm thigh grip and a reasonably loose seat, the backbone kept firmly upright but not rigid. If the animal is inclined to buck or pitch the thigh grip is especially advantageous. In such a case the rider should lean well back of the perpendicular in order that the momentum created by the animal's sudden starts forward may be counterbalanced. An attempt to hold the animal's head up and thus prevent it from bucking usually results in the animal throwing itself. The common idea that a horse is assisted in recovering its equilibrium if the reins are held tight is erroneous. At such times it needs all possible freedom of the neck muscles.

If a saddle animal develops the habit of rearing and falling back while under the saddle, great care must be exercised in dismounting as quickly as possible. This may be done by placing one hand either side of the saddle horn, against the fork, and springing backward from the saddle; or the rider may dismount to one side. In either case he should spring from the saddle with sufficient force to throw himself clear of the animal and prevent it from falling upon him. At the instant the animal starts to regain its feet he should remount; otherwise such an

animal, believing it has at last found a means of ridding itself of the rider's weight, will persist in the habit.

Reins.—These are held in the left hand, leaving the right free for the use of a rope, quirt, or other articles. Usually reins are tied together, although many riders prefer them separate, or "split." When used in the work of roping stock they are either in one piece or else tied together so they may be hung over the animal's neck or the saddle horn and not interfere with the use of the rope or the progress of the horse. The length, however, in general field work, is a matter of personal opinion, and nothing more definite on the subject can be offered here.

Reining.—This is simply the operation of guiding a horse. A very common method, especially common to all parts of the West, is known as "neck" reining. By this method a horse is turned to the right by laying the near rein against the left side of his neck just before the shoulders. He is turned to the left by a similar pressure of the off rein on the right side of his neck.

In many sections of the West, where stock must be handled from horseback, saddle animals are trained to stop when the reins are dropped to their necks. Ordinarily they are started again by a thrust with the spurs.

Another common method of guiding and stopping saddle animals is known as "legging." By this method the rider turns his mount to the left by pressure of his knee against that side, or, if personal likes dictate, he trains the animal to turn in the same direction by pressure of the other knee. The animal is stopped by pressure of both knees simultaneously.

In most parts of the East and South a saddle animal is turned by a pull at the bit on the side to which it is to turn.

Dismounting.—A practical knowledge of this operation is perhaps more important than knowing how to mount, and, like the latter, is accomplished in different localities in different ways. The safest method is to grasp the saddle horn firmly with the right hand, holding the reins securely in the left; the right foot is then withdrawn from its stirrup, the left foot is moved backward till the balls of the toes rest in the stirrups, the right leg is passed backward over the cantle and downward to the rear of the left leg, and the left foot is finally released from the stirrup by tipping the heel downward. This enables the horseman to alight squarely upon both feet at the same time, and still leaves

him facing in the same direction in which the animal has been or still may be traveling.

By holding the reins in his left hand he is able to check his horse's speed, while with his right at the horn he steadies himself until a proper equilibrium is obtained. He is also held well to the front and out of danger of being trampled upon or kicked.

This is the safest and about the only practicable method that can be used in dismounting from a rapidly moving animal. In such a case the rider must, of course, balance himself temporarily against the horse's left side before he releases his left foot. Very little practice will enable him to dismount while the horse travels at breakneck speed.

It may appear to the inexperienced field man that a knowledge of such a method of dismounting would seldom be put into effect, but when he considers that cattle or horses may have to be roped and then tied down before they can arise, or that a stray sheep or lamb must be captured and its earmarks read, or a falling or rearing horse may compel him to dismount as quickly as possible, he will see that such knowledge will not come amiss.

Another method of dismounting, particularly common to the South and known in the West as "backing out," is to grasp the saddle horn and the reins with the left hand and the cantle of the saddle with the right after the right leg has been thrown backward over the cantle, then, turning the body till the rider faces the animal, dismount by stepping down backward from the stirrup. This is safe enough with gentle and well-trained animals, but should not be used if fractious or partly broken animals are being ridden. The possibilities of having a foot hang in the stirrup and of an animal's sudden attempt to escape are too important to overlook.

Throughout the West saddle animals are usually trained to stand without being tied, the rider simply throwing his reins to the ground at the time he dismounts and making no further effort to confine the animal. It is very important that this custom be borne in mind, since if such animals are left with the reins hanging about the saddle horn, they frequently stray away or may even bolt and run to a distance that makes their capture a matter of considerable difficulty.

PACKING

In many sections of the West, where travel facilities are limited, supplies and equipment must be carried from place to place on pack animals. This is not as awkward a means of conveyance as it may seem. If the packer understands his work thoroughly and is possessed of considerable ingenuity he will have little or no difficulty in fastening a pack so it may be carried for a long distance. The load may be a cook stove, telephone wire or poles, fence posts, grain, bedding, fire-fighting tools, or water, or it may consist of a number of other articles, all of which may be transported in a very satisfactory manner if properly loaded and secured to the pack saddle.

Three important things to remember are: (1) A load that must be carried for a considerable distance should not exceed two hundred pounds in weight;¹ (2) The weight must be equally divided between the two sides of the pack; (3) The load must be firmly tied to the saddle but in such a manner as to permit quick unloading if the pack animal falls, becomes entangled, or otherwise requires immediate relief from the load. A pack weighing one hundred pounds is much more wearisome to an animal than the weight of a man weighing one hundred and fifty pounds. This is due to the fact that the pack is "dead" weight and either maintains the same position at all times or else slips about over the saddle with sudden, unyielding movements that soon tire the animal. If the man is a reasonably good rider he may shift his position and weight in such a way as to assist an animal in traveling over rough country. "One-side" packs, or packs so placed that the greater part of the weight is on one side, soon turn unless very securely tied. If they can not turn they soon injure an animal's back.

Complicated knots to be used in packing are not only difficult to tie, but they may even prove disastrous if a fallen animal is to be quickly relieved of its pack. The simplest knots that will hold are the ones to be used, possible opinions of old packers to the contrary notwithstanding.

¹ An instance of unusual physical power in a pack animal is of authentic record in central Arizona, where a 700-pound piece of mining machinery was carried a distance of $\frac{1}{4}$ -mile by a mule that weighed nine hundred pounds. The animal experienced no apparent ill effects from such exertion.

HITCHES USED

Grain Hitch.—This hitch is not required if panniers are to be used. Its use is confined chiefly to fastening sacks of grain or other loose articles to the pack saddle. Its construction as

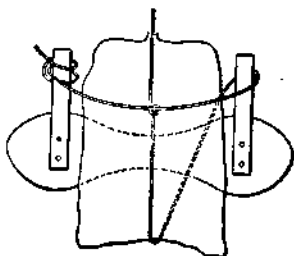

FIG. 128.

applied to the near side of the saddle is shown in Fig. 128. The off side is tied in a similar manner, the rope being 30 feet long and $\frac{1}{2}$ -inch in diameter.

This is somewhat longer than is absolutely necessary in tying the hitch, but being of that length, if the loose ends are so long that they can not readily be disposed of otherwise, they may be cut off and used as halter or tie ropes. It is given a clove hitch about the front fork of the saddle as shown in Fig. 129, the ends emerging from the front side of the hitch. A half-hitch is then taken about the rear fork, as shown in Fig. 130, the off end of the rope being used first and the near end in a similar

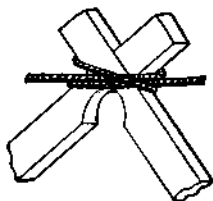

FIG. 129.—Clove hitch about front fork of pack saddle. Front view.

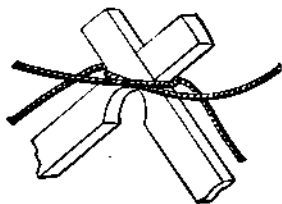

FIG. 130.—Loops about rear fork of pack saddle. Rear view.

manner later. The packer then shoulders the article to be packed, raises the length of rope passing from the front to the rear fork, and drops the load between it and the saddle, the loose end of the half-hitch passing up under and around the sack as shown in Fig. 128. This is fastened to the horizontal length of rope as shown in the same figure and the end is left

loose until the opposite side is loaded, the off side frequently being loaded first. The horizontal length of rope can best be tightened by pulling downward on the half-hitch. The two loose ends of rope are tied together after both sides of the pack have been loaded. After the ends have been crossed over each other a half-hitch in one may be turned about a loop in the other, thus providing a knot that may be released instantly by a pull at the loose end of the rope.

It should be remembered that the clove hitch about the front fork can not be slipped and that the rope must therefore be loosened at the rear fork first. This will permit the horizontal lengths to be pulled out far enough from the pack to let the pack fall through the loop to the ground.

Diamond Hitch.—There are a number of varieties of the diamond hitch, but only the one most widely used can be discussed here. It is suggested that the beginner familiarize himself with this

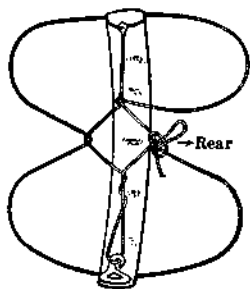

FIG. 131.—Top view of diamond hitch.

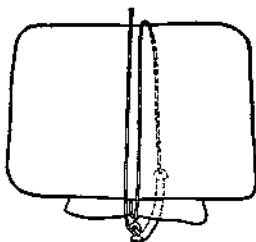

FIG. 132.—First position of lash rope. Near side.

form first and that he learn other forms after he has mastered it. A common mistake made by amateur packers is their propensity for trying to learn all the different forms of hitches used in packing before they are thoroughly versed in the use of one.

The diamond hitch described here and illustrated in Fig. 131 can be applied without difficulty by one man and will be found very convenient in fastening down the top pack. This part of the pack consists of bedding, tents, etc., usually carried over the grain or other articles confined by the grain hitch, and care must be taken to see that it is evenly balanced. Bedding should

be wrapped in a tarpaulin or tent before it is packed. The canvas protects it from rain and brush.

The lash rope should be 30 feet long and $\frac{1}{2}$ -inch in diameter. If there is good reason to believe that there will be no occasion to use it except for packing purposes then the end may be made fast to the ring in the lash cinch by means of an eye splice. Otherwise it should be merely tied into the ring so it can be removed with less difficulty. When the pack is ready to be lashed down the lash cinch is thrown over it from the near side, the packer catches the lash hook as it swings upward from beneath the animal's body, hangs it over the lash rope with the open side of the hook to the rear, and then passes the rope upward along itself to the top of the pack, allowing 2 or 3 feet of the end to remain on the near side. This is the first position of the lash rope and is illustrated in Fig. 132.



FIG. 133.—
Second position of
lash rope.

He then takes a bight, or bend, in the second length about the first length at the top of the pack as shown in Fig. 133, passing the second twice around the first and from the upper side. The loose end is passed to the rear, downward, forward under the off grain pack, upward around the off forward part of the top pack, through the bight, downward around the near forward part of the top pack, rearward under the near grain pack, and upward around the near rear part of the top pack to the first length of rope over the pack. It is tied here in an overhand loop knot and the hitch is completed as shown in Fig. 131. To be effective the hitch must be drawn very tight. This is done by beginning at the hook and successively tightening each length.

Axes, picks, rakes, shovels, crowbars, tripods and other similar instruments may be thrust through under the ropes after the hitch has been completed and made fast. This not only holds them more securely, but also serves to tighten the ropes about the pack. Instances may occur, of course, where such a method of loading these articles is not desirable, and in such cases they must be placed on the pack before the ropes are tightened and tied. Care must be taken to see that the forward ends do not project upward or forward to an extent that may cause them to hang in brush or against low branches.

The ax should always be so fastened to the pack that it may

be removed quickly and without difficulty. Picket ropes, hobbles, bells, morrales, canteens, and other such articles may be distributed about the pack at the most convenient points, but none of them should be allowed to hang loose and dangle or hang in brush.

The hitch is released by pulling the loop from the overhand knot. This usually loosens the rope enough to permit removal

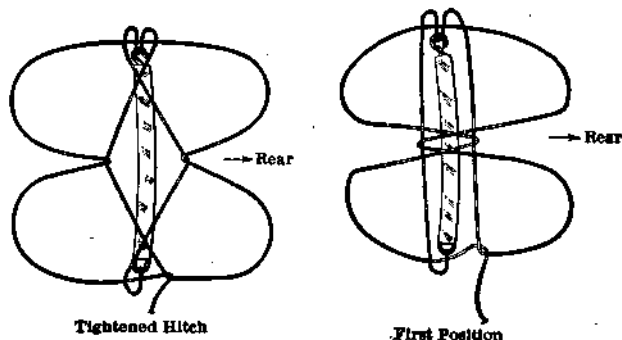

FIG. 134.—Top view of a variation of the Diamond hitch. (Shaded portions of rope come under the pack.)

of the hook, after which the rope may be thrown off at one side. During his first leisure moments after unpacking the packer should see that his pack ropes are all untangled and neatly coiled for use the next time. Badly tangled or misplaced ropes are a great inconvenience when hurried packing becomes necessary or when bad weather makes the work unpleasant. A variation of the diamond hitch is shown in Fig. 134. This is a favorite hitch among wood packers, and aside from being especially effective for such use is so quickly and easily applied that little time is wasted. It differs from the first form of the diamond hitch shown in that each successive length of rope is tightened as it is reached. The cinch is usually passed beneath the animal's body from the rear side, thus allowing the final tightening to be done from the front rather than at the rear of the animal.

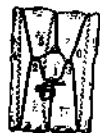

FIG. 135.—One form of the "squaw" hitch.

Squaw Hitch.—This hitch also requires the services of two men. In one form of the hitch the rope is double at about one-third its length and the loops 1, 2, and 3, shown in Fig. 135, are

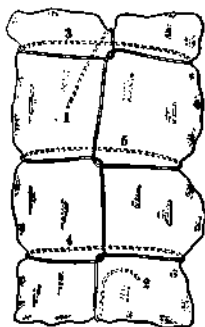

FIG. 136.—Half-hitch.

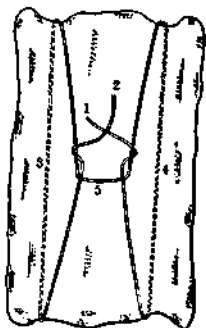

FIG. 137.—Cross hitch.

placed in position on top of the pack and held there by one man while the other disposes of the lengths 4, 5, and 6 by passing them beneath the animal's body and making them fast as indi-

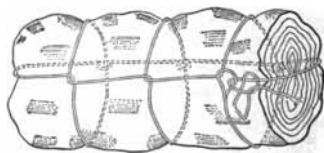

FIG. 138.—Bed roll ready for transportation by wagon.

cated. The hitch is not only difficult to construct properly but it is also too cumbersome and complicated to prove satisfactory otherwise.

Half-Hitch.—This is shown in Fig. 136 and consists merely of the half-hitches 3, 4, and 5 placed about the tent or bed roll. Ends 1 and 2 are tied together beneath the animal. The hitch is very unsatisfactory when poorly trained or half-broken pack animals are used. It usually allows the pack to turn sidewise

or slip forward or backward, and thus requires continual readjustment.

Cross Hitch.—This hitch is tied at the top of the pack as shown in Fig. 137. The lengths of rope 3 and 4 pass beneath the animal's body. It possesses the same disadvantages as the half hitch.

WAGONS

The use of wagons by field men in the Forest Service is very limited except in transporting camp equipment or supplies in reconnaissance work or on extended camping trips and in hauling provisions, feed, and other supplies into camp or to Ranger stations.

Occasionally, however, they may be required in improvement work such as road- or trail-building or construction of telephone lines and other similar work. They are seldom purchased outright but are frequently hired for temporary use unless the field man has one of his own which he is willing to use in official work. Nevertheless it is well for him to know what type of wagon is best fitted for the work to be done and to secure strong, reliable wagons in preference to others that may require constant repairing. It is seldom possible to find an ideal wagon for hire, but if one is selected as nearly as possible in accordance with the following suggestions it will give general satisfaction:

Type.—Since practically all wagon work done by the Forest Service is in rough, mountainous country a regulation mountain wagon is most desirable. This is of the narrow-track style, being 4 feet 6 inches from center to center of the tires on the ground.¹ It carries a 38-inch bed, weighs approximately twelve hundred pounds and has a safe carrying capacity of thirty-five hundred pounds.

Size.—The size of a wagon is determined by the outside diameter of the skein at its shoulder and by the length of surface presented to the boxing of the hub. Thus a 3 by 9 wagon, which is the best size for general work, has skeins 3 inches in diameter at the shoulder with a 9-inch bearing length. See Fig. 139. The size will be found stenciled on the back of the rear bolster.



FIG. 139.—Skein.

¹ A wide-track wagon measures 5 feet from center to center of the tires on the ground.

Wheels.—Regular size narrow tires for 3 by 9 mountain wagon wheels are $1\frac{1}{2}$ inches wide and $\frac{3}{4}$ inch thick. They may or may not be secured to the felloes by means of tire rivets. The latter are inserted between the felloes and the tire and are rivet-headed at each end. Some manufacturers claim that they are detrimental to a wheel by reason of the fact that in hot, dry weather, during which the felloes shrink and the tires expand, they have a tendency to split and batter the felloes as the tire is forced sidewise on rough roads. They also assert that the rivet heads soon wear away, allow the rivets to work out, and thus cause the tires to loosen more quickly. These objections to tire rivets or bolts are logical so far as they go, but when tires are so loose as to allow the rivet heads to batter the felloes they should be reset as soon as possible. Moreover, especially in regions remote from repair shops, it is much better to have a loose tire secured to the felloes than to have it run off and allow a wheel to be broken down.

Felloes and hubs, the latter well ironed, should be of seasoned white oak (*Quercus alba*). Spokes should be of seasoned second growth white oak or hickory (*Hicoria ovata* or *alba*). The regular number of spokes in a wheel is twelve front and fourteen rear, but those which bear fourteen front and sixteen rear are about one-sixth stronger than the others. A wheel height of 44 inches front and 52 rear will be found most satisfactory for general work.

Two very widespread though erroneous ideas with reference to wheels are that when a wagon sets on approximately level ground the front end of the bed is lower than the rear, or that, in the same position of the wagon, the rear end of the bed is lower. The first is no doubt based on the supposition that the fore wheels, being smaller in diameter than the rear wheels, necessarily lower that end of the bed. The second probably originates in failure to observe the difference in diameter of fore and rear wheels, and is merely an assumption that since the front end of the bed comes even with or above the wheel top, while the rear end is considerably lower than the rear wheel top, the rear end of the bed is consequently lower. As a matter of fact, except when the construction has been for some particular purpose, a wagon gear is usually so constructed that when it sets on level ground the bed is also level. Fore wheels are made smaller than rear wheels in order not only to provide

room for the sand board and usually heavier rocking bolster, but also to facilitate turning the wagon about in close quarters.

The smaller circumference of low wheels allows them to drop into ruts over which higher wheels pass with greater facility, and since less leverage is provided by the short spokes such wheels make a wagon pull harder on rough roads than if it were fitted with high wheels.

Dish.—Each wheel should have a dish equal to one-half the width of a regular narrow tire, and the tires should be strong enough to maintain such a dish. Wheels without dish are no stronger than the spoke tendons in the hubs, and a very light load, or even the weight of an empty bed, carried over a rough road may force the hubs through.

Wagons should not be hired if their tires have been set so often as to produce excessive dish. In such wheels the spokes do not stand perpendicularly under the load and can not therefore support a heavy weight. Moreover, they cause the rims to bind in ruts, they destroy the proper pitch and gather, and they are generally unsatisfactory to use.

Gather.—This is provided for in fitting the skein to the axle. The object of such construction is to force the hub toward rather than away from the shoulder of the skein when a heavy load is being carried. Otherwise the wheels of the same pair would have a tendency to pull away from each other and thereby offer much greater resistance to the road. Properly gathered wheels of the same pair are from 3 to 4 inches nearer each other at their forward circumference than at their rear circumference.

Pitch.—This term is known in some localities as "tread," or it may be designated as "set." It has reference to the difference in distance between the lower circumference of the same pair of wheels as compared with the upper circumference, in properly pitched wheels about the same as in gather. When it is measured from outside to outside the distance between the rims at the point nearest the ground should be the same as that just under the hub. Pitch is also provided for in fitting the skeins to the axle. It not only brings the weight of the load more in a perpendicular line over the bearing portion of the wheels, but it also serves to hold the hubs against the shoulders of the skeins and counteracts the wheels' tendency to run off.

Track.—This term has reference to the action of the rear

wheels in following the track of the fore wheels. It is at once apparent that unless the construction is such as to permit this the rear wheels will offer greater resistance to the road and the draft must be increased accordingly. Difficulty in this respect

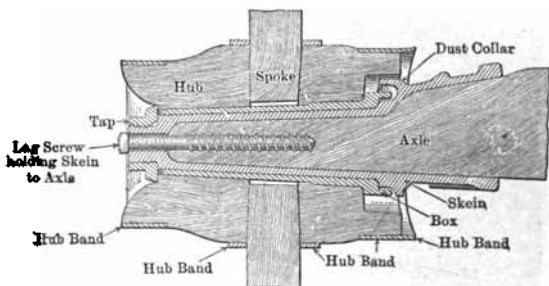

Method of attaching skein to wood axle.

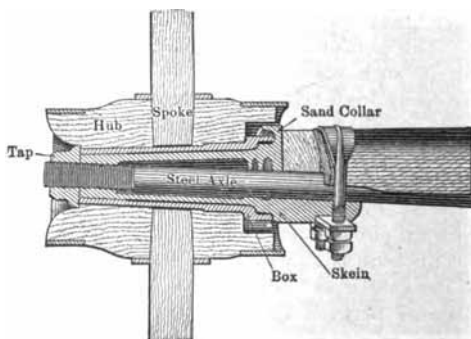

Method of attaching skein to steel axle.

FIG. 140.

may be due to a crooked reach or tongue, excessive dish may be present in one or more wheels, the skeins may not be properly fitted to the axle, or the boxing may not be squarely set in the hubs.

If the wheels track and have the proper pitch and gather a wagon may be run over a smooth road without taps so long

as the direction of travel is forward. The gather will of course force the wheels off soon after the wagon is started backward.

Skins.—These should be given a very thorough examination before a wagon is hired. If it has had considerable wear this

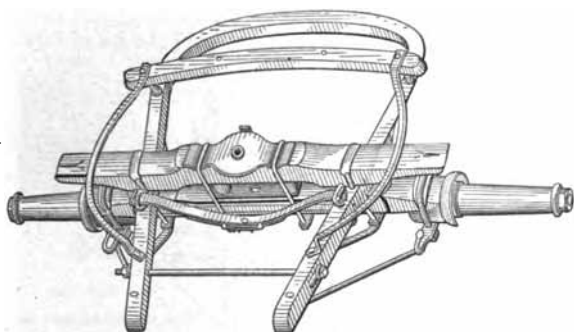

Top view.

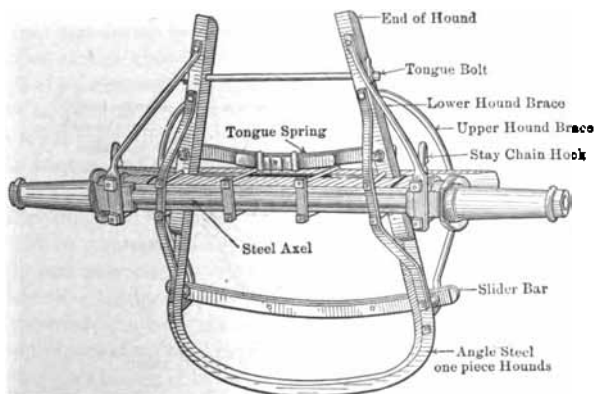

Bottom view.

FIG. 141.—Front gear. (Steel axle.)

will be apparent at the shoulder. It will be especially prominent at the upper side of the shoulder and the lower side of the point if the pitch has been lost. Lost gather will be indicated

by wear at the rear side of the shoulder and the front side of the point.

Skins are attached to axles as shown in Fig. 140.

GEARS

Hounds.—This is sometimes spelled “hawns,” and this form of the word will be frequently met with in catalogs of hardware

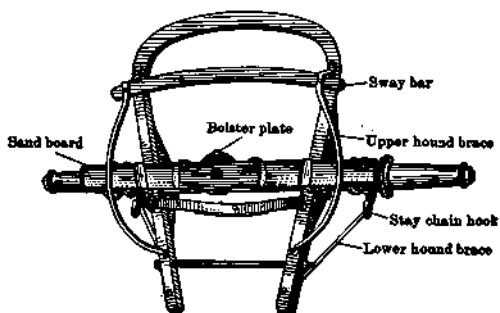

Top view.

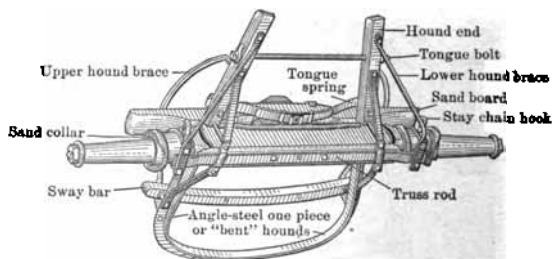

Bottom view.

FIG. 141a.—Front gear. (Wood axle.)

and woodenware. They should be of seasoned hickory or white oak and well ironed and braced. See Figs. 141 and 141a. The front end of the rear hounds should be bolted securely together through the reach plate as shown in Fig. 142. Angle-steel bent one-piece front hounds, wood filled before the axle, are preferable to all-wood square hounds by reason of the fact that there is

less surface exposed to brush and stumps. Both front and rear hounds should be well "bushed" or ironed at all points where wear of the reach will occur. This of course puts all the wear

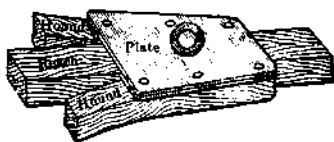

Reach plate.

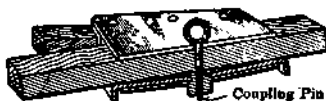

FIG. 142.—Sectional view of reach plate.

on the reach, but when it becomes worn to a degree that requires a new reach this may be secured with much less trouble and expense than hounds or any of their parts.

Front Bolster.—This should be of hickory or white oak, well ironed, and fitted with hollow steel stakes into which longer wooden stakes, known as "false" stakes, may be thrust if high loads of poles, posts, or similar articles are to be hauled. If fitted with iron-bound wooden stakes the irons should be rounded at the lower ends, threaded, and bolted through the bolster rather than bent at right angles and fastened to the upper side of it. The hollow steel stakes are illustrated in Fig. 143. The lower bolster plate, attached to the sand board as shown in Fig. 144, should be equipped with a catch which locks it to the upper plate and prevents the king bolt from being withdrawn by the bolster if a tightly fitting bed is to be removed. It should also have a raised center as shown in the same figure. This prevents wear or breakage of the king bolt and serves to steady a top-heavy load. This bolster is known also as a "rocking" bolster.

Rear Bolster.—This bolster is rigidly clipped to the rear axle as shown in Fig. 146. Other fittings, except lower plates which these bolsters do not have, should be the same as for the front bolster.

Brake.—A regular mountain brake is shown in Fig. 146 and this style should be used in all mountain hauling. The blocks

should be kept in good repair and should be heavy enough to withstand the hardest usage. They are fastened in the shoes by being beveled inward from the rear edges. The most satis-

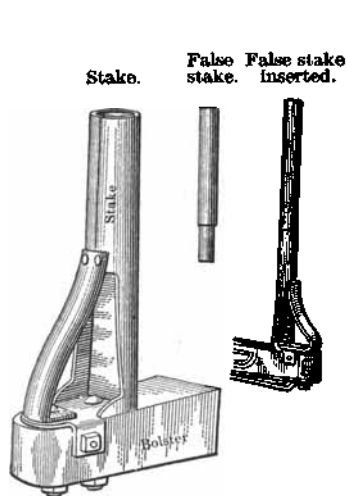

FIG. 143.

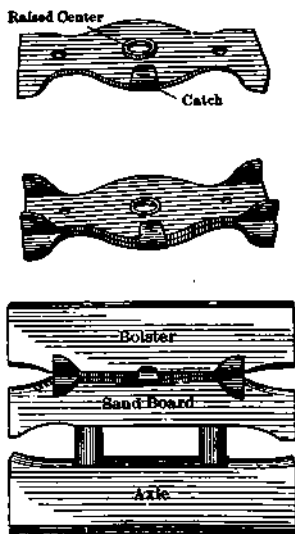

FIG. 144.—Bolster plates.

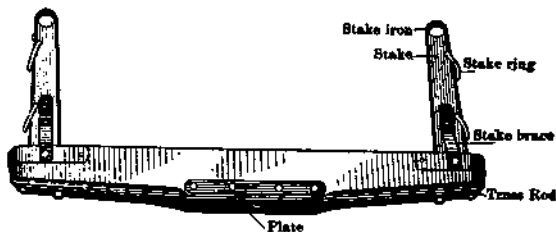

FIG. 145.—Front or "rocking" bolster.

factory and convenient method of keeping them in good condition is to nail pieces of 1- or 2-inch plank to the faces and thereby prevent direct contact of the blocks with the tires. Other pieces

may be nailed on as the old ones are worn through or torn off. Iron shoes will be found preferable to wooden shoes, as the latter catch grit that soon becomes imbedded in them and causes

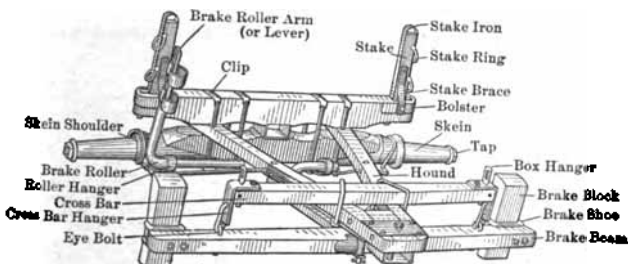

FIG. 146.—Rear gear with mountain brake.

severe wear on the tires. Jump welds in the brake roller are to be avoided, as they may break at a critical moment and cause serious damage to the wagon, team, or driver. The roller is connected with the brake lever, shown in Fig. 147, by means of what is known as the "brake rod." If gear hauling is to be done a pole is thrust into the rings of the roller arm and serves the purpose of a brake lever.

Bed brakes with two and three bars are shown in Fig. 148. They can not be used in gear hauling.

Tongue.—Straightness and absolute soundness are the two chief requirements in a wagon tongue. One that crooks to either side or is improperly set in the hounds has a tendency to lead the fore wheels out of the road and is a continual source of annoyance. The forward end should be exactly the same distance from the shoulder of either front skein. If not so fitted, trouble will invariably result. Iron parts should all be fastened down securely and not allowed to project and offer possible means of injury to the team. If more than two horses are to be used the forward end may be fitted either with an iron ring into which a chain may be looped or with an upright hook known as a

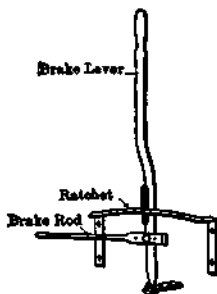
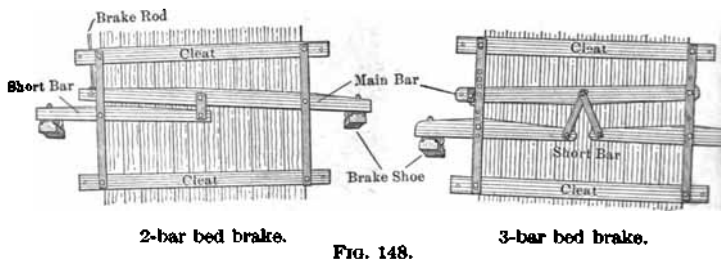

FIG. 147.

"goose neck." The latter is always used when cattle are to be worked, but in such a case the tongue must be shorter and heavier than that used for horses.

Stiff tongues, which are so fastened into the front hounds that the forward end can not be dropped, and which are known



2-bar bed brake.

FIG. 148.

3-bar bed brake.

in most localities as "poles," are not satisfactory when heavy hauling is to be done over rough roads. They whip the team and render control of the fore wheels difficult. Half-drop tongues may be used on comparatively smooth roads, but for all-round work drop tongues are preferable.



FIG. 149.—Tongue.

Neck Yoke.—This is frequently known as a "breast yoke," the term probably originating from the fact that the article works before the horses' breasts. It should be straight and sound and must be especially reliable if heavy downhill hauling is to be done. This is due to the weight of the load being thrown against it at the center ring. The end ferrules must be kept tight and both end- and center-rings must be strong. The upper side should be ironed if either or both animals in the team are cribbers. See Fig. 150.

Evener.—Another common name of this article is "double tree." It is a very important part of the gears, since the entire weight of the load is pulled directly from its center hole. For this reason it must be of especially strong material free from

flaws, such as knots and cracks or crooked, twisted, or warped grain.

Together with the single trees it is illustrated in Fig. 152.

Single Trees.—In many localities these are known as "whiffle"-trees. They serve as a means of attaching the team to the load,



FIG. 150.—Neck yoke

and, like the double tree, must be of very sound material. They should be fitted with a straight center clip and ring, end ferrules rather than loops, and end clips so constructed that the traces of the harness will not work out easily. Substantial clevises fitted with screw pins should be used to attach them to the double tree. If straight pins are used care must be taken to see that they do not work up and allow the clevis to be broken.

Bed.—For heavy hauling this should be extra strong and well braced. If numerous boxes, bundles, duffle bags, and similar articles are

to be hauled the most satisfactory type of bed is that known as a "rack." This is built in different sizes from 10 feet to 15 feet and 6 inches long, made 38, 42, and 44 inches wide, has from 5- to 8-inch sills, 10- to 14-inch side boards, a tool box at the front end, has an elevated seat and weighs from three hundred and forty to six hundred and seventy-five pounds. Bulky loads may be hauled without difficulty if the side boards are fitted with wings.

The first pair of side boards of an ordinary wagon bed make the sides of the "bottom" box; the second pair make the "top" box; and the third pair make the "tip-top" box. The last are seldom used except in hauling cotton, grain, and similar articles. They are shown in Fig. 153. Rub irons should be in



FIG. 151.—Evener end. Showing bushing of clevis pin hole.

good condition and thick enough to prevent wear of the tires against the lower corners of the bed. See Fig. 154.

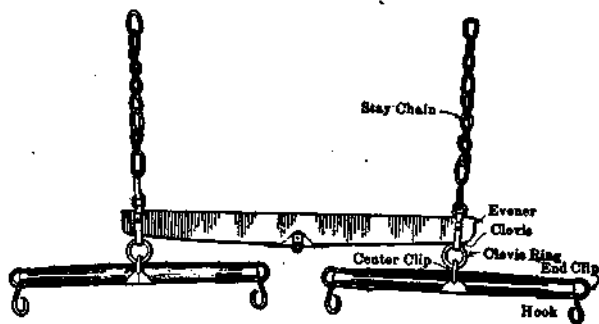

FIG. 152.—Evener and single trees.

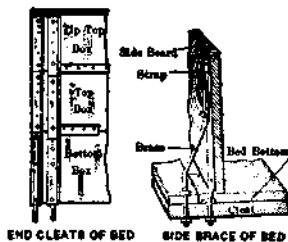

FIG. 153



FIG. 154.—Rub iron. "Cut-under" type.

CARE OF WAGONS

Oiling or Greasing.—Oil or grease should always be placed on the upper side of the skein immediately next to the shoulder. The wheel will gradually work it around from there to all parts of the skein and the boxing, and particularly to those points where the greatest pressure comes. Castor oil is the best lubricant that can be obtained, and not more than a thimbleful is necessary for one application. If more than this is used it will work out and be wasted.

Grease may be smeared on the skein with a small paddle short enough to be kept in the grease box. The amount used at one application need not exceed one-half cubic inch, and if

the skeins are greased regularly every day two-thirds of this amount will be sufficient.

Removal and Replacement of Taps.—These operations are performed by means of the wrench-headed bolt which holds the evener or double tree to the tongue and which is known as a

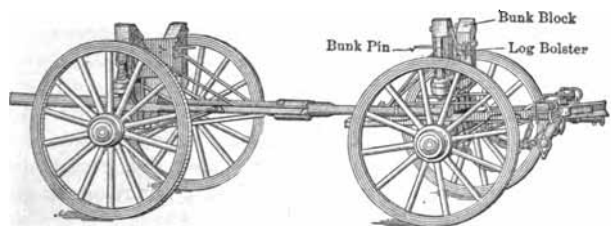

Log gears.

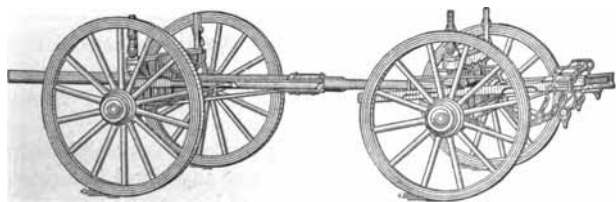

Log gears with log bolsters removed. (For hauling lumber.)

FIG. 155.

“wagon hammer” or “wagon wrench.” In removing a tap its edge nearest the front of the wagon is turned upward and backward toward the rear. This rule applies to all four taps, two of which are “left-handed” or “left-threaded.” These are the ones on the left side of the wagon. They are replaced of course by turning them in an opposite direction. It will be seen at once that as the result of being screwed to the skeins in this manner they have a tendency to tighten rather than loosen as the wheels revolve forward.

When removed they should not be laid with the greasy side downward but should be so disposed of that the side which works next the boxing of the hub is up. If two or more are removed at the same time and those from opposite sides become mixed they may be identified by a raised letter which

appears on one of the square sides. On taps of the left side this letter is L and on the others it is R. No tap can be screwed on a skein opposite that for which it was intended, although taps of the same side will fit either the front or rear skein of that side.

Removal and Replacement of Wheels.—These need not be completely removed when greasing is to be done. The wheel is simply lifted from the ground after the tap is removed and is then slid outward about 3 inches from the skein shoulder. It is then lowered to the ground, and if necessary tipped further outward to enable the skein to be reached more readily. After the grease has been applied the wheel is tipped back to the perpendicular, lifted straight up, and then slid straight back against the skein shoulder. This method of removing the wheel for greasing is very convenient when no wagon jack is available, and a man with ordinary strength will experience no difficulty in raising the wheel of an unloaded wagon, the easiest way of doing which is to seize a spoke in either hand as he faces the wheel and then lift straight up and slightly outward. In replacing a wheel raised with a jack it should be lifted till the boxing strikes the under side of the skein and then slid back against the skein shoulder.

The coning of skeins and boxing makes it impossible to put a wheel on backward, and the boxing of any wheel in a set will fit any skein of the corresponding set unless special construction is responsible for front and rear skeins of different sizes. In other words, so long as a set is not broken, rear wheels may be used on front skeins, front wheels may be used on rear skeins, wheels of the right side may be used on the left side or wheels of the left side may be used on the right side.

In specially constructed wagons having front and rear skeins of different sizes the skeins of the same axle are of the same size.

Greasing the Bolster Plates.—Many teamsters attempt to make travel easier for their teams by keeping the bolster plates well greased in order to facilitate turning. Turning is without doubt performed with greater ease when the plates are greased, but for this very reason the tongue whips the animals more severely when rough roads are traveled over and the resultant disadvantages far outweigh the advantages gained by greasing the plates. Consequently, the practice is to be avoided except in certain cases when for some unusual reason turning can be accomplished only with difficulty unless the plates are greased.

Tires.—Tight tires constitute the chief factor in economical upkeep of a wagon. Efficiency of a wheel depends wholly upon the strength of the tire and the degree of closeness with which it fits against the felloes. Weak or loose tires, therefore, lessen a wheel's capacity for supporting a heavy load, and if allowed to remain on the wheel will eventually let it break down. If they become so loose that they must be tied or wired to the felloes, they should be re-set immediately. This should not be done, however, by an inexperienced person, but the work should be taken to a competent blacksmith or wheelwright. If tires merely slip to one side they may be forced back into position by slight taps against the exposed felloes immediately beneath those portions which have slipped. They can not be forced into position by blows directed against the projecting edges.

Use of the Brake.—Proper use of their brake is one important feature of good driving that many teamsters overlook, and the usual result is sore necks for the team, damage to the wagon, or even severe accidents to both the driver or his team and wagon. The brake is supplied for the purpose of regulating the speed with which a load descends a grade, and the weight of the wagon, whether loaded or empty, should never be allowed to jam suddenly against the center ring of the neck yoke. Neither should the brake be set at one pressure and left there throughout the entire descent of a grade. It should be regulated in such a way as to keep the load moving at a uniform momentum in descent. Its proper and intelligent use gives the driver almost absolute control of his load at all times, and a little experience will soon teach him just what pressure must be applied under given conditions.

DRIVING

Simple as this work may seem, it is by no means possible for a novice to perform it with success until he has learned three very important things, viz.: To hold the reins moderately taut and not allow them to hang low down between the animals; to speak to the animals in clear, distinct tones little louder than those used in addressing a person; and to use the brake when necessary.

Customarily the reins, or "lines," are held in the left hand and

the brake is operated with the right. The line to the off horse passes through between the thumb and forefinger as the hand is held palm downward and the other line enters the hand from the opposite side, the two crossing beneath the palm. Holding them in this manner permits the driver to turn his team easily with a lateral movement of the wrist. It may be necessary in some instances to allow one line to slip through the hand, especially when short, sharp turns are made, but it may be replaced immediately afterward.

The checks are the shorter lengths of leather that buckle into the line and work across to the bit ring of the opposite horse. They should be adjusted in such a manner that each animal may carry its head straight in line with its body and in a natural position.

The tones used in addressing the team should be moderately loud and very clear and distinct. Most draft animals are trained to respond to certain verbal directions, and if these are muttered indistinctly or issued in loud, angry tones more or less confusion to the animals will be the result. Work animals in many rural districts are guided almost entirely by the driver's voice. Thus he calls out "get up" to start the animal, "haw" to turn it to the left, "gee" to turn it in the opposite direction, "whoa" to stop it, and issues other instructions according to the work being done and to the manner in which the animal has been trained. When the team is to be stopped the brake should be applied in order to assist in checking the progress of the load, and if the team is to be left standing or tied for a considerable period of time the brake should be left firmly set. It should also be applied when the team is stopped for a short rest on a steep grade, and should not be released before the traces have been tightened preparatory to starting. If released sooner it allows the load to start backward down the grade, and this requires a much greater draft to start forward again than the motionless load would. Frequent short intervals of rest on grades are preferable to fewer and longer ones and will prove much more beneficial to the team.

Another important use of the brake is checking the wagon as it crosses short, sharp dips, such as small ravines or large ruts. Many drivers disregard these short grades altogether, but the practice is to be strongly condemned. The whole secret of the proper use of the brake lies in applying it whenever it will pre-

vent the whole weight of the load from jamming suddenly down against the center ring of the neck yoke.

The regulation freight wagon, designed especially for hauling that requires the use of two or more pairs of animals, usually has the brake lever on the near side. This facilitates its use by the driver, who generally rides the near-wheel animal, and who operates the brake by means of a rope passed back to the lever from the saddle horn. Brake levers of trailers are attached to this lever in a similar manner and all are operated from the saddle.

The animal working at the left side in a team of two is known as the "lead," "wheel," or "near" horse, and the other is the "off" horse. Those on the right and left sides in the front of a team of four are known respectively as the "off leader" and the "near leader," and such a team is known as a "four" team or four "span"¹

A "six" team includes six animals, those between the leaders and wheel horses being known as "middles."

An "eight" team includes eight animals and consists, from front to rear, of the leaders, the "first" and "second" middles, and the wheelers.

A "spike" team includes an extra animal working alone before the leaders, such an animal being known as the "spike."

A six team hauling a wagon and one trailer is known as a "two-six" team. A second trailer makes it a "three-six." Thus a train of freighting wagons including two eight-teams each hauling two trailers, three six-teams each hauling one trailer, and a four-team without a trailer, would be known as "two three-eights, three two-sixes, and a four."

Other combinations of animals and wagons are designated according to the number of each in an outfit.

When using a team of more than four, the driver usually rides the near wheel animal and guides the whole team by means of a "jerk" line attached to the bit ring of the near leader. A steady pull on this turns the leader to the right, while a succession of slight jerks, usually three in number, turns it in an opposite direction. Jerk lines can be used only on animals

¹ The term "span" is usually applied to a pair of mules, but may be, and frequently is, applied to a pair of mares. Its use with reference to horses is limited.

that have been well trained. Poorly trained or fractious animals must be controlled by means of bits and lines.

WOODS WORK

The ranger or woodsman may find it necessary to cut and hew logs for cabins or bridges, telephone poles may be needed, timber and brush must be cut out along roads and trails or felled in case of fire, fuel must be secured, and numerous other lines of similar work may demand his attention. It is, therefore, to his advantage to know how to handle certain tools involved, and he must in any event know something about the use and care of an ax.

Axes.—Contrary to a general idea held by inexperienced persons, there are a number of different styles of axes, each especially adapted to a particular use and many unsuited to other uses. Thus, a broadax, constructed for hewing, is not suited to general woods work; and pole-axes, designed for all-round chopping, are not convenient tools to use for hewing. The marking hatchet, used by officers of the Forest Service in marking certain timber to be removed, is in reality a light ax, but is unsuited to heavy work. A general description of a number of different axes is given merely to serve as an outline of the uses to which they can be put to best advantage.

Pole-ax.—This is made with one round-cornered bit, somewhat longer at the rear than in front, and a square or rounded



Pole-ax.



Pole-ax handle.

FIG. 156.

pole, and is fitted with a curved handle, which can be inserted in the eye in only one way. See Fig. 156. The pole may, in emergencies, be used in driving pegs or stakes, but the curved

handle, inverted at such times, makes the ax a very inconvenient tool to use.

Pole-axes may be secured upon requisition for official work. For general use they should be fitted with a 36-inch handle, and should not exceed four pounds in weight. Their cost, including the handle, varies from \$1.25 to \$1.50.

Double-bitted Ax.—Instead of having a square or rounded pole this ax bears two bits, both in line with the handle, and the latter, unlike that of a pole-ax, is straight with a swell at the end, and is so constructed that it may be used with equal facility with either bit. See Fig. 157. Woodsmen differ widely in their opinions as to what constitutes the best all-round ax,

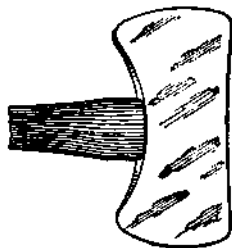

Double-bitted ax.



Handle for double-bitted ax

FIG. 157.

but for all purposes work in the woods a four-pound double-bitted ax with 36-inch handle is recommended. The flat side of this may be used in driving stakes or tent pegs; one bit may be used exclusively for such work as may cause it to be thrust intentionally or accidentally into the ground; and the other bit may be kept sharp for felling or for other regular field chopping. If such an ax can not be secured by requisition it can be purchased for about the same price as a pole-ax.

Broadax.—This is made especially for hewing. It has an extra wide bit, with almost square corners, and the bit is beveled only on one side. The eye is so constructed as to permit the insertion of the handle from either side, thus providing for the use of the ax by either a right- or a left-handed person. On ac

count of the single bevel it is unfit for any use except hewing. See Fig. 158.

Handax.—This is simply a light broadax designed for use in one hand. Ordinarily any hewing that can be done with a

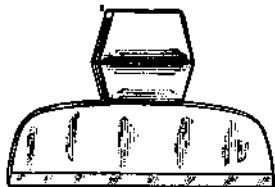

Broadax.



Broadax handle.

FIG. 158.

handax can be accomplished with very little more labor with a common pole-ax or a double-bitted ax. Their inclusion in a camp outfit is not recommended. See Fig. 159.



FIG. 159.—Handax.

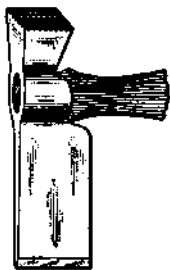

FIG. 160.—Shingling
or lathing hatchet.

Marking Hatchet.—This is a light, specially constructed ax supplied the field man for use in marking timber that is to be felled or removed. The pole bears the raised letters US, which are used in stamping Government timber, and the corners of the bit are somewhat more angular than those of the regulation pole-

ax. Two lengths of handles are furnished, and for extensive marking or blazing the longer length is recommended. Marking hatchets are supplied upon requisition, and particular care must be observed not to lose one, since it might be utilized for illegal purposes if found and used by an unauthorized person.

Belt-ax.—This is a very small ax with a short handle, sometimes folding, and designed to be carried at the belt of the woodsman. It can be used only in very light work, such as blazing trails, lopping off small branches, or trimming out brush. On camping trips where no other form of ax is available a belt-ax is a very convenient tool, but its inclusion in a camp outfit under any other conditions is not recommended.

Shingling Hatchet.—This is shown in Fig. 160. The bit is narrow, the front straight, the pole flat and usually rough-surfaced for driving, and the blade is notched at the rear side for pulling nails. The tool is of little use other than for the work for which it is designed, but is a most convenient article for use in shingling.

Carpenter's Adz.—In reality this is a broadax having the bit at right angles to the handle. It is a particularly convenient ax for hewing the upper surface of timbers as the operator stands astride of or faces them. It is practically useless for any other work. It costs from \$1.25 to \$2.00.

Care of Axes.—*Grinding.*—The manufacturer, in order to secure better protection of his goods in shipping, puts only a blunt edge on an ax and does not expect the tool to be used before



Adz.



Adz handle.

FIG. 161.

it has been properly sharpened. New axes, therefore, can not be used with satisfaction until this has been done. The ax should never be ground on a dry stone, since this will not only heat it and have a more or less detrimental effect on the temper, but will also wear or break the stone away faster. Contrary to a common belief that a better cutting edge may be obtained by turning the stone away from the ax, it may be turned in either

direction with equally satisfactory results both to the ax and to the stone so long as the former is not held at an angle that forces its edge deep into the surface of the latter. The ax should be held against the stone in such a way that the bevel of the bit is ground back evenly and uniformly, leaving the shoulders in the same relative position to the edge as they were before the ax was ground; otherwise the edge will be left either too blunt or too thin. In the former case extra force must be applied to make the edge enter a timber; in the latter the edge will bend or chip away and break.

Whetting.—This is the finishing operation in sharpening. It can best be done by the use of a small stone which can be rubbed against the bit rather than the bit against it. The object of whetting the bit is to remove any rough or "feather" edges that may have been produced by grinding. If such edges are left on the bit they will interfere seriously with chopping.

Filing.—It not infrequently happens that the field man's supply of tools does not include either grindstone or whetstone, and as a result he is forced to use a file for a substitute. Much needless muscular effort will be avoided if the field man remembers that a file cuts only on the forward thrust. If a whetstone is available the ax may be whetted after filing the same as after grinding and much better results will be secured.

Removal of Broken Handles.—The wedge in the end of the handle should, if possible, be withdrawn and the handle then pulled backward out of the eye; but if the wedge can not be removed then the handle should be cut or sawed off close up against the ax and the portion left in the eye driven forward. The wedge will prevent it from being driven backward. If it can be driven neither way, then, if a brace and bit can be secured, several holes may be bored through it and the sections split out one at a time. In an emergency it may even be burned out by placing the ax in a fire, but this will prove injurious to the temper of the ax and should be resorted to only as a last resource.

Making New Handles.—These should be of sound, seasoned, heart white oak (*Quercus alba*), post-oak (*Q. minor*), or hickory (*Hicoria ovata* or *alba*). Sound sapwood of any of these is also good, but the idea that sound hickory heartwood is not as strong as the sapwood is erroneous. Such timber should be straight-grained and free from knots, cracks, and season checks.

The broken handle, temporarily reassembled, may be used as

a pattern by which to mark off the new handle. The latter is then roughly hewn out, dressed down with a pocket-knife or draw-shave, and finally finished with glass or sandpaper. The end to be inserted in the eye should be so shaped as to fill the eye completely before being wedged.

Inserting New Handles.—It is very important that this operation be performed with greatest care if the ax is to “hang” properly. The bit must be exactly in line with the handle, the blade must set perpendicularly to the curve, and the rear corner of the bit must not set too far back. It is always a wise precaution to use the ax in light work for a short time before the handle is wedged in permanently. Dry hardwood wedges are preferable to iron wedges.

Chopping.—This operation, like all others involving the use of a certain tool, is a distinct art that can be acquired only through extensive practice, and there will be no attempt made here to elucidate it except as to the superficial points.

It may be performed either right- or left-handed. In the former the end of the handle is grasped in the left hand, the right being placed approximately half-way down the handle, and the ax is swung over the right shoulder. On the downward thrust, the force is about equally divided between the pushing motion of the right hand and the pulling motion of the left. In left-handed chopping the respective positions and movements of the hands and arms are reversed, and the ax is swung over the left shoulder. Considerable practice is necessary before the bit of the ax can be directed in every instance against a desired spot on a timber, and even after that ability has been acquired there remains the problem of tilting the ax at the proper time and angle required to dislodge the chip and throw it out.

A very common mistake made by novices is their attempts to cut squarely across the grain of a timber. Instead of directing the bit exactly across the grain it should be thrust obliquely into it, unless certain conditions, such as the need for a square-ended timber, for instance, prohibit this.

In chopping through a timber it should be notched from one side to or near the center, the notch forming an angle of approximately 45 degrees. The timber is then rolled over and a second notch, cut in such a manner that its apex will meet the apex of the first, is made. If an attempt is made to cut through a

large log from one side the notch will necessarily be so wide that satisfactory results can not be obtained.

The only general rule for cutting squarely across the grain of

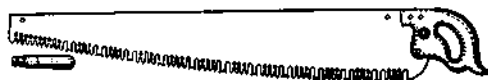
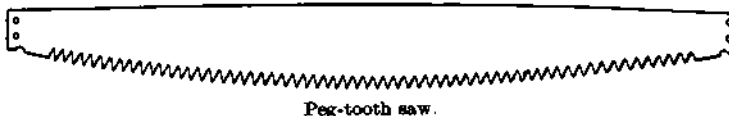
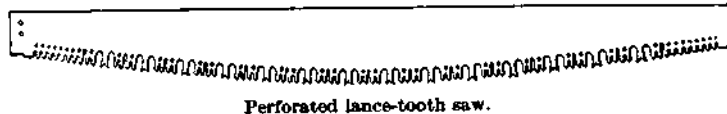
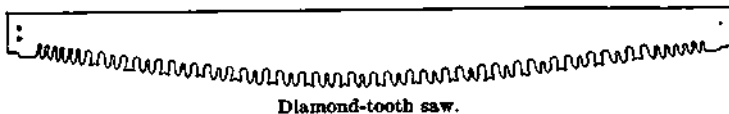

FIG. 162.—Two-man saw handles.

a timber is followed in notching a tree that is to be felled, and even in that case the grain is cut diagonally in one direction.

Any operation with an ax is so completely governed by local conditions that only actual experience can dictate exactly what rules to follow.

Splitting.—This operation differs from chopping, as the *serm* is generally used, in that the grain of a timber is split apart rather than severed.

The greatest problem that novices must solve is in keeping the blade of an ax from passing clear through a timber and into the ground. This may be avoided, however, by a slight tilt of the poll to one side immediately after the bit enters the timber.

This not only utilizes the grain at one side of the bit as a fulcrum for the bit to act on against that of the other side, but it also serves to turn the blade from its direct course through the timber and thereby prevents it from sticking fast.

Tough, gnarly timber that cannot be split through the center may be worked up by "slabbing." This consists of splitting off slabs around the outer portions of the timber, gradually working in toward the heart, and finally reducing it to such a diameter as will permit its being split open. Large knots may be split without difficulty by directing a tilting blow against them in line with the grain of the tree.

Saws.—Saws used for general field work may be roughly classed as one-man and two-man cross-cuts, a third variety for light work about camp and other such places being the "buck" saw. For hand-saws, see page 119.

Two-man saws are made in three principal styles, all of which are shown in Fig. 162, and which are known as "Diamond Tooth," "Perforated Lance Tooth," and "Peg Tooth." For any ordinary work none of these should be less than 5½ feet in length. The perforated lance tooth variety is recommended for field use.

This same variety is also recommended in a one-man saw for light work about a station. It will be found especially satis-

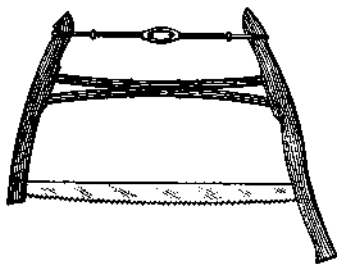

FIG. 163.—Buck-saw.

factory in cutting fuel wood, and is recommended in preference to the common buck-saw.

Buck-saws may or may not be constructed with drag teeth, but if such a saw is to be used it is suggested that one with drags be secured.

The one-man and the two-man cross-cut saws and the drag-tooth buck-saw all cut in both the forward and backward stroke.

Sawing.—Neither man should push a cross-cut saw; it is constructed in such a way as to provide for cutting when it is pulled, but it is too limber to be pushed. The strokes should be full and the whole cutting length of the blade should be utilized. Short strokes, not wearing upon the teeth near the ends of the blade, leave them so long and thick in comparison with the teeth that are continually used that a full stroke of the blade soon becomes impossible.

Each stroke should be even and regular and no extra force should be directed against the teeth to make them cut faster; such saws are so constructed that their own weight will feed the teeth fast enough if these are kept in good condition.

In cutting through horizontal timbers both handles of the saw should be held as nearly at right angles to the log as possible, and should be slightly raised at the outward end of the stroke. This eliminates stiff, unyielding strokes, the cutting edge of the saw being made convex in order to provide for the longitudinal rocking motion thus produced.

In felling timber with a cross-cut saw the latter is of course started into the tree approximately at right angles to it, and in this case must be held against the wood with sufficient force to produce satisfactory progress. The operators may grasp their respective handles with both hands, or one hand may grasp the handle and the other the back of the saw near the handle, depending entirely upon personal ideas of convenience.

Filing.—Examination of a saw will show two sets of teeth, viz.: (1) The cutting teeth, and (2) the drag teeth or "rakers." The first are made in such a way that only a sharp point cuts, and these points are arranged alternately along the blade. The second are forked, have square bits, and are not provided for cutting purposes, but are solely for use in dragging or raking out the chips cut away by the teeth.

In filing the teeth they should be left as nearly in their original shape as possible, a very common failing of saw-filers being their propensity to cut away, or "dub off," the points without filing back the shoulders; this results in blunt teeth that will not cut as clean or as fast as long, tapering teeth.

Particular care must be observed to have the teeth all the same length after the saw has been filed; if some are left longer

than the others the saw will jump or hang, feed to one side, or otherwise prove disagreeable to work with.

Rakers should be left slightly shorter than the teeth, or they will prevent the latter from entering the wood and a rough, jerking motion in sawing will be the result. They should be left short enough so that when the sawyer looks along the edge of the blade he will observe a shallow groove, the ends of the rakers forming its bottom, and the short sides of the teeth its sides. This difference in length between the teeth and rakers should not exceed $\frac{1}{64}$ -inch nor be less than $\frac{1}{100}$ -inch, depending upon the nature of the wood to be cut, softer woods of course permitting the length of shorter rakers.

If no vise is available in filing, a stump may be sawed into from the top and the saw held in the cut, teeth upward. After all teeth on one side have been filed the saw is reversed and the remaining teeth are filed; this will be much more convenient than trying to file each tooth of both sides as the saw is passed through the cut. After the teeth have all been carefully "jointed," or filed to the same length, the rakers are next sharpened and filed down to the proper length, care being taken to see that they are all the same.

Setting.—This is necessary in order to allow for a kerf wide enough for the blade of the saw to pass through without binding, and is especially necessary when green or very soft timber is to be cut; a much narrower set is sufficient for hard timber through which the saw passes slowly.

The operation of setting a saw properly calls for considerable skill unless the woodsman has access to a regulation saw set made especially for the purpose; in such a case all that need be done is to regulate the set and then operate on each tooth.

But if no set is available the saw may be laid flat on a stump, and all the points along one side of the blade may be bent slightly outward by being tapped with some iron instrument. When the points along one side have been thus treated, the blade is turned over and the other teeth are given similar treatment. The chief disadvantage of this method of setting is the utter impossibility of directing the same amount of force against each tooth, thus leaving some with more set than others.

Rakers are never set.

Wedges.—These are used in hastening or directing the felling of timber, in relieving a saw of the pressure from the sides of

the kerf, in splitting or otherwise opening timbers, and forcing back the sides of the kerf when a saw is to be removed. There are of course numerous other uses to which wedges may be put, but these are the principal ones.

Wedges to be driven into kerfs where severe binding has occurred should not be struck a sharp blow at first; if this is done they are quite likely to rebound. Slight taps should be delivered



FIG. 164.—Wedges.

until they have been firmly set in the kerf, after which more vigorous blows may be struck.

If they prove to be too small or too thin for the splitting of heavy timbers, larger wooden wedges, known as "gluts," may

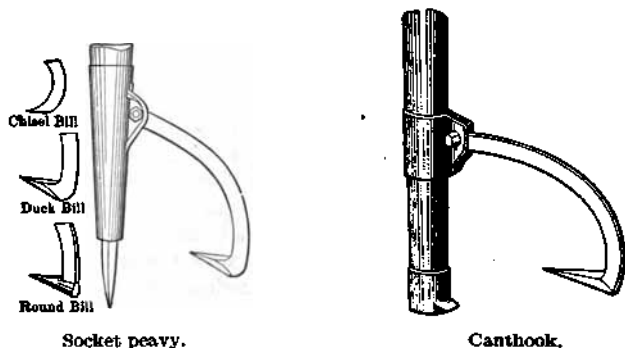

FIG. 165.

be used to insert beside them. These, too, may rebound if struck too hard at first. They should be of very hard wood, and should have the large end rounded off to avoid splitting; ragged edges should be trimmed away.

ESTIMATING TIMBER

So many influencing factors enter into this line of work that a rather formidable problem is presented. The varieties and

sizes of timber, its condition and quality as affected by altitude and latitude and general climatic conditions, its accessibility by wagon or otherwise, its distance from market, the probable effect on other timber that its removal may have, and numerous other points involved, must all be given due consideration by the estimator and included in his reports. It is therefore obvious that to be a good estimator a field man must be a very close observer and must have good judgment and active perceptive powers.

Methods of estimating timber vary in different localities. Deductions for defects may be made from an ocular estimate; a certain number of average trees may be used as a basis for compiling an estimate on a given tract; or strips may be run through a country, estimates made to a certain distance either side of the center line, and the final report based on data thus secured. Local conditions are largely responsible for the different methods.

For example: Owing to the varieties of woods found on the same areas in the Arkansas forests, two men have worked together, one running the compass, pacing distances, and mapping the country, the other securing an estimate of the timber to a given distance either side of the line followed by the compass man. Ordinarily these lines were run through the center of each forty-acre tract and estimates were made to a point two rods away on either side. The area thus actually considered embraced two acres, or 5%, of the whole forty, and reports for the forty were based on the data so secured. Observations of poles, seedlings, and saplings were taken at given points along the line and covered given areas.

Reconnaissance men work alone, however, where timber occurs in solid stands, each man doing his own pacing, running his own lines, and making his own maps. Forty-acre tracts may be crossed twice if the density of the stand demands it.

A line through a forty is not run at random, as may be supposed, but is started and run from a regularly established point. Temporary base lines are established in unsurveyed country, and corners are set along these at intervals of 80 rods and at points which bring them at the middle of the forty lines. Such corners are only temporary in nature and are marked usually by stakes driven into the ground and scribed or numbered as desired. The base lines are started from some known corner

in a regular survey, as shown in Fig. 166, and are run in any direction the work may demand, usually however due north and south or east and west.

The cruiser starts at one of these temporary corners and paces

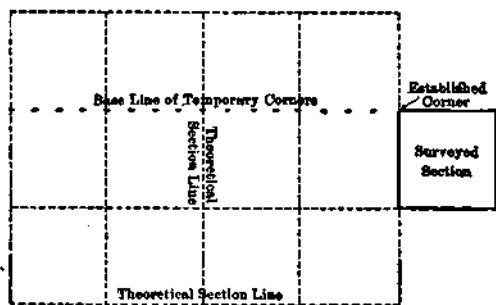

FIG. 166.

the distance from there to the center of the forty he is to "work." From there he runs through the middle of each succeeding forty as shown in Fig. 167, the arrows indicating his line of travel. He is expected to check his distances on section or quarter corners when he is working in surveyed territory, and thereby

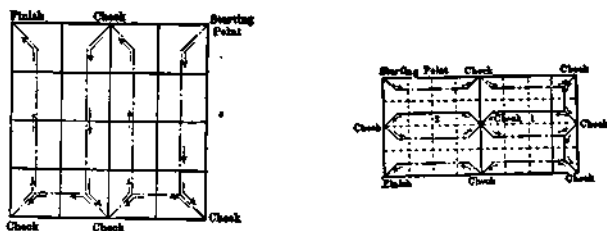

FIG. 167.

enable himself to rectify any errors in pacing that may have occurred. A little experience will soon make his work quite accurate and he will be able to check within a few rods of the corners.

In timber to be estimated, particular attention must be given

to all defects. These include, among others, spike tops, cat faces, frost cracks, crooked trunks, rotten limb stubs, holes, large or rotten knots, burned, rotten, or swelled butts, and other indications may appear which show a tree to be unsound.

There is no hard and fast rule that can be followed in determining just what constitutes a defect in standing timber, and the cruiser is therefore compelled to rely upon his own judgment and make his reports accordingly. His best and quickest method of securing a practical knowledge of defects is to follow defective logs through the mill and observe the internal condition of each one as it is opened up by the saw.

FELLING TIMBER

This begins after all preliminary estimates and other arrangements for a timber sale have been completed, and while it may not appear to be an important operation, it is, in fact, one which, unless it is carried on properly, may result in the sale being closed. It is imperative therefore that the field man in charge of the sale be familiar with what constitutes proper and improper felling.

If a tree's exterior condition is such as to preclude all doubt of a worthless interior it should be left standing unless the contract specifically states that such material must be removed or at least felled. In most Government sales the contract embraces a clause providing for the removal or felling of any timber that may present a fire menace or which may result in damage to other timber if left standing.

One precaution which the field man should observe in his movements about the sale area where felling is in progress is to be on the lookout for large limbs left hanging in other trees and known as "fool killers." Such limbs may fall at any time and it is never wise to work beneath them.

The first thing to be considered in felling is the direction in which the tree is to be thrown. If it is straight and the heavy top branches are evenly distributed around the stem, the ground is level, no strong wind is blowing, transportation facilities are equally good from any direction, other timber will not be damaged and other conditions permit, then it may as well be felled in one direction as another. If it leans as shown in Fig. 168, it should be felled if possible at right angles to the direction

of inclination. This eliminates to a degree the possibility of a broken or split stem as shown in the same figure.

If circumstances prevent it from being felled in such a manner

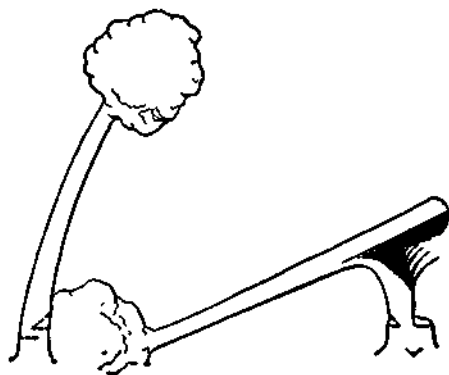

Method of notching and sawing leaning tree.

Stem split as result of improper notching.

FIG. 168.

it should be notched deeply on the side to which it leans. The saw should be started in on the opposite side at a point from 2 to 4 inches lower than the base of the notch; if started in above the notch the stem is much more apt to split. When splitting does occur, and the shattered butt is held high in the air, the workmen should retire in a line at right angles to the stem rather than backward from it. After precautions have been taken to see that the stem will not slip sidewise from the stump nor "kick" backward over it, the stump should be cut through from one side and the stem allowed to tip to that side. This operation is a dangerous one, as there is always a possibility of the crumpled branches in the top forcing the stem backward when the stump is cut through.

Double trees, growing together at a point sufficiently high to prevent them from splitting apart when felled, should be thrown as illustrated in Fig. 169. If it is apparent that they will split apart as soon as one is cut through, they may be felled away from each other.

A tree lodged in another as shown in Fig. 170 may be thrown

down by felling the supporting tree at right angles to it. A close watch should be maintained during this operation to see that pressure of the lodged tree does not cause the other to fall sooner or in another direction than that desired.

Felling timber across young growth and breaking it down should not be permitted, except, of course, where dense

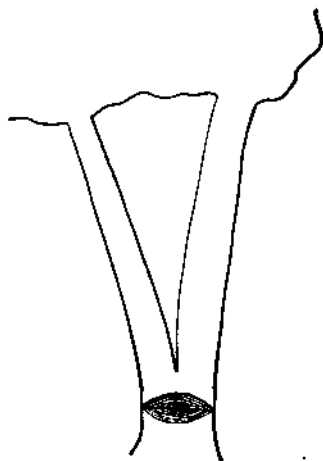

FIG. 169.—Notch for felling double trees.



FIG. 170.—Lodged tree.

stands of young growth can not be avoided. Particular attention is given to this point in all Government sales, and when such felling occurs after one or two warnings from the officer in charge of the sale it may be considered sufficient cause for prohibiting further operations in the sale.

Refuse resulting from trimming and other operations must be piled compactly or else scattered, depending upon the terms of the contract. High stumps, as shown in Fig. 171, must also be avoided, the stump height usually being specified in the contract. Certain local conditions, such as short, scrubby timber with large, heavy tops or defective trunks resulting from burns, may justify a deviation from certain fixed rules, but this should never be done without the approval of the proper authorities.

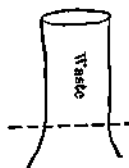

FIG. 171.

Another practice to be forbidden is felling trees across large logs, stumps, or rocks and shattering them until they are no longer merchantable.

Still another great loss may occur when trees are felled in such a position that the logs can not be hauled out without great expense. These points are all covered, however, in the contract,

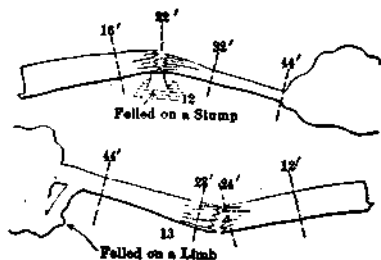

FIG. 172.

and they should receive the closest attention from the man in charge of the sale.

BUCKING LOGS

Improper bucking is responsible for one of the greatest losses in the lumbering industry. Crooked logs especially present excellent opportunities for careless buckers to waste an entire tree when one or more logs might, with proper bucking, be secured. If a tree is bucked at the 16-foot length as shown in Fig. 173, there is a 25% loss, all that portion of the log down

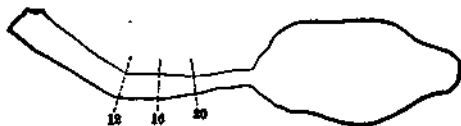

FIG. 173.

to the 12-foot length being total waste. If the same tree is bucked at the 12- and 20-foot lengths two good logs may be secured and practically all the tree utilized.

In Fig. 174, instead of cutting a butt log 16 or 18 feet long, losing the 2 or 4 feet in the crotch and going to the unnecessary trouble of cutting the two large limbs at 24 feet, and again at 36 feet, it would be much more profitable to cut a 12-foot butt

log, then cut the crotch at 24 feet and the branches at 36 feet, and thus secure four straight 12-foot logs. The ends of a few planks in the middle log might possibly be damaged, but the loss thus sustained would be much less than if the tree were bucked after the first method.

Fig. 175 represents loss in a top. The top log would provide enough sound lumber to make its removal from the woods profitable.

Another waste occurs where 2, 4, or 6 feet of sound log are left in a top merely because certain log lengths are desired.



FIG. 174.



FIG. 175.

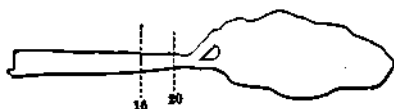

FIG. 176.

Thus, in Fig. 176, a 16-foot log is secured and a 4-foot length wasted. One 20-foot or two 10-foot logs would have resulted in practically no waste.

In Fig. 177 more than a foot of sound log is wasted. This is due to the fact that lumber is always cut in lengths of even

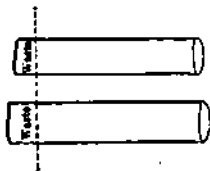

FIG. 177.

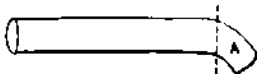
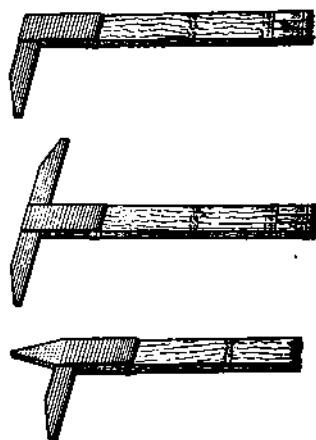

FIG. 178.

feet unless a special order calls for other lengths. Consequently the lumber in this log must all be cut back to 10 feet in length, while the log might have been cut 3 or 4 inches over 12 feet in length and made into 12-foot lumber.

The 11-foot log shown in Fig. 177 must also be made into 10-foot lumber. In Fig. 178 all of A is lost.

A trimming allowance of from 3 to 4 inches is usually allowed on all logs, although in Forest Service sales the allowance is usually specified as not more than 3 inches.



LOG SCALING

So many influencing factors enter into the prob-



(For large timber.)

FIG. 179.—Log rules.

lem of formulating a table by which the board feet contents of an unsawed log may be determined that there are a number of scales or rules used. Thus, the Scribner, among the oldest, may be used in one locality; the Doyle may be found in common use in another; the Doyle-Scribner is used in another; and the Champlain, International, Maine, or Cumberland River, or any one of thirty or forty others, may be used in other sections. Many small operators, particularly in the South, use no scale whatever, but measure each piece of lumber as it leaves the mill; others, operating solely for local trade, retain as their pay for sawing a certain per cent of the pieces sawed, this method being known as "sawing on shares." Official instructions issued to scalers are substantially as follow:

All scaling shall be done with the Scribner Decimal "C" rule.¹ Each log or piece, unless culled, shall be scaled, numbered, branded "U. S.," and recorded separately.

¹ For Log Rules, see p. 362, Appendix.

Standard ties (8 feet long, 6 inches thick, and 8 inches wide) may be sold either by the tie or by the thousand board feet, allowing thirty ties to the thousand feet. Ties of other dimensions may be sold likewise, except that a greater or smaller number, according to their size, must be allowed to the thousand feet.

Posts, poles, piles, stulls, etc., may be sold by the linear foot, by board measure, or by the piece, as stipulated in the contract. Each one shall be branded.

Wood sold by the cord should be branded both at the top and bottom of a pile, and a dozen or more other pieces in the pile also branded. "Merchantable" logs are those from which one-third or more of their contents as shown by the scale may be made into sound material. This term includes such material as will not grade lower than No. 3 Common as determined by the grading rules of the locality in which the timber is cut. Thus a log containing 240 board feet full measure is not "merchantable" if less than 80 feet can be made into "sound" material, but is merchantable if 80 feet or more can be utilized as "sound" material.

All logs exceeding 16 feet in length are to be scaled as two or more logs as nearly the same length as possible. This rule is departed from in Alaska and on the west slope of the Cascade Mountains in Oregon and Washington, where logs from 32 to 64 feet, inclusive, are to be scaled in a similar manner. Such scaling requires the operator to exercise his own judgment in allowing for increase in diameter of the lower logs. In doing this he can hardly follow any set rule although a



FIG. 180.—Board rule

table of such increase will be supplied for his general guidance.

Every fifth or sixth log shall be measured to ascertain whether or not the trimming allowance is being exceeded. In aggravated cases violation of this term of the contract shall be considered sufficient cause for cancelation of the contract. Other-

wise the scaler will charge for two extra feet of log and this will be recorded as a "penalty" scale. Measurements of the diameter are taken inside the bark at the small end of the log. If that end is elliptical rather than round an average diameter will be taken by securing a measurement at right angles across the short diameter and averaging the two. In all cases diameters are to be rounded off to the nearest inch.

Proper allowance will be made for all defects that will damage a log, but no definite rule can be followed. The only general

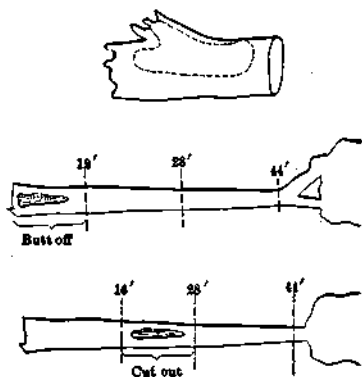

rule that can be followed successfully is to ascertain the amount of board feet included in the defect and deduct this from the full scale. The most common defects are: Hollows, cracks, shake, dote, circular-, uniform- and side-rot, dead, soft, or blue sap, seams, sweeps, and crotches. If a hollow extends the entire length of a log the scaler should deduct from the full scale as many board feet as may be contained in a square timber equal in diameter to the larger end of the hollow and as long as the log. Shorter hollows should be allowed for accordingly. Uniform rot, which extends completely through a log from end to end, should

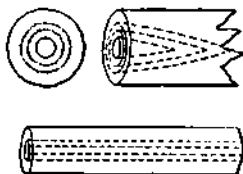

Rot

FIG. 181

be allowed for the same as a hollow, shorter rot deducted accordingly.¹

When cracks and shake are so extensive as to render material "unsound," they must be allowed for accordingly.

Circular and side rot should be treated in a similar manner.

Punk knots invariably indicate a worthless log. If the latter were sound they would not appear. They should not, however, be confused with pitch knots, as the latter seldom damage a log to any great extent and are usually removed in the slab.

Logs having dead, soft, or blue sap should be scaled inside such sap. Blue sap does not necessarily lower the grade of lumber, but always lessens its market value.

Seams should be treated the same as cracks unless they are spiral, in which case they may be so extensive as to render an entire log worthless. Sweep, or curve, as shown in Fig. 182, demands considerable attention, and local conditions must determine the amount to be deducted. As a general rule, no allow-

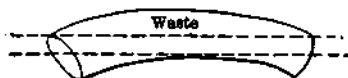

FIG. 182.

ance should be made for the defect when it occurs in logs exceeding 16 feet in length. It is agreed in the contract that log lengths will be varied in such a way as to permit close utilization. Crotches damage a log in proportion to their extent, and result in gnarled, cross-grained, brittle lumber.

Other defects may appear and the scaler must always be on the lookout for them. He should, if possible, devote his spare time to the study of defects as they appear in logs opened at the mill.



FIG. 183.

¹ As a matter of fact, a hollow log will saw out less lumber than a rotten log having a rot equal in diameter to the hollow of the first. This is accounted for by the fact that the carriage dogs will hold the rotten log until practically all the sound material can be cut from around the rot, while the hollow log can not be held after the hollow is reached. The walls of the hollow either split out or are not strong enough for the dogs to hold securely.

He should also keep a set of grading rules where they may be accessible at all times. A close study of these and of what qualities lumber must possess to be classed in certain grades will enable him to attain a greater degree of proficiency in making allowance for defects. He is supplied with blank records, made up in book form, which permit the contents of one hundred logs to be recorded on each double page. These are numbered from 1 to 00 and carry a column in which to enter lengths. Spaces are provided at the tops of the pages for the name of the purchaser, the date of the sale, the description of the area involved, and for other data pertinent to the sale. Page and grand totals are provided for at the bottom, and there is a separate blank space for the officer's signature and title. These records are open to inspection by the purchaser only in the presence of the Supervisor or a District officer.

LAND SURVEYS

In practically all of the numerous lines of work he must handle the field man will find the question of land lines involved, and it is essential that he have a thorough knowledge of at least the fundamental principles upon which land surveys are based. A detailed treatise on the subject would require volumes, and for that reason only the most important points will be discussed here. The rectangular system of surveys, in common use in this country, will be considered first.

Principal Meridians.—These are north-and-south lines established as a means of control by which the east or west boundary lines of townships may be determined. Owing to the curvature of the earth's surface and to the fact that all such lines, if extended, would converge at one point at the north, east-and-west correction lines are established at certain intervals in order to eliminate as far as possible the otherwise resultant trapezoidal form of townships. These are known as base lines.

Base Lines.—These are started at given points and are run due east and west. They serve as a base from which to run base lines and also provide increased facilities for the proper description or location of lands.

Standard Parallels.—These lines are run east and west, parallel with base lines, at intervals of 24 miles, and serve as correction lines for range boundaries. Being but 24 miles apart, they pro-

vide for the elimination of practically all convergence of north-and-south lines.

Guide Meridians.—These are run north from standard parallels at intervals of 24 miles, close on the next parallel north, and thus lay the country off in theoretical rectangles 24 miles square. These tracts are not, of course, perfect rectangles, but converge slightly to the north. Township boundaries are laid off after the standard parallels and guide meridians have been established.

Township Lines.—These are east-and-west lines, 6 miles apart, and mark the north and south boundaries of townships. The tract lying between them and extending from one guide meridian to the next is known as a "township," and is numbered north or south from the base line from which a given survey is made.

Range Lines.—Range lines are laid off after the township lines have been established. They mark the east or west boundaries of townships and the 6-mile strip of country between them is known as a "range," and is numbered east or west from the principal meridian from which the survey is made. The establishment of township and range lines divides the country into tracts 6 miles square, and these are also known as "townships."

Section Lines.—Townships are next divided into sections, each of which is as nearly 1 mile square as possible. These subdivisions are made by east-and-west and north-and-south lines established at intervals of 1 mile, thus forming thirty-six sections to the township. When convergence of the lines prevents the establishment of thirty-six regular mile-square sections, the extra large or small sections are thrown to the north and west sides of the township. Instances may, but seldom do, occur where irregular sections may be laid off along all four sides of the township.

Section Numbers.—Beginning with No. 1, which is at the northeast corner of the township, the series proceeds westward to the northwest corner of the township, where section No. 6 is found. No. 7 is immediately south of this, and the series then proceeds eastward to No. 12, which is south of No. 1. No. 13 is south of 12 and 18 is south of 7. Section 19 is south of 18 and 24 is south of 13. Section 25 is south of 24, 30 is south of 19, and 36 is south of 25 at the southeast corner of the township.

Section Subdivisions.—A system of subdivisions has been de-

vised whereby tracts of less than a section may be described. Each boundary line of a section is marked at the center with a "quarter" corner, and a line from one such corner to the one directly opposite divides a section into halves. It is divided into quarters by connecting the corners on the other sides. Quarter sections are divided in a similar manner into "quarter-quarter" sections. These may be divided into "quarter-quarter-quarter" sections and these into "quarter-quarter-quarter-quarter" sections, each of which contains two and one-half acres. It will be seen, therefore, that so long as its boundary lines coincide with those made possible by a regular survey a very small tract of land can be described or located.

Land Descriptions.—It is especially important that the field man familiarize himself with methods used in describing lands, and as the subject is such a simple one he should have no trouble in mastering it.

Sections.—The first thing given in the general description is the exact description of a section or its subdivisions. Next comes the township number, north or south of a base line, and the range number, east or west of a meridian, follows. Usually the name or number of the principal meridian or base line is also given.

Thus several sections might be described as: Sections 1, 2, 3, 4, 5, and 6 (or Sections 1-6, inclusive), Township Twelve North, Range One East, of a certain meridian and base line. The abbreviated form of this description would be: Secs. 1-6, T. 12 N., R. 1 E., etc.

Half Sections.—Three hundred and twenty acres, embracing exactly one-half section, might be described as: The West Half of Section One, Township Twelve North, Range One East of



FIG. 184.

a certain meridian and base line. Abbreviated it would read: W/2 Sec. 1, T. 12 N., R. 1 E., etc. See Fig. 184. If located in both halves of the section it might read: The East Half of the West Half and the West Half of the East Half, or E/2

W/2 and W/2 E/2. It might also be described as: The East Half of the Northwest quarter, the East Half of the Southwest quarter, the West Half of the Northeast quarter, and the West Half of the Southeast quarter. Abbreviated: E/2 NW/4; E/2 SW/4; W/2 NE/4; and W/2 SE/4.

Quarter Sections.—One hundred and sixty acres located exactly in one regular quarter-section might be described: The Northwest quarter of a given section. If included in two regular quarter-sections, as shown in Fig. 185, it might read: N/2 SW/4

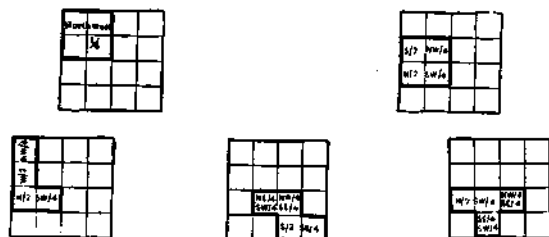

FIG. 185.

and S/2 NW/4. The same acreage, differently located would read: W/2 NW/4 and N/2 SW/4. Lying in this shape it would be known as an "L." If it should embrace N/2 SW/4, NW/4 SE/4, and SE/4 SW/4, it would be known as a "T." If it covered NE/4 SW/4, NW/4 SE/4, and S/2 SE/4, it would be designated as a "Z."

Quarter-Quarter Sections.—These embrace an area of forty acres and are described as SW/4 SW/4, or otherwise according to the actual location.

Quarter-Quarter-Quarter Sections.—Such subdivisions em-

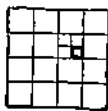

FIG. 186.

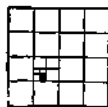

FIG. 187.

brace ten-acre tracts. The one illustrated in Fig. 186 would be described as SE/4 SW/4 NE/4.

Quarter-Quarter-Quarter-Quarter Sections.—These tracts in-

clude two and one-half acres, and if laid off as shown in Fig. 187 would be described as SE/4 SW/4 NE/4 SW/4.

Other Descriptions.—One hundred and sixty acres lying in two sections of the same township and range as shown in Fig. 188 would be described as: S/2 NW/4, Sec. 3 and E/2 NE/4, Sec. 4, T. 12 N., R. 1 E. Eighty acres, located in two sections, in

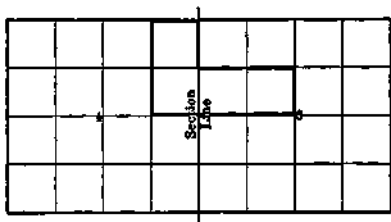

FIG. 188.

the same range but in different townships, as in Fig. 189, would read: SE/4 SE/4, Sec. 34, T. 11 N., and NE/4 NE/4, Sec. 3, T. 10 N., all in R. 1 E. Two hundred acres, located in different sections and in different townships and ranges, as in Fig. 190, would read: W/2 SW/4, Sec. 31, T. 11 N., R. 2 E; SE/4 SE/4, Sec. 36, T. 11 N., R. 1 E; NE/4 NE/4, Sec. 1, T. 10 N., R. 1 E; and NW/4 NW/4, Sec. 6, T. 10 N., R. 2 E. If the township line in Fig. 190 should be a base line and the range line a principal meridian, then the land in sections 31 and 36 would be described as east and west, respectively, of the meridian, and north of the base line, while that in sections 6 and 1 would be described as also east and west, respectively, of the meridian, but south of the base line.

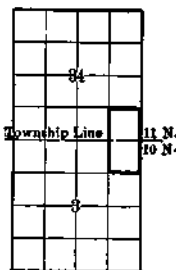

FIG. 189.

Corners.—Only section and quarter-section corners were set in the original surveys made by the United States Land Office. Unfortunately no one system of marking the corners seems to have been followed. In most parts of the middle West and in many parts of the South stones were set, and witness trees, usually four at section corners and two at quarter-corners, were

blazed and scribed with the section, township, and range numbers. In other localities pits were dug and mounds thrown up. In later surveys, particularly in the West and Southwest, stones were set at the corners and chiseled, as shown in Fig. 191. Quar-

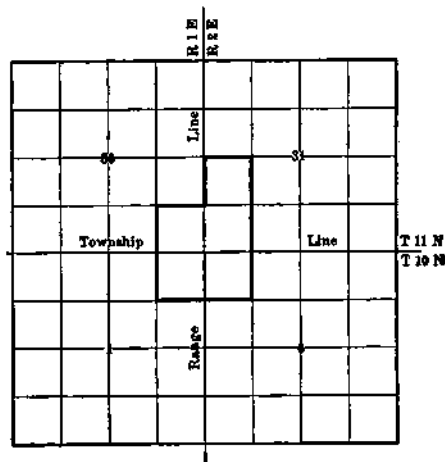

FIG. 190.

ter-corner stones in these surveys were chiseled " $\frac{1}{4}$ " on their west face in north-and-south lines, and in east-and-west lines the north face bore a similar inscription. Where trees were blazed as witnesses a second blaze near the ground was scribed "B T" or "W T," the initial letters of "Bearing Tree" and "Witness Tree," respectively. Such blazes should not be confused with the marks left by porcupines or with the numerous crosses cut through the bark by a religious sect known as the "Penitentes."

Throughout portions of the South, particularly Arkansas and Missouri, which were surveyed between 1840 and 1850, the blazes on witness trees have been covered with a new growth of wood and can be distinguished only after the closest scrutiny. Most of these trees, however, have been blown or burned down, and very few of the original corners can be located except with instruments.

Metes and Bounds Surveys.—Land lines in most parts of the Southeast and in certain parts of the East were not established

under the rectangular system of surveys, but were run and described by angles and courses tied to some permanent natural landmark. Such a line might be described as follows: "Beginning at the highest point on (.....) Peak, County of (.....), State of (.....), running thence S 24° E, 11.25 C; thence, S 42° E, 20.10 C; thence S 14° W, 11.25 C; thence S 20° E, 12.40 C;" and so on, finally closing the survey at the point of beginning.

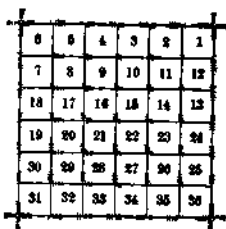

FIG. 191.—A common method of marking section corners. Used chiefly in the West.

Surveying Crews and Their Work.

—Ordinarily a surveying crew consists of the surveyor, or "transit man" or "compass-man," two chainmen, an axman, and flagman. The first superintends and is responsible for all work done, the chainmen measure distances, the axman removes brush that may interfere with

any of the operations of surveying, and the flagman works in advance of the rest of the party, indicating under instructions from the surveyor where the line is to run. The proper point at which to set his flag is made known to him by the surveyor, who signals with his arms, or by other means previously agreed upon. Assuming that a line is being run north and the flagman has not moved far enough east, this fact is made known to him by the surveyor, who extends his right arm, vertically if the distance is small, horizontally if great, intermediate distances being indicated by proportionate movements of the arm between the vertical and horizontal. If the flagman is to move to the west, the surveyor signals with his left arm. The flagman is to understand that he has reached the desired point when the surveyor raises and lowers, in quick succession, both arms simultaneously. He usually repeats this signal until he is sure the flagman has observed it, such observation on the part of the flagman generally being indicated by his repetition of the signal after the point of the flag has struck the ground.

If he has gone too far along the line the flagman may be brought back by a circular motion of the surveyor's uplifted arm, given at a time when the flagman happens to glance back. He is sent farther along the line when the surveyor raises his

arm and drops it forward. Or, when previously agreed upon, other signals may be used. These two men should, however, have a thorough understanding of all signals to be used.

The flag should be held squarely before the flagman's body, the point directly over the opening of the "V" formed by the flagman's feet as he stands erect, facing the surveyor. It should be gripped loosely between the thumb and forefinger of either hand at a point about on a level with the flagman's chest. This allows the pole to hang vertically and to fall straight down to the ground as soon as the grip is released. Later it is planted firmly and left standing until the surveyor arrives. It often happens that as the result of improper light, or the interference of brush or other obstacles, the surveyor is unable to see the flag unless it is held before the flagman in such a way that his clothing acts as a background; even then the pole may not be visible to the surveyor, but he will be able to ascertain its approximate location by reference to the flagman.

In clearing away brush from the line of sight, the axman needs only to hack it in one side and then bend it sidewise out of line and at right angles to the course, thus leaving a comparatively free opening for the chainmen to pass through.

A general rule in chaining is to use eleven pins, although many surveyors contend that ten are much more convenient, and that by their use mistakes are much less likely to occur. If eleven are used, one is set at the starting point and another is used at the end of every chain thereafter until ten chains (a "tally") have been measured off. When the rear chainman transfers the pins to the front chainman at the end of a tally, the last pin stuck is left sticking in the ground. Each time such transfers are made both men should count the pins to see that none has been overlooked and left behind. The best plan is for each to check the other as chaining proceeds. For instance, when the front man sticks his pin he may call out "Stuck!" and as the rear man recovers a pin he may call "Pin!"

In order to keep accurate count of the tallies chained, it is well for each man to record the number in some tangible method—*i.e.*, he should not attempt to keep the number in mind, but should keep check on it by means of pebbles, one placed in his pocket at the end of each tally, or should record it in a

note-book, or use some other means of record that can not be questioned.

Horizontal, or "level," chaining over rough country may necessitate "breaking" the chain. When this is done only a portion of the chain is used, thereby facilitating leveling. Most chains are equipped with a ring and snap at the middle, and in such work these may be loosened and the chain divided in half; otherwise a certain number of links must be used each time. If a half-chain is used, the eleven pins may be used to tally five chains instead of ten. Errors invariably occur when pins are thrown forward by the rear man to be used by the front man again in the same tally.

If steep slopes are to be level chained the rear man, when ascent is being made, raises his end of the chain until it is directly over the last pin stuck and as nearly as possible on a level with the front end. The front man is notified that the next pin may be stuck, and chaining proceed. In making a descent, the front man raises his end of the chain to a level with the rear end, holds his pin loosely, and then allows it to fall, point downward, when the rear man is ready. He then sets the pin firmly at the point where it first struck.

THE STANDARD FOREST SERVICE COMPASS

This instrument is so simple in construction that there should be no difficulty experienced in mastering a knowledge of its adaptability to a multitude of uses. The base is of aluminum and is 4 inches square. Its edges are beveled, and one bears a 4-inch rule graduated in $\frac{1}{10}$ -inches, while another bears a similar rule indicating $\frac{1}{8}$ -inches; the other two edges are graduated in degrees and half degrees and may be used as a protractor, thus rendering the instrument very useful in field mapping. A small level is attached to each of two corners, and these are used in leveling the instrument when it is set up.

At another corner is a milled nut which tightens or releases the lever that raises the needle from the center-pivot point. This nut should be kept screwed down when the compass is not in use; otherwise the needle will be allowed to swing about and soon the pivot-point will become worn or dulled to an extent that renders the use of the needle very unsatisfactory. However, care must be taken to see that the nut is loosened and the needle allowed to swing clear when the compass is being used.

It may seem that no field man would attempt to run a line with a tightly clamped needle, but as a matter of fact this very thing often occurs, the result, of course, of carelessness.

Suspended from the center pivot is a pendulum-like attachment known as a clinometer and supplied for the purpose of determining grades or elevations. It swings across an arc of 180 degrees, numbered from naught at the center to 90 on either end. To use the clinometer, the compass sights are opened and the base is held as nearly vertical as possible, allowing the clinometer to swing freely. The sights are then trained on the objective point, and the base is tipped carefully until the clinometer rests against it and becomes stationary.

The compass face is then turned carefully toward the observer and the reading is made, not in per cent but in degrees. If a per cent reading is required, a table, showing the relative values of per cent and degrees, must be consulted. For such a table see page, 354, Appendix.

A vernier attachment will be found on the side opposite the clinometer. This works over 44 degrees on one side and 27 degrees on the other side of naught, or no variation. Care must be taken in using it to see that variations are not reversed. If the vernier is not used it is very necessary that the operator be thoroughly conversant with the subject of variations; otherwise improper readings may be made and recorded.

Just above and attached to the base is a circle of 360 degrees numbered from naught, or "N" and "S," to 90 on the east and west points, according to the style of the compass. One style has the initial letter of each cardinal direction stamped on the circle, while another bears a star, or similar design, instead of "N," and "O" at other points instead of "S," "E," and "W." The style bearing initial letters of cardinal directions is so lettered as to lead a novice to believe that the manufacturer made a mistake and reversed the "E" and "W." In order that he may thoroughly understand this method of construction, the field man should turn his compass so the hair sight, which is always the front sight, is immediately over the north end of the needle after the needle has been released and allowed to settle. He will find that a line projected from the rear sight through the front sight will run north, no allowance being made for variation in this particular case. Turning the hair sight 90 degrees to his left, or to the west, he will observe

that the character which indicates West falls directly beneath the north end of the needle; turning it 90 degrees still further to his left, or to the south, he will notice the character which indicates South exactly beneath the north end of the needle; and turning still 90 degrees farther he will see that the character which indicates East is under the north end of the needle. It follows, therefore, that the character beneath the north end of the needle indicates the direction in which the sights are trained. If the north end of the needle is directly above 20 in the arc between "N" and "E" the reading is: "North, 20 degrees East," and is so recorded. If it points to 17 in the arc between "N" and "W," then the reading is: "North, 17 degrees West." If it indicates the figure 89 in the arc between "S" and "E," the reading is: "South, 89 degrees East." Pointing to 2 in the arc between "S" and "W" the reading is: "South, 2 degrees West." It will be observed from this that all readings begin either from north or south, the variation eastward or westward being expressed in degrees after the directions north and south have been read. Readings are recorded in the same manner in which they are made.

The sights are hinged to the base in such a way that they may be folded down across the glass face of the compass when not in use. The hair sight is always folded down first.

Around the glass will be found another circle divided into 360 degrees. Inasmuch as this circle is movable, readings should not be based upon it. Originally this form of compass was intended for underground work where wires were used in the slots when readings were taken.

On the under side of the square base, at one corner, will be found a diagram of a township divided into sections, each of which is numbered.

At the center of the under side will be found a shallow hole into which the upper end of the support is screwed. This support consists of a cylindrical socket into which one end of a ball-and-socket joint fits. The two are held together by means of a screw working in a groove in the pinion. Rotary motion of the socket about the pinion may be prevented by turning this screw up tight, but if necessary it may be left loose enough to allow such motion and still prevent endwise separation of the two pieces. At the lower end of the pinion a ball fits into a hollow circular nut attached to the upper end of another socket made

to fit over the end of a Jacob's staff or on to a tripod. In some instruments this nut has a notch in one side deep enough to allow the pinion at the ball to be tipped sidewise at right angles to the staff, thus permitting the use of the clinometer.

If a compass is to be stored away for any length of time it should be placed with the magnetized end of the needle to the north; otherwise a partially demagnetized needle may be the result. If it is to be carried in an electrically propelled vehicle it should not be placed near a motor or dynamo. While being used in the field metallic objects subject to magnetic action should not be allowed near it; even a heavy pocket knife, in close proximity to a very sensitive needle, may deflect it from a true course, and surveying pins or axes should be kept at a distance.

VARIATION

A diagrammatical explanation of variation will be found in Fig. 192. This drawing should not be considered as precisely accurate or even drawn to scale; it is purposely distorted in

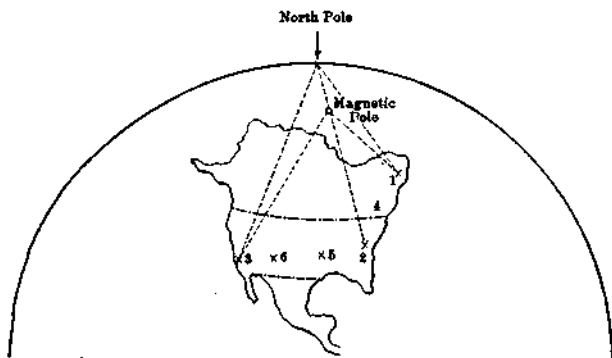

FIG. 192.—Variation.

order to facilitate the explanation and is sufficiently accurate for that purpose.

The location of the magnetic pole is not, as may be supposed, exactly at the north pole, but its situation with reference to the latter is similar to that shown in the illustration. Assuming that a compass is set up at 2, it will be seen that a straight line may be drawn from it through the circle to the north pole, and

that there is no variation at this point, because the compass, the magnetic pole, and the north pole are all in the same line. But, observed from 1, the magnetic pole varies to the west of the north pole, while from 6 it varies to the east, and from 3 the eastern variation is still greater. Therefore, if a line is to be run due north, it is necessary that the sights be in line with the north pole while the needle points to the magnetic pole.

The degrees of variation, at different points throughout the country, can most easily be secured about 9 P.M. The sights should be trained on the pole star, after the compass has been set on a firm table or post, and the needle should be released. It should be clamped as soon as it settles, and the difference in degrees between its north end and the corresponding compass sight will be the variation at that particular point. This variation is not, however, the same at all points along a line projected through the sights; it is subject to an irregular daily and annual increase and decrease and to local attraction.

The subject should be studied thoroughly from charts supplied for the purpose.

TRAVERSE TABLES

These are compiled for the purpose of indicating how great a distance has been covered in two directions following lines at right angles to each other when the diagonal distance has been obtained. In other words, they indicate the base and altitude of a right-angled triangle when the line of travel or the hypotenuse has been run. Thus, assuming that a surveyor is running a line N. 35° E. from a section line, he may, upon reaching a point 80 rods from where he started, require the distance due west to the section line. By referring to the traverse table he finds that in running at an angle of 35 degrees he departs from the section line .574 as far as he has actually travelled and that in this particular case he stands 11.48 rods due east of the section line. If he has occasion to ascertain how far north he may be of an east-and-west line extended through the starting point, his traverse table shows that his "latitude" is .819 of the distance he has traveled, or in this case 16.38 rods. If he has run 20 rods due north and then requires the distance due east to a point N. 25° E. of the starting point, the table shows him that the length of the north and south line is .906 of the line from the starting point to the

point in question. Accordingly, he divides 20 by .906 and finds that the diagonal line is approximately 22 rods long. Further reference to the table shows that when a line is run at an angle of 25 degrees the departure is .423 of the distance traveled, and since the latter in this case would have been 22 rods he finds that the point is approximately 9.30 rods east.

For traverse table of degrees only, see page 357, Appendix.

FIRE FIGHTING

Fire Trespass.—Acts which constitute fire trespass and which are prohibited on National Forest lands are shown on page 22, U. B., 1915, as follow:

REG. T-1. The following acts are prohibited on lands of the United States within National Forests:

- (A) Setting on fire or causing to be set on fire any timber, brush, or grass: Provided, however, That this regulation shall not be construed to prohibit the building of necessary camp fires or other fires for domestic or manufacturing purposes.
- (B) Building a camp fire in leaves, rotten wood, or other places where it is likely to spread, or against large or hollow logs or stumps, where it is difficult to extinguish it completely.
- (C) Building a camp fire in a dangerous place, or during windy weather, without confining it to holes or cleared spaces from which all vegetable matter has been removed.
- (D) Leaving a camp fire without completely extinguishing it.
- (E) Using steam engines or steam locomotives in operations on National Forest lands under any timber-sale contract or under any permit, unless they are equipped with such spark arresters as shall be approved by the forest supervisor, or unless oil is used exclusively for fuel.

Under the subject of Rewards on page 24, U. B., 1915, further official instructions are given as follow:

REG. T-2. Hereafter, provided Congress shall make the necessary appropriation or authorize the payment thereof, the Department of Agriculture will pay the following rewards:

First. Not exceeding \$250 and not less than \$50 for information leading to the arrest and conviction of any person, in any United States court, on the charge of wilfully and maliciously setting on fire, or causing to be set on fire, any timber, underbrush, or grass upon the lands of the United States within a National Forest.

Second. Not exceeding \$100 and not less than \$25 for information leading to the arrest and conviction of any person, in any United States court, on the charge of building a fire on lands of the United States within a National Forest, in or near any forest

timber or other inflammable material, and leaving said fire before the same has been totally extinguished.

Third. All officers and employees of the Department of Agriculture are barred from receiving reward for information leading to the arrest and conviction of any person or persons committing either of the above offenses.

Fourth. The Department of Agriculture reserves the right to refuse payment of any claim for reward when, in its opinion, there has been collusion or improper methods have been used to secure the arrest and conviction thereunder, and to allow only one reward where several persons have been convicted of the same offense or where one person has been convicted of several offenses, unless the circumstances entitle the claimant to a reward on each such conviction.

These rewards will be paid to the person or persons giving the information leading to such arrests and convictions upon presentation to the Department of Agriculture of satisfactory documentary evidence thereof, subject to the necessary appropriation, as aforesaid, or otherwise, as may be provided by law. Applications for reward, made in pursuance of this notice, should be forwarded to the Forester, Washington, D. C.; but a claim will not be entertained unless presented within three months from the date of conviction of an offender.

In order that all claimants for a reward may have an opportunity to present their claims within the prescribed limit, the department will not take action for three months from date of conviction of an offender. The above is applicable to offenses committed since July 1, 1910.

Under the subject of Cooperation in Enforcing State Fire Laws on page 25, U. B., 1915, further official instructions are given as follow:

REG. P-1. All forest officers will cooperate with State officials, so far as practicable, to enforce State laws for the prevention and extinguishment of forest fires. When authorized to do so by the proper State officers, they will, without additional pay, act as fire wardens with full power to enforce the local laws.

Under the subject of Fire Protection Cooperative Agreements on page 25, U. B., 1915, further official instructions follow:

REG. P-2. The Forest Service shall, whenever possible, and is hereby authorized to, enter into such agreements with private owners of timber, with railroads, and with other industrial concerns operating in or near the National Forests as will result in mutual benefit in the prevention and suppression of forest fires; provided, that the service required of each party by such agreements shall be in proportion to the benefits conferred.

Patrol.—Thorough and systematic patrol is the first essential in the question of forest fire control. If a carefully planned

system of patrol prevails fires may be attacked in their incipency and extinguished or controlled with little difficulty. Patrolmen should be required to travel along high ridges or other points from where the greatest territories subject to fire danger may be watched. Upon discovering a fire they should report that fact to the proper officers without delay.

Equipment.—The equipment generally provided for fire fighting consists of axes, saws, rakes, shovels, wooden or wire brooms, and such other articles as may be used to advantage in quick suppression of fires. Rakes and shovels may prove most effective in one locality, but large loose stones, thick underbrush, or other topographical features or vegetable growths may render them worthless in another. Consequently, before tools are requisitioned, the field man must exercise care and judgment in determining just what articles will prove most effective in his particular district or in the district in which the tools are to be used.

Tool Caches.—These should be located at points easily accessible from large territories in which fires may be expected to occur. They should contain such tools as can best be utilized in those particular sections and should be kept under lock and key in order to prevent their removal or destruction by unauthorized or maliciously inclined persons. The patrolman should have an itemized list of the number and kind of tools kept at such caches and should be sufficiently familiar with the location of each cache to enable him to reach them without delay whether a fire is reported in the daytime or at night.

Immediate Action.—Unless specifically instructed to the contrary, a field man is expected to proceed immediately to any fire that may be reported in the district assigned to his care. If the fire occurs at a point on the boundary line of his district, or a short distance across on another district, or on lands not within the National Forest, he is governed by whatever orders his superior officer may have issued on that subject.

Preliminary Inspection.—Upon his arrival at a fire of great size, possible danger, or difficult control, he should make a careful inspection of all advantages offered by natural barriers to the flames. These include such items as water courses, ridges, cliffs, cañons, and the absence of inflammable material at points where the fire may be attacked. Usually it is possible to utilize such conditions to good advantage, and without their due con-

sideration the suppression of a fire may require hours or even days of extra time, labor, and expense.

Procedure Following Preliminary Inspection.—As soon as the preliminary inspection has been completed the officer in charge should proceed to put into effect whatever course of action he may have decided upon. If the fight promises to be of several days' duration and will involve the services of a large number of men he should take immediate steps to secure the necessary labor. He should also see that the proper tools are available, that suitable camp sites are selected, and the camps arranged in most advantageous manner, that cooks, teamsters, and foremen are selected from among the most experienced men, and that every possible precaution is taken to systematize the work and to carry out a definitely fixed plan of operation as quickly and effectively as conditions will permit.

Classification of Fires.—In a general way fire may be divided into three principal classes, viz.:

(1) Ground Fires; (2) Surface Fires; (3) Crown Fires.

(1) **Ground Fires.**—These occur in regions where several years' accumulation of leaves, twigs, branches, and old logs forms a sort of peat or spongy mass which may burn or smoulder beneath the surface of the ground for days or even months. They are especially common to the Northeast.

(2) **Surface Fires.**—These consume the litter scattered over the surface of the ground. In thick beds of leaves, in old cuttings where slash is abundant, and in localities where numerous dead dry logs and stumps appear, they may prove very difficult to control. They are common to all timbered portions of this country.

(3) **Crown Fires.**—These are sometimes known as "top" fires and occur usually as the result of severe surface fires from which the flames pass to and ignite the trunks and tops of standing timber. They may be expected to occur when a combination of climatic conditions, such as extremely high winds during very dry weather, is especially favorable. They are common to areas where timber appears in dense stands such as are found in many parts of the Northwest.

Control.—(1) **Ground Fires.**—It is usually possible to control these by means of trenches cut through the peat to solid earth. Such trenches should be not less than 2 feet wide and should be absolutely free from all combustible material. Caution must

be exercised not to step accidentally on a place where the surface may give way and allow the workman to be precipitated into the live coals beneath.

(2) **Surface Fires.**—A variety of methods may be resorted to in the control of surface fires. In sandy localities where brush does not occur in dense stands, rakes may be used to clean out a wide path ahead of the fire. This should be at least 4 feet wide, wider if a strong wind is blowing. Where shovels can be used dirt or sand may be thrown on the flames, burning chunks or pieces of logs and branches may be buried, and trenches may be dug or paths shoveled out. Wire or wooden brooms may be used to rake away inflammable material from long strips ahead of and parallel with the fire line. Wire flails may be used in beating out the flames if these are not too hot to be approached and worked over. Bundles of bushes may be used in the same manner, or a small bush with a heavy growth of foliage may be utilized, as may also wet saddle blankets, gunny sacks, and blankets. In rough, rocky regions picks or mattocks may be necessary before the fire can be controlled. They are used in removing stone or rock, so shovels may be used later in cleaning off a bare strip of ground. Certain bags have been devised for use in fighting fires with water, but their use is of course limited to sections in which plenty of water is available. Chemical fire extinguishers have also been used.¹

(3) **Crown Fires.**—The chief method of control used in fighting these fires is to clear away the standing timber on a strip of

¹ See Bul. 113, U. S. Department of Agriculture, "Methods and Apparatus for the Prevention and Control of Forest Fires, as Exemplified on the Arkansas National Forest," by Daniel W. Adams.

See also the following: Bul. 117, U. S. Department of Agriculture, "Forest Fires: Their Causes, Extent, and Effects, With a Summary of Recorded Destruction and Loss," by Fred G. Plummer.

Clr. 205, U. S. Department of Agriculture, "Forest Fire Protection Under the Weeks Law in Cooperation with States," by J. Girvin Peters.

Bul. 82, U. S. Department of Agriculture, "Protection of Forests from Fire," by Henry S. Graves.

Bul. 111, U. S. Department of Agriculture, "Lightning in Relation to Forest Fires," by Fred G. Plummer.

"Fire Prevention and Control on National Forests," by S. C. Bartrum.

"Better Methods of Fire Control," by W. B. Greeley.

"National Forest Fire-Protection Plans," by Coert Du Bois.

"Light Burning in California Forests," by F. E. Olmstead.

ground from 75 to 100 or more feet in width. It may be found necessary in severe fires to clear two such strips parallel with each other and from 50 to 100 yards apart. The inflammable material on the intervening space is then fired, and this presents a check to the approaching fire. Such lines must of course be well in advance of the main fire line.

Fighting the Flames.—This should not be done in an irregular or unsystematic manner. Action should be moderately rapid, but not to an extent that will cause complete physical exhaustion in a few minutes. When rest, food, and sleep become necessary a reliable man should be placed in charge of operations until the field man is again able to resume supervision. Where two or more field men are present they may work in shifts of so many hours each, depending upon their number. This permits an officer to be in charge during the entire fight.

Patrolling the Backline.—Patrol of the backline, or the edge of the burned-over area, is the most important part of fire control. Only the most reliable men should be detailed to such work and they should be extremely careful to see that all burning logs, chunks, branches, and similar articles are thrown well back on the burned-over area. If such removal is impossible care must be taken to see that sparks do not blow from them to unburned territory and start another fire. Such work should not be centered at one point along the line, but should be distributed along the entire line, the patrolmen going along the line at regular intervals until all danger is past. This should be continued for several days if dry, windy weather follows suppression of the fire. Burning trees standing near the edge of the burned-over area should be felled backward on it when this can be done. Otherwise they should be felled and then carefully burned around after the upstanding branches have been cut away and compactly piled.

FIELD COOKING¹

Since cooking facilities in the field are necessarily limited, only the simplest recipes are given here, and it is suggested that the novice take advantage of his spare moments to experiment with other and more complicated dishes.

¹For list of provisions and supplies required and for table of cooking utensils necessary for from one to thirty men see "Fire Prevention and Control on National Forests," tables 2 and 3, by S. C. Bartrum.

A few general rules which will be of assistance to the beginner are offered. Chief among these is the mixing together of dry ingredients before liquids are added; the latter are then also mixed together, and finally the two mixtures are added together. This rule holds good in all cases unless specific advice to the contrary is given. Another point to be borne in mind is the fact that actual experience is essential to the best cooking and that satisfactory results can not always be obtained merely by following a given recipe. Ingredients may vary in strength of quality, fuel may not supply the proper heat, altitude has its effect, the water used has more, milk, which should be sour, may be only "turned," or the same condition may exist in milk that should be sweet. It should be borne in mind also that nothing definite on the subject of seasoning can be offered, since individual tastes differ so widely that they must be considered in every case. A recipe therefore can be considered only as a general guide and must be varied to suit local conditions. As a result the field man who is unable to exercise any ingenuity can never hope to become a proficient cook.

Canned Foods.—Camp food, or "chuck" or "grub," as it may be known in the camp vernacular, consists largely of canned meats, fruits, and vegetables, and as these undergo a more or less extensive process of cooking at the time they are canned they do not require a great amount of cooking prior to being served. With the exception of milk, which may stand in the open can for several days and not spoil, all canned goods should be removed from the can to glass, porcelain, or enamelware dishes immediately after the can is opened. This is especially true of acidulous fruits and also applies especially to meats. Chemical action may occur and render the foods poisonous if they are left exposed to air in the opened can. Care must be taken not to transfer them to other tin or iron dishes.

Bread.—Crackers will not prove satisfactory on extended trips and baker's bread soon becomes tiresome. Consequently camp-made bread is a necessity, but instead of presenting the difficult problem its preparation may appear to be, it is, in fact, a simple process.

Where quick meals are required the bread may be made in the form of biscuits or "flapjacks," but if a camp is in the nature of a semi-permanent establishment, then a more elaborate system of cooking may be followed.

The chief item in baking good bread is to have the oven hot when the dough is placed in it. Otherwise the bread will be heavy and unpalatable.

Sour Dough Bread.—Make a batter of flour and water and let this stand in a warm place until fermentation occurs. A half-pint of the fermented mixture is equal to a cupful of old yeast. Sour dough bread is made by adding a cupful of flour and a teaspoonful of salt to a cupful of the fermented mixture. If a tablespoonful of sugar is also added the bread will brown better in baking. Sour dough biscuits are made in a similar manner except that more flour is added and the dough made stiffer. The bread or biscuits should be baked in a hot oven.

Sour dough flapjacks must of course be made from much thinner batter than is used either for bread or biscuits.

A permanent supply of the fermented mixture may be kept on hand by replacing an amount equal to that removed at each baking, the "starter" being kept in a jar provided for that purpose.

Yeast Bread.—Add a teacupful of yeast to three teacupfuls of cold water, stir in sufficient flour to make a stiff batter and let it stand overnight. In the morning mix again till the batter is quite stiff. Bake in a well-greased pan in a hot oven.

The variety of yeast most commonly used in camp is known as "potato" yeast and is made as follows: Confine a handful of hops in a small bag and boil with two average size potatoes. Mash the latter when they are well done and add to them two cups of flour. Scald this mixture with the water in which the potatoes were boiled. When this has cooled add to it one yeast cake well soaked in warm water. The yeast cake may be procured at any grocery store.

Salt Rising Bread.—This is not as palatable as yeast bread, but is prepared with less trouble and bakes much more quickly. Scald half a teacupful of meal with half a pint of boiling sweet milk, add sugar and salt to suit, then let the mixture stand in a warm place overnight. Next morning scald a teaspoonful of salt, the same amount of sugar and half as much soda, with a pint of boiling water. Add this to the mixture prepared the night before and stiffen the whole with as much flour as may be required. Mix it quite stiff when it has become sufficiently light after having been left in another vessel hung in a kettle

of warm water. Add a tablespoonful of lard before molding into loaves. Bake in a well-greased pan in a hot oven.

Baking Powder Bread.—Mix a tablespoonful of baking powder and a teaspoonful of salt into a pint of flour. Stir thoroughly until the three are well mixed, then add water or milk and stir again. These should be added in quantities sufficient to make the dough as thick or thin as desired. The dough should be worked or handled as little as possible and should be baked in a well-greased pan in a hot oven. As soon as the water or milk begins to mix with the baking powder a gas forms that makes the bread light. If the dough is worked much this gas escapes before the dough becomes hard enough on top to keep it confined. Heavy bread is the result.

Potato Bread.—Boil four medium-size potatoes for each loaf of bread to be baked. When these are well done mash them thoroughly, then add two teacupfuls of flour and mix. Scald the mixture with the potato water. Knead well and let the dough stand overnight. Knead again the next morning and let it rise before molding into loaves.

Rye Bread.—Use the same sponge as for wheat or "light" bread and let it stand overnight. Then add a teaspoonful of salt, one pint each of sweet milk and water, half a teacupful of molasses or sugar, and stiffen the whole with rye flour. The dough should not be made as stiff as in wheat bread.

Rice Bread.—Boil a teacupful of rice in a pint of water till tender. Add half a pint of milk, then let the mixture cool. When cold add two teaspoonfuls of baking powder, half as much sugar, one-fourth as much salt, and one and one-half pints of flour. Mix well.

Corn Bread.—To a pint each of meal and buttermilk well mixed together add two eggs, two tablespoonfuls of melted lard or butter, one teaspoonful of soda and half as much salt, also well mixed together. If buttermilk can not be secured use water, but instead of using the soda with water a teaspoonful of baking powder should be used. Soda mixed with water or baking powder mixed with buttermilk will not produce satisfactory results.

Soda Biscuits.—Dissolve a level teaspoonful of soda in a pint of buttermilk, then add a heaping tablespoonful of lard and a teaspoonful of salt. Mix thoroughly, then stir in a quart of

flour. Let the dough rise for about twenty minutes before it is placed in a hot oven.

Baking Powder Biscuits.—Prepare the same as for bread and cut or mold the dough into lumps the size desired.

Johnny Cake.—Mix three teaspoonfuls of baking powder, one teaspoonful of salt, half a teacupful of sugar, all mixed well together, with two eggs and two tablespoonfuls of lard. Stir a quart of corn meal into a quart of sweet milk, then add the first mixture and stir again. If sour milk is to be used a heaping teaspoonful of soda should be substituted for the baking powder. Bake in a shallow pan.

Potato Cakes.—Add an egg to three peeled and grated potatoes of medium size, and salt to suit. Mix well together and fry in hot grease.

Rice Cakes.—Add one and one-half pints of flour to the same amount of boiled rice. To this mixture add three eggs, a heaping teaspoonful of butter or lard, one teaspoonful of soda, one teacupful each of sour and sweet milk, and salt to suit. Bake immediately.

Flour Cakes.—Use a quart of flour and sour milk for batter and let it stand overnight. Next morning dissolve a teaspoonful of soda in three times as much water and add it, together with two well-beaten eggs, to the batter. Salt to suit. Water may be used in lieu of sour milk, in which case use a heaping teaspoonful of baking powder instead of soda.

Buckwheat Cakes.—Add a teacupful of yeast to a quart of buttermilk and water, equal parts. Put in salt to suit, then stir in enough buckwheat flour to make a batter and let it stand overnight. Next morning dissolve a teaspoonful of soda in warm water and add it to the batter. Bake immediately.

Corn Meal Mush.—Add meal to boiling water and stir well to prevent lumps forming. Season with salt to suit and make the mush as thick or thin as desired.

Cracked Wheat Mush.—Stir a teacupful of cracked or rolled wheat into a quart of water and add salt to suit. Less boiling will be required if the wheat is soaked overnight.

Oatmeal Mush.—Add four or five tablespoonfuls of oatmeal to a quart of cold water, salt to suit, then boil slowly for half an hour, taking care to replenish the water as it boils away. Unless a double boiler is used the mixture should be stirred continually to prevent burning.

Hominy Mush.—Soak a teacupful of hominy overnight in a quart of well-salted water, then boil for an hour. With cream and sugar this makes an excellent breakfast food.

Cereals.—Nearly all packed cereals may be eaten raw with cream and sugar. However, oatmeal and cream of wheat should be well soaked and then boiled in salt water. This applies also to rice.

Game Meats.¹—Game meats include the meat of the bear, deer, rabbit, squirrel, wild turkeys, ducks and geese, grouse, quails, partridges, and such other birds and animals as may be considered edible. The list may also include opossums, raccoons, ground-hogs (woodchucks), hedgehogs, and snipe, plover, doves, pigeons, and yellow-hammers. Bear meat is at its best when the animal is killed during the autumn months while it is fat and immediately before the animal hibernates. After a season of hibernation the meat is dry and tough, no fat is present, and it is otherwise in such condition as to be far from palatable. Deer meat or venison is best in winter. The choicest parts are those of a fine, reddish-brown grain, such as the saddle, which is that part of the back from the ribs to the hips and which includes the hams. The most common and best method of preparation is by frying. The meat may also be dried and kept for long periods. The meat of an old game animal should be made tender by par-boiling. This is done by boiling it in a strong solution of soda and water for a period of from twenty minutes to an hour. Old animals may be recognized by their lack of plumpness and by their short, yellow, worn-out teeth and scaly claws. Young

¹ The following six rules for sportsmen in the National Forests are quoted from an official poster placed before the public in Sept., 1915:

1. *Prevent Forest Fires.* They destroy the hunting grounds and the game.

2. *Take the Game Law with You.* It may be obtained from any Forest Officer.

3. *Make Sure It's a Buck.* It may be a Doe, a Cow, or a Man. How would you feel?

4. *Wet the Hand Before Removing Undersized Fish.* It prevents breaking the mucous covering and the entrance of fatal molds.

5. *Don't Shoot Harmless Wild Life.* Only Sharp-shinned Hawks, Great Horned Owls, Prairie Dogs, Porcupines, and "Varmints" do more harm than good.

6. *Leave a Clean Camp and a Clean Record.* You may want to come back.

animals have white, sound, short teeth and smooth, symmetrical claws.

Old birds should also be parboiled. They may be known by their scaly legs and claws, their long spurs, if these are present, and the generally rough and more or less bedraggled appearance of their plumage. Young birds have smooth legs and feet, short spurs, and plumage of a healthy appearance.

Domestic Meats.—These include the meat of cattle, hogs, sheep and goats, and domestic fowls. The first is known as "beef" if from animals over about six months old, and as "veal" if from calves. The second comes under the head of "pork," the dried sides being known in many parts of the West as "salt horse" and in the South as "sow belly." Meat from the sheep is known as "mutton," and the same term is usually applied to goat meat as well.

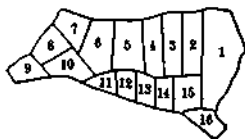

FIG. 193.—Cuts of beef.

1. Neck, or Sticking-Piece.
2. Chuck Ribs.
3. Middle Ribs.
4. Fore Ribs.
5. Sirloin.
6. Aitchbone.
7. Rump.
8. Buttock.
9. Hock.
10. Round.
11. Veiny Piece.
12. Thick Flank.
13. Thin Flank.
14. Brisket.
15. Shoulder.
16. Shin.

Any frozen meat should be thawed in cold salt water before being cooked. Certain portions of most meats, such as ribs and steak, are best when fried. Other parts, usually those including joints or large bones, are best boiled. For the different cuts of beef see Fig. 193.

Fresh beef and mutton are usually secured from private sources in the field, but pork comes in the shape of hams and shoulders or salt sides. Before being cooked, hams, shoulders, and salt sides should be freshened in cold or warm water. This removes a greater part of the salt used in the preservative treatment applied to them at the time they are packed.

Fried.—This method of preparing meat requires so much grease that the average person soon tires of such food, and whenever possible to do so the field man should vary the method of preparation by boiling, stewing, or roasting. In frying meats the pan should have a layer of grease over the entire bottom

of at least $\frac{1}{16}$ -inch in thickness. During the process of frying the meat should also be covered with a pan lid in order to keep in all the heat possible. Proper frying consists chiefly of heating the meat clear through at the earliest possible moment. It should also be turned frequently and not allowed to burn or harden on one side. The grease should be hot when the meat is placed in it.

Boiled.—This is done by dropping large pieces of meat into boiling water and boiling them till the layers of meat may be separated from each other without difficulty. It is a very satisfactory way of preparing joints and pieces of meat surrounding large bones, but is somewhat more troublesome than frying. The water in which such meats are boiled may be seasoned with salt, pepper, or other articles and is then known as soup. Vegetables may be boiled with the meat and the mixture is then known usually as a "stew" or "mulligan."

Broiled.—This method of preparation is usually applied to steaks and large pieces of meat having no bone in them. In such cases the meat is placed on a hot stove or over live coals. The process differs from frying in that no grease is used, and from roasting by reason of the fact that the meat is not allowed to come in contact with the flames. It soon causes the outer portions of the meat to assume a more compact nature, and thus serves to retain the meat juices.

Roasted.—This method is used when cooking utensils are not available, and consists merely in placing the meat near enough to the fire to render the former more tender and palatable by heating it through suddenly. The meat may be held in position by a forked stick or other similar contrivance or it may be suspended from a pot-rack. (See Fig. 194.)

Fish.—Fish taken from clear, fresh water may be cooked as soon as cleaned and dressed, but those which are taken from muddy or stagnant streams should be soaked in a strong solution of salt and water for from one to two hours. This will remove the unpleasant muddy taste when such fish are cooked. Frozen fish should be thawed in cold water to which a little salt has been added. Small fish, such as trout, perch, and small bass, are better when cooked whole, preferably by frying. The larger varieties should first be cut into pieces and then cooked. To prepare fish for cooking, remove the scales or skin, take out the entrails, wash clean both inside and out, and dry clean with a

soft cloth which absorbs water well. Catfish and others having no scales must be skinned. This is done by dipping them into boiling water and holding them there about ten seconds. This has a tendency to cook the skin and separate it from the flesh. If kept in boiling water much longer than that portions of the flesh will be removed with the skin. Eels should be skinned in

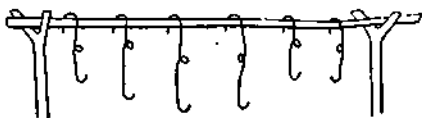

Wire hooks.

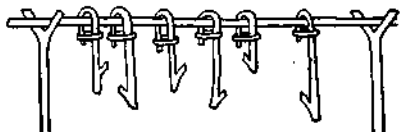

Wooden hooks.

FIG. 194.—Pot-racks.

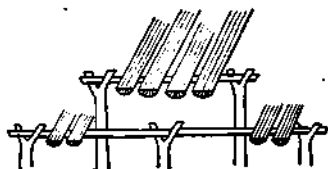

FIG. 195.—Camp table and seats.

a similar manner. After the dipping process has been completed the skin is cut around the neck immediately to the rear of the head and is then stripped backward over the body.

Fried.—Roll the fish in flour, meal, or bread or cracker crumbs and fry in plenty of grease over a hot fire. When one side has been browned to the desired degree turn the fish over and treat the other side likewise. Seasoning should be added to suit the individual taste.

Boiled.—Cut the fish into pieces of the required size and drop them into boiling water. They may be seasoned while being

boiled or the seasoning may be applied at the time they are served.

Eggs.—Fried.—Break the eggs into a separate dish, then slide them into a hot, well-greased pan in such a way that the yolks are not broken. Add salt and pepper to suit. Occasional bad eggs will not be broken in with good eggs if all are broken into some receptacle other than the pan in which they are to be fried.

Boiled.—If soft-boiled eggs are desired they should be boiled three minutes, in very high altitudes five minutes. Hard-boiled eggs require six minutes of boiling, in high altitudes ten. They may be considered as hard boiled when the shells dry immediately after they are removed from the water. One very common method of hard boiling is to place the eggs in cold water and heat slowly to a temperature just below boiling. Half an hour of such preparation is sufficient.

Scrambled.—These are prepared the same as for frying except that the whites and yolks are all beaten together.

Poached.—Slide the broken eggs into boiling water, taking care not to break the yolks. Boil as long as desired and season when served.

Roasted.—Cover unbroken eggs with live coals. Care must be taken to see that the eggs are not burned.

Baked.—Slide broken eggs into a hot and well-greased stew-pan and bake in a hot oven. If no stove is available use the Dutch oven.

Omelet.—Prepare the same as scrambled eggs, and add sweet milk and bread or cracker crumbs till the mixture is as thick as desired. Keep the mixture well stirred to prevent burning and season as desired.

VEGETABLES

Potatoes.—Boiled.—Pare them and cut the large ones in half, wash them thoroughly, then boil them till they offer little or no resistance to a fork thrust into them. When they reach this stage remove them from the fire, drain off the water, then set back over the fire to dry. Season when served.

Mashed.—Prepare the same as for boiling, then mash thoroughly and season when served.

Fried.—Peel and slice thin and fry in grease in a hot pan.

salt and pepper may be added as they fry. If boiled first and sliced when cold they will fry much more quickly.

Creamed.—Cut peeled potatoes in small pieces and boil in salt water, drain, add sweet milk, butter, salt and other desired seasoning, then boil again. Remove them from the fire shortly after the milk boils.

Baked.—Wash clean and bake in a hot oven. The skins need not be removed, but, if tough, should be pricked or punctured at a number of places in order to allow the escape of steam and gases.

Roasted.—Cover unpeeled potatoes with live coals. Care must be taken to see that they do not burn to a crisp.

Beans.—Boiled.—These increase in quantity about one-half when boiled. Remove all dirt, pebbles, and shriveled or decayed beans and wash the sound ones twice in cold water. Add a scant teaspoonful of soda to a half gallon of beans covered with water, boil thirty minutes, then change the water and wash the beans again. After this they should be boiled till all are soft. As the water boils away it should be renewed with boiling water. Cold water will retard the process of boiling. If soda is not available change the water after the beans have boiled about twenty minutes, using fresh cold water.

Onions.—Boiled.—Peel and quarter the onions and drop them into boiling water. Boil the same as potatoes, adding salt, pepper, or other seasoning to suit.

Fried.—Peel and slice the onions very thin, sprinkle with salt, pepper, or other seasoning, then fry in hot grease. These may be fried with potatoes and found to be very palatable.

Fresh.—Cut away the roots and the dead tops, wash carefully and place in cold water to keep them fresh. If the long green tops are not desired they may be cut away at the body of the vegetable.

Green Vegetables.—Boiled.—Wash the vegetables thoroughly and drop them into boiling water that has been salted in the proportion of one teaspoonful of salt to a quart of water. If such water is allowed to boil too long before the vegetables are placed in it they will have a less agreeable taste. This is due to the deposits that the boiling water makes on the sides and bottom of the vessel. Young or fresh vegetables boil more quickly than old or stale ones, but under ordinary circumstances the following table may be followed with generally satisfactory results:

Beans.....	boiled	1	to 2	hours	
Beets.....	"	1	" 5	"	
Cabbage.....	"	$\frac{3}{4}$	" 2	"	
Carrots.....	"	1	" 2	"	
Green corn.....	"	$\frac{1}{2}$	" 1	"	(depending upon its age)
Green peas.....	"	$\frac{1}{2}$	" 1	"	
Parsnips.....	"	1	" 2	"	
Potatoes.....	"	$\frac{1}{4}$	" $\frac{1}{2}$	"	
Potatoes.....	baked	$\frac{1}{2}$	" 1	"	
Sweet potatoes..	boiled	$\frac{1}{4}$	" $\frac{1}{2}$	"	
Sweet potatoes..	baked	$\frac{1}{2}$	" 1	"	
Rutabagas.....	boiled	$\frac{1}{4}$	" $\frac{1}{2}$	"	
Squash.....	"	$\frac{1}{3}$	" $\frac{1}{2}$	"	
String beans....	"	1	" 2	"	
Turnips.....	"	$\frac{3}{4}$	" 1	"	

Rice.—Boiled.—Rice swells to about three times its normal size and doubles in weight when boiled. It should be cleaned the same as beans and then washed thoroughly. Two quarts of water will be sufficient for boiling half a pound of rice. Add a tablespoonful of salt and boil twenty minutes, then drain off the water and place the vessel in another filled with boiling water. Cover the rice and steam it for fifteen minutes, then remove the cover and steam it five minutes longer. If a second vessel is not available boil the rice twenty minutes, then drain off the water, remove the rice from the kettle, sprinkle salt over the sides and bottom of the latter, rub them well with a dry cloth, then replace the rice and set it near the fire to dry and swell. Stirring it breaks the grains. To test it, squeeze a grain between the fingers. If done it will mash easily.

Sandwiches.—Egg.—Use coarse-grated, hard-boiled eggs and spread them on buttered bread. Add salt, pepper, mustard, sauce, or other seasoning to suit, then cover with a second slice of bread.

Ham or Tongue.—Stir the yolk of an egg into finely chopped ham or tongue, then prepare the same as an egg sandwich.

Fish.—Remove all skin or bones and prepare the same as ham or tongue.

FRUITS

Apples.—Baked.—Pare the fruit and remove the cores, fill with butter and sugar, bake in a stew-pan partly filled with water, and after a syrup has formed use it to baste the fruit with.

Stewed.—If dried fruit is to be used soak it overnight in cold water, then boil till done and season to suit.

Fresh fruit should be pared, cored, and quartered, then boiled in a syrup made of water and sugar, one quart of the former to a pound of the latter. Lemon juice or peel, preferably the latter, when added to the fruit improves the taste.

Peaches.—*Stewed.*—If dried fruit is to be used it should be soaked in cold water overnight and then boiled till it is quite tender and done. Seasoning should be added to suit.

Fresh fruit should be pitted, pared, and quartered and then boiled the same as apples. If the skins are to be left on, the fruit should be thoroughly washed and all the fuzz removed.

Prunes.—*Stewed.*—Soak the fruit overnight in cold water, then boil done and season to suit.

Jams.—Use a pound of sugar for every pound of fruit and boil to the desired consistency. Season to suit. Apples and pears should be pared, cored, and quartered; small fruit should be washed clean, then mashed or boiled to a pulp and prepared in the same manner.

Jellies.—These are prepared from the juice instead of from the pulp of fruits. Use a pint of sugar to each pint of strained juice and boil till the required consistency is reached. Huckleberries require less sweetening than any other fruit, while gooseberries require the most.

Pickles.—These are fruits, meats, or vegetables preserved in vinegar. They should never be prepared in tin or iron vessels, since the boiling vinegar may be so affected as to render it poisonous. Only stone jars, glass or porcelain vessels, or enamelware should be used. The last-named should be absolutely free from cracks or bruises where the iron or tin may be exposed to the vinegar. A wooden ladle should be used for stirring and all tin or iron spoons avoided.

Beets.—These should be boiled two hours, then allowed to cool. Pare and slice thin and cover with vinegar into which the desired seasoning has been boiled.

Onions.—Remove their skins and drop the onions into salt brine made strong enough to float an egg. Let them stand twenty-four hours, then remove them from the brine and cover with seasoned boiling vinegar. If the onions are pared under water, juice from them will not reach the cook's eyes.

Mixed.—Add a tablespoonful of salt to a quart each of finely

chopped raw cabbage and boiled beets. Add also a teaspoonful of pepper, a teacupful of finely grated horseradish, and two teacupfuls of sugar. Cover the mixture with vinegar.

Sweet.—For apples, pears, peaches, and melon rinds use as many pounds of sugar as of fruit. Boil the seasoning into the vinegar and use half a pint of this to three pounds of fruit. Cover the fruit with boiling vinegar prepared in this manner.

Ginger Snaps.—Mix together one teacupful of molasses, one teaspoonful of soda, half a teacupful of lard, and as much ginger as desired. Add flour and mix very stiff. Bake in a hot oven.

Fruit Pudding.—Add a teacupful each of sweet milk, minced suet, and molasses to a teacupful of raisins or other fruit. Mix in enough broken bread to make a stiff dough, and then steam the mixture till it is done.

Pie Crust.—Add a teaspoonful of salt and twice as much baking powder to a quart of flour. When these have been quite thoroughly mixed together add enough sweet milk to make stiff dough. Fruit juice will not soak through the crust if the latter is well spread over with a beaten egg.

Pies.—Fruit.—Prepare the crusts as above, place one in the pie pan after the latter has been greased to prevent sticking, put in the stewed fruit, cover with the other crust, close the edges of the two crusts well together, and then bake in a hot oven.

Rice.—Use a tablespoonful of rice for each pie required and boil it till quite done. After it has cooled add an egg and fruit and season to suit.

DRINKS

Coffee.—Pour a quart of boiling water over a liberal handful of ground coffee and let it stand ten minutes before serving. To settle the grounds, pour in about half a teacupful of cold water or drop a handful of snow into the coffee-pot. If such a pot is not available put the ground coffee in the Dutch oven and stir it as it heats. After it has been well heated pour boiling water on it and let it stand five minutes. Strain it through a cloth and then replace the liquid in the oven to keep it hot.

Tea.—Tea should never be boiled. Use a very scant teaspoonful of tea for each cupful required and pour on boiling water. Let it stand ten minutes before using.

Cocoa.—As a general rule it is always more satisfactory to

everybody concerned if each man mixes his own cocoa. This may be done by mixing a teaspoonful of sugar very thoroughly into the same amount of cocoa, then adding as much sweet milk as may be desired for the cup, and mixing it all together until no lumps remain. After this the hot water may be poured into the cup.

Chocolate.—Scrape the chocolate from the cake in a fine powder and then prepare the same as cocoa.

Lemonade.—One lemon is sufficient for two glasses of this drink, and should be of the thin-skinned variety. The tissues may be broken up and the juice released if the lemon is rolled until it becomes quite soft. When this has been done it may be cut in half and the juice squeezed out, or it may be cut in thin slices and pressed. Sugar and cold water are added to the juice in amounts sufficient to make the lemonade as strong as desired.

Beer.—To five gallons of water add half a pint of hops and half a peck (four quarts) of good wheat bran. Boil this mixture till the bran and hops sink. Strain the liquid through a cloth and add two quarts of molasses as soon as it becomes lukewarm. After the molasses has thoroughly dissolved pour the mixture into a keg and add a tablespoonful of yeast. After fermentation ceases cork the keg for a week before using the beer.

CARE OF COOKING UTENSILS

Vessels in which eggs have been prepared should either be filled with cold water and allowed to stand for a short time or be cleaned immediately after the eggs have been removed. Otherwise the eggs will stick and can be removed only with difficulty.

Milk vessels should be scalded when empty, thoroughly dried, and then set away in such a place and in such a manner that dust can not enter them. Unless carefully scalded and kept perfectly clean they soon become odorous and unsanitary.

Vessels in which dough has been mixed should be filled with cold water and allowed to stand for ten or fifteen minutes. This loosens the dough and permits its removal with greater ease. Hot water will only serve to make it stick worse.

Rust, grease, and burned food may be removed from cooking utensils by using common earth or fine sand for a scouring agent. If pans or kettles are allowed to rust, foodstuffs will stick in them and can be removed only by scouring.

Care must be taken not to crack or otherwise injure the enamel on enamelware dishes. Such openings in the enamel permit exposure of the inner metal, and this soon rusts.

Knives, forks, and spoons may be kept clean and bright by thrusting them into the ground a number of times before they are washed, nearly all soils carrying sufficient grit to provide a suitable scouring agent. After these articles have been washed they should be carefully dried and placed where snow or rain can not reach them.

BUTCHERING

It happens not infrequently that field men must act as butchers if they are to secure fresh meat, and it is therefore probable that a general knowledge of the operations involved will not come amiss.

Cattle and hogs are usually killed by being shot or by being knocked in the head. Immediately after this has been done they are bled by a thrust of a long-bladed knife which enters the heart. Such a knife should have a very long, thin point and should be started through the skin at a point just above the animal's breast-bone. In order to secure free bleeding at once, the knife-blade should be aimed directly at the root of the animal's tail. This usually leads it directly into the heart. Unless the blood gushes forth in a stream the heart has not been reached, and a second thrust, possibly a third one, will be necessary.

Cattle are skinned. In performing this operation the skin should first be cut entirely around the legs at or near the hoofs. It is then split from this incision along the inner side of each leg to the middle of the lower side of the body. Afterward the skin along the entire under side of the body is split open even to the tip of the tail. Another incision is made around the neck immediately to the rear of the head, and the skin is then ready to be removed. Usually it is removed from the legs and neck first. It may then be stripped off either to the rear or to the front. After this has been done the body is opened along the under side and the internal organs are removed. A block and tackle should be provided and the body hung up head downward. In this position the interior may be dashed with clean cold water and thus washed out. In hanging the body a 30-inch gambrel should be used. Its ends are inserted in slit-

cut through between the ham-strings and the bones of the hind legs, and it is then hung from the center to a pole or the branch of a tree. It should be of some tough wood and not less than 3 inches in diameter.

Hogs are scalded.¹ This may be done either by dipping the body into boiling water² or by dashing boiling water over it. The object of such scalding is to loosen the bristles so they may be scraped from the skin. After the bristles have been removed the body is hung the same as a beef, and is otherwise treated in a similar manner except that as a general rule the internal organs are not removed until the body has been hung. An 18-inch gambrel 2 inches in diameter is heavy enough to support a 400-pound hog.

Sheep and goats are killed by having the throat cut across back of the jaws and through to the bone in the neck. The animal is placed on its back, the chin is thrust forward with one hand and the butcher then wields the knife in the other. The skin may be removed and the body further dressed the same as that of a cow. Use the same size gambrel as for hogs.

Sheep- and goat-fat may be rendered into tallow, but should not be used for cooking purposes, as it has a very strong and disagreeable odor.

¹ In some States it is a violation of law to skin a hog, presumably because the identification marks in the ears would thus be removed.

² The most convenient method of heating water in the field is by placing large, hot stones in a barrel of water. The barrel should be firmly fixed at an incline to facilitate dipping.

LIVE STOCK

CARE OF HORSES

Horses are not naturally vicious or otherwise incorrigibly inclined, but such characteristics may develop as the result of improper training or treatment, and continually nagging at or unnecessarily annoying an animal is a practice that can not be too strongly condemned. There is a wide-spread idea prevalent that horses can neither think nor reason, but men who have spent years working with or about them will invariably dispute this theory.

Water.—A horse can exist on wonderfully short rations, but it is imperative that he have a certain amount of water. He should not be allowed free access to it, however, while he is extremely warm or fatigued, nor should he be given water immediately after being fed, as in this case the water will carry the grain or forage directly into the intestines before stomachical digestion has been completed. The invariable result of this is colic in more or less severity. The best time to water a tired or warm saddle or work animal is after it has been allowed to rest about twenty minutes and before it is fed. Stagnant or polluted water should never be given.

Feed.—*Grain.*—Various customs of feeding prevail in different localities, and that to which an animal has been accustomed should be followed whenever this is possible. Work animals in the South are usually fed grain and roughage three times a day, but in most parts of the West and Southwest grain only is fed and but twice a day, the animals being allowed to graze at night or at intervals during the day, and thus secure the necessary roughage for themselves.

Green Corn.—This must be fed in very small quantities until an animal's digestive organs adjust themselves to the work of assimilating it. Not more than four ears should be given at a feed and only twice daily for the first two weeks. The amount may then be increased two or three ears. An animal fed green corn should have free access to salt at all times.

Ear Corn.—This constitutes the principal grain feed of the

South, many portions of the North, and practically all parts of the middle West. It is very nutritious, but creates too much heat for a steady diet or for heavy summer work. Moreover, animals unaccustomed to eating it may have considerable difficulty at first in shelling it from the cob, and if they suffer from bad teeth they will have still more difficulty in masticating it. It is bulky and is not satisfactory grain to pack or transport by wagon from camp to camp.

A very common rule for measuring ear corn is by the number of average ears locally considered as constituting a bushel. Eighty selected ears make a bushel in the lower Missouri valley, one hundred and twenty average ears are accepted as a bushel throughout the middle West, but in most parts of the South and Southeast, where climatic conditions are not so favorable to the production of a good grade of corn, one hundred and twenty-five and sometimes one hundred and thirty average ears are considered a bushel. The weight of a bushel of ear corn is seventy pounds, fourteen of which are assumed to be the weight of the cobs.

For medium heavy work, whether pack, saddle, or wagon, eight ears twice a day will be sufficient for a thousand-pound horse, but an animal raised in the South should have an extra similar feed at noon. All worm dust and worm-eaten kernels should be removed. In addition to this amount of grain such animals should be given as much roughage as they will clean up at a feed. Mules should be fed a third less grain and their roughage allowance should be increased in proportion. Burros, of the type commonly used in the West for pack animals, can seldom be induced to eat ear corn, and the same is also true of Western range horses.

Shelled Corn.—This can not be recommended as a satisfactory grain feed. Animals that are tired, warm, or extremely hungry usually eat it too hurriedly and do not crush it fine enough. The result is that a large portion of it enters the stomach whole, where it is not only practically impervious to the digestive juices, but is also subject to such swelling that a severe attack of colic may ensue. Moreover, when it is improperly masticated, it passes through the alimentary canal without supplying the required amount of nourishment, and is therefore a total loss. It is an especially dangerous grain to feed an animal with poor teeth or one that bolts its food as quickly as possible.

However, if no other grain is available shelled corn should be fed very sparingly with a proportionately larger amount of roughage. Two quarts twice a day with roughage will be sufficient. About four average ears will produce a quart when shelled (except where eighty ears are considered a bushel) and will weigh approximately one and three-fourths pounds. Water should never be supplied immediately after an animal has had a feed of shelled corn, but should always be given at least half an hour before feeding.

Oats.—Oats can hardly be surpassed for a steady diet that will impart strength and general health to an animal, and their use is strongly recommended when they can be secured. In most States thirty-two pounds constitute a bushel, thus allowing one pound to the quart. The regular feed should be about four quarts twice or three times a day, depending upon the work being done and the manner of feeding to which the animal is accustomed.

Barley.—This constitutes the chief grain feed in many of the Western States, where it is crushed or rolled and put up in sacks, usually of seventy pounds, although in some localities a sack may hold as much as one hundred and forty pounds. A seventy-pound sack provides from fourteen to sixteen feeds.

Wheat.—In view of the fact that wheat swells when moist, it is not a very satisfactory horse feed, although, after an animal has become well accustomed to eating it, no ill effects follow. However, it is always advisable to have it thoroughly soaked before it is given an animal. The amount given at one feed should not exceed one-half gallon, which weighs approximately four pounds. It is a common grain-feed in the Northwest.

Bran.—This acts chiefly as a laxative, possesses a very low nutritive value, and should be fed once a week merely as an aid in keeping an animal's digestive apparatus in good condition. It should be moistened and mixed until it will not be blown about by the animal's breath. If a scant handful of salt is added to the feed it will prove more appetizing and will be eaten with greater relish. One gallon is sufficient for a feed.

Roughage.—This may consist of green range grass, tame grasses, or hays and fodders. The first is the most common form of roughage in the West, while the other forms are in common use throughout the middle West and all sections of the South.

Range Grasses.—There are so many varieties of these, such as the different grammas, blue grasses, rye grasses, broom grasses, and others, that the subject can not be discussed in detail here. A general treatise on range plants can be secured, and the field man should study it carefully at leisure times.¹

Tame Grasses.—Few of these appear on open range lands, but a large variety will be found in the pastures throughout the East, South, Southeast, and middle West. Chief among them may be mentioned blue grass, Johnson grass, blue stem, crab grass, foxtail, timothy, alfalfa, and clover. An animal should not be allowed free access to any green feed until it has become more or less accustomed to eating it. Wet or dewy clover is especially liable to cause colic.

Hay.—Alfalfa is the principal hay used in the West and Southwest. The first cutting may affect an animal's kidneys, and since an inexperienced person can hardly be expected to distinguish between this and subsequent cuttings he should take care not to feed too much alfalfa hay until he is sure it is having no ill effects. Customarily from twenty-eight to thirty-four bales are considered a ton.

Timothy hay is very common to the South, and can hardly be excelled for a steady roughage diet. From twenty-eight to thirty-three bales usually constitute a ton, although bales may weigh as much as one hundred and twenty or twenty-five pounds in some localities. In such a case sixteen bales are considered a ton.

Clover hay, also common to the South and weighing about the same as timothy, is a very satisfactory roughage if properly cured, but it molds so easily if stored away damp that a large per cent of it is usually unfit for horse feed, although it is apparently relished by cattle.

Any good grade of hay carries a large amount of leaves and blossoms or "flowers," is free from coarse stems, weeds, trash, and other such materials, and is of a bright green color.

Fodders.—These may be whole stalks, tops, or blades of corn, cane, or Kaffir corn. Whole stalks do not make satisfactory roughage by reason of the large amount of waste in the butts.

¹ See Notes on National Forest Range Plants, Part I, Grasses, by the Office of Grazing Studies, Forest Service.

Top fodders and blades are usually eaten up clean and little or no waste remains.

Salt.—Herbivorous animals obtain so little salt in their natural foods and require so much salt in the proper digestion of such foods that it is incumbent upon the field man, or any other stock-owner, to see that it is supplied in sufficient amounts and in such a manner that animals may have free access to it at all times. This can best be done by placing the salt in a box where the animals may lick it as they desire. The rock salt, so much in favor among cattle-owners, is not recommended for horses, the construction of their tongues being such that they can not secure salt from a hard mass as readily as cattle may. Regular table salt is somewhat more expensive than rock salt, but on account of its greater strength and purity and the ease with which a horse may secure it, it is recommended in preference to the rock salt. An average handful once a week will prove sufficient.

SHOEING

Kit.—If a man must shoe his own animals he should provide himself with the kit of tools shown in Fig. 196. This includes

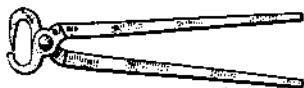

Hoof-parers.

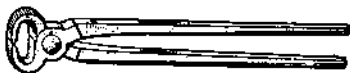

Nippers.

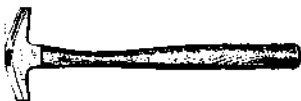

Shoeing hammer.



Paring knife.



Rasp.



Toe knife.



Buffer.

FIG. 196.—Horseshoer's kit.

a pair of hoof-parers, a pair of cutting nippers, a hammer, a paring knife, rasp, toe knife, and buffer, and costs from \$3.50 to \$5.00. The 14-inch parers, rasp, and nippers are recommended. Ordinarily he will be able to secure parers, rasp, nippers, and hammer by requisition.

Before he attempts to shoe an animal he should learn something of the structure and functions of the hoof, and thereby avoid mistakes so commonly made by amateur shoers.

Hoof.—The hoof is provided as a means of protection to the delicate nerves, membranes, and fibers that compose the foot. It is a tough, horny, fibrous substance, the fibers extending vertically and parallel with each other, and secretes an oil the object of which is to exclude external moisture and to retain internal moisture. The growth is from the upper edge or coronet downward and occurs at the rate of from 3 to 4 inches a year. In thickness it varies from $\frac{1}{4}$ - to $\frac{3}{8}$ -inch at the lower edge to about $\frac{1}{8}$ -inch at the extreme upper edge at the coronet.

From the latter edge downward the increase in thickness is rapid to a point about one inch below the coronet from where it is practically uniform to the lower edge.



FIG. 197.

It is generally conceded by horsemen and shoers that white or striped hoofs are not as strong and tough as black hoofs.

Parts of the Hoof.—These are the sole, frog, heel, toe, walls, bars, and coronet.

Each has its particular function to perform, and lameness or other trouble will occur if normal action is interrupted by careless attention or improper shoeing. It is therefore of the utmost importance that each part be given due consideration when old shoes are to be removed or new ones are to be nailed on.

Sole.—This is the portion of the hoof presented to the ground and is thickest at the edges where it meets the hoof walls and thinnest at the center along the edges of the frog. It grows from the sensitive sole above, the dead or worn-out tissues peeling from the under surface in flakes. Lameness will result if the sole is pared away too thin.

Frog.—This extends in a V-shape from the rear of the hoof

to or near the center of the sole, the partly cleft wide end being at the rear. A cleft also extends along either side and serves to increase the flexibility of the sole's connection with the frog. The growth is from the sensitive frog above. Its functions are similar to those of a cushion which prevents jars, and it also acts as a wedge which keeps the heel well spread, thereby maintaining a wider sole base. In unshod horses it prevents slipping or sliding forward or sidewise. It should be left free to come in contact with the ground and should not be pared deeply, since the dead tissues will wear away fast enough against the ground.

Heel.—This is located at the rear of the hoof and is apparently an upward extension and termination of the frog. It acts as a protection to the attachment of various tendons and ligaments, serves as a brace to prevent the hoof from turning sidewise, and provides a cushion which, in conjunction with the frog, absorbs most of the shock in fast or rough travel. It needs no attention in shoeing unless old injuries have caused the formation of large or hard scales or scabs. In that case it may become necessary to remove these in order that they may not hang in brush or rocks and tear out or otherwise injure the hoof.

Toe.—This is the lower forward edge of the hoof. It assists the animal in securing a firm footing and should be especially strong and healthy. The forward or outer upright portion should not be pared away deeply to make it fit the shoe. Such trimming not only causes improper traveling by shortening the toe and causing an animal to "break over" too quickly, but also weakens the hoof seriously. Furthermore, it removes a portion of the hoof wall which secretes the hoof oil and thus allows a certain amount of external moisture to enter and more or less of the internal moisture to escape. It is permissible, however, and even advisable, to rasp away the short, sharp, ragged edge that may project slightly over the shoe.

Walls.—These are the upright portions of the hoof. They serve as a protection to a number of joints and tendon and ligament attachments which occur at a point where compactness of arrangement is essential. Like the edge of the toe they should not be rasped away very deeply, if at all.

Bars.—These appear in the shape of ridges, one along either side of the frog, beginning at the heel wall and extending to the forward end of the frog. They act as reinforcements to t^h

parts of the sole immediately adjacent to the frog and also serve as a means of protection to the sides of the frog. They should not be pared away.

Coronet.—This is found at the junction of the hair and the hoof. Its function is to produce hoof material, and the health and strength of the hoof depend upon its healthy condition. Bruises or slight punctures made in it remain in the hoof wall until the downward growth removes them at the lower edge of the hoof.¹ The most common injury to the coronet, aside from wire cuts and injuries from nails and similar articles, occurs as the result of a bruise, appears in the form of an abscess, and is known as "quittor." (See page 256.)

Holding the Feet.—In holding a forefoot the shoer should place the cannon-bone or pastern joint between his knees as he stands with his back toward the animal's head; a hind foot is held most conveniently if he places the cannon bone over his thigh and allows the pastern joint to rest against his knees. A vicious animal should be thrown or have its forefeet tied up close to the elbows and the hind feet tied to the tail, or fastened as shown in Fig. 198. Blindfolding is also an effective means of control; it may be done by fastening a coat or a feed-sack over the animal's eyes, the coat-arms being tied together beneath its jaws, or the sack-ends thrust under the cheeks of a halter, hackamore, or bridle. The shoer should not touch a blindfolded animal until he has spoken to it and made it aware of his presence. Brutal treatment is never effective and only serves to make a fractious animal less tractable during future operations of shoeing.

Removal of Shoes.—Shoes that have been worn so long that

¹ Strictly speaking, these so-called scars are less in the nature of scars themselves than continuations of scars appearing in the coronet. They bear the same relation to the hoof walls that a crack, ridge, or other unnatural growth resulting from an injury to the matrix bears to the human toe- or finger-nail. Such a growth on the hoof merely indicates that the coronet has at some previous time been more or less severely injured and that its functions have been impaired to a degree which rendered it incapable of producing normal and uniform hoof material at the point of injury. Therefore, originating in an irregular and gnarled condition, that portion of the wall growing from the scarred point of the coronet remains so and thus appears in a form which may lead an inexperienced person to believe that the injury itself extended from the coronet completely through and to the lower edge of the hoof wall.

the hoofs have grown out long and narrow should be removed, and if possible the animal should be allowed to go without shoes for a week or two; this permits the hoofs to wear down evenly and naturally and also allows them to spread and regain whatever shape may have been lost as the result of the shoes' protection. Constant wearing of shoes soon tends to narrow the

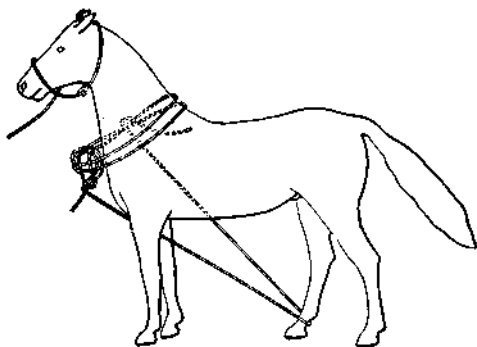

FIG. 198.—Shoeing rig.

hoof and this results in an unnatural strain on the tendons as the animal tries to keep the hoof from tipping.

Clinches should be cut away first, and when this has been done the nippers are forced between the shoe and one side of the heel and the handles are then forced downward. As soon as the shoe has been loosened it may be tapped back into place, leaving the nail head protruding far enough to be seized and drawn with the nippers.

The other side of the heel is then treated in a similar manner, and when the rear nails have been drawn the shoe may be tipped downward toward the toe and the remaining nails pulled. If one whole side of the shoe is removed first and the shoe is then tipped sidewise over the edge of the hoof it may cause the wall to be broken or torn as the nails are forced out.

Leveling the Hoof.—Long edges are cut away with the parers. If the latter are of the variety having only one cutting edge this edge is placed toward the center of the foot, the blunt jaw being brought to bear against the outer side of the wall. When the rougher edges have been thus cut away smaller irregularities

may be removed with the paring knife. Finally the rasp is used, and last, by means of the paring knife, the central portions of the sole are trimmed down till the shoe will rest directly against the lower edges of the walls. If it is allowed to bear against the sole too far in from the walls corns may result.

Fitting the Shoe.—Malleable shoes must be used when no forge and anvil are available. These may be fitted cold and are recommended for use by field men who are not familiar with the use of a forge. The practice of applying a hot shoe to the hoof for the purpose of burning the latter down till it fits the shoe is one to be avoided; the shoe should be shaped to fit the hoof. Preliminary fitting may result in the slight scorching of the hoof, but one or two light applications of the shoe should be sufficient to show what changes must be made in its shape.

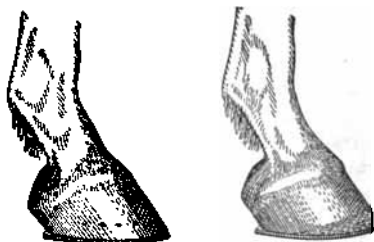

Shoe properly fitted. Toe cut away to fit the shoe.

FIG. 199.

It should be wide enough at the heel to prevent it from resting against the frog, and the outer edges should be flush with the edges of the hoof. For proper and improper fitting see Fig. 199.

Attaching the Shoe.—Under ordinary circumstances it is most convenient to drive one of the rear nails first. Careful inspection of a horse nail will show the point beveled to one side. In driving the nail this bevel is placed toward the center of the foot and thus leads the nail out of rather than into the hoof wall. After the nail has been driven up close, the protruding point is twisted off with the claws of the hammer, and the oppo-

site nail at the rear is driven in a similar manner. Remaining nails are then driven as convenience dictates.

In very flaring hoofs nails should be set slightly outside of a perpendicular to the face of the shoe, but in very straight hoofs it may be necessary to set them either perpendicularly to the shoe or even inside of a perpendicular.

Finishing.—When all the nails have been driven they are “set” securely by holding the buffer against the clinches and tapping the heads sharply with the hammer. Hammering should not, however, be unnecessarily violent. When they have been set, then the clinches are clipped back to not more than $\frac{1}{8}$ -inch in length and are then flattened against the hoof wall after the ragged edges of the nails and the nail holes have been rasped away. All sharp edges extending over the edge of the shoe are also rasped away.

Shoeing Mules.—Mules are shod the same as horses except that differently shaped shoes are used, as shown in Fig. 200.

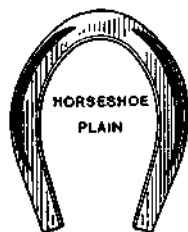

FIG. 200.—Shoes.

This difference is made necessary by the longer and narrower hoof, which requires a broader heel-base for proper support.

Shoeing Saddle Animals.—Many horsemen prefer plain shoes for saddle animals, but for travel in a mountainous country heel calks are recommended. They should not exceed $\frac{3}{8}$ -inch in height and should not be set further than $\frac{1}{8}$ -inch back of the heels. Toe calks are not recommended for saddle animals but are very satisfactory for use on draft animals.

HOBBLING

Double Hobbles.—These may be attached to either the forelegs or the hind legs, although they are seldom used on the latter. They should be buckled about the legs just above or below the pasterns and should not be drawn so tight as to impede circulation of the blood.

A very satisfactory substitute for leather hobbles may be had by using a rope, preferably of cotton. This is looped about one leg, twisted about itself for a distance of approximately 8 inches, then tied around the other leg.

Picket Hobble.—The common practice of buckling a picket hobble to the foreleg is one to be avoided; an animal tied in this manner will invariably throw itself and possibly sustain severe injuries if it becomes frightened and attempts to run. The safest method is to attach the hobble to a hind leg, thus leaving the animal's forelegs free and allowing it greater freedom of motion if it does start to fall. The probability of stifling an animal by attaching the picket hobble to a hind leg is small, a wide-spread belief to the contrary notwithstanding. Furthermore, if a hind leg is hobbled, there is little or no danger of rope "burns" being inflicted on the other legs.

Side Hobbles.—These may be used on an animal that has become so adept in the manipulation of regular double hobbles that they no longer serve as an adequate means of confining it to a limited area.

Ordinary double hobbles are used, however, but the short chain that connects them is replaced by a longer one and the two legs on one side are fastened together. When first used on an animal this chain should be long enough to allow the

legs and feet to assume their natural position as the animal stands still; it is shortened as the animal learns to travel better.

Such a method of hobbling is known in the South as "side lining."

It seldom proves effective on a horse that paces.

Cross Hobbles.—These are attached to the front and hind legs of opposite sides as shown in Fig. 201, and are especially effective when double hobbles or side hobbles fail to prevent

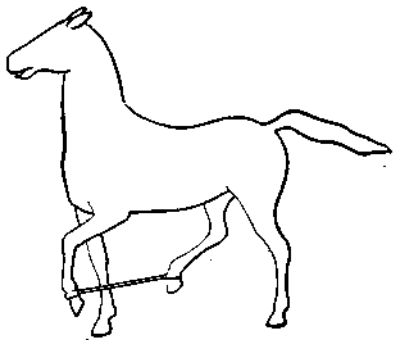

FIG. 201.—Cross hobble.

an animal from straying long distances. The method is known in the South as "cross lining."

Horseshoe Hobbles.—These are for use on an animal that stands quiet while being approached but manages to keep just out of reach and thereby avoid being caught. An ordinary horseshoe is slipped about the leg over the cannon-bone and pushed downward till it fits moderately tight. It usually prevents an animal from running.

Chaining.—This method of preventing an animal from straying or from running away when approached consists merely of linking a chain into a single, or picket, hobble; when the animal starts to run the chain whips the other legs. Such a chain should be about 2 feet long.

An animal that is hobbled should not be picketed at the same time; it is not only a dangerous practice, but is also quite unnecessary.

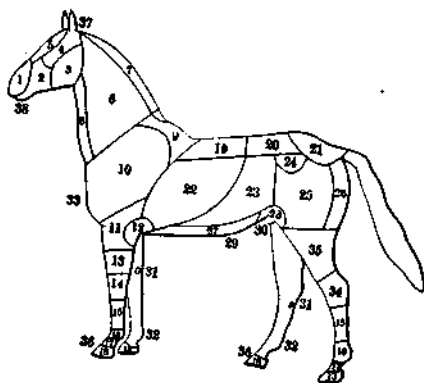

FIG. 202.—Parts of the horse.

1. Nose	14. Knee	27. Belly
2. Cheek	15. Cannon	28. Stifle
3. Jaw	16. Ankle	29. Umbilicus
4. Side of head	17. Pastern	30. Sheath
5. Face	18. Hoof	31. Chestnut
6. Neck	19. Back	32. Fetlock
7. Mane	20. Loin	33. Breast
8. Gullet	21. Rump or croup	34. Hock
9. Withers	22. Ribs	35. Leg or stifle
10. Shoulder	23. Flank	36. Coronet
11. Arm	24. Hip	37. Poll
12. Elbow	25. Thigh	38. Chin
13. Caster	26. Buttock	

DISEASES

1. HORSES

Horses are susceptible to such a multitude of ailments and injuries that a comprehensive treatise on the subject would require a volume too large and too expensive for the field man to carry about in his pack; consequently only the more common diseases, particularly those which may be expected to develop in the field, will be considered here.

Wind Colic.—*Causes.*—Overfeeding, watering while hot, use of feed to which the animal has not yet become accustomed, ordinary indigestion resulting from improper mastication, or systemic disorders. The affection is not contagious, infectious, or in the nature of an epidemic.

Symptoms.—The animal lies down frequently but soon gets up and walks about with short irregular steps and with the back “humped,” it looks back at the sides and flanks, which may be distended or appear bloated, and the bowels are clogged. This condition of the bowels is directly responsible for all the symptoms displayed; gases generated by fermentation of the contents of the stomach and intestines are not allowed to escape, and the result is that these organs soon become distended to an extent that subjects other internal organs to severe pressure and thereby interferes with their normal action.

Treatment.—Apply turpentine to the back immediately in front of the hip “coupling”; such applications may also be made to the umbilicus. (See Fig. 202.) Care must be taken not to rub the turpentine in or to confine it to one spot by means of bandages, or blistering and removal of hair will result. An ounce of chloral hydrate is also good. The animal should be kept rather strenuously exercised, and such other measures as will tend to keep the bowels open should be adopted.

As a general rule wind colic is not fatal.

Many horses are so constituted as to suffer an attack nearly every day, and always on the slightest change of feed.

Spasmodic Colic.—*Causes.*—The chief cause of this affection is the accumulation of large masses of indigested material in the intestines, preventing escape of the gases arising from fermentation, and thereby causing great pressure against the internal organs. This pressure is responsible for the internal pains suffered.

Symptoms.—Similar to those manifested in common wind colic but more pronounced; rolling is more vigorous and more pain is apparent, excessive perspiration may appear, and in advanced stages the ears and nose become cold; spasms of pain are intermittent with brief periods of comparative relief, and each spasm is more severe than the preceding one.

Treatment.—Action must be prompt as soon as the symptoms are recognized. Drench with a quart of warm water into which a teacupful of Epsom salt has been thoroughly boiled. (For Drenching, see page 267.) Repeat the dose if favorable results are not obtained within an hour. Chloral hydrate may also be given, the same as for wind colic.

If neither of these treatments proves effective an attempt should be made to remove the obstruction from the intestines

by hand. A viciously inclined animal may be thrown or it may be tied as shown in Fig. 198. After this has been done and before the operation proper begins, the attendant should have his hand and arm well oiled or greased in order that none of the delicate membranes encountered may be abraded. Ordinarily the intestines are clogged at a point where the obstruction may be reached and removed by hand.

Another method of removing the obstruction, by relaxation of the intestine walls, is to place a twist or a large handful of leaf tobacco as far up in the intestines as it may be forced by hand.

Large injections of warm water may also bring relief.

If none of these remedies gives relief, the animal may be tapped, but this operation should be performed only by a competent veterinarian, and the adoption of such a method by an inexperienced person is not recommended.

Founder.—*Causes.*—This is due, in the majority of cases, to over-feeding or over-watering while an animal is very warm or tired, but it may occur as the result of hard driving over a rough road. It attacks the forefeet, the hoofs of which eventually grow out long and irregular and turn up at the toe; the soles are also affected and may protrude downward to an extent that prevents the edges of the hoof from resting on the ground.

Symptoms.—These are frequently, but not always, preceded by symptoms of colic. The feet are extended forward, and as much of the body's weight as possible is borne on the heels, the hind feet are brought well forward under the body to relieve the forefeet of pressure, breathing may be laborious, pulse rapid, nostrils dilated, hoofs painful and feverish, and the animal may lie down for long periods.

Treatment.—Make alternate applications of hot and cold water to the hoofs for two or three hours; give half an ounce of nitrate of potash in the drinking water twice a day, and provide clean bedding, a roomy stall, and plenty of rest.

Distemper.—This disease (*febris pyogenica*) is confined chiefly to young horses, seldom attacks mules, and generally leaves an animal immune from further attacks. It ranges from an almost imperceptible form to malignant distemper, and is correspondingly serious in its effects.

Causes.—Contact with infected animals or surroundings.

Symptoms.—Slight or marked fever, depending upon the gen-

eral physical condition of the animal, appears first. This is followed by a watery discharge of a whitish color coming from the nose and air passages; there is loss of appetite, sluggishness is noticeable, slight chills occur, the coat is rough and dry and the hair stands erect; the animal has a dejected appearance, and stands with low-hung head and with the ears back. Frequent sneezing or coughing produces sounds which indicate surplus moisture in the lungs and air passages. Repeated attempts to drink result in the greater part of the water being spilled from the mouth, this being due to a sore throat. The discharge from the nostrils gradually changes from a whitish to a bluish color, becomes sticky and thicker, finally turns to a yellowish color, and increases in volume. Cessation of fever indicates a fully developed stage of the disease, and, conversely, the fever disappears at this stage. A swelling at the forward part of the throat distends the parts beneath the jaws and is decidedly puffed and very sensitive to the touch, becoming more so as the disease progresses. Relief is at once apparent as soon as this swelling breaks, and in case it does not break of its own accord it should be lanced when it appears to have reached the point of greatest distention, and the pus allowed to escape.

The discharge from it, and from other abscesses that may appear on the sides of the head or at other points on the body, stops in from two to five days. The animal should experience no permanent ill effects from the disease unless perhaps it may be left a "roarer."

Treatment.—After the discharges have been stopped, provide fresh, clean quarters, clean feed and water, and plenty of rest for complete recovery. Keep the animal warm. To reduce fever give a handful of Glauber salts three times a day.

If infection of other animals is undesirable the sick animal should be kept in secluded quarters at least 100 yards from other stock. Wholesale infection may eventually prove best, however, by reason of the fact that so far as a particular herd is concerned the trouble is over for all time.

Glanders—Farcy.—The average horseman attempts to classify glanders and farcy as two separate and distinct diseases, when as a matter of fact the latter is simply an external indication of the presence of the former. Veterinarians have not yet been able to combat the disease successfully, and the most reliable method of treatment is to kill the animal as soon as it is defin-

itely known to be infected. The disease may be temporarily checked or even forced into a dormant stage, but eventually it reappears and always with fatal results. Such a stage of dormancy may cover a period of months or even years, but no permanent relief other than shooting is possible.

The disease is infectious and contagious, and the animal should be quarantined as soon as the symptoms are recognized. Nearly all State legislatures have enacted laws requiring owners of infected animals to notify certain authorities immediately upon discovery that the disease is present; such officers then make a careful investigation of the case and the infected animal is ordered disposed of at once, the owner being wholly or in part reimbursed for the loss thus sustained.

There seems to be no authentic record of cattle ever having been attacked, but sheep are more or less susceptible, while mules are seldom affected. It may be transmitted to man by contagion or infection, and persons so infected should secure expert medical attention at the earliest possible moment.

The disease is due to a micro-organism called *bacillus mallei*.

Causes.—Either by contagion, or by contact with infected animals or articles used in connection with their care, litter and blankets being especially good vehicles for transmission of the germs.

Symptoms.—Fever, sluggishness, dulness, and a dry, rough coat. Numerous small abscesses appear in the skin, and are known as farcy "buds" or "buttons." Post-mortem examination reveals the presence in the lungs of numerous small punctures caused by abscesses, and these are no doubt responsible for the fatal termination of the diseases.

Treatment.—Keep the infected animal strictly quarantined in sanitary quarters, and supply clean feed, pure water, and complete rest until the proper authorities issue further directions. The quarters, and all articles used in connection with the care of the animal, should be burned immediately after the death of the animal, and the same disposition of the carcass should also be made.

The following remarks on page 119, U. B., 1915, under the subject of disposition of carcasses may prove of interest to persons not familiar with effective means of disposition in such cases:

REG. G-27. The carcasses of all animals which die on the National Forest from contagious or infectious diseases must be burned, and

the carcasses of all animals which die in the close vicinity of water must be removed immediately, and buried or burned.

Comment on this regulation is as follows:

"The carcasses of animals dying from blackleg, anthrax, glanders, and other bacterial diseases scatter germs on the range when they decompose, and a healthy animal may contract the disease. Therefore, to prevent the pollution of water supply and the spread of the disease among human beings, as well as live stock, this rule will be strictly enforced.

How to Burn a Dead Animal.—The destruction by fire of the carcass of an animal weighing perhaps a thousand pounds is not an easy matter. One of the best methods known is to dig a hole as close as possible to the carcass, about 2 feet deep and large enough otherwise to contain it. On the sides of this hole dig two or three small ditches or trenches sloping from the surface of the ground into the hole. These will secure a strong draft, which will aid materially in the success of the work. Having filled this hole with dry wood, piled so as to give the maximum draft, the animal can readily be rolled onto the pile, and with an additional supply of wood placed around the carcass the combustion will generally be almost complete. The earth taken from the hole can then be thrown back into it, covering what few bones are left unburned, and the job will be completed in a very satisfactory manner.

Owners Must Dispose of Dead Animals.—Where the ownership of a dead animal can be ascertained the work of burning or burying the carcass must be attended to by the owner or his employees. So far as practicable forest officers will notify persons of the presence upon the range of dead animals owned by them. Where this ownership can not be ascertained the duty of carrying out the regulation falls upon the local forest officer."

Since man is not immune to glanders, he should exercise the greatest precautions not to contract it. He should not remain in an infected animal's quarters longer than necessary, and should be especially careful not to allow cracks or open sores on the hands to come in contact with any part of the carcass.

Bots.—Horsemen disagree widely as to whether such a disease as bots, as the term is generally understood, really exists, some contending that the symptoms ascribed to the disease are due to other causes and do not indicate that the animal is suffering from "bots."

The disease as recognized by those who insist it does exist usually proves fatal if allowed to progress unattended.

Causes.—Said to be caused by the accumulation in an animal's stomach of the eggs of the "nit fly" or "bot fly." Here a certain process of development produces a worm or grub.

similar to that found in the backs of cattle and known as a "wolf" or "warble." The eggs are deposited by the fly on the animal's hair, and are found in greatest numbers on the inner sides of the fore legs and below the knees, where they appear as minute yellow specks. Their attachment to the hair produces a tickling sensation which causes an animal to nibble at them and thus take them into the stomach through the throat.

As development progresses here they finally attach themselves to the stomach walls, where they remain and increase in size, sometimes to half an inch in length and almost as much in diameter. Post-mortem examination may show them clustered so closely together as to completely hide the walls.

Treatment.—The primary stages are so likely to escape observation that the disease is usually fully developed before it becomes noticeable to the average horseman. The best treatment is of a preventive nature. The animal's stomach should be kept in a healthy condition by frequent doses, administered in the feed, of some article that will assist nature in throwing off the accumulations of eggs. Any good worm medicine will serve the purpose, or a small handful of powdered leaf tobacco in the feed once a month will do as well. Kerosene oil smeared on the animal's legs will repel the flies and at the same time prove so distasteful that the animal will nibble at its legs less.

Pink Eye.—This is a contagious fever and is so designated from the red, swollen eyes incident to it. One attack usually renders the animal immune thereafter, although this rule is not invariable.

It may be transmitted through the medium of litter, blankets, or other articles used about the animal, or may even be carried in the attendant's clothes. Horses from three to five years of age are attacked most severely.

Causes.—Generally results from contact with infected animals or articles used in their care.

Symptoms.—Dulness, violet color of natural openings, partial muscular paralysis, excessive lachrymal secretions that in running down over the sides of the nose may cause blisters, and partial or total blindness or deafness or both. The disease runs from two to three weeks.

Treatment.—Quarantine the animal in clean, well-ventilated quarters, and supply clean feed, water, and litter. Tempt the appetite with vegetables, apples, sugar, or anything the animal

exhibits a special fondness for. Copious injections of cold water will reduce the fever.

Horse Pox.—Horse pox is infectious, occurs chiefly in young horses and generally leaves an animal immune from further attacks. It should not prove fatal if proper care and attention are given.

Causes.—Unsanitary surroundings, such as polluted water, muddy stalls, poor feed and improper care.

Symptoms.—Small eruptions appear generally or locally in from three to four days and are most prominent on the mucous membranes, where they are of a bright-red color, and on the pastern joints where they have the appearance of small bird-shot under the skin. At a later stage a small, yellowish spot appears at or near their center and the eruptions become softer. Scabs appear still later and the pocks are completely healed in from seven to ten days. The eyes assume a reddish, feverish appearance, the pulse is accelerated, the appetite is poor and excessive thirst is apparent.

Treatment.—Feed clean hay, bran mash, vegetables, apples or other articles the animal exhibits a liking for. Protect from cold drafts with blankets. The legs may be protected by being clothed in an old pair of overalls supported from the blanket by pins.

Gangrene.—This exists in two forms known as "dry" and "moist" gangrene. The former will be considered first.

Causes.—Usually due to continuous pressure on one spot of an ill-fitting harness or saddle, but may be caused by forcing an animal to lie in wet, dirty litter.

Symptoms.—Dulled sensory nerves, resulting from dead tissues, dry leathery appearance of the skin and a general condition of drowsiness.

Treatment.—Supply clean litter, adjust the saddle or harness until it fits properly and apply fatty solutions or moist poultices.

Moist gangrene is characterized by swollen, inflamed, and moist skin, and the secretions produced may result in spreading of the affection unless properly controlled. After sloughing stops, treat the same as for dry gangrene.

Rabies.—The only available treatment for this disease is to kill the animal so affected. So far as known, there is no remedy that will check or cure it.

Causes.—Usually transmitted by the bite of an infected animal.

but may be contracted through contact of an open sore or wound with the slavers of such an animal.

Symptoms.—If resulting from a bite, the wound may heal over outside and appear to be properly healed inside. Internal healing, however, is not complete and usually produces such a sensation that in its attempts to secure relief the animal finally reopens the wound with its teeth. The most noticeable symptoms generally manifest themselves within about a month after the disease has been contracted, although instances have been known where no symptoms were developed until six or eight months or even a year afterward. Severe spasms occur at irregular intervals between periods of calmness and little apparent suffering and are so intensely painful and so affect the nervous system that the animal loses all control of itself. It rears, plunges, strikes, bites, and kicks at other animals or its stall or manger,¹ suffers from the most rigid contractions of the muscles, is extremely irritable and vicious, the eyes are blood-shot and the vision is affected, assaults on the stall may be made with such insane vigor that broken teeth or even broken jaws may result, and in its crazy rearing and plunging the animal usually brings about its own death by self-inflicted injuries.

Treatment.—The animal should be shot and put out of its misery at once. The carcass should be burned (see page, 244, Glanders—Farcy) or buried at a sufficient depth to prevent its disinterment by hogs or other animals.

The attendant should exercise the greatest care in venturing close to the animal during its periods of calmness. There is absolutely no means of knowing how long such a period may last. It may continue for hours or it may pass within a few minutes.

Blind Staggers.—*Causes.*—Generally due to the use of feed that is wormy, musty, or sour. Results are usually fatal.

Symptoms.—The most prominent symptom, from which the disease derives its name, is partial muscular paralysis which causes the animal to stagger about in an aimless or erratic fashion. It may rear, plunge, kick, or bite, or show other indications of a disordered brain, or have spasmodic fits or spasms, and usually dies within a few hours.

¹ Many veterinarians claim that inanimate objects are never attacked. In three different cases observed by the writer the manger has been severely damaged by the infected animals.

Treatment.—In most cases the primary stages go unobserved, and after the later stages have developed little can be done to secure relief. An experienced veterinary may handle the case successfully if called in time. Otherwise there is little hope of recovery.

Lampas.—This disease is generally known as “lampers.”

Causes.—In young horses, cutting teeth; in old ones, impaired digestive powers, or inflammation of the hard palate.

Symptoms.—The roof of the mouth is swollen downward and in an aggravated case this swelling may continue to such an extent that it projects beyond the ends of the upper teeth. The animal will quite often be noticed rubbing the roof of its tail against trees and buildings or posts.

Treatment.—Lacerate the affected parts slightly with the point of a sharp knife and produce moderate bleeding. Bathe the lacerations in a solution of alum water, using a dram of alum dissolved in a pint of warm water. Continue the treatment until the wounds have healed. Give only soft feeds, and keep fresh, cold water before the animal at all times. If lampas results from indigestion, remove the cause.

Injuries and Other Ailments.—The most common injuries to which horses are subject in the field are lameness, external or internal poisoning, burns, cuts, bruises, and abscesses in their various forms.

Lameness.—*Causes.*—Lameness may result from any one of a number of causes. An animal may step on an irregular stone and twist or sprain one or more joints; hard riding or heavy work may result in strained or displaced tendons; sharp blows or even apparently slight bruises may cause severe lameness, or continued travel through very muddy country may have the same effect.

Symptoms.—Lameness in a fore leg will be indicated by quick upward motions of the animal's head when the weight of the body comes on the injured member and the weight will be shifted to the opposite member as quickly as possible. This causes the animal to take short, quick steps with the lame leg, and as soon as the weight of the body has been transferred to the other leg the head and neck will be dropped. If lameness occurs in both forelegs the steps will be unnaturally short and quick on either side, the head will be held high, the shoulders will be kept rigid

and the hind feet will be kept well under the body in order to relieve the fore legs of as much weight as possible.

If lame in a hind leg the animal will object to backing and the hip corresponding to the injured leg will have a greater upward and downward motion when the animal travels. When both hind legs are affected backing will be still more painful and all the weight possible will be thrown on the front feet. This causes the head to be extended and held low.

Lameness in the heel or ankle is indicated when the foot is held forward or kept suspended above the ground. The animal moves with reluctance, and upon being allowed to remain quiet will immediately assume the position mentioned.

Shoulder lameness is indicated when the point of the hoof, or the toe, is rested on the ground. In such cases the foot is seldom extended forward but the knee is usually bent.

The same symptoms indicate lameness in the elbow joint.

If lameness occurs in the knee or hock the joint is held as rigid as possible and bent only when the animal is forced to do so.

Lameness in the hind legs is much more serious than in the fore legs, and if hip lameness is apparent the horse may be considered worthless, since the disease can not be cured. If there is reason to doubt the existence of hip lameness rap the hip-bone sharply. The affection will be indicated by a sudden flinching of the animal.

Treatment.—The best general treatment for any lameness is alternate applications of hot and cold water. Bandages should be used. Such treatment should continue for from one to six hours, depending upon the severity of the injury. Afterward the injured parts should be bathed twice a day with equal parts of turpentine and camphor, but this should not be rubbed vigorously or confined by means of bandages, or blistering and removal of hair will follow. This treatment should be continued for from one to six or seven days.

Internal Poisoning.—*Causes.*—This may result from mistakes made in filling prescriptions for medicine to be given an animal, may be caused by the animal eating loco weeds or other poisonous plants, or may result from snake bites or from numerous insect stings.

Symptoms.—The general symptoms of poisoning are thirst, laborious breathing, convulsions, nervousness, staggering, wide-spread feet, external swellings if due to snake bites or insect

stings, accelerated pulse, and bloating and dysentery accompanied by large quantities of mucus.

Treatment.—Drench with half a pint of cinchona in a quart of lukewarm water. Repeat the dose every five minutes until relief is secured.

Loco Poisoning.—*Causes.*—This poisoning is caused by animals eating a weed known as the “loco” or “rattle” weed, of which there are two principal varieties. These are the varieties known as *Aragallus lamberti* and *Astragalus mollissimus*. The former poisons sheep and cattle and the latter poisons horses. Cattle and horses do not as a rule relish the weed, but since it appears early in the spring before other green forage can be obtained they soon form the habit of eating it.

Symptoms.—These do not appear until a large amount of the weed has been eaten, after which the animal's eyes assume a glassy appearance; it is extremely nervous and often vicious, steps quickly and with unnaturally high movements of the knee and hock joints, and upon being suddenly startled or aroused may have convulsions. In the final stages of poisoning the stomach walls are so affected as to be unable to perform their functions and the animal soon weakens and dies.

Treatment.—Loco poisoning can not be treated successfully in its advanced stages. During the primary stages affected animals should be restricted from range areas in which the plant occurs. In addition to this horses should be given one-half ounce of Fowler's solution of arsenic once a day. Cattle should be given from one to three grains of strychnin a day. Sheep should be given one-third that amount of strychnin.

Poison Wounds.—*Causes.*—These may be due to the bite of a snake, tarantula, or centipede, or to numerous tick bites or insect stings. In all cases their treatment is the same.

Symptoms.—Partial muscular paralysis causes staggering, falling or other similar action; stiffness appears in the limbs, which are held wide apart; the head is hung low, thick, difficult breathing is prominent, and convulsions may occur. In most cases a swelling forms about the wound.

Treatment.—Locate the wound as soon as possible. If caused by a snake bite and bleeding is not profuse, make it so by an incision in the wound and allow the blood to flow freely for about five minutes. If the bite is on a limb apply a tourniquet after profuse bleeding has been secured. This may be impro-

vised from a halter- or picket-rope, bridle rein, or a string from the harness or saddle. By thrusting a stick beneath it and twisting the tourniquet up tight poison may be prevented from entering the circulatory system. However, the tourniquet will interfere with bleeding and should not be applied until after bleeding has stopped. Wash the wound thoroughly with water, into which a few drops of carbolic acid have been put, and then apply turpentine, ammonia, or kerosene oil and salt. Permanganate of potassium is also very effective, even for man. Allow the animal two or three days for rest.

If due to numerous insect stings, the symptoms in severe cases are similar to those resulting from snake bites. Bathe the animal in a strong solution of soda and water, rubbing thoroughly and vigorously to insure contact of the solution with the wounds, and then allow a good rest.

In removing ticks from an animal's body care must be taken to see that their heads are not left in the skin or serious complications may ensue. Vaseline, bacon grease, or lard smeared over the ticks will cause them to loosen their hold and drop off.

Burns.—Burns of different degrees of severity demand different treatment, yet in all cases the treatment must be such as to keep the air from the wound. This should not be done by means of bandages unless circumstances absolutely demand it, and then the bandages should be light enough and of a sufficiently coarse weave to allow the animal heat to escape from beneath them. Ointments, such as carbolated vaseline, or others of the consistency of syrup, will be found most satisfactory. In severe cases, after the wounds have been washed carefully, an application of alcohol, eggs, and milk will be found effective. The whites of two eggs should be thoroughly mixed into a pint each of alcohol and sweet milk. This mixture should be applied twice each day. Castor oil also makes an excellent dressing for burns and can be secured at any drug store.

Very slight burns need no treatment except careful washing. Applications of castor oil will do them no harm.

Cuts.—A general idea of the severity of a cut may be determined from the manner in which blood flows from it. Arterial bleeding is indicated by strong regular spurts of bright-red blood, and such a cut should be given prompt attention. A tourniquet should be used when possible. In arterial bleeding it is applied between the wound and the heart and twisted tight. (See

Poison Wounds, *Treatment*, page 251.) This retards the flow of blood and permits the attendant to dress the wound with less difficulty. If coagulation or clotting does not occur within a reasonable length of time, ligation should be resorted to. This is done by securing the severed artery ends and tying them shut with a thread, preferably of silk. This may appear to the inexperienced as a dangerous procedure, but nature will soon provide means whereby circulation will not long be impeded.

If a vein has been cut that fact will be indicated by a slow, steady flow of dark-colored blood, and coagulation will soon stop, bleeding in an ordinary case. If a tourniquet is necessary it must be applied at a point which brings the wound between it and the heart. This is due to the fact that the veins carry the blood back to the heart.

Blood which slowly oozes from a cut in numerous small drops or a few large ones indicates lacerated capillaries, and the wound needs no attention other than dressing.

Care must be taken in dressing any cut to see that it is washed clean, and its subsequent treatment should be such as to preclude any possibility of infection. Frequent applications of turpentine will serve to destroy germs, and a mixture of turpentine and camphor, equal parts, will remove soreness. When turpentine is used alone grease should be smeared on the hair around the cut. Otherwise removal of the hair will result.

Proud Flesh.—*Causes.*—This may occur as the result of improper attention and consequent infection of a cut or it may be due to systemic disorders or constitutional weakness.

Symptoms.—Proud flesh may be identified by its pink, frothy appearance. If present under the skin the latter will be swollen and sensitive and will not readily resume its former outline after being pressed into.

Treatment.—Apply burnt alum or granulated sugar twice daily. To burn the alum place it in an inverted lard-pail lid or in a tin-cup or can, and heat it. When cool pulverize the ash and sprinkle this over the affected parts. Bandages should not be used to confine it. Sugar is likewise sprinkled on the parts.

Bruises.—*Causes.*—Blows, kicks from other animals, falls, and similar accidents.

Symptoms.—External swellings may appear or no visible symptoms whatever may be present. For this reason the degree of

severity of a bruise can be determined only by speculation, unless the accident has been witnessed by the attendant or other persons. As a rule, however, lameness and stiffness appear, and unless experienced in such matters the horseman may conclude that certain tendons or ligaments have been strained.

Treatment.—Make frequent applications of hot water to the affected parts, follow with applications of cooler water, and finally use cold water. Continue the treatment until the soreness has disappeared.

Punctures.—*Causes.*—Stepping on nails, pieces of glass, stubble, or other sharp objects long enough to penetrate the sole of the hoof and injure the inner sole.

Symptoms.—These may not appear until weeks after the accident, and then lameness may develop. In many instances the outer portion, or the point of entrance to the puncture, heals over and is not discernible to a casual observer, and the animal's lameness may be ascribed to any one of a dozen different causes, none of which is responsible for the trouble.

Treatment.—Give the sole of the hoof a thorough examination for openings and, if necessary, remove the shoe. When the opening has been located trim it out funnel-shape and allow the pus to escape. Turpentine may be injected with a small syringe and infection prevented. Keep the wound open and clean until no more pus forms. The entrance of dirt may be prevented by binding a tow sack about the hoof and under the sole.

Abscesses.—*Causes.*—These are caused in most cases by blows inflicted at such a point on the body and in such a way that the deadened tissues can not escape, but decay and form pus under the skin.

Symptoms.—A swelling appears at the point of injury, and when pressed is found to be filled with a soft, watery fluid. Extreme sensitiveness is apparent and the skin is feverish.

Treatment.—As a general rule abscesses break of their own accord and the pus escapes through the opening. If, however, it appears that the swelling has reached its point of greatest distension and no opening occurs, it should be lanced. This may be done by thrusting the point of a knife-blade through the skin at a point where complete drainage of the abscess may be obtained. Keep the wound open as long as pus flows and inject one or two drops of turpentine twice a day. If an offensive odor is present apply hydrogen peroxid twice daily until "boil-

ing" no longer occurs. Hydrogen peroxid disinfects only in surface wounds where it is exposed to the air. On deep lacerations use a carbolic or coal-tar disinfectant.

Harness and Saddle Galls.—*Causes.*—These are the result of the use of improperly fitting harness and saddles and are in the nature of abscesses.

Symptoms.—Similar to those of other abscesses except perhaps the hair may be worn off and the skin may appear red and inflamed.

Treatment.—Since they are of the same nature as other abscesses they should be treated accordingly. Wash with clean water, into which a few drops of carbolic acid have been put; then treat with applications of turpentine and camphor, equal parts. The animal may be worked during treatment if the wounds are kept clean and the harness or saddle kept in a similar condition and properly fitted. The animal should, however, be given a complete rest if the galls fail to respond to this treatment.

Sitfasts.—*Causes.*—These result from continuous pressure of a harness or saddle on one spot, often extend deep into the flesh or muscles, and are similar in nature to corns on the human foot.

Symptoms.—A hard, almost horny, growth appears on the flesh, is bare and leathery and very sensitive, and increases in size as the animal is used.

Treatment.—Some horsemen claim that sitfasts can be removed only by freezing and, in accordance with that theory, turn affected animals on the range during the winter months. Under certain conditions this treatment might possibly prove effective, but where cures are obtained in such cases they are undoubtedly due more to the rest than to the freezing. The growths may be removed with a sharp knife or razor and with but little discomfort to the animal. Antiseptic precautions should be observed and the animal given a complete rest until recovery.

Fistula.—*Causes.*—This trouble, known generally as "fistulo," occurs at a horse's withers as the result of an ill-fitting harness or saddle. It is of the same nature as any abscess and should be treated accordingly. (See Abscesses, *Treatment*, page 254.)

Most horsemen limit the term "fistula" to its meaning as applied to this particular trouble. As a matter of fact any abscess bearing tubes or "pipes" leading to an internal cavity is a fistula, regardless of its location on an animal's body.

Poll Evil.—This is another abscess which appears at the back of the head between or behind the ears as the result of a bruise sustained from a blow against low, overhead beams or other similar articles. Treat the same as any abscess.

Quittor.—This abscess appears at the coronet of the hoof. (See Fig. 202.) It, too, is caused by a bruise and should be treated as any abscess.

Sweeney.—*Causes.*—This is an atrophic condition of the shoulder muscles and is caused by lack of exercise of those muscles, such as when an animal, suffering from lameness or other injuries, stands for long periods on one foot, leaving the muscles of the shoulder corresponding to the opposite leg in a continually relaxed condition.

Symptoms.—Gradual withering away of the shoulder until it presents a perceptibly shrunken appearance, tightness of the skin against the flesh of the affected shoulder, extreme pain when the animal is forced to use the affected member.

Treatment.—Unless injury of the leg is so severe as to preclude such treatment, force the animal to stand on it. This may be done by tying the other leg up to the body. Seize the skin of the shoulder and pull it outward from the flesh. A sharp, crackling sound will be produced and indicates the tearing away of deadened tissues. The operation will cause the animal considerable pain, but will eventually prove beneficial if repeated twice daily. Apply powdered May-apple root in the form of an ointment, made of as much of the root as will lie on a dime, mixed into half a teaspoonful of lard. Unless the lard is used blistering will result. Ten cents worth of the root will furnish enough for twenty or thirty applications. One application should be sufficient.

Scratches.—*Causes.*—This is caused by forcing an animal to stand in wet, dirty litter or manure, or by overfeeding on grain or unwholesome forage or anything which tends to derange the system.

Symptoms.—The skin on the fetlocks appears swollen and inflamed, cracks may appear in the skin and extend through to the flesh and a general tenderness and soreness of both will be apparent.

Treatment.—Provide clean quarters for the animal to stand or lie in, clip the hair from the fetlocks and apply carbolated vaseline or castor-oil to the skin three times a day.

2. CATTLE

The cattle industry requires a large amount of the average field man's attention on most National Forests and it is therefore imperative that he familiarize himself, to a certain extent at least, with conditions which directly affect the stock in his district. Badly diseased cattle are seldom found on the open range, but certain ailments to which cattle in all sections of the country are subject may be met with, and the field man should be able to take immediate steps looking to the cure or to the prevention of further infection.

Only the most common diseases will be considered here.

Bloat.—*Causes.*—This is a form of acute indigestion and may result from any one of a number of causes. Chief among these are overfeeding, feeding too much wet or frosty grass, or allowing access to large quantities of cold water when the paunch is full. Impaired digestive powers may also bring on the trouble.

Symptoms.—Great uneasiness is apparent, belching occurs, excessive secretions of saliva cause "slobbering," the animal staggers and the eyeballs protrude unnaturally. The left side is greatly distended and, when tapped or thumped, gives back a hollow, drum-like sound. Difficult breathing occurs as the result of unnatural pressure of the digestive organs against the lungs.

Treatment.—Drench with a tablespoonful of aromatic spirits of ammonia in a pint of water, or a teaspoonful of turpentine in a pint of raw linseed-oil, or two tablespoonfuls of common soda in a pint of water. If these remedies fail the animal should be tapped. This is done by thrusting the point of a sharp knife-blade through the skin and the wall of the paunch at a point immediately before the left hip-bone and half-way between it and the last rib. As the gas escapes from the paunch the latter will recede from the skin, and unless a pipe-stem, quill, or similar article is inserted in the two openings they will no longer coincide and the escape of gas will be prevented. The regular instrument used by veterinaries for this purpose is known as a "trocar."

A knife should be used only when no trocar is available. The wound will heal without treatment.

Bloat occurs quite frequently in calves, and as a general rule is the result of overfeeding after they have missed a meal or two. They should be drenched with a pint of raw linseed-oil, or four

tablespoonfuls of castor-oil, or half a pound of Epsom salt dissolved in warm water.

Loss of Cud.—This is not a disease, but is an indication of a disordered digestive system. Feed bran mash and vegetables or other easily digested foods and keep the digestive organs in proper condition.

Black Leg.—*Causes.*—This disease, also known as symptomatic anthrax, is caused by a germ called *Bacillus anthracis emphysematosa*, which means "air bloated." Formerly, it was generally believed to infect most severely such cattle as ranged on low, marshy areas, where stagnant water or periodical floods occurred. In recent years, however, many veterinarians doubt if such lands have any direct influence on the disease's appearance. Thrifty, fat young cattle, from six to twenty-four months old, are most susceptible, although older cattle may be attacked. Infection is not, as generally supposed, transmitted through the alimentary canal, but the germs usually enter through wounds made by thorns, barbs, cacti, and other sharp-pointed agents. The germs multiply only in the absence of oxygen, and large wounds are not, therefore, necessarily sources of infection. Black leg should not be confused with anthrax. The latter is caused by the germ *bacillus anthracis*, and attacks cattle of all ages, all domestic animals, and even man.

Symptoms.—If germs have entered through abrasions of the skin of the mouth the latter as well as the tongue will be so swollen as to cause the tongue to protrude. In addition to the protruding tongue a high fever will result if the germs have entered at other points on the body. This will be accompanied by rapid respiration and loss of appetite and the animal will move with difficulty. These symptoms are followed by the appearance of tumors which, when pressed, give back a crackling sound. Thick, dark blood may also ooze from the skin covering the tumors and the latter will be filled with gas.

The tumors in anthrax proper are hard and show no indications of containing gas.

Death usually results in from six to forty-eight hours. Carcasses should be burned, as should also the litter or bedding upon which the animal has lain or been treated. (For burning of carcasses, see Glanders-Farcy, page 243.)

Treatment.—Prevent access to range in low marshy areas, where pools or puddles of stagnant water may appear or where

periodical floods may occur. The disease may be successfully combated, or at least checked, by any one who understands the use of virus,¹ but ordinarily the average person can do little except to administer three times daily a dram of carbolic acid well diluted in water. (For measurement of medicine, see page 349.)

Mange.—*Causes.*—This disease, sometimes known as “cattle scabies,” is caused by the presence of a parasite known as *Psoroptes communis*, var. *bovis*, which appears in greatest numbers in the skin of the neck and shoulders and about the root of the tail. The bite produces an itching sensation which causes the animal to rub or scratch until the hair is often removed and scabs appear.

Symptoms.—Continual scratching or rubbing, gray or brownish scabs, thick, hard, dry, wrinkled skin.

Treatment.—Dipping is the most effective treatment. (See Mange, page 263.) A second dipping in ten or twelve days is often required to kill the mites which may have hatched after the first dipping.

Cow Pox (Variola).—*Causes.*—Cow pox results from improper action of the organs intended to keep the skin in a healthy and normal condition.

Symptoms.—Small nodules, about the size of buckshot, appear in the skin of the udder. These either break and form open sores or else they dry up and form scabs.

Treatment.—Cow pox is of a self-limited nature and requires no treatment unless it appears advisable to remove soreness and this may be done by frequent applications of carbolated vaseline or of turpentine and camphor, equal parts.

Lump Jaw (Actinomycosis).—Under extremely favorable conditions, such as a generally weakened physical state after calving, this may be transmitted to other cattle but should not be considered as invariably contagious.

Causes.—Due to the action and development of a vegetable parasite or fungus (*Actinomyces*), frequently found on grain husks and other vegetation. All domestic animals, and even man, may be affected.

Symptoms.—The most prominent symptom, and the one from

¹ Government vaccine may be obtained free of charge from the U. S. Department of Agriculture, Washington, D. C.

which the disease derives its name, is the appearance of a large tumor on the jaw, although other tumors may appear at different parts of the body. Final development of the tumor on the jaw usually results in death, as the animal soon loses the use of its jaws and virtually starves to death.

Treatment.—Mix four tablespoonfuls of iodide of potash in a pint of water and administer in about eight equal doses at the rate of one per day. Discontinue the treatment for a week; then repeat and continue alternate weekly treatment as long as necessary. Action of the medicine will be indicated by scales on the skin and discharges from the eyes and nose.

Tuberculosis.—*Causes.*—Generally due to unsanitary surroundings.

Symptoms.—Cheese-like nodules appear in the tissues of the body. Other prominent symptoms are a dry, rough coat, difficult respiration after moderate exercise, coughing, tight appearance of the skin, and loss of appetite and flesh. Breathing is intensely laborious in the advanced stage and may be accompanied by moaning, severe attacks of coughing occur, the extremities are cold and physical exhaustion is almost complete.

Treatment.—Tuberculosis may be checked by injections of tuberculin, but this should not be attempted by an inexperienced person.

Foul Feet.—*Causes.*—May be caused by forcing an animal to stand in dirty, muddy quarters, or may result from ranging it on soft ground where necessary wearing away of the hoof is prevented.

Symptoms.—The disease appears in various stages, from small cracks in the skin to separation of the hoof and foot, and may even result in loss of the bone.

Treatment.—In slight attacks wash the wounds with carbolic acid and water, 1 to 50 parts, then apply turpentine and camphor, equal parts, twice daily. If the attack is severe and formations of pus are apparent beneath the wall or edge of the hoof, bore through the hoof wall with a gimlet or small knife-blade at the point of greatest distention and allow the pus to escape. Use a small syringe to inject the turpentine and camphor, keep out all dirt and filth, and see that the pus is allowed to escape as fast as it forms. Keep the animal on dry ground until recovery is complete.

Foot and Mouth Disease.—*Causes.*—Generally due to use of

contaminated range upon which cattle have been grazed too long.

Symptoms.—Increase in temperature may occur even though the animal shivers, the hair is rough and dry, and extreme soreness is apparent between the claws. In from four to eight days a practically continuous blister covers the lining of the mouth and excessive secretions of saliva result. At this stage the hoofs may loosen.

Treatment.—Drench with a pound of Epsom salt dissolved in boiling water and administered while lukewarm. Wash the mouth with hydrogen peroxid diluted to half-strength; see that the feet are perfectly clean; then apply turpentine and camphor, equal parts, to them till all soreness disappears. (For Drenching, see page 267.)

Another effective treatment is to wash the mouth with a 100 to 1 solution of coal-tar dip and stand the animal in a trough containing a 20 to 1 solution of the same mixture. Disinfect thoroughly.

Milk Fever.—*Causes.*—This disease is not really a fever but partakes more of the nature of apoplexy and is peculiar to calving, fat cows being especially susceptible. Costiveness, lack of exercise, or rich feed may also cause it.

Symptoms.—Partial paralysis of the hind quarters, staggering, difficult breathing, high pulse, insensibility to pin pricks or other ordinary pain.

Treatment.—Give a scant tablespoonful of nux vomica every two hours by placing it on the tongue. Decrease the dose as soon as spasmodic muscular action appears. A physic should not be given, as it is slow in action and may even prove injurious. One treatment is to remove the urine by means of a catheter and empty the intestines by large injections of warm water. Another remedy, having a record of over 96% cures, consists of inflating the udder with sterilized air or oxygen or even water. This is given by means of a specially constructed kit which may be secured through any veterinary.¹

Choking.—*Causes.*—Attempts to swallow rags, blocks of wood, pieces of leather, or similar articles. It may also occur when dry coarse feed is used.

¹See Cir. 45, Bureau of Animal Industry, U. S. Department of Agriculture, Washington, D. C.

Symptoms.—Attempts are made to disgorge the obstruction from the gullet, the flanks are drawn in at short intervals, the back is "humped," and excessive slobbering occurs.

Treatment.—Drench with a pint of raw linseed-oil if the obstruction can not be broken up by kneading or squeezing. As long as the drench is returned through the nose the obstruction remains stuck fast. As a last resort "swabbing" may be necessary. Tie the animal in such a way that the extended head is in line with the neck, wrap one end of a flexible $\frac{1}{2}$ -inch stick with a well greased cloth, then thrust it down the throat and force the obstruction into the stomach.

Warbles.—**Causes.**—These are caused by two kinds of bots, viz.: *Hypoderma bovis* and *H. lineata*, which deposit eggs under an animal's skin. The larvæ increase in size until elliptical swellings, sometimes as large as walnuts, appear in and under the skin. These are known in many localities as "wolves." In others they may be confused with "screw-worms," which are the larval stage of a fly, *Comptosmia macelleria*.

Symptoms.—Swellings appear generally along either side of the backbone or even well down on the sides, the animal moves about as little as possible, and a generally drowsy appearance is noticeable.

Treatment.—Force the larvæ out by squeezing the swellings between the thumb and finger. If the opening in the swelling is too small to permit such ejection, it should be enlarged with a sharp knife. In event the larvæ can not be forced out they should be killed by being punctured with a needle. Afterward a drop of turpentine or gasoline may be injected into them. Ordinarily, two or three drops of turpentine should be placed in the wounds after the larvæ have been removed.



FIG. 203.—Reuff's method of casting.

Screw Worms.—These appear in open wounds and are especially active in rainy weather. Infected animals should have the affected parts bathed in turpentine, gasoline or chloroform.

Throwing Cattle.—When operations to be performed on cattle require them to be thrown, gentle animals may be tied as shown in Fig. 203, which represents what is known as "Reuff's Method of Casting." A rope is tied about

the animal's neck in such a way that strangling will not occur and two half-hitches are then taken about the body, one immediately to the rear of the fore legs, the other directly in front of the hind legs. The loose end of the rope is then pulled steadily backward until the animal lies down, after which it may be tied as desired.

Wild or vicious animals may be roped from horseback and thrown. Before they have time to regain their feet they should be secured by tying all four feet together.

3. SHEEP

On some of the National Forests, particularly in the Southwest, the field man is required to spend a large portion of his time seeing that the grazing regulations with reference to sheep are properly enforced. These include a number of regulations having to do with the physical condition of such animals, and the forest officer must be able to discern disease when it appears and know what action must be taken to combat it. Otherwise serious losses may occur, the range may be contaminated, and unpleasant complications may arise.

Mange (Scabies).—*Causes.*—Sheep mange is caused by a parasite, the most common of which is *Psoroptes communis*, var. *ovis*, and which by its action in the skin causes premature or improper shedding of the wool.

Symptoms.—Loss of wool before or after the regular shedding season, patchy or ragged wool, and scaly skin.

Treatment.—The disease may be prevented by dipping. Two compounds which are widely used in the Southwest are: (1) The arsenic dip; (2) The sulphur dip. The first is composed of a pound each of soda ash and arsenic dissolved in forty gallons of water. The sheep are held in this till it reaches the skin and are then released. They should not be allowed to return to the range until dripping stops or the range may be poisoned.

The sulphur dip consists of eight pounds of sulphur, five pounds of unslaked lime, one pound of tobacco leaves and fifty gallons of water. Sheep should be dipped when the mixture has been heated to a temperature of about 100° F. and should be held in it for a period of two minutes.

The chief ingredient in a third dip is coal-tar. This dip, of which there are any number of reliable makes on the market and which, if desired, can be made by the individual, although

it is generally more economical to purchase already compounded, is rapidly displacing the other dips formerly used for the correction of verminous conditions in sheep and other animals. This is probably due to several reasons, not the least of which are that it is economical, non-poisonous, and does not affect the quality of the wool or hide in other than a highly beneficial way. Such dips are used generally throughout the middle West and Northwest, as well as all over Canada and South America, and now exceed all others in quantity used. The United States Department of Agriculture authorizes them for use and sets the standard of dilution.

Foot and Mouth Disease.—This disease is of the same nature as that which occurs in cattle and all cloven-hoofed, herbivorous animals and should receive the same treatment in all cases. (See page 260.)

Foot Rot.—*Causes.*—This may result either from the use of contaminated range or from ranging sheep on ground that is too soft to keep the natural growth of the hoof cut away.

Symptoms.—Sore, lacerated, ragged and torn hoofs. Soreness and festering are especially prominent between the claws.

Treatment.—Cut away all affected parts of the hoof; then dress the hoof with a mixture of two tablespoonfuls of corrosive sublimate in a pint of turpentine. Animals so treated should be kept from the range at least a month after treatment. The disease is contagious.

Lung Worms.—These are small, thread-like worms (*Strongylus filaria*), from $\frac{1}{2}$ -inch to 1 or 2 inches long, and are found in the lungs of young sheep that have been ranged too long on the same areas.

Symptoms.—Affected animals lose flesh rapidly and finally become too weak to walk.

Treatment.—Drench with a tea made of three parts water to one part flaxseed, to which a tablespoonful of gasoline has been added. Keep the animals from infected range and change range frequently. To drench a sheep set the animal on its haunches and hold it in this position by pressure of the knees against either side. So long as its feet are not allowed to touch the ground it will struggle but little, if any.

Stomach Worms.—These infest the fourth stomach and certain portions of the intestines. There are two kinds, viz.: tape-worms (*Tænia plicata*) and hair-worms (*Tricocephalus*).

Symptoms.—The symptoms are the same as those caused by lung worms, but are accompanied by diarrhea. The last-named symptom distinguishes the presence of stomach worms from that of lung worms.

Treatment.—The same as for lung worms.

Holding Sheep.—A peculiar characteristic of sheep is their habit of remaining quiet as long as their feet are not allowed to touch the ground. The easiest method of holding them while medicine is to be administered, therefore, is to set them squarely on their rump and then hold them in this position by pressing the knees against either side.

4. HOGS

Except on the National Forests of the South and Southeast the average field man has little to do with the subject of range hogs, but if he is to be stationed in either of these localities he should know something of the diseases to which hogs are subject.

Cholera.—**Causes.**—Cholera may be the result of unsanitary surroundings or it may appear in the nature of an epidemic or contagion. It may also be carried by bird or animal scavengers. The germ is *Bacillus cholerae suis*.

Symptoms.—Intermittent fever and shivering, loss of appetite, accelerated respiration, general depression, and watery eyes filled with pus. Blue or bluish-red spots appear on the skin and great weakness is apparent. The disease is fatal in direct proportion to the susceptibility of the animal infected and to the virulence of the attack.

Treatment.—So far as known there has not yet been a reliable cure discovered, although inoculation has proven of distinct value. Many so-called cures may prove effective under extremely favorable conditions, but none of them is infallible. The best treatment is of a preventive nature, such as providing sanitary surroundings, frequent disinfection of quarters, strict isolation of infected animals, and careful disposal of carcasses by burning. (See Glanders-Farcy, page 243.)

Mange.—**Causes.**—Hog mange is caused by a parasite of the *Sarcoptes* group. The parasite is of sufficient size to be discernible with the naked eye and has the appearance of a minute white speck. The disease flourishes in unsanitary surroundings.

Symptoms.—The animal scratches itself frequently and rub

against the sides of the pen or against trees and posts; scabs and bare white spots appear on the skin, and a generally unhealthy appearance of the skin is noticeable.

Treatment.—Use a stiff brush and scrub infected animals thoroughly with a wash made of carbolic acid diluted with water, 1 to 50 parts. A weak solution of water and tobacco leaves is also good, but if made too strong may poison an animal. A good coal-tar dip or disinfectant, such as is used for sheep scab, is just as effective as either of these remedies and is much safer.

Thumps.—*Causes.*—Overfeeding and lack of exercise.

Symptoms.—The disease occurs chiefly among suckling pigs and is indicated by violent heart action, the heart striking the walls of the chest with sufficient force to cause the body to sway backward and forward. The action is plainly audible, hence the term “thumps.”

Treatment.—Regulate the feed by removing the pigs from the sow for three-hour periods twice a day. Allow plenty of exercise.

ADMINISTERING MEDICINES

Drenches.—These are liquid medicines and are administered by being poured into an animal's mouth from a long-necked bottle or similar receptacle. They should never be given through the nose; such procedure not only causes strangulation in many instances, but also results in more or less loss of the drench, while that portion that is utilized decreases in volume and strength as it passes over the extra membranes. Moreover, it may injure these membranes and permanently impair their usefulness.

Pills or Balls.—These are administered when powdered medicines are to be used. They should not exceed 1 inch in diameter nor 2 inches in length. They are placed far back on the tongue, after this has been drawn out as far as practicable, and are taken into the throat when the tongue is released. They should not be administered to cattle, as the digestive organs of these animals are so constructed that pills may pass into the paunch and remain there for some time, during which they are without effect; there is also a possibility of their being regurgitated with the cud and chewed over by the animal.

They should not be given dry, but should be soft and moist; otherwise they may stick in the throat until sufficient moisture

is absorbed from this passage to allow their progress into the stomach.

Drenching Horses.—Place an open loop of rope about the upper jaw to the rear of the tusks; then raise the head above a level with the neck by pulling downward on the rope after the other end has been passed over a tree limb or a beam; this permits introduction of the bottle-neck into the mouth in such a way that a minimum of medicine is spilled.

The bottle should be tipped upward until the contents run into the animal's mouth in a moderately full stream, but no attempt should be made to administer the entire drench at one operation; after a portion has been given, the animal should be allowed time to swallow before more is released. Horses frequently refuse to swallow, but this action may be overcome by tickling the roof of the mouth with the bottle. The practice of pinching, kneading, or squeezing the throat in order to induce swallowing is to be avoided, although it may be rubbed gently and no ill effects will follow.

The bottle-neck is thrust into the mouth between the bars of the jaws, and care must be taken not to place it so far back that the animal may crush it between the molars.

If the animal is inclined to be vicious and objects to being drenched, it may be tied as shown in Fig. 208.

Drenching Cattle.—This can be done if the services of two men are available; one holds the animal by the ears, horns, or nose, or ties it, while the other administers the drench. If one man must work alone he should tie the animal's head up higher than the throat. No trouble need be anticipated in a refusal to swallow; the throat and mouth are so constructed that the drench can not be retained in them as it may by a horse.

Drenching with a Syringe.—The tube of the instrument is placed well back in the mouth and the charge is released gradually, allowing the animal plenty of time to swallow. The charge should not be of such a nature that it will absorb a portion of the material of which the syringe is made.

SUBJUGATING HORSES

Throwing.—It not infrequently happens that a field man, purchasing a horse on short notice and without careful inspecting, secures an animal that has not been properly trained.

one that has been allowed to develop habits not desirable in a saddle animal. Many of these habits may be broken up by persistent treatment, although it is not an uncommon thing to find some animals that are too stupid to learn.¹

The plan of throwing an animal three or four times daily for a period of from three to six days, tying it down securely, and allowing it to remain in that condition for from fifteen minutes to an hour, usually results in the complete subjugation of a stubborn or viciously inclined animal. While it is thus rendered unable to resent any operations that may be performed on or about it, its feet, ears, head, or other parts of its body may be handled until it learns that it must submit peaceably to such treatment.

A very effective means of throwing is to use a casting rig similar to that illustrated in Fig. 208, except that instead of applying it to one hind foot only both hind feet are secured. Moreover, instead of merely raising one foot from the ground both are drawn up close to the body and thus rendered useless as means of offense or defense. As the pastern joints are forced upward they bend more sharply and there is little danger of the rig slipping as long as it is kept tight; it is advisable, however, to take an extra turn of the rope about them when they are to be tied firmly against the animal's body. One man working alone secures one foot at a time, tying it up securely by fastening the loose end of the rope into the rope collar about the animal's neck. When one foot has been secured in this manner the other is then secured in a similar manner. If two men are to work together, both hind feet may be drawn forward at the same time and then fastened after the animal is down.

If the animal is a kicker and refuses to have the loops placed about the pasterns by hand, they should be laid on the ground and the animal backed into them; or a stick may be used in placing them as desired.

When the hind feet have been brought up and made fast the fore feet are then tied back to them, care being taken in this operation to use a knot that may be released by a pull at the loose end of the rope. It is also necessary to have the rig secured

¹ Occasionally animals purchased by the United States army prove too stupid to recognize certain bugle calls or other commands; such animals are immediately condemned and disposed of by sale or otherwise.

in such a way that the animal can not effect its release before the operator is ready for it to do so. If an unusually severe lesson is deemed necessary the neck may be forced back along the side and the head securely tied to the feet.

Mules being thrown in this way usually fall to their knees first and retain their footing with the hind feet. This may be overcome by pushing them sidewise at the rear.

Whirling.—This is a very effective method of outwitting an animal that refuses to stand still long enough to be saddled or harnessed. The horseman grasps the halter rope in his left hand and the animal's tail in his right, then forces the animal to travel swiftly in a small circle about him until it becomes dizzy. It may then be saddled or harnessed before it regains its complete equilibrium.

Head-and-Tailing.—This is similar to whirling, except that the head is drawn back alongside the body and tied to the tail with the halter rope. The animal is then forced to travel in a circle, and as a result of dizziness soon casts itself. Care must be taken to fasten the halter rope in such a way that it may be released from the tail without difficulty.

Prominent Bad Habits.—*Biting.*—Little can be done to break a confirmed biter of the habit, but it may be temporarily checked by the use of a stiff bit fitted with a very short curb-strap. When the animal attempts to bite, the reins are drawn in quickly and the animal's mouth suffers so severely that temporary relief may be secured. A specially constructed bit, bearing upright prongs on the bar, is manufactured for this purpose; the prongs prevent the animal from closing its teeth together.

Kicking.—This is an especially dangerous habit and requires severe treatment. A very effective method is to pass a rope from a severe curb-bit to a rear pastern, leaving it short enough to allow the animal to inflict its own punishment each time it kicks. Proximity to the animal's heels may be avoided by using a long rope, laying a loop on the ground, backing the animal into it, and then drawing the rope up to the required length.

Stall Kicking.—This habit may be broken by the use of a pole hung behind the animal at a point about 2½ feet above the ground and close enough to permit it to swing against the animal each time it is kicked away. Its action soon discourages the kicker.

Striking.—This is a difficult habit to break, and in aggravated

cases such animals should be kept hobbled. Another plan is to rap the cannon-bones sharply with a stiff stick or whip each time the animal strikes.

Stall Pawing.—A 2-foot length of light chain buckled to the pastern of the leg most used generally breaks this habit; if it fails the chain may be buckled to the cannon-bone.

Cribbing.—This refers to an animal's action in setting the teeth into and sucking at a post, manger, tree, or similar object, and is frequently designated as "stump sucking." There is no means of permanently breaking the habit, but temporary relief may be obtained by sprinkling pepper or other distasteful material over the object at which the animal sucks.

Setting Back.—This refers to an animal's action in pulling back on the rope with which it is tied, and is a disagreeable habit that should not be tolerated. It may be broken, after repeated lessons, by tying the animal with a rope it can not break. Such a rope should be noosed about the neck and the animal should be allowed to choke itself down at each attempt to escape, being released just before insensibility ensues.

Another method is to loop a rope under its tail, pass the rope up through the chin ring of the halter or the bozal of the hackamore, tie it firmly to a substantial post, and then leave the animal where it may "set back." To prevent the rope from slipping down from around the root of the tail, it may be doubled, brought upward and along the back, twisted several times, and one end then run through the hackamore from either side of the neck.

A variation of this method is to use, in connection with the strong tail rope, a weaker halter rope that may be broken with moderate effort. Both ropes are then tied to the post, the halter rope being slightly shorter than the other. At the moment the halter rope breaks, or is cut, the animal's whole weight is thrown against the loop under the tail. Four or five lessons should prove sufficient.

Balking.—This may be the result of continued overloading, improper training, ill-fitting harness, shoulder sores, or pure stubbornness, although the last is seldom responsible. The habit can not be permanently broken, and an animal addicted to it should be disposed of at the first opportunity. It is peculiar to draft animals, and may, but seldom does, appear in saddle animals.

The common practice of pouring sand, fine gravel, or water into the ears is to be condemned. A better way to gain temporary relief is to loop a rope about one fore foot and pull the foot forward. As the animal attempts to replace it on the ground it will unconsciously step forward, or it may even lunge forward very suddenly. In the latter event care must be taken not to be trampled upon. A second man is needed to hold the reins when this method is being tried.

Another method is to tie the ear tips together. Still another is to back the animal several steps, if this can be done, and then urge it forward suddenly.

The sole object to be attained in the case of a balky animal is to divert its attention from its resolve not to move forward, but whipping or other ill-treatment seldom proves effective. Slight adjustment of the collar or other parts of the harness is always advisable.

Rearing in Harness.—This habit may be broken by using the rig shown in Fig. 204. When the animal rears the rope is drawn in, forcing its feet upward toward the body, and thus causing

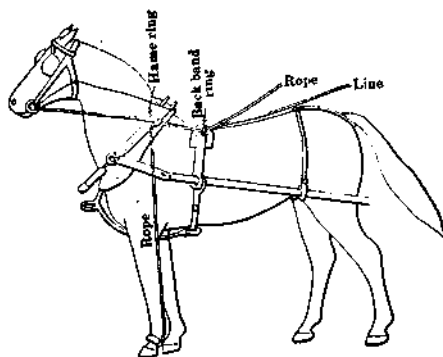

FIG. 204.—Rearing Rig.

it to lower the body in an attempt to replace the feet on the ground. In aggravated cases both fore legs may be treated in a similar manner, the services of a second man, of course, being necessary in handling either the rope or the reins.

Bolting.—Another term for this is the common one of “run-

ning away." If a harness animal acquires the habit it should be forced to continue running until exhausted. To break the habit in a saddle animal a 30- or 40-foot rope is noosed about its neck at the time the rider dismounts and the other end is tied securely to some stationary object. No attempt should be made to stop the animal as it bolts, except to call "whoa" just before it reaches the end of the rope. Immediately after it hears this command it will be precipitated headlong. This usually breaks the habit in about three lessons.

PURCHASING A SADDLE HORSE

In accordance with general administrative procedure, the new field man reporting for duty is immediately assigned to field work. Such a detail involves the purchase of a horse, which a regularly appointed field man must furnish himself, and in view of the fact that practically all of his field trips must be made by horse, the purchaser of a saddle horse should, when possible, exercise the greatest deliberation in inspection of the animal he proposes to buy. It is true of course, that a saddle animal which may suit one man may not suit another, but the suggestions which follow will assist the inexperienced buyer in selecting a fairly satisfactory animal for use until such time as his own experience may tell him that an animal of other qualities will suit his individual likes better.

The prospective purchaser should always make a personal inspection of the animal he is considering, this rule holding good in every case unless he can secure advice from some person whom he knows to be absolutely reliable. Professional horse dealers, and other persons having horses for sale, usually will not or else can not give the buyer complete details concerning the animal negotiated for. As a result of this the buyer may eventually discover characteristics in an animal that were not apparent, or were not made known to him, before or at the time the purchase was made.

Age.—Under ordinary circumstances a horse should be in his prime at from seven to ten years of age. As a matter of fact, however, most work or saddle animals are not given proper attention, and as a result may be of little value after they reach the age of seven or eight years. At any rate, if the buyer has reason to believe that he may want to sell the animal within a

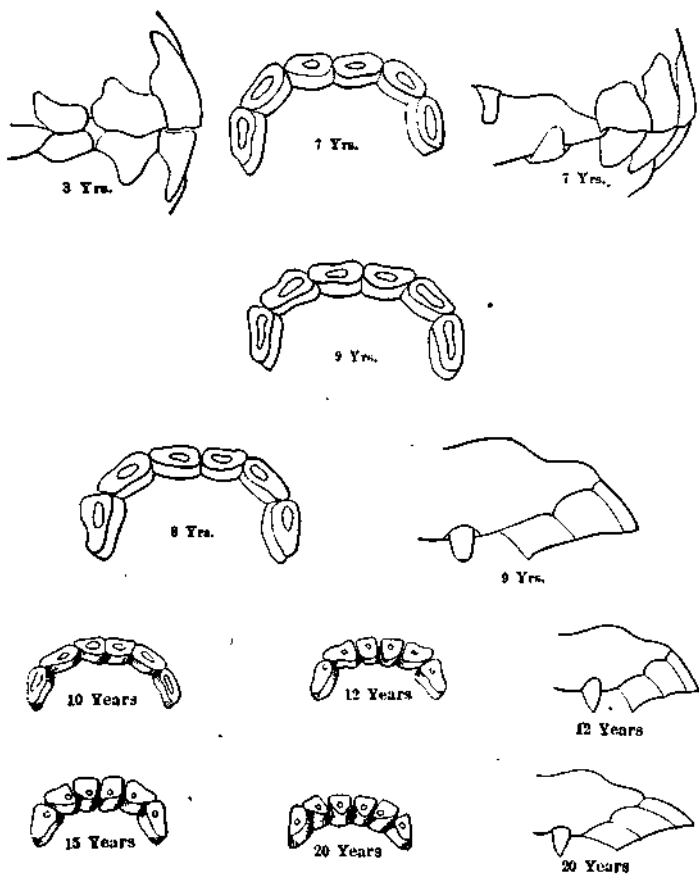

The horse's teeth at various ages.

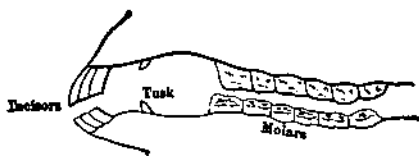

FIG. 205.—Jaws of an adult horse.

year or so, and wants to secure not less than the purchase price, he should not purchase an animal older than eight years unless there is every indication that the animal is perfectly sound; even then, in view of the fact that there is little demand for horses exceeding eight or ten years in age, there is always a question of being able to dispose of them on short notice.

A general rule for determining age by the appearance of the teeth follows, but this should not be considered as infallible. Quite naturally the condition of the teeth is affected by the nature of the feed an animal has been accustomed to; if it has been hard, tough, or gritty, then, of course, the teeth will be shorter or more worn in appearance than if softer feeds have been eaten.

The teeth at various ages are illustrated in Fig. 205.

The colt has six incisors, or front teeth, in both the upper and lower jaw, and three molars, or grinders, on either side in both. The permanent set which replaces these includes twelve more molars, three being added to each side of both jaws. The horse has four tusks at maturity, but these seldom appear in mares, and when they do are poorly developed. Thus the temporary teeth number twenty-four, while the permanent set includes from thirty-six to forty, depending upon whether or not the tusks are present.

The incisors, which are the teeth to be examined in determining age, are known, in the order of their appearance from the sides of the mouth to the center, as "corners," "dividers," and "nippers"; the grinders are examined only in reference to their general condition of evenness and soundness.

One to Three Years.—Nippers appear at the age of from one week to ten days, the uppers being cut first and the lowers appearing soon afterward; dividers appear at from four to five weeks, and are followed in eight or ten months by the corners. The temporary teeth are gradually pushed up from beneath by the permanent teeth, the process of shedding them beginning at two and one-half or three years of age. Permanent upper nippers may be visible at three years, but the temporary corners and dividers still remain. Usually the permanent teeth are the shorter.

Four Years.—The permanent dividers have appeared and the temporary corners still remain but are worn smooth and are much smaller than the permanent teeth.

Five Years.—A full set of permanent teeth is present and the animal is said to have a "full mouth." Nippers and dividers are worn almost level, but retain the narrow cavities known as "cups," which extend lengthwise through the crown. Tusks have appeared in the male.

Six Years.—Corners are well worn and dividers retain their cups, but the nippers are either worn level or have very shallow cups.

Seven Years.—Corners have shallow cups, dividers and nippers have none, and the tusks are well developed. Usually the upper corners, being wider than the lower ones, are not worn away at the rear but project somewhat below the edge of the crown of the lowers. All the incisors are quite white and have lost their former yellow tint.

Eight Years.—Corners are worn level and begin to assume an oval crown and dividers and nippers have grown thicker from front to rear and have decreased in width. All incline forward more and do not fit together so nearly endwise. The "star" appears in the crown approximately half-way between the front enamel and that at or near the center of the crown which is known as the "center" enamel.

Nine Years.—The notch found in the corners at seven has nearly disappeared, nippers and dividers have crowns quite oval in shape, and all are thicker from front to rear. The center enamel is nearer that at the rear and the star is quite distinct.

Ten Years.—Corners are now of little value in determining age and nippers and dividers have grown almost round. The star is nearer the center of the crown and the center enamel has assumed a triangular shape and receded toward the rear of the tooth.

Fifteen Years.—Dividers and nippers are distinctly triangular, the center enamel in the upper ones has disappeared, and the star has reached the center of the lower ones. All incisors protrude forward and are very thick from front to rear.

Twenty Years.—Nippers and dividers are thicker from front to rear than from side to side and their crowns have pulled away from each other; corners point inward and the jaw has shrunk until it is very narrow; deep notches appear in the upper corners as the result of wear against the rear edges of the lowers; all protrude forward to a very noticeable extent and set wide apart.

Size.—A horse weighing from nine hundred to one thousand pounds is sufficiently heavy for all ordinary field work. Larger ones do not possess the capacity for continued climbing, traveling over rough country, or subsisting on short rations that smaller animals do. They may prove satisfactory for level traveling over good roads, but can not be recommended for mountain travel.

Build.—The most efficient type of saddle animal for mountain work has a short back, is high at the withers and deep from there to the chest; the latter is full and very broad, the legs are moderately short and are straight and strong with compact joints and sound hoofs; the head is wide between the eyes and also between the ears and is carried well up, but not high, when traveling, the nose is slightly Roman, and the eyes are large and clear and show very little of the white.

Color.—Only three colors, with their variations, actually affect the efficiency of a saddle animal; these are white, what is known as "pinto," and "buckskin." The first usually indicates inbreeding, and when this is present the animal, of course, suffers from constitutional weakness in one or more forms. This color is not to be confused with the cream color of a distinct breed of horses noted for their great intelligence.

Pinto horses, which may also be known as "paint," "speckled," "piebald," or "calico," are descendants of the Indian pony, are very hardy and strong, but seldom attain great size.

Buckskin, or "dun" or "claybank," horses with dark stripes around the legs above and below the knees and hock joints and another extending the entire length of the spinal column, are descended from a distinct breed of Spanish ponies noted for their great powers of endurance. They are the toughest and hardest horses that can be secured, are intelligent and usually docile unless ill-treated, and are seldom vicious.

Black horses may suffer more from heat than other colors may, bays may be the most vicious, and chestnuts may have the tenderest skins, but actual experience in the field has failed to prove or disprove any of these theories.

General Disposition.—Many horses resent having their ears grasped when the halter or bridle is to be adjusted or removed, they object to being slapped on the side or flank, do not like to be rubbed or curried, pull back or kick at the stall or other animals when tied, and acquire many unpleasant habits of a

similar nature. Their examination in this respect should be very thorough, and when such tendencies are shown should constitute a valid reason for rejection of the animal. The common idea that such animals should be purchased merely because they may be secured for less money is a mistake that should never be made; animals having as few faults as possible will prove enough of a problem for the beginner in horsemanship.

Eyes.—A blind or partially blind horse is practically worthless for saddle use, and should never be secured for such work. The defect is often difficult to detect by casual observation of the animal's eyes and the examination in this respect can not be too thorough.

A very satisfactory method of doing this is to take the animal from the stable into strong sunlight; if the lids or pupils shrink the sight is defective or at least weak; the change of light should not cause any discomfort.

Another means of determining defective eyesight is to pass the hand quickly across an animal's line of vision and close to the eyes; when this is done and no apparent notice of it is taken by the animal the eyes are wholly or partially sightless.

A good, strong, sound eye is clear, the ball glistens, has a regular contour, and is not spotted or blotched; the white should be clear in color with only the faintest trace of minute thread-like blood-vessels showing beneath the surface. Excessive lachrymal secretions indicate an injured eye and should be carefully investigated. A "glass" eye is not necessarily weak, but its presence always lessens the market value of an animal. In old horses the eyeball is distinctly sunken in the socket.

Pulse.—Normal heart action is approximately as follows:

Colt, two to four weeks old	70 to 90	beats per minute
Colt, six to twelve months	45 " 60	" " "
Colt, two to three years	40 " 50	" " "
Mare	35 " 40	" " "
Gelding	33 " 38	" " "
Stallion	28 " 32	" " "

The pulse may be observed by placing the ear against the animal's left side just to the rear of the elbow joint. A dull, regular, thudding sound indicates a healthy heart; wheezing, roaring, rattling, or irregular sounds indicate the opposite.

Another method of observing the pulse is to place the fingers

up under and between the lower jaws immediately behind the flat cheek muscles; if the pulse is not located at once the fingers should be moved forward or backward or otherwise until the right spot has been reached.

Respiration.—This should be regular and without severe muscular effort, and in a healthy animal occurs at the approximate rate of one breath to every three beats of the heart. Unless the respiratory system is deranged the breaths are inaudible except at very close range.

Many animals suffering from improper respiration develop symptoms when strenuously exercised that are not apparent during inactivity; for that reason it is always well to give them ten or fifteen minutes of lively exercise before the purchase is made.

Hearing.—If an animal is spoken to sharply at a time when it happens to be looking away from the speaker its observation of the sound will be indicated by a sudden twitch of the ears or head toward the direction of the sound. If no such action results its hearing is probably impaired.

Legs.—The distance from the body between the fore legs to the ground should be about the same as that from the withers

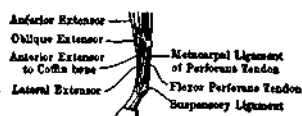

Front leg.

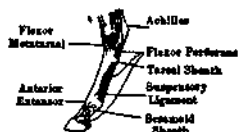

Hind leg.

FIG. 206.—Principal tendons and ligaments on the horse's legs.

to the body at the same point, the legs should set well apart at the breast, be straight and well muscled from the knee upward, and the knees should not buckle forward. The hind legs should be fairly straight at the hock joints, and the portions above these joints should be full and well muscled. None of the joints in any of the legs should buckle in any direction, bear any unnatural enlargements, or appear stiff.

Hoofs.—Sound hoofs have straight, symmetrical walls, broad heels, a full frog, and a generally oily appearance. Flaring, bell-shaped, cracked, or otherwise disfigured hoofs are to be

avoided. No horse with unsound hoofs will give satisfaction as a saddle animal.

Gaits.—The animal should be ridden at various rates of speed for a distance of two or three miles, during which a general test of its traveling capacity may be made. A running walk is a very desirable gait; a "pace," in which the animal moves the the legs of one side simultaneously, is to be avoided; a slow trot is a satisfactory gait provided there is sufficient spring in

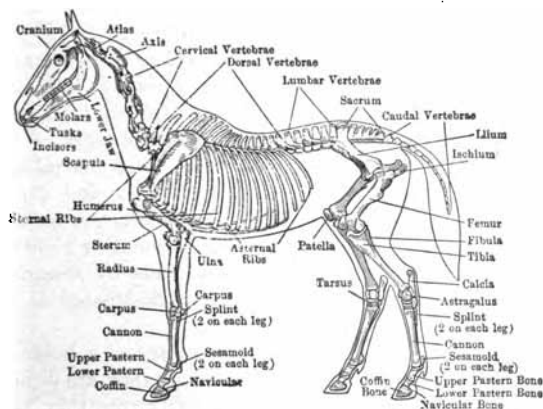

FIG. 207.—Bones of the horse.

the joints to relieve the rider of continual jarring; a "short lope" or a slow gallop is suitable for level traveling but is almost useless in the mountains; and the same is true of the "single foot" gait.

IDENTIFICATION OF STOCK

Obviously, when cattle or other stock belonging to a number of different owners use a common range, there must be some means possible whereby each owner may identify his own property. Consequently a system of identification, based on visible marks of ownership applied in some manner to an animal's body, has developed automatically until at the present time it has reached a stage where the inexperienced person has good reason to feel completely bewildered as he attempts to decipher some of

the characters used. Unfortunately their selection and application are not controlled by any fixed rule except the one statutory in nature in most States prohibiting different owners in the same locality from adopting the same characters of identification. If their cattle are branded alike then the ear marks must differ, and vice versa. The subject presents rather a difficult problem to elucidate in an intelligent manner, but it is believed that careful attention to the following remarks will provide the inexperienced field man with at least a fairly accurate working knowledge of the different methods used and of the designations and other terms applicable to each:

Methods Used.—The methods most widely used are applied, in the order of their prominence, in the forms of: (1) Brands; (2) Ear Marks; (3) Ear Buttons; (4) Ear Loops; (5) Ear Tags; and (6) Dewlaps, which will be discussed in this order.

1. **Brands.**—These may be divided into three general classes, viz.: (1) Fire Brands; (2) Inscribed Brands; and (3) Paint Brands. The first are made by burning characters on an animal's hide, hoofs, or horns; the second are cut or inscribed in the horns or hoofs; and the third are made by smearing tar or paint on an animal, and are sometimes designated as "tar" brands.

Fire Brands.—These are applied by means of a heated iron. When only a few animals are to be branded they are either cast or tied as shown in Fig. 208. In the latter case they are tied with what is known as a "branding rig." This consists of a bowline on a bight (see page 327), fastened about the neck, the loose end of the rope being passed about the rear pastern, on the side opposite that to which the brand is to be applied, and the corresponding foot is raised from the ground. This prevents the animal from rearing, kicking, or running, and unless it is very active or vicious will also prevent it from striking.

If a large number of animals are to be branded, they may be driven into a branding "chute," which is fitted with bars to prevent them from passing forward or backing out before the brand is applied.

The irons used in fire branding are known as: (1) Stamp Irons; (2) Bar Irons; and (3) Running Irons.

(1) *Stamp Irons.*—These are usually about 20 inches long by $\frac{1}{2}$ -inch in diameter. The character, or combination of characters, to be used as a brand, are of iron and are welded to one end of

the handle and at right angles to it. This end of the iron is heated and the character is then pressed against the animal's skin and held there as long as the experience of the operator dictates. If held against the skin too long, a blurred or indistinct brand, known as a "bone" brand, will be the result; if

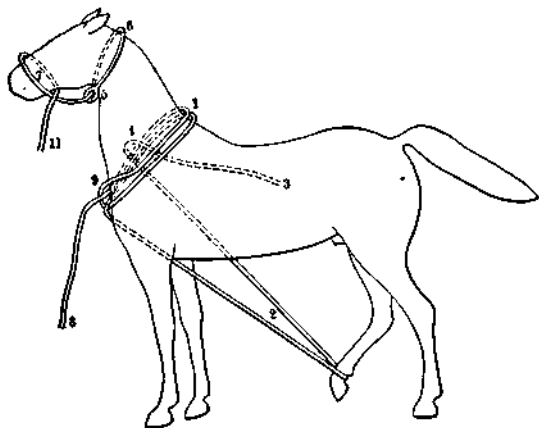

FIG. 208.—Branding Rig.

removed too quickly, no permanent, or at least no visible, scar will be left, and the animal is "hair" branded. The term "hair brand" is also applied to a character clipped in an animal's wool or hair.

A proper knowledge of the length of time required to leave a permanently visible scar can be obtained only through practice. The factors of heat, variety of iron used, and pressure applied to the iron, all have direct influences on the satisfactory application of the iron.

(2) *Bar Irons*.—These differ from stamp irons in that they have only a bar welded to the lower end of the handle and at right angles to it. Ordinarily this bar is about $\frac{1}{4}$ -inch thick, 2 or 3 inches long, and 1 or 2 inches wide. In using such an iron the operator makes only a portion of the desired character at a time, using either the long or short edge or one corner of the bar. Its use is confined chiefly to open range work, where

can be carried on the saddle with less inconvenience than a stamp iron. By reason of the longer time required in applying a brand with it, it is not as convenient in this respect as a stamp iron.

3. *Running Irons*.—These are either straight or hooked iron bars which, when heated, are used in tracing characters on an animal's skin. Hooked irons are especially convenient because, turned edgewise, the hook may be used in tracing straight lines and turned sidewise or flat may be used in burning curves.

Another form of running iron is a plain iron ring, usually about $2\frac{1}{2}$ or 3 inches in diameter, and made of $\frac{3}{8}$ - or $\frac{1}{2}$ -inch iron. This is heated and then applied by means of short sticks, secured on the open range, and used tong fashion. The chief advantage of this iron is the convenience with which it may be carried.

Many stockmen prefer copper rings, this preference being due to the fact that such rings heat more quickly and uniformly than common iron rings.

Some State legislatures have passed laws prohibiting the use of running irons, the reason for such action no doubt being the slowness with which brands are applied by their use.

Location of Fire Brands.—There is no fixed rule governing the location of fire brands, but there are general customs of applying them to specified parts of different animals. For example: Horses and mules are usually branded on the shoulder or on the lower portion of the hip as shown in Fig. 209; cattle are branded on the shoulder, hip, side, or back, frequently on the neck, and occasionally on the forehead. Burros, in addition to being branded the same as horses and mules, are quite frequently branded on the neck. Fire brands on sheep or goats are applied to the side of the nose, this location for the brand being used because fire brands on other parts of the body would be completely hidden by the wool. Hogs are seldom branded¹ but are invariably ear-marked.

Cancellation of Fire Brands.—When ownership of stock is

¹ In response to an inquiry as to whether a brand would discolor the meat of a hog through to the bone, in accordance with a very common idea, the packing firm of Armour & Company replied that possibly, if the iron were too hot, the brand might show to a depth of $\frac{1}{4}$ -inch below the skin. Swift & Company replied that they had had no experience with branded hogs.

transferred from one person to another it is customary to cancel the former owner's brand and thus remove his visible title to the property.

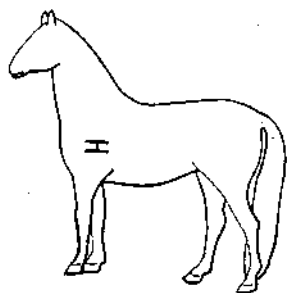

Shoulder brand.

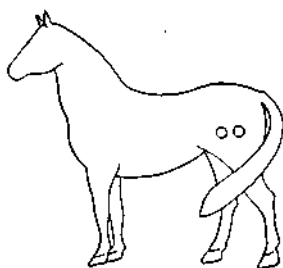

Thigh brand.

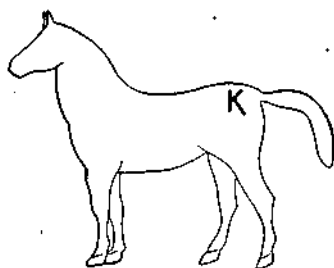

Hip brand.

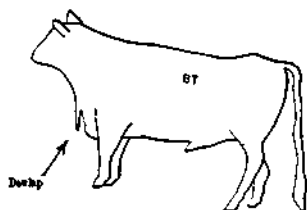

Rib brand.

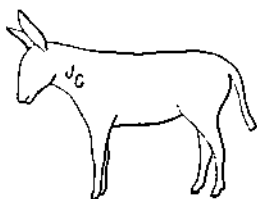

Neck brand.

FIG. 200.

When this has been done the new owner then applies his own brand to the animal.

Cancellation of a brand may be effected in either of two ways, viz.: (1) *Barring out*; (2) *Venting*.

(1) *Barring Out*.—This consists merely in superimposing a bar, slash, or rail across the former owner's brand as shown in Fig. 210, where the brand N has been barred out with a slash and the brand C with a rail. The brand K is canceled with a bar. This method of cancellation is used on both horses and cattle.

(2) *Venting*.—Cancellation by venting is commonly used on cattle and is illustrated in Fig. 211. It consists merely in applying a facsimile of a brand to the shoulder corresponding to

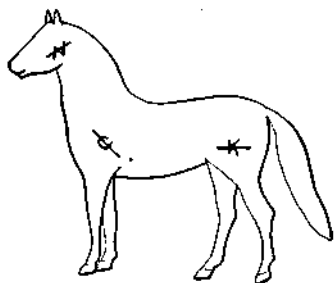

FIG. 210.—Jaw brand. Also cancellation of shoulder brand by rail and of thigh brand by bar.

the side carrying the original brand. Thus a brand on any part of the left side is vented by an application of its facsimile to the left shoulder, while brands on the right side are vented on the right shoulder. Horses are seldom vented.

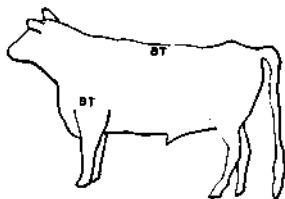

FIG. 211.—Cancellation by vent.

Inscribed Brands—These are cut in the hoofs or horns by means of an instrument known as a "scribe" or they may be

burned in with a fine running or stamp iron. Their use is confined chiefly to the horns of sheep and goats, to the horns of exhibition or graded cattle kept in pastures and to the hoofs of army horses and mules.¹

They are never applied to the hoofs of range horses. Natural growth of the hoofs necessitates reapplication of the brands about every four months.

Paint Brands.—These are made by smearing tar or paint on an animal's hair or wool and may be known in some localities as "hair" brands, although this term is usually applied to temporary brands clipped in the hair or wool. They may be smeared on with a straight stick or stamped on by means of a stamp shown in Fig. 213.

Characters Used as Brands.—These include: (1) All the conventional letters and figures; (2) Other conventional characters; (3) Arbitrary symbols; and (4) Combinations of the preceding

¹ A. W. 1063: "Public animals shall, upon the day received, be branded with the letters US on the left fore shoulder. (Sub¹.) Horses assigned to organizations will also be branded on the hoof of one fore foot 1½ inches below the coronet, with the designation of the company. Branding irons of uniform size and design will be supplied by the Quartermaster's Department. Letters and numbers of hoof brands on the same line to be three-fourths of an inch high, the letter to precede the number, and blocked so as to penetrate the hoof one-sixteenth of an inch. For example, the hoof brands on horses assigned to Band, Ninth Cavalry, would be CB9; to Troop A, Fifth Cavalry, would be BA4; to the Band, Second Regiment, Field Artillery, would be BA4; to Company A, Battalion of Engineers, would be BEA."

Excerpt, A. W. 922: ". . . Condemned animals will be branded IC on the neck under the mane. . ." (Sub².)

A. W. 1084: "Any alteration in the length or shape of the tails, manes, or forelocks of public horses by docking, banging or clipping, is prohibited, and only such reasonable trimming and plucking as may be necessary to prevent shagginess of appearance is permitted."

(Sub. 1.) In response to an inquiry as to whether the term left "fore" shoulder has any special significance or whether it is merely redundant the War Department through the Quartermaster-General's office replied: "Animals purchased for the army are branded on the left fore shoulder on the flat place over the true arm as shown in enclosed diagram." This diagram is reproduced herewith. However, the term is redundant. A horse has no "rear" shoulder, and its hip is never referred to as its "rear" hip.

(Sub. 2.) The letters IC are the initials of "Inspected; Condemned." and indicate that after inspection the animal has for some reason been found unfit for army use and has accordingly been condemned.

three. It should be remembered that the characters used as a brand do not necessarily represent an owner's initials, the age of the animal, its number in a herd, or any other specific fact

FIG. 212.—Army brand.¹

FIG. 213.

except an indication of title as this is recorded with the proper authorities.

Conventional Letters and Figures.—These are shown in their various positions in Fig. 214, each position being explained in

Conventional Letters and Figures								
Character in regular position.	Reversed	Inverted	Leaning	Lazy	Flying	Walking	Square	Crooked
4	ƚ	⌋	⋈	Ɔ	4	4	4	€
K	⋈	⌋	⋈	⋈	K	K	H	⊘

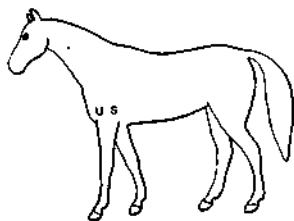
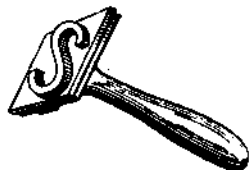
FIG. 214.

accordance with its theoretical reading. But, following a local custom, the flying K may be read as 7K; the walking K may

¹ Supplied by Quartermaster-General's office, War Department.
U. S. A.













Other Conventional Characters	
	Figure 1
	Bar
	Slash
	Rail
	Rafter
	Triangle
	Diamond
	Staple
	Square
	Half Circle
	Circle
	Half Moon
	Star

FIG. 215.

be known as LKL connected; and the crooked K may be read as Half-circle C connected or as YC connected. The flying 4 may be known as 74F connected, and the walking 4 as VL or 4L connected. In some localities a "leaning" character is known as "flying"; and "walking," "square," and "crooked" characters may not be designated as such.

Other Conventional Characters.—These are illustrated and explained in Fig. 215. No distinction may be made in some





















Arbitrary Symbols	
	Spur
	Winecup
	Hat
	Stirrup
	Beanpot
	Rockingchair
	Clawhammer
	Oil can
	Bud
	Bit
	Bush
	Fan
	Saddle
	Head
	Bowknot
	Clover leaf
	Coffee pot
	Thunderbolt
	Double cross
	Frying pan

FIG. 216.

localities between a "bar" and a "figure 1," or between "rails" and "slashes." A "square" may be known as a "box," and a half-circle as a "swipe"; otherwise the classifications here given are common to most parts of the country.

Arbitrary Symbols.—These are shown and classified in Fig. 216. The classifications given are common to all localities and the characters will be found widely used.

Combinations.—Combination brands may include any of the letters, figures or other characters heretofore referred to, and a few of the more common ones are shown in Fig. 217. They may appear in a group at one place on an animal's body or they may appear singly or in separate groups at different places. The brand known as a "breaching" consists of a bar across the rear side of both hams above the hocks. A "halter" is a rail applied on the side of the nose. A "hip strap" is a bar run across the back or hips and usually connects a combination brand applied to both sides of the animal.

Reading Brands.—Theoretically, brands are read from left to right and downward, but this rule is often disregarded when other methods of reading prove more convenient, such disregard being especially characteristic of stock owners who graze their stock on a common range. In such cases each owner is familiar with all the brands in his locality and his description of a brand, while it may be perfectly intelligible to his fellow stockmen, may mean little or nothing to the person not familiar with the brand.

Local designations of the same character may vary and it is not advisable to contend that a character is any other than that recognized locally. What one stockman may call a slash another may know as a rail, there being no hard and fast rules of designation.

If an animal carries a number of uncanceled brands or a combination brand the reading is from front to rear. Taking, for example, the fourth brand from the top in Fig. 217: If the A appears on the jaw, the bar on the ribs or back and the Y on the hip or thigh, the brand is read theoretically as "A-Bar-Y, jaw to ribs (or back) to hip (or thigh)," but in most instances is shortened simply to "A-Bar-Y."

Changing Brands.—This is a form of thievery which, although it was widely practiced on the western ranges in the early days of the cattle industry, is now punishable by such severe penal-

Combination Brands













-02	Bar O Two Bar Circle Two
7/B	Seven Slash B
J P	J P Combined
	A Bar Y
	Reversed 4 Slash Lazy L
	Half Circle D
	Rafter Triangle Bar
	V7 Two Bars
	Stirrup Dot Bar
	Flying M Diamond
56	Fifty-six Connected
G □	G Square G Box
1/2	One-half One Slash Two
	Lazy 3 Bar H
	M A Connected
	Bit Bar
	Bowknot O Bowknot Circle
	O X Circle X
	Square B F Connected
	B L Combined

FIG. 217.

ties that few cases occur. The two principal methods of changing brands are known as "running" and "sleeping."

Running.—To run a brand the operator merely adds to or changes it or else superimposes another upon it. Thus P may be run into R by adding a rail to the P, or it may be changed to B by adding a quarter circle to the P. The brand US may easily be run into OS, and no difficulty whatever would be experienced in running FI into ET, EL, or EH. A more difficult feat of running a brand is to run X I T into Star Cross but it has been done thus¹:



Such brands as the Flying Y J Bar and the V Dart can hardly be run without great danger of detection.

Sleeping.—This operation consists merely of burning part of a brand so lightly that no permanently visible scar is left, thereby making it possible to retrace and add to the brand later without arousing suspicion. For instance: Assuming that Jones runs the Diamond iron and Smith the W iron, Jones finds one of Smith's calves on the range, brands it with a W, and keeps it separated from its mother until it is weaned. However, he burns the W in very lightly though severely enough not to arouse suspicion except upon the very closest examination, and even if Smith or one of his men happens to discover the calf he naturally assumes that one of the other men employed by Smith branded it, and that the brand is therefore genuine. But as soon as a new growth of hair covers the burn, usually in less than two months, Jones rebrands the calf with his Diamond, running the lower half of the Diamond over one half of the W, and thereby obliterating the last trace of the letter. Consequently, by reason of the apparently fresh brand appearing on a calf unaccompanied by one of Smith's cows, neither Smith nor his men will suspect Jones of sleeping if they happen to observe the calf. This method of thievery is easily detected if the State law requires ear-marks with brands. Obviously, in such a case a calf branded in Jones's iron but ear-marked with Smith's mark would excite suspicion. Suspicion would also attach to a branded but un-

¹* It is said that running this brand in such a manner cost a Texas cattle company more than \$20,000.00 in loss by theft.

marked calf or to a calf bearing ear-marks which had evidently been "worked over."

2. **Ear-marks.**—As their name indicates, these are certain marks cut in the ears of animals and, like brands, they are used as a means of identification. Hog-raisers in the South rely almost wholly upon them for this purpose, while cattle in those sections are seldom branded but are invariably ear-marked. In the West, however, brands are usually accompanied by ear-marks, such a combination facilitating identification when one or the other may closely resemble that of some other owner.

Ear-marks may be applied to all classes of stock but are seldom used on horses or mules. They are, however, frequently applied to burros.

Classifications.—For greater convenience in explaining them here, ear-marks will be divided into fourteen general classes, viz., (1) Crops; (2) Half-crops; (3) Grubs; (4) Splits; (5) Swallow-forks; (6) Staples; (7) Half-moons; (8) Bits; (9) Scallops; (10) Slopes; (11) Hacks; (12) Slits; (13) Figure 7's; and (14) Holes. These may be further classified as "over" and "under" half-crops, staples, bits, scallops, slopes, hacks, and figure 7's, the term "over" applying to those cut in the upper edge of the ear, "under" referring to those cut in the under edge. Splits, swallow-forks, staples, half-moons, bits, scallops, slopes, hacks, and figure 7's may be cut through the interior

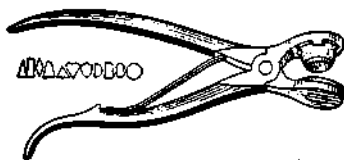

FIG. 218.—Ear punch and dies.

parts of the ear, but not out through the edge, and are then classified with the prefix "inner." Slits and holes are always cut within the ear-edges. They may be made with a common pocket-knife, or with punch and dies like those illustrated in Fig. 218.

Reading Ear-marks.—Theoretically these are read by starting at the mark nearest the head on the upper edge of the right ear and following around the ear downward and back to the

head, reading each mark as it is reached. Marks in the left ear are then read in a similar manner.

The marks shown in Fig. 219 are assumed as being observed from the front. Thus the right ear is at the reader's left and the left ear at his right.

Since ear-marks, like brands, are subject to designations fixed by local custom, the foregoing classifications must be modified accordingly. Local methods of applying marks may be responsible for a similarity in the shape of bits, staples, and half-scallops; swallow forks, end staples and half-moons; figure 7's, half-crops and bits; and crops and half-grubs. Little or no distinction is made in the West between bits, staples, and half-scallops, all of which may be known as bits. Hacks, slits, and splits may all be known as splits, while half-moons and end staples may be classified as swallow forks in some sections and bits in others.¹

The ones shown constitute the varieties of marks most widely used. There are several others possible, but they have not been found satisfactory, principally because stock bearing them are liable to tear their ears on brush or barbed-wire fences or have them torn off by dogs and thus partially or wholly obliterate the marks. Among the more unsatisfactory marks may be mentioned the "swipe," starting near the center of the ear, describing a half-circle and ending near the outer edge of the ear; the "X," a cross cut through the ear; the "paddle," a slit terminating in a hole; the "box," a removal of the greater portion of the interior of the ear leaving only a narrow strip around the edge; and the "jingle bob," which is made by cutting the ear in such a way that a large portion of it droops or hangs down beside the animal's jaw.

It will be seen at once that there is practically no limit to the number of marks possible and that the proper reading of certain combination marks may be attended with more or less difficulty. This is especially true in reading marks in ears that have been cut or remarked in such a manner that they lop down.²

¹ The readings given here are in accordance with general usage rather than theoretical rules.

² Examination of a cow's ear will show that two large cords run lengthwise through its center. If a split is made beneath the lower cord the portion of the ear under the split will drop till the mark resembles a wide swallow fork rather than a split. Unless the swallow fork effect is desired the split should be cut between the cords.

Right Ear.

Left Ear.

Half-grub.

It will be observed that the half-grub removes half of the ear.



Crop, or smooth crop, and inner over half-scallop.

The smooth crop removes approximately one-fourth of the ear.

Grub.

The grub removes the entire ear and is a mark as unnecessary as it is unsightly and injurious.

*Split.*

Splits terminate at the end rather than at the edges of the ears.

The passage to the inner ear frequently grows shut as the wound heals.

Over slope.

If both an over slope and an under slope are cut in the same ear the ear is said to be "pointed" or "sharpened."

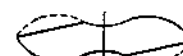
*Under slope.**Swallow fork.*

Swallow forks terminate at the edge of the ear tip. They may also be designated as "bits."

*Over bit.*

Bits terminate at the ear edge. They are usually smaller than swallow forks.

Inner slope and under figure 7.

Inner slopes are seldom used, as they are very unsatisfactory in brush.

*Under bit.*

Figure 7's may also be known as "bits."

Over hack.

Hacks terminate at the edge of the ear.

*Over figure 7 and under hack.**Over half-scallop and inner under bit.*

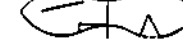
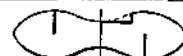
Scallops and half-scallops are cut rounded rather than sharp like bits. Inner bits are seldom used.

*Under half-scallop.**Over scallop.*

Scallops may be known as double bits.

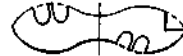
*Under scallop over half-crop.*

Half-crops are often known either as bits or swallow forks.

Under half-crop and over staple.

Staples may often be known as bits.

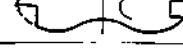
*Inner half-moon and end staple.*

Inner half-moons are seldom used.

Under staple.

This may also be known as an under bit.

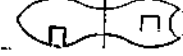
*Half-moon and inner under staple.*

Inner staples are seldom used.

Inner swallow fork and hole.

Inner swallow forks and holes are seldom used.

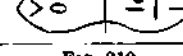
*Inner split, inner hack and split.*

Inner splits and inner hacks are seldom used.

FIG. 219.

3. **Ear Buttons.**—These are used chiefly on registered and graded stock kept within an enclosure and considered too valuable for exhibition purposes to justify their mutilation by marks or brands. The buttons may bear an animal's age, its number in the herd, the owner's name and address, or any other information required. They are made in two pieces as shown in Fig. 220 and are fastened in the animal's ear by means of a pair of pliers especially designed for the purpose. Their chief disadvantage lies in the fact that the information they bear is nec-



FIG. 220.

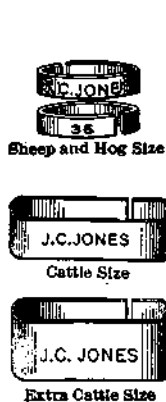

FIG. 221.

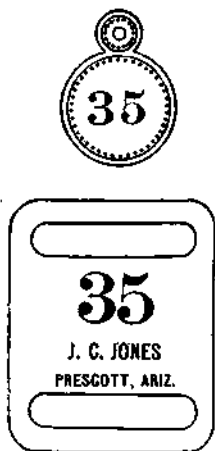

FIG. 222.—Ear tags.

essarily of such small characters that it can not be ascertained except at very close range.

4. **Ear Loops.**—These are shown in Fig. 221 and are fastened through a slit in the ear. Their use is confined chiefly to stock that is kept in pasture or for exhibition purposes. Like ear buttons they may bear any information desired.

5. **Ear Tags.**—Ear tags are suspended from a ring or loop in an animal's ear. They are seldom used on stock except when the animals are to be kept closely confined. Brush, stiff weeds, and barbs along wire fences soon tear them out.

6. **Dewlaps.**—A dewlap is an incision in the loose flap of skin under a cow's neck as shown in Fig. 209. This method of

marking is used on cattle that are pastured or ranged where there is little brush and few snags. If these are encountered the dewlap may be severely torn.

AGES OF CATTLE

Cattle, unlike horses, have no incisors in the upper jaw, this physical characteristic being common to all cloven-hoofed animals that chew the cud. The teeth to be examined in determining a cow's age are the incisors in the lower jaw. They are eight in number and are known, from center to the sides, as "pinchers," "middles," "laterals," and "corners."

To Two Years.—Temporary pinchers and middles are present at birth, or appear soon after, and are followed by the temporary laterals in from ten to twelve days and by the temporary corners in four or five weeks. All are replaced, in the order of their appearance, by permanent teeth, the pinchers appearing at the age of from sixteen to twenty months and being in place at two years.¹

Three Years.—The middles appear at about thirty months of age and are in place at three years.

Four Years.—Laterals appear at the age of three and one-half or four years and are well in place at four.

Five Years.—Corners appear at from three and one-half to four and one-half years and are in place at five, when the animal is said to have a "full mouth."

Over Five Years.—All incisors gradually grow thicker from front to rear, draw away from each other, and instead of being sharp, as in early age, have low, flat, triangular or circular crowns.

¹ Where cattle range on brushy areas and depend chiefly on browse for subsistence, as in the Southwest, the temporary teeth are often lost prematurely as the animals bite and pull at the brush. As a result their age can not always be determined with a satisfactory degree of accuracy.

MISCELLANEOUS

AILMENTS AND INJURIES

TREATMENTS

Antiseptics.—Antiseptic treatment of wounds is never necessary unless disinfection has been neglected, antiseptics merely counteracting putrefaction which never occurs except in infection.

Hydrogen peroxid, which acts only in wounds exposed to the air, has merely a mechanical action and is not a generally satisfactory antiseptic. Equal parts of turpentine and camphor, well shaken together, will be found about the most effective antiseptic that the field man can carry.

Disinfectants.—These are used to prevent the appearance of infectious germs in open sores or wounds, any of which, unless they receive proper preliminary treatment, may become infected. It is therefore always a wise precaution to treat any wound, whatever the degree of its severity, with a disinfectant as soon as possible after the injury is sustained.

A very effective disinfectant may be had by the use of equal parts of turpentine and camphor, well shaken together, and which may be secured at any drug store or at country stores where general merchandise is handled. Ordinarily, ten cents' worth of each will be sufficient for a year's use. In addition to preventing infection, this mixture will also remove soreness and at the same time promote healing. The chief disadvantages of its use are the burning sensations produced by its contact with an open wound and its occasional apparently poisonous effect on persons of subnormal or exceedingly sensitive physique.

Demulcents.—These are used on external sores or wounds for purposes similar in nature to those for which blands are used in some cases of internal poisoning, viz., as soothing and more or less direct healing agents. Thus, mentholatum, a camphorate preparation, may be used with very satisfactory results on chapped or cracked lips and hands, on sunburns, and even on bruises amounting to lacerations. Many persons prefer camphor ice for the same uses, and still others prefer a mixture of

equal parts of bay rum and glycerin, although the glycerin tends to dry out the skin. Still another demulcent, rather crude indeed, but nevertheless especially effective for use on chapped or cracked lips, is ear wax, removed from the ears and applied to the lips with the finger tips.

Witch-hazel is also a good demulcent.

Hot Treatments.—It is often desirable to have some means of supplying a patient with hot treatments when water-bags or bottles are not available. Such treatment may be made possible by the use of stones, flat-irons, horseshoes, or other irons heated and wrapped in cloths. The heated lid of a Dutch oven is especially convenient.

Another simple method is to cut away an old trouser leg, form it into a bag, and fill it with hot sand or earth.

AILMENTS

AILMENTS AND THEIR TREATMENT

The origin of practically all ailments to which man is subject may be traced either directly or indirectly to disordered digestive or respiratory action; consequently, as long as these two systems are kept in proper order, the average field man need anticipate no serious physical disorders.

Too much emphasis can not be placed upon the necessity for careful attention to the primary stages of any ailment, and, unless this attention is bestowed when and where it is specifically needed, other and more serious complications will inevitably follow.

Biliousness.—This may prove to be a persistent trouble in the field, but it constitutes about the only severe ailment a field man need expect. Carelessness in combating it, however, invariably results in serious complications. As a rule it is due to disordered or overworked digestive organs or to irregular or excessive eating. The primary stages are indicated by a bad taste in the mouth, dizziness, headache, a coated tongue, and sometimes a generally tired or aching feeling over the entire body may be present. Sudden changes of position, such as arising quickly or suddenly changing the line of vision, may result in transient blindness, the eyeballs throb and ache, a sensation of fulness appears in the head, and the circulation is poor. These symptoms indicate that the digestive system must

be given a complete rest and allowed to regain its normal condition.

This may be done by the use of some reliable purgative which will clean the organs and assist them in throwing off the excess load placed upon them. Such a purgative should contain a minimum of calomel, if any at all, or salivation may result. Calomel acts as a very efficient restorative, but care must be taken to see that it passes through the bowels without delay and that it is not allowed to accumulate there. Epsom salt, being more in the nature of a laxative than a purgative, may be used after calomel has been taken, and will in all ordinary cases thoroughly cleanse the bowels of any calomel that may have remained inactive in them.

Except in very severe cases, two or three days' use of a purgative should prove sufficient for the restoration of normal conditions in the alimentary canal.

Malaria.—The average field man is stationed high up in the mountains away from low, poorly drained localities where the malaria mosquito (*Anopheles*) breeds, and is therefore less likely to suffer from malaria than other men who may be required to work in mosquito-infected districts.

Malaria Mosquitoes.—The common mosquito may be taken as a fairly representative type of the twenty-four principal varieties of mosquito found in the United States. The proboscis of the male is too poorly developed to permit it being thrust into the skin of animals, and the male therefore feeds on plant juices. The female has a strong, needle-shaped proboscis, which, when viewed under a strong magnifying-glass, resembles a coarse, round file. She lays her eggs in boat-shaped masses, of from two hundred to four hundred eggs, in stagnant fresh water, and these hatch in about sixteen hours, producing larvæ known as "wrigglers." The larvæ feed upon minute aquatic organisms, and under favorable conditions, such as very warm weather, develop into pupæ in about seven days.

The pupæ float on the surface of the water for two or three days, and the perfect insect then appears, its entire life covering a period of from ten days to two weeks, unless cold weather has forced it into a dormant stage, in which it may remain during the winter.

The most effective method of preventing incubation and development of the larvæ and pupæ is to pour kerosene oil, gaso-

line, or petroleum into the pond or pool where eggs have been laid. The oil forms in a thin film over the surface of the water and prevents the immature insects from breathing. If no oils are available common salt may be used, making the water in the pool from 2% to 3% salt.

The malaria mosquito may be distinguished from the common mosquito by her spotted wings, while the yellow-fever mosquito (*Stegomyia*) has silvery stripes on the thorax and abdomen. The last-named mosquito is found only in very warm localities.

Transmission of Malaria.—The parasite which causes malaria is an animalcule called *Hæmamoeba*, which infests and remains in a red corpuscle until this is completely filled. It then divides into innumerable spores, which escape into the plasma of the blood and finally infest other corpuscles. Paroxysms of chills and fever are produced by the simultaneous release of great numbers of these spores. One variety of parasite causes daily paroxysms; another produces the spores every other day, the paroxysmal periods corresponding to the periods when the spores are liberated; and another variety, liberating the spores every third day, produces the paroxysms on these days.¹

Symptoms.—These may be and frequently are preceded by biliousness, persons in this condition being much more susceptible to malaria than those who do not suffer from disordered digestive organs. There is a general feeling of soreness throughout the body, and this is especially noticeable in the muscles at the small of the back. The patient is dull and listless, stretches and yawns frequently, and is unable to rest long in one position. Fever may be preceded by a distinct chill that causes the body to shake and the teeth to chatter. The chill lasts from thirty minutes to an hour, and during the interval the finger-nails assume a bluish or purplish tint. Fever may last from one to four hours and is succeeded by a sweating stage, and comparative comfort is then enjoyed until the next paroxysm. In some cases there may be no chill or cold stage, the patient merely having a high fever for several hours followed by defervescent sweating. In a mild case no paroxysm occurs the second day, but may be expected to appear on the third day, and if proper precautions have been observed should not be as severe as the

¹ In malarial districts of the South, malaria may be known as "every-other-day shakes," "every-day shakes," and "third-day shakes."

first. If malignant malaria results in daily paroxysms, a change of climate is advisable.

Treatment.—If constipation is present a good purgative is required. After the purgative acts, three-grain doses of quinine should be taken at intervals of two hours until the ears ring or nervousness begins to appear. Such treatment should be continued daily until paroxysms no longer occur. Two-grain doses of quinine three times daily for two or three days will prevent an immediate return of malarial symptoms, the bowels during this period being kept regular.

Quinine can best be taken in capsules, which may be filled at any drug-store.

Diarrhea.—This may result from a change of diet or water, and has a very weakening effect on the patient. It indicates the presence in the alimentary canal of some substance that nature is trying to eject.

The most effective treatment is a tablespoonful of castor oil, which will act as a mild purgative and thereby assist nature in removing an objectionable load from the digestive organs. Little or no food should be taken for a day or more, and the organs should be given a complete rest.

Dysentery.—This follows diarrhea. Castor oil should be taken the same as for diarrhea, and a complete rest is essential to quick recovery. After the purgative has acted, five drops of laudanum and ten grains of bismuth should be taken every three or four hours. A liquid diet is necessary.

Cholera Morbus.—This is another disorder of the digestive organs arising from the use of foods that have a more or less poisonous effect on them. Cramps or convulsions may occur, and intense pain is felt in the bowels. A very gentle emetic often proves effective, after which warm or hot-water bags should be applied over the seat of the pain. Drinks of hot pepper or ginger tea are also effective. If these fail to give relief ten drops of laudanum may be used.

Cramps.—This is merely another name for a very slight attack of cholera morbus, the symptoms being similar and requiring the same treatment.

Headache.—This is generally due to indigestion, and the cause must be removed before permanent relief can be obtained. Temporary relief may be secured by drinking half a pint of water in which two teaspoonfuls of powdered charcoal

have been mixed. Headache is usually one of the first noticeable symptoms of biliousness, and immediate precautions should be taken to combat this ailment.

Toothache.—Apply equal parts of pulverized alum and table salt to the affected tooth. Fill hollow teeth with absorbent cotton soaked in chloroform. If the nerve is exposed have the tooth attended to by a competent dentist.

Sore Lips.—Extremely dry, windy weather often causes the lips to crack or otherwise suffer as the result of their unnaturally dry condition. Soreness may be removed, healing promoted, and the skin softened by the use of mentholatum, camphor ice, or vaseline. After a few weeks of constant exposure to wind and dry weather the skin will become so toughened that little or no more trouble from soreness need be anticipated.

Sore Throat.—Gargle with a strong solution of salt water or saturate a woolen cloth or sock with hot turpentine and grease or lard, equal parts, and bind it about the throat upon retiring for the night.

Sore Lungs.—Bathe the chest, neck, and the sides of the body with hot turpentine and grease, equal parts, and rub vigorously. Upon retiring for the night pin a cloth, saturated with hot turpentine and grease, to the night clothes in such a manner that it will rest directly upon the breast.

Bleeding at the Nose.—Bathe the sides of the nose and the back of the neck in cold water or rub them with ice or snow. Snuffing cold water into the nostrils is also effective. Medical attention should be secured if bleeding is persistent and so profuse that the patient becomes weak through loss of blood.

Felon.—Apply a mixture of equal parts of hot turpentine and pulverized salt to the felon in the form of a poultice. Hot flaxseed poultices are also good. Any poultice should be removed as soon as it becomes cold and another hot one should be applied.

Chilblains.—This affection is the result of exposure to cold and generally proves most severe in the heels. Applications of ice or cold water usually remove the soreness. The feet should not be bathed in warm water to remove soreness.

Corns.—These result from the wearing of improperly fitting shoes. Apply tincture of iodine several times daily. Cover corns between the toes with a cloth soaked in the tincture and glycerin. Another effective treatment is frequent applications

acetic acid, which may be used on either hard or soft corns. Finally, wear shoes that fit.

Ingrowing Toenails.—Like corns, these are caused by ill-fitting shoes. They should be scraped thin at the top in order to weaken them at that point and allow a buckling-up process to take place, during which the edges will be drawn upward out of the sides of the toe.

Chapped Hands.—This trouble usually appears as the result of prolonged exposure to extreme frost or cold weather when there is not sufficient moisture or elasticity in the skin to prevent it from cracking, as it contracts through cold. Bay rum and glycerin, equal parts, will prove temporarily effective, but can not be recommended as preferable to mentholatum.

Laborers engaged in work that causes the skin on the palms and the lower surfaces of the fingers to thicken and harden often suffer from deep cracks in the skin surrounding the joints. This trouble is frequently remedied by means of a cord tied about the joint in such a way that it fits into the crack and against its raw surfaces, thus protecting these parts from injury and allowing the crack to heal from the bottom outward.

INJURIES

In the regular course of their work field men are subjected to a number of possible injuries, and unless they possess some knowledge of the treatment required in a specific case they may suffer from severe complications later on. Often they are remote from medical supplies or attention, and in such cases must of course treat themselves.

The most important factor in any treatment is presence of mind, and in case of an injury the field man who becomes excited only makes a bad matter worse.

Open wounds should be washed clean and kept so; if dirt or other foreign substances are allowed to enter, the wounds can not heal properly. Too much attention can not be given to antiseptic precautions or to sanitary measures, and a liberal use of disinfectants is always advisable. The most serious effects of injuries are not always due to the injuries themselves, but in many instances develop as the result of improper or careless preliminary treatment.

Cuts.—These probably constitute the chief injuries received

in the field, and unless they are unusually deep or ragged no complications should ensue. The first thing to determine is whether or not an artery has been severed, and this will be indicated by strong regular spurts of bright-red blood. When such a course is possible a tourniquet should be applied between the wound and the heart, and the injured part should be elevated above the latter. Soot, cobwebs, or mud should never be bound on a cut; it should be washed with from three to five drops of carbolic acid in a pint of water.

Darker blood, flowing in a slow, steady stream, indicates a severed vein, and such a wound seldom proves serious. Bleeding may be stopped by binding fresh flour to the wound. In severe cases a tourniquet may be used, being applied at a point which brings the wound between it and the heart.

Blood which merely oozes out in a few large drops or a number of very small ones indicates injured capillaries, and such a wound requires no attention other than possibly that of the use of a disinfectant.

Hydrogen peroxid applied to a wound will "boil" if the wound is festering or if other unnatural conditions exist. Soreness may be removed by frequent application of turpentine and camphor in equal parts. This will produce a severe burning sensation if applied to an open cut, and in some instances may even have a slightly poisonous effect on the patient, but as a general rule it is as effective a remedy as can be used.

Gunshot Wounds.—Ordinarily, by reason of the fact that the edges of the wounds are ragged or torn, these are more difficult to treat than other lacerations. Care must be taken to wash them thoroughly and to prevent infection as they heal. If very serious, they should be treated by a competent physician.

Burns.—Wash the wounds, then apply castor oil, taking care to see that no blisters are broken. Bandages should not be used, but if they are found to be absolutely necessary they should be light and open enough to allow the escape of natural heat from beneath them. Air may be kept from the wounds by applications of castor oil or vaseline. Cotton saturated with vinegar and laid on the wounds is said to prevent scars.

Bruises.—These should be bathed for an hour or two, according to their severity, in warm water. Allow the temperature of the water to decrease gradually, and finally bathe with cold water. Raw beef bound to the wound will remove discolora-

tion, or a cloth soaked in very hot water, wrung dry, and applied to the wound will serve the purpose as well.

Fractures.—Provide complete rest and see that the injured part is protected from unnecessary movement. Bathe the affected part in cold water to keep down fever, and secure expert medical attention at once. If a splintered bone is forced through the skin, no attempt should be made by an inexperienced person to replace it unless expert attention is absolutely out of the question. In such a case force the splintered end backward and if possible fit it into its natural position, fit the shattered ends together as well as circumstances will permit, and work the limb into a natural position and hold it there by means of splints. These may be made from barrel staves or pieces of wooden boxes, or may be hewn from green timber. See that they are perfectly smooth and that they fit the limb closely. Do not apply directly to the flesh, but bandage the latter lightly, then apply the splints and later make them secure with other bandages. The main object is to hold the fractured ends of the bone together in one position till they knit.

Dislocations.—Pull or otherwise force the joint into its natural position and then bathe the parts surrounding it with warm water and treat as a bruise. In some instances cold water may give more relief than warm water. Give the joint a complete rest and do not use it till all soreness has disappeared.

Sprains.—These are caused by excessive strain on the tendons. Allow a good rest of the injured parts and bathe in turpentine and camphor, equal parts. Do not use the member till soreness has disappeared.

Faint.—This may result from biliousness, fright, or sudden surprise, extreme mental or physical pain, or from a disordered circulatory system due to improper nerve control. The direct cause is lack of blood in the brain.

Lay the patient flat on his back with the limbs extended and the head lower than the body, loosen the clothing about the throat and waist, and dash cold water in the face. Stimulate with a tablespoonful of whiskey or with strong smelling salts held close to the nose. External stimulation may be secured by rubbing the body with alcohol or by chafing the hands and arms. Upon revival remove the patient to quiet quarters and allow a complete rest.

If due to biliousness remove the cause.

Shock.—This is similar to faint and should be given the same treatment.

Freezing.—There is little danger of serious freezing as long as a sensation of extreme cold is felt; freezing occurs at the time these sensations cease and is responsible for their disappearance. Frozen parts may be distinguished by their dead-white appearance and insensibility.

The first symptom is a feeling of extreme cold, which soon disappears and leads the patient to believe that warmth is returning; drowsiness soon appears and the patient has an uncontrollable desire for sleep. It is very necessary, however, to see that he is not allowed to sleep, as this invariably results fatally. He should be forced to exercise, and to adopt such other methods as will serve to stimulate circulation of the blood. If he has become so numb that physical action is impossible he should be taken into a snowbank or other shelter where the wind can not strike him and should then be rubbed vigorously with ice or snow or bathed in the coldest water obtainable. He should never be taken into a warm room until all frost has been removed and he no longer feels numb.

If amputation becomes necessary it should be done by a surgeon who is thoroughly familiar with the prevention of blood-poisoning.

Sunstroke.—Remove the patient to the shade and lay him flat on his back, dash cold water in his face, and see that the clothing is loosened. If recovery does not occur in from forty-five minutes to an hour, salt should be added to the water until a strong solution is secured. Recovery is seldom so complete that the patient will be able to withstand exposure to extreme heat again without a recurrence of the stroke.

Drowning.—Lay the patient face downward over a log or a roll of clothing in such a way that the pressure of the support is against his stomach. Place one or both fore-arms beneath his forehead to keep this from the ground, then press down vigorously on his back, afterward turning him over and pressing on his chest. Alternate pressing of the back and chest should be continued until all the water has been removed from the lungs.

If this treatment fails to remove the water, stand astride the patient's body as he lies face downward, seize him at either side just below the ribs, and give the body a sudden jerk upward,

taking care to see that the operation does not result in bruising the face against the ground. In event this also fails to remove the water from the lungs, the attendant, if he is strong enough, should hoist the patient to his back, the patient's head down and the crook of his knees resting over the attendant's shoulders, while the attendant holds the patient there by a firm grasp of the ankles. In this position the patient may be carried about at a rough, jolting walk or run for several minutes, during which time most of the water will be shaken from his lungs.

If natural respiration does not reappear soon after the water has been removed from the lungs, the patient should be laid flat on his back, and the attendant should then hold shut the nos-

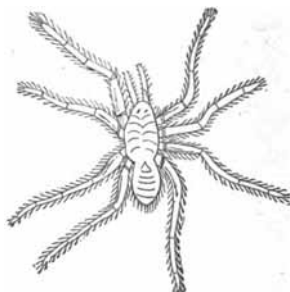

Tarantula.

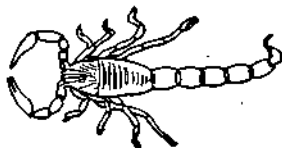

Scorpion.

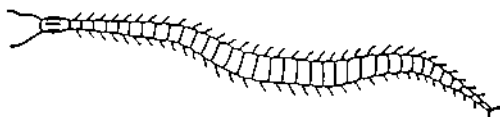

Centiped.

FIG. 223.

trils while he forces his own breath into the lungs of the patient, removing it by pressure on the chest. This should be continued until respiration begins again in a normal manner, care being taken, of course, not to interrupt the first faint breaths that occur.

The patient should be removed to quiet quarters and given a complete rest as soon as natural respiration has been secured.

Lightning Stroke.—This should be treated the same as sun-stroke.

Tarantula, Centiped and Scorpion Wounds.—These should be bathed in turpentine for about twenty minutes and care should be taken to see that all parts of the wounds are reached.

Contrary to a general belief that such wounds are invariably fatal they will seldom prove more than temporarily serious unless the patient is in a generally run-down physical condition.

Catfish Wounds.—These are inflicted by means of the spines appearing at the gills and at the front of the dorsal fin of the catfish. They frequently result in severe soreness, but no permanent ill effects should follow if the wounds are thoroughly bathed in turpentine immediately after they are inflicted.

Dog Bites.—Expert medical attention should be secured immediately if there is reason to believe that the bite has been inflicted by an animal suffering from hydrophobia.¹ The animal's brain should be secured in such cases if this is possible and should be examined by competent authority to ascertain whether or not indications of hydrophobia are present. In any case the wound should be well opened and filled with turpentine.

Snake Bites.—The average field man, in the course of his regular duties, encounters so few poisonous snakes that he gives little or no attention to the study of means to counteract the poison. It is well, however, for him to be prepared for emergencies and to know what should be done in case he is bitten by a poisonous snake.

The poison is primarily a violent blood poison rather than a stomach poison, although its presence in the circulatory system will cause severe illness and nausea. Thick, laborious breathing and physical exhaustion are prominent symptoms, nausea is present but vomiting is difficult, dizziness occurs and partial muscular paralysis attends the advanced stages. Severe internal pains produce spasms and a violent swelling appears about the wound.

¹ The following treatment is said to counteract hydrophobia poisoning, but since there has been no opportunity to verify its actual workings it is not offered as strictly infallible: Bruise up one and one-half ounces of green Elecampane root, a composite plant allied to the aster, and put it in a pint of sweet milk. If the green root is not available use the dried root, which can be secured at most drug stores. Boil the milk down to one-half pint, let it cool then drink it. Repeat the dose in ten or twelve hours but use two ounces of the root. Take a third two-ounce dose twelve hours later. Eat nothing for a period of from six to eight hours after each dose.

Action should be immediate. Locate the wound and make an incision in it to allow free bleeding. If the teeth are sound and the lips free from cracks or other lacerations and the wound can be so reached it should be sucked vigorously. A strong emetic, such as mustard water or warm salt water, should be taken immediately afterward in order to throw off any poison that may have entered the stomach through the mouth and throat.

Instances have been known where chewing and swallowing tobacco and its juice have counteracted the effects of the poison injected through the wound. Another method is to soak the wound in turpentine or in a strong solution of kerosene oil and salt. Moderate drafts of whiskey may prove effective, but in the majority of cases which prove fatal, death is doubtless due more to the excessive amounts of whiskey taken than to the effects of the poison itself.

The most effective remedy is an injection of permanganate of potash, one part of it being used with one hundred parts of water. It comes in the shape of small grains, similar in appearance to gunpowder, and can be secured at any drug store.¹

¹The following official memorandum, issued to Forest officers in District 3, on September 13, 1915, may prove of interest: "Snake bites are most often received on the legs, below the knees, and less frequently on the hands or arms. Wherever the bite may be located, first-aid treatment must be given quickly to be effective. In the case of a bite on the foot or leg below the knee, the first thing to do is to expose the limb instantly and bandage or ligature it just above the knee so tightly as to at once stop the flow of blood and prevent as far as possible the distribution of the poison to other parts of the body. In the case of a bite on the hand or forearm, place the bandage just above the elbow. Anything that can be tied, such as a rope, strap, handkerchief, will answer. A pad of cloth placed under the knee will help to make the bandaging more effective. The second step is to sink the point of a clean, sharp knife to the bottom of each wound made by the snake's fangs, which usually penetrate about one-fourth of an inch, and to slit the flesh parallel with the limb, for one-third to half an inch; avoid cutting across or around the limb, which is more likely to sever a blood vessel. Pinch and rub the flesh about the wound and suck the blood from it for several minutes, or as long as a free flow of blood continues. This will remove much of the venom. The blood and poison should be spit out quickly from time to time. (No one having abrasions, open sores, or cuts on the lips or in the mouth should suck a wound, as these may take up the poison.) The third step is to thoroughly sterilize the wound by an application of permanganate of potash. Spread the wound open and pour the crystals into the cut

It is true that so many bites may be inflicted that death may be almost instantaneous, but this is a very rare occurrence.

Poisoning.—This may occur as a result of impure foodstuffs being taken into the stomach, may result from mistakes made in compounding or administering drugs or medicines, or it may result from a deliberate attempt at self-destruction. Action in any case should be prompt and unattended by excitement or confusion, and should be persistent until the poison has been ejected or neutralized and the patient made as comfortable as conditions will permit.

In nearly every case it is advisable to administer an emetic as soon as the first indication of poisoning appears. While the stomach is being emptied, an antidote may be prepared, and action will thus be hastened and little or no time lost.

Emetics.—The most effective emetic that can be used consists of $\frac{1}{10}$ -grain of apomorphin hydrochlorid dissolved in a syringeful of water, the patient being given liberal quantities of water afterward for purposes of dilution. Another emetic consists of strong, warm, salt water, while another may be made of strong mustard water. If none of these is available vomiting may be induced by thrusting the finger far down in the patient's throat.

Antidotes.—These are given as means of neutralizing poisons to an extent that renders them ineffective. A general rule is to give an acid antidote for alkaline poisoning and an alkaline antidote for acid poisoning.

Blands.—Blands are of a demulcent or soothing nature, and should be given in all cases where the nature of a poison has

freely. An application of iodin in the form of a strong tincture or crystals will answer, if the permanganate is not available. Keep the limb bandaged for at least an hour after the blood has been thoroughly sucked from the wound. Then the bandage can be slackened a little provided the patient shows but little effect (depression), from the poison. If the patient is greatly affected, do not loosen the bandage. When snake bites are received in a part of the body where a bandage can not be applied effectively, opening the wound, sucking out the blood and poison, and sterilizing the wound is all that can be done before taking the patient to a doctor, which in all cases should, if possible, be done promptly. A large dose of whiskey, brandy, diluted alcohol, or aromatic spirits of ammonia should be given at once and repeated as often as is necessary to keep up the patient's strength. Of course, the services of a physician should be secured as soon as possible "

been such as to corrode or burn the membranes-attacked. Sweet milk, raw eggs, and olive oil are about the most effective.

Stimulants.—In event a poison leaves the patient physically exhausted or mentally depressed these conditions may be overcome by administering liberal drinks of strong tea or coffee, and if these are not available then whiskey or brandy may be used instead. The first two, however, are preferable in most cases. If the effect of the poison causes nervousness, extreme sensitiveness, or excitability, then, of course, a stimulant should not be used.

POISONS

These occur in such a multitude of forms that no attempt whatever will be made here to classify them in their various orders. Only such poisons as the field man may possibly encounter during his field work can be considered and these are arranged alphabetically for quicker reference.

Poisons	Symptoms	Treatment
Aconite.....	Numbness in lips and tongue; tingling sensation in limbs.	Emetic; complete rest; stimulant if necessary; warmth.
Alcohol.....	Unconsciousness; deep respiration; snoring; paleness; weak heart-action.	Emetic; large quantity of sweet milk or strong coffee.
Ammonium hydroxid....	Severe pains in stomach and bowels; stained lips and mouth; vomiting.	No emetic necessary; vinegar or lemon juice; bland; stimulant if necessary; rest and quiet.
Ammonia.....	(See above.)	
Arsenic.....	Vomiting; unconsciousness; pain in mouth, stomach and bowels; exhaustion.	Emetic; raw eggs well beaten; stimulant; rest.
Atropia.....	Drowsiness; unconsciousness; deep breathing; flushed face and dilated pupils.	Emetic; stimulants; keep the patient aroused, and, if necessary, produce artificial respiration.
Belladonna....	Staggering; delirium; face flushed; dry mouth and throat; bright, dilated pupils.	Emetic; strong coffee or tea; keep limbs warm; allow plenty of rest for complete recovery.
Bromin.....	Abdominal pains; vomiting; diarrhea; impaired heart-action and respiration; local muscular spasms.	Emetic; stimulant; warmth.

Poisons	Symptoms	Treatment
Camphor.....	Burning sensation in all parts attacked; dizziness; headache; impaired vision; convulsions; irregular pulse; nausea.	Emetic; castor oil or alcohol; rest.
Cantharides....	Externally, blisters; internally, same; nausea; vomiting.	Emetic; no oils should be given; give drinks of gruel, water and meal or flour or other mucilaginous drinks.
Carbolic acid...	Pains in mouth, stomach and bowels; lips and mouth burned white; tongue swollen; spasms and unconsciousness.	Sweet milk, melted butter or lard, or alcohol; bland; stimulant if necessary; rest.
Charcoal fumes	Flushed face; short and rapid respiration; surface of body cold; in slight attack similar to intoxication.	Provide plenty of fresh air; artificial respiration if necessary.
Chloral.....	Similar to intoxication; nausea; vomiting; irregular pulse and respiration; face flushed; extremities cold; convulsions may occur.	Emetic (strong); alkaline antidote; stimulant; keep the patient aroused and do not allow sleep; produce artificial respiration.
Chlorin.....	Inhaled: suffocation, coughing, pains in chest.	Plenty of fresh air; to relieve pain inhale ether.
Chloroform....	First stage, warm feeling and tingling sensations, followed by unconsciousness, relaxation and vomiting.	Artificial respiration; raise feet above head to force blood to brain; if taken into stomach give an emetic, then olive oil and stimulant; keep warm.
Chromic acid...	Muscular cramps; vomiting; diarrhea; slow respiration; collapse.	Emetic; large quantities of sweet milk.
Cicuta.....	Weakness; partial paralysis; dilated pupils; weakened respiration, which, in a fatal case, causes the death.	Emetic; stimulant; prevent cessation of respiration; force patient to breathe.
Cocaine.....	Dry, burning throat and nose; burning in stomach; quick pulse at first, but becomes slow; cold extremities; dilated pupils.	Emetic; liberal doses of powdered charcoal.

Poisons	Symptoms	Treatment
Copper.....	Bitter taste in mouth; nausea; vomiting; colic; thirst.	Emetic; flour paste, raw eggs, or sweet milk.
Corrosive sublimate....	Pain in mouth; vomiting; purging; abdominal pains; convulsions.	Emetic; raw eggs, sweet milk; stimulant.
Cyanid of potaesium...	Drowsiness; insensibility; flushed face; dilated pupils; deep breathing.	Emetic; keep patient awake; produce artificial respiration.
Digitalis.....	Impaired vision; headache; thirst; irritation in stomach; pulse slow but strong; impaired heart-action.	Emetic; stimulant; rest; warmth.
Ether.....	See Chloroform.	
Fly poisons....	These are generally arsenic; symptoms are similar to those in arsenic poisoning.	Emetic; raw eggs well beaten; stimulant; rest.
Formaldehyd...	See Chloral.	
Fowler's solution.....	See Arsenic.	
Hartshorn.....	See Ammonia.	
Hellebore.....	Burning sensation in stomach and bowels; slow, feeble pulse; drowsiness; dizziness; dilated pupils; nausea.	Emetic; place patient flat on his back with the feet higher than the head; give a stimulant.
Hydrates or Hydroxids of Ammonium (Ammonia or Hartshorn) Potassium Sodium.	Soapy taste; burning sensation in mouth, throat, and stomach; light, accelerated breathing; slow pulse; clammy skin.	Emetic; vinegar, lemon or lime juice; if antidote is not available, give a stimulant.
Iodin.....	Abdominal pains; diarrhea; vomiting; local muscular spasms; impaired heart-action and respiration.	Emetic; boiled rice, flour or meal; remove yellow stains from skin with ammonia.
Laudanum.....	Drowsiness; unconsciousness; flushed face; dilated pupils; deep breathing; snoring.	Emetic; prevent sleep and compel patient to move about; stimulant; no rest until effects wear off.
Lead salts.....	Pains in alimentary canal; spasms.	Emetic; raw tomatoes, lemons, oranges; stimulant.
Lye.....	Shriveled lips and tongue; vomiting; severe pains in alimentary canal.	No emetic necessary; raw tomatoes, lemons, or oranges; stimulants; rest.

Poisons	Symptoms	Treatment
Mercury salts...	Vomiting; pains in the alimentary canal; insensibility.	Emetic; bland; stimulants.
Morphin.....	Similar to laudanum, except pupils are contracted.	Treat as for laudanum.
Muriatic acid...	Stained and shriveled lips and mouth; pains in alimentary canal; vomiting.	Emetic; sweet milk, raw eggs, lime, plaster, magnesia, chalk; stimulant.
Mushrooms....	Spasms of stomach and bowels; interrupted heart action; excessive lachrymal secretions; contracted pupils.	Emetic; purgative.
Nicotin.....	Extreme nausea; vomiting; dizziness; rapid pulse and respiration; cold extremities.	Emetic; stimulant; warmth.
Nitric acid.....	See Carbolic acid.	
Nitroglycerin...	Inhaled: a severe "powder headache"; taken internally: colic, vomiting, dizziness, and great weakness.	Emetic; strong coffee.
Nux vomica....	Stiffness; spasmodic action of muscles; convulsions.	Emetic; strong purgative; complete rest.
Opium.....	See Morphin.	
Oxalic acid.....	Intense pain in alimentary canal; vomiting; stained or burned lips and mouth.	Emetic; chalk, lime, magnesia, or plaster; bland; stimulant.
Parogoric.....	See Morphin.	
Paris green.....	Pain in alimentary canal; convulsions; vomiting; purging.	Emetic; raw eggs, sweet milk, castor-oil; bland; stimulant.
Phosphorus....	Pain in alimentary canal; convulsions; vomiting; purging.	Emetic; chalk, lime, plaster, magnesia; bland; stimulant.
Picric acid.....	Fulness in head; roaring in ears; dullness; impaired vision; difficulty in swallowing; pulse weak.	Sweet milk, melted butter or lard, or alcohol; bland; stimulant; purgative will only further irritate bowels.
Poison Hemlock	See Cicuta.	
Potash.....	Pain in alimentary canal; vomiting; convulsions; burned lips and mouth.	No emetic necessary; give raw tomatoes, vinegar, or lemons; bland; stimulant.

Poisons	Symptoms	Treatment
Potassium chlorate.....	Pain in alimentary canal; vomiting; possibly diarrhea may occur.	Emetic; stimulant; rest.
Potassium nitrate.....	Pain in alimentary canal; vomiting; purging; local muscular spasms; impaired heart-action and respiration.	Emetic; stimulant; rest; warmth.
Prussic acid (Potassium cyanid).....	Palpitation of the heart; cold perspiration; dilated pupils; irregular respiration; convulsions.	If large amount has been taken no antidote will be effective; in very small amount give emetic, and produce artificial respiration.
Ptomaine.....	Severe pain in the alimentary canal; vomiting; purging; convulsions; cramps; extreme nausea.	Emetic; purgative; powdered charcoal or wood ashes in teaspoon doses; stimulant if necessary.
Rat poisons....	See Fly Poisons.	
Salicylic acid...	See Picric Acid.	
Silver nitrate...	Pains in throat and stomach; vomiting; vertigo; spasms.	Emetic; raw eggs, sweet milk; rest.
Strychnin.....	See Nux Vomica.	
Sulphuric acid..	Pain in alimentary canal; stained or burned mouth and lips; vomiting.	Emetic; soda, chalk, plaster, lime, magnesia; bland; stimulant.
Tartar emetic..	Pain in alimentary canal; vomiting; purging.	Milk or raw eggs; bland; stimulant.
Wood alcohol...	Nausea; headache; delirium; profuse perspiration; dilated pupils.	Emetic; stimulant; rest.
Zinc chlorid....	Excessive secretions of saliva; difficulty in swallowing; vomiting; collapse.	Emetic; raw eggs, milk, or strong green tea; rest.

Poisonous Plants.—It is impossible to classify these plants definitely because some of them may poison some persons and have no perceptible poisonous effect on others, some that are harmless to animals are very poisonous to humans and some that are poisonous in the raw state are harmless when cooked.

Among the poisonous plants of the United States the most prominent are water hemlock, poison hemlock, henbane, black nightshade, belladonna, lobelia, digitalis, aconit, hellebore, poke-weed and ivy.

The last is often confused with the Virginia creeper or five-

leafed ivy, which may also prove poisonous to some people, but may be distinguished from it by having only three leaves instead of five. It proves poisonous to most persons who come in contact with it and to many who get only in close proximity to it. The affection known as "ivy poisoning" appears in the form of numerous blisters, and extreme irritation of the infected parts ensues. On the hands it usually appears first between and at the base of the fingers, while on the feet it first appears between the toes.

An effective remedy is an application once or twice daily of buttermilk, lemon-juice, vinegar, or raw tomato. Sulphuric ether is also good, but must be used during the primary stages to be effective, and if not used till secondary inflammation appears will be of little use. Its action is to take into solution the volatile oil and to so spread it as to permit rapid oxidation and consequent weakening of the poisonous properties of the plant.

REPTILES

The Horned Toad.—This is not really a toad, but is a large lizard with a wide, flat body. It is common to the South and Southwest and is usually found in hot, dry, sandy localities. It has a flat, circular body, somewhat greater in diameter than a silver dollar, and on its back and head small horn-like protuberances appear which give it its name. These "horns" also appear around the edges of the body. The tail is blunt, the legs are rather long but slender, and the head is short and thick. The entire body is marked with dull red, orange, yellow, gray, and black spots and stripes which, together with the "horns," give the reptile an especially unnatural and repulsive appearance. It is perfectly harmless and makes frantic efforts to escape when approached.

The Mountain Boomer.—This is another large lizard found in the South and Southwest. It seldom exceeds 8 inches in length, has a long, cylindrical body, and a large, triangular head, and bears markings on the body similar in color to those of the horned toad, the chief difference being the brighter hues. It is extremely timid and, upon being approached, runs away with lightning-like rapidity. No reason can be given for the origin of the name.

The Gila Monster.—This reptile is found only in the Southwest, and is the largest and the only poisonous lizard found

this country. It grows to a length of 18 or 20 inches, and has a long, cylindrical body from 2 to 3 inches in diameter and marked with red and brown stripes, the legs are short and thick, the head and tail are blunt and striped with red and brown rings, and the movements are sluggish. It inhabits low, hot, sandy localities, and the bite, though poisonous, is not necessarily fatal.

Poisonous Snakes.—In this country these include the rattlesnakes, copperhead, and water moccasin or "cotton-mouth," the common and scientific names of which follow:¹

Common Name	Scientific Name	Habitat
Rattlesnakes		
Banded or timber	<i>Crotalus horridus</i>	Eastern and Central U. S.
Diamond back	<i>Crotalus adamanteus</i>	Southeastern U. S.
Dog-faced	<i>Crotalus molossus</i>	Ariz., N. Mex., North Mexico
Green	<i>Crotalus lepidus</i>	Southwestern U. S.
Horned	<i>Crotalus cerastes</i>	Deserts, Southwest U. S.
Massasauga	<i>Sistrurus catenatus</i>	Central U. S.
Pacific	<i>Crotalus oregonus</i>	West U. S.; Pacific region
Pigmy	<i>Sistrurus miliarius</i>	Southeastern U. S.
Prairie	<i>Crotalus confluentus</i>	East of Rocky Mountains
Price's	<i>Crotalus pricei</i>	Arizona
Red	<i>Crotalus atrox ruber</i>	South Cal.; Lower Cal.
Texas	<i>Crotalus atrox</i>	Texas, Ariz., N. Mexico
Tiger	<i>Crotalus tigris</i>	Southwestern U. S.
West. Massasauga	<i>Sistrurus catenatus con-</i> <i>sors</i>	Southwestern U. S.
White	<i>Crotalus mitchelli</i>	Deserts; Southwest U. S.
Copperhead	<i>Ancistrodon contortrix</i>	Eastern and Central U. S. to Texas
Water Moccasin	<i>Ancistrodon piscivorus</i>	Southwestern U. S.; Florida to Texas

Common Characteristics.—The most prominent physical characteristics common to all three snakes listed are the flat, triangular head, sharp nose, broad jaws, short, heavy body rather disproportionate to its length, the more or less regular and well-defined diamond-shaped markings of the skin, the hollow, needle-like fangs of the upper jaw and the muscular action involved in advancing or lowering them, the process of emitting poison from the poison glands, the inability to strike unless coiled, and the serious effects of the bite.

Fangs.—These are located in the upper jaw, one on either side, are from $\frac{1}{8}$ to $\frac{3}{8}$ -inch long, hollow, and very sharp, and

¹ Supplied by Bureau of Biological Survey, U. S. Department of Agriculture.

slightly curved toward the rear. Except when used for offensive or defensive purposes they repose backward along the jaw, but the roots are so attached to muscles that the fangs may be advanced instantly. Their backward curve causes them to hang to whatever they may be thrust into.

Poison Glands.—The poison glands are situated at the root of the fangs and consist merely of a small sac containing a violent blood poison which is provided in such quantities by the snake's system that the glands are always supplied, except immediately after a continued attack on the part of the snake. They refill within the space of an hour or so.

Emission of Poison.—When the fang is thrust into the victim, the root presses against the poison gland and forces the contents through the minute tube in the center of the fang. The process is similar to the action involved in using a hypodermic syringe.

The Poison.—This is a very thin, light green fluid having the nature of a blood poison, although its presence in the stomach will produce severe attacks of vomiting and even its odor may cause nausea. It is fatal to the snake when self administered through accident or otherwise.

General Comparison of Rattlesnakes, Copperheads and Moccasins.—*Size.*—The rattlesnake varies in length from 18 inches to 5 feet and instances have been known where this length was exceeded. The girth varies from 3 to 8 inches. The body is fairly well proportioned, although rather heavy for its length, and at the rear extremity bears a series of horn-like rings, commonly called "rattles,"¹ and from which the snake derives its name.

Copperheads are so called from the bright coppery appearance of the head. They attain a length of from 12 to 24 inches and in girth vary from 3 to 6 inches. The body is short and heavy and the head rather disproportionately large.

Moccasins, or "cotton-mouths" as they are frequently known, vary in length from 18 inches to 3 feet. The average girth is

¹ Contrary to a general belief, the number of rattles does not indicate the snake's age. The young snake at birth possesses the "button" seen at the end of a perfect series of rattles, and acquires a new "rattle" each time the skin is shed. Shedding may occur one, two, three or even four times in a year. The "rattles" are the only portion of the snake's skin that is not shed.

about 4 or 5 inches. The body is rather flat and somewhat too heavy for its length.

Color.—Rattlesnakes vary in color from rusty brown to light yellow. The diamonds or bands are darker and are well defined. The under side of the body may be spotted with yellow or brown markings. Copperheads are of a rusty brown or copper color. If shady places have been frequented the skin is bright and smooth with a light copper color; when sunburnt it appears rough and rusty. Like the rattlesnakes, copperheads are marked with "diamonds" along the upper side of the body. These diamonds may be lighter or they may be darker than other parts of the skin. They diminish in size toward the rear and finally disappear altogether, leaving the extreme tail tip a solid color and usually lighter than the rest of the skin. They also diminish in size toward the head but do not disappear entirely. The head is smooth and light brown and has a pronounced triangular shape.

Moccasins are also marked with the "diamonds." The general color is light or dark brown, depending upon whether or not the skin is sunburnt. The scales are large and widely separated so that when they are slightly displaced the white skin shows through between them.

Habits.—The general opinion that a rattlesnake always warns his victim by "rattling" is erroneous.¹ The rule is general but by no means invariable and can not be depended upon to indicate the snake's presence in all instances.

These snakes frequent clumps of bushes or grass and sage, may be found coiled under cacti or in rough cliffs or stone heaps, and frequently appear coiled or stretched at full length on the warm sand in full sunlight. They are by no means timid but are seldom the aggressor.

Copperheads are distinctively Southern, although they appear in some of the Northern States, and will be found about barns, granaries and other outbuildings infested by rats, mice,

¹ A diamond-back rattlesnake in southern Arkansas was pushed with a pole from the shadows of a bush into sunlight for its photograph and could not be induced to "rattle"; a prairie rattlesnake in South Dakota was carried for a distance of more than a mile entwined in a plum bush and never "rattled"; and in Arizona a dog-faced rattlesnake, coiled under a cactus, could not be induced to "rattle" even though it was dragged out and stoned to death.

and lizards. They may also be found under dwellings or about wells and springs where toads and frogs appear. At other places they may appear under clumps of brush or grass where they lie in wait for prey, or they may be found stretched out full length on a flat, warm rock in the sunshine. Frequently they are found in groups of from two to a dozen individuals. By nature they are pugnacious and vicious fighters and seldom attempt to escape when attacked. They are stealthy, move silently, and never appear in a hurry unless in an offensive or defensive attitude when they strike quickly, accurately, and repeatedly.

Moccasins, which on account of the soft white, cottonlike appearance of the lining of their mouths are frequently known as "cotton-mouths," inhabit lagoons, bayous, pools, and streams of running water. They also appear in swamps and drainage ditches or along water-filled ditches beside roads and trails. They are of a timid nature and will escape from danger when this is possible but fight with vigor when forced to defend themselves. Their strength and great size render them formidable opponents.

LOCATION OF CAMP SITES

Water.—The one thing of most importance in locating a camp site is a supply of water. This is absolutely essential except at temporary camps where a supply of water is provided in barrels or canteens.

When camps are to be more or less permanent in nature they should be located at a point far enough away from and above the source of water supply to prevent its contamination by contact with camp refuse if this is allowed to accumulate. It should, however, either be burned or buried.

Fuel.—This is the next important item to consider. Ordinarily, where camps are established in wooded regions, there will be found sufficient dead and down material to provide for all fuel needed either for heating or cooking purposes. But if no wood is available and a camp is to be made in open country, dry stock manure will prove an excellent substitute.

Accessability.—This also demands close attention. If transportation of equipment and supplies is to be by means of wagons it is especially desirable to have the camp located at a point where the wagons may reach it without difficulty and where they may even have plenty of room in which to be backed c

turned about. The camp may be located in a much rougher place, however, if pack animals are to be used. In either event it should be so located as to provide easy access to whatever work is to be done.

Protection.—After the questions of water, fuel, and accessibility have been satisfactorily settled, the one of protection should next be considered. For example: Winter camps located on north slopes where little sunlight can penetrate through possibly heavy timber prove very dreary and uncomfortable. On the other hand, summer camps located on bare, exposed south slopes are equally uncomfortable.

When camps must be established in country where stock grazes at large it is always advisable to construct some sort of fence about the tents or other equipment.

Camp Fires.—*Location.*—The average novice, when he builds his first camp fire, does so with absolute disregard of the wind's direction and velocity, the nature of the fuel he must use, and the amount of fuel he may have at his disposal. The fire should be located at a point far enough and in a direction from the camp to prevent embers or smoke from blowing into the tents or bedding. If the fire is to be cooked over, however, it should not be so far away from the dining tent that valuable time may be lost in going to and from it.

Building the Fire.—Small, dry fuel should be placed directly on the ground and covered with the coarser fuel, the latter being prevented from smothering the blaze by the support of stones or logs placed beside the spot selected for the fire. Green logs are preferable for this use and should be laid parallel with each other, one on either side of the fire; placed in this position they not only serve as a means of support for the fuel but they also act as walls for the confinement of the live coals.

Camp fires should never, in any instance, be built against the trunks of large trees or against large logs that will not be completely consumed by the time camp is to be moved. Neither should they be built in the midst of inflammable material until a wide area has been swept off quite clean.

Fuel Woods.—Dry wood will be found preferable to green wood if a quick, hot fire is desired either for heating or cooking. Dry heartwood of any of the pines makes good kindling but is not satisfactory when used exclusively in camp fires or camp stoves; the deposits made by the smoke soon clog a stovepipe,

and this demands frequent attention in the matter of opening the pipe.

Dead aspen (*Populus tremuloides*), or any of the oaks, hickories, or junipers, will be found very good for stove wood, as will also mesquit, chaparral, dry manzanita and greasewood. Dry juniper is not a satisfactory fuel for open camp fires; the constant snapping and cracking frequently throw live coals to a considerable distance and these may fall on the tents, bedding, or other inflammable equipment.

After a deep bed of live coals has been secured, any of the oaks will prove very satisfactory for extended heating purposes. The coals of such a fire may be well covered with ashes at night and enough of them kept alive to supply considerable heat the next morning.

Care of the Fire.—Regulations concerning camp fires in the National Forests are particularly stringent and good care must be taken to see that a general conflagration does not result from a camp fire. When camp is moved, the fire should be completely covered with dirt in order to prevent the escape of any flames or live coals. If water is available, it should be used freely and the coals thoroughly drenched, but in any case covering with dirt is advisable.

Six Rules for Prevention of Fires in the Mountains.—The following six rules for prevention of fires are quoted from page 22, U. S., 1915:

1. *Matches.*—Be sure your match is out. Break it in two before you throw it away.
2. *Tobacco.*—Throw pipe ashes and cigar or cigarette stumps in the dust of the road and stamp or pinch out the fire before leaving them. Don't throw them into brush, leaves, or needles.
3. *Making Camp.*—Build a small camp fire. Build it in the open, not against a tree or log, or near brush. Scrape away the trash from all around it.
4. *Leaving Camp.*—Never leave a camp fire, even for a short time, without quenching it with water or earth.
5. *Bonfires.*—Never build bonfires in windy weather or where there is the slightest danger of their escaping from control. Don't make them larger than you need.
6. *Fighting Fires.*—If you find a fire, try to put it out. If you can't, get word of it to the nearest United States forest

ranger or State fire warden at once. Keep in touch with the rangers.

Protection of the Public Health.—Unfortunately there appears to be a tendency on the part of a certain class of thoughtless campers to pay little or no attention to sanitary precautions in their own camps or to the welfare of the local residents among whom they may be temporarily located. Forest officers, however, have definite instructions to see that sanitary measures are adopted by the camping public, as will be seen in the following regulation appearing on page 29, U. B., 1915:

REG. P-4. The following acts are prohibited: Having or leaving in an exposed or insanitary condition on National Forest lands camp refuse or debris of any description, or depositing on National Forest lands or being or going thereon and depositing in the streams, lakes, or other waters within or bordering upon the National Forests any substance or substances which pollute or are liable to cause pollution of the said streams, lakes, or waters.

In explanation of this regulation "The Use Book" goes on to say:

"Every precaution will be taken by forest officers to protect the public health. All persons on National Forest lands are liable to trespass proceedings if insanitary conditions result from their presence. The main danger to be guarded against is that of typhoid fever, resulting from toilet accommodations which drain to waters used for domestic purposes, and from the exposure of refuse of all kinds to flies. In large or permanent camps latrines must be dug in suitable locations remote from the water, and disinfectants should be used freely. All camp refuse must be disposed of, either by burying or burning. In small temporary camps suitable precautions should be observed, and refuse of all kinds must be kept well away from the water. The carcasses of all dead animals when they are a menace to public health should be buried or burned. . . ."

"Forest officers will enforce compliance with Regulation P-4 on the part of all campers, stockmen, permittees, and other persons traveling through or occupying National Forest lands."

CONFUSION OF DIRECTIONS

This presents about as unpleasant a problem for the field man as any he encounters, and since its occurrence is so frequent and so common to the beginner in the field service a few general suggestions may prove of value.

When they are obtainable the field man should secure reliable maps of the country in which he is to work. He should make a special study of the location of streams, mountain ranges,

roads, trails, settlements, mines, sawmills, and other features which may serve as guides by which he may travel. He may observe, for example, that the drainage of a particular locality is westward, that main lines of travel are along valleys or on the tops of ridges, that a prominent mountain top has a certain easily remembered location with reference to other and less prominent peaks, that north slopes may be steeper than south slopes, or vice versa, that certain villages or ranches are located at peculiar or unusual points, and he may, by close observation, notice numerous other pertinent facts that may be of great value to him at a time when they are especially necessary.

It seldom happens that maps of this sort are not available, but in event they can not be secured, then the field man must rely either upon the advice of local settlers or else upon his own ability to reach his destination. It should be remembered that the inability to travel directly through strange territory is not confined strictly to inexperienced travelers; veteran woodsmen occasionally "get lost" and sometimes have considerable trouble in ascertaining even their approximate location. In such cases, however, their confusion is due to carelessness and to only casual instead of close observation of their surroundings.

It is always well to take frequent "back sights" at the country gone over. This presents to the traveler views of certain landmarks as they will appear on his return trip, and as a result he will be able to retrace his former route with less difficulty.

Upon proper requisition the field man may secure a regulation Forest Service compass, and if he has one of these along he should consult it immediately upon discovering that he has been traveling in the wrong direction. On such occasions he will invariably have a feeling that the compass may possibly be out of order and that it is not working properly, complete faith in his own sense of direction may make him unwilling to be guided by a mechanical contrivance, and he will follow the compass directions with reluctance. At such times there should be no doubt as to the reliability of the compass. It is true, of course, that the instrument may have been damaged by careless handling, and that as a consequence it will fail to work properly, but this or a similar contingency is the only one in which the compass should be disregarded.

On days when the sun may be seen a common watch may be used as a means of determining the approximate direction in

which a person is traveling. The end of the hour-hand is pointed toward the sun; a line projected from the pivot on which the hands are hung over a point mid-way between the end of the hour-hand and the figure "12" will run approximately south.¹

When "lost" at night the traveler may observe the stars, if these are visible, and ascertain his general direction of travel from them. A very prominent constellation is Ursa Major, or the Big Dipper, consisting of seven stars, each having an individual name and known from the end star in the handle successively as Benetnasch (a white sun), Mizar (white and emerald), Alioth (very bright), Megrez (yellow), Precda (yellow), Merak (greenish white), and Dubhe (yellow). Two of these, Merak and Dubhe, on the side of the dipper opposite the handle, are in line with the pole-star and are known as "pointers." The curved line marked by Alioth, Mizar, and Benetnasch points directly toward Arcturus. The pole-star forms the extremity of another constellation called Ursa Minor, or the Little Dipper, which also consists of seven stars. Another constellation in the immediate vicinity of these two consists of five stars of the third magnitude arranged somewhat in the shape of the letter M and called Cassiopeia. Further east are the Pleiades, six stars in number and all visible to the naked eye. Orion is the most prominent southern constellation, can best be studied during the winter months, and sets at the same time the constellation called the Scorpion rises. Another constellation, the Twins, appears in the region of the Pleiades. To the east of the Twins appears the Lion, consisting of three stars of the second magnitude and one of the first, others in the constellation not being easily discerned with the naked eye.

If neither the sun nor stars can be used in determining direction then the traveler must rely upon his general knowledge of the section in which he is located. It should be borne in mind that in sparsely settled localities the few settlements which do occur are found mostly along the watercourses which, consequently, should be followed rather than crossed. Ordinarily the first settler met with will be able to direct the traveler further.

Ascertaining directions by means of the moss on trees in localities where the timber-stand is dense is quite reliable, but

¹ Applicable only in the Northern Hemisphere.

is never a safe guide in sections where a thin stand of timber allows air and sunlight to penetrate thoroughly.

Confusion of directions on a prairie, where it is much more likely to occur than in timber, may be removed by careful attention to the manner in which the grass stems lean; prevalent southwest winds will eventually cause them to lean to the northeast.

In Colorado, New Mexico, and Arizona, the Occident ant (*Pogonomyrma occidentalis*) throws up a mound of coarse sand and fine gravel and in nearly every instance leaves an opening at the southeast side, presumably in order that the early morning sun may warm the runway sooner. Careful observation of a group of these mounds will assist the traveler in getting his bearings. In the same localities the Thatching ant (*Formica rubiginosa*) covers its mounds with pine needles, straws, grass stems, and small twigs, and also generally leaves an opening at the southeast side. This rule is not followed as closely, however, as in the case of the Occident ant.

Quite naturally, the realization that he is lost in strange territory confuses the average traveler, and this confusion may extend to and so affect his judgment that he may run wildly about in a frantic attempt to locate some known landmark and thus extricate himself from his dilemma. Under such conditions he may strike a road or trail that he has been over, but in his confusion is unable to recognize it, and he continues to wander about until physical exhaustion overcomes him.

Such excitement is, of course, wholly uncalled for. If night overtakes him he should make no attempt to proceed further, but should make the best of matters and wait for daylight; this may seem like a waste of time, but, on the contrary, it is the best means of saving time.

If he is accompanied by another person who is familiar with the country being traveled over he should not question that person's judgment even though it may seem that a contrary direction is being followed.

FASTENINGS

Knots.—The field man who must be continually packing, saddling, tethering animals, raising and lowering articles by means of ropes, or using ropes in a number of other ways should be

more or less familiar with those knots for which he may have the greatest use. Ordinarily, he need not have a general knowledge of all knots but he should possess a working knowledge of most of the simpler ones, and for that reason these are illustrated and discussed here.

In order to simplify the subject as much as possible, it will be considered as including knots, nooses, hitches, latigo ties, and splices. Technical terms will be avoided in so far as this may be practicable.

It is suggested that if the beginner wishes to practice the construction of the various knots by endeavoring to tie them as he refers to the illustrations, he provide himself with a 6-foot length of $\frac{1}{4}$ -inch braided cotton line. This will not twist or tangle as badly as twisted line. However, the latter must be used while splices are being studied. If knots or ties are to be made in leather he should secure a very pliant piece with which to experiment.

Overhand.—This is the simplest knot tied and its construction needs no explanation. It is used at the ends of ropes to prevent the strands from untwisting, may be used as a means of marking spaces along a line, or may serve as a check-knot for loops of lines working on others.

Surgical.—This is used chiefly by surgeons in securing severed artery ends and for other purposes where small knots that will not slip are required. It is constructed the same as the overhand except that one end is given an extra turn about the other. It may be released by pulling either end in a direction at right angles to the series of turns.

Staffordshire or Tait.—The term "Tait's" knot is taken from the name of the surgeon who first employed it. In construction it is the same as the surgical knot except that a round turn is taken before the latter is tied. It is also loosened the same as the surgical knot.

Square or Reef.—This is another common knot used chiefly in fastening loose ends together. Its construction is so simple as to require no explanation.

Combined Surgical and Reef.—The chief advantage of this knot over the plain surgical knot is the method by which the ends are made fast and which prevents them from slipping. It is opened by pulling the loose ends in a direction at right angles to the reef.



Overhand.



Granny.

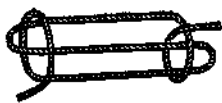

Sheep-shank.



Surgical.



Thief.

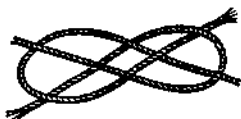

Carrick bend.



Staffordshire
or "Tait's."



Figure 8.



Double overhand.



Square or reef.



Single sheet bend.

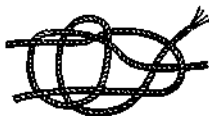

Double sheet bend.



Combined
surgical and reef.



Bowline.



Overhand
and half hitch.



Running bowline.

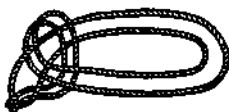

Bowline on a bight.

FIG. 224.—Knots.

Granny.—At first glance this appears to be identical in construction with the square or reef, but close observation will reveal the fact that in the latter the ends leave the other loop from the same side on which they entered it, while in the granny they leave from the opposite side.

Thief.—This also appears to be the same as the square and granny knots. However, it will be observed to differ from the first in having one loose end at the top and the other at the bottom. It differs from the second in that the ends enter and leave the knot at the same side.

Figure 8.—This knot is used chiefly for ornamental purposes, being frequently tied in the braid of official caps and uniforms. For practical purposes it is no better than the overhand.

Single Sheet Bend.—In making this the loop is the first part to be formed. The loose end is then passed through it, around the neck, and back between the loop and itself. The knot will not slip if properly constructed and is a very reliable method of tying animals by the neck. When used for this purpose the loop is constructed far enough back from the end of the rope to allow the latter to reach around the animal's neck and fasten into the loop. Its chief disadvantage for such use is that it may be drawn so tight that it can be opened only by cutting the rope. However, this trouble may be avoided if the loose end is tied in a draw loop.

Double Sheet Bend.—The construction of this knot is the same as that of the single sheet bend except that the loose end encircles the loop twice instead of once, passing beneath itself both times.

Bowline.—This is usually pronounced "bolan." Like the single sheet bend it can not slip if properly constructed. The loose end is passed through a half hitch in the long end from the under side, crosses under the long end, and doubles back over itself and through the half hitch from the upper side.

Running Bowline.—This is constructed the same as a bowline except that a larger noose is provided for. The bowline may be tied about the long end of the line or, if the latter is loose, it may be passed through the bowline. The running bowline is used where nooses must be opened and closed quickly and easily.

Bowline on a Bight.—The construction of this is slightly different from the other bowlines shown. Owing to the use of a

double line throughout the knot it is much more easily tied. If properly constructed the loop will not close up.

Sheep-shank.—The chief use of this knot is in taking up slack in a line. Its regular construction is rather too complicated to explain here, but a simpler and just as effective method is merely to turn the half hitches about the loops.

Carrick Bend.—Like the figure 8 this is used chiefly for ornamental purposes though it may be used in tying lines together. It will not slip if tightened evenly.

Turk's Head.—This knot is frequently used at the ends of lines to prevent the strands from untwisting. Four incorrect

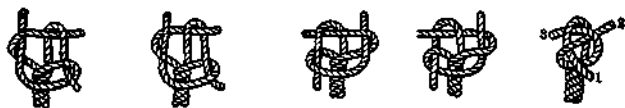

Incorrect starts.

Correct start.

FIG. 225.—Turk's head.

methods of starting it are shown. The fifth illustration shows the correct method. After the strands have been made fast under each other as shown here, the ends are disposed of as follows: No. 1 passes around outside of 3, upward between itself and 3, and out through the triangle formed by 1, 2, and 3; 2 passes around outside of 1, upward between itself and 1, and out through the triangle; 3 passes around outside of 2, upward between itself and 2, and out through the triangle. After the knot has been drawn tight the loose ends should be cut away close to it. Turk's heads are tied in lines of more than three strands by following the same method of procedure.

Overhand and Half Hitch.—The chief advantage of this knot lies in the ease with which it may be finished after the first part has been tied and while there is great draft on the lines. After the overhand has been tied a half hitch in one end is taken about a loop in the other. It may be completely released by pulling the loop backward through the half hitch. It is especially adapted to fastening down a grain pack.

Double Overhand.—This may be tied in rope but is especially suitable for tying leather and is frequently used at the end of a pair of reins. The two loops are first formed, the short end of the one to the left being toward the operator, and that of the the one to the right in the opposite direction. The end of the

first is then passed to the right around the second and forward through the loop formed by itself. The end of the second is passed to the left around the first and out rearward through its own loop.

Nooses.—*Hangman's Noose.*—This noose derives its name from the fact that it is frequently used in the execution of criminals. When used for this purpose the knot, usually consisting of nine turns, is placed at the left side of the neck against the ear. Being quite stiff it suddenly forces the head to the right at the moment the weight of the body comes against the noose



Hangman's.



Halter.



Slip.

FIG. 226.—Nooses.

and two or more of the neck joints are separated. When properly constructed it also closes quickly and becomes tighter as the weight remains suspended from it. It is also a favorite method used by horseman in disposing of long dangling ends of saddle-strings or in fastening up halter-ropes that will not be used for some time.

The turns begin at the noose after the long inner loop has been laid along the other side of the noose. The end is secured by being passed through the end of the inner loop. If it is to be constructed in such a manner as to remain open an overhand knot must be tied at either side immediately before the first turn.

Halter Noose.—This noose is made by passing the loose end of a rope through an overhand knot tied at a point far enough from the end to allow the noose to encircle an animal's neck. The end is also tied in an overhand knot which prevents it from pulling through the first one. The noose can not be closed by

draft on the long end of the rope, but the knots may be drawn so tight that it will be necessary to cut the rope before the noose can be opened.

Slip Noose.—For use where it must close by draft this noose is quite reliable. However, a very stiff rope can hardly be tied so the overhand will not open when the draft is applied. This trouble may be remedied by giving the loose end a half-hitch about itself just to the rear of the overhand.

Hitches.—*Half Hitch.*—Practically all of the more complicated knots include some use of the half-hitch or its more elab-



Clove hitch.



Clove and a half.

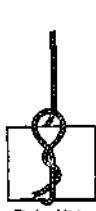
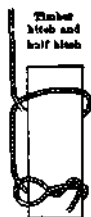

Timber hitch



Gling



Rolling hitch



Black wall hitch



Gate jaw



3 half hitches

Round turn
and 2 half
hitches

Anchor hitch



Noosing hitch



Telephone hitch

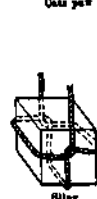

Gling

FIG. 227.—Hitches.

orate formation as a clove hitch. In constructing it, the line is grasped in both hands held with the palms downward, the thumbs toward each other. The left palm is then turned upward and the tips of the thumbs are brought together. The left thumb may be raised from the line and lowered on the

length which crosses just before it. In this way the hitch may be held with the left hand while the right is used otherwise, as may be required.

Clove Hitch.—Like the preceding hitch this one plays an important part in the construction of a number of the more complicated hitches. It will not slip when properly constructed and is therefore especially convenient in fastening tent ropes and in making ropes fast otherwise. It is constructed of two half hitches, one in either hand, the inner edge of the one to the right being passed under the corresponding edge of the one at the left and across to the opposite side. This permits the hitches to coincide, and the clove may then be dropped down over the tent-peg or other object to which the rope is to be tied.

Clove and a Half.—This is used for the same purposes as the clove and is constructed in a similar manner except that one more half hitch is included.

Timber Hitch.—This is made simply by taking a half hitch about the long end of a line and fastening the loose end by passing it over, around, and under the rope to the rear of the half hitch so it rests against the article about which the timber hitch is taken. It is used as a means of raising logs, timbers, or similar articles, or may be used in securing them to others. It is prevented from slipping by the pressure of the rope against the loose end passed under it, and can be easily loosened by releasing the draft on the long end. This allows the half hitch to be slipped backward and relieves it of its own pressure.

Timber and Half Hitch.—The most common use of this tie is in raising vertical timbers. The timber hitch not only provides greater binding capacity but also fastens the end of the half hitch. To release it, slack the long end of the line. This allows the timber hitch to be removed and the half hitch can then be taken off.

Overhand Sling.—This is for use in raising boxes, barrels, and similar articles. It consists of an overhand knot passed about the article to be raised, one length of the knot passing under it and the other two about the sides. Removal of the draft releases it.

Bowline Sling.—This may be used for the same purposes as the overhand sling and is especially adapted to raising articles that are not to be turned or rolled. Two half hitches are taken about the article and the loose ends are tied together in a bow-

line. Where great weight is likely to pull the bowline tight it should be tied with a draw loop. To release the sling, loosen the bowline.

Rolling Hitch.—This consists of a clove hitch with the ends passed under a turn taken between the two sides of the clove. To release it loosen one end. This opens the turn and permits the other end to be removed.

Mooring Hitch.—As its name indicates this hitch is used in mooring vessels to wharves. At first glance it may appear to be the same as the rolling hitch. However, its construction differs in having one side of the clove bound by the turn twice instead of once as in the rolling hitch. To release it loosen the side of the clove that is bound only once. This opens the clove and removes the pressure from both places on the other side.

Two Half Hitches.—This consists merely of a clove hitch taken about the long end of a line. If there is reason to believe it may be drawn so tightly as to be released only with difficulty the second half hitch should be made with a draw loop. If the article to which it is tied is very smooth or if it tapers considerably the loop may slip along.

Round Turn and Two Half Hitches.—The construction of this is similar to that of two half hitches except that the line is given a turn about the object to be tied. Its advantage over the two half hitches lies in the fact that the turn prevents the hitch from slipping unless an article has a very great amount of taper. It is released by removal of the second half hitch.

Anchor Hitch.—This is constructed the same as the preceding hitch, except that after the loose end has been passed about the line it is then passed through the turn before the second half hitch is taken about the line. To release it remove the second half hitch and pull the line downward as if starting a second turn. This loosens the turn already taken and permits the loose end to be drawn backward through it.

Telephone Hitch.—This is for use in dragging poles or timbers lengthwise. It is constructed by passing the ends of a doubled line about the timber from opposite directions and tying the ends together in an overhand knot. To release it pull the overhand backward and open it.

Cat's Paw.—Two lines may be used in this hitch. One is given a round turn about an object and the ends are then tied

together. The other is passed through the turn a number of times and made fast by passing the loose end through the turn about itself. To release it remove the draft and withdraw the loose end.

Blackwall Hitch.—This hitch is used in fastening a line into a hook and consists merely of a half hitch taken about the hook shank, the line crossing itself in the bend of the hook. Removal of the draft will release it.

Latigo Ties.—*Overhand.*—This tie is shown in Fig. 228. It is very simple in construction, is easily applied, and is a widely used

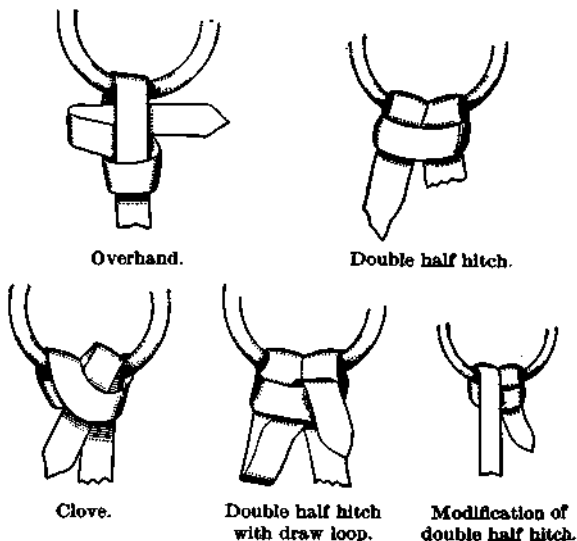

FIG. 228.—Latigo ties.

method of securing a latigo to the saddle ring. Its release is facilitated if a draw loop is used.

Double Half Hitch.—This is probably the most widely used of all latigo ties. It consists of two half hitches being taken through the saddle ring and, unless the latigo leather is unusually hard and stiff, will seldom or never slip. Like the overhand it may be removed with less difficulty if the draw loop is used.

Clove Hitch.—This tie is used about as often as the overhand

but, unless the latigo leather is very soft and pliant, will sometimes slip and allow the cinch to work loose. It should also be tied with a draw loop.

Splices.—Splices in rope may be either permanent or temporary. They may be supplied for the purpose of fastening two ropes together or they may be used to form eyes through which other ropes or eyes are passed.

1. *Permanent Splices.*—A general method of making permanent splices is shown in Fig. 229. To do this the strands of each rope end are untwisted and if the splice is to work through tackle blocks a portion of each strand may have to be cut away

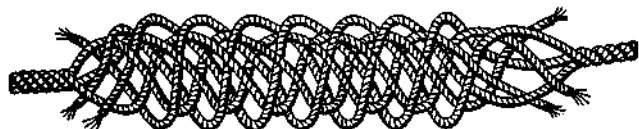

FIG. 229.—Permanent eye splice.

in order to reduce the diameter of the splice. A splice 8 inches long is sufficient for $\frac{1}{2}$ -inch rope. Larger rope should have proportionately longer splices.

The actual work of splicing begins after each strand of one rope has been passed through between two strands of the other and the tightly twisted portions of each have been brought close together.

One strand of the solid rope is raised each time and a strand of the untwisted rope is passed beneath it, the rear strand always being brought up first and drawn tight. The splice should terminate with a loose end projecting from each of the rope's three sides. These are cut off close to the rope and the splice is then rolled smooth and even.

The entire process will require considerable practice before it can be successfully followed, but a careful study of Fig. 229 should prove of material assistance to the beginner.

2. *Temporary Splices.*—These are used where spliced ropes must be taken apart frequently and may be made in a number of different ways. The chief temporary splices used are as follows:

Hawser Bend.—This consists of a loop in the end of one rope passed through a second loop in the other. The loose ends are

given a half hitch about and lashed to the respective ropes as shown in Fig. 230.

Clove and Overhand Splice.—This is also illustrated in the same figure with the hawser bend.

It consists of a clove hitch slipped over the end of another rope bearing an overhand knot at its end.

Toggle Splice.—Fig. 230 also shows how this splice is constructed. A toggle pin or stick is fastened into the end of one

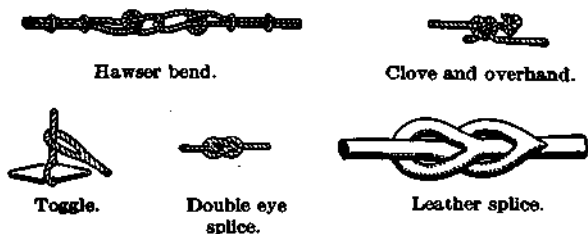

FIG. 230.—Splices.

rope and is passed through an eye splice in the other. The eye splice should be only long enough to permit the toggle pin to pass through beside the rope which carries it.

Double Eye Splice.—Ropes fastened together by means of this splice are each equipped with an eye as shown in Fig. 230. Such a splice is released by bending the rounded ends of the eyes toward each other.

Leather Splice.—Leather straps to be spliced together are both slit at one end. Each strap is then passed through the slit in the other, as shown in Fig. 230, and drawn tight.

Eye Splices.—A very common but improper method of starting an eye splice is shown in Fig. 231. By following such a method the strands of the loose end all start into the splice along one side of the rope. This leaves a very unsatisfactory connection that does not fit closely into the splice. The proper method of starting the splice is also shown in Fig. 231, where the three strands each enter the splice at different sides. This may leave one strand rather higher than the others at the end of the splice but the eye is substantially made and is generally satisfactory. After the strands have been started they are passed through between the others the same as in splicing two

ropes together. The same method is also followed when one rope is to be spliced into the side of another. Except in the matter of keeping up the extra strands ropes having more than

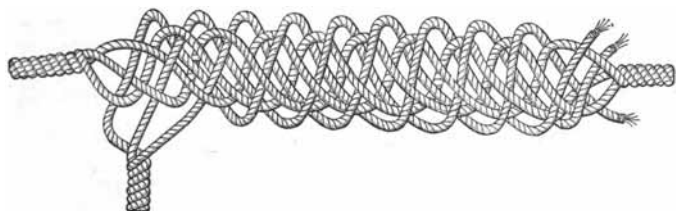

Incorrect method of starting an eye splice.



Correct method.

FIG. 231.

three strands are spliced the same as those having only three. Temporary eye splices may be made the same as the hawser bend. This same splice is frequently used in wire cables.

Flat Ends in Leather.—This method of fastening the ends of leather strands is employed chiefly in reatas and similar leather articles and presents a flat, compact end that does not carry a large, inconvenient knot. As the illustration shows, the lower strand of the series is split each time, remaining strands, regard-



FIG. 232.—Flat end for leather strands.

less of their number, are passed through it, after which each in its turn is split in a similar manner as it reaches the bottom of the series. Finally, at the extreme end in a series of four strands.

only the second and third strands from the top are passed through the bottom strand, thus permitting two strands to emerge from each side of the flat end. If six or eight strands are used then three or four strands, respectively, are passed through the slit.

Or, as is often done, all the remaining strands may be passed through the slit and the flat end will still be left flat and compact.

FIELD WORK IN THE PHILIPPINE ISLANDS¹

Field work in the Philippine Islands demands different equipment than that required in the United States. This is due to a number of facts, chief among which are: (1) The climate is warmer and damper; (2) traveling through the forests is done on foot rather than by horse; (3) men instead of animals are employed in packing; (4) there is no lack of laborers; (5) the days are about twelve hours long the year round.

Rains occur almost daily between June and December, but as a rule continue only a short time and generally occur after noon. During this season, however, typhoons, or hard rains with severe winds lasting from three to seven days may be expected. Extreme heat generally prevails throughout May. The chief trouble experienced during the rainy season is keeping equipment and supplies in good condition and preventing them from becoming moldy.

A light tarpaulin may be carried, but is not absolutely necessary, as the native woodsmen possess a skill in erecting shelters of rattan or *bejuco* leaves which renders them almost rain-proof. These shelters may be constructed in a very few minutes.

Clothing should consist of strong but light trousers, light underwear, and a medium weight woolen shirt such as is used in the army. Even on short trips the equipment should include one or two extra suits of underwear, as the climate induces considerable perspiration and the traveler may become chilly late in the evening unless dry underwear is available. Several pairs of medium weight woolen socks should also be included in the outfit and it is always well to carry an extra pair of shoes, preferably of canvas with substantial leather soles. Rubber boots or shoes are to be avoided on account of the warm climate. Hats should be of the wide-brimmed felt variety and as light as possible.

¹ Contributed by Forest Ranger Wayne Russell.

A woolen blanket on an ordinary army cot is sufficient for bedding, but the entire bed should be covered with a good mosquito bar. Very few poisonous snakes are encountered. Leeches are found in most localities and in general appearance resemble those of the States, but they inhabit wet grass instead of stagnant pools. They seldom appear in the lower altitudes during the dry seasons, but may be found as low as 500 feet above sea-level during the rainy season. The natives of the Province of Tayabas, which is the worst infected district, carry soap or grease with them on extended trips and rub this on the leeches if any attach themselves to the travelers' legs or feet. This causes them to drop off. Persons wearing shoes and leggings are seldom troubled with this pest.

Deer and wild hogs are numerous and several varieties of wild doves provide excellent fresh meat. Chickens and eggs may be procured at most villages. The former are transported alive by the native packers, are "staked out" at night by being tied to a stake or bush, and are killed and dressed as required.

A fern called *paco* and a rattan blossom known as *palasan* may be found in most sections, and both are edible. Very little of the wild fruit is fit to eat. Tame fruit, such as pineapples and bananas, should not be eaten at a time when great hunger is experienced, or cramps or other internal disorders will invariably result. Wild honey occurs in abundance, but is found suspended from a large branch or tree-trunk rather than in hollow limbs and trunks.

Rice and dried fish constitute the principal foods, and after the traveler once becomes accustomed to the native method of preparation these prove quite palatable to him. All foods should be eaten while warm and the use of canned foods should be avoided whenever this is possible.

Few cooking utensils are necessary, since the native packers can soon produce cups, saucers, plates, dippers, and other similar articles from a bamboo called *cana bojo*. Rice and such foods are prepared in earthen jars. The traveler may, if he prefers, carry a limited number of dishes for his own use, but the packers prefer to eat from leaves. Coffee may be prepared by pouring boiling water into a flannel sack partly filled with ground coffee. Bad water will be found quite frequently, and for that reason a canteen of good drinking water should always be carried.

Cigarettes should be carried for the packers and they are always willing to have their pay reduced accordingly.

Quinine and disinfectants should always be carried in the pack, as should also a good cramp remedy. A few bandages might also be included, but beyond this little else is required in the way of medicinal equipment.

The packers work singly or in pairs and the pack is suspended from a pole known as a *pingon*, which rests on the packers' shoulders as the pack is carried between them. Packs for one man may weigh from twenty-five to forty pounds; for two men from one hundred to one hundred and twenty-five pounds. Guides, or *guias*, expect to carry their own camp outfit.

The native packers have more respect for and are more deferential to travelers who require them to do all the work. They should be reprimanded only when this is absolutely imperative, and there should be no reference made to the matter later. Their attention and respect may be obtained only by firmness and dignity and no familiarity from them or the interpreter should be tolerated. Neither should implicit confidence be placed in the latter unless previous experience and acquaintance with him justify it.

APPENDIX

ADMINISTRATIVE DISTRICTS¹

U. S. Forest Service

District Number	1.—	Headquarters	Missoula, Montana
"	2.—	"	Denver, Colorado
"	3.—	"	Albuquerque, New Mexico
"	4.—	"	Ogden, Utah
"	5.—	"	San Francisco, California
"	6.—	"	Portland, Oregon
"	7.—	"	Washington, D. C.

FOREST SUPERVISORS' HEADQUARTERS¹

State	Dist. No.	Name of Forest	Supervisors' Headquarters
Alaska	6	Chugach	Ketchikan
	6	Tongass	Ketchikan
Arizona	3	Apache	Springerville
	3	Chiricahua	Portal
	3	Coconino	Flagstaff
	3	Coronado	Tucson
	3	Crook	Safford
	4	Dixie	St. George, Utah
	3	Manzano	Albuquerque, New Mexico
	4	Kaibab	Kanab, Utah
	3	Prescott	Prescott
	3	Sitgreaves	Snowflake
Arkansas	3	Tonto	Roosevelt
	3	Tusayan	Williams
Arkansas	7	Arkansas	Hot Springs
	7	Ozark	Harrison
California	5	Angeles	Los Angeles
	5	California	Willows
	5	Cleveland	Escondido
	6	Crater	Medford, Oregon
	5	Eldorado	Placerville

¹ Compiled from The Use Book, 1915.

FOREST SUPERVISORS' HEADQUARTERS (Continued)

State	Dist. No.	Name of Forest	Supervisors' Headquarters
California	5	Inyo	Bishop
	5	Klamath	Yreka
	5	Lassen	Red Bluff
	5	Modoc	Alturas
	5	Mono	Gardnerville, Nevada
	5	Monterey	Big Sur
	5	Pumas	Quincy
	5	Santa Barbara	Santa Barbara
	5	Sequoia	Hot Springs
	5	Shasta	Slason
	5	Sierra	Northfork
	6	Slakiyou	Grant's Pass, Oregon
	5	Stanislaus	Sonora
	5	Tahoe	Nevada City
	5	Trinity	Weaverville
Colorado	2	Arapaho	Hot Sulphur Springs
	2	Battlement	Collbran
	2	Cochetopa	Saguache
	2	Colorado	Fort Collins
	2	Durango	Durango
	2	Gunnison	Gunnison
	2	Hayden	Encampment, Wyoming
	2	Holy Cross	Glenwood Springs
	4	La Sal	Moab, Utah
	2	Leadville	Leadville
	2	Montezuma	Mancos
	2	Pike	Denver
	2	Rio Grande	Monte Vista
	2	Routt	Steamboat Springs
	2	San Isabel	Westcliffe
	2	San Juan	Pagosa Springs
	2	Sopris	Aspen
2	Uncompahgre	Delta	
2	White River	Meeker	
Florida	7	Florida	Pensacola
Idaho	4	Boise	Boise
	4	Cache	Logan, Utah
	4	Caribou	Montpelier
	4	Challis	Challis
	1	Clearwater	Orofino
	1	Coeur d'Alene	Coeur d'Alene

FOREST SUPERVISORS' HEADQUARTERS (Continued)

State	Dist. No.	Name of Forest	Supervisors' Headquarters
Idaho.....	4	Idaho.....	McCall
	1	Kaniksu.....	Newport, Washington
	4	Lemhi.....	Mackay
	4	Minidoka.....	Oakley
	1	Nesperce.....	Grangeville
	4	Pallisade.....	St. Anthony
	4	Payette.....	Emmett
	1	Pend Oreille..	Sandpoint
	1	St. Joe.....	St. Maries
	4	Salmon.....	Salmon
	4	Sawtooth.....	Hailey
	1	Selway.....	Kooskia
	4	Targhee.....	St. Anthony
	4	Weiser.....	Weiser
Kansas.....	2	Kansas.....	Garden City
Michigan.....	2	Michigan.....	East Tawas
Minnesota.....	2	Minnesota....	Cass Lake
	2	Superior.....	Ely
Montana.....	1	Absaroka.....	Livingston
	1	Beartooth.....	Billings
	1	Beaverhead...	Dillon
	1	Bitterroot....	Missoula
	1	Blackfeet....	Kalispell
	1	Cabinet.....	Thompson Falls
	1	Custer.....	Miles City
	1	Deerlodge....	Anaconda
	1	Flathead.....	Kalispell
	1	Gallatin.....	Bozeman
	1	Helena.....	Helena
	1	Jefferson.....	Great Falls
	1	Kootenai.....	Libby
	1	Lewis & Clark	Chouteau
	1	Lolo.....	Missoula
	1	Madison.....	Sheridan
1	Missoula.....	Missoula	
1	Sioux.....	Camp Crook, South Dakota	
Nebraska.....	2	Nebraska.....	Halsey
Nevada.....	5	Eldorado.....	Placerville, California

FOREST SUPERVISORS' HEADQUARTERS (Continued)

State	Dist. No.	Name of Forest	Supervisors' Headquarters
Nevada.....	4	Humboldt....	Gold Creek
	5	Inyo.....	Bishop, California
	5	Mono.....	Gardnerville
	4	Nevada.....	Ely
	4	Ruby.....	Deeth
	4	Santa Rosa...	Paradise
	5	Tahoe.....	Nevada City, California
	4	Toiyabe.....	Austin
New Mexico..	3	Alamo.....	Alamogordo
	3	Carson.....	Taos
	3	Chiricahua...	Portal, Arizona
	3	Datil.....	Magdalena
	3	Gila.....	Silver City
	3	Lincoln.....	Capitan
	3	Manzano.....	Albuquerque
3	Santa Fe.....	Santa Fe	
North Dakota.	1	Dakota.....	Camp Crook, South Dakota
Oklahoma....	7	Wichita.....	Cache
Oregon.....	6	Cascade.....	Eugene
	6	Crater.....	Medford
	6	Deschutes....	Bend
	6	Fremont.....	Lakeview
	5	Klamath.....	Yreka, California
	6	Malheur.....	John Day
	6	Minam.....	Wallowa
	6	Ochoco.....	Prineville
	6	Oregon.....	Portland
	6	Santiam.....	Albany
	6	Siskiyou.....	Grant's Pass
	6	Siuslaw.....	Eugene
	6	Umatilla.....	Pendleton
	6	Umpqua.....	Roseburg
6	Wallowa.....	Wallowa	
6	Wenaha.....	Walla Walla, Washington	
6	Whitman.....	Sumpter	
Porto Rico....	7	Luquillo.....	
South Dakota	2	Black Hills...	Deadwood
	2	Harney.....	Custer
	1	Sioux.....	Camp Crook

FOREST SUPERVISORS' HEADQUARTERS (Continued)

State	Dist. No.	Name of Forest	Supervisors' Headquarters
Utah.....	4	Ashley.....	Vernal
	4	Cache.....	Logan
	4	Dixie.....	St. George
	4	Fillmore.....	Richfield
	4	Fishlake.....	Salina
	4	La Sal.....	Moab
	4	Manti.....	Ephraim
	4	Minidoka.....	Oakley, Idaho
	4	Powell.....	Escalante
	4	Sevier.....	Panguitch
	4	Uinta.....	Provo
	4	Wasatch.....	Salt Lake City
Washington...	6	Chelan.....	Chelan
	6	Columbia.....	Portland, Oregon
	6	Colville.....	Republic
	1	Kaniksu.....	Newport
	6	Okanogan.....	Okanogan
	6	Olympic.....	Olympia
	6	Rainier.....	Tacoma
	6	Snoqualmie...	Seattle
	6	Washington...	Bellingham
	6	Wenaha.....	Walla Walla
6	Wenatchee...	Leavenworth	
Wyoming.....	4	Ashley.....	Vernal, Utah
	2	Bighorn.....	Sheridan
	2	Bonneville...	Lander
	2	Bridger.....	Pinedale
	4	Caribou.....	Montpeller, Idaho
	2	Hayden.....	Encampment
	2	Medicine Bow	Laramie
	4	Pallsade.....	St. Anthony, Idaho
	2	Shoshone.....	Cody
	4	Targhee.....	St. Anthony, Idaho
	4	Teton.....	Jackson
	2	Washakie.....	Lander
4	Wyoming.....	Afton	

LANDS ACQUIRED UNDER THE WEEKS LAW¹

State and Area	Headquarters
Georgia:	
Georgia area	Blue Ridge
Savannah (South)	Clayton
New Hampshire:	
White Mountain	Gorham
North Carolina:	
Mount Mitchell	Marion
Nantahala	Andrews
Pisgah	Asheville
Savannah (North)	Highlands
South Carolina:	
Savannah (South)	Clayton, Georgia
Tennessee:	
Cherokee	Etowah
Smoky Mountain	Townsend
Unaka	Johnson City
White Top (part)	Abingdon, Virginia
Virginia:	
Massanutten	Woodstock
Natural Bridge	Buena Vista
Potomac (part)	Woodstock
Shenandoah (part)	Harrisonburg
White Top (part)	Abingdon
West Virginia:	
Monongahela	Elkins
Potomac (part)	Woodstock, Virginia
Shenandoah (part)	Harrisonburg, Virginia

¹ Compiled from The Use Book, 1915.

WEIGHTS

AVOIRDUPOIS

Used in weighing practically all heavy articles.

27.34375 Grains = 1 Dram

16 Drams = 1 Ounce

16 Ounces = 1 Pound

14 Pounds = 1 Stone (An English measure of weight and used chiefly in reference to the weight of a person.)

100 Pounds = 1 Hundredweight (Cwt.)

20 Cwts. = 1 Ton

2240 Pounds = 1 Long Ton

NOTE.—1 pound Avoirdupois = 1.21528 pounds Apothecaries' or Troy weight.

TROY

Used in weighing precious metals and stones.

3.2 Grains	=	1 Carat (K)
24 Grains	=	1 Pennyweight (Dwt)
20 Dwts	=	1 Ounce
12 Ounces	=	1 Pound

APOTHECARIES'

Used in weighing medicines and drugs.

20 Grains	=	1 Scruple
3 Scruples	=	1 Dram
8 Drams	=	1 Ounce
12 Ounces	=	1 Pound

MEASURES

SURVEYORS'

Used in measuring lands.

LINEAR

7.92 Inches	=	1 Link
100 Links	=	1 Chain (Gunter's)
80 Chains	=	1 Mile (Land)

SQUARE

10 Sq. Chains	=	1 Acre (A)
640 Acres	=	1 Section

LONG MEASURE

Used in measuring distances or lengths.

6 Points	=	1 Line
12 Lines	=	1 Inch
3 Inches	=	1 Palm
3 Palms	=	1 Span, or 9 Inches
4 Inches	=	1 Hand
3 Hands	=	1 Foot, or 12 Inches
3 Feet	=	1 Yard
2 Yards	=	1 Fathom
5½ Yards	=	1 Rod (Also known as "Perch" and "Pole.")
40 Rods	=	1 Furlong, or ¼-Mile, Land
320 Rods	=	1 Mile, Land, or 5,280 Feet
3 Miles	=	1 League

NOTE.—A Knot, or Nautical or Sea Mile, or a Geographical Mile = 6,080.27 Feet.

SQUARE MEASURE

Used in measuring surfaces.

144 Sq. Inches	= 1 Sq. Foot
9 Sq. Feet	= 1 Sq. Yard
30.25 Sq. Yards	= 1 Sq. Rod
160 Sq. Rods	= 1 Acre (10 Sq. Chains)
640 Acres	= 1 Section

CUBIC MEASURE

Used in measuring bodies having length, breadth and thickness.

1728 Cu. Inches	= 1 Cu. Foot
24.75 Cu. Feet	= 1 Perch, a measure of stone 16½ feet long, 1½ feet wide and 1 foot thick.
27 Cu. Feet	= 1 Cu. Yard, generally considered a reasonable load of sand or gravel for a two-horse team.
128 Cu. Feet	= 1 Cord, a measure of wood 8 feet long, 4 feet high and 4 feet wide.

DRY MEASURE

Used in measuring vegetables, grain, etc.

2 Pints	= 1 Quart
8 Quarts	= 1 Peck, or 2 Gallons
4 Pecks	= 1 Bushel, or 2150.42 Cu. Inches per "struck" or "stricken" or leveled bushel. The "cone" of a "heaped" bushel is not less than 6 inches high and this measure = 1½ struck bushels.

LIQUID MEASURE

Used in measuring liquids.

4 Gills	= 1 Pint (Pt.)
2 Pints	= 1 Quart (Qt.)
4 Quarts	= 1 Gallon (Gal.)
32 Gallons	= 1 Barrel (Bbl.) (In most localities)
2 Barrels	= 1 Hogshead
2 Hogsheads	= 1 Butt or Pipe
2 Butts	= 1 Tun

APOTHECARIES' OR WINE MEASURE

Used in measuring liquid medicines, wines, etc.

60 Minims (M)	= 1 Fluid Dram (f ʒ)
8 Drams	= 1 Fluid Ounce (f ʒ)
16 Ounces	= 1 Pint (O)
9 Pints	= 1 Gallon (Cong: Abbreviation for Congius)

SPOON AND CUP MEASUREMENTS

This table gives only approximate amounts of medicines contained in teaspoons, tablespoons, and cups. It should be borne in mind that these articles may vary in size and that this table has reference only to those of average size. Liquids are measured in drops, minims, drams, and fluid ounces; powders are measured in grains, drams, and ounces.

1	Drop	= 1 Minim
60	Minims or Drops	= 1 Dram
1	Dram	= 1 Teaspoonful
4	Drams	= 1 Tablespoonful
1	Drop	= 1 Grain
60	Grains, Minims or Drops	= 1 Dram
8	Drams	= 1 Fluid Ounce
$\frac{1}{2}$	Fluid Ounce	= 1 Tablespoonful
16	Fluid Ounces	= 1 Pint
1	Pint	= 2 Cups

WEIGHTS AND MEASURES OF GRAIN, HAY, SEED,
AND VEGETABLES

Local conditions are often responsible for local acceptance of weights and measures of hay and grain that are not standard elsewhere. Thus, in Kansas and other portions of the middle West, where climatic conditions are more favorable to its production, corn is often measured "by the ear," 120 average size ears constituting a bushel. But in most parts of the South, where corn is generally of smaller ears or inferior quality, 125 and in some instances 130 ears are accepted as a bushel.

Eighty ears of selected corn constitute a bushel in the lower Missouri valley.

Two cubic feet of ear corn will make about one bushel when shelled.

Wheat is often "tested" and sold by "test." The standard bushel of wheat weighs 60 pounds, although a test may show that it weighs considerably more or less per 2150.42 cubic inches. The testing machine consists of a specially constructed scale which shows the weight of a given quantity, and the weight of a bushel of such grain is then determined from the figures thus secured.

Hay is sold by measure or weight. Loose hay varies in bulk, but when moderately well packed averages about 500 cubic

feet per ton. From 28 to 34 bales of alfalfa constitute a ton among buyers and sellers in the West, and from 30 to 33 bales of timothy or clover are considered a ton in nearly all parts of the South and Southeast, although in some sections of the South 16 bales of timothy or clover weigh a ton.

A bushel, as the term is used in the following table, contains 2150.42 cubic inches or approximately 1.24 cubic feet, and fills a cube approximately 12.91 inches in each dimension or a cylinder 8 inches deep and 18½ inches in diameter. It is unfortunate that the various States have not adopted a standard measure for different commodities, but this lack of uniformity is doubtless justified by difference in local conditions. The following table however will be found applicable to most sections:

Commodity	Pounds per Bushel
Alfalfa seed	60
Barley, whole	48
Beans, lima	56
Beans, navy	60
Beets	55
Blue grass seed, Kentucky	14
Brome grass seed	14
Broom corn seed	46
Buckwheat	50-52
Canada field peas	60
Cane seed	50
Clover seed, all varieties	60
Corn, field or Indian, ears	70
Corn, field or Indian, shelled	56
Corn, sweet	46
Cow peas	60
Emmer seed	40
Flax seed	56
Hemp seed	44
Johnson grass seed	25
Kaffir corn	56
Meadow fescue seed	24
Millet seed, common and German	50
Millet seed, Hungarian	48
Millet seed, Japanese	35
Millet seed, Siberian	50
Oat grass seed, tall	14
Oats	32
Onion sets, bottom	32
Onion sets, top	28
Orchard grass seed	14
Peanuts	22

Commodity	Pounds per Bushel
Peas, garden, wrinkled	58
Potatoes, Irish	60
Potatoes, sweet	50
Rape	60
Red top grass seed	14
Rye	56
Rye grass seed, Italian	24
Rye grass seed, perennial	24
Sheep fescue	14
Sorghum seed	45
Soy beans	60
Speltz	40
Sunflower seed, Russian	24
Timothy seed	45
Turnips	55
Vetch, hairy	60
Vetch, spring	60
Wheat	60

PER CENT MEASUREMENT OF GRADES

The grade, or inclination, of roads, trails, and railroads is usually expressed in per cent and is determined by the relation of the perpendicular distance to the horizontal distance as shown in the accompanying illustration. It will be observed that although there is a definite relation between the degrees and the per cent of a grade, these are two separate quantities. A 20 per cent grade equals a vertical angle of approximately 11 degrees, but a vertical angle of 45 degrees, or a rise of 100 feet in a horizontal distance of 100 feet, which equals a 100 per cent grade, is not a perpendicular, as might at first be supposed. See page 354, Appendix.

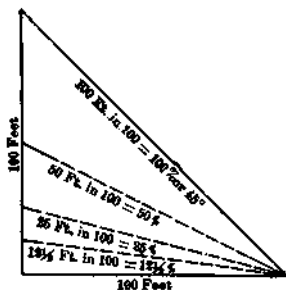

FIG. 233.—Per cent grade.

A very common and wholly inexcusable error often made by amateur road- or trail-builders is to assume that a 3 per cent grade, for instance, is a rise of 3 inches in a horizontal distance of 12 inches. Such a grade is of course a 25 per cent grade.

MISCELLANEOUS WEIGHTS

Commodity	WEIGHT IN POUNDS	
	Average per M. Ft.	Average per Cu. Ft.
Ash (lumber) ¹	3,915	47
Brick, ² soft.....	100
Brick, hard.....	125
Brick, pressed.....	150
Cast iron.....	450
Cast steel.....	450
Cement, ³ natural.....	85
Cement, Portland.....	105
Charcoal, oak.....	30
Charcoal, pine.....	20
Coal, anthracite, loose.....	52
Coal, bituminous, loose.....	49
Coke, loose.....	27
Dirt, loose, dry loam.....	76
Dirt, packed, dry loam.....	95
Dirt, loose, wet loam.....	95
Dirt, packed, wet loam.....	115
Feldspar.....	165
Flint.....	160
Gneiss, solid.....	168
Gneiss, crushed.....	95
Granite, solid.....	170
Granite, crushed.....	96
Gravel.....	98
Hemlock (lumber).....	2,100	25
Hickory (lumber).....	4,425	54
Ice.....	57
Lead.....	710
Limestone, solid.....	170
Limestone, crushed.....	96
Maple (lumber).....	3,350	50
Marble, solid.....	170
Marble, crushed.....	96
Oak (lumber) black.....	2,600	37
Oak (lumber) live.....	4,500	59
Oak (lumber) red.....	2,600	37
Oak (lumber) white.....	3,500	48
Peat.....	25
Pine (lumber) white yellow.....	2,500	36
Pine (lumber) white.....	2,000	25

MISCELLANEOUS WEIGHTS (Continued)

Commodity	WEIGHT IN POUNDS	
	Average per M. Ft.	Average per Cu. Ft.
Quartz, solid.....	165
Quartz, crushed.....	94
Quicklime ¹	53
Salt.....	60
Sand, dry quartz.....	98
Sandstone, solid.....	151
Sandstone, crushed.....	86
Slate.....	75
Snow, fresh dry.....	8
Snow, wet.....	22
Soapstone.....	170
Spruce (lumber).....	2,100	25
Steel.....	490
Sycamore (lumber).....	3,000	37
Tar.....	62
Tin.....	450
Trap, solid.....	187
Trap, crushed.....	105
Turf.....	25
Walnut, black (lumber).....	3,175	38
Water, fresh.....	62 $\frac{1}{2}$
Water, salt.....	64 $\frac{1}{4}$

¹ Figures referring to weights of lumber apply only to well-seasoned material which is perfectly dry. To secure approximate weights of green lumber add from $\frac{1}{5}$ to $\frac{1}{2}$ the weight of dry lumber, according to the degree of seasoning. The prevalent idea that 1,000 board feet must weigh the same as a solid body of 83 $\frac{1}{2}$ cubic feet of lumber is erroneous by reason of the loss in sawing, nearly all lumber being cut from $\frac{1}{8}$ - to $\frac{1}{4}$ -inch scant, but measured full. Crushed stone weighs less per cubic foot than solid stone, the decrease in weight being due to the numerous voids between the fragments. Sand consisting of coarse and fine grains weighs more per cubic foot than when the grains are more nearly uniform in size; the finer grains fill the voids between the larger grains, and thus tend to form a more compact mass. The weight of salt and ice depends upon the porosity and the amount of foreign material present. Salt water outweighs fresh water in proportion to the amount of salt held in solution.

² 22 bricks, with mortar, in a cubic foot of masonry. Standard brick, 2 x 4 x 8 inches, scant.

³ Natural cement, 300, and Portland, 380 pounds per barrel.

⁴ 66 Pounds per bushel.

RELATION OF DEGREES AND PER CENT

All road, trail, or railroad surveys of grades are expressed in per cent, while curves are expressed in degrees. For example: A 10 per cent grade rises 10 feet in a horizontal distance of 100 feet, while a 3-degree curve has a horizontal deflection of 3 degrees.

These points should be remembered and care taken not to confuse the two terms. The following table shows the relation they bear to each other:

Degrees	Per Cent	Degrees	Per Cent	Degrees	Per Cent
1.....	1.74	16.....	28.67	31.....	60.10
2.....	3.49	17.....	30.57	32.....	62.49
3.....	5.24	18.....	32.49	33.....	64.94
4.....	6.99	19.....	34.43	34.....	67.45
5.....	8.75	20.....	36.40	35.....	70.02
6.....	10.51	21.....	38.39	36.....	72.65
7.....	12.28	22.....	40.40	37.....	75.35
8.....	14.05	23.....	42.45	38.....	78.14
9.....	15.84	24.....	44.52	39.....	80.98
10.....	17.63	25.....	46.63	40.....	83.90
11.....	19.44	26.....	48.77	41.....	86.93
12.....	21.26	27.....	50.95	42.....	90.04
13.....	23.09	28.....	53.17	43.....	93.25
14.....	24.93	29.....	55.43	44.....	96.57
15.....	26.80	30.....	57.73	45.....	100.00

TO ASCERTAIN GRADES WITHOUT A GRADOMETER

The accompanying illustration shows one method of determining a grade when no gradometer is available. A 10-foot pole is used. One end is allowed to rest on the ground and the other end is held at a point which leaves the pole horizontal. The vertical distance from the high end to the ground is then secured and when multiplied by ten gives the per cent of the grade. An average of several such measurements taken at different points on a grade will give the approximate per cent of grade over the entire route.

In case no spirit-level is available for leveling the pole, a very satisfactory substitute may be had by the use of a bottle filled with water, tightly corked, and attached to the pole about

midway between the ends. The pole may be assumed to be approximately horizontal when the air-bubble in the bottle remains stationary at or near the middle of the bottle.

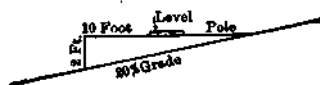

FIG. 234.

SAG TABLES

Pole Lines.—The following table shows the amount of sag to be allowed for in hanging No. 9 or No. 12 galvanized wire for telephone lines. An extra allowance of 2 inches should be made if No. 12 hard-drawn copper wire is used.

Temp., F.	-30°	-10°	10°	30°	60°	80°	100°
Length of Span, in Feet	Sag, in Inches						
75.....	1.0	1.5	1.5	2.0	2.5	3.0	4.5
100.....	2.0	2.5	3.0	3.5	4.5	5.5	7.0
115.....	2.5	3.0	3.5	4.0	5.5	7.0	9.0
130.....	3.5	4.0	4.5	5.5	7.0	8.5	11.0
150.....	4.5	5.0	6.0	7.0	9.0	11.5	14.0
176 ¹	6.0	7.0	8.0	9.5	12.0	15.0	18.0
300.....	22.0	25.5	29.5	33.0	42.5	49.0	55.0
400.....	43.0	48.5	54.5	60.0	76.0	84.0	96.0
500.....	72.0	84.0	90.0	96.0	114.0	132.0	150.0

¹ Length of standard span used by the Forest Service. See top page 358.

Tree Lines.—Greater sag must be allowed in lines hung on trees and should be not less than shown below for wires mentioned in the foregoing table.

Temp., F.	-30°	-10°	10°	30°	60°	80°	100°
Length of Span, in Feet	Sag. in Inches						
75.....	25.0	25.5	25.5	26.0	26.5	27.0	28.5
100.....	26.0	26.5	27.5	27.5	28.5	29.5	31.0
115.....	26.5	27.0	27.5	28.0	29.5	31.0	33.0
130.....	27.5	28.0	28.5	29.5	31.0	32.5	35.0
150.....	28.5	29.0	30.0	31.0	33.0	35.5	38.0
175 ¹	30.0	31.0	32.0	33.5	36.0	39.0	42.0
300.....	46.0	49.5	53.5	57.0	66.5	73.0	79.0
400.....	66.0	72.0	84.0	90.0	102.0	108.0	120.0
500.....	96.0	108.0	114.0	120.0	138.0	156.0	174.0

¹ Length of standard span used by the Forest Service.

TO ASCERTAIN DISTANT ELEVATIONS

The following table indicates the difference in altitude between distant points and the point from which observations are taken. It makes allowance for refraction, curvature of the earth's surface, and 4½ feet as the height of the instrument used in taking observations. The difference in altitude indicated should, of course, be added to the altitude of the point from which observations are taken if the reading is to include elevation above sea-level; otherwise the reading will cover only the difference in elevation between the point observed and the one from which observations are made.

DISTANCE, IN MILES	1	2	3	4	5	6	7	8	9	10
Vertical Angle, in Degrees	Feet									
1.....	97	191	286	383	480	768	678	778	880	984
2.....	189	376	563	752	941	1,131	1,324	1,516	1,710	1,906
3.....	282	560	840	1,121	1,403	1,685	1,970	2,255	2,541	2,829
4.....	374	745	1,118	1,491	1,865	2,240	2,617	2,995	3,374	3,754
5.....	467	931	1,396	1,862	2,329	2,797	3,267	3,737	4,208	4,681
6.....	560	1,117	1,675	2,234	2,794	3,355	3,918	4,481	5,046	5,612
7.....	653	1,304	1,955	2,607	3,261	3,915	4,571	5,227	5,886	6,545
8.....	747	1,491	2,236	2,982	3,729	4,477	5,227	5,977	6,729	7,483
9.....	841	1,680	2,519	3,359	4,200	5,043	5,887	6,731	7,577	8,425
10.....	936	1,869	2,803	3,738	4,674	5,611	6,550	7,489	8,430	9,372

TRAVERSE TABLE¹
SHOWING WHOLE DEGREES ONLY

Degrees	Latitude	Departure	
0	1.000	0.000	90
1	1.000	.017	89
2	.999	.035	88
3	.999	.052	87
4	.998	.070	86
5	.996	.087	85
6	.995	.104	84
7	.992	.122	83
8	.990	.139	82
9	.988	.156	81
10	.985	.174	80
11	.982	.191	79
12	.978	.208	78
13	.974	.225	77
14	.970	.242	76
15	.966	.259	75
16	.961	.276	74
17	.956	.292	73
18	.951	.309	72
19	.946	.326	71
20	.940	.342	70
21	.934	.358	69
22	.927	.375	68
23	.920	.391	67
24	.913	.407	66
25	.906	.423	65
26	.899	.438	64
27	.891	.454	63
28	.883	.470	62
29	.875	.485	61
30	.866	.500	60
31	.857	.515	59
32	.848	.530	58
33	.839	.545	57
34	.829	.559	56
35	.819	.574	55
36	.809	.588	54
	Departure	Latitude	Degrees

¹ For table showing traverse distances of fractional degrees consult "Instructions for Making Forest Surveys and Maps," 1912, U. S. Dept. of Agriculture. By Henry S. Graves, Forester.

Any other reliable work on general surveying should include similar information concerning traverse tables.

TRAVERSE TABLE (Continued)

SHOWING WHOLE DEGREES ONLY

Degrees	Latitude	Departure	
37	.799	.602	53
38	.788	.616	52
39	.777	.629	51
40	.766	.643	50
41	.755	.656	49
42	.743	.669	48
43	.731	.682	47
44	.719	.695	46
45	.707	.707	45
	Departure	Latitude	Degrees

PRESERVATIVE TREATMENT OF TELEPHONE
POLES.¹

Application of Creosote.—The equipment required for this work consists of one 10-gallon iron pot, a half-gallon dipper, a 2- or 3-gallon bucket, a 4-inch wire-bound brush, and a thermometer. Creosote is heated in the iron pot, dipped out into the bucket and carried about as desired, and applied to the poles with the brush. It should be heated to a temperature between 120° F. and 150° F. in hot, dry weather and to about 180° F. in cold weather. It should be applied to the poles while hot, the points of application being the end surfaces of the poles, and their entire outer surfaces from the lower end up to a point at least 18 inches above ground when the poles are set. A second application should be made twenty-four hours later. Braces, stubs, and re-enforcements should receive similar treatment.

If the creosote is allowed to boil over it may take fire and be consumed.

¹ See the following Forest Service publications:

Cir. 188, Volatilization of Various Fractions of Creosote after Their Injection into Wood.

Bul. 84, Preservative Treatment of Poles.

Bul. 78, Wood Preservation in the United States.

Cir. 191, Modification of the Sulphonation Test for Creosote.

Cir. 190, A Visual Method for Determining the Penetration of Inorganic Salts in Treated Wood.

SIZE AND NUMBER OF NAILS PER POUND

Size	Length in Ins.	Wire Gauge	App'ox. No. per Lb.	
<i>Common Wire</i>				
2.....	1	15	876	
3.....	1 1/4	14	568	
4.....	1 1/2	12 1/2	316	
5.....	1 3/4	12 1/2	271	
6.....	2	11 1/2	181	
7.....	2 1/4	11 1/2	161	
8.....	2 1/2	10 1/4	106	Used in all ordinary rough work such as building, fencing, out- side repairs, etc.
9.....	2 3/4	10 1/4	96	
10.....	3	9	69	
12.....	3 1/4	9	63	
16.....	3 1/2	8	49	
20.....	4	6	31	
30.....	4 1/2	5	24	
40.....	5	4	18	
50.....	5 1/2	3	14	
60.....	6	2	11	
<i>Common Wire, Galv'd</i>				
6.....	2	11 1/2	380	Used for the same pur- poses as common wire nails.
8.....	2 1/2	10 1/4	92	
10.....	3	9	60	
<i>Blued Wire</i>				
2 Common.....	1	15	876	Used in lathing. The bluing permits them to be held in the mouth without danger of infection.
3 Fine.....	1 1/4	15	778	
<i>Lath, Blue, Sterilized</i>				
2 Light.....	1	17	1,158	
<i>Fine Wire</i>				
2.....	1	16 1/2	1,351	Used when thin light nails are required.
3.....	1 1/4	15	778	
<i>Wire Casting</i>				
4.....	1 1/2	14	473	Used in ceiling, orna- mental work, and other fine work or repairing.
6.....	2	12 1/2	236	
8.....	2 1/2	11 1/2	145	
10.....	3	10 1/2	94	

Cement-coated nails are used as substitutes for common wire nails.

Ordinarily wire nails are shipped in lots of 100 pounds per keg, but the shipping weight of cement-coated nails varies from 88 pounds for 2ds to 90 pounds for 60ds. However, there are as

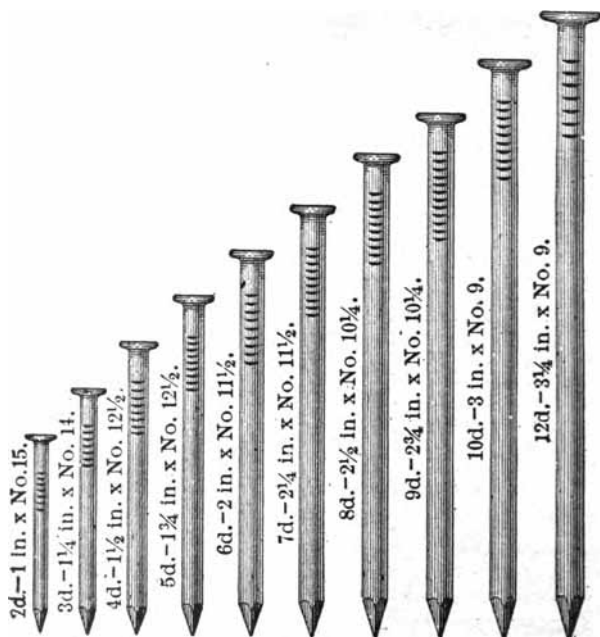

FIG. 235.—Wire nails.

many per keg as there are common wire nails of a corresponding size, the difference in weight being due to the lighter gauge.

They are also used where more adhesive resistance is required than is furnished by a common wire nail. It is claimed that the cement coating renders them from 20% to 30% more durable when exposed to extreme moisture. In a comparative test of adhesive resistance, a common wire 8d nail, driven 2 inches, showed a resistance of 146 pounds; a cement-coated nail of the same size, driven a like distance, showed a resistance of 322 pounds.

SIZE AND NUMBER OF FENCE STAPLES PER POUND¹

Size, in Inches.....	1	1 1/4	1 1/2
Number per Pound.....	120	100	80

¹ Supplied by Simmons Hardware Company, St. Louis, Mo.

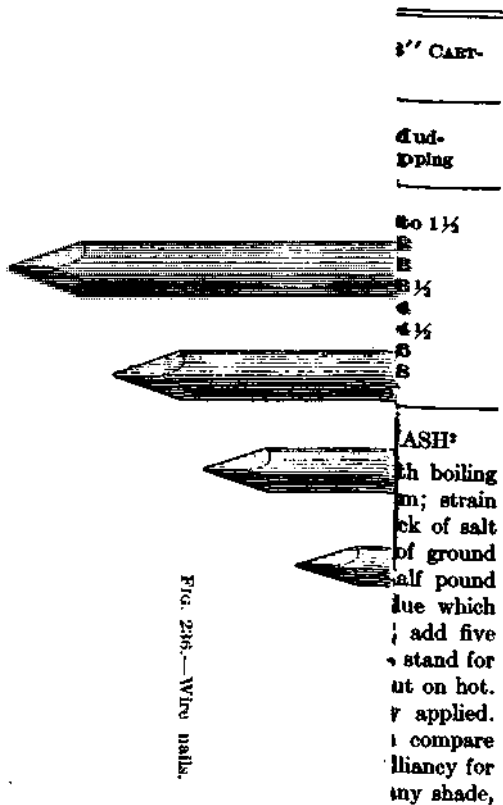
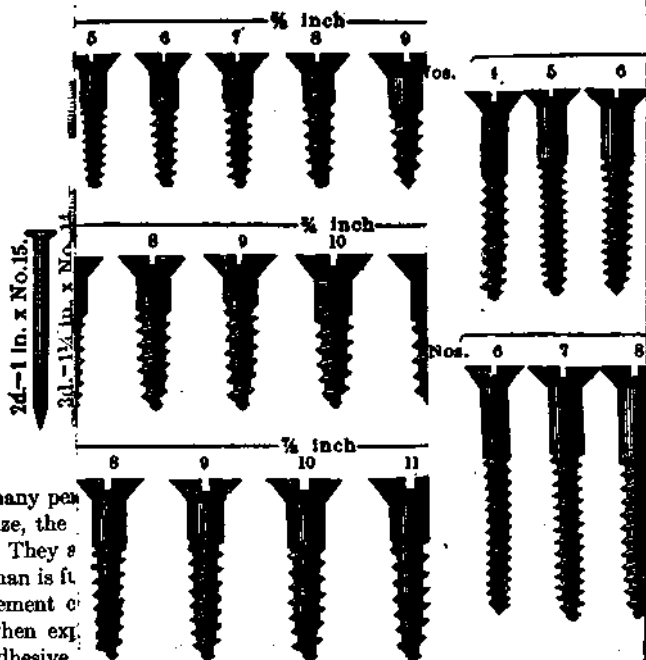

FIG. 236.—WIRE NAILS.

es are the
nd South,
sed in the
ghout the

Company,



many per
size, the

They are
than is fu
cement c
when exp
adhesive
showed a
same size
pounds.

SIZE A

Size, in In
Number p

Suppl

FIG. 238.—Screws.

BLASTING CHARGES¹

Weight of Boulder, Pounds	APPROXIMATE NUMBER OF 1¼" x 8" CARTRIDGES REQUIRED FOR		
	Block-holing	Snake-holing	Mud-capping
100 to 500.....	¼	½ to 1	½ to 1½
500.....	½	1½	2
1,000.....	¾	2½	3
1,500.....	1	3	3½
2,000.....	1¼	3½	4
2,500.....	1¾	4	4½
3,000.....	2½	5	6
4,000.....	3½	6	8

GOVERNMENT FORMULA FOR WHITEWASH²

Take half a bushel of unslacked lime; slack it with boiling water and cover during the process to keep in the steam; strain the liquid through a fine sieve or strainer; add a peck of salt previously well dissolved in warm water, 3 pounds of ground lime boiled to a thin paste; stir in boiling hot one-half pound powdered Spanish whiting and one pound of glue which has been previously dissolved over a slow fire, and add five gallons hot water to the mixture; stir well and let it stand for a few days, covered up from the dirt. It should be put on hot. One pint of mixture will cover a square yard properly applied. Small brushes are best. There is nothing that can compare with it for outside or inside work, and it retains its brilliancy for years. Coloring matter may be put in and made of any shade, as Spanish brown, yellow ochre, or common clay.

LOG RULES

The log rules most widely used in the United States are the Two-Thirds rule, used in many parts of the North and South, and the Southeast and Northwest; the Doyle, also used in the same sections; the Scribner, in common use throughout the

¹ Supplied by E. I. du Pont de Nemours Powder Company, Wilmington, Delaware.

² Contributed by International Harvester Co., Chicago, Ill.

country; the Doyle-Scribner, which is perhaps the most widely used of any; and the Scribner Decimal "C," which is the official log rule of the Forest Service.

Two-Thirds Rule.—This rule is based on a formula in which the square of two-thirds of the small diameter of a log is multiplied by the number of the log's length in feet, this result then being divided by 12. Thus, letting D represent the diameter, L the length, and C the number of board feet in a log, the formula

is $\frac{2D}{3} \times \frac{L}{12} = C$. For a 12-foot log the formula would, of course,

be $\frac{2D}{3} = C$. This scale crosses the Doyle at 18 and the Scribner at 15 inches, overrunning both to these respective diameters and underrunning them thereafter.

Doyle Rule.—This scale is also based on a formula, wherein 4 is subtracted from the small diameter and one-fourth of the remainder is squared and then multiplied by the number of the

log's length in feet, thus: $\left(\frac{D-4}{4}\right)^2 \times L = C$. A shorter formula,

applicable only to 16-foot logs, follows: $(D-4)^2 = C$. A third

formula, applicable to logs of any length, is: $(D-4)^2 \times \frac{L}{16} = C$.

The subtraction of 4 from the diameter is supposed to account for the loss in kerf and slabs, and, since it applies with equal force to large and small logs, is obviously unfair. The only means by which the mill tally may be made to agree with it are by scaling each log full with no allowance whatever for defect and by the very poorest and most wasteful sawing. Even then the mill overrun may be astonishing. The rule up to and including a 24-foot log 48 inches in diameter is shown on opposite page.

Numbers shown on the scale stick fail in several instances to agree with results obtained from the formula: $\left(\frac{D-4}{4}\right)^2 \times L = C$.

There appears to be no systematic disposition of fractions in computations involving the contents of logs having diameters other than multiples of 4, but the wide discrepancies noted in reference to contents of logs 10, 19, 22, 38 and 39 by 20, 23 by 14 and 16, 27 by 16, 31 by 22, and 39 by 12 elude explanation.

Some of these discrepancies are shown in table opposite.

Diameter in Inches	Lgth. in Feet	BOARD FEET AS SHOWN		DIFFERENCE	
		By Stick	By Formula	Loss	Gain
9.....	24	37	37.50	.50
10.....	20	46	45.00	1.00
14.....	18	112	112.50	.50
14.....	22	137	137.50	.50
15.....	24	181	181.50	.50
17.....	24	253	253.50	.50
18.....	18	220	220.50	.50
18.....	22	269	269.50	.50
19.....	20	280	281.25	1.25
21.....	24	433	433.50	.50
22.....	18	364	364.50	.50
22.....	20	404	405.00	1.00
22.....	22	445	445.50	.50
23.....	14	313	315.875	2.875
23.....	16	359	361.00	2.00
23.....	20	452	451.2575
23.....	24	541	541.50	.50
26.....	18	544	544.50	.50
26.....	22	665	655.50	.50
27.....	14	463	462.875	1.25
27.....	16	530	529.00	1.00
27.....	18	596	595.125875
29.....	20	782	781.25875
29.....	22	860	859.375625
31.....	20	912	911.25875
31.....	22	1,004	1002.375	1.625
34.....	14	787	787.50	.50
34.....	18	1,012	1012.50	.50
34.....	22	1,237	1237.50	.50
35.....	20	1,202	1201.2575
35.....	22	1,322	1321.375625
38.....	14	1,011	1011.50	.50
38.....	18	1,300	1300.50	.50
38.....	20	1,446	1445.00	1.00
39.....	12	910	918.75	8.75
39.....	20	1,530	1531.25	1.25
41.....	24	2,053	2053.50	.50
43.....	20	1,902	1901.2575
45.....	20	2,102	2101.2575
45.....	22	2,312	2311.375625
46.....	20	2,206	2205.00	1.00
47.....	20	2,312	2311.2575

DOYLE LOG RULE¹

Diam. in Inches	LENGTH IN FEET								
	8	10	12	14	16	18	20	22	24
8.....	8	10	12	14	16	18	20	22	24
9.....	12	16	19	22	25	28	31	34	37
10.....	18	23	27	32	36	41	46	50	54
11.....	24	31	37	43	49	55	61	67	74
12.....	32	40	48	56	64	72	80	88	96
13.....	40	50	61	71	81	91	101	111	122
14.....	50	62	75	88	100	112	125	137	150
15.....	60	75	91	106	121	136	151	166	181
16.....	72	90	108	126	144	162	180	198	216
17.....	84	106	127	148	169	190	211	232	253
18.....	98	122	147	171	196	220	245	269	294
19.....	112	141	169	197	225	253	280	309	338
20.....	128	160	192	224	256	288	320	352	384
21.....	144	181	217	253	289	325	361	397	433
22.....	162	202	243	283	324	364	404	445	486
23.....	180	226	271	313	359	406	452	496	541
24.....	200	250	300	350	400	450	500	550	600
25.....	220	276	331	386	441	496	551	606	661
26.....	242	302	363	423	484	544	605	665	726
27.....	264	330	397	463	530	596	661	726	794
28.....	288	360	432	504	576	648	720	792	864
29.....	312	391	469	547	625	703	782	860	938
30.....	338	422	507	591	676	761	845	930	1,014
31.....	364	456	547	638	729	820	912	1,004	1,094
32.....	392	490	588	686	784	882	980	1,078	1,176
33.....	420	526	631	736	841	946	1,051	1,156	1,262
34.....	450	562	675	787	900	1,012	1,125	1,237	1,350
35.....	480	601	721	841	961	1,081	1,202	1,322	1,442
36.....	512	640	768	896	1,024	1,152	1,280	1,408	1,536
37.....	544	681	817	953	1,089	1,225	1,361	1,497	1,634
38.....	578	723	867	1,011	1,156	1,300	1,446	1,590	1,734
39.....	612	765	910	1,070	1,225	1,379	1,530	1,684	1,838
40.....	648	810	972	1,134	1,296	1,458	1,620	1,782	1,944
41.....	684	856	1,027	1,198	1,369	1,540	1,711	1,882	2,053
42.....	722	902	1,083	1,264	1,444	1,625	1,805	1,986	2,166
43.....	761	951	1,141	1,331	1,521	1,711	1,902	2,091	2,282
44.....	800	1,000	1,200	1,400	1,600	1,800	2,000	2,200	2,400
45.....	840	1,051	1,261	1,471	1,681	1,891	2,102	2,312	2,522
46.....	882	1,103	1,323	1,544	1,764	1,985	2,206	2,426	2,646
47.....	925	1,155	1,387	1,618	1,849	2,080	2,312	2,542	2,774
48.....	968	1,218	1,452	1,694	1,936	2,178	2,420	2,662	2,904

¹ Supplied by Lufkin Rule Co., Saginaw, Mich.

Scribner Rule.—This rule is based on diagrams showing what logs of different lengths and diameters should saw out. It is fairly accurate on logs over 28 inches in diameter, but overruns on smaller logs unless these are very carefully culled and sawed. The rule up to and including a 20-foot log 36 inches in diameter follows:

SCRIBNER LOG RULE

Diam. in Ins.	LENGTH IN FEET						
	8	10	12	14	16	18	20
6....	4	5	6	7	9	10	11
7....	8	10	12	14	16	18	20
8....	12	15	19	22	25	28	31
9....	18	23	27	32	36	40	45
10....	24	30	37	43	49	55	61
11....	32	40	48	56	64	72	80
12....	40	49	59	69	79	88	98
13....	48	61	73	85	97	109	122
14....	57	72	86	100	114	129	143
15....	71	89	107	125	142	160	178
16....	79	99	119	139	159	178	198
17....	93	116	139	162	185	208	232
18....	106	133	160	187	213	240	267
19....	120	150	180	210	240	270	300
20....	140	175	210	245	290	315	350
21....	152	190	228	266	304	342	380
22....	167	209	251	292	334	376	418
23....	188	235	283	330	377	424	470
24....	202	252	303	353	404	454	505
25....	229	287	344	401	459	516	573
26....	250	313	375	439	500	562	625
27....	274	342	411	479	548	616	684
28....	291	363	436	509	582	654	728
29....	305	381	457	533	609	685	761
30....	328	411	493	575	657	739	821
31....	355	444	532	622	710	799	888
32....	368	460	552	644	736	828	920
33....	392	490	588	686	784	882	980
34....	400	500	600	700	800	900	1,000
35....	438	547	657	766	876	985	1,095
36....	462	577	692	807	923	1,038	1,152

Doyle-Scribner Rule.—By combining Doyle measurements for logs under 28 inches in diameter with Scribner measurements

for larger logs this rule eliminates the greatest faults of both and provides a fairly accurate rule for all logs.

Scribner Decimal "C" Rule.—This is merely a revision of the Scribner rule and is formulated by dropping units and rounding off tens to the next above or below. Therefore the figures representing board feet on the scale stick are not complete, but require the addition of a cipher except in 6- and 7-inch logs 6 feet long and 6-inch logs 8 feet long, the contents of all of which are indicated on the stick as 0.5, which, being theoretically multiplied by 10, as are all the other volume numbers, equal 5 board feet.

The system of revision seems to lack uniformity throughout the rule up to the 12-inch diameter.

Instructions concerning official use of the rule state that in Alaska and west of the summit of the Cascade Mountains, in Washington and Oregon, all logs up to 32 feet long, inclusive, will be scaled as one log. Logs from 34 to 64 feet, inclusive, will be scaled as two logs as nearly the same length in even feet as possible. Logs exceeding 64 feet in length will be scaled as three logs as nearly equal in lengths of even feet as possible. When such divisions of a log are necessary the scaler must make allowance for taper, but tables of taper may be secured upon requisition.

The rule up to and including a 32-foot log 120 inches in diameter follows:

SCRIBNER DECIMAL "C" LOG RULE¹

Diam. in Inches	LENGTH IN FEET													
	6	8	10	12	14	16	18	20	22	24	26	28	30	32
6.....	0.5	0.5	1	1	1	2	2	2	3	3	3	4	4	5
7.....	0.5	1	1	2	2	3	3	3	4	4	4	5	5	6
8.....	1	1	2	2	2	3	3	3	4	4	5	6	6	7
9.....	1	2	3	3	3	4	4	4	5	6	6	7	8	9
10.....	2	3	3	3	4	6	6	7	8	9	9	10	11	12
11.....	2	3	4	4	5	7	8	8	9	10	11	12	13	14
12.....	3	4	5	6	7	8	9	10	11	12	13	14	15	16
13.....	4	5	6	7	8	10	11	12	13	15	16	17	18	19
14.....	4	6	7	9	10	11	13	14	16	17	19	20	21	23
15.....	5	7	9	11	12	14	16	18	20	21	23	25	27	28
16.....	6	8	10	12	14	16	18	20	22	24	26	28	30	32
17.....	7	9	12	14	16	18	21	23	25	28	30	32	35	37
18.....	8	11	13	16	19	21	24	27	29	32	35	37	40	43
19.....	9	12	15	18	21	24	27	30	33	36	39	42	45	48
20.....	11	14	17	21	24	28	31	35	38	42	45	49	52	56
21.....	12	15	19	23	27	30	34	38	42	46	49	53	57	61
22.....	13	17	21	25	29	33	38	42	46	50	54	58	63	67
23.....	14	19	23	28	33	38	42	47	52	57	61	66	71	75
24.....	15	21	25	30	35	40	45	50	55	61	66	71	76	81
25.....	17	23	29	34	40	46	52	57	63	69	75	80	86	92
26.....	19	25	31	37	44	50	56	62	69	75	82	88	94	100
27.....	21	27	34	41	48	55	62	68	75	82	89	96	103	110
28.....	22	29	36	44	51	58	65	73	80	87	95	102	109	116
29.....	23	31	38	46	53	61	68	76	84	91	99	107	114	122
30.....	25	33	41	49	57	66	74	82	90	99	107	115	123	131
31.....	27	36	44	53	62	71	80	89	98	106	115	124	133	142
32.....	28	37	46	55	64	74	83	92	101	110	120	129	138	147
33.....	29	39	49	59	69	78	88	98	108	118	127	137	147	157
34.....	30	40	50	60	70	80	90	100	110	120	130	140	150	160
35.....	33	44	55	66	77	88	98	109	120	131	142	153	164	175
36.....	35	46	58	69	81	92	104	115	127	138	150	161	173	185
37.....	39	51	64	77	90	103	116	129	142	154	167	180	193	206
38.....	40	54	67	80	93	107	120	133	147	160	174	187	200	214
39.....	42	56	70	84	98	112	126	140	154	168	182	196	210	224
40.....	45	60	75	90	105	120	135	150	166	181	196	211	226	241
41.....	48	64	79	95	111	127	143	159	175	191	207	223	238	254
42.....	50	67	84	101	117	134	151	168	185	201	218	235	252	269
43.....	52	70	87	105	122	140	157	174	192	209	227	244	262	279
44.....	56	74	93	111	129	148	166	185	204	222	241	259	278	296
45.....	57	76	95	114	133	152	171	190	209	226	247	266	286	304

¹ Official rule of the Forest Service and used in all Government scaling.

SCRIBNER DECIMAL "C" LOG RULE (Continued)

Diam. in Inches	LENGTH IN FEET													
	6	8	10	12	14	16	18	20	22	24	26	28	30	32
46.....	59	79	99	119	139	159	178	198	218	238	258	278	297	317
47.....	62	83	104	124	145	166	186	207	228	248	269	290	310	331
48.....	65	86	108	130	151	173	194	216	238	260	281	302	324	346
49.....	67	90	112	135	157	180	202	225	247	270	292	314	337	359
50.....	70	94	117	140	164	187	211	234	257	281	304	328	351	374
51.....	73	97	122	146	170	195	219	243	268	292	315	341	365	389
52.....	76	101	127	152	177	202	228	253	278	304	329	354	380	405
53.....	79	105	132	158	184	210	237	263	289	316	341	368	395	421
54.....	82	109	137	164	191	218	246	273	300	328	355	382	410	437
55.....	85	113	142	170	198	227	255	283	312	340	368	397	425	453
56.....	88	118	147	176	206	235	264	294	323	353	382	411	441	470
57.....	91	122	152	183	213	244	274	304	335	365	396	426	457	487
58.....	95	126	158	189	221	252	284	315	347	379	410	442	473	505
59.....	98	131	163	196	229	261	294	327	359	392	425	457	490	523
60.....	101	135	169	203	237	270	304	338	372	406	439	473	507	541
61.....	105	140	175	210	245	280	315	350	385	420	455	490	525	560
62.....	108	145	181	217	253	289	325	362	398	434	470	506	542	579
63.....	112	149	187	224	261	299	336	373	411	448	485	523	560	597
64.....	116	154	193	232	270	309	348	387	425	464	503	541	580	619
65.....	119	159	199	239	279	319	358	398	438	478	518	558	597	637
66.....	123	164	206	247	288	329	370	412	453	494	535	576	617	659
67.....	127	170	212	254	297	339	381	423	466	508	550	593	635	677
68.....	131	175	219	262	306	350	393	437	480	524	568	611	655	699
69.....	135	180	226	271	316	361	406	452	497	542	587	632	677	723
70.....	139	186	232	279	325	372	419	465	512	558	605	651	698	744
71.....	144	192	240	287	335	383	430	478	526	574	622	670	717	765
72.....	148	197	247	296	345	395	444	493	543	592	641	691	740	789
73.....	152	203	254	305	356	406	457	508	559	610	661	712	762	813
74.....	157	209	261	314	366	418	471	523	576	628	680	733	785	837
75.....	161	215	269	323	377	430	484	538	592	646	700	754	807	861
76.....	166	221	277	332	387	443	498	553	609	664	719	775	830	885
77.....	171	228	285	341	398	455	511	568	625	682	739	796	852	909
78.....	176	234	293	351	410	468	527	585	644	702	761	819	878	936
79.....	180	240	301	361	421	481	541	602	662	722	782	842	902	963
80.....	185	247	309	371	432	494	556	618	680	742	804	866	927	986
81.....	190	254	317	381	444	508	572	635	699	762	826	889	953	1,016
82.....	196	261	326	391	456	521	586	652	717	782	847	912	977	1,043
83.....	201	268	335	401	468	535	601	668	735	802	869	936	1,002	1,069
84.....	206	275	343	412	481	549	618	687	755	824	893	961	1,030	1,099
85.....	210	281	351	421	491	561	631	702	772	842	912	982	1,052	1,123
86.....	215	287	359	431	503	575	646	718	790	862	934	1,006	1,077	1,149

SCRIBNER DECIMAL "C" LOG RULE (Continued)

Diam. in Inches	LENGTH IN FEET													
	6	8	10	12	14	16	18	20	22	24	26	28	30	32
87.....	221	295	368	442	516	589	663	737	810	884	958	1,031	1,105	1,179
88.....	226	301	377	452	527	603	678	753	829	904	979	1,055	1,130	1,205
89.....	231	308	385	462	539	616	693	770	847	924	1,001	1,078	1,155	1,232
90.....	236	315	393	472	551	629	708	787	865	944	1,023	1,101	1,180	1,259
91.....	241	322	402	483	563	644	725	805	886	966	1,047	1,127	1,208	1,288
92.....	246	329	411	493	575	657	739	822	904	986	1,068	1,150	1,232	1,315
93.....	251	335	419	503	587	671	754	838	922	1,006	1,090	1,174	1,257	1,341
94.....	257	343	428	514	600	685	771	857	942	1,028	1,114	1,199	1,285	1,371
95.....	262	350	437	525	612	700	788	875	963	1,050	1,138	1,225	1,313	1,400
96.....	268	357	446	536	625	715	804	893	983	1,072	1,161	1,251	1,340	1,429
97.....	273	364	455	546	637	728	819	910	1,001	1,092	1,183	1,274	1,365	1,456
98.....	278	371	464	557	650	743	835	928	1,021	1,114	1,207	1,300	1,392	1,485
99.....	284	379	473	568	663	757	852	947	1,041	1,136	1,231	1,325	1,420	1,515
100.....	289	386	482	579	675	772	869	965	1,062	1,158	1,255	1,351	1,448	1,544
101.....	295	393	492	590	688	787	885	983	1,082	1,180	1,278	1,377	1,475	1,573
102.....	301	401	502	602	702	803	903	1,003	1,104	1,204	1,304	1,405	1,505	1,605
103.....	307	409	512	614	716	819	921	1,023	1,126	1,228	1,330	1,433	1,535	1,637
104.....	313	417	522	626	730	835	939	1,043	1,148	1,252	1,356	1,461	1,565	1,669
105.....	319	425	532	638	744	851	957	1,063	1,170	1,276	1,382	1,489	1,595	1,701
106.....	325	433	542	650	758	867	975	1,083	1,192	1,300	1,408	1,517	1,625	1,733
107.....	331	442	553	663	773	884	995	1,105	1,216	1,326	1,437	1,547	1,658	1,768
108.....	337	450	563	675	788	900	1,013	1,125	1,238	1,350	1,463	1,575	1,688	1,800
109.....	334	459	573	688	803	917	1,032	1,147	1,261	1,376	1,491	1,605	1,720	1,835
110.....	350	467	583	700	817	933	1,050	1,167	1,283	1,400	1,517	1,633	1,750	1,867
111.....	356	475	594	713	832	951	1,069	1,188	1,307	1,426	1,545	1,664	1,782	1,901
112.....	362	483	604	725	846	967	1,087	1,208	1,329	1,450	1,571	1,692	1,812	1,933
113.....	369	492	615	738	861	984	1,107	1,230	1,353	1,476	1,599	1,722	1,845	1,968
114.....	375	501	626	751	876	1,001	1,126	1,252	1,377	1,502	1,627	1,752	1,877	2,003
115.....	382	509	637	764	891	1,019	1,146	1,273	1,401	1,528	1,655	1,783	1,910	2,037
116.....	389	519	648	778	908	1,037	1,167	1,297	1,426	1,556	1,686	1,815	1,945	2,075
117.....	396	528	660	792	924	1,056	1,188	1,320	1,452	1,584	1,716	1,848	1,980	2,112
118.....	403	537	672	806	940	1,075	1,209	1,343	1,478	1,612	1,746	1,881	2,015	2,149
119.....	410	547	683	820	957	1,093	1,230	1,367	1,503	1,640	1,777	1,913	2,050	2,187
120.....	417	556	695	834	973	1,112	1,251	1,390	1,529	1,668	1,807	1,946	2,085	2,224

COMPARISON OF LOG RULES ¹

The following table shows the comparison of measurements of 16-foot logs from 8 to 48 inches in diameter as these are given by the more widely used rules. Less prominent rules, such as

¹ Supplied by Lufkin Rule Company, Saginaw, Mich.

Doyle-Baxter, Herring, Drew, Minor, Beaumont, and numerous others are not listed in the table:

Diameter in Inches	Doyle Scale	Scribner Scale	Favorite Scale	Baxter Scale	Two-third Scale	Dusenberry Scale	Cumberland River Scale	St. Louis Hard- wood Scale	Northwestern Scale	Decimal Scale	Spaulding's Pacific Coast Scale	Combined Doyle and Scribner Scale
8.....	16	25	22	34	36	33	33	3	16
9.....	25	36	29	44	48	46	45	4	25
10.....	36	49	37	56	58	40	47	59	61	6	50	36
11.....	49	64	48	69	70	54	57	72	70	7	63	49
12.....	64	79	64	84	85	68	68	85	77	8	77	64
13.....	81	97	82	100	100	80	80	100	97	10	94	81
14.....	100	114	98	117	116	100	93	116	117	11	114	100
15.....	121	142	120	136	133	117	107	133	144	14	137	121
16.....	144	159	142	156	151	136	121	150	170	16	161	144
17.....	169	185	166	177	171	157	137	172	188	18	188	169
18.....	196	213	197	200	192	180	153	192	206	21	216	196
19.....	225	240	226	224	213	204	171	213	226	24	245	225
20.....	256	280	248	250	237	229	190	237	248	28	276	256
21.....	289	304	285	277	261	256	209	261	285	30	308	289
22.....	324	334	324	305	286	285	229	284	324	33	341	324
23.....	359	377	357	335	313	315	250	312	357	38	376	359
24.....	400	404	392	366	341	346	281	341	392	40	412	400
25.....	441	459	434	399	370	379	296	369	421	46	449	441
26.....	484	500	476	432	400	414	320	400	450	50	488	484
27.....	530	548	520	468	432	450	345	432	520	55	528	530
28.....	576	582	562	504	464	487	372	464	536	58	569	576
29.....	625	609	596	543	498	526	399	498	584	61	612	609
30.....	676	657	632	582	533	567	427	533	632	66	656	657
31.....	729	710	678	623	569	609	456	568	678	71	701	710
32.....	784	736	725	665	606	652	485	608	725	74	748	736
33.....	841	784	785	709	648	697	516	645	785	78	796	784
34.....	900	800	845	754	685	744	548	685	845	80	845	800
35.....	961	876	882	800	725	792	581	725	882	88	897	876
36.....	1,024	923	920	848	768	841	614	768	920	92	950	923
37.....	1,089	1,029	978	897	811	892	649	810	978	103	1,006	1,029
38.....	1,156	1,068	1,037	946	855	945	685	856	1,037	107	1,064	1,068
39.....	1,225	1,120	1,098	999	901	999	721	901	1,090	112	1,124	1,120
40.....	1,296	1,204	1,160	1,052	944	1,054	759	947	1,160	120	1,185	1,204
41.....	1,369	1,272	1,213	1,107	995	1,111	798	996	1,213	127	1,248	1,272
42.....	1,444	1,343	1,266	1,163	1,045	1,170	835	1,045	1,266	134	1,312	1,343
43.....	1,521	1,396	1,334	1,221	1,095	1,227	877	1,334	140	1,377	1,396
44.....	1,600	1,480	1,402	1,280	1,147	1,300	918	1,402	148	1,448	1,480
45.....	1,681	1,518	1,474	1,340	1,200	1,350	960	1,474	152	1,512	1,518
46.....	1,764	1,587	1,546	1,401	1,253	1,410	1,003	1,546	159	1,581	1,587
47.....	1,849	1,656	1,621	1,464	1,309	1,470	1,048	1,621	166	1,652	1,656
.....	1,936	1,728	1,696	1,529	1,365	1,580	1,092	1,696	173	1,724	1,728

Doyle Scale

Scribner Scale

GLOSSARY

In any locality to which he may be assigned the new field man will experience more or less confusion in his dealings with local residents who may use terms which are vague or even meaningless to him.

A word or phrase that may be typical of one region may not be used in another, or, being used, may be so corrupted or modified as to take on an entirely different meaning, and it is therefore impossible to compile a glossary covering each and every strange term in all its phases. It is believed, however, that the following list of words and their definitions covers most of the terms the new man will not at first understand. The definitions given are not in every case precisely in accordance with those preferred by many philologists, but they will be found applicable to their respective terms as these are used and generally understood in the field.

Technical terms, applicable to special lines of work, are usually defined in an official glossary that may be secured upon requisition, and for that reason only the more common ones are included here.

A key to the abbreviations used follows:

n.	= Noun.	N.	= North.
v.	= Verb.	S.	= South.
a.	= Adjective.	E.	= East.
adv.	= Adverb.	W.	= West.
pro.	= Pronounced locally.	NE.	= Northeast.
col.	= Colloquialism in.	NW.	= Northwest.
cf.	= Compare with.	SE.	= Southeast.
Sp.	= Spanish origin.	SW.	= Southwest.
com.	= Common to.	AS.	= All sections.

Where reference has been had to a dictionary, Webster's Intercollegiate has been used.

A

- adobe, n.** (1) A brownish-colored variety of stiff clay found in SW. and portions of W. (Sp.: *adobar*, to plaster.) Pro. *ah-doe'-bay*, but generally abbreviated to "dobe."
(2) A sun-dried brick made of adobe.
(3) A building made of adobe brick. Generally known as a "dobe."

alfalfa, n. A homestead entered in a National Forest under the Act of June 11, 1906. Col. W. and SW. See JUNE 11.

arrastra, n. A crude form of ore-crusher, the ore being ground rather than crushed. An upright shaft sets in a circular rock-bottomed enclosure and usually bears two or four horizontal arms, to the outer ends of which heavy stones are hung in such a manner that the ore is ground between them and the rock bottom of the pit. The shaft is rotated by means of water-, horse- or man-power. (Sp.: *arrastrar*, to crawl, to creep.) Pro. "raster." Especially com. SW., and frequently used in other gold-producing regions.

v. To crush ore in an arrastra.

arroyo, n. A deep, narrow ditch or gully. (Sp.: *arroyo*, a rivulet.) Pro. ah-roy'-yoh. Com. W.

B

backfire, n. A fire started in front of another in such a manner as to burn toward it and consume inflammable material upon which it would otherwise feed.

v. To fight one fire by means of another.

balky, a. A term applied to an animal that refuses to work in harness.

band, n. A group of sheep or goats, usually from 2,000 to 2,200 in number.

bang, v. To cut away an animal's foretop. Cf. ROACH.

bar, n. (1) The ridge at the side of an animal's frog.

(2) That part or a bit which passes through an animal's mouth.

(3) That part of an animal's jaw between the molars and incisors.

(4) One of the crosswise ridges at the roof of an animal's mouth.

(5) One form of branding-iron.

(6) A horizontal mark used as part of or to cancel a brand.

(7) The wooden side of a saddle-tree.

(8) One of a set of poles used in lieu of a gate.

(9) A shallow ridge formed in the bed of a river by action of the current. Also col. S. and SE. for a long, low, flat stretch of clean gravel or sand appearing between the river's edge and the bank proper.

(10) See CROW BAR and PINCH BAR.

iron, n. A straight iron rod with a shorter piece or bar welded at right angles to it at one end and used as a branding-iron.

barrow, n. A castrated hog.

bay, n. A bay animal.

a. Reddish-brown in color.

- bay, v.** The action of a "cow" dog in barking at and otherwise engaging a cow's attention until she can be caught by the stockman.
- bed, n.** (1) A wagon box.
 (2) The foundation of a trail or road tread.
 (3) The bottom of a ditch or cañon.
- v.** (1) To prepare ground upon which cotton is to be raised. Com. AS. where cotton is raised.
 (2) To "bed down" cattle or sheep; to stop and keep them quiet over night.
- beetle, n.** A heavy wooden mallet used in driving iron wedges or wooden gluts into timbers that are to be split open. The head sets at right angles to the handle and is bound at either end with an iron band. Cf. MAUL.
- bevel-square, n.** A small adjustable square used in laying off angles.
- bit, n.** (1) That part of a bridle which works in an animal's mouth.
 (2) The blade or cutting portion of a tool.
 (3) Col. S., SE., W. and SW. for twelve and one-half cents
 (4) A variety of earmark.
- blab, n.** A flat piece of wood or heavy tin or leather suspended from a calf's nose in such a way as to fall before the calf's mouth and thereby prevent sucking. The calf soon learns to throw it forward and out of the way in feeding from the ground.
- v.** To attach a blab to a calf's nose.
- boar, n.** An uncastrated hog.
- board, n.** Col. S., SE., and W. for clapboard or shake (q.v.).
 foot: The unit of lumber measure; equal to a plank 12 inches square and 1 inch thick.
- bob, v.** To cut away the hair at the end of an animal's tail. Cf. ROACH.
- bog, n.** A small area of stiff mud deep enough to entrap animals that enter it in their attempts to secure grass or water. Also known as "boghole."
- v.** (1) To bog down; to be entrapped in a boghole.
 (2) Bog pulling, the operation of pulling or assisting an animal out of a boghole.
- bole, n.** The trunk or stem of a tree.
- bolster, n.** That portion of a wagon gear upon which the bed rests.
- bone-brand, n.** A blurred brand due to excessive heat or protracted pressure of the iron at the time the brand is applied.
- v.** To burn an animal severely in branding.
- bozal, n.** That part of a halter, hackamore or bridle which passes about the animal's jaws above the mouth. (Sp.: *bozal*, a muzzle, a novice.) Pro. bo-zahl'. Com. W. and SW.

brand, *n.* A character burned into or otherwise applied to an animal's skin, hoofs, or horns to facilitate identification. Also applied to tools and other property for the same purpose.

v. To apply identification marks to property.

branding-hatchet, *n.* See MARKING-HATCHET.

breast-collar, *n.* (1) A leather strap passed from one side of the saddle rig beneath the animal's neck and across to the other side of the rig and supplied in order to facilitate leading or dragging stock from the saddle-horn.

(2) That part of a buggy or carriage harness which passes before an animal's breast and which is supported from a strap across the neck immediately before the withers.

strap, *n.* That part of a harness which supports the end of the neck yoke.

yoke, *n.* That part of a wagon gear which is suspended from the team's collars and which supports the forward end of the pole. More commonly known as "neck" yoke. The term "breast yoke" doubtless originates from the fact that the yoke works before the animals' breasts.

brindle, *a.* Marked with streaks of (usually) black and brown, although often used in reference to a similar arrangement of other colors.

brisket, *n.* That portion of an animal's breast next to the ribs. The term applies only to cattle.

broncho, *n.* A half-tamed animal, applicable alike to horses, mules, burros and cattle. (Sp.: *broncho*, rough, sturdy, wild.) Pro. brong'-ko. Com. all parts W. Cf. MUSTANG.

a. Wild, rough, uncouth. Col. all parts W.

broom tail, *n.* An undersized or poorly developed pony. Col. SW.

broomy, *n.* See above.

brow band, *n.* That part of a bridle or halter which passes before and at the base of an animal's ears.

browse, *n.* The leaves and twigs of brush. Pro. browse.

v. To eat browse. Pro. browse.

buck, *n.* (1) An uncastrated goat. Also frequently used in reference to an uncastrated sheep. Col. AS.

(2) An Indian (male). Col. W.

v. (1) To cut a tree stem into log lengths.

(2) The action of an animal in attempting to unseat the rider by means of a series of sudden, irregular jumps.

buckaroo, *n.* Vaquero (*q.v.*). Pro. buck-a-roo', or buck-kay'-roe. Col. SW.

bucker, *n.* (1) One who cuts tree stems into log lengths.

(2) An animal that bucks.

buck-rim, *n.* An obsolescent style of cante. It differs from a bound cante in having the rear side of its edge fitted with a

rim sometimes 2 inches wide and set at right angles to it. The term probably originates from the rim's frequent utilization as a handhold when an animal pitches or bucks.

bug, n. An improvised lantern made by fastening a candle in a tin can and fitting the latter with a wire bail or handle. Com. all parts W. Also col. same section for "lantern."

bugs, n. Col. all parts W. for "screw worms."

"To have the bugs": to be tubercular. Col. all parts W. Com. SW.

bulge, n. The outward swell at either side of a saddle fork.

bull, n. An uncastrated male of the ox kind.

v. A common term used among stockmen in reference to a cow's desire to copulate.

bulldog, v. A very rough and more or less dangerous form of amusement practiced by cattlemen and expert horsemen of the West. The bulldogger leaves the saddle at the moment his mount carries him alongside a steer, alights with his body on the steer's neck or on its head between the horns, seizes a horn in either hand, and then throws the steer either by sheer brute strength or else by twisting its head to one side and holding it there till the steer becomes exhausted and falls.

bunk, n. (1) A bedstead usually built against and attached to a wall.

(2) The bolster of a log wagon.

block: The block attached to either end of a bolster to prevent logs from rolling off.

house: A house used as sleeping-quarters.

v. To sleep in a bunk.

butte, n. A prominent peak. (French: *butte*, a target, a landmark.) Pro. *beaut*, as in beauty. Com. W.

C

cabin, n. A small building. Col. S. Cf. SHACK.

cabresto, n. A hair rope. (Sp.: *cabresto*, a hair rope.) Pro. *cah-vrase'-toe*. Col. SW.

cache, n. (1) A secreted place in which articles may be temporarily stored or hidden. Pro. *cash*.

(2) The articles stored or hidden in a cache. Com. SW. and parts W.

v. To hide or temporarily store articles.

calico, n. or a. See PINTO.

calve, v. To give birth to a calf.

camino, n. A road. (Sp.: *camino*, a road.) Pro. *cah-me'-no*. Col. and com. SW.

- cannon, n.** That part of an animal's leg between the knee and pastern.
- canyon, n.** Col. W. for a deep hollow or ravine. (Sp.: *canyon*, a hollow.) Pro. can'-yon.
- canthook, n.** A tool used in logging. Cf. PEAVY.
- cantinas, n.** The leather bags supplied field men for use in carrying papers, blank forms, stationery, etc. (Sp.: *cantinas*, cellar, canteen.) Pro. can-teen'-as.
- canter, n.** A slow gallop.
v. To travel at a slow gallop.
- cantle, n.** The upright rear portion of a saddle-seat.
- cap, n.** (1) A small tube closed at one end and loaded with a combustible explosive substance, used in detonating dynamite.
(2) The surface of a road or trail bed. In this case the word "cap" refers to the material used rather than to the surface presented to travel. Cf. TREAD (4).
- cast, v.** To throw an animal to the ground and hold it there by means of ropes.
- cavallo, n.** Col. SW. for horse. (Sp.: *cavallo* or *caballo*, a horse.)
● Pro. cah-wah'-yo.
- cayuse, n.** Col. W. and SW. for horse. The cayuse proper is a species of small inbred pony originated by the Cayuse Indians. Pro. ki'-use or ki-use'-y.
- center fire, n.** Col. all parts W. for a single cinch rigged saddle.
- chafe, n.** A leather guard attached to a cinch ring to prevent injuries to an animal's side.
v. To make sore by rubbing.
- chap, v.** To whip with a pair of chaparejos or a heavy belt. A rough form of amusement or punishment indulged in in most parts W. when a "tenderfoot" is to be initiated or an offender punished. Pro. shap.
- chaparejos, n.** Seatless leather or canvas trousers or leggings worn as a protection against brush. (Sp.: *chaparejos*, leather trousers.) Pro. chop-ah-ray'-hos. Com. all parts W.
- chaps, n.** Chaparejos. Col. all parts W. Pro. shaps.
- chestnut, n.** (1) The tough, horny protuberance appearing above the knees and below the hocks at the inner sides of the legs of horses, mules, and burros. A smaller chestnut is found at the rear of the pastern and is surrounded by the fetlock.
(2) A chestnut-colored animal.
a. Of a dark bay color.
- chink, n.** A Chinaman. Col. all parts W.
v. To fill the crevices of a wall with mud or other material.
- chinking, n.** The material used in filling the crevices of a wall.

chock, *n.* A log, stone, or similar article placed beneath a wheel to prevent it from revolving.

v. To place an obstruction beneath a wheel.

block, *n.* The obstruction used to prevent a wheel from revolving.

choker, *n.* A link made larger at one end than at the other. It is usually the end link of a chain and is used in lieu of a hook. Other links pass freely through the wide end, but are held securely when dropped edgewise into the narrow end. Sometimes known as a "choke hook."

cholla, *n.* A genus of herbaceous plants indigenous to SW. and some parts of W. It bears a tall, woody central stalk springing from a low clump of tough, pointed leaves, and is variously known as yucca, mescal, century plant, agave and American aloe. (Sp.: *cholla*, skull, judgment.) Pro. *choy'-yah*.

chops, *n.* Coarsely ground corn.

chuck, *n.* (1) An instrument used for holding a tool so it may be rotated.

(2) Food, provisions. Col. all parts W.

v. To throw the rider. Col. W.

ribs, *n.* The first ribs back of the shoulders. Applies to cattle.

steak, *n.* The steak immediately over the chuck ribs.

wagon, *n.* The wagon used in transporting food, bedding, and other supplies on a "cow works."

churn drill, *n.* A long drill for use by two men in drilling stone.

v. To operate a churn drill

cinch, *n.* A saddle girth. (Sp.: *cincha*, a band, a fastening).

v. To make a saddle girth fast.

clip, *n.* (1) The hook at the end of a single-tree into which the tug or trace is fastened.

(2) The amount of wool or mohair taken from a band of sheep or goats in one season. Com. among sheep and goat raisers.

v. (1) To shear an animal's hair or wool close to the body.

(2) To shear sheep or goats.

(3) To remove the tuft of hair, or fetlock, at an animal's pastern.

cockeye, *n.* The eye at the end of a tug or trace through which the single-tree clip passes.

comb, *n.* The peak of a roof.

concha, *n.* A metal or leather button. (Sp.: *concha*, a silver shell.)
Pro. *cont'-shah*.

cord, *n.* A measure of wood 8 feet long, 4 feet high, and 4 feet wide.

v. To arrange wood symmetrically for measurement.

cork, *v.* To injure one hoof by a blow from the shoe on the opposite hoof. Cf. INTERFERE, FORGE, and OVERREACH. Col. among horsemen for "calk."

coronet, n. That part of an animal's leg at the junction of the hair and hoof and from which the hoof grows.

corral, n. A small enclosure in which to confine stock. (Sp.: *corral*, enclosure, yard, playhouse.) Pro. ko-rel'. Com. all parts W.
Cf. Lot.

v. To enclose stock in a corral.

See TRAP CORRAL.

coupling-pole, n. See REACH.

cow outfit, n. A cattle ranch.

works, n. The operations involved in rounding up and branding cattle.

cows, n. A general term used by stockmen, particularly in all parts W., in reference to cattle regardless of age or sex.

coyote, n. A small species of wolf. (Mexican: *coyotl*, a sneak.)
Pro. ki'-yote or ki-yo'-te.

crab, n. A geared machine used in raising or erecting heavy weights. It is operated by means of one or two cranks, the loose end of the intake cable running from the drum to a snub-post.

cramp, v. To turn the front wheels of a vehicle out of line with the rear wheels to facilitate turning the vehicle by backing it.

crib, n. A pen used for the confinement of stone which is to serve as piers.

v. To gnaw, bite, or suck posts, poles, trees, mangers, etc.
The term applies usually to horses only.

cribber, n. An animal addicted to cribbing.

crimp, n. The crease which binds a cap to the fuse.

v. To compress the open end of a cap about the fuse.

crosscut, n. An opening running at about right angles to a mine tunnel.

v. To run a cut-out at one side of a tunnel.

saw, n. A saw having teeth so constructed as to cut across the grain of a timber.

saw (two-man), n. A crosscut saw fitted with a handle at either end and designed for use by two men.

crow bar, n. A heavy iron bar beveled on two sides of the point and used in moving heavy weights. Cf. PINCH BAR.

crowns, n. (1) The top of a tree.

(2) That part of a bridle, hackamore or halter which passes upward over an animal's head back of the ears.

(3) The upper surface of an animal's tooth.

fire, n. A fire occurring in the tops or crowns of timber. Com. NW.

crutch, n. (1) A pole or other timber inserted in a wheel in such a way that the wheel's strength is maintained after the dish has been lost.

- crutch, (n.)** (2) A pole placed under the end of an axle and supported from the bed in such a way that the wagon may be moved by sliding: used when a wheel has been broken down.
- curb strap, n.** The strap which passes from one bit ring to the other beneath an animal's jaws. Used as a means of better control.
- cut, n.** (1) A trench made through high ground in order to maintain a uniform grade.
 (2) A piece of meat or a steak.
- v.** (1) To separate certain stock from a herd.
 (2) To castrate.

D

- dally, n.** The turn of a rope about a saddle-horn.
v. To take several turns of a rope about a saddle-horn in such a way that slack may be taken up or paid out quickly if necessary.
- dewlap, n.** (1) The pendulous skin along the under side of a cow's neck.
 (2) An identification mark.
v. To make an incision in the dewlap for purposes of identification.
- diangling, a. or adv.** Diagonally. Col. S. and SE.
- dike, n.** A line of rock projecting above the surface of the ground.
- dish, n.** In an upright wheel, the difference in distance horizontally between the outer spoke surfaces at the hub and the outer edge of the rim.
faced, a. With a noticeably sunken profile.
- dobe, n.** Adobe. Col. SW. See ADOBE.
- dock, v.** To cut away a portion of an animal's tail. The operation is frequently performed on lambs at the time they are castrated and marked. In some sections the meaning of the term is restricted to removal of the hair only, and may also be known as "bobbing."
- doe, n.** A ewe (*q.v.*). Col. SW.
- dogey, n.** A motherless young calf. Usually applied to one that has lost its mother through death. Cf. MAVERICK. Pro. doe'-gay. Col. W.
- double-jack, n.** A sledge requiring the use of both hands in drilling stone.
v. To drill stone, one man holding the drill, the other striking.
- tree, n.** That part of a wagon gear to which the single-trees are attached. Cf. EVENER.
- drench, n.** A quantity of liquid medicine to be given an animal.
v. To administer liquid medicine to an animal.

drift, n. (1) See **CROSSCUT**.

(2) A herd's gradual movement to a new range or location.

v. (1) To move gradually to a new range or location.

(2) To depart hurriedly and continue a journey. Col. W.
fence, n. A length of fence provided for directing the movements of stock.

drill, n. (1) An instrument used in driving holes in stone.

(2) An augur used in boring holes in either wood or metal.

v. Col. most parts W., meaning to depart.

drop, v. To give birth to a calf. Thus a calf is said to be "dropped" or "calved" rather than born. Cf. **CALVE**.

dugout, n. (1) An excavation made in the side of a hill and used as a room.

(2) A water-trough made by hewing out the inside of a log.

dump, n. The accumulation of refuse material at the mouth of a tunnel or shaft.

v. To throw the rider. Col. AS.

dutchman, n. A plank nailed to a tree for the purpose of serving as a support for barbed or other wires, but designed primarily as a means of preventing the wire from being imbedded in subsequent growth of the tree.

E

earmark, n. An incision made in an animal's ear for purposes of identification.

v. To make an incision in an animal's ear.

end gate, n. The upright board forming the end of a wagon bed or box. Usually known as "head" gate, front, and "tail" gate or "tail board," rear.

epidemic, n. A disease attacking great numbers simultaneously.

evener, n. See **DOUBLE-TREE**.

ewe, n. A female sheep. See **DOE**.

eye splice, n. A loop made in a rope by splicing one end of the rope back into itself.

F

fell, v. To cut down a tree. Also spelled "fall," this term being col. N. and S. woods.

feller, n. One who fells trees. Generally called "faller."

felloe, n. A section of the rim of a wagon wheel. Frequently called "felly" and "feller."

fender, n. The broad leather between the rider's leg and the animal body, attached to the stirrup strap.

fetlock, n. The tuft of hair at an animal's pastern joint.

- filly, n.** A young mare. Usually applied to a mare up to the birth of her first colt.
- fire brand, n.** (1) A brand made by burning.
(2) A piece of burning material.
- fistula, n.** An abscess having tubes or pipes leading to an internal cavity. Frequently, though improperly, called "fistulo."
- flag, n.** The pole used by a surveyor to indicate where a line is to be run.
v. (1) To set a flag pole.
(2) To stop a runaway horse or team. Col. W.
- flake, n.** One of the loose sections of a bale of hay. These may vary in number in a bale from two to a dozen or more, depending upon the length and tangle of the grass stems. It is, therefore, misleading to say that one flake or two flakes or any other number of flakes should be sufficient hay for one feed.
- foal, n.** A very young colt.
v. To give birth to a colt. Thus a colt is said to be "foaled" (improperly called "foalded") rather than born.
- fool killer, n.** A broken branch left hanging in the top of a tree. Com. AS. where logging is carried on.
- foretop, n.** That part of an animal's mane which hangs down over the face.
- forge, n.** A specially constructed furnace used by blacksmiths.
v. (1) To make an article of iron.
(2) An animal's action in striking the heel of the forefoot with the toe of the hind foot in traveling. Cf. OVERREACH.
- frog, n.** The V-shaped ridge on the sole of a horse's hoof.
v. To putter about in an aimless manner. Col. W. The term doubtless originates from the one used in playing the game of Solo or Sluff, wherein a "frog" is the lowest bid that can be made.
- fuse, n.** A slender, flexible tube filled with combustible material, which when ignited conveys a flame to the cap inserted in a dynamite cartridge.

G

- gag runner, n.** The iron loop through which the check rein passes at or near the upper end of the bridle cheek.
- gall, n.** (1) An abrasion caused by friction of a saddle or harness.
(2) A knot-like growth on leaves, twigs, and branches of trees.
v. To abrade an animal's skin with an improperly fitting saddle or harness.
- gallows frame, n.** A structure erected over the mouth of a shaft to facilitate hoisting.

- gambrel, n.** A stick used by butchers to keep the legs of a carcass spread well apart during the operation of cleaning or washing. The ends are sharpened and are thrust into the legs between the bone and the ham string, and in addition to spreading the legs the gambrel may also be used as a means of support for the carcass.
- gather, n.** The difference in distance between the front rim edges of the same pair of wheels as compared with the distance between the rear rim edges.
- v.** (1) To assemble stock in a herd.
(2) To harvest. Col. S. and SE.
- gear, n.** (1) The framework of a wagon exclusive of the bed or box.
(2) Harness. Col. S. and SE.
- gee, n.** A word of command used by teamsters to turn a team to the right.
- gelding, n.** A castrated horse.
- gilt, n.** A young sow. Commonly applied to one up to the birth of her first litter of pigs.
- gin poles, n.** Poles used in erecting heavy timbers or beams.
- glut, n.** A large wooden wedge used in opening timbers after they have been partly split open with smaller iron wedges.
- goose neck, n.** An iron hook fitted to the forward end of a wagon pole and provided as a means of attaching other teams to the pole. The term is also applied to the hook which connects the pole with an ox yoke.
- grain rope, n.** The rope used in tying sacks of grain or other bulky articles to a pack saddle.
- Greaser, n.** A Mexican. Col. all parts W.
- Greener, n.** A tenderfoot (*q.v.*). Col. all parts W.
- ground fire, n.** A fire occurring in peaty ground. Com. NE.
- grout, n.** Concrete made very thin in order to facilitate pouring and settling in narrow forms.

H

- hackamore, n.** A halter-like article used in breaking or controlling horses. See JAQUIMA.
- hair brand, n.** An indistinct brand resulting from insufficient heat or pressure of the iron at the time the brand is applied. Occasionally used in reference to a tar or paint brand, and frequently in referring to characters burned or clipped in an animal's hair or wool.
- ham string, n.** The large tendon which connects with the point of the hock in an animal's leg.
- v.** To make lame by cutting or otherwise injuring the ham string.

- haw, n.** A word of command used by teamsters to turn a team to the left.
- headstall, n.** Halter; the leather part of a bridle.
- heifer, n.** A young cow. Commonly applied to one up to the birth of her first calf.
- herd, n.** A number of animals grouped together or owned by one person.
- v.** (1) To confine stock to one place when no fences are available.
- (2) The action of other persons in preventing a pitching animal from colliding with posts, trees, etc., where a sudden stop might injure either it or the rider or both. Col. W.
- hill billy, n.** A mountaineer. Col. S. and SE. Cf. RIDGE RUNNER.
- hip, v.** To injure an animal's hip.
- hipped, a.** Having one or both hips injured.
- hobble, n.** Any article used in tying an animal's legs together to prevent straying. Frequently spelled "hopple."
- v.** (1) To tie an animal's legs together.
- (2) To tie the stirrups together beneath an animal's body. A common practice among horsemen when a saddle animal is expected to pitch vigorously. Having the stirrups fastened in this manner provides increased facilities for retaining the seat.
- honda, n.** The eye in the end of a rope. (Sp.: *honda*, a sling.)
Pro. hon'-doo.
- horse camp, n.** Winter quarters for horses used in handling cattle. In charge of a "wrangler" (*q.v.*).
- hounds, n.** The parts of a wagon gear which brace the axles on the pole and reach. Sometimes spelled "hauns" and "hawns."
- housewife, n.** A cloth or leather receptacle for sundries used in repairing clothes.

I

- interfere, v.** To strike the ankle or pastern joint of one leg with the hoof or shoe of the opposite leg. Cf. CORK and FORGE.
- iron, n.** The abbreviated form of "branding-iron." Com. all parts W.

J

- Jacob's staff, n.** The iron-shod wooden pole used as a support for a compass. Also known as Jake staff, Jake rod, Jake stick, Jake pole, Jim rod, Jim pole and joy stick.
- jaquima, n.** An Indian word from which the word "hackamore" is derived. Pro. yak'-i-mah.

- jerk, v.** To dry thin strips of meat in the sun.
- jerk line, n.** A single line used in guiding a team. Customarily one steady pull turns the team to the right and three short jerks turn it to the left. It is commonly used in teams of four or more animals and is attached to the near bit ring of the near lead horse. Other animals in the team are trained to follow the lead pair.
- jerky, n.** Sun-dried meat. Com. SW.
- jockey, n.** The leather which forms the side of a saddle seat immediately over the fender.
- box, n.** A tool box built against an end gate.
- stick, n.** A stick used in lieu of a halter rope and designed to keep a vicious animal at a distance from the attendant.
- jump weld, n.** The attachment of the end of one iron at right angles to and against the side of another.
- June 11, n.** A homestead entered in a National Forest under the Act of June 11, 1906. Col. among Forest officers.

K

- kak, n.** A saddle. Sometimes used in reference to a very old horse. Col. SW.
- kayak, n.** A box frame covered with rawhide and used in packing loose articles. Also spelled "kaiak" and "kyack." Pro. ki'-ack. Plural, kyax.
- keel, n.** Lumbermen's designation of marking crayon.
- kerf, n.** The opening resulting from a saw's passage through a timber. Commonly expressed in fractions of an inch.
- kid, n.** A young goat.
- v.** To give birth to a kid. The young is "kidded" or "dropped" rather than born.
- king bolt, n.** The bolt which connects the forward end of the reach with the front axle.

L

- lamb, n.** A young sheep.
- v.** To give birth to a lamb. The young is "lambled" or "dropped" rather than born, and the ewe is said to "lamb" rather than to give birth to young.
- lariat, n.** A noosed rope used in catching stock. (Sp.: *la reata*, a rawhide rope used in tying animals together.) Pro. lary-et'. Cf. REATA.
- v.** To catch stock with a noosed rope.
- lash rope, n.** The rope used in tying the top pack to the grain pack or pack saddle.

- lasso**, *n.* A noosed rope used in catching stock. (Sp.: *lazo*, a noose.)
v. To catch stock with a noosed rope. Col. W., "lass."
- latigo**, *n.* The leather strap which connects the cinch with the rig of a saddle. (Sp.: *latigar*, to lash or make fast.)
- lead**, *n.* The left, or near, side of a horse, wagon, etc. Pro. leed.
- horse**, *n.* The near horse in a team. Also a horse that is to be led.
- side**, *n.* The left, or near, side of an animal or team.
- team**, *n.* The foremost animals in a team of four or more.
- lean**, *a.* Applied to mortar carrying a minimum amount of lime or cement.
- lean-to**, *n.* A shed or side room. Col. S. and some parts W.
- lepe**, *n.* A motherless calf. (Sp.: *lepe*, a motherless calf.) Pro. lep'-py. Col. SW. Cf. DOGUE.
- light**, *v.* To dismount. Col. S. and SE.
- lightered**, *n.* Dry pitch pine. Also known as "lightwood," the term probably originating from the quick, bright blaze coming from the burning wood. Col. S. and SE.
- lobo**, *n.* A species of wolf that runs or hunts alone. (Sp.: *lobo*, a wolf.) Pro. loe'-boe. Also known as "loafer" wolf.
- loco**, *n.* A poisonous range plant. (Sp.: *loco*, mad, crazy.)
a. Crazy. Col. W.
v. To drive frantic. Col. W.
- lode**, *n.* A vein containing metallic ore. Pro. load.
- loggy**, *a.* Dull, tired, listless. Applied to a wornout horse. Col. W. Pro. loe'-gay.
- log scale**, *n.* (1) A rule or scale which shows the contents of a log in board feet.
 (2) The number of board feet contained in all the logs taken from a certain area or sawed at a certain time. Cf. MILL RUN.
- lot**, *n.* An enclosure for stock. Col. S. and SE. Cf. CORRAL. Verb. PEN.
- lunger**, *n.* Col. W., especially SW., for a person suffering from pulmonary tuberculosis.

M

- manana**, *n.* Col. W., especially SW., for a person who continually and habitually procrastinates. (Sp.: *mañana*, tomorrow.) Pro. man-yan'-ah.
- marking-hatchet**, *n.* A light ax bearing the raised letters US on the poll and used by Forest officers in marking timber. Also known as "branding-hatchet," and "marking-ax."
- marlin-spike**, *n.* A sharp-pointed instrument used in separating the strands of a rope.

- mash, n.** A thick mixture of bran and water.
- mattock, n.** A double bitted tool used in loosening and moving earth. One bit is in line with the handle, the other at right angles to it.
- maul, n.** A heavy wooden mallet or hammer. It differs from a beetle in having the head and handle in one piece and in line lengthwise with each other. Cf. BEETLE.
- maverick, n.** An unbranded calf. Usually applied to one that has left its mother after being weaned. The term is said to have originated in Texas, where one Maverick, observing that other stock raisers branded their animals, concluded the most distinctive evidence of ownership that he could use would be the absence of any brand whatever on his stock. He accordingly claimed all unbranded stock.
- mecate, n.** A hemp rope. (Sp.: *mecate*, a hemp rope.) Col. SW. Pro. may-cot'-ay.
- mesa, n.** A high plateau or flat-topped peak. (Sp.: *mesa*, a table.) Com. W. Pro. may'-sah.
- mill, n.** (1) An establishment where ore is crushed or refined or lumber is sawed or dressed.
 (2) The result of a herd of frightened horses or cattle swimming frantically about in a circle, each trying to escape from the water by climbing upon another's back. Com. all parts W.
- v.** (1) To crush and refine ore.
 (2) To swim frantically about in a circle. Sometimes used in reference to the restless and uneasy movements of a herd on land. Also applied to a throng of people who continually move about. Col. W.
- run, n.** The number of board feet of lumber actually sawed out regardless of the amount indicated by a log scale.
- monument, n.** A pile of stone set up to mark a line or corner of land.
- morral, n.** A feed bag designed to be suspended from an animal's head. (Sp.: *morral*, a feed bag.) Pro. mo-rel'. Com. all parts W.
- muck, n.** Mud and refuse material from a mine.
v. To loosen and remove muck.
- mucker, n.** One who removes muck.
- mud, n.** An injection used by drillers to indicate that for some reason striking must be temporarily suspended.
 Also Col. AS. for "mortar."
- muley, n.** A naturally hornless individual of any horn-bearing species. Also applied to a McClellan saddle or any other saddle not fitted with a horn.

- muley, a.** Without horns. The term can not be applied to an animal that has been dehorned.
- mustang, n.** See BRONCHO. (Sp.: *mesteno*, wild.)

N

- nanny, n.** A ewe. Col. among sheep and goat raisers.
- near side, n.** An animal's left side. See LEAD SIDE.
- neat, a.** Applied to mortar having only lime or cement for the body.
- neck yoke, n.** See BREAST YOKE. In reference to the term as applied to work with oxen, the word "neck" is usually omitted and "ox" is frequently, though not always, substituted.
- nester, n.** A settler, usually a homesteader. Col. W.
- nigh side, n.** See NEAR SIDE. Col. S. and SE.

O

- off color, a.** A term applied to stock not colored like others of the herd. Thus, a black cow in a herd of Herefords would be called "off color," and in most instances would not sell for as high a price as the Herefords, although the latter might not be as large or in as good condition.
- off side, n.** An animal's right side.
- orejano, -a, n.** A maverick, male or female, respectively. (Sp.: *orejano, -a*, unclaimed.) Col. SW. Pro. *ory-han'ay*.
- outlaw, n.** A term applied to a horse too wild or vicious to be ridden or worked. Also applied to other animals that have never been branded, or having been branded have never received any further attention from their owners, and have been allowed to run wild.
- overreach, v.** To place the hind foot at a point on the ground in advance of where the fore foot was set. Improperly called "forging." Cf. INTERFERE.

P

- pacer, n.** An animal that moves both legs of the same side simultaneously.
- paint brand, n.** See TAR BRAND.
- paling, n.** See PICKET. Col. S.
- pannier, n.** A leather or canvas bag used in packing. Cf. KAYAK.
- peavy, n.** A tool used in moving logs. It differs from a canthook in having the lower end armed with a pike instead of a lip.
- picket, n.** One of the upright pieces in a fence made of sharpened stakes or scantlings.
- v.** To tie an animal to a picket pin.
- pin, n.** An iron stake to be used in lieu of a post and to which a grazing animal may be tied.
- rope, n.** The rope by which an animal is tied to a picket pin.
- piebald, n. or a.** See PINTO.

pinch bar, n. A heavy iron bar beveled on one side of the point and used in moving or raising heavy weights. Cf. CROW BAR.

pinto, n. A spotted pony. Also known W. and SW. as piebald, calico, paint, and speckled. (Sp.: *pinto*, spotted.)

pitch, n. (1) The degree of slope of a roof.

(2) The difference in distance between the lower rim edges of the same pair of wheels as compared with the distance between the upper rim edges. Frequently known as "tread" or "set."

(3) A name applied to the sap of a pine tree.

v. A horse's action in trying to unseat its rider. Pitching differs from bucking in being more vigorous and irregular, and action is prolonged to a greater degree.

placer, n. The short term for "placer claim" or "placer mine."

Nearly all such claims or mines are located on gold-bearing streams, where gold-dust may be separated from the earth by "panning," an operation in which a flat, shallow pan is filled with earth and water and then shaken vigorously. The water is allowed to spill gradually and takes the refuse material with it, the gold settling to the bottom of the pan. Another method is to perform a similar operation by means of an apparatus known as a "rocker." Still another method of securing the gold is to throw the gold-bearing earth into a "flume," through which water flows swiftly. Bars or "rifles" across the bottom of the flume catch the gold as it settles. Pro. "plaser," as in plaster.

point, n. A prominent peak or landmark. Col. S. Cf. BUTTE.

v. (1) To mark an animal's ear with both an over- and an under-slope, thus leaving it pointed.

(2) To ride ahead of a herd of cattle being moved and thus supply them with an object to follow.

pole, n. A wagon tongue.

strap, n. The strap of a harness which connects the breast yoke of the wagon gear with the belly band or breeching of the harness.

poll, n. The head of an animal or tool.

pommel, n. The highest part of a saddle immediately before the seat.

slicker, n. A water-proof coat having very long, wide skirts designed to protect both the rider and the saddle from rain.

poncho, n. A sleeveless, water-proof garment with a hole at the center, through which the wearer's head is thrust. (Sp.: *poncho*, lazy.) (Col. Sp.: *poncho*, a sleeveless garment.) Com. W. Pro. *pont'-cho*.

- port, n.** The arch in the bar of a bridle bit.
- pull, n.** The distance, on the ground, between a telephone pole and the point where it should be set to be in direct line with the first pole at either side of it.
- v.** To pull leather: to seize some part of the saddle with one or both hands when an animal pitches.
- puncher, n.** One who works with cattle. Col. all parts W. The term originates from the practice of prodding cattle that persist in lying down while being shipped by rail or boat.
- puncture, n.** A small hole resulting from the entrance of a nail, wire or similar article in a horse's hoof.

Q

- quarter corner, n.** A corner set approximately half-way between section corners on the same line.
- crack, n.** A perpendicular crack in an animal's hoof.
- quarterming, a.** Diagonally.
- quirt, n.** A short riding-whip of sewn or plaited leather. (Sp.: *cuerda*, a rope.)
- quitter, n.** A balky animal.
- quittor, n.** An abscess at the coronet.

R

- racker, n.** An animal that travels in a manner between that of a trot and a gallop.
- rake, n.** The distance from the vertical to which a telephone pole inclines outward when set in a curve. Designed to offset the extra strain imposed by pull (*q.v.*).
- ram, n.** An uncastrated sheep.
- v.** To tamp concrete.
- ranch, n.** Either a stock- or grain-farm of any size. Contrary to a general belief of persons from the East, a ranch may consist of no more than two or three acres, or may even include no more than a fraction of one acre. (Sp.: *ranchito*, a stock farm.)
- v.** To operate a ranch.
- ranchero, n.** A stock raiser or a farmer. (Sp.: *ranchero*, one who conducts the business of a ranch.) Pro. ranch-er-roo' or ran-chay'-roe.
- range, n.** (1) The strip of land lying between north-and-south lines located approximately 6 miles apart. Such a strip of land is described as being east or west of a given meridian.
- (2) The area upon which stock grazes.
- (3) The forage secured from a range by stock.
- v.** To graze stock on a certain area

raster, *n.* See **ARRASTRA**.

v. To crush ore in an arrastra.

rattler, *n.* See **ROARER**. Also the abbreviated form for "rattlesnake."

reach, *n.* (1) The pole which connects the front and rear axle of a wagon.

(2) The distance an animal steps in traveling.

plate, *n.* An iron plate connecting the forward ends of the rear hounds in a wagon gear and securing them to the reach.

reata, *n.* A rope, usually though not always of rawhide, used in catching stock. (Sp.: *la reata*, a rawhide rope used for tying animals together.) Pro. ray-ah'-tah. Com. W. and SW.

remuda, *n.* A reserve herd of mounts. (Sp.: *remuda*, exchange; a change of shift when stock is being held in herd.) Pro. ray-moo'tha. Com. SW.

renegade, *n.* See **OUTLAW**.

rich, *a.* Applied to mortar carrying a large amount of lime or cement.

rick, *n.* (1) A measure of wood 8 feet long, 4 feet wide, and of the same width as the length of the sticks. Cf. **CORN**.

(2) A windrow of freshly cut hay. Com. S.

v. (1) To pile wood symmetrically for measurement.

(2) To rake hay into long piles preparatory to removal from the field. Col. S.

ride, *n.* A journey by horseback. Com. AS.

v. To work with cattle or other stock.

ridge runner, *n.* A mountaineer. Col. SW.

rig, *n.* That part of a saddle to which the cinches are attached.

rim, *n.* (1) The edge of a mesa. Com. W.

(2) That part of a carriage wheel which corresponds to the felloes of a wagon wheel. It differs from the latter in carrying half the number of the spokes in a wheel while a felloe carries only two spokes.

fire, n. Applied to a single cinch rigged saddle.

rise, *n.* (1) The perpendicular distance between the plates and the comb of a roof.

(2) A gentle slope. Col. S.

rive, *v.* To split out boards, shakes or palings.

reach, *v.* To trim an animal's mane or tail. Usually applied to mules.

roan, *n.* A roan-colored animal.

a. Of a mixed color, consisting usually of white or gray spots in bay.

roarer, *n.* An animal that breathes in an audible manner as the result of a throat affection.

- rodso**, *n.* See **ROUNDUP**. (Sp.: *rodear*, to go a roundabout way.)
 Pro. ro-day'-o or ro-day'-er. Com. NW., W. and SW.
- roll**, *n.* A stuffed leather pad used by riders to prevent injury against the saddle fork or horn.
- rope**, *n.* and *v.* See **LASSO**.
- burn**, *n.* An injury inflicted on an animal's leg by the sliding motion of a rope drawn swiftly and violently against it.
- rosette**, *n.* An ornamental button used on saddles and harness. It differs from a concha usually in having a loop at the back instead of eyes through the center for the passage of thongs or straps.
- roughage**, *n.* Grass, hay, fodder, etc. Com. W.
- roughness**, *n.* See above. Com. S. and SE.
- roundup**, *n.* The assembling of all or a part of the stock on one range.
- v.* To assemble stock.
- rowel**, *n.* The spiked wheel of a spur, or the roller in a bit.
- v.* To spur an animal vigorously.
- rub iron**, *n.* An iron plate attached to the lower corner of a wagon bed for protection of the bed when the fore wheel is cramped under it.
- run**, *n.* (1) The horizontal distance between the plate and the comb of a roof.
 (2) The amount of ore milled or lumber sawed at one time.
 (3) The country covered in a day's cruise. Ccl. among reconnoissance men.
- v.* (1) To gallop at a high rate of speed.
 (2) To run an iron: To own, lease or otherwise handle the stock bearing that brand.
 (3) To run a brand: To change it by superimposing another upon it.
- running iron**, *n.* A straight iron rod used in tracing brands.

S

- safety belt**, *n.* A heavy leather belt used by telephone linemen.
- strap**, *n.* A heavy leather strap used by telephone linemen in securing themselves to a pole when the desired height has been reached.
- sag**, *n.* The distance below the horizontal to which a telephone wire is allowed to hang at or near the center of the span.
- scantling**, *n.* A thin, narrow strip of lumber. The term usually applies to pieces of odd lengths, uneven edges and other irregular surfaces.
- scissor bill**, *n.* A mountaineer. Com. S. and SE. Cf. **HILL BIT**

- scratch, v.** To draw the spurs along an animal's sides from its neck or shoulders to its flanks or thighs, thus inducing it to pitch more vigorously.
- screw bug, n.** See SCREW WORM. Col. all parts W.
- worm, n.** The larval stage of a fly (*Comptosia macelleria*) which attacks open sores and wounds.
- set, n.** (1) The cutting thickness of a saw.
 (2) See Pitch (2).
 (3) A corruption of "site." Thus, a good "set," instead of a good "site," is frequently used in reference to the location of a sawmill, and may include such features as the contour of the ground, the amount of timber available, and all other factors which help to make the site desirable.
- shack, n.** A small building. Com. W. Cf. CABIN.
- shake, n.** (1) A flat piece of split timber used as a shingle.
 (2) The chill caused by ague. Col. S.
 v. To shiver with ague. Col. S.
- shank, n.** (1) That part of an animal's leg between the knee and the foot; usually applies to cattle. Cf. CANNON.
 (2) That part of a tool which connects the handle with the acting part.
- shear, n.** One of a pair of gin poles.
 v. To cut or clip away wool or mohair of sheep or goats.
- sheave, n.** The wheel of a pulley. Also known as "shive" and "shiv."
- shim, n.** A thin wedge used to align a plank.
 v. To align a plank by means of a thin wedge.
- sill, n.** The lowest timber in the frame of a building.
- silla, n.** Col. SW. for saddle. (Sp.: *silla*, chair or seat.) Pro. see'-yah.
- single-footer, n.** An animal that raises only one foot at a time in traveling.
- jack, n.** A sledge hammer for use in one hand in drilling.
- tree, n.** That part of a wagon gear to which the traces are hooked. Frequently known as "whiffle" tree, and improperly called "swingle" tree.
- sitfast, n.** A corn-like growth caused in an animal's back by constant pressure.
- skein, n.** The iron covering at the end of an axle and upon which the wheel revolves.
- skew back, a.** Having a slight downward curvature along the back. Applies to hand saws. Cf. SWAY BACK.
- slavers, n.** Excessive secretions of saliva. Also spelled "slabbers" and "slobbers."

- sleeper, n.** A horizontal supporting timber of a floor or ceiling; usually applied to the first. Cf. STRINGER.
- v.** To change a lightly burned brand by burning a heavier one over some portion of it.
- sleeve, n.** (1) That part of a carpenter's brace which covers the chucks.
- (2) Part of a wagon skein.
- (3) A double tube used in splicing copper telephone wire.
- slicker, n.** A water-proof garment with narrow skirts. Cf. POMMEL SLICKER.
- slough, v.** To peel away, as dead skin. Pro. sluff.
- snub, n.** The turn of a rope about a snub-post.
- v.** To take a number of turns about a post in such a way that the rope may be released quickly.
- post, n.** The post to which a rope is snubbed.
- sombrero, n.** A hat, usually of the wide-brimmed felt variety. (Sp.: *sombra*, shade.) Pro. som-bray'-ro. Col. W., "sombo."
- sorrel, n.** A sorrel-colored animal.
- a.** Of a light bay color.
- spade, n.** An inverted V-shaped attachment placed on the bar of a bit designed for the control of vicious animals.
- span, n.** (1) A team of two animals; usually applied to mares or mules.
- (2) The length of a telephone wire between two poles.
- (3) The distance between two supports of a bridge.
- spay, v.** To remove the ovaries.
- spike, n.** The foremost animal in a team having an odd horse in the lead.
- team, n.** A team with an extra animal in the lead.
- spile, n.** A length of sumac, elder, or similar wood with the pith removed. It is inserted in a hole bored in a tree and serves as a spout by which sap may be carried to a bucket. Com. all parts E.
- spill, n.** A rolled or twisted paper used in lieu of a match after being ignited at an open fire. Com. S. and SE.
- v.** To throw the rider. Col. all parts W.
- splint, n.** (1) An unnatural growth on the bone of a horse's leg and due to a bruise or blow. It seldom appears except on the foreleg and below the knee.
- (2) A strip of padded wood or other material used to hold the ends of fractured bones together till they knit.
- spreader, n.** A strap bearing an iron ring through which the check of a line passes. The other end is buckled into a hame staple. The object of a spreader is to provide greater freedom of motion in the use of the check.

stag, n. Any male animal castrated after the age of about four years.

stall, n. A compartment in a stable for an animal.

- v. To overload a team or drive them into a place from which they can not extricate the load.

stampede, n. A wild rush of excited cattle or horses.

- v. To frighten cattle or horses till they run wildly, all in the same or different directions.

stamp iron, n. A branding iron bearing a certain character at one end.

stave, n. One form of the word "stay." Col. S. and SE. See below.

stay, n. A short post or paling set loosely in a panel of fence to strengthen it.

- v. To brace a fence with stays.

steer, n. A castrated young male of the ox kind.

stem, n. The bole or trunk of a tree.

straightedge, n. A plank, usually about 10 feet long, dressed exactly straight along one edge and used by carpenters in leveling and plumbing.

stretcher, n. A substitute for a single- or double-tree. A chain provides a means of central attachment and is fitted with hooks or clevises into which cockeyes or other stretchers may be fastened. The ends of the chain are held apart by a stick or rod having each end sharpened with a shoulder and thrust into a link at the desired distance from the end of the chain. Also known in some localities as a "spreader."

string, n. (1) A flight of stairs.

- (2) A number of extra saddle animals held in reserve for alternate use.

- (3) Col. all parts W. for lasso (*q.v.*).

stringer, n. A supporting timber of a floor or ceiling; usually applied to the latter. Also applies to the floor timbers of a bridge. Cf. SLEEPER.

stub, n. A short post set beside a telephone pole and provided as a means of re-enforcement.

- v. To brace a telephone pole with a stub.

stump sucker, n. See CRIBBER.

surface fire, n. A fire occurring in the litter on the surface of the ground. Com. AS.

- measure, n. The method of computing lumber in units of square feet regardless of the thickness of the blanks.

swab, n. A slender, flexible stick wrapped with cloth at one end and used in forcing obstructions down a cow's throat.

- v. To force an obstruction from the throat to the stomach by means of a stick.

swamp, v. To clear away brush and other obstructions or debris as in clearing out for a road or trail or telephone line or in logging.

swamper, n. One who swamps or "swamps out."

sway back, a. Abnormally low in the back. Applied to horses. Cf. **SKEW BACK.**

sweller, n. An animal that inflates the lungs as the saddle cinch is tightened.

T

tail board, n. See **END GATE.**

down, v. To throw an animal by pulling it to one side by the tail.

gate, n. See **END GATE.**

tailings, n. Refuse material from a mine.

tally, n. (1) The number of calves born in a herd in one year. Thus a stock raiser may assume that the number of his entire herd is equal to two, three, or four times the number of calves branded, depending upon whether or not there has been a good "calf crop," and in this way keep a fairly accurate check on the number of cattle he owns. Sales, slaughters, and losses are, of course, deducted from the number thus obtained.

(2) A unit of measure used by surveyors; usually 10 chains.

tamp, v. To pack earth or other material about posts, or poles, or over shots by repeated slight strokes of a crow bar or similar tool.

tamping, n. The material packed about posts, poles, etc.

tap, n. (1) The burr or nut which holds a wagon wheel to the skein.

(2) The abbreviated form of "tapadera" (*q.v.*). Col. all parts W.

v. To pierce an animal's side at such a point and in such a manner that internal gases may escape from the paunch. The operation as performed by veterinarians involves the use of a trocar and canula. It is frequently resorted to as a means of relief for cattle suffering from bloat, but is adopted only as a last recourse in cases of horses suffering from colic.

tapadera, n. The leather covering of a stirrup. (Sp.: *tapar*, to cover.)

tar brand, n. A brand made by smearing tar or paint on an animal's hair or wool. Usually applied to sheep and goats. Also known as "paint" brand.

tenderfoot, n. A person unacquainted with Western customs. Col. all parts W.

thimble, n. See **SKEIN.**

- thumb, v.** To draw the ends of the thumbs suddenly and simultaneously along both sides of an animal's neck in a forward or diagonally upward direction. This usually induces a half-broken animal to pitch.
- top fire, n.** A fire occurring in the crowns or tops of timber. Also known as "crown" fire. Com. NW.
- pack, n.** Bedding, tents, etc., placed over the grain pack.
- tooley, n.** A tourist. Col. SW. A helper about an oil well is known as a "tooley."
- track, n.** The distance, on the ground, from center to center of tires of the same pair of wheels.
- v.** The action of the rear wheels in following the path of the fore wheels.
- trailer, n.** A wagon attached and pulled behind another.
- trap, n.** A name loosely applied to several varieties of rock of volcanic origin.
- corral, n.** A corral fitted with a gate so arranged that it may be opened from the outside by an animal attempting to reach the bait, usually salt, placed just inside the gate. The gate closes automatically after the animal has passed through and can not be opened from the inside. Such corrals are used chiefly in rough or mountainous country inaccessible to horsemen and in corralling stock too wild to be caught otherwise.
- tread, n.** (1) The width, from front to back, of a stair step.
(2) Used in some localities with reference to track, and in others meaning width of tire. Cf. GATHER.
- trocar, n.** A large, hollow needle, or a needle encased in a tube, used in tapping cattle.

U

- undercut, n.** A notch cut into a tree to facilitate felling it in a desired direction. Sometimes designated as "kerf."
- v.** To notch a tree for felling.
- underrunner, n.** The strap which connects the breeching with the pole strap in a harness.

V

- vaquero, n.** Col. SW. for one whose profession is breaking horses or handling cattle. (Sp.: *vaquero*, a "cowboy.") Pro. buck-a-roo' or buck-kay'-roe.
- vault, n.** To mount an animal by springing into the saddle without the aid of the stirrup.

- vent, n.** Cancellation of a brand by reproducing it in fac-simile on the shoulder of the same side. The term is probably either a corruption or a derivative of the verb "vend."
- v.** To cancel a brand by reproducing it in fac-simile.
- voids, n.** The interstices between fragments of stone or grains of sand used in concrete.
- volt, n.** The unit of electro-motive force in use among electricians, and defined legally in terms of the ampere and ohm.
- voltage, n.** Electro-motive force reckoned in volts.

W

- warble, n.** A grub hatched from an egg deposited in the backs of cattle by the gadfly.
- wether, n.** A castrated sheep; also used in reference to a castrated goat.
- wheel horse n.** One of the animals in the team next to the load; usually applied to the near animal.
- whiffle-tree, n.** See SINGLE-TREE.
- whim, n.** A machine fitted with a drum about which a cable works in hoisting material from a shallow shaft.
- horse, n.** The animal used to furnish power in revolving a whim.
- wind-broken, n.** Chronic suffering from impaired respiration, due usually to over-exertion; applies to horses.
- sucker, n.** See CRIBBER.
- withers, n.** The high, bony part of a horse's anatomy immediately over the shoulders.
- wolf, n.** See WARBLE.
- wrangler, n.** One who "wrangles" or takes care of saddle animals used in handling cattle.



INDEX

Numbers refer to pages; illustrations are indicated by an asterisk (*) after the page number.

A

- Abscesses, 254
- Administering medicine to stock, 286
- Administrative districts, 341
- Adze, 173*
- Age of cattle, 295
 - of horses, 272
- Ailments, 297
 - Biliousness, 297
 - Bleeding at the nose, 301
 - Chapped hands, 302
 - Chilblains, 301
 - Cholera morbus, 300
 - Corns, 301
 - Cramps, 300
 - Diarrhea, 300
 - Dysentery, 300
 - Felon, 301
 - Headache, 300
 - Ingrowing toe-nails, 302
 - Malaria, 298
 - Sore lips, 301
 - Sore lungs, 301
 - Sore throat, 301
 - Toothache, 301
- Ailments and injuries, 296
- Animal equipment, 24
 - Bells, 27
 - Combs and brushes, 27*
 - Feed bags, 26*
 - Halters, 24*
 - Hobbles, 25*
 - Picket pin and rope, 26*
- Antidotes, 309
- Antiseptics, 296
- Appendix, 341
- Apples, preparation of, 221
- Axes, 170
 - Belt ax, 173
 - Broad ax, 171, 172*
 - Care of, 173

Axes,

- Double bitted ax, 171*
- Filing, 174
- Grinding, 173
- Hand ax, 172*
- Handles, inserting, 175
 - Making new, 174
 - Removal of broken, 174
- Pole ax, 170*
- Whetting, 174

B

- Baking powder bread, 213
- Balls or pills, 266
- Bar irons, 281
- Barring out, 284*
- Beans, preparation of, 220
- Bedding, 7
- Bed roll, 152*
- Beef, cuts of, 218*
- Beer, recipe for, 224
- Bells, 27
- Biliousness, 297
- Biscuits, preparation of, 213
- Bits, 122
 - Bridle, 12*
 - Carpenter's, 123*
- Bites, dog or snake, 307
- Blackleg, 258
- Blands, 309
- Blanket, saddle, 13
- Blasting, 74
 - Blasting out boulders, 80
 - Blockholing, 80, 81*
 - Mudcapping, 80*
 - Snakeholing, 81*
 - Blasting out trees and stumps, 81, 82*, 83*, 84*
- Caps, 75
- Charges, 369
- Crimper, 76*
- Dynamite, 75

- Blasting.**
 Firing, 79
 Fuse, 76
 Inserting cap in cartridge, 77*
 Loading, 78
 Misfires, 79
 Mistakes to be avoided, 84
 Preparing the charge, 76
 Attaching cap to cartridge, 77*
 Attaching cap to fuse, 76*
 Attaching fuse to cartridge, 77*
 Tamping, 78
- Bleeding at the nose, 301**
- Blind staggers, 248**
- Bloat, 257**
- Board rule, 189***
- Bootees, 5**
- Boots, riding, 5**
 Rubber, 6
- Bots, 245**
- Brace, carpenter's, 122, 123***
- Branding rig, 281***
- Brands, 280, 283***
 Arbitrary symbols, 287*, 288
 Army brand, 286*
 Cancellation of, 282, 284*
 Barring out, 284*
 Venting, 284*
 Combination, 288, 289*
 Conventional letters and figures, 286*
 Fire, 280
 Inscribed, 284
 Location of, 282
 Other conventional characters, 287*
 Paint, 285
 Reading, 288
 Running, 290*
 Sleeping, 290
 Tar, 286*
- Bread, baking powder, 213**
 Corn, 213
 Potato, 213
 Rice, 213
 Rye, 213
 Salt rising, 212
 Sour dough, 212
 Yeast, 212
- Bridges, 66, 67***
- Bridles, 10, 11***
- Bruises, on animals, 253**
 On the human body, 303
- Buildings, 85**
 Attachment of corner studding, 87*
 Attachment of plates, 89*
 Attachment of ribs to studding, 89*
 Attachment of sleepers, 87*
 Attachment of stringers to plate, 89*
 Attachment of studding, 87*
 Classifications, 86
 Box frames, 91
 Full frames, 86
 Half frames, 90
 Log frames, 92
 Cornice, 92
 Door and window casings, 98
 Estimates, 87
 Foundations, 85
 Hog trough corner, 91*
 Hog trough sill, 86*
 Laying the floor, 97
 Laying the roof, 92
 Matched flooring, 97
 Materials, 85
 Nails required for shake roof, 96
 Nails required for shingle roof, 94
 Notch for wall logs, 92*
 Rafters cut too long, 89*
 Rafters cut too short, 89*
 Saddle board, 96
 Self-supporting roof, 90*
 Shakes, 95
 Shakes required, 96
 Sheeting, 93
 Shingles required, 94
 Shingling, 93
 Studding braces, 89*
 Truss roof, 91*
 Unmatched flooring, 97
 Walls, 97
 Water board, 98*
 Wind beam, 90*
- Burns, on animals, 252**
 On the human body, 303*
- Bush hook, 62***
- Butchering, 225**

O

- Cakes, buckwheat, 214
- Flour, 214
- Johnny, 214
- Potato, 214
- Rice, 214
- Camp fires, 320
- Building, 320
- Care of, 321
- Fuel woods, 320
- Location of, 320
- Camp sites, 319
- Accessibility, 319
- Fuel, 319
- Location of, 319
- Protection, 320
- Protection of the public health, 322
- Water, 319
- Camp tables and seats, 218*
- Canned goods, 211
- Canthook, 180*
- Carpenter's kit, 119
- Bits, auger, 122, 123*
- Car, 122, 123*
- Drill, 123*
- Expansive, 122, 123*
- Gimlet, 123*, 124
- Brace, 122, 123*
- Calliper, 125, 126*
- Calliper rule, 126
- Chisels, 124, 125*
- Claw-hammer, 126*
- Compass, 125, 126*
- Files, 126
- Saw, 126
- Wood, 126
- Grindstone, 127*
- Handsaws, 119
- Crosscut, 119, 120*
- Filing, 120
- Keyhole, 121*
- Rip, 121
- Setting, 121
- Level-plumb, 125*
- Monkey-wrench, 126*
- Planes, block, 124*
- Jack, 124*
- Square, 122, 127
- Whetstone, 127*
- Carpenter's square, 127
- Board scale, 129*
- Diagonal scale, 128*
- Graduations, 128
- Improvised, 136, 137*
- Octagon rule, 132*, 135*
- To lay off octagons without the rule, 135*
- One-hundredth-inch scale, 129
- Other uses, 132
- Parts, 127
- Pitch table, 131, 132*
- Rafter table, 130*
- Tables and scales, 128
- To bisect an angle without a square, 136, 137*
- To erect a perpendicular without a square, 136*
- To lay off a lookout, 134*
- To lay off rafters, 132, 133*
- To lay off stair strings, 134*
- To obtain the center of a circle, 135*
- To obtain the center of a rectangle, 135*, 136
- To obtain rafter lengths, 133*
- Catfish wounds, 307
- Cattle, ages of, 295
- Diseases of, 257
- Blackleg, 258
- Bloat, 257
- Choking, 261
- Cowpox, 259
- Foot-and-mouth disease, 260
- Foul feet, 260
- Loss of cud, 258
- Lump jaw, 259
- Mange, 259
- Milk fever, 261
- Screw worms, 262
- Tuberculosis, 260
- Warbles, 262
- Throwing, 262*
- Cement, natural, 99
- Portland, 99
- Centiped, 306*
- Centiped wounds, 307
- Cereals, 215
- Chaparejos, 18, 19*
- Chapped hands, 302
- Chilblains, 301

- Chisels, 125*
- Chocolate, 224
- Choking, 261
- Cholera, in hogs, 265
Morbus, 300
- Chopping, 175
- Clawhammer, 126*
- Clothing, 1, 9
Bootees, 5
Boots, riding, 5
Rubber, 6
Cap, 2
Coat, 2, 10
Coat sweater, 2
Hat, 2
To use as a drinking-cup, 2
Heel plates, 4
Hob-nails, 4
Hose supporters, 6
Moccasins, 6
Shirt, 3, 9
Shoe calks, 4, 10
Shoe strings, 4
Slicker, 3
Socks, 6, 10
Storm rubbers, 6
Trousers, 3, 9
Underwear, 3, 9
Work shoes, 3
- Cocoa, 223
- Coffee, 223
- Colic, spasmodic, 241
Wind, 240
- Compass, carpenter's, 125, 126*
- Saw, 121
- Standard Forest Service, 200
- Concrete work, 99
Aggregate, 101
Cinders, 101
Crushed stone, 101
Gravel, 101
Cement, 99
Natural, 99
Portland, 99
Cement finish, 104
Concrete, 99
Concrete blocks, 104
Filling forms, 103
- Concrete work,
Forms, 103
Material required, 362
Mixing, 102
Proportions, 100
Reinforcement, 102
Sand, pit, 100
River, 101
Sea, 101
Setting, 103
Water, 102
- Confusion of directions, 322
- Construction work, 31
- Cooking, field, 210
Biscuits, 213
Bread, 211
Cakes, 214
Canned goods, 211
Cereals, 215
Drinks, 223
Equipment, for stations, 28
For temporary camps, 29
Eggs, 219
Fish, 217
Fruits, 221
Ginger snaps, 223
Jams, 222
Jellies, 222
Mush, 214
Pickles, 222
Pie crust, 223
Pies, 223
Pudding, fruit, 223
Rice, 221
Sandwiches, 221
Utensils, care of, 224
Vegetables, 219
- Copperheads, 316
- Corduroy, 68*, 69
- Cornbread, 213
- Corrmeal mush, 214
- Corns, 301
- Cowpox, 259
- Cracked wheat mush, 214
- Cramps, 300
- Crowbar, 62*
- Crown fires, 206
- Culverts, 66, 68*
- Curry combs and brush, 27*
- Cuts, on animals, 252
On the human body, 302

D

- Degrees, relation of, to per cent,
354
- Demulcents, 296
- Dewlaps, 283*, 294
- Diarrhea, 300
- Diseases of cattle, 257
- Of hogs, 265
- Of horses, 240
- Of sheep, 263
- Disinfectants, 296
- Dislocations, 304
- Distemper, 242
- Dog bites, 307
- Drenches, 266
- Drenching cattle, 267
- Horses, 267
- With a syringe, 267
- Drilling, rock, 72
- Drinks, beer, 224
- Chocolate, 224
- Cocoa, 223
- Coffee, 223
- Lemonade, 224
- Tea, 223
- Driving, 167
- Drowning, 305
- Duffle bags, 7
- Dynamite, composition of, 75
- Strength, 75
- Use of different strengths, 75
- Dysentery, 300

E

- Ear Buttons, 294*
- Loops, 294*
- Marks, 291, 293*
- Punch and dies, 291*
- Tags, 294*
- Eggs, preparation of, 219
- Elevations, to ascertain distant,
356
- Emetics, 309
- Equipment, 1
- Animal, 24
- Cooking, for stations, 28
- For temporary camps, 29
- For a field trip, 9
- Packing, 20

- Equipment,
 Personal, 1
- Riding, 10

F

- Faint, 304
- Farcy-Glanders, 243
- Fastenings, 325
- Feed bags, 26*
- Felon, 301
- Fences, 107
- Barbed wire, 112*
- Brush, 112
- Corner posts, 115
- Setting and bracing, 115*
- Gates, 117*
- Guy, 118*
- Hinges, 118*
- Tie, 116*
- Lightning-rods, 117
- Line posts, 116
- Setting or driving, 116
- Logs, 106*
- Paling, 112*
- Pickets, 111*
- Plank, 112
- Post and rail, 110*
- Rack for sharpening posts, 116*
- Rail, 106, 109*
- Stakes and riders, 109*
- Stone, 107, 108*
- Woven wire, 114*
- Stretcher, 114*
- Field work in the Philippine
 Islands, 338
- Fire brands, 280
- Fire fighting, 205
- Classification of fires, 206
- Crown fires, 206
- Ground fires, 206
- Surface fires, 206
- Control, 208
- Crown fires, 209
- Ground fires, 206
- Surface fires, 209
- Equipment, 207
- Fighting the flames, 210
- Immediate action, 207
- Patrol, 206
- Patrolling the back line, 210
- Preliminary inspection, 207

- Fire fighting.**
 Procedure following preliminary inspection, 208
 Tool caches, 207
 Trespass, 205
Fish, preparation of, 217
Fistula, 255
Flat ends, 337*
Flooring, matched, 97
 Unmatched, 97
Foot and mouth disease, cattle, 260,
 Sheep, 264
Foot rot, 264
Footwear, 3
Forest fires, six rules for prevention of, 321
Forest service compass, 200
Forest Supervisors' headquarters, 341
Formula for whitewash, Government, 369
Foul feet, 260
Founder, 242
Fractures, 304
Freezing, 305
Fruits, preparation of, 221
Fuel woods, 320
- G**
- Gates, fence, 117***
Galls, harness and saddle, 255
Gangrene, 247
General comparison of rattlesnakes, copperheads and moccasins, 317
 Color, 318
 Habits, 318
 Size, 317
Gila monster, 315
Ginger snaps, 223
Glanders-Farcy, 243
Glossary, 379
Government formula for whitewash, 369
Grades, per cent measurement of, 351
 To ascertain without a graduated, 354, 355*
- Grindstone, 127***
Ground fires, 208
Gunshot wounds, 303
- H**
- Hackamore, 13***
Halters, 24*
 Leather, 24
 Rope, 25
 Tie rope, 25
Handkerchiefs, 7, 10
Harness and saddle galls, 255
Hat, 1, 10
Hatchet, marking, 172
 Shingling, 172*, 173
Headache, 300
Heel plates, 4
Hitches, 331*
 Anchor, 333
 Blackwall, 334
 Bowline sling, 332
 Cat's paw, 333
 Clove, 332
 Clove and a half, 332
 Cross, 152*, 153
 Diamond, 149*
 Grain, 148*
 Half, 152*, 331
 Mooring, 333
 Overhand sling, 332
 Rolling, 333
 Round turn and two half hitches, 333
 Squaw, 151*, 152
 Telephone, 333
 Timber, 332
 Timber and a half, 332
 Two half, 333
Hobbles, 25*
 Chain, 239
 Cross, 239*
 Double, 238
 Horseshoe, 239
 Picket, 238
 Side, 238
Hobbling, 238
Hob-nails, 4
Hoes, 61*
Hogs, diseases of, 265

- Hogs, diseases of,**
 Cholera, 265
 Mange, 265
 Thumps, 266
Hominy, 215
Horses, age of, 272, 273*
 Bad habits of, 260
 Balking, 270
 Biting, 269
 Bolting, 271
 Cribbing, 270
 Kicking, 269
 Rearing in harness, 271
 Setting back, 270
 Stall kicking, 269
 Stall pawing, 270
 Striking, 269
 Bones of, 279*
 Care of, 227
 Barley, 229
 Bran, 229
 Ear corn, 227
 Feed, 227
 Fodders, 230
 Grain, 227
 Green corn, 227
 Hay, 230
 Oats, 229
 Range grasses, 230
 Roughage, 229
 Salt, 231
 Shelled corn, 228
 Tame grasses, 230
 Water, 227
 Wheat, 229
 Diseases of, 240
 Abscesses, 254
 Blind staggers, 248
 Bots, 245
 Bruises, 253
 Burns, 252
 Colic, spasmodic, 241
 Wind, 240
 Cuts, 252
 Distemper, 242
 Fistula, 255
 Founder, 242
 Gangrene, 247
 Glanders-Farcy, 243
 Harness and saddle galls,
 255
Horses, diseases of,
 Horsepox, 247
 Injuries and other ailments,
 249
 Internal poisoning, 250
 Lameness, 249
 Loco poisoning, 251
 Pink eye, 246
 Poison wounds, 251
 Poll evil, 256
 Proud flesh, 253
 Punctures, 254
 Quittor, 256
 Rabies, 247
 Scratches, 256
 Sitfasts, 255
 Sweeney, 256
Hobbling, 238
 Chaining, 239
 Cross hobbles, 239*
 Double hobbles, 238
 Horseshoe hobbles, 239
 Picket hobbles, 238
 Side hobbles, 238
Hoof, the, 232, 236*
 Bars, 233
 Coronet, 234
 Frog, 232
 Heel, 233
 Parts of, 232
 Sole, 232
 Toe, 233
 Walls, 233
Jaw of, 273*
Legs of, 278*
Parts of, 240*
Purchasing a saddle horse, 272
 Age, 272, 273*
 Build, 276
 Color, 276
 Eyes, 277
 Gaits, 279
 General disposition, 276
 Hearing, 278
 Hoofs, 278
 Legs, 278
 Pulse, 277
 Respiration, 278
 Size, 276
Shoeing, 231
 Attaching the shoe, 236

- Horses, shoeing,
 Finishing, 237
 Fitting the shoe, 236
 Holding the feet, 234
 Kit, 231
 Leveling the hoof, 235
 Removal of shoes, 234
 Subjugation of, 267
 Head-and-tailing, 269
 Throwing, 267
 Whirling, 269
 Horsepox, 247
 Hose supporters, 6
 Hot treatments, 297
 Housewife, 10

I

- Identification of stock, 279
 Methods used, 280
 Brands, 280
 Fire brands, 280
 Bar irons, 281
 Cancellation of, 282
 Barring out, 284*
 Venting, 284*
 Location of, 282
 Running irons, 282
 Stamp irons, 280
 Inscribed brands, 284
 Paint brands, 285, 286*
 Changing brands, 288
 Running, 290*
 Sleeping, 290
 Characters used, 285
 Arbitrary symbols, 287*,
 288
 Combinations, 288, 289*
 Conventional letters and
 figures, 286*
 Other conventional char-
 acters, 287*
 Reading brands, 288
 Dowlaps, 283*, 294
 Ear buttons, 294*
 Loops, 294*
 Marks, 291, 293*
 Classifications, 291
 Reading, 291
 Tags, 294*
 Ingrowing toe-nails, 302

- Injuries, to animals, 249
 To the human body, 302
 Bruises, 303
 Burns, 303
 Catfish wounds, 307
 Cuts, 302
 Dislocations, 304
 Dog bites, 307
 Drowning, 305
 Faint, 304
 Fractures, 304
 Freezing, 305
 Gunshot wounds, 303
 Lightning stroke, 306
 Poisoning, 309
 Shock, 305
 Snake bites, 307
 Sprains, 304
 Sunstroke, 305
 Tarantula, centiped, and
 scorpion wounds, 307
 Inscribed brands, 284
 Irons, bar, 281
 Branding, 280
 Running, 282
 Stamp, 280

J

- Jams, 222
 Jellies, 222
 Johnny cake, 214

K

- Knots, 325, 327*
 Bowline, 328
 Bowline on a bight, 328
 Carrick bend, 329
 Combined surgical and reef, 326
 Double overhand, 329
 Double sheet bend, 328
 Figure 8, 328
 Granny, 328
 Overhand, 326
 Overhand and half hitch, 329
 Running bowline, 328
 Sheepshank, 329
 Single sheet bend, 328
 Square or reef, 326
 Staffordshire or Tait's, 326
 Surgical, 326

- Knots,
Thief, 328
Turk's head, 329
- L
- Lameness, 249
Lampas, 249
Land descriptions, 194
Lands acquired under the Weeks law, 346
Land surveys, 192
Base lines, 192
Corners, 196, 198*
Guide meridians, 193
Half sections, 194*
Land descriptions, 194
Metes and bounds surveys, 197
Other descriptions, 196, 197*
Principal meridians, 192
Quarter sections, 195*
Quarter-quarter sections, 195
Quarter-quarter-quarter sections, 195*
Quarter-quarter-quarter-quarter sections, 195*
Range lines, 193
Sections, 194
Section lines, 193
Numbers, 193
Subdivisions, 193
Standard parallels, 192
Township lines, 193
Lash hook, 23*
Lash rope and cinch, 23
Latigo ties, clove, 334*
Double half hitch, 334
Overhand, 334
Lemonade, preparation of, 224
Level-plumb, 125*
Lightning stroke, 306
Live stock, identification of, 279
Brands, 280
Dewlaps, 283*, 294
Ear buttons, 294*
Loops, 294*
Marks, 291, 293*
Tags, 294*
Location of camp sites, 319
Log rules, 369
Comparison of, 377
- Log rules,
Doyle, 370
Doyle-Scribner, 373
Scribner, 373
Scribner Decimal C, 374
Two-thirds, 370
Logs, bucking, 186*, 187*
Scaling, 188*, 190*, 191*
Loss of cud, 258
Lump jaw, 259
Lung worms, 264
- M
- Malaria, 298
Malaria mosquito, 298
Transmission of malaria, 299
Mange, cattle, 259
Hog, 265
Sheep, 263
Mattock, 60*
Measures, 347
Apothecaries' or wine, 348
Cubic, 348
Dry, 348
Grain, hay, seed, and vegetable, 349
Liquid, 348
Long, 347
Spoon and cup, 349
Square, 348
Surveyors', 347
Meats, boiled, 217
Broiled, 217
Domestic, 216
Fried, 216
Game, 215
Roasted, 217
Milk fever, 261
Moccasins (footwear), 6
(Reptiles), 316
Morals, 26*
Mountain boomer, 315
Mules, shoeing, 237
Mush, 214
- N
- Nails, number per pound, 359, 360*
Nooses, halter, 330*
Hangman's, 330
Slip, 331

O

- Oatmeal, preparation of, 214
- Oil stone, 127*
- Onions, preparation of, 220

P

- Packing, 147
 - Attachment of ropes to saddle, 148*
 - Hitches used, 148
 - Cross, 152*, 153
 - Diamond, 149*, 150*, 151*
 - Grain, 148*
 - Half, 152*
 - Squaw, 151*, 152
- Packing equipment, 20
- Pack saddle, 20
 - Combination, 20, 21*
 - Cross-tree, 20
 - Fork of, 21*
 - Tree of, 21*
 - Full rigged, 23*
 - Muley, 20
 - Fork of, 20*
- Pack saddle parts, 21
 - Breast collar, 21, 22*
 - Breeching, 21, 22*
 - Cinches, 22*
 - Latigoes, 22
 - Rig, 22
- Paint brands, 285
- Painting, 105
 - Amount of paint required, 107
 - Care of paint brushes, 107
 - Coats, 106
 - Colors, 106
 - Composition, 105
 - Object, 105
- Panniers, 23
- Peavy, 180*
- Per cent, relation of to degrees, 354
 - Of grades, 351*
- Pick, 60*
- Picket pin and rope, 26*
- Pickles, preparation of, 222
- Pie crust, preparation of, 223
- Pies, preparation of, 223
- Pills or balls, 268
- Pinch bar, 62*

- Pink eye, 246
- Planes, 124*
- Poisoning, loco, 251
 - Internal, in animals, 250
 - In the human body, 309
- Poisonous plants, 314
- Poisonous snakes, 316
 - Common characteristics, 316
 - Emission of poison, 317
 - Fangs, 316
 - General comparison of, 317
 - Color, 318
 - Habits, 318
 - Size, 317
 - Poison glands, 317
 - Poison, the, 317
- Poisons, 310
 - Antidotes, 309
 - Blands, 309
 - Emetics, 309
 - Stimulants, 310
- Poison wounds, 251
- Posts,
 - Corner, 115
 - Setting and bracing, 115
 - Line, 116
 - Setting or driving, 116
- Potatoes, preparation of, 219
- Pot rack, 218*
- Protection of the public health, 322
- Proud flesh, 253
- Provisions, 30
 - For stations, 30
 - For temporary camps, 30
- Pudding, preparation of, 223
- Punctures, 254

Q

- Quilt, 18*
- Quiltor, 256

R

- Rabies, 247
- Rattlesnakes, 316
- Rearing rig, 271*
- Reptiles, 315
 - Gila monster, 315
 - Horned toad, 315
 - Mountain boomer, 315
- Rice, preparation of, 221

- Riding, 139
 Adjusting the blanket, 139
 Cheeking, 142
 "Climbing on," 143
 Dismounting, 145
 Mounting, 141
 Placing the saddle, 139
 Position, 143
 Reining, 145
 Reins, 145
 Removing the saddle, 141
 Saddling, 139
 Tightening the cinch, 140
 Vaulting, 142
 Riding equipment, 10
 Bit, 12*
 Bridle, 10, 11*
 Chaparejos, 18, 19*
 Hackamore, 13*
 Quirt, 18*
 Saddle, 14*
 Saddle blanket, 13
 Spurs, 17, 18*
 Rock drilling, 72
 Churn drilling, 74
 Double jacking, 72
 Removing the cuttings, 74
 Single jacking, 72
- 8
- Saddle, military, 14*
 Pack, 20, 21*
 Fork of, 21*
 Full rigged, 23*
 Parts of, 22*
 Stock, 14*
 Saddle blanket, 13
 Cinch buckle, 17*
 Cinches, 15*
 Horns, 16*
 Seat plate, 16*
 Stirrups, 15*
 Tapaderas, 16*
 Tree, 14*
 Saddle galls, 255
 Saddle horse, purchasing a, 272
 Shoeing, 238
 Sag tables, 355
 Sandwiches, preparation of, 221
 Sawing, 178
 Sawing,
 Filing, 178
 Saws, hand, 119
 Buck, 177*
 Crosscut, 119
 Keyhole, 121*
 Rip, 121
 Setting, 179
 Teeth, 120
 Saws, two-man, 176*, 177
 Scabies, 263
 Scales, log, 369
 Scorpion, 306*
 Scorpion wounds, 307
 Scratches, 256
 Screws, 363*-368*
 Screw worms, 262
 Shakes, 95
 Shears, 137, 138*
 Sheep, diseases of, 263
 Foot and mouth disease, 264
 Foot rot, 264
 Lung worms, 264
 Mange, 263
 Stomach worms, 264
 Sheep, holding, 265
 Shingles, 93
 Shingling, 93
 Shirt, 3, 9
 Shock, 305
 Shoe calks, 4
 Shoeing horses, 231
 Mules, 237
 Saddle animals, 238
 Shoeing kit, 231*
 Rig, 235*
 Shoes, 10, 237*
 Shoe strings, 4, 10
 Shovels, 61*
 Sitfasts, 255
 Sleeping, 290
 Slicker, 8
 Snake bites, 307
 Snakeholing, 80
 Socks, 8, 10
 Sore lips, 301
 Lungs, 301
 Throat, 301
 Splices, 335*, 336*, 337*
 Clove and overhand, 336
 Double eye, 336

- Splices,
 Eye, 336
 Hawser bend, 335
 Leather, 336
 Permanent, 335
 Temporary, 335
 Toggle, 336
- Splitting, 176
- Sprains, 304
- Spurs, 17, 18*
- Square, carpenter's, 127
- Stimulants, 310
- Stomach worms, 264
- Storm rubbers, 6
- Sunstroke, 305
- Surface fires, 208
- Surveying crews and their work,
 198
- Surveys, land, 192
- Sweeney, 256
- T
- Tarantula, 306*
 Wounds, 307
- Tar brands, 285
- Tarpaulins, 7
- Tea, preparation of, 223
- Telephones, 49
 Installation of, 49
 Connections at protector, 50
 Connection of batteries, 51*
 Connection of fuse with set,
 49
 Connections in the set, 50
 Dead ending the line wire, 49
 Drip loops, 50
 Ground rods, 50
 Joints and splices, 50
 To test dry batteries, 51
 Tubes, 50
 Ohms resistance of ringer coils,
 49
 Protection, 49
 Troubles, 51
- Telephone lines, 31
 Approaches and crossings, 46
 Climbers, 41*
 Climbing, 41
 Connections, 47*, 50*
 Costs, 31
- Telephone lines,
 Damage to telephone lines, 52
 Dead ends, 45*, 46*
 Equipment, 32
 General, 31
 Laying wire, 40
 Lightning rods, 47
 Location, 32
 Other lines, 48
 Poles, 33
 Attaching brackets and in-
 sulators, 36*
 Dimensions, 34
 Holes, 36
 Material, 33
 Methods of strengthening, 38
 Braces, 38, 39*
 Guys, 38, 39*
 Re-enforcements, 38
 Stubs, 39*, 40*
 Uses of guys and braces, 38
 Pole steps, 42
 Poles in place, 35
 Preparation, 34
 Preservative treatment of,
 358
 Pull, 37*
 Rake, 37*
 Roof, 34*
 Setting, 37
 Spaces, 36
 Tamping, 37
 Use of different lengths, 35
 Utilization, 36
 Preliminary survey, 31
 Right-of-way clearance, 33
 Sag, 43
 Splices, 44*
 Hook, 45
 In galvanized iron wire, 44
 In hard drawn copper wire,
 45
 Ties, 42*, 43*, 44*
 Figure 8, 43
 Horseshoe, 43
 Swinging, 43
 Tree lines, 48
 Transportation, 32
 Throwing cattle, 262*
 Horses, 267
 Thumps, 266

Tie rope, 25*

Timber cruising, 182*
 Estimating, 180
 Felling, 183, 184*, 185*, 186*

Toothache, 301

Trail construction, 52
 Bed, 65
 Blazes, 71
 Bridges and culverts, 66
 Capping, 71
 Clearing, 55
 Corduroy, 69*
 Cross-section of trail, 65*
 Disposal of debris, 55
 Drain ditches, 70
 Grade, 54
 Grading, 55
 Blasting, 55
 Care of tools, 64
 Tools required, 55
 Axes, 62, 170*, 171*, 172*
 Brush fork, 63*
 Bush hook, 62*
 Combined pick and mattock, 59, 60*
 Graders, 59
 Grubbing hoes, 60, 61*
 Mattock, 59, 60*
 Pick, 59, 60*
 Pinch bar, 62*
 Plow, 56
 Rake, 62
 Shovels, 61*
 Use of picks, mattocks, etc., 63
 Locating the route, 54
 Preliminary survey, 53
 Purpose, 53
 Retaining walls, 65
 Switchbacks, 66
 Tread, 70

Traverse table, 204, 357

Troubles, telephone, 51

Trousers, 3, 9

Tuberculosis (cattle), 260

Turk's head, 329*

U

Underwear, 3, 9
 Utensils, cooking, care of, 224

V

Variation, 203*
 Vegetables, preparation of, 219
 Venting, 284*

W

Wagons, 153
 Bed, 163, 164*
 Bolster plates, 160*
 Brake, 159, 162*
 Lever, 161*
 Use of, 167
 Care of, 164
 Dish, 155
 Evener, 162, 164*
 Evener end showing bushing, 163*
 Front bolster, 159, 160*
 Gather, 155
 Gears, 158
 Front, steel axle, 157*
 Wood axle, 158*
 Log, 165*
 Rear, with mountain brake, 161*
 Greasing the bolster plate, 166
 Hound*, 158
 Neck yoke, 162, 163*
 Oiling or greasing, 164
 Pitch, 155
 Reach plate, 159*
 Rear bolster, 159
 Removal and replacement of taps, 165
 Removal and replacement of wheels, 166
 Rocking bolster, 160*
 Rub iron, 164*
 Single trees, 163, 164*
 Size, 153
 Skains, 153*, 156*, 157
 Attachment of to axle, 156*
 Standards, 160*
 Tires, 167
 Tongue, 161, 162*
 Track, 155
 Type, 153
 Wheels, 154

Warbles, 262

Water moccasins, 316

- Wedges, 179, 180*
Weeks law, lands acquired under,
346
Weights, 346
 Apothecaries', 347
 Avoirdupois, 346
 Miscellaneous, 352
 Troy, 347
Whitewash, Government formula
for, 369
Woods work, 170
Work shoes, 3, 10
Wounds, catfish, 307
 Centiped, 307
Wounds, poison, 251
 Tarantula, 307
Y
Yeast, 212
Yeast bread, 212

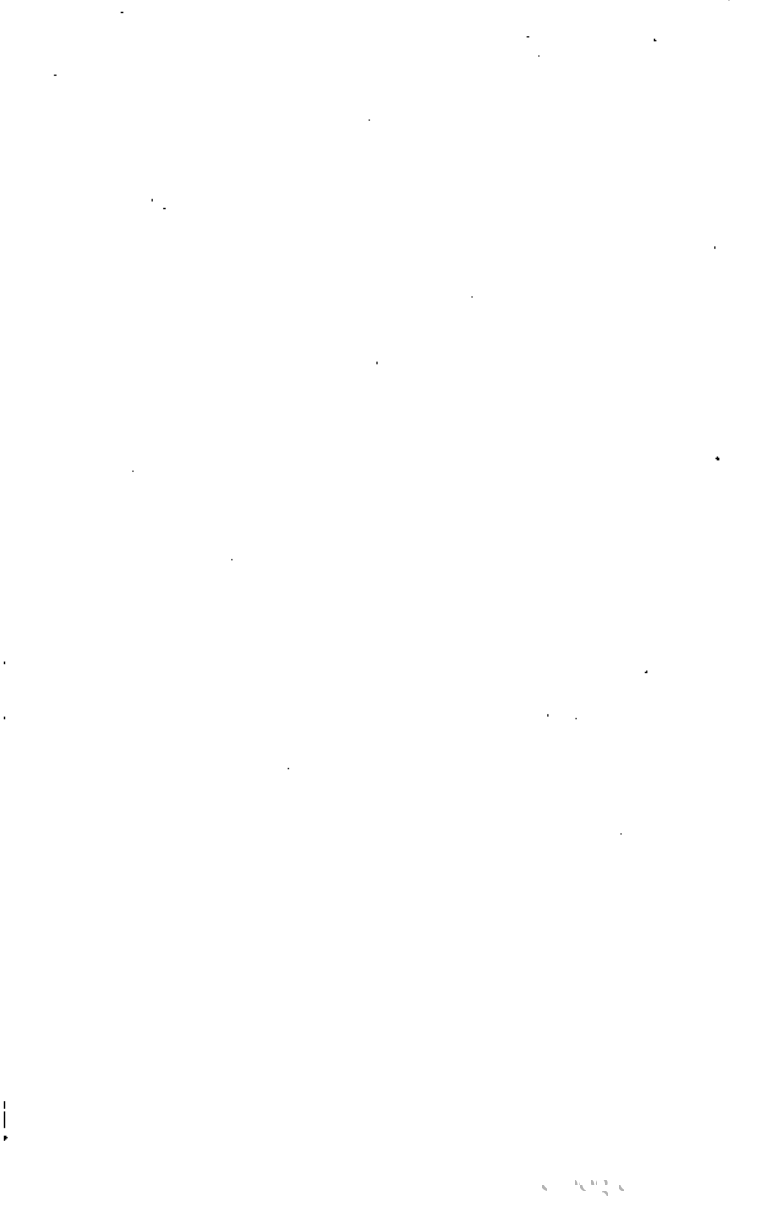

22

1886

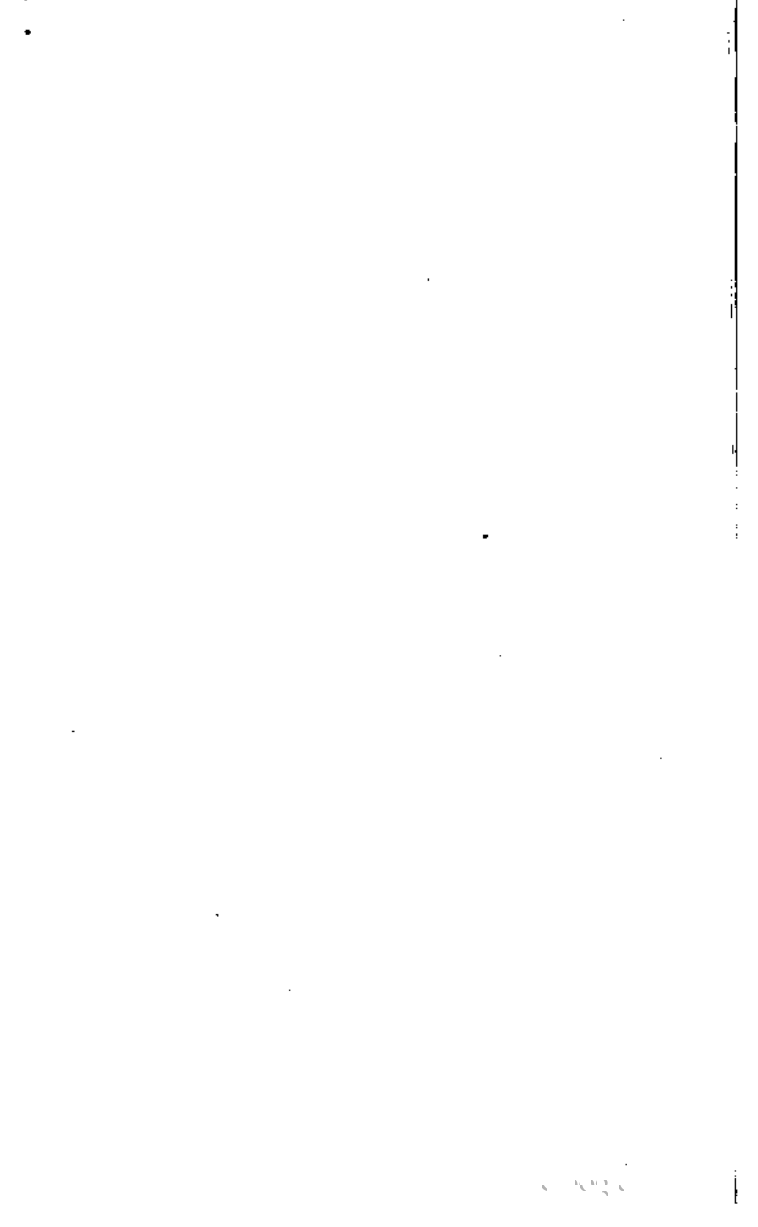

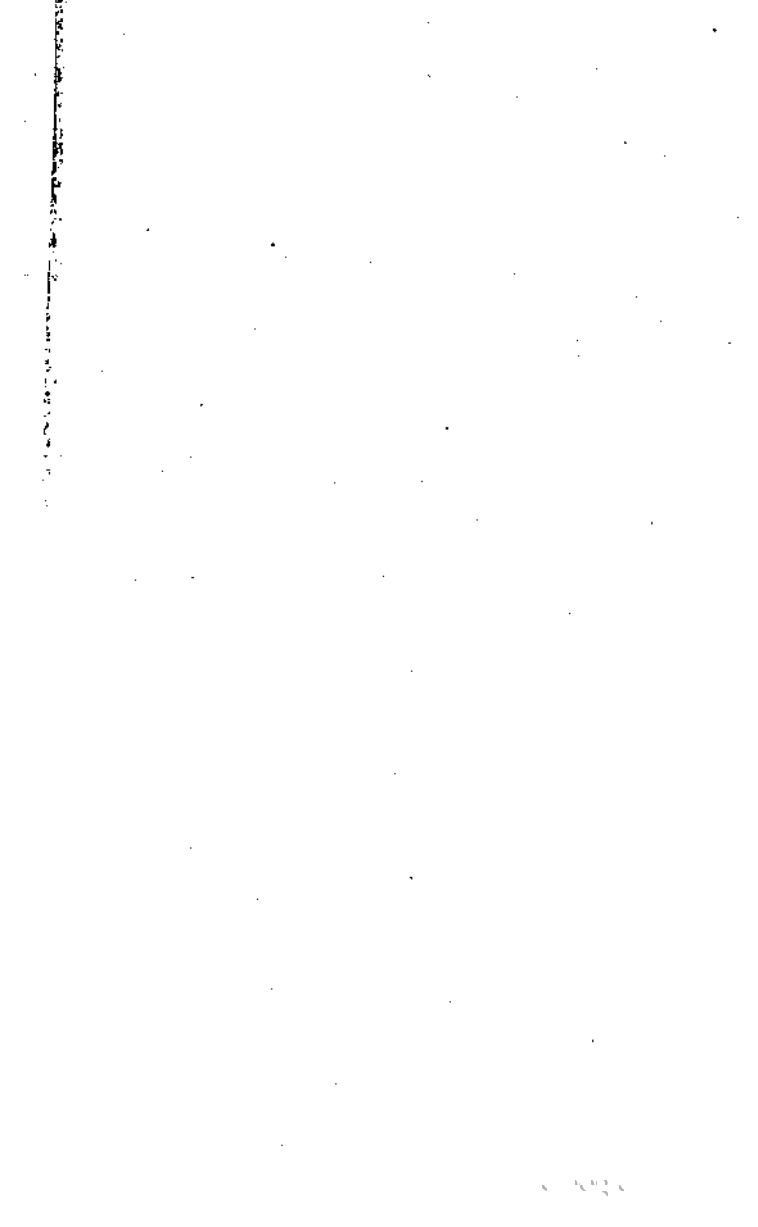

AUG 14 1934

