

# HOMESTEAD

---

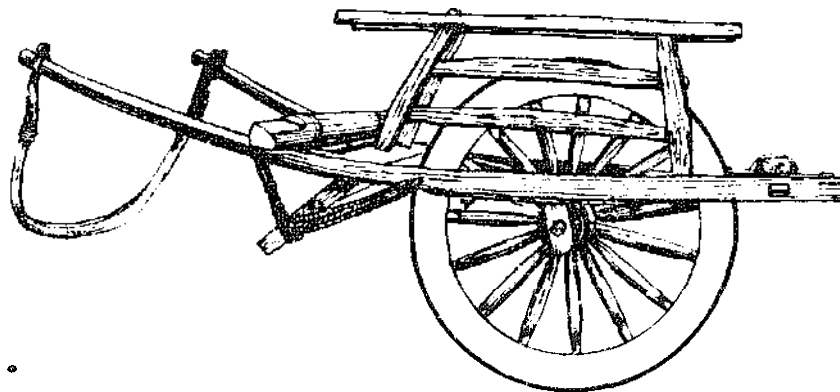

1.

A CHINESE WHEELBARROW. This has only one wheel and so can travel along very narrow paths. Loads of equal weight must be balanced on each side of the wheel to keep it upright.



- Carrying aids: (a) carrying support with flattened buckets; (b) carrying pole with supporting stick.

**Three** ways of carrying loads suspended from the shoulders

### FILTERING WATER

Drinking water should always be boiled for at least five minutes, It is also good to filter it .

The picture shows two earthen pots. The top one has had a small hole bored into the bottom of it through which the water drips into the bottom jar. In the top jar a layer of small stones has first been placed and, on top of these, has been placed a layer of charcoal crushed into small pieces. The stones and the sand must be washed before putting them in the pot, The water will pass through these layers and they will remove much of the suspended matter.

From time to time the layers should be taken out and washed and then put back again,

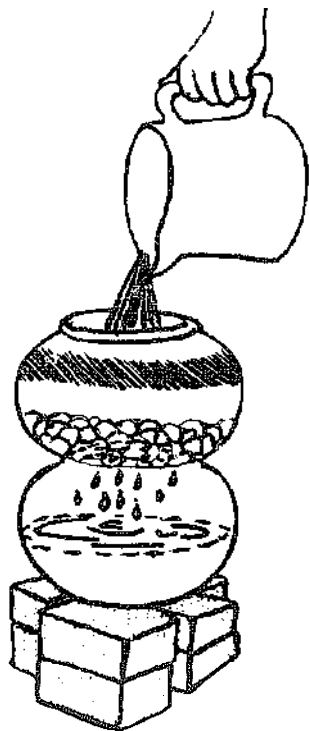

2.

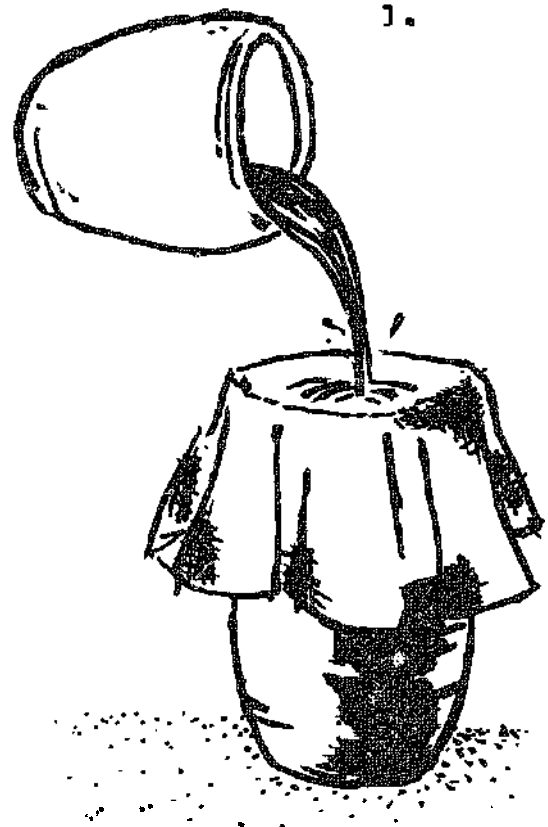

1.

Another way of removing impurities from the water.

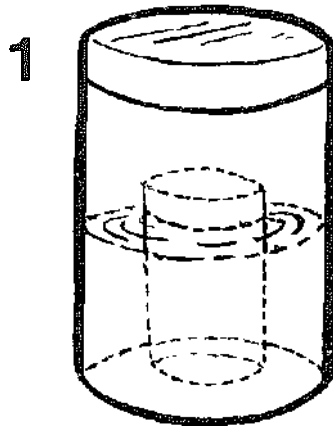

Three ways of  
keeping food  
cool.

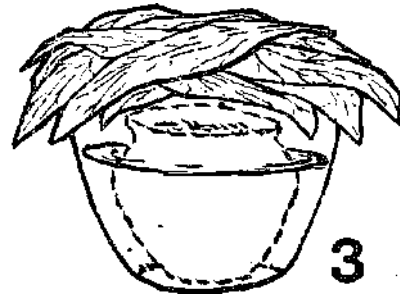
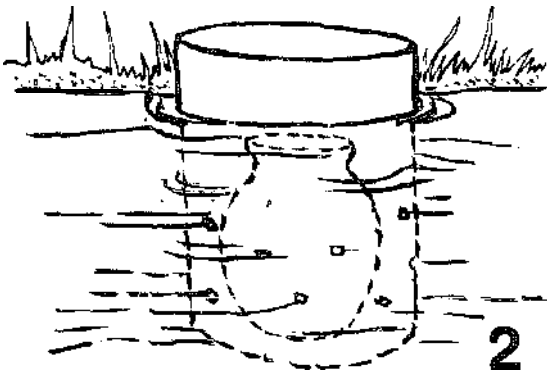

#### COOL WATER

4. If a kalsi is filled with water and then hung up outside in strong sunlight, by means of a piece of rope tied round its neck, the water inside will stay cool and be good to drink.

The kalsi must hang, not 'be placed on the ground, so that the air passes under it and must not be glazed, The water will cool by evaporation and this is why it must be in the sun

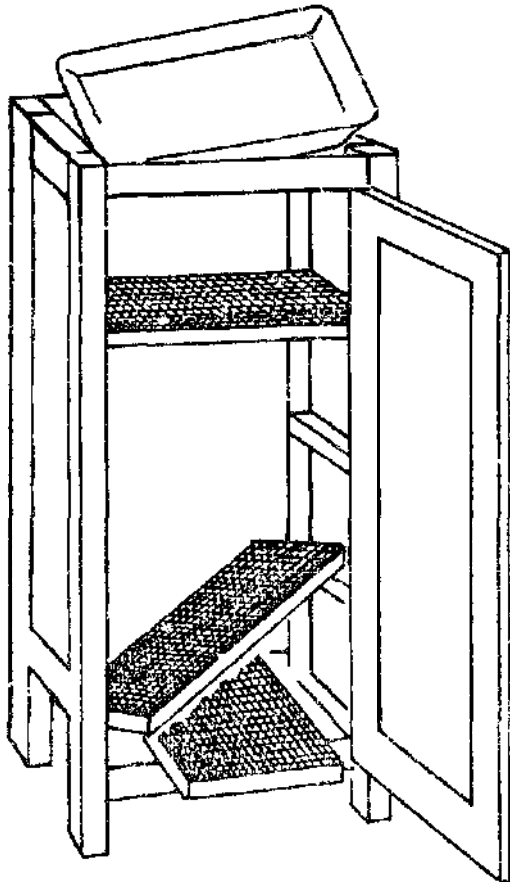

Framework of iceless refrigerator.

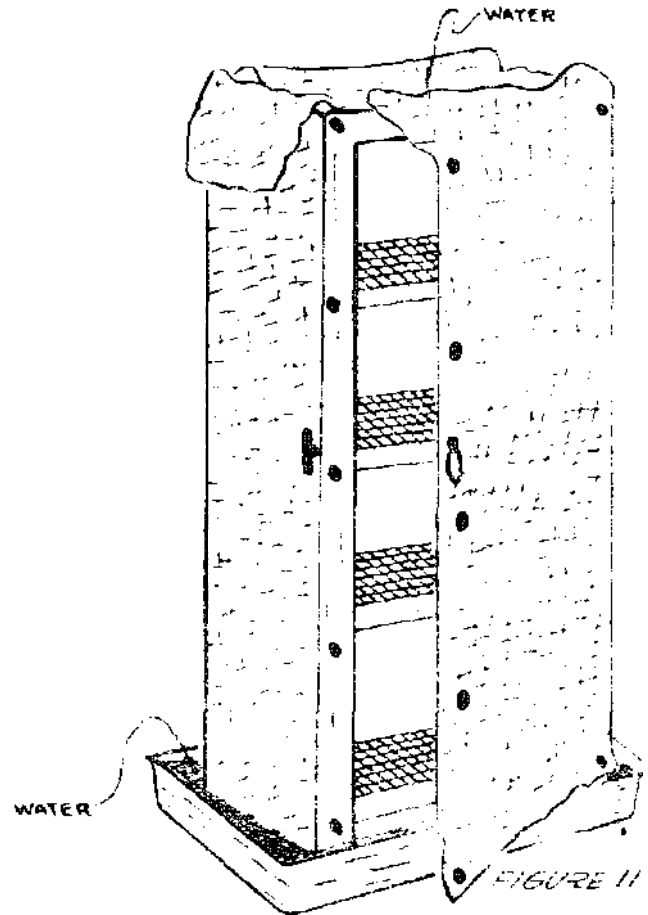

#### AN ALMIRAH TO KEEP FOOD COOL

Make a wooden frame similar to the one shown in picture 1 to the desired size, but not larger than 56 inches high or 12 - 14 inches wide. The shelves inside should be removable. If it is possible put wire netting on the sides and top but this is not essential.

Obtain a flat metal tray about 4 inches deep and a little larger than the base of the frame and stand the almirah inside this. Obtain a similar tray or a bucket for the top of the almirah.

Cover the frame loosely with hessian, as shown in picture 2 and allow this to hang down in to the bottom tray, this is most important.

On the top of the almirah sew four wicks (salta), such as are used in lamps, on to the hessian, then put water in the upper tray, or bucket, and stand this on top of the almirah, put the loose ends of these wicks into the water. Always keep this tray full of water.

Put water in the bottom tray also. The first time the Almirah is used wet the hessian all over. Stand the almirah in a shady place where there is plenty of air to blow round it, and the food inside will stay cool through evaporation.

## SECOND ICELESS COOLER

Take a large pot with a wide mouth and a basket small enough to go inside it. Put two bricks inside the pot on which the basket can stand. Make a lid for the basket and sew a piece of hessian round the rim so that it hangs loose at the bottom of the basket. Put the food inside the basket and then place this inside the pot standing on the bricks. Put a little water inside the pot and let the hessian from the basket hang down into this, also, the first time, make the hessian itself wet, but do NOT let the basket itself stand in the water, it should be just above it, on the bricks. If the hessian cloth is in the water at the bottom of the pot it will stay wet a long time and will keep the food in the basket cool.

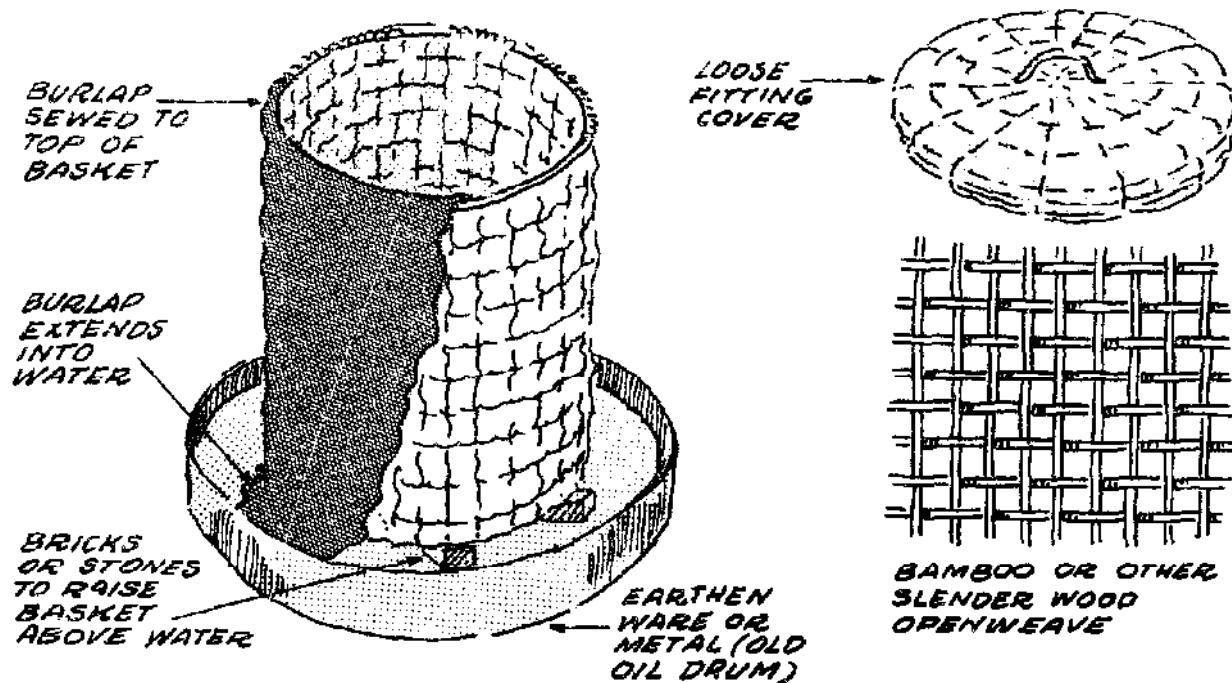

1.

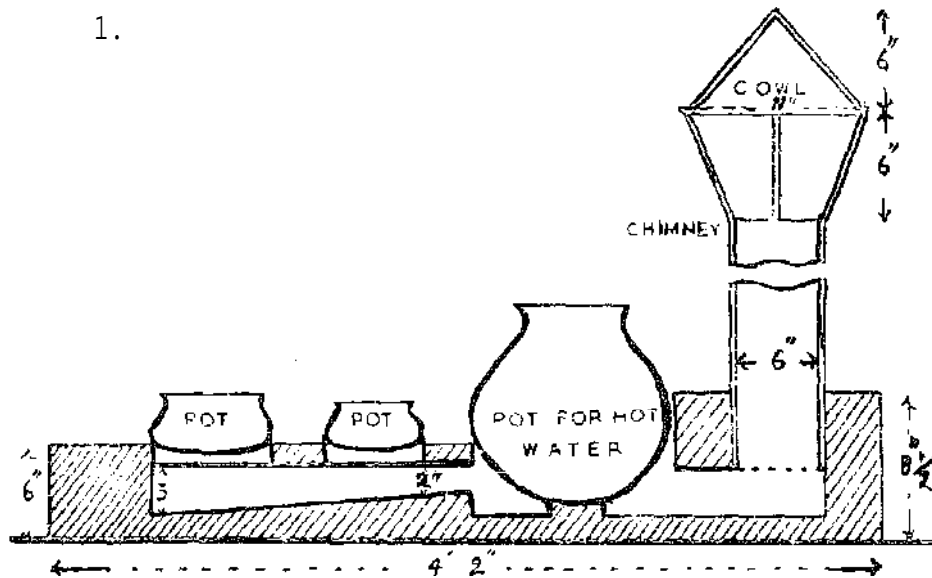

#### IMPROVED CHULA

The drawings show an improved type of **chula** which can be made out of mud or brick. Measurements are shown on the plans. The diameters of the holes in the top should be about an inch smaller than the pots which will be used on them and any holes which are not in use should be covered over to prevent the smoke coming out and also to stop a back draught.

The floor of the fire duct should slope slightly upwards as shown in picture 1. A step, or ledge should be built underneath the opening for the fire wood to stop long pieces falling out on to the floor,

Picture 3 shows the chimney going straight up through the roof, when this is of tin or of tiles. Picture 4 shows how it should be bent away from the roof when this is made of more inflammable material.

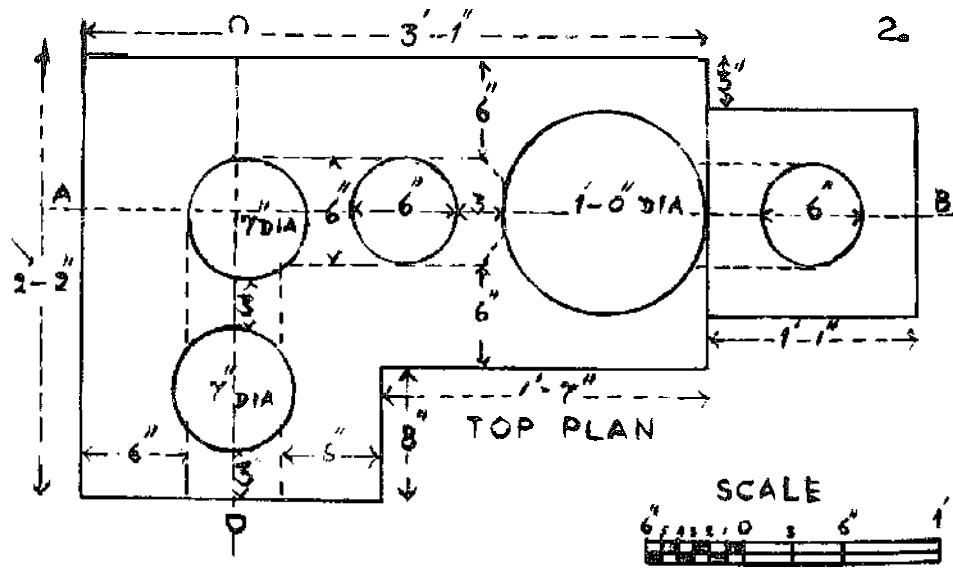

PLANS FOR IMPROVED CHULA

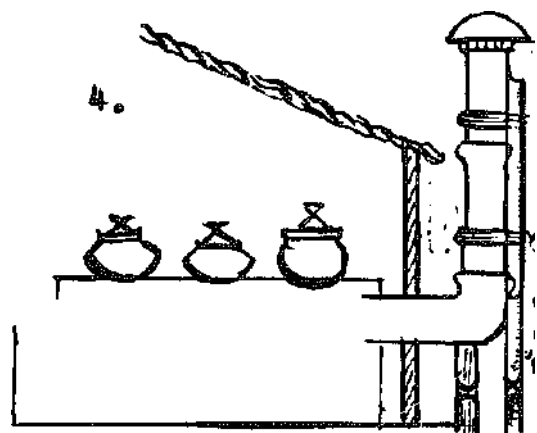
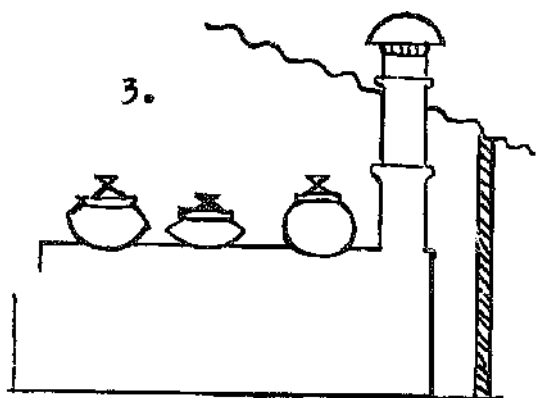



A stove using rice hulls ( husks ) which will save fuel.  
Use a four gallon kerosene or similar tin to make the stove.

### Rice Hull Stove

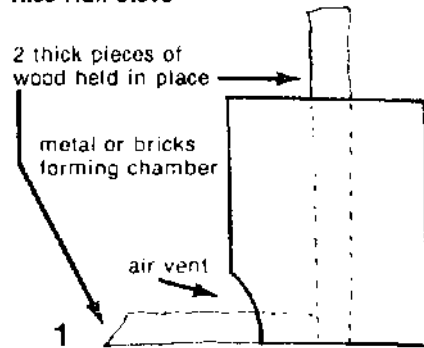

rice hulls are poured in and packed down with a piece of wood

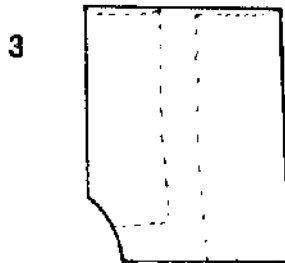
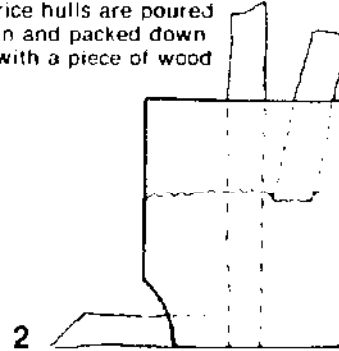

When the chamber is filled up to 1-2 inches from the top, the pieces of wood are carefully removed, leaving an air vent and chimney.

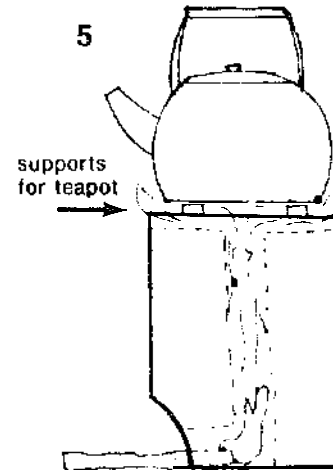
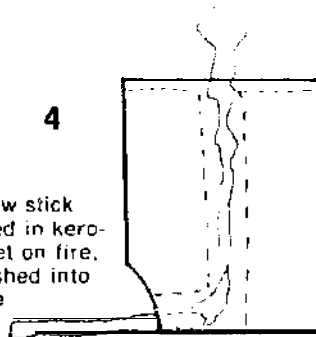

The burning stick pushed in through the bottom opening, to **start** the husks **burning, must** be only half the width of the opening or it will shut out the air. A one yard long piece of wood, pushed in further as the end burns up and a full tin of rice husks will provide a usable cooking flame for about two hours.

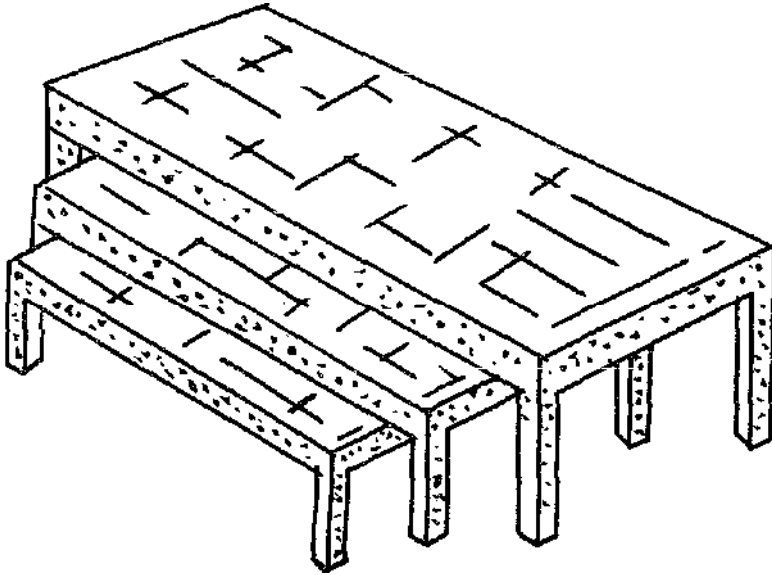

If the space in a house is limited make each wooden cot a little shorter and a little lower than the other ones, then, in daytime, they can be placed under one another, as the picture shows.

Another way of saving space is to **build** one bed above the other, as is done in ships and in the **sleeping** compartments on trains.

Two ways of keeping rats away. **These** can also be placed on ropes so that they cannot run up or down these.

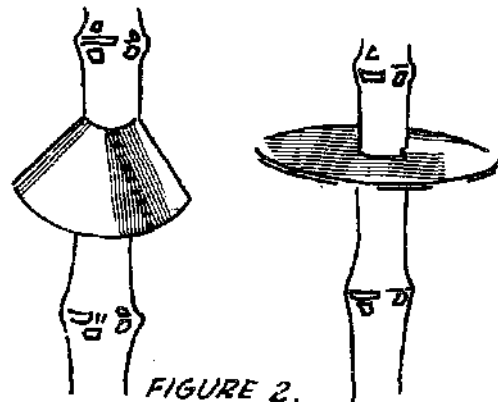

FIGURE 2.

## A HAY BOX

Put a layer of hay, straw or rice husks in the bottom of a wooden or tin box and make a lid for this and pad it with some **old, clean** cloth.

Stand the cooking pot you intend to use on this layer and pack the hay, straw or rice husks tightly round it, then take out the pot.

Put inside it whatever you intend to cook and put the pot on the chula to get hot. When the contents are boiling take the pot off the chula and put it back in the hay box. Put the lid on the cooking pot and the other lid on the hay box to keep the heat in.

Leave the cooking pot in the box for several **hours, the** pot will stay hot and the food will go on cooking inside it.

If you do not have a suitable box a large, wide mouthed jar will **do, providing** that it is **large** enough to take the cooking pot and if it has a lid to keep the heat in.

Cooking food **this way you** will use very **little** fuel, only what is necessary to bring the pot to the boil.

## SOAP MAKING

## 'RECIPE NO.1

Required :- 5 bottles of oil      **1** pint size  
 3 bottles of water      1 pint size  
 1 tin of caustic soda 1 lb size  
 1 large enamel or earthenware bowl  
 1 smaller bowl

DO NOT USE **ALUMINIUM** FOR THESE  
 Suitable moulds for the soap, or this  
**can** be poured into a wooden box or a  
 strong card board box.

Put the water into the smaller basin end then, very carefully, pour the caustic soda from the tin into the water. **NEVER PUT THE WATER INTO THE CAUSTIC SODA, THIS IS DANGEROUS.** The water will bubble up when the soda is poured in but this is **quite correct.** Do not let any of this mixture splash on to your skin or clothes or put your finger in it or it will burn you,

Leave this for several hours to cool down BUT BE VERY CAREFUL THAT CHILDREN OR ANIMALS CAN NOT GET AT IT **OR IT WILL HARM THEM.**

The next day melt the oil in a pan over the fire **and** then pour it into the large bowl to cool. When it is ready very slowly and steadily pour the first mixture ,of caustic soda and water, into this oil ,**stirring** slowly all the time., with a wooden spoon **and for** about 48 minutes. When it 'begins to thicken pour it into the moulds or the boxes, having first lined these with sheets of paper so that the soap will be easy to lift out ( an old piece of cloth would also do )

Leave the soap to cool for a day or two **and** then take it out of the box and cut it up into pieces with a sharp knife or by means of a thin piece of wire held tightly stretched in the hands.

This recipe is for soap for washing clothes. **Any** vegetable oil will do .

## HOW TO CORRECT MISTAKES

If your soap is unsatisfactory it may be because : -

1. You used rancid or salty fat
2. You used too cold or too hot a temperature, stirred the soap too vigorously or did not mix it very thoroughly.

To put matters right : -

1. Cut up or shred the soap into a pot and add the lye which separated **out**.
2. Add 5 pints of water ( 5 bottles )
3. Melt the soap in a gentle **heat, stir occasionally**.
4. **Raise** the heat and boil the soap gently until it becomes thick and jelly like and drops in sheets from the spoon .
5. Pour it into a **mould** and cover it and let it stand **for** 48 hours. Then cut it up.

Always : -

Measure carefully  
Have lye and water mixture only **luke-**  
**w - 9** at body temperature .  
Stir slowly and in the same direction .

### SECOND RECIPE FOR SOAP

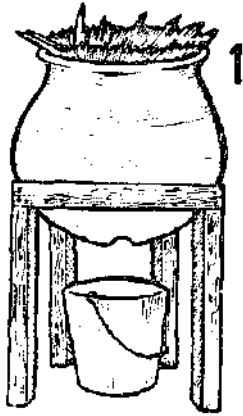

Make this in the same way as shown on page 11.

- |         |                             |
|---------|-----------------------------|
| 13 cups | Vegetable oil or animal fat |
| 13 ozs  | Caustic soda                |
| 5 cups  | Water, rain water is best.  |

This will make 9 pounds of soap.

### RECIPE FOR MAKING LYE

Caustic soda is necessary to make hard soap, for washing clothes but, if it is not **obtainable**, it is possible to make soft soap with home made lye. Remember that, just as with caustic **soda, THIS CAN BURN** so be very careful not to let it splash on to the skin. Should this happen by accident wash the skin well and then wash it again with a solution of water and vinegar. Be very careful to keep the pot and the bucket out of the reach of children or animals.

To make lye **take** an earthenware pot with a hole in it and put this on a stand, as shown in picture 1. Place a bucket beneath the hole, Put some straw in the pot to act as a **filter**. Fill the pot with wood ashes, scoop a hole-in the middle' of these and fill this with water, add more water each day as the ashes absorb the water. The lye will drip through into the bucket beneath. Continue to do this for 3 weeks. Then take an uncooked, raw, potato end put it into the bucket, do this with a spoon, do not get the lye on your hands. If the potato floats the lye is ready for use, if hot, wait a little longer.

The ashes can be used **again** but the lye will not be so strong the second time, Use the lye in the same way as the caustic soda.

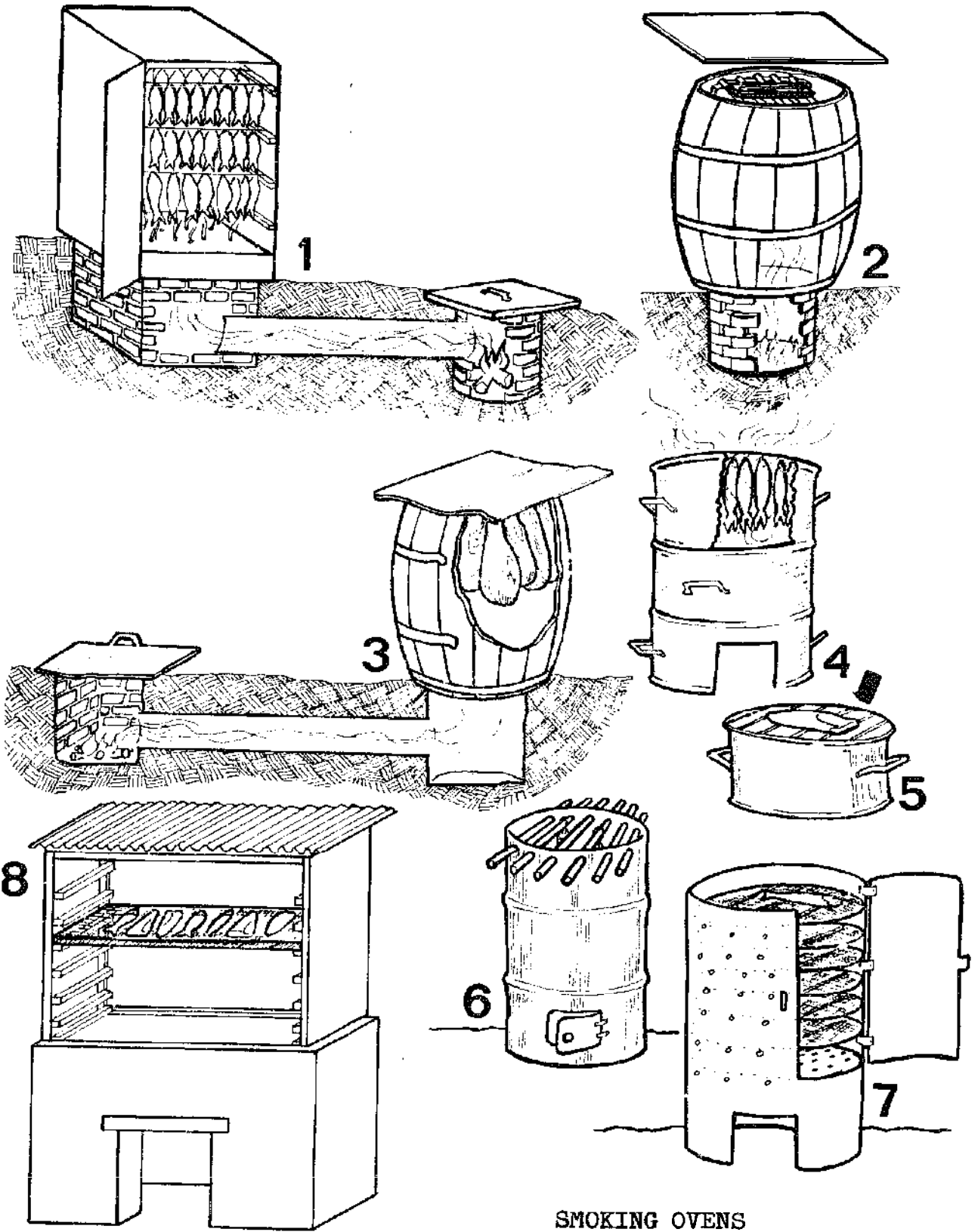

SMOKING OVENS

## OVENS FOR SMOKING FISH e t c .

### Various types

1. Permanent-type oven with remote brick fire pit underground. Fire pit cover of sheet metal.
2. Improvised oven from wooden barrel with brick fire pit underground. Barrel cover of sheet metal.
3. Improvised oven from wooden barrel with remote brick fire pit underground. Barrel and fire pit covers of sheet metal.
4. Improvised oven from oil drum cut in three sections. Lowest section used for firebox. Middle and top sections fitted with bars from which the fish or meat is hung.
5. One section of the three-tier improvised oven shown in 4.
6. Improvised oven from oil drum showing door in firebox and only one set of bars for hanging the fish or meat.
7. Improvised oven from oil drum fitted with trays and door.
8. Simple Altona-type oven.

## HOW TO SMOKE FISH

### A. You will need:

1. Small whole fish, small split fish, large split fish or fillets.
2. Five to six parts of water to one part of salt for the brine solution, if pre-salting or brining is to be used.

**B. When smoking is done for preservation, the main objective is to cook and dry the fish. The name of the process is smoke-drying. The drying can be partially or fully accomplished inside the smoker. When it is only partially accomplished within the smoker, it is continued outside the smoker, normally as sun-drying. When fish are prepared for smoke-drying they are not usually pre-salted or brined because salting depends upon local taste preferences and local conditions, and may be omitted if desired. Dependent upon climatic conditions, salt is advantageous for the ultimate keeping quality of the fish. Fish for smoking can be prepared as whole fish (either gutted or ungutted) or split, filleted, in chunks or slices, etc. Here again, local tradition and preference will decide.**

1. If required, pre-salt the fish for at least 10 to a maximum of 90 minutes in a brine of six parts water to one part salt. The time required will depend upon the size of the fish, its preparation (whether split, filleted or whole) and its degree of fatness (a fatter fish needs longer brining) and can be determined more exactly by experimentation. If the fish are not pre-salted they should be washed.
2. Hang the fish from a stick or lay them on a mesh tray taking care that they do not touch each other. If the fish are placed on a mesh tray they may be turned during the process for more even smoking. The fish can be hung in different ways. Whole fish can be hung on a stick threaded through the gill covers, or by a string tied around the tail. Split fish can be hung with a string around the tail or with an S-shaped hook through either the head end or through the tail. If split fish are suspended through the head end, it is an advantage to have the gill bone left in place, as fish flesh can tear under its own weight.
3. Build a fire in the firebox. At the beginning the fire should be smouldering, to dry the surface of the fish. The temperature should then be increased, by allowing in more air. This phase should last about two hours and will cook the fish. If the initial drying is not carried out properly the flesh will cook too rapidly and the fish will fall from the sticks or break up on the trays. After cooking, drying should be continued for several hours at a lower temperature. This would be in the sun, if climatic conditions are favourable, but the fish must be covered with mosquito netting or gauze to prevent infestation by flies and beetles. The finished product should have the consistency of rough wood and should be thoroughly dry. Mould growth will rapidly result if any parts of the fish are not properly dried.
4. This product, if protected from insect infestation, will keep for several months. Under humid conditions it can be packed in airtight containers or heavy-gauge polyethylene. Otherwise, if this is too expensive, it can be redried from time to time.



### SUN DRYING OF FISH

For best results split medium or large sized fish but a salted, gutted, whole fish can also be dried. Use smoked fish, non salted or salted fish ( but rinse this in boiled water.)

Place the fish on mesh, bamboo or other trays that will permit free circulation of air. Keep in the shade for the first day or two ( depending on the humidity ) If the fish is put straight away into the sun a crust will form which will hamper drying. When the surface begins to appear dry then put the trays in the sun. During the night cover the fish with plastic sheeting.

when the fish is ready it will not bend easily. Non salted dried fish and salt dried fish will keep for a long time if stored in earthenware pots.

### SUN DRYING OF FRUIT & VEGETABLES

It is possible to preserve acid fruits and vegetables such as **tomatos** by bottling them under pressure in Kilner or Mason jars. Annexure **No. 7** " A Manual of **Food Preservation** " sets out this process in detail.

Fruit and vegetables **can** also be sun dried to preserve them but they must be of good quality, freshly **har-**vested and ripe. Damaged or dirty fruit or vegetables will spoil.

They should be washed in boiled water and, after trimming, cut up into slices.

Vegetables such as okra, carrots and green beans should be blanched. To do this place them in a square piece of clean cloth, tie the corners together, push a stick through and suspend this bundle in boiling water for about six minwtes. Then take it out end place it in cold water.

Spread the fruit or vegetables out on drying trays or a piece of plastic sheeting and turn every hour or so. Do this as soon as possible after slicing the product or it will **discolour**.

The length of time needed to fully dry the product will depend on the strength of the sun but is usually **24 hours..**

CREEP FEEDERS FOR  
BABY CHICKS

KEEP THE BIG  
CHICKENS OUT

POULTRY

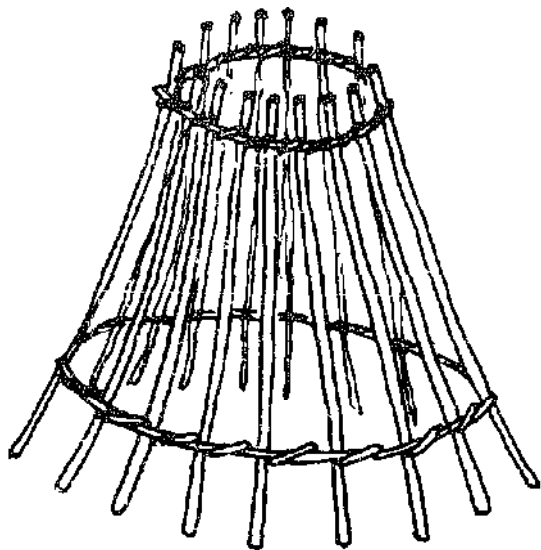
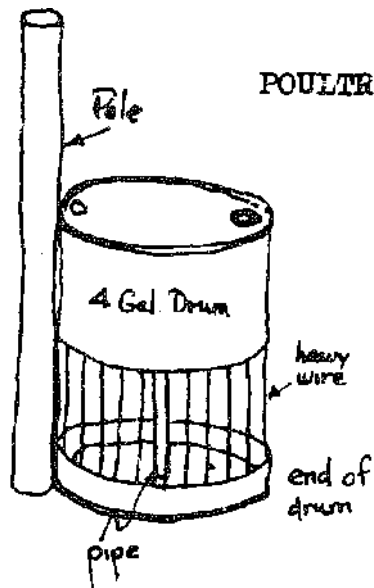

Split or Bamboo

If the food for the very small chicks is put inside either of the containers shown above, they can get through the bars but the bigger hens cannot do so and cannot, therefore, take their food.

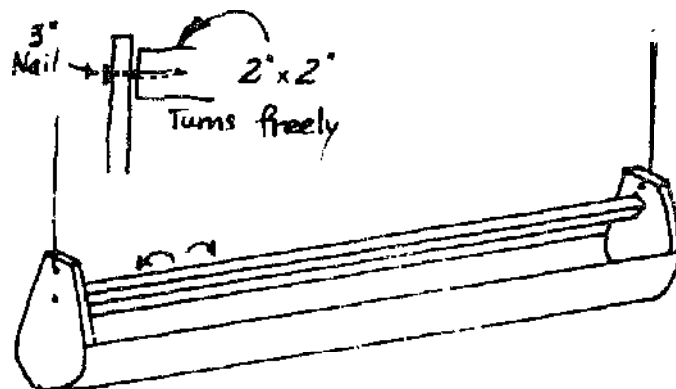

HANGING POULTRY FEEDER  
prevents chickens from standing  
in feed.

# POST HARVEST ACTIVITIES

---

1.

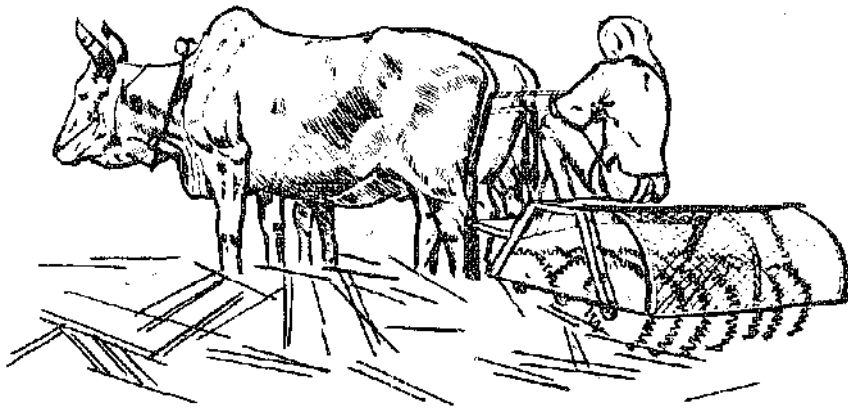

- Olpad thresher, made in India on the pattern of the Egyptian Norag thresher; diameter of disks about 45 cm. disk spacing 15 cm. number of disks 20

**THRESHING**

STONE ROLLER 2.

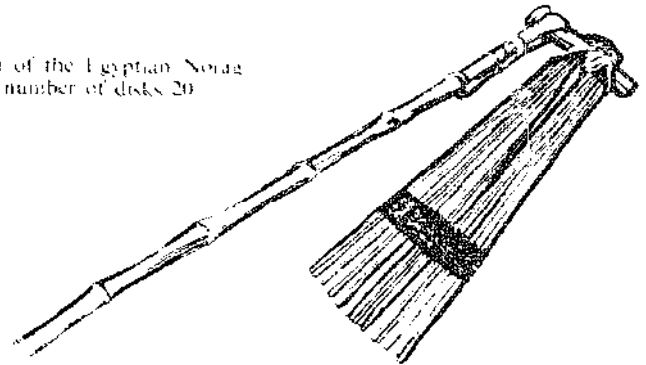
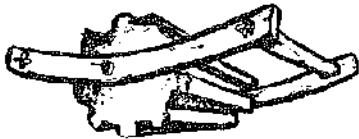

CHINESE FLAIL 4.

3.

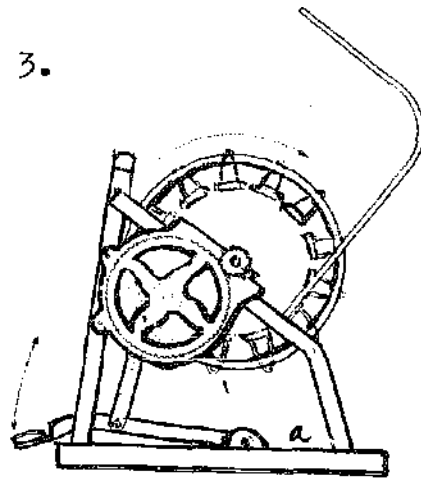

5.

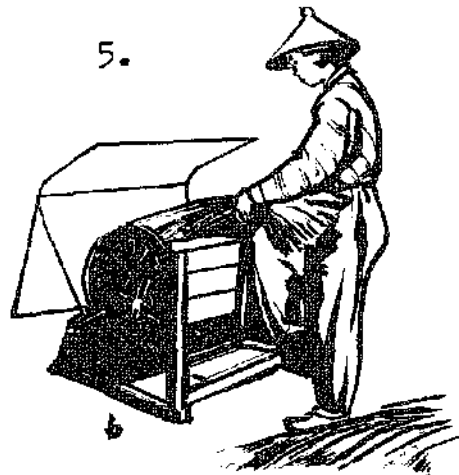

- Japanese rice thresher: (a) sectional view of rice thresher; (b) rice threshing with a pedal-operated machine.

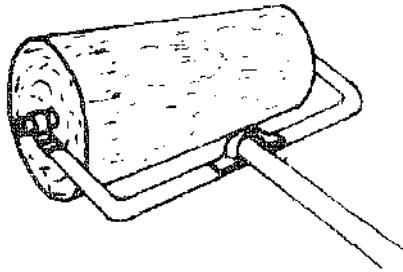

### STONE THRESHING ROLLER

This threshing roller is tapered so that it can easily be pulled round in circles over the crop by the animals.

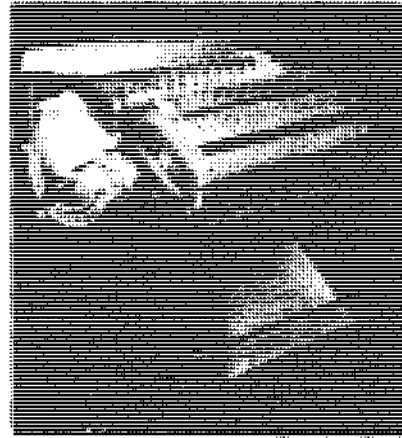

### ROTARY THRESHER

This is a pedal operated thresher running on ball bearings. The sheaves are held against the rotating drum, which is fitted with wire teeth, and the grain is threshed out.

Weight 46.5 kg.

Threshing capacity 650 to 850 kg per day.

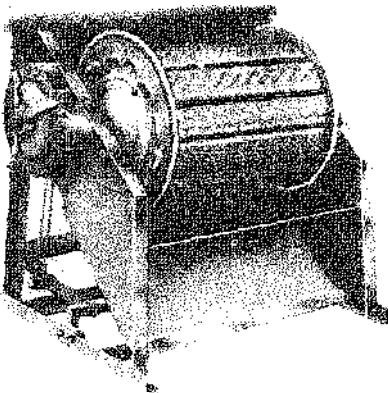

### AKSHAT AK-51 ROTARY PADDY THRESHER

#### Pedal Driven

Threshing is done by holding paddy sheaves in suitable bundles close to teeth on the rotating cylinder and the cylinder is kept in motion by pedalling. The grains are thus separated or combed out from ears by wire teeth on spokes of cylinder.

#### Specification

Machine working in 5 ball bearings ensures smooth running, easy operation and high efficiency. Angle iron frame and base covered with steel sheets, simple but strongly built mechanisms easily accessible for servicing.

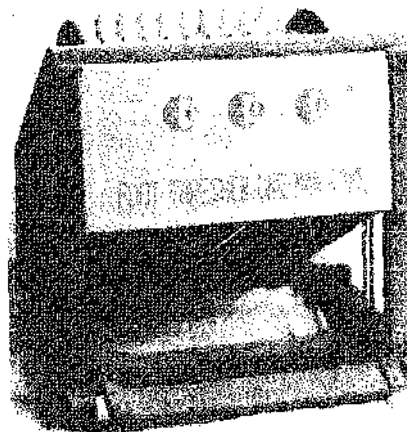

### CECOCO LIGHT FOOT THRESHER

Designed for threshing rice.

Wire threshing teeth are fitted in the rotating drum, which turns at approximately 450 rev/min when the treading rate is 90 strokes per minute.

Threshing rate 115 kg per hour.

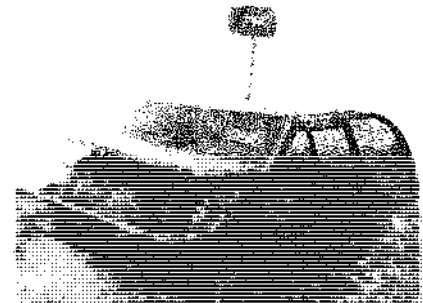

### OLPAD THRESHER

This machine has serrated discs of 450 mm (18") diameter. The frame is of angle iron. The discs are mounted on a steel shaft. Cast-iron spools keep the discs in position. A comfortable seat is provided for the operator with a back rest and foot rest. Back and front safety guards eliminate risk of injury to the operator. The harvest is spread on threshing floor and the machine is drawn round a hand round thus separating grain. A" extraraking attachment can be fitted for stirring straw during threshing operation. This thresher is available in 20, 14, 7 1 and 8 disc sizes.

Weight: 20 Disc 190.0 Kg.

14 Disc 125.0 Kg.

11 Disc 110.0 Kg.

8 Disc 92.1 Kg.

Threshing rate: 3 5 0 to 850 Kg. according to size in day.

An overhead  
animal power gear

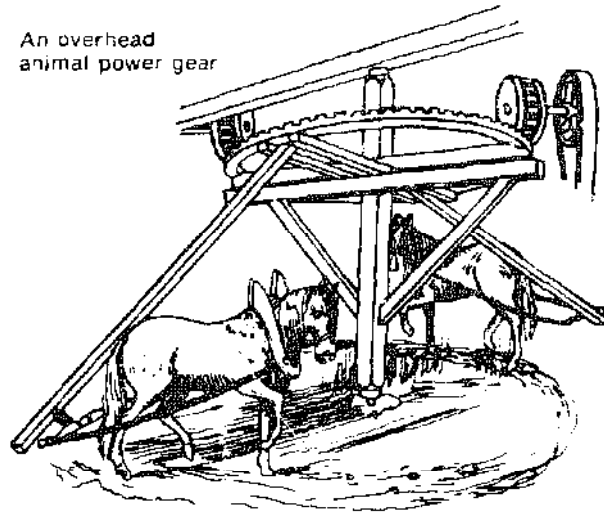

1.

## ANIMAL POWER GEARS

2.

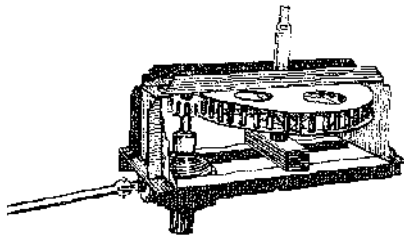

BULLOCK GEAR

This mechanism converts the power of bullocks walking slowly round in circles into high speed rotary motion of a shaft. This shaft can be used to drive any stationary machines.

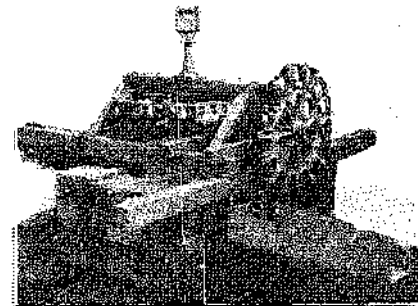

3.

ANIMAL-DRAWN CHAIN PUMP

This pump is capable of lifting water from a depth of 40 ft (13 metres). Since the diameter of the chain wheel is small, the pump can be installed in wells whose diameter is as small as 3 ft (1 metre). The pump also has the advantage that the gearing is low. The pole drive from the main gear to the animal can be taken direct and does not have to be carried underground. The rubber washers are replaceable. Weight of the pump is 840 lb (380 kg), and the output is 3000 to 4000 gal/hr (13,500 to 15,000 litres per hour).

1.

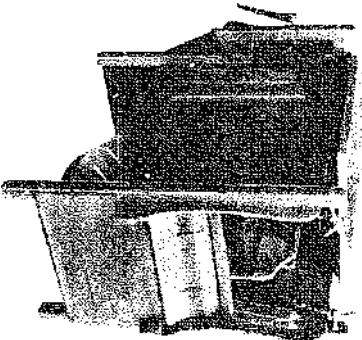
**No. 8 WINNOWER**

This is a hand powered machine constructed mainly of wood, but with metal moving parts and an oscillating bottom screen. It is fitted with five 40 cm x 40 cm metal sieves for the efficient screening of all kinds of grain including wheat, barley, and maize.

2.

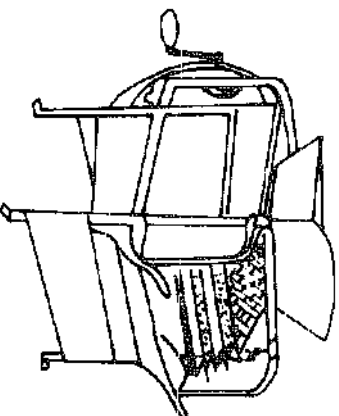
**WINNOWER**

Air draught controllable, sieves replaceable. Runs on four ball bearings.

4.

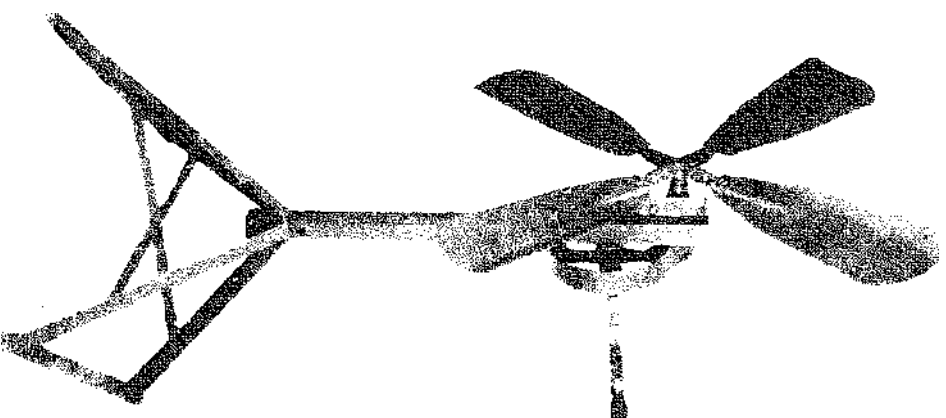
**HAND WINNOWER**

This is a cheaper version of the cycle winnower. Two people can winnow in front of it.

Weight 25 kg.

3.

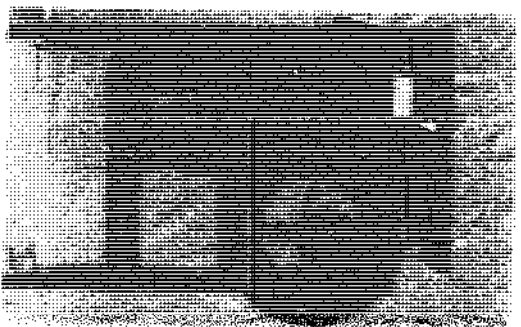
**HAND GRAIN WINNOWER TYPE A1.**

All steel construction.

Three separate outlets for first quality clean grain, second quality grain and chaff.

Capacity 650 kg. grain per hour.

Weight 30 kg.



### JAVA HAND-POWERED RICE HULLER

This is a small machine intended for the grower of small quantities of rice paddy, and for domestic use. It replaces the *Paddy Pounder*. Paddy can be shelled at a maximum rate of about 30 lb (14 kg) of paddy an hour, but the capacity may vary considerably depending on the type of paddy and its condition. The machine has three adjustments controlling the feed, the discharge and the hulling knife. A perforated plate allows dust to escape, and the machine can be opened easily for cleaning. Strongly made, it weighs 23 lb (10.5 kg) net and is provided with holding-down screws and spanners.

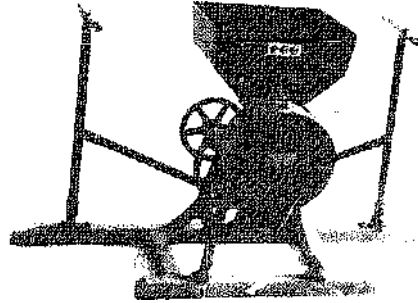

### TWO MAN RICE HULLER

Two men pull the hand levers and rotate the huller at 3,500-4,000 rev/min

Output 250 kg/hour at 90% hulling efficiency.

Weight 60 kg.

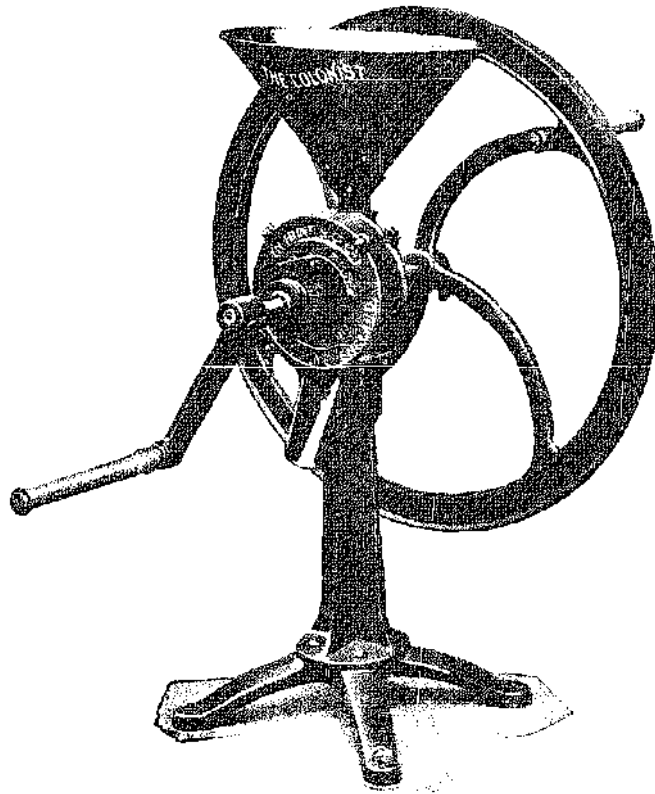

This grinding mill is turned by two people, it is a large mill (some 4 feet high) and strong enough to stand up to being used continually by many people. It will grind, maize, wheat, coffee, millet etc.,





Chinese straw cutter (Shansi Province, Mainland China), with iron teeth to prevent straw slipping.

1.

2.

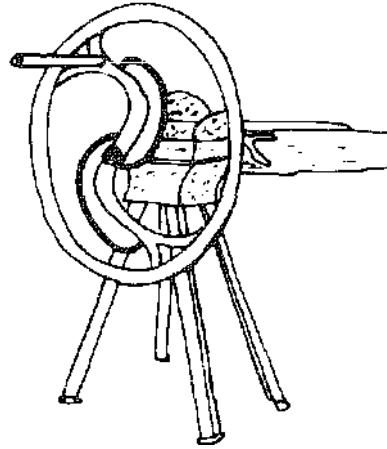

#### HAND CHAFF CUTTER

This implement is used to cut chaff into pieces approximately one inch (25 mm) long.

Straw cutters - for animal feed.

3.

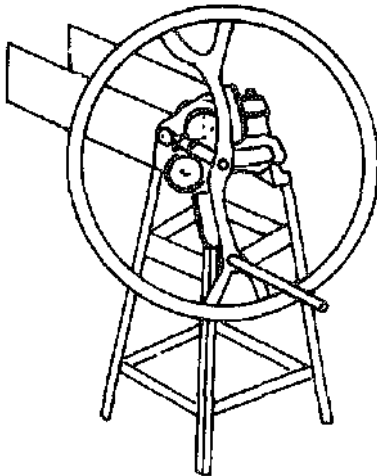

#### CHAFF CUTTER

All cast iron flywheel type, manually operated. Runs on two ball bearings.

4.

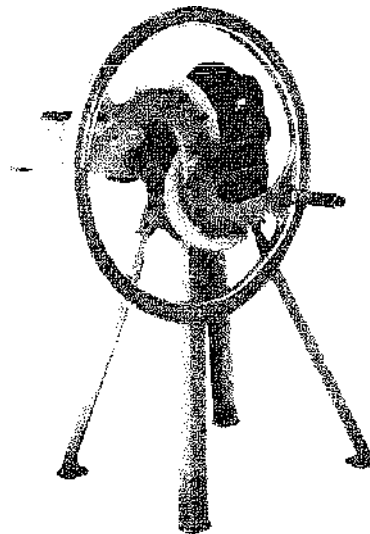

#### SIMPLEX CHAFF CUTTER

Hand powered implement. Power driven models also available.

1.

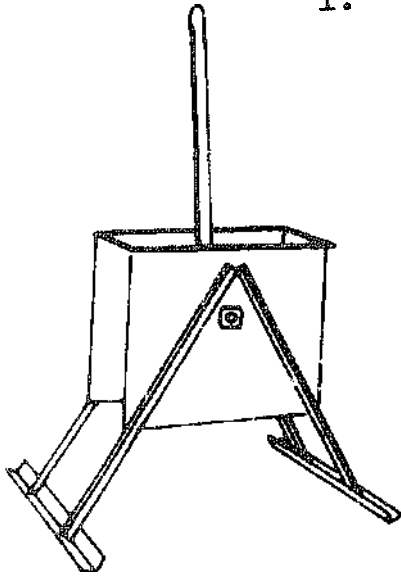

GROUNDNUT SHELLER

2.

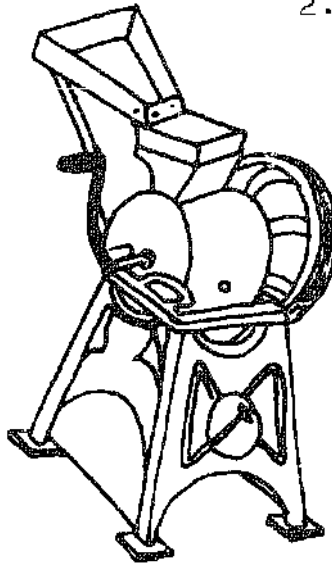

HAND OPERATED GROUNDNUT DECORTICATOR

3.

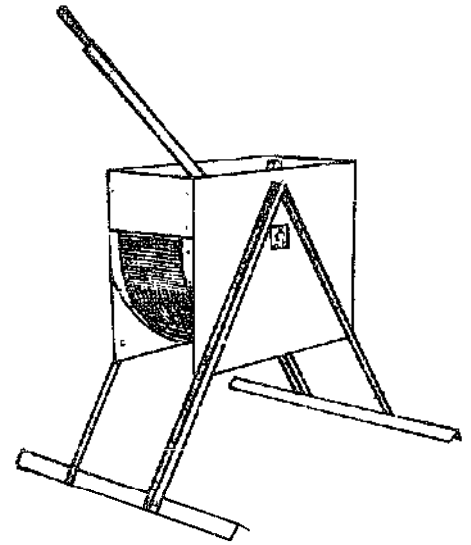

GROUNDNUT DECORTICATOR

This hand operated decorticator uses galvanised, heavy gauge wire mesh for a screen. The distance between the screen and the rubbing bars can be adjusted to suit the type of groundnuts being decorticated. Four different sizes of screen can be supplied.

4.

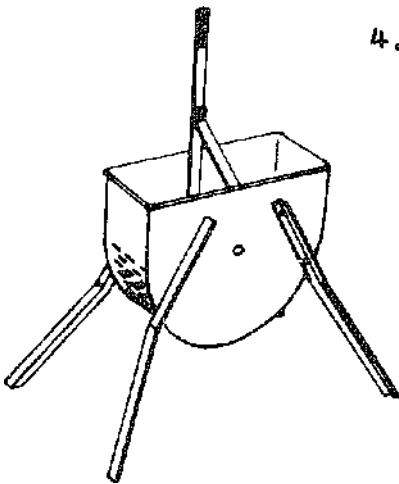

"HANDY" GROUNDNUT DECORTICATOR

Nuts to be shelled are placed in the receptacle and the operating handle is then moved backwards and forwards. This causes the nuts to be rubbed between the spiked cast iron rustlers and the shelling grid which forms part of the outer casing. The nut kernels and broken shells fall through the perforations in the shelling grid to the ground. There is no facility for separating the shells from kernels.

5.

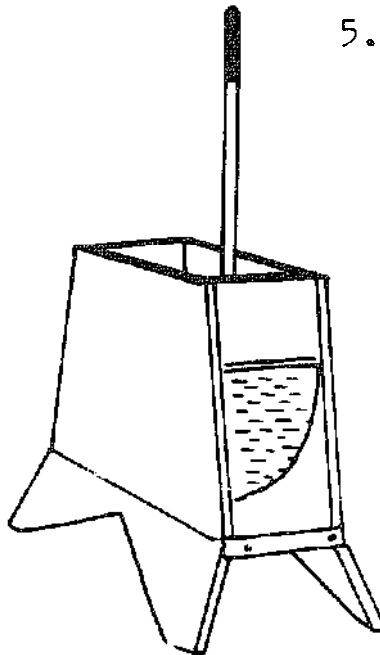

ALTERNATING HUSKER

This is a reciprocating hand-operated groundnut decorticator fitted with a pressed screen with oblong holes. Screens can be supplied to give six different sizes of hole.

6.

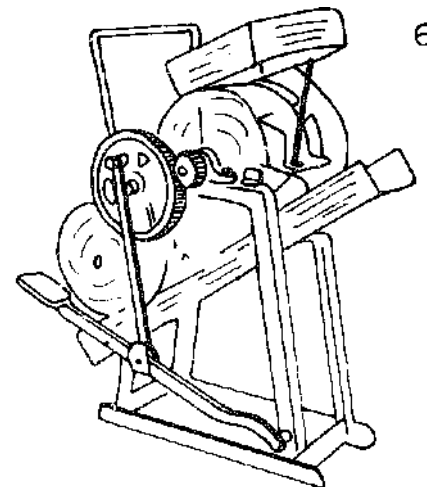

FOOT OPERATED GROUNDNUT SHELLER

Fitted with a flywheel for easier operation and with a blower to separate the shells from the kernels.

The machine can be operated and fed by one person and can shell 200 kg in an 8 hour day.

## PEANUT SHELLER

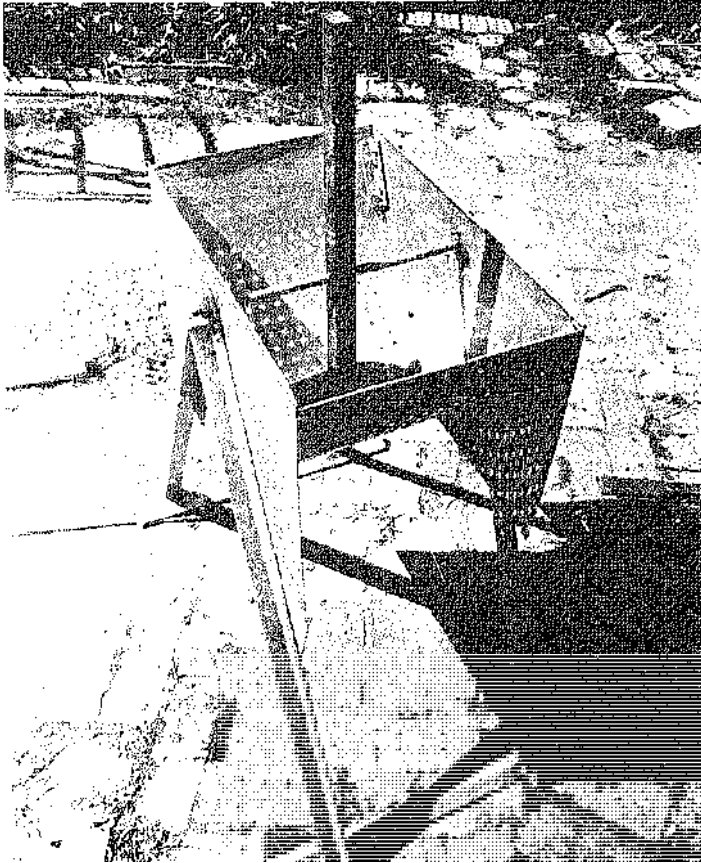

This peanut sheller was built in Bangladesh by a group of women of the Gonoshasto Kendro Workshop in Savar.

The peanuts are put into the machine, the "roller is pulled backward and forward and the shelled peanuts pour through the holes into a receptacle put underneath.

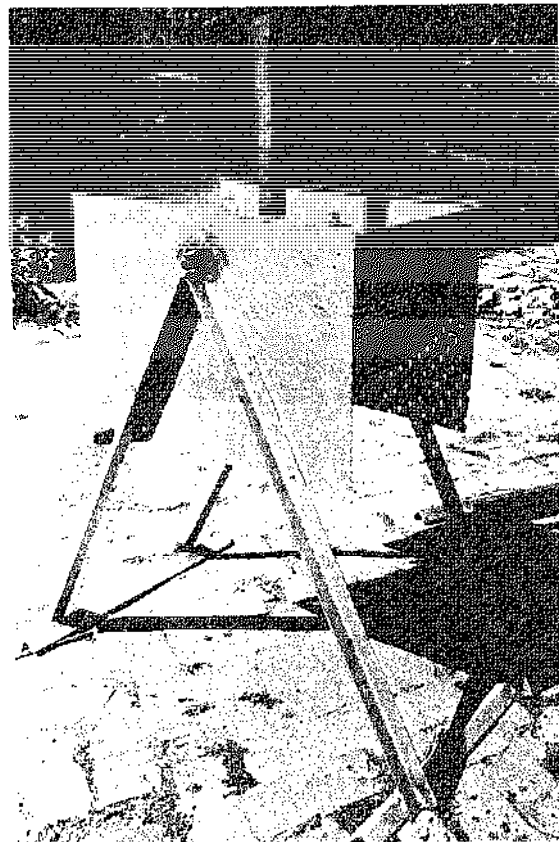

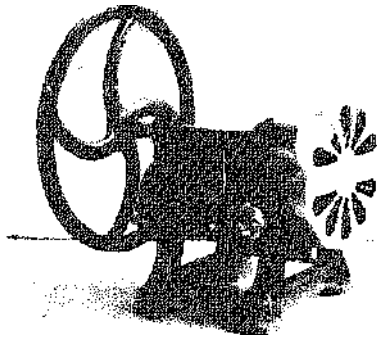

### HAND SUGAR CANE SQUEEZER

3 roller pattern.  
Capacity 115 kg/hour of cane.

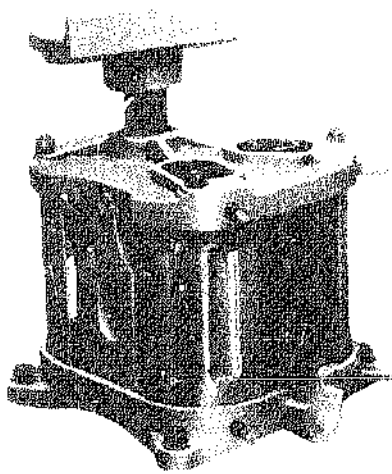

### KUMAR CANE CRUSHER

This is a vertical three roller sugarcane crusher which can be driven by one pair of animals.

Crushing capacity 300-350 lb/hour (136-158 kg/hour)

Also available *KARAMAT* and *KAMAL* vertical three roller crushers with higher capacity.

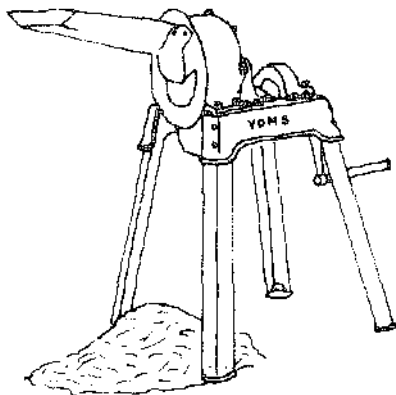

### VOMS HAND PALM NUT CRACKER

This simple machine is turned by a handle and has an output of 150-200 kg/hour with 95% of the nuts being cracked.

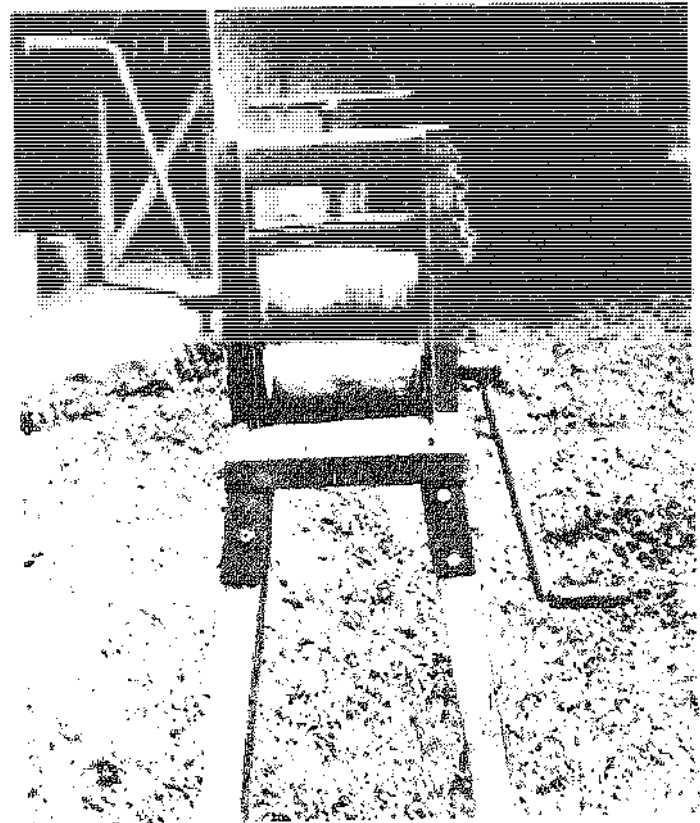

### SUGAR CRUSHER

This is a simple 2-man sugar crusher without gears. It can easily be fabricated if you have access to a welder and cutting torch.

Sugar cane is passed j or 4 times, with adjustment screw on the top tighter each time.

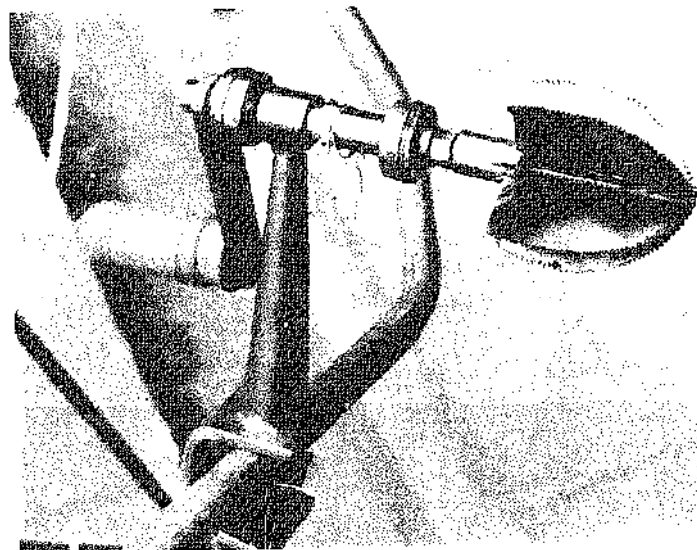

Coconut scraper, using front axle and bearing of bicycle wheel.

## GRAIN STORAGE

A great deal of **grain** is spoiled now through faulty storage techniques, The illustrations on the next page show how to build a mud storage hut to protect the grain from rats, as well as from flooding,

Choose a place where the ground is firm, mark a square out and knock in four forked poles, one in each corner. Round each pole fasten a circular **,or** Conical and tight fitting piece of tin, as shown in the illustration also, this will prevent rats from climbing up the hole into the hut.

Lay four strang poles horizontally across these up - right poles, placing them in the **forks**, so that a hollow square is formed, then lay bamboos across this to make a floor and then plaster this over with mud. As this will be three feet above the ground it should be above normal flood water and it **can**, of course be made higher than this.

Build up the walls in the same **way** as is done for a house, out of mud and bamboo **and** put a flat, mud and bamboo roof on top. Do not keep old baskets, sacks etc, on this roof though or they will attract insects.

Leave a small **opening** in one wall, near the top (about two feet square) so that the grain can be put inside and, when this has been done, seal it up tightly with mud and bamboo. In the same wall, but down near the bottom, put two large empty tins such as those in which baby food is sold, with lids, but first cut the bottoms out. These tins should. be lying on their sides **,with** the lid end facing **outwards**. When it is desired to take any grain out of the store when the lid is taken off these tins the grain will run out into a basket.

Cover the completed storage hut with a thatch **roof, sup-**ported on separate poles and wider than the hut **,so** that the sun and rain will not strike the walls. Be sure that the grain is really dry before putting it in,

Grain store of mud  
and bamboo

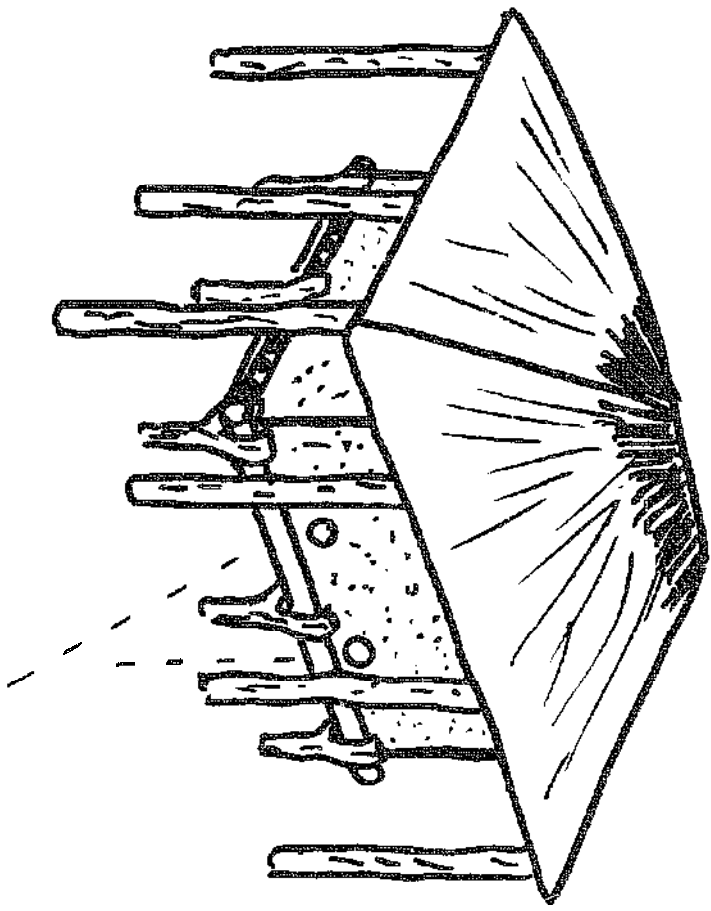

Double roof

tins inserted in wall

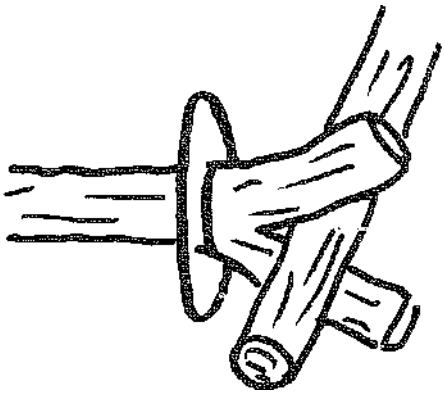

Forked pole at corners

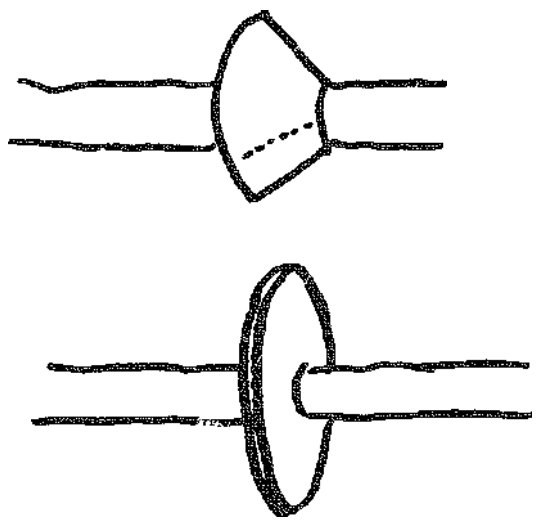

Method of preventing rats climbing  
up the poles

WATER

---

---

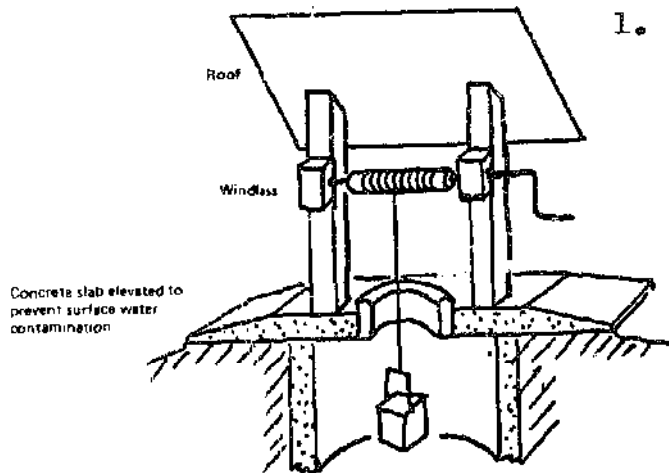

Well fitted with a windlass to lift the water.

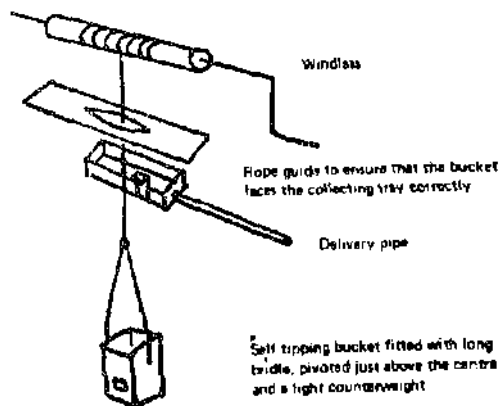

A modification which can be fitted to a totally enclosed well head or may be adapted to deliver directly to a head tank.

A windlass, this will also help to prevent the rope from fraying.

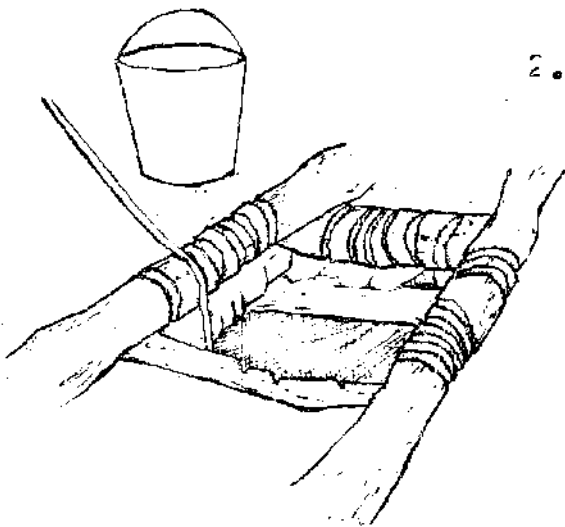

Way of saving the edges of the well from being damaged by the rope.

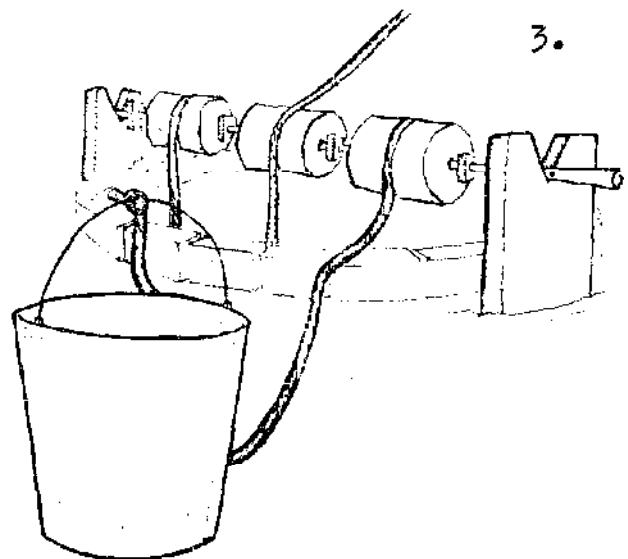



### IMPROVEMENTS TO WELLS

Picture 1, on the opposite page, shows a well in soft earth with stones packed round it, These could be bricks in Bangladesh.

The bamboos round the well hole help to prevent the sides being damaged by the rope used to draw the water up and the cover keeps the water clean. The pipe sticking out, which can be of bamboo, helps to drain off the spilt water so that it is not muddy round the well.

Picture 2, shows an improved well which has been fenced in to prevent animals getting too close to it and fouling the ground round it.

Picture 3 shows an improved version in which the waste water is allowed to flow into a small tank from which the animals can drink. This well has also been fitted with a means of winding the bucket up and down so that drawing the water up is much easier. If the same bucket is used all the time the water is less likely to be contaminated.

Wells can also be fitted with hand pumps, such as those shown on pages 33, 34, and 35. This has the advantage that the well can then be covered over which will prevent rubbish being dropped in to the well.

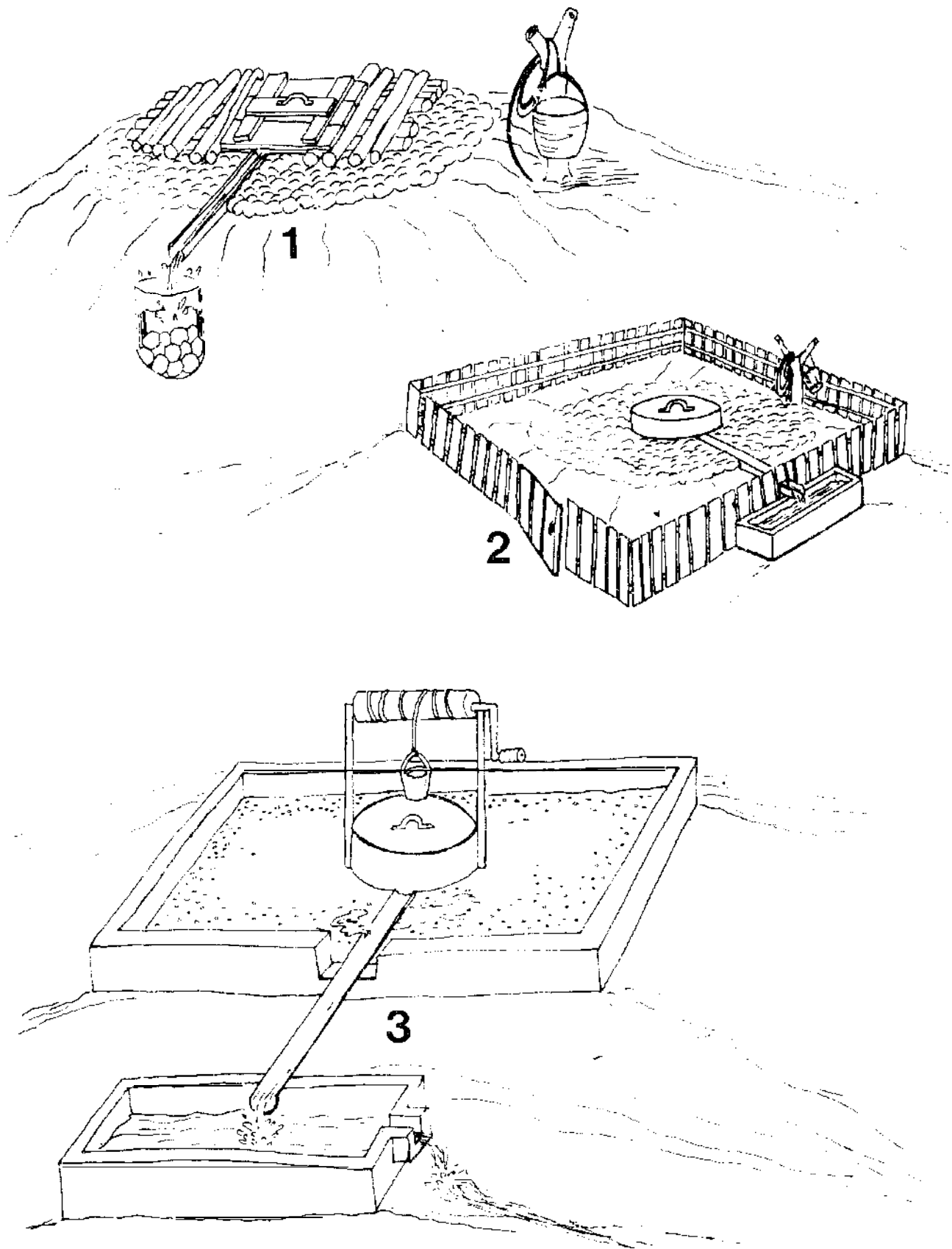

THE SHADUF

2.

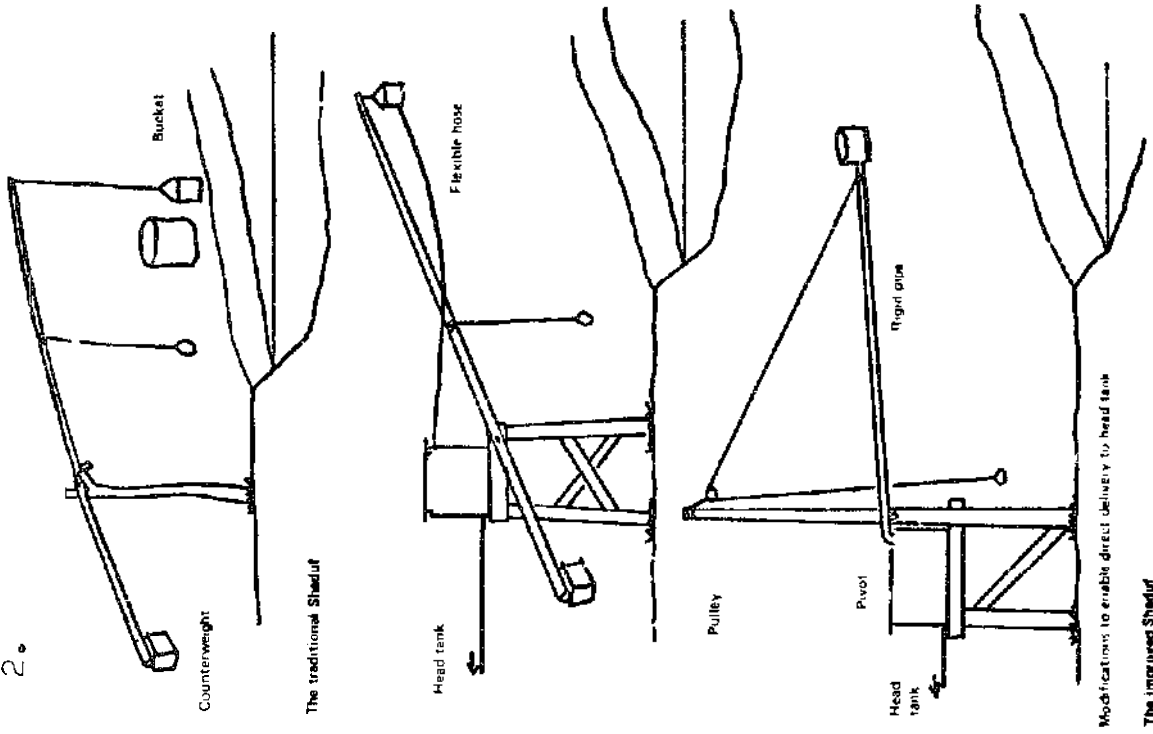

THE ROPE LIFT

1.

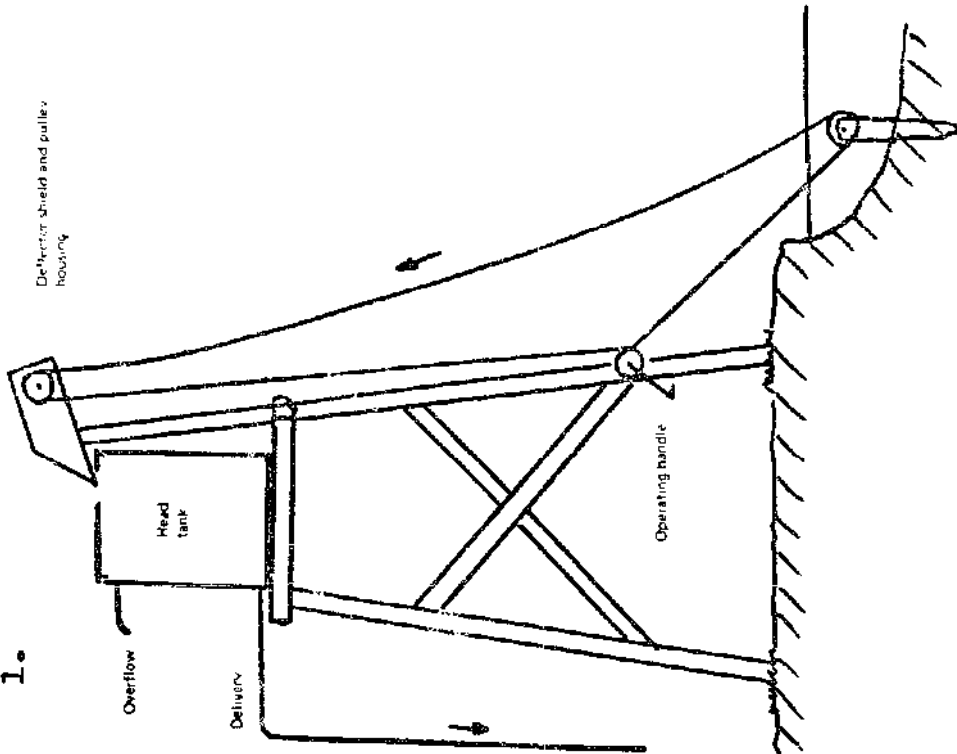

1

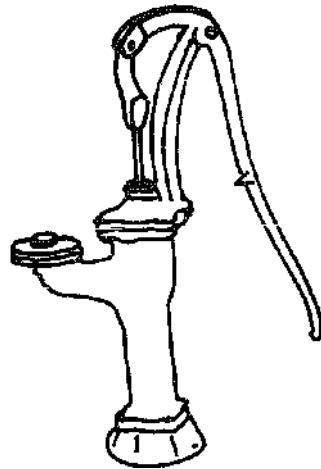
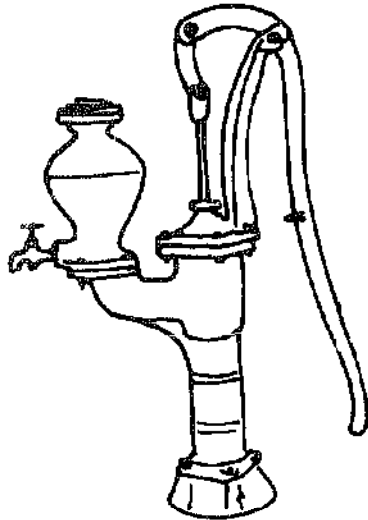

HAND PUMPS

3

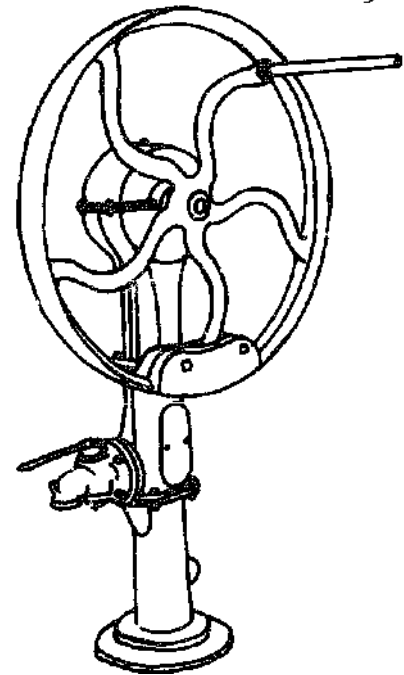

CLIMAX HAND PUMPS

This pump is suitable for deep wells up to 100 ft (30 metres), although pumps fitted with a fly-wheel and operated by two men can work to greater depths. The pump consists of a suction pipe, brass foot valve and strainer. Within the pipe is fitted a rod and valve which can be withdrawn for maintenance when required. The diameter of the suction pipe varies from 2.25 in (5.7 cm) to 4 in (10.16 cm) and the output depends on size of pipe and lift.

4

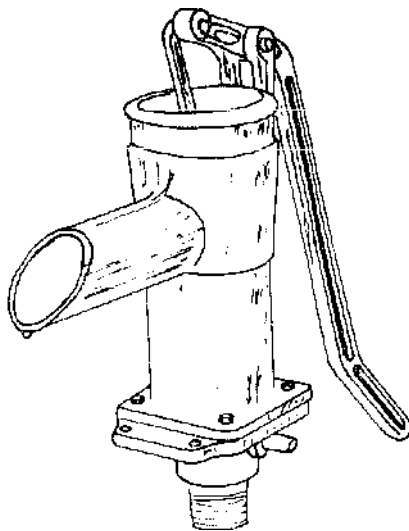

GRILLOT PISTON PUMP

Available with piston diameters 70 mm, 80 mm, 90 mm, and 100 mm.

5

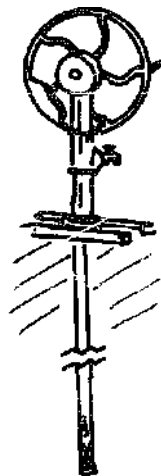

OASIS HAND OPERATED BORE HOLE PUMPS

Suitable for total heads up to 60 m with one hand wheel or 120 m, with two hand wheels fitted. Delivery 350 - 1,200 litres/hour.

6

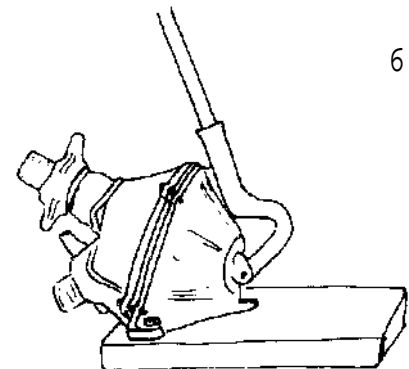

DIAPHRAGM PUMP

Output 3m<sup>3</sup>/hour (13,000 litres/hour)  
Outlet diameter 40 mm.

1

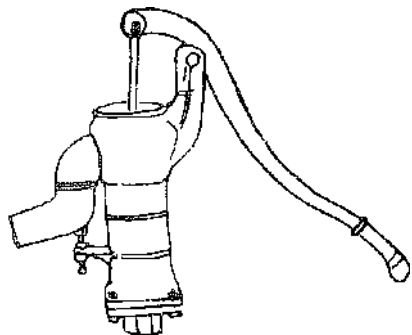
**TOMOE No. 5 PUMP**

Inside diameter of suction pipe 32 mm  
Capacity per hour 2,700 litres  
Suction lift 8.2 m  
Weight 9.6 kg

2

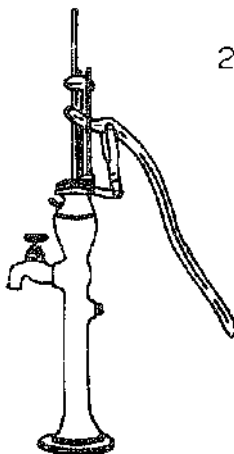
**JAL JAVAHAR PUMP**

Lift and force pump with 150 mm stroke

3

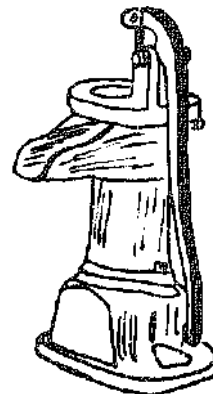
**PITCHER SPOUT LIFT PUMP**

3 inch (80 mm) diameter barrel  
1 inch (25 mm) or 1 1/4 inch (32 mm) diameter suction pipe.

4

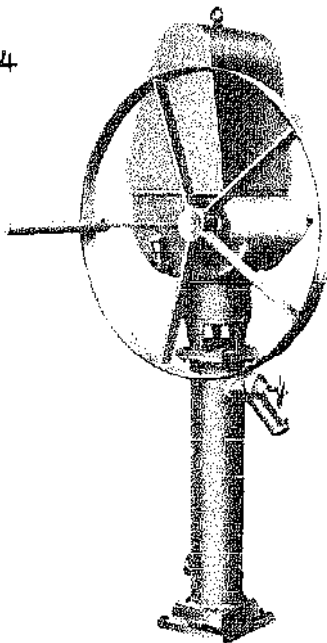
**GODWIN X AND W1H HAND PUMPS**

Two wheel-operated hand pumps, designed for wells and boreholes exceeding 25 ft (7.6 metres). Outputs of up to 500 gal/hr (2250 litres/hour) can be obtained with maximum lifts of 320 ft (97 metres). The mechanism is totally enclosed, with oil bath lubrication, and a second handwheel can be fitted if required. Alternatively, the pump can be connected easily to power drive by attaching a belt to the handwheel.

5

**GOODWIN HLD AND HLS HAND PUMPS**

These all-steel pumps can be supplied for lift only, or for lift and force. The HLD range is designed for boreholes exceeding 25ft (7.6 metres) deep. Outputs range up to 660 gal hr (3000 litres). The HLS range is designed for boreholes of less than 25ft (7.6 metres) and to give outputs up to 760 gal/hr (3500 litres).

6

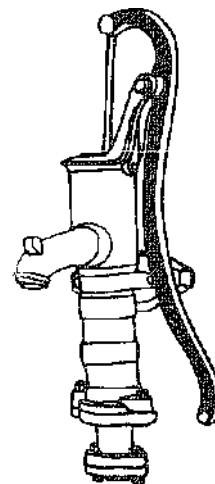
**PISTON PUMP**

Various types available with barrel diameters from 65 mm to 90 mm, giving discharges per stroke from 0.5 litres to 1.1 litres.

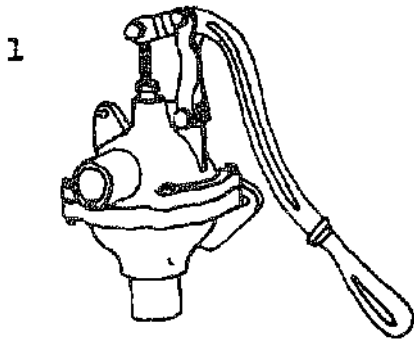

MIDGET LIFT AND FORCE PUMP

Suitable for sandy or gritty water and semi-solids. Construction either all-iron or all-bronze.

Size (mm)	19	25	32	38	50
Capacity (l/h)	900	1600	2250	3650	5900
Weight (kg)	3.9	6.8	11.8	14.5	25.9

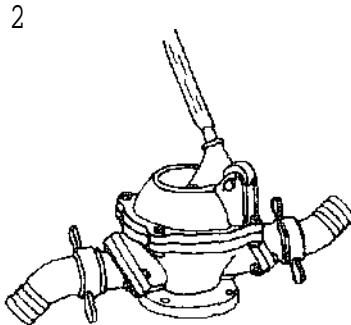

DIAPHRAGM PUMP

Heads obtainable: suction 6-7 m  
 delivery 10-12 m  
 Discharge 5000-7000 litres/hour  
 Weight 28 kg.

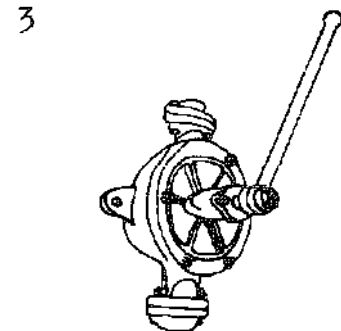

SEMI ROTARY PUMP

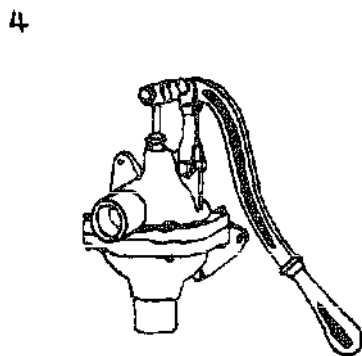

MINIATURE LIFT AND FORCE PUMP

A diaphragm pump with capacity 900-5,400 litres/hour according to size.

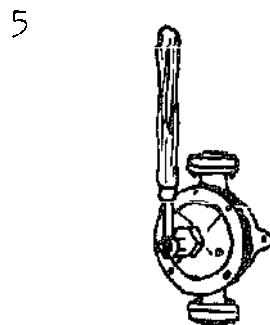

SEMI-ROTARY WING PUMP

Capacity ranges from 680 - 4,100 litres/hour according to size.

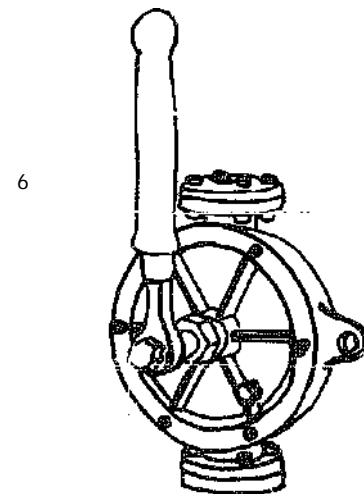

SEMI ROTARY PUMP

Suction head maximum 7.5 m (Foot valve is recommended for suction heads greater than 2 m.)

Delivery head 15 m maximum.  
 Available in six sizes with capacities from 1200 litres/hour to 6600 litres/hour.

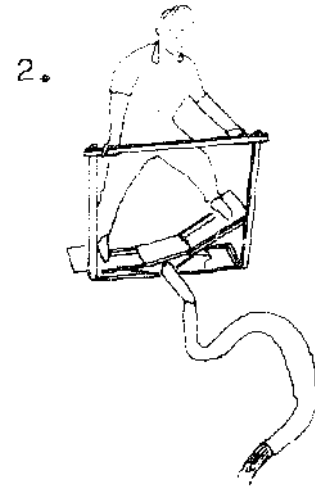
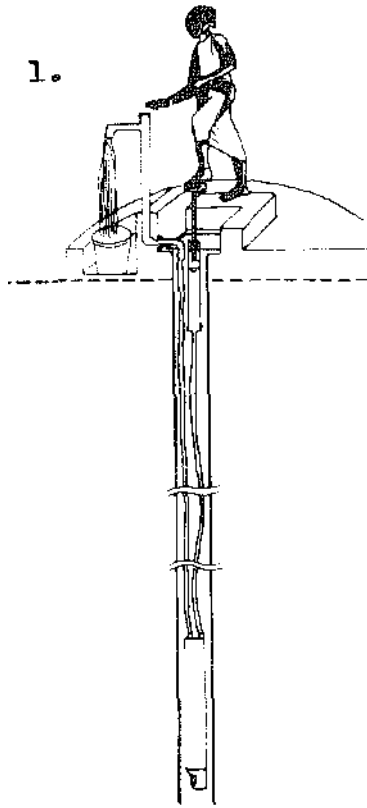

**I.R.R.I. BELLOWS PUMP**

This pump was designed by the International Rice Research Institute in the Philippines. It consists of two canvas bellows which are foot powered, the operator changing his weight from one foot to the other.

Capacity 150 litres/min at 0.5 m head  
 " 120 litres/min at 0.5 m head  
 " 90 litres/min at 1.5 m head

**VERGNET HYDRO-PUMP**

This pump was designed in Upper Volta for use in remote areas where maintenance facilities are limited.

A foot operated piston at the surface forces water through the "command pipe" to the bottom of the bore hole. This water from the "command pipe" causes a flexible bag to expand inside a rigid cylinder. The rigid cylinder is fitted with two check valves and acts as the body of a diaphragm pump, the flexible bag serving as the diaphragm.

Groundwater from the bore hole is taken in through one check valve into the rigid cylinder and forced out through the other valve, up the output pipe to the surface.

The water in the "command pipe" system does not mix with the water being pumped and remains free from sand or other contamination.

The "command pipe" can be extended horizontally at the surface, therefore the operator is not forced to stand directly above the bore hole.

The pump can be fitted into a bore hole of 10 cm diameter.

*Performance:*

Bore hole depth	20 m	40 m	60 m
Output	1.5 m <sup>3</sup> /h	0.7 m <sup>3</sup> /h	0.5 m <sup>3</sup> /h

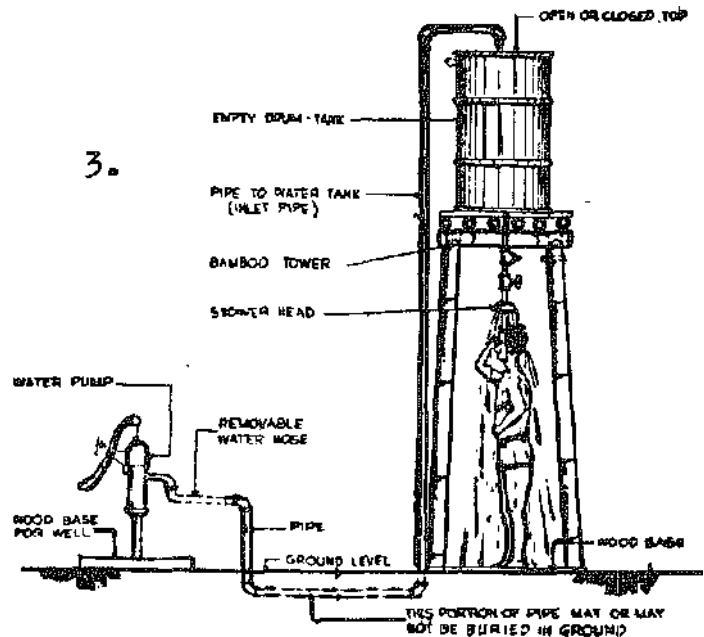

A simple type of shower worked from a hand pump,

# GENERAL

---



## AN EASY WAY TO SPLIT BAMBOO

knock two strong posts into the ground, tie two pieces of iron or two hard wood sticks to them in the shape of a cross. These should be about one inch thick. (Picture 1.)

At the top end of the bamboo make four cuts at right angles to each other.

Hold these cuts open by means of wedges and put the bamboo on the cross in the way shown in Picture 1.

Take out the wedges and push and pull the bamboo towards the cross until it splits the whole way down.

To split the bamboo again, after it has been split into four pieces, mount an iron wedge on top of one of the posts and push the bamboo against this.

**Picture.**

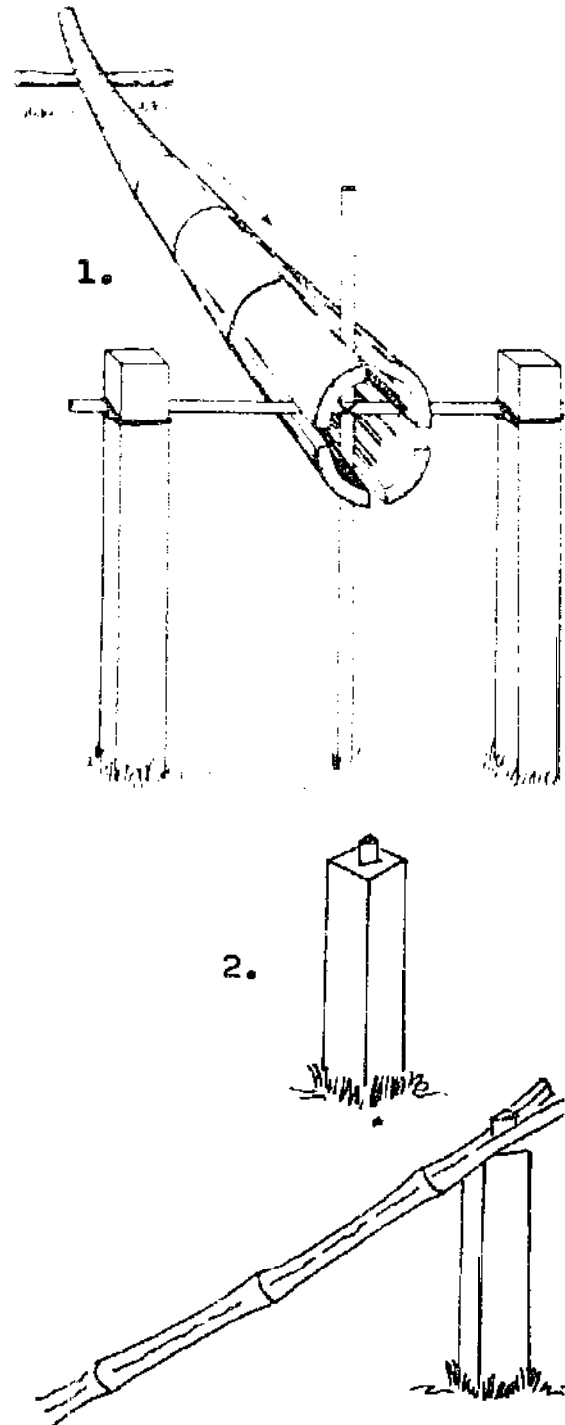

Another way of splitting bamboo,

Preserving bamboo  
 To preserve bamboo mix 5% boric acid with 95% water to make BORAX. Soak green bamboo in this mixture until it has become thoroughly saturated. Let it dry before using. There may be an unpleasant smell for a week or two but this will fade.

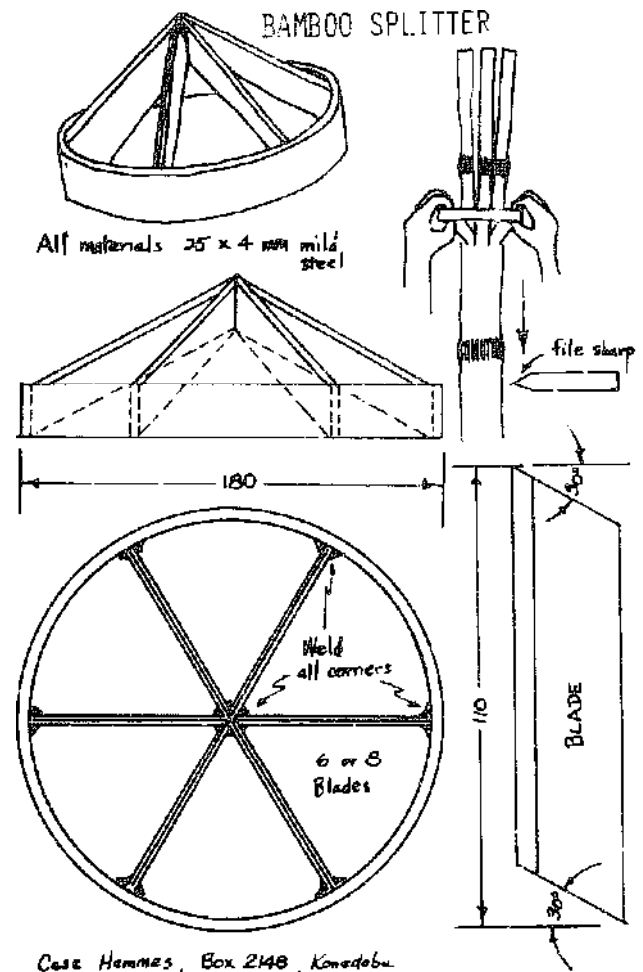

A	B	C	D
Plant 1st year	Plant 2nd year	Plant 3rd year	Plant 4th year
Cut after :- 4th year 8th 12th  etc	Cut after 5th year 9th 13th  etc	Cut after: 6th year 10th 14th  etc	Cut after: 7th year 11th 15th  etc.

### FUEL PLANTATIONS

If self regenerating trees, such as certain kinds of eucalyptus are planted as shown above, the trees at A should be ready to be cut down by the end of the 4th year, B can be cut down the next year and C and D the next two years, by which time A will have grown up again and be ready for re-cutting.

In this way a supply of firewood can be assured for ever providing that the plantation is properly managed and unauthorised cutting prohibited.

### PROPAGATING BAMBOO

Take four nodes from a stem about a year old. Plant near a stream or a place that will usually have plenty of water. Put into the ground at a 45 degree angle, with 2 nodes under the ground and two nodes above it. Plant several sticks in one place but not too close together.

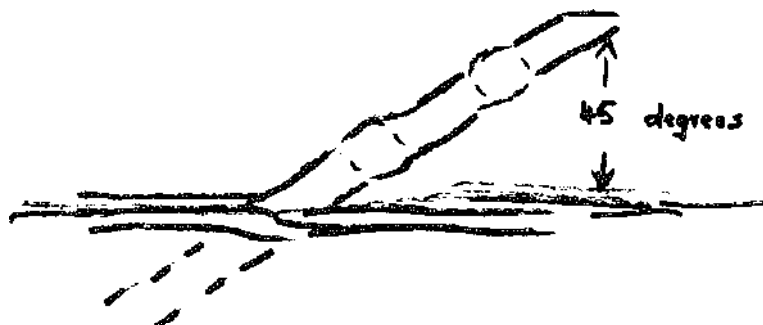

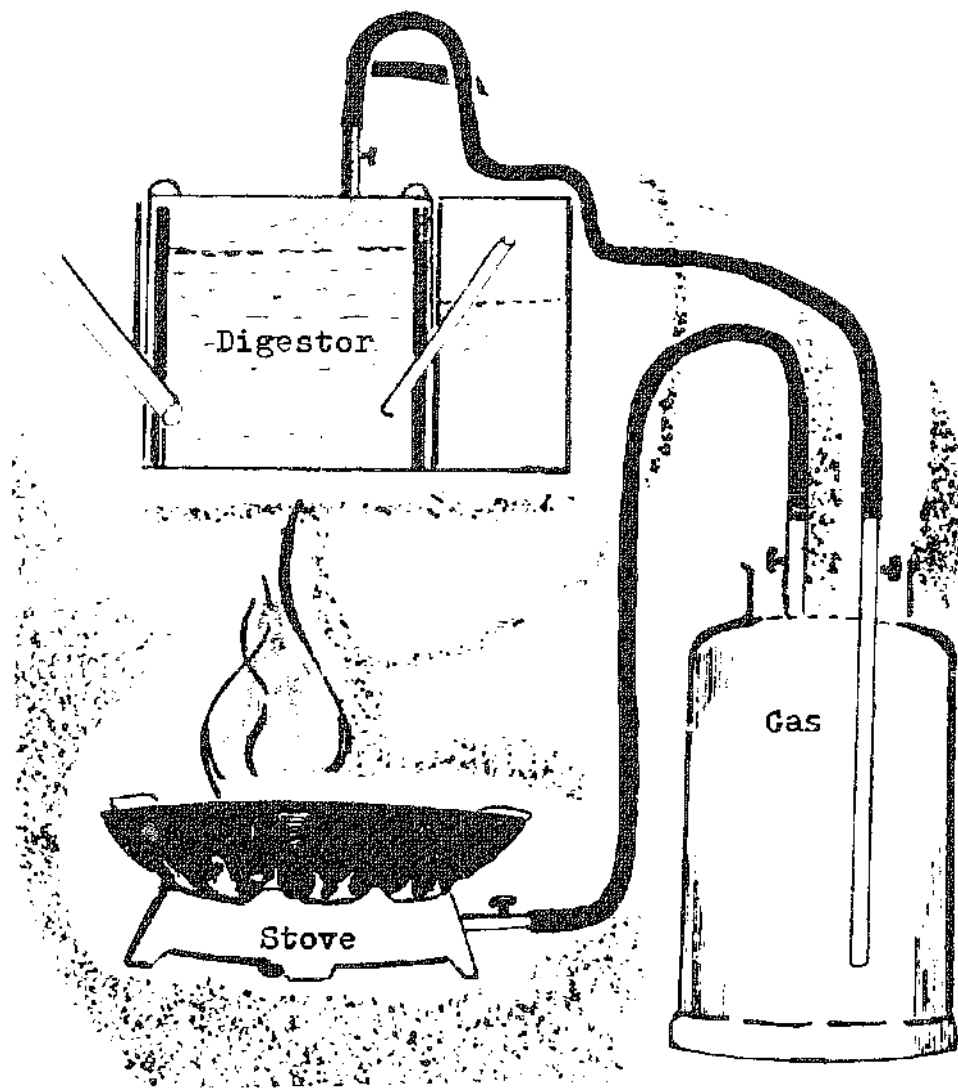

### BIO ,OR METHANE GAS

If animal dung from sheep, goats or cows and also poultry, together with such things as sludge from fish ponds as well as other organic matter is fermented in an airtight and water tight tank these will produce methane gas which can be piped to a near-by house and used for cooking and lighting purposes.

An air tight container is necessary, called a digester, in which the waste is processed. The gas is collected in a storage tank.

At present the cost of building the digester and tank is high for a rural family but many attempts are being made to reduce this. Both India and China now have many of these plants in action.