

AT MICROFICHE
REFERENCE
LIBRARY

A project of Volunteers in Asia

Painting Inside and Out

by Science and Education Administration

Published by:

USDA
(publication no. 203N)

Available from:

Superintendent of Documents
Consumer Information Center
Box 100
Pueblo, Colorado 81002
USA

Reproduced by permission.

Reproduction of this microfiche document in any form is subject to the same restrictions as those of the original document.

PAINTING

INSIDE AND OUT

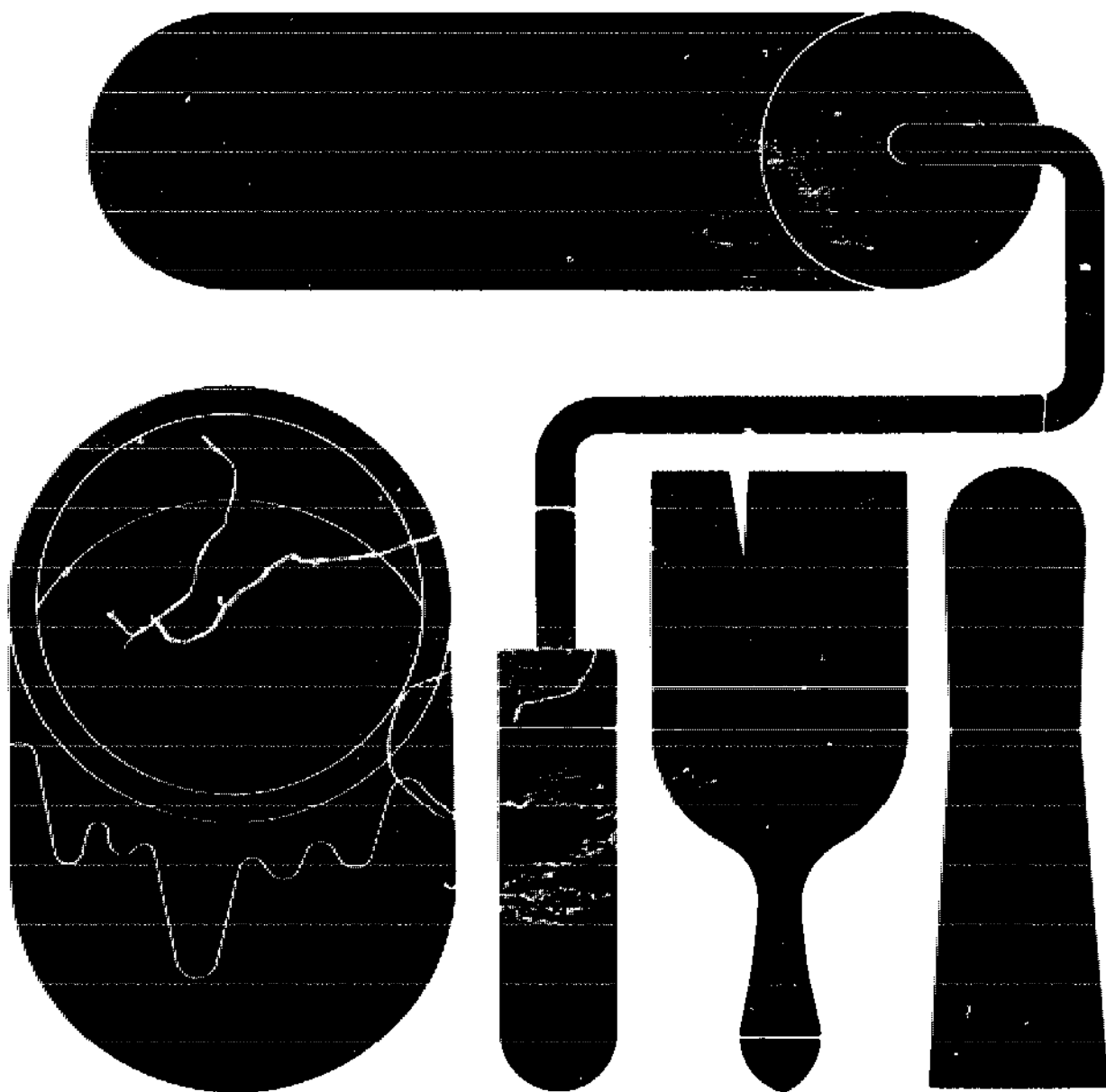

UNITED STATES
DEPARTMENT OF
AGRICULTURE

HOME AND
GARDEN BULLETIN
NUMBER 222

PREPARED BY
SCIENCE AND
EDUCATION
ADMINISTRATION

On January 24, 1978, four USDA agencies—Agricultural Research Service (ARS), Cooperative State Research Service (CSRS), Extension Service (ES), and the National Agricultural Library (NAL)—merged to become a new organization, the Science and Education Administration (SEA), U.S. Department of Agriculture.

This publication was prepared by the Science and Education Administration's Federal Research staff, which was formerly the Agricultural Research Service.

For sale by the Superintendent of Documents, U.S. Government Printing Office
Washington, D.C. 20402

Stock No. 001-000-03874-5

ACKNOWLEDGMENTS

Information for this publication was compiled under the direction of Robert G. Yeck, Staff Scientist, SEA-FR, National Program Staff, Beltsville, Maryland, 20705; T.E. Bond, Research Leader, SEA-FR, Rural Housing Research Unit, Clemson, S.C. 29631; and Glenda Pifer, Housing Specialist, SEA-E, Washington, D.C. 20250. Manuscript materials for the publication were consolidated and prepared in final form by Robert E. Fleischbein, writer-editor, SEA-FR, Information Division, Publications Branch, Hyattsville, Maryland 20782. Most grateful acknowledgment is given the National Paint and Coatings Association, 1500 Rhode Island Avenue, N.W., Washington, D.C. 20005, for many constructive contributions to this publication. Appreciation must also be expressed to Dr. William C. Feist, Chemist, USDA Forest Service, Forest Products Laboratory, Madison, Wisconsin 53705 and William T. Cox, Agricultural Engineer, SEA-E, Washington, D.C. 20250 for their review and assistance.

Mention of a proprietary product in this publication does not constitute a guarantee or warranty of the product by the U.S. Department of Agriculture and does not imply its approval by the Department to the exclusion of other products that may also be suitable.

CONTENTS

	Page		Page
Acknowledgments	iii	Interior	14
Introduction	1	Exterior	15
Surface Preparation	1	Using Natural Finishes and Stains	17
General	1	Interior	17
Plaster, Drywall and Masonry		Exterior	18
Surfaces	2	Whitewashing	19
Wood Surfaces	3	General	19
Metal Surfaces	4	Surface Preparation	19
Paint Selection	4	Mixing	19
General	4	For general woodwork	19
Kinds of Paint	4	For brick, concrete, or stone	19
Paints for barn walls	5	For plaster walls	19
Paints for wood siding	9	Coloring	20
Paints for woodtrim, windows,		Application	20
shutters, and doors	9	Cleanup	20
Paints for masonry	9	Paint Failures	20
Paints for galvanized iron	9	Blistering and Peeling	21
Paints for aluminum	10	Prevention and correction	21
Paints for concrete or wood porches		Cross-grain cracking	21
and steps	10	Prevention and correction	21
Choosing Colors	10	Mildew	22
Estimating Quantity	10	Prevention and correction	22
Application	11	Intercoat Peeling	23
General	11	Prevention and correction	23
Equipment	11	Excessive Chalking	23
When to Paint	12	Prevention and correction	24
Number of Coats	12	Related Publications	24
Safety Precautions	13	Table 1	6
How to Paint	14	Table 2	8

This publication supersedes Home and Garden Bulletins No. 155, "Exterior Painting," and No. 184, "Interior Painting in Homes and Around the Farm."

Painting—Inside and Out

INTRODUCTION

Some people enjoy painting the house; for others it's a chore. But it must be done occasionally. One reason is for appearance. Another important one is for protection of the surface.

Delay, when repainting is needed, can mean extra work when you finally do paint. Old paint that blisters, cracks, and peels will have to be removed before the new paint can be applied.

If you wait too long, there could be costly damage. Moisture may reach the interior where it can cause damage. Some metals rust when not protected; others develop a corrosive

wash that stains surrounding surfaces.

Take time to do a good job when you paint. For an attractive, long-lasting paint job, you need to—

- Properly prepare the surface for painting. Even the best paint won't last on a poorly prepared surface.
- Read the paint container label! Choose the correct coating for the proper surface.
- Use good quality paint. It gives longer and better protection.
- Apply the paint correctly. Improper application can be as damaging as a poorly prepared surface.

SURFACE PREPARATION

General

Preparation of the surface—cleaning and patching—may take the most time in painting, because it is of major importance in the job. Even the best paint will not adhere well to an excessively dirty or greasy surface or hide large cracks or scratches. It is especially desirable to scrape peeling paint and cover it in old homes where original paints may have had a lead-base *and as such are a hazard for small children who naturally sometimes put these chips in their mouth*

and eat them. Ingesting lead-base paints can be very harmful or even fatal.

In general, a surface that is to be painted should be firm, smooth, and clean. With oil-base paint, it must also be completely dry. If necessary, latex or water-base paint can be applied to a damp—but not wet—surface. Ideal conditions, though, are dry surfaces. Check the paint-can label for additional or special instructions for preparing the surfaces.



BN-33618

Scrape off—or otherwise remove—all loose paint before you repaint.

Grease or grime must be removed for good paint adhesion. Oil and grime may be removed by washing surfaces, other than drywall, with a detergent solution, ammoniated cleansers, or mineral spirits.

Kitchen walls and ceilings are usually covered with a film of grease from cooking that may extend to the walls and ceilings just outside the entrances to the kitchen.

Bathroom walls and ceilings may have excessive grime.

Plaster, Drywall and Masonry Surfaces

Clean and dust all surfaces thoroughly before you apply the first coat of primer or paint. On masonry surfaces, remove dirt, loose particles, or efflorescence with a wire brush. "Efflorescence" is a white powdery condition that sometimes occurs on masonry or brick as a leachate from water seepage.

Newly plastered walls should not be painted with oil-base paint until they are thoroughly cured—usually about 2 months. Then, a primer coat should be applied first.

If it is necessary to paint uncured plaster, apply *one coat* of a latex paint or primer. Latex, or water-base, paint will not be affected by the alkali in new plaster and will allow water to escape as the plaster dries. Subsequent coats of paint—either oil-base or latex—can be added when the plaster is dry.

Unpainted plaster readily picks up and absorbs dirt and is difficult to clean. The one coat of latex paint or primer will protect it.

For new drywall, a latex primer or paint is recommended for the first coat. Solvent-thinned paints tend to cause a rough surface. After the first coat of latex paint, subsequent coats can be of either type.

New concrete should weather for several months before being painted.

Fresh concrete may contain considerable moisture and alkali, so it is best to use specially formulated coatings which are alkali-resistant. Portland cement masonry paint may also be used.

Patch any crack or other defects in masonry surfaces. Pay particular attention to mortar joints.

On old plaster and drywall surfaces, the first step is to inspect the surface for cracks and chips. Fill small hairline cracks with spackling compound and larger cracks with special patching plaster. Follow the directions on the container label when using the patching material. When the patch is completely dry, sand it smooth and flush with the surrounding surface.

Nailheads tend to "pop out" in drywall and ceilings. Countersink the projecting heads slightly and fill the hole with spackling compound. Sand the patch smooth when it is dry. It is desirable to prime *all* newly spackled or patched spots, particularly if you are applying only one coat.

On all masonry surfaces it is especially important to remove dirt, loose particles, and efflorescence with a wire brush. Loose, peeling, or heavily chalked paint may be removed by sandblasting. If the old paint is moderately chalked and otherwise "tight" and nonflaking, coat it with a recommended sealer or conditioner before you repaint with a water-base paint.

The finish on kitchen and bathroom walls and ceilings is usually a gloss or semigloss. It must be "cut" so that the new paint can get a firm hold. For best results, rub the surface with fine sandpaper or steel wool.

Wood Surfaces

New wood siding and window woodwork, doors, and baseboard preferably should not contain resinous knots or pitch streaks. But if they do, clean the knots and streaks with turpentine and seal with a good knot sealer. The knot sealer will seal in oily extractives and reduce staining and cracking or the paint in the knot area.

If there are any bare spots in the wood, prime them with an undercoater.

To prevent future staining by rusty nails, set nailheads below the surface, prime them, and caulk the hole. Loose wood siding should be fastened with nonrusting-type nails. Prime and caulk all cracks. Sand the area smooth after the compound dries.

Remove all rough, loose, flaking, and blistering paint. Spot-prime the bare spots before repainting. Where the cracking or blistering of the old paint extends over a large area, remove all old paint down to bare wood. Prime and repaint the old surface as you would a new wood surface. Sand or "feather" the edges of the tight old paint before repainting.

Smooth any rough spots in the wood with sandpaper or other abrasive. Before applying paint, wipe off any dust or residue that is left on the surface from cleaning or surface preparation.

Old paint may be removed by sanding, scraping, or burning, or with chemical paint remover. Scraping is the simplest but hardest method. Sanding is most effective on smooth surfaces. Chemical paint remover can be expensive for large areas. *Burning is not recommended.*

CAUTION

Correct the condition that caused the blister, cracking, or peeling of the old paint before you repaint. Otherwise, the same trouble may reoccur. It may be a moisture problem. See "Paint Failures," page 20.

Metal Surfaces

New galvanized steel surfaces should weather for about 6 months before being painted. If earlier painting is necessary, first wash the

surface with a very mild and dilute acid such as vinegar, or a commercially available compound, and rinse it thoroughly. This will remove any manufacturing residue and stain inhibitors.

Apply a special metallic zinc dust primer or other specially formulated primers before painting.

Rust and loose paint can usually be removed from old surfaces with sandpaper or with a stiff wire brush. Chipping may be necessary in severe cases. Chemical rust removers are also available.

Oil and grease may be removed with a solvent such as mineral spirits. Rinse the surface thoroughly.

PAIN T SELECTION

General

There are a number of different types of paint. Selection need not be too much of a problem, however.

First consider whether you need an exterior (exposed to weather) or an interior paint. Then consider the surface you are painting: wood, metal, or masonry? Some paints can be used on all three; others on only two. Many are formulated for one particular surface material. Condition of the surface is important also. Old chalky surfaces, for example, are not generally a sound base for latex or water-base paints.

Next consider any special requirements. For example, nonchalking paint may be advisable where chalk rundown would discolor adjacent brick or stone surfaces. Perhaps mildew is a problem. If so, mildew should be removed and efforts made

to correct its cause—excess moisture is the major culprit. Mildew-resistant paints are available for use where such problems occur.

Many different kinds and formulations of paints and other finishes are available for interior and exterior use. New ones frequently appear on the market. Use the tables on pages 6 and 8 as a general guide in making your selection. For a more specific selection consult your paint dealer. Reputable paint dealers keep abreast of the newest developments in the paint industry and stock the newest formulations.

Kinds of Paint

Paint may be categorized as solvent-thinned or water-thinned. Solvent-thinned paints are most commonly oil-base paints but some

specialty coatings such as catalyzed epoxies, polyesters, and urethanes are also solvent-thinned but are not oil-base paints. Enamels which are made with a varnish, or resin, base instead of the usual linseed-oil vehicle, are included under the broad oil-paint grouping. Water-thinned paints are most commonly latex paints but there are non-latex paints that are water-thinned.

Oil-base paints are very durable, are highly resistant to staining and damage, can withstand frequent scrubbing, and give good one-coat coverage. Many latex paints are advertised as having similar properties.

The main advantages of latex paint are easier application, faster drying, and simpler tool cleanup. The brushes, rollers, and other equipment can be easily cleaned with soap and water.

Paints usually come in three finishes; gloss, semigloss or flat. Glossy finishes look shiny and clean easily. Flat finishes reduce glare but more readily become dirty. Semigloss finishes have properties of both glossy and flat finishes. Both oil-base and latex paints are available in gloss, semigloss, and flat finishes.

Because enamel is durable and easy to clean, semigloss or full-gloss enamel is recommended for woodwork and for the walls of kitchens, bathrooms, and laundry rooms. For the walls of nurseries and playrooms, either oil-base or latex semigloss enamel paint is suggested. Flat paint is generally used for the walls of living rooms, dining rooms, and other non-work or non-play rooms.

Penetrating sealers are available as a finish for other wood used in the home such as paneling or furniture. It

is easy to apply and penetrates into the surface with little buildup. It avoids the high gloss to which some people object.

"House paint" is the commercial term for exterior paints. Generally it refers to paint which is applied to siding and other large exterior wall surfaces. Trim paint is the terminology that is usually used for base-board, window sills, etc., jobs. There are paints specifically formulated for a particular requirement, such as rust-preventative for metal.

House paint comes in both oil-base and latex (water-base) paint. The vehicle of oil-base paint consists usually of alkyd resin with turpentine or mineral spirits as the thinner. Latex paint vehicle consists of fine particles of resin emulsified (held in suspension) in water.

Again, the advantages of latex paints include easier application, faster drying, usually better color retention, resistance to alkali and blistering. "Bone dry" surfaces are ideal for painting. But if it is impossible to attain this condition, some latex paints will perform satisfactorily on slightly damp surfaces. Brush and tool cleanup is simpler with latex because it can be done with soap and water and doesn't require the purchase of paint thinner.

Use tables 1 and 2 as a guide in selecting paint. Your paint dealer can help you also. Here are some specific suggestions:

Paints for barn walls

Walls in farm-service buildings must withstand almost constant rubbing by animals and frequent wash-

Table 1.—Interior Paint Selection Chart¹

SURFACE	PAINT CHOICE																				
	Alkali Resistant Enamel	Alkyd Exterior Masonry Paint	Alkyd Flat Enamel	Alkyd Floor Enamel	Alkyd Glossy Enamel	Alkyd Semi-Glossy Enamel	Epoxy Enamel (Opaque)	Epoxy Finish (Clear)	Laquer	Latex Exterior Masonry Paint	Latex Flat Wall Paint	Latex Floor Enamel	Latex Glossy Enamel	Latex Semi-Glossy Enamel	Pigmented Wiping Stain	Portland Cement Masonry Paint	Portland Cement Metal Paint	Shellac	Urethane Enamel (Opaque)	Urethane Finish (Clear)	Varnish
MASONRY																					
Brick	X 11	X 11	X 8, 11		X 8, 11	X 8, 11	X 11 7			X 11	X 8, 11		X 8, 11	X 8, 11					X 11 7		
Cement Block	X 11		X 4, 7		X 11	X 4, 7	X 4, 7				X 4, 7		X 4, 7	X 4, 7		X 11			X 11, 7		
Ceramic Tile Flooring				X 11			X 11				X 11								X 11		
Concrete	X 11		X 4, 11	X 11	X 4, 11	X 4, 11	X 11			X 4, 11	X 11	X 4, 11	X 4, 11	X 4, 11		X 11			X 11		
Concrete Flooring	X 11			X 11			X 11				X 11								X 11		
Drywall			X 6		X 6	X 6	X 6, 11			X 6, 11		X 6	X 6	X 6					X 6, 11		
Plaster			X 6,2		X 6,2	X 6,2	X 6,11			X 6, 11		X 6	X 6	X 6					X 6, 11		
METAL																					
Aluminum			X 1		X 1	X 1	X 1			X 1		X 1	X 1						X 1		
Galvanized Steel			X 14		X 14	X 14	X 14			X 14		X 14	X 14	X 14		X 10	X 10		X 14		
Iron and Steel			X 1,5		X 1,5	X 1,5	X 1,11			X 1,5		X 1,5	X 1,5	X 1,5		X 10	X 10		X 14		
Steel Flooring				X 11			X 11									X 10	X 10		X 11		
WOOD																					
Flooring				X 11			X 11	X 11	X 11		X 11				X 13, 12			X 11	X 11	X 11	X 13, 12
Trim and Paneling			X 3		X 3	X 3	X 3,11	X 11	X 11	X 3		X 3	X 3	X 3	X 13, 12			X 11	X 3, 11	X 11	X 13, 12
MISCELLANEOUS																					
*Accoustical Tile			X 2							X 11											
Vinyl Wallcovering, Smooth, with Design			X 11		X 11	X 11				X 11		X 11	X 11								
Vinyl Wallcovering, Smooth, without Design					X 11	X 11				X 11											
Vinyl Wallcovering, Textured			X 9, 11		X 9, 11	X 9, 11				X 11											
Wallpaper			X 6,2		X 6,2	X 6,2				X 6,2		X 6,2	X 6,2								

¹ X = Paint Choice and Numbers = Primer Choice; code on next page.

Code to Table 1

* Accoustical surfaces often require only a thin coating that will lend decorative properties but that will not affect the surface's sound-proof characteristics.

Almost every new or bare surface will require the use of a primer or prime coat before application of the topcoat. Often this primer is a product specially formulated to protect the surface, as well as provide a coating to which the topcoat can tightly adhere. In some situations the topcoat material can be applied as a prime coat, according to manufacturer's directions, after which a second, and possible third, topcoat would be applied.

Below is a list of primers used with topcoats applied to surfaces found in a home's interior. Each primer has a key number which appears on the chart. Remember these primer-topcoat combinations are *general* recommendations. For *specific* priming instructions, consult the container label.

Interior Primers:

- | | |
|---------------------------|-------------------------------------|
| 1. Alkyd Metal Primer | 8. Masonry Surface Conditioner |
| 2. Alkyd Primer | 9. Oil-Base Primer |
| 3. Enamel Undercoater | 10. Portland Cement Metal Primer |
| 4. Exterior Masonry Paint | 11. Topcoat Material Used as Primer |
| 5. Latex Metal Primer | 12. Wood Filler |
| 5. Latex Primer | 13. Wood Sealer |
| 7. Masonry Block Filler | 14. Zinc-Rich Metal Primer |

Table 2.—Exterior Paint Selection Chart¹

SURFACE	PAINT CHOICE														
	Aluminum Paint	Asphalt Emulsion	Awning Paint	Cement Base Paint	House Paint (Oil)	House Paint (Latex)	Metal Primer	Porch-and-Deck Enamel	Primer or Undercoater	Roof Cement or Coating	Spar Varnish	Transparent Sealer	Trim-and-Trellis Paint	Water Repellent Preservative	Penetrating Wood Stain (Latex or Oil)
MASONRY															
Asbestor Cement					X●	X									
Brick	X			X	X●	X			X			X			
Cement and Cinder Block	X			X	X●	X			X			X			
Cement Porch Floor									X						
Stucco	X			X	X●	X			X			X			
METAL															
Aluminum Windows	X				X●	X●	X						X●		
Galvanized Surfaces	X●				X●	X●	X						X●		
Iron Surfaces	X●				X●	X●	X		X				X●		
Siding (Metal)	X●				X●	X●	X●						X●		
Steel Windows and Doors	X●				X●	X●	X						X●		
WOOD															
Frame Windows	X				X●	X●			X				X●		X
Natural Siding and Trim											X				X
Porch Floor								X							X
Shingle Roof														X	X
Shutters & Other Trim					X●	X●			X				X●		X
Siding					X●	X●			X						X
MISCELLANEOUS															
Canvas Awnings			X												
Coal Tar Felt Roof		X							X						

¹ X = Paint Choice and ● = Primer or Sealer May Be Required, Check Container Label.

ings to remove manure and dirt; and storage building walls often also suffer hard use. Durable paint is required. *However, lead-base paint should not be used around animals because the animals may lick the paint.*

A catalyzed enamel, epoxy, polyester, or urethane type may cost more than ordinary paint, but are more durable and washable. The ingredients usually come in two containers and must be mixed. Label instructions should be followed carefully for mixing and using the paint.

Paints for wood siding

Either latex or oil-base house paint may be used. An oil-base primer is recommended for use over resinous woods such as pine and those that tend to bleed such as redwood and western red cedar.

Penetrating semi-transparent stains are preferred by many homeowners who wish to preserve the beauty of the wood. See page 17 for more information on stains.

Paints for trim, windows, shutters, and doors.

Because wood trim is usually treated with a water repellent preservative before finishing, any form of latex or oil-base paint or stain can be used. Latex trim enamels are good choices. Their properties include rapid drying, high gloss, good color and gloss retention, and good durability. Regular house paint may not retain its gloss as long. Chalking paints should be avoided wherever there is concern about discoloration of adjacent surfaces.

Paints for masonry

Exterior latex masonry paint is a standard paint for masonry. Cement-base paint may be used on nonglazed brick, stucco, cement, and cinder block.

For an inexpensive, attractive masonry paint—

Mix 1 part of hydrated lime with 5 parts of white Portland cement. Add water until the mixture has the consistency of condensed milk. High-grade mineral coloring may be added to obtain light tinting. (Add 2 parts of fine sand to the mix if you will need to completely fill the pores of rough cinder block. Excellent block fillers are available in paint stores also.)

Dampen the surface before applying the paint. Brush or spray the paint on. A short, stiff-bristled brush will help fill pores.

The paint should dry slowly for proper curing. After it becomes firm, keep it damp with sprayed water for about 48 hours. Surfaces painted with this paint will require a sealer before they can be repainted with other types of paint.

Paints for galvanized iron

Ordinary house or trim paints may be used for the finish coats on gutters, downspouts, and hardware or grilles. A specially recommended primer must be used on each. For instance, a metallic zinc dust primer is recommended on galvanizing and red lead or zinc chromate primer on iron. There are other surface preparation techniques available for metal

too. Carefully follow instructions for their use. Specific formulations of enamel are available for ferrous window screens.

Paints for aluminum

Aluminum normally requires no paint for protection but there may be a need to "touch-up" or otherwise repaint factory applied finishes. See tables 1 and 2 for alternatives.

Paints for concrete or wood porches and steps

Porch-and-deck paint may be used on both concrete and wood. On wood, an oil-base primer is applied after first treating the wood with a water repellent preservative solution that is suitable for future covering with a regular paint.

CHOOSING COLORS

Color is mostly a matter of personal preference. Remember that light colors will repel heat while dark tones absorb heat. Chalking paints should be avoided where the chalking may discolor adjacent surfaces.

Paints are available in a wide range of colors and shades. Some are ready mixed; others the dealer has to mix by adding or combining different colors. Dealers usually carry color charts showing the different possibilities. Here are some points to keep in mind in selecting your colors.

- Light colors make a small room seem larger. Conversely, dark colors make an overly large room appear smaller.

- Ceilings appear lower when darker than the walls and higher when lighter than the walls.

- Paint generally dries to a slightly different color or shade. For a fast preview of the final color, brush a

sample swatch of the paint on a piece of clean, white blotting paper. The blotting paper will immediately absorb the wet gloss, and the color on the paper will be about the color of the paint when it dries on the wall.

- Colors often change under artificial lighting. Look at color swatches both in daylight and under artificial lighting.

- The type of artificial lighting can also make a difference. For instance, incandescent lighting casts a warm, yellow glow. On the other hand, fluorescent lighting usually gives off a cooler, blue hue, unless a warm white fluorescent tube is used.

- Keep in mind that most paint stores use fluorescent lighting, and consequently a color that looks one shade in the paint store may look another shade in your home. Adjacent colors also affect the appearance.

ESTIMATING QUANTITY

For large jobs, paint is usually bought by the gallon. The label usually indicates the number of square feet a gallon will cover *when applied as directed*. To determine the number of gallons you will need:

1. Find the area of the walls in square feet by multiplying the length of each wall by its height.

2. Subtract from this figure one-half the total area—in square feet—taken up by doors and windows. This

is done simply by multiplying the height and width of each unit, adding the results, and dividing by 2.

3. Divide the figure obtained in step 2 into the number of square feet a gallon of paint will cover. Then multiply that figure by the number of coats to be applied. This will determine the number of gallons needed.

Ceilings are often painted a different shade than the walls, and need to be figured separately. To find the

square-foot area of the ceiling, simply multiply the length by the width.

Remember that unpainted plaster and wallboard soak up more paint than previously painted walls and will require more paint or primer. Extra paint may also be required to cover old colors if there is much change involved. It is more desirable to slightly overestimate the amount of paint needed in order to avoid the risk of having to buy a small second batch later that might not exactly match the original batch.

APPLICATION

General

Read the paint can label carefully before starting to paint. It will contain general application instructions as well as any special instructions and directions for applying the paint, and drying requirements. *Do not become careless and ignore safety practices.*

Equipment

For speed and convenience, homeowners usually prefer to use a roller on walls, ceilings, and other large surfaces, and then use a brush at corners, along edges, and in other places a roller cannot reach. Rollers work well on masonry and metal surfaces. Proper depth of the pile or nap on the roller covers is important and varies from one surface to another. Follow the manufacturer's recommendations.

Rectangular applicators are available that offer the speed and convenience of rollers. They too are desirable to use on large surfaces.

These applicators are available through most retailers. Again, follow the manufacturer's recommendations.

Special shaped rollers and other applicators are available for painting woodwork, corners, edges, and other close places. Some may work fine; others not so well. A small brush may still be best for such work.

Woodwork is usually painted with a brush. A brush will usually give better penetration on wood than rollers or spray painting.

Keep in mind that different kinds of brushes and rollers are recommended for use with different kinds of paint. The characteristics of the bristle affect how well paint is transferred to the painting surface. Your paint dealer should be able to furnish sound advice on what kind of brush or roller to buy.

Indoor spray painting is not generally done by the homeowner, except for small jobs using pressurized cans of paint. On outside jobs, spraying is often the fastest method. But, you

may not get proper penetration on wood surfaces. On masonry surfaces, voids that are difficult to fill with a brush or roller can be coated adequately by spraying. On any spray job—large or small—take care that spray does not drift to surrounding surfaces—particularly parked cars.

Other equipment needed for painting includes a stepladder, protective coverings to avoid splash or spillage on the wrong surfaces (needed outside as well as inside) and wiping rags.

When to Paint

For best results with either oil-base or latex paint, and for an easier and better paint job—

Paint when the weather is mild and dry. The less humidity in the air, the quicker paint will dry. Never apply an oil-base paint when the temperature is below 40° F. Freezing temperatures should be avoided with any paint. Temperatures above 90° F are not only uncomfortable to the painter but they may cause paint to dry too quickly. Consult label for temperature limitations.

- Start outside painting *after* the morning dew has evaporated. Stop outside painting in late afternoon or early evening on cool fall days. This is more important with latex paint than with oil-base paint.

- Paint surfaces after they have been exposed to the sun and are in the shade. A good rule is to “follow the sun around the house.” Painting in sunlight will cause the paint to dry more quickly and especially in hot weather, this may cause brush “lap” marks to appear in the freshly painted surface.

- Do not paint in windy or dusty weather or when insects may get caught in the paint. Insects are usually the biggest problem during fall evenings. Don't try to remove them from wet paint; brush them off after the paint dries.

Number of Coats

Three coats of paint are recommended for new wood surfaces— one primer and two finish coats. Two coat systems will last only about half as long as a three coat system.

On old paint surfaces in good condition, one top coat may be sufficient. But if the paint is very thin, apply two top coats, especially on outside surfaces areas exposed to weather or any surface exposed to heavy use.

On bare surfaces or surfaces with very little paint left on them, apply a primer and two top coats. Remove heavy chalk before repainting, especially when repainting with latex.

Allow the primer coat to dry according to the manufacturer's label instructions. Allow longer drying time in humid weather. Apply the finish coats as soon as the primer has dried sufficiently. Usually it is desirable to allow about 48 hours drying time between oil-base finish coats. Two coats of latex paint may be applied in one day. If you must wait a month or more, clean the surface thoroughly before applying the top coats.

On metal surfaces, prime both new metal and old metal from which the paint has been removed. Good primers usually contain zinc dust, red lead, zinc yellow, or some rust-inhibiting pigment as one of the

ingredients. After the primer has dried sufficiently, apply one or two finish coats of paint.

The Forest Products Laboratory recommends applying a water-repellent preservative before priming new wood that has not been so treated.

Some preservatives need to dry for two warm, sunny days before the primer is applied. Ask your paint dealer about the recommendations of the paint manufacturer. See Home and Garden Bulletin No. 203, "Wood Siding—Installation, Finishing, Maintaining," (see p. 24).

SAFETY PRECAUTIONS

For a safer paint job—

- Never paint in a completely closed room, nor in a room where there is an open flame or fire. Solvent paints give off fumes that can be flammable, and also dangerous to breathe. Good cross ventilation not only helps to remove fumes and odors, but can shorten paint drying time.

- *Some fumes can be especially harmful to infants, children, canaries, and other delicate pets. Avoid sleeping in a freshly painted room until the fumes subside.*

- Use a sturdy stepladder or other support when painting high places. Make sure the ladder is not defective. Check the rungs and side rails carefully. Check any ropes and pulleys also to make sure they are securely fastened and work properly.

- Be sure the ladder is positioned firmly, both on the ground and against the wall. Set the foot of the ladder away from the wall one-fourth of the distance of the height to be climbed. If you use scaffolding, make sure it is secure.

- Always face a ladder when climbing up or down. Hold on with both hands. Carry tools and supplies in your pocket or haul them up with a line.

- Be sure the paint bucket, tools, and other objects are secure when you are on a ladder or scaffolding. Falling objects can injure persons walking below.

- Lean toward the ladder when working. Keep one hand free—ready to grab the ladder just in case. *Do not overreach when painting.* A good rule is not to let your belt buckle extend beyond the side rails.

- Move the ladder frequently rather than risk a fall. Take a few sec-

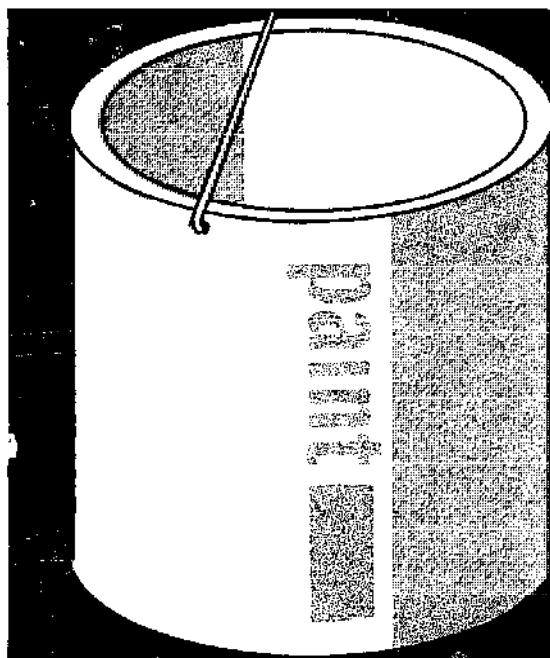

BN-33620

A wire across the top of the paint can or paint bucket is convenient for holding the brush.

onds to remove the paint from the ladder before you move it.

- *Avoid any electrical wiring within the area of work. This is especially important if you are using a metal ladder.*

- When you finish painting, dispose of used rags by putting them in a covered metal can. If left lying around, the oily rags could catch fire by spontaneous combustion.

- Store paint in a safe, well-ventilated place where children and pets cannot get to it—well away from furnaces or other sources of ignition that might cause an explosion. It is better not to store in the house. Some paints cannot withstand freezing. Unless needed for retouching, small quantities of paint may not be worth saving.

HOW TO PAINT

Interior

Preferably, remove all furnishings from a room to be painted. Otherwise, cover the furniture, fixtures, and floor with drop clothes or newspapers. No matter how careful you are, there will always be some spill, drip, or splatter of paint.

If you do not wish to paint light-switch and wall-plug plates, remove them before painting. Guard against shock. Otherwise they can be painted along with the rest of the wall.

Stir or shake paint thoroughly before starting to paint. Stir it frequently while painting.

If using a gallon of paint, transfer it to a larger container or pour about half into another container. There will be less chance of spillage or drip.

Dip your brush about one-third the length of the bristles. A wire stretched across the top of the can is useful in removing excess paint from the brush, or use the inside of the can for this purpose. Do not scrape the brush across the rim of the can.

Wipe up spilled, splattered, or dripped paint as you go along. Usu-

ally paint splatter or spillage is easier to clean up when wet.

When using latex paint, wash your brush or roller occasionally with water. A buildup of the quick-drying paint in the nap of the roller or at the base of the bristles of the brush can cause excessive dripping.

Do not let the paint dry out in the can or in brushes or rollers between jobs or during long interruptions in a job. During long interruptions in a job, replace the can lid, and either clean brushes or rollers, or suspend them in water.

Paint a room's ceiling first. Don't try to paint too wide a strip at a time. The next strip should be started and lapped into the previous one before the previous one dries. Paint strips across the narrow width of the room. "Cut in" at the junction with the walls before painting the walls, even when applying two coats on the ceiling.

Start painting a wall at the upper left corner and work down toward the floor. If left-handed, start at upper right corner. See illustration on page 16.

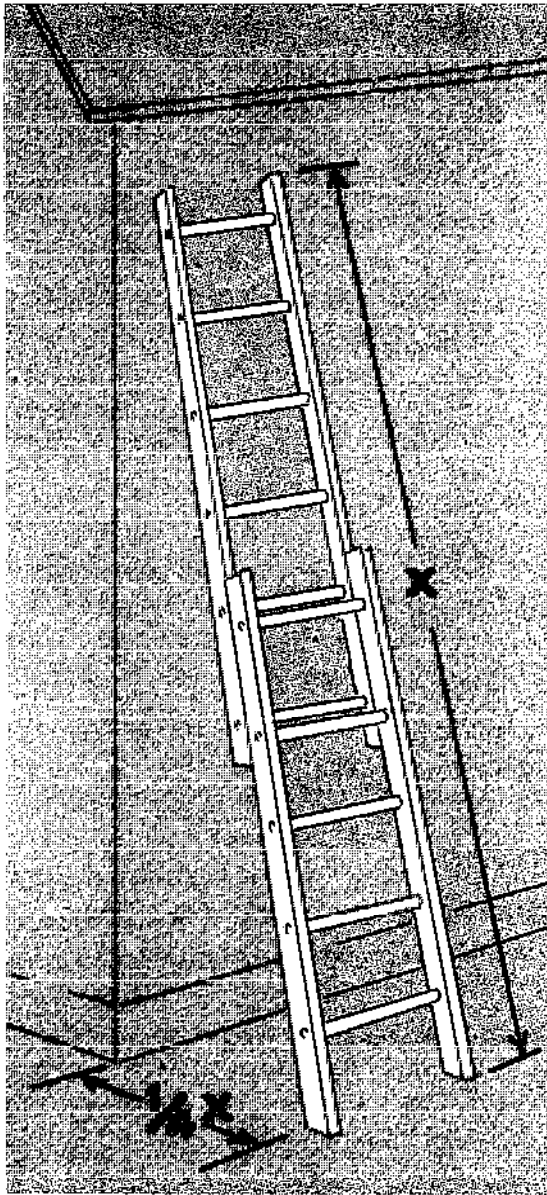

Set the ladder at a safe angle when you paint.

You may want to refinish your wood floors to complement your paint job. This should be done before you paint.

Complete renewal of the floors requires complete removal of the old finish. This can be done by sanding or with paint and varnish remover. Sanding is probably the fastest and easiest method. Electric sanders can be rented. Be sure to sand with the grain of the wood until you have a clean, smooth surface.

To retain the natural color, hardwood floors should be refinished with varnish, penetrating sealer, or shellac. To change the color, stain may be applied—preferably on the raw wood. Oil stains are the easiest to work with.

One or more coats of wax will help protect your new floors.

Paint dealers generally have instruction pamphlets on re-doing floors.

Concrete floors can be painted, but it is important to use an enamel that has good alkali resistance. There are good rubber-based, epoxy, and urethane types available. Also available and recommended are latex paints made especially for concrete floors.

Clean dirt and grease from concrete floors before you paint them. Trisodium phosphate is a good cleaner to use.

Slick concrete floors should be roughened slightly before they are painted. To roughen or etch the floor, treat it with a solution of 1 gallon of muriatic acid mixed with 2 gallons of water. After treating, rinse the floor thoroughly and allow it to dry completely before painting. *Protect yourself and other surfaces from direct contact with the acid.*

Exterior

On the exterior start painting at a high point of the house—at a corner or under the eave. Paint from top to bottom. Complete one wall before starting another.

Apply paint to an unpainted area and work into the wet edge of the previously painted portion. Use long, sweeping arm strokes, keeping an even pressure on the brush or roller. Apply both sides of each brushfull.

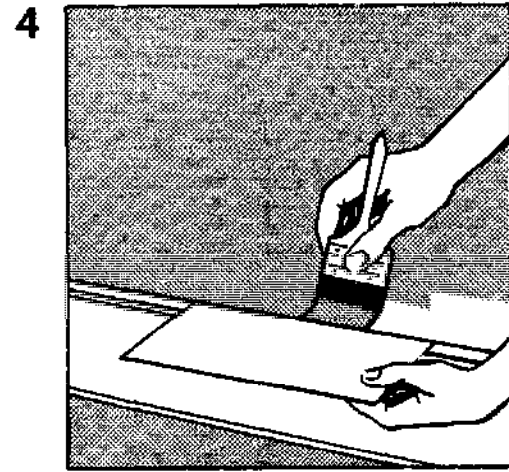
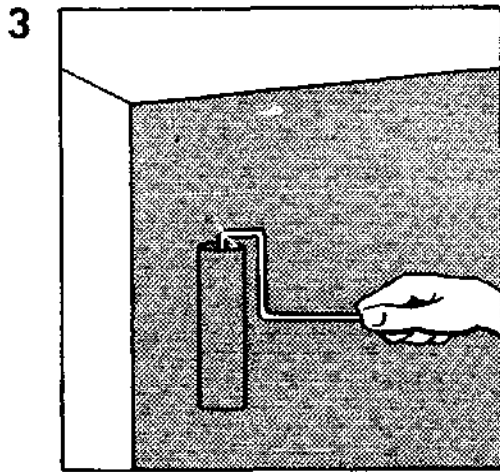
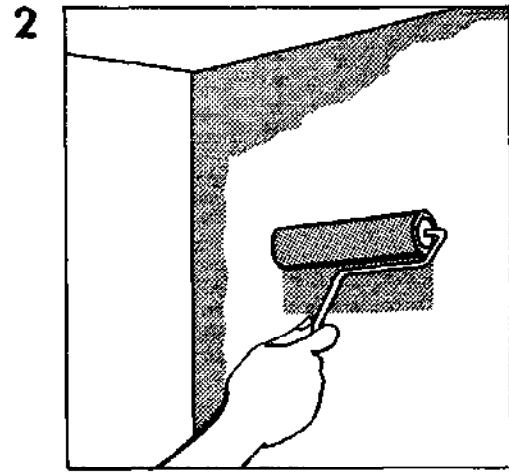
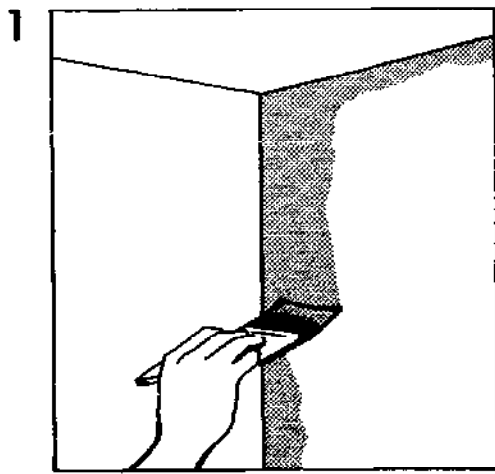

Painting walls with a roller: (1) Starting at the upper left-hand corner, brush a strip just below the ceiling line for a width of 2 feet. Also paint a strip along the left edge from the ceiling to the floor. (2) Starting in an unpainted area, roll upward toward the painted area. (3) Complete an area about 2 feet wide and 3 feet deep at a time. (4) At the bottom of the wall, "cut in" with the brush where you couldn't reach with the roller. Use a cardboard guard to protect the woodwork.

End each stroke with a light, lifting motion. Paint along the grain of wood. When you finish an area, go over it with light, quick strokes to smooth any minor marks and to recoat any unnoticed thin spots.

On windows, paint the wood dividing the glass first. Then paint the frame, trim, sill, and apron. Follow the order shown in the drawing on page 17.

Shutters and storm sash are easier to paint if removed from the house and laid flat on supports. Clean off

dust and dirt before painting them. Shrubbery might need to be covered with drop cloths.

Some people prefer to paint the windows after the walls have been completed. Some people prefer the opposite. In any event, be sure whichever is painted first is completely dry before painting the other.

Windows are easier to paint and to clean afterward if the glass is masked.

One simple way to protect the glass is to cover it with a piece of wet newspaper. The moisture will paste it

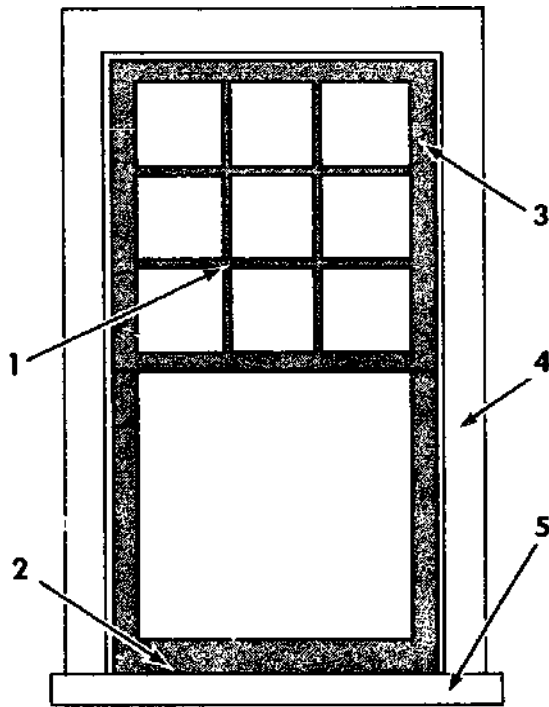

Paint windows in this order: (1) Mullions, (2) horizontal of sash, (3) verticals of sash, (4) verticals of frame, (5) horizontal frame and sill.

to the glass and also prevent paint from soaking into the absorbent paper. When you strip the paper from the glass after painting, the paint will come with it. Another method is to wipe a light layer of petroleum jelly such as Vaseline around the edges of the glass with your finger. After the paint has dried, the jelly and paint can be cleaned away with any ordinary glass cleaning compounds or formulations.

Both masking tape and liquid masking are available at hardware and paint stores. Masking tape is applied around all edges of the glass, bordering all wood areas to be painted. When the paint is dry to the touch, remove the masking tape. Waiting too long may result in dried paint cracking upon removal of the tape, causing damage to the new paint job.

If so desired, no masking need be applied. However, paint smeared on the glass may be removed with a single-edged razor blade or other suitable scraper. After the paint is set but before it hardens, cut through the paint where the glass meets the wood. Then, starting at one corner, carefully scrape up a section of the paint, and slowly lift it off the glass. If this strip of paint breaks, again carefully peel up a section large enough to grasp with your fingers, and continue to carefully lift it away from the glass. Other drips or splatters of paint inadvertently applied to the glass may be easily scraped off at the same time.

As noted earlier, flush doors can be painted with a roller. On paneled doors, some parts can be painted with a roller, others will require a brush. If you prefer your doors and other trim in natural color, see below.

USING NATURAL FINISHES AND STAINS

Interior

Some doors, particularly flush doors, and other inside woodwork can be quite attractive with the natural wood grain exposed. However, they will discolor and soil easily unless protected. For such protection,

many kinds of products are now on the market and new ones often appear. Your paint dealer should be able to offer suggestions on how to finish inside woodwork.

The first step is to be assured of the proper color tone. To help you make

a decision, you can experiment on scrap pieces of wood—preferably the same kind of wood.

The next step is sealing. One coat of shellac is usually adequate. When the shellac is dry, the surface should be sanded smooth, wiped free of dust, and varnished. Rubbing the surface with linseed oil, as is done in furniture finishing, provides a nice soft finish, but requires more work. Linseed oil finishes also tend to collect dust more readily.

Penetrating sealers are useful. Sometimes no staining is required—the clear finish alone is enough to bring out the desired color tone. This finish is useful for doors, paneling, framing, or furniture.

For a natural finish on interior trim, you need to specify the desired kind and grade of wood at time of construction but this can add substantially to construction costs.

Exterior

Natural finishes come as surface-coating finishes and as penetrating finishes. An exterior varnish is not very durable. It may have to be refinished every 1 or 2 years.

Penetrating stains do not fail by peeling. The U.S. Forest Service developed "Forest Products Laboratory (FPL) Natural Finish" is one of the more durable types. It has a linseed oil vehicle and contains ingredients to protect against mildew and excessive water entry at siding joints. It also contains enough durable pigment to provide color, but not

Repaint Only When Necessary

Too frequent repainting with an oil-base paint builds up an excessively thick film that is more sensitive to the deteriorating effects of the weather. Ordinarily, every 4 years will be often enough to repaint a house.

Sheltered areas, such as eaves and porch ceilings, may not need painting every time the body of the house is painted; every other time may be sufficient.

enough to hide the grain of the wood. One initial brush application should last about 3 years on a smooth surface, but 2 coats applied to a rough surface will last about 10 years. Penetrating stains are especially recommended as a finish for exterior plywood.

Good penetrating stains are inexpensive, more durable than clear coatings, and are easily maintained. Stains penetrate and color the wood. Common colors are dark brown, green, red, and yellow; however, almost any color or shade is possible except white. The most natural of all exterior finishes are the water-repellent preservatives or penta solutions. These prevent greying of wood by mildew and permit the wood to weather to a light brown color. They do need to be refurbished, however, about every 2 years. Pigmented stains or paints can be applied over the preservative type finishes at any time.

WHITEWASHING

General

Whitewashing is a relatively simple and inexpensive way to brighten the interior of livestock and other service buildings. The whitewash may be applied with either a brush or a spray gun.

Surface Preparation

Remove all dirt, scale, and loose material by scraping or brushing with a wire brush. Many whitewashing jobs have been quite satisfactory without further surface preparation. However, for the best job, wash off as much of the old coat of whitewash as possible with hot water and vinegar or *weak* hydrochloric acid solution.

Dampen the walls before applying whitewash. Unlike most paints, the application and adherence of whitewash are improved when the surface is slightly damp.

Mixing

Lime paste is the basis of whitewash. *Protect your eyes and skin during mixing.* It may be prepared by either:

(a) Soaking 50 pounds of hydrated lime in 6 gallons of water. Refined limes such as chemical hydrate, agricultural spray hydrate, finishing lime, and pressure hydrated lime, have fewer lumps and will make a smoother paste.

(b) Slaking 25 pounds of quicklime in 10 gallons of boiling water. Cover and allow to slake at least 4 days.

Each of these preparations makes about 8 gallons of paste.

Different whitewash mixes are suggested for different surfaces. Smaller batches of whitewash may be prepared by reducing the ingredients by an equal proportion in the formulas given below.

For general woodwork

Dissolve 15 pounds of salt in 5 gallons of water. Add this solution to the 8 gallons of paste, stirring constantly. Thin the preparation to the desired consistency with fresh water.

To reduce chalking, use 5 pounds of dry calcium chloride instead of the salt.

For brick, concrete, or stone

Add 25 pounds of white Portland cement and 25 pounds of hydrated lime to 8 gallons of water. Mix thoroughly to a thick slurry. Thin to the consistency of thick cream. Mix only enough for a few hours use.

To reduce chalking, add 1 to 2 pounds of dry calcium chloride dissolved in a small amount of water to the mix just before using.

For plaster walls

Either of three formulas are recommended:

(a) Soak 5 pounds of casein in 2 gallons of water until thoroughly softened—about 2 hours. Dissolve 3 pounds of trisodium phosphate in 1 gallon of water, add this solution to the lime, and allow the mixture to dissolve. When the lime paste and the casein are thoroughly cool, slowly add the casein solution to the lime, stirring constantly.

Just before use, dissolve 3 pints of formaldehyde in 3 gallons of water, and add this solution to the white-

wash batch, stirring constantly and vigorously. *Do not add the formaldehyde too rapidly.* If the solution is added too fast, the casein may form a jelly-like mass, thus spoiling the batch.

(b) Dissolve 3 pounds of animal glue in 2 gallons of water. Add this solution to the lime paste, stirring constantly. Thin the mixture to the desired consistency.

The first formula, or mix, given for use on plaster walls, above, is a time-tested, long-life mix also suitable for general use. The following is also:

Dissolve 6 pounds of salt in 3 gallons of boiling water. Allow the solution to cool, and then add it to the lime paste. Stir 3 pounds of white Portland cement into the mix.

Coloring

Pigments may be added to whitewash to provide color. The following have proven satisfactory:

Black: Magnetic black oxide of iron
Blue: Ultramarine or cobalt blue
Brown: Pure precipitated brown oxide of iron or mixtures of black oxide or iron with turkey or Indian red
Green: Chromium oxide, opaque, or chromium oxide, hydrated
Red: Indian red made from pure ferric oxide
Violet: Cobalt violet and mixtures of reds, white, and blues
White: Lime itself
Yellow: Precipitated hydrated iron oxides.

Application

Some surfaces may require two coats of whitewash. Two coats are better than one coat that is too thick.

Strain the mix through three layers of cheesecloth before using a spray gun.

CLEANUP

After each job, replace the can lid, making sure that it is on tight. Brushes, rollers, and other equipment should be cleaned as soon as possible after use.

Equipment used to apply oil-base paint may be a little harder to clean. Soak brushes in turpentine or thinner long enough to loosen the paint.

Then work the bristles against the bottom of the container to release the paint. To release the paint in the center of the brush, squeeze or work the bristles between the thumb and forefinger. Rinse the brush in the turpentine or thinner again, and, if necessary, wash it in mild soapsuds. Rinse in clear water.

PAINT FAILURES

Some paint failures can be avoided by simply following the directions on the paint can label. In fact, some of the new paints are guaranteed against

specific failures if applied according to directions. The following are some of the more common paint failures.

Blistering and Peeling

Excessive wetting of the paint from behind or from the front will cause blistering, peeling, and discoloration problems. Water from rain, melted snow behind ice dams, or condensed water vapor may be getting in behind the paint.

Prevention and correction

Correct possible problems before painting. Some searching may be required to detect the source. Check for leaks in roofs and sidewalls. Is the cause related to a damp basement? Are insulation, vapor barriers, and ventilation adequate? Make sure moisture from such appliances as a clothes drier is vented to the outside. Check for leaky plumbing.

Remove all loose paint. Apply a water-repellent preservative to joints that show damage; allow them to dry 2 days, or as directed on the container label. Prime bare surfaces and repaint. Use blister-resistant paint.

Cross-Grain Cracking

Cross-grain cracking may be caused by too-frequent repainting with oil-base paint. The thick paint coating built up by many paintings becomes too hard to stand the constant expansion and contraction of the wood and eventually cracks.

Prevention and correction

Repaint only when necessary.

Remove all of the paint, down to the bare wood. Prime the bare wood properly and repaint.

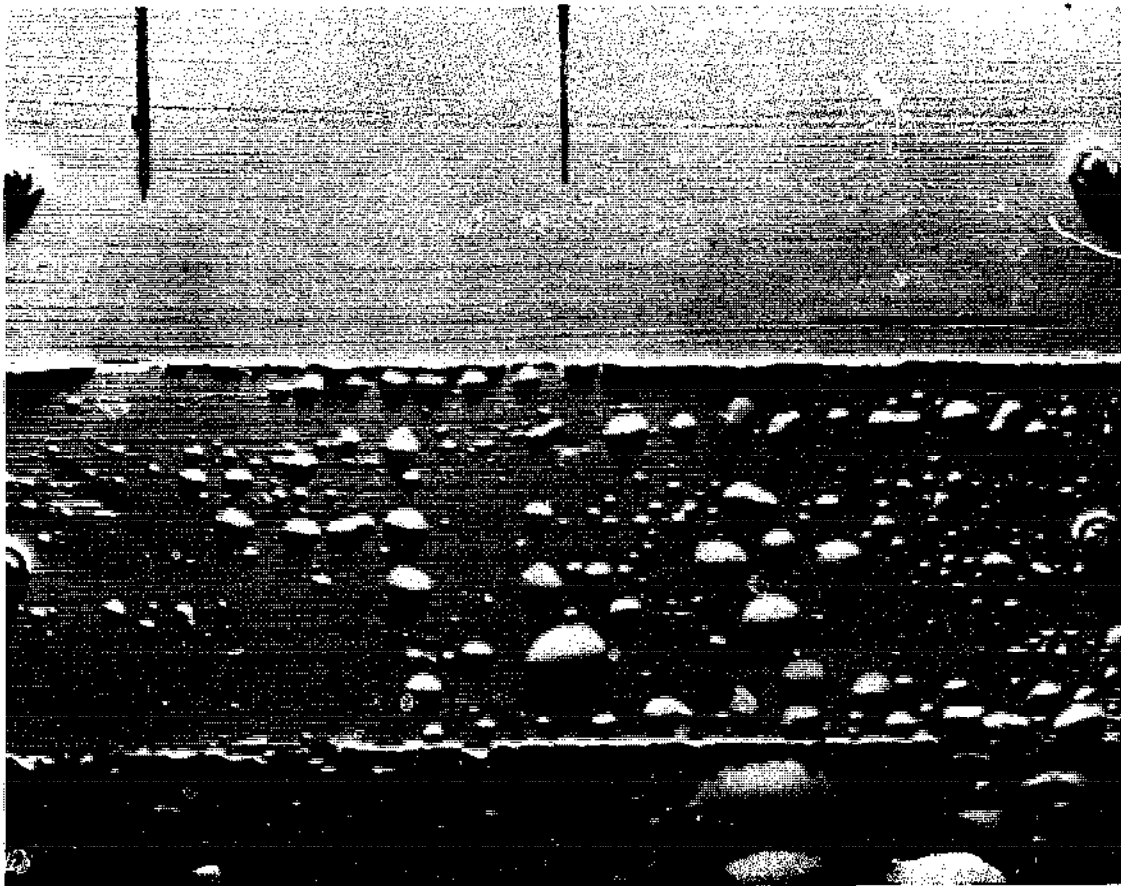

Blistering paint.

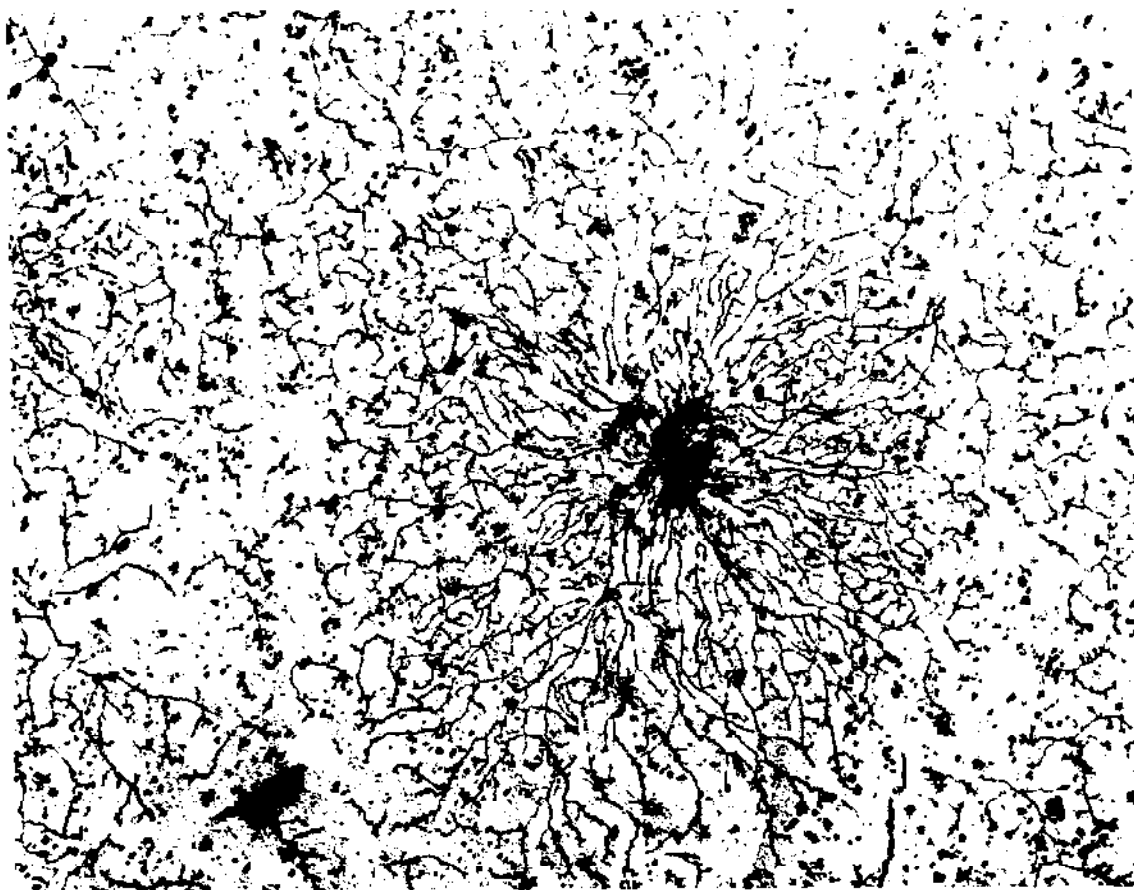

BN-33619

Mildew.

Mildew

Mildew may occur where continuous warm and damp conditions prevail.

Prevention and correction

If possible, correct moisture condition that promotes mildew. Use mildew-resistant paint or add a mildew resistant compound to the paint.

Thoroughly remove all signs of mildew before repainting. To remove mildew, mix one quart household bleach and three quarts warm water. Scrub the mildewed surface thoroughly with this solution. Next, give the surface a thorough rinsing with fresh water. Be sure to wash your hands and arms well when you are through.

WARNING

Caution against mixing ammonia with bleach. Mixed together, the two are a lethal combination, similar to mustard gas. There have been several instances of people dying from breathing the fumes from such a mixture. Many household cleaners contain ammonia, so consumers must be extremely careful in what types of cleaners with which they mix bleach. **AVOID MIXING BLEACH WITH AMMONIA OR ANY DETERGENTS OR CLEANSERS CONTAINING AMMONIA!** Such a combination can be lethal if the fumes are breathed.

The household bleach solution will kill the mildew growth and remove it. Usually, dirt will be removed by this treatment also. If dirt remains on the surface, wash with a detergent recommended for cleaning painted surfaces. Rinse the area well with clear water and allow it to dry thoroughly before paint application.

Wear rubber gloves when applying bleach solution, and protect plants. People with a known allergy to bleach or especially sensitive skin should avoid all skin contact with this solution

Intercoat Peeling

Intercoat peeling is usually caused by lack of adhesion between the top and under coats. The primer and top coats of oil-base paint are incompatible because of too long a delay between coats or the surface was too smooth, hard, glossy, or oily. Latex paint will separate from old paint surfaces which are excessively chalky because latex paint systems will not penetrate well.

Prevention and correction

To provide for good wetting and adhesion, apply primer and top coats within 2 days to 2 weeks of each other. Remove gloss with a strong detergent, steel wool, or fine sandpaper. Remove oil or grease with mineral spirits or a household cleaner that contains ammonia.

Remove chalk materials before painting with latex and test for adhesion of paint by seeing how well existing paint resists being pulled off by tape such as is used for mending torn paper. Remove all loose paint, sand the edges, properly prime the bare surfaces, and repaint.

Excessive Chalking

Chalking or other characteristics that might cause discoloration of adjacent surfaces should be considered when choosing paint. Chalking may occur where poor quality paint was used, the paint was improperly applied, or the paint was thinned excessively.



Chalking.

BN-33617

If You Have the Painting Done

You may prefer to have all or part of your painting done by a professional painter. Painting contractors usually offer three grades of paint jobs: premium, standard, and minimum. The difference is in the quality and cost of the work. When you hire a contractor, it is a good idea to get a signed agreement specifying:

- The specific price for the job.
- Exactly what areas or surfaces are to be painted.
- The types, brands, and quality of paints to be used and the number of

coats, including primer coats, to be applied.

- The measures to be taken to protect the floors, furnishings, and other parts of the house.

- A complete cleanup guarantee.

- A completion date (allowing for possible delays—because of bad weather for example).

Check the contractor's work with friends or neighbors who may have hired him in the past. Be sure that he is adequately insured as required by pertinent local regulations; otherwise, you could be held liable for accidents that might occur on your property.

Prevention and correction

Use non-chalking paint.

Remove the chalky materials by brushing the surface or washing it

with mineral spirits or a good household cleanser. Apply two coats of good quality paint. Allow 3 days drying time between coats.

RELATED PUBLICATIONS

The following related publications are available as indicated below. Please be sure to include your full name, address, and ZIP Code when ordering any publications.

For sale only, and may be obtained by writing directly to the Superintendent of Documents, U.S. Government Printing Office, Washington, D.C. 20402:

Wood Decay in Houses: How to Prevent and Control It. USDA Home and Garden Bulletin No. 73, 1969.

A limited number of single free copies of the following publication may be obtained by writing directly to the Office of Governmental and Public Affairs, U.S. Department of Agriculture, Washington, D. C. 20250:

Wood Siding: Installing, Finishing, Maintaining. USDA Home & Garden Bulletin No. 203, 1973.

Single free copies of the following publications may be obtained by

writing directly to the U.S. Forest Products Laboratory, U.S. Forest Service, U.S. Department of Agriculture, P. O. Box 5130, Madison, Wisconsin 53705:

Forest Products Laboratory Natural Finish, Note FPL-046, 1975.

Inorganic Surface Treatments of Weather-Resistant Natural Finishes, Research Paper FPL-232, 1974.
Water-Repellent Preservatives, Note FPL-0124, 1975.

Weathering of Wood, Note FPL-0135, 1966.

USDA policy does not permit discrimination because of race, color, national origin, sex, or religion. Any person who believes he or she has been discriminated against in any USDA-related activity should write immediately to the Secretary of Agriculture, Washington, D.C. 20250.

U. S. DEPARTMENT OF AGRICULTURE
AGRICULTURAL RESEARCH SERVICE
HYATTSVILLE, MARYLAND 20782

OFFICIAL BUSINESS
PENALTY FOR PRIVATE USE, \$300

POSTAGE AND FEES PAID
U. S. DEPARTMENT OF
AGRICULTURE
AGR 101



Department publications contain public information. They are not copyrighted and may be reproduced in whole or in part with or without credit.