

**AT** MICROFICHE  
REFERENCE  
LIBRARY

A project of Volunteers in Asia

Solar Dwelling Design Concepts

by: The American Institute of Architects Research  
Corporation

Published by:

The United States Department of Housing and  
Urban Development  
Office of Policy Development and Research  
Washington, DC 20410 USA

Paper copies are \$ 2.30. Ask for stock number  
023-000-00334-1 when ordering.

Available from:

US Government Printing Office  
Washington, DC 20402 USA

Reproduction of this microfiche document in any  
form is subject to the same restrictions as those  
of the original document.

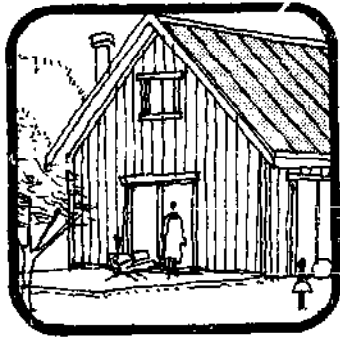

# Solar Dwelling Design Concepts

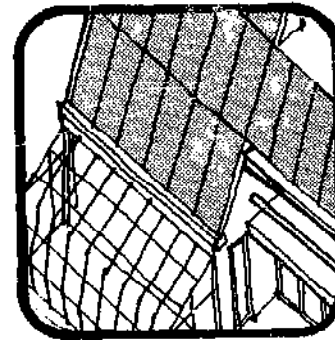
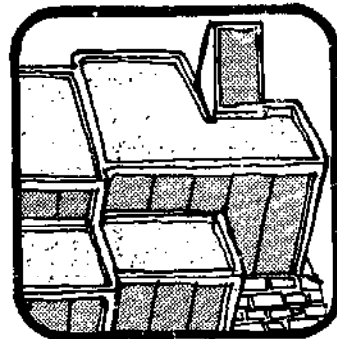
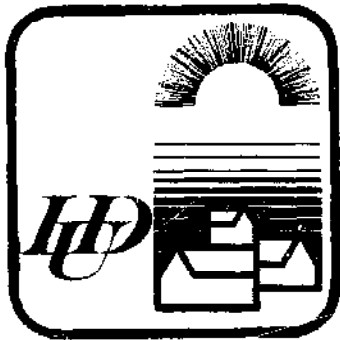
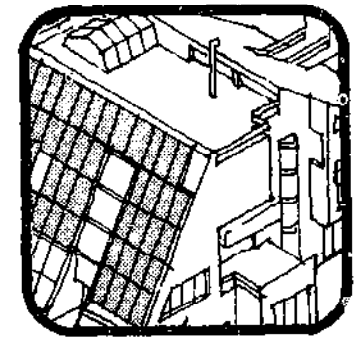
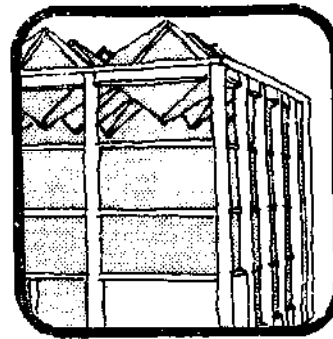
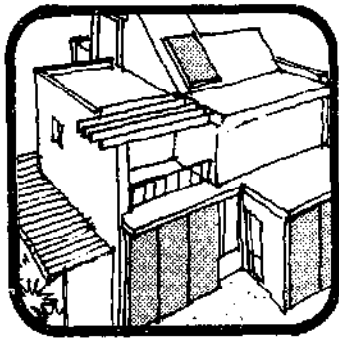

U. S. Department of Housing and Urban Development

Office of Policy Development and Research

# **Solar Dwelling Design Concepts**

MAY 1976

by  
The AIA Research Corporation  
Washington, DC

for  
The US Department of Housing and Urban Development  
Office of Policy Development and Research

Contract IAA H-5574

The research and studies forming the basis of this report were conducted by The AIA Research Corporation pursuant to a contract with The National Bureau of Standards' Center for Building Technology, Institute for Applied Technology, in support of The Department of Housing and Urban Development Office of Policy Development and Research. The statements and conclusions contained herein are those of the contractor and do not necessarily reflect the views of The National Bureau of Standards or The Department of Housing and Urban Development.

---

## FOREWORD

Solar energy has captured the imagination of the American people. It has done so for two good reasons. First, the rising cost and uncertain availability of conventional fuels has made the use of solar energy for space heating, cooling and domestic water heating an increasingly attractive alternative; and second, the environmental problems associated with most conventional fuels are not present with solar energy.

The Department of Housing and Urban Development (HUD) in cooperation with the Energy Research and Development Administration (ERDA) and other federal agencies has undertaken an extensive program to demonstrate the economic and technical feasibility of solar heating and cooling. In response to the Solar Heating and Cooling Demonstration Act of 1974 and other federal legislation, HUD, ERDA and other designated agencies will manage a large scale research, development and demonstration effort to remove the barriers, both technical and institutional, to the widespread application of solar heating and cooling systems.

One important component to the successful accomplishment of these objectives is the timely distribution of information. Therefore, as a first step to an increased awareness and understanding of solar heating and cooling and its application to dwelling design, HUD is making available this publication.

It is a general resource document intended for use by designers, home builders, community leaders, local officials and home owners who are interested in the application of solar heating and cooling to

residential structures or are considering participating in the federal solar energy program.

The publication provides historical background information, a concise report on existing solar dwellings and systems, a list of design considerations and numerous dwelling and site design concepts. It is not the intent of this publication to present housing designs ready to build but to identify a basis for future solar design by professionals.

We encourage all interested parties to participate in the development and application of solar energy. We hope this publication assists in that effort.

Charles J. Orlebeke  
Assistant Secretary for Policy Development and  
Research  
Department of Housing and Urban Development

## PREFACE

This publication is about solar energy and how its use for heating and cooling will effect dwelling design and site planning. It has been prepared as a brief introduction for consumers, designers and builders interested in solar heating and cooling.

Beginning with a brief history of solar energy applications, a more thorough description of solar energy components and how they are organized into heating, cooling and domestic hot water systems follows. Next, factors which influence the design of solar dwellings and systems are discussed. The remaining portion of the publication illustrates dwelling and site design concepts responsive to these factors for various housing types, solar systems, and climates.

The document was prepared for The Department of Housing and Urban Development's Office of Policy Development and Research by The AIA Research Corporation under contract with The National Bureau of Standard's Office of Housing and Building Technology. Assistance was received from ten sub-contractors — eight architectural firms and two schools of architecture — who prepared the bulk of the research information and design concepts included in this publication. The architectural firms were: The Continuum Team, Bridgeport, Connecticut; Donald Watson, AIA, Guilford, Connecticut; Giffels Associates, Detroit, Michigan; Joint Venture, Boulder, Colorado; Massdesign, Cambridge, Massachusetts; RTL, Inc., Paramount, California; The Architects Taos, Taos, New Mexico; and Total Environmental Action, Harrisville, New Hampshire. The

two schools were The School of Architecture and Environmental Studies of the University of Detroit, and the College of Architecture of Arizona State University. Their efforts have added much to the advancement of solar dwelling design.

Charles McClenon and Gary Robinette of the American Society of Landscape Architects Foundation with the assistance of six consultants are responsible for preparation of research information regarding site planning and solar energy utilization. The consultants were Sasaki Associates, Watertown, Massachusetts; Rahenkamp Sachs Wells and Associates, Philadelphia, Pennsylvania; Sasaki, Walker Associates, Inc., Sausalito, California; Johnson, Johnson and Roy Associates, Ann Arbor, Michigan; Land/ Design Research, Columbia, Maryland; and Edward D. Stone, Jr. Associates, Ft. Lauderdale, Florida.

Numerous individuals, organizations, and federal agencies have contributed to the completion of this research undertaking. We would especially like to thank Charles A. Gueli, Project Director, and Director, Community Design Research Program, HUD; Joseph Sherman and David Moore, Division of Energy, Building Technology and Standards, HUD; and Thomas Faison and Robert Dikkers, Office of Housing and Building Technology, NBS.

The AIA Research Corporation staff responsible for coordinating the research and organizing the final publication are: Michael Holtz, Project Manager and Author, Lucy Leuchtenburg, Research Assistant; and Jo Ann Masterson, manuscript typist. Massdesign Architects and Planners, Inc., under sub-contract to the

AIA Research Corporation, is responsible for Chapter 5 design concepts, graphics and production of this publication. Peter Clemons, graphic designer

John P. Eberhard, President  
The AIA Research Corporation

## TABLE OF CONTENTS

PAGE		PAGE		PAGE	
3	<b>FOREWORD</b>	39	<b>CHAPTER THREE</b>	97	<b>CHAPTER SIX</b>
4	<b>PREFACE AND ACKNOWLEDGEMENTS</b>		<b>SOLAR DWELLING DESIGN:</b>		<b>SOLAR DWELLING DESIGN</b>
			<b>INFLUENCING FACTORS</b>		<b>CONCEPTS</b>
6	<b>INTRODUCTION</b>	39	Solar Design Factors	141	<b>CHAPTER SEVEN</b>
9	<b>CHAPTER ONE</b>	40	Climate: The Given Conditions		<b>SOLAR DWELLING DESIGN:</b>
	<b>THE EMERGING AGE OF</b>	42	Climate and Solar Dwelling Design	144	<b>A SUNNY FUTURE?</b>
	<b>SOLAR ENERGY</b>	48	Comfort: The Desirable Conditions	144	<b>REFERENCES</b>
9	Solar Energy: An Old Idea Reborn	53	Buildings: The Controlling Variable	144	<b>PHOTOGRAPH CREDITS</b>
11	Solar Heating and Cooling: A Historical Perspective	56	Architectural Design Implications of Solar Systems	146	<b>BIBLIOGRAPHY</b>
17	<b>CHAPTER TWO</b>	64	<b>CHAPTER FOUR</b>		<b>CREDITS</b>
	<b>SOLAR HEATING/COOLING</b>		<b>SITE PLANNING FOR</b>		
	<b>AND DOMESTIC HOT</b>		<b>SOLAR ENERGY</b>		
	<b>WATER SYSTEMS</b>		<b>UTILIZATION</b>		
17	Solar System Components	64	The Site Planning Process		
20	Solar Collectors	73	Integration of the Buildings and Site		
27	Solar Heat Storage	81	<b>CHAPTER FIVE</b>		
30	Thermal Energy Distribution		<b>IMPACT OF SOLAR ENERGY</b>		
31	Collector-Storage-Distribution Component Interface		<b>UTILIZATION ON</b>		
			<b>TRADITIONAL DWELLING</b>		
			<b>DESIGN</b>		

## INTRODUCTION

The United States presently faces two interrelated problems. One, we are endangering our environment by polluting the atmosphere, ground, and water with the by-products of our technological society. Two, we are quickly running out of the fuels which have enabled us to achieve a high standard of technological development. This perplexing dilemma has resulted in a nationwide investigation of energy choices.

Among the many energy alternatives being considered is solar energy. Harnessing the sun's power is considered an attractive alternative because it is a renewable resource which does not pollute. In contrast to conventional fuels, its use eliminates the need for refining, transporting, and conveying fuel and power over long distances. The use of solar energy for heating and cooling promises a more rapid payoff than other energy alternatives because the basic technology already exists and needs only minor refinements. Considerable research, development, and demonstration activities have been initiated in the public and private sectors to facilitate the widespread utilization of solar energy.

Everyday the sun showers the earth with several thousand times as much energy as we consume. The solar energy reaching the earth every three days is greater than the estimated total of all the fossil fuels on earth. In fact, the solar energy annually striking the roof of a typical residence is ten times as great as its annual heat demand.

However, these figures assume a capture and utilization efficiency of 100 percent, while our

present technology allows us to capture and efficiently use only a small percentage of the sun's energy. Nevertheless, the energy potential of the sun is great enough to warrant serious consideration and continuous development of ways to harness this energy for man's use.

Why are we not making use of this tremendous source of energy provided by the sun? The answer, of course, is that we are using it and have been for quite some time. However, instead of directly using the sun's power, we have been using stored or indirect solar energy in the form of fossil fuels which were created by the sun and trapped in the earth ages ago and only recently reclaimed by drilling and mining.

Because of industrial development dependent on fossil fuels, the costs associated with using stored solar energy became significantly less expensive than developing means to collect and utilize energy received directly from the sun. However, as world fossil fuel demand increases and conventional fuel supplies decrease, the direct use of the sun's energy has emerged as a powerful alternative to man's increasing energy and environmental problems.

Although solar energy is available and free, the capture and utilization of it is not. There are some very difficult technical, social and economic problems which must be resolved in order to change the existing patterns of energy conversion and consumption. To deal with these problems, the Congress, in late 1974, enacted four laws which established a National Solar Energy Program. Overall ad-



ministration of the program rests with the Energy Research and Development Administration (ERDA). ERDA and HUD have joint responsibility for the residential demonstration part of the program which is designed to investigate the practical application of solar energy for heating and cooling of dwellings.

The major elements of the National Solar Energy Program are: demonstrations of solar technology in both commercial and residential buildings initially utilizing available systems; development of solar technology to support such demonstrations, initially using available sub-systems and components; research and development of advanced heating and cooling technology; and dissemination of information on the results of the above efforts.

As part of the National program, the residential demonstration program will:

- install solar systems in both new and existing dwellings;
- develop performance criteria and certification procedures for solar heating and cooling equipment;
- undertake market development efforts to encourage the rapid and widespread acceptance of solar heating and cooling technologies by the housing industry; and
- disseminate solar heating and cooling information.

Through these activities the major barriers to the use of solar heating and cooling will be identified and programs and incentives to alleviate these barriers proposed. There is, however, another stumbling block effecting the use of solar energy — one that this publication hopes to remove — concerning the strong suggestion of magic or trickery inherent with the idea that energy can be simply pulled out of thin air and sunbeams. A primary purpose of this publication is to remove the mystery associated with using the sun's energy to heat and cool our homes and heat our water.

The understanding of solar heating and cooling begins with an appreciation of the historical process by which solar energy utilization has evolved. The early uses of solar energy to power mechanical devices and to heat dwellings provide the background from which the development of current efforts to harness solar energy emerge.

The focus of this publication is how the interaction of climate, comfort, building sites, and solar systems influence the design of solar heated and cooled dwellings. The material is organized to illustrate and discuss these influences: first, as individual elements, and, second, as interrelated issues which affect design decisions. The emphasis of the publication is on new construction as opposed to the redesign of existing dwellings for solar heating and cooling systems. However, the major factors influencing new solar dwelling design are by and large the same as those affecting the redesign of existing dwellings for solar energy utilization. A major portion of the publication il-

lustrates a number of solar dwelling and site design concepts.

We hope that the ideas presented here will help to expand our knowledge of how solar energy works, how it can be adapted to our current architectural preferences, and how it may influence the shape of our homes in the future.

# 1

## THE EMERGING AGE OF SOLAR ENERGY

### SOLAR ENERGY: AN OLD IDEA REBORN

The idea of using solar energy to heat and cool our homes or to heat our water is not new. For centuries man has made use of the sun's energy. Without the sun's energy mankind cannot survive. All our food and fuel have been made possible by the sun through the photosynthetic combination of water and atmospheric carbon dioxide in growing plants. Fossil fuels represent energy photosynthesized and stored in dead plant and animal matter millions of years ago. The earth's climate is also dependent on solar energy. The winds, tides, rivers and ocean currents all rely on the daily heat of the sun for their motion. Man has long made use of these forms of solar energy. He has used the wind and water currents to move from place to place; and he has used the sun to grow his food and warm his shelter.

Early man knew of the advantages of finding a cave or placing wall openings in the direction of the sun's path to capture its warmth during winter days. He also discovered the unique ability of certain materials to retain the sun's warmth and release it later after the sun had set. Man's use of solar energy continued and, indeed, increased as he became part of a tool and craft society. Instruments which focused the sun's energy to produce fire or boil water became more sophisticated applications of his earlier experiences. Since these simple beginnings man has continually explored new avenues of harnessing solar energy for the service of mankind.

Man's earliest attempts to harness the sun's energy

include the fabled burning of the Roman fleet by Archimedes in 212 B.C. Archimedes reputedly set the attacking Roman fleet afire by means of "burning glass composed of small square mirrors moving every way upon hinges which when placed in the sun's direct rays directed them upon the Roman fleet so as to reduce it to ashes at the distance of a bowshot".\*



*Reconstruction of Archimedes' storied burning of an enemy fleet with a solar furnace.*

Whether or not Archimedes actually set fire to the sails of the attacking ships does little to dampen the fact that early in history solar devices were being designed and built. As the number and occurrence of these devices increased, man's mythical relationship with the sun changed. Early religious and cultural attitudes and beliefs towards the sun began to disappear and by 1600 A.D. the attention of science was focused beyond superstition and magic.

\* References are presented on page 144

The marvelous inventions of the Renaissance, an age of artistic and scientific revival in Europe lasting from the 14th Century A.D. to the 17th Century A.D., included many solar devices. One of the most original inventions of the period, however, was built by Salomon de Caus of France. He used the sun to heat air in his solar "engine" which in turn pumped water. Although a simple mechanical application of solar energy, it is remarkable in that more than two hundred years elapsed before the solar engine was reinvented.

The solar devices of the Renaissance were generally purposeless "gadgets" with little practical application, other than providing a means of acquiring knowledge about solar energy. However, this trend was reversed during the later part of the 18th Century. During this time solar furnaces capable of smelting iron, copper and other metals were being constructed of polished-iron, glass lenses and mirrors. The furnaces were in use throughout Europe and the Middle East. One furnace designed by the French scientist, Antoine Lavoisier, attained the remarkable temperature of 1750° C (3182° F). The furnace used a fifty-two inch lens plus a secondary eight inch lens to attain temperatures far exceeding those achieved by man up to that time and, as it turned out, to be achieved by man for the next one hundred years.

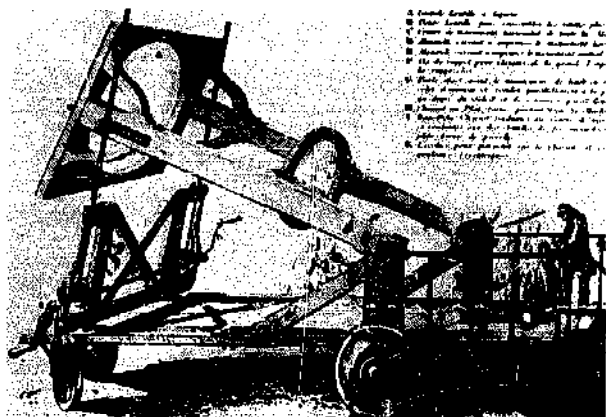

Lavoisier's solar furnace

Early in the 19th Century, numerous hot air engines were developed. The famous Stirling two-piston air engine, although not designed to be operated by the sun, was ideally suited for such use and later was adapted for solar power. A curious assortment of solar engines were built over the next hundred years, powering everything from printing presses and electric lights to distillation operations.

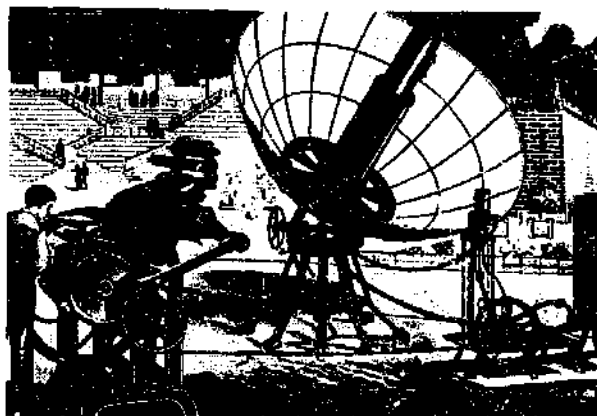

Solar powered printing press at Paris Worlds Fair 1889

One unique variation which occurred during the late 1800's and early 1900's was the use of "flat-plate" collectors to intercept the sun's rays and power equipment. Until this time most solar devices used what is called a "focusing" collector — one that focuses the sun's rays upon a single area where the energy is collected. The "flat-plate" type collector, however, does not focus the sun's rays to a single point but collects the solar energy over a uniform horizontal surface. Flat-plate collectors had the advantage of being less expensive and simpler to construct and operate than the focusing type collector. Also, whereas focusing collectors require clear skies for operation, flat-plate collectors could function under cloudy conditions. Several solar powered pumping facilities were constructed during the early 1900's in the United States which illustrate both forms of solar collection.

A. G. Eneas in 1901 installed a thirty-three foot diameter focusing collector which powered a water pumping apparatus at a Pasadena, California ostrich

farm. The device consisted of a large umbrella-like structure open and inverted at an angle to receive the full effect of the sun's rays on the 1,788 mirrors which lined the inside surface. The sun's rays were concentrated at a focal point where the boiler was located. Water within the boiler was heated to produce steam which in turn powered a conventional compound engine and centrifugal pump. During the next 50 years many variations of this process were designed and constructed using focusing collectors as the means of heating the transfer or working fluid which powered mechanical equipment.



The Pasadena sun-heat absorber of 1901

Frank Shuman, an inventive engineer, however, favored the more economical flat-plate collector. Using twelve hundred square feet of collector area, his test engine produced 3.5 horsepower. The flat-plate collector, constructed in 1907, was used to heat water which, in turn, boiled ether. The ether vapor was then used to drive a vertical steam engine which pumped water. Although Shuman's solar engine did not develop anything near the 100

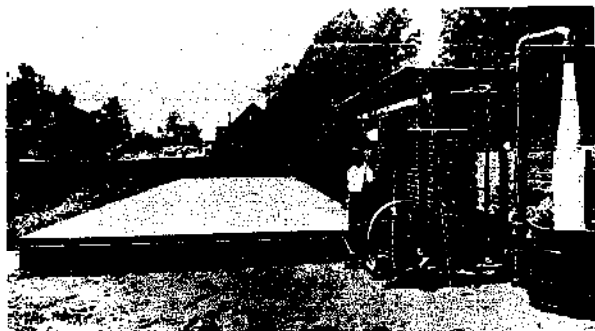

*Shuman's flat-plate collector and pumping operation*

horsepower predicted, in part due to the polluted air and cloudy conditions of Tacony, Pennsylvania, the process and technique of collecting and utilizing solar energy were significantly advanced.

Despite the increased sophistication and reliability of solar powered devices, none of these early applications of solar energy survived competition with the emerging use of cheaper fossil fuels. For although solar energy was free and readily available, the capital investment was so high for the necessary solar collectors and associated equipment that it cost much more to run a solar engine than a conventional type.

For hundreds of years man has attempted to harness the sun's energy. After slowly accumulating knowledge about the nature of the sun's energy and developing a simple technology to capture it, solar pioneers came up against the most frustrating of roadblocks — the apathy of their fellow man. However, the completely different energy and environmental situation which we now face has made solar energy an idea whose time has come and gone — and come again — this time to stay.

## **SOLAR HEATING AND COOLING: A HISTORICAL PERSPECTIVE**

Dwellings which have used the sun's energy to heat or cool have been constructed for thousands of years. Although perhaps initially stimulated by a

necessity for survival, solar dwelling design has become an expression of man's attempt to harness solar energy for his benefit and advancement. The marvelous tools and devices just discussed are testament to man's intellectual curiosity and unceasing quest for knowledge about the world around him. Using solar energy to increase crop yields, to power needed mechanical equipment, to heat and cool buildings and to heat water is a natural progression of an intellectually restless man fascinated with the sun.

Intuitively, man's dwellings have responded to the beneficial effects of proper building exposure to the sun and local climatic conditions. Indigenous American Indian and colonial architecture — the Pueblo structures of the Southwest and the New England "saltbox" — are both good examples of dwellings responsive to the demands of sun and climate.

### **The Pueblo Structures of the Southwest**

The hot-arid climate of the Southwest is characterized by high daytime temperatures and uncomfortably low nighttime temperatures. The solution best suited to such a wide temperature fluctuation is delaying the entry of heat as long as possible so that it will reach the interior late in the day, when it is needed. The Pueblo Indians achieved this desired



*Taos pueblo, New Mexico.*

thermal performance by using materials of high heat capacity, such as adobe, mud and stone which provide a "heat sink," absorbing heat from the sun during the day and reradiating it into the dwelling during the night. Also by crowding their dwelling spaces together, side by side and one on top of another, the Pueblo's achieved maximum volume with the minimum surface area exposed to the outside heat, thereby reducing the area exposed to the sun while increasing the mass of building as a whole, thus increasing the thermal time-lag\*.

Another important consideration for hot-arid climates is to avoid interior heat build-up during the day. The Pueblo's accomplished this by separating the cooking space from the living spaces, by reducing the number and size of windows and placing them high on walls to reduce radiation gain, by painting the dwelling white or some other light color to reflect a maximum of radiant heat, and by minimizing ventilation during the hottest portion of the day.

A unique example of these principles of solar design is to be found in the cliff dwellings of the Sinagua and Anasazi Indians in Arizona. The cliff dwellings, called Montezuma's Castle, built in 1100 A.D., made

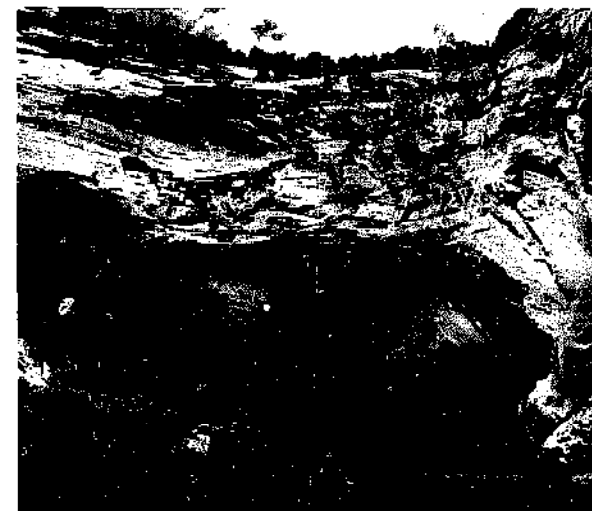

*Montezuma's Castle, 1100 A.D.*

\* Thermal Time Lag is a time function relating to the transfer of heat through a material.

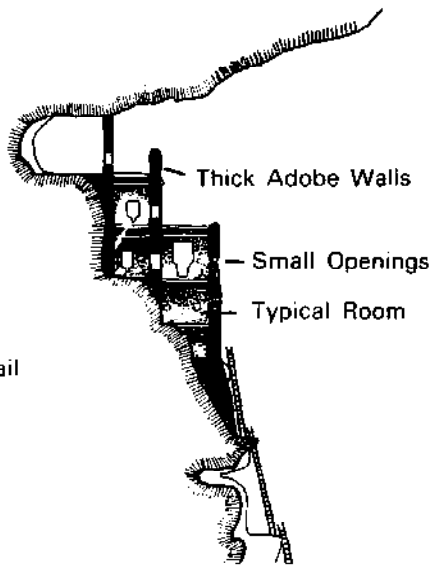

Section Detail

Montezuma's Castle (cliff dwelling) Camp Verde, Arizona

use of the heat capacity of mud, rock and other indigenous materials to absorb direct solar radiation on the south facing vertical walls. The heat was then reradiated to the interior spaces during the evening. The compactly grouped dwellings were light in color and had small wall openings to reduce direct and reflected radiation heat gain. The cliff dwelling also had one interesting feature which distinguished it from the Pueblo structures of the surrounding area. Because the dwellings were built under an extended portion of the mountain, the overhang blocked the high summer sun, thereby providing natural cooling for the dwellings.

### The New England "Saltbox"

Although there are different degrees of cold, both in duration and intensity, the principles of keeping warm are the same and are related closely to those

ture heat given off by cooking and space heating. Reducing heat loss is achieved by a compact plan, a minimum surface area exposed to the outside, materials of good insulating characteristics and the prevention of drafts and air leaks. Also, by sloping the roof on the north side of the dwelling toward the ground, shelter from the wind and a reduction of surface area exposed to the cold is achieved. This allows snow to build up on the roof and thus further to insulate the dwelling from heat loss. Another difference from hot-arid areas is the desire to capture as much solar radiation as possible during cold weather. Therefore, the windowed two-story portion of the dwelling faces south and the dwelling is painted a dark color (dark colors absorb more solar energy than light colors).



New England "saltbox"

Pueblo and colonial architecture are representative of the intuitive responses to local climatic conditions and the beneficial effects of proper building exposure to solar radiation that were developed in many parts of the world. The intuitive approach to solar heating and cooling has laid the ground work from which a scientific understanding of solar radiation and its corresponding climatic impact on building has recently developed.

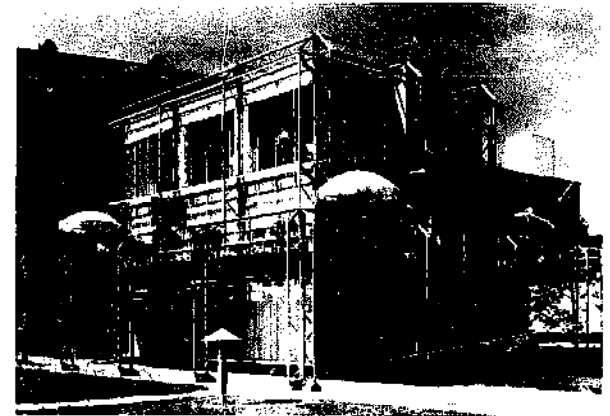

Crystal House, Worlds Fair 1934, Chicago, Illinois

collect, store and distribute solar energy as a principle heat source for human comfort. The Crystal House at the 1933 Chicago World's Fair is cited as an early example of the direct "greenhouse" effect whereby glass walls or windows were used as heat collectors. George and William Keck, architects for the Crystal House, began to incorporate the ideas developed from this design into other dwellings. Their designs used large expanses of south facing glass which allowed the low winter sun to heat the interior masonry floors and walls of the building during the day (in much the same way as the Pueblo structures), which in turn radiated the stored heat to the spaces during the evening.

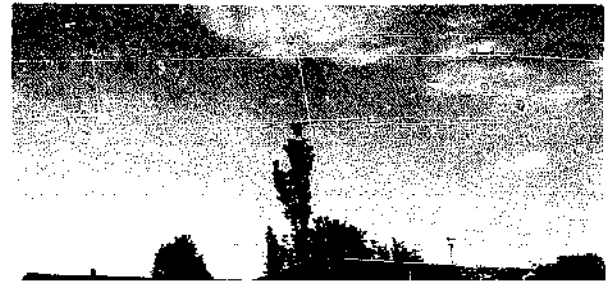

photo He

photo Hedrich Blessing

A reporter for the Chicago Tribune began to describe houses with these features as "solar houses" and since that time there has been a rekindling of interest in using the sun's energy to heat and even cool buildings.

The houses built by MIT as part of the Cabot Solar Energy Conversion Project between 1939 and 1956, and the Peabody/Raymond/Telkes house built in 1949, were the first fully documented solar dwelling designs where a major portion of the heat requirement of a dwelling was obtained by a formal solar collector and storage system. In the case of the latter, the entire heat requirement was obtained by solar collector and storage systems.

In all, four solar-heated dwellings were built by MIT. The first two, built in 1939 and 1947, were

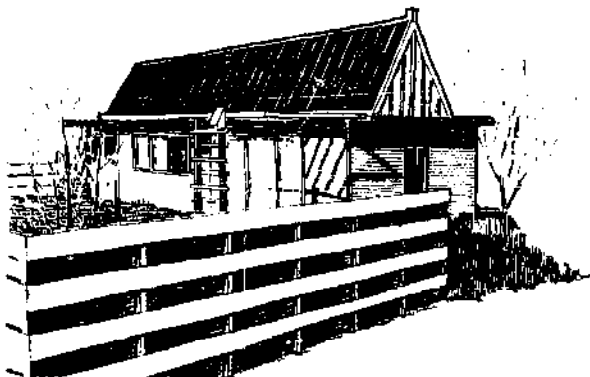

*MIT Solar House No. 3, Cambridge, Massachusetts*

more experimental laboratories for evaluating solar equipment than actual dwellings for family living. The third dwelling, remodeled in 1949 from the shell of the second, however, was designed to house a student family with one child. The solar heating system consisted of a south-facing flat-plate collector mounted on the roof with a large water storage tank located directly behind it. Solar radiation, collected by water circulated through the flat-plate collector and distributed by copper tubing mounted in the ceiling, provided for more than three quarters of the dwelling's heating load. The large windows along the south wall of the dwelling provided heat in excess of

need for several hours of the day in sunny winter weather and as a consequence had to be released by ventilation. During the hot summer months however, the south facing windows were shaded by an overhang.



*Telkes-Raymond-Peabody House, Dover, Massachusetts*

Also during 1949, a solar heated house was built in Dover, Massachusetts independent of the MIT solar housing program. The house was engineered, designed and sponsored by the Misses Telkes-Raymond and Peabody, respectively. The major objectives were to prove the feasibility of complete solar heating in the Boston area despite the chance of three to five consecutive sunless days with no collection, and to demonstrate the merits of using the heat of fusion of Glauber salt\* as a means of storing heat. The dwelling used both south facing windows and vertical collectors to capture direct and reflected solar radiation from the low winter sun. The hot air removed from the solar collectors was used to heat five gallon storage cans filled with Glauber salts. When heat was needed, air was circulated around the cans by small fans, heated, and distributed to each room. The technical feasibility of total solar heating in the Boston area and the use of the heat of fusion of Glauber salt as a storage medium were both adequately demonstrated by the Dover house.

The fourth and final solar house built by MIT under the Cabot Foundation Project was constructed in 1956 at Lexington, Massachusetts. The house had both solar space heating and solar domestic water heating. The dwelling used a flat-plate collector tilted

\* See Page 29 for more detailed information.

towards the south and covered with two panes of glass. Water was heated by the sun as it circulated through the collector and was stored in a 1,500 gallon insulated storage tank located in the basement. Heat from the water storage tank was transferred to air by a heat exchanger and distributed throughout the house by blower and ducts. This house provides evidence of the emerging sophistication of solar dwelling design. The relationship of the dwelling with the solar equipment (collector, storage, distribution) was treated as an integral problem and not as the separate concerns of equipment design and dwelling design.

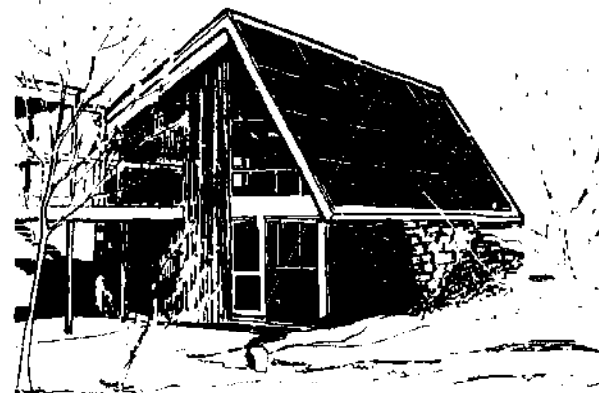

*MIT Solar House No. 4, Lexington, Massachusetts*

With the exception of an active, but relatively unheralded community of solar researchers who built upon the MIT work, an interruption of almost 10 to 15 years occurred in the application of solar technology to buildings. Two notable exceptions are the work of George Lof and Harry Thomason.

George Lof, a chemical engineer from Denver, Colorado, who has been involved in solar energy research and applications since 1944, constructed a solar house in Denver in 1957. The solar heating system, which is still in operation, consists of two arrays of south-facing flat-plate collectors and two vertical storage cylinders filled with granite rock.

A blower draws air through the rooftop collectors to the storage cylinders and distributes the heat through floor ducts to the individual rooms.

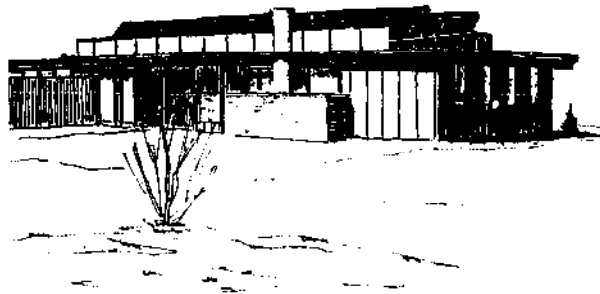

*Löf House, Denver, Colorado*

Domestic hot water is preheated by running the hot water piping through the incoming heated air duct from the collector.

Harry Thomason, a lawyer from Washington, D.C., constructed three solar dwellings in the Washington area between 1959 and 1963. A similar solar energy system is used in each dwelling. The collector is made of blackened corrugated aluminum covered with a single pane of glass placed on either a sloping roof or wall facing south or slightly west of south. Solar radiation is collected by water "trickling" down the open channels of the corrugated aluminum. The heated water is transferred to a storage tank surrounded by fist-size rocks. The rocks which are heated by the water in the tank provide an additional storage media and the mechanism for transferring the heat from water to air. To heat the

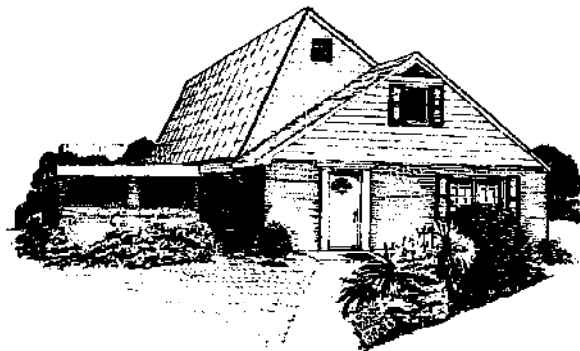

*Thomason Solar House No. 3, Washington, D.C.*

house, air is drawn from the house through the rock bed, picking up heat from the tank and rocks and blown through ducts into the individual's rooms. Thomason's last two solar dwellings have incorporated a compression refrigeration system for cooling. Operated at night, the system chills air which cools the rock storage for distribution during the day.

Early in the 1970's, the economic and environmental cost of conventional fuels brought attention back to solar energy as an alternative energy source for heating and cooling. Although the earlier solar houses at MIT and Dover have all met various fates (they are either demolished or are operating without their solar equipment) they nonetheless proved that solar heating was possible with existing technology. Given sustained technical refinement, appropriate architectural design, and industry and marketing economies, solar energy could possibly become a major source of energy for the heating and cooling of buildings.

The concerns of solar designers in the early 1970's were practical — "plumber's work" as it is called — in contrast to the theoretical research conducted and refined during the previous three decades. In the last five years, the number of operating solar dwellings has increased to approximately sixty. Although this amounts to a minuscule percentage of the total United States housing market, it does represent an increasing energy, economic and environmental awareness. Additionally the growing number of solar dwellings reaffirms the feasibility of solar heating and cooling with existing technology.

The solar dwellings built over the last several years range from those that require no mechanical equipment for their operation to one which generates its own electricity from solar energy as well as collecting and storing radiation for heating and cooling. The following solar dwellings built between 1972 and 1974 represent a variety of solar dwelling designs illustrating different ways of collecting, storing and distributing solar energy for space heating and cooling and domestic water heating.

The first example, the David Wright residence of Santa Fe, New Mexico, built in 1974, illustrates a

modern adaptation of the Pueblo Indian structures. The design is extremely simple and open. On first inspection the only "collector" visible is a 32 square foot solar water heater on the ground, and some might question the use of the terminology "solar dwelling." However, the sun dictated the design of the house from the very beginning. The solar aspects are so well integrated that the house actually becomes the solar collector and the heat storage system. The south wall of the house is constructed

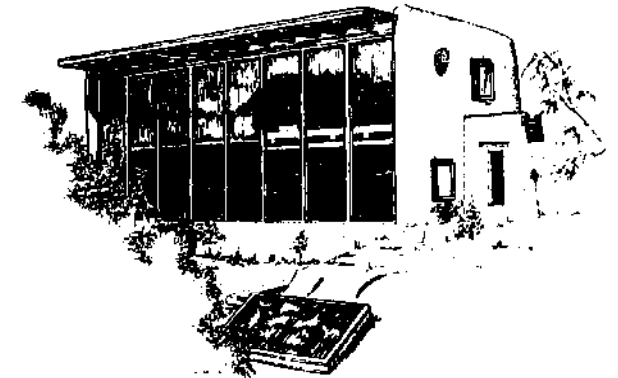

*David Wright House, Santa Fe, New Mexico*

entirely of insulating glass and serves as the solar heat collector. Adobe in the exterior walls and beneath the brick floor provides heat storage by absorbing incident solar radiation. Several 55 gallon drums filled with water are buried beneath an adobe banco along the south wall to provide additional heat storage. Insulation is located around the entire outside of the adobe walls, and beneath the adobe floor. The insulation minimizes the flow of heat from the walls and floor to the colder outside air and the ground. Thus the heat is stored until the temperature inside the house drops and then the stored heat is radiated and convected into the space. The fabric of the building is capable of storing enough heat to keep the home comfortable for three or four sunless days.

The solar house of Atascadero, California, illustrates another variation in solar collection and storage design. The Atascadero solar house uses horizontal water ponds (in plastic bags) located within the roof structure for solar collection, storage, and distri-

bution. The house's solar concept, developed and patented by Harold Hay, is capable both of heating and cooling. During the heating cycle, insulating panels which cover the ponds are removed so that on sunny winter days the water bags underneath are entirely exposed to the sun's rays. The solar radiation warms the mass of water, which in turn warms the supporting steel ceiling deck, the ceiling radiates the collected solar heat to the interior of the dwelling. At night, the panels are rolled back automatically to cover the water ponds and thus act as a "thermal valve" to retain the heat which has been collected during the day.

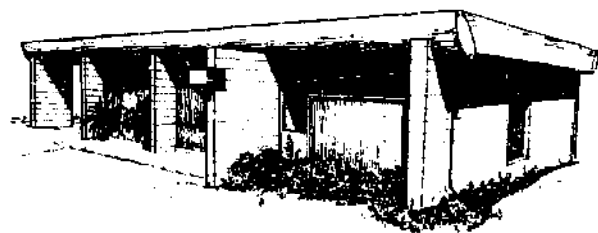

*Hay House, Atascadero, California*

Cooling is provided by reversing the winter procedure and opening the insulating panels at night so that the heat which the roof ponds have absorbed during the day can be dissipated by nocturnal cooling. The water in the ponds thus cooled is able to absorb heat from the house during the day. As the heat is absorbed, the interior of the house is cooled. Radiation to the sky, evaporation and, at certain times, convection all play a part in the nocturnal cooling process. This system is most effective in regions where the summer dew point temperature or humidity is relatively low.

The Hay's System in concept is similar to a solar dwelling constructed in France in 1956. Dr. Felix Trombe, Director of Solar Energy Research for the Centre Nationale de la Recherche Scientifique, and architect Jaques Michel, designed a solar house which instead of using horizontal roof ponds for solar collection and storage used a massive vertical south-facing concrete wall with a glass wall in front of it. The warmth from the inner surface of the concrete wall, trapped by the glass cover, provides most of the heat at night during the winter.

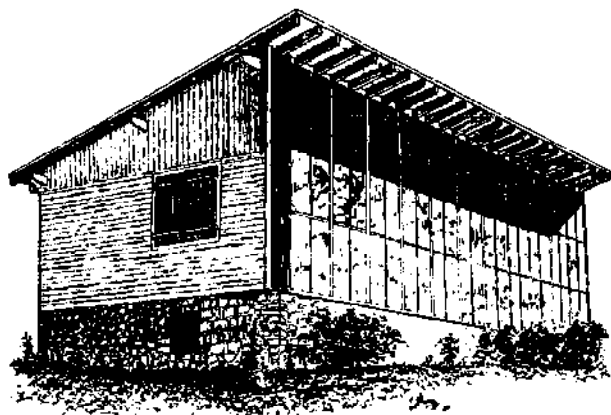

*Odeillo Solar House, Odeillo, France*

The United States modification of the Trombe/Michel concept involves the use of additional thermal storage in the form of a rock bed located beneath the floor. By the use of blowers, the heat from the south wall can be stored in a rock bed located beneath the house and thus storage capacity of the system can be considerably increased.

The "Phoenix of Colorado Springs" is a solar house built during the winter of 1974 when the residents of Colorado Springs found themselves faced with a critical shortage of natural gas. The solar system of this dwelling is significantly different from those of the previous solar dwellings. Solar energy is captured by two banks of solar collectors facing due south at an angle of 55 degrees. The aluminum collector panels are covered with two panes of glass to reduce heat loss from the collection surface. The fluid which circulates through the collector to absorb the heat is propylene glycol which will not freeze in the extremely low temperatures of the Colorado



*Phoenix of Colorado Springs, 1974*

Springs area. Heat from the collector is transferred to a large storage tank buried beside the house. The distribution system is composed of two heat exchangers, both located in the storage tank. The first transfers the collected heat to water which in turn heats air for distribution through ducts to each room, the second preheats the domestic hot water before it passes through a conventional electric water heater.

"Solar One" is the first building in which both thermal and electrical energy are derived from the sun. The dwelling, located in Newark, Delaware, has been designed and built under the auspices of the Institute of Energy Conversion of the University of Delaware, with support from the National Science Foundation and Delmarva Power and Light Company. The south-facing roof of the dwelling, tilted at 45 degrees to the horizontal, supports 24 solar panels, all of which will eventually be covered with cadmium sulfide photovoltaic cells. Also, six vertical collector panels, reminiscent of the Dover house of 1949, are mounted on the south-extending bays. Storage for the solar electric system consists of automobile type 12 volt storage batteries which are housed in a small frame shed on the east side of the house. Eutectic salts,\* in small plastic containers, are used to store heat from the solar thermal collectors.



*'Solar One' University of Delaware, Newark, Delaware*

"Solar One" represents the first attempt to combine the on-site generation of electricity with the collection and storage of thermal energy. Economical and technical attainment of these goals would be a long stride toward making dwellings energy self-sufficient.

\* See Page 29



## **Solar Energy in Other Countries**

The growing interest in solar energy along with increased research, development and application has not been confined to the United States, but continues throughout the world. Japan, Israel, and Australia, in particular, have a long tradition of using solar energy for domestic hot water heating. In addition, India, France, and the Soviet Union have been involved for many years in developing and applying solar heating and cooling technology in both commercial and residential buildings.

At one time, the United States also had the beginnings of a widespread use of solar energy. During the 1930's and 40's, prior to the availability of inexpensive energy and utility services, solar domestic water heating found widespread application in Florida, Arizona, and Southern California. In fact, it is estimated that in the Florida area alone approximately 50,000 solar domestic water heaters were in use before natural gas and electricity replaced solar energy as a primary fuel service. The resurgence of interest in solar energy today may once again give rise to buildings heated and cooled by the sun.

There are innumerable design variations possible to achieve total or partial solar heating and cooling. The preceding survey provides just a glimpse of the range of possibilities both in dwelling design and solar system design. The appropriateness of a particular solar dwelling design will be dependent on a number of factors. Among them are climate, occupant comfort, site conditions, building characteristics and the proposed solar system. Taken together, these are the primary factors which shape the design of solar dwellings. These factors are discussed in the next two chapters.

# 2

## SOLAR HEATING/COOLING AND DOMESTIC HOT WATER SYSTEMS

Solar heating/cooling and domestic hot water systems which are properly designed and integrated into the dwelling to use heat efficiently can provide a large percentage of a dwelling's space heating, cooling and domestic hot water requirements. Technically, it is possible to achieve close to 100 percent solar heating and cooling; however, a more realistic and economically feasible goal, given present technology would be 70 percent solar space heating and 90 percent solar hot water heating. Mechanical solar cooling\*, on the other hand, while technically feasible requires additional research and development to achieve the same levels of efficiency and cost-effectiveness as present solar heating systems. Therefore, the focus of this chapter will be on solar heating and domestic hot water systems.

In some cases, with total energy conserving design, a renewable auxiliary energy source, and a provision for solar produced electrical power to operate appliances and controls, a dwelling can become completely independent of non-renewable fossil fuels. Lower utility costs and the possibility of total energy self-sufficiency are two major factors for the growing interest in solar energy.

\* Mechanical solar cooling involves the use of solar produced heat to power conventional mechanical cooling equipment. Heat pumps, absorption cycle and rankine cycle systems are representative of mechanical cooling equipment which can be powered by solar produced heat.

---

### SOLAR SYSTEM COMPONENTS

Several characteristic properties apply to all solar heating/cooling and domestic hot water systems, whether they are simple or relatively complex. Any solar system consists of three generic components: collector, storage and distribution, and may include three additional components: transport, auxiliary energy system and controls. These components may vary widely in design and function. They may, in fact, be one and the same element (a masonry wall can be seen as a collector, although a relatively inefficient one, which stores and then radiates or "distributes" heat directly to the building interior). They may also be arranged in numerous combinations dependent on function, component compatibility, climatic conditions, required performance, and architectural requirements.

Solar energy, also known as solar radiation, reaches the Earth's surface in two ways: by direct (parallel) rays; and by diffuse (non-parallel) sky radiation, reflected from clouds and atmospheric dust. The solar energy reaching the surfaces of buildings includes not only direct and diffuse rays but also radiation reflected from adjacent ground or building surfaces. The relative proportion of total radiation from these sources varies widely in each climate, from hot-dry climates where clear skies enable a large percentage of direct radiation to reach a building, to temperate and humid climates where up to 40 percent of the total radiation received may be diffuse, to northern climates where snow reflection from the low winter sun may result in a greater amount of in-

cident radiation than in warmer but cloudier climates. As a result of these differences in the amount and type of radiation reaching a building, as well as in climate, time of year and type of use — space heating, cooling or year round domestic water heating — the need for and the design of solar system components will vary in each locale. Recognition of these differences is important for the proper design and/or selection of solar system components

Following a brief definition of each component in a solar system, the various methods of collecting, storing and distributing solar energy will be discussed and illustrated. The individual solar components will then be assembled into solar heating/cooling and domestic hot water systems and the process by which solar radiation provides heating and cooling discussed. A simplified diagram of a solar heating system is presented below

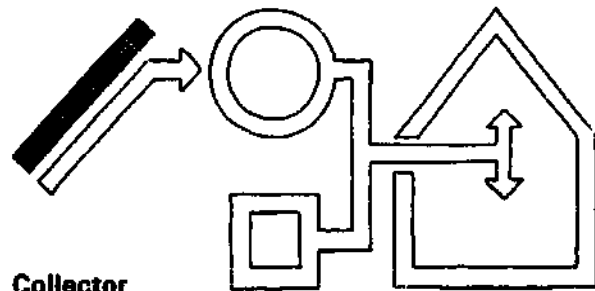

**Collector**

The collector converts incident solar radiation (insolation) to usable thermal or electrical energy\* by absorption on a suitable surface. In the case of non-photovoltaic (non-electrical) systems, the thermal energy captured is transferred to a heat transfer

\* Direct conversion of solar radiation into electricity is in an early stage of development and application. Therefore, because of its present limited application and extremely high cost, this publication will focus on the use of thermal energy derived from the sun rather than electrical energy. The "Solar One House" and several other test facilities are evaluating the methods and problems of providing electricity from solar energy for buildings. As the technology advances there will undoubtedly be numerous breakthroughs which will allow a more widespread utilization of solar derived electrical energy

medium, usually gas or liquid, within the collector. Collectors are generally classified as focusing or non-focusing, depending upon whether the sun's energy is concentrated prior to being absorbed or collected at the density received at the Earth's surface. A range of solar collection methods is presented on page 20.

Collectors generally use a transparent cover sheet (cover plate) to reduce convective and radiative cooling of the absorber. Glass or plastic is commonly used as the cover sheet or plate because they have a high "transmittance" of short-wavelength (ultraviolet) solar radiation and a high "absorbance" of long-wavelength radiation, thus trapping heat that is "re-emitted" from the absorber. Ideally a cover sheet and an absorber should be normal, that is perpendicular, to the sun's rays. When the angle at which the sun's rays strike the collector is less than 30°, the loss of radiation by reflection can be greater than that being collected.

An absorber can be any building material on the inside of the cover sheet. However, an efficient ab-

sorber surface will have a high solar "absorbance" and low "emittance" (that is, it will absorb solar radiation and not reradiate it). When the absorber is used to conduct heat to a liquid or gas, it must have high thermal "conductivity" as well. Most absorber surfaces are coated with a dark substance, either paint or a special chemical coating, to increase their absorption of radiation. Some coatings are designed to be selective in nature, that is they maximize the rate of absorption and minimize emissivity losses.

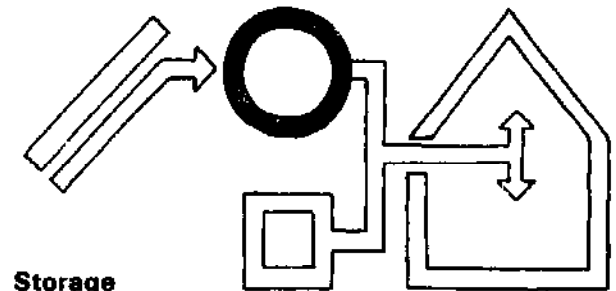

**Storage**

The storage component of a solar system is a reservoir capable of storing thermal energy. Storage is required since there may be an energy demand dur-

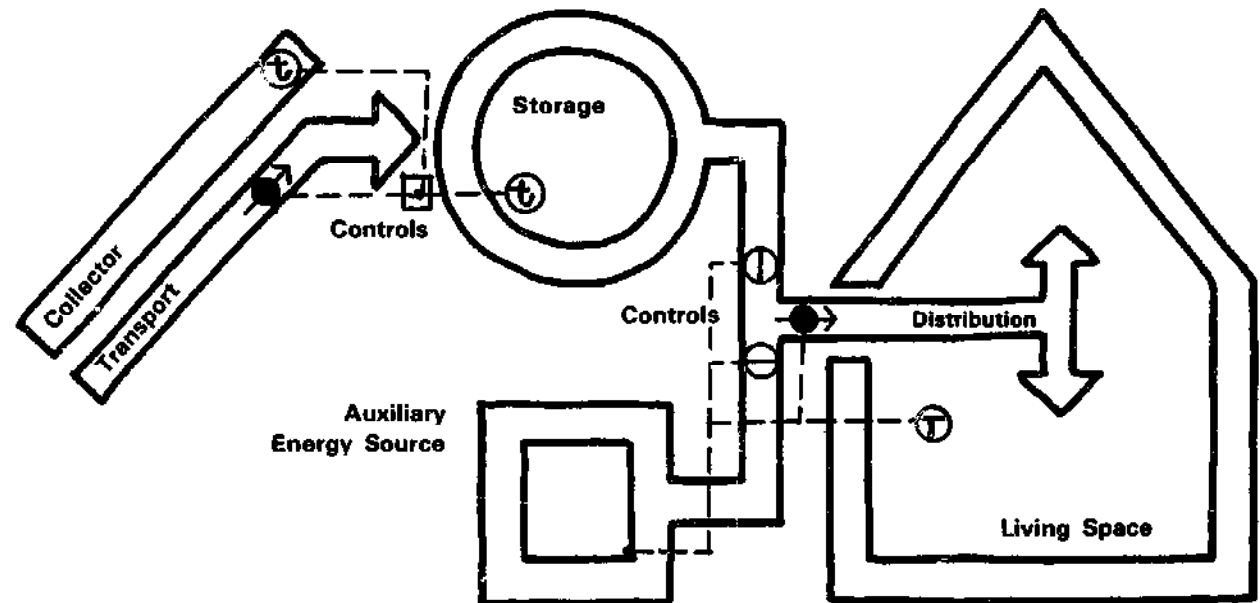

**Simplified Diagram of a Solar Heating System.**

ing the evening or on consecutive sunless days when collector is not occurring. Storage acquires heat when the energy delivered by the sun and captured by the collector exceeds that demanded at the point of use. The storage element may be relatively simple such as a masonry floor which can store and then reradiate captured heat, or may, by comparison, be relatively complex such as chemical phase change storage. Heat storage is also required for solar-assisted domestic water heating. This may be provided within the larger space heat storage component, with a separate but smaller storage tank, or in conjunction with the storage capacity of a conventional water heater.

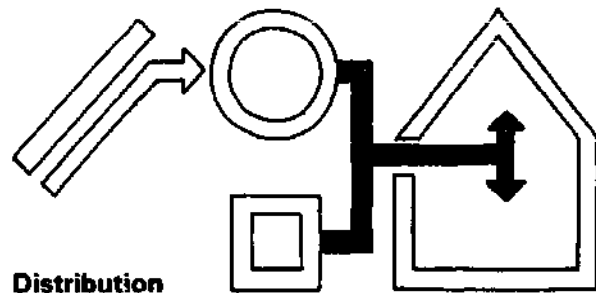

### Distribution

The distribution component receives energy from the collector or storage component and dispenses it at points of consumption — spaces within the dwelling. For example, comfort heat is usually distributed in the form of warm air or warm water by ducts or pipes within a building. Distribution of energy will depend upon the temperature available from storage. Temperatures as low as 90°F may still be useful for space heating, if the baseboard convectors are increased in size or if used in conjunction with a heat pump or auxiliary heating system.

Because solar produced temperatures in storage are normally in the low range (90 to 180° F), distribution ducts and radiating surfaces are normally larger than those used in conventional heating systems. Therefore, careful consideration is required in the design of heat distribution systems throughout the dwelling.

Domestic water heating is also a part of the distribu-

tion component. Its distribution system generally consists of a heat exchanger, back-up heater, piping and controls

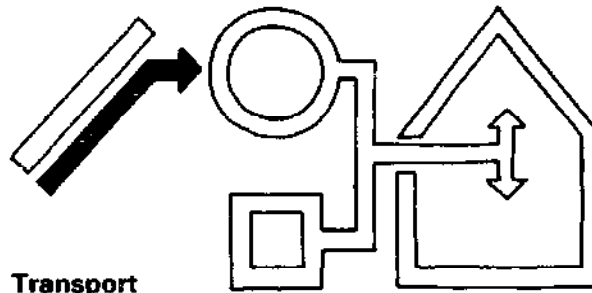

### Transport

Most solar systems have an energy transport component which provides the means of moving a fluid carrying thermal energy to and from the collector and storage. The transport component also regulates the flow through the collector and storage. In liquid or gas systems this component consists of pumps, valves, and pipes, or blowers, dampers, and ducts.

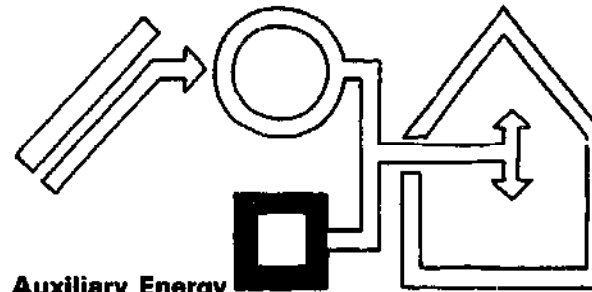

### Auxiliary Energy

The auxiliary energy component provides a supply of energy for use during periods when the solar system is inoperable or during periods of extremely severe weather or extended cloudy weather when solar produced temperatures from the collector and storage are not sufficient to satisfy the building's heating or cooling load. Presently, the experimental nature of solar heating, cooling and domestic hot water systems and the possibility of extended sunless days generally require that the auxiliary energy component be capable of providing the total energy demand of the house if the solar system is inoperable.

The auxiliary system can be powered by conventional fuels such as oil, gas and electricity, by alternative fuel sources such as wood burned in fireplaces, methane gas, or wind generated electricity, or by a combination of these. The component may operate independent of or in conjunction with the solar system. This is usually accomplished by locating the auxiliary energy system between the storage and distribution components to permit a full or partial operation, or by supplying the energy directly to the heat storage component thereby raising it to a usable temperature.

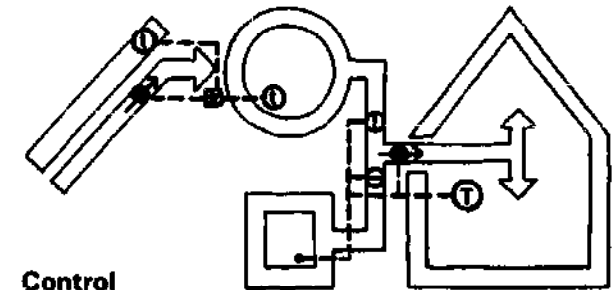

### Control

The control component performs the sensing, evaluation and response functions required to operate the system in the desired mode. For example, the temperature in the house is sensed by a thermostat and relayed to the distribution component (pump or blower) when heat is required. The controls generally distribute information, including fail-safe instructions, throughout the system by means of electrical signals. However, the control function can be performed by automatic pneumatic controls or by the dwelling occupants who initiate manual adjustments to alter the system's operation.

## SOLAR COLLECTORS

There are numerous concepts for the collection of solar radiation. These concepts range from the most simple — a window — to those that are quite complex and require advanced technology for their development — a solar cell for instance. Historically, solar collectors have been classified as either focusing or non-focusing.

A non-focusing collector is one in which the absorber surface is essentially flat and where the absorber area is equal to the aperture for incident radiation. A focusing collector, however, is one in which the absorber area is smaller than the aperture for incident radiation and consequently there is a concentration of energy onto the absorber surface. Numerous solar collectors have been developed which illustrate each of these concepts. Several recent collector designs have been developed which do not fit into either category, creating considerable confusion in collector classification. Consequently,

the following description of solar collector concepts is not separated exclusively into focusing or non-focusing collectors.

The brief concept descriptions are presented to offer a general classification of solar collectors. The reason for collector classification is not to provide an exhaustive catalog of available equipment, or even to detail the specific physical principles or engineering calculations required to understand how the collectors work. Instead, the purpose is to introduce the reader to a range of solar collector concepts which may be used singly or together for the capture of solar radiation and to indicate in general terms their present applicability.

---

### Flat-Plate Collectors

Of the many solar heat collection concepts presently being developed, the relatively simple flat-plate collector has found the widest application. Its low

fabrication, installation, and maintenance cost as compared to higher temperature heat collection shapes has been the primary reason for its widespread use. Additionally, flat-plate collectors can be easily incorporated into a building shape provided the tilt and orientation are properly calculated.

Flat-plate collectors utilize direct as well as diffuse solar radiation. Temperatures to 250°F (121°C) can be attained by carefully designed flat-plate collectors. This is well above the moderate temperatures needed for space heating, cooling and domestic water heating.

A flat-plate collector generally consists of an absorbing plate, often metallic, which may be flat, corrugated, or grooved; painted black to increase absorption of the sun's heat, insulated on its backside to minimize heat loss from the plate, and covered with a transparent cover sheet to trap heat within the collector and reduce convective cooling of the absorber. The captured solar heat is removed from the absorber by means of a working fluid, generally air

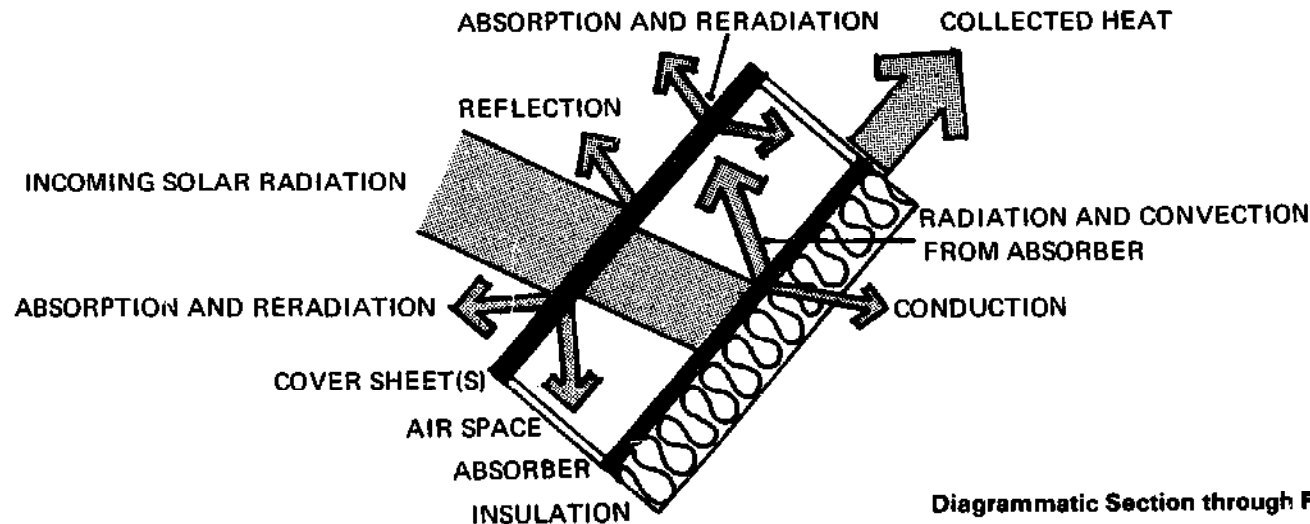

Diagrammatic Section through Flat-Plate Collector

or treated water, which is heated as it passes through or near the absorbing plate. The heated working fluid is transported to points of use or to storage depending on energy demand.

Three types of flat-plate collectors are discussed. There are innumerable variants, but the following serve as an introductory classification. A complete discussion of flat-plate collectors is given by Yellott.<sup>2</sup> In selecting any particular collector, one should consider thermal efficiency, the total area and orientation required, durability of materials, and initial operating cost.

### Open Water Collector

At present, collectors which are factory-produced and shipped to the building site are relatively high in cost due in part to the small volume manufactured. Collectors built from commonly available materials and fabricated on the site are less expensive. Their thermal efficiency, however, may be lower than fac-

tory produced units. An open water collector of the type used in the Thomason House described earlier is representative of on-site fabricated collectors which use corrugated metal roofing panels painted black and covered with a transparent cover sheet. The panels thus provide open troughs in the corrugations for trickling water to be fed from a supply at the top of the roof to a collection gutter at the base, where it is then transported to storage. Heat losses that occur by evaporation in open systems are reduced in some designs by the nesting of two corrugated sheets with a small enough passage in-between them to force the water into contact with the top sheet. Open water collectors should be carefully evaluated before use in cold climates, to determine the extent of condensation and corresponding loss of efficiency.

### Air-Cooled Collector

Collectors that employ air (or gas) as the transport medium between collector and storage have been developed — notably as designed and installed by

George Lof on his own residence in Denver, Colorado, where the solar system has been in operation since 1957. Low maintenance and relative freedom from the freezing problems experienced with liquid cooled collectors are two of the chief advantages of air collectors. In addition, the heated air can be passed directly into the dwelling space or into the storage component. Disadvantages are the inefficient transfer of heat from air to domestic hot water and the relatively large duct sizes and electrical power required for air transport between collector and storage. Although few air collectors are now readily available from manufacturers, in contrast to the more than one dozen sources of liquid cooled collectors, it is predicted that air cooled collectors will soon become more widely used.

### Liquid-Cooled Collector

Most collectors developed since the time of the MIT experimental houses have used water or an antifreeze solution as the transport medium. The liquid is heated as it passes through the absorber

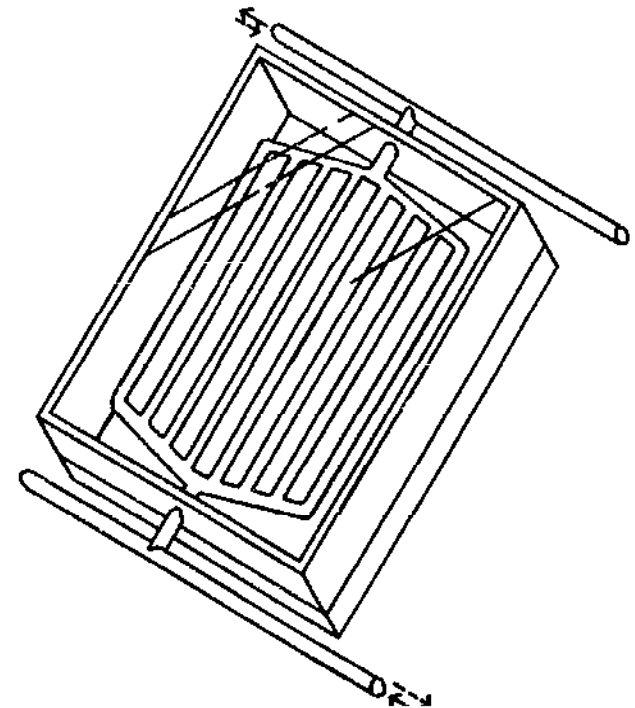
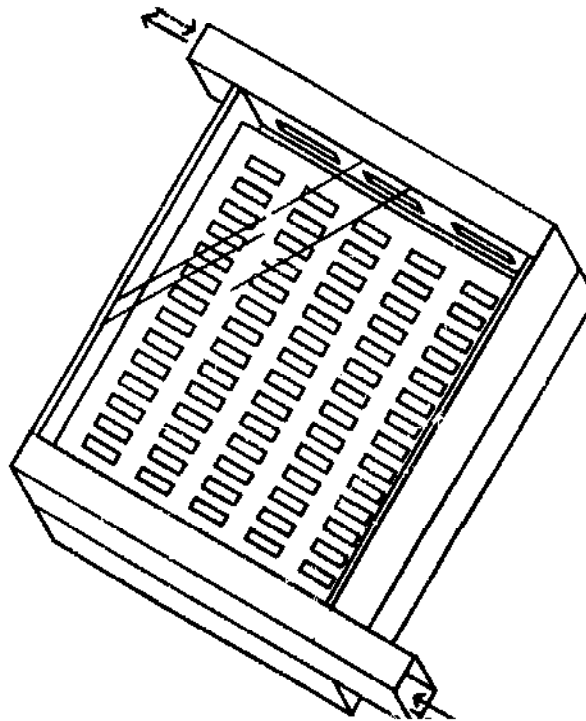
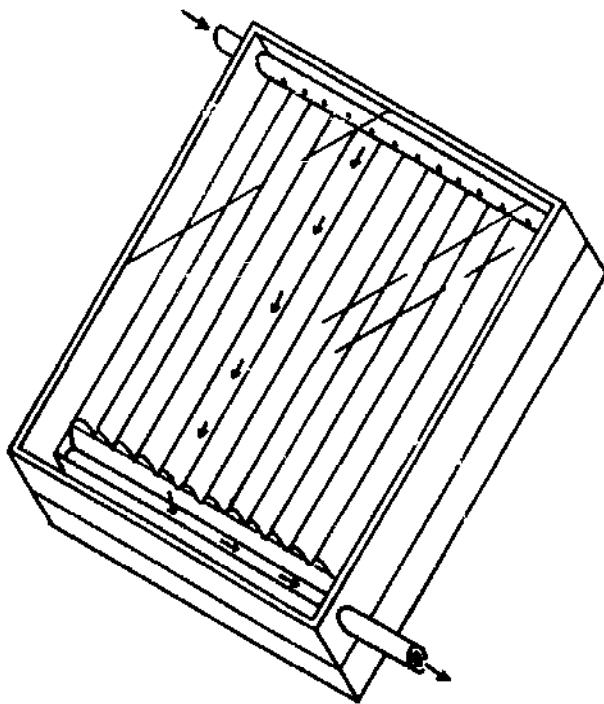

plate of the collector and then is pumped to a storage tank, transferring its heat to the storage medium.

The prevention of freezing, corrosion and leaks have been the major problems that have plagued liquid-cooled systems, which are otherwise efficient collectors and transporters of heat. This is generally accomplished by using oil or water treated with corrosion inhibitors as the transport medium or by designing the collectors to drain into storage during periods of non-collection.

---

---

### Increasing the Performance of a Flat-Plate Collector

Flat-plate collectors are frequently mounted on the ground or on a building in a fixed position at prescribed angles of solar exposure — which vary according to the geographic location, collector type, and use of absorbed solar heat. The fixed mounting has advantages of structural security and design integration, but must be oriented within prescribed limits to receive a level of solar radiation commensurate to the capital investment involved in installing a solar energy system. For space heating a tilt of latitude plus  $15^\circ$  and an orientation true south to southwest (afternoon air temperatures are higher and thus bias an orientation west of true south) are considered optimal based on existing solar experiments in operation at this time. For combined space heating and cooling, collector orientation remains the same while collector tilt is changed to latitude plus  $5^\circ$ . Variations are generally tolerable only within  $10^\circ$  to  $15^\circ$  of these optima. There have been several proposals to improve the annual thermal performance of flat-plate collectors. One concept involves the use of adjustable/sun-tracking flat-plate collectors that are continually or periodically adjusted, while another uses reflecting panels to increase thermal yield.

Mounting a flat-plate collector on adjustable or sun-tracking mechanisms can improve the annual thermal performance of the collector by as much as 70 percent. A collector can be tilted from the annual optimum (described as latitude plus  $15^\circ$  for space heating) to more closely approximate the seasonal optimums. For instance, season optimum for space heating will vary  $47^\circ$  from December to June. A monthly adjustment can be made manually, provided there is access to the collectors, which can yield at least a 10 percent improvement over a fixed position. Adjustable tilt mechanisms can usually be accommodated most easily on ground or flat roof installations.

A collector can also be rotated on one axis to follow the daily path of the sun's orientation from east to west. This will require an automatic tracking mechanism, unless a method for manual adjustment during the day is provided. With an automatic sun-tracking mechanism, annual energy increases of 40 percent could be expected in areas where the predominant source of thermal energy is direct radiation.

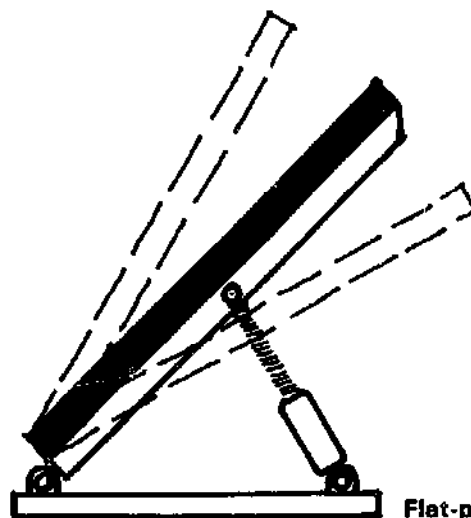

Flat-plate Collector with Adjustable Tilt

The tilt and orientation of a flat-plate collector can be maintained in any optimum position throughout the day and year by use of a heliostatic mount. A heliostatic mechanism maintains the collector at a perpendicular (normal) exposure to direct solar radiation. Although the control mechanism and structural mounting are complicated, a sun-tracking flat-plate collector could collect 70 percent more solar radiation than the same flat-plate collector in a fixed optimum position. The cost of such a sophisticated tracking solar collector should be compared with the cost of a larger fixed collector which would deliver the same energy output.

Another concept for increasing the thermal yield per unit of flat-plate collector area is the use of panels which reflect additional solar radiation onto the collector, thereby increasing its thermal performance. The same panels, if so designed, can also be used to cover and insulate the collector during non-collection periods, at night, and on cloudy days. The panels may be operated by sun sensitive automatic controls or manually. In either case, questions of maintenance and operation should be considered, particularly in areas that experience snow or ice.

There are also collection arrangements that reflect incoming solar radiation several times onto a focused or concentrated area, thereby using an optical gain to increase the unit collection of the absorbing surface. As a result, the area of collector absorbing surface needed is reduced. There are numerous concepts based on such principles. One patented idea that has found application is a flat-plate collector that is located in a roof shed where an adjustable reflecting panel directs the radiation to an otherwise weather-protected collector. As mentioned above, cost, fabrication and maintenance of adjustable reflectors is a major consideration for use.

---

---

## Concentrating Collectors

Concentrating collectors use curved or multiple point-target reflectors to increase radiation on a small target area for either a tube or point absorber. Presently, concentrating collectors are greater in cost than the flat-plate collectors described above, with added problems of reflective surface maintenance. For use in sunny climates however, they promise more than double the temperature generated by flat-plate collectors. Concentrating collectors are best suited for areas with clear skies where a major portion of solar radiation is received in direct rays. Their inability to function on cloudy or overcast days is a significant disadvantage of concentrating collectors as compared to flat-plate collectors. However, they may find a particularly viable role as a collector for solar cooling systems, but at present require more development than flat-plate collectors. Farrington Daniels' text contains a detailed description of concentrating collectors.<sup>3</sup>

### Linear Concentrating Collector

A reflector curved in one direction that focuses radiation on a pipe or tube absorber is a linear concentrating collector. Heat is removed from the absorber by a working fluid circulating through the pipe and transported to point of use or storage. The absorber is generally covered with a transparent surface to reduce convective or radiative heat losses. The working fluid should have a boiling point above the expected operating temperatures of the collector and also be resistant to freezing.

Linear concentrating collectors can be designed with the long axis horizontal (in an east-west direction) or at an optimum tilt (in a north-south direction). Since the change in the sun's altitude during the day is less than the change in its compass direction, horizontal linear concentrating collectors can be designed for manual adjustment every few days, to track the average path of the sun as it changes from season to season. Tilted linear concentrators with the long axis north-south

must track the sun throughout the day, as must horizontal linear concentrators designed for precise focussing.

### Circular Concentrating Collector

A reflector in the shape of a dish or hemisphere that is used to focus solar radiation on a point target area is a circular concentrating collector. An absorber located at the focal point absorbs solar produced heat where a working fluid then transports it away from the collector. The collector may be fixed and the target area (absorber) moveable to accommodate the daily path of the sun as the focus point changes with the direction of incoming rays. More commonly, the entire reflector and absorber assembly is made to follow the sun. Several experimental designs have been constructed utilizing this principle. The high temperatures achievable by such collector mountings may eventually justify their use despite problems of operation, durability, design integration and structural mounting, if they permit economies in the design of the total system or the building itself.

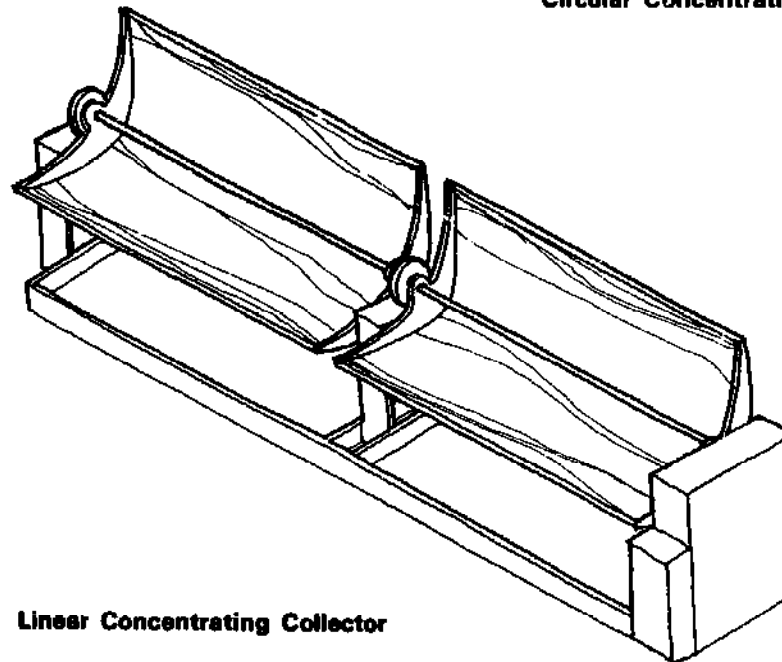

Linear Concentrating Collector

Circular Concentrating Collector

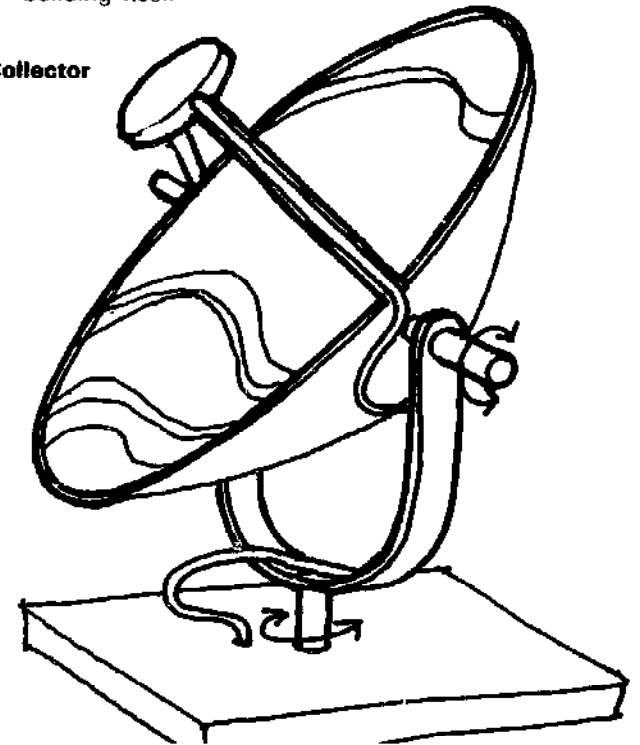



---

---

## Passive Collectors

The collector concepts discussed to this point have been relatively independent elements which can be organized and operated quite apart from the building itself. That is, the relationship of the collector to the building it serves can vary significantly without a major alteration of system performance. There is a point when it is advantageous in terms of cost, building design and system operation that the collector, storage and building be physically integrated.

There are numerous collector concepts where the relationship of the collector to the building is direct and the alteration of collector design will modify in varying degrees the building's design. These concepts use the entire building or various elements of the building (walls, roof, openings) as solar components. As such, the collector and building are one and the same element and therefore cannot be separated from each other. This type of collection method has come to be known as inherent or passive solar collection.

The integrated nature of passive solar collectors permits the design of a variety of collector concepts. The imagination of the designer and builder is the only limiting factor. Passive collectors can be as simple as a window or greenhouse.

Three general passive collector concepts are discussed below. There are innumerable other concepts, but the following will serve as an introduction to inherent or passive solar collectors.

### Incidental Heat Traps

All collectors are "heat traps" in that they capture heat from direct solar or diffuse sky radiation or from adjacent ground or building surface reflection. There are numerous building components including windows, roof monitors, and greenhouses discussed below, which are not normally considered solar collectors but can be used as such along with their other principle function. Because they can serve

various purposes — visibility, ventilation, natural illumination — as well as incidental heat collection, they become particularly valuable building components in integrated solar dwelling design. Additionally, they illustrate that energy conservation does not preclude the use of windows, glass structures, or skylights if they are designed to maximize direct solar heat gain.

The use of south-facing windows to increase heat gain directly into a building is well known. Beginning with the Crystal House in 1933, the concept was used in the United States in popular house plans that were often referred to in the 1940's and 1950's as "solar homes." The south wall orientation is considered ideal compared to east and west walls because in northern climates shading of a south window to prevent summer overheating is easily accomplished by an overhang calculated to equinox sun angles. In such arrangements, careful attention must be given to insulating the window at night, preferably from the interior, to reduce heat loss. With an interior insulating drapery, or even better, a shutter which is much more air-tight, windows do in-

deed function as effective heat traps and have been shown to be able to provide a sizable percent of the annual heat requirements of a building (estimates vary from 25 to 60 percent, depending on climate and use).

Windows used as solar collectors have the drawback of overheating the space they serve. In order to reduce the overheating effect, masonry surfaces such as concrete, brick, tile, or stone on the floor or on the walls can be used for their heat storage capacity, absorbing the heat during the day and radiating it subsequently for several hours or more. The storage effect of a particular floor or wall can be calculated as a function of the specific heat\* of the masonry, its volume and weight, and the expected temperature differences it will experience throughout the day. Too great a storage effect in the exposed room surfaces can have a negative effect on occupant comfort or fuel consumption if the morning "reheat" time of the materials is too long. However, properly designed the thermal mass of construction materials can play a significant role in an integrated solar dwelling design.

\* Specific heat is the quantity of Btu's which can be stored per pound per degree F

South-Facing Window as a Solar Collector

Overhang protects window from summer sun

Moveable insulation to reduce heat loss

Massive floor to prevent overheating

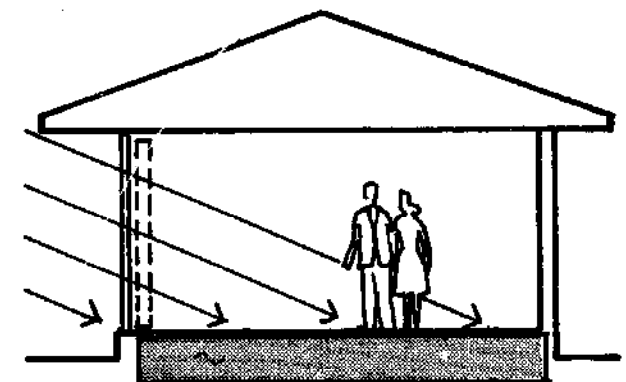

The use of a greenhouse as an incidental heat trap is a further elaboration of the solar window concept. It exposes more glass area to solar radiation than a window but with greater heat loss if no provision is made for insulation. Fiberglass panels and temperature sensitive gels are under development to reduce heat loss while allowing a comparable amount of direct solar radiation to enter the greenhouse. Another idea that has found application is a patented vacuum-driven system which fills and empties a cavity between two sheets of glass or plastic with polystyrene beads, thus substantially increasing the insulation characteristics of the transparent surface.

Again, storage such as masonry surfaces or a rock pile under the greenhouse may be necessary to avoid overheating the space. One advantage of a greenhouse as a solar collector is that it can be closed off from the rest of the house on sunless days, thereby reducing the net heated area of the dwelling. However, during some periods of cooler weather it can be used as a supplementary space of the house — an atrium, a sun room, a day room, or a garden room.

Another passive collector concept valuable because of its versatility is a roof monitor. A roof monitor is a cupola, skylight, or clerestory shed arrangement that is designed to control heat gain, natural light, and/or ventilation. Roof monitors by themselves are poor devices for gaining usable heat, first, because the heat enters at the high point of the building, and second, because the roof exposure gains so much solar radiation in the summer that shading or insulating arrangements are required. Also, because of the low winter sun angle, the sun entering through the roof monitor would probably not reach the floor or lower wall surfaces to offer any storage effect. However, if a return air register is located at a high point in the space, the trapped heat can be recirculated. This technique will prevent a temperature stratification within a building by continually returning solar heat gained through the building and roof monitor to the lower occupied spaces.

Roof monitors are of particular interest because they are excellent sources of natural lighting and can be used in summer months to augment natural cooling through the "thermal chimney" effect. Roof monitors, designed with proper insulating and ven-

\* The thermal chimney effect refers to the natural rise of hot air in a building which is vented to the exterior, thereby causing a continuous circulation of air for ventilating purposes.

tilating controls, can be used to great advantage in a low energy approach to design.

### Thermosyphoning Walls/Roof

Another set of passive collector concepts makes use of heat that is built up within a wall or roof structure by "syphoning" or drawing it off and supplying it to a room or storage element. "Thermosyphoning," a term traditionally applied to mechanical systems that use the natural rise of heated gases or liquids for heat transport, is the primary method for moving captured heat to point of use or storage. To avoid overheating in the summer, the space where the heat builds up is vented to the exterior. Three thermosyphoning concepts are discussed below.

One thermosyphoning concept which has found application in traditional as well as solar designs is the use of solar heat trapped in air spaces in walls and roofs. When the trapped air temperature exceeds the temperature of the internal building space, it can be drawn off by direct venting or forced air duct arrangements.

Greenhouse as a Solar Collector

Moveable insulation

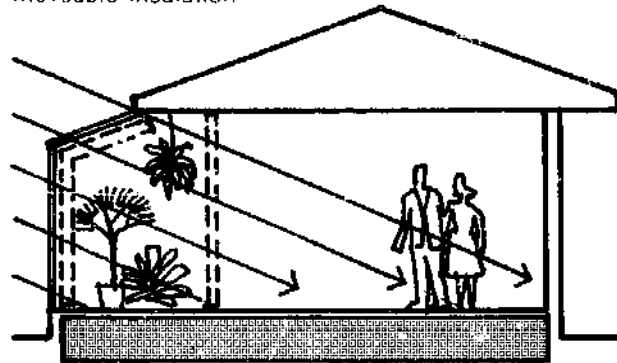

Roof Monitor as a Solar Collector

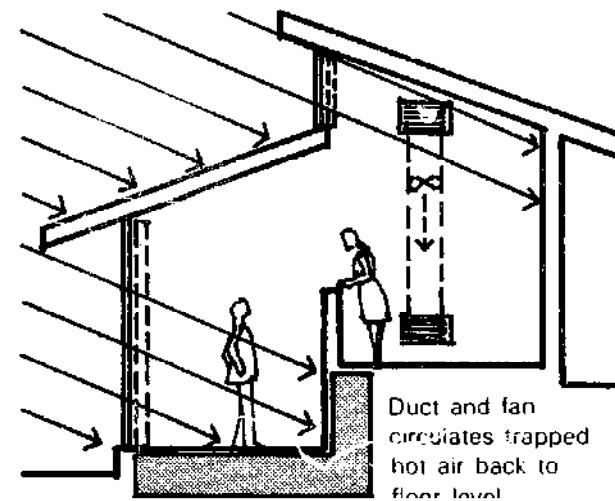

Thermo-syphoning Roof as Solar Collector

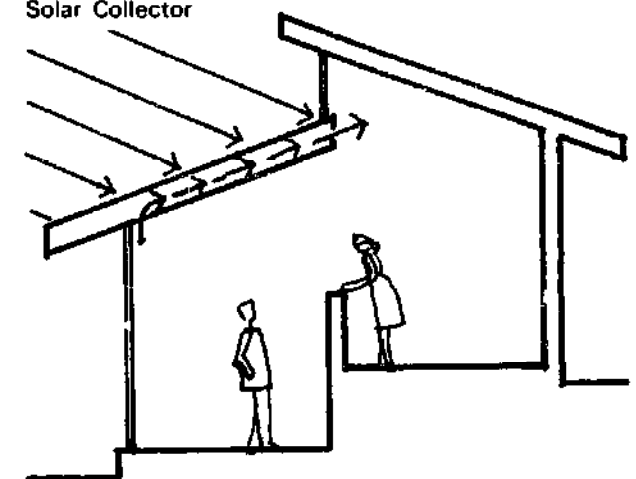

This method of solar heat collection is marginal at best due to the small amount of heat collected, problems in the control of temperature differences between the inside of the wall or roof structure and the occupied space, and the large ducts and electrically powered fans needed to move any sizable volume of heated air. However, the concept of using the solar heat that is built up within a building's walls or roof deserves consideration as a multi-purpose solution to annual climate conditions.

A more effective variant of the preceding concept is one where the external surface or internal and external wall or roof surface are transparent. The heated air trapped between the building surfaces can be used because it will usually be hotter than the temperature of the occupied space. Ducted fiberglass panels are under development for just such an application. This concept is not as effective a formal solar heat collector (i.e., flat-plate collector) but it has the advantages of admitting natural light, and providing better insulation than a plate glass window.

The previous two thermosyphoning concepts used the walls and roof of the building for solar heat collection. In a further elaboration, the building envelope is also used as storage. In several ex-

amples described previously, notably the Michel/Trombe House, a glass wall is placed over an absorbing material — generally masonry — which is painted dark and serves as heat storage for a time-lag capacity that has been previously calculated. The air space between the glass wall and the absorbing material is vented to the interior at the top of the wall or ducted to rock storage elsewhere in the building. A cold air return must be located at the bottom of the collector so that a thermosyphoning arrangement can be used to facilitate air circulation. As previously mentioned, the morning reheat time of large storage media becomes a design calculation that is particularly critical with such direct storage concepts.

### Solar Ponds

A solar pond is a particularly interesting passive collector concept because it can provide for both heating and cooling. Also, a solar pond may be integral with the building structure — on the roof for example — or entirely separated from the building on adjacent ground. For either situation, control must be maintained over the heating and cooling processes for efficient operation. This can be accomplished by the use of movable insulating panels to expose or conceal the pond, by filling and draining the pond

according to the heating and cooling demand or by covering the pond with a transparent roof structure.

Although solar ponds at present have found limited application confined to the southwest, they have also been proposed for use in northern climates. Solar ponds are particularly appropriate to climates where the need for cooling is the principle design condition and where summer night temperatures are substantially lower than daytime temperatures. The combination of these climatic conditions, found usually in hot-arid regions, permits the ponds and elements of the building (exterior walls) to be cooled by natural radiation to the night sky and to effect a time-lag of temperature through the building envelope, in ideal cases up to eight or more hours. This permits numerous design concepts to aid natural cooling by radiation and evaporation. In hot-humid climates, high vapor pressure, cloudiness and a small diurnal temperature range limits the cooling efficiency of solar ponds.

Roof ponds have found a more widespread application than ground ponds. The major advantage of a solar roof pond is that it does not dictate building orientation or exposure, and as long as there are no barriers between sun and pond it will provide a completely even heating or cooling source over the entire

Thermosyphoning Wall

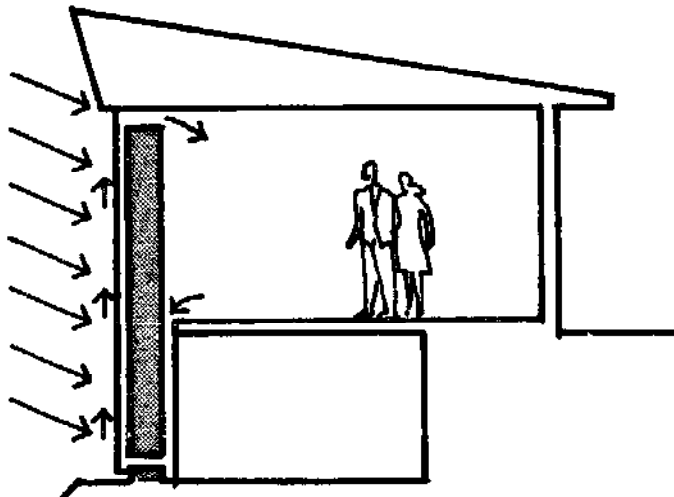

Patented Solar Pond Concept used in Atascadero House

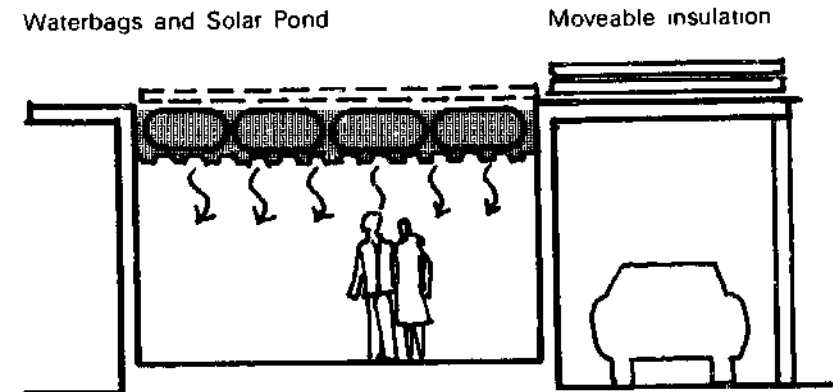

living area of a building. Several dwellings incorporating a solar roof pond have been designed and constructed. The Atascadero house, briefly discussed in the previous chapter, is an example of a dwelling concept using a roof pond. In this patented design, water containers are disposed on a flat roof and covered with insulating panels. During summer days the panels are closed. At night the panels are removed to lose heat to the cooler night sky. Suitably cooled, the water containers then draw heat during the day from the building interior (usually through a metal deck roof). In winter, the process is reversed, exposing the containers during the day to collect and store solar thermal radiation and then covered by the insulating panels at night, providing heat to the interior.

The same process is applicable in northern climates. However, the roof pond is now covered by a transparent roof structure oriented to receive maximum incident solar radiation. Heat is trapped in the attic space thus warming the pond. Insulating panels cover the transparent surface during periods of no collection to reduce heat loss. The transparent surface could be removed during the summer to increase evaporative and convective cooling.

An alternative to water containers covered with insulating panels or enclosed in an attic space is a roof pond with circulating water between the roof and a storage tank located below or within the occupied space. With this system the need for movable insulating panels is eliminated. During the heating cycle, circulation would take place during the daytime. The water, heated by the sun, would be stored or distributed depending on the dwelling's heating requirement. To prevent cooling by evaporation the pond must be covered by a transparent surface — glass or plastic which can float on the surface. During the cooling cycle, the circulation of water would take place only during the night. The cooled water would be stored to draw heat during the day. The transparent cover sheet would no longer be needed for efficient cooling operation, since cooling would be achieved by night sky radia-

---

## SOLAR HEAT STORAGE

The intermittent availability of solar radiation requires that heat be stored during times of favorable collection for later use for such purposes as space heating, cooling and domestic water heating. Solar heat may be stored by raising the temperature of inert substances such as rocks, water, masonry, or adobe (sensible heat storage), or it may be stored by reversible chemical or physical/chemical reactions such as the dehydration of salts or phase changes (latent heat storage).

In many cases the use of several storage methods or the storage of heat at different temperatures has been shown to be advantageous for supplying the heating and cooling demand of specific buildings. The type, cost, operation, and required size of the solar storage component will be determined by the method of solar collection, the dwelling's heating and cooling requirement and the heat transfer efficiency to and from the storage unit.

The following heat storage concepts are classified in broad categories. Each storage method falls within the two previously mentioned generic methods: sensible heat storage and latent heat storage. The technical feasibility of each method has been demonstrated either in actual use or in experimental testing.

---

### Sensible Heat Storage

#### Room Air and/or Exposed Surfaces

The solar radiation received from south facing windows or transparent panels increases the temperature of room air and surfaces exposed to the sun's rays. As such, the room's air and exposed surfaces (walls, floors, etc.) are the solar storage com-

situations the storage capacity of the air and surfaces will not be sufficient for long periods of heating demand. Additionally, in the process of "charging" the storage, the space may become overheated and possibly extremely uncomfortable for the occupants.

To use effectively the radiation stored in the air and room surfaces, careful attention must be given to minimizing the loss of heat at night or when collection is not occurring. Insulated drapes, shutters, and other such devices are necessary to reduce heat loss and increase the use of trapped heat. The room size, the window placement, the material composition, volume and weight, and the expected temperature difference will also determine the performance of the solar storage.

A more direct application of this storage concept involves the placement of a glass or transparent wall over an exposed masonry surface such as concrete. The exposed surface which serves as the heat store is painted a dark color and located directly behind

Heat Storage in Massive Floor

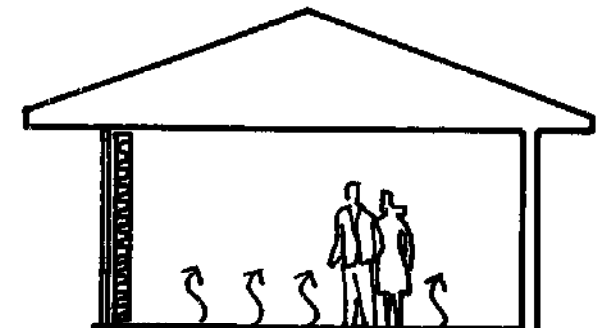

the transparent surface. The thermal conductivity and specific heat of the wall material and the expected temperature range will determine the volume of the wall. The reradiation time-lag must be accurately calculated to assure proper heating of the space. It is sometimes necessary to place insulation on the room side of the storage wall to avoid overheating the space. The exposed masonry storage method is usually used in conjunction with interior and exterior vents to control the heat distribution to the space or to another storage system.

A variation of exposing a masonry surface to solar radiation is to expose containers filled with water. The exposed water containers may be placed on the roof or used as interior or exterior walls. The previously described Atascadero house which uses plastic bags filled with water placed on the roof is an example of this method of storage. Again, careful calculations are required to properly size the storage capacity. Also, a similar means of thermal control is necessary to assure a proper lag-time and to avoid overheating.

### Rock Storage

A common method of heat storage, most often associated with air-cooled flat-plate collectors, is rock storage. Pebble beds or rock piles contained in an insulated storage unit have sufficient heat capacity to provide heat for extended sunless periods. The rock storage is heated as air from the collector is forced through the rock container by a blower. Rock storage will require approximately 2½ times the volume of water storage, assuming the same temperature range. For example, a rock pile with a void space of one third of the total volume can store approximately 23 Btu/cu ft/degree F, while water can store 62.5 Btu/cu ft/degree F.

A convenient rock size for storing solar heat is about 2 inches in diameter. A decrease in pebble size increases the air flow resistance through the storage and may affect blower and duct size and distribution efficiency. Unlike the previous storage methods, rock storage does not have to be in close proximity to the collector. However, as the distance increases, the heat transfer losses between the heated air and the rocks also increases and larger air ducts and more electrical power are generally required for moving air between the collector, storage, and heated spaces.

### Water Storage

Water has the highest heat capacity per pound of any ordinary material. It is also very inexpensive and therefore is an attractive storage and heat-transfer medium. However, it does require a large storage tank which may be expensive. The storage tank is usually insulated to reduce conductive heat losses. Also, it is sometimes practical to compartmentalize the storage tank to control temperature gradients (different temperatures within storage tank) and to maintain an efficient heat transfer. Potential disadvantages of water storage include leakage, corrosion and freezing.

Heat is generally transferred to and from storage by a working fluid circulated by an electric pump. The heated working fluid itself may be placed in storage or its heat transferred to the storage tank by a heat exchanger. The process of heat transfer to water is more efficient than to rock and therefore less surface for the heat exchanger is required. With water storage, proximity of storage to the collector is not as critical as with rock storage. Also, compared to rock storage, water occupies a comparatively small volume.

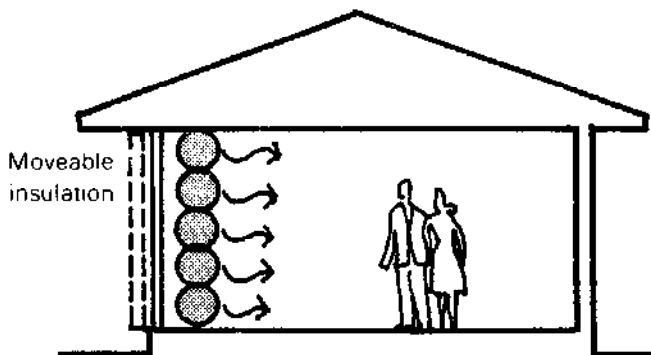

Heat Storage in Water Tanks behind Wall Collector

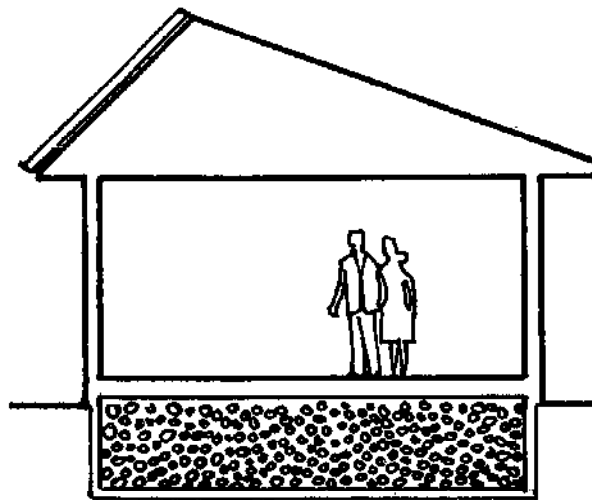

Rock Heat Storage

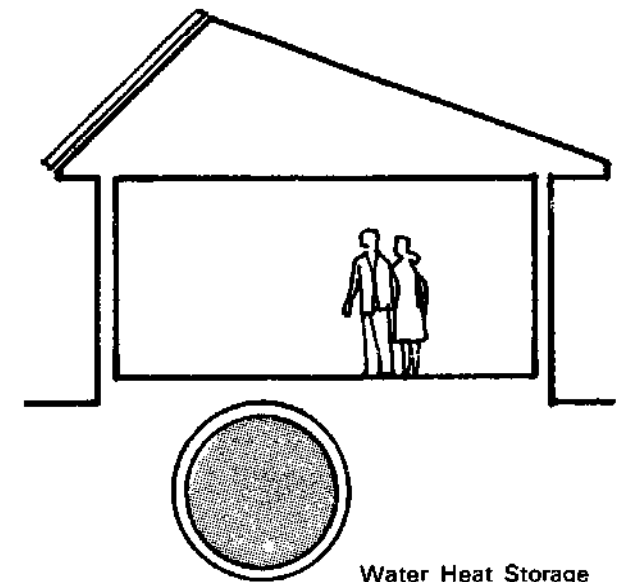

Water Heat Storage

## Latent Heat Storage

The use of the heat of fusion or heat of vaporization associated with changes of state or with chemical reactions offers the possibility of storing a great deal of heat in a small volume. Although numerous physical/chemical processes have been investigated and offer numerous advantages compared with sensible heat storage, there is not at the present time a completely reliable storage method using latent heat. However, to illustrate the basic principles of latent heat storage, several examples are presented.

## Salt Hydrates

The salt hydrates are among the simplest types of chemical used for heat storage. The heat storage process involves a phase change — generally, liquid to solid to liquid — which is induced by and produces heat. When the temperature of salts (such as the Glauber salt used in the Dover house) is raised to a specific value dependent on the chemical composition, heat is absorbed, releasing water of crystallization which dissolves the salt. When the temperature drops below the crystallization temperature, the stored heat is released and the solution recrystallizes. This phase change allows the salts to store a large amount of heat per unit volume. Unfortunately, after many phase change cycles the salt hydrates have a tendency to break down thus discontinuing their heat-evolving crystallization.

## Paraffin

Paraffin storage is similar to salt hydrate storage in that thermal energy is stored by heat-of-fusion. Paraffin does not have the crystallization problem common with salt hydrates. However, waxes do have a

tendency to shrink on solidifying and thus lose contact with the heat exchange surfaces (i.e., walls of the containing vessel), thereby reducing the rate of heat transfer.

## Comparison of Storage Volumes

The chart below illustrates the relative temperature and volume of heat storage media required to provide energy to a typical house for three days at an outside temperature of 20°F (-7°C). For heating,

the lower the storage temperature the greater the volume required. Since storage temperatures for most locales will not exceed 200°F (94°C) during winter conditions, it becomes imperative that the building be designed to use heat efficiently.

### ENERGY STORAGE VOLUME FOR THREE DAYS AT 20 DEG F

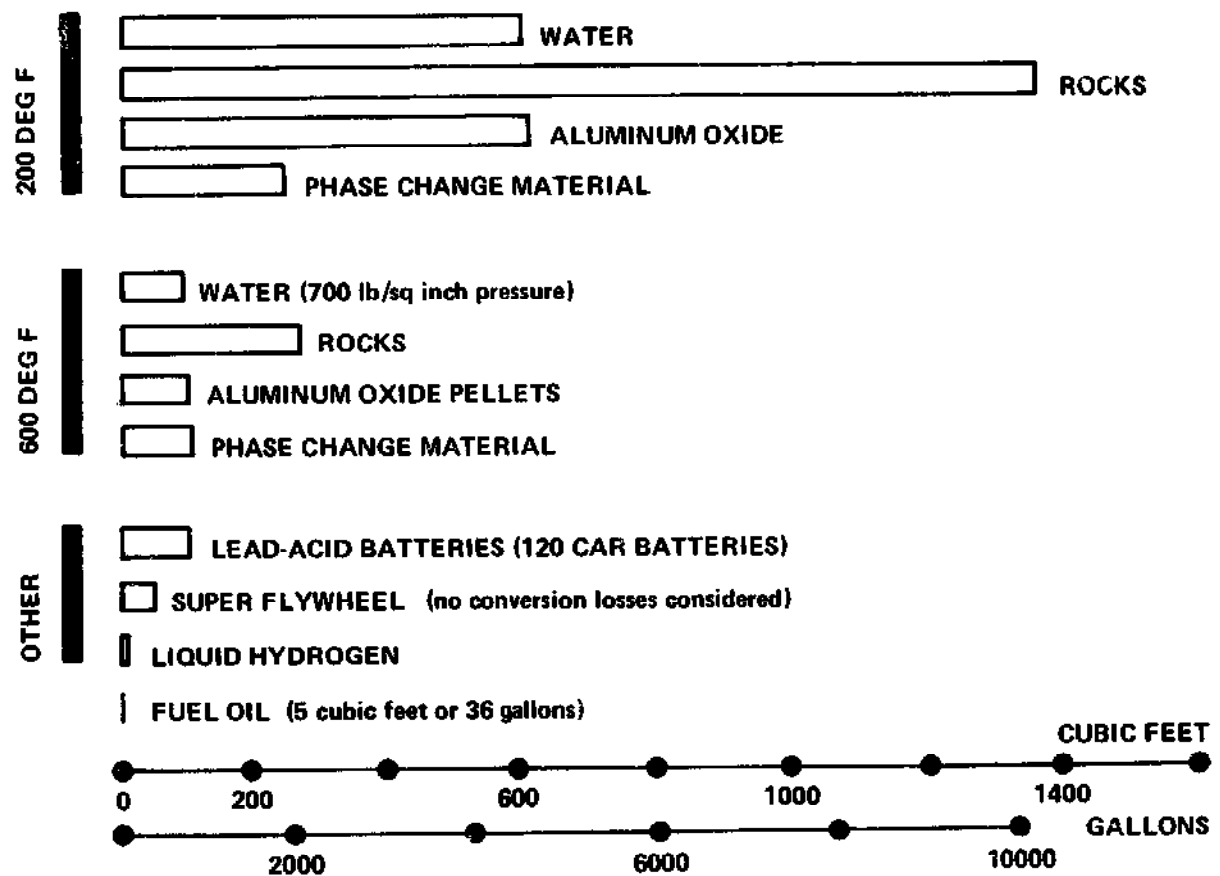

\* Heat of fusion is the latent heat involved in changing between the solid and liquid states while heat of vaporization is the latent heat involved in changing between liquid and vapor states.

## THERMAL ENERGY DISTRIBUTION

Generally speaking, there are three methods by which thermal energy from storage or collector can be distributed to point of use: gas flow, liquid flow and radiation. Within each category there are several techniques by which the distribution of energy to occupied spaces can be accomplished. Some involve mechanical and electrical equipment and processes while others utilize natural convection and radiation. The manner in which solar radiation is collected and stored will usually determine the means of distribution. For example, if an air-cooled flat-plate collector is used to capture solar radiation and a rock pile is used to store the heat, distribution is usually accomplished by air.

### Gas Flow Distribution

#### Natural Convection

Natural convection is the circulatory motion of air caused by thermal gradients without the assistance of mechanical devices. An example of convection is the motion of smoke towards room lamps — the hot air generated by the lamp rises because it is less dense, and cooler air moves in to replace it.

Natural convection is a useful means of distributing solar thermal energy because it requires no mechanical or electrical input. However, for this same reason, careful attention to design is required to maintain proper control of convective distribution methods. The placement of solar collectors, storage, interior and exterior walls and openings is extremely important for the successful operation of convective distribution.

The operation cycle of natural convective distribution is quite simple. Heat from the collector or storage is

supplied to the habitable space. This process is controlled by the collector or storage design or by wall or floor vents. As the hot air rises to displace cooler air, convection currents similar to those causing winds occur, and the air is distributed through the space. The air is cooled, becomes dense and falls toward the floor, where it is captured by cool air return vents, passed through the collector and storage and once again distributed. The cycle will continue as long as there is a temperature difference between the collector/storage components and the room air. When the convection heating cycle is not desired, in the summer for instance, the warmer air may be vented to the exterior.

#### Forced Air

A forced air system relies on mechanical equipment and electrical energy for the distribution of thermal energy. Design for solar systems is much the same as for conventional forced air systems. However, because solar produced temperatures in storage are often relatively low, distribution ducts and vents must

normally be larger than those used in conventional heating/cooling systems. Therefore, to achieve maximum efficiency in a solar system, careful attention to the design of air distribution throughout a dwelling is required.

Forced air distribution for solar systems is similar to conventional air distribution. Air from either the collector or storage is blown through ducts to the occupied spaces. The type of solar collector or storage is not the determining factor for selection of a forced air ducted system; the system is adaptable to rock, water or phase change storage components. For rock and containerized phase change storage, air is simply blown through the storage to ducts which supply the dwelling spaces. In the case of water storage, a heat exchanger is required to transfer heat from the liquid to air which is distributed to dwelling spaces.

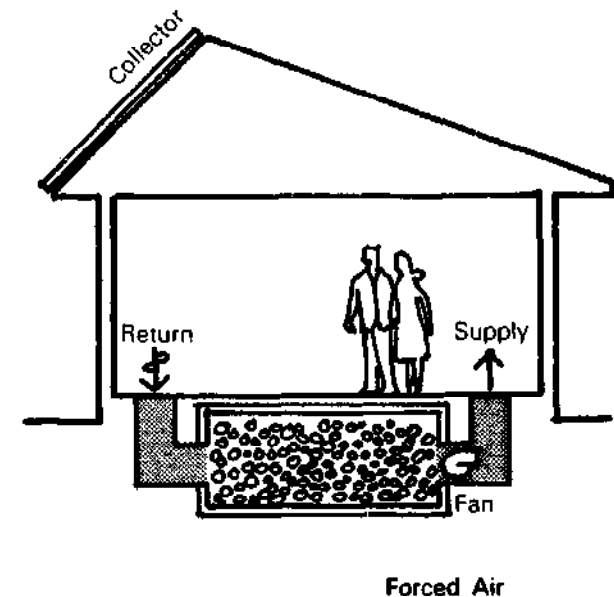
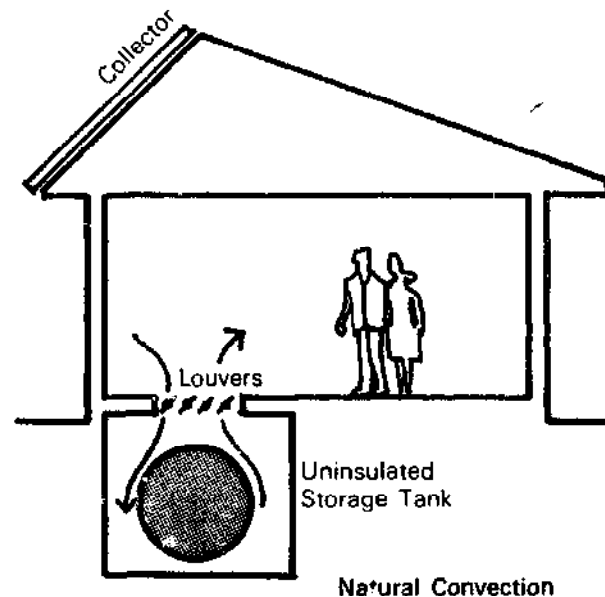

---

---

## Liquid Flow Distribution

### Forced Radiation

Forced radiant distribution relies on the transfer of heat to air in the occupied spaces by radiation and convection from circulating hot water through tubes. For cooling, the forced radiant system is generally used in conjunction with a refrigeration unit which passes chilled water through a fan coil unit located at the point of distribution. A blower is used to force air through the cooled fan coil unit and into occupied spaces.

The piping for the radiant system may be located in the ceiling, floor, or along the wall in fin tube baseboard units. The only significant alteration required of conventional radiant systems for use by solar systems is the enlargement of the radiating surfaces — larger fin tubes or closer spaced ceiling or floor coils — because of lower temperatures from storage.

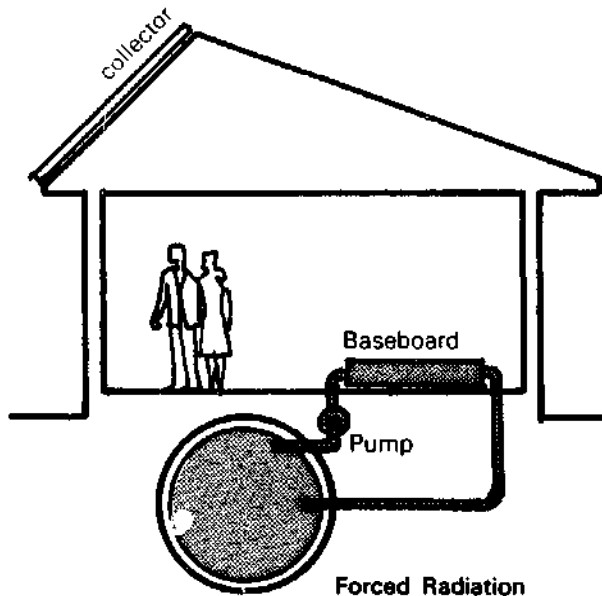

---

---

## Natural Radiation

Natural radiation is the transfer of heat by electromagnetic waves without the assistance of mechanical devices. The radiation properties of the emitting and absorbing surfaces, which are influenced by their temperature, will determine the rate of heat flow between them.

Unlike natural convection, which is dependent on differential air temperatures for distribution, natural radiation is dependent on differential surface temperatures. An example of natural radiation is the sun warming a greenhouse on a cold day. The radiant energy is transferred directly to the greenhouse surfaces and is not significantly affected by the cool temperature of the surrounding air. Natural radiation is particularly useful for collector or storage systems which are directly exposed to the occupied spaces. The captured energy can be emitted by natural radiation directly to the room's surface. The walls, floors, and ceiling of a dwelling,

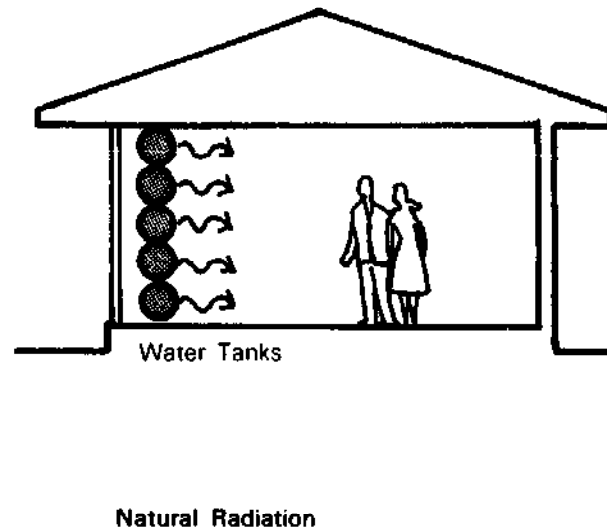

which are used to collect and/or store thermal radiation will radiate directly to a room's other cooler surfaces. The Atascadero house in California is an example of solar heat distribution by natural conduction and radiation.

---

---

## COLLECTOR — STORAGE — DISTRIBUTION COMPONENT INTERFACE

Solar system design, in its many different approaches, assembles the collector, storage, and distribution components into a heating, cooling and/or domestic hot water system. Each component of a solar system (collector, storage, and distribution) may be compatible with a limited number of other solar components or may be compatible with many. For example, a solar collector may be compatible with a specific storage component which in turn may serve one or several types of distribution systems.

To illustrate the compatibility of various solar components and to describe the process of converting solar radiation into thermal energy for heating and cooling, several representative solar systems will be discussed. Each representative solar system will be made up of a collector, storage, and distribution component described earlier in this chapter.



## A Solar System

A solar system may be diagrammed as shown below.

The basic function of a solar system is the conversion of solar radiation into usable energy. This is accomplished in general terms in the following manner. Radiation is absorbed by a **collector**, placed in **storage**, with or without the assistance of a **transport medium**, and **distributed** to point of use — an occupied space. The performance of each operation is maintained and monitored by automatic or manual **controls**. An **auxiliary energy system** is usually available for operation, both to supplement the output provided by the solar system and to provide for the total energy demand should the solar system become inoperable.

With this relatively simple process in mind, a more detailed explanation of several solar systems is presented illustrating variations in solar system design and operation.

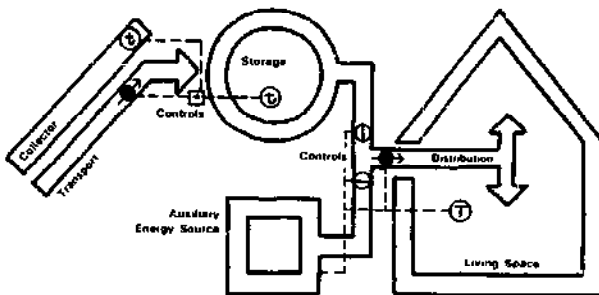

## A SOLAR SYSTEM

### Representative Solar System One: Warm-Water Flat-Plate System

Solar heating using water as the heat transfer and storage medium is the most common system in use today. More information is available about the behavior of water systems than about either air or passive systems.

The basic components of a typical water system consist of a collector; storage; a system of piping, pumps, and controls for circulating water from storage through the collector; and a distribution network for transferring stored heat to the dwelling space. The relationship of the various components of a warm-water solar system is diagrammed on the opposite page.

### Component Description and Operation

The liquid-cooled flat-plate **collector** has a flat absorbing surface integrated with transfer fluid piping which collects both direct and diffuse radiation. Energy is removed from the collector by a liquid flowing through conduits in the absorber plate. The transport fluid is pumped to storage where its heat is transferred to the storage medium (water in this case) and then returned to the collector to absorb more heat. Generally, the transfer fluid is circulated through the collector only when the absorbing surface is hotter than storage (except in instances when snow has covered the collector surface and the heated transport fluid is circulated through the collector to melt it).

**Storage** consists of either a concrete or a steel tank located near or beneath the building (access should be provided). The tank should be insulated to minimize heat loss. A concrete tank should be lined with a leak-proof material capable of withstanding high storage temperatures for extended periods without deterioration. Heat from the collector is transferred to storage by a heat exchange coil passing through the storage tank. Coil length and size is dependent on expected collector operating temperatures.

The **distribution system** consists of a pump and pipes which deliver heated water to the occupied spaces. A thermostat controls the operation of water flow or fan coil unit use in each room or dwelling. **Baseboard heaters** (convectors) require careful evaluation when not used in conjunction with a fan coil unit. Liquid-cooled flat-plate collectors seldom deliver water above 150°F in winter operation without auxiliary energy or reflected surface focusing. For this reason most warm water distribution systems use fan coil units or enlarged convectors.

Energy is **transported** away from the collector to storage by water or a water/antifreeze solution. Liquid transport fluids should be carefully evaluated before selection. The liquid must absorb heat readily at various collector temperatures and easily give up heat to the storage medium. Additionally, the liquid should not be corrosive to the system components, toxic, or susceptible to freezing or boiling.

A gas-fired conventional boiler is integrated with the solar system to provide an **auxiliary energy** supply should the solar system fail to function or not meet the dwelling's heating requirement. The distribution piping is run through the boiler where an energy boost may be supplied when temperatures from storage are not sufficient to heat the dwelling adequately.

**Domestic hot water** piping is run through the central storage tank prior to passing through a conventional water heater. Storage heat is transferred to the hot water piping, thereby either eliminating the need for additional heating or substantially reducing the energy required to raise the water to the needed distribution temperature. The domestic water heating system may operate independent of the space heating system. This is very useful for summer months when space heating is not required.

**Schematic Diagram of Warm-Water Flat-Plate System**

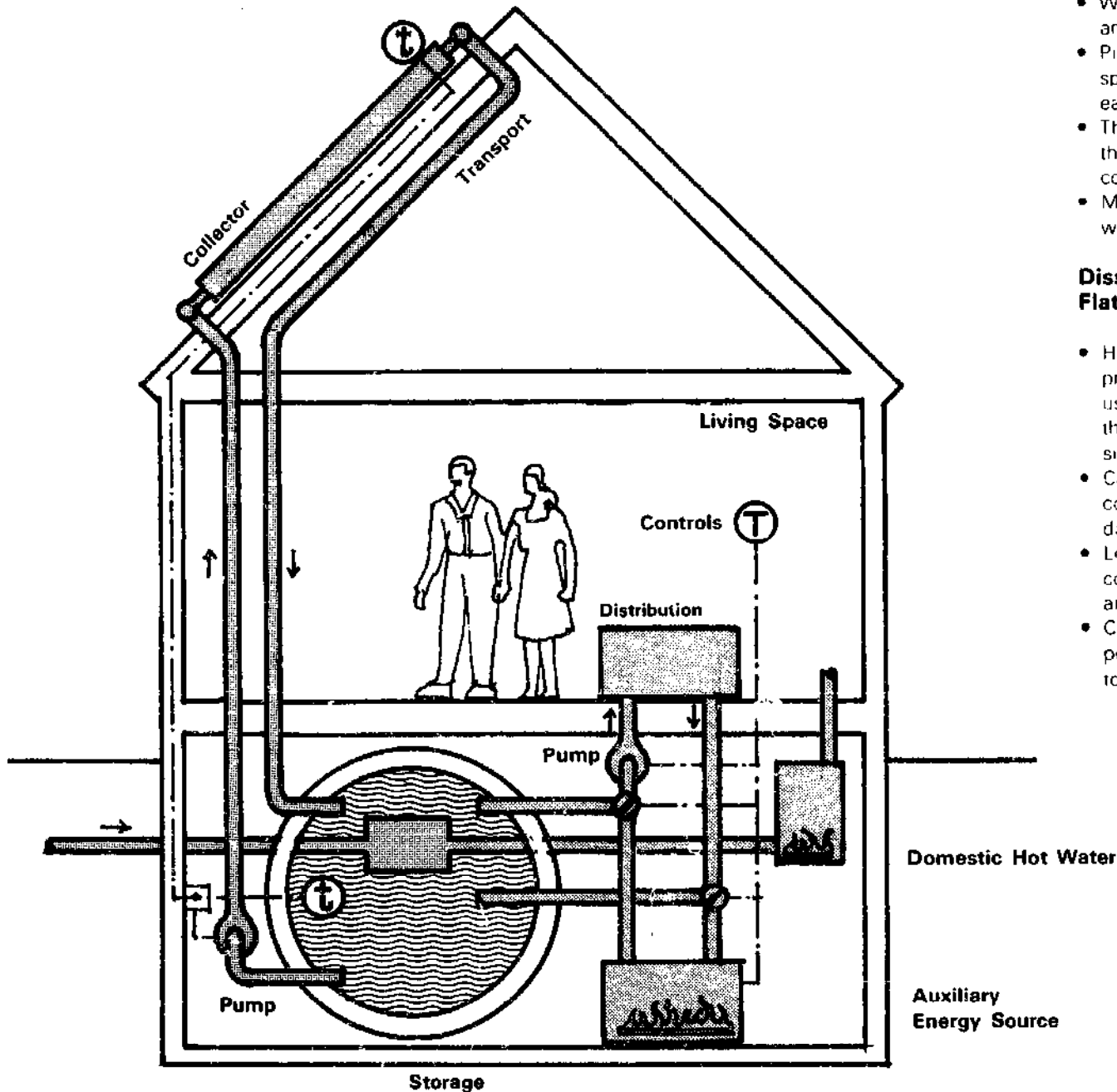

**Advantages of Warm-Water Flat-Plate Systems**

- They have repeatedly been proved to work well
- Water is a cheap and efficient heat transfer and storage medium
- Piping, as opposed to ductwork, uses little floor space, is easily interconnected, and can be routed easily to remote places and around corners
- The circulation of water uses less energy than the circulation of air with corresponding heat content
- Much less heat exchanger area is required than with an air system

**Disadvantages of Warm-Water Flat-Plate Systems**

- High initial cost, particularly when expensive prefabricated collectors are employed. With the use of large areas of lower-efficiency collectors, the total system cost may be lowered considerably
- Care must be taken to prevent the occurrence of corrosion, scale, or freeze-up capable of causing damage or blockage
- Leakage anywhere in the system can cause considerable amount of damage to the system and the dwelling
- Contamination of the domestic hot water supply is possible if a leak allows treated water storage to enter the domestic water system

## Representative Solar System Two: Warm-Air Flat-Plate System

Warm-air systems differ from warm-water systems in that air is used to transfer heat from collector to storage. The storage medium can be water, but more typically rock piles are used for warm-air systems. Heat, stored in the rock pile, can easily be distributed to the dwelling space by a forced air system. One possible arrangement of a warm-air system is diagrammed below.

### Component Description and Operation

The air-cooled flat plate collector has a solid absorbing surface and collects both direct and diffuse radiation. Energy is removed from the collector by air flowing in ducts beneath the absorber plate. As shown in the diagram, the system may be operated in four different modes:

1. heating storage from collector
2. heating house from collector
3. heating house from storage
4. heating house from auxiliary energy system

The four modes of operation are regulated by several sets of dampers. One set of dampers will direct air flow from the collector into storage or directly into the occupied spaces while another set will regulate air flow from storage to the occupied spaces. The dampers may be adjusted by manual or automatic controls. During modes two and three, an energy boost may be supplied to the warm air by the auxiliary energy system before the air is distributed to the occupied space. The amount of the energy boost is determined by the temperature of the air passing through the auxiliary heater and the amount of heat required at the point of use.

**Storage** consists of rocks about two inches in diameter, contained in a concrete bin in a basement area or underground beneath the building. The con-

Schematic Diagram of Warm-Air Flat-Plate System

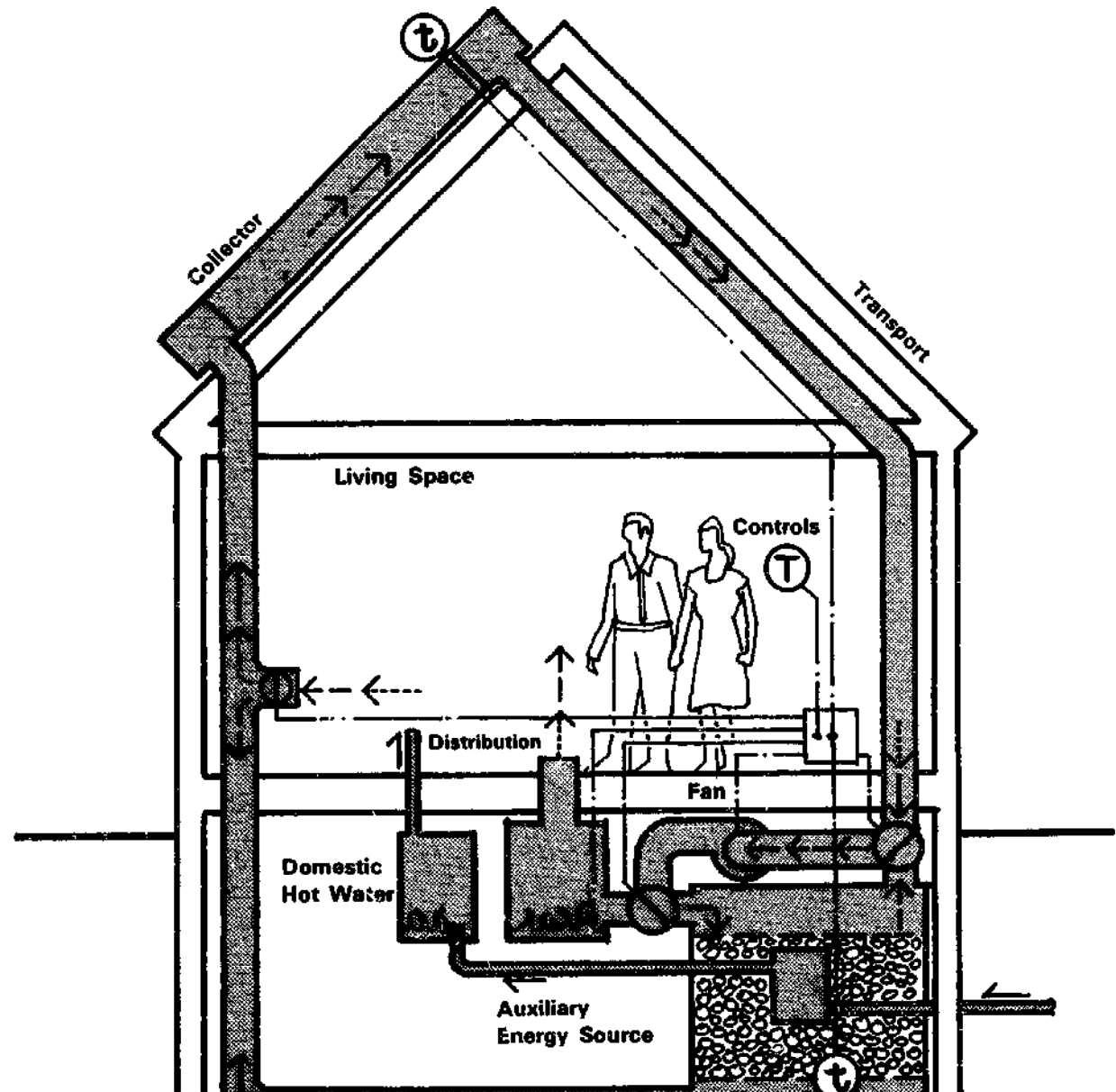

Because the temperatures in rock storage are typically highly stratified from inlet to outlet, the air flow providing heat to storage should be from top to bottom. This insures that the temperature of air returning to the collector from the storage is as low as possible, thereby increasing collector efficiency. The air flow, when removing heat from storage, should be in the opposite direction to insure that air returning to the rooms is as warm as possible.

The hot air **distributed** to the rooms comes either directly from the collectors or from storage. The ducting required to conduct the air from the collectors to storage is extensive when compared to analogous piping requirements for liquid-cooled collectors. Two blowers are required to distribute air throughout the system.

Almost any type of **auxiliary energy** system may be used in conjunction with a solar system. The auxiliary system may be completely separate or fully integrated with the solar heating/cooling system. However, in most cases it makes economic sense to integrate the back-up system with the solar system. This may mean running the distribution component from heat storage to the occupied space through the auxiliary system where an energy boost may be supplied when storage temperatures are low. Heat from storage may also be used in conjunction with heat pumps, absorption units or rankine engines. The heat pump, a device which transfers heat from one temperature level to another by means of an electrically driven compressor, utilizes the solar heat available from storage to supply necessary heat to the occupied space. The advantage of the heat pump/solar system integration is the reduction of electrical energy required by the heat pump because of heat supplied by solar storage. Also, the heat pump is the most efficient device presently available for extracting and transferring electricity into heat.

Piping for the **domestic hot water** is run through the rock pile storage bin. As a result, the domestic hot water is preheated before passing through a conventional water heater, thus reducing the water heater's energy requirement.

### **Advantages of Warm-Air Flat-Plate Systems**

- Capital cost tends to be lower than a water system of the same capacity.
- There is no problem with corrosion, rust, clogging or freezing.
- Air leakage does not have the severe consequences of water leakage.
- Domestic hot water supply is not subject to contamination by leakage from heat storage, as in the water system.

### **Disadvantages of Warm-Air Flat-Plate Systems**

- Ductwork risers occupy usable floor space and must be aligned from floor to floor.
- Air, having a lower thermal storage capacity than water, requires correspondingly more energy to transfer a given amount of heat from collector to storage, and from storage to occupied spaces.
- Air collectors and storage may need frequent cleaning to remove deposits of dust (filters may solve this problem).
- Air systems require a much larger heat exchange surface than liquid systems.

---

---

### **Representative Solar System Three: Warm-Water Concentrating System**

Solar systems with concentrating collectors have not been extensively used for the provision of space heating or cooling. The absence of such equipment from the market, the high cost and uncertain reliability of tracking or concentrating equipment under freezing rain, ice or wind and snow conditions have been the primary reasons for their limited use. However, they do offer advantages over flat-plate collectors — primarily the generation of high temperatures to operate heat driven cooling systems.

Representative solar system three utilizes a linear concentrating collector. The system is diagrammed on the following page.

### **Component Description and Operation**

The **collector** is a linear concentrator with a glass-enclosed pipe absorber. The collector captures only direct radiation and is, therefore, limited to climatic regions with considerable sunshine and direct radiation in winter. However, where applicable the linear concentrating collector offers considerable economies over flat-plate collectors since the necessary absorber area is reduced and the assembly is often simpler to construct.

The absorber pipe is a black metal tube within a glass enclosure under vacuum to reduce convection and radiation losses. Radiation is focused on the absorber by a trough-shaped reflector surrounding the pipe.

**Storage** consists of a steel tank or a lined concrete block enclosure filled with water. Again, the storage unit should be insulated to minimize heat loss. As with most all solar storage techniques, special structural support will be required if the storage tank is to be located in the dwelling.

The distribution system is by heated water to baseboard convectors. Heat is removed from storage by liquid-to-liquid heat exchanger. The heated water is pumped to baseboard convectors located throughout the building. If storage is below a preset minimum temperature the pump continues to operate with a conventional oil or gas-fired furnace assist in the liquid distribution loop.

As shown in the system diagram, collector fluid transport is by means of a pump which causes the fluid to flow through the absorber, and into the storage heat exchanger from which energy is removed and transferred to storage. The working fluid should be a heat transfer medium which has excellent transport properties and a boiling point above the expected operating temperature of the collector.

Domestic hot water piping is run through a heat exchanger in storage, thus preheating the water, before it proceeds to a conventional water heater which also provides storage. The water heater may or may not supply a boost to the water depending on its temperature.

### Advantages of Warm-Water Concentrating Systems

- Potential for more than double the temperatures of either air or water flat-plate collectors (particularly useful for solar cooling)
- Total absorber area needed is substantially smaller than flat-plate collectors
- Collector forms lend themselves to mass production techniques

### Disadvantages of Warm-Water Concentrating Systems

- Capital cost of collectors at present is greater than either air or water flat-plate collectors.
- Concentrating collectors may present problems of operation, reflecting surface durability, and structural mounting.
- Leakage at flexible absorber connections may present possible problems
- Climatic applicability for winter space heating is limited

Schematic Diagram of Warm-Water Concentrating System

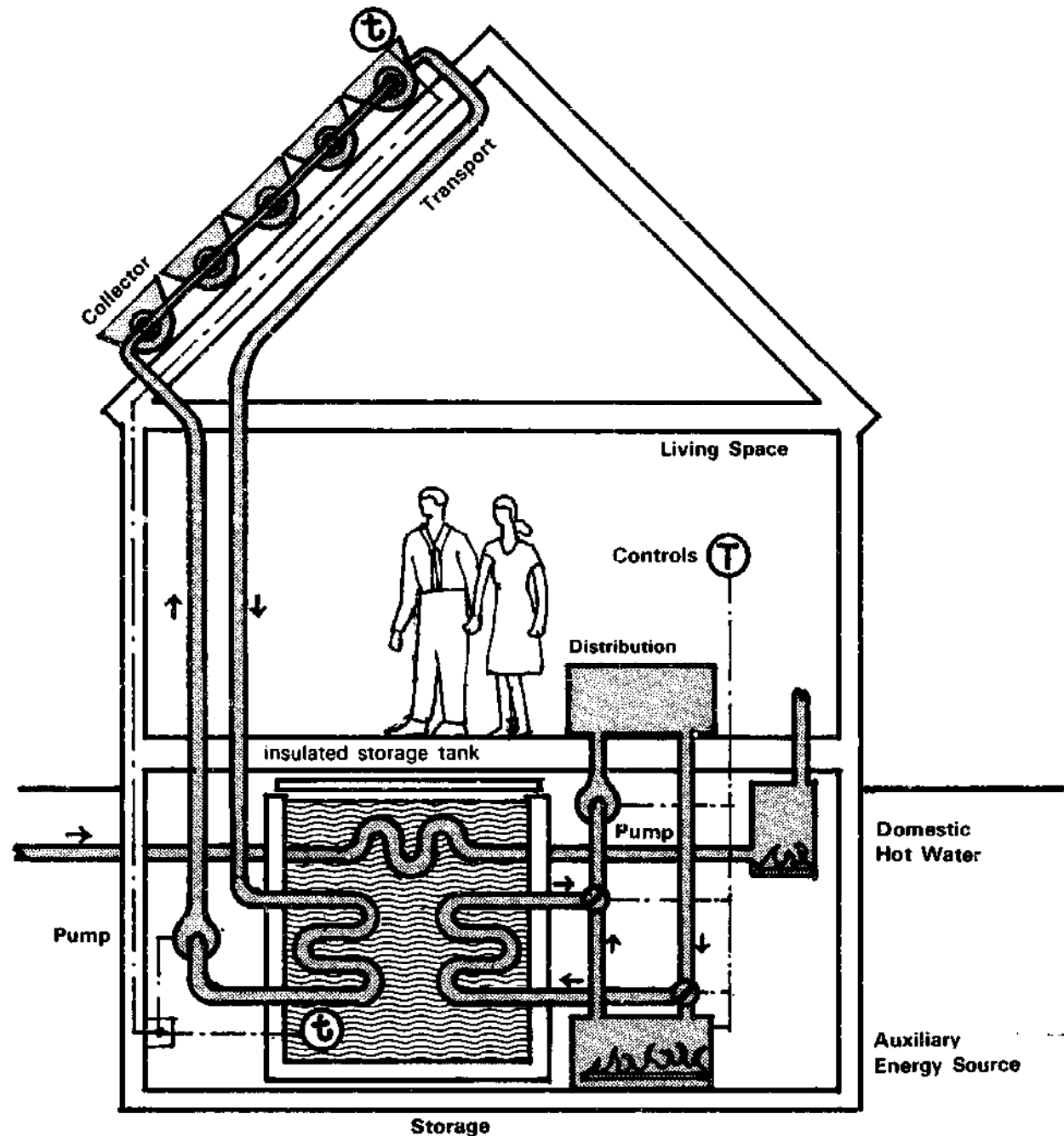

### Representative Solar System Four: Warm-Air Passive System

The passive system described here is one possible concept among many. It makes use of extensive south-facing glazing with an intermediate collection/storage wall between the glazing and the occupied space. It relies in part on the thermosyphoning principles discussed earlier. Diagrammatically, the passive system can be represented as illustrated.

#### Component Description and Operation

The passive collector, made up of a massive south-facing wall of either concrete or masonry separated by an air space from an outer wall of glass, captures direct, diffuse and reflected solar radiation. With the use of automatic or manually operated dampers and vents, the system may operate in four modes:

1. natural ventilation — no collection
2. house heating from collector
3. storage heating from collector
4. house heating from collector and storage

When no collection or heat distribution is required the vents and dampers may be opened to provide natural ventilation and removal of heat striking the collector. The space may be heated directly from the collector by closing the storage vent duct, thus forcing the heated air into the occupied space. Once sufficient heat has been transferred to the space, the storage vent may be opened and heated air from the collector transmitted to storage. If heat is required at a later time, the storage vent may be opened to allow stored heat to enter the occupied space.

The system employs several storage concepts. The exposed masonry wall which the radiation strikes acts as a storage element. The warmed masonry surface transmits collected heat to the occupied space by radiation. The second storage element is a rock pile located beneath the occupied space. Insula-

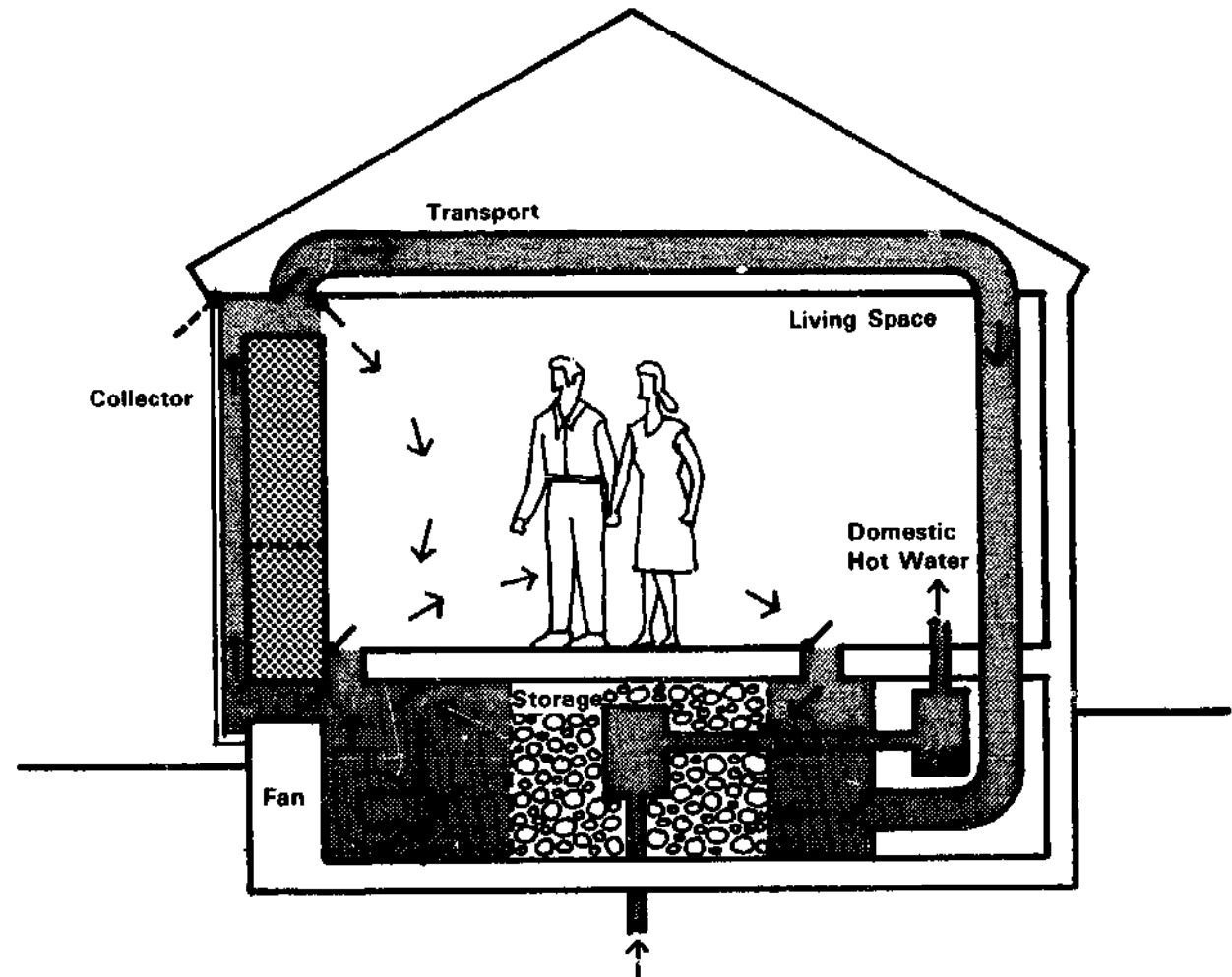

tion is placed between the rock pile and floor surface to avoid overheating the space. Water or containerized salts could have also been used as the storage medium.

Heat is **distributed** to the occupied spaces from the collector or storage component. Ducting is required to transport the heated air from the collector to storage, and a small fan may be necessary to circulate this air. Heat is distributed to the space by convection from the collector and/or storage, by radiation from the collector and surrounding surfaces, and to a small degree, by conduction from the collector and surrounding surfaces.

**Domestic water heating** is not directly integrated in the solar space heating system. However, a storage tank or the domestic hot water piping may be placed in the rock pile storage to preheat the water before it passes through a conventional electric or gas water heater.

### **Advantages of Warm-Air Passive Systems**

- A system with electrical controls can be designed to operate manually in a power failure.
- Cost should be reduced through simpler technology and elimination of a separate collector.
- Collector serves multiple functions (i.e., can be a wall or roof).

### **Disadvantages of Warm-Air Passive Systems**

- May not be cost effective relative to warm air or water flat plate collector systems.
- In many cases, require automatic or manual insulating devices which are expensive and may require life style modification.
- Larger unobstructed area needed to the south of the house for a vertical passive collector than for a roof collector.

- In some climates and for some passive systems low winter sun angles may be disturbing to the occupants.
- Potential problems of occupant-privacy for passive systems with large expanses of south facing glass
- Potentially large nighttime thermal losses from collector if not properly insulated

# 3

## SOLAR DWELLING DESIGN: INFLUENCING FACTORS

For thousands of years man has intuitively designed his dwellings to make use of the sun's energy. However, it has only been within the last 40 years that a concerted effort has been undertaken to scientifically develop and apply solar energy principles to building design. During the historical survey of solar dwellings presented in Chapter One and the discussion of solar components and systems presented in Chapter Two, many different solar heating and cooling concepts have been discussed and illustrated. What needs to be done at this point is to explain briefly the terminology and principles of solar dwelling design. In this chapter, the major factors influencing solar dwelling and system design will be identified.

Solar heating and cooling systems are substantially different from conventional systems, the major difference being the use of solar radiation as a fuel source, requiring a large collection and storage area not associated with conventional systems. As a consequence, a necessarily major portion of the solar system is exposed. It cannot be easily hidden, nor should it be. Rather, the exposed components of a solar system should be integrated with the architectural design to enhance the overall appearance of the dwelling.

---

### SOLAR DESIGN FACTORS

Solar building design is inextricably related to a number of critical factors which individually and

together influence the resultant architectural expression. There are those factors which affect the realistic opportunity for the utilization of solar heating and cooling systems, and there are those issues which affect the physical capability of designing and constructing dwellings and solar systems. The first category relates to considerations which may impede or accelerate the use of solar energy systems, while the second includes considerations which will influence the physical design of the dwelling and solar system. Listed below are the major factors in each category.

#### Opportunity Factors

- Legal — such as building codes or zoning ordinances.
- Economic — cost effectiveness of solar heating and cooling.
- Institutional — such as lender's attitudes towards solar energy.
- Sociological — such as a society's energy and environmental attitudes.
- Psychological — such as an individual's expectations.

#### Physical Factors

- Climate — sun, wind, temperature, humidity.
- Comfort — such as an occupant's comfort zone.
- Building characteristics — the thermal behavior of buildings.
- Solar system — collector, storage and distribution component integration.
- Site conditions — such as topography, ground cover and vegetation.



The interrelationship of these and other factors will ultimately affect the design of solar heated/cooled buildings. This chapter addresses the first four physical design factors while site planning for solar energy utilization is discussed separately in Chapter Four. While opportunity factors are of critical importance, they are not directly addressed in this document.

## CLIMATE: THE GIVEN CONDITIONS

Sun, wind, temperature, humidity and many other factors shape the climate of the earth. Basic to using the sun for heating and cooling is understanding the relationship of sun and climate. What are the elements of climate? How do they affect solar dwelling design for a specific site or climate?

Global climatic factors such as solar radiation at the Earth's surface, tilt of the Earth's axis, air movement, and the influence of topography determine the climatic make-up of any area on Earth. These factors will determine the temperature, humidity, solar radiation, air movement, wind and sky conditions for any specific location. Regional patterns of climate will emerge from a commonality among these climatic influences. Local climates are additionally influenced by site topography, ground surface, and three dimensional objects. The sum total of the above climatic factors will determine the need for and the design of solar dwellings and sites. In essence, climate is the given condition within which solar dwellings are designed.

### Definition of Climate

Climate (from Greek Klima) is defined by the Webster dictionary as "the average course or condition of the weather at a place over a period of years . . ." Since weather is the momentary state of the atmospheric environment (temperature, wind velocity, and precipitation) at a particular location, climate could be defined as the sum total of all the weather that occurs at any place. Like the weather, climates are directed by the sun and are influenced by all the

physical conditions of the earth — the nearness of an ocean, the presence or absence of a mountain, prevailing winds, and so on. The climates of particular localities are comparatively constant, and despite pronounced and rapid changes, have an inherent character of weather patterns that repeat themselves time and again. Cold days occasionally occur in hot climates, and hot days are not unknown in cold climates; dry climates often have rainy periods, and wet ones extended periods of drought. Even so, every place on the face of the earth over an extended period of time exhibits its peculiar combination of heat and cold, rain and sunshine.

In response to these differing climatic conditions, housing styles in one area of the country have developed which are substantially different than those found in other areas. This same differentiation will be particularly true for dwellings heated and/or cooled by the sun.

### Elements of Climate

The Earth's climate is shaped by thermal and gravitational forces. Regional pressure, temperature, and topographical differences influence the climatic

conditions on a continental scale. The conditions of weather which shape and define local and regional climates are called the elements of climate. The five major elements of climate are temperature, humidity, precipitation, air movement, and solar radiation. Additionally, sky condition, vegetation, and special meteorological events are also considered elements of climate.

A designer or builder is primarily interested in the elements of climate which affect human comfort and the design and use of buildings. This is especially true if the building is to be powered by solar energy. The information a designer would like to know includes averages, changes, and extremes of temperature, the temperature differences between day and night (diurnal range), humidity, amount and type of incoming and outgoing radiation, direction and force of air movements, snowfall and its distribution, sky conditions and special conditions such as hurricane, hail, or thunderstorm occurrence.

Climate data is gathered for each of these elements at airports and meteorological stations by the National Weather Service. The information is generally not collected specifically for use by builders or

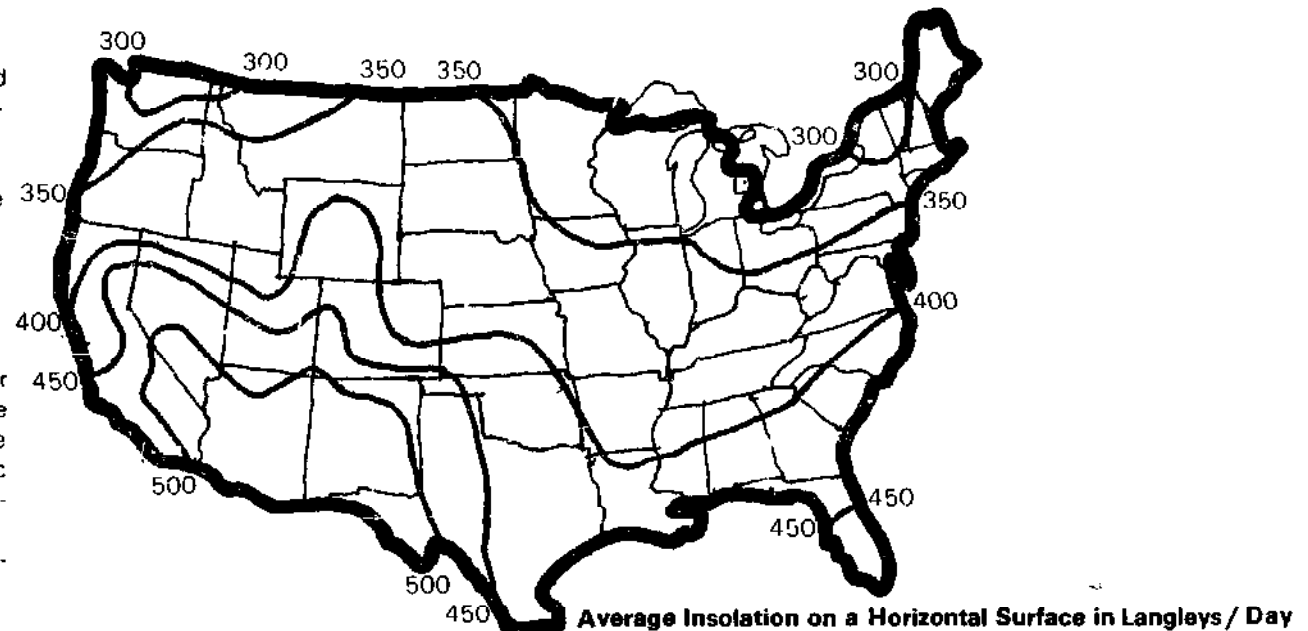

designers, and may omit data relevant to solar building design. Therefore, it is often necessary to supplement published data with information obtained directly from the meteorological station. In many cases, however, the most frequently used climatic data is organized into helpful design manuals.<sup>4</sup> The use of these climatic design tools eliminates the need for painstaking analysis of unedited climatic data. The careful analysis of climatic elements will identify the local climatic features which are potentially beneficial or detrimental to human comfort and solar dwelling and site design.

### Climatic Regions of the United States

A commonality of climatic conditions within a geographic area will constitute a climatic region or zone. A number of systems have been proposed for classifying climatic regions within the United States.<sup>5</sup> For purposes of discussing the variation in solar dwelling and system design which result because of different climatic conditions, only a broad description of climates of the United States is required. W. Koppen's classification of climates, based upon vegetation, has been the basis of numerous studies about housing design and climate.<sup>6</sup> Using this criterion, four broad climatic zones are to be found in the United States: cool, temperate, hot-arid, and hot-humid. The areas of the United States which exhibit the general characteristics associated with each zone are shown below. The boundary between regions is not as abrupt as indicated. Each different climatic region merges gradually and almost invisibly into the next one.

The climatic characteristics of each region are not uniform. They may vary both between and within regions. In fact, it is not unusual for one region to exhibit at one time or another the characteristics associated with every other climatic region. However, each region has an inherent character of weather patterns that distinguishes it from the others. A brief description of the four climatic zones will identify the general conditions to which solar dwelling and site designs in those regions must be responsive. The variation in dwelling and solar system design, because of these climatic differences will become

apparent in Chapters Four, Five, and Six where numerous site and dwelling concepts will be presented.

**Cool regions:** A wide range of temperature is characteristic of cool regions. Temperatures of minus 30° F (-34.4°C) to plus 100° F (37.8°C) have been recorded. Hot summers and cold winters, with persistent winds year round, generally out of the NW and SE, are the primary identifiable traits of cool regions. Also, the northern location most often associated with cool climates receives less solar radiation than southern locations.

**Temperate regions:** An equal distribution of overheated and underheated periods is characteristic of temperate regions. Seasonal winds from the NW and S along with periods of high humidity and large amounts of precipitation are common traits of temperate regions. Intermittant periods of clear sunny days are followed by extended periods of cloudy overcast days.

**Hot-arid regions:** Hot-arid regions are characterized by clear sky, dry atmosphere, extended periods of overheating, and large diurnal temperature range. Wind direction is generally along an E-W axis with variations between day and evening.

**Hot-humid regions:** High temperature and consistent vapor pressure are characteristic of hot-humid regions. Wind velocities and direction vary throughout the year and throughout the day. Wind velocities of up to 120 mph may accompany hurricanes which can be expected from E-SE directions.

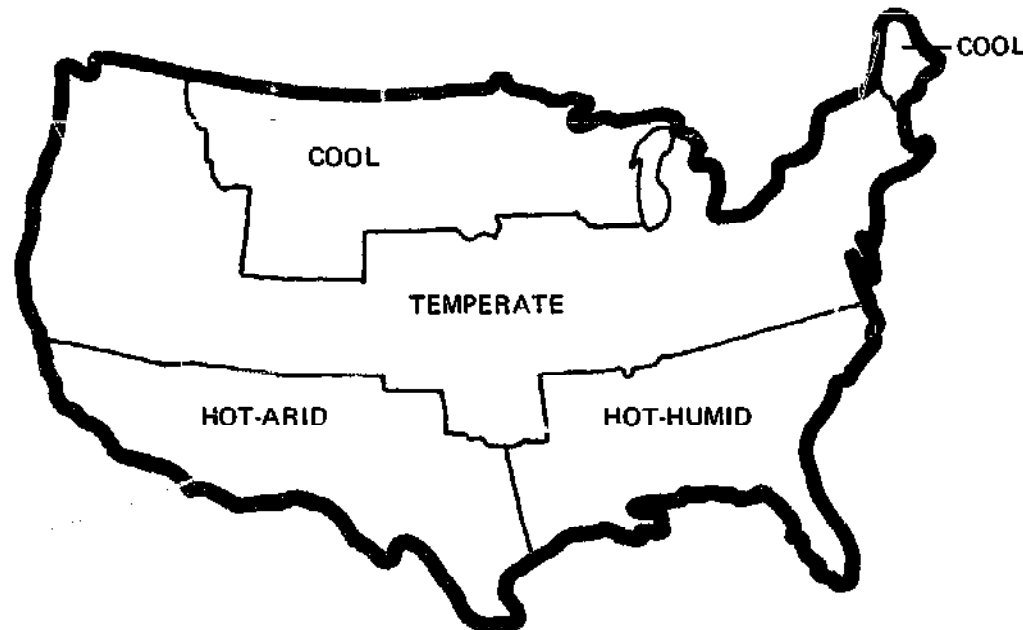

## Climate and Solar Dwelling Design

Although numerous atmospheric and surface conditions shape the Earth's climate, there are four elements of climate which are particularly important for solar dwelling and system design. These are solar radiation, air temperature, humidity, and air movement. Each of these climatic elements will impose specific design conditions to which the dwelling, site and solar system should be responsive. In some cases, protection of the building and solar system from excessive climatic exposure will be of the primary concern while in others it will be to maximize climatic impact. Regardless of the area of the country, a careful analysis of these elements should be undertaken before detailed dwelling or solar system design.

### Solar Radiation

The sun provides the Earth with almost all of its energy, in the form of radiation. Solar radiation is electromagnetic radiation transmitted in wavelengths which vary from .29 microns to 3 microns in length (one micron equals one thousandth of a millimeter). VHF and other radio waves are familiar examples of infrared or long wave radiation; x-rays, gamma-rays from radioactive substances, and cosmic rays are examples of ultraviolet or short wave radiation. The human eye perceives radiation in the region between ultraviolet and infrared, specifically between 0.36 and 0.76 microns, as visible light. Visible light is therefore only a part of solar radiation. Solar radiation and light should not be confused with each other. Recognition of this difference is of critical importance for the design of solar dwellings and systems since collector designs and building materials will respond differently to solar radiation.

### Solar Constant

The intensity of radiation reaching the upper surface of the atmosphere is taken as the solar constant. The solar constant may actually vary  $\pm 2$  percent due to variations in the sun's energy output and

$\pm 3.5$  percent due to changes in distance between the earth and sun. The solar constant (on a plane perpendicular to the sun's rays) equals 429.2 Btu's\* per square foot per hour, or 1,353 watts per square meter ( $w/m^2$ ).

The radiation which finally arrives at the earth's surface — called insolation — is less than the solar constant and arrives in either direct (parallel) rays or diffuse (non-directional) rays. The solar radiation reaching a building includes not only direct and diffuse rays but also radiation reflected from adjacent ground or building surfaces. It is these three sources of solar radiation which may be used to heat and cool buildings.

### Insolation

The insolation at a particular point on the earth is affected by several factors. The angle at which solar radiation strikes the earth's surface changes because of the earth's curvature and the tilt of its axis. Consequently, the radiation received per unit area perpendicular to the incoming radiation is greater than that received per unit area on a horizontal surface. It is for this reason that solar collectors are generally placed on an angle. Radiation reaching the earth's surface is also affected by the condition of the atmosphere: its purity, vapor, dust and smoke content. Radiation is absorbed and scattered by ozone vapors and dust particles in the atmosphere. The lower the solar altitude angle, the longer the path of radiation through the atmosphere, thus, reducing the amount reaching the earth's surface. Another obvious factor which effects the amount of radiation striking a particular location will be the length of the daylight period, which is dependent on the day of the year.

Each area of the earth will be affected differently by these factors. The percentage of direct and diffuse in-

solation at a particular location will vary as a result of these modifying factors. The figure on page 41 maps the average solar radiation on a horizontal surface striking the United States in Langleys\* per day

### Tilt of the Earth's Axis

The earth rotates around its own axis, one complete rotation in 24 hours or one day. The axis of this rotation (the line joining the North and South Poles) is tilted at an angle  $23.5^\circ$  degrees to the plane of the earth's orbit and the direction of this axis is constant.

Maximum intensity of solar radiation is received on a plane normal, that is perpendicular, to the direction of radiation. The equatorial regions of the earth, which are closest to the direction of solar radiation, would always receive maximum radiation if the axis of the earth were perpendicular to the plane of the orbit. However, due to the tilt of the earth's axis, the area receiving the maximum solar radiation moves north and south, between the Tropic of Cancer (latitude  $23.5^\circ$ N) and the Tropic of Capricorn (latitude  $23.5^\circ$ S). This is the primary cause of seasonal changes.

### Atmospheric Conditions

The momentary and long term state of the atmosphere has considerable effect on the type and amount of insolation at the earth's surface. Clouds will reflect a considerable portion of incoming radiation back into outer space while water droplets, dust, smoke, or other particulate matter will absorb or scatter solar radiation. Even during clear sky conditions as much as 10 percent of the total insolation may arrive as diffuse, scattered solar radiation. The insolation at the earth's surface is greatly reduced during cloudy weather and most of the radiation that gets through is diffuse sky radiation

\* Btu (British thermal unit) is the amount of energy necessary to increase the temperature of one pound of water one degree fahrenheit.

\* One Langley is equivalent to one calorie of radiation energy per square centimeter. One Langley equals 3.69 Btu per square foot ( $Btu/ft^2$ ).

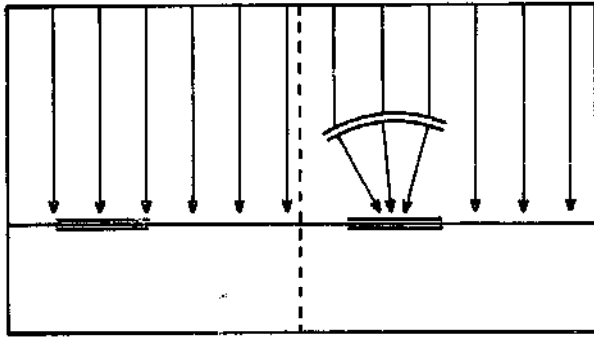

### 1. SOLAR CONSTANT

THERE IS A NEARLY CONSTANT AMOUNT OF SOLAR ENERGY STRIKING THE OUTER ATMOSPHERE — 429 BTU PER S.F. PER HOUR — AND THIS QUANTITY IS KNOWN AS THE SOLAR CONSTANT.

**NOTE:**

You cannot increase the amount of solar energy striking a collector of a given size by focusing. You may increase the collector's efficiency, or the temperature of the working fluid.

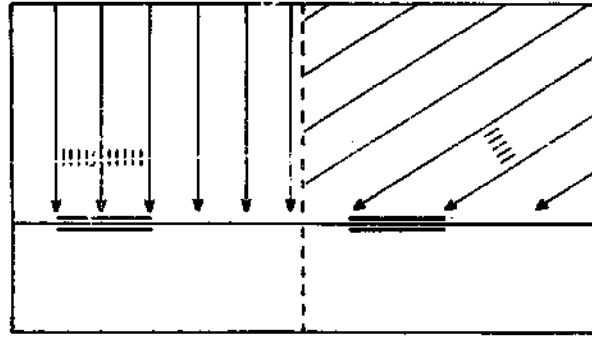

### 2. COSINE LAW — HORIZONTAL SURFACE

LESS SOLAR RADIATION STRIKES A GIVEN HORIZONTAL AREA AS THE SUN GETS LOWER IN THE SKY. THE AMOUNT CHANGES BY THE COSINE OF THE ANGLE, MEASURED FROM DIRECTLY OVERHEAD.

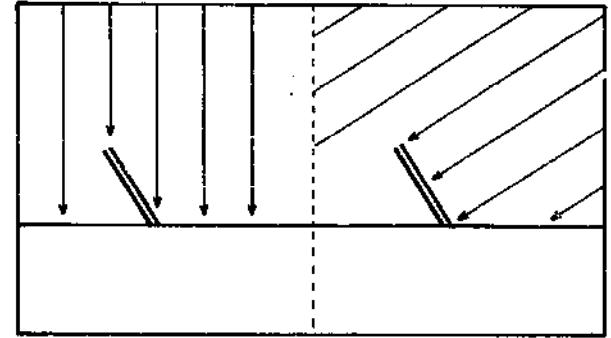

### 3. COSINE LAW — TILTED SURFACE

THE SAME LAW APPLIES TO A TILTED SURFACE, SUCH AS A SOLAR COLLECTOR. BY TILTING THE COLLECTOR SO THAT IT IS MORE NEARLY PERPENDICULAR TO THE SUN, MORE ENERGY STRIKES ITS SURFACE.

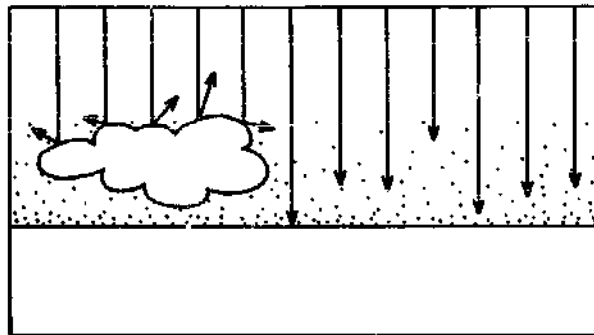

### 4. ABSORPTION AND REFLECTION

NEARLY HALF THE SOLAR RADIATION ENTERING THE EARTH'S ATMOSPHERE IS LOST THROUGH ABSORPTION BY MATERIAL IN THE ATMOSPHERE, OR BY REFLECTION FROM CLOUDS.

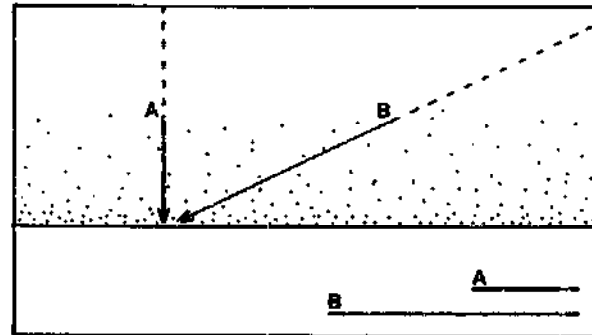

### 5. LENGTH OF TRAVEL THROUGH THE ATMOSPHERE

MORE SOLAR RADIATION IS LOST BY ABSORPTION AT LOW SUN ANGLES BECAUSE THE LENGTH OF TRAVEL THROUGH THE ATMOSPHERE IS GREATLY INCREASED (THAT IS WHY YOU CAN LOOK DIRECTLY AT THE SUN AT SUNSET.) HIGH ALTITUDES HAVE MORE SOLAR RADIATION FOR THE SAME REASON.

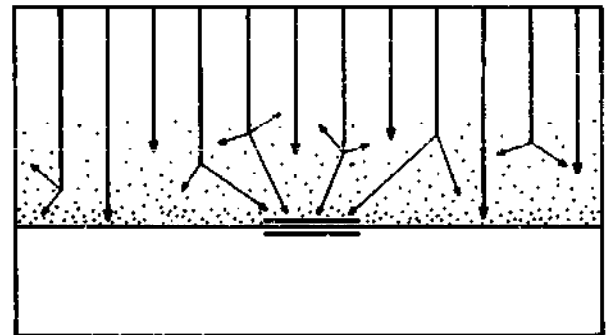

### 6. DIFFUSE RADIATION

CLOUDS AND PARTICLES IN THE ATMOSPHERE NOT ONLY REFLECT AND ABSORB SOLAR ENERGY, BUT SCATTER IT IN ALL DIRECTIONS. BECAUSE OF THIS, SOLAR ENERGY IS RECEIVED FROM ALL PARTS OF THE SKY — MORE SO ON HAZY DAYS THAN ON CLEAR DAYS. SUCH RADIATION IS CALLED *DIFFUSE*, AS OPPOSED TO THE NORMAL *DIRECT* RADIATION.

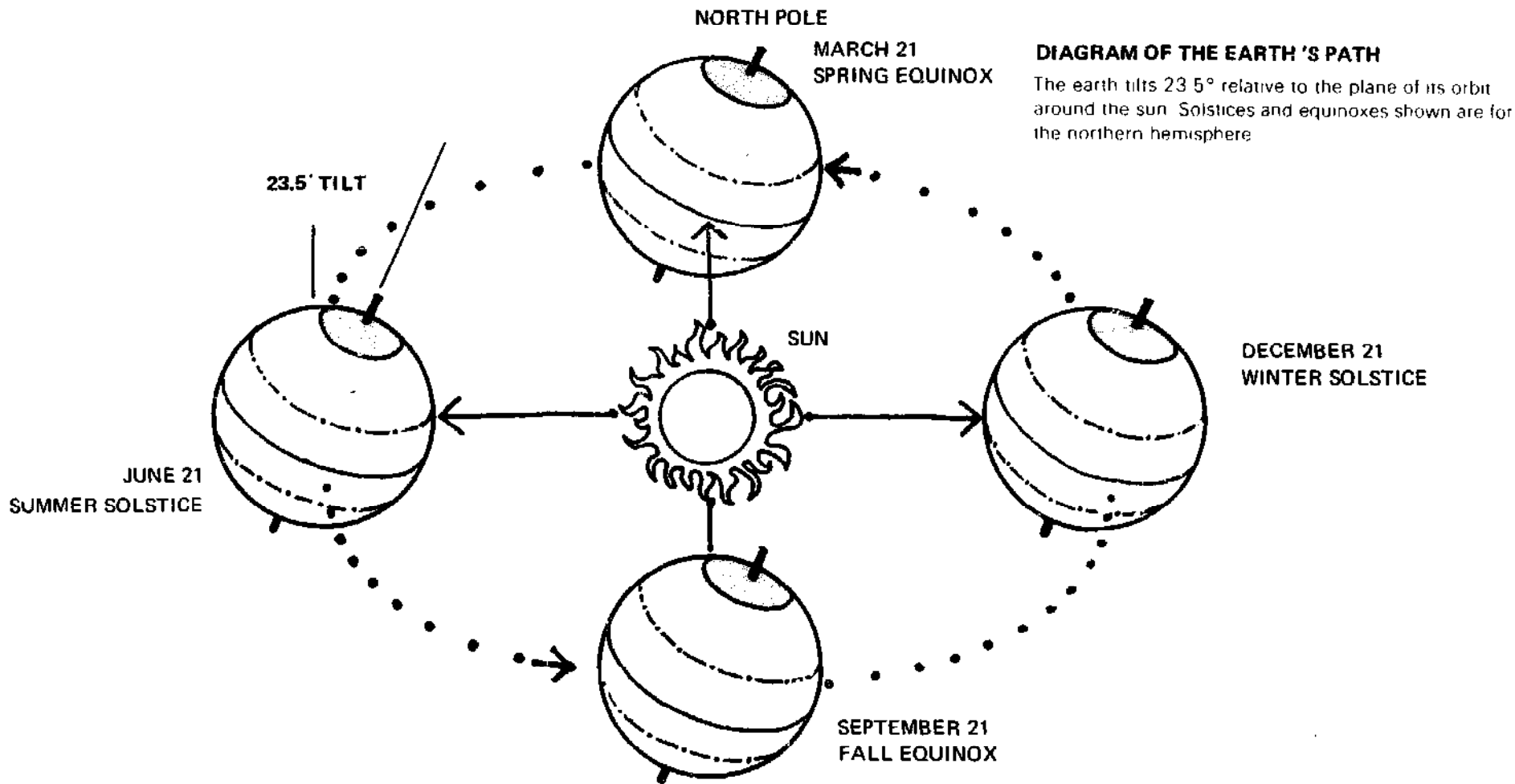

**WHAT THE SUN 'SEES'**

The ● shows the latitude at which the sun would be directly overhead

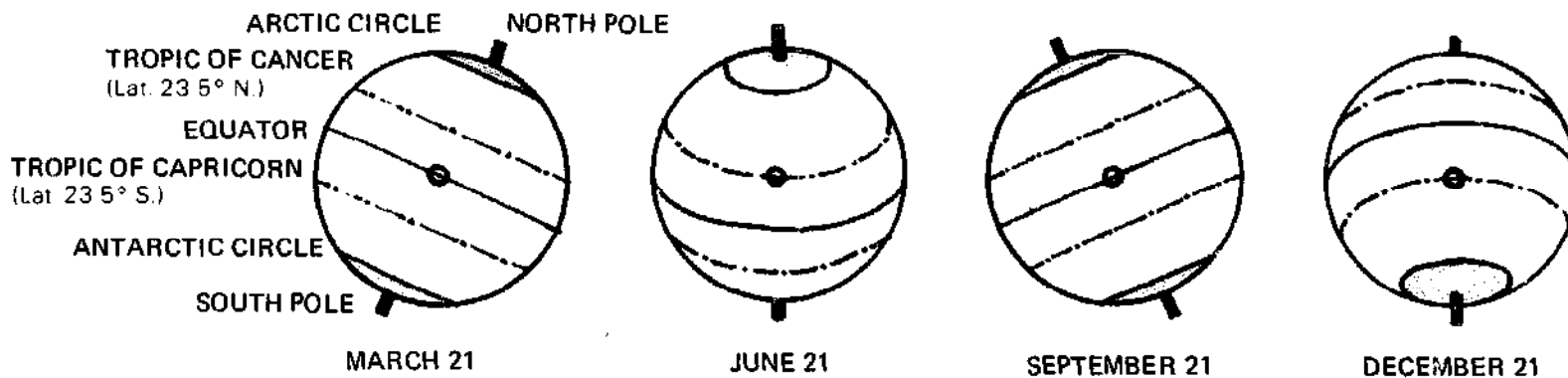

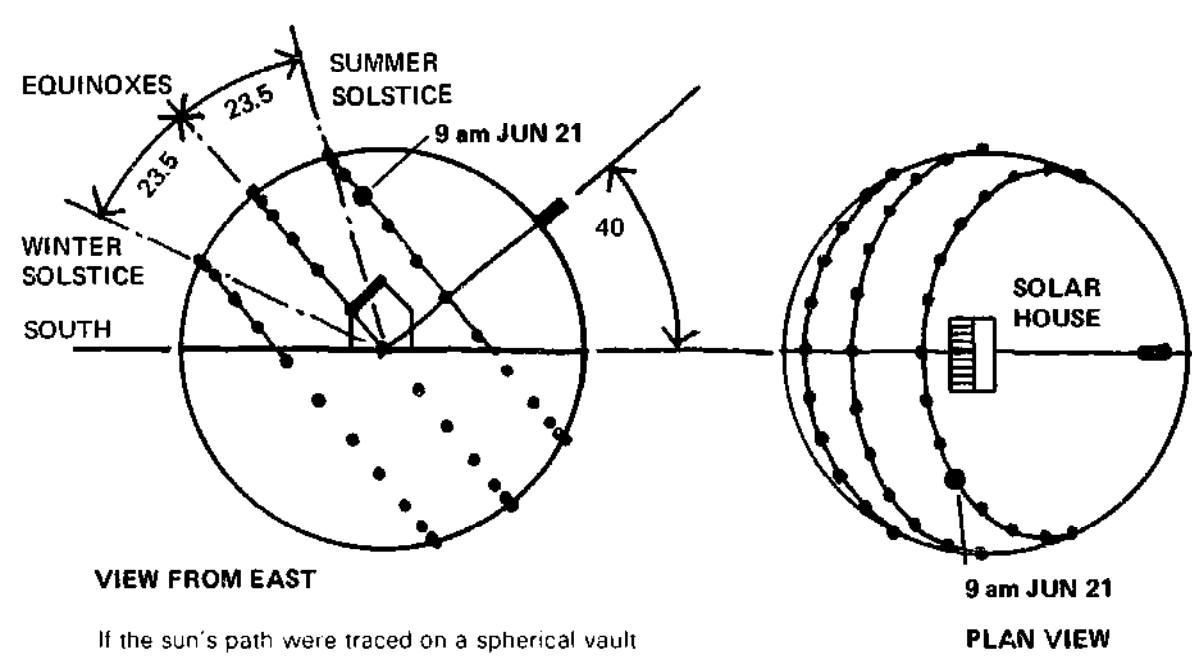

If the sun's path were traced on a spherical vault overhead, the result would look like this, as seen from the east side and from the top. Each day's path describes a circle around an axis pointing toward the North Pole, the axis being tilted from the horizon by the latitude angle, in this case  $40^\circ$ .

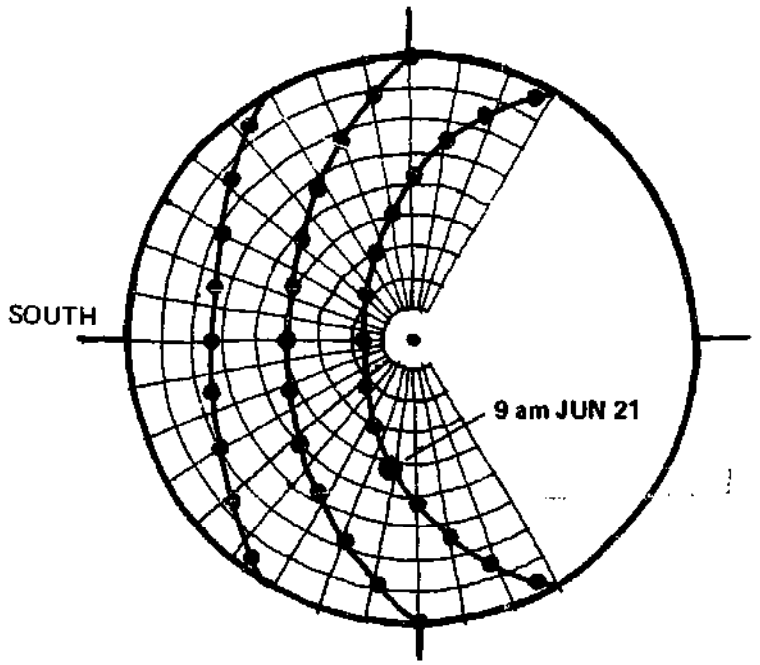

A Sun Path Diagram, such as this one for latitude  $40^\circ$  North, is an equidistant circular graphic "map" of the azimuth (compass direction) and elevation (angle from the horizon) of the sun at all hours of the day for each day of the year.

Another way of plotting the same information is a Mercator sky map, showing the sun's path on an equidistant rectangular grid of azimuth and elevation.

SUMMER SOLSTICE  
EQUINOX  
WINTER SOLSTICE

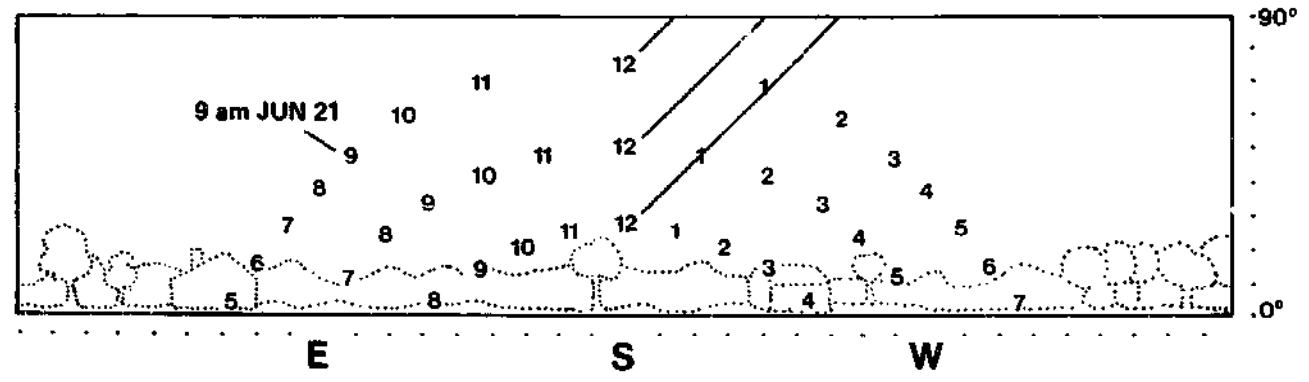

## Air Temperature

Temperature is not a physical quantity. Rather, it can be thought of as a symptom or as the outward appearance of the thermal state of a substance. For instance, if energy is conveyed to a substance — the human body for example — the molecular movement within the body is increased and it appears to be warmer. If this molecular movement spreads from the body to other substances — to air for instance — its intensity within the body decreases and the body appears to be cooling. This principle applies to all substances — living or inanimate. As such, air temperature measured in degrees Fahrenheit ( $^{\circ}$  F) or degrees Celsius ( $^{\circ}$  C) is considered the basic determinant of heat loss or gain of a substance such as the human body or a building.

## Degree Day Concept

An analysis of selected temperature differences (design conditions) between the interior and exterior of a building will establish the heating and cooling load of the building. The relationship of the outdoor air temperature to a building's heating and cooling load has led to the concept of a "degree day" for predicting the energy consumption of a building. The degree day concept is particularly useful for relating the energy load of a building to the amount of solar energy available to satisfy this load.

"Heating degree days" are the number of degrees that the daily mean temperature is below  $65^{\circ}$  F. A day with an average temperature of  $45^{\circ}$  F has 20 heating degree days ( $65-45 = 20$ ), while one with an average temperature of  $65^{\circ}$  F or more has no heating degree days. A similar degree day concept has been recently developed for cooling. As with the heating degree day, the point of departure for a "cooling degree day" is  $65^{\circ}$  F, so that a mean daily temperature of  $85^{\circ}$  F would result in 20 cooling degree days ( $85-65 = 20$ ).

The relationship between degree days and residential fuel consumption is linear. For example, a doubling of the degree days doubles the energy requirement. However, deviation from the degree day norm of  $65^{\circ}$  F or the design of an energy conserving

building will substantially alter the energy requirement of the building and thereby change the linearity of the degree day/energy consumption relationship. It remains, however, a useful concept for relating the overall need for heating and cooling of a particular area with the amount of solar radiation available for use. By plotting degree days per month and insolation on a horizontal surface per month simultaneously, illustrated in the figures below, it is possible to derive a "figure of merit" which indicates, in general terms, a relative feasibility for solar systems in various parts of the country. The figure of merit is a qualitative description and takes into account only climatic data. Other factors such as solar system performance, functional characteristics, cost, and socio-economic conditions must be examined and traded off against climatic conditions before a realistic appraisal of solar heating or cooling is possible.

## Air Temperature Patterns

Patterns of air temperature are also important for solar dwelling and system design. The fluctuation of

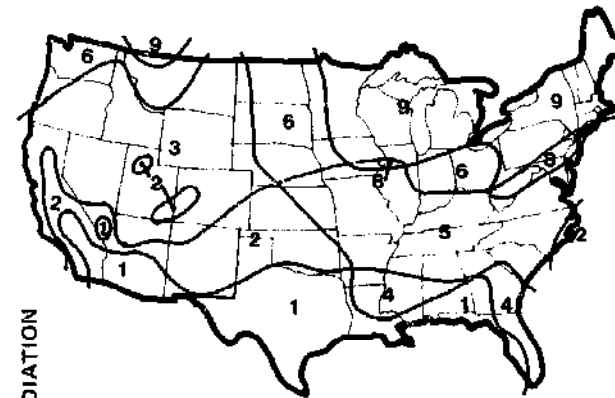

MEAN DAILY SOLAR RADIATION	COOLING DEGREE DAYS*			
	LY	BTU/FT <sup>2</sup>	2000-4000	1000-2000
500-650	1845-2399	1	2	3
450-500	1661-1845	4	5	6
450	1661	7	8	9

REGIONAL CLIMATIC CLASSIFICATION FOR THE COOLING SEASON (MAY-OCTOBER)

air temperature throughout the year and during regular day-night cycles will establish criteria for system design. Regular day-night cycles are important for systems dependent on thermal inertia for heating or cooling. Convective and radiative cooling both require appreciable day-night temperature differences to function effectively. Similarly, collector size and storage capacity will be influenced by patterns of air temperature associated with changing weather conditions. There will be constant patterns of air temperature throughout the year intermixed with oscillations resulting from unexpected weather conditions. Solar systems are usually designed for the former and not the latter conditions. In general, patterns of air temperature and weather will be more useful to system design than averages because they take into account variations in conditions which may cluster for several days.

## Humidity

The humidity of the air can be described in two ways: absolute humidity and relative humidity.

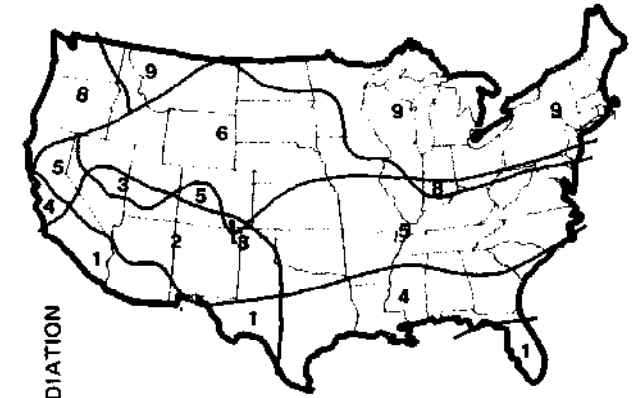

MEAN DAILY SOLAR RADIATION	HEATING DEGREE DAYS*				
	LY	BTU/FT <sup>2</sup>	0-2500	2500-5000	5000-9000
350-450	1292-1661	1	2	3	
250-350	923-1292	4	5	6	
175-250	646-923	7	8	9	

REGIONAL CLIMATIC CLASSIFICATION FOR THE HEATING SEASON (NOVEMBER-APRIL)

Absolute humidity is the amount of moisture actually present in a unit mass or unit volume of air. The amount of moisture the air can hold is dependent on its temperature. Relative humidity (rh) is the ratio of the actual amount of moisture in the air (absolute humidity) to the amount of moisture the air could hold at a given temperature. Relative humidity is the more useful of the two quantities because it gives a direct indication of evaporation potential. This information becomes crucial for maintaining indoor occupant comfort and for designing solar cooling systems which utilize evaporative cooling techniques.

Humidity, *per se*, has no meaning as an environmental index without knowledge of the accompanying dry-bulb air temperature.\* High humidity at low dry-bulb temperatures has a negligible effect on human comfort; air temperature will be the governing factor for dwelling and solar system design under these conditions. When relative humidities of 60 percent or more are accompanied by dry-bulb temperatures above 65° F (18° C) conditions unfavorable to human comfort are likely to occur, thereby requiring natural or mechanical relief or curtailment of activities.

The total heat content of air during conditions of high humidity and high temperature is substantially larger than during periods of low humidity and high temperatures. Cooling is the most effective method of restoring comfort. This can be accomplished by natural ventilation or mechanical cooling. Under certain conditions, it is not desirable or feasible to restore comfort by natural air movement alone and mechanical equipment will be needed. Solar cooling should be considered if conditions of high humidity and high temperatures are prevalent during a large percentage of the year. In general, humidity is not a problem in low temperature (winter) conditions, but is primarily an issue during high temperature (summer) conditions. Dwelling and solar system design for areas experiencing high temperature and high humidity will require special attention to air movement and perhaps the use of solar cooling systems.

\* Dry-bulb temperature is the index of cold or warmth as determined by a simple dry-bulb thermometer.

Areas where cooling is the primary design condition and the humidity is low can make use of nocturnal cooling. Evaporation facilitated by the low humidity is the primary process of nocturnal cooling. Convection and radiation will also play a part if night time temperatures are low, winds constant and skies clear. The cooling medium — usually water — loses moisture during the evening, thereby cooling the water which is stored for daytime or continuous use.

### **Air Movement**

Air movement is measured in terms of wind velocity and direction. The wind in a particular location may be useful for natural ventilation at certain times of the year, and detrimental to the thermal performance of a building or solar collector at other times. Consequently, air movement in and around the building and site becomes an important consideration for dwelling and solar system design.

Summer winds, if properly directed by the natural topography or site design and captured by the dwelling, can substantially reduce or eliminate the need for a mechanical cooling system. This will be particularly helpful in areas where the cooling requirement is small and the cost effectiveness of solar cooling unlikely. Solar cooling at present is quite expensive and by eliminating the need for it, significant benefits will be achieved in terms of cost, maintenance, and operation.

Winter winds, on the other hand, can be quite detrimental to the thermal behavior of the dwelling or solar system. Cold winds will increase the surface conductance of the dwelling's exterior walls, thereby increasing its heat loss. A dwelling's heat loss can be reduced by the careful selection and combination of building materials, an attention to the shape and position of the dwelling on the site, and the location of landscaping around the building. A similar heat loss condition will exist for solar collectors. Cold winds blowing across the transparent face of the collector will increase convective heat losses. A single layer of glass or plastic in some instances may not reduce heat losses to an acceptable level. When this occurs, two or more transparent surfaces

may be desirable. Also, landscaping or other devices can be used to reduce wind striking the collector so long as solar radiation collection is not impaired.

Wind can become an issue in snowfall areas where drifting is likely or in high wind areas where additional structural support of large collectors may be necessary. Solar dwellings should be designed to reduce the drifting of snow on or in front of the solar collector. Special consideration is also required to assure that adequate wind support of the collector and cover plates is provided in high wind areas. This is particularly true for large free-standing or saw-tooth collector arrangements. Pressure differences caused by air movement around the building can also result in collector and cover plate instability.

### **Solar Design Determinants — Climate**

The following is the first of four sections, one for climate and for each of the next three design factors, which reiterates the major issues affecting solar dwelling and site design discussed during the section. The design determinants are presented in a much abbreviated form. The purpose is to present just those issues which are very important to solar dwelling and site design. The site and dwelling concepts presented in Chapters Four through Six illustrate how the application of the solar design determinants influence dwelling and site design.

The climatic factors which influence the design of solar dwellings and systems include:

- Type of solar radiation reaching the site — direct, diffuse, reflected — and percentage of each at time of maximum energy demand.
- Geographic location of the site — tilt of the earth's axis alters the relationship of sun to site throughout the year. Therefore, dwelling, site, and solar system should be designed to accommodate variations in sun angle to assure proper exposure to solar radiation.
- Capture the full spectrum of solar radiation from ultraviolet to infrared — dependent on collector design and materials.



- Heating or cooling load of the dwelling — expressed in hourly and daily units — mean or average long-term loads expressed in weekly or monthly units.
- Numerous regional, local, and site climate anomalies which could be potentially beneficial or detrimental to dwelling or solar system performance — dwelling and solar collector should be shielded from potentially detrimental winds (cold winds increase heat loss, lowers collector efficiency) or meteorological events (hail, snowstorms, tornadoes may necessitate special protective devices or precautions). Conversely, proper exposure of the dwelling and solar collector to sun and wind will temper indoor climate and reduce demand on or need for heating and cooling systems.

Climate — the given conditions — is a primary factor shaping the design of buildings and sites for the utilization of solar energy for heating and cooling. Additionally, demand for heating and cooling can be reduced by properly exposing to and/or shielding the building from those climatic elements which may be beneficial or detrimental to a building's thermal performance.

## COMFORT: THE DESIRABLE CONDITIONS

Climate affects man both physically and emotionally and is therefore a factor of considerable importance in building design. A designer's major task is to create the best possible environment (indoor as well as outdoor) for the occupants' activities. The challenge of the designer is to provide total human comfort, which may be defined as the sensation of complete physical and mental well-being.

Air temperature, humidity, radiation, and air movement all affect human comfort, and must be considered simultaneously if an acceptable residential indoor environment is to be provided. These factors must be considered whether or not the building being designed is heated or cooled by solar energy or fossil fuels.

To effectively design dwellings for human comfort, it is necessary to understand the basic thermal processes of the body. How the body generates and loses heat is crucial for identifying an occupant comfort zone and for designing heating, cooling and humidity control systems. Two complementary approaches for the provision of human thermal comfort have developed. One seeks to maintain thermal conditions within an established comfort zone while the other attempts to modify the comfort zone. Both approaches are used during solar dwelling design.

Human comfort takes on added importance for solar dwellings, which are either totally or partially dependent on the sun for their energy needs. The manner in which solar energy is collected, stored, and distributed can greatly affect the comfort of the dwelling occupants.

### The Body's Heat Production

The body is continuously producing heat. Everyday activities such as sleeping, walking, working, and playing are all heat producing. The entire portion of the body's energy requirement is supplied by the consumption and digestion of food. The process of transforming foodstuff into usable energy is called

metabolism. Of all the energy generated by the metabolic process, the body uses only 20 percent and the remaining 80 percent must be lost to the environment.

### The Body's Heat Loss

Body temperature, as contrasted to skin temperature, must be maintained at 98.6°F (37°C) for the body to adequately perform its functions. To maintain this constant temperature balance, all surplus heat must be dissipated to the environment. Heat gained from the environment, solar radiation for example, must also be dissipated.

The body loses approximately 80 percent of its heat to the environment by convection and radiation. The remaining 20 percent of the body's surplus heat is lost by evaporation with a very small percentage of heat by conduction.

### The Body's Heat Balance

The sum total of the body's heat gain and loss should at all times equal zero — a constant body temperature of 98.6° F or 37° C. If the body's heat gain is more than its corresponding heat loss, an uncomfortable feeling will occur and sweating will begin. Likewise, if the body's heat loss is more than its heat gain, body temperature will drop and shivering will occur.

The body has numerous regulatory mechanisms to maintain a constant temperature. Blood circulation may increase or decrease, sweat glands may open or close, and shivering may begin to raise the body's temperature. Also, continuous exposure to similar climatic conditions, called acclimatization, can cause a change in the basal metabolism process, an increased sweat rate, or a change in quantity of blood. It is not surprising, therefore, to learn that Eskimos prefer cooler temperatures than equatorial Africans.

### Heat Loss in Various Thermal Environments

Like climatic regions human comfort is shaped by four major factors: air temperature, humidity, air

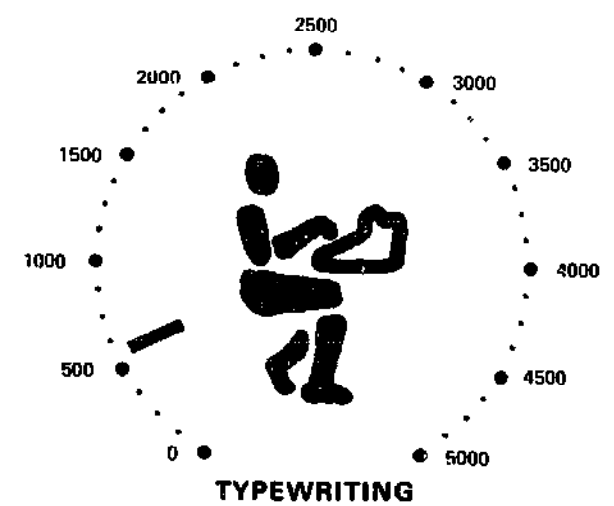
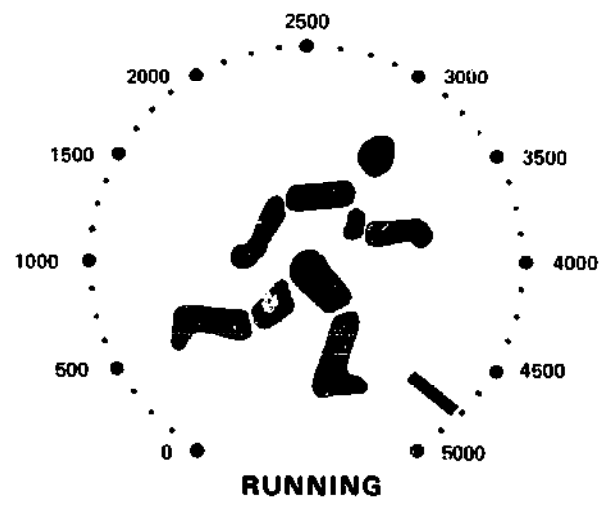
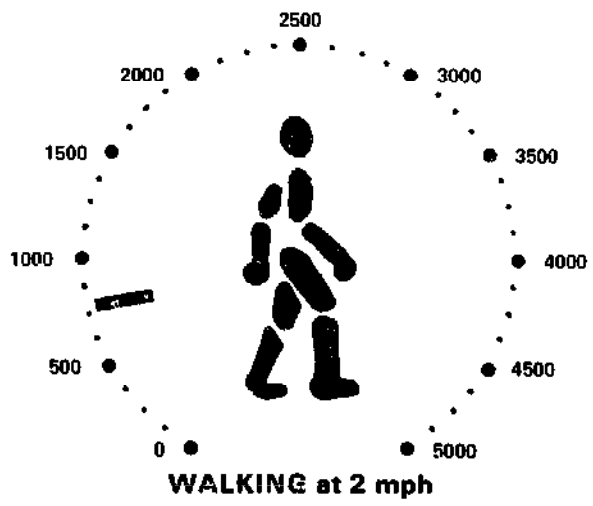

(Maximum energy capacity of a normal healthy 20 year old male)

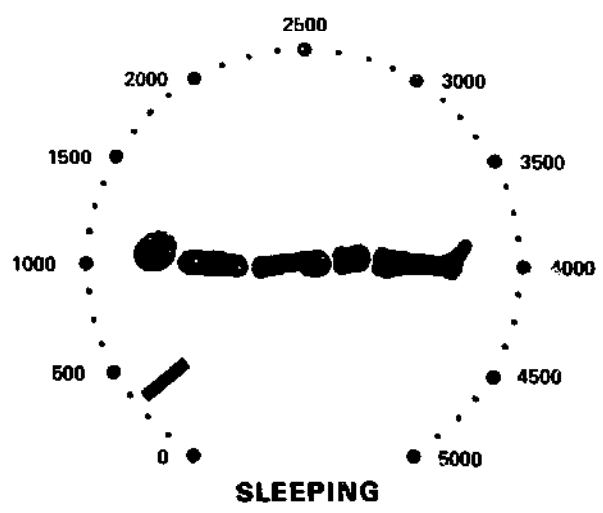
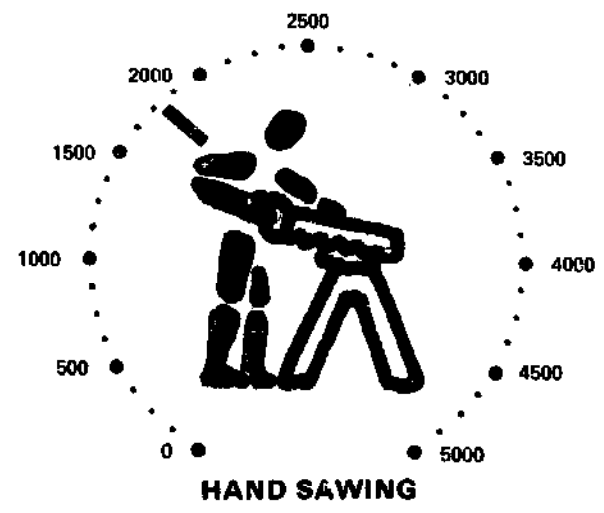

**BODY HEAT PRODUCTION IN BTU's PER HOUR FOR AN AVERAGE PERSON**

SOURCE: ASHRAE Handbook of Fundamentals, 1972, pp. 129-130.



+

BODY HEAT



-

EVAPORATION



RADIATION



RADIATION



CONDUCTION

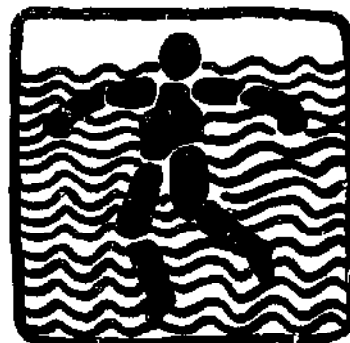

CONDUCTION



CONVECTION

+

BODY HEAT  
RADIATION  
CONDUCTION

-

EVAPORATION  
RADIATION  
CONDUCTION  
CONVECTION



**THERMAL BALANCE OF THE BODY**

Under a wide range of circumstances, the body maintains a deep body temperature of 37 C (or 98.6 F).

movement, and radiation. Accordingly, the heat exchange process between the human body and its environment may be aided or impeded by these climatic variables. For example, convective heat loss is severely impeded by high air temperatures, and evaporative heat loss may be simultaneously restricted by high humidity. Different regions will have different dominant climatic features which will affect human comfort. Indoor comfort in hot-humid climates, for example, is very much dependent on internal air flow and temperature to control humid conditions. To effectively design comfortable indoor environments, the relationship of outdoor climatic conditions to indoor activities and to thermal controls must be properly balanced.

### Subjective Variables

The four climatic variables previously discussed are the primary determinants of human comfort or discomfort. A number of subjective or individual factors, however, will influence thermal preferences. These include one's clothing, age, sex, body shape, state of health and skin color. Additionally, there are psychological and sociological variables which will influence thermal comfort. Whether one is happy or sad, active or confined, alone or in a group will influence thermal preferences.

### Thermal Comfort Scale

An assessment of the impact of local climate on the body's heat dissipation process is important in providing a comfortable indoor environment. However, to do so, four independent climatic variables must be assessed simultaneously (temperature, humidity, radiation and air movement). The difficulty of this task has led to the development of "thermal indices" or "comfort scales" which combine the effects of these four variables.

A "comfort scale" therefore is the composite of the interactions between climatic variables. Through observation and measurement in the laboratory, the characteristics of human comfort (comfort zone) have been identified and may be compared to local climatic conditions, thereby defining the need for and the type of thermal controls.

### Comfort Zone

The comfort zone is established by analyzing the relationship between air temperature and three climatic variables: mean radiant temperature (the temperature of the surrounding surfaces), humidity, and air velocity.

The analysis will establish the range of thermal conditions (comfort zone) over which the majority of adults feels comfortable. The comfort zone is, at best, an imprecise approximation of human thermal comfort, realizing the many variations due to human preferences, physiological and psychological characteristics, and the nature of the activity being performed. However, it does provide the designer and builder with a "ball park" estimate of human thermal comfort by which outdoor climatic conditions of a locale may be evaluated so that appropriate methods of achieving a comfortable indoor climate are chosen.

### Providing Human Comfort

There are two ways of looking at the provision of human comfort. The first involves establishing a comfort zone based upon the occupants' thermal preferences and proposed activities and comparing this comfort zone to existing or anticipated climatic conditions. In this manner, the appropriate methods for returning the climatic conditions to within the comfort zone will be established. The second viewpoint accepts the existing or anticipated climatic conditions as given, and identifies methods of altering the comfort zone to be compatible with the climate. The two viewpoints of providing human comfort are diagrammed on the following page.

The far left diagram illustrates the first viewpoint. Given an occupant comfort zone, what can be done to bring a parcel of air with a known temperature and humidity from outside the zone to inside the zone? Five simple diagrams in circles are shown with shading on areas outside the zone. Each area of the shading corresponds to the state of air that can be brought into the comfort zone by a given method (heating, evaporative cooling, air conditioning, dehumidification and humidification). The

second viewpoint is illustrated in the diagram to the far right. Without modifying temperature or humidity, what factors can alter the comfort zone? A sedentary person is shown in the shade with his corresponding comfort zone. If the wind blows, his comfort zone moves. So also if he exercises or sits in the sun.

A building functions in much the same manner. An occupant comfort zone can be established and mechanical equipment provided to assure that thermal conditions remain in the zone. On the other hand, the building can be designed to respond to the positive and negative affects of temperature, humidity, wind and radiation so that the occupant comfort zone is altered as external climatic conditions change. Given the scarcity and rising cost of conventional fuels and the cost of mechanical climate control equipment, the most effective and inexpensive approach may be to design the building as a whole to respond to the external climatic conditions thus altering the occupant comfort zone. Only when the natural thermal control processes have been exploited to a realistic maximum, should mechanical energy systems be employed to make up the remaining comfort burden. A range of natural climatic thermal controls available to designers and buildings is identified in the next section.

### Human Comfort and Solar Energy

Solar systems are designed to maximize the collection and storage of thermal energy. The thermal energy, in turn, is used to heat spaces or domestic hot water supply or power heat activated cooling systems. All of these processes necessitate the capture, transport, storage and distribution of an incredibly large amount of energy. Properly designed and regulated, this energy will provide an indoor climate suitable for the occupant's activities. If, however, the energy systems are not carefully organized and arranged, human comfort and activities may be seriously impaired. All channels of thermal energy flow should be considered in terms of their potential impact on human comfort. For example, heat transport piping or duct work between the solar collector and storage will lose considerable heat to the occupied spaces if not properly insulated. Large

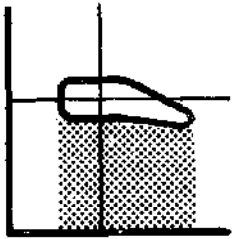

**HEATING**

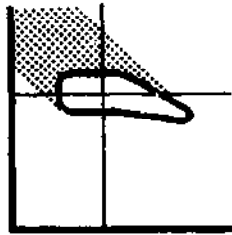

**EVAPORATIVE COOLING**

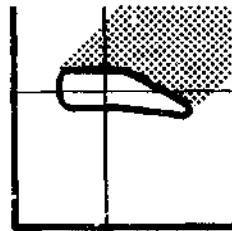

**AIR CONDITIONING**

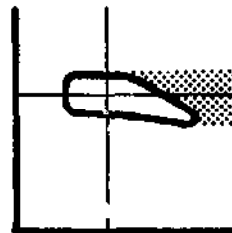

**DEHUMIDIFICATION**

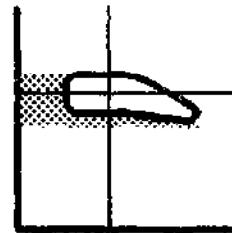

**HUMIDIFICATION**

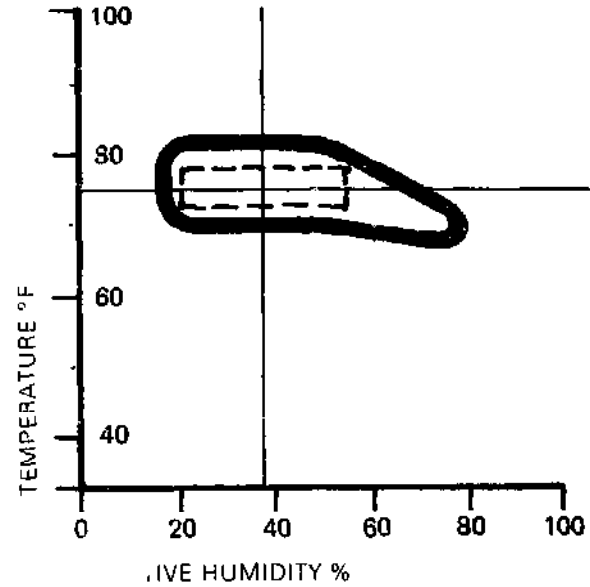

▲ **A STANDARD COMFORT ZONE**  
(THE ASHRAE COMFORT STANDARD IS SHOWN  
DOTTED FOR COMPARISON)

**IN ORDER TO FEEL COMFORTABLE:** ▶

- 1  
A PERSON SITTING IN THE SHADE NEEDS AIR IN  
THE "STANDARD" COMFORT ZONE
- 2  
A PERSON RUNNING IN THE SUN NEEDS COOLER,  
DRIER AIR
- 3  
A PERSON SITTING IN THE SUN NEEDS COOLER,  
AIR
- 4  
A PERSON SITTING IN THE SHADE IN A COOL  
BREEZE NEEDS WARMER AIR

◀ **UNCOMFORTABLE AIR CAN BE MADE  
COMFORTABLE BY USING APPROPRIATE  
METHODS**

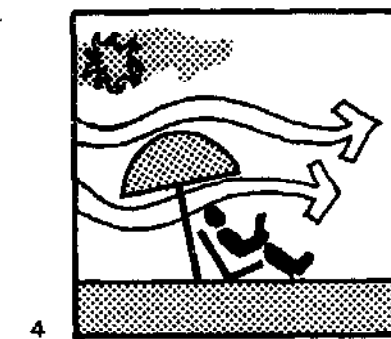
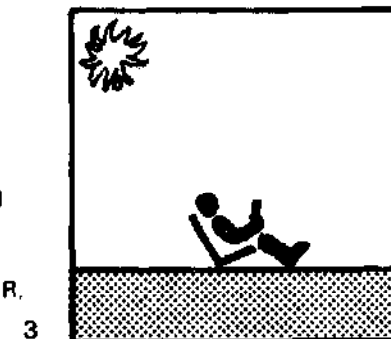
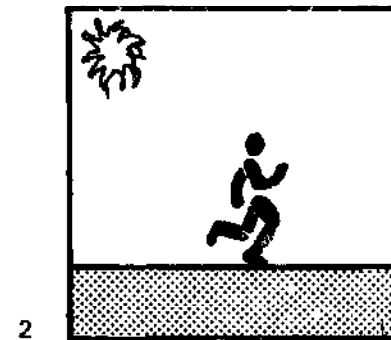
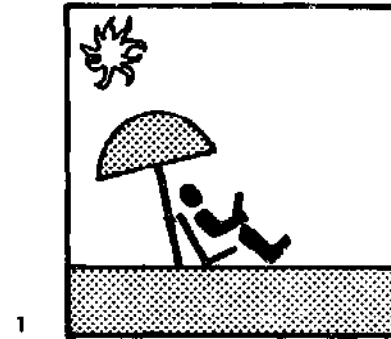

concentrations or reservoirs of thermal energy must also be evaluated in terms of their effect on occupant comfort. This is particularly true for large solar collector arrays or storage areas which are in close proximity to a habitable space. The maintenance of the indoor climate within the comfort zone should be the goal of building and solar system design

---

### Solar Design Determinants — Comfort

The comfort factors which influence the design of solar dwellings and systems include:

- Body's heat loss and heat gain — degree of each is related to activity, climatic condition and thermal preferences.
- Zone of human comfort and its relation to regional, local, and site climates. Will identify need for and design of type(s) of thermal control(s) necessary to return conditions to comfort zone.
- Relation of heat sources to occupied space. Proper control of solar collection, storage, and distribution is crucial for providing and maintaining indoor comfort.

The sole purpose for housing, solar systems, and other thermal controls is the provision of a comfortable, suitable residential environment for the occupants' activities. Designers and builders should be aware of this fact in the design of buildings in general, and solar buildings in particular. A solar dwelling which is designed to capture, store, and distribute the tremendous energy provided by the sun is especially vulnerable to situations unfavorable to human comfort. The first consideration should always be to the individuals who will inhabit the dwelling.

### BUILDINGS: THE CONTROLLING VARIABLE

The thermal characteristics of a building are extremely important for the design of solar dwellings and the provision of human comfort. It is at the building itself where the demands of climate and human comfort must be resolved.

Buildings are constructed to moderate the extremes of external climate to maintain the building interior within the narrow ranges of temperature and humidity that support occupant comfort. Building design can begin to accomplish this role, by working with instead of against, climatic impacts. A building, like the human body, can be examined by its heat exchange process with the outdoor environment. The ways buildings gain and lose heat can be examined and methods of thermal control developed to assure satisfactory performance of a building's heat exchange processes. Mechanical controls, such as heating and cooling systems, whether conventional or solar powered, may be evaluated by their performance in compensating for a building's heat loss or gain; while structural (non-mechanical) controls such as insulation, shading devices or building shape may be evaluated by their performance in reducing the demand on or the need for mechanical systems by controlling a building's heat loss or gain.

In most cases, a mix of mechanical and structural controls will be necessary to assure the best possible indoor climate. Appropriate thermal controls for a particular building will be dependent on the local climatic and site conditions, cost, construction practice, and the architectural requirements of the design. The design of dwellings that incorporate energy conserving techniques, particularly solar heating and/or cooling systems, will modify in varying degrees the construction practices and the architectural image of today's dwellings. How solar systems can affect the architectural image of buildings is discussed in the next section.

A building, in essence, is the controlling variable which can be modified in numerous ways to recon-

cile the demands of climate and comfort

### Heat Exchange of Buildings

In the last section, the dependence of the human body on appropriate thermal conditions was analyzed by its heat exchange process with the environment. In a similar manner, a building's provision of thermal comfort may be examined by its heat exchange processes with the outdoor environment. A building gains or loses heat by conduction, convection, evaporation, radiation, internal heat sources, and mechanical systems.

The flow of heat by **conduction** through walls, floors, and ceilings may occur in either direction. Generally speaking, conductive heat losses will occur in winter, while conductive heat gains happen in summer. The material composition of the walls, floors and ceiling of buildings will determine the rate of conduction. With some solar systems, the material composition of the building is of critical importance for the satisfactory performance of the solar system. For instance, if south-facing windows are used as solar collectors, the thickness of the floor and wall material is extremely important for achieving proper absorption and reradiation of solar heat.

Heat exchange by **convection** can occur through building surfaces by the movement of air between areas of different temperatures. For example, movement of air between the outside and inside of a building in winter around doors and windows is considered a convective heat loss. The heat exchange between the interior of a building and the outdoor air may be unintentional air infiltration — "leakage" — or deliberate air regulation — "ventilation."

**Radiation** of heat through glass or other transparent surfaces can add considerable heat to a building. Conversely, thermal radiation from interior surfaces to cool exterior walls will influence to a small degree a building's heat loss. The amount of radiant or solar heat gain is influenced by window area, building orientation and shading. Properly placed windows or other transparent surfaces which can be insulated when the sun is not shining can provide a substantial portion of a building's heat demand.

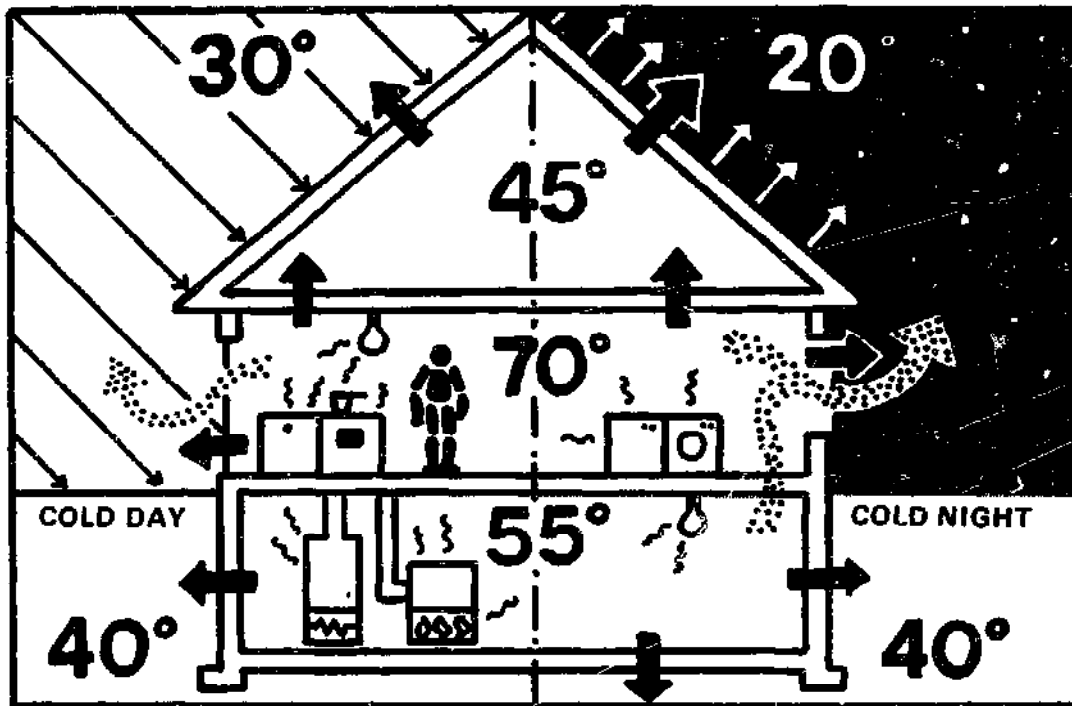

**IN COLD WEATHER, A HOUSE IS HEATED UP BY:**

- SUN'S RAYS THROUGH RADIATION
- PEOPLE, LIGHTS, COOKING, WASHING, DRYING, PILOT LIGHTS, HOT WATER
- SOLAR, FOSSIL FUEL, ELECTRIC OR WOOD SPACE AND HOT WATER HEATING

**IN COLD WEATHER, A HOUSE IS COOLED DOWN BY:**

- RADIATION TO DARK SKY
- HOUSE WALLS AND GLASS, BY CONDUCTION TO COLD OUTSIDE AIR
- COLD OUTSIDE AIR, BY CONVECTION (INFILTRATION, VENTILATION AND COMBUSTION AIR)
- HUMIDIFICATION (AIR TEMPERATURE DROPS AS HUMIDITY RISES UNLESS EXTERNAL HEAT IS APPLIED)
- GROUND, IF BASEMENT IS WARMER THAN GROUND
- DRAINS AND FLUES --- HEAT IS LOST DOWN THE DRAIN, UP THE FLUE

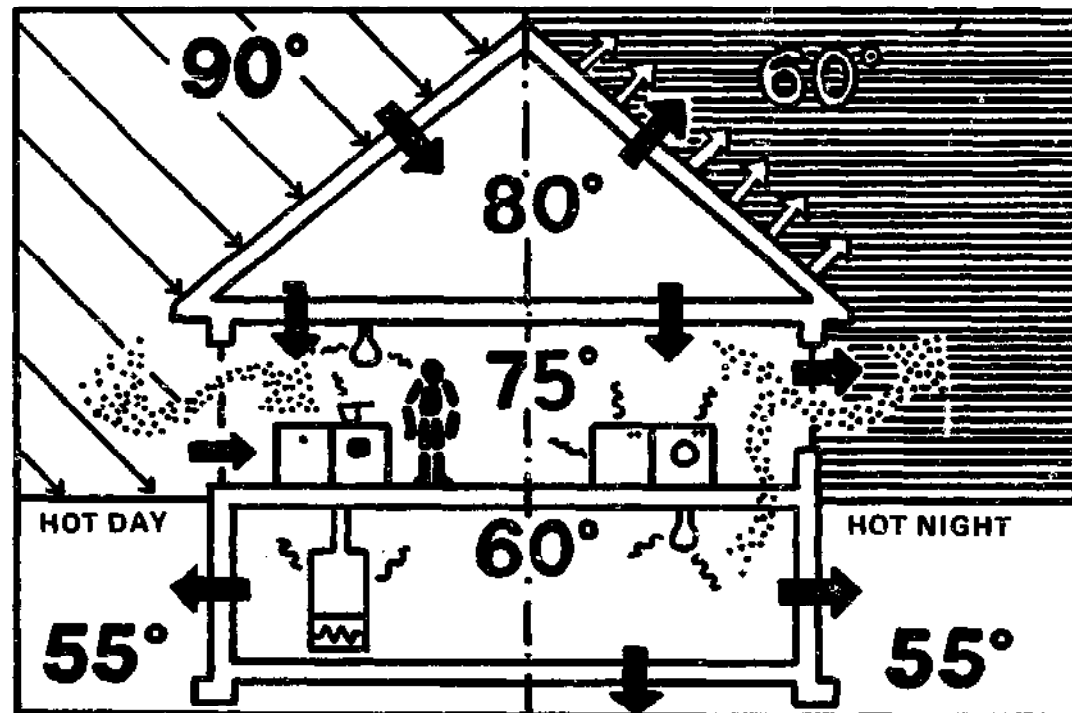

**IN HOT WEATHER, A HOUSE IS HEATED UP BY:**

- HOUSE WALLS AND GLASS, BY CONDUCTION WHEN OUTSIDE AIR IS HOT
- HOT AND/OR HUMID OUTSIDE AIR, BY CONVECTION (INFILTRATION, VENTILATION AND COMBUSTION AIR)
- PEOPLE, LIGHTS, COOKING, WASHING, DRYING, HOT WATER, PILOT LIGHTS

**IN HOT WEATHER, A HOUSE IS COOLED DOWN BY:**

- RADIATION TO DARK SKY
- HOUSE WALLS AND GLASS, BY CONDUCTION WHEN OUTSIDE AIR IS COOL
- COOL OUTSIDE AIR, BY CONVECTION (VENTILATION)
- GROUND, BY CONDUCTION FROM THE BASEMENT OR CRAWL SPACE
- HUMIDIFICATION, IF AIR IS DRY (ADIABATIC COOLING)

**Internal heat sources** such as human bodies, lamps, motors and appliances can provide as much as 25 percent of a building's heating load. This source of heat is rarely considered in residential design.

**Mechanical equipment** may introduce or remove heat from a building by utilizing some form of outside energy such as natural gas, oil, electricity or solar radiation. The amount of heat and cold produced by these systems is controlled by the designer and is dependent on the heat lost or gained by the other factors. Mechanical equipment, as the dependent variable, therefore can be adjusted according to the thermal balance of the other factors.

Finally, a building may lose heat by **evaporation** from its surfaces or from sources within the building. Evaporation from these and other sources will produce a cooling effect as water vapor is removed.

The thermal balance of a building is maintained if the heat lost and gained from the above sources equals zero. If the building is losing more heat than it is gaining from the above sources, the building will be cooling off; if it is gaining more heat than it is losing, the building will be warming up. Regulating a building's heat loss and heat gain cycle within a level of occupant comfort through the day and year is a function of building design and mechanical system selection.

A dwelling designer and builder share the responsibility of properly selecting building materials, determining building size, volume, and orientation, and sizing and orientating windows, doors, overhangs, and other thermal controls to assure occupant comfort. Each of these considerations will influence the magnitude of one or several of a building's heat exchange processes. The trade-offs between heat exchange factors will most likely be based on climate, cost, and construction practices. For example, since mechanical equipment is expensive, it may be appropriate to reduce heat loss and gain by structural methods. By working with instead of against climatic impact, a reduction of a building's need for mechanical equipment may be realized. This, in turn, may result in a reduction in the amount of fossil fuel or

the size of a solar system required to adequately heat and/or cool a dwelling.

## Thermal Controls

Thermal controls are devices (i.e., furnace) or methods (i.e., dwelling orientation to capture summer winds) for moderating the extremes of outdoor climate to bring the interior within the narrow ranges of temperature and humidity that support human comfort. Thermal controls can be discussed by either the nature of the control — mechanical or structural — or the climatic variable regulated — wind, sun, or temperature. In either case, the objective of thermal controls can be briefly stated as follows:

1. When cold discomfort conditions prevail:
  - minimize heat loss
  - maximize use of heat gain from the sun and internal sources
  - compensate for any net heat loss, by heating which uses some form of energy supply (preferably a renewable resource)
2. When hot discomfort conditions prevail:
  - minimize heat gain
  - maximize heat loss
  - remove any excess heat by cooling, which uses some form of energy supply (preferably a renewable resource)
3. When conditions vary diurnally between hot and cold discomfort:
  - even out variations
  - (1) in the cold phase and (2) in the hot phase (as above)
  - compensate for both excesses by a flexible heating/cooling system.

It has been stated, "the degree of sophistication (in environmental controls) is largely a socio-economic question." In other words, the provision of any specified set of indoor conditions is possible, but preferences and sophistication of controls will be influenced by an individual's social status, standard of living and financial means. The decision as to what degree of comfort is to be achieved at what

degree of cost involves a value judgment. This is the perplexing issue we face in the United States today regarding energy in general and solar energy in particular.

All elements of climate can be moderated in specific degrees to maximize heat retention, or solar heat gain or internal air flow as needed in different combinations for various climatic conditions. It may be more useful, therefore, to discuss thermal controls by the climatic variable regulated. The thermal control strategies are organized by climatic variables — temperature, sun, and wind. Numerous other techniques are available to the designer that can be combined for climate control. The emphasis here is on those control strategies which do not require a conventional energy input for their operation.

## Temperature Controls

Control strategies for temperature can be classified into two broad categories: thermal retention and thermal regulation. Thermal retention is simply the capture of heat produced within the building or from a surrounding heat source. Underground massing of the building to reduce heat loss, and the use of resistive insulation and fireplace design to maximize the radiation of heat into occupied space are examples of thermal retention strategies.

Thermal regulation, on the other hand, is the manipulation of building design to moderate the indoor climate. Thermal regulation would include: reducing the heated/cooled area and volume of the dwelling during the day or throughout periods of maximum energy demand by the internal zoning of spaces so that portions of the dwelling may be closed off; locating vegetation and land forms around the building to reduce climatic impact of temperature fluctuation in the building, and in regions with low vapor pressure and a clear night sky designing buildings to make use of nocturnal cooling.

## Sun Controls

Strategies for sun control can be organized into two categories: solar exposure and light regulation. Solar



exposure strategies moderate the exposure of the building and adjacent site to solar radiation. Light regulation, on the other hand, regulates the amount of sunlight reaching the interior of the dwelling. In numerous cases, however, one technique will serve both functions. For example, site vegetation — trees and high shrubbery — can be placed to block unwanted radiation from striking the building during certain periods of the day or year and can also be used to regulate the amount of sunlight entering the dwelling's openings.

Other solar exposure strategies include capacity insulation to regulate (by thermal capacity) solar heat gain through the building's walls and roof (best for areas with large diurnal temperature swings and high solar heat gain), groundcover to control reflected radiation gain and ground temperature, and solar collectors positioned to capture solar radiation for space heating/cooling and domestic water heating.

Light regulation strategies include window designs to regulate the sunlight entering the building, interior shading devices such as shutters (preferably insulated), draperies, louvers, and proper location and orientation of the dwelling's openings.

### **Wind Controls**

Strategies for wind control can be classified into two general categories: wind regulation and internal air flow. Wind regulation primarily moderates the impact of wind on the building and adjacent site while internal air flow strategies manipulate air movement within the building.

Wind regulation techniques range from designing the building itself as a wind-controlling form through aerodynamic massing, to the placement of natural or man-made elements (i.e., vegetation, land forms or fences) on the site surrounding the building to regulate wind direction and force. Similarly, internal airflow strategies are quite varied and range from the use of roof monitors to create a "thermal chimney" for increased ventilation to channeling wind flow for use in evaporative cooling.

The challenge that confronts the designer is to select that combination of thermal controls which moderates climate to expected levels of occupant comfort at a justifiable cost in construction and energy consumption. From energy cost escalation in the past few years, it is apparent that our previous design assumptions are no longer valid, that energy consuming mechanical equipment cannot make up by brute force for what building designs disregard in natural climatic impact.

---

### **Solar Design Determinants — Building Characteristics**

The building characteristics which influence the design of solar dwellings and systems include:

- Dwelling's heat loss or gain — will determine heating and cooling requirement
- Dwelling's total volume of heated/cooled area — will affect heating and cooling requirement.
- Dwelling's total surface area exposed to the outdoor environment.
- Dwelling's orientation — critical for controlling heat exchange with outdoor environment and solar collection.
- Dwelling's thermal controls — means of tempering or utilizing outdoor climate to provide a comfortable indoor climate. May substantially reduce a building's heating and cooling requirement.
- Dwelling's material composition — will determine rate of heat loss/gain and may be used to store solar energy.

A building is where the demands of climate and comfort must be resolved. An understanding of local climatic conditions, human comfort requirements, and the thermal characteristics of buildings will enable the designer to identify the most effective (and energy conserving) methods for providing human comfort in building design — including the use of a solar system. Numerous thermal control strategies are available for inclusion in building design. Their use can substantially reduce the energy requirements of the building. As a result, a smaller

solar energy system will be sufficient for the building's energy requirement, thereby achieving a considerable cost saving.

---

### **ARCHITECTURAL DESIGN IMPLICATIONS OF SOLAR SYSTEMS**

Solar systems, as noted earlier, vary widely both in design and function. They may utilize complex technology or require only common sense design decisions. They may be used for space heating, cooling and domestic hot water heating. The components which make up a solar system — collector, storage, and distribution — may be arranged in numerous combinations dependent on function, component capability, climatic conditions, required performance, and architectural requirements

Associated with the design of buildings using solar systems for the provision of human comfort are a number of design implications related to climate, comfort, thermal characteristics of buildings and solar systems. Each of these design variables presents a unique set of criteria which must be adhered to within a prescribed range if the desired level of occupant comfort and system performance is to be achieved. The design issues related to climate, human comfort, and the thermal characteristics of buildings have been briefly discussed earlier in this chapter. It now remains to identify the design issues associated with the use of solar heating and cooling systems.

Since there are a variety of methods for collecting, storing, and distributing solar energy and an almost infinite number of ways these concepts may be utilized in a building design, the following architectural implications of solar systems are necessarily simplified. However, some design issues are of a general nature and should be considered early in the design of dwellings incorporating solar systems. These range from the location, size and orientation of a solar collector to the placement of room air outlets for comfort heat distribution. To assist under-

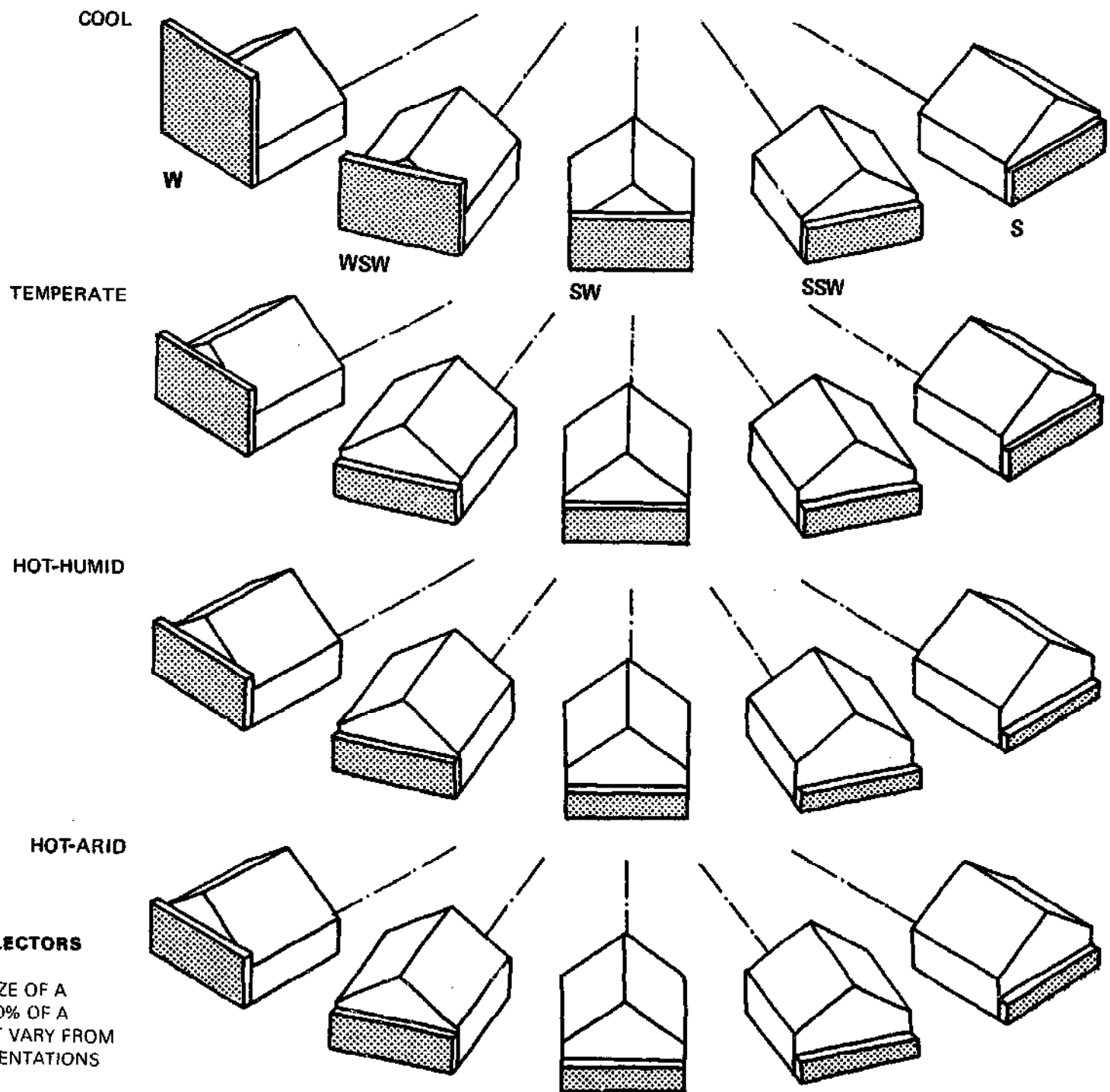

**ORIENTATION OF VERTICAL COLLECTORS**

THIS DIAGRAM SHOWS HOW THE SIZE OF A VERTICAL COLLECTOR SUPPLYING 50% OF A DWELLING'S HEATING NEEDS MIGHT VARY FROM CLIMATE TO CLIMATE, AND FOR ORIENTATIONS FROM SOUTH TO WEST.

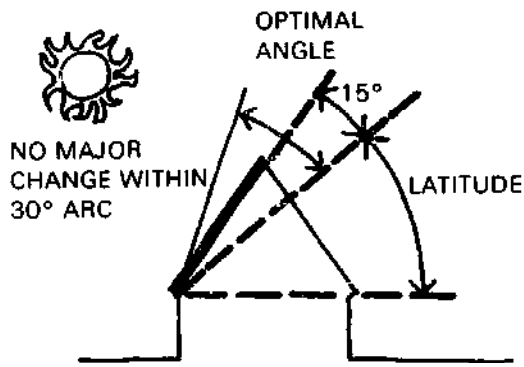

COLLECTOR TILT FOR HEATING

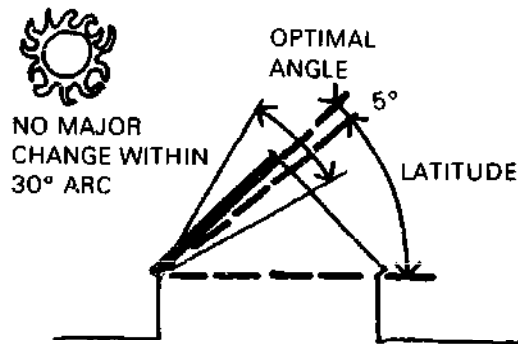

COLLECTOR TILT FOR COOLING AND HEATING

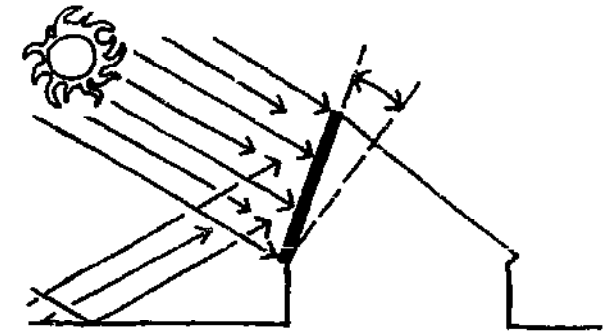

OPTIMAL HEATING ANGLE CAN BE INCREASED IF REFLECTION IS TAKEN INTO ACCOUNT



STEEP ROOFS ALLOW SNOW TO AVALANCHE OFF WITH LITTLE ENERGY LOSS

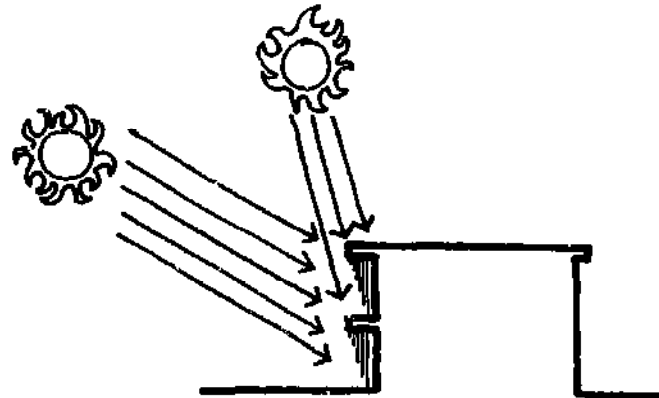

WINDOWS USED AS COLLECTORS SHOULD BE SHADED IN THE SUMMER

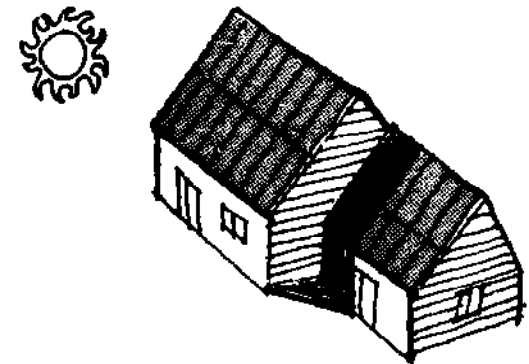

OFFSETS IN COLLECTORS CAUSE SELF-SHADING WITH RESULTANT LOSS OF EFFICIENCY AND POSSIBILITY OF COLLECTOR FREEZE-UP



LOW-SLOPE ROOFS HOLD SNOW AND DIRT

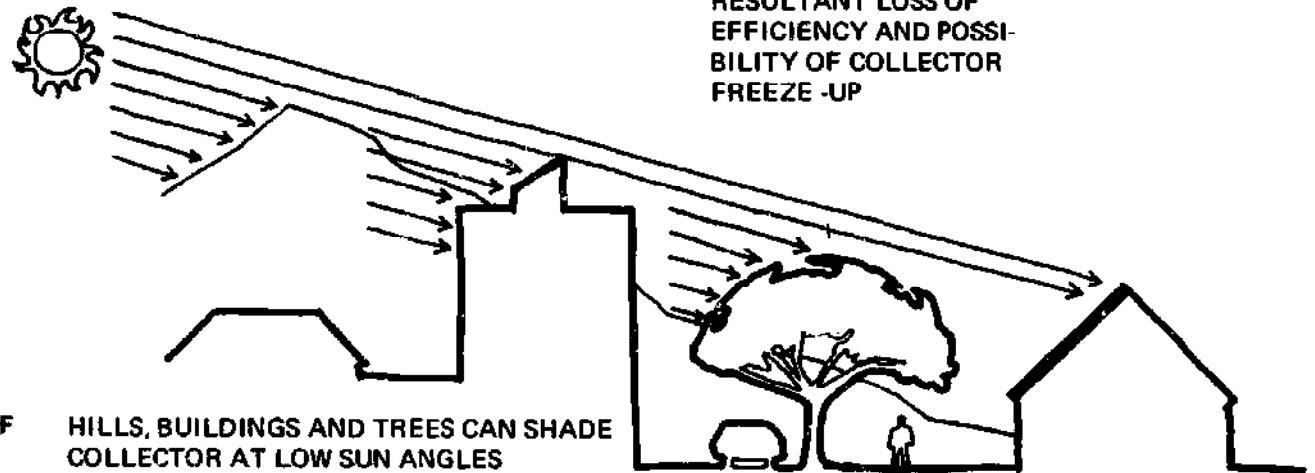

HILLS, BUILDINGS AND TREES CAN SHADE COLLECTOR AT LOW SUN ANGLES

ARCHITECTURAL DESIGN IMPLICATIONS OF SOLAR COLLECTORS

standing the architectural implications of solar systems, they are discussed according to type of system component. For example, the design implications associated with solar collectors are presented in one area followed by the design implications of solar storage in another and so on.

---

## Architectural Design Implications of Solar Collectors

### Location

There are basically three locations for the placement of solar collectors: detached from the building, attached to the building, and integrated with the building. Additionally, there are numerous collector placements associated with each generic location. For instance, collectors may be integrated with the walls, roof and interior spaces of a building or detached by placement on the ground or on ancillary structures.

The appropriateness of one collector location or another will be dependent on a host of variables particular to each design condition. For example, the type and size of the collector, the climatic and site conditions and whether the collector is for new or existing construction will all influence collector location and building design for any given project.

### Orientation

Collector orientation is critical for the optimum exposure of the collector to solar radiation. For stationary collectors, as opposed to "tracking" collectors which follow the sun across the sky, an orientation of true south in most situations is the best position for radiation collection. However, research to date indicates that a 20° variation, either side of true south, does not significantly alter the size or performance of most solar collectors. In fact, in some cases it may be necessary to orient the collector away from true south. For instance, if incoming radiation will be obstructed from striking the collec-

tor because of adjacent buildings and trees, or if morning fog or haze may interfere with collection, a deviation from true south may be absolutely necessary. When deviation from true south does occur, the size of collector needed to provide a similar level of performance will generally increase. Each collector area shown on P. 57 provides 50 percent of the dwelling's heating demand. As can be seen, the collector area varies significantly within and between climatic regions. Because of these variations collector orientation can be crucial to a dwelling's design and should not be understated or overlooked.

### Tilt

In addition to collector orientation, collector tilt is an important consideration for dwelling and system design. Again, we are referring primarily to stationary collectors and not to tracking and concentrating collectors. The angle at which a collector is tilted towards the path of incoming radiation will greatly affect its performance characteristics and the building design of which it is a part. The tilt of a collector, to a large degree, is determined by the geographic location of the dwelling (site latitude) and the functional requirement of the solar system (space heating, cooling or domestic water heating).

Due to the tilt of the earth's axis, discussed earlier, the angle at which the sun strikes every location on earth varies throughout the year. Therefore, a proper collector tilt for winter heating and summer cooling will be different for each geographic location. This variation in tilt fluctuates about 30° from heating optimum to cooling optimum. Consequently, most collectors are positioned within this range, generally with their location nearer the angle associated with the locality's primary energy requirement — heating or cooling.

The snowfall characteristics of an area may influence the appropriateness of an optimum collector tilt. Climates receiving a large amount of annual snowfall may experience snow build-up on the collector or drifting in front of the collector. For these situations, tilt angles of 40° or more are generally required to induce natural "avalanche" off the collector.

Numerous guidelines have been proposed for determining collector tilt based upon site latitude. The most often mentioned rule of thumb is latitude plus 15° for heating and latitude plus 5° for heating and cooling. For example, a collector tilt for northern climates such as Minneapolis, Minnesota — where the primary energy requirement is for heating — would be Minneapolis' latitude 42° plus 15° equaling a collector tilt of 57°. Variation of 10 to 15 degrees either side of this optimum will not significantly alter collector performance. Caution, however, should be observed before unquestioningly accepting this rule of thumb without an analysis of the solar system's performance. For instance, in the example just mentioned, 57° was indicated as an optimal collector angle without considering the reflective properties of snow usually associated with northern climates. Since the winter sun angle will be low for the Minneapolis area, the reflective radiation could be considerable and the designer may wish to consider a vertical collector.

The angle at which a collector is positioned has a direct relationship to the amount of collector area required to provide equal levels of performance. This relationship is easily illustrated. Assuming a northern climate and a collector sized to provide 50 percent of a 1,000 square foot house's heating demand, the resulting change in collector area resulting from changes in tilt angle would be as follows:

- Using a collector size at an angle of 50° facing due south as the base for comparison, the collector size will increase 18 percent if the collector tilt is lowered to a 40° angle.
- Increasing the base angle 10° to 60° increases collector size 6 percent.
- However, increasing collector angle to 30° and assuming a reflective radiation gain from snow or another reflective surface in front of the collector decreases the base collector size 14 percent.

This simple example shows the importance of performing a general system analysis before proceeding into detail design. The impact that the collector angle may have upon the design of the dwelling

which is to incorporate the system can be substantial and careful consideration should be given to all factors before a decision is made

### **Shadowing of Collector**

Another issue indirectly related both to collector orientation and tilt is shadowing. Care must be taken in locating solar collectors so that they are not in the shadow of adjacent buildings, landscaping, or another collector during periods when collection is desired.

In some cases, however, shadowing of the collector may be desired. For instance, if the collector is to provide heating only it may be desirable to shadow the collector and residence during hot summer months. This would be particularly true for windows designed as solar collectors. By properly calculating an overhang, the hot summer sun will be blocked before entering the dwelling.

### **Type and Size**

The type and size of a solar collector will have a significant impact on the physical appearance of a solar dwelling. Each method of solar energy collection, discussed in Chapter Two, has a unique set of criteria for effective capture and utilization of solar radiation which will influence a dwelling's design. For example, the design requirements of a solar pond are significantly different than those of a liquid-cooled flat-plate collector. In addition, the performance characteristics of each collection method will vary with climate, building characteristic and comfort requirement, thereby requiring different size collector areas to achieve an equal level of performance.

The influence of collection type and size on dwelling design is best illustrated by examining the relationship of the solar collector to the building. There are two basic relationships between a solar collector and a building. The first is where the entire building or various components of the building (walls, roof) act as the solar collector — a passive collector. In this case, the collector and building are one and the same element. The type and size of collector directly affect how the building will look. For example, if the method of collection is a thermosiphoning wall or a solar pond, the building design is strongly influenced by the size, orientation, and volume of the collection surfaces.

Examples of this relationship are the David Wright house, the Atascadero house, and the Trombe/Michel house discussed earlier. One cannot divorce the discussion of the solar collection system from the design of the house.

The second collector building relationship is not as direct as the first. The collector and building are seen as independent elements which may be organized in many ways with varying degrees of impact on each other.

The size and type of solar collector, in most situations, will provide an indication of whether the collector should be attached, detached or integrated with the dwelling. In some cases it may not be possible to locate the collector on the building and therefore the collector may be best located away from or adjacent to the dwelling. As a result, the site planning problems may become more significant than the architectural problems. If, however, the collector and building are to be attached in one way or another, the type and size of collector are signifi-

cant architectural considerations. For instance, when a large vertical collector area is required and south-facing windows, balconies, and patios are also desired, it becomes a difficult design problem to balance the need for collection area with the desire for architectural amenities.

Even with a roof-top collector, it is not just a simple matter of placing solar collectors on a dwelling's roof. The volume, roof slope, floor area, structure and building orientation, to name but a few considerations, will all influence collector type, size and location.

---

---

## **Architectural Design Implications of Solar Storage**

### **Type and Size**

The type and size of solar heat storage will have varying influence on a dwelling's design. Storage type and design will be closely related to the solar collector used and the size of storage will be dependent on its performance characteristics and the dwelling's storage capacity requirement (determined by energy load and days without collection).

The influence of solar storage on the physical appearance of the dwelling may be unnoticeable with some systems and immediately apparent for others. For example, a storage tank located in the basement or buried adjacent to the dwelling will not affect the physical appearance of the dwelling. However, if a solar system which combines solar collection and storage in the same element is used, the

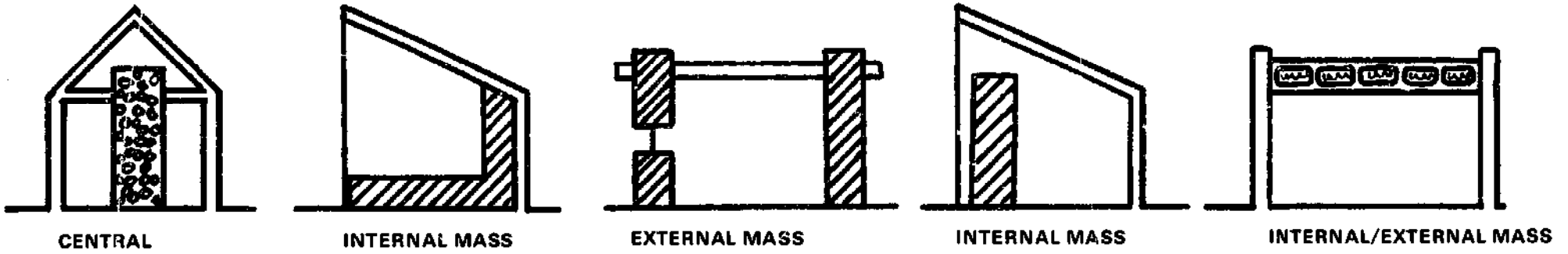
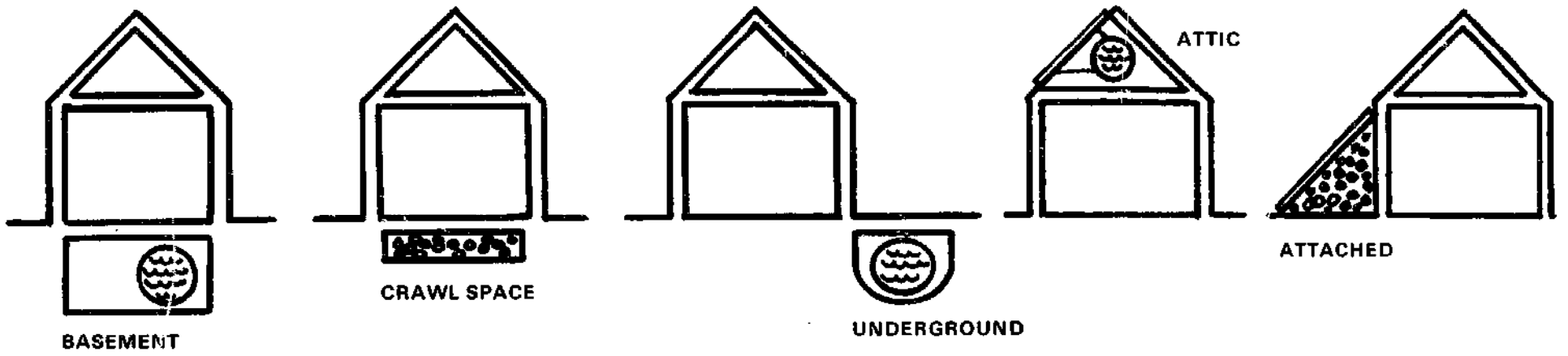

**STORAGE CONCEPTS**

**DISTRIBUTION CONCEPTS**

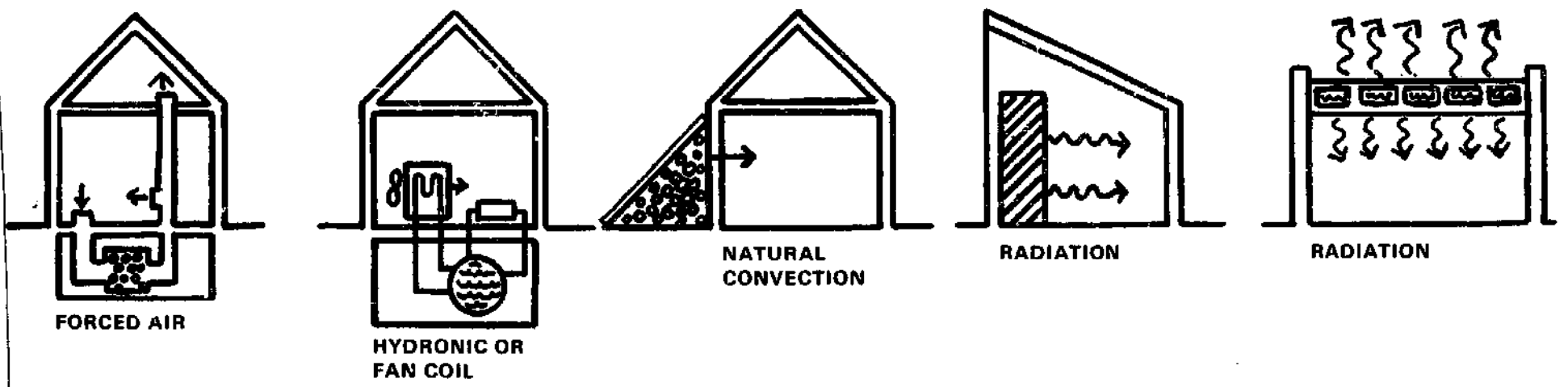

solar collector/storage component will be immediately visible and have a direct and substantial influence on the architectural character of the dwelling. For most storage designs, however, there will be only minimal architectural modification because of storage type or size.

One of the most important design considerations for solar heat storage inclusion in building design is to provide sufficient building or site area for the large volume associated with most storage components — especially with water or rock storage. Since the storage component is generally sized to provide for the dwelling's heating/cooling requirement over several days — usually 1 to 3 days — the size of storage can become quite large. It is not uncommon to have storage size range from 500 to 2000 gallons of water or 10 to 50 tons of rock for a single family dwelling. This amount of storage will require 65 to 270 cubic feet of space for water storage and 160 to 800 cubic feet of space for rock storage. A savings in storage size is possible for multi-family or other large buildings where a centralized storage component services all the living units. This method will generally be advantageous in terms of cost, efficiency and operation over many individual storage elements.

### Location

Storage location can become critical for the efficient operation of the solar system. If storage is located at a considerable distance from the collection and distribution components, heat transfer between components may be inefficient and the total energy reaching the occupied space will be reduced.

There are three basic locations for solar storage: within the building, outside the building, and integrated with building or other solar system components. Storage location will be determined primarily by the collector type, storage performance characteristics, required thermal capacity (size), and the architectural requirements imposed by the building's design.

Within the building, the storage component can be located wherever there is sufficient room. In most

cases, however, storage is located in the basement, if there is one, or buried beside the dwelling, if there is not. Other storage locations within the building include an attic space, a storage closet (especially in the case of physical/chemical storage), or a specially built storage room or element.

Outside the building, storage is usually buried alongside of the exterior wall closest to the mechanical equipment room. Where burying is not feasible, because of a low water table for instance, storage can be placed in a well-insulated free-standing element adjacent the building. Burying is recommended because of the added insulation value of the earth. Also, because the storage component is outside the building, interior space does not have to be provided.

Solar storage which is integrated with the building other solar system components, in certain instances, encompasses the best features of the previous two storage locations. Integrated storage elements serve several functions simultaneously. For example, the walls, floors, and roof of a building can be used to store solar energy as well as perform their intended function. The Pueblo Indian structures and the houses designed by George and Fred Keck are examples of this storage concept.

Storage can also be integrated with the other components of a solar system. A solar system which combines several functions in the same element can be used additionally as an architectural element. For instance, the solar pond of the Atascadero house not only collects, stores, and distributes solar energy, it is also the roof of the dwelling. This same principle applies to solar systems which can be used for exterior or interior walls — such as found in the Trombe/Michel house.

Regardless of storage location, the component should be designed to control heat loss. For storage outside the building, heat loss should be reduced to a minimum by enclosing the element with insulation and burying it to a sufficient depth. Storage within the building should be regulated so that unwanted heat loss does not escape to the outside or adjacent interior spaces. Where storage is integrated with

building or solar system components, it is extremely important that heat loss from storage be carefully controlled so that the occupied space served by storage does not overheat.

---

## Architectural Design Implications of Solar Heat Distribution

### Type and Size

The type of distribution method chosen for use in a dwelling may have a significant effect on its architectural appearance. For instance, distribution dependent on natural convection and radiation will require careful attention to room size and shape, opening placement, ceiling height, building material selection, to name but a few considerations. The same degree of attention would not be required if a forced warm-air or warm-water distribution was used. Selection of the distribution method should not be quickly decided without some analysis of the architectural implications of the choice.

The manner in which solar radiation is collected and stored will usually determine the means of distribution. The number of possible combinations between solar system components is limited. Consequently, for any specific collector — storage combination — there will be a limited number of compatible distribution methods. Once collection and storage components have been selected, a number of distribution methods may be identified and analyzed.

The size of the distribution component is dependent on the operating temperature of the solar collector and storage, the amount of area/volume to be heated/cooled, and the distance between collector/storage and the point of use. In some instances, there will be no size associated with distribution. For example, the solar pond of the Atascadero house is placed on top of metal ceiling panels above the serviced area. The panels, heated by solar radiation striking the pond, distribute collected energy to the dwelling's interior without conventional distribution elements — ducts and pipes — by natural radiation.

and convection. However, solar systems which rely on mechanical devices for energy distribution will generally require more attention to distribution size and location than conventional heating and cooling systems.

Warm-air distribution, for instance, will, in most instances, require larger duct and blower sizes because solar produced temperatures in storage are often in the low range. Consequently, the layout of distribution ducts can significantly influence a dwelling's spatial arrangement to accommodate efficient distribution and the added duct size.

### Location

The location of solar distribution components within a dwelling are much the same as conventional heating and cooling distribution components. Methods using ducts and pipes can be located in a basement, attic, dropped ceiling space or under the floor slab if the house is built on grade. The possibility of larger duct sizes due to lower storage temperatures may become a significant factor in the location of duct runs through the dwelling. This, in turn, can influence the location and arrangement of rooms and the placement of outlet diffusers. Distribution methods dependent on natural radiation and convection, which in most cases do not rely on ducts or pipes, require special attention to energy source and target area. Since radiation and convection are dependent on the differential temperature of surfaces and air respectively, the location of the energy source — collector or storage — relative to occupied spaces is important for efficient distribution. This in turn will suggest room sizes, shapes, and materials which are compatible with radiation and convection distribution.

---

### Solar Design Determinants — Solar Systems

The solar system factors which may influence the design of solar dwellings, systems and sites include:

- Solar collector's location — whether the collector is detached, attached, or fully integrated with

the building structure will significantly influence the design of the dwelling, site and system.

- Collector type(s) and size(s) — dependent on climatic conditions, thermal characteristics of dwelling, efficiency of collector, and functional requirement (e.g., space heating) Various collector types may be used simultaneously.
- Solar collector's orientation — generally 10°-20° either side of true south.
- Tilt of solar collector — should be normal to the sun's rays during periods of collection. Annual optimum collector angle for space heating is generally considered latitude plus 15° and latitude plus 5° for space heating and cooling. Seasonal optimums will vary from December to June within a total range of approximately 30°.
- Energy loss at the back and sides of collector — should be properly insulated to reduce unwanted heat loss from collector to external climate or internal spaces.
- Storage type(s) and design — must be compatible with collector and distribution systems.
- Storage size — should accommodate collector(s) performance characteristics, building's energy demand (generally for 1 to 3 days), and climatic variations.
- Minimized heat loss from storage to surrounding environment — storage should be well insulated to reduce heat loss on cool days or when collection is not occurring. However, in the case of an integral collector/storage system, a thermosyphoning wall for example, heat loss should be properly calculated to deliver heat at the rate desired.
- Efficient transfer of heat from collector to storage, storage to distribution — an important consideration for regulating the efficiency of solar radiation collection and distribution.
- Reliability of storage medium — long life regeneration of storage medium.

- Placement of storage to maximize efficiency and minimize human discomfort — location of storage to be compatible with collector and distribution systems, but also not in conflict with human comfort considerations. For example, storage may be located within or below an occupied space and may cause overheating of that space if not properly designed or insulated.
- Distribution type(s) and design — must be compatible with collector and storage systems.
- Distribution size — system may have to be larger than conventional distribution systems because temperatures are generally lower.
- Placement of air distribution outlets — moving air which is only a few degrees above room temperature feels relatively cool to the occupants, even though it is actually warming the space. With the lower delivery temperatures common in solar warm air heating systems, warm air outlets should be positioned to avoid creating drafts which could be annoying to the occupants.

Recognition of the many design implications associated with the use of solar systems is crucial for the efficient capture and utilization of solar energy for heating and cooling. Additionally, the architectural appearance of the dwelling will be shaped by the design criteria associated with the various solar components chosen for inclusion in the design. Solar dwelling design to be successful must reconcile any conflict between these design issues and skillfully coordinate them into a dwelling design responsive to the climatic conditions and the occupant's needs.



# 4

## SITE PLANNING FOR SOLAR ENERGY UTILIZATION

The building site is an extremely important solar design consideration. Together with the solar design factors presented in the previous chapter, the conditions and characteristics of the building site will influence both solar dwelling and system design. Existing vegetation, geology, topography, and climate are the primary site characteristics considered during site planning and design. These factors will influence not only the design of dwellings incorporating solar heating and cooling systems but also the layout and organization of groups or neighborhoods of solar dwellings.

Every building site will have a unique combination of site conditions. As a result, the same solar dwelling placed on various sites will generally require completely different site planning and design decisions. Therefore, the site for a solar heated or cooled dwelling should be selected with care and modified as necessary to maximize the collection of solar energy and to minimize the dwelling's need for energy.

---

### THE SITE PLANNING PROCESS

Site planning is concerned with applying an objective analysis and design process to specific site-related problems at increasingly smaller scales. While the building site and the dwelling design may vary significantly from one project to another, the process of site planning is replicable and easily adapted to the requirements of most projects. In the case of solar dwelling design, the process is altered to in-

clude design criteria related specifically to the use of solar heating and cooling systems.

Site planning for the utilization of solar energy is concerned with two major issues: 1) access to the sun, and 2) location of the building on the site to reduce its energy requirement. The placement and integration of the solar dwelling on the site in response to these concerns entails numerous decisions made at a variety of scales. The process may commence at a regional climatic and geographic scale and terminate at a specific location on the building site. At every scale, decisions regarding site selection, building orientation and placement, and site planning and design are made.

---

### SITE SELECTION

At times, a builder, developer or designer may have the option of selecting a site or of determining the precise location on a larger site for the placement of the solar dwelling or dwellings. In such instances, the best site for effective solar energy utilization should be chosen by analyzing and evaluating carefully all of the following factors:

Geography of the area surrounding the site

- the daily and seasonal path of the sun across the site
- the daily and seasonal windflow patterns around or through the site
- the presence of earthforms which may block the sun or wind

- the presence of low areas where cold air could settle

#### Topography of site

- steepness of the slope — can it be built upon economically
- the presence of slopes beneficial or detrimental to energy conservation and solar energy utilization

#### Orientation of slopes on the site

- south-facing slopes for maximum solar exposure
- west-facing slopes for maximum afternoon solar exposure
- east-facing slopes for maximum morning solar exposure
- north-facing slopes for minimum solar exposure

#### Geology underlying the site

- depth and type of rock on the site
- unbuildable areas on the site

#### Existing soil potential and constraints

- soils with engineering limitations unable to support structures
- soils with agricultural limitations, unable to support vegetation

#### Existing vegetation

- size, variety and location of vegetation which would impair solar collection
- building sites which would disturb existing vegetation to a minimum
- size, variety and location of vegetation which would assist in energy conservation

#### Climatically protected areas on the site

- areas protected at certain times of the day or year
- areas protected by topography
- areas protected by vegetation

#### Climatically exposed locations on the site

- areas exposed to sun or wind
- areas exposed primarily in winter
- areas exposed primarily in summer
- areas exposed all seasons of the year

#### Natural access routes to and through the sites

- adjacent streets for vehicular access to the site
- adjacent walkways for pedestrian access to the site

#### Solar radiation patterns on the site

- daily and monthly
- seasonal
- impediments (e.g., vegetation that may cover the site or shadow buildable areas on the site)

#### Wind patterns on the site

- daily and monthly
- seasonal
- impediments (e.g., thick vegetation or underbrush that may block air movement on or through the site)

#### Precipitation patterns on the site

- fog movement, collection or propensity patterns
- snow drift and collection patterns
- frost "pockets"

#### Temperature patterns on the site

- daily and monthly
- seasonal
- warm areas
- cold areas

#### Water or air drainage patterns on or across the site

- seasonal air or water flow patterns
- daily air or water flow patterns
- existing or natural impediments to air or water flow patterns

Tools for site analysis include air photos, topographic maps, climatic charts or direct observations on the site. Site selection at whatever scale must take into account the distinctive characteristics of the major climatic regions of the United States mentioned earlier. Once the data is collected and organized, it can be used to evaluate, rate and eventually select a specific location or site for the placement of the dwelling, solar system, and other site related activities

A simplified example of the site analysis process for determining preferred locations for solar dwellings in western temperate climates is shown in the following illustrations.

### ALTITUDE AND SCOPE

THE TOPOGRAPHY IS ANALYZED IN BOTH PLAN AND CROSS SECTION TO LOCATE BUILDABLE AREAS ON UPPER AND MIDDLE SLOPES.

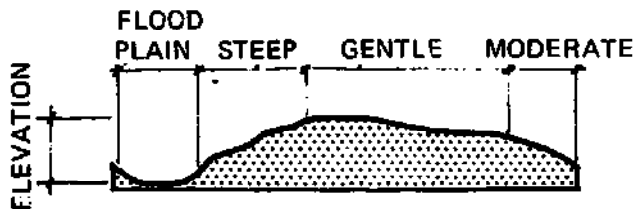

### ORIENTATION AND WINDS

THE SITE IS NEXT ASSESSED FOR AREAS ORIENTED IN A SOUTHERLY DIRECTION FOR MAXIMUM SOLAR EXPOSURE. ALSO, THE PREVAILING AND STORM WINDS WHICH MOVE REGULARLY OR OCCASIONALLY ACROSS THE SITE ARE PLOTTED.

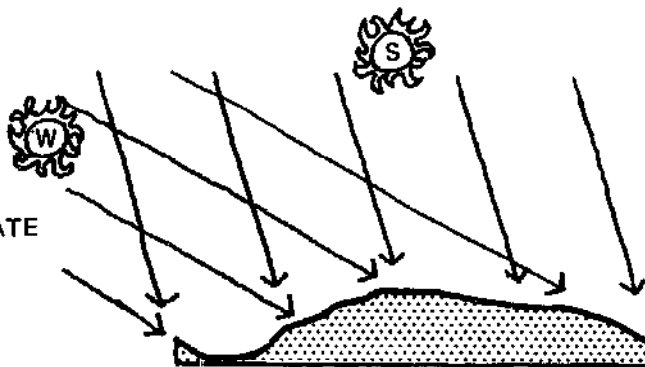

### VEGETATION AND MOISTURE

EXISTING VEGETATION AND MOISTURE PATTERNS ON THE SITE ARE RELATED TO THEIR POTENTIAL FOR ASSISTANCE IN THE CREATION OF SUN POCKETS AND FOR PROVIDING WIND PROTECTION. THE DENSITY AND TYPE OF VEGETATION ARE ANALYZED AND GRAPHICALLY DEPICTED IN ORDER TO GAIN AN UNDERSTANDING OF THE PATTERNS OF SHADE OR PROTECTION AND AIR OR MOISTURE FLOW.

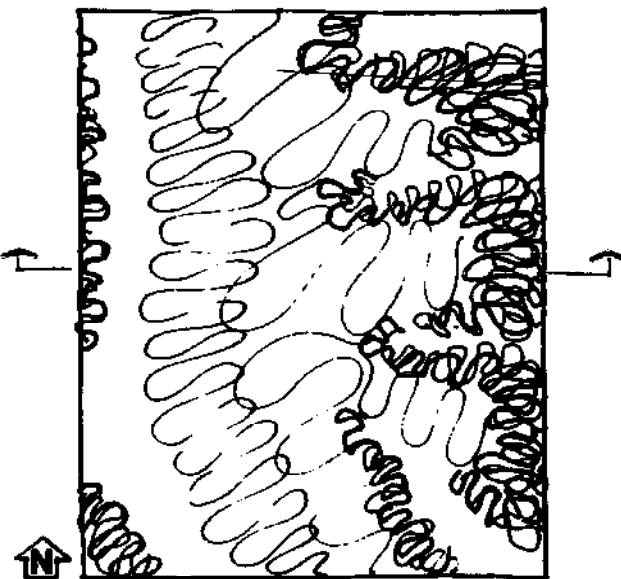
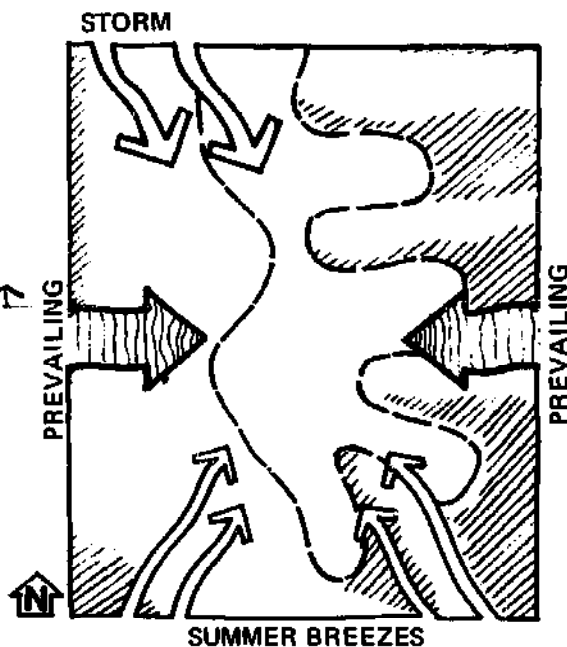
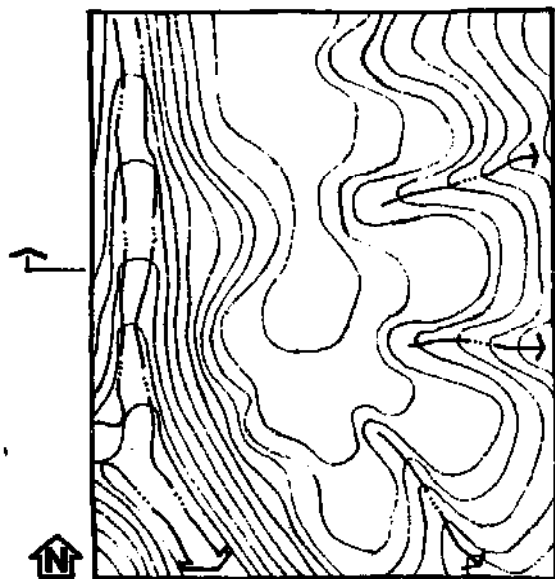
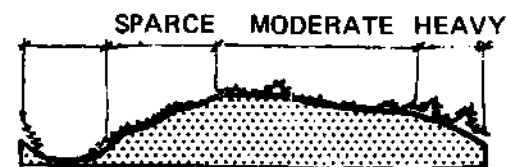

## COMPOSITE SHOWING PREFERRED SITES

A COMPOSITE IS PREPARED FROM THE PRECEDING FACTORS SHOWING A RANKING OR A RATING OF THE PREFERRED SITES FOR PLACEMENT OF A SOLAR DWELLING ("a" BEING BEST, "b" NEXT BEST AND SO ON).

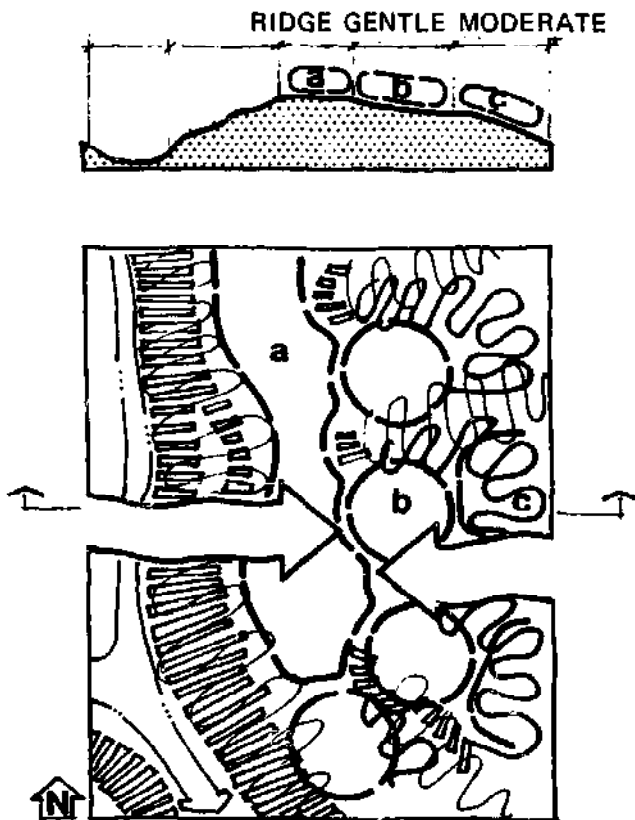

## Siting and Orientation

Optimum solar energy utilization is achieved by the proper placement and integration of the dwelling, solar collectors, and other site-related activities and elements on the building site.

In addition to the dwelling, the most common activity areas found on residential sites include

- means of access (entrances to the site and to the dwelling),
- means of service (service and storage areas),
- areas for outdoor living (patios, terraces, etc.), and
- areas for outdoor recreation (play areas, pools, courts, etc.)

On sites where the dwelling(s) will be heated or cooled by solar energy, additional site planning factors must be considered for accommodating solar collection — either by dwelling or on-site collectors.

Each of the four major climatic regions in the United States has different siting and orientation considerations. The following is an overview of the major determinants for each region.

## Cool Region

Maximum exposure of the dwelling and solar collector to the sun is the primary objective of site planning in cool regions. Sites with south-facing slopes are advantageous because they provide maximum exposure to solar radiation. Outdoor living areas should be located on the south sides of buildings to take advantage of the sun's heat. Exterior walls and fences can be used to create sun pockets and to provide protection from chilling winter winds.

Locating the dwelling on the leeward side of a hill or in an area protected from prevailing cold northwest winter winds — known as a wind shadow — will conserve energy. Evergreen vegetation, earth mounds (berms) and windowless insulated walls can also be used to protect the north and northwest exterior walls of buildings from cold winter winds.

Structures can be built into hillsides or partially covered with earth and planting for natural insulation.

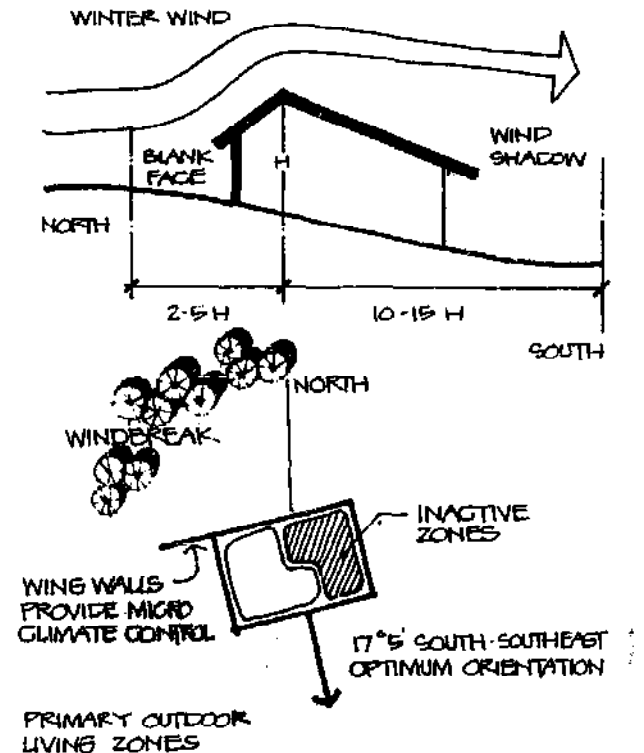

## Temperate Region

In the temperate region it is vital to assure maximum exposure of the solar collectors during the spring, fall and winter months. To do so, the collector should be located on the middle to upper portion of any slope and should be oriented within an arc 10° either side of south. The primary outdoor living areas should be on the southwest side of the dwelling for protection from north or northwest winds. Only deciduous vegetation should be used on the south side of the dwelling since this provides summer shade and allows for the penetration of winter sun.

The cooling impact of winter winds can be reduced by using existing or added landforms or vegetation on the north or northwest sides of the dwelling. The structure itself can be designed with steeply pitched roofs on the windward side, thus deflecting the wind and reducing the roof area affected by the winds. Blank walls, garages, or storage areas can be placed on the north sides of the dwelling. To keep cold winter winds out of the dwelling, north entrances should be protected with earth mounds, evergreen vegetation, walls or fences. Outdoor areas used during warm weather should be designed and oriented to take advantage of the prevailing southwest summer breezes.

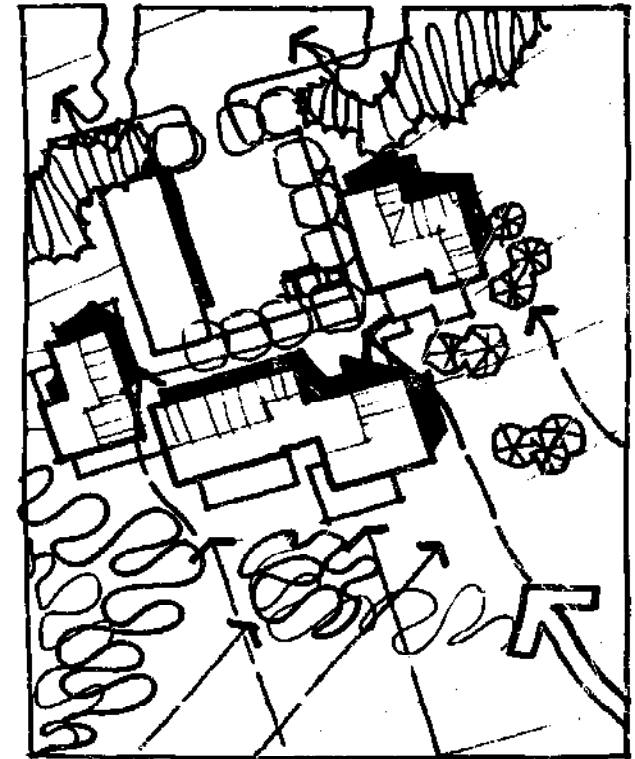
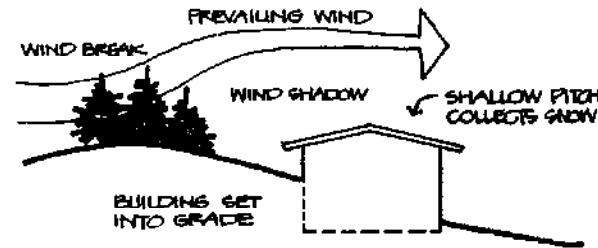
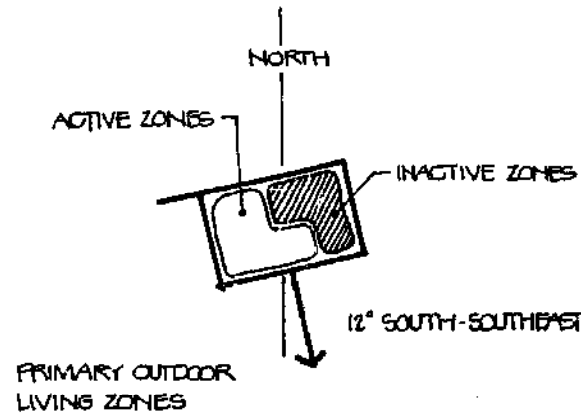

FOR CLUSTERED MULTI-FAMILY DWELLINGS, TERRACES AND OUTDOOR LIVING AREAS SHOULD BE INTEGRATED WITHIN THE BUILDING CLUSTERS. THIS WILL REDUCE COLD AIR MOVEMENT IN WINTER AND WILL CHANNEL AND DIRECT BREEZES IN SUMMER.

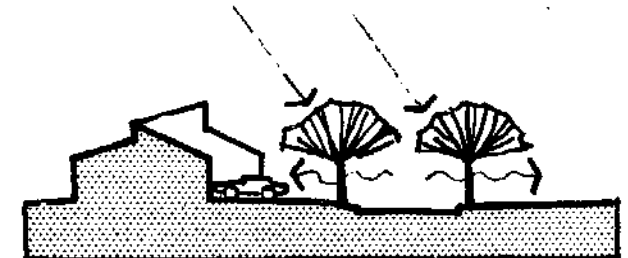

STREETS AND PARKING AREAS SHADED WITH DECIDUOUS VEGETATION WILL ALSO CHANNEL SUMMER BREEZES AND REDUCE RADIATION REFLECTION WHILE ALLOWING THE SUN TO PENETRATE DURING THE WINTER.

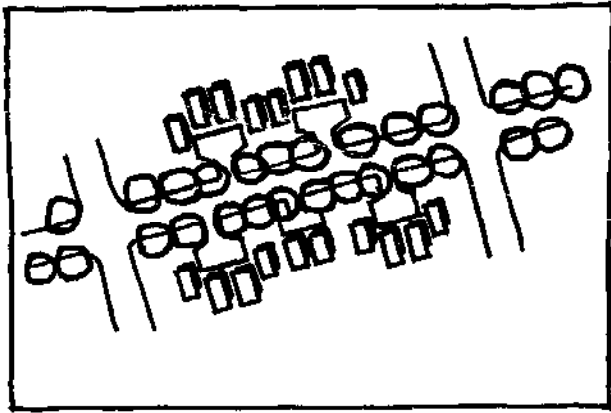

ROADWAYS CAN SERVE TO CHANNEL AND DIRECT DESIRABLE BREEZES OR BLOCK UNWANTED COLD WINDS. FOR TEMPERATE REGIONS, AN EAST-WEST STREET ORIENTATION CAN BEST SERVE THESE PURPOSES.

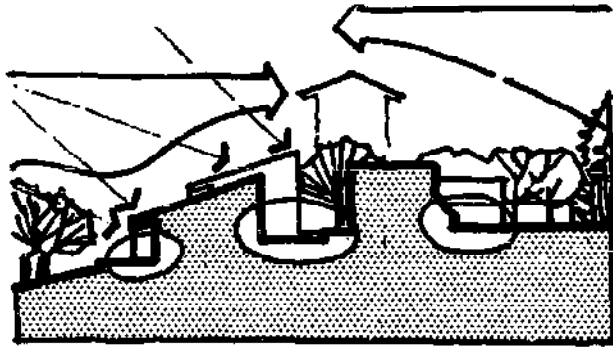

"SUN POCKETS" OR "SOLAR NOOKS" LOCATED ON THE SOUTH SIDES OF BUILDINGS MAY HELP EXTEND PERIODS OF SEDENTARY OUTDOOR LIVING DURING COOLER MONTHS.

## Hot-Humid Region

In hot-humid regions where the heating requirement is small, solar collectors for heating only systems require maximum exposure to solar radiation primarily during the winter months. During the remainder of the year air movement in and through the site and shading are the most important site design considerations. However, for solar cooling or domestic water heating, year round solar collector exposure will be required. Collector orientation within an arc  $10^\circ$  either side of south is sufficient for efficient solar collection. The drawings below and on the next page illustrate a number of site planning and design considerations for solar energy utilization and energy conservation.

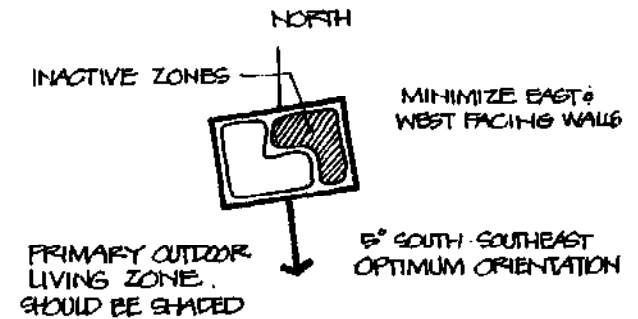

PLANTING SHOULD SHADE STRUCTURE WHENEVER POSSIBLE, AS WELL AS OUTDOOR SPACES.

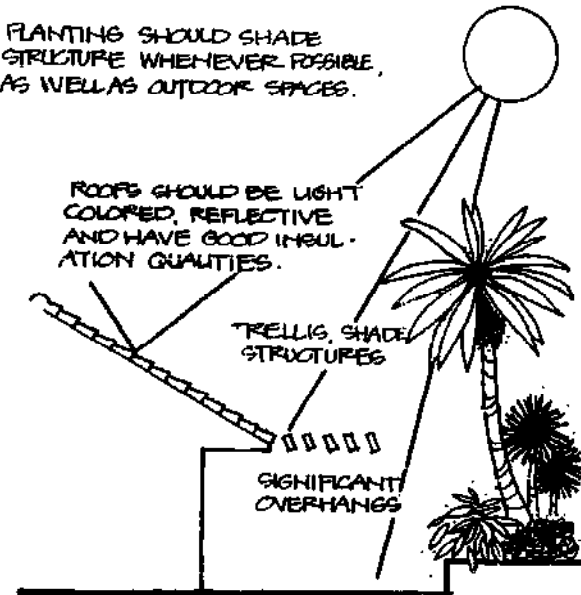

**SITE PLAN FOR HOT-HUMID REGION  
ILLUSTRATING PRINCIPLES OF ORIENTATION  
AND PLACEMENT OF BUILDINGS, STREETS  
AND PLANTING.**

NORTH

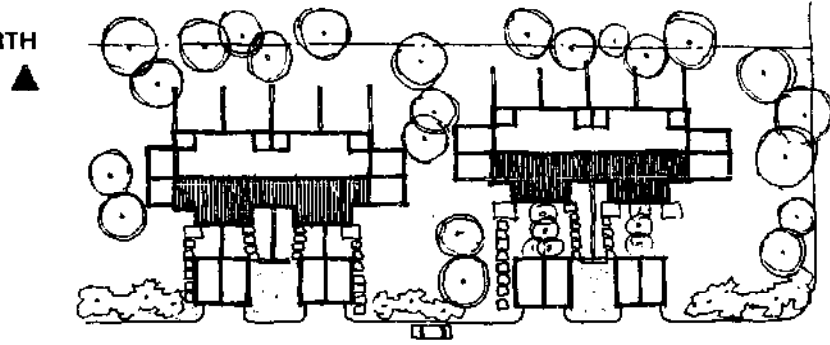

CLUSTER ENDS OPEN TO ALLOW BREEZES TO  
FLOW AROUND HOUSES.

ROOF-MOUNTED SOLAR COLLECTORS

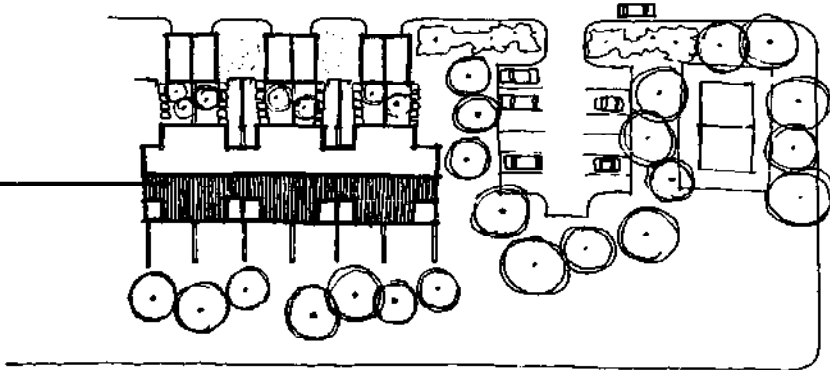

LOCAL STREETS RUN EAST-WEST TO TRAP  
EASTERLY BREEZES.

BUILDINGS ORIENTED FOR MAXIMUM SOLAR  
COLLECTION DURING WINTER.

TREES ON THE PROPERTY LINE PROVIDE BOTH  
MORNING & AFTERNOON SHADE.

PREVAILING EASTERLY BREEZES FLOW  
BENEATH HIGH-CANOPY TREES WITH LITTLE  
UNDERSTORY GROWTH.

VARIATION IN SETBACK ALLOWS MAXIMUM  
VENTILATION.

HOUSES FACING SOUTH MUST BE DESIGNED  
WITH COLLECTORS ON THE FRONT.

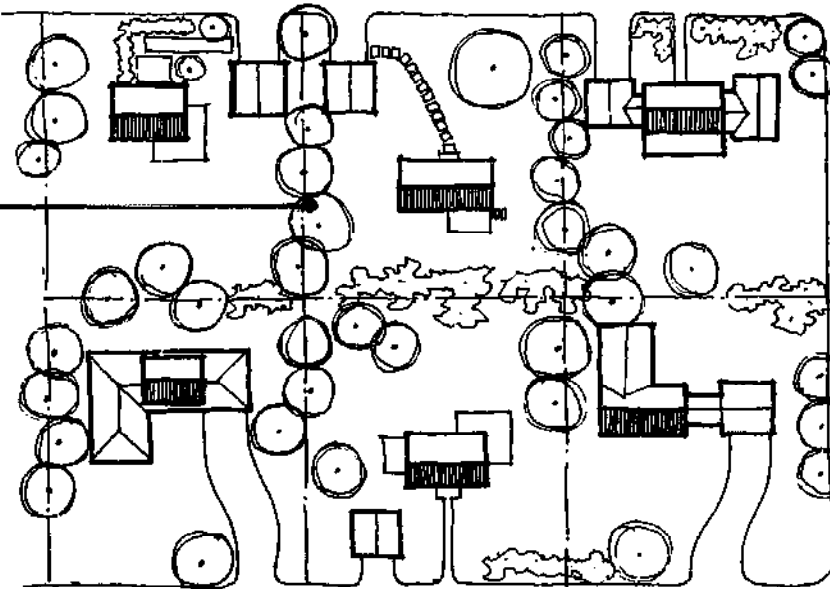

## Hot-Arid Region

The objectives of siting, orientation and site planning in hot-arid regions are to maximize duration of solar radiation exposure on the collector and to provide shade for outdoor areas used in late morning or afternoon. To accomplish these objectives, the collector should be oriented south-southwest and the outdoor living areas should be located to the southeast of the dwelling in order to utilize early morning sun and take advantage of shade provided by the structure in the afternoon.

Indoor and outdoor activity areas should take maximum advantage of cooling breezes by increasing the local humidity level and lowering the temperature. This may be done by locating the dwelling on the leeward side of a lake, stream, or other bodies of water. Also, lower hillside sites will benefit from cooler natural air movement during early evening and warm air movement during early morning.

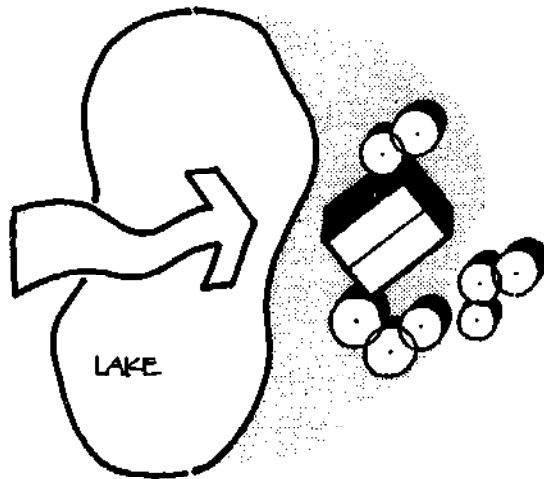

BODIES OF WATER OFFER THE OPPORTUNITY TO PLAN FOR THE COOLING EFFECTS OF EVAPORATION.

Excessive glare and radiation in the outdoor environment can be reduced by providing:

- small shaded parking areas or carports;
- turf adjacent to the dwelling unit;
- tree shaded roadways and parking areas;
- parking areas removed from the dwelling units, and
- east-west orientation of narrow roadways.

Exterior wall openings should face south but should be shaded either by roof overhangs or by deciduous trees in order to limit excessive solar radiation into the dwelling. The size of the windows on the east and west sides of the dwelling should be minimized in order to reduce radiation heat gain into the house in early mornings and late afternoons. Multiple buildings are best arranged in clusters for heat absorption, shading opportunities and protection from east and west exposures.

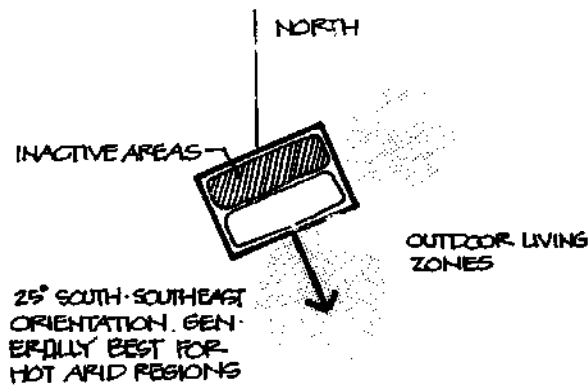

## Site Orientation Chart

Each climatic region has its own distinctive characteristics and conditions that influence site planning and dwelling design for solar energy utilization and for energy conservation. The following chart suggests the general objectives of site planning and dwelling design for each climatic region as well as some methods for achieving these objectives. The chart reflects the seasonal trade-offs made between climatic optimums. In all cases, a detailed analysis should be undertaken to identify the site trade-offs between optimums for solar energy collection and optimums for energy conservation.



## SITE ORIENTATION CHART

	Cool	Temperate	Hot Humid	Hot Arid
<b>Objectives</b>	Maximize warming effects of solar radiation. Reduce impact of winter wind. Avoid local climatic cold pockets.	Maximize warming effects of sun in winter. Maximize shade in summer. Reduce impact of winter wind but allow air circulation in summer.	Maximize shade. Maximize wind	Maximize shade late morning and all afternoon. Maximize humidity. Maximize air movement in summer.
<b>Adaptations</b>				
<b>Position on slope</b>	Low for wind shelter	Middle-upper for solar radiation exposure	High for wind	Low for cool air flow
<b>Orientation on slope</b>	South to Southeast	South to Southeast	South	East-southeast for P.M. shade
<b>Relation to water</b>	Near large body of water	Close to water, but avoid coastal fog	Near any water	On lee side of water
<b>Preferred winds</b>	Sheltered from North and West	Avoid continental cold winds	Sheltered from north	Exposed to prevailing winds
<b>Clustering</b>	Around sun pockets	Around a common, sunny terrace	Open to wind	Along E-W axis, for shade & wind
<b>Building Orientation*</b>	Southeast	South to Southeast	South, toward prevailing wind	South
<b>Tree forms</b>	Deciduous trees near bldg. Evergreens for windbreaks	Deciduous trees nearby on west. No evergreens near on south	High canopy trees. Use deciduous trees near building	Trees overhanging roof if possible
<b>Road orientation</b>	Crosswise to winter wind	Crosswise to winter wind	Broad channel, E-W axis	Narrow; E-W axis
<b>Materials coloration</b>	Medium to dark	Medium	Light, especially for roof	Light on exposed surfaces, dark to avoid reflection

\*Must be evaluated in terms of impact on solar collector, size, efficiency and tilt.

## INTEGRATION OF THE BUILDING AND SITE

Ideally, a building is designed for the specific site on which it is to be placed. Commonly, however, a building design may be replicated with only minor changes on different sites and in different climates.

Site planning solutions are not as easy to replicate, because each site has a unique geography, geology and ecology. The most appropriate way to integrate any building and its site is first to analyze the site very carefully, and then to place the building on the site with a minimum of disruption and the greatest recognition and acceptance of the site's distinctive features.

It is possible, however, to provide general techniques for integrating buildings with their sites. Historically, a number of such techniques have evolved, among which are indigenous architectural characteristics adapted to local site conditions; architectural extensions to the building such as walls and covered walks; the use of native materials found on the site; and techniques for preserving or enhancing the native ecology.

In each climatic region, guidelines can be determined to help apply the many techniques available for integrating a building and its site in ways appropriate to the particular region. These guidelines can be particularly helpful in maximizing energy conservation and increasing the opportunity for successful use of solar heating and cooling. The bibliography contains several documents pertaining to the integration of the building and site

### Detailed Site Design

The detailed design of a site for optimum solar energy utilization and energy conservation entails the use of a variety of types of vegetation, paving, fences, walls, overhead canopies and other natural and man-made elements. These elements are used

to control the solar exposure, comfort and energy efficiency of the site and the dwelling.

The materials used in site design have the ability to absorb, store, radiate, and deflect solar radiation as well as to channel warm or cool air flow. For instance, trees of all sizes and types block incoming and outgoing solar radiation, deflect and direct the wind, and moderate precipitation, humidity and temperature in and around the site and dwelling. Shrubs deflect wind and influence site temperature and glare. Ground covers regulate absorption and radiation. Turf influences diurnal temperatures and is less reflective than most paving materials. Certain paving surfaces, fences, walls, canopies, trellises and other site elements may be located on the site to absorb or reflect solar radiation, channel or block winds and expose or cover the dwelling or solar collector.



**DECIDUOUS TREES CAN BE USED FOR SUMMER SUN SHADING OF THE DWELLING AND YET ALLOW WINTER SUN PENETRATION THROUGH THEIR BARE BRANCHES FOR SOLAR COLLECTION. BARE BRANCHED DECIDUOUS TREES DO, HOWEVER, CAST A SUBSTANTIAL SHADOW AND WILL REDUCE COLLECTION EFFICIENCY. EVERGREENS SHADE COLLECTORS HEAVILY ALL YEAR.**

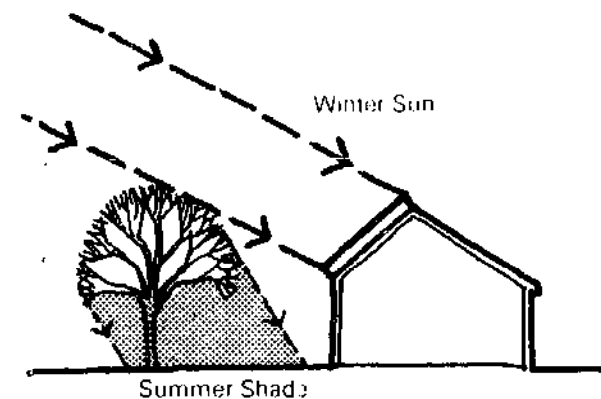

**BECAUSE TREE IS AWAY FROM HOUSE TO AVOID SHADING ROOF COLLECTOR IN WINTER, IT CANNOT SHADE THE SOUTH WALL OF THE HOUSE IN SUMMER.**

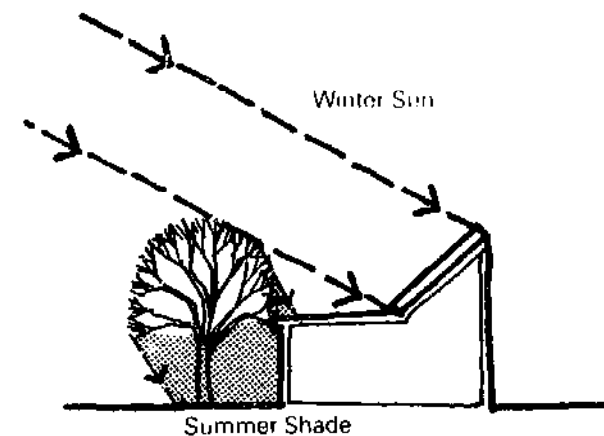

**BY MOVING COLLECTOR BACK, TREES CAN BE GROWN NEAR THE HOUSE TO PROVIDE SUMMER SHADE, WITHOUT ALSO SHADING COLLECTOR IN WINTER.**

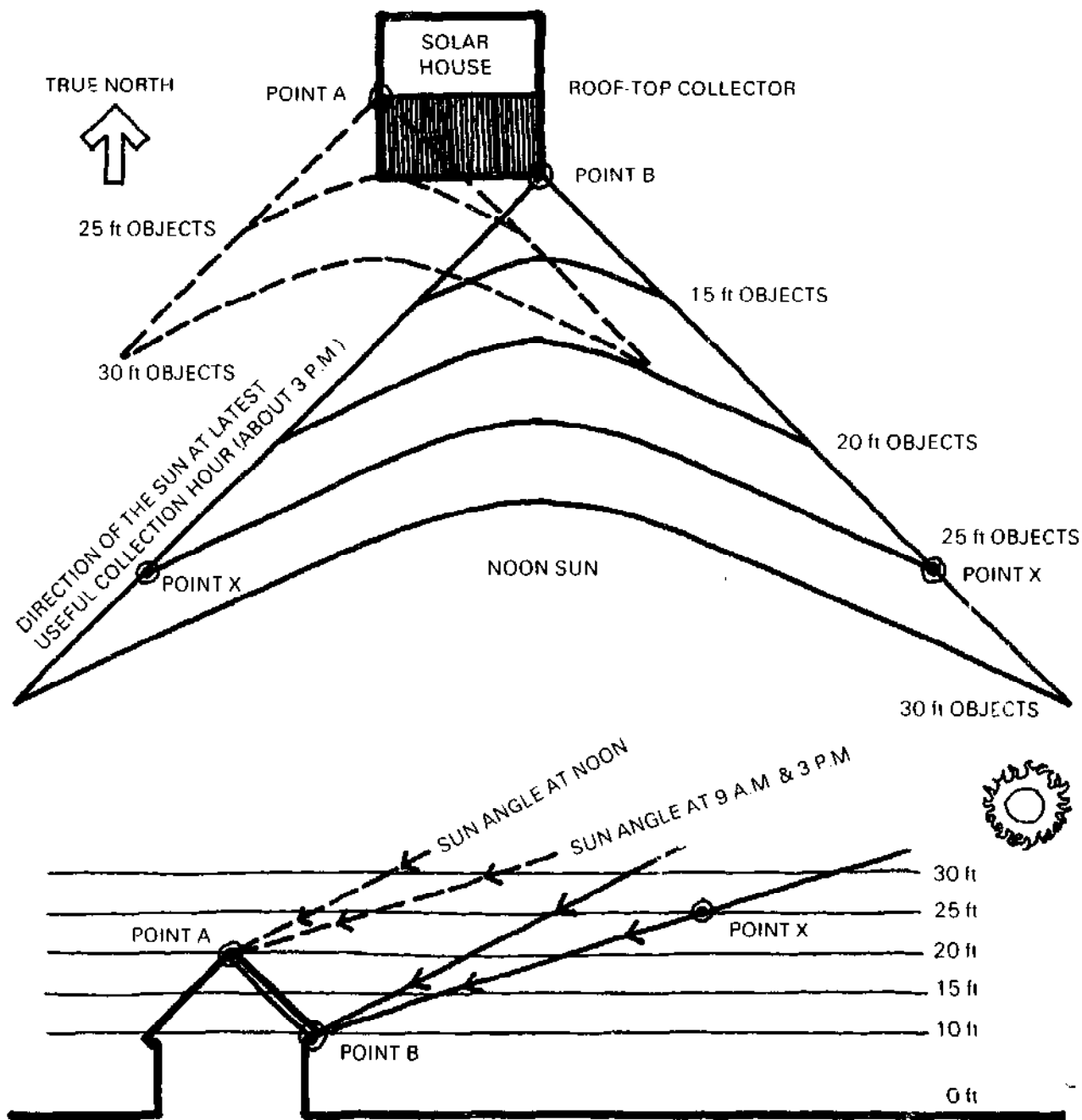

### SOLAR INTERFERENCE BOUNDARIES OF INDIVIDUAL POINTS

LATITUDE 40  
DECEMBER 21 WINTER SOLSTICE

EVERY POINT ON THE COLLECTOR FOR A GIVEN LATITUDE AND DAY OF THE YEAR, HAS A SET OF SOLAR INTERFERENCE BOUNDARIES. THESE DEFINE THE AREAS WITHIN WHICH OBJECTS OF A GIVEN HEIGHT ABOVE A FLAT SITE WILL CAST A SHADOW ON THE COLLECTOR AREAS BEFORE AND AFTER USEFUL COLLECTION HOURS ARE NOT INCLUDED

SOLAR INTERFERENCE BOUNDARIES ARE DRAWN BY PLOTTING IN PLAN THE POINTS OF INTERSECTION BETWEEN THE SUN ANGLES AND THE VARIOUS ELEVATIONS ABOVE THE ZERO GRADE. (SUCH AS POINT X)

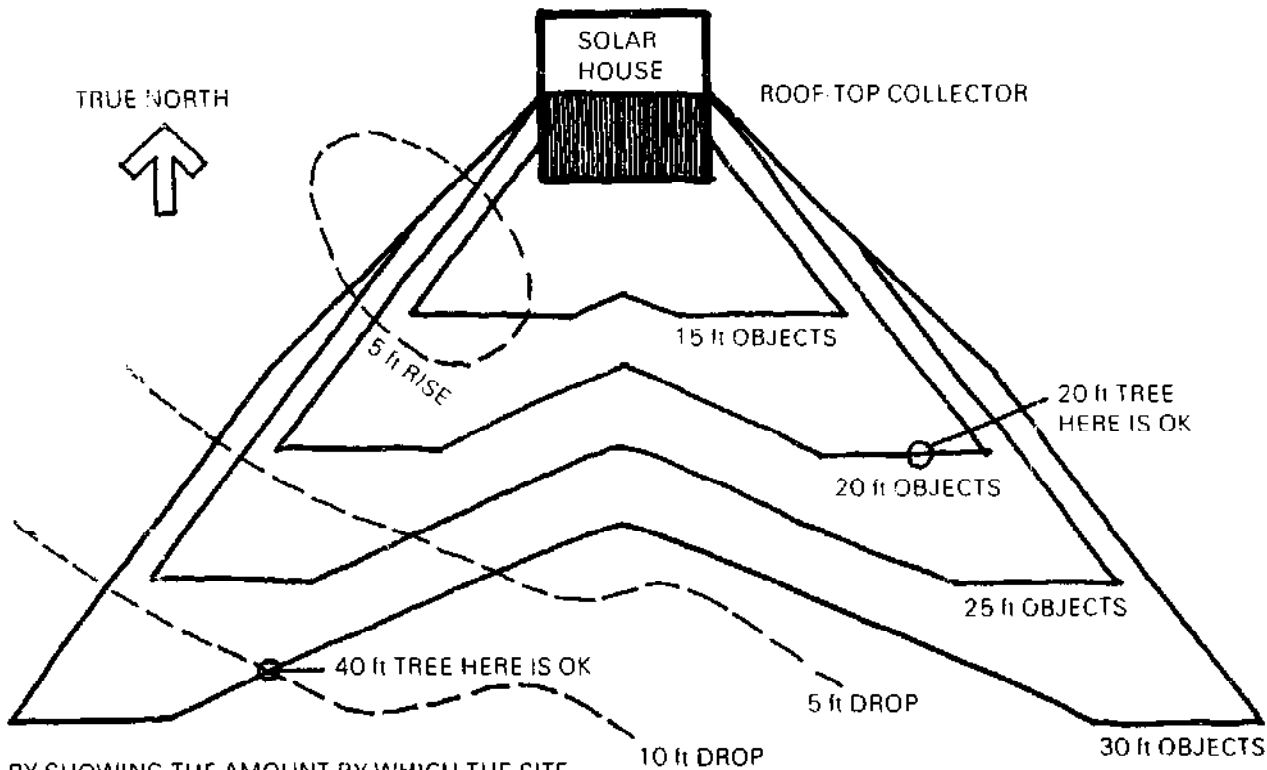

BY SHOWING THE AMOUNT BY WHICH THE SITE RISES OR DROPS AWAY FROM A FLAT SITE, IT IS POSSIBLE TO FIND THE TALLEST ALLOWABLE OBJECT AT ANY POINT IN THE SITE.

### COMPOSITE SOLAR INTERFERENCE BOUNDARIES FOR ENTIRE COLLECTOR

LATITUDE 40  
DECEMBER 21 WINTER SOLSTICE

A COMPOSITE PLAN OF THE SOLAR INTERFERENCE BOUNDARIES FOR EVERY POINT ON THE COLLECTOR CAN BE MADE RELATIVELY SIMPLY

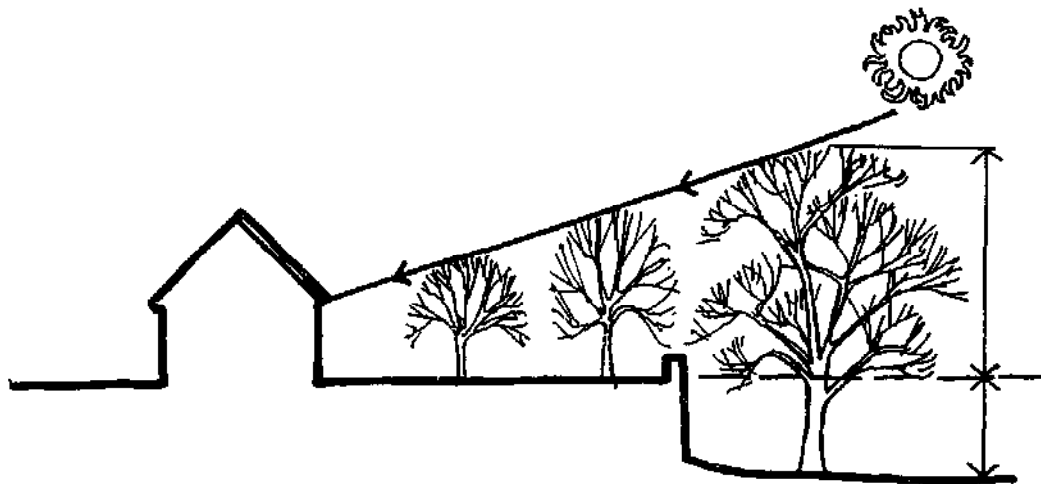

IF THE SITE FALLS AWAY TO THE SOUTH, LARGER TREES CAN BE PLANTED WITHOUT SHADING THE COLLECTOR

THE EXTRA HEIGHT ALLOWABLE CAN BE SHOWN IN PLAN:

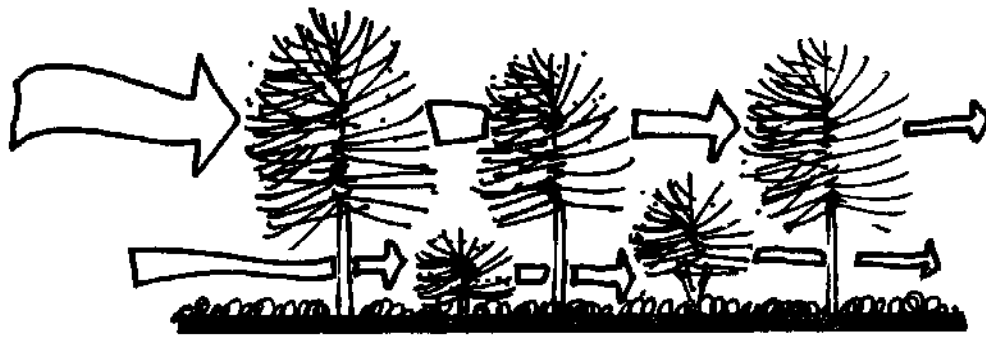

**MULTIPLE BRAKING EFFECT**

MULTI-LAYERED VEGETATION INCLUDING CANOPY TREES AND UNDERSTORY TREES OR SHRUBS PROVIDES A MULTIPLE BRAKING EFFECT, SUBSTANTIALLY DECREASING THE WIND VELOCITY MOVING OVER A SITE.

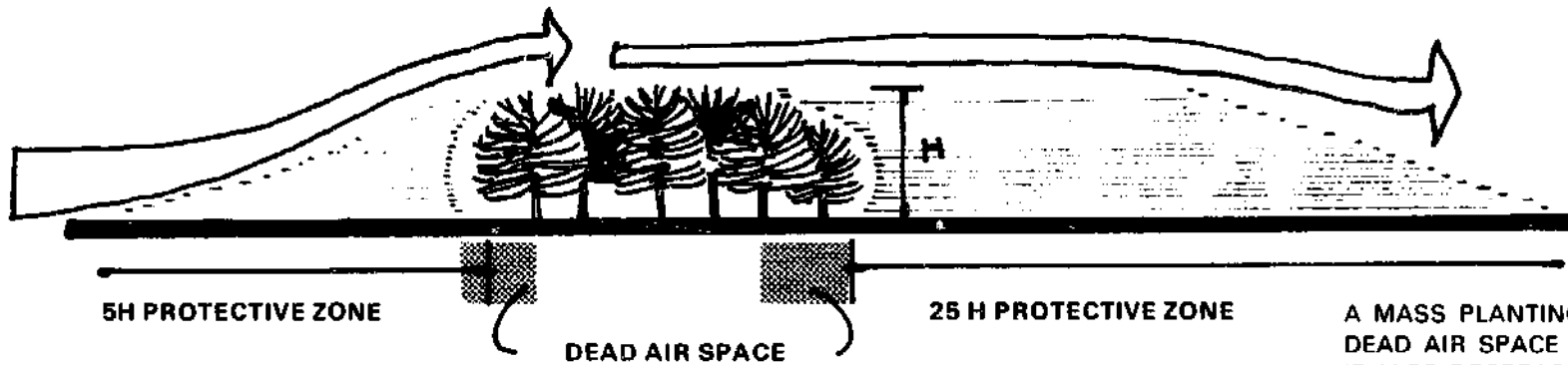

A MASS PLANTING OF TREES PROVIDES A DEAD AIR SPACE UNDER AND AROUND ITSELF. IT ALSO DECREASES THE AIR VELOCITY 5 TIMES ITS HEIGHT TO WINDWARD AND 25 TIMES ITS HEIGHT TO LEEWARD OF THE PLANTING.

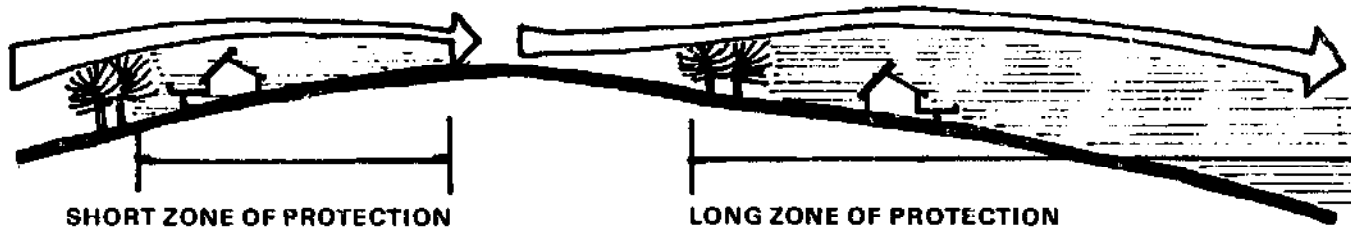

PLANTING ON THE LEEWARD SIDE OF A HILL SUBSTANTIALLY INCREASES THE DOWNWIND ZONE OF REDUCED AIR VELOCITY, WHILE PLANTING ON THE WINDWARD SIDE CORRESPONDINGLY DECREASES THE ZONE.

FENCES, WALLS OR VEGETATION CAN BLOCK NATURAL AIR FLOW PATTERNS. CARE MUST BE TAKEN DURING SITE DESIGN TO PROVIDE THE NECESSARY VISUAL CONTROL WHILE AVOIDING ADVERSE CLIMATIC CONDITIONS. AS COOLER AIR FLOWS DOWNHILL IN THE EVENING, FENCES, WALLS OR PLANTINGS SHOULD NOT UNINTENTIONALLY DAM THIS FLOW AND THUS CREATE A COLD AIR POCKET WHERE IT IS NOT WANTED.

VEGETATION MAY BE PRESERVED OR PLACED IN SUCH A WAY AS TO CHANNEL OR BLOCK DAILY OR SEASONAL AIR FLOW PATTERNS.

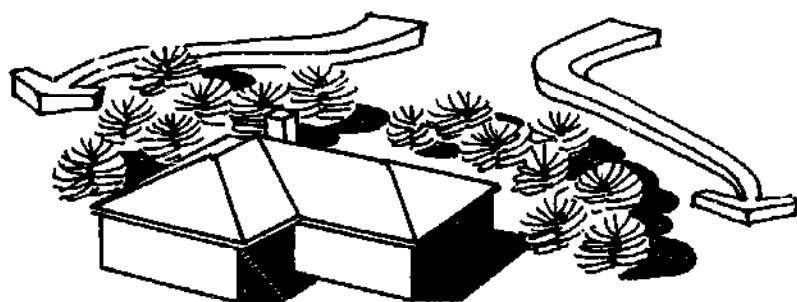
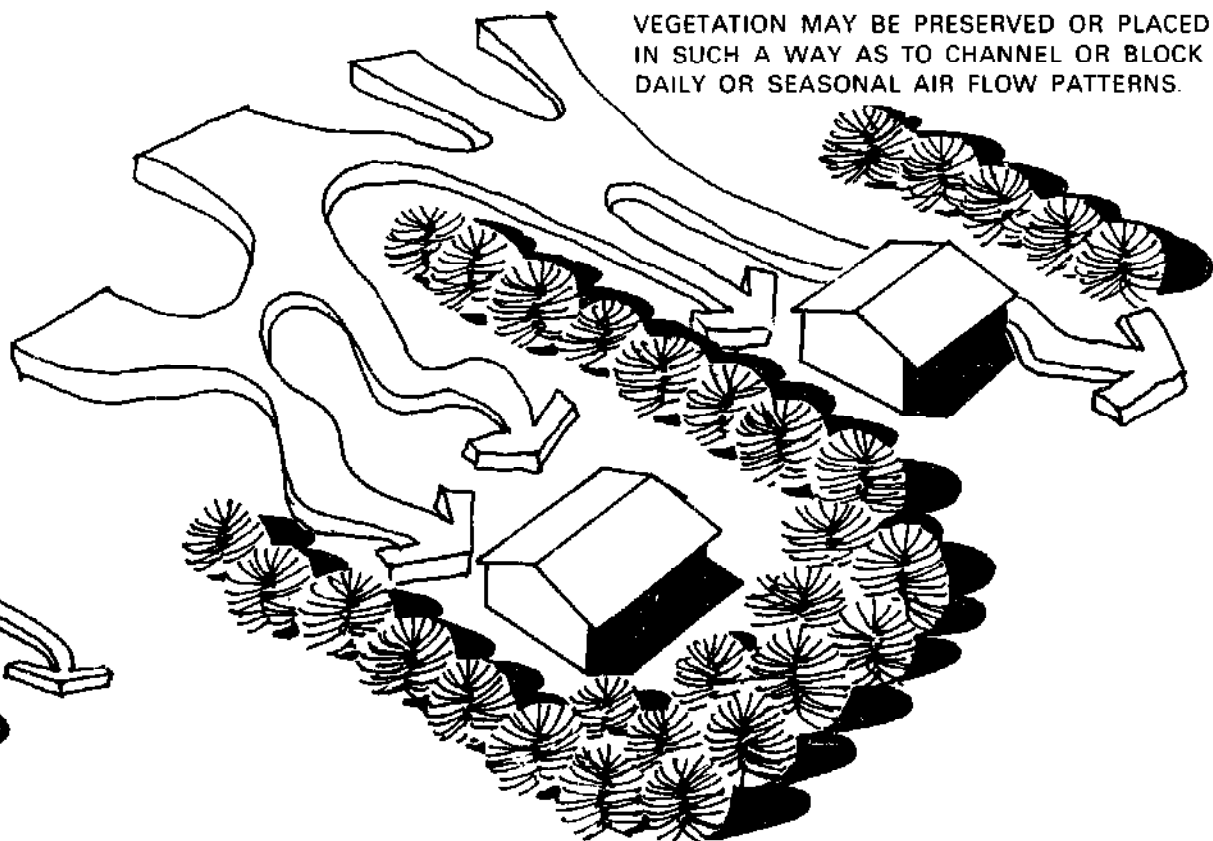

VEGETATION PROPERLY PLACED CAN DEFLECT RATHER THAN DAM COLD AIR FLOW

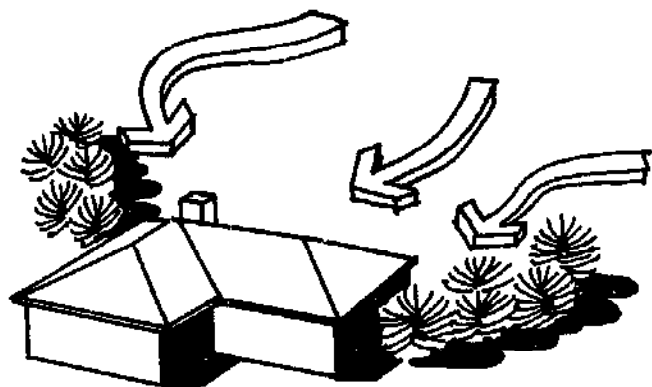

DWELLING UNPROTECTED FROM COLD AIR FLOW

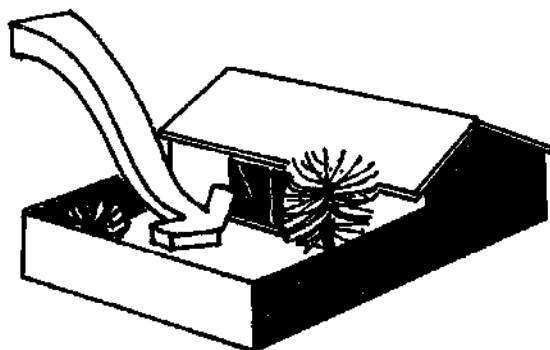

COLD AIR TRAPPED BY FENCE

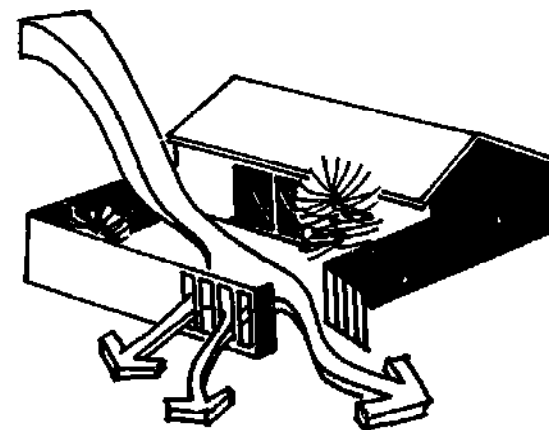

FENCE DESIGN CAN PROVIDE FOR COLD AIR DRAINAGE

**SITE PLANNING FOR SOLAR ENERGY UTILIZATION AND ENERGY CONSERVATION BASED ON THE VEGETATION, TOPOGRAPHIC AND CLIMATIC ANALYSIS OF THE SITE SUGGESTS SOUTHERN EXPOSURE, NORTHERN PROTECTION AND UNIMPAIRED AIR MOVEMENT FOR MULTI-FAMILY HOUSING PROJECT LOCATED IN A COOL CLIMATE.**

**VEGETATION ANALYSIS**

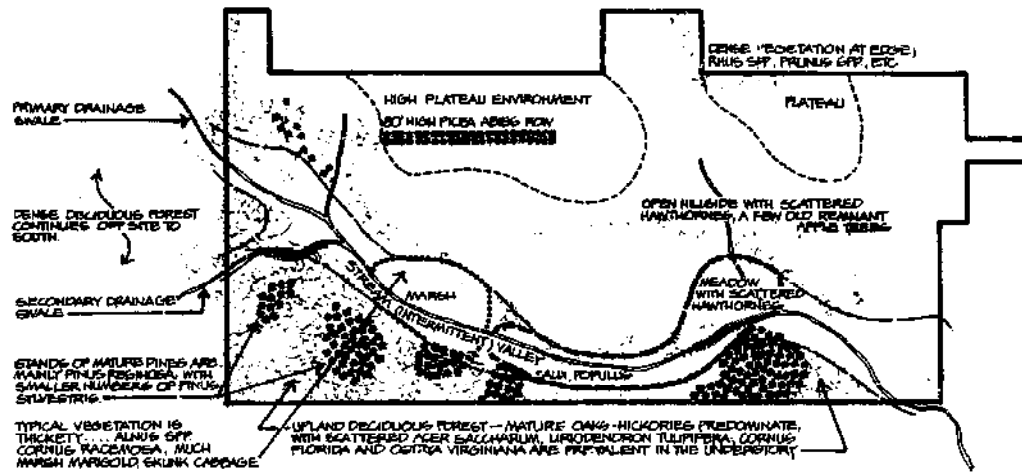

**TOPOGRAPHIC ANALYSIS**

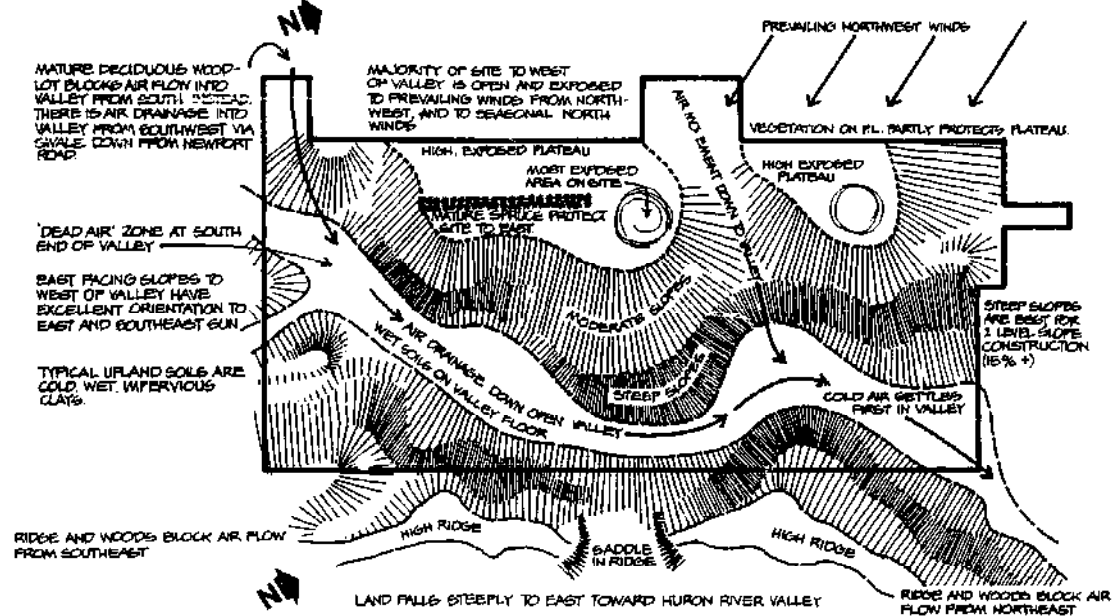

**SECTION**

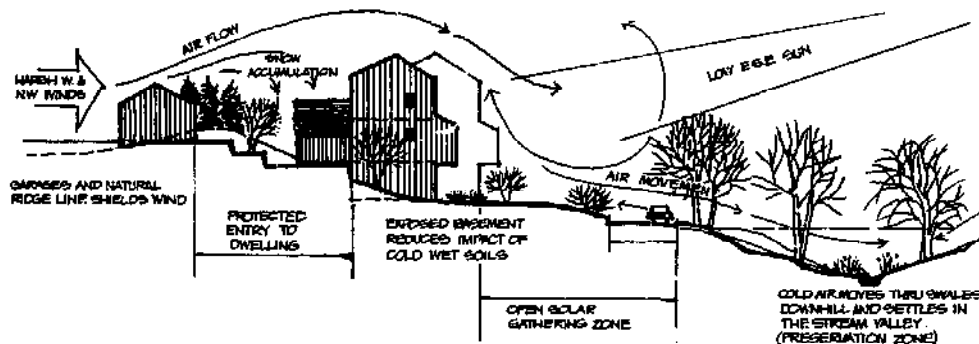

THE FOLLOWING SITE PLAN AND DWELLING DESIGN CONCEPT ARE INDICATIVE OF THE SOLAR ENERGY UTILIZATION AND ENERGY CONSERVATION CONSIDERATIONS FOR THE COOL AND TEMPERATE REGIONS. THE TECHNIQUES EMPLOYED INCLUDE:

- the use of windbreak planting;
- the orientation of road alignment with planting on either side to channel summer breezes;
- the location of units in a configuration suggested by the topography;
- the use of the garage to buffer the dwelling from northwest winter winds;
- the use of berms to shelter outdoor living terraces;
- the use and location of deciduous trees to block or filter afternoon summer sun.

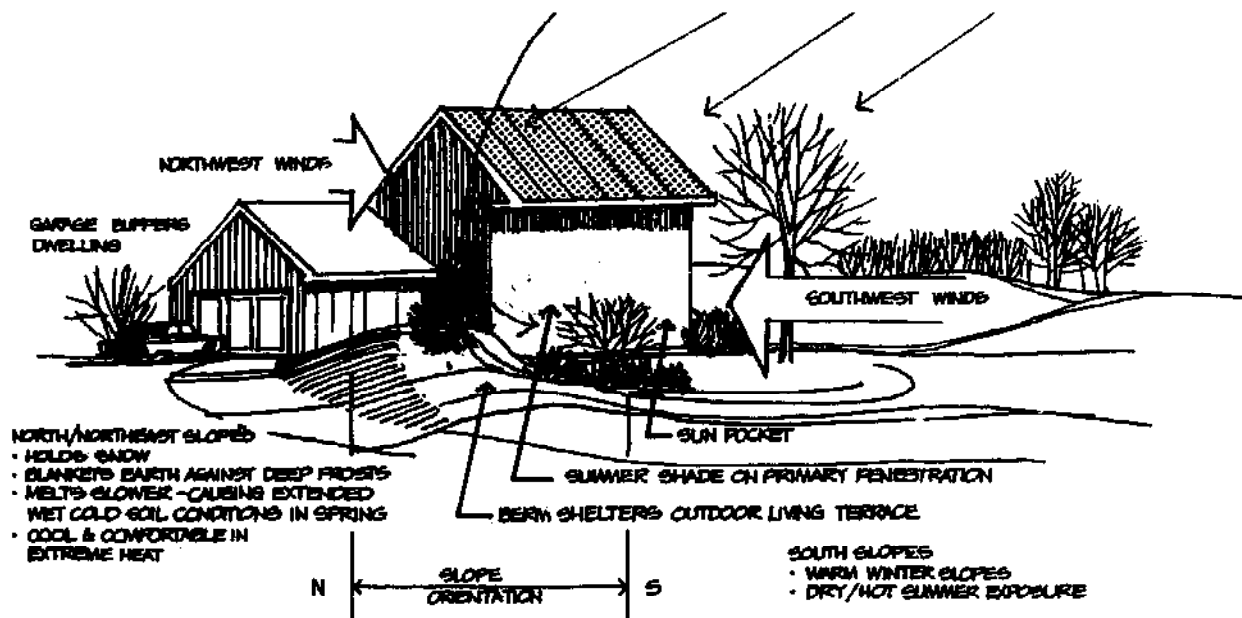
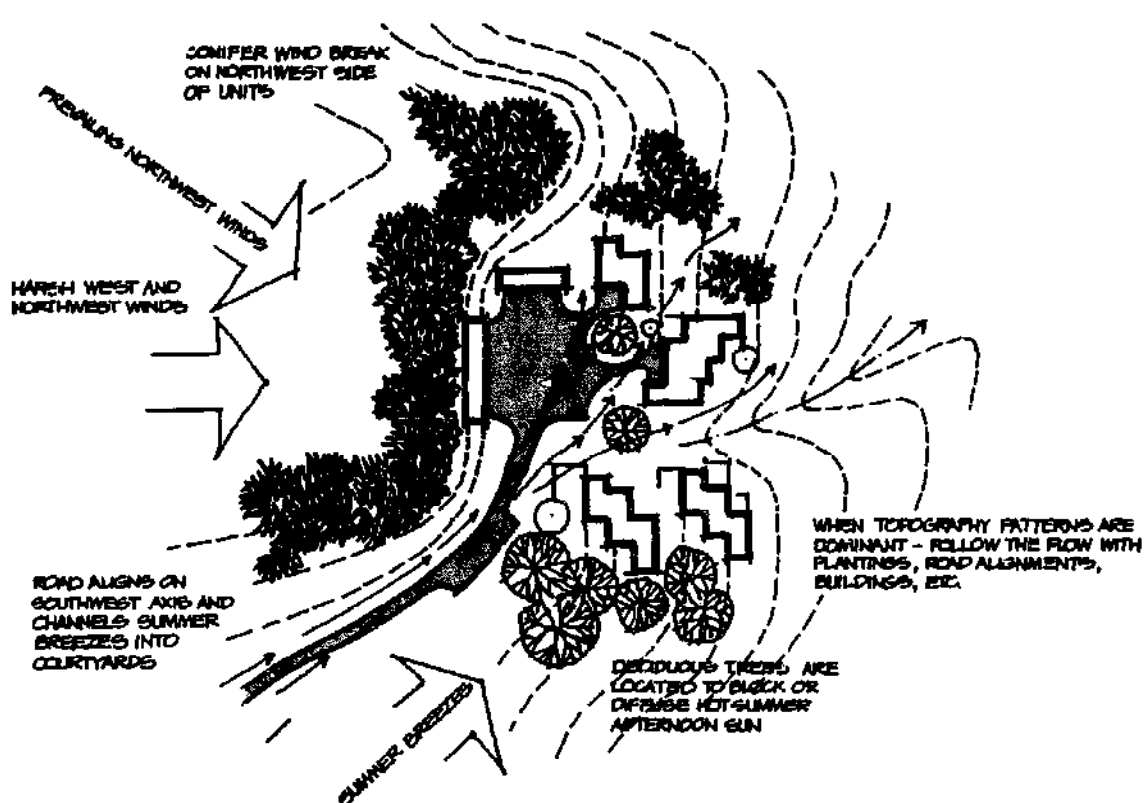



## On-site Solar Collectors

In some situations, it may be desirable or necessary to place the solar collector at some distance from the dwelling. When this happens, there are three alternative approaches available to the site designer. The first approach is to screen the solar collector from view. The second approach is to integrate the collector with the site by the use of earth forms, vegetation, or architectural elements. A third approach is to emphasize the collector as a design feature.

Regardless of the approach taken, on-site solar collectors, together with any structural supports or additional equipment, may be unsightly, hazardous and subject to vandalism. Earthforms, planting, and other site elements can be used effectively to hide the collector and associated apparatus and to prevent easy access. In some cases it is possible to use the space under the collector if this can be done without interfering with its performance.

The following illustrations indicate several methods by which on-site solar collectors can be screened, integrated, or emphasized, and the space under the collector used, through the manipulation of earthforms, planting and architectural elements.

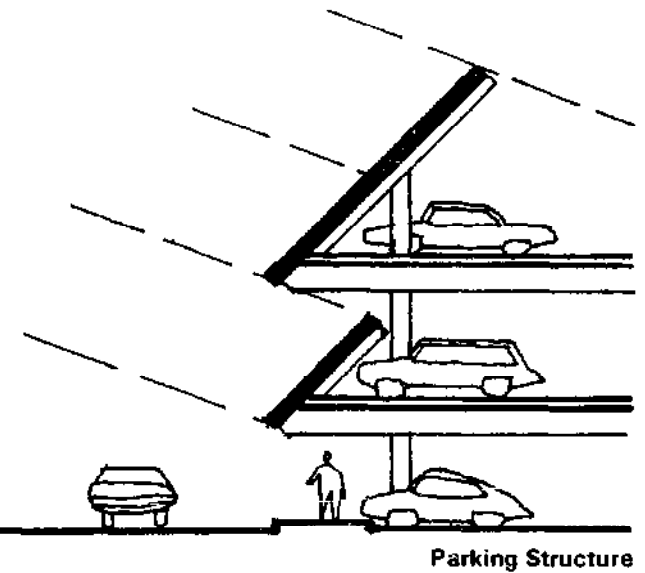
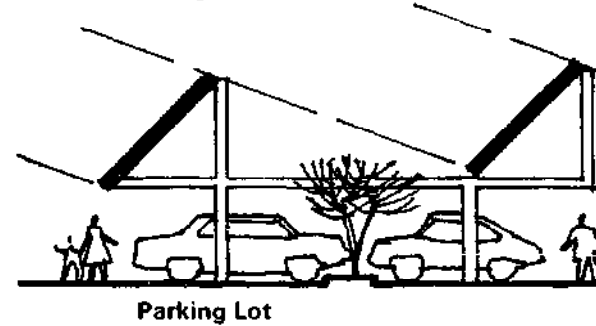
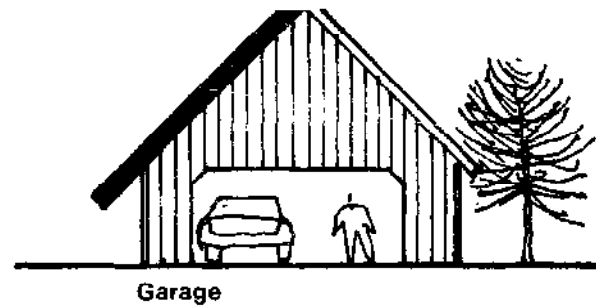
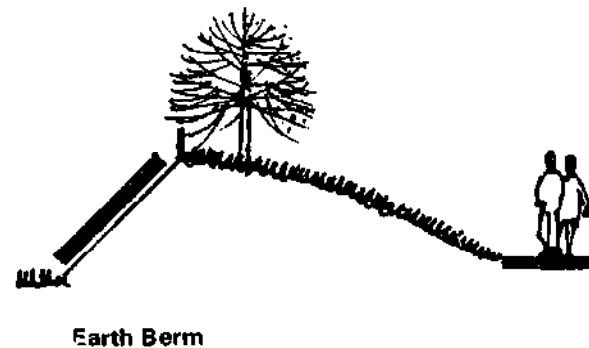
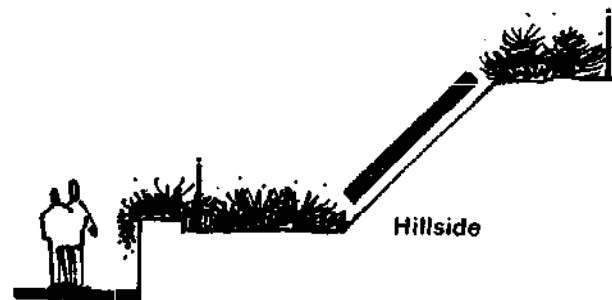
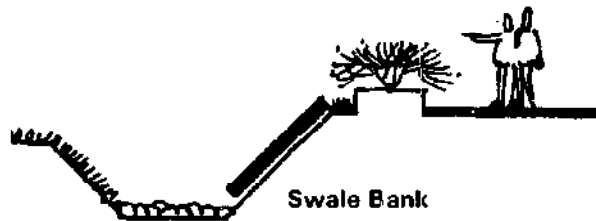

## Summary

Site selection, planning, and design can significantly influence the effective use of solar energy for residential heating and cooling. The topography, geology, soils, vegetation, and local climate of a building site should be considered prior to site selection or building placement. Each climatic region has its own distinctive characteristics and conditions that influence site planning and design for solar energy utilization and for energy conservation. These should be recognized during the development of design objectives for each proposed site in terms of building-collector placement and orientation, relation of building-collector to wind, water, and existing vegetation, and the merits of clustering, new vegetation, and material selection.

Besides building design and orientation, the careful selection and location of all forms of planting, paving, fences, canopies, and earthforms can contribute to the effective and efficient use of solar energy. Dwelling design and site design for the utilization of solar energy are complementary and should be considered simultaneously throughout the design process.

# 5

## UTILIZATION ON TRADITIONAL DWELLING DESIGN

The use of solar energy for space heating, cooling and domestic water heating imposes certain design requirements which the dwelling design must recognize. Some of these requirements relate to climatic issues such as achieving optimum capture of solar radiation by optimum tilt of the collector, while others involve the solar system components themselves, such as the area requirement for flat-plate collectors. Consequently, the integration of solar heating and cooling systems into traditional housing styles may, in some instances, require significant changes in the architectural appearance of these dwellings.

The vast majority of housing styles in the United States have developed from a historical tradition of dwelling design responsive to local climatic conditions. However, over the years the relation of housing design to climate has diminished, due in large part to the availability of mechanical heating and cooling systems which were not climate dependent. Excessive cold heat, or humidity could be overcome simply by the turn of a switch which activated the mechanical equipment.

We are now faced with a situation where the fuel to power the mechanical equipment is in short supply. As a consequence, we are beginning to look to an infinite fuel source — the sun — to heat and cool our homes and to heat our domestic hot water. Because the energy comes directly from the sun, solar dwellings must necessarily respond to the climate. This, in turn, will influence the architectural appearance of the dwelling. The issue, therefore, is the adaptation of familiar, traditional housing styles to the design requirements for solar heating and cooling.

The more housing design responds to climatic factors — using the sun for its energy, the wind for cooling, the earth for insulation, and trees and vegetation for shading and protection — the less of an impact solar energy systems will have on the dwelling design. Stated another way, the more energy-conserving the house design, the easier it will be to solar heat or cool.

The solar dwelling concepts presented in this chapter illustrate what traditional housing styles may look like when modified for solar heating and cooling in different areas of the country. The design concepts were developed by the architectural firm of Massdesign, located in Cambridge, Massachusetts. The traditional flavor of the housing style has been retained whenever possible. The housing concepts are illustrative of the changes in solar dwelling and system design resulting from climate differences. The design concepts have been prepared for single family housing, both attached and detached, and for low-rise multi-family housing. Only solar systems which are readily available today have been integrated into the designs.

A rough approximation of solar system performance is presented for each design concept. This provides a general indication of the dwelling's heating and domestic hot water load supplied by solar energy. The solar contribution figures are rough estimates of expected solar system performance for conceptual dwelling designs and for generalized climatic conditions. The solar designs illustrated are concepts only and are not presented as ready-to-build housing designs. Further assistance from design professionals will be necessary to develop a design and solar system that is responsive to the client's needs, climatic conditions and site characteristics.

## Cape Cod

The Cape Cod housing style was developed in response to the harsh climatic conditions of the New England and Atlantic seaboard area. Its compact floor plan and small exterior wall and roof area made the house easily heated by the centrally located fireplace. South facing dormers allowed for ventilation, lighting, and views at the second level of the two story house. It could be rapidly and easily constructed on a variety of sites, and was relatively inexpensive. Although well suited to the natural resources and construction techniques of colonial America, the Cape Cod design has become a favorite architectural style throughout the United States.

Very little alteration of the traditional Cape Cod style is necessary to incorporate the added components of a solar heating system. One side of its double-pitched roof has an area equivalent to one-half its net floor area for solar collector installation, sufficient to provide a major portion of the dwelling's annual heating demand in a cool climate. Also, the traditional steeply pitched roof is within acceptable angles of tilt for winter solar collection for most northern climates. Solar heat storage and distribution can be located in a basement, crawl, or attic space with little or no alteration of the traditional Cape Cod design.

In the solar design concept shown, the only modification of the traditional Cape Cod has been the orientation of the dormers to the north, leaving the entire south facing roof area free for solar collectors.

The housing style is equally adaptable to either a warm-air or warm-water solar heating system. Natural ventilation is used in lieu of mechanical solar cooling due to the small cooling requirement of the New England climate. Massdesign has selected a warm-water solar heating system for the design concept shown. The system consists of a liquid-cooled flat-plate collector with automatic drain down to avoid freezing, forming the 45° roof, an insulated water storage tank located in the basement, and associated piping, valves, and controls. Solar domestic water preheating is provided by running the supply line for the conventional water heater through a heat exchanger in

the storage tank. The solar system is designed to supply approximately two-thirds of the annual heating and domestic hot water energy needs of this 1900 square foot house in a New England climate



North Elevation



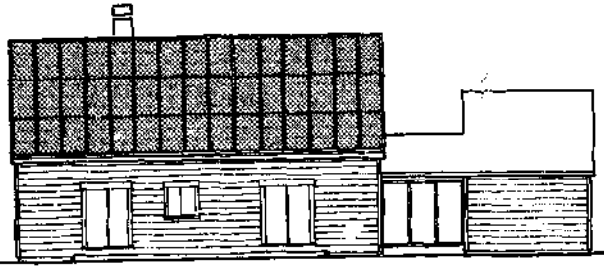

South Elevation

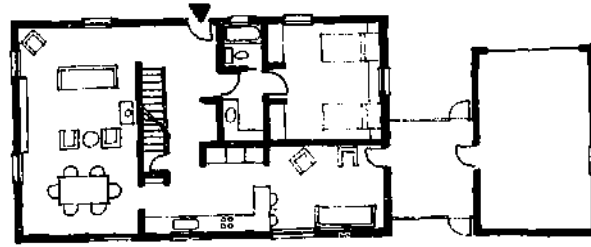

First Floor

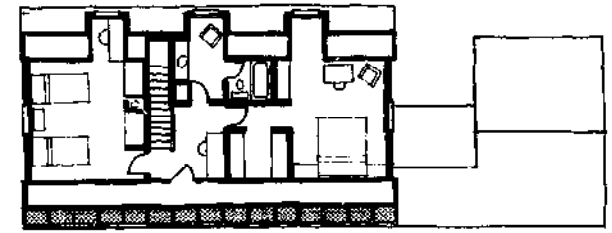

Second Floor

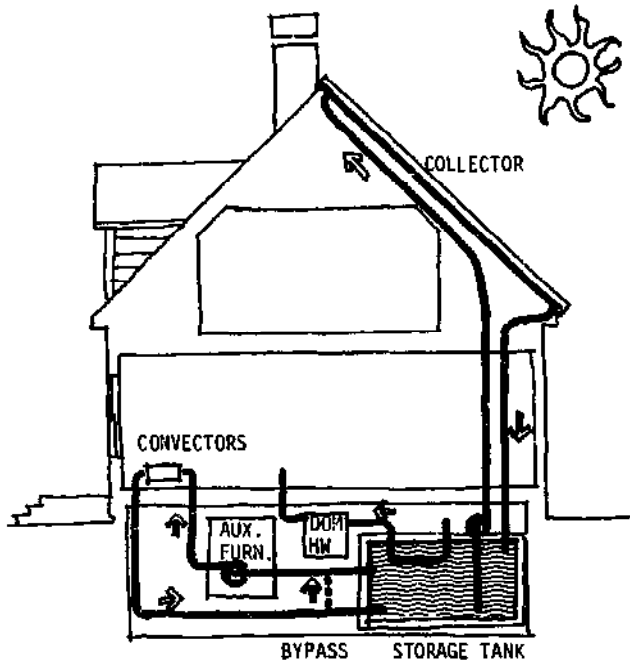

Schematic Section

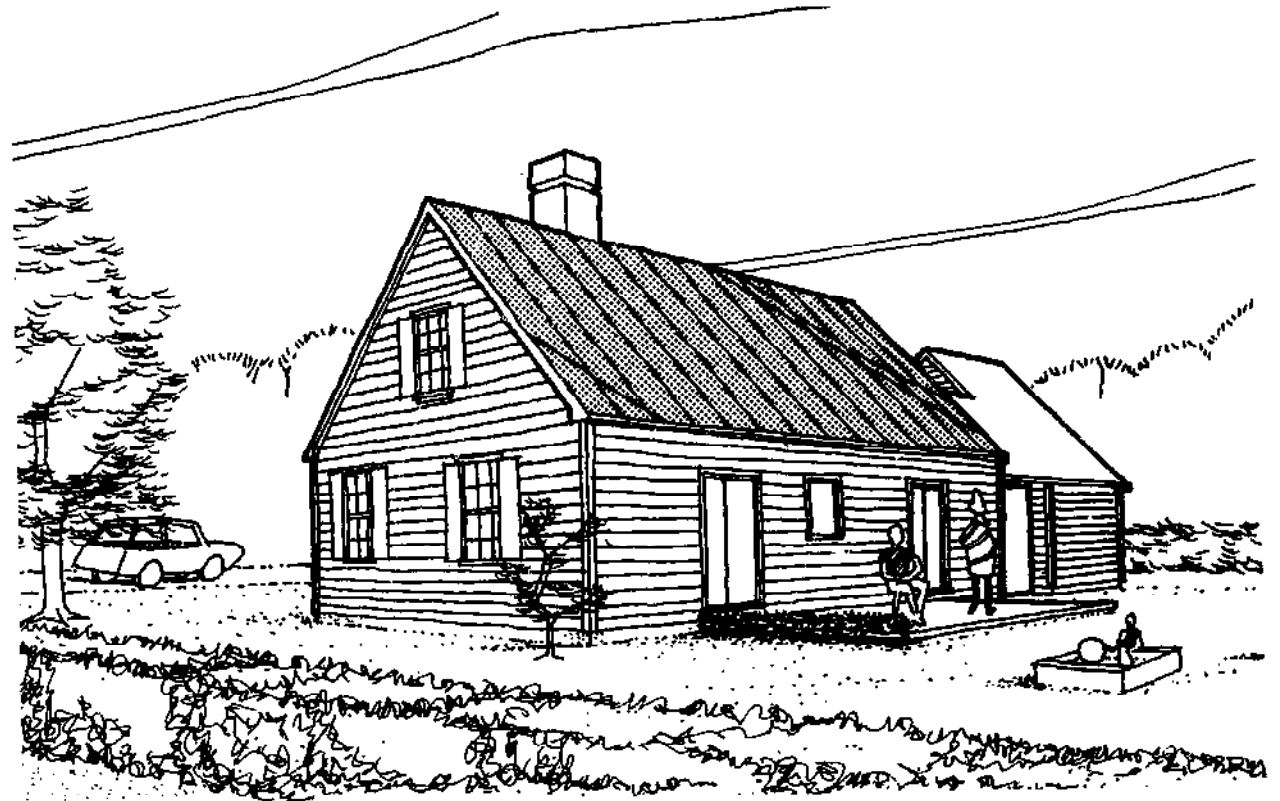

## Saltbox

The Saltbox is a close relative of the Cape Cod housing style. Like the Cape Cod, the Saltbox design developed in response to the harsh climatic conditions of New England. The arrangement of spaces and use of materials are similar in the two styles. The Saltbox differs from the Cape Cod style in having an extended north roof sloping to the first floor ceiling level and full two-story southern exposure. These design changes increase the enclosed floor area, decrease the exposure of interior spaces to cold northwest winds and increase the southern exposure of habitable spaces to the warm winter sun.

The Saltbox, like the Cape Cod, is easily adapted for solar heating. Its large roof area can accommodate sufficient collector area at an acceptable tilt to provide the major portion of the dwelling's heating demand in the New England climate, provided that the house's traditional orientation is reversed, with facing the extending roof slope south instead of north. A consequence of this orientation is that the house should be placed on the site with the front entrance facing north. The storage component can be located in a basement, crawl space, or special storage room. Distribution ducts or pipes can easily be accommodated in floor, ceiling and wall area of the Saltbox design.

The housing style is equally adaptable to either a warm-air or a warm-water solar system. A warm-air system has been incorporated in the design concept shown.

The solar heating and solar domestic hot water preheating are supplied by a system consisting of an air-cooled, flat-plate collector, forming the roof at a 45° slope; an insulated heat storage bin filled with fist-sized rocks located in the basement; a hot-water preheat tank within the rock bin, and associated fans, ductwork, dampers, controls and insulation. This system is designed to provide approximately half to three-quarters of the annual heating domestic hot water energy needs of this 1900 square foot house in a New England climate.

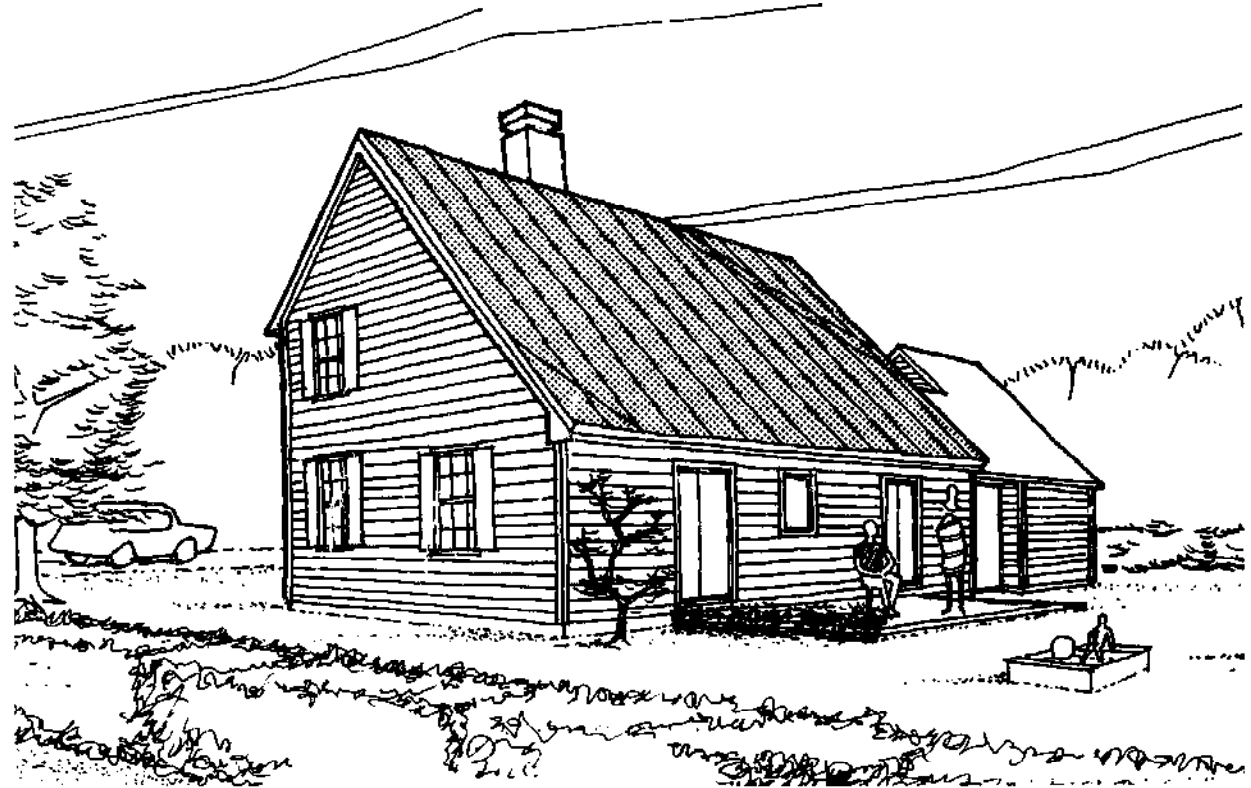
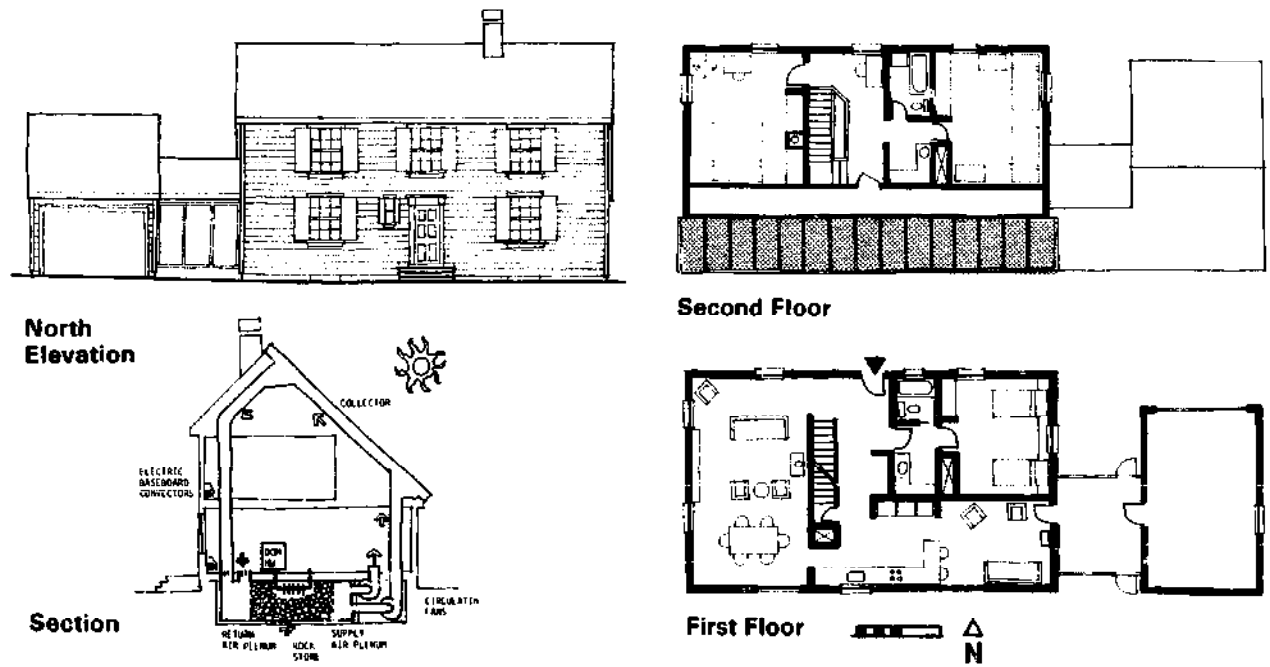

## Farm House

The early housing styles of middle America were uniquely adapted to the cold and windy conditions of the Midwest and Great Plains. Originally consisting of one room log cabins or sod huts, the housing styles gradually changed as the population grew and larger settlements developed. Although borrowing numerous design and construction techniques from the East, Midwest housing styles evolved into unique designs suitable to the new climatic and geographic conditions. The houses were easily heated, resistant to strong winds, and adaptable to variations in orientation and topography.

A case in point is the traditional Farm House. The house design consisted of several buildings, sometimes connected, organized around a central yard. The buildings were usually one story in height, with a sleeping loft. They were sited to block cold winter winds but to capture the cooling summer breezes. The Farm House design has changed considerably over the years but continues to find widespread application throughout the United States.

Massdesign has borrowed the best of the Farm House design features for adaptation to solar heating. The roof above the living areas rises at a steep pitch to accommodate the collector, while the bedroom wing retains a conventional lower pitch for economy. Two different one-story "L" shaped plans permit any orientation of the house on the site as shown in the site plan diagrams. Each plan for this 3 bedroom house is accommodated economically in less than 1600 feet, excluding garage.

The collector area requirement for cool regions is greater than for other climatic regions. As a result, to achieve a substantial portion of the dwelling's seasonal heating requirement by solar energy, the Farm House design maximizes roof area for solar collection and minimizes energy consumption by increased insulation, double-glazed windows, and insulated shutters. Also, solar heat storage is located beneath the house in a basement or crawl space so that any heat loss is to an occupied space.

The design concept is adaptable to both a warm-air or warm-water solar heating system. The warm water system incorporated in the design below is sized to supply approximately 50 percent of the dwelling's space heating and domestic hot water requirements for a cool climate. The solar heating system consists of a liquid-cooled, flat-plate collector, a buried water storage tank, and associated piping pumps, valves, and controls. Domestic hot water is preheated by running the supply line through a heat exchanger in the storage tank, and then a conventional water heater.

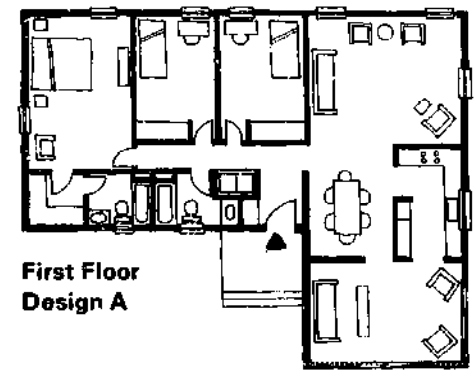
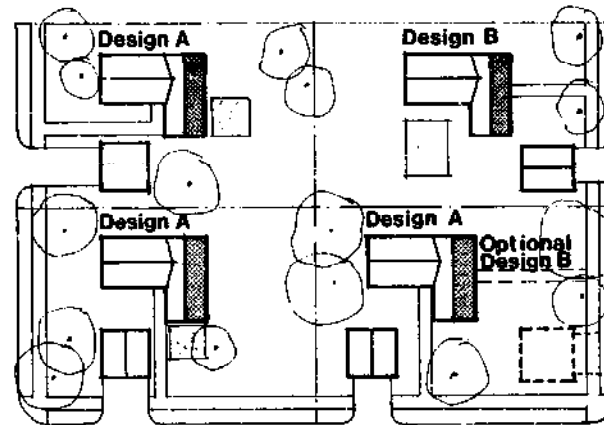

First Floor  
Design A

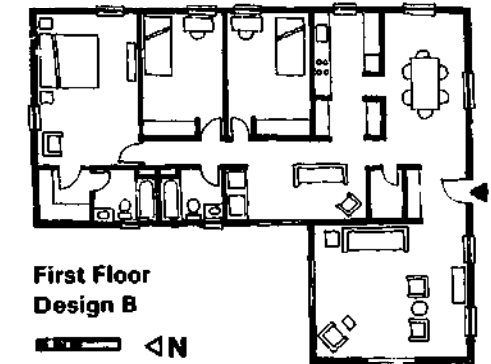

First Floor  
Design B

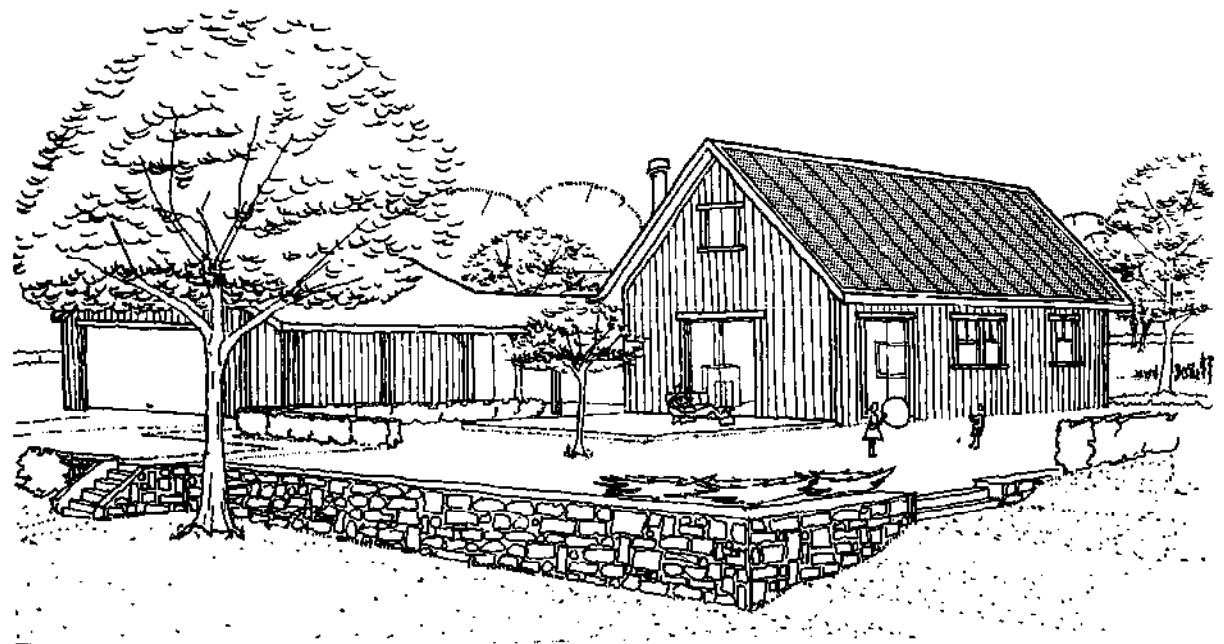

## Southern Ranch

The hot-humid climate of the South Atlantic Seaboard, Gulf Coast, and southern portion of California is suited to housing styles which allow maximum heat loss and minimum heat gain during the summer months. A "ranch" type housing style has developed which is responsive to both of these concerns. It incorporates large window and louver areas for natural ventilation and extended roof overhangs for protection from direct solar heat gain. The one story plan arrangement containing 1750 square feet is open and spread out to capture and channel air movement through the house. Although cooling is the primary design condition, heating is required 4 to 5 months out of the year. Therefore, the house is also properly insulated for easier heating during the winter months. Wall and roof insulation, double-layered glass in all doors and windows, and large southern exposed window area add substantially to the thermal performance of the house.

The energy conserving design, along with the low heating requirement of the climate, makes the Southern Ranch easily adapted to solar heating. Since the heating load is relatively small, the roof area required for solar collectors is also small. The Ranch design shown here accommodates the required collector area and tilt by the use of a raised roof area located over the living-dining room. The ceiling of a portion of the living-dining room follows the shape of the raised roof area, thus forming an interesting interior space. Solar heat storage and distribution are easily accommodated with only minor changes to the architectural style. The solar heating system consists of an air-cooled, flat-plate collector; a buried rock storage bin and associated ductwork, fans, dampers and controls. Solar domestic water preheating is provided by a preheat tank located in the storage bin. Solar cooling is not included in lieu of natural ventilation. The collector can be mounted on either side of the raised roof. This, combined with rotation of the "L" shaped plan, allows the house to fit most suburban lots, regardless of the direction of the street. The design shown has the additional advantage that the collector is far from the lot line, minimizing collector shading from neighboring trees.

The collector and storage area is sufficient to provide approximately 80 percent of the dwelling's heating requirement and domestic hot water load for a hot-humid climate.

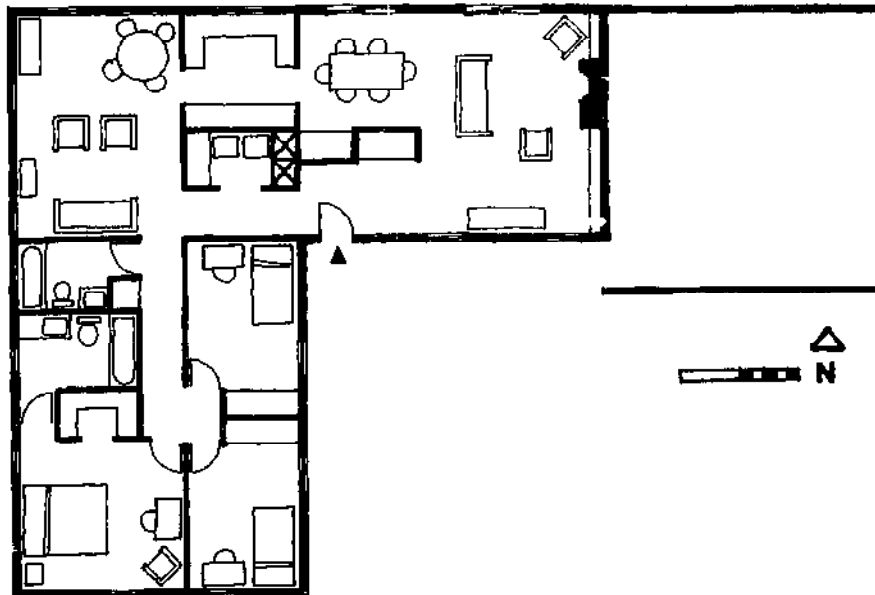
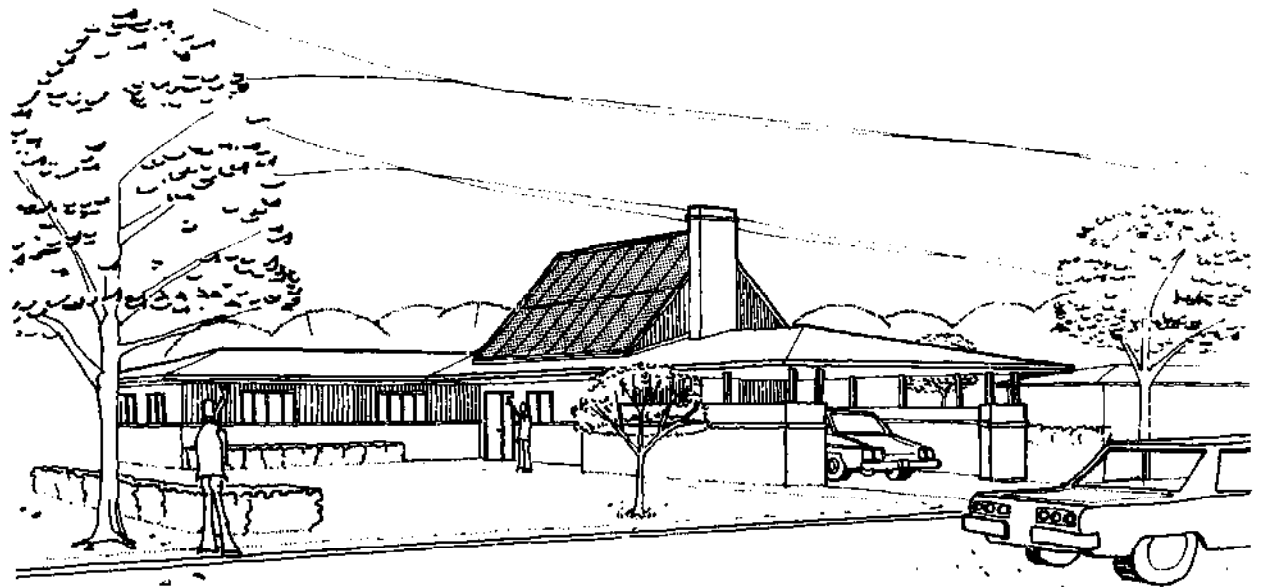

## Adobe

The architectural style of the Southwest has evolved from a combination of climatic and cultural influences. Adobe construction, characteristic of the region, is well-suited to the wide fluctuation in temperature experienced between day and night. The adobe walls act as a heat sink, absorbing the heat during the day and radiating it to the interior at night. The various Indian communities of the region developed this unique construction technique to a fine art prior to the arrival of the Spaniards in 1540. It was the Spaniards who called the native inhabitants Pueblo Indians because of the communal environment in which they lived. The Spaniards adopted the same materials of adobe and native rock for their house construction.

This Massdesign concept retains the architectural flavor of the region, while at the same time incorporating solar heating. The traditional flat roof of the Pueblo structures simplifies the integration of the solar collectors into the housing design. Two raised enclosures along the south edge of the roof house the two banks of flat-plate solar collectors. The collectors are positioned at a steep but acceptable angle for collecting maximum radiation during the heating season. The storage and distribution components of the solar system are easily integrated into the one story structure. The storage bin and distribution ducts are both located under the concrete floor slab. Dampers and filters are reached by access panels located in the floor. This allows adjustment and cleaning without unnecessary disruption to the house.

Solar heating and solar domestic hot water preheating are supplied by a system consisting of an air-cooled, flat-plate collector; a rock pile storage bin; a preheat tank located in storage; and associated ducts, dampers, controls, and insulation. The solar heating system is designed to supply approximately 85 percent of this 2000 square foot dwelling's heating requirement and domestic hot water needs.

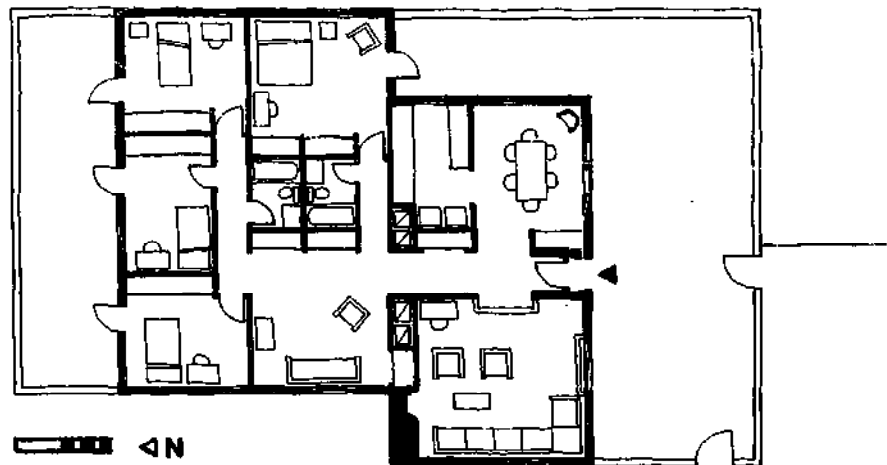
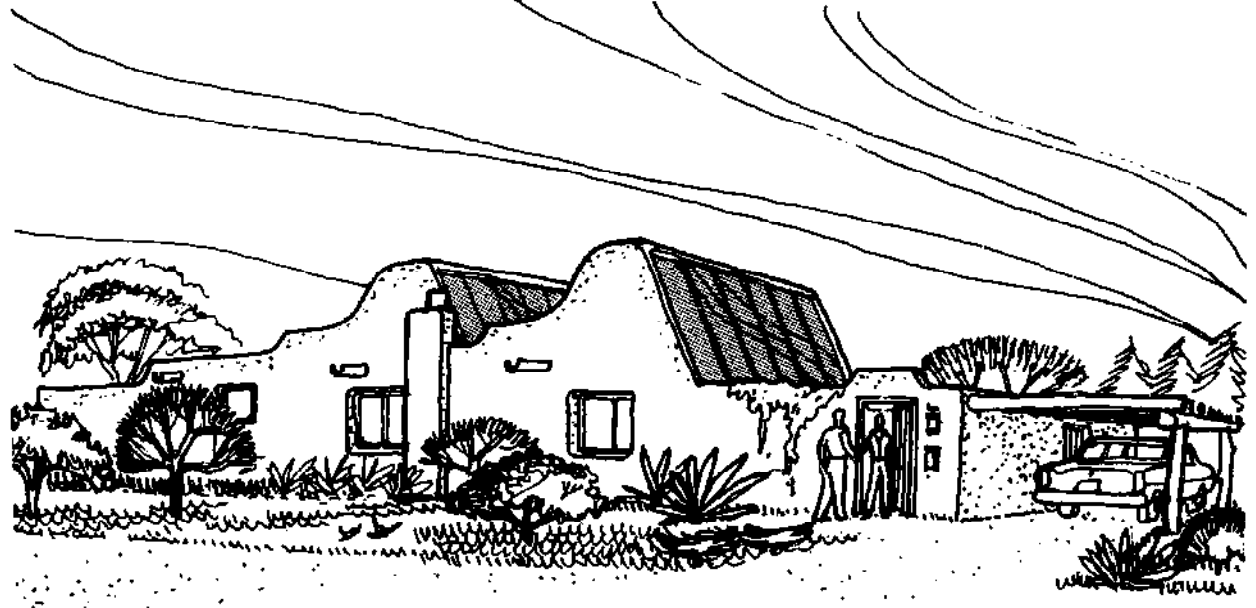



## Brick Colonial

Just as the Cape Cod and Saltbox designs are favorites in New England, house styles based upon the beautiful brick Queen Anne and early Georgian masterpieces of the Atlantic Seaboard and Tidewater Virginia have a continuing popularity south of New England

Typical of the Brick Colonial style are the decorative center entrance, spacious central hallway, flanking chimneys at each end, brick exterior walls and frequently symmetrical wings. The Brick Colonial design shown below retains the architectural flavor of the traditional Colonial style, while at the same time incorporating solar heating. The 1900 square foot design has a central entrance and generous porch area to capture east, south, and westerly breezes. The sloped south-facing roof has sufficient area for solar collection installation to provide a considerable portion of the dwelling's heating requirement in a Mid-Atlantic climate. The screened porch roof could be coated with a reflective surface to increase incident radiation on the collector, thus improving solar system performance. Ample space in the basement (reached from the garage) is provided for solar heat storage and distribution.

The solar heating system consists of a liquid-cooled, flat-plate collector, a water storage tank and associated piping, pumps, valves, and controls. Domestic hot water is preheated by running the supply line through the heat exchanger in the storage tank and then to the conventional water heater. The system is designed to supply approximately 85 percent of the annual space heating and domestic hot water requirement for a hot-humid or hot-arid climate. In a cooler climate, the system could supply about 40 percent solar heating and 70 percent water heating.

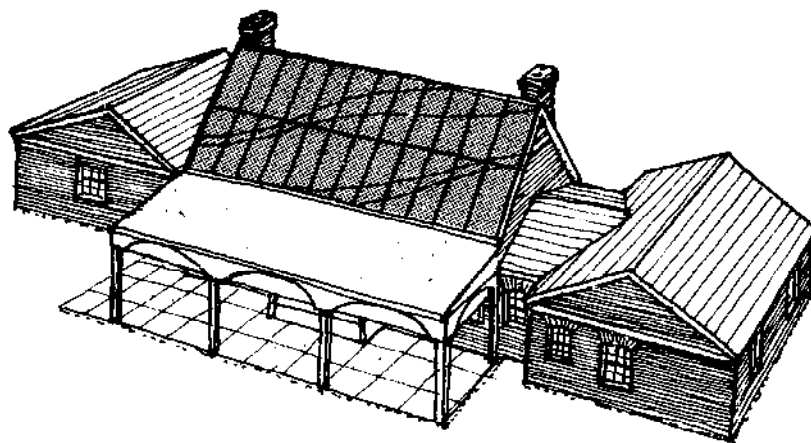

Aerial View  
From South

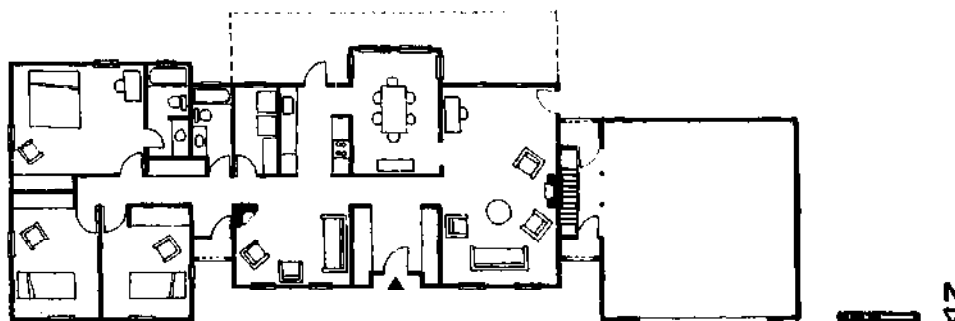
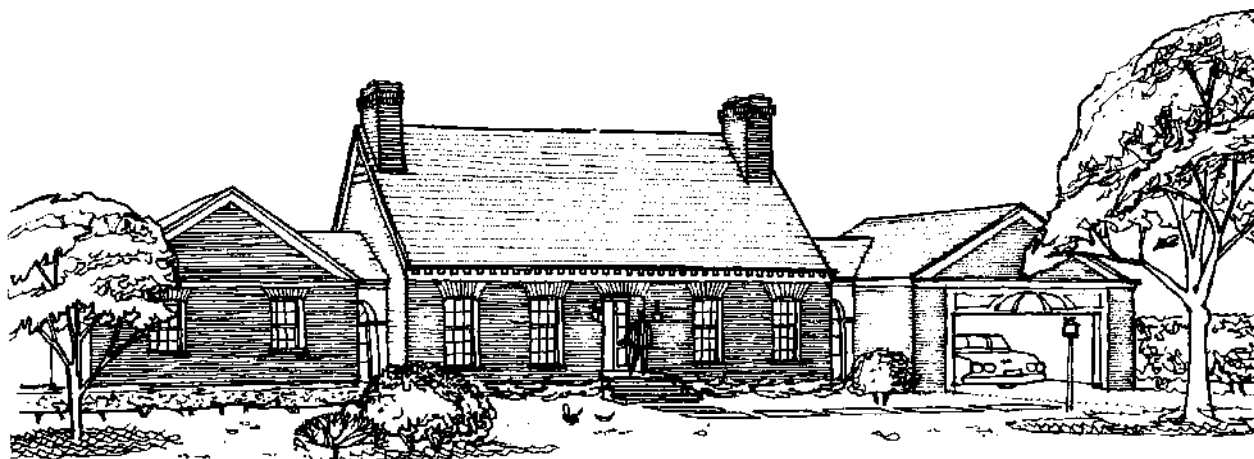

## Contemporary Split Entry

The Split Entry bi-level house is a relatively new housing style that has become popular throughout the United States during the past 15 years. The Split Entry design achieves housing economies by staying within a rectangular plan and building the lower story into the hillside. The design developed by Massdesign is typical of the more contemporary versions, with an overhanging upper floor, simple construction details, and a deck off the upper floor.

Heating the Split Entry with solar energy requires modifying the conventional roof pitches to accommodate the solar collectors, and orienting the dwelling to receive optimum solar radiation. The ideal building orientation from an architectural standpoint has the back of the house facing south with the main entrance from the north. However, by reversing the roof pitches, the reverse orientation is also possible but with less desirable results, primarily because the living spaces would be oriented away from the sun.

Accommodating the required collector tilt for either orientation requires increasing the pitch of the traditional roofs. As shown below, the roof pitch on the south side is steeper than on the north, resulting in an asymmetrical roof design.

The house plan places one bedroom upstairs and two downstairs, with the primary living spaces along the south side of the house, and contains about 1850 sq. ft. Providing the occupants do not draw the curtains on sunny winter days, causing the living spaces to overheat somewhat, considerable solar heat could be captured through large areas of south glass. The use of insulating drapes or shutters at night will greatly reduce the heat loss through these large areas of glass, retaining the captured heat and making a useful contribution to the heating needs of the house. (The design concept shown has only a moderate amount of south-facing glass area.)

A warm-water solar heating system is incorporated into the design. A warm-air solar system could also have been selected, provided sufficient wall and floor area were set aside for ducts from collector to

storage, and from storage to distribution throughout the house. The warm-water system consists of a liquid-cooled, flat-plate collector; an insulated water storage tank located beneath the entry hall and associated piping, pumps, valves, and controls. Distribution of heat throughout the house is by baseboard convectors, although a forced-air duct system could have been chosen. Domestic hot water is preheated by passing the supply line through a heat exchanger in the storage tank before feeding a conventional water heater.

The solar system will provide an estimated 50 to 60 percent of the dwelling's heating and domestic hot water heating requirements in a cool climate and up to 70 or 80 percent in a temperate or warmer climate.

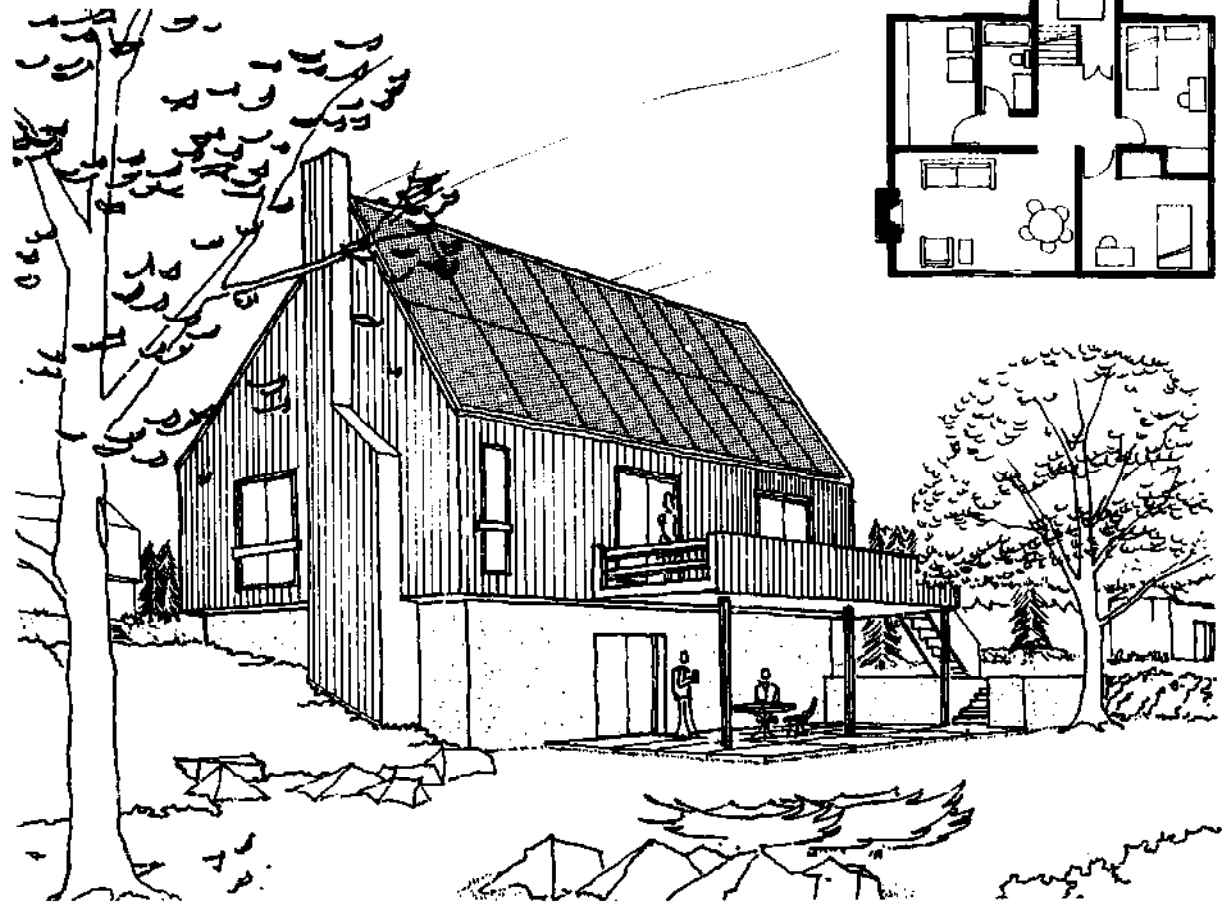

## Northern Townhouse

The architectural form of the Northern Townhouse design shown below, borrows many features from the Cape Cod housing style, and adapts them to the requirements of attached houses — (houses built in rows with shared party walls separating adjacent units). The design is typical of many townhouses built in recent years in New England and other cold and temperate climates. Some of the traditional architectural details of the Cape Cod style, such as shutters, are eliminated in this design in favor of clean simple moldings, but the traditional clapboard siding is retained.

Four dwelling units are included in the townhouse cluster; each with three bedrooms, 2½ baths, a small family room, a kitchen and a large living-dining room in a compact plan of 1,690 square feet. A two-story space under the collector provides a dramatic high ceiling over the living room and stairway. The sloping south-facing roof which houses the solar collector is penetrated by a small protected terrace that provides light and air to the master bedroom.

The solar collectors located on each dwelling unit in one row feed a single shared storage tank buried outside the townhouse cluster or located in a basement. The economic advantage of such an arrangement, combined with the intrinsically lower heat loss of compact attached dwellings, make townhouses excellent candidates for solar heating. Piping, controls, and other components of the solar system are easily integrated within the townhouse structure, thus requiring little alteration to the building design.

A warm-water solar system is incorporated into the design concept shown. The system provides approximately 80% of the total Townhouse heating and domestic hot water heating for a cool or temperate climate.

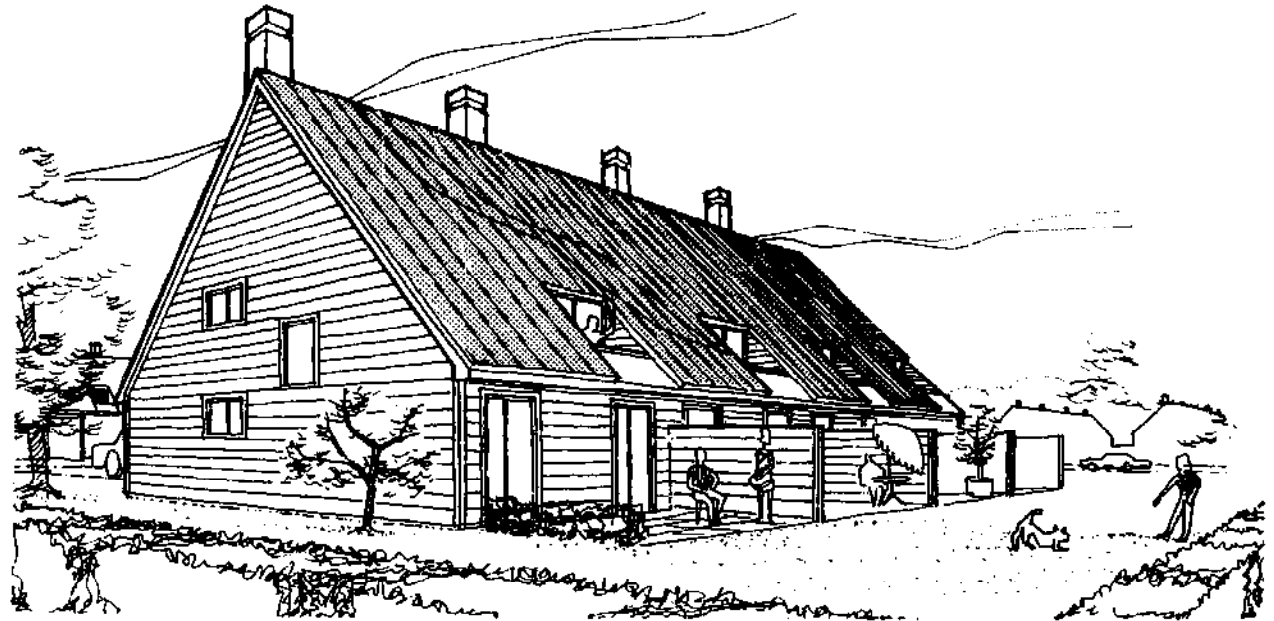
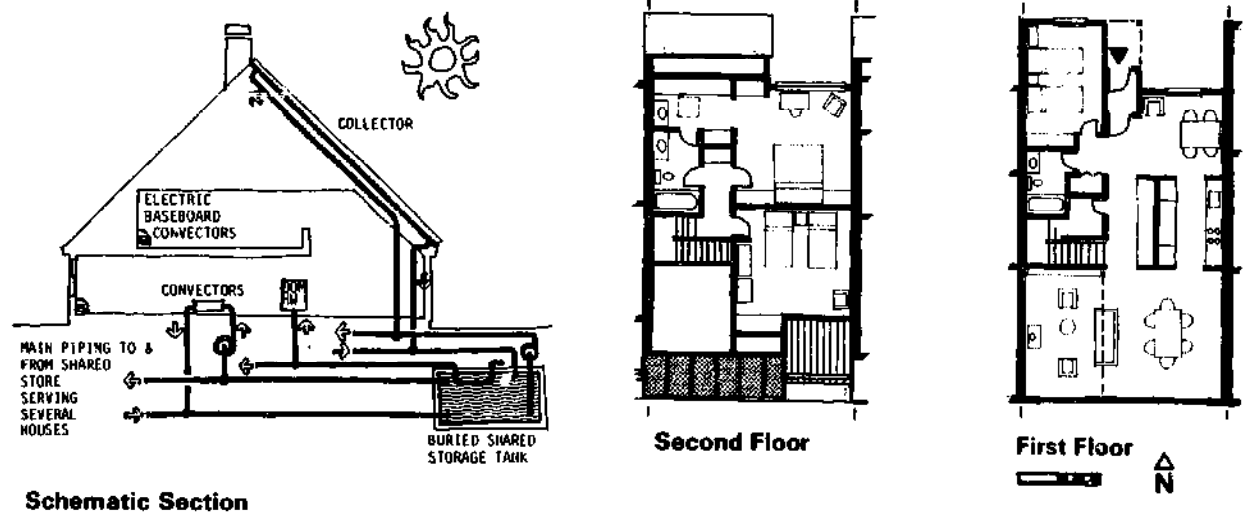

## Northern Rowhouse

The Rowhouse design concept by Massdesign is another modern adaptation of a traditional architectural style. Each two-story rowhouse has a compact, economical plan with 3 bedrooms and 2½ baths in less than 1,600 square feet. The houses are oriented to show how solar collectors could be integrated with the roof structure of buildings facing in an east and west direction (unlike the Northern Townhouse). Such an arrangement would be necessary if several rows of houses were organized around a central courtyard, where some rows would be oriented perpendicular to the others. This kind of flexibility can be very helpful in developing interesting site plans, or adapting housing designs to difficult contours or restricted site boundaries.

Each bank of collectors ends in a traditional gable, with a near-flat roof between. In areas of heavy snow, it would be advisable to raise the bottom of the collector higher above this intermediate roof than is shown in the sketch, to avoid an excessive buildup of snow at the base of the collector. Between each gable at the front is a sloping roof which reaches down to the first story, helping to break up the scale of these small houses, and helping to avoid a factory-like "sawtooth" roof. The angle between the top of a collector and the base of the one adjacent must be calculated carefully to avoid excessive self-shading.

An individual or shared solar collection and storage system can be utilized in the rowhouse concept. However, as mentioned in the description of the Northern Townhouse, there are significant economic and operational advantages with a shared collection and storage solar system. Either a warm-air or warm-water solar system can be integrated into the rowhouse design. Water is perhaps a more economical choice because of the transport distances involved and the fire separation problems between houses caused by air duct penetration through fire walls.

The solar system is designed to supply approximately 50 percent of the heating requirement of each rowhouse in a cold climate. The solar domestic hot water system, on the other hand, should supply about 75 percent of the hot water demand of each rowhouse.

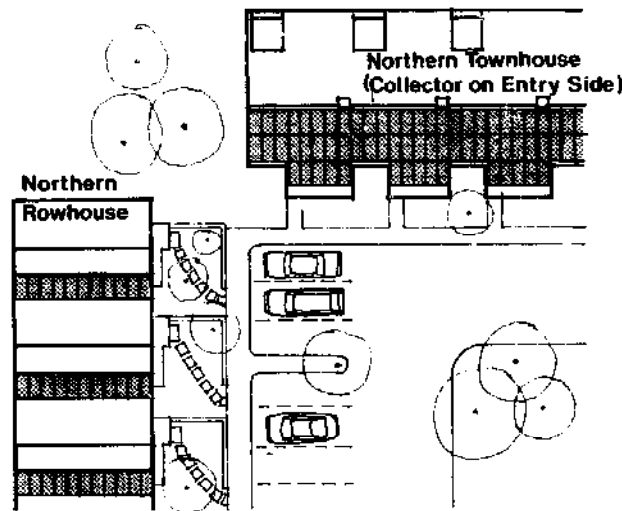

Site Plan

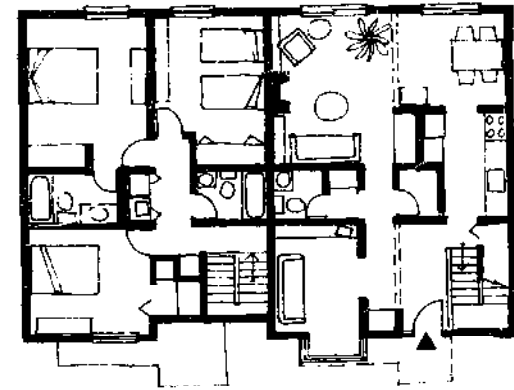

Second Floor

First Floor

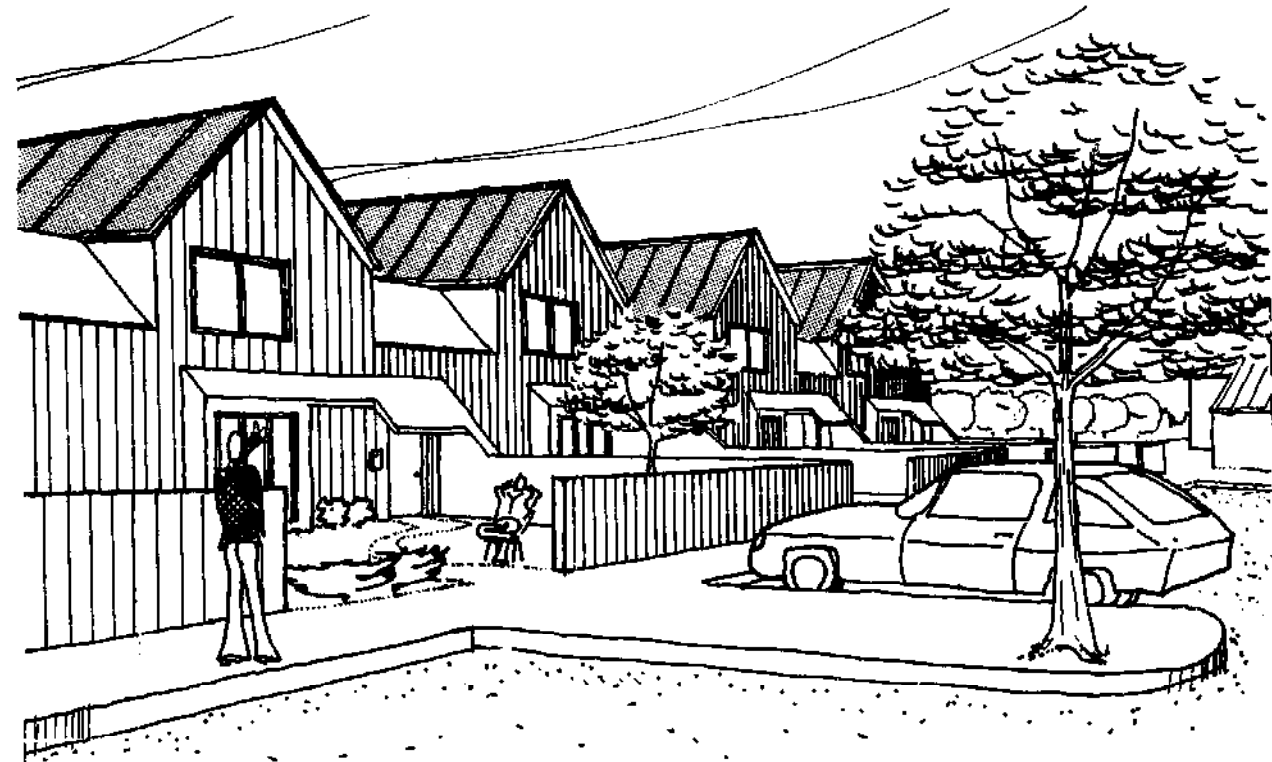

## Brick Townhouse

Solar heating and cooling can be as much a part of an urban situation as a suburban or rural setting. The Brick Townhouse design concept shown illustrates the application of a simple roof-mounted solar collector arrangement to a typical medium density urban situation. The design shown has two stories, but it is possible to use the same collector concept on a three or four story design

The design concept has wide applicability for infill row housing in the built-up sections of a city. However, certain design requirements must be met in order to assure the satisfactory performance of the solar system. For example, when the collectors run parallel to the street, as shown in the large perspective the street must run roughly in an east-west direction for practical solar collection. A design with a gable end toward the street (similar to the northern rowhouse) is shown in a small sketch, but the resulting architectural expression is visually less satisfactory in an urban context than the one shown, in which the collectors are integrated with the townhouse in the form of a glazed mansard roof. To solve every possible street orientation, a design with collectors running at an angle to the building would also be required, again shown in a small sketch

For all the various design conditions, however, the ridge of each bank of collectors must be far enough from the next bank of collectors to the north, to avoid excessive shading during periods of solar collection. In addition, the buildings and trees around the houses should not impair solar collection to the extent that it becomes economically unfeasible. A neighborhood with continuous two, three and four story buildings and relatively small street and backyard trees would be ideal

Solar heat storage can be placed anywhere within the building structure but is generally located in a basement space. Piping or duct runs from the collector to storage are easily accommodated within mechanical chases generally associated with townhouse construction

With careful analysis and design integration, solar heating in the heart of the city can be a practical and attractive possibility

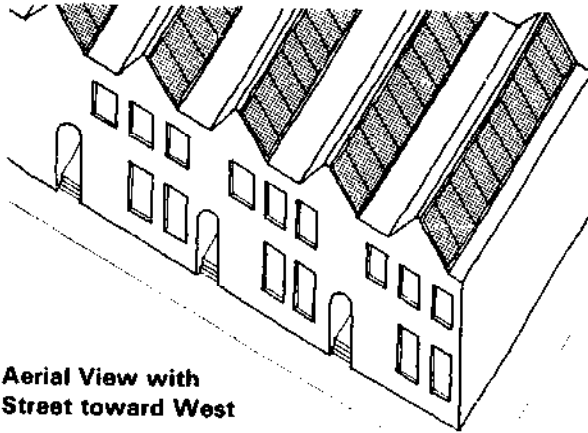

**Aerial View with Street toward West**

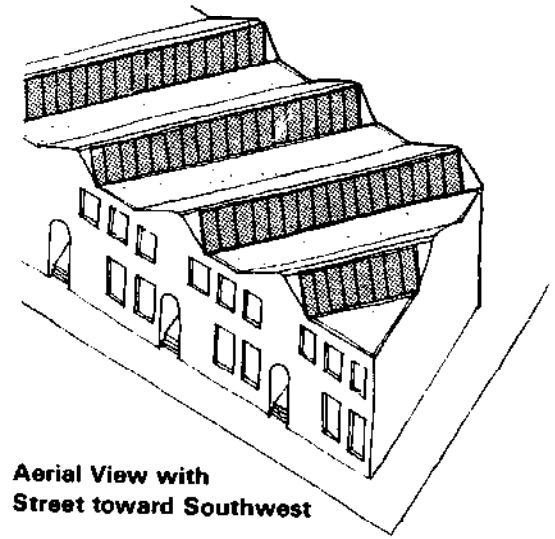

**Aerial View with Street toward Southwest**



## Mid-Atlantic Garden Apartments

The garden apartment is a relatively new housing style in the United States. Whereas rowhouses and townhouses are most often associated with an urban situation, garden apartments are generally associated with a suburban setting. With more developable land areas than an urban setting, garden apartment design is able to utilize the natural topography, vegetation, and conditions of the site to their best advantage.

The garden apartments shown step up a gentle slope in blocks of four units. Each unit is a two-bedroom design, although various combinations could easily be developed. The living unit is entered through a gallery off which are the kitchen and living room. A fireplace, located in the living room, is included in each apartment unit. Since the flue of the fireplace would pass through the solar collectors mounted on the south roof if extended vertically, the chimney flue slopes within the attic space to emerge on the north side of the roof. Also, each apartment unit block is set back from its neighbor as they step up the hill, thus allowing the plane of the solar collectors to continue unbroken, while avoiding problems of collector shading caused by breaks in the roof plane.

The design incorporates a warm-water solar system. A central water storage tank is buried in an accessible location adjacent the building, carefully insulated and protected from moisture. Transport lines from the collector to storage and from storage to apartment distribution are also heavily insulated to minimize heat loss. The large attic space created by a 45° roof pitch necessary for solar collection is used for apartment storage in the absence of a basement space in the design.

With the large area of solar collectors shown, the design should be capable of supplying 80 percent of the garden apartments heating demand in a temperate climate and almost all of the domestic hot water requirement.

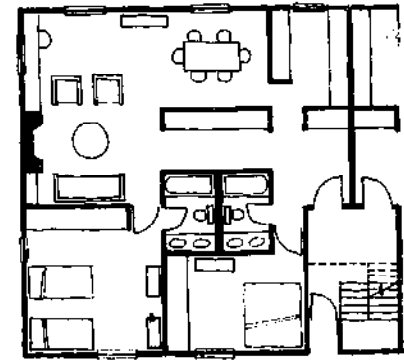
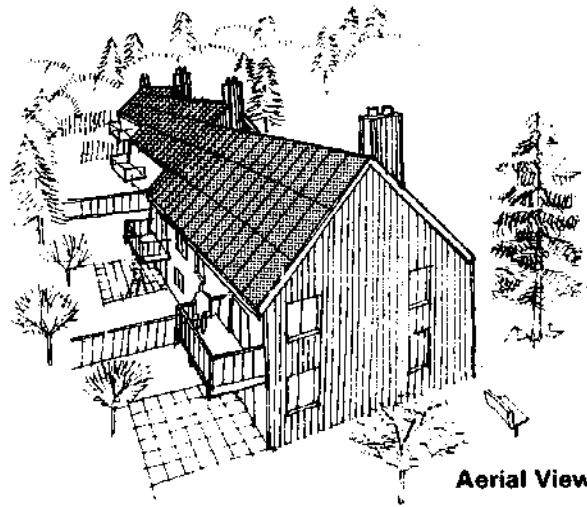

Floor Plan (ground floor unit shown)

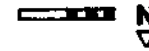

## In-Town Apartments

The three-story brick-faced apartment building shown below is designed for a Southern or Mid-Atlantic urban or high-density suburban site. Although thoroughly modern in its appearance, with a concrete frame, large glass areas and precast concrete lintels, its curved arches, traditional brick and black metal railings retain the architectural spirit of older buildings in these southern areas. In many historic urban settings, this building could take its place without destroying the continuity and scale of the older buildings.

The metal railings serve two purposes. First they help unite the new building with the old setting; and second, the railings help to subdue the large-scaled, tilted solar collector banks on the roof behind a familiar visual element. Unlike a solid parapet, however, the open railings do not completely shade the ends and lower parts of the collectors during the hours of low sun — common during the heating season. The screening is accomplished without a noticeable loss in system performance.

The rows of roof top collectors are mounted at the optimum tilt on rigid frames attached to the roof structure. The design concept employs a warm-water solar system with piping running between the collector banks to a large central water storage tank in the basement. The heated water is pumped from storage to the individual apartments for distribution by fan coil units. With such an arrangement the architectural modifica-

tions required to integrate the system are minor and as long as the building is designed to be energy conserving, the solar system should satisfy a major percentage of the building's heating needs. For climates with a large cooling requirement, solar assisted cooling may be feasible. It may be necessary in these cases to

design the collectors so that the angle of tilt may be adjusted from heating optimum to cooling optimum. The design as shown has sufficient collector area and storage capacity to provide approximately 90 percent of the buildings heating and domestic hot water demand with solar energy.

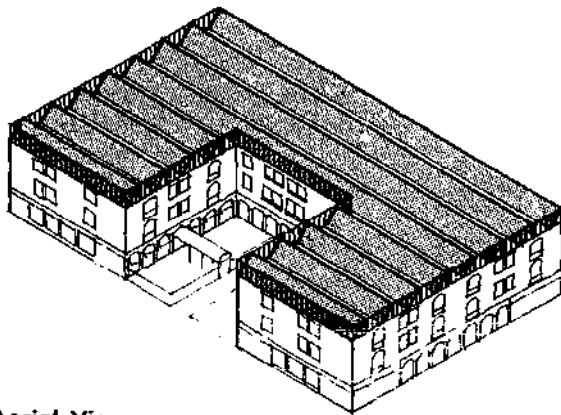

Aerial View

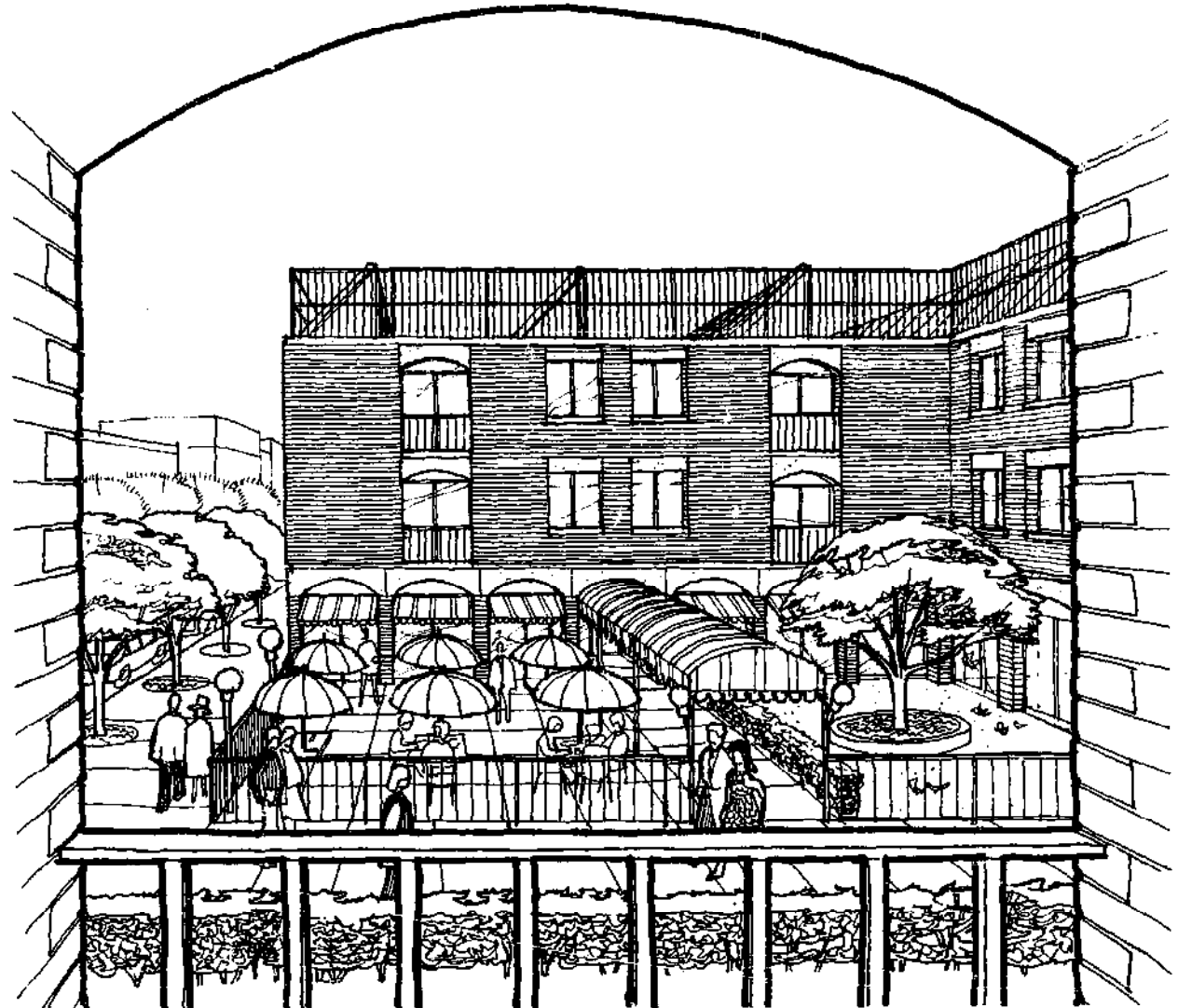

## Balcony-Access Apartments

The Balcony-Access Apartments shown below are organized around a central garden courtyard. The apartment design is typical of units that are built in climates where exterior access is acceptable. The design incorporates several solar collector concepts. Concentrating collectors, appropriate for regions with clear sunny weather, are mounted on the roof; while liquid-cooled flat-plate collectors are mounted vertically on the railings of each floor.

The roof collector is a type of linear concentrator with the long axis running east-west. A tracking mechanism keeps the sun focussed on the absorber by rotating the reflector and its glazed cover around the absorber, to follow the sun's apparent up and down motion as it crosses the sky. The concentrated solar energy produces high temperatures in the working fluid, useful for summer cooling as well as winter heating.

Supplementing the energy captured by the concentrating collectors on the roof are fixed vertical flat-plate collectors mounted on the railings of the balconies serving the upper floors. These collectors operate only during the winter since in the summer their vertical tilt angle allows them to collect relatively little heat in southern latitudes. For the railing collectors to operate efficiently, the courtyard must be wide enough and the vegetation in them low enough to let the low winter sun strike the collectors.

Energy captured by both collector systems is removed by a working fluid and stored in a central compartmentalized heat storage tank. During the heating season, the heated fluid is pumped from storage to fan coil units located in each apartment. An energy boost is supplied by a central auxiliary boiler if storage temperatures are not sufficient for apartment heating. During the cooling season, the heated fluid is used to power a low-temperature absorption-cycle cooling system. The cooled fluid is again pumped to the fan coil units located in each apartment for distribution. Domestic hot water is preheated by passing the supply line through a heat exchanger located within the central storage tank.

The system should be able to supply most of the building's yearly heating and hot water load, and a good part of the cooling load, for the coldest climate in which balcony-access apartments are acceptable.

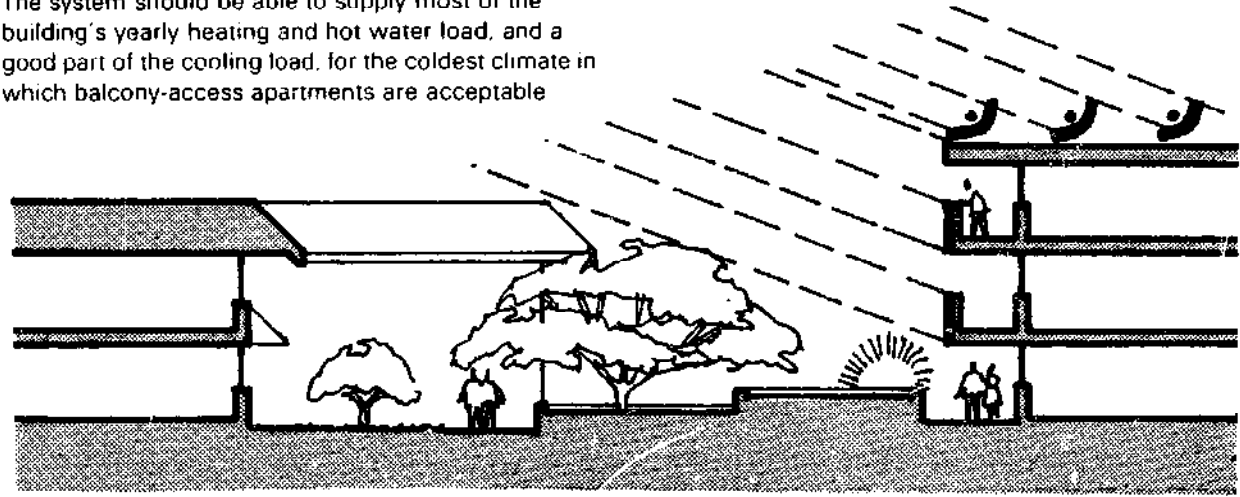

Site Section

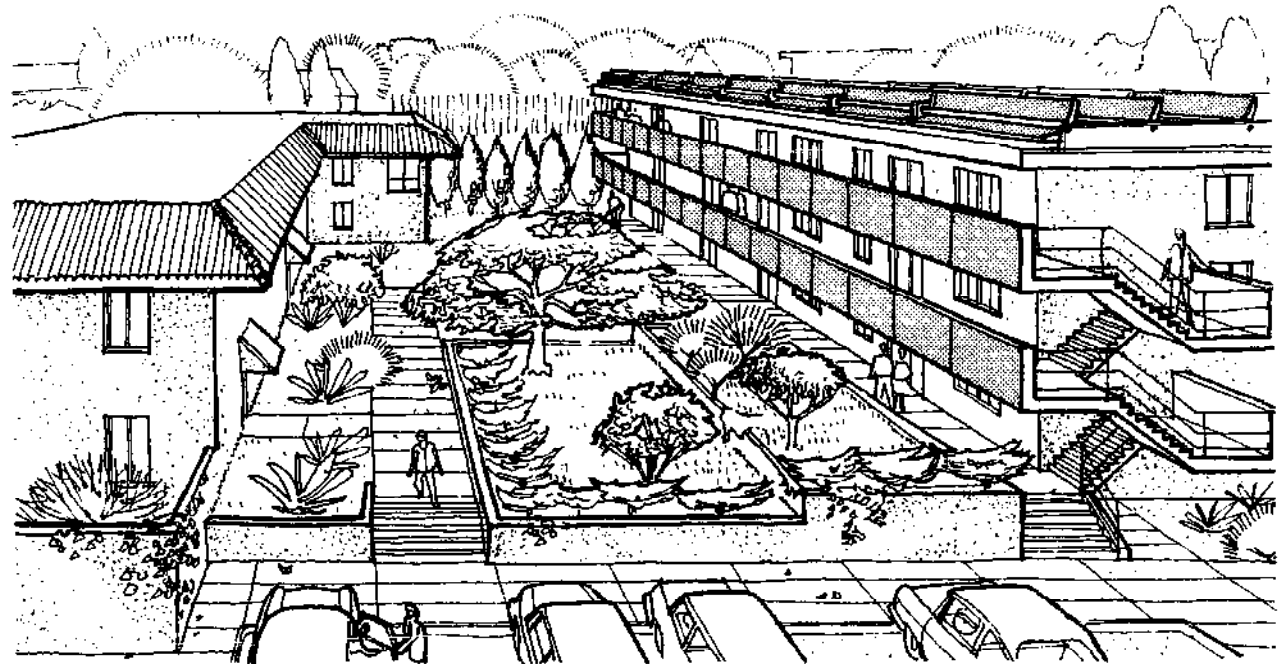



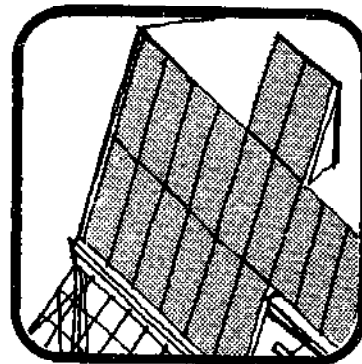
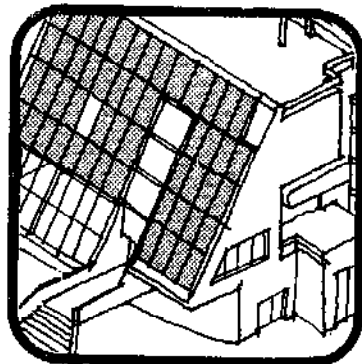
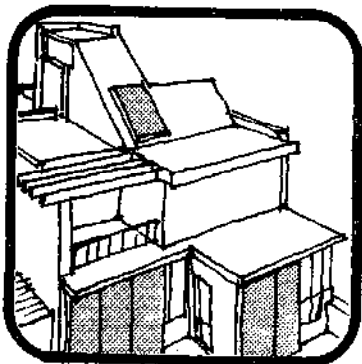
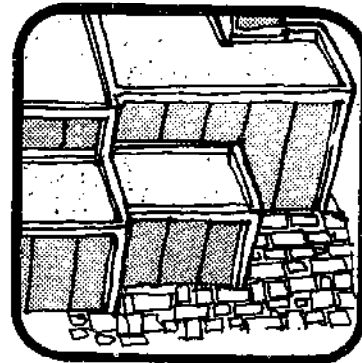
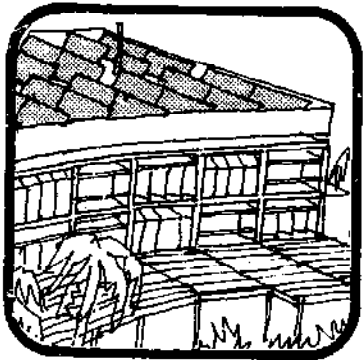
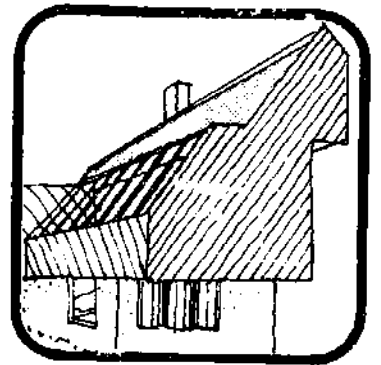
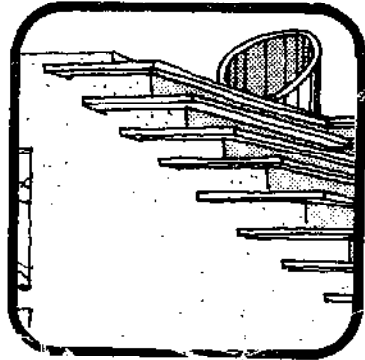
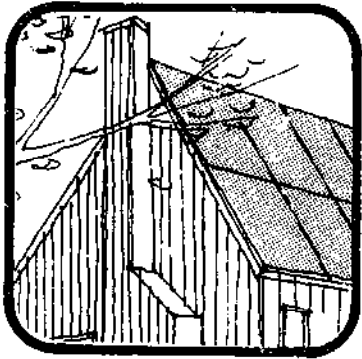

# 6

## SOLAR DWELLING DESIGN CONCEPTS

Climate, comfort, building characteristics, and solar systems shape the design of solar dwellings. Additionally, the local conditions of the building site and the surrounding neighborhood affect design decisions and choices. These factors have been discussed on an individual and isolated basis or as they influence traditional housing styles. Dwelling design responsive to the demands of sun and climate will give rise to architectural styles particularly suited to each climatic region. The Pueblo structures of the hot-arid southwest and the "saltbox" homes of New England are examples of housing styles responsive to the sun and climate of their particular region.

The last chapter focused on a number of housing styles which have evolved from a traditional, intuitive approach to architectural design. There are, however, new architectural styles emerging from a reinterpretation of these traditional beginnings. They have as a major form-giving element the utilization of solar energy for heating and cooling. This chapter provides a brief glimpse of the beginnings of an architectural style which is responsive both to the historic tradition of regional architecture and to the demands of solar heating and cooling.

The following solar dwelling design concepts are three dimensional expressions of the solar design determinants that have shaped them. Climate, in most cases, is the primary form-giving factor, while in others the solar system or the architectural image is the primary concern. It must be clearly understood that the concepts are only representative examples of solar dwelling design and should be viewed as such. They are not the optimal or the best or the

end-all in solar dwelling design. The design concepts have been developed to illustrate the principles of solar dwelling design and provide an inkling of what solar dwellings may look like for various climates and solar systems. The solar dwelling design appropriate for a particular client in a specific climate at a specific site will be as varied as there are clients, climates, and sites.

The concepts are presented not as housing designs ready to build but as a basis for future solar design by professionals and as a basis for increased understanding by clients, the general public, and policy makers. It should be clear to everyone that solar dwelling design is an architectural challenge as much as, if not more than, a mechanical engineering development.

### Representative Solar Dwelling Designs

The focus of these residential design concepts is on single family, low-rise multi-family, and mobile homes. The designs have been developed for different climatic conditions and for different solar systems. Each design, therefore, is responsive to a unique problem (design) context made up of three variables: dwelling type, climatic region, and solar system. The designers — architects and engineers throughout the United States — working within their unique problem (design) context have proceeded from the analysis of design determinants to the development of responsive design solutions.

What follows are a number of solar dwelling design concepts responsive to different combinations of context variables. The designs are presented as brief case studies, organized by housing type. Each case study includes one or more solar dwelling designs. The solar concepts focus on two issues: 1) the integration of different solar systems into different housing types, and 2) the integration of solar dwelling concepts into different climatic regions.

Total Environmental Action (TEA), for instance, selected a solar system applicable to different climatic regions of the United States and incorporated this system into four single family housing

designs appropriate to each region. The Architects Taos, on the other hand, developed one prototypical solar dwelling design and documented the changes required to adapt/modify the heating and solar system to different climatic regions. Donald Watson, Architect, focused on the architectural factors influencing flat-plate collector area and its integration with other collector concepts and architectural features during the development of a single family, solar dwelling concept for cool-temperate climates.

Similar analyses were undertaken by Giffels Associates, Joint Venture, and the Continuum Team for multi-family housing. The Giffels' design task was identical to TEA's, except that the solar system was integrated into a multi-family housing design. Joint Venture documented the design changes and opportunities created by the integration and utilization of different solar systems in multi-family housing, and the Continuum Team developed a modular living unit adaptable to different solar systems and different climates.

The adaptation of mobile homes for use of solar energy systems was the focus of the design task performed by RTL, Inc. The resultant mobile home concepts were designed to accommodate the solar system through varying geographic and climatic regions and from an individual unit to mobile home park application.

The designers were not specifically asked to address the issue of dwelling and solar system cost. However, they were asked to base their design decisions upon acceptable architectural and construction practices with an attention to cost, material selection, and energy conservation. In addition, the solar systems selected for integration into the dwelling design concept were to be developed to a point of demonstrated practicality. In some cases, the designers did in fact develop detailed cost data for the dwelling and solar system while in others only a "ball park" figure was prepared. For further information regarding the economics of solar energy utilization, the reader is referred to the bibliography.

Total Environmental Action (T.E.A.) of Harrisville, New Hampshire has designed a single family solar dwelling for each of the four climates of the United States. The design concept for each climatic region is based upon the same generic solar system and the same architectural program requirements. The solar system is a warm-air type with variation in collector, storage, and distribution design depending on climate, heating load and architectural design requirements. The architectural program is based upon the requirements of a family of two adults and



#### BACKGROUND DATA

**ARCHITECT:** Total Environmental Action

**CLIMATIC REGION:** Temperate

**BUILDING TYPE:** Single-family detached

**AREA:** 906 sq. ft. heated floor area

#### SOLAR SYSTEM

**COLLECTOR:** Air-cooled flat-plate

**STORAGE:** Central rock bin, thermal mass-walls/floors/water tanks

**DISTRIBUTION:** Forced air, natural radiation

**AUXILIARY ENERGY:** Oil-fired furnace, heating/storage

**DOMESTIC HOT WATER:** Preheat tank in rock bin, conventional tankless heater auxiliary

**SPACE COOLING:** Natural ventilation

two children. T.E.A.'s solar design concepts, although based upon these constant design parameters, are substantially different for each climatic region due to variations in the amount and type of solar radiation, other climatic factors, site conditions, and the heating and cooling load of the dwelling.

The first design is for a temperate climate. The energy requirement for temperate regions includes both heating and cooling, and humid conditions are also prevalent during the hot summer months.

T.E.A.'s response to these conditions has been to develop a flexible dwelling and solar system design. During the winter, a south-facing greenhouse on the second level and a flat-plate collector located on the third level capture solar radiation to heat the house. However, during the summer months, the greenhouse can be closed off and natural ventilation created by opening the windows and solar collector manifolds.

The solar heating system uses air as the heat

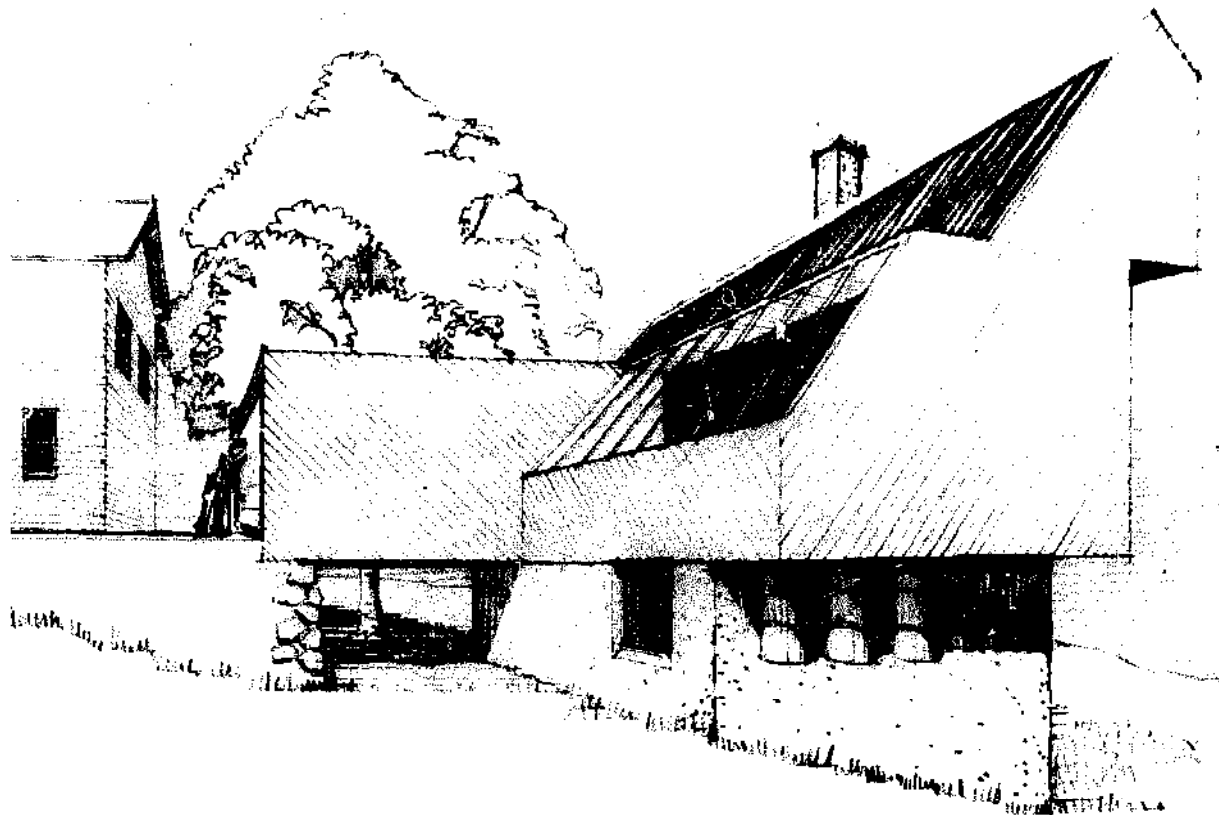

transfer medium avoiding problems of freezing and higher maintenance costs associated with liquid cooled, flat-plate collectors. The collector totals 345 square feet and is tilted to an angle of 60 degrees. Heat is stored in an insulated tank filled with 350 cubic feet of fist-sized rocks located in the basement. The heated air from the collectors enters the top of the storage container, transfers its heat to the stones, and exits at the bottom of the container. Distribution to the living spaces is accomplished by hot air blown through ducts. Air is drawn from return

air ducts through storage where it is heated and circulated to the living spaces. Two blowers operate the distribution throughout the entire system.

The system has been designed to provide 60 percent of the dwelling's seasonal heating load. The balance of the heat load is provided by an oil-fired hot air auxiliary system located adjacent to the heat storage tank.

The domestic hot water tank is located within the rock storage container. Depending on the tempera-

ture of storage, the water is heated to a useful temperature or simply preheated before being heated conventionally. Solar energy will satisfy between 45 and 60 percent of the annual domestic hot water demand.

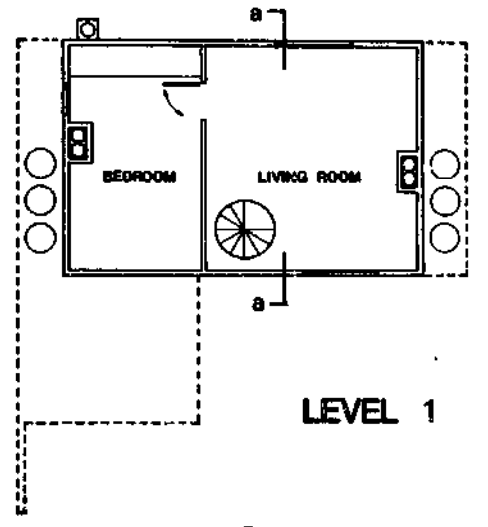

LEVEL 1

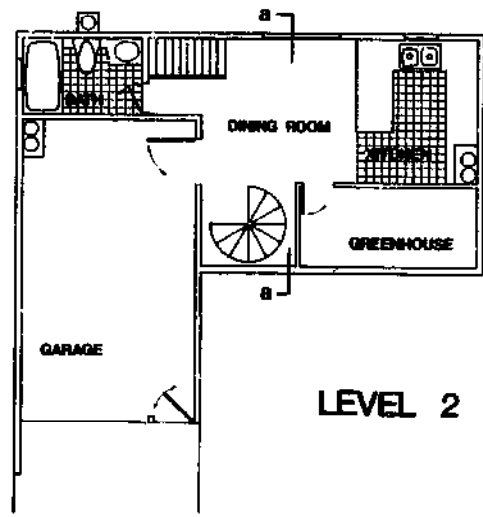

LEVEL 2

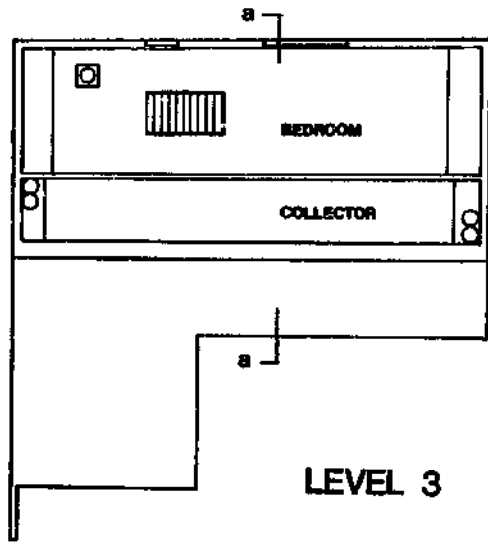

LEVEL 3

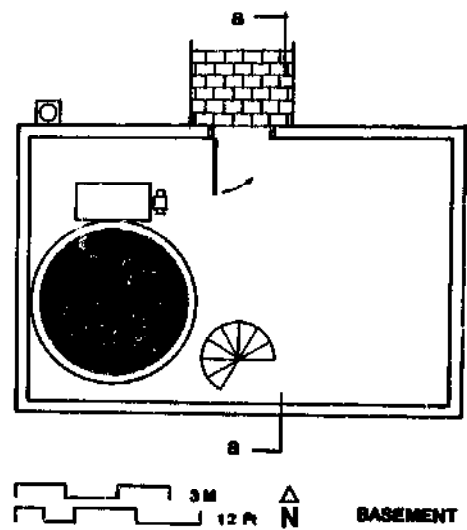

BASEMENT

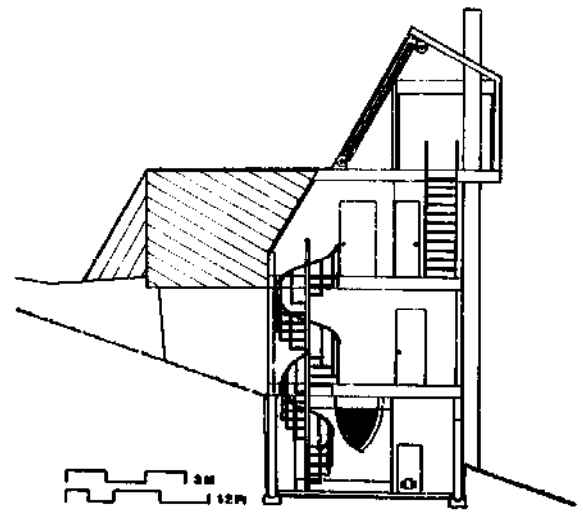

Section a-a

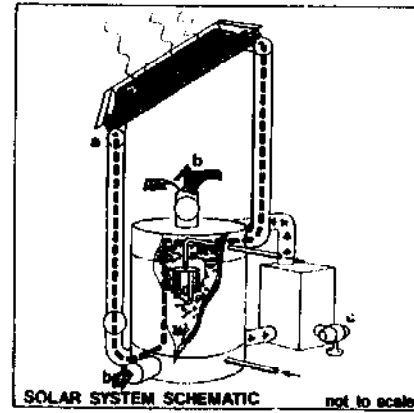

SOLAR SYSTEM SCHEMATIC not to scale

T.E.A.'s second design is representative of the concerns for dwelling design in cool climates; namely, reduction of heat loss and utilization of solar heat gain. The dwelling form and site plan have been developed to reduce heat loss by blocking cold winter winds and increasing solar heat gain by maximizing the building's southern exposure. In addition, the primary building material is concrete masonry units with insulation applied to the exterior of the outside walls, thus increasing the thermal mass inside the occupied spaces. Closets are located on the

north walls for added insulation. Also, all windows have multiple glazing to reduce heat loss, and are operable to induce ventilation when required.

The solar system consists of two banks of vertical air collectors which form the south walls of the dwelling, a central heat storage cavity wall of 8-inch concrete masonry units with a 4-inch cavity filled with fist-sized rocks, and a distribution component of 8-inch hollow concrete floor planks which span from the central heat storage wall to the vertical solar

collectors. The hollow floor planks act as ducts between the collectors and storage and also as added storage capacity. A flat floor extension provides shading for the second level windows and a reflecting surface for third level solar collectors, thereby increasing the incident radiation on the collectors, especially in winter months.

Two fans are used to circulate air through the first and third level solar collectors to the heat storage mass. The cores of the concrete floor planks are

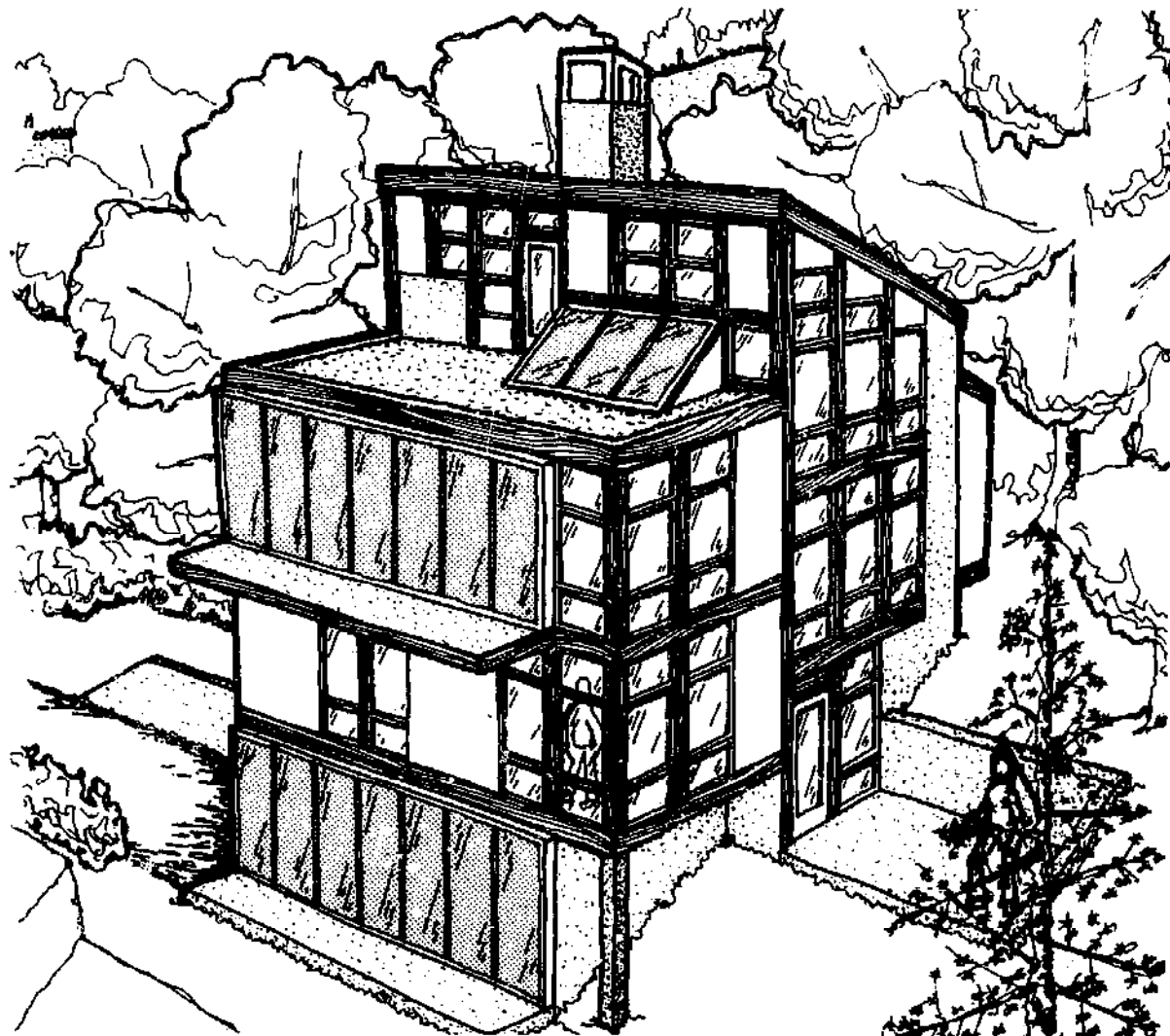

#### BACKGROUND DATA

**ARCHITECT:** Total Environmental Action

**CLIMATIC REGION:** Cool

**BUILDING TYPE:** Single-family detached

**AREA:** 1380 sq ft heated floor area

#### SOLAR SYSTEM

**COLLECTOR:** Air-cooled flat-plate, south-facing windows w/ insulated shutters

**STORAGE:** Central storage wall filled with rock, thermal mass walls, floors

**DISTRIBUTION:** Forced air, natural radiation

**AUXILIARY ENERGY:** Gas fired furnace, heating/storage

**DOMESTIC HOT WATER:** Liquid-cooled flat-plate collector w/ preheat tank, gas-fired auxiliary

**SPACE COOLING:** Natural ventilation

used to distribute air throughout the dwelling and solar system. Air return is accommodated by operating transoms above doors opening on the central stairway, which acts as a plenum returning air to the auxiliary furnace air intake on the ground level. Automatic and manual dampers control the flow of air throughout the system. A gas-fired auxiliary heater warms air to heat the thermal storage mass, should the solar system fail to function or to provide for the dwelling's total energy requirement.

Domestic hot water is heated by a liquid-cooled flat-plate collector located on the south-facing roof deck at an angle of 45 degrees. The collector is connected to a domestic hot water preheat tank located above a conventional hot water heater in the entry-utility space. The water is pumped from the bottom of the preheat tank through the solar collector where it is heated, and passed back to the preheat tank where it is available for distribution. Cool water from the street water main is supplied to the bottom of the preheat tank to provide water as required for the

house hot water supply. The solar hot water collector drains automatically when the pump is turned off. This allows the use of a total water system which does not require antifreeze in the collector loop.

The warm-air solar system has been estimated to provide 40 percent of the seasonal heating load. The separate domestic hot water solar system provides 60 percent of the energy for domestic water heating. The dwelling and site have been designed to maximize natural ventilation in lieu of air conditioning, which is rarely needed in cool climates.

**LEVEL 1**  
580 SF

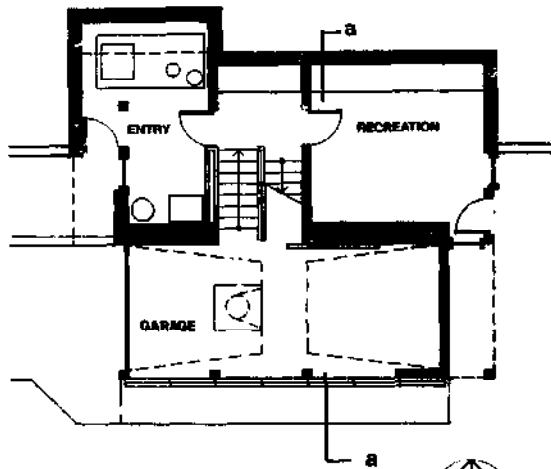

**LEVEL 2**  
640 SF

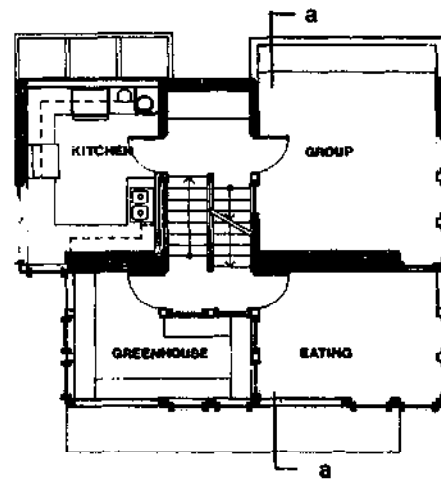

**LEVEL 3**  
480 SF

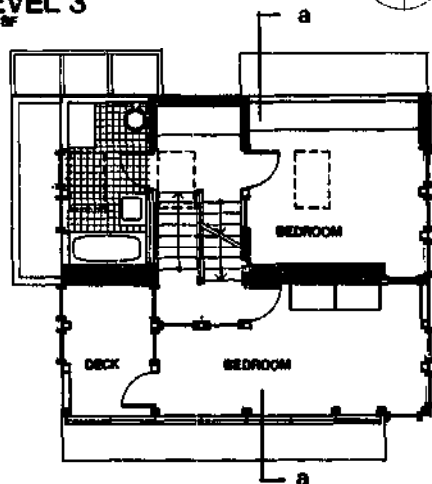

**LEVEL 4**

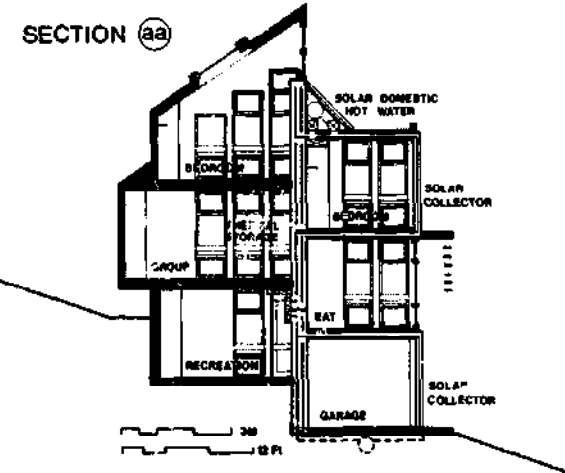
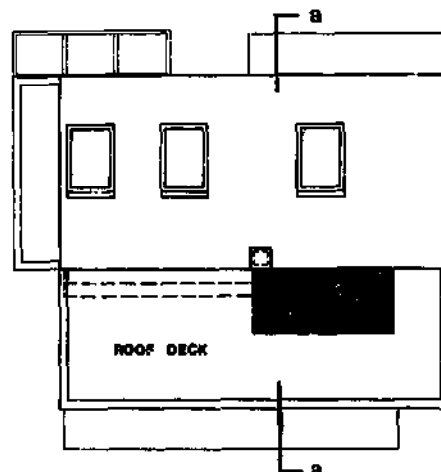

**SYSTEM SCHEMATIC**

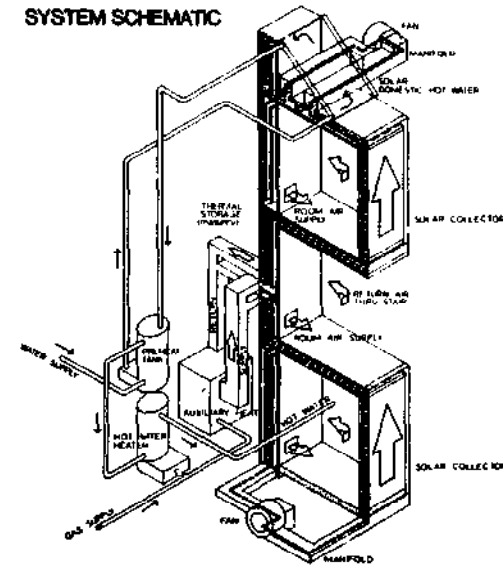

T.E.A.'s solar concept for a hot-humid climate provides for maximum heat loss, prevention of heat gain, and removal of excess heat and humidity by natural ventilation. Instead of a compact, heavily insulated multi-leveled layout common to cool or temperate climates, the design concept is open and spread out to direct and capture seasonal and daily winds. The dwelling's solar and conventional energy systems make up the winter heating demand not provided by direct collection through the dwelling's many south-facing windows.



Hot-humid areas are characterized by high air temperatures and relative humidity. Considerable air movement is necessary to bring this combination of high temperature and humidity into the comfort zone. The house is designed to take maximum advantage of winds passing through the building site. Summer winds are constant and from the southwest. The "L" shaped plan of the house and the operable window design of the bedroom wing wall are intended to collect and focus southwest winds through the house. The house should be sited so that

cold winter winds will be deflected away from the south-facing glass area by neighboring buildings or by vegetation to the west.

The solar system consists of an air-cooled flat-plate collector, two water container storage closets and ceiling distribution ducting. The south-facing windows and greenhouse are also designed to collect solar radiation. There is sufficient mass in the hall of the bedroom wing, the back wall of the greenhouse, and 4-inch concrete floor slab throughout the house.

#### BACKGROUND DATA

**ARCHITECT:** Total Environmental Action  
**CLIMATIC REGION:** Hot humid  
**BUILDING TYPE:** Single-family detached  
**AREA:** 1144 sq. ft. heated floor area

#### SOLAR SYSTEM

**COLLECTOR:** Air-cooled flat-plate, south facing windows, greenhouse  
**STORAGE:** Containerized water, thermal mass walls/floor  
**DISTRIBUTION:** Forced air, natural radiation  
**AUXILIARY ENERGY:** Electrical resistance heating storage  
**DOMESTIC HOT WATER:** Liquid-cooled flat-plate collector thermosyphoning into preheat tank and electric water heater  
**SPACE COOLING:** Forced ventilation

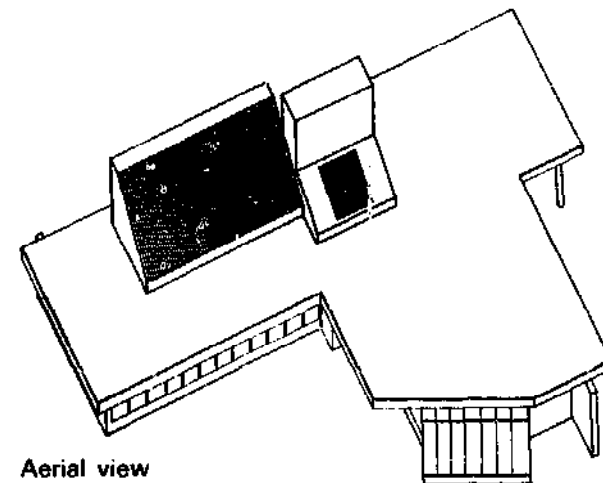

Aerial view

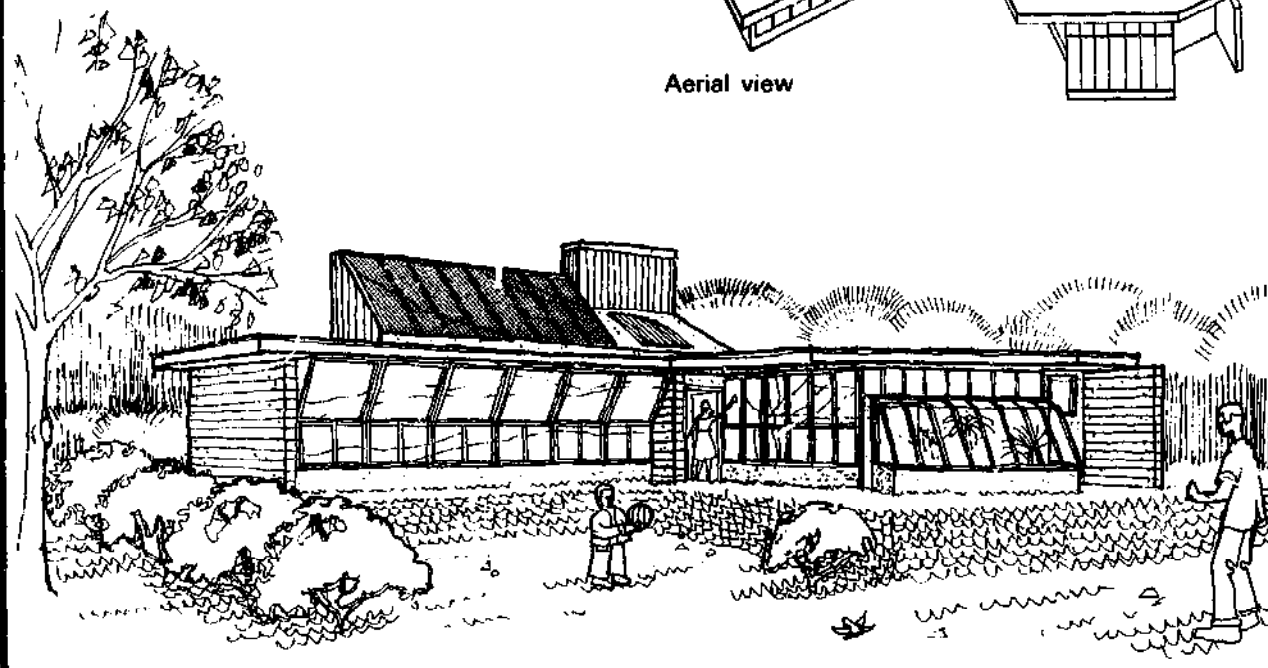

to provide thermal storage for one winter day's heat demand.

Domestic hot water is heated by a separate liquid-cooled flat-plate collector organized in a thermosyphoning arrangement — storage tank located above the collector so that heated water rises into the tank. The water flows from storage by gravity through a conventional water heater where it is heated again if necessary and distributed to points of use.

The solar heating system operates as follows: Air is drawn into the inlet manifold at the bottom of the collector from the bottom of both the storage spaces. "Cool" air from the bottom of storage thermosyphons up through the collector. This air movement is aided by a fan below the outlet manifold in the single down feed duct. Only one fan is used for the entire closed heat collection system. The collected "hot" air is ducted back into the tops of the two storage chambers. The entire system is a closed loop system and the air will continue down

through the storage and back up through the collector again, (picking up more heat) by the combined action of vertical thermosyphoning and the fan. Water used as thermal storage is held in stacked 20-gallon molded plastic containers. These are designed to interlock together forming zig-zag diagonal air ducts that run from the top to the bottom of the chamber. The total storage volume is 370 cubic feet, 50 percent of which is void space.

Hot air is distributed to the house from the top of each storage enclosure. One duct from each enclosure requires one distribution fan per storage area. All heated areas are supplied from these distribution ducts. The bedrooms and bathroom are heated by one storage wall, and the living and kitchen areas by the other. Heat enters at the ceiling in each room, and as it cools falls down and into the returns which are mounted in the floor.

The solar system has been designed to supply approximately 70% of the dwelling's heating requirements and up to 50% of the domestic hot water load.

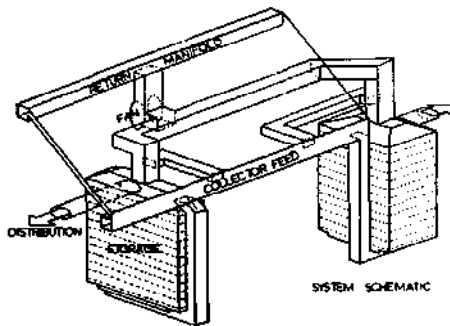
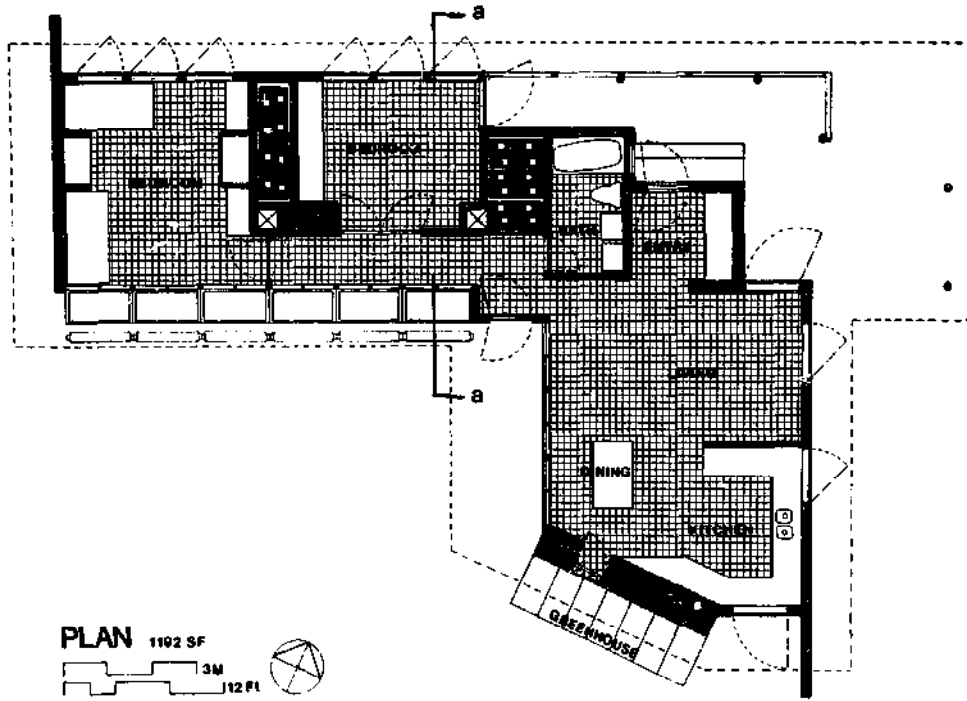

SYSTEM SCHEMATIC

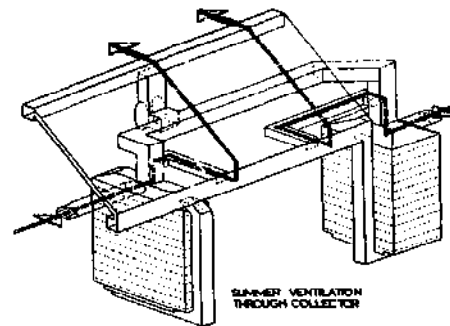

SUMMER VENTILATION THROUGH COLLECTOR

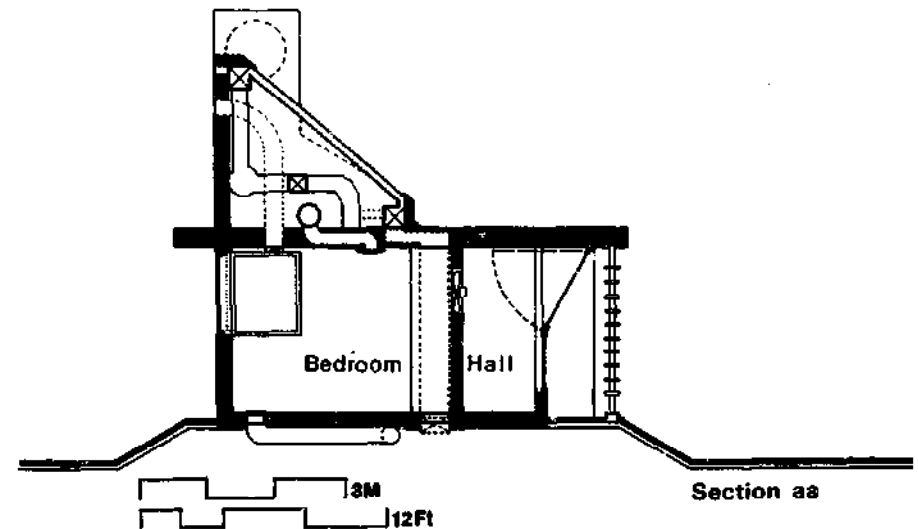

Section a-a



T.E.A.'s design concept for a hot-arid climate incorporates numerous climate control strategies reminiscent of the Pueblo Indian structures. The dwelling has a compact two story plan, small exterior openings, and massive adobe walls. Also, an effort has been made to reduce overall heat gain during the summer months. Unshaded glass area on the south, west, and east walls is limited to 24 square feet. Additional shaded glass area is concentrated on the lower floor, seen as the location of most daytime activities. On this floor, deep

overhangs, vertical shading devices, and ground contours shaped to minimize reflection into the dwelling keep out the high summer sun while admitting most of the lower winter sun.

Solar radiation is captured for space heating by south-facing vertical warm air collectors. Domestic hot water is heated by a roof mounted liquid-cooled flat-plate collector at a 40 degree tilt, thermosyphoning into a 150 gallon storage tank. Cooling is achieved by circulation of cool nighttime air through

storage, by a large roof monitor located over the stairwell, and by an interior/exterior water pool cooled at night by radiation to the sky, and in turn cooling and humidifying the inside during the day.

Relatively high outdoor air temperatures during the heating season in hot-arid regions permit the use of higher operating temperatures in the collector than is possible in cool or temperate climates. As a result, the useful temperature range in storage is increased and the required thermal mass for storage can be



#### BACKGROUND DATA

**ARCHITECT:** Total Environmental Action

**CLIMATIC REGION:** Hot-arid

**BUILDING TYPE:** Single family detached

**AREA:** 1,035 sq. ft. heated floor area

#### SOLAR SYSTEM

**COLLECTOR:** Air-cooled flat-plate, south facing windows

**STORAGE:** Containerized water, rock storage beneath floor, thermal mass floors/walls

**DISTRIBUTION:** Forced air, natural radiation

**AUXILIARY ENERGY:** Electrical resistance heating/storage

**DOMESTIC HOT WATER:** Liquid cooled flat-plate thermosyphoning into preheat tank, auxiliary

**SPACE COOLING:** Natural ventilation, interior ponds

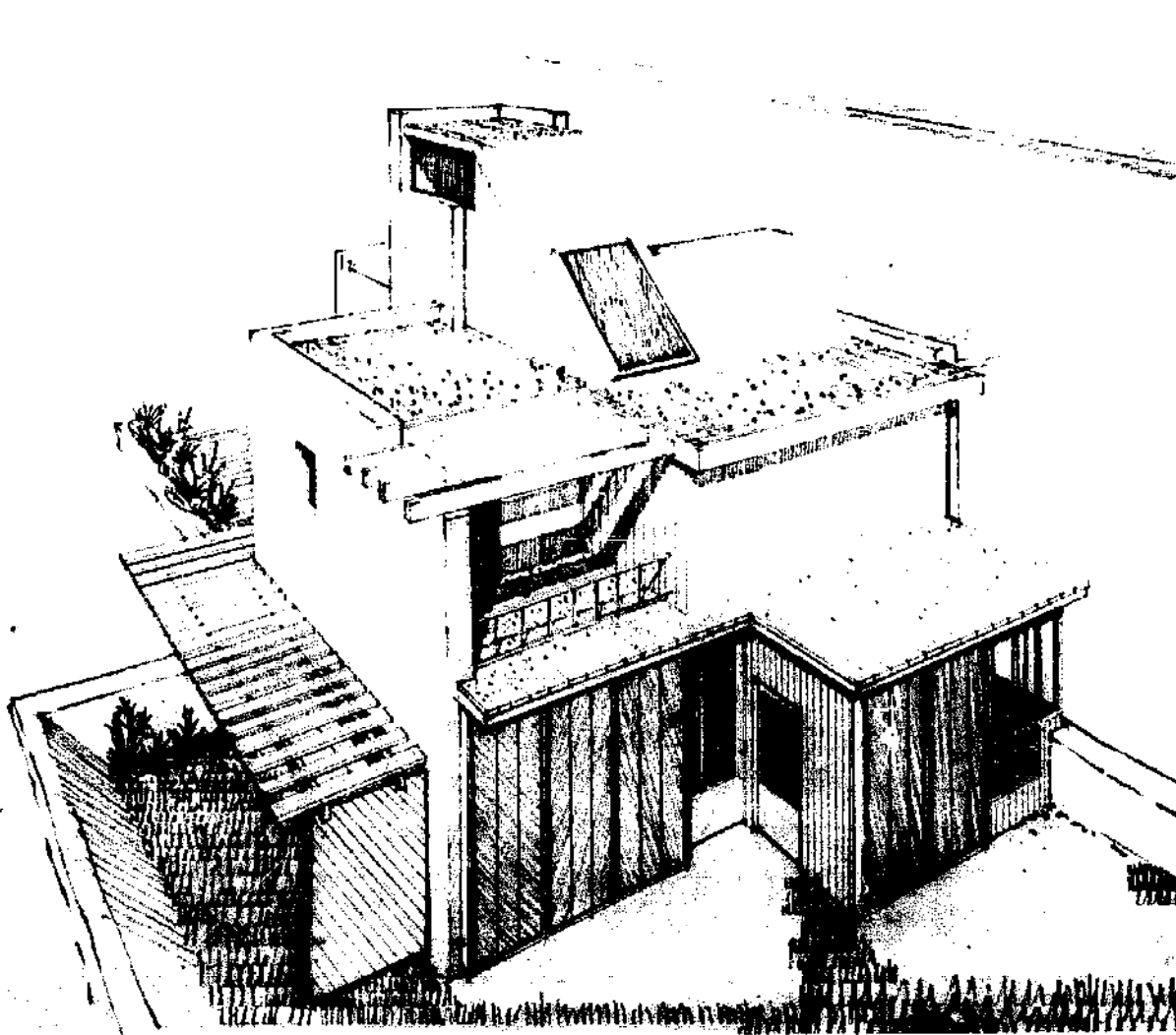

decreased. Two bins of stacked water containers are used to store heat from the vertical collectors. Also, the concrete floor slab and rocks located in the air supply return to the collector provide additional thermal storage mass. Total heat storage is sufficient for two or three January days.

Distribution throughout the system is accomplished by ducts located in the ceiling and floor area. Auxiliary heating of both domestic hot water and the liv-

ing spaces is provided by electrical resistance elements placed in the appropriate storage tanks.

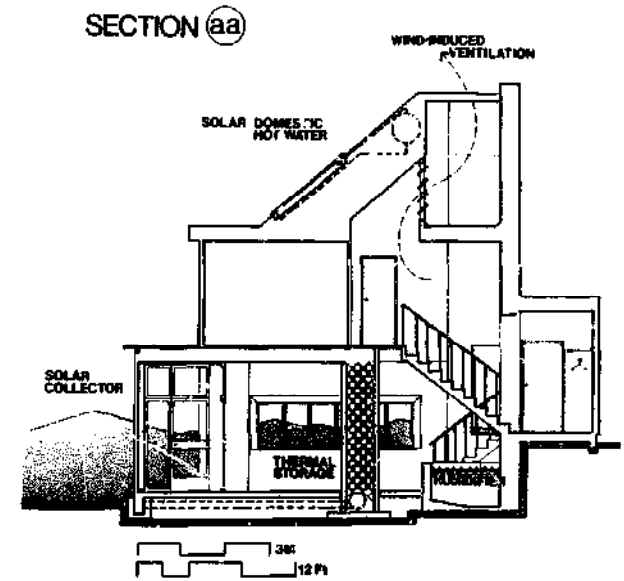
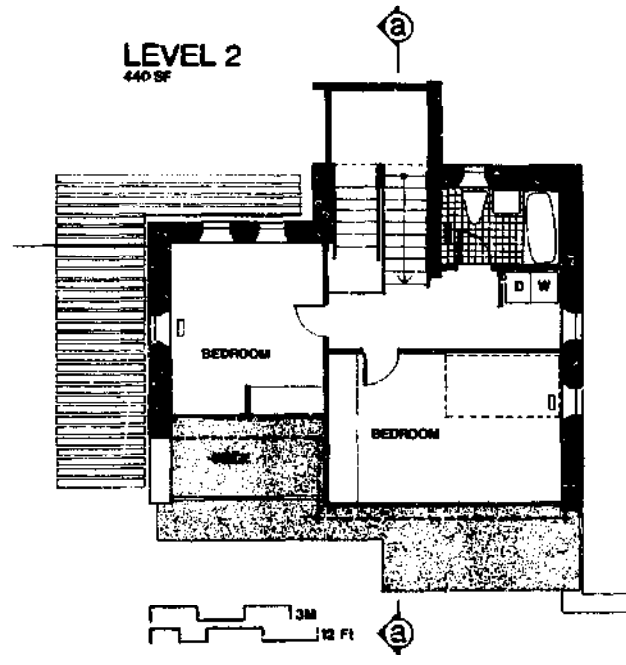
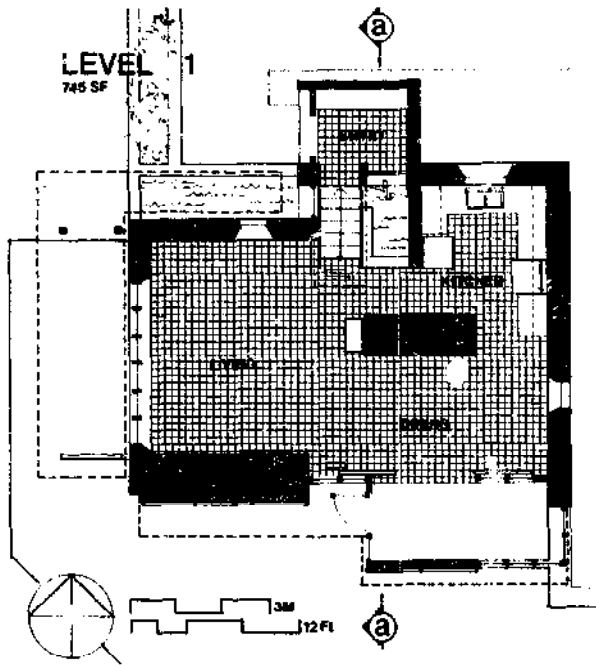

**SYSTEM SCHEMATIC**

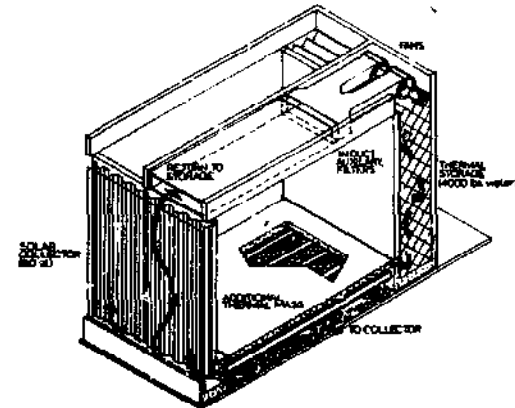

The Architects Taos of Taos, New Mexico have developed a prototype single family solar dwelling for a temperate climate and have adapted the prototype to the climatic conditions of cool and hot-arid climates. The prototype solar dwelling and its adaptations clearly illustrate the architectural design changes necessary to successfully integrate a solar dwelling and system within different climatic conditions.

The prototype solar dwelling, nicknamed "Birdcage,"



#### BACKGROUND DATA

**ARCHITECT:** The Architects, Taos

**CLIMATIC REGION:** Temperate

**BUILDING TYPE:** Single-family detached

**AREA:** 1950 sq ft heated floor area

#### SOLAR SYSTEM

**COLLECTOR:** TCA-controlled windows, walls, roof monitors

**STORAGE:** Exposed water tanks

**DISTRIBUTION:** Natural radiation and convection from TCA-equipped water tanks

**AUXILIARY ENERGY:** Fossil-fuel fired boiler heating solar domestic hot water storage tank, forced air distribution

**DOMESTIC HOT WATER:** Liquid-cooled flat-plate collector to high temperature water tank w/ conventional water heater auxiliary

**SPACE COOLING:** Evaporative cooling ponds on roof

is designed for a temperate climate. The architectural program for the prototype is based upon the needs of a family of two adults and two children and remains constant throughout prototype modification for different climates. To clearly illustrate the dwelling-solar system integration issues for various climates, an inherent or passive solar system was selected by the designers for the prototype design.

The primary concern of passive solar systems is the location of the collector and storage within the

dwelling. In most cases, a direct relationship between collector, storage and the occupied space best. To achieve this desired relationship the collector becomes a dwelling space (greenhouse effect and storage becomes an architectural element (dividing wall). As a result, the prototypical solar dwelling makes use of a collection room whose interior walls collect, store and distribute solar energy. The operation of the solar system is controlled by the use of Thermally Convertible Assemblies (TCA) which regulate thermal energy flow through the

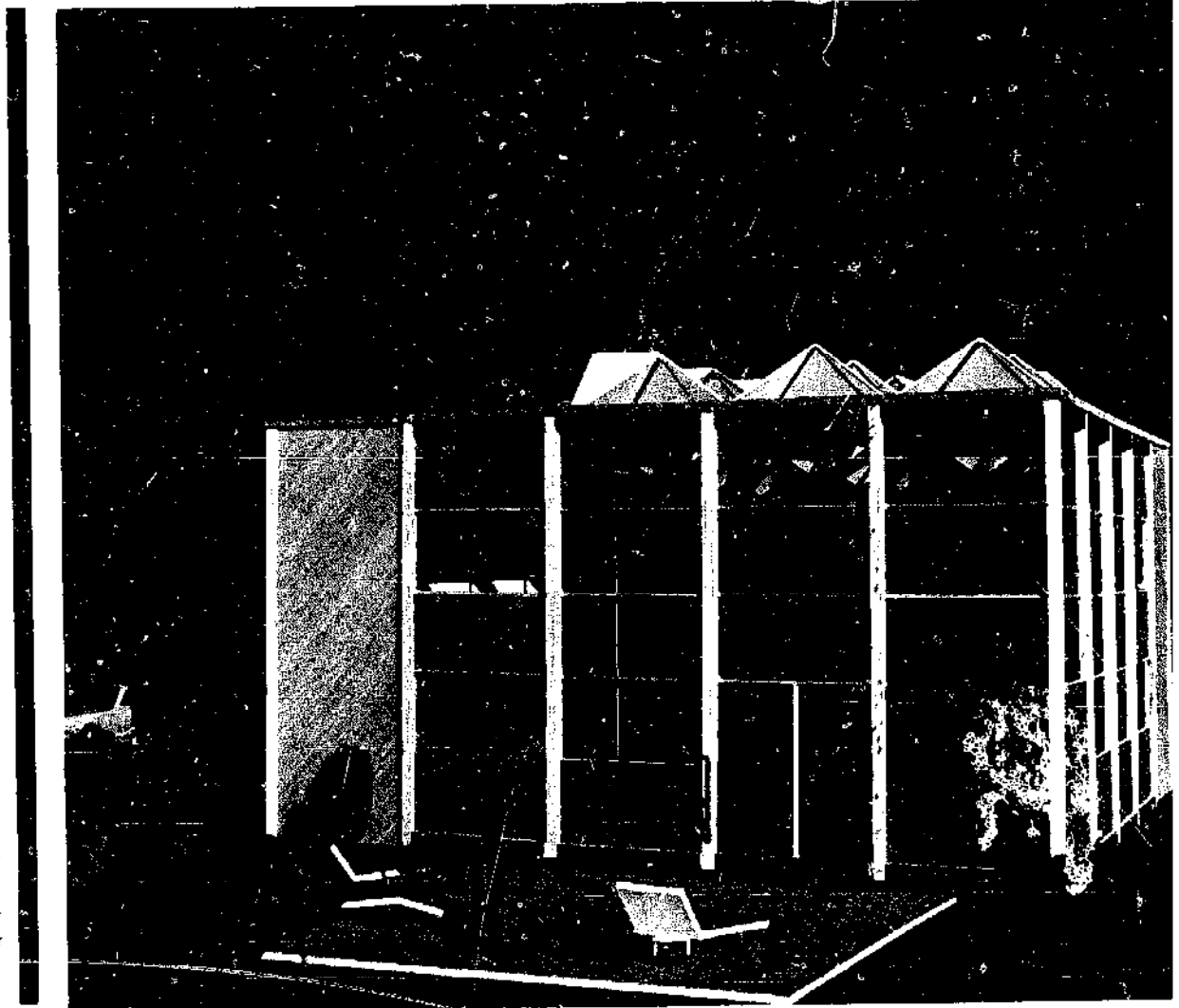

building envelope and within the spaces. An example of a TCA is the insulated folding door which separates the heat storage tanks from the bedrooms and dining-kitchen area. The doors are opened or closed depending on the thermal conditions of the occupied spaces. Two other examples of TCA's shown in the prototype are the operable insulated shutters of the windows and roof monitors, and the rotating heat shields on the heat storage tanks.

The solar system consists of large vertical cylinders

which store solar energy received from the collection room (living room). The amount and distribution of stored energy is controlled by the use of TCAs. The solar system is adaptable to many climatic conditions and solar components. For example, the storage tanks can be used in conjunction with roof top evaporative cooling ponds in temperate and hot-arid regions or with flat-plate or concentrating collectors in cool regions. The modifications of the prototype for various regions does in fact alter the dwelling and solar system design to accommodate

differing requirements imposed by the climatic conditions of these areas.

The solar collection and storage tanks are arranged within the dwelling so as to maximize their exposure to daily solar input during seasonal periods of high heating demand and to achieve direct proximity to habitable rooms within the heated enclosure. In the instance of the prototype, the tanks are arranged on two sides of the collection room, facing TCA-equipped windows on the opposite walls. Pyramids (roof monitors) on the south corner of the roof are equipped with TCAs which allow sun to reach the upper portions of the tanks during midday collection periods.

Pyramidal forms on the north roof corner enclose conventional flat plate collectors for hot water heating. The solar collectors are designed to operate in conjunction with the hot water boiler to supply heat for the domestic hot water and supplemental space heating unit. This unit discharges warm air into underfloor ducts for heating the dwelling when sufficient solar input is not available.

The evaporation cooling ponds are for summer cooling of the storage tanks, and operate passively on a thermosyphon principle. Water, cooled in the ponds by evaporation and radiation to the night sky, flows down through an appropriate piping loop to the tanks, where heat from the dwelling is absorbed and carried back to the roof ponds. The effectiveness of the cooling ponds is a function of dewpoint and temperature variations during the cooling season.

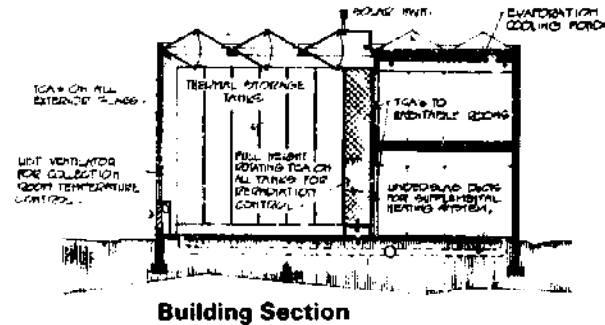
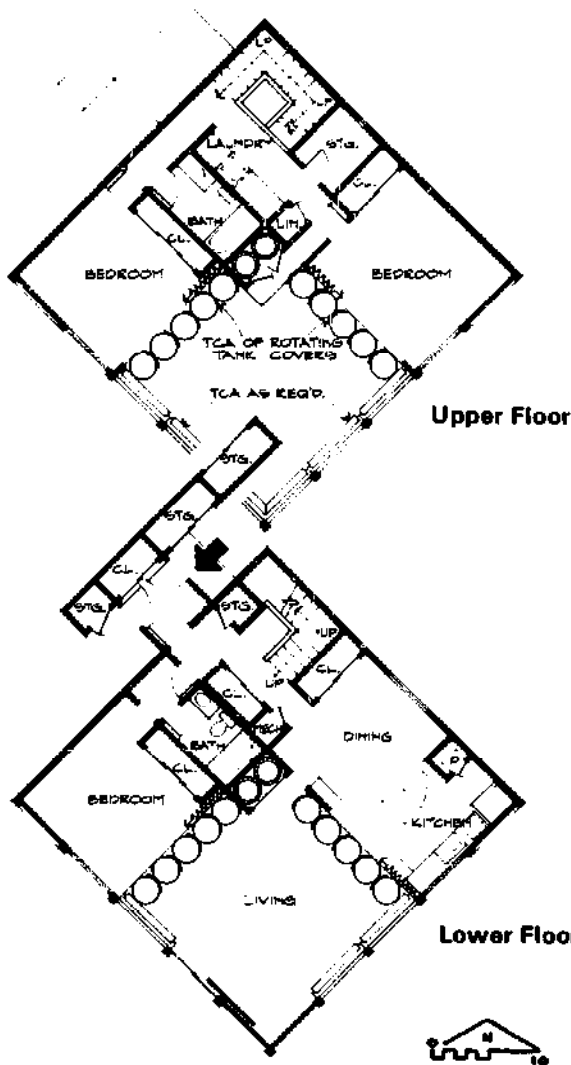

Building Section

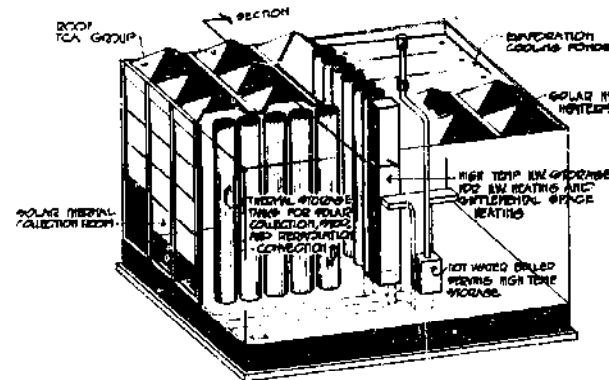

Solar System Diagram

Adaptation of the prototype solar dwelling to cool climates significantly modifies the architectural image while retaining the basic plan arrangement and solar system operation. The architects have nicknamed the adapted prototype "Suntrap." The major adaptations include: increasing the effective collector area to the limit allowed by the prototypical floor plan, improving the collector efficiency; increasing the thermal storage capacity; reducing the heat losses from the dwelling, and increasing the capacity of the solar hot water heater and auxiliary space heating

system. These design considerations are applicable to most solar dwellings to be built in cool regions.

The changes in architectural design as a result of adaptation to a cool climate are significant. The collection room is abandoned, the living room is sunk 3 to 4 feet below grade and provided with TCA equipped windows and a reflective roof as shown on the building section on page 109. The thermal collector and storage tanks remain in the same location but are increased in height. The collector

window is only 3 feet in front of the tanks, allowing for a shutter-type TCA with minimum clearance for tank maintenance. The form of the collector is thus severely modified, and the effective area is increased to 506 square feet, 154 square feet greater than the Birdcage prototype. Collector efficiency is increased in the range of 7 to 11 percent as a result of the re-entrant collector configuration, which now intercepts approximately 50 percent of the normal reflective losses.



#### BACKGROUND DATA

**ARCHITECT:** The Architects Tapscott

**CLIMATIC REGION:** Cool

**BUILDING TYPE:** Single-family detached

**AREA:** 1950 sq. ft. heated floor area

#### SOLAR SYSTEM

**COLLECTOR:** TCA-controlled double glazed windows and roof monitors

**STORAGE:** Exposed water tanks

**DISTRIBUTION:** Natural radiation and convection from TCA-equipped water tanks

**AUXILIARY ENERGY:** Fossil-fuel fired boiler heating solar domestic hot water storage tank, forced air distribution

**DOMESTIC HOT WATER:** Liquid-cooled flat-plate collector to high temperature water tank w/ conventional water heater auxiliary

**SPACE COOLING:** Natural ventilation

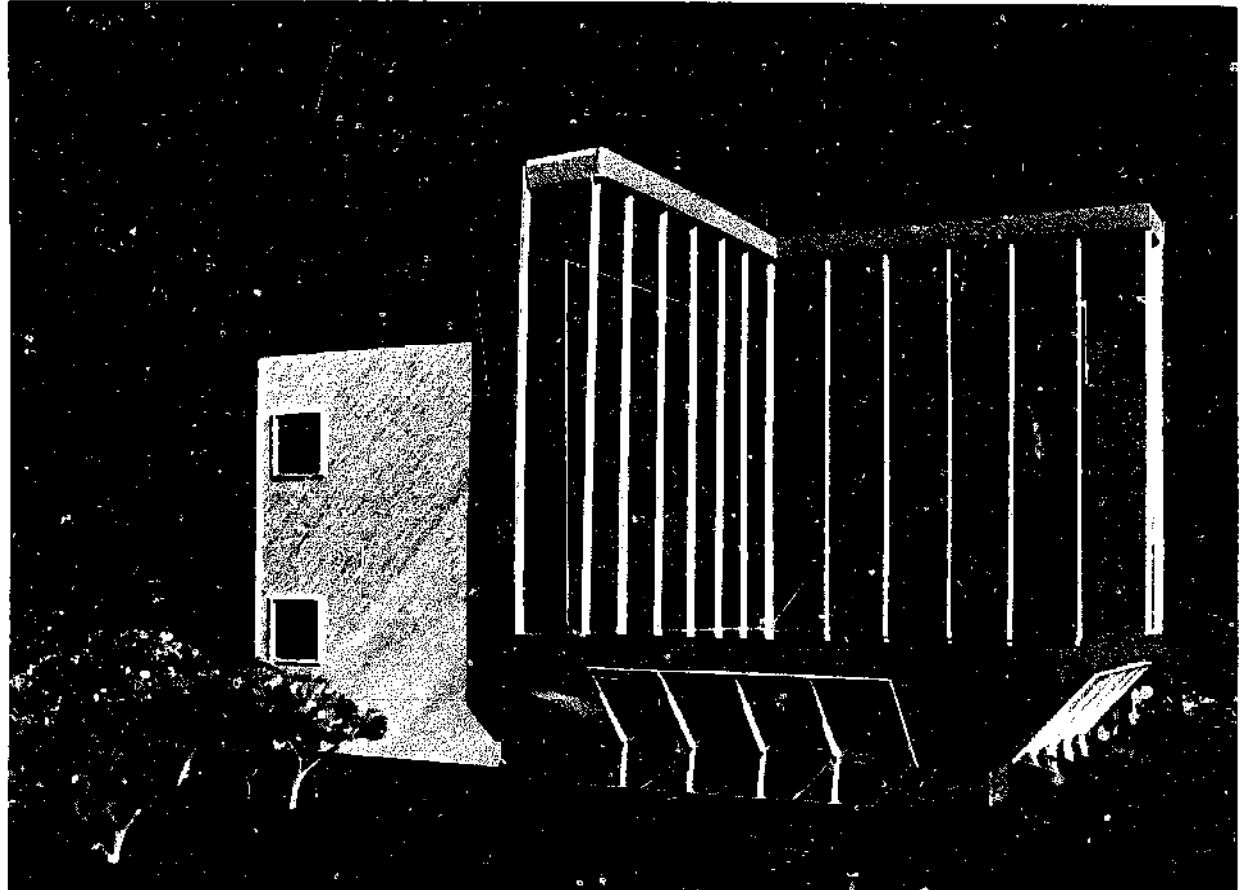

Thermal storage is increased from that of the Birdcage prototype. The maximum tank temperature of the Birdcage prototype was governed by collection room comfort considerations. However, the Suntrap adaptation avoids this problem, since collection surfaces are not reradiating to the habitable space. Also, the added tank height increases the thermal storage capacity. A high temperature storage tank located either in a basement space or buried outside adjacent to the building provides additional storage. The tank is for back-up services only and is charged

by a low capacity heat pump with heat borrowed from the primary collection and storage tanks.

Heat loss from the building is reduced by using smaller non-collecting window areas and TCA's on all living room and bedroom windows, and by partially burying the building (living room) to reduce transmission losses.

The solar domestic hot water collector is redesigned into a higher profile to avoid shadows from the roof

extension of the primary collector. Collector area is also increased to 55 square feet. The collector area can be increased to 100 square feet if the solar hot water system is to provide a large percentage of back-up system heating. A large auxiliary boiler is used in conjunction with the larger secondary space heating storage tank. The boiler is sized to carry the worst case heating load with all solar systems in-operative.

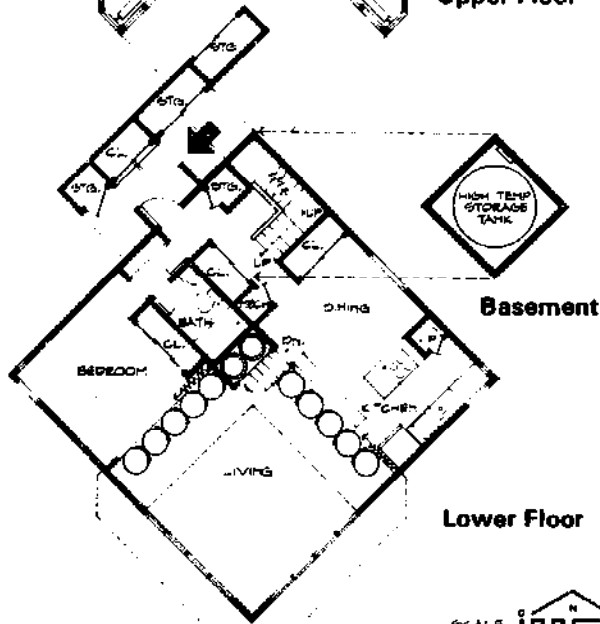
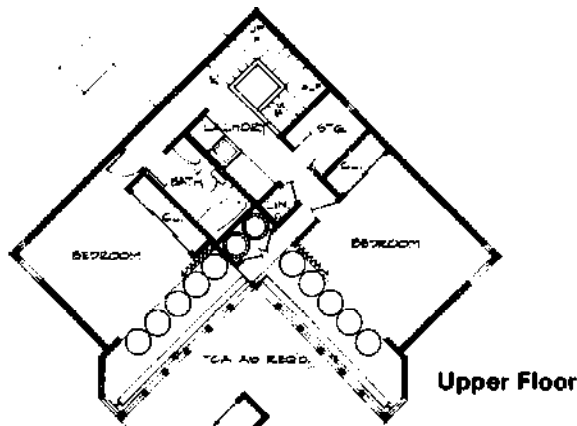

Lower Floor

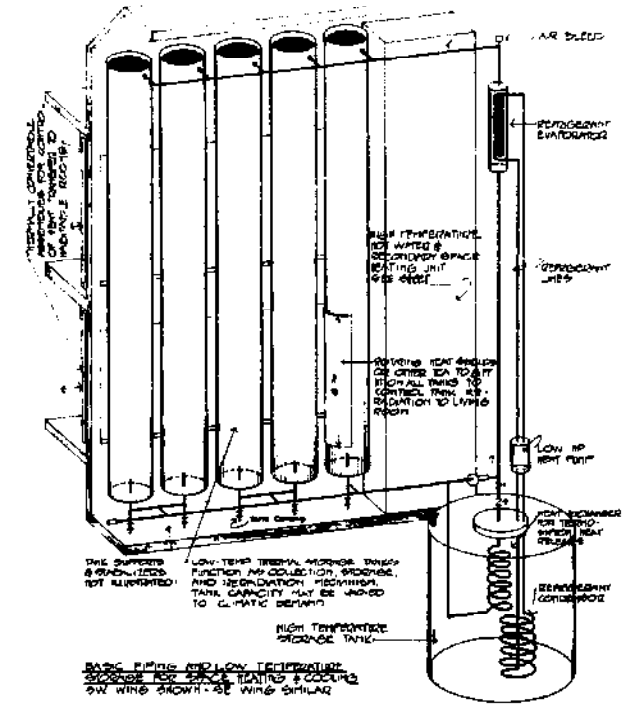
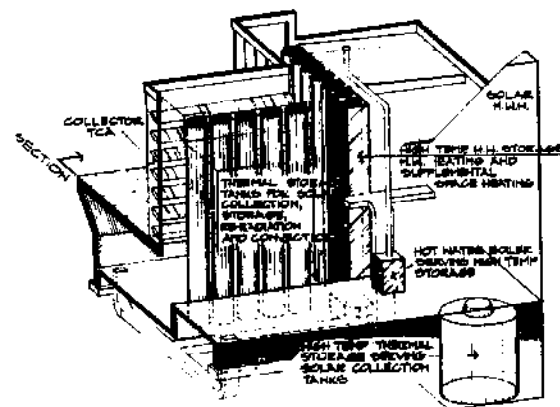
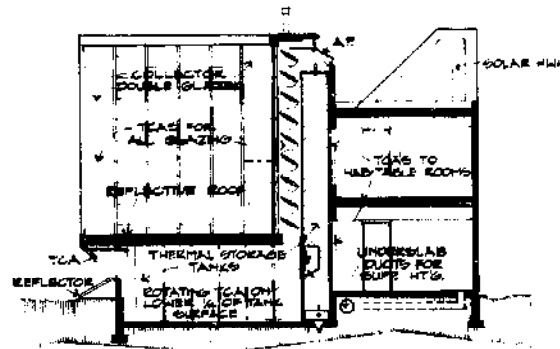

Adaptation of the prototype solar dwelling to hot-arid climates involves considerable modification of the plan and solar system to accommodate the higher cooling load associated with this climate. The major adaptations include: eliminating the special solar collector for space heating; interfacing the solar domestic hot water collector with the space heating system; using the maximum available roof area for evaporation-radiation cooling; reducing solar heat gain to the dwelling; and orienting the dwelling in

response to site wind conditions

The above adaptations affect the prototype design in several significant ways. Due to the low heating loads generally associated with hot dry climates, the use of a solar collection and storage concept of a type designed for cool or temperate climates is not deemed appropriate or economically reasonable. Instead, the domestic hot water heating system used on the Birdcage prototype is provided with a larger

collector (or a tracking collector) and the prototype back-up heating system is now used in a primary heating mode. The back-up hot water heater can be sized to carry the worst case heating demand plus hot water requirement. The heat storage and discharge tank is relocated in the stairwell to reduce unwanted heat transmission to habitable rooms during periods of cooling demand.

The roof of the prototype is redesigned in a stepped



#### BACKGROUND DATA

**ARCHITECT:** The Architects Taos

**CLIMATIC REGION:** Hot-arid

**BUILDING TYPE:** Single family detached

**AREA:** 1950 sq ft heated floor area

#### SOLAR SYSTEM

**COLLECTOR/STORAGE:** Thermal mass exterior walls

**DISTRIBUTION:** Natural radiation and convection from TCA equipped water tanks

**AUXILIARY ENERGY:** Fossil-fuel fired boiler heating solar domestic hot water storage tank, forced air distribution

**DOMESTIC HOT WATER:** Tracking circular concentrating collector to high temperature water tank w/ conventional water heater auxiliary

**SPACE COOLING:** Evaporative cooling ponds on roof to water storage tanks for radiant cooling

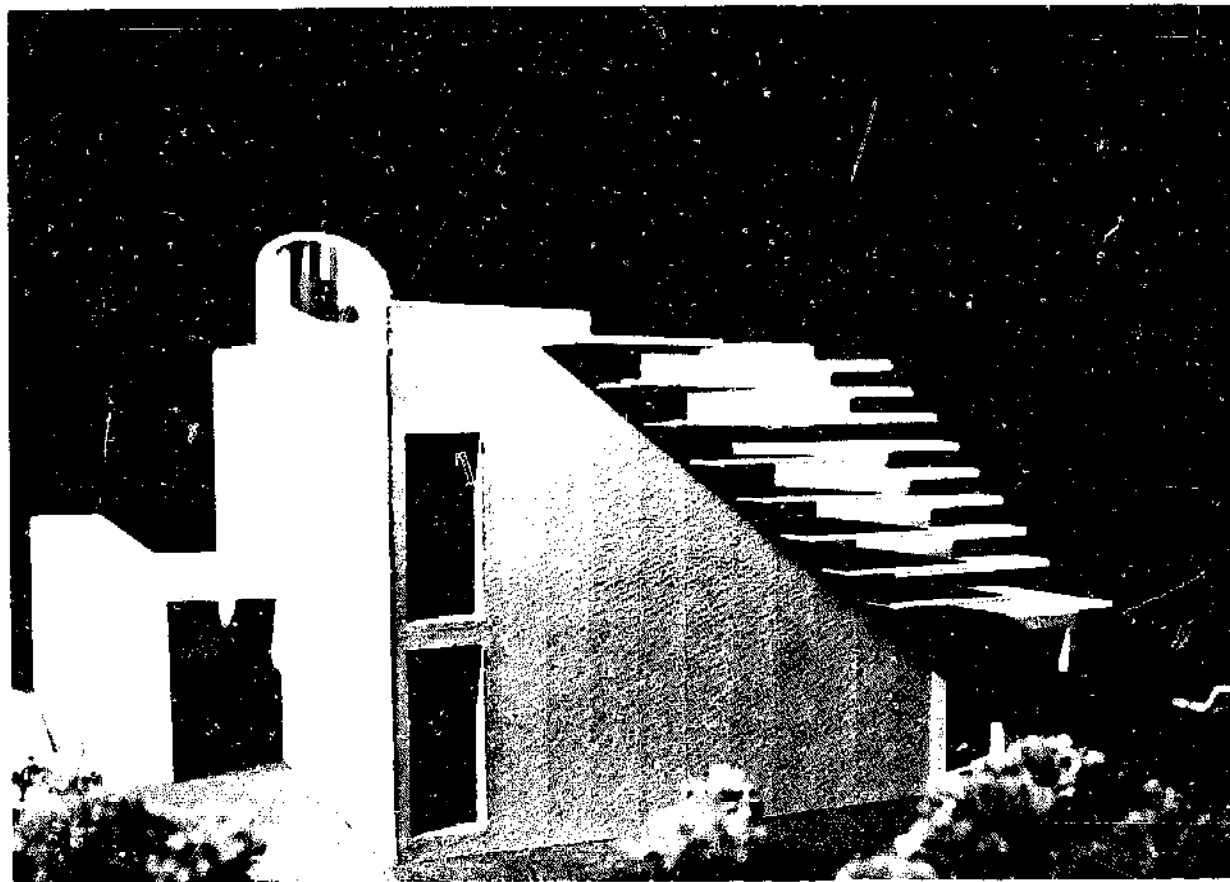

fashion to increase the cooling pond area to a net of 150 percent of first floor area. This was done to maximize the pond area, and not to meet a specific climatic requirement. Orientation of the dwelling is in respect to local wind conditions to maximize evaporation rates. As a consequence of the roof configuration, the thermal storage cooling tanks are relocated along the exterior walls

Windows are inset into the dwelling to achieve maximum shading. The inset allows an opportunity for exterior blinds and shades for situations where the orientation of the dwelling requires them. A sunshade is attached to the west wall of the dwelling to minimize late afternoon heat transmission to the storage cooling tanks.

imum shading. The inset allows an opportunity for exterior blinds and shades for situations where the orientation of the dwelling requires them. A sunshade is attached to the west wall of the dwelling to minimize late afternoon heat transmission to the storage cooling tanks.

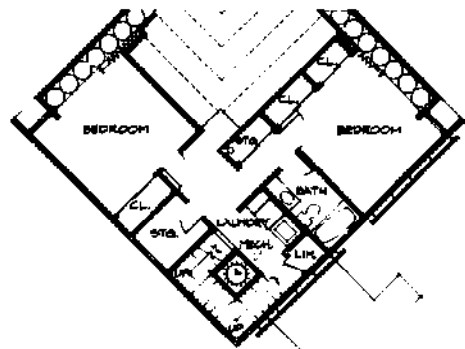

Upper Floor Plan

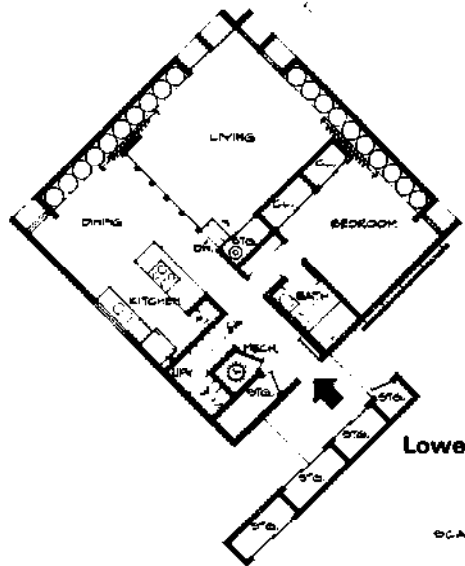

Lower Floor Plan

VARIES AS PER MICROCLIMATE  
SCALE 1/8" = 1'-0"

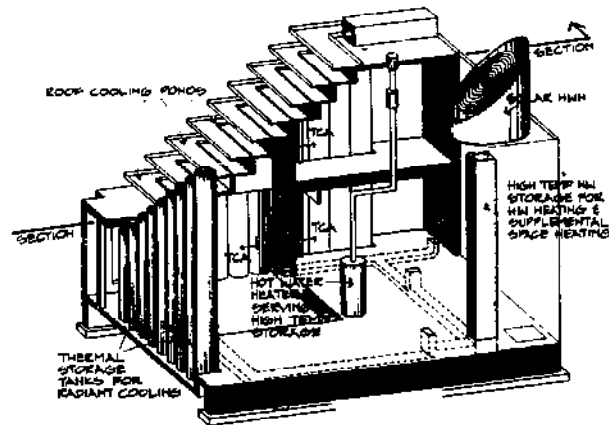
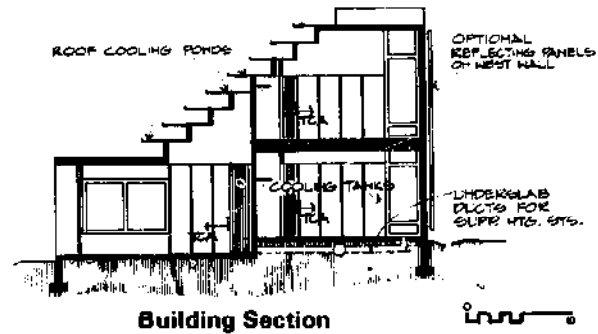

Cooling and Heating System Dimetric

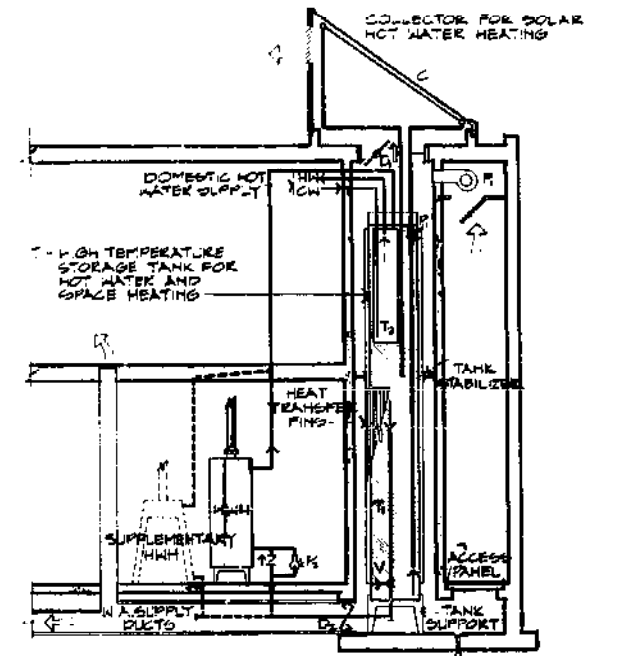

PICTORIAL SECTION ILLUSTRATING WATER HEATING STORAGE, TYPICAL PIPING, AND AIR FLOW



The firm, of Donald Watson, Architect, AIA, of Guilford, Connecticut has developed a self-sufficient single family, solar dwelling concept for cool-temperate climates that receives 100 percent of its heating requirement from solar energy. In addition, it has investigated the architectural factors influencing flat-plate collector area and its integration with other collector concepts and architectural features.

Prior to the development of a self-sufficient solar dwelling for cool-temperate climates, the architects

undertook a design study to investigate what percentage of flat-plate collector area might be reasonably incorporated into a dwelling design. An issue was a number of rules-of-thumb which indicated that a large collector area to heated floor space ratio was needed to obtain the most beneficial space heating capacity of a solar heating system. As a result, severe restrictions were placed on solar dwellings designed for cool and temperate climates. Obviously, the more efficient a flat-plate collector, the less collector area required and the greater the

design options in applying other solar collector concepts and architectural features.

The design study was based upon the following assumptions: 1) collector designs and efficiencies as currently available are integrated into the building envelope; 2) collectors are in a fixed position at optimum angles for winter space heating; 3) first floor of the south facade is left free of flat plate collectors in order to be available for windows, doors, patios, and greenhouse options; and 4) common design

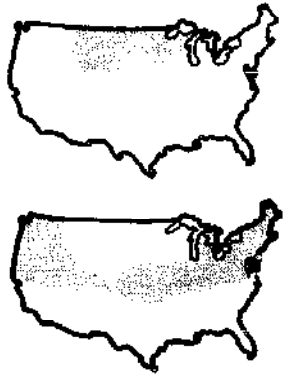

#### BACKGROUND DATA

**ARCHITECT:** Donald Watson, AIA

**CLIMATIC REGION:** Cool-Temperate

**BUILDING TYPE:** Single-family detached

**AREA:** 1000 sq ft, heated floor area (not including 270 sq ft greenhouse)

#### SOLAR SYSTEM

**COLLECTOR:** Liquid-cooled flat-plate, south-facing windows w/ insulated shutters, south-facing greenhouse

**STORAGE:** Water tank w/ heat exchanger, rock bin below greenhouse, thermal mass interior walls/floors

**DISTRIBUTION:** Forced air, natural radiation and convection

**AUXILIARY ENERGY:** Fireplace w/ heat exchanger to storage

**DOMESTIC HOT WATER:** Storage tank w/ heat exchanger

**SPACE COOLING:** Natural ventilation



standards and dimensions encountered in general house construction practice are applied.

Given these limits, the number of alternative collector panel locations are reduced to four basic sections, shown below. Section A has the greatest collector area to heated floor space ratio (60 percent) while section D has the least (20 percent). Next, a floor plan was developed which enabled any three of the four alternative sections to be variously combined in one dwelling. A number of

design alternatives emerge if the four basic sections are combined with any one of the plan locations. For example, there is one alternative design solution with a collector area to space enclosed ratio of 60 percent, while there are eight alternatives with a 40 percent ratio. Some of these alternatives are shown below.

What becomes apparent as a result of this simplified exercise is that within a 40 percent collector coverage ratio, there are a sufficient number of

design alternatives offered to meet various site, climate, and density requirements, and the number of alternatives greatly diminishes above 40 percent. Thus, while cool and temperate climates do represent the worst case for solar engineering restrictions, it is possible for solar design to flourish relatively unburdened by collector coverage requirements if collector efficiencies allow solar heating capacities to be achieved with collector coverage not exceeding 40 percent of the heated floor area.

### Alternative Sections



SECTION A

up to 60% collector/floor area ratio  
clerestory roof monitor  
no 2nd fl. south windows

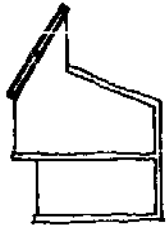

SECTION B

up to 40% collector/floor area ratio  
clerestory roof monitor  
2nd fl. south windows or balconies



SECTION C

up to 40% collector/floor area ratio  
minimum wind exposure  
no 2nd fl. south windows

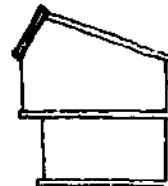

SECTION D

up to 20% collector/floor area ratio  
2nd fl. south windows or balconies

### Alternative Ground Floor Arrangements

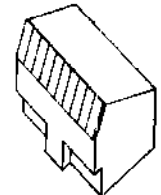
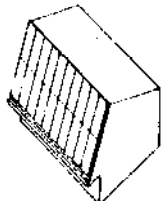

SHADED SOUTH WINDOWS

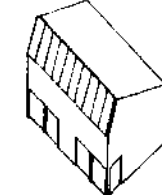
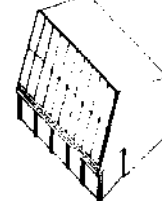

SUNPORCH

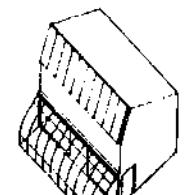
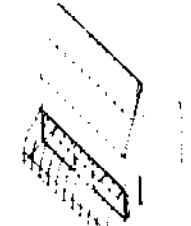
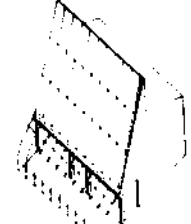

GREENHOUSE

Based upon the preceding analysis and the range of solar concepts and components available for inclusion in solar dwelling design, a self-sufficient solar dwelling for cool and temperate climates was developed by the designers. Given high insulation standards with additional thermal efficiency through room layout, internal zoning, and fireplace design, the design concept is largely independent of non-renewable fossil fuels for space heating. The solar system is designed to provide 80 percent or more of the annual heating requirements. The dwelling totals

1,000 square feet of heated floor space, not including the intermediate greenhouse/sun room of 270 square feet. The net collector area is 400 square feet.

Numerous thermal control strategies are incorporated into the design. These include: *fireplace*, with an extended flue to absorb chimney heat, located on the plan interior to operate in tandem with the solar heating system; *internal zoning* of living and bedroom areas within minimal envelope of

1,000 square feet, extendable to the intermediary spaces, temperatures permitting; *resistive insulation* in the walls and roof; *windows* with large fixed lights and smaller operable ventilators, all with insulating shutters; and a *roof monitor* for controlled ventilation, natural cooling and natural lighting.

The concept includes several storage elements in tandem. Water storage is in an insulated concrete tank provided with a removable liner and heat exchange coils. The domestic water heater has a

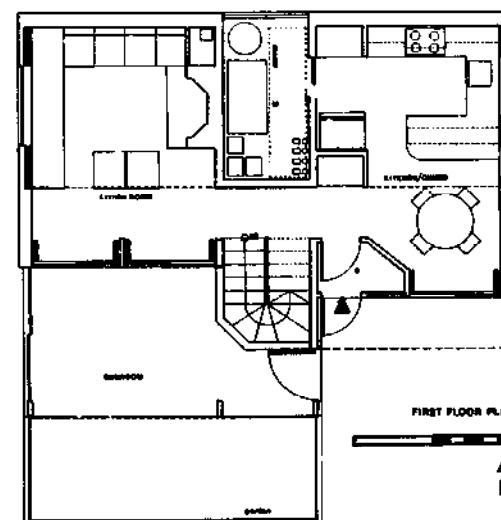
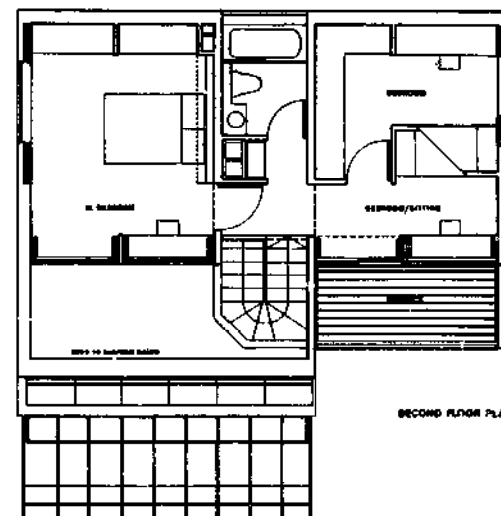
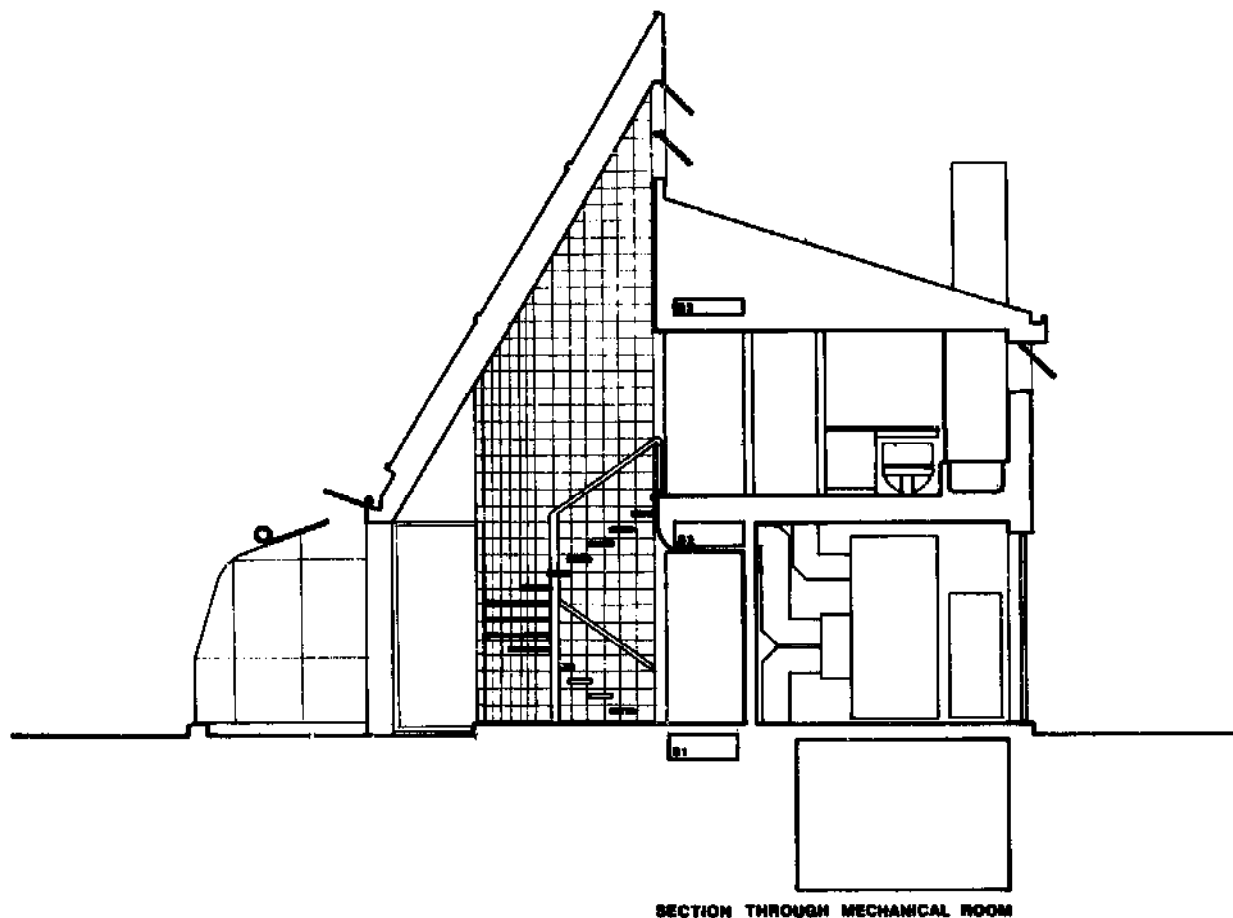

heat exchange coil between it and the larger water storage to preheat water from the well or main. The thermal capacity of the masonry floors and walls and the fireplace mass acts as a low temperature heat sink, to moderate daytime overheating and by a time lag effect, to distribute daytime heat during the cooler evening hours. This is necessary to control overheating in the greenhouse and behind the south-facing windows.

The distribution component is sized to permit the efficient movement of low temperature air and is consolidated within the structure and the mechanical core. Two return air systems permit independent zoning of the greenhouse and of the house proper. A return air vent is located high in the two story roof monitor space to capture heated air and recirculate it to a rock pile under the sunroom.

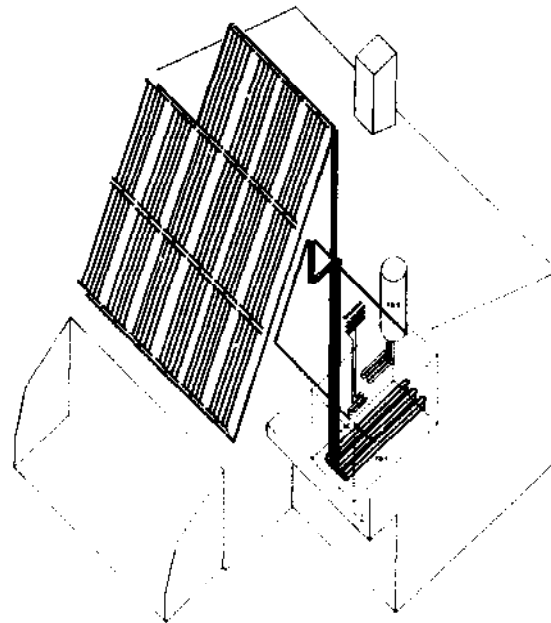

**Collector to Storage Transport Subsystems**

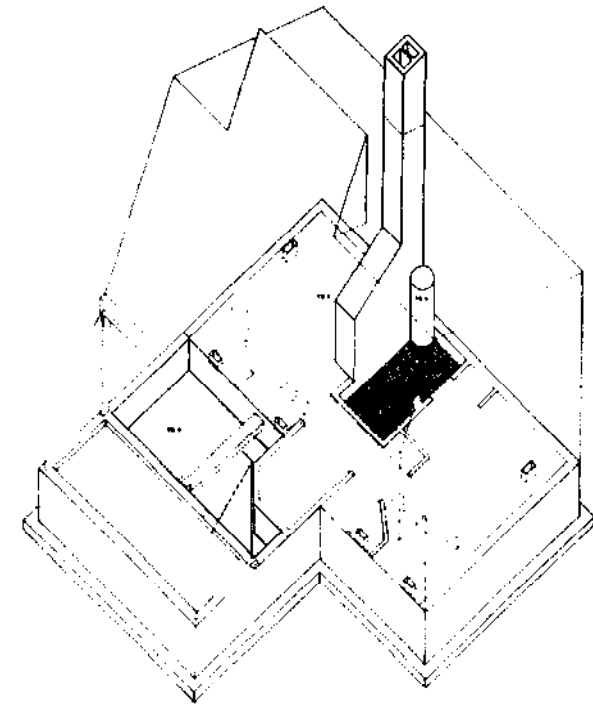

**Thermal Storage Subsystems**

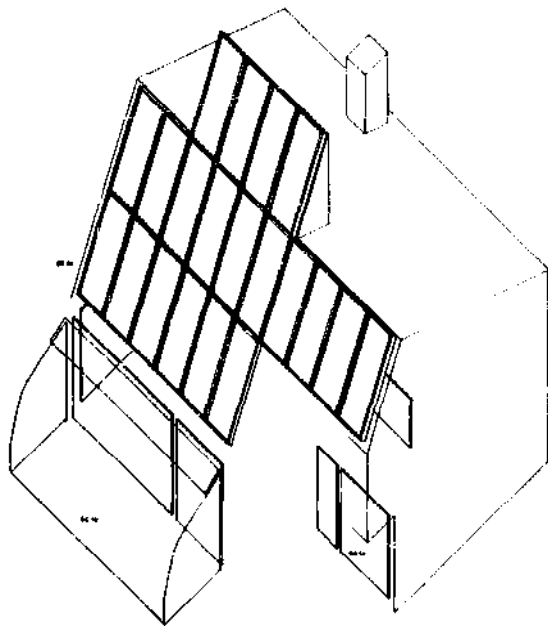

**Solar Collector Subsystems**

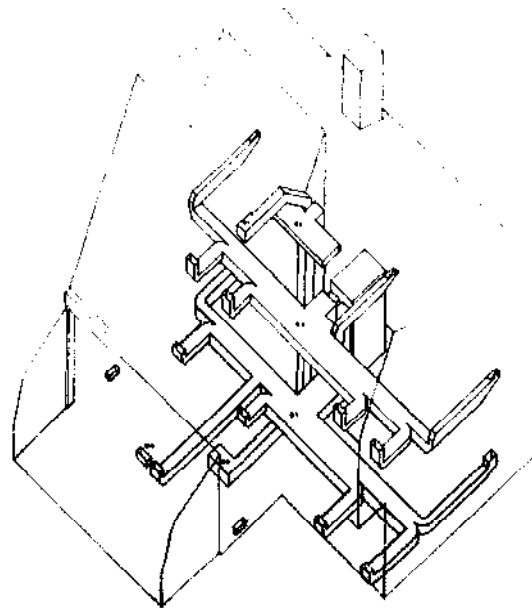

**Storage to Room Distribution Subsystems**

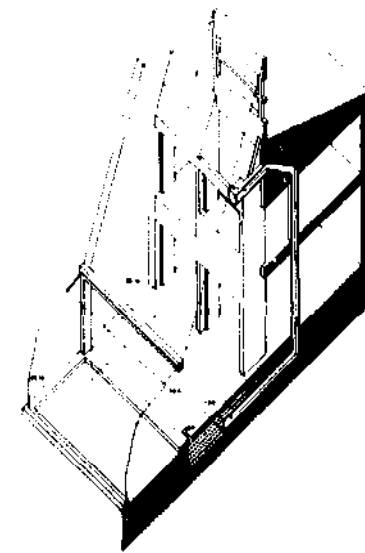

**Greenhouse Heating System**

Giffels Associates of Detroit, Michigan has designed a low-rise, multi-family solar dwelling for each of the four climatic regions of the United States. The multi-family solar concepts are based upon one prototypical living unit which is modified to suit the design requirements of each climatic region. Although the basic nature of the living unit remains the same, significant differences in building design result because of climatic conditions. A similar solar system is used for each concept: each multi-family complex has a central solar collection and storage

system with individual fan-coil distribution units in each living unit.

The basis for all the design concepts is the prototypical living unit. The number of living units in each concept varies because of differences in site acreage and housing density. However, the architectural program requirements for the living units remain the same. The prototypical living unit is a two bedroom, two story residence, adaptable to occupancy by sharing adults or small families, and con-

taining about 1,200 square feet. The living unit includes a number of design features which directly or indirectly affect the energy needs of the unit and the use of energy by the occupants, as these vary from region to region.

The living units for cool regions are organized in four buildings, around a central community space enclosed for protection from cold winter winds. The buildings range in height from one to four stories, with roofs and roof-mounted solar energy collectors



## BACKGROUND DATA

**ARCHITECT:** Giffels Associates, Inc.

**CLIMATIC REGION:** Cool

**BUILDING TYPE:** Low-rise multi-family, four buildings

**AREA:** 1100 sq. ft. heated floor area per unit

## SOLAR SYSTEM

**COLLECTOR:** Liquid-cooled flat-plate, south-facing windows/skylights w/ insl. shutters

**STORAGE:** Central compartmentalized water tank

**DISTRIBUTION:** Fan-coil forced air each living unit

**AUXILIARY ENERGY:** Gas-fired boiler w/ heat exchanger in central storage tank, fireplace

**DOMESTIC HOT WATER:** Preheat tank in central storage w/ gas-fired auxiliary

**SPACE COOLING:** Natural ventilation

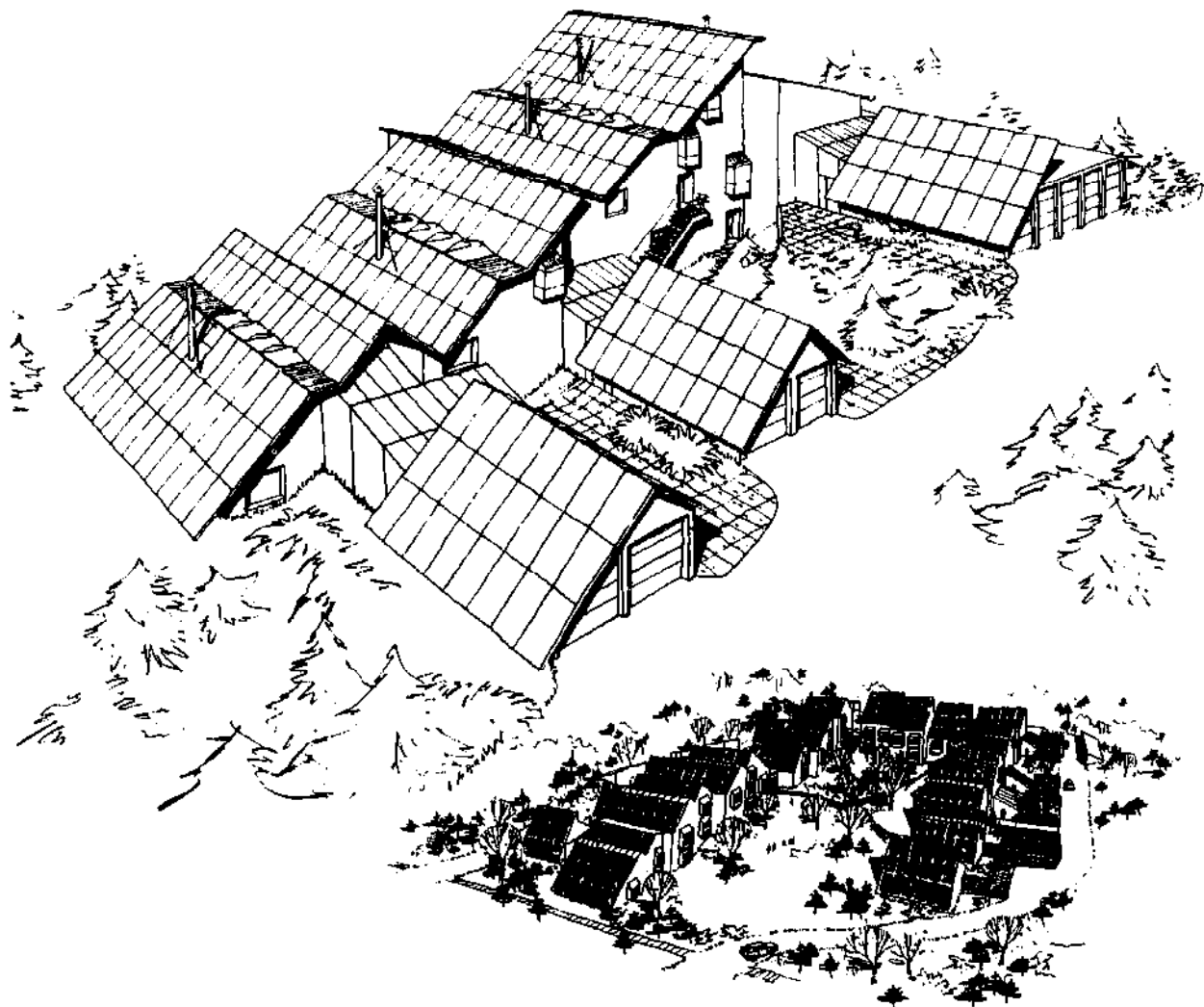

oriented to the south-southeast. To provide the large collector area required, garage roofs are also used to house solar energy collectors. Garages and skylit covered entry courts are clustered about the west, north, and east sides of the buildings to isolate the living units from the on-site traffic and the cold winter winds. Fences, coniferous vegetation and hedges augment this protection as well as sheltering the entry points. Additional enclosure and buffer space is provided by smaller sheds along exterior surfaces and garages.

Energy conserving features for cool regions include a central fireplace and kitchen for maximum use of generated heat, skylights for solar radiation collection and daylight penetration, and bay windows at the east and west exterior walls to provide an insulating buffer between interior and exterior conditions.

The solar energy system for cool regions supplies space heating and domestic hot water heating only. Solar cooling is not provided because the need for cooling in this region is relatively small and the cost

and sophistication of solar cooling systems at present are high. With proper considerations for energy conservation and natural ventilation, space cooling should not be necessary during most of the cooling season.

Solar radiation is collected by liquid-cooled flat-plate collectors with a water/antifreeze transport fluid. The solar heated fluid is stored in two insulated tanks, located in the basement of each building. When heating is required, the heated fluid is pumped from the primary heat storage tank to individual fan-coil units located within each living unit. Space heating is augmented by ductwork integral with the fireplace. A second and smaller storage tank is used to heat the domestic hot water, while a gas-fired furnace heats both storage tanks when solar produced temperatures are not sufficient.

The exceptionally large collector area — approximately 1000 square feet per living unit — captures sufficient solar energy to meet over 90% of each unit's heating and domestic hot water requirements.

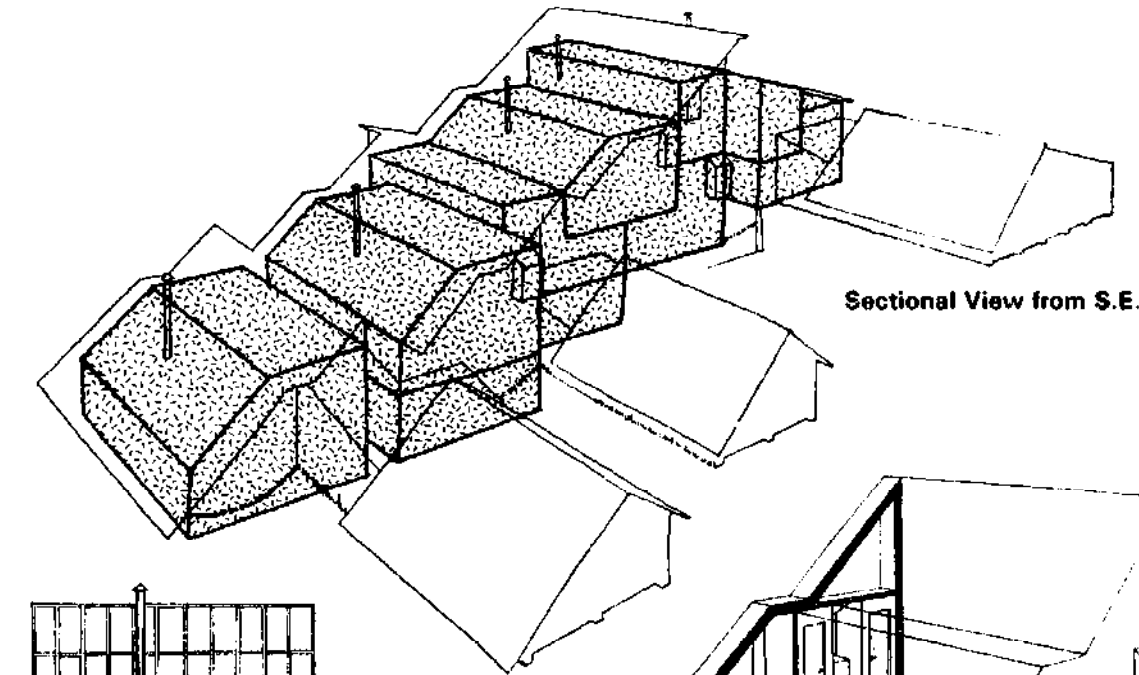

**Sectional View from S.E.**

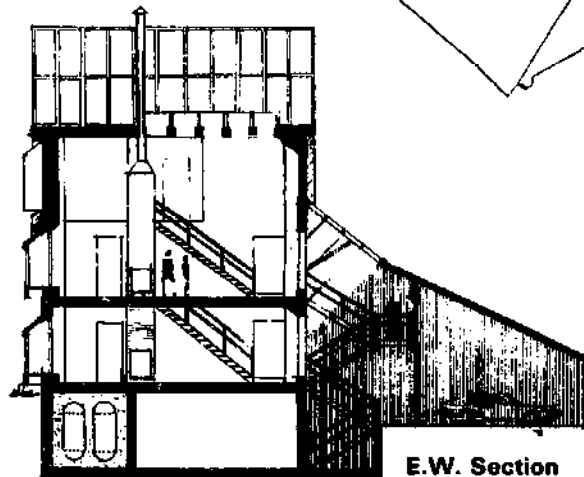

**E.W. Section**

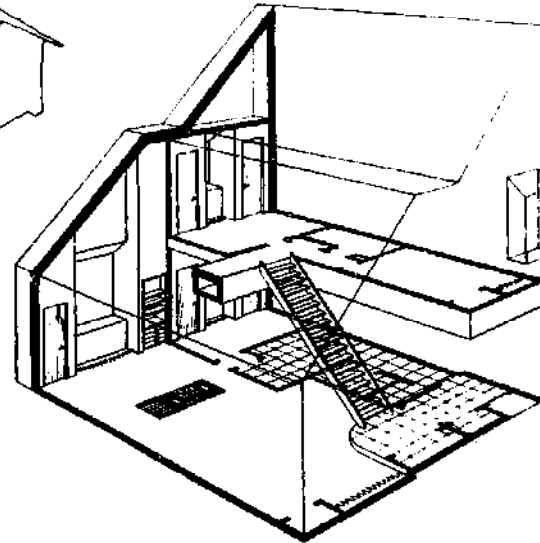

**Cutaway Perspective of Living Unit**

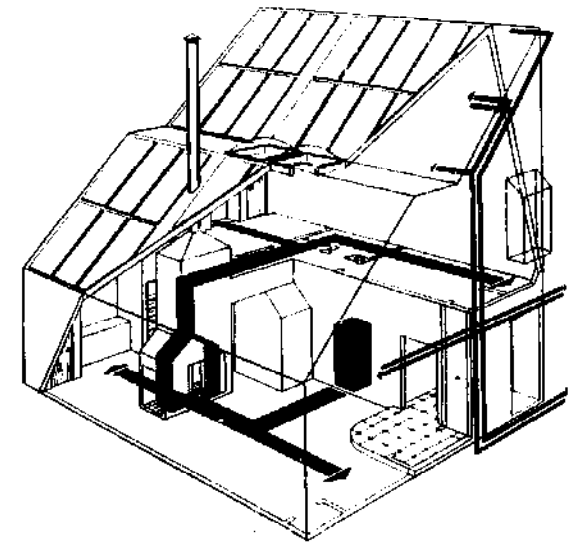

**Cutaway Perspective of Solar Energy System**

The design concept for a temperate climate has the living units clustered within six buildings, oriented to provide protection of exterior spaces from winter winds and exposure to solar radiation. The buildings vary in height from one to three stories, with roofs and roof mounted solar collectors facing the south-southwest. The garage roofs are also used to house the large collector area required in temperate climates.

The prototypical living unit is modified by adding two



#### BACKGROUND DATA

**ARCHITECT:** Giffels Associates, Inc

**CLIMATIC REGION:** Temperate

**BUILDING TYPE:** Low-rise multi-family, six buildings

**AREA:** 1200 sq. ft. heated floor area per living unit

#### SOLAR SYSTEM

**COLLECTOR:** Liquid-cooled flat-plate, south-facing windows/skylights w/ insulated shutters

**STORAGE:** Central compartmentalized water tank

**DISTRIBUTION:** Fan-coil forced air each living unit

**AUXILIARY ENERGY:** Gas-fired boiler w/ heat exchanger in central storage tank, fireplace

**DOMESTIC HOT WATER:** Preheat tank in central storage w/ gas-fired auxiliary

**SPACE COOLING:** Natural ventilation

unheated but glazed porches adjacent to the living and dining spaces. This provides for porch space in lieu of the interior space during the summer, as well as providing a thermal barrier during the winter. Four skylights located centrally in the house supply natural light, as well as solar heat in the winter. Insulated shutters close off the skylights during cold winter nights and hot summer days.

The solar system for a temperate climate is identical to that for a cool region. Again, a heating only

system is used because of the small amount of cooling required. Roof mounted liquid-cooled flat-plate collectors are used in conjunction with two central storage tanks. The heated fluid from the collector passes through the first, heating the domestic hot water and into the second, where it is available for circulation to individual fan-coil units located in each living unit. A heat exchanger warms air for distribution throughout the residence.

The large amount of solar collector area together

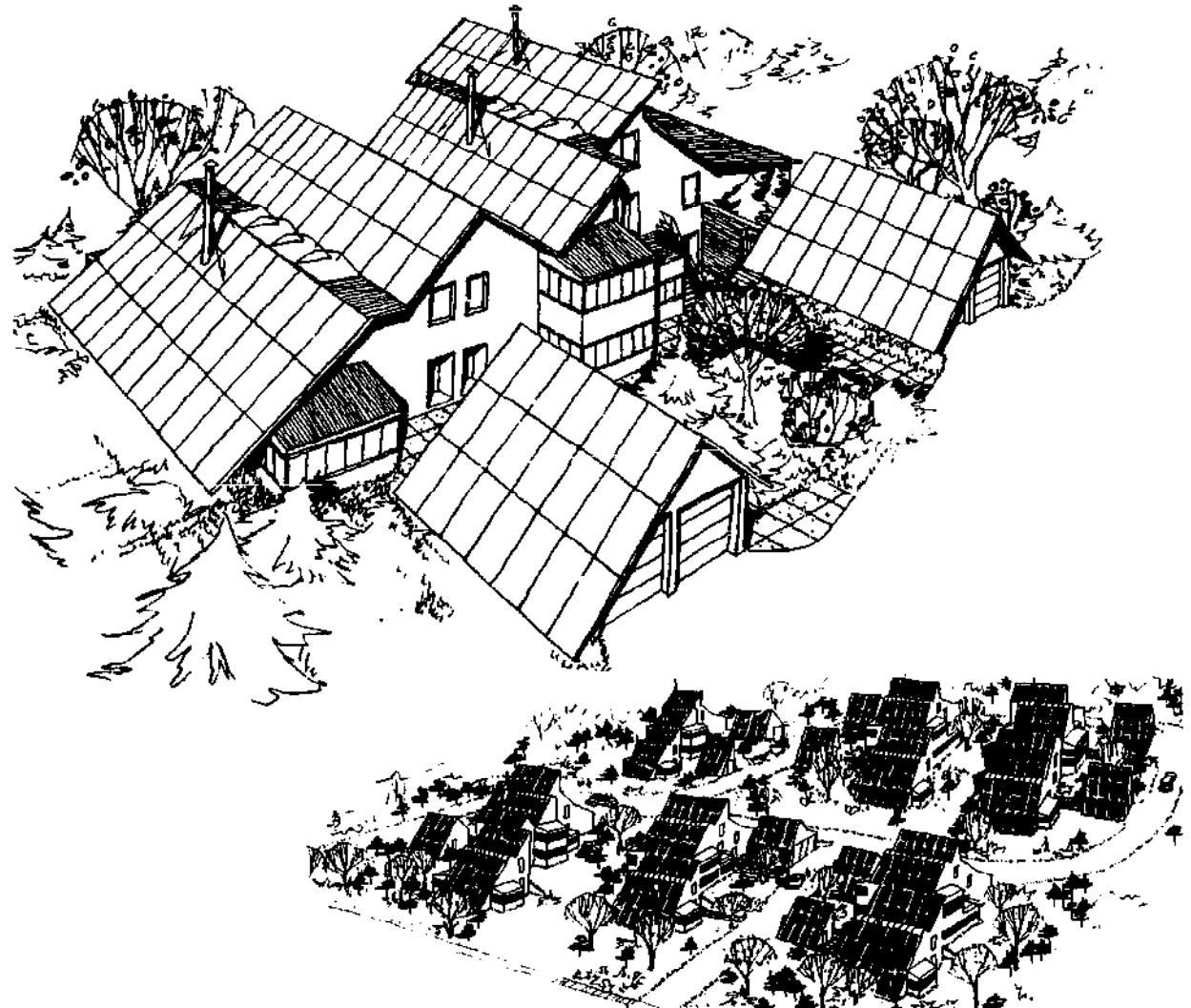

with a compact floor plan enables the solar system to supply more than 90% of each unit's heating and domestic hot water requirement.

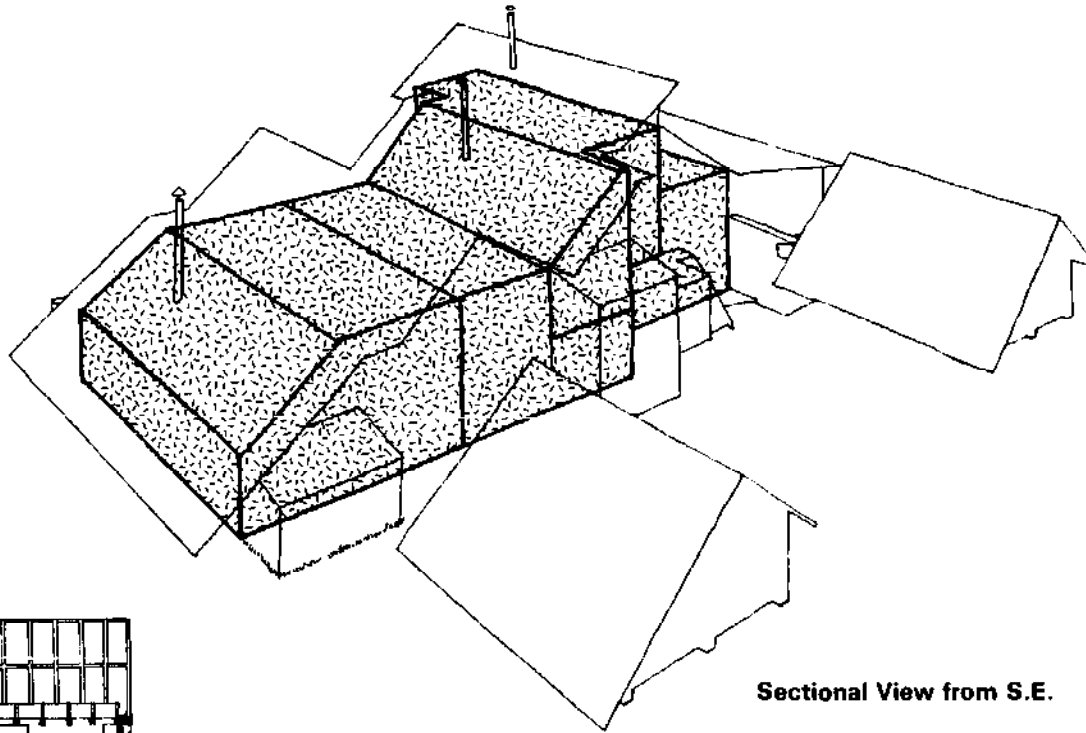

Sectional View from S.E.

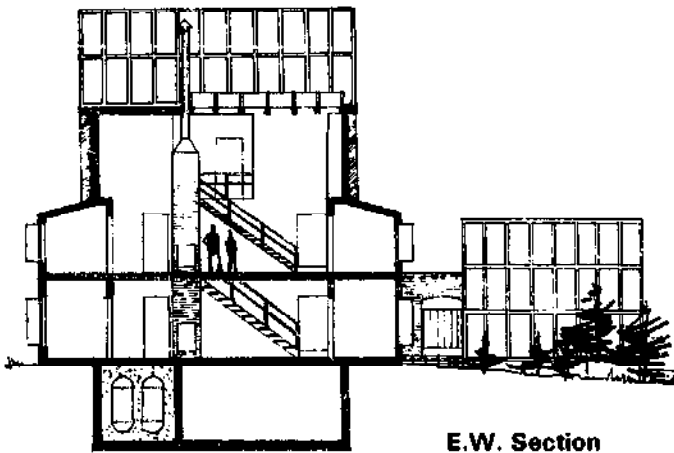

E.W. Section

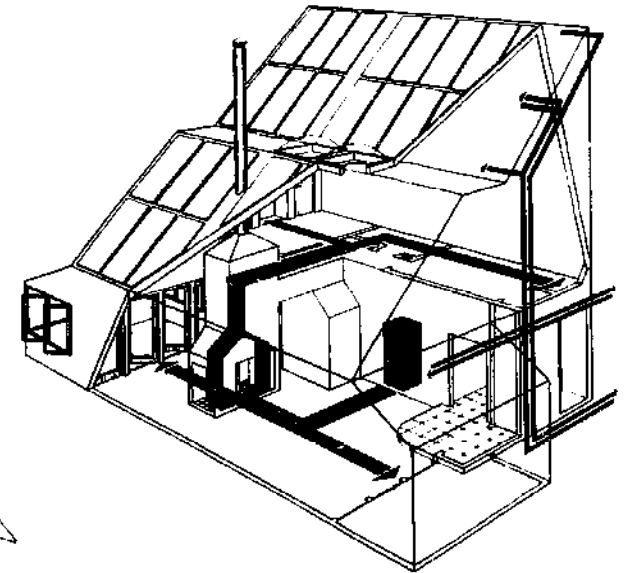

Cutaway Perspective of Solar Energy System

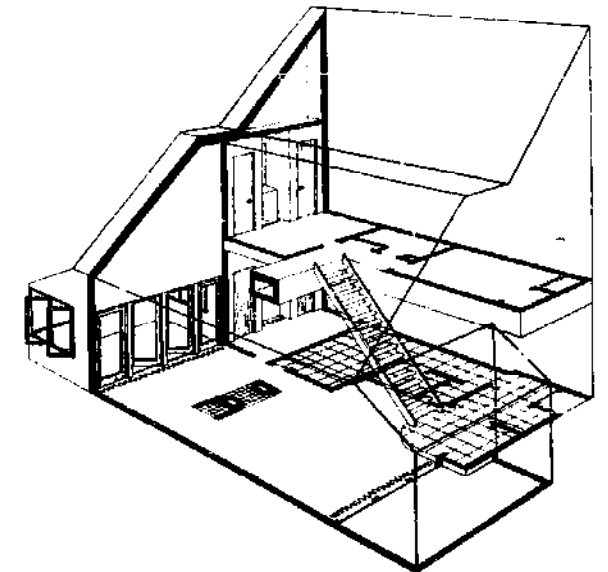

Cutaway Perspective of Living Unit



The design concept for a hot-humid climate has the living units arranged in four buildings around a central community space. The buildings are oriented to expose each living unit to a cooling north-south summer wind. The buildings are three stories in height raised above partial basement areas and utilize double roof construction. Parking shelter roofs are used to house the solar collectors, and berm construction beyond the parking covers the heated fluid storage. The southern exposure of all the buildings is protected from direct sunlight by large

horizontal louvered sunscreens, open balconies, exterior living spaces and open entryways. These elements combine with the double roof construction to provide almost total isolation of the building from hot direct sunlight.

The solar system for the hot-humid region has provisions for both solar heating and cooling, to provide relief from the long periods of high temperature and humidity and the relatively short periods of cool temperature.

Adjustable liquid-cooled flat-plate collectors are located on the parking shelter roofs. A water/antifreeze solution absorbs solar radiation as it passes through the collectors. The heated fluid is transported to a central storage area buried beneath an earth berm. Each building has its own collection and storage element. Storage consists of three separate insulated tanks: a domestic hot water heating tank, a main low temperature tank for space heating and a high temperature tank for space cooling. As the heated fluid arrives from the collector,



#### BACKGROUND DATA

**Architect:** Giffels Associates, Inc.

**CLIMATIC REGION:** Hot-humid

**BUILDING TYPE:** Low-rise multi-family, four buildings

**AREA:** 1000 sq. ft. heated floor area per unit

#### SOLAR SYSTEM

**COLLECTOR:** Liquid-cooled flat plate

**STORAGE:** Central compartmentalized water tank

**DISTRIBUTION:** Fan-coil forced air in each living unit

**AUXILIARY ENERGY:** Gas-fired boiler w/ heat exchanger in central storage tank, fireplace

**DOMESTIC HOT WATER:** Preheat tank in central storage w/ gas-fired auxiliary

**SPACE COOLING:** Central absorption unit w/ hot water from central storage tank boosted by gas-fired auxiliary, fan-coil forced air distribution in each living unit

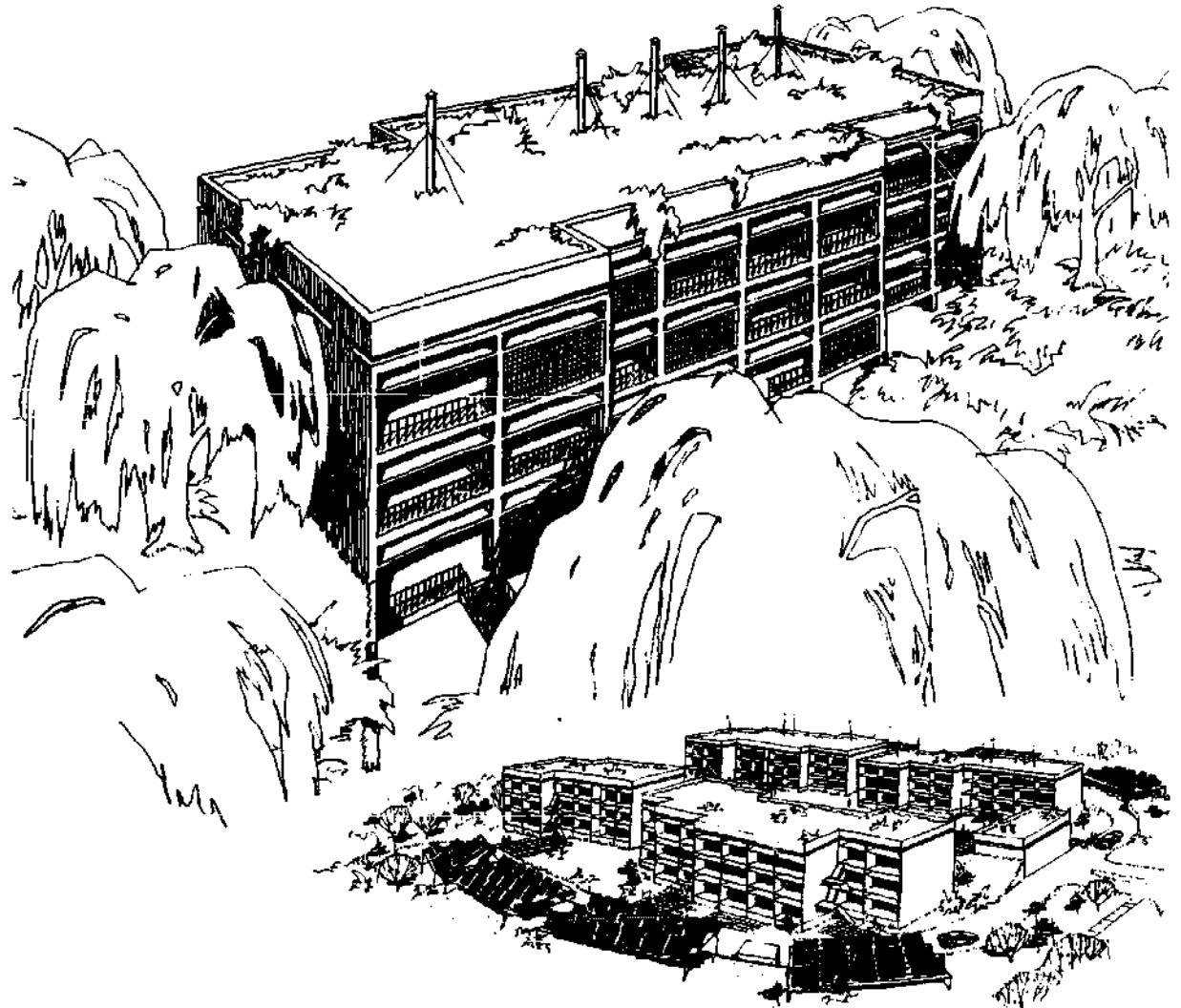

it first passes through the domestic water storage tank where a heat exchanger transfers some of the captured heat to the domestic water supply. the solar heated fluid then flows into the main low temperature storage tank

During the heating season, the fluid is stored here until there is a heating demand in one of the living units. Upon initiation for this demand, part of the stored solar heated fluid is pumped to the unit's individual fan-coil unit where the heat is transferred.

via a heat exchanger, to the hot air ductwork distribution system within the dwelling unit

During the cooling season, part of the solar heated fluid is pumped to a separate storage tank where it is elevated in temperature by a gas-fired heater to provide the higher temperatures needed by the absorption cooling machine. The building's central absorption cooling machine generates the chilled water for the individual dwelling unit's fan-coil air-conditioners. The fluid cooled air is distributed by living unit's ductwork

The domestic hot water, main solar heated fluid storage tank, and the high temperature fluid storage tank are supplemented by gas-fired auxiliary heating units, where the auxiliary heat is transferred to the solar storage systems via the use of fluid-to-fluid heat exchangers

The solar system is designed to meet over 90% of the building's heating and domestic hot water requirements and over half the building's cooling needs

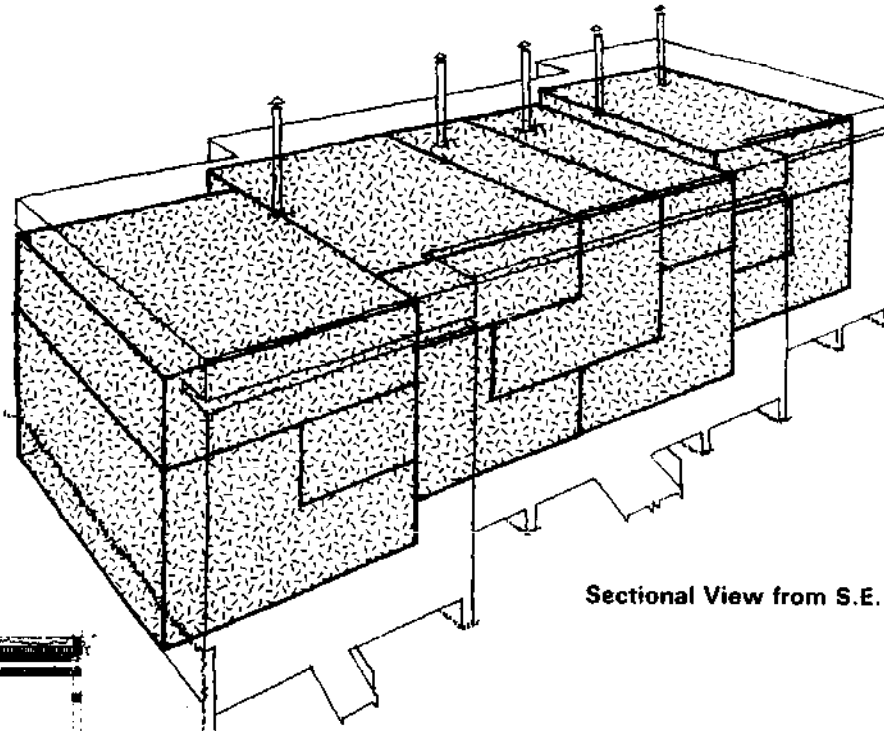

Sectional View from S.E.

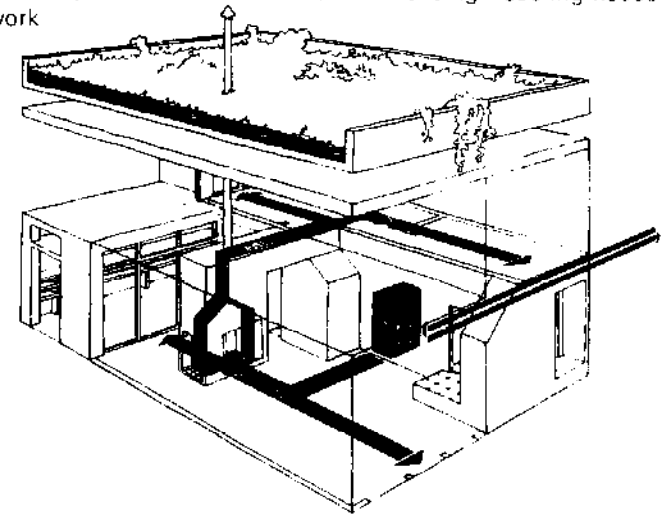

Cutaway Perspective of Solar Energy System

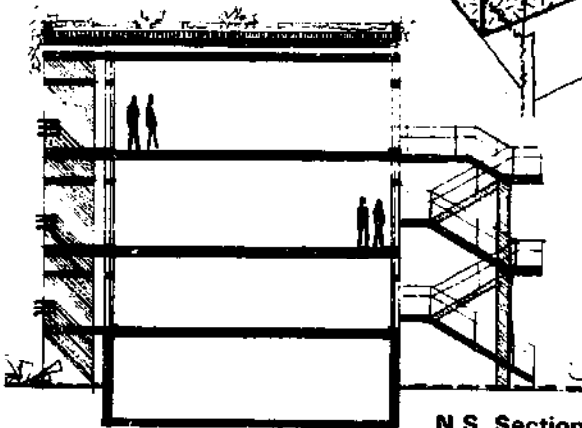

N.S. Section

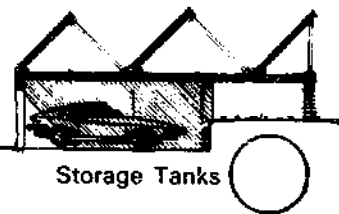

Storage Tanks

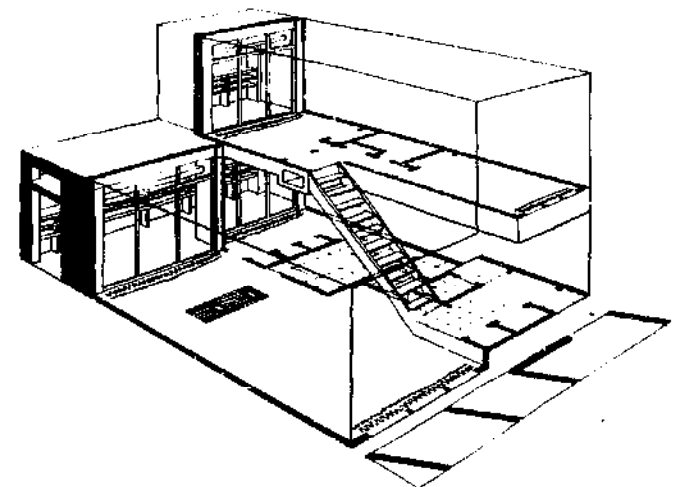

Cutaway Perspective of Living Unit

The design concept for hot-arid climates consists of two buildings along a central community space. The buildings are oriented to capture a cooling east-west summer breeze. The buildings are three stories in height, with partial basements for storage and laundry facilities. Double roof construction, similar to that of the hot-humid design concept is used to collect rainwater and shield the roof area from hot summer suns. Vertical louvered sun screens, open balconies, awnings and other elements are also incorporated in

the design to reduce exposure of the building to direct sunlight

The solar system provides both solar heating and cooling as well as domestic water heating. Solar cooling is very appropriate for hot-arid climates due to the long periods of high temperature. The solar system is identical to that used for hot-humid regions. The collectors, however, are located on the roof of the building. Three storage tanks are again

used with distribution of hot and cold air by fan-coil units in each living unit

The collector area totals approximately 700 square feet per living unit, sufficient to meet over 90% of the building's heat and domestic hot water requirements, and over half the building's cooling needs



#### BACKGROUND DATA

**ARCHITECT:** Giffels Associates, Inc.

**CLIMATIC REGION:** Hot arid

**BUILDING TYPE:** Low-rise multi-family, two buildings

**AREA:** 1100 sq. ft. heated floor area per living unit

#### SOLAR SYSTEM

**COLLECTOR:** Liquid-cooled, flat-plate

**STORAGE:** Central compartmentalized water tank

**DISTRIBUTION:** Fan-coil forced air each living unit

**AUXILIARY ENERGY:** Gas-fired boiler w/ heat exchanger in central storage tank, fireplace

**DOMESTIC HOT WATER:** Preheat tank in central storage w/ gas-fired auxiliary

**SPACE COOLING:** Central absorption unit w/ hot water from central storage tank boosted by gas-fired auxiliary, fan-coil forced air distribution in each living unit

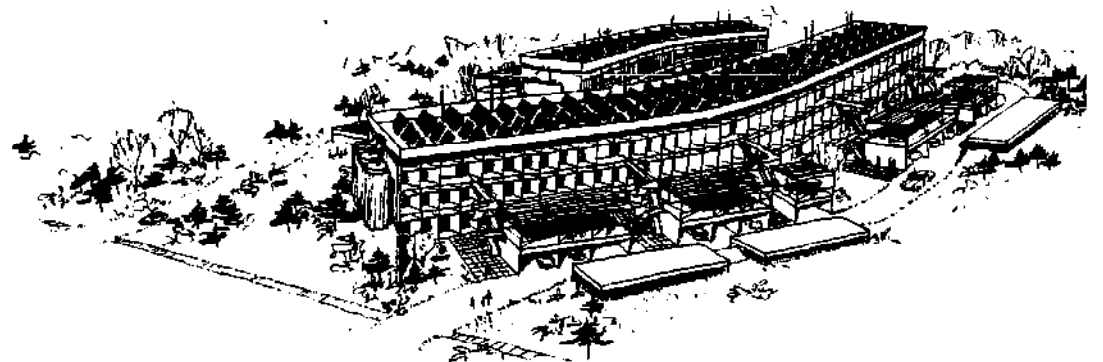
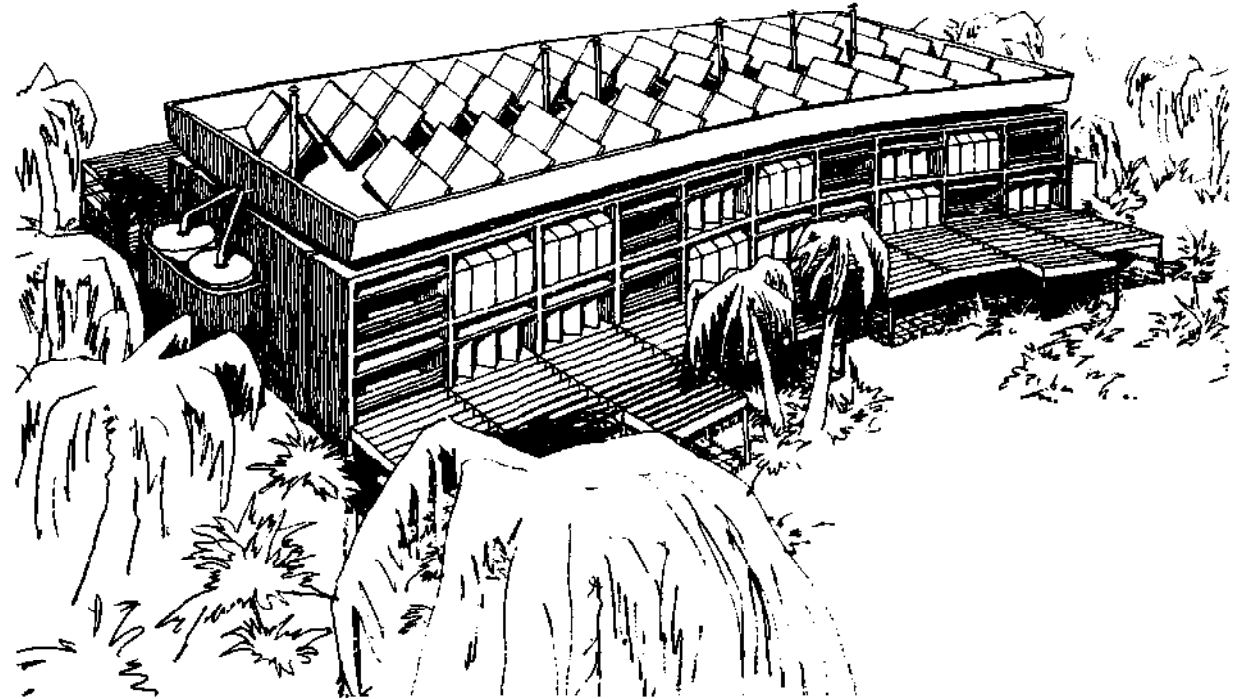

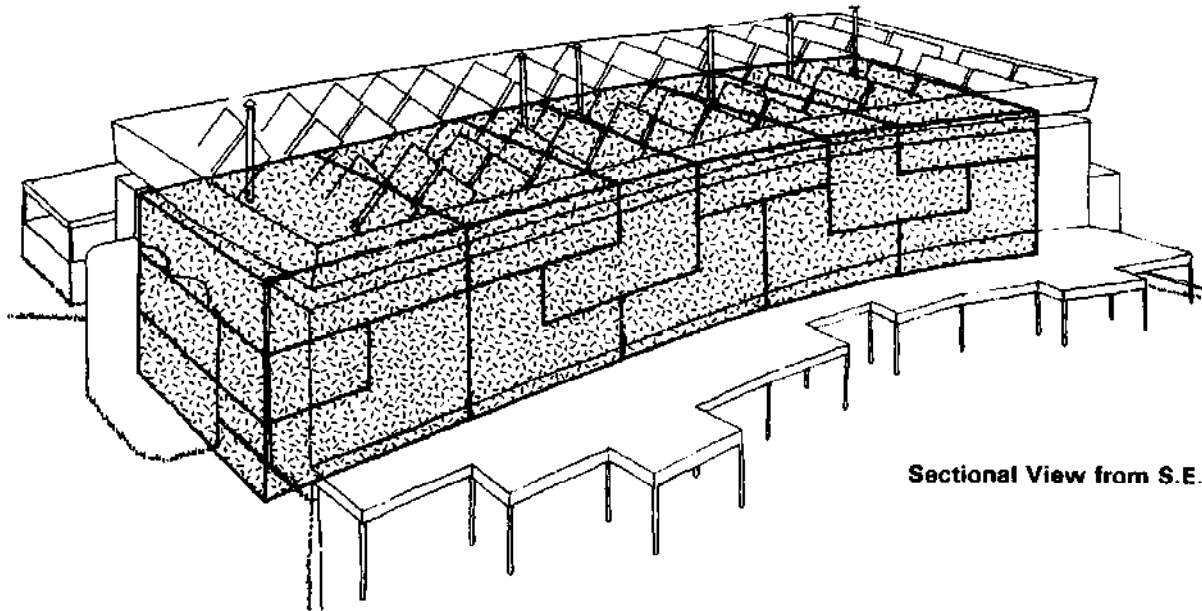

Sectional View from S.E.

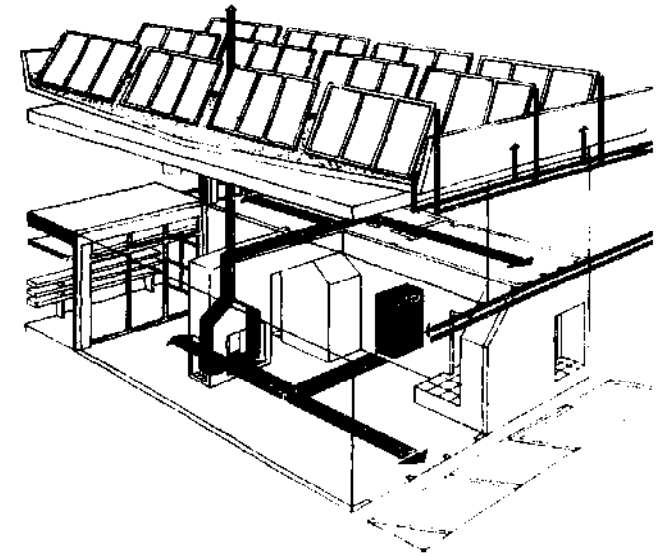

Cutaway Perspective of Solar Energy System

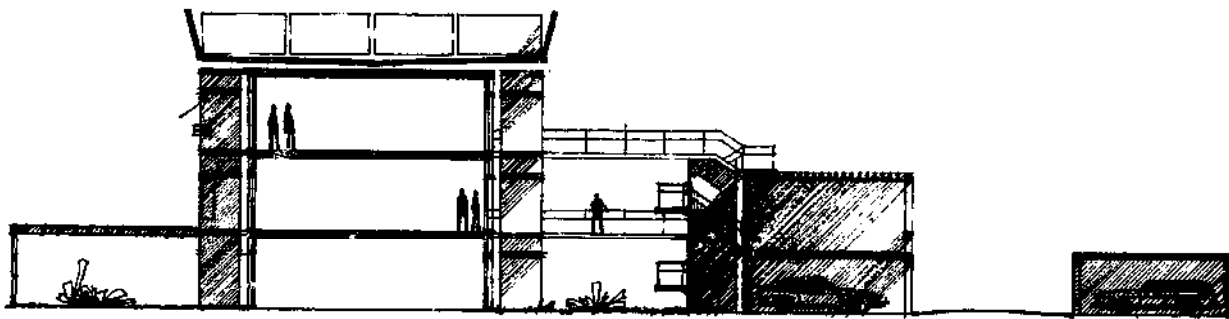

E.W. Section

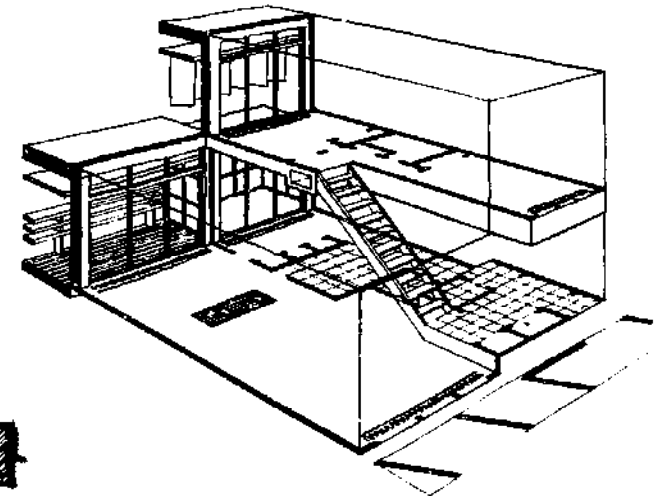

Cutaway Perspective of Living Uni

The Continuum Team of Bridgeport, Connecticut has designed a low-rise multi-family solar dwelling for the climatic conditions of cool and hot-arid regions. A prototypical living unit is the basis for dwelling design in each region. The designers have focused on the integration of applicable solar systems into the dwelling concept and the modification of the living unit to accommodate the climatic conditions of cool and hot-arid regions.



#### BACKGROUND DATA

**ARCHITECT:** The Continuum Team

**CLIMATIC REGION:** Cool

**BUILDING TYPE:** Low-rise multi-family clusters

**AREA:** 1215 sq. ft. heated floor area per unit

#### SOLAR SYSTEM

**COLLECTOR:** Liquid-cooled flat-plate, semi-focused, altitude tracking windows w/ insulating panels, south-facing windows w/ insulating shutters

**STORAGE:** Central compartmentalized water tank, thermal mass of walls/floor

**DISTRIBUTION:** Forced radiation from baseboard radiators, forced air from central air chamber

**AUXILIARY ENERGY:** Fossil-fuel fired boiler

**DOMESTIC HOT WATER:** Preheat coils through central storage to preheat tank w/ conventional water heater auxiliary

**SPACE COOLING:** Natural ventilation, precool ducts buried in earth connected to central air chamber.

A three bedroom "L" shaped prototypical living unit was developed by the design team. The prototype living unit is capable of being stacked and arranged to accommodate different densities and site conditions. In addition, the living unit is adaptable to design constraints imposed by different solar systems and different climatic conditions

The prototype living unit is organized with other units to form a multi-family cluster. The clusters are arranged for a cool region to shield habitable spaces

from northwest: winter winds while exposing maximum opening and surface area for solar collection and natural ventilation. Entries and stairways are enclosed for weather protection and bedroom closets are placed along the north wall for increased thermal insulation. The heat loss of the multi-family clusters is reduced to about half that of conventional housing by the use of additional insulation, careful placement and design of fenestration, and the use of shutters, closure panels and other window treatment

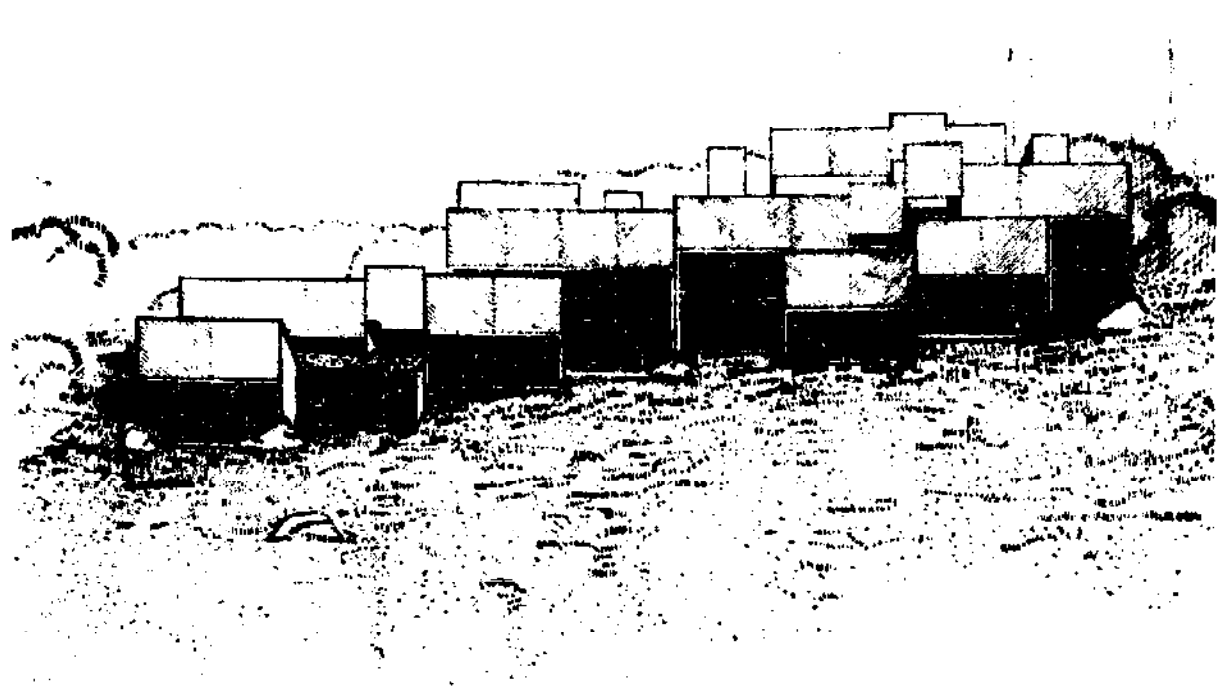

**View with Reflective Panels Closed**

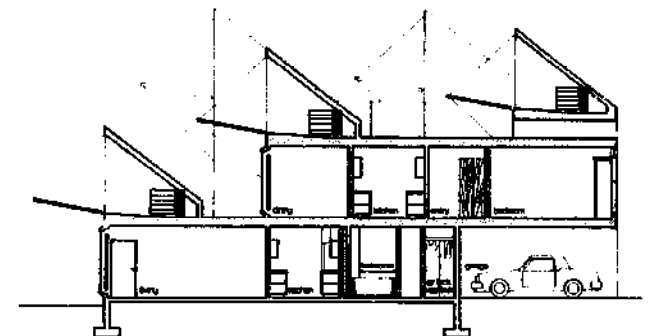

**Section a-a  
with Reflective Panels Open**

The solar system is designed to accommodate the insolation characteristics, the need for snow protection of the collector, and the long period of cloudiness (requiring large heat storage capacity) associated with cool regions. The collector concept chosen is a liquid-cooled flat-plate collector in a shed enclosure for weather protection, with an adjustable hinged reflective panel to increase the incidence of radiation on the collector. The reflective panel is adjusted for seasonal or geographic variation in sun altitude. The optical gain achieved by

radiation reflection provides higher temperatures than those of a conventional flat-plate collector. As a result, a smaller area of collector is required. The hinged member is also used to close the optical enclosure when there is no sunshine, thus protecting the collector from rain, snow, wind, glass breakage, dust and freezing, and avoiding the need for an antifreeze heat transfer fluid. The collection sheds are placed on the multi-family clusters in whatever numbers are deemed appropriate to satisfy totally or partially the heating/cooling load.

The heated fluid from the collector is transported to a central compartmentalized storage tank where its heat is given up to the water storage medium. The storage tank has four compartments so that a usable high temperature is maintained in one compartment while the others are being charged. A distribution loop flows from storage through the central auxiliary boiler, boosting the water temperature when needed, through the domestic hot water preheat tank, and finally to the living units for distribution by baseboard convectors.

### Partial Upper Level Plan

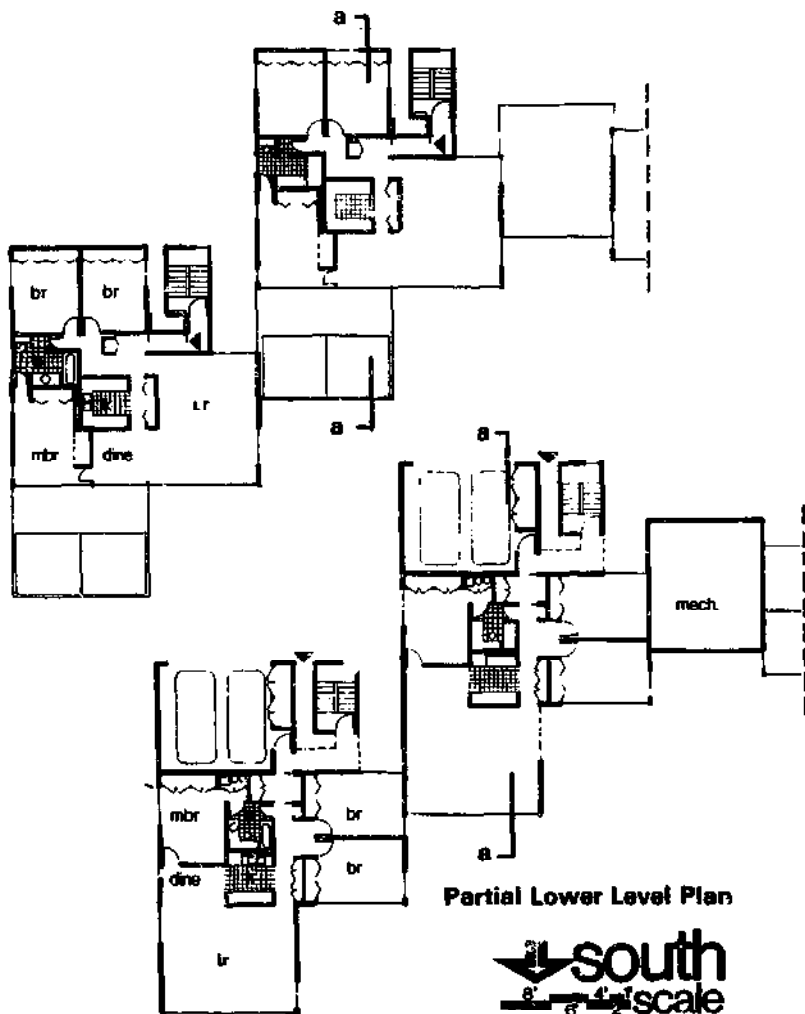

Partial Lower Level Plan

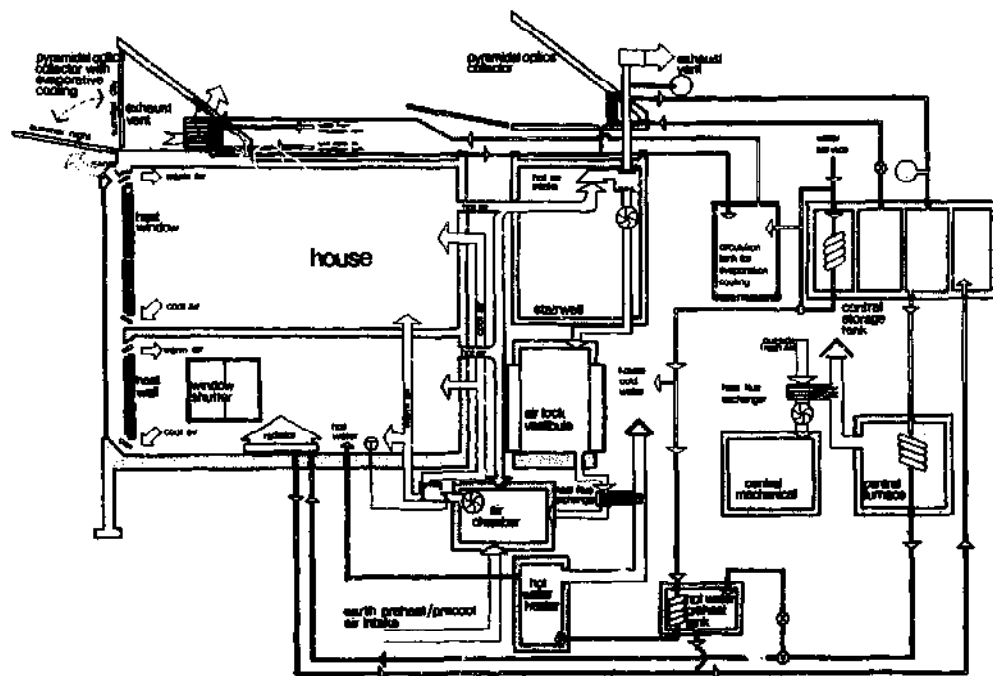

Total System Diagram for All Units

The design concept for hot-arid climates has the prototypical living units clustered to shade adjacent units, maximize the exposure of the solar system to insolation, and capture the constant east/west night breezes. The building materials, adobe and other indigenous material, are used because of their heat sink capacity and relationship to the architectural character of the region.

The hot arid climate requires a solar system capable of both heating and cooling. The systems chosen in-



#### BACKGROUND DATA

**ARCHITECT:** The Continuum Team

**CLIMATIC REGION:** Hot-arid

**BUILDING TYPE:** Low-rise multi-family, clusters

**AREA:** 1215 sq ft heated floor area per unit

#### SOLAR SYSTEM

**COLLECTOR/STORAGE:** Waterbags on roof w/ movable insulating covers, masonry wall behind south-facing glazing

**DISTRIBUTION:** Forced air from central air chamber, natural convection, radiation from walls

**AUXILIARY ENERGY:** Fossil-fuel fired furnace supplying hot air to central air chamber

**DOMESTIC HOT WATER:** Liquid-cooled, flat-plate collector to preheat tank w/ conventional water heater auxiliary

**SPACE COOLING:** Solar ponds on roof, wading pool

clude a solar pond (water bags), a heat wall, and a liquid-cooled flat-plate collector. Solar ponds are located on all roof surfaces except for the stairway where the flat-plate collectors are mounted for domestic water heating. The solar ponds are the primary means of heating and cooling the living units. The heating function is supplemented by heat walls of 18-inch concrete located on the south side of the units.

Water in sealed plastic bags on the exposed roof is

heated during sunny winter days for space heating. The roof is flooded above the level of the sealed bags during cool summer nights for evaporative and radiative cooling. A plenum located between the solar ponds and the second level living units links the ponds to a central distribution air chamber. Heated air from both the heat wall and the solar ponds is ducted to the central air chamber where it is distributed by blowers and ducts to the individual living units. A similar process occurs for the distribution of cool air.



Domestic hot water is heated by a combination of solar and conventional energy. Solar energy captured by liquid-cooled flat-plate collectors is used to heat a central storage tank. The domestic hot water supply is preheated as it passes through the tank. A conventional water heater boosts the temperature if solar preheating is not sufficient.

Partial Upper Level Plan

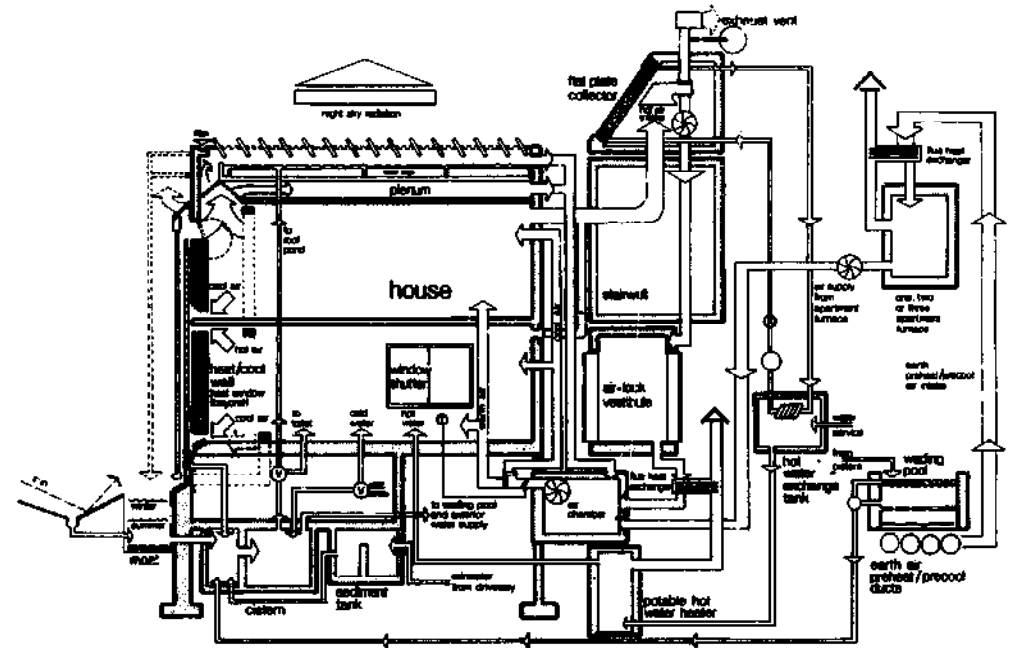
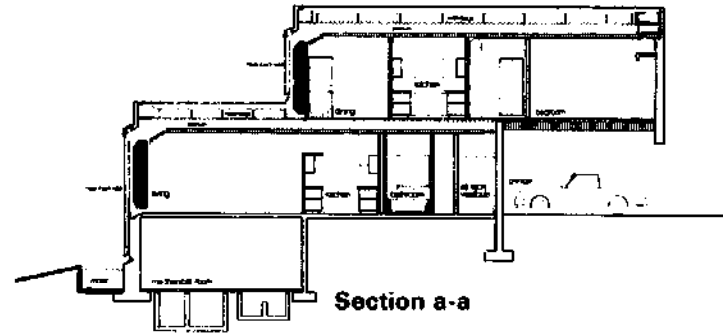
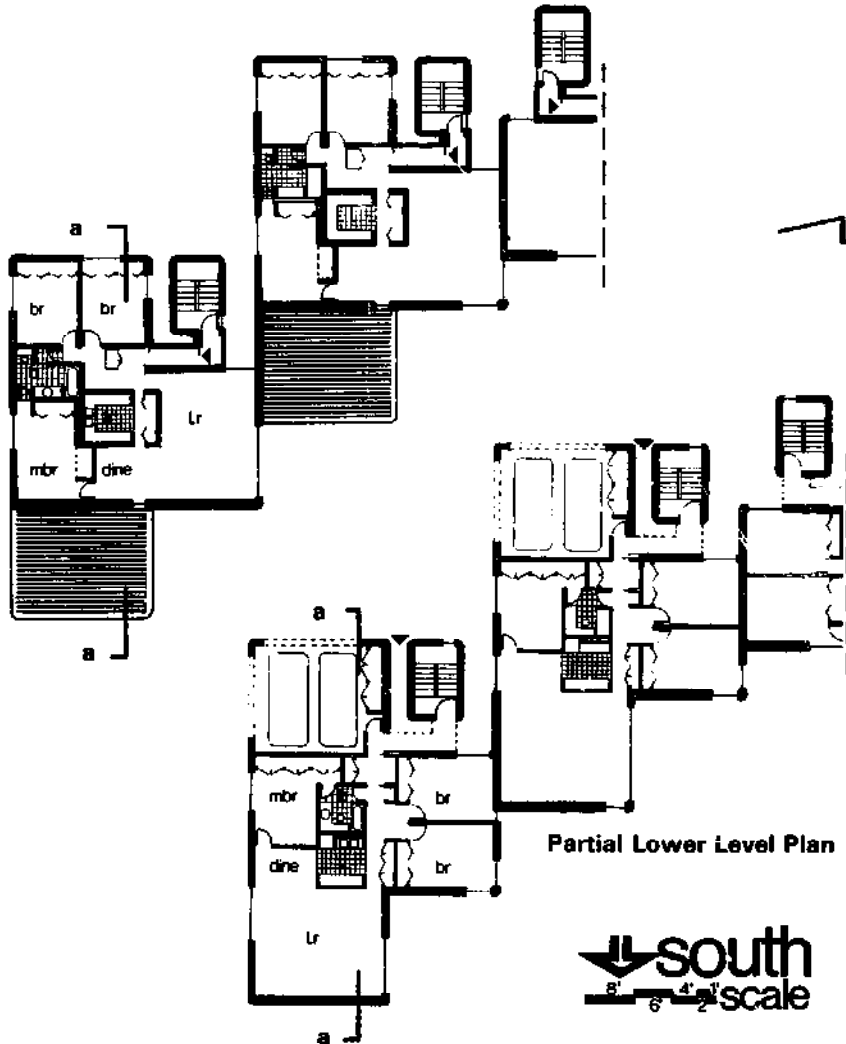

Total System Diagram for All Units



Joint Venture, an architectural and environmental design firm from Boulder, Colorado, has developed four low-rise multi-family solar design concepts for climatic conditions of the Colorado area. The designers have focused on the interaction of different architectural forms with different solar systems. The four design concepts exemplify some of the possible modifications and adaptations to buildings and solar systems which can result in a successful integration. The concepts also demonstrate that the variety of expression in solar buildings can be as great as in



#### BACKGROUND DATA

**ARCHITECT:** Joint Venture

**CLIMATIC REGION:** Temperate

**BUILDING TYPE:** Low rise multi family, ten buildings (Scheme one)

**AREA:** 1100 sq. ft. heated floor area per unit

#### SOLAR SYSTEM

**COLLECTOR:** Liquid-cooled flat-plate or air-cooled flat-plate

**STORAGE:** Central water tank or central rock bin

**DISTRIBUTION:** Fan-coil forced air in each living unit or forced air from central rock storage bin

**AUXILIARY ENFRGY:** Heat pump heating water or air prior to distribution, fireplace

**DOMESTIC HOT WATER:** Preheat coil in central storage w/ conventional water heater auxiliary

**SPACE COOLING:** Natural ventilation

conventionally heated buildings

Each design concept contains approximately 100 living units equally divided between two and three bedroom units. The living units, however, are organized into different densities and architectural forms. Four solar systems, representative of a range of solar collection, storage and distribution concepts, were selected for integration. The interaction of the architectural forms with the solar systems generates four distinctly different building designs

Scheme One illustrates the architectural form concept of fragmentation. The design scheme combines a "conventional" warm-air or warm-water-system with the least energy conserving building form -- 10 small buildings of 10 living units each, instead of one large building configuration. The scheme demonstrates the necessity of dealing with the large south-facing collector area as a major architectural design problem in and of itself.

The design is dominated by the 1,000 square foot



south-facing flat-plate collector required to provide a major portion of the building's heating load. The living units behind the angled collector are organized on the east/west axis for maximum exposure to cooling winds and sunlight. Heat loss is reduced by an earth berm on the north side of the building, use of entry airlocks, and use of six-inch exterior walls filled with insulation.

Scheme One is designed to accommodate either a warm-water or warm-air solar system. Central collec-

tion and storage is provided for both methods. In the case of the warm-water system, a water/antifreeze solution transfers heat from the collector to a 2,700 gallon insulated storage tank located beneath the building. Heat is provided to the living units by hot water pumped from storage to fan coil units located in each dwelling. Domestic hot water is preheated by running the piping through the storage tank and then to a conventional water heater.

The warm-air solar system operates in much the

same manner. However, instead of a water solution, air is circulated through the collectors and transported by ducts to rock storage where it gives up its heat. Extensive duct work is required to distribute warm air from storage to each living unit. The building water supply passes through the warm-air distribution duct, thereby preheating it before it flows through a conventional water heater. A heat pump is used as an auxiliary heating system in both solar systems.

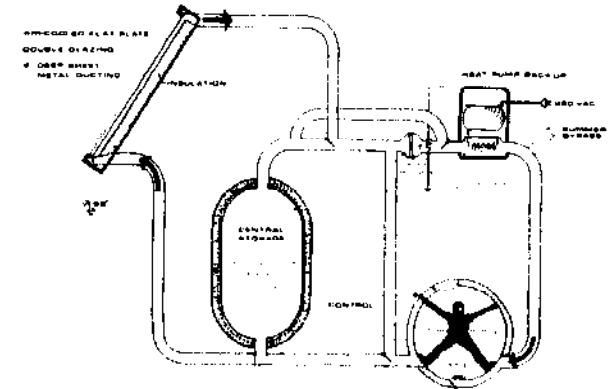
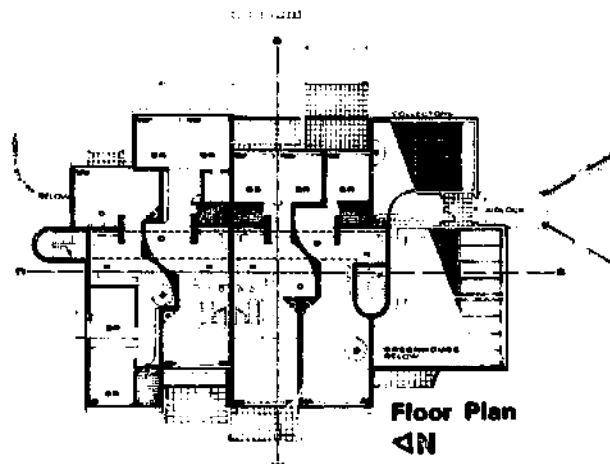
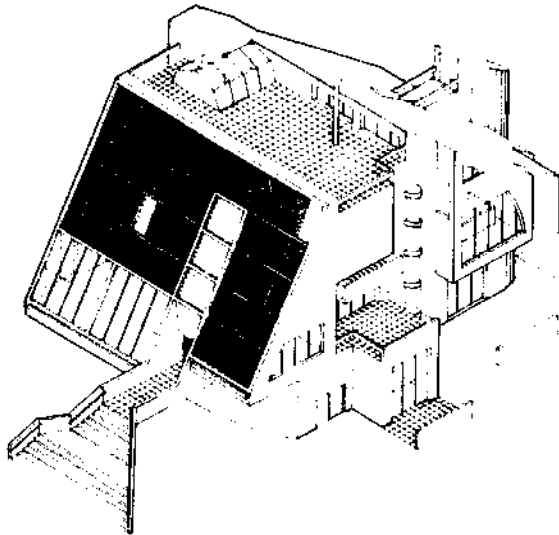

**Air-Cooled Flat Plate System**

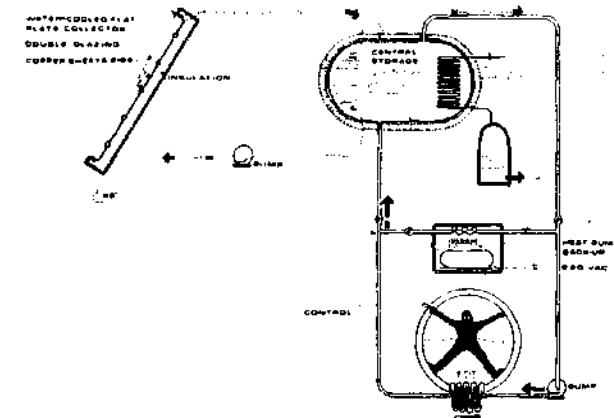

**Water-Cooled Flat Plate System**

Scheme Two illustrates the architectural form of linearity. The scheme contains 100 living units organized in a manner reminiscent of medium density multi-family housing for an urban environment. The concept combines a higher efficiency flat-plate collector — the Compound Parabolic Concentrator (CPC) — with a highly energy-conserving building form — one large building configuration. The concept is in some ways the opposite of Scheme One, illustrating the relative freedom of the south wall —

terracing, balconies, windows and greenhouses — made possible by a small solar collection area and a more energy-conserving architectural form

The solar system is much the same as the warm-water system of Scheme One. The significant difference is the use of the Compound Parabolic Concentrator collector. The CPC collector was invented in the late 1960's for use in a high energy physics application by Dr. Roland Winston of

Argonne National Laboratories. It consists of two segments of a parabolic trough, oriented at a specific angle to each other so that direct radiation which enters within an acceptance zone is reflected to the absorber surface at the bottom of the trough. The heat is removed from the absorber plate by a liquid transport fluid.



#### BACKGROUND DATA

**ARCHITECT:** Joint Venture

**CLIMATIC REGION:** Temperate

**BUILDING TYPE:** Low rise multi family, one building (Scheme Two)

**AREA:** 1100 sq. ft. heated floor area per unit

#### SOLAR SYSTEM

**COLLECTOR:** Liquid-cooled flat-plate w/ compound parabolic concentrating, south-facing windows w/ insulated shutters

**STORAGE:** Central water tank

**DISTRIBUTION:** Fan-coil forced air in each living unit

**AUXILIARY ENERGY:** Heat pump heating water prior to distribution, fireplace

**DOMESTIC HOT WATER:** Preheat coil in central storage w/ conventional water heater auxiliary

**SPACE COOLING:** Natural ventilation

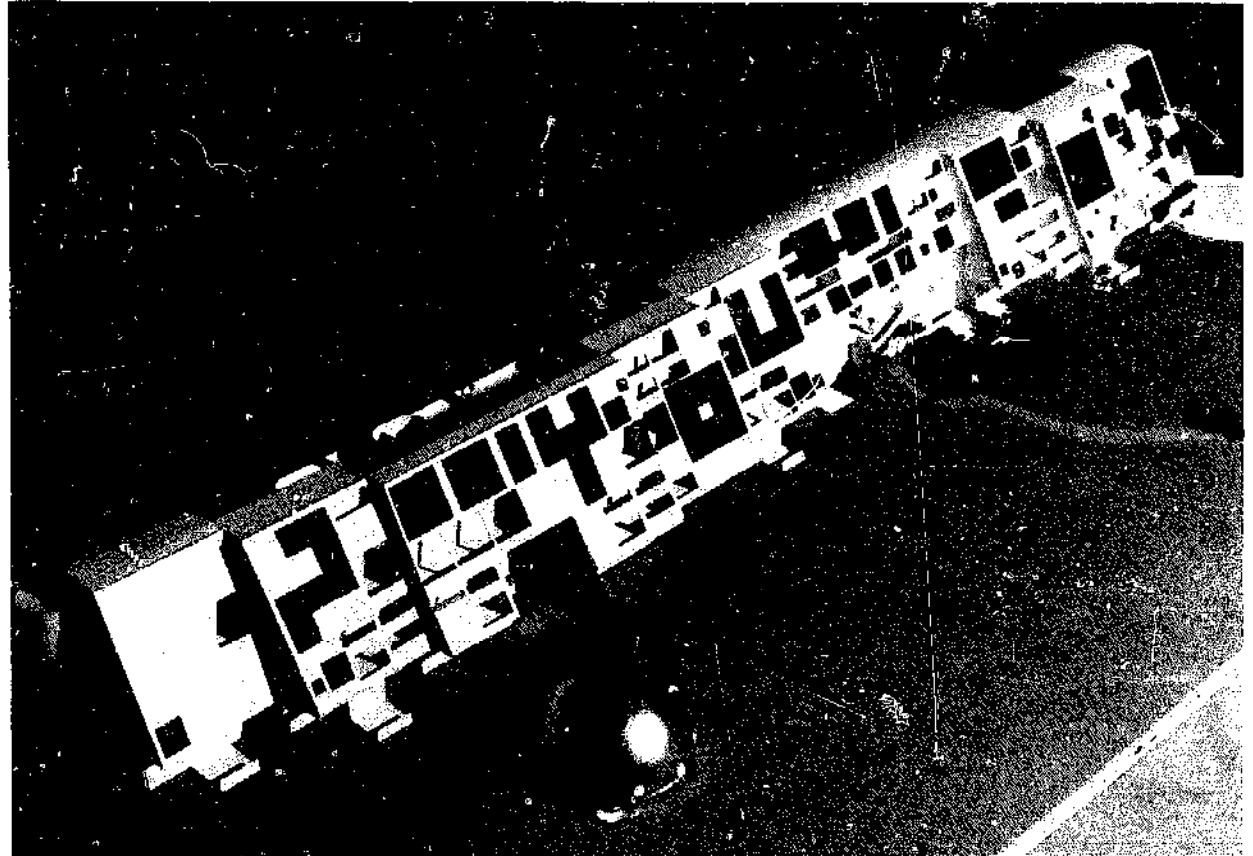

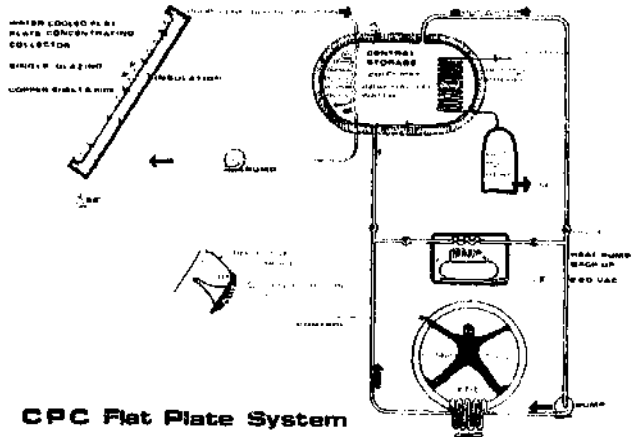
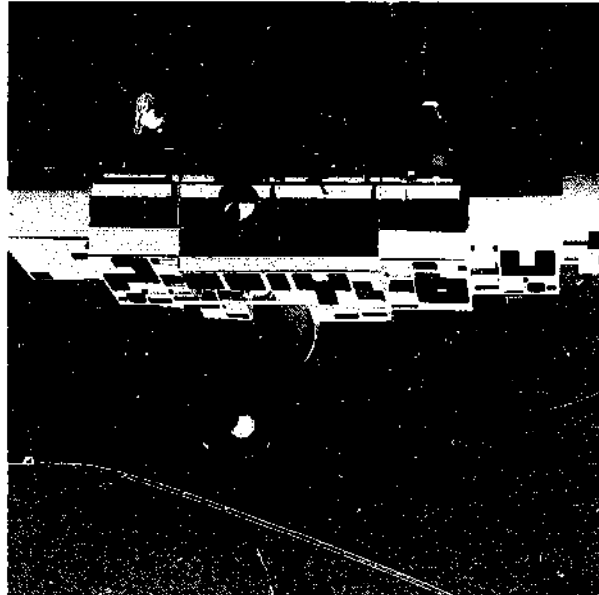
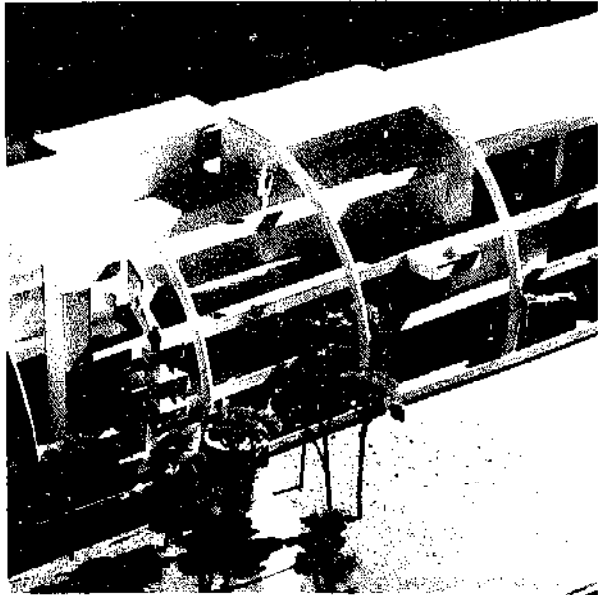

Scheme Three illustrates the architectural form of orientation. The design contains 100 living units located in two curvilinear structures. The concept combines the highest efficiency collector of the four schemes — the Stationary Reflector/Tracking Absorber (SRTA) — with an extremely energy conserving building form — two compact building configurations. The concept illustrates the maximum allowable freedom in building orientation made possible by the minimal collection area and the method and form of the collection device itself.



#### BACKGROUND DATA

**ARCHITECT:** Joint Venture

**CLIMATIC REGION:** Temperate

**BUILDING TYPE:** Low-rise multi-family, two buildings (Scheme three)

**AREA:** 1100 sq. ft. heated floor area per unit

#### SOLAR SYSTEM

**COLLECTOR:** Adjustable concentrating w/ stationary reflector-tracking absorber south-facing windows w/ insulating shutters

**STORAGE:** Aluminum oxide pellets in central storage bin, thermal mass interior walls/floors

**DISTRIBUTION:** Fan-coil forced air in each unit, natural radiation and convection

**AUXILIARY ENERGY:** Heat pump heating water prior to distribution to each unit, fireplace

**DOMESTIC HOT WATER:** Preheat coil in collector to storage transport loop w/ conventional water heater auxiliary

**SPACE COOLING:** Natural ventilation

The SRTA collector, developed by Dr. W. Gene Steward of Boulder, Colorado, is a fixed reflector concentrator in which a small absorber pipe moves to track the sun. The unique operation and form of the SRTA allows relative freedom in building form and orientation as compared to the rectangular geometry demanded by the collection concepts of Schemes One and Two. Collectors are located on the roofs of the two buildings, thereby allowing considerable flexibility in living unit design and use of southern exposure. All the units have south-facing

terraces, protective sun screening and large glazed surfaces.

The solar system of Scheme Three is considerably different than that of the first two designs. A transport fluid capable of functioning properly at temperatures in excess of 350°F is circulated through the SRTA collector to a heat exchanger where captured solar heat is removed and transferred by air to storage. Storage consists of a central insulated enclosure filled with aluminum oxide pellets, which have twice the heat capacity of ordinary gravel. Distribution of heat to the living units is by heated water to fan-coil units in each dwelling. Heat is removed from storage by a blower which forces air through a heat exchanger, thus heating the water. A heat pump again provides auxiliary heating for the living units should the system fail to function or should temperatures from storage not be sufficient.

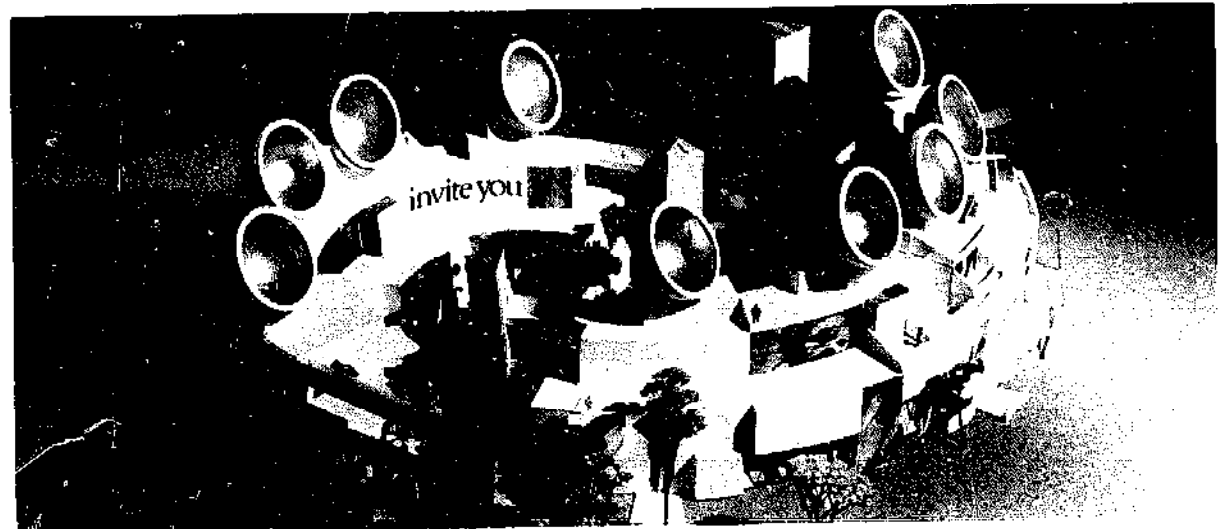
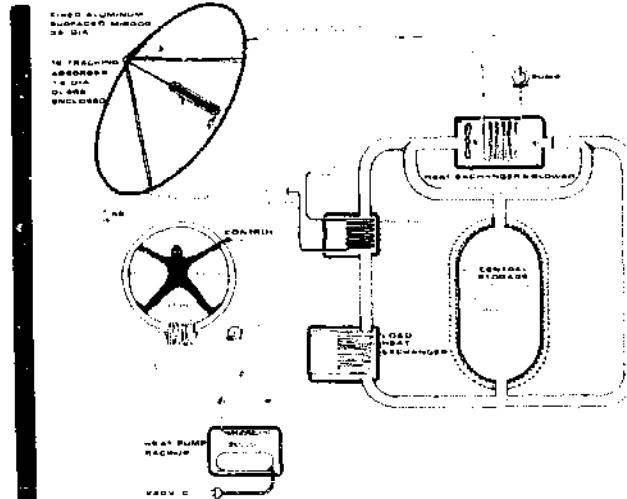

into a very dense and rigid geometric solution. This scheme illustrates the most energy-conserving shape — the hemisphere — with the least efficient solar system — a photovoltaic conversion system. It is only with such a combination that the photovoltaic concept could be considered. The design also illustrates the concept of a detached collection system, since the building and collector shapes are not compatible.



#### BACKGROUND DATA

**ARCHITECT:** Joint Venture

**CLIMATIC REGION:** Temperate

**BUILDING TYPE:** Low-rise multi-family one building (Scheme four)

**AREA:** 1100 sq. ft. heated floor area per unit

#### SOLAR SYSTEM

**COLLECTOR:** Photovoltaic cells in conjunction with liquid-cooled flat-plate, south-facing glazed central atrium.

**STORAGE:** Central storage batteries or fuel cell, central water tank, thermal mass of atrium walls/floors.

**DISTRIBUTION:** Forced-air in each unit from water to air heat exchanger in distribution duct, electrical wiring from storage or directly from collector.

**AUXILIARY ENERGY:** Heat pump heating air prior to distribution in each unit.

**DOMESTIC HOT WATER:** Preheat coil in central thermal storage w/ conventional water heater auxiliary.

**SPACE COOLING:** Natural ventilation, unit air conditioners.

quently, the design concept has a minimum of heat loss through the surface. A pie-shaped, glazed opening facing due south provides for natural lighting, ventilation and solar heat gain. The living units are organized around the interior community space which includes gardens, ponds and stairways.

The solar system combines the generation of elec-

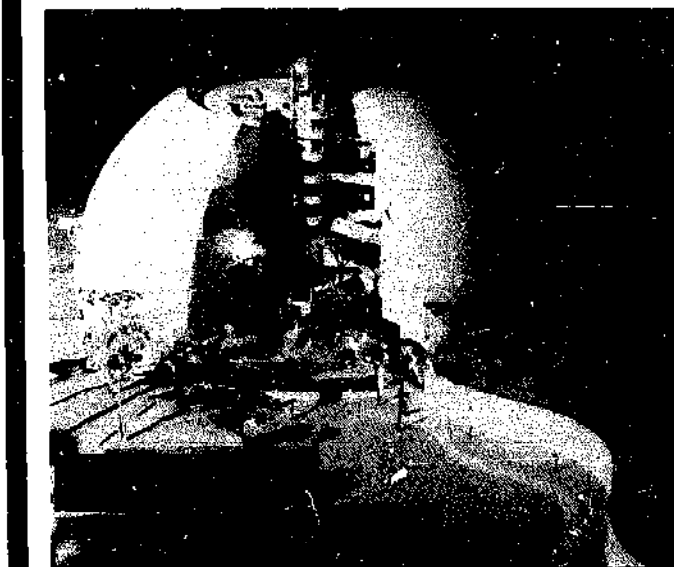
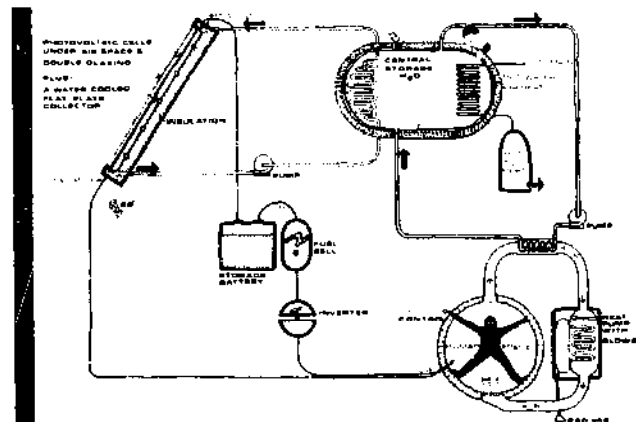

trical energy and stored either in car batteries or fuel cells (electrical storage in chemical form). A converter transforms DC power in storage to AC power for use with conventional appliances. Thermal energy captured by the flat-plate collectors is moved by a water/antifreeze solution. The solution is pumped to a central storage tank where it heats water. Water from storage passes through a heat exchanger giving up its heat to air which is distributed by blowers and ducts to each living unit.

cooled flat-plate collector, a requirement to prolong the life of the cells by cooling them.

developed the first... solar heating and cooling by mobile homes. The first involves the design of a prototype solar mobile home, while the second relates to use of ancillary structures which could support solar collectors or storage for individual mobile homes or groups of mobile homes. The first strategy assumes that the nature of the mobile home will have to change significantly to accommodate solar heating and cooling systems. The second strategy, however, assumes

additional structures must be added to the home or site to accommodate the solar system.

Mobile homes have evolved over the years from the original mobile trailer to a factory-built residence capable of being relocated. A number of federal, state and local regulations control the construction and transportation of mobile homes. These include requirements imposed by the highway departments

with the uncertain orientation of the home when it reaches the site, contribute to numerous problems which limit the installation of solar systems in the factory.

As a consequence, RTL has developed a prototype mobile home capable of factory construction, over the road shipment, and multiple on-site orientation. The prototype is made up of three modules. The 12



#### BACKGROUND DATA

**ARCHITECT:** RTL, Incorporated

**CLIMATIC REGION:** Varies

**BUILDING TYPE:** Mobile home, prototype A

**AREA:** 1000 sq ft heated floor area

#### SOLAR SYSTEM

**COLLECTOR:** Liquid-cooled flat plate

**STORAGE:** Water tank

**DISTRIBUTION:** Fan coil forced air

**AUXILIARY ENERGY:** Electric or fossil-fuel fired water heater w/ heat exchangers in forced-air distribution unit

**DOMESTIC HOT WATER:** Preheat coil in water storage tank w/ conventional water heater auxiliary

**SPACE COOLING:** Natural ventilation

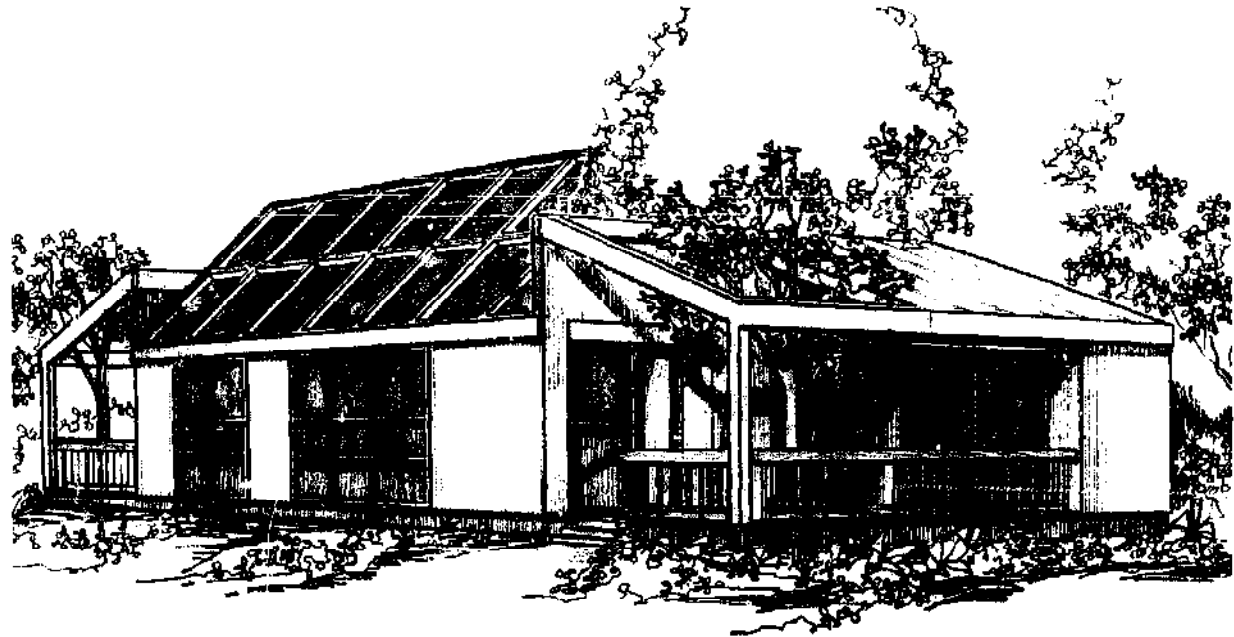

foot wide modules, which vary in length from 35 to 60 feet, are combined to form various dwelling units depending on the owner's needs. The modules, when combined to form a dwelling unit, have four roof surfaces on which solar collectors can be applied. The area and tilt of the collector can vary with location because the collectors are installed at the site.

The prototype solar mobile home, shown below, combines two of the modules into a two-bedroom.

1,000 square foot dwelling unit with courtyards on either end. The solar collectors have been placed on the south-facing roof surface of the bedroom/living room module.

The solar system is composed of a liquid-cooled flat-plate collector, water storage tank, two heat exchangers, auxiliary water heater and a warm-air distribution network. The collectors are positioned on the roof at a tilt appropriate to location and use. The storage tank is buried beside the home. However, for

convenience of relocation and piping connections, storage can also be located in an insulated tank above grade. Heated fluid from the collector is pumped through storage and by way of a heat exchanger transfers its heat to the water. The heated water from storage is pumped to an air-handling unit where again by way of a heat exchanger gives up its thermal energy for distribution throughout the home by ducts. A conventional water heater provides auxiliary space heat and heats the domestic water supply as it comes preheated from the storage tank.

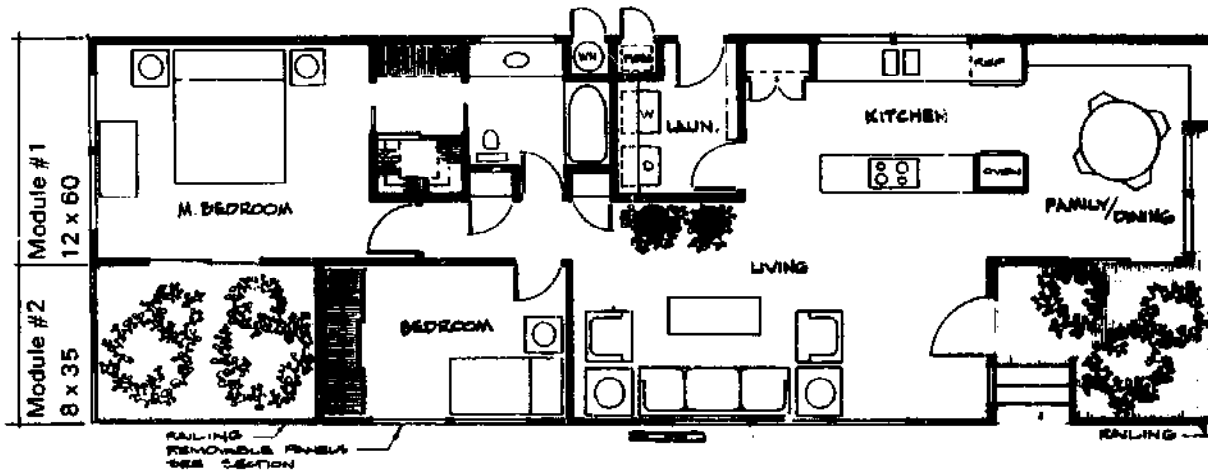

Floor Plan

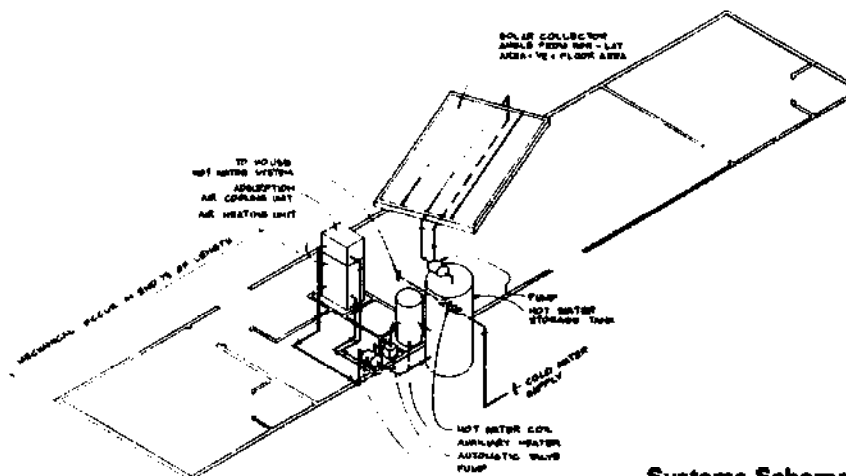

Systems Schematic

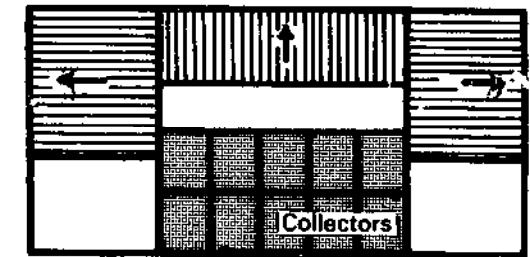

△ Roof Plans Showing Possible  
N Collector Locations

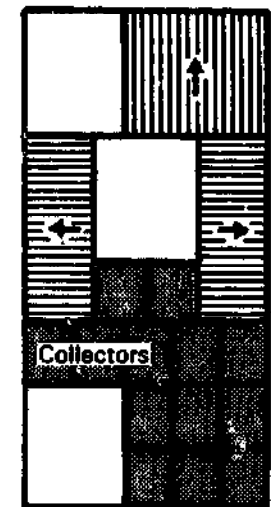



Prototype solar mobile home B. shown below, combines the two largest modules to form a 1,440 square foot dwelling unit. A family room and a second bathroom account for the increased space relative to the first prototype. A larger solar collector is incorporated in the south-facing roof because of the increased heated floor area.

The solar system is similar to that of the first prototype. A liquid-cooled flat-plate collector is combined with a buried water storage tank, heat ex-

changer, air-handling unit, and an auxiliary water heater. The piping connections between solar components inside and outside the mobile home are installed at the factory and require no on-site alteration for solar system installation. All exterior pipes, however, are insulated to reduce heat loss and the possibility of freezing. Also, because the collectors are free standing elements on the mobile home's roof surface, special anchorage is provided to avoid wind damage.

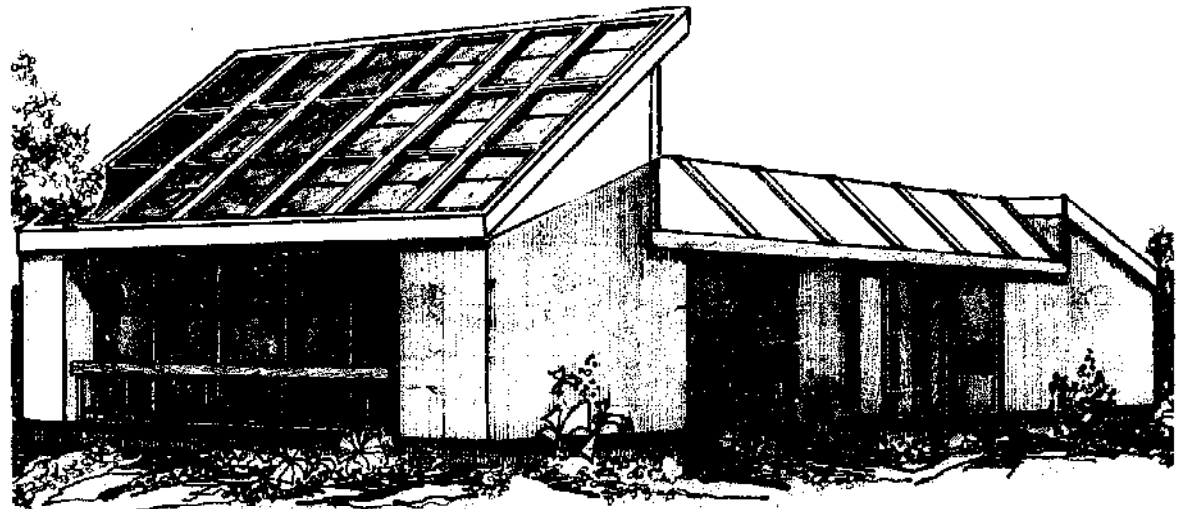

#### BACKGROUND DATA

**ARCHITECT:** RTL, Incorporated

**CLIMATIC REGION:** Varies

**BUILDING TYPE:** Mobile home, prototype B

**AREA:** 1440 sq. ft. heated floor area

#### SOLAR SYSTEM

**COLLECTOR:** Liquid-cooled flat-plate

**STORAGE:** Water tank

**DISTRIBUTION:** Fan-coil forced air

**AUXILIARY ENERGY:** Electric or fossil-fuel fired water heater w/ heat exchanger in forced-air distribution unit

**DOMESTIC HOT WATER:** Preheat coil in water storage tank w/ conventional water heater auxiliary

**SPACE COOLING:** Natural ventilation

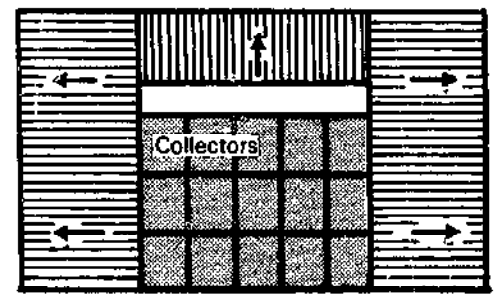
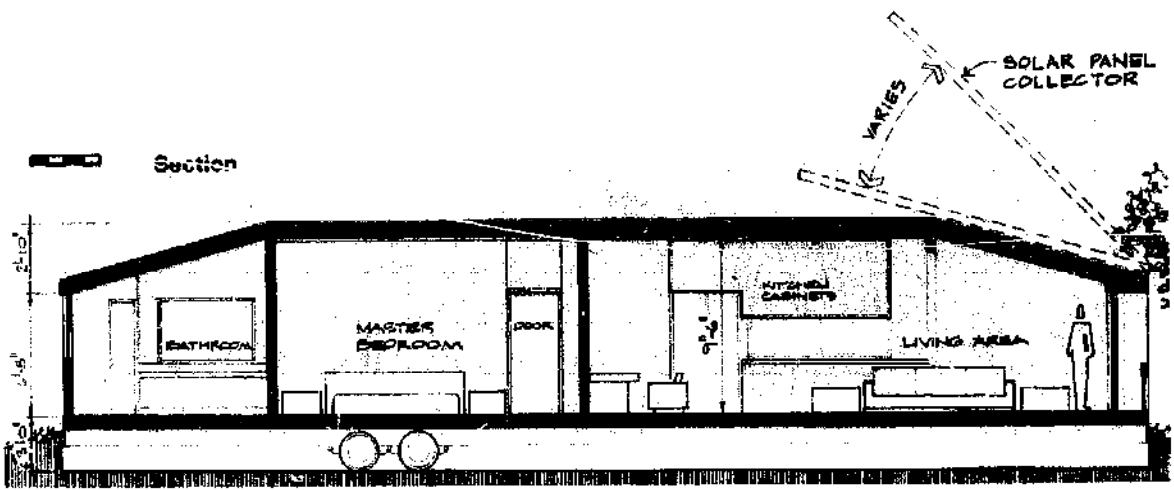
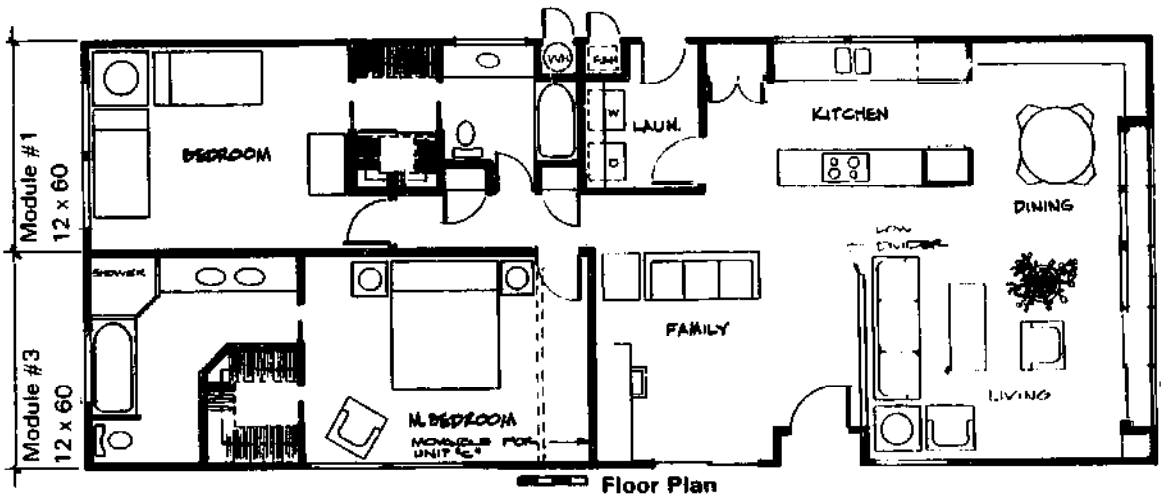

△ Roof Plans Showing Possible  
N Collector Locations

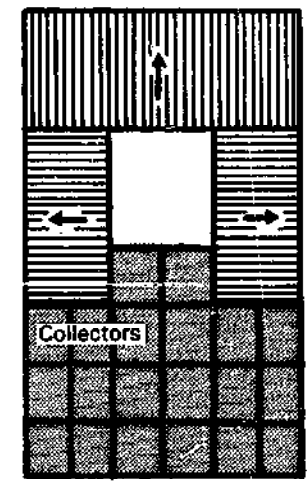

The use of ancillary structures for the location of solar system components is an attractive alternative to the redesign of existing mobile homes. Not only are the solar components easily installed but the ancillary structure continues to be used for its intended function. The ancillary structures and solar systems can be designed for an individual mobile home, or can be sized to accommodate several units located around the structure in a mobile home park or planned development.

There are numerous ancillary structures which lend themselves to the installation and integration of solar collection and storage components. These include carports, trellis or porch covers, roof top structures, berm units, and permanent site structures such as fences or storage buildings. Each of these can be used in conjunction with individual mobile homes or with groups of mobile homes.

Where storage is not directly associated with the ancillary structure supporting the collectors, it can be centrally located to serve any number of solar collectors. This concept is particularly useful in home parks.

Where storage is not directly associated with the an-

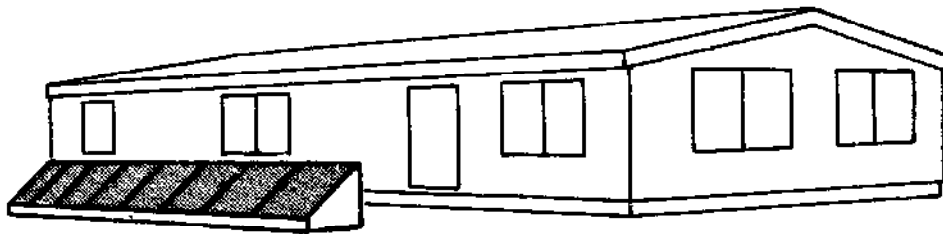

**Berm Unit**

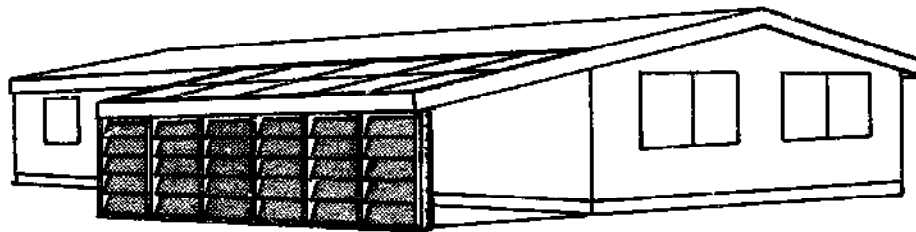

**Porch Cover**

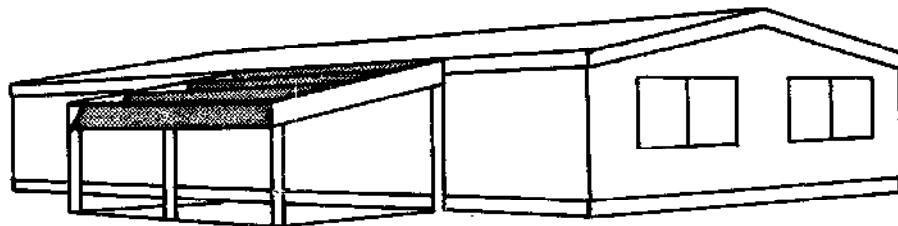

**Carport Screen Unit**

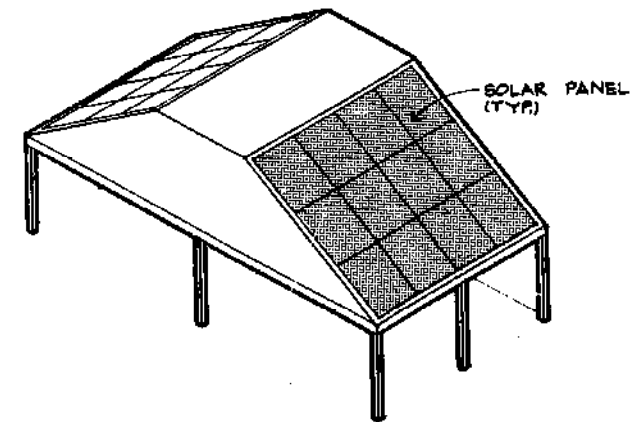

**Carport Cover**

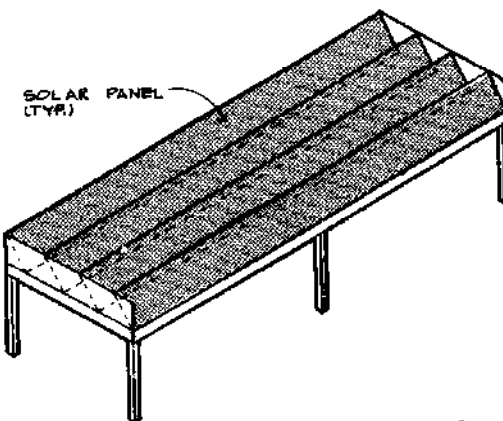

**Carport Cover**

## SUMMARY

All of the preceding solar dwelling design concepts have two characteristics in common: first, they each recognize the importance of reducing a dwelling's need for energy as a prerequisite for effective solar energy utilization; and second, they each treat dwelling design and solar system design as an integral problem.

A reduction of a dwelling's energy requirement greatly enhances its ability to use collected solar energy efficiently. This requirement is directly related to how well the building design is suited to the site and climate in which it is located. The many ways a dwelling can be fitted to its site and climate were discussed in Chapters Three and Four and further illustrated in the preceding solar design concepts. General techniques include, but are not limited to orientation of the dwelling on the site, use of additional wall or roof insulation, selection of building materials and mechanical systems, placement and size of exterior wall openings, and location of trees, vegetation, and other elements on the site. The specific energy conserving design alternatives illustrated in the solar concepts included the integration of the dwelling into a hillside or earth berm as employed by TEA and Joint Venture, the use of double roof construction as used by Giffels Associates, and the incorporation of roof monitors for solar heat gain and natural ventilation enhancement as proposed by TF and Don Watson.

The design of the dwelling changes in response to different climatic conditions as does the design of the solar system. Lowering a dwelling's energy requirement reduces the size of the solar system, thus making it easier to integrate the solar system with the dwelling design.

The selection and integration of solar systems for each of the previous design concepts was considered in relation to the design of the entire dwelling. At issue was not solely the integration of the solar system, but also its relationship to the arrangement of interior and exterior spaces, the provision of

human comfort, and the architectural appearance of the dwelling design. Considered in this manner, the selection and integration of the solar system should complement the dwelling design.

The case studies illustrate a number of possibilities for integrating solar systems with dwelling design. A number of the collection, storage, and distribution components discussed in Chapter Two were used by one or more of the solar design concepts. In most cases, the components of the solar system performed other functions such as serving as a wall, floor or roof of the dwelling. This has advantages of material savings and system performance as well as architectural appearance.



## SOLAR DWELLING DESIGN: A SUNNY FUTURE?

What does the future hold for the use of solar energy to heat and cool our homes? Further, what initiatives both public and private are being taken to increase the use, performance and reliability of solar systems?

These two questions have been asked since the beginning of the development and application of solar energy systems. The answers in most cases were prophecies of a new era of solar energy utilization and of increased support from government and private enterprise. However, in all but a few instances this was not to be the case. The many conferences, workshops, and headlines about solar energy research which stirred the imagination of the American people were all too quickly forgotten and the promise of solar energy remained unfulfilled.

Is today another such period when solar energy rises to the forefront of American consciousness only to recede as temporary hardships are overcome? Or can we at last welcome a period in history where the direct utilization of the sun's energy for heating and cooling will find its place among established government and private interests and activities?

Recognizing the poor record of past projections and realizing the demoralizing effect of raising false hopes, it nevertheless appears that the age of solar energy has arrived. America's energy and environmental problems in all probability will provide by themselves the necessary impetus for an increased use of solar energy. Further, the growing interest and demand by the American people for energy-conserving designs utilizing solar systems and the

fact that Congress has passed and the President has signed into law legislation firmly establishing federal involvement in solar energy activities are evidence that solar heating and cooling is here to stay.

Federal government involvement in solar heating and cooling is spelled out in a *National Plan for Solar Heating and Cooling\** prepared by an interagency task force chaired by the Energy Research and Development Administration (ERDA). The plan calls for the demonstration within a three-year period of the practical use of solar heating systems and the development and demonstration within a five-year period of combined solar heating and cooling systems. It is expected that through federally funded demonstrations reliable, cost-effective solar systems will be developed and demonstrated, thereby overcoming the reluctance of consumers, industry and financial institutions to purchase, produce and finance solar energy applications to buildings. At the same time, any barriers — other than technical — to the widespread use of solar heating and cooling systems will be identified and appropriate changes in existing procedures, programs, and legislation recommended to remove them.

HUD, which is responsible for the demonstration of solar heating and cooling systems in residential structures, has already initiated the first series of demonstration projects. Over the next five years solar demonstration dwellings are to be located in most

\*Available on written request from ERDA Technical Information Center, P.O. Box 62, Oak Ridge, Tennessee 37830 — Order Document No. ERDA-23A.

parts of the country. One purpose of this publication is to acquaint builders, designers, public officials and homeowners with solar heating and cooling so that as the demonstration units are constructed in their locality they will be familiar with the concepts and principles of solar dwelling design. Additionally, the information presented in the preceding six chapters should be helpful to builders and designers who are interested in using solar energy or who are considering participation in the solar residential demonstration program.\*

### **Residential Solar Heating and Cooling: Impact on U.S. Energy Demand**

The impact solar heating and cooling will have on present building energy consumption is difficult to predict. Studies by the National Science Foundation project 4.4 million solar building applications by the year 2000, saving 2.5 percent of the fuel used for heating and cooling.<sup>8</sup> This amounts to 400 thousand barrels of oil a day or 146 million barrels a year. Another study predicts that approximately 596,000 dwellings and 55,000 commercial buildings will be using solar energy systems by the year 1985, saving a total of 31 million barrels of oil a year.<sup>9</sup>

These projections, however, are just a glimpse of the possibilities. If, in addition to new buildings incorporating solar heating and cooling systems, existing buildings are redesigned to include solar systems,

\*HUD encourages maximum participation in the program. Further information can be obtained by contacting the HUD Solar Demonstration Program Office, Room 8158, 451 7th Street, S.W., Washington, D.C. 20410.

the impact may be far greater than anticipated. This possibility holds more promise than relying on new construction to reduce United States' energy demand. There are over 70 million homes in the United States today. The vast majority of these are easily adaptable to solar domestic hot water heating, while a significant number could be redesigned for solar heating, cooling and domestic water heating.

The same principles of solar dwelling and system design for new construction mentioned throughout this publication are applicable to the redesign of existing buildings for solar heating and cooling. However, reducing an existing dwelling's energy load and integrating a solar system within an established physical form are not as easily solved for existing homes as for new construction. Additionally, non-optimal building orientation, existing trees and vegetation or a neighboring building may make the redesign for solar heating and cooling very difficult. In these instances, other design alternatives could be evaluated — a neighborhood solar collection and storage system for example.

Solar heating and cooling is possible in most areas of the country. In many situations, it is readily adaptable to existing dwellings. As the number of new homes heated by the sun grows so too will the number of existing homes that are modified to include a solar system. The problems of redesign for solar heating and cooling are difficult to solve but the benefits of energy savings are greater.

### **Solar Technology**

Technically, solar energy systems will become more reliable and cost effective. Increased public and private support for solar research and development will lead to breakthroughs in material and system design. A better scientific and technical understanding of the phenomenon of solar radiation conversion to thermal energy will improve both the products and processes of solar heating and cooling. Also, the time from research, development and demonstration to widespread application of solar systems will be reduced. The solar system components in use today are the first generation of an idea and technology with their beginnings in the early 1940's and 50's. New ideas and technologies for solar heating and cooling are presently being developed which are significantly different from first generation solar systems. They will improve the performance and cost-effectiveness of solar heating and cooling in locations where it has been only marginally feasible. In addition to improved solar heating and cooling systems, photovoltaic, bioconversion,\* wind and other areas of solar energy will be developed, thus providing a multitude of techniques for reducing a building's demand on fossil fuels. These changes will not occur overnight but the initial steps are being made today.

\*The conversion of biological materials to energy sources, including such processes as the conversion of wood or other plants to alcohol and fermentation or decomposition of organic by-product materials to produce methane or other fuels.

Performance data compiled during the national solar demonstration program will provide the necessary information for the effective and efficient design of solar dwellings and systems for areas throughout the country. Designers, suppliers, code officials, financial institutions, and tradesmen will become familiar with solar energy systems, thereby reducing any reluctance on the part of homeowners and building clients to utilize the systems.

### **Solar Dwelling Design: A Sunny Future**

Diligence and dedication on the part of advocates of solar energy are necessary today to assure widespread use tomorrow. Problems of inertia should be overcome by the present federal effort to support solar research, development, and application. However, in the long run the use of solar energy to heat and cool buildings will increasingly be dependent on the actions of consumers, building clients, manufacturers, suppliers, designers, state and local code officials, and lending institutions, and other participants of the building industry. Without continued support and direction by these groups solar energy utilization will remain the interest of researchers and backyard tinkerers and not a solution to a growing and threatening national energy and environmental problem.

It has taken thousands of years to arrive at the threshold of large scale solar energy utilization. A few more years to nurture the beginnings of government, industry and consumer support for an innovation that has the potential to change the energy

consumption and conversion patterns of the world is certainly time well spent.

The widespread use of solar energy for heating and cooling has the potential not only as a fuel source but as an opportunity to reintroduce the sun as a dominant element in our lives. The sun provides sunlight and sunshine as well as solar energy. Dwellings which are responsive to all three are dwellings in harmony with their environment and their occupants. The use of solar energy to heat and cool can lead to a generation of buildings in harmony with their environment, and at the same time assist in bringing to an end an era of energy waste. To this end, this publication has been prepared.

## REFERENCES

1. Tetzes, Johannes. 12th Century author.
2. Yellott, John. "Utilization of Sun and Sky Radiation for Heating and Cooling of Buildings." *ASHRAE Journal*, December 1973. Available at most public libraries or write ASHRAE, 345 East 97th Street, New York, New York 10017.
3. Daniels, Farrington. *Direct Use of the Sun's Energy*. Ballentine, New York, 1964.
4. Information regarding temperature, degree days, solar radiation and other climatic data can be found in the following documents:
  - ASHRAE Handbook of Fundamentals. American Society of Heating, Refrigeration, and Air-conditioning Engineers, Inc., 1972.
  - National Association of Home Builders (NAHB). *Insulation Manual: Homes, Apartments*, 627 Southlawn Lane, P.O. Box 1627, Rockville, Maryland 20850.
  - U.S. Climatic Atlas. Government Printing Office, Washington, D.C., June 1968.
5. G.T. Trewartha. *An Introduction to Climate*. McGraw-Hill Book Co., New York, 1968.  
L.W. Thornwaite. "An Approach Toward a Rational Classification of Climate." *Geography Review*, 38 55 (1948).
6. V. Olgyay. *Design with Climate*. Princeton, New Jersey: Princeton University Press, 1963.  
J. Aronin. *Climate and Architecture*. New York: Reinhold Publishing Corporation, 1953.  
B. Givonni. *Man, Climate and Architecture*. New York: Elsevier Publishing Co., Ltd., 1969.
7. Lee D.A.R. Proprioclimates of Man and Domestic Animals in UNESCO *Climatology* (Reviews of Research) Paris, 1958.
8. Phase "O" Studies performed by TRW, Westinghouse, and General Electric for the National Science Foundation, 1974.
9. Energy Research and Development Administration (ERDA). National Program for Solar Heating and Cooling, Oak Ridge, Tennessee, October 1975.

## PHOTOGRAPH CREDITS

The following illustrations and photographs are printed by permission and may not be reproduced.

PAGE	SOURCE
8	AIA Research Corporation slide collection
10	Arizona State University, Hayden Library, Special Collections
10	Arizona State University, Hayden Library, Special Collections
10	Annual Report, Smithsonian Institution, 1915
11	Engineering News Record
11	William R. Current
12	Hedrich-Blessing Studios, George F. Keck and William Keck, FAIA, Architects
12	Hedrich-Blessing Studios, George F. Keck and William Keck, FAIA, Architects
140	AIA Research Corporation slide collection

## BIBLIOGRAPHY

The subcontractors' reports which form the basis of this publication are available from AIA/RC and from NTIS. The titles of the reports are listed below.

- Solar-Oriented Architecture**. College of Architecture, Arizona State University.
- Site Planning for Solar Energy Utilization**. American Society of Landscape Architects Foundation.
- Solar Heated Houses for New England**. Massdesign
- Solar Energy Home Design in Four Climates**. Total Environmental Action.
- Solar Energy and Housing: Three Passive Prototypes**. The Architects Taos.
- Innovation in Solar Thermal House Design**. Donald Watson, AIA.
- Solar Energy and Housing: Design Concepts**. Giffels Associates, Inc.
- Design of Multi-Family Solar Dwellings for Minneapolis and Phoenix**. The Continuum Team
- Here Comes the Sun — 1981**. Joint Venture.
- Mobile Home Solar Energy Systems Development**. RTL, Inc.
- Solar Energy Proposal for Mobile Homes**. School of Architecture, University of Detroit.

NTIS  
5285 Port Royal Road  
Springfield, Va 22151

Numerous periodicals, reports and books are available on the subject of solar energy. The following list of publications has been prepared as the next level of information the reader may wish to consult if additional technical information is desired.

- Anderson, Bruce. *Solar Energy and Shelter Design*. Harrisville, New Hampshire, Total Environmental Action, (1973).
- Aronin, J. *Climate and Architecture*. New York: Reinhold Publishing Corporation, (1953).
- Buchberg, H. and Naruishi, J. "Build," *Scientific*, 21(1) (1967), pp 37-57.



- Daniels, Farrington. *Direct Use of the Sun's Rays*. New Haven: Yale University Press, (1964).
- Duffie and Beckman. *Solar Thermal Processes*. New York: John Wiley & Sons, (1974).
- Eckbo, Garrett. *Landscape for Living*. New York: Architectural Record with Duell, Sloan and Pearce, (1950)
- Egan, M. David. *Concepts in Thermal Comfort*. Englewood Cliffs, New Jersey: Prentice-Hall, Inc., (1975)
- Evans, R.B. "Some Examples of Cost Effectiveness Analysis of Solar Energy Systems." Georgia Institute of Technology, School of Engineering, Atlanta, Georgia, (February 4, 1975). (Mimeographed)
- Fitch, James Marston. "Buildings Designed for Climate Control in the United States of America." *Weather and the Building Industry*, Research Conference Report No. 1, Washington Building Research Advisory Board of National Research Council, (1950).
- Givonni, B. *Man, Climate and Architecture*. New York: Elsevier Publishing Company, Ltd., (1969)
- Halacy, D.S., Jr. *Coming Age of Solar Energy*. New York: Harper and Rowe, (1973).
- Hand, Irving F. "Charts to Obtain Solar Altitudes and Azimuths." *Heating and Ventilating*, Vol. 38, (October 1948).
- Hill, J.E. and Richtmyer, T.E., *Design and Construction of a Retrofitted Residential Solar Heating and Cooling System*. National Bureau of Standards, Center for Building Technology, Washington D.C., Technical Note 892. (March 1975).
- Kreider, J.F. and Kreith, F. *Practical Design and Economics of Solar Heating and Cooling*. New York: McGraw-Hill, (1975).
- Landsberg, Helmut E. "Use of Climatological Data in Heating and Cooling Design," *Heating, Piping and Air-Conditioning*, Vol. 19, No. 9, pp. 121-125.
- Magnas, Howard. "Life Cycle Cost Analysis: Residential Space Heating, Retrofitting Homes with Insulation and Solar Collectors." Washington: Office of Energy Statistics, Federal Energy Administration. (Mimeographed)
- Olgay, Victor and Olgay, Aladar. "The Theory of Solar Air Orientation," *Architectural Forum*, (March 1954), pp. 104-108.
- \_\_\_\_\_. *Solar Control and Shading Devices*. Princeton, New Jersey: Princeton University Press, (1957).
- Olgay, Aladar. "Solar Control and Orientation to Meet Bioclimatic Requirements," *Architectural Forum*, (March 1954), pp. 38-46.
- Olgay, Victor. *Design with Climate*. Princeton, New Jersey: Princeton University Press, (1963).
- Proceedings of the United Nations Conference on New Sources of Energy, Rome, 1961*. New York: United Nations, (1964).
- Proceedings of the World Symposium on Applied Solar Energy, Phoenix, 1955*, Menlo Park, California: Stanford Research Institute, (1956).
- "Regional Climate Analysis and Design Data." The House Beautiful Climate Control Project in the *Bulletin* of the AIA, Washington: American Institute of Architects, (March 1950)
- Ruegg, Rosalie T. "Solar Heating and Cooling in Buildings: Methods of Economic Evaluation." Washington: Center for Building Technology, National Bureau of Standards, (July 1975).
- Science* (April 1974), "Energy Issue."
- Shurcliff, William A., *Informal Directory of the Organizations and People Involved in the Solar Heating Of Buildings*, Cambridge, Ma., William A. Shurcliff (Dec. 12, 1975) (Mimeographed)
- Shurcliff, William A., *Solar Heated Buildings — A Brief Survey*, Cambridge, Ma., William A. Shurcliff (Revised Periodically — Twelfth Edition, March, 1976) (Mimeographed)
- "Solar Energy in Housing." *Architectural Design*, (October 1973).
- The U.S. Department of Housing and Urban Development, *Interim Performance Criteria for Solar Heating and Combined Heating/Cooling Systems and Dwellings*. U.S. Government Printing Office, Washington, D.C. 20402. Stock Number 003-003-01388
- Tybout, Richard A. and Lof, George O.G. "Solar House Heating." *Natural Resources Journal*, Vol. 10, No. 2, (April 1970), pp. 268-326
- Yellott, John I. and Hay, Harold. "Thermal Analysis of a Building with Natural Air-Conditioning." *ASHRAE Transactions*, No. 2103, (1969).

## **CREDITS**

The following organizations and individuals have contributed to the completion of this research undertaking.

### **U.S. Department of Housing and Urban Development**

Charles Gueli  
Joseph Sherman  
David Moore  
John Mooney  
Toba Penny, Consultant  
John Fitzpatrick

### **U.S. Department of Commerce, National Bureau of Standards**

Thomas Faison  
Robert Dikkers  
David Waksman  
Richard Crenshaw  
Elmer Streed

### **National Association of Home Builders**

Jesse Baker  
Herman Smith  
John Koelermij  
Paul Ball  
Roy Rainey  
Milton Smithman

### **American Society of Landscape Architects Foundation**

Gary Robinette  
Charles McClenon

### **Consultants:**

Sasaki Associates  
Rahenkamp, Sachs, Wells and Associates  
Sasaki, Walker, Associates  
Johnson, Johnson and Roy Associates  
Land/Design Research  
Edward D. Stone, Jr. Associates

### **The AIA Research Corporation**

John Eberhard  
Michael Holtz  
Lucy Leuchtenburg  
JoAnn Masterson

### **Consultants:**

The Continuum Team  
Donald Watson - Architect  
Giffeis Associates  
Joint Venture  
Massdesign  
RTL, Inc.  
The Architects Taos  
Total Environmental Action  
School of Architecture and Environmental Studies,  
University of Detroit  
College of Architecture, Arizona State University