

*Your*  
**BASEMENT  
FALLOUT  
SHELTER**

**BLUEPRINT  
FOR  
SURVIVAL No. 1**

## FOREWORD

In announcing the policy of the Government concerning shelters for civil defence purposes, I stated that substantial protection against radioactive fallout could be achieved by family shelters built at home at a modest cost. I said a pamphlet would be issued giving detailed suggestions for those wishing to provide such protection for their families. This is it. Another will be issued shortly with suggestions for shelters that can be built in a backyard.

Although Canada will persist in its efforts to avoid war, and to settle international disputes by peaceful means, there still remains some risk of nuclear war. Should a nuclear war occur, the risk of radioactive fallout will be very widespread, and will endanger many of us in our homes, even though a long way from the bomb explosion. The best and simplest way to safeguard against fallout is by household shelters which will provide protection.

The shelter described in this booklet, although not affording protection against the blast of a nuclear explosion or the fires that may result, will provide good protection against the more widespread radiation danger. These shelters will be a practical and reasonable means of insuring one's family against this risk that would arise should a war occur.

Each householder can and should decide whether or not to have this form of family protection. I recommend it.

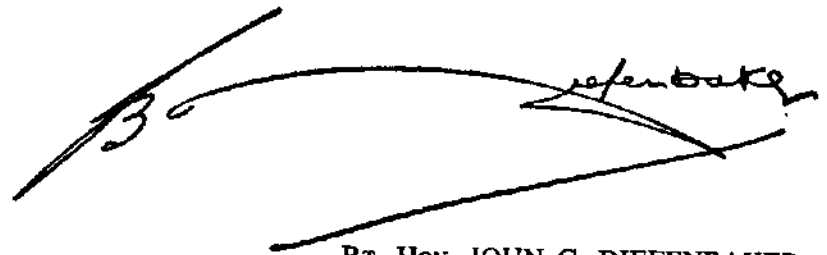
A large, stylized handwritten signature in black ink, appearing to read 'Diefenbaker', is written over a horizontal line. The signature is written in a cursive, somewhat slanted style.

Rt. Hon. JOHN G. DIEFENBAKER  
*Prime Minister*

## TABLE OF CONTENTS

<i>Section</i>	<i>Page</i>
1. WHY A FALLOUT SHELTER . . . . .	1
2. WHERE AND WHEN FALLOUT SHELTERS . . .	3
3. THE SHELTER AND HOW TO BUILD IT . . . .	5
4. LIFE IN THE SHELTER . . . . .	16
5. HEALTH AND SAFETY . . . . .	23
6. LEAVING THE SHELTER . . . . .	25
7. BUILD IT NOW . . . . .	26
8. ACTION GUIDE . . . . .	27
9. SHELTER SUPPLIES . . . . .	29
10. FOOD AND WATER . . . . .	31
11. ADDITIONAL SERVICES AVAILABLE . . . . .	32
12. BUILDING MATERIALS . . . . .	33

### NOTE

"The Associate Committee on the National Building Code of the National Research Council considers this design of household fallout shelter to be structurally acceptable for its intended use for installation in the basements of dwellings, for emergency use only.

The Associate Committee makes this statement since the provisions of the National Building Code are intended for use with building for normal conditions of occupancy and not for emergency use."

Produced by the Emergency Measures Organization of the Privy Council Office by Authority of the Prime Minister of Canada, The Right Honourable John G. Diefenbaker.

*See enclosed wall chart for working plans*

PRINTED BY ALGER PRESS LIMITED  
UNDER THE AUTHORITY OF  
ROGER DUHAMEL, F.R.S.C., QUEEN'S PRINTER  
OTTAWA, CANADA, 1961

## WHY A FALLOUT SHELTER

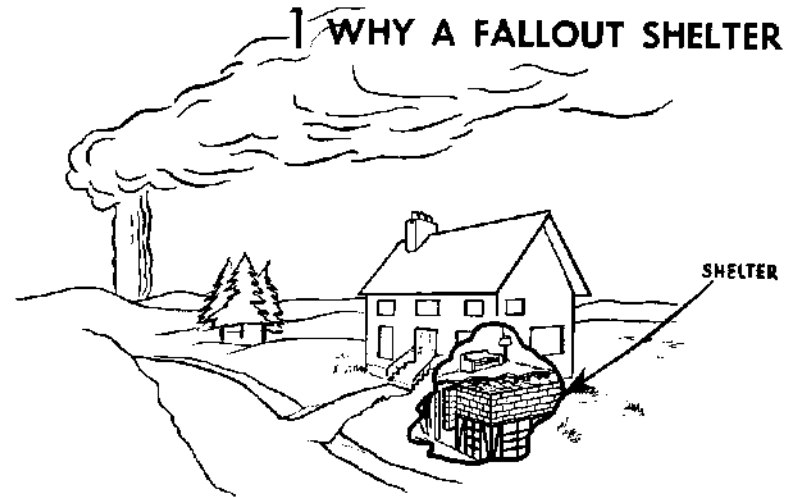

If nuclear war comes, the greatest danger to the greatest number of Canadians is likely to come from radioactive fallout. Fortunately, this danger can be averted or considerably reduced by the use of comparatively simple measures.

To understand how you can protect yourself against fallout, you must know something of its nature.

When a nuclear bomb explodes so that its fireball touches the ground, a considerable amount of earth and other pulverized material is drawn up into the cloud, becoming radioactive in the process. This dust is carried downwind and may be deposited over thousands of square miles of territory. After it has fallen onto the ground, or buildings, it still continues to emit radiation which cannot be detected by the human senses but is harmful to the human body.

For people outside the immediate blast area, one of the greatest dangers may be this radioactive dust. So we should keep such dust away from us.

Study of radiation has shown us how to protect ourselves against it. We know, for example, that the further one is from any source of radiation, the less one is affected by it. Then, while

radiation can pass through walls and other solids, we know that the denser the obstacles it encounters the more its intensity is reduced. That is to say, a solid brick, or stone, or concrete wall will reduce radiation effects more than wooden walls. So, by placing some type of heavy construction between ourselves and the sources of radiation, we can achieve a considerable amount of protection.

Finally, fallout radiation decreases with time; its strength is reduced day by day. So one method of survival open to us is to stay in some form of protected accommodation until the radiation intensity has dropped to the point where it is safe for us to resume a more normal pattern of living.

You would be wise to follow to the letter the procedures recommended here. The fallout shelter has been designed to make maximum use, at minimum cost, of the protective measures already known to be effective. Some choice has been left to the householder—for example: selection of the shelter size and equipment. But unless something is clearly indicated to you as a matter of choice, in your own interest you should consult your local civil defence authority or the Emergency Measures Organization at the address given on Page 32 before you deviate from the pamphlet's recommendations.

The shelter design will allow you to live without fear of radiation or harmful fumes generated within the shelter. In spite of a possible loss of electrical power and normal facilities, there will be enough heat in the shelter, even in our Canadian winters—if you wear warm clothes—to safeguard you from the worst effects of exposure to cold. A prolonged stay in the shelter will almost certainly prove uncomfortable at times, but it should not be unbearable.

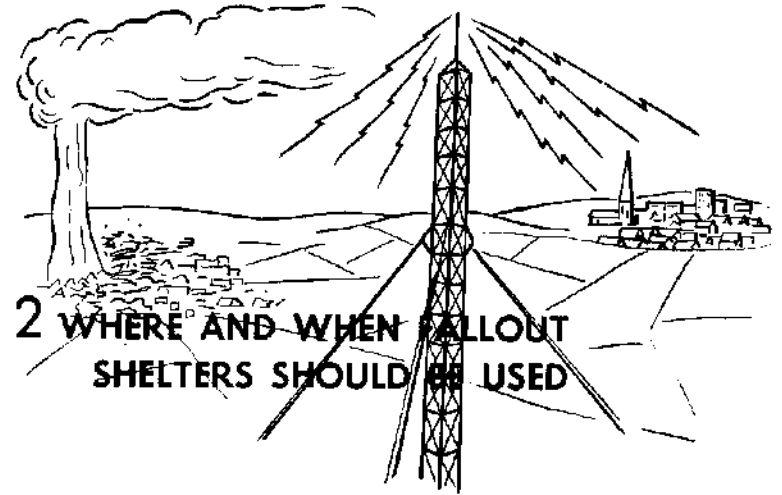

**D**anger from radioactive fallout may occur in any part of Canada, if a nuclear war occurs, and will be greatest in the southern parts of the country. It would be just as great in rural areas as in towns, and in small communities as well as large. It may come from bombs dropped on defence bases or on large centres or ports selected as targets, from bombs going off in aircraft shot down in battle, or from missiles that miss their targets. Consequently, it is prudent for all Canadians to consider protection against this risk in their own homes.

### **It's not a blast shelter**

You should not take refuge in a fallout shelter as a protection against the blast of an exploding weapon. There is a greater danger in the shelter than elsewhere because it may collapse as well as the house, and it may be more difficult to escape from the shelter if the house catches fire. It is better to seek protection elsewhere against the blast—in the basement lying down near a wall, under a heavy table, close to some exit in case of fire. The fallout shelter is for *after* the explosion, if you're in an area that has not been

devastated by blast and fire but is in the path of the fallout. Warnings of fallout will be broadcast by radio.

## Until you build your shelter

If an attack should come before you have time to finish your shelter and your area is subjected to fallout, you should take refuge in a basement, in a corner, if possible under a heavy table, or other support on which should be piled as much heavy material as possible—bricks, books, piles of newspapers, lumber, etc. You should lie **there** for forty-eight hours, or until notified you can come out. It is much better in such circumstances to suffer from hunger, cold, thirst or other hardships than to run the risk of death or serious injury from radiation poisoning.

## Other shelters in target areas

Those living in possible target areas, such as the larger cities, may prefer to build household shelters that will protect them and their family against blast and fire as well as fallout, in case a weapon explodes a few miles away. These are more difficult and expensive to build, costing several times as much as fallout shelters. Detailed suggestions for building such antiblast shelters are being prepared. Those living in or near potential target areas who do not feel prepared to go to the expense of building stronger shelters, can and should protect their families against the fallout danger.

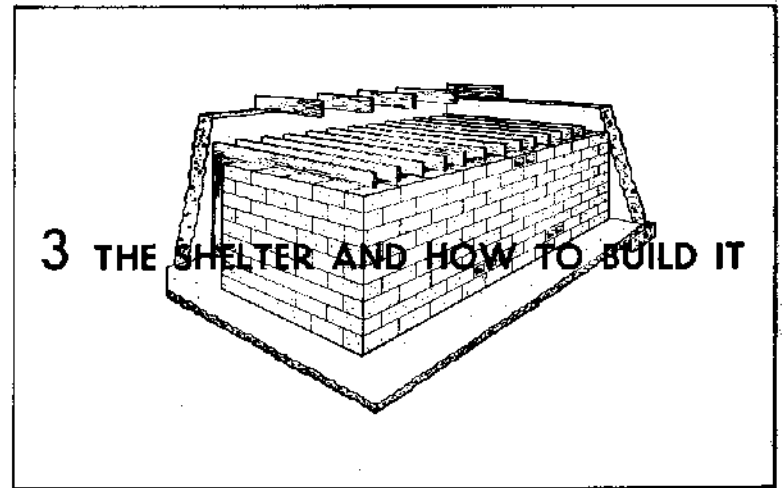

Even an ordinary house provides some protection against radioactive fallout. The safest place inside is a corner of a basement. However, even in this part of the house there will not be, in most cases, sufficient protection to ensure the survival of the householder and his family. It is therefore necessary to add to the protection afforded, and this can best be done by building a basement fallout shelter. The shelter described in this pamphlet will provide the additional protection that is required.

## Selection of site

Because the protection already available is highest in a corner of the basement, one of these should be chosen. That corner of the basement with the highest outside ground level will give the best protection and will simplify construction of the shelter. If, however, the ground is level with the basement floor or varies only slightly, then you should place the shelter below a room which contains a considerable amount of heavy equipment, such as a kitchen. In this way you increase overhead protection, and you can improve this further, after a fallout warning has been received, with more furniture, books, magazines, etc.

The corner you select should not have any basement windows inside the shelter. If it does, however, the windows and wood frame must be removed and the opening filled with brick or solid concrete blocks at least eight inches thick. (See Diagram 7(a) on the enclosed chart).

## The nature of the shelter

The basement fallout shelter described here has been designed as a "do-it-yourself" project. An able-bodied person should be able to build it by following the instructions in this booklet and the plans on the enclosed chart.

The shelter is a small, protected room built on the concrete basement floor. The walls are made of heavy concrete blocks, except against that part of the cellar wall which is below the level of the ground outside. Here there is no danger from radiation and the wall of the shelter is simply a framework of lumber to hold the concrete blocks above it. The roof of the shelter consists of two layers of loose concrete blocks, laid on planks which are supported by strong wooden joists resting on the two sides of the shelter. The entrance is a short passageway built of concrete blocks to prevent direct radiation coming in the doorway.

Diagram 1 on the enclosed chart shows an outline plan of such a shelter located in the corner of a house basement.

## Size

This shelter has been designed to a minimum width of 6 feet 8 inches inside its walls. This width is recommended because it provides for a full-length bed along the end wall furthest from the shelter entrance.

Most houses have a maximum distance of about 10 feet in the clear between the external wall and the beam supporting the floor joists. Thus the shelter will fit into most houses without interfering with the existing structural framework. The height from the underside of floor joists to the basement floor in an average Canadian home is approximately 7 feet 3 inches. This should

still give adequate headroom in the shelter after its roof has been put in place. If the height of your basement is less, the height of the shelter must be reduced by using a method described later in this section.

Diagram 1 on the enclosed chart shows the dimensions of a typical shelter required to accommodate five persons, using a width of 6 feet 8 inches between the inside walls. The size of the shelter should not, if possible, be reduced for families with fewer than five persons because a smaller size shelter is likely to be much less comfortable and may create ventilation problems. Changes in length required to accommodate additional persons are as follows:

<i>No. of People</i>	<i>Clear Inside Width</i>	<i>Clear Inside Length</i>	<i>Overall Length</i>
5	6'8"	9'4"	14'0"
6	6'8"	10'8"	15'4"
7	6'8"	13'4"	18'0"
8	6'8"	14'8"	19'4"

Diagrams 2, 3 and 4 on the chart show various construction details. The materials required to construct the shelter include concrete blocks of several sizes for the walls and roof (solid blocks are suggested but you may use hollow blocks *provided* their hollows are completely filled with sand or mortar as work proceeds); heavy lumber to support the roof and construct the framework against the basement walls; hydrated lime, cement and sand to make mortar; nails, lag screws, bars and washers to be used as described below. The detailed amounts required for the four sizes of shelters noted above are listed on Page 33. Tools required for the project include:

- Mortar Mixing Board
- Shovel and Pail
- Bricklayer's Trowel
- Level and Bricklayer's Line
- Long Straightedge
- Saw
- Hammer
- Drill with masonry bit
- Spanner or Wrench

## How to make mortar and lay up masonry

The mortar mix recommended for shelter construction is one part of cementing material to three parts of clean sand. The cementing material may be masonry cement, or Portland cement plus hydrated lime in equal proportions, or Portland cement alone. The usual cement used in construction, called Portland cement, will not give as easy a mix to work with when used alone as will masonry cement. Prehydrated lime, purchased in bags, gives a workable mix when added to Portland cement, but means that an extra ingredient must be purchased.

A ready mortar mix in bags containing both cement and sand, and requiring only mixing with water, is available in some localities.

Mix the cementing materials and sand while dry, then add water and mix again thoroughly. Do your mixing in a shallow box, on a metal or plywood sheet or on a board platform. You may even use the basement floor for mixing, if you do not object

FIGURE 1

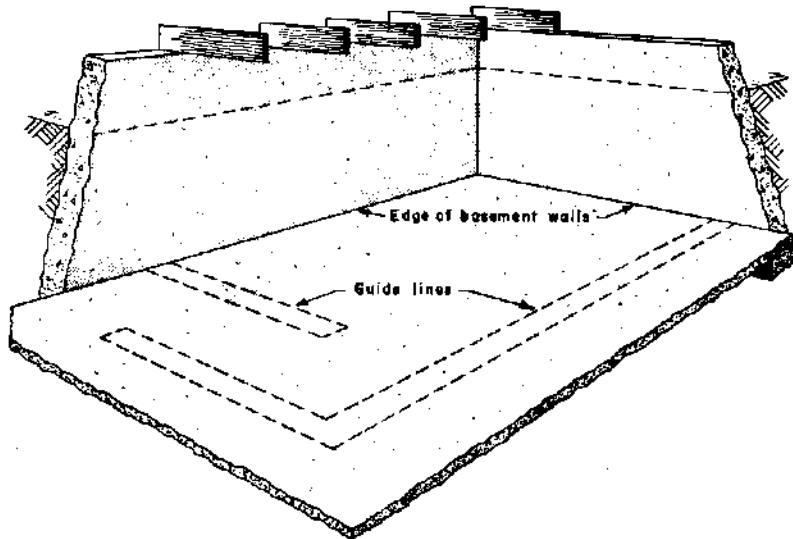

to its discoloration by the cement, but a box or plywood sheet will be more convenient. Mortar sets quickly, so mix only as much material at once as you can use conveniently in fifteen or twenty minutes.

## Lay it on the line

Having decided the size of shelter you need for your family, the first step is to mark out "guide lines" on the basement floor as illustrated in Figure 1 on Page 8.

## Start on the level

After marking out your "guide lines", check to see if the floor is level. If it is not level, then the procedure illustrated in Diagram 9 on the enclosed chart should be followed. This is to construct a shallow form in which are placed guide blocks to indicate the level to which the concrete is to be finished. The mortar is placed inside this form and finished level with the tops of the guide blocks. After it has set, the form and guide blocks can be removed and the spaces left by them filled in with the aid of an elementary form as shown in Figure 2 below.

FIGURE 2

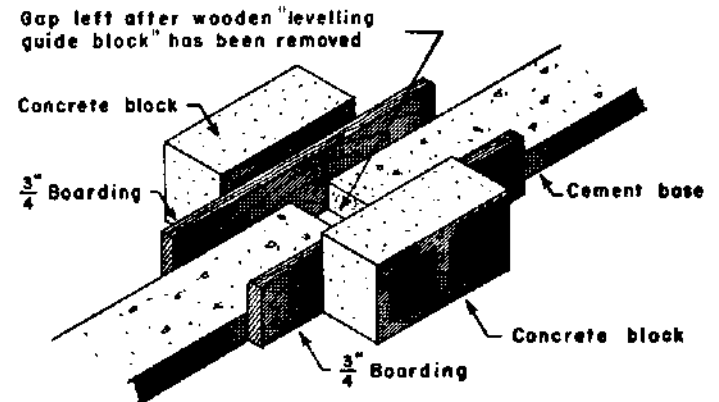



## Plan your work

Now that you have a level base, plan so that the walls come out straight and true (See Diagram 11) and to the exact height desired at each stage. Measure carefully the dimensions of the block you have available and remember to add  $\frac{1}{2}$  inch to the block height for the thickness of the mortar joint when calculating the heights at any given course.

At corners the blocks must alternate and be fitted together, so you must keep the corresponding mortar joints at the same heights on all walls. Make use of a long, wooden straightedge, a level and a bricklayer's line in checking your work. Do not forget that the cores of hollow blocks *MUST* be filled as work progresses in order to give the desired degree of protection.

Consider carefully how many rows of whole blocks you can get into the height of your wall. The top row of blocks must not be closer than 16 inches to the existing floor joists or you won't have room for your roof. You may not be able to use the nine rows of blocks needed to give you the six feet of clearance within the shelter. (The shelter described in this pamphlet is, of necessity, calculated on the basis that the average Canadian house has 7 feet 3 inches of clearance between floor joists and basement floor).

However, you will want to make use of every inch of headroom your basement offers. If a wall of nine courses, or rows, of blocks is too high and one of eight courses not high enough, the difference can be made up by increasing the height of the level footing you make for the wall and, if necessary, by combining this with a top course of 4-inch blocks on the wall.

The following table will show you how to do this:

<i>If your basement headroom is:</i>	<i>You will need this number of 8-inch courses of blocks</i>	<i>and this increase in height to your level wall footing</i>
7'4" and over	9	Nil
7'3"	8½*	3"
7'2"	8½*	2"
7'1"	8½*	1"
7'0"	8½*	Nil
6'11"	8	3"
6'10"	8	2"
6'9"	8	1"
6'8"	8	Nil

\*The half course consists of 4-inch blocks.

If the basement headroom is less than 6 feet 8 inches, which means a shelter headroom of 5 feet 4 inches, you should build the next larger size of shelter in order to ensure having the correct volume of air space inside.

## Framing

The blocks which are built against the existing basement walls of the house, above the ground level, rest on 2-inch by 8-inch timber framing, which itself must be supported on a course of cement blocks or concrete at least 3 inches thick (See Diagram 10 on the enclosed chart). The framing reduces the number of concrete blocks required and provides storage space.

Below outside ground level and immediately adjacent to the shelter, the existing concrete wall of the house and the existing ground will provide adequate protection. Therefore, the height of the framing and the number of courses of blocks on top will depend on the level of the ground outside the basement wall. As an example, if it is 4 feet 6 inches from ground level to basement floor, then the top 2-inch by 8-inch board on which blocks are laid must not be more than 4 feet 6 inches from the floor. If the grade outside is lower, so must be the height of the framing. If the ground level is higher than the top side of the shelter roof, then concrete blocks would not be required on these walls. But timber framing must be built on these walls to support the ends of the roof joists. The timber framing must be properly braced

with diagonal pieces and all pieces well "spiked" together, using 4-inch nails (See Diagrams 2 and 3 on the chart).

The framing must be anchored to the existing basement wall as shown in Diagrams 5 and 8 on the chart.

It is important to remember that the height of your framing and blocks on top of it must always correspond to the height of the rows of blocks on the opposite walls so that your shelter will end up at the same height on all sides.

The surfaces of the framing which are to be placed in contact with concrete or masonry should first be treated with some suitable timber preservative such as copper naphthanate. You just paint it on; you'll get the necessary instructions on its use when you buy it.

## Walls

Having set the timber framing in position, the corner of the shelter on top of the framing is built about four blocks high (using blocks 16 inches long by 8 inches wide by 8 inches deep), and the remainder of the wall then built to the same height (See Diagram 10). Continue building the wall in this way to the required height.

The blocks which form the 90-degree angles at the corners need to be "toothed" together (as shown in Diagram 11 of the chart) in order to achieve proper bonding and rigidity.

These blocks must support the heavy roof of the shelter. For this reason the wall must be anchored to the existing basement walls. This is done by imbedding a metal bar at every other block between the two top courses of blocks and securing it to the basement wall by means of a lag screw (Diagram 8). Don't forget to drill the holes in the basement wall and secure the bars in place (bent as shown in Diagram 6) before laying the top course.

The first row, or base course, of blocks which form the other walls is set in about  $\frac{3}{4}$  of an inch of wet mortar along the guide lines you have drawn on the floor. You then move to the corner

nearest the centre of the basement, build that corner about four blocks high and continue with the remaining walls in the same manner as described above.

Don't forget to insert the vent or air-circulating blocks as shown in position in Figure 3 below and Diagram 1 on the chart. Hollow blocks laid on edge will form suitable openings.

FIGURE 3

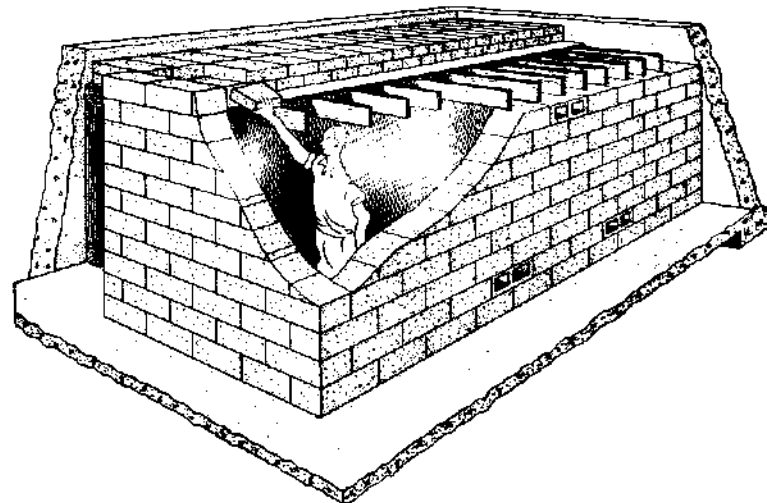

Block designs differ but most blocks will provide about the same area of opening, 40 square inches per block. Four blocks should be arranged for vents, two at the top and two at the bottom of the shelter, providing up to 80 square inches of opening at each level. You may, if you wish, arrange to provide the equivalent area of opening in some other way, such as by leaving out half a block. (If you plan to use solid blocks in your construction programme, it would be an idea also to buy four hollow blocks for the vents).

Before construction of the outer wall has gone too far, all bulky fittings and furniture such as cots, bunks or tables should be placed inside the shelter. Even when these have been put in

place, the walls should not be built all the way to the basement ceiling since a clear space of at least 16 inches is needed overhead to permit construction of the shelter roof.

The baffle wall protecting the shelter entrance from direct radiation must be the same height as the shelter walls.

## The roof

When the mortar in the block wall has dried for a period of at least 48 hours, the roof joists may be installed. As the inside width of the shelter is 6 feet 8 inches, then joists, 2-inches by 6-inches by 7 feet 4 inches, should be set 10 inches apart (on 12-inch centres) and placed across the shelter. Each joist should bear on the block walls for a distance of 4 inches at its end. A 6-inch blocking piece is nailed between each pair of joists flush with the inside face of the shelter walls to hold the joists in place.

The space between the joists where they rest on the wall **MUST** be filled with mortar to maintain the required 8 inches of thickness to the top of the roof. This is done by laying one course of 4-inch thick solid blocks which will butt against the end of the joists and which when completed will form a "box" into which the mortar can be poured. (The "box" is formed by the blocking piece between the joists, the sides of two joists and the 4-inch concrete block).

You should note on Diagram 2 of the chart that the joists carrying the roof over the entranceway are supported on two 4-inch by 4-inch posts and a beam placed there for that purpose.

After the spaces between the 4-inch blocks and the joists on the house foundation wall side of the shelter have been filled with mortar, the laying of the 1-inch roof boards may be started at that side of the shelter. The first one or two boards should be placed in position across the roof joists. These boards are nailed to the joists by reaching up through the open space between the joists. Four-inch thick solid concrete blocks are then passed between the joists and placed on the boards. (There is no need to mortar them together). These roof blocks are in two layers which form a total thickness of 8 inches as shown in Figure 3.

Work on the roof continues in a similar manner until the inside of the opposite wall is reached. Again the space between the joists

where they rest on the wall must be filled with mortar. When this has been done, continue with the remaining course of 8-inch blocks to complete the wall. (Note in Diagrams 2 and 3 of the chart that the wall goes up beyond the rafters and the roof does not cover the walls).

## Building sequence

In summary, the steps which you should follow in constructing the shelter are:

- (1) Plan your work well. Use the pamphlet in conjunction with the diagrams on the enclosed chart.
- (2) Mark out guide lines on the basement floor.
- (3) Erect timber framing against the outer basement walls and fasten it to them.
- (4) Build the concrete block wall on top of the framing to the required height and anchor it to the basement walls.
- (5) Build the remaining walls to the required height, remembering to move larger objects inside before the walls have been raised too high.
- (6) Place the joists or rafters into position, inserting the necessary blocking pieces between them and filling the spaces between joists and blocks with mortar.
- (7) Construct the overhead protection by nailing on roof boards and placing 4-inch concrete blocks in position, working from the outside wall of the house inwards towards the centre of the basement.

## 4 LIFE IN THE SHELTER

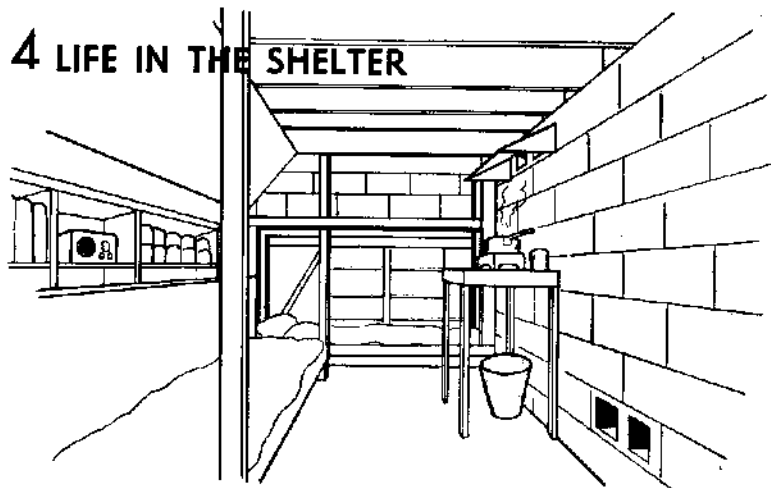

### Shelter layout

There isn't much space inside the shelter by normal living standards. And as you may have to live in it for a considerable period, it is wise to arrange the accommodation as compactly and neatly as possible. If, for example, a shelter is to accommodate five people, you could save space by using a 3-tier and a 2-tier bunk. (Three tiers are the most you can fit into the available headroom).

The living space will be improved if bunks can be built so that they can also serve as additional seating or table space. Suggestions on how this might be done are shown in Figure 4. A folding table will leave you more floor area between meal times.

You will undoubtedly adapt the shelter to suit yourself. However, such measures as painting the inside walls of the shelter, painting the concrete floor or placing an old carpet on it, putting up shelves and other minor fittings will all go a long way to improving your comfort.

Proper understanding of the recommended shelter facilities, and good planning in laying out and stocking a shelter can reduce discomfort to a minimum.

FIGURE 4 2 TIER BUNK

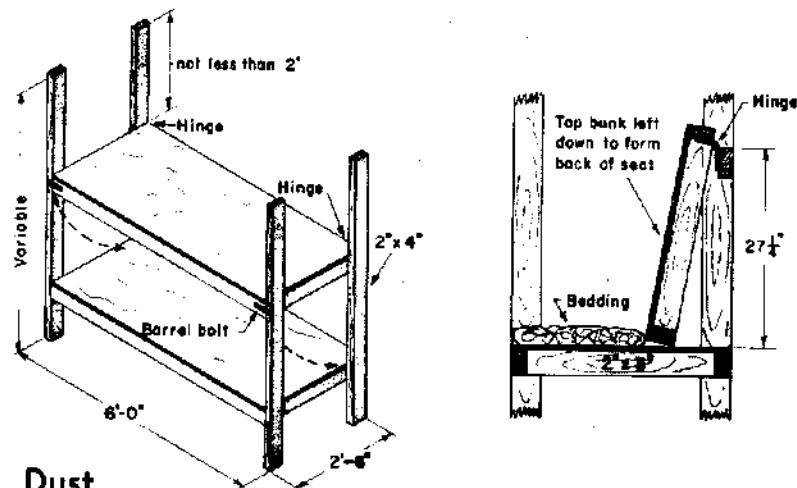

### Dust

Ventilation need not be a problem. The shelter does not have to be made airtight or sealed off from the basement. Radiation does not travel with air movement, and provided the house itself is closed up in the normal way (doors and windows closed) radioactive dust will be kept outside.

It is possible that if you live in an area within 25 miles of a potential target, the windows of your house could be blown in without any other serious damage being caused to the house. In this case, it is possible that a small amount of radioactive dust might be deposited inside the house, but this can be kept out of the basement by arranging to have a door or curtain between the basement and the rest of the house. You should also make provision to block up all basement windows. (See Diagram 7(b) on the chart).

### Ventilation

The shelter air supply can be regulated by adjusting the curtain in the doorway. (This curtain should be of some heavy material such as canvas). Adjusting the curtain will also, to some extent,

control the heat within the shelter. When the curtain is closed, the air flow will be restricted to the vents in the wall and the temperature and humidity in the shelter will rise. When the curtain is open, air flow will be at a maximum and the temperature will fall.

When the basement is cold, ventilation should be restricted by closing the curtain tightly and perhaps even by blocking half the vent openings top and bottom in order to maintain a comfortable temperature in the shelter. This can be done quite safely so long as no fuel-burning appliance is operating in the shelter. When a fuel-burning appliance is in use and the basement is cold, the curtain may be kept tightly closed but the vent openings should be kept completely clear. At all other times, when the need for heat is not great, both vents and curtain should be used for ventilation while operating an open, unvented fuel-burning appliance.

## Heating and cooking

It is possible that damage outside the area where you live may interrupt the supply of electrical power for long periods. This makes it essential to provide for other than electrical methods of cooking and heating which do not involve your making visits to other parts of the house or basement. However, since power may not be interrupted in all areas, or it may be quickly restored, your shelter design may also include facilities to take advantage, up to 1,500 watts, of the normal electrical supply when this is in operation. Wiring should, of course, be installed by a qualified electrician.

In winter, the shelter will almost certainly need to be heated and this will help to increase the air circulation and reduce humidity which might otherwise become oppressive. For shelter heating, high-quality, kerosene-fuelled appliances, available at hardware stores, etc., seem to offer the most satisfactory features. (**WARNING: DO NOT USE** gasoline and other highly volatile liquids because they are far too hazardous for use in a confined space).

The hot gases produced by an unvented fuel-burning appliance will tend to rise. They may be collected and led out of the shelter by placing the appliance directly under a small hood located at one of the top vents. This procedure is recommended for all times when the heat produced is not needed for heating the shelter.

When an open, unvented, fuel-burning appliance is used to warm the shelter, a problem arises. A top vent hood will not only draw off an appliance's gases, but much of the heat produced and existing warm air in the shelter. Further, the warm air in the shelter will rise, leaving the floor cool. So, for the best heating performance under these conditions, the heating appliance should be placed near the floor. Of course, you would be better off with a small closed stove, fitted with a vent pipe. This would heat without subjecting you to unpleasant odours or dangerous gases.

Don't try to convert a small open fuel burner into a closed stove; there can be real danger if the burner and fuel tank are made to operate at too high a temperature. You should use an open hood above the burner.

The quantities of fuel required are not excessive. Even under winter conditions, one gallon of liquid fuel per day should be adequate for all heating, lighting and cooking purposes within the shelter. About  $\frac{1}{4}$  pint per hour will provide adequate heating. If this rate of fuel consumption is not exceeded, the ventilation system will be more than adequate to ensure that no hazard to health occurs from depletion of oxygen or production of carbon dioxide. A hood and vent over cooking or heating appliances is recommended. This will both improve ventilation and remove combustion products.

In summer, the shelter may be uncomfortably hot and you should therefore keep cooking to an absolute minimum.

## Lighting

Battery-powered lamps, candles or kerosene lanterns or lamps can be used. At least twelve, No. 6 dry cell batteries would be required to provide one watt of electrical output during waking

hours for a two-week period. During hot weather you should use lighting generated from batteries. There are many types of emergency lighting equipment on the market today.

## Sanitation

Inside the shelter, the health of your family will depend to a large degree upon the standards of sanitation and personal hygiene that you adopt. Cleanliness is the keynote.

Your major concern will be the disposal of human waste. It is recommended that you install a sanitary toilet provided with polyethylene bags. Your shelter should be pre-equipped with at least a two-weeks supply of large-size bags. After use they should be tied at the neck and deposited in the garbage can or other suitable metal container until they can be disposed of. For the first 48 hours at least, the toilet and garbage can should be placed in the entrance passageway to the shelter. (See Diagram 1). During this period, you and your family should remain within the shelter, unless otherwise officially advised, so blocking this passageway will not matter. After 48 hours, it may be possible to move both items further out into the basement. You will be advised officially. Families with infants should ensure that at least a two-weeks supply of disposable diapers is stored. These too should be placed in polyethylene bags after use and deposited in the waste container.

Washing, especially of hands, is of great importance. Soap, detergents and water do the job best. But, naturally, the waste water from this—and perhaps cooking—has to be disposed of. So it will be important for you to make use somehow of the basement drainage system which normally exists in most houses. One way is to lead a hose from your basement drain to the shelter entranceway, equip the end with a funnel and get rid of the waste water that way. If this is not possible, waste water will have to be treated in the same way as garbage and an additional receptacle for it placed alongside the garbage can.

For reasons of hygiene, and in order to reduce shelter odour, you should provide a number of changes of underclothing for all occupants of your shelter.

## Food and water

Radiation conditions may make it necessary for you to live in the shelter for two to fourteen days. Better make sure, then, that you have enough food and water inside the shelter for at least two days; the balance of your supplies—which can be stored outside but close to the shelter—should be enough for at least twelve days. On Page 31 you will find a list of suitable foodstuffs for a 14-day period. These may be bought and stored over a period of time.

As for water, you should have enough to give at least half a gallon daily to each person; a gallon would be even better. Even if you find that the normal water supply to your house has not been cut off after an attack, you should *NOT* use it until you are told definitely that it is safe to do so. The water could be contaminated without your knowing it. In fact, one of the last things you should do before occupying your shelter is turn off the water at the main shut-off valve. (Make sure you know where it is). You should not open it again until you have been advised to do so by local authorities. Once the valve is closed you may use the water stored in your hot water tank as an additional supply.

## Communications

Your only contact with the outside world, once you are in the shelter, will be by radio. It is vital, therefore, that you have a battery-powered radio as part of your shelter equipment. It is important that you check the reception in the shelter when you install it; it is possible that you will require an aerial to ensure adequate reception. The radio will *keep you informed* of any changes in the general situation in your area. Broadcasts will let you know when, and for how long, it is possible for you to leave the shelter. Under NO circumstances should you leave the shelter before being told it is safe to do so.

## Equipment

The items of equipment with which your shelter should be stocked are listed, for handy reference, on Page 29. After all

essentials which you need, and for which there is adequate room, have been stored, you should give thought to additional items which might make shelter life more pleasant, and which will not take up too much space.

## Daily routine

The degree of comfort in shelter living will be governed by two factors—daily routine, and outside conditions. The first of these you can control by the planning that you put into working out a routine for daily life within the shelter. The second you cannot control. Conditions outside the shelter may or may not permit limited excursions to other parts of the house or even out of doors.

In planning a daily routine you should break up the day into various periods for rest, individual and group activity, cooking and feeding, shelter chores, and so on.

## 5 HEALTH AND SAFETY

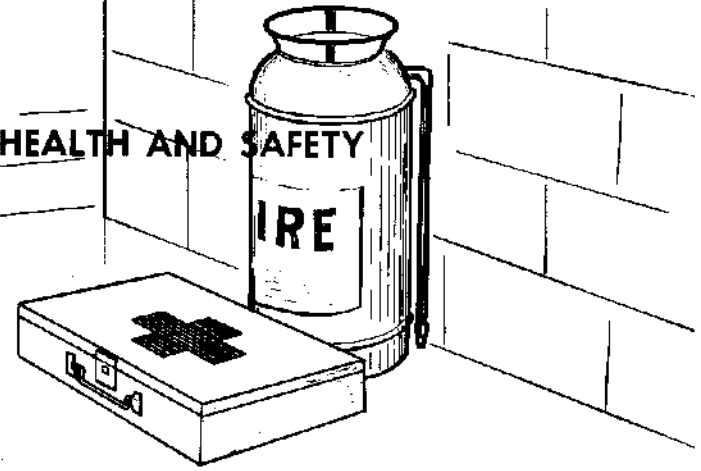

## Sanitation and hygiene

Polyethylene bags used for the disposal of human waste, diapers, etc., must be tied at the neck after use and deposited in the garbage can until they can be disposed of by burial or other means.

Water must be rationed according to your supply. Remember, part of the ration will be for washing, especially hands.

Changes of underclothing must be planned according to the supply available.

The main water supply valve must NOT be turned on again until you receive instructions that it is safe to do so.

## Ventilation and heating

In winter, the shelter should be heated if at all possible. This will increase air circulation and reduce humidity. Use a kerosene appliance for cooking and heating. Do not burn more than one gallon of fuel per day since this will be adequate for all heating, cooking and lighting purposes. At this rate of consumption there is no problem of fumes.

In summer, the shelter may be too hot and you should aim at reducing the heat generated inside the shelter by keeping cooking to a minimum and using lighting generated by batteries.

## Fire precaution

DO NOT use gasoline or other volatile fuels in the shelter. Kerosene is recommended. Consult your local fuel oil company concerning the best grade of kerosene for long-term storage.

DO NOT use dished, reflector-type electric heaters.

Store your fuel in non-leaking containers and make sure that taps, bungs, etc., are out of the reach of children.

See that all sources of ignition such as matches, etc., are in your possession at all times and not accessible to children.

DO NOT locate cooker or heater where a chance fire could block the entrance.

Take great care in refuelling appliances and always use a funnel. It is safer to wait until the appliance has cooled off before refuelling.

## Medical supplies

Don't forget to store adequate First Aid supplies, etc., and special medicines if required.

DO NOT leave such supplies within reach of children. A medicine cabinet which can be locked would be a valuable addition to your shelter furnishings.

## 6 LEAVING THE SHELTER

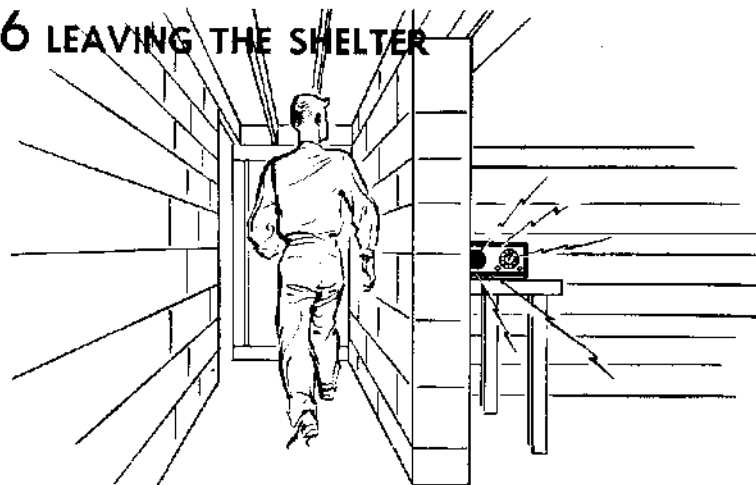

As the radiation intensity outside the house is reduced, it will be possible for you to come out of your shelter for limited periods of time. When you may do so, for how long and where you may go safely will be the subject of instructions issued at the time by local civil defence authorities. Normally, these instructions would be broadcast; under certain circumstances they may be delivered by word of mouth. By whatever means you receive these instructions it will be, of course, extremely important to follow them carefully, otherwise you may endanger the lives of yourself and your family.

Generally, it is anticipated that you will have to remain within your shelter continuously for 48 hours if you happen to be in an area of high radiation. After that, your excursions from the shelter will be in accordance with instructions given you at the time. Even then you should make a point of using the shelter for all non-productive activity, such as sleeping, eating, resting, and listening-in.

In an area subjected to fallout there are safety zones at your home. Safest place is in your shelter; next safest is in the basement below ground; next is upstairs in the house; least safe is outside the house.



## 7 BUILD IT NOW

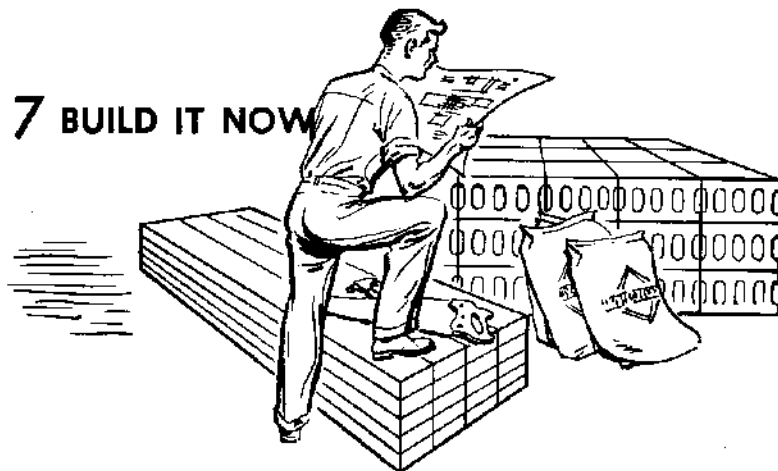

By now you will have realized that there *IS* a great deal you can do to protect yourself and your family from the dangers of radioactive fallout. The shelter described here is based upon the best knowledge available today. However, studies continue and simple means of improving it still further may be found in the future. You should therefore keep in touch with your local civil defence authority.

It is not an expensive shelter, as you will find when you price the list of materials, and if you are prepared to do the work yourself this represents a modest price to pay for your survival. Talk it over with your neighbours and your friends. Perhaps you can all get together and build your shelters as a team—it could be a real community project. You might even consider building the shelter for relatives, friends or neighbours who are not able, for one reason or another, to build their own.

You can accomplish a great deal at little cost, with little effort and a little forethought. What is important, however, is to build the shelter *NOW*. The work cannot be done at the last minute, and it will be too late when the warning is given.

## 8 ACTION GUIDE

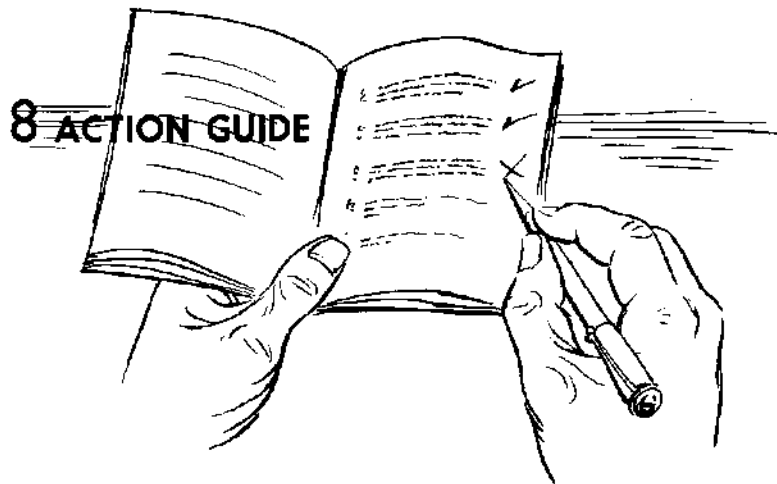

### Now You Can:

1. Build your shelter in accordance with the enclosed working drawings.
2. Install the suggested items of equipment. Check them against the list on Page 29. Have you got all the essentials, particularly the shelter radio?
3. Store all the food, water, fuel, batteries, etc., that you will need. Arrange to use and replace at the specified intervals.
4. Plan a family drill for occupying the shelter and practise it. (Remember, *any* adult or adolescent in your home may have to assume command of the situation at the time of an emergency).
5. Plan a daily routine for shelter life.
6. Make preparations so that all basement windows can be quickly and effectively shielded in accordance with instructions.
7. Keep the shelter warm and dry.

### If Warning Comes:

1. Turn on your home radio. Wait for instructions. You will be told when to go into your shelter.

2. If there is time—you will be told how much—do as many of the following tasks as you can in this order of priority:

- (a) Shield all basement windows;
- (b) Move clothes and bedding, suitable for the season, into the shelter;
- (c) Move as much furniture, books, magazines, papers, etc., as possible into the room above your shelter;
- (d) Fill up any additional water containers which may be useful later on. These can be left outside the shelter for use when you are told it's safe to venture into the basement;
- (e) Take in any extra reading material, etc., you might need;
- (f) Open an upstairs tap and turn off the water at main shut-off valve.

## Go Into The Shelter

1. Last person in places toilet and garbage can in passageway.
2. Turn on the shelter radio. Listen for instructions.
3. Put daily shelter routine into effect.
4. Remain in the shelter until instructed to leave. (In most cases this will come via radio but in some instances civil defence officials may notify you in person).
5. Keep calm. Your family will look to you for leadership.

## 9 SHELTER SUPPLIES

### Equipment

- Beds (Bunks or folding)
- \*Table (Folding or other facility)
- \*Stools (Fold flat)
- Cooking vessels
- Cups and Plates (disposable)
- Knives, forks, spoons
- Can openers
- Paper towels
- Kerosene cooker
- Kerosene Lamp
- Electric Lamp and Batteries, spare bulbs
- Flashlight
- 10 Gallons Kerosene (2 gals. in shelter; remainder in basement)
- Matches
- Garbage can (2 if no waste water run-off is possible)
- Garbage bags

- Toilet
- Polyethylene bags for toilet (two-week supply)
- Shovel
- Crowbar
- Axe
- Pocket knife
- Whistle
- \*Saw
- \*Screwdriver
- \*Hammer
- \*Screws
- \*Nails
- Pliers
- Fire Extinguisher (non-carbon tetrachloride)
- \* $\frac{1}{4}$ -inch Rope
- String
- Battery Radio
- Clock
- Spare Radio batteries
- Hand basin

### Recreational

- \*Calendar
- \*Books
- Paper
- Pencils
- \*Playing cards
- \*Chess, checkers, other games
- \*Crossword, other puzzles
- \*Knitting, sewing, etc.
- \*Hobby materials

**Toiletries**

Soap, toothpaste, tooth-brushes  
 Detergent  
 Nail brush  
 Razor, blades and soap

\*Women's basic cosmetics  
 Tissues (face and toilet)  
 Face cloth  
 Towels  
 Brush and comb

**Personal**

Bedding (blankets preferable)  
 Warm sweaters and socks  
 Change of underclothing and socks  
 Personal hygiene items for women

Baby clothes  
 Baby feeding equipment  
 Disposable diapers (two-week supply)  
 Plastic sheeting

**Medical**

First Aid dressings and drugs (commercial First Aid kit)  
 \*Aspirins  
 \*Bicarbonate of soda  
 \*Cough drops  
 \*Nose drops

Specific medicines such as insulin, heart medicines, etc. as required (100-day supply)  
 Disinfectant  
 Scissors

**Protective clothing**

Coveralls, rubber boots, rubber gloves for adults. To be used in venturing outside even after instructions have been given that this is safe for short periods.

\*Desirable but not essential.

**Food**

These are the requirements *per person* for 14 days. Canned foodstuffs should be used and replaced once every six months. Check off the items as you stock them in the shelter.

*Milk*: 4 cans milk (1 lb. cans, evaporated or dried skim milk)

*Vegetables*: 6 cans (15 oz. or 20 oz. cans—beans, peas, tomatoes)

*Fruits*: 6 cans (15 oz. or 20 oz. cans—peaches, pears)

*Juices*: 6 cans citrus juice (20 oz. cans—apple, grapefruit, lemon, orange, tomato)

*Cereals*: 14 individual packages (sealed in wax bags inside or outside)

*Biscuits*: 2 packages crackers (1 lb.)  
 2 packages cookies

*Main Dish Items*:

2 cans meat (12 oz.—corned beef, luncheon meats)

2 cans beef and gravy

2 cans beans (15 oz. or 20 oz. cans—baked beans, pork and beans)

2 jars cheese

2 cans fish (8 oz.)

*Canned and Dehydrated Soups*: 2 cans (10 oz.—bean, pea, tomato, vegetable)

*Infant Foods*: Meat and vegetable soup, precooked baby cereal, assorted strained fruits.

*Other Foods*:

1 can honey

2 lbs. hard candy

1 jar or can peanut butter

1 package tea bags

1 jar sugar

1 jar instant coffee

Salt and pepper

Jam, syrup, molasses, jelly

Chocolate powder

Chewing gum

## Water

*Requirement:* 7-14 gallons for each member of the family.

*Containers:* Store in clean, tightly covered containers such as large thermos jug, new fuel cans, large vinegar bottles, etc.

*Change:* Change the stored water at least once a month.

## 11 ADDITIONAL SERVICES AVAILABLE

If you have difficulty in adapting the design to your basement, you may obtain advice on possible modifications by writing to the Emergency Measures Organization, Privy Council Office, East Block, Ottawa, Ontario.

Extra copies of the pamphlet may be obtained from your local or provincial civil defence or emergency measures coordinator.

## 12 BUILDING MATERIALS

Item	Size	Amount in shelter for:			
		5 people	6 people	7 people	8 people
<i>Concrete Blocks</i> (preferably solid but can be hollow (a))					
Walls	8"×8"×16"	220	240	260	300
	8"×8"×8"	20	20	20	20
Roof	4"×8"×16"	210	250	300	340
Inner Layer Shielding: (b)	8"×8"×16" – allow for each course	13	14	16	17
	4"×8"×16" one course only	7	8	10	11

(a) If solid blocks are used, add 4 hollow blocks to the list for ventilation purposes.  
(b) Height depends upon height of shelter above ground level.

Item	Size	Amount in shelter for:			
		5 people	6 people	7 people	8 people
<i>Mortar</i>					
Hydrated Lime		200 lbs.	250 lbs.	300 lbs.	350 lbs.
Cement		18 bags	21 bags	27 bags	31 bags
Mortar Sand		3 cu. yd.	3½ cu. yd.	4 cu. yd.	4½ cu. yd.
<i>Lumber (c)</i>					
Posts and Beam	4"×4"×10'0"	2 pcs	2 pcs	2 pcs	2 pcs
Stud wall					
Plates (short)	2"×8"×8'0"	3	3	3	3
Stud wall					
Plates (long)	2"×8"×10'0"	3	—	—	—
	2"×8"×12'0"	—	3	—	—
	2"×8"×14'0"	—	—	3	—
	2"×8"×16'0"	—	—	—	3
Studs	2"×8"× (d)				
Rafters	2"×6"×8'0"	14	16	19	20
Blocking pieces	2"×6"×10'0"	3	4	4	4
Curtain frame	2"×4"×8'0"	2	2	2	2
Roof boards	1"×6"×14'0"	14	—	—	—
	1"×6"×16'0"	—	14	—	—
	1"×6"×18'0"	—	—	14	—
	1"×6"×20'0"	—	—	—	14
Shelving	1"×8"×10'0"	4	5	6	7

(c) Commercial lengths are listed. See diagram dimensions for lengths you cut.  
(d) Length depends upon height of shelter above ground level.

Item	Size	Amount in shelter for:			
		5 people	6 people	7 people	8 people
<i>Hardware</i>					
Nails	6 inch	1 lb	1 lb	1 lb	1 lb
	4 inch	6 lbs	7 lbs	8 lbs	9 lbs
	2 inch	3 lbs	3½ lbs	4 lbs	4½ lbs
Copper Naphthanate		As Required			
<i>Framing Anchor</i>					
Lag screws & plugs	3/8"	4	4	4	4
Washers		4	4	4	4
Lumber	2"×4"×8"	2	2	2	2
<i>Wall Anchor</i>					
Lag screws & plugs	1/4"	5	5	6	7
¾" Bar	12" long*	5	5	6	7
Washers		5	5	6	7

\*Bent as in Diagram 6 on the wall chart.



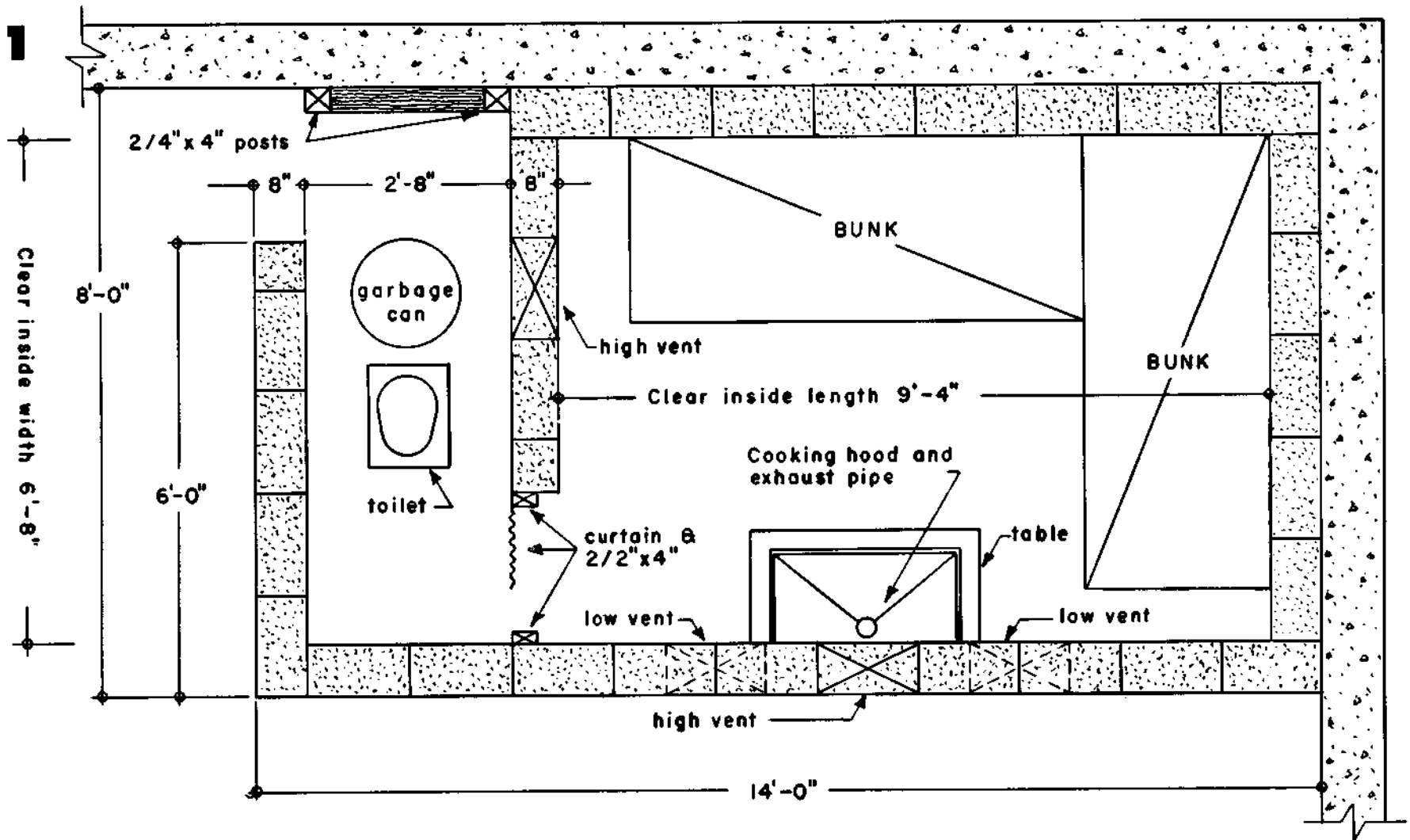

**2**

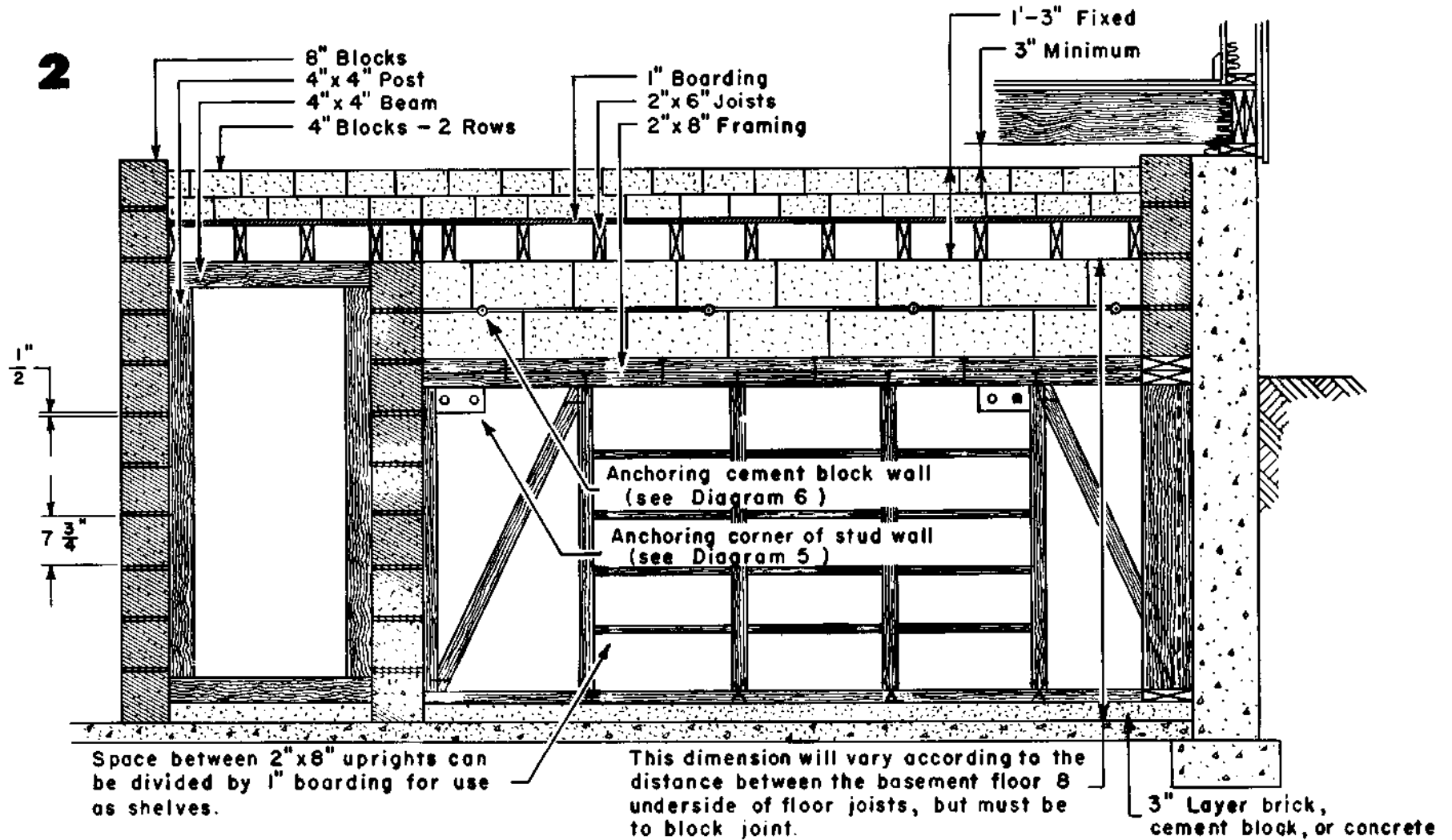



**3**

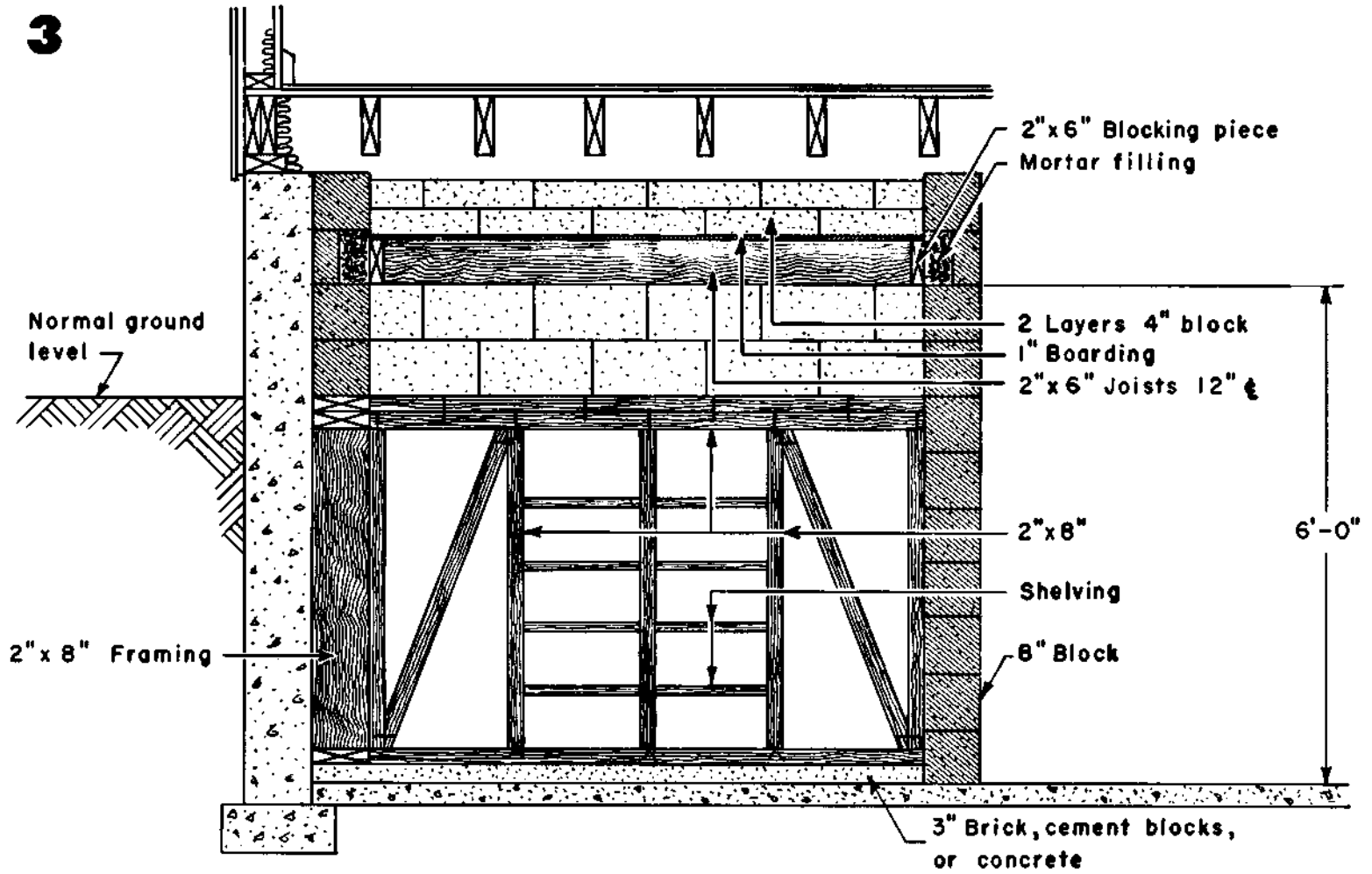

**4**

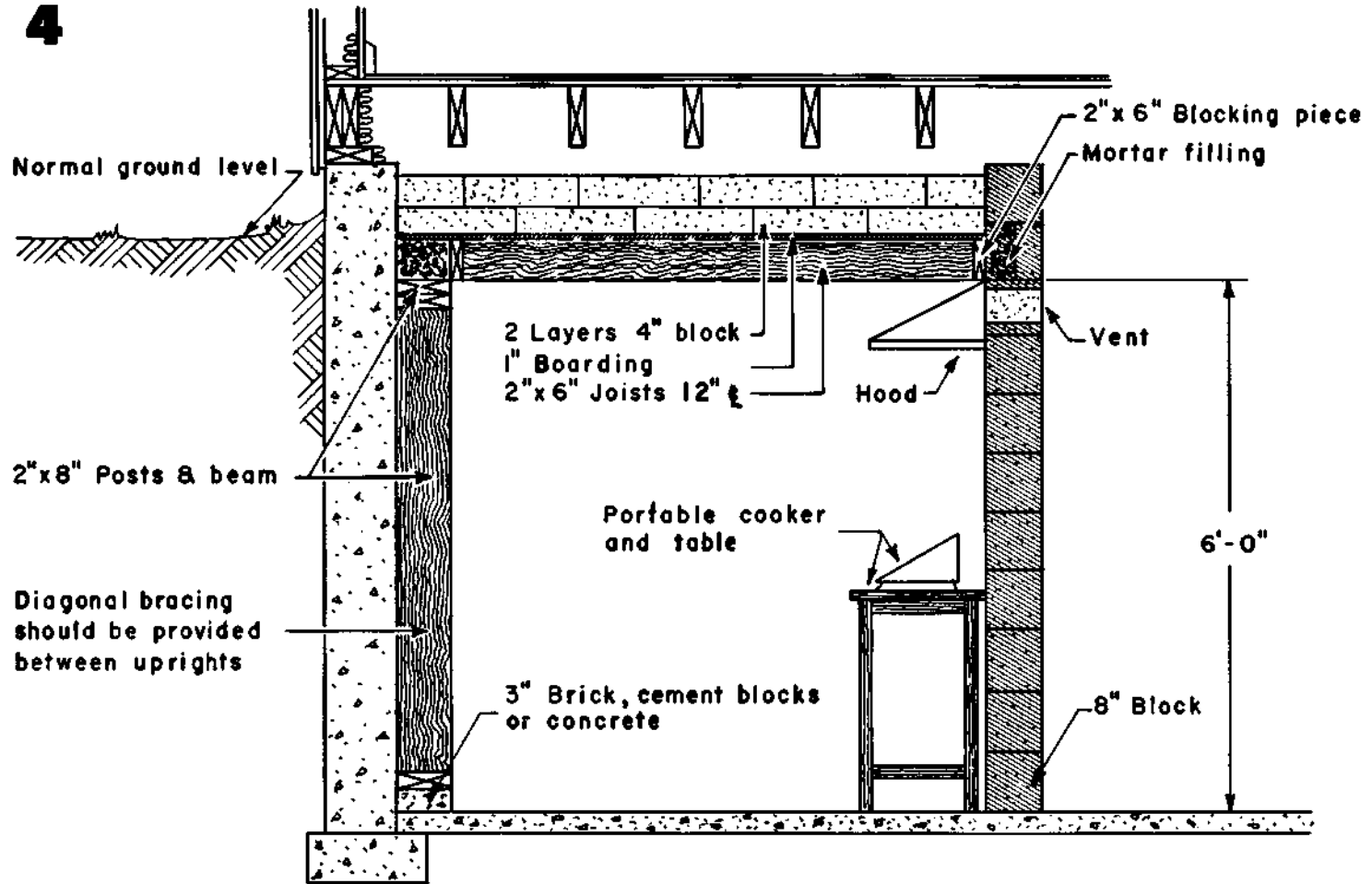

**5**

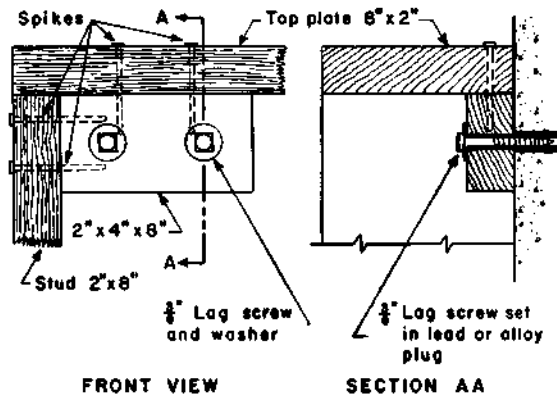

**6**

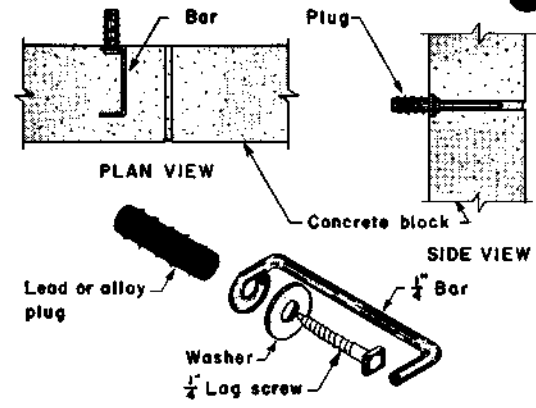

**7**

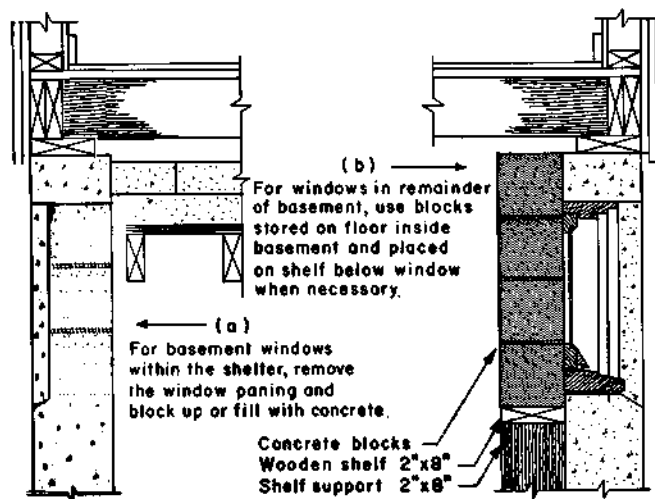

**8**

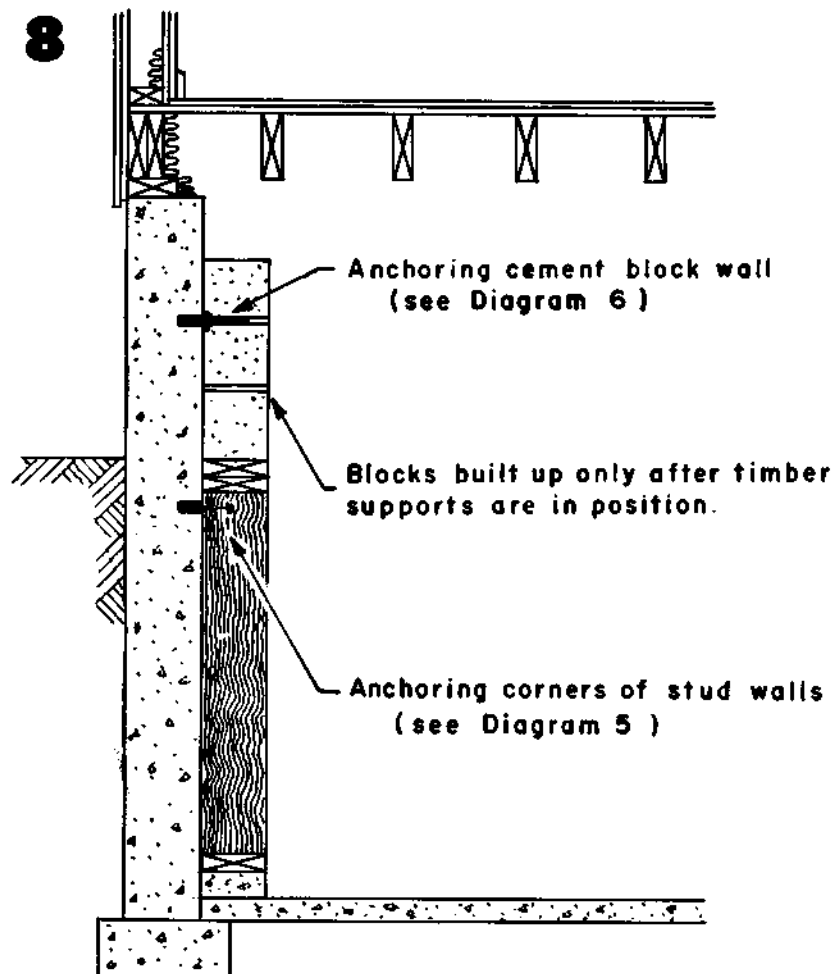

9

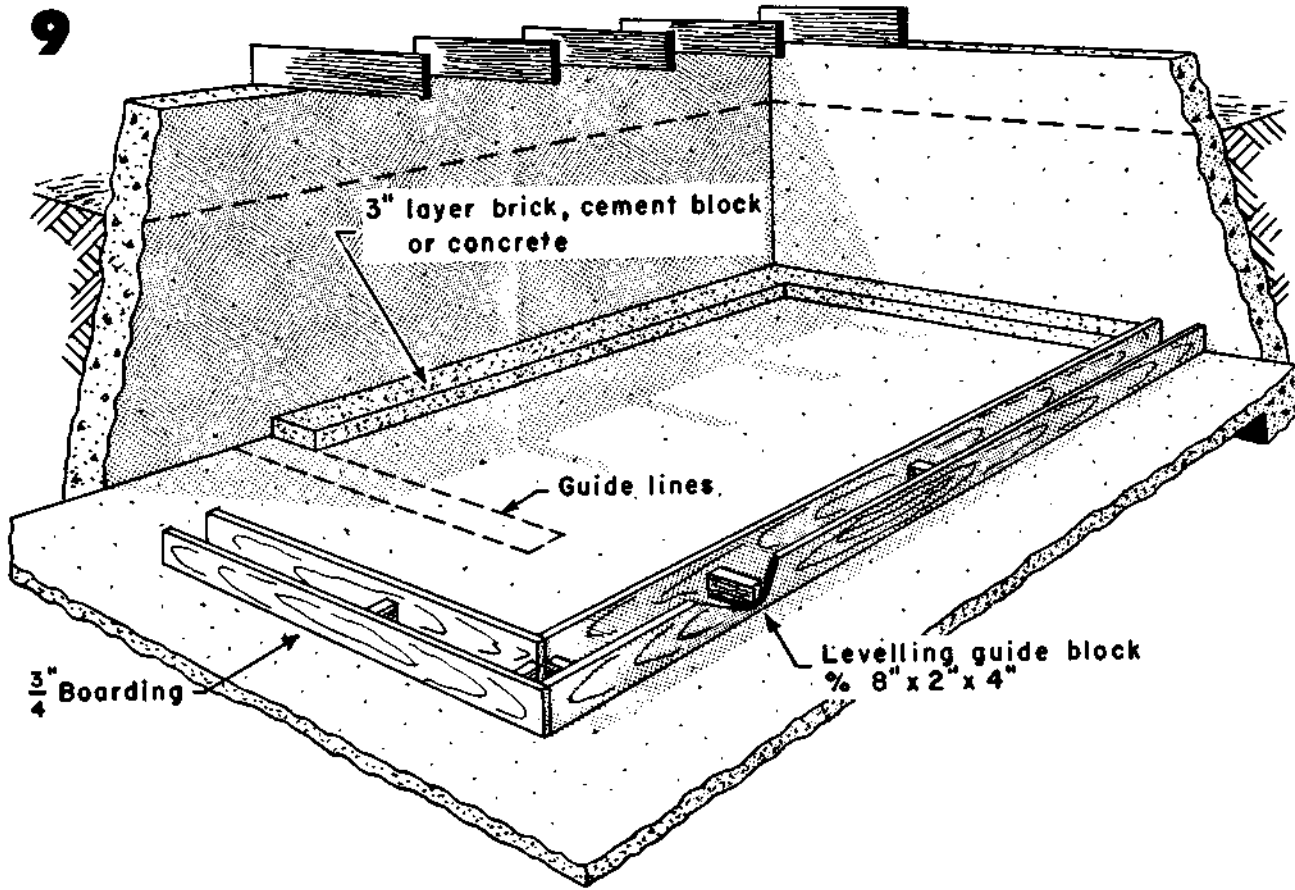

**10**

← Normal ground level

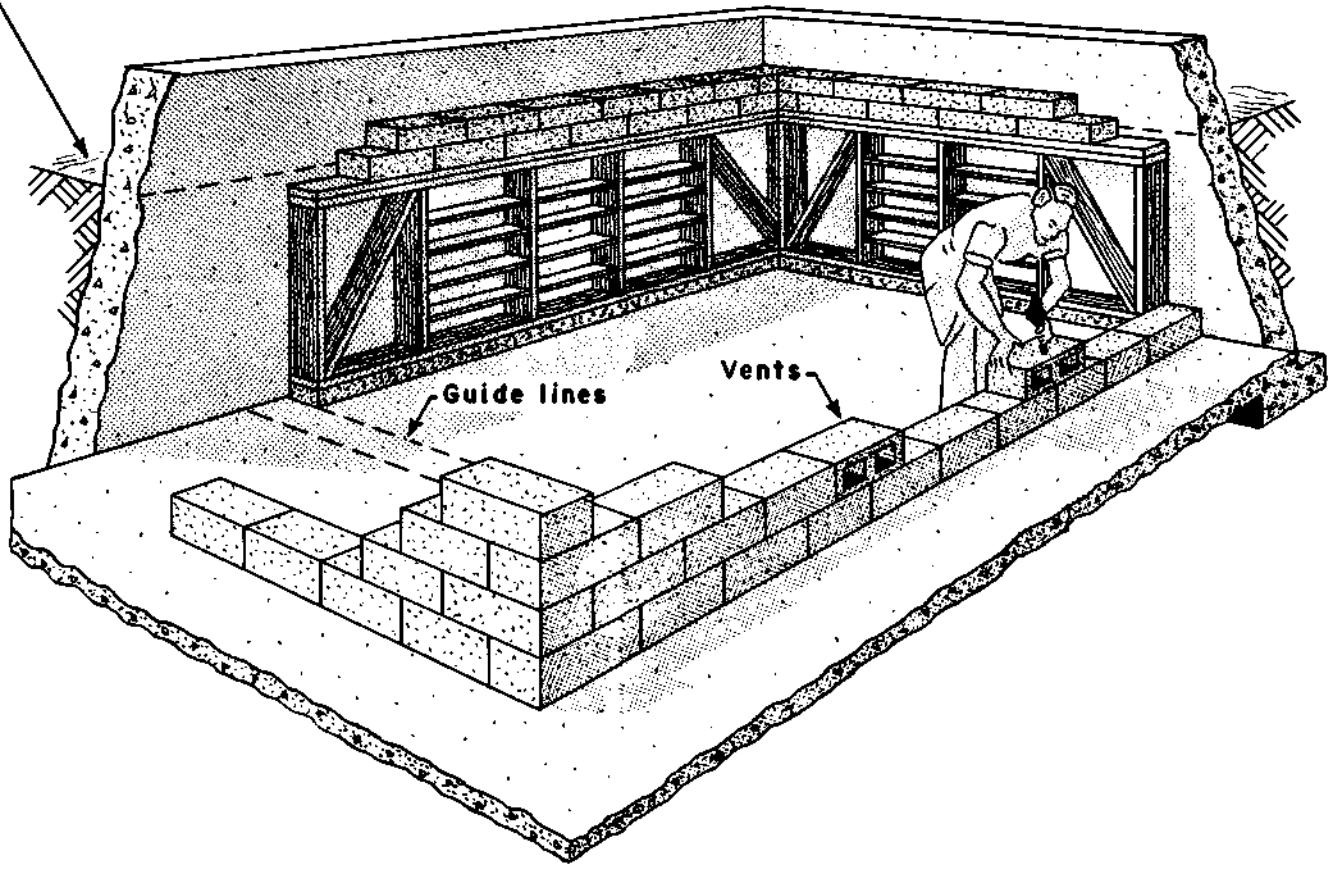

11

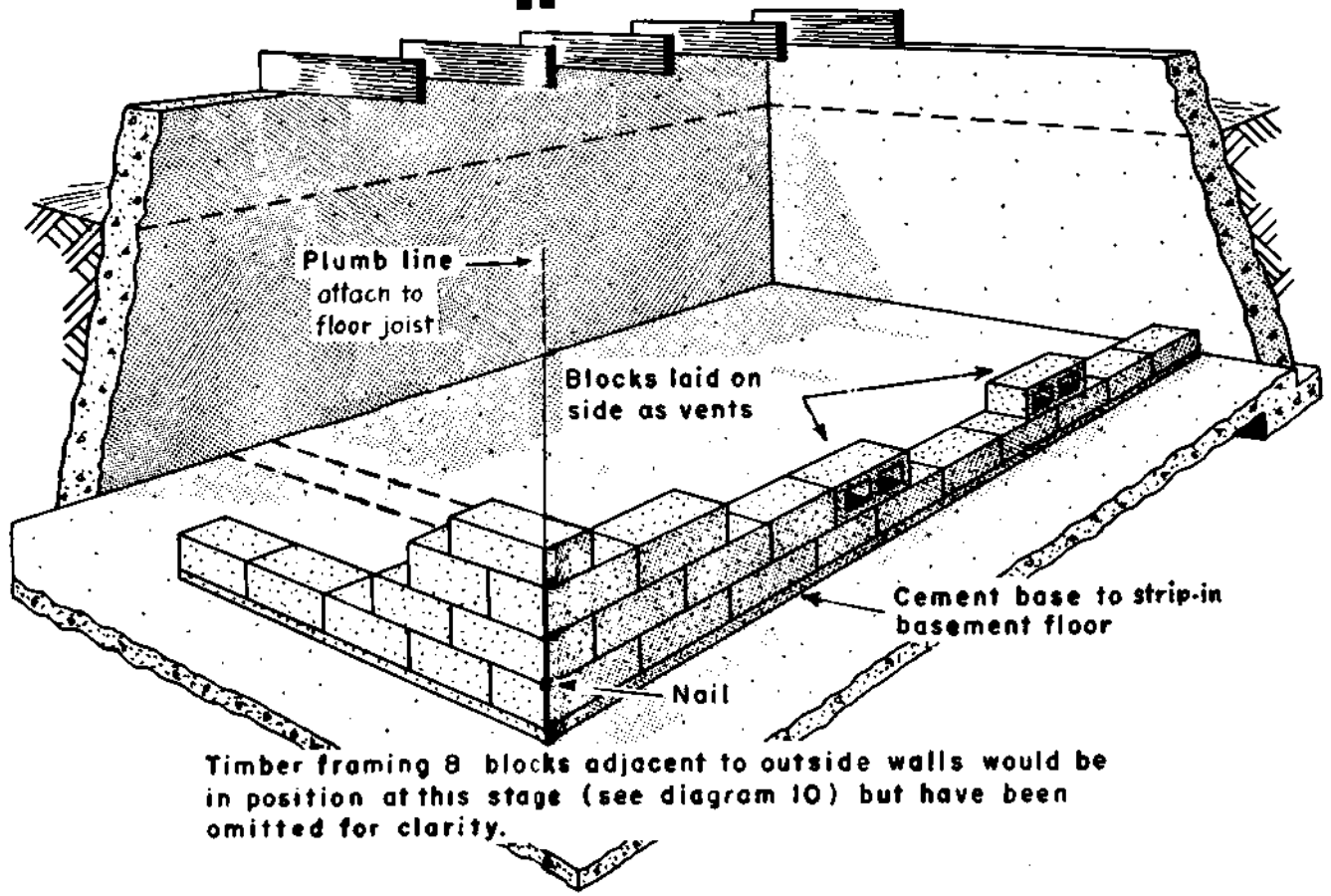

Timber framing & blocks adjacent to outside walls would be in position at this stage (see diagram 10) but have been omitted for clarity.