

ZIG ZAG COLLECTOR

MANUAL ON THE CONSTRUCTION OF A SOLAR WATER HEATER



- BACIBO** - Non-profit consultancy for solar energy in developing countries.
WOT - Knowledge centre for small-scale applications of sustainable energy and hand pumps for developing countries.

2004

Table of Contents

1. Introduction.....	3
Manual and Videotape.....	3
1.1. Using solar energy.....	3
1.2. Parts of the solar water heater.....	4
1.3. Working principle of the solar hot water system.....	4
1.3. Working principle of the solar hot water system.....	5
1.4. The use of hot water systems.....	5
2. Construction of the solar collectors.....	6
2.1. Constructing the absorber.....	7
2.1.1. Preparing the ½” galvanised pipe.....	7
2.1.2. The pipe-bending set.....	8
Constructing the wooden frame for the pipe-bending set.....	8
Preparing the pipe-bending set.....	11
2.1.3. Starting the pipe bending.....	13
The pipe bending procedure.....	16
2.1.4. The cutting of the galvanised sheet.....	19
2.1.5. Preparations to join zigzag-pipe and sheet.....	20
2.1.6. Connecting the pipe and sheet.....	21
Connecting the pipe and sheet with wire loops.....	21
Connecting the pipe and sheet by riveting.....	22
Connecting the pipe and sheet by soldering.....	23
2.1.7. The painting of the absorber.....	26
2.2. Construction of the collector-box.....	27
2.2.1. Preparations to make the wooden collector-box.....	28
2.2.2. Constructing the wooden collector-box.....	28
2.3. Preparing the insulation layer.....	30
2.4. Preparing the glass cover of the collector.....	31
3. The insulated storage tank and accessory pipe-connections.....	33
The soldering procedure.....	34
The insulation of the storage tank.....	35
The metal envelope and the cap.....	37
4. The buffer tank.....	38
5. Determining the location and position of the solar hot water system.....	39
6. The foundation.....	39
7. The installation of the solar powered hot water system.....	40
Placing the collectors.....	41
Placing the storage tank.....	42
Testing the hot water system.....	43
The insulation of pipe connections.....	43
Other collector set-ups.....	43
8. Maintenance.....	44
Checking enclosed air in the system.....	44
Checking dust.....	45
9. Financial aspects and labour costs.....	46
10. Time-span of the project.....	46
11. Summary of needed materials to construct one system.....	46
Appendix - Construction of a saddle-press.....	47

1. Introduction

Health and social communities in developing countries are institutes that daily use large quantities of hot water. When such communities are situated in areas that are hardly accessible, they mainly use wood fuel for water heating. Because firewood supply becomes an ever-growing problem, it is sensible to look for an alternative source of energy. Given the fact that solar radiation is present in abundance, it seems justified to manufacture self-made hot water systems.

Manual and Videotape

This manual is based on experiences gained during many years of building solar powered hot water systems in developing countries. It may be helpful in constructing solar collectors and building hot water systems especially for communities using large quantities of hot water.

By means of existing technical facilities, a selected group of skilled technicians and locally available materials, it is possible to produce zigzag collectors and to build up sustainable hot water systems. By using clear explanations and many pictures we hope to be of service to those who are motivated to build a hot water system all by themselves.

Since 1997 a videotape entitled "Heated by the sun" has been composed as an additional illustration of the manual. It shows all activities as described in the manual. Therefore it is advisable to use the manual and videotape jointly. The videotape can be acquired from the BACIBO-foundation.

1.1. Using solar energy

The pluriform influence of solar radiation on life on earth can be used for several purposes. Proven applications for among other things generating electricity, water heating, cooking, and crop drying with solar energy exist. Small amounts of electricity can be generated with so-called P.V.-systems (Photo-Voltaic). These systems can be reliable energy providers for remote areas (in which sometimes hospitals and clinics are situated). P.V.-systems are rather expensive. For maintenance and repair you need the manufacturers assistance. P.V.-systems can be used for:

- Lighting;
- Cooling boxes for storing medicines and blood plasma;
- Radio communication and T.V.

For solar powered water-heating technical appliances are rather simple and much cheaper than P.V.-systems. Institutions like hospitals require a substantial supply of hot water 24 hours a day. Because the use of solar radiation is limited to the daily hours of sunshine, it is necessary to construct a hot water system that collects as much heat as possible during the daytime and preserves the collected heat as much as possible after sunset. For this reason a hot water system has been figured out which is named the thermo-syphon system, or the system based on natural circulation.

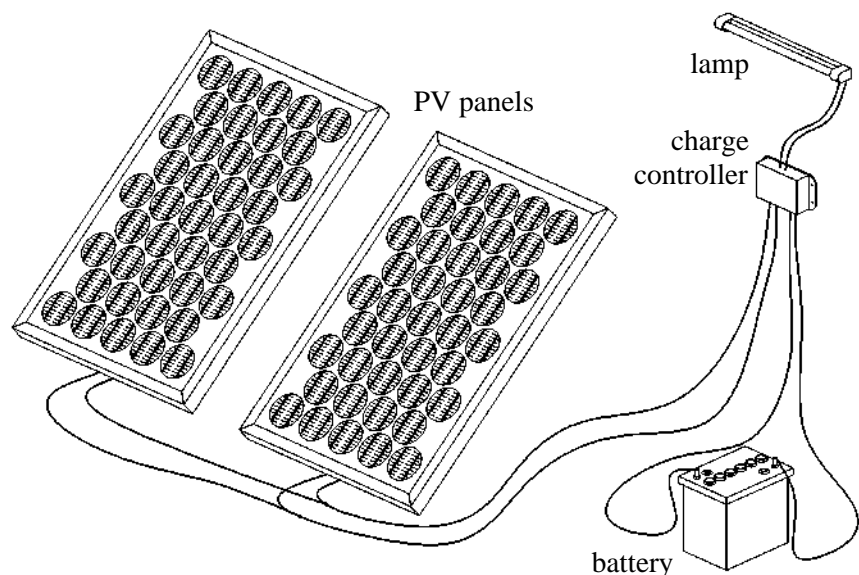

Overview of a typical installation of a P.V.-system for electricity generation.

1.2. Parts of the solar water heater

The solar water heater consists of the following parts, see the figure;

1. The solar **collector**, in which water is heated by solar radiation.
2. An insulated **storage tank**, in which the heated water from the collector is stored. The storage tank must be put higher than the top of the collector.
3. An insulated pipe connecting the lower part of the collector and the upper part of the storage tank.
4. An insulated pipe connecting the lower part of the storage tank and the bottom of the collector.
5. A **cold water inlet** connecting an existing water supply system to the storage tank. Usually the cold water inlet runs via a buffer tank with a floating gauge.
6. An insulated **hot water outlet** running from the storage tank to the tap.
7. A **vent** (air escape pipe) to prevent overpressure, caused by air or steam.

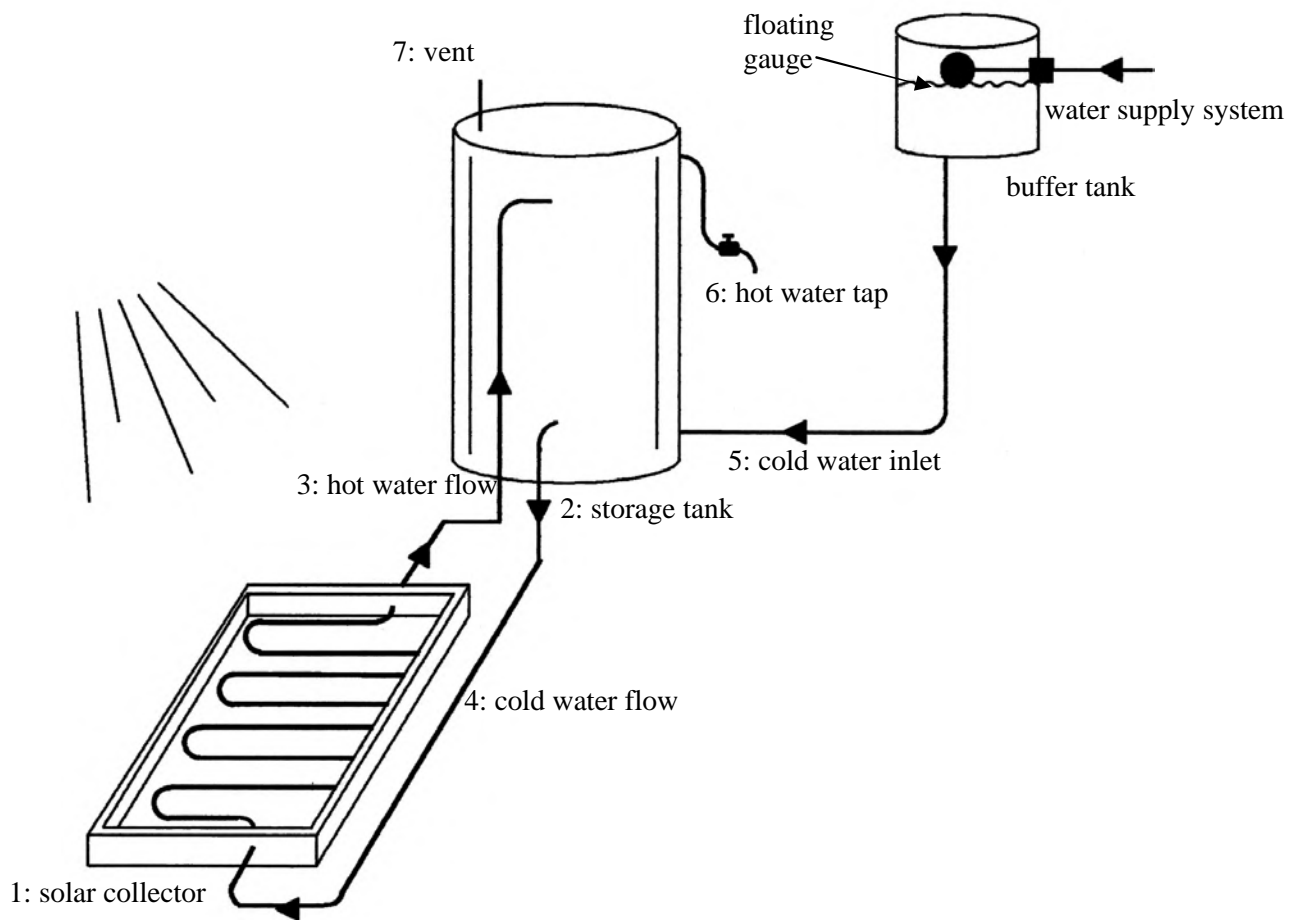

Parts of the solar water heater.

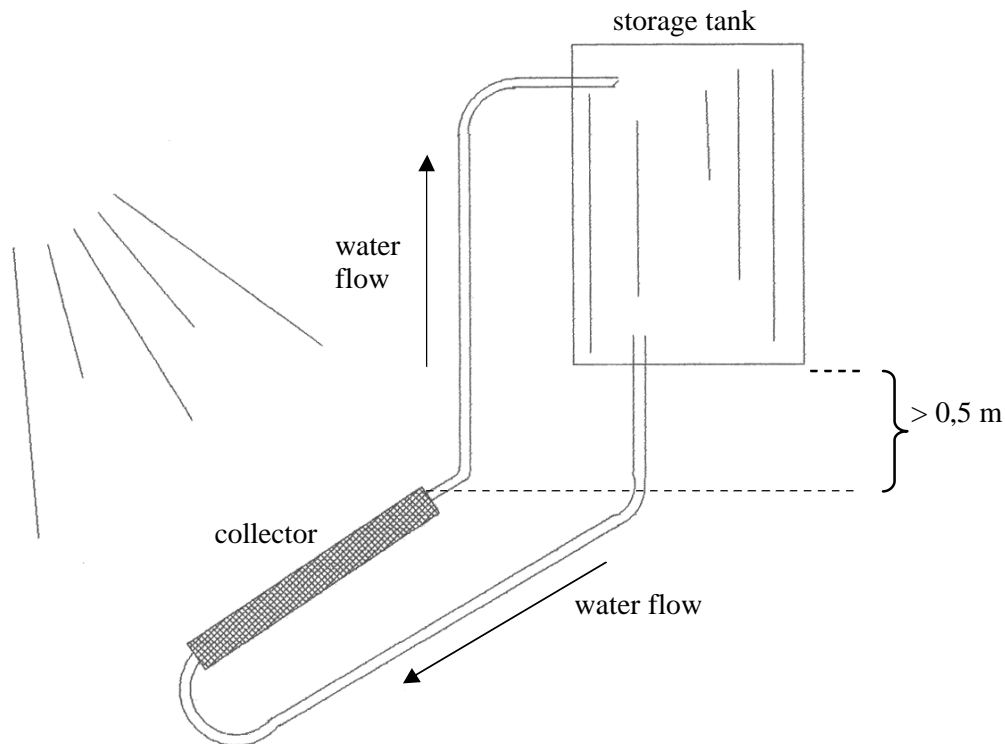

The working principle of natural circulation.

1.3. Working principle of the solar hot water system

When solar radiation heats the collector, the water inside will be heated as well. The heated water starts rising through the connection on top of the collector to the insulated storage tank. Heated water entering the storage tank displaces cooler water that is in turn forced via the connection to the bottom of the collector. In this way a circulation comes into being. We call it natural circulation or thermo-syphon principle. The cold water -entering the collector- will be heated again by solar radiation. Because the water temperature inside the collector becomes much higher than inside the storage tank, the natural circulation continues as long as the sun heats the collector. Consequently, the water inside the storage tank will get hotter and hotter. Depending on the amount of solar radiation and insulation, the system can produce water temperatures between 40 and 70 degrees Celsius.

1.4. The use of hot water systems

If we want to use the hot water in the storage tank, we have to tap it. When hot water is tapped, the storage tank must be refilled. Therefore the storage tank is connected via a buffer tank to an existing water supply system (for instance a big rainwater tank or a borehole). The buffer tank is provided with a floating-gauge or ball-valve. When tapping a bucket of hot water, the system will be refilled automatically via this floating gauge.

The efficient use of a hot water system depends on the daily need. For various institutions like hospitals, rehab centres, children homes etc. different quantities of hot water at different temperatures and for different purposes are required. The efficiency of the hot water supply depends on the way in which it is organised and controlled by the management of the concerning institute. The average heating up period per system per day can be put at 6 hours. When a system is properly insulated, hot water can be drawn 24 hours a day. So even at night hot water can be used. Practice has shown that solar powered hot water systems are especially useful for laundries and washing patients. With optimal use of a solar powered hot water system, a saving of up to 70% of the usual firewood consumption can be achieved.

2. Construction of the solar collectors

A solar collector consists of 4 parts:

1. The absorber

This is a dull-black painted metal body on which the zigzag pipe containing the water is fixed. The black coating absorbs almost all the solar radiation that falls on it. The collected radiation is transformed into heat and simultaneously heats the water inside. Temperatures of 100 °C or more can be reached.

2. The casing or collector box

The absorber is put into a box made of wood with a depth of 10 to 15 cm. The absorber is adjusted about half way the total depth so that there is sufficient space underneath as well as above the absorber.

3. The insulation layer

The space underneath the absorber is filled with insulation material that retains the heat of the absorber. Usually the insulation layer should be about 5 cm thick.

4. The cover sheet

To retain the heat in the collector, the box is covered by glass. Thickness of the glass-sheet must be at least 4 to 5 mm. The glass-sheet allows sunshine to pass through without absorbing too much solar radiation. Also, it prevents the cooling of air by wind.

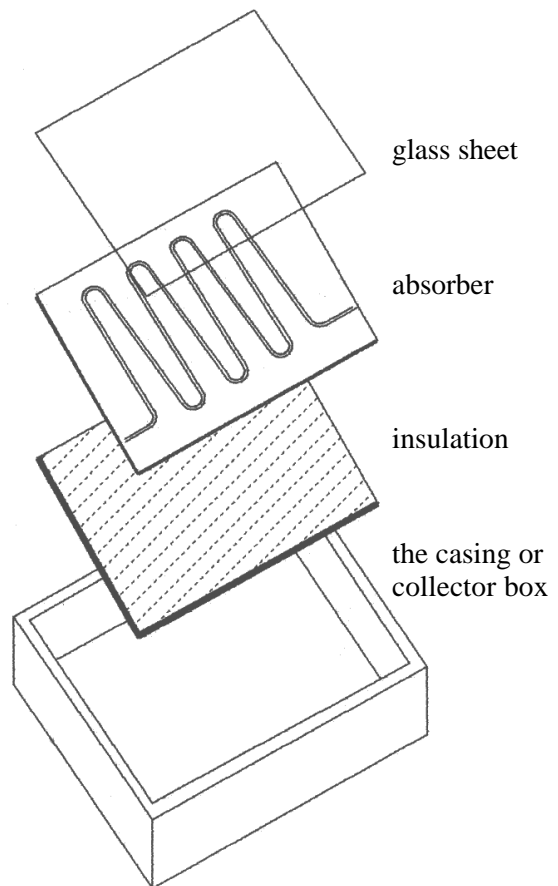

The collector consists of a cover sheet, absorber, insulation and casing.

2.1.2. The pipe-bending set

The pipe-bending set consists of 2 parts:

- a wooden frame fixed to an existing bench
- an iron bending set, to be fixed to the wooden frame

The wooden frame -composed of different blocks- is needed to support the bending set. It also provides the horizontal zigzag-shape of the pipe. The wooden frame has to be made of strong timber.

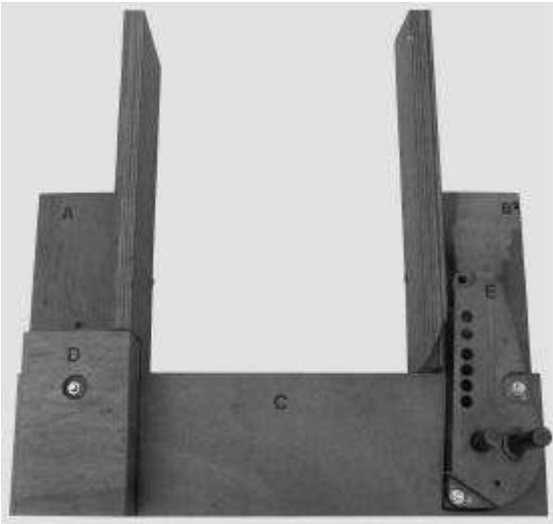

The wooden frame is needed to support the iron parts of the pipe bending set.

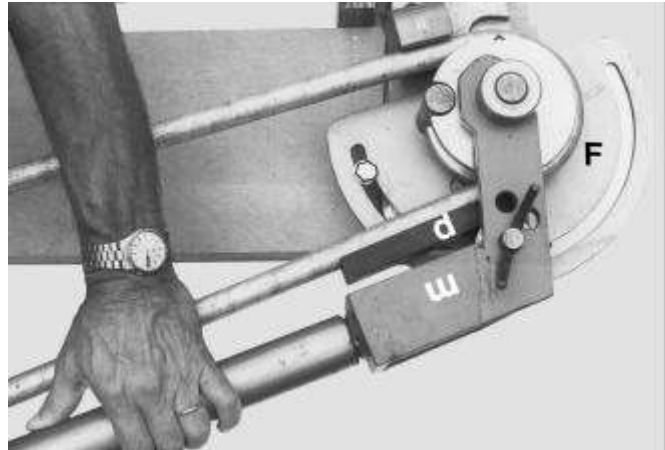

The pipe-bending set consists of interacting iron parts. It also provides the horizontal zig zag-shape of the pipe.

Constructing the wooden frame for the pipe-bending set

The following **tools** are needed:

- a big hand saw or sawing machine
- a carpenter's square
- a folding ruler
- a marker
- a hammer
- a plane
- a chisel
- a drill (4-6-8 mm.)
- a screw-driver

The following **materials** are needed:

- sturdy timber
- screws (thickness at least 6 mm.)
- bolts and nuts

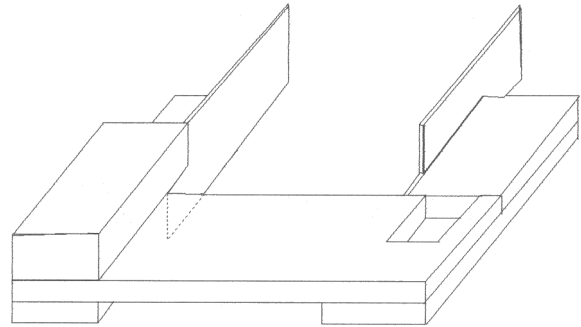

Saw 2 blocks with the following measurements
(see picture alongside)

- length 50 cm
- width 16 cm
- thickness 4 cm. Mark the 2 blocks with A and B.

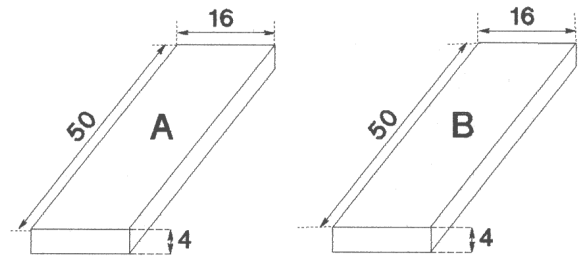

Saw 1 block with measurements:
(see picture alongside)

- length 75 cm
- width 16 cm
- thickness 4 cm

Cut out at 4 cm. from the end of one long side a rectangular space of 8 cm. by 8 cm. (see picture).
Mark the block with C.

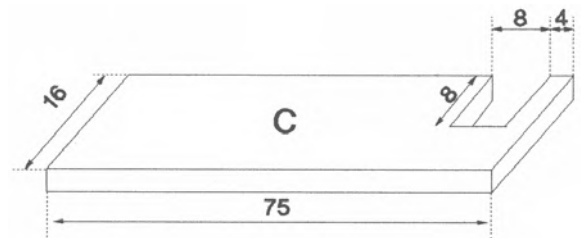

Saw 1 block with measurements:
(see picture alongside)

- length 34 cm
- width 16 cm
- thickness 4 cm. Mark the block with B-2.

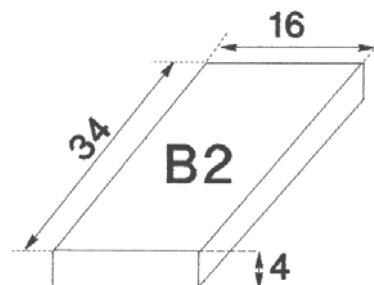

Join the block A, B, and C together as shown in picture alongside.

Then fasten block B2 onto block B.

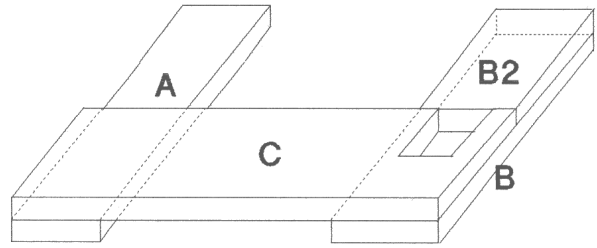

Saw 1 block with measurements:
(see picture alongside)

- length 25 cm
- width 18,5 cm
- thickness 8 cm

Mark block with D

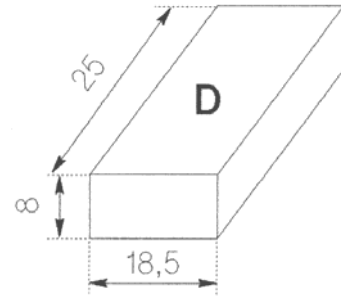

Fasten block D onto block C as shown in picture alongside.

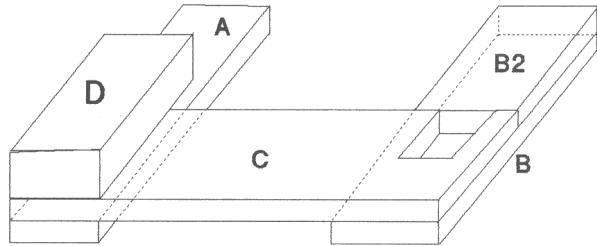

Saw 2 planks of the following measurements
(see picture alongside).

- length 60 cm
- width 16 cm
- thickness 2,5 cm

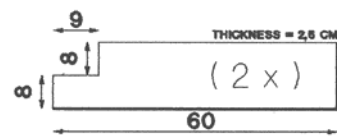

Cut out at one end of the long side a rectangular space of 8 cm. from the top and 9 cm from the middle. Put both planks against block A and B. Both planks must touch block C. Block D fits into the space. Now fasten the planks to block A and B. The wooden frame is complete.

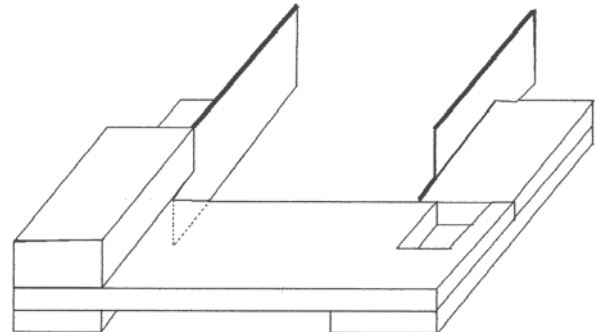

Preparing the pipe-bending set

The following **tools** are needed:

- a drill-brace and drills
- some spanners (ring spanner nr. 17)
- a screw-driver
- some adjustable wrenches

Put the wooden frame on an existing bench. The bench must be a very stable one because of the forceful power needed to bend the pipes.

Pay attention that there is a free space with a radius of at least 3 metres around point X of the wooden frame. (see picture below)

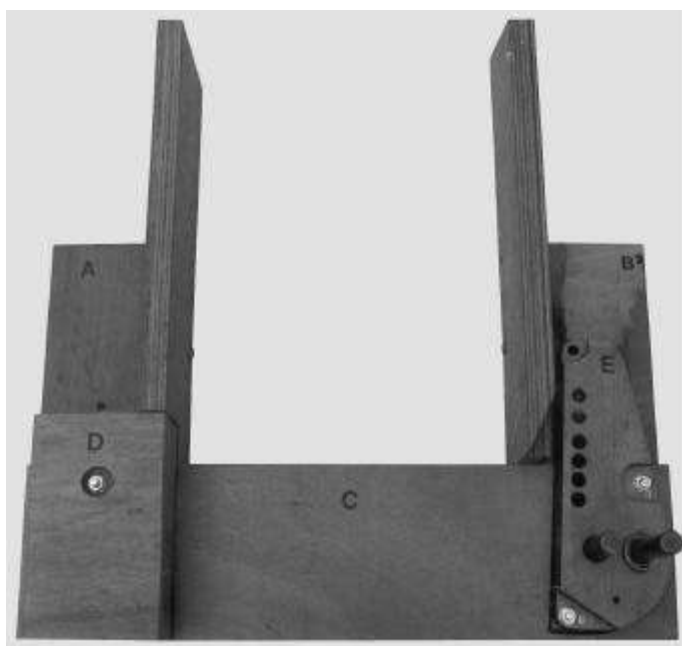

The wooden frame for the pipe-bending set is completed.

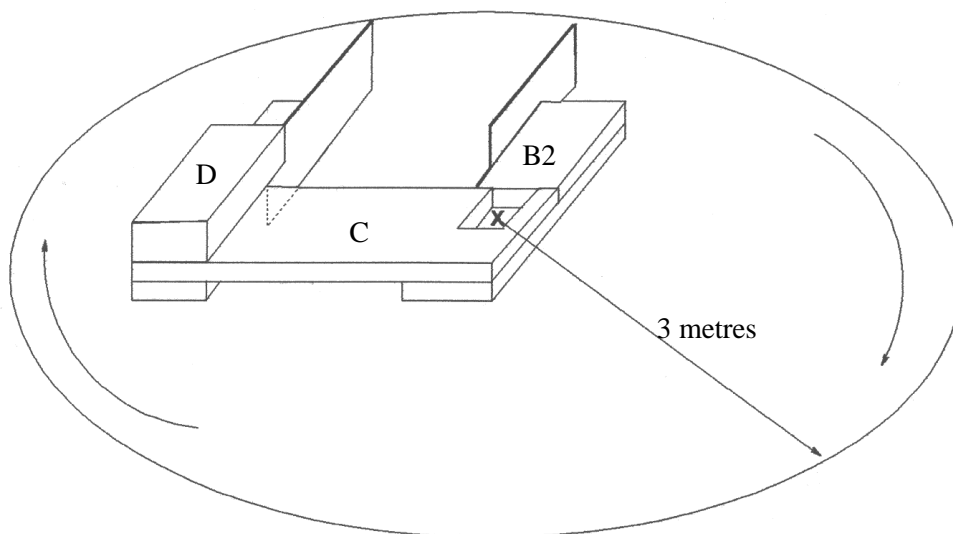

Pay attention that there is a free space with a radius of at least 3 metres around point X of the wooden frame.

Put groundplate E on the indicated place of the wooden frame. The big nut at the bottom of E fits into the rectangular space in block C. Drill 2 holes through E, and 1 hole through block D (see black arrows). The drilled holes also perforate blocks C, B and A. By means of fixing bolts, groundplate E and block D are tightly fastened to the frame. (keep the bolts on top (see photo))

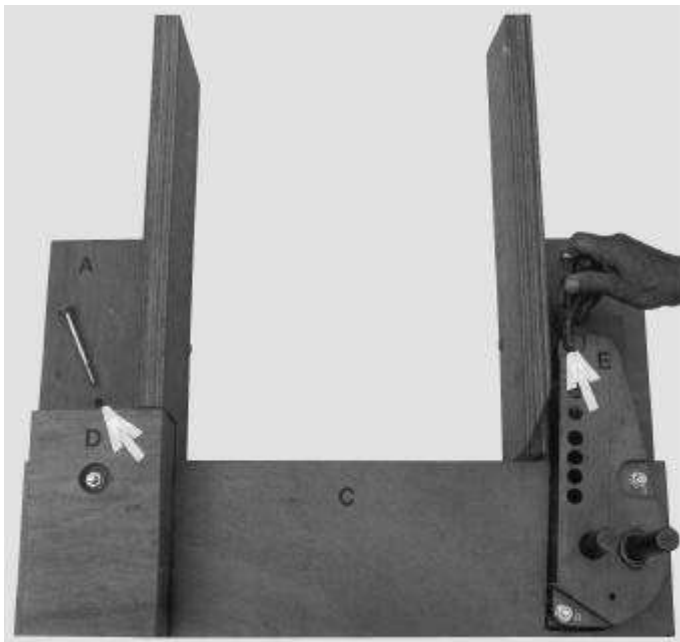
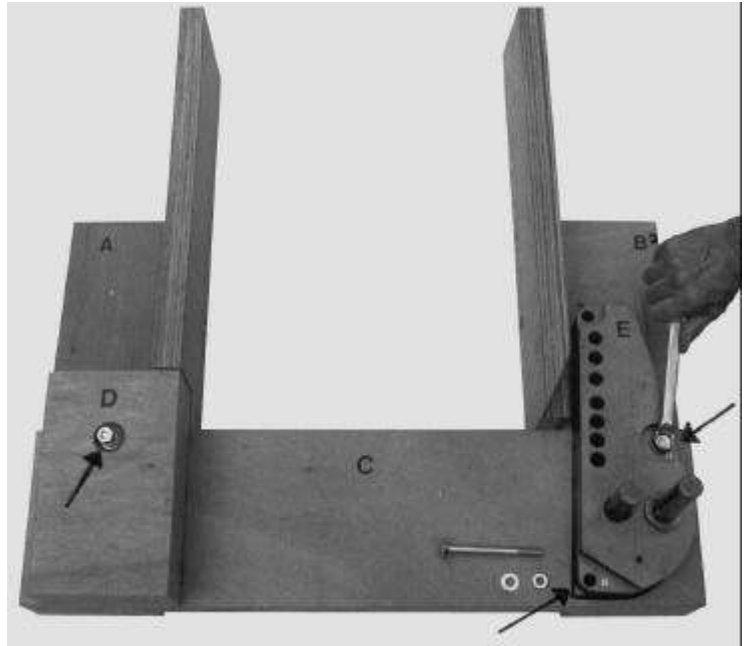

Drill 2 holes through block A and groundplate E (see white arrows). The drilled holes must also perforate the bench. By means of big fixing bolts the wooden frame is fastened to the bench. If necessary use some extra fixing bolts to secure the connection between frame and bench. The connection must be as firm as a rock.

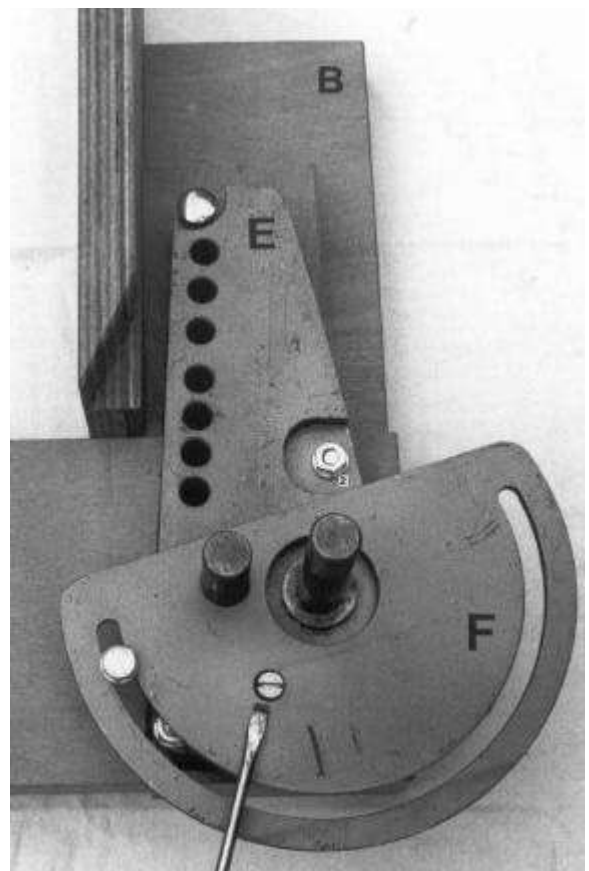

Fasten the bending plate F onto the groundplate E by means of a screwdriver.

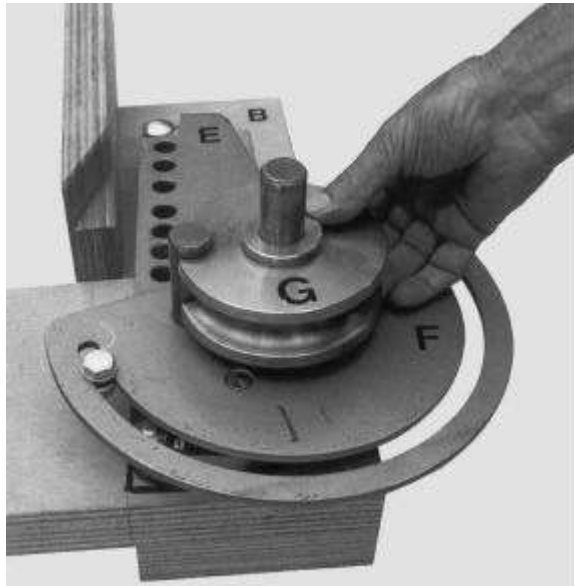

Slip the bending disk G over the long spindle.

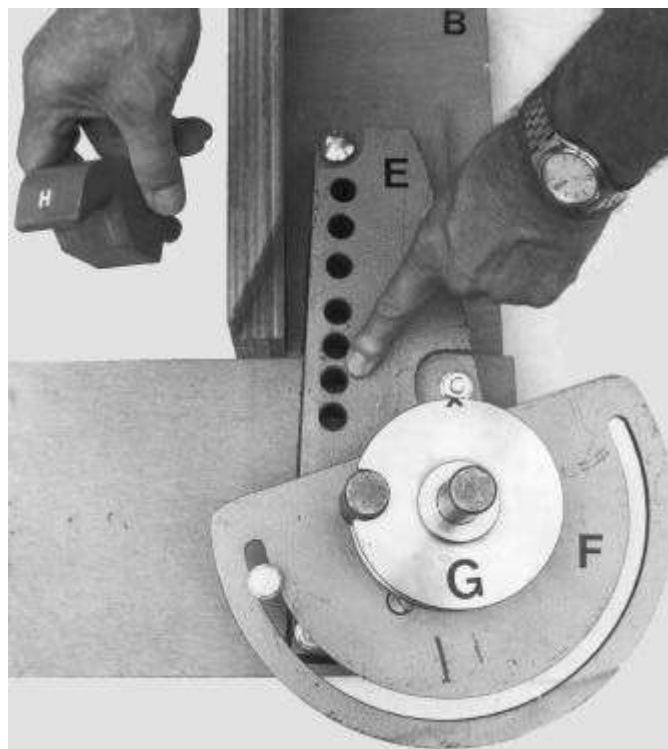

Stick the clamping-block H into the second hole of groundplate E.

2.1.3. Starting the pipe bending

Slip a 1/2" pipe into the set. The pipe is locked between disk G and block H.

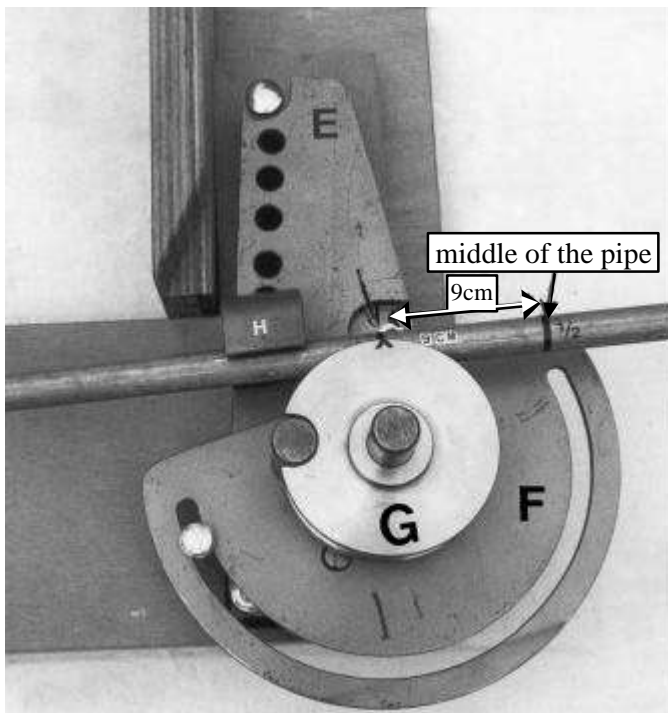

*To start bending we use a bending-claw **m** with accessory cylinder **K** plus half-shaft. Put cylinder **K** half-shaft into the third hole of bending-claw **m**.*

Mark a second point at 9 cm left to the indicated middle of the pipe. The second market point must correspond with the mark on the disk. Here the first bend will begin.

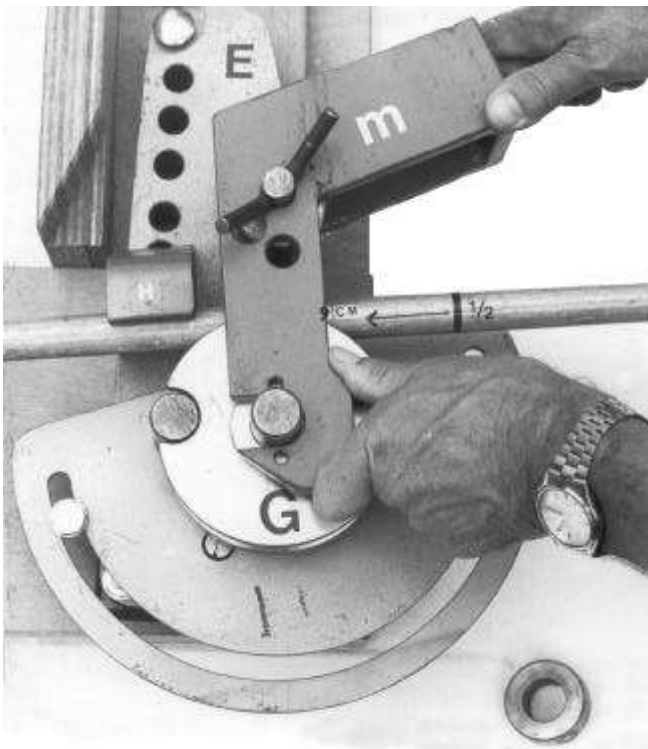

*Slip the bending-claw **m** over the spindle. (disk **G** and pipe are in between the claw)*

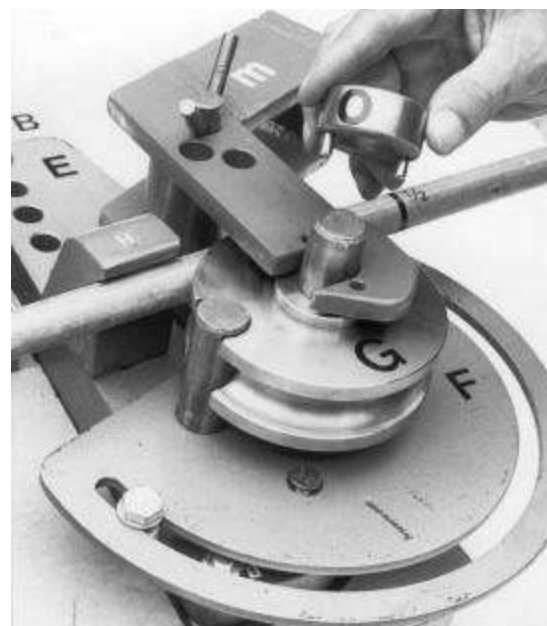

*Fix ring **O** over the spindle and lock it up with the 2 doweled joints.*

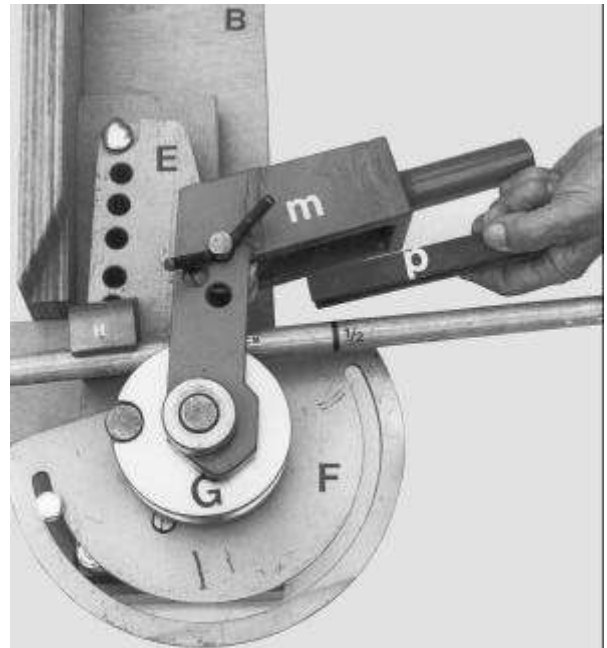
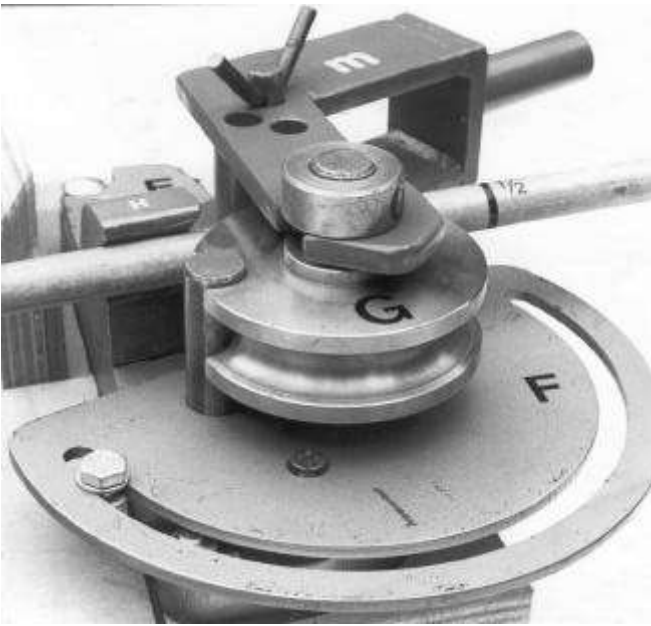

Press pipe-guide P between pipe and cylinder K.

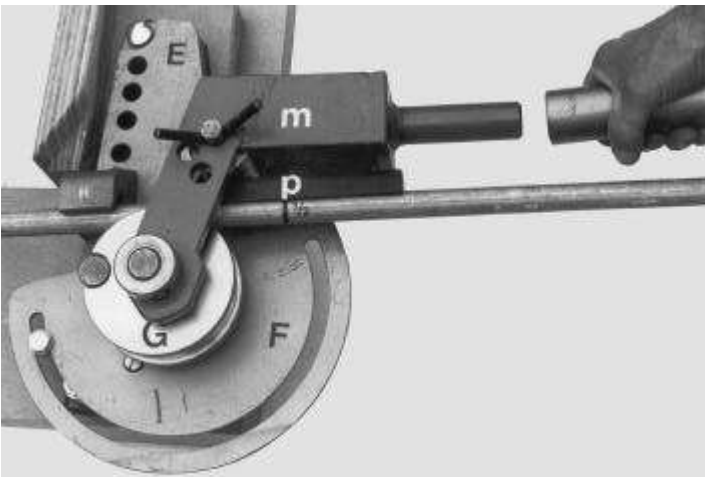

Slip the lever over the handle of bending-claw m and pull the lever towards you.

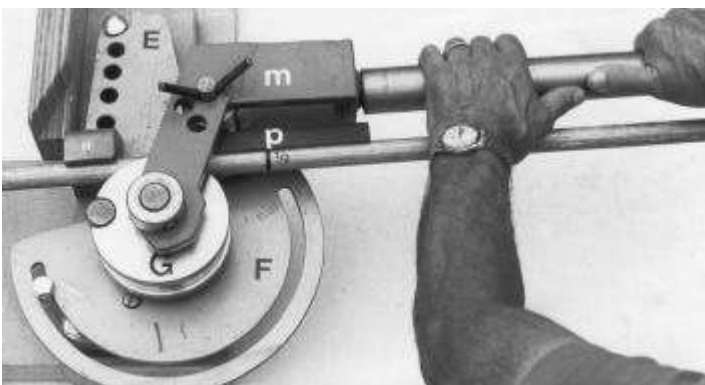

Pipe and lever are now in parallel position.

WARNING: Be sure that the second mark on the pipe is still corresponding with the mark on the disk G.

The pipe bending procedure

To bend correctly use the following instructions:

- Bend gradually without forcing the set.
- About halfway the bend pipe-guide **P** must be moved forward.
- Press the lever until the bending-claw runs up against the adjusting-nut in the groove of bending plate **F**.
If the radius of the bend looks too wide, the adjusting nut should be moved. The horizontal pieces of the pipe should be slightly inclined upwards to avoid airlocks.

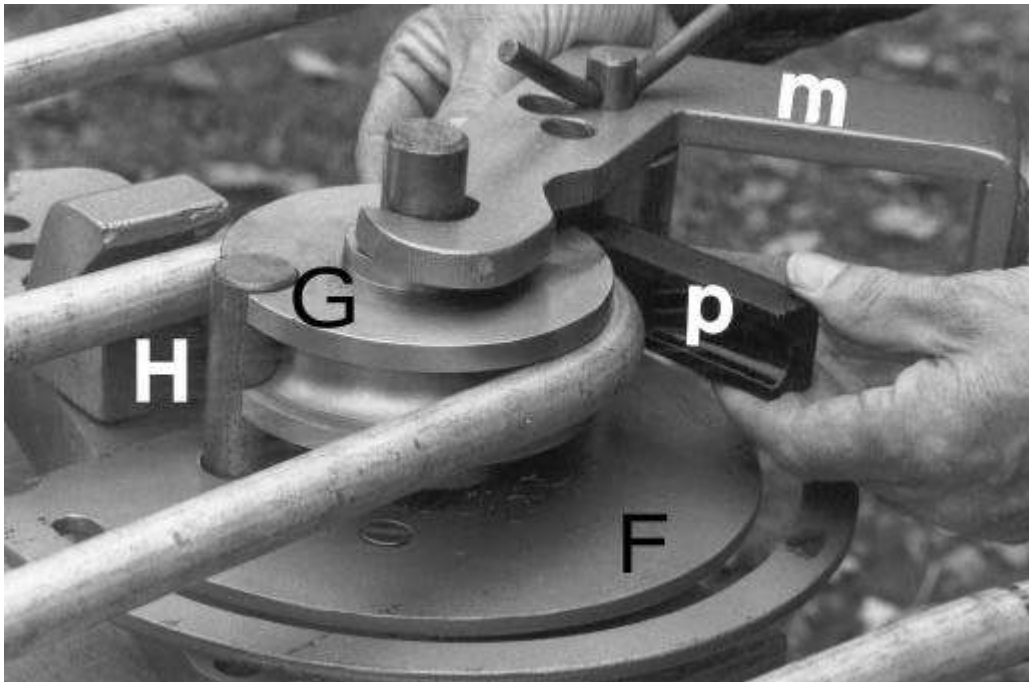

*Moving the pipe-guide **P**.*

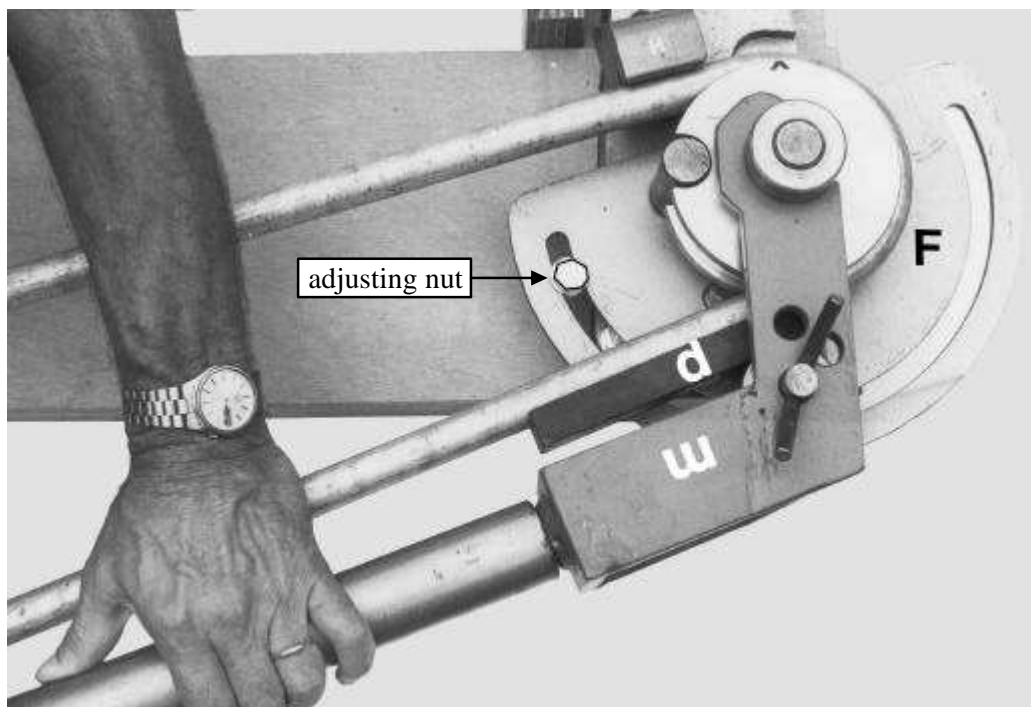

The location of the adjusting nut. Use this nut to set the correct (maximum) bending angle of the pipe.

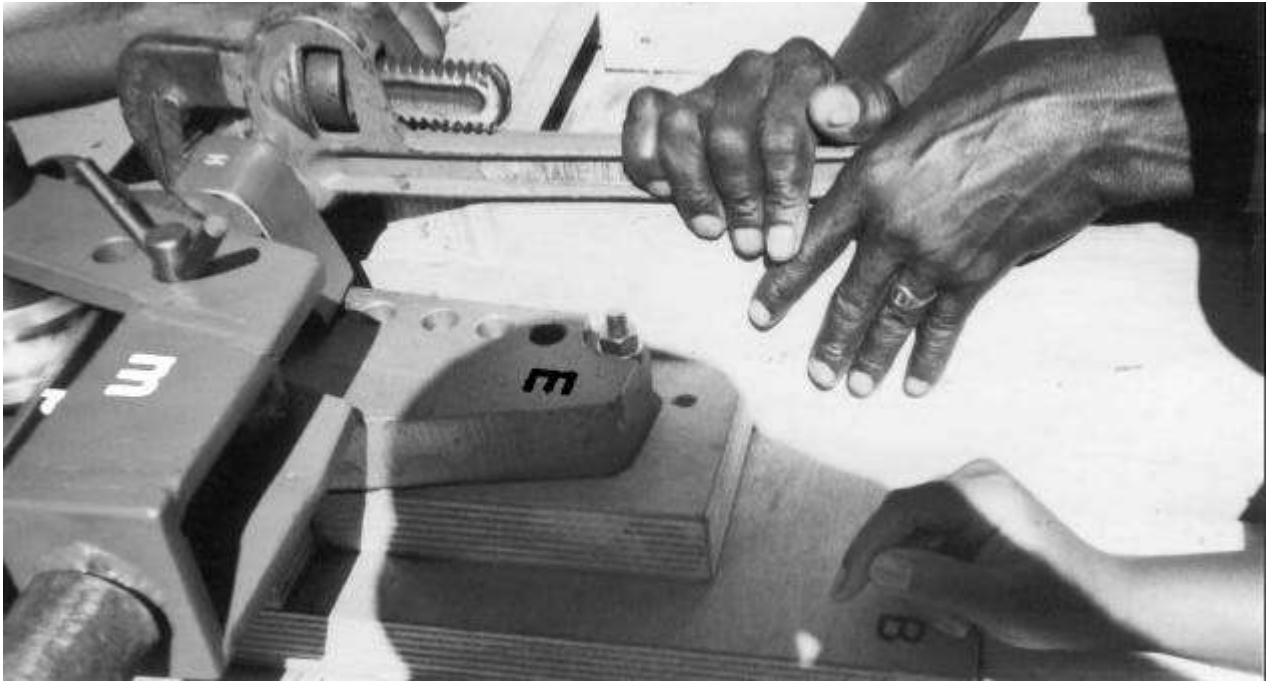

*Use a water pump plier to prevent that the pipe slips away during the bending activity. Keep the pipe tight just in front of block **H**.*

- After the first bend is completed put a mark at 56 cm distance from the beginning of the first bend. Here we will start the second bend.
- For all the next bends the same manner is used. The pictures on the next page indicate the bending procedure while making the 7 bends. The videotape shows you exactly how to make the 7 bends.



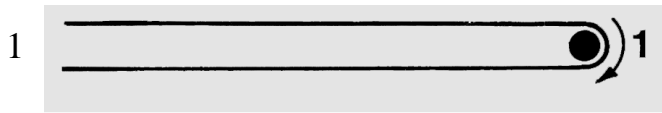

After the first bend is completed, put a mark at 56 cm distance from the beginning of the first bend. Here we will start the second bend.

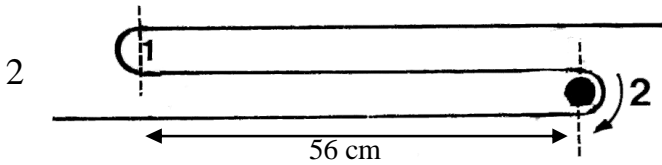

For all the next bends, repeat this procedure.

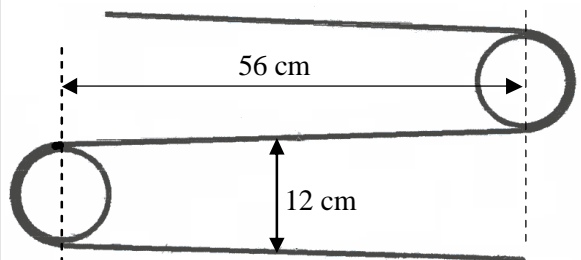
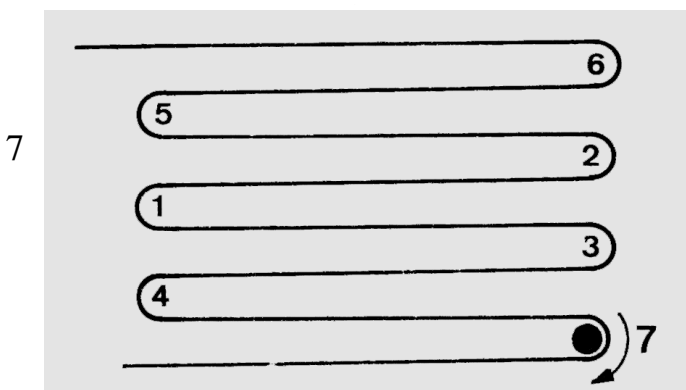
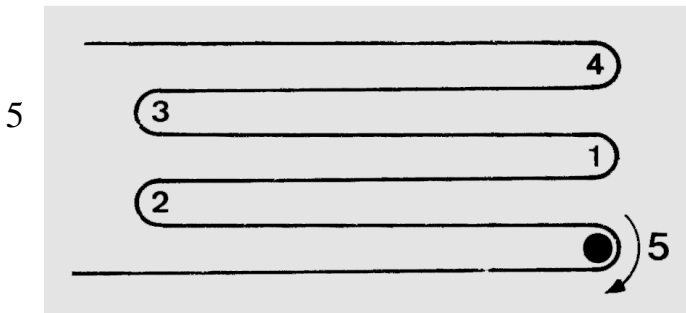
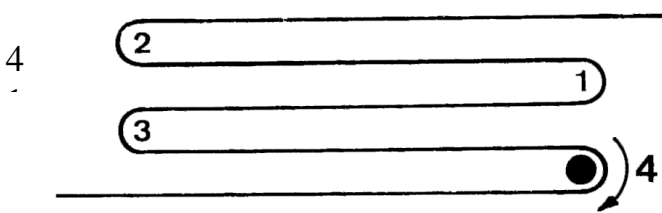
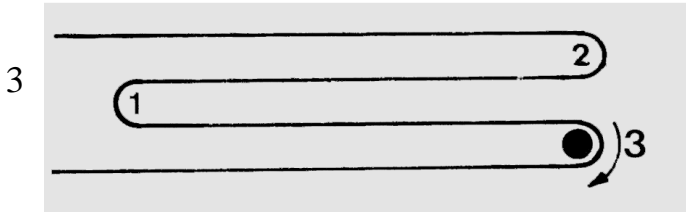

After bending the pipe, it will spring back. To keep the right angle in between the bends, you have to measure 12 cm. (in the middle)

2.1.4. The cutting of the galvanised sheet

The following **tools** are needed:

- a folding ruler
- a marker (felt pen)
- a carpenters square (to mark the right angles)
- a cutting shear or a good tin snips
- a straight lath. (to draw the needed lines on the sheet)

Out of an available sheet we have to cut the required surface of the absorber. The most favourable thickness is 1 mm, but 0,5 mm can also be used.

Set out the following measurements:

- length 110 cm
- width 80 cm

Cut out the measured surface with a cutting shear.

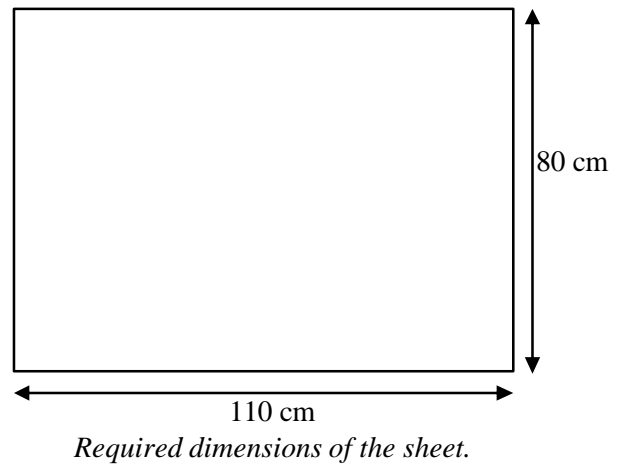

2.1.5. Preparations to join zigzag-pipe and sheet

The following **tools** are needed:

- a folding ruler or measuring rod
- a felt pen
- the complete bending set
- a carpenters square

Put a zigzag-pipe on top of a sheet of 110 cm x 80 cm. All bends, both to the right and to the left must be at an equal distance away from both ends of the sheet. (about 6 cm).

The distance from both pieces on top and bottom to the edges of the sheet must be equal as well. (see picture below).

Now mark the contours of the entire zigzag-pipe on the sheet with a felt pen. (see picture on the right).

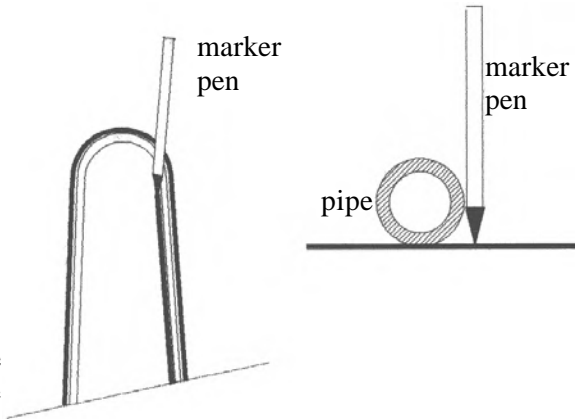

Mark the contours of the entire zigzag-pipe on the sheet with a felt pen.

Put a mark at 22 cm from both ends of the zigzag-pipe.

Transfer the mark to the sheet. From that marked point we have to draw a line. Use a carpenter's square to draw that line, which makes a square angle to the edge of the sheet. (see picture below). This line indicates the angle to be made by bending both pipe ends. The angle between pipe end and sheet must be 90°. (see picture below).

Now we use again the bending set. The bending must be carried out with caution. After bending, put the zigzag-pipe again on the sheet. Check the angle between pipe-end and sheet by means of a carpenter's square. If the angle is not 90°, improve it.

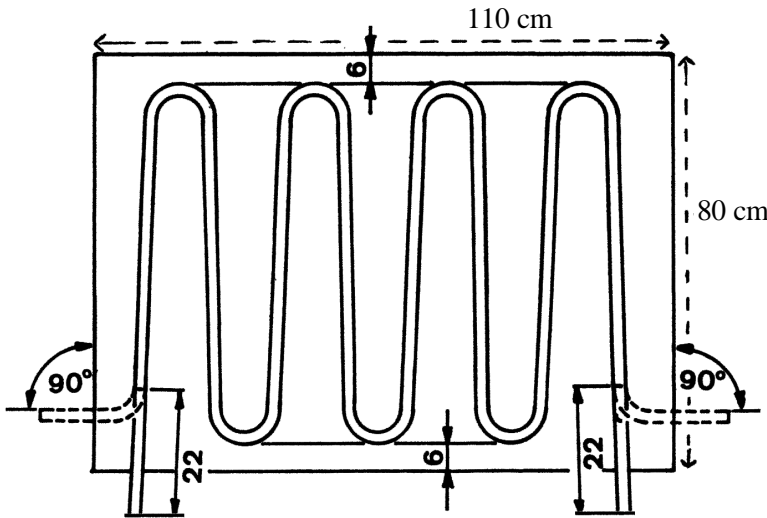

Measurements of the bended pipe on the sheet.

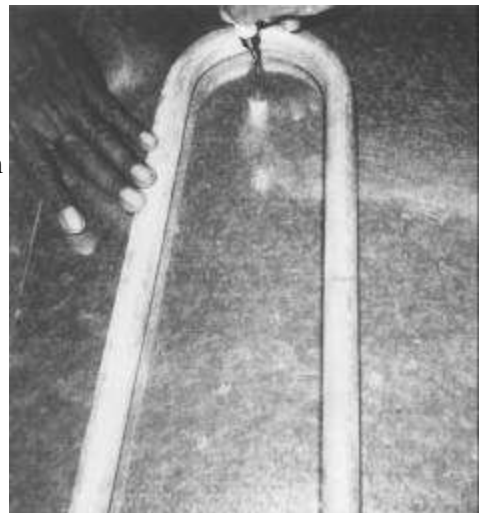

Marking the contours of the entire zigzag-pipe on the sheet with a felt pen.

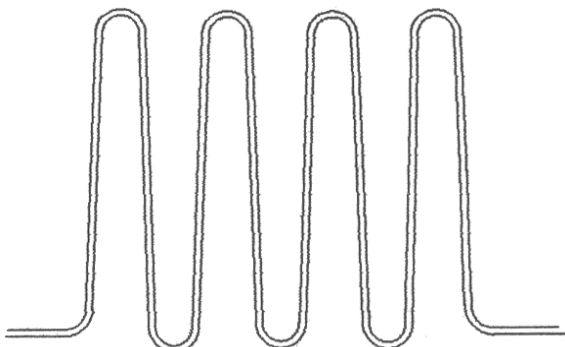

After the bending procedure, the pipe should look like this.

2.1.6. Connecting the pipe and sheet

There are different ways of fixing together the zigzag-pipe and sheet;

1. wire loops
2. riveting
3. soldering

Connecting the pipe and sheet with wire loops

The first and simplest way is using wire loops. The following **tools** are needed:

- iron wire
- a pair of tongs
- a measuring rod
- a felt pen
- a drill (1,5 mm)

Put the zigzag-pipe between the indicated lines marked on the sheet. Drill holes left and right of the pipe at intervals of 10 cm. The pair of holes must be as close as possible to the pipe. Cut pieces of wire with a length of 10 cm. Thread a piece of wire through a pair of holes and wound it around the pipe until it is firmly fixed to the sheet. Continue the winding until all wire loops are completed. Check that the zigzag-pipe and the sheet are entirely fixed together. Now the absorber is ready to be painted.

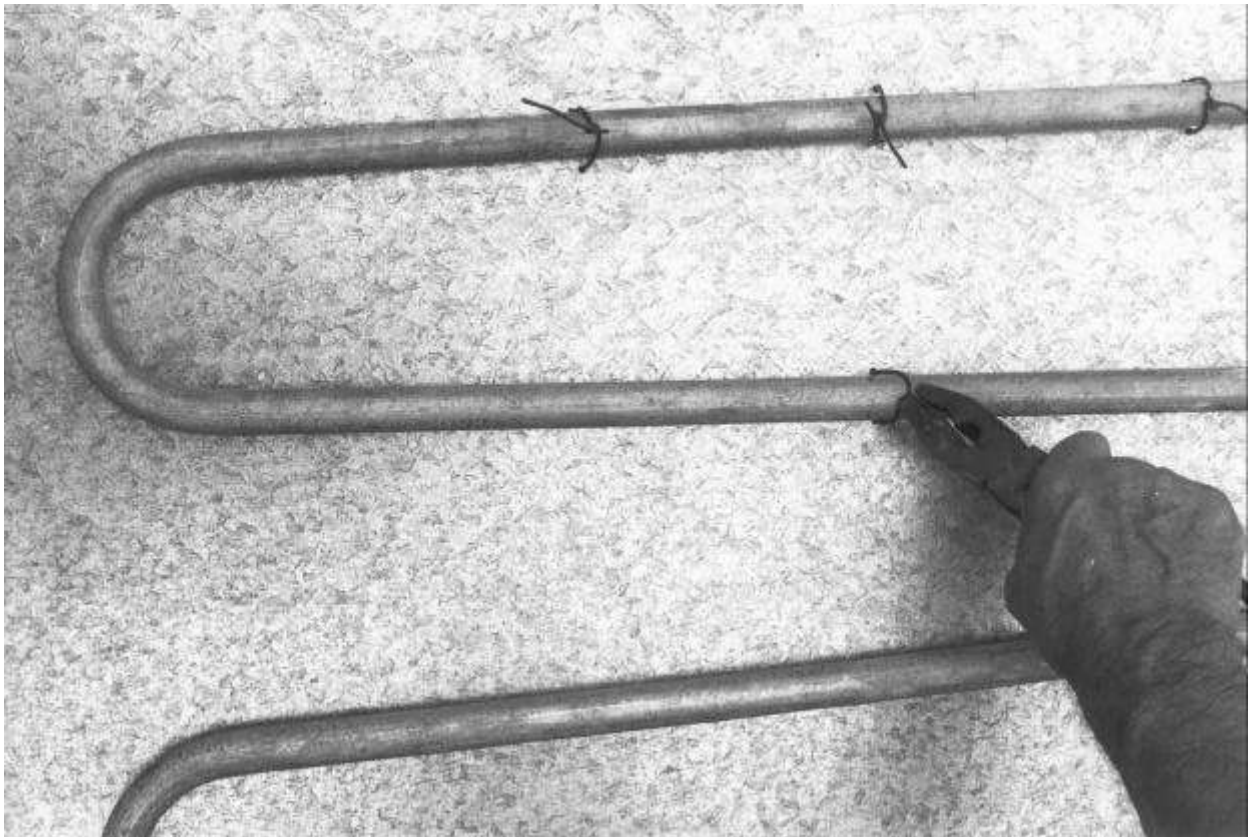

Connecting the pipe and sheet with wire loops.

Connecting the pipe and sheet by riveting

The following **tools** are needed:

- pop-rivets (e.g. aluminium 3.0 x 6.0)
- riveting clamp
- a drill (3.1 mm.)
- galvanised sheet (thickness 0.5 mm)
- a hammer
- a vice
- a measuring rod + felt pen
- a cutting shear or tin snips

To make saddles, cut out pieces of 80 x 86 mm (thickness 0.5 mm). Draw lines of 1½ cm on two opposite sides of the pieces (see photo). Use a vice and hammer to bend 2 flanges of 90 degrees along these lines.

By using a piece of ½ inch pipe shape a suitable saddle around the pipe (see photo). The video shows you exactly how to make the saddles.

If you intend to make a large number of saddles, you can make a saddle-press. The saddle-press bends the square pieces in the correct shape. For a description of the saddle-press look in the appendix.

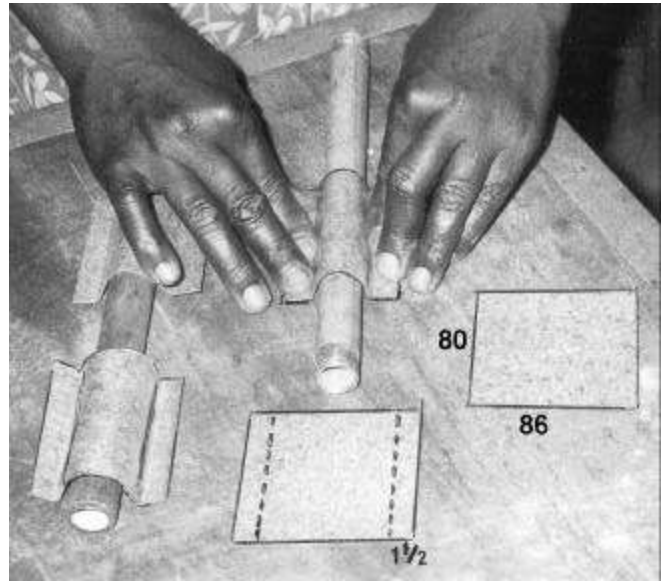

Riveting the pipe to the sheet.



Drilling holes through the metal saddles and metal sheet.

Start fixing the saddles in the middle of the zigzag-pipe (see photo above). Press a saddle firmly around the pipe and drill a hole through the saddle and the sheet. Immediately join the saddle and sheet with a pop-rivet.

Drill a second hole at the same side of the saddle and join another pop-rivet into it. Then start to join pop-rivets at the other side of this saddle. Try to drill the holes as close as possible to the pipe. To fix the whole zigzag-pipe onto the sheet about 22 saddles are needed. To fix the in- and outlet bends of the pipe 2 small saddles of 30 x 86 mm are necessary. Check that the whole zigzag-pipe is fixed firmly and in the correct position onto the sheet.

The video shows you exactly how to use saddles to fix the zigzag-pipe onto the sheet.

Connecting the pipe and sheet by soldering

Soldering gives the best heat conduction between pipe and sheet.

The following **tools** are needed:

- a soldering lamp (see photo) with fuel (e.g. petrol or kerosene)
- matches and a candle
- sandpaper;
- soldering flux
- soldering tin
- an injection syringe
- a soldering clamp consisting of 2 parts, a steel triangle and a wooden support. (see picture below)
- a cutting shear
- a hammer
- 1 or 3 screw-drivers
- a bucket filled with cold water
- some cloths
- a measuring rod
- a felt pen



Soldering lamp.

Constructing the wooden support of the soldering clamp

The soldering clamp belongs to the outfit of your tool set. It has a triangle-form steel body with 2 holes. (One at the base and one at the top). Through the holes 17 cm long M10 bolts must be stuck. (with the thread ends at the topside). Onto the thread-ends wing-nuts can be fastened and unfastened. To use the steel triangle for soldering, a rectangular-form wooden support has to be made.

For constructing the wooden support, the following **tools** are needed:

- a ruler and a marker
- a saw
- a drill
- a chisel
- a carpenter's square
- a water level

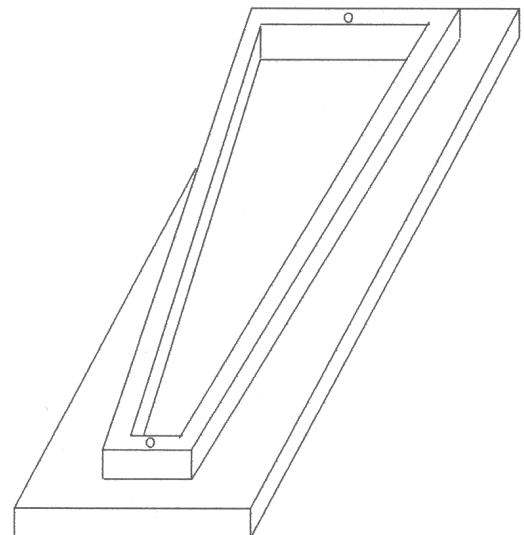

The soldering clamp.

The following **material** is needed:

- timber of a good quality.

The timber must be sawed into 1 block with the following dimensions:

- length 100 cm.
- width 24 cm
- thickness 5 cm

After constructing the wooden block, put the triangle lengthways on top of the wooden support. Perforate through the holes in the steel triangle the wooden support. (see picture below)

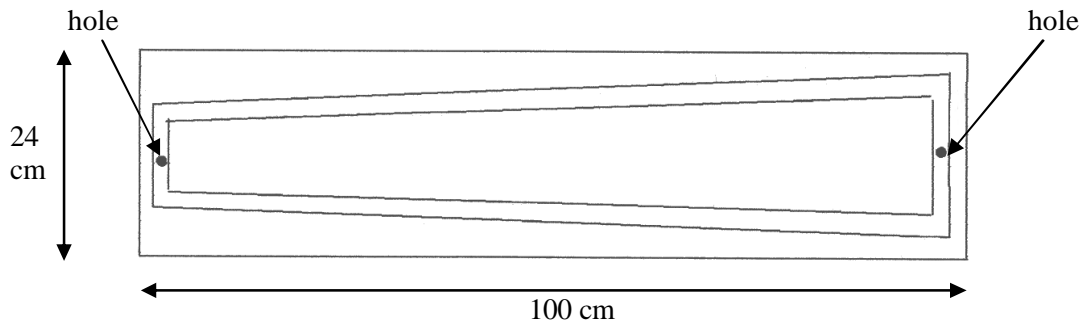

Now the wooden support can be fixed to the steel triangle by using the long bolts and wing-nuts.

Preparing the soldering

Put the zigzag-pipe between the indicated lines on the sheet. Mark with a felt pen the 4 outer bends of the pipe with the numbers 1-2-3-4. Copy next to the four bends the numbers also on the sheet. (see picture below).

Draw 3 lines from the middle of the 3 inner bends. Cut the sheet along the 3 drawn lines into 4 stripes. Sand the marked place in between the indicated lines. (see photo). Sand it thoroughly with sandpaper without wiping out the contours and numbers.

Sand also thoroughly the bottom side of the zigzag-pipe (the number of the 4 bends are at the top (see photo). Then free also the sanded pipe from dust.

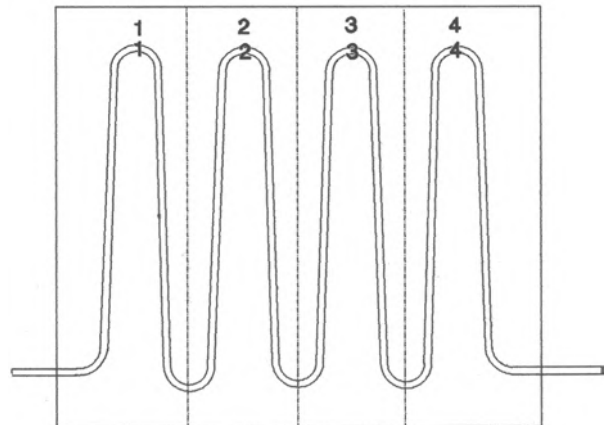

Mark the 4 outer bends of the pipe with the number 1-2-3-4. Copy these numbers to the sheet next to the numbers.

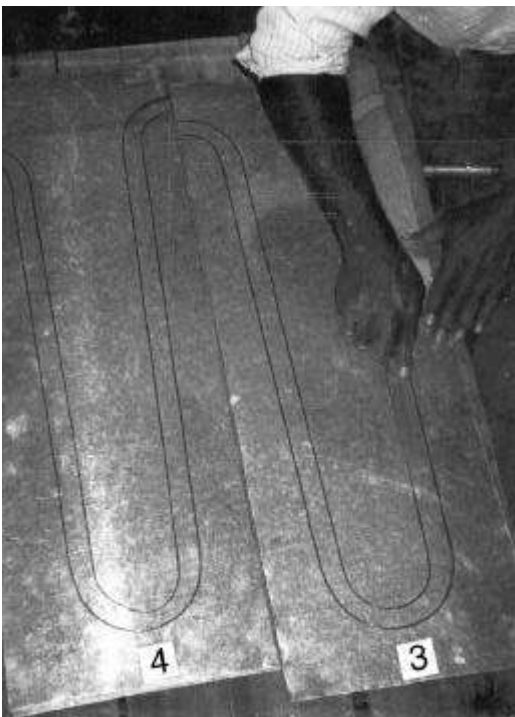

Sand the marked area in between the lines.



Clean it afterwards with some dry cloth.

The soldering procedure

The soldering of indicated sheet-strips and corresponding pipe-pieces is done one by one. The sequence is 2-3-4-1. For soldering we need thin and flat strips of tin solder of 10 cm length. Cut available wire tin solder into strips of 10 cm and flatten it with a hammer. If no special soldering flux is available (S.39) pour hydrochloric acid in a glass jar and dissolve some small pieces of zinc in it. After a few days the liquid will get a bluish-green colour. Then it can be used as soldering flux.

For soldering we use a solid table around which you can easily walk. Put the triangle clamp onto the table. Unscrew the two wing-nuts and take off the steel triangle. Put the sheet strip with number 2 on the wooden support and fit the zigzag-pipe with outer bend 2 on strip 2.

Replace the steel triangle on the pipe. The bend must protrude equally to both sides. Turn home firmly the two wing nuts. Check that pipe and sheet are entirely pressed together. Fill the soldering lamp with needed fuel and start the preheating procedure.

For different kinds of soldering lamps there are different instructions. Read these instructions punctually.

While preheating the soldering lamp, light on a candle because during the start of the burner escaping vapours often extinguish the preheating flame. As soon as the soldering lamp burns regularly, fill the injection syringe with soldering flux. Inject the flux evenly between pipe and sheet. Follow the outer contour of the zigzag-pipe from beginning to end. (see photos on next page).

Then squeeze the 10 cm strips of tin-solder between zigzag-pipe and sheet. (see photos on next page)

Use a screw-driver to press the strips firmly under the pipe. The tin strips should curve with the bend and follow the outer contour of the zigzag-pipe (just in the same places where the soldering flux was injected). Take the burning soldering lamp and move it slowly to and for alongside the triangle. After preheating the triangle point the burner to the pipe and follow slowly the pipe-sheet connection (never point the burner directly to the sheet). (see photos on next page).

If necessary, inject some more soldering flux. Should one of the tin strips slip out, squeeze it in again with a screw-driver. As soon as the tin becomes liquefied, follow the flow line along the entire pipe-sheet connection. After that, stop the soldering procedure immediately. Wait a moment for the tin solder to solidify. Then cool down the solder joint of pipe and sheet with damp cloths and next to remove the superfluous soldering flux. (see photo on next page).

Unscrew the wing nuts of the triangle. Use safety gloves and take care for they are hot. Take off the steel triangle and clean the sheet and pipe once more with a damp cloth. The pipe-sheet connection nr.2 is now completed.

Put sheet strip nr. 3 on the wooden support and fit the zigzag-pipe with outer bend nr. 3 on the strip. Repeat now the whole soldering procedure. That is to say: The Fasten the steel triangle, inject soldering flux, squeeze in tin solder strips and start soldering. Take care that you have an exact connection with the adjoining sheet strip.

After finishing pipe-sheet connections nr. 4 and nr. 1 the four strips are soldered together. Therefore keep two sheet strips in position with a pair of pliers. Drop a few drops of soldering flux on the seam of the two connecting sheets. Heat this spot with the soldering lamp and liquefy a few drops of tin solder on it. After solidification of the solder cool down the joint with a damp cloth. Now the soldered absorber is ready to be painted.

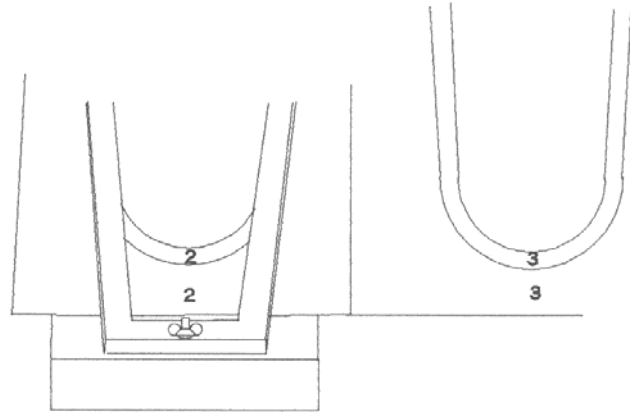

Put the sheet strip with number 2 on the wooden support and fit the zigzag-pipe with outer bend 2 on strip 2.



1: Inject the flux evenly between pipe and sheet.



2: Press the strips firmly under the pipe.



3: Take the burning soldering lamp and move it slowly to and for alongside the triangle.



4: Wait a moment for the tin to solidify.



5: Then cool down the solder joint of pipe and sheet with damp cloths and next to remove the superfluous soldering flux.

2.1.7. The painting of the absorber

The following **tools** are needed:

- a tin red lead paint or primer (content 1 litre)
- a tin dull blackboard paint (content 1 litre)
- 1 brushes
- sandpaper (fine)
- water soap and cloths

Clean the absorber thoroughly with soap suds and then dry it with cloths. Remove possible rests of stained soldering flux with sandpaper. After freeing the absorber of dust, paint the topside (where zigzag-pipe and sheet are joined together) with red lead. Paint it well coated but not too thick. Leave the red painted absorber to dry. Finish the absorber by painting the topside twice with dull blackboard paint. (see photo) The painting procedure is similar for absorbers with wire loop or riveting construction. The black painted absorber is now ready to be placed into a casing.



After the red lead paint or primer, paint the topside of the absorber with two layers of dull blackboard paint.

2.2. Construction of the collector-box

To complete the solar collector we must put the absorber into a wooden box. (see picture below) The wooden box consists of four vertical sides a-b-c-d and bottom e. Inside the box supporting laths F are fastened to a-b and c. (see picture below). The absorber is placed on these supporting laths. The box is covered with a glass sheet.

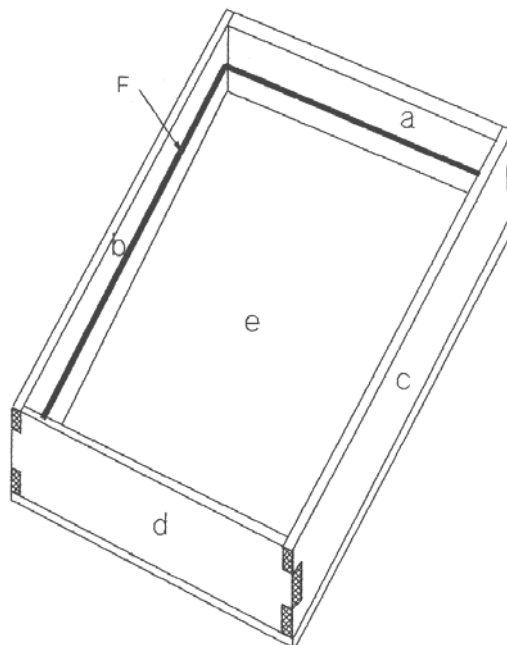

2.2.1. Preparations to make the wooden collector-box

The following **tools** are needed:

- a hammer
- a saw
- a pair of tongs
- a plane
- a rabbet-plane
- a chisel
- a drill
- a carpenter's square
- a waterlevel
- files (round and flat)
- screw-drivers
- screws and nails
- a mitre box
- a folding ruler
- a marker (pencil or felt pen)
- a glass-cutter
- a straight lath (to draw straight lines)



The following **materials** are needed:

- timber of good quality divided into the following parts and dimensions
 - 2 planks for sides a and d: length 90 cm, width 10 cm, thickness 3 cm
 - 2 planks for sides b and c: length 120 cm, width 10 cm, thickness 3 cm
 - 3 supporting laths: length 120 cm, width 2.5 cm, thickness 2.5 cm
 - planks for the bottom: depending on available sizes, thickness 2.5 cm
- insulating material (kapok, sawdust, coconut fibre, etc., enveloped in bags)
- rubber strips (made out of old inner-tires of cars)
- glass to cover the box (thickness about 5 mm.)
- silicone-kit or putty
- galvanised sheet with a thickness of 0.5 to 1 mm (for making angle-sections)

2.2.2. Constructing the wooden collector-box

Before you start to make the box, pay attention to the following points:

- The size of the absorber determines the internal dimension of the collector-case.
- When an absorber has the following measurements: length 110 cm., width 80 cm, the internal dimension of the case must be 111 cm (length) and 81 cm (width). It means that a space of half a cm must be all around the absorber.
- The depth of the collector-case must be 10 to 15 cm. Halfway the depth, which means at 5 to 7.5 cm, supporting laths must be fastened on which the absorber is placed.

Now we can start the following activities:

(see picture)

- Saw to size the four sides of the box (a-b-c-d).
- Cut a rebate of 1.5 cm wide and 1 cm deep in the top of sides a-b-c. Make the topside of d level to the rebates of a-b-c. (see picture).
- Put a mark halfway the depth of a-b-c and draw a line along the marks.
- Saw the supporting laths for sides a-b-c. The supporting laths must be placed along the marked line. The topside of the supporting laths must touch the lines. (see picture).
- Fasten the supporting laths to sides a-b-c.
- To test the dimensions of the box, put sides a-b-c together and place the absorber onto the supporting laths.
- Mark the point of the pipe-outlet on side a.
- Bore a hole on the marked point and stick out the pipe through side a. (see photo below)
- Place side d towards the absorber and mark the point of the pipe-inlet on d.
- Make a hole in side d. Now you can move side d towards sides a-b-c while the pipe-inlet and outlet stick out of the box.
- Test the internal dimension of the box. That means look if there is enough space all around the absorber.
- Move away side d and take out the absorber. Side d will remain open until the absorber can be placed definitively into the box.

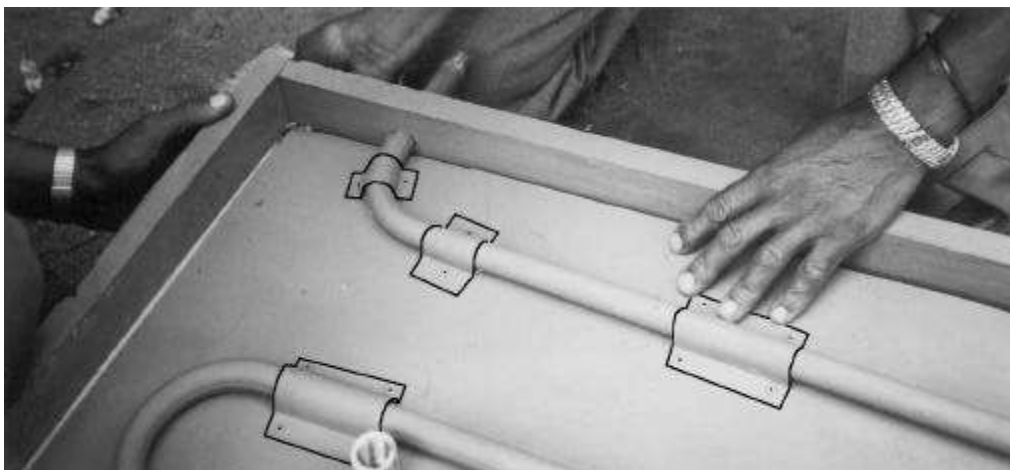
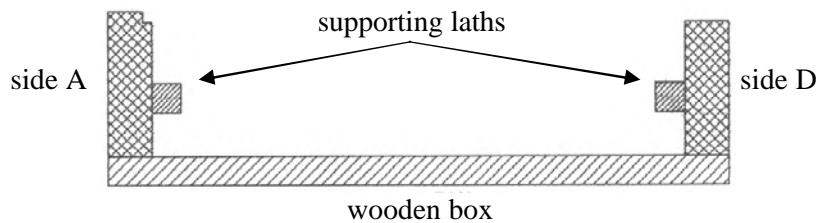
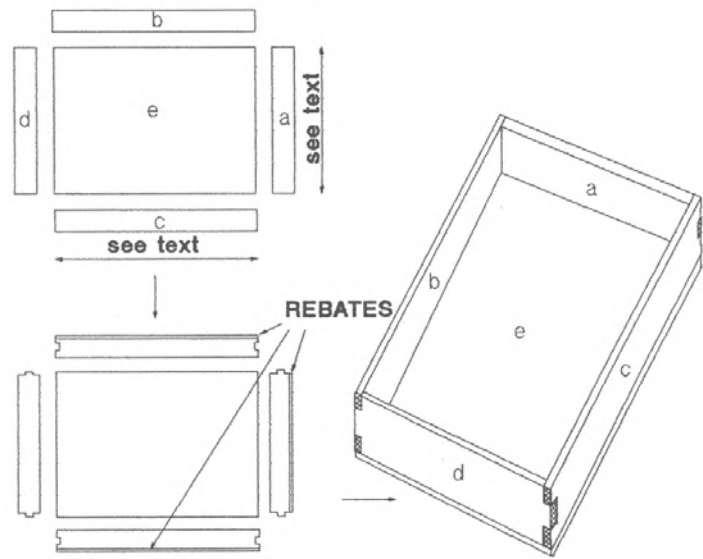

For the pipe to be able to enter and leave the collector box, bore a hole in side a and d.

2.3. Preparing the insulation layer

The insulation layer must be placed at the bottom of the collector-box. (see photo)

The following **tools** are needed:

- a sewing machine
- sewing-thread
- a pair of scissors
- a strong needle
- a ruler
- a pencil or felt pen

The following **materials** are needed:

- empty bags of jute or fibre
- kapok, saw-dust, coconut-fibre, glass-wool or any kind of other insulating material

Measure the total surface of the bottom of the box. Measure also the thickness of the insulation layer. (the layer must fill-up the space between the bottom of the collector box and the top of the supporting laths). Make an empty envelope out of the bags, which can fill-up the indicated space. It is advisable to sew 4 or 5 parallel running empty tracks into the envelope to be filled-up with insulation material. Now we put the filled envelope onto the bottom of the box. Check that the thickness of the insulation layer is equal all over the bottom (and does not reach too much above the supporting laths).



The insulation layer is put in the collector-box. The absorber is placed over the insulation layer next.

Place the absorber onto the supporting laths. The absorber covers the insulation layer at the bottom of the box. Now replace side d and join the four sides A-B-C-D firmly together. Use screws, nails or wooden pins.

2.4. Preparing the glass cover of the collector

The following **tools** are needed:

- a glass-cutter
- a folding ruler
- a straight metal lath
- a felt pen
- a carpenters square
- a level table useful to cut the glass-sheet
- a blanket to cover the table
- a pair of scissors
- a cutting shear
- a drill
- a screw-driver

The following **materials** are needed:

- a glass-plate of about 4 mm thickness and a surface of at least 125 x 90 cm
- an old inner-tire of a motorcar
- silicone-kit or putty
- a galvanised sheet with a thickness of 0.5 mm
- small screws and nails

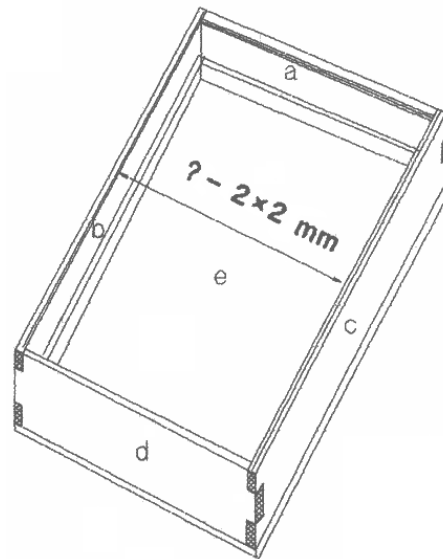

Make sure the width of the glass sheet is at both sides 2 mm shorter than the measured distance.

Now you can estimate exactly the needed surface of the glass-sheet to cover the collector-box. Clean the available glass-plate (125 x 90 cm.) with a wrap. Put the available glass-plate onto the table, covered with a blanket. Draw the measured length and width onto the available glass-plate. Use a carpenter square. Put the metal lath along the drawled lines on the available glass-plate. Strike with the glass-cutter the exact length and width of the needed glass-sheet. By using the glass-cutter carve the needed glass-sheet out of the available glass-plate.

Now you have the needed surface of the glass-sheet to cover the box. Before placing the glass-sheet onto the box start making rubber strips out of the inner-tire. Measure the width of the rebates of sides A-B-C and also the total width of side D. Cut out small rubber strips from the inner-tire. The rubber strips must cover the width of the rebates of sides A-B-C as well as the total width of side D. Fasten with small nails these strips onto the rebates of A-B-C and onto side D.

Start to measure the exact width between the rebates of sides B and C. (see picture above). Use a carpenters square. The width of glass-sheet must be about 2 mm smaller at both sides. The length of the glass-sheet must reach from the rebate on top of the box to about 2 cm over the width of side D.

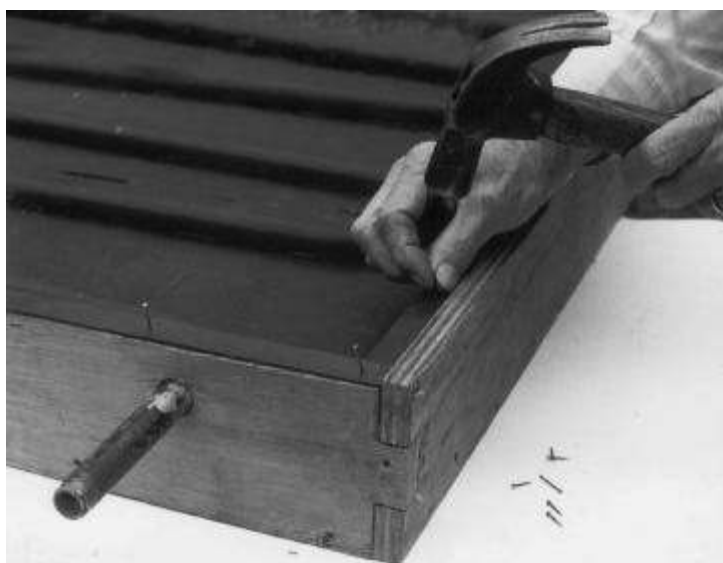

Fasten rubber strips over the rebates of sides A-B-C and D.



Slip rubber discs over the inlet and outlet pipe of the absorber.

Cut out also 2 rubber discs with a diameter of 8 cm. Make a small hole in the middle of the discs. Slip the discs over the in- and outlet pipes of the absorber. Nail the discs to the collector-box.

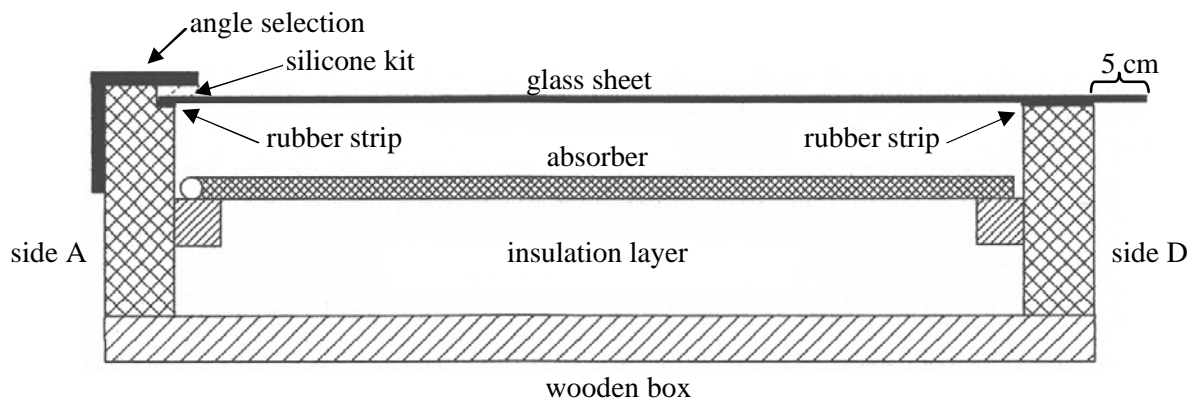

Now you can place the glass-sheet onto the rubber strips. (see picture above) To finish the covering of the collector-box, make angle sections out of galvanised sheet. (see also picture above). The angle sections must cover the total length of sides B and C and the width of side a. The sections must be fastened by small screws. Fill-up the space between angles and glass-sheet with silicone-kit or putty. Finally seal all corner joints of the collector-box with putty and paint the box completely outside.



Fill-up the space between angles and glass-sheet with silicone-kit or putty.

3. The insulated storage tank and accessory pipe-connections

For the storage tank we use a 200-litre drum. It should be a closed one in which no chemical or other dangerous fluids have been stored. Oil, diesel, petrol and soap drums are usable provided they can be cleaned with hot water and soda. To the storage tank there are 5 pipe-connections to be joined. And afterwards the tank must be insulated very well.

The following **tools** are needed:

- a folding ruler
- a marker
- a centre point
- a drill (6 mm and 16 mm)
- a hammer
- a round file
- a steel cone
- a hack-saw or pipe cutter
- a thread-cutter. ($\frac{1}{2}$ " and $\frac{3}{4}$ ")
- a carpenters square
- a piece of sandpaper
- a soldering lamp

The following **materials** are needed:

- a 200 litre (second hand but in good condition)
- a $\frac{1}{2}$ " galvanised pipe with a length of 1 meter
- a $\frac{3}{4}$ " galvanised pipe with a length of 60 cm
- soldering flux and tin

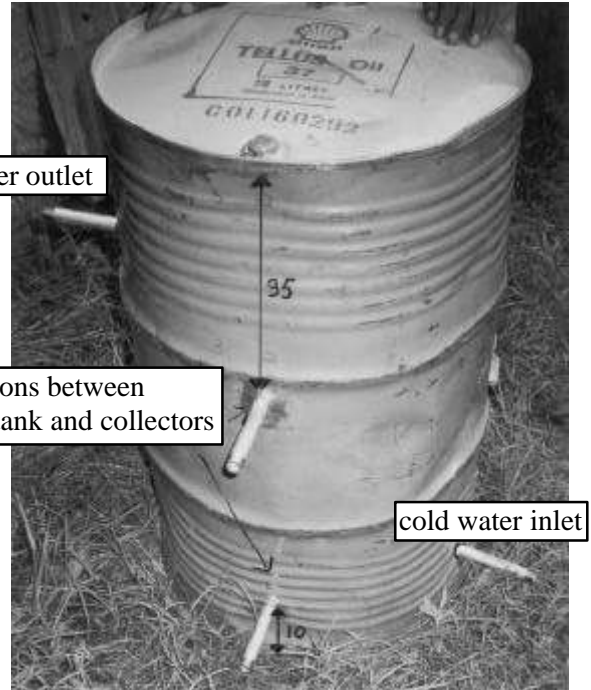

Start to saw 4 pieces of $\frac{1}{2}$ -inch pipe. Each with a length of 15 cm. Make thread at one side of each piece and clean the other side with sand-paper. These 4 pieces have to be fitted into the drum. 2 pieces will be used for the connections between storage tank and collectors, 1 for the cold water inlet and 1 for the hot water outlet (see photo above). Saw another piece of $\frac{3}{4}$ inch with a length of 30 cm. Make thread at both sides. This piece of pipe is fitted into the $\frac{3}{4}$ bughole at the top of the drum. This is the vent (see photo below)



*Fit the $\frac{3}{4}$ " piece into the bughole.
This is the vent.*

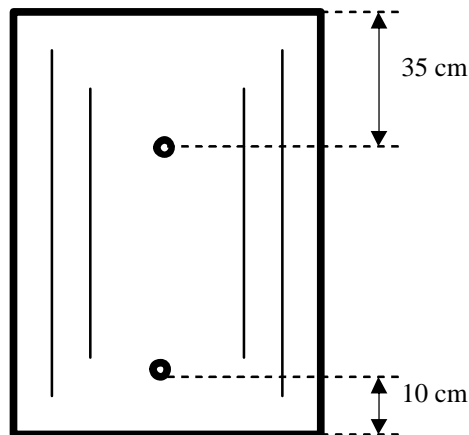

Locations of the connections between storage tank and collectors.

The soldering procedure

Right down of the vent we mark 2 spots onto the drum, 1 at 35 cm from the top and 1 at 10 cm from the bottom of the drum. Strike both sides spots with a centre-point. Then drill first a hole of 6 mm and afterwards a hole of 16 mm into the same spot (see photo 1).

Put the drum horizontal and debur one hole with a round file (see photo 2). Widen that hole by using a steel cone and a hammer (photo 3) until the pipe fits exactly (photo 4). Finally, clean the hole (photo 5) and start soldering (photo 6). Do the same with the other pipe-pieces. Squared to the collector-connections fit the hot water outlet at 25 cm from the top of the drum. Just opposite the hot water outlet fit the cold water inlet at 10 cm from the bottom of the drum.



Photo 1: First, drill a hole of 6 mm and afterwards a hole of 16 mm into the marked spots.



Photo 2: Debur the holes with a round file until the holes have diameter of 18 mm.



Photo 3: By using the steel cone and hammer widen one hole until a 1/2" piece of pipe fits in.



Photo 4: The thread-end of the pipe must be kept outside of the drum. All pipes stand perpendicular of the drum.



Photo 5: Thoroughly clean the pipe and driven-in hole with sand-paper.



Photo 6: Then solder the piece of pipe in upright position securely into the hole.

The insulation of the storage tank

To preserve the water temperature inside the storage tank, we have to insulate it. Therefore an insulating layer of at least 5 cm thickness all around and on top of the storage tank is necessary. For insulating we can use different kinds of materials such as: kapok, coconut, fibre, sawdust, and any other available insulating material. The insulating material must be locked into a cover. Empty sacks can be used but it seems better to make suitable covers by yourself. The self-made covers must have a length of 90 cm. (corresponding the height of the drum). Divide the covers in parallel running casings. The total width of the self-made covers must easily surround the circumference of the drum. Take care that the soldered pieces of pipe stick out.

After surrounding the storage tank with insulating covers, entwine them with ropes or iron wire. To insulate the top of the storage tank, use a self-made pillow. To protect the insulation layer against rain and dust, make a metal envelope out of a galvanised corrugated or flat-plate sheet. On top of the metal envelope you can make a cap. Take care that all pieces of pipe stick out of the metal envelope. To fasten the metal envelope use iron wire, screws or riveted joints.



The total width of the self-made covers must easily surround the circumference of the drum.



After surrounding the storage tank with insulating covers, entwine the covers with ropes or iron wire.

Take care that the soldered pieces of pipe stick out.

The metal envelope and the cap

Around the insulation layer of the storage tank we make a metal envelope. Corrugated or flat galvanised sheets are useful. The length of envelope is about 95 cm. The circumference depends on the thickness of the insulation layer (usually 2 or 3 pieces are necessary). Start to place the insulated storage tank on a wooden disk (diameter 70 cm). Fold the envelope-pieces around and measure the spots where pipe-pieces stick out. Make holes at the indicated spots. Fold the envelope-pieces again and entwine them with ropes or iron wire. Fix the envelope with nails to the wooden disk. Finally, fix the pieces of the envelope together by entwining it with iron wire. After insulating the top of the storage tank with a self-made pillow, we start to make a metal cap. Use a flat plate disk with a diameter of 100 cm. (see drawing below). Make a gash to the central-point of the disk. By sliding you can make a cap-model. Measure the spot where the vent sticks out. Make a hole at the indicated spot. Finally, fix the cap onto the top of the metal envelope. (see photo)

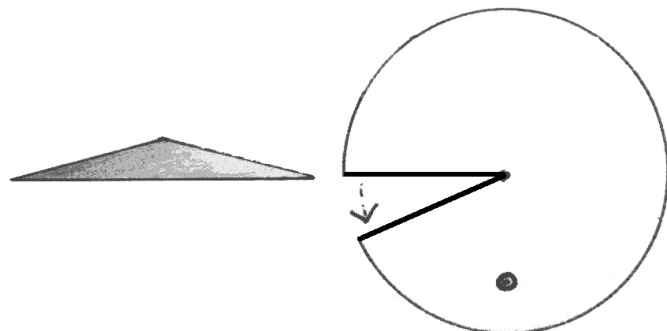

Side and top view of the cap.

By experience it is easier to work up a flat-plate cover around the storage tank than to use a corrugated one.



When using a plastic tank, the floating gauge can be placed in the plastic tank. A separate buffer tank is not required in this case.

4. The buffer tank

To replenish the storage tank we use a buffer tank. The buffer tank is connected to an existing water supply system. Therefore the buffer tank is provided with a floating gauge. Via a flexible hose the buffer tank is connected to the storage tank. For safety an overflow protects the buffer tank from derangement.

A buffer tank can be made of a washing tub, a plastic tub or a half 200-litre drum. When using a metal body like washing tub or half drum, solder a piece of $\frac{1}{2}$ " pipe into the buffer tank to connect it with the storage tank. (see soldering procedure page 34). To finish the buffer tank, make a cover to close the open side on top.

The buffer tank should be placed higher than the storage tank. This makes sure that the storage tank is always full with water. Otherwise, air can get into the storage tank, which caused corrosion. When a plastic buffer tank is used, it is not necessary to construct a separate buffer tank. The floating gauge can then be placed inside the plastic buffer tank.

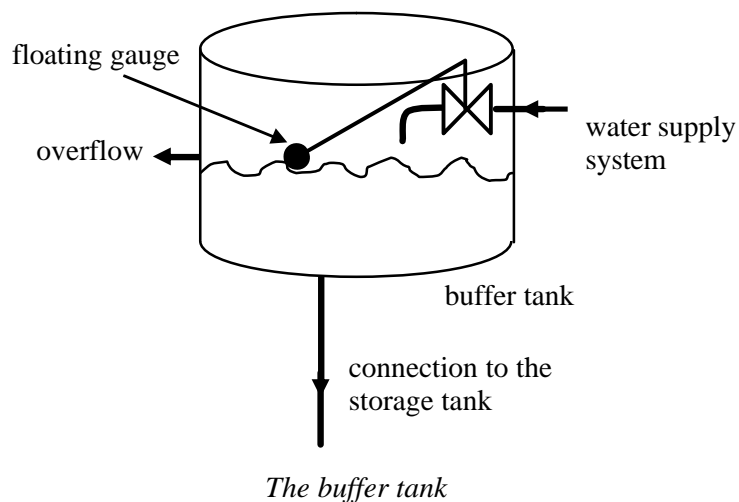

5. Determining the location and position of the solar hot water system

With self-made collectors, an insulated storage-tank and a buffer tank the needed components are ready to set up a solar powered hot water system. Before starting to build up the constructional provisions, some questions have to be considered such as:

- What is a suitable place where frequently hot water is needed? (for instance a laundry, the maternity or the kitchen)
- Where is the nearest place to connect the hot water system to the existing water supply? (check the diameter of the existing water supply pipes)
- What is the possible influence of shadows of nearby trees and buildings?
- In which direction must the collectors be placed concerning the orbit of the sun? (regard the orbit from sunrise to sunset, especially the position of the sun at noon); to find the most efficacy collector position, the following rules apply:
 - Collectors on the Southern Hemisphere (south of the equator) are faced to the north.
 - Collectors on the Northern Hemisphere (north of the equator) are faced to the south; the angle of inclination of the collectors is dependent on the latitude of the place on earth where the hot water system is set up.

When all these considerations have been checked, you can start to build up the foundations on which the collectors, the storage tank and buffer tank will be placed.



Explanation of the numbers:

1. solar collectors
2. storage tank
3. upper connection from collectors to storage tank (hot water)
4. lower connection from storage tank to collectors (cold water)
5. buffer tank to refill storage tank
6. vent

A complete solar hot water system, installed at Hospital Peramiho.

6. The foundation

For the construction of the foundations various kinds of materials can be used. It is obvious that stones, blocks and bricks are convenient construction materials. They can usually be made on the spot.

For example we will describe a construction composed of walls built of bricks with unequal height to support the collectors. 1+2 pedestal as a supporting point for the insulated storage tank and buffer tank 3. (see both pictures)

For the construction of foundations built of bricks, the following **tools** are needed:

- a complete outfit for masonry (among others trowels)
- a water level
- a folding ruler

For **materials** we use:

- bricks
- cement
- sand

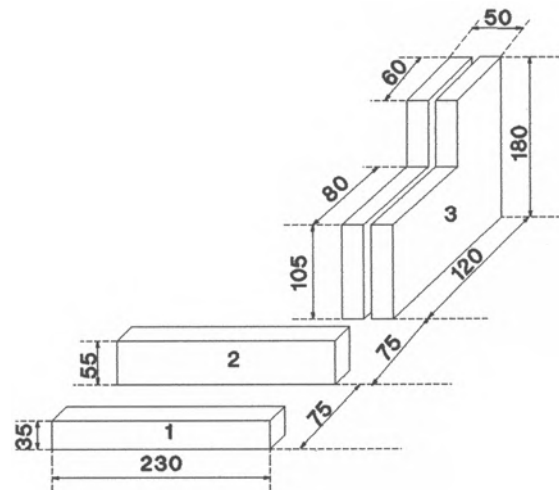

Dimensions of a brick foundation.

For an exact design and all needed measurements to build up these foundations see the following sketches. As you can see the pedestal for the storage tank is 50 cm higher than the second (highest) wall on which the collectors are placed. This provision is necessary to secure that the natural circulation of the hot water system comes into being. All details about the construction are described below.

Numbers 1-2-3 in the pictures are foundations.

- A = water supply system (to buffer tank)
- B = refilling pipe (buffer to storage tank)
- C = lower connection (to collectors)
- D = upper connection (to storage tank)
- E = hot water outlet to tap

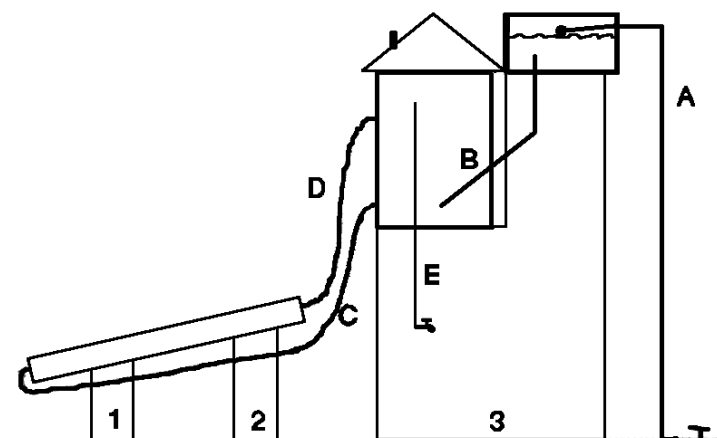

Make sure that the top of the storage tank is at the same level as the bottom of the buffer tank. This ensures that the storage tank is always completely filled with water, which prevents the storage tank from corroding.

7. The installation of the solar powered hot water system

After the foundations are completed you can start to install the collectors, the storage tank and the buffer tank. For installation of the hot water system, the following **tools** are needed:

- a pipe-cutter or hack-saw
- a pipe holding clamp. (fasten on a solid bench)
- a screw thread cutter
- spanners and adjustable wrenches
- water pump pliers
- a water level
- a folding ruler;
- a marker
- screw-drivers

The following **materials** are needed:

- 2 or 3 1/2" galvanised water supply pipes (*)
- 8 galvanised 1/2" elbows
- 6 same 1/2" sockets
- 6 same 1/2" T-pieces
- 3 same 1/2" plugs
- 3 same 1/2" caps
- 2 same 3/4" to 1/2" reducing sockets (*)
- 3 same 1/2" unions (*)
- 2 same 1/2" stop rocks
- 2 same 1/2" taps
- 5 meter heat-resistant flexible hose. (inner diameter 18 mm.)
- 30 hose clips

(*) = depending on which materials are locally available and how to make the joints with the existing water supply system.

Placing the collectors

We start to place the collectors onto the foundation walls. It is advisable to rinse them before placing, because inside the zigzag-pipes dirt and vermin may have been collected. For example, we describe the formation of 3 collectors set up in parallel position.

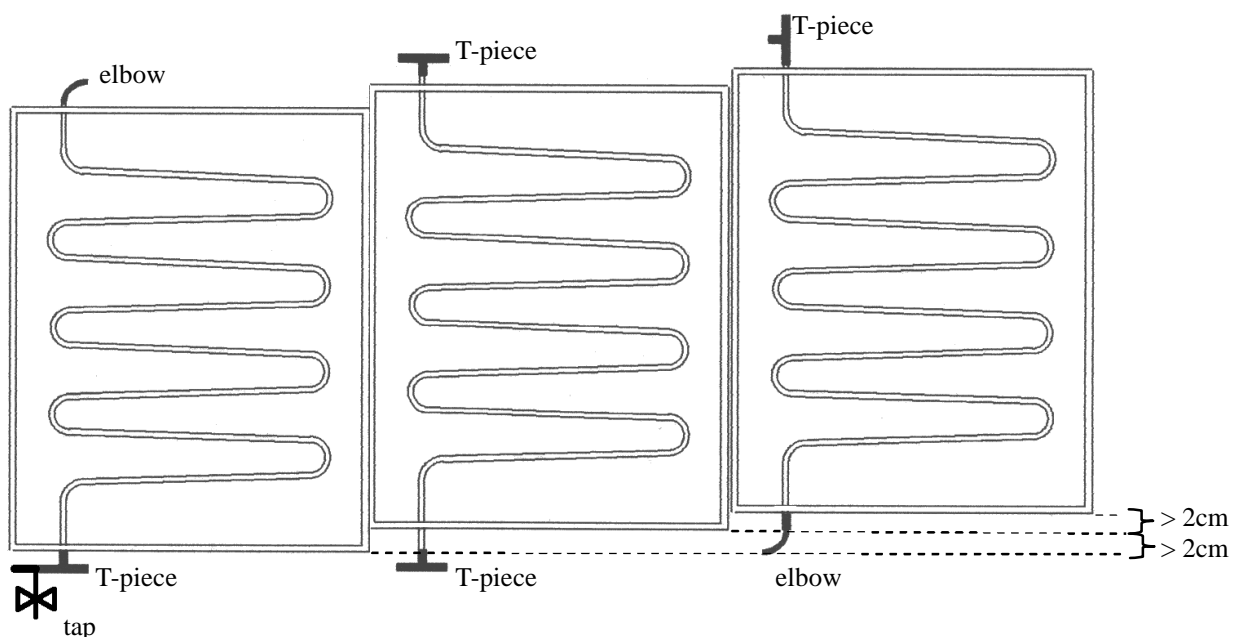

As you can see (in the picture on the previous page) there are 3 collector inlets at the bottom-side and also 3 collector outlets at the topside. At the bottom side, an elbow, 2 T-pieces and a tap are fit to the inlets. By opening the tap it is possible to drain the whole system when necessary. Draining the system is necessary for example when too much dust has been collected in the collector-pipes; this hinders the flow of water through the system. At the top side of the collectors, connect an elbow on the left connection, and two T-pieces to the other two connections as indicated in the picture on the previous page.

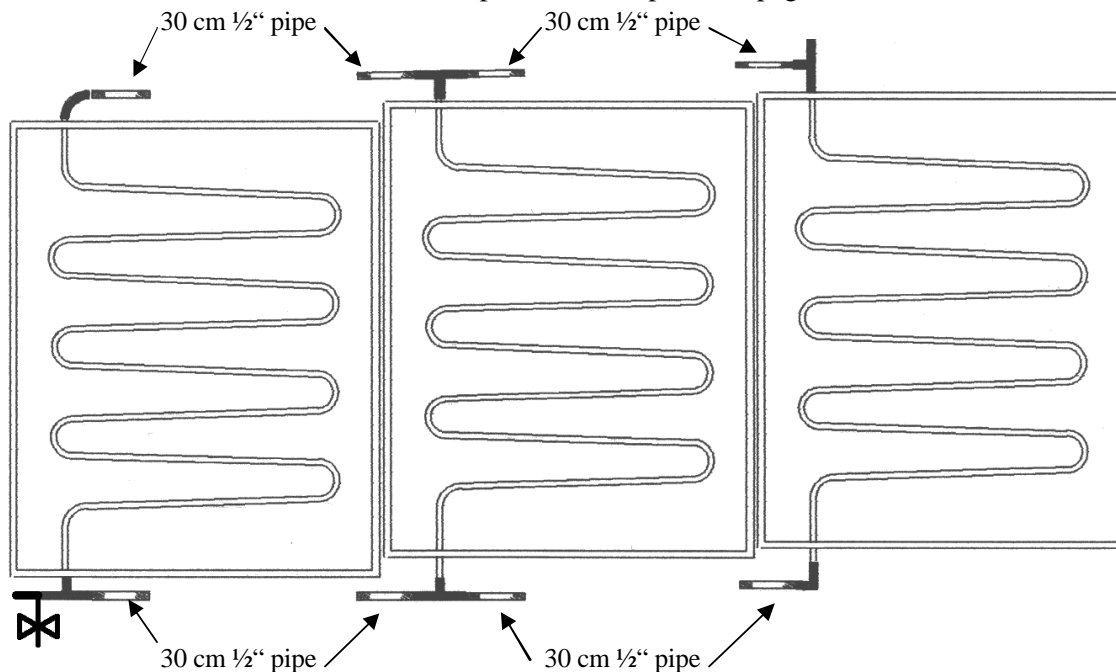

$\frac{1}{2}$ " pipes with a length of 30 cm each are used to connect the collectors. (see picture above) Each piece of pipe has thread at both sides. Screw the 8 pieces of pipe into the T-pieces.

The inlets and outlets are now faced horizontally towards each other. The space in between the horizontal pipes must be filled up with pieces of flexible hose. To obtain the natural circulation, the interconnected outlets must slope upwards. Therefore a difference in height of 1 to 2 cm between the collectors is required. The pieces of flexible hose must be attached to the pipes by hose clips.

Placing the storage tank

After the interconnection of the 3 collectors is completed, we start to install the storage and buffer tank. It is advisable to support both tanks with planks before putting them onto the foundation. The surface of the supporting planks corresponds with the diameter of the tanks. Face the storage tank towards the collectors with the 2 pipes that are destined for it. Now start to connect the existing water supply to the floating gauge in the buffer tank. The buffer tank must be placed with the inlet backwards. Install a $\frac{1}{2}$ " stop cock between water supply and buffer tank. The stop cock should remain closed until the whole installation is finished. Make the connections between buffer tank and storage tank, the connections between storage tank and inlet at the bottom of the collectors and the connections between the outlet of the collectors and the storage tank.

ATTENTION

The connection between the outlet of the collectors and the storage tank must continuously slope upwards. Otherwise the natural circulation does not come into being. The last connection to be made is the hot water outlet from storage tank to tap. All connections are partly made by $\frac{1}{2}$ " pipes and pieces of flexible hose.

Testing the hot water system

When the hot water system has been installed we start to test the system. Open the stop cock on the water supply pipe. Also open the hot water tap. Cold water starts entering via the floating gauge into the buffer tank and from there via the connection into the storage tank. From the storage tank the water flows via the lower connection to the inlets at the bottom of the 3 collectors. As soon as the collectors are filled-up with cold water, the solar radiation starts heating up the water inside the collectors. The heated water will start rising up to the storage tank via the upper connection. During the hot water flow from the collectors to the storage tank, air-bubbles and possibly steam will escape via the vent on top of the storage tank. When the whole storage tank is almost filled up, hot water will flow out of the warm water tap. (maybe it starts with some escaping air-bubbles). Now close the tap and check all connections of the system. When the whole system functions without leaking, you can start the insulation of the hot water system.

The insulation of pipe connections

Without proper insulation of the pipe connections between collectors and storage tank a large part of the output of the hot water system will get lost. The hot water outlet from storage tank to the tap must be insulated as well. Pipe insulation has to be renewed from time to time. For insulating the pipe connections various materials can be used. Pay attention that the outside of the insulation must be water-repellent.

Some example insulation materials:

- Woollen cloths cut into strips and winded around the pipes, for this use plastic also cut into strips has to be winded round the woollen cloths.
- Bracts of banana trees are also useful because they are water-repellent by themselves. After wetting the banana bracts, you can wind them easily around the pipes. To finish it tie them up with their own grain.
- Many other materials can be used for insulation. It depends on what is locally available.

While insulating the pipe connections keep attention to the basic principle:

ALL CONNECTIONS FROM COLLECTORS TO STORAGE TANK MUST SLOPE UPWARDS

Other collector set-ups

Besides the given example of a system with 3 parallel connected collectors, there are other ways to connect the collectors. For example **connection in series**. (see picture). To do this, make a set-up of 2 or 4 collectors. As you see, the collector in-and-outlets are directed towards each other. On both the collector outlets at the top 2 elbows of 90 degrees are placed and directed to the centre. In the centre itself a T-piece or twin elbow is placed. At the bottom, the collectors are connected in the same way. To improve the outcome of a system it is possible to install a set-up of 4 collectors that are connected 2 by 2 in series.

The advantage of such set-ups is that it is of lesser importance that the collectors need to be placed in such a way that the water flow remains up-going.

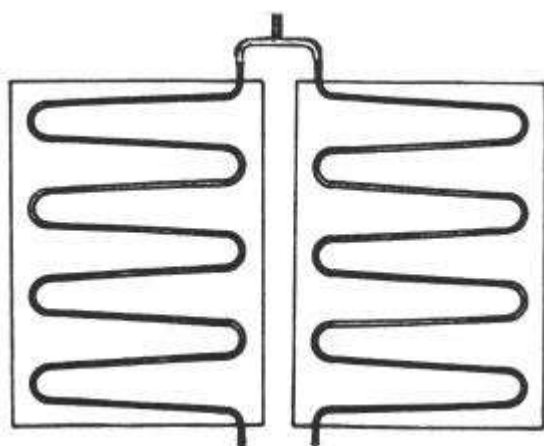

Connecting the collectors in series.



Twin elbow.

8. Maintenance

To keep a hot water system in good condition it is necessary to maintain it regularly. There are 2 possible things interrupting the operation of the system; enclosed air and dust.

Checking enclosed air in the system

The natural circulation of the water in the system only works when there is no air enclosed in the system. There are two possible causes for enclosed air; the air vent is choked or not **all** the connections slope upwards.

When hot water circulation starts inside the collectors, small air bubbles will join the circulation. These air bubbles start rising up to the top of the storage tank and leave it via the vent (air-outlet). So it is necessary to check the vent to see that it is not choke.



The vent on top of the storage tank should not choke.

To maintain the hot water circulation of a system all connections must slope upwards.

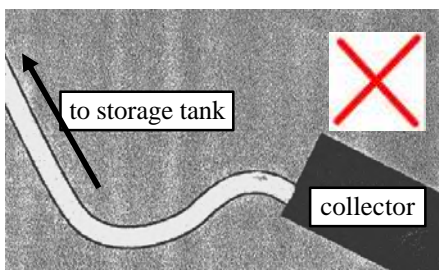

Here you see a connection from collector running up to storage tank. Because there is a dip in that connection an air bubble will block the circulation immediately and consequently the system stops functioning.

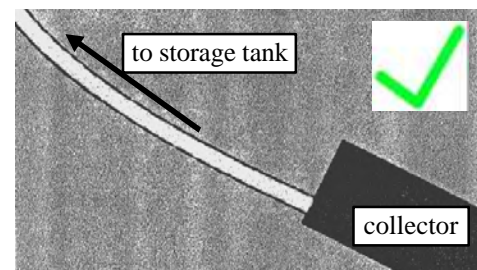

This connection is sloping upwards and so there are no problems with the hot water circulation.

Here you see two collectors.

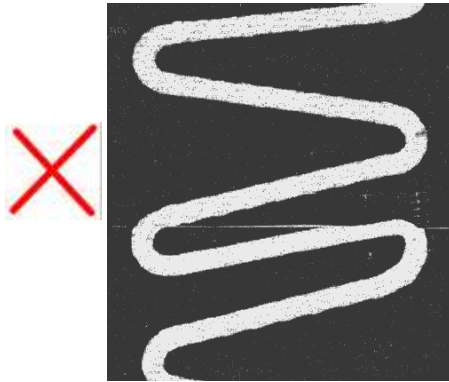

The second bend of this collector is pointed down. Air bubbles will not pass it. So the circulation will be blocked.

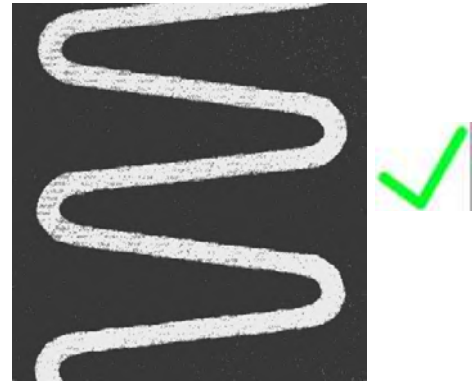

This collector is well bend because all bends are sloping upwards. So the hot water circulation continues without any problem.

Checking dust

At the lowest point of the collectors (the lowest point of the system) a tap or movable plug has to be installed (a vertical T-piece). If there are problems with the hot water circulation (not because of air) you have to open the tap. This will cause the dirt to flow out of the system..

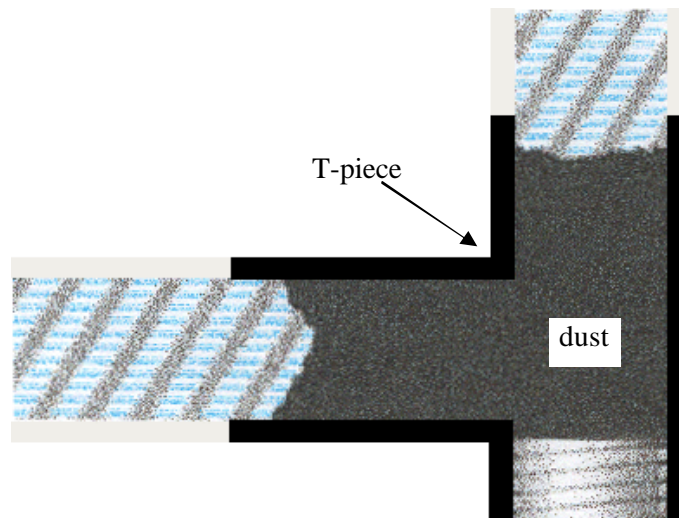

Dust in the lowest point of the system may prevent the water flow.

Dust clouds falling down upon the glass cover of the collectors will dim the radiation of the sun. So clean the glass covers from time to time.

9. Financial aspects and labour costs

As prices differ enormously from one country to the other, it is difficult to make a universally valid estimation of the total costs of materials. For a complete hot water system the costs will generally not surpass US\$ 450. The labour costs are also difficult to estimate in general terms. If local technicians are employed by a Mission or Governmental Health Organisation they usually work on the project as participants. If on the other hand technicians have to be especially recruited, this is often based on a short-term contract. When a training project is carried out at a Technical School, labour costs are mainly involved into the educational premium.

10. Time-span of the project

Depending on the availability of local facilities, materials, a suitable workshop and last but not least skilled technicians, a complete system can be build in about 12 to 14 days. A clear made agreement between BACIBO Foundation and the counterparts as well as thorough preparations are necessary to attain a successful outcome.

11. Summary of needed materials to construct one system

- 5 6 m ½" galvanised pipe (3 for the collectors and 2 for the connections)
- 3 galvanised sheets 0.5 – 1 mm thickness (for the collectors)
- 2 corrugated sheets normal size (for insulation of the storage tank)
- 2 200-litre drums (as storage tank)
- 1 ½" floating gauge
- 1 5 m flexible hose + hose clips (for the connection of the collectors and the storage tank)
- 10 ½" galvanised elbows
- 10 ½" galvanised sockets
- 6 ½" T-pieces
- 1 ½" stop cock
- 1 ½" plug
- 1 ½" tap
- red lead or primer
- dull blackboard paint
- timber for collector boxes
- glass sheets to cover the boxes
- insulation material
- building materials for foundation

Text	Bart Deuss
Photos	Jan Groot
Drawings	Freddy Alferink and Alex Gerretsen
Edited (2004)	Arzad Ohorella and Ferdinand Kroon
Saddle press	Ton Pütt

For more information contact one of the following organisations;

Foundation BACIBO
Achterhoekseweg 11
7556 BB Hengelo (O)
The Netherlands
Tel: ++ 31 74 2508100
Fax: ++ 31 74 2508019
e-mail: bacibo@scarlet.nl

Working Group On Development Techniques (WOT)
University of Twente
P.O.Box 217
7500 AE Enschede
The Netherlands
Tel: ++ 31 53 4892845
e-mail: wot@tdg.utwente.nl

Appendix - Construction of a saddle-press

When the zigzag pipe is fixed to the sheet by riveting, saddles are needed. For a large number of saddles it might be useful to construct a saddle-press. To make sure the saddles fit exactly around the 1/2" pipe, the press has to be made accurately. The dimensions of the press that are marked in the drawings in a bold or large font are crucial. Only if these dimensions are accurately followed, will the saddles fit perfectly around the 1/2"-pipe. The other dimensions in the drawings are not crucial. These dimensions will depend on the available materials from which the press and moulds are constructed. However, make sure the lever can move up and down sufficiently. When the lever is in the up-position, it should be possible to slide a sheet of metal (80x86mm) in the lower-matrix. When the lever is in the down-position, the pressure-plate of the upper-mould should touch the lower-mould.



The press in the picture was made at WOT, and is entirely made of waste materials.

Upper mould

When using the press, it is crucial that the metal sheets maintain their position, and do not turn. This is ensured by providing the lower part of the upper mould with two pointy pins. They slightly deform the sheet, but make sure the sheet is pressed correctly.

There is an additional sheet of 2.5 mm between the Ø 20 mm and the pressure plate. The Ø 20 mm and the pressure plate must be smoothed with a vice.

Lower mould

The inner surface of the U-profile and the angled profile of the lower mould must be smoothed with a vice. Round the inner sides to prevent damage to the saddle. The inner corner of the angled profiles must be (made) sharp. The dimension of 87 mm (see drawing) is accomplished by adding additional sheets of 1.5 mm between the U-profiles and the angled profiles.

Because the surfaces have been smoothed, no oil is needed to create the saddles.

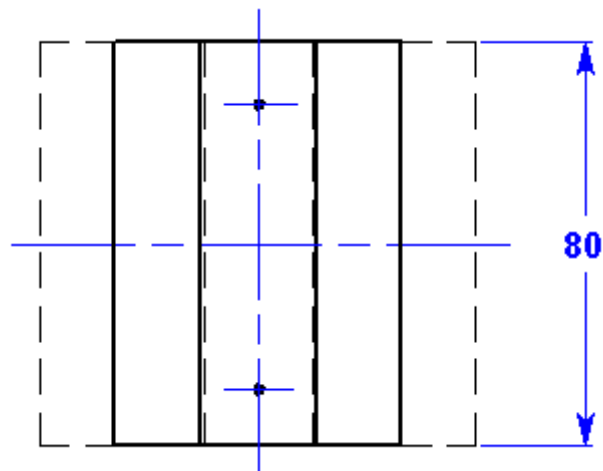
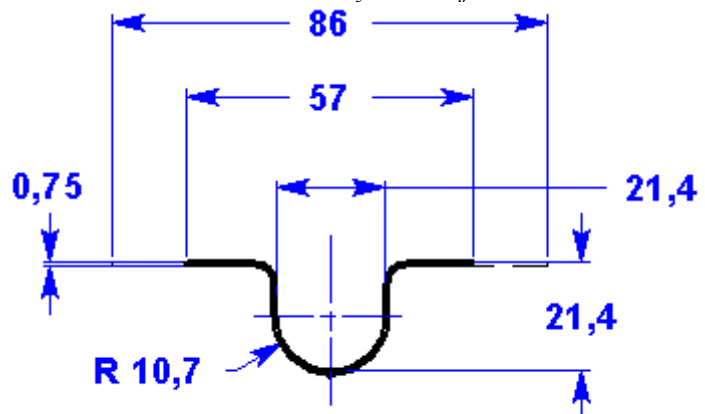

Dimensions of the saddles.

UPPER MOULD of the saddle press

Needed materials:

- 1x U-profile, 30 mm, length 95 mm
- 1x 8 mm thick plate, 32 mm x 95 mm
- 1x steel rod, diameter 20 mm, length 95 mm
- 1x 2.5 mm thick sheet, 8 mm x 95 mm
- 2x angled profile 20 mm x 20 mm x 3 mm, length 25 mm
- 2x pin for positioning, diameter 2.5 mm, length 7 mm.

