

# Solar Water Heating

## A DIY guide

Paul Trimby

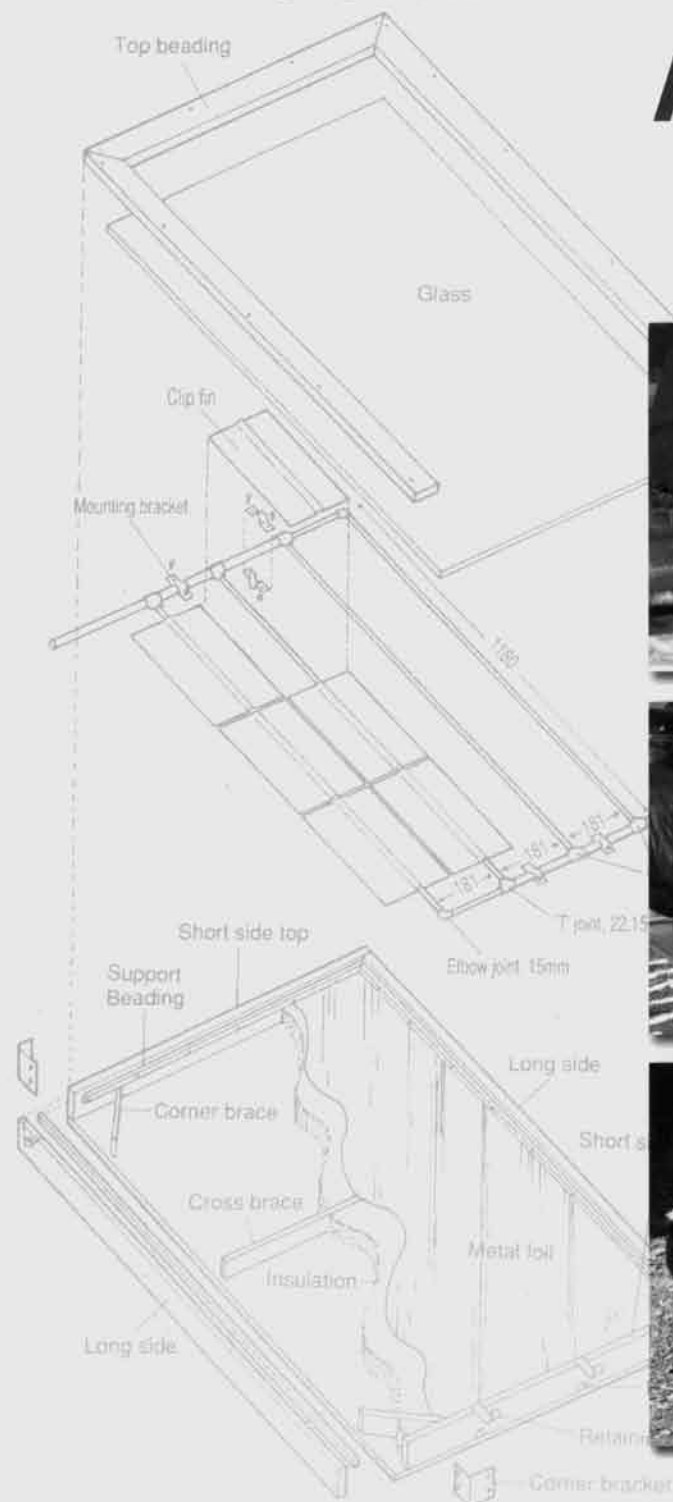



# Solar Water Heating

## A D-I-Y Guide

### Contents

The general idea: introduction to the principles	2
The clip fin design: step-by-step construction details	5
The radiator panel: step-by-step construction details	13
Connecting and mounting the panels: and instructions for filling up the system with liquid, hints on plumbing, wood preserving and soldering techniques	17
The solar controller: instructions for making a solar water heating controller	20
Resource guide: a comprehensive guide to where to obtain products, components and further information.	24
Mail order form: for ordering some of the books and products listed	27

You may also need *Tapping The Sun - A Solar Water Heating Guide* - which describes varieties of domestic hot water systems incorporating solar water heating panels. For other complementary C.A.T. Publications, see the Publications List at the back.

NEW FUTURES 10



© March 1999

All rights reserved:

**The Centre for  
Alternative  
Technology**

Machynlleth, Powys

SY20 9AZ, UK

Tel. 01654 702400

Fax. 01654 702782

Email:

help@catinfo.demon.co.uk

**Written by**

Paul Trimby

**Research + Assistance**

Graham Preston,

Sandra Painter

**Illustrations**

John Urry

**Photographs**

Tom Barker

**Editor**

Dave Thorpe

The details are provided in good faith and believed correct at the time of writing, however no responsibility is taken for any errors. Our publications are updated regularly; please let us know of any amendments or additions which you think may be useful for future editions

**Printed on chlorine  
free paper from a  
sustainable source by  
Imprint, Newtown  
(01686 624137)**

8th printing

ISBN 1 89804911 4

# Capturing The Sun

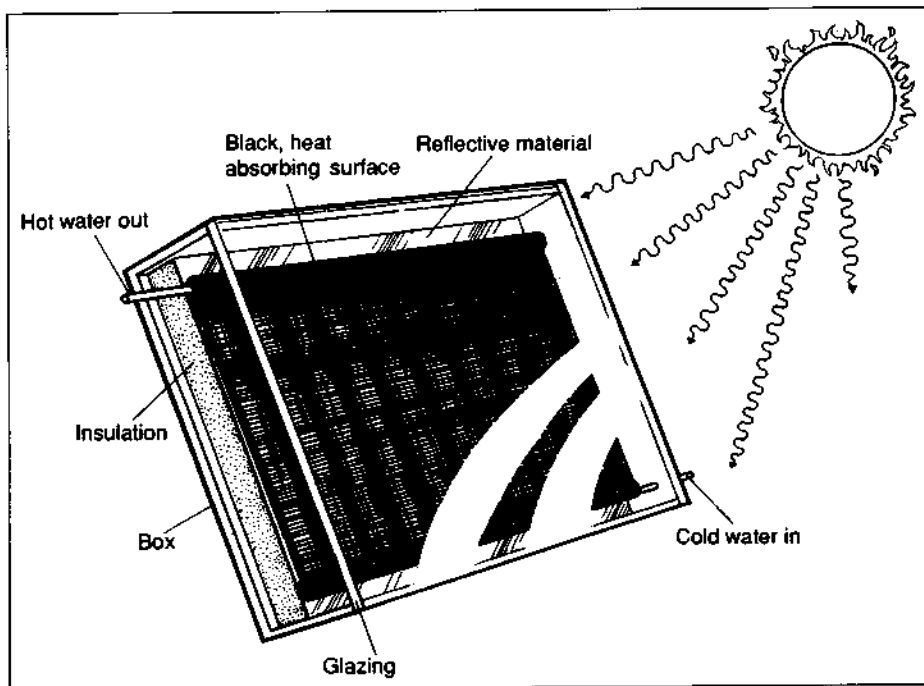

Fig. 1:  
A solar collector is basically a black-painted surface, well glazed and insulated, that passes the sun's heat to water flowing through it.

## Clear skies, hazy clouds, silver linings...

Let us assume that you are interested in using solar energy to heat the water in your taps. You may have decided that the cost of the outlay will be greatly reduced if you can do some of the work yourself. This booklet is intended to help. Firstly, it is a guide to the construction of two types of solar water heater - or solar collector as they are also known. These are the 'radiator' and 'clip fin' types.

These panels can be made by anyone with quite basic woodworking and plumbing skills, and make an ideal practical project for schools and science courses.

Whether you have acquired or made your own solar collectors you may find the sections on the connection, mounting and filling of collectors helpful. Similarly there are hints on soldering and plumbing. A Resource Guide for further information and sources of materials is at the back of this booklet.

We also show you how to make a solar controller. Some systems don't need pumps to drive the water round. But if you cannot position your panel far enough below your water tank to take advantage of natural thermosiphoning, (where the water circulates by itself) then you will need one. If so, you will also need a 'smart' switch, which switches on the pump only when there's enough solar heat outside to be useful. This is called a solar controller, and can be built by those with a little skill at electronics.

If you are hoping to have a thermosiphon system, remember that in general these are

less efficient than pumped systems and require every single bit of the pipe work between the panel and the storage tank to have an uphill gradient.

Your choice on whether to buy manufactured panels or to make your own depends on your skills, your time, the relative costs and the amount of hot or warm water you need around the year. It is a good idea to work out how much you spend on heating water before deciding what to do.

There are various ways to integrate the collectors with your plumbing system, depending on your present arrangement. Details of these, the use of thermosiphon or pumped systems, frost protection etc., can be found in the companion volume *Tapping the Sun - A Solar Water Heating Guide*.

### How useful is solar energy?

Of all the energy received by the Earth from the sun, two thirds is converted into heating the air, ground and water. One third drives the hydrological cycle of evaporation, precipitation and drainage. A mere 0.5% is used to drive the wind, waves, ocean currents and plant growth by photosynthesis.

If society could only use a tiny part of the solar radiation reaching the Earth's surface every year (15-20,000 times current global energy consumption), there would be no more energy problem. This may be a long time in the future, but by using solar water heating panels you are certainly tapping into energy that otherwise dissipates.

Do not believe those who tell you that solar energy is only useful in Mediterranean and equatorial climes. Even in Scandinavia, the amount available per year varies between 600 and 1000kWh per m<sup>2</sup>. In the UK, the figure is around 1000kWh per m<sup>2</sup>.

### How economic is it?

Modern manufactured solar collectors - such as evacuated tubes, which contain a vacuum to minimise heat loss from the metal plate inside - can have efficiencies of up to 50%. With a D-I-Y system it is usually possible to collect between one quarter and one third of the available solar energy. A total solar collector area of around 4m<sup>2</sup> is recommended for a typical domestic water heating installation. A bit of maths shows us that with an array of 4 square metres you could collect up to 1200kWh per year which, if you were using electric water heating, would have cost you slightly over £70. We estimate that the total cost of the clip fin design should be around £55 per 1m<sup>2</sup> collector, and with the radiator type substantially cheaper (but only if the radiators are second hand or free). Thus you can see that the system could 'pay back' in as little as five years, after which the heating it provides will be virtually free. Naturally, the precise economics will vary a great deal from region to region and by many other factors, including your use of the heat and the amount of alterations you need to make to your present plumbing. So the more efficient your system the better.

To achieve the best performance, the solar heated water is usually passed through a pre-heat tank which heats cold water before it goes into the existing hot water tank (see Fig. 2). It should have a capacity of about 50 litres (10 gallons) per square metre of collector - i.e., 200 litres - although this is not very critical. Too small a tank and it might possibly boil in hot weather. Too large a tank and it won't heat up enough. The balancing act also depends on the distance from the tank to the panel - which also determines how much water there is in the panel's loop. The tank - and all the hot pipes - should be very well

Fig. 2:  
A typical system design employing solar collectors to pre-heat water before the immersion heater or boiler finishes the job. This system is pumped and uses a solar controller.

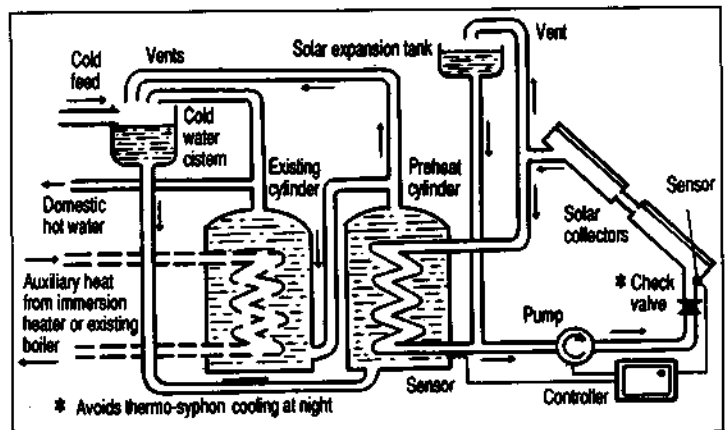

insulated, mainly because sunshine has a habit of heating the water at times when you are probably less likely to use it.

### Which D-I-Y design?

A panel is something through which you can pass water so that the heat of the sun warms it up. If you paint it black to absorb more heat, put it in a box, insulate and glaze it, then it becomes more efficient (see Fig. 1). The D-I-Y models outlined here use two elaborations of this method to pass through water and collect the heat.

The 'clip fin' design uses commercially available fins that 'clip' on to a grid of copper piping. Its total weight is less than the radiator type and it responds more quickly to sunlight falling on it. It is not significantly more expensive to make than the radiator type if you are having to buy the radiators. Although we have suggested here a particular size of collector it is of course possible to alter the size of the individual panels to suit your site. There are two recommended ways of connecting these panels together in this booklet. The first will occupy a rectangle at least 1.7 metres wide and 2.7 metres high and the second a rectangle 3.6 metres wide and 1 metre high (see page 17).

The radiator design simply uses a standard pressed steel central heating radiator as the solar collector. If you can obtain sufficient radiators of the correct design, free or second-hand, then this type of collector is very cheap to make and undoubtedly avoids the time-consuming work involved in constructing an absorber from clip fins and pipes. However, because a radiator contains more water than a similar size clip fin design, it is slow to respond to changes in solar radiation. This will cause some reduction of performance in the winter, but is thought to have little effect on the total energy collected over the year.

Each design utilises a box to house the pipework and insulation. The basic design for the box in each case is similar (see Fig. 3). There is a frame with corner- and cross-braces, plywood backing, insulation, beading, breather holes and glazing. However, details like the exact dimensions, the positioning of the holes for the pipes, and the orientation will be different in each case. The clip fin model is 'portrait' format (i.e., it is taller than it is wide), and the radiator model is 'landscape' format - to suit the shape and size of the radiator you have. It is important that the radiator you choose has an inlet for cold water at the bottom of one side and the hot water outlet at the top of the opposite side.

A total solar collector area of around 4m<sup>2</sup> is recommended for a typical domestic system, i.e. four of either of the collector designs. However, because of the difference in the performance of the two designs we do not recommend that you install a 'mixed' system; all the panels should be either of a radiator type or a clip fin type.

We'll look at the clip fin design first. The instructions include making the box. The general principles for this can then be adapted if you choose to make the radiator model instead.

Fig. 3:  
The basic design for the box - which can be adapted to house either design of collector you make.

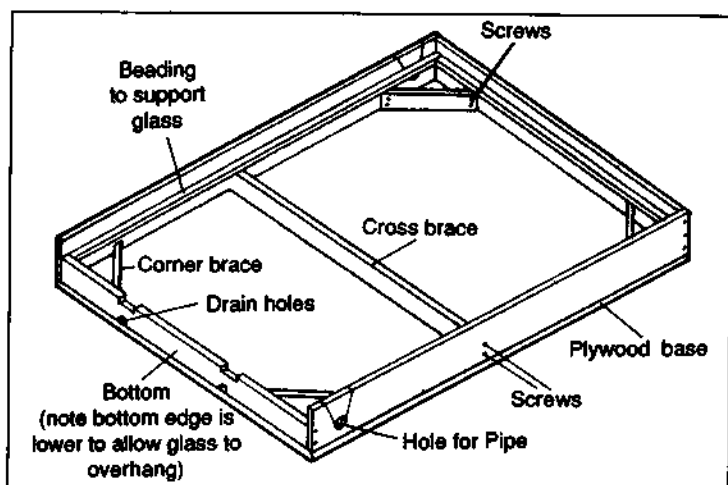

# The Clip Fin Design

## Design summary

This design consists of aluminium clip fins attached to copper piping. Heat from the sun is absorbed by the black painted aluminium fins and transferred via the copper piping to the water passing through the pipes. The piping is arranged in a simple grid. Cold water enters the grid at the bottom, passes through the grid, where it is heated, and hot water leaves the panel at the top, diagonally opposite the point at which it entered.

Clip fins are pieces of 380mm x 200mm aluminium sheet with an indent designed to fit on to a standard 15mm copper pipe.

A collector is made up by simply clipping a number of fins to a grid of pipe and encasing the result in a glazed insulated wooden box (which reduces heat losses and protects the physically vulnerable collector). Heat losses are further reduced by putting a layer of reflective foil behind the pipework assembly. Rainwater can run off the glass overhang at the bottom, and sealant around the glass prevents water entering the box. Breather holes are provided to allow any water vapour condensing in the box to escape. This design uses 12 clip fins.

The instructions that follow begin with a discussion and complete list of materials needed to make the panel followed by details of the construction method.

## Timber

All timber sizes are metric and exact and all the timber used is PAR (Planed All Round). You may find that your timber supplier uses imperial measurements. Imperial measurements tend to refer to the size of the piece of timber from which the planed timber was produced. Thus 4 x 1 PAR will actually be 3.75 inches by .75 inches. This is not particularly critical, though it is as well to be aware of the difference. We recommend that the finished box is painted with a three coat paint system and in an ideal world the box should be repainted every three years. If, for any reason, this is unlikely to happen, then we would recommend that the timber is tanalised (see margin note on page 8) as well as painted. An alternative to tanalising would be to use a rot resistant wood such as cedar, European larch or oak. These will be more expensive to obtain and harder to find. All should be sold to you as air dried and not green. You may also wish to investigate other timber treatments which you can use at home and you should be aware that there are 'organic' alternatives to the common treatments such as Cuprinol and Protim. Details of these alternatives are available via the Resource Guide.

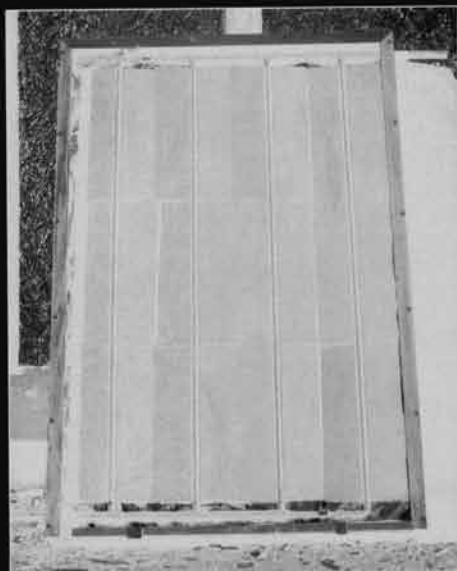

Fig. 4:  
The completed clip fin  
model solar collector,  
shown being made on  
the following pages.

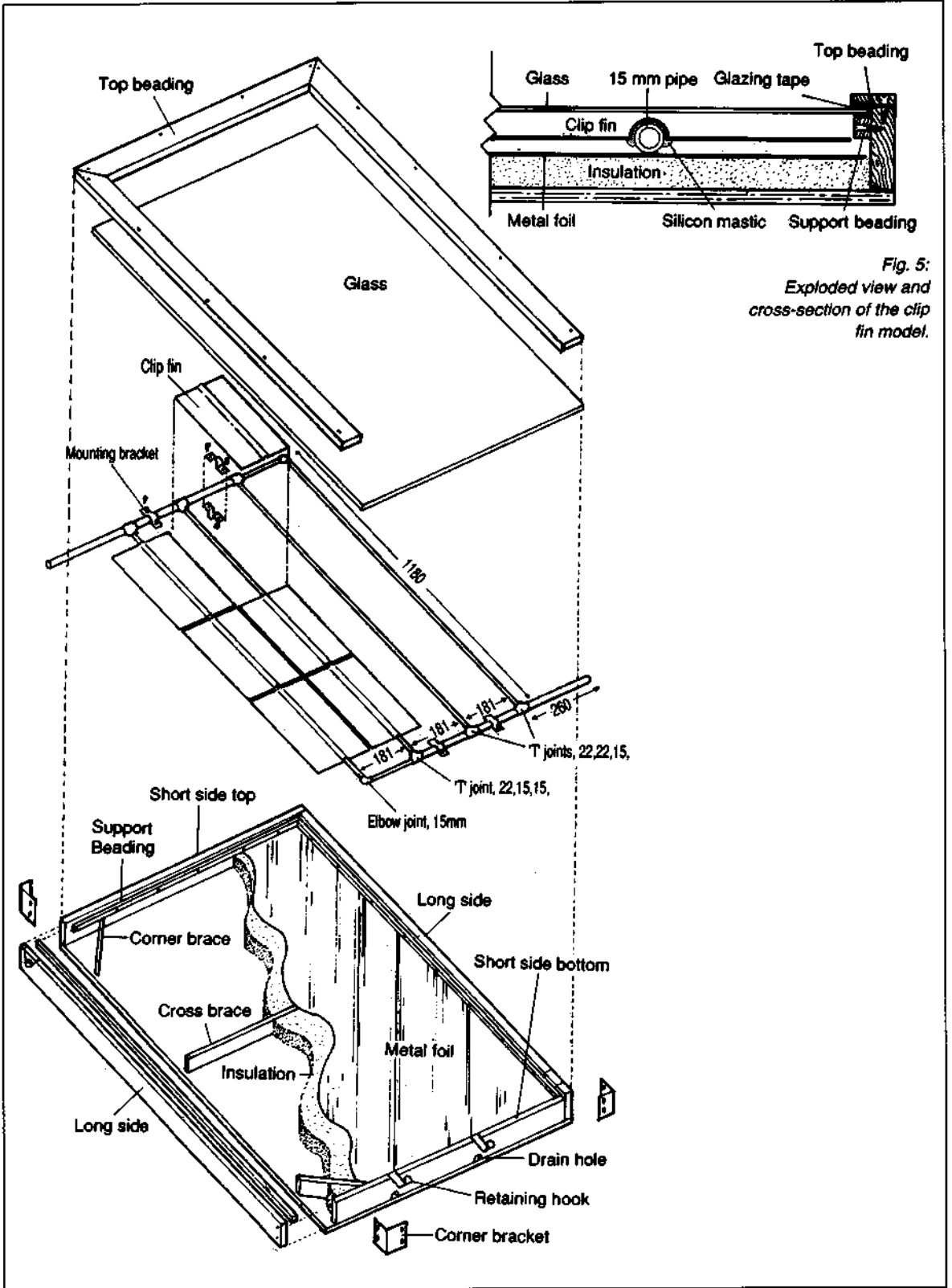

Fig. 5:  
Exploded view and  
cross-section of the clip  
fin model.



## Glazing

Single glazing is recommended. You can use 3mm window glass - buy cut to size after measuring the completed box, leaving a 2mm gap to allow the glass to expand on heating. The collector could be made slightly cheaper by redesigning it to suit standard sized sheets of horticultural glass. Alternatives to glass are UV-resistant polycarbonates and acrylics, and reinforced plastic (transparent fibreglass) materials such as 'Filon', tolerant to temperature changes, much lighter in weight than glass, and not easily damaged by stones, etc. Filon comes in 2.4m x 1.2m (8ft x 4ft) sheets of 5mm thickness and can be cut with a general purpose saw. There are even some special glazing materials which let in the right frequencies of light and don't let out your precious heat. Actually, glass is already quite good at this, but you will find some addresses in the Resource Guide if you want to investigate further.

The glazing should overhang the bottom edge of the case by 12mm (1/2"), allowing rain to drain off easily. Its weight is carried by metal hooks fixed to the inside of the lower edge of the box - a similar method to that used on greenhouses.

## MATERIALS NEEDED FOR ONE 1m<sup>2</sup> PANEL

### THE BOX

#### Pretreated timber (tanalised):

(It may be cheaper to do your own treatment after the box is made, or to use a more rot-resistant timber such as cedar.)

Dimensions are all given in finished sizes in mm: e.g. 20 x 94mm is the planed size of 25 x 100mm.

Size	Length	Number
20 x 94	1285mm	2 (sides)
20 x 94	860mm	1 (top)
20 x 82	820mm	1 (bottom edge)
20 x 50	820mm	1 (cross brace)
20 x 50	350mm	4 (corner braces)

#### Ply

1 sheet 9mm cut down to 1305 x 860 mm

#### Beading

35 x 10 3.5 metres  
10 x 15 3.4 metres (support)

#### Screws (plated steel or brass)

No.6 1" 30 off (for beading)  
No.8 1" 20 off  
No.8 2" 20 off  
25mm panel pins

### PIPEWORK

#### Copper pipe

15mm: 5 metres, cut into four 1180mm lengths and two 185mm lengths  
22mm: 1.25 metres, cut into four 181mm lengths and two 260mm lengths

#### Fittings

(Measurements are based on the use of pre-soldered or 'Yorkshire' fittings.)

Elbows: 15mm - 2 off  
T Junctions: 22 22 15mm - 4 off  
22 15 15mm - 2 off

#### Clips

15mm - 2 off 22mm - 4 off

### CLIP FINS

12 Clip fins of 200 x 380mm size.

Clip fins are manufactured by Pullman Pans and are available from us (see Resource Guide).

### INSULATION

Aluminised building foil, 1.2m<sup>2</sup>

50mm x 1.2m<sup>2</sup> Warmcel insulation, available from us (see Resource Guide). Don't use polystyrene - it melts.

### GLAZING

1.5mm Filon or 3mm glass, 811 x 1297mm

### MISCELLANEOUS

Matt black metal paint

Undercoat and gloss

Silicon mastic - comes in a tube, you make a 'gun' to squeeze it out

Foam bedding strip - 8.5 metres

Glazing clips for bottom edge of glass - made from 50mm offcut of 15mm copper pipe

Wood glue (waterproof)

### TOOLS

Hammer

Saw

Tape measure

Try-square

Screwdriver

Drill + bits (incl. 25mm flat bit)

Stanley knife

Bradawl to mark screw holes

Plane/chisel to tidy up saw cuts

Blow torch

Pipe-cutter or hacksaw + files

Wirewool

Solder - for improving badly-made pre-soldered joints

Soldering flux

## 'Tanalising' or pressure treatment

Tanalising is a proprietary name for a process of introducing preservatives into timber. The preservatives are salts of chrome, copper and arsenic. Such chemicals are added to the timber under pressure, to ensure deep penetration of the preservatives - at least half a centimeter. After treatment the timber should be left to dry for 48 hours. It is then safe to handle. Normally, no planed timber is sold treated in this way, but most good timber yards will be able to get your order treated. It is not expensive and should not add significantly to the cost of the panels. Tanalised timber is not hazardous to handle, but the process does produce hazardous wastes. Ideally it would be better to cut to length all the pieces of timber you need before sending them off to be treated. This is because any offcuts of treated timber you may have should strictly speaking be treated as hazardous waste and not burned, but shredded and dispersed. Also, if the timber is cut after tanalising, the cut ends should be treated by standing them in preservative for 3 minutes before assembly. Treatment using borax salts is more ecologically sound, but unfortunately not suitable for timbers that are to be wet a lot of the time.

## Insulation

We recommend using Warmcel insulation, made from fireproofed, shredded, recycled paper. It is the most environmentally sound type of insulation, having much less embodied energy (energy expended in manufacture) and a cleaner production process than rockwool or fibreglass. It is non-toxic and a better insulator (eg 125mm depth of Warmcel gives equivalent insulation to 150mm of fibreglass). You can order it through the Resource Guide and mail order form.

Air movement between the insulation and the back of the collector must be avoided by ensuring that the two are in good contact. It is virtually impossible to make the collector totally water-tight over a long period, and even if the rain is kept out, some internal condensation will occur. This problem is not serious if drain holes are provided. These also allow the box to 'breathe' and therefore to dry out if it has become wet. We recommend two or three 6mm (1/4") holes along the bottom edge of the box behind the collector, close to the ply backing sheet.

## Construction

It is recommended to start with the plumbing work to ensure that the box is then made to fit round it. This is particularly true if you vary any of our suggested measurements. It is also probably worth waiting until the box is finished before getting the glass cut, so that an exact fit can be obtained.

### Hints on basic plumbing techniques

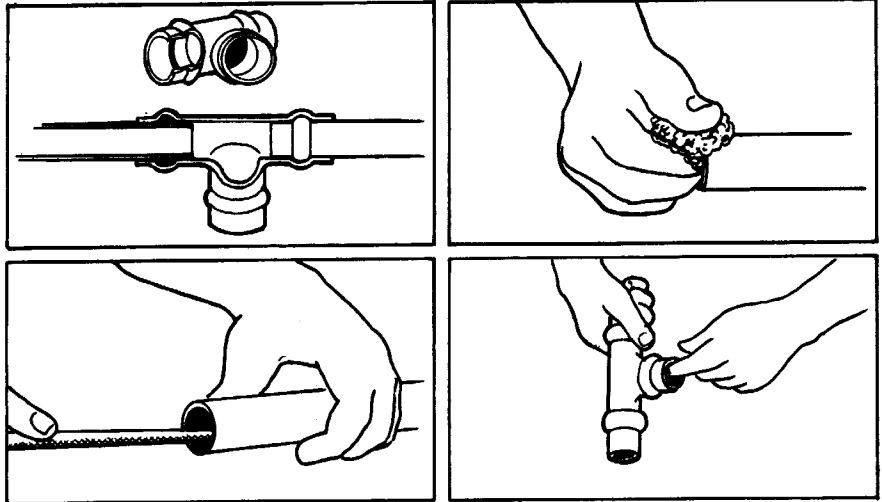

- Capillary or Yorkshire fittings are considerably cheaper than compression fittings and fairly easy to use. Inside each joint is a ring of solder which melts when heated and flows between the surfaces of the fitting and the pipe to form the joint. All that is necessary is for the end of the pipe to be cleaned and smeared with flux and then pushed into the fitting. It can then be heated with a butane blow torch to melt the solder. The flux is needed to help the solder flow along the joint. Without it you will not make a successful joint.
- Remember that if you are using a hacksaw to cut a pipe, always clean off any burrs with a file. Always clean the ends of the pipe with wire wool or emery paper - even on a new pipe. Always use plenty of flux. With pre-soldered fittings, the joint will have been made when you see a thin silver ring of solder appear round the joint. When adding solder to a joint, e.g. when repairing a joint, warm the fitting before applying the solder. Always clean off any excess flux before painting the pipes.

### Step 1



Cut the pipe. In order to ensure the framework is square, tack wooden supports to bench or floor and solder the pipework whilst in this frame. Remember not to move it until all joints are cold.

### Step 4



To ensure that there is no air between the clip fin and pipework, and to maximise conductivity, smear a thin layer of silicon mastic in the groove of the fins. It also prevents corrosive reactions occurring between the aluminium and copper.

### Step 2



Fit together using capillary pre-soldered joints.

### Step 5

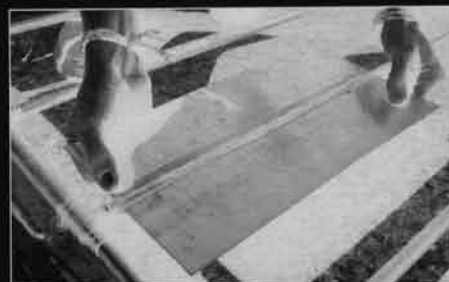

Clip the fins under the pipework.

### Step 3



Test for leakage at joints by running water through.

### Step 6



Paint the pipework and front of the fins with black matt metal paint. Leave to dry while making the box.

### Step 7



Now for the box. First fasten the sides together with 2" screws and glue to make the frame.

### Step 8

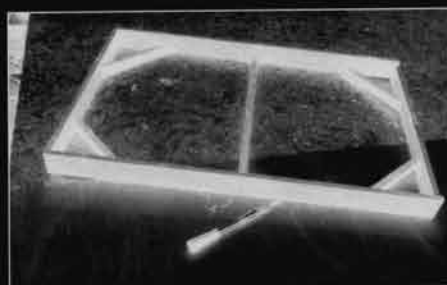

Now screw and glue in a cross brace using 2" screws, followed by the corner braces using the 1.5" screws.

This is what it should look like.



### Step 9



Tack on the backing sheet of plywood with the 25mm panel pins.

### Step 10



Screw, with the 1" screws, and glue the beading along the top and both sides, 8mm from the top edge.

### Step 11



Drill two breather holes 8mm diameter in the bottom edge of the box. These can be filled loosely with 'plugs' of Warmcel to keep insects out.

### Step 12



Now for the satisfaction of putting pipework and box together. Place the pipework over the box - with equal spacing at top and bottom - and mark the positions of incoming and outgoing pipes.

### Step 15



Cover the whole of the inside of the box with metal foil and staple it to the wood.

### Step 16



Taking care that there is no gap between the insulation layer and collector surface, place the pipework (with fins) on top.

### Step 13



Drill 25mm holes at these marked points for the pipes and cut out a V shape.

### Step 17



Fasten the pipes down on to the corner braces using the pipeclips (photo before).

### Step 14



Insert the insulation to a depth of 50mm (the height of the braces).

### Step 18



Place the V-shaped wedges you sawed off back over the pipes, screw (but not glue) them into place and seal the gaps around the pipes with mastic. If you are installing a pumped system with a solar controller, and if this panel is the last one in the series, then you will need to fit the sensor to the pipe at the output end and run the wire out of the box alongside the pipe before you seal it. Once the fittings have been tightened on to the pipes, it becomes very difficult to remove the absorber from the box.

### Step 19



Fit the foam bedding strip on the beading and along the bottom edge for the glass to rest on.

### Step 20



Fit the glazing clips to hold the glass at the bottom edge of the frame. These can be

made from 50mm lengths of 15mm copper pipe hammered flat and bent into shape.

### Step 21

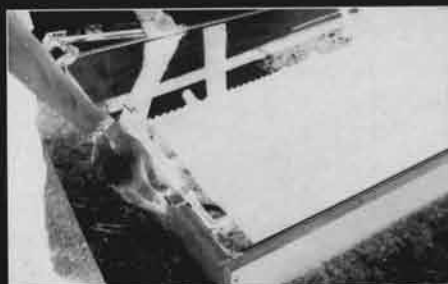

Carefully place the glass or filon (with a 12mm over-hang) on the top.

### Step 22



Fit an extra bedding strip around the edge.

### Step 23



Fit 35 x 10mm beading round top and sides. Seal with mastic between beading and glass.

### Step 24

Paint the outside of box with primer, undercoat and gloss. You are now ready to mount and install the panel into your plumbed system.

# The Radiator Design

## Design summary

This simple design uses a standard pressed steel central heating radiator as the collector. Such radiators are relatively cheap and readily available, and their use avoids the time-consuming construction of a solar heat collector from sheet metal and tubing. The thermal efficiency of a collector using a central heating radiator can be nearly as good as some commercial designs. However, the relatively large water content makes the collector slow to respond to changes in the amount of the sun's heat reaching it. This will cause reduced performance.

A particular type of radiator panel - the Stelrad - is recommended, as this has tapped connecting holes at all four corners so that the necessary 'diagonal' flow of water is easily achieved. Other types with only two bottom connections can be modified by constructors with skills and equipment. The radiator panel is painted with matt black metal paint which gives a suitably high absorptivity.

All comments for the clip fin model on timber, glazing, insulation and construction apply for this model too, as the box is pretty much the same. The dimensions given in the materials list assume you're using a Stelrad radiator. Simply adjust them to suit the size of your radiator. We estimate that a 4m<sup>2</sup> system can be built and installed for £300-£350, using mostly new materials, but good second-hand radiators.

## Assembly

### Step 1

Prepare your collector. It should be painted black with matt metal paint. So should all the pipes and connectors that will be exposed to sunlight.

### Step 2

Cut the wood to length. To protect against weathering, the wood can be treated, c.f. the notes on tanalising on page 8.

### Step 3

Screw and glue together the four lengths of wood for the frame of the box as shown in the exploded diagram.

### Step 4

Screw and glue the backing ply on to the frame.

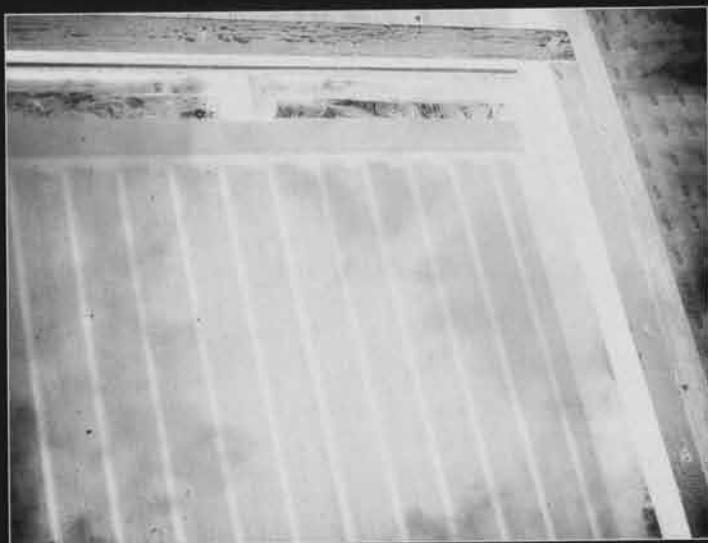

*Fig. 6:  
A radiator model solar collector - this one is a display model at the Centre for Alternative Technology.*

## Materials needed for one 1m<sup>2</sup> panel

### Softwood

Planed all round, treated against rot. Dimensions are finished sizes in mm - e.g. 95 x 20 is the planed size of 100 x 25.

Part	Size	Length	Amount
long side, top	95 x 20	1875	1
long side, bottom	89 x 20	1835	1
end sides	95 x 20	670	2
beading, top side	20 x 10	1835	1
beading, ends	20 x 10	640	2
cross brace	45 x 20	650	2
corner braces	20 x 50	350	4
central beading	45 x 20	650	1
top beading, long side	40 x 8	1875	1 mitre ends
top beading, end sides	40 x 8	702	2 mitre ends
top beading	40 x 8	665	1
retaining blocks	45 x 20	60	4

### Plywood

Exterior quality 9mm, 1875 x 690.

### Glass (or 'Filon')

2 sheets 3mm approx., 900 x 680 (measure collector).

### Absorber

'Stelrad' No. 44 section, 1780 x 580, or similar, from most builders or plumbers merchants.

### Glass Retaining Hooks

Flattened 15mm copper pipe - 4 off.

### Corner brackets

Sheet metal 60 x 60 angle, 95mm deep.

### Insulation

50mm thick Warmcel (supplied by us - see Resource Guide).  
Sheet of aluminiumised building paper approx. 2m x 0.75m

### Miscellaneous

Matt black metal paint or selective absorption paint (see Resource Guide)  
Wood primer  
Undercoat and gloss  
Foam bedding strip  
PTFE tape  
Silicon mastic, acrylic putty (often sold as metal window frame putty) or glazing tape  
Two screw thread fittings per radiator - to connect 15mm copper pipe to the radiators

### Tools

Hammer  
Saw  
Tape measure  
Screwdriver  
Drill and bits  
Stanley knife  
Bradawl to mark screw holes  
Plane/chisel to tidy up saw cuts  
Adjustable spanner

### Step 5

Attach the four corner plates on to the frame and backing ply.

### Step 6

Fix the reinforcing wooden battens inside the box, then put the Warmcel insulation between the sections.

### Step 7

Cover the whole of the inside of the box with metal foil and staple it down on to the wood.

### Step 8

Connect a short length of copper pipe to the appropriate corners of the radiator using the correct screw thread fittings. First remember to wrap PTFE tape around the thread on the radiator. This will help seal the joint.

### Step 9

Drill two 15mm holes in the sides of the box to line up with the short lengths of pipe connected to the radiator and cut out a V shape (see Fig. 8).

### Step 10

Position the radiator and secure it in place with the retaining blocks, making sure that there is no gap between the insulation and the radiator - any air movement between them

Fig. 8:  
Cutting the V-shaped wedge and 15mm hole in the box frame for the pipes.

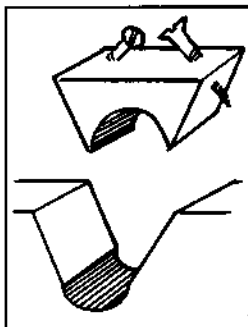
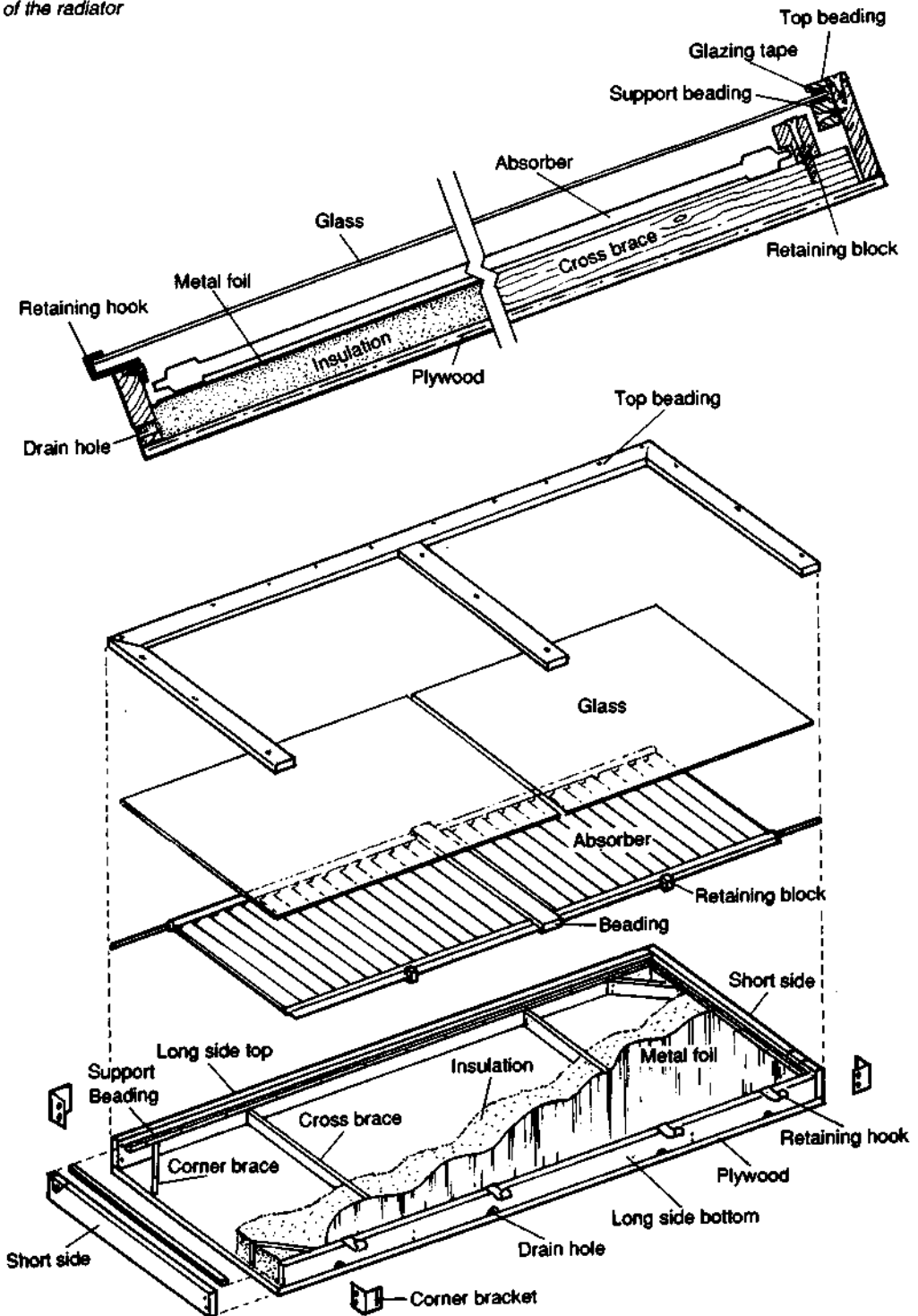



Fig. 7:  
Exploded view and cross-section of the radiator model.



would reduce efficiency. If you are installing a pumped system with a solar controller, and if this panel is the last one in the series, then you will need to fit the sensor to the radiator at the output end and run the wire out of the box alongside the output pipe before you seal it.

**Step 11**

Place the V-shaped wedges back in their positions and screw them down. Do not glue. Seal the pipes to the box with mastic or silicon sealant.

**Step 12**

Fit the beading around the sides and top of the box to support the glazing, then the central support.

**Step 13**

Drill the drainage holes at the bottom.

**Step 14**

Paint the outside of the box with primer, then undercoat, and finally gloss.

**Step 15**

Fit the foam bedding strip on the beading and along the bottom edge for the glass to rest on.

**Step 16**

Fit the glass retaining hooks at the bottom of the box.

**Step 17**

Carefully position the 3mm Filon, polycarbonate or glass, and secure or glaze it with silicon mastic, acrylic putty or glazing tape. Do not use linseed oil putty - it will weather badly.

**Step 18**

Screw on the glass retaining cover strips.

**Step 19**

Position the panel in place.

**Step 20**

Connect the pipes of your system to the radiator (see next section) and seal with mastic. Once the fittings have been tightened on to the pipes, it becomes very difficult to remove the collector from the box.

Well done.

# Connecting and Mounting

## Connecting the panels

If you are intending to make four panels and want to connect these in an array you should be aware that in making some of them you must make small changes to the basic instructions in this booklet.

Fig. 9 shows how four panels of either the radiator or clip fin type may be connected up in a 'grid' layout. If you follow the instructions in this booklet you will end up having a panel that looks like numbers 1 and 4 in the diagram. To get panels that look like 2 and 3 you will have to drill the holes in the opposite sides of the box, so the entry and exit pipes will be in different positions. Otherwise, just follow the instructions as above and re-position each radiator and pipes to match the new locations of the holes.

When connecting the individual panels together it is better to use compression fittings rather than the soldered type, as this will allow you to remove individual panels more easily should the need arise. Remember also to insulate all pipe work outside the box as heavily as possible to minimise the loss of your precious heat. Another measure you can take to do this is to keep the length of pipe on the outside of the building as short as possible.

For the clip fin model there is an alternative linear layout (Fig. 10) for connecting them, which may be more suitable for your positioning site. It does require more changes to the design than the grid layout.

As you can see, the configuration of the inlet and outlet pipes in none of the panels in this diagram resembles the one described in this booklet. The differences are not hard to work out. The pipe work is the same (mirror-ways) in panels 1 and 4, and in panels 2 and 3. In panels 2 and 3 the horizontal feed and head pipes are both 22mm wide throughout - they do not change to 15mm - so your purchase of length of pipe and T-junctions will be affected. Apart from that it's just a question of drilling the holes in the right places in the frames.

## Where should the panels go?

To avoid the use of a pump, the panels really need to be positioned at least 60cm below the hot water and pre-heat tanks so that the vertical distance between the tank and the panels is at least a quarter of the horizontal distance between the tanks. Then it may be possible for the water to circulate by itself using the thermosiphoning principle (hot water rises, cool water sinks and the resulting pressure differences suck the water round the system). If you can't achieve this, then you will need a pump.

Needless to say, they should be in a south-facing, unshaded position, preferably sheltered from prevailing wind. Although maximum benefit derives from direct sunlight, there is one third as much energy in the diffuse light in the sky, so even on cloudy days the water in the panels will heat up somewhat.

The collectors should ideally be oriented to face a little west of south and tilted at about 35° to the horizontal. Other orientations between SE and SW, and tilts from 10° to 50°, cause only minor reductions in the overall energy collected.

Fig. 9 (top)  
Grid layout for panels.

Fig 10 (bottom)  
Linear layout for  
panels.

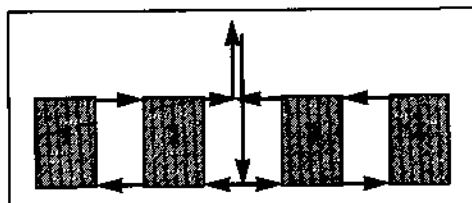
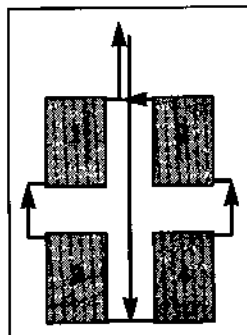

## Mounting the panels

There are many ways in which panels can be mounted. If you have a site at ground level you will need to make a support frame of some kind. However, most panels will probably be mounted on a roof. There are many ways this can be done. Here we will describe a possible method which you may adapt to your particular situation.

Screw to the roof a length of angle iron along the line of what will be the bottom edge of the panels. This will mean drilling through the tiles or slates (refer to Fig. 12). You should take care that these holes go through the tile (or slate), the support batten and a rafter. If you really can't drill through the tile (e.g. it may be brittle concrete) then you will have to remove a tile, and replace it with some other roofing material you can make a hole through.

Now drill holes in the angle iron to correspond with the holes in the roof. At the same time drill two holes per panel in the other flange of the angle iron. The spacing between the holes should be not more than 500mm. Put a ring of silicon sealant around each hole, place the angle iron in position on top and screw down. Put another line of sealant where the angle iron and tile meet. Rest the panels on this support and repeat the operation at the top of the panel.

Now screw the panels to the angle iron.

On a slated roof this will require some care but should be relatively easy. On a tiled roof the angle iron may have to be spaced a way above the roof so that the panels can sit well on the roof. This can be achieved by using treated wooden lengths of wood to act as spacers, with holes drilled in the right places. Screw the wood to the roof, the angle iron to the wood, and then attach the panels to the angle iron.

To take the pipes out onto the roof and back into the house again, drill through the tile (or slate), taking care not to break it (see Fig. 11). This time make sure that the hole misses support battens and rafters. The pipe can be passed through this hole and the joint between them sealed with exterior silicon sealant. Do not make this final seal until all the pipework, inside and out, has been done.

If you have a pumped system and are therefore installing a solar controller, then you'll need to fix the sensor to the last panel in the series and pass the wire through the same hole the pipe goes through the roof, before sealing it. Don't forget - you don't want to kick yourself for having to make the same hole twice.

## Pumps and check valves

A pump rated at 30 watts or so is adequate for most solar water installations. A more powerful pump such as a 60W standard central heating pump would only cost you more when it's running. A supplier of low-energy pumps is mentioned in the Resource Guide.

The pump is positioned in between the collector and the pre-heat cylinder, after the check valve, which is there to stop water from the cylinder being drawn back up to the panel at night when the panel is cold, and cooling off all your nice hot water. This is most likely to happen if your pipes are large bore - such as the 22mm one needed for the clip fin design.

However, if you are making a radiator design-based system, and using a pump, then it's important to note that 15mm piping throughout will work fine - and will avoid the need for a check valve, since the narrowness of the pipe restricts the flow sufficiently to prevent reverse thermosiphoning.

The pipes should not be narrower in the plumbing loop for your collector than in the collector itself - otherwise bottlenecks will occur and the liquid won't circulate freely.

Fig. 11 (top):  
Passing the pipes through the roof.  
Fig. 12 (below):  
Attaching the collector to the roof.

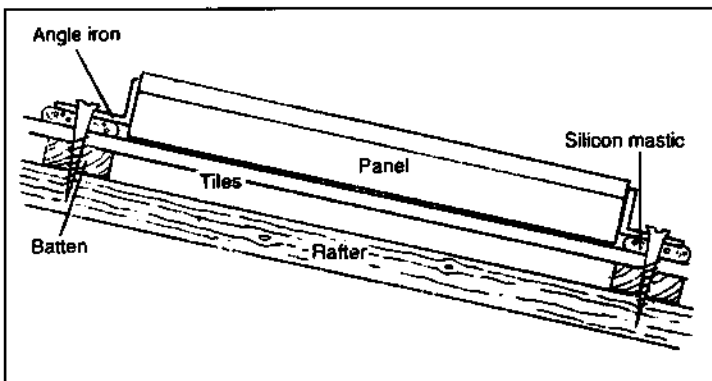
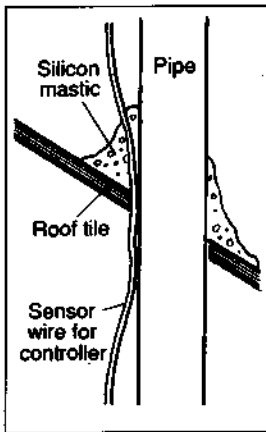

## **Filling your system**

At last you're ready, after all your hard work, to fill your system, including the panels. This is simplicity itself. You fill it via the solar expansion tank.

First mix up a quantity of water and Fernox, the recommended type of anti-freeze. Do not use car anti-freeze as, if it leaks into the drinking water system, it is toxic. Fernox is non-toxic. It is also extremely viscous and needs a thorough mixing up with water before adding - or it will never permeate the entire circuit. The correct proportions according to volume and likely lowest temperature are in the instructions that come with the anti-freeze. Add this mixture to the expansion tank while the rest of the water is allowed in, to ensure as thorough mixing as possible.

Do this as follows. The expansion tank will either have a ball cock or not. If it does, turn on the water, and the circuit will fill up to the level fixed by the position of the ball cock. If not, fill it up with a hosepipe or bucket until it is reasonably full. The liquid will gurgle down and fill up the system. If you have one, the pump will come on when the controller tells it to. Either way, the water will circulate around as it warms up. Any air pockets will automatically be expelled from the overflow pipe that leads into the expansion tank.

You are now ready to enjoy the warm water the system will produce.

If you have no ball cock in your system, you will need to check the level every now and then. It will slowly evaporate and need topping up - your system should not be allowed to lose too much water. Every five years, drain it, flush and refill with the anti-freeze/water mixture.

# The Solar Controller

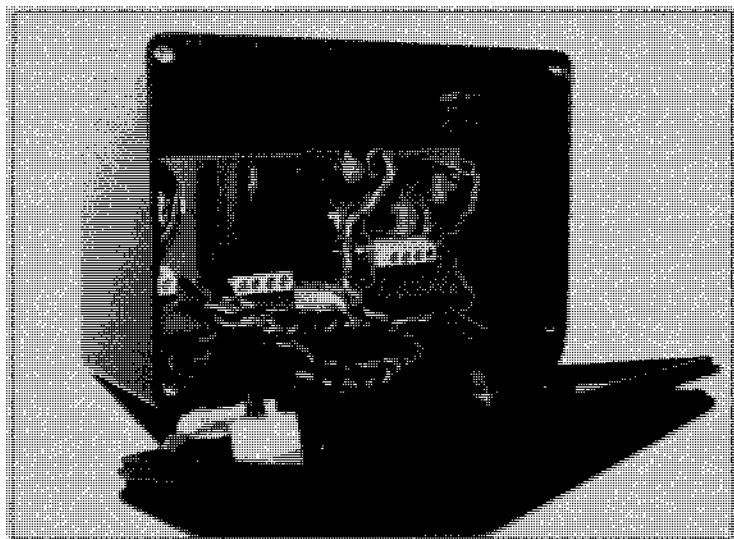

## Why use a controller?

A solar water heating controller is a gadget used in conjunction with a solar water heating panel array to supply hot water to your taps. In the simplest systems, water circulates by itself. However, if you install a pump it means greater choice over where you position the panel, plus improved thermal efficiency. The controller is a simple thermostat that only switches on your pump to carry water from the heater when it's hot enough to be of use. This section tells you how to make and install one from standard electrical components.

The controller we describe can be used for most solar heated water systems. Let's look first at how it works and then at

## LIST OF COMPONENTS

<b>Resistors</b>	<b>Value</b>	<b>Colour code</b>	<b>D7</b>	green LED (with clip)
R1,R2	4K7 (two)	yellow, violet, red	D8	red LED (with clip)
R3,R13	100R (two)	brown, black, brown	<b>Others</b>	
R4,R5,R6	2K2 (three)	red, red, red	TR1	BC182L transistor
R7,R8	10K (two)	brown, black, orange	IC1	LM741 op-amp
R9	4M7 (see note)	yellow, violet, green	RLA	10A single pole changeover relay, 24V coil
R10	1K5	brown, green, red	T1	3 VA transformer, 240V primary, 20-0-20V secondary
R11	330R	orange, orange, brown	S1	d.p.s.t. rocker switch, 240V AC 4A
R12,R14	2K2, 0.5Watt	red, red, red	S2	s.p.s.t. toggle switch, 30V DC1A
R15	1K 1Watt	brown, black, red	FS1	1 amp fuse
VR1	100R cermet preset			
<b>Capacitors</b>				
C1	470nF capacitor polyester 100V			3 way terminal block
C2,C3	100nF capacitor polyester 100V (two)			4 way terminal block (two)
C4	330uF capacitor radial electrolytic 40V			p.c.b. terminal pins (ten)
C5	100nF suppression capacitor			fuse clips (two)
<b>Diodes</b>				plastic case
D1	8V2 zener diode			rubber grommets (three)
D2,D3,D4	1N4148 (three)			printed circuit board
D5,D6	1N4002 or 1N4007 (two)			twin 7/0.25mm cable
				epoxy putty and (maybe) silicone sealant

making the control box, fitting the sensors, choosing the temperature difference, testing procedure, installation, and some additional technical detail.

**Hints on soldering**

**How it works**

Two sensors are mounted, on the hot water tank and on the solar panel. They measure the difference in temperature between the two. When the panel is sufficiently hotter, they tell the controller automatically to switch on the pump. When the tank has heated up it will switch the pump off. There is also a manual override switch.

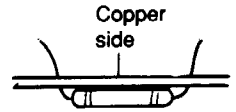

**Building the control box**

Most of the components are fitted on to a printed circuit board. This is shown in Figures 15 & 16 on the next page. Figure 14 shows the circuit diagram. The board was designed to fit inside a plastic case measuring 150mm by 80mm by 50mm, although any reasonable size may be used; you could adapt something or build it out of wood. It should be possible to solder together and construct the controller, and put it in the case, with careful reference to the diagrams and photograph. However the following points are offered to avoid some of the mistakes that might occur.

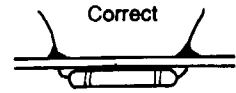

Three rubber grommets are fitted to cable holes in the lid of the case, and the LEDs and switches are fitted in the lid. Take care to position these lid-mounted parts so that there's enough clearance space when the case is put together. When fitting the diodes and the capacitor C4, make sure that their polarity is correct and that the integrated circuit IC1 is the right way round. Similarly, when completing the interwiring between the components, pay careful attention to the polarity of the LEDs, to make sure they are connected the right way round.

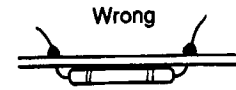

Check the wiring of switch S1 since this will carry mains voltage. When the components of the board are all securely soldered in place, lower the board into the case you have made and connect a three core mains cable to the three way terminal block. The cable should be fitted with a 3 amp fused plug.

*If you've never done any soldering before, you may find these notes useful.*

**Installing the sensors**

First, make up the two sensor leads, one for the solar panel and one for the hot water tank. Use twin core 7/0.25mm cable. The type with one side marked with a coloured stripe or ribbing is ideal. At this stage each lead may be about 2 metres long. If necessary, extend them with more cable later; or calculate first the distance you want to position the controller from the panel and tank.

- Good quality soldering is essential for good connections and proper working of the circuit.

The sensors themselves are 1N4148 diodes. Simply solder them to the end of each lead as shown in Figure 17. Seal the bare wire and joints with epoxy putty against water. This will harden in a few minutes.

- First push the component lead through the board, then turn the board over and slightly splay the leads to stop the component dropping out.

Thread the two sensor leads through the grommet on the end of your box and connect them into the terminal block as shown in Figure 16.

- Place the tip of a fine-tipped soldering iron on to the joint so that it touches both the copper board and the lead.

**Choosing the temperature difference**

The size of the temperature difference between the tank and the panel that switches the pump on or off is controlled by the component called R9. This is a feedback resistor of the 741 amplifier. You can choose its specification to give a temperature difference as shown below:

- After a few seconds, when it is hot, run solder on to the joint and wait until it flows completely round the lead and on to the copper track.

SPECIFICATION	TEMPERATURE DIFFERENCE
3M3	10°C
4M7	7°C
10M	3.5°C

- Remove the iron and check that the solder has spread evenly over the joint.

You may wish to experiment with installing different resistors at different values to find the one that works best for your conditions. Alternatively you could fit a variable resistor, and having found the optimum position, leave it there.

- Snip the leads off with small side cutters.

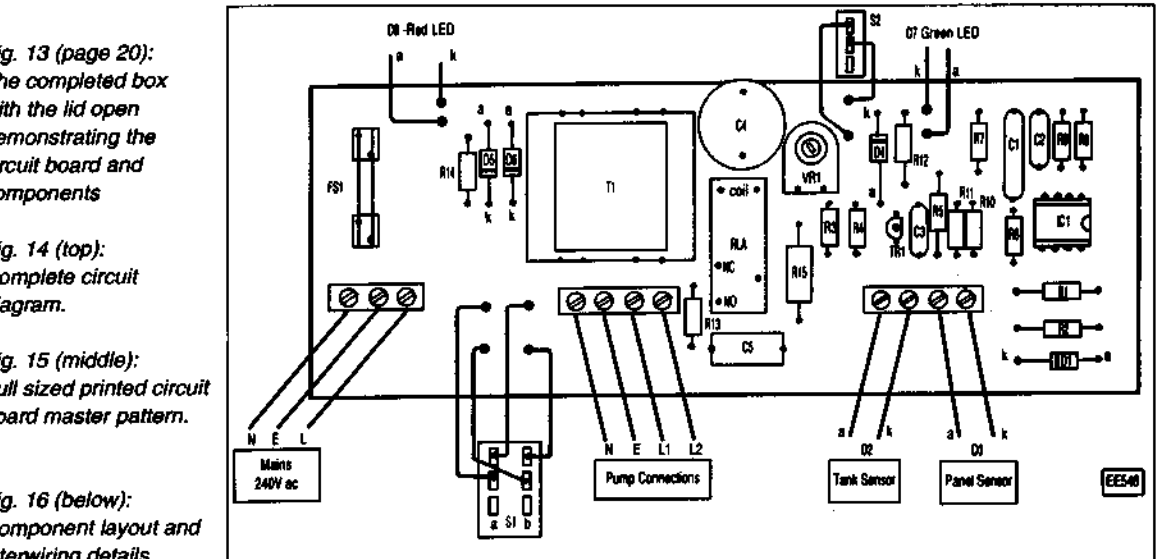
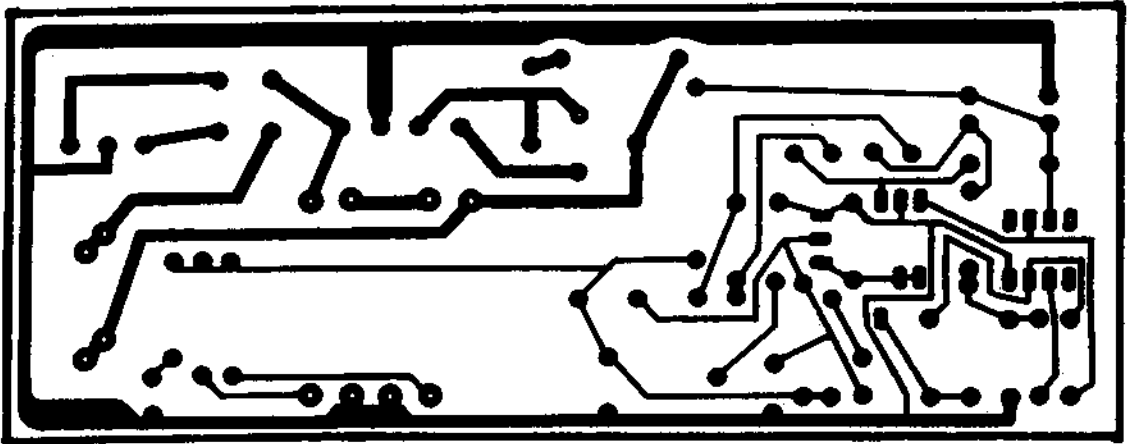
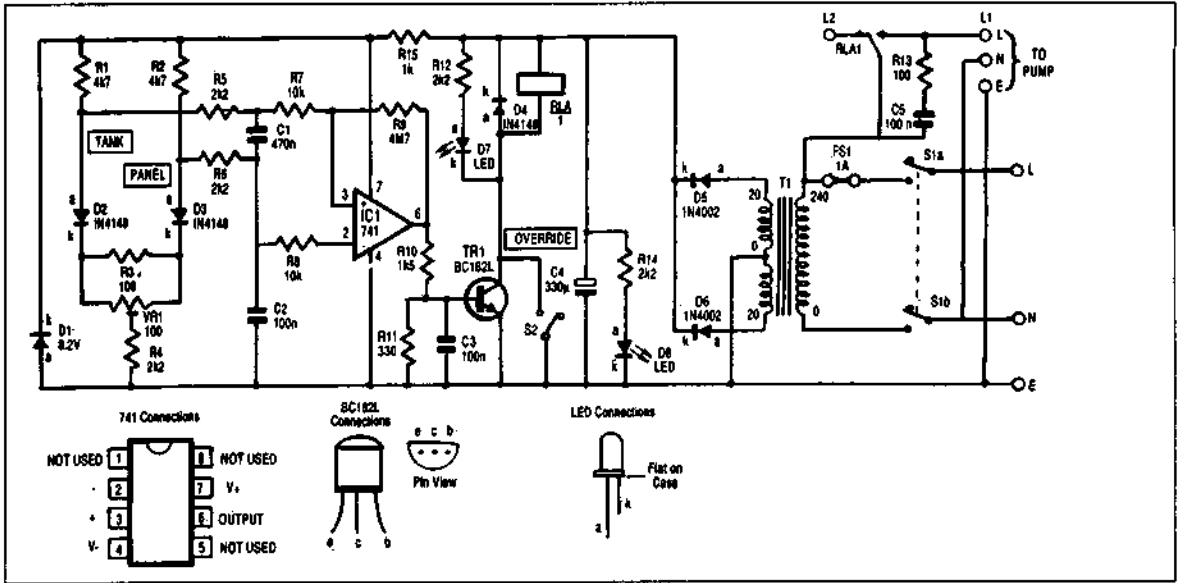



## Test procedure

You're ready to try it out. Plug in the unit and turn switch S1 on. If it's all connected properly, the red LEDs should light up. Now switch S2 into the auto position. Take care. The fuse clips and components near the 3-way terminal block are now live, as is the back of switch S1.

Next, ensure that the two sensors are near to each other, and therefore at the same temperature. Turning the preset dial [VR1] should cause the relay and the green LED to turn on and off. If it does, the next step is to find the correct point at which to set VR1. This is done by turning it until the relay just comes on. Then turn it back until it is just past the point at which the relay turns off. Five degrees of rotation past the turn off point is about right. Leave it there.

You're now ready to see if a temperature difference between the sensors turns on the switch. Find something hot like a soldering iron and hold it near or against the panel sensor. The relay should click on after a few seconds. If you then leave the sensor to cool down for a few minutes the relay should turn off. If it does all this you've succeeded so far. Now disconnect the unit from the mains. You may now to install it.

## Installation

Have another look at Figure 2 on page 3, which shows a typical solar heated system. The solar energy collected by the panels is pumped to the pre-heat cylinder. The pump is switched on by the solar panel controller. This pre-heated water is then drawn through the existing hot water tank.

The pump is connected to your controller on the terminals marked L1, N and E on the controller's four way terminal block. Take note of the fact that terminal L2 is live when the green LED is off.

Now you can position the controller box. It should be in a visible and accessible position so the switching of the pump can be monitored. It should also be somewhere where the temperature won't vary widely. Don't put it in the attic.

It's now time to fix the sensors. If you don't get this right, the whole system won't work. Firstly, don't run the leads near mains leads, because they cause interference. Fit the sensors in place with epoxy putty or silicone sealant and cover them with insulation, such as polystyrene. Figure 17 shows this arrangement. The tank sensor should be mounted on the pipe running from the pre-heat cylinder to the solar panels, and as near as possible to the tank. The actual connection flange is an ideal place.

The panel sensor goes on the outlet pipe inside the box of the last solar panel in the sequence. After the putty has dried, you're now ready to switch on, and the whole system should work.

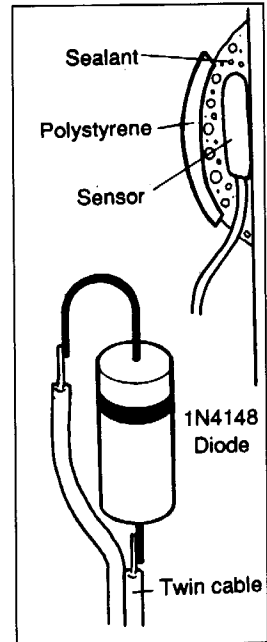

Fig. 17:  
Sensor construction  
and mounting

## For electronics buffs

This is for electronics buffs who wish to know the functions of each of the components in the circuit.

Diodes D2 and D3 act as sensors. A current is passed through each of them via resistors R1 and R2. One property of small signal diodes is that a change of temperature will cause their forward conduction of voltage to vary in a repeatable manner. This 'differential' voltage is applied to the inputs of the IC1, which is configured to act as a Schmitt trigger with positive feedback introduced by R9.

R3 and VR1 are used to balance the Schmitt trigger inputs initially so that a differential temperature change within the desired range will be detected.

If the solar panel diode, D3, becomes hotter than the tank diode, D2, the output voltage of the amplifier will rise. Resistor R9 ensures that the output switches

cleanly between the supply rails. This turns on TR1 which activates the relay. The green LED, D7, indicates when this happens.

The power supply for the circuit comprises TR1, D5, D6 and C4, giving a full wave rectified and smoothed 30V nominal. This is then dropped through R15 and clamped by D1 at 8.2V to power the op-amp and provide a stable voltage drop across R1 and R2.

Capacitor C1 has been incorporated to reduce differential input noise. Any common mode noise is filtered by C2. C3 has been provided to reduce the effects of interference on switching transistor TR1.

C5 and R13 protect the relay contacts from the arcing that occurs when attempting to switch an inductive load. They also provide suppression of any outside electrical interference.

# Resource Guide

This guide provides details of organisations, equipment suppliers and publications concerned with the topics covered in this booklet. The inclusion of any company does not constitute a recommendation for that company's products or services. Potential customers are advised to contact several companies to compare products, services and prices. You are directed to the Resource Guide in Tapping the Sun for further information, including suppliers of ready-made equipment. Please use the order form provided.

## Organisations

### CENTRE FOR ALTERNATIVE TECHNOLOGY

*Machynlleth, Powys SY20 9AZ.*

*Tel. 01654 702400 Fax. 01654 702782.*

*email. info@catinfo.demon.co.uk*

Visitor centre with displays and information on solar water heating systems including DIY. Provides information, consultancy, public courses and publications on environmental building, alternative sewage systems, organic gardening, renewable energy and energy efficiency. Mail order service.

### NATIONAL ENERGY FOUNDATION

*3 Benbow Court, Shenley Church End, Milton Keynes, Bucks. MK5 6JG.*

*Tel. 01908 501908 Fax. 01908 504848.*

*email. smreac@natenerg.demon.co.uk*

Independent charity working towards a more efficient innovative and safe use of energy. Promotes energy efficiency through the NHER - National Home Energy Rating Scheme.

### RENEWABLE ENERGY ENQUIRIES BUREAU

*ETSU, B168 Harwell Laboratory, Oxfordshire OX11 0RA.*

*Tel. 01235 432450 Fax. 01235 433066.*

Range of free publications on solar research programmes. Coordinates development of renewable energy in the UK on behalf of the Department of Trade and Industry.

### THE CENTRE FOR ENERGY RESEARCH AND SERVICES

*Dept of Mech.Eng./Energy Study University Of Wales Cardiff, Queens Building, The Parade, PO BOX 685, Cardiff CF2 3TA.*

*Tel. 01222 874314 Fax. 01222 874317.*

*email. sprattmr@cardiff.ac.uk*

Information on solar energy. Basic, applied and policy research; performance testing service for solar thermal and solar electric systems. Also manufactures and supplies world-wide testing equipment. Publish research reports in various scientific and technical journals. Only approved testing centre in the U.K.

### SOLAR TRADE ASSOCIATION

*Pengillan, Lerryn, Lostwithiel, Cornwall PL22 0QE.*

*Tel/Fax. 01208 873518.*

Aims to maintain standards within the solar industry and to promote the use of solar power in general. Codes of conduct, list of members available. National enquiry centre.

### THE SOLAR CLUBS PROJECT

*c/o The Centre for Sustainable Energy, The Create Centre, B-Bond Warehouse, Smeaton Road, Bristol BS1 6XN.*

*Tel. 0117 929 9404 Fax. None.*

Pilot scheme in Bristol and Leicester with DTI funding. Aims to

halve the cost of installing solar panels by bulk buying equipment and providing training so that people can more easily DIY solar water heating. Prices expected to be between £1000 and £1500. The contact in Leicester is Environ 0116 222 0222.

### UK-ISES (INTERNATIONAL SOLAR ENERGY SOCIETY UK) SECRETARIAT

*Department of Engineering, Brookes University, Gypsy Lane Campus, Headington, Oxford OX3 0BP.*

*Tel. 01865 484 367 Fax. 01865 484 263.*

*email. uk-ises@brookes.ac.uk*

Promotes all forms of solar and other renewable energy. Communicates ideas and developments through conferences and publications. Membership open to both professional and interested lay-people.

## Suppliers and Manufacturers of D-I-Y Kits

### AES

*The Park, Findhorn Bay, Forres, Morayshire IV36 0TZ.*

*Tel. 01309 676911 Fax. 01309 671086.*

*email. aes@findhorn.org*

Supplies and installs lightweight high performance flat plate solar collectors and DIY kits.

### BREDONDALE SOLAR

*5 Smiths Way, Pershore, Worcs. WR10 1QP.*

*Tel. 01386 561133 Fax. 01386 556555.*

*email. bredondale@aol.com*

Installer of Thermomax evacuated tube systems. Swimming pool heating. DIY kits supplied. Member S.T.A.

### DULAS Ltd.

*Dyfi Eco Parc, Machynlleth, Powys SY20 8AX.*

*Tel. 01654 705000 Fax. 01654 703000.*

*email. dulas@gn.apc.org*

Renewable energy company experienced in all aspects of R.E. from policy formation and market stimulation to design and implementation. Focuses on commercial applications of solar water heating, R&D into low cost heat meters for solar water heaters and market development.

### ENERGY ENGINEERING

*Herons Reach, Cound Moor, Shrewsbury, Shropshire SY5 6BB.*

*Tel. 01694 731648 Fax. 01694 731696.*

*email. energyengineering@btinternet.com*

Over 20 years experience in manufacturing and installing solar water heating systems including swimming pools and DIY kits. Design service, consultancy also offered. Member S.T.A.

**NATURAL ENERGY SYSTEMS**

2 Arderon Court, Adelaide Street, Norwich, Norfolk NR2 4ER.  
Tel. 01603 661863 Fax. 01603 618 145.

Designs, supplies and installs domestic/commercial solar hot water and swimming pool systems. Central heating/plumbing, repairs.

**SENSIBLE ENERGY SYSTEMS**

The Moorings, Pilgrims Lane, Chilham, Canterbury, Kent CT4 8AB.  
Tel. 01227 731169 Fax. None.

Energy conservation consultancy for detailed design of industrial energy efficiency measures, management and solar energy thermal systems.

**SOLAR COMPANY**

Solar House, Victoria Drive, Eastbourne, E. Sussex BN20 8LG.  
Tel. 01323 646979 Fax. 01323 411224.

*email.* dsolarco@aol.com

Supplies and installs Thermomax tubes, also service other solar systems - NOVITHERM (insulation panel for use behind radiators); DIY solar kits. Low cost pool heating.

**SOLAR SENSE**

c/o The Environment Centre, Pier Street, Swansea SA1 1RY.  
Tel. 01792 371690 Fax. 01792 371390.

Installs and supplies solar heating and electrical systems. Full range of new and second hand equipment. Practical advice and technical support to contractors, DIY installers and architects. Supplies a solar pump board which consists of a complete control/pump kit for DIY installers and plumbers.

**SOLAR STORE**

1 Bush Farm Cottages, Acrise, Folkstone, Kent CT18 7EA.  
Tel. 01303 892491 Fax. None.

Manufactures solar hot water systems, install flat plate systems, supplies DIY kits. Member S.T.A.

**SOLARWORKS**

c/o Mark Norman, Frogs Hall Farm, Lavenham, Suffolk CO10 9QH.  
Tel. 01787 247359 Fax. 01787 248458.

Supplies and installs all forms of solar water heating, including flat plate collectors, evacuated tubes and DIY kits. Swimming pool heating systems. Member S.T.A.

**SUNDWEL SOLAR Ltd.**

7 Tower Road, Glover Industrial Estate, Washington, Tyne and Wear NE37 2SH.  
Tel. 0191 416 3001 Fax. 0191 416 3001.

*email.* solar@sundwel.com

Specialises in water (flat plate systems) heating, offers a design service, supply of materials and installation instructions. DIY kits. Manufactures and supplies direct to the construction industry. Member S.T.A.

**Solar absorbers (paint and 'clip fins')****CENTRE FOR ALTERNATIVE TECHNOLOGY**

(See Organisations)

Supplies clip-fin solar collectors designed to clip onto standard 15mm copper water pipe. Each fin measures 380 x 200mm. Can supply any number from one upwards.

**PULLMAN PANS**

Eastfield Ind. Est., Penicuik, Edinburgh, Scotland EH26 8HA.  
Tel. 01968 678386 Fax. 01968 678918.

Manufactures solar clip fins which can be clipped over standard 15mm copper piping. Bakeware manufacturers.

**Insulation**

(For insulating DIY panels). We recommend Warmcel, made from fireproofed recycled newsprint - highly effective, non-toxic, non-irritant. This is available in 8kg bags - enough for four panels.

**EXCEL INDUSTRIES**

13 Rassau Ind Estate, Ebbw Vale, Gwent NP3 5SD.  
Tel. 01495 350655 Fax. 01495 350146.

*email.* excel.ind@btinternet.com

Manufacturer of WARMCEL cellulose fibre insulation, made from recycled newspaper. Developed 'breathing' wall system. Good environmental record.

**Solar anti-freeze****FERNOX FRY TECHNOLOGY UK**

Tandem House, Marlow Way, Beddington Farm Road, Croydon, Surrey CR0 4XS.  
Tel. 0181 665 666 Fax. None.

Supplier of Alpha -11 non-toxic anti-corrosion and anti-freeze, and Superfloc low toxic system cleaner to protect and clean your system. Technical help number 01799 550 811.

**Pumps****GRUNDFOS PUMPS Ltd.**

Grovebury Road, Leighton Buzzard, Bedfordshire LU7 8TL.  
Tel. 01525 850000 Fax. 01525 850011.

Manufactures various pumps. Heating, hot water and chilled water circulation, water boosting, supply and distribution, cooling, condensate, drainage, sewage and other general pumping applications. Solar powered pumping systems

**Plastic Glazing Materials****FILON PRODUCTS Ltd.**

Aldridge Road, Streetly, Sutton Coldfield, B74 2DZ.  
Tel. 0121 353 0814 Fax. 0121 352 0886.

Manufacturer of glass fibre sheet glazing, will advise on local distributors

**FORMERTON SHEET SALES Ltd.**

Unit 39, City Industrial Park, Southern Road, Southampton, Hampshire SO1 0HG.

Tel. 01703 332761 Fax. 01703 225148.

Stocks and distributes plastics and polycarbonate glazing materials. They have good light transparency, high insulation, high impact strength and excellent durability which combine to provide an energy conserving glazing material.

**INCO ALLOYS Ltd.**

Wiggen Works, Holmer Road, Hereford HR4 9SL.  
Tel. 01432 382200 Fax. 01432 264030.

Manufacturer of Maxorb, materials designed to absorb but not re-radiate solar energy, from which you can make other types of collectors.

**Timber treatment and paint****AURO ORGANIC PAINT SUPPLIES Ltd.**

Unit 1, Goldstones Farm, Ashdon, Saffron Walden, Essex CB10 2LZ.  
Tel. 01799 584888 Fax. 01799 584042.

Manufacturer of organic paints and full range of adhesives and wood treatments. Uses only naturally occurring ingredients in low-energy production process.

## CONSTRUCTION RESOURCES

16 Great Guildford Street, London SE1 0HS.

Tel. 0171 450 2211 Fax. 0171 450 2212.

email. [info@ecoconstruct.com](mailto:info@ecoconstruct.com)

Builders merchant specialising in ecological materials - natural paints, clay bricks, insulation and flat plates and evacuated tubes for solar water heating and space heating

## JOTUN-HENRY CLARK Ltd.

Unit 16, Alston Dr., Bradwell Abbey, Milton Keynes, Bucks. MK13 9HA.

Tel. 01908 321818 Fax. 01908 315073.

Water based and low solvent paint systems for wood, steel and concrete surfaces.

## LIVOS NATURAL PAINTS

Unit D7, Haws Craft Centre, Jackfield, Ironbridge, Shropshire TF8 7LS.

Tel. 01952 883288 Fax. 01952 883 200.

Manufactures and supplies natural paints and finishes by mail order, including wall paints, glosses, wood varnishes and floor oils.

## NUTSHELL NATURAL SUPPLIES

Hamlyn House, Mardle Way, Buckfastleigh, Devon TQ11 0NR.

Tel. 01364 642892 Fax. 01364 643888.

Manufactures and supplies environmentally friendly paints, wood treatments, pigments and wallpaper paste.

## Solar controllers

### DULAS Ltd.

(See DIY Kits).

### ELECTROMAIL

P.O. Box 33, Corby, Northants NN17 9EL.

Tel. 01536 204555 Fax. 01536 405555.

Mail order service. Stock includes solar system controllers components.

### HAWCO Ltd.

Cathedral Hill Industrial Estate, Guildford, Surrey GU2 5YB.

Tel. 01483 560606 Fax. 01483 575973.

email. [sales@hawco.co.uk](mailto:sales@hawco.co.uk)

Distributor of temperature and pressure instruments, controls and related products. Range of solar applications - detectors/pyrometers.

### MAPLIN ELECTRONICS

P.O. Box 777, Rayleigh, Essex SS6 8LU.

Tel. 01702 554155 Fax. 01702 554001.

email. [recipient@maplin.co.uk](mailto:recipient@maplin.co.uk)

Supplies individual components of solar controllers by mail order.

### RAYDAN Ltd.

The Sussex Innovation Centre, Science Park Square,

Falmer, Brighton, Sussex BN1 9SB.

Tel. 01273 704442 Fax. 01273 704443.

email. [sales@raydan.com](mailto:sales@raydan.com)

Supplier of differential temperature controllers for solar heating systems.

## Consultants and agents

Many of the organisations listed will offer advice and consultancy, in particular the Centre for Alternative Technology. Surveys may well include other aspects of energy generation and conservation.

## Publications

The following books are available from C.A.T. Please use the mail order form opposite, or photocopy it. (There is a full colour book and products catalogue covering all aspects of sustainable technology available for five second-class stamps.) Prices correct at time of printing.

### C.A.T. Publications:

**A Pupil's Guide to Solar Power** £ 1.50  
CAT Publications, (1992) 12pp.  
Project resource booklet for GCSE.

**Renewable Energy Resource Guide** £ 1.50  
CAT Publications, (1994) 8pp.  
General useful contacts, suppliers and further reading.

**Solar Energy Factsheet** £ 2.50  
CAT Publications, (1995) 8pp.  
General introduction to the many ways of tapping the sun's energy.

**Tapping The Sun** £ 3.50  
CAT Publications, NF1 (1995) 16pp.  
Describes various layouts for your plumbing system to cope with solar water heating.

**Wired Up To The Sun** £ 3.95  
CAT Publications, NF4 (1994) 32pp.  
Introduction to photovoltaics and their applications including domestic sized systems.

### Other books:

**Heating water by the Sun** £ 8.00  
Solar Energy Society, 2nd edn. (1995) 22pp.  
A layperson's guide to the use of flat plate solar collectors for domestic water heating and for heating swimming pools.

**Hot Water From The Sun** £ 24.99  
J. Streib, 2nd edn. (1992) 134pp.  
In depth guide on how to construct your own solar panel. Included are specific site examples and scientific data.

**Practical Solar Handbook** £ 6.95  
Bushell, (1998) 24pp.  
Demistifies the installation of solar hot water systems. Intended for the reasonably capable DIYer it covers the basic essentials.

**Solar Energy in Building Renovation** £ 15.00  
International Energy Agency, (1997) 64pp.  
Solar design can play an important role in building renovation. This series of four brochures introduces the strategies and considerations required for major renovation concepts, etc.

**Solar Homes in London** £ 1.00  
Kinslake & Bond, NATTA (1985) 26pp.  
Illustrated tour of over 200 houses fitted with solar panels.



# C.A.T. Mail Order Form

For ordering items listed as being available from us, **ONLY!** Please check to avoid disappointment.

Please cut out or photocopy and send this form (with a continuation sheet if necessary) to:

**Mail Order, CAT, Machynlleth, Powys SY20 9AZ.** Please write in capitals.

A complete catalogue of environmental books and products, 'Buy Green By Mail',  
is available on request for five first-class stamps.

You can phone or fax credit card orders to us on **01654 703409** (24 hours).

email. [orders@catmailorder.demon.co.uk](mailto:orders@catmailorder.demon.co.uk) Website. <http://www.cat.org.uk>

CAT Publications	QUANTITY	PRICE	TOTAL
<b>Other Books and Goods</b>			
Total of goods, books, and CAT Publications			
Add postage and packing (see chart below)			
Donation towards the work of CAT Charity (Thank You.) (charity number 265239)			
Membership of the Alternative Technology Association (£14.00)			
<b>GRAND TOTAL</b>			

**U.K. postage and packaging rates as of January 1998 until further notice**

◇ Goods total below £10	add £1.75
◇ Goods total £10.01-£20	add £3.50
◇ Goods total £20.01-£40	add £4.00
◇ Goods total over £40	add £4.50

**Ordering overseas Postage & Packing**  
Europe, including Republic of Ireland - add 20% of order value. (minimum £2.00)  
Rest of the world - add 30% of order value. (minimum £3.00)

Title \_\_\_\_\_ Initials \_\_\_\_\_ Surname \_\_\_\_\_  
 Address \_\_\_\_\_  
 \_\_\_\_\_  
 Postcode \_\_\_\_\_ Tel \_\_\_\_\_  
 I enclose a cheque/p.o. made out to CAT plc   
 Please debit my Visa/Access/Mastercard/Connect/Switch   
 Card number \_\_\_\_\_ Signature \_\_\_\_\_  
 Expiry date \_\_\_\_\_ Issue no. \_\_\_\_\_ Date \_\_\_\_\_

# **New Futures**

## **A series about sustainable environmental solutions from CAT Publications**

The following titles are now available from our mail order department or your local bookshop.

### **General**

**Careers and Courses in Sustainable Technologies** Shepherd, A (1995) NF7, 96pp

### **General Technology**

**Off the Grid: Managing Independent Renewable Electricity Systems**

Allen, P and Todd, R (1995) NF6, 60pp

**Power Plants: A Guide to Biofuels** Horne, B (1996) NF16, 64pp

### **Wind Power**

**Where the Wind Blows: An Introduction to Wind Power** Horne, B (1994) NF9, 28pp

**It's a Breeze: A Guide to Choosing Windpower** Piggott, H (1995) NF13, 36pp

**Windpower Workshop** Piggott, H (1997) NF14, 160pp

### **Solar Power**

**Tapping the Sun: A Solar Water Heating Guide** Horne, B (1994) NF1, 16pp

**Wired Up to the Sun: A Guide to the Photovoltaic Revolution** Allen, P (1994) NF4, 32pp

### **Energy Conservation**

**Save Energy Save Money: A Guide to Energy Conservation in the Home**

Jackson, F (1995) NF2 40pp

### **Environmental Building**

**The Whole House Book: Ecological Building Design and Materials**

Borer, P and Harris, C (1998) NF19, 320pp

**Out of the Woods: Ecological Designs for Timber Frame Self Build**

Borer, P and Harris, C (1997) NF11, 124pp

### **The Food Cycle**

**Safe to Drink? The Quality of Your Water** Stauffer, J (1996) NF8, 158pp

**Sewage Solutions: Answering the Call of Nature**

Grant, N, Moodie, M and Weedon, C (1996), NF12, 190pp

**Fertile Waste: Managing Your Domestic Sewage** Harper, P (1994) NF3, 32pp

# Bathe in the sun's heat...

Take advantage of the sun's heat by making your own solar collectors. You can capitalise on the energy produced by this renewable resource and pre-heat your domestic water year round, saving pounds on your fuel bills.

This practical DIY guide is packed with photographs and diagrams designed to help you through the process from design to construction and installation.

**Includes:**

- how to make two types of solar panel, one using commercially available fins that clip onto copper pipes, and one that uses a typical central heating radiator;
- how to connect panels together, mount and install them;
- how to make a control device for a pumped system;
- where to go for more information;
- how to cope with the plumbing, wood preserving and soldering.

The panels described in the book can be made by anyone with basic woodworking and plumbing skills and also make ideal practical projects for schools and science courses.

ISBN 1-89804-933-5



Centre for  
Alternative  
Technology  
Publications