

AT MICROFICHE
REFERENCE
LIBRARY

A project of Volunteers in Asia

Tanning of Hides and Skins

Published by:

International Labour Office
CH-1211 Geneva 22
SWITZERLAND

Copyright 1981

Available from:

Publications Branch, ILO, same address

Reproduced by permission.

Reproduction of this microfiche document in any form is subject to the same restrictions as those of the original document.

Tanning of hides and skins



Tanning of hides and skins

Prepared under the joint auspices of the International
Labour Office and the United Nations Industrial
Development Organisation

Copyright © International Labour Organisation 1981

Publications of the International Labour Office enjoy copyright under Protocol 2 of the Universal Copyright Convention. Nevertheless, short excerpts from them may be reproduced without authorisation, on condition that the source is indicated. For rights of reproduction or translation, application should be made to the Editorial and Translation Branch, International Labour Office, CH-1211 Geneva 22, Switzerland. The International Labour Office welcomes such applications.

ISBN 92-2-102904-2
ISSN 0252-2004

First published 1981

The designations employed in ILO publications, which are in conformity with United Nations practice, and the presentation of material therein do not imply the expression of any opinion whatsoever on the part of the International Labour Office concerning the legal status of any country or territory or of its authorities, or concerning the delimitation of its frontiers.

The responsibility for opinions expressed in signed articles, studies and other contributions rests solely with their authors, and publication does not constitute an endorsement by the International Labour Office of the opinions expressed in them.

Reference to firm names and commercial products and processes do not imply the endorsement of the International Labour Office (ILO), and any failure to mention a particular firm, commercial product or process in connection with the technologies described in this volume is not a sign of disapproval.

ILO publications can be obtained through major booksellers or ILO local offices in many countries, or direct from ILO Publications, International Labour Office, CH-1211 Geneva 22, Switzerland. A catalogue or list of new publications will be sent free of charge from the above address.

CONTENTS

| | <u>Page</u> |
|---|-------------|
| Acknowledgements | v |
| Preface | vi |
| <hr/> | |
| CHAPTER I. Choice of technology for leather manufacture: some strategic, commercial and technical issues... | 1 |
| CHAPTER II. Selection and storage of skins and hides | 6 |
| I. Selection | 6 |
| II. Storage | 10 |
| CHAPTER III. Tanning technologies and projects | 16 |
| I. The tanning process | 16 |
| II. The individual stages | 17 |
| III. Outline of tanning projects | 26 |
| CHAPTER IV. Medium-large tannery: 200 hides per day | 32 |
| I. Input, output and organisation of production | 33 |
| II. Stage-by-stage description | 33 |
| III. Over-all project features | 87 |
| CHAPTER V. Medium-small tannery: 20 hides per day | 96 |
| I. Input, output and utilisation | 97 |
| II. Stage-by-stage description | 97 |
| III. Over-all process schedules | 119 |

| | |
|---|-----|
| CHAPTER VI. Medium-small tannery: | |
| 200 skins per day | 127 |
| I. Input, output and utilisation | 129 |
| II. Stage-by-stage description | 129 |
| III. Over-all project schedules | 154 |
| CHAPTER VII. Very small rural tannery: | |
| 2 hides per day | 160 |
| I. Input, output and utilisation | 160 |
| II. Stage-by-stage description | 161 |
| III. Over-all project schedules | 170 |
| CHAPTER VIII. Framework for project costing.... | 173 |
| I. Framework | 173 |
| II. Indicative project cost comparisons... | 180 |
| III. Discounted cash flow method (DCF) of project evaluation | 192 |
| CHAPTER IX. National leather production strategy | 194 |
| I. Socio-economic impact of alternative tanning projects..... | 194 |
| II. Elements for a national leather production strategy | 196 |

APPENDICES

| | | |
|--------------|---|-----|
| APPENDIX I | Equipment manufacturers..... | 207 |
| APPENDIX II | Selected bibliography..... | 219 |
| APPENDIX III | Selected list of technical institutions..... | 221 |
| APPENDIX IV | Glossary of terms..... | 224 |

QUESTIONNAIRE

ACKNOWLEDGEMENTS

The publication of this memorandum has been made possible by a grant from the Ministry of Overseas Development of the United Kingdom, through the Intermediate Technology Development Group (ITDG, London). The International Labour Office and the United Nations Industrial Development Organisation acknowledge this generous support.

PREFACE

In their efforts to industrialise, developing countries have often relied on technologies developed in industrialised countries. These technologies are generally imported in the form of 'turn-key' factories, and few adjustments - if any - are made in order to adapt them to local socio-economic conditions. An alternative approach consists in importing equipment specified in plant designs prepared by local or foreign engineering firms. Whatever the approach, the choice of technology is generally restricted to those technologies developed and marketed in industrialised countries. Only a few countries have established local engineering firms capable of developing plant designs suitable to local socio-economic conditions and of producing appropriate capital goods.

Reliance on technologies imported from industrialised countries would not necessarily be harmful if these technologies were suitable for prevailing local socio-economic conditions. This is, unfortunately, not always the case. A large number of studies show that, in a large number of cases, these technologies are not appropriate for countries suffering from high unemployment and underemployment, lack of foreign exchange, capital, and a strong industrial structure (e.g. capital goods industries, adequate physical infrastructure), and an insufficiently large pool of highly skilled labour. These technologies tend to make a heavy use of scarce resources while abundant resources, such as labour, are little utilised.

What explains such reliance on imported technologies? Although a large number of reasons may be advanced to explain this phenomenon, the following three reasons are probably the most important ones: Firstly, local technologies used by small-scale enterprises, artisans, and cottage industries have often proved to be less competitive than imported technologies, both in terms of production costs and the quality of output. These production units have not also been able to adapt their production to changing tastes, or to increase the supply of consumer goods and capital goods at a rate commensurate with that of demand for these goods. Secondly, foreign investors (e.g. as in the case of joint ventures) tend to adopt technologies used in their home countries and their local partners (private entrepreneurs or public enterprises) are generally not in a position to propose and/or impose alternative technologies. Thirdly, in the case of export industries, the type and quality of goods in demand in industrialised countries often require the use of technologies developed in these countries.

While the above reasons may explain the current reliance on imported technologies, one should not conclude that developing countries have no other choice than to adopt these technologies. A number of these countries have developed and successfully applied technologies which are both more cost-effective than technologies developed in industrialised countries and more suitable to socio-economic conditions prevailing in developing countries. They make a larger use of available labour than do imported technologies, require few imports, generate important multiplier effects on the economy (e.g. through the local production of equipment used by these technologies) and do not rely extensively on foreign skills and know-how. These technologies have been developed for a large number of products and processes, especially those of particular interest for developing countries.

Unfortunately, information on these technologies is not generally available in a useful form, if available at all. They are mostly known in the countries

where they have been developed and applied, and are rarely transferred to other developing countries. This may be explained by various reasons. Firstly, those who develop these technologies were either not interested in disseminating them, or did not have the necessary means for the publication and dissemination of the technological information. Secondly, most of these technologies are neither patented nor marketed internationally by engineering firms or equipment suppliers. Finally, they are not advertised in trade journals published in industrialised countries. Developing countries are therefore not aware of the existence of these technologies, or cannot obtain detailed information which would enable them to apply these technologies.

Consequently, the International Labour Office and the United Nations Industrial Development Organisation have joined efforts in order to improve the dissemination of information on appropriate technologies among developing countries. One outcome of this joint collaboration was the decision to publish a series of technical memoranda on specific industrial products and processes, and to disseminate these as widely as possible among potential and established private and public enterprises.

The technical memoranda are mostly intended for potential producers who have some difficulties in choosing and applying technologies best suited to their own circumstances. However, they should also be of interest to public planners, project evaluators from industrial development agencies, training institutions and national and international financial institutions. In short, the memoranda should be useful to all those who are in a position to influence the choice of public or private investment and therefore the choice of technologies associated with these investments.

The technological information contained in the memoranda is fairly detailed as it would be difficult for the reader to obtain missing information. Thus,

clear and detailed descriptions of processes as well as drawings of equipment which may be manufactured locally are provided, and lists of equipment suppliers - from both developing and developed countries - are included whenever the local manufacture of equipment may not be easily undertaken. A methodological framework for the evaluation of alternative technologies is provided in order to enable the reader to identify the least cost or most profitable technology. Some information on the socio-economic impact of alternative technologies is also included for the benefit of public planners and project evaluators.

While an attempt has been made to provide fairly detailed technical information, there would undoubtedly be cases where some information will still be missing. The reader may contact technology institutions or research centres listed in a separate appendix or order additional books or journals included in the bibliography. The ILO and UNIDO may also be contacted and every effort will be made in order to provide the missing information.

Technical memoranda are not intended as training manuals. It is assumed that the potential users of the technologies described in the memoranda are trained practitioners and that the memoranda are only supposed to provide them with information on alternative technological choices. Memoranda may, however, be used as complementary training material by training institutions.

This first technical memorandum on the tanning of hides and skins provides technical details on small-scale tanning only (range of daily outputs from 2 hides to 200 hides). No technical details on large-scale production are provided for two main reasons. Firstly, potential tanners who may wish to invest in large-scale capital-intensive plants costing many million dollars would most probably use the services of a specialised engineering firm in view of the large investment involved.

Secondly, information on technologies used in these plants is readily available from engineering firms or equipment suppliers from industrialised countries.

The effective dissemination of technical memoranda would require the active participation of various government agencies, trade associations, workers' and employers' organisations, training institutions, etc. Seminars may be organised for the benefit of established or potential tanners in order to review the proposed tanning technologies, identify those which are particularly suited to prevailing local conditions, and identify the type of assistance needed by tanners who wish to adopt one of the technologies described in the memorandum.

This memorandum may be directly used by functionally literate tanners who are familiar with accounting methods, and are capable therefore of evaluating the proposed technologies on the basis of local factor prices. However, some tanners may not be functionally literate, especially rural tanners who may be interested in the very small scale of production (2 hides per day) described in Chapter VII. In this case, information on alternative tanning techniques may be disseminated among these tanners by extension officers or training institutions.

Names of equipment and material suppliers are provided in some of the sections of the memorandum. This does not, however, imply a special endorsement of these suppliers by the ILO. These names are only provided for illustrative purposes, and tanners should try to obtain information from as many suppliers as feasible.

A questionnaire is attached at the end of the memorandum for those readers who may wish to send to the ILO or UNIDO their comments and observations on the content and usefulness of this publication. These will be taken into consideration in the future preparation of additional technical memoranda.

This memorandum was prepared by J. Keddie and R. Poulter (consultants) in collaboration with M. Allal, staff member of the Technology and Employment Branch of the ILO.

A.S. Bhalla,
Chief,
Technology and Employment Branch.

CHAPTER I

CHOICE OF TECHNOLOGY FOR LEATHER MANUFACTURE: SOME STRATEGIC, COMMERCIAL AND TECHNICAL ISSUES

This memorandum will, hopefully, help tanners in developing countries to choose and operate tanning processes. While it is written primarily for tanners or would-be tanners, some of the information provided - particularly in this chapter and in chapters III, VIII and IX - should also be of assistance to public planners, project evaluators and financial institutions.

The present chapter outlines some strategic issues in choosing a project and a process. It highlights, among other factors, the great importance of securing an adequate and appropriate supply of hides or skins for processing. In recognition of this, Chapter II deals separately with procedures for selecting and storing hides and skins while Chapter III gives an overview of the tanning process and the range of alternative techniques available at its various stages. It emphasises the extreme diversity of tanning projects and processes, and the implication that detailed project descriptions can only be illustrative of a very wide range of options.

Chapters IV to VII which, provide such descriptions, are nonetheless the heart of the Memorandum, getting down to the practical detail of technological specification. In Chapter IV, a low investment cost tannery

project model for handling 200 hides per day is described. The output is finished leather for shoe uppers. In Chapter V to VII, three smaller model projects are described: a 20 hides per day project, a 200 skins (goat and sheep) per day project, and a 2 hides per day project. All projects are described stage-by-stage and also overall. The exposition and schedules are complemented by figures and diagrams.

Chapter VIII puts the technical exposition into some economic perspective by presenting a costing framework and indicative project costs. Included in these economic comparisons are two more mechanised variants on the 200 hides per day scale. Finally, Chapter IX provides some observations on the socio-economic impact of alternative tanning technologies, and some elements for the formulation of a national leather production strategy.

A Memorandum such as this, presenting both broad issues and technical detail, has to strike a balance between repetition and reference. The procedure adopted allows some repetition between chapters and sections of strategic themes and points, but severely restricts repetition of process details between projects. It is sometimes irksome to be referred back to previous descriptions, but it may be equally wearisome to bear with prolonged repetition of already covered detail. It is hoped that an appropriate balance has been struck between these two necessary evils.

SOME STRATEGIC ISSUES IN CHOICE OF PROJECT AND TECHNOLOGY

Tanneries are immensely diverse in product-type, scale and process. Although it is possible - and indeed necessary - to adapt to changing conditions, the tanner should have a clear initial idea of his intended product (and basic raw material), scale of operations and technology.

These project features cannot normally be determined independently. They are all affected by similar or overlapping combinations of factors. The principal circumstances to be considered are outlined below.

(a) Availability and terms of finance:

Money is basic to tannery projects, although it is not a sufficient condition for their success. The amount and terms of money available may affect or determine:

- (i) the project scale, for obvious reasons
- (ii) the technology: if money or specific equipment is available on easy terms, this may affect technology choice toward the use of more equipment.

Of these effects, (i) is probably the more important in practice.

(b) Market opportunities and restrictions:

Market conditions affect primarily the product and only indirectly the technology. They rarely restrict the project scale. Moreover, even developing country national markets for staple lines, such as shoe upper leather, are large and growing. Thus, the primary choice in market terms is of product (i.e. whether to produce specialist finished leather, staple finished lines or semi-finished leather).

A market opportunity in specialist finished items usually rests on access to special skills, and hides and skins of a particular quality. More generally, the choice is between finished staples and semi-finished leather. For export markets, governments often restrict tanners to the sale of finished leather, but the choice is more frequently a real one. The tanner with close access to hides and skins supplies, but without a great deal of capital or experience, may find it most profitable to produce semi-finished leather for sale either to local leathergoods manufacturers and craftsmen, or to specialist or skilled finishing tanners at home or abroad. On the other hand, a tanner with considerable reserves of capital may find finished leather markets opportunities more attractive, for instance in serving strong and protected local markets for shoe upper leather.

(c) Product choice:

The choice of product affects the choice of technique. Finished leather, including staple items, almost

always involve more complex technology than semi-finished leather. The latter can be produced by tanning with vegetable preparations, whereas a tannery producing finished leather usually employs mineral (chrome) tanning, and performs a longer series of subsequent operations on the leather once it has been tanned.

(d) Hides and skins supply:

This is - or ought to be - the usual limiting factor (capital availability apart) on project scale. Most tanneries in developing countries will depend on domestic supplies, since fewer hides and skins are now being exported from the surplus countries and the competition for supplies on the international market is correspondingly intense.

Domestic supplies depend on the extent and type of animal husbandry. If the population is sparse, a large tannery will have difficulty in securing enough hides or skins, and will often suffer from low capacity utilisation and the consequent high processing costs. The same effects may also result from a variety of pre-tannery practices reducing the effective supply of materials: inadequate protection of the animal during its life, poor flaying, and ineffective temporary preservation (curing) of the hides or skins before they are tanned.

On the other hand, these very problems may present opportunities for projects of the right scale or technology. Vegetable tanning is able to handle satisfactorily a lower average quality of hides or skins than mineral (chrome) tanning: it is better at remedying surface defects. Thus, a small vegetable tannery may be able to thrive on that portion of the total supply which a chrome tanner must reject. Moreover, small projects located close to dispersed sources of supply may be able to mitigate the effects of poor curing. They will receive the hides or skins before they are spoilt, and by tanning, indefinitely preserve them for retannage and finishing in larger tanneries elsewhere.

The above are the main intertwining determinants of product, scale and process, although secondary factors also frequently play a part. One of these factors is water availability. Tanning requires considerable amounts of uncontaminated water. This requirement may

limit the practicable scope of project scale, particularly in arid areas. The foreign exchange position of the country may affect choices in any of a number of ways. The government may forbid semi-finished leather exports, in an attempt to maximise foreign exchange earnings. Foreign exchange shortages may affect technology directly by limiting the opportunities to import equipment or indirectly, by restricting specialist chemical imports.

Finally, labour availability may be important. It would probably be risky to compete in export markets for finished leather without access to a sizeable nucleus of skilled and experienced labour, though protected domestic markets may be less demanding. Skill apart, the prevailing wage scale should also be taken into account when choosing a technology. Many operations can be mechanised or performed manually, and at the lower wage levels prevailing in many developing countries, the balance of economic advantage often lies on the side of less mechanised techniques.

Thus, the crucial project choices - including choice of technology - depend on a complex of factors, and each set of circumstances must be considered on its own merits. It is clear that various types of projects and processes will offer opportunities and have a role to play, including - probably simultaneously and side-by-side in many developing countries - both large tanneries and smaller, more dispersed projects. The field is not limited to the large 'turnkey'¹ mechanised chrome tannery which frequently emerges from the present procedures of technological advice and supply (e.g. a developing country entrepreneur or public agency may approach a developed country equipment manufacturer, or a technical consultant who will put together a consortium of such manufacturers). These channels of supply are established and well-known, and this Memorandum is designed to supplement them by providing detailed outlines of smaller or less mechanised projects. It is hoped this will enable the tanner to make better-informed decisions on choices, and provide him with a detailed operating guide if he decides to diverge from the turnkey model.

¹So-called because the equipment is delivered, installed and commissioned as a package, and the new project-owner supposedly has nothing more to do than turn the key of the front door and walk in.

CHAPTER II

SELECTION AND STORAGE OF SKINS AND HIDES

The prime importance of a supply of hides and skins appropriate to the tanning project was stressed in the previous chapter. Correct choice of project type and location will do much to secure supplies. In addition, the tanner must make a careful selection of hides and skins, and ensure a proper storage of those he has selected.

Selection and storage are integral parts of tannery operations, and are most commonly collocated with the tannery itself. Nevertheless, they are made the subject of this brief separate chapter in the memorandum in order to highlight the importance of starting the tanning process with satisfactory materials. The chapter is confined to principles and techniques. These are common to all the projects in Chapters IV to VII, and are embodied in physical facilities included in the project schedules.

I. SELECTION

There are many sorts of defects which can reduce, or even negate, the economic value of hides or skins for tanning. The basic principle is to select those without defect or - since this is a counsel of perfection - with minor defects only, while rejecting those so flawed that it would be unprofitable if not impossible to tan them.

I.1 Defects

The most common defects are briefly described below.

- (a) Badly shaped hides: If the hide or skin has been inexpertly flayed, it may not be symmetrical about the backbone. This may hinder the maximum use of its various parts, since these have differing thicknesses. A symmetrical hide appears as shown in Figure II.1. The parts along the backbone tend to be thicker than the rest of the hide.

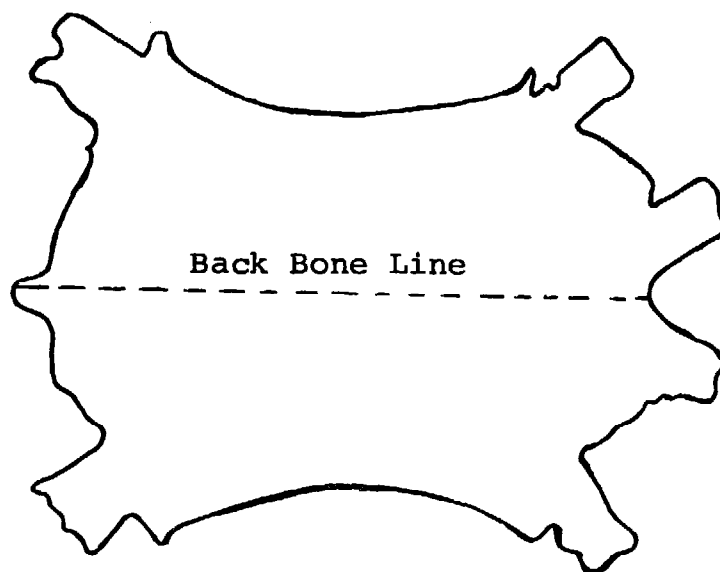

FIGURE II. 1
Symmetrical Hide

A hide or skin may also be badly shaped because some parts of it have been lost or cut away as having other defects.

- (b) Flaying cuts: Inexpert flaying can also result in deep knife marks and cuts into the flesh (inner) side of the hide. These will reduce the possibility of 'splitting'

off a secondary layer of useful leather on the side of the thickest part of the hide, and will spoil the appearance of other parts of it.

- (c) Vein marks and bloodstains: These may spoil the appearance of a hide on the flesh side. They may result whenever an animal has been lain too long before being flayed, or has been insufficiently bled. They may be responsible for premature putrefaction.
- (d) Scratches and blemishes on the grain (outer) side of the hide: These are various, and may result from thorny bushes, barbed wire, other animal's horns, predators' attacks, or healed insect damage. Since the grain side is usually on the outer side of leather products, such defects may seriously reduce the sale value of the leather.
- (e) Holes: Insects, particularly the warble fly and tick, can leave holes in the hides whenever these have had insufficient time to heal. Holes can also result from insect or rodent attack after the animal's death, if a hide has not been carefully stored and protected before presentation to the tanner. The holes can seriously reduce the useful leather area derived from the hides.
- (f) Putrefaction: This is an important defect which is not always easy to detect. Putrefied portions of a hide will not tan properly and may dissolve during the process. If putrefaction is detected in a hide after its acceptance, the putrefied portions should be cut away and disposed of at once, as they are both useless and a source of spreading putrefaction in other, as yet undamaged hides. Alternatively, the whole hide may be disposed of, or - if the defect is detected before purchase - rejected.

Putrefaction may be detected from the smell of ammonia from a hide, or from hair-

slip (i.e. loss or looseness of hair from the grain side). Hairslip is the first sign of putrefaction and, if it is at all extensive, the hide should be rejected.

The above are the more important defects to look for.¹ Normally they will be more common in locally supplied hides and skins than in graded imports. They will also be harder to detect in goods which have been cured (temporarily preserved to enable tannery use) by wet salting rather than by drying with or without salt. The damp hair on a wet salted hide or skin hinders close inspection of the grain side and only heavy damage is clearly visible. On the other hand, putrefaction is more difficult to detect in dried hides and skins, as loose hair may remain in place, though bare patches are of course, signs of hairslip.

I.2 Preventive Measures

Having chosen his source of supply, the tanner must, to a large extent, accept the world as he finds it. Many defects stem from environmental circumstances and animal husbandry practices which are not easily or quickly changed. However, here is a list of some measures to upgrade the quality of local supply which the tanner may wish to consider, particularly if he is linked to farmers by a cooperative or his purchases are large in relation to total local supplies.

- (a) To encourage the spraying and dipping of animals against insects.
- (b) To encourage the branding on less valuable parts of the hide.
- (c) To encourage the prompt flaying of 'fallen' animals (that is those which have a natural death) on the spot. This will reduce the risk of vein marks, stains and putrefaction

¹A more elaborate list will be found in FAO (1960), pp. 13-18. Newcomers to tanning, particularly if they plan to rely on local hides and skins, may wish to consult this excellent publication also, or seek expert advice locally.

and also of damage to the grain side from dragging the carcase.

- (d) To encourage the slaughtering near to the tannery, followed by prompt flaying.
- (e) To try to improve flaying techniques. The carcase should be properly bled before flaying. The hide should be flayed symmetrically and flaying knives should be very sharp but have no point at the end, thus reducing the risk of flaying cuts on the flesh side.
- (f) To encourage a more effective curing if hides have to be brought from a distance. Drying should be done off the ground, to allow free circulation of air. If goods are dried on the ground, the undersides nearest the ground remain moist but hot - ideal conditions for the development of putrefaction. In salting, a common fault is not using enough salt: 40-50% of hide weight is needed.
- (g) To encourage the prompt delivery of fresh uncured hides. If hides do not have to be brought from a distance, they may be delivered without curing to the tannery, but this must be accomplished within a very few hours of slaughter and flaying.
- (h) To accept only useful hides and pay lower prices for those which, while usable, have significant defects. Few farmers, butchers or hide suppliers will take the trouble or expense of upgrading or preserving quality without a financial incentive.

II. STORAGE

Once hides and skins have been selected and purchased, every effort should be made to preserve their quality until the time comes for them to be tanned. Preservation may involve pre-storage measures as well as good storage practices.

II.1 Pre-Storage Measures

Pre-storage measures will vary with circumstances. The following measures are widely used by established tanneries.

- (a) Fresh hides or skins must be cured promptly on purchase. As noted above, if drying is used, the goods should be dried off the ground. One method is to stretch the hides out with ropes attached to simple upright wooden frames (see Figure II.2). After drying, they may still be attacked by beetle or mould and should be sprayed or dusted with appropriate insecticides, for example a 0.25 per cent solution of sodium arsenite. If salting is used, the fresh hides should first be well drained of blood, flesh side up on sloping slats above the ground. About 40-50% of hide weight of salt should then be spread on the flesh side. Another hide is then put on top of the first, flesh side up and salted in its turn, then another, and so a pile of about 50 hides is built up. This is left for about three days, after which the remaining wet salt is shaken off each side. The goods may then be stored still damp. This has the advantage of making them easier to 'soak' at the start of the tanning process (see Chapters IV to VII). Alternatively, they may be dried hung over ropes, after salting. This makes them easier to store for long periods before tanning.

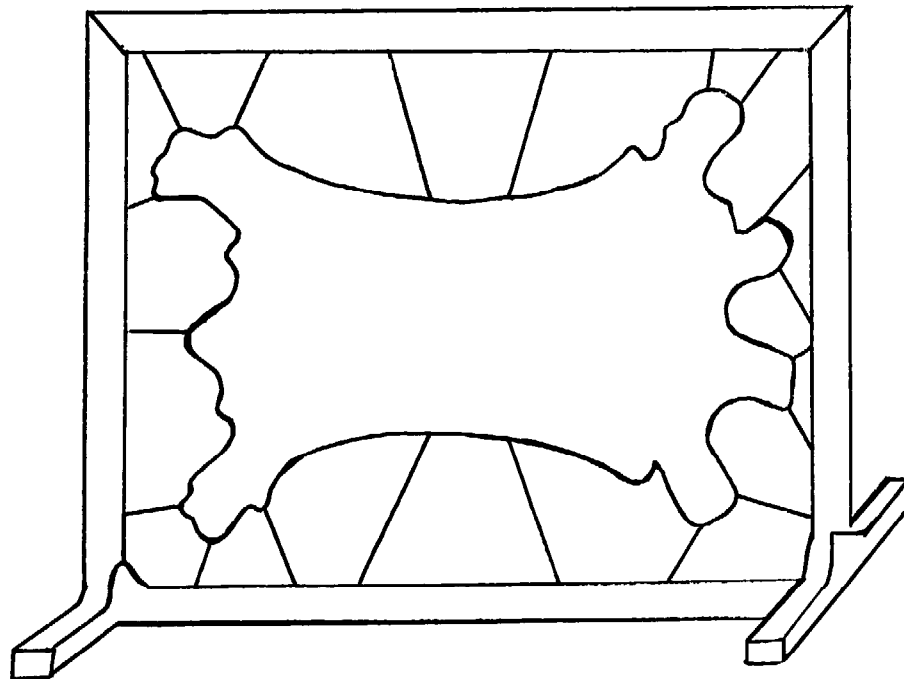

FIGURE II. 2

Wooden Frame for drying Hide

- (b) Cured hides may also need extra preservative measures. More salt may be applied to wet salted goods on which not enough salt seems to have been used. Dried hides may be sprayed or dusted against insects as noted above.
- (c) Putrefaction. Any putrefaction in accepted hides or skins should be cut out immediately and disposed of, without being allowed to come near undamaged goods. This practice (or disposal of the whole hide) should, of course, be followed if putrefaction is subsequently discovered during storage or at any later stage.

II.2 Storage Practice

The details will vary with circumstances. The objective is constant: to preserve the hides and skins in good condition. It requires adequate protection against attack by rodents and other vermin, and against excessive damp and heat, in a manner which allows periodic inspection of goods if they are to be stored for more than 3 or 4 days. Facilities for appropriate pre-storage measures - for example, a salt store - should be allowed for in planning the store, as should a selection area and a moveable machine for weighing the hides and skins. The store could, of course, be a roofed building, to afford protection against the sun's rays, rain and theft.

Some observations covering particular circumstances:

- (a) Scale of store. This will vary with the scale of the tannery, and should be sufficient for a three or four days supply as is assumed in the projects described in Chapters IV to VII, if deliveries are regular. However, if deliveries are intermittent, the tanner might assure supply by keeping up to 14 days' needs and these might be accommodated at a reception and selection warehouse separate from the tannery. In this latter case, the store needs only be large enough for a one day's supply.
- (b) Wet salted goods. These are stacked in heaps of 50 or less (larger heaps would heat up in a hot climate) in booths separated by low walls, with floors sloping downwards to open drains

for carrying away any excess brine (see Figure II.3). The chief danger is putrefaction, and this is accelerated by heat. Hence, the building should have walls 4 or 5 metres high, to protect the goods better from the heat of the sun. If storage is for less than 3 or 4 days, no inspection is needed. Each booth should be washed down when a batch of hides or skins is sent on for tanning, to prevent passing on any contamination to an incoming batch. If the goods are stored for longer periods, they should be turned over every 2 or 3 days. If there is any sign of incipient putrefaction, they should be used in the tannery as soon as possible, after a thorough washing in water.

- (d) Dried goods. These are stacked, again in heaps of 50 or less, on wooden platforms resting about 30 cm above the floor on wooden posts or poles. This affords some protection against rodents and damp. The floor in this case is level (see Figure II.4). Once they have been treated against beetles and mould, dried goods need less frequent inspection than wet salted goods. The risk of putrefaction is less, though it is still preferable for the building walls to be 4 or 5 metres high. If dried goods should become damp - for example from a leak in the roof - they should at once be spread out, or hung on ropes, to dry again.

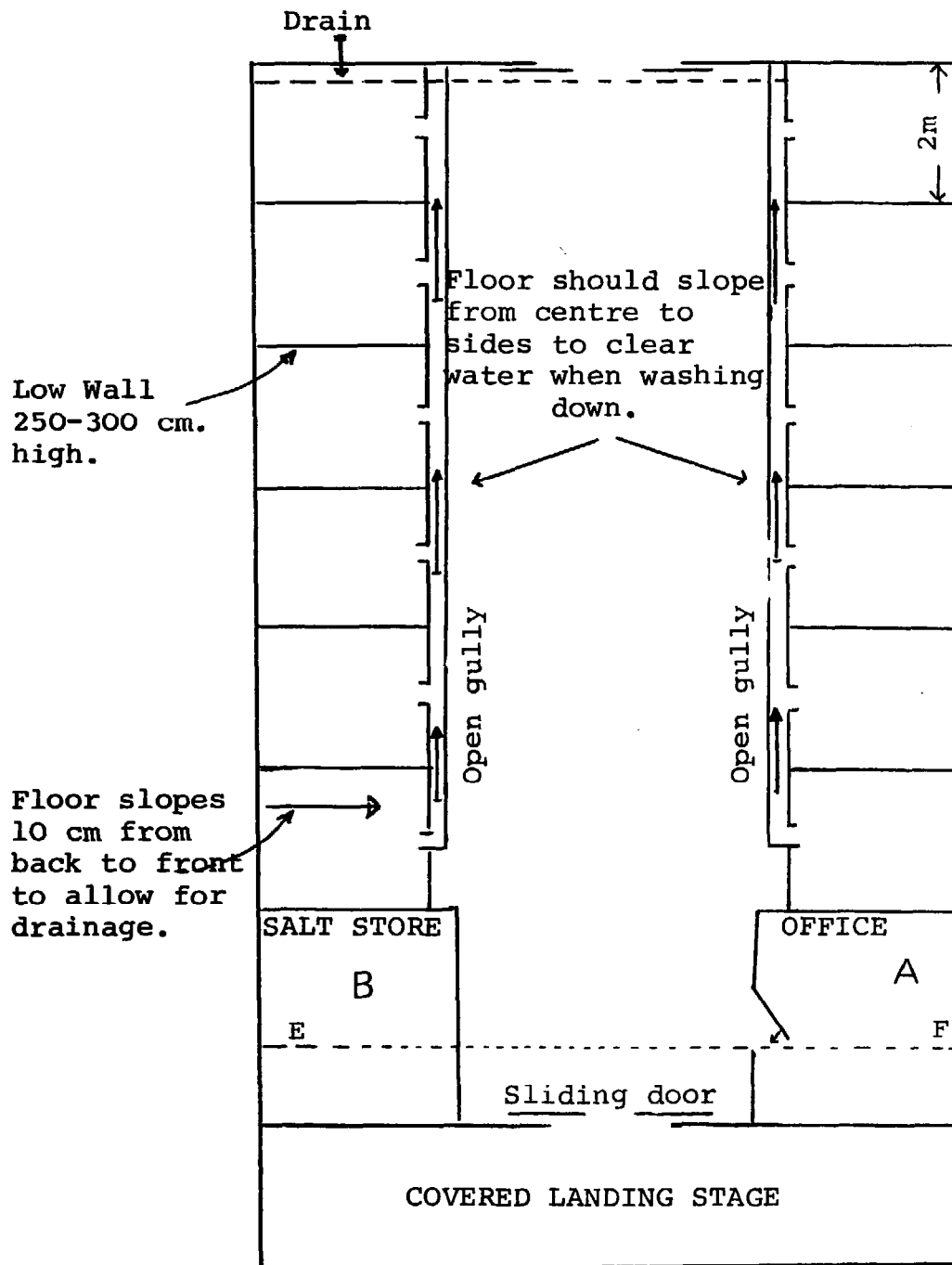

NOTE: Office only required if storage is in different location from tannery. If in the tannery, the door and front wall would be at dotted line EF, and areas A and B would be available for salt storage.

FIGURE II. 3

Store for wet-salted hides

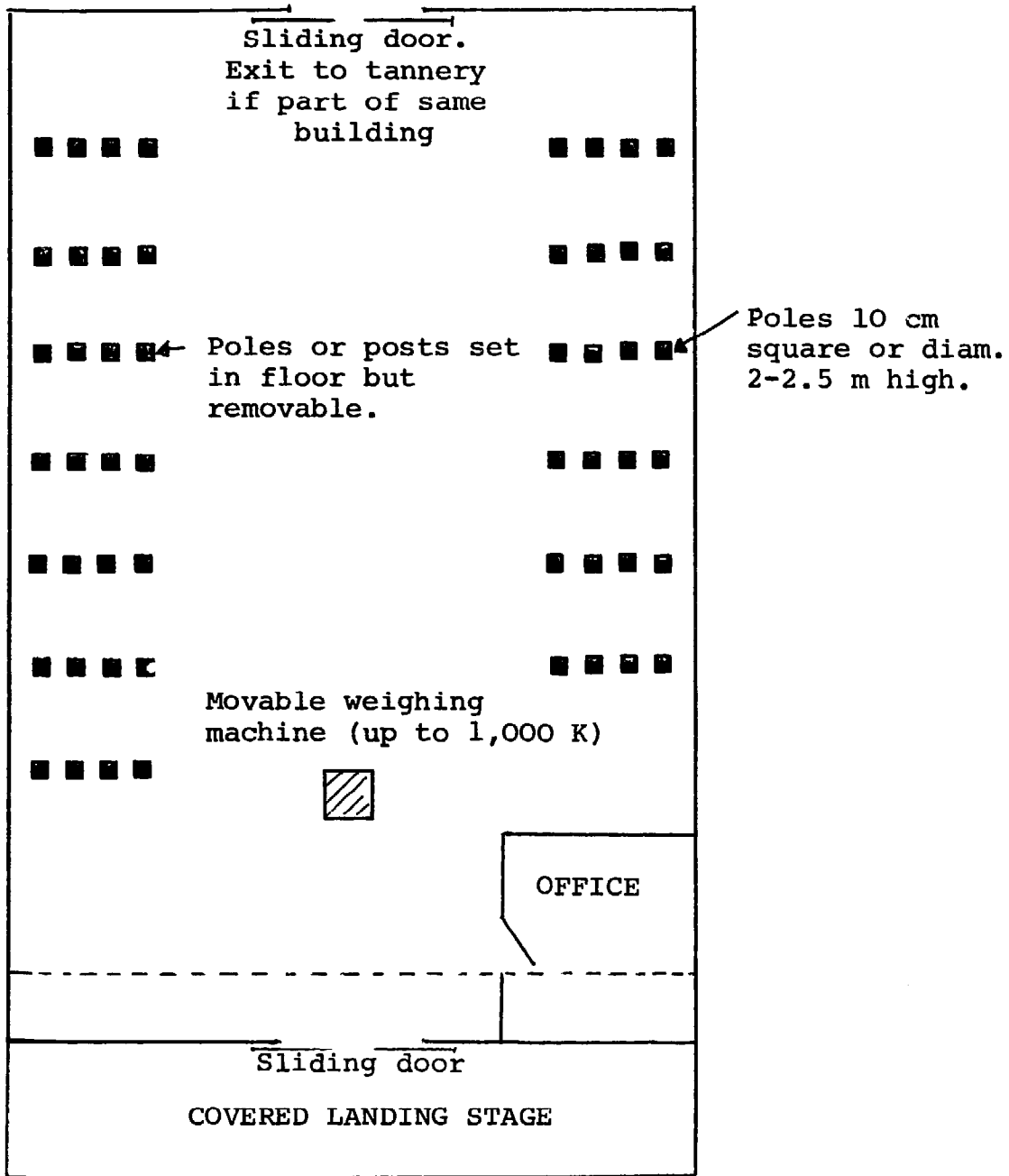

NOTE: Office only required if storage is in a different location from tannery.

FIGURE II. 4

Store for dried hides

CHAPTER III

TANNING TECHNOLOGIES AND PROJECTS

It is a principal purpose of the Memorandum to provide detailed, practical outlines of some useful tanning projects. This is attempted in Chapters IV to VII. The present chapter sets the scene by providing overviews of the tanning process and the choice of technology in tanning, followed by brief introductory sketches of the projects of Chapters IV to VII.

I. THE TANNING PROCESS

Figure III.1 provides an illustrative flow diagram of the complete tanning process, from the hides or skins to 'finished' leather.

As the figure indicates, the process involves many distinct stages. These have evolved over the years, yielding additional characteristics of finished leather and making other stages easier or more effective. Before passing to a brief description of the function of the various stages, and of the techniques available for accomplishing them, it may be helpful to note that the process divides naturally into three groups of stages, namely:

- (i) those, from hides and skins storage to pickling, which prepare the goods for tanning.
- (ii) tanning itself, the vital stage that converts the hide or skin material into leather, a substance which resists putrefaction indefinitely

(iii) the subsequent stages, from draining and sammying onwards, which impart other desired characteristics - for example, colour, suppleness, surface smoothness and finish - to the leather.

These stages will now be described, in some detail, in the following sections.

II. THE INDIVIDUAL STAGES

Within each stage, different techniques have been highlighted by underlining. Some technical terms, common in the trade, have also been introduced.

II.1 Processing Stages

Stage 1 : Hides and/or skins storage: The techniques and function of storage have been covered in Chapter II: the objective is to preserve the material from putrefaction and damage by pests.

Stage 2 : Soaking. The goods are soaked for a period of hours or days in water to wash off dirt and blood, and remove salt. Disinfectants and wetting agents can be added to the water. If the goods have been dry-cured, soaking will also soften and swell them, and usually takes longer than for wet-salted goods. Soaking is normally done in open pits.

Stage 3 : Liming and fleshing. The hides or skins are then immersed in a mixture of water, lime and other chemicals. This destroys or softens the outer layer (epidermis) of the hide, facilitating the removal of hair. It also destroys or softens sweat glands, nerves, blood vessels, and other parts of the hide which will not be converted into leather. Furthermore, liming swells up any flesh still attached to the hide, making its removal easier. Liming

PROCESS STAGES

SERVICE STAGES

PROCESS STAGES

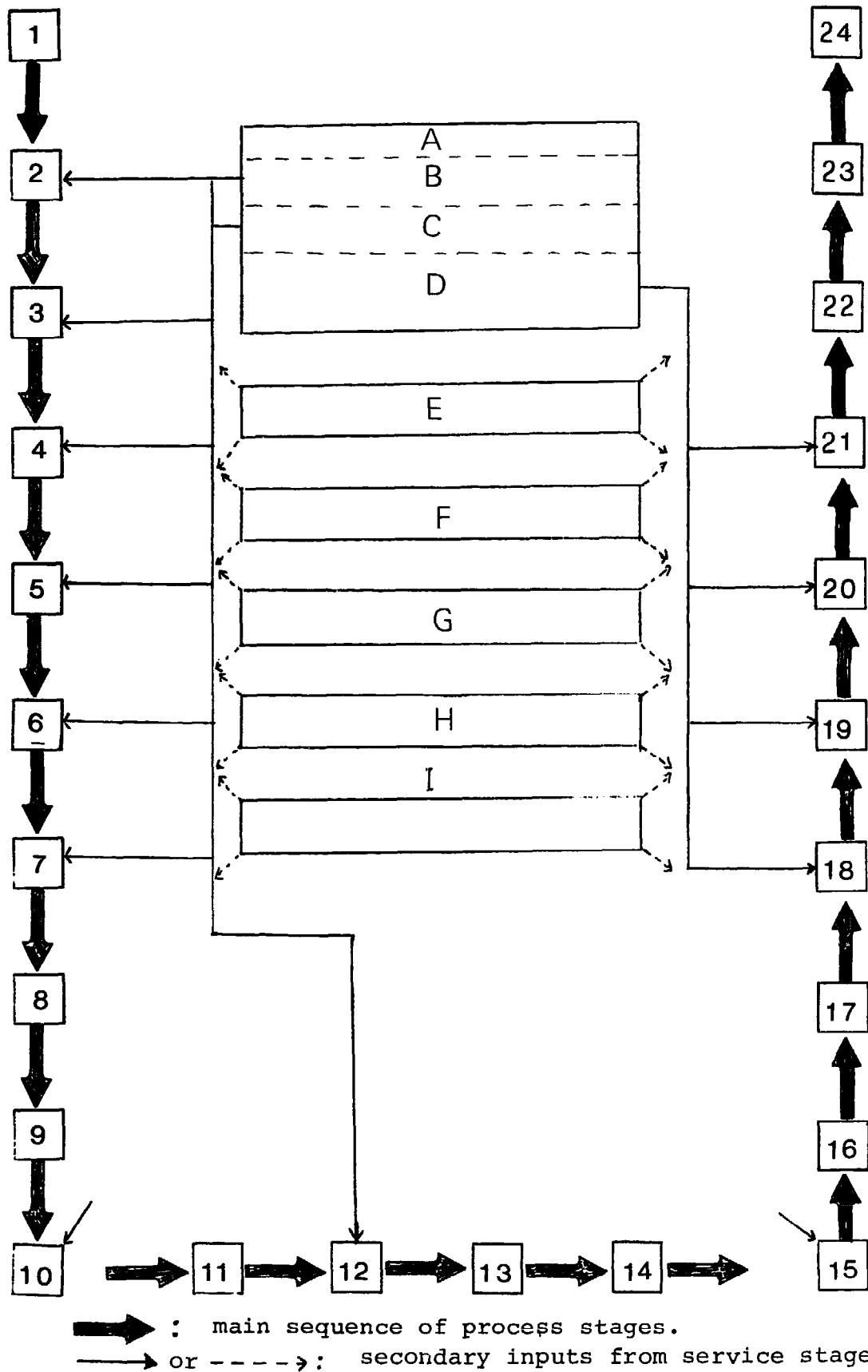

➡ : main sequence of process stages.
➡ or - - - -> : secondary inputs from service stages.

FIGURE III. 1

Simplified flow diagram of the complete tanning process

FIGURE III. 1 (continued)

Designation of process and service
stages on flow diagram

| <u>PROCESS STAGES</u> | <u>SERVICE STAGES</u> |
|--------------------------------------|---|
| 1. Hides and skins storage | A. Chemicals storage |
| 2. Soaking | B. Limeyard chemicals |
| 3. Liming and Fleshing | C. Tanyard chemicals |
| 4. Deliming | D. Finishing chemicals and materials |
| 5. Bating | E. Water (mostly to limeyard and tanyard) |
| 6. Pickling | F. Effluent disposal (mostly from limeyard and tanyard) |
| 7. Tanning | G. Process heat (to various stages as process requires) |
| 8. Draining and sammying | H. Electricity (to various stages as process requires) |
| 9. Setting | I. Maintenance (to all stages as required) |
| 10. Splitting | |
| 11. Shaving | |
| 12. Retanning, dyeing, fat liquoring | |
| 13. Draining and setting | |
| 14. Drying | |
| 15. Conditioning | |
| 16. Staking | |
| 17. Drying and flattening | |
| 18. Buffing | |
| 19. Padding and drying | |
| 20. Spraying and drying | |
| 21. Plating | |
| 22. Measuring | |
| 23. Sorting | |
| 24. Finished goods storage | |

may be done in pits, or inside a rotating wooden drum. The rotation agitates the hides and speeds up the process. However, drums are more expensive than pits to install. Associated with liming is fleshing and unhairing, that is the actual removal of flesh and hair from the hide or skin. These are achieved by either manual scraping, (using specially shaped knives) or by a machine. The hide is then reduced to the tough fibrous material ('collagen') which is convertible into leather. In this condition, the hide is called a 'pelt'.

Stage 4 : Deliming. Some or all of the lime in the hides is now washed out of them, using water and ammonium sulphate. If too much lime is left in the material, it will make tanning more difficult and less effective. Deliming may be done in pits or rotating drums.

Stage 5 : Bating. Frequently, the hides or skins are then immersed in water to which certain biological chemicals (enzymes) have been added. This helps to produce a soft and pliable leather. Bating may be done in pits or drums.

Stage 6 : Pickling. This stage consists in immersing the hides in a weak acid solution, in pits or drums. Pickling makes the hides slightly acid, a desirable condition at the start of the tanning stage.

Stage 7 : Tanning. The hides or skins are now fully prepared for the actual tanning, or the conversion of the collagen fibres into non-putrescible leather. This is also achieved in pits or drums by immersion in water to which a tanning agent ('tannin') has been added. The tannin may be of vegetable or mineral origin. The commonest vegetable tannin is mimosa, although there

are many others. The most common mineral is chrome powder, and leather which has been tanned with this is known as 'wet blue' because of its characteristic colour at the end of the tanning stage.

Stage 8 : Draining and 'sammying'. Draining consists in removing surplus tan liquor from the newly tanned 'pieces' of leather, by piling them on top of each other, and allowing them to drain. The pieces are then dried further and given an even moisture content. This latter step is known as 'sammying' (semi-drying). It gets the leather into the right condition for working. It may be done by applying pressure with a hand-tool or in a machine with rollers.

Stage 9 : 'Setting' and drying. 'Setting' or 'setting out' is the application of a stroking pressure from one end of a piece toward the other. This removes further moisture, and flattens out creases which might otherwise carry over into the finished leather. It may be done by machine or with a rounded hand-tool called a 'slicker'.

Stage 10: Splitting. Hides are thicker on the back of the animal than on its belly, often too thick for many applications of leather. Hence the practice of splitting off a separate layer ('split') of leather from the back portion of the main piece, on the flesh side. The split is smaller in area, and frequently thinner than the main piece. It also lacks a grain side, and if thick enough to be used for shoe uppers, will be finished as suede or given a treatment to simulate a natural grain surface. Splitting is done on a special cutting machine, which must be very carefully set.

Stage 11: Shaving. Most applications of leather require a uniform thickness. Shaving achieves this, whether in split or unsplit pieces. Skins, in particular, are not

normally thick enough for splitting, and thus may require extensive shaving to give them a uniform thickness. Shaving can be done manually with a double-handled knife. However, tanneries aiming for a quality product almost always use a machine.

Stage 12: Retanning, dyeing and fatliquoring. These steps constitute a combination stage, performed in a rotating wooden drum. It gives the leather the desired colour and degree of firmness or suppleness. The pieces are 're-tanned' by immersion in a liquor of water containing tanning agents. This makes penetration by dyes and fats easier. Dyeing imparts colour and fatliquoring works in the required quantity of oils and fats to give the leathers its required degree of suppleness. Each step is performed by agitating the pieces in an appropriate liquor in the drum.

Stage 13: Draining and setting. The pieces are then piled on top of each other over wooden frames known as 'horses', to drain and allow the fat liquor to stabilise. The leather is then set in the same manner as earlier in stage (9) above. As before, this removes moisture and creases. A machine or a hand-tool may be used to carry out this stage.

Stage 14: Drying. Further moisture must then be taken out of the leather. This may be achieved either by hanging it over rails for some hours, or more rapidly through the use of a vacuum dryer.

Stage 15: Conditioning. The pieces are then conditioned for softening by equalising the moisture content on their grain and flesh sides. This is done by piling them flat on top of each other under plastic sheeting.

Stage 16: Staking. This is the principal softening operation. It was traditionally performed by pulling the leather back and forth

over a steel blade set in an upright wooden 'stake'. Nowadays, the working action is performed by one of a variety of machines in larger tanneries.

Stage 17: Drying and flattening. The leather may now be stretched, dried and flattened as a final preparation before surface finishing. A vacuum dryer may be used, or various methods of stretching the pieces out flat under tension, such as nailing on boards, or frames with spring clips (toggles).

Stage 18: Buffing. The sequence of finishing stages and the techniques used, are almost infinitely varied, depending on the type of leather and finish desired. The sequence described in the following stages (18) to (21) is one which may be used in finishing shoe upper leather.

The sequence starts with buffing, that is the grinding of the grain surface with an abrasive to remove blemishes. Any dust settling on the buffed surface will spoil the subsequent finish, so buffing is done in a separate chamber or room with provision for extraction of the dust created by the process. The buffing action is executed by one of a variety of machines.

Stage 19: Padding and drying. Various finishes (i.e. mixtures to give the leather gloss, superior water resistance, etc.) are then applied with 'pads' made out of wooden blocks to which cloth has been attached. The leather pieces are then dried off on rails.

Stage 20: Spraying and drying. Further finishes are then applied by spraying, using one of a variety of machines. Again, the finishes are allowed to dry by hanging the leather on rails, possibly arranged radially round hubs in a 'spider-dryer'.

Stage 21: Plating. The final finishing stage is the application of pressure, often in combination with heat, to allow the finishes to flow into a continuous film over the leather surface for further gloss and uniformity. Either presses or hand-irons may be used for this purpose.

Stage 22: Measuring. Finished leather is generally sold by its area, which must accordingly be measured. There are several ways of doing this, but one of the simplest is a table marked out in squares.

Stage 23: Sorting. Despite all the tanner's skill and effort, leather is rarely a uniform product, even if only one type is being produced. Sorting of output by type or grade is therefore usually necessary. Sorting is done by visual inspection.

Stage 24: Finished goods storage. The sorted finished pieces are then stored in above ground racks or compartments in a dry, cool covered store. Since the goods are now immediately marketable, adequate precautions against theft should be taken.

II.2 Service Stages

The sequence of actual process stages is now complete. The hides or skins have become finished pieces of leather, ready for market. The process has to be supported, between stages, by various services, which are briefly described below.

Service Stage 25: Chemicals storage. As will be clear from the above, the process uses chemicals at many stages, from hides and skins storage onward. A good supply of these is usually kept by a tannery, as it cannot always anticipate frequent and certain deliveries.

Service Stage 26: Water. This is also an important input to many stages. It should be soft and free of iron and other contaminants, if good leather were to be obtained.

Rainwater is an ideal source, if stored in tanks lined with mortar or bitumenous paint. Any other water source, even running streams or deep wells, should be tested for contaminants before use. The tanner should consult a specialist manual or a local expert, on testing and pre-treatment procedures.

Service Stage 27: Effluent disposal. The tanning process produces many waste liquors. Adequate drainage must therefore be provided to run these off within the tannery. Furthermore, since the raw effluent is a harmful pollutant if discharged in the environment, it should rest for a few days in a series of settling tanks, and then settle in a lagoon. By this means, some of the pollutants settle out as a sludge, while the remaining pollutants are naturally oxidised. The purified waste liquor may then be allowed to overflow into a local lake, river or canal. The sludge may be used as an agricultural fertiliser if vegetable tanning has been used. In the case of chrome tanning, it should be buried or dumped in a 'sink' of water large enough to receive it relatively harmlessly (for example, some way out from the shores of the sea or a large deep lake). The tanner should take good effluent disposal very seriously. Otherwise, serious harm to the environment may take place irreversely.

Service Stage 28: Process Heat. The need to heat process liquors varies greatly with the process details, and to some extent with the climate of the country or region. If the need is extensive, it is best met by a central boiler. In other cases, a simple tank over a wood or coal fire will suffice. Solar heating systems may also provide a cheap source of energy.

Service Stage 29: Electricity. The main potential use of electricity, other than for occasional lighting, is for power to drive

machines. Power can be drawn from the mains or from a diesel-electric generator. The load can vary enormously, depending on how many stages it is decided to mechanise. It is possible to manage with little or no electricity, particularly in small tanneries.

Stage 30: Maintenance. In common with all industrial plants, tanneries need maintenance. The sophistication, staff and maintenance equipment required will vary with many factors, including the size of the project, its degree of mechanisation, the ease or difficulty of commissioning outside contractors to do maintenance work, and the attitude and skills of the tannery management. There is no set formula, but at least, tanners must be aware of the need and keep some tools, together with a stock of any machine spare parts not readily replaceable from outside.

III. OUTLINES OF TANNING PROJECTS

III.1 The Diversity of Tanneries in Practice

Tanning is an industry thousands of years old. Yet the millenia have not imposed uniformity on the industry, unsurprisingly in view of the diversity of hides and skins or finished leather. However, even with the same raw material and finished product, different tanners will have their own variants on the same basic process. Some stages may be deleted, the sequence of stages may be altered, and the combinations of chemicals, process temperatures and the duration of stages may be modified. Process diversity may extend even further. There are alternative methods - manual, or with varying degrees of mechanisation - of performing many particular stages. The choice among them is largely an economic question, depending on prevailing wage rates, the skills of labour, not to mention the desired scale of production, and product prices in the various markets for finished leather. In general, a degree of mechanisation will be more appropriate if:

- local wage rates are high
- mechanical skills are abundant
- markets, raw material supplies, finance, etc., favour a large-scale tannery
- there is a particularly high premium in the available markets for high quality, uniform finished leather.

When the varying circumstances and opportunities in respect of raw materials and markets, that have been noted in Chapter I as affecting the choice of project scale and type, are considered together with the above technical and economic factors likewise making for diversity, it will be appreciated that tannery projects and processes are extremely varied. Indeed, it is the exception rather than the rule to find even two tanneries with no significant differences between them.

III.2 Specific Project Outlines

Nevertheless, one can simplify the diversity found in the real world, and usefully describe in detail, workable projects illustrating some of the main alternatives in making non-specialised leathers. The tanner can then select the described project most nearly appropriate to his circumstances, perhaps adapting it to fit his needs even more closely.

Thus, an attempt has been made in what follows to cover a range of project scales, and the main process alternatives and materials.

However, some techniques at the more mechanised end of the available range have not been treated in practical detail. They are probable candidates for use only in larger tanneries. Even if such large scale projects are planned, detailed information on these highly mechanised techniques can very readily be obtained from the manufacturers and equipment contractors who supply them and who regularly advertise in the national and international trade press. Practical information - both for large and small projects - is often harder to get on the less mechanised alternatives. This is a gap which this Memorandum is partly designed to fill in order to enable potential tanners to identify the technology best suited

for their own circumstances. For all that, the availability of the highly mechanised techniques should not be simply ignored. Accordingly, although they are not included in the detailed project descriptions of Chapters IV to VII, they are compared in economic terms in Chapter VIII with less mechanised technologies. In anticipation of this comparison, alternative project outlines using mechanised technology at the larger scale are included in this section.

The outlines of all the projects are given in Figure III.2 This is largely self-explanatory, and needs only limited comment. It is particularly worth noting to whom the various projects might be of special interest. This has been indicated by the underlinings in (e) and (f) below.

- (a) Projects at three scales are outlined: Very Small (VS), 2 hides per day; Medium-Small (MS), 20 hides or 200 skins per day; and Medium-Large (ML) 200 hides per day.
- (b) The detailed project descriptions extend right across the range of scales. In addition, economic comparisons will also be made in Chapter VIII with the two more mechanised ML-scale projects outlined in the two rightmost columns of the figure.
- (c) All the ML-scale projects produce finished shoe upper leather, and therefore embrace the complete tanning process. At the tanning stage itself, they use chrome tanning. In contrast, the VS and MS projects use vegetable tanning, and produce a semi-finished leather. This may be sold direct to leather working craftsmen in local markets or to larger chrome tanneries for retanning and finishing. In either application, the VS and MS projects produce real leather, properly tanned and indefinitely resistant to putrefaction. These leather products lack only the complete finish that some markets require.
- (d) Cattle hides are the basic raw material at all scales. However, a variant of the MS project is described that uses skins instead.

Figure III.2 - Tannery project outlines

| Stages | Detailed technical descriptions | | | | Economic comparison only | |
|---------------------------------------|--|--|---|---|---|---|
| | Very small 2 hides/day Low investment | Medium-small 20 hides/day Low investment | Medium-small 200 skins/day Low investment | Medium-Large 200 hides/day Low investment | 200 hides/day Semi-meehanised | 200 hides/day Mechanised |
| 1. Hides and skins storage | See Chapter II - Techniques do not vary with scale | | | | | |
| 2. Soaking | Earth/Concrete pits | Concrete pits | Concrete pits | Concrete pits | Concrete pits | Concrete pits |
| 3. Liming and fleshing | Lined pit, manual, on beam | Concrete pits manual, on beam | Concrete pits manual, on beam | Concrete pits manual, on beam | Powered wooden drums (steam) manual on beam | Powered wooden drums (steam) machine |
| 4. Deliming | Earth/concrete pit | Concrete pit | Pit/paddles | Powered wooden drum (Chrome tanning) | Powered wooden drums (steam) (Chrome tanning) | Powered wooden drums (steam) (Chrome tanning) |
| 5. Bating | - | - | Pit/paddles. | | | |
| 6. Pickling | (vegetable) | (vegetable) | (vegetable) | | | |
| 7. Tanning | Lined pit | Concrete pits | Pit/paddles | | | |
| 8. Draining and sammying | On wooden horse - | On wooden horse - | On wooden hors - | Pallets, burying in saw-dust | Pallets machine | Pallets machine |
| 9. Setting | Manual | Manual | Manual | Followed by manual setting | - | - |
| 10. Splitting | - | - | - | Machine | Machine | Machine |
| 11. Shaving | - | - | - | Machine | Machine | Machine |
| 12. Retanning/dyeing and fatliquoring | - - Manual oiling | - - Manual oiling | - - Manual oiling | Powered wooden drums | Powered wooden drums (Steam) | Powered wooden drums (Steam) |
| 13. Draining and setting | - | - | - | | | |
| 14. Drying | - | - | - | On rails | On rails (Steam) | Vacuum dryer |

Figure III.2 - Continued

| Stages | Detailed technical descriptions | | | | Economic comparison only | |
|----------------------------|---|--|---|---|--|--|
| | Very small 2 hides/day Low investment | Medium-Small 20 hides/day Low investment | Medium-Small 200 skins/day Low investment | Medium-Large 200 hides/day Low investment | 200 hides/day Semi-mechanised | 200 hides/day Mechanised |
| 15. Conditioning | | - | - | Dipping in water and piling over-night | Dipping in water and piling over night | Dipping in water and piling over night |
| 16. Staking | Manual | Manual | Manual | Slocomb-type Machine | Slocomb-type Machine | Vibratory machine |
| 17. Drying and flattening | - | - | - | Nailing-out on boards | Nailing-out on boards | Toggle dryer |
| 18. Buffing | - | - | - | Machine | Machine+air blast dusting accessory | Machine+air blast dusting accessory |
| 19. Padding and drying | - - | - - | - - | Manual on rails | Manual Spider dryers | Manual Spider dryers |
| 20. Spraying and drying | - | - | - | Hand-op. machine on rails | Hand-op. machine on rails | 3-gun spray on wooden horse |
| 21. Plating | - | - | - | Heavy hand irons | Hydraulic press | Hydraulic press |
| 22. Measuring | Scales | Scales | Scales | Marked board | Marked board | Electronic machine |
| 23. Sorting | - | Manual | Manual | Manual | Manual | Manual |
| 24. Finished goods storage | Manual on racks | Manual on racks | Manual on racks | Manual, on racks | Manual, on racks | Manual, on racks |
| 25. Chemical storage | Slatted platforms | Slatted platforms | Slatted platforms | Racks | Racks | Racks |
| 26. Water | Source varies | Source varies | Source varies | Source varies | Source varies | Source varies |
| 27. Effluent disposal | Soak-away | Tanks/lagoon | Tanks/lagoon | Tanks/lagoon | Tanks/lagoon | Tanks/lagoon |
| 28. Process heat | Wood/coal fire | Wood/coal fire | Wood/coal fire | Wood/coal fire or boiler | Boiler | Boiler |
| 29. Electricity | - | - | Mains supply | Mains supply | Mains supply | Mains supply |
| 30. Maintenance | Not significant | Not significant | Hand tools/drills | Hand tools/drills, spares | Small machine shop, spares | Small machine shop, spares |

Goatskins are assumed. The process for sheepskins is very similar and variations from the goatskin process are indicated at appropriate points in Chapter VI.

- (e) All the MS and ML projects are of sufficient scale and complexity to be considered and planned as 'formal' industrial units, with their own buildings, a labour force, and organised supply, marketing and effluent disposal arrangements. The VS project, on the other hand, is definitely on a 'cottage industry' scale, probably managed by a single family in outbuildings with a less complex effluent disposal system.
- (f) Despite their 'formality' the MS and ML projects described in detail in Chapters IV to VI have the minimum degree of mechanisation and technical complexity consistent with their scale, type and quality of final output. They are low investment cost projects and should be within the financing capability of local or regional entrepreneurs or co-operatives. The two more mechanised alternative ML projects outlined for comparison naturally have higher investment costs and correspondingly more extensive financing needs.

In conclusion, it may be added that the project outlined in Figure III.2 are outlines only. They give the general flavour of each project and its technology, while omitting much detail. However, they do illustrate how the tanning process may be exploited in a wide variety of specific projects and technologies, and set the stage for the detailed project descriptions of the next chapters. The ML project, which embraces the complete tanning process, is described in Chapter IV, the smaller and less complex MS and VS projects in Chapters V to VII.

Readers wishing to set up a tanning project are therefore advised to skim through Chapter IV in order to gain a first impression of the ML project's technical and financial requirements. Only if these are judged to be of practicable scope for a particular reader, should he then give the chapter detailed study. Even then, he may still wish to compare the ML project's opportunities and requirements with those of the smaller, less ambitious projects described in Chapters V to VII.

CHAPTER IV

MEDIUM-LARGE TANNERY : 200 HIDES PER DAY

This chapter describes in detail a project producing finished shoe upper leather for national and possibly international markets. It also produces suede shoe linings from 'splits' off the main hide. This is a project of substantial size, and careful planning is needed. In particular, it should be ensured that hide and water supplies, and market outlets are adequate. In this chapter, it is assumed that the project has been pre-planned correctly, and the project description focuses essentially on production operations.

The project description is arranged as follows:

- (a) An introductory summary of hide input, and plant and labour utilisation. The process at each stage is then described in practical working detail, and is accompanied by a flow diagram summarising the sequence of operations, and by schedules of necessary equipment, water, chemicals, heat, power and labour. Where appropriate, the description is illustrated by sketches of equipment which may be manufactured locally.
- (b) The stage-by-stage description is amplified by an account of overall project features, comprising:
 - (i) a floor plan
 - (ii) a summary schedule of equipment
 - (iii) a summary schedule of chemicals, fuel, water and electricity usage.

(iv) a summary schedule of the labour force.

I. Input, Output and Organisation of Production

Input : 200 cattle hides per day, dry weight averaging 7 kg each or equivalent wet-salt weight averaging 14 kg each.

Output : Each hide yields 6.5 kg wet blue shaved weight of upper leather, and 2.5 kg wet blue shaved weight of splits, translating respectively into 2.6 square meters of finished grain upper shoe leather, and 1.12 square meter of suede shoe linings from splits.

Organisation of Production: The tannery works one shift per day, 300 days per year. The total time needed for all tannery operations per day is about 10-11 hours, but each man's working day is only 8-9 hours. In the stages from liming to tanning, which are started early (say 6 a.m.), some men come in at the start and leave before the tannery is closed for the night at about 5 p.m.

In practice, labour is also lent from one stage to another at various times during the day, and each tannery finds its own way of working.

II. Stage-by-Stage Description

Stage No. 1 : Hides selection and storage

Process description: See Chapter II, Section II.

Flow diagram: Stage 1

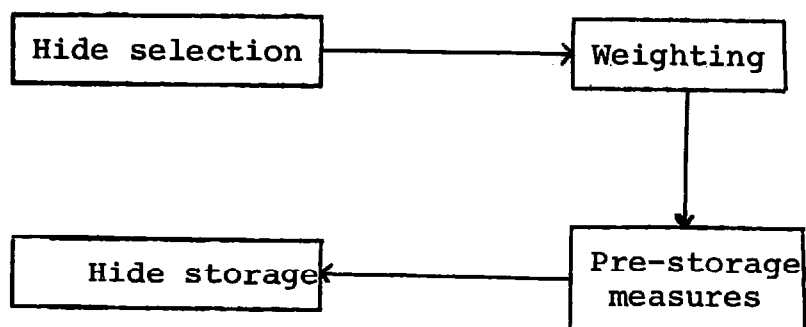

Schedules

- Equipment. Equipment will consist mostly of fittings. It may be inferred from the floor plan shown on Figure IV.14. All is locally producible, except possibly the weighing scales. These should be movable and capable of weighting up to 1000 kg.

- Water, chemicals, heat, electricity. Water and chemicals (salt, sodium arsenite) requirements will vary with circumstances as explained in Chapter II. Because of this, no definite usages may be specified. For wet-salt storage, water for washing down the boots might amount to 5-10 cubic meters per day. Salt for salting or re-salting dry or wet salts might vary up to 600 kg per day. One or two kg per day of concentrated sodium arsenite should be adequate to produce an insecticide diluted to a 0.25% solution.

No process heat or electricity is needed.

- Labour. 3 workers are needed, including one stock clerk. (This assumes that no extensive pre-storage measures are necessary). In addition, the tannery manager will be involved in hide selection, since this is critical to the tannery's success.

Stage No. 2 : Soaking

Process description

Soaking is a separate stage only if dried hides are used. It may reveal hitherto undetected damage or putrefaction (smell of ammonia). The hides should be inspected during soaking, and damaged or putrefying parts should be cut out or thrown away.

Soaking, a two-day process, is performed in 2 sets of pits. Each set handles half the input, that is 100 hides per day throughput, and each individual pit holds 100 hides for one day (either the first or second day) of the process. The dimensions of each pit are 2.5 m x 2 m x 2 m deep.

The process, which is identical for each set of two pits is as follows:

A batch of 100 hides is immersed in the first pit. These are either laid flat, or, for ease of handling, suspended on strings from poles laid across the top of the pit. The liquor in the first pit consists of:

- 8000 litres of lukewarm water (25°C)
- 4 kg sodium sulphide¹
- 4 kg anionic wetting agent, e.g. Teepol²
- 1.6 kg disinfectant

¹All quantities of sodium sulphide in the Memorandum refer to 'solid' (60%) sodium sulphide, not 'flake' (30%).

²In many cases, generic descriptions of chemicals used in tanning would be unhelpful unless supplemented by an identifiable branded example. In such instances, a brand name is given, but merely as an example to help the reader to identify the type of chemical needed. The brand names of a particular UK company are extensively used in the Memorandum, but this does not imply a special endorsement of it by the author or ILO of that company's chemicals. Rival brands from reputable firms will generally be found just as effective, provided the tanner follows their manufacturer's instructions on their use.

The batch lies overnight in the liquor. In the morning, the pit is drained, the batch is taken out and immersed in the second pit, in a liquor consisting of:

- 8000 litres of lukewarm water
- 4 kg sodium sulphide
- 100 kg salt

Meanwhile, the first pit is refilled with the same liquor as the day before and a fresh (second) batch of 100 hides immersed in it.

Both batches lie overnight in their liquors. In the morning, both pits are drained and refilled, the first batch of hides being transferred to liming, and the second batch being transferred to the second pit.

The process continues like this indefinitely, each batch of hides resting one day in the first pit and one day in the second, before being transferred to liming.

Flow diagram : Stage No. 2

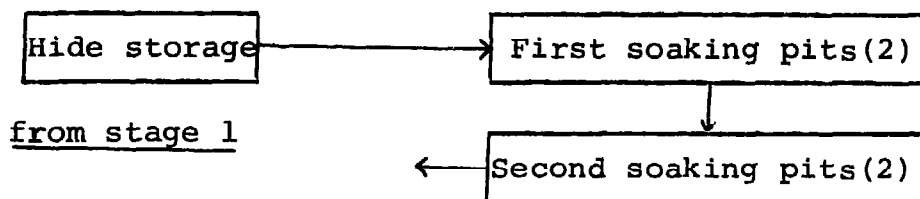

If desired, the hides can be transferred between pits - or indeed between stages - in wooden trucks (see Figure IV.1).

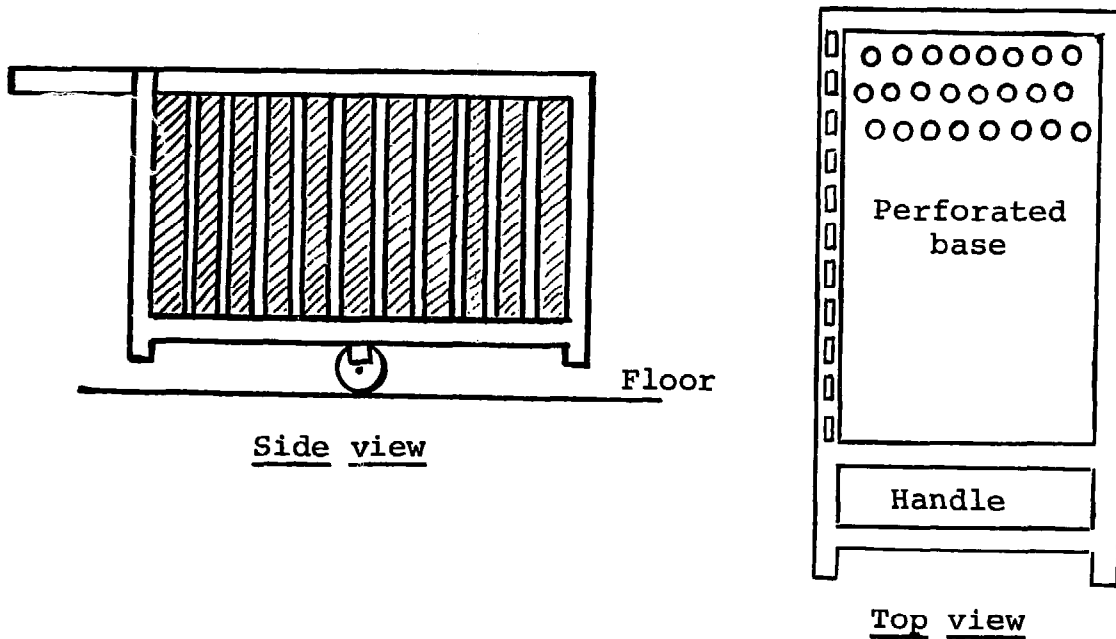

The truck dimensions may be 1.25 long x 1.00 m wide x 3/4 m deep. The truck can have slatted sides, as illustrated, for limeyard work. In every case, they should have a perforated bottom.

The truck stands nearly level and is tilted slightly to wheel away. The sides are fitted into the frame work.

FIGURE IV.1

Wooden truck

Schedules

- Equipment. The equipment used in soaking includes the following:

- . 4 concrete pits with drainage. Each pit is 2.5 m x 2 m x 2 m deep, and may be built on, or sunk into, the tannery floor (see Figure IV.2)
- . Wooden trucks, if desired, for hide transfer (refer to figure IV.1). Slotted sides are preferable for the stages from soaking to delimiting.

All this equipment may be manufactured locally.

- Water, chemicals, heat, electricity.

(NB: Hereafter in the Memorandum, only what is required will be entered under this heading, not that some input is not required. For example, no electricity is needed for soaking, hence no entry is made for electricity. This procedure saves space and makes the text easier to read).

Daily usages

- | | | |
|--------------------------|-------------------|-----------------|
| . Water | 32 m ³ | (32,000 litres) |
| . Sodium sulphide | 16 kg | |
| . Anionic wetting agents | 8 kg | |
| . Disinfectant | 3.2 kg | |
| . Salt | 200 kg | |
- . Process heat - Little or no artificial heat is needed in a warm climate. The ambient temperature of the water in the water storage tank will be adequate for soaking, as for most stages in this project.

In a cold climate, a central boiler must be installed. The load at various stages will depend on the severity and duration of the cold season. Tanners should consult a boiler supplier or heating engineer.

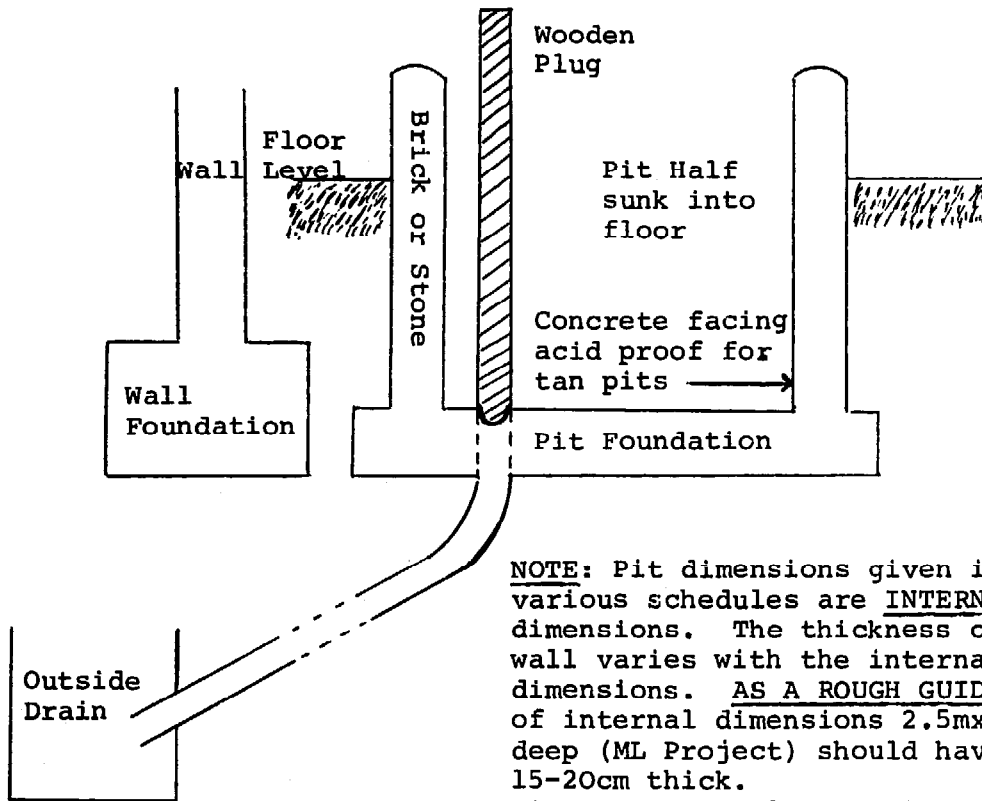
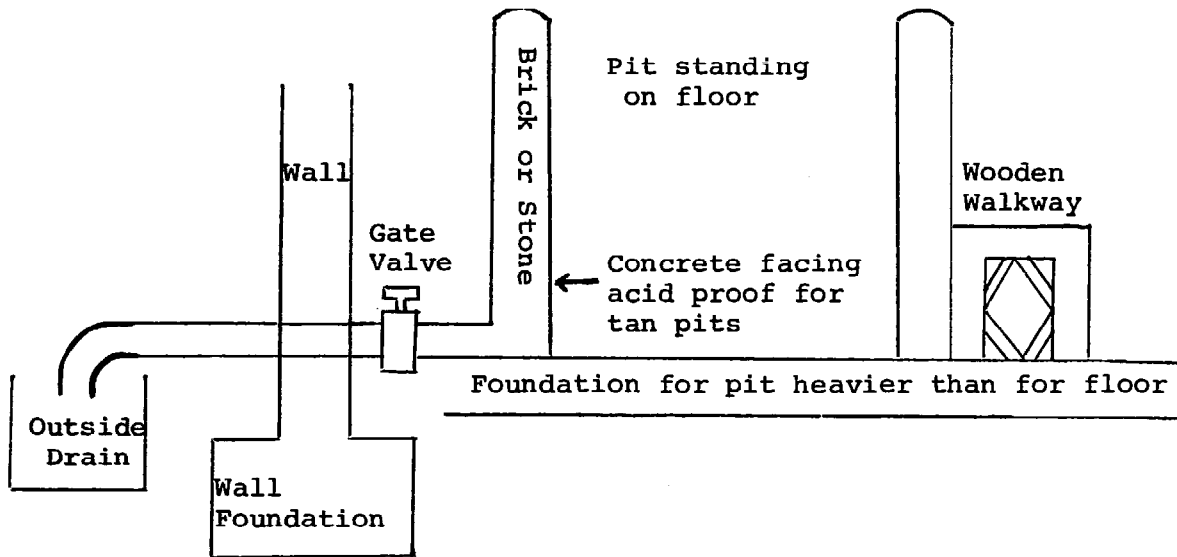

NOTE: Pit dimensions given in the various schedules are INTERNAL dimensions. The thickness of the wall varies with the internal pit dimensions. AS A ROUGH GUIDE, pits of internal dimensions 2.5mx2mx2m deep (ML Project) should have walls 15-20cm thick.

Pits of internal dimensions 2mx1.5mx2m deep (MS-Hide Project) should have walls 15cm thick.

Pits of internal dimensions 1.5mx1.2mx1.2m deep (MS-Skins Project) should have walls 10-15cm thick.

FIGURE IV. 2

Pit Designs

- Labour. One person, exercising normal care and vigilance.

Stage No. 3 : Liming and fleshing

Process description

The process for liming is in many ways similar to that for soaking. It also involves successive immersion of batches of hides in series of pits containing different liquors. The pits are of identical construction and dimensions to the soaking pits. Thus, two parallel sets of pits are required, each handling 100 hides per day throughput. However, liming is a four day process and there are four pits to each set, each containing a different liquor. Every batch rests for one day in each of the four pits.

The cycle is illustrated in Figure IV.3, which shows the position on each day in either of the sets of four pits. Each batch rests successively in progressively newer (stronger) liquors. On day 1, for example, Batch D rests in a 3-day old liquor, on day 2, in a 2-day-old liquor, on day 3, in a 1-day-old liquor, and finally on day 4, in new liquor.

The liquor does not merely age each day, it changes in composition as more chemicals are added to it. In Figure IV.3, this is explicitly shown for pit number 4 on the right. In that pit, new liquor is made up on day one from:

- 8000 litres lukewarm water
- 160 kg hydrated lime

On day two, the new liquor is converted to two-day-old liquor by adding:

- 80 kg sodium sulphide
- 40 kg salt

On day three, one-day-old liquor is converted to two-day-old liquor by adding:

- 40 kg sodium sulphide

On day four, no additions are necessary. The three-day-old liquor is merely a day older than a two-day-old liquor.

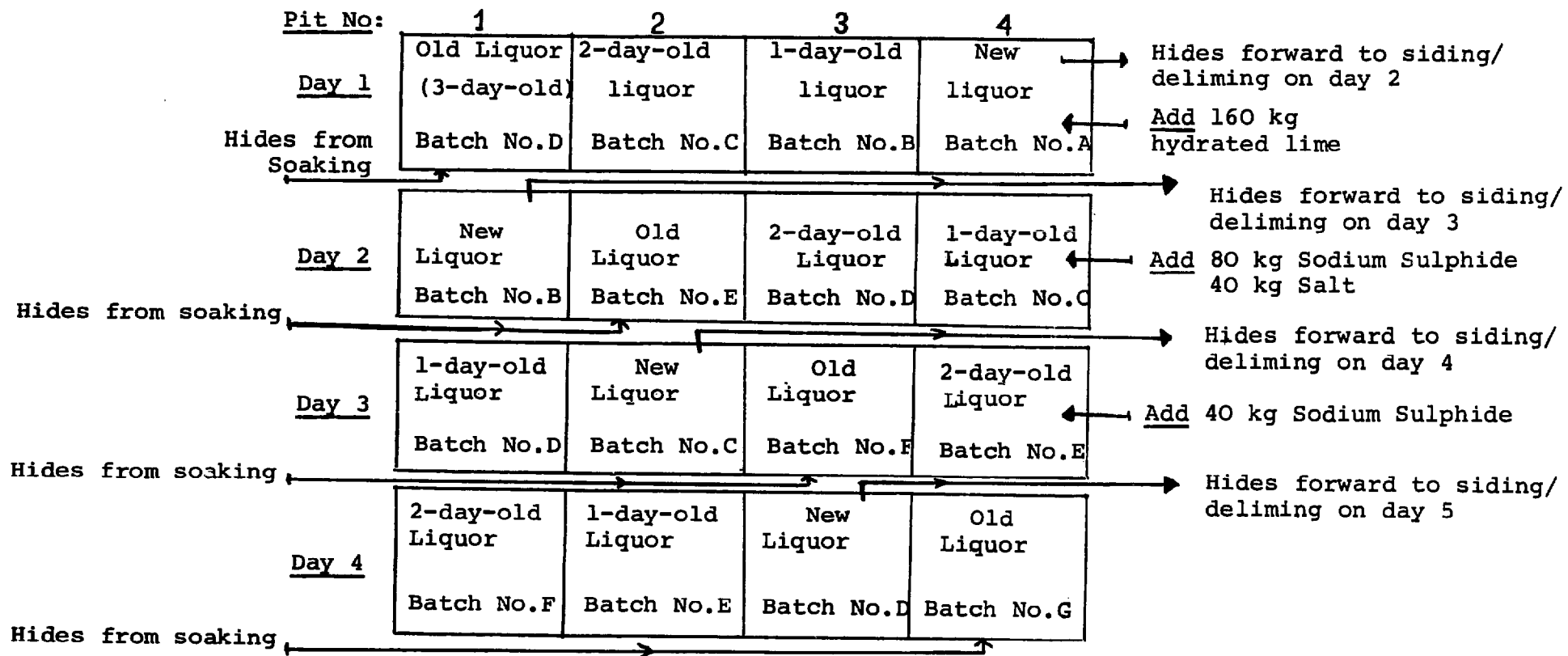

FIGURE IV. 3

4-day liming cycle in pits

On day five, the cycle in pit number 4 starts again. The liquor, by now four days old, is drained off at the start of the day, and a fresh charge of new liquor is made up.

The additions are shown only for pit number 4 in order to avoid over-complicating the figure. However, they are precisely paralleled as to quantities and sequence in the other three pits, the only difference lying in the starting (new liquor) day of the sequence. For pit number 1, this is day 2, for pit number 2, day 3, and for pit number 3, day 4. Because of this even staggering of starting days, the set of pits will, on each day, contain the four different liquors required. Thus, as the figure illustrates, each pit can be kept in continuous use, and every day four batches of hides are each advanced one day in their liming cycle.

The process may seem complicated at first sight, but it is quite simple in principle, and so, of course, is the equipment. Together with other seemingly complex operations, the process soon becomes second nature to practising tanners.

The hides should be suspended from poles laid across the tops of the pits. This facilitates transfer between pits, and permits easy 'plunging' (agitation) of the hides in the liquors to keep the latter stirred up. Plunging should be done periodically through the working day, say every hour or two.

Fleshing and unhairing should be done on each batch at the start of the fourth day of its cycle, that is just prior to its immersion in new liquor. The two operations are performed adjacent to the pits, on tanners' beams (Figure IV.4). Each hide is placed on a beam, then the flesh is cut off its flesh side, and the hair is scraped off its grain side. A single knife (Figure IV.5) can be used for both operations. The convex blade is very sharp and is used for fleshing, which is a sweeping movement slicing off the flesh while leaving the actual hide uncut. This takes care and skill. The concave blade is not very sharp, and is used in a scraping action to dislodge the hair. Both the fleshing and unhairing actions are done down the beam towards the floor. The workman stands at the raised end of the beam, facing and working down it.

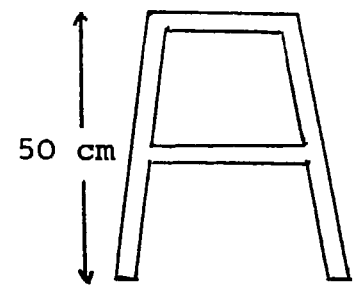
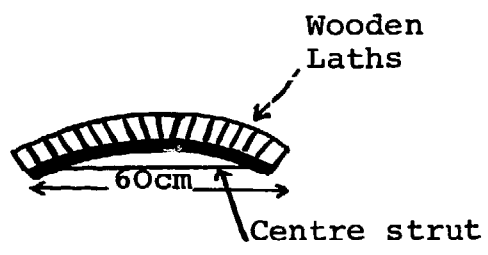
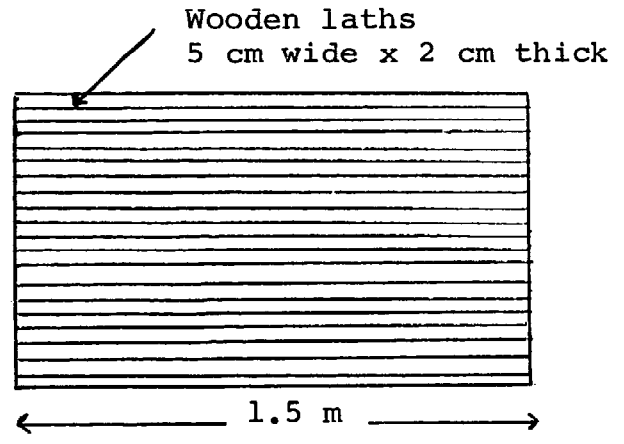
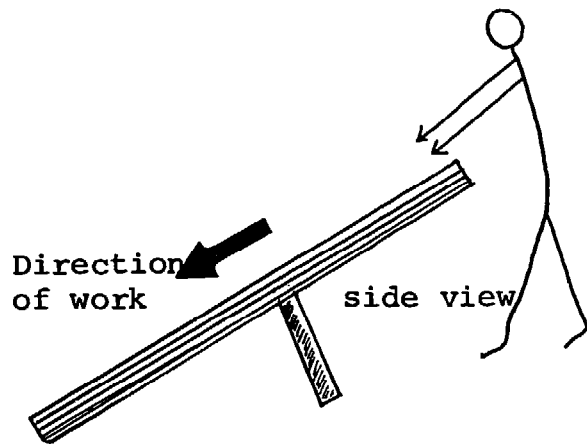

'A' frame fits under centre strut. Not fixed so that angle of beam can be adjusted to size of man using it.

FIGURE IV.4

Tanner's beam

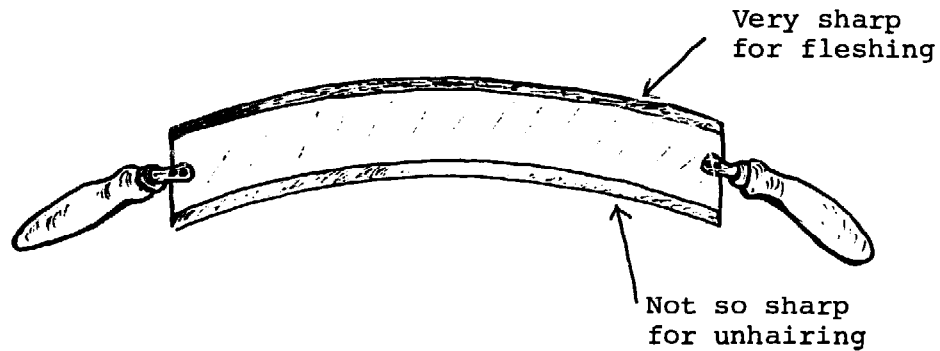

FIGURE IV.5

Fleshing/unhairing knife

Cutting of hides into sides. After the liming cycle is complete, the hides may be cut into 'sides' that is, cut in half along the backbone. This makes them easier to handle in the remaining stages. The cutting is done with an ordinary strong sharp pointed and bladed knife, with the hide resting over a stationary wooden horse (Figure IV.6). The 1 cm gap between the two upper struts of the horse permits the knife to move freely during the cutting. The horse should be stable and solid (e.g., constructed of 5 cm by 10 cm timber).

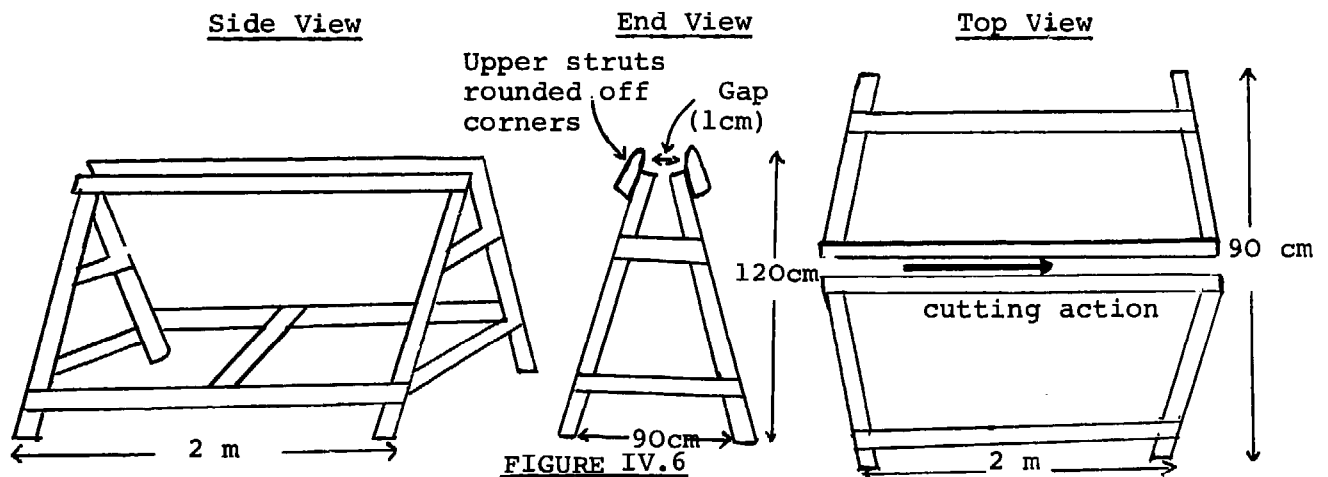
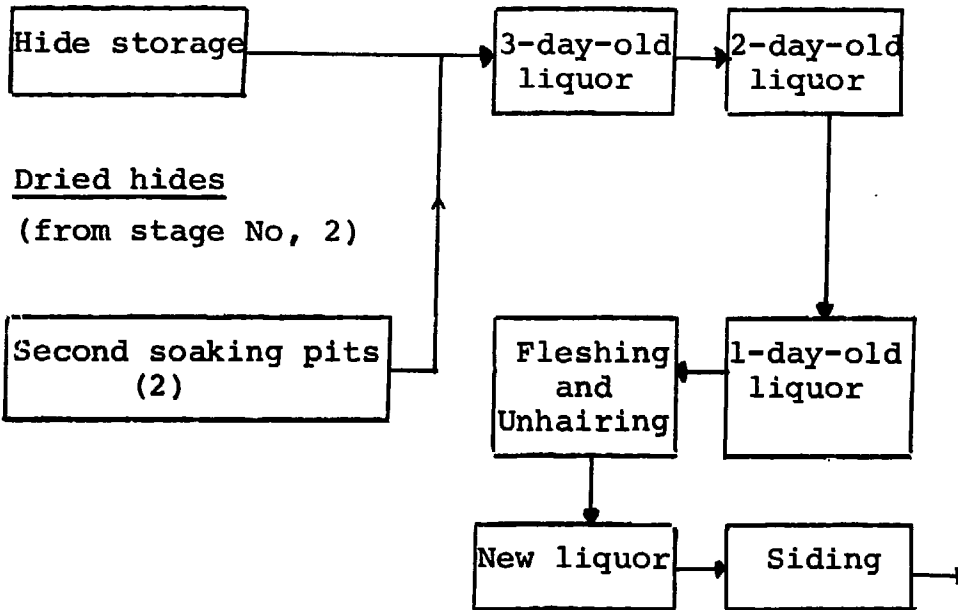

FIGURE IV.6

Stationary wooden horse for siding

Flow diagram : Stage 3

- (a) Wet-salted hides
(from stage No. 1)



- (b) Dried hides
(from stage No, 2)

Second soaking pits
(2)

Schedules

- Equipment.

- . 8 concrete pits with drainage. Each pit 2.5 m x 2 m x 2 m deep
Construction as in stage 2 Soaking (see Figure IV.2)
- . 8 tanners' beams, including 1 spare
- . 8 fleshing/unhairing knives, including 1 spare
- . 3 stationary horses
- . 3 cutting knives
- . 400 wooden poles, 2.5 m x 4.5 cm diam
(2 hides per pole)

All this equipment may be manufactured locally.

- Water, chemicals, heat, electricity.

Daily usages

| | |
|-------------------|---|
| . Water | 16 m ³ |
| . Hydrated lime | 320 kg |
| . Sodium sulphide | 240 kg |
| . Salt | 80 kg |
| . Process heat | Little or none except in cold climates |

- Labour.

A total of 11 workers will be needed, 7 of whom required for fleshing and unhairing. Fleshing requires care and skill, and some prior experience or training is preferable.

Stage 4 to 7 : Deliming, bating, pickling and (chrome) tanning

Process description:

These stages involve the immersion and intermittent agitation, over a two day period, of the hides (by this point known as 'pelts' or 'sides') in a series of liquors. This is done inside a large wooden cylindrical drum mounted on a hollow horizontal axle. Four such drums are required, each 2.5 m long by 2 m in diameter and handling 100 hides (200 sides) per 2-day cycle.

The drums have water inlets through their axles to permit washing of the sides and the formation of liquors inside them. To provide agitation, they are rotated ('run') by associated electric motors (7.5 kw, or 10 H.P.) which rotate the drums at approximately 5 revolutions per minute (5 r.p.m.).

Drums at this project scale are complex pieces of equipment, and good design by a reputable manufacturer is critical. They may not be produced from scratch by local craftsmen. However, a tanner may be able to purchase one as a specimen from a manufacturer, together with the necessary sets of ironwork for the remaining drums. The woodwork and assembly of these might then be locally performed, working to the design of the specimen. This is not, however, an option to be lightly adopted, not least because these stages are crucial to the entire tanning process.

The drums are installed with various associated features to facilitate their operation (Figures IV-7(a) and IV-7(b)). These are briefly described below:

- (i) A low (30-40 cm) retaining wall surrounding each drum. This prevents flooding the tannery floor when washing sides in, or emptying the drum. A perforated cover provides an inlet to the drain. The floor inside the wall slopes slightly towards this inlet.
- (ii) The rear wall slopes outwards at its base. This deflects the sides forward when emptying them out of the drum.
- (iii) The drums may have a mixing tub each, mounted on a raised platform between them. Warm water is preferable, though not essential for bating (Stage 5), and hot water can be fed from the tub to warm up the water in the drum while it continues to rotate. The particular arrangement shown in the figure assumes the use of steam to produce hot water in the tub. Steam is not essential for this purpose, but the sketch will be of interest to tanners in cold climates, since their need for process heat is more definite and general.

The process starts with weighing the hides. Their total limed weight should be about 225% of dried hide weight or 112% of wet salted weight. Given the input assumptions noted in section I above, a daily limed weight will be $200 \times 112\% \times 14 \text{ kg} = 3136 \text{ kg}$, but this may vary from day to day. All water and chemicals usage are given below as percentages of total limed weight of any particular batch of sides.

The process is identical in each drum.

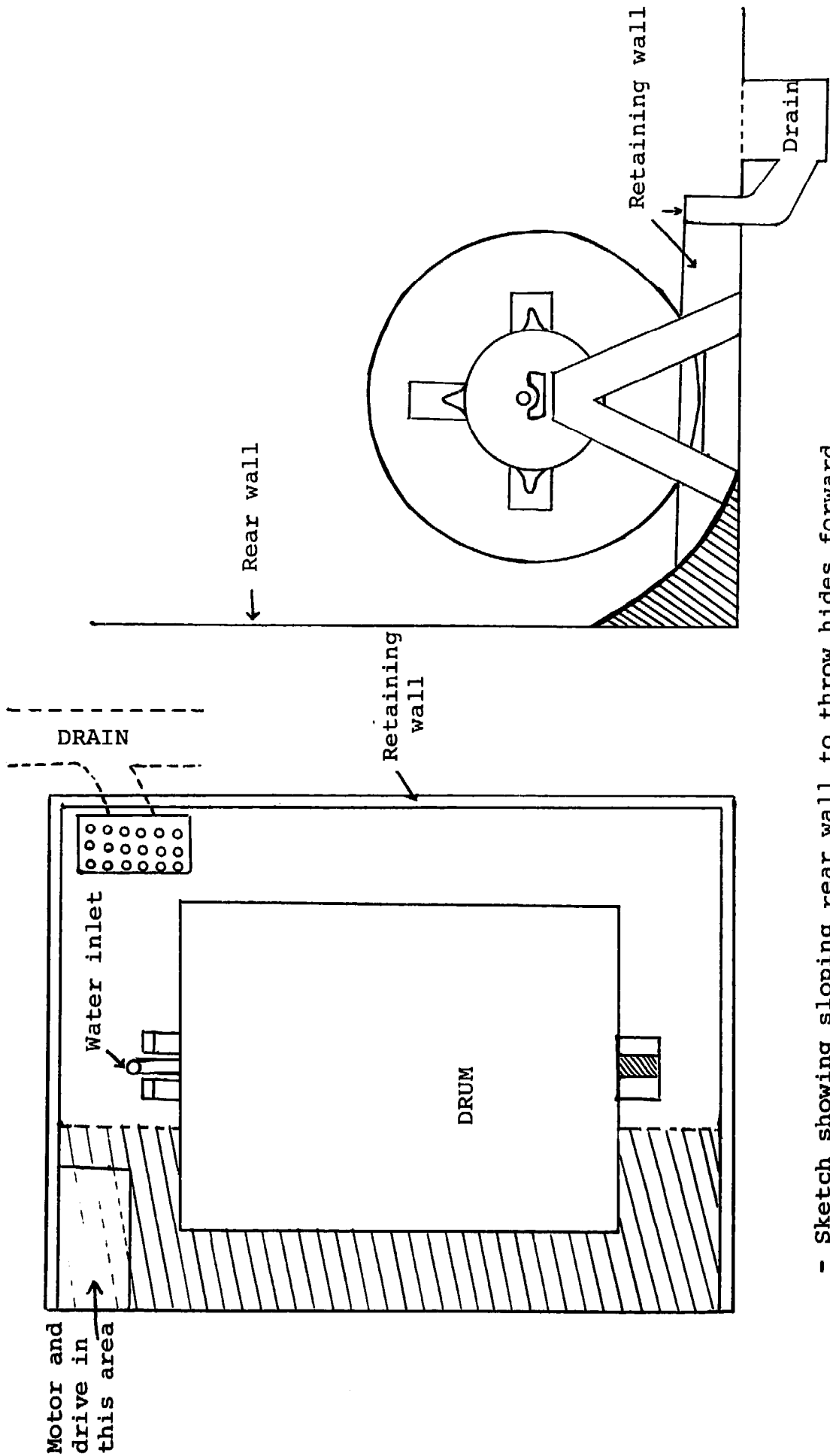

- Sketch showing sloping rear wall to throw hides forward.

- Diagram of drum is indicative only - Precise drum design will vary with manufacture.

Figure IV.7(a)

Tanning drum - Top and side views

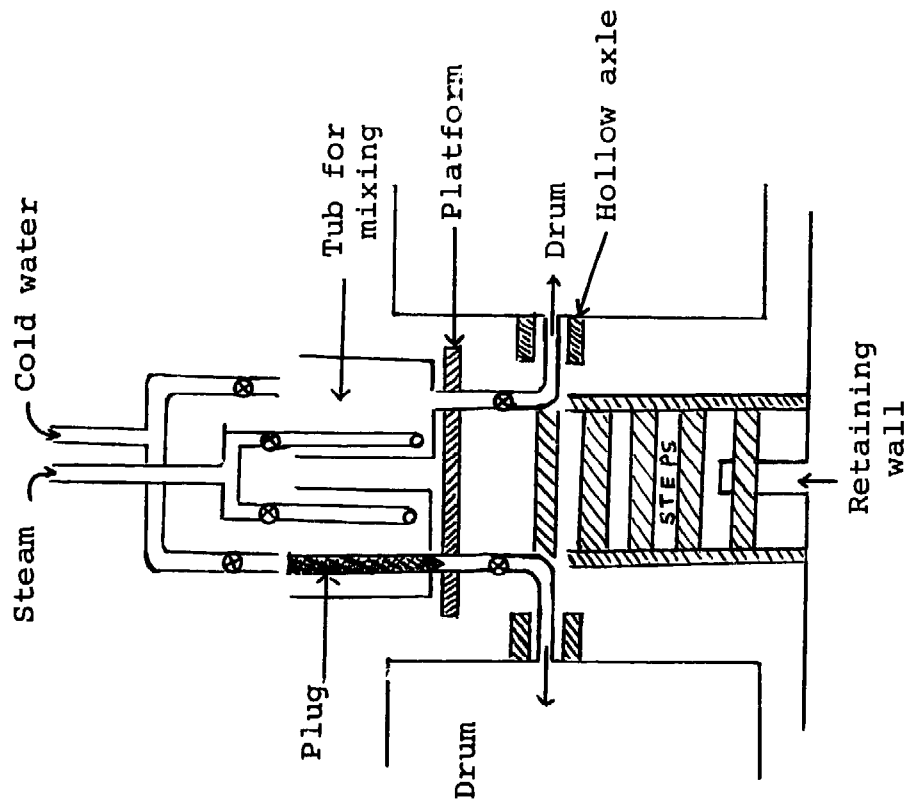

Mixing vessel for direct feeding of chemicals into drum

FRONT VIEW

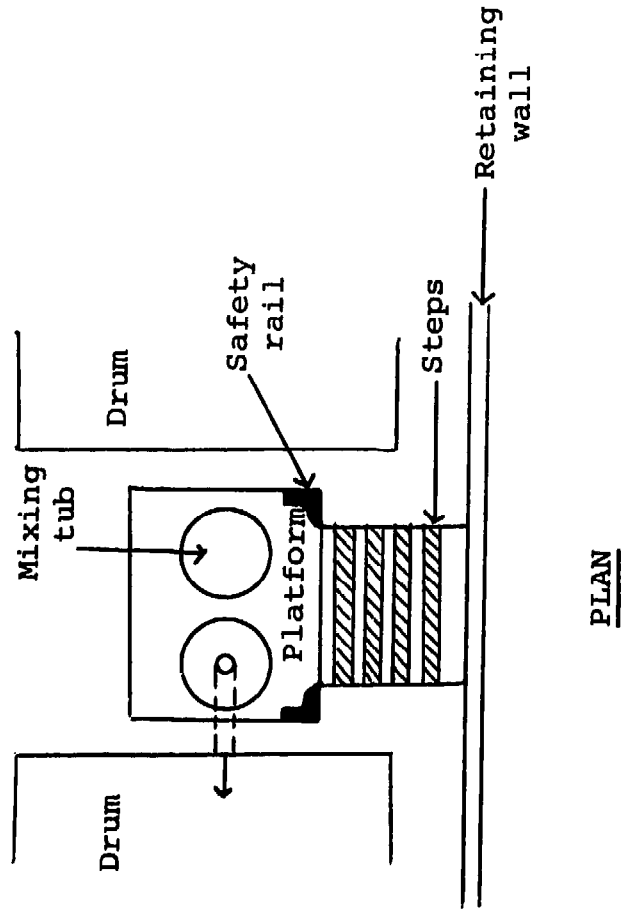

PLAN

Figure IV.7(b)
Tanning drum - Front and plan views of
mixing vessel for chemicals

Stage 4 : Deliming

The sides are washed in unheated (ambient temperature) water running for 30 minutes through the drum. Water usage is approximately equal to 500-600% of the limed sides weight. 100% to 150% of this water is left in the drum as 'float' for the liquor. 1.5% ammonium sulphate is then added and the drum is rotated for 30 minutes with sides immersed in the liquor.

At this stage, the pH¹ of the liquor should² be checked. It should be pink to phenol phtalein.

Stage 5 : Bating

Add to the liquor 1% synthetic bate (e.g. Panereol ZA)

Run the drum for 30 minutes, preferably with the liquor at 37°C. It may be raised to this temperature and kept at this temperature by adding hot water from the mixing tub.

Wash the sides in 500-600% unheated running water for 30 minutes.

¹The degree of acidity (or its converse, alkalinity) in a substance is measured on the pH logarithmic scale from 0 to 14. 0 indicates extreme acidity, 14 extreme alkalinity. 7, the mid-point, indicates a neutral substance, neither acid nor alkaline. Water is a neutral substance. Typical acids are vinegar (acetic acid) and sulphuric acid. Typical alkalis are caustic soda (used in making soap) and lime. For a technical account of the pH scale, see Sharpouse (1971), pp. 57-61.

²Phenol phtalein is the active ingredient in one of a number of common indicator papers for determining ranges of pH. If dipped in liquors ranging from pH 8.2-9.8, the colour of the paper will range from white (colourless) to red. Thus, the pH after deliming, if phenol phtalein is pink, will be between 8.2 and 9.8, the desired range at that point. Other useful papers are congo red, which changes from blue to red over the pH range 3.0-5.2, and brom cresol purple, changing from yellow to purple over the range 5.3-6.8. There are also available mixed or 'universal' indicators which range through a variety of colours over a very wide pH range. The tanner should consult a supplier of tannery chemicals.

Stage 6 : Pickling

Reduce the 'float' (amount of liquor in the drum) to 60%

Add 5% salt and 0.5% calcium formate

Run 10 minues

Add 1.25% sulphuric acid, diluted in 10% unheated water

Run 1 hour

Stage 7 : Chrome tanning

Add 3% chrome powder (25%Cr₂O₃, 33,3% basic)

Run 1 or 2 hours, according to the time available , and lie overnight

Next morning, run 15 minutes

Add 4.7% chrome powder (as above) and 0.7% alkaline agent (e.g. compound 3B)

Run about 6 hours. The pH at the end of the run should be 3.8-3.9 and the liquor temperature should have arisen spontaneously to 30-35°C

Drain drum, empty out sides and transfer them to pallets for draining.

Flow diagram : Stages 4 to 7

From stage 3

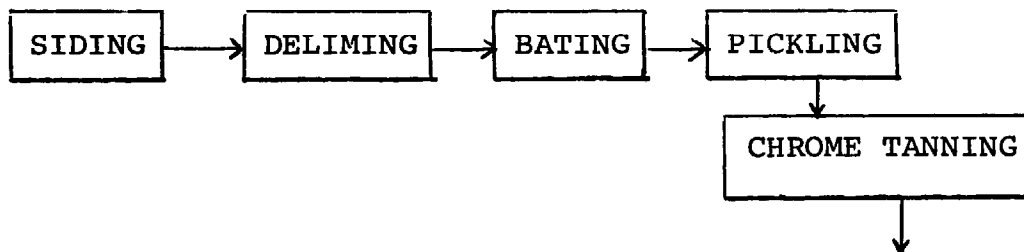

Schedules

- Equipment.

- . 4 drums, 2.5 m x 2 m diameter (internal dimensions) or 1 such drum and 3 sets iron work for local woodwork, and assembly of 3 more such drums.
- . A 7.5 kw motor for each drum.
- . 4 sets of associated featured walls, mixing tubs , etc. (see Figures IV.7(a), IV.7(b)).
- . Thermometers (up to 5, including 1 spare).

Associated features may be locally manufactured, including possibly the woodwork and assembly for 3 drums.

- Water, chemicals, heat, electricity.

Daily usages (assuming a daily limed weight of 3136 kg)

- | | |
|---------------------|---|
| . Water | 36 m ³ approximately (18 for deliming, 18 for bating and 0.3 for pickling) |
| . Ammonium sulphate | 47 kg |
| . Synthetic bate | 31 kg |
| . Salt | 157kg |
| . Calcium formate | 16 kg |
| . Sulphuric acid | 39 kg |
| . Alkaline agent | 22 kg |
| . Chrome powder | 241.5 kg |
| . Process heat | Little or none, except in cold climates. If bating is done at 37°C, then 600-800 litres of boiling water may need to be added slowly to the liquor. For heating arrangements, see stage 28. |
| . Electricity | 4 drum motors x 7.5 kw x 5 hours approximately (averages over 2-day cycle)=150 kw/h |

- Labour. Three workers will be needed. Normal care and vigilance are required, but the process is fairly straightforward with modern chemicals. Nevertheless, because delimiting, bating and tanning are crucial, the foreman for the 'wet' stages (2-13) should supervise closely stages 4 to 7.

Stage 8 : Draining and Sammying

Process description

The sides have now become 'pieces' of 'wet blue' leather. They are piled on top of each other (in piles of about 50) on wooden pallets for 24 hours. This, the drainage stage, allows drainage of excess tan liquor, and permits fixation of any as-yet uncombined tanning agent in the leather.

After this, the pieces are semi-dried ('sammed' or 'struck out') by laying each one on a table, flesh side up, and pushing forward over the surface with a hand-tool called a 'slicker' (Figure IV.8). The blade of this tool is blunt or rounded, and is made of a corrosion-resistant hard substance such as brass, glass, stainless steel or plastic. The pressure exerted via the blade squeezes out further moisture from the leather.

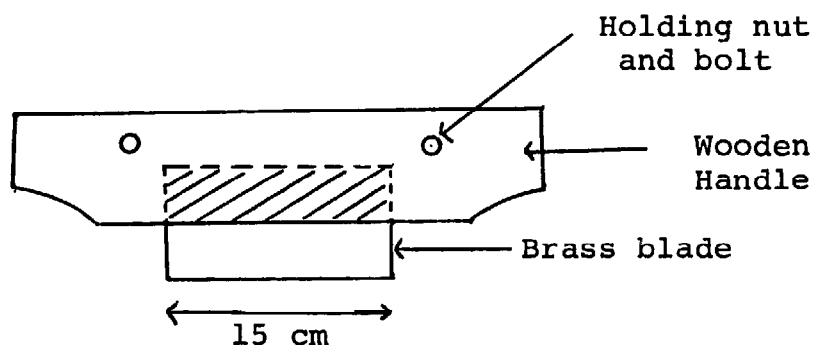
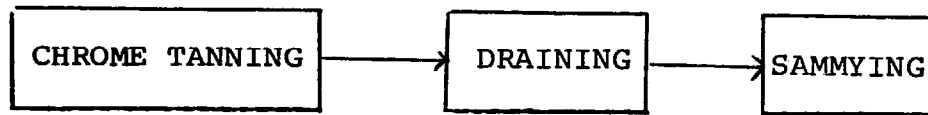

Figure IV.8

Slicker

Flow diagram : Stage 8 :



From stage 7

Schedules

- Equipment.

- . 8 wooden pallets, each 1.5 m x 1 m x 15 cm high
- . 3 wooden tables with plastic or formica tops, each 2 m x 1.2 m x 1 m high
- . 4 slickers (including 1 spare).

- Water, chemicals, heat, electricity. None.

- Labour. 2 workers are needed for most of the time, plus 1 worker borrowed from time to time from other stages. Normal care and vigilance.

Stage 9 : Setting

Process description

The pieces are turned grain side upwards on the tables and the slickers are used as in stage number 8 above. This removes further moisture, and also 'sets' the grain, that is, flattens out creases and smooths the grain surface.

The leather is then ready for splitting.

Flow diagram : Stage 9

From stage 8



Schedules

None. All input requirements are included in Stage number 8 above.

Stage 10 : Splitting

Process description

Splitting is done on an electrically-powered band knife splitting machine. An endless band knife is driven transversely across the line of flow of the leather, splitting the pieces as they are driven past it through the machine by the action of powered rollers. The machine is complex, and should be purchased from a reputable manufacturer. Careful setting and operation are crucial. If the grain upper portion is too thin it loses in value, whereas if it is too thick, the splits will lose in value and an unnecessary amount of work will have to be done in shaving the upper leather down to the required thickness.

The thicknesses actually required will naturally vary with the demands of particular markets, but the machine is capable of adjustment to produce various thicknesses.

Flow diagram : Stage 10

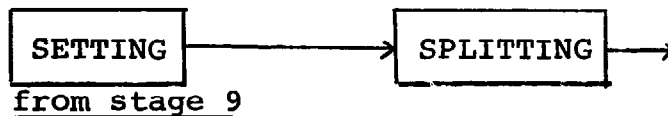

Schedules

- Equipment.

- . 1 band knife splitting machine

This is manufactured in a few countries.

- Water, chemicals, heat, electricity.

Daily usages:

- . Electricity : 13 kw x 4½ hours = 59 kw/hr.

- Labour. 4 workers are needed. They may be shared with stage number 11 below. Skill in setting and adjusting the machine is required, possibly from the foreman. Operators must be able to recognise when an adjustment is necessary.

Stage No. 11 : Shaving

Process description

Descriptions from this point on are slightly complicated at certain stages as there may be two parallel production flows: for grain upper leather and for splits. This complication is kept to a minimum by mentioning splits explicitly only when the process which applies to the latter differs from that which applies to upper leather (whether by omission of an operation, or in different process details). Unless such separate mention is made, the process described can be assumed to apply both to upper leather and splits.

Shaving is performed on an electrically-powered shaving machine. The pieces are fed through powered rollers into the machine past a rotating cylinder with cutting blades mounted on it for shaving unevenness or excess thickness off the leather. Like the splitting machine, this is a specialist equipment manufacturer's item.

The upper leather should be shaved immediately after being split, and then transferred to the retanning drum (stage No. 12) as soon as possible.

The splits will normally be less uniform than the upper leather, and will probably need trimming, as well as sorting for thickness and area, before being shaved. If they have to be left overnight before shaving, they should be piled under plastic sheeting, on pallets on a clean floor in order to prevent them from drying out. In this project, it is assumed that they are shaved on the same day.

Flow diagram : Stage 11

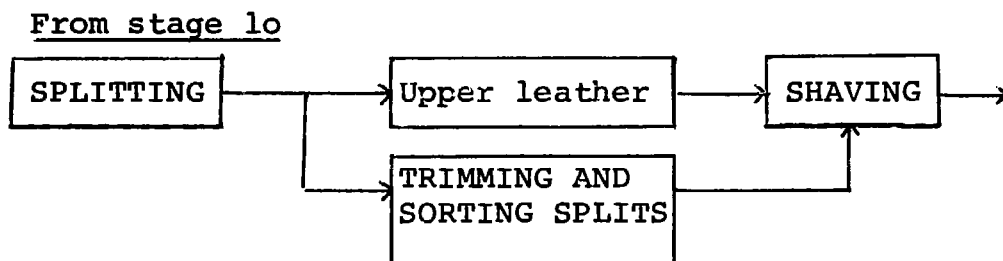

Schedules

- Equipment.

- . 1 shaving machine
- . 3 or 4 pairs of strong scissors (say 15 cm blades) for trimming splits, plus possibly 2 or 3 pallets and 6-8 m² of plastic sheeting.

The pallets and possibly the scissors should be locally available.

- Water, chemicals, heat, electricity.

Daily usages:

- . Electricity : 42 kw x 4½ hours = 189 kw/hr.

- ### - Labour. It is the same labour as that included in stage number 10 above. Normal care and vigilance required for shaving. Operator skill will increase hourly throughout.

Stage No. 12 : Retanning, Dyeing and Fatliquoring

Process description

This is a combination stage performed in drums similar to, but smaller than, those used for the stages from delimiting to tanning. Like those stages, this one involves immersion and agitation of the goods in a succession of liquors. The features associated with the drums are analogous to those for tanning drums (though, of course, on a proportionally smaller scale), and the tanner is referred to Figure IV.7(a) and IV.7(b) which apply equally to this stage.

Three drums, each 2.5 m x 1.2 m diameter are required - the first two for the upper leather -, each drum handling two batches of 100 pieces daily. The third drum is used for the splits, handling them in two equal batches daily. The processes are short enough to permit this daily double-batching in one drum.

The processes are as follows, all quantities of water and chemicals being given as percentages of the shaved weight of leather input:

(a) Grain Upper Leather

Retanning

- The pieces are weighted then lie overnight, from shaving, in 100% unheated water in the drums.
- Wash in 300% water, preferably at 40°C, for 15 minutes.
- Drain.
- Add 40% water, preferably at 40°C, and 8% retanning and neutralising agent (e.g. Retannex HP).
- Run 30 minutes.

Dyeing

(If required: may be omitted if a neutral back leather is required)

- Add 50% water at 60°C and run 5 minutes.
- Add 1% acid dye in 10% water at 60°C and run 20 minutes.
- Add 0.5% formic acid in 5% water at 60°C and run 20 minutes, then drain.

Fatliquoring

- Add 100% water, preferably at 40°C.
- Add 2.5% sulphited oxidised cod oil (e.g. Trisul C.E.X.),
2.5% sulphited whale oil (NB: not sperm oil), (e.g. Cremol SW), and
1% raw nealsfoot oil, or substitute (e.g. Remsynol 58).
- Run 60 minutes.
- Drain.
- Empty out the leather and pile over a horse to drain overnight.

(b) Splits (process for suede shoe linings)

The splits should be about 1.0 - 1.2 mm thick. They may be placed on a glass-topped table with an electric light (say 40w) shining from below. If the light shines through parts of the split, these parts should be trimmed off and discarded before the process begins.

Retanning

- Weigh the splits and place them in the drum.
- Wash 250% unheated water into drum over a 15 minute period, then drain.
- Add 100% unheated water, preferably at least lukewarm.
- Add .4% chrome powder (25%Cr₂O₃, 33% basic), and
 .4% alum synthetic tanning agent (e.g. Neosyn RH).
- Run 45 minutes.

Dyeing

Not required, therefore omitted.

Fatliquoring

- Add 3% sulphited oxidised fish oil (e.g. Trisul A15).
- Run 3 hours.
- Drain and wash with 300% unheated water for 15 minutes.
- Drain again.
- Empty out the splits and pile over a horse to drain overnight.

Flow diagram : Stage 12

From stage 11

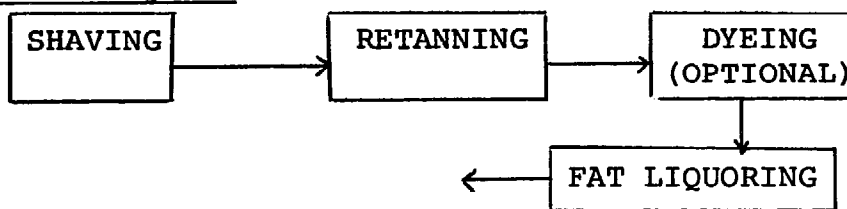

Schedules

- Equipment.

- . 3 drums, 2,5 m x 1.2 m diameter (internal dimensions), or 1 such drum and 2 sets ironwork for local woodwork and assembly of 2 more such drums. Each drum motor, 5 kw.
- . 3 sets associated features (walls, mixing tubs, etc. - See Figures IV.7(a) and (b)).
- . Thermometers (up to 4, including 1 spare).
- . 1 glass-topped table, 1.5 m x 1 m x 1 m high, plus electric light.

Associated features may be manufactured locally, including possibly the woodwork and assembly for 2 drums and the glass-topped table.

- Water, chemicals, heat, electricity

Daily usages:

(Based on 6.5 kg input of upper leather, and 2.5 kg of splits, per hide).

| | <u>Upper leather</u> | <u>Splits</u> |
|---------------------------------|----------------------|---------------------|
| . Water | 7.9 m ³ | 3.25 m ³ |
| . Retanning agent | 104 kg | - |
| . Chrome powder | - | 20 kg |
| . Alum, synthetic tanning agent | - | 20 kg |
| . Acid dye | 13 kg | |

| | <u>Upper leather</u> | <u>Splits</u> |
|-------------------------------|---|-----------------------------|
| . Formic dye | 6.5 kg | - |
| . Sulphited oxidised cod oil | 32 kg | - |
| . Sulphited whale oil | 32 kg | - |
| . Raw nealsfoot oil | 15 kg | - |
| . Sulphited oxidised fish oil | - | 15 kg |
| . <u>Process heat</u> | 400-900 litres of boiling water assuming a warm climate | |
| . <u>Electricity</u> | 10 kw x 2.5 hours = 23 kw/hr | 5 kw x 3.5 hours = 19 kw/hr |

- Labour. Two workers are needed. These should be supervised by the 'wet stages' foreman, since this is a crucial stage, particularly for the upper leather.

Stage No. 13 : Draining and Setting

Process description

The pieces are taken from fatliquoring and piled over wooden horses (Figures IV.9) overnight, probably no more than 2 piles of 50 pieces per horse. This permits draining and allows the fatliquor to stabilise in the leather. As Figure IV.9 shows, the horses have wheels and are suitable for transporting the leather between stages. In this respect, they are alternatives to the wooden trucks shown in Figure IV.1.

After draining, the pieces are 'set' with slickers on tables. The operation repeats that noted in stage number 9 above. Here, however, the pieces are set on both sides. They are first set on the flesh or inner side, then re-set on the grain or outer side. Before the re-setting, the pieces are allowed to dry partially by hanging them for a couple of hours from wooden hangers on rails (Figure IV.10).

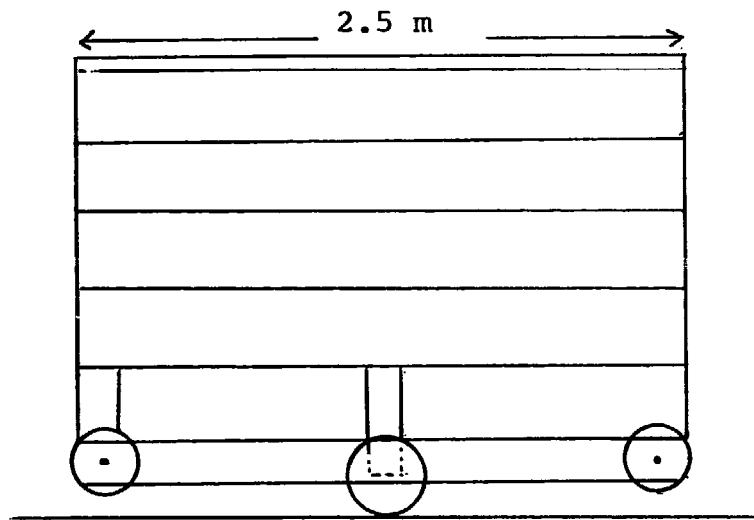

SIDE VIEW

The end wheels are set higher than the centre wheels to allow easy turning. The illustration gives a horse 2.5 m in length and 1.5 m high to hold two lots of sides

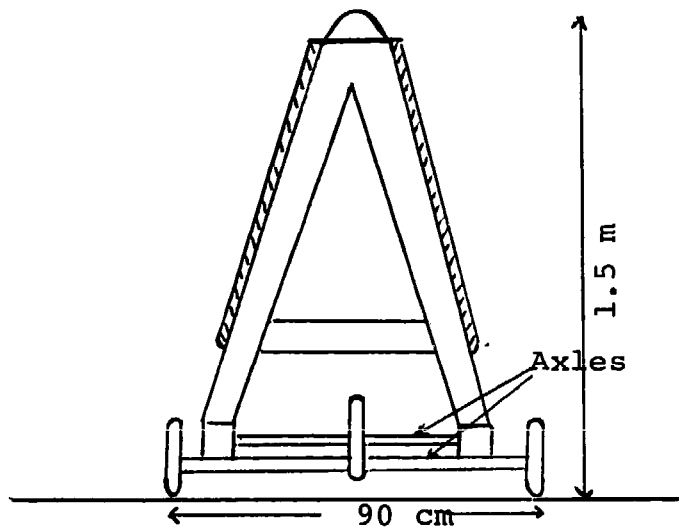

END VIEW

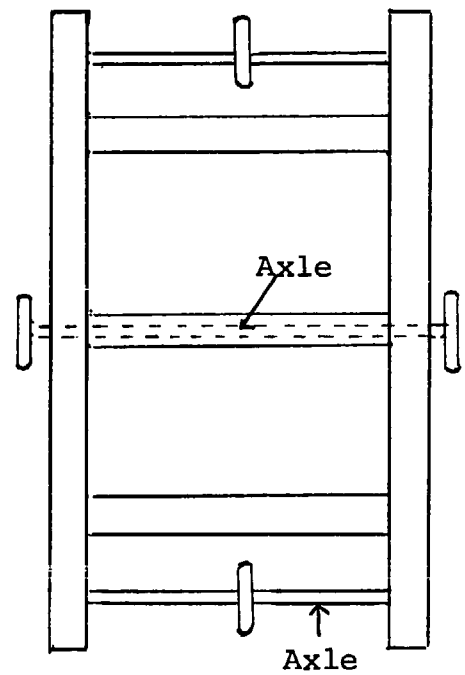

BASE

Figure IV.9

Horse with wheels for draining and transferring leather

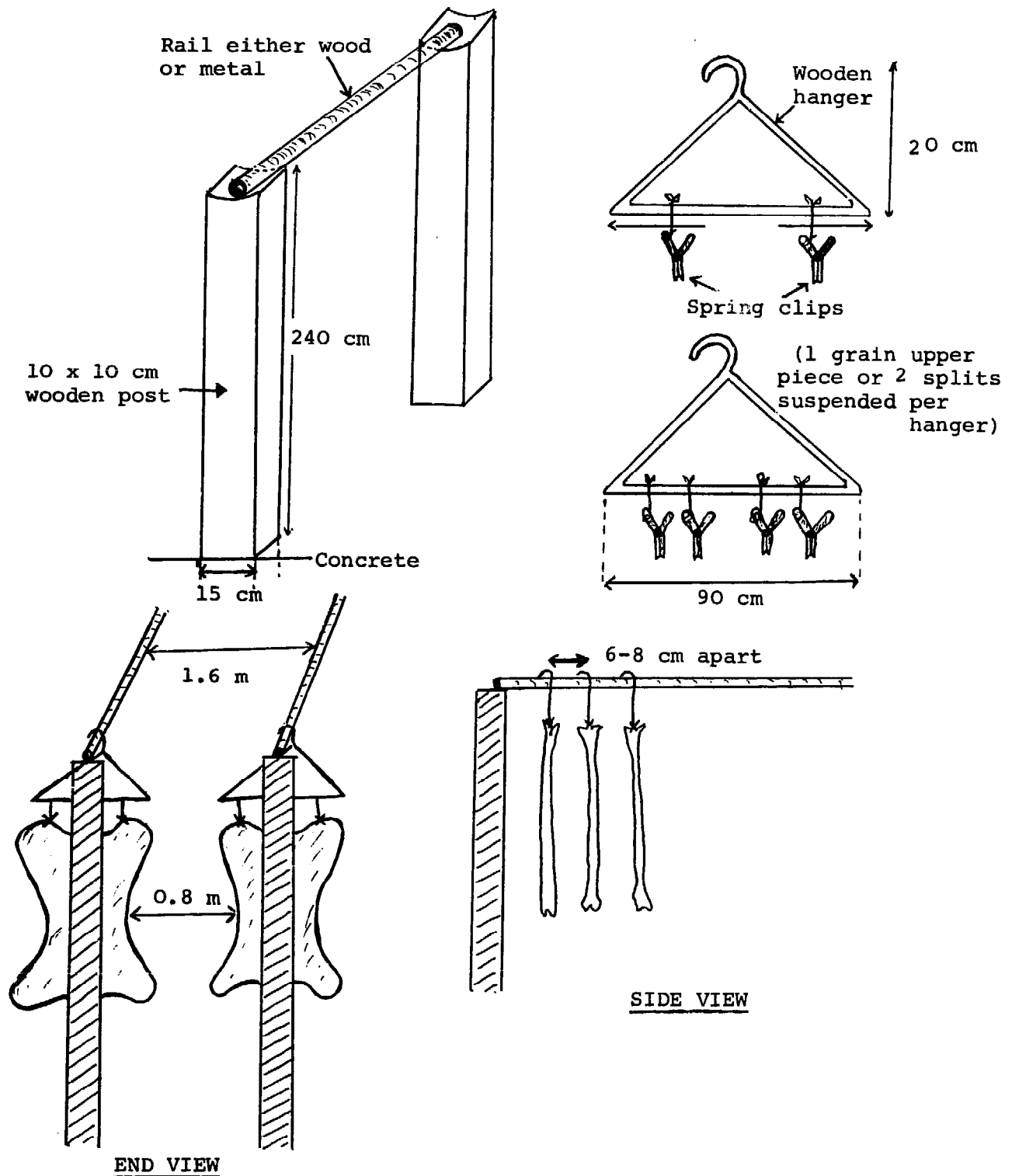
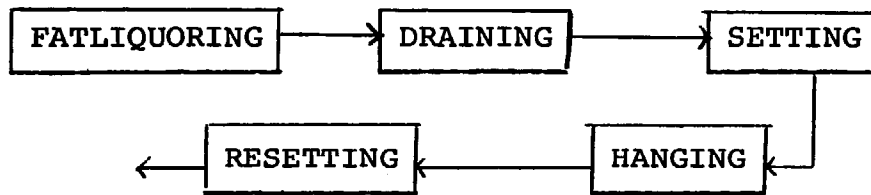

Figure IV.10
Rails for hanging leather

Flow diagram : Stage 13

From stage 12



Schedules

- Equipment.

- . 3 wooden tables with plastic or formica tops, each 2 m x 1.2 m x 1 m high.
- . 4 slickers (including one spare)
- . 40 m of rails, 2.4 m high (see Figure IV.10) and 600 hangers with 1600 clips
- . 6 wheeled wooden horses (see Figure IV.9) 2.5 m x 1.5 m high

All equipment may be manufactured locally.

- Water, chemicals, heat, electricity.

None.

- Labour. Two workers are needed for most of the time, plus 3 workers borrowed from time to time from the next two stages. Normal care and vigilance required.

Stage No. 14 : Drying

Process description

After re-setting, the pieces are hung from the same rails as before and left to dry overnight.

Flow diagram : Stage 14

From stage 13



Schedules

- Equipment.
 - . 40 m rails, included in stage number 13 above.
- Water, chemicals, heat, electricity
None.
- Labour. Eight workers are needed, shared with stage 15 (conditioning) and also, from time to time, with other stages. Normal care and vigilance required.

Stage No. 15 : Conditioning

Process description

The leather is conditioned for staking by dipping it in water and then piling it overnight, in piles of about 50 pieces, under plastic sheeting on a clean floor.

Flow diagram: Stage 15

From stage 14

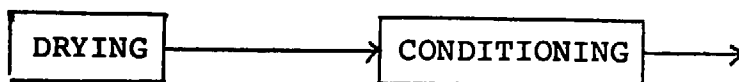

Schedules

- Equipment.
 - . 2 concrete dipping troughs, 2 m x 1 m x 50 cm deep
 - . Approximately 25 m of strong flexible plastic sheeting, say 3-5 mm thick
- Water, chemicals, heat, electricity

Daily usages

- . Water : 1 m³

- Labour. Included in stage number 14 above.
Normal care and vigilance required.

Stage No. 16 : Staking

Process description

Staking is performed on an electrically-powered 'Slocomb'-type machine. A piece of leather is clamped in a fixed clamp at one end, then placed between two arms of a jaw which moves back and forth in a rapid reciprocating horizontal motion. The lower arm is fitted with upright steel blades, the upper with steel rollers. On the outward stroke of the motion, the arms close on the leather. As they move back on the inward stroke, the leather is flexed and stretched over the blades. Then the motion cycle starts again. The number of repetitions per piece depends on the degree of softness required by particular markets, and also on the machine purchased. This is a complex item of specialist equipment and should be obtained from a reputable manufacturer.

Two such machines are required for a project of this scale, each handling half the daily throughput.

Flow diagram : Stage 16

From stage 15

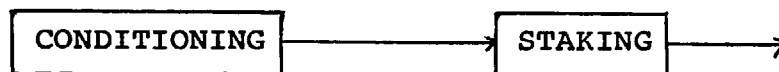

Schedules

- Equipment.
 - . 2 'Slocomb'-type staking machines.
- Water, chemicals, heat, electricity

Daily usages

- . Electricity : 2 x 4 kw x 5 hours, approximately = 40 kw/hr

- Labour. 2 operators are needed. They must exercise care and skill in avoiding tears or deformation of the leather. Training and experience is advisable.

Stage No. 17 : Drying and flattening

Process description

The leather is nailed out on wooden boards and left to dry overnight. This stretches and flattens it. 300 boards are required, each accomodating one grain upper piece, or two splits, on each side. The boards rests above the floor on wooden supports or a low wall and are stacked against wooden uprights (Figures IV.11(a) and IV.11(b)). The distance pieces shown as part of each board, ensure that the centre struts, and the pieces of leather nailed to them, are kept out of contact with each other. Movable wooden trestles permit easy working: a board can rest horizontally on a trestle while the leather is being nailed on or detached the following day.

Flow diagram : Stage 17

From stage 16



Schedules

- Equipment.

- . 300 wooden boards (1.5 m x 1m) with 2,500 2 cm nails, preferably galvanised or brass
- . 6 sets of supports, each set with 2 parallel horizontal supports, 10 m long by 0.2 m high, and 2 transverse uprights 1.5 m long by 1.4 m high
- . 3 movable wooden trestles, 1.5 m x 1m x 0.85 m high

- Water, chemicals, heat, electricity.

None.

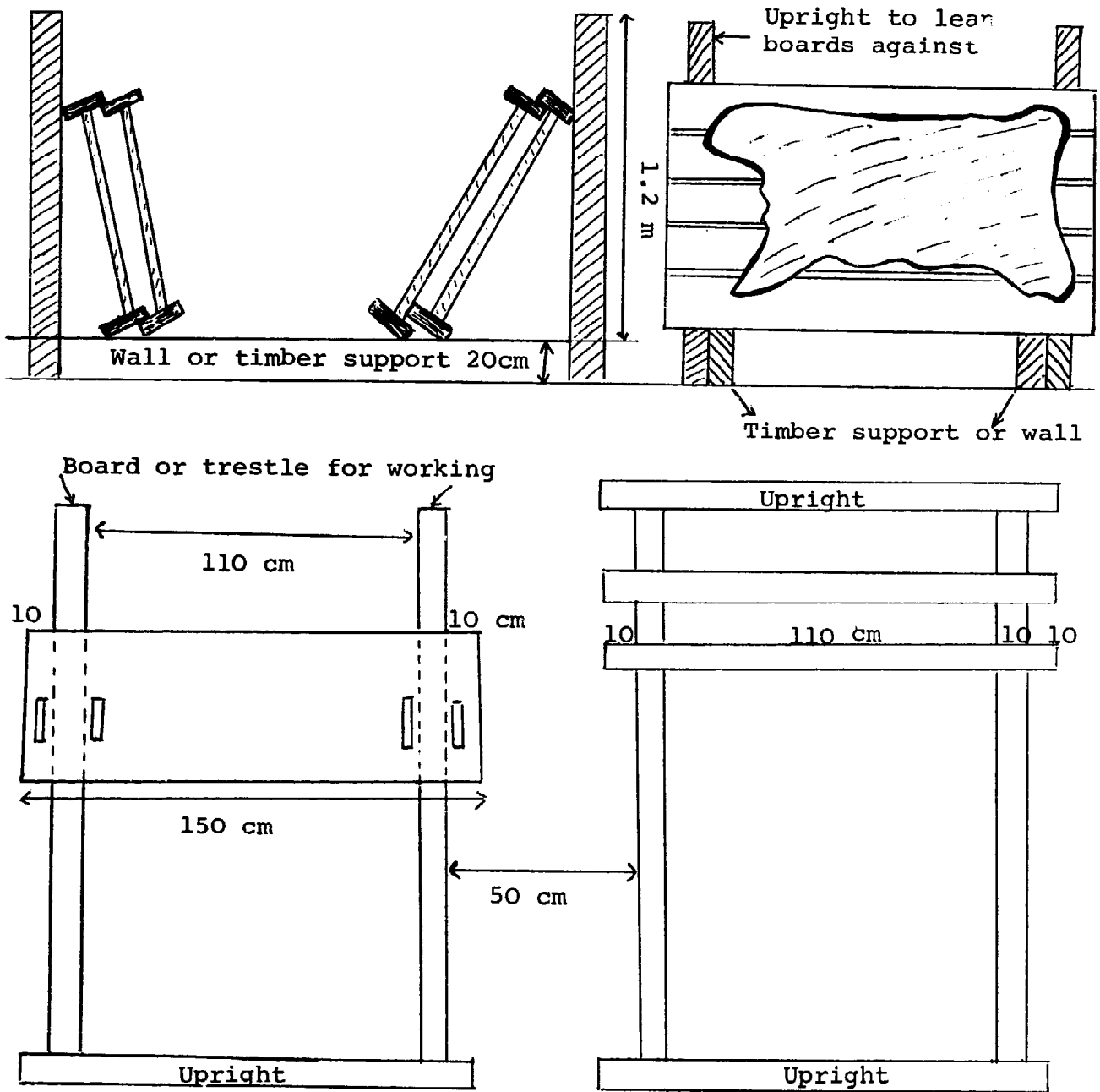

TOP VIEW

Figure IV.11(a)

Nailing boards

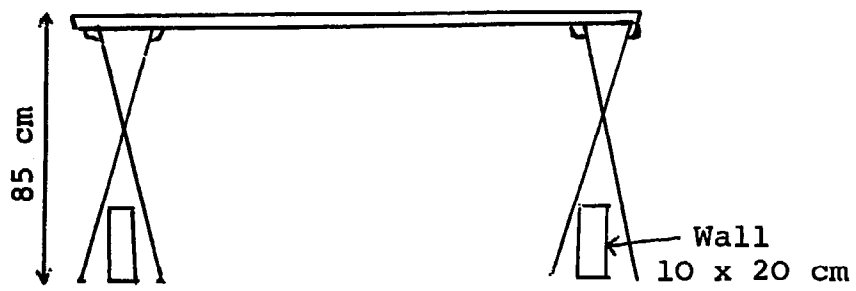
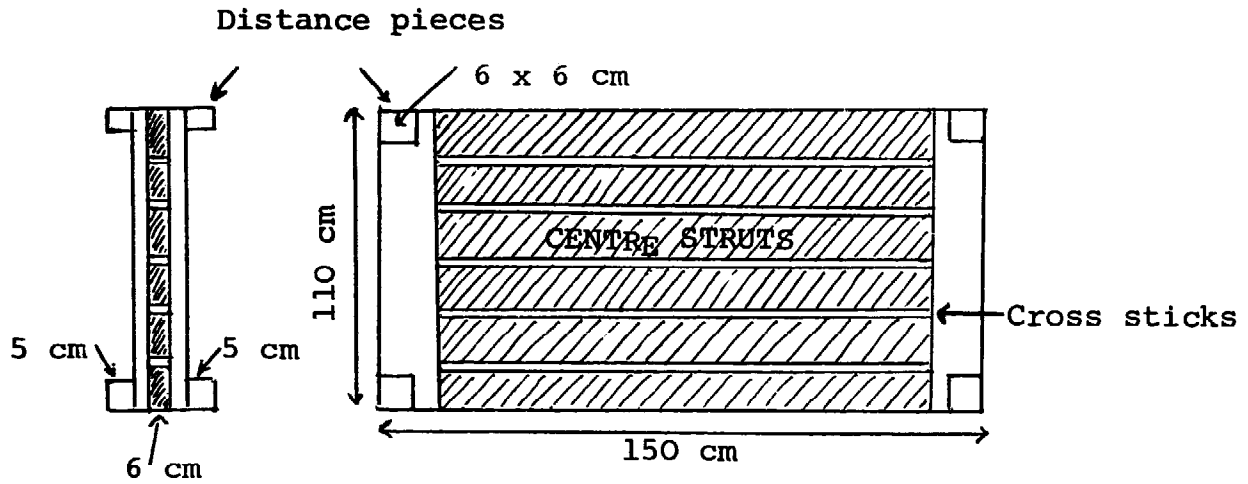

SIDE VIEW

Figure IV.11(b)

Nailing boards

- Labour. 6 workers will be needed. Normal care and vigilance required.

Stage No. 18 : Buffing

Process description

Buffing removes blemishes from the surface of the leather by grinding with an abrasive. It is done by machine in a separate, enclosed buffing chamber within the tannery. The leather, having been fed into the machine by the operator is guided by powered rollers past a rotating cylinder roller wrapped around with paper ('buffing paper') coated with an abrasive material. Adjacent rotating brushes and a ducting system remove the resultant dust. The machine is placed against the tannery wall, and the dust passes in a duct through the wall to collection bags outside, which must be emptied periodically of the accumulated dust. Meanwhile, the leather is fed back to the operator standing at the front of the machine.

Two machines are required, a large one for handling the grain upper leather and some of the splits, and a small one for splits and preliminary 'rough' work on large blemishes with coarse buffing papers. Both are complex, electrically-powered, specialist items, and should be purchased from a reputable manufacturer who will also advise on types and consumption rates of buffing papers. The grain upper will require a finer paper, say 400 grade, than the splits. The latter need 220 paper, which is appropriate for finishing suede shoe linings.

All remaining dust on the leather after buffing must be carefully removed to avoid spoiling the subsequent finish. This is done by brushing off the dust by hand on tables. The tables should be outside the tannery walls whenever possible, to eliminate the risk of dust dispersion within the tannery. When weather does not permit work outside under the eaves of the roof, the tables should be placed in a far corner of the buffing chamber, which should be carefully swept and washed down after each day's operations.

Note that the physical process for splits is now completed, although of course, measuring, sorting, etc remains.

Flow diagram : Stage 18

From stage 17

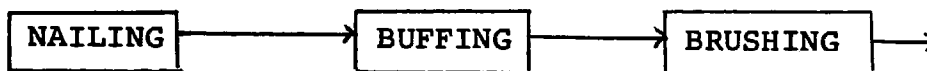

Schedules

- Equipment.

- . 2 buffing machines, a small one and a large one.
- . 4 brushing tables, wooden with plastic tops, 2 m x 1.5 m x 1 m high
- . 5 soft brushes (including one spare)

- Water, chemicals, heat, electricity

Daily usages

- . Buffing papers: To use, for example, grades 400 and 220. The manufacturer should be consulted for grades and consumption rates
 - . Electricity: 1 x 15 kw x 6 hours, plus 1 x 2.5 kw x 6 hours = a total of 105 kw/hr.
- Labour. 8 workers will be needed, including 4 for brushing. They may be shared from time to time with other stages. Care required, particularly for brushing. Training in careful working habits is indicated. However, this stage does not require high skills.

Stage-No. 19 : Padding and Drying

Process description

Finishes have now to be applied to the (grain upper) leather. This process which involves a long and complex sequence of operations (see flow diagram overleaf) starts with padding. The pad is a wooden block, sized for easy holding in one hand by the operator, to which a piece of high-grade plush cloth has been attached (see Figure IV.12). The pad is dipped in a prepared fluid finish, and rubbed evenly across

the grain side. The action of the bristles of the cloth on the leather surface aids absorption of the finish so that the latter remains firmly fixed in the leather during drying and ironing. During padding, the piece of leather rests on a table with a smooth washable top.

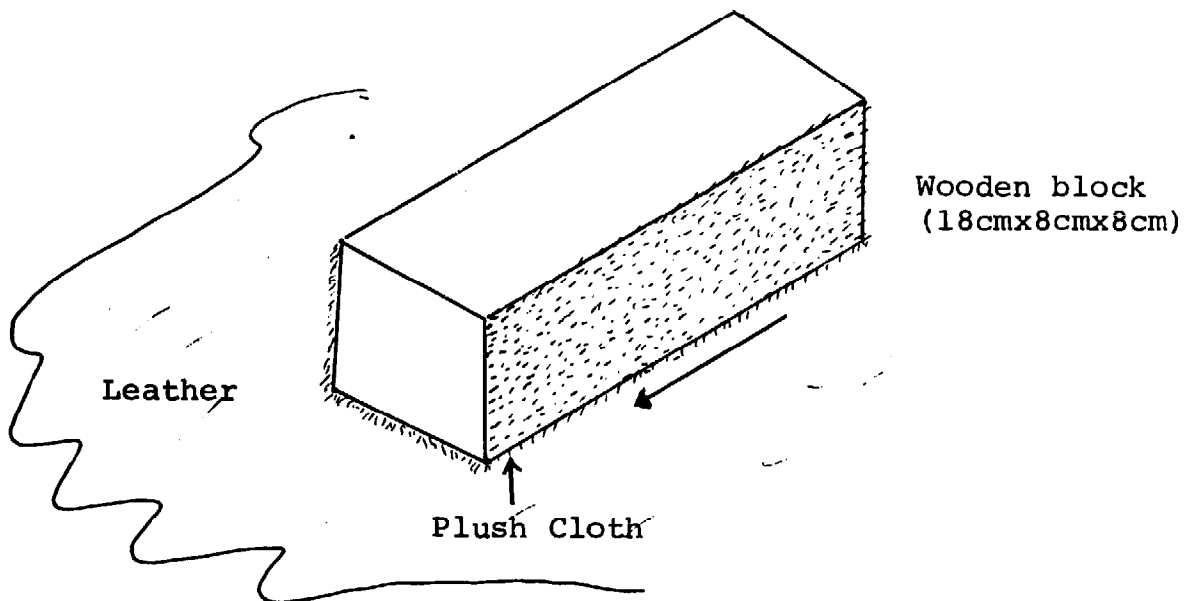

Figure IV.12
Pad for applying finishes

Many particular regimes of application and fixing of finishes are possible. Those described below (stage numbers 19 to 21) are for corrected grain upper leather.

A filler finish is made up from:

- 700 parts water
- 200 parts filler finish (e.g. Encryl 1 MP)
- 100 parts penetrating agent (e.g. Penetrator 113)

This mixture is applied by pad to the grain side. About 215 g. should be applied per m², in two or three

consecutive coats. To determine how many coats are necessary to achieve the required weight, a sample piece in a batch should be weighted before and after successive applications.

The leather is then dried by hanging from rails like those already described in stage number 13 above (Figure IV.10), except that the pieces will probably be hung 10 cm, rather than 6-8 cm, apart, thus minimizing unwanted contact between the still-wet finished and adjacent pieces. Hangdrying takes about 1-2 hours, after which the pieces are piled flat overnight, grain side up, in piles of about 50 pieces on wooden pallets.

The next day the pieces are examined, and any with serious surface blemishes should be re-buffed with fine grade paper.

Stages 19 to 21 : Finishing stages

Explanatory note:

The process involves a series of operations which cannot readily be divided into distinct 'stages'. The complete sequence of finishing operations, from the start of stage number 19 to the completion of stage number 21, is represented in the flow diagram below, which also indicates the inevitably rather artificial 'divisions' which have been made between stages to break up and simplify the exposition.

It may be seen from the flow diagram below that the process intermingles padding, drying, spraying and ironing (plating) operations which all work together to 'finish' the leather. Nevertheless, these operations are evidently physically different from one another, and their sequence varies with the type of leather. It is therefore worth distinguishing padding, spraying and plating as separate stages, particularly since - as noted above - such operations breaks up an exposition which would otherwise be too long for ready comprehension.

Thus, stage number 19 is considered to end at the completion of hang-drying after the padding of the second-application of colour coat. Stage number 20, (spraying and drying) ends with the spraying of the first coat of fixative. The remaining operations fall into stage number 21 (plating).

Flow diagram : Stage 19 to stage 21

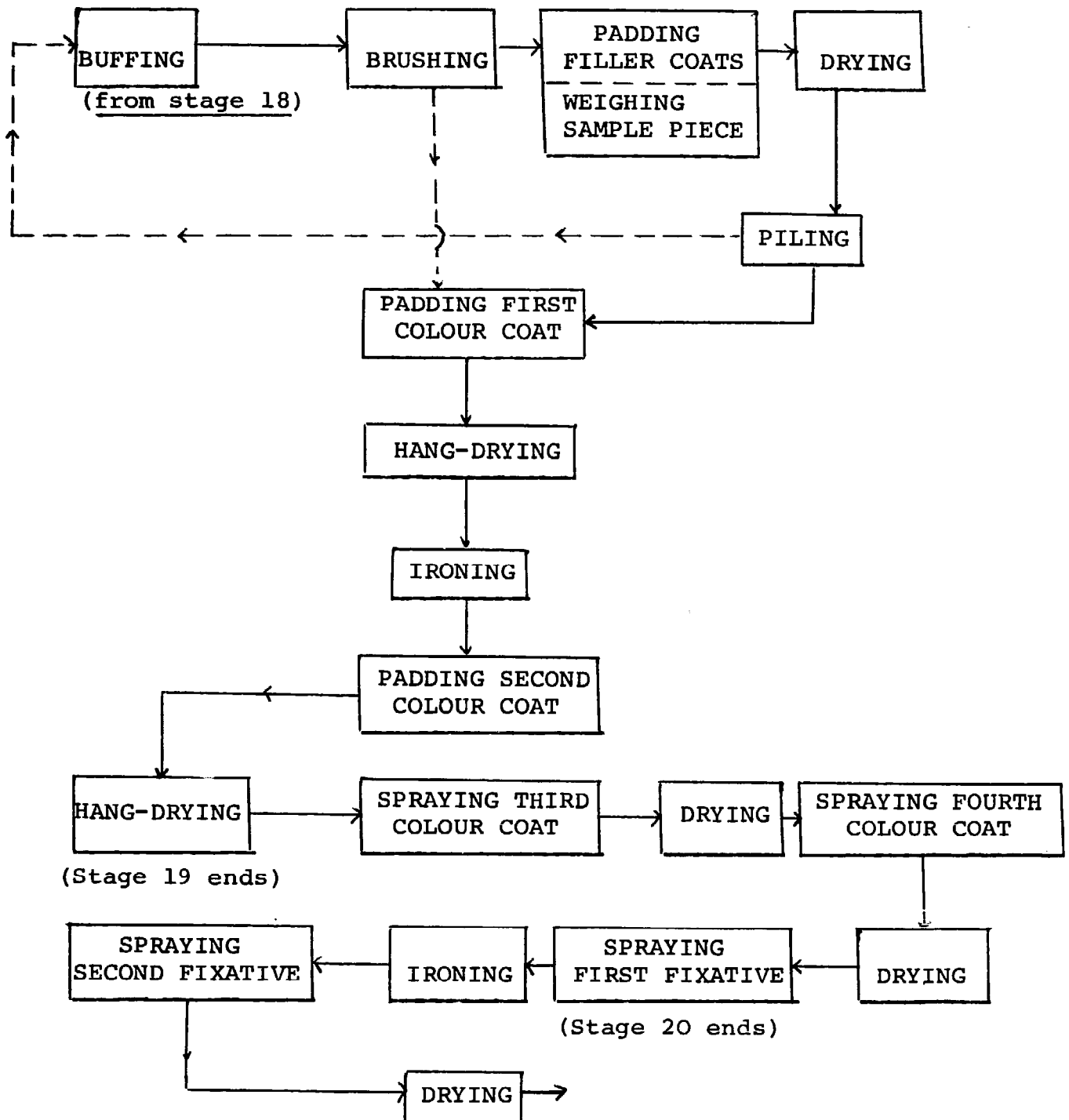

The operations are described in the order in which they occur, but the stage schedules accumulate the inputs required for all padding operations under stage number 19, for all spraying operations under stage number 20, and for all ironing operations under stage number 21. All borrowings and sharing of inputs between stages are duly noted.

Continuation of process description

After any necessary re-buffing, a colour finish is made up from:

- 575 parts water
- 150 parts pigment paste
- 25 parts wax (e.g. FF50)
- 250 parts finish (e.g. Encryl FN)

A total of 295g/m^2 should be applied between four coats on the grain side, the first two by padding. Again, the achievement of the required weight may be checked by re-weighing a sample piece, probably after the third coat, which is applied by spraying in stage number 20.

After the first application by pad, dry off the leather by hanging from rails as before.

Iron the finish with a heavy laundry type hand-iron set at 65°C , to impart gloss and uniformity. The leather is set on ironing tables.

Pad again with the colour finish and dry off by hanging from rails.

Schedules

- Equipment.

- . 12 pads, wooden with plush cloth (including one spare)
- . 10 tables, wooden with plastic or formica tops, 2 m x 1.5 m x 1 m high
- . 2 wooden or plastic mixing tubs, each of a capacity of about 100 litres

- . 40 m of rails, 2.4 m high
- . 400 hangers with 800 clips (see Figure IV.10)
- . 1 pair of scales to weigh up to 10 kg of leather, accurate to 10 g (shared with stages number 20 and 21)

All equipment, except the scales, may be manufactured locally. The rails are shared with stage number 21, also serving for the final hang-drying that concludes that stage.

Hand-irons and ironing tables are recorded under stage number 21, plating.

- Water, chemicals, heat, electricity

Daily usages

(based on 520 m² throughput of grain upper leather, and including at this stage the materials for all four coats of colour finish).

- . Water 0.167 m³
- . Filler finish 22.4 kg.
- . Penetrating agent 11.2 kg
- . Pigment paste 23.0 kg
- . Wax 3.8 kg
- . Finish 38.3 kg
- . Electricity None. Electricity for hand-irons recorded under stage number 21.

- Labour. 10 workers are needed for padding and drying. The operations share with stage numbers 20 and 21 the supervision of 1 foreman. Care and vigilance required.

Stage No. 20 : Spraying and Drying

Process description

- Spray on third coat of colour finish, dry off by hanging from rails

- Check weight, and if necessary
- Spray on fourth coat of colour finish
- Dry off by hanging from rails
- Make up fixative (totalling enough for 90 g per m², between two coats on grain side) from:
 - . 600 parts clear emulsion
 - . 400 parts water
- Spray on first coat of fixative

Flow diagram : Stage 20

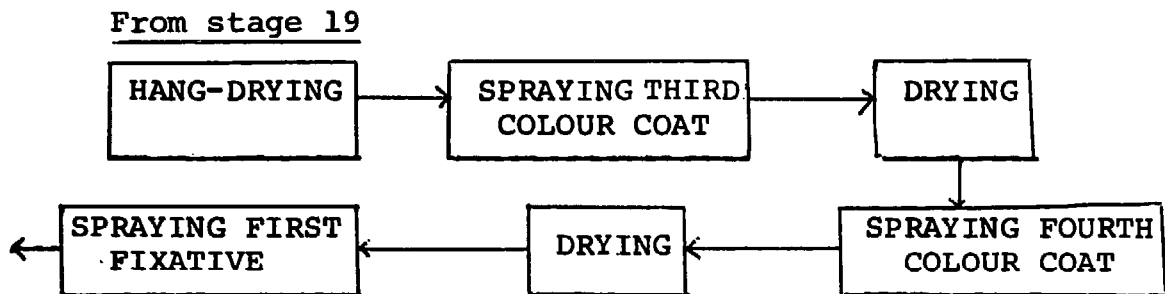

Spraying is done with two compressed air spray guns, driven from a single compressor. Each gun is used (with the leather on a table) in a booth with a fan fitted to extract any excess spray through a filter wall at the back. Each gun and booth handles half the daily throughput. These are specialist equipment items and should be bought from a reputable manufacturer.

Schedules

- Equipment.
 - . 1 wooden or plastic mixing tub, 50 litres capacity
 - . 2 spray guns and 3.5 m wide booths, with compressor
 - . 2 tables, wooden with plastic or formica tops, 2 m x 2.5 m x 1 m high
 - . 20 m of rails, 2.4 m high
 - . 200 hangers with 400 clips (see Figure IV.10)

The tables and rails may be manufactured locally.

The spray guns, booths, compressor and tables are shared with stage number 21, also serving for the second coat of fixative included in that stage.

- Water, chemicals, heat, electricity

Daily usages

(based on 520 m² throughput of grain upper leather, including at this stage the materials for both coats of fixative)

| | |
|------------------|---------------------------------|
| . Water | 0.019 m ³ |
| . Clear emulsion | 28.0 kig |
| . Electricity | 2 x 4 kw x 6 hours= 48 kw/hr |

- Labour. 6 workers are needed for spraying and drying, including the second fixative coat at stage number 21. 1 foreman may be shared with stage number 19 and 21. 1 general assistant may also be shared with stage number 21. Normal care and vigilance required.

Stage No. 21 : Plating

Process description

- Iron with hand-iron set at 65°C
- Spray on second coat of fixative, dry off by hanging from rails

Flow diagram : Stage 21

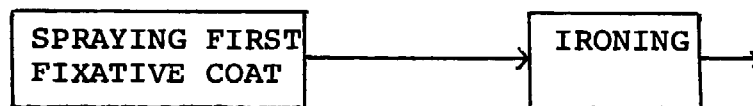

From stage 20

Schedules

- Equipment.

- . 10 heavy laundry-type electric hand-irons (including 2 spares)
- . 8 ironing tables, wooden with formica or heat-resistant plastic tops, and a small portion of these tops covered with asbestos for resting irons (2 m x 1.5 m x 1 m high)

All equipment is locally available.

- Water, chemicals, heat, electricity

Daily usages

- . Electricity : $8 \times 1.5 \text{ kw} \times 5 \text{ hours} = 60 \text{ kw/hr}$

- ### - Labour.
- 8 workers are needed, the same as those for the ironing operation in stage number 19. These 8 workers may be shared with other stages from time to time. This stage shares 1 foreman and 1 general assistant as noted above. Care is required in ironing in order to avoid damage to finishes and leather.

Stage No. 22 : Measuring

Process description

The area of leather (both grain upper and splits) is measured on a table marked out in square decimeters. The measurer notes the size of the rectangle which bounds the piece of leather, and subtracts from this the areas between the rectangle and the edges of the piece, to arrive at the area of the latter.

Flow diagram : Stage 22



From stage 21

Schedules

- Equipment.

- . 1 wooden table with smooth top marked out in decimeters, 2 m x 1.5 m x 1 m high. It may be manufactured locally.

- Water, chemicals, heat, electricity

None

- Labour. 2 workers are needed, shared from time to time with other stages.

Stage No. 23 : Sorting

The pieces are sorted by type (grain upper, suede linings), colour and grade. The operation is done manually and is directed by the sorter's judgement and visual inspection. Grading criteria will vary with market demand. In most cases, the area of a piece will not affect its grade, and its thickness will be controlled by the tanner to meet market needs. Grading will therefore be largely dependent on the degree of blemish inherited through the tanning process from the hide.

Flow diagram : Stage 23

From stage 22



Schedules

- Equipment. None

- Water, chemicals, heat, electricity. None

- Labour. 1 worker is needed for both this stage and stage number 24 (finished goods storage). Care is of course required in sorting. The sorter may need supervision from time to time from the finishing stages foreman or the tannery managers.

Stage No. 24 : Finished goods storage

Process description

The sorted goods are bundled up in rolls of about 5 pieces. Each roll is then marked with the number of pieces it contains, their combined area and their common colour and grade. It is then stacked in the appropriate rack in the finished goods warehouse. The racks can usually take the form of shelves about a metre or so wide, accessible from intervening aisles on both sides, and with the length of the shelves divided at intervals by vertical dividing walls. In this way, each set of shelves can be broken up into compartments suitable for storing together all the leather of a particular sort. The lowest shelves should be 30 cm above the floor, to discourage pest attack.

Finished goods stock will depend on market characteristics, but leather is not cheap, and normally, stocks should not exceed one month's throughput.

Flow diagram : Stage 24

From stage 23



Schedules

- Equipment.

. Shelves and racks as required. They may be manufactured locally from smooth wood in order to avoid abrading the finished goods.

- Water, chemicals, heat, electricity. None

- Labour. 2 workers are needed, including a reliable clerk. The tannery manager responsible for sales will obviously also be sometimes in the store.

Stage No. 25 : Chemicals storage

Process description

Various chemicals are required during the process. The bulk of the chemicals is primarily needed for stages number 2 to 7 (and 12), with smaller amounts of finishing chemicals and supplies needed at stage numbers 18 to 21.

Accordingly, chemicals tend to be stored adjacent to the sections to which they are fed, that is, the limeyard, tanyard and finishing section. To avoid premature moistening of liming and tanning chemicals during storage, they should be kept outside the main tannery building, in adjoining sheds or outhouses, and above floor level unless sealed in waterproof drums.

If solid sodium sulphide is used, it will require breaking up before use in liquors. Care should be exercised since fragments and dust can harm the face and skin.

Many common chemicals will be locally available, and large stocks of these need not be kept. Other, more specialised chemicals, may have to be brought from a distance or even imported, and if there is any uncertainty about regular deliveries, it may be advisable to keep up to six months supply of an item.

Schedules

No formal schedules. Besides the mixing tubs for finishing chemicals recorded at stage numbers 19 and 20, others may be used for pre-mixing (e.g. as in stage number 12 (dyeing)). The tanner should consult the supplier of the chemicals.

Stage No. 26 : Water

Process description

Obviously, an appropriate piping and plumbing system is required, gravity-fed if possible, in addition to an adequate source of basic supply (rainwater, stream or water main). The details both of basic supply and distribution will vary widely with circumstances, and

the tanner should consult a local water engineer and/or plumbing contractor. The system within the tannery should be capable of substantial hourly flow rates, bearing in mind that soaking of dried hides (for example) has a daily water usage of 32,000 litres which ideally should be supplied over a period of a couple of hours, or so, implying a flow-rate of over 250 litres per minute.

A further point is worth noting. The tanning process described in this chapter assumes the use of unheated or lukewarm water wherever possible, thus minimising the use of scarce and expensive heating fuels and cutting down on investment costs. The costs of installing a boiler and steam distribution system are not light, although they may be unavoidable if the tannery is in an area with a prolonged cold season. Even in a generally warm climate, however, the tanner cannot always assume that his basic water supply will be lukewarm (25°C). It may, for example, be drawn from a deep well. If, for this or other reasons, the basic supply is considerably colder than 25°C, the tanner may wish to let the sun warm it up for him by storing it for a period of hours (or even a day or two) in a mortar or bituminous paint-lined tank exposed to the sun. Again, he should seek engineering advice, but a useful device for increasing the effectiveness of solar heating is a matt (that is, non-glossy) black painted cover over the tank. Care should, of course, be taken that the stored water does not get over-heated. For most operations in the project described in this chapter, a water temperature of above 25°C is not indicated. If the water in the tank gets too hot, the black cover may be removed, and water fed into the process from the tank may be mingled with colder water from the basic supply.

Schedules

None.

Stage No. 27 : Effluent disposal

Process description

The waste liquors flow through the main drain of the tannery into a series of effluent settling tanks (see Figure IV.13), where pollutants either settle as

sediment or are oxidised by the action of the sun. As each day's liquors arrive in tank 1, it overflows into tank 2, and so on down the line until tank 3 overflows into the lagoon, where the final stage of purification takes place prior to running the liquor into a local lake or river. The settling tanks which are mortar-lined, have a combined volume equal to a day's outflow of waste liquors. The lagoon should also be capable of holding at least two days' liquors.

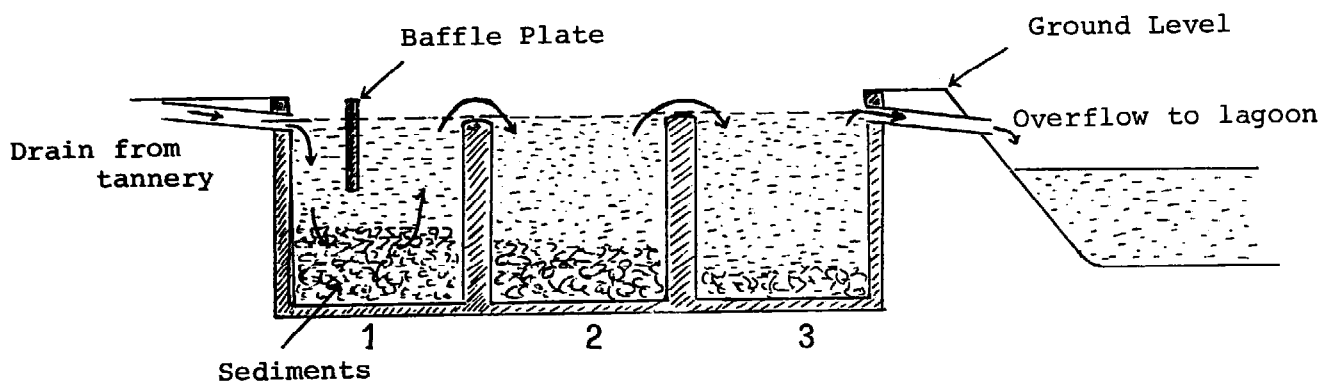

Figure IV.13

Effluent settling tanks and lagoon

The sediment settling in the tanks must be periodically removed. One method is to mix it up with the liquor into a fluid sludge with a plunger and pump it out with a sludge pump to a deep burial or soakaway pit.

Schedules

- Equipment.

(Based on the use of wet-salted hides and thus no separate soaking stage, the daily volume of waste liquors - including water to wash down the

tannery, might be 80-90 m³. Thus, each tank might hold 55-60 m³, and the lagoon about 200 m³. These volumes would be increased by 50% if soaking of dried hides is needed).

- . 3 mortar-lined tanks, each about 6 m x 5 m x 2 m deep, if no soaking
- . 1 moveable sludge pump
- . 1 lagoon, say 20 m x 10 m x 1 m deep,

Only the sludge pump may need to be imported.

- Water, chemicals, heat, electricity. No formal schedules. Periodic small demand for electricity and labour is needed when using the sludge pump.

Stage No. 28 : Process heat

Process description

The need for water above lukewarm temperature (25°C) occurs at two points: in bating (stage number 5) and dyeing, and perhaps in the fatliquoring of grain upper leather (stage number 12). This need may be met by raising about 1,500 litres of water to or near the boiling point. Perhaps the simplest way of doing this is to mount a lagged metal tank on brick above a wood or coal fire. The heated water can then be pumped through lagged pipes to the required points, using a small pump. The operation would be conducted in a small outhouse near the tanyard section of the main tannery. If this solution is adopted, care should be taken to keep the fire under proper control, and the tank must have a vent for water vapour and steam or dangerous pressures will build up inside it. The tanner should seek engineering or plumbing advice.

The need of process heat, even for this relatively small amount of heated water, may possibly be avoided partly or completely, by solar heating (see stage number 26 above). The temperatures required for the tannery process are nowhere high, and the highest temperatures - 60°C for dyeing - involves only 850 litres. These low-grade heat requirements may be easily obtained - at least partly - in hot sunny climates. The

interested tanner may wish to use the simple method outlined at stage number 26, or to seek engineering advice on the possibility of more elaborate methods.

If, however, the tannery is in an area with a long cold season, the daily need for fuel-heated water or steam will seasonally exceed by an order of magnitude the 1,000 - 2,000 litres noted above. It will be appropriate to purchase a formal oil-fired boiler from a specialist manufacturer and install a steam distribution system to most of the wet stages (2 to 7 and 12). The suppliers or a consulting engineer will advise on the required steam-raising capacity.

Schedules

(Based on an assumed need to raise 1,500 litres of water from 25°C to 100°C, in two batches of 750 litres; and assuming overall thermal efficiency of about 33%).

- Equipment.

- . 1 lagged, vented cylindrical tank of 1,500 litres volume to allow for vapour/steam pressure, mounted, with axis horizontal, on a brick firebox with a rear flue.

- Water, chemicals, heat, electricity.

Daily usages

- . Wood 50 kg

(1,500 litres of water, already included in process water at stage numbers 5 and 12).

- Labour. Small demand, met by borrowing from time to time from other stages.

Stage No. 29 : Electricity

Process description

The project is assumed to draw its supply from the mains. Simultaneous loads of over 100 kw can be expected, and an appropriate distribution board and system must be installed. The tanner should employ a reputable

electrical contractor, and will probably also consult the local electricity supply company.

(If mains supply is not available, or inadequate, a diesel-electric generator may be employed instead. It should probably have a KVS rating of 200 or more, but the tanner should consult a specialist supplier).

Schedules

None.

Stage No. 30 : Maintenance

Process description

With normal access to outside contractors, a tannery on this scale should employ them on major overhauls, installations and breakdowns, rather than have a large in-house maintenance staff who would not be fully employed most of the time. A jointer and a fitter are all that is required, doing day-to-day maintenance with hand and simple powered tools. The tannery should, however, carry up to one year's supply of spare parts for specialist items of equipment bought from a distance.

Schedules

No formal schedules. Equipment manufacturers' advice may be sought on vital spares, consumables and tools. 2 men are needed, a jointer and a fitter.

III. OVERALL PROJECT FEATURES

III.1 Floor Plan

The floor plan is shown on Figure IV.14 at a scale of 1:300 (1 cm = 3 m). It is largely self-explanatory and needs little comment. The main points to note are:

Drain to effluent disposal

Scale: 1 cm = 3 m

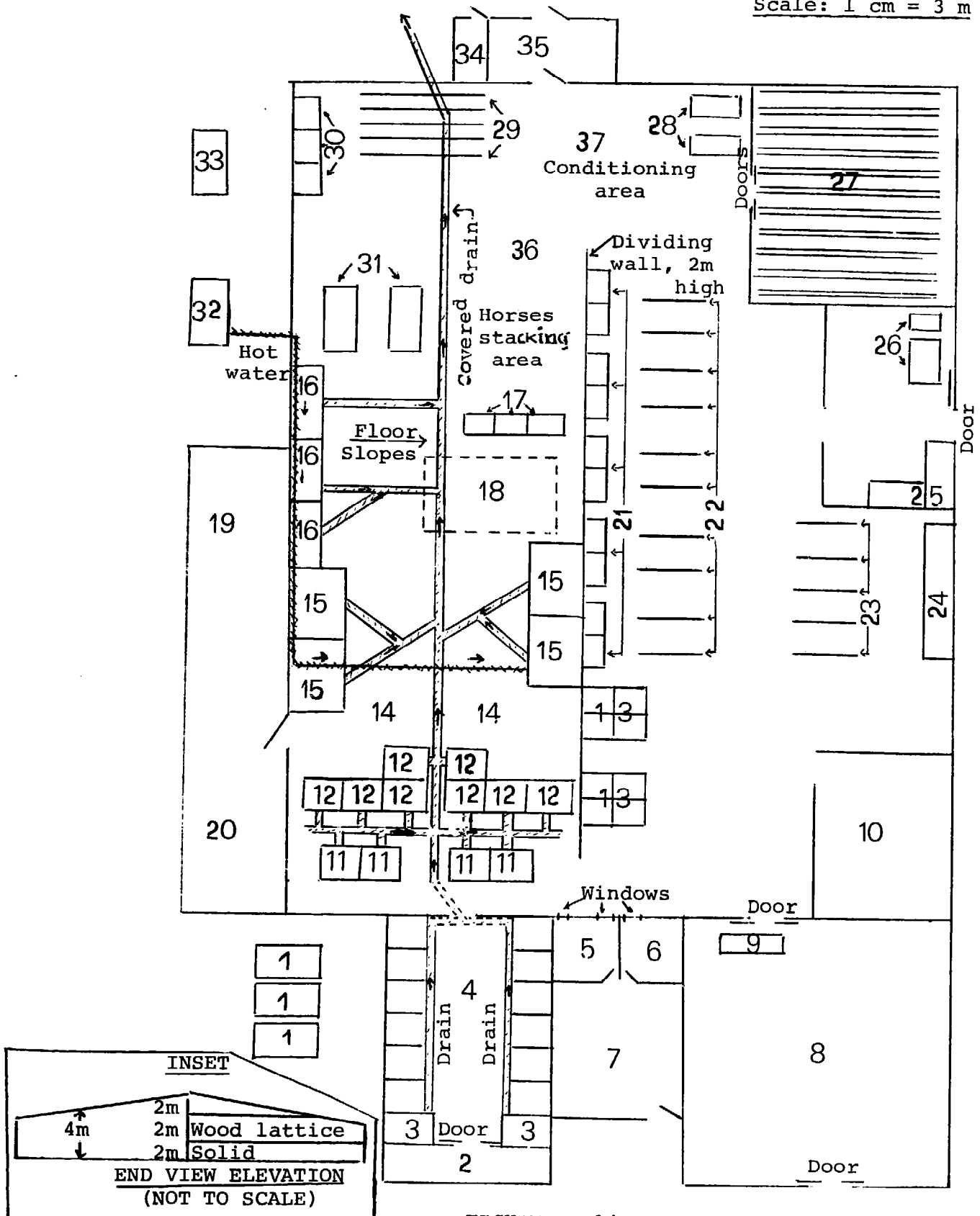

FIGURE IV-14
 Floor plan for low investment cost tannery
 Handling 200 hides per day (ML Project)

FIGURE IV-14 (continued)

Designation of work areas on floor plan

1. Elevated water storage tanks
2. Covered landing Stage
3. Salt stores
4. Hide store
5. Production manager office
6. Sales manager office
7. General office
8. Finished leather warehouse
9. Measuring station
10. Finishing chemical store
and preparation
11. Soak pits
12. Lime pits
13. Ironing tables
14. Fleshing beams
15. Delime, bate, pickle and tan
drums
16. Re-tan, dye and fat liquoring
drums
17. Sammying and setting tables
18. Draining area for wet blue
19. Store for tan, dye, etc.
chemicals
20. Store for lime, chemicals
21. Padding tables
22. Hanging rails for after padding
23. Hanging rails for after spraying
24. Spray booths
25. Brushing tables (may be set
outside the tannery)
26. Buffing tables
27. Nailing boards
28. Stakers
29. Hanging rails to dry
leather
30. Setting tables
31. Shaving M/C
32. Process heat
33. Wood or coal store
34. Electric distribution
board
35. Maintenance workshop
36. Horses stacking area
37. Conditioning area.

- (i) A tannery at this scale is a substantial industrial project. The total floor space area of the buildings approaches 3,000 m².
- (ii) The work of the process flows round in a 'U', from the bottom left to the top to the bottom right.
- (iii) For simplicity of the service distribution systems, drainage and hot water only are shown. In addition, unheated lukewarm water must be piped to stage numbers 2 to 7 (soaking to tanning), 12 (retanning, dyeing, fatliquoring), 15 (conditioning), 25 (finishing chemicals, storage and preparation), and 28 (process heat). Electricity must be distributed on power circuits to stage numbers 4-7 (delimiting to tanning), 10 (splitting), 11 (shaving), 12 (retanning, dyeing, fatliquoring), 16 (staking), 18 (buffing), 20 (spraying), 21 (plating) and 30 (maintenance). Power circuits may also be needed for pumping at stage numbers 26 (water), 27 (effluent disposal), and 28 (process heat). Lighting circuits are advisable to all offices and stores, and to the finishing stages (numbers 18-21).
- Finally, the effluent settling tanks and lagoon are not shown on the floor plan.
- (iv) The hides storage area is shown laid out for wet salts. If these were the basic raw materials, soak pits would not normally be necessary, but their position is indicated for illustrative purposes.
- (v) The inset diagram gives an indication of the main features of the vertical elevation of the tannery buildings. The upper half of the walls all the way round the tannery may be latticed, to let daylight in and provide ventilation.

(In areas with a very cold season, this may not be possible, and all-solid walls plus windows may have to be used in conjunction with artificial lighting and ventilation.)

- (vi) The roof may be of corrugated aluminium, asbestos tiles or plaited of local leaves or bamboo. All these materials provide coolness for easy working. Corrugated iron is not recommended, as condensation dripping from an iron roof will stain leather and liquors. If corrugated iron is used, it should be well galvanised and or painted.

III.2 Overall Equipment Schedules

Note : Summary descriptions only are provided. For details, see individual stages above. Indicative 1980 prices have been given for non-locally producible equipment which are marked *. Equipment for water and electricity, distribution and maintenance have been excluded, since no formal schedules apply. The same applies to fixtures in the stores, which are regarded as part of the building.

| | <u>Indicative 1980 price ex-works U.K. (US\$)</u> |
|---|---|
| - 1 moveable weighing machine* | 1,200 |
| - 4 soaking pits (if dried hides) | |
| - 8 liming pits | |
| - 8 tanners' fleshing beams | |
| - 8 fleshing/unhairing knives | |
| - 3 stationary horses | |
| - 3 cutting knives | |
| - 400 poles | |
| - 4 drums 2.5 m x 2 m,*, plus associated features | 78,000 (Total) |
| or, according to circumstances | |
| - 1 drum 2.5 m x 2 m, and 3 sets ironwork* plus associated features | 42,500 (Total) |

| | |
|--|----------------|
| - 5 thermometers* | 100 (Total) |
| - 8 pallets | |
| - 3 sammying tables | |
| - 4 slickers | |
| - 1 band knife splitting machine, 1880 mm working width* | 63,000 |
| - 1 shaving machine, 1500 mm working width | 77,700 |
| - 4 pairs scissors | |
| - 3 drums, 2.5 m x 1.2 m plus associated features | 36,500 (Total) |
| or | |
| - 1 drum, 2.5 m x 1.2 m and 2 sets ironwork* plus associated features | 20,300 (Total) |
| - 1 glass-topped table | |
| - 4 thermometers* | 100 (Total) |
| - 3 setting tables | |
| - 4 slickers | |
| - 40 m rails, 600 hangers, 1600 clips | |
| - 6 wheeled horses | |
| - 2 concrete troughs | |
| - 25 m ² plastic sheeting | |
| - 2 staking machines 'Slocomb-type', each of table width 1200 mm | 38,500 (Total) |
| - 300 boards | |
| - 60 m of supports for boards | |
| - 3 moveable trestles | |
| - 1 buffing machine, 1500 m working width | 32,300 |
| - 1 smaller buffing machine* | 5,500 |
| - 5 brushes | |
| - 12 pads | |
| - 10 padding tables | |
| - 2 mixing tubs | |
| - 40 m rails, 400 hangers, 800 clips | |
| - 1 pair scales for weighing finishing chemicals* | 500 |
| - 2 spray guns,* 2 spray booths* and 1 compressor | 22,000 |
| - 2 tables for spray booths | |
| - 20 m rails, 200 nangers, 400 clips | |
| - 1 mixing tub | |
| - 10 hand irons* | 700 (Total) |
| - 1 table marked out for measuring areas | |
| - Water storage tanks (according to circumstances) | |
| - 3 effluent settling tanks | |
| - 1 lagoon | |
| - 1 sludge pump* | 1,500 |
| - 1 water heating tank, 1 pump*, 1 fire- box (according to circumstances) | 300 |

Only a minority of the equipment items may need to be imported. This is an indication of the relatively low level of mechanisation assumed. Even so, it is a measure of the scale of the project that the total of the indicative prices given for such equipment is over US\$300,000 even if local woodwork and assembly for all but two of the tanning and dyeing drums is assumed.

III.3 Overall Schedules of Daily Usages

Note : Annual usages are also shown, at 300 times daily usages. Indicative unit prices are also provided. Items marked * should probably be imported.

| | Daily usage | Annual usage | Indicative 1980 unit price, US\$ (ex-works UK) |
|--|-------------------|-----------------------|--|
| Water (assuming wet salts no soaking) | 85 m ³ | 25,500 m ³ | 1 (est.) |
| Salt (ditto) | 237 kg | 71,000 kg | 0.088 |
| Sodium sulphide, solid | 240 kg | 72,000 kg | 1.02 |
| <u>Additional usages, assuming dried hides and soaking</u> | | | |
| Water (including washing down allowance of about 30% of process water) | 42 m ³ | 12,600 m ³ | 1 |
| Salt | 200 kg | 60,000 kg | 0.088 |
| Sodium sulphide, solid | 16 kg | 4,800 kg | 1.02 |
| Anionic wetting agent e.g. Teepol | 8 kg | 2,400 kg | 0.50 |
| Disinfectant | 3.2kg | 960 kg | 1.21 |
| Hydrated lime | 320 kg | 96,000 kg | 0.078 |
| Ammonium sulphate | 47 kg | 14,100 kg | 0.171 |
| Synthetic bate*, e.g. Pancreol 2A | 31 kg | 9,300 kg | 0.679 |

| | Daily usage | Annual usage | Indicative 1980 unit price, US\$ (ex-works UK) |
|---|----------------|-----------------|---|
| Calcium formate* | 16 kg | 4,800 kg | 0.30 |
| Sulphuric acid | 39 kg | 11,700 kg | 0.077 |
| Chrome powder* | 261.5kg | 78,450 | 0.924 |
| Alkaline agent, eg Compound S.B.* | 22 kg | 6,600 kg | 0.143 |
| Retanning agent, eg Retannex HP* | 104 kg | 31,200 kg | 1.24 |
| Alum syntan, eg Neosyn RH* | 20 kg | 6,000 kg | 1.53 |
| Acid dyes* | 13 kg | 3,900 kg | 11 |
| Formic acid* | 6.5 kg | 1,950 kg | 0.82 |
| Sulphited oxidised cod oil, eg Trisul C.E.X* | 32 kg | 9,600 kg | 1.72 |
| Sulphited whale oil, eg Cremol SW* | 32 kg | 9,600 kg | 1.34 |
| Raw nealsfoot oil, or substitute eg Remaynol 58* | 13 kg | 3,900 kg | 1.74 |
| Sulphited oxidised fish oil, eg Trisul A15* | 15 kg | 4,500 kg | 1.25 |
| Filler finish, eg Encryl 1 MP | 22.4 kg | 6,720 kg | 1.57 |
| Penetrating agent, eg Penetrator 113* | 11.2 kg | 3,360 kg | 2.64 |
| Pigment paste* | 23 kg | 6,900 kg | 2.2 |
| Wax, eg FF 150* | 3.8 kg | 1,140 kg | 1.4 |
| Finish, eg Encryl FN | 38.3 kg | 11,400 kg | 1.54 |
| Clear emulsion | 28 kg | 5,400 kg | 2.39 |
| Electricity (allowing 20-25% extra on con- sumption recorded at individual stages, for possible water pumping, lighting, etc.) | 900 kw/hr | 270,000 kw/hr | 0.08 (est.) |
| Wood (according to circumstances) | 50 kg | 15,000 kg | 0.016 (" |

III.4 Overall Labour Schedule

| | | 'Sections' | |
|---|----------------|-------------------------|----------------------|
| - Managers | 2 | Administration | 4 |
| - Foremen | 2 | | |
| - Hide store | 3* | Hide store | 3 |
| - Soaking (if needed) | 1 | | |
| - Liming, siding | 4 | Limeyard | 12 (with soaking) |
| - Fleshing | 7* | | |
| - Deliming to tanning | 3* | Tanyard | 3 |
| - Draining, sammying setting | 2 | Shaving | 6 |
| - Splitting, shaving | 4 | | |
| - Retanning, dyeing, fatliquoring | 2* | Retanning | 2 |
| - Draining, setting | 2 | | |
| - Drying, conditioning | 8 | Drying | 18 |
| - Staking | 2* | | |
| - Drying, flattening | 6 | | |
| - Buffing, brushing | 8* | Buff and brush | 8 |
| - Padding, drying | 10 | | |
| - Spraying, drying | 6 | Finishing | 25 |
| - Plating, general assistant (finishing) | 9* | | |
| - Measuring | 2 | Finished goods store | 5 |
| - Sorting, storing fin- ished leather | 3 | | |
| - Maintenance | 2 | Maintenance | 2 |
| | 88 | | 88 |
| | (with soaking) | | (with soaking) |

* Indicates special care, supervision and skill required.

CHAPTER V

MEDIUM-SMALL TANNERY : 20 HIDES PER DAY

The previous chapter described a tannery which, although relatively unmechanised, is still a substantial industrial project producing a highly finished product for national and international markets. However, opportunities in tanning are not limited to such large projects. This chapter describes a less ambitious tannery which may be of special interest to smaller businessmen or rural cooperatives.

This tanning project uses vegetable - rather than chrome - tanning, and produces less highly finished leather which may be sold to local craftsmen for direct conversion into leather products, or to other tanneries at home or abroad for retanning and further finishing. The leather produced is real leather. It will not putrefy. Even if it is intended for further processing in another tannery, it offers marked advantages over dried or salted hides as a material for trans-shipment, particularly from remote areas with poor communications and under sub-standard hide-curing. Moreover, trade between tanneries is often mutually profitable in other circumstances. The purchasing tanner may be a specialist finisher, or be in closer touch with the needs of particular markets. European tanners frequently trade amongst themselves on this basis. The vegetable tanner should, therefore, always be alert to the opportunities offered of purchase by other tanners in competition with the local leather products trade. The balance of advantage is subject to continual change with market circumstances.

The project described below is labelled 'medium-small' (MS), handling 20 hides per day. Projects of this type may be located in both rural and urban areas as long as sufficient water of adequate quality is available. The following two chapters describe respectively a medium-small tannery handling 200 skins per day and a very small tannery handling 2 hides per day. The latter tannery is essentially a rural, single-family business.

I. INPUT, OUTPUT AND UTILISATION

Input : 20 cattle hides per day, assumed identical to those used in the 200 hides per day project : that is an average dried weight of 7 kg or a wet-salt weight of 14 kg.

Output : Each hide is converted to 9 kg of semi-finished leather.

Utilisation : The tannery is assumed to operate 300 days per year, on one 8-9 hours shift per day.

II. STAGE-BY-STAGE DESCRIPTION

Stage No. 1 : Hides Selection and Storage

Process description

(See Chapter II above. The process is similar to that for the 200 hides per day (ML) project. At this scale, dried rather than wet-salted hides are more likely to be the main raw material, but this will vary with local practice and circumstances).

Flow diagram : Stage 1

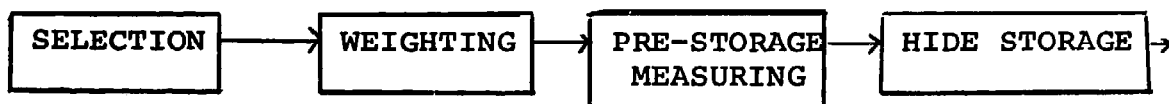

Schedules

- Equipment.

- . 1 moveable weighing machine, capable of weighing up to 100 kg.

- Water, chemicals, heat, electricity.

As in ML, requirements will vary with circumstances, but will typically be one-tenth as large as those in ML at this stage.

- Labour. One person exercising due care and vigilance is needed. The labourer may be shared from time to time with stage numbers 3 and 4. The tannery manager will also be present at the times of hide selection.

Stage No. 2 : Soaking

Process description

As in ML, soaking is a separate stage only if dried hides are used. The process is entirely similar to that in ML stage number 2, to which reference should be made for qualitative details. Only the scale of the operation is changed, so that in MS, the pits are smaller (2 m x 1.5 m x 2 m deep). Only one set of two such pits is needed to handle the whole throughput. The hides are soaked in the two pits as follows:

. First pit (first day of process) : Hides soaked in:

- 5,000 litres of lukewarm water (25°C)
- 2.5 kg sodium sulphide
- 2.5 kg anionic wetting agents, eg. Teepol

The hides lie overnight, then the pit is drained and the hides transferred to the second pit.

. Second pit (second day of process) : Hides soaked in:

- 5,000 litres of lukewarm water (25°C)
- 2.5 kg sodium sulphide
- 62.5 kg salt
- 1 kg disinfectant

The hides lie overnight in the pit, then the latter is drained and the hides transferred to liming.

Flow diagram : Stage 2

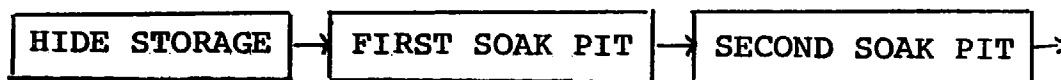

From stage 1

(Dried hides only)

Schedules

- Equipment.

- . 2 concrete pits with drainage. Each pit is 2 m x 1.5 m x 2 m deep, and may be built on, or sunk into, the tannery floor (refer to Figure IV.2)
- . wooden trucks, if desired, for hide transfer (refer to Figure IV.1): slotted sides are preferable for the stages from soaking to delimiting.

- Water, chemicals, heat, electricity.

Daily usages

- | | |
|--------------------------|---|
| . Water | 10 m ³ (10,000 litres) |
| . Sodium sulphide | 5 kg |
| . Anionic wetting agents | 2.5 kg |
| . Disinfectant | 1 kg |
| . Salt | 62.5 kg |
| . Process heat | Little or no artificial heat is required in a warm climate. The ambient temperature of water will be adequate. In a cold climate, some provision will be made for regular hot water. See Stage 28, process heat, below. |

- Labour. One worker shared from time to time with stage numbers 3 and 4. Normal care and vigilance.

Stage No. 3 : Liming and Fleshing

Process description

A two day process is required using a simple set of two pits which handles the whole throughput. The pits are identical in construction and dimensions to the soaking pits. The hides are suspended in the pit liquors from poles resting transversely across the top of each pit (see Figure V.1)

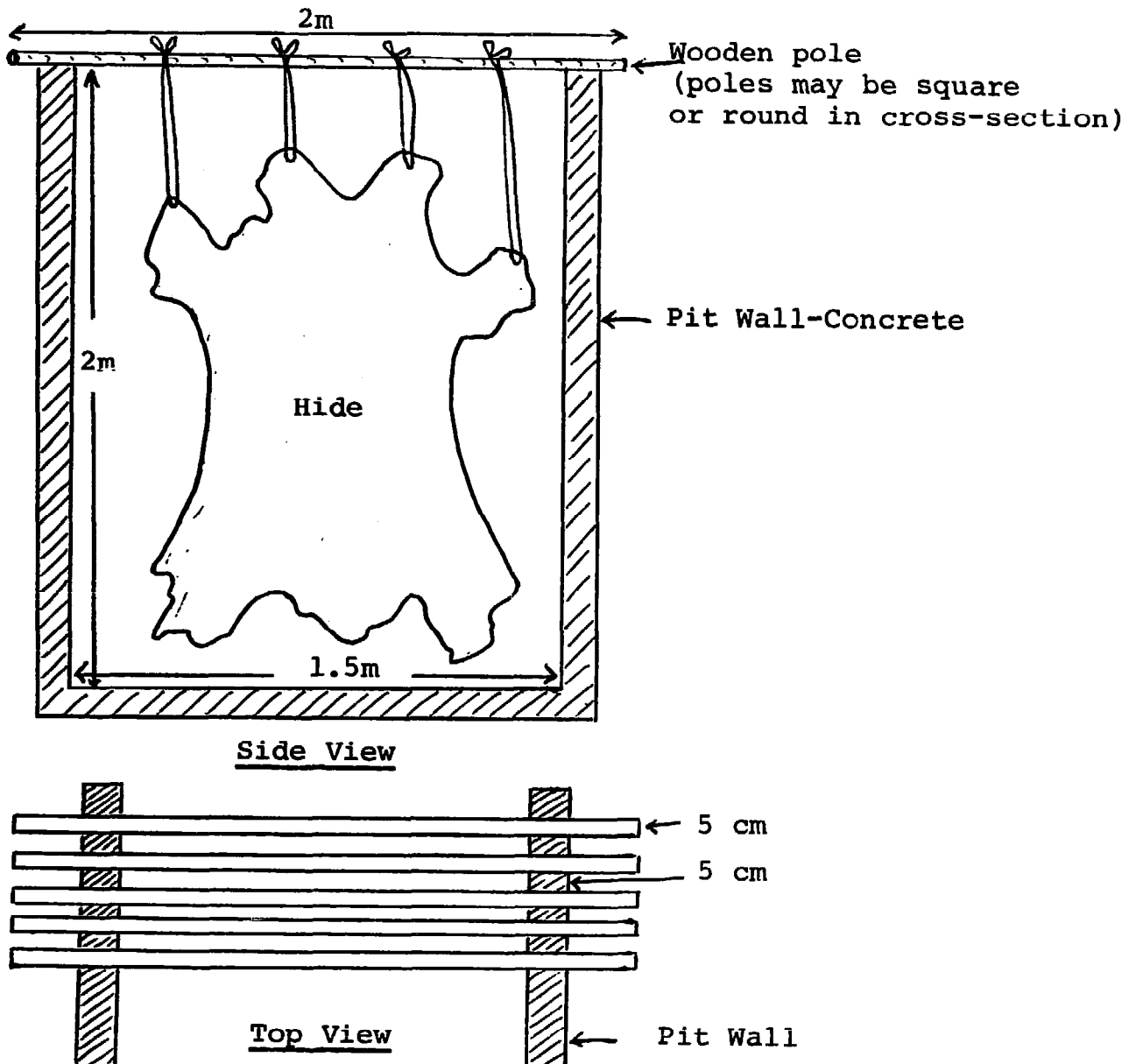

Side View

Top View

Figure V.1
Suspension of hides
in pits

The process starts in the first pit, which contains a liquor of:

- 5,000 litres unheated water
- 100 kg hydrated lime
- 100 kg sodium sulphide

The hides are agitated ('plunged') regularly at one- or two-hourly intervals during the day, and left overnight.

The next day, take the hides out and flesh and unhair them with knives over a tanner's beam. This process is identical to that described at stage number 3 in the ML project.

Then hang the hides in the second pit, which contains a liquor of:

- 5,000 litres unheated water
- 100 kg hydrated lime
- 25 kg sodium sulphide

Plunge hides regularly at one- or two-hourly intervals, and leave overnight. Next day, take hides out and transfer to delimiting.

The liquors in both pits may be used without draining for one week (6 working days) if the following are added on each day from the second day on:

- First pit: 20 kg hydrated lime
20 kg sodium sulphide
- Second pit: 25 kg hydrated lime
5 kg sodium sulphide

After one week, the pits must be drained and fresh liquors made up as specified above.

Flow diagram : Stage 3

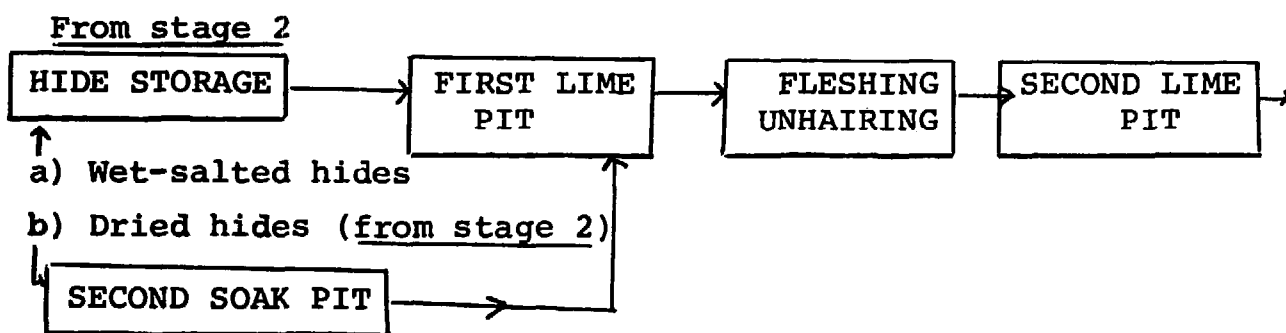

Schedules

- Equipment.

- . 2 concrete pits with drainage. Each pit is 2 m x 1.5 m x 2 m deep (construction as in stage 2, soaking)
- . 40 wooden poles for hanging hides, 2 m x 5 cm diameter
- . 3 tanner's beams, including 1 spare (refer to Figure IV.4)
- . 3 fleshing/unhairing knives, including 1 spare

All the equipment may be manufactured locally.

- Water, chemicals, heat, electricity

Daily usages (Average over 6 working days)

- . Water 1.67 m³
- . Hydrated lime 70.8 kg
- . Sodium sulphide 41.7 kg

- ### - Labour. Two workers are needed for this stage. Skill and care are necessary, particularly for fleshing.

Stage No. 4 : Deliming

Process description

Deliming requires hanging the hides in a single pit of identical dimensions and construction to those above at stage numbers 2 and 3.

The pit contains a liquor of:

- 5,000 litres unheated water
- 50 kg ammonium sulphate.

Hang the hides in the pit and allow them to rest two hours.

Take out and transfer to first tan pit.

Flow diagram : Stage 4

From stage 3



Schedules

- Equipment.

- . 1 concrete pit with drainage, 2 m x 1.5 m x 2 m deep. Construction as in stage 2 (soaking)
- . 20 wooden poles for hanging hides, 2 m x 5 cm diameter

All the equipment may be manufactured locally.

- Water, chemicals, heat, electricity.

Daily usages

- . Water 5 m³
- . Ammonium sulphate 50 kg

- Labour. One worker shared from time to time with stage numbers 2 and 3. Normal care and vigilance needed.

Note: Stages 5 and 6, Bating and Pickling, are not required and are omitted in this process.

Stage No. 7 : Vegetable Tanning

Process description

Tanning proceeds by hanging each day's batch of hides in pits containing successively stronger tanning liquors. The vegetable tanning agent ('tannin') assumed in this exposition is the commonest, mimosa extract. Substitutes may be prepared from a wide variety of plants and trees, usually from the bark. Examples which may grow locally are the camachile, acadia and quebrachia trees, and myropalan fruits. The tannin-bearing material, bark or fruits, is chopped or ground up, and the tannin is leached out of it by stages, in a battery of wooden or concrete vats, each filled with a liquor of the

material and water. Fresh material is put each day into the vat with the liquor of greatest strength accumulated from previous leaching. The material is then leached each successive day in liquors of progressively weaker accumulated strength, until given its final leaching in a vat of fresh water, preferably hot. The water goes in the opposite direction through the leaching cycle, becoming each day a stronger and stronger liquor, until it is used at its strongest to perform the first leaching of the fresh material. The process keeps each vat in continuous use, as fresh water and fresh material are fed in each day, into the vats at the opposite ends of the leaching cycle. The liming cycle described at stage number 3 in the ML project provides an illustrative example of such continuous use for the interested tanner. However, the making-up of a tannery's own tannin is in most circumstances a refinement, and the tanner is advised to start his operations using mimosa extract - which is widely available and has standard properties - before experimenting with his own tannins. Those who are forced by local circumstances, or encouraged by accumulating experience, to make up their own tannin, may wish to consult FAO, Agricultural Development Paper No. 68, Rural Tanning Techniques, Rome, 1960, Chapters IV and V passim, for a long and detailed account of various vegetable tanning materials and their preparation.

In the tanning pits themselves, the liquors are made up of water, tannin (assumed here and noted above to be mimosa extract), salt and sodium bisulphite. The strength of the liquor in each pit is checked with a barkometer, a specially graduated hydrometer for converting the specific gravity (density) of the liquor into °Bk'. A liquor of specific gravity 1.01 (density 1.01 times that of water) is of strength 10°Bk'; one of specific gravity 1.02 is of strength 20°Bk', and so on.

The various liquors should be made up to their required strength each day by adding fresh strong ('stock') liquor to the strongest pit liquor; the strongest to the weakest. The hides are thus enabled to progress from day to day through successively stronger liquors of controlled strength.

In detail, the process is as follows:

There are four pits containing tanning liquors, plus one of stock liquor (see Figure V.2). Each pit

is 2 m x 1.5 m x 2 m deep, and handles the whole throughput for one day of the four-day process.

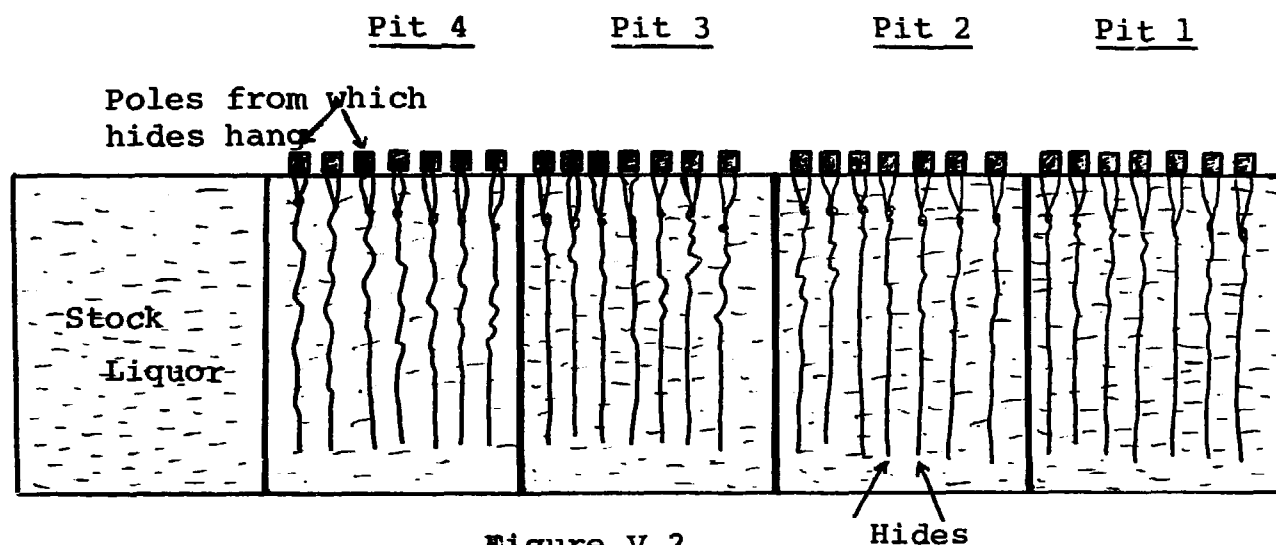

Figure V.2

Tanning pits plus stock pit

The stock pit liquor is made up from:

- 5,000 litres unheated water
- 500 kg mimosa extract
- 50 kg salt
- 25 kg sodium bisulphite

The liquor strength must be 30°Bk'

The fourth tanning pit is made up from:

- 5,000 litres unheated water
- 450 kg mimosa extract
- 50 kg salt
- 25 kg sodium bisulphite

The third tanning pit is made up from:

- 5,000 litres unheated water
- 400 kg mimosa extract
- 50 kg salt
- 25 kg sodium bisulphite

The second tanning pit is made up from:

- 5,000 litres unheated water

- 300 kg mimosa extract
- 50 kg salt
- 25 kg sodium bisulphide

1

The first tanning pit is made up from:

- 5,000 litres unheated water
- 150 kg mimosa extract
- 50 kg salt
- 25 kg sodium bisulphite Bk' = 7°

The procedure, which has a 4-day initiating phase, and then follows an indefinitely repeated daily cycle, is illustrated in Figure V.3. This is largely self-explanatory, but the following additional details should be noted:

- (a) Each day, after the batches have been shifted and the liquors established, 2 kg of sulphuric acid is added slowly, with constant plunging of the hides, to the first tanning pit. This completes deliming.
- (b) In the indefinitely repeated daily cycle, the run-off starts through a drain from the first tanning pit. Then a further 'one fifth quantity' of stock liquor, that is:
 - . 1,000 litres of unheated water
 - . 100 kg mimosa extract
 - . 10 kg salt
 - . 5 kg sodium bisulphite

¹Quantities given assume the use of solid mimosa extract. For those making up their own tannin, it may be helpful to note that this extract contains about 63% active tanning agent. The typical tannin-bearing raw material, bark or fruits, contain 20-40% tanning agent. Thus a rough guide to the strength of made-up tannins can be obtained by weighing the amount of raw materials that go into them: allowing for incomplete leaching, the tanner may allow 2½-4 times as much raw material to be required as mimosa extract (e.g. 1250-2000kg per stock pitfull of stock pit liquor). But this is an indication only: the tanner must experiment to determine the exact quantities needed.

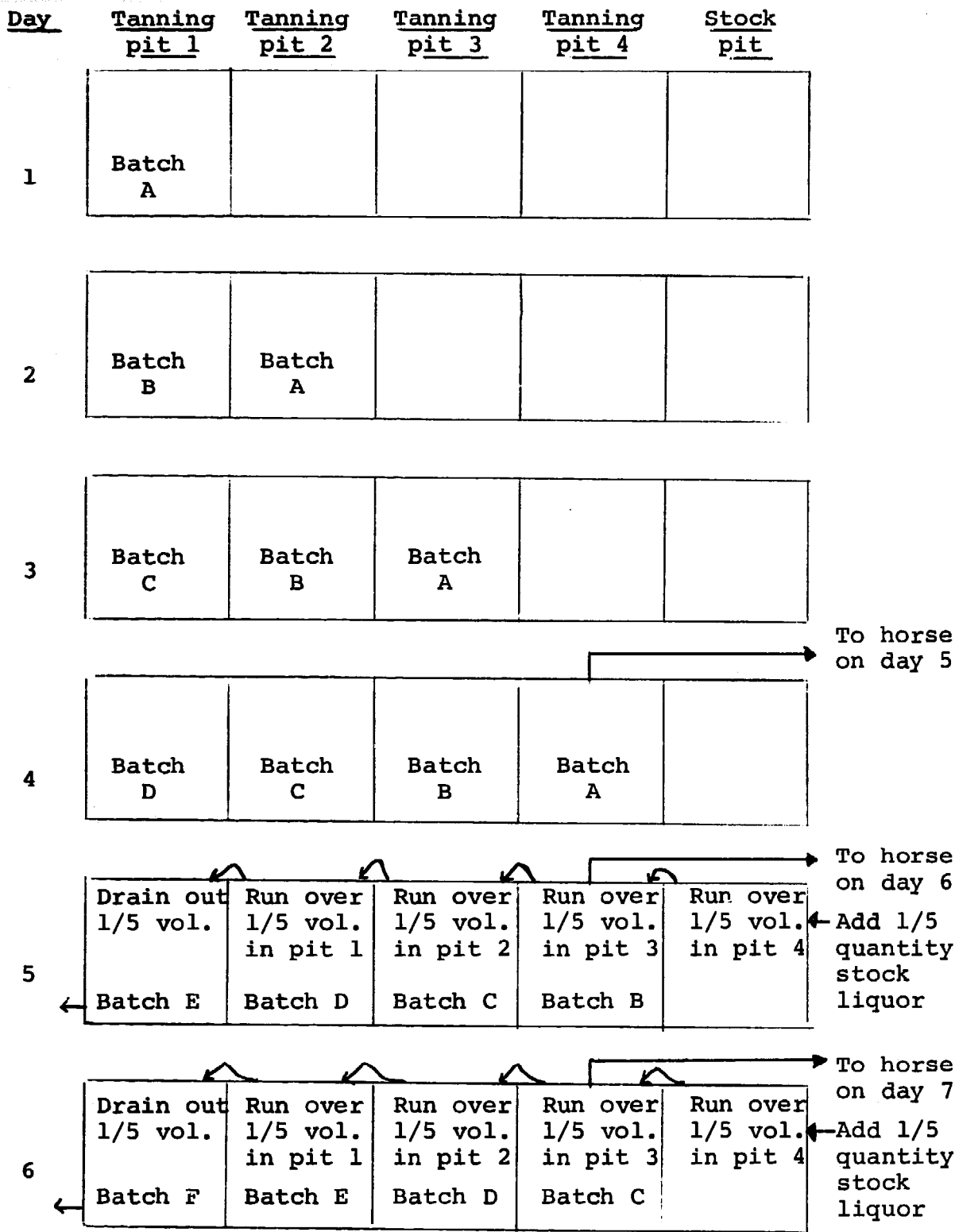

FIGURE V.3(a)
Procedure for 4-day vegetable tanning of hides

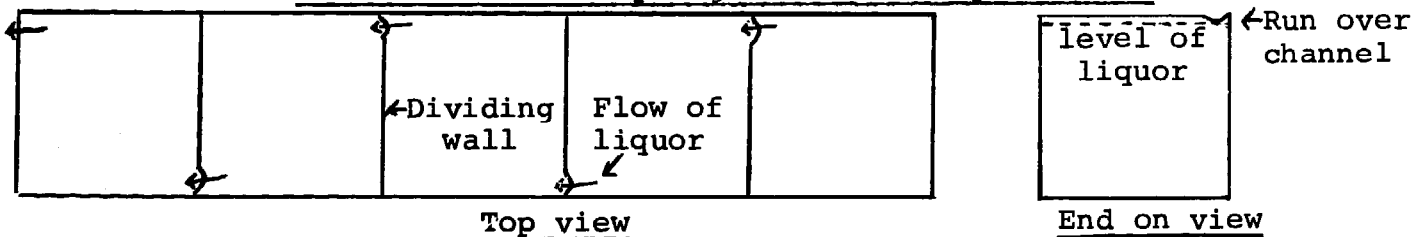

Figure V.3 (b)
Configuration for run-over between pits

is added slowly to the stock pit, which runs over into the fourth tanning pit, causing that pit in turn to run over the third, and so on down to a run-over from the second pit to make up the level in the first pit. The run-over channels should be placed at such a level as to function only with the hides in place: if they are lower than this, the liquors will intermingle when the hides are hung in the pits.

- (c) The addition, running-over and run-off of 'one fifth quantities' is a trial daily procedure. The actual proportion transferred is ultimately determined by checking the Bk' of the first tanning pit each day after running over from the second pit. If the Bk' begins to rise above 7-8 , the quantities run-off, added and run-over should be reduced. If it falls below 7-8 , they should be increased. After a week or so of the daily cycle, the run-off, etc. quantities needed to maintain the pits at a steady Bk' should have been determined. They will probably not differ much from the trial 'one-fifth quantities'.
- (d) The hides are hung in the tanning pits from poles as at stage numbers 2 to 4 above. This permits ready transfer of hides from pit to pit and also facilitates preventing the hides touching each other for any extended period of time. If this were not prevented, tan would not penetrate the touching areas, which would show up white as 'kiss marks'. The poles permit occasional agitation, to avoid such kiss marks and also ensure general full penetration of tanning agents throughout the thickness of the hides. Penetration may be checked by a small cut made through a thick part of the hide.

Flow diagram : Stage 7

From stage 4

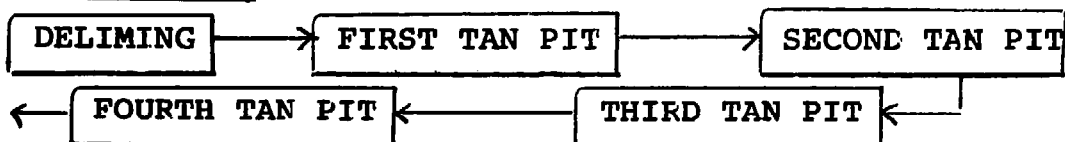

Schedules

- Equipment.

- . 5 concrete pits, with drainage from at least the first tanning pit, and provision for flow (see Figure V.3) between the 4 pits. Each pit is 2 m x 1.5 m x 2 m deep. Construction as in stage numbers 2 to 4, except that drainage is not obligatory (although preferable) for each pit.
- . 2 barkometers, including 1 spare
- . 80 wooden poles for hanging hides, 2 m x 5 cm diameter
- . A mixing vat for making up additions in stock liquor, and buckets for transferring it to the stock pit. These may be any size thought to be convenient, e.g. 200 litre vat and 2 or 3 10 litre buckets. Alternatively a small hand pump and hose may be used for transfer.

All equipment may be manufactured locally, except the barkometer and possibly a hand pump.

- Water, chemicals, heat, electricity.

Daily usages (assuming indefinite transfer of one-fifth quantities)

- | | |
|---------------------|------------------|
| . water | 1 m ³ |
| . mimosa extract | 100 kg |
| . salt | 10 kg |
| . sodium bisulphite | 5 kg |
| . sulphuric acid | 2 kg |

The initial quantities of water, mimosa extract, salt and sodium bisulphite are, as indicated above, equal respectively to 25,000 litres, 1,800 kg, 250 kg and 125 kg.

- ### - Labour.
- Three workers are needed for this stage. Normal care and vigilance required, plus supervision from the manager from time to time, since the stage is obviously a crucial one.

Stage No. 8 : Draining and scouring

Process description

At the completion of tanning, the hides (now become leather) are piled to drain overnight over a wooden horse, probably wheeled for ease or subsequent transfer (see Figure IV.9). Then, they are scoured, that is, clean water is poured over their surfaces on both flesh and grain sides.

Flow diagram: Stage 8

From stage 7

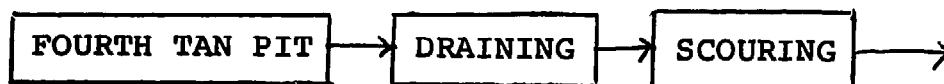

Schedules

- Equipment.

- . 1 wheeled horse, 2.5 m x 1.5 m high
- . 1 x 10 litre bucket for pouring water

- Water, chemicals, heat, electricity.

Daily usages

- . Water 100-200 litres

- Labour. Borrowed as needed from other stages, e.g. stage number 7, tanning.

Stages No. 9, 12 and 14 : Setting, oiling
and drying

Process description

The hides are laid one by one on a moveable table, and each side in turn - flesh side first, then the grain side - is set, that is, worked over with a blunt-bladed 'slicker' (see Figure IV.8), which is pushed by hand forward over the leather surface. The blade is non-corrosive, that is made of brass, glass, stainless steel or plastic. The operation removes moisture and flattens out creases on the grain side.

The leather is now ready for oiling, which is analogous to fatliquoring in the ML project.

Note: Stage numbers 10 and 11, Splitting and Shaving, and the first parts of stage number 12, Retanning and Dyeing, are not required in this process and are omitted.

The hides are again laid on the table, and an oiling mixture is rubbed into them on both sides. The mixture is made out of:

- 1 part water
- 1 part sulphited whale oil,
eg. Cremol SW

2 kg of this mixture is used per hide.

The hides are then hung over wooden rails (see Figure V.4) for a few hours until partially dry. They are then piled flat in the late afternoon on a wooden pallet and covered with sacking to even out the moisture content overnight.

The next morning, a fresh batch of hides is taken from scouring, set, oiled and hung up to get partially dry.

In the early afternoon, the previous day's batch is taken from the pallet (to the vicinity of which the table may be moved) and the leather is re-set and oiled again on the grain side only. The oiling mixture this time is 100% oil and may either be sulphited whale oil as before, or a local product such as castor or

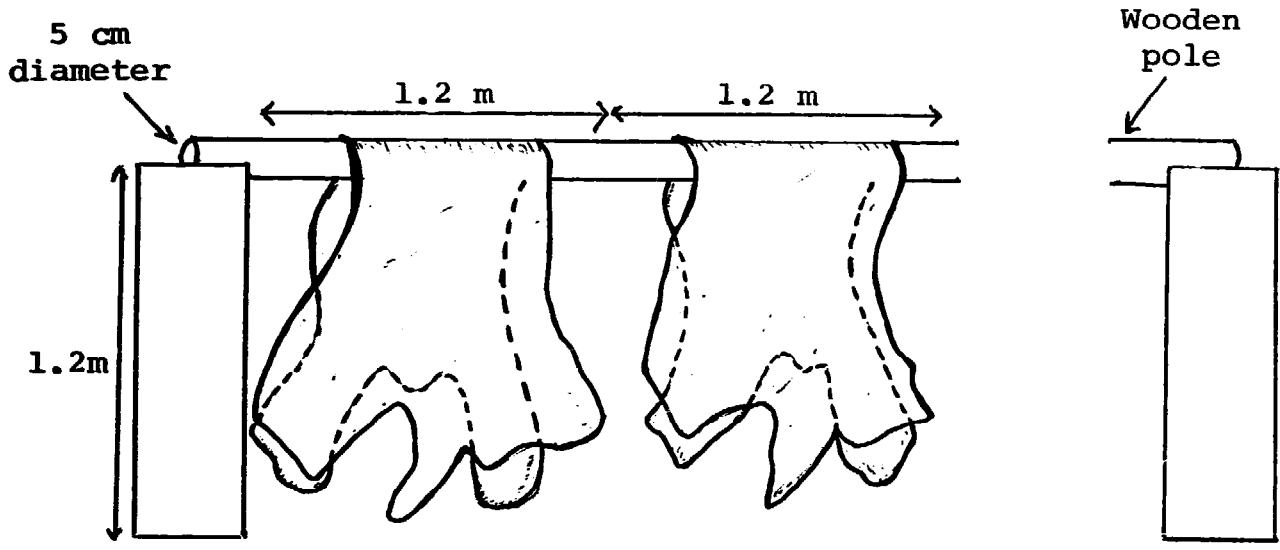

SIDE VIEW

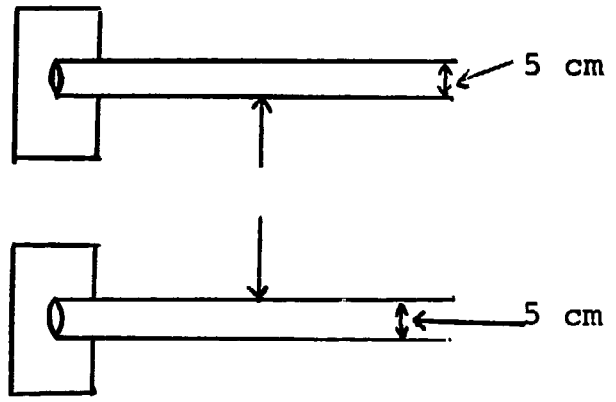

TOP VIEW

Figure V.4

Drying rails for oiled hides

cottonseed oil. 1 kg is used per hide. The batch is then hung over wooden rails to dry overnight.

Finally, the batch of hides which received its first setting and oiling that morning, is taken down from its wooden rails and piled under sacking on the pallet overnight.

The process continues in this way indefinitely (see Figure V.5).

Flow diagram : Stages 9, 12, 14

From stage 8

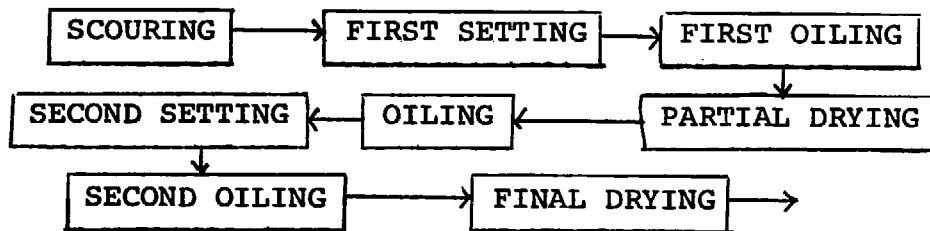

| | Batch A (started day 0) | Batch B (started day 1) | Batch C (started day 2) |
|----------------|---|---|--|
| <u>Day 1</u> | | | |
| Morning | | Taken from scouring, given first setting and oiling, hung to dry partially | |
| Afternoon | Taken from overnight piling, given second setting and oiling, hung overnight to dry finally | | |
| Late Afternoon | | Taken from partial drying, piled flat overnight | |
| <u>Day 2</u> | | | |
| Morning | (forward to next stage) | | Taken from scouring, given first setting and oiling, hung to dry partially |
| Afternoon | | Taken from overnight piling, given second setting and oiling, hung overnight to dry finally | |
| Late afternoon | | | Taken from partial drying, piled flat overnight |

Figure V.5
Setting, oiling
and drying

Schedules

- Equipment.

- . 2 moveable wooden tables, with plastic or formica tops, each 2 m x 1.2 m x 1 m high
- . 3 slickers, including 1 spare
- . 48 m of rails, 1.2 m high (see Fig. V.4)
- . 2 20-litre plastic or wooden basins for oiling mixtures
- . 1 wooden pallet, 2 m x 1 m x 15 cm high
- . sacking or plastic sheeting, 2.5 m x 1 m

All the equipment may be manufactured locally.

- Water, chemicals, heat, electricity

Daily usages

- . water 20 litres
- . sulphited whale oil 40 kg or
- . { sulphited whale oil 20 kg
local castor oil, 20 kg

- ### - Labour. Two workers are required. Normal care and vigilance needed.

Stage No. 22 and 23 : Measuring and Sorting

Note : The physical process ends on completion of stage number 14, drying. The leather is in a condition for sale, either to another tannery for further finishing, or to the local leather products market. Stage numbers 15 to 21 are omitted.

Process description

The semi-finished leather is normally sold by weight, hence measuring consists of weighing. It will probably be preceded in this process by sorting and baling by size and quality. The bales, of about 3 hides each, are then weighted and marked with their grade and weight. Grading is largely by degree of apparent surface blemish and is done by eye.

Flow diagram : Stages 22, 23

From stage 14



Schedules

- Equipment.

- . 1 moveable weighing machine, capable of weighing up to 100 kg (This could probably be shared with stage number 1, hides selection and storage, if it is washed each time before use at that stage).

- Water, chemicals, heat, electricity

None

- Labour. Two workers are needed, shared with stage number 24. Normal care and vigilance required.

Stage No. 24 : Finished goods storage

Process description

The goods may be stored by grade, on racks like those described at this stage in the ML project.

Flow diagram : Stage 24

From stage 23

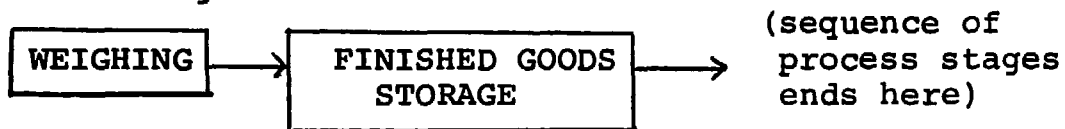

Schedules

- Equipment.

Shelves and racks as required. They may be locally manufactured from wood, which should be planed smooth to avoid abrading the finished goods.

- Water, chemicals, heat, electricity

None

- Labour. Included at stage numbers 22 and 23 above. The manager, being responsible for sales, will also obviously be sometimes in the store.

Stage No. 25 : Chemicals store

Process description

Limeyard and tanyard chemicals (the latter including oils) are stored on slatted wooden platforms off the tannery floor, close to their respective stations. As with the ML project, about 6 months' supply of chemicals which have to be bought from a distance, should be kept. However, there are few of these in this process, perhaps only sulphited whale oil, mimosa extract and sulphuric acid.

If solid sodium sulphide is used, it will require breaking up before use in liquors. This may be done in a lean-to open shed outside the main tannery building. Care should be exercised, since the fragments and dust can harm the face and skin.

Schedules

None, apart from the slatted platforms themselves (see the floor plan).

Stage No. 26 : Water

Process description

See the discussion at this stage for the ML project. It is largely applicable here, except that flow rates are smaller.

Schedules

None.

Stage No. 27 : Effluent Disposal

Process description

The process is the same as that described at this stage for the ML project, except that the outflow from the lagoon can in this case be used directly for the irrigation of crops. Also, at this smaller scale, a sludge pump may not be necessary. Given shallow settling tanks, sediment can probably be kept down to acceptable levels using a large shallow scoop fixed on the end of a pole (see Figure V.6).

Schedules

- Equipment.

Note: Assuming the use of dried hides, and thus a soaking stage, the daily volume of waste liquors - including water to wash down the tannery - might be about 23 m³. Thus each tank might hold 15 m³, and the lagoon about 45 m³

- . 3 mortar-lined tanks, each about 5 m x 3 m x 1 m deep
- . 1 lagoon, say 9 m x 5 m x 1 m deep
- . 1 scoop, with pole and rope (see Figure V.6)

All the equipment is locally producible.

- Water, chemicals, heat, electricity.

None.

- Labour. Periodic small demand for labour (2 men) borrowed from other stages, for sediment clearance.

Stage No. 28 : Process Heat

Process description

Except in an area with a long cold season, the project will almost certainly need no fuel-heated water. If a cold season must be reckoned with, the

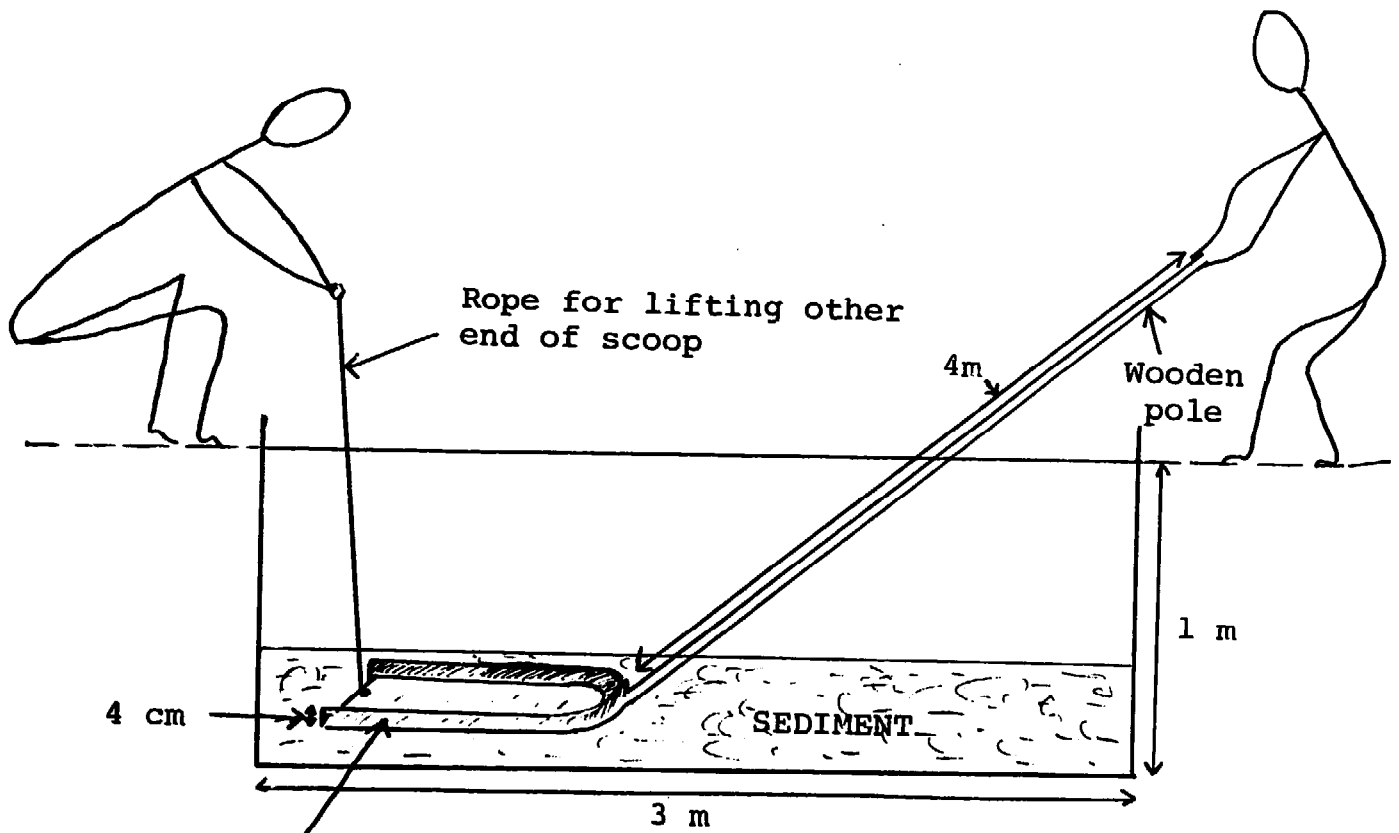

Sheet iron or wooden scoop

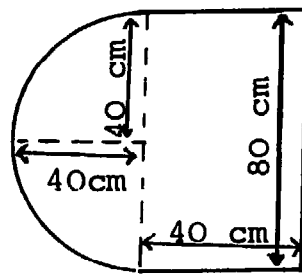

Scoop details

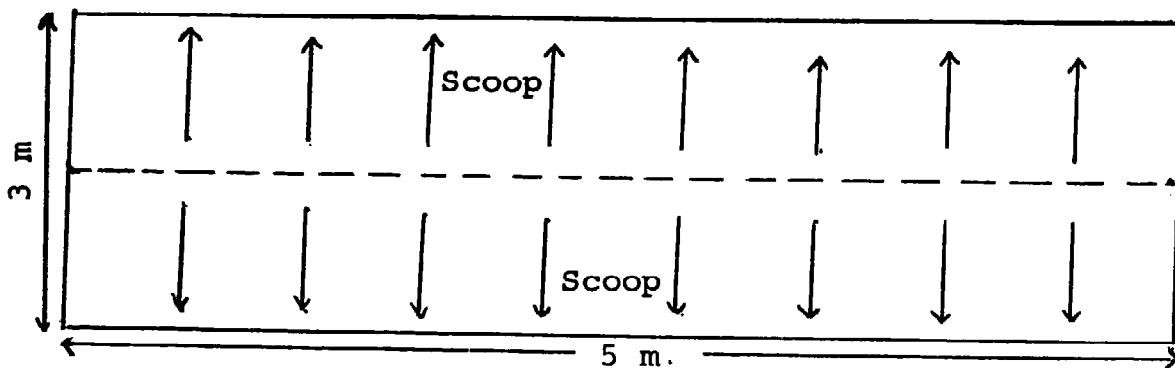

Figure V.6

Scoop for clearing sediment from settling tanks

indicative equipment described at this stage for the ML project will probably be found adequate at this scale of output.

Schedules

No formal schedules

Stage No. 29 : Electricity

Not required. Omitted

Stage No. 30 : Maintenance

Process description and schedules

Only a few simple wood-working tools are required. Any major jobs on relatively large-scale equipment, eg. pits, can be put out to local plasterers, plumbers, etc.

III. MS (20 HIDES PER DAY) PROJECT: OVERALL PROCESS SCHEDULES

III.1 Simplified Overall Flow Diagram of Process

This is shown below as Figure V.7, which is self explanatory.

III.2 Floor Plan

The floor plan is shown on Figure V.8 (1 cm = 1 m). It needs very little comment. Points worth noting are:

- With its simpler process or smaller scale, this is a much smaller tannery than the ML project. The building floor space area is only a little over 300 m².

Note : Heavy lines (➡) trace the main sequence of process stages. Light lines (—→) or (---→) indicate secondary inputs from service stages.

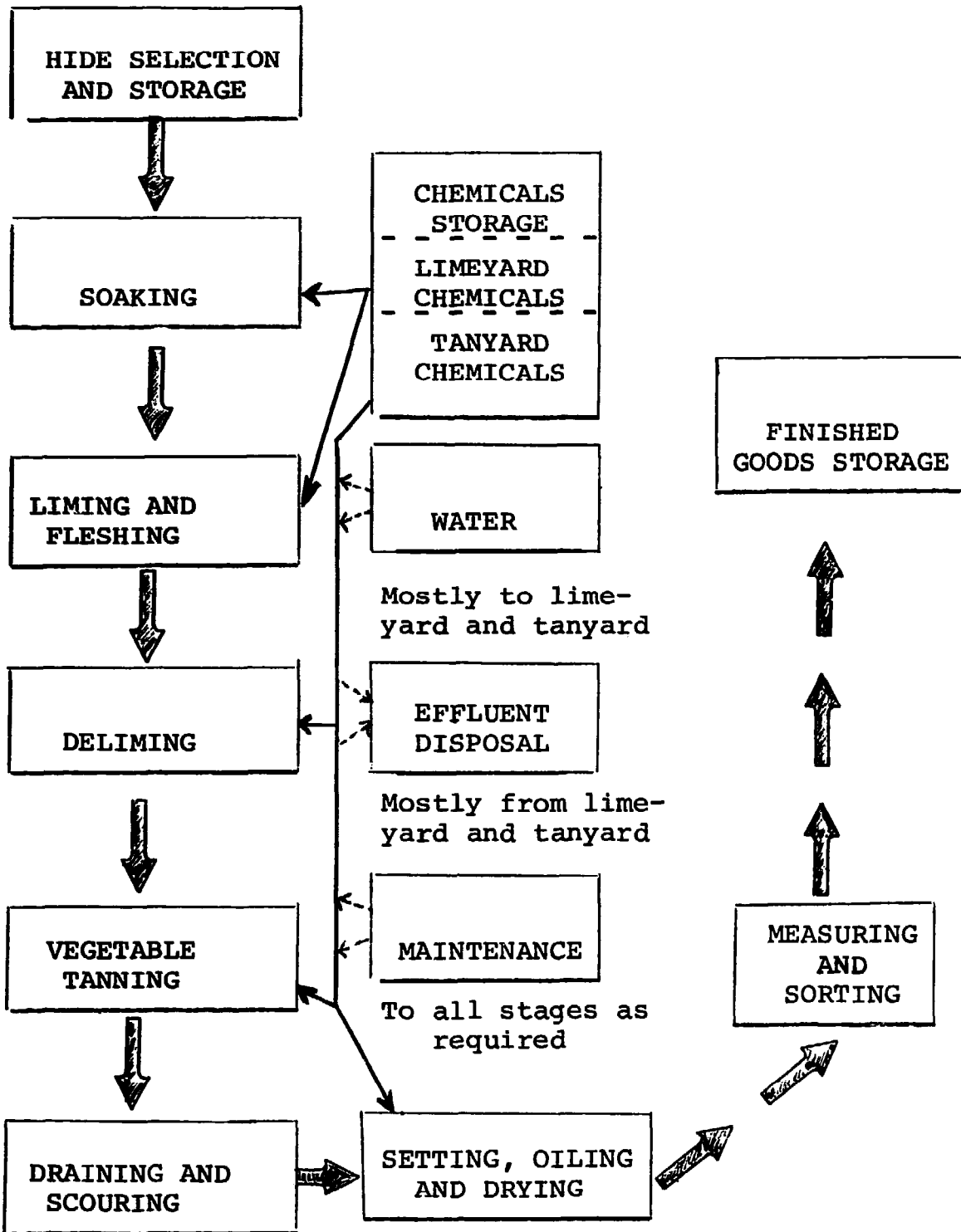

Figure V.7
Simplified diagram for the vegetable tanning of hides (MS-hides project)

- As with the ML project, the work flows round in a 'U' from the bottom left to the bottom right.
- Because of the simplicity of the process, the two service distribution systems of water and drainage - within the tannery - are readily shown, including the possibility of drainage from all the tan pits.
- The use of dried hides, and thus soaking, is assumed but it will be appreciated that only minor changes in the floor plan would be necessary to accomodate wet salts: they would include extension of the drains into the hides store (see the ML floor plan).
- The inset diagram gives an indication of the main features of the vertical elevation of the tannery building. The upper half of the walls all the way round the tannery may be latticed, to let daylight in and provide ventilation. (In areas with a very cold season, this may not be possible and all-solid walls plus windows may have to be used in conjunction with artificial lighting and ventilation).
- The roof may be of corrugated aluminium or asbestos tiles, or plaited of local leaves or bamboo. All these materials preserve coolness for easy working. Corrugated iron is not recommended, as condensation dripping from an iron roof will stain leather and liquors. If corrugated iron is used, it should be well galvanised and/or painted.
- The plan permits ready expansion of the project as and when demand and output build up beyond 20 hides per day. The workflow 'U' and tannery building is extended away from the stores and office. Some of the tan pits, for example, could become lime pits, and further tan pits installed beyond the present back wall as the tannery building was extended. However, if expansion is thought a strong possibility, provision should be made at the outset for adequate water and drainage to accomodate larger flow rates, and the effluent settling tanks and lagoon should be placed out of the way of possible extensions to the building.

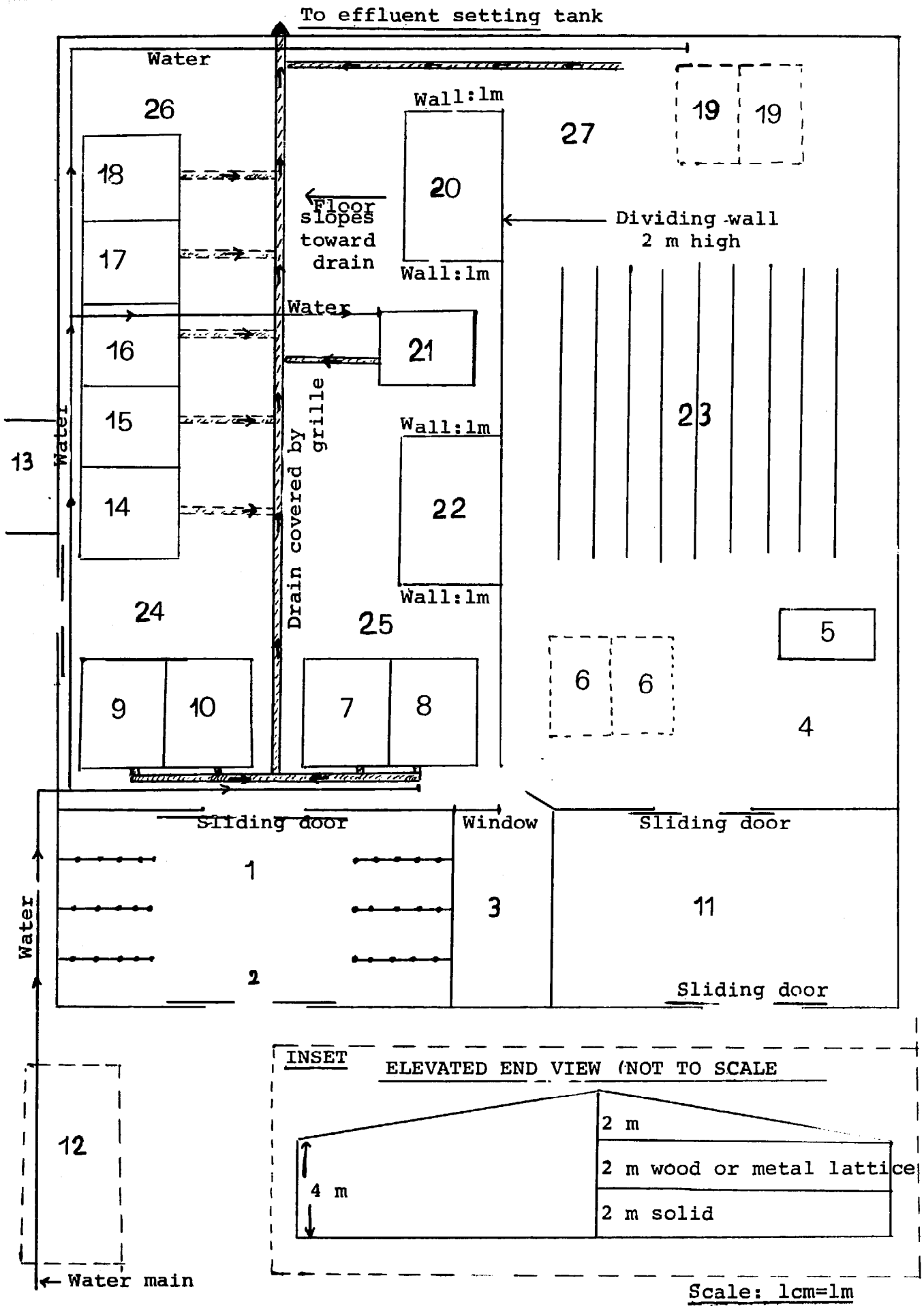

Figure V.8
Floor plan for vegetable tanning of 20 hides per day

Figure V.8 (continued)

Designation of work areas on floor plan

1. Hide storage
2. Weighing area
3. Office
4. Measuring and sorting area
5. Pallet
6. Movable setting and oiling tables
7. Lime pit ONE
8. Lime pit TWO
9. Soaking pit ONE
10. Soaking pit TWO
11. Finished leather warehouse
12. Elevated water storage tank (optional)
13. Open lean to for sulphide
14. Tanning stock pit
15. Tanning pit FOUR
16. Tanning pit THREE
17. Tanning pit TWO
18. Tanning pit ONE
19. Movable setting and oiling tables
20. Slatted platform, 30cm off floor for tanyard chemicals
21. Delimiting pit
22. Slatted platform, 30cm off floor for limeyard chemicals
23. Drying rails
24. Fleshing area
25. Unhairing area
26. Draining area
27. Scouring area

III.3 Overall Equipment Schedules

Note: This is a summary description only. For details, see individual stages above. Indicative 1980 prices have been given for the items of non-locally producible equipment, marked*. Water distribution equipment and fixtures in the stores are excluded.

| | Indicative 1980 prices (ex-works UK (US\$)) |
|---|---|
| <hr/> | |
| - 1 moveable weighing machine | 300 |
| - 2 soaking pits (dried hides assumed) | |
| - 2 liming pits | |
| - 40 hanging poles | |
| - 3 tanners' beams | |
| - 3 fleshing/unhairing knives | |
| - 1 deliming pit | |
| - 20 hanging poles | |
| - 2 barkometers* | 100 |
| - 1 mixing vat | |
| - 80 hanging poles | |
| - 3 buckets | |
| - 5 pits for tanning and stock liquors | |
| - 1 wheeled wooden horse | |
| - 1 bucket | |
| - 2 moveable tables | |
| - 3 slickers | |
| - 48 m of hanging rails | |
| - 2 mixing basins | |
| - 1 wooden pallet | |
| - 4 m ² (approx.) sacking or plastic sheeting | |

- 3 mortar-lined effluent settling tanks
- 1 lagoon
- 1 scoop for sediment clearance
- simple woodworking tools

It will be noted that only two minor items of equipment are assumed not to be producible locally.

III.4 Overall Schedules of Daily Usages

Note : Annual usages are shown, at 300 times daily usages, as well as indicative unit prices. Items marked * may not be purchaseable locally.

| | Daily usage | Annual usage | Indicative 1980 prices (ex-works UK (US\$)) |
|---|-------------------|----------------------|---|
| Water (assuming soaking 10 m ³) | 23 m ³ | 6,900 m ³ | 1 (est.) |
| Sodium sulphide, solid (do. 5 kg) | 46.7 kg | 14,000 kg | 1.02 |
| Anionic wetting agent, e.g. Teepol (do. 2.5 kg) | 2.5 kg | 750 kg | 0.50 |
| Disinfectant (do. 1kg) | 1 kg | 300 kg | 9.21 |
| Salt (do. 62.5kg) | 72.5 kg | 21,750 kg | 0.088 |
| Hydrated lime (do. 1kg) | 70.8 kg | 21,240 kg | 0.078 |
| Ammonium sulphate | 50 kg | 15,000 kg | 0.171 |
| Mimosa extract, solid* | 100 kg | 30,000 kg | 0.756 |
| Sodium bisulphite | 5 kkg | 1,500 kg | 0.29 |
| Sulphited whale oil, e.g. Cremol SW* | 40 kg | 12,000 kg | 1.34 |
| Sulphuric acid | 2 kg | 600 kg | 0.077 |

Note : 20 kg per day of the sulphited whale oil may be replaced by local castor, cottonseed, etc. oil. A fair estimate of the price of local vegetable oil in developing countries is 0.8 - 1.0 US\$ per kg. say 0.9 US\$ per kg.

III.5 Overall Labour Schedule

| | | ' Sections' | |
|--|-----------|---------------------------|-----------|
| - Owner, managers, foreman | 1 | Administration | 1 |
| - Hide store | 1 | Hide store | 1 |
| - Soaking | 1 | Limeyard | 3 |
| - Liming, fleshing | 2 | | |
| - Deliming | 1 | Tanyard | 4 |
| - Tanning | 3 | | |
| - Setting, oiling, drying | 2 | Setting, oiling drying | 2 |
| - Measuring, sorting storing finished leather | 2 | Finished goods store | 2 |
| Total | <u>13</u> | | <u>13</u> |

Note : Deliming may alternatively be included in the limeyard for purposes of labour organisation.

CHAPTER VI

MEDIUM SMALL TANNERY:200 SKINS PER DAY

This tannery is best described with reference to its sister project, handling 20 hides per day. The scales of the two are very much the same, and their processes differ significantly only at certain stages. This is illustrated by Figure VI.1 below, which provides a summary comparison of their processes stage by stage.

No stage description is needed or given for MS (skins) where the process is identical to that of MS (hides). At stages where the process is qualitatively identical, but some quantities differ between the two tanneries, the MS (skins) quantities are presented. Finally, at stages where the process does differ both qualitatively and quantitatively, stage descriptions for MS (skins) are given. Flow diagrams are not provided as they are identical to those pertaining to the 20 hides per day project.

However, whatever the detailed differences between the two tanneries, they are very similar overall. Both produce semi-finished leather on roughly the same scale for the same general markets, that is, other tanneries or the local leather products trade. And both do so with basically similar (vegetable) tanning process, using simple equipment.

The use of goatskins is assumed throughout. The process descriptions also apply to sheepskins at the

| <u>Stage No.</u> | <u>Stages of MS (skins) process</u> | <u>MS (hides) process:</u> | | <u>Differs signifi- cantly.</u> |
|------------------|---|----------------------------|---|---|
| | | <u>Identical</u> | <u>Different only in quantities</u> | |
| 1 | Skins selection and storage | x | | |
| 2 | Soaking | | | x |
| 3 | Liming and fleshing | | | x |
| 4 | Deliming | | | x |
| 5 | Bating | | | x |
| 6 | Pickling | | | x |
| 7 | (vegetable) tanning | | | x |
| 8 | Draining and scouring | | x | |
| 9, 12 | Setting and oiling | | x | |
| 14 | and drying | | x | |
| 16 | Staking | | | x |
| 22/23 | Measuring and sorting | x | | |
| 24 | Finished goods storage | x | | |
| 25 | Chemicals storage | x | | |
| 26 | Water | | x | |
| 27 | Effluent disposal | | x | |
| 28 | Process heat | | | x |
| 29 | Electricity | | | x |
| 30 | Maintenance | x | | |

The stage numbering used for the complete tanning process of the ML project (200 hides per day) is retained. Stages not appearing in the figure are omitted in both small projects.

Figure VI.1

Stage-by-stage comparison of processes
MS (skins) and MS (hides) project

great majority of points. Any significant process differences for sheepskins are indicated in the footnote at the appropriate points, but are not described in detail. This procedure keeps the exposition to a manageable length, while still providing a working basis for the tanner interested in sheepskins. The schedules of usages, like the process descriptions are based on the use of goatskins. They would not however, differ significantly if sheepskins were substituted as the raw material.

I. INPUT, OUTPUT AND UTILISATION

- Input : 200 goatskins per day, average dried weight of 0.75 kg or average we-salt weight of 1.5 kg.
- Output : Each skin is converted to 0.9 kg of semi -finished leather.
- Utilisation : The tannery is assumed to operate 300 days per year, on one 8-9 hours shift per day.

II. STAGE-BY-STAGE DESCRIPTION

Stage No. 1 : Skins selection and storage

Identical to MS (hides)

Stage No. 2 : Soaking

(a) Wet-salted skins

Soak overnight in a pit containing:

- 1,400 litres of unheated water.

Next day, drain¹ and transfer to liming.

¹Goatskins will drain quickly in soaking and liming pits, but sheepskins - particularly of wooly sheep - need to be piled over the pit-edge or over a wooden horse to get the liquor out of them quickly.

(b) Dried skins

A two-day process is needed, using two pits which each handles a day's throughput (a batch of 200 skins) on a staggered alternate basis. That is, the first pit starts its soaking cycle on days (say) 1, 3 5... and finishes them (transfers batches to liming) on days 3, 5 7... While the second pit starts its cycles on days 2, 4 6... and transfers batches on days 4, 6, 8... In this way, a batch of 200 skins is transferred to liming each day from one or other of the pits.

In each pit, the cycle is as follows:

First day : Make up a liquor in the pit from:

- . 1,500 litres of unheated water
- . 3 kg sodium sulphide
- . 0.25 kg anionic wetting agent, e.g. Teepol.

Put the skins in the liquor and leave them overnight.

Second day: Drain off liquor and work the skins over a tanner's beam. They are placed on the beam and the bluntish concave blade of a working knife (see Fig. VI.2) is pushed forward and downward over each side of the skin.

Meanwhile, make up a fresh liquor in the pit from:

- . 1,500 litres of unheated water
- . 3 kg sodium sulphide

Put the skins back in the pit and leave them overnight. In the morning, drain off the liquor and transfer the skins to liming. The pit is then ready to start a new cycle.

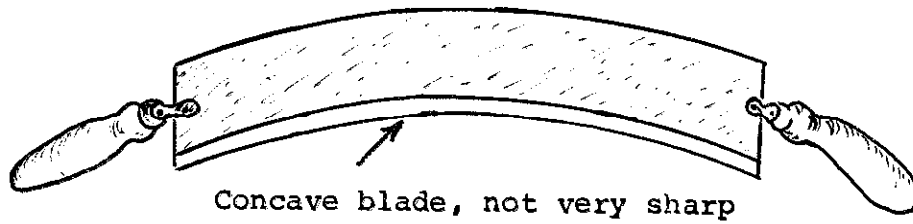

WORKING KNIFE

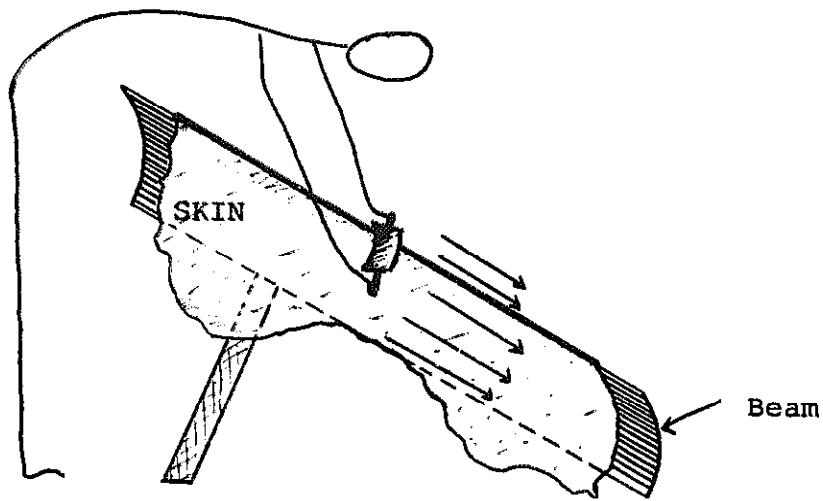

Unhairing skin over a tanner's beam

Figure VI.2

Working skins over a tanner's beam

Schedules

(a) Wet-salted skins

- Equipment.

- . 1 concrete pit with drainage, 1.2 m x 1.2 m x 1.2 m deep

- Water, chemicals, heat, electricity.

Daily usages

- . Water : 1.4 m³

- Labour. One worker, shared with other stages.

(b) Dried skins

- Equipment.

- . 2 concrete pits with drainage. Each pit is 1.2 m x 1.2 m x 1.2 m deep. The pits may be built on, or sunk into, the tannery floor (refer to Figure IV.2).
- . 1 tanner's beam (refer to Figure IV.4)
- . 1 working knife (refer to Figure V.9)

- Water, chemicals, heat, electricity

Daily usages

- . Water : 3 m³
- . Sodium sulphide : 6 kg
- . Anionic wetting agent : 0.25 kg

- Labour. One worker, shared from time to time with stage number 3. Normal care and vigilance required. Refer to process description for the ML project at this stage for the need to inspect the goods for putrefaction during soaking.

Stage No. 3 : Liming and Fleshing

Process description

(a) Application of "paint" and unhairing

The skins are taken from soaking as early in the morning's work as possible, and piled over horses, preferably wheeled, to drain until mid-afternoon. This helps absorption of the 'paint' which has been made up on the previous day, from:

- 70 litres water
- 6 kg sodium sulphide
- 25 kg hydrated lime

by first dissolving the sulphide into half the water heated to about 60°C, adding the rest of the water and then stirring in the lime. This should produce a smooth even paste or 'paint'.

The paint is applied to the skins on the flesh side with a piece of sacking.

The skins are then piled in heaps of 40-50, flesh side to flesh side (see Figure VI.3) and left overnight.

The next morning, they are unhaired over a beam (see Figure VI.4). The blade is pressed forward and downward over the grain (hairy) side of the skin. The edge of the blade should be checked each morning for irregularities which might scratch the skins.

(b) Liming

The skins are then limed in pits. A three-day process is used, each daily batch of hides lying successively for a day in different liquors. Figure VI.5 below illustrates the process.

Each batch lies for a three day treatment in successively 'newer' liquors - one day in each liquor - reaching the newest and strongest (the 'white lime') on the third and final day of its treatment (see the 'Key' annexed to the Figure).

As the main figure shows, one of the pits (e.g. pit 3) is filled on any one day of operations with 'white' lime'. This is made up from

- 1,500 litres of unheated water
- 50 kg hydrated lime

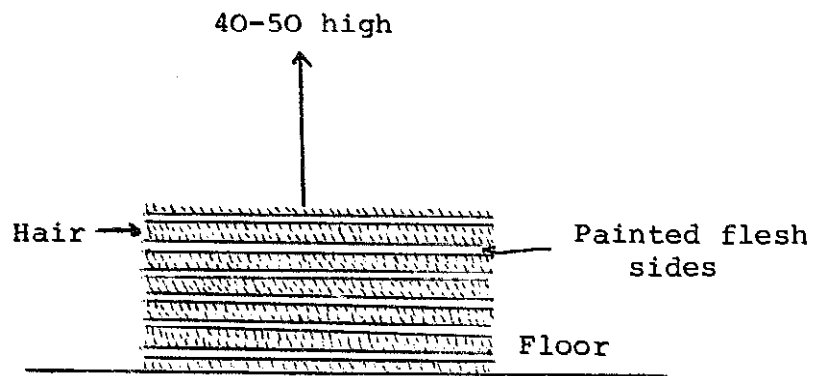
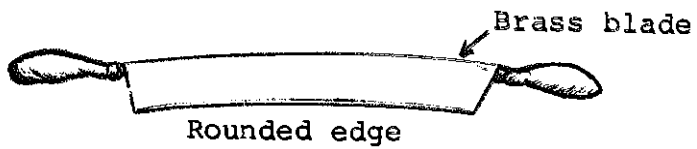
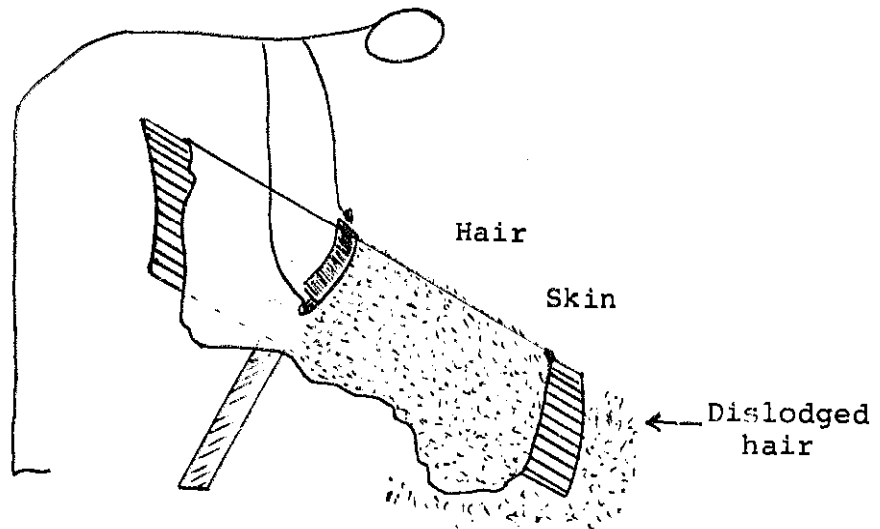

Figure VI.3
Skins piled after painting



Brass-bladed unhairing knife



Unhairing over a beam

Figure VI.4
Unhairing skins over a beam

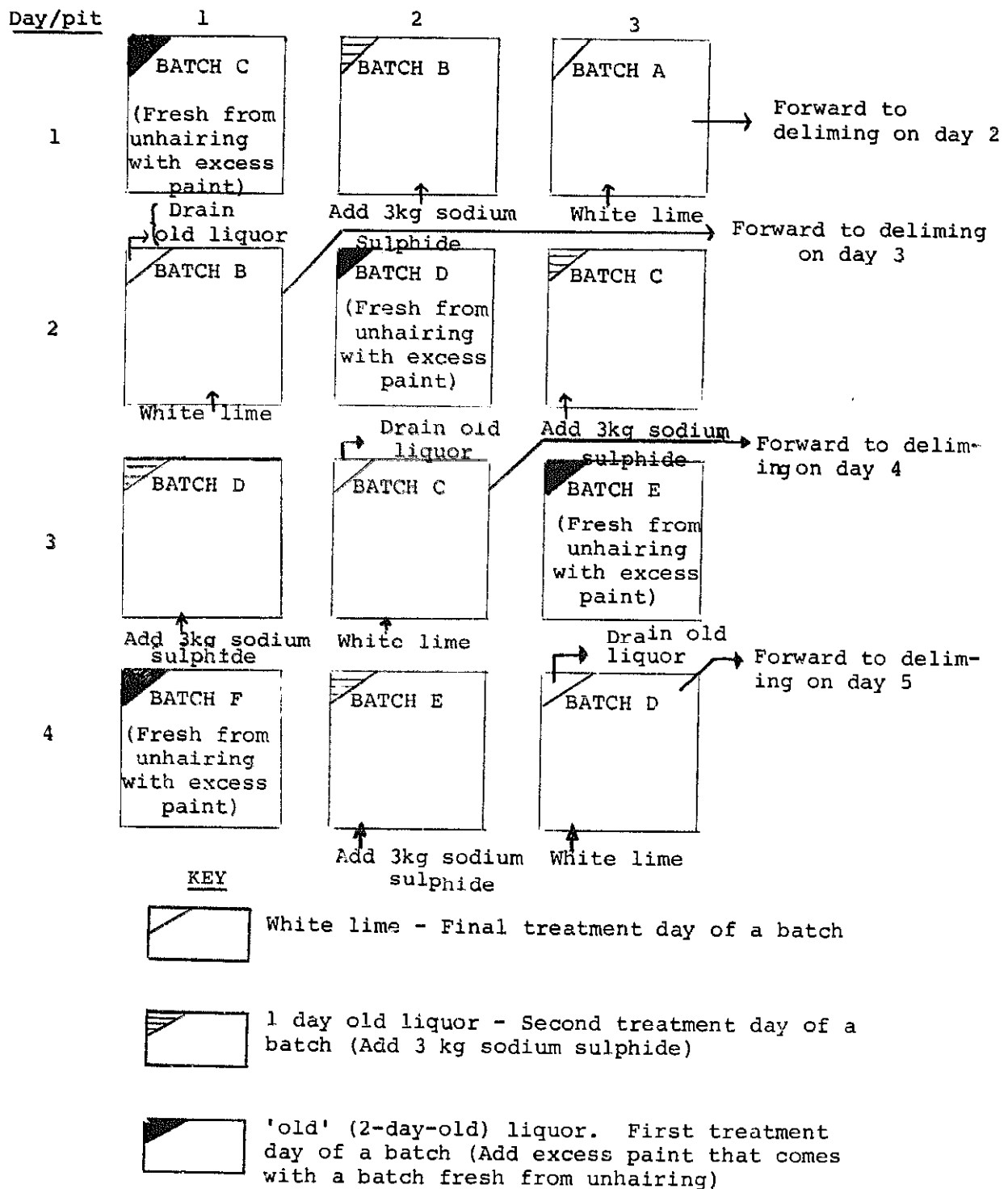

Figure VI.5

3-day pit liming process for goat skins

The next day, 3 kg of sodium sulphide is added, and the white lime has become 1-day old liquor.

After another day, the liquor receives a fresh batch of skins (e.g. batch E in the case of pit 3 in the figure) with excess paint still residing in it immediately after unhairing. With the addition of this, the liquor has become 'old', and after one day's further use giving the first treatment to the fresh batch of skins, it is drained off and the pit is ready for a new white lime liquor.

The figure illustrates how this ageing cycle of liquors proceeds concurrently in all three pits, with the cycle starting with white lime on a different day for each of them. In this way, on any day, one of the pits contains white lime, one contains one-day old liquor and one contains old liquor.

This enables them to be kept in continuous use. Each day, each of them advances one of the daily batches of skins through one day of its 3-day treatment. The figure illustrates this, showing how the system each day sends one batch forward to the next stage, deliming, after the batch has lain for the final day of its treatment in white lime.

Although the process is complicated to describe, it is quite simple in principle and like other seemingly complex operations, soon becomes second nature to practising tanners. The following process details should also be noted:

- (i) When a tannery is starting up, no old liquor is obviously available. It is then necessary to follow the sequence as described below:

Day 1: Soak batch A in pit 1 filled with white lime

Day 2: Soak batch A in pit 2 filled with white lime - Add 3 kg sodium sulphide to pit 1 - Soak batch B in pit 1.

Day 3: Soak batch A in pit 3 filled with white lime - Add 3 kg sodium sulphide to pit 2 - Soak batch B in pit 2 - Soak batch C in pit 1 (now full with 'old' liquor).

Day 4 : Batch A goes to delimiting -
Drain pit 1 and fill with white
lime - Soak batch B in pit 1 -
Add 3 kg sodium sulphide to pit
3 - soak batch C in pit 3 - soak
batch D in pit 2 (now full with
'old' liquor.)

The cycle may now be repeated in a normal fashion, with batch B going to delimiting, batch C moved to pit 2 filled with white lime, batch D going to pit 1 to which 3 kg of sodium sulphide has been added, and a new batch E soaked in pit 3 in 'old' liquor.

- (ii) The skins do not hang from poles, they are simply thrown into the pits.
- (iii) Each fresh batch of skins is 'plunged' (agitated) every hour in old liquor during the first day of treatment, then left overnight in the liquor.
- (iv) Agitation every hour continues during the second day's treatment in 1-day-old liquor. The skins are again left overnight.
- (v) Before the third day's treatment in white lime, the skins are fleshed (see below). Hourly agitation then continues in the white lime, and the skins are again left overnight.
- (vi) The next morning, the skins are scudded (see below)¹, and sent immediately forward to delimiting¹.

(c) Fleshing and scudding

Fleshing and scudding are performed like unhairing on tanners' beams. As with unhairing, the skin is placed over the beam and work proceeds downwards and forwards (see figure VI.2).

¹The process for sheepskins is very similar, but takes two days and pits only. The old liquor is eliminated and the skins go directly - residual excess paint and all - into 1-day-old liquor. This apart, the process - the subsequent sequence of operations and the composition of the liquors - is identical to the goat-skin process.

The details, however, differ importantly. In fleshing, the skin is placed flesh side up and the very sharp convex blade of a fleshing knife (see Figure VI.6) is used in a sweeping movement slicing off the flesh while leaving the actual skin uncut. This takes care and skill. In scudding, the skin rests grain side up, and a blunt concave blade like that used for unhairing (see Figure VI.4 above) is used to squeeze out further unwanted material, such as hair roots, loose tissue, etc. which is known as 'scud'.

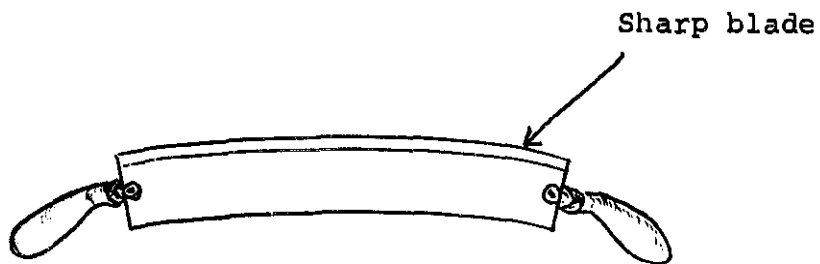
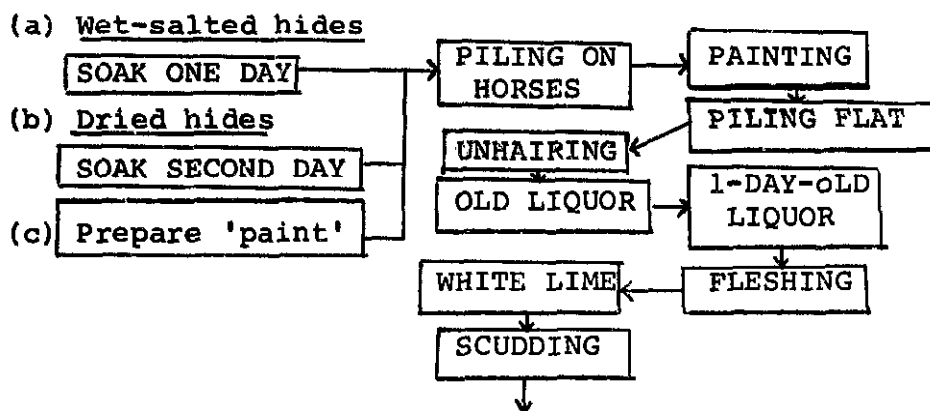

Figure VI.6
Fleshing knife

Flow diagram : Stage 3



Schedules

- Equipment.

- . 2 wooden horses, preferably wheeled (refer to Figure IV.9), 2.5 m x 1.5 m high. 2 piles of 50 skins each are accommodated on each horse
- . 1 mixing tub for paint, 100 litres capacity, wooden or plastic
- . 2 thermometers, capable of measuring up to 100°C, including 1 spare
- . Swabs of sacking as required
- . 3 concrete pits with drainage, each 1.5 m x 1.2 m x 1.2 m deep and built on, or sunk into, the tannery floor (refer to Figure IV.2)
- . 2 unhairing knives, including 1 spare (see Figure VI.4)
- . 5 tanners' beams, including 1 spare (refer to Figure IV.4)
- . 5 fleshing knives, including 1 spare (see Figure VI.6)
- . 5 blunt-edged knives for scudding, including 1 spare (refer to Figure VI.4)

- Water, chemicals, heat, electricity

Daily usages

- . Water 70 litres + 1,500 litres = 1.57m³
- . Sodium sulphide 6 kg + 3 kg = 9 kg
- . Hydrated lime 25 kg + 30 kg = 55 kg
- . Process heat: Approximately 16 kg of boiling water, to raise initial water temperature to 60°C in paint-mixing. See stage 28, process heat, below.

- Labour. 4 workers, plus 1 borrowed from time to time from soaking. Fleshing requires care, skill and training.

Stages No. 4, 5 and 6: Delimiting, Bating
and Pickling

Process description

This series of stages involves immersion and agitation of the skins in a succession of different liquors. The process is performed in pits, each of which holds a whole daily batch, equipped with motor-driven paddles to provide agitation and having curved bottoms to facilitate the ready motion of the agitated liquors (see Figure VI.7 for details). The paddle axles and axle mountings should be of wood, plastic or stainless steel. Iron should not be used, since it may stain the liquors and skins. The paddles themselves, as the figure shows, are made of wood, and the nails or pegs used in their construction should also preferably be of non-corrosive material, that is wood, steel, brass or treated iron. Paddle speed should be between 5 and 10 r.p.m., sufficient to keep the skins in motion without entangling them in the blades.

Weigh the daily batch of skins from scudding. Their total weight should be about 220% of dried weight. Given the input assumptions for the project noted in section I of this chapter, daily scudded weight will be $200 \times 220\% \times 0.75 \text{ kg}$ (330 kg) but this may vary from day to day. Those water and chemicals usages given as percentages below should be reckoned as percentages of the total scudded weight of any particular daily batch of skins.

(a) Delimiting

Throw the batch of skins from weighing into a pit, and wash in 500% unheated water for 30 minutes.

Drain the pit, run in 1,500 litres unheated water, add $\frac{1}{2}\%$ ammonium sulphate and run (rotate) the paddle 30 minutes. This completes delimiting.

(b) Bating

If possible, warm the liquor in the pit up to 35°C by adding hot water.

Then add 2% synthetic bate, e.g. Pancreol 5A, or Pancreol 5A CW if liquor is unheated.

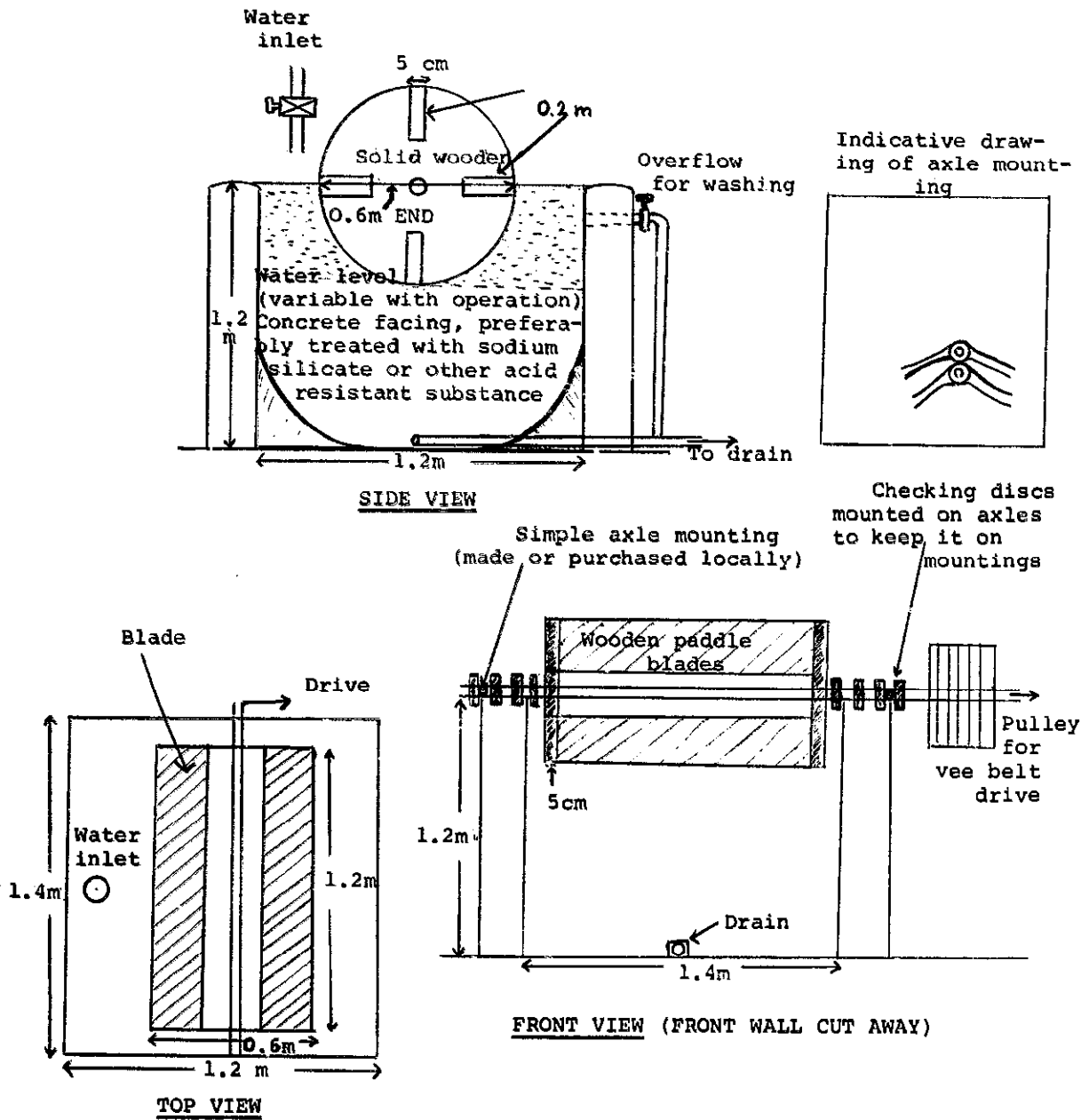

Figure VI.7

Pit paddles

Leave the skins in the liquor 120-150 minutes, then drain pit.

Run 1,500 litres unheated water into the pit to wash and cool the skins, transfer them to pickling and drain the pit¹.

(c) Pickling

For pickling, make up an initial liquor in a separate pit from:

- 1,500 litres unheated water
- 75 kg salt
- 6 kg sulphuric acid

Run the paddle 10 minutes to mix the liquor thoroughly.

Throw in the skins, run the paddle 60 minutes and leave overnight.

Next morning, check that the pH (refer to footnotes in chapter IV for an explanation of pH and its measurement) is 3.4 - 3.7, run the paddle 10 minutes, take out the skins, and drain them over a horse for an hour or two before tanning.

The pickling liquor is made back up to volume by adding water, then more salt is added to bring the gravity to 35°Bk' (1.035 specific gravity - refer to the process description in Chapter V for an explanation), and 2.5 kg of sulphuric acid is also added.

Run the paddle 10 minutes, and the liquor is then ready for use for the next day's batch of skins.

The pit should be drained once a month and an initial liquor made up as above.

¹The process for sheepskins varies slightly from the goatskin process, inasmuch as only 1% synthetic bate (e.g. Pancreol 3A at 35°C, or Pancreol 3A CW for unheated liquor) is used and the skins are left for 30-60 minutes, not 120-150 minutes as for goatskins.

Flow diagram : Stages 4 to 6

From stage 3

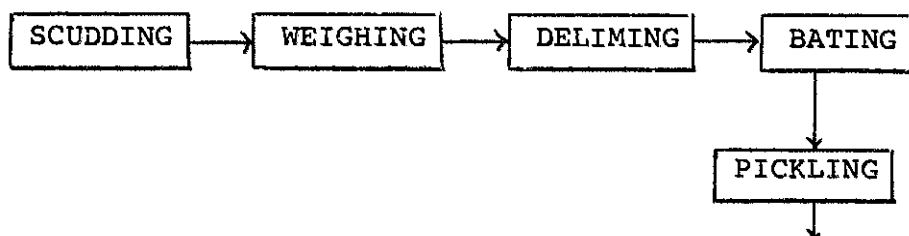

Schedules

- Equipment.

- . 2 pit-paddles, 1.4 m x 1.2 m x 1.2 m deep (see Figure VI.7) plus 2 drive motors about 1 h.p. each
- . 2 barkometers, including 1 spare, shared with stage number 7 - Tanning. (The machine to weigh the skins may be borrowed from the skins store)

The pit paddles, except for the drive motors, may be manufactured locally.

- Water, chemicals, heat, electricity

(assuming scudded weight of batch = 330 kg)

- . Water 5.0 m³ (assuming a daily₃ addition of approx. 0.1m³ to make up pickling liquor to strength)
- . Ammonium sulphate 1.65 kg
- . Synthetic bate 6.6 kg
- . Salt 10.3 kg (assuming a daily addition of approx. 16 kg to make up pickling liquor to strength)
- . Sulphuric acid 2.7 kg
- . Process heat Approximately 150 kg of boiling water, if bating performed at 35°C (see stage 28)
- . Electricity Approximately 2 kw/hr. If mains supply is not available, a small stationary diesel engine might be used as a drive motor (say) about 1 l. of diesel fuel.

- Labour. 3 workers, shared with stage number 7, tanning. Normal care and vigilance.

Stage No. 7 : Vegetable tanning

Process description

Tanning proceeds by immersing and agitating each day's batch of skins in pit-paddles containing successively stronger tanning liquor.

The process is illustrated by Figure VI.8(a) below. The principles of the tanning and of the cycle passed through by each batch are identical to those in the MS-project. The only differences are:

- (i) tanning pit paddles are used rather than hanging from poles in simple pits as in MS-hides.
- (ii) the dimensions of the pits, and the physical daily usages, are smaller in MS-skins.
- (iii) the skins receive a 3-day tanning process, rather than 4 days as in MS-hides. Thus, only three tanning pit-paddles are needed, plus a stock pit.

To avoid much repetition, therefore, the tanner is referred to the process description at stage 7 in the MS-hides project. (It is worth noting that the comments made there on making up one's own tanning agents, also apply equally well to the tanning of skins). The process description here is limited to quantities and other particular details.

The first pit-paddle liquor is initially made up from:

- 1,500 litres unheated water
- 50 kg mimosa extract
- 15 kg salt
- 7.5 kg sodium bisulphite, Bk' = 7-8°

The second pit-paddle liquor is made up from:

- 1,500 litres unheated water
- 100 kg mimosa extract
- 15 kg salt
- 7.5 kg sodium bisulphite

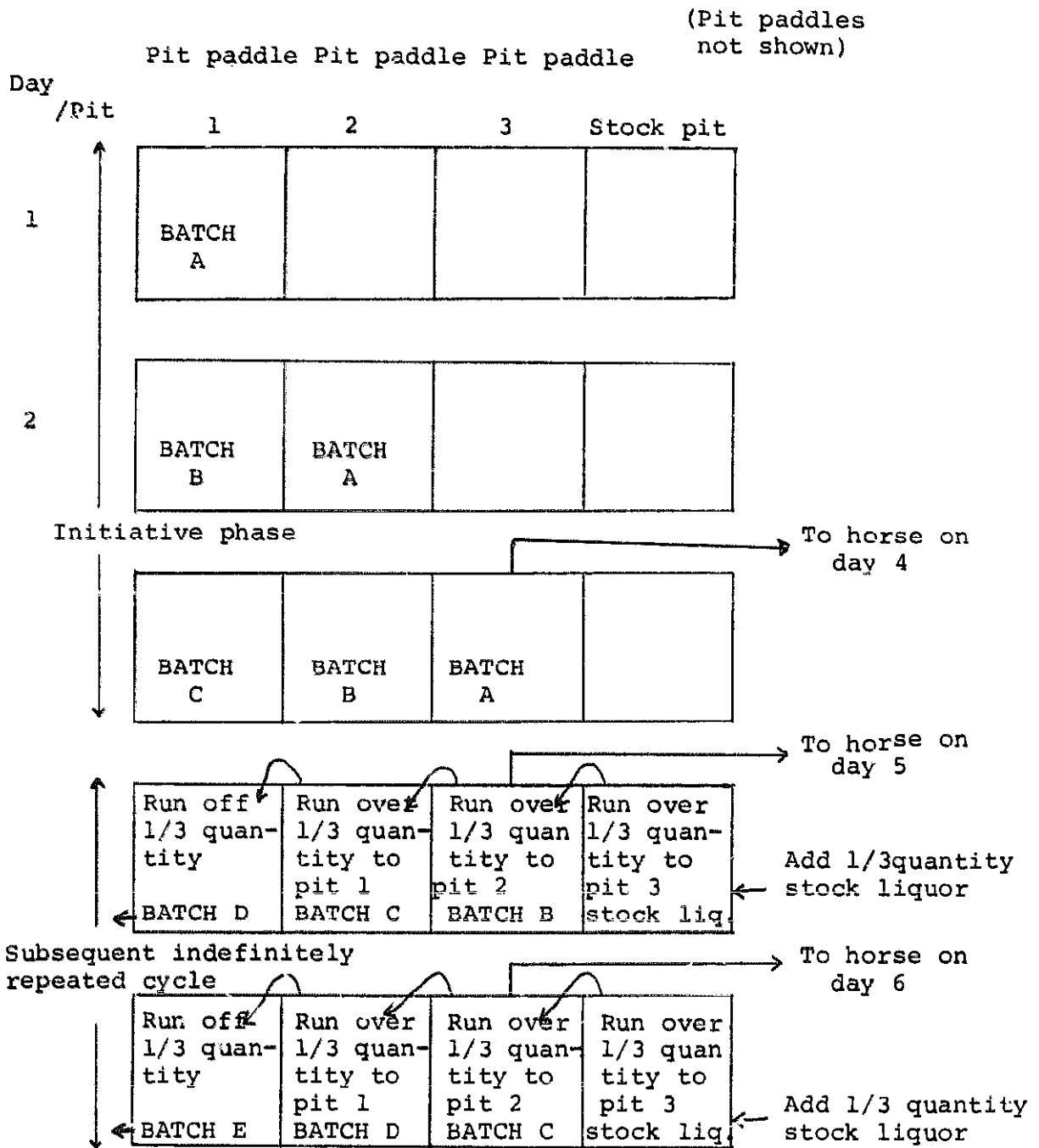

Figure VI.8(a)

Procedure for 3-day pit paddle vegetable tanning of skins

The third pit-paddle liquor and stock pit liquor are each made up from:

- 1,500 litres unheated water
- 150 kg mimosa extract
- 15 kg salt
- 7.5 kg sodium bisulphite, $Bk' = 30^{\circ}$

Batches are then thrown into the pit-paddles progressively as shown in Figure VI.8(a) until on day 4, a 'one-third quantity' of stock liquor is made up from:

- 500 litres unheated water
- 50 kg mimosa extract
- 5 kg salt
- 2.5 kg sodium bisulphite

The batches are shifted into the pit-paddles as shown. One-third of the liquor in the first pit is run off, and the freshly made up extra one-third stock liquor is added to the stock pit, causing the liquors to run over successively as shown.

Figure VI. 8 (b) illustrates a possible configuration of the pit and pit-paddles to achieve this. The pit-paddles are slightly separated from each other and the tops of adjacent walls connected by level channels or pipes: this allows unhindered motion of the three paddles.

On subsequent days, the day 4 procedure is repeated indefinitely, except that - analogously to the process in MS hides - the 'one-third' addition is a trial quantity and the actual amount added and transferred is ultimately determined by checking the Bk' of the first pit-paddle liquor each day after running over liquor from the second pit-paddle. A Bk' rising above $7-8^{\circ}$ should be counteracted by adding less than one-third stock liquor. A Bk' falling below $7-8^{\circ}$, by adding more than one-third.

The amount found to be needed to maintain a steady Bk' will probably not differ much from the trial 'one-third' quantity.

Finally, agitation is provided daily in each pit-paddle by running the paddle for 10 minutes immediately after the batches are in position and the liquors

established, and for five minutes each working hour of the day thereafter.

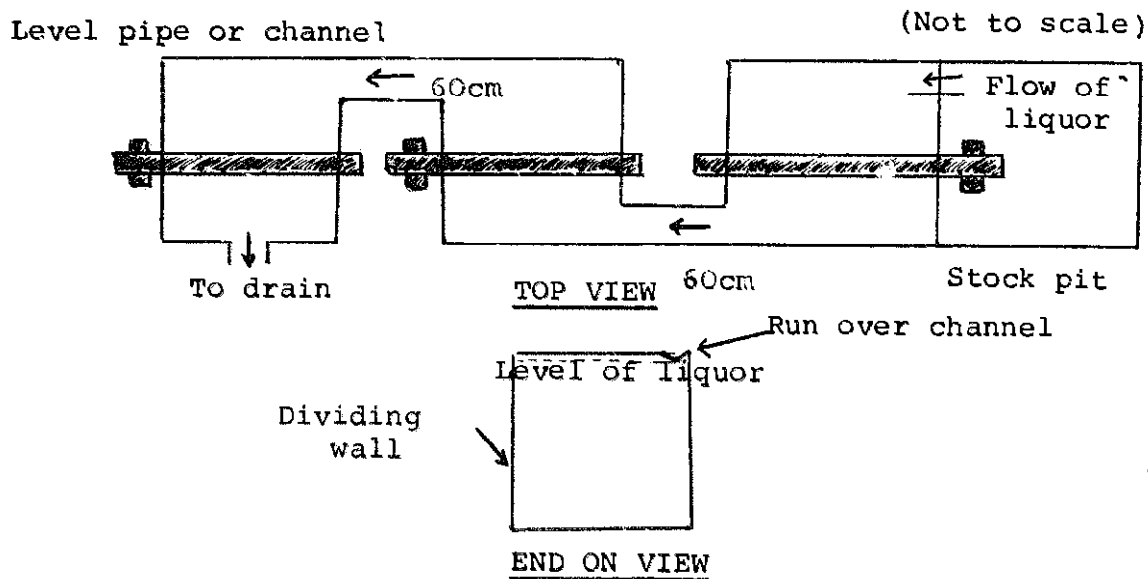

Figure VI.8 (b)

Configuration for run-over between pitpaddles

Flow diagram : Stage 7

From stage 6



Schedules

- Equipment.

- . 3 concrete pit-paddles, with drainage from at least the first of them, and 1 stock pit with provision for flow between them (see, e.g. Figure VI.8 (b)). Pit-paddle dimensions are 1.4 m x 1.2 m x 1.2 m with construction as in Figure VI.7. Stock pit dimensions are 1.2 m x 1.2 m x 1.2 m, built on the tannery floor.

- . 1x200 litres mixing vat for making up additions to stock liquor.
- . 3 x 10 litre buckets for transferring stock liquor to the stock pit
- . 2 barkometers, included in deliming to pickling (the previous stage) are shared with this stage.

- Water, chemicals, heat, electricity

Daily usages

- | | |
|---------------------|--|
| . Water | 0.5 m ³ |
| . Mimosa extract | 50 kg |
| . Salt | 5 kg |
| . Sodium bisulphite | 2.5 kg |
| . Electricity | Approximately 3 kw/hr, or (say) 2 litres of diesel fuel. |

- Labour. 3 workers are shared between this stage and the pickling and deliming stages. Normal care and vigilance required, plus supervision from the manager from time to time, since the stage is obviously crucial.

Stage No. 8 : Draining and Scouring

Identical to MS (hides), except that 2 horses will probably be required, not 1, and 200-300 litres of water, not 100-200 litres.

Stage No. 9, 12 and 14 : Setting, oiling and drying

Identical to MS (hides), except that each skin receives one-tenth as much oiling mixtures as each hide (i.e. 0.2 kg of mixture per skin) and there will be two hanging rails for skins between each set of posts (see Figure VI.9). There will need to be 60 m of these pairs of rails, rather than the 48 m of single rails needed for MS (hides).

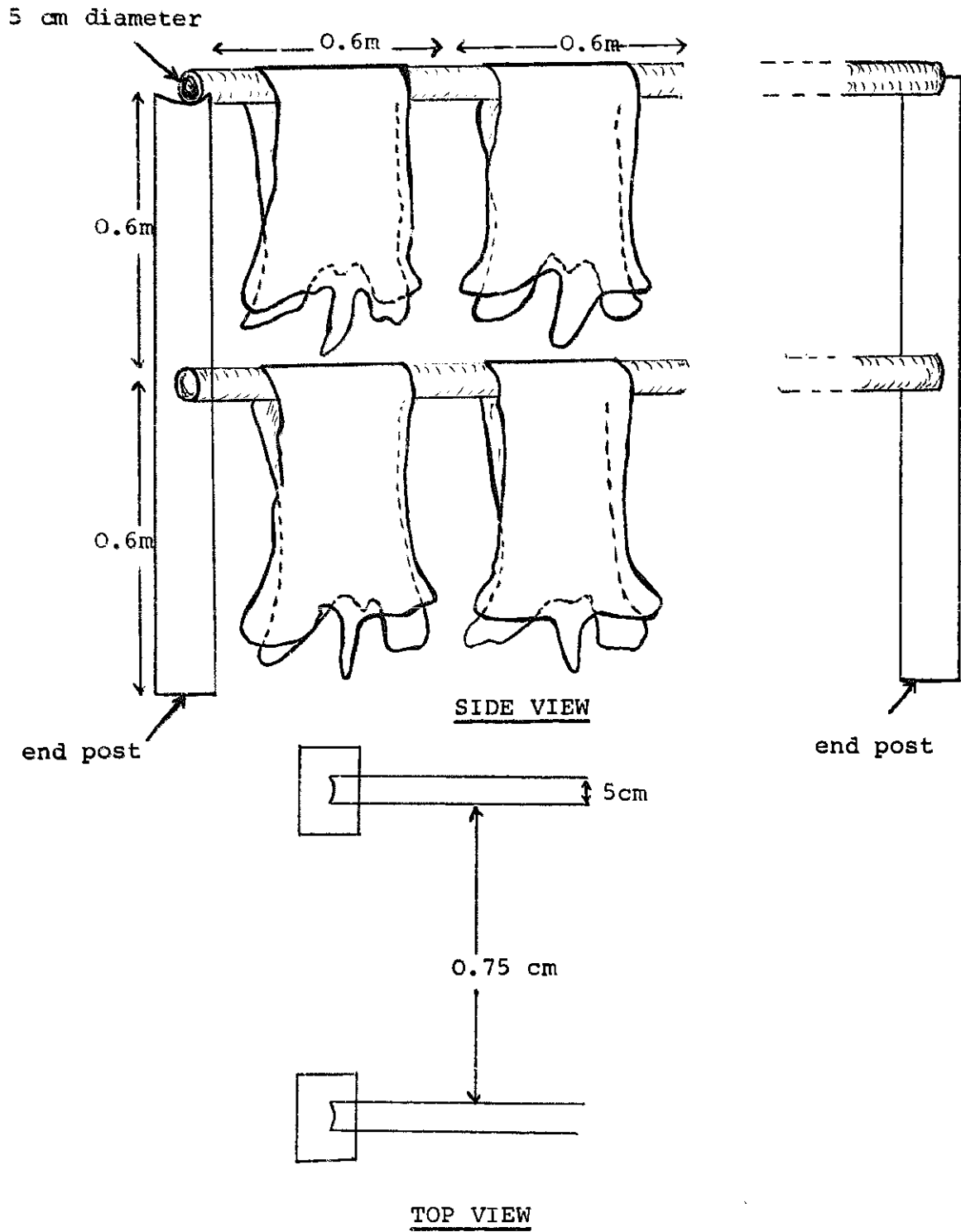

Figure VI.9

Drying rails for oiled skins

Stage No. 16 : Staking

Process description

If the leather is to be sold to other tanners for further finishing, this stage is omitted in MS (skins), as in the MS (hides) project. However, if the leather is destined for the local leather products market, it may first be softened by staking. This is done by hand over a rounded steel blade attached to the top of an upright wooden post, called a 'stake' (see Figure VI.10).

The leather is put flesh side down on the edge of the blade, and is then worked backward and forward over it with some downward pressure. The process requires great care and skill if tearing or deformation of the leather are to be avoided. It is best performed during the final drying of the skins after their second oiling (refer to the process description of stage numbers 9, 12 and 14 in MS (hides), which applies also to MS (skins)), since the skins should be slightly damp when staked. The skins are taken down from the rails, staked and hung up again.

Flow diagram : Stage 16

From stage 14:

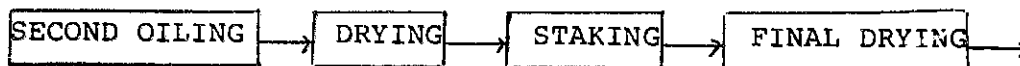

Schedules

- Equipment.

. 1 stake. Replacement stakes are locally producible, but an initial sample should be purchased from a specialist manufacturer.

- Water, chemicals, heat, electricity

None

- Labour. One worker is needed. Care and skill is necessary and training may be needed.

(a) Stake (Indicative only)

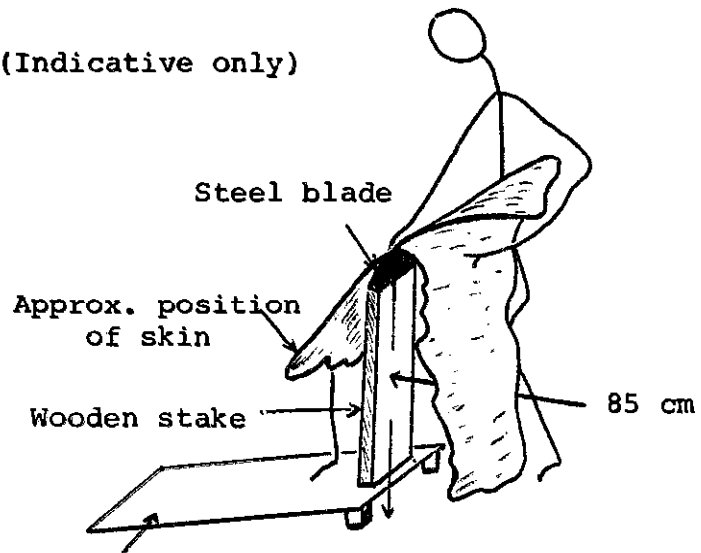

(b) Staking motion

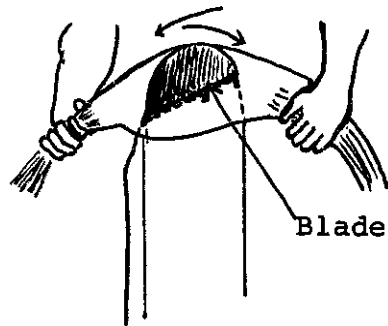

Figure VI.10

Hand staking

Stage No. 22 and 23 : Measuring and Sorting

Identical to MS (hides).

Stage No. 24 : Finished goods storage

Identical to MS (hides)

Stage No. 25 : Chemicals storage

Identical to MS (hides)

Stage No. 26 : Water

As for MS (hides), see the discussion at this stage for the ML project. It is largely applicable here, except that flow rates are smaller.

Stage No. 27 : Effluent disposal

Identical to MS (hides), except that the daily volume of waste liquors is smaller. Assuming the use of dried skins and thus a₃soaking stage, the daily volume might be about 14m³.

Schedules

- Equipment.

- . 3 mortar-lined tanks, each about
3 m x 3 m x 1 m deep
- . 1 lagoon, say 7 m x 4 m x 1 m deep
- . 1 scoop, with pole and rope (refer to
Figure V.6)

- Water, chemicals, heat, electricity.

None.

- Labour. Periodic small demand for labour
(2 men) borrowed from other stages, for sedi-
ment clearance.

Stage No. 28 : Process heat

Process description

Unless there is a long cold season, the need for fuel-heated water will be very small: about 170 kg of boiling water, or about one-tenth of that if bating is done in unheated water. Such small needs may be supplied very simply. For example, a drum of water could be heated over a wood-fire, and the boiling water tapped out to another drum - preferably insulated - which could be wheeled into the main tannery building.

If there is a long cold season, the indicative equipment described at this stage for the ML project will probably be found adequate at this scale of output.

Schedules (No long cold season. Bating at 35°C)

- Equipment.

- . 1 aluminium 200 litre drum with a vent for steam at the top and a tap extending from the bottom, mounted over a brick or stone firebox with a short flue at the back.
- . 1 or 2 x 50 litre wooden or plastic drums with taps at their bottom, preferably insulated, and mounted on simple wheeled trollies.

All this equipment may be manufactured or available locally. Note that iron drums should not be used.

- Water, chemicals, heat, electricity

Daily usages

- . 180 litres of near-boiling water, already included in process water at stage numbers 3 and 5 plus (say) 10-15 kg of wood, allowing for low thermal efficiency.

- Labour. Small demand of labour, met by borrowing from time to time from other stages.

Stage No. 29 : Electricity

Process description

If a mains supply is available, a local electrician can make the simple connections required.

If electricity is not available, the paddles may be driven instead by small stationary diesel engines.

Stage No. 30 : Maintenance

Identical to MS (hides).

III. OVERALL PROJECT SCHEDULES

III.1 Simplified overall flow diagram of process

This is shown below as Figure VI.11 which is self-explanatory.

III.2 Floor plan

See Figure VI.12. This is an outline drawing at a scale of 1:100 (1 cm = 1.0 m). The plan is very similar to that for MS (Hides), having the same floor area and almost identical flow of work. The comments made on the hides plan also apply here, and the tanner should refer to them. The only differences between the plans are points of detail, e.g. mains electricity supply, larger drying area and a stake in MS (skins).

III.3 Overall equipment schedules

Note : Summary descriptions only. For details see individual stages above. Indicative 1980 prices have been given for the items of non-locally producible equipment marked*. Water and electricity distribution systems and fixtures in the stores are not included.

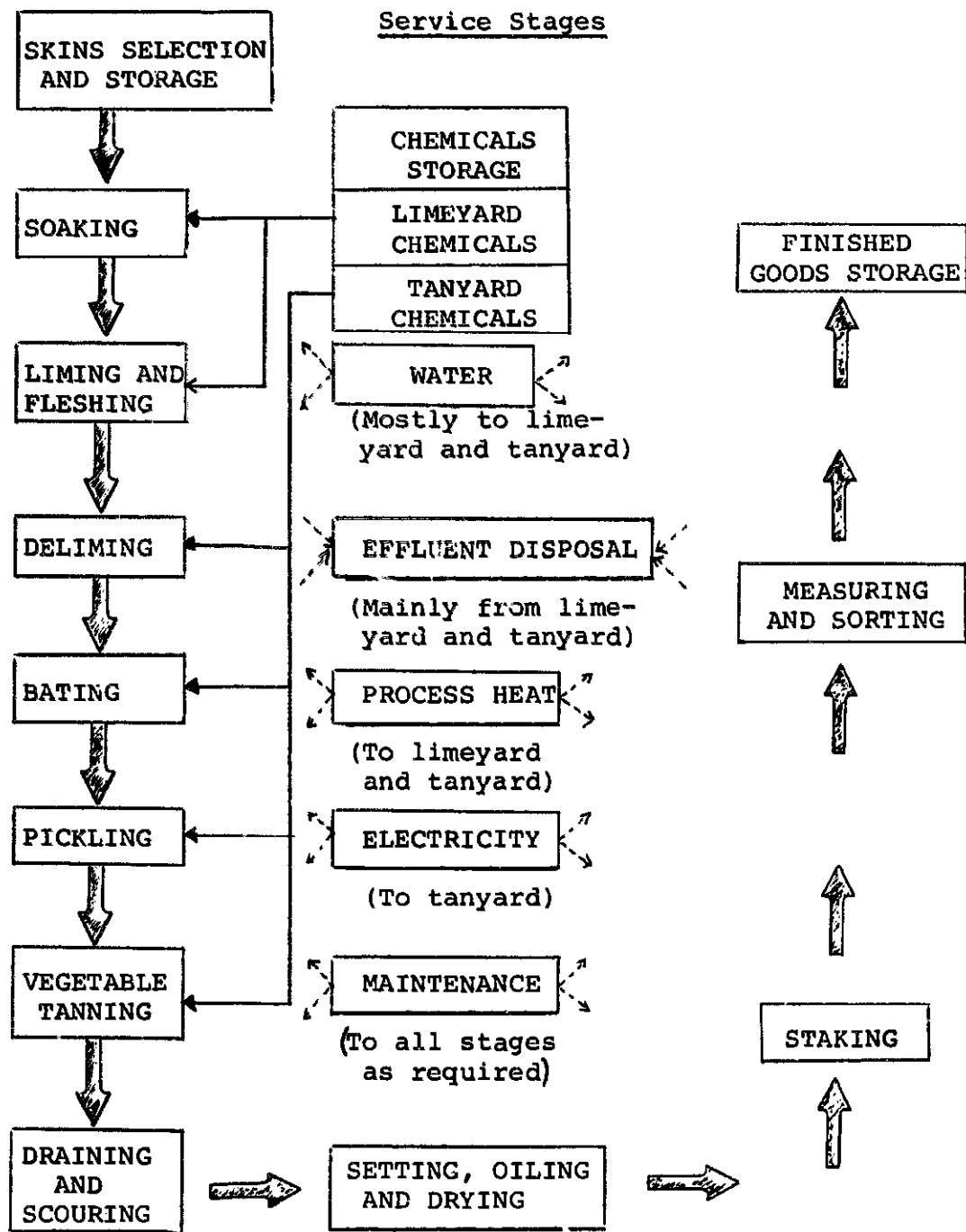

Heavy lines (→) trace the main sequence of process stages. Light lines (→) or (→) indicate secondary input from services stages.

Figure VI.11

Overall Flow Diagram of
the Vegetable Tanning of Skins

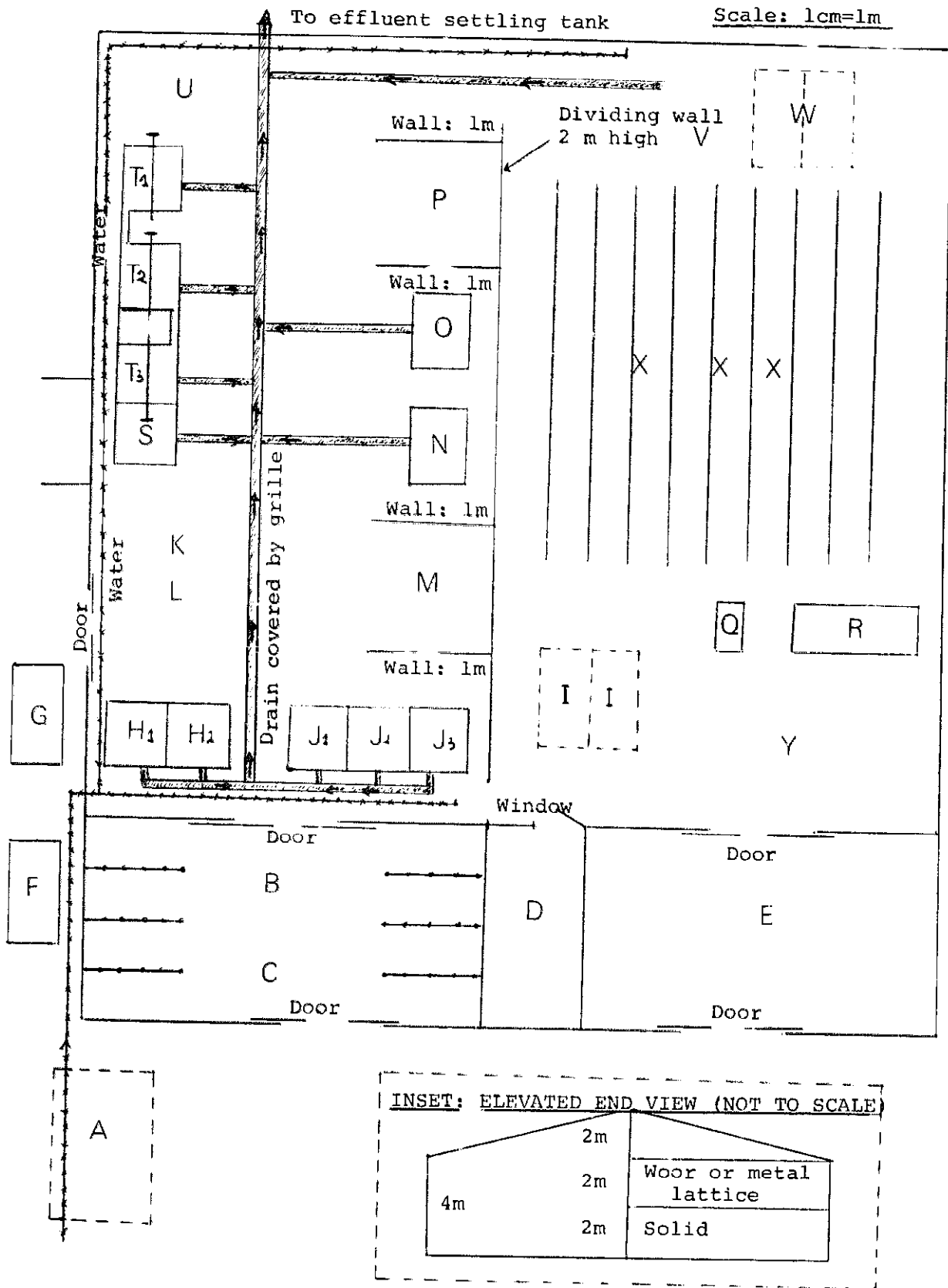

Figure VI.12

Floor plan for vegetable tanning for 200 skins/day
(MS-skins project)

Figure VI.12 (continued)

Designation of work areas on floor plan

- A. Elevated water storage tank (optional)
- B. Hide store
- C. Weighing area
- D. Office
- E. Finished goods storage
- F. Wood store
- G. Process heat
- H₁ Soaking pit ONE
- H₂ Soaking pit TWO
- I. Movable setting and oiling tables
- J₁ Liming pit ONE
- J₂ Liming pit TWO
- J₃ Liming pit THREE
- K. Fleshing area
- L. Unhairing area
- M. Slatted platform, 30cm off floor, for limeyard chemicals
- N. Deliming and bating pit
- O. Pickling pit
- P. Slatted platform, 30cm off floor, for tanyard chemicals
- Q. Stake
- R. Pallet
- S. Stock pit
- T₁ Tanning pit ONE
- T₂ Tanning pit TWO
- T₃ Tanning pit THREE
- U. Draining area
- V. Scouring area
- W. Movable setting and oiling tables
- X. Drying rails
- Y. Measuring and sorting area

| | Indicative 1980 prices (ex-works UK (US\$)) |
|--|---|
| 1 moveable weighing machine* | 300 |
| 2 soaking pits (dried skins assumed) | |
| 1 tanner's beam | |
| 1 working knife | |
| 2 wheeled wooden horses | |
| 3 liming pits | |
| 5 tanners' beams | |
| 5 fleshing knives | |
| 5 scudding knives | |
| 2 thermometers* | 50 |
| Swabs of sacking | |
| 2 pit-paddles for deliming, bating and pickling + 2 drive motors* | 200 |
| 2 barkometers* | 100 |
| 1 stock pit | |
| 3 pit-paddles for tanning, plus 3 drive motors* | 300 |
| 1 mixing vat | |
| 3 buckets | |
| 2 wheeled wooden horses | |
| 1 bucket | |
| 2 moveable tables | |
| 3 slickers | |
| 60 m of hanging double rails | |
| 2 mixing basins | |
| 1 wooden pallet | |
| 4 m (approx.) sacking or plastic sheeting | |
| 1 stake* | 150 |
| 3 mortar-lined effluent settling tanks | |
| 1 lagoon | |
| 1 heating drum, 2 transfer drums on trolleys, 1 firebox | |
| Simple woodworking tools. | |

The total expenditure for non-locally producible equipment is US\$ 1,000 ex-works.

Note that for sheepskins, 1 less liming pit would be needed.

III.4 Overall schedules of daily usages

Note : Annual usages are also shown, at 300 times daily usages. Indicative unit prices are also provided. Items marked* may not be purchaseable locally.

| | Daily usage | Annual usage | Indicative 1980 unit price (US\$) (ex-works UK) |
|---|---------------------|---------------------|---|
| Water (assuming soaking 3m ³) | 10.4 m ³ | 3120 m ³ | 1 (est.) |
| Sodium sulphide, solid (do. 6 kg) | 9 kg | 2,700 kg | 1.02 |
| Anionic wetting agent, e.g. Teepol, (do. 2.5 kg) | 2.5 kg | 750 kg | 0.50 |
| Hydrated lime | 55 kg | 16,500 kg | 0.078 |
| Salt | 15.3 kg | 4,600 kg | 0.088 |
| Ammonium sulphate | 1.65 kg + | 330 kg + | 0.171 |
| Synthetic bate, e.g. Pancreol 5A* | 6.6 kg + | 1,980 kg + | 0.679 |
| Sulphuric acid | 2.7 kg | 810 kg | 0.077 |
| Mimosa extract, solid* | 50 kg | 15,000 kg | 0.756 |
| Sodium bisulphite | 2.5 kg | 750 kg | 0.290 |
| Sulphited whale oil, e.g. Cremol SW* | 40 kg++ | 12,000 kg ++ | 1.34 ++ |
| Electricity | 5 kw/hr | 1,500 kw/hr | 0.08 (est.) |
| Wood | 12.5 kg | 375 kg | 0.016 (est.) |

+ quantities assuming daily scudded weight of skins 330 kg - usages would vary proportionately with actual scudded weight. Also for sheepskins, the ratio of bate to scudded weight is halved.

++ 20 kg per day of the sulphited whale oil may be replaced by local castor, cottonseed, etc. oil, at a price of (say) 0.9 US\$ per kg for the local oil.

III.5 Overall labour schedule

| | | 'Sections' | |
|---|-----------|-------------------------|-----------|
| Owner/manager/foreman | 1 | Administration | 1 |
| Skin store | 1 | Skin store | 1 |
| Soaking | 1 | Limeyard | 5 |
| Liming, fleshing | 4 | | |
| Deliming, bating, pickling tanning | 3 | Tanyard | 3 |
| Setting, oiling, drying | 2 | | |
| Staking | 1 | Finishing | 3 |
| Measuring, sorting, storing finished leather | 2 | Finished goods store | 2 |
| Total | 15 | Total | 15 |

CHAPTER VII

VERY SMALL RURAL TANNERY: 2 HIDES PER DAY

This is a very small rural enterprise receiving hides from a very restricted area. It is conceived as a single-family concern, not as an 'organised' tannery. Accordingly, it is described less formally than the ML and MS projects: individual circumstances will vary so widely that a lengthy description would be unnecessarily forbidding and spuriously precise. The main sequence of process stages is described, daily usages are given for guidance, and also an indication of the equipment used. However, arrangements for storage and service stages, labour schedules and floor plans are not treated formally. At this scale of output, commonsense does not need precise guidance in these matters.

Moreover, the VS project produces the same product from the same raw goods - cattle hides - as MS (hides), but at one-tenth the scale. At some stages, the process is identical, and this is noted without further process description.

I. INPUT, OUTPUT AND UTILISATION

Input : 2 cattle hides per day assumed identical to those used in the MS (hides) project.

- Output : Each hides is converted to
9 kg of semi-finished leather.
- Utilisation : The tannery is assumed to
operate 300 days a year, on a
one 8-9 hours shift per day.

II. STAGE-BY-STAGE DESCRIPTION

Stage No. 1 : Hides selection and storage

Hide selection follows the same principles as other projects. The tanner is referred to Chapter 2. At this scale, it is worth noting that the hides may be received freshly flayed, rather than dried or wet-salted, as is probable in larger tanneries. This reduces the danger of prior putrefaction, and makes selection easier.

However, if fresh hides are not to be processed immediately, the tanner must do his own curing before storage, as outlined in Chapter 2, and the same storage precautions should be followed as in larger projects (for example dried hides should be stored above ground-level, and wet salts allowed drainage and periodically inspected and turned).

In all probability, however, the VS project will do little or no hide storage. The tanner will proceed immediately with the main process, starting with soaking. Whether or not this is so, he will need a weighing machine, preferably weighing up to 100 kg, for this and other stages of the process.

Stage No. 2 : Soaking

Process description

(a) Fresh or wet-salted hides

Soak the hides overnight in a large vessel (e.g. concrete, earthenware or wooden vessel, see Figure VII.1) containing a liquor of

. 200 litres unheated water

Next day, drain and transfer to liming.

(b) Dried hides

Soaking is a two-day process, using two vessels, each of which handles 2 hides.

First day of process: Soak a day's batch of hides overnight in a vessel (as above) containing a liquor of:

- . 200 litres unheated water
- . 0.1 kg sodium sulphide
- . 0.1 kg anionic wetting agent,
e.g. Teepol

Next morning, drain the vessel, transfer the hides to the other vessel for the second day of their processing, and repeat the first day of the process on a new daily batch of hides.

Second day of process: In the other vessel, make up a liquor of:

- . 200 litres unheated water
- . 0.1 kg sodium sulphide
- . 3 kg salt

Transfer a batch of hides from the first vessel after they have gone through the first day of the process and soak overnight.

Next morning, drain and transfer the hides to liming. Repeat the second day of the process on another daily batch of hides transferred from the end of the first day of the process.

Schedules

(a) Fresh or wet-salted hides

- Equipment.

- . 1 piece of rubber tubing for siphon drainage
- . 1 x 250 litre earthenware, concrete or wooden vessel

- Water, chemicals, heat, electricity

(NB : No process heat or electricity is needed
in the VS project)

Daily usages

- . Water 200 litres

(b) Dried hides

- Equipment.

- . 2 x 250 litre earthenware, concrete or wooden vessels
- . 1 piece of rubber tubing for siphon drainage.

- Water, chemicals, heat, electricity

- . Water 400 litres
- . Sodium sulphide 0.2 kg
- . Anionic wetting agent 0.1 kg
- . Salt 3 kg

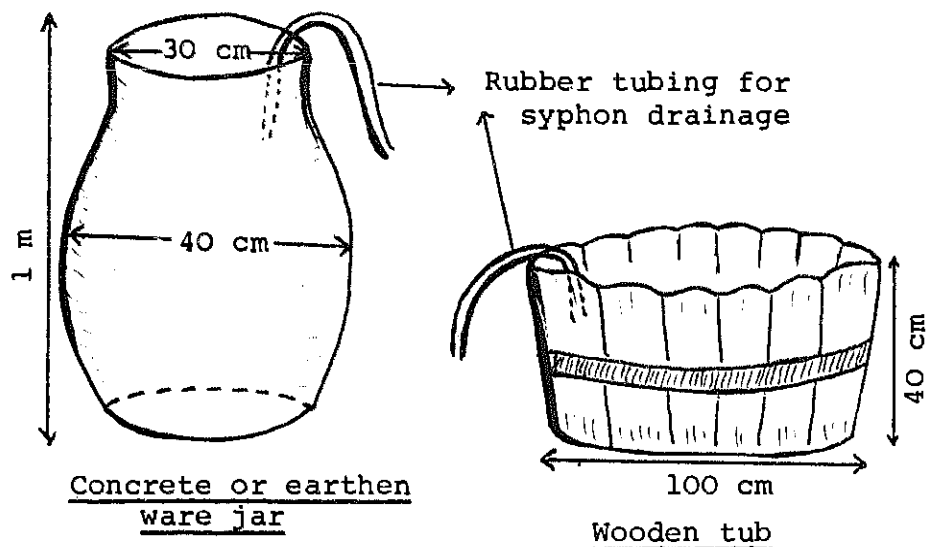

Figure VII.1

Jar or tub for soaking hides

Stage No. 3 : Liming and fleshing

Process description

Liming is performed in a shallow mortar-lined pit sunk into the ground. The hides are laid in the pit folded along the backbone (see Figure VII.2). The pit is 2.2 m x 1 m x 1 m deep. It must accommodate six hides at a time, or 3 days inputs since the liming of any one daily batch takes about 3 days. Each batch should be marked in order to keep track of how long it has been in the pit. This can be done by attaching wooden or plastic tags of three different shapes (one for each day of the liming cycle, for example, a square tag for day 1, a round tag for day 2 and a triangular tag for day 3) to the hides with strings. The appropriate tags may then be attached each day to the new batch of hides and those which have already started the cycle the previous two days.

The hides may be pulled from the pit with a wooden pole. The operator should wear rubber gloves in order to avoid contact of the lime with the skin.

The liming, as well as the tanning pit (see Stage number 7) should be provided with a moveable wooden cover to be used in case of rain or sand storm.

The hides are unhaired and fleshed, after lying for 2 or 3 days in the pit. This is done with a knife over a tanner's beam as described in the ML project (Chapter IV). If unhairing/fleshing is done after 2 days, the hides will probably be returned for another day in the liming pit before going to stage number 4, deliming. If it is done after three days, the hides will probably go straight forward to deliming.

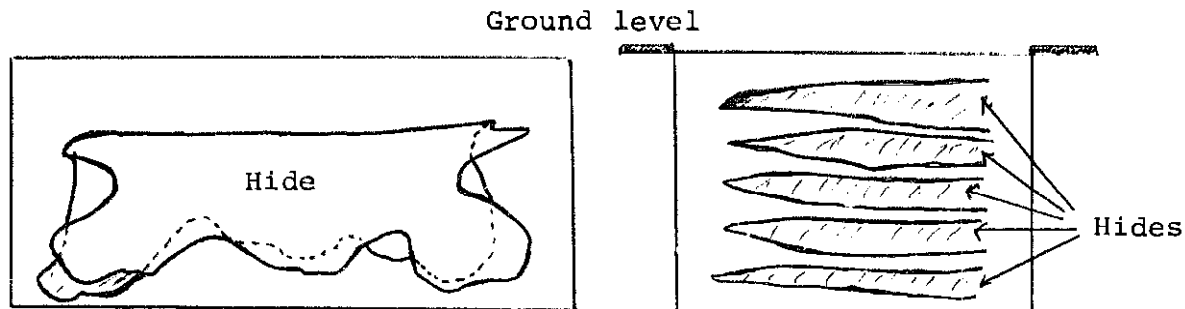

Figure VII.2

Hides folded in lime pit

The liquor in the pit is made initially from:

- 2,000 litres unheated water
- 40 kg hydrated lime
- 20 kg sodium sulphide

The composition of the above liquor should then be adjusted daily with:

- 20 kg hydrated lime
- 10 kg sodium sulphide

as a new batch of hides is added from soaking.

At the end of each week, all the hides in the pit are withdrawn, and the two batches (4 hides) which must continue the liming cycle put back into a fresh initial liquor at the start of the following week.

Flow diagram : Stage 3

From stage 2:

(a) Fresh or wet-salted hides

SOAK ONE DAY
AND NIGHT

(b) Dried hides

SOAK SECOND DAY
AND NIGHT

LIMING

UNHAIRING/
FLESHING

Schedules

- Equipment.

- . 1 mortar-lined pit, 2.2 m x 1 m x 1 m deep sunk into the ground
- . 3 x 10 litre buckets, preferably of wood or plastic for emptying the pit (which could, alternatively, have provision for drainage)
- . 1 tanner's beam (refer to Figure IV.4)
- . 1 fleshing/unhairing knife (refer to Figure IV.5)

- Water, chemicals, heat, electricity

Daily usages (averaged over a 6-day week)

- . Water 333 litres
- . Hydrated lime 23.3 kg
- . Sodium sulphide 11.7 kg

Stage No. 4 : Deliming

Process description

Make up a liquor in a jar or tub from:

- 200 litres unheated water
- 2 kg sodium bisulphite
- 1 kg ammonium sulphate

Put in a daily batch of hides from stage number 3 (liming and fleshing), agitate them occasionally during the day and leave them overnight. Next morning, drain and transfer to hide tanning.

Flow diagram : Stage 4



Schedules

- Equipment.

- . 1 x 250 litres earthenware, concrete or wooden vessel

- Water, chemicals, heat, electricity

Daily usages

- . Water 200 litres
- . Sodium bisulphite 2 kg
- . Ammonium sulphate 1 kg

Stage No. 5 and 6 : Bating and Pickling

Not required. Omitted

Stage No. 7 : Vegetable tanning

Process description

Tanning is performed in a pit like that used for liming at stage number 3, above. The pit contains an initial liquor:

- 2,000 litres unheated water
- 150 kg mimosa extract
- 20 kg salt
- 10 kg sodium bisulphite

The pit must hold five daily batches (10 hides) at any one time, since the tanning cycle lasts five days.

Each day, the hides are taken out and worked over a tanner's beam with a bluntish working knife, (refer to Figure V.9). The blade of the knife is pushed forward and downward over each side of the hide. This helps to absorb the tanning liquor more quickly.

After the hides have been worked for a few minutes each, the following amounts of mimosa extract and sodium bisulphite are added to the initial liquor:

- 10 kg mimosa extract
- 1 kg sodium bisulphite

The hides - minus those going forward to the next stage (draining and scouring) and plus the 2 incoming hides from deliming - are then returned to the pit and agitated occasionally during the day and left overnight in the liquor.

The next morning, the daily procedure starts again. Occasionally some extra water will have to be added along with the daily addition of chemicals (e.g. 10 litres).

Each batch of hides takes 5 days to tan in the pit, after which it goes forward to draining and scouring. The batches of hides should be marked as in the case of liming in order to keep track of the total number of days spent by each batch in the tanning pit.

Flow diagram: Stage 7

From stage 4



Schedules

- Equipment.

- . 1 mortar-lined pit, 2.2 m x 1 m x 1.1 m deep
- . 1 working knife (refer to Figure V.9), plus a tanner's beam borrowed from stage number 3.

- Water, chemicals, heat, electricity

Daily usages

- . Water Approximately 10 litres average
- . Mimosa extract 10 kg
- . Sodium bi-sulphite 1 kg

These daily usages do not take into account the initial amounts of salt, mimosa extracts, sodium bisulphite, and water used to fill up the pit.

Stage No. 8 : Draining and scouring

Process identical to that in MS (hides). The hides may be drained over any convenient object such as a wall, and 10-20 litres of water will be needed for scouring.

Stage No. 9, 12 and 14 : Setting, oiling and drying

Process identical to that in MS (hides). The usage of oiling mixtures is the same per hide, so total daily usages are reduced to 2 litres of water and 4 kg of oil. One table will be needed, which need not be moveable because of the small scale of the operation. 5 m of drying rail will be required if there is no convenient object on which to hang the hides.

Note : As in MS (hides), stage numbers 10, 11, 13, 15, 16, 17, 18, 19, 20 and 21 are omitted. The first two in the list are splitting and shaving, the remainder are various extra finishing stages. The interested tanner may refer to the stage-by-stage description of the ML project in chapter IV.

Stages No. 22 and 23 : Measuring and sorting

Process identical to that in MS (hides), though probably less formal. To a large extent, the purchaser of the finished leather will do his own sorting.

Stage No. 24 : Finished goods storage

As in other projects, the finished goods should be stored off the ground, but at this scale of output, there will probably not be a separate formal storage building; only a convenient dry, covered area, preferably cool and well-secured against intruders.

Stage No. 25 : Chemicals storage

Again, the chemicals are stored in a dry place off the ground, and in sufficient quantities to reduce the risk of shortfalls to acceptable levels. Individual circumstances will vary very widely, not least the tanner's ability to treat other tanners as a fall back source if his primary supplier occasionally fails him.

Stage No. 26 : Water

A large scale source of water is not necessary, as the project needs only about 1,000 - 1,500 litres daily. Nevertheless, if a reliable piped source is not available, the tanner should locate his enterprise close to a good well, running stream or the like, which should, if possible, be tested for contaminants by an expert before deciding to use it.

Stage No. 27 : Effluent disposal

The scale of the problem is much reduced, with daily waste liquors amounting to about 1,000 - 1,500 litres. An elaborate system is not needed. The liquors may be channeled into a soakaway pit dug in the ground, preferably 10 metres or more from the scene of process operations.

Stage No. 28 : Process heat

Not required. Omitted

Stage No. 29 : Electricity

Not required. Omitted

Stage No. 30 : Maintenance

Minimal. Only simple woodworking tools required

III. OVERALL PROJECT SCHEDULE

III.1 Simplified Overall Flow Diagram of Process

The tanner may refer to Figure V.7, the MS (hides) overall flow diagram which also applies to this project although as noted above, several stages become less 'formal' in execution.

III.2 Layout of Operations

No formal floor plan is presented. In a single family enterprise, circumstances will vary too widely for such a plan to be useful. Practically, any area 60 m² or more in extent will suffice. The 'wet' stages (numbers 2 through 7) would ideally be clustered together. The 'dry' stages, and particularly any storage areas, should be kept covered and dry, and as noted above, provision should be made for appropriate water supplies and drainage.

III.3 Overall Equipment Schedules

Note : Summary descriptions only. For further indications see individual stages above. Only the weighing machine may not be manufactured locally or readily available. An indicative price for it is US\$300, ex-works UK.

- 1 moveable weighing machine, for weighing up to 100 kg
- 1 (if fresh or wet-salted hides) or 2 (if dried hides) 250 litre soaking vessels
- 1 piece rubber tubing for siphon drainage of vessels
- 1 mortar-lined liming pit, 2.2 m x 1 m x 1 m deep
- 3 x 10 litre buckets
- 1 tanner's beam
- 1 fleshing/unhairing knife
- 1 x 250 litre delimiting vessel
- 1 mortar-lined tanning pit, 2.2 m x 1 m x 1 m deep
- 1 working knife
- 1 setting/oiling table, 2m x 1.2 m
- 1 slicker
- 1 5 m rail, 1.2 m high, for drying hides
- 1 mixing basin for oil mixtures
- 1 wooden pallet
- 4 m (approx.) sacking or plastic sheeting
- Simple woodworking tools

III.4 Overall Schedules of Daily Usages

Note : Annual usages are also shown at 300 time daily usages. Indicative unit prices are also provided. Items marked * may not be manufactured locally.

| | Daily usage | Annual usage | Indicative 1980 unit price (US\$) (ex-works UK) |
|--------------------------------------|--------------------|--------------------|---|
| Water+ (a) Fresh or wet-salted hides | 1 m ³ | 300 m ³ | 1 (est.) |
| (b) Dried hides | 1.3 m ³ | 390 m ³ | 1 |
| Sodium sulphide, solid | | | |
| (a) Fresh or wet-salt | 11.7 kg | 3,510 kg | 1.02 |
| (b) Dried | 11.9 kg | 3,570 kg | 1.02 |
| Anionic wetting agent, eg. Teepol | | | |
| (a) Fresh or wet-salt | - | - | n/a |
| (b) Dried | 0.1 kg | 30 kg | 0.50 |

| | Daily usage | Annual usage | Indicative 1980 unit price (US\$) (ex-works UK) | |
|--|-------------|--------------|---|---------|
| Salt (a) Fresh or wet-salt | - | ++ | - | n/a |
| (b) Dried | 3 kg | | 900 kg | 0.088 |
| Hydrated lime | 23.3 kg | | 7,000 kg | 0.078 |
| Sodium bisulphite | 3 kg | | 900 kg | 0.29 |
| Ammonium sulphate | 1 kg | | 300 kg | 0.171 |
| Mimosa extract, solid* | 10 kg | | 3,000 kg | 0.756 |
| Sulphited whale oil, eg. Cremol SW* | 40 kg | +++ | 1,200 kg+++ | 1.34+++ |

+ including an allowance for washing down.

++ there is an initial need for salt in the tanning pit, but no significant use thereafter

+++ 2 kg per day of the sulphited whale oil may be replaced by local castor, cottonseed, etc. oil at a price of (say) 0.9 US\$ per kg. for the local oil.

III.5 Overall Labour Requirement

The work in the VS project can easily be got through by 2 adults, from a single family. Prior experience in another tannery would be helpful but not essential, in developing a successful enterprise. Literacy and numeracy of at least one family member is, however, almost certainly essential, particularly if no prior tanning experience has been gained.

CHAPTER VIII

FRAMEWORK FOR PROJECT COSTING

This memorandum, as its name implies, deals primarily with the technical aspects of tanning. But it would be incomplete without some account of project costing. The present chapter therefore briefly outlines a framework for project costing, illustrating this with indicative figures applicable to the projects described in Chapters IV to VII, and including two more mechanised variants on the ML (200 hides per day) project in the cost comparisons.

I. FRAMEWORK

I.1 Classification of Costs

From the economic or financial point of view, a project can be seen as a collection of the inputs - land, buildings, equipment, raw materials, labour, etc. - needed to carry on the production process. All or most of these inputs have purchase price attached to them, and costs can be determined by multiplying these prices by the respective input quantities required for any given period, say a month or a year.

For many inputs, that is all there is to it. However, other inputs - land, buildings and equipment - have long useful lives, and are not wholly used up by the process during any year. A convention is therefore

applied, apportioning their total initial (investment) costs over their anticipated useful lives. For example, if buildings are anticipated to last for 30 years before they should be replaced, then only 1/30th (3 $\frac{1}{3}$ %) of their initial cost is apportioned to be accounted against any one year's production. These apportioned costs are known as 'depreciation' and provide a proper accounting of how such long-lived inputs are progressively 'used up' by year after year of production.¹ They are not to be confused with the ongoing expenses of maintaining the buildings and equipment in such a condition that they will last out their anticipated useful lives: such 'maintenance' expenses are recorded separately.

There is, finally, a less tangible but still important cost category: interest on money capital invested. To set up and operate a business, one need to borrow money, or invest money of one's own that could earn a return elsewhere - say, out of a loan - if it were not tied up in the business. Either way, the cost of using the money may be reckoned as interest - that is, the total amount borrowed or invested multiplied by the prevailing interest rate. Since stocks of materials and finished goods require an investment to purchase and build up, interest is reckoned on them also, as well as on 'fixed assets' - land, buildings and equipment.

Depreciation and interest are sometimes known as 'fixed' costs (i.e. those which are applicable whether or not production is actually proceeding) as opposed to the remaining ('variable') costs, which are associated with production. However, the distinction is not hard-and-fast. For example, interest on stock investment will vary with production, and some labour will have to be paid whatever the production level. While it is noted here, it is not highlighted below.

I.2 Costing Framework

The costing framework outlined below is that normally used by accountants in commercially-run enterprises. It is different from other accounting methods,

¹Land, of course, is not 'used up'. It has an initial investment cost, but no annual or monthly depreciation cost.

in some respects. It is, however, relatively easy to apply and yields valid results when the purpose is to compare alternative production techniques and scales of production. This section describes, in general terms, the costing framework while section II applies the methodology to six tanning projects on the basis of assumed factor prices.

The objective of the exercise is to estimate the unit production cost of tanned hides or skins in terms of local currency per kg or per unit of area (e.g. sq. ft or m²), depending on local customs or circumstances. The potential tanner may then compare this unit production cost with the retail prices of imported leather or leather produced by other tanning plants in the country. The decision to adopt a given production technique and/or a given scale of production will depend on the above comparison: unit production costs should be low enough to allow the competitive production of leather and an acceptable profit margin.

(a) Estimation of total investment costs

The potential tanner would like to first know the level of initial investment he (she) must make for a given scale of production. This is an important factor, as large investment funds may not always be available from banks or private sources.

Once for all investment costs cover the cost of land, buildings, equipment and of initial stocks of raw materials and chemicals.

(i) The cost of land (L) may be estimated on the basis of the total area of plants suggested in previous chapters and local unit land costs. Land may be rented or bought. In case it is rented, annual rent payments should be fully reflected in unit production costs. In case land is bought, its value may increase, decrease or remain constant over the project life and part of its value should not, therefore, be reflected in unit production costs. This matter will be further analysed below.

(ii) The cost of equipment (E). The potential tanner should first establish two lists of equipment: one for imported equipment and one for equipment which may be manufactured locally, given the adopted production

technique and scale of production (see previous chapters). For imported equipment, he may use the indicative prices provided in the following section of this chapter, or write for information to equipment suppliers listed in Appendix I or advertised in trade journals. The price of imported equipment may then be obtained by adding transportation costs and custom duties to import prices.¹ For locally manufactured equipment, the potential tanner may obtain a price estimate from local workshops or equipment retailers. The total cost of imported equipment and that of local equipment should be estimated separately.

(iii) The cost of buildings (B). The potential tanner may prepare a rough architectural plan of the tannery and obtain an estimate of building costs from local contractors. The tannery floor plans suggested in the previous chapters may be used as a basis for the drawing of architectural plans.

(iv) Stocks of raw materials and chemicals (S).

The estimation of this item will depend on the ease with which raw materials and chemicals may be procured from the local market and from abroad. The tanner should investigate local conditions and estimate the potential delays in obtaining ordered chemicals and raw materials. In some countries, it may be wise to stock 50% or more of the total yearly inputs of imported chemicals in order to avoid having to shut down operations for an extended period of time.

Unit prices of imported and local materials may be obtained from foreign and local suppliers, and the amount of each material for the adopted scale of production may be estimated - for various periods - from the preceding chapters.

It may be noted that the cost of the stock of materials will be recovered at the end of the project life. It is the interest payments on the value of the stock which must be reflected in unit production costs (see next section).

¹Information on transport costs and custom duties may be obtained from local importers.

(v) Stock of finished goods and receivables. A stock of finished goods should be maintained by the tannery. Allowance should be made for a month's stock of finished goods, and a further month's "receivables", that is a need to finance a month's supply of goods already sold to the trade on a 30-day credit term. The value of this stock (ie. two months supply from the tannery) may be estimated on the basis of the tannery expected monthly output and a unit price of leather equal to 80% of prevalent unit retail prices.¹

(vi) Overall investment costs. Overall investment costs are equal to:

$$L + E + B + S + F$$

This is the amount of funds which the potential tanner must secure, given the adopted scale of production and processing technology. The tanner should also ascertain the availability of foreign exchange for the procurement of imported equipment and initial stock of chemicals.

(b) Estimation of annual production costs.

Annual production costs include the cost of the following:

- Material costs
 - . hides and skins
 - . chemicals
 - . water
 - . energy
- Labour
- Depreciation costs
 - . buildings
 - . imported equipment

¹This is an approximative unit price which may be different from the unit production cost of leather produced by the tannery. This approximation is used in order to simplify the estimation procedure.

- Maintenance costs
 - . buildings
 - . imported equipment
 - . local equipment
- Annual interest payments
 - . fixed assets (land, buildings, equipment)
 - . stocks

Information on how these separate annual costs may be estimated will now be provided.

(i) Material costs. These costs should be estimated on the basis of the yearly quantities of materials needed for the adopted scale of production, local materials prices, and those of imported materials. Some indicative prices of imported materials are provided in the following section, but the reader may also obtain these prices from leading manufacturers of chemicals or from local importers of the latter. Transport costs and custom duties should be added to the manufacturers' quoted prices.

The price of water is that of water available at the plant side. In case the plant uses water produced on site (e.g. from a well), the price of water should be estimated on the basis of the investment needed to develop the water source. The same comments apply to the price of energy.

(ii) Labour costs. Prevailing wage rates for qualified labour at the plant site should be used when estimating labour costs. The owner of the plant should add his own salary, which may be equal to the salary he would obtain in his next best employment alternative. It may be noted that the salary does not include profits, which are accounted for separately.

In case of labour being constituted exclusively of family members, a salary may be estimated on the basis of prevalent wage rates in the plant area.

(iii) Depreciation costs.

- Buildings may be assumed to be fully depreciated at the end of 30 years. Annual depreciation costs for the buildings may then be estimated at 3.33% of the total building costs.

- Imported equipment should have a useful life of approximately 15 years, and annual depreciation costs may be estimated at 6% of imported equipment costs.

- Locally produced equipment should have a useful life of 10 years, and annual depreciation costs may be estimated at 10% of the cost of equipment.

It may be noted that buildings and equipment may still have some value left in them at the end of their useful lives (e.g. scrap value of equipment), but this is negligible and need not be taken into account when estimating unit production costs.

(iv) Maintenance costs. Annual maintenance costs may be estimated as follows:

- 2% of total cost of buildings
- 5% of total cost of imported and local equipment.

(v) Annual interest payments. These should be estimated for fixed assets (land, buildings and equipment) and for stocks (raw materials, chemicals, finished goods and receivables) using the prevalent interest rate. It may be noted that the inclusion of interest payments for land assumes that the value of land will not increase over the project life. Although this assumption may not prove valid, it may be adopted whenever it is difficult to assess the future land value at the end of the project.

An interest rate of 10% is assumed in the indicative project costs comparisons developed in the following section.

(c) Estimation of unit production costs

An estimate of unit production costs may now be obtained by dividing the sum of annual cost items (ie. cost items (i) to (v)) by the total annual output expressed in kg, square feet, or square meters, depending on local marketing circumstances.

The estimated unit production cost should be compared with prevailing unit retail prices of leather of an equivalent quality. This comparison will then indicate whether production would be profitable.

The estimation procedure may be repeated for various scales of production and technologies, and the potential tanner may then adopt the most profitable scale of production/technology.

Although this memorandum covers six tanning projects only, the exercise may be repeated for other tanning projects (e.g. 50, 100, 150, 250, 300 hides per day) through an adjustment of inputs described in the previous chapters. For example, if a tannery project of 50 hides per day is being considered, the tanner may estimate the needed inputs as follows, if the MS (20 hides per day) technology were to be adopted.

- Materials inputs should be 2.5 times larger than those needed for the 20 hides project.
- The number of pieces of some of the equipment (e.g. horses, drying rails, etc.) would need to be 2.5 times larger than that used for the 20 hides project.
- The total plant area would need to be increased in order to house the additional equipment.
- The number of workers should be approximately 2.5 times larger than that of the 20 hides per day project.

The amounts of various inputs should not be systematically 2.5 times larger than those used for a 20 hides per day project, since a 50 hides per day project should benefit from some economies of scale when compared to the former project.

II. Indicative Project Cost Comparisons

The costing framework may be illustrated by indicative cost comparisons between six projects: the four which formed the subject of Chapters IV to VII, plus two more mechanised project variants of the ML (200 hides per day) scale. These variants use the same basic materials and process, and produce the same products on the same scale as the ML project itself, but substitute more mechanised methods at several stages. The

main differences in moving from the ML project to the semi-mechanised variant (ML₂), are the substitution of:

- drums for pits in liming (stage number 3)
- a powered-roller setting machine for manual setting (stage number 9)
- steam-assisted spider dryer for drying rails after padding (stage number 19)
- a hydraulic press for hand-irons in plating (stage number 21)
- a steam-raising boiler for wood-fired heating of process water (stage number 28)

The mechanised variant (ML₃) retains the above substitutions and further substitutes:

- a powered roller setting machine for manual setting (stage number 13)
- a vacuum assisted heat evaporation dryer for the drying rails (stage number 14)
- a large staking machine for two smaller ones (stage number 16)
- a steel-frame spring clip (toggle) dryer for boards (stage number 1)
- a three-gun rotating spray for the two spray booths (stage number 19)
- an electronic area-measuring machine for a measuring board marked out in squares (stage number 22).

None of these substitutions change the principles of the process or its various stages. Their main function is to save labour and substitute mechanical for manual skills. Indeed the ML₃ project typifies the 'turnkey' technology which is currently installed in new projects in Europe, where very high wage levels prevail and there is an overriding incentive to save labour at every possible point. This need is not so

pressing in most developing countries, where - with lower wage rates - the balance of economic advantage may lie with less mechanised techniques. Despite this, turnkey-type technology is frequently found in developing countries: on many occasions, no doubt appropriately, but perhaps more often because it has been promoted - for obvious and quite understandable reasons - by developed country equipment suppliers. The tanner will have no difficulty in learning details of mechanised techniques. They are intensively advertised by their suppliers in the trade press. More frequently, his problem is lack of detailed knowledge about less-mechanised alternatives, and thus of the ability to make a reasoned choice of technology. It is hoped that this Memorandum will help him in this respect, and this section includes an indicative economic comparison of the three ML-scale variants.

Figure VIII.1 present summary schedules of inputs for the six projects. For comparative purposes, all of them are assumed to use dried raw goods (hides or skins) and thus a separate soaking stage. The two more mechanised ML variants (ML₂ and ML₃) need somewhat less buidling floor space than the low investment cost ML project, but have a considerably higher investment in imported equipment, which is recorded at ex-works price plus a 20% allowance for freight, installation, piping and electrical connections, etc. An allowance is also recorded separately for an initial stock of spare parts for imported equipment. Use of such equipment is minimal in the MS and VS projects, but in all three ML variants, it vastly overshadows the amount attributable to locally-producible equipment (e.g. pits, wooden horses, boards, rails, tables, hand-tools, etc.) Such items principally require cement, wood, and local labour. The price of these will vary from place to place, but in very many developing countries it is likely that the required items will be obtainable for total sums somewhere within the ranges indicated. For further calculations in this section, it has been assumed here that the midpoints of these ranges apply.

Annual water usages are based on the inclusion of soaking in all projects. For chemical usages, the tanner is referred to the individual project schedules in Chapters IV to VII. The usages in the more mechanised ML variants duplicate those of the ML project, except in liming, where the substitution of drums for pits permits the chemicals savings shown.

Figure VIII.1

Six tannery projects : Summary schedules of inputs

| Project Designation | | ML | ML ₂ | ML ₃ | MS-Hides | MS-Skins | VS |
|--|-------------|--|---|---|---------------------------------------|---------------------------------------|-----------------------------------|
| Scale/Type of Raw Input | | 200 Hides/Day | | | 20 Hides/Day | 200 Goatskins/Day | 2 Hides/Day |
| Scale/Type of Output | | 6.5kg Grain Upper + 2.5kg Suede Shoelining | | | 9 kg Oiled Leather/Hide | 0.9 kg Oiled Leather/Skin | 9 kg Oiled Leather/Hide |
| Technology | | Low Investment Cost (1) | Semi-Mechanised (2) | Mechanised (3) | Low Investment Cost (4) | Low Investment Cost (5) | Low Investment Cost (6) |
| INPUTS | USEFUL LIFE | | | | | | |
| Land | Infinite | 4,700m ² | 4,200m ² | 4,300m ² | 750m ² | 750m ² | 60m ² |
| Buildings | 30 years | 2,700m ² | 2,200m ² | 2,300m ² | 330m ² | 330m ² | 30m ² |
| Imported Equipment Intailed (Ex-Works 20%) | 15-20 years | US\$ 130,000 | US\$ 756,000 | US\$ 1,072,000 | US\$ 500 | US\$ 1,200 | US\$ 350 |
| Initial Stages (5% of ported Equipment) | | US\$ 21,500 | US\$ 37,800 | US\$ 53,600 | Negligible | Negligible | Negligible |
| Locally Produced Equipment | 10 years | US\$ 20,000/ 40,000 (say: 30,000) | US\$ 18,000 /35,000 (say: 26,000) | US\$ 10,000 /20,000 (say: 15,000) | US\$ 4,500 / 9,000 (say: 6,750) | US\$ 4,500 / 7,500 (say: 5,750) | US\$ 600 / 1,200 (say: 900) |
| Water p.a. | | 38,100m ³ | 38,100m ³ | 38,100m ³ | 6,900 m ³ | 3,120 m ³ | 390 m ³ |
| Chemicals p.a. | | See ML Schedules | As for ML project less 46,500 kg sodium sulphide, less 54,000 kg hydrated lime, less 7,200 kg salt. | As for ML ₂ project | See MS-Hides schedules | See MS-Skins schedules | See VS schedules |

Figure VIII.1 - Continued

| Technology | | (1) | (2) | (3) | (4) | (5) | (6) |
|---|-------------|------------------------------------|--|--|-----|-------------------------------|-----|
| INPUTS | USEFUL LIFE | | | | | | |
| Energy p.a. | | -270,000Kwhr - 15,000Kg Wood | -410,000Kwhr -150,000Litres Fuel Oil | -455,000Kwhr -150,000Litres Fuel Oil | NIL | -1,500Kwhr - 375Kg Wood | NIL |
| Labour (No. of people) | | 88 | 76 | 56 | 13 | 15 | 2 |
| <u>Stocks</u> Raw Goods and Working Process | | 1/30 year's Supply | ← | ditto | → | | |
| Chemicals: - imported - local | | 60%-1/2 years Supply | ← | ditto | → | | |
| | | 40%-1/12 " Supply | ← | ditto | → | | |
| Finished Goods and Receivables | | 1/6 year's Supply | ← | ditto | → | | |

On the other hand, the use of more machines and a steam-raising boiler considerably raises the demands of the ML₂ and ML₃ projects for energy. In contrast, at the other end of the scale, the MS-hides and VS projects need no power and fuel at all. Mechanisation does, however, reduce the demand for labour, the ML project needing more than half as many workers as the mechanised ML variant. Perhaps, even more significant, is the reduction in labour demand with increasing scale of output: the MS projects for example, have one-tenth of the output scale of the ML projects, yet employ considerably more than one-tenth as much labour.

Finally, needs for stocks will vary so widely that no more than the barest indication can be given to them. The regime shown applies to all projects, and assumes economical stocking of raw goods and locally supplied chemicals, but a much larger supply of specialised chemicals which in many developing countries have to be imported. Allowance is also made for a month's stock of finished goods, and a further month's 'receivables', that is, a need to finance a month's supply of goods already sold to the trade on 30-day credit terms.

The input schedules translate into the project costings shown in Figure VIII.2. They are shown in 1980 US\$, but it must be emphasised that - even so dated - they can only be indicative. The prices for all the inputs, even internationally - traded equipment and chemicals, will vary with place and circumstances. Nevertheless it is believed that, apart from providing an illustration of the costing framework, Figure VIII.2 does give a reasonable indication of comparative project costs in developing country conditions.

The figure first presents initial investment costs. It will be noted that investments in stocks are of the same order of magnitude as those in fixed assets. This is primarily due to the generous allowance made for finished goods stocks and receivables.¹ If, in individual circumstances, this could be substantially reduced,

¹In calculating investment requirements and project annual costs, finished goods stocks and receivables are properly recorded not at their sales value - which includes a profit element - but at the direct costs of raw goods, materials and labour incorporated in them. The chief element of direct costs will almost invariably be raw goods.

the investment burden would be considerably lower in all the projects and particularly in the smaller ones. Because of this, smaller tanners are especially likely to try for a maximum of stock clearance and cash sales in their commercial strategy.

Within the fixed assets total, imported equipment is the dominant item at the ML scale, whereas in the smaller projects, buildings are the main investment. This mainly reflects the minimal need for imported equipment at these smaller scales.

Turning to the annual costs, the largest item will almost certainly be raw goods, the hides or skins processed. However, no cost entry has been made for these in the figure, because prices will vary so widely in practice as to make such an entry unhelpful. More than for any other item, the tanner must ascertain his own raw goods prices. They are unlikely, in any event, to vary with the technology he uses, except possibly in moving from ML chrome-tanning to the smaller vegetable tanning projects. Vegetable tanning is better able to remedy defects of appearance in raw goods, and the tanner may thus be able to accept a lower priced average grade of hide or skin. However, the product and commercial circumstances of the smaller projects are not really comparable with ML scale chrome tanning. They represent different, not clearly competitive opportunities.

In the figure, indicative or notional raw goods prices are included only for illustrating the calculation of stock requirements. Their assumed levels - US\$3.50 per kg leather equivalent for hides, US\$6 per kg for goatskins - should be taken as indicating two points only: first, that raw goods costs are likely to exceed considerably all other costs combined, and second, that in many countries, goatskins are, weight for weight, more expensive than cattle hides, and are converted into leather with a correspondingly higher price.

Raw goods apart, the largest element of annual costs in all projects is chemicals. Their relative costs are particularly high in the smaller projects, reflecting a tendency of pit techniques to use more chemicals per kg input of raw goods than drums. This is, however, to some extent, compensated by lower equipment and energy costs.

FIGURE VIII.2
Six Tanning Projects : Indicative Cost Comparisons (1980 US\$)

| Project Designation | ML (1) | ML ₂ (2) | ML ₃ (3) | MS-Hides (4) | MS-Skins (5) | VS (6) |
|--|------------------|------------------------|------------------------|-----------------|-----------------|---------------|
| INITIAL INVESTMENT | | | | | | |
| Land (5 \$ M2) | 23,500 | 21,000 | 21,500 | 3,550 | 3,750 | 300 |
| Buildings (90 \$ M2) | 243,000 | 198,000 | 207,000 | 29,700 | 29,700 | 2,700 |
| Imported Equipment | 430,000 | 756,000 | 1,072,000 | 500 | 1,200 | 350 |
| Initial Spares for Imported Equipment (5%) | 21,500 | 37,800 | 53,600 | negligible | negligible | negligible |
| Locally produced Equipment (approx) | 30,000 | 26,000 | 15,000 | 6,750 | 5,750 | 900 |
| SUB-TOTAL: | | | | | | |
| Fixed Assets | 748,000 | 1,038,800 | 1,369,100 | 40,500 | 40,400 | 4,250 |
| Stocks | | | | | | |
| - Raw Goods ^{*1/} | 63,000 | 63,000 | 63,000 | 6,300 | 10,800 | 630 |
| - Chemicals ^{2/} | 131,900 | 113,300 | 113,300 | 20,000 | 10,600 | 2,735 |
| Finished Goods and Receivables ^{3/} | 405,000 | 405,000 | 405,000 | 40,500 | 63,000 | 4,050 |
| SUB-TOTAL: | | | | | | |
| - Stocks | 599,900 | 581,300 | 581,300 | 66,800 | 84,400 | 7,415 |
| TOTAL INITIAL - Investment | 1,347,900 | 1,620,100 | 1,950,400 | 107,300 | 124,800 | 11,665 |
| ANNUAL COSTS | | | | | | |
| (Exclusive Raw Goods) | | | | | | |
| Chemicals | 392,800 | 340,200 | 340,200 | 60,100 | 31,300 | 8,195 |
| Water | 38,100 | 38,100 | 38,100 | 6,900 | 3,100 | 390 |
| Energy ^{4/} | 21,800 | 74,800 | 78,600 | NIL | 200 | NIL |
| Labour ^{5/} | 70,400 | 60,800 | 44,800 | 10,400 | 12,000 | 1,600 |
| US\$800 p.a. (\$2,000 p.a.) | (176,000) | (152,000) | (112,000) | (26,000) | (30,000) | (4,000) |

Figure VIII.2 - Continued

| Project Designation | ML (1) | ML ₂ (2) | ML ₃ (3) | MS-Hides (4) | MS-Skins (5) | VS (6) |
|---|----------------|------------------------|------------------------|-----------------|-----------------|----------------|
| <u>DEPRECIATION</u> | | | | | | |
| Building (3 1/3%) | 8,100 | 6,600 | 6,900 | 1,000 | 1,000 | 90 |
| Imported Equipment (6%) | 25,800 | 45,400 | 64,300 | negligible | 100 | 20 |
| Locally produced Equipment (10%) | 3,000 | 2,600 | 1,500 | 700 | 600 | 90 |
| <u>MAINTENANCE</u> | | | | | | |
| Spares for Buildings (2%) | 4,900 | 4,000 | 4,100 | 600 | 600 | 55 |
| Improved Equipment (5%) | 21,500 | 37,800 | 53,600 | negligible | negligible | negligible |
| Locally produced Equipment (5%) | 1,500 | 1,300 | 800 | 300 | 300 | 45 |
| <u>INTEREST</u> | | | | | | |
| Fixed Assets (10%) | 74,800 | 103,900 | 136,900 | 4,100 | 4,000 | 215 |
| Stocks (10%) | 60,000 | 58,100 | 58,100 | 6,700 | 8,400 | 741 |
| <u>TOTAL ANNUAL COST</u> ⁵ | 722,700 | 773,600 | 827,900 | 90,800 | 61,600 | 11,441 |
| (Exclusive Raw Goods) | (828,300) | (864,800) | (895,100) | (106,400) | (79,600) | (13,841) |
| <u>ANNUAL LEATHER OUTPUTS (KG)</u> | 540,000 | 540,000 | 540,000 | 54,000 | 54,000 | 5,400 |
| <u>ANNUAL COSTS/ KG LEATHER OUTPUT</u> ⁶ | 1.34 (1.53) | 1.43 (1.60) | 1.53 (1.66) | 1.68 (1.97) | 1.14 (1.48) | 2.11 (2.56) |

1/ Notional Prices US\$3,50/kg. Leather Equivalent (Hides), \$6/kg. Leather Equivalent (Goat Skins).

2/ Estimated at approximately 1/3 of total annual cost of chemicals.

3/ Add \$1/kg Leather Equivalent, Chemicals, etc. Cost to Raw Goods Price.

4/ \$0.08/kw Hour; \$0.016/kg Wood; \$0.28/Litre Fuel Oil.

5/ Higher Labour Wages and Costs shown between parenthesis.

6/ Higher Costs reflect higher Wages.

No other items share with chemicals a consistently high level. Water is a relatively minor item in cost terms in all projects,¹ as is energy except in the mechanised ML variants where the combined costs of electricity and fuel oil are quite substantial. Labour costs will evidently vary with the prevailing wage rates. Two indicative average rates for tannery labour - US\$800 and \$2000 p.a. - will illustrate the situations in 'low' and 'high' wage developing countries respectively. At the lower rate, labour costs are substantial only in the low investment cost projects. Conversely, depreciation and maintenance costs only emerge as really substantial in the mechanised ML variants, based primarily on their large required investments in imported equipment. Finally, interest costs, at an annual interest rate of 10%, generally tend to be substantial, but are relatively higher at the ML scale, where they are boosted by the large equipment element in fixed asset investment.² This feature is particularly marked for the mechanised variants.

Even with the exclusion of an entry for raw goods, the annual cost totals - which represent the total annual costs of actually processing the hides or skins - are comparable in magnitude to the initial investment costs on which they are partly based. With the inclusion of raw goods, annual costs would probably considerably exceed initial investment costs. However, investments must of course be laid out without a comparable immediate return, whereas annual costs will normally be more than balanced by the tannery's sales of leather.

It is more instructive to consider the unit processing costs implied by the annual totals. These are presented per kg of leather output. They are, of course, higher at the higher wage rate for labour,

¹Given its technical importance - noted at various points in the previous chapters - this cheapness reinforces the incentive for taking pains to ensure a first class water supply.

²Interest rates in most developing countries are probably higher than 10%. If this were the case, less mechanised techniques would be further favoured.

although not very significantly - particularly at the ML scale - in the perspective of raw goods costs, which might vary by as much as (say) US\$2-3 per kg leather from location to location. Unit processing costs are also higher in the smaller projects than at the ML scale, because they use more of almost every input (imported equipment being the most notable exception) per unit output than do the larger projects.

This might appear to be a serious drawback to small-scale production, particularly since the output is less finished than at the ML scale. However, at least three points should be borne in mind. First, the alternative to small projects may either be no project at all - because the financial or raw goods resources of an area may be inadequate to support a larger project - or at best an ML₁ scale project limping along at low utilisation rate¹ on a raw goods supply deficient either in quantity or quality. Second, the smaller projects serve different markets. Their relatively high unit costs, if uncompensated (see the third point below) make them a poor bet for partial processing of grain upper leather, if the finishing tanner of such leather can get hold of the raw goods in adequate condition to do his own chrome tanning of them. But he may not be able to do so, more particularly if he is located away from the country or region of hide supply. Thus, the small vegetable tanner may still have a useful and profitable supplying role, and this will be especially the case if he can establish relations with finishing tanners who are producing a more specialised and higher-priced product than grain upper leather.

1

For example, even if ML-scale projects operate as much as (say) 150 days per year on deficient raw goods supplies, unit costs rise considerably. Assuming the annual chemical, water, energy and stock interest costs are only half the 300 day per year level; labour and maintenance costs, two-thirds that level; and depreciation and fixed asset interest costs unchanged: then unit costs rise even in the low investment cost ML project to US\$1.60 and US\$1.88 respectively at the low and high wage levels. The increases are sharper as more mechanisation is adopted, and in the ML mechanised variant, unit costs at 150-day utilisation rise to US\$1.98 and US\$2.15 at low and high wages. In contrast, 150-day utilisation in MS hides - which is less likely to occur - raises unit costs only to US\$1.90 and US\$2.29 respectively at the two wage levels.

Third, the unit costs have been calculated at the same input prices for all the projects, and this may render those of the smaller projects misleadingly high. Unit chemical prices may, it is true, be higher as smaller quantities are ordered, but the exacerbating effect of these on cost differentials is likely to be more than outweighed by opportunities of cheaper raw goods (because of the lower average grade acceptable in vegetable tanning, noted above), cheaper labour, particularly in rural areas and - at least in the case of the VS single-family enterprise - cheaper buildings.

In contrast, the three ML scale projects are much more directly comparable with each other, and it is of interest that the low investment cost variant emerges - at least in this indicative costing - with the lowest unit costs of the three. Its higher labour and materials costs are more than counteracted by the increased interest, maintenance, depreciation and energy costs of the more mechanised variants. The labour cost differentials naturally increase with the assumed wage rate, but the annual wages factor would have to be about US\$4,000 per man for the unit processing costs of the mechanised variants to fall below those of the low investment cost project. Wage levels are, of course, much higher than this over most of the industrialised world, hence the tendency of developed country tanneries to mechanise. The indicative costing shows that the choice of mechanised versus more manual techniques must at least be much more carefully weighed in the developing countries.

Concluding remarks on indicative cost comparisons

It must be emphasised that the potential tanner should not base his (her) choice of technology and scale of production on the results of the indicative costs comparisons shown in this section. Too many factors may influence the costing exercise, and one cannot generalise the results to all countries and circumstances. It is therefore very important that the reader undertakes his (her) own cost comparisons before deciding which scale of production and technology to adopt.

The potential tanner should first identify the market he wishes to supply. This factor will determine, to some extent, the scale of production and technology. He may then undertake cost comparisons on the basis of information contained in Chapters IV to VII. Cost comparisons should be based on reliable factor prices, and it is very important that the reader obtain precise estimates of the costs of raw materials, chemicals, energy, imported equipment, local equipment, buildings, etc.

Once the appropriate scale of production and technology have been identified, the potential tanner should investigate whether constraints exist which may render his investment unprofitable, contrary to the results obtained from the project evaluation. Potential constraints may include the following:

- inadequate or insufficient water
- unreliable supply of quality hides and skins
- Difficulties in obtaining foreign currency for the import of chemicals, which may disrupt production for long periods of time.
- Unavailability of qualified labour.

These and other potential constraints should be carefully investigated before launching a project.

III. Discounted Cash Flow (DCF) method of project evaluation

The costing framework, outlined and applied in the previous section, is that normally used by accountants in commercially-run enterprises. The alternative DCF method is sometimes used in pre-evaluating proposed projects by financial analysts and economists, although it rarely produces comparative conclusions about alternatives significantly different from those reached by the conventional accountant's framework.

An alternative DCF analysis is not presented here, but those familiar with the method may readily derive their own analysis from the data in the Figure VIII.2.

The DCF method is briefly outlined below:

- the 10% interest rate will become a 10% 'discount rate'
- the total initial investment will become a cash outflow in year 0 of a project's life.
- project lives may be reckoned at 30 years, the life of the buildings, and appropriately timed investments in replacement equipment will be allowed for, say, in years 10 and 20 for locally producible equipment and year 17 for imported equipment.
- the annual costs, to be 'discounted' over the 30-year project life, will exclude depreciation and interest, but will include all the other itemised annual costs presented in Figure VIII.2.

CHAPTER IX

NATIONAL LEATHER PRODUCTION STRATEGY

The previous chapter evaluated alternative tanning projects from the point of view of commercial profitability. However, the development of the leather tanning sector should also have an impact on the national economy, and should, therefore, also be of direct interest to public planners. Governments have an important role to play in the formulation of a national leather production strategy and in the promotion of appropriate leather production units. This chapter first analyses the potential effects of a growth of this sector, and then provides some elements for the formulation and implementation of a national leather production strategy. It should, however, be noted that the formulation of such a strategy is mostly relevant to countries producing relatively large quantities of hides and skins, and may therefore substantially benefit from an expansion of leather production. On the other hand, the formulation of a leather production strategy may not be required for countries producing relatively small quantities of hides and skins.

I. SOCIO-ECONOMIC IMPACT OF ALTERNATIVE TANNING PROJECTS

The main potential socio-economic effects of an expansion of the leather sector include the following:

- Employment generation
- Improvement of the balance of payments
- Expansion of rural industries, incomes and employment
- Multiplier effects on the economy through backward linkages (collection, treatment, storage and transport of hides and skins) and forward linkages (e.g. expansion of the leathergoods industry).

These potential effects may not, however, be fully realised unless governments favour the implementation of tanning projects which make an optimal use of local resources, labour and expertise, while producing the right type of leather products at competitive prices. This point is further elaborated below.

- Employment generation.

The number of workers needed for a given daily output of processed hides or skins will depend on the adopted scale of production and technology. For example, a very small rural tannery of the VS type (2 hides per day) uses 3.5 times more labour than a turn-key factory of the ML₃ type (200 hides per day) for an equivalent output of processed hides. Similarly, a medium-small unit of the MS type (20 hides per day) uses approximately 2.5 times more labour than the same ML₃ unit.

- Improvement of the balance of payments.

The adopted technology and scale of production will also affect the balance of payments. For example, 10 MS projects - processing 20 hides per day each - require a total of 35,000 dollars of imported equipment against 1,100,000 dollars for a turn-key project producing 200 hides per day (ML₃ type factory). Similarly, a low mechanisation project of the ML type (200 hides per day) requires less than half of the foreign exchange needed for the import of equipment used in a project of the ML₃ type.

- Expansion of rural industries.

The adopted scale of production and technology also determine the location of tanneries. Large-scale plants, which make use of imported technologies, must generally be located in urban areas where they may be assured of adequate supplies of water and energy, adequate transport facilities and of the presence of a pool of skilled labour. Thus, policies which favour the establishment of such plants will generally fail to promote rural industrialisation and will further aggravate the current rural to urban migration. On the other hand, the promotion of small-scale tanneries, which use local technologies, will generally favour the establishment of rural tanneries as these do not need large water and energy supplies and can find the necessary expertise in rural areas.

- Backward linkages

The adopted scale of production and technology will also determine the size of backward linkages and therefore, the socio-economic impact of alternative tanning projects. Small-scale tanneries, which adopt local technologies, make proportionately a greater use of locally manufactured equipment than do large-scale plants which adopt imported technologies. For example, the value of local equipment used in small-scale plants (e.g. of the MS type) is 10 times higher than that used in large scale plants (e.g. of the ML₃ type). The production of equipment constitutes a backward linkage which further favour the establishment of small tanneries in place of large-scale imported plants. Furthermore, small-scale tanneries tend to use locally produced vegetable tannins while large scale plants tend to use chrome tanning, and must generally import most of the chemicals needed for the tanning process. Again, the local production of vegetable tannins constitutes a backward linkage which favours the establishment of small-scale tanneries.

- Greater use of hides and skins.

A large number of hides and skins produced in rural areas are often wasted for lack of an appropriate collection system and transport facilities.

This is particularly the case whenever hides and skins originate from rural areas located at a large distance from tanneries. One solution would be to improve transport facilities and establish an efficient collection and storage system. This solution may not, however, be feasible in the short and medium terms as large public investments would generally be required. Another solution may, therefore, be to promote the establishment of small rural tanneries close to the hides supply areas. The tanner may then obtain the hides immediately after flaying from local butchers or farmers. He may also induce the proper flaying of animals by offering higher prices for good quality hides and skins. Thus, the establishment of these tanneries will considerably reduce the wastage of hides and skins produced in isolated areas of the country. Another beneficial impact could be the production of leathers by rural artisans who could not afford to buy imported leather or leather produced by tanneries in urban areas.

While small-scale tanneries, which use local technologies, may yield various positive effects (e.g. high employment generation, improvement of the balance of payments, substantial backward linkages), it should not be concluded that large-scale, capital-intensive tanneries do not have a useful role to play. In many countries, the establishment of both small-scale and large-scale tanneries, using different tanning technologies and supplying different markets may constitute an optimal solution which takes into consideration both the local and foreign demand for leather, and the adopted country's socio-economic objectives. This topic is further elaborated in the following section.

II. ELEMENTS FOR A NATIONAL LEATHER PRODUCTION STRATEGY

The formulation of a national leather production strategy will require investigations of the following:

- Current and potential production of hides and skins
- Current and potential local demand of leather of various qualities and types

- Current and potential volumes of export of leather of various qualities and types
- International prices of leather of various types and qualities
- Current production of leather by large and small tanneries, type and quality of output and retail prices.
- Local availability of chemicals needed by tanneries
- Efficiency of tanning technologies used by small local tanneries
- Location of tanneries

These investigations will provide the needed information for the formulation of a national leather production strategy. Elements of such strategy are briefly discussed below.

II.1 Hides and skins

Hides and skins constitute a valuable raw material, and maximum efforts should therefore be made in order to avoid wasting them. As already indicated in Chapter II, a number of reasons may be advanced for the wastage of hides and skins, including the following:

- Absence of an efficient collection system
- Inadequate pre-treatment and storage of hides
- Inadequate flaying methods

The improvement of the situation will therefore require the establishment of an efficient collection system, and the provision of training for the appropriate flaying, pre-treatment and storage of hides and skins. Two approaches may be adopted to achieve the latter, depending on the location of the supply areas.

(i) Hides and skins produced in isolated areas of the country

Some areas of the country may lack adequate transport facilities necessary for a regular collection of hides and skins from butchers or private individuals. For example, transport may not be possible or reliable during the rainy season. Since hides and skins tend to spoil rapidly - especially in warm climates - they may be treated locally and stored until they can be transported. This solution may not, however, be feasible as it would require the training of a large number of persons and the provision of salts and disinfectants for a proper treatment of the hides and skins after flaying. Another solution would be to promote the establishment of small local tanneries in the supply areas. The owner of the tannery will then be responsible for the collection of hides and skins. He may also provide advice to butchers on proper flaying techniques, and induce them to use these by offering higher prices for quality hides and skins. These local tanneries may produce finished leather for local leather-goods producers or semi-finished leather for other larger scale tanneries. These tanneries would need sufficient stock of chemicals and spare parts in order not to have to discontinue production when transport facilities are not available.

(ii) Hides and skins produced in areas serviced by adequate transport facilities

Tanneries may undertake the collection of fresh hides and skins by touring regularly the supply areas. Another solution - which will apply to large-scale tanneries - would be to establish collection and storage posts in the main supply areas and to collect the stored hides and skins whenever the stock of raw materials reaches a pre-determined level. Hides and skins may be stored in the wet-salt state in order to minimise processing costs.

Advice on flaying techniques may be provided by a tannery's worker, and butchers may be

induced to supply quality hides and skins by offering them higher prices for high quality materials.

Training courses for the proper flaying of hides and skins may be organised by national tanning institutions for established butchers and workers of slaughterhouses. However, in many countries, a large number of animals are slaughtered by private individuals who may not, for practical reasons, benefit from regular training programmes. Thus, hides and skins originating from the above source would probably be of poor quality. This situation may not be improved unless private slaughtering is outlawed and legislation on this matter is forcefully applied.

Governments should also obtain estimates of the total quantities of hides and skins which may be collected and processed each year by small and large tanneries. This information is essential for the formulation of a national leather production strategy.

II.2 Leather for the export market

In general, any surplus of hides and skins - after the local demand has been satisfied - should be easily exported to industrialised countries. However, they should first be processed as their value should increase by 20% to 350% depending on the stage in which they are exported. A study by the Tropical Products Institute¹ indicates that the value of raw hides and skins should increase by 20% by pickling, 25-30% by tanning, and 50-250% by finishing.

While it may be profitable to export finished leather, the production of the latter may not be easily undertaken in developing countries as the market for finished leather is a very specialised one, and the type

¹Tropical Products Institute: Tanning of hides and skins (London, Overseas Development Administration, 1974).

of leather produced must be constantly adapted to new fashions and requirements. Thus, sophisticated marketing research should be undertaken if export of finished leather is being considered. Furthermore, given the large range of finishing machines needed to produce the above leather, the scale of production should be at least 1200 hides per day if full or nearly full capacity utilisation is to be achieved.

A careful study should therefore be undertaken with a view to determine whether the production of finished leather for the export market is feasible and profitable.

On the other hand, developing countries should have no difficulties in exporting semi-finished leather (e.g. in the "crust" or "wet-blue" form). Semi-finished quality leather for the export market may be produced by both small and large tanneries.

The owners of small tanneries may require some advice or training to help them produce the quality of leather required by the export market.

An investigation of the level of leather finishing which may be undertaken profitably by local tanneries should be made by exploring foreign markets in both developing neighbouring countries and developed countries. A level of finishing past the "crust" or "wet-blue" stages may be undertaken for neighbouring countries' markets where demand for different qualities of leather could be similar to that of the home country.

II.3 Leather for the local market

The local needs of leather will generally cover the following:

- leather for the various parts of shoes
- leather for the production of leathersgoods
- leather for the production of harnesses
- leather for the production of parts of furnitures.

Some of the above leather may be produced by small tanneries with little equipment. On the other hand, various types of finished leather for the local market will require imported equipment with indicated throughputs of 100 hides per hour or more. Thus, the scale of production of tanneries using this type of equipment should be at least 800 hides per day (e.g. a 100 hides per day fleshing or splitting machine). The use of other finishing machines will probably require higher scales of production.

For countries where the local demand for finished leather is equal or exceeds 800 processed hides per day (or, approximately 25,000 hides per year) it would be feasible to establish one or more medium to large-scale tanneries to satisfy the local market. These tanneries need not undertake the whole processing of hides and skins. For example, they may be supplied with semi-finished leather by small-scale tanneries using less mechanised technologies. This approach may be particularly suited to large-scale tanneries which would have some difficulties obtaining a regular daily supply of 800 hides or more per day for reasons provided in Section II.1. These tanneries may, therefore, process semi-finished leather (e.g. "crust" or "wet-blue") including the splitting, shaving, sammying, dyeing, etc. stages. The decision on whether a large-scale tannery should also engage in tanning and pre-tanning operations would depend on the supply of hides, production costs, and the socio-economic objectives of the government. For example, although the production costs may favour the full processing of hides and skins by large-scale, capital-intensive tanneries, the government may, for socio-economic considerations, promote the production of semi-finished leather by ¹small tanneries located in rural and/or urban areas.

For countries where the local demand for finished leather is less than 800 hides per day, and which may face great difficulties in penetrating the foreign markets, it may be more profitable to import the needed finished

¹The decision on which scale of production and technology should be promoted may be based on a socio-economic analysis which takes into consideration the "true" social costs of the factors of production (e.g. use of "shadow pricing").

leather than to establish a high-cost leather finishing plant operating at an unprofitable low capacity utilisation. The establishment of such a plant may require that the government protect the locally produced leather through the imposition of high tariff duties or quotas - thus penalising the consumer - or through the provision of subsidies. Either solution may be justified in the short run if the local demand for finished leather is expected to increase at more than 800 hides per day. Otherwise, it is recommended that the needed amount of leather be imported. In any case, any decision to establish a leather finishing plant should be based on a careful analysis of demand by the local market and of production costs.

II.4 Choice of tanning technology

The technical chapters of this memorandum provide a detailed description of four alternative tanning technologies covering a range of scales of production from 2 hides per day to 200 hides per day. These four alternatives do not, however, cover the majority of choices offered to the potential tanner. Other choices exist which may be found more appropriate to local conditions. They are described in various publications issued by technology institutions and leather research institutes, such as the Central Leather Research Institute of India. Governments should therefore investigate development in this field through the setting-up of a special leather research institute, or the setting-up of a leather research unit in the national technology institution, or a university department. Such a unit or institute should keep track of new developments in this field, and evaluate alternative technologies on the basis of local factor prices and conditions. It may also provide advice to potential tanners, or to government departments in charge of analysing industrial projects. It may be noted that the successful development of the leather industry in India was, to some extent, the result of intensive research and development work in this field. Such R and D Work has led to the promotion of technologies much better fitted to India's socio-economic environment than technologies currently in use in industrialised countries.

II.5 Over-all development plan for the leather sector

Once estimates of the quantity of hides and skins

produced in various areas of the country have been obtained, and the local and foreign markets for leather of various types and qualities have been investigated, an overall development plan for the national production of leather should be formulated. This plan will indicate the following:

- Types and quantities of leather to be produced for the local and foreign markets
- Mix of technologies which may be used by small and large tanneries
- Location of tanneries, and appropriate scales of production
- Assistance measures needed to implement the overall development plan.

This plan should take into consideration the following:

- Availability of transport facilities in the supply areas of hides and skins
- Availability of adequate supply of water in areas selected for the establishment of tanneries
- Unit production costs for alternative tanning technologies, scales of production and locations.
- Availability of chemicals in the country
- Capacity of local engineering firms and workshops to produce equipment for small-scale tanneries
- Availability of skilled labour in various parts of the country
- The country's socio-economic objectives
- Environmental factors (disposal of effluents).

Large-scale investments in this sector, if any, should be based on the recommendations provided in the overall development plan.

Assistance measures which may be needed to implement the development plan should be identified and costed. These assistance measures may include advice to potential tanners on demand for leather by the local and foreign markets, information dissemination on alternative tanning technologies, training of labour, provision of imported chemicals and equipment, promotion of the production of local chemicals (e.g. vegetable tannins), promoting the collection of hides and skins, setting-up of quality standards for leather, enforcing the legislation on slaughtering, and provision of training for the proper flaying of hides and skins.

A P P E N D I C E S

APPENDIX I

Equipment Manufacturers

The following list provides the name and address of equipment manufacturers for the most important pieces of equipment listed in chapters IV to VIII of the memorandum. Numbers between parenthesis indicate the type of equipment marketed by the equipment manufacturer (see Annex to this Appendix). This list includes the names of all equipment manufacturers known to the authors at the time of publication. A number of additional manufacturers are probably missing and the reader is urged to obtain information on the latter from engineering firms and equipment suppliers established in his country. It must be emphasised that neither the ILO nor UNIDO do specifically endorse any of the equipment suppliers shown in the following list. These names are only provided for illustrative purposes, and tanners should try to obtain information from as many manufacturers as feasible.

ANNEX

Designation of Equipment

1. Band knife splitting machines
2. Buffing or sueding machines
3. Cutting machines (siding)
4. Drums, paddles and vats
5. Dust extraction equipment
6. Fleshing machines
7. Ironing plates
8. Knives for splitting machines
9. Liming machines
10. Measuring machines (area or substance)
11. Padding equipment and machines
12. pH meters
13. Reconditioned tanning machines
14. Rolling machines
15. Sammying machines
16. Setting out machines
17. Shaving machines
18. Splitting machines
19. Spray exhaust equipment
20. Spray finishing equipment and cabinets
21. Stacking machines
22. Tannery tools
23. Toggles, clips and accessories
24. Trucks and horses

| <u>Name and Address</u> | <u>Equipment designation</u> |
|---|------------------------------|
| <u>Australia</u> | |
| - Barker, L.S. Pty. Ltd 660 Waterdale Road, West Heidelberg, Victoria | 2 |
| - Lovel, Neil A. Pty Ltd, 6 Sartre Crt., P.O. Box 250, Glen Waverley, Vic. 3150 | 6, 13 |
| <u>Belgium</u> | |
| - Challenge-Cook Bros. Inc., 168 Ave. de Tervueren, 1150 Bruxelles | 12 |
| <u>Brazil</u> | |
| - Himeca - Hidromecanica de Vettori Av. Mal. Masc. de Moraes 4989 Recife | 3, 14, 22 |
| - IMAC-Industria de Maquinas para curtumes Rue Arthur Leopoldo Ritter 210 Estancia Velha, CP 56 RS 48 | 15, 20 |
| - Industria de Maquinas Enko Ltda Ave Pedro Adams Filho 795 CP 24 Novo Hamburgo, RS | 2, 6, 17, 18 |
| - Maquinas Piratininga SA Rua Rubiao Junior 235 Sao Paulo | |
| - Maquinas Seiko Ltda CP 86, Novo Hamburgo RS | 2, 6, 16, 17, 18 |
| - Milloil SA Industria Comercio Avenida Pe. Francisco Culturato 1924, CP 253, 14800 Araraquara, SP | 5, 20 |
| <u>Canada</u> | |
| - Cambar Products Ltd Box 280, Waterloo Ont. NZJ 4A7 | 4 |

Czechoslovakia

- Investa Ltd
Kodanska 46
Praha 10 6, 7, 10, 15, 16, 17, 18,
21

East Germany

- Veb Tachometerwellen-Und
Maschinenbau Leipzig
Claubbruchstrasse 1-7
DDR-7026 Leipzig 21

Finland

- Ins. Tsto Llari Seppa Ky
62100 Lapuka Kp 4 20

France

- Charvo SA
1 Rue Leconte-de-Lisle
38100 Grenoble 7, 11, 19
- Mercier Frères
BP 128
07104 Annonay 1, 6, 10, 15, 16, 17,
18, 20
- Metraplan - SPAA
Rue Lesdiguières
38640 Claix- Grenoble 10
- Etablissements Jean Rouanet
Zone Industrielle de Bonnetcombe
BP 100
81203 Mazamet 4, 9
- SOVAP
30 Rue Ampere
85000 La-Roche-Sur-Yon 4, 9

India

- A.V.M. Enterprises
64 Shivaji Udyam Nagar
Kolhapur
Maharashtra 17
- Auroelectronics
P.O. Box 18
Pondicherry 605 001 10

- Bengal Machinery Company
9A New Tangra Road
Calcutta 700 046 6, 14, 17
- Bharat Ydyog
19 Shivaji Ydyam Nagar
Kolhapur
Maharashtra 2
- Chens Brothers
50 South Tangra Road
Calcutta 700 046 8, 13, 16
- Deepu Industries
4-D Ram Mansion
34 Pantheon Road
Madras 600 - 008 2, 17, 19, 20, 21
23
- Guest Keen Williams Ltd,
97 Andul Road
Howrah 711 103 1, 2, 6, 8, 13, 15, 16
West Bengal 17, 18
- Hindustan Engineering Works
1328/2 Jawahar Nagar
Kolhapur 41 6001
Maharashtra 1, 10
- M.S. Industrial Products
Flat 9B
25 Camac St,
Calcutta 700 016 7
- Shalimar Engineering Works
12 Prabhuram Sarkar Lane
Calcutta 15 6, 17
- Tannery Machinerics Manufacturing Co.
91 Middle Road
Calcutta 14 2, 17
- Vedaguru Engineering
30 Madras Callicut Road
Ambeir (N.A. Distt) 6, 17

Italy

- Aetti Giovanni & Figli
Via Tiepolo 14
21100 Varese 2, 15, 17
- Billeri, Ricardo & Figli
Via Val d'Orme 59
50053 Empoli 4

- Carrara Impianti Industriali
CP 502
37100 Verona 10, 20
- E.D.A. Elettronica
Via Arso
36072 Chiampo 10, 20
- Electronsistem S.P.A.
Via C. Battisti 134
24025 Gazzaniga 10
- Flamar S.P.A.
Via del Bosco 9
56029 S. Croce 2, 17
- Foglia, Fr.
Via G. Capponi 20/24
10148 Torino 23
- Gozzini Emilio & Figli
Via San Vito 13
CP 52 4, 6, 10, 15, 16, 17, 18
56029 S. Croce Sull'Arno 20, 21, 23
- Lamebo S.R.L.
Via Settimo 72 bis
10099 San Mauro Torinese (TO) 1, 8
- Lo Stampo di Milani & C.
Via Bergamo
22055 Merate (Co) 6, 16, 17, 21
- Meccaniche Bergi di Giovanni
Begozza
Via Montorso 4
36071 Arzignano 2
- Meneghetti, F.lli S.N.C.
Via Roma 108
36028 Rossano 13, 15
- Mosconi & C. S.P.A.
Officine Meccaniche
Viale del Commercio 7
37100 Verona 18
- Mostardini, P & Figli S.P.A.
Via Piovola 12
50053 Empoll 10
- O.F.B. Officine di Furlan
Via Montorso
36071 Arzignano
Vicenza 11

- Officine di Cartigliano S.P.A.
Via San Giorgio
36050 Cartigliano 21
- Poletto F.lli Mecc. S.N.C.
Viale Vienna 50
36071 Arzignano 2, 4, 6, 10, 13, 15,
17
- Polvara, Francesco
Via Turbigo 3
20012 Cuggiono (MI) 5, 6, 15, 16, 17, 23
- Rizzi, Soc. Luigi & C.S.P.A.
Via Manfredo Fanti 88
41100 Modena 1, 6, 15, 16, 17
- Rotopress S.P.A.
Strada Del Francese 132
10156 Torino 11, 20
- Selin-Electronica e Meccanica
Industriale
Via del Chiu 18
40131 Bologna 10, 12
- Tomboni Costruzioni Meccniche
Via G. Mazzini 4
20029 Turbigo 10, 11, 20
- Vallero, Cesare & Figli
Via Torino 4
10080 Salassa 4, 12, 24

Netherlands

- Arendonk B.V.
Goirkekanaaldijk 14
Tilburg 1, 2, 4, 5, 6, 11, 13, 15
16, 17, 21
- S. & G. International B.V.
Grotestraat 97
Waalwijk 4, 8, 12, 13, 14, 22, 23

Spain

- Construcciones Prenafeta S.A.
Polignono Industrial "Can Cortès"
Naves 28 y 29, Palau de Plegamans
Barcelona 2, 4, 6, 15, 16, 17, 18
21, 23
- Cots-Bodyplast S.A.
Crta. Barcelona-Puigcerda
Km. 69-600 Polig. Industrial
"Mas Gali"
s/n P.O. Box 159, Vich,
Barcelona 2, 6, 10, 15, 24

- Girbau S.A.
Apdo Correos 29
Ctra Manlieu
Km. 1 Vic. Barcelona 9
- Mecanica Industrial Albi S.A.
Calle Prim,
258-272, Nave 19
Barcelona 5 2, 6, 15, 16, 17, 21
- Olcina Laserna, Jorge
Carretera de Caravaca 56
Lorca,
Murcia 4
- Oliver & Batlle S.A.
Calle Independencia 51-53
Badalona
Barcelona 15
- Serax S.A.
Industria, s/n Llisa de Vall
Barcelona 4, 24
- Serra, Jaime
Calle Juan de Austria 84
Barcelona 5 1, 3, 6, 7, 8, 10, 17
- Talleres Capdevila S.A.
Riera Blanca 53-55
Barcelona 14 2, 6, 15, 21

Switzerland

- Hüni & Co. A.G.
Bahnhofst. 29
8810 Horgen 12
- Isal A.G.
CH-4006 Basel 4
- Kueny, Werner
St. Jakob Strasse 38
CH-4132 Muttenz 3
- Schweizerische Industrie
Gesellschaft A.G.
8212 Neuhausen am Rheinfal 6
- Urben & Co.
4657 Dulliken S0 18

United Kingdom

- Airmaster Engineering Ltd
Olympia Works
Roundhay Road
Leeds LS8 4BH Yorks 5
- Automatic Equipment Ltd
Auteq Works
Daleside Road
Nottingham NG2 4DN 19, 20
- Carty and Son Ltd
Woods Road
Peckham, London SE15 2PX 4
- Fearnehough W. Ltd
Riverside Works
Bakewell, Derbyshire DE4 1GJ 1, 8, 22, 23
- Martin, T.G. & Co. Ltd
Gilmar
Gee Cross
Hyde, Cheshire SK14 5RN 7, 14
- Norris Industries Rushden Ltd
Wellingborough Rd,
Rushden, 4, 5, 10, 11, 13, 19, 20
Northants NN10 9BE 24
- Rizzi (UK) Ltd
388 Meanwood Rd
Leeds LS7 2LB 2, 5, 11, 19, 20
- Thompson, F. Ltd,
Central Works
14-16 Rock St,
Wellingborough, Northants 4, 24
- Tomlinsons (Rochdale) Ltd
Newey Road
Milnrow, Rochdale
Lancs. 10, 11, 20
- Turner Machinery Ltd
P.O. Box BR4
Stanningley Rd, 1, 2, 4, 6, 7, 10, 15, 16
Bramley, Leeds LS13 2TF 17, 18
- Wilson, Edward & Son Ltd
Aintree Rd
Bootle 4, 6, 8, 10, 11, 13, 15
Liverpool L20 9DL 16, 22, 23

- Wright, B & J. & Sons Ltd
Bushington Lane
Leeds LS7 2DD 1, 2, 4, 6, 8, 10, 13, 15

U.S.A.

- Exeter Machine Co. Inc,
309 S. Water Street
Lomira
Wisc. 53048 4, 6, 10, 13, 15, 16, 17
19, 20, 21, 24
- Hampton Machine Co. Inc.
Exeter Road
Hampton
N.H. 03842 3, 4, 6, 10, 13, 15, 16
17, 19, 20, 21
- Koko Machine Co.
6 Nichols Street
Salem
Mass. 01970 13
- Speco Inc.
58 Rantoul Street
Beverly
Mass. 01915 2, 5, 6, 13, 15, 19, 21

West Germany

- Alber G.m.b.H & Co., Rudolph
Stuttgarter Strasse 121
Postbox 1109
D-7333 Ebersbach/Fils 8
- Altena, Pet. Arn
Hohenbirker Strasse 43
Postfach 140105
5630 Remscheid 1 8, 9, 13, 22, 23
- Arenco-BMD Maschinenfabrik, GmbH
Pfinztalstrasse 90
Postfach 410140
D-7500 Karlsruhe 41 1, 2, 4, 6, 14, 15, 16,
17, 18
- Brendel, Friedrich
Fresenius Strasse 3
D-6384 Schmittent/Ts 23
- Bürkle G.m.b.H. & Co., Robert
Stuttgarter Strasse 123
Postfach 160
D-729 Freudenstadt 14

- Clasen Nicolai
Grosse Brunnenstrasse 63
200 Hamburg - Altona
1, 2, 6, 7, 8, 10, 13,
14, 15, 16, 17, 18, 22
- DCE Vokes G.m.b.H.
Hendrik-Witte-Strasse 6
Postfach 383
43 Essen 1
5
- Deutsche Metrohm G.m.b.H. & Co.
Schulstrasse 23
7024 Bernhausen
12
- Dose, Maschinenbau G.m.b.H.
Industriestrasse 5,
D-7585 Lichtenau
4,
- Drees & Co., G.m.b.H.
Schützenstrasse 36-38
Postfach 43
476 Werl
4, 7, 14, 15, 16, 17
- Fortuna-Werke Maschinenfabrik
G.m.b.H.
Pragstrasse 140,
Postfach 500 440
D-700 Stuttgart 50
1, 8, 18
- Gokenbach, E. OHG
Theodor-Körner-Strasse 34-36
Postfach 1230
D-7150 Backnang
4
- Heusch, Severin
Krugnofen 29-33
D- 5100 Aachen
6, 16, 17, 18
- Intama G.m.b.H.,
Postfach 1368
D-6233 Kelkheim
1, 2, 9, 10, 13, 15,
18, 21
- KELA Spezialmaschinen G.m.b.H.
Siemens Strasse 21
Postfach 1325
D-6233 Kelkheim
1, 2, 4, 6, 9, 10, 13,
15, 16, 17, 21, 22
- Kellar Lufttechnik G.m.b.H. & Co.
K.G.
D-7312 Kirchheim/Teck-Jesingen
5
- Kiefer, Eric Lufttechnische
Anlagen G.m.b.H.
Postfach 44
D-7031 Gaertringen/Wurth
20

- Klingenberg, W. Ferd. Söhne
Berghäuser Strasse 54/63
D-5630 Remscheid 8
- König & Günther K.G.
Postfach 247
423 Wesel 4
- Lenze & Co. K.G. Hans
Postfach 425
325 Hameln
D-3251 Gross-Berkel 2
- Liedl, Franz
Gabrielenstrasse 10
D-8 München 19 6, 15
- Möenus, Maschinenfabrik A.G.
Voltastrasse 74-80
P.O.Box 90.60.69.6
Frankfurt/Main 90 1, 6, 8, 10, 16, 17, 18
- Pöhländt, Rudolph
Württembergische Pelmaschinenfab.
7157 Murrhardt 6
- Sandt, J.A.G. Maschinenfabrik
Lemberger Strasse 82
678 Pirmasens 5
- Selbeck & Co.
403 Ratingen/b
Postfach 1628
Düsseldorf 2, 6, 16, 17, 18
- Sieper & Horn G.m.b.H.
Borner Strasse 65
5630 Remscheid-Lennep 6
- Specht, Otto G.m.b.H. & Co. K.G.
Porschestrasse 11
7000 Stuttgart 40 8, 12, 13, 22, 23
- Trockentechnik G.m.b.H.
Homburg
Postfach 170 347
D-4100 Duisburg 17 9, 11, 20
- Turner G.m.b.H. Maschinenfabrik
Postfach 1580
D-637 Oberursel 1, 2, 6, 8, 10, 14, 15,
16, 17, 18, 21

APPENDIX II

Selected Bibliography

1. Aten, R.; Faraday Innes, R., and Knew, E.: The flaying and curing of hides and skins as a rural industry, FAO Agricultural Development paper NO. 49 (Rome, FAO 1955).
2. British Standards Institution, Glossary of leather terms; (London, British Standards House, 1972).
3. ESCAP; Report of a seminar on technology transfer in leather and leather products in the ESCAP Region; (Bangkok, 1980).
4. FAO; Rural Tanning Techniques, in FAO Agricultural Development paper NO. 68 (Rome, FAO, 1960).
5. Howes, F.N.; Vegetable tanning materials, in *Chronica Botanica* (Massachusetts, Waltham, 1953).
6. Humphreys, G.H.W. and Jones, C.R., The Manufacture of sole and other heavy leathers (Oxford, Pergamon, 1966).
7. International Council of Tanners; International Glossary of leather terms (London, International Council of tanners, 1967).
8. Jeannin, A., Lobry, M. and Robinet, A.; Manuel des agents du conditionnement des cuirs et peaux en zone tropicale (Paris, Eyrolles, 1970).
9. Leather Guide - International Directory of the Industry (London, Benn Publications Limited, Annual Publication).
10. SHARPHOUSE, J.H.; The leather technician's handbook; Leather Producers' Association (London, 1971).
11. Tancons, J.J., Roddy, W.T. and O'Flaherty, F.; Skin, hide and leather defects (Cincinnati, Ohio, Western Hills Publishing Co., 1959).
12. Tanning Extract Producers Federation; Modern method of tannage (Zurich).

13. Thorstensen, T.C.; Practical leather technology
(London, Van Nostrand-Reinhold, 1969).
14. Tropical Products Institute; Tanning of hides and
skins (London, TPI, 1974).

APPENDIX III

Selected list of technical institutions

The list which follows is obviously only partial, but will give an indication of the wealth of technical expertise available.

Argentina, Centro de Investigacion de Tecnologia del Cuero (ITEC), Avenida 52 entre 121 y 122, La Plata, Buenos Aires.

Australia, Leather Research Group, CSIRO, Division of Protein Chemistry, 343 Royal Parade, Parkville, Victoria.

Belgium, Centre de Recherche du cuir, Avenue P.H. Spaak 27, Bte 15, 1070 Bruxelles.

Brazil, Centro tecnologico do couro, Calcados e afins, Rua Joaquim Pedro Soares, 5403 Andar, C.P. 468, 93300 Novo Hamburgo.

Bulgaria, Scientific and technical Institute for leather and shoe industry, Str. "Industrialna" NO. 11, Gabrovo.

Canada, Footwear and leather Institute of Canada, 14 Eiffel-Mart E, P.O.Box 355, Place Bonaventure, Montreal, Quebec H5A 1B5.

Czechoslovakia, Shoe and leather research Institute (VUK), 762 65 Gottwaldov.

Denmark, TI Leather Research Laboratory, Bronskojvej 17, 2700 Copenhagen.

East Germany, German Leather Institute, Terrassengasse 1, Freiberg.

Finland, State Institute for Technical Research, Leather Investigations Laboratory, Lönnrotinkater 37, Helsinki 18.

- France, Centre technique du cuir, 181 Avenue Jean-Jaurès
Lyon 7e, B.P. 1, 69342 Lyon CEDEX 2.
- Guatemala, Instituto Centroamericano de Investigacion
tecnologia Industrial (ICAIT), Avenida la Reforma
4-47, Zona 10.
- Hungary, Research Institute of the leather, artificial
leather and footwear industries, 1047 Budapest,
Pacsi Jozsef V. 43.
- India, - Central Leather Research Institute, Adayar,
Madras 600 020,
- College of Leather Technology, Calcutta,
- Institute of leather technology, Canal Rd.,
Adayar, Madras 600 020.
- Indonesia, - Indonesia Leather Institute, Djl. Diponegoro
NO. 101, Djakarta,
- Leather Research Institute, Jalan Sokonandi 3,
Yogyakarta.
- Italy, Institute for leather research, Via Poggioreale 39,
80143 Napoli.
- Japan, Japan leather research Institute, 1, I Chome,
Midori-Cho, Senju, Adachi-Ku, Tokyo.
- Morocco, Institute National du Cuir et du Textile,
B.P. 1725, Fes.
- Netherlands, Institute for leather and shoe research NTO,
Mr. Van Coothstraat 55, 5141 ER Waalwijk.
- New Zealand, New Zealand leather and shoe research association,
Private bag, Palmerston North.
- Nigeria, Leather Research Institute, P.B. 1052, Zaria.
- Pakistan, - Pakistan Society of Leather Technologists,
P.O.Box 7542, Bambino Chambers, Garden Rd.,
Karachi-3.
- Leather Research Centre, PCSIR, Karachi.
- Poland, Leather Research Institute, Lodz.
- Rumania, The Institute of hide and shoe research,
Bella Breiner St., 93, 74259 Bucharest 4.

Spain, Asociacion de Investigacion de las Industrias de Curtidos y anexas, Jorge Girona Salgado s/n (Edificio Juan de la Cierva), Barcelona 34.

Sudan, Hides, Skins and leather Institute, P.O.Box 8, Khartoum.

Tunisia, Centre National du cuir et de la Chaussure, 6, rue Djebel Mansour, Tunis.

United Kingdom, - British leather manufacturers research association, Milton Park, Egham, Surrey TW209UQ
- Leather Institute, Leather trade House, 9, St. Thomas St., London SE1.
- National leathersellers Centres, School of Science, Nene College, Moulton Park, Northampton NN2 7AL.

U.S.A., Tanners Council Research Laboratory, University of Cincinnati - Campus Station, Cincinnati, OHIO 45221.

U.S.S.R., Central Scientific Research Institute for the leather and footwear Industry, Ulitsa Piatnitskaia 74, Moscow.

APPENDIX IV

Glossary of terms

Technical terms are explained as they occur in the text. In particular, the terms for the various process stages - liming, tanning, setting, etc. - are explained in a block in Chapter III. The following are some of the other terms which appear frequently in the text.

| | |
|----------------------|--|
| Beam, tanner's beam | frame with curved sloping wooden upper surface, over which hides or skins are hung for working with curved knives |
| Chrome tanning | performing the tanning stage using chrome as a tanning agent |
| Curing | pre-tannery hide or skin preservation, involving salting and/or drying the goods. Indefinite preservation is not achieved by curing, but requires actual tanning |
| Dried hides or skins | hides or skins cured by drying |
| Drum | large cylindrical wooden container, rotating on a horizontal axis, in which hides or skins are placed with process liquors and agitated by the rotation |
| Finished leather | leather which has gone through the complete tanning process |
| Flaying | removal of the hide or skin from the carcass of the animal |
| Flesh side | the inner side of the hide or skin, adjoining the flesh of the animal in life |
| Grain side | the outer side of the hide or skin, so called after its 'grain' or pattern |
| Grain upper leather | leather with a grain side, suitably finished for use in making the upper parts of shoes (as opposed to their soles) |

| | |
|-------------------------------|--|
| Horse | large inverted-V wooden frame, with or without wheels, for draining process liquors out of hides or skins draped over it |
| Limeyard | the area of the tannery devoted to the soaking, liming and fleshing stages |
| Pelt | the hide or skin after it has been fleshed and unhaired and before it has been tanned |
| Piece | the hide, side or skin after it has been tanned |
| Pit | large concrete-lined depression or tank for containing hides or skins together with process liquors |
| Pit-paddle | a pit with a rotating paddle mounted on top, for agitating the hides or skins in the process liquor |
| Process liquor | mixture of water with appropriate chemicals for acting on the hides or skins in contact with it |
| Process stages | the main sequence of physical operations performed on the hides or skins in the tanning process |
| Putrefaction | biological decay of the hides or skins, averted temporarily by curing and indefinitely by tanning |
| Raw goods | hides or skins as they enter the tanning process, whether cured or freshly flayed |
| Scouring | pouring water over hides or skins after vegetable tanning |
| Tannin | active tanning agent. May be either vegetable or mineral in nature |
| Wet blue | description of chrome tanned leather immediately after tanning |
| Wet salted hide, Wet salts | raw goods which have been cured by the application of salt without drying |

QUESTIONNAIRE

1. Full Name
2. Address
.....
3. Profession (check the appropriate case)
 - (a) Practising Tanner
 - (b) Would-be Tanner
 - (c) Government Official.....

If yes, specify position
.....
.....
 - (d) Employee of a financial
Institution.....

If yes, specify position
.....
.....
 - (e) University staff member.....
 - (f) Staff member of a Technology
Institution.....

If yes, indicate name of
institution
.....
.....
 - (g) Staff member of a Training
Institution.....

If yes, specify
.....
.....
 - (h) Other.....

If yes, specify
.....
.....



4. From where did you get a copy of this memorandum?
Specify if given free or bought.

5. Did the memorandum help you achieve the following?
(check the appropriate case).

(a) Learn about tanning techniques
you were not aware of _____

(b) Obtain names of equipment suppliers _____

(c) Estimate unit production costs for
various scales of production/technologies _____

(d) Order equipment for local manufacture _____

(e) Improve your current production technique _____

(f) Cut down operating costs _____

(g) Improve the quality of leather produced _____

(h) Decide which scale of production/
technology to adopt for a new tannery _____

(i) If a government employee, to formulate a
national leather production strategy _____

(j) If an employee of a financial institution,
to assess a request of a loan for the
establishment of a tannery _____

(k) If a trainer in a training institution,
to use the memorandum as a supplementary
training material _____

(l) If an international expert, to better
advise counterparts on tanning techniques _____

6. Is the memorandum detailed enough in terms of:

- Technical Aspects _____ YES NO

- Names of Equipment Suppliers _____ YES NO

- Costing Information _____ YES NO

- Information on Socio-Economic Impact YES NO

- Bibliographical information _____ YES NO



If some of the answers are 'NO', please indicate why below or on a separate sheet of paper.

7. How may this memorandum be improved if a second edition were to be published?

8. Please send the Questionnaire, duly completed, to:

TECHNOLOGY AND EMPLOYMENT BRANCH
International Labour Office
Case postale 500
CH-1211 GENEVA 22
Switzerland

9. In case you need additional information on some of the issues covered by this memorandum, the ILO and UNIDO would do their best to provide the requested information.



Other ILO publications

Guide to tools and equipment for labour-based road construction

In recent years it has been shown that labour-based techniques of road construction can be, and often are, preferable to capital-intensive techniques, not only for their reduced cost but also for the job opportunities they create. For labour-based techniques to be effective, however, the available tools and simple equipment need to be improved. The information given in the Guide will help those responsible for planning and managing labour-based road construction projects to specify the appropriate tools and simple equipment for the job, by showing them how to establish testing procedures, how to advise local manufacturers on the production of good-quality implements, how to contact sources of supply and how to ensure the correct use and maintenance of the tools and simple equipment selected.

Whilst the Guide is concerned with road construction, it is obvious that the information provided could also find wider application in civil engineering generally, in agriculture and in forestry.

ISBN 92-2-102539-X

Technology series

A total of 11 technical memoranda, including this technical memorandum, will be jointly published by the ILO and UNIDO in 1982 and 1983. The following four technical memoranda should be available in 1982: small-scale footwear production (eight pairs to 1,000 pairs per eight-hour day), mini-paper plants, maize milling, and small-scale weaving. Six additional memoranda are at various stages of preparation. These are: grain storage, production of windows and doors for low-cost housing, oil extraction from groundnuts and copra, ceramics production, production of bricks, and production of stabilised earth blocks. Readers interested in one or more of the above memoranda may order them from ILO Publications, International Labour Office, CH-1211 Geneva 22, Switzerland.

Field handbook on the choice of appropriate technology in Philippine forestry, by the International Labour Office and the Philippines Bureau of Forest Development.

This field handbook is intended to serve as a detailed technical guide for various levels of management personnel in the application of appropriate technology in specific forestry operations. In particular, the handbook provides practical information through simplified diagrams, and sketches the operation of simple forestry hand-tools and working techniques, keeping in view the creation of greater employment, the attainment of higher productivity and the principles of ergonomics and work safety.

Tanning of hides and skins

A number of developing countries have developed and successfully applied technologies that are suitable to the socio-economic conditions obtaining in these countries, that is, technologies which make a better use of abundant labour and scarce capital than do technologies developed in industrialised countries. Unfortunately, these technologies are rarely disseminated outside the countries where they have been developed. Consequently, the ILO and UNIDO have joined forces in order to make available to small-scale entrepreneurs in developing countries detailed technical and economic information on these technologies. This information will be published in the form of technical memoranda, and will cover products and processes of particular interest to developing countries.

This first technical memorandum covers the tanning of hides and skins. It provides detailed technical and economic information on four scales of production, namely 200 hides per day, 20 hides per day, two hides per day, and 200 goatskins per day. Six alternative technologies are described, from a fully mechanised 200 hides per day project to a highly labour-intensive two hides per day project. Subprocesses are described in great detail, including diagrams of pieces of equipment which may be manufactured locally. A list of equipment suppliers is also provided for those pieces of equipment which may need to be imported.

It is hoped that the information contained in this memorandum will help would-be or practising tanners to choose and apply tanning techniques which will minimise production costs while improving the quality of the leather.

ISSN 0252-2004

ISBN 92-2-102904-2

Price: 25 Swiss francs