



This is a digital copy of a book that was preserved for generations on library shelves before it was carefully scanned by Google as part of a project to make the world's books discoverable online.

It has survived long enough for the copyright to expire and the book to enter the public domain. A public domain book is one that was never subject to copyright or whose legal copyright term has expired. Whether a book is in the public domain may vary country to country. Public domain books are our gateways to the past, representing a wealth of history, culture and knowledge that's often difficult to discover.

Marks, notations and other marginalia present in the original volume will appear in this file - a reminder of this book's long journey from the publisher to a library and finally to you.

Usage guidelines

Google is proud to partner with libraries to digitize public domain materials and make them widely accessible. Public domain books belong to the public and we are merely their custodians. Nevertheless, this work is expensive, so in order to keep providing this resource, we have taken steps to prevent abuse by commercial parties, including placing technical restrictions on automated querying.

We also ask that you:

- + *Make non-commercial use of the files* We designed Google Book Search for use by individuals, and we request that you use these files for personal, non-commercial purposes.
- + *Refrain from automated querying* Do not send automated queries of any sort to Google's system: If you are conducting research on machine translation, optical character recognition or other areas where access to a large amount of text is helpful, please contact us. We encourage the use of public domain materials for these purposes and may be able to help.
- + *Maintain attribution* The Google "watermark" you see on each file is essential for informing people about this project and helping them find additional materials through Google Book Search. Please do not remove it.
- + *Keep it legal* Whatever your use, remember that you are responsible for ensuring that what you are doing is legal. Do not assume that just because we believe a book is in the public domain for users in the United States, that the work is also in the public domain for users in other countries. Whether a book is still in copyright varies from country to country, and we can't offer guidance on whether any specific use of any specific book is allowed. Please do not assume that a book's appearance in Google Book Search means it can be used in any manner anywhere in the world. Copyright infringement liability can be quite severe.

About Google Book Search

Google's mission is to organize the world's information and to make it universally accessible and useful. Google Book Search helps readers discover the world's books while helping authors and publishers reach new audiences. You can search through the full text of this book on the web at <http://books.google.com/>



UNIV. OF
CALIFORNIA

ESSENTIALS

OF

Veterinary Physiology

BY

D. NOËL PATON, M.D., B.Sc., LL.D., F.R.S.

PROFESSOR OF PHYSIOLOGY, UNIVERSITY, GLASGOW

LATE LECTURER IN PHYSIOLOGY, ROYAL (DUKE) VETERINARY COLLEGE, EDINBURGH

AND

JOHN BOYD ORR, D.S.O., M.C., M.A., M.D., D.Sc.

DIRECTOR, ROWETT INSTITUTE FOR RESEARCH IN ANIMAL NUTRITION, ABERDEEN

RESEARCH LECTURER ON PHYSIOLOGY OF NUTRITION, UNIVERSITY, ABERDEEN

THIRD EDITION

REVISED AND ENLARGED

NEW YORK
WILLIAM WOOD & COMPANY

1920

THE
ANNALS

ST 721
P3
1732
BIOLOGY
LIBRARY
G

PREFACE TO THE FIRST EDITION

BETWEEN the Physiology of Man and that of the Domestic Animals there is no fundamental difference, and most of our knowledge of human physiology has been acquired from experiments upon the lower animals. But while the tissues of a man, a dog, and a horse act much in the same manner, the mode of nutrition of these tissues is somewhat different, and requires special attention in the case of each.

In this volume the attempt is made to give the essentials of general physiology and of the special physiology of the domestic animals in a form suitable to the requirements of Students and Practitioners of Veterinary Medicine. The book is not intended to take the place of the demonstrations and practical work from which alone physiology can be properly learned, but merely to supplement these and to focus the information derived from them.

The student must take every opportunity of acquiring a really practical knowledge, and, to facilitate the more direct association of the practical and systematic study of physiology, throughout these pages references are made to descriptions of the experimental and chemical work which the student should try to do for himself or have demonstrated to him. The histological structure of the tissues and organs which is now studied practically in every school is here described only in so far as it is essential for the proper understanding of their physiology.

D. N. P.

461269

PREFACE TO THE THIRD EDITION

THE Preface to the First Edition sufficiently explains the scope and purpose of the book.

The present Edition has been almost entirely rewritten in order to bring it up to date and to give greater prominence to those parts of Physiology which have the most direct bearing upon veterinary practice.

Our thanks are due to Dr. Burns for the section on hydrogen ion concentration in Appendix III., and to Mr. William Dunlop of Dunure for valuable suggestions on the section dealing with the limbs of the horse.

D. N. P.
J. B. O.

September 1920.

CONTENTS

PART I

THE GROWTH OF PHYSIOLOGY	PAGE 1
------------------------------------	-----------

PART II

SECTION I

PROTOPLASM

1. The Nature of Protoplasmic Activity	5
2. The Structure of Protoplasm	11
3. The Chemistry of Protoplasm	12

SECTION II

THE CELL

1. Cell Protoplasm	23
2. Nucleus	26
3. Reproduction of Cells	28

SECTION III

THE TISSUES

A. THE VEGETATIVE TISSUES—

I. Epithelium	32
1. Protective—Squamous Epithelium	32
2. Absorbing—Columnar Epithelium	33
3. Secreting Epithelium and Glands	34
4. Motile—Ciliated Epithelium	37
II. Connective Tissues	37
1. Mucoïd Tissue	37
2. Fibrous Tissue	38
i. Fibres	39
ii. Spaces	40

	PAGE
iii. Cells	40
Modifications of Cells—	
a. Endothelium	40
b. Fat Cells and Fat	41
c. Pigment Cells.	43
3. Cartilage	43
i. Hyaline Cartilage	43
ii. Elastic Fibro-Cartilage	45
iii. White Fibro-Cartilage	45
4. Bone	45
i. Development and Structure	45
ii. Chemistry	49
iii. Metabolism	50
B. THE MASTER TISSUES—NERVE AND MUSCLE—	
General Arrangement	51
NERVE—	
1. Development	53
2. Structure	55
3. Chemistry	57
4. Physiology of Neurons	58
A. Single Neurons or Neurons in Nerves	58
a. Nerve Fibres—	
1. Manifestation of Activity	59
2. Excitation	60
3. Conduction	69
4. Classification of	73
5. The Nature of the Nerve Impulse	74
b. Nerve Cells	75
Degeneration and Regeneration of Nerves	76
Changes in the Cell	77
B. Action of Neurons in Series	77
The Neural Arcs	78
A. Arrangement	78
B. General Action	80
I. THE SPINAL ARC—Reflex Action	82
Trophic Action	91
Peripheral Reflexes.	92
II. THE CEREBRAL AND CEREBELLAR ARCS	95
A. The Ingoing Side of the Arcs	95
I. Body Receptor Mechanisms	97
i. Visceral	97
ii. Cutaneous—	
Pain	100
Touch	101
Temperature	103

CONTENTS

xi

	PAGE
iii. Muscle and Joint	105
Connection of Body Receptors with Central Nervous System—	
1. Ingoing Nerves	106
2. Upgoing Fibres in Spinal Cord	107
3. Connections with Brain-Stem and Cerebrum	112
4. Cerebellar Synapses	117
Labyrintho-Cerebellar Mechanism	117
1. Labyrinth	117
(1) Structure	117
(2) Connection	119
(3) Physiology	121
2. The Cerebellum	125
(1) Structure	125
(2) Connections	126
(3) Physiology	127
 III. DISTANCE RECEPTORS OF THE HEAD—	
I. FOR CHEMICAL STIMULI—	
1. Buccal Mechanism—Taste	131
2. Nasal Mechanism—Smell	133
II. FOR VIBRATION OF ETHER—VISION	136
A. General Considerations	136
B. Anatomy of the Eye	139
C. Physiology	143
(I.) Monocular Vision	144
Formation of Images upon the Retina	144
1. The Dioptric Mechanism	144
Accommodation	146
2. Stimulation of the Retina	151
1. Reaction to Varying Illuminations	151
2. Localising the Direction of Illumination	155
3. Colour Sensation	155
(II.) Binocular Vision	158
Single Vision with Two Eyes	158
(III.) Connections of the Eyes with the Central Nervous System	162
1. Optic Nerves and Tracts	162
2. Visual Centre	164
III. FOR VIBRATION OF AIR—HEARING	166
1. General Considerations	166
2. The External Ear	167
3. The Middle Ear	167
4. The Internal Ear	170
5. Connections with the Central Nervous System	172
6. Auditory Centre in Cortex	173

	PAGE
IV. THE LOCALISATION OF RECEIVING AREAS IN THE CORTEX	176
V. THE INTEGRATION OF SENSATIONS IN THE CORTEX	179
1. Structural Development	181
2. Functional Development	182
3. Storing and Associating Part of Cortex	185
4. Relationship of Consciousness to Cerebral Action	185
5. Time of Cerebral Action	186
6. Fatigue	186
7. Sleep	187
8. Hypnosis	188
VI. THE DISCHARGING SIDE OF THE CEREBRAL ARC	189
i. The Basal Ganglia	189
ii. The Cortex Cerebri	189
iii. Fibres from Discharging Area	194
iv. Outgoing Nerves	195
Cranial Nerves	200
THE EFFECTORS—MUSCLE	202
i. Development and Structure	202
ii. Chemistry	207
iii. Physical Characters and Physiology	210
iv. Death of Muscle	214
v. Muscle in Action	215
A. Visceral Muscle	215
B. Skeletal Muscle—	
1. Direct Stimulation of Muscle	217
2. Methods of Stimulating Muscle	218
3. The Changes in Muscle when Stimulated	219
4. Mode of Action	231
5. Special Mechanism of the Horse	233
6. Work Done	242
7. Heat Produced	246
8. Relationship of Work Production to Heat Production	248
9. The Efficiency of the Horse as a Machine	252
10. Capacity of the Horse for Work	252
11. Chemical Changes and Source of Energy	254
GENERAL METABOLISM	264
A. Exchange of Energy—	
I. Basal Metabolism	264
II. Factors Modifying Metabolism	266
1. Muscular Work	266
2. Rate of Cooling	267
Loss of Heat	267
Heat Production	268
Heat Regulation	269

CONTENTS

xiii

	PAGE
3. Taking of Food	272
4. Prolonged Fasts	272
5. Semi-starvation	274
<i>B.</i> Exchange of Material	275
Water	275
Amino Acids	275
Salts	279
Accessory Factors	281

PART III.

THE NUTRITION OF THE TISSUES.

SECTION I.

FOOD.

The Nature of Food	283
<i>A.</i> Food-Things Yielding Energy	283
1. Nitrogenous Compounds	283
2. Fats and Allied Bodies	285
3. Carbohydrates	285
<i>B.</i> Food-Things not Yielding Energy	288
4. Ash (Inorganic Elements)	288
5. Water	289
6. Accessory Factors	289
Classification of Feeding Things for Herbivora	290

SECTION II.

DIGESTION.

I. Structure of the Alimentary Canal	291
II. Physiology	301
<i>A.</i> Digestion in Carnivora and Omnivora	302
I. Digestion in the Mouth	302
(a) Mastication	302
(b) Insalivation	302
II. Swallowing	306
III. Digestion in the Stomach	308
<i>A.</i> Stomach during Fasting	309

	PAGE
<i>B. Stomach after Feeding</i>	310
1. Vascular Changes	310
2. Secretion	310
(1.) Characters of Secretion	310
(2.) Source of Constituents	310
(3.) Course of Gastric Digestion	311
(a) Amyolytic Period	311
(b) Proteolytic Period	311
(4.) Digestion of the Wall of the Stomach	313
(5.) Antiseptic Action of the Gastric Juice	313
(6.) Influence of Food on the Gastric Juice	313
(7.) Nervous Mechanism of Secretion	314
(8.) Chemical Stimulation	315
3. Movements of Stomach	315
1. Character	315
2. Nervous Mechanism	317
<i>C. Absorption from the Stomach</i>	318
<i>D. Regurgitation of the Gastric Contents</i>	318
1. Into the Gullet	318
2. Vomiting	318
IV. Intestinal Digestion	319
<i>A. Pancreatic Secretion</i>	319
<i>B. Bile</i>	323
<i>C. Succus Entericus</i>	328
<i>D. Bacterial Action</i>	329
<i>E. Fate of the Digestive Secretions</i>	331
<i>F. Movements of the Intestine</i>	332
1. Small Intestine	332
2. Large Intestine	334
3. Defæcation	335
<i>B. Digestion in Herbivora</i>	336
1. Digestion in Ruminants	337
2. Digestion in the Horse	341

SECTION III.

ABSORPTION OF FOOD.

1. State in which Food is Absorbed	347
2. Mode of Absorption	348
3. Channels of Absorption	348
Storage of Surplus Food	351
The Liver as a Regulator of the Supply to the Muscles	353
1. Regulation of the Supply of Sugar	353
2. Regulation of the Supply of Fats	358
3. Regulation of the Supply of Proteins	359

CONTENTS

xv

	PAGE
The Fæces	361
Availability of Food	363
Digestion Experiments	364
Food Requirements	368
1. Method of Determining Requirements	369
2. Rations	371
3. Feeding Standards	375
4. Manurial Values	380

SECTION IV.

MANNER IN WHICH NOURISHING FLUIDS ARE SENT TO THE TISSUES.

THE CIRCULATION.

I. General Considerations	382
II. The Heart	384
A. Structure	384
B. Relations	393
C. Physiology	393
I. The Cardiac Cycle—	
(A) Frog	393
(B) Mammal	394
1. Rate	394
2. Sequence of Events	395
3. Duration of Phases	396
4. Changes in the Shape of the Chambers	397
5. The Cardiac Impulse	398
6. Changes in Intracardiac Pressure	399
7. Action of the Valves	402
8. The Flow of Blood through the Heart	404
9. Sounds of the Heart	407
II. The Work of the Heart	410
III. The Influence of the Central Nervous System	418
IV. The Maintenance and Control of Cardiac Rhythm	424
1. The Initiation of Contraction	424
2. The Conduction of Contraction	427
V. The Nature of Cardiac Contraction	427
III. Circulation in the Blood and Lymph Vessels	431
1. Structure	431
2. Physiology	432
A. Blood Pressure	432
1. General Distribution of Pressure	432
2. Rhythmic Variations of Pressure	434

	PAGE
(a) Changes Synchronous with the Heart Beats—	
1. The Arterial Pulse	434
2. The Capillary Pulse	444
3. The Venous Pulse	444
(b) Changes Synchronous with Respirations—	
1. Arterial	446
2. Venous	447
3. The Mean Blood Pressure	447
I. Pressure in the Arteries—	
(1.) Methods of Determining	447
(2.) Normal Pressure	449
(3.) Factors Controlling	450
i. Heart's Action	451
ii. Peripheral Resistance— Condition	
of the Arteries	451
1. Method of Investigating	452
2. Normal State	453
3. Nervous Control	454
Vaso-Constrictor	455
Vaso-Dilator	458
II. Pressure in the Capillaries	460
III. Pressure in the Veins	463
IV. Pressure in the Lymphatics	464
B. Flow of Blood	464
1. Velocity	465
2. Special Characters	467
C. Special Characters of Circulation in Certain Situations	468
D. Extra-Cardiac Factors Maintaining the Circulation	470
1. Movements of Respiration	470
2. Intermittent Muscular Exercise	470
E. Influence of Posture on the Circulation	471
F. Fainting	472
G. Time taken by the Circulation	472
H. Flow of Blood through Different Organs	473

SECTION V.

FLUIDS CARRYING NOURISHMENT TO THE TISSUES.

BLOOD AND LYMPH.

A. Blood	474
I. General Characters	474
II. Clotting	475
III. Plasma and Serum	479

CONTENTS

xvii

	PAGE
IV. Cells of the Blood	483
Leucocytes	483
Blood Platelets	484
Erythrocytes	485
V. Gases of the Blood	492
VI. Source of the Blood Constituents	498
VII. Total Amount of Blood	501
VIII. Distribution of the Blood	503
IX. Fate of the Blood Constituents	503
B. Lymph	507
1. General Character	507
2. Formation of Lymph	508
C. Cerebro-Spinal Fluid	511

SECTION VI.

RESPIRATION.

A. External Respiration	513
I. The Structure of the Respiratory Mechanism	513
II. Physiology—	
1. Physical Considerations	515
2. Passage of Air into and out of the Lungs	516
i. Movements of Respiration	516
Inspiration	516
Expiration	521
Special Respiratory Movements	522
ii. Amount of Air Respired	522
iii. Interchange of Air by Diffusion	523
iv. Breath Sounds	524
v. Rhythm of Respiration	525
vi. Nervous Control of Respiration	526
1. Chemical Regulation	527
2. Reflex Regulation	532
3. Interaction of Circulation and Respiration	535
A. Influence of Respiration on Circulation	535
B. Influence of the Heart on Respiration	536
4. Interchange between the Air and the Blood	537
i. Effects of Respiration on the Air Breathed	537
ii. Effects of Respiration on the Blood	538
iii. The Causes of the Respiratory Exchange	539
1. Partial Pressure of Gases in the Air Vesicles	539
2. Partial Pressure of Gases in the Blood	541
B. Intermediate Respiration	545
C. Internal Respiration	547

<i>D.</i> Extent of Respiratory Exchange	546
<i>E.</i> Ventilation	547
<i>F.</i> Asphyxia	548

VOICE

<i>A.</i> Structure of the Larynx	550
<i>B.</i> Physiology of Voice	552

SECTION VII.

EXCRETION OF MATTER FROM THE BODY.

<i>A.</i> Excretion by the Lungs (<i>see</i> Respiration).	
<i>B.</i> Excretion by the Intestine (<i>see</i> Intestine).	
<i>C.</i> Excretion by the Kidneys	554
<i>I.</i> Urine	554
1. General Consideration	554
2. Physical Characters	557
3. Composition	558
<i>II.</i> Formation of Urine	567
1. Structure of the Kidney	571
2. Physiology of Secretion	572
(<i>a</i>) Malpighian Bodies	573
(<i>b</i>) Tubules	575
<i>III.</i> Excretion of Urine	581
<i>D.</i> Excretion by the Skin	582
Sweat Glands	583
Sebaceous Glands	585

SECTION VIII.

THE REGULATION OF GROWTH AND FUNCTION.

<i>I.</i> Heredity	586
<i>II.</i> The Nervous System	587
<i>III.</i> Chemical Regulation: The Endocrinetes	588
Developed—	
(<i>a</i>) From the Nervous System—	
1. Chromaffin Tissue	590
2. Hypophysis	594
(<i>b</i>) From the Buccal Cavity—	
3. Thyreoid	595
4. Pituitary	599
(<i>c</i>) From Intestinal Mucosa—	
5. Pancreas	601
6. Mucosa of Small Intestine	601

CONTENTS

xix

	PAGE
(d) From the Branchial Arches—	
7. Thymus	602
8. Parathyroids	603
(e) From the Mesothelium of the Genital Ridge—	
9. Gonads	605
10. Inter-renals	609
The Interaction of the Endocrinetes	611
The Mode of Action of the Internal Secretions	611
Protective Modifications of Metabolism—Immunity	612

PART IV.

THE ANIMAL AS PART OF THE SPECIES.

A. REPRODUCTION.

I. Determination of Sex	617
II. The Gonads	618
III. The Secondary Sexual Organs	621
IV. The Oestrous Cycle	622
V. Impregnation	623

B. DEVELOPMENT.

I. Early Stages of Development	624
II. Attachment of Embryo to Mother	626
III. The Nourishment of the Fœtus	628
IV. Growth of the Fœtus	630
V. Metabolism in Pregnancy	631
VI. The Young Animal at Birth	631
VII. Fœtal Circulation	631
VIII. Gestation and Delivery	633
IX. Lactation	634
APPENDICES	641
INDEX	655

PART I.

SECTION I.

THE GROWTH OF PHYSIOLOGY.

PHYSIOLOGY formerly embraced the study of all nature (*φυσικῆς*), but it is now restricted to the study of life and the activities of living things. It is really an older science than anatomy, for even before any idea of pulling to pieces, or dissecting plants and animals had suggested itself to our forefathers, speculations in regard to the causes and nature of the various vital phenomena were indulged in, some of which foreshadowed in a truly wonderful way the scientific discoveries of to-day. Thus, about 500 B.C., Empedocles not only formulated a doctrine of evolution, but indicated that the struggle for existence played a part in the process. About a century later Hippocrates insisted on the importance in the treatment of disease of studying the normal action of the body, and recognised the importance of the *vis medicatrix nature*. His followers adopted the idea of a *pneuma*, a subtile agent attracted to the lungs and distributed to the body as the basis of all vital phenomena. The physiology of to-day is the offspring of such speculations.

Organ and Function.—The first great and true advance was through anatomy. Galen, about 200 A.D., dissected and made observations on the physiology of animals. He described various organs and endeavoured, more or less successfully, to ascertain their mode of action by experiments on living animals. He may well be called the father of physiology.

The Dark Ages fell upon Europe, and little further advance was made till, in the sixteenth century, the group of Italian anatomists showed how the body is built up of

definite organs which they described in detail, and thus prepared the way for the work of Harvey, which led to such important discoveries, and which established the relationship of *function to organ*.

The connection between organ and function having been demonstrated, the question of why these various functions are connected with the respective organs—why the liver should secrete bile and the biceps muscle contract, next forced itself upon the attention.

Tissues and Function.—Again anatomy paved the way to the explanation. The dissecting knife and the early and defective microscope showed that the organs are composed of certain definite structures or *tissues*, differing widely from one another in their physical characters and appearance, and, as physiologists soon showed, in their functions. By the end of the seventeenth century Leuwenhoek and Malpighi had so advanced the knowledge of the tissues that Haller, in the middle of the eighteenth century, was able to indicate that the function of an organ is really the function of the tissue of which it is composed.

Early in the nineteenth century Johannes Müller, taking a comprehensive survey of a great mass of observations which had accumulated, and adding to them the results of his own investigations, created the modern science of physiology.

Cells and Function.—Physiologists and anatomists alike devoted their energies to the study of these various tissues, and, as the structure of the microscope improved, greater and greater advances were made in their analysis, till at length Schwann was enabled to make his world-famous generalisation, that all the tissues are composed of certain similar elements more or less modified, which he termed cells, and it became manifest that *the functions of the different tissues are dependent on the activities of their cells*.

The original conception of the cell was very different from that which we at present hold. By early observers it was described as composed of a central body or nucleus, surrounded by a granular cell substance with, outside all, a cell membrane. As observations in the structure of the cell were extended, it soon became obvious that the cell membrane

was not an essential part; and later, the discovery of cells without any distinct nucleus rendered it clear that the essential part is the cell substance. This substance von Mohl named *protoplasm*, by which name it has been since generally known.

Protoplasm and Function.—So far, physiology had followed in the tracks of anatomy, but now another science became her guide. Chemistry, which during the early part of the nineteenth century advanced with enormous strides, and which threw such important light upon the nature of organic substances, lent her aid to physiology; and, morphologists having shown that the vital unit is essentially a mass of protoplasm, *the science of life has become the science of the chemistry of protoplasm.*

The prosecution of physiology on these lines has changed the whole face of the science. Physiology is no longer the follower of anatomy. It has become its leader, and at the present time, as we shall afterwards see, not only the various activities, but also the various structural differences of the different tissues, are to be explained in terms of variations in the chemical changes in protoplasm.

Already these chemical studies have shown that protoplasm is not a single substance, but a mixture of many substances in a constant state of flux and change, and that its condition is largely determined by the physical relations of the substances in the mixture.

Within recent years the application of molecular physics to physiology has greatly advanced the knowledge of many of the obscure characters of living matter.

In the study of physiology the order of its development must be reversed, and from the study of protoplasm the advance must be made along the following lines:—

1. **Protoplasm**—the physical basis of life; its activities and nature.
2. **Cells**.—The manner in which protoplasm forms the vital units of the body.
3. **Tissues**.—The manner in which these are formed by

cells. Their structure, physical and chemical properties, and vital manifestations.

- a. The Vegetative Tissues, supporting, binding together, protecting and nourishing the body.
- b. The Master Tissues—*nerve* and *muscle*—through which the external world acts upon the body, and the body reacts upon the surroundings.

4. Nutrition of Tissues.

- a. The manner in which substances necessary for the tissues are supplied—

Food.

Digestion.

- b. The manner in which the nourishing fluids are brought into relationship with tissues—

Circulation.

- c. The fluids bathing the tissues—

Blood and Lymph.

- d. The supply of oxygen and the elimination of carbon dioxide.

Respiration.

- e. The manner in which the waste products of tissues are eliminated—*Excretion, Hepatic, Renal, Pulmonary, Cutaneous.*

5. Reproduction and Development.

Students who have not the knowledge of Chemistry and Physics necessary for the Study of Physiology are referred to the Appendices.

PART II.
SECTION I.
PROTOPLASM.

I. Nature of Protoplasmic Activity.

THE first step in the study of physiology must be to acquire as clear and definite a conception as possible of the nature of protoplasmic activity in its most simple and uncomplicated form, for in this way an idea of the essential and non-essential characteristics of life may best be gained.

The common yeast (*Saccharomyces Cerevisiæ*) affords such a simple form of living matter.

This plant consists of very minute oval or spherical bodies frequently connected to form chains, each composed of a harder outer covering or capsule, and of a softer inner substance which has all the characters of protoplasm.

1. **Manifestations of Life.**—Its vital manifestations may be studied by placing a few torulæ in a solution, containing glucose, $C_6H_{12}O_6$, some nitrogen-containing substances such as urea, CON_2H_4 , or ammonium nitrate, NH_4NO_3 , with traces of disodium phosphate, Na_2HPO_4 , and of potassium sulphate, K_2SO_4 (*Practical Physiology*).

If the vessel be kept all night in a warm place, the clear solution will in the morning be seen to be turbid, and probably covered with froth. An examination of a drop of the fluid shows that the turbidity is due to the presence of myriads of torulæ. In a few hours the few torulæ placed in the fluid have increased many hundredfold. The whole mass of yeast has grown in amount by the growth and multiplication of the individual units.

This power of growth and reproduction under suitable conditions is an essential characteristic of living matter.

2. Conditions necessary for Manifestations of Life.—

(a) If the yeast be mixed with the solid constituents of the solution in a dry state, no growth or reproduction occurs. *Water is essential.*

(b) If the yeast, mixed with the solution, be kept at the freezing point no growth takes place, but this proceeds actively at about 36° C. *A certain range of temperature is necessary for the vitality of protoplasm.*

In the absence of these conditions, protoplasm is only potentially alive, and in this state it may remain for long periods without undergoing any change, as in the seeds of plants and in dried bacteria.

3. Essentials for Growth.—In order that the growth of the yeast may take place, there must be:—

(a) A SUPPLY OF MATERIAL from which it can be formed. The chemical elements in protoplasm are carbon, hydrogen, oxygen, nitrogen, sulphur, and phosphorus. These elements are contained in the ingredients of the solution used. If yeast be sown in distilled water, even if it be kept at a temperature of 36° C., it does not grow.

(b) A SUPPLY OF ENERGY to bring about the construction. The source of the energy is indicated by an examination of the fluid in which the yeast has grown. The sugar, $C_6H_{12}O_6$, has decreased in amount, being converted into alcohol, C_2H_5O , and carbon dioxide, CO_2 —



It is this oxidation of the carbon to carbon dioxide which yields the energy, just as the combustion of the coals in the furnace yields the energy for an engine. But in this case the O_2 comes from the $C_6H_{12}O_6$, and not from outside, and the energy evolved in the reaction is only about a tenth of that liberated by the complete oxidation to CO_2 and H_2O which occurs in the animal body. The formation of alcohol from sugar does not lead to the liberation of energy. So far as this is concerned, the alcohol may be considered as a by-product.

The behaviour of the yeast plant shows that such *protoplasm, when placed in suitable conditions, has the power of breaking down certain complex substances, and of utilising the energy so liberated for building itself up, and thus increasing and growing.* It is this power of using this energy for growth which has enabled living matter to exist and to extend over the earth.

4. Liberation of Energy by Protoplasm.—How is this oxidation and liberation of energy effected?

The answer to this question has been given by the demonstration by Buchner that the expressed juice of the yeast *torulæ* acts on the sugar in the same way as the

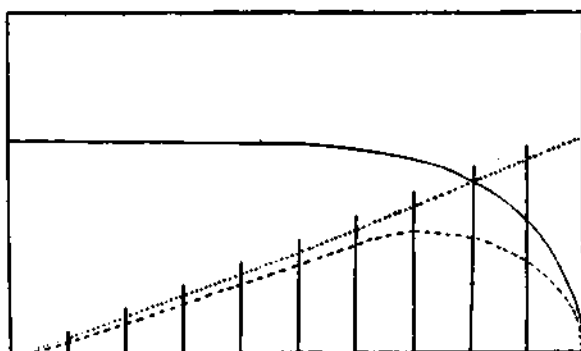

FIG. 1.—To show the relationship of the rate of enzyme action to temperature. The vertical lines represent different temperatures. The dotted line represents the rate of enzyme action as modified by temperature. The continuous line shows the destruction of the enzyme as the temperature rises. The dash line shows the actual rate of enzyme action as modified by these two factors.

living yeast. The yeast therefore manufactures something which splits the sugar. This something belongs to the group of **Enzymes** or **Zymins** which play so important a part in physiology generally.

(1) **Conditions of Enzyme Action.**—For the manifestation of their activity these enzymes require the presence of water and a suitable temperature—in the case of the yeast enzyme about 36° C. is the best. At lower temperatures the reaction becomes slower and is finally stopped, and at a higher temperature it is delayed and finally arrested by the destruction of the enzyme (fig. 1).

(2) **Nature of Enzyme Action.**—(i.) Enzymes act by hastening reactions which go on slowly without their presence, but they do not themselves take any direct part in the reaction; they modify its *rate* but not its *extent*. Hence, a very small quantity may bring about an extensive change in the substance acted upon. (ii.) The reaction does not pass beyond the point of equilibrium. Thus, when the enzyme *maltase* acts upon malt sugar, it converts it only in part into dextrose. (iii.) With certain enzymes at least, the action may actually be reversed; the enzyme, which splits esters into their component acid and alcohol, may cause a linking of those components to form esters. (iv.) The rapidity of the reaction is retarded as it proceeds sometimes by the accumulation of H ions, sometimes by the accumulation of the products of the change. When these are removed the action may again be accelerated.

The general action of enzymes is *catalytic*. It may be compared to the action of an acid in the inversion of cane sugar—



Here an acid merely hastens a reaction which would go on slowly in the presence of water alone.

(3) **Mode of Action of Enzymes.**—(a) The precise way in which such catalytic actions are brought about is still not quite clear, but there is evidence that the catalyser acts as a middleman between the reacting substances—in the case of H_2O_2 taking up the O and then giving it off and in the case of the decomposition of cane sugar taking up H_2O and handing it on. In the same way in the oxidation of glucose which occurs when it is boiled with an alkali, a metallic oxide, such as cuprous oxide, may take oxygen from the air, becoming cupric oxide, and then hand the oxygen on to the glucose, thus making the oxidation more rapid.

(b) While such catalysers as the inorganic acids act upon many different substances, the enzymes have generally a *specific action* upon one substance alone, the *substrate* of the enzyme. It is as if each enzyme fitted one special substrate as a key fits one special lock. They are generally

designated by attaching the suffix *ase* to the name of their substrate, thus *maltase* is the enzyme that acts upon malt sugar.

Our knowledge of the chemistry of enzymes is not complete, because when attempts are made to isolate them it is frequently found difficult to separate them completely from their substrate. Maltase has been shown not to be of the nature of a protein.

(4) **Essential Nature of Enzymes.**—They are *colloids* (see p. 12), and their colloidal character helps to explain their activity.

The energy liberated by the enzyme of yeast is used by the protoplasm for growth.

5. **Metabolism of Protoplasm.**—While ordinary protoplasm gets its energy by breaking down complex molecules and liberating their stored energy, *green plants*, by the action of their chlorophyll, are able to store the energy of the sun's rays by building up complex molecules such as sugar and starch. It is through these green plants that the energy of the sun is made available for all living things upon the earth.

Protoplasm is not only growing, it is also constantly breaking down, and, if yeast be kept at a suitable temperature in water without any supply of material for construction, it gives off carbon dioxide and decreases in bulk on account of these disintegrative changes. These are as essential a part of its life as the building-up changes, and it is only when they are in progress that the latter are possible.

Protoplasm (living matter) is living only in virtue of its constant chemical changes (metabolism), and these changes are on the one hand destructive (katabolic), on the other constructive (anabolic).

Living matter thus differs from dead matter in this respect, that, side by side with destructive changes, constructive changes are always going on, whereby its amount is maintained or increased, so that it has been able to spread all over the surface of the earth.

Hence our conception of living matter is not of a definite chemical substance, but of a set of substances constantly

undergoing internal changes. It might be compared to a whirlpool constantly dragging things into its vortex, and constantly throwing them out more or less changed, but itself continuing apparently unchanged throughout. Hoppe-Seyler expresses this by saying: "The life of all organisms depends upon, or, one can almost say, is identical with, a chain of chemical changes." Foster puts the same idea in more fanciful language: "We may speak of protoplasm as a complex substance, but we must strive to realise that what we mean by that is a complex whirl, an intricate dance, of which what we call chemical composition, histological structure, and gross configuration are, so to speak, the figures."

Death.—While the continuance of these chemical changes in protoplasm is life, their stoppage is death. For the continuance of life the building-up changes must be in excess of, or equal to, the breaking-down—the evolution of energy must be sufficient for growth or maintenance. It is only the surplus over this which is available for external work. In the young the surplus energy is largely used for growth and development; in adult life for work. When failure in the supply or in the utilisation of the energy-yielding material occurs, the protoplasm dwindles and disintegrates. Death is sudden when the chemical changes are abruptly stopped, slow when the anabolic changes are interfered with.

The series of changes which occur between the infliction of an incurable injury and complete disintegration of the protoplasm constitute the processes of **Necrobiosis**, and their study is of importance in pathology.

Stimuli.—The rate of the chemical processes in protoplasm may be quickened or slowed by changes in the surroundings, and such changes are called **stimuli**. If the stimulus increases the rate of change, it is said to *excite*; if it diminishes the rate of change, it is said to *depress*. Thus the activity of the changes in yeast may be accelerated by a slight increase of the temperature of the surrounding medium, or it may be depressed by the addition of such a substance as chloroform.

II. Structure of Protoplasm.

Protoplasm occurs as a semifluid transparent viscous material, usually in small individual particles—CELLS—more or less associated. It may, however, occur as larger confluent masses—PLASMODIA.

Protoplasm in its simplest state may be regarded as a fluid, since fine particles in it are seen to move freely in Brownian movement (p. 13 (3)), and if it contains drops of water they assume a spherical form; certain plasmodial masses of protoplasm among the myxomycetes in which granules exist may creep through cotton wool and emerge without their granules, having actually filtered them off.

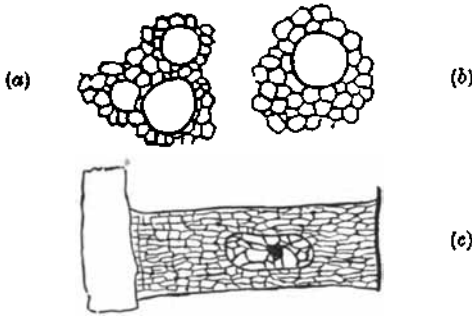

FIG. 2.—(a) Foam structure of a mixture of Olive Oil and Cane Sugar; (b) Reticulated structure of Protoplasm; (c) Reticulated structure of Protoplasm after fixation in the cell of an earth-worm (after BÜTSCHLI).

But while protoplasm may thus be looked upon as essentially a fluid, a reticulated appearance can frequently be made out even in the living condition (fig. 2), and from this it has been concluded, chiefly as the result of Bütschli's investigations, that there is a somewhat more solid part arranged like the films of a mass of soap-bubbles, with a more fluid interstitial part, a sort of foam structure which might be compared to an emulsion of oil in a colloidal gum solution. A certain amount of organisation is thus present in most protoplasm, and in certain cells this organisation becomes very marked. This conception of the structure of protoplasm leads us to regard each vesicle as a minute

independent chemical laboratory, separated from others by more or less permeable colloidal walls.

There is good evidence that when protoplasm is coagulated, a marked netted appearance may be observed which may vary greatly in character according to the fixing reagent by which the coagulation has been produced, and which is purely an artifact.

.III. Chemical and Physical Conditions.

Protoplasm is not a substance, but a mixture of various substances, a heterogeneous complex, in a constant state of flux and change.

A. WATER.

Water, holding or held in a Colloidal Complex with certain crystalloids, constitutes something over 75 per cent., and acts as the solvent or suspender of the other materials.

B. COLLOIDAL COMPLEX.

The series of substances which constitute the mass of all protoplasm exist in a colloidal state.

Colloids.

(1) Colloids were long ago distinguished by Graham from crystalloids by the fact that they do not *dialyse* through an animal membrane when mixed with water, and he concluded that this is due to the large size of the molecule which constitutes such colloids. More recent investigations have shown that this explanation is insufficient, since substances of small molecular weight may at one time exist in a crystalloid state, and at another in a colloid condition, *e.g.*, silicic acid.

The essential character of the colloidal state consists in the existence of matter in two conditions, "phases," often so finely subdivided as to render the detection of the condition very difficult. The natures of the external or continuous phase and of the internal or dispersed phase

suspended in the other may vary greatly. Bayliss gives the following table to illustrate this :—

Internal or Dispersed Phase.	External or Continuous Phase.	Example.
1. Gas	Liquid	Foam
2. Liquid	Gas	Fog
3. Liquid	Another immiscible Liquid	Emulsion or Emulsoid ; mists
4. Liquid	Solid	Jelly, as Gelatine in some forms
5. Solid	Gas	Tobacco Smoke
6. Solid	Liquid	Ordinary Colloid Solution or Suspensoid
7. Solid	Another Solid	Ruby Glass

Protoplasm may be regarded as an emulsoid.

The emulsoids are characterised by showing considerable viscosity.

Colloids have sometimes been divided into *sols* when they are fluid, and *gels* when they are more solid, and there is some evidence that in the latter condition the dispersed phase is the more fluid. (2) It is now known that if a beam of light is allowed to pass through a colloid it is rendered visible—the Faraday-Tyndall phenomenon—whereas when it passes through crystalloids in water it is not seen. (3) If a suspensoid be placed under a microscope, and a ray of light be passed into it along the plane of the stage, it may be seen to be full of shining, dancing particles. These last two tests indicate the two phases in the colloid.

This fine subdivision of the two phases introduces an element in the behaviour of a colloid which is not present in the case of a solution, namely, the presentation of an enormous extent of surface between the two phases. It has been calculated that a sphere of gold with a radius of 1 millimetre, if subdivided into a gold sol or suspensoid, would present a surface of no less than 100 square metres. This allows of extensive interactions between the phases, and these interactions will depend upon chemical changes in each. Thus great activity of change is rendered possible.

The phenomena of surface tension between the phases

must manifest themselves on account of the large surfaces exposed. Surface tension is, of course, most easily studied at the surface bounding a fluid and air. At such a surface a skin of increased tension exists. Its condition is modified by many factors, among others by the solutes in the fluid. Inorganic salts generally increase, while organic salts decrease it. The solutes which lower surface tension tend to be more concentrated at the surface, those raising it tend to be less concentrated.

The amount of concentration at such surfaces is often greater than can be accounted for by the condition of the fluid. A process which has been called **adsorption** occurs, one substance tending to deposit in large amounts upon the surface of another. This seems to depend mainly upon the electric charge of the two substances, those of opposite charges tending to cling together. This may occur between substances in solution and colloids, or between different colloid particles in a compound sol, and may lead to an increase in the size of the particles and to precipitation. It may also explain the membrane-like covering of many cells.

It is impossible to analyse such an ever-changing substance as protoplasm, and, although what is left when these chemical changes are stopped can be examined, such analyses give little insight into the essential nature of the living matter.

The chief constituents found after the death of protoplasm are the proteins, along with small amounts of fatty substances, carbohydrates, and crystalloids.

Substances entering into the Colloidal Complex.

1. Proteins.

1. Physical Characters.—The Native Proteins—those which may be separated from the residue of living matter—have a white, yellow, or brownish colour when dried. In structure they are usually amorphous, but many have been prepared in a crystalline condition, and it is probable that all may take a crystalline form. The crystals vary in shape, being usually small and needle-like, but sometimes forming larger rhombic

plates. In protoplasm proteins form part of the emulsoid complex. But some purified proteins form colloidal suspensions—hydrosols—in water, some require the presence of neutral inorganic salts, others of an acid or alkali, while some are completely insoluble and unsuspendable without a change in their constitution. The animal proteins are insoluble in alcohol; all proteins are insoluble in ether.

All proteins rotate the plane of polarised light to the left on account of the action of the amino acids of which they are composed (p. 16).

2. **Chemistry.**—(1) **PERCENTAGE COMPOSITION.**—Proteins contain the following chemical elements:—Carbon, hydrogen, oxygen, nitrogen, and sulphur, in about the following percentage amounts:—

C.	H.	N.	S.	O.
52	7	16	1	24

It is important to remember the amounts of nitrogen and carbon, since proteins are the sole source of the former element in the food and an important source of the latter.

(2) **SIZE OF MOLECULES.**—As regards the number of atoms of these elements which go to form a single molecule, information is afforded by the percentage of sulphur in the molecule, and by the number of atoms of various metals which combine with a molecule of the protein. The following probable formula for the molecule of the chief protein of the white of egg is given simply to show how complex these substances are:— $C_{204}H_{322}N_{52}O_{68}S_2$.

(3) **CONSTITUTION.**—The constitution of the protein molecule has been investigated (A) by studying the products of the decomposition of the molecule by various agents, and (B) by attempting to build up the molecule by the synthesis of the products of disintegration.

(A) The native proteins have very large molecules, and they tend to break down into simpler proteins. This decomposition is accompanied by hydration, and it is accelerated by the action of acids, and by a group of enzymes which may be named proteolytic enzymes.

Under the action of alkalies and under the influence of

certain bacteria other lines of breaking down may occur, but these have thrown less important light upon the constitution of the proteins.

As the molecules become smaller the colloidal characters decrease, diffusion through animal membranes becomes more marked, and the tendency to precipitate is lessened. This latter property has been used to classify the proteins into three main groups—

- | | |
|--------------------|---|
| | Precipitated by— |
| 1. Native Proteins | boiling and by saturation with $(\text{NH}_4)_2\text{SO}_4$. |
| 2. Proteoses. | not by boiling but by saturation with $(\text{NH}_4)_2\text{SO}_4$. |
| 3. Peptones. | not by boiling, nor by saturation with $(\text{NH}_4)_2\text{SO}_4$. |

Products of Disintegration.—Under the influence of a prolonged action of acids and of certain enzymes such as the erepsin of the intestine (p. 328) the splitting of the molecule is carried further, till finally the greater part of the nitrogen of the protein comes to be distributed in bodies of three different classes—

- | | |
|---|--------------------|
| 1. Mon-amino acids | about 70 per cent. |
| 2. Di-amino acids | „ 20 „ |
| 3. Amides and ammonia compounds | „ 10 „ |

1. **Mon-amino Acids** are thus the bodies from which the proteins are chiefly formed, and the character of the proteins of different animals and of different tissues depends largely upon the mon-amino acids which predominate.

The different proportions of these which occur in different proteins is indicated by the following table:—

	Glycin.	Alanin.	Leucin, &c.	Arginin.	Trypto- phan.	Tyrosin.
Serum Albumen	0·0	2·7	20	?	+	2·1
Excelsin (from Brazil Nut)	0·6	2·3	8·7	16·0	+	3·1
Gelatin	16·5	0·8	2·1	7·6	0·0	0·0
Salmin (from Sper- matozoa of Salmon)	0·0	0·0	+	87·4	?	0·0

In most, iso-amino-caproic acid, or leucin, is the most abundant, and in disintegrative diseases of the liver, such as acute yellow atrophy, it may appear in the urine, separating out as oily-looking spherules.

Some of the non-amino acids split off from the protein molecule attached to the benzene ring, or to the benzene ring linked to a pyrrol ring. In **Tryptophan**, amino-propionic acid (*Alanin*) is linked to such a complex—

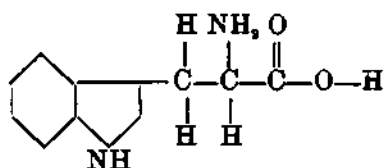

In **tyrosin**, alanin is linked to an hydroxy benzene ring.

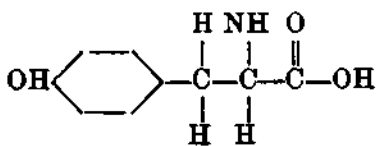

Like leucin, it may appear in the urine in disintegrative diseases of the liver. It takes the form of rosettes of acicular crystals.

2. **Di-amino Acids.**—In most proteins, the di-amino acids are less abundant than the mon-amino. But, in a simple form of protein, which occurs linked with nucleic acid in the heads of spermatozoa, called by Kossel protamine, these di-amino acids constitute about 80 per cent. of the molecule. They are—

Lysin—di-amino-caproic acid.

Arginin—amino-valerianic acid linked to guanidin (p. 209).

Histidin—amino-propionic acid linked to the iminazole ring.

Of these three arginin is the most abundant.

3. **Amides** are always present in small amount, linked together as in biuret $H_2N-CO-NH-CO-NH_2$, and it is

these which give the biuret test—the pink or violet when sodium hydrate is added to the protein with which a trace of cupric sulphate has been mixed.

The different stages of the disintegration of the native protein molecule may be arranged as follows, according to their reactions to heat, ammonium sulphate, and alcohol :¹—

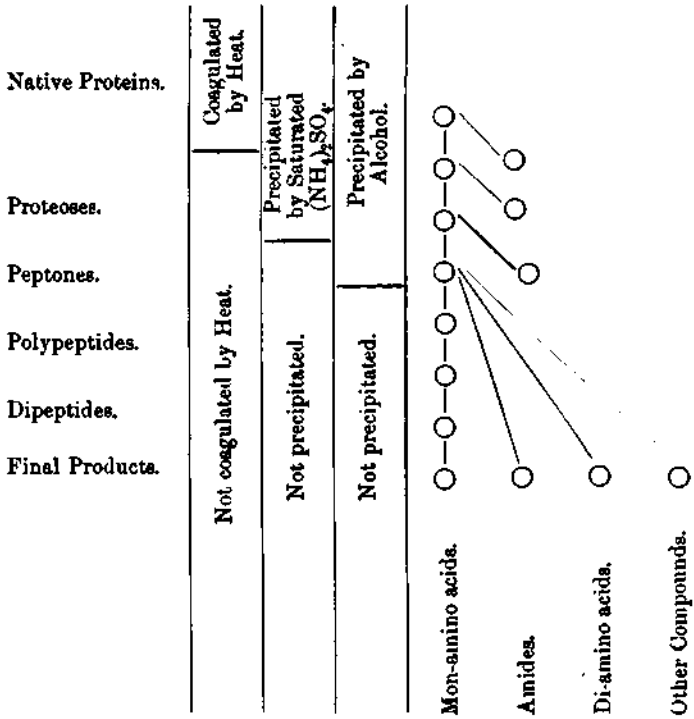

For a "Classification of Proteins," see Appendix. *The tests for the Proteins must be learned practically.*

B. Synthesis of Proteins.—Emil Fischer and his co-workers have succeeded in building up from the amino acids a series of bodies containing several of the amino acid molecules, linked to one another in series, the hydroxyl, OH, of

¹ For a short account of the chemistry of these products of disintegration, see Appendix.

one being linked on to the amidogen of the other with the giving off of H_2O , thus :—

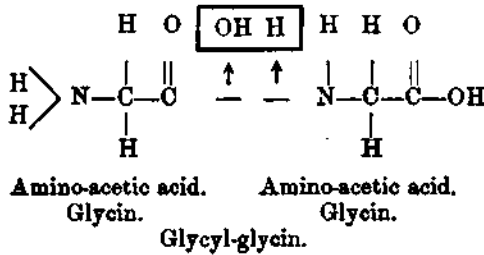

This he calls glycyl-glycin,—the amino acids which have lost the OH of the acid being designated by the terminal *yl*.

Such compounds he calls **peptides**, characterising them, according to the number of molecules linked, as di-, tri-, tetra-, and poly-peptides.

Some of the higher of these give the biuret test for proteins from the presence of the linked $CO.NH_2$ group; and if an acid with the benzene ring is in the chain, they also give the xantho-proteic test.

He has also succeeded in building the pyrrol derivative, pyrrolidine-carboxylic-acid, or *prolin*, into polypeptides.

2. Fats and Lipoids.

In addition to ordinary fats (see p. 41), protoplasm also contains a group of substances which are, like the fats, soluble in alcohol and ether, and which have been called **Lipoids**. These are generally most abundant in the outer layers of protoplasmic units, where they help to form a covering membrane.

One of the most important is **Cholesterol**. This is a mono-hydric unsaturated alcohol, which, when dissolved in hot alcohol, tends to crystallise out on cooling in flat square plates, generally with a notch out of a corner.

Some of the lipoids contain phosphorus, and have been grouped as **Phosphatides**. The most important of these is **Lecithin**.

This is a fat in which one of the acid radicles is replaced

by phosphoric acid linked to cholin — hydroxyethyl-trimethyl-ammonium-hydroxide.

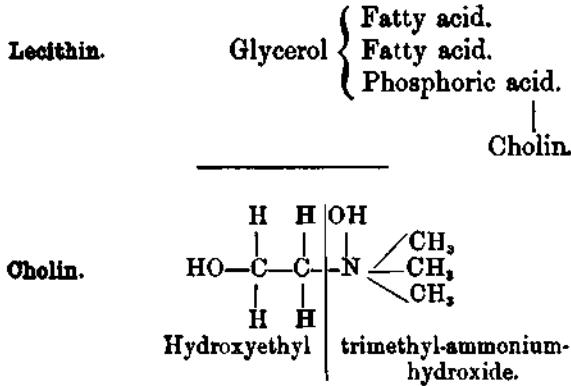

Cholin has some action upon visceral muscle, and some of the symptoms occurring in degenerative changes of the nervous system may be due to its presence. It is closely allied to *muscarin*, a very powerful poison of vegetable origin.

In protoplasm, the lipoids are intimately associated with the proteins, and form part of the colloidal complex. By their tendency to adsorb to the surface, and thus to form membranes, they help to differentiate masses of protoplasm from their surroundings and to present a more or less permeable membrane, through which exchanges between the living matter and its surroundings go on.

3. Carbohydrates.

Closely connected with the proteins and fats, and sometimes actually built into the molecule of the former, are small quantities of carbohydrates, bodies belonging to the class of starches and sugars (p. 285).

C. CRYSTALLOIDS.

These may either exist in true solution or be combined with the proteins and lipoids in the colloidal state. Those

in solution may not be ionised, e.g. glucose, or they may be ionised into an-ions and cat-ions. Among the more important of the cat-ions are potassium, calcium, and sodium. The presence of such crystalloids free in true solution chiefly determines the osmotic pressure of the mass of protoplasm, and hence this may vary from time to time according to whether these substances are united to the proteins or are free.

The osmotic pressure in the protoplasm of a cell may be ascertained by subjecting it to fluids of different osmotic equivalents and determining whether it swells by the passage of fluid inwards or shrinks by the passage of water outwards, thus ascertaining the molecular concentration of the surrounding fluid and so of the cell itself. This has been called the method of *Plasmolysis*. The red cells of the blood have a very definite osmotic pressure, and when subjected to a fluid of lower osmotic pressure, they swell, while in a fluid of higher osmotic pressure, they shrink. This is called the method of *Hæmolysis*.

IV. Protoplasmic Activity.

This complex of substances called protoplasm is, during life, in a constant state of active chemical change. All its conditions make for great instability: its colloidal nature, its demarcation from its surroundings as the result of surface tension with adsorption, its frequent division into innumerable vesicles separated from one another by very unsubstantial and temporary septa ever changing as the result of internal chemical changes, all of these combine to produce a very labile condition. Thus oxidation may be going on in one part of the mass, drawing oxygen from another, and thus leading to a simultaneous process of reduction. Such a mechanism is pregnant with possibilities as a transformer of energy and as a producer of movement.

That such movements really can be produced, even in dead matter, by the combination of changes brought about by osmosis and by alteration in surface tension, may be demonstrated by the behaviour of mixtures of such substances as camphor and water.

SECTION II.

THE CELL.

PROTOPLASM occurs in the animal body as small separate masses of **CELLS**. These vary considerably in size, but in the higher animals, on an average, they are from 7 to 20 micro-millimetres¹ in diameter. The advantage of this subdivision is obvious. It allows nutrient matter to reach every particle of the protoplasm. In all higher animals each **CELL** has a perfectly definite structure. It consists of a mass of protoplasm, in which is situated a more or less defined body, the nucleus.

A. Cell Protoplasm.

1. **Structure.**—The general characters of protoplasm have been already described (p. 11). In some cells condensation at the surface is marked, and a so-called membrane surrounds them.

At some point in the protoplasm of many cells, one or two small spherical bodies, the **centrosomes** (fig. 3), are found, from which rays pass out in different directions. For the detection of these bodies special methods of staining and the use of very high magnifying powers are required. They will be again considered when dealing with the reproduction of cells.

The cell protoplasm frequently contains **granules**, either formed in the protoplasm, or consisting of material ingested by the cells.

In the protoplasm, **vacuoles** are sometimes found, and from a study of these vacuoles in protozoa, it appears that

¹ The micro-millimetre is the $\frac{1}{1000}$ th of a millimetre.

they are often formed round material which has been taken into the protoplasm, and that they are filled with a fluid which can digest the nutritious part of the ingested particles. In some cells, vacuoles may appear in the process of disintegration.

2. **Activities.**—(a). Many cells have the power of ingesting foreign material. This **phagocytic** action plays an

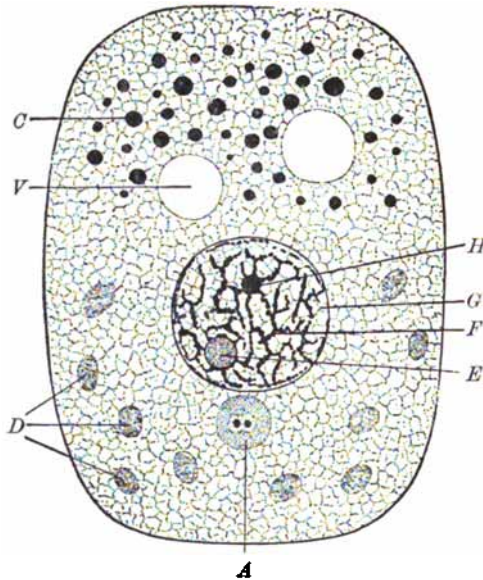

FIG. 3.—Diagram of a Cell to show structure of Protoplasm and Nucleus. In the protoplasm—*A*, attraction sphere enclosing two centrosomes; *V*, vacuole; *C*, included granules; *D*, plastids, present in some cells. In the nucleus—*E*, nucleolus; *F*, chromatin network; *G*, linin network; *H*, karyosome or nodal swelling. (WILSON.)

enormously important part both in physiological and in pathological processes in the body.

(b) In certain cells, protoplasm undergoes changes in shape (*amœboid movement*). This may be studied in the white cells in the blood of the frog or newt. Processes (*pseudopodia*) are pushed out, and these are again withdrawn, or the whole cell may gradually follow the process, and thus change its position.

In some unicellular organisms movements take place along some definite line, and fibrils are found arranged more or less parallel to the line of movement. Such contractile processes, from their resemblance to muscles, have been termed *myoids*. In other protozoa the pseudopodia manifest a to-and-fro rhythmic waving movement, which may cause the cell to be moved along, or may cause the adjacent fluid to move over the cell. Such mobile processes, when permanent, have been called *cilia*. These movements are the result of chemical changes in the protoplasm, by which alterations in the osmotic pressure and changes in the surface tension of the various parts are produced.

The movements are modified by the various *Stimuli* which alter the activity of the chemical changes (p. 10). The stimulation may be (a) *General*.—Cooling diminishes and finally stops them. Gentle heat increases them, but when a certain temperature is reached they are stopped. Drying and various drugs, such as chloroform, also arrest the movements.

(b) *Unilateral*.—Changes in the surroundings may cause either contraction or expansion, may repel or attract. When an attracting or a repelling influence, a positive or a negative stimulus, acts at one side of the cell—*unilateral stimulation*—it may lead to movement of the cell away from it or towards it. If the action is towards the stimulus, it is said to be *positive*; if away from it, *negative*.

Chemiotaxis is the attraction or repulsion produced by one-sided application of chemical stimuli. This is well seen in the plasmodial masses of *athalium septicum*, which grows on tan. Oxygen and water both attract it, exercising a positive chemiotaxis. It is also seen in the streaming of the white cells of the blood to disintegrating tissues, or to various micro-organisms introduced into the tissues which have to be destroyed to prevent their poisoning the organism, and in the attraction exercised by the ovum upon the male element in reproduction.

Barotaxis is the effect of unilateral pressure or mechanical stimulation. Many protozoa appear quite unable to leave the solid substance—*e.g.* the microscope slide—with which

they are in contact, the unilateral pressure seeming to cause a positive attraction in that direction. It is well seen in climbing plants.

Phototaxis.—Light, which plays so important a part in directing the movements of the higher plants, also acts positively or negatively on many unicellular organisms. Thus, the swarm spores of certain algæ are positively attracted by moderate illumination, streaming to the source of light, while they are negatively stimulated by strong light, and stream away from it. Light also plays an important part in directing the movements of certain bacteria.

Thermotaxis.—The unilateral influence of temperature is well seen in the plasmodium of *æthaliium septicum* which streams from cold water towards water at a temperature of about 30° C.

Galvanotaxis.—A current of electricity has a marked effect in directing the movements of many cells. Certain infusoria, when brought between the poles of a galvanic battery, stream towards the negative pole, while other organisms move to the positive.

The effects of this unilateral stimulation are of great importance in physiology and pathology, since they explain the streaming of leucocytes to the intestine during digestion and to parts of the body infected by micro-organisms and other poisons. They also explain the apparently volitional acts of unicellular organisms. Many of these organisms appear definitely to select certain foods, but in reality they are simply impelled towards them by this unilateral stimulation.

B. Nucleus.

(1) **Structure.**—The nucleus, seen with a moderate magnifying power, appears in most cells as a well-defined circular or oval body situated towards the centre of the cell (figs. 2 (c)

and 3). Sometimes it is obscured by the surrounding protoplasm. It has a granular appearance, and usually one or more clear refractile bodies—the *nucleoli*—are seen within it. It stains deeply with many reagents of a basic reaction, such as hæmatoxylin, carmine, methylene blue, etc.

In some cells the nucleus is irregular in shape, and in some it is broken up into a number of pieces, giving the cell a multi-nucleated character.

It is usually composed of (*a*) fibres arranged in a complicated network (fig. 3). These fibres appear to be of two kinds: (1) those forming a fine network—the *linin* network (*G*); and (2) those forming generally a coarser network, the fibres of which have a special affinity for basic stains—the *chromatin* network (*F*).

The chromatin fibres vary in their arrangement in different cells. Usually they form a network, but occasionally they are disposed as a continuous skein. In nuclei with the former arrangement of fibres, swellings may be observed where the fibres unite with one another—the *nodal swellings*, or *karyosomes*, distinct from the nucleolus. The resting nucleus appears to be surrounded by a distinct *nuclear membrane*, which is either a basket-like interlacement of the fibres at the periphery, or a true membrane produced by adsorption.

Between the fibres is (*b*) a more fluid material which may be called the *nuclear plasma* or *karyoplasm*. Digestion in the stomach removes the nuclear plasma, but leaves the network unacted upon.

(2) **Chemistry.**—The nuclear network is composed of **Nucleins**. These are combinations of protamines (p. 17) with nucleic acid.

Protamines constitute about one-third and nucleic acid about two-thirds of the nucleins. The chief di-amino acid in them is Arginin, which constitutes nearly 90 per cent.

The nucleic acid may be broken down into—

1. Purins, such as guanin and adenin (see Appendix).

2. Pyrimidin Bases, such as thymine, which contain the asymmetric ring

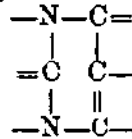

3. Hexoses ($\text{C}_6\text{H}_{12}\text{O}_6$), (p. 285).
 4. Metaphosphoric Acid (HPO_3).

(3) **Functions.**—The part taken by the nucleus in the general life of the cell is not fully understood.

1st. It exercises an influence on the nutritive processes, since it has been observed in certain of the large cells in lower organisms that a piece of the protoplasm detached from the nucleus ceases to grow, and, after a time, dies. In certain cells, *e.g.* cells of the nervous system, it has been found to shrink and to become displaced from its central position as a result of continued activity. Important interchanges of material go on between the nucleus and the protoplasm.

2nd. It is the great reproductive organ of the cell playing an important part in transmitting inherited characters (p. 617).

C. Reproduction of Cells.

Cells do not go on growing indefinitely. When they reach a certain size they generally either divide to form two new cells, or die and undergo degenerative changes. The reason of this is possibly to be found in the well-known physical fact, that, as a sphere increases in size, the mass increases more rapidly than the superficies. Hence, as a cell becomes larger and larger, the surface for nourishment becomes smaller and smaller in relation to the mass of material to be nourished. Probably the altered metabolism so produced sets up the changes which lead to the division of the cell. These changes have now been very carefully studied in a large number of cells, and it has been shown that the nucleus generally takes a most important part in division.

A. Mitotic Division.—In a cell about to divide, the first change is a general enlargement of the nucleus. At the same time the centrosome becomes double, and the two portions travel from one another, but remain united by delicate lines to form a spindle-shaped structure (fig. 4 (1)). The *spindle* passes into the centre of the nucleus, and seems to direct the changes in the reticulum. The nuclear membrane disappears, and the nucleus is thus not so sharply

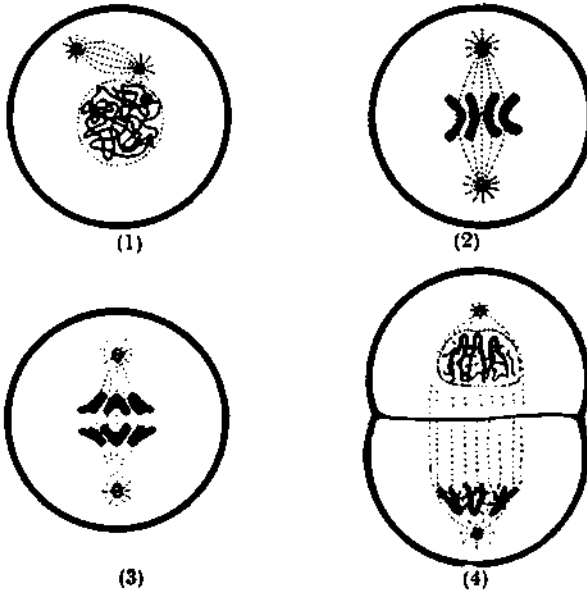

FIG. 4.—Nucleus in Mitosis. (1) Convoluted stage; (2) Monaster stage; (3) Dyaster stage; (4) Complete division.

marked off from the cell protoplasm. The nucleoli and nodal points also disappear, and with them all the finer fibrils of the network, leaving only the stouter fibres, which are now arranged either in a skein, or as loops with their closed extremity to one pole of the nucleus and their open extremity to the other. The nucleus no longer seems to contain a network, but appears to be filled with a convoluted mass of coarse fibres, and hence this stage of nuclear division is called the *convoluted stage*.

The spindle continues to grow until it occupies the whole

length of the nucleus. The two centrosomes are now very distinct, and from them a series of radiating lines extends out into the protoplasm of the cell.

The nuclear loops of fibres break up into short, thick pieces; and these become arranged around the equator of the spindle in a radiating manner, so that when the nucleus is viewed from one end it has the appearance of a rosette or a conventional star. This stage of the process is hence often called the single star or *monaster* stage (fig. 4 (2)).

Each loop now splits longitudinally into two, the divisions lying side by side (fig. 4 (2)).

The next change consists in the separation from one another of the two halves of the split loops—one half of each passing up towards the one polar body, the other half passing towards the other. It is the looped parts which first separate and which lead the way—the open ends of the loops remaining in contact for a longer period, but, finally, also separating. In this way, around each polar body, a series of looped fibres gets arranged in a radiating manner, so that the nucleus now contains two rosettes or stars, and this stage of division is hence called the *dyaster* stage (fig. 4 (3)).

The single nucleus is now practically double. Gradually in each half finer fibres develop and produce the reticular appearance. Nuclear nodes, nucleoli, and the nuclear membrane appear, and thus two resting nuclei are formed from a single nucleus. Between these two nuclei a delicate line appears, dividing the cell in two, and the division is completed (fig. 4 (4)).

The network of the nucleus of actively dividing cells is rich in nucleic acid, but in cells which have ceased to divide, in which the nucleus has ceased to exercise its great reproductive function, the amount of nucleic acid diminishes, and may be actually less than the amount in the cell protoplasm.

B. Amitotic Division.—In some cells the nucleus does not appear to take an active part, the cell dividing without the characteristic changes above discussed.

SECTION III.

THE TISSUES.

ALL the tissues of the body are formed from a single cell—the ovum.

In unicellular organisms the functions of nutrition and of reproduction are performed by the one cell. In the metazoa there is a differentiation into *gametic* or reproductive cells, and *somatic* or body cells which form the various tissues of the individual. The latter are primarily developed to nourish and protect the gametic cells which are potentially eternal, going on from generation to generation, while the somatic cells perish with the death of the individual.

The mammalian ovum is holoblastic and undergoes complete division. The cells get arranged in three layers, the epiblast, mesoblast, and hypoblast, and from these the tissues are developed.

The structure of the tissues must be studied practically in the class of Histology. Here all that will be given is a brief summary of their development, and of their structural and chemical characters.

(A) THE VEGETATIVE TISSUES.

The Vegetative Tissues are those which support, bind together, protect, and nourish the body. They may be divided into the Epithelial Tissues, formed from the epiblast or hypoblast, and consisting of cells placed upon surfaces, and the Connective Tissues developed from the mesoblast, and consisting chiefly of formed-material between cells.

I. EPITHELIUM.

1. Squamous Epithelium—

(a) **Simple Squamous Epithelium.**—This is seen lining the air vesicles of the lungs. It consists of a single layer of flat, scale-like cells, each with a central nucleus. The outlines of these cells may be made visible by staining with nitrate of silver, which blackens the cement substance between the cells.

(b) **Stratified Squamous Epithelium** (fig. 5).—The skin and the lining membrane of the mouth and gullet are covered by several layers of cells. The deeper cells divide, and, as the young ones get pushed upwards towards the surface and away from the nourishing fluids of the body, their nutrition is modified, and the protoplasm undergoes a change into **keratin**, a substance belonging to the group of sclero-proteins

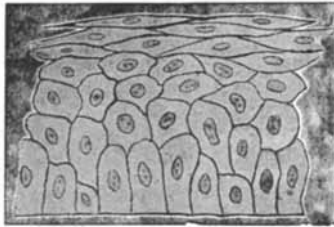

FIG. 5.—Stratified Squamous Epithelium from the cornea.

(Appendix). It is a hard, horny material. It composes the nails and hair, and the horns and hoofs of certain animals. It first makes its appearance as a number of little masses or granules in the cells, and these run together to fill the cells which become flattened out into thin scales.

It forms an admirable protective covering to the body, not only on account of its hardness and toughness, but because poisons cannot readily pass through it, and also because it is not easily acted on by chemicals. It is characterised by the large proportion of loosely combined sulphur which it contains. Hence, lead solutions colour keratin black by forming the black sulphide of lead, and are much used as hair dyes (see *Chemical Physiology*).

The sulphur is largely in the form of *cystin*—

two thio - amino - propionic acid molecules linked together.

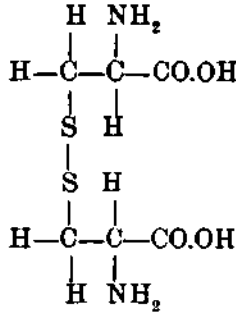

Tyrosin (p. 17) is also relatively abundant.

(c) **Transitional Epithelium.**—A slightly modified stratified squamous epithelium lines the urinary passages. It is char-

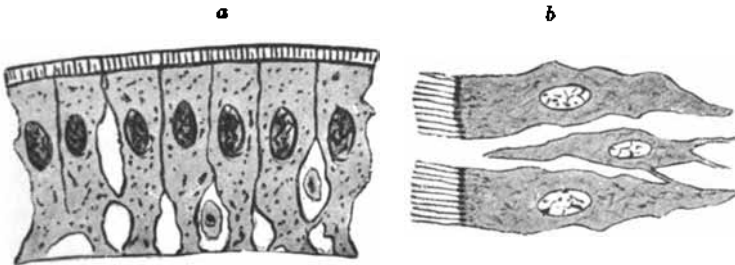

FIG. 6.—(a) Columnar Epithelium from the small intestine; (b) Ciliated Epithelium from the trachea.

acterised by the more columnar or pear-like shape of the cells of the deeper layers, and by the cells being very elastic, so that they may be stretched or compressed according to the state of the viscus they line.

2. Columnar Epithelium (fig. 6, a).—The cells lining the stomach and intestine in the embryo elongate at right angles to their plane of attachment, and become *columnar* in shape. The free border of the cells has an appearance like a hem, due to a series of short rods placed side by side. The great function of this form of epithelium is to absorb the digested matter from the intestine, and to pass it on to the blood.

Among these occur some larger, somewhat pear-shaped, cells, attached by their small extremity. Their protoplasm is collected at their point of attachment, while the body of the cell is filled with *mucin*, a clear, transparent material. These **chalice cells** producing mucin lead to the study of the next type of epithelium.

3. Secreting Epithelium.—This type of epithelium, which has as its function the production of some material which is to be excreted from the cell, is generally arranged as the lining of depressions or pits—the **glands**.

The simplest form of gland is the *simple tubular*—a test-tube-like depression, lined by secreting cells. Instead of being simple, the tube may be branched, when the gland is described

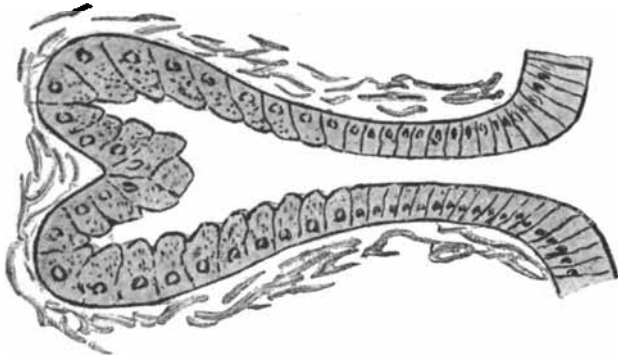

FIG. 7.—A Zymogen-secreting Gland, to show an acinus lined by secreting cells containing zymogen granules, and the duct.

as *racemose*. In many glands the secreting epithelium is confined to the deeper part of the tube, *acinus* (fig. 7), while the more superficial part is lined by cells which do not secrete, forming the *duct*.

In many situations several simple glands are grouped together, their ducts opening into one common duct, and a *compound gland* results.

Secreting epithelium varies according to the material it produces.

(A) **Mucin-secreting Epithelium.**—Many glands have for their function the production of mucus, a slimy substance of use in lubricating the mouth, stomach, intestine, etc. The

acini containing such cells are usually large. The cells themselves are large, and are placed on a delicate basement membrane, a condensation of the subjacent fibrous tissue, which bounds the acinus. The nuclei are situated near to the attached margin of the cells. These are somewhat irregular in shape, and are packed close together.

Their appearance varies according to whether the gland has been at rest or has been actively secreting.

Resting State.—In the former case, in the fresh condition, the cells are large, and pressed closely together. Their protoplasm is filled with large shining granules. After treatment with reagents, each cell becomes distended with clear, transparent mucin formed by the swelling and coalescence of the granules, and the cells tend to burst, so that the lumen of the gland becomes filled with the glairy mass.

After Activity.—After the gland has been actively secreting, the cells are smaller and the granules are much less numerous, being chiefly situated at the free extremity of the cell, and leaving the nucleus much more apparent.

This form of epithelium, during the resting condition of the gland, takes up nourishing matter and forms this mucin-yielding substance. During the active state of the gland the mucin-yielder is changed to mucin, and is extruded from the cells into the lumen of the gland.

Mucin is a substance which occurs in many tissues. When precipitated and freed from water it is white and amorphous. On the addition of water it swells up and forms a glairy mass. In the presence of alkalis it forms a more or less viscous emulsoid, and from this it is precipitated by acetic acid. It is a conjugated protein (Appendix)—a protein linked to *glucosamine*—a glucose molecule in which one of the hydroxyls is replaced by amidogen—NH₂—

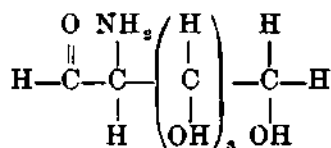

It is therefore called a *glyco-protein*. When boiled

with an acid it yields a sugar (see *Chemical Physiology*).

(B) **Zymin-secreting Epithelium.**—Another kind of secreting epithelium forms the various juices which act upon the food to digest it. These juices owe their activity to the presence of enzymes or zymins (p. 7).

A zymin-forming gland, after a prolonged period of rest, shows cells closely packed together, so that it is difficult to make out their borders. The protoplasm is loaded with granules which are much smaller than those seen in the mucin-forming cells, and which do not swell up in the same way, under the action of reagents. The nucleus is often obscured by the presence of these granules.

When the gland has been actively secreting, the granules become fewer in number, and are confined to the free extremity of the cell; they are obviously passing out. The cell becomes smaller, and its outline is more distinct and the nucleus more apparent.

The granules which fill the cells are not composed of the active enzyme. If extracts of the living cells be made, they are inert, and it is only after the granules have left the cell, or are in the process of leaving, that they become *activated*. Hence, the granules are said to be composed of zymin-forming substance or *zymogen*.

The series of changes are parallel to those described in the mucin-forming cells. During the so-called resting state of the gland, the cells are building up zymogen. When the gland is active, the cells throw off the material they have accumulated, and it undergoes a change to zymin.

(C) **Excreting Epithelium** does not manufacture materials of use in the animal economy, but passes substances *out of* the body. Such epithelium is seen in the kidneys and sweat glands, and probably in the liver. The cells are composed of a granular protoplasm, in which the presence of the material to be excreted either in its fully elaborated condition, or in process of preparation, may frequently be demonstrated—*e.g.* iron-containing particles. These cells do not merely take up material from the blood and pass

it out, but they may profoundly alter it before getting rid of it.

4. **Ciliated Epithelium** (fig. 6 (b), p. 33).—The cells are usually more or less columnar, and the free border is provided with a series of hair-like processes, the *cilia*, which vary in size in different situations.

In the living state the cilia are in constant rhythmic motion, each cilium being suddenly whipped or bent down in one direction, and then again assuming the erect position.

All the cilia on a surface work harmoniously in the same direction, and the movement passes from the cilia of one cell to those of the next in regular order, beginning at one end of the surface and passing to the other.

As a result of this constant harmonious rhythmic movement, any matter lying upon the surface is steadily whipped along it; and, since the cilia usually work from the inner parts of the body to the outside, this matter is finally expelled from the body. They line the respiratory passages, and their movement plays an important part in getting rid of dust which has been inhaled.

The movements of the cilia are dependent on the changes in the protoplasm, and everything which influences the rate of chemical change modifies the rate of ciliary movement, which may thus be taken as an index of the protoplasmic activity.

II. CONNECTIVE TISSUES.

These are the binding and supporting tissues of the body—*fibrous tissue, cartilage, and bone*. They are formed from the mesoblast of the embryo, and most of them contain blood-vessels.

1. **Mucoid Tissue**.—The cells of the mesoblast of the embryo, which at first lie in close apposition with one another, become separated, remaining attached by elongated processes. Between the cells a clear, transparent substance

makes its appearance, forming a soft, jelly-like tissue. It contains an abundance of mucin (p. 35). This tissue is widely distributed in the embryo as a precursor of the connective tissues, and after birth it is still to be seen in the

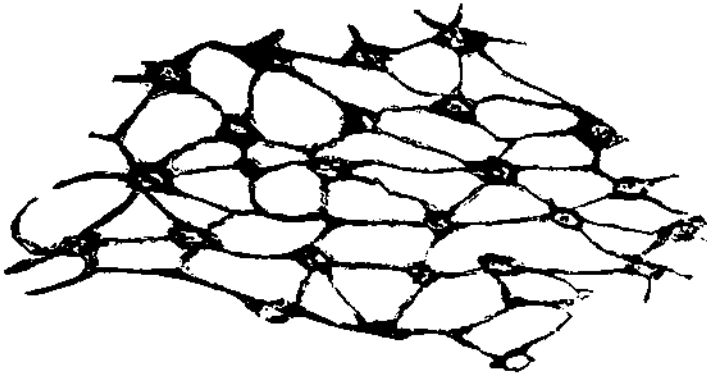

FIG. 8.—Mucoid Tissue from an embryo rabbit.

pulp of a developing tooth and in the vitreous humour of the eye (fig. 8).

2. **Fibrous Tissue.**—As development advances, the cells of mucoid tissue elongate and become spindle-shaped, and are

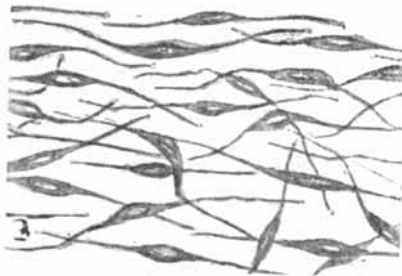

FIG. 9.—Fibroblasts from young fibrous tissue.

continued at their ends into fibres (fig. 9). These cells are often called *fibroblasts*.

The connective tissues are thus clearly distinguished from the epithelia by having the formed material *between* and

not *in* the cells. They are composed of the following parts :—

- I. Formed material.
 - (a) Fibres.
 - (b) Matrix.
- II. Spaces (Connective Tissue Spaces).
- III. Cells.

I. FORMED MATERIAL.—(a) *Fibres* (fig. 10).—1st. Non-elastic (**White Fibres**). These are delicate, transparent fibrils arranged in bundles. They do not branch, and they have a mucin-like matrix between them. They are composed of a non-elastic substance, collagen. This is a sclero-protein (Appendix), and it gives the biuret reaction but not the tests

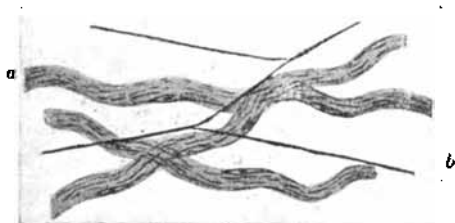

FIG. 10.—Bundles of White Fibres, with Fibroblasts (a) and Elastic Fibres anastomosing with one another (b).

for the proteins depending on the presence of the benzene nucleus. It contains neither tryptophan nor tyrosin (p. 17), but it is rich in amino-acetic acid—glycin. It is insoluble in cold water, but swells up and becomes transparent in acetic acid. It has a great affinity for carmine, and stains a pink colour with it. When boiled, it takes up water to form a hydrate, **gelatin**, a substance soluble in hot water, and forming a jelly on cooling (see *Chemical Physiology*).

2nd. **Elastic Fibres**. These are highly refractile elastic fibres, which branch and anastomose with one another. They are composed of **Elastin**, a sclero-protein which is very poor in tyrosin, and hence gives the xantho-proteic test very faintly. It is insoluble in both cold and hot water and is not acted on by acetic acid. It stains yellow with picric acid and it has no affinity for carmine.

(b) *Matrix*.—This is composed of the mucus-like material which is so abundant in the foetal mucoid tissue.

According to the arrangement of the fibres, and to the preponderance of one or other variety, various types of fibrous tissue are produced.

When a padding is required, as under the skin and under mucous membranes, the fibres are arranged in a loose felt-work to constitute *areolar tissue*.

In *fascia*, in *tendon sheaths*, and in *flat tendons*, the fibres are closely packed together to form more or less definite layers. In *tendons* and *ligaments* the fibres run parallel and close together. In the tendons of muscles, where elasticity is not required, the fibres are of the white or non-elastic variety. In ligaments, where elasticity is desirable, the elastic fibres preponderate.

II. The SPACES of fibrous tissue vary with the arrangement of the fibres. In the loose areolar tissue under the skin they are very large and irregular, in fascia they are flattened, while in tendon, where the fibres are in parallel bundles, they are long channels.

III. The CELLS of fibrous tissue (Fibroblasts) vary greatly in shape. In the young tissue they are elongated spindles, from the ends of which the fibres extend. In some of the loose fibrous tissues they retain this shape, but in the denser tissues they get squeezed upon, and are apt to be flattened and to develop processes thrust out into the spaces.

In certain situations, peculiar modifications of fibroblasts occur.

(A) *Endothelium*.—When these cells line the larger connective tissue spaces they become flattened, and form a covering resembling simple squamous epithelium. Such a layer lines all the serous cavities of the body, and the lymphatics, blood-vessels, and heart, all of which are primarily large connective tissue spaces. To demonstrate the outlines of these cells it is necessary to stain with nitrate of silver, which has a special affinity for the interstitial

substance, and which thus forms a series of black lines between the cells.

(B) **Fat Cells.**—In the areolar tissue of many parts of the body, fat makes its appearance in the cells round the smaller blood-vessels, and when these cells occur in masses *Adipose Tissue* is produced.

Little droplets of oil first appear, and these become larger, run together, and finally form a large single globule, distending the cell, and pushing to the sides the protoplasm and nucleus to form a sort of capsule (fig. 11).

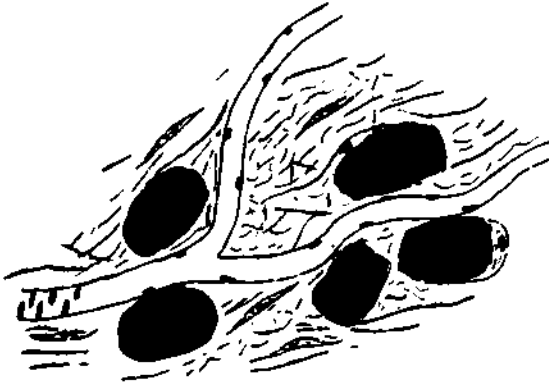
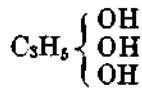

FIG. 11.—Fat Cells stained with osmic acid, and lying alongside a small blood-vessel.

If the animal be starved, the fat gradually disappears out of the cell, and in its place is left a clear albuminous fluid which also disappears, and the cell resumes its former shape.

Fats.—The ordinary fats are esters of the triatomic alcohol, glycerol (see Appendix)—



formed by the replacement of the hydrogen of the hydroxyls by the radicles of the fatty acids.

The most abundant fatty acids of the body are:—

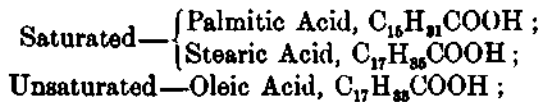

The unsaturated acids are more readily oxidised than the saturated. They tend to break at the double link in the chain thus—

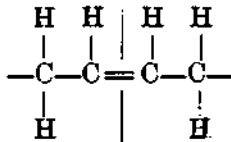

The three fats are—

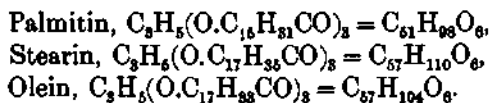

It will be observed that the molecules of these fats are very rich in carbon and hydrogen, and very *poor* in oxygen, containing only about 12 per cent., *i.e.* they contain a large amount of material capable of being oxidised, and thus capable of affording energy in the process of combustion.

The fats resemble one another in being insoluble in water, but soluble in ether and in hot alcohol. As the alcohol cools, they separate out as crystals. They differ from one another in their melting point, palmitin melting at the highest and olein at the lowest temperature. Fat which is rich in palmitin and stearin, as ox fat, is thus hard and solid at the ordinary temperature of the air, while fat rich in olein, as dog fat, is semi-fluid at the same temperature. Olein acts as a solvent for the fats of a higher melting point. (For tests, see *Chemical Physiology*.)

The functions of adipose tissue are twofold:—

1st. *Mechanical*.—The mass of adipose tissue under the skin is of importance in protecting the deeper structures from injury. It is a cushion on which external violence expends itself. Further, this layer of subcutaneous fat

prevents the loss of heat from the body, being, in fact, an extra garment.

2nd. Chemical.—Fat, on account of its great quantity of unoxidised carbon and hydrogen, is the great storehouse of energy in the body.

(C) **Pigment Cells.**—In various parts of the eye the connective tissue and other cells contain a black pigment—**Melanin**. The precise mode of origin of this pigment is not known. It contains carbon, hydrogen, nitrogen, oxygen, and it may also contain iron. Melanin is closely related to a series of dark pigments which are produced by heating protein with mineral acids—the melanoidins—and like them, when heated with potash, it yields indol and skatol (see p. 330). It is therefore probably connected with tyrosin or with tryptophan (see p. 17). It has nothing to do with the blood-pigments. Melanin-like pigments are widely distributed in nature, occurring not only in the connective tissue pigment-cells of animals, but also in epithelial cells of the epidermis, hair, and eye, and in the tissues of some plants. Its function in the eye is to prevent the passage of light through the tissues in which it is contained.

The fibrous-tissue cells containing the pigment are branched, and in many cases they possess the power of movement. This is specially well seen in such cells in the skin of the frog, where contraction and expansion may be studied under the microscope. By these movements the skin is made lighter or darker in colour. The movements of these cells are under the control of the central nervous system.

3. Cartilage.—While fibrous tissue is the great binding medium of the body, support is afforded in foetal life and in certain situations in adult life by cartilage.

Where cartilage is to be formed, the embryonic cells become more or less oval, and secrete around them a clear pellucid capsule. This may become hard, and persist through life, as in the so-called *parenchymatous cartilage* of the mouse's ear.

(1) **Hyaline Cartilage.**—Development, however, usually goes further, and before the capsule has hardened, the cartilage cells again divide, and each half forms a new

capsule which expands the original capsule of the mother cell, and thus increases the amount of the formed material. This formed material has a homogeneous, translucent appearance, and a tough and elastic consistence, and cuts like cheese with the knife (fig. 12).

The formed material of cartilage, *chondro-mucoid*, is not a special substance, but a mixture of chondroitin-sulphuric acid with collagen in combination with proteins. Chondroitin, when decomposed, yields *glucosamine*, a sugar-like substance containing nitrogen (p. 35); *glycuronic acid*, a sugar with the terminal carbon oxidised to the carboxyl state; and *acetic acid* probably derived from the amino-acetic acid of collagen.

Cartilage is surrounded by a fibrous membrane, the perichondrium, and frequently no hard-and-fast line of demarcation can be made out between them. The fibrous tissue gradually becomes less fibrillated, the cells become less elongated and more oval and the interfibrillar substance increases in amount and becomes of the same refractive

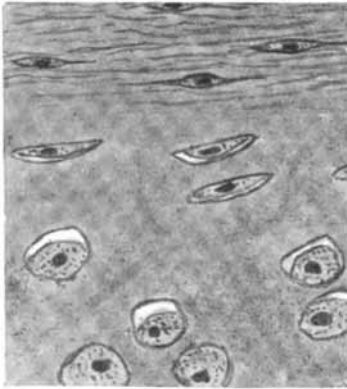

FIG. 12.—Hyaline Cartilage covered by perichondrium.

index as the fibres. During old age, a fibrillation of the homogeneous-looking cartilage is made manifest, especially in costal cartilage, by the deposition of lime salts in the matrix, between the fibres. It was long ago shown that in inflammation of cartilage this fibrillation appears; and by digesting it in baryta water, a similar structure may be brought out. The close connection of cartilage with fibrous

tissue is thus clearly demonstrated.

Such homogeneous *hyaline cartilage* precedes most of the bones in the embryo, and covers the ends of the long bones in the adult (articular cartilage), forms the framework of the larynx and trachea and constitutes the costal cartilages.

(2) **Elastic Fibro-Cartilage.**—In certain situations—*e.g.* in the external ear—a specially elastic form of cartilage is developed, elastic fibres appearing in the cartilaginous matrix, and forming a network through it.

(3) **White Fibro-Cartilage.**—In other situations—*e.g.* the intervertebral discs—a combination of the binding action of fibrous tissue with the padding action of cartilage is required; and here strands of white fibrous tissue with little islands of hyaline cartilage are found. It is also found where white fibrous tissue, *e.g.* tendon, is inserted into hyaline cartilage, and it is really a mixture of two tissues—white fibrous tissue and cartilage.

4. **Bone.**—The great supporting tissue of the adult is BONE.

(1) **DEVELOPMENT AND STRUCTURE.** — Bone is formed by a deposition of lime salts in layers or *lamellæ* of white fibrous tissue. But while some bones, as those of the cranial vault, face, and clavicle, are produced entirely in fibrous tissue, others are preformed in cartilage, which acts as a scaffolding upon which the formation of bone goes on.

A. Intra-membranous Bone Development.—This may be studied in any of the bones of the cranial vault where cartilage is absent (fig. 13).

At the *centre of ossification*, the matrix between the fibres becomes impregnated with lime salts, chiefly the phosphate and carbonate. How this deposition takes place is

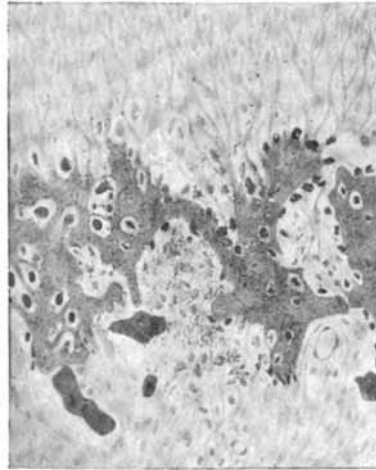

FIG. 13.—Intra-membranous Bone Development in the lower jaw of a fetal cat. Above, the process of ossification is seen shooting out along the fibres, and on the lower surface the process of absorption is going on. Two osteoclasts—large multi-nucleated cells—are shown to the left.

not known, and how far it is dependent on the action of cells has not been clearly determined; but in front of the process, as it shoots outwards from the centre in all directions, accumulations of cells are to be seen, and these cells have been called *osteoblasts*. The cells get enclosed in definite spaces, *lacunæ*, and become *bone cells*. Narrow branching channels of communication are left between these *lacunæ*, the *canaliculi*.

The fully formed adult bone, however, is not a solid block, but is composed of a compact tissue outside, and of a spongy bony tissue, *cancellous tissue*, inside. This cancellous tissue is formed as a secondary process. Into the block of calcareous matter, formed as above described, processes of the surrounding fibrous tissue burrow, carrying in blood-vessels, lymphatics, and numerous cells (fig. 13, lower surface). This burrowing process seems to be carried on by the cells, which eat up the bony matter formed. In doing this they frequently change their appearance, becoming large and multi-nucleated (*osteoclasts*). Thus the centre of the bone is eaten out into a series of channels, in which the marrow of the bone is lodged, and between which narrow bridges of bone remain.

It is by the extension of the calcifying process outwards, and the burrowing out of the central part of the bone, that the dense diploë and spongy cancellous tissue are produced.

B. Intra-cartilaginous Bone Development.—In the bones preformed in cartilage, the process is somewhat more complex. But all the bone is developed in connection with fibrous tissue, and the cartilage merely plays the part of a scaffolding and is all removed.

Where the adult bone is to be produced, a minute model is formed in hyaline cartilage in the embryo, and this is surrounded by a fibrous covering, the *perichondrium*. In the deepest layers of this perichondrium the process of calcification takes place as described above, and spreads outwards, thus encasing the cartilage in an ever-thickening layer of bone (fig. 14, a).

At the same time, in the centre of the cartilage, at what is called the *centre of ossification*, the cells begin to divide

actively, and, instead of forming new cartilage, eat away the material, and thus open out spaces (fig. 14, *b*). Into these spaces processes of the perichondrium bore their way, carrying with them blood-vessels, and thus rendering the cartilage vascular. The vascularisation of the centre of the cartilage having been effected, the process of absorption extends towards the two ends of the shaft of cartilage, which continues to elongate. The cartilage cells divide and again divide, and, by absorbing the material between them, form

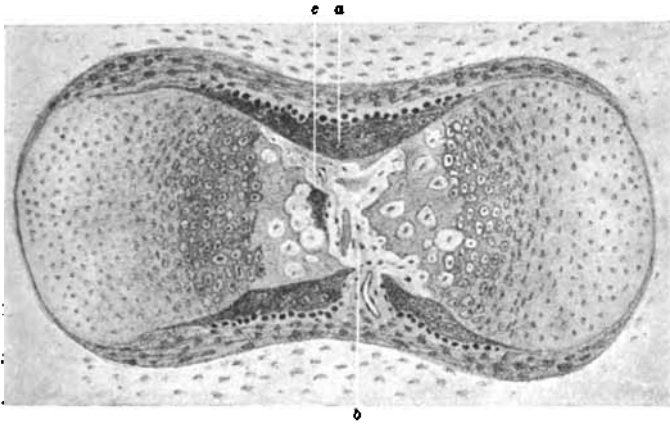

FIG. 14.—Intra-cartilaginous Bone Development. A phalanx of a fetal finger showing the formation of periosteal bone round the shaft (*a*); the opening up of the cartilage at the centre of ossification and the vascularisation of the cartilage by the invasion of fibrous tissue (*b*); and the calcification of the cartilage round the spaces (*c*).

long irregular canals running in the long axis of the bone, with trabeculæ of cartilage between them. Into these canals the processes of the periosteum extend, and fill them with its fibrous tissue. A deposition of lime salts takes place upon the trabeculæ, enclosing cells of the invading fibrous tissue, and thus forming a crust of bone, while the cartilage also becomes calcified. If this calcification of the cartilage and deposition of bone were to go on unchecked, the block of cartilage would soon be converted to a solid mass of calcified tissue. But this does not occur. For, as rapidly as the trabeculæ become calcified, they are absorbed,

while the active changes extend further and further from the centre to the ends of the shaft. The centre, which was once formed by the embryonic cartilage, is thus changed to a space filled by fibrous tissue which afterwards becomes the bone marrow.

The process of absorption does not stop at the original block of cartilage; but after all of this has been absorbed, the bone formed *outside* the cartilage in the fibrous tissue is attacked by burrowing processes from inside and outside,

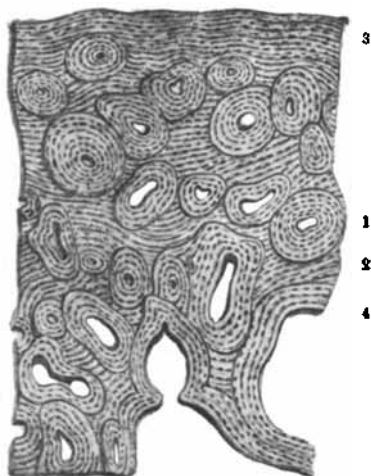

FIG. 15.—Cross section through part of the shaft of an adult long bone to show the arrangement in lamellæ distributed as Haversian (1), interstitial (2), peripheral (3), and medullary (4).

which hollow out long channels running in the long axis of the bone. These are the *Haversian spaces* (fig. 15). Round the inside of each, calcification occurs, spreading inwards in layers, and enclosing connective tissue cells, until at length only a small canal is left, an *Haversian canal*, containing some fibrous tissue, blood-vessels, lymphatics, and nerves, with layer upon layer of bone concentrically arranged around it. This constitutes an *Haversian system*. In this way the characteristic appearance of the shaft of a long bone is produced, with layers of calcified fibrous tissue, the bone

lamellæ, arranged as Haversian, interstitial, peripheral, and medullary lamellæ (fig. 15).

One important function performed by the cartilage is in bringing about the increase in *length* of the bones. As growth progresses, the cartilage grows in length, and the formation of bone *outside* the cartilage spreads to each end, and thus the shaft of the bone is formed. But, in addition to the centre of ossification in the shaft—the *diaphysis*, one or more similar centres of ossification form at each end of the bone. These are the *epiphyses*. Between these and the diaphysis a zone of actively growing cartilage exists until adult life, when the bones stop lengthening. In this zone, the cells arrange themselves in vertical rows, divide at right angles to the long axis of the bone and form cartilage. This cartilage, as it is formed, is attacked by the bone-forming changes at the diaphysis and epiphyses. But the amount of new cartilage formed is at first proportionate to this, and thus a zone of growing cartilage continues to exist until early adult life, when epiphyses and diaphysis join and growth in length is stopped. The rate and extent of this growth of the cartilage determines the length of the limbs. It is influenced by many factors, such as the general nutrition of the animal, and also by the influence of the internal secretions of various structures, such as the thyroid and pituitary body (see pp. 595, 599).

(2) CHEMISTRY.—The composition of adult bone is roughly as follows:—

Water, 10 per cent.
Solids, 90 per cent.
Organic, 35 per cent.—chiefly collagen.
Inorganic, 65 per cent.
Calcium phosphate, 51.
„ carbonate, 11.
„ fluoride, 0.2.
Magnesium phosphate, 1.
Sodium salts, 1.

The most important points are the small amount of water,

the large amount of inorganic matter, chiefly calcium phosphate, and the nature of the organic matter—collagen.

(3) **METABOLISM.**—Although bone consists so largely of inorganic matter it is permeated by blood-vessels and living cells, and it undergoes metabolic changes not only during development but in the full grown animal. In fasting and in the conditions of acidosis (p. 481) the lime salts may be removed from the bone to the blood and excreted. In *rickets* the metabolism of growing bone is modified, the lime salts not being properly laid down or being too rapidly removed; possibly both these changes go on together. The bones are thus softened and undergo deformity. In *osteomalacia* there is a softening of the bones due to the removal of lime salts.

(B) THE MASTER TISSUES—NERVE AND MUSCLE.

By means of the epithelial and connective tissues the body is protected, supported and nourished. It performs purely vegetative functions, but it is not brought into active relationship with its environments. By the development of **Nerve** and **Muscle** the surroundings are able to act upon the body, and the body can react upon its surroundings.

These tissues may therefore be called the **Master Tissues**, and it is as their servants that all the other tissues of the soma functionate.

Upon them the very existence of an animal depends. It lives in a world of constant change. The surrounding conditions are not always compatible with life; the temperature may be too high or too low, or it may find itself plunged in a medium in which it cannot breathe and it must escape; food may be wanting, and it has to be obtained. A thousand changing conditions have to be daily, hourly, almost momentarily met by adjustments of the body, and to make these appropriate the various different kinds of change must each produce different effects.

Some means by which they can do so is the first essential for the continuance of the animals' existence. Not only must each produce its special effect, but means must exist by which each different effect or combination of effects may produce an appropriate reaction.

In unicellular organisms changes in the surroundings act



FIG. 16. — Poterio-dendron in its capsule, to illustrate the first stage in the evolution of a neuro-muscular system.

directly on the cell protoplasm, *e.g.* an amœba, when touched, draws itself together. But, even in these simplest organisms, certain kinds of external conditions will produce one kind of change, while others will produce a different one, as has been shown in considering unilateral stimulation (p. 25). Even among unicellular organisms—*e.g.* among the infusoria—animals are found in which the cell is differentiated into a *receiving* and a *reacting* part. *Poteriodendron*, a little infusorian sitting in a cup-like frame, consists of a long process or cilium extending up from a cell, while a contractile myoid attaches the cell to the floor of the cup. When the cilium is touched the myoid contracts, and draws the creature into the protection of its covering (fig. 16).

In multicellular organisms the result is secured by the development at the surface of the body of special structures or **Receptors**, each kind of which is stimulated or made to undergo a change, more especially by some one kind of external change.

Thus one kind is specially stimulated by the contact of gross matter, another by the addition of heat, another by its withdrawal; another kind is specially acted on by the vibration of air called by physicists "sound waves," another by the ethereal "waves of light"; yet another by the presence of substances suspended in air or in solution in water.

But before the reaction of the body upon its surroundings can be appropriate, the effects of these various changes must be brought together and harmonised and integrated, and this is secured by the existence of strands of living matter, **nerves**, which pass from each receptor and lead to a common or to several common receiving arrangements or stations in the **central nervous system**.

The combined effect of all the different stimuli from without call into play a series of the other stations in the central nervous system which set in action the great reacting or effector arrangements, the **Muscles**.

It is impossible to study the mode of action of the receptors without also considering the mode of action of the

transmitting nerves and of the receiving stations in the central nervous system.

This involves the study of the motor reactions which may follow any given set of stimuli.

Before proceeding to study the physiology of the complex set of receptors, nerves, central nervous system, and effectors, it will be well first to consider—

1. How the nervous system is developed.
2. The physiology of single nerve units.

I. Development of the Nervous System.

To form the nervous mechanism, a part of the epithelial covering of the embryo sinks inwards as a canal, and the cells of this form functional connections with the surface on the one hand, and with the reacting structures on the other.

At first the cells composing this tube are undifferentiated and alike (*neuroblasts*), but later some of them throw out processes (*a*) towards the surface, and others (*b*) towards the reacting structures. These cells with their outgrowths form the units of which the nervous system is built up—the **Neurons**. They are separate from one another, but are associated by the close propinquity of their branching twig-like processes or *dendrites*, such an association being known as a *synapse* (fig. 17).

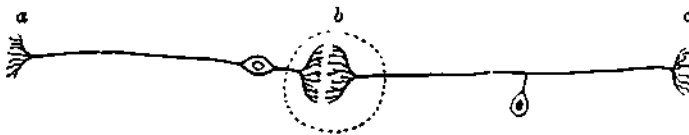

FIG. 17.—To show a *receiving* (*c*) and a *reacting* Neuron (*a*), each with dendrites at its extremities, and their connection to one another through a Synapsis (*b*).

1. **Neurons to and from the Body Wall.**—The nerve fibres are formed as outgrowths from the nerve cells. This has been demonstrated by the histological investigations of Ramon-y-Cajal, who used a method of impregnating the

fibres with silver, and still more strikingly by the experimental investigations of Ross Harrison upon the tadpole. The nerves which come from the central nervous system each consist of two roots, one coming from the back of the neural canal, the other from the antero-lateral aspect. Harrison was able to remove the cells from the back of the neural canal, and he then found that the posterior roots of the nerves did not grow, but that the anterior roots did grow. He also removed the cells from the front part of the neural canal, leaving those at the back, and he then found that processes grew out in the position of the posterior roots only. He also found that from these posterior cells were derived certain covering cells which afterwards formed the

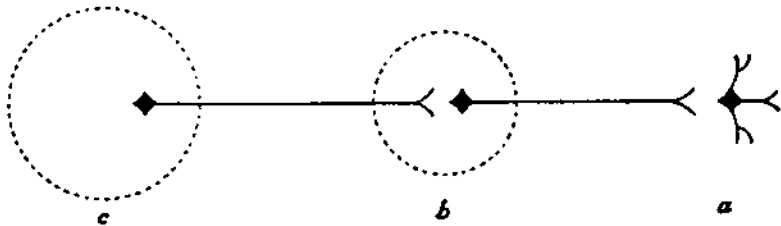

FIG. 18.—To show the formation of a Visceral Nerve. *a*, the neurons which have travelled out to form the *terminal ganglion*; *b*, an emigrated neuron which has come to rest in a *sympathetic ganglion*; *c*, a neuron which has remained in the spinal cord and sent out a process so that it may act upon the emigrated neurons.

sheaths of the nerve fibres. Lastly, he excised part of the neural canal before the cells had differentiated, and kept it alive for five weeks in lymph, and he was able to observe the outgrowth of the processes which afterwards form the axons of the nerve fibres. The evidence thus seems to be conclusive, that these somatic nerve fibres are essentially outgrowths from nerve cells.

2. **Neurons to the Viscera.**—While the nerves to and from the *body wall* are formed as described above, those passing to the *viscera* are developed by a migration outwards of neuroblasts. Some of these come to rest in the *sympathetic ganglia* in front of the spinal column, others travel on and come to rest in more remote ganglia, while a large number pass right out into the tissues, there to throw out processes

and to form a network which may be called a *terminal plexus*. These are kept in connection with the central nervous system by the outgrowths of processes from cells which remain in the spinal cord (fig. 18). In certain positions, *e.g.* in the wall of the gut, these terminal plexuses control the activity of the structure in which they are placed (see fig. 48, p. 109).

It is as if the central nervous system had devolved

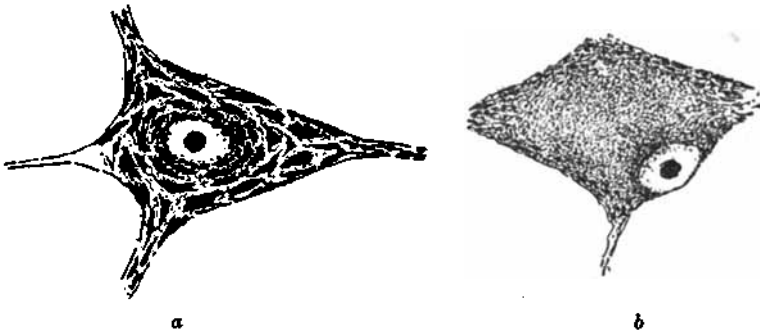

FIG. 19.—(a) A Nerve Cell with Nissl's Granules; (b) a similar cell showing changes on section of its axon.

the power of local government upon these emigrated neurons.

II Structure.

1. **Cells.**—The shape and characters of the cells, and their position upon the processes vary greatly, but they have all the following features in common:—They are nucleated protoplasts, the protoplasm of which, after fixing and staining, shows a well-marked network, in the meshes of which a material which stains deeply with basic stains, and which seems to be used up during the activity of the neuron, may accumulate in granules. The granules formed of this material are generally known as **Nissl's granules** (fig. 19).

Mott has failed to find such a structure in living nerve cells, and by the use of the ultra-microscope has observed particles moving freely in the colloidal fluid contents,

which they could not have done had there been such structures.

These cells give off at least one process, which continues for some distance, as the **axon**. Frequently other processes are given off, which form a branching system of **dendrites**. The axons end in dendrites, so that all the processes are essentially the same. These processes appear to be fibrillated, and in fixed specimens the fibrillæ may be traced through the protoplasm of the cells, but this appearance is probably an artefact due to the action of the fixing agents employed. In many cases the dendrites show little buds or **gemmules** upon their course, and, according to some observers, it is through these that one neuron is brought into definite relationship at one time with one set of neurons, and at another with other adjacent neurons. There is also some evidence that the dendrites as a whole may expand and contract, and thus become connected with those of adjacent neurons.

2. **Axon**.—The axon process, as it passes away from the cell, becomes a **Nerve Fibre**, and acquires one or two coverings.

(1) A thin transparent membrane, the **primitive sheath** or **neurolemma**, is present in all peripheral nerves. Between it and the **axis cylinder** there are a number of nuclei surrounded by a small quantity of protoplasm, the **nerve corpuscles**. Fibres with this sheath alone have a grey colour, and they may be called *grey* or *non-medullated fibres*. They are abundant in the visceral nerves. This sheath is absent from the nerve fibres of the central nervous system.

(2) A thick white sheath—the **medullary sheath** or white sheath of Schwann—which gives the white colour to most of the nerves of the body appears somewhat late in the development of many nerve fibres. It lies between the primitive sheath with its nerve corpuscles and the axon. It is not continuous, but is interrupted at regular intervals by constrictions of the neurolemma at the nodes of Ranvier (fig. 20). It is composed of a sponge-work or felt-work of

a horn-like substance—*neuro-keratin*—the meshes of which are filled with a peculiar fatty material.

The nerve fibres run together in bundles to constitute the nerves of the body, and each bundle is surrounded by a dense fibrous sheath, the *perineurium*. When a bundle divides, each branch has a sheath of perineurium, and in many nerves this sheath is continued, as the *sheath of Henle*, on to the single fibres which ultimately branch off from the nerve.

Not only do nerves branch and anastomose in the great nerve plexuses, but in the nerves themselves a similar plexus-like rearrangement of the bundles and fibres takes place.

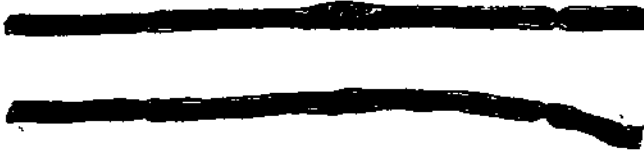

FIG. 20.—Pieces of two white Nerve Fibres.

Each nerve fibre ends in a series of dendritic expansions, which vary greatly in character according to the structures to which they pass.

III. Chemistry of Nerve.

The chemistry of neuron cells and their processes has been deduced from a study of the chemistry of the grey matter of the brain where they preponderate, while the chemistry of the white fibres is indicated by the analysis of the white substance of the brain, which consists chiefly of medullated fibres.

The grey matter contains over 80 per cent. of water. The solids consist of rather less than 10 per cent. of proteins. Two globulins, one coagulating at a low and the other at a higher temperature, and a nucleo-protein have been isolated. Lecithin and cholesterol each constitute about 3 per cent.

The white matter contains only about 70 per cent. of water. The proteins, similar to those in the grey matter, constitute between 7 and 8 per cent. Lecithin occurs in

about the same amount as in the grey matter, but cholesterol and lipoids, other than lecithin, constitute more than 15 or 16 per cent.

From the fatty material of the white sheaths various mixtures of lipoid substances have been isolated. These have been named *Cerebrosides* and have been classified into—

1. Galactosides yielding a sugar—galactose, nitrogen, but no phosphorus.
2. Phosphatides, of which lecithin is the most important (p. 20).
3. Cholesterol, a monohydric alcohol, belonging to the group of terpenes.

IV. Physiology of Neurons.

The neurons form a most intricate labyrinth throughout all parts of the body, and more especially throughout the central nervous system. Each is brought into relationship with many others by its dendritic terminations, and there is a continued interaction between them, the activity of any one influencing the activity of many others. In this way the constant activity of the nervous system, which goes on from birth to death, during consciousness and in the absence of consciousness, is kept up.

It is unnecessary and gratuitous to invoke the conception of automatic action on the part of any portion of the nervous system. Throughout life these neurons are constantly being acted upon from without; and activity, once started by any stimulus, sets up a stream of action which may be coexistent with life.

A. SINGLE NEURONS,

OR NEURONS LYING SIDE BY SIDE IN NERVES.

It has been shown that the great purpose of neurons is to enable external changes to produce appropriate reaction (p. 52). The changes set up in the receptors at the surface must be conducted to the stations in the central nervous system, and again conducted out to the muscles. **Conduction** is thus the great property of nerve.

1. Manifestations of the Activity of Neurons.

When conducting, nerve, like a telegraph wire, manifests no visible change. Its activity is shown chiefly by changes in the structures to which it passes, but also by certain electrical disturbances in the conducting part.

(1) **Action on other Structures.**—The activity of the **outgoing neurons**—neurons conducting impulses from the central nervous system to muscles, glands, etc.—is manifested by changes in the muscles or other structures to which they go: while the activity of **ingoing neurons** is made evident (*a*) by their action on outgoing neurons to muscles, etc. (see fig.

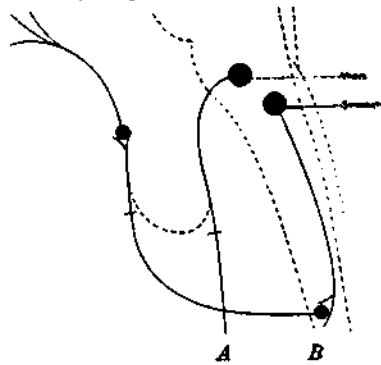

FIG. 21.—To show the union of the vagus *A* to the anterior end of the sympathetic *B* in the neck. The part of the central nervous system which normally acted upon the abdominal viscera becomes trained to act upon the structures in the face and head.

17, p. 53), and (*b*) sometimes by modifications in the state of consciousness which may be of the nature of a simple brief sensation, or, by the implication of a number of other neurons, may develop into a series of changes accompanied by a corresponding series of sensations.

Very interesting results follow from this fact, that *the activity of neurons is made manifest by changes in the structure to which they pass*. Langley has demonstrated that, if the vagus, which conducts downwards to the abdominal viscera, be cut, and the cervical sympathetic, which conducts upwards to the head, be also cut, and the central end of the vagus united to the peripheral end of the sympathetic (fig. 21), fibres grow outwards from the vagus

into the sympathetic, and when the vagus is stimulated, the results which naturally follow stimulation of the sympathetic occur.

Kennedy has shown that, if the nerves to the flexors and the nerves to the extensors of a dog's forelimb be cut, and the central end of the former united to the peripheral end of the latter, and *vice versa*, the normal co-ordinate movements of the limb are restored, and that, if that part of the brain which naturally causes extension be stimulated, flexion occurs. He has applied the information thus gained to the treatment of abnormal conditions in the human subject. In a woman who suffered from spasmodic action of the muscles of the face supplied by the seventh cranial nerve, he divided this nerve and connected its peripheral end with the central end of the spinal accessory and thus secured a complete recovery. Such observations are of great interest, since they indicate that the activity of the cells and synapses from which the fibres come may undergo profound alteration in function, that they may in fact be trained or educated to take on activities not natural to them.

(2) **Electrical Changes.**—The part of the neuron in action is electro-positive to the rest of the neuron. This simply means that the parts in action become to the rest of the neuron what the zinc plate (the electro-positive element) in a zinc and copper galvanic cell is to the copper. The flow of current set up along the wire connecting the elements of the cell is made manifest by the deflection of a galvanometer needle. In the same way the zinc-like (electro-positive) action of the acting part of the neuron is made manifest if wires are led off from the nerve round a galvanometer (fig. 22).

In order that neurons may produce their effect they must be capable of *Excitation* and *Conduction*, and these must now be studied.

2. Excitation of Neurons.

Neurons, like all other protoplasm, react to changes in external conditions; they are capable of stimulation.

A. A neuron is usually stimulated from one or other of its terminal dendritic endings, either by changes set up in the tissues round these, or by changes in other neurons. Thus (fig. 17) one set of neurons may be thrown into action by changes in the tissue at their extremity, and a second set may be stimulated by the activity of the first.

B. Neurons may also be stimulated at any part of their course, as may be demonstrated by pinching the ulnar nerve behind the internal condyle of the humerus, when a sensation localised on the ulnar side of the hand is experienced, and by the contraction produced in the gastrocnemius muscle of

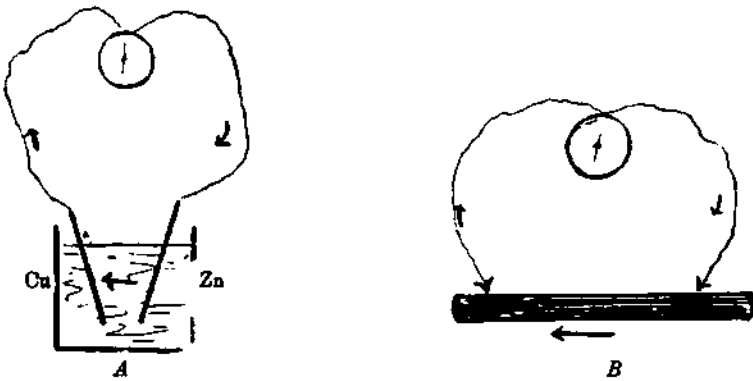

FIG. 22.—A, To show a galvanic cell with a zinc and copper element and the flow of the electric current passing round a galvanometer. B, A nerve in which the dark part is in action and is acting to the rest of the nerve as the zinc elements in the cell.

the frog when the sciatic nerve is stimulated in its middle (*Practical Physiology*).

Means of Stimulation.

Any sudden change tends to excite to activity, whether it be *mechanical*, as in pinching a nerve, or a change in the *temperature*, or in the *electric* conditions, or in the *chemical* surroundings of the neurons; agents which withdraw water, like glycerine, stimulating strongly.

The electrical method of stimulating nerve is constantly used in medicine, and it must be studied carefully. It is a

matter of no importance how the electricity is procured, but most usually it is obtained either—

- 1st. Directly from a galvanic battery, accumulator, or electric main ; or
- 2nd. From an induction coil.

1st. Galvanic Stimulation.

A. EXPOSED NERVE.

The sciatic nerve of the frog passing to the gastrocnemius muscle may be placed upon the wires from a galvanic battery, and the contraction of the muscle may be taken as the index of the stimulation of the nerve.

It will be found that—(a) On making the current, and upon breaking the current, a contraction results. While the current is flowing through the nerve, the muscle *usually* remains at rest ; but if the current is suddenly increased in strength, or suddenly diminished in strength, the muscle at once contracts. With strong currents, a sustained contraction—galvanotonus—may persist while the current flows (*Practical Physiology*).

It is the *suddenness* in the variation of the strength of the current, rather than its absolute strength, which is the factor in stimulating, as may be shown by inserting some form of rheonome into the circuit by which the current may be either slowly or rapidly varied. This fact is of great importance in applying galvanic currents in the treatment of various diseases in the human subject. Great care is necessary to increase *slowly* and to decrease *slowly* the strength of the current, or painful stimulation may be produced (*Practical Physiology*).

(b) The stimulus on *making* is stronger than that on *breaking*, so that, if a current be made weaker and weaker, breaking ceases to cause a contraction, while making still produces it (*Practical Physiology*).

(c) The two poles do not produce the same effect. The negative pole or cathode stimulates on making ; while the positive pole or anode stimulates at breaking. This may

be stated—the nerve is always stimulated at the point where the current leaves it. On making this is at the cathode; on breaking at the anode (fig. 23) (*Practical Physiology*).

These results may be summarised as follows:—

1. Stimulation on closing (making); stimulation on opening (breaking).
2. Closing stimulation stronger than opening stimulation.
3. Stimulation at cathode on closing, at anode on opening.

Or, taking the contraction of the muscle as the sign of stimulation, and representing it by C, the law of galvanic stimulation may be expressed thus:—

1. C.C · C.O
2. CC > CO
3. CCC CAO

Explanation of Electric Stimulation.—A study of the influence of the current while it is flowing throws important light on this point. This condition of the tissue is known as **Electrotonus** (*Practical Physiology*).



FIG. 23.—To show stimulation at the cathode on closing and at the anode on opening, at the point where the current leaves the nerve.

While the current simply flows through a nerve no stimulation is produced, but the excitability is profoundly modified.

Round the cathode the nerve becomes more easily stimulated, while round the anode or positive pole it becomes less easily stimulated. This may be expressed by saying that the part of the nerve under the influence of the cathode is in a state of *catelectrotonus*, of increased excitability, while the part of the nerve under the influence of the anode is in a state of *anelectrotonus*, of decreased excitability or of more stable equilibrium. This is easily demonstrated by passing a galvanic current along a nerve going to a muscle, and

stimulating first in the region of the cathode and then in the region of the anode. A much stronger stimulus will be found necessary to cause contraction of the muscle at the second point, in the region of the anode.

It is the *sudden* production of increased excitability at the cathode on closing which causes an explosion, a stimulation. The sudden removal of the increased stability round the anode when the current is broken is sufficient to cause an explosion if the current is strong enough.

The study of electrotonus thus explains (1) why any sudden change in the flow of electricity through a muscle stimulates it; (2) why the stimulation starts from the cathode on closing and from the anode on opening; and (3) why the closing contraction is stronger than the opening.

This law of Polar Excitation, while it applies to normal

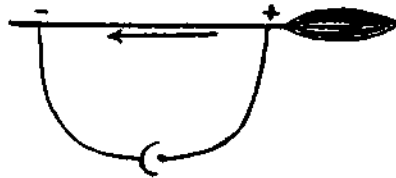

FIG. 24.—To show the passage of a galvanic current along a nerve so that distinct polar effects are produced.

muscle and nerve, does not apply to all protoplasm. Thus, *amoeba* shows contraction at the anode and expansion at the cathode when a galvanic current is passed through it.

B. NERVE UNDER THE SKIN.

In practice the galvanic current may be used to stimulate nerves and muscles *in situ* under the skin. To use the current for this purpose an electrode is placed over the nerve or muscle to be investigated and the other over some indifferent part of the body. The very considerable electrical resistance of the skin has to be overcome by using rather large electrodes usually covered with chamois leather well soaked in saturated salt solution.

Applied in this way, the current passes from pole to

pole, not *along* the nerve or muscle (fig. 24), but more or less *across* it (fig. 25).

The nerve, if under the cathode, is thus under the influence of the cathode on the side near the pole, and under the influence of the anode on the side away from the pole, and, *vice versa*, under the anode (fig. 25).

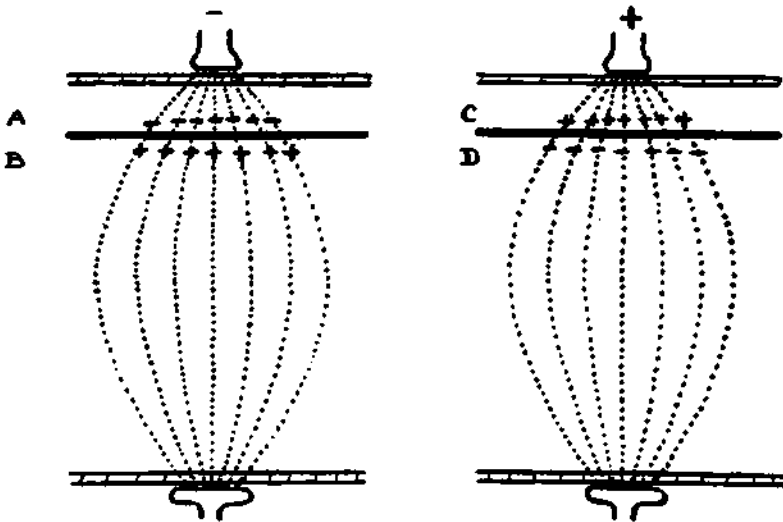

FIG. 25.—Electrical Stimulation of human muscle or nerve to show the passage of the current across the structure, and the consequent combination of effects under each pole.

Hence there will be a stimulation both at making and at breaking (p. 63) under both cathode and anode.

The cathodal closing contraction is the stronger because of its dependence upon the more effective pole, the cathode, as it is a closing contraction, and also because the excitation begins at *A*, which is near the stimulating pole. The cathodal opening contraction has the less effective pole—the anode as its origin, since it is an opening contraction, and the excitation is at the less effective position *B*, which is separated from the stimulating pole—the anode by a

greater distance than is *A* from the cathode. Similarly, the anodal closing contraction has the *better* pole, the cathode as the stimulating pole, but in the worst position *D*, far from the cathode. The anodal opening contraction has the less effective pole—the anode as the origin of excitation, but in the better position *C*, close to the stimulating pole.

	Pole.	Position.	Strength of Current necessary to stimulate.
Cathode, Closing A	Better Better Worse Worse	Better Worse Better Worse	Weakest Medium Medium Strongest
Anode, Closing D } C.C.			
Anode, Opening C } A.O.			
Cathode, Opening B }			

The strength of the current required to stimulate is measured in milliamperes. The effective strength varies greatly, even in normal individuals of the same species.

Changes in Disease and Injury.—In tetany in children, and after the removal of the parathyroids in man and animals (p. 603), a condition of increased excitability of the nerves to mechanical and galvanic stimulation occurs, and this is used in the diagnosis of these conditions when other symptoms are latent.

When the nerve to a muscle is cut it rapidly loses its power of responding to electrical stimulation (p. 76), but the muscle continues to respond, and its response, although at first it may be decreased, is afterwards increased and becomes peculiarly slow. Some neurologists have maintained that there is a *qualitative* change in the response, that the response to anodal closing—A.C. becomes greater than that to cathodal closing—C.C. With fine electrodes applied to exposed muscle this does not occur. It is probably due to the fact that in normal muscle it is the *nerve endings* which are stimulated, but that in degeneration the response depends upon the number of muscular fibres stimulated rather than upon the pole applied. Hence in anodal closing the worst

position, far from the pole, acts upon more fibres than the cathode acts upon in closing.

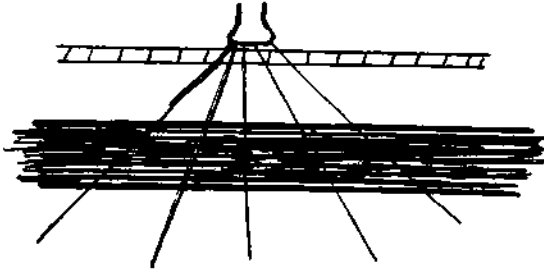

FIG. 26.—To illustrate the reason for the increase in the anodal closing stimulation in a muscle after degeneration of the nerve and nerve endings.

2. Faradic Stimulation.

When nerve is stimulated by induced or faradic electricity

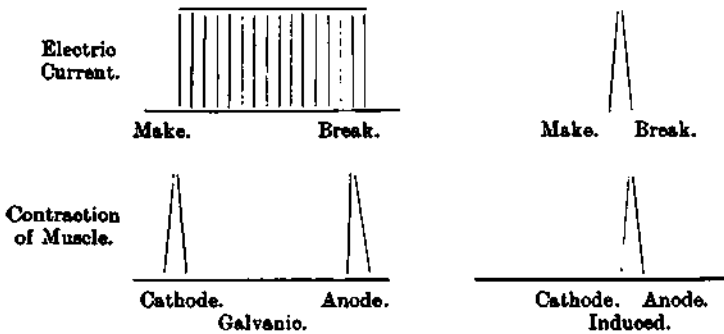

FIG. 27.—To show separation of make and break stimuli and of anodal and cathodal effects when a galvanic current is used, and their combination when the induction coil is used (faradic).

(fig. 28), with each make and break, or with each sudden alteration in the strength of the primary circuit, there is a sudden appearance and equally sudden disappearance of a flow of electricity in the secondary coil. If, therefore, wires from the secondary coil are led off to a nerve, each change in the primary circuit causes the sudden and practically simultaneous appearance and disappearance of an electric

current in the nerve, and this, of course, causes a contraction. But here the effects of closing and opening the current are practically fused, and hence the influence of the anode and cathode, and of closing and opening, need not be considered (fig. 27) (*Practical Physiology*).

It must, of course, be remembered that in an induction coil the opening of the primary circuit produces a more powerful current in the secondary coil than the closure of the primary circuit, and therefore a more powerful stimulation of the nerve (fig. 28).

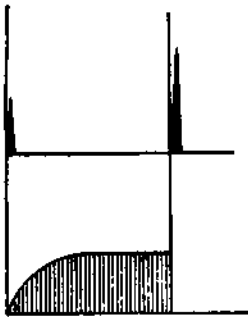

FIG. 28.—Course of Electric Current in primary circuit (lower line), and in secondary circuit (upper line) of an induction coil. Observe that in the secondary the make (up-stroke) and break (down-stroke) are combined, and that a stronger current is developed in the secondary circuit upon breaking than upon making the primary circuit.

Relationship of the Excitation to the Strength of the Stimulus.—A nerve is made up of a series of axons placed side by side. The difference in the effect of a weak and of a strong stimulus as indicated by the contraction of the muscle supplied may be due either to a graded effect of the stimulus on every fibre or to the number of fibres stimulated by the different strengths of stimulus. The cutaneous dorsi nerve of the frog is composed of only ten fibres, and, as the strength of stimulus is *steadily* increased, the resulting contractions increase in ten stages. The conclusion is that the result depends upon the number of fibres stimulated, and that, when a

stimulus excites a fibre, it does so to call forth its full action—the stimulation of each axon is either all or nothing.

Variations in Excitability.—The influence of the galvanic current upon the excitability of nerve has been already considered (*Electrotonus*, p. 63).

Many other factors modify its excitability. It may be increased by a slight cooling, but it is decreased at lower temperatures. It is increased by warming up to a certain point. *Drying* at first increases excitability, then abolishes

it. It is influenced by many *chemical substances*, some of which increase its excitability in small doses, and diminish it in larger doses; some again even in the smallest dose depress its activity, *e.g.* potassium salts, and such drugs as chloroform and ether.

Continued activity has no effect on the excitability of axons, and the phenomena of fatigue are not manifested in them.

This may be proved by taking two nerve-muscle preparations, A and B, and stimulating both nerves repeatedly with

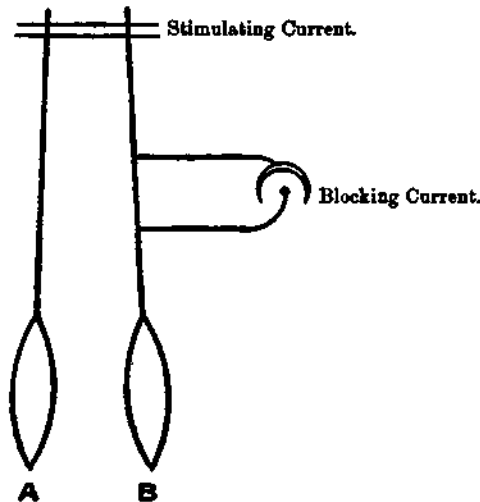

FIG. 29.—Experiment to show that a nerve cannot be fatigued. Two muscle nerve preparations, A and B, are stimulated by the faradic current. B is blocked by a galvanic current or by cooling, till the muscle of A no longer contracts. The block is then removed, and B contracts.

the same electric current, but preventing the stimulus from reaching one of the muscles, B, by blocking its passage by passing a galvanic current through the nerve (see p. 71) or by applying ice to it (fig. 29).

If, after muscle A no longer contracts, the block is removed, muscle B will contract, showing that the nerve is not fatigued.

3. Conduction in Neurons.

When a neuron is stimulated at any point, some time elapses before the result of the stimulation is made manifest,

and the further the point stimulated is from the structure acted upon, the longer is this latent period. This indicates that the change does not develop simultaneously throughout the neuron, but, starting from one point, is conducted along it.

(a) The rate of conduction may be determined—

1st. By stimulating a nerve going to a muscle at two points at a known distance from one another, and measuring the difference of time which elapses between the contraction

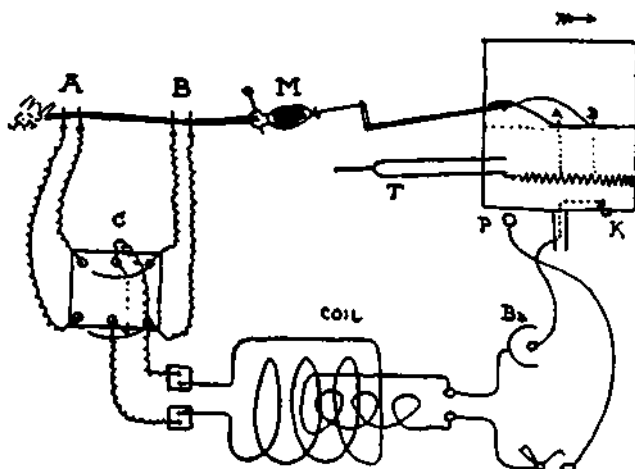

FIG. 30.—*M*, Muscle attached to crank lever marking on revolving drum. The secondary circuit of an induction coil is connected with a commutator, with the crossed wires removed so that the current may be sent either through the wires going to the nerve at *A* far from the muscle, or at *B*, a point at a measured distance nearer the muscle. On the drum, *A* represents the onset of contraction on stimulating at *A*, and *B* the onset on stimulating at *B*. To secure stimulation in each case with the drum in the same position, the make and break of the primary circuit is caused by the point of *K* touching and quitting the point *P*.

resulting from stimulation at each (fig. 30) (*Practical Physiology*).

2nd. By taking advantage of the fact that the conducting part of a neuron is electro-positive, *i.e.* like the zinc element in a galvanic cell, to the rest (p. 60), and by finding how long after stimulation at one point this electric change reaches another point at a measured distance from it (fig. 31).

The rate of conduction varies considerably; everything stimulating protoplasmic activity accelerating, and everything

depressing protoplasmic activity diminishing it. Under normal conditions in the fresh nerve of the frog, the velocity is about 33 metres per second. In man it is about 100 to 150 metres per second, and in the octopus only about 2 metres.

(b) **Factors modifying Conduction.**—Conduction is modified by *temperature*. Cooling a nerve lowers its power of conduction; gently heating it increases it. Various *drugs* which diminish protoplasmic activity—*e.g.* chloroform, ether, carbon dioxide, etc.—diminish conduction. But while the *excitability* of the part of the nerve under the

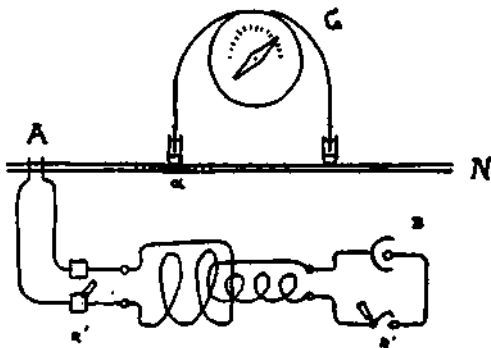

FIG. 31.—*N*, a piece of a Nerve connected by non-polarisable electrodes to the galvanometer, *G*. By an induction coil it may be stimulated at *A*. When the nerve impulse reaches *a*, a deflection of the galvanometer needle takes place.

influence of these agents undergoes a steady decrement, *i.e.* the contractions of the muscles supplied steadily decrease, the *conduction* of the impulse is either completely blocked, or, if it is transmitted, it regains its full strength in the part of the nerve peripheral to the block. Very important conclusions as to the nature of the nerve impulse have been based upon this fact. The *electric current*, too, acts differently on conduction and on excitability (p. 63). While a weak current has little or no effect, a strong current markedly decreases conductivity round the positive pole, and to a less extent decreases it at the negative pole, so that the general effect of a strong current is to decrease conductivity and to block the passage of impulses (fig. 32).

From this influence of the electric current upon (a) *excitability* and (b) *conductivity* certain differences are to be observed in the effects of stimulating an exposed nerve with currents of different strengths and of different direction—downwards, *to*, the muscle or upwards, *from*, the muscle. These have been formulated as Pfüger's Law. But since they have no bearing upon the stimulation of unexposed nerves in animals they need not be considered here.

(c) When a neuron is stimulated in the middle, the change travels in both directions, although its result is only made manifest by the action of the structure at the end on which it normally acts. (i.) This two-way conduction may be

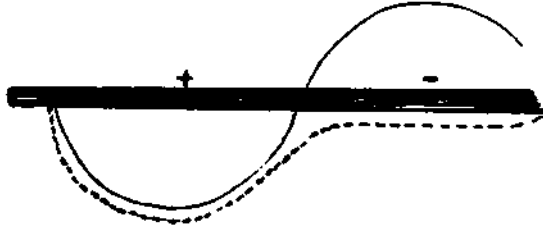

FIG. 32.—To show the effect of a galvanic current upon the excitability (continuous line) and upon the conductivity (broken line) of a nerve.

demonstrated by using the electric changes as an index of nerve action connecting a galvanometer with the nerve on each side of the point stimulated instead of with only one side, as in fig. 31. (ii.) It is also demonstrated by the experiment of "paradoxical contraction," in which the electric variation, set up by stimulating the branch of the sciatic nerve of the frog going to the muscles of the thigh, stimulates the nerve fibres to the gastrocnemius lying alongside of it, and causes that muscle to contract. That this does not occur when impulses from the central nervous system pass along the nerve is because the strength of these impulses, *i.e.* the number of fibres implicated, as indicated by the electrical change, is very much weaker than that of impulses caused by direct stimulation (*Practical Physiology*).

4. Classification of Neurons by the Direction of Conduction.

Since a nerve is normally stimulated from either the one or the other end, and hence conducts in one direction, and since the passage of impulses along it is made manifest by changes in the structure to which it goes (p. 59), it is possible to classify nerve fibres according to whether they conduct to or from the central nervous system, and according to the structure upon which they act.

To find out the direction of conduction and the special mode of action of any nerve, after its anatomical distribution has been determined, two methods of investigation may be employed—

1st. The nerve may be cut, and the results of section studied.

2nd. The nerve may be stimulated, and the result of stimulation noted.

Usually these methods are used in conjunction; the nerve is cut, and when the changes thus produced have been noted, first the upper or central end and then the lower or peripheral end of the cut nerve are stimulated.

It is, of course, only if a nerve is constantly transmitting impulses that section reveals any change. If the nerve is not constantly in action, stimulation alone will demonstrate its functions.

A. *Outgoing or Efferent Nerves.*—Section of certain nerves produces a change of action in muscles, glands, etc., or, if the nerve is not constantly acting, stimulation of the peripheral end of the cut nerve causes some change in the activity of these structures. Stimulation of the central end of such nerves produces no effect. These nerves therefore conduct impulses *outward* from the central nervous system.

The nerves going to the *skeletal muscles* may cause either an increased activity or a decreased activity according to the way in which they are called into action, so that at one time the nerve may be an *excitor* of the muscle, at another time an *inhibitor*.

The nerves going to the *visceral muscles*, on the other

hand, are either augmentor or inhibitory, but they do not act at one time in the one way, at another in the other.

B. Ingoing or Afferent Nerves.—Section of another set of nerves may produce loss of sensation in some part of the body. When the peripheral end of the cut nerve is stimulated no result is obtained. When the central end is stimulated, sensations, with or without some kind of action may result. Such nerves obviously conduct *inwards* to the central nervous system. Those which, when stimulated, give rise to sensations may be called *sensory*; those which give rise to some action are called *excito-reflex*, because the action which results is produced by *reflex action* (p. 82). But these two are not distinct from one another, and a nerve which at one time, when stimulated, causes a sensation, may at another time cause a reflex action without sensation. The branch of the fifth cranial nerve which passes to the conjunctiva of the eye is an example of such a nerve. When the conjunctiva is touched—*i.e.* when this nerve is stimulated—the orbicularis palpebrarum is brought into action through the seventh cranial nerve, and the eye is closed. The conjunctival branch of the fifth cranial nerve is thus an *excito-motor nerve*.

When the terminations of the lingual branch of the fifth nerve in the tongue are stimulated, the result is a free flow of saliva, through the action of the secretory fibres of the seventh nerve and of the glosso-pharyngeal. The lingual nerve is thus *excito-secretory*.

Stimulation of the nerves from any part—*e.g.* by a mustard blister—causes relaxation of the blood-vessels of the part, and such afferent nerves may be called *excito-vaso-dilator*.

C. Many nerves of the body contain both afferent and efferent nerve fibres, and are called *mixed nerves*.

5. The Nature of the Nerve Impulse.

The impulse which passes along a nerve is due to changes in the axis cylinder, since this, without its sheaths, can conduct. Further, it is dependent on the vitality of

the nerve. Death of the nerve, as when it is heated to 47° C., at once stops the transmission of an impulse.

We may at once dismiss the idea that the impulse is due to a mere flow of electricity. Electricity travels along a nerve at about 300 million metres per second, a velocity much higher than that of the nerve impulse.

Two possibilities remain. The impulse may be of the nature of the molecular vibration, such as occurs in the stethoscope which conducts sound vibration, or it may consist of a series of chemical changes, such as cause the activity of protoplasm generally.

In considering this matter it must be remembered that the amount of energy evolved in a nerve impulse need not be great. All it has to do is to *start* the activity of the part to which it goes. Hence, if chemical changes are the basis of the impulse, these may be extremely small in amount and difficult to detect, while at the same time recovery may be extremely rapid.

As a matter of fact, the evidence of chemical changes in nerve fibres is slight. No change in reaction, no heat production, and no phenomena of fatigue can be demonstrated. But two bits of evidence point to the existence of chemical changes. Oxygen is required; and the fact that, if an impulse succeeds in passing through a piece of nerve in which conduction is decreased by cold or by drugs, it regains its original strength must mean that the impulse is due to a chemical change similar to that which occurs as a spark passes along a trail of gunpowder. The spark may be delayed and reduced to a minimum in a damp part of the trail, but, if it passes this, it regains its original strength when a dry part is reached.

NERVE CELLS.

1. **Automatic Action?**—It has sometimes been supposed that nerve cells originate nerve impulses, that they have an automatic action. The nerve cells which send fibres to muscles may be isolated from the influence of incoming neurons by cutting the posterior roots of the spinal nerves

(p. 107), and when this is done the muscles supplied remain soft, flaccid, and motionless. Under normal conditions no impulses pass from the cells.

2. **Conduction ?**—That the cells do not play an essential part in conduction has been most clearly demonstrated by experiments upon the common crab, where it is possible to remove the nerve cell from the fibre with which it is connected without injuring the fibre. For some time after this is done the fibre continues to conduct.

3. **Nutrition of the Neuron.**—The function of the cell is to preside over the nutrition of the neuron. It appears to have the power of accumulating a reserve of material which, when the cells are fixed, appears as Nissl's granules, for it has been found that after continued action these granules diminish in amount. The nucleus, too, gives off material for the nourishment of the neuron, and in conditions of excessive activity it has been found shrunken and distorted.

If any part of the neuron is cut off from its connection with the cell, it dies and degenerates, and later the cell may also undergo changes.

(a) **Degeneration and Regeneration of Nerves.**—In the cat, excitability disappears after three days (p. 66), and the white sheath shows degenerative changes in eight days. The fatty matter runs into globules and stains black with osmic acid, even after treatment with chrome salts (Marchi's method). This seems to be due to the fact that osmic acid acts upon the unsaturated oleic acid, and that this, in the normal nerve, is oxidised by the chrome salt, whereas, in the degenerated nerve, so much is set free that it cannot all be oxidised, and therefore stains with osmic acid. The white substance gradually disappears; at the end of a month the phosphorus has all gone, and by the end of about forty-four days the fat can no longer be detected. At this stage Marchi's method is useless, and the degenerated fibres may be demonstrated by the fact that they do not stain with osmic acid or with Weigert's hæmatoxylin method which stains the white sheaths of normal fibres. As the degeneration advances, the axis cylinder breaks down, and the nerve

corpuscles proliferate and absorb the remains of the white sheath, so that nothing is left but the primitive sheath filled by nucleated protoplasm.

Into this, axons may grow downwards from the central end of the nerve, and *regeneration* may occur. This generally begins after about forty days and is well marked after about one hundred days.

Some investigators have maintained that regeneration occurs by the development of new fibrils in the degenerated nerve itself, but the mass of evidence indicates that, when an apparent peripheral regeneration has occurred, it has been due to the ingrowth of axons from adjacent cut nerves.

The neurolemma with its nuclei appears to be essential for regeneration. It is not present in the white fibres of the central nervous system, and hence regeneration does not occur there after the nerve fibres have been severed and have degenerated.

(b) The cell is dependent for its proper nutrition upon the condition of the rest of the neuron. When the axon is cut, the chromatin of the cell nucleus slowly decreases, and the nucleus becomes displaced to one side, and ultimately the whole cell may degenerate. This is sometimes called *Nissl's degeneration* (see fig. 19, b).

B. ACTION OF NEURONS IN SERIES.

So far, the physiology of single neurons, or of neurons running side by side in nerves, has been considered. But in the nervous system, as already indicated, they are arranged in chains or series, the activity of one set leading to changes in other sets (fig. 17, p. 53).

The apparently inextricable labyrinth of neurons running throughout the nervous system may be arranged in three groups or arcs, according to their distribution.

Each arc consists of ingoing neurons, starting from

Receptors on the one side, and outgoing neurons ending in **Effectors** on the other side; the neurons between them constituting the **Conductor** mechanism.

THE NEURAL ARCS.

A. Arrangement.

The neural arcs will later have to be studied more in detail. At present a mere outline of their distribution will be given.

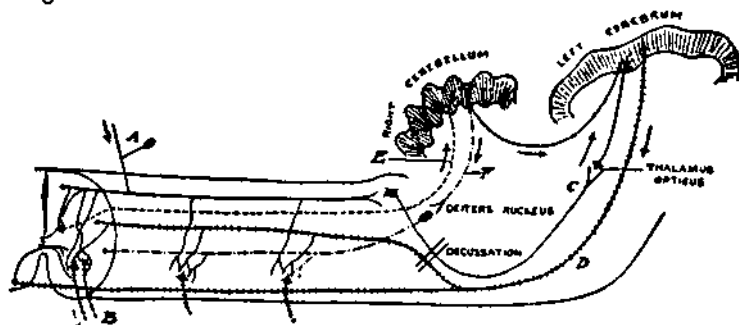

FIG. 33.—To show the three Arcs in the Central Nervous System. *A*, Peripheral ingoing neuron giving off collaterals in the cord and some terminating above in the nuclei of the posterior columns; *B*, peripheral outgoing neurons; *C*, ingoing cerebral neurons; *D*, outgoing cerebral neurons, crossing to the opposite side //; *E*, ingoing cerebellar neurons; *F*, outgoing cerebellar neurons.

1. **Spinal Arc.**—**A. Ingoing Neurons** (fig. 33, *A*)—This set of neurons is developed primarily in connection with the surface of the body, but they also start in muscles, joints, and internal organs. They start in dendritic expansions at the periphery, and enter the cord by the dorsal roots of the spinal nerves in the swelling or ganglion upon which the cell of each neuron is situated (see p. 106). In the cord they divide into (*a*) branches running for a short distance down the cord; (*b*) branches running up the spinal cord. From these branches, processes pass forward to form synapses with the neurons in the ventral part of the spinal cord from which the outgoing fibres to the skeletal muscles

spring. It is probable that several series of *intercalated neurons* exist between the ingoing and outgoing neurons.

B. Outgoing Neurons (fig. 33, *B*).—(*a*) From the nerve cells in the ventral part of the grey matter of the cord, fibres are given off which pass out in the anterior or ventral roots of the spinal nerves to skeletal muscles, and (*b*) from cells situated in the lateral part of the grey matter of the cord fibres pass out to be connected with the visceral neurons which pass to muscles or to glands (p. 54).

The fibres entering and leaving the base of the brain by the **cranial nerves** belong to this spinal arc.

The action of these spinal neurons is controlled and modified by the two other arcs.

2. Cerebral Arc.—**A. Ingoing Neurons** (fig. 33, *C*).—*Lower Neurons.*—The ingoing fibres of the spinal cord and cranial nerves not only give off branches to form the spinal arcs, but they also form other synapses in or just above the cord from which fresh neurons run upwards, cross the middle line to the opposite side, and finally form synapses higher up and chiefly in the thalamus (fig. 101). From these fibres pass (*a*) to other basal ganglia such as the red nucleus, and (*b*) to the cortex cerebri to form synapses. From these fibres pass to the outgoing neurons.

B. Outgoing Neurons.—These cross the middle line and run down the spinal cord to act upon the spinal arcs (fig. 33, *D*).

3. Cerebellar Arc.—**A. Ingoing** (fig. 33, *E*).—(*a*) Some of the branches of the spinal ingoing neurons from muscles and joints end in synapses round nerve cells at the side of the grey matter of the spinal cord. From these, fibres run up to the cerebellum to form, directly or indirectly, synapses round the cells in this organ.

(*b*) Fibres from the synapses, formed by the incoming fibres from the vestibular part of the labyrinth of the ear, also course to the cerebellum.

B. Outgoing (fig. 33, *F*).—From the cells of the cortex of the cerebellum (*a*) fibres pass to masses of grey matter—the roof nuclei—and to a mass of cells lying outside the cerebellum on each side—Deiters' nucleus—where they form

synapses with neurons which send their axons down the same side of the spinal cord, and give off collaterals which act upon the spinal arcs. (b) Fibres also pass to the red nucleus of the cerebrum, from which fibres pass down the cord to modify its action.

B. General Action of the Arcs.

The special action of each of these arcs may be studied by observing the effect of interruption of its different parts.

1. **Cerebral Arc.**—(1) If, in a normal *frog*, the attitude, movements, responses to various stimuli and power of balancing be studied, and if (2) the anterior part of the brain, the

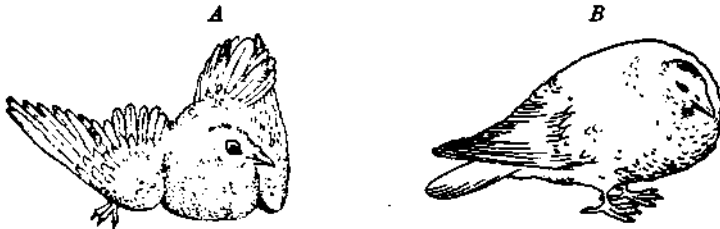

FIG. 34.—*A*, Pigeon with the Cerebellum destroyed to show struggle to maintain the balance; *B*, Pigeon with Cerebrum removed to show balance maintained, but the animal reduced to somnolent condition.

cerebrum, be removed, it will be found that the animal still sits in its characteristic posture. When touched it jumps; when thrown into water it swims. It is a perfect reflex machine, with the power of balancing itself unimpaired. But it differs from a normal frog in moving only when directly stimulated, and in showing no signs of hunger or of thirst. A worm crawling in front of it does not cause the characteristic series of movements for its capture which is seen in a normal frog. Generally a condition of decerebration rigidity appears after a time, and the frog, when held by the sides and placed upon the table, remains with its legs rigidly stretched, supporting the body well above the surface, with the back arched like that of an angry cat.

In the *pigeon* (fig. 34, *B*), removal of the cerebral hemi-

spheres reduces the animal to the condition of a somnolent reflex machine. The bird sits on its perch, generally with its head turned back, as if sleeping. If a sudden noise is made, if light is flashed in its eye, or if it is touched, it flies off its perch and lights somewhere else. Clapping the hands and letting peas fall on the floor both produce a start, but the bird makes no endeavour to secure the peas, as it would do in the normal state.

In the *dog*, by a succession of operations, Goltz removed the greater part of the cerebral cortex without causing paralysis of the muscles. The animal became dull and listless, and did not take food unless it was given to it. It showed no sign of recognising persons or other dogs, and did not respond in the usual way when petted or spoken to. But it snapped when pinched, shut its eyes and turned its head away from a bright light, and shook its ears at a loud sound. It did not sit still, but walked constantly to and fro when awake. It slept very heavily. In fact, all the responses of the animal might be classed as reflex responses to immediate excitation.

In *monkeys*, removal of the cerebral cortex leads to such loss of the so-called voluntary movements that all other symptoms are masked. But recent experiments have shown that, after removal of considerable parts of the cortex, recovery of functions may occur.

2. Cerebellar Arc.—If the part of brain behind the cerebrum, including the cerebellum, be removed from the frog, all power of balancing is lost and the animal lies on its back or belly as it may have been placed. But when the toes are pinched the legs are drawn up into their characteristic attitude of flexion alongside the body and are maintained there, while the muscles feel firm.

3. Spinal Arc.—When the spinal cord is destroyed the muscles are flaccid and soft, and the limbs remain in any position they may be placed, and no response to pinching occurs.

I. THE SPINAL ARC.

Reflex Action.

When the cerebrum and cerebellum are destroyed, the **frog** is under the influence of the spinal arcs alone, and it may be used for studying the action of these arcs uncomplicated by the disturbing effects of the cerebral or cerebellar arcs.

For the study of the action of the spinal arcs in higher animals, Sherrington has used a **dog** with the spinal cord cut below the level of the phrenic nerves, which supply the diaphragm—the great muscle of respiration, so that the dog can continue to breathe.

In such an animal it is possible to record the movements of a limb as a whole by attaching it to a reducing lever, *i.e.* a lever in which the power is applied to the long limb, so that the extent of movement is reduced on the record.

The action of any muscle or muscles may be recorded by cutting their tendons and attaching them to the lever.

In the **horse**, as a result of injury or disease, the lower part of the cord may be cut off from the higher arcs and its uncomplicated action may be studied.

Beginning with the **frog** with the whole brain destroyed, it is found that if one of the toes is pinched the leg is drawn up. This is one of the simplest examples of reflex action.

Reflex Action may be defined as *the response of effectors to the stimulation of receptors without volition being involved.*

Such reflex actions are *definite and purposeful.* This may be demonstrated by placing a small bit of blotting-paper dipped in acetic acid on the thigh of the frog, when a series of movements will be made, manifestly with the object of removing the paper (*Practical Physiology*). These movements involve the most perfectly co-ordinated action of a large series of muscles, some contracting, some relaxing, the contraction and relaxation alternating in an orderly manner between the groups of muscles.

The mechanism involved consists of the **receptors** stimulated, the **ingoining nerves** to the spinal cord, the great

labyrinth of intercalated neurons in the cord, the outgoing neurons and the muscles upon which these act.

The marvel is, that in the labyrinth of neurons in the cord any sufficiently definite course can be taken to secure the perfectly harmonious and co-ordinated response which occurs, and it is not surprising that the definite passage of the impulse may be readily interfered with. Thus, the administration of strychnine leads to the abolition of definite reaction and to a generalised contraction of the muscles.

Only by a long process of evolution can such definite paths have been marked out through this labyrinth, and only on the supposition that, if once a certain response has followed a given stimulus, the same response will tend to follow it again, can we understand how these definite reflex actions have been gradually established. The reflexes are then inherited reactions and in the process of evolution only those of benefit to the species have survived.

Primarily reflex action was confined to the segment of the body in which it was originated, but gradually the reflex association of all segments, of different levels of the cord, has been established.

In order that the appropriate response should follow a given stimulus, the structural and functional integrity of all the structures involved is of course essential, and any modification in the condition of any part may seriously alter the result.

Above all, the condition of the spinal cord itself is of importance.

1. The impulse in passing across the synapses in the cord takes time, and the period between the application of the stimulus and the resulting action is much longer than the time which the impulse would take to travel up the ingoing nerve and down the outgoing nerve (p. 70). This is called the **latent period** of reflex action.

The duration of the latent period varies with the strength of the stimulus, and with the condition of the spinal cord. It also probably varies with the number of synapses which have to be crossed in the cord, and hence some simple

reflexes, such as the knee-jerk (p. 89), have very much shorter latent periods than more complex reflexes.

2. As a result of the impulse having to traverse these various synapses, there is not the same strict correspondence between the strength of the stimulus and the resulting action as is found in stimulating single sets of neurons in a nerve (p. 68). The result does vary with the strength of the stimulus—a weak stimulus producing a feeble contraction of only a few muscles, and a stronger stimulus a more vigorous response in a larger number of muscles. But it also varies with the condition of the spinal cord, after the administration of strychnine the least touch produces a powerful generalised contraction, while if the cord is cooled a much feebler response is obtained.

3. When a nerve is stimulated, the excitation stops as soon as the stimulus ceases. But in reflex action there is apt to be a continuance, an *after-discharge*, for some time after the stimulus is removed. This is well seen when the toes of the spinal frog are pinched; the leg, when drawn up, remains in position for a considerable time. The duration of this after-discharge varies with the strength of the stimulus, and with the condition of the synapses in the cord (*Practical Physiology*).

4. The rhythmic repetition of a subminimal stimulus is more capable of liberating a reflex action than it is of causing a stimulation of a neuron. Apparently the resistance to the passage of the impulse over the synapses is decreased by repetition; just as while one knock at a door may not secure its opening, a series of knocks may do so.

5. While a nerve conducts impulses in both directions, a reflex arc allows its passage across the synapse in one direction only, *from* the receiving to the reacting neuron. There is, as it were, a *valve action*. This was demonstrated by using the electric variation which accompanies the passage of a nerve impulse (p. 60). If the ingoing neuron *A* (fig. 35) and the outgoing neuron *B* are connected with galvanometers, when *A* is stimulated, an electric variation occurs in *A* and in *B*. But if *B* is stimulated while an

electric variation occurs in *B*, it does not occur in *A*. The impulse has failed to cross the synapse.

6. A nerve may be stimulated again and again at very short intervals of time, the refractory period being about $\frac{1}{8000}$ sec. Reflex arcs manifest much more prolonged refractory periods during which it is impossible to elicit another response. This is of importance because a reflex act takes a very appreciable time to be completed, and unless it is completed before it is again started confusion of movements would be produced.

By the use of the spinal dog (p. 82) Sherrington has been able to show how it is that definite reflex actions are possible, and how, in spite of the number of stimuli which are constantly falling on the body, there is no confusion, no mixture of reflexes.

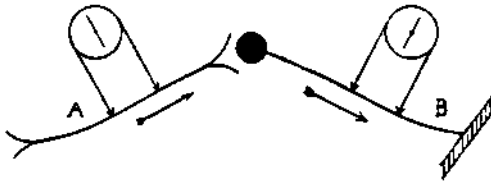

FIG. 35.—To show the method of demonstrating the Valve Action in reflexes by means of the electrical response.

He finds that the response varies with the character and locality of the stimulus.

Thus, if the hind foot of the dog be pinched, a **flexor withdrawal** of the leg occurs varying in extent with the strength of the stimulus. If the stimulus is strong, this may be accompanied by an extension of the opposite leg—a **crossed extensor thrust**.

If, on the other hand, a finger is thrust into the pad of the dog's hind foot, an **extensor thrust**, such as occurs in the act of walking, is produced.

If, while this extensor thrust is being produced, the foot is pinched—*i.e.* if a harmful stimulus is applied, the extensor reflex is checked and is replaced by the flexor withdrawal reflex. As Sherrington puts it, *nocuous stimuli are prepotent*.

(1) In the example given, the harmful pinch caused the replacement of one reflex by another. But (2) occasionally the application of a second stimulus may simply cause the disappearance of the reflex in progress.

(3) A third effect may be produced. The second stimulus, if it is of a somewhat similar nature to the first, and in proximity to it, may cause a simple augmentation of the action.

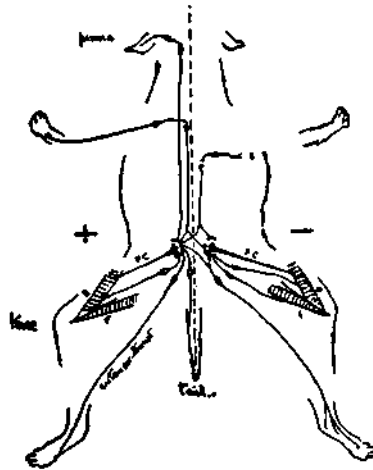

FIG. 36.—To show the play of different ingoing neurons upon a motor neuron *FC* to the vasto-crureus muscle *e* of dog in producing reflex action. Stimulation of the ear, tail, forefoot, and pressure on the pad of the hind foot of the same side, all cause excitation, as also do stimulation of the shoulder of the opposite side and nocuous stimuli of the opposite hind foot. On the other hand, stimulation of the shoulder of the same side, as in the scratch reflex and nocuous stimuli of the hind foot of the same side inhibit it. (SHERRINGTON.)

In both the flexor withdrawal and the extensor thrust the same muscles of the thigh are used—the extensors and flexors; but in flexor withdrawal the extensors are inhibited, while in the extensor thrust they are contracting. The nerve to the extensors, therefore, in the first action carries *checking* impulses, in the second *stimulating* impulses. It is the **common path** for both kinds of outgoing impulses.

The ingoing neurons from the body are about five times as numerous as the outgoing. Each set may be looked

upon as the *private path* of the special reflex it produces. In acting upon the muscles the special incoming impulse has to get command of the common outgoing path.

Fig. 36 shows how one set of outgoing neurons is played upon by a whole series of ingoing neurons from different parts of the body.

When any muscle is made to contract, its antagonist is inhibited or relaxed. This has been demonstrated by taking a simultaneous record from flexors and extensors.

Under the influence of strychnine the inhibitory effects

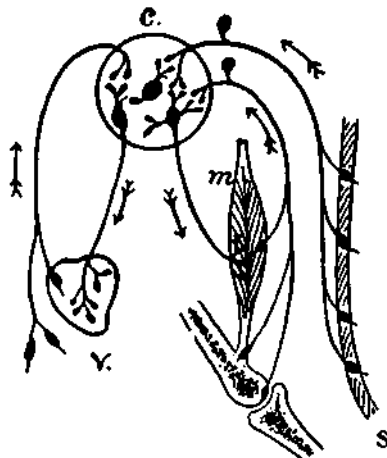

FIG. 37.—To show the way in which the different Reflex Arcs react on one another. *S.*, skin; *M.*, muscle; *V.*, viscus; *C.*, spinal cord with synapses. (M'DOUGALL.)

may be converted into excitor effects, and when this occurs havoc is played with the co-ordination of the reflex.

A study of the familiar "scratch reflex" which can often be produced by rubbing the shoulder of a normal dog, and which can much more inevitably be produced in the spinal animal, has demonstrated that, whatever be the character of the stimulus producing it, the scratching movements occur at a perfectly definite rate of four or five per second, and that the movements consist of a perfectly rhythmical alternation of contraction and relaxation of the flexor and extensor muscles by which the leg is first

drawn up, then extended, again drawn up, and so on. The cause of this is that the first movement of muscles and joints leads to the stimulation of nerves from the muscles and joints to the spinal cord (fig. 37), and it is these which bring about the reversal of action. This leads to a fresh set of impulses from the muscles and joints which re-establishes the first action. So the rhythm is maintained for a considerable time after the stimulus which started it has stopped.

These impulses from the muscles and joints do not always, as in the scratch reflex, bring about a reversal effect. In many cases they tend to keep up the position produced, and

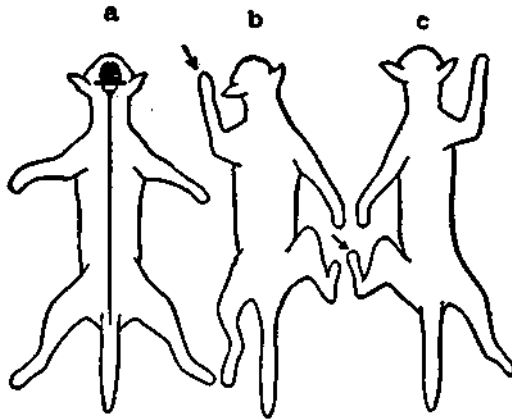

FIG. 38.—Reflex Figures struck in Decerebrate Cat on stimulating a fore and a hind paw. (SHERRINGTON.)

hence to fix a particular posture. This is best seen in animals which have had their cerebrum removed above the tectum (fig. 38).

Postural Reflexes.—By putting such an animal in certain postures, sustained reflex movements may be caused, or they may be inhibited.

Magnus has shown that, in decerebrate cats, the position of the head and the cervical vertebræ modifies the tonus of the muscles of the limbs, and so determines the position taken by the animal. If the head is bent forward, as when a cat looks under an object in pursuit of its prey, the tonus of the fore limbs decreases, that of the hind limbs increases,

and the cat sinks down on its forequarters. This is due, not merely to stimuli coming from the joints of the neck, but also to stimuli coming from the labyrinth of the internal ear (p. 121).

In ducks it has been found that by placing the head and neck in various positions—*e.g.* in that taken up in diving—a postural reflex inhibition of the movements of breathing is induced.

Fatigue of the Reflex Arc.—Nerve fibres do not manifest fatigue (p. 69), but reflex arcs readily do so, apparently through a change in the synapses. These synapses are also much more susceptible to the influence of poisons—*e.g.* deficiency of oxygen or the action of such drugs as chloroform—than are nerve fibres. As a reflex response decreases from fatigue it becomes more and more easily replaced by other reflexes. But a very brief cessation of the stimulus, and, still more, the brief substitution of another reflex, rapidly restores the activity of the action.

Visceral Reflexes.

Reflex actions in connection with various visceral muscles are also connected with the spinal cord. Many of these are complex reflexes involving inhibition of certain muscles and increased action of others, some visceral, some skeletal. The best marked of these are the reflex acts of micturition (p. 581), defæcation (p. 335), erection, and ejaculation (p. 623). The lumbar enlargement is the part of the cord involved.

As has been shown by the study of postural reflexes, the nervous arcs in the cord exercise a constant reflex tonic action, due to the constant inflow of incoming impressions. When this tonic action is interfered with by any condition which interferes with the integrity of the reflex arc, the response from the muscle may be diminished. This is exemplified in the contraction of the quadriceps extensor femoris which occurs when the ligamentum patellæ is struck sharply, causing a kick at the knee joint—the knee jerk

(fig. 39). When the reflex arc at the level of the 3rd and 4th lumbar nerves is interfered with, the knee jerk is diminished or is absent, and when the activity of the arc is increased, by the removal of the influence of the cerebrum, the jerk is increased. The fact that the latent period is very much shorter than that of most reflex actions has been used as an argument against the reaction being a true reflex. But the reflex arc is certainly necessary for its production, and, in spite of the short latent period, it may be regarded as a true reflex from the quadriceps extensor muscle involving

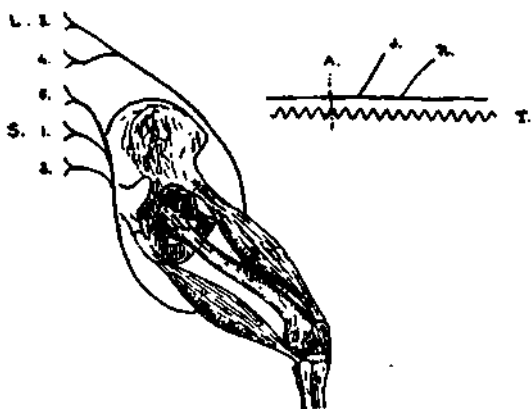

FIG. 39.—The Neuro-muscular Mechanism concerned in the Knee Jerk, and the time of the knee jerk (*A.J.*) compared with the time of a reflex action (*A.R.*).

only one or two synapses and set up by the sudden development of tension in the muscle which is being maintained in a state of tonus (fig. 39).

Tonus is most manifest in muscles concerned with the maintenance of posture, and it might be called a postural reflex response.

When, as the result of disease or injury, a part of the spinal cord has been severed from the brain, a marked increase in the spinal reflexes is manifest. This is particularly well seen when the downcoming fibres from the cerebrum are interrupted (p. 194). In this case the condition is similar to that of the decerebrated dog or cat,

and the tonic condition of the muscles is increased because the impulses from the vestibulo-cerebellar arc (p. 121), which increase the tonic action of the spinal arcs, are no longer held in check by impulses from the cerebrum.

When the cerebellar arc is thrown out of action one of the most marked features is a loss of muscular tone.

Trophic Influence of the Cord.

The spinal cord presides over the nutrition of the muscles, which are directly supplied by fibres coming from cells in the cord. When disease destroys the cells of the anterior horn, the muscles atrophy and degenerate.

Injury of the cells connected with the outgoing visceral fibres does not lead to the same atrophy and degeneration of the visceral muscles supplied. Apparently the post-ganglionic neurons survive degeneration of the pre-ganglionic fibres (p. 76), and are able to maintain the nutrition of the structures supplied. Even after the post-ganglionic fibres have degenerated, it is probable that the terminal nerve plexuses, which in the intestine at least act as local reflex centres, survive and are capable of presiding over the nutrition of the tissue.

Certain facts seem to indicate that the ingoing fibres with their cells in the ganglion upon the posterior root are connected with the nutrition of the structures from which they pass. Thus shingles—*herpes zoster*, an outbreak of vesicles along the distribution of a cutaneous nerve—has been found to be associated with inflammatory conditions of the ganglia (p. 93).

Relationship of Nerve Cells to Muscles.

The Nissl's degeneration (p. 77) of special groups of cells in the anterior horn of grey matter after amputation of the leg at different levels seems to indicate that the various groups of cells have definite connections with individual muscles (see fig. 40).

Peripheral Reflexes.

There is evidence that reflex action occurs in groups of neurons outside the spinal cord in connection with the viscera.

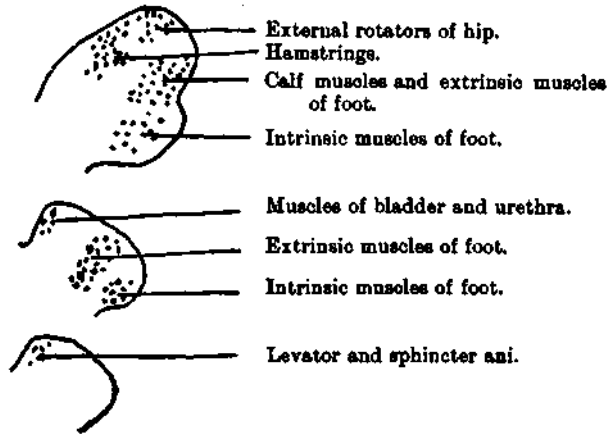

FIG. 40.—The Groups of Cells in the Anterior Horn of grey matter at the level of the 2nd, 3rd, and 4th sacral nerves, as determined by the degenerations which follow amputation. (From BRUCE.)

1. **The Myenteric Plexus.**—The terminal plexus in the wall of the alimentary canal acts reflexly to produce the characteristic movements by which the contents are churned up and driven down the gut (p. 332).

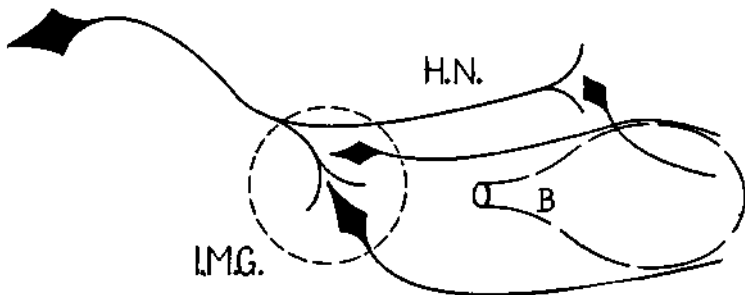

FIG. 41.—To show the possible Axon Reflex in connection with the bladder. I.M.G., the inferior mesenteric ganglion; H.N., the hypogastric nerve; B., the bladder.

2. **Bladder Reflex.**—In connection with some of the collateral ganglia apparent reflex action has been described. The bladder is supplied by the hypogastric nerves which come from the inferior mesenteric ganglion. The pre-ganglionic fibres to this are in the splanchnic nerves. When the splanchnics are stimulated the bladder contracts. But if they are cut above the ganglion, stimulation of the central end of one cut hypogastric will cause contraction of the bladder if the other hypogastric is intact (fig. 41).

Langley and Anderson argue that this is not a true reflex, but that it is due to the fact that a nerve will conduct in both directions, so that, if the hypogastric nerve is stimulated, an impulse is carried up in a fibre which

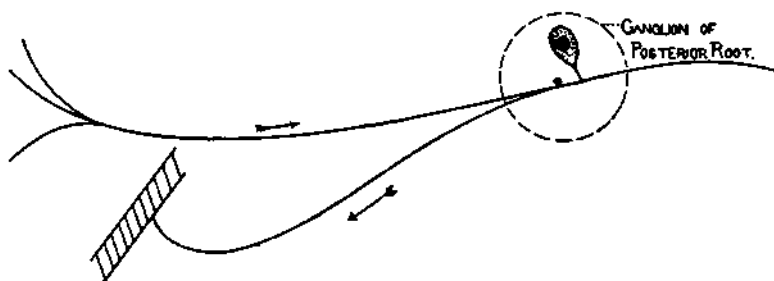

FIG. 42.—To show possible Axon Reflex in fibres of posterior root.

bifurcates in the ganglion, one branch passing through, one forming a synapse, and that, through the synapse, post-ganglionic fibres in the other nerve are set in action (fig. 41). They have called this an *axon reflex*.

It seems just as possible that true ingoing fibres give off side branches in the ganglion and produce the reflex.

The possibility of axon reflexes occurring in visceral nerves requires further investigation.

3. **Posterior Ganglion Reflex.**—Bayliss has found that stimulation of the peripheral end of the posterior root of a spinal nerve causes vaso-dilatation in the hind leg of the dog, and Bruce has shown that this may be reflexly excited by applying irritants to the skin, even if the posterior root is cut centrally to the ganglion. The conclusion has been drawn

that bifurcating fibres pass from the ganglion, one limb going to the skin, one limb to the blood-vessels, and that thus a reflex occurs in one axon without passing through a synapse (fig. 42). It is, however, not proved that synapses do not exist in the ganglion on the posterior root.

II. THE CEREBRAL AND CEREBELLAR ARCS.

IN reflex action involving the spinal arcs the ingoing fibres from the receptors in the skin and subjacent parts of the body when stimulated produce inevitable results varying only with the condition of the spinal neurons and synapses.

When the cerebral and cerebellar arcs are brought into play, the resulting actions are much more complex, and the possibility of differences in the resulting action is enormously increased.

The object of the development of these higher arcs is simply to secure a more appropriate response to external conditions, to enable the different external conditions acting through the various receptors (p. 52) not only to produce each its own special effect, but also to ensure that the effects may be brought together so that the resulting action may be determined by their combined effect.

In studying the action of these arcs it will be convenient to take the ingoing side first and the outgoing side later, and in the study of the cerebral arc to intercalate between these a consideration of the relationship of brain action to consciousness and to mental activity.

A. INGOING SIDE OF THE ARCS.

Special parts of the central nervous system are connected and associated with the peripheral structures, so that a definite reaction to each of the various kinds of stimuli may occur. These reactions may be accompanied by changes in consciousness—by *sensations*; and since the lower animals have not the power of communicating the character of these sensations by speech, the possibility of studying them is restricted.

If the special part of the nervous system with which any set of receptors is connected be destroyed or become disconnected from the receptors, stimulation will produce no effect. The condition is that of a telephone with the transmitter intact but with the receiver out of action.

The study of the physiology of the peripheral receptors must therefore be taken up along with that of those parts of the central nervous system with which they are connected.

These, when thrown into action through the receptors, may (1) produce certain inevitable reactions, as has been shown by the study of reflex action (p. 82), and these may or may not (2) be accompanied by changes in the consciousness known as sensations, which cannot be investigated in lower animals.

Receptor Arrangements.

The **Receptors** may conveniently be grouped in three classes.

1. Those connected with the viscera and stimulated by the activity of these organs—the **Interoceptive Receptors**.

2. Those connected with the surface and stimulated by changes in the surroundings—the **Exteroceptive Receptors**.

Some are acted upon by changes at the surface of the body, such as the contact of gross matter, others by changes originating at a distance, *e.g.* light waves. The former may be called *non-distance receptors*—the latter *distance receptors*.

3. A set of receptors called into play by movements of the body, *i.e.* by the action of the body itself, and hence called **Proprioceptive Receptors**.

We have already seen that each special effect is brought about by the development of special receptors, each responding chiefly to one kind of external change (p. 52).

It is not the case that each reacts to one kind of change only, but rather that it reacts specially to one kind, that it is tuned to one kind and responds much less readily to all others. As Sherrington puts it, it has a "low threshold" for one kind of stimulus, a "high threshold" for all others. Thus, the eye is generally stimulated by the ethereal vibra-

tion of light, but it may be stimulated by sudden pressure or by electrical changes.

In whatever way any special variety of receptor is stimulated, the sensation which results is of the same kind. Thus the retina of the eye may be stimulated by ethereal vibrations of light, or by mechanical pressure, or by an electric current, but however stimulated, a sensation which we call visual is produced. This fact was formulated by Johannes Müller as the doctrine of Specific Nerve Energy. The converse holds good that the same kind of stimulus applied to different kinds of receptors produces different kinds of sensation.

The sets of Receptors developed in the body wall and viscera may first be considered. They may be called the **Body Receptors**.

I. BODY RECEPTOR MECHANISMS.

A. General Arrangement and Physiology.

I. Visceral (Intero-ceptive).

A. Structure.—Throughout the internal organs are various peripheral terminations of ingoing nerves, some of the nature of simple dendritic expansions, some of dendritic expansions enclosed in definite fibrous capsules (Pacinian corpuscles).

B. Physiology.—These are called into action by different kinds of stimulation, nocuous and innocuous, to produce reflex adjustments of the bodily mechanism either without or with the involvement of consciousness—that is, either without or with the production of sensation.

(a) **Central Reflex Adjustment.**—When food is taken into the stomach, it stimulates the ends of the afferent nerves, and these carry the impulse up to the central nervous system to produce a reflex dilatation of the gastric blood-vessels.

(b) **Peripheral Reflex Adjustment.**—Many of these visceral reflexes occur apart from the central nervous system in peripheral plexuses (p. 92). This is specially well seen in

the wall of the alimentary canal where the co-ordinated reflex of peristalsis (p. 333), involving co-ordinated contraction behind the contents of the gut and inhibition in front of the contraction, is dominated by the myenteric plexus. The peripheral mechanism is controlled by impulses from the central nervous system passing by excitor and by inhibitory nerves which are reflexly called into play when any modification of the ordinary peristalsis is required. The importance of the local mechanism is indicated by the small number of nerve fibres which pass to the spinal cord from the viscera.

When the visceral receptors are abnormally stimulated, abnormal reflex responses may result. Thus, when the stomach and certain other parts of the visceral tract are irritated, the act of vomiting may be produced.

Normally the visceral reflexes, peripheral and central, are carried out without consciousness being involved. But, in abnormal conditions, consciousness may be implicated and sensations may be produced which direct the attention to the condition of the viscera. This is sometimes called **common sensibility**.

In the stomach and intestine these sensations are generally the result of stretching of the muscular coats. This may lead to a feeling of distension or to actual pain. Later, the existence of a separate set of pain receptors and pain nerves in the skin will be considered. In the viscera there is no evidence of their existence, and the unpleasant sensation characterised as painful must be considered as due to overstimulation of nerves which, when normally stimulated, give rise to no sensation. But there is evidence that abnormal stimulation of visceral nerves may give rise to pain, which is referred by the sufferer to the distribution of the corresponding somatic nerve, such referred pain is seen in heart disease (p. 423). The stomach and intestines seem to be destitute of receptors capable of stimulation by touching, pricking, or by changes of temperature. Hence, after the abdominal wall is divided, abdominal operations may frequently be performed without a general anæsthetic.

The gullet and anal canal are provided with more

specialised receptors, resembling in some respects those of the skin.

The sensation of *hunger* is associated with rhythmic periodic contraction of the empty stomach, and it also is due to stimulation of the ingoing nerves in the muscular wall of the viscus.

The sensation of *thirst*, although it is due to deficient water throughout the body generally, is experienced in the mouth and throat, which are not moistened by the free secretion of saliva. In these regions alone does the deficiency of water stimulate any receptive mechanism.

The outside of the body is richly supplied with a variety of receptors, each one of which has a low threshold of stimulation for one particular kind of stimulus and a very high threshold for all other kinds.

Those developed in connection with the skin are generally stimulated by changes in the immediate vicinity, while those developed in the head, such as the eye, ear, and olfactory receptors, are stimulated by changes at a distance, thus warning the animal of conditions it is approaching.

II. Cutaneous.

A. Structure.—The cutaneous receptors are of three kinds :—

1. Dendritic terminations of nerves between the cells of the deep layer of epidermis.

2. Tactile corpuscles, consisting of a naked branching varicose dendrites enclosed in a fibrous capsule (fig. 43).

3. A plexus-like arrangement of the dendrites of nerve fibres round the roots of the hairs.

B. Physiology.—When the sole of the foot is stroked, the leg is involuntarily, *i.e.* reflexly, drawn up. If the skin of the foot is subjected to a high temperature, it is withdrawn. These are examples of simple responses to stimulation of the receptors in the skin, and these responses are frequently accompanied by sensations of a definite kind.

Much of our knowledge of the mode of action of these cutaneous mechanisms has been gained by a study of the relation of the changes of consciousness to the nature of the stimuli producing them.

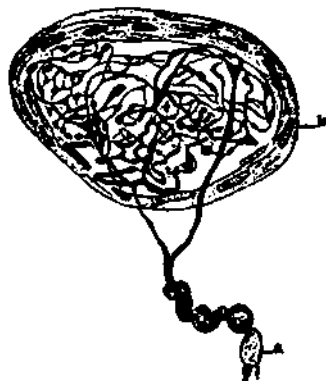

FIG. 43.—Simple form of sensory nerve termination. In the tactile corpuscle the nerve fibre coils round the capsule before entering. (DOGIEL.)

In studying reflex action it has been seen that the stimuli acting upon the skin may be divided into harmful, or nocuous, and non-harmful, and that these tend to produce different reactions and are accompanied by different kinds of sensation—the former characterised as unpleasant or painful; the latter by other characters, such as contact, warmth, or cold.

The mechanisms for the reception and transmission of nocuous or painful stimuli and of ordinary cutaneous stimuli seem to be independent.

1. Reaction to Nocuous Stimuli—Pain.

By exploring the surface of any small area of skin with the point of a very sharp needle it will be found that pricking certain parts gives rise to a more painful sensation than pricking other parts. The first may be called **pain spots**. By gentle pressure by a bristle with a rounded end other spots may be discovered, which, when touched, give a sensation of contact. These are the **touch spots**. Pieces of skin cut out from the pain spots show no special nerve endings, but pieces cut out from the touch spots show the presence of a tactile corpuscle in a papilla under the epidermis.

It must be recognised that the mechanism of the pain spots has been developed to lead to appropriate responses to nocuous stimuli, and that the implication of consciousness is secondary.

In fact pain is purely a relative term, and conditions which in one animal will cause pain will not cause it in another, while stimuli which will produce what are called painful sensations when the nervous system is debilitated may give rise to sensations not considered as painful when the nervous system is normal.

All pain, since it means a change in consciousness, is metaphysical. There is no such thing as "physical pain." The fatigue and the other sequences to any kind of pain are frequently cited as proofs of the influence of the mind on the body. But we have no right to assume that they are caused by the "pain" rather than by the physical disturbances in the nervous system of which the pain is an accompaniment.

Separate nerve fibres appear to carry pain-producing impulses up the spinal cord, and in some diseases the sense of touch may be lost without loss of the sense of pain, and *vice versa* (p. 112).

2. Reactions to Contact.

The Tactile Sense.

The tactile sense may best be studied under three heads:—

1. **The Power of Distinguishing Differences of Pressure.**—Variations of pressure in time and space are alone distinguished. We live under an atmospheric pressure of 760 mm. of mercury, but this gives rise to no sensation. Any *sudden* increase or diminution of pressure, however, leads to a marked change of sensation, but a slow change causes a lesser modification of consciousness. When a finger is immersed in mercury, the sensation of pressure is felt as a ring at the surface of the mercury, where the greater pressure of the mercury joins the lesser pressure of the air (*Practical Physiology*).

The acuteness of the pressure sense varies in different parts of the body, being greatest where the nerve terminations are most abundant, as in the lips of the horse.

The acuteness of the sense is influenced by the condition

of the mechanism, peripheral or central. (a) *Peripheral*—When the skin is cold, the sense is much less acute than when it is warm. (b) *Central*—The nerve centres are readily fatigued, and the power of appreciating sensation is thus decreased.

2. **The Power of Localising the Place of Contact.**—Where the tactile organs are abundant, the power of distinguishing

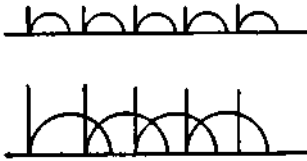

FIG. 44.—Relationship of Sensation to Stimulus, with weak and strong stimuli. Stimuli represented by vertical lines—the strength being indicated by their height. Sensations represented by the curves.

accurately the point touched is more acute than in places where they are more scattered. For this reason, if two contacts are made at the same time, they may be very close together in the former situation, e.g. the lips, and each of them may be localised and felt as distinct from the other, whereas in the latter situation they may be felt as a single contact.

3. **The Power of Distinguishing Contacts in Time.**—If the finger be brought against a toothed wheel rotated slowly, the contacts of the individual teeth will be felt separately. But, if the wheel is made to rotate more and more rapidly, the separate sensations are no longer felt, and a continuous sense of contact is experienced (*Practical Physiology*). This indicates that, if stimuli follow one another sufficiently rapidly, the sensations produced are fused. From this it is obvious that the sensation lasts longer than the stimulus—the contact (fig. 44).

The duration of the sensation depends upon the degree of stimulation of the peripheral tactile organs.

Probably two sets of **receptors** are involved in the tactile sense.

1st. The **tactile corpuscles**, which are stimulated by direct pressure on the surface of the skin. It is these which form the centres of the touch spots already mentioned. They are best investigated by von Frey's bristles—bristles of varying thickness fixed in suitable handles and with the pressure required to bend them determined by pressing on a spring balance.

2nd. The plexuses round the roots of hairs, and possibly in the epidermis, which are stimulated when a small piece of soft cotton-wool is drawn over the skin. This might be called the *kinetic* stimulation of the tactile mechanism, and the other the *static* stimulation.

3. Reactions to Changes of Temperature.

Thermal Sense.

Heat, like light, is physically a form of vibration of the ether.

1. The temperature sense depends upon the fact, that when heat is withdrawn from the body, a sensation of *coolness* or *cold*, and, when heat is added to the body, a sensation of *warmth* or *heat* is produced. This depends upon the temperature of the body in relation to the surroundings, and not merely on the temperature of the surroundings. If three basins of water are taken, one very hot, one very cold, and one of medium temperature, and if a hand be placed, one in the very hot and one in the very cold water for a short time, and then transferred to the basin with water at a medium temperature, the water will feel hot to the hand that has been in the cold water and cold to the hand that has been in the hot water (*Practical Physiology*).

2. The rate at which heat is abstracted or added is the governing factor in causing the sensation; a sudden change of temperature stimulates far more powerfully than a slow change. For this reason the **thermal conductivity** of substances in contact with the skin has an influence upon the sensation. If a piece of iron and a piece of flannel laid side by side be touched, the first will feel cold, the second will not. This is because the former has high thermal conductivity, the latter has not, and thus the former abstracts heat more rapidly than the latter. When the skin of a horse is covered by sweat, heat is rapidly abstracted and shivering may be produced (p. 267).

3. Certain parts of the skin are stimulated by the withdrawal of heat, and their stimulation is accompanied by sensations of cold, while others are stimulated by the addition

of heat and give rise to a sense of warmth. This may be demonstrated by taking the cold point of a pencil and passing it over the back of the hand, when it will be felt as cold only at certain points; such points have been called *cold spots*, while similar spots, stimulated by the addition of heat, are called *hot spots*. Such cold and hot spots have been excised and examined microscopically, but no special receptor mechanisms have been found. In all probability, special developments of the intercellular plexus in the epidermis form the receptors (*Practical Physiology*).

4. The temperature sense is independent of the tactile sense, and the changes set up travel in separate fibres in the cord (p. 112). The one sense may be lost and the other retained.

4. Special Cutaneous Receptors.

In certain regions of the skin special receptor organs exist, stimulation of which excites reflexes in connection with the sexual and other special functions. In the anal canal tactile and thermal receptors exist, but distension gives rise to a special sensation—the desire to defæcate.

Von Frey's observations on man indicate that in the skin there are at least four receptor mechanisms, stimulated separately by pain, by touch, by the withdrawal of heat, and by the addition of heat. He finds that certain parts of the surface do not respond to all three kinds of stimuli, but only to one or two. Thus, pain alone can be produced from the cornea, tooth pulp and dentine, and the parietal pleura; pain and temperature sensations, but not sense of touch, from the edge of the cornea and conjunctiva; and touch and temperature sensations alone from certain patches inside the mouth.

When a severed nerve begins to unite and regenerate (p. 77), an imperfect return of all these types of sensation occurs, but only after complete regeneration are the senses completely restored.

In addition to the interoceptive and exteroceptive receptors of the body, other receptors are found throughout

the muscles, tendons, and joints which are stimulated by movements generally originated by stimuli from without, and which we have already seen (p. 88), may have an important influence on the course of the movements produced. These are one kind of the group of receptors which Sherrington has called **Proprioceptors**. They might be called the muscle-joint receptors.

III. Muscle and Joint (Proprioceptive).

A double mechanism is involved—1st. A mechanism stimulated by the contraction of the muscles; and 2nd, a mechanism acted on by movements at the joints.

A. **Structure**—(1st) *Muscle Spindles*.—Among the fibres of the muscles are found long fusiform structures containing modified muscle fibres. Into each spindle a medullated nerve passes and breaks up into a non-medullated plexus round these fibres (fig. 45). That these nerves are ingoing and not ordinary motor fibres is shown by the fact that they do not degenerate when the anterior root of a spinal nerve which carries the motor fibres is cut, but that they do degenerate when the posterior root is cut outside the ganglion.

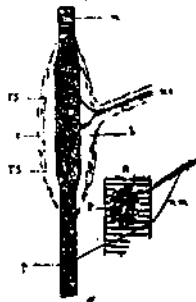

FIG. 45. — Structure of muscle spindle—only one fibre represented. *b*, capsular space; *c*, capsule; *p*, motor termination; *T.S.*, sensory termination on the spindle fibre. (From REGAUD AND FAYRE.)

(2nd) *Organs of Golgi* are small fibrous capsules in the tendons near the muscle fibres, and into each a medullated fibre enters, and, losing its white sheath, forms a plexus of fibrils with varicosities upon them.

(3rd) Varicose terminations of axons surrounded by fibrous tissues are found in the synovial membranes and round joints.

B. **Physiology**.—Through these mechanisms information is transmitted to the central nervous system as to the position and movements of the various parts, and this is of the utmost importance in modifying and **guiding the movements** without consciousness being necessarily implicated (p. 83).

When the consciousness is affected, valuable information as to the conditions of the surroundings may be afforded by this sense in conjunction with the sense of touch. In estimating the weight of bodies, these sensations are much used. The body to be weighed is taken in the hand, and by determining the amount of muscular contraction required to support or raise it, the weight is judged. The shape and size of objects are also determined by this sense in conjunction with the sense of touch. In the dark, the distance of objects is also judged by estimating the extent of movement of the limb necessary to touch them.

The sensibility to deep pressure which exists after section of the cutaneous nerves must be due to a stimulation of these receptors.

B. Connection of Body Receptors with the Central Nervous System.

1. Ingoing Nerves.

The ingoing nerves from these various receptors pass towards the spinal cord in regular segmental series (fig. 46),

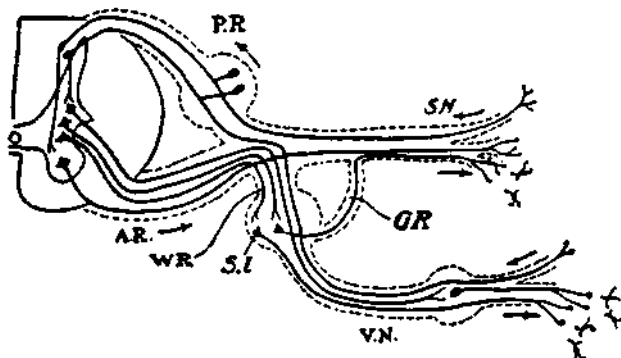

FIG. 46.—Structure of a Typical Spinal Nerve. *P.R.*, posterior root with ganglion; *A.R.*, anterior root; *S.I.*, ganglion of sympathetic chain; *W.R.*, its white ramus; *G.R.*, its grey ramus; *V.N.*, visceral nerve with collateral ganglion ending in terminal plexus; *S.N.*, somatic nerve.

except where the symmetry is interrupted by the outgrowth of a limb. There the segmental arrangement is disturbed into a pre-axial and post-axial arrangement.

The fibres enter the spinal cord by the **posterior roots** of the spinal nerves (fig. 46).

(i.) *Section* of a series of posterior roots leads (a) to loss of sensation in the structures from which the fibres come, and (b) to a loss of muscular co-ordination, as a result of cutting off the afferent impulses connected with the muscle-joint mechanism (p. 105), and (c) to loss of tone in these muscles.

As a result of this section, the parts of the fibres cut off from the cells of the ganglia on the posterior root die and degenerate (p. 76). Therefore, if the root is cut between the ganglion and the cord, the degeneration extends inwards and up the posterior columns of the cord, and, if it is cut outside the ganglion, the degeneration passes outwards to the periphery.

Stimulation (a) of the central end may cause reflex movements and pain; (b) of the peripheral end may, in certain situations, cause dilatation of blood-vessels (p. 93).

(ii.) *Section* of the anterior root causes paralysis of the muscles and other structures supplied by the outgoing fibres, and the fibres die and degenerate (p. 76).

Stimulation of the peripheral part causes contraction of the muscles supplied.

2. Course of the upgoing Fibres in the Spinal Cord.

In the spinal cord the course of the upgoing fibres has been traced by experiment, by clinical observation, and by pathological investigation, chiefly in man and in the ape.

(1) **Section of Posterior Roots.**—As already pointed out, when the posterior roots are cut reflex action is abolished and all sensation in the part of the body supplied by the nerve likewise disappears.

(2) **Section of Spinal Cord.**—If the spinal cord is cut across, after a certain period of spinal shock, reflex action occurs and may be increased, but all sensation is absent below the level of the section.

It must therefore be concluded (1) that these ingoing nerves act upon the effector mechanism in the cord by

which reflex action is produced (p. 82); (2) that other parts of the ingoing nerves run up the spinal cord to act upon some part of the brain the activity of which is related to those changes in consciousness which we call sensations.

(3) **Hemisection of Spinal Cord.**—If only one half of the spinal cord is cut across all sensation of changes of temperature, and all sensation of pain are lost on the opposite side below the level of section, but tactile sense is partially lost for some distance below on the same side, and further down on the opposite side. The proprioceptive sensations are lost on the same side.

The fibres connected with pain and with heat and cold

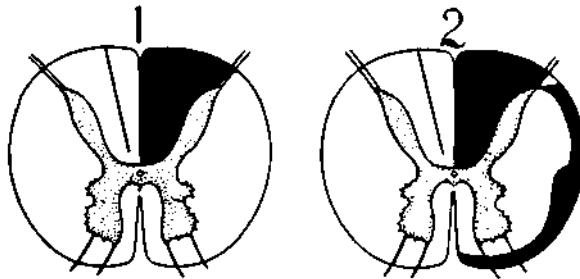

FIG. 47.—To show the Ascending Degeneration in the Spinal Cord. 1, after section of the posterior roots. 2, after hemisection of the cord.

receptors must cross the middle line at once and run up the opposite side of the cord, while those connected with touch must run for some distance, probably in part, right up the same side of the cord. Those connected with the muscle-joint sense must run up the same side of the cord. (For outgoing fibres see p. 195.)

(4) **Ascending Degenerations of Cord.**—Taking advantage of the fact that nerve fibres when separated from their cells die and degenerate (p. 76), light has been thrown upon the course of these fibres in man and apes by studying the degeneration which follows:—

1. Section of a series of posterior roots inside the ganglia.
2. Section of one half of the cord.

It must be remembered that the nerve fibres of the spinal cord do not regenerate, since they have no neurolemmal sheath.

Fig. 47 shows where the degenerated fibres are found in each case.

1. Section of the posterior roots leads to degeneration extending up in the posterior columns.

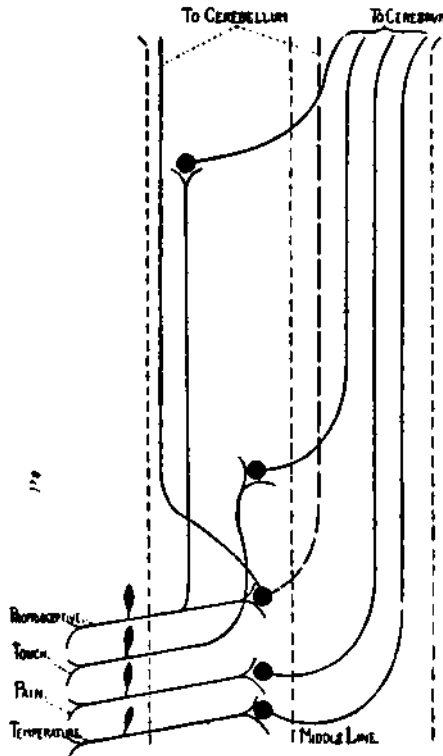

FIG. 48.—To show Redistribution of Impulses in the Cord and the general course of impulses of different kinds.

2. Section of the cord leads to this, and, in addition, to a zone of degeneration round the lateral and anterior columns.

The conclusions to be drawn are—(1) that the fibres of the posterior columns are a direct continuation of the

posterior root fibres which have their cells in the ganglion upon the posterior root.

(2) That the fibres which degenerate only after section of the cord must have their cells *in* the cord itself, *i.e.* that the incoming fibres of the posterior roots have formed synapses with fresh neurons (fig. 48).

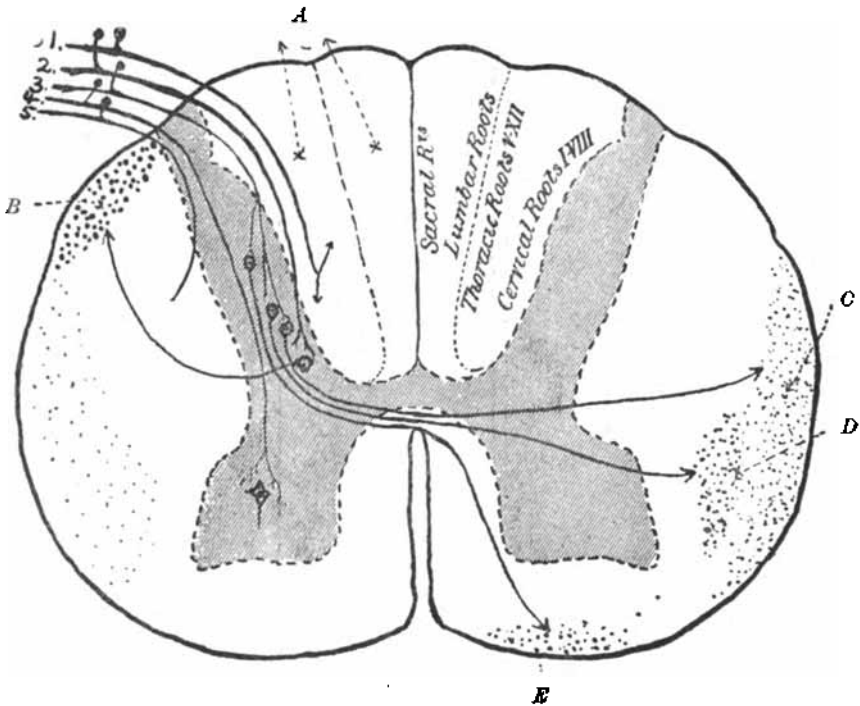

FIG. 49.—To show Redistribution of Impulses in the Cord. 1 to 5, incoming fibres of posterior root; A, tract of kinæsthetic sense and touch for some distance before crossing; B, tract of unconscious impulses for muscular co-ordination and tone; C, same as B, but on opposite side; D, tract of impulses of pain, heat and cold; E, tract of impulses of touch and pressure. (PAGE MAY.)

The degenerated fibres may be traced across the anterior white commissure to the opposite side of the cord from cells situated in the posterior horn of grey matter.

The ingoing fibres thus enter the cord, some pass straight up the posterior columns, some enter the grey matter to form synapses with fresh neurons (fig. 49) from which fibres pass up on the lateral and anterior aspects of the cord.

By tracing these degenerated fibres upwards, it is found that they end as follows:—

(a) **Fibres of the Posterior Columns.**—These end in the nuclei of the postero-internal and postero-external columns in the lower part of the medulla oblongata, where they form synapses with fresh neurons. From these nuclei (1) fibres cross to the opposite side and run up in the fillet through the medulla, through the pons Varolii, through the mesial fillet, till they reach (a) the tectum, where they form synapses; (b) the thalamus opticus, where synapses are also formed; (2) fibres pass to the cerebellum of the opposite side.

(b) **Fibres in the Lateral and Anterior Columns.**—These pass up till the medulla is reached, and here they separate into two distinct sets.

i. **Those going to the Cerebellum.**—These are the more marginal set of fibres in the cord.

(a) Those on the postero-lateral aspect enter the cerebellum by its inferior peduncle.

(b) Those on the more anterior aspect enter by the superior peduncle (p. 127).

ii. **Those going to the Tectum and Cerebrum.**—These pass up with the mesial fillet, and (a) on reaching the tectum some form synapses there, (b) some run on and end in the thalamus opticus, where they form synapses (fig. 50, p. 113).

(5) **Pathological conditions and injuries of the cord in man** show that, when the lesion is towards the anterior margin, tactile sensations are abolished, and if it is more in the anterior part of the lateral column painful and thermal sensations are lost. In gunshot injuries to the cord the anterior part is more apt to escape, so that the sensations of touch may persist while painful and thermal sensations are lost. The sense

of tickling is lost, not with tactile sense, but with the sense of pain.

The upgoing fibres in the lateral columns may thus be sorted out into five sets as is shown in fig. 49.

They may be called—

1. The direct cerebellar tract, *B*.
2. The anterior cerebellar tract, *C*.
3. The lateral spino-thalamic, *D*.
4. The spino-tectal.
5. The anterior spino-thalamic, *E*.

Injury to the posterior columns causes a marked loss of the muscle-joint sense and of tactile sense for some distance below the lesion.

The fibres from each of the several kinds of receptors in the body which run side by side in the nerves are thus sorted out physiologically in the spinal cord by passing through synapses—(1) Those from pain receptors being sent up a definite tract in the lateral column (fig. 49). (2) Those from temperature receptors passing along with the last. (3) Those from tactile receptors passing up the posterior columns for a considerable distance before forming synapses and after crossing the middle line (fig. 48) being grouped at the anterior margin of the cord. (4) Those from the proprioceptive receptors of muscles and joints (*a*) passing up the posterior columns to the top of the cord before forming synapses from which fibres lead up the brain-stem and finally to the cortex cerebri; (*b*) forming synapses in the grey matter of the cord in Clark's vesicular column, from which fibres run up in the two cerebellar tracts to the cerebellum (p. 127).

3. Connections with the Brain-Stem and Cerebrum.

These various fibres from the synapses in or above the cord which pass up the brain-stem end by synapses—

A, in the *tectum* (*T*, fig. 58).

B, in the *thalamus* (*Th*, fig. 58).

while from the thalamus fresh fibres pass on to the *cortex* to end in the area situated round the central fissure.

Each of these—tectum, thalamus, and cortex—is a shunting station, from which impulses are sent down the cord to act upon the spinal reflex arcs.

1. **Spino-tectal Synapses.**—In the tectum these incoming impulses from the body are associated with incoming impulses from the eye and ear (fig. 50, C.Q.).

If the brain-stem be cut above the tectum, as it is in the

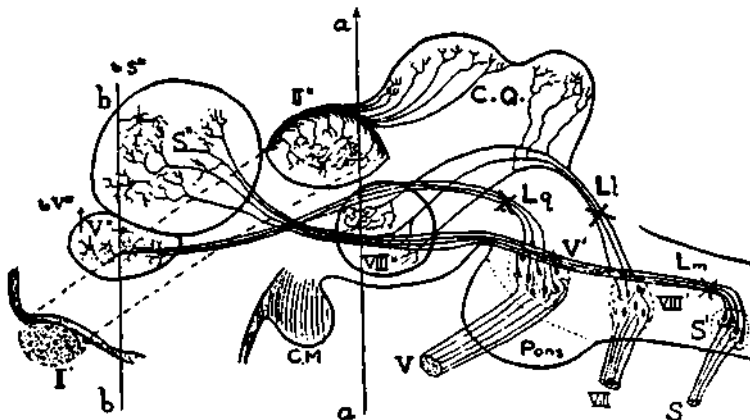

FIG. 50.—To show the endings in the thalamus of the ingoing fibres from all the receptor mechanisms. *S.*, ingoing fibres from the body generally; *VIII.*, ingoing fibres from the cochlea; *V.*, ingoing fibres of the fifth cranial nerve; *II.*, ingoing fibres of the optic nerve; *C.Q.*, tectum. (ELLIOT SMITH.)

process of decerebration, the tectal synapses and the cerebellar connections are left intact.

The action of these, uncontrolled by the upper cerebral synapses, is to set up an extensor tone of the muscles known as **decerebration rigidity**. In man the disconnection of the cerebral cortex from the cord by the interruption of the pyramidal tracts brings about this condition with a characteristic increase in the spinal reflexes (p. 82).

2. **Spino-thalamic Synapses.**—It was from the thalamus

and other basal ganglia that the cortex cerebri originally developed, and in lower vertebrates the separation is incomplete except as regards the rhinencephalon, which originally developed independently as the centre for the olfactory organs (p. 133); (fig. 50, V., S., VIII.).

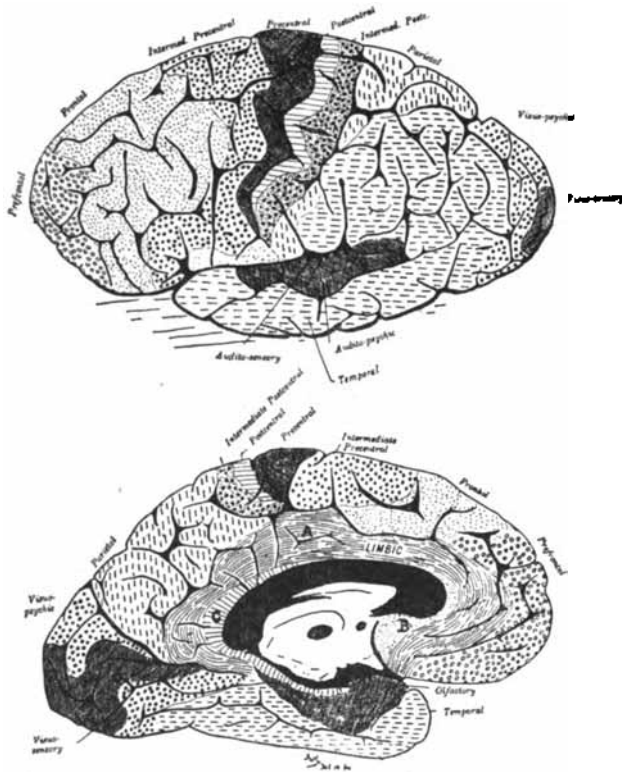

FIG. 51.—To show the mapping out of the Cerebral Cortex in man on its outer and inner aspects into areas by the character and distribution of the cells, and fibres to show the convolution round the central fissure connected with the reception of stimuli from the body-receptors. (CAMPBELL.)

In the thalamus the ingoing fibres from the body receptors are brought into close association with those from the distance receptors of the head, the eye, and the ear, and in this region there is some evidence in man that

stimulation may be associated with crude modification of consciousness.

As will be seen later there is good evidence that stimulation of the thalamus may lead to muscular movements without implication of the cortex through the corpus striatum and red nucleus (p. 189).

3. **Synapses in the Cortex Cerebri.**—From the nuclei of the thalamus fibres, which early get their white sheath, extend

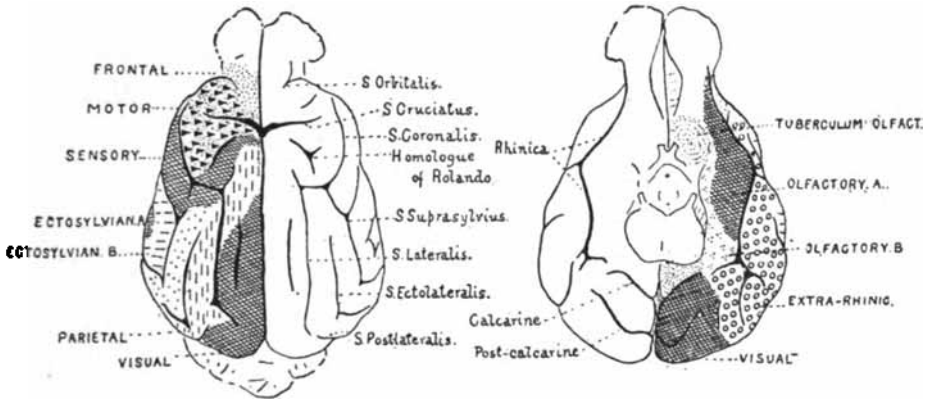

FIG. 52.—Superior and inferior aspects of the brain of the dog to show the various sulci and the distribution of the chief receiving and reacting mechanisms.

outwards to that part of the cortex cerebri which lies round the central fissure (figs. 50 and 53). That this part of the cortex is closely associated with the changes in consciousness has been proved both by studying the effects of (a) stimulation, and of (b) removal, and (c) by careful observation of the symptoms following disease or injury.

Mott found that, when the cortex round the central fissure on one side of the brain of a monkey is removed, clips may be attached to the skin on the opposite side of the body without attracting attention, while if they are placed on the same side they are at once removed. He therefore regards this region of the brain as connected with the reception of tactile impressions.

These conclusions have been supported and amplified by experimental observations during operations on the human brain.

Harvey Cushing has described a case in which, for relief of epileptic attacks beginning in the right hand, the brain was exposed and stimulated. When certain parts of the post-central convolution were stimulated, sensations, not painful in character, were experienced in the right hand, with also a vague sensation of warmth.

Horsley has described a case in which, for severe spasmodic contraction of the hand and arm, he removed a considerable part of the pre-central convolution from the brain of a boy. This was followed by temporary loss of tactile

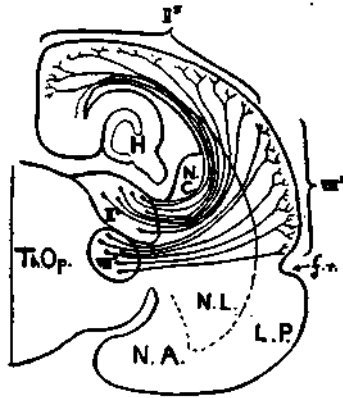

FIG. 53.—The passage of fibres from the nuclei of the thalamus to the cortex cerebri of a primitive mammal. *Th.Op.*, thalamus; *L.P.*, lobus pyriformis; *f.r.*, fissura rhinica; *VIII*, auditory area; *II*, visual area; *H.*, hippocampus. (ELLIOT SMITH.)

and thermal sensibility and of knowledge of the position of the limb of the opposite side—*stereognostic sense* (p. 106).

The evidence thus seems conclusive that the area of the cortex round the central fissure is receptive for what may be called the various bodily sensations of touch, temperature, and muscle-joint sense. But, so far, no indication that it is connected with painful sensations is forthcoming.

Very probably, as is indicated by the observations of Cushing, in man and in apes the post-central is

mainly receiving, just as we shall afterwards find the pre-central is mainly discharging. The arrangement and character of the cells in these two regions are distinctly different.

This area must be a sort of chart of the opposite side of the body in which each part is represented.

4. Connections with the Cerebellum.

The ingoing fibres from the muscles and joints have been seen to play an important part in guiding ordinary spinal reflex action.

It has also been shown that by their connection with the cerebral cortex consciousness is implicated and special sensations produced (p. 115).

Through their connection with the superior vermis of the cerebellum they become associated with incoming impressions from the skin and from special receptor mechanism in the head, through the action of which the position and movements of the head in space bring about adjustments of the balance of the body.

The eyes play a certain part in such adjustments, but the special mechanism developed is the labyrinth of the internal ear for which the cerebellum has developed as the great receiving and reacting centre. The mechanism may be studied as the labyrintho-cerebellar mechanism.

Labyrintho-Cerebellar Mechanism.

I. Labyrinth.

1. Structure.

In the petrous part of each temporal body there is a somewhat complex space, the bony labyrinth, consisting of three separate parts. (1) The vestibule; (2) the cochlea connected with hearing which will be considered later; and (3) three semi-circular canals opening from the superior and posterior aspect of the vestibule (see p. 170) of the internal ear. One lies in the horizontal plane and has a

swelling or ampulla anteriorly. The other two lie in vertical planes each placed diagonally to the mesial plane of the body as

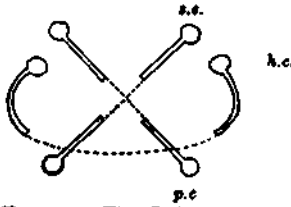

FIG. 54.—The Relationship of the Semicircular Canals to one another. *h.c.*, horizontal canal; *s.c.*, superior canal; *p.c.*, posterior canal.

indicated in fig. 54. The superior of these has a swelling or ampulla in front; the posterior has an ampulla behind.

The horizontal canals may be considered as forming the arc of a circle with an ampulla at each end. The superior canal of one side has its ampulla in front, while its twin—the posterior of the opposite side—has its ampulla behind, and they together form

the arc of a circle with an ampulla at each end (fig. 54).

The bony labyrinth contains a clear lymph-like fluid, and in this a *membranous labyrinth* lies.

(a) In the vestibule are two small vesicles, the *saccul*e and *utricle*, connected by a narrow duct.

(b) From the latter of these the *membranous semicircular canals* run into the bony canals. Each of them has an ampulla which almost completely fills the bony ampulla in which it lies, while the part lying in the bony canal is very narrow and occupies only a small part of the lumen (fig. 55).



FIG. 55.—Bony and membranous canal and ampulla to illustrate their mode of action.

On the convex aspect of each ampulla is a thickened ridge covered with columnar cells with stiff hair-like processes, and among these cells the dendritic terminations of the vestibular nerves run. Similar patches exist on the inner aspects of the utricle and of the saccul. A somewhat viscous endolymph fills the membranous labyrinth, and in it over these swellings lie small concretions of carbonate of lime—the *otoliths*.

2. Connections with the Central Nervous System.

The fibres of the vestibular root take origin in dendrites between the cells of the maculæ in the ampullæ of the semicircular canals and of the saccule, and have their nerve cells upon their course (fig. 56).

They enter the medulla ventrally to the auditory nerve, along with which they are described as the eighth cranial nerve.

They have wide and important central connections which may be divided into four arcs:—

(1) **Labyrintho-Spinal Arc.**—As the fibres enter the medulla they divide and run upwards and downwards. Those passing down form synapses with the higher spinal arcs which take part in spinal reflex actions. From the upward and down-going branches, collaterals enter the nucleus of Deiters lying in the side of the pons Varolii and there form synapses. From these fresh neurons send fibres down the cord on the same side and on the opposite side to act upon the spinal arcs.

(2) **Labyrintho-Oculo-Motor Arc.**—This is essentially a part of the spinal arc, but it is so important that it may be dealt with separately. The ingoing fibres form synapses in Deiters' nucleus, from which fibres pass to act upon the oculo-motor nuclei, and thus to influence the movements of the muscles of the eyes (p. 161).

(3) **Labyrintho-Cerebellar Arc.**—Some of the upgoing fibres pass to the deep nuclei of the cerebellum, from which fibres pass down the spinal cord to act upon the spinal reflex arcs.

(4) **Labyrintho-Cerebral Arc.**—Other upgoing fibres pass to the cerebrum forming synapses in the optic thalamus, from which fibres pass on to the cortex. From this, fibres extend down the cord to act upon the spinal reflex arcs and upon the oculo-motor mechanism.

3. *Physiology.*

A. *Labyrintho-Spinal and Cerebellar Arcs.*—This mechanism acts in two ways:—

- 1st. As a great tonic dominator of the muscular system.
- 2nd. As a great proprioceptive reflex adjuster of movements.

B. *Labyrintho-Cerebral Arc.*—This acts by modifying consciousness.

A. *Labyrintho-Spinal-Cerebellar.*—1. **Tonic Action.**—One effect of removal of the labyrinth on one side is to cause a loss of tone in the muscles of the same side. If the labyrinths on both sides are removed, a general loss of tone occurs. The result of this is that a very small force is capable of preventing the muscles from adjusting the position of the head. In a pigeon deprived of its labyrinths, if a small weight is attached to the head and the head is bent over the back, it remains in this abnormal position. It is the cerebellar arc which is involved in the maintenance of tonus, and after removal of the deep nuclei of the cerebellum and the paracerebellar nuclei the tonus is lost. The cerebellar arc acts upon the spinal arcs (*a*) through its connections with the red nucleus (p. 127), under the tectum; (*b*) probably directly through descending fibres of the vestibulo-spinal tract. If the spinal arcs are interfered with by section of a series of posterior roots, the influence of the labyrintho-cerebellar arc is lost.

The importance of this tonic action is illustrated by the pugilist's "knock-out" blow on the chin, which drives the condyles of the lower jaw against the petrous part of the temporal bone which contains the labyrinths, and throws them out of action. Instantly there is a complete loss of muscular tone, and the man falls in a heap on the ground.

The cerebral arc is not involved. In fact, an increased tonus appears after removal of the cerebrum.

2. **Proprioceptive Reflex Adjustment of Movements.**—(1) This action of the labyrinth is shown *by the effects of injury and removal.* When one of the canals is opened, an operation which can be performed in the pigeon with

comparative ease, the head is rotated backwards and forwards in the plane of the canal. If the labyrinth on one side is removed, rotation to that side from overaction of the labyrinthine mechanism on the opposite side occurs. It is, however, soon recovered from. The same result follows section of the vestibular nerve.

(2) *Stimulation of one of the canals* by electricity in the cartilaginous fishes causes movements of the eyes and fins as if the animal were being rotated in the plane of the canal stimulated.

Injury to a canal causes loss of control of the group of muscles which govern the movements of the head round the axis of that canal. Overaction, on the other hand, causes muscular adjustments to counteract movements round the same axis.

Such a mechanism might be called into play either—

- (1) By the position of the head in space.
- (2) By the movements of the head.

(1) That the position of the head in space acts is indicated by (a) the experiments of Kriedl upon the shrimp *Palinurus*. When this creature casts its shell it also casts its otic vesicle with the contained grains of sand that act as otoliths, and, when its new shell is grown, it inserts particles of sand into the vesicles. By supplying it with particles of iron, Kriedl compelled it to insert these, and when, by means of a magnet, they were brought into contact with different parts of the vesicle, the animal took up different positions.

(b) The static action of the labyrinths is further shown by the production of definite postures in decerebrated cats, by placing the head in different positions (p. 88). It is also shown by the production of apnoea, absence of breathing, in ducks, by placing the head in certain positions, *e.g.* directed straight down in the diving position. Another element—a proprioceptive reflex from the joints of the cervical vertebrae—plays a secondary part in these adjustments.

These static actions probably depend upon the part of the nerve terminations in the utricles and saccule upon

which the otoliths press at any time as a result of the force of gravity.

Such a static mechanism accounts for the adjustment of the optic axis in the blind according to the position of the head.

(2) That movements of the head play an important part is shown by the fact that, when an animal, deprived of its labyrinths, attempts to move, the most marked disturbances of muscular action occur. It is still more clearly indicated by a consideration of how the system of semicircular canals is influenced by any *acceleration* or *retardation* of movements of the head.

If the head is moved in any plane, certain changes are set up in the ampulla or ampullæ towards which the head is moving, and converse changes in the ampulla or ampullæ at the other end of the arc of the circle.

If, for example, the head is suddenly turned to the right, the inertia of the endolymph and perilymph tends to make them lag behind. Thus the endolymph in the ampulla of the left horizontal canal will tend to flow into the canal, but the canal is so small that the fluid will merely accumulate in the ampulla, and thus a high pressure will be produced (fig. 55 + +). The perilymph will tend to lag behind, and a low pressure will result outside (fig. 55 -). The converse will take place in the opposite horizontal canal.

When the movement is continued the pressures will be readjusted, and, on stopping the movement, the opposite conditions will be induced.

In forward nodding movement of the head, the two superior canals have the pressure of endolymph increased in their ampullæ—in backward movement this occurs in the two posterior canals. In nodding to the right the superior and posterior canals of the right ear undergo this change.

B. *Labyrintho-Cerebral Arcs*.—**Modifications of Consciousness**.—These changes, which can be studied only in man, act, not only in bringing about an adjustment of the balance through the cerebellar arc, but also on account of the connections with the cerebrum, in modifying consciousness, giving a sensation of movement in the

direction of the ampullæ in which the pressure is increased. The mode of action may be analysed by a study of the sensations which accompany acceleration or retardation of movements. Acceleration produces a sensation; when the motion is uniform there is no sensation, but when it is suddenly stopped a sensation of rotation in the opposite direction is produced. The fact that only fairly rapid acceleration or retardation of movements

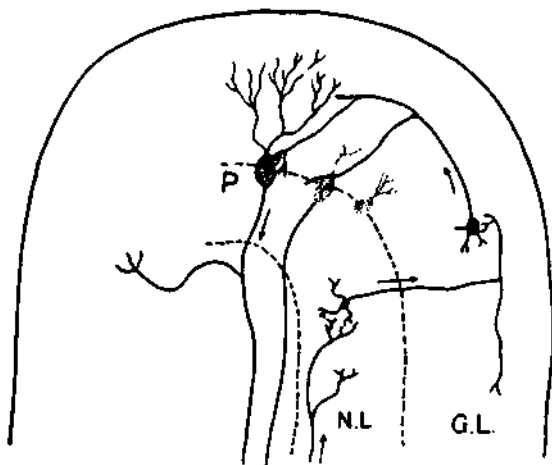

FIG. 57.—Diagram of the Arrangement of Fibres and Cells in the Cortex of the Cerebellum. *G.L.*, molecular layer; *N.L.*, nuclear layer; *P.*, Purkinje's cells sending out axons to the deeper ganglia. (After RAMON Y CAJAL.)

produces an effect explains why it is that the action of the canals may fail to make an aviator when flying in cloud aware of his position in space, so that he may actually be upside down without knowing it.

The information conveyed from the labyrinth must concord with that derived from other channels, *e.g.* from vision. When they do not accord, a sensation of giddiness and an inability to maintain the balance are induced. If one sets a poker point down upon the ground, then places the forehead on the top and rapidly circles the poker three times, when one stands up one experiences a sense of

giddiness and an inability to walk steadily. This is due to the fact that the sudden stoppage of rotation induces the sensation of rotation in the opposite direction, while the visual impressions convey the information that this rotation is not actually taking place.

B. The Cerebellum.

The cerebellum is developed primarily as the ganglion or receiving mass of cells for the vestibular mechanism, and in it stimuli from that mechanism are associated with those from other receptors, so that they may be harmonised and all the movements of balancing adjusted without implication of consciousness.

1. Structure.

The cerebellum lies above the fourth ventricle, and is joined to the cerebro-spinal axis by three peduncles on each side (fig. 58). It consists of a central lobe, the upper part of which is the *superior vermis*, and two lateral lobes, each with a secondary small lobe, the *flocculus*. Its surface is raised into long ridge-like folds running in the horizontal plane, and is covered over with grey matter, the *cortex*.

In the substance of the white matter, forming the centre of the organ, are several masses of grey matter on each side, the most important of which are—(i.) the group of *roof nuclei*; and (ii.) the *dentate nucleus* (fig. 58).

The *cortex* may be divided into an outer somewhat homogeneous layer (the *molecular layer*, fig. 57, *G.L.*) and an inner layer studded with cells (the *nuclear layer*, *N.L.*). Between these is a layer of large cells—the cells of Purkinje (*P.*).

By Golgi's method the arrangement of fibres and cells in the cerebellar cortex has been shown to be as follows:—

(i.) Fibres coming into the cortex from the white matter either end in synapses round cells in the nuclear layer, or proceed at once to the outer layer (fig. 57). (ii.) From the cells in the nuclear layer, processes pass to the outer layer

and there form synapses with other cells. (iii.) From these, processes pass to the cells of Purkinje, round which they arborise; and (iv.) from Purkinje's cells the outgoing fibres of the cerebellum pass into the white matter and so to the deep nuclei, to Deiters' nuclei, and to the red nuclei (fig. 58).

2. Connections.

The cerebellum is connected (fig. 58)—

1. *With the Spinal Cord.*

(a) *Incoming Fibres.*—1. The direct cerebellar tract (p. 112) passes up in the restiform body to end chiefly in the superior vermis on both sides. 2. The ventro-spinal tract (p. 112) passes to the cerebellum in the superior peduncle and ends in the superior vermis. 3. Fibres from the nuclei of the posterior columns of the same side, and also from the opposite side (p. 112), pass in the restiform body to the cerebellum. 4. Fibres from the vestibular root of the eighth nerve also pass to the cerebellum (fig. 58, p. 127).

(b) *Commissural Fibres.*—Strong bands of fibres connect the dentate nucleus and other parts of the cerebellum with the inferior olivary nucleus of the opposite side.

(c) *Outgoing Fibres.*—Fibres pass from the superior vermis to the deep nuclei, and to Deiters' nuclei (fig. 58), from which others pass down in the descending antero-lateral tract of the cord.

2. *With the Cerebrum.*—1. Fibres run down in the crura of each crus from the frontal and occipital parts of the cortex cerebri. They form synapses with cells in the pons, and from these, fibres pass in the middle peduncle to the cerebellum. 2. The fibres of the superior peduncle, coming chiefly from the dentate nucleus and superior vermis, cross in the middle line and end—(a) partly in the red nucleus of the opposite side, from which the rubro-spinal, or pre-pyramidal tract, extends downward into the spinal cord; (b) partly in the thalamus opticus. From the thalamus fibres pass, some to the cortex, some to the oculo-motor nuclei.

Functionally these connections are:—

A. *Ingoing.*—1. From the spinal cord—chiefly proprio-

ceptive, but also tactile. 2. From the labyrinth of the internal ear—proprioceptive. 3. From the cerebrum—chiefly visual.

B. Outgoing.—1. To the spinal cord to act on the reflex arcs. 2. To the oculo-motor mechanism. 3. To the cerebrum, through the thalamus and red nucleus. These

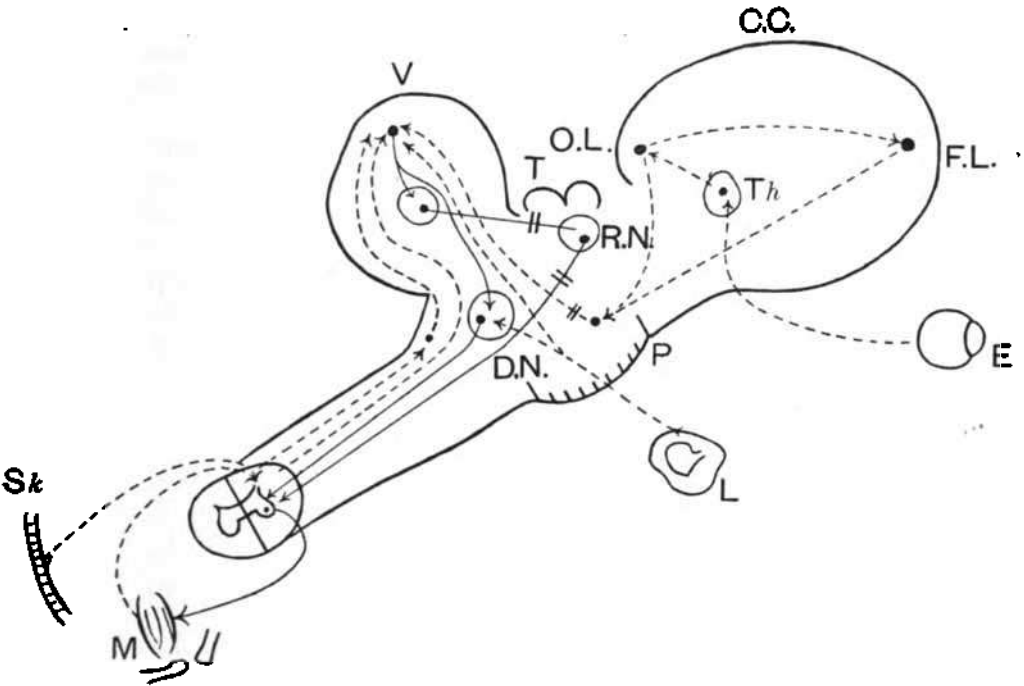

FIG. 58.—The more important connections of the Cerebellum. *Sk*, skin; *M*, muscle; *V*, vermis; *D.N.*, Deiters' nucleus; *L*, labyrinth; *P*, pons; *T*, tectum; *R.N.*, red nucleus; *Th*, thalamus; *E*, eye; *C.C.*, cortex cerebri; *E*, eye.

influence the spinal arcs through the rubro-spinal and through the cortico-spinal arcs (p. 79).

The cerebellum thus constitutes the central part of one of the great nervous arcs (p. 79).

3. Physiology.

1. **Removal of Cerebrum.**—Something may be learned of the functions of the cerebellum by a study of animals from

which the cerebrum above the tectum has been removed. Decerebration rigidity in the position of extension manifests itself. This rigidity is removed on one side, if that side of the spinal cord in the neck be divided, showing that it is a cerebellar action. The hypertonus is not removed on slicing away the cerebellum until the basal nuclei and nucleus of Deiters are destroyed. Apparently the cerebellum is controlled by the cerebrum, and acts to excess after its removal, either (a) directly upon the spinal arcs, or (b) indirectly through its superior peduncles and the red nucleus.

While *absinthe* leads to clonic spasms in the intact animal, when one cerebral hemisphere is removed the *clonus* is replaced by *tonus* on the opposite side, the *absinthe* now stimulating the cerebellum alone.

2. **Removal of the Cerebellum.**—This operation is easily performed in the pigeon (fig. 34, p. 80), and the animal, for a time at least, loses the power of balancing itself, and, when disturbed, makes violent movements to recover its equilibrium.

In the dog three stages are seen—

(1) *Irritative Stage.*—Immediately after removal, there is marked extension of the spine—*opisthotonus*—extension of the fore limbs, and alternating clonus of the hind limbs. In the monkey the same symptoms appear, but there is tonic flexion at the elbows.

(2) *Stage of Inadequacy.*—These symptoms gradually pass off, and the animal then shows general muscular weakness.

(3) *Stage of Compensation.*—Later still, this condition may in large measure be recovered from.

3. **Partial Removal.**—If one side of the cerebellum be removed the symptoms are—(1) At once a tonic contraction of the muscles of the limbs of the same side by which the fore limb in the dog may be powerfully extended. The head is twisted with the ear to the shoulder of the side of the removal, and the chin to the opposite shoulder, and the animal may be driven round its long axis to the opposite side. The eyes show a coarse lateral nystagmus—a jerking

from side to side. (2) These irritative symptoms soon pass off, and the animal then manifests inadequacy or weakness in the limbs of the affected side, so that it droops to that side, and, if a quadruped, may circle to that side. (3) After some weeks these symptoms disappear, compensation for the loss of one side of the cerebellum being established.

When compensation is completed in the dog, destruction of the cerebral cortex of the opposite side leads to a reappearance of the muscular inadequacy.

In some cases in man, when slowly progressing disease has destroyed the organ, no loss of equilibration appears. In other cases the cerebellum has been congenitally almost absent, and yet the individual has not shown any sign of want of power of maintaining his balance. Evidently, therefore, in such cases the cerebrum compensates for the absence of the cerebellum.

4. Stimulation of the cerebellum has yielded results somewhat difficult of interpretation, but the most recent investigations seem to show that stimulation of the cortex with currents strong enough to produce movements when applied to the discharging part of the cerebral cortex in the monkey (see p. 192), does not produce manifest effects. On the other hand, comparatively weak currents applied to the basal nuclei do produce movements, the most manifest of which are conjugate movements of the eyes, and of the eyes and head to the side stimulated. If the nucleus of Deiters is stimulated, the movements are rather in the muscles of the limbs of the same side.

It has been further found that powerful stimulation may also cause flexion of the elbow of the same side and extension of the opposite elbow with extension of the trunk and lower limbs. This may be associated with the maintenance of the body in the erect position and with the alternate movements of the legs in the act of progression.

Although stimulation of the cerebellar cortex has failed to reveal any localisation of function, a study of the relative development of different parts in different groups of animals, and a study of the effects of local removal, seem to indicate that the median part is connected with the movements of

paired muscles—the anterior part with the movements of the eyes, tongue, and muscles of the face; the middle part with the muscles of the neck; and the posterior part with the synergic movements of the hind limbs in walking, etc.

The lateral lobes seem to be connected with the independent movements of the limbs of the same side. These various parts are concerned, not with special anatomical groups of muscles, but with definite co-ordinated movements. Removal of a part concerned with the movements of a limb in one direction is accompanied by a spontaneous deviation in the opposite direction.

4. General Conclusions—

1. The cerebellum, through the influence of the incoming fibres from the labyrinths and probably also from the spinal proprioceptive mechanism keeps up a constant *tonic influence on certain of the muscles of the body.*

2. It is a great central mechanism of *reflex adjustment of the balance* when disturbed in any way. In performing this function, its action is guided by incoming impressions (1) from the labyrinths (p. 121); (2) from the spinal proprioceptive mechanism (p. 105); (3) from visual impressions received through the cerebrum (p. 165); and (4) from tactile impressions. It acts upon the spinal reflex arcs to modify and regulate their action upon the muscles.

It may thus be described as a ganglion superimposed upon the brain-stem which associates incoming impulses to secure tonic maintenance of the balance and appropriate readjustment of the balance without consciousness being involved.

III. DISTANCE RECEPTORS OF THE HEAD.

We have now studied—

1. The ordinary reflex response through the spinal arcs to stimulation of receptors (p. 82).

2. The way in which this is modified by the stimulation of muscle-joint receptors (p. 105).

3. The inward course of the fibres from the receptors of the body to their termination in different parts of the brain (p. 106 *et seq.*).

4. The mode of action of these various parts of the brain (p. 116 *et seq.*).

5. The adjustment of the head and body brought about through the vestibulo-cerebellar arrangement (p. 121).

We must next consider a series of receptors developed in the head which are stimulated by *changes at a distance*, and which thus warn the animal, so that it may prepare to adapt itself to these conditions.

I. For Chemical Substance.

1. BUCCAL MECHANISM.

Taste.

This is really a modification of cutaneous sensibility, and it might have been studied along with it; but its close association with the sense of smell makes it more convenient to deal with it here.

The mouth is richly supplied with receptors for tactile, painful and thermal stimuli, and the receptors for thermal stimuli extend down to the lower end of the gullet.

In the mouth special receptors have been developed with the object of determining whether any particular material should be swallowed or rejected, according to whether it is beneficial or nocuous. Pavlov found that, in dogs, the flow of saliva varies with the material put in the mouth. Flesh calls forth a flow of viscous saliva which lubricates the mass and facilitates the act of swallowing, while sand placed in the mouth causes a free flow of very watery saliva to wash out the nocuous substance. Pavlov used the reflex flow of saliva to study what he has called **Conditioned Reflexes**—*i.e.* reflexes associated with changes in consciousness. Two different notes were sounded near a dog, and it was habitually fed after one of these but not after the other. It was found that sounding the former produced a flow of saliva.

A. Receptors.—The most important receptors consist of groups of spindle-shaped cells with which the dendritic terminations of the nerves from the mouth are connected. Each group of cells is surrounded by a series of flat epithelial cells like the staves of a barrel to form a taste bulb. These taste bulbs are most abundant on the sides of the large circumvallate papillæ which form the prominent V-shaped line on the posterior part of the dorsum of the tongue.

B. Connection with the Central Nervous System.—The posterior third of the tongue is supplied by the glosso-pharyngeal nerve. The anterior two-thirds are supplied by the lingual of the fifth and the chorda tympani of the seventh. It has been maintained that all the taste fibres enter the medulla by way of the Gasserian ganglion and the root of the fifth nerve; but the study of cases in man in which the ganglion has been removed does not support this view, and the evidence seems to indicate that the fibres enter the medulla by the roots of the nerve in which they run.

The first synapses are in the medulla and pons, and from this the lemniscus quinti—the fillet of the V.—passes up, crosses, and forms synapses in a special nucleus of the thalamus (fig. 50), from which fibres must pass to the cortex, but to what part is not clearly determined.

The close association of taste and smell, and the results of Ferrier's experiments (p. 136), make it possible that the cortical representation is in the hippocampal region. On this point evidence is by no means conclusive.

C. Physiology.—As to the way in which this mechanism is stimulated our knowledge is very imperfect. In order to act, the substance must be in solution. The strength of the sensation depends (i.) on the concentration of the solution, (ii.) upon the extent of the surface of the tongue acted upon, (iii.) upon the duration of the action, (iv.) and upon the temperature of the solution. If the temperature is very high or very low, the taste sensation is impaired by the sensations of heat or cold.

It is most difficult to classify the many various taste

sensations which may be experienced, but they may roughly be divided into four main groups:—

- | | |
|------------|------------|
| 1. Sweet. | 3. Acid. |
| 2. Bitter. | 4. Saline. |

2. NASAL MECHANISM.

Sense of Smell

The olfactory organs are the most fundamental of all distance receptors, and they play a most important part in

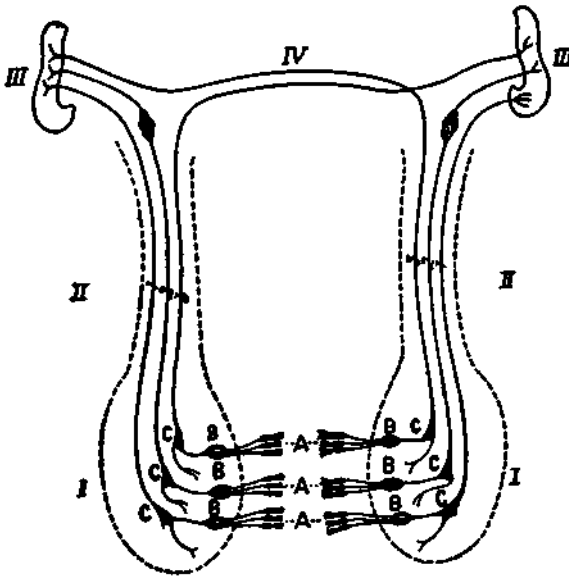

FIG. 59.—The Connections of the Olfactory Fibres. *A*, olfactory cells; *B*, synapses in the olfactory bulb *I*; *II*, olfactory tracts; *III*, olfactory centre; *IV*, decussation of fibres. (HOWELL.)

the life of the lower animals in guiding them to their food and repelling them from danger, in causing positive and negative chemiotaxis.

Smell, as Sherrington puts it, is taste at a distance. Just as the taste organs are stimulated by substances taken into the mouth, so the olfactory organs are stimulated in

human brain. To this the fibres from the olfactory bulb, the *secondary olfactory neurons*, pass. These form synapses from which the *tertiary olfactory neurons* pass to the *fascia dentata* running along the edge of the hippocampus, and to the *hippocampus (Hc.)*. From these structures the fornix (*F.*) arises which carries fibres across to the opposite hippocampus and backwards on the same side to the thalamus (*T.A.*). The olfactory fibres from the pyriform lobe have also extensive sub-thalamic connections. They pass to form synapses in each corpus mammillare (*M.*), from which fibres extend down in the tegmentum, probably to act on the spinal arcs.

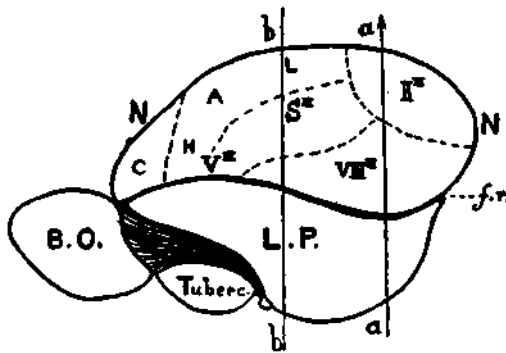

FIG. 61.—Side view of the Cerebrum of one of the Lowest Mammals. *B.O.*, olfactory bulb; *T.O.L.*, olfactory tract; *Tuberc.*, olfactory tubercle; *L.P.*, lobus pyriformis; *f.r.*, fissura rhinica, above which is the neopallium, divided into receiving areas; *I*^{''}, visual; *VIII*^{''}, auditory; *S*^{''}, sensations from body; *V*^{''}, sensations from face; *L.A.H.*, motor areas for leg, arm, and head. (ELLIOT SMITH.)

The evidence points to the hippocampus, including the fascia dentata, being the receiving area, the area which when stimulated, gives rise to sensations of smell, while the fibres of the fornix serve to connect these impressions with those from the other sense organs.

The cortex in this olfactory region, the rhinencephalon, contains cells arranged in two layers—(1) outside a layer of small cells, often in clusters, the *granular layer*; (2) below this layers of larger cells, the *sub-granular layer*. The fibres passing to it get their medullary sheaths at an early stage of development.

Ferrier states that removal of the hippocampal convolution, including the lobus pyriformis, leads in monkeys to loss of taste and smell, and that stimulation causes torsion of the nostrils and lips, as if sensations of smell or taste were being experienced.

Other experimenters have observed interference with the sense of smell in destructive lesions of the hippocampal lobe, and one case at least has been described in which a tumour of the right gyrus hippocampus was associated with sensations of smell.

C. Physiology.—To act upon the olfactory mechanism of terrestrial animals the substance must be volatile, and must be suspended in the air. In this condition infinitesimal quantities of such substances as musk are capable of producing powerful sensations. The mucous membrane must be moist, and this is secured by the activity of Bowman's glands, situated in it. These are under the control of the fifth cranial nerve, and section of this leads indirectly to loss of the sense of smell through dryness of the membrane.

II. FOR VIBRATION OF ETHER.

Vision.

A. General Considerations.

While the addition to and withdrawal from the surface of the body of the slower ethereal waves which are the basis of heat act upon the special nerve terminations in the skin to give rise to sensations of *heat* and *cold*, a certain range of more rapid vibrations act specially upon the nerve-endings in the eye. These produce molecular changes which in turn affect the centres in the brain, and play a most important part in the adjustment of movements for the benefit of the body, and which give rise to changes in consciousness which we call *sight*. The range of vibrations which can act in this way is comparatively limited, the slowest being about 435 billions per second, the most rapid about 764 billions. Vibrations more rapid than this, while

capable of setting up chemical changes, as in photography, do not produce visual sensations.

1. The action of light upon the protoplasm of lower organisms has been already considered (p. 26), and it has been seen that it may be either general or unilateral, producing the phenomena of positive or negative phototaxis.

2. In more complex animals, special sets of cells are set apart to be acted on by light, and these are generally imbedded in pigmented cells to prevent the passage of light through the protoplasm. Such an accumulation of cells constitutes an *eye*, and, in the simpler organisms, an eye can have no further function than to enable the presence or absence of light or various degrees of illumination to produce their effects through the impulses which are sent to the nervous system.

3. In the higher animals these cells are so arranged that certain of them are stimulated by light coming in one direction, others are stimulated by light coming in another, and while the former are connected with one set of synapses in the brain, the latter are connected with another. Thus, light from one point will stimulate one set of cells which, through the nerve fibres passing to the central nervous system, will excite one part of the brain, and light from another point will act upon other cells which will excite another part of the brain, and thus not merely the degree of illumination but also the source of illumination becomes distinguishable.

By this arrangement it becomes possible to gain knowledge of the *shape* of external objects. One directs the eye to the corner of the ceiling, and the idea that it is a corner is due to the fact that three different degrees of illumination are appreciated, and that these can be localised—one above, one to the right, and one to the left. One set of cells is stimulated to one degree, another set of cells to another degree, and a third set of cells to a third degree; and the different stimulation of these different sets of cells leads to a different excitation of separate sets of neurons in the brain. These changes in the brain are accompanied by the *perception* of the three parts differently

illuminated. From the previous training of the nervous system we have been taught to interpret this as due to a "corner." But this interpretation is simply a judgment based upon the sensations, and it may or may not be right. Instead of actually looking at a corner we may be looking at the picture of one.

From the very first it must be remembered that the modification of our consciousness which we call vision is not directly due to external conditions, but is a result of changes set up in our brain. Our sensation is associated with changes in our brain produced by changes in the eye set up by rays of light coming from the object.

Usually such changes are set up by a certain range of vibrations of the ether, but they may be set up in other ways—*e.g.* by the mechanical stimulation of a blow on the eye; but however set up, they give rise to the same kind of changes in consciousness—visual sensation. It was in connection with vision that Johannes Müller formulated the doctrine of **specific nerve energy**, that *different varieties of stimuli applied to the same organ of sense always produce the same kind of sensation*. The converse also holds good, that *the same stimulus applied to different organs of sense produces a different kind of sensation for each*.

4. The visual mechanism gives the power not only of appreciating the **degree** and **source** of illumination, but also of appreciating **colour**. *Physically* the different colours are simply different rates of vibration of the ether; *physiologically* they are different kinds of changes set up in the retina; *psychologically* they are different kinds of sensations. The slowest perceptible vibrations produce changes accompanied by a sensation which we call red, the most rapid vibrations produce a different set of changes which we call violet. But, as will be afterwards shown, these sensations may be produced by other modes of stimulating the eye.

A **flat picture** of the outer world is formed, and, from this flat picture, we have to make *judgments* of the size, distance, and thickness of the bodies looked at.

The idea of size is based upon the extent of the eye-cells

stimulated by the light coming from the object. If a large surface is acted upon, the object seems large; if a small surface, the object seems small. But the extent of eye-cells acted on depends not merely upon the size of the object, but also upon its distance from the eye, since the further the object is from the eye the smaller is the image formed. Hence, ideas of size are judgments based upon the size of the picture in the eye, and the estimation of the distance of the object and past experience plays an important part.

The idea of thickness or contour of an object is also largely a judgment based upon colour and shading. When a cube is looked at, it is judged to be a cube because of the different degrees of illumination of the different sides—degrees of illumination which may be reproduced in a flat picture of such a cube.

B. Anatomy of the Eye.

Before attempting to study the physiology of the eye, the student must dissect an ox's or a pig's eye, and then make himself familiar with the microscopic structure of the various parts.

The eye may be described as a hollow sphere of fibrous tissue (fig. 62), the posterior part, the *sclerotic (Scl.)*, being opaque; the anterior part, the *cornea (Cor.)*, being transparent and forming in most animals part of a sphere of smaller diameter than the sclerotic. In the horse the curvature of the cornea is less in the horizontal plane than in the vertical. Inside the sclerotic coat is a loose fibrous layer, the *choroid (Chor.)*, the connective tissue cells of which are loaded with melanin, a black pigment. This is the vascular coat of the eye—the larger vessels running in its outer part, and the capillaries in its inner layer. Anteriorly, just behind the junction of the cornea and sclerotic, it is thickened and raised in a number of ridges, the *ciliary processes (Cil.M.)*, running from behind forward and terminating abruptly in front. The *ciliary muscle* is situated in these. It consists of two sets of non-stripped muscular fibres—first, radiating fibres which take origin

from the sclerotic just behind the corneo-sclerotic junction, and run backwards and outwards to be inserted into the bases of the ciliary processes; second, circular fibres which run round the processes just inside the radiating fibres. The choroid is continued forward in front of the ciliary processes to the pupil as the iris, and in it are also two sets of non-

striped muscular fibres—first, the circular fibres, a well-marked band running round the pupil, and called the *sphincter pupillæ* (*Sph.P.*) muscle; second, a less well-marked set of radiating fibres, which are absent in some animals, and which constitute the *dilator pupillæ* muscle (*D.P.*). In the horse the pupil is elliptical, the long axis being in the horizontal plane, and from the edge of the iris a process like a small bunch of grapes projects, and, when the pupil is contracted, nearly occludes it.

The *membrana nictitans*, lying on the inner aspect of the orbit, consists of a flexible plate of elastic fibro-cartilage covered with conjunctiva. When the eye is retracted the post-orbital fat is pushed

forwards and thrusts the membrane over the inner half of the eyeball (p. 160).

The part of the eye in front of the iris is filled by a lymph-like fluid, the *aqueous humour*, while the part behind is occupied by a fine jelly-like mucoid tissue, the *vitreous humour*. The vitreous humour is enclosed in a delicate fibrous capsule, the *hyaloid membrane*, and, just behind the ciliary processes, this membrane becomes tougher, and is so

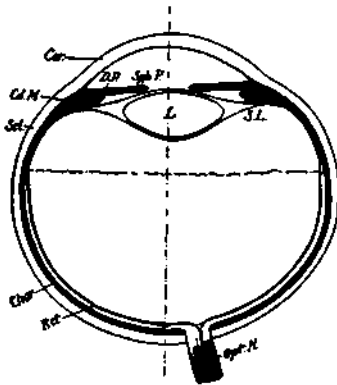

FIG. 62.—Horizontal section through the Left Eye. *Cor.*, cornea; *Scl.*, sclerotic; *Opt.N.*, optic nerve; *Chor.*, choroid; *C.M.*, ciliary processes with ciliary muscle; *D.P.*, dilator pupillæ muscle; *Sph.P.*, sphincter pupillæ muscle; *L.*, crystalline lens; *S.L.*, hyaloid membrane forming suspensory ligament and capsule of lens; *Ret.*, retina. The vertical line passing through the axis of the eye falls upon the central spot of the retina.

firmly adherent to the processes that it is difficult to strip it off. It passes forward from the processes as the *suspensory ligament (S.L.)*, and then splits to form the *lens capsule*. In this is held the *crystalline lens (L.)*, a biconvex lens, with its greater curvature on its posterior aspect. It is an elastic structure, and it is normally kept somewhat pressed out and flattened between the layers of the capsule; but, if the suspensory ligament is relaxed, its natural elasticity causes it to bulge forward. This happens when the ciliary muscle contracts and pulls forward the ciliary processes with the hyaloid membrane.

Between the hyaloid membrane and the choroid is the *retina (Ret.)*. This is an expansion of the optic nerve, which enters the eye to the inner side of the posterior optic axis (fig. 62). The white nerve fibres pass through the sclerotic, through the choroid, and through the retina, to form the white *optic disc*. This is about 1.5 mm. in diameter in the human subject. The fibres lose their white sheath, and spread out in all directions over the front of the retina, to form its first layer—the layer of *nerve fibres (1)* (fig. 63). These nerve fibres take origin from a layer of *nerve cells (2)* behind them, forming the second layer. The dendrites of these cells arborise with the dendrites for the next set of neurons in the third layer, the *internal molecular layer (3)*. The cells of these neurons are placed in the next or fourth layer, the *inner nuclear layer (4)*, and from these cells, processes pass backwards to form synapses in the fifth, or *outer molecular layer (5)*, with the dendrites of the terminal neurons. These terminal neurons have their cells in the sixth or *outer nuclear*

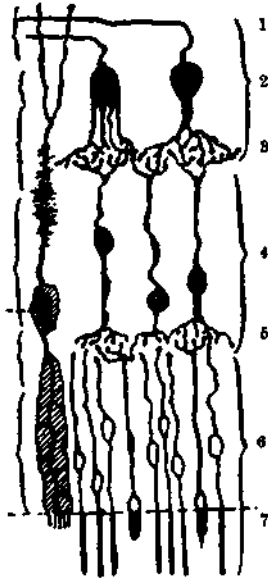

FIG. 63.—Diagram of a Section through the Retina stained by Golgi's method. For description, see text. (From VAN GEBUCHTEN.)

layer (6) of the retina, and they pass backwards and end in two special kinds of terminations in the seventh layer of the retina—the *rods and cones* (7). These structures are composed of two segments—a somewhat barrel-shaped basal piece, and a transparent terminal part which in the rods is cylindrical and in the cones is pointed. Over the central

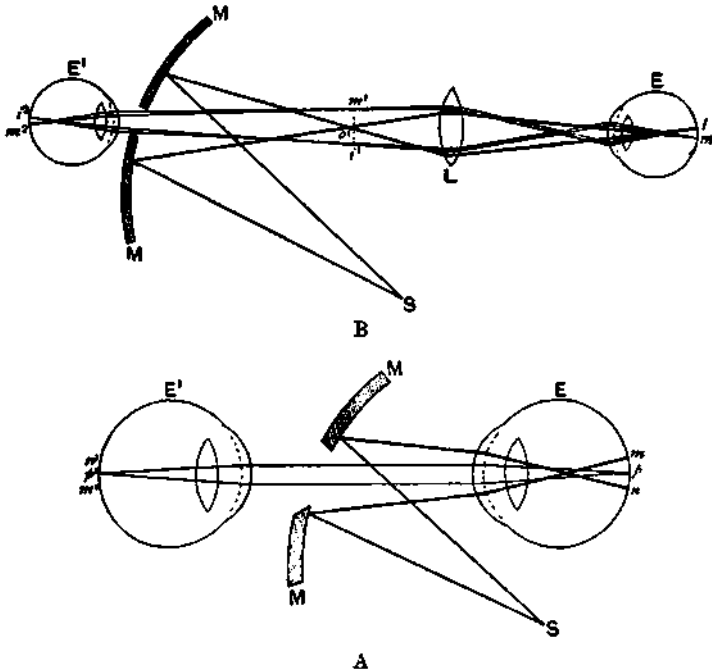

FIG. 64.—The use of the Ophthalmoscope, A, by the direct method. B, by the indirect method. *E*, eye observed. *E'*, observer's eye. *M*, mirror. *S*, source of light. *L*, convex lens. The direction of the ingoing rays is shown in strong lines, of the rays from the observed eye in thin lines.

spot of the eye there are no rods, but the cones lie side by side, and the other layers of the retina are thinned out. The rods and cones are imbedded in the last or eighth layer of the retina—the layer of pigment cells, or *tapetum nigrum*. The retina stops abruptly in front at the *ora serrata*, but the *tapetum nigrum*, along with another layer of epithelial cells representing the rest of the retinal structures, is continued

forwards over the ciliary processes and over the back of the iris.

The blood-vessels of the retina enter in the middle of the optic nerve, and run out and branch in the *anterior* layer of the retina.

The interior of the eye may be examined by the **Ophthalmoscope**, either by the *direct* or by the *indirect* method (fig. 64). By the direct method light is reflected from a small mirror into the eyes, and the observer examines the fundus directly through a hole in the middle of the mirror (fig. 64, A). By the indirect method he reflects light from a slightly concave mirror into the eye, and then inserts between the eye and the mirror a biconvex lens so that an image of the fundus is formed, and this is examined (fig. 64, B) (*Practical Physiology*).

The fluid which distends the eyeball may be considered as a form of lymph.

It is derived by exudation from the vessels in the ciliary processes. Some passes back into the vitreous humour, but the greater quantity passes forward into the anterior chamber, from which it is drained away in the lymph spaces in the anterior part of the sclerotic called the spaces of Fontana, which open into the canal of Schlemm. When these spaces become obstructed, the fluid tends to accumulate, and the pressure in the eyeball rises and it feels hard to the touch. This condition of *glaucoma* leads to disturbances in the nutrition of the eyeball.

The pressure in the eyeball varies with the arterial pressure, and it is also influenced by any obstruction to the flow of blood in the veins from the head so that in cases of intracranial tumour the vessels of the retina are apt to become congested.

C. Physiology.

The study of vision may be taken up in the following order :—

1. The mode of formation of pictures on the nerve structures (retina) of the eye.

- (1) One eye (monocular vision).
 - A. The method in which rays of light are focussed (dioptric mechanism).
 - B. The stimulation of the retina.
- (2) Two eyes (binocular vision).
 2. The conduction of the nerve impulses from the retina to the brain.
 3. The mode of action of the parts of the brain in which the changes accompanying visual sensations are set up (the visual centre).

1. THE MODE OF FORMATION OF PICTURES UPON THE RETINA.

(I.) MONOCULAR VISION.

I. The Dioptric Mechanism.

1. **Distant Vision.**—The eye may be compared to a photographic camera, having in front a lens, or lenses, to focus the light upon the sensitive screen behind. The picture is formed on the screen by the luminous rays from each point outside being concentrated to a point upon the screen. This is brought about by refraction of light as it passes through the various media of the eye—the cornea, aqueous, crystalline lens, and vitreous. The refractive indices of these, compared with air as unity, may be expressed as follows:—

Cornea . . .	1.33	Lens . . .	1.45
Aqueous . . .	1.33	Vitreous . . .	1.33

When a ray of light passes from a medium of lower into one of higher refractive index, it is bent towards a line drawn at right angles to the surface (fig. 65), and, conversely, in passing from a medium of higher into one of lower refractive index, it is bent away from a line at right angles to the surface.

Light therefore passes from a medium of one refractive index into a medium of another refractive index (fig. 65)—

1. At the anterior surface of the cornea, from a medium

of lower to one of higher refractive index, so that the peripheral rays are bent towards the perpendicular. Since in the horse the curvature of the cornea is less in the horizontal plane, rays of light in this plane are less refracted.

2. At the anterior surface of the lens, from lower to higher, so that the rays are again bent in the same way.

3. At the posterior surface of the lens, from higher to lower refractive index, so that the rays are bent away from the perpendicular, that is, again towards the axial ray.

The degree of bending depends upon—1st, The difference of refractive index ; 2nd, The obliquity with which the light

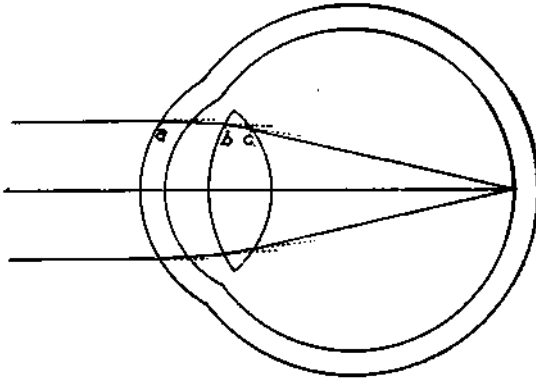

FIG. 65.—To show how parallel rays are brought to a focus on the retina by refraction at the three surfaces (a), anterior surface of the cornea; (b), anterior surface of the lens ; and (c), posterior surface of the lens.

hits the surface. This will vary with the convexity of the surface.

The posterior surface of the lens has the greatest convexity with a radius of 6 mm. The anterior surface of the cornea has the next greatest, with a radius of 8 mm. The anterior surface of the lens has the least, with a radius of 10 mm.

A ray of light passing obliquely through these media will be bent at the three surfaces proportionately to the curvature of each.

These media, in fact, form the **physiological lens**, a compound lens composed of a convexo-concave part in front,

the cornea and aqueous, and a biconvex part, the crystalline lens, behind. In the resting normal eye (emmetropic eye) the principal focus is exactly the distance behind the lens at which the layer of rods and cones in the retina is situated, and thus it is upon these that light, coming from luminous points at a distance, is focussed.

2. **Near Vision—Positive Accommodation.**—If an object is brought nearer and nearer to the eye, the rays of light enter-

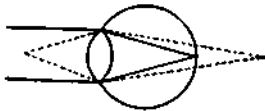

FIG. 66.—To show that rays from distant and near objects are not focussed on the retina at the same time.

ing the eye become more and more divergent, and if the eye be set so that rays from a distance—i.e. parallel rays—are focussed, then rays from a nearer object will be focussed behind the retina, and a clear image will not be formed (fig. 66). This means that near

and far objects cannot be distinctly seen at the same time, a fact which can be readily demonstrated by *Scheiner's Experiment (Practical Physiology)*.

Make two pinholes in a card so near that they fall within the diameter of the pupil. Close one eye and place the holes in front of the other. Get someone to hold a needle against a sheet of white paper at about three

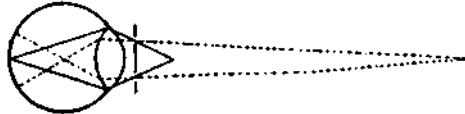

FIG. 67.—Scheiner's Experiment ——— represents rays from the near needle when it is looked at, and - - - rays from the far needle.

yards from the eye, and hold another needle in the same line at about a foot from the eye. When the near needle is looked at, the far needle becomes double (fig. 67).

In man it is found that objects at a greater distance than 6 metres may practically be considered as "distant," and that they are focussed on the retina.

Objects may be brought nearer and nearer to the eye, and yet be seen distinctly up to a certain point, the **near point of accommodation** within which they cannot be sharply focussed

upon the retina. This, however, requires a change in the lens arrangement of the eye, and this change, beginning in man when the object comes within about 6 metres (the **far point of accommodation**), becomes greater and greater, till it can increase no further when the near point is reached. The change is called **positive accommodation**, and it consists in an increased curvature of the anterior surface of the lens. This may be proved by examining, in a dark room, the images of a candle formed from the three refracting surfaces (**Sanson's images**), when it will be found that the image from the anterior surface of the lens becomes smaller and brighter when the eye is directed to a near object. The examination of these images is facilitated by the use of the Phacoscope (*Practical Physiology*).

Positive accommodation is brought about by contraction of the **ciliary muscle** (see p. 139), which pulls forward the ciliary processes to which the hyaloid membrane is attached, and thus relaxes the suspensory ligament of the lens and the front of the lens capsule, and allows the natural elasticity of the lens to bulge it forward (fig. 68).

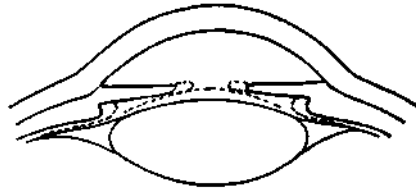

FIG. 68.—Mechanism of Positive Accommodation. The continuous lines show the parts in negative accommodation, the dotted lines in positive accommodation.

This change of positive accommodation is accompanied by a contraction of the pupil due to contraction of the sphincter pupillæ muscle. By this means, the more divergent peripheral rays which would have been focussed behind the central rays to produce a blurred image are cut off, and spherical aberration is prevented.

The muscles acting in positive accommodation—the ciliary and sphincter pupillæ—(fig. 69, *C.M.* and *S.P.*) are supplied by the third cranial nerve (*III.*), while the dilator pupillæ is supplied by fibres passing up the sympathetic of the neck. The centre for the third nerve is situated under the aqueduct of Sylvius, and separate parts preside over the ciliary muscle and the sphincter pupillæ.

The sphincter centre is reflexly called into action, and the pupil contracted—

1st. When strong light falls on the retina and stimulates the optic nerve. In this way the retina is protected against over-stimulation. The two eyes act together in this reflex; if one be covered the pupils of both eyes dilate. In the horse the light-reflex is sluggish.

2nd. When the image upon the retina becomes blurred as the object approaches the eye and the centre for the ciliary muscle is called into play to produce accommodation.

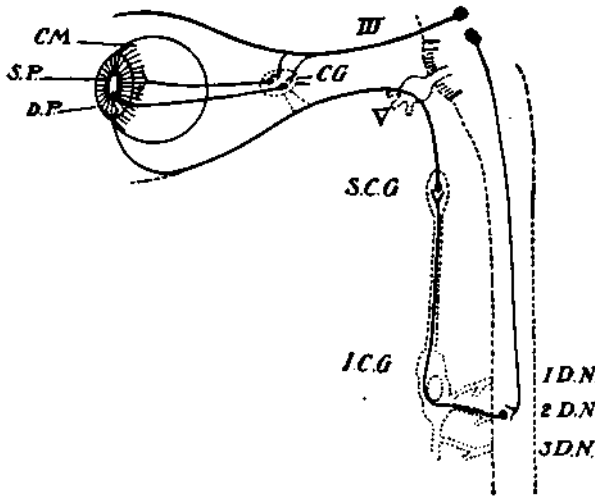

FIG. 69.—Nerve Supply of the Intrinsic Muscles of the Eye (see text).

3rd. The sphincter centre is also stimulated by morphine and other drugs, and in the first stages of asphyxia. In chloroform anæsthesia the pupil at first responds to light, later, when the anæsthesia is full, it is contracted. If the chloroform is pressed further, it dilates and does not respond to light. This is a danger signal.

4th. In sleep the pupil is contracted.

The centre for dilatation of the pupil is situated in the medulla oblongata. Like the centre of the sphincter it may be reflexly excited stimulation of ingoing nerves causing

a dilatation of the pupil when the medulla is intact (fig. 69).

The dilator fibres pass down the lateral columns of the spinal cord to the lower cervical and upper dorsal region, where they arborise round cells in the anterior horn (cilio-spinal region). From these, fibres pass by the anterior root of the second (Fig. 69, *2 D.N.*), possibly also of the first and third dorsal nerves, and, passing up through the inferior cervical ganglion, run on to the superior ganglion, where they arborise round cells which send axons to the Gasserian ganglion of the fifth cranial nerve (*V.*), which course through this and pass along the ophthalmic division and its long ciliary branches to the dilator fibres of the iris (*D.P.*).

There is evidence of the existence of a peripheral mechanism in the iris. The pupil may be seen to contract and dilate in the eye of a cat after decapitation, and various drugs act directly upon it. Atropin causes a dilatation and physostigmin and pilocarpin cause a contraction. Adrenalin causes dilatation when placed in the eye of a mammal, but only after removal of the superior cervical ganglion of the same side, which seems to render the peripheral mechanism more sensitive. A nerve plexus exists in the iris, and this probably acts upon the muscular fibres.

3. Range of Accommodation.—The power of positive accommodation varies at different ages, being greatest in young animals, because in early life the lens is most convex and more elastic.

Presbyopia.—The “range of accommodation,” i.e. the difference between the “near point” and the “far point,” steadily decreases as age advances till the condition of **Presbyopia**—old-sightedness—is produced.

Imperfections of the Dioptric Mechanism.

(1) **Hypermetropia.**—The eye may be too short from before backwards, and thus, in the resting state, parallel rays are focused behind the retina, and, in order to see even a distant

object, positive accommodation is required. As the object is approached to the eye, it is focussed with greater and greater

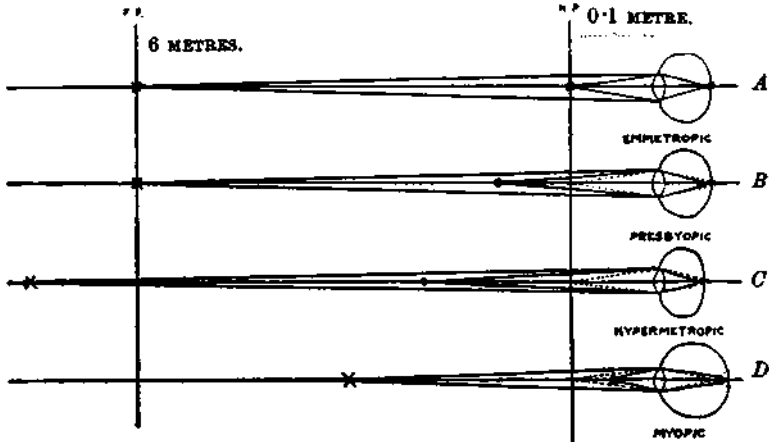

FIG. 70.—To illustrate Presbyopia, Hypermetropia, and Myopia. *A*, emmetropic eye; *B*, presbyopic eye; *C*, hypermetropic eye; *D*, myopic eye; *N.P.o*, the near point, and *F.P.x*, the far point of accommodation.

difficulty, and the near point is further off than in the emmetropic eye (fig. 70, *C*).

This long-sighted eye differs from the slightly presbyopic in the fact that not merely divergent, but also parallel rays, are unfocussed in the resting state.

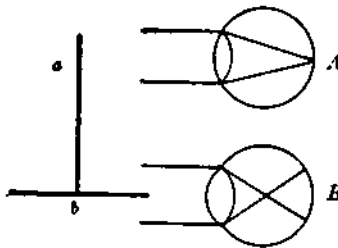

FIG. 71.—To show the cause of Astigmatism. *A*, a slight curvature of the cornea in the vertical plane; *B*, more marked curvature in the horizontal plane, leading to rays from *b*—a horizontal line—being focussed in front of the retina when *a*—a vertical line—is looked at.

(2) **Myopia.**—In certain individuals the antero-posterior diameter of the eye is too long, and, as a result, parallel rays—rays from distant objects—are focussed in front of the retina, and it is only when the object is brought near to the eye that a perfect image can be formed. In myopia no positive accommodation is needed till the object is well within the

modation is needed till the

normal far point. The near point is approximated to the eye (fig. 70, *D*).

(3) **Astigmatism** is a defect due to unequal curvature of one or more of the refracting surfaces in different planes. If the vertical curvature of the cornea is greater than the horizontal when a vertical line is looked at, horizontal lines cannot be sharply focussed at the same time (fig. 71).

Errors of refraction are common in the horse, astigmatism being present in something like fifty per cent.

II. Stimulation of the Retina.

1. Reaction to Varying Illuminations.

(1) **The Blind Spot.**—At the entrance of the optic nerve the retina cannot be stimulated because there are no end-

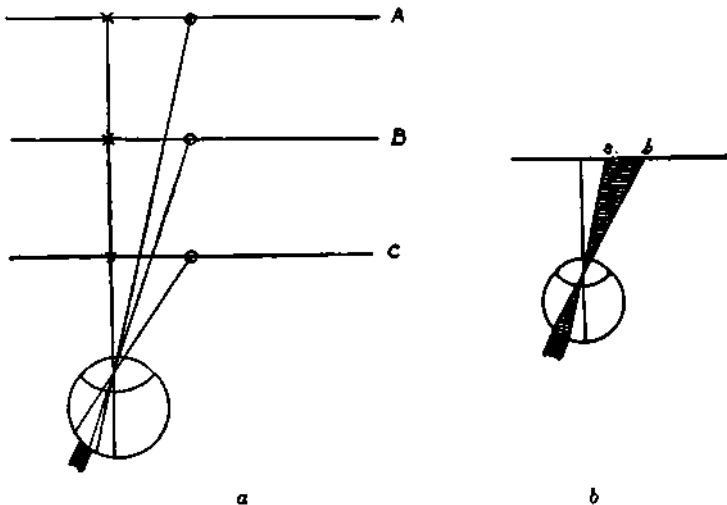

FIG. 72.—Methods of demonstrating the Blind Spot : *a*, by Mariotte's experiment ; *b*, Area subtending the Blind Spot in which objects cannot be seen.

organs in that situation. The existence of such a blind spot may be demonstrated in man—

1st. By Mariotte's experiment, which consists in making two marks in a horizontal line on a piece of paper, closing

the left eye, fixing the right eye on the left-hand mark with the paper held at such a distance from the eye that both marks are visible, then bringing the paper nearer to the eye, when the right-hand mark will first disappear. When the paper is brought still nearer it will reappear (fig. 72, *a*) (*Practical Physiology*).

2nd. By making a mark on a sheet of paper, and, with the head about a foot from the paper, moving the point of a pencil to the right for the right eye, or to the left for the left eye, when the point will disappear and again reappear. The eye is blind for all objects in the shaded region (fig. 72, *a, b*) (*Practical Physiology*). By resolving the various triangles, the distance of the blind spot from the central spot of the eye may be determined, and the diameter of the blind spot may also be ascertained. Hence subtending this blind spot is a region in which objects are not seen (fig. 72, *a, b*).

The *shape* of the blind spot may be mapped out by fixing the head about a foot from the paper, moving the point of the pencil out till it disappears, and then moving it in different directions and marking when it reappears (fig. 72, *b*). It is never quite circular, and often shows rays extending from its edge which are due to the blood-vessels (*Practical Physiology*).

(2) **The Field of Vision.**—The rest of the retina, forward to the ora serrata, is capable of stimulation.

(3) **The layer of the retina capable of stimulation** is the layer of rods and cones. This is proved by the experiment of Purkinje's images, which depends upon the fact that, if a ray of light is thrown through the sclerotic coat of the eye, the shadow of the blood-vessels stimulates a subjacent layer (fig. 73, *c*), and the vessels appear as a series of wriggling lines on the surface looked at. If the light be moved, the lines seem to move, and, by resolving the triangles, it is possible to calculate the distance behind the vessels of the part stimulated, and this distance is found to correspond to the thickness of the retina. The shadows of the blood-vessels are not seen in ordinary vision, because they then fall

upon parts of the retina which are insensitive (*Practical Physiology*).

(4) **The Central Spot**.—Of all parts of the retina the central spot is the most sensitive to differences of illumination in bright light.

The cones, which entirely replace the rods on the central spot of the eye, are the more specialised elements of the retina, and they react more particularly to bright light, which soon exhausts the rods. The rods, again, react to faint illumination, and are readily fatigued by bright light. This explains why it is that, when we go out into a dark night from a brightly-lighted room, we can see nothing at first, but after a time, when the rods have recovered, we begin to see objects more distinctly. The eye must become adapted to the dark, and the adaptation is better in some people than in others.

The rods seem incapable of giving rise to colour sensation, and when the solar spectrum is looked at in a very dim light, it appears as a greyish band of illumination with the red end wanting, because the slow red vibrations fail to stimulate the rods. It is because the blue end of the spectrum is the more active in faint illumination that the illusion of a moonlight scene may be got by looking through a blue glass, while looking through a yellow glass gives the idea of sunlight and brilliant illumination (*Practical Physiology*).

(5) **Modes of Stimulation**.—The rods and cones are generally stimulated by the ethereal light vibration, but they may be stimulated by mechanical violence or by sudden changes in an electric current. But, however stimulated, the kind of sensation is always of the same kind—a visual sensation (see p. 138).

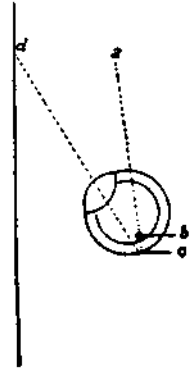

FIG. 73.—To show that the hindmost layer of the retina is stimulated (*Purkinje's Images*). a, source of light; b, blood-vessel of retina; c, shadow of vessel on rods and cones; d, image of shadow mentally projected on to the wall.

(6) Of the nature of the changes in the retina when stimulated we know little. But we know that—

1st. Under the influence of light the cells of the tapetum nigrum expand forward between the rods and cones.

2nd. A purple pigment, which has been called rhodopsin, exists in the outer segment of the rods, and this is bleached by the action of light. Even although there is no purple in the cones, which alone occupy the sensitive central spot of the eye, this change in colour suggests that a chemical decomposition accompanies stimulation.

3rd. Electrical changes occur (p. 61).

(7) **Fatigue.**—If a bright light be looked at for some time, the parts of the optic mechanism, retina, and nerve centre acted upon is temporarily blinded, and hence, when

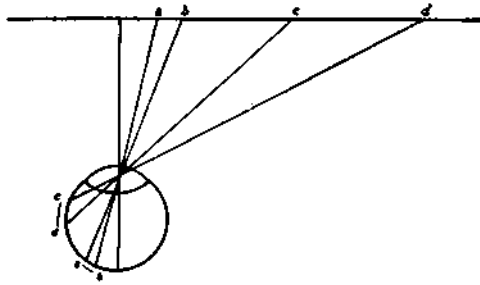

FIG. 74.—The Power of Localising the Source of Illumination on different parts of the retina. The two points, *a-b*, subtended by the small angle, fall close together at *a-b* near the centre of the retina, and still give rise to a double sensation; but if two points, *c-d*, have their images formed on the periphery of the retina, *c-d*, these images must be far apart to cause a double sensation.

the eye is directed away from the bright light, a dark spot is seen. This is sometimes called a **negative after-image**. When coloured lights are used, the phenomena of complementary colours are produced (*Practical Physiology*).

Sometimes the stimulation of the retina or of the brain neurons connected with it may last after the withdrawal of the stimulus, when a continuance of the sensation—a **positive after-image**—is seen. This may be observed if, on opening the eyes in the morning, a well-illuminated window is looked

at and the eyes closed; a persisting image of the window may be seen.

2. The Power of Localising the Source or Direction of Illumination.

This may be determined by finding how close together two separate stimuli may fall and still give rise to a double sensation. Over the central spot two points of illumination may be very near, and still two sensations be experienced (fig. 74).

On passing to the more peripheral part of the retina, where the cones are more scattered, the power of localising decreases.

3. Colour Sensation.

1. **Physics of Light Vibration.**—Physically the various colours are essentially different rates of vibration of the ether, and only a comparatively small range of these vibrations stimulates the retina. The slowest acting vibrations are at the rate of about 435 billions per second, while the fastest are not more than 764 billions—the relationship of the slowest to the fastest is something like four to seven. The apparent colour of objects is due to the fact that they absorb certain parts of the spectrum, and either transmit onwards or reflect other parts.

The vast variety of colours which are perceived in nature is due to the fact that the pure spectral colours are modified by the *brightness* of illumination, and by *admixture* with other parts of the spectrum (*saturation*). Thus, a surface which, in bright sunlight, appears of a brilliant red, becomes maroon, and finally brown and black, as the light fades. Again, a pure red when diluted with all the spectrum—*i.e.* with white light—becomes pinker as it becomes less and less saturated (*Practical Physiology*).

2. **Physiology of Colour Sensation.**—(1) The peripheral part of the retina in man is colour blind—is incapable of acting, so as to produce colour sensations. Yellow and blue can be distinguished further out upon the retina than can red and green. There is a zone of retina which is blind to red and

green, but which can react to blue and yellow. Only the more central part of the retina is capable of being stimulated by all colours. These zones are not sharply defined, and vary in extent with the size and brightness of the coloured image (fig. 75) (*Practical Physiology*).

(2) While the various sensations which we call colour are generally produced by vibrations of different lengths falling on the retina, colour sensations are also produced in various other ways.

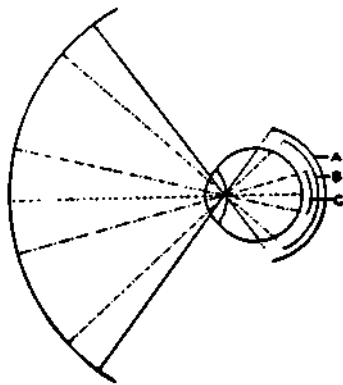

FIG. 75.—Distribution of Colour Sensation in relationship to the surface of the retina (*Colour Perimeter*). *A* indicates the extent of retina stimulated by white and black; *B*, the part also capable of stimulation by blue and yellow; and *C*, the central part capable also of stimulation by red and green.



FIG. 76.—Disc which, when rotated in a bright light, gives the impression of colours.

(a) By mechanical stimulation of the retina. By pressing on the eyeball as far back as possible a yellow ring, or part of a ring, may often be seen (*Practical Physiology*).

(b) Simple alternation of white and black upon the retina may produce colour sensation, as when a disc of paper marked with lines, as shown in fig. 76, is rotated rapidly before the eye (*Practical Physiology*).

(3) By allowing different parts of the spectrum to fall upon the eye at the same time, it is possible to produce either a sensation of white or of some other part of the spectrum (*Practical Physiology*). To produce a sensation of white from two or three different parts of the spectrum a due proportion of each part must be taken, since different parts have different sensational activity.

This effect of mixing different parts of the spectrum means that *by different modes of stimulation of the retina the same sensation may be produced*. The sensation of orange may be produced, either when vibrations at about 580 billions per second fall on the eye, or when two sets of vibrations, one about 640 and one about 560 billions, reach it. By no possible physical combination of the two is it possible to produce the intermediate rate of vibration.

The sensation of colour, therefore, depends upon the nature of the change set up in the retina, and not upon the condition producing that change.

What we call colours are particular changes in consciousness accompanying particular changes in brain neurons produced by particular changes set up in the retina, in whatever way these changes may have been produced.

Colour-blindness.—While every one is colour-blind at the periphery of the retina, a certain proportion of people—about 5 per cent.—are unable to distinguish reds and greens, even at the centre of the retina. Colour-blindness for yellow and blue is very rare.

In complete loss of colour vision—monochromatic vision—everything appears grey, and usually there is blindness in the middle of the field over the central spot. Possibly it is produced by a loss of function in the cones.

It is not known whether a condition of colour-blindness exists in lower animals.

When white light passes through a lens it is partly decomposed into its component parts, the blue rays being more refracted than the red, and *chromatic aberration*, the unequal focussing of the different parts of the spectrum on

the retina, is thus made possible. The way in which the more divergent peripheral rays are cut off by the iris prevents this from manifesting itself in vision (p. 148).

(II.) BINOCULAR VISION.

A. Advantages.

In most of the lower animals, the field of vision of each eye is separate and distinct at all times, but in the horse and dog the two eyes can be directed forwards so that the fields of vision overlap as they always do in man and in apes.

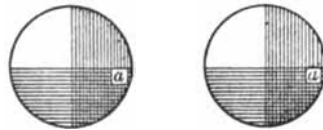

FIG. 77.—Corresponding Areas of the two Retinae in Binocular Vision. The upper and outer area of the right retina corresponds to the upper and inner area of the left retina, and the other areas correspond as shown by the shading. In each pair of areas definite points correspond with one another, $a-a$.

When in this position, the combined action of the eyes affords a means of determining the distance and solidity of near objects.

1. **Distance of Near Objects.**—As an object is approached, the two eyes have to be turned forwards by the internal recti muscles, and by the degree of contraction of these, an estimation of the distance is made.

2. **Solidity of an Object.**—If the object is near, a slightly different picture is given on each retina, and experience has taught that this *stereoscopic vision* indicates solidity.

B. Single Vision with Two Eyes.

1. **Corresponding Areas of the Two Retinae.**—In order that single vision may occur with the two eyes, the eyes must be directed to the same place, as can be done in the horse and

dog in certain position of the eyes, so that the image of that place falls on each central spot (*Practical Physiology*). If this does not occur, double vision results. The central spot of one eye thus **corresponds** to the central spot of the other, and definite points in each retina have *corresponding points* in the other, which, when the eyes are working together, are stimulated by the same part of the picture (fig. 77).

2. Movements of Eyeballs.—To secure harmonious action of the two retinæ, it is necessary that the eyes should be

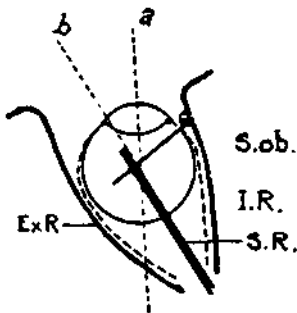

FIG. 78.—The left Eyeball in the Orbit from above, with the muscles acting upon it. The axis of the orbit, *b*; the axis of the eyeball, *a*.

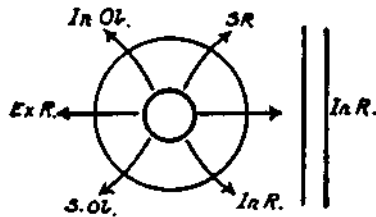

FIG. 79.—The Movements of the Eyeball caused by the various Muscles of the Eye. (Right Eye.)

freely movable. Each eye in its orbit forms a ball and socket joint in which the eyeball moves round every axis (fig. 78). The orbit looks forward and outwards, but the axis of the eye (*a*) is directed straight forward and is set obliquely to the axis of the orbit (*b*). The centre of rotation is behind the centre of the ball. The movements are produced by three pairs of muscles.

- (1) The internal and external recti (*I.R.* and *Ex.R.*).
- (2) The superior and inferior recti acting along the lines indicated (*S.R.*).
- (3) The superior and inferior obliques acting in the line (*S.ob.*).

The internal rectus rotates the pupil inwards.				
„ external	„	„	„	outwards.
„ superior	„	„	„	{ upwards and in- wards.
„ inferior	„	„	„	{ downwards and in- wards.
„ superior oblique	„	„	„	{ downwards and out- wards.
„ inferior	„	„	„	{ upwards and out- wards.

In directing the eyes to the right, the external rectus of the right eye acts along with the internal rectus of the left. In directing the eyes straight upwards, the superior rectus and inferior oblique of each eye act together; and in looking downwards, the inferior rectus and superior oblique come into play (fig. 79). Every movement of the eye involves the co-ordinated excitation and inhibition of muscles (see p. 193).

In the **horse, dog,** and other similar animals the eye is set more nearly in the axis of the orbit, and the obliques do not pass backwards upon the ball, but act more purely as rotators; the superior oblique swinging the outer angle of the pupil upwards and inwards, the inferior oblique downwards and inwards. The superior and inferior recti move the pupil more directly upwards and downwards.

In the **horse** and other herbivora a retractor oculi muscle is inserted all round the ball inside these muscles just described, and it can retract the eye in the orbit, and at the same time pushes forward the fatty tissue to which the nictitating membrane is attached and thus thrusts this over the front of the eye.

4. “**Glance**” **Movements of the Eyes.**—When the eyes are allowed to sweep over a landscape or any series of objects, or when these move rapidly past the eyes, or the eyes rapidly past them, as in travelling by train, the axes are directed in a series of glances to different points, and the succession of pictures thus formed gives the idea of a continuous series of objects. The jerking movement of the eyes may be well seen in a passenger looking out of a railway carriage in motion. This “glance vision” is taken advantage of in the cinematograph.

5. **Nervous Mechanism.**—A somewhat complex nervous mechanism presides over these various movements of the eyes. All the muscles are supplied by the third cranial nerve, except the superior oblique, which is supplied by the fourth nerve, and the external rectus, which is supplied by the sixth nerve (fig. 80).

The centres for the third and fourth nerves are situated in the floor of the aqueduct of Sylvius under the corpora quadrigemina, while the centre for the sixth is in the pons Varolii (fig. 80).

The various centres are joined by bands of nerve fibres which pass between the sixth and fourth and third centres, and, in part at least, cross the middle line.

A combined mechanism, each part of which acts harmoniously with the other parts, thus presides over the ocular movements, and this mechanism is controlled by impulses constantly received (a) from the two retinæ; (b) from the ears; and (c) from the brain. Thus, in convergence of the optic axes, the parts of the nuclei of the third nerves which supply the internal recti muscles must act harmoniously together, and hence a mechanism to direct

this convergence may be postulated. In lateral deviation of the eyes, such as is reflexly produced by sudden auditory or visual stimulation on one side, that part of the nucleus of the third nerve which presides over the internal rectus of one side acts harmoniously with the sixth nerve supplying the external rectus of the other side, and hence it may be supposed that a directing mechanism for lateral deviation

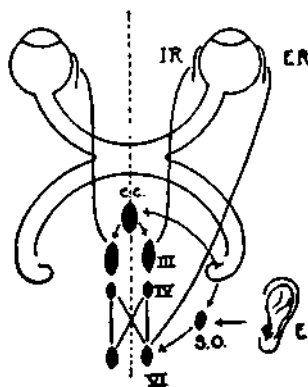

FIG. 80.—The Nervous Mechanism presiding over the combined movements of the two Eyes. *I.R.*, internal rectus; *E.R.*, external rectus; *C.C.*, convergent centre acting on the nuclei of the third nerve; *S.O.*, superior olive (centre for lateral divergence) acting on the external rectus of the same side through the nucleus of the sixth, and on the internal rectus of the opposite side through the nucleus of the third; *E.*, ear.

exists, possibly in the superior olive (fig. 80). Similarly a centre or centres presiding over the movements of the eyes in a vertical plane may be supposed to exist.

6. **Disturbances of the Neuro-Muscular Mechanism.**—Paralysis of these muscles and of the nerves supplying them leads to a loss of the co-ordinated movements of the two eyes, with the result that the optic axes are no longer parallel and squint is produced. As a result of this, corresponding points on the two retinæ are not stimulated by rays from the same object, and double vision, *diplopia*, results in men and apes.

III. CONNECTIONS OF THE EYES WITH THE CENTRAL NERVOUS SYSTEM.

1. THE OPTIC NERVES AND OPTIC TRACTS.

From each eye the optic nerve extends backwards and inwards to join the other optic nerve at the chiasma. A partial crossing of the fibres takes place in the chiasma, the extent of decussation varying in different animals and being fairly extensive in the horse. From the chiasma the two optic tracts pass upwards round the crura cerebri to end in two divisions—

1. A posterior division passing to the anterior colliculus of the tectum on the same side (fig. 81, *A.C.Q.*).
2. An anterior division running to the external geniculate body on the posterior aspect of the thalamus opticus (fig. 81, *Op.Th.*).

In most of the lower animals a complete decussation of the optic fibres takes place, so that the nerve fibres from the left eye go to the right side of the brain, and *vice versa*. But in man and apes a partial crossing of the fibres takes place in the chiasma—fibres from the middle and internal part of the retina decussating, those from the outer part remaining on the same side. For this reason, *section of the right optic tract* leads to partial blindness of both retinæ—on the outer part of the right eye and on the inner and middle part of the left eye, so that objects on the left side of the field of vision are not seen.

The fibres of the *posterior division* of each optic tract ends in synapses with neurons in the anterior colliculus of the tectum, and the fibres of these neurons pass downwards and control the oculo-motor mechanism already described (fig. 81).

The fibres of the *anterior division* make synapses with other neurons in the external geniculate body and pulvinar

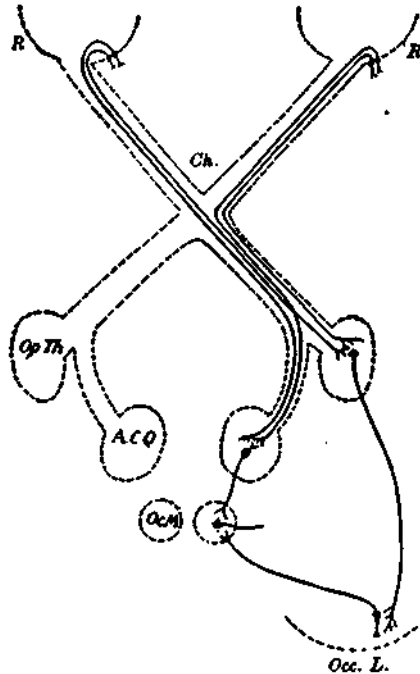

FIG. 81.—The Connections of the Retina with the Central Nervous System. *R*, retina; *Ch.*, chiasma leading to optic tract; *Op.Th.*, optic thalamus; *A.C.Q.*, anterior colliculus of the tectum; *Oc.M.*, oculo-motor mechanism (fig. 80); *Occ.L.*, occipital lobe of the cerebrum.

of the thalamus, and in the thalamus visual impressions become associated and integrated with those of other receptors—touch, hearing, etc. (fig. 81, *Op.Th.*; see also fig. 50, p. 113).

From the thalamus a great band of fibres, which early get their white sheath, sweeps outwards and backwards to cortex on the internal aspect of the occipital lobe.

2. THE VISUAL CENTRE IN THE CORTEX CEREELLI

An extensive lesion of one—say the right—occipital lobe, (fig. 82), is accompanied by no loss of muscular power but by blindness for all objects in the opposite side of the field of vision—i.e. the right side of each retina is blind. The central spot of neither eye is completely blinded, because

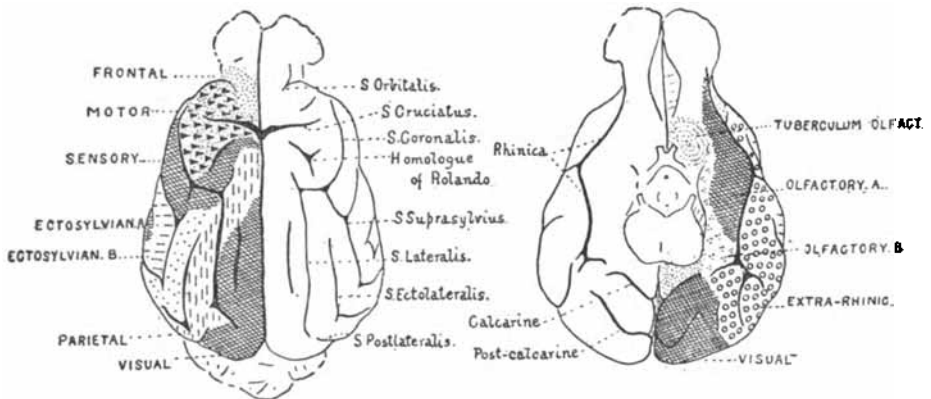

FIG. 82.—Superior and inferior aspects of the brain of the dog to show the various sulci and the distribution of the chief receiving and reacting mechanisms. Sensory is body sensibility.

the fibres from the macula lutea only partially decussate at the chiasma.

Stimulation in this region in the monkey causes movement of the eyes to the opposite side, as if some object were perceived there. But destruction of the area does not paralyse the movements of the eyes.

In man, and the higher apes, the cortex in this region shows a definite arrangement of cells, and a well-defined band of white fibres in the middle of the layer of granules (p. 183), which is thus duplicated (fig. 92). This is the band of Gennari. In long-standing cases of blindness the thickness of the layer of Gennari may be reduced by 50 per cent., and of the outer layer of granules by 10 per cent.

The special characters of this area become more and more

defined as we pass from the simpler mammals, with separate vision for the two eyes, to the primates with combined vision with the two eyes.

The evidence that it is this part of the brain which must be stimulated in order that visual sensations may be experienced is convincing. But it must be remembered that there are lower arcs connecting with the oculo-motor mechanism from the optic nerves—(1) through the thalamus and red nucleus, and (2) through the anterior part of the tectum, and that stimulation of the eye may lead to movements of the body and of the eye through these without consciousness being involved. This is seen in the reaction of the pupil to light and in the reflex movements of the eyes in response to unilateral auditory stimulation.

The centre is united by a strong band through the middle peduncle with the cerebellum (see p. 130), and in the higher apes by another band of fibres with an area in the frontal region, concerned with the movements of the eyes, and this is again connected with the cerebellum (fig. 58).

Usually the visual area is stimulated by changes passing up the series of neurons from the retina, but it may also be stimulated directly, as is sometimes seen in the early part of an epileptic fit, or by the previous action of other chains of neurons, as in dreaming.

The *strength of the sensation* varies with the strength of the stimulus, and the smallest difference of sensation which can be appreciated is a constant factor of the degree of stimulation.

The *sensation lasts longer than the stimulus*, and thus, if a series of stimuli follow one another at sufficiently rapid intervals, a fusion of sensations is produced. If a wheel rotating slowly is looked at, the individual spokes are seen, but when it is going more rapidly, the appearance of a continuous surface is presented. When the light is dim, this fusion takes place more readily than when the light is bright.

The visual centre of each side must be regarded as a *chart* of the opposite field of vision, each part corresponding

to a particular part of the field. The two centres acting together give the whole field of vision. Since *the blind spot is not represented* in the centre, it is not perceived in the field of vision.

The centre is said to *rectify the inverted image* formed on the retina, but this simply means that, as a result of experience, we have learned that changes in, say, the lower part of the retinae, and in the corresponding parts of the visual centres, are produced by light from above the head.

Since the retinal changes vary only with the degree of illumination, *i.e.* the amplitude of vibration of the ethereal waves, and with the rate of these waves, and since the part of the retina acted on is determined by the direction of the rays, we have the means of getting a **flat picture** only of what we look at, but no special arrangements for having different sensations according to the distance of an object or according to whether it is flat or in relief. The means of determining the size, distance, and form of objects by the visual mechanism is very limited (p. 138).

III. FOR VIBRATION OF AIR.

SENSE OF HEARING.

1. General Considerations.

The vibratory changes of pressure in the air, known to physicists as sound waves, stimulate special receptor structures placed in the ear of higher animals. Even simple organisms, devoid of any special organ of hearing, may be affected by vibratory changes, and in fish it is difficult to be certain how far such vibrations produce their effect through the ear or through the body generally. But in higher vertebrates it is chiefly through the ear that they act. In it there is a special arrangement by which the vibrations of the air are converted into vibrations of a fluid in a sac situated in the side of the head. In this a series of ciliated cells is situated, and round these are the dendritic terminations of the auditory nerve fibres.

The importance of such a mechanism in the anterior part of the animal in warning it of danger or making it aware of the presence of its prey is manifest.

In mammals the organ of hearing consists of the *external*, the *middle*, and part of the *internal* ear. The purpose of the first is to conduct the vibrations of the air to the second, in which these vibrations produce to-and-fro movements of a bony lever, by which the fluid in the third is alternately compressed and relaxed.

2. External Ear.

The structure of this presents no point of special physiological interest. In lower animals the pinna is under the control of muscles, and is of use in determining the direction from which sound comes.

3. Middle Ear.

The object of the middle ear is to overcome the mechanical difficulty of changing vibrations of air into vibrations of a fluid.

It consists of a chamber, the *tympanic cavity*, in the petrous part of the temporal bone (fig. 83). Its outer wall is formed by a membrane, the *membrana tympani* (*Ty.*), which is attached to a ring of bone. Its inner wall presents two openings into the internal ear—the *fenestra ovalis* (*f.o.*), an oval opening, situated anteriorly and above, and the *fenestra rotunda* (*f.r.*), a round opening placed below and behind. Throughout life these are closed, the former by the foot of the stapes, which is attached to the margin of the hole by a membrane, the latter by a membrane only. The posterior wall shows openings into the mastoid cells, and presents a small bony projection which transmits the *stapedius* muscle. The anterior wall has (*a*) above, a bony canal carrying the *tensor tympani* muscle, and (*b*) below this, the canal of the *Eustachian tube* which communicates with the posterior nares (fig. 83, *En.T.*).

In the tympanic cavity are three ossicles—the *malleus* (*m.*), *incus* (*i.*), and *stapes* (*s.*), forming a chain between the mem-

brana tympani and the fenestra ovalis. The handle of the malleus is attached to the membrana tympani, and each time a wave of condensation falls upon the membrane it drives this inwards, and with it the handle of the malleus. This locks the malleo-incal joint (fig. 83, *m.i.*), and pushes inwards the long process of the incus, which thrusts the stapes into the fenestra ovalis, and thus increases the pressure in the enclosed fluid of the internal ear. By the "give" of the membrane in the fenestra rotunda, the increased pressure is relieved. The bones rotate round an antero-posterior axis passing through the heads of the malleus and incus. They

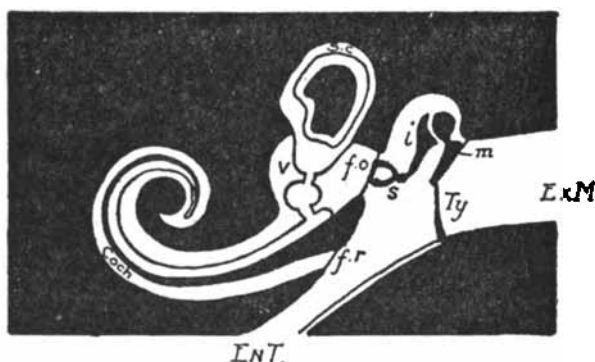

FIG. 83.—Diagram of the Ear. *Ex.M.*, external meatus; *Ty.*, tympanic membrane; *m.*, malleus; *i.*, incus; *s.*, stapes; *fo.*, fenestra ovalis; *f.r.*, fenestra rotunda; *En.T.*, Eustachian tube; *v.*, vestibule with the atriole and sacculæ; *s.c.*, semicircular canal; *Coch.*, cochlea.

thus form a lever with the arm to which the power is applied—the handle of the malleus—longer than the other arm. The advantage of this is that, while the range of movement of the stapes in the fenestra ovalis is reduced, its force is proportionately increased. A further increase of force is gained by the small size of the fenestra ovalis as compared with the tympanic membrane.

On account of the fact that the annular ligament is narrow on one side and broader at the other, the movement of the foot of the stapes is not a straight thrust but a movement round a hinge.

If the *membrana tympani* is forced violently *outwards* by closing the nose and mouth and forcing air up the Eustachian tube, as in one clinical method of overcoming obstruction of the Eustachian tube, the incus and stapes do not accompany the malleus and the membrane, because the malleo-incal articulation becomes unlocked, and the head of the malleus slides on the incus.

The *membrana tympani* is so loosely slung that it has no proper note of its own, and responds to a very large range of vibrations. By the attachment to it of the handle of the malleus it is well damped and stops vibrating as soon as waves of condensation and rarefaction have ceased to fall upon it.

Two slender muscles are attached to the ossicles—

(1) The *stapedius* is carried from the posterior wall of the cavity and is inserted into the orbicular process of the stapes. It tends to twist the stapes in the oval window and so to limit its range of movement inwards and to favour its outward movement. It is supplied by the seventh cranial nerve, and in paralysis of this loud sounds may be heard with painful intensity.

(2) The *tensor tympani* passes from the inner walls of the cavity outwards to the base of the handles of the malleus. It tends to pull the tympanic membrane inwards and to thrust the head of the stapes further into the oval window. It is supplied by the fifth cranial nerve, and when this is paralysed hearing is impaired.

These two muscles are thus antagonistic to one another and, as in the case of other antagonists, their action is probably co-ordinated. They must exercise a balancing action on the movement of the stapes inwards during the positive phase of a sound wave and outwards during the succeeding negative phase.

The *Eustachian tube* has a double function. It allows the escape of mucus from the middle ear, and it allows the entrance of air, so that the pressure is kept equal on both sides of the *membrana tympani*. Its lower part is generally closed, but opens in the act of swallowing. This part is surrounded by an arch of cartilage to one side of which fibres

of the tensor palati are attached, so that, when this muscle acts in swallowing, the arch of cartilage is drawn down and flattened, and the tube opened up (fig. 84).



FIG. 84.—Transverse Section through the cartilaginous lower part of Eustachian Tube, to show the cartilaginous arch cut across, and the way in which it is pulled down and the tube opened in swallowing (shaded).

The Eustachian tube may get occluded, as a result of catarrh of the pharynx, and the oxygen in the middle ear is then absorbed by the tissues, and the pressure falls. As a result, the membrane is driven inwards by the atmospheric pressure, and does not readily vibrate, and hearing is impaired. When this blocking occurs, and it is necessary to force air into the middle ear, a tube connected with a rubber ball is inserted into a nostril, the mouth and other nostril are closed, and, as the patient swallows, air is forced into the naso-pharynx and so through the Eustachian tube.

4. Internal Ear.

The internal ear is a somewhat complex cavity in the petrous part of the temporal bone, the *osseous labyrinth*. It is filled with fluid, the *perilymph*. It consists of a central space, the *vestibule* (*V.*), into which the fenestra ovalis opens. From the anterior part of this, a canal makes two and a half turns round a central pillar. This is the *osseous cochlea* (fig. 83, *Coch.*). From the central pillar a bony shelf (fig. 85, *L.*) projects into the canal. From the edge of the bony shelf the *basilar membrane* extends to the outer wall of the cochlea (fig. 85, *B.M.*). It is composed of fibres radiating outwards. The inner is more elastic than the outer part. At the base of the cochlea the bony lamella is broad, but at the apex its place is chiefly taken by the membrane, which there measures about three times its width at the base.

A canal which communicates with the vestibule, into which the oval window opens, called the *scala vestibuli* (fig. 85, *S.V.*), thus runs above the bony shelf and basilar membrane, while another canal, the *scala tympani*, runs below them, and ends

at the round window. They communicate with one another through a small opening at the apex, the helicotrema.

The **semicircular canals** (fig. 54) also open from the vestibule. Their functions have been discussed (p. 121).

A complex membranous bag, the **membranous labyrinth**, lies in the **perilymph** of the bony labyrinth. This has an outer fibrous coat, and inside this a homogeneous layer.

In the vestibule the membranous labyrinth consists of the **utricle** and **saccul**e, the functions of which are related to

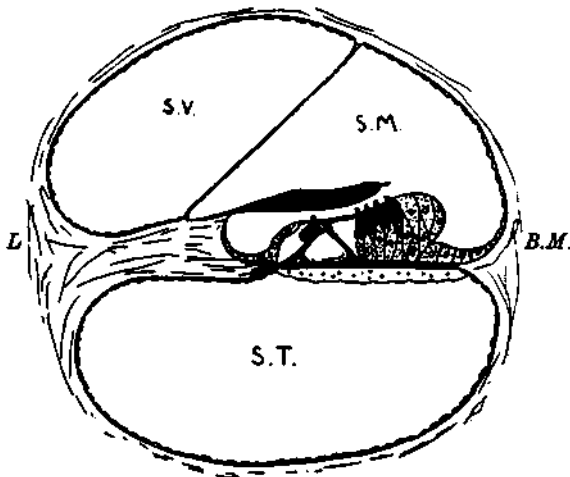

FIG. 85.—Transverse Section through one turn of the Cochlea to show the Organ of Corti on the Basilar Membrane. *S.M.*, scala media; *S.V.*, scala vestibuli; *S.T.*, scala tympani. The tectorial membrane normally lies upon the hair cells of Cortis organ.

those of the canals. From the saccul a narrow **canalis reuniens** runs to the membranous cochlea, which lies upon the basilar membrane, as the **scala media**, between the scala vestibuli and scala tympani and ends blindly at the apex of the cochlea (fig. 85, *S.M.*).

In the membranous cochlea, the **organ of Corti** (fig. 85) is formed by a special development of the epithelium lining the tube. It is set upon the inner more elastic part of the basilar membrane, and consists from within, outwards, of—*1st.* A set of elongated supporting cells; *2nd.* A row of columnar cells, with short, stiff, hair-like processes projecting

from their free border; *3rd.* The inner rods of Corti, each of which may be compared to an ulnar bone attached by its terminal end, and fitting on to the heads of the outer rods; *4th.* The outer rods of Corti, each resembling a swan's head and neck—the neck attached to the basilar membrane, and the back of the head fitting into the hollow surface of the inner rods. The two sets of rods thus form an arch; *5th.* Several rows of outer hair cells, with some spindle-shaped cells among them; *6th.* The outer supporting cells; *7th.* Lying over the inner and outer hair cells is the membrana reticularis, which resembles a net, and through the meshes of which the hairs project; *8th.* Lying upon this organ, with the cilia of the hair cells embedded in it, is a homogeneous membrane—the membrana tectoria, the inner margin of which is firmly attached to the denticulate lamina as shown in fig. 85 and fig. 87.

The terminal neurons both to the vestibule and to the cochlea end in dendrites among the hair cells.

5. Connections with the Central Nervous System.

The dorsal or auditory part of the VIII. nerve is the true nerve of hearing. (*a*) Its fibres (fig. 86) (*Coch. R.*) begin in dendrites between the hair cells of the organ of Corti, and have a neuron-cell upon their course. When they enter the medulla, they branch into two divisions, which end either in the tuberculum acusticum or in the nucleus accessorius (*N. Acc.*), where they form synapses.

(*b*) From these cells axons pass across the middle line in the striæ medullares and corpus trapezoideum, and, turning sharply upwards, run as the lateral fillet to the posterior colliculi of the tectum of the opposite side. Here many of the fibres form synapses, and fresh fibres pass to the oculo-motor mechanism. When the cochlea is destroyed in young animals, the opposite posterior colliculus atrophies.

(*c*) The rest of the fibres run onwards to the medial geniculate body of the thalamus where synapses are formed.

(*d*) From these fresh fibres, which get their white sheath early, course outwards to the cortex cerebri in the superior temporo-sphenoidal lobe.

6. Auditory Centre in the Cortex Cerebri.

Ferrier, by removing the superior temporo-sphenoidal lobe in the monkey, produced no motor disturbance, but found evidence of loss of hearing in the opposite ear. When the region was stimulated, he found that the monkey pricked up

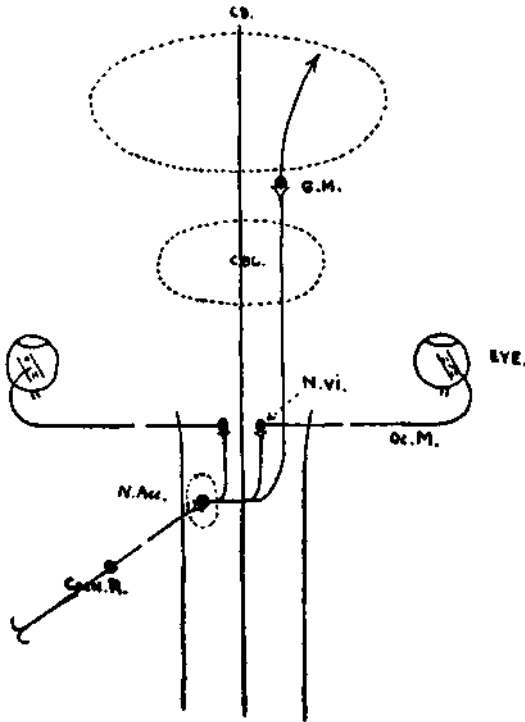

FIG. 86.—Connections of Cochlea with the Central Nervous System. *Coch.R.*, cochlear root of eighth nerve; *N.Acc.*, tuberculum acusticum and nucleus accessorius sending fibres to the cerebrum (*C.B.*) and to the oculo-motor mechanism (*N.vi.*) through the posterior colliculi; *C.B.L.*, cerebellum; *G.M.*, the corpus geniculatum mediale.

its ears and looked to the opposite side, and he considered that these observations prove the existence of a special localised mechanism for the reception of stimuli from the ear.

The receptor arrangements in the ear enables loudness—amplitude of vibration; pitch—rate of vibration; and

quality—the character of the sound given by the over-tones to be distinguished. The perception of this last is essentially a perception of pitch.

Loudness.—It is easy to understand how the peripheral neurons in the internal ear are more powerfully stimulated by the greater variations in the degree of pressure which are produced by more powerful aerial waves, and how the greater stimulation of the receptive centre in the brain will be accompanied by a sensation of greater *loudness*.

Pitch.—The auditory mechanism has an extraordinary power

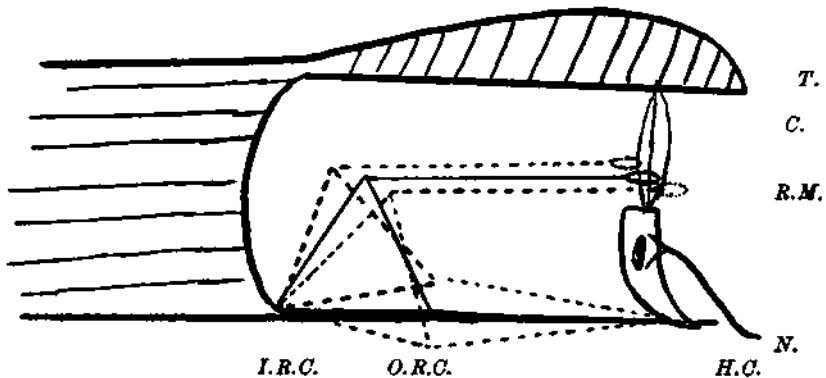

FIG. 87.—To show the movements of the basilar membrane with the passage of a sound wave, and the manner in which, by the displacement of Cortis' arch *I.R.C.*, *O.R.C.*, the reticular membrane pulls upon the cilia *C.*, which are embedded in the tectorium *T.*, and thus may stimulate the nerve endings *N.*

of enabling the appreciation of the pitch and quality of sound, and of enabling complex sounds to be analysed. How it does so is still somewhat problematical. Helmholtz maintained that it is by resonance, the fibres of the basilar membrane acting like the strings of a piano, each one of which, or each set of which, is made to vibrate by a particular note and its overtones, and thus to stimulate the nerve endings among the hair cells situated upon these parts of the membrane. Some experiments on dogs, in which the appreciation of notes of lower pitch was apparently lost after the upper turns of the cochlea were destroyed, and some few cases of partial destruction of the cochlea in the human

subject with alterations in pitch perception, give support to this theory.

But it has recently been pointed out by Wrightson that there is no real proof of this theory, and that it assumes that the air waves are propagated up the scala vestibuli, through the helicotrema, and down the scala tympani.

It has further been urged that the small size of the opening at the helicotrema and the large extent of scala media exposed to the perilymph must tend to favour a transmission of pressure *across* this scala from the scala vestibuli to the scala tympani, and so to the round window.

Now this would cause a displacement of the basilar membrane—

1st. Downwards.

2nd. Back to the horizontal.

3rd. Upwards.

4th. Back to the horizontal, as in fig. 87.

This would result in a lateral displacement of Cortis' arch round the base of the internal rods as a hinge, and this would lead to a pull first in one direction then in the other of the reticular membrane, which would lead to a bending of the cilia embedded in the tectorial membrane, which is firmly attached to the denticulate lamina, and this might stimulate the cells, thus stimulating the nerve endings and so leading to stimulation of the auditory centre.

This view of the action of the ear brings hearing into accord with the sense of touch, and it is of interest that the otic vesicle is developed as an invagination of the skin. The mechanism is a most delicate one for "weighing" the small variations of pressure which constitute sound waves.

Such a theory serves to explain the possibility of notes of different pitch producing different effects in the short stumpy cochlea of the bird, which is difficult to understand on Helmholtz's theory.

IV. THE METHODS BY WHICH THE RECEIVING AREAS HAVE BEEN LOCALISED.

The determination of the exact parts of the cortex cerebri concerned with the reception of the incoming impressions from the different peripheral receptors has proved to be by no means easy, but the combination of various methods has overcome these difficulties and has enabled the localisation to be made with exactness.

1st. *Experimental Methods.*—(a) Sensations are the usual accompaniment of the activity of the receiving mechanism. But, in the lower animals, it is not possible to have a direct expression of whether or not sensations are experienced, and therefore, in determining whether removal of any part of the brain has taken away the power of receiving impressions, we have to depend upon the absence of the usual mode of response to the given stimulus. But the absence of this may mean, not that the receiving mechanism is destroyed, but either that the reacting mechanism is out of action, or that the channels of conduction have been interfered with (see fig. 88).

Thus, if light be flashed in the eye of a monkey, it responds by glancing towards the source of illumination; and if this movement is absent it may be due to (1) loss of the receiving mechanism; (2) loss of the mechanism causing the movements; or (3) interruption of the channels between them.

Again, it is quite possible that, after removing the receiving mechanism in the cerebrum, external stimuli may lead to the usual response *by acting through lower reflex arcs* (fig. 88). If, for instance, we suppose the receiving part of the cerebrum connected with the reception of tactile impressions to be entirely destroyed, scratching the sole of the foot may still cause the leg to be drawn up, just as if a sensation had been experienced. Here, although the upper arc is out of action, the lower arc still acts.

(b) In the lower animals, stimulation of a part of the brain, if it be connected with the reception of impres-

sions, may cause the series of movements which naturally follow such an impression. But these movements may also be caused by directly stimulating the reacting mechanism.

When, however, *removal of a part of the brain causes no loss of power of movement, and yet prevents a stimulus from causing its natural response, it is justifiable to conclude that that part of the brain is connected with reception.*

2nd. Clinical and Pathological Methods.—In man, the chief difficulty of obtaining information is in finding cases where only a limited part of the brain is affected. But such cases have been observed. Tumours of the inner aspect of an occipital lobe, for instance, have been found to be associated with loss of visual sensations without loss of muscular power, and thus the conclusion has been drawn that this part of the occipital lobe is the receiving mechanism for stimuli from the eyes.

3rd. Pathological.—As a result of the destruction of certain parts of the nervous system, in the region of the thalamus, either by experiment in the lower animals or by disease in man, a degeneration of nerve fibres may occur to some definite region of the cortex, and this generally shows that the area is a receiving one.

4th. Anatomical Methods.—When it has been found possible to assign a definite function to any area of the cortex, its extent and limits may be determined by the extent and distribution of the particular character of the arrangement and structure of the nerve cells.

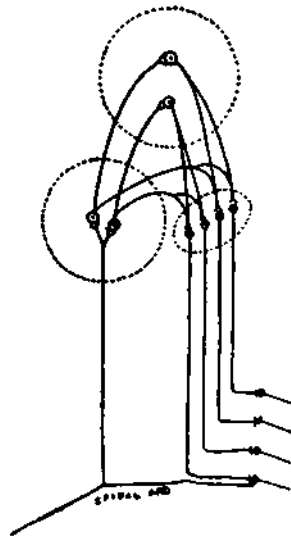

FIG. 88.—Diagram to Illustrate Different possible Channels of Cerebral Response to Stimulation, and to show how, through reflex action of the lower arcs, the action of the higher arcs may be simulated.

of which is specially associated with the higher mental activities (fig. 90).

Further, in the group of mammals which depend largely on olfactory impressions, the rhinencephalon is markedly developed, while in those in which smell plays a subordinate part this portion of the brain is only slightly developed (fig. 61).

It must at once be recognised that *if such special parts exist, each must be in nature receiving, reacting, and, to some extent, associative.* Thus, if one part of the cortex is specially connected with the reception of impulses from the eye, it must be able to bring about appropriate reactions either by sending impulses directly outwards or by acting upon some part of the brain which has the function of bringing about a reaction. And, in order that the reaction may be appropriate, some associative mechanism, either in these parts of the cortex or elsewhere, must be brought into play (fig. 89).

V. THE INTEGRATION OF SENSATIONS IN THE CORTEX.

The Cortex Cerebri and Mental Life.

We have seen that stimulation of definite parts of the cortex cerebri may lead not only to modification of movement through the spinal arcs, but also to changes of consciousness, which have been described as sensations.

But the great object of the development of the cerebral cortex from the basal ganglia is to furnish a means by which these sensations are associated and integrated, so that more complex changes of consciousness may result. A full study of this is beyond the domain of physiology and encroaches on the territory of the psychologist.

A pine tree may, through the visual mechanism, produce a sensation of green of a certain extent and from a certain direction; the odour may act upon our olfactory mechanism; the wind in the branches may stimulate our hearing, and when we approach and touch the tree our

cutaneous sensations are evoked and our muscle-joint sense is aroused.

But, unless these sensations are brought together and integrated, we can have no recognition that some one object, a pine tree, is calling them forth. It is only by an association of the sensations that we gain the knowledge that all are due to the object which we agree to call a pine tree.

If, at a later date, some of these different sensations called forth by this tree are again elicited, they are associated

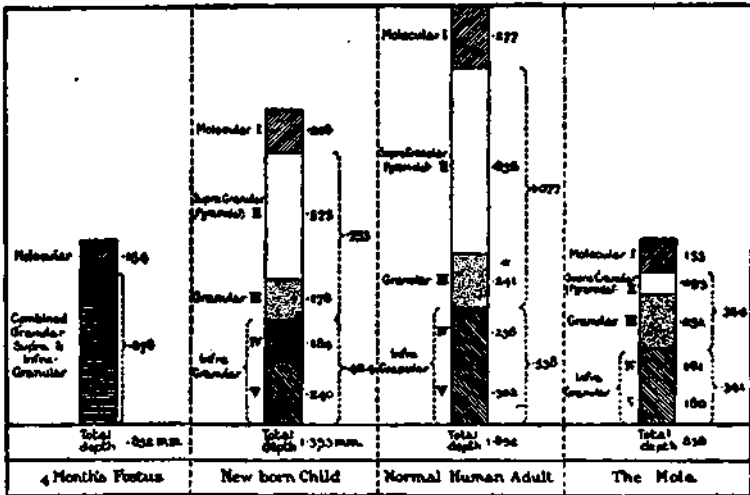

FIG. 90.—To show the development of the different layers of the cortex in man, and their condition in one of the lower mammals—the mole. The first column shows the two layers, from the lower of which the infra-granular, granular, and supra-granular layers of the adult cortex are formed. The second column shows the cortex at the time of birth. The third column shows the growth of the supra-granular layers as adult life is reached. In the fourth column the cortex of the adult mole is shown for comparison. (After BOLZON.)

with the past impressions and again call forth the idea of the pine tree and may lead us to conclude that we are near one.

This means that each sensation and each combination of sensations or perceptions of the object producing them must leave an impress on the brain which is the physical basis of memory, and that the repetition of some of them, by

association with these previous impressions, leads to their renewal, leads to our *recollecting* the past experiences.

1. Structural Development.

In the lower vertebrata the differentiation of the cortex from the basal ganglia is incomplete, and it is only in the higher mammals—monkeys and man—that the cortex reaches full physiological importance.

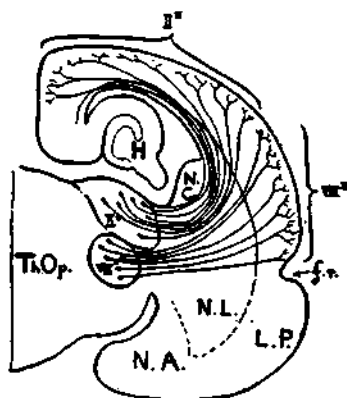

FIG. 91.—The passage of fibres from the nuclei of the thalamus to the cortex cerebri of a primitive mammal. *Th.Op.*, thalamus; *L.P.*, lobus pyriformis; *f.r.*, fissura rhinica; *VIII''*, auditory area; *H.*, hippocampus. (ELLIOT SMITH.)

The cerebrum originally developed as a ganglion in connection with the organ of smell, and in the osmatic mammals—those in which smell plays a great part in guiding their actions—a large part of the cerebrum remains specially connected with the nose. This may be called the *rhinencephalon* (fig. 61, p. 135).

The *cortex cerebri*, or neopallium, is a secondary development from the thalamus, with which it remains closely associated by outgoing and ingoing neurons (fig. 91).

In the human fœtus at four months, two layers are visible in the cortex—(1) an outer molecular layer of fibres, and under this (2) layers of undifferentiated cells (fig. 90).

By the sixth month this second layer has become divided into two by a well-developed layer of small cells, the

granular layer. The deeper layer becomes differentiated into a layer of *polymorphic cells*, and outside of this a layer of fibres, the *layer of Baillarger*. Outside the granular layer a *layer of pyramidal cells* appears below the *outer layer of fibres*.

Histology.—At birth, the cortex in the neopallium, from without inwards, consists of (fig. 92)—

1. Outer layer of fibres.
2. Layer of pyramidal cells.
3. Layer of granules.
4. Inner layer of fibres (Baillarger's layer).
5. Layers of polymorphic cells.

It is the supra-granular layers which increase as development advances. The adult mole has a cortex like that of the six-month human fœtus (fig. 90).

The cells of the cortex send dendritic processes up towards the surface, where they form a complicated series of synapses, and they also send axon-processes downwards into the white substance of the brain.

From these fibres, collaterals come off which connect different parts of the cortex of the same side, and which also connect the cortex of one side with that of the other, and with the basal ganglia (fig. 93).

In the rhinencephalon three layers develop in the cortex—(1) the outer layer of fibres; (2) the layer of granules, often curiously broken up into nests; and (3) the layer of polymorphic cells.

2. Functional Development.

An animal at birth is little more than a reflex machine, and the functions of its cortex cerebri are still in abeyance. But the ingoing tracts from the visual, auditory, tactile and other receptors are fully developed, and hence from the first a stream of stimuli pours in upon the cortex.

Although these may not at first be properly integrated, they influence and colour one another, giving rise to the pleasurable state of consciousness in the creature signified by

a condition of rest, and to the unpleasant state associated with restlessness and crying.

Only when sensations become more completely integrated in the developing cortex is any real mental life possible. The power of integrating largely depends upon:—

(1) The *previous history of the brain*, both phylogenetic and ontogenetic. For, just as in the spinal cord channels of action are formed, so in the cerebrum, if a given reaction once follows a given stimulus, it will tend to follow it again.

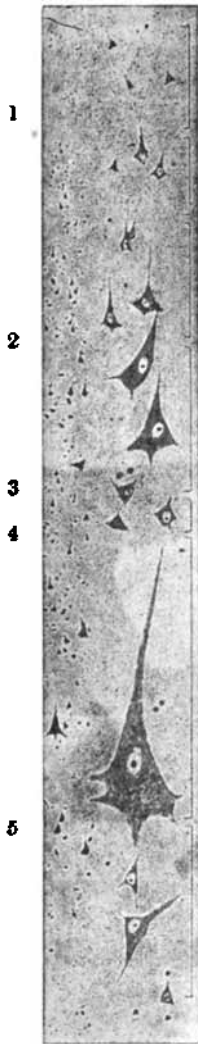

A

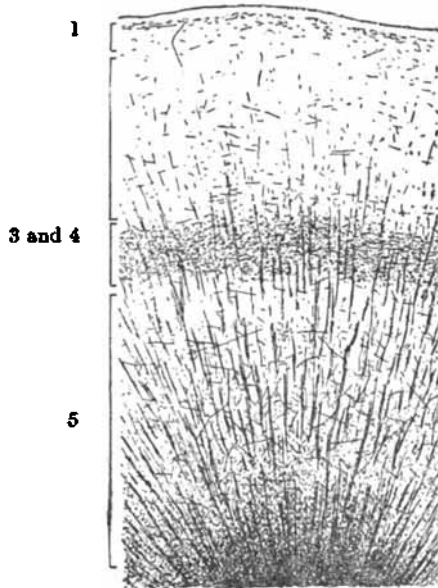

B

FIG. 92.—A, Section of cerebral cortex in the pre-central lobe (a motor area). (For description of zones, see text.) B, Section through cerebral cortex in the region of the calcarine fissure (visual area), stained to show the arrangement of the fibres. (For description of zones, see text.) (CAMPBELL.)

(a) This training or preparation of the brain is in part *hereditary*. Each member of a species is born with well-established lines of action in the process of development, and throughout life these inherited channels play an important part in determining the results of stimulation. In young fowls, as soon as they are hatched, the acts of running and of pecking are at once performed, and in many families particular gestures or expressions follow certain modes of stimulation in many different individuals without the

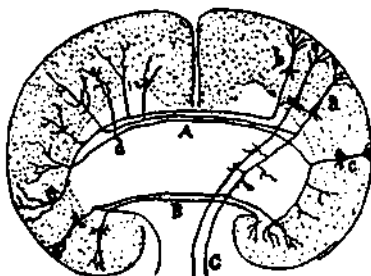

FIG. 93.—Diagram of collateral connections of different parts of the cerebral cortex. *a*, *b*, *c*, pyramidal cells of the cortex, all connected by collateral branches with other parts of the cortex in the same and in the opposite hemisphere. *a* give off the pyramidal fibres to the cord. (After RAMON Y CAJAL.)

consciousness of the person being involved. They are *inherited cerebral reflexes*. (b) Paths may also have been developed in the individual as the result of previous activities of the nervous mechanism. For, if a given action has once followed a given stimulus, it always tends to follow it again. This, in fact, is the basis of all training of animals—to open up paths in the nervous system by which the most suitable response may be made to any given stimulus, and to prevent the formation of paths by which inappropriate reaction may be produced.

(2) *The nutrition of the brain*.—Not only will the previous training of the brain thus act as the directive force in the response to stimuli, but the *nutrition of the brain* also plays an important part. The action of a brain when well nourished and freely supplied with pure blood is often very different from that of the same brain when badly nourished or imperfectly supplied with blood.

3. Storing and Associating Part of the Cortex.

The existence of a special part or parts of the brain connected with the storing of impressions, so that they may be associated with present sensations, is indicated by the following considerations:—It is this association of present stimuli with past sensations which is the basis of intellectual life, and in man the frontal and parietal lobes of the brain are much more developed than in the lower animals. So far, stimulation of these has failed to give any indication of resulting sensations, or to produce muscular movements. They may be extensively injured without loss of sensation and without paralysis, and hence it has been concluded that the storing and associating functions must be chiefly located in them.

In these regions the nerve fibres acquire their medullary sheath at a very late date.

4. The Relationship of Consciousness to Cerebral Action.

Cerebral action frequently goes on without consciousness being implicated; but, so far as we know, consciousness without accompanying cerebral action is unknown, and there is evidence that it is only when the actions of the various parts of the cerebrum are co-ordinated that consciousness is possible. In cases of Jacksonian epilepsy, as a result of a small centre of irritation on the surface of the brain, a violently excessive action of the cerebral neurons starts at the part irritated and passes to involve more and more of the brain. In such fits, it is found that at first the patient's consciousness is not lost, but that, when a sufficient area of brain is involved in this excessive and inco-ordinated action, consciousness disappears.

Unconsciousness may be produced by many conditions which modify the nutrition of the brain. (1) Many drugs, of which chloroform and ether may be taken as types, poison the brain and cause loss of consciousness. (2) Similar poisons may develop in the body as the result of faulty metabolism, as is seen in diabetic coma. (3) A sudden failure of the supply of blood to the higher centres may cause the loss of consciousness which occurs in fainting.

(4) Hæmorrhage into the brain, or a tumour inside the skull may interfere with the blood supply by pressure and also cause loss of consciousness.

The study of the action of drugs which abolish consciousness—*e.g.* chloroform and morphine—on the dendrites of brain cells suggests a physical explanation of the condition. It is found that these drugs cause a general extension of the gemmules of all the dendrites; and, if we imagine that the co-ordinated action of any part of the brain is secured by definite dendrites of one set of neurons coming into relationship with definite dendrites of another set of neurons by their gemmules so as to establish definite paths, the want of co-ordinate relationship established by the general expansion would explain the disappearance of the definite sensations which constitute consciousness.

5. Time of Cerebral Action.

The cerebral mechanism takes a very appreciable time to act, and the time varies (1) with the complexity of the action and (2) with the condition of the nervous apparatus.

Of the time between the presentation of a flash of light to the eye or a touch to the skin and a signal made by the person acted upon when it is perceived, part is occupied in the passage of the nerve impulses up and down the nerves and in the latent period of muscular contraction, but a varying period of something over one-tenth of a second remains, representing the time occupied in the cerebral action (*Practical Physiology*).

Continued action of the nerve centres may lead first to a shortening of the reaction time as a result of the facilitation of the passage of the impulses over the synapses (*practice*), but this is soon followed by a prolongation (*fatigue*). The latter condition is produced by the action of alcohol, chloroform, and other poisons.

6. Fatigue of the Cerebral Mechanism.

Fatigue of the cerebral mechanism is manifested (*a*) by decrease in the power of attention, comparable to the loss

of command of the common path seen in the spinal reflex action (p. 86) ; (b) by prolongation of the reaction time ; and (c) by a more rapid decrease of the force of muscular contraction.

The seat of the change is in the cerebral synapses, and, after these have failed to act, the spinal arcs may still be unaffected and spinal reflexes may be produced.

The cause of the condition is probably primarily the accumulation of the products of activity and the lack of a free supply of oxygen to the brain, and the condition may often be removed by (a) a short rest, or by (b) the substitution of a change of occupation, or by (c) muscular exercise, which increases the flow of blood through the brain, or (d) by sleep. The act of yawning (p. 522) is simply a reflex which increases the flow of blood to the heart and thus on to the brain. It is Nature's effort to overcome cerebral fatigue.

As to how the synapses are affected, a consideration of the possible way in which such poisons as chloroform act upon the dendrites and gemmules to abolish definite lines of action suggests that in fatigue the same thing may occur to a lesser degree.

Continued action also leads to well-marked changes in the cell protoplasm of the neurons. The Nissl's granules diminish and the nucleus shrivels and becomes poorer in chromatin.

7. Sleep.

Fatigue of the cerebral mechanism is closely connected with sleep. As the result of fatigue, external stimuli produce less and less definite effects, and thus the changes, which are the physical basis of consciousness, become less and less marked. At the same time, by artificial means, stimuli are usually so far as possible excluded. Absence of light, of noise, and of tactile and thermal stimuli all conduce to sleep. The purpose of hypnotic drugs is to render the brain less susceptible to external or internal stimuli.

As sleep advances (1) consciousness fades away, and, as the cerebral activity diminishes, (2) the arterioles throughout

the body dilate, the arterial blood pressure falls, and thus less blood is sent to the brain, and the organ becomes more bloodless. This may be seen in cases of trephining, where a sinking of the trephine scar occurs during sleep. (3) The eyelids close, (4) the eyeballs turn upwards, (5) the pupils contract, and (6) the voluntary muscles may relax. In the horse, ox, etc., the tonic contraction of the muscles, with the assistance of the ligaments (p. 237) sustaining the body in the standing position, may persist, and the animal may sleep in that position.

The **depth of sleep** may be measured by the strength of the stimuli required to overcome it.

The prejudicial effect of want of sleep has been demonstrated by observations upon young dogs. It was found that they died in five days if prevented from sleeping, while, if allowed to sleep, they withstood even the withdrawal of food for no less than twenty days.

More sleep is required by young than by old animals.

8. Hypnosis.

This is a condition in some respects allied to sleep. In many of the lower animals it is readily produced, simply by holding the animal firmly and placing it in any unusual position, as on the back, especially if stimuli from without are cut off—*e.g.* by bandaging the eyes. It may then lie without moving for a prolonged period, and may react much in the same way as if decerebrated. The condition may be induced in many people by powerfully arresting the attention, and it is probably due to a removal of the influence of the higher centres over the lower. The respirations and pulse become quickened, the pupils dilate, and the sensitiveness of the neuro-muscular mechanism is so increased that merely stroking a group of muscles may throw them into firm contraction. This suggests an abrogation of the cerebral function and a dominance of the tonic vestibulo-cerebellor-spinal arc. The individual becomes a reflex machine even as regards the cerebral arcs, and each stimulus is followed by an immediate reaction.

VI. THE DISCHARGING SIDE OF THE CEREBRAL ARC.

In the previous section the way in which changes in the external world act upon the body and the consciousness has been considered.

The reactions of the body through the spinal arcs in reflex action have also been dealt with, and the way in which these reactions are controlled and adjusted by the concomitant action of the proprioceptive mechanisms of the muscles and joints on the one hand, and of the vestibule and semicircular canals on the other, has been explained (p. 121).

I. The Basal Ganglia.

The way in which all incoming impulses are interrupted and associated in the thalamus has been considered (p. 113).

The **thalamus** is connected not only with the cortex, but also with the different nuclei of the corpus striatum and with the red nucleus from which fibres pass down the cord in front of the crossed pyramidal tract (fig. 97).

In man and apes the functions of these connections have been largely handed over to the control of the cortex, but in lower mammals they are of primary importance.

Corpus Striatum.—There is some evidence that the corpus striatum plays a part in controlling temperature (p. 269). It was found that stimulation leads to increased heat production, which must be due to increased chemical change in the muscles. More recently it has been found that stimulation by means of cold leads to a rise of temperature, while stimulation by heat leads to a fall, the first causing a constriction of the blood-vessels of the skin, the second causing a dilatation.

II. The Discharging Area of the Cortex Cerebri.

The way in which movements are originated and dominated by the cortex cerebri, as the result of the integration of the stimuli falling on the body, and their association with one another and with the impressions of

previous stimulation, so that the resulting action may be appropriate to the surroundings, must now be studied.

Ample evidence is forthcoming that in men and apes the part of the cortex round about and chiefly in front of the central fissure performs this function. In the dog, cat and pig it is situated round the cruciate fissure (figs. 52, p. 115, and 94).

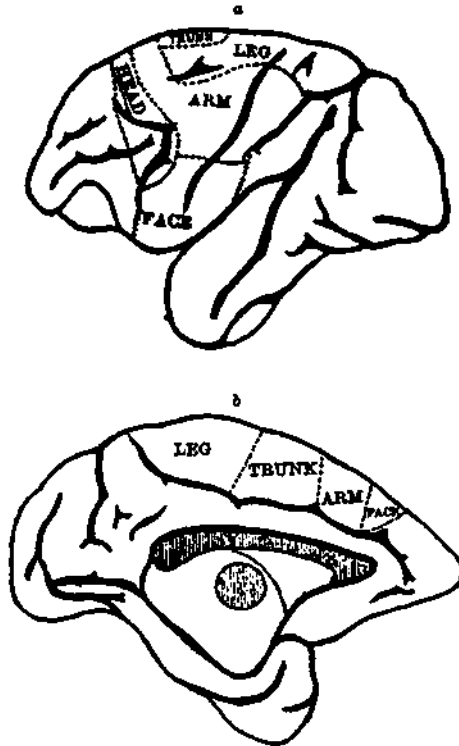

FIG. 94.—(a) Surface of the left Cerebral Hemisphere of a Monkey to show the situations of some of the Discharging Mechanisms (front to left); (b) Mesial Surface of the same Hemisphere (front to right).

This area is played upon by all the sensory and associative arrangements in the cortex. Like every other part of the brain it receives and discharges impulses (fig. 89). But unlike the receiving areas, which have been already considered, it discharges outwards from the brain upon the spinal arcs.

The evidence as regards its position is both clinical and experimental.

1. Clinical and Pathological Evidence.—Destructive lesions of this area on one side cause a loss of the so-called voluntary action of groups of muscles on the opposite side of the body, while the muscles themselves and the spinal reflexes connected with them are not interfered with. The spinal reflexes may in fact become more active.

Certain lesions may directly stimulate these centres, causing them to act without the previous action of the other cerebral mechanisms and may cause convulsions. This is seen in Jacksonian epilepsy, where, as the result of a spicule of bone or a thickened bit of membrane, one part of the cortex is from time to time excited. This produces movements of certain groups of muscles, which spread outwards to other groups as the stimulation of the cortex extends outwards from its seat of origin, till finally all the muscles of the body are involved in a general convulsion.

2. Experimental Evidence.—Experimental observations have fully confirmed and extended the conclusions arrived at from such pathological evidence.

(a) **Removal.**—If parts of these convolutions be excised in the monkey, the animal loses the power of voluntary movement of certain groups of muscles on the opposite side of the body. Movements requiring the co-operative action of muscles of both sides, e.g. movements of the eyes and trunk, are not abolished by unilateral destruction.

In these motor areas *the lesion must be extensive to cause complete paralysis of any group of muscles.* A limited lesion may simply cause a loss of the finer movements. Thus, a monkey with part of the middle portion of the Rolandic areas removed may be able to move its arm and hand, but may be quite unable to pick up objects from the floor of its cage.

Even after removal of a fairly extensive part of these centres, with resulting muscular paralysis, it has been found that after a time more or less complete *recovery takes place.* Evidently some other part than that removed can take upon

itself the function, is capable of education, just as the lower spinal centres seem capable of adaptation.

(b) Stimulation by electricity causes movements of group of muscles of the opposite side of the body and of muscles on both sides when bilateral co-operation is required.

These movements are elicited by much weaker currents than are required to produce them on stimulating the typical receiving area already studied.

If the cortex is stripped off and the white fibres below

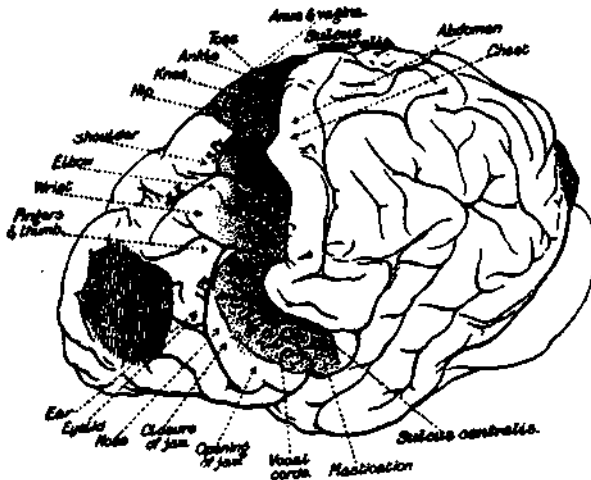

FIG. 95.—Left Hemisphere of Brain of Chimpanzee to show the results of stimulating different parts. The Sulcus Centralis is the fissure of Rolando. (From GRÜNBAUM and SHERRINGTON.)

it are directly stimulated, the latent period is shortened and the strength of current required to produce movements is greater.

The work of Grünbaum and Sherrington on the brain of anthropoid apes has shown that the discharging mechanism is chiefly in the pre-central convolution (fig. 95), extending forwards into the posterior parts of the superior, middle and inferior frontal convolutions, with a patch far out in the frontal area by stimulation of which movements of the eyes are produced. This is present only in men and apes which use binocular vision. It is associated by a band of

fibres with the visuo-sensory area, and fibres pass from it down the cerebro-pontine tracts to reach the cerebellum (fig. 58).

The discharging part of the cortex may be considered as a map of the various muscular combinations throughout the body, the map being mounted so that the lower part represents the *face*, the middle part the *arm*, and the upper part the *leg*, probably corresponding closely to the map of cutaneous and muscle-joint sensibility, although this may lie rather more posteriorly. Each large division is filled in so that all the various combinations of muscular movement are represented (fig. 95). It must be remembered that these centres do not send nerves to single muscles, but that they play upon the spinal centres to produce combined movements of sets of muscles.

These movements involve inhibition as well as excitation, just as the spinal reflexes do.

This is very clearly shown as regards the eye movements. In the monkey, the resting position of the eyes is straight forward with the optic axes parallel. If all the nerves to the ocular muscles be cut, this position is assumed, and, if the position of the eye be passively altered, upon removing the displacing force, it springs back to this position. If the III. and IV. nerves of the left side be cut (p. 161), so that the external rectus alone is unparalysed, then, exciting a part of the cortex which causes movements of the two eyes to the right, produces not only a movement of the right eye in that direction, but a movement of the left eye to the right as far as the middle line—the position of rest—showing that the VI. nerve has been inhibited.

Stimulation of the cortex causes flexion more readily than extension, apparently because the inhibitory mechanism for the extensors is better developed than that for the flexors. Sherrington finds that this condition is reversed under the influence of strychnine or of tetanus toxin, and that stimuli, which in normal conditions will cause flexion, now cause powerful extension, and hence co-ordinated movement is impossible.

III. Fibres passing outwards from the Discharging Parts of the Cerebrum.

The fibres coming from this area of the cortex are mixed up with the ingoing fibres from the thalamus already

described. But they are distinguished from them by the fact that they get their medullary sheaths at a late date, so that they may be traced right down into the cord as the pyramidal tract in the following situations:—

1st. In the corona radiata (figs. 96 and 97).

2nd. In the anterior two-thirds of the posterior limb of the internal capsule, the face fibres lying to the front, the arm fibres behind these, and the leg fibres furthest back (figs. 96 and 97).

3rd. In the central part of the crura of the crus, arranged from within outwards—face, arm, leg (fig. 97).

4th. In the pons Varolii, between the deep and superficial transverse fibres. The face fibres cross here (fig. 97). Hence a unilateral tumour in this situation may cause paralysis of the face on one side and of the limbs on the other—a crossed paralysis.

5th. In the anterior pyramids of the medulla

oblongata. Most of them decussate at the junction of the medulla and spinal cord (fig. 97).

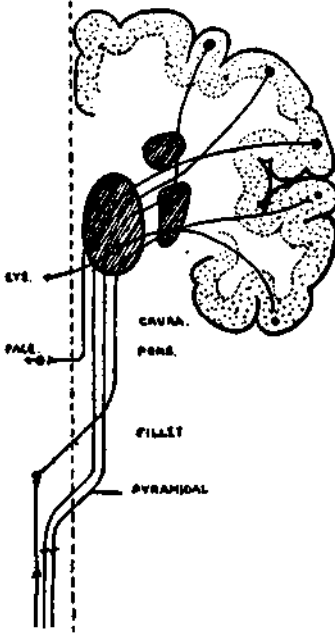

FIG. 96.—Diagrammatic horizontal section through base of cerebral hemisphere, showing (1) the outgoing fibres for the leg, arm, and face springing from the cortex of the central areas, passing through the internal capsule between the thalamus and the lenticular nucleus. The face fibres cross in the pons, the leg and arm fibres in the medulla. (2) The incoming fibres (fillet, eye, etc.) have cell stations in the thalamus, and then pass on to the cortex.

6th. In the spinal cord they constitute the crossed pyramidal tract of the opposite side. Those which do not cross run down for some distance in the antero-median tract as the direct pyramidal fibres to cross lower down (fig. 98).

7th. From the pyramidal fibres collaterals come off and act, through intercalated neurons, on the outgoing neurons from the anterior horn of grey matter to the skeletal muscles (fig. 33). These pyramidal fibres degenerate when the motor cortex is destroyed or when they are severed by a hæmorrhage into the internal capsule.

Fibres from the Basal Ganglia.—Degeneration of the rubro-spinal and of the tecto-spinal fibres does not occur unless this interruption is below the level of the tectum (p. 113).

The course of the various outgoing fibres in the spinal cord in man is shown in fig. 98.

In addition to the tracts from the cerebrum, the downgoing fibres forming the outgoing part of the vestibulo-cerebello-spinal arc are also shown (fig. 98).

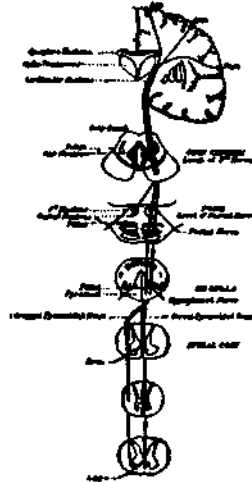

FIG. 97.—To show the Course of the Pyramidal Tract from the Cortex of the Precentral Convolution.

IV. Outgoing Nerves from the Spinal Cord.

These outgoing nerves from the spinal cord emerge in the anterior roots (p. 107). They may be divided into two sets :—

1. Somatic, to the skeletal muscles.
2. Visceral, to the viscera, blood-vessels, glands, etc.

1. **Somatic.**—The course and distribution of these are fully studied in anatomy.

2. **Visceral.**—These outgoing fibres are characterised by their small size. They take origin, as described on p. 54, chiefly in a lateral column of cells, which is well developed

in the dorsal region of the cord (see p. 54), and pass out as medullated fibres by the anterior root. From this they pass by the *white* root to a sympathetic ganglion, whence they may proceed in one of two ways (fig. 46).

1. They may form synapses with cells in the ganglion, and fibres from these cells may pass—

(a) Outwards with the splanchnic nerves.

(b) Back into the spinal nerve by the grey root, and so down the somatic nerve to blood-vessels, muscles of the

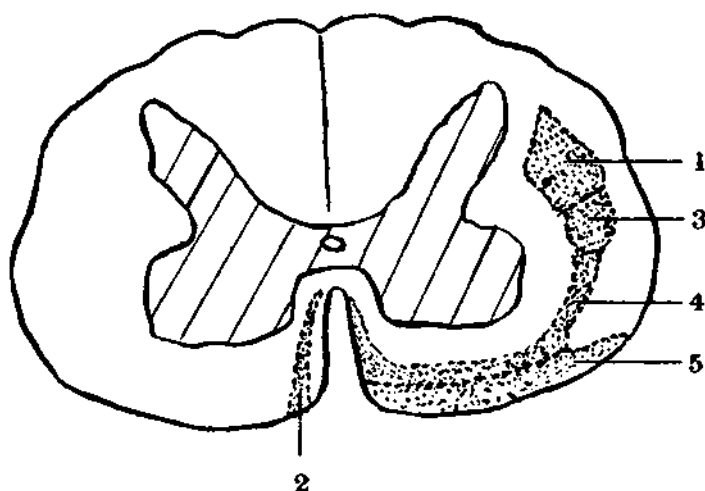

FIG. 98.—Cross section of the Spinal Cord in the cervical region to show the position of the various groups of outgoing fibres:—1, The crossed pyramidal tract; 2, the direct pyramidal tract; 3, the rubro-spinal tract; 4, the tecto-spinal fibres; 5, the vestibulo-spinal fibres.

hairs, sweat glands, etc. The ganglia from which fibres pass back into spinal nerves are known as *lateral ganglia*.

(c) Upwards or downwards into other sympathetic ganglia.

2. They may pass through the ganglion to one more peripherally situated in which they form synapses with other neurons which are continued onwards. The ganglia, from which fibres do not pass back, are called *collateral ganglia*. Before their first interruption these fibres are

termed *pre-ganglionic fibres*; after their interruption *post-ganglionic*.

3. The various fibres, after their interruption, proceed,

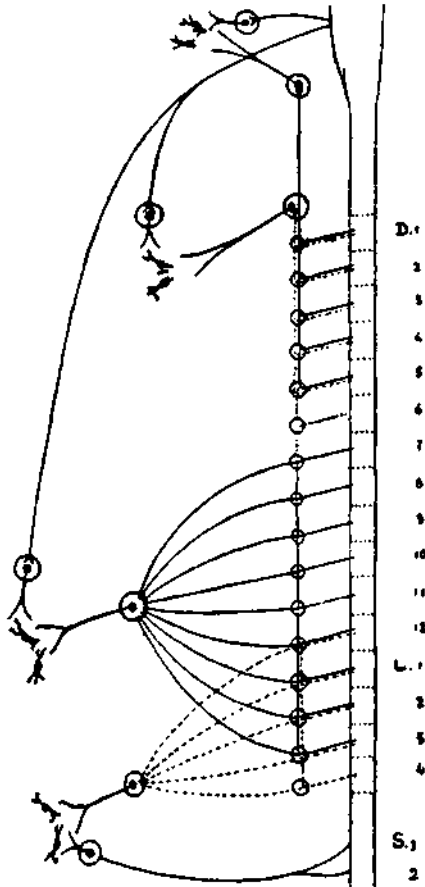

FIG. 99.—Scheme of Distribution of the Thoraico-Abdominal (the true sympathetic) and the Cranial and Sacral (the para-sympathetic) Splanchnic Nerves.

generally as non-medullated or grey fibres, to their termination. Here they form synapses with the network of fibres and cells which constitute the *terminal plexuses*. Upon these, in the gut at least, the control of the tissues is largely devolved.

The interruption of fibres in ganglia, or their passage through these structures, has been determined by taking advantage of the fact that *nicotine*, in one per cent. solution when painted on a ganglion, poisons the synapses but does not influence the fibres. Hence, if when a ganglion is painted with nicotine, stimulation of the fibres on its proximal side produces an effect, it is proved that the break is not in that ganglion.

The Visceral Nerves may be divided into two sets—

I. The Thoracic-Abdominal or True Sympathetic Fibres. which come out in the middle region of the spinal cord and pass through the lateral ganglia of the sympathetic chain (fig. 99). They are distributed to the—

(1) *Head and Neck.*—These leave the spinal cord by the upper five dorsal nerves and pass upwards in the sympathetic cord of the neck to the superior cervical ganglion where they have their cell stations. From these, fibres are distributed to the parts supplied. Stimulation of these fibres causes—*1st*, Vaso-constriction of the vessels of the face and head; *2nd*, Dilatation of the pupil (see p. 148); *3rd*, Prominence of the eyeball, due probably to the stimulation of visceral muscular fibres in the eyelids by which these are drawn apart and the eye exposed and allowed to bulge forward; *4th*, Secretion of the salivary, lachrymal, and sweat glands.

(2) *Thorax.*—The fibres to the thoracic organs also come off in the upper dorsal nerves. They have their cell stations in the stellate ganglion in the dog, and pass to the heart and lungs.

(3) *Abdomen.*—These fibres come off in the lower dorsal and upper lumbar nerves. They course through the lateral ganglia and form synapses in the collateral ganglia of the abdomen—the solar plexus and the superior and inferior mesenteric ganglia. From these, they are distributed to the abdominal organs, being vaso-constrictor to the vessels, and inhibitory to the muscles of the stomach and intestine.

(4) *Pelvis.*—The fibres for the pelvis leave the cord by the lower dorsal and upper lumbar nerves, and have

their cell stations in the inferior mesenteric ganglia, from which they run in the hypogastric nerves to the pelvic plexus. They are vaso-constrictor, inhibitory to the colon, and generally motor to the bladder, uterus, and vagina.

(5) *Arm.*—These fibres, coming out by the middle dorsal nerves, have their synapses in the ganglia of the sympathetic chain, and passing back into the spinal nerves by the grey rami, course to the blood-vessels, hairs, and sweat glands of the limb.

(6) *Leg.*—The fibres take origin from the lower dorsal and upper lumbar nerves, have their cell stations in the lateral ganglia, and pass to the leg in the same way as do the fibres to the arm.

II. The Cranial and Sacral, or Para-sympathetic Fibres.—These pass out from the upper and lower ends of the cord. They do not pass through the lateral ganglia but have their cell stations in some of the collateral ganglia.

(a) **Cranial**—

(1) The *third cranial nerve* carries fibres which have their synapses in the ciliary ganglion, and pass on to the sphincter pupillæ and ciliary muscle.

(2) The *seventh nerve* carries fibres through the chorda tympani to cell stations in the submaxillary and sublingual ganglia. These are secretory to the submaxillary and sublingual glands.

(3) The *ninth nerve* sends fibres to the parotid gland, which have their cell station in the otic ganglion.

(4) The *vagus* sends inhibitory fibres to the heart, which form synapses in the cardiac plexus. It also sends augmentor fibres to the œsophagus, stomach and intestine.

(b) **Sacral**—

The *nervi erigentes* or *pelvic nerves* come off from the second and third sacral nerves, and pass to the hypogastric plexus near the bladder where the fibres have their cell stations. They are the vaso-dilator nerves to the pelvic organs; they inhibit the sphincter of the bladder, and are motor to the bladder, colon, and rectum.

partly of anterior root fibres. The vagus is the great ingoing nerve from the abdomen, thorax, larynx, and gullet, while, by outgoing fibres, passing through it or through the accessorius, it is augmentor for the muscles of the bronchi and alimentary canal, inhibitory to the heart, dilator to blood-vessels of the thorax and abdomen, and motor to the muscles of the larynx and to the levator palati. The accessorius is also motor to the sterno-cleido-mastoid and trapezius.

The IX. (Glossopharyngeus) is essentially a posterior root, and is the ingoing nerve for the back of the mouth, the Eustachian tube, and tympanic cavity. It also contains outgoing somatic fibres to the stylo-pharyngeus and middle constrictor of the pharynx, and outgoing visceral fibres which are secretory and vaso-dilator to the parotid gland.

The VII. (Facial) is almost purely an anterior root, transmitting somatic motor fibres to the muscles of expression and to the stapedius muscle, visceral secretory fibres to the submaxillary and sublingual glands and the glands of the mouth, and vaso-dilator fibres. It also carries ingoing fibres from the anterior two-thirds of the tongue. It is the cranial nerve most frequently paralysed, and this condition is often caused by inflammatory changes in the canalis facialis in which it passes through the temporal bone. The condition in man is known as *Bell's paralysis*. It occurs in the horse, and it is characterised by a drooping of the ear on the affected side, by the upper eyelid being pulled to the middle line, while the lower eyelid droops, by an elongation of the nostril and difficulty of breathing through it, and by a pendulous condition of the lips so that saliva and food dribble from the mouth.

The V. (Trigeminal) is chiefly a posterior root, but it has a distinct anterior or motor root which joins it, and it carries the motor fibres to the muscles of mastication and to the tensor tympani. It is the great ingoing nerve for all the face.

The VI. (Abducens) supplies the external rectus of the eye.

The IV. (Trochlearis) supplies the superior oblique.

The III. (Oculo-motorius) supplies all the muscles of the eye except those supplied by VI. and IV.

C. THE EFFECTORS.

MUSCLE.

So far as the chemical changes in the body are concerned, muscle is more important than nerve, for three reasons—1st. It is far more bulky, making up something like 45 per cent. of the total weight of the body in men, and 38 per cent. in women. 2nd. It is constantly active, for even in sleep the muscles of respiration, circulation, and digestion do not rest; and 3rd. The changes going on in it are very extensive, since its great function is to set free energy from the food. *So far as the metabolism of the body is concerned, muscle is the master tissue.* For muscle we take food and breath, and to get rid of the waste of muscle the organs of excretion act. Hence it is in connection with muscle that all the problems of nutrition—digestion, respiration, circulation, and excretion—have to be studied.

Muscle is the great liberator of energy in the body, and the energy is used—

1. To perform mechanical work.
2. To heat the body.

I. Development and Structure.

Most free protoplasmic units have the power of contracting and expanding. A muscle cell or fibre is specially developed to contract and relax in one direction and to use a large proportion of the energy liberated in work.

The first trace of the evolution of muscle is found among the infusoria, where, in certain species, in parts of the protoplasm, long parallel fibrils run in the direction in which the cell contracts and expands. Such a development has been termed a *myoid*.

Even a cursory examination of mammalian muscles shows that those of the trunk and limbs, **skeletal muscles**, are different from those of such internal organs as the bladder, uterus, and alimentary canal, **visceral muscles**.

1. The **visceral muscles** appear to be formed from cells similar to ordinary connective tissue cells. These elongate and become definitely longitudinally fibrillated. They thus become spindle-shaped cells, varying in length from about 50 to 200 micro-millimetres. A delicate covering membrane, the *sarcolemma*, is said to be present, but bridges of protoplasm may extend from one fibre to another. In mammals the nucleus is usually long, almost rod-shaped, and is independent of the fibrillæ of the protoplasm. The *nerves* which pass to these muscles are post-ganglionic, and they form a plexus between the fibres.

In many situations, e.g. the wall of the intestine, well-developed peripheral nerve ganglia are present.

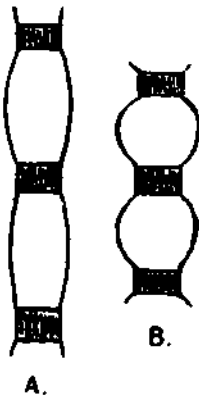

FIG. 102.—To illustrate the possible structure of a fibril as a series of potential apertures in the relaxed and in the contracting condition.



FIG. 101.—(a) Some of the sarcous substance of a fibre of skeletal muscle teased to show the constituent fibrils (sarco-styles) with transverse markings; (b) dim band; (c) clear band with Dobie's line.

2. The **skeletal muscles** develop from a special set of cells, early differentiated as the muscle-plates in the mesoblast down each side of the vertebral column of the embryo. Each cell elongates. The nucleus divides across, but the cell, instead of also dividing, lengthens, and continues to elongate as the two daughter nuclei again divide. A longitudinal fibrillation develops in the protoplasm, and a series of transverse markings appears

across the cell. Lastly, a covering, the *sarcolemma*, is formed. The fully-formed fibre thus consists of three parts.

- (1) The *Sarcolemma* is a delicate, tough, elastic membrane closely investing the fibre, and attached to it at Dobie's lines.

(2) The *Muscle corpuscles* consist of little masses of protoplasm each with a nucleus, which lie just under the sarcolemma.

(3) The *Sarcous substance* is made up of a series of longitudinal fibrils, each made up of alternate *dim* and *clear* bands embedded in the protoplasm or sarcoplasm, as it is generally called. The dim bands stain deeply with eosin (fig. 101). In the middle of the clear band is a narrow dark line, Dobie's line. The fibres and fibrils tend to break across in the region of the clear band, showing that they are weakest at that part. The clear band differs from the dim band, not only in not taking up eosin, but also in the fact that it entirely prevents the

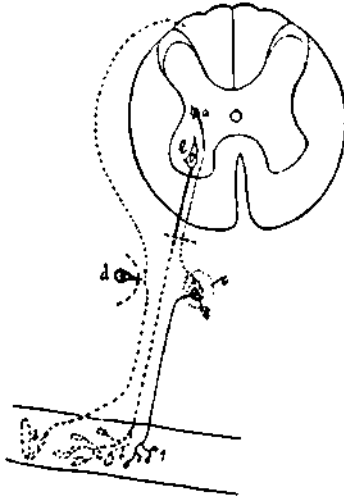

FIG. 103.—To show the nerves connected with skeletal muscle. 3, The ingoing proprioceptive fibres; e, the nerve cells of the anterior horn, from which spring the true somatic fibres which have been cut in the anterior root; the degenerated part is shown in the dotted line; 1, the fibres of the sympathetic system with their cell stations in the sympathetic ganglion. The post-ganglionic part is not degenerated, and its endings persist in the muscle, as shown in fig. 105. (BARENNE.)

passage of polarised light except in one position of the analysing prism, while the dim band allows polarised light to pass, whatever be the position of the prism. The fibrils of a muscle fibre must be considered as a distinct development of the sarcoplasm in which they lie embedded. They have been called *sarcostyles*. Various explanations of the cross striping have been given.

It is clear that the substance of the dim band and of Dobie's line is different from that of the clear band, and the view has been advanced that each sarcostyle is a tube divided into compartments by a membrane at Dobie's line, and with a spongy material in the dim band, into and from which the more fluid constituents of the tube, situated in the clear band, may flow in contraction and in relaxation.

It would perhaps be better to regard each fibril as made up of a series of potential spheres drawn out and elongated in the long axis of the fibril in the resting condition, but capable of approaching the spherical form when their surface tension is increased, as it probably is in contraction (fig. 102).

Two types of fibres, the **white** and the **red**, are present, sometimes forming separate muscles, as in the fowl, sometimes mixed in one muscle. In the white the sarcostyles are most developed, while in the red the sarcoplasm is more abundant.

These skeletal muscle fibres are generally about 30 to 40 mm. in length, but they may be as much as 30 cm. In diameter they also vary greatly—from about 0.01 mm. to 0.1 mm.

In muscles the fibres are joined end to end through their sarcolemma. They are held side by side by fibrous tissues which carries the blood-vessels, lymph-vessels, and nerves.

The somatic nerves to these fibres are medullated, and the neurolemma joins the sarcolemma, while the axon spreads into dendrites on the sarcous substance forming the **neuromyal junction** (fig. 104). It is difficult to say at what point nerve ends and muscle begins.

There is considerable evidence that post-ganglionic sympathetic fibres also end in the muscle fibres (figs. 103 and 104).

The origin in muscle of the ingoing nerves has been already considered (p. 105).

3. The **muscle of the heart** consists of a syncytial network of fibres which have a longitudinally fibrillated and transversely striped sarcous substance, with nuclei placed deeply in this substance and surrounded by undifferentiated protoplasm. The sarcolemma is apparently absent.



FIG. 104.—The endings of true somatic outgoing fibres in skeletal muscle fibres.



FIG. 105.—The endings of sympathetic nerve fibres in skeletal muscle after section of the anterior roots of spinal nerves. (BOERX AND BARENZ.)

II. Chemistry of Muscle.

Like all other living tissues, muscle is largely composed of water. It contains about 75 per cent. The 25 per cent. of solid constituents is made up of a small quantity, about 2 per cent. of ash, and 22 per cent. of organic substances.

The following table gives an idea of the average composition of mammalian muscle freed from visible fat:—

Water	74 per cent.
Solids	26 ..
Proteins	18 ..
Collagen	2 ..
Fat	2 ..
Glycogen	under 1 ..
Creatin	0.3 ..
Other Organic Substances
Ash	2 ..

1. **Proteins.**—Of the organic constituents, by far the greater part is made up of **Proteins**.

They may be extracted either by—

A. Cooling the muscle at once to near the freezing-point and expressing the juice in a press.

When the temperature is raised the fluid tends to clot, becoming a gel on account of some change in the colloidal complex. The clot is **myosin**, and it is of the nature of a globulin.

B. Rubbing the muscle in a mortar with NaCl, and then diluting so as to make a 5 per cent. solution of the salt. By this method the proteins may be divided into—

- (1) Those soluble in neutral salt solutions.
- (2) Those insoluble in them.

(1) These belong to the class of globulins. They are:—

- (a) **Myosinogen**, which constitutes about 75 per cent. of

the proteins, and which coagulates at between 55° and 65° C.

(b) **Paramyosinogen**, which constitutes about 13 per cent., and coagulates at 46° to 51° C.

Both of these, after the death of the muscle, change into an insoluble form, **Myosin**. In the case of myosinogen this takes place in two stages—first, the formation of a soluble myosin, coagulating at a very low temperature—35° to 40° C.; and second, the insoluble myosin. The soluble myosin exists preformed in the muscles of cold-blooded animals.

(c) **Myoglobulin**, another globulin which does not clot, is present in the muscles of fish and amphibia.

Whether such separate proteins actually exist in living muscle, or whether they are the result of some change in the colloidal complex at death, it is impossible to say, but the fact that the living muscle when gradually heated undergoes a sharp shortening at the temperatures at which these proteins coagulate favours the view that they do exist.

(2) The insoluble protein of muscle, **Myostromin**, seems to be of the nature of a nuclein, and probably forms the framework of the fibrils.

(3) In the residue after extraction of the globulins, it is always mixed with the **Collagen** of the fibrous tissue of muscle, from which it may be separated by dissolving it in carbonate of soda solution, and reprecipitating by weak acetic acid (*Chemical Physiology*).

2. In addition to the proteins, small quantities of other organic substances are found in muscle—

(1) **Carbohydrates**.—**Glucose** ($C_6H_{12}O_6$) is present in muscle, as in all other tissues.

Glycogen ($C_6H_{10}O_5$)—a substance closely allied to ordinary starch, but giving a brown reaction with iodine—is always present in muscle at rest. The amount is variable from 0.3 to 1.0 per cent., but the mass of muscle is so great that about one-half of all the glycogen of the body is in the muscles, the rest being chiefly in the liver. If the muscle has been active, the glycogen diminishes, being probably converted to glucose, and used for the nourishment

of the tissue. (For the chemistry of the carbohydrates, see p. 285.)

(2) **Fat** is present in small quantities in the fibres, and often in very considerable quantities in the fibrous tissue between them, especially in some animals, *e.g.* the pig.

(3) **Inosite**, formerly called muscle sugar, is present in small amounts. It is an isomere of glucose $C_6H_{12}O_6$, but it is a cyclic compound and not a carbohydrate.

(4) **Sarcolactic Acid**.—Hydroxy-propionic acid—

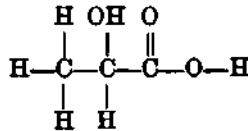

This dextro-rotatory isomere of ordinary lactic acid is hardly to be detected in resting muscle when the latter is rapidly removed and at once placed in ice-cold alcohol. But it is rapidly formed in excised muscle, and it is markedly increased both in muscle and in the urine by hard exercise and by mal-oxygenation. Along with CO_2 and NaH_2PO_4 it plays a part in causing the phenomena of fatigue.

(5) From muscle, after removal of the proteins, a series of bodies containing nitrogen may be extracted. The chief of these is **Creatin**, methyl-guanidin-acetic acid. Guanidin $\text{C.NH}(\text{NH}_2)_2$ is a near ally of urea $\text{CO}(\text{NH}_2)_2$.

Methyl-guanidin is produced by replacing an H in guanidin by CH_3 , and in creatin this is linked to acetic acid—

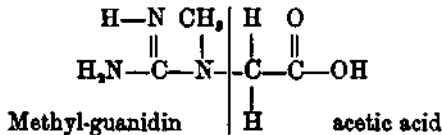

There is some evidence that methyl-guanidin may exist as such in muscle.

The amount of creatin in the muscles of various species of animals is very constant. In man about 0.4 per cent. may be extracted. Some maintain that it does not exist

free, but as part of the muscle complex. It is more abundant in white than in red muscle, and when muscle degenerates it decreases in amount. How it is formed is not known, but it may be produced from methyl-guanidin by union with acetic acid, methyl-guanidin being toxic while creatin is inert. The fate of creatin will be considered later.

Purin Bodies (see Appendix), in the form of the amino-purins, adenin and guanin, are present in small quantities.

7. **The Colour of Muscle** varies considerably, according to the preponderance of one or other type of fibre, some muscles being very pale, almost white in colour—*e.g.* the breast muscles of the fowl; others again being distinctly red, even after all the blood has been removed. This red colour is, in some cases, due to the presence of the pigment of blood, *hæmoglobin*, but in certain muscles it is due to a peculiar set of pigments, *myohæmatins*, giving different reactions from the blood pigment.

8. **Inorganic Constituents.**—The ash consists chiefly of potassium and phosphoric acid, with small amounts of sulphuric and hydrochloric acids and of sodium, magnesium, calcium, and iron. The sulphuric acid is derived from the sulphur of the proteins, and a part of the phosphoric acid is derived from the phosphorus of the nucleins of muscle, and probably from other organic combinations.

III. Physical Characters and Physiology.

(1) Muscle is **translucent** during life, but, as death-stiffening sets in, it becomes more opaque.

(2) Muscle is markedly **extensile** and **elastic**. A small force is sufficient to change its shape, but, when the distorting force is removed, it returns completely to its original shape, provided always that the distortion has not overstepped the limits of elasticity.

When a distorting force is suddenly applied to muscle—*e.g.* if a weight is suddenly attached—the distortion takes place at first rapidly, and then more slowly, till the full effect is produced. If now the distorting force is removed,

the elasticity of the muscle brings it back to its original form, at first rapidly, and then more slowly (*Practical Physiology*). This is seen in muscle relaxing after contraction.

The advantages of these properties of muscle are, that every muscle, in almost all positions of the parts of the body, is stretched between its point of origin and insertion. When it contracts it can therefore act at once to bring about the desired movement, and no time is lost in preliminary tightening. Again, the force of contraction, acting through such an elastic medium, causes the movement to take place more smoothly and without jerks, and a force acting through such an elastic medium produces more work than when it acts through a rigid medium because less energy is lost as heat.

The extensibility of muscle is of value in allowing muscles to act without being strongly opposed by their antagonistic muscles, which, however, are actively relaxed through the action of nerves (p. 86). The elasticity of muscles tends to bring the parts back to their normal position when the muscles have ceased to contract.

The extensibility of muscle is increased when it is stimulated, so that the application of a weight causes a greater lengthening than when the muscle is unstimulated.

(3) **Tonus of Muscle.**—The tense condition of resting muscle between its points of origin and insertion is not due to passive elasticity, but is caused by a continuous contraction or tone kept up by the action of the nervous system. If the nerve to a group of muscles be cut, or the spinal cord destroyed, the muscles become soft and flabby and lose their tense feeling.

Alterations in the tonicity of the muscles is an essential feature in certain diseases. It is lost in infantile paralysis where the cells presiding over the nerves to the muscles are destroyed, and it is increased in the condition of myotonia, a disease the cause of which is not known, in the idiopathic tetany of infants, in animals after removal of the parathyroids (p. 603), and after decerebration (p. 113). In decerebration rigidity Sherrington finds that the extension

tone may be overcome by force, but that the limb then remains fixed in the position in which it is placed. This has been termed **plastic tone**.

It has been found that the rate of chemical change in muscle in decerebration tonus is low when compared with the rate in ordinary contraction (p. 266). There seems to be some difference between the processes. It has been suggested that the sarcostyles are the essential elements in contraction, and that the sarcoplasm may be responsible for tonus, but evidence is wanting.

Some have maintained that the tone of the muscles is due to the presence of visceral fibres in the motor nerves (fig. 105). Such fibres have been demonstrated in many muscles, *e.g.* in the extrinsic muscles of the eye after the third nerve has been cut. Certainly tone depends upon the integrity of the reflex arc (p. 82).

(4) **Heat Production.**—Muscle, like all other living protoplasm, is in a state of continued chemical change, constantly undergoing oxidation and reconstruction. As a result of this chemical change, heat is evolved. But the heat evolved by muscle at rest is trivial when compared with that evolved during contraction, and heat production will later have to be considered fully (p. 266).

(5) **Electrical Conditions.**—(1) Uninjured resting muscle, when at rest, is iso-electric, but if one part is injured, it acts to the rest like the zinc plate in a galvanic battery—becomes electro-positive. Hence, if a wire passes from the injured to the uninjured part round a galvanometer, the needle is deflected, indicating a current passing along the wire from the uninjured to the injured part; just as, when the zinc and copper plates in a galvanic cell are connected, a current is said to flow through the wire from copper to zinc (fig. 106). This is the *Current of Injury*. In investigating the electrical condition of muscle, non-polarisable electrodes must be used.

(2) When a muscle contracts certain electrical changes occur. These may best be studied in the ventricle of the heart of a frog, which is a muscle which can be exposed without injury.

By applying one non-polarisable electrode to the base and the other to the apex, and leading off round a galvanometer, it is found—1st, that, when the heart is at rest, it is of equal electrical potential throughout, and that no current passes round the galvanometer; 2nd, that, with each contraction of the ventricle, an electric current is set up, the base, where the contraction begins, first becoming “zincy” to the apex, and later the apex, which contracts later, becoming “zincy” to the base. There is a *diphasic* variation.

This means that, when the contraction occurs, the part which first contracts becomes of a higher electric potential (more “zincy”) than the rest of the muscle. The contract-

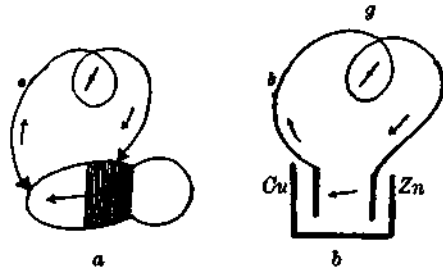

FIG. 106.—To show electric current of action in a muscle (a) compared with that in a galvanic cell (b). The contracting part of the muscle is shaded. (g) Galvanometer.

ing part is thus similar to the positive *element* of a battery—the zinc—the uncontracting part to the negative element. The wire coming from the contracting part will therefore correspond to the negative *pole*—that from the uncontracting part to the positive *pole*. This current of action precedes the period of contraction.

When a muscle, in which the current of injury exists, is stimulated, the contracting part becomes electrically more like the injured part; thus the difference of electric potential is decreased, and a *negative variation of the current of injury* occurs.

The electric variations may be demonstrated by laying the nerve of one muscle-nerve preparation over the muscle of another muscle-nerve preparation, or over the beating heart,

when it will be found that the first muscle contracts with each contraction of the second, being stimulated by the current of action (*Practical Physiology*).

These electrical changes in muscle are of importance—because by means of them the tetanic nature of voluntary contraction of muscle has been demonstrated (p. 230), and because they are now used in the diagnosis of heart disease (p. 428).

In medicine the *string galvanometer* is generally used. This consists of a silvered quartz fibre stretched between two powerful magnets. When a current passes through the fibre it is deflected, and the reflected light is thrown upon a moving photographic plate.

IV. Death of Muscle.

The death of the muscle is not simultaneous with the death of the individual. For some time after somatic death the muscles remain alive and are capable of contraction under stimulation. Gradually, however, their irritability diminishes and finally disappears. They are then dead, and *necrobiotic changes* begin. The first of these—*Rigor Mortis*—is a disintegrative chemical change whereby carbon dioxide and sarcolactic acid are set free, and, at the same time, the soluble myosinogen changes to the insoluble myosin and the muscle becomes contracted, less extensile, less elastic, and more opaque. The contraction is a feeble one, and since it affects flexors and extensors equally, it does not generally alter the position of the limbs, although it may sometimes do so. As these changes occur, heat is evolved and the muscles become warmer.

The time of onset of rigor varies with the condition of the muscles. If they have been very active just before death stiffening tends to appear rapidly. It may appear in from 10 minutes to about 7 hours. It generally begins in the head and passes downwards, and it disappears in the same order.

It lasts for a period which varies with the species of animal and with the condition of the muscles, and as it

disappears the muscles again become soft, and the body becomes limp. In all probability this latter change is due to a solution of the myosin by a proteolytic enzyme which seems to exist in all the tissues, and to lead to autolysis or self-digestion. It acts in the presence of an acid, and the appearance of sarcolactic acid, therefore, allows it to come into play.

It is doubtful if a condition of rigor mortis occurs in visceral muscle. The shortening is due to the fall of temperature.

V. Muscle in Action.

A. VISCERAL MUSCLE.

1. **Independence of the Nervous System.**—The great character of visceral muscle is its independence of the central nervous system which seems to have granted it an autonomy. As already indicated (p. 54), neuroblasts migrate outwards in great numbers and form plexuses associated with the layers of visceral muscle which exist in the walls of the various viscera. The part played by these plexuses will be considered in discussing the movements of the intestines (p. 332).

The nerves passing from the central nervous system are of two kinds—augmentors and inhibitors.

2. **Tonus.**—When all these nerves are cut, the muscles still manifest a continuous semi-contraction or *tone* which may be modified by the conditions in which they for the time exist. Thus, stretching of the muscles, *e.g.* by slowly injecting fluid into the bladder, may cause a decrease of tone and allow the viscus to be distended. But a point is reached at which the tone is increased and a forcible contraction is produced, and this occurs sooner if the injection is made rapidly.

3. **Rhythmic Variations of Tone.**—In most situations these muscles manifest a rhythmical increment and decrement of tone, an apparent rhythmic contraction. This is best seen when they are slightly stretched. If a strip of the intestine of a rabbit be placed in Ringer's solution supplied with oxygen and kept at the temperature of the body, and if it be

attached to a lever with a slight load upon it, the strip of tissue will manifest a beat at a rate of about 12 per minute (*Practical Physiology*).

4. **Stimulation.**—Any sudden change will cause these muscles to contract.

(1) *Mechanical.*—A blow or a pinch to the gut will set up a contraction, as is seen when the gut is pinched in strangulated hernia. Any sudden stretching may cause a contraction.

(2) *Thermal.*—A lowering of temperature causes a contraction, and the more sudden the change the more powerful is the stimulus. Exposure to a continued low temperature sets up a sustained contraction, as may be seen in the gut after death. By warming the gut this contraction may be made to pass off.

A sudden increase of temperature also stimulates, and this is sometimes taken advantage of in obstetrical practice by injecting hot solution to make the uterus contract.

(3) *Electrical.*—The make and break of a galvanic current will cause a contraction as it does in skeletal muscle (p. 219), and it is more effective than the more sudden variation of a faradic current.

(4) *Chemical.*—Some chemical substances cause contraction, e.g. salts of barium, while some cause relaxation, e.g. nitrites.

If any stimulus is sufficient to make visceral muscle contract, it causes a full contraction because all the fibres are stimulated at once. Further, the continued repetition of a stimulus, insufficient to cause a contraction, may produce one, just as such repetition may liberate a reflex action (p. 84).

5. **Characters of Contraction.**—The contraction which is produced is a slow one. A distinct interval occurs between the application of the stimulus and the contraction—the *latent period*. This may occupy nearly a second. A slow contraction and a slow relaxation follow. These may be recorded by the methods used for skeletal muscle (p. 222).

6. **Refractory Period.**—If a second stimulus is given before the contraction has passed off, probably no second contraction will be produced. But, if the relaxation phase is in progress, a second contraction may be superimposed upon the

first. Evidently a *refractory period* follows stimulation so that the muscle refuses to respond again until it has nearly finished relaxing. It is almost impossible to produce a tetanus (p. 228).

7. *Propagation of Contraction.*—When a contraction is set up in any part of a sheet of visceral muscle it passes over the rest as a wave. The importance of this will be considered later.

The physiology of **Heart Muscle**, which closely resembles visceral muscle, will be dealt with when describing the action of the heart (p. 423).

B. SKELETAL MUSCLE.

1. Direct Stimulation of Muscle.

Skeletal muscle is directly under the control of the central nervous system. It remains at rest indefinitely until

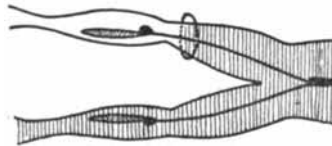

FIG. 107.—Curare Experiment, to show sciatic nerves exposed to curare, but nerve endings protected on the left side; while on the right side the curare is allowed to reach the nerve endings in the muscle.

stimulated to contract, usually by changes in the nerves, produced by changes in the central nervous system.

Can skeletal muscle be made to contract without the intervention of nerves—can it be directly stimulated?

(1) To answer this, some means of throwing the nerves out of action may be resorted to. If curare, a South American arrow poison, be injected into a frog, the brain of which has been destroyed, it soon loses the power of moving. When the nerve to a muscle is stimulated, the muscle no longer contracts. But if the muscle be *directly* stimulated, in any of the various ways to be afterwards mentioned, it at once contracts.

It might be urged that the curare leaves unpoisoned the endings of the nerve in the muscle, and that it is by the stimulation of *these* that the muscle is made to contract. But that these are poisoned is shown by the fact that, if the artery to the leg be tied, just as it enters the muscle, so that

the poison acts upon the whole length of the nerve except the nerve endings in the muscle, stimulation of the nerve still causes muscular contraction. Only when curare is allowed to act upon the nerve endings in the muscle does stimulation of the nerve fail to produce any reaction in the muscle, while direct stimulation of the muscle causes it to contract. This clearly shows that it is the *nerve endings which are poisoned by curare*, and that therefore the application of stimuli to the muscle must act directly upon the muscular fibres (fig. 107), (*Practical Physiology*).

(2) The action of various chemical substances also demonstrates that muscle may be directly stimulated. Thus, ammonia vapour fails to stimulate nerve, but stimulates even those parts of muscle which are devoid of nerve fibres. Glycerol, on the other hand, stimulates nerve but does not act on muscle.

Muscle, although it can be directly stimulated, is more *readily* made to contract through its nerves, and a knowledge of the points of entrance of the nerves into muscles, the *motor points*, is of importance in medicine, in indicating the best points at which to apply electrical stimulation. Charts of the various parts of the body are given in clinical text-books.

2. Methods of Stimulating.

In investigating the *direct* stimulation of muscle apart from nerve, it is necessary to throw the nerves out of action by curare, since it is most easily stimulated through nerve, and since nerve responds to most of the stimuli which act on muscle.

1st. Various **chemical** substances when applied to a muscle make it contract before killing it, while others kill it at once (*Practical Physiology*).

Alterations in the proportions of the salts or of the **cat-ions** normally present in muscle—sodium, potassium, and calcium—may modify its excitability and may actually cause contraction. An excess of sodium ions has a special action in this direction which is checked by the addition of calcium ions. Potassium, on the other hand, although the chief base of muscle, when added in the free ionic condition,

checks excitability, produces the phenomena of fatigue, and may finally kill. A balance between the proportion of these ions, such as exists in the lymph bathing the tissues, is necessary for normal action. Ringer's solution is an attempt to reproduce the balance required for the tissues of the frog.

2nd. A sudden **mechanical** change such as may be produced by pinching, tearing, or striking the muscle will cause it to contract. This may be seen in fractures, and in operative interference with muscles (*Practical Physiology*).

3rd. Any sudden change of **temperature**, either heating or cooling, stimulates. A slow change of temperature has little or no effect. Muscle, however, passes into a state of contraction, *heat rigor*, when a temperature sufficiently high to coagulate its protein constituents is reached—in mammals about 46° C. This, however, is not a true living contraction.

4th. Muscle like nerve is stimulated by any sudden change in the strength of an **electric current** passed through it, and what has been said of the stimulation of nerve (pp. 62 to 67) applies also to the stimulation of muscle.

The slower make and break of the galvanic current is a more effective stimulus to muscle than the more rapid combined make and break of the faradic current, which is more effective upon nerve (p. 67).

3. The Changes in Muscle when Stimulated.

1. Change in Shape.

The result of stimulation of a muscle is the sudden **development of tension**. It is as if a piece of string passing between two points were suddenly changed into a stretched rubber band. If the two ends are fixed, tension develops, but the muscle cannot shorten. If the ends are not fixed the most manifest change is shortening and thickening of the muscle. This any one can see in the contracting biceps muscle.

In skeletal muscle the development of tension and the shortening and thickening of the muscle as a whole is due to the development of tension in and the **shortening and thickening of the individual fibres and their fibrils**.

In these fibrils the shortening and thickening is most

marked in the dim band. The clear band also slightly shortens, and at the same time appears to become darker. These appearances may best be explained on the assumption that the fibrils are the part of the fibre which shorten and thicken, that these fibrils chiefly change in the dim band, and that, by the contraction of the fibrils in the clear band, adjacent dim bands are pulled nearer to one another, and so cast a shadow over the clear band.

That no fundamental chemical change takes place in either band is indicated by the fact that they retain their reaction to polarised light and to staining reagents (p. 204).

Various theories have been advanced as to how these changes are produced, and it will be shown later that the change is of the nature of an increase in surface tension. Suppose a fibril to be made up of elongated potential spheres in the dim bands, an increase in the surface tension of each would cause it to assume a more spherical form, and this change occurring all along the fibril would lead to a shortening (fig. 102).

It has been maintained that the sarcoplasm is also capable of contraction, and that the tonic contraction of muscle is due to this (p. 211).

Usually, in a maximum contraction, all the fibres contract **simultaneously**. In a lesser contraction fewer fibres are involved but they contract simultaneously. This is because a nerve fibre passes to every muscle fibre. When, as sometimes occurs in disease, the nervous mechanism acts abnormally, the muscular fibres may not all act at once, and a peculiar *fibrillar twitching*, a jerky contraction of one set of fibres apart from the other, may be produced, a condition which most people have experienced in the orbicularis oculi or in some other muscle.

If the muscle be *directly* stimulated at any point, the contraction starts from that point, and passes as a **wave of contraction** outwards along the fibres. This may be seen by sharply percussing the fibres of the pectoralis major in the chest of an emaciated individual. The rate at which the wave of contraction travels is ascertained by finding how

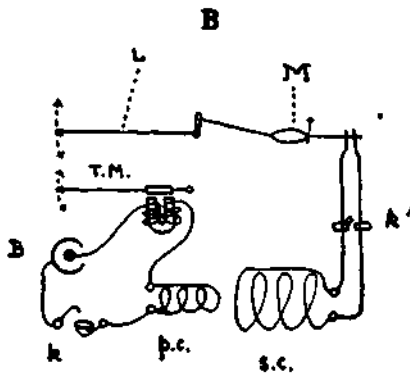
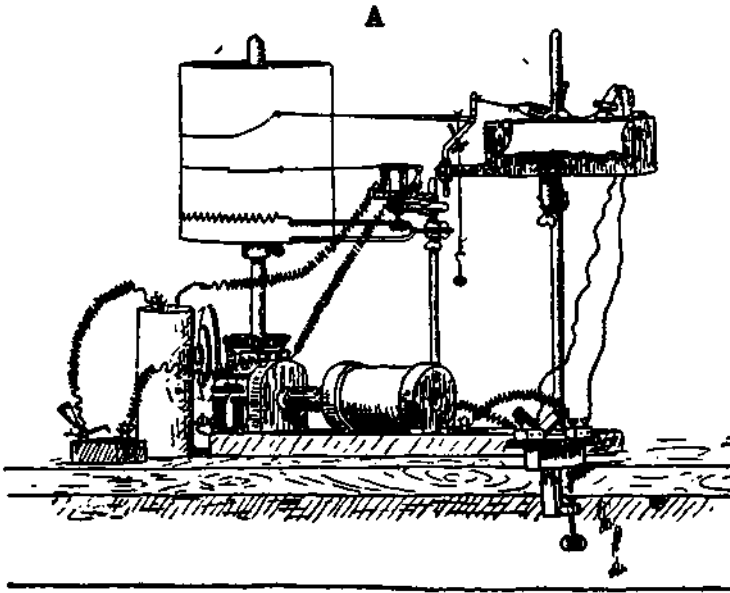

FIG. 108.—A, Method of Recording Muscular Contraction. B, Key to parts of Apparatus. *M*, Muscle attached to crank lever *L*. *p.c.*, Primary circuit, and, *s.c.*, secondary circuit of an induction coil with short circuiting key, *k'*, in secondary circuit. *B*, Galvanic cell, and, *k*, a mercury key for closing and opening the primary circuit. *T.M.*, a lever moved by an electro-magnet placed in the primary circuit and marking the moment of stimulation. In A, a tuning-fork beating 100 times per second is shown recording its vibration on the drum.

long it takes to pass between any two points at a known distance from one another. Its velocity is found to vary much according to the kind of muscle and the condition of the muscle. In the frog in good condition it travels at something over *three metres* per second. When the muscle is in bad condition the wave passes more slowly, and in badly nourished muscle, *e.g.* in advanced phthisis, it may remain at the point of stimulation (*Practical Physiology*).

Contraction of a Muscle as a whole may best be studied under the following heads:—

- 1st. The course of contraction.
- 2nd. The extent of contraction.
- 3rd. The force of contraction.

1st. Course of Contraction (fig. 108).

By attaching the muscle (*M*) to the short limb of a lever (*L*), (fig. 108), and allowing the point of the lever to mark upon some moving surface, a magnified record of the shortening of the muscle when stimulated may be obtained.

A revolving cylinder covered with a smoke-blackened glazed paper is frequently used for this purpose, and, to stimulate and mark the moment of stimulation, an induction coil (*p.c.*, *s.c.*), with an electro-magnetic marker (*T.M.*), is introduced in the primary circuit.

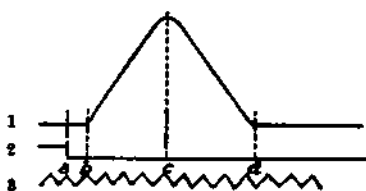

FIG. 109.—Trace of Simple Muscle Twitch (1) showing periods of latency (*a-b*), contraction (*b-c*), and relaxation (*c-d*); record of moment of stimulation (2); and a time record made with a tuning-fork vibrating 100 times per second (3).

To find the duration of the contraction, a tuning-fork, vibrating 100 times per second, may be made to record its vibration on the surface (fig. 108, A) (*Practical Physiology*).

In this way such a tracing as is shown in fig. 109 is produced. The appearance of the trace will, of course, vary with the rate at which the recording surface is moving,

being more spread out the greater the velocity of the movement of the surface.

(*a*) From such a trace it is evident that the muscle does not contract the very moment it is stimulated, but that a short latent period supervenes between the stimulation and the contraction. In the muscle of the frog, attached to a lever, this usually occupies about 0.01 second; but, if the change in the muscle be directly photographed without any lever being attached to it, this period is found to be very much shorter, only about 0.0025 second.

(*b*) The latent period is followed by the period of contraction. At first it is sudden, but it becomes slower, and finally stops. Its average duration in the frog's muscle is about 0.04 second.

(*c*) The period of relaxation follows that of contraction, and it depends essentially on the elasticity of the muscle, whereby it tends to recover its shape when the distorting force is removed (p. 210). The recovery is therefore at first fast and then slow, and it lasts in the frog's muscle about 0.05 second.

The whole contraction thus lasts only about 0.1 second in the frog's muscle. In mammalian muscle it is much shorter, in the rabbit about 0.07 second; in the muscle of insects shorter still, about 0.003 second.

2nd. Extent of Contraction.

From the height of the trace the actual shortening of the muscle may be calculated by measuring the two limbs of the lever (*Practical Physiology*).

While, as will be afterwards considered, the extent of contraction is modified by the strength of stimulus and the state of the muscle, the total extent of contraction is primarily determined by the length of the muscle. If a muscle of two inches contracts to one-half its length, the amount of contraction is one inch, but if a muscle of four inches contracts to the same amount, it shortens by two inches (fig. 124, p. 243).

3rd. Force of Contraction.

The force of contraction, that is the tension developed, is

measured by finding what weight the muscle can lift (*Practical Physiology*).

The absolute force of a muscle may be expressed by the weight which is just too great to be lifted by it. The lifting power of a muscle depends—(1) upon its thickness or *sectional area*, *i.e.* on the number of fibres. The absolute force of a muscle may therefore be expressed per unit of sectional area. In mammals the absolute force per 1 sq. cm. is probably 5000 to 10,000 grams.

(2) Upon the length of the muscle *when stimulated*. In the body a muscle may be in different conditions of length between its origin and insertion. The force of contraction or tension is greatest when the muscle is extended slightly beyond its greatest normal length, and rapidly

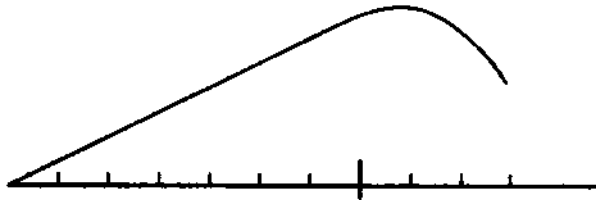

FIG. 110.—To show the relationship of tension developed to the length of the muscle. The abscissa represents the length of the muscle, | is the normal length in the body. The curve represents the tension developed.

decreases if it is shorter, *e.g.* when the brachialis anticus is stimulated in partial flexion of the elbow.

The relationship of length to the tension developed is shown in fig. 110. This relationship is of importance, for it indicates that the development of tension is a surface tension phenomenon.

The force of contraction during different parts of the contraction period may be recorded by making the muscle pull upon a strong spring, so that it can barely shorten. The slight bending of the spring may be magnified and recorded by a long lever, and in this way it is found that the ordinary curve of contraction gives a somewhat untrue representation of the force, inasmuch as the lever, from its inertia, is carried too high and seems to represent a continuance of tension

beyond the point at which it has ceased. This method of recording the force of contraction is sometimes called the **isometric** method, in distinction to the **isotonic** method of letting the muscle act upon a light lever.

Muscle may start contracting isometrically, overcoming the inertia of the weight, and then proceed in isotonic contraction while lifting the weight; or the converse condition may occur.

In clinical medicine the **dynamometer** is used for measuring the force of muscular contraction. This has generally the form of an oval steel spring which is compressed by the hand. The degree of compression is indicated on a dial (*Practical Physiology*).

The contraction of the **unexposed muscles** in the body of the mammal may be studied by recording their thickening by means of Marey's muscle forceps. These consist of a tambour, placed between one pair of the limbs of forceps hinged in the centre. This is pressed upon by the contraction of a muscle or group of muscles held between the opposite limbs. The pressure is transmitted by a tube to another tambour which carries a recording lever (*Practical Physiology*).

It may also be investigated by fixing a limb and attaching the tendons of the muscles to be studied to levers. This method has been used by Sherrington in his work upon reflex action.

The Factors modifying Contraction.—1. **Kind of Fibre.**—In skeletal muscles, the *pale* fibres contract more rapidly and completely than the *red* fibres, which contain more sarcoplasm and nuclei. The peculiarities of the contraction of visceral muscles have been already considered.

2. **Species of Animal.**—In vertebrates, the contraction of the muscles of warm-blooded animals is more rapid than the contraction in cold-blooded animals, in the rabbit about 0.07 sec. The most rapidly contracting muscles are met with in insects.

3. **State of the Muscle.**—(1) *Continued Exercise.*—If a

muscle is made to contract repeatedly, the contractions take place more and more sluggishly. At first each contraction is greater in extent, but, as they go on, the extent diminishes



FIG. 111.—Influence of continued Exercise on Skeletal Muscle
—(1) The first trace; (2) a trace after moderate exercise; (3) a trace when fatigue has been induced.

as fatigue becomes manifest, and stimulation finally fails to call forth any response (fig. 111) (*Practical Physiology*).

This condition is probably caused by the accumulation of the products of activity in the muscle, and especially by an increase in the hydrogen ion concentration. The same phenomena may be induced by the application of dilute acids and

certain other drugs, and may be removed, for a time, by washing out the muscle with salt solutions or very dilute alkalis. These products act first upon the nerve endings in the muscle, and thus, in ordinary conditions of stimulation through the nerve, the muscle is protected against the onset of fatigue.

As a result of repeated stimulation a condition of incomplete relaxation—*contracture*—may appear and then gradually wear off. Its onset may explain the stiffness of muscles when first brought into play, and the advantages of “warming up” exercises before an athletic contest.

Later, as fatigue becomes manifest, a contracture due to the very slow relaxation may be observed.

(2) *Temperature*.—If a muscle be *warmed* above the normal temperature of the animal from which it is taken, all the phases of contraction become more rapid, and the contraction may be at first increased in extent, but is subsequently decreased.

If, on the other hand, a muscle be *cooled*, the various periods are prolonged. At first the force and extent of contraction becomes greater, a fact which indicates that the development of tension must be of the nature of a change in surface tension (p. 205). As the cooling process goes on, the contraction becomes less and less, until

finally the most powerful stimuli produce no effect. Cooling has thus practically the same effect on contraction as continued exercise (fig. 111) (*Practical Physiology*).

(3) Many *drugs* modify muscular contractions, e.g. veratrin enormously prolongs the relaxation period.

4. **Strength of Stimulus.**—A stimulus must have a certain intensity to cause a contraction. The precise strength of this *minimum effective stimulus* depends upon the condition of the muscle. The application of stronger and stronger stimuli to the nerve causes the muscular contraction to become more and more rapid, more and more complete, and more and more powerful, by involving more and more fibres. Each fibre when stimulated undergoes the “all or nothing” change

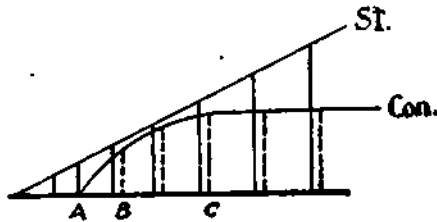

FIG. 112.—Influence of increasing the Strength of the Stimulus upon the contraction of Skeletal Muscle. *St.*, the stimulus; *Con.*, the resulting contraction. *A*, a subminimal stimulus; *B*, the minimum adequate stimulus; *C*, the optimum stimulus; —, stimuli; - - -, contractions.

already described (p. 68). But increase in the contraction is not proportionate to the increase in the stimulus. If the stimulus is steadily increased, the increase in contraction becomes less and less. This may be represented diagrammatically in the accompanying figure, where the continuous lines represent the strength of the stimuli and the dotted lines the extent of the contractions (fig. 112).

After a certain strength of stimulus has been reached, further increase of the stimulus does not cause any increase in the muscular contraction, since all the fibres have been made to contract. This smallest stimulus which causes the maximum muscular contraction may be called the *optimum stimulus*.

Increasing the strength of the stimulus shortens the

latent period, but lengthens the periods of contraction and relaxation, and thus lengthens the whole period of contraction.

5. **Resistance to Contraction—Weight to be Lifted.**—A small weight attached to the muscle may actually increase the extent of contraction by lengthening the fibres (p. 224 (2)), but greater weights diminish it, and when a sufficient weight is applied, the muscle no longer contracts, but may actually slightly lengthen, because its extensibility is increased during stimulation (fig. 113, a).

The application of weights to a muscle causes the latent period and period of contraction to be delayed, while it renders the period of relaxation more rapid, and an over-extension may be produced followed by a recovery resembling

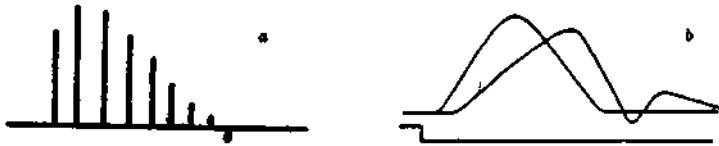

FIG. 113.—Influence of Load on a Muscular Contraction. (a) The effect of increasing the load on the extent of contraction; (b) the effect of load on the course of contraction.

a small after-contraction and due to the elasticity of the muscle (fig. 113, b), (*Practical Physiology*).

6. **Electrotonus.**—As already explained in dealing with nerve (p. 63), the passage of a galvanic current through a muscle decreases its excitability, and hence its contractility, at the anode and increases them at the cathode.

7. **Successive Stimuli.**—So far, we have considered the influence of a single stimulus on the shape of muscle. But, in nearly every muscular action, the contraction lasts much longer than 0·07 of a second, which is about the time taken by a single contraction of mammalian muscle.

How is this continued contraction of muscles produced? To understand this it is necessary to study the influence of a series of stimuli.

(1) If, to a frog's muscle that takes 0·1 of a second to contract and relax, stimuli at the rate of say 7 per second are

applied, it is found that a series of simple contractions, each with an interval of 0.05 of a second between them, is produced (fig. 114 (1)). If the stimuli follow one another at the rate of 10 per second, a series of simple contractions is still produced, but now with no interval between them.

(2) If stimuli be sent more rapidly to the muscle, say at the rate of 12 per second, the second stimulus will cause contraction before the contraction due to the first stimulus has entirely passed off (fig. 114 (2)). The second contraction will thus be superimposed on the first, and it is found that the second contraction is more complete than the first, and the third than the second. But, while the second contraction is markedly greater than the first, the third is not so markedly greater than the second, and each succeeding stimulus causes a less and less increase in the degree of contraction, until, after a certain number, no further increase takes place, and the degree of contraction is simply maintained.

When the contractions follow one another at such a rate that the *relaxation* period of the first contraction has begun, but is not completed, before the second contraction takes place, a lever attached to the muscle, and made to write on a moving surface, produces a toothed line. The contraction is not uniform, but is made up of alternate shortenings and lengthenings of the muscle. This constitutes "*incomplete tetanus*" (fig. 114 (2)).

(3) If the second stimulus follows the first so rapidly that it reaches the muscle before the *contraction* period has given place to *relaxation*, then the second contraction will be superimposed on the first, the third on the second, and so on continuously and smoothly without any relaxations, and thus the lever will describe a smooth line, rising at first rapidly, then more slowly, till a maximum is reached

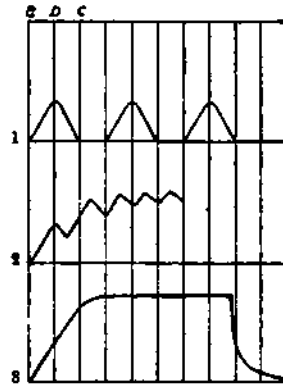

FIG. 114.—Effect of a series of Stimuli on Skeletal Muscle. (See text.)

and being maintained at this level, till the series of stimuli causing the contraction is removed, or until fatigue causes relaxation of the muscle. This is the condition of "*complete tetanus*" (fig. 114 (3)), (*Practical Physiology*).

The rate at which stimuli must follow one another in order to produce a tetanus depends upon a large number of factors. Anything which increases the duration of a single contraction decreases the number of stimuli per second sufficient to produce a tetanus, and thus, all the various factors modifying a single muscular contraction modify the number of stimuli required (p. 225).

The red fibres in tetanus give a more powerful contraction than do the white fibres.

The reason why a very rapid series of stimuli cause a tetanus in skeletal muscle is that the refractory period is so very short (p. 216). Hence, if the stimuli follow one another sufficiently rapidly they fail to produce a tetanus.

Every voluntary contraction of any group of the muscles is probably of the nature of a tetanus; and the question thus arises:—At what rate do the stimuli which cause such a tetanus pass from the spinal cord to the muscles?

Taking advantage of the electrical change which accompanies each muscular contraction (p. 212), and using the string galvanometer (p. 214), it has been shown that, in sustained voluntary contraction, electric variations occur at a more or less definite rate in different muscles, faster in the shorter, and slower in the longer muscles.

	Rate per Second.
Masseter muscle	88 to 100
Arm muscles (flexors)	47 „ 50
Quadriceps extensor femoris	38 „ 41

Hence it may safely be concluded that impulses at these various rates pass from the spinal cord to the muscles to produce the sustained contraction of voluntary action.

Besides change in shape muscle when stimulated undergoes electrical changes (p. 212), changes in elasticity (p. 211), changes in temperature, heat production (p. 246), and chemical changes (p. 254).

4. Mode of Action of Muscles.

The skeletal muscles act to produce movements of the body from place to place, or movements of one part of the body on another. This they do by pulling on the bony framework to cause definite movements of the various joints.

The muscles are arranged in opposing sets in relation to each joint—one causing movement in one direction, another in the opposite direction—and named according to their mode of action, flexors, extensors, adductors, abductors, etc. In the production of any particular movement at one joint—say flexion of the phalanx of a foot—the opposing muscles, the extensors, have their activity suppressed or inhibited (p. 86).

Other muscles which give the support needed for the

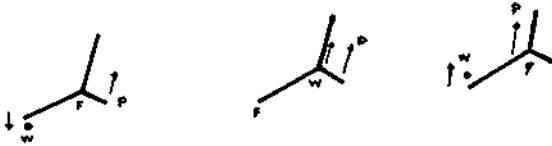

FIG. 115.—The three types of lever illustrated by the movements at the ankle-joint.

movement also come into action. This may be called their **Co-operative Antagonism**. These muscles, when acting alone, cause a movement in the opposite direction to that being produced, *e.g.* extension instead of flexion. If the part of the brain which causes flexion of the hand of the monkey be stimulated and the nerve to the flexors divided, the co-operative action of the supporting extensors brings about an extension of the hand.

It is very probable that the red muscles act specially in this fixation of joints to enable the pale muscles to bring about different kinds of movements. Thus, with the ankle fixed, the gastrocnemius may flex at the knee; with the knee fixed, it may extend at the ankle.

The muscles act upon the bones, arranged as a series of levers of the three classes at the various joints (fig. 115). These may be illustrated by the foot in man.

1st Class.—Fulcrum between power and weight. In the ankle this is seen when, by a contraction of the gastrocnemius, we push upon some object with the toes.

2nd Class.—Weight between fulcrum and power. In

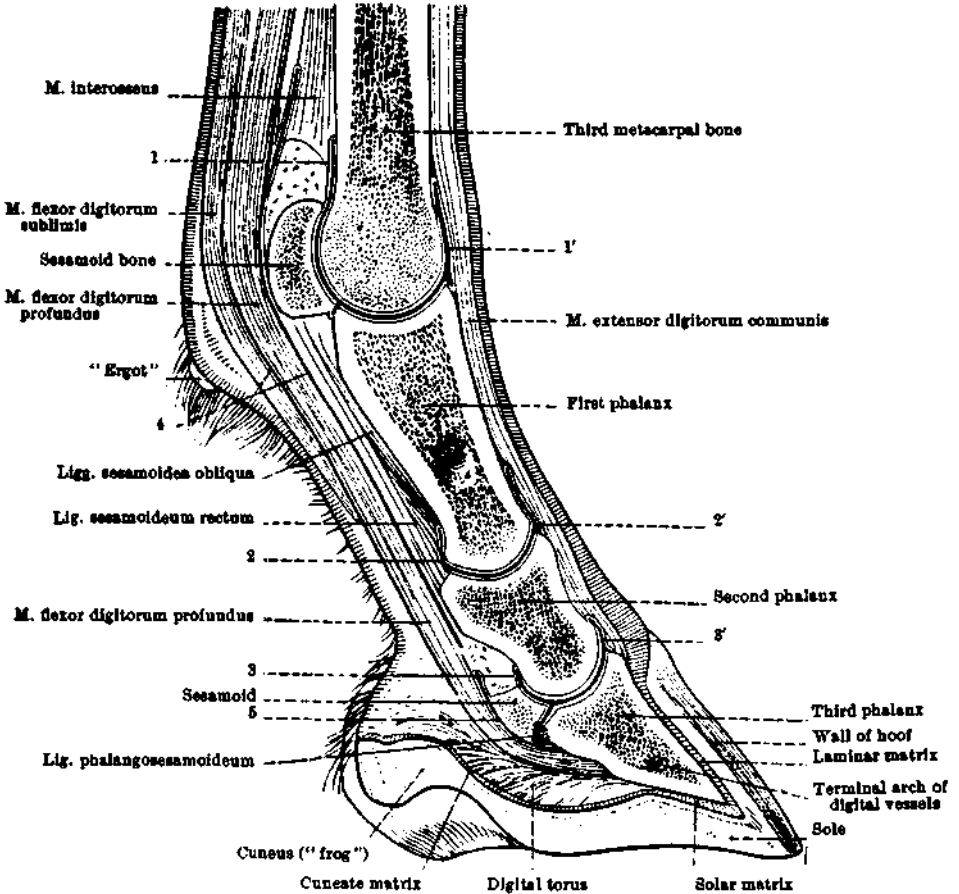

FIG. 116.—Longitudinal Section of Digit.

1 and 1', 2 and 2', 3 and 3' = Joint capsules. 4 = Synovial sheath of flexor tendons. 5 = Synovial sheath of deep flexor tendon. (From "The Limbs of the Horses." BRADLEY.)

rising on the toes, the base of the metatarsals is the fulcrum, the weight comes at the ankle and the power on the os calcis.

3rd Class.—Power between fulcrum and weight. In raising a weight placed on the dorsal aspect of the toes by the contraction of the extensors of the foot, we have the weight at the toes, the power at the tarsus, and the fulcrum at the ankle.

In the joints of animals actions involving the principle of each of these levers may be found.

5. Special Mechanisms in the Horse.

(1) The Limbs of the Horse.

The condition of the feet and legs is the chief limiting factors in work production in the horse. An intimate knowledge of the anatomy of the various structures involved must be obtained in the dissecting room.

The Foot.—The weight of the horse is transmitted through the second phalanx to the foot (fig. 116).

The articular surface of the second phalanx is larger than that of the third, so that its posterior part rests upon the sesamoid bone which is supported by the tendons of the flexor muscles and further held in position by the sesamoid ligaments. This yielding articulation assists in reducing and distributing shock. The tendon of the flexor muscle rests upon the digital torus (the plantar cushion). This is a pyramidal shaped mass of yellow elastic and white fibrous tissue which stretches between the cartilages of the third phalanx to which its edges are attached (fig. 117). The superficial (volar) surface of this structure is arched, but becomes flattened out under pressure. The cartilages to which it is attached are elastic and yield under pressure, being pushed out slightly. The digital torus rests upon the elastic cuneus (the frog), which in the normal unshod hoof is on a level with the wearing edge of the wall. The sole of the foot (fig. 118) is concave. When the weight of the animal is put on it, the arch tends to flatten out, and at the same time there is slight expansion of the heel. This is provided for by the walls at the heel being deflected inward to form the bars instead of being continuous to complete the circle.

The bars, which are also elastic, receive part of the weight of the animal. The posterior part of the foot which first comes to the ground and receives the impact is thus well adapted for the absorption and dissipation of shock.

If the toe of the foot were provided with these elastic yielding structures the propulsive force would be dissipated.

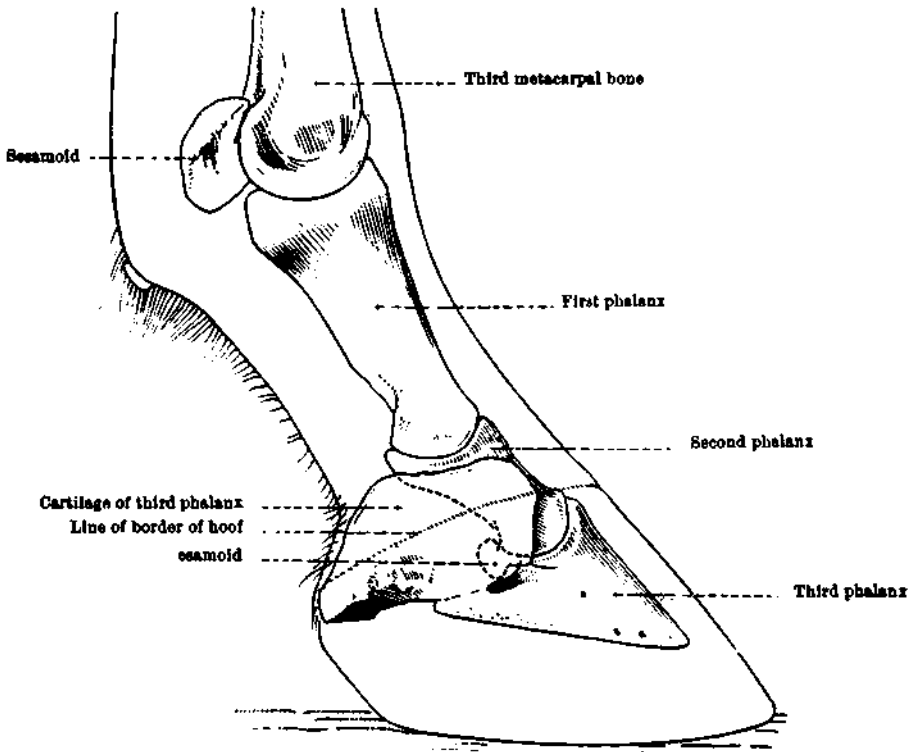

FIG. 117.—Lateral Aspect of the Phalanges and the Cartilage of the Third Phalanx. (BRADLEY.)

Rigidity is required to transmit the force from the toe which acts as the fulcrum. In the toe, therefore, the matrix of the hoof is directly adherent to the bone, and the horny part of the hoof is thicker and less elastic than at the heel, so that the force of the thrust with the toe is passed direct from the hoof to the bony column of the leg.

The breadth of the bearing edge of the hoof is greatest at the toe where it is about 10 mm. It becomes less towards the heel, where it is about half that of the toe. The inner surface of the wall of the hoof is marked off from the border of the sole by a line of pale soft horn—"the white line." This line is taken as an indication of the limit of safety in driving shoe nails to avoid the sensitive part of the foot. *The histology of the hoof must be studied practically.*

The Leg.—The conformation of the legs is of great

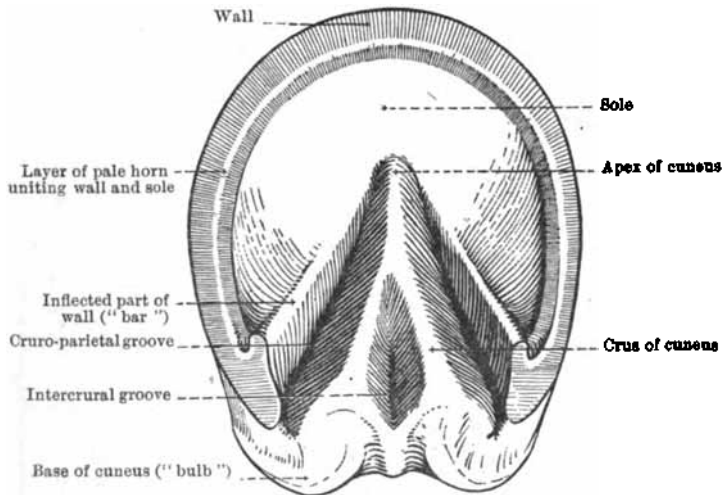
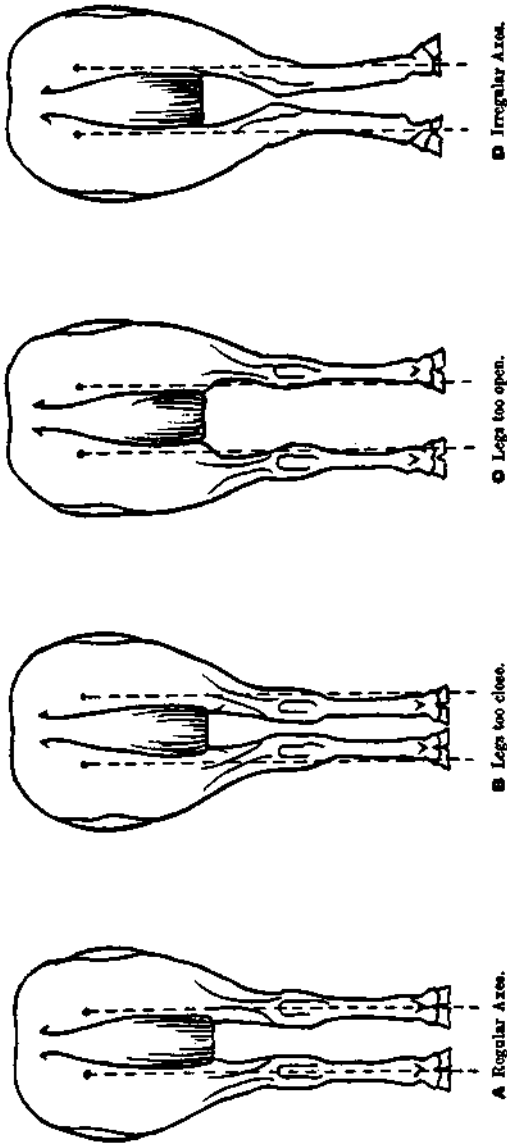

FIG. 118.—Volar Aspect of the Hoof. (BRADLEY.)

importance, as the resultant forward thrust of the pressure of the toe on the ground is diminished unless the line of action of the force be in the true direction.

To obtain this action, in the fore leg viewed from the front a vertical line from the middle of the scapulo-humeral articulation should divide the leg into two equal halves and meet the ground at the middle of the toe. In the hind leg, viewed from behind, a vertical line dropped from the tuberosity of the ischium should divide the leg into two equal halves and reach the ground in the middle of the heel (fig. 119, A). When the legs are as indicated, the line of



A Regular Area. **B** Legs too close. **C** Legs too open. **D** Irregular Area.

FIG. 119.—Diagram to illustrate faulty conformation of legs. B, C, and D. (After GOUBAUX and BARRIER.)
Dotted line = perpendicular line from Ischial Tuberosity.

- A** *Regular*. Perpendicular line divides lower part of leg into equal halves and meets ground in centre of hoof.
- B** *Narrow base of support*. Hocks and feet inside perpendicular line.
- C** *Wide base of support*. Hocks and hoofs outside perpendicular line.
- D** *Twisted area*. Hocks inside, feet outside perpendicular line.

progression of the hoof is a straight line and the full force of the thrust is obtained in moving the mass of the body forward.

When the conformation deviates from this standard, as in fig. 119, B, C, D, the line of progression of the foot is in segments of circles. Part of the force is lost and the hoof, or in the shod animal, the shoe, wears unevenly.

The shape of the hoof and the slope of the phalanges are of great importance. The slope of the wall of the hoof and of the phalanges should be the same—about 45° to 50° in the front foot, and about 50° to 55° in the hind foot. When the phalanges are too perpendicular, as in the "upright pastern" or "boxy foot" (fig. 120, A), the concussion absorbing mechanism is less effective, as more of the shock is transmitted direct from the third phalanx to the second. When the phalanges are too obliquely placed (fig. 120, C) undue strain is thrown upon the tendons and ligaments supporting the sesamoid bones. These are consequently more liable to injury. A high heel is usually associated with upright phalanges and a low heel with sloping phalanges.

The more upright the foot the shorter and lower the stride. Fig. 120 illustrates how the course of the flight of the foot is determined by its shape.

(2) Action of the Limbs.

(1) In **standing** the weight of the body is chiefly slung by the serrati magni on the scapulæ, which are supported by the bony columns of the fore limbs. The flexor and extensor muscles maintain the condition of partial flexion at the elbow joint. The metacarpo-phalangeal articulation (the fetlock joint) is supported chiefly by the tendons of the flexor muscles and by the interosseus muscle (the suspensory ligament). This is a muscle which has become tendinous in form and function. By it the sesamoid bone is suspended.

The tendons of the flexor muscles, which are the chief supports for the fore legs, are connected to the bony column by fibrous bands (the check ligaments). These act as mechanical stays to the limb, relieving the muscles from

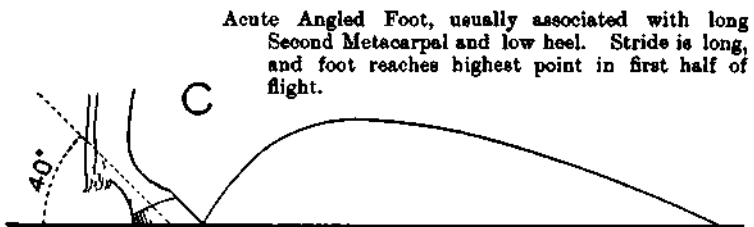
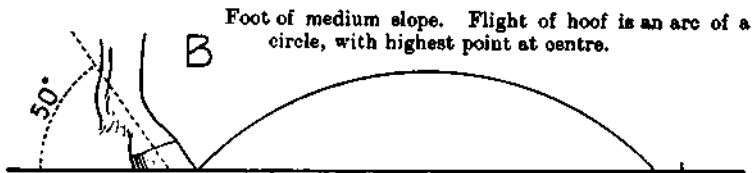
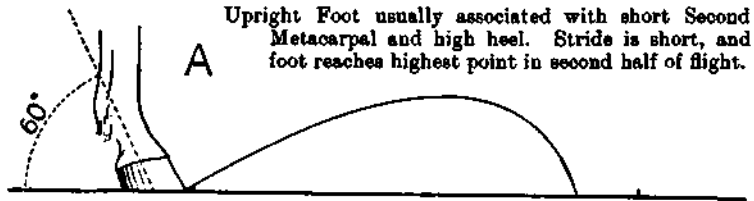

FIG. 120.—Diagram showing influence of slope of foot (fore) on flight of hoof in walking. (After LUNGWITZ.)

strain when the standing position is long continued. A like arrangement of mechanical braces exists in the hind limbs.

The centre of gravity is in a vertical plane passing about 6 inches behind the elbow. In standing, therefore, the greater weight, some 10 to 20 per cent. more, is borne by the fore legs than by the hind. The proportion depends largely on the position of the head. As the head comes down and forward as in sleep, the centre of gravity moves forward, and the proportion of weight carried by the fore legs is increased.

In standing for any length of time the hind legs are used alternately to support the weight of the posterior part of the body, the one not in use being partly flexed and resting on the toe. From the fact that the hind legs are less straight than the fore legs, more work is required by the leg muscles in using them as supports.

2. **Lying.**—Owing to the sharp edge of the sternum the horse cannot lie vertically. It either lies inclined to one side with the four feet tucked under the body, or flat on the side with head and legs extended.

3. **Rising.**—In rising the head is raised, the fore feet are placed on the ground in front, and the hind legs are placed well below the body and push it up. The raising of the head is the first part of the act of rising, and if it be kept down the animal cannot rise.

4. The movements of the horse at the different paces have been analysed by instantaneous photography.

Walk.—The body being balanced on three legs, as shown in fig. 121, one fore leg is advanced, the body moves forward on the corresponding hind leg, and the opposite hind foot leaves the ground before the fore foot reaches it, so that for a moment the horse is balanced on diagonal legs (2). The hind foot which has left the ground is now advanced, and before it is planted the corresponding fore foot is lifted (3), and thus, at this stage, the animal is balanced on the fore and hind leg of the same side (4). As the hind foot comes to the ground, the condition described at the starting is again reached and the process is repeated.

Normally in walking the heel comes first to the ground,

but in drawing a heavy load the step is shortened and the toe reaches the ground first.

The speed attained in walking is usually about 4 miles

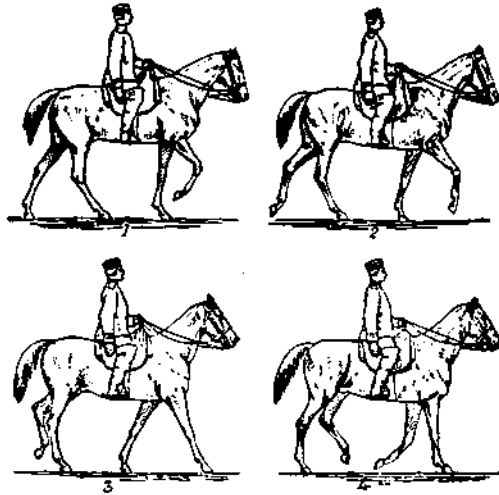

FIG. 121.—The Walk.

per hour. Among draught horses the greatest speed is got in the Clydesdale, which has been bred largely for the quality of the feet and legs.

Trot.—The body is driven forward by the alternate propulsive action of the diagonal fore and hind legs. The off



FIG. 122.—The Trot.

fore and near hind feet leave the ground together, propelling the body upwards and forwards (fig. 122, 1), and are then advanced to again reach the ground, when the near fore and off hind feet repeat the same movements (3).

The length and stride of the trot is about 8 or 9 feet. The pace is usually about 7 or 8 miles an hour, but in horses trained for speed in trotting the pace may approach that of the gallop.

Amble.—Here the two legs of the same side act together as do the diagonal legs in trotting.

Gallop.—At one stage of the pace all the feet are off the ground and well tucked under the body (fig. 123, 1). One

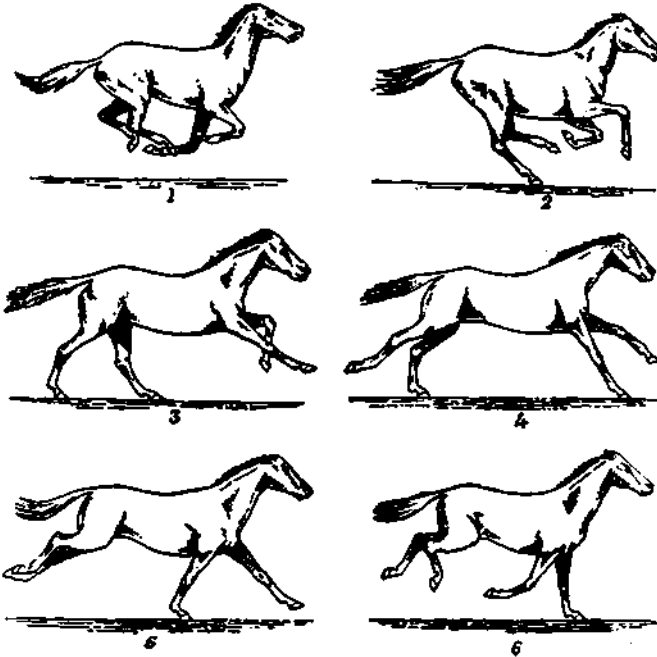

FIG. 123.—The Gallop.

hind foot, say the off, first reaches the ground (2), and immediately after the opposite hind foot is planted in advance of it (3). The off fore now comes to the ground, and as it does so the off hind is lifted and the horse rests on diagonal fore and hind legs (4). Then the off hind foot leaves the ground and the animal is now on the off fore foot (5). The near fore foot is now planted and the off fore leaves the ground (6), and finally the near fore is also raised and the horse is again in the air.

The stride in the gallop is about 15 to 20 feet. The speed is variable. Race horses attain a speed of 30 to 35 miles an hour on a race course of one to two miles length.

Canter.—The canter is a less energetic gallop. At one moment all the feet are off the ground, and they are planted in the same order as in the gallop—near hind, off hind, near fore. But while in the gallop the near hind has left the ground before the near fore is planted, in the canter all these are on the ground at once, and it is only as the off fore comes to the ground that the near hind followed by the near fore is raised. The off hind and then the off fore next follow, and all the feet off the ground. Both the length of the stride and the speed are less in the canter than in the gallop.

Jump.—The fore legs propel the body upwards, and the hind legs give a further forward and upward propulsion, and are then fully flexed under the body to clear the obstacle. The animal alights on its fore feet, one reaching the ground before the other.

6. Work of Muscle.

As the result of the changes in shape, muscle performs its great function of doing mechanical work; and the most important question which has to be considered in regard to muscle, as in regard to other machines, is the *amount of work* it can do. The work unit generally employed is the **kilogram-metre**—the work required to raise one kilogram to the height of one metre against the force of gravity.

Since the work done depends upon the weight moved and the distance through which it is moved, the work-doing power of muscle is governed by the (*a*) *force of contraction*, *i.e.* the tension developed which determines the weight which can be lifted, and by (*b*) the *amount to which the muscle can shorten*, for this governs the distance through which the weight may be moved.

It has been already shown that the force of contraction depends upon the sectional area of a muscle. A thick muscle is stronger than a thinner one. On the other hand, the extent of contraction depends upon the length of the

muscle, since each muscle can contract to a fixed proportion of its original length. A glance at the diagram will at once make this plain (fig. 124). The *size of the muscle* is thus the first great factor which governs its work-doing power.

But the tension developed also depends upon the length

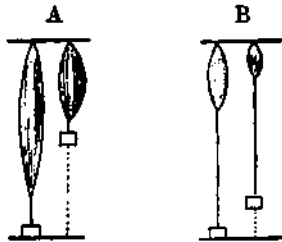

FIG. 124.—Influence of the length of a Muscle upon the work done. A is a muscle of two inches, and in contracting to half its length it lifts a weight to one inch. B is a muscle of one inch. It lifts the weight to half an inch.

of the muscle at the moment of stimulation (p. 224); this and every factor which influences the force of muscular contraction also influences the work which can be done (see p. 245 *et seq.*).

One factor, the effect of the load, requires special consideration. It has already been shown that as this is increased the lift or extent of contraction is diminished.

The following experiment, represented in fig. 125, illustrates the influence of increasing the load on the work-doing power of a muscle—

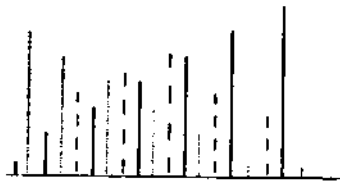

FIG. 125.—To show the influence of Load on the Work done.

————— Load.
 Lift.
 - - - - - Work.

It will be seen that increasing the load at first increases the amount of work done, but that, after a certain weight is reached, it diminishes it. There is, therefore, for every

muscle, so far as its working power is concerned, an **optimum load**.

In studying the amount of work which a muscle, or set of muscles can do, the element of *time* must always be considered. Obviously, contracting muscles will do more work in an hour than in a minute.

Further, the *rate* at which the work is done has an important influence, and the amount of work which can be done per unit of time will depend not merely on the *condition of the muscle* and the *load*, but upon the *rate* at

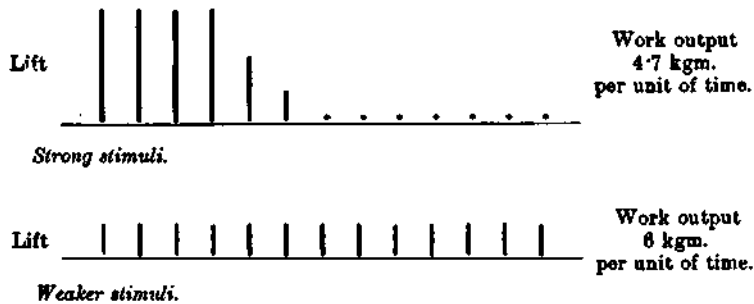

FIG. 126.—To show the influence of varying the strength of stimulation on the work done per unit of time.

which the lifting is performed. This will depend upon (1) the strength of the stimuli and (2) the rate of stimulation.

(1) Increasing the rate of work by the application of a very strong stimulus at short intervals may rapidly lead to fatigue, and thus to a comparatively low output of work in the time of the experiment, while a smaller stimulus at the same rate may cause a much longer continuance of the response of the muscle and an actually greater output in the total time (fig. 126).

(2) On the other hand, a stimulus too rapidly applied may soon lead to fatigue, while if more slowly applied the onset of fatigue may be postponed and the work done increased (fig. 127).

The same is seen when the work of muscles in bulk is studied. Experiments by Zuntz showed that in the horse,

as the speed in walking rose above 78 metres per minute, the rate of expenditure of energy per unit of distance covered was increased. This is confirmed by experiments done on man. It has been found that in marching, the optimum rate—the rate at which the most work can be done on the least expenditure of energy—is something over 3 miles an hour. To force the pace above this leads to a disproportionate demand for energy and is less economical.

Fig. 128, showing the extent of combustion in muscle measured by the CO_2 produced, illustrates this.

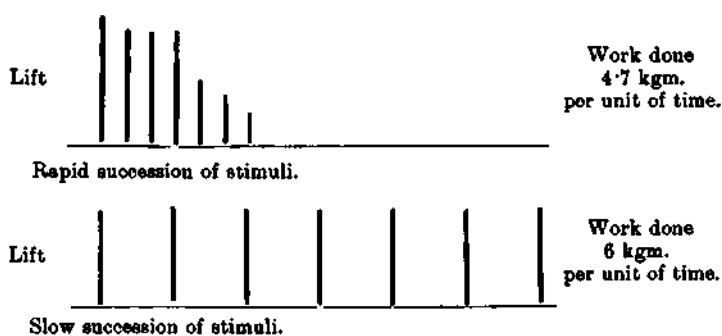

FIG. 127.—To show the influence of varying the rate of stimulation on the work done per unit of time.

The efficiency of a muscle as a machine thus depends upon the—

1. Load lifted.
2. Rate at which work is done.

Hence the efficiency of a machine is often expressed in terms of Horse Power—the unit being 76 kgm. per sec.

Measurement of work—

1. In the isolated muscle—

(a) The work done by the single isolated muscle of the frog in a single twitch is got by multiplying the weight lifted by the extent of shortening of the muscle (*Practical Physiology*).

(b) If the work during a series of contractions is to be measured, some means of adding the effect of each contraction to its predecessor must be employed, as is done by the work-collector of Fick (*Practical Physiology*).

2. *In groups of muscles in the body.*—When the work done by groups of muscles within the body has to be studied, some form of work-measurer or *ergometer* must be devised. A horse may be made to walk upon a platform which moves against a known resistance, or the pull exerted may be measured by means of a dynamometer, a simple form

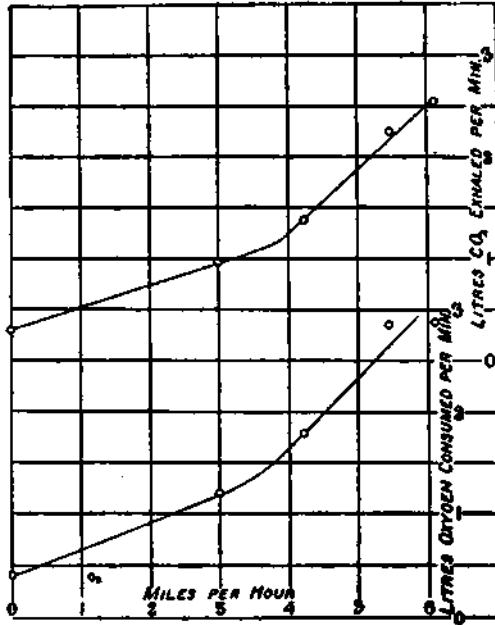

FIG. 128.—Graph to show the effect of increasing the pace of walking upon the expenditure of energy measured by the oxygen consumed and carbon dioxide given off. (BRIGGS.)

of which would be a spring balance inserted between the horse and the object pulled. By these means the capacity of the horse for work (p. 252) has been determined experimentally.

7. Heat Production in Muscle.

In muscle, as in a steam-engine or any other machine, by no means the whole of the energy is used for the production of mechanical work. Much of the energy is lost as heat. But while this is an actual loss in the steam-engine, the pro-

duction of heat is necessary in warm-blooded animals to maintain the temperature of the body at a level at which the chemical changes essential for life are possible.

That heat is given off by muscles in contraction is shown by the fact that, after muscular exercise, the temperature of the body rises for a short time. Some delicate method of measuring the temperature must be employed to demonstrate heat production in single isolated muscles. The mercurial thermometer is hardly sufficiently sensitive, and, therefore, the thermo-electrical method is most generally employed. Various forms of *thermopile* may be used (Appendix).

The rise of temperature in a muscle after a single contraction is extremely small, but after a tetanic contraction, lasting for two or three minutes, it is much greater.

By the use of extremely delicate thermopiles it has been

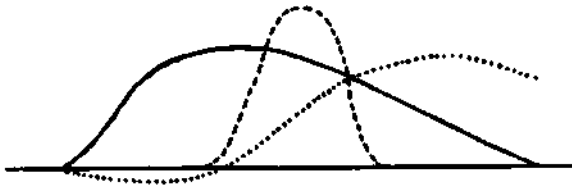

FIG. 129.—The continuous line shows the contraction of the heart of the terrapin: the dash line the production of heat, and the dotted line the temperature.

shown that in contraction most of the heat is evolved in the relaxation phase. This is more easily demonstrated in the slow contraction of the heart of the terrapin than in skeletal muscle.

The above diagram shows the relation of mechanical shortening to heat production (fig. 129).

The amount of heat produced by a single isolated muscle may be calculated if (a) the weight of the muscle, (b) its temperature before and after contraction, and (c) the specific heat of muscle, are known.

The specific heat of muscle is slightly greater than that of water, but the difference is so slight that it may be disregarded. If, then, a muscle of ten grams had a temperature of 15° C. before it was made to contract, and a tempera-

ture of 15·05° C. after a period of contraction, then 0·5 gram-degrees of heat have been produced ; *i.e.* heat sufficient to raise the temperature of 0·5 gram of water through 1° C.

The amount of energy liberated as heat may be calculated by the various methods considered in studying metabolism (p. 259).

The heat units employed are the small and large calories—the small calorie, the heat required to raise one gram of water through one degree Centigrade, and the large Calorie—generally written with a large C—the heat required to raise a kilogram of water through one degree Centigrade.

8. The Relationship of Work Production to Heat Production.

The Mechanical Efficiency of Muscle.

The proportion of work to heat is not constant in muscle any more than it is in an engine. If an unloaded muscle is made to contract, no work is done and all the energy is given off as heat, and the same thing happens when, in isometric contraction, a muscle is so loaded that it cannot contract when stimulated.

Since it is possible to measure the tension exercised upon a spring in isometric contraction and to measure the amount of heat produced, and since in such a contraction all the energy is finally given off as heat, it is possible to calculate the proportion between these. The efficiency in such conditions is found to be nearly 100 per cent. ; but this is no measure of the *actual* efficiency of the muscles.

The point of practical importance to decide is—How much of the energy liberated by muscle *in normal conditions* is available under favourable circumstances for mechanical work, and how much is lost as heat ?

To determine this, the way in which muscle develops tension when stimulated must be studied.

The Development of Tension by Muscle.

It has for long been recognised that muscle like other protoplasm gets its energy from food. But the problem

to be considered is whether muscle develops the tension by which it can shorten and do work by a process of direct oxidation, or in some indirect way.

Pflüger long ago deprived a frog of all free oxygen in an air-pump and then kept it in an oxygen-free atmosphere and found that it moved and gave off CO_2 . He concluded that the process of oxidation is not a direct one.

Subsequent experiments have confirmed this view.

It has been found that—

1. The muscle of a frog may be made to go on contracting for some time in nitrogen in the absence of oxygen, but that fatigue is soon manifested and is not removed by

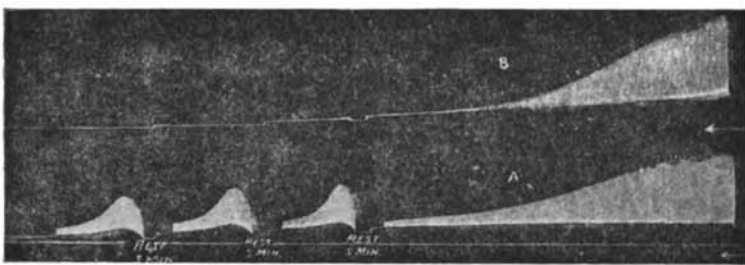

FIG. 130.—(To be read from right to left). Contractions of muscle. *A*, in oxygen; *B*, in nitrogen with no oxygen. In both, note onset of fatigue; in *A* recovery after brief rest, in *B* no recovery. (FLETCHER.)

rest. Sarcolactic acid is liberated but no carbon dioxide is produced (fig. 130, *B*).

2. In the presence of oxygen, sarcolactic acid does not accumulate. It is oxidised to CO_2 and H_2O . The muscle recovers from fatigue after a short rest (fig. 130, *A*).

3. Hence contraction is not due to oxidation, but to the throwing out of sarcolactic acid, *i.e.* to an increase of H ions which produces changes in surface tension with the development of "tension." The tension varies with the length of the fibre, which indicates that it is a surface phenomenon (Appendix). When shortening occurs the tension is decreased, and the potential energy becomes kinetic. Muscle, therefore, in contracting does not act as a heat engine by liberating energy by combustion, but as a compression engine which liberates energy already stored.

4. The work of restoring the potential energy is due to the oxidation of sarcolactic acid and of carbohydrates, proteins, and fats. These also yield the materials in which the energy is latent for reconstruction. From these latter "foods" the muscle molecule is regenerated and the energy, therefore, ultimately comes from them.

This is a process requiring oxidation, and hence CO_2 and H_2O are liberated and heat is produced (p. 247) in proportion to the work done by the muscles.

5. In the contraction phase the efficiency may be nearly 100 per cent., but, when the process of restitution is included, only at most 50 per cent. In considering the efficiency of muscle in liberating the energy stored in the food this point must be taken into consideration.

Muscle, like secreting epithelium (p. 35), thus does its work by storing the material from which energy may be liberated during its resting phase, and this process dominates the metabolism of muscle. For this, muscle requires *food* to yield the material and energy for restoration and the *oxygen* which is necessary to carry out the recuperation.

The efficiency of the muscles of the body may be measured by determining the *total energy* liberated in doing a measured amount of work

upon some form of ergometer by direct or indirect calorimetry (p. 259). It has been found that some 30 per cent. of the total energy liberated is about the *maximum mechanical efficiency*.

The efficiency of muscle thus compares favourably with that of an ordinary steam-engine which yields some

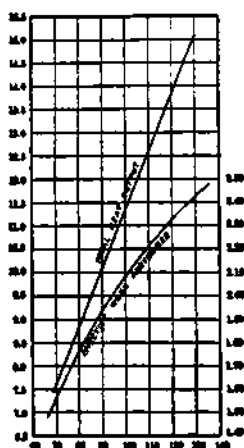

FIG. 131.—To show the changes in the efficiency of the muscles as the work done is increased. The decrease in efficiency is indicated by the divergence between the lines. The ordinates on the left are Calories per minute, those on the right indicate work units converted to Calories. The abscissae are the number of revolutions of the bicycle at constant work.

5 to 20 per cent. of the energy of the coal in mechanical work.

In the steam-engine, where heat energy is converted to work, the efficiency depends upon the difference of temperature between the cylinder and condenser. The high efficiency of muscle, with an absence of marked temperature variations, shows at once that it is not a heat engine (p. 247). Compared with other energy transformers, muscle does not stand so high. A Diesel engine gives a theoretical efficiency of about 75 per cent, and a practical efficiency of about 50, and an electric battery from 80 to 90 per cent.

It must, however, be recognised that the heat produced by muscle is necessary to keep the temperature of the body at such a level that the chemical changes, which are the basis of life, may go on.

Probably a return of 30 per cent. is seldom yielded under ordinary working conditions by the whole muscular system.

Within certain wide limits of work done, the efficiency of muscle remains constant, that is, the total energy evolved is directly proportionate to the work done.

But if excessive work is put upon muscles, or if the work has to be done at a rate greater than the optimum, the mechanical efficiency decreases and the total energy expenditure rises out of proportion to the work done, just as, when a steamer is driven above a certain speed, the coal consumption is increased out of proportion to the increased speed. This is well illustrated by the increased production of CO_2 , which occurs when the rate of marching is forced from 3 to 5 miles an hour (fig. 128).

Fig. 131 shows the relationship of the work done (effective work performed) to the total output of energy (total heat output). Such a figure indicates very clearly that, while for moderate increments of work the mechanical efficiency of the muscle is fairly constant, with greater increments the efficiency becomes less, *i.e.* the total expenditure of energy increases out of proportion to the work done.

9. The Efficiency of the Horse as a Machine.

The total amount of energy liberated by the horse in performing a measured amount of work has been estimated by the indirect method of calorimetry (p. 260). By this means the efficiency of the horse as a machine has been determined by Zuntz and others.

The total energy expended in work, as in drawing a load, is the sum of three separate items :—

(1) The amount for maintenance purposes. This is required whether the animal is working or at rest.

(2) The amount spent in moving the body of the animal.

(3) The amount spent in moving the load.

The proportion which the amount of useful work done bears to the total energy liberated (1 + 2 + 3) is called the *gross efficiency*. The proportion which the work done bears to the part of the energy expended in moving the load is called the *net efficiency*. The amount spent solely in moving the load is, of course, the total output (1 + 2 + 3) minus the output when the animal is moving without a load (1 + 2). The net efficiency under the most favourable conditions of load and speed is found to be 30 to 35 per cent., which is about equal to that obtained in man.

10. Capacity of the Horse for Work.

Draught.—The amount of work performed by the draught horse has been measured by means of the moving platform (p. 246). Over two million kilogram-metres (about 7000 foot tons) has been registered in an experimental day's work, and the amount of work which the horse is capable of performing daily has been estimated as high as 6000 foot tons (1,854,720 kilogram-metres). F. Smith, however, considers that 5000 foot tons (1,545,600 kilogram-metres) is a severe day's work, and that 3000 foot tons (927,360 kilogram-metres) is a fair average. The capacity of the draught horse for work is doubtless being increased by selective breeding designed to increase the weight of the

animal and improve the conformation and qualities of feet and legs. The former has improved in Shires and the latter in Clydesdales.

The force that a horse can extend on a steady pull has been found by F. Smith to be about 75 per cent. of its body weight. The load which can be pulled depends largely on the condition of the road and the nature of the vehicle. On a level road a total weight—vehicle plus load—of 2·5 to 4·5 times the weight of the animal can be pulled at a walking pace.

On a rising gradient, in addition to the pull to overcome the inertia of the load on starting and the friction in motion, the load and the animal itself must be raised against gravity. The load that can be drawn up-hill therefore decreases very rapidly as the gradient rises.

As the co-ordination of muscle of two or more horses pulling together is not so perfect as that of a single animal, the amount that can be pulled by more than one horse is always less than the sum of the amounts each can pull separately.

Carrying.—The horizontal spine of the horse is not adapted for carrying weights. About one-fifth of the body weight is the maximum load a horse can carry comfortably for any length of time. In this respect it is less efficient than man with his vertical spine. An infantry soldier can march carrying more than a third of his weight. The smaller breeds of horse can carry more in proportion to their weights than the larger. Consequently a mule or pony is a more efficient pack animal than a large horse.

Over-work.—A horse that is worked beyond its capacity rapidly deteriorates and is liable to injury of the feet and legs caused by excessive strain. When the muscles are tired undue strain is allowed to fall upon the supporting tendons which become injured. Co-ordination of tired muscle is less perfect, and “brushing” and stumbling occur. Severe work, necessitating a propulsive force as in heavy draught, or concussion as in high speed, greater than the elasticity of the structures of the foot can accommodate, is apt to injure the matrix and produce laminitis. Horses

are oftener off work for lameness than for any other ailment, and the chief cause of lameness is work that is excessive either in amount or in rate.

The nature of the chemical changes in muscle—the metabolism of muscle—must next be studied.

11. The Chemical Changes in Muscle.

Metabolism of Muscle.

It has been already pointed out that, on account of (1) its bulk, (2) its constant action, (3) the extent of its chemical changes, the metabolism of muscle dominates the metabolism of the body as a whole. As already stated, it is to supply energy to muscle that food is taken. It is to oxidise this food and to liberate its energy that air is drawn into the lungs, and it is to get rid of the carbon dioxide formed in muscle that air is breathed out. It is to adjust the reaction of the fluid bathing the muscle and to get rid of the products of muscular metabolism that urine is secreted. It is to prepare food for muscle that the digestive organs work. It is to carry food and oxygen to muscle that the flow of blood is maintained, and it is to regulate the supply of food to the muscle that the liver performs its functions.

Hence the study of the metabolism of muscle is really the study of the general metabolism of the body. The intake and output of matter and of energy are alike dominated by the requirements of the muscles.

One caution, however, must be given. The amount of food taken is not always regulated by the requirements of the body, and hence any surplus over what is required must either be stored for future use (p. 351), or be got rid of from the body, just as the coals thrown into a furnace in excess of the requirements of the engines are burned away. In studying the influence of various factors upon muscular metabolism the influence of food has therefore always to be considered, and should either be eliminated by fasting or be kept constant throughout the observations.

(1) **The Oxidation in Muscle: Coefficient of Oxidation.**—The

amount of oxygen used in muscles at rest and in action is ascertained by determining (1) the decrease in the amount of oxygen in the blood leaving the muscles (p. 498); (2) the amount of blood flowing through the muscles per unit of time (p. 473); and (3) the weight of the muscle. This allows the coefficient to be stated in terms of c.cm. of oxygen per gm. of muscle per minute. In the skeletal muscles of mammals the following variations have been found according to the condition of activity:—

	Oxygen per minute per gm. of muscle in c.cm.
Nerve cut : Tone absent	0·003
Tone existing in rest	0·006
Gentle Contraction	0·020
Active Contraction	0·080

With active contraction the consumption of oxygen may be increased more than twenty-fold.

Similar results are obtained when the influence of muscular work upon the oxygen consumption of the body as a whole is studied (p. 266).

Is this increased oxidation in contraction accompanied by any change in the composition of the muscle? So long as the blood stream is intact it is probable that any change which may occur is at once made good. But if muscle deprived of its blood supply is investigated it is unsafe to conclude that a change in composition is the result of contraction and is not due to the decreased supply of blood. It has been shown that when muscle contracts without a supply of oxygen, sarcolactic acid accumulates; but that when it contracts in oxygen, this is oxidised to carbon dioxide (p. 249). In contraction the supply of glycogen in muscle is decreased, and after fasting and strychnine convulsions, it may practically disappear.

(2) **Material Oxidised by Muscle.**—The study of the coefficient of oxidation of muscle leads to the consideration of what is oxidised to yield the energy.

It has been found that only the three great constituents of the body and of the food—the *proteins*, *carbohydrates*, and *fats*—are freely oxidised to yield energy in the body, although some other substances, *e.g.* alcohol, are capable of a limited oxidation.

(3) **The Mode of Oxidation.**—Every one knows that, at the temperature of the body, proteins, fats, and carbohydrates do not undergo combustion. To bring this about, the action of something comparable to an enzyme with an activator is necessary.

The enzyme-like substance appears to be formed, possibly from the lipoids of the protoplasm, by an auto-oxidation by which a *peroxide* is formed, which has a greater power of oxidising than free oxygen has.

But peroxides alone are not sufficient to bring about the combustion of sugars, lactic acid, etc., an *activator* is necessary, and such an activator has been prepared from various cells, and, since it activates the peroxide, it has been termed a *peroxidase*.

In the oxidation of food-stuffs in muscle and other protoplasm the following steps seem necessary :—First, the formation of a peroxide in which oxygen is stored at a high potential; second, the activating action of a peroxidase. These together may be called an *oxydase*.

(4) **Energy Value of Proteins, Fats, and Carbohydrates.**—To determine the amount of energy yielded by the oxidation of each, all that is necessary is to find the amount of heat evolved by its combustion. This is done by burning a known weight in a water calorimeter, an apparatus by which all the heat evolved is used to heat a known volume of water. The **Bomb Calorimeter** is generally used for this purpose. It consists of a thick metal case in which a weighed quantity of the food to be investigated can be placed in oxygen. By means of wires it can be completely burned by an electric spark. The metal case is placed in a known quantity of water and the heat given off from the food goes to heat this water. By taking the temperature before and after the combustion the amount of energy in heat units, or calories, may be calculated. Suppose that 1 gram of starch was put in the bomb calorimeter and the case then placed in 1 litre, *i.e.* 1 kilogram of water; suppose the temperature of the water was raised 4.1° C., this would mean that 1 gram of starch had liberated 4.1 Calories of energy.

It is known that, in the normal individual, fats and

carbohydrates are burned completely to CO_2 and H_2O , and therefore yield the same amount of energy as in the calorimeter.

On the other hand, the proteins are not completely burned in the body, the process of combustion stopping at the formation of urea, CON_2H_4 . Something like 3 gm. of protein yield 1 gm. of urea.

In the case of fats and carbohydrates where the combustion in the body is the same as in the calorimeter, this method is at once applicable to determine the energy which muscle can liberate. The *physical* and *physiological availability* is the same.

1 gm. fat—9.3 Calories.

1 gm. carbohydrate—4.1 Calories.

But in the case of proteins it is necessary to determine—
(1) The energy evolved in complete combustion in the calorimeter. (2) The energy evolved by the combustion of the urea formed, and to subtract the latter from the former.

Complete combustion of 1 gm. yields about 5.6 Calories—the *physical energy equivalent*. The combustion of the urea formed from 1 gm. of protein yields about 1.3 Calories. Hence about 4.3 Calories are available in the body—the *physiological energy equivalent*. Variations occur according to the nature of the protein used, and generally it is accepted that—1 gm. protein yields in the body 4.1 Calories.

5. **The Determination of the Amount of Proteins, Fats, and Carbohydrates oxidised in the Body.**—To determine the amounts of each of these proximate principles oxidised in the body, it is necessary to investigate—

A. Proteins.—The amount of nitrogen excreted gives a measure of the protein used since protein contains 16 per cent. of nitrogen. Hence the nitrogen excreted $\times 6.25$ = amount of protein used.

Proteins contain nearly $3\frac{1}{2}$ times as much carbon as nitrogen, so for each gm. of nitrogen from protein, 3.4 gm. of carbon are excreted (fig. 132).

B. Fats and Carbohydrates.—All carbon excreted, above that derived from proteins, must come from fats and carbohydrates (fig. 132). In the fasting animal it comes from

fats alone. When food is taken, the determination of the extent to which each of them is being oxidised depends upon the fact that carbohydrates are rich in oxygen, while fats are poor in oxygen. Hence, to oxidise a given weight of fat to CO_2 requires more oxygen than to oxidise the same weight of carbohydrates.

For this reason the amount of oxygen required to produce say 100 c.c. of CO_2 is greater when fats are being

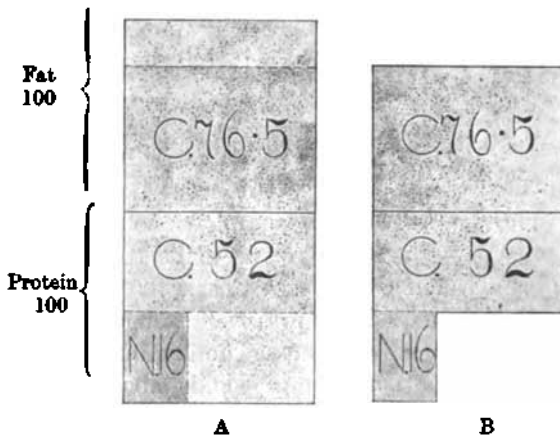

FIG. 132.—Output of Nitrogen and Carbon in a fasting animal to show how the combustion of Proteins and Fats is calculated from it. A, the Protein and Fat metabolised. B, the Nitrogen and Carbon excreted, derived from A.

consumed than when carbohydrates are being used, and hence, if the CO_2 output and the O_2 intake are determined and their proportion expressed as—

$$\frac{\text{CO}_2}{\text{O}_2}, \text{ the Respiratory Quotient.}$$

This is found to be, in the case of Fats, 0.7, and in the case of Carbohydrates, 1.0.

In the case of proteins, in which the amount of oxygen is intermediate between that in fats and carbohydrates, the respiratory quotient is about 0.8.

Knowing the amount of carbon coming from proteins we can calculate the O_2 necessary for their combustion, and any excess of CO_2 and of O_2 over this is due to com-

bustion of fats and carbohydrates. When this is expressed as a respiratory quotient, the amount of fats and carbohydrates respectively used can be determined.

Tables giving the significance of different respiratory quotients are prepared and are used in such investigations.

The following gives a rough indication of such a table.

R.Q.	Carbohydrates.	Fats
1.00	100 per cent.	0 per cent.
0.90	66 "	34 "
0.80	32 "	68 "
0.70	0 "	100 "

Owing to the fact that the amount of protein decomposed during the relatively short period of the collection of the sample of expired air is, as a rule, trivial, the calculation may be based solely on the combustion of carbohydrates and fats.

Calorimetry.

To determine the extent of these exchanges two different methods have been employed.

(1.) **Direct Calorimetry.**—By this method the amount of energy liberated as heat is directly measured by means of a Respiratory Calorimeter. This consists of an air-tight double-walled room, in which an animal may be kept for a day or longer at a time. It is provided (1) with an arrangement by which air is supplied and the amount of air measured; (2) with an arrangement by which the heating of the air and the amount of water vaporised may be measured; (3) with an air-tight double window, through which the animal can be observed.

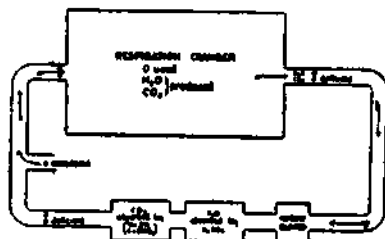

FIG. 133.—Diagram of a Respiration Chamber to show the method of analysis of the expired air and the renewal of the supply of oxygen.

With this chamber it is possible to measure—

(1.) The heat given off. This is measured by the extent to which water circulating in special coils is heated and by the amount of water vaporised.

but it has been found that under normal conditions during experiments of short duration, their combustion is so small that it may be neglected.

The composition of the air taken in being known, when (1) the quantity of air expired and (2) its composition is ascertained, it is possible to determine how much O_2 has been taken up and how much CO_2 has been given off in a definite time.

In experiments on man this is done by collecting the air in a special rubber bag devised by Douglas, and which can be carried

on the back of the subject. A mouthpiece is fitted with two valves, through one of which air is inspired, and through the other of which it is expired into the bag (fig. 135). The amount of air breathed may be measured by passing it through a gas meter, and it may be analysed by means of Haldane's apparatus.

In animals the exchange can be determined by using a canula inserted into the trachea instead of a mouthpiece. This method has been used by Zuntz and his co-workers on experiments on horses at work.

The indirect method has been tested against the direct method, and has been found to give very concordant results.

Zuntz also used another indirect method. He measured the work done on some form of work-measurer or ergometer, *e.g.* a wheel turned against a measured resistance. By converting the work units of the work thus done into heat units and subtracting this from the total energy of the food, expressed in heat units, the energy lost as heat may be determined, since all energy not used for mechanical work is dissipated as heat. Thus the relationship between work

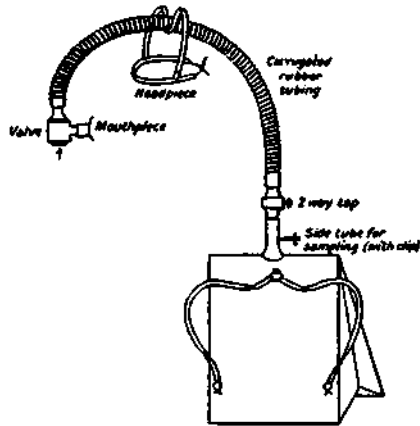

FIG. 135.—Douglas bag for collection of expired air.

production and heat production may be ascertained, as is shown in the following table for a man :—

	Kgm.	Calories.
Food	3000
Work	212,500	500
Heat		2500

6. **Results of these Investigations.**— Investigations by these methods have shown that when there is an abundant supply of carbohydrates and fats, they are used as the chief source of energy, the carbohydrates being the more readily used.

Only when the work requires more energy than can be supplied from these sources are the proteins used to any great extent (fig.136). But in a lean animal, *i.e.* an animal with no

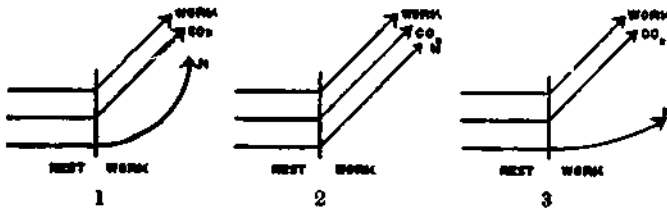

FIG. 136.—To illustrate the influence of Muscular Work upon the Excretion of Carbon dioxide and of Nitrogen—(1) in a fasting or underfed animal; (2) in an animal fed on proteins; (3) in an animal on a normal diet.

great store of fats and carbohydrates, fed on proteins the energy for work may be got almost entirely from them.

All the three proximate principles of the food are available, but the great use of proteins is in the growth and repair of muscular tissue.

It may therefore be concluded that, in a lean fasting animal and in an animal fed on proteins, the muscles get their energy chiefly from proteins, but that, in an animal with an adequate store of fat or upon an ordinary diet, the muscles get it chiefly from the carbohydrates of the food or from the fats of the food and of the body.

A study of the ordinary diet of horses doing muscular work corroborates these conclusions. In this country the diet of

a draught horse consists of something like the following proportions of food constituents per 1000 kilos. of body weight :—

	Amount in Grams.	Yielding Calories.	
		Actual.	Per Cent.
Proteins	2300	9500	14
Fats	800	7500	11
Carbohydrates	12,500	50,000	75

GENERAL METABOLISM OF THE BODY.

A. EXCHANGE OF ENERGY.

As already indicated (p. 254), the energy exchanges of the body as a whole are determined by the chemical changes in the muscles. Further, the temperature of the body must be maintained at a level at which these chemical changes can go on. For this purpose heat must be produced to compensate for cooling. It will be shown later (p. 272) that the rate of heat production is influenced by the amount and nature of the food taken. Hence the energy requirements depend upon:—

- (1) Muscular activity ;
- (2) The rate of cooling, *i.e.* the amount of heat that must be produced ;
- (3) The food taken.

Before considering the influence of these factors, the lowest rate of metabolism compatible with the maintenance of life must be investigated.

I. The Basal Metabolism.

The basal, or, as it might perhaps better be called, the standard metabolism, is the rate of metabolism necessary to maintain life when the three factors mentioned above are reduced to a minimum.

The factors of outstanding importance in determining the basal metabolism of an animal are (1) size and (2) age.

1. **Size.**—The variation in size is in proportion, not to the weight but to the surface, *i.e.* the rate of cooling. This is shown by comparing the basic energy expenditure of animals of different size.

	Calories per kilo.	Calories per square metre of surface.
Horse	11.3	948
Pig	19.1	1078
Goose	66.7	969
Mouse	212.0	1188

It is seen that this relative uniformity of the ratio of basal metabolism to surface area is present even in animals of different species. This relationship may be due to the regulation of the rate of metabolism by stimuli from the skin. This is doubtless true so far as heat production to compensate for loss of heat is concerned, since the rate of cooling is directly proportional to surface area. It is probable, however, that metabolism is also dependent upon the mass of active tissue, *i.e.* muscle, and that this accounts for the relatively small variations found in the ratio of metabolism to surface.

A comparison of the metabolism in different animals should thus be based on the surface area. In bodies similar in material and shape but differing in size, the surface is proportional to two-thirds the power of the weight. As animals of the same species are relatively constant in shape and composition, the surface area can be calculated from the weight by the following, known as Meeh's formula :—

$$S = kW^{\frac{2}{3}}$$

where "S" = unit of surface, W = unit of weight,
 "k" = constant for each species.

The value of "k" for different species has been determined by direct measurement of the surface area and calculating the relationship of unit of surface to unit of weight. Some of the values found are :—

Horse	9.0
Pig	8.7
Bullock, fat	7.7
„ thin	9.9
Sheep	12.1
Dog	10.3-11.2

A direct determination of the extent of body surface of

an animal is a difficult matter. It can be estimated, however, from the weight. Since, for animals of the same species and type, the factor "k" is constant, the basal metabolism is proportional to two-thirds the power of the weight and can be compared on that basis. Thus, for example, if an animal of 1000 lbs. live weight has a basal metabolism of 7000 Calories, another of the same species and type, of 1500 lbs. would have a basal metabolism of approximately

$$7000 \times \left(\frac{1500}{1000}\right)^{\frac{2}{3}}, \text{ i.e. } 9172 \text{ Calories.}$$

2. *Age.*—In the young animal not only is energy required for growth, but the active tissues of the body are in greater proportion than in the full-grown animal. Actual measurements in the calorimeter have shown that the basal energy requirements of a boy of ten years of age are about 25 per cent. greater per unit of surface area than those of the adult. A similar relative increase doubtlessly exists in all young animals. The influence of age on metabolism and the energy requirements of growth have not, however, been fully investigated.

II. Factors modifying the Metabolism.

1. Muscular Activity.

Since the energy for muscular work comes ultimately from the processes of oxidation in muscle, the rate of metabolism varies with the amount of work done, and with the rate at which it is done.

This is by far the most important factor determining the extent of metabolism and the energy requirements of the individual. Under the influence of muscular work a tenfold increase has been observed in man. In the horse, with its great muscular development, an even greater increase is doubtless sometimes obtained.

The close parallelism between muscular activity and energy expenditure is remarkable. Movements which are scarcely noticeable, and even increased tonus of muscle apart from motion, are accompanied by an appreciable rise in the rate of metabolism. Thus a soldier standing rigidly at attention may expend 10 per cent. more energy than

when standing at ease, even although in the former case there is no visible movement. The lowest rate of metabolism is reached in sleep when the skeletal muscles are relaxed and the action of the other muscles is reduced to a minimum.

2. Rate of Cooling.

Since under ordinary conditions the temperature of the surrounding air is lower than that of the body, there must be a constant loss of heat and consequently a constant production of heat to keep the temperature of the body steady.

Loss of Heat.

1. **Skin.**—Heat is lost from the body by the skin in two ways:—(a) by conduction and radiation, and (b) by evaporation of sweat.

(a) *Conduction and Radiation.*—The extent of this loss depends upon the difference between the temperature of the body and that of the air. Radiation plays the most important part when an animal is at rest in still air; conduction when the exchange of air over the surface is rapid, as in wind.

The influence of variation in the temperature of the air is minimised by the covering of fur or feathers, which retains a stationary layer of air of about 25° to 30° C. over the skin.

Cold stimulates the growth of hair. On the other hand, the heavy winter coat tends to be shed when an animal is confined in a warm atmosphere.

(b) *Evaporation of Sweat.*—Heat is rendered latent by the evaporation of sweat, and is taken from the body which is thus cooled, just as the hand may be cooled by allowing ether to evaporate upon it. The extent of loss depends not only on the amount of sweat secreted, but also upon the rapidity with which the evaporation goes on. This is governed by the dryness and temperature of the air, and the rapidity of its exchange by wind and other air currents.

The horse sweats easily. Working under ordinary conditions of climate, it may lose from 5 to 10 litres of water as sweat per day.

The pig has sweat glands only on the snout; the dog only on the muzzle and foot pads. The sheep has few sweat glands and perspires very little. Cattle also perspire little, except on the muzzle.

Moisture in the air increases the conductivity of the body covering, and consequently the loss of heat by conduction and radiation in a cold atmosphere is greater in proportion to the humidity. On the other hand, moisture in the air hinders the free evaporation of sweat, so that loss of heat by evaporation is less rapid in a hot climate that is moist than in one which is dry. Consequently in climates with temperatures above that of the body the heat is better borne by animals when the air is dry and moving.

2. Respiratory Passages.—Evaporation from the respiratory passages and the heating of the respired air may account for 10 to 20 per cent. of the heat lost. In the dog the amount of heat lost in this way may be considerably greater (p. 269).

3. Urine and Fæces.—A certain amount of heat is lost by raising the ingested food and water to body temperature, at which the urine and fæces are voided. In the dog the amount is small—something less than 2 per cent. Where the food is bulky—as, for example, in ruminants on a heavy root diet—the amount may be as much as 10 per cent. of the total heat lost.

Heat Production.

A. Muscle.—As already indicated, muscle is the great heat producer on account of its great bulk and constant activity. Not only may it be demonstrated that (1) the temperature of muscle in action rises, but (2) it has been found that the temperature of blood coming from the muscles is slightly higher than that of blood going to them. (3) Muscular exercise raises the temperature of the body. (4) Drugs which interfere with muscular contraction, such as curare, diminish the temperature, and (6) young animals, before their muscular tissues become active, have a low temperature unless kept in warm surroundings.

B. Glands.—A certain amount of heat is produced in

glands and chiefly, on account of its great size, in the liver. During active digestion the temperature of the blood coming from the liver is distinctly higher than that of the blood going to the organ, and, since the amount of blood passing through the organ is large, an appreciable amount of heat is derived from it. The production in glands, however, is trivial when compared with the production in muscle.

Heat Regulation.

In spite of wide fluctuations in rate of heat production and heat loss, the body temperature varies within very narrow limits. This constancy is maintained by two means, called respectively the *physical regulation*, which controls the rate of loss of heat, and the *chemical regulation*, which controls the rate of production.

Physical Regulation.—When heat production exceeds heat loss, the resultant rise in body temperature is accompanied by dilatation of the cutaneous vessels, so that more blood is brought to the surface and the loss of heat increased. Along with this an increased secretion of sweat occurs.

Conversely, when heat loss exceeds heat production, constriction of cutaneous vessels and decrease of sweat secretion reduce the loss of heat.

These adjustments in the skin to maintain the balance between heat production and heat elimination are reflex effects.

In the dog, which has no sweat glands on the part of the body covered by hair, increased elimination of heat is brought about by a panting respiration that increases the loss of heat by the respired air and by evaporation from the respiratory passages. The mouth is held open and the tongue allowed to hang out, so that as large a moist surface as possible may be exposed to the air to allow cooling by evaporation. In cattle increased elimination of heat by sweating is small in amount, and their temperature is therefore especially liable to rise with exercise.

Chemical Regulation.—As the temperature of the environment of an animal falls, a point may be reached at which even with loss of heat restricted to the utmost, heat pro-

duction may be insufficient to balance heat loss, and the body temperature begins to fall. When this occurs the rate of metabolism and consequently of heat production is increased either by increased muscle tonus or by muscular exercise. This increased muscular activity may consist of

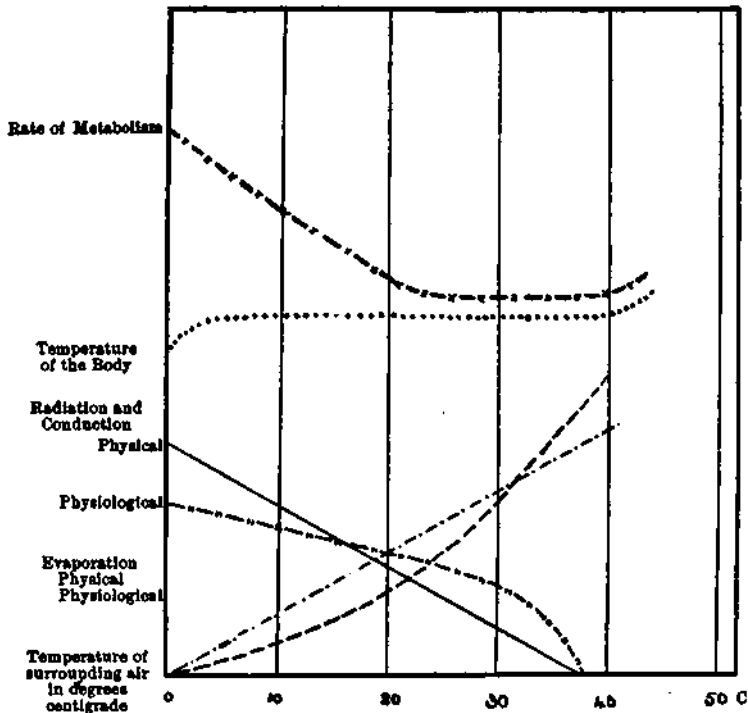

FIG. 137.—To show the physical and the chemical regulation of temperature. Note that roughly between 20° and 40° C. the regulation is by changes in the loss of heat, and that below 20° C. increased heat production occurs. Above 40° C. a hyperthermal increase of heat production occurs.

voluntary movements, or, if these be prevented, by a shivering fit which is simply a reflex, involuntarily bringing into action a large number of muscles.

The voluntary movements for heat production are seen in the "freshness" of a horse brought out of a warm stable into a cold atmosphere. A shivering fit is often seen in the horse after drinking a large quantity of cold water, which

abstracts heat from the body in being raised to body temperature.

The way in which the rate of metabolism rises as loss of heat increases, with a fall of temperature, is shown by the following results obtained by Rubner on a fasting dog:—

Temp. C.	Rate of Metabolism in Cal. per kg. body wt.
35	68.5
30	56.2
25	54.2
20	55.9
15	63.0
7	86.4

In this chemical regulation energy-yielding materials, usually carbohydrates and fats, are metabolised solely for the purpose of heat production.

Wind has a very marked effect upon the rate of cooling, and consequently upon the rate of metabolism, especially in an animal like the pig where the hair is scanty. Hill has shown that in man exposure to a cold wind may nearly double the energy expenditure.

Critical Temperature.—In the case of the fasting dog quoted above, the lowest rate of metabolism is reached in an environment with a temperature of about 25° C. Below this level the rate of metabolism is increased for heat production by chemical regulation. As the temperature rises above 25° C. not only is loss of heat decreased, but metabolism is stimulated by the rise in temperature, so that heat is produced beyond requirements, and its elimination is hastened by physical regulation. The level of the external temperature at which chemical regulation gives place to physical, or *vice versa*, is known as the *critical temperature*. It is the temperature of minimum metabolism, and consequently of lowest food requirements.

Experimental evidence is lacking to determine the exact critical temperature for domestic animals. It is probably about 20° to 25° C. in the horse and pig, and somewhat lower in ruminants. In the individual it varies with the condition of the coat and the amount of subcutaneous fat.

The taking of food causes an increase in rate of metabolism.

The critical temperature of the fed animal is therefore lower than that of the fasting animal.

3. Effect of taking Food on Metabolism.

The consumption of food by an animal increases the basal metabolism, as is seen in the following results obtained on a horse:—

	Calories per hour per kg.
Fasting	1·02
3½ hours after feeding	1·13

The increase is influenced by the quantity and character of the food. Each of the proximate principles stimulates chemical changes. Proteins have a special influence in this direction, and, when eaten, metabolism is so increased that something like 30 per cent. of the energy they contain may be liberated as heat. This is called their *specific dynamic action*. Lusk has shown that it is due to the direct action of certain of the amino-acids upon the metabolism.

The increased metabolism following feeding was formerly attributed to (1) the muscular work involved in peristalsis, and (2) to the liberation of energy in the disintegration of the molecules of the food in the process of digestion. Hence it was said to be due to the "work of digestion," an unfortunate term still widely used. Experiments have shown that the energy expended in the mechanical work done by the intestinal tract is negligible, and that the chemical reactions involved in digestion are isothermic.

It is thought that the fermentation that takes place in the digestive tract of the ruminant produces a considerable amount of heat. To what extent this occurs and what increase follows feeding little is known.

4. Metabolism in Prolonged Fasts.

When the usual supply of energy in the food is cut off, the animal gets the energy required by oxidising its own stored material and its tissues. This is shown by the fact that it loses weight and goes on excreting carbon dioxide.

urea, and the other waste products of the activity of the tissues.

Prolonged fasts have been borne by both men and animals, and, in one or two of these in man, careful observations have been made by physiologists. It has been found that during the first day or two of a fast, the organism draws most lavishly on its store of carbohydrates, and that there is a marked diminution in the protein metabolism. As soon as the carbohydrate depots are exhausted, the protein metabolism suddenly increases, to fall slowly as the fast progresses. Fat metabolism falls slowly throughout the fast. The following figures obtained by Benedict on a subject who fasted for thirty-one days clearly demonstrates the effect of fasting.

Amount of Proteins, Fats, and Carbohydrates in grms. catabolised in twenty-four hours during a fast.

Day.	Protein.	Fat.	Carbohydrates.
1	42.6	135	68.8
5	62.5	133	15.1
10	60.3	120	3.9
15	50.8	116	...
20	46.1	110	...
25	46.9	109	...
31	41.6	115	...

(1) *It is from the stored fats that the energy is chiefly derived*, and the result of this is that before death the fats of the body are to a great extent used up. (2) The protein-containing tissues waste more slowly and waste at different rates, the less essential being used up more rapidly than the more essential, which, in fact, live upon the former. In cats, deprived of food till death supervened, the heart and central nervous system scarcely lost weight; the bones, pancreas, lungs, intestines, and skin each lost between 10 and 20 per cent. of their weight, the kidneys, blood, and muscles between 20 and 30, and the liver and spleen between 50 and 70.

The *rate of waste* during a fast depends upon the amount of energy required, and it is therefore increased by muscular work and by exposure to cold (p. 266).

The power of withstanding starvation depends chiefly upon the extent of the store of fat in the body. Pigs and sheep have been known to withstand starvation for 60 days

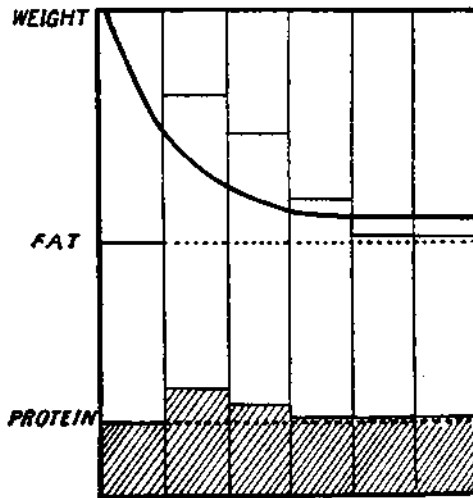

FIG. 138.—To show the Effects on the Metabolism of Proteins and Fats of Feeding a Fasting Animal. The continuous horizontal lines indicate the amount of material metabolised, the broken horizontal lines the amount taken. The differences between the levels of these indicate the amount of protein and of fats of the animal body which are metabolised. The first column represents the condition in fasting—the succeeding columns the intake and output each day when food is given.

and dogs for 30 days without permanent injury. In man fasts of 30 days have been borne without injury. Horses and cattle succumb sooner than men.

5. Metabolism in Semi-Starvation.

When the food supply of an animal is inadequate to yield the necessary supply of energy, the energy expenditure is reduced by the restriction of all unnecessary movements. Experiments show that, in ruminants at least, the digestibility of a ration is increased as its amount is diminished

(p. 366), so that a greater proportion of the energy of the food is rendered available for metabolism. The stimulus due to taking food is also, of course, decreased as the amount is decreased (p. 272). Hence life is maintained more economically in an under-fed than in a well-fed animal.

Short periods of under-feeding cause no damage beyond some loss of weight. From the evidence in man it is most probable, however, that in prolonged periods of under-nutrition the power of resisting disease is diminished.

B. EXCHANGE OF MATERIAL.

Not only is material necessary as a source of energy, it is also required for the formation of new tissue in growth, and for repair in the full-grown animal.

In protoplasmic activity (p. 21) there is a continuous breaking down of complex substances to simpler bodies. Some of these products of katabolism can be re-used to build up the living protoplasm, others, however, are excreted as waste. In some cases, too, essential materials are carried off from the body in combination with excretory products (p. 280). New materials must therefore be supplied to make good the waste to ensure that the destructive phase of metabolism shall be balanced by the constructive.

In addition, certain accessory factors (p. 281) are required to secure the harmonious working of the metabolic processes which is necessary to health.

Metabolism therefore involves an exchange of material as well as an exchange of energy.

The substances that take part in metabolism are :—

- (1) Water.
- (2) Amino-acids.
- (3) Salts.
- (4) Accessory factors.

Water is the chief constituent; since it is daily given off in large quantities by the kidneys, lungs, skin, and bowels, it must be supplied in sufficient amounts, or the chemical change cannot go on, and death supervenes.

Amino-acids.—Nitrogenous material is lost to the body in the catabolism of the protein in the tissues and in the

cells shed from the mucous membranes and from the skin and its coverings. Material is used up in the production of enzymes and of internal secretions (p. 588). The new nitrogenous matter required for the replacement of this used-up material and also for formation of new tissue in growth must be supplied to the tissues in the form of amino-acids.

The various proteins differ in their amino-acid build-up (p. 16), and hence they are of different value in the growth and repair of the body. Their relative value has chiefly been investigated by feeding young white rats on a basal diet consisting of protein-free dried milk, since this is known to be an adequate diet when suitable proteins, such as the milk proteins, caseinogen and lactalbumin, are added to it. Various proteins or amino-acids may be added to this, and the effect upon the rate of growth and the duration of life determined.

In this way it has been shown that some of the amino-acids, certainly glycine, can be formed from others, since caseinogen, which contains no glycine, has proved adequate for normal growth.

Other amino-acids cannot be formed in the body, or cannot be formed in sufficient amounts for adequate nutrition. Some proteins contain all the necessary amino-acids, some do not. It has been found that among those which are adequate to maintain normal growth when given in sufficient amount are—

Animal Origin.	Vegetable Origin.
Casein (milk).	Edestin (hemp seed).
Lactalbumin (milk).	Glutelin (maize).
Ovalbumin (hen's egg).	Glutenin (wheat).
Ovovitelin (hen's egg).	Glycine (soy bean).

While among those which are inadequate are—

Legumelin (soy bean).	Hordein (barley).
Gliadin (wheat).	Zein (maize).
Legumin (pea).	Gelatin.

The reason for this failure is the absence of essential amino-acids.

Gelatin lacks tyrosine and tryptophan.

Zein lacks the tryptophan group and the diamino-acid lysin.
Gliadin and hordein lack lysin.

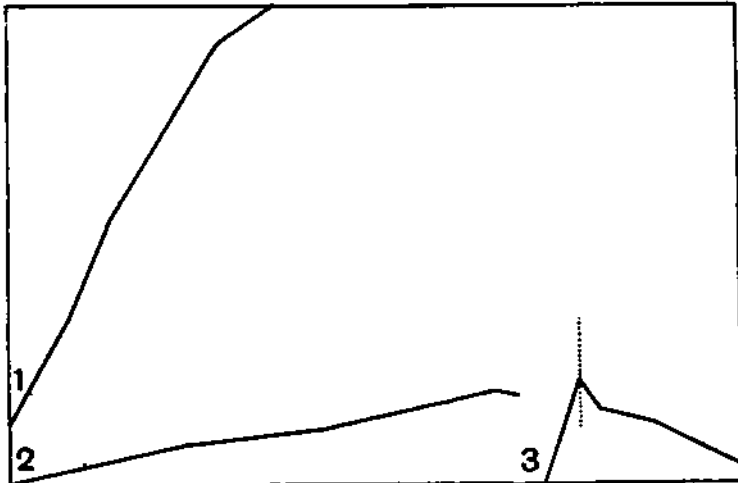

FIG. 139.—Showing typical growth of rats on diets containing a single protein. (1) On casein food (devoid of glycine) satisfactory growth is shown; (2) on gliadin food (deficient in lysin) little more than maintenance of body weight is shown; (3) after a mixed diet with satisfactory growth, zein food (devoid of glycine, lysin, and tryptophan) even maintenance is impossible. (MENDEL.)

Chart 1 shows the results of feeding rats on an adequate and on an inadequate protein diet.

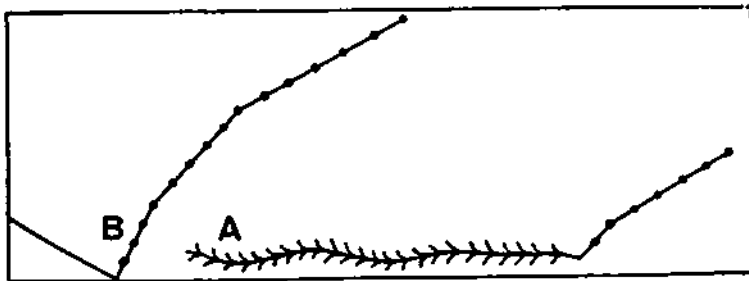

FIG. 140.—To show the effect of the addition of tryptophan (A) and of tryptophan and lysin (B) to the food of rats on zein diet. A gives maintenance of weight alone, A and B increase of growth. (MENDEL.)

Chart 2 shows the effect of adding the lacking amino-acid.

Some proteins contain only small amounts of certain essential amino-acids, and a larger supply must be given to supply a sufficient quantity. This is well seen in feeding with casein, which is poor in the sulphur-containing cystin. If too small an amount of casein be given the rate of growth is decreased, but it is accelerated when cystin is added (Chart 3). Similarly, if too small amounts of edestin be given,

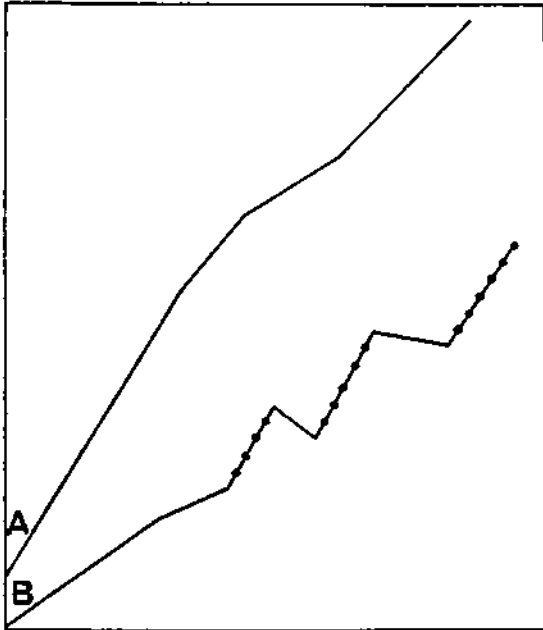

FIG. 141.—To show satisfactory growth of rat upon 18 per cent. of casein (A) and defective growth on 9 per cent. without the addition of cystin, but adequate growth when cystin, in which casein is deficient, was added (B). (MENDEL.)

the small amount of lysin it contains renders it inadequate, and the addition of lysin is required to restore growth.

A most interesting point brought out in these experiments is the fact that, however long the rate of growth has been checked by an insufficient supply of the constituents of the food necessary for growth, when they are again supplied growth begins again, and proceeds till the normal size may be reached.

These results explain why a smaller amount of some proteins than of others is sufficient to repair the wear and tear. The more nearly the amino-acid make-up of the protein in the food approaches that of the tissues, and chiefly of the muscular tissue, of the animal consuming it, the smaller is the quantity required.

This has been shown by feeding a man on a carbohydrate and fat diet, yielding the energy required and finding the amount of nitrogen excreted, *i.e.* the amount of protein oxidised, and then adding different proteins. It was found that, while a small quantity of some is capable of making good the loss of nitrogen, much larger quantities of others are required.

Protein of—	Grms. per Day.
Meat	30
Milk	31
Rice	34
Potato	38
Bean	54
Bread (wheat)	76
Maize	102

In wheat the defective gliadin forms half the protein content.

It has been found that in the dog the loss of nitrogen is covered by the smallest protein intake when dog's flesh is given—a physiological justification of cannibalism.

On account of the different values of different proteins, Lusk proposes to classify them into three groups according to their amino-acid build-up and their resultant availability for growth and repair:—

- 1st Class, *e.g.* Caseinogen of milk.
- 2nd Class, *e.g.* Gluten of wheat flour.
- 3rd Class, *e.g.* Gelatin.

Salts.—It has been seen (p. 218) that salts as ions play an essential part in regulating the osmotic pressure of the body fluids.

Salts are, however, continually being drained off from the body in the urine and fæces.

In the katabolism of proteins the sulphur and phosphorus which they contain are oxidised to sulphuric and phosphoric acids. In herbivora hippuric acid is produced in considerable amounts. To maintain the neutrality of the body fluids, the acids are neutralised by the bases contained in the carbonates and basic phosphates of the blood, and are then excreted. An equivalent amount of the base need not be excreted, as the kidney is able to separate some of the phosphoric acid, which is then excreted as acid phosphate. Certain amounts of bases are, however, lost to the body in this way. In carnivora these bases are not so necessary, since ammonia is formed from the nitrogen of the proteins in sufficient amounts to neutralise the acids produced in their katabolism.

The supply of bases for herbivora is obtained from the sodium and potassium salts of citric, malic, and tartaric acids, which are abundant in green fodder. These are oxidised in the tissues to carbonates which are alkaline salts.

Sodium chloride is the salt usually given in largest quantities in the diet. When not supplied in the food, it is retained in the tissues, and hence animals can, when necessary, live on a comparatively small supply. One purpose which it serves is to supply the chlorine required for the gastric secretion.

Animals, especially those fed on certain kinds of hay rich in potassium salts, often show a hunger for sodium chloride. Bunge has shown that this is caused by the presence in the food of excessive amounts of potassium, which causes an increase in the osmotic pressure in the body fluids. To readjust this, the kidney eliminates sodium as well as potassium, and consequently a shortage of sodium is produced.

Iodine is required for the production of the internal secretion of the thyroid (p. 595). Iron is used for building up the hæmoglobin of the blood. Calcium and phosphorus are especially essential for growing animals for bone formation.

Accessory Factors.—By feeding young rats upon diets containing an adequate amount of pure proteins, fats, carbohydrates, and inorganic salts, it has been shown that growth is arrested unless two substances, the chemical nature of which is still unknown, are present.

(1) **Fat Soluble A.**—This usually occurs in close connection with animal fats. It is particularly abundant in milk fats and in cod-liver oil. It is also present in green fodder.

In rats its absence from the diet not only causes an arrest of growth, but also a peculiar inflammation round the eyes.

Rickets is a disease affecting young animals, notably dogs. It is characterised by such constitutional symptoms as muscular weakness, and by changes at the epiphyseal cartilages, and softening of the bones, either due to loss of lime salts or to failure in calcification. An attempt has been made to explain it as a result of a deficient supply of the fat soluble A or of some allied substance, but no sufficient evidence has been adduced in proof of this, and the cause of the disease is still unknown.

(2) **Water Soluble B.**—(a) **Anti-neuritic.**—This is present abundantly in the germs of plants, but not in the endosperm, in young leaves, and in flesh. Its presence is necessary for growth, and it is at least probable that when the supply is insufficient symptoms of neuritis may develop.

A disease known as beri-beri develops in people living too exclusively on polished rice, which is poor in this substance. A polyneuritis which is substantially the same as beri-beri can be similarly produced in animals and especially in fowls. This condition can be cured by adding substances containing water soluble B in the diet. Hence it has been called an anti-neuritic substance.

(b) **Anti-scorbutic.**—A closely-allied substance, abundantly present in orange and lemon juice and in many fruits and vegetables, seems to be essential, and in its absence *scurvy* is apt to develop, either in men or animals. It may be called the anti-scorbutic substance.

Practically nothing is known about the relation of these substances to one another.

Accessory substances are destroyed by prolonged heating, so that they are for the most part absent in food stuffs that have been boiled.

Animals receiving green stuffs are not likely to suffer from the lack of these accessory factors. The exclusive use of artificially-prepared feeding stuffs which have been heated in the course of their manufacture may, however, produce malnutrition and arrest of development.

These accessory factors have been given the name of "vitamines," an unfortunate title, since we do not know if they are amines or what they have to do with life.

PART III.
THE NUTRITION OF THE TISSUES.

SECTION I.

The Supply of Energy and Material to the Body.

THE FOOD.

CONSTITUENTS OF THE FOOD.

THE nature of the requirements of the energy and material have been considered. The supply of these in the food must now be studied.

The different constituents of food-stuffs may be classified as:—A. Those supplying energy.

- (1) Nitrogenous compounds.
- (2) Fats.
- (3) Carbohydrates.

B. Those supplying no energy.

- (4) Ash (inorganic elements).
- (5) Water.
- (6) Accessory factors.

A. Food-Stuffs yielding Energy.

1. Nitrogenous Compounds.

Nitrogenous compounds are divided into two classes, viz.—(a) proteins, and (b) soluble nitrogenous compounds.

(a) **Proteins.**—The chemistry and nature of these have been already discussed (p. 14).

Occurrence.—Proteins form the chief and characteristic

constituent of protoplasm. They are present to a much smaller extent in plants than in animals. While carbohydrates form the chief bulk of plant tissues, the greater part of the animal body, apart from bones, visible fat, and water, consists of proteins.

Plant Proteins.—The vegetable proteins belong to three groups of native proteins—(a) the *globulins*; (b) the *glutelins*, requiring a dilute alkali for their solution; and (c) the *gliadins*, soluble in 70 to 80 per cent. alcohol. They differ from the animal proteins in the proportion of amino-acids which they contain. Generally they are poorer in leucin, but richer in glutamic acid ($C_5H_9NO_4$) and in arginin (p. 17). They have a higher percentage of nitrogen than those of animal origin, so that the factors 6·25 which is used to multiply the amount of total nitrogen present to obtain the amount of protein is too high in vegetable protein. The true factor varies between 5·5 and 6·0 for the different substances.

(b) **Soluble or Non-Protein Nitrogen.**—In addition to proteins, feeding-stuffs contain nitrogenous substances of a simple chemical structure. These are all soluble in water, and the term "soluble nitrogen" is advantageously used to indicate the group.

In most cases they are early stages in the building up of proteins from nitrates or ammonium salts (diagram, p. 381). In other cases they are parts of protein that have undergone disintegration to a soluble form, *e.g.* amino-acids or peptides, for transportation in the fluids of the plant.

Amino-acids, therefore, constitute the most abundant group forming usually from 50 to 70 per cent. of the whole. The amides (Appendix), asparagine and glutamine, are usually present to the extent of 10 to 20 per cent. The whole group of soluble nitrogenous substances are sometimes loosely termed "amides," an unfortunate term liable to create confusion.

For purposes of analysis this group is differentiated from proteins by the fact that they do not coagulate on heating and are not precipitated by certain reagents which precipitate proteins, *e.g.* copper hydrate.

Occurrence.—Non-proteins are most abundant in plants where growth is most active, *e.g.* seedlings. In young plants the amount of nitrogen in these compounds may exceed that in proteins. As the plant reaches maturity the amount of nitrogen in non-protein form decreases. Soluble nitrogen compounds are especially abundant in roots and tubers. In the potato the greater part of the nitrogen is in the non-protein form.

2. Fats and Allied Bodies.

Nature.—The chemistry (p. 41) and energy value (p. 257) of the fats have been already considered.

In the food they may be substituted for an amount of carbohydrate of equal energy value, *i.e.* they are isodynamic with the carbohydrates.

Occurrence.—Fats are more abundant in animals than in plants. The amount present in the animal body varies within very wide limits. In fat oxen and sheep nearly 50 per cent. of the weight of the carcass may consist of fat.

In plants they occur chiefly in oil seeds where they form a concentrated reserve material. Small quantities are present, however, in all parts of plants.

In addition to true fats there exist in plants fatty acids and various bodies related to fats. These, together with resins and waxes which resemble fats in their physical properties rather than in their chemical composition, can all be extracted with ether, which is the conventional method adopted in quantitative analysis. In dealing with the constituents of feeding-stuffs, therefore, it is customary to class all these bodies soluble in ether as "crude fat," or more properly as "ether extract."

3. Carbohydrates.

Nature.—Carbohydrates contain carbon, hydrogen, and oxygen, the carbon atoms of the molecule usually numbering six or some multiple of six, and the hydrogen and oxygen are in the same proportions in which they occur in water. They are *aldoses* or *ketoses* (Appendix), and derivatives of these, of the hexatomic alcohol, $C_6H_{14}O_6$ (Appendix).

The simplest carbohydrates are the **monosaccharids**, of which *glucose* or *dextrose* or *grape sugar* is the most important. It is the sugar of the animal body.

Closely allied to glucose in chemical composition is the *fructose* or *lævulose*, a sugar which, instead of rotating the plane of polarised light to the right as glucose does, rotates it to the left, but which in most other respects behaves like dextrose.

The other monosaccharid of importance is *galactose*, a sugar produced by the splitting of milk sugar, and also found in combination in the nerve tissue (p. 58). It does not occur free in the body.

These monosaccharids are easily tested for by boiling their solution with Fehling's solution. A reddish precipitate is formed.

Under the influence of yeast they split into ethyl alcohol and carbon dioxide, galactose, however, only very slightly.

By the polymerisation of two monosaccharid molecules with the loss of water, **disaccharids**, or double sugars, are formed. Thus, two glucose molecules polymerise to form one *maltose* molecule.

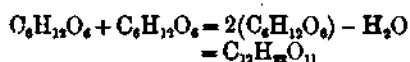

Maltose is the sugar formed by the action of malt and other vegetable and animal enzymes upon starch. By the action of dilute acids and other agents it can be split into two dextrose molecules. Like the monosaccharids it reduces Fehling's solution, and it ferments with yeast.

Lactose, the sugar of milk, is a disaccharid composed of a molecule of dextrose united to a molecule of galactose with dehydration. It readily splits into these two monosaccharids. It reduces Fehling's solution, but it does not ferment with yeast.

Cane sugar or *sucrose* or *saccharose* consists of a molecule of dextrose united to a molecule of lævulose with the elimination of a molecule of water. It does not reduce Fehling.

Monosaccharids and disaccharids which are soluble and crystalline substances are usually called sugars.

By further polymerisation of monosaccharids with the further loss of water, molecules of greater size are produced and form the set of substances known as the **polysaccharids**.



The polysaccharids are distinguished from the sugars by being precipitated from their solutions by alcohol. They do not reduce Fehling's solution, nor do they ferment with yeast. In cold neutral or acid solution most of them strike a blue or brown colour with iodine. On hydrolysis they split into monosaccharids. Some can be split by dilute mineral acids, or by enzymes. Others can be acted upon by strong acids. Most are insoluble in water.

Polysaccharids form a series of bodies of which the following are the most important:—

Starch is built up of a large number of dehydrated monosaccharid molecules. Common starch seems to have a molecular weight of 20,000 to 30,000. On hydrolysis it yields glucose.

Glycogen occurs mainly in the livers of animals. On hydrolysis it yields glucose. It gives an opalescent solution, and strikes a brown colour with iodine.

Cellulose is the basis of the cell walls of plants. It can be hydrolysed only by strong acids, and is not acted upon by the body ferments. There is in plants, however, a ferment *cytase* which can act upon it. On hydrolysis it yields glucose. It is attacked and disintegrated by bacteria in the first stomach of the ruminant and in the colon of the horse. On bacterial disintegration it yields lower fatty acids, and the gases methane and carbon dioxide.

Pentosans.—In addition to the carbohydrates described above, which all contain either six, or some multiple of six, atoms of carbon in the molecule, there is a group having five carbon atoms, and hence called *pentoses*. The polysaccharids of this group are called *pentosans*. They are represented by gums, pectins, mucilages, and other substances in plant bodies where they occur in great variety. It is supposed that in digestion they are disintegrated by bacteria, yielding the same end products as cellulose.

Occurrence of Carbohydrates.—In animals, except in carnivora, carbohydrates form the chief source of energy in the food, but only small amounts are present in the body.

Glucose is present in blood to the extent of 0·1 to 0·15 per cent. usually. Lactose is present in milk; glycogen in the liver and muscles.

In plants, carbohydrates occur in great variety, and form the chief constituents. All the monosaccharids, except galactose, and disaccharids, except lactose, occur in solution in plant juices. Those that are present in greatest amount are glucose, fructose, and cane sugar. Starch is found in large quantities as a reserve food in tubers and seeds, such as the potato and in the common grains, and also in small quantities in all green plants. The cell walls which form the framework or skeleton of the plant is formed of cellulose. In the young plant, the cell wall consists mainly of cellulose, but as the plants increase in size, the framework is made stronger by impregnating the cellulose of the cell walls with hard tough substances. The chief of these is *lignin*, which is a typical constituent of the woody parts of plants. The older and larger the plant, the greater is the amount of this fibrous material present.

In the conventional analysis of food stuffs the carbohydrates are divided into two groups.

(1) "**Nitrogen free extract.**"—This consists of those compounds in solution, or which can be brought into solution by the action of dilute acids or alkalies. This group includes all the monosaccharids and disaccharids, and also those polysaccharids like starch that can be hydrolysed to the soluble form by these reagents.

(2) "**Crude Fibre.**"—This includes all the remainder which resist their reagents. Cellulose and lignin are typical, and form the major part of the group.

B. Not yielding Energy.

4. Ash (Inorganic Elements).

Salts are present in all feeding stuffs, though in different amounts and proportions. An ordinary mixed ration is

likely to contain a sufficiency of all the essential inorganic elements except sodium, which is usually added in the form of sodium chloride. Calcium and phosphorus are of special importance in the feeding of dairy cows and growing animals. In the former there is a loss of these elements in the milk, and in the latter they are required for growth of bone. Calcium is abundant in leguminous hays and in animal products, such as meat meal. It is present only in small quantities in grains. Maize is especially deficient in this element. Phosphorus, as phosphates and phospholipins, *e.g.* lecithin (p. 19), is present in relatively large amounts in feeding stuffs that are rich in proteins, such as animal products and leguminous seeds. It is also abundant in bran, middlings, and oil seeds. Roots and straws are deficient. Potassium is abundant in fodders where it is sometimes present in excessive amounts (p. 280).

The total amount of ash of feeding stuffs is determined by incinerating a weighed example, and weighing the residue.

5. Water.

The amount of water present in feeding stuffs is very variable, in different foods, and in the same material at different stages of growth. The following table gives a rough idea of the water content of some common feeding stuffs:—

	Water per cent.
Roots and tubers	80-90
Green fodder	65-80
Hay and Straw	7-15
Grain	10-12
Feeding cakes and meals	under 10

As the water yields no energy the percentage present dilutes the nutrition value. Fermentation and the growth of moulds are liable to occur when the water content exceeds 17 or 18 per cent.

The percentage of water is estimated by determining the loss of weight on drying a sample at a temperature of 100° C.

6. Accessory Factors.

These have been dealt with (p. 281).

Classification of Feeding Stuffs for Herbivora.

Feeding stuffs may be arranged in the following groups:—

(1) **Green fodder.**—Examples—Grasses, silage. These contain a high percentage of water. In the young growing plant the thin cell walls are full of protoplasm. These are therefore rich in protein and easily digested. As the plant gets older and larger the percentage of protoplasm decreases, and the cell walls become impregnated with fibrous matter, difficult to digest. On the other hand, the seeds with their reserve store of food become more valuable as the plant reaches maturity.

(2) **Dry fodder.**—Examples—Hay, straw. These are bulky foods characterised by a high percentage of crude fibre.

(3) **Roots and Tubers.**—Examples—Potatoes, turnips. These contain a high percentage of water and a small amount of crude fibre.

(4) **Concentrates.**—Examples—Grain, oil cakes. A high percentage of digestible material and small amounts of crude fibre and water are the characteristics of this group.

(5) **Animal Products.**—Examples—Milk, fish meal. With the exception of milk, these are concentrated feeding stuffs rich in proteins.

The following table shows the approximate results of analysis of some common feeding stuffs:—

Average Percentage Composition.

	Water.	Protein.	Fat.	Fibre.	Carbo- hydrate.	Ash.	
Grass	80	4	1	4	10	1	20 to 30 per cent. of nitrogen not in proteins.
Hay	15	10	2	26	40	7	About 10 per cent. of nitrogen not in proteins.
Peas	14	22	2	6	53	3	About 10 per cent. of nitrogen not in proteins.
Oats (crushed)	14	12	6	9	57	2	Less than 10 per cent. of nitrogen not in proteins.
Potatoes	76	2	0	1	20	1	Over 40 per cent. of nitrogen not in proteins.

SECTION II.

DIGESTION.

DIGESTION is the preparation of the food in the alimentary canal for absorption and utilisation by the tissues.

I. STRUCTURE OF THE ALIMENTARY CANAL.

The anatomy and histology of the alimentary tract must be studied practically. A mere outline of the various structures, such as will assist in the comprehension of their physiology, is given here.

The alimentary canal (fig. 142) may be divided into the mouth, the œsophagus or gullet, the stomach, the small and large intestine, and the following supplementary structures—the salivary glands, the liver, and the pancreas.

The Mouth.—The lips, the tongue, and the teeth are the organs of prehension. The lips of the horse are strong and mobile, and possess acute sensation. Those of the ox are thick and immobile. The upper lip of the sheep is divided into two parts, which can move independently of each other.

The horse's tongue has a smooth covering, and is broad at the apex. It is seldom protruded. The tongue of the ox tapers to the apex, which is capable of extensive movement, and can be easily protruded. It has a strong, rough covering, which gives it a better grip, and also protects it from injury when used for collecting the grass in grazing.

The inside of the mouth of the ox has papillæ sloping inwards. These help to prevent the food from falling out.

In ruminants the incisor teeth are loosely fixed, and meet the dental pad obliquely. This arrangement prevents injury to the dental pad.

The teeth of the horse are peculiar in having an invagination of the enamel covering of the crown. As the crown wears, there comes to be two consecutive rings of hard enamel, enclosing softer cement. This provides an uneven surface, well suited to the grinding of the food. The horse has incisors in both the upper and the lower jaw, and these are used to bite the grass in feeding. The horse thus crops closer than the ox.

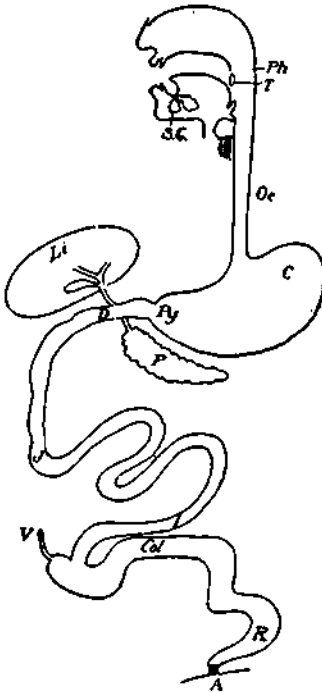

FIG. 142.—Diagram of the Parts of the Alimentary Canal, from Mouth to Anus. *T.*, tonsils; *Ph.*, pharynx; *S.G.*, salivary glands; *Oe.*, oesophagus; *C.*, cardiac, *Py.*, pyloric portion of stomach; *D.*, duodenum; *Li.*, Liver; *P.*, pancreas; *J.*, jejunum; *I.*, ileum; *V.*, vermiform appendix, present in man and in rabbit; *Col.*, colon; *R.*, rectum.

The incisor teeth of the young horse are vertically placed. With use they gradually come to assume an oblique position and get pushed out of their sockets, so that the fangs are reduced in length and the shape of the teeth altered. The shape and slope

of the teeth, and the extent of wear on the crowns, give an indication of the age of the animal.

The complex joint of the upper and lower jaws in herbivora allows the movements in mastication to be not only up and down, but also lateral, and to some extent from front to rear. This freedom of movement is more marked in

the ox than in the horse. In the dog, movements other than vertical are very limited. In herbivora the lower jaw is narrower than the upper (fig. 143), so that when the molar surfaces of the upper and lower teeth meet on one side they do not come into contact on the other. Mastication is therefore always unilateral. In the lateral movement of mastication, the outside of the lower molar teeth and the inside of the upper have the greater amount of wear and tear, and consequently the tables come to be oblique instead of horizontal. In the horse this sometimes produces long, sharp, ragged edges, which prevent the

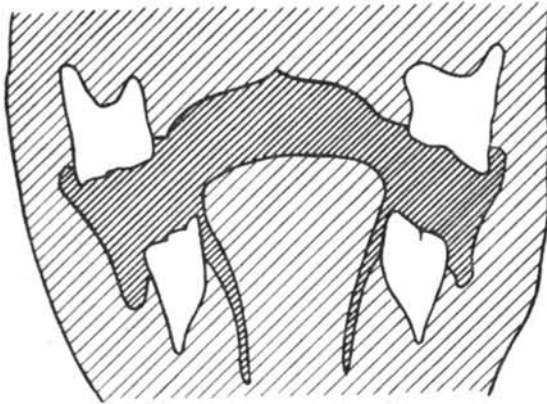

FIG. 143.—Showing relative widths of lower and upper jaw in the horse.

proper mastication of the food and consequently lead to malnutrition.

Salivary Glands.—Three pairs of salivary glands—parotid, submaxillary, and sublingual—open into the mouth. These are compound tubular glands, and are well developed in herbivora. The acini are lined with mucus and enzyme secreting epithelium (p. 34). The parotid has the most copious secretion, and except in the ox, where the submaxillary is developed to an equal size, it is the largest of the three glands.

The **Esophagus** is a muscular walled tube, lined by squamous epithelium. The muscles are in two layers—an outer longitudinal and an inner circular. This general

muscular arrangement is present in the whole alimentary canal, from the œsophagus to the anus. In the horse the lumen diminishes, and the muscular wall becomes thicker just outside the stomach. In the ox the lumen is wider and more dilatable than in the horse.

In the ruminant there is a series of dilatations near the point where the œsophagus enters the stomach. These are the rumen, the reticulum, and the omasum, which are frequently described as parts of the stomach.

The **Rumen** is a great sac, containing in its walls strong muscular bands that enable it to contract on its content. It

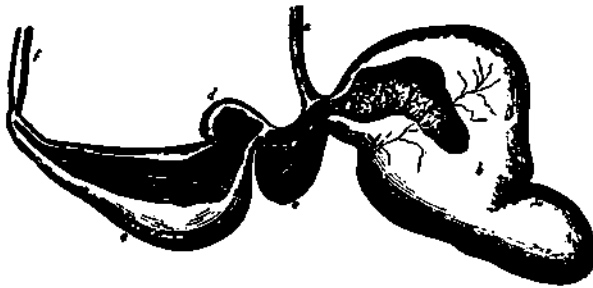

FIG. 144.—Stomach of a Ruminant. *a*, œsophagus; *b*, rumen; *c*, reticulum with œsophageal groove above; *d*, omasum; *e*, abomasum; *f*, duodenum.

is lined by stratified squamous epithelium. It is a temporary storehouse for the food.

The **Reticulum**—the second reservoir—is very much smaller than the rumen. The membrane lining its walls is raised in intersecting ridges, which are arranged to form polyhedral cells resembling a honeycomb. It communicates with the omasum, and also with the rumen, whose overflow it receives.

The **Omasum**—the third compartment—is rather larger than the reticulum. Into its interior are projected folds of its walls, forming leaf-like structures. There are almost a hundred of these of different sizes. They are covered with hard papillæ. The omasum opens into the abomasum, the fourth compartment, which corresponds to the stomach in other animals.

The **oesophageal groove**, formed of two longitudinal muscular folds, is a continuation of the lumen of the oesophagus, which runs along the wall of the first three compartments and ends in the abomasum. By this means fluid food can pass directly from the oesophagus to the abomasum. When the pillars are relaxed the groove communicates with the rumen and the reticulum.

The crop of the fowl is a dilatation of the oesophagus that occurs at the root of the neck. It corresponds to the rumen, reticulum, and omasum of the ruminant.

The **Stomach** is a dilatation of the alimentary canal. It bulges out at the oesophageal end—the fundus. Towards the outlet it tapers off to the pyloric canal. A strong circular band of muscle between the stomach and intestine controls the outflow of its contents. In the dog the fundus is separated from the pylorus by a circular band of muscular fibres—the prepyloric sphincter. The mucous membrane is largely composed of tubular glands. Those at the oesophageal end secrete hydrochloric acid and pepsin, those at the pyloric end pepsin only.

In the horse (fig. 145) the stratified squamous epithelium of the oesophagus is continued into the stomach, and lines nearly one half of the organ. Only the pyloric part and the fundus are covered with the glandular mucous membrane. The opening of the oesophagus to the stomach is small, and partially occluded by folds of the lining membrane.

The **Small Intestine** is a long convoluted narrow muscular tube suspended in the folds of a membrane slung from the spinal region of the body cavity. The mucous membrane is projected into the lumen of the tube as a series of delicate finger-like processes—the villi—which are covered by columnar epithelium.

There are two kinds of glands that secrete the intestinal fluid—the succus entericus.

(1) *Lieberkühn's follicles* are found throughout the whole small intestine. They are simple test-tube like glands which open between the villi.

(2) *Brunner's glands* are found only in the upper part of the small intestine. They are branching glands that pene-

trate the submucous layer. The mucous membrane contains masses of lymph tissue scattered throughout it. In some places these are massed together and form *Peyer's patches*, which are largest at the lower part of the small intestine.

The Large Intestine (fig. 142).—The small intestine enters the proximal end of the large intestine at one side, and the opening is guarded by a fold of mucous membrane and a ring of muscular fibres which form the ileo-cæcal valve.

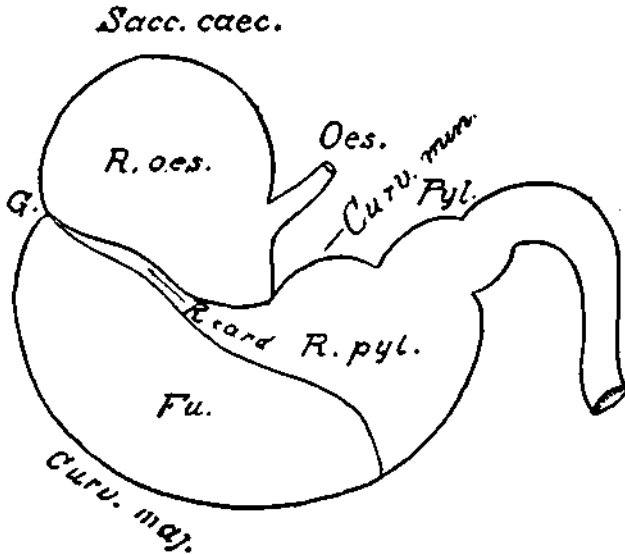

FIG. 145.—Stomach of the Horse to show—*R. œs.*, the œsophageal part; *Fu.*, the fundus with true gastric glands; *R. pyl.*, pyloric part.

Above this opening there is a diverticulum—the cæcum—which is very large in herbivora and only vestigial in carnivora. Below the opening of the small intestine is the colon (*col.*). This ends in the short rectum which opens into the anal canal, and this is surrounded by a strong band of muscle—the internal sphincter ani—by which it is compressed. An external sphincter ani composed of striped muscular fibres encircles the anal orifice.

The whole large intestine is lined with columnar epithelium, and is studded with Lieberkühn's follicles, in which the epithelium is chiefly mucus-secreting in type. There are no villi.

In the horse (fig. 147) the cæcum is an enormous sac

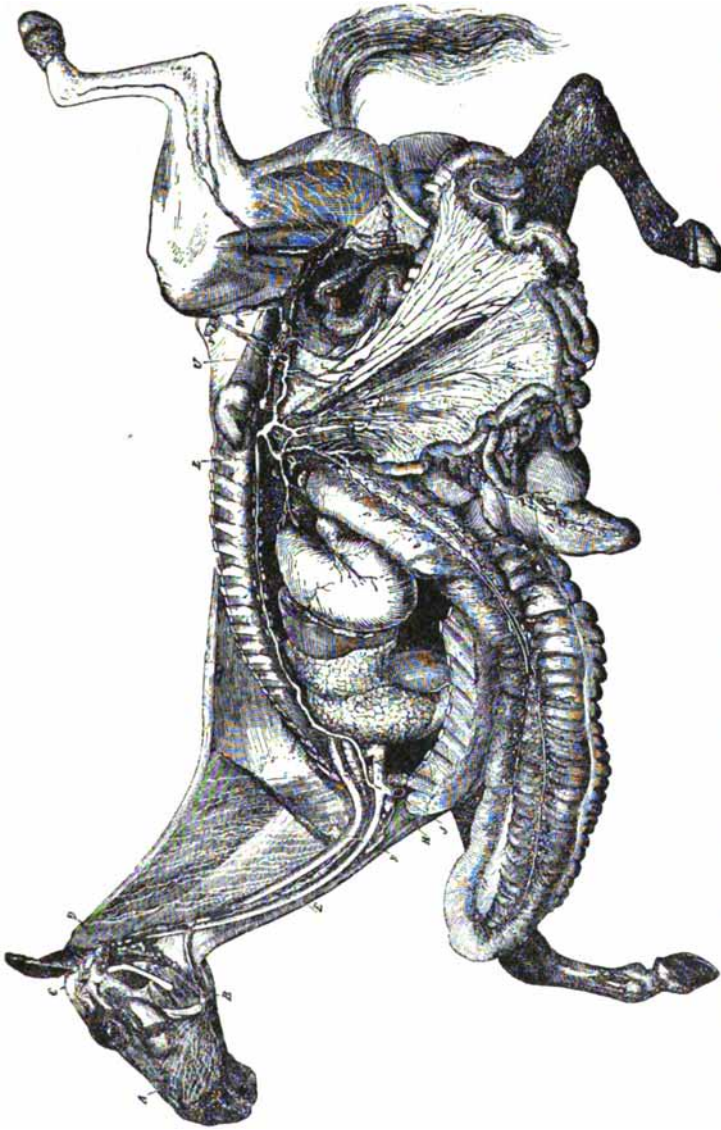

FIG. 146.—Viscera of the Horse, to show the Small Intestine, *h*, ending in the large Colon, *d*, and Cæcum, *o*. The Stomach is seen above the Colon. In the mesentery are seen the lymphatic vessels entering the **Receptaculum Chyli and Thoracic Duct.** (CHAUVVEAU.)

with a capacity of 25 to 30 litres. Both extremities are blind, and the two openings are only separated by about two

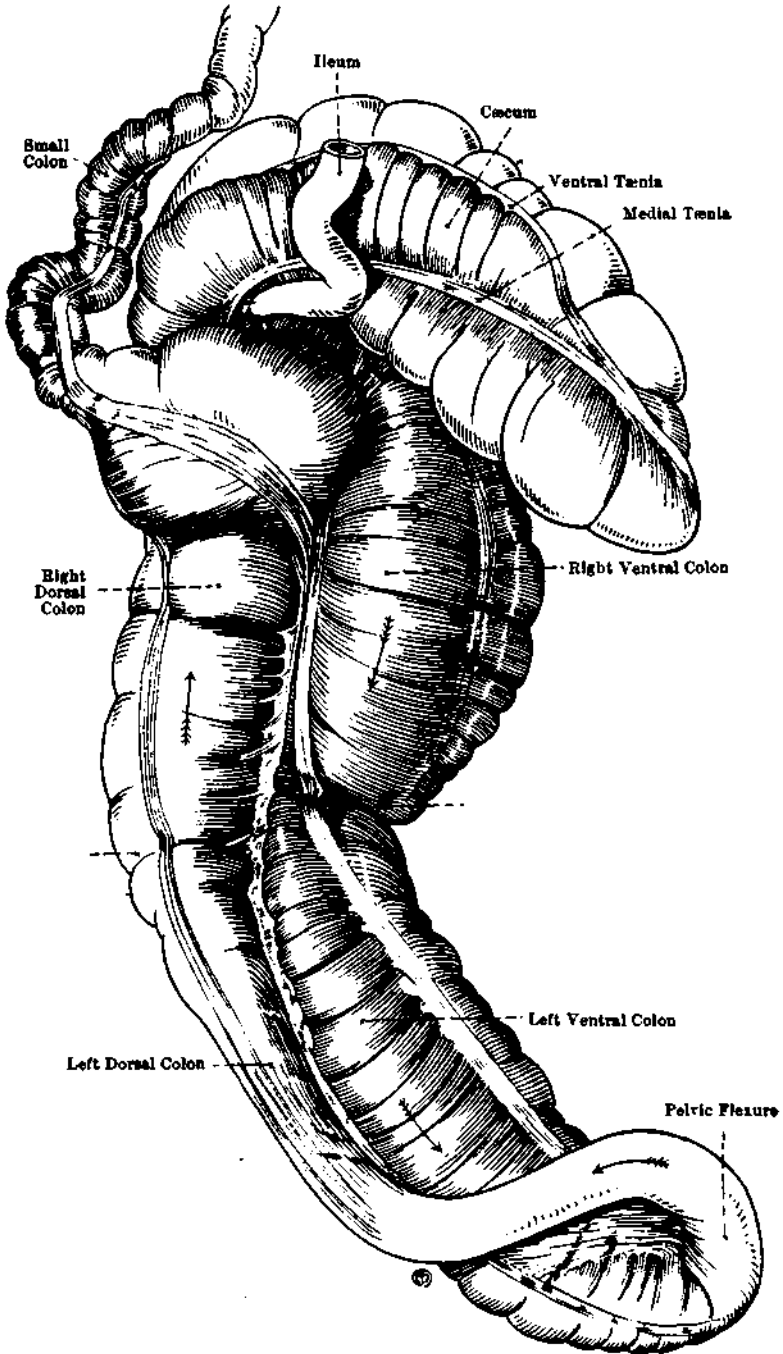

FIG. 147.—The Colon and Cæcum of the Horse.
 (From Bradley's *Topographical Anatomy of the Abdomen of the Horse.*)

inches. That leading to the colon is situated above the ileo-cæcal opening, so that the contents are passed to the colon against gravity.

The large colon is more than double the capacity of the cæcum. The diameter near the cæcum is only two to three inches, but it increases rapidly to nine or ten in the ventral portions. At the pelvic flexure the diameter becomes reduced to three or four inches but rapidly increases, to reach a maximum of as much as twenty inches in the right dorsal colon, which narrows down like a funnel to join the small colon. The small colon has a diameter of three to four inches. The cæcum and the ventral portion of the large colon have four longitudinal bands of muscle—*tænia*—and four rows of sacculations. The small colon has two bands and two rows of sacculations. These sacculations increase the surface area. According to F. Smith, irregular contractions of the muscular bands produce displacements and distortions of the colon which are causes of "colic" to which the horse is so liable.

Supplementary Structure.—(1) The salivary glands have been described (p. 293).

(2) **The Liver** is a large solid organ, formed originally as a double outgrowth from the alimentary canal. Each of these outgrowths branches repeatedly, and the blood coming from the mother to the fœtus flows in a number of capillary channels between the branches. Later, when the alimentary canal has developed, the blood from it is streamed between the liver tubules. The fibrous tissue supporting the liver cuts it up into a number of small divisions, the lobules, each lobule being composed of a series of obliterated tubules arranged radially with blood-vessels coursing between them.

The portal vein, which takes blood from the stomach, intestine, pancreas, and spleen, breaks up in the liver, and carries the blood between the lobules. From the interlobular branches capillaries run inward and enter a central vein which carries the blood from each lobule, and pours it into the hepatic veins, which join the inferior vena cava. The supporting tissue of the liver is supplied by the hepatic

artery, the terminal branches of which have a very free communication with those of the portal vein.

(3) **The Pancreas** like the liver develops as an outgrowth from the intestine. It is an enzyme secreting gland. In the lobules are certain little masses of epithelium-like cells closely packed together—the islets of Langerhaus (fig. 148).

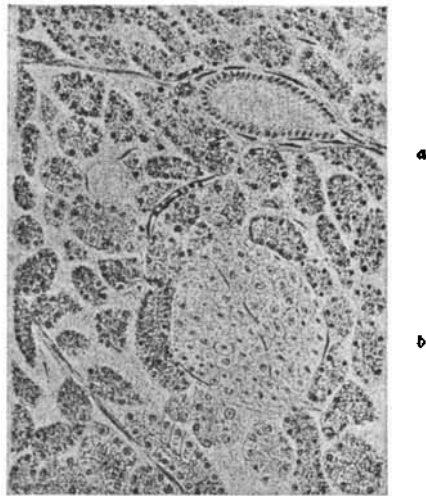

FIG. 148.—Section of Pancreas to show Acini of Secreting Cells; a large duct (a), and in the centre an Island of Langerhaus (b).

The Nerve Supply of the Alimentary Canal.

The muscles round the mouth are supplied by the fifth, seventh, and twelfth cranial nerves. The nerve supply of the salivary glands will be considered later. The pharynx and the œsophagus are supplied by the ninth and tenth cranial nerves, and by fibres from the sympathetic.

The stomach and small intestine get their nerve fibres from the vagus and the abdominal sympathetic (p. 198). The large intestine is supplied by the abdominal sympathetic, the various fibres passing through the abdominal sympathetic ganglia. The upper part is also supplied from the vagus and the lower part from the pelvic nerves. In the wall

of the stomach and intestine these nerves end in an interlacing set of fibres with nerve cells upon them, from which fibres pass to the muscles and glands. One of these plexuses (Auerbach's, or the myenteric plexus) is placed between the muscular coats—the other (Meissner's) is placed in the submucosa.

Size and Capacity of Organs.

The following tables give some idea of the size and capacity of the parts of the alimentary canal in full-grown animals:—

Average Length in Feet of Intestines.

	Ox.	Sheep.	Horse.	Pig.
Small Intestine	130	80	70	60
Large Intestine	35	21	25	15

Capacity.

	Ox.	Sheep.	Horse.	Pig.
	Lit. Gals.	Lit. Gals.	Lit. Gals.	Lit. Gals.
Stomach	182 40	18 4	16 3·5	9 2
Small Intestine	77 17	11 2·5	55 12	11 2·5
Large Intestine	36 8	7 1·5	159 35	13 2·75

In the ox and sheep the figures given as capacity of stomach include the rumen, the reticulum, and the omasum. The relative capacity of these for the ox are:—rumen, 80 per cent. ; reticulum, 5 per cent. ; omasum, 7 per cent. ; and abomasum, 8 per cent. The great capacity of the large intestine of the horse should be noted. In this animal the cæcum is also large. Its capacity is 25 to 30 litres ; that of the ox is 8 to 10.

II. PHYSIOLOGY.

Although the nature of the food is very different in different species of animals, the essential features of the digestive processes are common to all. In herbivora there are adaptations for dealing with bulky food. For the most part, however, these are developed after birth as the animal begins to change its diet from milk—an animal product—to the bulky vegetable food. They are merely modifications of the simpler system of carnivora, which may be regarded

as the more fundamental type. It is convenient, therefore, to deal first with digestion in carnivora, and thereafter indicate the modifications that exist in herbivora. Omnivora, *e.g.* man and pig, present such minor differences from carnivora that they can be included with these. Indeed, the work done to elucidate the physiology of human digestion has been done mainly on the dog—a carnivorous animal.

A. DIGESTION IN CARNIVORA AND OMNIVORA.

I. DIGESTION IN THE MOUTH.

(a) Mastication.

In the mouth the food is broken up and mixed with saliva in the act of chewing. Mastication is less perfectly performed in carnivora than in herbivora. The dog masticates very imperfectly. After a few rapid chews the food is swallowed.

(b) Insalivation.

The saliva is formed by the salivary glands—the parotid, submaxillary, sublingual, and various small glands in the mucous membrane of the mouth.

1. **Saliva**—(1) **Characters**.—The Saliva is a somewhat turbid fluid which, when allowed to stand, throws down a white deposit consisting of shed epithelial scales from the mouth, leucocytes, amorphous calcic and magnesian phosphates, and generally numerous bacteria. Its specific gravity is low—generally about 1003. In reaction it is neutral or faintly alkaline.

(2) **Chemistry**.—It is found to contain a very small proportion of solids. The saliva from the parotid gland contains only about 0.4 per cent., while that from the sublingual may contain from 2 or 3 per cent. The sublingual and submaxillary saliva, in man, is viscous, from the presence of mucin formed in these glands, while the parotid saliva is free from mucin. In addition to mucin, traces of proteins are present, and in certain animals an enzyme—*ptyalin*—is associated with these proteins. Ptyalin is present in man and in the pig. It is absent in carnivora.

(3) **The functions of the saliva are twofold :—**

(1) *Mechanical.*—Saliva moistens the mouth and gullet, and thus assists in chewing and swallowing. Since the salivary glands are absent from aquatic mammals, and since in carnivorous animals saliva has no chemical action, it would appear that this is the important function.

(2) *Chemical.*—Under the action of the ptyalin of the saliva, starches are broken down into sugar. The starch is first changed into the dextrins, first into *erythrodestrins* and then into *achroödextrins*, and lastly into the disaccharid *maltose* (see p. 286), (*Chemical Physiology*). Like other enzyme actions, the process requires the presence of water and a suitable temperature, and it is stopped by the presence of strong acids or alkalies, by various chemical substances, and by a temperature of over 60° C., while it is temporarily inhibited by reducing the temperature to near the freezing point. During the short time the saliva acts on the food in the mouth, the conversion is by no means complete.

2. Physiology of Salivary Secretion.—(1) The changes which the secreting cells undergo during the so-called resting state of the gland and during secretion have been already considered (p. 35).

(2) *The nervous mechanism of secretion.*—In order to study the influence of different factors upon salivary secretion, a cannula may be inserted into the duct of one of the glands, and the rate of flow of saliva or the pressure of secretion may be thus measured. In this way, it may be shown that in the dog the taking of food, or simply the act of chewing, or, in some cases, the mere sight of food, causes a flow of saliva. This shows that the process of secretion is presided over by the central nervous system, a fact which is further illustrated in man by the decrease in the secretion of saliva which accompanies some emotional conditions.

The submaxillary and sublingual glands are supplied—

(1) By branches from the lingual division of the fifth cranial nerve ; and (2) by branches of the perivascular sympathetic fibres coming from the superior cervical ganglion. The

parotid gland is supplied by the auriculo-temporal division of the fifth and by sympathetic fibres (fig. 149).

(a) The influence of these nerves has been chiefly studied on the **submaxillary** and **sublingual** glands.

(1) It has been found that, when the lingual nerve is cut, the reflex secretion of saliva still takes place, but that, when the *chorda tympani* (*Ch.T.*), a branch from the seventh nerve, which joins the lingual, is cut, the reflex secretion does not

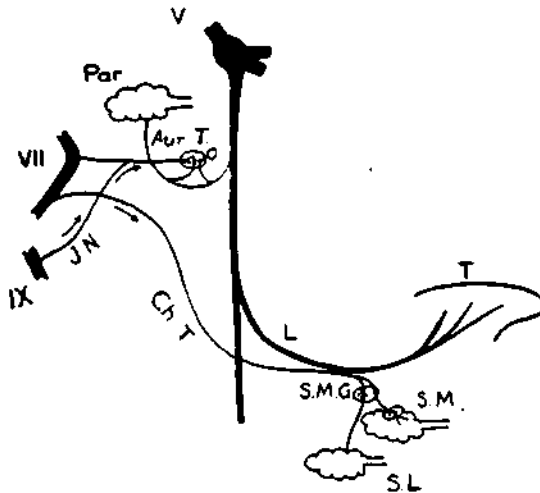

FIG. 149.—Nervous Supply of the Salivary Glands. *Par.*, parotid, and *S.M.* and *S.L.*, the submaxillary and sublingual glands; *VII.*, the seventh cranial nerve, with *Ch.T.*, the chorda tympani nerve, passing to *L.*, the lingual branch of *V.*, the fifth nerve, to supply the glands below the tongue, *T.*; *IX.*, the glossopharyngeal giving off *J.N.*, Jacobson's nerve, to *O.*, the otic ganglion, to supply the parotid gland through *Aur.T.*, the auriculo-temporal nerve.

occur. Stimulation of the chorda tympani causes a copious flow of watery saliva, and a dilatation of the blood-vessels of the glands. If atropine has been first administered, the dilatation of the vessels occurs without the flow of saliva. This indicates that the two processes are independent of one another.

The secreting fibres all undergo interruption before the glands are reached; the fibres to the sublingual gland having their cell station in the submaxillary ganglion (*S.M.G.*), the

fibres to the submaxillary gland having theirs in a little ganglion at the hilus of the gland (*S.M.*). This was demonstrated by painting the two ganglia with nicotine (p. 198). When applied to the submaxillary ganglion, the drug does not interfere with the passage of impulses to the submaxillary gland, but stops those going to the sublingual.

If the duct of the gland be connected with a mercurial manometer, it is found that, when the chorda tympani is stimulated, the pressure of secretion may exceed the blood pressure in the carotid, showing that the saliva is not formed by filtration.

(2) When the perivascular sympathetics, or when the *sympathetic cord of the neck* is stimulated, the blood-vessels of the gland constrict, and a flow of very viscous saliva takes place.

Some time after section of the chorda tympani nerve an increased flow of saliva has been observed. It may be due to the uncontrolled action of the peripheral nervous mechanism.

(b) On the parotid gland (1) the auriculo-temporal nerve (*Aur.T.*) acts in the same way as the chorda tympani acts on the other salivary glands. But stimulation of the fifth nerve above the otic ganglion, from which the auriculo-temporal takes origin, fails to produce any effect. On the other hand, stimulation of the *glossopharyngeal nerve (IX.)* as it comes off from the brain, acts upon the parotid gland. Since the glossopharyngeal is united by *Jacobson's nerve (J.N.)* to the small superficial petrosal which passes to the otic ganglion, it is obvious that the parotid fibres take this somewhat roundabout course (fig. 149).

(2) When the *sympathetic fibres* to the gland alone are stimulated, constriction of the blood-vessels but no flow of saliva occurs; but if, when the flow of watery saliva is being produced by stimulating the glossopharyngeal or Jacobson's nerve, the sympathetic fibres are stimulated, the amount of organic solids in the parotid saliva is very markedly increased.

The nerve fibres passing to the salivary glands are presided over by groups of cells, the **Salivary Centre**, in the medulla oblongata which may be stimulated reflexly or

directly by the condition of the blood. Stimulation of the lingual or glossopharyngeal leads to a reflex flow of saliva. Other nerves may also act on this centre. Thus gastric irritation, when it produces vomiting, causes a reflex stimulation of salivary secretion. In asphyxia the condition of the blood may directly stimulate the centre.

According to the investigations of Pavlov, the salivary glands react appropriately to different kinds of stimuli through their nervous mechanism. When sand or bitter or saline substances are put in a dog's mouth, a profuse secretion of very watery saliva ensues to wash them out. When flesh is given, a saliva rich in mucin is produced. When dry food is given, saliva is produced in greater quantity than when moist food is supplied.

Pavlov further states that the sight of different kinds of food produces a flow of the kind of saliva which their presence in the mouth would produce. The flow of saliva has been used by him for the study of cerebral, or "conditioned," reflexes.

II SWALLOWING.

1. **Voluntary Stage.**—The food, after being masticated, is collected on the surface of the tongue by the voluntary action of the buccinators and other muscles, and then, the point of the tongue is pressed against the hard palate behind the teeth. By a contraction passing backwards the parts of the tongue behind the tip are raised, along with the hyoid and with the larynx, and the bolus of food is thus pushed along the palate and through the pillars of the fauces.

2. **Reflex Stage.**—Swallowing now becomes a pure reflex. It can be performed only if something is present to excite it, and it is abolished by paralysing the receptors in the pharynx by means of cocaine.

(1) The exact position of the **receptor spots**, stimulation of which thus reflexly causes swallowing, varies in different animals. In man they are chiefly about the base of the tongue and the posterior pharyngeal wall. Supplementary

receptor spots of less importance also exist, from which swallowing may be elicited when food gets lodged upon them.

(2) The **excito-reflex nerves** are the *fifth*, via the sphenopalatine ganglion, and the *vagus*. The *glossopharyngeal* also may contain fibres which act; but section of this nerve causes a sustained tonic contraction of the gullet, and stimulation of its central end inhibits swallowing. It probably acts chiefly to prevent a second act of swallowing occurring while one is already in progress.

(3) The **centre** is situated in the medulla oblongata, and swallowing is readily induced in a decerebrated cat by pressing a bolus of cotton wool through the pillars of the fauces upon the receptor points in the pharynx.

(4) The **effector mechanism** leads to the following changes :—(a) The hyoid and larynx are pulled upwards by the muscles which act upon these structures.

(b) The upper orifice of the **larynx** is closed by the action of the lateral crico-arytenoidei, the arytenoidei, and the thyreo-arytenoidei, which pull forward the arytenoids against the posterior surface of the epiglottis. The whole larynx is pulled forwards as well as upwards, and thus the upper part of the œsophagus is opened, and the food slides over the back of the epiglottis and down the posterior aspect of the larynx into the gullet.

(c) The passage of food into the **naso-pharynx** is prevented by the contraction of the glossopharyngeus, palato-pharyngeus, and the levator and tensor palati muscles, which approximate the soft palate and the back wall of the pharynx.

(d) The constrictors of the pharynx contract from above downwards and force the bolus on into the true œsophagus, which may be said to begin at the level of the cricoid cartilage.

(5) The **outgoing nerves** involved are the hypoglossal, the third branch of the fifth, the glossopharyngeal to the stylo-pharyngeus and middle constrictor, and the *vagus* which supplies both the pharynx and the œsophagus.

Section of the vagi nerves paralyzes the upper part of the

gullet. In this condition food is forced down entirely by the pressure from the mouth.

Fluids are normally shot right down the relaxed gullet by the pressure from the mouth and from the constrictors. Less fluid matter is passed down the œsophagus by a true peristalsis—a zone of relaxation passing down in front of a zone of contraction. This peristalsis is stopped for some time if the vagi nerves are cut and as a result food cannot be swallowed. The vagus is the great efferent nerve for the reflex part of the act of swallowing. But it has been found that, after the vagus has been cut for twenty-four hours or more, distension of the œsophagus by food may cause a peristalsis passing on to the stomach. The peripheral nerve plexus in the wall of the gullet must be capable of stimulation by such distension, and it must be able, in these conditions, to initiate and to maintain peristalsis.

Time of Swallowing.—Observations made on the human subject by feeding with food impregnated with bismuth and studying the changes in the œsophagus by X-rays have shown that fluids and solids, well masticated and mixed with saliva, are passed rapidly down the gullet, reaching the orifice of the stomach in about three seconds. Here they are delayed, and do not pass into the stomach for another period of about three seconds. Dry solids take much longer to pass down the gullet, sometimes as much as fifteen minutes.

III. DIGESTION IN THE STOMACH.

Most important work on digestion in the stomach has been accomplished by Pavlov on dogs. His method is to make a small gastric pouch opening on the surface, and separated from the rest of the stomach (fig. 150). This is done by cutting out a V-shaped piece along the great curvature, the apex being towards the pylorus and the base being left connected with the stomach wall. By a series of stitches, the opening thus made in the stomach is closed up (top line of $\lambda\lambda$ s in fig. 150), while the cut edges of the V-shaped flap are stitched together to form

a tube. The one end of this is made to open upon the skin surface *A, A*, and, by folding in the mucous membrane, the deep end is isolated from the stomach. Thus a pouch is formed, still connected with the muscular coat and with the nerves and the vessels of the stomach, the condition of which represents the condition of the whole stomach.

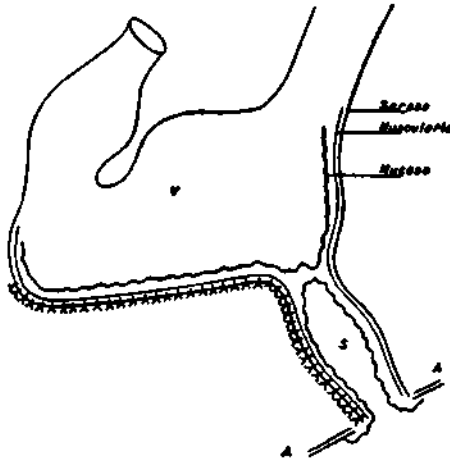

FIG. 150.—Diagram of Pavlov's Pouch made on the Stomach of a Dog.

The condition of the stomach is very different in fasting and after feeding.

A. Stomach during Fasting.

(i.) The organ is collapsed, and the mucous membrane is thrown into large ridges. (ii.) It is pale in colour because the blood-vessels are not dilated. (iii.) The secretion is scanty, only a little mucus being formed on the surface of the lining membrane. (iv.) Movements may be absent, or rhythmic contractions may occur at regular intervals of from one-half to three or four minutes. These movements are generally associated with the sensation of hunger, and they may be called "*hunger contractions*." They are best marked when the muscular tone of the stomach wall is good; when it is decreased by section of the vagi, they are less marked;

when it is increased by section of the splanchnic nerves, they are more marked. But they persist after section of both nerves, and they must therefore be presided over by the local nervous mechanism in the wall of the stomach. They are inhibited by taking food and even by the sight or smell of food. They do not stop during sleep.

B. Stomach after Feeding.

When food is taken, (1) the blood-vessels dilate, (2) a secretion is poured out, and (3) movements of the organ become more marked.

1. **Vascular Changes.**—The arterioles dilate, and the mucous membrane becomes bright red in colour. This is a reflex vaso-dilator effect, impulses passing up the vagus to a vaso-dilator centre in the medulla, and coming down the vagus from that centre. Section of the vagi is said to prevent its onset.

2. **Secretion.**—There is a free flow of gastric juice from all the glands in the mucous membrane.

(1) **Characters of Gastric Secretion.**—The gastric juice from the cardiac end is a clear watery fluid, which is markedly acid from the presence of free hydrochloric acid. In the dog the free acid may amount to over 0·4 per cent., but in the pig it is less abundant, and, when the gastric juice is mixed with food, the acid rapidly combines with alkalies and with proteins and is no longer free. In addition to the HCl, small quantities of inorganic salts are present. Traces of proteins may also be demonstrated, and two enzymes are associated with these—one a proteolytic or protein-digesting enzyme, *pepsin*, the other a milk-curdling enzyme, *rennin*. The fact that dilution may abolish the peptic activity while leaving the curdling action intact seems to show that these are not separate bodies but phases in the activity of one body.

The secretion from the pyloric portion is alkaline in reaction.

(2) **Source of the Constituents of the Gastric Juice.**—The *hydrochloric acid* is formed at the cardiac part of the stomach. This may be shown by making a small stomach by the method of Pavlov. Since the parietal or oxyntic cells

are confined to this portion of the stomach, it may be concluded that they are the producers of the acid. The NaCl of the blood plasma must be the source of the HCl.

Pepsin and *Rennin* are produced in the chief or peptic cells which line the glands both of the cardiac and of the pyloric parts of the stomach. During fasting, granules are seen to accumulate in these cells, and when the stomach is active they are discharged. These granules are not pepsin but the forerunner of pepsin—pepsinogen (p. 36).

(3) **Course of Gastric Digestion.**—(a) **Amylolytic Period.**—The action of the gastric juice does not at once become manifest. In the pig for about two hours after the food is swallowed, the ptyalin of the saliva goes on acting, and the various micro-organisms swallowed with the food grow and multiply, and thus there is a continuance of the conversion of starch to sugar which was started in the mouth, and, at the same time, the micro-organisms go on splitting sugar to form lactic acid, which may thus be regarded as a normal constituent of the oesophageal end of the pig's stomach during the first two hours after a meal.

(b) **Proteolytic Period.**—Before the amylolytic period is completed, the gastric juice has begun its special action on **Proteins**. This may be readily studied by placing some coagulated protein in gastric juice, or in an extract of the mucous membrane of the stomach made with dilute hydrochloric acid, and keeping it at the temperature of the body. The protein swells, becomes transparent, and dissolves. The solution is coagulated on boiling—a *soluble native protein* has been formed. Very soon it is found that, if the soluble native protein is filtered off, the filtrate gives a precipitate on neutralising, showing that an *acid* compound—a *meta-protein*—has been produced. If the action is allowed to continue and the meta-protein precipitated and filtered off, it will be found that the filtrate gives a precipitate on half saturation with ammonium sulphate, showing that *proto-proteoses* have been formed. These differ somewhat in their reaction, and apparently differ in the proportion of their constituent amino-acids. On filtering off these proteoses, the filtrate yields a precipitate on saturating with ammonium

sulphate, indicating the formation of *deutero-proteoses*; and, if the filtrate after precipitating this be tested, the presence of yet another set of proteins may be demonstrated. These are *Peptones* (p. 18) (*Chemical Physiology*).

These changes may be represented in the following table:—

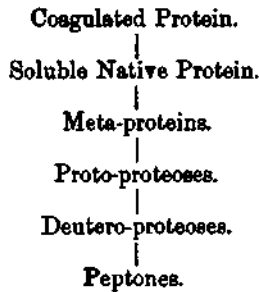

The process is one of breaking down a complex molecule into simpler molecules, probably with hydration. It is the first step to the more complete disintegration of the protein to amino-acids which seems necessary before it can be built into the special protoplasm of the body of the particular animal.

On certain proteins and their derivatives the gastric juice has a special action. On *collagen* the HCl acts slightly in converting it to gelatin. The gastric juice acts on *gelatin*, converting it to a gelatin peptone.

On *nucleo-proteins* it acts by digesting the protein part and leaving the *nuclein* undissolved.

Hæmoglobin is broken down into hæmatin and globin, and the latter is changed into peptone. It is the formation of acid hæmatin (p. 490) which, after a short time, gives the vomited matter in cases of hæmorrhage into the stomach a brown colour.

The *caseinogen calcium compound* of milk (p. 636) is first coagulated, and then changed to peptone. The coagulation is brought about by what is generally described as a second enzyme of the gastric juice—*rennin*. Very probably this action is merely a phase of the action of pepsin.

The stomach contains an enzyme, *lipase*, which splits **Fats**

into fatty acids and glycerol if they are in a very fine state of subdivision, as in milk, but it has no action on fats not so subdivided. It is probable that this lipase comes from the duodenum. When fats are contained in the protoplasm of cells, they are set free by the digestion of the protein covering.

On **Carbohydrates** the free mineral acid of the gastric juice has a slight action at the body temperature, splitting the polysaccharids and disaccharids into monosaccharids.

(4) **Digestion of the Stomach Wall.**—When the wall of the stomach dies either in whole, as after the death of the animal, or in part, as when an artery is occluded or ligatured, the dead part is digested by the gastric juice and the wall of the stomach may be perforated. The typical *gastric ulcer* which so frequently occurs in man in anæmia is of this nature. In the normal condition, a substance may be extracted from the mucous membrane which antagonises the action of pepsin and may be called *antipepsin*.

(5) **Antiseptic Action of the Gastric Juice.**—In virtue of the presence of free HCl, the gastric juice has a marked action in inhibiting the growth of, or in killing, bacteria. Some organisms, while they do not multiply in the stomach, pass on alive to the intestine, where they may again become active.

(6) **Influence of Various Diets upon the Gastric Secretion.**—This has been chiefly investigated by Pavlov on dogs with a gastric pouch (p. 309).

He found that—(1) The amount of secretion depends upon the amount of food taken. (2) The amount and the course of secretion vary with the kind of food taken. Thus, with flesh the secretion reaches its maximum at the end of one hour, persists for an hour and then rapidly falls, while with bread it reaches its maximum at the end of one hour, rapidly falls, but persists for a much longer period than in the case of flesh. (3) The digestive activity of the secretions was tested by allowing them to act upon capillary glass tubes filled with egg-white coagulated by heating (Mett's tubes). The extent to which this was digested out of the tube in unit of time gave the activity of the secretion. It varies with the

kind of food and with the course of digestion. It is higher and persists longer after a diet of bread, which is difficult to digest, than after a diet of flesh, which is more easily digested. (4) The percentage of acid does not vary markedly. When more acid is required, more gastric juice is secreted. (5) The work done by the gastric glands, as measured by the amount of secretion multiplied by its

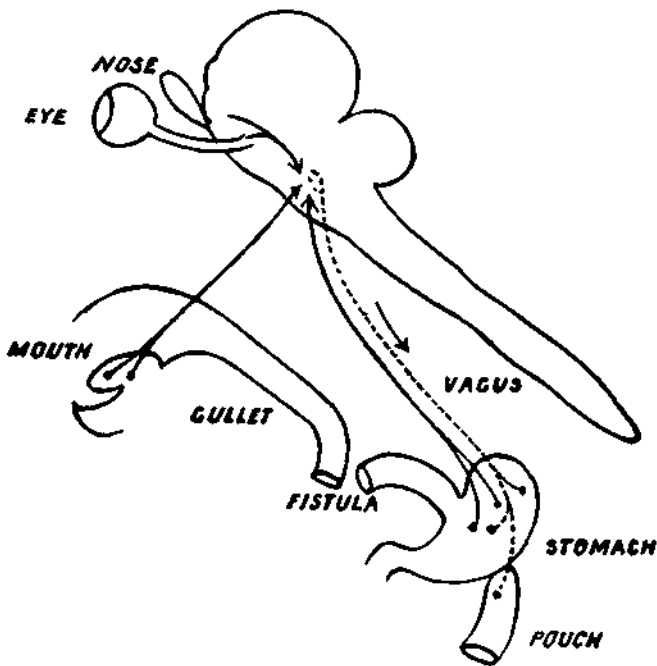

FIG. 151.—To show the Nervous Mechanism of Gastric Secretion and how it is reflexly induced through various ingoing channels.

activity, is greater in the digestion of bread than in the digestion of flesh.

(7) **Nervous Mechanism of Gastric Secretion.**—

(a) *Intrinsic.*—It has been proved that in the dog the secretion of gastric juice can go on after the nerves to the stomach have been divided, and this has been ascribed to a reflex stimulation of the nerve plexus in the submucosa.

(b) *Extrinsic.*—Pavlov found that, when the vagus is cut

below the origin of the cardiac nerves so that the heart cannot be inhibited, stimulation of the lower end of nerve, with a slowly interrupted induced current, causes a flow of gastric juice after a long latent period of a minute or two.

This action of the vagus may be called into play, either by the contact of suitable food with the mouth or by the sight of food. This he demonstrated by making an oesophageal fistula in a dog with a gastric pouch, so that food put in the mouth escaped from the gullet and did not pass into the stomach (fig. 151). Mere mechanical or chemical stimulation of the mouth produces no effect, but the administration of meat produces it. In a fasting dog the sight of food produces, after a latent period of five minutes, a copious flow of gastric juice. Pavlov calls this "psychic" stimulation. It is an example of how the "distance receptor" in the eye reflexly brings about an appropriate reaction—just as the "non-distance receptor" in the wall of the stomach, under other stimuli, brings about an appropriate reaction.

(8) **Chemical Stimulation.**—There is some evidence that the formation of gastric juice is also influenced by the action of a chemical substance produced in the mucous membrane of the pyloric end of the stomach. It has been found that the injection into the blood-stream of an extract of this membrane, made by boiling with acid or peptone, causes a production of gastric juice. In all probability the initial secretion of gastric juice is dependent on the nervous mechanism, and the secondary secretion, when food is in the stomach, on the action of this substance. The secretion is also increased by the presence in the stomach of meat extracts and of weak solutions of alcohol.

3. Movements of the Stomach.—These have been studied by feeding an animal or a man with food containing bismuth, and then applying X-rays, which are intercepted by the coating of bismuth, so that a shadow picture of the shape of the stomach is given (fig. 152).

1. Character.—It is found that soon after food is taken, a constriction forms about the angular incisure at the

middle of the stomach, due to the contraction of the *prepyloric sphincter* which separates the cardiac from the pyloric end. This contraction passes on towards the pylorus. Another contraction forms and follows the first, and thus the pyloric part of the stomach is set into active movement.

The fundus acts as a reservoir, and, by a steady contraction, presses the gastric contents into the more active pylorus, so that, at the end of gastric digestion, it is completely emptied.

While the food is well mixed in the pyloric canal, no

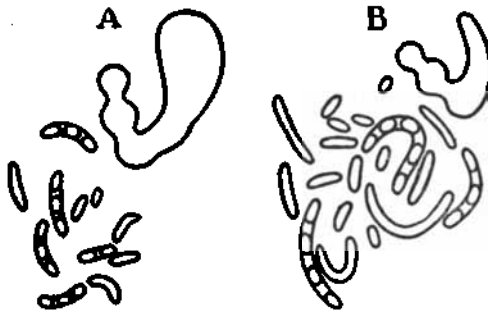

FIG. 152.—Tracings of the Shadows of the Contents of the Stomach and Intestine of a Cat two hours after feeding (A) with boiled lean beef, and (B) with boiled rice to show the more rapid emptying of the stomach after the carbohydrate food. The waves of contraction in the pyloric part of the stomach are shown. The small divisions of the food in some of the intestinal loops represent the process of rhythmic segmentation. (CANNON.)

great mixing takes place in the fundus of the stomach, and, by feeding with different coloured foods, its distribution may clearly be seen (fig. 153).

The pylorus is closed by the strong *sphincter pylori* muscle, which, however, relaxes from time to time during gastric digestion to allow the escape of the more fluid contents of the stomach into the intestine. These openings are at first slight and transitory, but, as time goes on, they become more marked and more frequent, and, when gastric digestion is complete—after an ordinary meal at the end of four or five hours, the sphincter is completely relaxed and allows the stomach to be emptied. The openings are regu-

lated by a local nervous mechanism which is reflexly brought into play by the escape of the acid gastric contents into the duodenum. This leads to an immediate closure of the pylorus, which does not again open till the contents of the duodenum have been neutralised by the alkaline secretions which are poured into it.

The rate of passage from the stomach of various kinds of food has been studied by feeding cats with equal amounts of different kinds of food mixed with bismuth, and then, by X-rays, getting the outline of the contents of the small intestine at

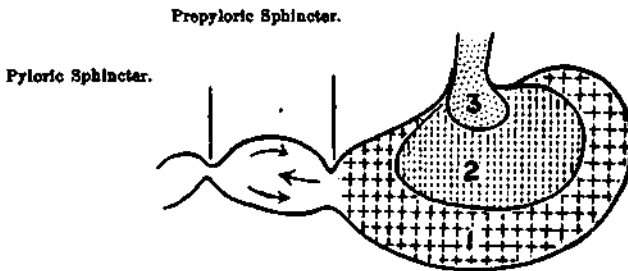

FIG. 153.—Stomach of a Dog fed successively with three different foods to show the absence of mixing at the cardiac end.

different periods. Carbohydrates were found to pass on most rapidly and fats most slowly (fig. 152).

In man after a moderate meal the stomach is usually emptied in about four hours.

2. Nervous Mechanism of Gastric Movements—

(a) *Intrinsic*.—Even after the section of all the gastric nerves, the movements of the stomach may be observed to go on regularly. They are therefore due to a mechanism in the wall of the organ, and, in all probability, judging from the analogy of the small intestine (p. 333), they are controlled by the plexus of neurons in the muscular coat.

(b) *Extrinsic*.—(i.) The vagus maintains the tone of the muscular coat and augments the movements of the pylorus. It also seems to act upon the cardiac sphincter to relax it. (ii.) The sympathetic fibres decrease the tone and the movements, but seem to maintain the contraction of the pyloric sphincter. Their terminations are stimulated by adrenalin.

C. Absorption from the Stomach.

By ligaturing of the pyloric end, it has been found that the stomach plays a very small part in the absorption of food; water is not absorbed, although alcohol and many drugs are rapidly taken up. There is a slight absorption of peptones and of sugars.

While the stomach plays a certain part in digestion, its action is by no means indispensable, for it has been removed in animals and in men without disturbance of the health. It has been shown, however, that the splitting of proteins is somewhat different if peptic precedes tryptic digestion.

Its main function is to act as a reservoir, and probably the antiseptic action of its secretion is of considerable importance.

D. Regurgitation of Gastric Contents.

1. **Regurgitation into the Gullet.**—Normally, the contents of the stomach are prevented from passing back into the gullet by the cardiac sphincter. The tone of this sphincter is easily overcome, and it is relaxed by repeated swallowing, so that no sound is heard as the contents pass into the stomach. Since adrenalin inhibits it, it is probably relaxed by the sympathetic nerves. Stimulation of the vagus first inhibits and then causes it to contract. It tends to undergo rhythmic relaxations, during which the gastric contents pass back into the œsophagus, even up to the mouth, and then, by œsophageal peristalsis, are again passed down. The tone of the muscle is increased by the presence of hydrochloric acid in the stomach, and thus regurgitation does not take place in normal digestion, but is associated with a neutral reaction of the stomach contents which is well marked in some forms of *atonic dyspepsia* that occur in man.

2. **Vomiting.**—Sometimes the stomach is emptied upwards through the gullet instead of downwards through the pylorus. This act of vomiting is generally a reflex one, resulting from irritation of the gastric mucous membrane,

and more rarely from stimulation of other nerves. It is a reaction to nocuous stimuli. In some animals, as the dog, it may be voluntarily induced.

Usually vomiting is preceded by a free secretion of saliva. The glottis is then closed, and, after a forced inspiratory effort by which air is drawn down into the gullet, a forced and spasmodic expiration presses on the stomach, while at the same time the cardiac sphincter is relaxed, and the contents of the stomach are shot upwards. They are prevented from passing into the nares by the contraction of the muscles of the soft palate. The wall of the stomach also acts, the pyloric end being firmly contracted and the cardiac end being also in a state of tonus. But its action is non-essential, since vomiting may be produced in an animal in which a bladder has been inserted in place of the stomach.

The centre which presides over the act is in the medulla oblongata, and, while it is usually reflexly called into action, it may be stimulated directly by such drugs as apomorphine.

IV. INTESTINAL DIGESTION.

After being subjected to gastric digestion the food is generally reduced to a semi-fluid grey pulraceous condition of strongly acid reaction known as *chyme*, and, in this condition, it enters the duodenum.

Here it meets three different secretions :—

- A. Pancreatic secretion.
- B. Bile.
- C. Intestinal secretion.

A. Pancreatic Secretion.

The secretion of the pancreas may be procured by making either a temporary or a permanent fistula. In the former case, the duct is exposed, and a cannula fastened in it; in the latter, the duct is made to open on the surface of the abdomen, a small piece of the intestinal wall, with the mucous membrane round the opening of the duct, being

stitched to the abdominal opening. For experiments on pancreatic digestion extracts of the pancreas are generally used.

1. **Characters and Composition.**—When obtained immediately from a temporary fistula, the pancreatic juice is a clear, slimy fluid, with a specific gravity of about 1015 and an alkaline reaction. It contains an abundance of a native protein having the characters of a globulin, and its alkalinity is probably due to sodium carbonate and disodium phosphate. From a permanent fistula a more abundant flow of a more watery secretion may be collected.

2. **Action.**—Closely associated with the protein, and precipitated along with it by alcohol, are the enzymes, upon which the action of the pancreatic juice depends (*Chemical Physiology*).

1st. *A Proteolytic Enzyme—Trypsin.*—This, in a weakly alkaline or neutral fluid, converts native proteins into peptones, and then breaks these peptones into simpler non-protein bodies.

The pancreatic juice brings about this breaking down of proteins in stages. It does not cause solid proteins to swell up, but simply erodes them away. Fibrin and similar bodies first pass into the condition of *soluble native proteins* and then into *deutero-proteose*. The deutero-proteose is then changed into *peptone*, and part of that peptone is split into a series of bodies which no longer give the biuret test. These consist chiefly of the component *polypeptides*, *amino-acids*, and of *ammonia* compounds (see p. 18).

Amino-propionic acid linked to indol—*tryptophan*—is also split off, and, if chlorine water is added to a pancreatic digest which has proceeded for a long time, this gives a rose-red colour.

On *nucleo-proteins*, trypsin acts by digesting the protein and dissolving the nucleic acid so that it may be absorbed.

On *collagen* and *elastin* trypsin has little action; but on *gelatin* it acts as upon proteins.

2nd. *A Diastase or Amylolytic Enzyme.*—This acts in the same way as ptyalin, but more powerfully, converting a

certain part of the maltose into dextrose. It acts best in a faintly acid medium.

3rd. *A Lipase or Fat-splitting Enzyme.*—This is the most easily destroyed and the most difficult to separate of the enzymes. It breaks the fats into their component glycerol and fatty acids. The fatty acids link with the alkalies which are present to form soaps, and in this form, or dissolved as free fatty acids in the bile, they are absorbed.

But the formation of soaps also assists the digestion of fats by reducing them to a state of finely divided particles, an *emulsion*, upon which the lipase can act more freely. This process of emulsification is assisted by the presence of proteins in the pancreatic juice and also by the presence of bile.

4th. It is doubtful whether the pancreatic secretion contains rennin apart from trypsin, although it produces a modified clotting of milk, under certain conditions.

That these enzymes are independent of one another is shown by the facts that one may be present without the other, *e.g.* diastase is absent in man in early childhood; and also that diastase may be in an active state while the trypsin is in its inactive trypsinogen state.

As to the mode of production of these enzymes, it is known that trypsin is not formed as such in the cells, for the secretion, direct from the acini, has no tryptic action. A forerunner of trypsin—trypsinogen—is produced, and this changes into trypsin after it is secreted. The intestinal secretion contains a substance of the nature of an enzyme, *enterokinase*, which has the power of bringing about this change of trypsinogen to trypsin, thus activating it (fig. 154).

3. **Physiology of Pancreatic Secretion.**—(a) *Chemical Control.*—The secretion of pancreatic juice is not constant, but is induced when the acid chyme passes into the duodenum. This occurs, even when all the nerves to the intestine have been cut, and it appears, from the investigations of Bayliss and Starling, to be due to the formation of a material, which has been called *secretin*, in the epithelium

lining the intestine, under the influence of an acid. This is absorbed into the blood in which it is carried round the circulation, and, on reaching the pancreas, stimulates it to secrete (fig. 154). It has been shown that the injection into a vein of an extract, made with dilute hydrochloric acid, of the lining membrane of the upper part of the small intestine, leads to a flow of pancreatic juice. Secretin is

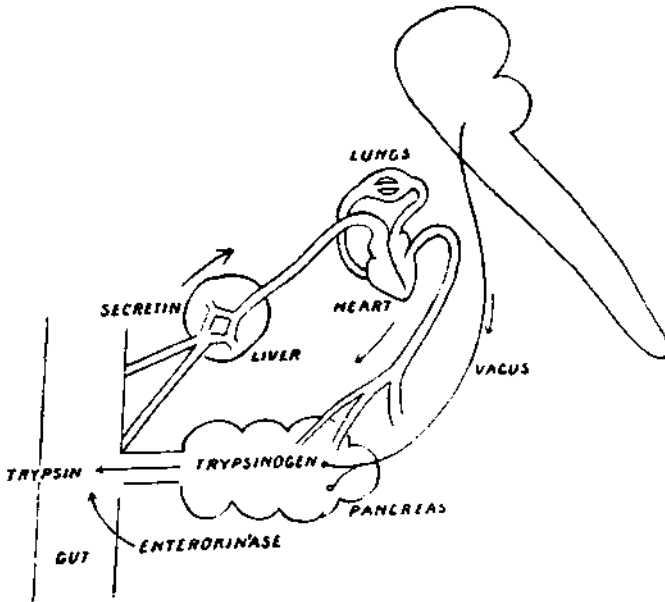

FIG. 154.—To show the Mode of Action of Secretin and of the vagus nerve on the secretion of the pancreas and the activation of trypsinogen by enterokinase.

not destroyed by boiling, and is soluble in strong alcohol. It is therefore not of the nature of an enzyme.

(b) *Nervous Control.*—But, while secretin seems to play so important a rôle, it has been found that stimulation of the vagus nerve, after a latent period of several minutes, increases pancreatic secretion, so that it must be concluded that the process of secretion is, to a certain extent, under the control of the nervous system.

The influence of the pancreas in the general metabolism will be considered later (p. 357).

B. Bile.

1. **Characters and Composition.**—The bile is the secretion of the liver, and it may be procured for examination—(a) from the gall bladder, or (b) from the bile passages by making a fistula into them. This may be *temporary* when a tube is placed in the common bile duct, or *permanent* when the common bile duct is ligatured, the fundus of the gall bladder stitched to the edges of the abdominal wound and an incision then made into it; the bile thus flows through the gall bladder to the surface.

Bile which has been in the gall bladder is richer in solids than bile taken directly from the ducts, because water is absorbed by the walls of the bladder, and the bile thus becomes concentrated.

Analyses of gall bladder bile thus give no information as to the composition of the bile when formed. In several cases, where surgeons have produced biliary fistulæ, opportunities have occurred of procuring the bile directly from the ducts during life in man.

Such bile has a somewhat orange-brown colour, and is more or less viscous, but not nearly so viscous as bile taken from the gall bladder. It has a specific gravity of almost 1005, while bile from this gall bladder has a specific gravity of about 1030. Its reaction is slightly alkaline, and it has a characteristic smell.

It contains about 2 per cent. of solids, of which more than half are organic.

(1) **Bile Salts** (*Chemical Physiology*).—The most abundant solids are the salts of the bile acids. In man the most important is sodium glycocholate. Sodium taurocholate occurs in small amounts. These salts are readily prepared from an alcoholic solution of dried bile by the addition of water-free ether, which makes them separate out as crystals.

Glycocholic acid splits into *glycin*—amino-acetic acid, $\text{H}_2\text{N}\cdot\text{CH}_2\cdot\text{CO}\cdot\text{OH}$ —and a body of unknown constitution, *cholalic acid*, $\text{C}_{22}\text{H}_{40}\text{O}_6$.

Taurocholic acid yields amino-ethyl sulphonic acid or

taurin, $H_2N.CH_2.CH_2.SO_2OH$, which is amino-acetic acid linked to sulphuric acid. This is joined to cholalic acid. In man there is very little taurocholic acid.

Since both are amino-acids, they must be derived from proteins. That they are formed in the liver and not merely excreted by it, is shown by the fact that, while they accumulate in the blood if the bile duct is ligatured, they do not appear if the liver is excluded from the circulation. The bile salts manifest the following actions:—

(i.) They are solvents of lipoids, and they activate the lipase of the pancreatic secretion. For this reason (a) they assist in the digestion and absorption of fats. When bile is excluded from the intestines no less than 30 per cent. of the fats of the food may escape absorption and appear in the fæces. When this is the case, as in jaundice in man from obstruction of the bile duct, the fæces have a characteristic white or grey appearance from the abundance of fat. (b) They keep cholesterol in solution. (c) They act as powerful hæmolytic agents dissolving the lipid capsules of the erythrocytes and allowing the escape of hæmoglobin.

(ii.) While the salts have no action on proteins, free taurocholic acid precipitates native proteins and acid meta-proteins.

(iii.) They lower the surface tension of solutions, and in this way they may bring the fat and other substances into more intimate contact with the mucous membrane.

(2) **Bile Pigments.**—These amount to only about 0·2 per cent. of the bile. In human bile, the chief pigment is an orange-brown iron-free substance, *bilirubin*, $C_{32}H_{38}N_4O_6$, while in the bile of herbivora, *biliverdin*, a green pigment, somewhat more oxidised than bilirubin, $C_{32}H_{36}N_4O_8$, is more abundant. By further oxidation with nitrous acid, other pigments—blue, red, and yellow—are produced, and this is used as a test for the presence of bile pigments (Gmelin's test) (*Chemical Physiology*).

The pigments are iron-free, and they are closely allied to hæmatoporphyrin and hæmatoidin (see p. 491). They are derived from hæmoglobin by the splitting of the hæmatin

molecule into an iron-containing part, which is retained in the liver, and the iron-free biliary pigment. Their amount is greatly increased when hæmoglobin is set free or injected into the blood. Old and breaking down red cells are scavengered from the blood by the endothelial cells of the hepatic capillaries, while free hæmoglobin is taken up directly by the liver cells.

That the pigments are formed in the liver is shown by the fact that, when the liver is excluded from the circulation, the injection of hæmoglobin is not followed by their appearance in the blood. But the formation of hæmatoidin, which is practically identical with bilirubin, apart from the liver, indicates that other tissues have the power of splitting hæmatin into its iron-containing and iron-free portions.

The liver has the property of excreting not only these pigments formed by itself, but also other pigments. Thus, the liver of the dog can excrete the characteristic pigment of sheep's bile when this is injected into his blood.

(3) **Cholesterol** is a monatomic alcohol— $C_{26}H_{48}OH$ —which occurs free in small amounts in the bile. It is very insoluble, and is kept in solution by the salts of the bile acids. It readily crystallises in rhombic plates, generally with a notch out of the corner.

The significance of cholesterol in metabolism and its source in the bile is not definitely known. It is a constituent of all cells, and under various conditions its amount in the blood plasma may be increased, *e.g.* when the amount in the food is large. It then appears in larger quantities in the bile, and it must therefore be concluded that it is excreted by the liver. Possibly it is derived, at least in part, from the stroma of the erythrocytes.

(4) **Fats and Lecithin.**—The true fats and the phosphorus-containing lecithin are present in small amounts in the bile, and apparently they are derived from the fats of the liver cells. The fats may be increased in amount by the administration of fatty food.

(5) **Nucleo-protein and Mucin.**—The bile owes its viscosity to the presence of a mucin-like body, which, however, does

not yield sugar on boiling with an acid and which contains phosphorus. It is precipitated by acetic acid, but the precipitate is soluble in excess. It is therefore a nucleo-protein. In some animals a certain amount of mucin is also present (*Chemical Physiology*).

(6) **Inorganic Constituents.**—The most abundant salt is calcium phosphate. Phosphate of iron is present in traces. Sodium carbonate, calcium carbonate, and sodium chloride are the other chief salts.

2. **Flow of Bile.**—The bile, when secreted by the liver cells, may accumulate in the bile passages and gall bladder, and later be expelled under the influence of the contraction of the muscles of the ducts or of the pressure of the abdominal muscles upon the liver. The flow of the bile into the intestine thus depends upon—1st, The secretion of bile; 2nd, the expulsion of bile from the bile passages. It is exceedingly difficult to separate the action of these two factors.

The taking of food increases the flow of bile, and the extent to which it is increased depends largely on the kind of food taken. In the dog, a protein meal has the most marked effect, a fatty meal a less marked effect, and a carbohydrate meal hardly any effect. The increased flow of bile following the taking of food does not reach its maximum till six or nine hours after the food is taken, and some observers have found that the period of maximum flow is even further delayed.

Pavlov found in dogs, in which a biliary fistula had been made leaving the opening of the bile duct in the mucous membrane of the intestine, that an *expulsion* of bile follows the taking of food; and Starling finds that the flow of bile is increased by the injection of secretin. It thus tends to run parallel with the flow of pancreatic juice.

Influence of Nerves upon the Flow of Bile.—(a) *Expulsion of Bile.*—There is good evidence that nerve fibres pass to the muscles of the bile passages and that they may cause an expulsion of bile by stimulating them to contract.

(b) *Secretion of Bile.*—There is no convincing evidence that nerve fibres act directly upon the secretion of bile.

This appears to be governed by the nature of the material brought to the liver by the blood, and by the activity of the liver cells. It is an example of function regulated by chemical substances rather than by a nerve mechanism; although it is quite probable that these chemical substances act through the rich terminal plexus of nerves which runs throughout the liver.

3. Mode of Secretion of Bile.—It has been seen that the bile salts are actually formed in the liver-cells, and there is good evidence that the water of the bile is not a mere transudation but is the product of the living activity of these cells. The pressure under which bile is secreted may be determined by fixing a cannula in the bile duct or in a biliary fistula, and connecting it with a water manometer. In man the pressure is as much as 20 to 30 mm. Hg, while the pressure in the portal vein of the dog is only 7 to 16 mm. Hg. Hence bile cannot be formed by a process of filtration.

4. Nature and Functions of Bile.—Bile is not a secretion of direct importance in digestion—(1) It has practically no action on proteins or carbohydrates, and its action on fats is merely that of a solvent. Pavlov maintains that it activates the lipase of the pancreatic juice, and others have found that it increases the activity of trypsin and possibly of diastase, while its action on the surface tension of the intestinal contents may favour the absorption of fat. It may thus be considered as an adjuvant to the action of pancreatic juice. (2) Its secretion in relationship to food does not indicate that it plays an active part in digestion. It is formed during intra-uterine life and during fasting, and it is produced many hours after food is taken, when digestive secretions are no longer of use in the alimentary canal. (3) Digestion can go on quite well without the presence of bile in the intestine, except that the fats are not so well absorbed. (4) The composition of bile strongly suggests that it is a waste product. The pigment is the result of the decomposition of hæmoglobin and the acids are the result of protein disintegration.

All these facts seem to indicate that *bile is the medium by which the waste products of hepatic metabolism are eliminated*, just as the waste products of the body generally are eliminated in the urine by the kidneys. (The action of the liver in general metabolism is considered on p. 353.)

C. Secretion of the Intestinal Wall.

(Succus Entericus).

1. **Method of Procuring.**—This is formed in the Lieberkühn's follicles of the intestine, and it may be procured by cutting the intestine across at two points, bringing each end of the intermediate piece to the surface, and connecting together the ends from which this piece has been taken away, so as to restore the continuous tube of the intestine.

2. **Characters.**—On mechanically irritating the mucous membrane, a pale, yellow, clear fluid is secreted, which contains native proteins and mucin, and is alkaline in reaction from the presence of sodium carbonate.

3. **Action.**—The succus entericus contains:—(1) An enzyme or enzymes which split some disaccharids, as maltose and cane sugar, into monosaccharids, but do not seem to act on lactose. A special *lactase* seems to be present in the intestine of young animals taking milk. (2) Lipase is also present. (3) **Erepsin**, an enzyme which seems to act more powerfully than trypsin in splitting peptones into their component non-protein crystalline constituents, the polypeptides and amino-acids. (4) **Enterokinase**—a zymine which, acting on trypsinogen, converts it into active trypsin (p. 321).

4. **Mechanism of Secretion.**—The taking of food leads to a flow of intestinal secretion which reaches its maximum in about three hours; and this flow is much greater from the upper part of the bowel than from the lower. There is some evidence that the injection of secretin calls forth this secretion, and, according to some observers, the injection of succus entericus into the circulation acts in the same way.

Mechanical stimulation undoubtedly causes a secretion, probably through a reflex in the nerve plexuses in the wall of the gut.

As regards the action of **extrinsic nerves** very little is known. It has been found that, if the intestine be ligatured in three places so as to form two closed sacs, and the nerves to one of these be divided, that part becomes filled with a clear fluid closely resembling lymph. The dilatation of the blood-vessels may, however, account for this, without secretion being implicated.

D. Bacterial Action in the Alimentary Canal.

Numerous micro-organisms of very diverse character are swallowed with the food and saliva. It has been suggested that the leucocytes, formed in the lymphoid tissue of the tonsils and pharynx, attack and destroy such organisms, but so far, definite proof of this is not forthcoming.

When the food is swallowed, the micro-organisms multiply for some time in the warm, moist stomach, and certain of them form lactic and sometimes acetic acid by splitting sugars. But, when sufficient gastric juice is poured out for the hydrochloric acid to exist free, the growth of micro-organisms is inhibited, and some of them, at least, are killed.

Those which are not killed pass on into the intestine, and, as the acid in the chyme becomes neutralised, the acid-forming organisms begin to grow, and, by splitting the sugars, form lactic or acetic acid and render the contents of the small intestine slightly acid. Towards the end of the small intestine, and more especially in the large intestine, the alkaline secretions have neutralised these acids, and, in the alkaline material so produced, the putrefactive organisms begin to flourish and to attack any protein which is not hydrolysed by the digestive enzymes—splitting it up and forming among other substances a series of aromatic bodies, of which the chief are indol, skatol, and phenol.

Aromatic Bodies.—This splitting probably occurs through

the liberation of *tryptophan*—in which amino-propionic acid is linked to a pyrrol-benzene.

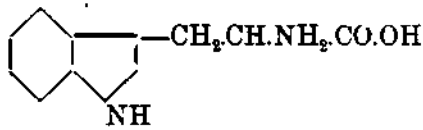

By the breaking down of the amino-propionic acid, *skatol*—

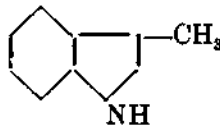

is formed, and, by the removal of the methyl, *indol* is produced—

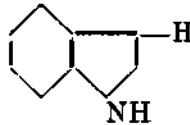

Phenol—

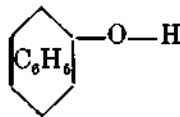

is a further stage of disintegration.

Amines (Appendix) may also be formed, and some of them have a toxic action. Their absorption from the gut may lead to marked symptoms. Dale has shown that some amines are vaso-constrictors of great strength.

Folin has suggested that *ammonia* is also formed in the bacterial changes, and that this may account for the traces of ammonia which have been found in the portal blood.

Bacterial action is not essential to digestion. By taking embryo guinea-pigs at full time from the uterus and keeping them with aseptic precautions, it has been shown that the absence of micro-organisms from the intestine does not interfere with their nutrition.

E. Fate of the Digestive Secretions.

1. **Water.**—Although it is impossible to state accurately the average amount of the various digestive secretions

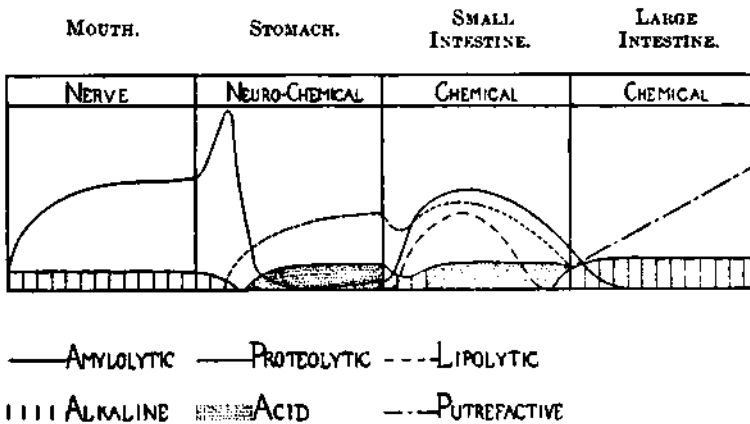

FIG. 155.—A Synopsis of the Conditions and Processes in the Different Divisions of the Alimentary Canal in the pig and in man. The nature of the control—nervous or chemical—is indicated in the top line.

poured into the alimentary canal each day, it must be very considerable, probably more than one-half of the whole volume of the blood. Only a small amount of this is given off in the feces, and hence the greater part must be re-absorbed. There is thus a constant circulation between the blood and the alimentary canal, or what may be called an **entero-hæmal circulation**. One portion of this, the **entero-hepatic**, is particularly important. The blood-vessels of the intestine pass to the liver, and many substances, when absorbed into the blood-stream, are again excreted in the bile and are thus prevented from reaching the general

circulation. Among these substances are the salts of the bile acids and their derivatives, many alkaloids such as curarine, and in all probability the amines formed by putrefactive decomposition of proteins in the gut. The liver thus forms a protective barrier to the ingress of certain poisons.

2. **Enzymes.**—*Ptyalin* appears to be destroyed in the stomach by the hydrochloric acid. *Pepsin* is probably partly destroyed in the intestine, but a proteolytic enzyme acting in an acid medium is present in the urine, and this may be absorbed pepsin. *Trypsin* appears to be destroyed in the alimentary canal; but the fate of the other pancreatic enzymes and of the enzymes of the succus entericus is unknown.

3. **Bile Constituents.**—1. The *bile salts* are partly reabsorbed from special parts of the small intestine—sodium glycocholate being taken up in the jejunum and taurocholate in the ileum. The acids of these salts are also partly broken up. The glycocholic acid yields amino-acetic acid, which is absorbed and passes to the liver to be excreted as urea; while the taurocholic acid yields amino-isethionic acid, which goes to the liver, and yields urea and probably sulphuric acid. The fate of the cholalic acid is not known, but it is supposed to be excreted in the fæces. 2. The *pigments* undergo a change and lose their power of giving Gmelin's reaction. They appear in the fæces as *stercobilin*. It is probably formed by reduction of bilirubin in the intestines as the result of the action of micro-organisms. 3. The *cholesterol* is passed out in the fæces in a modified form as *coprosterol*.

F. Movements of the Intestine.

1. The Small Intestine.

These are of two kinds—segmental and peristaltic.

1. The **segmental** movements consist in the formation of local constrictions, which divide the gut up into little segments or compartments. A constriction next forms in the middle of each of these, and the former constriction is

relaxed, and its site becomes the centre of another compartment. This process goes on repeating itself, and thus the contents of the gut are thoroughly mixed and churned. This may be seen by feeding with food mixed with bismuth and employing X-rays. These movements occur when all the nerves have been divided. How far they are dependent upon the action of the myenteric plexus is not definitely established.

2. The peristaltic movements are much more complex and powerful. They consist of a constriction of the muscles, which seems to be excited by the distension caused by the contents, and they may be caused by inserting a bolus of

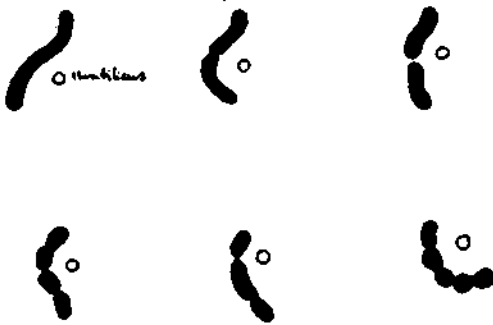

FIG. 156.—Skigrams to show Segmentation of the Small Intestine. (HERTZ.)

cotton-wool covered with vaseline. Starting at some point of the intestine, the wave passes slowly downwards and gradually dies away. In front of the contraction, the muscular fibres are relaxed, and thus the contracting part drives its contents into the relaxed part below. This movement of the contents of the intestine, when they are mixed with gases produced by fermentation, frequently produces gurgling noises.

The peristaltic movements go on after the nerves to the gut are cut, but they are stopped when the ganglia in the wall of the intestine are poisoned by nicotine. The myenteric plexus undoubtedly forms a local reflex mechanism which is stimulated by the presence of the residue of the food in the intestine and which brings about the co-

ordinated contraction and relaxation, which together constitute a true peristalsis.

But, while peristalsis is thus independent of the central nervous system, it is nevertheless controlled by it. The *splanchnic nerves* inhibit, while the *vagus*, to the small intestine and possibly the first part of the large gut, and the *nervi erigentes* or *pelvic nerves* to the greater part of the large gut are augmentor nerves, increasing the peristalsis. Stimulation of the splanchnic fibres, which inhibit peristalsis, causes contraction of the ileo-cæcal sphincter.

The movements of the intestine may be inhibited either by interference with the local nervous mechanism or by reflex action through the central nervous system. Thus, it has been found that roughly handling the gut will lead to a prolonged inhibition, even after the extrinsic nerves have been cut. Other stimuli—such as crushing the testis under an anæsthetic—lead to a reflex inhibition, which is manifest only if the splanchnic nerves are intact. When a cat, under observation with X-rays, manifests signs of anger, the gastric movements and movements of the small intestine are checked. Under these conditions the movements of the large intestine may be increased and the fæces voided.

The Ileo-Cæcal Sphincter and Valve.—This sphincter prevents the free passage of the contents of the small into the large intestine, and causes a stasis in the ileum—possibly to allow of complete absorption of all the nutrient constituents. It relaxes from time to time, and allows the contents to be forced into the large gut. The valve is formed by a sleeve-like projection of the end of the ileum into the cæcum, but it does not completely prevent the backward passage of the contents of the large into the small intestine.

Usually the contents of the small intestine travel down at about 1·5 metres per hour. In abnormal conditions the rate of passage may be greatly retarded or accelerated.

2. The Large Intestine.

In the large intestine peristaltic waves like those of the small intestine are not prominent, and the segmental move-

ments seem to be replaced by rhythmic contraction of the saccules. In the cat peristalsis in a backward direction—an anti-peristalsis—starts in the middle of the colon and passes to the cæcum.

On several occasions, usually after taking food, a rapid movement of the contents downwards in mass has been observed. This must be due to the rapid passage of a very powerful contraction, and it appears to be originated as a reflex from the stomach—a gastro-colic reflex.

The result of the movement of the large intestine is to pass the contents onwards towards the rectum. In this passage the contents become less fluid from the absorption of water.

3. Defæcation.

By the peristalsis of the intestine the matter not absorbed from the wall of the gut is forced down and accumulated in the rectum. It is prevented from escaping by two sphincter muscles, viz. the internal sphincter, which is merely a thickening of the circular muscular coat of the colon, and the external sphincter, which is of skeletal muscle.

(1) The mechanism of the act of defæcation is a **local reflex**, similar to that controlling the rest of the intestine. In a dog, with all the lower part of the spinal cord removed, defæcation can, after some time, take place normally.

(2) The peripheral mechanism is controlled by a **centre in the lumbar enlargement of the spinal cord**. When this is destroyed, the sphincters are for a time relaxed, and fæces are passed whenever they are driven down by intestinal contractions. The centre thus seems to exercise a tonic influence on the sphincters. Its action is inhibited by impulses sent up the sacral nerves from the distended rectum.

(3) The lumbo-spinal centre is dominated by **higher centres** in the cerebrum, by the action of which defæcation may be inhibited for a time or the reflex may be liberated.

The local centre is stimulated when distension of the rectum is produced by the accumulation of material—

undigested constituents of the food and excretory products. The undigested material usually forms the greater part of the accumulation, especially in herbivora. It has been shown that rabbits on a diet freed from cellulose cease to defæcate and die of intestinal obstruction.

The higher centres are stimulated by excitement, which, especially in timid animals, may produce diarrhœa. Muscular exercise helps to induce the reflex, probably partly by a sympathetic increased muscular action of the colon, and partly by the contraction of the abdominal muscles forcing material into the lower bowel. The influence of exercise is well seen in dogs, which often defæcate after being released and allowed a run.

When defæcation takes place, all the various muscles which can increase the pressure in the abdomen are called into play. A deep inspiration is taken, and then, with the glottis closed, expiratory efforts are made. The levator ani which supports the anus is relaxed, and the upper part of the rectum is brought more into line with the lower part of the pelvic colon. Fæces may thus be forced into the rectum, and the reflex act of defæcation with contraction of the colon and relaxation of the sphincters is effected. The act is completed by the contraction of the internal sphincter from above downwards and by the contraction of the levator ani and external sphincter.

B. DIGESTION IN HERBIVORA.

The food of herbivora is characterised by its bulk, and by the fact that the digestive material is for the most part enclosed in cells whose cellulose walls are not dissolved by the enzymes of the digestive tract. The distinctive feature about digestion in herbivora is therefore the provision for detaining a large quantity of food in a specially developed part of the alimentary canal, where, under the influence of bacteria, the cellulose is dissolved and the enclosed digestible material liberated.

1. Digestion in Ruminants.

Prehension.—In the ox, in grazing, the mobile tongue curls round the grass and pulls it into the mouth, when it is cut off by the incisor teeth against the dental pad. The papillæ in the inside of the mouth (p. 292) assist in preventing the food from dropping out. The divided upper lip of the sheep allow the teeth and dental pad to bite closer to the ground than in the case of cattle.

In drinking the lips are closed except for a small orifice which is put below the surface of the water. The tongue acts like the piston of a pump and the water is sucked in.

Mastication and Insalvation.—Mastication in ruminants is chiefly a side-to-side movement by which the food is ground between the molar teeth. It goes on usually for several minutes in one direction and then changes to the opposite direction. The parotid gland on the side on which the animal is chewing secretes much more actively than that of the opposite side. The sublingual and submaxillary glands secrete equally on both sides. The quantity of saliva poured into the mouth is very large. When dry food is eaten between 50 and 60 litres may be secreted in twenty-four hours. The specific gravity of the saliva is high, nearly 1010.

It is doubtful whether the saliva of ruminants contains any ptyalin. If it is present it is in very small amounts.

The food is swallowed after a preliminary incomplete chewing. It is returned to the mouth for more complete mastication during rumination which takes place after feeding has ceased. Ruminants can therefore eat food about three times as fast as the horse, which completes mastication before swallowing.

Rumination.—This complication of the digestive process is peculiar to ruminants. It consists essentially of a re-mastication of the food after a preliminary storage.

(1) **Mechanism.**—The food, when first swallowed, may enter any of the compartments with which the œsophageal groove is connected (p. 294). Liquids for the most part pass on

direct to the abomasum or true stomach. But when solid food is taken the pillars of the œsophageal groove relax, and the œsophagus then communicates with the rumen and reticulum to which the food passes. The fluid part tends to accumulate in the reticulum. After feeding, if the animal be comfortable and undisturbed, rumination or "chewing the cud" begins. By fixation of the diaphragm in the position of inspiration, and the contraction of the muscular walls of the rumen and reticulum and of the abdomen, some of the contents of the rumen accompanied by fluid from the reticulum is passed into the œsophagus. A bolus is cut off by contraction of the cardiac end of the œsophagus, and by a reversed peristalsis, is carried to the mouth. The fluid is immediately squeezed out and reswallowed, passing along the œsophageal groove to the omasum and thence to the true stomach. The mass left in the mouth undergoes a second process of mastication and insalivation. The finely comminuted pasty material is then reswallowed, and by a contraction of the pillars of the œsophageal groove the omasum is drawn towards the œsophagus, and receives the material.

In the omasum it is reduced to a still finer state of division by the grinding action of the hard leaves, between which it filters through to the true stomach. Even after remastication the food, if not in a fine enough state of division, may pass again to the rumen instead of to the omasum.

A certain degree of distension of the rumen is necessary to make regurgitation possible. This is maintained by the constant activity of the parotid glands, whose secretion constitutes a considerable proportion of the contents of the rumen.

The flow of saliva and the process of rumination cease in disease. Under these conditions the food may become dry and caked and set up inflammatory changes. Impaction may occur, especially in the omasum. The moist mouth indicating a flow of saliva, and the commencement of rumination are of great value in prognosis.

The ox spends about seven hours out of the twenty-four ruminating. A bolus of about 100 grams is regurgitated, remasticated, and reswallowed in rather less than one minute.

Rumination is a reflex act. The centre has not been located with certainty. It is probably situated in the medulla. The two chief nerves involved are the phrenic and the vagus. If the former be cut the diaphragm cannot be contracted, but the food can still be regurgitated by a more powerful contraction of the walls of the cavity and of the abdomen. If the vagus be cut, the walls of the cavities are paralysed and the process ceases.

It is a remarkable fact that, though boluses can be returned from the rumen to the mouth, the ox does not vomit, even when distension of the rumen causes distress. Why vomiting does not occur is unknown. It has been suggested that the vomiting centre in the medulla is undeveloped.

(2) **Digestive Changes in the Rumen.**—The contents of the rumen are subjected to a churning by the contraction of the powerful muscular bands in the wall of the cavity. Newly added food is therefore mixed with the previous contents. No digestive juice is secreted, the only fluid added to the food being the alkaline saliva from the mouth.

In this warm alkaline mass the fibrous substances become softened and prepared for the further digestive processes. It is probable that finely-divided material may pass direct from the rumen to the omasum, though doubtless the greater bulk is remasticated.

The conditions in the rumen where the contents are warm and alkaline favour the conversion of starch to maltose by the enzyme ptyalin. Whether ptyalin is present in ruminants, however, is doubtful, and the extent to which the conversion takes place is unknown.

Certain enzymes contained in the food may act. Cytase has a feeble action on cellulose. Proteolytic enzymes may act on protein, and amolytic enzymes on starches. These changes due to enzymes contained in the food are, however, of minor importance.

Fats are freed by the disintegration of enclosing substances, but in this compartment they undergo no chemical changes.

The rumen swarms with bacteria which attack the

cellulose and probably also the pentosans, breaking them down to various organic acids, chiefly acetic and butyric. These combine with the bases of the alkaline saliva. The resulting salts are absorbed from the intestine and are sources of energy. In the upper part of the rumen the contents may be acid from the accumulation of these organic acids. The gases, methane, carbon dioxide, and in small quantities hydrogen, are produced and excreted in the breath. The process is therefore largely a destructive fermentation. It is estimated that about 60 per cent. of the cellulose of the food is disintegrated in the rumen. As the cellulose is broken down the cell contents are liberated and rendered accessible to the digestive juices of the following parts of the digestive tract.

In addition to cellulose, starch and sugars undergo destructive fermentation. It has been shown that the addition of starch to a fixed diet leads to a corresponding increase in the excretion of methane.

Nitrogenous material is also broken down by bacteria, and used to build up the proteins of their own protoplasm. It seems that the soluble non-protein compounds are more readily utilised than the proteins. When a plentiful supply of soluble nitrogen is available, the multiplication and activity of bacteria is increased, and consequently there occurs a more extensive disintegration of cellulose.

It has been suggested that the protoplasm of bacteria, which are carried on into the stomach, is digested, and the resulting products absorbed, and that it is by the bacteria consuming the non-protein nitrogenous material and then being themselves digested that non-protein nitrogen is made available. Whether bacterial protein can be hydrolysed by the digestive enzymes is disputed. As the non-protein nitrogenous material consists chiefly of amino-acids and amides—the normal cleavage products of digestion (p. 320)—it seems unnecessary to involve the aid of bacteria for their utilisation.

Stomach.—After being triturated between the leaves of the omasum, the food enters the abomasum or true stomach. The course of events in the stomach has been studied by making a Pavlov's pouch in the goat.

The stomach contents for some time after being received from the omasum are alkaline. Micro-organisms flourish and break down sugars to form lactic acid. An amolytic enzyme converting starch to sugar seems to be produced.

Before this amolytic period is completed pepsin and hydrochloric acid are secreted in sufficient amounts to make the contents acid and enable peptic digestion to begin. The concentration of hydrochloric acid, however, is never so great as in carnivora.

Intestines.—In the small intestine, so far as is known, the secretions and digestive processes are the same as have been described for carnivora. But a smaller proportion of the food is digested and absorbed so that a bulky residue reaches the cæcum and colon. Here the destructive fermentation of cellulose by bacteria is resumed, and digestive processes are continued by enzymes that have been carried on from the small intestine. The large intestine is therefore a more important structure in herbivora than in carnivora, where its main function is the absorption of water and the storage of food residues and excretory products prior to expulsion in the fæces.

In ruminants where important changes go on in the rumen before the food passes through the stomach and small intestine digestion in the cæcum and colon are much less important than in the horse (p. 344).

Fæces.—The fæces which consist chiefly of undigested residues of the food are more fluid in the ox than in the sheep. The amount varies with the food. In the ox the average weight per diem is about 30 kilos. The composition of the fæces is dealt with later (p. 361).

2. Digestion in the Horse.

Prehension.—In grazing, the lips of the horse are drawn back to allow the teeth free access to the grass. If the nerves supplying the lips cut, it becomes impossible for the horse to graze. In manger-feeding the lips are used to gather the food.

In drinking, as in the ruminant (p. 337), the tongue acts like

the piston of a pump sucking in the water. If an opening be made in the cheek above the level of the water so that air gets in water cannot be sucked up. When drinking, the head is extended, and there is a forward movement of the ears as each gulp is swallowed. The reason for this peculiar backward and forward movement of the ears in the horse when drinking is unknown.

Mastication and Insalivation.—The process of mastication is very completely performed, the animal taking about five to ten minutes to eat a pound of corn and about fifteen to twenty minutes to eat the same amount of hay. As in the ruminant, mastication is chiefly a side-to-side movement and is unilateral, the parotid gland on the chewing side being the more active.

The parotid gland is relatively large in the horse, being about twice as large as that of the ox. Unlike the ruminant where the parotid secretion never ceases in health the gland is only active during mastication. The saliva probably contains ptyalin.

The quantity of saliva secreted has been measured by making an cesophageal fistula and collecting the boluses of food which are swallowed, and so finding the amount of fluid which has been secreted in the mouth. About 40 to 50 litres may be produced in a day. The amount is determined by the dryness of the food. Dry fodder absorbs about four times its weight of saliva ; green fodder about half its weight.

In abdominal pain there is complete cessation of all the salivary glands, and the mouth and tongue become dry.

Stomach.—In the horse the process of gastric digestion differs from that of carnivora in the following particulars.

In the first place, the horse has to eat a very large quantity of food in proportion to the size of its stomach, and it is found that part of the food begins to pass very rapidly through the stomach into the intestine. Colin found, when he killed a horse which in two hours had eaten 2500 grms. of hay, that the stomach contained only 1000 grms. But while this is the case, a small residue of the meal remains for a very long time in the stomach, and passes out only when the next meal is taken.

The churning action of the stomach is less complete in the horse than in the dog, and hence when the animal has received hay, followed by oats, these are found lying more or less separate. Even when the animal has taken water the contents are not much disturbed (p. 367).

In the horse, the amyolytic period is well marked, and the percentage of hydrochloric acid is never so high as in the dog. Lactic acid is always formed from the carbohydrate

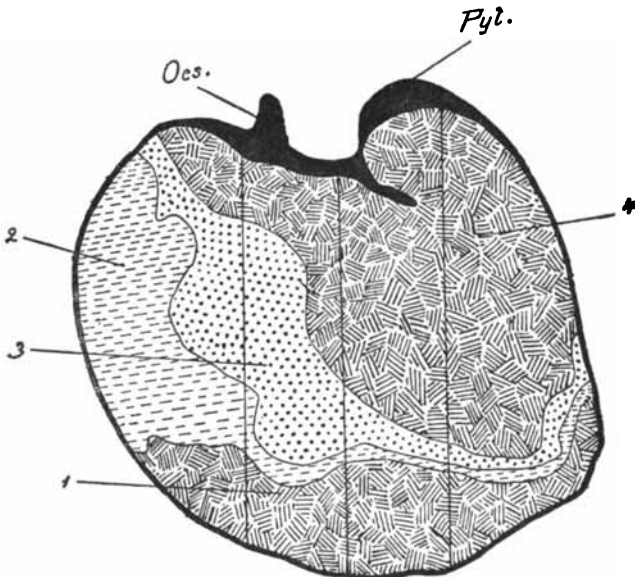

FIG. 157.—Stomach of Horse fed successively on four differently coloured foods to show the distribution of the various foods in the viscus.

of the food, and on a diet of hay it may exceed the hydrochloric acid.

The proteolytic action of the gastric juice of the horse is slower than that of carnivora, but it is very marked, and peptones are found abundantly in the stomach at the end of digestion. In the stomach of the horse the cellulose of the food is partly decomposed, probably by the action of an enzyme in the grain.

Intestines.—In the small intestine the processes that go on are much the same as in carnivora.

In the large intestine the cæcum and double colon perform much the same function as the cesophageal diverticula of the ruminant (p. 339).

The Cæcum acts as a reservoir. The contents of the small intestine pass through it to reach the colon. Water drunk passes very rapidly to the cæcum. The contents are always fluid, varying from a pea-soup-like consistency to a quite watery liquid, with particles of undissolved food floating throughout it. Some of the food may remain for as long as twenty-four hours in the cæcum. On the other hand, some may pass rapidly through to the colon. Food has been found in the colon four hours after being eaten.

The outlet to the colon is above the level of the inlet—the ileo-cæcal valve. The contents therefore are emptied against gravity by the contraction of the four longitudinal muscular bands in the walls of the organ.

The contents of the large colon and of the first foot or so of the small colon resemble those of the cæcum. Thereafter by the absorption of water the contents rapidly become inspissated, and by the sacculation of the colon, formed into balls of fæces, ready for expulsion.

The digestive change that takes place in the cæcum and large colon are much the same as those that occur in the rumen of the ox. The contents are alkaline in reaction and swarm with bacteria. Fibrous material that has resisted the action of the stomach and small intestine becomes macerated. Cellulose is attacked by bacteria and broken down, yielding the same products as the disintegration of cellulose in the rumen (p. 340). The gases appear as little bubbles scattered throughout the fermenting mass.

As the cellulose envelope is broken down, the contents that were protected from the action of the digestive secretion of the stomach and small intestine are hydrolysed by the enzymes that have been carried into the large intestine.

Proteins that have not been hydrolysed by the digestive enzymes are disintegrated by putrefactive organisms giving rise to a series of aromatic bodies (p. 329), which are absorbed. Some of these are toxic and affect the health of the animal.

Absorption of the products of digestion takes place in the

cæcum and colon. So rapid is absorption in the lower bowel that the animal may be easily anæsthetised by giving ether per rectum. The rapid absorption allows of life being maintained by nutrient enemata.

Some of the movements of the alimentary tract are of special interest in the horse.

In neither the small nor the large intestine have segmental movements been observed, but an *anti-peristaltic* movement has been described. As the contents of the intestine are liquid

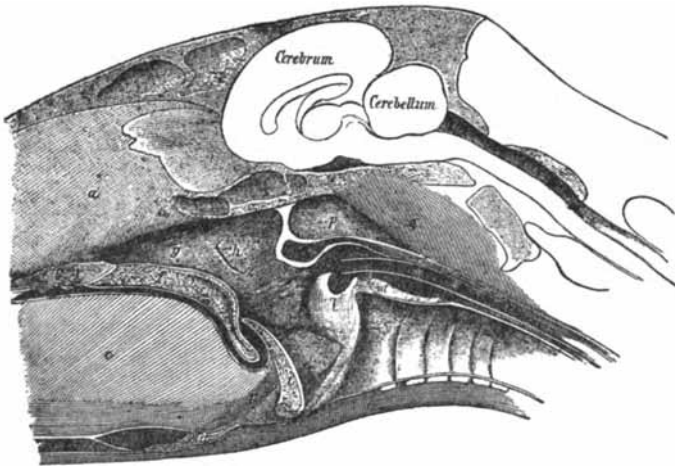

FIG. 158.—Mesial Section through the Head of a Horse, to show the long soft palate, *f*, lying against the front of the epiglottis, *t*; *c*, the tongue; *l*, the arytenoids. (ELLENBERGER.)

segmentation is unnecessary. Anti-peristaltic movements serve by mixing the contents to bring the food into more intimate contact with the intestinal secretions, and also prevent the too rapid emptying of the small intestine into the cæcum.

In defæcation the contraction of the rectum is so powerful that the act can be performed without fixation of the diaphragm or closing of the glottis, though these usually occur when the animal is at rest. The crouching attitude common to nearly all animals is not adapted. The horse can therefore defæcate when trotting.

Vomiting in the horse seldom occurs. The œsophagus joins the stomach very obliquely and folds of mucous membrane of the stomach tend to prevent the passage of stomach contents back into the œsophagus. Further, the lumen of the œsophagus is diminished at the cardiac end, and there the circular coat is thicker and firmer. On the few occasions when vomiting does occur the vomited material, which is prevented from entering the mouth by the long soft palate, escapes from the nostrils (fig. 158).

SECTION III.

ABSORPTION OF FOOD

1. State in which Food leaves the Alimentary Canal.

(1) The **carbohydrates** generally leave the alimentary canal as monosaccharids; but some resist the action of digestion more than others. Lactose seems to be broken down in the intestine only when the special enzyme, *lactase*, is present in the succus entericus, but in all cases it is broken down before it reaches the liver. Cane sugar, when taken in large excess, may also be absorbed unchanged, and it is then excreted by the kidneys.

(2) The **proteins** are absorbed as amino-acids, formed by the action of trypsin and erepsin (pp. 320 and 328). Native proteins may be absorbed to a small extent unchanged, as is shown by the fact that the administration of very large amounts of egg albumin may cause its appearance in the urine. Egg-white, when injected into the pelvic colon isolated from the rest of the intestine, and hence free of proteolytic enzymes, may disappear, probably as the result of bacterial action; but in carnivora the amount absorbed, as indicated by the increased excretion of nitrogen, is trivial. In the horse absorption in the colon is more complete (p. 344).

(3) Non-protein nitrogenous material may be absorbed as amino-acids, the form in which it is largely present in the food, or may be acted upon by bacteria prior to absorption (p. 340).

(4) The **fats** are chiefly absorbed as soaps and as fatty acids.

(5) The results of the digestion of cellulose are absorbed as salts of organic acids (p. 340).

2. Mode of Absorption of Food.—That absorption is not due merely to a process of ordinary diffusion is clearly indicated by many facts.

(1) Heidenhain has shown that absorption of water from the intestine takes place much more rapidly than diffusion through a dead membrane.

(2) The relative rate of absorption of different substances does not follow the laws of diffusion. Grüber's peptone passes more easily through the intestine than the more diffusible glucose, while sodium sulphate, which is more diffusible than glucose, is absorbed much less readily. Again, an animal can absorb its own serum under conditions in which filtration into blood capillaries or lacteals is excluded.

(3) Absorption is stopped or diminished when the epithelium is removed or injured, or poisoned with fluoride of sodium, in spite of the fact that this must increase the facilities for diffusion.

(4) During absorption, the oxygen consumption by the wall of the gut is increased.

3. Channels of Absorption.—There are two channels of absorption from the alimentary canal (see fig. 162, p. 383)—(1) the veins, which run together to form the portal vein of the liver, and (2) the lymphatics, which run in the mesentery and, after passing through some lymph glands, enter the *receptaculum chyli* in front of the vertebral column. From this, the great lymph vessel, the thoracic duct, leads up to the junction of the subclavian and innominate veins, and pours its contents into the blood stream. The lymph formed in the liver also passes into the thoracic duct.

(1) **Proteins.**—(1) During the digestion of proteins the number of leucocytes in the blood is enormously increased, sometimes to more than twice their previous number. This is due to an emigration from the red marrow of bone. The *digestion leucocytosis* passes off in a few hours, but what becomes of the leucocytes is not known. Possibly they are

the carriers of the amino-acids which are formed in digestion ; but, since it has been found possible to dialyse these from the blood, the leucocytes must either break down in the blood stream or give up the amino-acids before the tissues are reached.

(2) The amount of *amino-acids* is increased in the blood. That they are absorbed by the blood-vessels and not by the lymphatics is indicated by the fact that ligature of the thoracic duct does not interfere with the absorption of the nitrogen of the proteins.

(3) The amino-acids are rapidly removed from the blood by the tissues, and chiefly by the liver. Their concentration

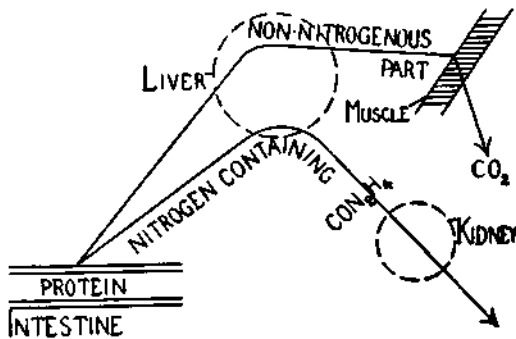

FIG. 159.—To show the Splitting of the Amino-acid Part of Proteins into a nitrogenous part, which is changed to urea in the liver and excreted by the kidneys, and into a non-nitrogenous part yielding sugar, which is sent into the muscles.

in this organ may be three or four times that of the blood. Apparently, any surplus over that immediately required by the tissues, accumulates in the liver and is so prevented from exercising a toxic action on the heart. In the liver the stored amino-acids are rapidly split up and the amidogen portion converted to *urea* and excreted by the kidneys, while the non-nitrogenous part is converted into carbohydrates to a greater or less extent (fig. 159). The muscles and other tissues accumulate these amino-acids to a much smaller extent and hold them longer, probably for the

synthesis of their proteins, and possibly in order to use their non-nitrogenous part as a source of energy.

(2) **Carbohydrates.**—These are absorbed as monosaccharids in solution, and are carried away in the blood of the portal vein. Any surplus, over that required by the body, may be stored in the liver and subsequently sent to the tissues (p. 354).

(3) **Fats.**—After being split up into their component acids and glycerol, fats pass, as soluble soaps or as fatty acids soluble in the bile, through the borders of the intestinal epithelium. Here they appear to be again converted into fats by a synthesis of the acid with glycerol. Fine fatty particles are found to make their appearance in the cells at some distance from the free margin and to increase in size. A similar synthesis occurs even when free fatty acids alone are given, so the cells must be capable of producing the necessary glycerol to combine with the acids. The fats are sent on from the cells, through the lymph tissue of the villi, into the central lymph vessels, and thus on, through the thoracic duct, to the blood stream. Unlike the proteins and carbohydrates, *they are not carried directly to the liver.* In some animals they are stored in the fatty tissues, in others to a certain extent in the liver.

Since neither the character nor the amount of food consumed are determined by the actual requirements of the muscular and other tissues, it is of importance that there should be some regulator which will control the amount and character of the nourishment sent to the muscles.

Such a regulator is found in the liver.

When more food is taken than is at once required by the tissues, one of three things may happen—

1. It may be oxidised with the evolution of heat. This is specially the case with proteins, the high specific dynamic action of which markedly increase heat production (p. 272).

2. It may be excreted, unchanged in the urine, as in the case of sugar.

3. It may be stored and sent to the muscles as it is required, and thus the supply of energy-yielding material may be regulated.

A. Storage of Surplus Food.

1. **Fat.**—Since, bulk for bulk, fat has more than twice the energy value of proteins or carbohydrates (p. 257), it is an advantage to store surplus food as Fat. In fat oxen or sheep the fat may constitute nearly 50 per cent. of the weight of the carcase. This stored fat is not immediately available. It may be regarded as invested capital which has to be placed at current account before it can be used.

This storage takes place chiefly in three situations: (1) Fatty tissue; (2) Muscle; (3) Liver.

(1) **In Fatty Tissue.**—In most mammals the chief storage of surplus food is in the fatty tissues.

(a) That the fat of the food can be stored in them is shown by the fact that the administration of large amounts of fats, different from those of the body, leads to their appearance in those tissues. The administration of erucic acid to dogs leads to its appearance in the fat, and cows fed on maize oil yield butter of a low melting-point. Fats stained with Sudan III. carry the stain into the fatty tissue in which they are deposited.

(b) That fat is formed from carbohydrates was proved by Laws and Gilbert in the feeding of young pigs. Two of a litter were taken and one was killed and analysed. The other was fed for weeks upon maize, the amount eaten being weighed, and the excretion of nitrogen by the pig being determined. The animal was then killed and analysed, and it was found that the fat gained was more than could be accounted for by the fat and protein of the food eaten.

In this process of fat formation the respiratory quotient may rise above 1.0. It is probably carried out as follows:—

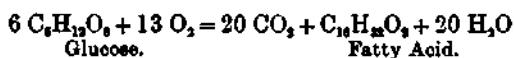

The greater energy of the fatty acid molecule as compared with that of the sugar is got by the oxidation of some of the sugar along with a reduction of the rest.

(c) The evidence that fats may be formed from the **proteins** of the food is conflicting. (1) In the ripening of

cheese it is undoubted that, under the influence of micro-organisms, proteins are changed to fats. (2) In all probability the same thing occurs in the formation of the fatty adipocere in the muscles of the dead body during putrefaction. (3) At one time it was supposed that, under the influence of such poisons as phosphorus, the proteins of the cells of the mammalian tissues are changed to fat. But careful chemical examination has shown that the so-called fatty degeneration is due to accumulation of already existing fats in the affected organs. (4) If a dog be fasted till all the fat of the body is used up, and then fed on lean beef, it will lay on fat. But analysis of such beef shows that it contains enough fat and glycogen to yield all the fat laid on.

At present we have no direct evidence that the fats of the body are formed from proteins, although the facts (1) that carbohydrates are formed from proteins (p. 354), and (2) that fats are formed from carbohydrates, make it possible that proteins may be a source of fat, but that their specific dynamic action prevents the fat from accumulating.

(2) **In the Liver.**—In some animals, *e.g.* the cod and the cat, fats are largely stored in the liver.

(3) **In Muscle.**—The salmon stores fats *within* its muscle fibres; but in mammals such a storage is very limited in amount, although large amounts may be deposited between the bundles of fibres (p. 374).

2. **Proteins** may, to a small extent, be stored in muscle, especially after a fast or a prolonged illness, and during rapid growth a suckling animal may store more than 40 per cent. of the protein of the mother's milk. But in the normal mammal it is difficult to induce such a storage, except in athletic training, where the muscles may be enormously increased by the building up of the protein-derivatives of the food into their protoplasm.

3. **Carbohydrates** are stored to a small extent in the liver and in muscle (p. 354). Probably, at most about 10 per cent. of glycogen occurs in the liver and 1 per cent. in

muscle. The amount varies with the diet, and in a dog which is not fasting, it may be anything from 5 to 30 grms. per kilo of body weight. This small store is rapidly used up in fasting and is drawn upon in muscular exercise. Glycogen may be compared to money at current account; glucose, like money in the pocket, may be used at once.

B. The Liver as a Regulator of the Supply to Muscles.

The liver develops as two diverticula from the embryonic gut, and is thus primarily a digestive gland. In invertebrates it remains as a part of the intestine both structurally and functionally. But in mammals, early in foetal life, it comes to have important relationships with the blood going to nourish the body from the placenta (see p. 623). The vein, bringing the blood from the mother, breaks up into a series of capillaries in the young liver.

- (1) *Blood Formation.*—The development of the cells of the blood goes on for a considerable time in these capillaries.
- (2) *Bile Secretion.*—Soon the liver begins to secrete bile.
- (3) *Glycogenic Function.*—Animal starch and fat begin to accumulate in its cells.

Gradually, the formation of blood cells stops, and the mass of liver cells becomes larger in proportion to the capillaries. As the foetal intestine develops, the vein bringing blood from it—the portal vein—opens into the capillary network of the liver, so that, when at birth the supply of nourishment from the placenta is stopped, the liver is still associated with the blood which brings nutrient material to the body, and *it performs an important function in regulating the supply of nourishment to the tissues*, and more especially to the great energy-liberating tissue, muscle.

1. **Regulation of the Supply of Sugar.**—It has been already shown that sugar is an essential source of energy in muscle.

(1) *Production of Sugar.*—The relationship of the liver to the metabolism of sugar was discovered by Claude Bernard in the middle of last century. Even in the most prolonged fast, the liver continues to supply to the blood enough dextrose to maintain the normal proportion of about

0.15 per cent. In fasting the only possible sources of this sugar are the *proteins* and the *fats* of the body. (a) That *proteins* are a source of sugar is shown by the fact that, in diabetic patients and in dogs rendered diabetic by removal of the pancreas, *i.e.* in animals which are excreting and not using the sugar (p. 357), the output of sugar is increased by giving proteins. It has further been found that most of the amino-acids which build up the proteins, undergo the same change, the non-nitrogenous part being to a greater or less extent converted to sugar, the nitrogenous part being excreted as urea. Claude Bernard had discovered that, after feeding a dog, which had fasted till all the stored carbohydrates of the liver had disappeared, on lean beef, glycogen, the precursor of sugar, appeared in the liver.

(b) The question of whether the liver can form sugar from the *fats* of the body is more difficult to answer. The argument in favour of such a conversion is that in many cases of pancreatic diabetes the amount of sugar formed is more than could be derived from the proteins decomposed, as indicated by the nitrogen excreted. Hence, it would seem that it must be derived from the fats.

(2) *Storing Sugar as Glycogen.*—The liver not only manufactures sugar for the muscles when the supply from outside is cut off, but it also has the power of storing sugar derived from an excess of carbohydrates in the food, or from an excess of proteins. This it does by converting the monosaccharid into a polysaccharid—animal starch, or **glycogen**. This substance accumulates in the protoplasm of the cells, and its presence may be demonstrated by staining with iodine. Since the same glycogen is derived from all the single sugars, lævulose (a ketose) as well as dextrose (an aldose), the liver protoplasm must perform a chemical change in the process of synthesising them into glycogen, from which dextrose alone is formed. The storage of glycogen may be very great, amounting in certain conditions to as much as 10 per cent. of the weight of the liver.

(3) *Conversion of Glycogen to Dextrose.*—When sugar is required by the muscles, it is again converted to glucose, and passes off in the blood. This subsequent conversion of

glycogen to glucose is generally ascribed to the action of an hepatic *diastase*. This conclusion is supported by the fact that the liver tissue, after prolonged treatment with alcohol, has an active diastatic action. But (i) fresh liver has no greater diastatic power than any other tissue. (ii) While the conversion of glycogen to glucose in the liver removed from the animal immediately after death, is at a maximum during the first few minutes and gradually decreases, the conversion of glycogen to glucose, under the influence of liver tissue treated with alcohol, gradually reaches a maximum in an hour and gradually wanes. (iii) It has also been shown that the injection of methylene blue, which poisons protoplasm, but does not interfere with the action of enzymes, checks the conversion, and (iv) that stimulating the splanchnic nerves going to the liver increases the conversion of glycogen, without increasing the amyolytic enzyme in the liver and blood. It is therefore possible that the conversion results from chemical changes in the protoplasm which are controlled by the nerves of the liver. These nerves are derived from the true sympathetic system.

Carbohydrate Tolerance.—If more sugar is taken than the liver can deal with, it passes on into the general circulation, and is excreted in the urine. Every animal has a certain power of oxidising or of storing sugar. If the carbohydrates are taken as starch instead of sugar, the process of digestion and the slower absorption enables the liver to deal with much larger quantities. The carbohydrate tolerance varies greatly, and even in the same animal it is different under different conditions.

Glycosuria.—If the limit of carbohydrate tolerance is overstepped, sugar increases in amount in the blood (*glycæmia*) and appears in the urine. Glycosuria is produced.

Glycosuria may be caused in several different ways.

1. By decreased carbohydrate tolerance—**alimentary glycosuria** (fig. 160).

2. When the glycogen stored in the liver is changed to glucose more quickly than is required by the tissues, the glucose may, to a small extent, be again stored in the

muscles as glycogen (p. 352), or it may accumulate in the blood and be excreted in the urine. This latter condition is seen when large doses of **adrenalin**, the active principle of the medullary part of the suprarenal bodies (p. 593), is injected subcutaneously. This substance has a specific action on the termination of the true sympathetics, and, in all probability, it acts upon the termination of the splanchnic nerves in the liver to increase the conversion of glycogen to

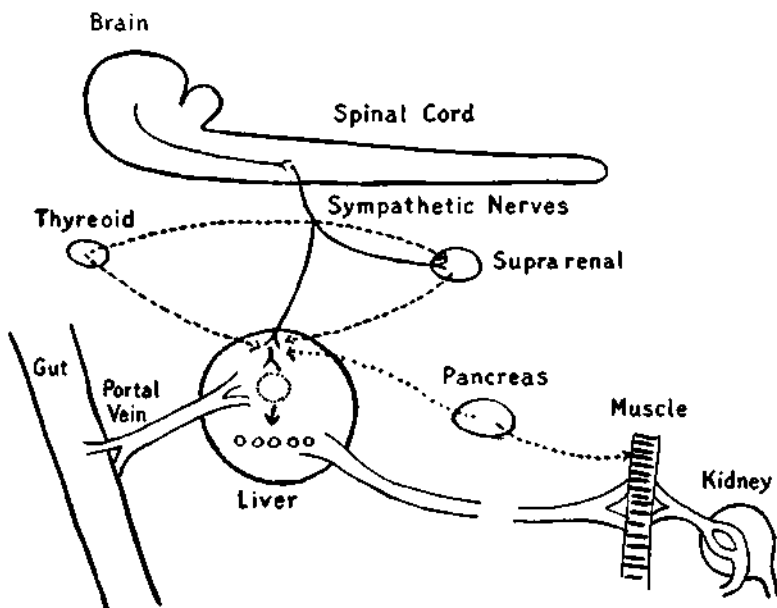

FIG. 160.—To show the various ways in which glycosuria may be produced (see text).

glucose. Ergotoxin, which checks its action elsewhere (p. 592), also limits its power of causing glycosuria (fig. 160).

3. The condition is also caused, if the liver is rich in glycogen, by **puncturing the posterior part of the floor of the fourth ventricle of the brain**. Since this effect is not produced after the suprarenals have been removed, it has been concluded that it is due to a stimulation of these structures through the splanchnic nerves by which an increased outpouring of adrenalin is induced. This might

act in the same way as the administration of large doses of adrenalin. It is probable that two elements are involved—(a) the stimulation of the suprarenals, and (b) the stimulation of the branches of the splanchnic nerves to the liver and that the latter action is merely facilitated or activated by the former, since the accumulation of adrenalin in the blood found in puncture diabetes is not sufficient in itself to cause the glycosuria, and since M'Leod found that section of the hepatic nerves generally prevents its onset (fig. 160).

4. The injection of phloridzin and some other substances such as chrome salts, or even solutions of neutral sodium salts, also causes sugar to appear in the urine. Under the influence of these, the sugar in the blood is not increased. It must be concluded that they act by causing the kidneys to excrete glucose too rapidly, so that it is not available for the tissues. But, even when carbohydrates are withheld or cleared out of the body, phloridzin causes glycosuria. Hence, a formation of glucose from the proteins of the blood plasma must occur (fig. 160).

5. Removal of the pancreas also causes glycæmia and glycosuria. This may be prevented by transplanting a piece of the pancreas under the skin if the graft grows (p. 601). The pancreas forms something which (i) checks the conversion of glycogen to glucose in the liver, so that, when it is removed, this process goes on too rapidly. (ii) At the same time the utilisation of sugar by the muscles seems to be interfered with. This failure to use sugars is indicated by the fact that the respiratory quotient (p. 258) is low in diabetes, indicating that proteins and fats are being used and not carbohydrates, and that it is not raised when sugar is administered. The carbohydrates of the food are no longer available as a source of energy, and the animal has to use proteins and fats alone.

(i) But the part of the *proteins* which is normally used as a source of energy is the non-nitrogenous, and this is not available and is simply excreted as sugar. Hence, although the animal decomposes its proteins, the non-nitrogenous part is lost as sugar, and energy is not got from them.

(ii) Nor are the *fats* fully available, because the metabolism of carbohydrates is necessary for their combustion, and this is in abeyance. As a result of this incomplete metabolism of fats, β -oxybutyric acid is produced, which leads to a decrease in the alkalinity of the blood and tissues, to a condition of *acidosis*.

The β -oxybutyric acid is not oxidised to CO_2 and H_2O as it normally is, but is converted to diacetic acid, and this in turn to acetone, and these bodies may be detected in the urine (*Chemical Physiology*).

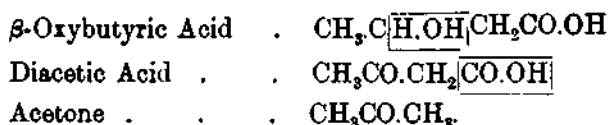

Hence, in fully-developed pancreatic diabetes, none of the proximate principles of the food yield the energy required, and the animal or man rapidly becomes weak, emaciates and dies.

2. **Regulation of the Supply of Fats**—(1) **Storage**.—The fats leave the intestine not by the blood of the portal veins which goes straight to the liver, but through the lymphatics which enter the blood stream, just where it returns to the heart, through the thoracic duct. They thus reach the liver by the arterial blood. Nevertheless, when taken in excess of the immediate requirements, they are stored in large amounts in the liver of some animals—*e.g.* the cod among fish and the cat among mammals. Animals which have little power of storing fat in the muscles and other tissues seem to have a marked capacity for accumulating it in the liver. Even in starvation, the fats do not disappear from the liver, and throughout all conditions of life a fairly constant amount of *lecithin* (p. 20) is present in the liver cells. *Lecithin*, in the yolk of the egg, is an intermediate stage in the formation of the more complex nucleins of living cells; and the formation of *lecithin* in the liver by the synthesis of glycerol, fatty acids, phosphoric acid, and *cholin* is probably a first step in the construction of these

nucleins. The fat of the liver thus plays an important part in retaining and fixing phosphorus in the body.

(2) **Change in Liver.**—The fats of the liver have a higher iodine value than the fats of adipose tissue, *i.e.* they are less saturated, and the theory has been advanced that this indicates that in the liver the first stage in the breaking down of fats takes place, in preparation for their use in the muscles. When the fatty acid chain has two hydrogens removed at any point so that a double link between carbon atoms is formed, this becomes a weak point in the chain at which the higher acids are apt to break across with the production of lower acids.

Lower fatty acids, liberated by the de-aminisation of certain amino-acids from proteins, *e.g.* leucin, tyrosin, phenyl-alanin are not changed to glucose (p. 354) but to β -oxybutyric acid, which is oxidised.

3. **Regulation of the Supply of Proteins.**—The part played by the liver in the storage of the surplus amino-acids formed from proteins and in their de-aminisation, and the conversion of the amidogen to urea, has already been indicated (p. 349). When the supply of amino-acids is too large, or when the liver is not acting properly in grave hepatic disease, this conversion takes place imperfectly and amino-acids appear in the urine.

Urea is the bi-amide of carbonic acid.

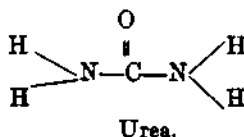
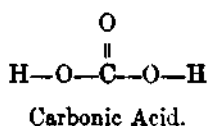

It contains 46.6 per cent. of nitrogen. It is a white substance crystallising in long prisms. It is very soluble in water and alcohol—insoluble in ether. With nitric and oxalic acids it forms insoluble crystalline salts. It is readily decomposed into nitrogen, carbon dioxide and water by nitrous acid and by sodium hypobromite in excess of sodium hydrate (*Chemical Physiology*).

Urea is chiefly formed in the Liver.—This is indicated—(1) By the fact that when an ammonium salt, such as the carbonate, dissolved in blood, is streamed through the organ, it is changed to urea; (2) by the evidence that the liver stores the surplus amino-acids, and that, as they again disappear from the liver, urea increases in the blood; (3) by the observation that, when the liver is cut out of the circulation, the urea in the urine rapidly diminishes, and ammonia and lactic acid take its place.

The exclusion of the liver from the circulation in mammals is difficult, because, when the portal vein is ligatured, the blood returning to the heart tends to accumulate in the great veins of the abdomen. But this difficulty has been overcome by Eck, who devised a method of connecting the portal vein with the inferior vena cava, and afterwards occluding the portal vein, and of thus allowing the blood to return from the abdomen to the heart without passing through the liver.

That it is not produced in the *kidneys* was first shown by the French chemist Dumas. He found that when these organs are excised, urea accumulates in the blood. Later investigators found that when ammonium carbonate is added to blood artificially circulated through the kidney of an animal just killed, no urea is formed.

That it is not formed to any marked extent in the *muscles* is shown—(1) By the absence of a definite increase in urea formation during muscular activity; (2) by the fact that when the blood, containing ammonium carbonate, is streamed through the muscles, urea is not produced.

The Sources of Urea.—(1) The source of urea from the amino-acids formed in the digestion of proteins in the food has already been discussed (p. 349). (2) But urea is also formed during starvation, and it must therefore be derived from the proteins of the tissues. It has been found that in starvation there is an increase of the amino-acids in such tissues as muscle, and it would thus seem that they are products of the disintegration of the muscle proteins, and that they are carried to the liver to be converted to urea.

The fate of hæmoglobin tends to show that the whole

process of protein catabolism may be conducted in the liver cells. When hæmoglobin is set free from the corpuscles in moderate amounts, the nitrogen of its protein part is changed to urea, while the pigment part is deprived of its iron and excreted as bilirubin.

The process of urea formation from proteins may be divided into four stages—(1) The liberation of the amino-acids. (2) The de-aminisation of the amino-acids. This is probably effected by de-aminising enzymes. (3) The ammonia set free is probably linked to carbonic acid; and (4) the carbonate of ammonia is then dehydrated by other enzymes and so changed into urea (p. 559).

The nitrogen excreted is not all in the form of urea. The other nitrogen-containing waste products are dealt with on p. 559 *et seq.*

Summary of the Functions of Liver.—The functions of the liver may be briefly summarised as follows:—(1) It regulates the supply of glucose to the muscles (*a*) by manufacturing it from proteins when the supply of carbohydrates is insufficient, and (*b*) by storing it as glycogen when the supply of carbohydrates is in excess, and giving it off afterwards as required. (2) Along with the intestinal wall, it regulates the supply of proteins to the body by de-aminising any excess, conserving the non-nitrogenous part by converting it into glucose for use by the muscles, and giving off the nitrogen, as urea, etc. (3) It regulates, in many animals at least, the supply of fat to the body by storing any excess; and it probably plays an important part in de-saturating the fatty acids, and thus making them more available for combustion in the tissues. (4) It breaks down the hæmoglobin of old erythrocytes, and retains the iron for further use (see p. 491). (5) From the part it plays in the enterohepatic circulation, it protects the body against certain poisons by excreting them in the bile (see p. 331).

The Fæces.

The unabsorbed contents of the alimentary tract, whether originally derived from the food or from the tract itself, are

constantly being passed onward to the lower part of the large intestine. Here absorption of water leaves a more or less inspissated mass which collects and is periodically voided as the fæces.

(1) **Carnivora.**—(a) In **fasting animals**, fæces are passed at long intervals, and consist of mucin, shed epithelium, the various products of the bile constituents, inorganic salts, and enormous numbers of bacteria.

(b) In **feeding animals** the amount and character of the fæces depend largely (1) upon the amount and character of the food; and (2) upon the bacteria which are growing in the large intestine. If digestion and absorption of food are complete, the fæces are the same on different diets, and consist of the intestinal products, which are increased in amount by the stimulating action of the food in the alimentary canal.

The solids of the fæces of a feeding animal consist of the same constituents as the fæces in a fasting animal, with the addition of the undigested constituents of the food—elastic and white fibrous tissue, remains of muscle fibres, fat, and the earthy soaps of the fatty acids, the fat forming about one-third of the weight of dry fæces. When a vegetable diet is taken, the cellulose of the vegetable cells, and sometimes starch, are present. The cellulose, by stimulating the intestine, is a valuable natural purgative.

Phosphates, as well as calcium, magnesium, and iron, derived from the metabolism of the tissues, are largely excreted into the large intestine, and are passed out in the fæces.

Probably in an ordinary mixed diet some 30 to 40 per cent. of the phosphorus, about 90 per cent. of the calcium, some 70 per cent. of the magnesium are excreted in the fæces.

The odour is due to the presence of many different substances, and it varies with the character of the bacterial flora of the large intestine.

(2) **Herbivora.**—In these the residual products of digestion are very bulky and evacuation is more frequent than in carnivora. The horse usually defæcates about ten times a day. The amount passed in twenty-four hours varies with the nature of the food. On an ordinary diet about 15 kilos per diem are passed by the horse, and about 20 by the ox.

An idea of the average amount of water present is shown in the following table given by Gamgee:—

Approximate percentage Composition of the Fæces.

	Horse.	Cow.	Sheep.	Pig.
Water	76	84	58	80
Organic Matter	21	13·6	36	17
Mineral Matter	3	2·4	6	3
	100	100	100	100

When first passed fæces usually float in water owing to the amount of gas contained in them. They are nearly always acid in reaction from the presence of organic acids.

As in carnivora fæces consist of material derived from two sources—(1) food residues ; and (2) excretions by way of the intestines.

Food Residues.—These consist of indigestible material such as lignin and waxes, which pass through the gut unchanged, and also of material that has escaped digestion either because as in the case of cellulose digestion is difficult, and only part is dealt with, or because it is protected by an envelope that is not dissolved by the digestive juices. This part consists chiefly of the constituents of the crude fibre of the diet.

Excretions.—These consist of the same material as in the case of carnivora. Inorganic matter, *e.g.* calcium, magnesium, iron, and phosphates are, however, excreted by the bowel to a much greater extent than in carnivora.

Meconium is the name given to the first fæces passed by the young after birth. It is greenish-black in colour, and consists of inspissated bile and shed epithelium from the intestine.

Availability of Food-Stuffs.

Only that part of the food which is digested and absorbed is available as a source of either energy or material to the animal. In carnivora the indigestible residue is very small. In herbivora, however, a very large proportion of the food is not digested. In comparing the value of different food-stuffs, therefore, it is necessary to know what proportion is available.

In the literature of animal nutrition the term "digestibility" is used in a specific sense. It denotes the percentage of the food or of any constituent of the food that is absorbed from the alimentary tract. Thus in a digestion experiment on a horse, 57 per cent. of the protein of hay was apparently digested and absorbed as that proportion was not recovered in the fæces. The "digestibility" of the protein of hay for the horse in this case is said to be 57 per cent. The percentage of digestibility is often termed the "coefficient of digestibility."

Digestion Experiments.

The availability of food-stuffs is determined by digestion experiments. In these the animal is fed on a weighed quantity of the food to be tested for a preliminary period of about ten days to make sure that the previous food has completely passed out of the intestinal tract. The feeding is then continued for another period of not less than ten days, during which time twenty-four hourly collections of fæces are made. The difference between the amount of each constituent of the food eaten and that found by analysis in the fæces is regarded as the digested portion.

Concentrates cannot be fed alone to ruminants. Their availability is determined by superimposing a weighed quantity upon a roughage diet, whose availability has been previously determined. The increased amount of the various constituents found in the fæces is regarded as the undigested matter of the concentrate tested.

Accuracy of the Method.—Digestion experiments, though of great use, indicate only *apparent* digestibility. The issue is confused by (1) excretory products; and (2) loss through fermentation.

(1) Nitrogenous substances, ether soluble substances, and inorganic salts are present in the fæces even if absent in the food (p. 362). The smaller the amount of these present in the food the greater is the percentage error due to excretory products; with fats and salts the error may be so great as to make the results of little value as a means of determining the *real* amount digested.

In the case of protein an attempt has been made to differentiate between *excretory nitrogen* and *undigested nitrogen*, by regarding nitrogenous material which can be rendered soluble by pepsin and hydrochloric acid as excretory, and that which remains insoluble as undigested nitrogen. It has also been suggested that for every 100 grams of dry matter in the food, 4 grams of nitrogen of the *faeces* should be regarded as excretory nitrogen.

Even if precautions such as those indicated be taken, the results of digestion experiments on food-stuffs with small amount of nitrogenous constituents should be received with caution. It is probable that in the adult animal at least, a more accurate determination of the percentage digestibility of nitrogenous material would be obtained by regarding the urinary nitrogen as an index of the amount digested and absorbed, instead of taking the *faecal* nitrogen as an index of the amount not digested (see p. 558 *et seq.*).

(2) The part of the crude fibre and soluble carbohydrate that disappears in transit through the alimentary canal is not all digested. Part is lost through destructive fermentation (p. 340). In estimating the availability of the food, this must be taken into account. The excretion of methane and hydrogen gives an indication of the extent of the fermentation. According to Armsby, the following deductions should be made for fermentation losses :—

Factors for computing Fermentation Losses.

Per 100 grams digested carbohydrates—		
	Weight.	Equivalent Energy.
	Grams.	Calo.
Ruminants—Methane	4.5	60.1
Swine—Methane	0.65	8.7
Hydrogen.	0.07	2.4
Total	0.72	11.1
Per 100 grams digested crude fibre—		
Horse—Methane	4.7	62.7
Hydrogen	0.2	7.0
Total	4.9	69.7

The loss in the pig is comparatively small. In the horse fermentation occurs in the cæcum and colon after the food has passed through the small intestine. Consequently, it is chiefly the crude fibre, the constituent that has resisted the digestive processes that is affected.

Factors affecting Availability—(1) Species.—Concentrates are equally well digested by all farm animals. Differences occur in the availability to digest fodders, or other food-stuffs containing much crude fibre. These are utilised more completely by the ruminant than by the horse. The following table shows the average percentages of the constituents of oats and hay digested by the horse and the sheep :—

Hay.	Nitrogenous Material.	Ether Extract.	Carbohydrates (Nitrogen Free Extract).	Crude Fibre.
Horse	57	24	55	36
Sheep	57	51	62	56
Oats.				
Horse	86	71	74	21
Sheep	80	83	76	30

The pig digests pure cellulose well, but owing to the lack of a macerating compartment like the rumen of the ox or the cæcum and colon of the horse, fibre with encrusting material in it is very incompletely digested. Of the crude fibre of ordinary feeding-stuffs it digests little more than 50 per cent. of the amount digested by the ruminant.

(2) **Amount of Food.**—The availability of the food is little affected by the amount eaten unless on heavy mixed feeding with fodder and concentrates, in which case the percentage digested is decreased. The decrease is due to the too rapid passage of the food through the alimentary tract. On feeding with fodder alone, however, the results of experiments show that the amount eaten makes no appreciable difference on the percentage digested.

(3) **Cooking and Grinding.**—Starchy foods like potatoes are more completely digested after cooking. With this exception cooking usually decreases the percentage digested, proteins being especially affected.

For horses and swine the digestibility of grain is increased by crushing, and still more by grinding. In

ruminants whole grain is digested as completely as crushed grain.

(4) **Watering.**—It is commonly believed that drinking after eating tends to wash the food out of the stomach and decrease the amount digested, and that therefore animals, and especially horses, should be watered before being fed. According to Scheunert, however, water drunk by the horse after feeding, passes between the wall of the stomach and its contents to the duodenum with very little disturbance or dilution of the contents, and experiments by Tangl show that less water is drunk and the food is not so completely digested when watering takes place prior to feeding, and no water is allowed during or after feeding. These results agree with those obtained on both dogs and men.

Unless there be some good reason supported by experimental evidence, the prevention of an animal from drinking either before, during, or after feeding according to its inclination does not seem to be warranted. It should be noted, however, that in watering and feeding any sudden change in a system that the animal has been accustomed to may lead to disturbance of the digestive functions.

(5) **Proportion of Constituents of Food.**—Excess of carbohydrates in the diet decreases the percentage availability of all the constituents, but especially the *apparent* availability of the nitrogenous substances. According to Kellner, decreased digestion occurs when the nutritive ratio (p. 368) is wider than 1.8 in ruminants and 1.12 in pigs.

Armsby suggests that the decrease in the amount digested is caused by a modification of the fermentation processes due to the presence of excessive amounts of soluble carbohydrates which bacteria attack in preference to the crude fibre. The fibre consequently escapes disintegration and carries off the contained digestible constituents. On the addition of protein to the diet the digestibility is increased, the reason assigned being that the increase of nitrogenous material stimulates the multiplication and activity of the bacteria.

As Kellner has pointed out, the apparent decrease in the percentage of protein digested is not a true decrease. As

the undigested nitrogen in the faeces decreases in amount, as occurs on a low nitrogen intake, the relative proportion of excretory nitrogen becomes greater, so that on a very low protein intake the apparent amount digested may become a negative quantity.

FOOD REQUIREMENTS.

Food is the source of (1) *the energy*, and (2) *the material* (p. 283) which the animal kept for profit transforms into the products desired by the feeder. Thus, the horse changes the chemical energy of oats and hay into work. Grass and other food-stuffs are changed by the dairy cow to milk, by the bullock to meat, by the sheep to mutton and wool. The problem of the feeder is to secure the greatest return of these products with the most economical consumption of food.

Nutritive Ratio.—Protein is of special importance in the food. This constituent can replace fats and carbohydrates as a source of energy, but none of the other constituents of the food can replace protein as the source of material for growth and repair (p. 275). In comparing the values of different food-stuffs or combination of food-stuffs, therefore, it is necessary to know what proportion of the energy value of the *digestible portion* of the food consists of protein. This is expressed by the nutritive ratio, sometimes called the “albuminoid ratio.” It might be written—

Protein : fats + carbohydrates = nutritive ratio.

In calculating the ratio it must be remembered that fats can liberate, weight for weight, about two and a quarter times as much energy as carbohydrates (p. 257). Fats are therefore multiplied by 2.25. For example, if a sample of meadow hay contained the following percentage of digestible nutrients—nitrogen free extract 28, crude fibre 15, fats 1.2, protein 5—the nutritive ratio would be—

$5 : 28 + 15 + 1.2 \times 2.25$, *i.e.* 5 : 45.7, or 1 : 9.14.

The ratio gives useful information as to the suitability of a food for purposes that require much protein, *e.g.* growth

or milk production, or for purposes that require less protein, *e.g.* work, fat formation or maintenance without production. As protein is usually the most expensive energy yielding constituent of the food, a knowledge of the nutritive ratio is of importance to feeders.

1. Methods of determining Requirements.

1. **Live Weight Test.**—In these, the value of the food in meeting the requirements of the animal is determined by alterations in live weight. When the weight increases, the food is providing more than the maintenance requirements, and the excess is being stored in proportion to the increase in weight. When the weight decreases the food is deficient, and the animal is using its own tissues as a source of energy. In the case of dairy cows, of course, the milk secreted must be taken into account.

Provided a large number of animals be considered and the weighing be continued over a long enough period, these experiments give results of practical value. Normally, however, the weight fluctuates from day to day, especially in the case of ruminants, owing to the great weight of the contents of the intestinal tract. A bullock may vary from day to day as much as 20 kilos, the change being in the contents of the gut, and not in the living tissue of the animal.

2. **Slaughter Tests.**—In these experiments a group of animals as nearly identical as possible in age and condition are taken. Some are killed and the carcasses analysed. The others are fed for varying periods before being killed and analysed. The difference in those analysed before feeding and those after feeding is taken as an indication of the value of the food.

In these experiments, which are very laborious and require a long time to carry out, it is *assumed* that the animals killed at the beginning of the experiment are identical in percentage composition with what the fed group were at the beginning.

3. **The "Balance Sheet" Experiment.**—An exact determination of the food requirements of an animal and of the value of any food-stuff in meeting these requirements can only be

determined when a complete detailed account is kept of the intake and output of both energy and material. This can be done by the use of the calorimeter (p. 259), which registers the amount of energy liberated, and also the consumption of oxygen and the output of carbon dioxide in the expired air. The additional information obtained by analysis of the collected urine and faeces give a complete account of the *sum of the changes* in the food taking place within the body. The energy and material intake in the food can be compared with the energy and material output and the gain or loss determined. The comparatively few complete balance experiments which have been done on large animals have afforded valuable information as to food requirements and the productive value of the different feeding stuffs and their constituents.

Protein Requirements.—Protein beyond the requirements for construction and repair of tissues is catabolised yielding energy, the nitrogen being excreted in the urine. By substituting carbohydrates and fats as a supply of energy the protein intake may be reduced. When the intake is reduced below the level of the protein requirement, the protein of the tissues is used and consequently the nitrogen of the urine exceeds that in the food.

The *minimum* protein requirement therefore can be determined by the lowest intake which is just balanced by the urinary nitrogen plus a small estimated amount for loss in nitrogen excretions in faeces and in hair, hoofs, etc.

In lactating animals account must be taken of the loss to the body of the protein of the milk. In young animals, the question is complicated by the growth of new tissue.

The *minimum* amount of protein is not necessarily the optimum amount. It is found in man, at least, that when reduction of protein in the diet reaches a certain level more than isodynamic quantities of fats and carbohydrates must be substituted to maintain nitrogenous equilibrium, so that, on a very low protein intake, the total caloric intake is increased. Further, the influence on the availability of the food (p. 367), and also the fact that all proteins are not of equal value (p. 276), must be considered. It is usual therefore in

computing rations to allow a margin of safety in fixing the nutritive ratio.

2. Rations.

Feeding tables are contained in text-books on animal nutrition. Owing to the number of different kinds of animals and different kinds of production aimed at in feeding, these tables are somewhat extended. It is only necessary here to indicate the physiological principles on which feeding standards should be based.

In arranging rations, the chief consideration is that *available* energy and material will be supplied in sufficient amounts to yield the desired products, *e.g.* work, milk, or increased weight. It is also usually necessary to arrange by a combination of different feeding stuffs that the total bulk will be suitable for the animal. In practice, other considerations such as relative costs, manurial values (p. 380), and the labour involved in preparing the food, are taken into account in deciding what feeding stuffs and what combinations and proportions of these are most economical.

1. **Maintenance.**—A maintenance ration is one that supplies just sufficient energy and protein to sustain life without production and without either gain or loss of tissue. This ration is the *commercial base line*, since it is only what the animal assimilates *beyond* its maintenance requirement that can be transformed to a marketable product.

The ration must cover the basal metabolism (p. 264) plus the increased metabolism due to the consumption of the food (p. 272). If the environment be below the critical temperature (p. 271), a further addition is necessary for heat production to maintain the body temperature.

A horse of 1000 lbs. weight housed comfortably and doing no work requires a daily ration the digestible nutrients of which yield about .5 kilos protein and 15,000 Calories.

2. **Growth**—(1) **Material.**—In the growing animal there is formation of new tissue and bone. The food therefore must be rich in protein and ash. The rate of growth diminishes from birth onward, and, therefore, the younger the animal the higher is the proportion of protein and ash required. Experi-

mental results obtained by Bull and Emmett show how the protein requirement relative to weight decreases with age.

Age (Lamb) Months.	Protein requirement in food per 1000 lbs. live weight.
5	0.32
7	0.27
9	0.23
15	0.17

The milk of the mother contains the material necessary for growth in the requisite proportions. Bunge has shown that the proportion of protein and ash in milk varies with the rapidity of growth.

	Time in days to double weight.	Milk contains	
		Protein.	Ash.
Horse	60	2.0	.4
Calf	47	3.5	.7
Dog	8	7.1	1.3

The accessory factors (p. 281) are of importance in growing animals in confinement after the sucking is stopped, especially when the food is cooked. It is probable that certain diseases to which young pigs are liable are really nutritional disorders caused by the absence of these.

A deficiency of calcium and phosphorus limits bone formation. In pigs it is usual to allow free access to a mineral mixture containing these.

(2) **Energy.**—The available energy of the food must be sufficient (1) to meet the maintenance requirement, *i.e.* the amount liberated as heat, and (2) to supply an amount of energy equal to that contained in the new tissue formed.

The maintenance requirement can be determined by the calorimeter (p. 259). It is greater per unit of surface in the growing than in the full-grown animal. It is certain that energy is expended in the structural organisation of growing tissue, but to what extent is not known.

The energy content of the new tissue is determined by slaughter tests (p. 369). It is found to vary with age, being less in very young animals, where the increase is chiefly in protein tissue, which contains about 75 per cent. of water, and greater as the animal approaches maturity, when a higher proportion of the increase is fat.

Rations vary for different species. According to Murray, the food for growing cattle should contain as follows :—

Live Weight. Lbs.	Digestible Nutrients.	
	Protein. Lbs.	Calories.
300	·63	9,300
400	·70	10,974
500	·78	12,276
600	·85	13,950
700	·93	15,252

3. **Fattening.**—In the full-grown animal there is no growth of muscle tissue ; the process of fattening therefore consists essentially of changing to fat the food absorbed beyond what is utilised by the animal for its maintenance. It is estimated that when the maintenance energy requirements have been met, about 40 to 50 per cent. of the excess energy of the digestible nutrients of the food can be stored in fat.

Ordinary food-stuffs contain very little fat. Carbohydrates form by far the most important source of the fat deposited during fattening (p. 351). It is doubtful whether proteins can form fat except indirectly by first being changed to carbohydrates (p. 354), and only certain of the amino-acids yield these. On the average about 50 per cent. of protein is convertible to carbohydrates, the deaminised portion of the remainder being catabolised, yielding heat (p. 272). In cold weather proteins may replace carbohydrates in producing heat—an uneconomical process, as protein is the most expensive constituent of the food. In full-grown animals there is no need for the nutritive ratio to be higher for fattening than for maintenance. If the ratio be kept constant, the increased amount of food will supply all the extra protein that the animal can utilise in the process of fattening. In practice, the percentage of protein is often higher, because many of the concentrated foods used contain relatively large proportions of this constituent. It is probable that on a diet with a high percentage of protein the return on the protein in fattening is in increased manurial value rather than in increased fat formation.

As the object in fattening is to get the greatest increase in weight in the shortest time, the animal is fed to the fullest

capacity of its digestive powers, and concentrated foodstuffs are added to the ration to increase its energy value. A bullock should increase in weight about two pounds per day when receiving a ration containing digestible nutrients yielding 30,000 Calories and .75 to 1.5 lbs. of protein.

4. Meat Production.—In meat production, the animal *before it reaches maturity* is confined and subjected to intensive feeding. The process of fattening is thus superimposed upon the process of growth, and so muscle formation and deposition of fat proceed simultaneously. Some of the fat is deposited between the muscle bundles, producing the so-called “marbling” of the meat upon which its quality largely depends.

As in fattening in the adult animal, the object desired is to get as large an increase in weight per day as possible. The animal therefore is allowed to eat as much as it can digest, and concentrated foods are given to increase the energy value of the ration. The total energy of the food given is usually about twice the maintenance requirement. The proportion of protein varies with the rate of growth, being greater the younger the animal. According to Haecker's standard, the ration of meat-producing bullocks should be as follows:—

Live Weight. Lbs.	Digestible Nutrients per 1000 lbs. live weight.		
	Protein. Lbs.	Carbohydrates. Lbs.	Fats. Lbs.
200	3.05	11.6	0.55
500	1.90	11.1	0.60
1000	1.64	9.5	0.48

5. Milk Production.—The food requirement in dairy cows depends upon the amount of milk produced. According to Kellner's experiments, after the maintenance requirement is met, from 60 to 70 per cent. of the excess energy of the digested food is recovered in the energy values of the constituents of the milk. The protein is much better utilised for milk production than for fat formation. In some experiments nearly 100 per cent. of the excess above maintenance requirement has been recovered in the milk. The value of protein for milk production varies with the amino-acid content (p. 276). Casein stands highest. The proteins of maize and wheat are of much less value.

Haecker's standard for dairy cows allows for maintenance for a 1000 lbs. cow 0·7 lbs. of protein, 7·0 lbs. of carbohydrates, and ·1 lb. of fat. The additional food requirement for the production of the milk varies with the composition of the milk, which is judged by its fat content.

Fat as Milk. Per Cent.	Digestible Nutrients required per lb. Milk.		
	Protein.	Carbohydrates.	Fat.
2·5	·0446	·176	·0151
3·0	·0469	·199	·0170
3·5	·0492	·221	·0189
4·0	·0539	·242	·0208
4·5	·0572	·264	·0226

6. **Work.**—The efficiency of the horse and its capacity for mechanical work have been considered (p. 252). (a) The *energy* of the food must cover the maintenance requirement (p. 371). If the efficiency be taken as $33\frac{1}{3}$ per cent., the food must in addition supply $3\frac{1}{3}$ times the energy expended in mechanical work. It is estimated that a horse of 1000 lbs. weight, working a full day of eight hours, will do work equivalent to between 4000 and 5000 Calories. The food therefore should contain between 12,000 and 15,000 Calories, in addition to the maintenance requirement.

(b) The protein metabolism is little affected by work, so long as a sufficient supply of carbohydrates and fats are available as a source of energy (p. 262). There is therefore no need for any marked increase of the protein above the maintenance requirement.

The food requirement for a working horse, doing a full eight-hour day's work, should yield about 1 to 2 lbs. protein and 30,000 Calories, *i.e.* nearly double the maintenance requirement.

3. Feeding Standards.

Various feeding standards have been proposed as guides to feeders. In these, the food required for different animals and for different kinds of production are usually stated in lbs. for an animal of a fixed weight—1000 lbs. live weight for large animals. The ration for any individual animal can be calculated according to its weight (p. 265).

Three standards which are commonly used may be briefly

indicated. They illustrate three different methods used to compare the values of different feeding stuffs.

(1) **The Wolff-Lehmann standards** were first published by Wolff in 1864, and were the basis of further work done on the subject. They were modified later by Lehmann. The requirements are stated in terms of lbs. of total dry substances, and of digestible protein, carbohydrate, and fat. The nutritive ratio is also given.

These standards were originally based on the conception that protein was especially valuable for fat formation and for work. The protein requirement therefore as stated is too high. The part of the food-stuff taken as digestible is the *apparent* digestible portion (p. 364). This is not a certain indication of its energy value to the animal. From this should be deducted—(1) the loss of energy in fermentation, and (2) the energy of certain non-nitrogenous substances that appear in variable amounts in the urine of herbivora). These substances are chiefly derived from the fodders, and consequently the energy value of fodders as calculated from the *apparent* digestibility is less than the real energy value. The productive value of a food therefore is not always the same as the value calculated from the digestible nutrients.

(2) **Kellner's Standards.**—In these it is recognised that the apparent digestibility of a food is not a reliable indication of its productive value. Foods are therefore compared according to their *fat-forming* value. Starch is taken as the standard, and it is estimated by Kellner that the fat-forming power of the digestible nutrients of the food bear the following relationship to starch :—

1 part protein	= 0.94 parts starch equivalent.
1 part fat, in coarse fodders, chaff, and roots	= 1.91 " "
1 part fat, in grain	= 2.12 " "
1 part fat, in oil seeds	= 2.41 " "
1 part nitrogen-free extract and crude fibre	= 1.00 " "

The value of a food is determined by multiplying the

percentage of the respective digestible constituents by these factors and then *deducting* a certain percentage of the total. The deduction is supposed to represent the loss of fat-forming value due to energy expended in "the work of mastication and of digestion." It includes loss in fermentation and in the non-nitrogenous substances in the urine. The percentage to be deducted is indicated in Kellner's tables, where each food-stuff is assigned a "value" which varies roughly, inversely with the amount of crude fibre in the food. The lower the value the greater is the percentage to be deducted. It is taken as 100 minus the value number. The method of calculation is shown by the following example given for rape cake:—

24·8%	digestible proteins	× 0·94	= 23·3%	starch equivalent.
6·3%	digestible fat	× 2·41	= 15·2%	„
20·5%	digestible nitrogen			
	—free extract +			
	crude fibre	× 1·00	= 20·5%	„
	Total .		59·0%	starch equivalent.

The "value" of rape cake is 95, so 5 per cent. is deducted. The final result, 56 per cent., is termed the "starch value," or "starch equivalent" of rape cake. It means that 100 lbs. of rape cake is equal in value to 56 lbs. of starch.

Certain modifications of the method of calculation are advised in the case of food stuffs containing much crude fibre.

In Kellner's standards, food requirements are stated in lbs. of protein and lbs. of starch. In the tables showing the composition and digestibility of the various food-stuffs, a starch value is assigned to each. The object aimed at in the system is to give a common basis for comparing the productive value of the various feeding stuffs.

This starch equivalent method of comparing the values of food-stuff is widely used in this country. It is of doubtful value. The use of a pound of starch as the unit for

measuring what is essentially the energy of a food leads to confusion. The logical as well as the simplest unit for this is the Calorie. The method of calculating the starch value is open to question. One gram of protein is almost certainly not equal to 0.94 grams of starch for fat formation on account of its specific dynamic action (p. 272). In foodstuffs rich in protein the error must be considerable. Even if the relative starch values be taken as accurate, the values are for fat formation and are not applicable without error for other purposes.

(3) **Armsby's Standard.**—In these, food requirements are stated in terms of pounds of digestible protein and "therms" of "net energy," and the accompanying tables of food values give the lbs. of protein and therms of net energy per 100 lbs. of the different food-stuffs. A therm is 1000 calories. "Net energy" is available energy minus the energy liberated as heat in the increased metabolism due to food consumption. It is regarded as the "productive energy value" of the food.

The following extracts illustrate the way in which the food requirements and food values are stated:—

Maintenance requirements for Cattle.

Live weight.	Digestible Protein. Lbs.	Net energy. Therms.
500	0.25	3.78
750	0.38	4.95
1000	0.50	6.00

Table of Food Values.

VALUES PER 100 LBS. FOR RUMINANT.

Grains. Cereal Grains.	Dry Matter. Lbs.	Digestible.		Net Energy Value. Therms.
		Crude Fibre. Lbs.	True Protein. Lbs.	
Corn (maize) meal .	88.7	6.9	6.4	85.20
Oats	90.8	9.7	8.7	67.56
Oatmeal	92.1	12.8	11.5	86.20

In calculating the ration "true protein" is taken as "digestible protein." Separate tables of food values are given for ruminants, horses, and swine.

Armsby's system is less open to objection than Kellner's. If the net energy values which he assigns to the different feeding stuffs be used only in conjunction with his feeding standards no error is likely to arise, since the requirements are estimated in accordance with, and stated in terms of, these values.

While a unit of productive value enables the feeder to compare different food-stuffs on a common basis, its use is apt to focus attention too exclusively on the food to the neglect of other factors that affect the productive value of rations. Two of these may be briefly indicated.

(1) For maintenance, the energy value for food depends upon the energy that can be liberated by the animal, and, consequently, foods can be compared according to their caloric values (p. 257). For productive purposes, however, the energy value of different foods cannot be compared on the basis of any common unit. For example, in fattening, after the maintenance requirements are satisfied, of the surplus food absorbed, about 87.5 per cent. of the energy of the starch can be transformed to energy in deposited fat, while only a doubtful proportion, certainly less than 50 per cent. of the energy of the surplus protein, can be so transformed. On the other hand, if protein tissue be the form of production, as in growth, nearly 100 per cent. of the energy of the surplus protein may be deposited in the growing tissue, whereas for tissue formation starch has only an indirect value as a protein saver.

(2) In both Kellner's and Armsby's systems, in estimating the productive value, the heat liberated in increased metabolism due to taking food is regarded as waste and deducted. Whether or not it is waste depends upon the external temperature. Below the critical temperature (p. 271), it serves to maintain body temperature, and so saves food of an equiva-

lent energy value from being catabolised merely as fuel for heat production. At low temperatures *more* than the amount of heat liberated by increased metabolism due to taking food may be necessary, and an amount of food varying with the temperature must be consumed to yield heat, leaving a variable surplus for production. The productive value of a ration therefore is not a fixed quantity applicable to all conditions.

Whatever feeding standard or unit of production value is used, it should constantly be kept in mind that a food-stuff has only two real energy values:—(1) The amount that can be transformed to heat by complete combustion in a bomb calorimeter (p. 256)—the *physical energy*; and (2) the amount that can be transformed by the animal body—the *physiological energy*. What proportion of the physiological energy is available for production depends upon—

(1) The maintenance requirement of the animal, which is partly determined by an external condition—the temperature.

(2) The nature of the product, *e.g.* milk, fat, meat, or work.

These factors are not qualities of the food, and consequently the absolute productive value of a food cannot be determined by any system of calculation based solely on percentages of digestible nutrients. The productive values given are merely hypothetical, and error arises unless they are regarded as such.

4. Manurial Values.

In farm animals the further question of the manurial value of the food has to be considered. The constituents of the excreta which are of special manurial value are nitrogen, phosphorus, and potash. Since so little nitrogen is fixed in the body of the adult animal as proteins, the greater quantity of the nitrogen of the food is recoverable in the urine and faeces. In ruminants the phosphorus is chiefly excreted in

the faeces. Hence, by careful storage of the excreta and its proper disposal, a large return to the land may be made. This cycle between animal and plant may be illustrated by the following diagram :—

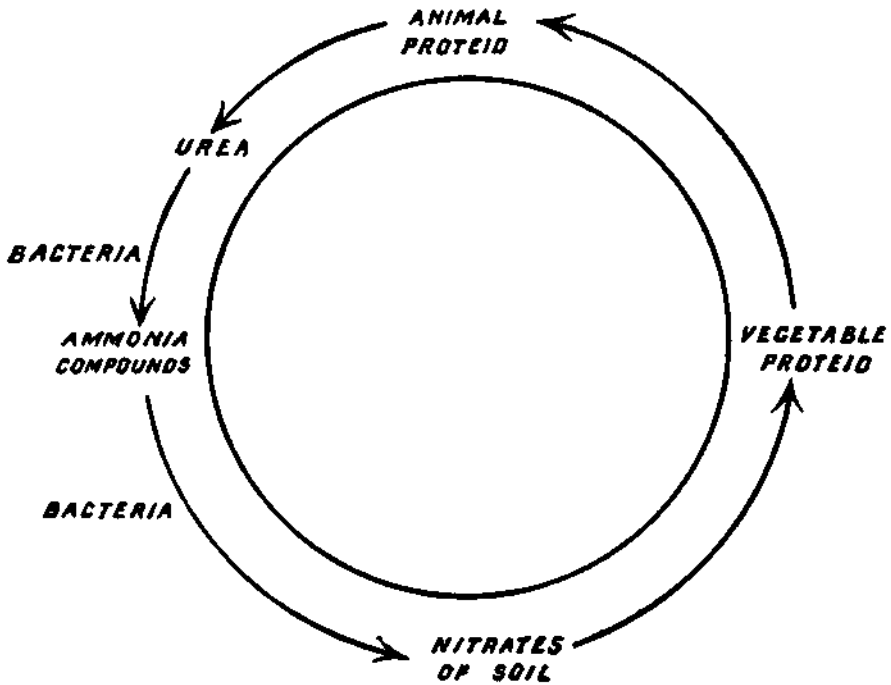

FIG. 161.—Diagram to illustrate Nitrogen Cycle.

The nutritive products of digestion reach the blood and have to be distributed to the muscles and other tissues. The oxygen of the air has also to be conveyed to the tissues, while the products of combustion must be removed.

The way in which the circulation of the blood is carried out must next be considered.

SECTION IV.

A. The Manner in which the Nourishing Fluids are Brought to the Tissues.

THE CIRCULATION.

I. GENERAL CONSIDERATIONS.

THE arrangement by which the blood and lymph are distributed to the tissues may be compared to a great irrigation system.

It consists of a central force pump—the **systemic heart** (fig. 162, *S.H.*)—from which passes a series of conducting tubes—the *arteries*—leading off to every part of the body, and ending in innumerable fine irrigation channels—the *capillaries* (*Cap.*)—in the substance of the tissues. From these some of the blood constituents are passed into the spaces between the cells as *lymph*. From these spaces the fluid either passes back into the capillaries, or flows away in a series of *lymph vessels*, which carry it through *lymph glands* (*Ly.*), from which it gains certain necessary constituents, and finally bring it back to the central pump.

The fluid, which has not passed out of the capillaries into the tissues, has been deprived of many of its constituents, and this withdrawal of nutrient material by the tissues is made good by some of the blood being sent through the walls of the stomach and intestine (*Al.C.*), in which the nutrient material of the food is taken up and added to the

blood returning to the heart. At the same time, the waste materials added to the blood by the tissues are partly got rid of by some of the blood being sent through the liver and kidneys (*Liv.* and *Kid.*).

The blood is then poured back through the veins into a subsidiary pump—the *pulmonic heart (P.H.)*—by which it is pumped through the lungs, there to obtain a fresh supply of oxygen, and to get rid of the carbon dioxide excreted into it by the tissues. Finally the blood, with its fresh supply of oxygen from the lungs, and of nourishing sub-

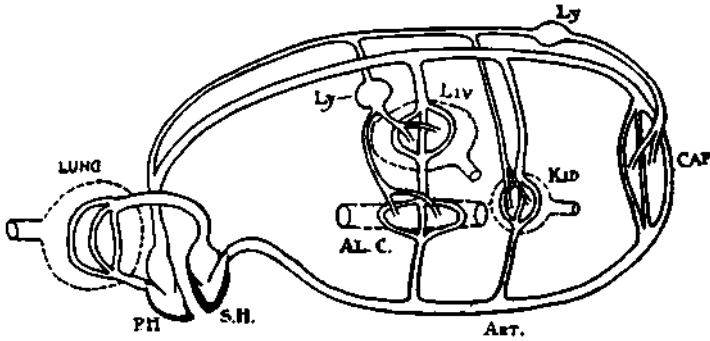

FIG. 162.—Scheme of the Circulation. *S.H.*, systemic heart sending blood to the capillaries in the tissues, *Cap.* The blood brought back by veins, and the exuded lymph by lymphatics, *Ly.*, passing through glands; blood sent to the alimentary canal, *Al. C.*, and from that to the liver, *Liv.*; blood also sent to the kidneys, *Kid.*; the blood before again being sent to the body is passed through the lungs by the pulmonic heart, *P.H.*

stances from the alimentary canal, is poured into the great systemic pump—the left side of the heart—again to be distributed to the tissues.

Thus the circulation is arranged so that the blood, exhausted of its nourishing material by the tissues, is replenished in the body before being again supplied to the tissues.

The sectional area of the vascular system varies enormously. The aorta leaving the heart has a comparatively small channel. If all the arteries of the size of the radial were cut across and put together, their sectional area

would be many times the sectional area of the aorta. And if all the capillary vessels were cut across and placed together, the sectional area would be about 700 times that of the aorta.

From the capillaries, the sectional area of the veins and lymphatics steadily diminishes as the smaller branches join with one another to form the larger veins and lymphatics; but, even at the entrance to the heart, the sectional area of the returning tubes, the veins, is about twice as great as that of the aorta.

The circulatory system may thus be compared to a stream which flows from a narrow deep channel, the aorta, into a gradually broadening bed, the greatest breadth of the channel being reached in the capillaries. From this point the channel gradually narrows until the heart is reached.

Hence the blood stream is very rapid in the arteries where the channel is narrow, and very sluggish in the capillaries where the channel is wide, so that in them plenty of time is allowed for exchanges between the blood and the tissues.

II. THE CENTRAL PUMP—THE HEART.

A. Structure.

1. **Myocardium.**—The heart in the early embryo is a simple tube which undergoes regular rhythmic contractions. These start from the venous end and pass along the tube to the other end, and thus force the blood from the veins to the arteries.

As development advances, a receiving chamber—the **auricle**, and an expelling chamber—the **ventricle**, grow out from the primitive tube, and thus break up the continuous sheath of primitive tissue which constitutes the embryonic heart (fig. 163).

In fish this primitive tissue is found as a ring round the entrance of the veins into the heart with an extension, as a narrow band over the auricles to the ventricles (*S.V.*).

In the mammal, where the heart is double, one part of

the primitive tissue—the **sino-auricular node**—is found at the junction of the superior vena cava and the right auricle, the other—the **auriculo-ventricular node**—extends from a point just below and to the left of the coronary sinus to the upper part of the inter-ventricular septum to form the auriculo-ventricular band. Here it divides into a right and left bundle which pass down under the lining of the heart (the endocardium) to end in fine ramifications in the papillary muscles and in the ventricular wall. A continuation of the primitive tissue, from the former to the latter of these nodes, along the posterior walls of the auricles, has been described.

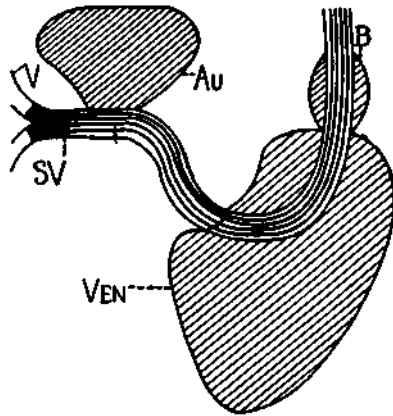

FIG. 163.—To show the Development of Auricle, Ventricle, and Bulbus on the Primitive Tube of the Heart.

The essential features of cardiac muscle are (i) that the fibres are continuous with one another, and form a syncytial network; (ii) that the network contains fibrils which are cross striped (p. 205); (iii) that there are nuclei placed deeply in the sarcoplasm; and (iv) that a sarcolemma is absent.

In the nodal tissue and auriculo-ventricular band, the fibres have a larger quantity of sarcoplasm between the fibrils and round the nuclei.

The muscular fibres of auricles and ventricles take origin from three fibrous rings—the **auriculo-ventricular rings**—(1) one encircling the opening between the right auricle and ventricle, and crescentic in shape; (2) one, more circular in shape, encircling in common the left auriculo-ventricular and the aortic orifice, and (3) one encircling the pulmonary opening. The auricles are attached to the auriculo-ventricular rings above, the ventricles are attached below, while the valves of the heart are also connected with them.

The muscular fibres of the auricles are arranged in two badly-defined layers—

1st. An outer layer running horizontally round both auricles.

2nd. An inner layer arching over each auricle, and connected with the auriculo-ventricular rings. The inmost fibres are raised into longitudinal ridges—the *pectinate muscles*.

Contraction of the first layer diminishes the capacity of the auricles from side to side. Contraction of the second set with the pectinate muscles draws the ventricles upwards towards the auricles, and thus over the blood that is being



FIG. 164.—Cross Section through the Ventricles of the Heart looking towards Auricles, to show the right Ventricle placed on the Central Core of the left Ventricle. The Cusps of the Auriculo-ventricular Valves are also shown.

expelled from the auricles, and also pulls the auricles downwards towards the ventricles, and thus diminishes their capacity from above downwards.

The peculiar striped muscle fibres of the auricular wall extend for some distance along the great veins which open into these chambers.

The left ventricle forms the cylindrical core to the heart, and the right ventricle is attached along one side of it. The septum between the ventricles is the right wall of the left ventricle, and it bulges into the right ventricle with a double convexity from above downwards and from before backwards (fig. 164).

The muscle fibres of the ventricles are arranged essentially in three layers:—

(1) The outmost layer takes origin from the auriculo-ventricular and pulmonic rings, and passes downwards and to the left till it reaches the apex of the heart. Here it turns inwards, forming a sort of vortex, and becomes continuous with the inmost layer.

(2) The middle layer is composed of fibres running horizontally round each ventricle. It is the thickest layer of

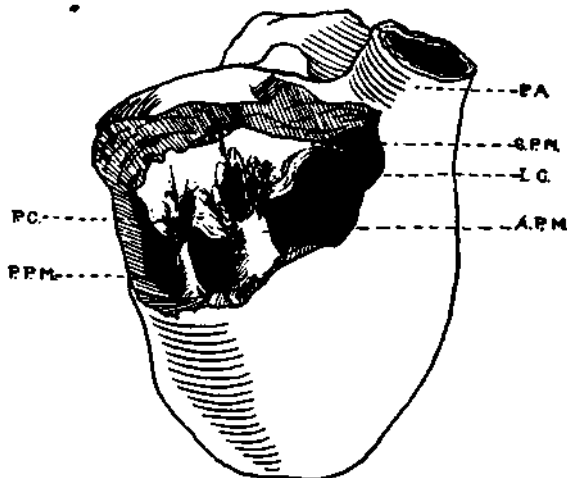

FIG. 165.—The Right Ventricle and Tricuspid Valve to show the relationship of the Papillary Muscles and Chordæ Tendineæ to the Cusps of the Valve. (See text.)

the heart, and in contracting it pulls the walls of the ventricles towards the septum ventriculi.

(3) The inmost layer is continuous with the outmost layer, as it turns in at the apex, and it is mixed with primitive fibres of the auriculo-ventricular band. It may be considered as composed of two parts—(a) A layer of fibres running longitudinally along the inside of each ventricle from the apex upwards to the auriculo-ventricular ring. These fibres are raised into fleshy columns, the *columnæ carnes*. (b) A set of fibres, constituting the *papillary muscles* (fig. 165, *P.M.*), which, taking origin generally from the apical part of

the ventricles, extend freely upwards to terminate in a series of tendinous cords (the *chordæ tendinæ*), which are inserted partly into the auriculo-ventricular valves, presently to be described, and partly into the auriculo-ventricular rings. The papillary muscles are merely specially modified *columnæ carneæ*. In many cases, actual muscular processes extend from the apex of the papillary muscles to the auriculo-ventricular ring.

In the *left ventricle* there are two papillary muscles, or groups of papillary muscles, one in connection with the anterior wall of the ventricle, and one in connection with the posterior wall.

In the *right ventricle* there are—(1) One or more small horizontally running papillary muscles just under the pulmonary orifice, their apices pointing backwards—(fig. 165, *S.P.M.*). (2) A large papillary muscle taking origin from the mass of fleshy columns at the apex of the ventricle (*A.P.M.*). (3) One or more papillary muscles of varying size arising from the posterior part of the apical portion of the ventricle (*P.P.M.*). (4) A number of small septal papillary muscles arising from the septum.

The distribution of the *chordæ* from these muscles will be considered in connection with the auriculo-ventricular valves.

In *contraction*, the outmost and inmost layers of the ventricles tend to approximate the apex to the base of the ventricles, but this is resisted by the contracting middle layer. The apex tends to be tilted towards the right, the papillary muscles shorten, the *columnæ carneæ* by their shortening and thickening encroach upon the ventricular cavity, and help to abolish it, while the auriculo-ventricular rings are drawn inwards towards the septum and downwards.

2. The Distribution of Neurons in the Heart.—(1) In the *frog's heart* the nervous structures are generally described as distributed in three groups or ganglia, but the separation of these from one another is artificial (fig. 166).

(a) In the wall of the sinus venosus a plexus of nerve cells and nerve fibres constitutes the ganglion of the sinus (Remak's ganglion).

(b) In the inter-auricular septum a similar plexus constitutes the ganglion of the auricular septum.

(c) In the auriculo-ventricular groove a plexus forms the auriculo-ventricular ganglion (Bidder's ganglion).

With these intra-cardiac ganglia the terminations of the cardiac branch of the vagus nerve to the heart form definite synapses.

(2) In the mammalian heart, on the right side an interrupted chain of nerve cells extends from near the sino-auricular node to the posterior part of the inter-auricular septum and down to the auriculo-ventricular node. On the

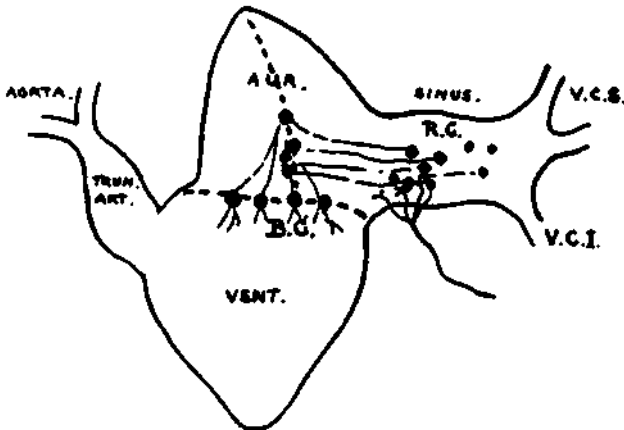

FIG. 166.—Scheme of the Various Chambers of the Frog's Heart and of the Distribution of the Intracardiac Nervous Mechanism.

left side, a similar chain of cells begins rather lower on the back of the left auricle and extends inwards to the septum to end near the auriculo-ventricular node. Through all the primitive tissue there is a dense plexus of nerve fibres, and this, according to Dogiel and Bethe, also extends between the ordinary fibres of auricles and ventricles. Bodies like muscle spindles have been described among the fibres.

3. Pericardium.—The myocardium is covered by a layer of fibrous tissue with endothelium on its surface. This is the visceral pericardium. The parietal pericardium, in which the heart lies, is a fibrous sac lined by endothelium, firmly

attached to the great vessels above and to the diaphragm below.

4. **Endocardium.**—This is a thin layer of fibrous tissue lined by endothelium extending from the vessels over the inner aspect of auricles and ventricles. At certain points flaps of this endocardium are developed to form the valves of the heart.

In the heart, valves are situated at the entrance to and at the exit from the expelling cavities—the ventricles. There is thus on each side of the heart a valve between the auricles and the ventricles, and a valve between the ventricles and the great arteries.

(1) **Auriculo-ventricular Valves.**—On each side of the heart the auriculo-ventricular valve is formed by flaps of endocardium, which hang downwards from the auriculo-ventricular ring like a funnel into the ventricular cavity, and which are attached to the apices of the papillary muscles by the chordæ tendinæ (figs. 165 and 167).

(i.) On the left side of the heart there are two main cusps, forming the **mitral valve** (fig. 167)—

(a) An anterior or right cusp, which takes origin from, and is continuous with, the right posterior wall of the aorta. It hangs down into the ventricle between the aortic and auriculo-ventricular orifices. This cusp is very strong, and the chordæ are inserted chiefly along its edges.

(b) The posterior or left cusp is smaller. It takes origin from the back part of the auriculo-ventricular ring. The chordæ tendinæ are not only inserted into its edge, but run up along its posterior aspect to be inserted into the auriculo-ventricular ring.

When the papillary muscles contract, the cusps are drawn together. The edge of each cusp thins out to form a delicate border, which, when the cusps are approximated, completely seals the aperture.

(ii.) On the right side of the heart the auriculo-ventricular orifice is separate from the pulmonary opening, and the three cusps of the **tricuspid valve** are developed in connection with the crescentic opening from the auricle

(fig. 165). One rises from the auriculo-ventricular ring above the septum, and hangs down into the ventricle upon the septum. The two larger outer cusps are held down by chordæ tendineæ rising from the papillary muscles near the apex of the ventricle. When these two sets of papillary muscles contract, the outer cusps are drawn flat against the septal cusp lying upon the bulging septum.

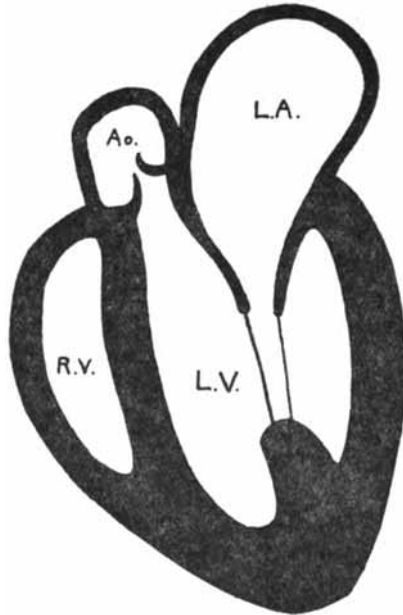

FIG. 167.—Vertical Mesial Section through Heart to show Aortic and Mitral Valves. *R.V.*, right ventricle; *L.V.*, left ventricle with papillary muscle; *L.A.*, left auricle with the mitral valve extending into the left ventricle; *Ao.*, aorta with anterior cusp on top of septum.

(2) **Semilunar Valves.**—The valves situated at the opening of the ventricles into the great arteries are also formed as special developments of the endocardium.

Each is composed of three half-moon-shaped membranous pouches attached along their curved margin to the walls of the artery and upper part of the ventricle, and with their concavities directed away from the ventricle. In the centre of the free margin is a fibrous thickened nodule, the corpus

Arantii, from which a very thin piece of membrane, the lunule, extends to the attached margin of the edges. A pouch, the sinus of Valsalva, lies behind each cusp.

The arrangements of these various cusps is of importance in connection with their action (fig. 167).

(i.) **Aortic Valve.**—The anterior cusp is largest, and lies somewhat deeper in the heart than the others. At each side it is attached to the aortic wall, but below it is attached to the upper part of the septum ventriculi, so that the base of the sinus of Valsalva is formed by the upper part of the

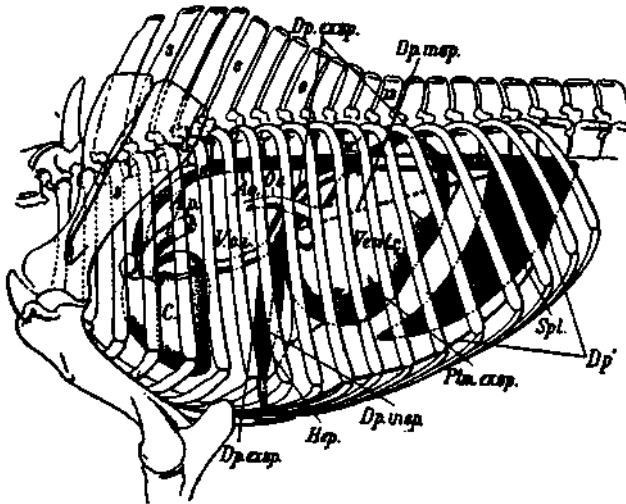

FIG. 168.—Relations of the Thoracic Viscera in the Horse. *C.*, heart; *Dp.*, the diaphragm; *exp.*, in expiration; *insp.*, in inspiration; *Ventr.*, stomach; *Spl.*, spleen. (From ELLENBERGER.)

septum. At a somewhat higher level is a cusp which is partly attached to the upper part of the septum, partly to the posterior wall of the aorta, where this becomes continuous with the anterior cusp of the mitral. The third cusp is still higher, and is attached to the aortic wall, where it becomes continuous with the anterior cusp of the mitral.

(ii.) **Pulmonary Valve.**—The posterior cusp is mounted on the top of the septum ventriculi, and is at a somewhat lower level than the other two.

Thus, in each valve the cusp placed lowest is mounted on a muscular cushion, the use of which will afterwards be considered.

B. Attachments and Relations of the Heart.

The heart is attached, by the great vessels coming from it, to the dorsal wall of the chest.

In the horse the heart hangs downwards from the vertebral column, and the apex is in relation to the posterior end of the sternum and a little to the left (fig. 168).

Behind, the heart is in relation to the tendon of the diaphragm.

All round it are the lungs, completely filling up the rest of the thorax.

The heart is enclosed in a strong fibrous bag, the *Pericardium*, which supports it and prevents over-distension. When, in disease, fluid accumulates in this bag the auricles are pressed upon and the flow of blood into them is impeded.

C. Physiology of the Heart.

I. The Cardiac Cycle.

Each part of the heart undergoes contractions and relaxations at regular rhythmical intervals, *and the sequence of events from the occurrence of any one event to its recurrence constitutes the cardiac cycle.*

A. Frog.

In the frog (fig. 169) a contraction, starting from the openings of the veins, suddenly involves the sinus venosus, causing it to become smaller and paler. This contraction is rapid and of short duration, and is followed by a relaxation, the cavity again regaining its former size and colour. As this relaxation begins, the two auricles are suddenly

contracted and pulled downwards towards the ventricle, at the same time becoming paler, while the ventricle becomes more distended and of a deeper red. The rapid brief

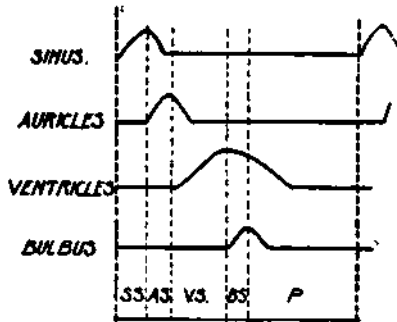

FIG. 169.—Scheme of the Cardiac Cycle in the Frog. *S.S.*, sinus systole; *A.S.*, auricular systole; *V.S.*, ventricular systole; *B.S.*, bulbus systole; *P.*, rest of all chambers. The upstrokes represent systole, the downstrokes diastole.

auricular contraction now gives place to relaxation, and, just as this begins, the ventricle is seen to become smaller and paler, and, if held in the fingers, is felt to become firmer. This event takes place more slowly than the contraction of either sinus or auricles. The chief change in the ventricle is a diminution in its lateral diameter, though it is also decreased in the antero-posterior and vertical directions. During ventricular contraction the bulbus is seen to be distended and to become of a darker colour. The ventricular contraction passes off suddenly, the ventricle again becoming larger and of a deep red colour. At this moment the bulbus aortæ contracts and becomes pale and then relaxes before the next ventricular contraction (*Practical Physiology*).

Each chamber of the heart thus passes through two phases—a contraction phase, a *systole*, of short duration and a longer relaxation phase, the *diastole*. The sequence of events in the frog's heart might be schematically represented as in fig 169.

B. Mammal

1. **Rate of Recurrence.**—The rate of recurrence of the cardiac cycle varies with the animal examined. In man it is, in adult life, about 72 per minute. In the adult horse it is about 36 to 40 per minute.

Rate of heart per minute in different animals :—

Horse	36 to 40
Ox	45 to 50
Sheep	70 to 80
Dog	90 to 100
Rabbit	120 to 150

Many factors modify the rate of the heart, among the most important of which are—

(1) *The Period of Life.*—The following table shows the average rate of the heart at different ages :—

HORSE

New born	92 to 132 per minute
Under 1 year	50 to 68 „
4 years	50 to 56 „

(2) *The Period of the Day.*—The rate is generally lowest in the early morning, and quickest in the evening.

(3) *Temperature of the Body.*—The rate varies with the body temperature, in man being increased about ten beats with each degree Fahr. of elevation of temperature.

(4) *The condition of the central nervous system* may modify the rate of the heart, any disturbance accompanied by emotional changes either accelerating or retarding it.

(5) Muscular exercise markedly accelerates the heart (*Practical Physiology*).

2. **Sequence of Events.**—The sequence of events making up the cardiac cycle is simpler in the mammal than in the frog.

(1) The contraction starts in the neighbourhood of the sino-auricular node. This is indicated by the fact that Lewis has found that this region is the first to become electro-positive, or “zincy,” to the rest of the auricles (p. 212). The contraction spreads out rapidly in all directions, over the auricles and up the mouths of the great veins, as the circle of waves produced by throwing in a stone pass over the surface of the pond. It next seems to pass to the strip

of primitive tissue along the back of the auricular septum, and then to the mouths of the great veins partially occluding them, then over the rest of the auricles, which become smaller in all directions and seem to be pulled down towards the ventricles. The contraction of the auricles in mammals is not accompanied by so marked a dilatation of the ventricles as in the frog.

(2) The wave of contraction in the auricles is propagated to the ventricles through the auriculo-ventricular band, and when this is diseased the passage of the wave of contraction is interfered with.

(3) As the ventricles contract, the auricles relax.

The ventricular contraction develops suddenly, lasts for some time, and then suddenly passes off. The wave of contraction is chiefly conducted by the primitive tissue which runs on the interior aspect of the ventricles. Lewis has shown

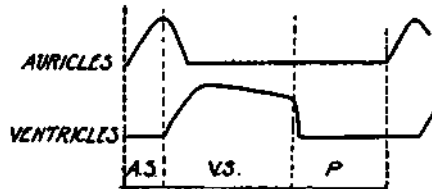

FIG. 170.—Scheme of the Cardiac Cycle in the Human Heart. *A.S.*, auricular systole; *V.S.*, ventricular systole; *P.*, pause.

that, if this layer is divided, conduction is markedly delayed, while, if the outer fibres of the ventricles are cut, no marked delay occurs.

(4) The contraction of the ventricles is followed by a period during which both auricles and ventricles remain relaxed. This is called the **pause** of the cardiac cycle.

The cardiac cycle in mammals may be represented as in fig. 170.

3. Duration of the Phases.—Ventricular systole lasts three times as long as auricular systole.

The duration of these two phases in relationship to the pause varies very greatly. Whatever may be the rate of

the heart, the auricular and ventricular systoles do not vary, but in a rapidly acting heart the pause is short, in a slowly acting heart it is long. Taking the ordinary human heart rate of 72 per minute, the auricular systole lasts for one-eighth of the whole cardiac cycle, the ventricular for three-eighths, and the pause for four-eighths.

4. Changes in the Shape of the Chambers.

1. *Auricles*.—These simply become smaller in all directions during systole.

2. *Ventricles*.—The changes in the diameters of the ventricles may be studied by fixing them in the various phases of contraction and measuring the alterations in the various diameters.

The shape in *diastole* when the muscular fibres are relaxed is determined by the fibrous pericardium which surrounds the heart, and by the position of the body, the force of gravity leading to the expansion of the ventricles at their dependent part. The condition at the *end of systole* may be studied by rapidly excising *the heart* while it is still beating, and plunging it in some hot solution to fix its contraction.

The condition *in the early stage of systole*, before the blood has left the ventricles, may be studied by applying a ligature round the great vessels, and then plunging the heart in a hot solution to cause it to contract round the contained blood which cannot escape.

Measurements of hearts so fixed show that, at the beginning of contraction, the antero-posterior diameter is increased, while the lateral diameter is diminished. In contracting, the lateral walls appear to be pulled towards the septum—the increase in the antero-posterior diameter being largely due to the blood in the right ventricle pressing on and pushing forward the thin wall of the infundibulum below the pulmonary artery.

As the ventricles drive out their blood, both antero-posterior and lateral diameters are diminished—but the diminution in the lateral direction is the more marked, and thus the section of the heart tends to become more circular.

There is no great shortening in the long axis of the ventricles; but the auriculo-ventricular grooves are drawn somewhat downwards towards the apex, which does not alter its position. This was demonstrated by Leonardo da Vinci in the living pig by inserting long pins through the chest wall into the wall of the ventricle and observing the movements.

In systole the ventricles have the form of a truncated cone.

5. The Cardiac Impulse.

(1) Cause.—During contraction the heart undergoes, or attempts to undergo, a change in position. In the relaxed

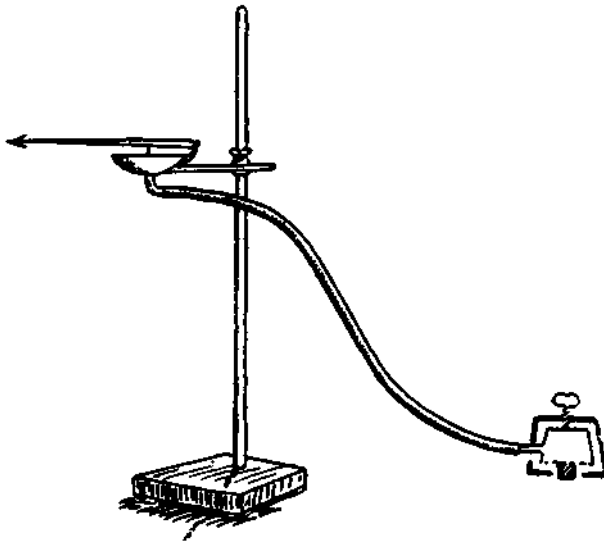

FIG. 171.—Cardiograph consisting of a Receiving Tambour, with a button on the membrane which is placed upon the cardiac impulse, and a Recording Tambour connected with a lever.

condition it hangs downwards from its plane of attachment, but when it becomes rigid in ventricular contraction, it tends to take a position at right angles to its base—*Cor sese erigere*, as Harvey describes the movement. Since the apex and front wall are in contact with the chest, the result of this

movement is to press the heart more forcibly against the chest wall. This gives rise to the cardiac impulse with each ventricular systole (fig. 168), but this is not easily felt in the horse unless the action of the heart is exaggerated.

If the chest is opened and the animal placed on its back this elevation of the apex is readily seen.

(2) **Position.**—The position of the impulse is determined by the relationship of the heart to the anterior chest wall and to the lungs.

(3) **Character.**—It is felt as a forward impulse of the tissues, which develops suddenly, persists for a short period, and then suddenly disappears. In many forms of heart disease its character is markedly altered.

The cardiac impulse may be recorded graphically by means of any of the various forms of cardiograph (fig. 173). One of the simplest consists of a receiving and a recording tambour connected by means of a tube (fig. 171) (*Practical Physiology*).

6. Changes in the Intracardiac Pressure.—These have been studied in the horse and dog.

(1) **Methods.**—The most common way of determining the pressure in a cavity is to connect it to a vertical tube and to see to what height the fluid in the tube is raised. If such a method be applied to the ventricles of the heart, the blood in the tube undergoes such sudden and enormous changes in level that it is impossible to get accurate results.

The same objection applies to the method of connecting the heart with a manometer, a U tube filled with mercury. When this is done, the changes in pressure are so sudden and so extensive that the mercury cannot respond to them on account of its inertia.

Various means of obviating these difficulties have been devised. (1) One of the best is to allow the changes of pressure to act upon a small elastic membrane tested against known pressures. A tube is thrust through the wall of the heart and connected with a tambour covered by a membrane to which a lever is attached. (2) Probably the most delicate method is by the use of Piper's stilette manometer (fig. 172),

which consists of a tube or cannula with a sharp pointed trocar, which can be thrust out of the end of the tube to perforate the chest and ventricular wall, and then retracted through a tap, which can be closed. On the tube is a membrane carrying a small mirror, from which a beam of light may be reflected on to a sensitive paper covering a moving surface so that the variations of pressure are photographed.

(2) **Results.**—*A. Pressure in the Great Veins* (small dotted line in fig. 173).—The pressure in these is so low and undergoes such small variations that it may be investigated by a water manometer.

When the auricles contract, the flow of blood from the great veins into these chambers is arrested, and, as a result, the pressure in the veins rises. As the auricles relax the

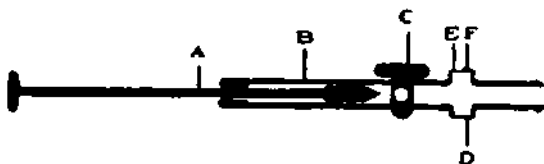

FIG. 172.—Piper's Stilette Manometer. *A.*, trocar for puncturing (with-drawn); *C.*, tap to close cannula; *E.*, rubber membrane with mirror, *F.*

pressure falls, but, as the auricles fill up, it again rises. When the ventricles relax blood again flows in from the great veins and the pressure falls, again to rise, as the auricles and veins are both filled up, towards the end of the pause.

B. Pressure in the Auricles (dash line in fig. 173).—At the moment of auricular contraction there is a marked rise in the intra-auricular pressure. When the auricular systole stops, the pressure falls rapidly, but the fall is interrupted by a rise due to the upward pressure from the closed auriculo-ventricular valves. It reaches its lowest level early in ventricular systole. From this point the pressure in the auricles rises until the moment when the ventricles relax, when another fall in the pressure is observed. The pressure again rises slightly and remains

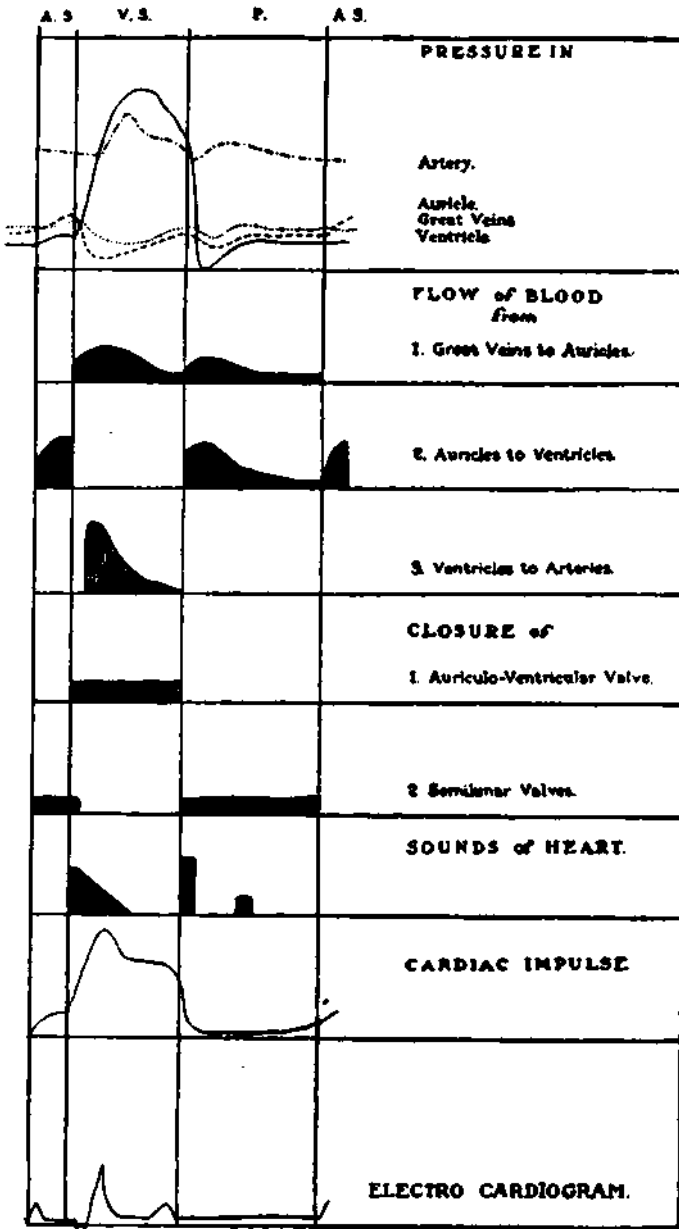

FIG. 173.—Diagram to show the Relationship of the Events in the Cardiac Cycle to one another. A.S., auricular systole; V.S., ventricular systole; P., pause.

about constant from this point until the next auricular contraction.

C. Pressure in the Ventricles (continuous line in fig. 173).—The intra-ventricular pressure rises slightly during auricular systole. It rises suddenly at the moment of ventricular systole to reach its maximum, but on the trace there is sometimes a shoulder due to the opening of the semi-lunar valves. It then falls, but the fall is gradual, and is interrupted by a more or less well-marked period during which the pressure remains constant. When the ventricles relax, the pressure suddenly falls to zero, then rises a little, and is maintained until the next ventricular systole. The diastolic expansion of the ventricle is due chiefly to the inflow of blood from the auricles and veins, possibly in part to the elasticity of the muscular wall, and to the filling of the coronary arteries which takes place in diastole.

D. Pressure in the Arteries (dot-dash line in fig. 173).—This, since it is always high and undergoes no great and sudden variations, may be measured by means of a mercury manometer. The aortic pressure is high throughout. There is a sudden rise soon after the beginning of ventricular systole, as the blood rushes out of the ventricles. The pressure then falls, but the fall is not steady. Often it is interrupted by a more or less marked increase corresponding to the later part of the ventricular contraction. At the moment of ventricular diastole the fall is very sharp and is interrupted by a well-marked and sharp rise. Following this, the fall is continuous till the next systolic elevation.

These changes in the pressure in the different chambers are due to—

1st. The alternate systole and diastole of the chambers, the first raising, the second lowering, the pressure in the chambers.

2nd. The action of the valves.

7. Action of the Valves of the Heart.

A. Auriculo-ventricular (fig. 174).—These valves have already been described as funnel-like prolongations of the

auricles into the ventricles. They are firmly held down in the ventricular cavity by the chordæ tendineæ. When the ventricles contract, the papillary muscles pull the cusps of the valves together and thus occlude the opening between auricles and ventricles. The cusps are further pressed face to face by the increasing pressure in the ventricles, and they may become convex towards the auricles. They thus form a central core around and upon which the ventricles contract.

On the *left side* of the heart, the strong anterior cusp of the mitral valve does not materially shift its position. It may be somewhat pulled backwards and to the left. The posterior cusp is pulled forwards against the anterior.

On the *right side*, the infundibular cusp of the tricuspid



FIG. 174.—State of the various parts of the Heart throughout the Cardiac Cycle. 1, auricular systole; 2, beginning of ventricular systole (latent period); 3, period of outflow from the ventricle; 4, period of residual contraction; 5, beginning of ventricular diastole.

valve is stretched between the superior and inferior papillary muscles, and is thus pulled towards the bulging septum, against which it is pressed by the increasing pressure inside the ventricles. The posterior cusp has its anterior margin pulled forward and its posterior margin backwards, and is thus also pulled toward the septum. The septal cusp remains against the septum. The greater the pressure in the ventricle, the more firmly are the two outer cusps pressed against the septum, and the more completely is the orifice between the auricle and the ventricle closed. On the right side of the heart other factors play an important part in occluding the orifice; the muscular fibres which surround the auriculo-ventricular opening contract, and the papillary muscles pull the auriculo-ventricular ring downwards and inwards by means of the chordæ which are inserted into it.

Nevertheless, the occlusion of this orifice is apt to be incomplete when the right side of the heart becomes in the least over-distended, and this gives rise to what may be called a safety-valve action from the right ventricle, which prevents over-distension.

The auriculo-ventricular valves are open during the whole of the cardiac cycle, except during the ventricular systole (fig. 173).

B. Semilunar Valves.—Before the ventricles contract these valves are closed and the various segments pressed together by the high pressure of blood in the arteries.

As the ventricles contract the pressure rises, until the intra-ventricular pressure becomes greater than the pressure in the arteries. This is the *presphygmic period*. Then the cusps of the valves are thrown back and remain open until the blood is expelled. When the outflow of blood is completed, the cusps are again approximated by the pressure of blood in the arteries. As relaxation of the ventricles occurs, the intra-ventricular pressure becomes suddenly very low, and the high pressure of the blood in the arteries at once falls upon the upper surfaces of the cusps, which are thus forced together and downwards, and completely prevent any back-flow of blood.

The prejudicial effect of too great pressure upon these cusps is obviated by the lower cusp of each being mounted on the top of the muscular septum upon which the pressure falls—the other cusps shutting down upon this one (fig. 167).

The semilunar valves are open only during the flow of blood from the ventricles to the arteries in the second and third periods of ventricular systole (fig. 173).

8. The Flow of Blood through the Heart.—The circulation of blood through the heart depends upon the differences of pressure in the different chambers and upon the action of the valves.

A. From Great Veins into Auricles.—This occurs when the pressure in the great veins is greater than the pressure in the auricles (fig. 173).

The pressure in the auricles is lowest at the moment of their diastole. At this time there is therefore a great flow of blood into them, but gradually this becomes less and less, until, when the ventricles dilate, another fall in the auricular pressure takes place and another rush of blood from the great veins occurs. Gradually this diminishes, and, by the time that the auricles contract, the flow from the great veins has stopped.

The contraction of the mouths of the great veins in auricular systole drives blood from the veins into the auricles, and prevents any back-flow from the auricles.

B. From Auricles to Ventricles.—As the ventricles dilate, a very low pressure develops in them, and hence a great rush of blood occurs from the auricles. During the later stage of ventricular diastole, the intra-ventricular pressure becomes nearly the same as the intra-auricular, and the flow diminishes or may stop. When the auricles contract, a higher pressure is developed causing a fresh flow of blood into the ventricles. When the ventricles contract the auriculo-ventricular valves are closed, and all flow of blood from the auricles is stopped (fig. 173).

C. From Ventricles to Arteries.—When the ventricles begin to contract, the intra-ventricular pressure is low, while the pressure in the arteries is high, which keeps the semi-lunar valves shut. This is the *Latent* or *Presphygmic Period*. As ventricular systole goes on, the intra-ventricular pressure rises, until, after about 0.03 of a second, it becomes higher than the arterial pressure. Immediately the semi-lunar valves are forced open and a rush of blood occurs from the ventricles. This is the *Period of Outflow*, which usually lasts less than 0.2 second.

(a) If the ventricles are contracting actively, and if the pressure in the arteries does not offer a great resistance to the entrance of the blood, *the ventricles rapidly empty themselves* into the arteries, and the intra-ventricular pressure varies as shown in fig. 175, *b*.

(b) If the heart, however, is not contracting actively, or if the arterial pressure offers a great resistance to the entrance of blood, then *the outflow is slow and more continued*, and in

this case, the trace of the intra-ventricular pressure is as in fig. 175, *a*, with a well-marked *Period of Residual Contraction*. It is not the *absolute* force of the cardiac contraction or the *absolute* intra-arterial pressure which governs this, but the relationship of the one to the other. The heart may not be acting very forcibly, but still, if the pressure in the arteries is low, its action may be *relatively* strong.

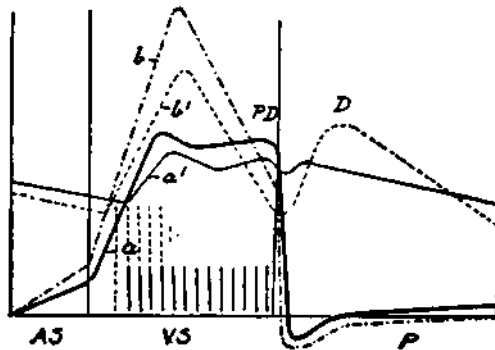

FIG. 175.—Diagram to show the Relationship of the Pulse Wave to the Cardiac Cycle and the effect of altering the relationship between the activity of the heart and the arterial blood pressure. — — — — *b* is the curve of intra-ventricular pressure, and *b'* is a pulse curve with an active heart and a relatively low arterial pressure. — *a* and *a'* are the same with a sluggish heart and a relatively high arterial pressure. The period of outflow under each condition is also shown.

The **Coronary Arteries**, unlike all the other arteries, are filled during ventricular diastole. During systole they are compressed by the contracting muscle of the heart, and it is only when the compression is removed in diastole that blood rushes into them. This helps to dilate the ventricles.

The interpretation of the various details of the **Cardiogram** (fig. 173) is now rendered more easy. The ventricles, still full of blood, are suddenly pressed against the chest wall in systole. As the blood escapes into the arteries they press with less force, and hence the sudden slight downstroke. But, so long as the ventricles are contracted, the apex is kept tilted forward, and hence the horizontal plateau is

maintained. The pressure of the heart disappears as the ventricles relax.

9. Sounds of the Heart.—On listening over the region of the heart, a pair of sounds may be heard with each cardiac cycle, followed by a somewhat prolonged silence. These are known respectively as the First and Second Sounds of the Heart (fig. 173) (*Practical Physiology*).

By placing a finger on the cardiac impulse, while listening to these sounds, it is easy to determine that the **first sound** occurs synchronously with the cardiac impulse—i.e. synchronously with the ventricular contraction.

It develops suddenly, and dies away more slowly. In character it is dull and rumbling, and may be imitated by pronouncing the syllable *lüb*. In pitch it is lower than the second sound.

The **second sound** is heard at the moment of ventricular diastole. Its exact time in the cardiac cycle has been determined by recording it on a cardiac tracing by means of a microphone. It develops suddenly and dies away suddenly. It is a clearer, sharper, and higher-pitched sound than the first. It may be imitated by pronouncing the syllable *düpp*.

According to the part of the chest upon which the ear is placed, these sounds vary in intensity. Over the apical region the first sound is louder and more accentuated; over the base the second sound is more distinctly heard.

A. The Cause of the Second Sound is simple. At the moment of ventricular diastole, when this sound develops, the only occurrence which is capable of producing a sound is the sudden stretching of the semilunar valves by the high arterial pressure above them and the low intra-ventricular pressure below them. The high arterial pressure comes on them suddenly like the blow of a drum-stick on a drum-head, and, by setting the valves in vibration, produces the sound.

Aortic and Pulmonary Areas.—The second sound has thus a dual origin—from the aortic valve and from the pulmonary valve; and it is possible, by listening in suitable positions, to distinguish the character of each of these.

B. The Cause of the First Sound is twofold. When it is

heard, two changes are taking place in the heart, either of which would produce a sound.

1st. The muscular wall of the ventricles is contracting.

2nd. The auriculo-ventricular valves are being stretched.

1st. That the first factor plays a part in the production of the first sound is proved by rapidly cutting out the heart of an animal and listening to the organ with a stethoscope while it is still beating—but without any blood passing through it to stretch the valves. With each beat the lūb sound is distinctly heard.

Apparently the wave of contraction, passing along the muscular fibres of the heart, sets up vibrations, and, when these are conducted to the ear, the external meatus picks out the vibration corresponding to its fundamental note, and thus produces the characters of the sound.

2nd. The auriculo-ventricular valves are being subjected on the one side to the high ventricular pressure, and on the other to the low auricular pressure. If the valves are destroyed or diseased, the characters of the first sound are materially altered, or the sound may be entirely masked by a continuous musical sound—a murmur. It has been maintained that a trained ear can pick out in the first sound the note corresponding to the valvular vibrations.

The idea that the impulse of the heart against the chest wall plays a part in the production of this sound is based upon the fallacious idea that the heart “hits” the chest wall. All that it does is to press more firmly against it.

Mitral and Tricuspid Areas.—On account of the part played by the valves in the production of the first sound, it may be considered to be double in nature—due partly to the mitral valve, partly to the tricuspid. The *mitral valve element* may best be heard *not* over the area of the mitral valve—which lies very deep in the thorax—but over the apex of the heart, as at this situation the left ventricle, in which the valve lies, comes nearest to the thoracic wall and conducts the sound thither.

A *third sound* has been described by Gibson. It is heard during the diastole of the ventricles, and it has been ascribed to the rebound of the semilunar valves.

By means of the microphone applied over the heart, two faint sounds have been recorded during auricular systole, but so far they cannot be considered as of clinical importance.

Cardiac Murmurs.—When the valves are diseased and fail to act properly, certain continuous sounds called cardiac murmurs are heard.

These owe their origin to the fact that, while a current of

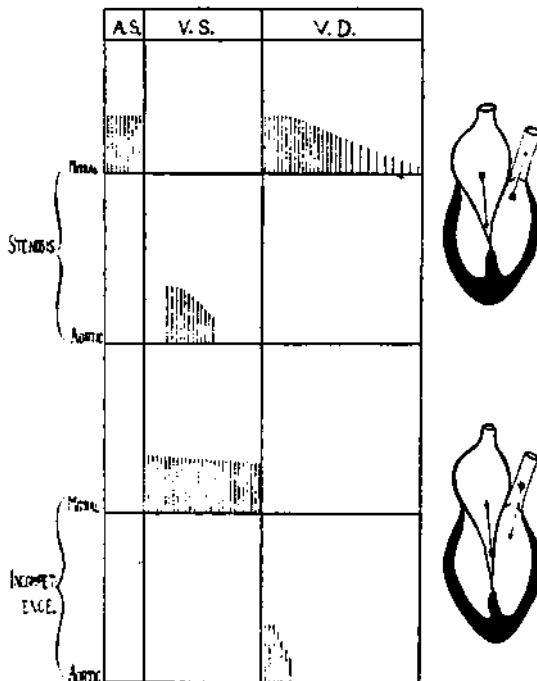

FIG. 178.—To show the Periods in the Cardiac Cycle at which the various Murmurs of Stenosis and Incompetence occur.

fluid passing along a tube of fairly uniform calibre is not thrown into vibrations and therefore produces no sound, when any marked alterations in the lumen of the tube occurs—either a sudden narrowing or a sudden expansion—the flow of fluid becomes vibratory, and, setting up vibrations in the solid tissues, produces a musical sound.

Such changes in the calibre of the heart are produced in two ways:—

1st. By a narrowing, either absolute or relative, of the orifices between the cavities—*stenosis*.

2nd. By a non-closure of the valves—*incompetence*.

1st. *Stenosis*.—If one of the auriculo-ventricular orifices is narrowed, a murmur is heard during the period at which blood normally flows through this opening (p. 405). A reference to fig. 176 at once shows that this occurs during the whole of ventricular diastole, and that the flow is most powerful during the first period of ventricular diastole and during auricular systole.

If the aortic or the pulmonary valve is narrowed the murmur will be heard (fig. 176) during ventricular systole.

The narrowing need not be absolute. A dilatation of the artery will make the orifice *relatively* narrow, and will produce the same result.

2nd. *Incompetence*.—If the auriculo-ventricular valves fail to close properly, then, during ventricular systole, blood will be driven back into the auricles, and a murmur will be heard during this period (fig. 176).

If the aortic or the pulmonary valve fails to close, the blood will regurgitate into the ventricle from the arteries during ventricular diastole, and a murmur will be heard during this period (fig. 176).

By the position at which these murmurs are best heard the pathological condition producing them may be determined.

II. The Work of the Heart.

The enormous variations in metabolism which the muscles undergo between rest and activity have already been considered (p. 266). The oxygen intake and output of carbon dioxide may increase tenfold during muscular work.

To supply this oxygen the flow of blood through the muscles must be proportionately increased, and this increase is secured by (1) a dilatation of the blood-vessels going to the muscles with, at the same time (2), a constriction of the blood-vessels of the abdomen.

But the flow of blood is determined by the difference of pressure between the arteries and veins, and hence the arterial pressure must be maintained when the dilatation of the small arteries is allowing the increased outflow of blood.

This must be met by an increased action of the heart to maintain the pressure. The heart must be capable of great variations in its action, so that at one time it may pump out only a small amount of blood, at another an enormously greater quantity. The heart must be able to perform very varying amounts of work.

To determine the variations in the work done, it is necessary to measure the amount of blood expelled and the resistance against which it is expelled. A certain amount of work is done in giving velocity to the blood, but this is small when compared with the work of overcoming resistance.

(1) The resistance in the aorta may be measured by a mercury manometer (p. 447).

(2) The determination of the amount of blood expelled from the heart has proved a very difficult problem. It has been attempted both by direct and by indirect methods.

A. Direct Methods.

So far it has not proved possible to measure the output of the heart by a direct method with the heart acting normally *in situ*.

(1) **Cardiometer Method.**—The output of blood at each beat of the heart of the dog may be measured by a cardiometer, a rigid walled air-tight case, which is placed round the heart and connected with a piston-recorder, so that the decrease in the volume of the enclosed heart, due to the blood leaving it, may be directly recorded by means of a lever attached to the piston.

(2) **The Isolated Heart-Lung Preparation.**—We shall presently consider the way in which Starling was able to remove the heart and lungs from a dog and to allow blood to circulate through them. Fig. 178 shows how, by means of the side tube, the blood driven from the heart may be collected and its amount measured.

These methods, of course, give no measurement of the normal output of the heart.

B. Indirect Methods.

1. **The Oxygen Method.**—(1) By finding the amount of oxygen which the blood gains per unit of time in passing through the lungs, and (2) the amount of oxygen which is taken from the lungs per unit of time, the amount of blood passing through the lungs, *i.e.* leaving the right ventricle may be calculated. Since the right and left ventricles must discharge equal amounts of blood, the output of the left ventricle is thus ascertained.

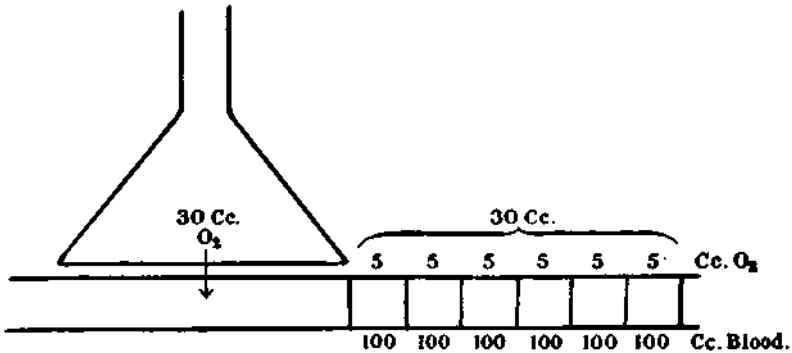

FIG. 177.—To illustrate the method of determining the amount of blood leaving the right ventricle. The inverted funnel represents the lungs from which 30 c.c. of O₂ have been taken up by the blood. The blood has gained 5 c.c. of O₂ per 100 c.c. Therefore 600 c.c. of blood must have passed through the lungs, *i.e.* left the right ventricle.

(1) *The amount of oxygen in the blood* is determined as described on p. 497 (*Practical Physiology*). To ascertain the amount of oxygen in the blood going to the lungs, blood from a vein is taken; for the amount of oxygen in the blood leaving the heart the blood from an artery is taken.

If lower animals, *e.g.* goats, are used, the method may be made even more accurate by taking blood by means of trocars simultaneously from the right (venous blood) and left ventricle (arterial blood).

(2) *The amount of oxygen taken from the lungs* is determined by means of the Douglas bag (p. 261). Suppose the blood gains 5 per cent. of oxygen, and suppose that in

unit of time, 30 c.c. of oxygen are taken up by the lungs, then this 30 c.c. must be distributed in the blood to the extent of 5 c.c. for each 100 c.c. of blood (fig. 177), and hence 600 c.c. of blood must have passed through the lung in unit of time.

2. The Nitrous Oxide Method.—Instead of estimating the increase in the oxygen of the blood, a measured quantity of nitrous oxide, N_2O , the solubility of which in the blood at the pressure and temperature at which it is present in the lungs is known, may be inhaled into the lungs and estimate may be made of—

(1) The amount of N_2O in the arterial blood. (2) The amount of N_2O which has been taken from the lungs by the blood per unit of time.

From this the amount of blood passing through the lungs, *i.e.* from the right ventricle, may be calculated as it is by the oxygen method.

Krogh has shown that the left ventricle in man pumps blood into the arteries at the following rates according to the condition of muscular activity:—

1. At rest	about	3 litres per minute.
2. With moderate exercise	„	12 „ „
3. With hard	„	21 „ „

In the horse the quantities are probably greater.

The Average Work.—It is thus impossible to attempt to form an estimate of the average work of the heart since these variations are so great.

The Adaptation of the Work.—A more interesting question is—How is the heart able to adapt itself to perform the very different amounts of work required? This has been elucidated by Starling by the use of the *isolated* heart-lung preparation (fig. 178).

(i.) The heart and lungs are carefully removed from a dog, all the vessels being clamped or ligatured. (ii.) The

trachea is connected with a pump and the lungs are thus supplied with air so that the blood is oxygenated. (iii.) A tube or cannula is tied into a carotid artery, *CA.*, and it has a side attachment to a mercury manometer to measure the arterial pressure, *M_p*. (iv.) The tube passes on to a very thin piece of tubing, *R.*, enclosed in a rigid walled glass tube, *T.*, in which the pressure can be raised to any extent which may be desired, and may be measured by a manometer, *M_p*. (v.) The tube

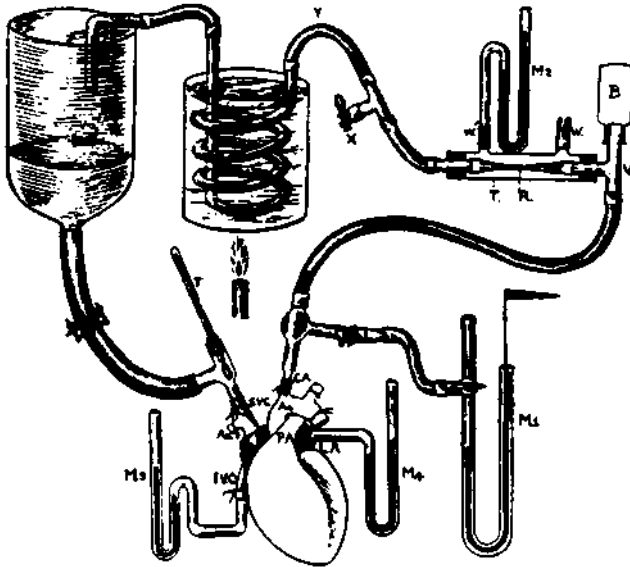

FIG. 178.—The isolated heart-lung preparation (the lungs are not shown). For description see text. (STARLING.)

passes on and is provided with a by-pass, *X.*, from which the blood may be allowed to escape if the amount passed through the heart is to be measured. (vi.) The blood passes through an arrangement by which the blood is kept at body temperature. (vii.) It returns to the superior vena cava, *SVC.*, and right auricle by a tube provided with a clamp so that the amount entering the heart may be controlled. (viii.) The blood then passes to the right ventricle, and so through the lungs in which artificial respiration is kept up, back to

the left side of the heart. (ix.) Variations in the size of the heart may be recorded by enclosing the ventricles in some form of cardiometer (p. 411).

(1) It has thus been shown that the adaptation is largely independent of the central nervous system, although this too, as will later be shown, plays an important part.

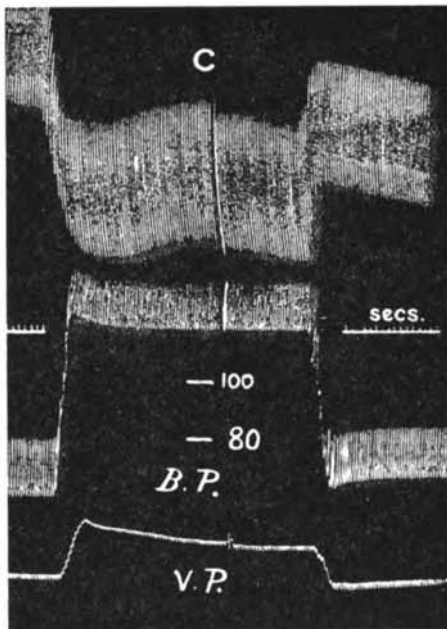

FIG. 179.—To show the effect of a sudden rise in arterial pressure upon the cardiac contractions recorded by enclosing the heart in a cardiometer. The upstrokes are systolic. Note the increased diastole with the increase in the systole. *B.P.*, the arterial blood-pressure; *V.P.*, the venous blood pressure. (STARLING.)

(2) By such an apparatus it is found that the output of blood is not dependent on the arterial pressure, but that within wide limits of pressure the heart continues to pump out the same amount of blood at each systole, thus doing a greater and greater amount of work as the arterial pressure rises. With a sudden rise of pressure it may fail to do so

for the first few beats, and the ventricles may thus become distended (fig. 179), but with this distension and the resulting elongation of the muscular fibres of the heart the force of contraction is increased (p. 224), and the heart performs the increased work. In the healthy animal this dilatation

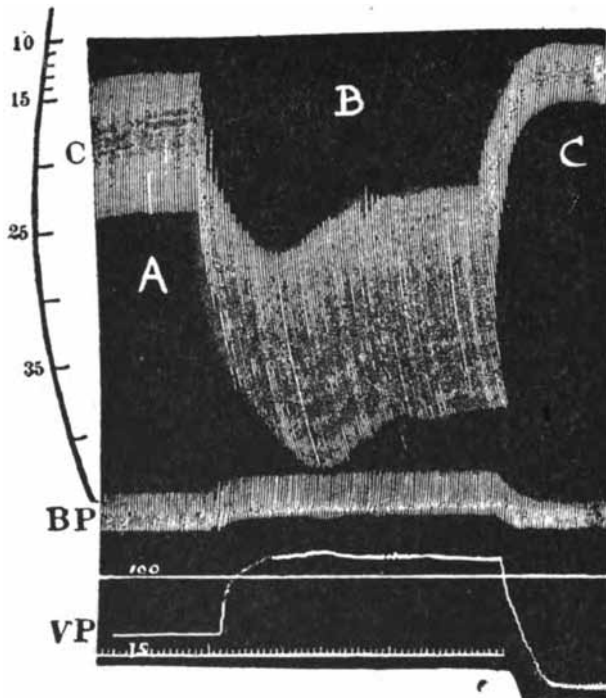

FIG. 180.—To show the effect of increasing the venous filling of the heart recorded as in fig. 178. The upstrokes are systolic. Note the enormous increase of the diastolic filling with the very marked increase in the systolic contraction leading to an increased output of blood. (STARLING.)

is temporary, but, in conditions of debility, over-distension beyond the physiological limit may be produced, and permanent distension may result. Next time a strain is put upon the heart the distension may be still further increased, and heart-failure may occur.

The muscle of the heart thus acts as we have seen skeletal muscle to act within physiological limits,

the force of contraction varies with the length of the fibres.

For increased work the heart muscle requires more oxygen, and the increased supply is secured by the increased arterial pressure driving more blood into the coronary arteries. This has been demonstrated by actual experiment.

The output of the heart is thus not controlled by the arterial pressure.

(3) It is controlled by the inflow from the veins, as may be shown by loosening the clamp on the venous tube, and allowing more blood to enter the heart (fig. 180). The increased inflow leads to a distension of the ventricles, and so to an increased force of contraction. This depends upon the lengthening of the ventricular fibres. *The normal heart drives out just as much blood as it receives from the veins.*

The way in which the heart adjusts itself may be seen in a man or animal starting to run.

(1) The muscular movements pump more blood into the heart from the veins.

(2) The heart is distended, and pumps more blood into the arteries.

(3) The pressure in these is further raised, in spite of the dilatation of the arterioles to the muscles, by the contraction of the abdominal vessels.

In discussing the rapid adaptation of the heart to the varied requirements, the possibility of the production of a chronic dilatation has been discussed.

When, as the result of some obstruction to the flow of blood, the heart is called upon to perform continuously an increased amount of work, it is found that the muscle of the ventricular walls increases or *hypertrophies*. In this way the prejudicial effects of grave valvular disease of the heart may be compensated for. But this compensation is apt to be disturbed and heart-failure to be induced by any interference with the flow of blood through the coronary arteries.

The self-regulation of the heart is itself insufficient to maintain the necessary distribution of pressure throughout

the vessels. Some means must be provided of preventing a too great rise of arterial pressure and of preventing an over-distension of the heart when the venous return is too great.

This is effected by the action of the central nervous system.

III. The Influence of the Central Nervous System on the Heart.

In the frog, a branch from the vagus connects the central nervous system with the heart. When the branch is cut no effect is produced, showing that it is not constantly in action; but, when the lower end is stimulated, the heart is generally slowed or brought to a standstill. Sometimes the effect is not produced. The reason for this is that the cardiac branch of the vagus in the frog is really a double nerve, derived in part from the spinal accessory, and in part from fibres which reach the vagus from the superior thoracic sympathetic ganglion. If the spinal accessory nerve, or the medulla oblongata from which it springs be stimulated, the heart is always slowed; and if the sympathetic fibres are stimulated, it is quickened. Generally, stimulation of the cardiac branch containing these two sets of fibres simply gives the result of stimulating the former, but sometimes the stimulation of the latter masks this effect (*Practical Physiology*).

In the mammal three sets of nerve fibres pass to the heart:—

1st. The *superior cardiac* branch of the vagus starts from near the origin of the superior laryngeal nerve, and passes to the heart to end in the endocardium (fig. 181, *S.C.*).

2nd. The *inferior cardiac* branch of the vagus leaves the main nerve near the recurrent laryngeal, and passes to join the superficial cardiac plexus in the heart (fig. 181, *I.C.*).

3rd. The *sympathetic* nerve fibres come from the superior thoracic and inferior cervical ganglia, and also end in the superficial cardiac plexus (fig. 181, *S.*).

1st. The **Superior Cardiac Branch of the Vagus** is an ingoing nerve. Section produces no effect; stimulation of the lower

end causes no effect; stimulation of the upper end causes (1) slowing of the heart and (2) a marked fall in the

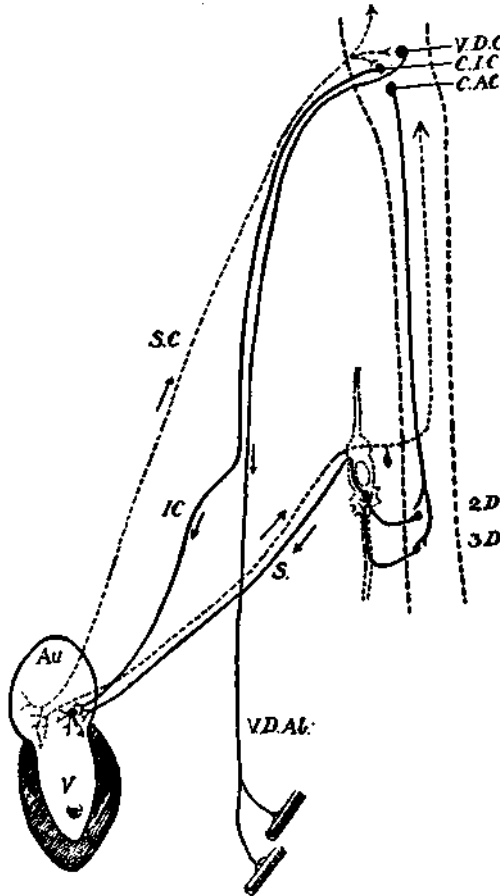

FIG. 181.—Connections of the Heart with the Central Nervous System. *Au.*, auricle; *V.*, ventricle; *V.D.C.*, abdominal vaso-dilator centre; *C.I.C.*, cardio-inhibitory centre; *C.A.C.*, cardio-augmentor centre; *S.C.*, superior cardio branch of the vagus; *I.C.*, inferior cardio branch of the vagus with cell station in the heart; *S.*, cardio-sympathetic fibres with cell station in the stellate ganglion; *V.D.A.*, vaso-dilator fibres to abdominal vessels. The continuous lines are outgoing, the broken lines are ingoing nerves.

pressure of blood in the arteries, and it may cause pain. The slowing of the heart is a reflex effect through the

inferior cardiac branch; and the fall of blood pressure, which is the most manifest effect, is due to a reflex dilatation of the vessels of the abdomen, causing the blood to accumulate there, and thus to lessen the pressure in the arteries generally. On account of its effect on the blood pressure, this nerve is called *the depressor nerve*.

2nd. Inferior Cardiac Branch of Vagus.—*Section* of the vagus or of this branch causes acceleration of the action of the heart. The nerve is therefore constantly in action. Stimulation of its central end has no effect; *stimulation* of its peripheral end causes a slowing or stoppage of the heart. Less blood is pumped into the arteries, and the pressure in them falls (fig. 188). It is therefore the checking or *inhibitory* nerve of the heart. The *right vagus* is chiefly connected with the sino-auricular node, and its stimulation slows the rate of the heart. The *left vagus* is specially connected with the auriculo-ventricular node, and its stimulation tends to slow or prevent conduction of contraction from the auricles to the ventricles. But these two actions are not always clearly differentiated.

1. *Course of the Fibres.*—These fibres leave the central nervous system by the spinal accessory, and pass to the heart to form connections with the cells of the cardiac plexuses.

2. *Centre.*—The fibres arise from cells in the medulla oblongata, which can be stimulated to increased activity either directly or reflexly.

(1) *Direct stimulation* is brought about by (a) sudden anæmia of the brain, as when the arteries to the head are clamped or occluded; (b) increased velocity of the blood, as when respiration is interfered with; (c) the concurrent action of the respiratory centre (see p. 535).

(2) *Reflex stimulation* is produced through many nerves, e.g. those of the abdomen—a point of great importance in abdominal surgery. The superior cardiac branch of the vagus from the ventricles and wall of the aorta is stimulated when the arterial pressure rises and leads to a reflex slowing of the heart, which, along with the dilatation of the abdominal vessels, reduces the pressure.

The reflex stimulation of the centre may be used to determine its *position*. It can be induced after removal of the brain above the medulla, but destruction of the medulla entirely prevents it.

(3) The action of this centre may be checked or inhibited. This happens when the diastolic filling is markedly increased as a result of increased venous inflow, and since it does not occur after section of the vagi it is a central effect.

3. *Mode of Action*.—These inhibitory fibres appear to act by stimulating the intra-cardiac nervous mechanism. When these peripheral neurons have been poisoned by atropine, the vagus cannot act (*Practical Physiology*). Nicotine, which poisons the synapses between the vagus nerve and the terminal neurons, also prevents stimulation of the vagus from slowing the heart, but, as is shown by experiments on the heart of the frog, direct stimulation of the terminal neurons does act.

Gaskell found that stimulating the inhibitory fibres causes a positive variation of the current of injury, indicating that the difference between the living part of the heart and the injured part is increased (p. 213), and he concluded that they excite anabolic changes in the heart.

4. *Result of Action*.

(a) The *rate* of both auricles and ventricles is slowed, but the effect on the auricles is more marked than upon the ventricles. The right vagus has usually the most marked effect upon the rate of the heart (fig. 182, A.).

(b) The *force* of contraction of the auricles is decreased. In the ventricles the systole becomes less complete and the cavities become more and more distended, partly as a result of decrease in the force of contraction, partly as a mechanical result of over-distension due to the decreased output.

(c) *Conduction*, especially from auricles to ventricles, is decreased so that the ventricles may not contract with each auricular contraction, and a condition of heart-block may be established. This is usually best marked upon stimulation of the left vagus.

C. *Sympathetic Fibres*.—The *outgoing* fibres are the aug-

mentors and accelerators of the heart's action. When they are cut the heart beats slower, therefore they are constantly in action. When the peripheral end is stimulated, the rate and force of the heart are increased.

1. *Course of the Fibres.*—These are small medullated fibres, which leave the spinal cord by the anterior roots of

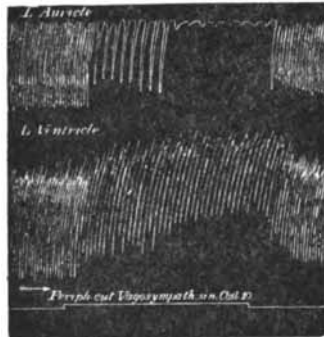

A.

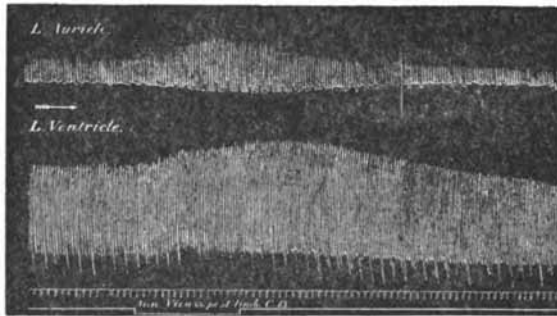

B.

FIG. 182.—Simultaneous Tracing from Auricles and Ventricles. *A.*, during stimulation of the vague; *B.*, during stimulation of the sympathetic. Each downstroke marks a systole, each upstroke a diastole. (From ROY and ADAMI.)

the 2nd, 3rd, and 4th dorsal nerves, and in most animals pass to the stellate ganglion where they have their cell stations (fig. 181). From the cells in this ganglion, non-medullated fibres run on in the annulus of Vieussens, and from this and from the inferior cervical ganglion, they pass out apparently directly to the muscular fibres of the heart.

2. *The Centre* is in the medulla, and it may be reflexly stimulated through various ingoing nerves, such as the sciatic; or it may be set in action from the higher nerve centres in various emotional conditions. It is also called into play, along with inhibition of the action of the vagus, when increased venous inflow in diastole leads to over-distension.

3. *Mode of Action*.—The fibres seem to act (*a*) upon the muscular fibres, by increasing their excitability and conductivity; (*b*) upon the inhibitory mechanism, by throwing it out of action.

4. *Results of Action* (fig. 182, *B*).

(*a*) The rate of the rhythmic movements of auricles and ventricles is increased.

(*b*) The force of contraction of auricles and ventricles is increased.

Thus, the output of blood from the heart is increased, and the pressure of blood in the arteries is raised.

It is probable that the cardiac sympathetic also carries *ingoing fibres* which enter the cord in the lower cervical region. The pain experienced down the inside of the arm in heart disease in man is generally thought to be due to the implication of these fibres leading to sensations which are referred to the corresponding somatic nerves.

The *vagus* is thus the protecting nerve of the heart, reducing its work and diminishing the pressure in the arteries, and it is called into action when the systolic pressure rises too high, while it is inhibited when the venous inflow is too much increased.

The *sympathetic* is the whip which forces the heart to increased action in order to keep up the pressure in the arteries, and it is brought into action by increase in the venous inflow, so that the intrinsic response is supplemented by this extrinsic effect.

IV. The Maintenance and Control of the Cardiac Rhythm.

That there is an intrinsic mechanism in the heart for the maintenance and control of its action is shown by the fact that the excised heart continues to beat in cold-blooded animals for a considerable time without any supply of blood and in warm-blooded animals if oxygenated blood is supplied at a suitable temperature.

In considering the nature of this mechanism, it must be borne in mind : *first*, that two distinct questions have to be investigated :—

1st. How the rhythmic contractions are initiated and maintained ;

2nd. How they are propagated over the heart ;
and *second*, that nerve structures as well as muscular fibres exist in the heart, so that either one or other or both of these may be involved in the starting and conduction of contractions.

1. **The Initiation and Maintenance of Rhythmic Contraction.**—

(1) In the embryo, the heart begins to beat before any nervous structures can be shown to have migrated into it.

(2) Hooker finds that, after removal at a very early stage of development of the anterior part of the neural canal from which the neurons to the heart come, the formation of the heart still goes on while it beats in a normal manner.

(3) A little piece of the heart of an embryo kept under aseptic precautions in the animal's blood plasma will grow, and will manifest typical rhythmic contractions.

(4) Even in the adult amphibian it is possible to start rhythmic contractions in the apex of the ventricle—a part in which nerve cells have not been observed—either by repeated rhythmic stimulation or by distending it with Ringer's solution perfused through a tube. *The conclusion thus seems inevitable that rhythmic contraction is primarily a function of the muscle.*

But there is evidence that, when nerve structures have

grown out to reach the heart, they play a not unimportant part in initiating contraction.

(1) There is the negative evidence that, if during life the apex of the frog's ventricle has been separated from the rest by crushing, it remains passive.

(2) Chloral, apparently by poisoning the nervous structures, may stop the rhythmic action of the heart, but leave the muscle capable of responding to stimulation

(3) Carlson has shown that the heart of the king crab stops if the nervous structures are dissected off it. But the muscle of this heart is of the type of skeletal muscle, and it is perhaps unsafe to apply these results to ordinary heart muscle.

(4) The contractions normally start in the sinus region, a part of the heart richly supplied with nerve cells and fibres (p. 388). The importance of this part of the heart in originating the movements of the rest of the organ is shown by experiments on the heart of the frog (*Practical Physiology*).

If a ligature be applied between the sinus and auricles, the sinus goes on beating while the rest of the heart stops (*Stannius' Experiment*). This shows the dominant influence of the sinus. But, if now a ligature be applied between the auricles and ventricles, these latter generally begin to beat with a slower rhythm than the sinus (*Practical Physiology*).

The second part of this experiment seems to indicate that each part of the heart has the property of rhythmic contractility. It has also been shown that if the ventricle be made to beat faster than the sinus, the contraction wave may travel in the reverse direction, from ventricle to sinus. It, and not the sinus, becomes the "pace-maker."

The whole question of the relative parts played by nerve and muscle in starting contraction is still unsettled. The evidence seems to indicate that the rhythmicity is a function of the primitive cardiac tissue which is at first purely muscular, but which later contains nervous elements, and in connection with which, in the mammal, the chief masses of nerve cells occur.

The maintenance of this rhythmic contraction and relaxa-

tion depends upon the presence of certain **electrolytes** in the circulating blood. A due admixture of salts of sodium, potassium, and calcium is essential. For the frog's heart Ringer found that the proportions which give the best results are—

NaCl	0.70 per cent.
KCl	0.03 „
CaCl	0.025 „

The mammalian heart may be kept contracting for a long time after removal from the body by perfusing the coronary arteries through a tube fixed in the aorta with a suitable saline solution well oxygenated and kept at the temperature of the animal.

Sodium salts when supplied alone to the heart in considerable amounts cause relaxation. Potassium salts in much smaller amounts have the same effect. Calcium salts when in excess cause a sustained contraction.

The amount of carbon dioxide in the blood circulating in the coronary system affects the action of the heart. A decrease in the amount accelerates the heart, an increase leads to increased diastolic relaxation ; but at first the contractions are also so increased that the output of blood remains unaltered. Later the contractions decrease in force and the heart may stop in diastole.

The intra-cardiac nervous mechanism seems to exercise a controlling influence on cardiac contraction. (1) If the region between the sinus and auricles in the frog's heart is stimulated by the interrupted current from the induction coil, the heart is slowed or stopped, even after the synapses with the nerves coming from the central nervous system have been poisoned by nicotine. If atropine, which poisons the terminal plexus, be first applied, electric stimulation is without result (*Practical Physiology*).

(2) Further, if the intra-ventricular pressure in the heart of the frog is raised by clamping the aorta, a slowing of the rhythm occurs even after section of the vagi, but not after the intra-cardiac neurons have been poisoned by atropine.

2. **Conduction of Contraction.**—There is little evidence that nerve structures play a part in the conduction of the impulse when once started. The syncytial structure of heart muscle is specially well fitted to secure the propagation of the contraction, and poisoning the nerve structures with chloral does not abolish this.

While conduction is a function of the muscular tissue of the heart, it is undoubtedly modified through the action of nerves (p. 418).

The propagation of the wave of contraction over the auricles and ventricles and the part played by the primitive tissue have been already considered (p. 395).

V. The Nature of Cardiac Contraction.

The contraction of the ventricle lasts for a considerable fraction of a second. Is it of the nature of a single contraction, or of a tetanus?

(i.) A single stimulus applied to heart muscle produces a single prolonged contraction (*Practical Physiology*).

(ii.) It is impossible to tetanise the heart by rapidly repeated induction shocks. This is due to the long *refractory period* after contraction has occurred. The resistance to further stimulation gradually wanes, till, just before the onset of the next contraction, a very small stimulus is effective. By a slower sequence of stimuli it is therefore possible to produce an *incomplete* fusion of contractions.

(iii.) The steady passage of the contraction wave along the heart is against the idea that the normal action of the heart is a tetanus.

(iv.) That it is really a single contraction is demonstrated by taking advantage of the fact that the contracting part of a muscle is electro-positive ("zincy") to the rest. By the use of the string galvanometer, it is possible to show that the region of the sino-auricular node first becomes "zincy," and that this variation then travels over the auricle and onward to the ventricle.

In *man*, by leading off from the right hand and left foot

to the galvanometer, it is possible to get an **electrocardiogram**, the left foot being the pole connected with the apex, the right hand that connected with the base. Such tracings not only throw important light upon the nature and course of contraction, but have proved of considerable importance in the diagnosis of abnormal conditions of the heart. The string galvanometer is generally used for this purpose (p. 214).

The base of the heart shows first (*a*) an electro-positive phase (fig. 173) due to auricular contraction. This may be followed by (*b*) an electro-negative variation just at the beginning of ventricular contraction, which has been ascribed to the early contraction of the papillary muscles at the apex, making that part of the heart electro-positive to the base. (*c*) This is immediately followed by the most marked electro-positive variation, due to the contraction of the ventricle starting at the base. (*d*) At the very end of ventricular contraction another small electro-positive variation occurs, and this has been ascribed to the contraction ending in the infundibulum of the right ventricle.

Heart muscle resembles visceral muscle in that the minimum stimulus is also a maximum stimulus—*i.e.* the smallest stimulus which will make the muscle contract makes it contract to the utmost. This seems to be due to the fact that, while in skeletal muscle a small stimulus calls into play a few fibres a more powerful stimulus calls into play a greater number, whereas in heart muscle all are stimulated at once by the minimum effective stimulus, because of the continuity of the fibres in the syncytial network. The general law of the "all or nothing" in contraction applies to heart muscle. But while this is the case, the strength of stimulus necessary to call forth a contraction varies at different periods of the cardiac cycle as indicated above.

In cardiac muscle, perhaps more than in any other, a staircase increase in the extent of contraction with a series of stimuli is manifested.

Tone of Heart Muscle.—As already indicated, tonus is a

marked feature of visceral muscle (p. 215), and it is also manifest in skeletal muscle (p. 211). It would, therefore, be curious if it were absent in cardiac muscle. The rapid rhythmic contraction makes it more difficult to investigate, and some physiologists actually deny its existence and maintain that tone of the heart muscle, which should prevent over-distension, is rendered unnecessary by the action of the fibrous pericardium.

But there is considerable evidence that it does exist, and that it plays a not unimportant part. Gaskell found in the heart of cold-blooded animals that perfusing a fluid containing a weak alkali gradually decreased the diastolic filling and finally stopped the heart in systole, while perfusing a weak solution of lactic acid increased the diastole and reduced the systole, and, finally, brought the heart to a standstill in full diastole. Strophanthus acts like an alkali.

Clinically a condition of over-distension of the heart is frequently observed and the administration of strophanthus is found to decrease the distension. Physicians generally regard this as due to loss of tone. Some investigators maintain that it is simply due to too great diastolic filling, with too great lengthening of the muscle fibres.

Pathological Disturbances of Contraction and Conduction.

(1) **Heart-block.**—Since, in the mammalian heart, muscular continuity between auricles and ventricles through the band of His is of small extent, the wave of contraction is delayed at this point, and in the dying heart and in various pathological conditions, the contraction frequently fails altogether to pass this block, and the ventricles do not contract after each auricular systole, and may either stop, or contract only after two or three auricular contractions have occurred. In such cases the pulse rate is reduced to a half or even less of its normal rate. A condition of *bradycardia* through "heart-block" is produced. This condition is revealed by a study of the pulse in the veins of the neck or by the electrocardiogram.

(2) **Auricular Flutter.**—Another condition in which the

contraction wave is not regularly propagated from auricles to ventricles is seen in the condition of *auricular flutter* when, as the result of increased excitability of the sino-auricular node, the normal "pacemaker," the rate of contraction of the auricles is enormously increased, sometimes to two or three hundred per minute. In such cases the contraction reaches the auriculo-ventricular band while the ventricular fibres have not completed their contraction while they are still in the refractory phase. Hence, only one ventricular contraction for every two or three auricular contractions may occur. In these cases there is practically a heart-block, but the rate of the ventricles is not decreased as in true heart-block. The condition is fairly common, and it may be detected by the study of the venous pulse, or still better, by the electro-cardiogram.

(3) **Fibrillation.**—While under normal conditions the contractions are conducted in an orderly manner over auricles and ventricles, interference with the coronary circulation with the consequent decreased supply of oxygen to the wall of the heart is apt to lead to marked inco-ordination of the contractions, so that some bundles of fibres are contracting while others are relaxing. Thus a peculiar fluttering and ineffective fibrillar contraction or *fibrillation* is seen in the myocardium. This may affect either the auricles or the ventricles. Since the auricles are practically the cisterns of the heart, the condition does not so seriously interfere with the circulation when it affects them as when it affects the ventricles which are the pumps. Ventricular fibrillation prevents the proper expulsion of blood and soon leads to a fatal result. It may be produced by powerful electrical stimulation of the ventricles and is one factor in causing death in electrocution.

III. CIRCULATION IN THE BLOOD AND LYMPH VESSELS.

The general distribution of the various vessels—arteries, capillaries, veins, and lymphatics—has been already considered (fig. 162, p. 383).

1. STRUCTURE.

(The structure of the walls of each kind of Vessel must be studied practically.)

The **capillaries** are minute tubes of about 12 micromillimetres in diameter, forming an anastomosing network throughout the tissues. Their walls appear to be composed of a single layer of endothelium.

On passing from the capillaries to arteries on the one side, and to veins and lymphatics on the other, non-stripped muscle fibres make their appearance encircling the tube. Between these fibres and the endothelium, a fine elastic membrane next appears, while, outside the muscles, a sheath of fibrous tissue develops. Thus the three essential coats of these vessels are produced:—

Tunica intima, consisting of endothelium set on the internal elastic membrane.

Tunica media, consisting chiefly of circularly arranged visceral muscular fibres.

Tunica adventitia, consisting of loose fibrous tissue.

A. Arteries.—The coats of the arteries are thick. In the *large arteries*, the muscular fibres of the media are largely replaced by elastic fibres, so that the vessels may better stand the strain of the charge of blood which is shot from the heart at each contraction.

The great characteristic of the walls of the *large arteries* is the toughness and elasticity given by the abundance of elastic fibrous tissue, and of the *small arteries*, the contractility due to the preponderance of muscular fibres.

B. Veins.—In the *veins*, double flaps of the *tunica intima* form valves which prevent any back-flow of blood. The walls of the veins are thin.

2. PHYSIOLOGY.

The circulation of blood in the vessels is that of a fluid in a closed system of elastic-walled tubes, at one end of which (the great arteries) a high pressure, and at the other (the great veins) a low pressure, is kept up. As a result of this distribution of **pressure**, there is a constant **flow** of blood from arteries to veins.

Many points in connection with the circulation may be conveniently studied on a model, or schema, made of india-rubber tubes and a Higginson's syringe (*Practical Physiology*).

A. Blood Pressure.

The distribution of pressure is the cause of the flow of blood, and must first be considered.

1. General Distribution of Pressure.

That the pressure throughout the greater part of the blood-vessels is positive—greater than the pressure of the atmosphere—is indicated by the fact that if a vessel is opened, the blood flows out of it. *The force with which blood escapes is a measure of the pressure in that particular vessel.* If an artery be cut, the blood escapes with great force; if a vein be cut, with much less force.

1. **Arteries.**—If the pressure in the aorta, in the radial, in the dorsalis pedis, and in one of the smallest arteries is measured, it is found that there is no marked change till the very smallest arteries are reached, when the pressure rapidly falls. In the aorta the pressure may be over 150 mm. Hg, while in the capillaries it may be only about 20 mm. Hg. This distribution of arterial pressure may be plotted as in fig. 183, *Ar.*

2. **Veins.**—If the pressure in any of the small veins, in

a medium vein, and in a large vein near the heart be measured, it will be found—

1st. That the venous pressure is less than the lowest arterial pressure.

2nd. That it is highest in the small veins, and becomes lower in the larger veins. In the great veins entering the heart during inspiration it is lower than the atmospheric pressure.

3. Capillaries.—The pressure in the capillaries must

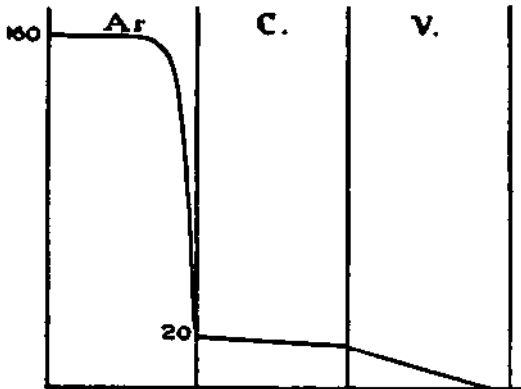

FIG. 183.—Diagram of the Distribution of Mean Blood Pressure throughout the Blood Vessels. *Ar.*, the arteries; *C.*, the capillaries; *V.*, the veins.

obviously be intermediate between that in the arteries and in the veins.

The pressure in any part of a system of tubes depends upon two factors:—

1st. The force propelling fluid into that part of the system.

2nd. The resistance to the outflow of fluid from that part of the system.

The pressure in the arteries is high, (1) because with each beat of the heart the contents of the ventricle are thrown with the whole contractile force of the heart into the corresponding artery; and (2) because the resistance offered to the outflow of blood from the arteries into the capillaries and veins is enormous, since the blood, as it passes into

innumerable small vessels, is subjected to greater and greater friction—just as a river, in flowing from a deep narrow channel on to a broad shallow bed, is subjected to greater friction.

Thus, in the arteries the powerful propulsive force of the heart and the great resistance to outflow keep the pressure high.

When the capillaries are reached, much of the force of the heart has been lost in dilating the elastic coats of the arteries, and thus the inflow into the capillaries is much weaker than the inflow into the arteries. At the same time, the resistance to outflow is small, for, in passing from capillaries to veins, the channel of the blood is becoming less broken up and thus offers less friction to the flow of the blood.

When the veins are reached, the propelling force of the heart is still further weakened, and hence the force of inflow is very small. But there is no *resistance* to outflow from the veins into the heart during diastole. Further, the great veins, before they reach the heart, pass into the thorax, an air-tight box in which, during each inspiration, a low pressure is developed.

What has been said of the pressure in the veins applies equally to that in the lymphatics.

2. Rhythmic Variations in Blood Pressure.

Before considering the methods of investigating the pressure in these different vessels, and the changes which they undergo, certain rhythmic variations in pressure may first be considered.

A. CHANGES IN PRESSURE SYNCHRONOUS WITH THE HEART BEATS.

1. The Arterial Pulse.

With each ventricular systole, the contents of each ventricle are thrown into the already full arteries, and the pressure in these vessels is suddenly raised.

If the finger be pressed upon an artery, a distinct expansion, due to this rise of pressure, will be felt following each systole. This is the *arterial pulse*. It is simply a rise of pressure, and it has nothing to do with the flow of blood.

The pulse wave may be compared to a wave at sea, which is also a wave of increased pressure, the only difference being that, while the wave at sea travels freely over the surface, the pulse wave is confined in the column of blood, and manifests itself by expanding the walls of the arteries.

If a vein be investigated in the same way, it will be found that no such pulse can be detected. In the capillaries, also, this pulse does not exist.

It is best marked in the great arteries, and becomes less and less distinct as the small terminal arteries are reached.

1. *Causes of the Pulse.*—The arterial pulse is due to—

1st. The *intermittent inflow* of blood. The arteries expand from the sudden increase of pressure due to each sudden rush of blood from the heart into the arterial system.

2nd. The *resistance to outflow* from the arteries into the capillaries.

If blood could flow freely from the arteries into the capillaries, then the inrush of blood from the heart would simply displace the same amount of blood into the capillaries and the arteries would not be expanded. As already indicated, the friction between the walls of the innumerable small arterioles and the blood is so great that the flow out of the arteries is not sufficiently free to allow the blood to pass into the capillaries as rapidly as it is shot into the arteries. Hence, with each beat of the heart, an excess of blood must accumulate in the arteries to be passed on into the capillaries and veins between the beats.

3rd. The *elasticity of the walls*. To allow of their expanding to accommodate this excess of blood the walls of the arteries must be *elastic*.

It is upon these three factors that the arterial pulse depends. Do away with any of them, and the pulse at once disappears.

2. **Why is there no Pulse in the Veins?**—Their walls have a certain amount of elasticity, but, instead of there being a resistance to the outflow of blood from the veins into the heart, this is favoured by the suction action of the thorax in inspiration. Hence, even if an intermittent inflow were well marked, the absence of resistance to outflow would in itself prevent the development of a venous pulse. But the inflow is not intermittent. The arteries are so overfilled that *just as much blood passes into the veins between the beats as during the beats of the heart*. Hence the most important factor in causing a pulse, an intermittent inflow, is absent.

With no intermittent inflow, and with no resistance to outflow, the development of a pulse is impossible.

In certain abnormal conditions, where, from the extreme dilatation of the arterioles, the inflow into the veins is very free, and where the outflow from the part of the body is not so free, a local venous pulse may develop.

A special pulse in the great veins near the heart is considered on p. 444.

3. **Characters of the Pulse Wave.**—If a finger be placed on the carotid artery and another upon the radial artery, it will be felt that the artery near the heart expands (pulses) before that further from the heart (*Practical Physiology*). The pulse develops first in the arteries near the heart and passes outwards towards the periphery. The reason for this is obvious. The arteries are always overfilled with blood. The ventricle drives its contents into the overfilled aorta, and, to accommodate this, the aortic wall expands. But, since the aorta communicates with the other arteries, this *increased pressure* passes outwards along them, expanding their wall as it goes.

It greatly simplifies the study of the pulse to regard it in this light, and to study it just as we should study a wave at sea.

1. **Velocity.**—To determine how fast a wave is travelling, the time may be ascertained which it takes to pass from one point to another at a known distance from the first. So with the pulse wave: two points on an artery at a known

distance from one another may be taken, and the time which the wave takes to pass between them may be measured.

In this way it is found that the pulse wave travels at about 9 or 10 metres per second—about thirty times as fast as the blood flows in the arteries (p. 465).

2. *Length of the Wave.*—To determine this in a wave at sea is easy, if we know its velocity and know how long it takes to pass any one point. The same method may be applied to the pulse wave. We know its velocity, and, by placing the finger on an artery, we may determine that one wave follows another in rapid succession, so that there is no

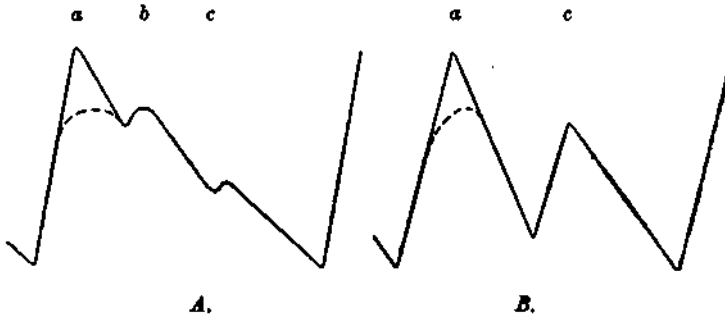

FIG. 184.—Two Pulse Tracings—A. with a relatively sluggish heart and relatively high arterial pressure; B. with a relatively active heart and relatively low arterial pressure. Both show the primary crest exaggerated by the inertia of the sphygmograph.

pause between them. Each wave lasts the length of a cardiac cycle. There are about 40 cycles per minute—*i.e.* per 60 seconds; hence, each must last 1.5 second. The pulse wave takes 1.5 second to pass any place, and it travels at 10 metres per second; its length then is 15 metres, or about *five times the length of the body*. It is then an enormously long wave, and it has disappeared at the periphery long before it has finished leaving the aorta.

3. *The Height of the Wave.*—The height of the pulse wave, as of a wave at sea, depends primarily on the pressure causing it. It is really the difference between the maximum systolic pressure (fig. 190) and the minimum diastolic pressure. It may be most accurately measured by determin-

ing these by means of the Riva Rocci apparatus (p. 448). The character of the arterial wall modifies it very largely and the true height of the pulse wave in the great arteries near the heart is masked by the thickness of the arterial wall.

The pulse wave is highest near the heart, and becomes lower and lower as it passes out to the periphery, where it finally disappears altogether (fig. 190). This disappearance is due to its force becoming expended in expanding the arterial wall.

4. *The Form of the Wave.*—Waves at sea vary greatly in

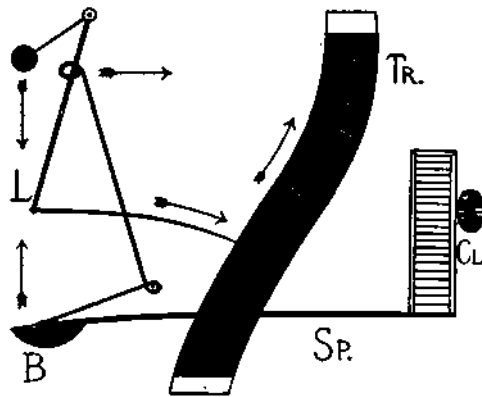

FIG. 185.—Diagram of Dudgeon's Sphygmograph. *Cl.*, clockwork driving the smoked paper, *Tr.*, under the writing point of the liver, *L.*, *Sp.*, is a steel spring, with a button, *B.*, which is applied over the radial artery. With each expansion of the artery the button is moved upwards, and causes a movement of the system of levers indicated by the arrows.

form, and the form of the wave might be graphically recorded on some moving surface, such as the side of a ship, by some floating body. If the ship were stationary, a simple vertical line would be produced as the wave passed, but, if she were moving, a curve would be recorded, more or less abrupt according to her speed. From this curve the shape of the wave might be deduced, if the speed of the vessel were known.

The same method may be applied to the arterial pulse. By recording the changes produced by the pulse wave as it

passes any point in an artery the shape of the wave may be deduced from the tracing.

This may be done by any of the various forms of *sphygmograph* (fig. 185), (*Practical Physiology*).

Such a tracing is not a true picture of the wave, but simply of the effect of the wave on one point of the arterial wall. Its *apparent* length depends upon the rate at which the recording surface is travelling, and not upon the length of the wave.

Its apparent height depends (i.) upon the length of the

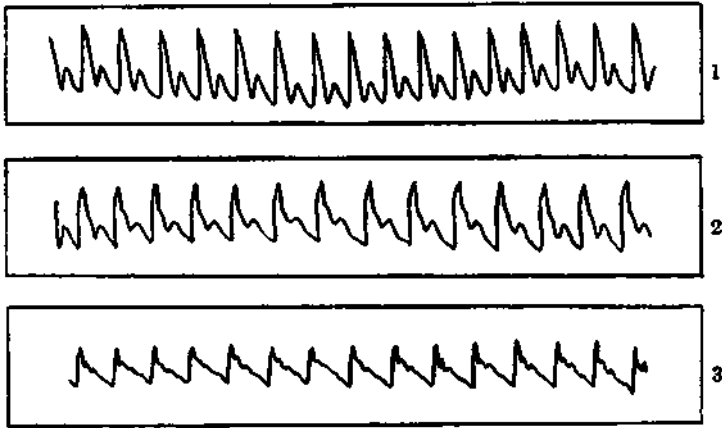

FIG. 186.—Three Sphygmographic Tracings made from the Radial Artery of a healthy man in the course of one hour without removing the sphygmograph. 1 was made immediately after muscular exercise; 2 was made after sitting still for half an hour; and 3, after an hour.

recording lever, (ii.) upon the resistance offered by the instrument, (iii.) upon the degree of pressure with which the instrument is applied to the artery, and (iv.) on the thickness of the arterial wall.

Such a trace (figs. 184 and 186) shows—

1st. That the pulse waves generally follow one another without any interval.

2nd. That the rise of the wave is much more abrupt than the fall.

3rd. That there are one or more secondary waves upon the descent of the primary wave.

One of these is constant and is very often well marked. It forms a second crest, and is hence called *the dicrotic wave* (fig. 184, c).

Between the chief crest and this secondary crest, a smaller crest is often manifest (fig. 184, A., b). From its position, it may be called *the predicrotic wave*. If the wave has only one crest the pulse is called a one-crested or monocrotic wave. If the dicrotic crest is well marked it is called dicrotic.

That the wave actually has the characters disclosed by a sphygmographic tracing may be demonstrated by letting the blood from a cut artery play upon a moving surface when a *Hæmautograph* showing the waves is produced.

To understand the various parts of the pulse wave, it is necessary to compare it with the changes in the intra-ventricular pressure throughout the cardiac cycle. This may be done by taking synchronously tracings of the intra-ventricular pressure and of the aortic pressure (fig. 173, p. 401).

Such a tracing shows that, at the moment of ventricular systole, the pressure in the aorta is higher than that in the left ventricle.

As ventricular systole advances, the intra-ventricular pressure rises and becomes higher than the aortic. At that moment, the aortic valves are thrown open and a rush of blood takes place into the aorta, raising the pressure and expanding the artery, and causing the upstroke and *crest* of the pulse curve. In a sphygmographic tracing this crest is exaggerated by the inertia of the instrument (fig. 184). After the ventricle has emptied itself, the intra-ventricular pressure tends somewhat to fall, and, at the same time, a fall in the intra-aortic pressure begins, and goes on till ventricular diastole, while the elastic wall of the artery recovers and reduces the size of the vessel. With diastole, the intra-ventricular pressure suddenly becomes less than the intra-aortic, and the semilunar valves are forced downwards towards the ventricles, and thus the capacity of the aorta is slightly increased and the pressure falls sharply. This fall

in pressure is indicated by the *dicrotic notch*. But the elasticity of the semilunar valves at once makes them spring up, thus increasing the pressure in the aorta and causing the second crest, the *dicrotic wave* (fig. 184, *c*). After this the pressure in the arteries steadily diminishes till the minimum is reached, to be again increased by the next ventricular systole.

If all the blood does not leave the ventricle in the first gush, *e.g.* when the intra-aortic pressure is high as compared with the force of the heart (fig. 175, continuous line), there is a residual outflow which, by catching the lever of the sphygmograph on its back-spring from the initial crest, may again raise it, causing the *predicrotic wave*.

It is thus manifest that *the form of the pulse wave varies* according to the relationship between the arterial pressure and the activity of the heart. It is not the actual activity of the heart or the actual arterial pressure, but their relationship to one another which is of importance. Thus, a heart actually weak may, with a low arterial pressure, be *relatively* active.

(A) If the heart is active and strong *in relation to the arterial pressure*, the main mass of the blood is expelled in the first sudden outflow, and the residual flow is absent or slight (fig. 175, dotted line). In this case there is a sudden and marked rise of the arterial pressure, followed by a steady fall till the moment of ventricular diastole. The rebound of the semilunar valves is marked and causes a very prominent dicrotic wave, while the predicrotic wave is small or absent (fig. 184, *B*). Such a condition is well seen after violent muscular exertion, and in certain fevers. In these conditions the dicrotic wave may be so well marked that it can be felt with the finger.

(B) On the other hand, if the ventricles are acting slowly or feebly *in relationship to the arterial pressure*, the initial outflow of blood does not take place so rapidly and completely (fig. 175, continuous line), and the initial rise in the pulse is thus not so rapid. The residual outflow of blood is more marked and causes the well-marked secondary rise in the pulse curve—the predicrotic wave. In certain cases,

this may be higher than the primary crest, producing the condition known as the *anacrotic pulse*. The relatively high intra-arterial pressure in such a case prevents the development of a well-marked dicrotic wave.

In extreme cases of this kind, when the arterial walls are very tense, they may recover in an irregular jerky manner, and may give rise to a series of katacrotic crests producing a polycrotic pulse (fig. 186, s).

From what has been said, it will be seen that a study of the pulse wave gives most valuable information as regards the state of the circulation, and the physician constantly makes use of the pulse in diagnosis.

Palpation of the Pulse.—On placing the finger on the artery the points to determine are—

1st. The rate of the pulse—*i.e.* the rate of the heart's action.

2nd. The rhythm of the pulse—*i.e.* of the heart's action, as regards—(1) *Strength of the various beats.*—Normally the beats differ little from one another in force—since the various heart-beats have much the same strength. Respiration has a slight effect which will afterwards be considered (see p. 535). In pathological conditions great differences in the force of succeeding pulse waves may occur. (2) *Time relationship of the beats.*—Normally the beats follow one another at regular intervals—somewhat shorter during inspiration—somewhat longer during expiration. In pathological conditions great irregularities in this respect may occur.

3rd. The volume of the pulse wave. Sometimes the wave is high and greatly expands the artery—sometimes it is less high and expands the artery less. This is a measure of the difference between systolic and diastolic pressure. The former condition is called a full pulse (*pulsus plenus*), the latter a small pulse (*pulsus parvus*). The fulness of the pulse depends upon two factors:—1st. The average tension in the arteries between the pulse-beats—the diastolic pressure. If this is high, the walls of the artery are already somewhat stretched, and therefore the pulse wave may expand

them further only slightly. On the other hand, if the diastolic pressure is low, the arterial wall is lax, and is readily stretched to a greater extent. *2nd.* The force of the heart which determines the systolic pressure. To stretch the arterial wall to a large extent requires an actively contracting heart throwing a large wave of blood into the arterial system at each systole. The full pulse is well seen after violent exertion, when the heart is active and the peripheral vessels moderately dilated. It is also seen in a slow pulse, on account of the greater diastolic filling of the ventricles.

4th. **Tension** of the pulse. This is really a measure of the maximum systolic blood pressure, which may be more accurately measured by the Riva Rocci apparatus (p. 448). To test it, two fingers must be placed upon the artery, and the one nearer the heart pressed more and more firmly on the vessel until the pulse wave is no longer felt under the other finger.

The tension of the pulse varies directly with the force of the heart and with the peripheral resistance. The first statement is so obvious as to require no amplification. It is also clear that, if the peripheral resistance is low, so that blood can easily be forced out of the arteries into the capillaries, the arterial wall will not be so forcibly expanded as when the resistance to outflow is great. Hence a high-tension pulse is indicative of a strongly acting heart with constriction of the peripheral vessels. It is well seen during the shivering fit which so frequently precedes a febrile attack, since at that time the peripheral vessels are constricted and the heart's action excited.

5th. The form of the pulse wave may be investigated by means of the finger alone, or by means of the sphygmograph. The points to be observed are:—

(1) Does the wave come up suddenly under the finger? In the *pulsus celer* (or active pulse) it does so; in the *pulsus tardus*, on the other hand, it comes up slowly. The former condition is indicative of an actively contracting heart with no great peripheral resistance—the latter indicates that the heart's action is weak in relationship to the arterial blood pressure.

(2) Does the wave fall slowly or rapidly? Normally the fall should not be so sudden as the ascent. When the aortic valves are incompetent the descent becomes very rapid (p. 410) in the so-called "water-hammer" pulse.

(3) Are there any secondary waves to be observed? The only one of these which can be detected by the finger is the dicrotic wave, and this only when it is well marked. When it can be felt, the pulse is said to be *dicrotic*, and, as before stated, this indicates an actively contracting heart with an arterial pressure low relatively to the strength of the ventricles (p. 441).

2. The Capillary Pulse.

For the reasons already given, there is normally no pulse in the capillaries (p. 434). If, however, the arterioles to a district are freely dilated, so that little resistance is offered to the escape of blood from the arteries, and if, at the same time, the outflow from the capillaries is not proportionately increased, intermittent inflow and resistance to outflow are developed, and a pulse is produced. Such a condition is seen in certain glands during activity.

3. The Venous Pulse.

1. The absence of a general venous pulse has been already explained. But just as in the capillaries, so in the veins, a local pulse may develop.

2. In the veins entering the auricles and in the veins at the root of the neck a pulse occurs. This may be recorded by means of M'Kenzie's polygraph which consists of a small metal cup connected with a recording tambour. The cup is applied closely to the skin over the vein. This pulse has no resemblance to the arterial pulse, although depending on the same three factors.

Its form is indicated in fig. 187.

Its features are to be explained as follows:—

(a) *Normal*.—Blood is constantly flowing into the great veins, pressed on from behind. (i.) When the auricles contract, the outflow from these veins into the heart is suddenly

checked, and consequently the veins distend, causing a crest (A.S.). At the moment of auricular diastole the outflow is again free, a rush of blood takes place into the distending auricles, and thus the pressure in the veins falls. (ii.) But, as this is occurring, two things happen—(a) blood is shot from the ventricles into the arteries, and the carotid, lying behind the jugular vein, transmits its pulse through the vein; (b) the auriculo-ventricular valves are closed and pressed upon from the ventricular side, and thus a wave of pressure is sent back through the auricles. These two together cause a second wave early in ventricular systole. (iii.) While the ventricle is

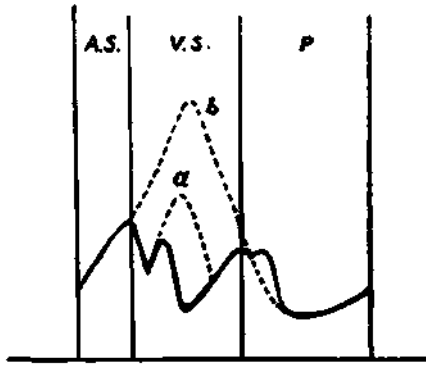

FIG. 187.—Tracings of the Pulse in the Great Veins in Relationship to the Cardiac Cycle. — normal venous pulse, on which is shown the fourth crest which is often absent. *a* and *b*, venous pulse in tricuspid incompetence.

contracted, blood cannot pass on from the auricles, and hence it accumulates in the great veins and makes a third crest at the end of ventricular systole. At the moment when the ventricles dilate, a sudden rush of blood takes place from the veins and auricles into the ventricles, and thus a sudden fall in the pressure is produced. (iv.) This may be interrupted by the rebound of the auriculo-ventricular ring, which was pulled downwards during ventricular systole, and this may cause a fourth crest on the pulse. Gradually, as the ventricles fill, the pressure in the auricles and veins increases till the next auricular systole.

(b) *Pathological*.—If the auriculo-ventricular valves are incompetent (p. 410) blood is forced back into the auricles and veins when the ventricles contract, and the crest during ventricular systole becomes more and more marked (fig. 187, b). The height of this crest is a good index of the amount of regurgitation.

B. CHANGES IN PRESSURE SYNCHRONOUS WITH THE RESPIRATION.

1. *Arterial*.—Not only do rhythmic changes in the arterial pressure occur with each beat of the heart, but

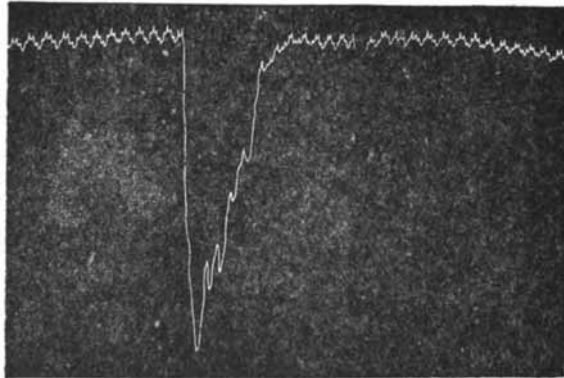

FIG. 188.—Tracing of the Arterial Blood Pressure to show large respiratory variations, and small variations due to heart beats upon these, and the sudden fall in the pressure produced by stimulating the inferior cardiac branch of the vagus nerve.

larger changes are caused by the respirations—the rise in pressure in great measure corresponding to the phase of inspiration, the fall in pressure to the phase of expiration. This statement is not quite accurate, as will be seen when considering the influence of respiration on circulation (see p. 535). These variations are easily seen in a tracing of the arterial pressure taken with the mercurial manometer (fig. 188).

2. **Venous**.—A pulse, synchronous with the respirations, may also be observed in the *great veins at the root of the neck* and in the venous sinuses of the cranium when it is opened. With each inspiration they tend to collapse; with each expiration they again expand. The reason for this is that during inspiration the pressure inside the thorax becomes low, and hence blood is sucked from the veins into the heart. Hence the danger that in operating on the neck a vein may be opened and air sucked into the circulation to block the vessels in the lungs. During expiration, the intra-thoracic pressure becomes higher and thus the entrance of blood into the heart is opposed.

3. Mean Blood Pressure.

I. PRESSURE IN THE ARTERIES.

(1) Methods.

A. **In Lower Animals**.—1. The first investigation of the pressure in the blood-vessels was made by the Rev. Stephen Hales in 1733. He fixed a long glass tube in the femoral artery of a horse laid on its back, and found that the pressure supported a column of blood of 8 feet 3 inches, while, when the tube was placed in a vein, only 1 foot was supported. The capillary pressure is, of course, intermediate between these two.

2. At the present time, instead of letting the blood pressure act directly against the force of gravity, it is found more convenient, in studying the pressure in an artery, to let it act through a column of mercury placed in a U tube (fig. 189, A.). (1) To record the changes in pressure a float is placed upon the mercury in the distal limb of the tube, and this carries a writing style which records the changes upon a moving surface. (2) The tube and the proximal end of the manometer are filled with a strong solution of sodium sulphate to prevent clotting and to transmit the pressure to the mercury. (3) Before the artery is unclamped, the pressure is raised in the proximal

end of the manometer so that it nearly equals that in the artery, and thus prevents the animal from bleeding into the tube.

With such an apparatus a record such as is shown in fig. 188 is given. The actual pressure is measured by taking the difference between the level of the mercury in the two limbs of the tube. To make the measurement, it is customary to describe an abscissa when the mercury is at the same level in the two sides of the tube. The height of

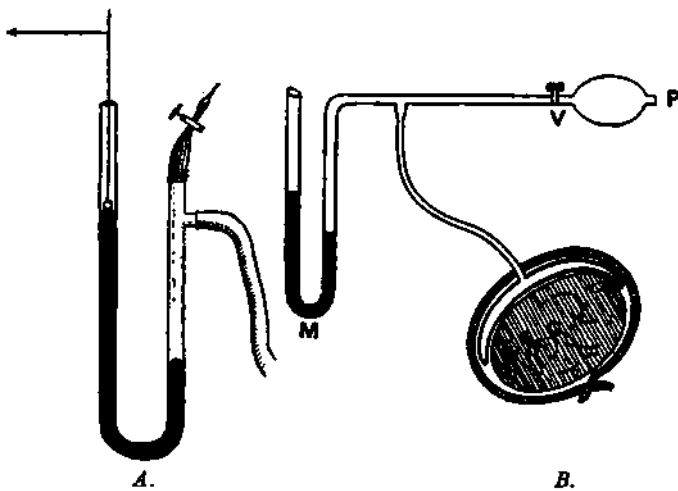

FIG. 189.—A., The Mercurial Manometer with Recording Float, used in taking records of the arterial blood pressure of lower animals. The clamped tube is to allow of the pressure being raised. The long tube is connected with the cannula placed in the artery. B., The Riva Rocci Sphygmometer, for measuring the arterial pressure in man. M., manometer; P., pump; V., valve.

the style above the abscissa must be multiplied by two to give the pressure, on account of the depression in the proximal limb which accompanies the rise in the distal limb.

On the record made with such an instrument, the rhythmic variations in the arterial blood pressure already considered on p. 434 *et seq.* are clearly visible (*Practical Physiology*).

B. In the intact Animal.—1. To measure the **systolic pressure** it is necessary to find the pressure which must be applied to an artery in order to prevent the pulse from passing.

This may be done with Riva Rocci's apparatus (fig. 189, (B.) by applying a bag round the limb so that it rests upon the brachial artery. The bag is firmly strapped on by means of a broad supporting belt, and it is connected with a pump, by which the pressure within it may be raised, and with a mercurial manometer by which the pressure applied may be measured in mm. of mercury. The pressure is then raised either (a) till the pulse beyond the band is no longer felt, or (b) till no sound is heard with each pulse wave through a stethoscope applied to the artery beyond the band. The pressure is then gradually relaxed till (a) the pulse is again

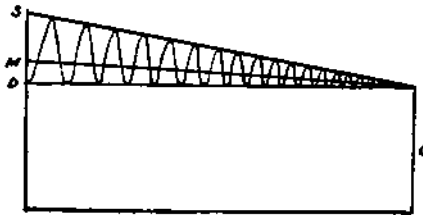

FIG. 190.—To show the Difference between Systolic, Diastolic, and Mean Blood Pressure throughout the Arterial System. *S.*, systolic pressure; *D.*, diastolic pressure; *M.*, mean pressure.

felt or (b) the sound with each pulse wave heard through the stethoscope reappears. The column of mercury, at this moment, indicates the systolic pressure in the artery (*Practical Physiology*).

2. The **diastolic pressure** may be measured by further relaxing the pressure and noting the point at which the pulse sound again disappears.

(2) Normal Arterial Pressure.

By these methods it has been found that the systolic pressure in the brachial artery of man is about 120 mm. of

mercury, while the diastolic pressure is only about 70 mm. The difference between these, of course, gives the pulse pressure.

(3) Factors controlling Arterial Pressure.

(1) The *force of the heart* and (2) the degree of *peripheral resistance* both modify the arterial pressure, and normally these so act together that any disturbance of one is compensated for by changes in the other. Thus, if the heart's action becomes increased and tends to raise the arterial pressure, the peripheral resistance falls and prevents any marked rise. Similarly, if the peripheral resistance is increased, the heart's action is diminished, and the rise in the pressure is checked. Under certain conditions, however, this compensatory action is not complete, and changes in the arterial pressure are thus brought about.

(3) The *volume of blood* has a comparatively small influence on the arterial pressure (1) because by changes in the degree of contraction of the peripheral vessels, the volume of the vascular system may be adapted to the volume of blood contained, and (2) because there is a very free exchange of water between the blood and the tissues through the walls of the capillaries. Hence, after a hæmorrhage, the volume of the blood is rapidly restored, and hence, after transfusion of salt solution, the fluid rapidly passes out of the vessels. But if an excessive loss of blood occurs, or if a large quantity of blood stagnates in any region and is thus put out of effective circulation, the vessels may not be able to adapt themselves, and the arterial pressure may fall. From observations made during the Great War it appears that in man a loss of 40 per cent. of the blood is generally accompanied by a fall of the systolic pressure to about 80 mm. Hg.

When the pressure falls in this way it may be restored by injecting into a vein a sufficient amount of some fluid which has no prejudicial action on the blood and which does not too readily transude out of the capillaries. In man, gum arabic in 6 per cent. solution has been used.

I. **Heart's Action.**—The influence of this may be readily demonstrated by stimulating the vagus nerve while taking a tracing of the arterial pressure. The heart is inhibited, less blood is forced into the arteries, and the pressure falls (fig. 188).

If, on the other hand, the augmentor nerve is stimulated, the increased heart's action drives more blood into the arteries, and the pressure rises.

II. **Peripheral Resistance.**—The resistance to outflow from the arteries to the capillaries and veins depends upon (1) the *resistance offered in the small arteries*, the walls of which are surrounded by visceral muscle fibres. When these fibres are contracted, the vessels are small and the resistance is great. When they are relaxed, the vessels dilate, and the resistance to outflow is diminished. **This muscular tissue of the arterioles acts as a stop-cock to the flow of blood from the arteries to the capillaries.** It is of great importance—*1st*, in maintaining the uniform pressure in the arteries; *2nd*, in regulating the flow of blood into the capillaries.

(2) *The condition of the capillaries.*—Krogh has shown that in resting muscle most of the capillaries are closed, while in contracting muscle they are dilated and filled with blood even when the arterial pressure has not been allowed to rise. The capillaries thus seem able to contract and expand. Recently Dale has shown that the administration of histamine to dogs and monkeys causes such a dilatation with, at the same time, a contraction of the arterioles. Krogh also finds that a dilatation of capillaries may be produced by stimulating directly.

He considers that the state of the arterioles regulates the *pressure* of blood in the arteries, while the state of the capillaries regulates the rate of *flow*. A slow current through dilated capillaries means arteriole constriction.

Dilatation of the arterioles and of the capillaries is generally local, and its effects upon the general arterial pressure is

generally compensated for by contraction in other parts of the body (p. 460).

(3) *The viscosity of the blood.*—The friction between the walls of the blood-vessels and the blood is modified by the viscosity of the latter (p. 475). After severe hæmorrhage this is markedly decreased, and the resistance to the flow in the small vessels is correspondingly decreased, and hence the arterial pressure tends to fall.

(1) **Methods of Studying the Condition of the Arterioles and Capillaries.**

1st. By direct observation.—1. With the naked eye. A red engorged appearance of any part of the body may be due to dilatation of the arterioles leading to it. But the capillaries may be more particularly dilated, when, as a result of partial stagnation and the more complete removal of oxygen from the blood, the part may have a bluish colour. The engorgement may, however, be due to some obstruction to the *outflow* of blood from the part. 2. With the microscope. In certain transparent structures, such as the web of the frog's foot, or the wing of the bat, or the mesentery, it is possible to measure the diameter of the arterioles and the capillaries by means of an eye-piece micrometer, and to study their dilatation and contraction.

2nd. Engorgement of the capillaries brought about either by dilatation of the arterioles, of the capillaries, or of both, or simply by increased force of the heart raising the arterial pressure, manifests itself also in an increased *size of the part*. Every one knows how, on a hot day, when the arterioles of the skin are dilated, it is difficult to pull on a glove which, on a cold day, when the cutaneous vessels are contracted, feels loose. By enclosing a part of the body in a case with rigid walls, filled with fluid or with air, and is connected with some form of recording tambour, an increase or decrease in the size of the part, due to the state of its vessels, may be registered. Such an instrument is called a **bulk-measurer (plethysmograph or oncograph)**.

3rd. When the arterioles in a part are dilated and the blood is flowing freely into the capillaries, the part becomes warmer, and, by fixing a thermometer to the surface,

conclusions as to the condition of the arterioles may be drawn. The temperature of the surface of the body is also modified by the activity of the heart; if the heart begins to fail the temperature tends to fall.

4th. By streaming blood through the vessels, generally of a frog, and observing the rate at which it escapes, the changes in the state of the small vessels may be made out. This **perfusion method** is much used in studying the action of drugs (*Practical Physiology*).

5th. Since the state of the arterioles influences the arterial pressure (p. 450), *if the heart's action is kept uniform*, changes in the **arterial blood pressure** indicate changes in the arterioles—a fall of pressure indicating dilatation, a rise of pressure, constriction.

(2) **Normal Condition of the Arterioles.**—Normally the arterioles are in a state of semi-contraction; but if the arterioles in some transparent tissue be examined, they will be found to undergo periodic slow changes in calibre. The ear of a white rabbit shows such slow changes; it seems at one time pale and bloodless, at another time red and engorged. During this latter phase numerous vessels appear which in the former condition were invisible. These slow changes are independent of the heart's action and of the rate of respiration. They appear to be due to the periodic rhythmic contraction of the walls of the vessels.

During the functional activity of a part, a free supply of blood to its capillaries is required. This is brought about by a relaxation of the muscular coats of the arterioles leading to the part, and probably by an active as well as a passive dilatation of the capillaries. When the part returns to rest, the free flow of blood is checked by the contraction of the muscular walls of the arterioles, and probably of the walls of the capillaries.

The action of the arterioles is well seen under the influence of certain drugs (vaso-dilators and vaso-constrictors). If *nitrite of amyl* is inhaled by the animal, it will be seen that the skin and mucous membranes become red and engorged with blood, while at the same time the arterial pressure falls. Nitrites cause the muscular

coat of the arterioles to relax, and thus, by diminishing peripheral resistance, permit blood to flow freely from the arteries into the capillaries.

Salts of *barium* have precisely the opposite effect, causing the skin to become pale from imperfect filling of the capillaries, and producing a marked rise in the arterial pressure. Contraction of the muscles of the arterioles is produced, and the flow of blood from arteries to capillaries is retarded.

Histamine seems to have the peculiar action of constricting the arterioles, and in some animals at least of dilating the capillaries.

(3) **Nervous Mechanism Controlling the Arterioles.**—If the sciatic nerve is cut, the small vessels in the foot at once dilate. If the nerve is stimulated, they contract. The same results follow if the anterior roots of the lower spinal nerves, from which the sciatic takes origin, are first cut and then stimulated.

The central nervous system, therefore, exerts a constant tonic influence upon the arterioles, keeping them in a state of semi-contraction, and this action may be increased, and thus a constriction of the arterioles produced. In this way, if the effect is a general one, the flow of blood from arteries to capillaries is obstructed and the arterial pressure may be raised. This influence may also be diminished, so that the arterioles dilate and allow an increased flow into the capillaries from the arteries. Thus the arterial pressure may be lowered if the action is not too local, and is not compensated for by constriction elsewhere.

These mobile arterioles, under the control of the central nervous system, constitute a **vaso-motor mechanism**, which plays a part in nearly every vital process in the body. By it the pressure in the arteries is governed, the supply of blood to the capillaries and tissues is controlled, and the loss of heat from the skin is largely regulated (p. 269).

This **vaso-motor mechanism** consists of two parts :—

1st. Peripheral.—This consists of the muscular fibres in the walls of the arterioles with the nerve structures among them.

2nd. Central.—The portions of the central nervous system presiding over these and the nerves which pass from them.

1st. Peripheral Mechanism.—The muscular fibres are maintained in a state of tonic semi-contraction by nerves passing to them, and when these nerves are divided, the muscular fibres relax. But if, after these nerves have been cut, the animal be allowed to live, in a few days the *arterioles again pass into a state of tonic semi-contraction*, although no union of the divided nerve has taken place.

Certain drugs, *e.g.* digitalis and the salts of barium, act as direct stimulants to these muscle fibres, while nitrites inhibit their activity.

The precise part played by the **nerve plexus** in the walls of the arterioles has not been definitely established, but certain drugs appear to act specially upon it. Thus, apocodeine, while it does not prevent barium salts from constricting the vessels, prevents the constricting action of adrenalin, even when the nerves are cut. Hence, it must be concluded that apocodeine paralyzes a nervous mechanism in the arteriole wall which is stimulated by adrenalin. On the other hand, nicotine seems to block the action of barium, but not that of adrenalin. Deductions from the antagonistic action of drugs are by no means satisfactory, as their action varies so much with dosage and with the functional condition of the tissues at the time when they are administered.

2nd. Central Mechanism.—When a nerve, going to any part of the body, is cut, the arterioles of the part generally dilate; when it is stimulated, the arterioles *usually* contract; sometimes, however, they dilate. In no case does section of a nerve cause constriction of the arterioles.

These facts prove that the central vaso-motor nervous mechanism may be divided into two parts:—

- A. Vaso-constrictor mechanism.
- B. Vaso-dilator mechanism.

A. Vaso-constrictor Mechanism.—The fact that section of most nerves at once causes a dilatation of the arterioles

proves that they are constantly transmitting vaso-constrictor impulses from centres in the nervous system.

(1) *Course of the Nerves.*—The course of these fibres has been investigated by section and by stimulation (fig. 191).

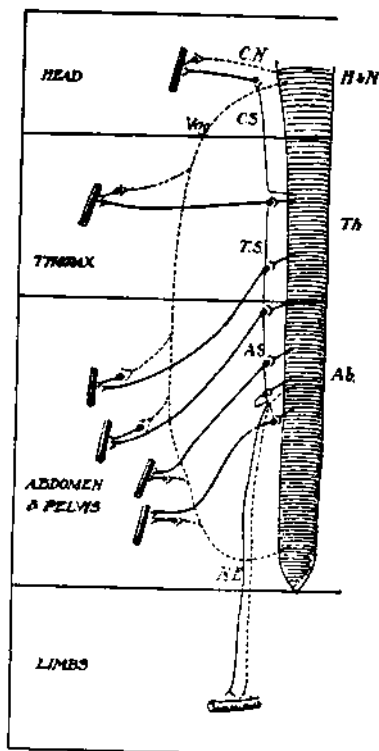

FIG. 191.—Diagram of the Distribution of Vaso-motor Nerves. The continuous line shows the vaso-constrictors, the dotted line the vaso-dilators. *C.N.*, cranial nerves; *Vag.*, vagus; *T.S.*, thoracic sympathetic; *A.S.*, abdominal sympathetic; *N.L.*, nerves to the leg.

able of reflex excitation. In ordinary conditions, so many afferent nerves are constantly being stimulated, that it is not easy to say how far the tonic action of this centre is reflex and dependent on the stream of afferent impulses.

(b) *Direct Stimulation.*—The centre may undoubtedly

been investigated by section and by stimulation (fig. 191).

They leave the spinal cord, chiefly in the dorsal region, by the anterior roots of the spinal nerves, pass into the sympathetic ganglia, where they have their cell stations, and then, as non-medullated fibres, pass, either (a) along the various sympathetic nerves to the viscera, or (b) back through the grey ramus (see fig. 46, p. 106) into the spinal nerve, in which they run to their terminations.

(2) *Mode of Action of the Mechanism.*—This mechanism is constantly in action, maintaining the tonic contraction of the arterioles.

(a) *Reflex Stimulation.*—If any afferent nerve be stimulated the effect is to cause a general constriction of arterioles, and thus to raise the general arterial pressure. A central mechanism therefore exists capable

be directly acted upon by the condition of the blood and lymph circulating through it. When the blood becomes charged with carbon dioxide, as in asphyxia, this centre is stimulated and a general constriction of arterioles with high blood pressure results (p. 548). The same thing happens as a result of a marked decrease in the amount of oxygen in the blood. This leads to an imperfect oxidation of such products as lactic acid, and to their accumulation in the blood, and this concentration of H ions stimulates the vaso-motor mechanism.

(3) *Position of the Centres.*—(a) **Primary Centre.**—In investigating the position of the centre advantage may be taken of—

1st. Its constant tonic influence. Removal of the centre at once causes dilatation of the arterioles.

2nd. The fact that it may be reflexly stimulated. If the vaso-constrictor centre be removed, stimulation of an afferent nerve no longer causes constriction of the arterioles.

Removal of the whole brain above the pons Varolii leaves the action of the centre intact.

Separation of the pons Varolii and medulla oblongata from the spinal cord at once causes a dilatation of the arterioles of the body with a marked fall in arterial pressure, and prevents the production of reflex constriction by stimulation of an afferent nerve.

The main part, at least, of the vaso-constrictor mechanism therefore is situated in the pons Varolii and medulla oblongata.

The extent of this centre has been determined by slicing away this part of the brain from above downwards, and studying the influence of reflex stimulation after the removal of each slice.

It is found that, at a short distance below the tectum, the removal of each succeeding part is followed by a diminution in the reflex constriction, until, at a point close to and just above the calamus scriptorius, all reflex response to stimulation stops.

The centre is therefore one of very considerable longitudinal extent.

(b) **Secondary Centres.**—It has been found that if, after

section of the spinal cord high up, the animal be kept alive for some days, the dilated arterioles again contract. If the spinal cord below the point of section be now destroyed, another marked fall of blood pressure occurs. This shows that **secondary vaso-constrictor centres** exist all down the grey matter of the spinal cord. Normally these are under the control of the dominant centre, but when this is out of action they then come into play.

B. Vaso-dilator Mechanism.—A good example of a vaso-dilator nerve is to be found in the chorda tympani branch of the facial nerve, which sends fibres to the submaxillary and sublingual salivary glands. If this nerve be cut, no change takes place in the vessels of the glands, but, when it is stimulated, the arterioles dilate and allow an increased flow of blood through the capillaries. These fibres, therefore, instead of increasing the activity of muscular contraction, inhibit it. The gastric branches of the vagus carrying vaso-dilator fibres to the mucous membrane of the stomach, and the *nervi erigentes* carrying vaso-dilator fibres to the external genitals, are further examples of vaso-dilator nerves.

1. *Course of the Fibres.*—The vaso-dilator nerves of most parts of the body run side by side with the vaso-constrictor nerves, and hence curious results are often obtained. If the sciatic nerve of a dog be cut, the arterioles of the foot dilate. If the peripheral end of the cut nerve be stimulated, the vessels contract. But after a few days, if the nerve be prevented from uniting, the arterioles of the foot recover their tonic contraction. If the sciatic nerve be now stimulated, a dilatation, and not a constriction, is brought about. The vaso-constrictor fibres seem to die more rapidly than the vaso-dilator fibres which run alongside of them. Under certain conditions, the activity of the vaso-dilator fibres seems to be increased. Thus, if the sciatic nerve be stimulated when the limb is warm, dilatation rather than constriction may occur. Again, while rapidly repeated and strong induction shocks are apt to cause constriction, slower and weaker stimuli tend to produce dilatation.

The vaso-dilator nerves pass out chiefly by the anterior

roots of the various spinal nerves, and do not pass through the sympathetic ganglia, but run as medullated fibres to their terminal ganglia (fig. 191). Bayliss has shown that the vaso-dilator fibres for the hind limb of the dog leave the cord by the posterior roots. Evidence has been adduced that dilatation can be brought about by irritation of the skin even after the posterior root is cut above the ganglion, but not when it is cut below it (p. 93). The possible action of this secondary vaso-dilator mechanism in the production of inflammation and of such trophic disturbances as shingles or *herpes zoster* is worthy of attention.

The probable existence of a *peripheral vaso-dilator mechanism* indicated by the action of nitrites and of weak acids may be of importance in explaining local dilatation of vessels during the functional activity of a part (p. 455).

2. Mode of Action.—

(a) **Reflex Stimulation.**—This mechanism is not constantly in action, since section of a vaso-dilator nerve does not cause constriction. It may, however, be excited reflexly.

Stimulation of an afferent nerve causes a dilatation of the arterioles in the part from which it comes, and a constriction of the arterioles throughout the rest of the body. If a sapid substance such as pepper be put in the mouth, the buccal mucous membrane and the salivary glands become engorged, while there is a constriction of the arterioles throughout the body. The vaso-dilator mechanism is not general in its action like the vaso-constrictor, but is specially related to the different parts of the body.

Again, it has been shown that stimulation of the central end of the depressor nerve (superior cardiac branch of the vagus) causes a dilatation of the arterioles, chiefly in the

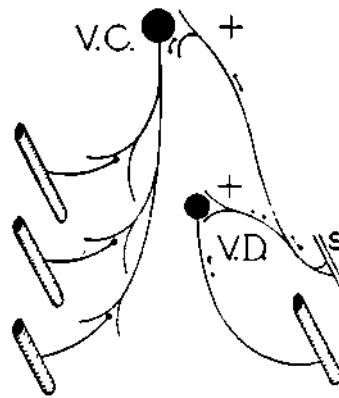

FIG. 192.—To show Local Vaso-dilatation with General Vaso-constriction. S., skin; V.D., local vaso-dilator centre; V.C., vaso-constrictor centre.

abdominal cavity, but also throughout the body generally. This is the most generalised vaso-dilator reflex known (see p. 418).

(b) *Stimulation from the Cerebrum.*—Not only does peripheral stimulation thus act reflexly, but various states of the brain, accompanied by emotions, may stimulate part of the vaso-dilator mechanism, as in the act of blushing.

The vaso-constrictors and vaso-dilators have a reciprocal action, and this is of the greatest importance in physiology and pathology. It explains the increased vascularity of a part when active growth is going on. The changes in the part, or the products of these, stimulate the afferent nerve. This reflexly stimulates the vaso-dilator mechanism of the part, and thus causes a free flow of blood into the capillaries, and, at the same time, maintains or actually raises the arterial pressure by causing a general constriction of the arterioles, and thus forces more blood to the situation in which it is required. It also explains the vascular changes in inflammation (fig. 192).

This reciprocal action may be disturbed just as the reciprocal action of motor and inhibitory nerves in reflex action may be disturbed. The administration of strychnine, which in reflex action converts inhibitory into motor responses, also converts vaso-dilator into vaso-constrictor responses, while chloroform tends to convert vaso-constrictor into vaso-dilator actions.

(3) *Position of the Centres.*—While the dominant vaso-constrictor centre is in the medulla, the vaso-dilator centres seem to be distributed in the medulla and spinal cord. The vagus is the great outgoing vaso-dilator nerve from the centres in the medulla, and the *nervi erigentes*, or pelvic nerves, from the sacral part of the cord.

II. PRESSURE IN THE CAPILLARIES.

This may be determined (a) by finding the pressure required to blanch the skin or to occlude the capillaries of some transparent membrane, or (b) by inserting a hypodermic

needle connected with a reservoir of water and a manometer, and estimating the capillary pressure by the pressure required to drive the water into the subcutaneous tissue. The assumption is made that the pressure in the tissues is about equal to that in the capillaries. The movement of the water may be determined by watching the movement of a bubble of air in the tube (fig. 193).

At the level of the heart the capillaries may be compressed by a pressure of some 10 to 20 mm. Hg, but in the leg about 90 mm. is required.

It has already been shown that the pressure is less than in the arteries and greater than in the veins.

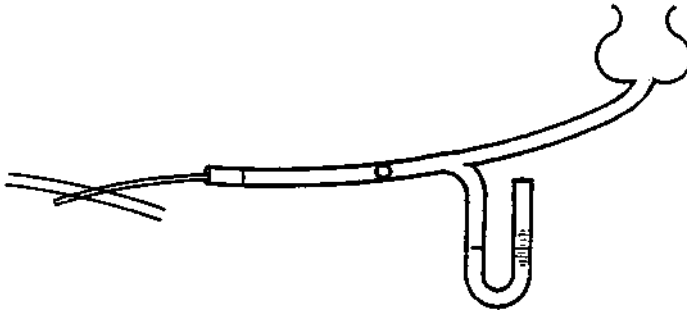

FIG. 193.—Method of Estimating Capillary Blood Pressure (see text).

Like the pressure in the arteries, the pressure in the capillaries depends upon the two factors—

- 1st. Force of inflow.
- 2nd. Resistance to outflow.

It must be remembered that all the blood does not flow through capillaries, but that in many situations arterioles open directly into venules. Thus, in obstruction of the capillaries, the blood may find its way through to the veins.

1st. Variations in the Force of Inflow.—The capillary pressure may undergo marked local changes through the *vaso-motor mechanism*. Wherever the function of a part is active, dilatation of the arterioles and an increased capillary pressure exist, and, as has been already seen, the condition of the capillaries plays a part.

But the capillary pressure may also be modified by the

heart's action, inasmuch as the arterial pressure, by which blood is driven into the capillaries, depends upon this. In cardiac inhibition not only is arterial pressure lowered, but capillary pressure may also fall. In augmented heart action both arterial and capillary pressure are raised (fig. 194, B.).

2nd. *Variations in Resistance to Outflow.*—Normally the flow from capillaries to veins is free and unobstructed; but,

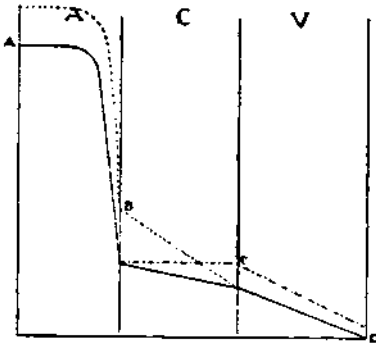

FIG. 194.—The Changes in Blood Pressure in the Capillaries produced by increasing the arterial pressure, and by obstructing the venous flow — — — — —. A., arteries; C., capillaries; V., veins.

if the veins get blocked, or if the flow in them is retarded by gravity, the capillaries get engorged with blood. This increased pressure in the capillaries is very different from that caused by increased inflow. The flow through the vessels is slowed or may be stopped instead of being accelerated, and the blood gets deprived of its oxygen and of its nourishing constituents, loaded with waste products, and tends

to exude into the lymph spaces, causing *dropsy* (fig. 194, C). A very similar condition results if the arterioles are contracted and the capillaries dilated; the same stagnation of blood may occur.

It is therefore most important to distinguish between high capillary pressure from dilated arterioles or an active heart, and high pressure due to venous obstruction.

A condition very similar to that described, but producing a capillary pressure high relatively to the pressure in the arteries—though not absolutely high—is seen in cases of failure of the heart, when that organ is not acting sufficiently strongly to pass the blood on from the venous into the arterial system. Here the arterial pressure becomes lower and lower, the venous pressure higher and higher, and, along with this, the capillary pressure becomes high in relationship to

the arterial pressure. The blood is not driven through these channels, and congestion of the capillaries and dropsy may result.

3rd. The influence of gravity plays a very important part on the capillary pressure, since it has so marked an influence on the flow of blood in the veins. At the level of the heart the pressure is about 20 mm. Hg. In the feet it is much higher. When, through heart failure or want of exercise, the blood is not properly returned from the legs, this increased pressure becomes very marked, stagnation of blood occurs, and swelling of the legs is apt to occur.

4th. Volume of the Blood.—The pressure in the capillaries may also, to a certain extent, be varied by the *withdrawal of water from the body*, as in purgation or in diuresis, or by the addition of large quantities of fluid to the blood. In both cases there is a rapid readjustment by the passage of water from the tissues to the blood, or *vice versa*. The venous system is so capacious that very great changes in the amount of blood in the vessels may take place without materially modifying the arterial or capillary pressure.

III. PRESSURE IN THE VEINS.

The pressure in the veins is so low that it may best be determined in the lower animals by a water manometer.

In man it may be estimated in a prominent superficial vein by stroking the vein downwards from the peripheral side of a valve, applying the band of a Riva Rocci apparatus (p. 448), and then relaxing the pressure and allowing the blood to flow up into the emptied vein, and reading the pressure at which this occurs. It may also be estimated in the veins of the hand by finding at what level above the heart they collapse.

In the veins the force of inflow is small; the resistance to outflow is *nil*. Hence the pressure is low, and steadily diminishes from the small veins to the large veins entering the heart (fig. 183).

The venous pressure may be modified by variations in these two factors. Constriction of the arterioles tends to lower the

venous pressure, dilatation to raise it. In the legs the veins are abundantly supplied with valves which support the long column of blood. When the veins of the legs become over-distended and the valves incompetent, the veins become large and tortuous and are known as *varicose veins*. The condition is temporarily relieved by elevating the legs.

Compression of the thorax retards the flow of blood from the great veins into the heart, and thus tends to raise the venous and to lower the arterial pressure.

Venous pressure may be temporarily modified by the *loss or gain of water*, but the venous system is so capacious that it can accommodate a considerably increased volume of fluid without any marked rise of pressure. Further, there is a very rapid adjustment between the fluid in the vessels and in the tissues.

IV. PRESSURE IN THE LYMPHATICS.

No exact determination of the lymph pressure in the tissue spaces has been made, but, since there is a constant flow from these spaces through the lymphatic vessels and through the thoracic duct into the veins at the root of the neck, the pressure in the tissue spaces must be higher than the pressure in the great veins.

This pressure is kept up by the formation of lymph from the blood, and from the cells of the tissues (see p. 508).

B. FLOW OF BLOOD.

The flow of blood, as already indicated, depends upon the distribution of pressure, a fluid always tending to flow from the point of higher pressure to the point of lower pressure. Since a high pressure is maintained in the aorta and a low pressure in the veins entering the heart and in the cavities of the heart during its diastole, the blood must flow through the vessels from arteries to veins (*Practical Physiology*). If for any reason the difference of pressure is decreased, the

rate of flow must be decreased. This occurs in various forms of heart failure, and when the heart has an insufficient supply of blood to contract upon.

1. Velocity.

The velocity of the flow of a fluid depends upon the width of the channel. Since in unit of time unit of volume must pass each point in a stream, if the fluid is not to accumulate at one point, the velocity must vary with the sectional area of the channel. In other words, the velocity (V) of the stream is equal to the amount of blood passing any point per second (v) divided by the sectional area of the stream (S)—

$$V = \frac{v}{S}$$

where S is the radius squared multiplied by the constant 3.14.

In the vascular system the sectional area of the aorta is small when compared with the sectional area of the smaller arteries; while *the sectional area of the capillary system may be no less than 700 times greater than that of the aorta*. In the venous system the sectional area steadily diminishes, although it never becomes so small as in the corresponding arteries, and, where the great veins enter the heart, it is about twice the sectional area of the aorta (fig. 195).

This arrangement of the sectional area of the vascular system gives rise to a rapid flow in the arteries, a somewhat slower flow in the veins, and a very slow flow in the capillaries.

The suddenness of the change of pressure has a certain influence on the rapidity of flow, as is well seen in a river. If from any cause the pressure is raised at one point, the flow will tend to be more rapid from that point onwards till the normal distribution of pressure is re-established. When the difference between the pressure at the arterial end and at the venous end of a set of capillaries is increased, a more rapid flow of blood takes place through the tissues.

Friction has also a certain effect. A river runs much faster in mid-stream than along the margins, because near the banks the flow is delayed by friction, and, the more broken up and subdivided is the channel, the greater is the friction and the more is the stream slowed.

In the capillary system considerable resistance is offered by friction in the innumerable small channels, and this is markedly influenced by the viscosity of the blood (p. 475).

Measurement of Velocity.—The velocity of flow in the arteries and veins may be measured by various methods, of

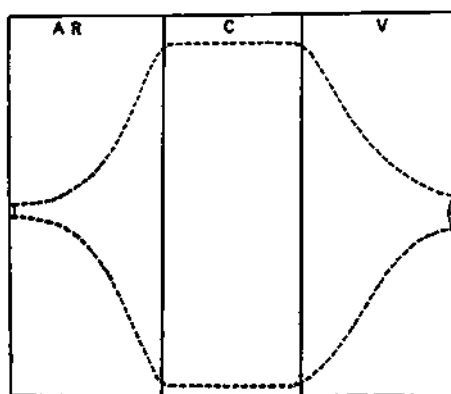

FIG. 195.—Diagram of the Sectional Area of the Vascular System, upon which the velocity of the flow depends. *A.R.*, arteries; *C.*, capillaries; *V.*, veins.

which one of the best is that by means of the *stromuhr*, an instrument by which the volume of blood passing a given point in an artery or vein in a given time may be determined (*Practical Physiology*).

The velocity of the flow in the capillaries may be measured in transparent structures by means of a microscope with an eye-piece micrometer.

The velocity of the blood varies greatly but is roughly as follows:—

Carotid of the dog about	300 mm. per sec.
Capillaries about	0.5 to 1 m. „
Vein (jugular) about	150 mm. „

Definite figures for the velocity of the lymph stream cannot be given.

Disturbance of any of the factors which govern the rate of flow will bring about alterations in the velocity of the blood in arteries, capillaries, and veins.

2. Special Characters of Blood Flow.

(a) **Arteries.**—This may be investigated by a *hæmodromograph*, which consists of a paddle suspended in a box. By means of a tube at each end the box is inserted into the course of an artery, and with each acceleration of the flow the paddle is pressed forward. The movements of the other end of the paddle are recorded through a tambour on a cylinder.

The flow of blood in an artery is rhythmically accelerated with each ventricular systole. This is due to the pulse wave. As the wave of high pressure passes along the vessels, the blood tends to flow first forwards and then backwards from it—so that in front of the wave there is an acceleration of the stream and behind it a retardation, just as occurs in a wave at sea.

(b) **Capillaries.**—In the capillaries the flow is uniform, unless when in excessive dilatation of the arterioles the pulse wave is propagated to them.

(c) **Veins.**—In most veins the flow is uniform, but in the great veins near the heart it undergoes acceleration—

1st, with each diastole of auricle and of ventricle (p. 444);

2nd, with each inspiration (p. 447).

In all vessels, the blood in the centre of the stream moves more rapidly than that at the periphery on account of the friction between the blood and the vessels. This rapid "*axial*" and slow "*peripheral*" stream is well seen in a small vessel placed under the microscope. The erythrocytes are chiefly carried in the axial stream, while the leucocytes are more confined to the peripheral stream, where they may

be observed to roll along the vessel wall with a tendency to adhere to it.

When, from any cause, the flow through the capillaries is brought to a standstill, the leucocytes creep out through the vessel walls and invade the tissue spaces. This is the process of *diapedesis*, which plays an important part in inflammation.

C. SPECIAL CHARACTERS OF THE CIRCULATION IN CERTAIN SITUATIONS.

1. *Circulation Inside the Cranium* (fig. 196).—Here the blood circulates in a closed cavity with rigid walls, and therefore its amount can vary only at the expense of the cerebro-spinal fluid (p. 511). This is small in amount, some 150 c.cm., and permits of only small variations in the volume of blood.

Increased arterial pressure in the body does not therefore markedly increase the *amount* of blood in the brain, but simply drives the blood more rapidly through it.

There seems to be no regulating nervous mechanism connected with the arterioles of the brain, and the cerebral pressure simply follows the changes in the general arterial pressure. The splanchnic area is the great regulator of the supply of blood to the brain.

Since the cerebral arteries are supported and prevented from distending by the solid wall of the skull, the arterial pulse tends to be propagated into the veins. In these veins the respiratory pulse also is very well marked.

The condition of the intra-cranial circulation is indicated by the circulation in the fundus of the eye which communicates with it, and this may be observed by means of an ophthalmoscope (p. 143).

2. *Circulation in the Lungs*.—The action of the vaso-constrictor nerves is feeble, and adrenalin fails to cause a constriction of the arterioles. The amount of blood in the lungs is regulated by the blood pressure in the systemic vessels, and hence the intravenous administration of adrenalin,

by increasing the arterial pressure, drives more blood to them.

The circulation through the lungs is impeded in many cases of heart disease, and especially in mitral stenosis

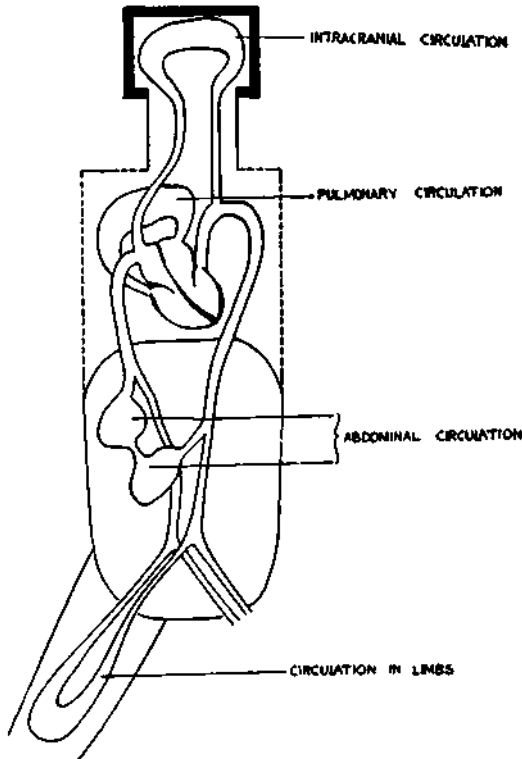

FIG. 196.—Scheme of the Circulation, modified from Hill, to illustrate the influence of the various extra-cardiac factors which maintain the flow of blood.

(p. 410), and a condition of *passive congestion* is set up, which may lead to hæmorrhage from the lungs.

3. **Circulation in the Heart Wall.**—The sympathetic fibres are vaso-dilator not vaso-constrictor to the arterioles of the coronary vessels and the administration of adrenalin dilates these arterioles.

4. **Circulation in the Spleen.**—Here the blood has to flow through a labyrinth of large sinusoid capillaries in the

pulp, and it is driven on by the alternate contraction and relaxation of the non-striated muscle in the capsule and trabeculae (see p. 215).

5. **Bone-Marrow.**—The tissue is surrounded by rigid bony walls, and the amount of blood can vary only slightly. The circulation is through sinusoid capillaries.

D. EXTRA-CARDIAC FACTORS MAINTAINING CIRCULATION.

The central pump, the heart, is not the only factor maintaining the flow of blood through the vessels (fig. 196).

1. **Movements of Respiration.**—(i.) The thorax, in the movements of respiration, is a suction pump of considerable power, which draws blood into the heart during inspiration. The auricles may be regarded as the *cisterns* of the heart, the abdominal blood-vessels as the great blood *reservoir*, and the diaphragm, contracting in inspiration, presses the blood from this reservoir up into the thorax and heart.

(ii.) Expiration also helps, for the blood, which has filled the vessels of the lungs in inspiration, is driven on into the left side of the heart in expiration. The blood is thus forced on into the arteries. The respiratory movements apparently play a great part in maintaining the circulation when the heart has undergone extensive calcareous degeneration.

2. **Intermittent Muscular Exercise.**—This acts in three ways: (1) by increasing the respiratory movements; (2) by augmenting the action of the heart; (3) by the contracting and relaxing muscles pressing on the blood-vessels, and so forcing the blood onwards into the veins and to the heart, back-flow in the veins being prevented by the valves; (4) by the increased venous filling of the heart leading to stronger contractions (p. 417), and reflexly to acceleration (p. 421).

The arterial blood pressure is thus raised and the intracranial circulation accelerated, so that more blood is sent to the brain. Too marked a rise of pressure during such exercise is prevented by dilatation of the arterioles throughout the body.

In **sustained muscular strain** the thorax is fixed, and hence, (a) *at first* (1) the pressure on the heart and thoracic organs is raised, and the increased pressure in the thorax helps to support the heart and to prevent over-distension. (2) The rigid thorax prevents the blood being sucked into the heart by the respiratory movements. (3) The abdominal vessels are pressed upon by the contraction of the abdominal muscles, and the blood is pressed on to the heart, while the sustained contraction of the limb muscles tends to prevent the free flow of blood through the capillaries.

Arterial pressure is thus raised, and the blood is forced to the central nervous system in which the pressure rises, and, if a weak spot in the vessels is present, rupture is apt to occur.

(b) *Later*, if the strain is still further sustained, the high intra-thoracic pressure tends to prevent proper diastolic filling of the heart, and the pumping action of respiration is in abeyance. The abdominal vessels being pressed upon prevents the free flow of blood through them to the heart, and the venous inflow fails and the force of contraction of the heart decreases. Thus, less blood is sent to the arteries and the arterial pressure falls, less blood goes to the brain, and fainting may result (see below).

E. INFLUENCE OF POSTURE ON CIRCULATION.

In the "**head down**" position, as in the horse in drinking, the accumulation of blood in the head is prevented by the vessels being packed inside the skull, and in the right side of the heart by the supporting pericardium.

In man, in the **erect posture**, the position of the abdominal reservoir of blood at a lower level than the heart increases the work of that organ. Especially is this the case with animals, in which the abdominal wall is lax, so that the blood can accumulate in the abdominal vessels, *e.g.* rabbits bred in confinement. In these, failure of the heart or fainting may occur when they are placed in the "**head up**" position. In the normal position of quadrupeds the work is much easier, for the reservoir is on the same level as the pump.

F. FAINTING.

This is a sudden loss of consciousness produced by failure in the supply of blood to the brain. It is accompanied by loss of control over the muscles. It may be induced by any sudden lowering of the arterial blood pressure, whether due to decreased inflow of blood or to decreased peripheral resistance.

1. Decreased inflow may be caused by—(1) Cardiac inhibition brought about reflexly (*a*) by strong stimulation of ingoing nerves, and more especially of the nerves of the abdomen; (*b*) by strong stimulation of the upper brain neurons accompanied by changes in the consciousness of the nature of emotions—(2) Failure of the heart to pump blood from veins to arteries against the force of gravity, as when a hutch rabbit is held in the "head up" position for some time.

2. Decreased resistance to outflow through sudden dilatation of arterioles may result from changes in the upper brain neurons, sometimes as a result of digestive disturbances.

However induced, the anæmic state of the brain leads to a stimulation of the cardio-inhibitory centre and the condition is thus accentuated. In man the cerebral anæmia is accompanied by pallor of the face.

The *treatment* consists in depressing the head to allow the force of gravity to act in filling the cerebral vessels and in giving diffusible stimulants to increase the action of the heart.

G. THE TIME TAKEN BY THE CIRCULATION.

This has been determined by injecting ferrocyanide of potassium into the proximal end of a cut vein, and finding how long it took to appear in the blood flowing from the distal end. From observation in the horse, dog, and rabbit, it appears that the time corresponds to about twenty-seven beats of the heart, so that in man it should amount to about twenty-three seconds.

H. FLOW OF BLOOD THROUGH DIFFERENT ORGANS.

This may be studied—

(A) In lower animals in the following ways:—(1) By use of the Stromuhr (p. 466); (2) by the plethysmograph method. This consists in enclosing the organ in a plethysmograph, and, while the blood is flowing, clamping the vein for a very brief period. The organ expands according to the amount of blood which flows in, and the increased volume gives a measure of the blood flow. The vein is again unclamped, and the observation may be repeated.

In lower animals it has been found that the flow of blood through different organs when measured per 100 gm. of organ per minute is very different, in the stomach only about 21 c.c., in the kidney, 150 c.c., and in the thyreoid no less than 560 c.c.

(3) The time taken by the blood to pass through an organ may be determined by injecting some electrolyte, *e.g.* NaCl solution, into the artery, and measuring the electrical conductivity of the blood in the vein by means of a Wheatstone's bridge. When the salt solution reaches the vein this is increased.

SECTION V.

The Fluids carrying Nourishment to the Tissues.

BLOOD AND LYMPH.

THE blood carries the necessary nourishment to the tissues, and receives their waste products. But it is enclosed in a closed system of vessels, and does not come into direct relationship with the cells. Outside the blood-vessels, and bathing the cells, is the lymph which plays the part of middleman between the blood and the tissues, receiving nourishment from the former for the latter, and passing the waste from the latter into the former.

A. BLOOD.

The physical, chemical and histological characters of blood must be investigated practically.

I. General Characters.

Colour. — Blood, when it has stood for some time, is dark purple, but when shaken with air it assumes a bright cinnabar red colour. **Elements of Blood.** — Microscopic examination shows that blood is composed of a clear fluid (Liquor Sanguinis or Plasma) in which float myriads of small disc-like yellowish-red cells (Erythrocytes), a smaller number of greyish cells (Leucocytes), and certain very minute grey particles (Blood Platelets). **The Opacity of Blood** is due to the erythrocytes, and, when the pigment is dissolved out of them by water and they are rendered transparent, the blood as a whole becomes transparent and is said to be “laked” (p. 485). **The Specific Gravity** is about 1055. It

may be estimated by finding the specific gravity of a solution of sodium sulphate or of chloroform and benzene in which a drop of blood remains where it is placed, neither sinking nor floating. The lowering of the freezing-point of blood or Δ is 0.56° C. This is equivalent to the osmotic pressure of a solution of about 0.9 per cent. of NaCl, and is the same as that of the cells of the tissues. **Viscosity.**—The viscosity of blood, or the intermolecular and intermolar friction, may be measured by the time taken to pass through a given length of capillary tube compared by the time taken by water. It depends partly on the viscosity of the plasma, which, being of the nature of an emulsoid colloid, manifests viscosity, but chiefly upon the blood cells. Hence when these are diminished in number the viscosity of the blood is decreased. The **Taste and Smell** are characteristic, and must be experienced. **Reaction.**—Blood, so far as the balance of H and OH ions is concerned, is slightly alkaline, its hydrogen ion concentration, C_H , being lower than that of pure water (see Appendix III.).

The cells of the blood constitute about 33 per cent., one-third of its weight, and the total solids of the blood are about 20 per cent.

II. Clotting or Coagulation.

Blood, when shed, becomes a firm jelly in the course of three or four minutes. The primary object of the process is to seal wounds in the blood-vessels, and so to prevent hæmorrhage. When the blood is collected in a beaker or other dish, the process starts from the sides, and spreads throughout the blood until, when clotting is complete, the dish may be inverted without the blood falling out. In a short time, drops of clear fluid appear upon the surface of the clot, and, in a few hours, these have accumulated and run together, while the clot has contracted and drawn away from the sides of the vessel, until it finally floats in the clear fluid—the **Serum**. If clotting occurs slowly, e.g. when the shed blood is cooled, the erythrocytes subside, leaving a layer of clear plasma above, which, when coagulation takes place, forms a "buffy coat" in the upper part of the clot.

Clotting is due to changes in the plasma, since this fluid will coagulate in the absence of corpuscles.

The change may be represented thus:—

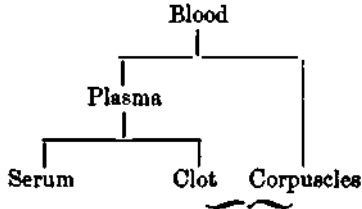

The change consists in the formation of a series of fine elastic threads of fibrin throughout the plasma, and, if red corpuscles are present, they are entangled in the meshes of the network and give the clot its red colour.

These threads may be readily collected in mass upon a stick with which the blood is whipped as it is shed. The red fluid blood which is left, consisting of blood cells and serum, is said to be *defibrinated*.

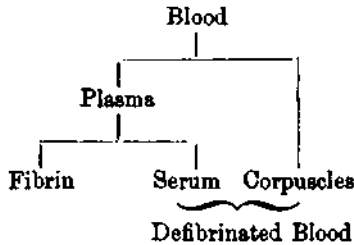

A study of clotting blood by means of the ultra-microscope shows that the fibrin first separates as small acicular particles which run together to form threads.

Fibrin is a protein substance. It is slowly dissolved in solutions of neutral salts. It is coagulated by heat, and is precipitated when an excess of a neutral salt is added. It therefore belongs to the group of globulins.

The plasma, before clotting, and the serum, squeezed out from the clot, both contain in the same proportions an albumin (*serum albumin*) and a globulin, or series of globulins, which may be classed together as *serum globulin*. But the

plasma contains a small quantity—about 0·4 per cent.—of another globulin (**fibrinogen**) which coagulates at a low temperature, and which is absent from serum. It is this which undergoes the change from the soluble form to the insoluble form in coagulation. If, by taking advantage of the fact that it is more easily precipitated by sodium chloride than the other proteins, it is separated from them, it may still be made to clot. The source of this substance seems to be the intestine and liver, and when these are removed it is not formed.

The essential points in coagulation were discovered by Andrew Buchanan in 1845. He showed that something which he called “soluble fibrin” exists in the plasma and that this changes to insoluble fibrin. He further showed that the addition of the white cells of the blood brings about the change.

The process of clotting is due to the action of a substance, **thrombin**, which does not exist as such in the blood, but which is formed by the union of a precursor with **calcium ions**. This is proved by the fact that if blood is directly collected in alcohol, it is found to yield no thrombin, although when treated with alcohol *after* clotting it is rich in this substance. Its precursor may be called **prothrombin**.

If calcium salts are precipitated by the addition of oxalates to the blood, clotting does not take place. The mere conversion of the calcium from an ionised state to a non-ionised state, such as that in which it exists in the citrate, prevents clotting. Hence, when unclotted blood is wanted, it may be collected in a vessel containing some potassium oxalate or a solution of sodium citrate (*Chemical Physiology*).

Although prothrombin and calcium ions exist together in the blood, they do not form the thrombin necessary to produce clotting, apparently because an **anti-prothrombin** is also present. This may be separated from fibrinogen and from prothrombin by heating the plasma to 60° C., which precipitates the fibrinogen and destroys the prothrombin, but leaves the antithrombin unaltered.

Before clotting can occur, antithrombin must be thrown

out of action by the development of some substance which neutralises it. Such a substance is yielded by the breaking down of tissue cells or the cells of the blood, especially the platelets. It is perhaps best called **thromboplastin**. It is a lipid compound, probably identical with cephalin.

The steps in the process might thus be represented as follows :—

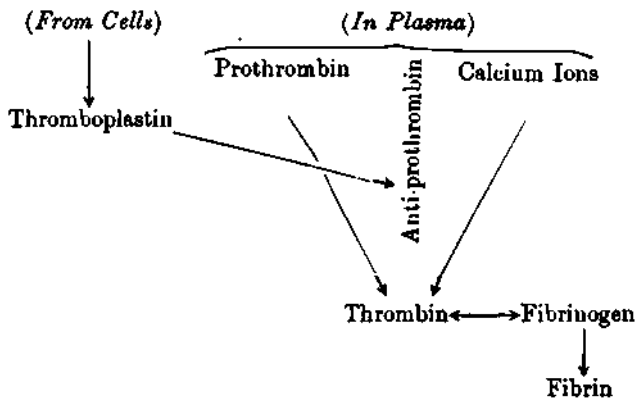

Many circumstances influence the rapidity of clotting. Temperature has a marked effect, a low temperature retarding it, a slight rise of temperature above the normal of the particular animal accelerating it. If a trace of a *neutral salt* be added to blood, coagulation is accelerated; but if blood be mixed with strong solutions of a salt, coagulation is prevented because the formation of thrombin is checked. *Calcium salts* have a marked and important action, and if they are precipitated by the addition of potassium oxalate, blood will not clot, apparently because thrombin cannot be formed.

The injection into the blood-vessels of a living animal of *commercial peptones*, which consist chiefly of proteoses, generally prevents the blood from clotting when shed. This appears to be due to the formation, probably in the liver, of an excess of anti-thrombin. *Hirudin*, an extract of the head of the medicinal leech, also retards clotting, both when injected into the blood-vessels and when added to the blood

when shed. It appears to be of the nature of an anti-thrombin.

The blood does not coagulate in the vessels under normal conditions because of the absence of thromboplastin in any quantity and the presence of anti-thrombin. Under certain conditions clotting does take place. (1) If inflammation is induced in the course of a vessel, coagulation occurs rapidly. (2) If the inner coat of a vessel be torn, as by a ligature, or if any roughness occurs on the inner wall of a vessel, coagulation is apt to be set up. (3) Various substances injected into the blood stream may cause the blood to coagulate, and thus rapidly kill the animal. Among such substances are extracts of various organs—thymus, testis, and lymph glands, which yield thromboplastin—and snake venom, which seems to contain active thrombin. The injection of pure thrombin does not usually cause clotting, apparently because an anti-thrombin is developed to neutralise it.

The blood usually clots when shed, because the damaged tissues yield thromboplastin, and thus thrombin is formed. This acts upon the fibrinogen before it can be antagonised by the anti-thrombin. If blood is received into oil, or into a vessel anointed with vaseline and filled with paraffin oil, it will remain fluid for a considerable time. Any roughness in the wall of the blood-vessel or of the vessel in which the blood is received probably serves to catch the blood platelets (p. 484), so that thromboplastin is liberated freely as they disintegrate.

III. Plasma and Serum.

These may be considered together, since serum is merely plasma *minus* fibrinogen. As serum is so much easier to procure, it is generally employed for examination, but plasma may be readily obtained by centrifuging blood which has been prevented from clotting by the addition of an oxalate or a citrate (p. 477).

Both are straw-coloured fluids, the colour being due to a yellow lipochrome. Sometimes they are clear and trans-

parent, but, after a fatty diet, they become milky. They have a specific gravity of about 1025, and contain about 90 per cent. of water and 10 per cent. of solids. The chief solids are the native proteins—**serum albumin** and **serum globulin** (with, in the plasma, the addition of **fibrinogen**). The proportion of the two former proteins to each other varies considerably in different animals, but the variations are small in the same animal at different times. The globulin probably consists of at least two bodies—**euglobulin** precipitated by weak acid, and **pseudoglobulin** not so precipitated. The amount of albumin is generally greater when the body is well nourished. In man they together form about 7 per cent. of the serum. In virtue of the presence of these proteins the plasma is colloidal, and it has little tendency to transude through the walls of the vessels. These proteins further seem to have a small osmotic pressure (p. 574).

The other constituents of the serum are in much smaller amounts, and may be divided into—

1. **Substances to be used by the tissues.**

Glucose is the most important of these. It occurs only in small amounts—about 0·1 to 0·15 per cent. Part of it is free, but part is probably in combination. It is present in larger amount in blood going to muscles than in blood coming from them, and this difference seems to be more marked when the muscles are active.

Fats occur in very varying amounts, depending upon the amount taken in the food, but in addition to these true fats there is also a small amount of other lipoids.

2. **Substances given off by the tissues.**

The chief of these is **urea**, which occurs constantly in very small amounts in the serum—about 0·05 per cent. It will afterwards be shown that it is derived from the liver, and that it is excreted in the urine by the kidneys (p. 559).

Creatin and **uric acid**, and some allied bodies, appear to be normally present in traces, and their amount may be increased in diseased conditions, especially of the kidneys.

3. **Inorganic constituents.**—The most abundant is **chloride of**

sodium, to which the osmotic pressure of the plasma is partly due, and which is present in the proper proportion of sodium with the other cations, potassium, calcium, and magnesium, to maintain the activity of the tissues (p. 218). Perhaps the most important salt is **sodium bicarbonate**, which maintains the reaction, the C_H (see Appendix III.) of the blood, and of the body fluids, at the level at which their chemical activity can best be carried on. **Sodium phosphate** is also present in very small quantities. Calcium, potassium, and magnesium occur in very small amounts.

Sodium bicarbonate is an ideal salt for maintaining the balance of H and OH ions in the blood. When stronger acids, such as sarcolactic acid, are liberated from the tissues, they combine with some of the sodium, and the weak, slightly dissociated CO_2 is set free, and is at once got rid of by the lungs (p. 527). When, on the other hand, alkalies are absorbed and added to the blood, there is available in the tissues an abundant supply of CO_2 , with which they will combine as bicarbonates. The maintenance of the proportion of $NaHCO_3$ in the blood is of the utmost importance. It may be termed its **alkaline reserve**. Only when this alkaline reserve is drawn upon can anything like a real condition of *acidosis*, a real increase in the C_H , occur. This has been termed an *uncompensated acidosis*, to distinguish it from the condition in which an increased production of acids has been met by the alkaline reserve (*compensated acidosis*).

In venous blood there are something like 60 parts of CO_2 per 100 parts of blood. Of this, at the temperature of the body and the pressure of CO_2 in the lungs to which the blood is subjected (p. 539), some 3 parts are dissolved; the remainder is in combination with sodium as $NaHCO_3$, so that the balance is

$$\frac{H_2CO_3}{NaHCO_3} = \frac{3}{60} = \frac{1}{20}$$

If the amount of CO_2 is increased, then it must either be got rid of from the lungs, or the proportion of Na in the denominator must be increased, while if the Na is combined

with other acids, such as β -oxybutyric, then the amount of CO_2 must be decreased.

The proteins of the blood are amphoteric, and it has been suggested that they too may combine with CO_2 . The protein of the pigment of the red cells does seem to form such a combination. This will be considered later.

Behind the regulation of the C_H of the blood by the NaHCO_3 and the lungs are two further lines of defence.

1. The dissociated HCl of the NaCl of the plasma can, when the C_H of the blood increases, pass into the cells and, seizing upon some of the sodium of the Na_2HPO_4 , turn out NaH_2PO_4 into the plasma to be excreted by the kidneys. Thus some of the excess H ions is got rid of.

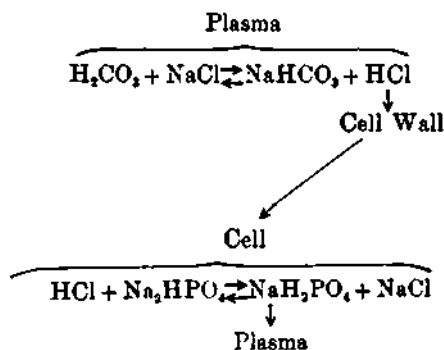

In fact, the kidneys play a part only second to the lungs in regulating the C_H of the blood by getting rid of any excess of H ions in acidosis and of OH ions in alkalosis.

2. With any increase of the H ions and the development of acidosis, the ammonia, which is in the liver normally converted into urea, is passed into the blood to unite with and neutralise the acids (p. 360).

IV. Cells of Blood.

1. Leucocytes—White Cells.

These are much less numerous than the red cells, and their number varies enormously in normal conditions. On an average there are about 7500 per cubic millimetre. (*The method of counting must be studied practically.*)

They are soft, extensible, elastic, and sticky, and each contains a nucleus and a well-developed double centrosome. In size they vary considerably, most being larger than the red cells, some slightly smaller. The character of the

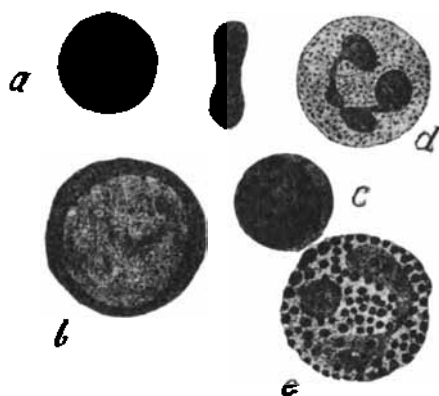

FIG. 197.—Cells of the Blood. *a*, erythrocytes; *b*, large, and *c*, small lymphocyte; *d*, polymorpho-nuclear leucocyte; *e*, eosinophil leucocyte.

nucleus varies greatly, and from this and from variations in the protoplasm, they may be divided into three classes.

(1) **Lymphocytes**.—Cells with a clear protoplasm and a more or less circular nucleus. Some are very small, while others are larger. They constitute about 20 to 25 per cent. of the leucocytes (fig. 197, *b* and *c*).

(2) **Polymorpho-nuclear leucocytes** have a much-distorted and lobated irregular nucleus and a finely granular protoplasm whose granules stain with acid and neutral stains. These constitute about 70 to 75 per cent. of the leucocytes (fig. 197, *d*).

(3) **Eosinophil or oxyphil leucocytes** have a lobated nucleus

like the last, but large granules in the protoplasm which stain deeply with acid stains. From 1 to 4 per cent. of the leucocytes are of this variety (fig. 197, e).

Basophil leucocytes are practically absent from normal blood. They have a lobated nucleus and granules in the protoplasm staining with basic stains.

Myelocytes are large leucocytes with a large circular or oval nucleus and a finely granular protoplasm. They are not normal constituents of the blood, but appear when the activity of the bone-marrow is increased in certain pathological conditions.

The leucocytes show—

(a) **Amœboid movement.**—Under suitable conditions they undergo changes in shape, as may be readily seen in the blood of the frog or other cold-blooded animal. The motion may consist simply of the pushing out and withdrawal of one or more processes (pseudopodia), or, after a process is extended, the whole corpuscle may follow it and thus change its place, or the corpuscle may simply retract itself into a spherical mass. As a result of these movements the corpuscles, in certain conditions, creep out of the capillary blood-vessels between the endothelial cells and wander into the tissues (*diapedesis*). The amœboid movement is best marked in the polymorpho-nuclear leucocytes.

(b) **Phagocyte Action.**—The finely granular leucocytes and the lymphocytes have further the power of taking foreign matter into their interior, and of digesting it. By this devouring action useless and effete tissues are removed and dead micro-organisms in the body are taken up and got rid of. This scavenger action of the leucocytes is of vast importance in pathology.

2. Blood Platelets.

These are small circular or oval discoid bodies about one-third the diameter of a red blood corpuscle. Some observers have stated that they contain a central nucleus. They are very sticky and mass together when blood is shed and adhere to a thread passed through the blood or to any rough point in the lining of the heart or vessels. They

there form clumps, and in these they disintegrate, probably liberating thromboplastin, and so start clotting. They are present in the blood of mammals only. Their source is not definitely known, but it has been suggested that they are the extruded nuclei of developing erythrocytes, or that they are derived from the giant cells of the bone-marrow (p. 500).

3. Erythrocytes—Red Cells.

1. **Characters**.—All mammals, except the camels, have circular, biconcave, discoid erythrocytes, which, when the blood is shed, tend to run together like piles of coins. The camels have elliptical biconvex corpuscles. The fully developed mammalian erythrocytes are without a nucleus. In birds, reptiles, amphibia and fishes, the corpuscles are elliptical biconvex bodies, with a well-marked central nucleus.

2. **Size**.—The size of the human erythrocytes is fairly constant—on an average 5·5 micro-millimetres in diameter.

3. **Number**.—The number of red cells in health is about 7,000,000 in the horse, but in disease it is often decreased. The number of corpuscles per cubic millimetre is estimated by the **Hæmocytometer**. This consists of (1) a pipette by which the blood may be diluted to a definite extent with a salt solution of the same osmotic equivalent as the plasma, and (2) a cell of definite depth ruled in squares; each containing above it a definite small volume of blood, so that the number of corpuscles in that volume may be counted under the microscope (*Practical Physiology*).

The pale yellow colour of the individual corpuscles is due to a pigment held in a fine sponge-like stroma which seems also to form a capsule round the cell.

4. **Hæmolysis**.—This pigment may be dissolved out by various agents, and the action is termed hæmolysis. It may be brought about in different ways—

1st. By placing the erythrocytes in a fluid of lower osmotic equivalent, i.e. of lower molecular concentration, than the blood plasma and corpuscles. A solution of 0·9 per cent. of sodium chloride has the same osmotic equivalent as the plasma and preserves the corpuscles unaltered; in more dilute fluid the corpuscles tend to swell up by

endosmosis, the capsule bursts, and the pigment escapes. Erythrocytes may therefore be used as a means of determining the osmotic equivalent—the molecular concentration—of a fluid.

2nd. By the action of substances which dissolve the lipoids of the stroma, *e.g.* salts of the bile acids (see p. 324), chloroform, ether, etc.

3rd. By Hæmolysins. (a) The serum of each species of animal contains a substance, destroyed by heating to 55° C., which is hæmolytic to the blood of animals of other species, *e.g.* the serum of eels' blood contains a powerful hæmolysin for rabbits' erythrocytes, and the serum of the dog a less powerful one. (b) Further, by injecting the blood or the erythrocytes of one species of animal into another species, a hæmolysin is developed which has a specific action on the erythrocytes of the first species (p. 614).

4th. By killing the erythrocytes in the body by injecting substances which poison them, such as phenylhydrazin. They are subsequently disintegrated and their pigment removed. This, of course, is not a true hæmolysis.

5. **Chemistry.**—(1) The stroma of the erythrocytes which is left after the pigment is washed out is a sponge work made up of a globulin-like substance, in which lipoids, such as cholesterol and lecithin, occur in considerable quantities, and seem to form a capsule or cell membrane. Potassium is the base most abundantly present in man.

(2) **Hæmoglobin.**—The pigment is Hæmoglobin. It constitutes no less than 90 per cent. of the solids of the erythrocytes. In many animals, *e.g.* the rat, when dissolved from the corpuscles, it crystallises very readily (*Chemical Physiology*). The crystals prepared from human blood are rhombic plates. When exposed to air they are of a bright red colour, but if placed in the receiver of an air-pump at the ordinary temperature they become of a purplish tint. The same thing occurs if the hæmoglobin is in solution, or if it is still in the corpuscles. The addition of any reducing agent such as ammonium sulphide or a ferrous

salt causes a similar change. This is due to the fact that *hæmoglobin has an affinity for oxygen*, which it takes up from the air, forming a definite compound of a bright red colour in which one molecule of hæmoglobin links with a molecule of oxygen, HbO_2 . This is known as **oxyhæmoglobin**.

Hæmoglobin is closely allied to the proteins, but differs from them in containing 0.42 per cent. of iron in organic combination.

When light from the sun is allowed to pass through solutions of blood pigments, certain parts of the solar spectrum are absorbed, and when the *spectrum* is examined,

dark bands—the absorption bands—are seen. In a weak solution of **oxyhæmoglobin** in a thin layer, a dark band is seen in the green and another in the yellow part of the spectrum between Fraunhofer's lines D and E, while the violet end of the spectrum is absorbed (fig. 199). These bands may be broadened or narrowed by strengthening or weakening the solution, or varying the thickness of

the layer. In stronger solutions they become broader and finally run together, while more and more of the violet end of the spectrum is absorbed, until, with a solution of sufficient strength, only the red end of the spectrum is visible (fig. 198).

When the oxygen is taken away and the dark reduced hæmoglobin is formed, a single broad band between D and E takes the place of the two bands (fig. 199). If the solution is again shaken up with air, oxygen is taken up and the bands of oxyhæmoglobin reappear (*Chemical Physiology*).

The property of taking oxygen from the air and of again giving it up at a moderate temperature and under a low

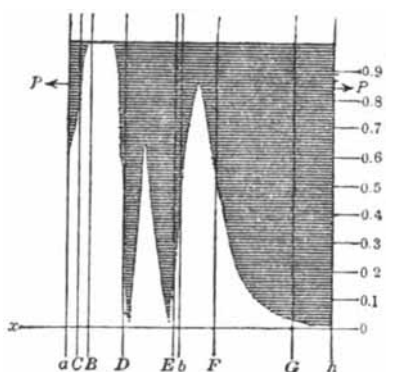

FIG. 198.—The parts of the spectrum absorbed by solutions of oxyhæmoglobin of different percentage strengths in a layer of 1 cm. thick.

pressure of oxygen is the great function of the blood pigment in the body. The hæmoglobin plays the part of a middle-man between the air and the tissues, taking oxygen from the one and handing it on to the other (*Chemical Physiology*).

Amount.—Hæmoglobin constitutes about 13 or 14 per cent. of the blood, but in various diseases its amount is decreased.

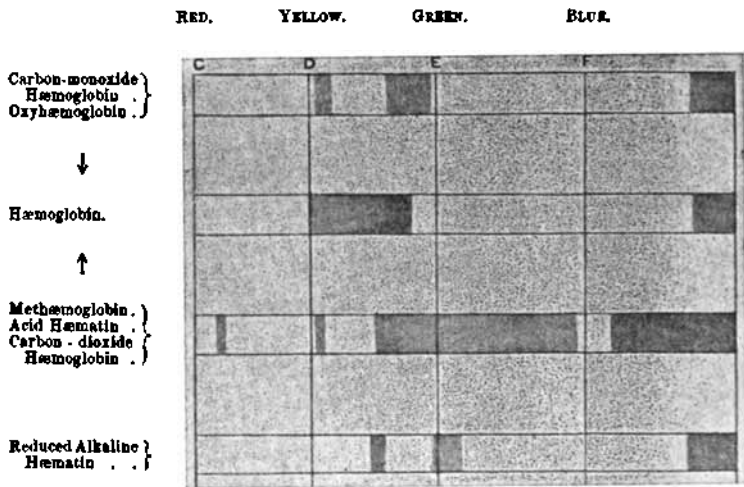

FIG. 199.—Spectra of the more important Blood Pigments and their more important derivatives. (The spectra of oxyhæmoglobin and carbon monoxide hæmoglobin and those of acid hæmatin and methæmoglobin are not identical.) The arrows indicate that oxyhæmoglobin and methæmoglobin are changed to hæmoglobin by reducing agents.

The best method of estimating its amount is by Haldane's **Hæmoglobinometer**. This consists of two tubes of uniform calibre, one filled with a 1 per cent. solution of normal blood saturated with carbon monoxide, and another containing water in which 20 c.mm. of the blood to be examined, measured in a pipette, are placed, mixed with coal gas to saturate with CO, and then diluted till it has the same tint as the standard tube. The percentage of hæmoglobin, in terms of the normal, is indicated by the mark on the tube at which the fluid stands (*Chemical Physiology*).

Derivatives of Hæmoglobin.—The following pigments are derived from hæmoglobin :—

(1) **Methæmoglobin.**—Hæmoglobin forms another compound with oxygen—methæmoglobin; a substance which must be acted on by strong reducing agents before it will part with its oxygen. When, therefore, this pigment is formed in the body, the tissues die from want of oxygen. It may be produced by the action of various substances on oxyhæmoglobin. Among these are ferricyanides, nitrites, and permanganates. It crystallises in the same form as oxyhæmoglobin, but it has a chocolate brown colour. Its spectrum is also different from hæmoglobin and oxyhæmoglobin, showing a narrow sharp band in the red part of the spectrum, with two or more bands in other parts according to the reaction of the solution in which it is dissolved (fig. 199). It is of importance, since it occurs in the urine in such pathological conditions as *paroxysmal methæmoglobinuria*.

(2) **Carboxyhæmoglobin.**—Hæmoglobin also combines with some other gases. Among these is Carbon monoxide, CO. Hæmoglobin has a greater affinity for this gas than it has for oxygen, so that, when carbon monoxide hæmoglobin is once formed in the body, the blood has little power of taking up oxygen, and the animal dies. Carbon monoxide is evolved freely in the fumes from burning charcoal, is present in coal gas, and is found in the air of coal mines after explosions. Carbon monoxide hæmoglobin forms crystals like oxyhæmoglobin, and has a bright *pinkish* red colour, without the yellow tinge of oxyhæmoglobin. Since, after death it does not give up its carbon monoxide and become changed to purple hæmoglobin, the bodies of those poisoned with the gas maintain the florid colour of life. Its spectrum is very like that of oxyhæmoglobin, the bands being slightly more to the blue end of the spectrum (fig. 199). It may be at once distinguished by the fact that when gently warmed with ammonium sulphide it does not yield reduced hæmoglobin (*Chemical Physiology*).

(3) **Nitric oxide, NO,** has even a greater affinity for Hb than has CO. The compound is very similar in all its

characters to the last. Some of it is generally found, along with methæmoglobin, after poisoning with nitrites.

(4) **Carbon dioxide Hæmoglobin.**—By bubbling CO_2 through a solution of hæmoglobin, in the absence of oxygen, a two-banded spectrum resembling methæmoglobin has been produced, and on evacuating the gas in an air-pump the single band of hæmoglobin has been found to appear. This, again, gives place to the two bands when CO_2 is passed through the solution. It appears from this that hæmoglobin can carry CO_2 as a definite compound. Probably it is the globin part of the molecule which acts in this way, while the hæmatin part carries the oxygen.

Decomposition of Hæmoglobin.—Hæmoglobin is a somewhat unstable body, and, in the presence of acids and alkalies, it splits up into about 96 per cent. of a colourless protein—globin, belonging to the group of histones (Appendix II.), and about 4 per cent. of a substance of a brownish colour called hæmatin (*Chemical Physiology*).

(1) **Hæmatin.**—The spectrum and properties of hæmatin are different in acid and alkaline media. (a) In acid media it has a spectrum closely resembling methæmoglobin, but it can at once be distinguished by the fact that it is not changed by such reducing agents as ferrous salts. It is sometimes important to distinguish between these pigments, since both may appear in the urine, methæmoglobin occurring in paroxysmal methæmoglobinuria and acid hæmatin as the result of the action of the acid salts of the urine upon hæmoglobin present as the result of kidney disease. (b) Hæmatin, in alkaline solution, can take up and give off oxygen in the same way as hæmoglobin does. **Reduced alkaline hæmatin** has a very definite spectrum (fig. 198), and its preparation affords a ready means of detecting old blood stains (*Chemical Physiology*).

Hæmatin contains the iron of the hæmoglobin, and it is this pigmented iron-containing part of the molecule which has the affinity for oxygen. It is the presence of iron which gives it this property, 1 grm. of iron being able to carry 400 c.cm. of oxygen.

(2) **Hæmatoporphyrin.**—If hæmoglobin is broken down and the iron removed from the hæmatin by means of sulphuric acid, a purple-coloured substance, *iron-free hæmatin*, hæmatoporphyrin, is formed, which has no affinity for oxygen. This pigment occurs in the urine in some pathological conditions (*Chemical Physiology*).

One point of great interest in the chemistry of hæmatin and its derivatives is that they, like the green chlorophyll of plants, yield upon decomposition very similar bodies belonging to the pyrrol group (see Appendix).

(3) **Bilirubin and Hæmatoidin.**—In the liver, hæmoglobin is broken down to form bilirubin and the other bile pigments (p. 324). These are iron-free, and, like hæmatoporphyrin, do not take up and give off oxygen. But not only are these iron-free pigments formed from hæmoglobin in the liver, but they are produced in the cells of other parts of the body, and thus in blood-extravasations a yellow pigment hæmatoidin is formed which is really the same as bilirubin.

(4) **Hæmin**—the hydrochloride of hæmatin—is formed when blood is heated with sodium chloride and glacial acetic acid. It crystallises in small steel-black rhombic crystals, and its formation is sometimes used as a test for blood stains (*Chemical Physiology*).

The following table shows the relationship of these pigments to one another :—

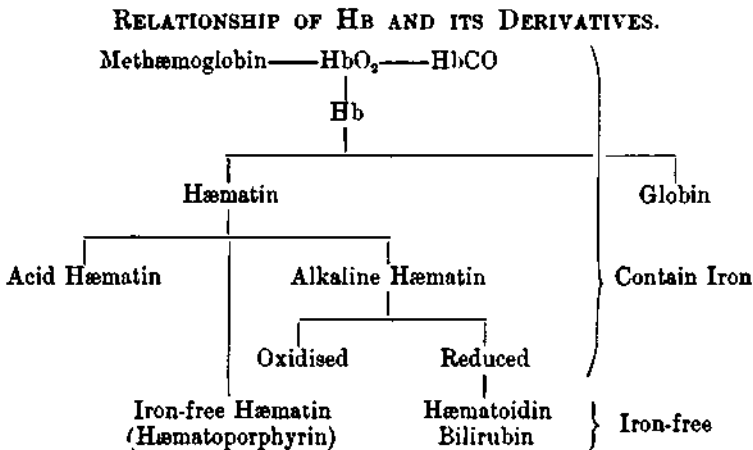

V. Gases of the Blood.

A. The Oxygen of the Blood.

The study of the pigments of the blood has shown that the function of hæmoglobin is to carry oxygen from the lungs and to give it off to the tissues. It has been shown that it is the coloured iron-containing hæmatin, constituting only about 4 per cent. of the molecule which acts as the carrier.

Hæmoglobin carries oxygen in virtue of the fact that, when it is exposed to a high partial pressure of the gas in the lungs it takes it up, while it gives it off when exposed to a low pressure in the tissues.

The partial pressure of a gas in an atmosphere is got by multiplying its percentage amount by the atmospheric pressure and dividing by 100. Thus, taking the oxygen at 20 per cent. of atmospheric air, at normal pressure at sea-level of 760 mm. Hg the partial pressure of the oxygen is—

$$\frac{20 \times 760}{100} = 152 \text{ mm. Hg.}$$

The *tension* of a gas in a fluid, *i.e.* its tendency to escape, may be measured by finding the partial pressure of the gas in the atmosphere to which the fluid is exposed at which the gas is neither given off nor taken up. Thus, if three vessels containing oxygen in blood had over the fluid 2, 5, 10 per cent. of O₂, *i.e.* O₂ at partial pressures of 15.2, 38.0, and 76.0 mm. Hg, and it were found that O₂ came off in the first and was taken up in the third, but remained constant in the second, we should say that the *tension* of the gas was 38 mm. Hg.

	O ₂		
Beginning in Air	2 % 15.2 mm. Hg.	5 % 38.0 mm. Hg.	10 % 76.0 mm. Hg.
Blood	↑ =====	=====	↓ =====
End in Air	5 % 38.0 mm. Hg.	5 % 38.0 mm. Hg.	5 % 38.0 mm. Hg.

The *amount* of oxygen taken up and given off is not proportionate to the partial pressure of the gas to which the Hb is exposed.

This has been ascertained by exposing solutions of Hb to atmospheres with different percentages of oxygen, *i.e.* to oxygen at different *pressures*.

Starting from an atmosphere containing no oxygen—with

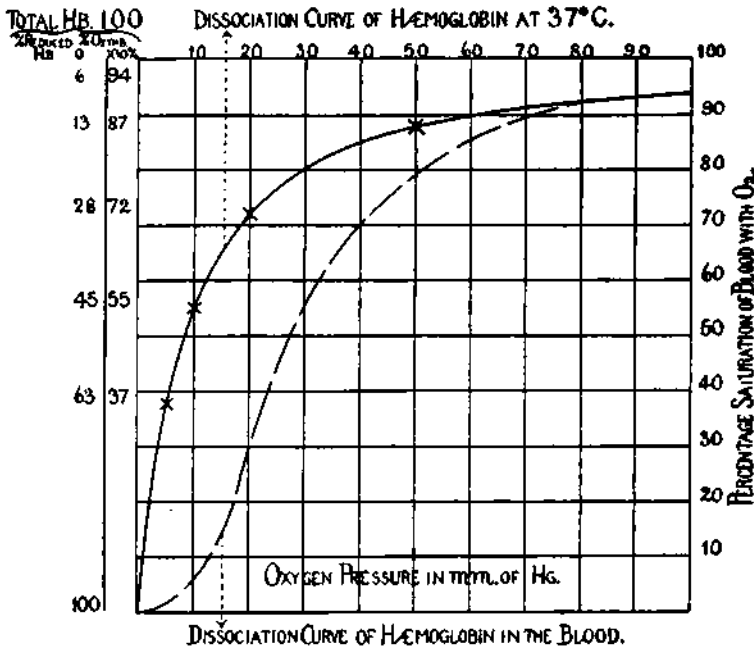

FIG. 200.—The Dissociation Curve of Hæmoglobin in pure solution (continuous line) and in blood (broken line). The oxygen pressure in mm. is indicated by the ordinates, and the percentage saturation is indicated by the abscisse. Note the more rapid dissociation under 50 mm. Hg in blood than in pure solution of Hb.

no partial pressure of oxygen—it is found that the Hb is entirely reduced—carries no oxygen. When exposed to atmospheres containing higher and higher percentages of oxygen it is found that the amount taken up rapidly increases till at 30 mm. Hg, equivalent to about 6 per cent. of oxygen in the atmosphere at sea-level, the Hb is saturated to about 80 per cent.

Further increasing the proportion and pressure of oxygen in the air brings about only a slightly increased taking up.

Conversely, if Hb saturated with oxygen is exposed to lower and lower pressures of the gas, it gives up its oxygen slowly till a pressure of 30 mm. Hg is reached and then more rapidly.

This is shown in fig. 200.

In blood the curve given is different because of the

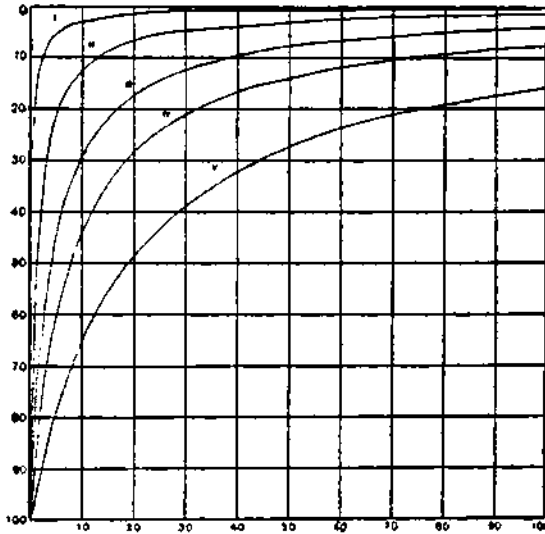

FIG. 201.—Dissociation curves of oxyhemoglobin to show the influence of temperature I., at 16°; II., at 25°; III., at 32°; IV., at 38°; and V., at 49° C. Oxygen pressure along abscissa percentage of reduced hemoglobin on vertical line.

presence of CO_2 and of electrolytes. The taking up of oxygen rises rapidly to 50 mm. Hg, equivalent to 10 per cent. of oxygen in the air, when the hemoglobin is saturated to about 80 per cent. The giving off takes place in the same ratio (fig. 200).

This association of Hb and O_2 and the dissociation are modified by—

1st. *Temperature*.—Fig. 201 gives the results at IV. about the temperature of the body. If the temperature

is raised the dissociation curve is lowered *v.*, and if the temperature is lowered the curve is raised *i.*, *ii.*, *iii.*

2nd. The H ion concentration of the blood.—This, as already shown (p. 481), is controlled by the sodium bicarbonate of the plasma, and is chiefly determined by the amount of dissociated H_2CO_3 in the blood. Any increase of the C_{H^+} alters the form of the curve, tending to bring about dissociation of HbO_2 at higher pressures, as is shown in fig. 202.

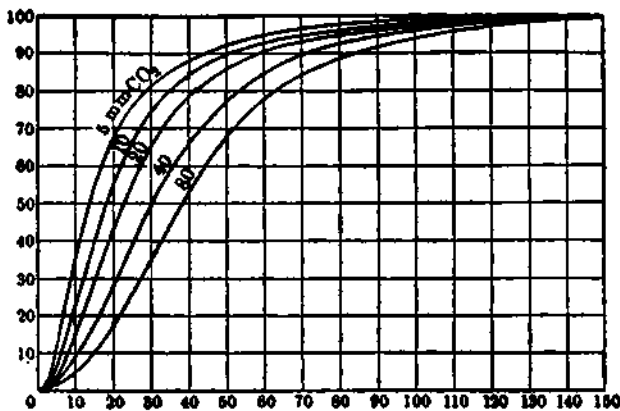

FIG. 202.—To show the effect of the tension of CO_2 in the blood upon the giving off of oxygen. The pressures of oxygen are given as the abscissæ in mm. Hg, and the saturation of the hæmoglobin as the ordinates. Note the marked difference at 20 mm. Hg of oxygen with 5 and with 40 mm. Hg pressure of CO_2 .

In fact, the CO_2 of the blood plays a most important part in setting free the O_2 for the tissues, since it raises the C_{H^+} of the blood.

3rd. The presence of electrolytes also lowers the curve.

B. The Carbon Dioxide in the Blood.

The carriage of CO_2 in the blood has already been dealt with. It has been shown that it exists to a large extent as $NaHCO_3$ and to a small extent in solution (p. 481).

By subjecting blood to different pressures of CO_2 , it is found that the amount carried practically varies directly

with the partial pressure in the air to which the blood is exposed.

As already indicated, the proteins of the blood plasma and of the red cells, notably the globin, which is the chief constituent of hæmoglobin, may combine with CO_2 .

Attempts have been made to determine the amounts of CO_2 in the various combinations, but at present our knowledge is too defective to allow of definite figures being given.

It has been maintained that, since NaHCO_3 is not dissociated at the temperature of the body with a partial pressure of CO_2 such as occurs in the lungs, therefore the bicarbonate does not play the part of carrying the CO_2 from the tissues to the lungs, and that the main carrier is the hæmoglobin, the HbCO_2 being more unstable in the presence of O_2 .

This theory seems to ignore the significance of the proportion between $\frac{\text{H}_2\text{CO}_3}{\text{NaHCO}_3} = \frac{1}{20}$ and its adjustment under various conditions.

It is certain that the amount of CO_2 which leaves the blood in the lungs is a very small part of the amount held in the blood (p. 498).

The actual quantities of oxygen and of carbon dioxide in the blood are of much less importance than their tension.

Method of Determining.

(i.) They may be extracted by subjecting the blood to the Torricellian vacuum over the barometric column of mercury. Many forms of mercury gas pumps have been devised. One is shown in fig. 203. By raising the mercury ball *M.B.*, air may be driven out of the blood bulbs *a-b* by filling them with mercury. On clamping at *a* and lowering *M.B.*, a Torricellian vacuum is produced. The bulbs are then detached and weighed, and blood is collected in them from a vessel. The blood bulbs are then connected with the apparatus and a vacuum produced in *G.B.*, where the gases are collected. By turning the two-way tap *T.*, they can be passed into the eudiometer tube *E.*, and then analysed, the carbon dioxide being absorbed by caustic soda and the oxygen by alkaline sodium pyrogallate.

The fact that the CO_2 can be completely removed from blood containing the red cells but not from the plasma without the addition of a weak acid seems to show that the hæmoglobin acts as an acid.

(ii.) Haldane and Barcroft have devised a convenient method, which depends upon the fact that the oxygen can

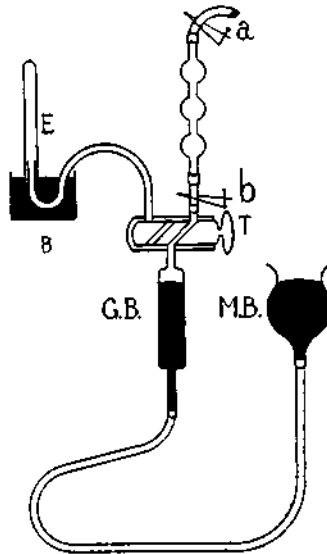

FIG. 203.—Diagram of one Form of Mercury Pump for Collecting the Gases of the Blood. *M.B.*, the mercury bulb which can be raised so as to fill *G.B.* and *a-b* with mercury, and lowered so as to produce a Torricellian vacuum in them. *a* and *b*, clamps by which the blood bulbs may be shut off, to be weighed and to receive the blood. *G.B.*, the bulb in which the gases are collected. *T.*, the three-way tap by which the gas bulb *G.B.* is connected, either with the blood bulb, or with the eudiometer tube, *E.* *B.* is the bath of mercury in which the tube filled with mercury is set.

be driven off from blood treated with dilute ammonia, by the addition of potassium ferricyanide, and that the carbon dioxide is liberated by adding an acid. The amount of gas may be (*a*) directly measured in a Dupré's apparatus, or (*b*) determined by measuring the increased pressure in the tube in which the gas has been given off, by means of Barcroft's apparatus (*Chemical Physiology*).

(iii.) Van Slyke has devised an apparatus for the liberation of the CO_2 of the blood by weak sulphuric acid and of the O_2 by potassium ferricyanide. The gases are then collected in a Torricellian vacuum and measured at atmospheric pressure. The method may be carried out in a few minutes and is of use in clinical work.

Amounts of Gases.—The amount of gases which may be extracted varies considerably. About 60 c.c. of gas, measured at 0°C . and 760 mm. pressure, from 100 c.c. of blood may be taken as a rough average. The proportion of the gases varies in arterial and venous blood.

**AVERAGE AMOUNT OF GASES PER HUNDRED VOLUMES
OF BLOOD.**

	Arterial Blood.	Venous Blood.
Oxygen	20	8-12
Carbon dioxide	40	46-60

Recently a series of analyses of the arterial and venous blood in normal men has been made, and it has been found that the average content is about

	Arterial Blood.	Venous Blood.
Oxygen	21	14
Carbon dioxide	50	55

In the lungs the blood gains about 5 per cent. of oxygen and loses about 5 per cent. of carbon dioxide.

While there is an exchange of something like 36 per cent. of the oxygen, the exchange of carbon dioxide amounts to only between 8 and 9 per cent. of the total amount in the blood.

In the tissues there is, of course, a reversal of the changes that go on in the lungs.

VI. Source of the Blood Constituents.

A. Plasma.—The water of the blood is derived from the water ingested. But there is a free interchange of water between the blood and the tissues so that after bleeding water rapidly passes into the blood to make up the original

volume, and after the injection of hypotonic saline and other non-colloidal fluids into the blood-vessels, water passes out into the tissues. The volume of the blood is thus regulated.

The origin of the **proteins** is unknown, although ultimately they must come from the food; very probably they are in part derived from the tissues. But the significance of the two proteins, albumin and globulin, and of their variations has not yet been elucidated.

The **glucose** is derived from the carbohydrates and from the proteins of the food, and during starvation it is constantly produced in the liver and poured into the blood (p. 354).

The **fats** are derived from the fats and carbohydrates of the food and tissues (p. 351).

The **urea** and other waste constituents are derived from the various tissues. A transference of sodium phosphate from the tissues to the blood occurs when acidosis is threatened, probably by the dissociated HCl of the NaCl of the blood passing into the cells and turning out the phosphate as NaH_2PO_4 to be excreted (p. 482).

B. Cells—**I. Leucocytes**.—1. In the embryo these are first developed from the mesoderm cells generally. In extra-uterine life they are formed in the lymph tissue and in the red marrow of bone.

2. **Lymph Tissue** is very widely distributed in the body, occurring either in patches of varying shape and size, or as regular organs, the **lymphatic glands** (fig. 205). These are placed on the course of lymphatic vessels, and consist of a sponge-work of fibrous tissue, in the interstices of which are set patches of lymph tissue, in which multiplying lymphocytes are closely packed together. Each mass of lymphatic tissue is surrounded by a more open network, the *sinus*, through which the lymph flows, carrying away the lymphocytes from the germ centres. In the sinuses are found many cells with a marked phagocytic action, and, when erythrocytes are destroyed by hæmolytic agents, the pigment and the iron derived from the hæmoglobin are often found abundantly in the cells in the sinuses of lymph glands.

Round some of the lymphatic glands of certain animals large blood spaces or sinuses are seen, and these glands are

called **hæmolymph glands** (fig. 205). They are intermediate between lymphatic glands and the spleen.

3. **Bone Marrow** (fig. 204).—Young leucocytes or **leucoblasts**, in the condition of mitosis, are abundant in this tissue, often in patches, the leucoblastic areas, and they pass away in the blood stream. They are of all varieties. In digestion leucocytosis and in certain pathological conditions the formation of these cells is increased and a leucocytosis results.

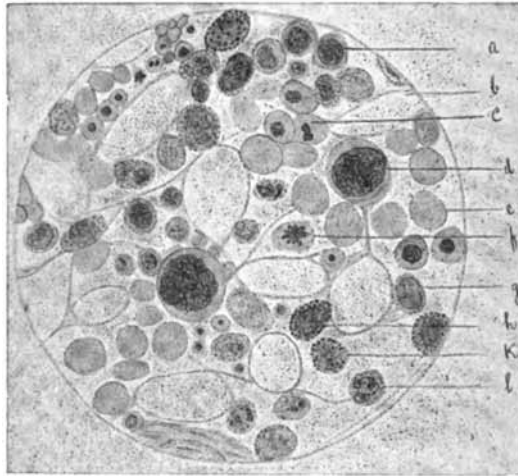

FIG. 204.—Section of Red Marrow of Bone. *a*, lymphocyte; *b*, fat cell; *c*, erythroblast; *d*, giant cell; *e*, erythrocyte; *f*, erythroblast in mitosis; *g*, neutrophil myelocyte; *h*, eosinophil myelocyte; *k*, eosinophil leucocyte; *l*, polymorpho-nuclear leucocyte.

II. Erythrocytes.—In the embryo, these cells seem to be formed by a process of budding from the mesoderm cells, which become vacuolated to form the primitive blood-vessels. The primitive red cells are larger than those of later life, and they have a very distinct nucleus. In extra-uterine life they occur in the blood as *megaloblasts* in some blood diseases.

A new set of nucleated red cells next develops in the liver, and later in the spleen and bone marrow. They are smaller than the megaloblasts, and they are known as *normoblasts* when they appear in the blood in extra-uterine life, as they

do in certain pathological conditions. After birth, erythrocytes are formed in the red marrow of bone (fig. 204).

Marrow consists of a fine fibrous tissue with large blood capillaries or sinusoids running in it. In the fibrous tissues are numerous *fat cells* (clear spaces *b* in fig. 204) and generally a considerable number of multi-nucleated *giant cells* (*d*) and *myelocytes* (*g*). In addition to these are the young leucocytes, *leucoblasts* (*a.g.h.*), and lastly, young nucleated red cells, the *erythroblasts* (*c.f.*). After hæmorrhage, the formation of these becomes unusually active, and may implicate parts of the marrow not generally concerned in the process, and hence, the red marrow may spread from the ends of the long bones, where it is usually situated, towards the middle of the shaft.

After hæmorrhage, when the process of regeneration is very active, red cells with nuclei, *normoblasts*, escape into the blood. Young erythrocytes, even after they have lost their nucleus, may be distinguished by a peculiar reticulated appearance when they are stained with brilliant cresyl blue.

The nuclei of the erythroblasts atrophy, and the cells escape into the blood stream.

The red marrow has the power of retaining the iron of disintegrated erythrocytes, which, in different stages of disintegration, are found enclosed in large modified leucocytes or phagocytes. The iron is often very abundant after a destruction of erythrocytes.

VII. Total Amount of Blood in the Body.

1. Welcker's method consists in (1) bleeding an animal, measuring the amount of blood shed, and determining the amount of hæmoglobin contained in it; (2) then washing out the blood-vessels, and, after measuring the amount of fluid used, determining the amount of hæmoglobin in it to ascertain the amount of blood it represents. By this method the amount of blood was found to be about $\frac{1}{3}$ —7.7 per cent. of the body weight.

2. Haldane and Lorrain Smith have devised a method which can be applied to the living animal. It depends upon

the fact that, after an animal or person has inhaled carbon monoxide, it is possible to determine to what proportion the gas has replaced oxygen in the oxyhæmoglobin. If, then, an individual breathes a given volume of carbon monoxide, and if a measured specimen of blood is found to contain a definite percentage of the gas, the rest of the gas must be equally distributed through the blood, and thus the amount of blood may be deduced. If, for instance, 50 c.c. have been taken up, and there is 1 per cent. in the blood, the whole blood holding the 50 c.c. must be 5000 c.c. They conclude that the blood is about $\frac{1}{20}$, 5 per cent., of the weight of the body in the human subject. This method has been adversely criticised on the ground that the CO may be taken up by the tissues of the body as well as by the blood.

3. Dreyer has devised another method for the living animal. After bleeding, the volume of blood is restored in a few minutes by the passage of fluid from the tissues (p. 450).

The number of red cells per c.mm. is determined. A definite amount of blood is drawn; and after a few minutes the number of corpuscles is again counted. The reduction indicates the dilution of the blood. Thus, suppose the first count gave 5,000,000 per c.mm., and that 400 c.c. of blood were taken, and that the second count gave 4,500,000—a fall of 500,000 or 10 per cent.—the 400 c.c. must be 10 per cent. of the whole blood which is thus 4000 c.c.

4. The vital red method. Vital red is a non-toxic pigment, which forms a colloidal solution in the blood, and does not readily transude from the vessels. By injecting a measured quantity into a vein and determining its dilution in the blood plasma, the total amount of plasma may be calculated, and if the volume of cells is determined by centrifuging in an hæmatocrit, the total volume of blood may be calculated. These last two methods give results corresponding to Welcker's (*Practical Physiology*).

As has been shown in the study of circulation (p. 450), the total amount of blood in the body does not always correspond with the amount in **effective circulation**. In such conditions as wound or operation shock considerable amounts of blood may stagnate in the capillaries, and thus

reduce the volume in circulation to such an extent that the supply of oxygen to the tissues is seriously interfered with.

VIII. Distribution of the Blood.

Roughly speaking, the blood is distributed somewhat as follows :—

Heart, lungs, large vessels	1
Muscles	1
Liver	1
Other organs	1

IX. Fate of the Blood Constituents.

A. Of the Plasma.—The water of the blood is got rid of by the kidneys, skin, lungs, and bowels.

About the fate of the proteins we know nothing.

The glucose and fat are undoubtedly used up in the tissues.

The urea and waste products are excreted by the kidneys.

As already indicated, the salts of the blood play the triple part (1) of supplying the tissues with the necessary cations; (2) of maintaining the osmotic pressure of the blood; (3) of regulating the C_m of the blood. Their due proportion is maintained chiefly by the action of the kidneys, which respond at once to any change in the C_m of the blood by eliminating the excess of anions or of cations.

B. Of the Cells.—(1) The leucocytes break down in the body—but when and how is not known. They are greatly increased in number after a meal of proteins (digestion leucocytosis, p. 348), and, since the increase lasts only for a few hours, they are probably rapidly broken down, possibly to liberate amino-acids. But it is also possible that they may return to the bone-marrow and lymph tissue, from which they emerged during digestion.

(2) The erythrocytes also break down. How long they live is not known. It is found that, after injecting blood from another animal of the same species, the original number of corpuscles is not reached for about a fortnight; and hence it has been concluded that the corpuscles live for that

period. Advantage has been taken of the fact that the blood of different individuals belongs to one of four groups as regards power of agglutinating cells of other groups. If a man be transfused with a blood which does not belong to his group, specimens of his blood treated with a serum which agglutinates his corpuscles leaves the transfused corpuscles unagglutinated. It has been found that this condition may last for over a month, indicating that the corpuscles have continued in the blood for this period of time. The methods are unsatisfactory, and the results must be accepted with reservation.

The method of disposal of old and effete erythrocytes in the body has been studied by poisoning them with various reagents such as phenylhydrazin. It is then found that they are removed from the circulation more especially by two organs.

1. The Liver.

In the endothelial cells lining the capillaries, erythrocytes in all stages of disintegration may be seen, and the iron of the hæmoglobin in a compound, or series of compounds, generally called hæmoxidarin, may be demonstrated by the green colour developed by treating with hydrochloric acid and potassium ferrocyanide. When hæmoglobin is set free in the plasma, it is chiefly taken up by the true liver cells. That the pigment is split up and the iron-free part excreted is shown by the presence of the bile pigments in the bile.

2. The Spleen.

1. *Structure.*—This organ is composed of a fibrous capsule containing visceral muscle, and of a sponge-work of fibrous and muscular trabeculæ, in the interstices of which is the spleen pulp. The branches of the splenic artery run in the trabeculæ, and twigs pass out from these trabeculæ, and are covered with masses of lymph tissue forming the Malpighian corpuscles. Beyond these, the vessels open into a series of complex sinusoids, lined by large prominent endothelial cells. From these capillary sinuses the blood is collected into channels, the venous sinuses, which carry it

back to branches of the splenic vein in the trabeculae. The pulp may thus be compared with the blood sinuses of the hæmolymph glands, and the spleen may be considered as being a still further development of the hæmolymph gland from the lymph gland (fig. 205).

2. Functions—

A. *Blood Formation.*—(1) **Lymphocytes** are undoubtedly formed in the Malpighian corpuscles. But their formation is probably unimportant. Their number is not greater in the blood of the splenic vein than in that of the artery, and

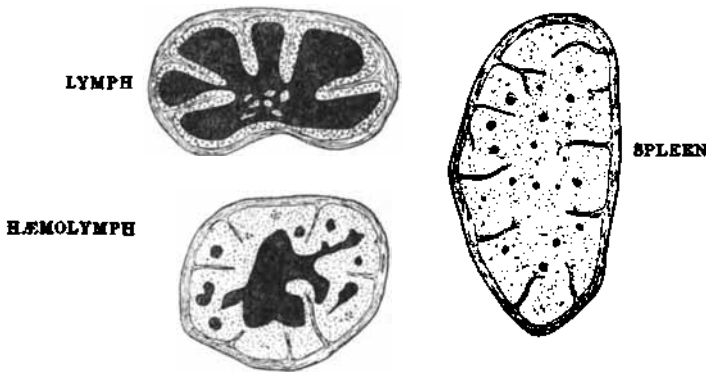

FIG. 205.—To show the Relationship of the Spleen to Lymph Glands and Hæmolymph Glands. The black indicates lymphoid tissue; the coarsely spotted part, lymph sinuses, and the finely dotted part, blood sinuses. (LEWIS.)

removal of the spleen causes no change in the number in the blood.

(2) **Erythrocytes.**—That the spleen is not a seat of the formation of erythrocytes in normal extra-uterine life is indicated—(i) by there being no greater number in the blood of the splenic vein than in that of the splenic artery; (ii) by the fact that removal of the spleen causes no decrease in the total number of erythrocytes; and (iii) by the equally rapid regeneration of erythrocytes in animals from which the spleen has been removed and in normal animals.

B. *Blood Destruction.*—1. That it takes no active part in

the destruction of erythrocytes is shown by the facts (i) that injections of extracts of the spleen cause no change in the number of corpuscles; (ii) that removal causes no increase in the number of erythrocytes; (iii) that, when blood is injected, the added corpuscles are not removed more quickly in the normal than in the spleenless animal.

2. The spleen is rather to be regarded as a scavenger, which removes dead erythrocytes from the blood. This is indicated by the facts (i) that, after injecting hæmolytics, such as phenylhydrazin, there is less marked anæmia in the spleenless animals on the fourth day, because the dead corpuscles are not removed from the blood; (ii) that the remains of the corpuscles may be seen in the cells of the spleen, and chiefly in the endothelial cells of the sinuses; (iii) that iron compounds from the hæmoglobin accumulate in the spleen after hæmolysis. A result of this is that if rabbits are fed on a food poor in iron such as rice they become anæmic more rapidly if the spleen has been removed, because they have a smaller store of iron to draw upon.

C. *Digestion.*—It has been suggested that the spleen manufactures a kinase which activates the pancreatic juice, but the evidence is against this theory.

The spleen probably acts as a blood reservoir regulating the supply of blood to the digestive organs.

On the purin metabolism it may have an effect (see p. 556); on the general metabolism it has no action.

D. *Movements.*—The visceral muscle in the framework of the spleen undergoes rhythmic contraction and relaxation, and the organ thus contracts and expands at regular intervals of about a minute. In the dog the movements are very marked.

These movements may be recorded by enclosing the organ in an oncometer, a closed capsule connected with some form of recording apparatus. They are controlled by nerve fibres, from the true sympathetic system, leaving the spinal cord chiefly in the 6th, 7th, and 8th dorsal nerves of both sides. Strong stimulation of these causes contraction, which is also caused by the intravenous injection of adrenalin.

B. LYMPH.

Lymph is the fluid which plays the part of middleman between the blood and the tissues. It fills all the spaces in the tissues and bathes the individual cell elements. Those who maintain that the lymphatics are shut off from the tissue spaces prefer to call the fluid filling these spaces *tissue fluid*. They consider that it is separated from the lymph in the lymphatics by a layer of endothelium. These spaces in the tissues open into vessels—the lymph vessels—in which the lymph flows away and is conducted through lymph glands and back to the blood through the thoracic duct (see fig. 162, p. 383).

1. **Characters of Lymph.**—Lymph varies in character according to the situation from which it is taken and according to the condition of the animal.

(1) Lymph taken from the lymph spaces—*e.g.* the pericardium, pleura, or peritoneum—is a clear straw-coloured fluid. It has little or no tendency to coagulate. Microscopic examination shows that it contains few or no cells—any cells which may exist being lymphocytes. It has the same C_{22} as the blood plasma. The specific gravity varies according to its source, being lowest when from the limbs and highest when from the liver.

Apparently the cause of the non-coagulation of such lymph is the absence of cells from which thromboplastin may be set free. If blood or leucocytes be added to it, a loose coagulum forms.

(2) Lymph, taken from lymphatic vessels after it has passed through lymphatic glands, is found to contain a number of lymphocytes and to coagulate readily.

Chemically, lymph resembles blood plasma, but the proteins are generally in smaller amount, while the inorganic salts are in the same proportion as in the blood. The amount of proteins varies in lymph from different organs.

Lymph of	Proteins.
Limbs	About 2-3 per cent.
Intestines	„ 4-6 „
Liver	„ 6-8 „

In the lymphatics, coming from the alimentary canal, after a meal containing fat, the lymph has a milky appearance and is called chyle. This appearance is due to the presence of fats in a very fine state of division, forming what is called the *molecular basis* of the chyle.

Lymph, in various diseases, tends to accumulate as serous effusions in the large lymph spaces—e.g. the pleura, peritoneum, pericardium—and these effusions behave differently as regards coagulation. The following table helps to explain this (S.A. is Serum Albumin, S.G. Serum Globulin):—

COAGULABILITY OF LYMPH, SERUM, AND EFFUSIONS.				
Plasma and Lymph.	Serous Effusion.			Serum.
	Cong.	Coag. with Thrombin.	Uncoag.	Uncoag.
S.A.	S.A.	S.A.	S.A.	S.A.
S.G.	S.G.	S.G.	S.G.	S.G.
Fibrinogen.	Fibrinogen.	Fibrinogen.
Prothrombin and Thromboplastin.	Prothrombin and Thromboplastin.	Thrombin.
Ca	Ca	Ca	Ca	Ca

2. **Formation of Lymph.**—The amount of lymph formed is measured by opening the thoracic duct in the neck and collecting the lymph which flows from it.

Lymph is derived partly from the blood and partly from the tissues. Two processes may be involved—(1) *Filtration*, the forcing of fluid and of substances dissolved in it through the pores of a membrane under pressure. (2) *Osmosis*, the passage of water through semi-permeable membranes—membranes allowing the passage of water, but not of substances in solution—to a point of higher molecular concentration. *Diffusion*, or the passage of dissolved substances through a membrane from a point of high to a point of low concentration, can play only a small part.

If the formation of lymph cannot be explained in terms of these purely physical processes, then some unknown action of the cells of the capillaries must be invoked to

explain it. The most careful study seems to show that these physical factors are adequate and that filtration plays the most prominent part.

(1) The formation of lymph from the blood depends largely upon the *permeability of the walls of the capillaries* and the *pressure of blood in the blood-vessels*. Thus, although the pressure in the blood-vessels of the limbs is much higher than the pressure in the vessels of the liver, hardly any lymph is usually produced in the former, while very large quantities containing a high percentage of proteins are produced in the latter—apparently because of the slight permeability of the limb capillaries and the great permeability of the hepatic capillaries. The permeability may be increased by the injection of hot water or of proteoses, probably because these injure the capillary walls, but possibly because they increase the activity of the organ.

While the permeability of the vessel wall is the most important factor controlling lymph formation, any increase of the *intravascular pressure* of a region may increase the flow of lymph, and for this reason any obstruction to the free flow of blood from a part leads to increased lymph production from that area.

Asher has pointed out that the flow of lymph from the salivary glands and from the liver is increased with the increased activity of the organ irrespective of changes in blood pressure. Even after death, the flow of lymph may go on. He explains this by supposing that the activity of a gland leads to the breaking down of larger into smaller molecules, which increases the *osmotic pressure* of the fluid in the lymph spaces and thus causes an osmosis of water and an increased lymph formation. After death the disintegrative changes may produce these smaller molecules and have the same effect.

A method of washing out wounds by causing a flow of lymph has been based upon this action of osmosis. The application to the wound of a hypertonic saline brings it about.

(2) That lymph is also formed from the tissues is indicated by the fact that the injection of substances of high osmotic

equivalent into the blood—such as sugar or sodium sulphate—leads to a flow of fluid into the blood by a process of osmosis so that it becomes diluted, and also, to an increased formation and flow of lymph. This increase of water in both blood and lymph can be explained only by its withdrawal from the tissues (fig. 206).

(3) The amount of lymph formed is not great. In man probably only about 100 c.cm. of lymph pass into the blood per hour. Hardly any of this comes from the muscles, although these hold about 70 per cent.

of the water in the body; nearly all comes from the abdominal organs, chiefly from the liver, although these hold only about 7 per cent. of the water of the body.

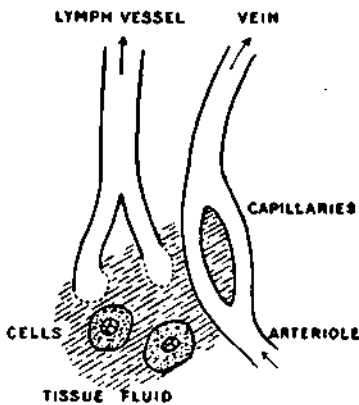

FIG. 206.—Diagram to illustrate the formation of lymph and the interchange between the blood and the tissue fluids.

and, when blood is withdrawn from the vessels, the water of the tissues very rapidly passes into the vessels to make up the original volume. It is by way of the blood-vessels that serous effusions into the pleura, peritoneum and other serous cavities are removed, as is indicated by the fact that methylene blue, injected into the pleural cavity, appears in the urine in about 10 minutes, but is not found in the lymph for from 20 to 120 minutes. Such facts as these rather favour the view that the true lymph is separated from the tissue spaces by a layer of endothelium (fig. 206).

C. THE CEREBRO-SPINAL FLUID.

1. **Distribution.**—This fluid fills the pericellular spaces so that the nerve cells lie bathed in it, the perivascular spaces, the subarachnoid space, the ventricles of the brain and the central canal of the spinal cord. At the base of the brain the subarachnoid spaces filled with fluid are large and they protect this important part of the nervous system against injury by acting as a water cushion.

2. **Characters.**—The cerebro-spinal fluid is clear and transparent, with a specific gravity of 1006 to 1008. It is devoid of cells and contains only traces of proteins. Its C_H is practically the same as that of the blood plasma. Its principal constituent is sodium chloride with sodium bicarbonate and traces of phosphates, urea and dextrose. It has much the composition of Locke's modification of Ringer's solution, and it contains oxygen in considerable amounts.

3. **Source.**—It was formerly supposed to be formed like lymph by filtration from the blood. The amount formed may be measured by inserting a cannula into the sub-cerebellar space. (i) In this way it is found that, while the amount produced does vary with the blood pressure, it is not proportional to it. (ii) On the other hand, any increase of CO_2 in the blood, the administration of such anæsthetics as chloroform, and, above all, the injection of extracts of the choroid plexus increase its production.

While diffusible substances pass readily into the lymph they do not all pass from the blood to the cerebro-spinal fluid. Some, like urethane and alcohol, do pass, but salvarsan is held back and is thus of little use in the treatment of syphilitic affections of the nervous system in man.

The fluid thus seems to be a *secretion from the choroid plexus*. This is covered by cubical vacuolated cells, and is, in fact, an inverted gland, which passes on from the blood the inorganic constituents and oxygen, but which holds back the proteins and many toxic substances.

On the other hand, diffusible substances pass out readily

from the cerebro-spinal fluid of the brain to the blood ; but in the lower part of the spinal cord they do not pass out freely, and therefore anæsthetics like cocaine may be injected into the subarachnoid space in this region to anæsthetise the cord.

This outward passage into the blood seems to show that the fluid secreted by the choroid plexus is carried away in the blood stream. It may escape along certain of the cranial nerves, more especially along the olfactory nerve. This channel is of importance in allowing the entrance of certain micro-organisms such as those of infective poliomyelitis and of cerebro-spinal meningitis in man.

It is also probably passed into the blood of the dural sinuses by the arachnoidal villi which project into these, and which are covered by curious collections of cells, and from the perivascular spaces into the capillaries which they surround.

Excessive secretion or blocking of the lateral ventricles may cause an increase in the fluid, a rise of pressure and cerebral symptoms. The fluid naturally escapes from the fourth ventricle by the foramen of Magendie and the foramen of Luschka into the subarachnoid space.

4. **Quantity.**—The quantity of fluid contained is small, in man about 130 c.cms.

5. **Functions.**—(i) The cerebro-spinal fluid, filling all the spaces in the brain, equalises pressure throughout the cerebro-spinal system and acts as a water cushion, especially at the base of the brain, protecting the medulla against shock. (ii) In the perivascular lymphatics it acts as a support to the thin-walled blood-vessels. (iii) It also acts as an adjusting mechanism in variations of blood supply to the central nervous system. (iv) It plays the part of a middle-man between the blood and the nerve cells.

SECTION VI.

RESPIRATION.

THE study of the metabolism of muscle has taught that a process of oxidation is constantly going on in the living tissues for which *oxygen* is constantly required, and by which *carbon dioxide* is constantly being produced.

In the lowliest animals a direct exchange of gases takes place between the cells and the surrounding medium.

In the higher and more complex animals a special mechanism has been evolved for carrying the oxygen from outside to the tissues, and of transporting the carbon dioxide from the tissues to the exterior.

This is the **Respiratory Mechanism**.

In mammals it consists of arrangements by which—

1. Air is brought into relationship with the blood.
2. The exchange of gases between air and blood takes place.
3. The blood carries the oxygen to the tissues, and the carbon dioxide from the tissues.
4. The oxygen is passed from the blood to the tissues, and the carbon dioxide from the tissues to the blood.
5. The oxygen brings about combustion in the tissues.

The first two constitute the process of *External Respiration*, the third and fourth that of *Intermediate Respiration*, and the last that of *Internal Respiration*. This last has been already dealt with in the study of muscle (p. 255) and of metabolism, and it dominates the other parts of the process.

A. EXTERNAL RESPIRATION.

I. STRUCTURE OF THE RESPIRATORY MECHANISM.

In aquatic animals the mechanism by which this process is carried on is a gill or gills. Each consists of a process

from the surface covered by a very thin layer of integument, just below which is a tuft of capillary blood-vessels. The oxygen passes from the water to the blood; the carbon dioxide from the blood to the water.

A lung is simply a gill or mass of gills, turned outside in, with air, instead of water, outside the integument. While in aquatic gill-bearing animals there is constantly a fresh supply of water passing over the gills, in lung-bearing animals the air in the lung sacs must be exchanged by some mechanical contrivance.

(The structure of the various parts of the respiratory tract must be studied practically.)

The lungs consist of myriads of small thin-walled air sacs attached round the funnel-like expansions (infundibular

passages) in which the air passages terminate. These infundibula are the most expansile structures in the lung, and they are largest where the expansion of the lung is greatest (fig. 207).

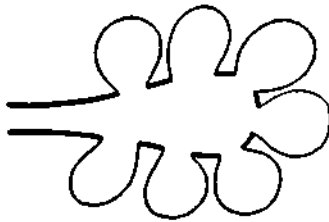

FIG. 207.—Scheme of the Distribution of a Bronchiole, Infundibular Passage, and Air Sacs of the Lung.

Each air sac is lined by a layer of simple squamous epithelium, with smaller, more granular cells between them.

The cells are readily stimulated to proliferate by the action of irritant substances, and the cells so produced take upon themselves a phagocytic action. The epithelium is placed upon a framework of elastic fibrous tissue richly supplied with blood-vessels. It has been calculated that, if all the air vesicles in the lungs of a man were spread out in one continuous sheet, a surface of about 100 square metres would be produced and that the blood capillaries would occupy about 75 square metres of this. Through these vessels about 5000 litres of blood pass in twenty-four hours, and during muscular exercise the flow may be increased some sevenfold (p. 413).

The larger air passages are supported by pieces of hyaline cartilage in their walls, but the smaller terminal passages,

the bronchioles, are without this support, and are surrounded by a specially well-developed circular band of non-stripped muscle—the *bronchial muscle*—which governs the admission of air to the infundibula and air sacs.

II. PHYSIOLOGY.

I. Physical Considerations.

The lungs are packed in the thorax round the heart, completely filling the cavity.

They may be regarded as two compound *elastic-walled* sacs, which completely fill an air-tight box with movable walls—the thorax—and which communicate with the exterior by the windpipe or trachea.

No space exists between the lungs and the sides and base of the thorax, so that the so-called *pleural cavity* is simply a potential space.

The lungs are kept in the distended condition in the thoracic cavity by the atmospheric pressure within them.

Their elasticity varies according to whether they are stretched or not. As they collapse, their elastic force naturally become less and less, as they are expanded, greater and greater. Taken in the average condition of expansion in which they exist in the chest, the elasticity of the excised lungs of a man is capable of supporting a column of mercury of about 30 mm. in height, so that they are constantly tending to collapse with this force.

But the *inside* of the lungs freely communicates with the atmosphere, and this, at the sea-level, has a pressure of about 760 mm. Hg. During one part of respiration, this pressure becomes a few mm. less, during another part a few mm. more; but the mean pressure of 760 mm. of mercury is constantly expanding the lung, and acting against a pressure of only 30 mm. of mercury, tending to collapse the lung (fig. 208).

Obviously, therefore, the lungs must be kept expanded and in contact with the chest wall.

When a pleural cavity is opened, the distribution of

forces is altered, for now the atmospheric pressure tells also on the outside as well as on the inside of the lung and acts along with the elasticity of the organ; so that now a force of $760 \text{ mm.} + 30 \text{ mm.} = 790 \text{ mm.}$ acts against 760 mm. , causing a collapse of the lung, which comes to occupy a small space posteriorly round the bronchus and pulmonary vessels (fig. 208).

In the surgery of the thorax, as well as in the physiology of respiration, these points are of great importance.

It is possible that a small opening may not immediately lead to collapse, because the surface tension between the

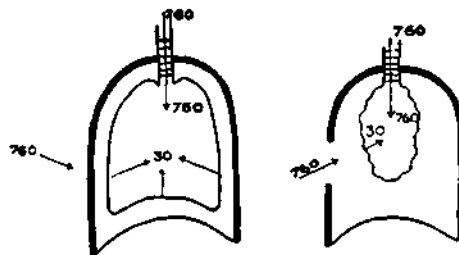

FIG. 208.—Shows the Distribution of Pressure in the Thorax with the Chest Wall Intact, and with an Opening into the Pleural Cavity. (\downarrow) indicates the atmospheric pressure of 760 mm. of mercury; 30 is the elasticity of the lungs, also in mm. of mercury.

parietal and pulmonary pleura may be sufficient to overcome the atmospheric pressure.

II. The Passage of Air into and out of the Lungs.

This is brought about—

1st. By the movements of respiration—breathing.

2nd. By diffusion of gases.

The air is made to pass into and out of the lungs by alternate *inspiration* and *expiration*.

1. Movements of Respiration.

1. *Inspiration*.—During this act, the thoracic cavity is increased in all directions—lateral, vertical, and antero-

posterior. As the thorax expands, the air pressure inside the lungs keeps them pressed against the chest wall, and the lungs expand with the chest. As a result of this expansion of the lungs, the pressure inside becomes less than the atmospheric pressure, and air rushes in until the pressures inside and outside again become equal. This can be shown by placing a tube connected with a water manometer in the mouth, closing the nostrils, and breathing (*Practical Physiology*).

This expansion of the lungs can readily be determined in the antero-posterior direction by percussion, and in the transverse planes by measurement. By tapping the chest with the finger over the lung in the intercostal spaces, a resonant note is produced, while if the percussion is performed below the level of the lung, a dull note is heard. If the lower edge of this resonance be determined before an inspiration, and again during it, the lung will be found to have expanded backwards (*Practical Physiology*). The change from before backwards cannot be seen directly, but it is indicated by a downward movement of the wall of the abdomen. It will be further described when considering the mechanism by which it is brought about.

The expansion of the chest in inspiration is a muscular act and is carried out against the following forces:—

1st. *The Elasticity of the Lungs*.—To expand the lungs their elastic force has to be overcome, and the more they are expanded the greater is their elasticity. This factor therefore plays a smaller part at the beginning than towards the end of inspiration.

2nd. *The Elasticity of the Chest Wall*.—The resting position of the chest is that of expiration. To expand the chest the costal cartilages have to be twisted.

3rd. *The Elasticity of the Abdominal Wall*.—As the cavity of the thorax increases downwards, the abdominal viscera are pushed against the muscular abdominal wall, which, in virtue of its elasticity, resists the stretching force.

The changes in inspiration are brought about by—

1st. *An Increase in the Thorax from before backwards*.

This is due to the contraction of the diaphragm (fig. 209); see also fig. 168, p. 392.

In expiration this dome-like muscle, rising (a) from the vertebral column, and (b) from the lower costal margin, arches forwards, lying for some distance along the inner surface of the ribs, and then curving inwards to be inserted into the flattened central tendon, to which is attached the pericardium containing the heart.

In inspiration the muscular fibres contract. But the central tendon being fixed by the pericardium does not undergo extensive movement. The result of the muscular

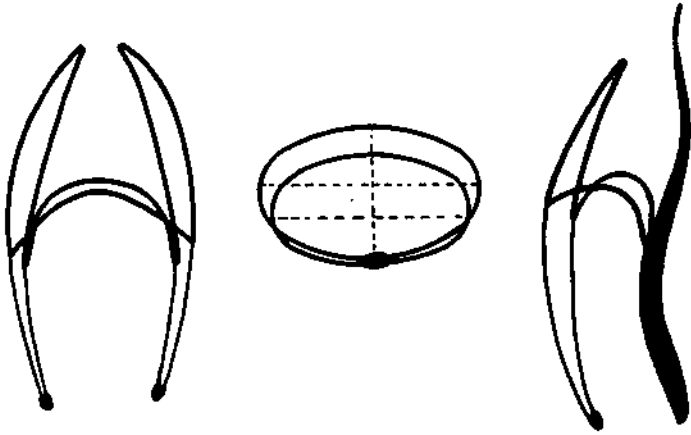

FIG. 209.—Vertical-tangential, Transverse, and Vertical Mesial Sections of the Thorax in Inspiration and Expiration in man. Similar changes occur in quadrupeds.

contraction is thus to flatten out the more marginal part of the muscle and to withdraw it more or less from the chest wall—thus opening up a space, the **complemental pleura**, into which the lungs expand (fig. 209).

The vertebral part of the diaphragm pulls downwards, the costal part pulls backwards, and together they act like a piston extending the vertical diameter of the thorax (fig. 168).

2nd. An Increase in the Thorax in the transverse and vertical diameters.

This is brought about by the pulling forwards of the ribs which rotate round the axes of their attachments to the vertebral column.

To understand this, the mode of connection of the ribs

to the vertebral column must be borne in mind. The head of the rib is attached to the bodies of two adjacent vertebræ. The tubercle of the rib is attached to the transverse process of the hinder of these vertebræ. From this, the shaft of the rib projects outwards, downwards, and backwards, to be attached in front to the sternum by the costal cartilage running forwards. If the rib is made to rotate round its two points of attachment, its lateral margin is elevated and carried outwards, while its sternal end is carried downwards and forwards.

The first pair of ribs does not undergo this movement; the motion of the second pair of ribs is slight, but the range of movement becomes greater and greater as we pass downwards. This greater movement is simply due to the greater length of the muscles moving the ribs. The muscles are the external intercostal muscles, and they may be considered as acting from the fixed first rib. Now, if the fibres of the first intercostal muscle are one inch in length, the second rib can be pulled forwards, say, half an inch. The first and second intercostals acting on the third rib will together be two inches in length, and, in contracting, they can move the third rib through, say, half of two inches—*i.e.* one inch. The first, second, and third intercostals, acting on the fourth rib, are three inches in length, and can therefore move this rib half of three, or one and a half inches. The floating ribs are fixed by the abdominal muscles, and limit the movement of the ribs next above them.

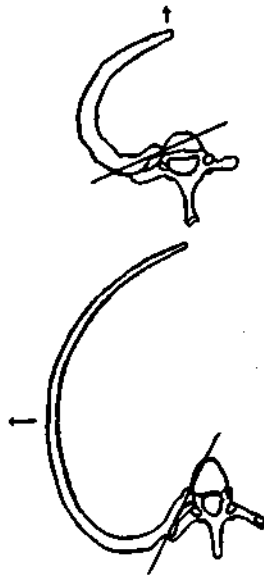

FIG. 210.—Rib and vertebral column, *A.*, in an anterior rib segment, and *B.*, in a posterior rib segment to show the difference in the obliquity of articulation and the resulting difference in the expansion of the chest, which is greater from side to side in the more posterior part of the chest.

The expansion of the lungs is very unequal, being most marked at the anterior and lower margins and much less marked posteriorly, especially round the roots.

The ventilation of the air vesicles is thus much greater in the former than in the latter parts, where, if the breathing be shallow, the exchange of gases comes to depend more largely upon diffusion from the air of the dead space (p. 523).

In these parts the proportion of carbon dioxide in the vesicles will be greater and the proportion of oxygen less than in the other parts of the lungs.

When the diaphragm takes the chief part in inspiration the breathing is said to be *abdominal in type*—when the intercostals take the chief part it is said to be *thoracic*.

The diaphragm and the external intercostals are the essential muscles of inspiration, but other muscles also participate in the act. The nostrils dilate with each inspiration. The nostrils expand due to the action of the *dilatatores narium*, which contract synchronously with the other muscles of inspiration. Again, if the larynx be examined, it will be found that the vocal cords slightly diverge from one another during inspiration. This is brought about by the action of the *posterior crico-arytenoid muscles* (p. 551), and this movement is interfered with in "roarers" (p. 553).

Forced Inspiration.—This comparatively small group of muscles is sufficient to carry out the ordinary act of inspiration. But, in certain conditions, inspiration becomes forced. A forced inspiration may be made voluntarily; often it is produced involuntarily. Every muscle which can act upon the thorax to expand it is brought into play. The body and spinal column are fixed. The head is thrown back and fixed by the posterior spinal muscles. The forelimbs and shoulders are fixed, and every muscle which can act from the fixed spine, head and shoulder girdle upon the thorax is brought into play. Normally, these act from the thorax upon the parts into which they are inserted; now they act *from* their insertions *upon* their points of origin. The sterno-mastoids, sterno-thyroids, and sterno-hyoids assist in expansion of the thorax. The serratus

magnus, pectoralis minor, and posterior fibres of the pectoralis major, and the part of the latissimus dorsi which passes from the humerus to the posterior ribs, also pull these structures forwards. The facial and laryngeal movements also become exaggerated.

2. **Expiration** is a return of the thorax to the position of rest. The various muscles of inspiration cease to act, and the forces against which they contended contract the thorax in its three diameters—

The *elasticity of the lungs* is no longer overcome by the muscles of inspiration, and the external atmospheric pressure acting along with it drives the chest wall inwards.

The *elasticity of the costal cartilages* tends to bring the chest back to the position of rest; the *elasticity of the abdominal wall* drives the abdominal viscera against the relaxed diaphragm and again arches it towards the thorax, bringing its marginal portion in contact with the ribs and occluding the complementary pleura. By this constriction of the thorax, the air in the lungs is compressed and the pressure is raised above the atmospheric pressure outside, and so the air is driven out.

Experimental evidence shows that the **internal intercostals** contract with each expiration, and help to draw the ribs backwards.

Ordinary expiration is thus normally mainly a passive act, being simply a return of the thorax to the position of rest. But voluntarily, and, in certain conditions, involuntarily, expiration may be forced.

Forced expiration is due to the action of muscles. Every muscle which can, in any way, diminish the size of the thorax comes into play. Chief of these are the abdominal muscles, which, by compressing the viscera, push them upwards and press the diaphragm further up into the thorax. At the same time, by acting from the pelvis to pull back the ribs, they decrease the thorax from side to side and from below upwards. The serratus posticus inferior and part of the sacro-lumbalis pull downwards the lower ribs, and the triangularis sterni also assists in this.

3. **Special Respiratory Movements.**—There are several peculiar and special reflex actions of the respiratory muscles, each caused by the stimulation of a special region, and each having a special purpose. They are generally protective reflexes in response to nocuous stimuli.

Coughing.—This consists of an inspiration followed by a strong expiratory effort during which the glottis is constricted but is forced open repeatedly by the current of expired air. It is generally due to irritation of the respiratory tract, and its object is to expel products of inflammation or foreign matter.

Sneezing.—This is generally produced by irritation of the nasal mucous membrane, and its object is to expel irritating matter. It consists in an inspiratory act followed by a forced expiration during which, (*a*) by contraction of the pillars of the fauces and descent of the soft palate, and (*b*) by the tip of the tongue being pressed against the hard palate, the air is compressed and finally forced through the nose and mouth.

Hiccough consists in a sudden reflex contraction of the diaphragm causing a sudden inspiration which is interrupted by a spasmodic contraction of the glottis. It is allied to vomiting. Abdominal irritation is its chief cause.

Sighing and **Yawning** are deep involuntary inspirations which serve to accelerate the circulation of the blood in the brain when, from any cause, it becomes less active. They are probably due to cerebral anæmia, which they help to correct by increasing the general arterial pressure, and they are the result of direct chemical stimulation of the respiratory centre rather than reflex actions (p. 527).

II. Amount of Air Respired.

The amount of air respired is different in ordinary and in forced respiration (fig. 211).

In an ordinary respiration in the horse about 3000 c.cms. of air enter and leave the chest. That is called the **tidal air**. Its amount varies with the size and muscular development of the chest.

By a forced inspiration a much larger quantity of air may be made to pass into the lungs—a quantity varying with the size and strength of the individual—but on an average about 14,000 c.cms.

This is called the **complemental air**.

By forced expiration, an amount of air much larger than the tidal can be expelled, an amount usually about the same as the complemental air, and called the **reserve air**.

The total amount of air which an individual can draw into and drive out of his lungs is a fair measure of the size and muscular development of the thorax, and it has been called the **vital capacity** of the thorax, and in the horse it amounts to something like 25,000 to 30,000 c.cms.

Even after the whole of the reserve air has been driven out of the chest, a considerable quantity still remains in the air vesicles, its amount depending upon the size of the chest, but averaging about 10,000 c.cms. This is called the **residual air**.

This very important point must always be remembered, that *the air taken into the chest never fills the air vesicles, and that air is never driven completely out of them. The air in them is thus not changed by the movements of respiration, but by the process of diffusion.*

A fairly reliable conclusion as to the vital capacity may be arrived at by measuring the circumference of the chest in expiration and inspiration (*Practical Physiology*).

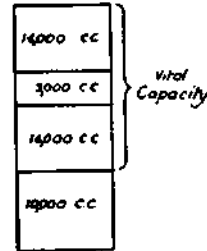

FIG. 211.—The Amount of Air Respired in Ordinary Respiration, and in Forced Inspiration and Expiration.

III. Interchange of Air in the Lungs by Diffusion of Gases.

Since, in ordinary breathing in the horse, a residue of almost 24,000 c.cms. of air remains in the lungs while only 3000 c.cms. pass into and out of them, the question whether any of this gets to the air vesicles must be considered. The trachea and bronchi have a capacity of probably about 1400 c.cms. and they constitute a "dead space," so that, after filling these, about 1600 c.cms. are available to reach the vesicles. But, so large is the capacity of

these vesicles, that, if this air were uniformly distributed, it would add only about $\frac{1}{4}$ th to the volume of each. The exchange of gases depends, in fact, largely upon the process of diffusion (fig. 212).

Oxygen is constantly being removed by the blood from the air in the air vesicles, and carbon dioxide is constantly being added to it. Hence, the pressure of oxygen is lower and the pressure of carbon dioxide higher than in the air breathed, and hence, a diffusion of oxygen to the air in the vesicles and a diffusion of carbon dioxide from it are constantly going on. In the less expansile parts of the lung the exchange of gases will

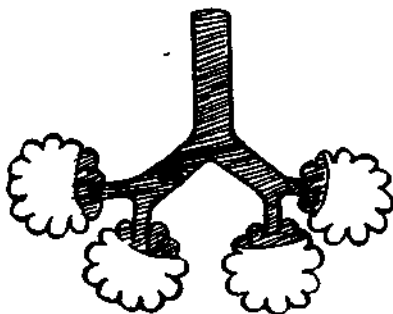

FIG. 212.—To show the exchanges of gases by diffusion between the tidal air and the reserve and residual air.

depend more largely upon diffusion than in the more expansile parts.

IV. Breath Sounds.

The air, as it passes into and out of the lungs, produces sounds that may be heard on listening over the thorax. The character of the breath sounds is of the utmost importance in the diagnosis of diseases of the lungs, and must be studied practically (*Practical Physiology*).

On listening over the trachea or over the bifurcation of the bronchi behind (between the 4th and 5th dorsal vertebræ), a harsh sound, something like the guttural *ch* (German *ich*), may be heard with inspiration and expiration. This is called the **bronchial sound**.

If the ear be applied over a spot under which a mass of air vesicles lies, a soft sound, somewhat resembling the sound of

gentle wind among leaves, may be heard throughout inspiration, and for a third or less of expiration. This is called the **vesicular sound**.

When the air vesicles become consolidated by disease, the vesicular sound is lost, and the bronchial sound takes its place. The cause of the vesicular character is therefore to be sought in the vesicles, infundibula, or small bronchi.

The cause of the bronchial sound has been determined by experiments on horses. In the study of the cardiac circulation, it was shown that a column of fluid moving along a tube of uniform calibre, or with the calibre only slowly changing, produces no sound. The same is true of a column of air. Any sudden alteration in calibre produces vibration and a musical sound, as explained on p. 409. The first sharp constriction of the respiratory tract is at the glottis, and it is here that the bronchial sound is produced. If the trachea be cut below the larynx and drawn freely outwards, the bronchial sound at once stops and the vesicular sound becomes lower and less distinct.

The cause of the vesicular sound is not so satisfactorily explained. It is in part due to propagation of the bronchial sound, altered by passing through vesicular tissue; but it is also probably due to the expansion and contraction of the infundibula drawing in and expelling air. The reason why the sound is best heard during inspiration may be that the sound is best conducted in the direction of the air stream.

V. Rhythm of Respiration.

The movements of respiration are carried on in a regular rhythmic manner. They may be recorded—

1. By recording the movement of the chest wall by some form of *stethograph*.

2. By recording the movements of the column of air by placing a glass tube in one nostril and connecting it with a recording tambour (*Practical Physiology*).

3. In lower animals, by connecting a strip of the diaphragm to a lever.

Their rate varies with many factors; but the average number of respirations per minute in the adult horse is about

ten to twelve, or about one to every four or five beats of the heart. Deep breathers are slow breathers, and shallow breathers are quick breathers, and in the latter a smaller part of the lung is ventilated.

The most important factor modifying the rate of respiration is muscular exercise. After galloping the respirations may be over 60 per minute.

The other modifications in the rate of breathing will be better understood after studying the nervous mechanism of respiration.

Inspiration is more rapid than expiration (see fig. 216). As soon as it is completed, a reverse movement occurs, which is at first rapid, but gradually becomes slower, and may be followed by a pause, during which the chest remains in the collapsed condition. The existence and duration of this pause varies much, and it may really be regarded as the terminal period of expiration. Considering it in this light, we may say that inspiration is to expiration as 6 is to 7.

VI. The Nervous Control of Respiration.

The rhythmic movements of respiration require the harmonious action of a number of muscles, and this is directed by the nervous system.

The Respiratory Centre.

If the spinal cord be cut above the third cervical nerves the movements of respiration at once stop. Obviously there is some nervous mechanism above this level presiding over these muscles.

A. Position.—Removal of the brain above the medulla oblongata does not stop the respiratory rhythm. The mechanism must therefore be situated in the medulla oblongata.

If the medulla be split into two by an incision down the middle line, respiration continues, but the two sides do not always act at the same rate. The mechanism, then, is bilateral. Normally the two parts are connected, and thus act together.

Destruction of the part of the medulla lying near the root

of the *vagus* arrests respiration, and it may therefore be concluded that the nervous mechanism presiding over this act is situated there.

This centre sends fibres down the lateral column of the cord to act upon the outgoing neurons to the muscles of respiration, and it is by influencing the activity of these that the respiratory centre controls the act of respiration.

Outgoing Nerves.—The diaphragm is supplied by the *phrenic nerves* arising from the third and fourth, and partly from the fifth cervical nerves. The *intercostals* are supplied by branches from their corresponding dorsal nerves.

If the spinal cord be cut or the neck broken below the fifth cervical nerves, the intercostal muscles cease to act. If the section be made above the third cervical nerves, the diaphragm, too, is paralysed, and the animal dies of suffocation.

B. Mode of Action.—The respiratory centre is under the control of higher nerve centres, and, through these, it may be thrown into action at any time, or prevented from acting for the space of over a minute and, under certain conditions, for two or three minutes. But, sooner or later, the respiratory mechanism acts in spite of the most powerful attempts to prevent it.

Pearl divers rarely are able to stay under water for more than 85 seconds; the record period of submergence is 4 minutes 45 seconds.

I. Chemical Regulation.

A. Carbon dioxide.

The activity of the centre is chiefly regulated by the tension of CO_2 in the blood going to it (p. 495), and everything which leads to an increase in the CO_2 increases the activity of respiration, while everything which decreases it decreases the activity of breathing.

The tension of CO_2 in the blood is directly proportional to the partial pressure of CO_2 in the medium to which the blood is exposed (p. 496). The amount and tension of CO_2 in the blood and therefore its action upon the respiratory centre, depend upon its production in the muscles on the one hand, and on its tension in the alveolar air on the other. The latter may be raised by breathing air with an increased amount of CO_2 , e.g. 5 per cent.

With any increase in the amount, the respiratory centre is stimulated and the respirations increased (*hyperpnœa*), till the tension of CO_2 in the blood becomes normal. The power of adjustment is extraordinarily efficient, so efficient that the tension of CO_2 in the alveolar air is maintained at a constant level of about 40 mm. Hg under wide variations of atmospheric pressure. It has been found that an increase of 0.2 per cent. in the CO_2 of the alveolar air, i.e. a rise of tension from 40 to 41.6 mm. Hg is sufficient to double the ventilation of the lungs.

By forced breathing the tension of CO_2 in the alveolar air may be so lowered that the tension in the blood is markedly reduced, and the stimulus to the respiratory centre so decreased, that a long period without breathing, an *apnœa*, may occur. In fact, in some cases in man, the face may become livid from want of oxygen before breathing is re-established.

Alveolar Air		
CO ₂ tension 40 mm. Hg.		
45	40	35
Tension of CO ₂ in Blood in mm. Hg.		
Hyperpnœa	Normal Breathing	Apnœa

B. Oxygen.

The influence of the oxygen content of the blood upon the respiratory centre is not so manifest.

The amount and tension of O_2 in the blood, and its transit to the tissues and the respiratory centre, are in some respects more complex than in the case of CO_2 .

As already explained (p. 493)—(1) the amount in the blood is not directly proportional to the partial pressure of the gas to which it is exposed. As the latter rises from zero the amount in the blood rapidly increases, till at 50 mm. Hg the hæmoglobin

is saturated to the extent of about 80 per cent., and a further rise causes only a slight increase in the saturation.

(2) The giving off of O_2 from the hæmoglobin depends upon the hydrogen ion concentration of the blood which is mainly determined by the tension of CO_2 . With a pressure of 80 mm. Hg of CO_2 75 per cent. of the oxygen is given off at an oxygen pressure of 20 mm.; with 5 mm. Hg pressure only about 30 per cent. is given at the same pressure (fig. 202). With a low CO_2 tension the blood may pass through the tissues and the respiratory centre and remain of a bright red colour because it has not parted with its oxygen, and the tissues and the centre may thus have an inadequate supply.

A due proportion of CO_2 in the blood is therefore of importance in securing an adequate transference of O_2 to the centre.

When oxygen deficiency is sufficiently marked, the respiratory centre not only becomes more sensitive to the stimulating action of CO_2 , but may be stimulated quite apart from any action of CO_2 . This is seen in the oxygen-want experienced in high aviation and in re-breathing air from which the CO_2 is removed by passing over soda lime. The rate rather than the depth of breathing is increased.

This increase may lead to an increased intake of oxygen although, on account of the rapid shallow breathing, it does not necessarily do so (p. 526). It may thus fail to relieve the condition, because at the same time the CO_2 is driven out of the blood and thus the giving off of oxygen to the respiratory centre may be decreased.

The result is that, under the continued want of oxygen, the respiratory centre may fail, the breathing stop, and death supervene, as is seen in death from asphyxia (p. 548).

Fortunately, the decreased supply of O_2 to the muscles leads to a failure to oxidise the sarcolactic acid, which may accumulate in the blood and by causing an acidosis—an increase in the C_{π} of the blood—may stimulate the respiratory centre, and at the same time facilitate the giving off of O_2 to the tissues.

The primary increase of breathing with oxygen-want appears to be due to a direct action on the centre, and not as was formerly supposed to the development of an acidosis. It

occurs under conditions when such an acidosis could hardly develop.

While an increase of free CO_2 increases the depth, and also generally the rate of breathing, and thus secures a more thorough ventilation of all parts of the lung, oxygen deficiency seems chiefly to cause an acceleration of rate. In consequence of this quicker, more shallow breathing only the more expansile parts of the lung are ventilated (p. 523). The result is that a greater proportion of the blood passes through parts of lung imperfectly ventilated, from the alveoli of

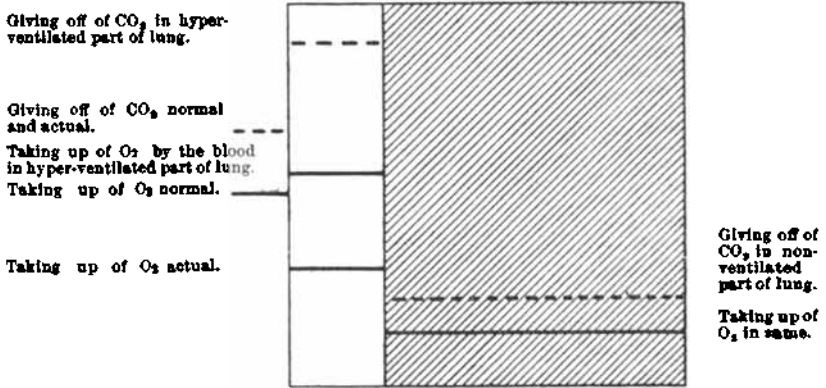

FIG. 213.—To show effects of shallow breathing and imperfect ventilation of the lungs upon the taking up of O_2 and giving off of CO_2 . The shaded part of the square represents the badly ventilated part.

which the oxygen gets used up and reduced to a low partial pressure. If the pressure falls below 50 mm. Hg the blood will be imperfectly oxygenated. The rest of the blood passing through the well-ventilated expansile part of the lung cannot take up much more oxygen than it does at a pressure of a little over 50 mm. Hg (p. 493), so that any rise in the partial pressure as the result of better ventilation produces only a small effect. Thus imperfectly oxygenated blood is mixed with a smaller quantity of *normally* oxygenated blood, and thus the total blood leaving the lungs carries less oxygen than normally (fig. 213).

On the other hand, since the CO_2 tension varies directly with the partial pressure, the decreased giving off of CO_2 in the badly ventilated parts of the lung may be compensated for

by the increased giving off in the well-ventilated parts, and thus the amount of CO_2 in the blood may not be raised, and so the normal stimulus to the respiratory centre may not come into play (fig. 213).

It has been suggested that in these conditions the addition of CO_2 to the air breathed may have an even more beneficial effect than the addition of oxygen. Possibly a combination would be more efficacious.

There is some evidence that a sufficient clearing out of CO_2 from the blood by forced breathing may so decrease the C_R of the blood, may produce so marked an *alkalosis*, that the HbO_2 is not dissociated, and the central nervous system may be so imperfectly supplied with oxygen that consciousness may be lost, the arterioles may contract and the heart fail as in

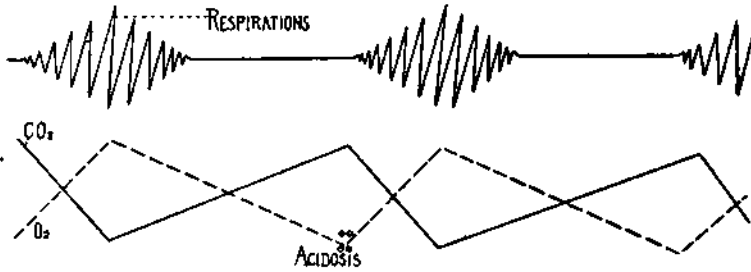

FIG. 214.—To show the Characters of Cheyne-Stokes Breathing and the factors producing it (see text).

asphyxia. This has been termed by Yandell Henderson *acapnia*.

In some people and under some conditions a deficient supply of oxygen to the respiratory centre leads to a periodic type of breathing. The patient stops breathing for a time (*apnœa*), then begins to breathe, first quietly, then more forcibly (*hyperpnœa*), and, after several respirations, again with decreasing depth till the respirations stop. In these cases, the respiratory centre is less excitable than usual, and it is called into action only when CO_2 has accumulated in the blood. After this accumulation has been got rid of by the forcible respirations, the activity of the centre again wanes. Since the forced breathing tends to produce excessive clearing out of CO_2 , it may lead to a decreased dissociation of HbO_2 , and to a

limitation of the free supply to the tissues of the oxygen which has been taken up by the blood. This has been called Cheyne-Stokes breathing (fig. 214).

2. Reflex Regulation.

The respiratory centre is also acted upon by various ingoing nerves.

(1) **The Vagus.**—Since the vagus is the ingoing nerve of the respiratory tract, we should expect it to have an important influence on the centre (fig. 215).

Section of one vagus generally causes the respirations to become slower and deeper; but, after a time, the effect wears

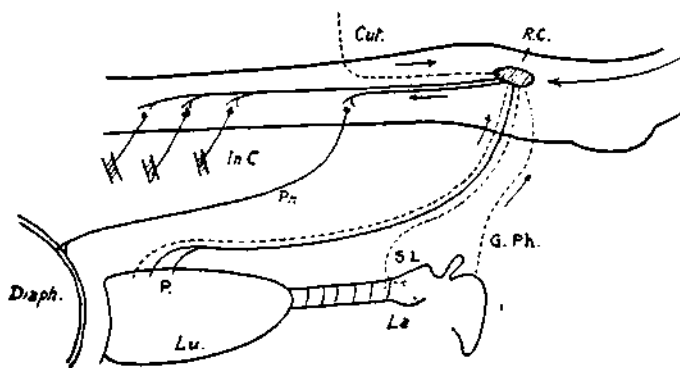

FIG. 215.—Nervous Mechanism of Respiration. *R.C.*, respiratory centre; *Cut.*, cutaneous nerves; *Ph.*, phrenics; *In.C.*, intercostal nerves; *P.*, pulmonary branches of vagus; *S.L.*, superior laryngeal branch of vagus; *La.*, the larynx; *G.Ph.*, glossopharyngeal nerve; *Diaph.*, diaphragm.

off and the previous rate and depth of respiration are regained (fig. 216).

Section of both vagi causes a very marked slowing and deepening of the respiration, which persists for some time, and passes off slowly and incompletely. But if, after the vagi have been cut, the connection of the respiratory centre with the *upper brain tracts* is severed, the mode of action of the centre changes. Instead of discharging rhythmically, it may discharge irregularly (fig. 216, c).

To investigate further this influence of the vagus it is necessary to study the effect of stimulating the nerve.

Strong stimulation of the pulmonary branches of one

vagus, below the origin of the superior laryngeal, generally causes the respirations to become more rapid, the inspiratory phase being chiefly accentuated. Weak stimuli, on the other hand, may cause inhibition of the respirations.

Such experiments prove that impulses are constantly travelling from the lungs to the centre to regulate its rhythmic activity.

Positive and Negative Ventilation, i.e. passively inflating and deflating the lungs, shows that two sets of fibres come into play in normal respiration.

If the lungs be forcibly inflated, the inspirations become feebler and finally stop. The nature of the gas, if non-irritant,

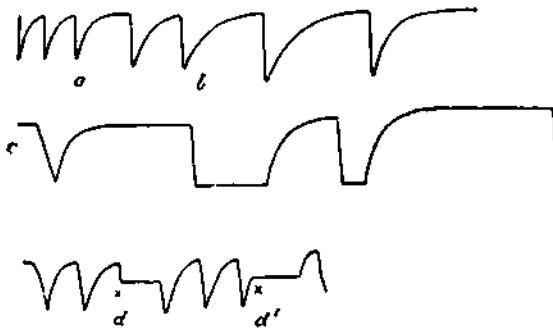

FIG. 216.—Tracings of the Respiration—Downstroke is inspiration; Upstroke is expiration. At *a* one vagus nerve was cut; at *b* the second was divided; at *c* the upper brain tracts also were cut off; *d* and *d'* show the effect of stimulating the glossopharyngeal nerve.

with which this inflation is carried out, is of no consequence. If, on the other hand, air is sucked out of the lungs, inspirations become more dominant, and may end in a spasm of the inspiratory muscles.

Inspiration is thus checked by one set of fibres and expiration by another, and *the vagus thus regulates the action of the respiratory nervous mechanism, much as the pendulum regulates the action of a clock.* Under some conditions, e.g. after gassing, the activity of this reflex may be increased so that inspiration and expiration are checked too soon, and the breathing may thus be made shallow and quick.

(2) **Other Ingoing Nerves.**—(*a*) Section of the superior laryn-

geal branch of the vagus, the sensory nerve of the larynx, does not alter the rhythm of respiration. Stimulation of the upper end of the cut nerve causes first an inhibition of inspiration, and, if stronger, produces forced expiratory acts. This is well illustrated by the very common experience of the effect of a foreign body, such as a crumb, in the larynx. The fit of coughing that ensues is a series of expiratory acts reflexly produced through this nerve.

(b) When the **splanchnics** in the abdomen are stimulated, inspiration is inhibited. Every one has experienced the "loss of wind" as the result of a blow on the abdomen.

(c) The **glossopharyngeal**, which supplies the back of the tongue, when stimulated, as by the passage of food in the act of swallowing, causes an instant arrest of the respiratory movements either in inspiration or expiration. The advantage of this in preventing the food, as it is swallowed, from passing into the trachea is obvious (fig. 216, *d* and *d'*).

(d) Stimulation of the **cutaneous nerves** stimulates the inspiratory centre and causes a deep inspiration. This is seen when cold water is dashed upon the skin. Stimulation of the skin by slapping is sometimes used to establish breathing in the newly born infant. The reaction is most clearly demonstrated in animals with the **vagi** cut when an inspiratory movement may often be liberated by merely touching the skin.

3. **Influence of Temperature.**—The temperature of an animal also acts on the respiratory centre. Increase in temperature accelerates the rate of the heart and it also accelerates the rate of the respirations in about the same proportion. This is seen in feverish attacks, where pulse and respirations are proportionately quickened so that their ratio remains unaltered. When the respiratory rate rises out of proportion to the rate of the pulse it is usually an indication that some pulmonary irritation is present.

4. **Postural Control.**—In diving birds the respirations are controlled by a postural reflex from the labyrinths and neck. When the head is put in the diving position respirations are stopped. The respiratory centre in these birds does not respond to the C_H of the blood, but rather to the want of oxygen.

III. Interaction of Circulation and Respiration.

The lungs and heart, being packed tightly together in the air-tight thorax, and both undergoing periodic changes, necessarily influence one another. At the same time, the close proximity of the respiratory and cardiac centres in the medulla seems to lead to the activity of one influencing the other.

A. Influence of Respiration on Circulation.—The circulation is modified in two ways by respiration. First, the pulse, and second, the arterial blood pressure undergo alterations.

1st. Pulse.—(a) *Rate.*—If a sphygmographic trace, giving the pulse waves during the course of two or three respirations, be examined, it will be found that during inspiration the heart is acting more rapidly, while during expiration its action is slower.

If the vagus be cut, these changes are not seen, showing that the inspiratory acceleration is not the result simply of the larger amount of blood which enters the heart during inspiration, but is really due to changes in the cardio-motor centre—the accelerating part of which has its activity increased during inspiration, while the inhibitory part is more active during expiration. This is therefore partly a reflex effect from the lung through the vagus, although it may be in part due to the proximity of the centres in the medulla.

(b) *Volume.*—Not only is the rate of the pulse altered by respiration, but the waves are smaller during inspiration and larger during expiration. This is simply due to there being more time for diastolic filling when the heart is beating more slowly.

2nd. Blood Pressure.—A. If, in an anaesthetised animal, tracings of the arterial pressure and of the respiratory movements are taken at the same time, it is found that there is a general rise of pressure during inspiration and a general fall during expiration, but that at the beginning of inspiration the pressure is still falling, and at the beginning of expiration it is still rising. This influence of respiration on arterial pressure is chiefly a mechanical one, depending on the variations in the pressure in the pericardium, which is decreased during inspiration, allowing

greater diastolic filling. By allowing access of air into the pericardial sac the differences are abolished.

B. In man, and this is probably also the case in the unanaesthetised animal, in *thoracic breathing* the arterial pressure falls during inspiration and rises during expiration, on account of the retention of blood in the distended thorax in inspiration and its expulsion in expiration, and that, in *abdominal breathing*, the reverse is the case; inspiration, by pressing on the abdominal vessels and sending more blood on into the arteries, increasing the pressure.

B. Influence of the Action of the Heart on Respiration.—The

heart lies in the thorax surrounded by the elastic lungs. As it contracts and dilates it must alternately pull upon and compress the lungs, and thus tend to cause an inrush and an outrush of air—the **cardio-pneumatic movements**.

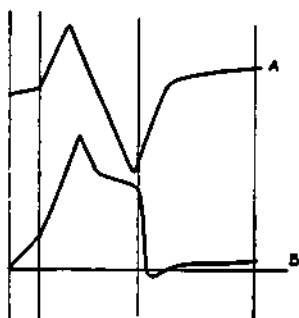

FIG. 217.—To show Relations of Cardio-pneumatic Movements, *A.*, to the Cardiac Cycle, *B.* In *A.* the upstrokes are expiratory, the downstrokes inspiratory.

If a simultaneous tracing of the heart-beat and of the movements of the air column be taken, it will be seen that (1) at the beginning of ventricular systole there is a slight outrush of air from the lungs, probably caused by the blow given to the

lungs by the suddenness of the systolic movement. (2) This is followed by a marked inrush of air corresponding to the outflow of blood from the ventricles, and caused by the fact that the contracting ventricles draw on and expand the lungs. (3) Succeeding this is a slower outrush of air corresponding to the active filling of the ventricles during the beginning of ventricular diastole. (4) Lastly, during the period of passive diastole, the cardio-pneumatic movements of air are in abeyance (fig. 217).

These cardio-pneumatic movements are of importance in two ways. (1) In animals during hibernation, the ordinary

respirations almost stop, but a sufficient gaseous interchange is kept up by these cardio-pneumatic movements.

(2) If, as is often the case in bronchitis, there is a plug of mucus in a small bronchus near the heart, the rush of air past it may give rise to a murmuring sound, in character very like a cardiac murmur and synchronous with the heart's action.

IV. Interchange between the Air breathed and the Blood in the Lung Capillaries.

I. Effects of Respiration upon the Air breathed.—I. Method

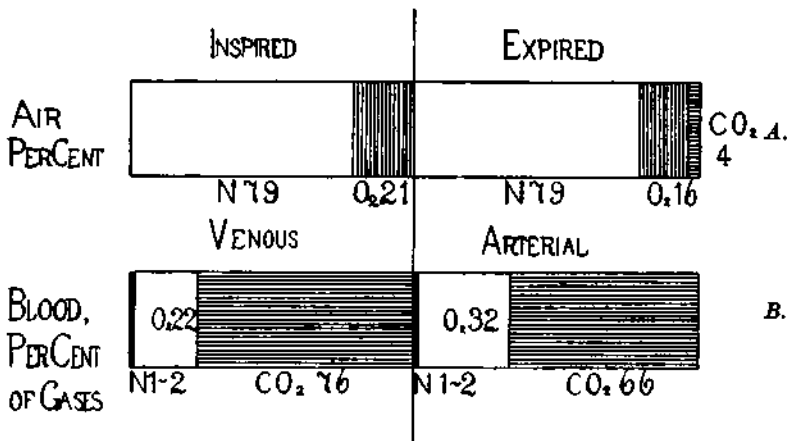

FIG. 218.—A. Shows the Composition of Inspired and Expired Air. B. Shows the Difference in the percentage Composition of the Gas of Venous and Arterial Blood.

of Investigation.—A measured quantity of air is collected in a graduated burette. It is then forced into a chamber containing caustic potash, by which the CO₂ is absorbed, and the volume of air is again measured. It is next forced into a chamber containing sodium pyrogallate in caustic soda, which absorbs the O₂, and is again measured. The residue is nitrogen. In this way the amount of the gases present is determined (*Practical Physiology*).

2. *Results.*—(1) **Gases.**—The following table shows the average percentage composition of the air inspired and the air expired (fig. 218):—

Per Cent. of	N.	O ₂ .	CO ₂ .
Inspired air	79	21	0
Expired air	80	16	4

i.e. about 5 per cent. of oxygen is taken from the air, and about 4 per cent. of carbon dioxide is added to it. In man the amount of carbon dioxide given off is smaller than the amount of oxygen taken up, and hence, as already explained (p. 258), the *Respiratory Quotient*— $\frac{\text{CO}_2 \text{ given off}}{\text{O}_2 \text{ taken up}}$ is generally less than unity—usually about 0·8 to 0·9—and the *percentage of nitrogen in expired air is increased.*

(2) Expired air is saturated with watery vapour, and therefore it usually contains more *water* than inspired air.

(3) Expired air also contains small amounts of *organic matter*, which may give it an offensive odour. These are not derived from the lungs, but are produced by putrefactive changes in the mouth and nose. The injurious effects of the “foul air” in overcrowded spaces are chiefly due to bad ventilation with imperfect movements of the air, which result in an increased humidity and a decreased elimination of heat, and at the same time to the accumulation of the volatile products from dirty skins.

(4) Expired air is *usually* warmer than inspired air, because usually the body is warmer than the surrounding atmosphere. When, however, the temperature of the air is higher than that of the body, the expired air is cooler than the inspired.

II. Effects of Respiration on the Blood.—To understand these changes in the air, we must refer to the changes in the gases of the blood in passing through the lungs. These have already been partly considered when dealing with the gases of the blood (p. 492). Analyses show that the blood going to the lungs is poorer in oxygen and richer in carbon dioxide than the blood coming from the lungs (fig. 218).

The following table gives not the percentage composition of

the gas extracted from blood, but the amount of each gas per 100 parts of blood :—

Amount in 100 parts of Blood (Human).

	CO ₂ .	O ₂ .
Venous	55	13
Arterial	50	20

Oxygen is taken by the blood from the air, carbon dioxide is given by the blood to the air.

III. The Causes of the Respiratory Exchange.—How is this effected? The extensive capillary network in the walls of the air vesicles in man, if spread out in a continuous sheet, would present a surface of about 75 square metres. Between the blood in the capillaries and the air in the air vesicles are two layers of living cells—

1st. The endothelium lining the capillaries.

2nd. The flattened cells lining the air vesicles.

Through these cells the interchange of gases must take place.

The interchange might take place in either or both of two ways—

1st. By simple diffusion.

2nd. By some special action of the cells.

If the process follows strictly the laws of diffusion, it is unnecessary to invoke the activity of the cells as playing a part. But, if the gaseous interchange does not *strictly* follow these laws, we must conclude that the cells do play a part.

Diffusion takes place from the point of higher partial pressure to the point of lower pressure till equilibrium is established.

To determine if the process can be accounted for by diffusion, it is therefore necessary to know—

1. The partial pressure of the gases in the air in the vesicles of the lungs.

2. The partial pressure or tension of the gases in the blood going to and coming from the lungs.

1. **Partial Pressure of Gases in the Air Vesicles.**—The method

of determining the partial pressure or tension of a gas in the atmosphere has been described on p. 492, and it has been shown that at sea-level, with an atmospheric pressure of 760 mm. Hg, the tension of oxygen is about 152 mm. Hg.

The air in the vesicles or alveoli is renewed partly by direct ventilation from without, and partly by a process of diffusion (p. 492). For this reason the amount of oxygen in the vesicles must be smaller, the amount of carbon dioxide larger, than in the air respired.

Haldane has devised a method of procuring samples of the alveolar air for analysis. A wide tube is fitted with a measured glass bulb near one end, and this bulb is made a vacuum. The

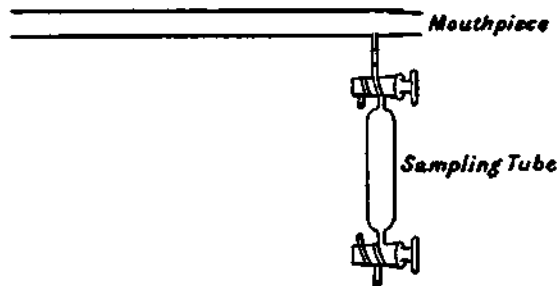

FIG. 219.—Haldane's Apparatus for Determining the Composition of Alveolar Air.

end of the tube near the bulb is put in the mouth or fitted to a mask, and the person under observation breathes through it. At the end of an ordinary inspiration he expires deeply through the tube, closes the mouthpiece with his tongue, and by opening the upper stop-cock collects a sample of the expired air. A second sample is taken in the same way at the end of a normal expiration. The mean of these samples represents the average composition of the alveolar air (fig. 219).

By the use of this method, it has been found that the partial pressure of the O_2 varies within wide limits, while the partial pressure of the CO_2 remains very constant.

Thus, at the top of Ben Nevis the tension of oxygen in the air vesicles was 76 mm. Hg, at the bottom of a mine it was 111 mm.; while in both places the *tension* of carbon

dioxide was about 42 mm., the *amount* varying from about 4 to 5.5 per cent.

At sea-level the partial pressure or tension in the alveoli may be taken as about—

$$\begin{aligned} O_2 &= 100 \text{ mm. Hg.} \\ CO_2 &= 42 \text{ mm. Hg.} \end{aligned}$$

From the great inequality in the expansion of the lungs in different parts of the thorax and the resulting differences in the ventilation of the air vesicles, the samples of alveolar air taken by Haldane's method will tend to give too low a carbon dioxide and too high an oxygen figure, since the sample is chiefly derived from the better ventilated part of the lung.

This means that in the less expanding parts of the lung the blood is subjected to a higher partial pressure of CO_2 , and a lower partial pressure of O_2 .

2. The Partial Pressure or Tension of the Gases in the Blood.—The tension of O_2 and CO_2 in the blood has been already considered (p. 492). Whether a gas is simply dissolved, or whether it be held in loose chemical combination, its amount will depend upon the *temperature* of the fluid and upon the *pressure* of the gas over the fluid. If the temperature is raised, the fluid will hold less of the gas.

If the pressure of a gas over a fluid is increased, some will be taken up by the fluid; if it be decreased, the gas will tend to come off from the fluid, as occurs when a bottle of soda water is opened.

Thus, for every temperature, there is a certain pressure of the gas in the atmosphere at which the solution or chemical combination exposed to it will neither give off nor take up more of the gas, and this gives the measure of the tension of the gas in the fluid.

Theoretically, the determination of the tension of a gas in a fluid is simple (p. 492). But when it has to be carried out in circulating blood it becomes extremely difficult. It must be carried out without marked disturbance of the circulation, and a thorough exposure of the air to the blood must be secured. The trouble of clotting has also to be faced.

The best results have been obtained by the aerotonometer of Krogh, in which a bubble of air is exposed to the blood,

and, after equilibrium has been established, is withdrawn and analysed. Its volume is measured in a fine graduated tube.

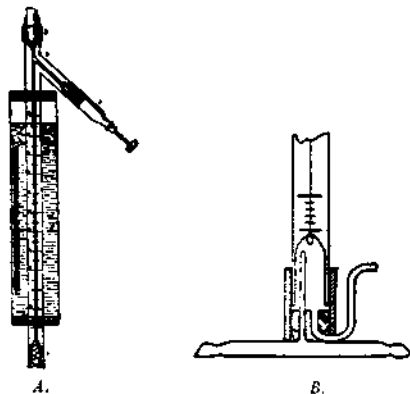

FIG. 220.—Krogh's Microtonometer. *B.*, chamber attached to blood-vessel with bubble of air; *A.*, fine graduated tube in water jacket for analysis of gases.

It is then forced through caustic soda solution till all the CO_2 is absorbed, again drawn into the tube and measured, the decrease in volume giving the amount of CO_2 . Next, it is passed through a solution of sodium pyrogallate in caustic soda to absorb the O_2 and is again measured. The residual gas is nitrogen, a small amount of which is always dissolved in the blood. From the percentage of these gases in the bubble their ten-

sion in the circulating blood in which the bubble of air lay is calculated. The apparatus is shown in fig. 220.

It has been found that the tension of CO_2 in arterial blood is identical with that in the air in the vesicles of the lungs. When the amount in the air is altered, the tension in the blood follows the variation.

The O_2 tension in venous blood is in all cases lower (by 1 to 4 per cent.) than that in the air of the lung vesicles, and it also follows any alteration in the latter.

Krogh has also shown that, by modifying the air breathed, O_2 may be made to come off from the blood, and CO_2 to be taken up by the blood.

The difference in the pressure of these gases in the alveolar air and in the blood may be represented as follows in mm. Hg:—

	Oxygen.	Carbon Dioxide.
Alveolar Air	100	42
Blood from Lungs	96	42

The exchange of gases between the air of the lungs and the blood may therefore be explained by simple diffusion.

So perfect is the exchange that the tension of a gas in the air of the alveoli may be taken as a measure of the tension in the blood flowing through the lungs. Brodie has suggested that a dead lung, through the vessels of which the blood is allowed to flow, might be used a tonometer.

Haldane maintains that at low partial pressures of oxygen, the passage of the gas from the alveoli to the blood cannot be explained by diffusion and that it must be due to some as yet unknown factor.

Certainly the accumulation of gas in the swim bladder of fishes cannot be explained by the laws of diffusion of gases, and it seems to be dependent on the activity of the cells lining the bladder. It may be arrested by section of the nerves supplying the bladder.

A. The Effects of Decreased Atmospheric Pressure.—The fact that the hæmoglobin in the blood is so nearly fully oxygenated at a pressure of only 50 mm. Hg (p. 493), explains why the pressure of this gas in the atmosphere may fall to about one-half of its normal 152 mm. Hg without interfering with the supply of oxygen to the blood, why men and animals can live at high altitudes, and why aviation to such enormous heights is possible. The record height is probably 30,500 feet, or about 10,000 metres.

The following table shows the relationship of the height, partial pressure of oxygen in the alveolar air, and the percentage saturation of the hæmoglobin with oxygen, and it shows that at about 5000 metres (16,000 feet) the marked decrease in the oxygen carrying capacity of the blood begins (consult p. 545).

When an animal is suddenly subjected to a very marked decrease of pressure, especially if it has to do muscular work, as in climbing, the decreased supply of oxygen leads to shortness of breath, palpitation, and even to sickness (**mountain sickness**). These symptoms generally pass off, increased pulmonary ventilation and increased heart's action augmenting the intake of oxygen. Hence, residence in high altitudes tends to increase the power of the respiratory muscles and the strength of the heart. It also increases the richness of the blood in erythrocytes and in hæmoglobin.

If a markedly deficient supply of oxygen is long continued, permanent damage may be done to many important structures, such as the heart and the central nervous system, and the respiratory centre may be so seriously modified that it may fail to act. The early implication of the higher centres in the brain may prevent the

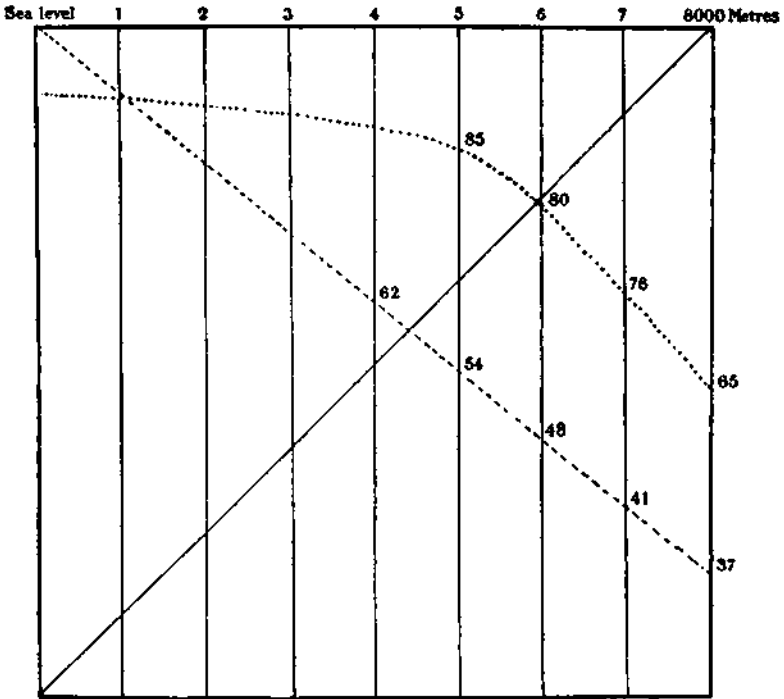

FIG. 221.—To show the effects of altitudes from sea-level to 8000 metres upon the pressure of oxygen in the alveoli of the lungs — — — and the saturation of the blood with oxygen

individual from noticing the onset of the symptoms till consciousness is lost. It is therefore most important to administer oxygen as early as possible in such cases.

B. The Effects of Increased Atmospheric Pressure.—On the other hand, the atmospheric pressure may be enormously increased without any change in the respirations being produced. The hæmoglobin will not take up more than a definite amount of oxygen, and any increase is due to the gas dissolved in the plasma.

In a diving bell, 200 feet under water, a pressure of seven atmospheres—5120 mm. Hg—is sustained. As a result of the high pressure of the gases of such an atmosphere, they are dissolved in large quantities in the blood and tissues, and there is great danger in a too sudden relief of pressure, since this may cause bubbles of gas to be given off in the vessels, and these may lead to air embolism and a plugging of the smaller vessels (Caisson disease).

B. INTERMEDIATE RESPIRATION.

1. The Carriage of Gases in the Blood has been already considered (p. 492).

2. The Passage of Gases between Blood and Tissues.

1. Oxygen.—In studying the metabolism of muscle (p. 254), which may be taken as a type of all the active tissues, it was seen that oxygen is constantly being used by the muscle. The living tissues have such an affinity for oxygen that they can split it off from such pigments as alizarin blue. The tension of oxygen in muscle is therefore always very low. We have seen that the tension of oxygen in arterial blood is nearly 100 mm. Hg, and that, below a pressure of 50 mm., the oxygen is rapidly given off, till at 10 or 20 mm. Hg the oxyhæmoglobin is largely reduced. The influence of the C_H of the blood and of temperature upon the process has already been considered (p. 495). Hence, when the blood is exposed to a low tension of oxygen in the capillaries, the oxygen comes off from the blood and passes into the tissues by the ordinary laws of diffusion.

The process takes place in three stages. The "head of oxygen," as it may be called in arterial blood, *i.e.* the difference of tension between that of the HbO_2 and that of the tissues is, in normal conditions, far in excess of the requirements. The hæmoglobin is generally saturated to about 95 per cent., but in various pathological conditions of the lungs, *e.g.* pneumonia, it may fall to as low as 50 per cent. saturation and still the same amount of oxygen per unit of volume of blood may be given off to the tissues, the saturation of the venous blood falling proportionately, *i.e.* the difference between them remaining at about 5 per cent. (fig. 222).

The tissues must be able to take up the oxygen they require from a wide range of pressure in the blood.

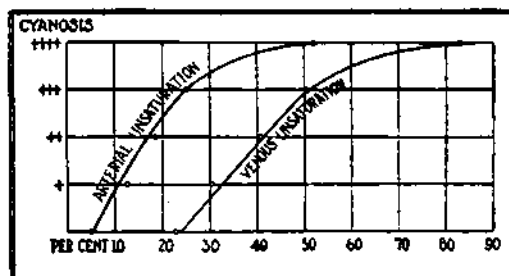

FIG. 222.—To show the relationship between the saturation or unsaturation with oxygen of arterial and venous blood, with variations in the unsaturation of arterial blood from 5 to 50 per cent., in cases of pneumonia, with different degrees of cyanosis. (STADIE.)

Such results cannot fail to raise the question of the beneficial effects of administering oxygen in pneumonia in order to increase the supply to the tissues.

When a stagnation of blood in the capillaries occurs, it is very probable that the removal of oxygen is so complete that a true oxygen starvation of the tissues exists.

(1) The tissue elements are always taking up oxygen from the tissue fluids, because of the very low tension of oxygen in the protoplasm.

(2) As a result of this, the oxygen pressure in the fluids falls and becomes lower than the oxygen pressure of the blood plasma, and thus the gas passes from the blood, through the capillary walls, to the fluids.

(3) As a result of the withdrawal of oxygen from the plasma, the partial pressure round the erythrocytes is diminished, a dissociation of oxyhæmoglobin takes place, and the oxygen passes out into the plasma, leaving some of the hæmoglobin in the erythrocytes in a reduced condition.

2. **Carbon Dioxide.**—The tissues are constantly producing carbon dioxide, so that it is at a high tension in them—about 60 mm. Hg. In the blood, as already indicated, it is partly dissolved and partly combined with sodium as the bicarbonate. Possibly it is partly combined with the proteins of the plasma, and probably in part with the globin of hæmoglobin (p. 496). It

is at a tension of a little over 40 mm. Hg in venous blood. Hence there is a constant passage of carbon dioxide from the tissues to the blood. The amount of CO_2 which the blood carries from the tissues to the lungs to be eliminated is a very small proportion of the total amount carried—only between 8 and 9 per cent. of the whole. Possibly this amount may be carried by the hæmoglobin (p. 496).

C. INTERNAL RESPIRATION.

This has been already considered under muscle (p. 254 *et seq.*).

The rate of internal respiration depends upon the activity of the tissues, and not upon the amount of oxygen in the blood. It has been shown that, when a tissue is stimulated, the increased activity precedes the increased taking up of oxygen and giving off of carbon dioxide, thus confirming the view that the evolution of energy is not due to a direct oxidation (p. 249 *et seq.*).

When the oxidation processes in the tissues are decreased as in poisoning with cyanides, the oxygen tension in the tissues is not lowered and CO_2 is not evolved. Under these conditions the sarcolactic acid liberated passes into the blood and increases the C_n . But without the low tension in the tissues the partial pressure of the oxygen in the blood plasma remains so high that dissociation of HbO_2 does not take place and bright red blood passes on to the veins.

D. EXTENT OF RESPIRATORY EXCHANGE.

This has been studied under metabolism of muscle (p. 254 *et seq.*).

The extent of the respiratory interchange in the lungs is governed by the extent of the internal respiratory changes, *i.e.* by the activity of the tissues and chiefly of muscle. Merely increasing the number or depth of the respirations has only a transient influence on the amount of the respiratory interchanges. Every factor which increases the activity of the metabolic changes in the tissues increases the intake of oxygen and the output of carbon dioxide by the lungs.

E. VENTILATION.

The rate of gaseous exchange governs the necessary supply of fresh air. The subject is considered under Stable Management. In byres, some 800 cubic feet are generally allowed per cow.

The bad effects of breathing in a crowded, close, badly-ventilated space is dealt with on p. 538.

F. ASPHYXIA.

This is the condition caused by any interference with the supply of oxygen to the blood and to the tissues. (a) It may be induced rapidly and in an acute form by preventing the entrance of air to the lungs, as in drowning or suffocation, or by causing the animal to breathe air deprived of oxygen, or by interfering with the flow of blood through the lungs, or with the oxygen-carrying capacity of the blood, as in CO poisoning, or with the processes of oxidation in the tissues, as in poisoning with cyanides. (b) It is slowly induced, in a less acute form, when the muscles of respiration fail as death approaches.

In *acute asphyxia* there is (1) an initial stage of increased respiratory effort due to the accumulation of CO₂, the breathing becoming panting, and the expirations more and more forced. The pupils are contracted, and the heart beats more slowly and more forcibly, while the arterioles are strongly contracted, and a rise in the arterial pressure is generally produced. In some animals this is very transitory. When the vagi are cut, the slowing of the heart does not occur, and the rise of blood pressure may be more marked. (2) Usually within a couple of minutes, a general convulsion, involving chiefly the muscles of expiration, occurs. The intestinal muscles and the muscles of the bladder may be stimulated, and fæces and urine may be passed involuntarily. (3) Then, as the result of oxygen want, the respirations stop, deep gasping inspirations occurring at longer and longer intervals. The pupils are dilated, and consciousness is abolished. The heart fails, and thus, although the arterioles

are still contracted, the pressure in the arteries falls. (4) Finally, the movements of the heart cease and death supervenes.

Before the heart has stopped, recovery may be brought about by **artificial respiration**, which may be performed by slow rhythmic compressions of the thorax and abdomen at a rate not exceeding the normal rate of breathing in the animal or by connecting the trachea to a respiration pump.

VOICE.

IN connection with the respiratory mechanism of many animals, an arrangement for the production of sound or voice is developed. This is constructed on the principle of a **wind instrument**, and it consists of (1) a bellows, (2) a windpipe, (3) a vibrating reed, and (4) resonating chambers. In man and other mammals the bellows is formed by the lungs and thorax; the windpipe is the trachea; the vocal cords in the larynx are the vibrating reeds; and the resonating chambers are the pharynx, nose, and mouth.

A. Structure of the Larynx.

The points of physiological importance in the structure of the larynx are the following:—

1. **Cartilages** (figs. 223, 224).—The ring-like *cricoid* (*Cr.*), at the top of the trachea, is thickened from below upwards at its posterior part and carries on its upper border two pyramidal cartilages, triangular in section—the *arytenoids* (*Ar.*). These articulate with the cricoid by their inner angle. At the outer angle, the posterior and lateral crico-arytenoid muscles are attached. The vocal cords arise from their anterior angles and run forward to the thyroid¹. The *thyreoid* cartilage (*Th.*) forms a large shield, which articulates by its postero-inferior processes with the sides of the cricoid, so that it moves round a horizontal axis. The *epiglottis*, or cartilaginous lid of the larynx, is fixed to its upper and anterior part.

2. **Ligaments**.—The articular ligaments require no special attention. The true vocal cords are fibrous ligamentous structures which run from the anterior angle of the arytenoids forward to the posterior aspect of the middle of the thyroid. They contain many elastic fibres and are covered by a stratified squamous epithelium, and they appear white and shining.

The vocal cords increase in length as the larynx grows; in adult life, they are generally longer in the male than in the

¹ The name thyroid, instead of thyreoid, is based upon a mistake; *θυρεος* is a shield, while *θυρος* is a door or aperture.

female and the whole larynx is larger. The cleft between them is the *rima glottidis*.

3. Muscles.—The *crico-thyreoidei* take origin from the antero-lateral aspects of the cricoid, and are inserted into the inferior part of the lateral aspect of the thyreoid. In contracting they approximate the two cartilages anteriorly, and render tense the vocal cords (fig. 223).

The *crico-arytenoidei postici* arise from the back of the cricoid and pass outwards to be inserted into the external or muscular process of the arytenoids. In contracting, they pull these processes inwards, and thus diverge the anterior processes and open the glottis (fig. 224).

The *crico-arytenoidei laterales* take origin from the lateral aspects of the cricoid, and pass backwards to be inserted into the muscular processes of the arytenoids. They pull these forwards, and so swing inwards their anterior processes and approximate the vocal cords (fig. 224).

A set of muscular fibres runs between the arytenoids—the *arytenoideus transversus*—while other fibres run from the arytenoids up to the side of the epiglottis. These help to close the upper orifice of the larynx.

The *thyreo-arytenoidei* bands are of muscular fibres lying in the vocal cords, and running from the thyreoid to the arytenoids. Their mode of action is not fully understood.

4. Mucous Membrane.—The mucous membrane of the larynx is raised on each side into a well-marked fold above each true vocal cord—the *false vocal cord*. Between this and the true cord on each side is a cavity—the *ventricle of the larynx*. The other folds of mucous membrane, although of importance in medicine, have no special physiological significance.

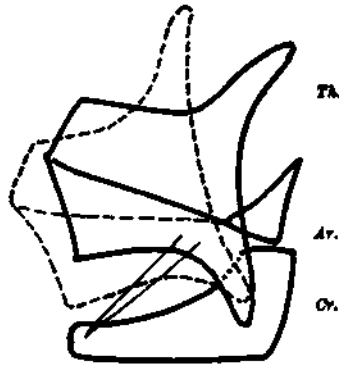

FIG. 223.—Side View of the Cartilages of the Human Larynx. *Cr.*, cricoid cartilage; *Ar.*, left arytenoid cartilage; *Th.*, thyreoid cartilage. The dotted line shows the change in the position of the thyreoid by the action of the crico-thyroid muscle, and the stretching of the vocal cords which results.

The interior of the larynx may be examined during life by the laryngoscope (*Practical Physiology*).

5. **Nerves.**—The muscles of the larynx are supplied chiefly by the recurrent laryngeal branch of the vagus, which comes off

in the thorax, and arches upwards to the larynx. On the left side, where it curves round the aorta, it is apt to be pressed upon in aneurismal swellings. Paralysis of this nerve causes the vocal cord on that side to assume the cadaveric position, midway between adduction and abduction, and makes the voice hoarse or abolishes it altogether.

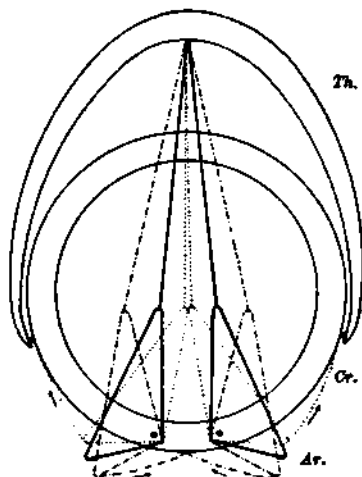

FIG. 224.—Cross Section of the Larynx, to show the cricoid, *Cr.*; thyroideal, *Th.*; arytenoid cartilages, *Ar.* The continuous line shows the parts at rest, the dotted line under the action of the lateral crico-arytenoid muscle, and the dot-dash line under the action of the posterior crico-arytenoid.

The superior laryngeal is the great ingoing nerve, but it also supplies motor fibres to the crico-thyroid muscle. Paralysis prevents the stretching of the vocal cords, makes the voice hoarse, and renders it impossible to produce a high note.

Centre.—These nerves are presided over by (a) a centre in the medulla. When this is stimulated abduction of the vocal cords is brought about. (b) This centre is controlled by a cortical centre situated in the inferior frontal convolution. Stimulation of this causes adduction of the cords as in phonation, while destruction leads to no marked change.

B. Physiology of the Voice.

When a blast of air is forced between the vocal cords when they are approximated by the lateral crico-arytenoids, they are set in vibration both wholly and in segments like other vibrating

reeds and sounds are thus produced. These sounds may be varied in loudness, pitch, and quality.

The **loudness**, or amplitude of vibration, depends upon the size of the larynx and of the resonating chambers—the pharynx, naso-pharynx, and mouth—and upon the force of the blast of air acting upon the cords.

The **pitch**, or number of vibrations per second, depends upon the length and tension of the vocal cords. The greater length of the vocal cords in the male, as compared with the female, makes the voice deeper. The tension of the cords is varied by the action of the crico-thyroid muscle.

The power of varying the pitch of the voice differs greatly in different animals. The average difference between the lowest and the highest note which the ordinary human individual can produce is about two octaves.

The **quality** of the voice, upon which the characteristic sound produced by each species of animal is largely due, depends upon the overtones which are made prominent by resonance in the pharynx, nose, and mouth. By varying the shape and size of these cavities, and more especially of the mouth, the quality of sound may be considerably altered.

Roaring is the peculiar sound made by some horses when exercised. It is due to paralysis of the posterior crico-arytenoid muscle on the left side. This when in action abducts the vocal cord of that side, but when not in action it allows it to be drawn inward. This partially occludes the rima glottidis, and thus not only causes the characteristic sound, but also limits the entrance of air and oxygen to the lungs. The condition appears to be due to disease of the recurrent laryngeal nerve. It is more common in stallions than in mares, and most frequent in thoroughbreds. By some it is considered to be hereditary. Tracheotomy with the insertion of a tube into the trachea relieves the evil effects of the condition.

SECTION VII.

EXCRETION OF MATTER FROM THE BODY.

I. EXCRETION BY THE LUNGS(see Respiration, p. 513 *et seq.*).

II. EXCRETION BY THE BOWEL (see p. 361).

III. EXCRETION BY THE KIDNEYS.

I. URINE.

I. General Consideration.

THE urine is a fluid formed in the kidneys, and in it are excreted from the body—

1. The nitrogen, sulphur, and phosphorus containing products of the catabolism of proteins and of nucleo-proteins of the body and of the blood.

2. Any excess of H or OH ions in the blood.

3. Any excess of certain substances taken with food or produced in the body, *e.g.* sugar and sodium chloride.

4. Various drugs.

Its composition should be studied in the light of the catabolism of proteins and nucleo-proteins.

(*In reading this part, the Table on pp. 568 and 569 should be constantly referred to.*)

1. **Catabolism of Proteins.**—As already indicated, the protein molecule breaks down into its constituent amino-acids (p. 16), and these are de-aminised chiefly in the liver (p. 359).

The ammonia liberated, probably as ammonium carbonate, is dehydrated chiefly in the liver (p. 359) to form urea—

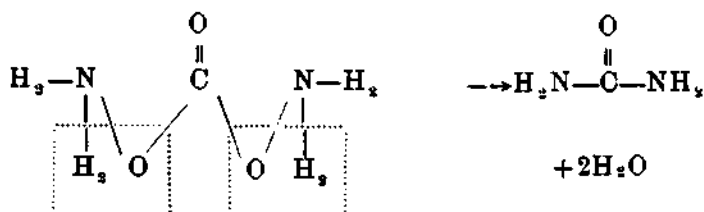

When a condition of acidosis (p. 482) develops, a certain proportion of the ammonia is not dehydrated, but is used to neutralise the acid and to decrease the C_w of the blood (p. 482), and the proportion of NH_3 to $\text{CO}(\text{NH}_2)_2$ is thus raised. When alkalis are given the proportion of ammonia is decreased.

In the diamino acids, such as lysin, arginin, histidin (p. 17), the amidogen is dealt with as in the mon-amino acids. But in the case of arginin, where the guanidin nucleus—

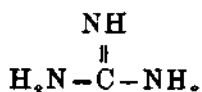

is present, this may in part, at least, escape complete oxidation to urea, may be methylated and then linked to acetic acid to form creatin (p. 209), from which creatinin may be formed by dehydration.

The amino acids linked to the benzene ring, *e.g.* tyrosin, are deaminised and the amidogen changed to urea, while the propionic acid chain is oxidised from its free end with the formation of homogentisic acid (alkapton) then hydroquinone, which is finally oxidised to CO_2 and H_2O , the former of which is largely excreted by the lungs.

In one abnormality of metabolism the oxidation stops at alkapton, and this is excreted in the urine. It oxidises to a black pigment.

In tryptophan not only is the propionic acid chain oxidised, but the pyrrol ring is split off and the molecule then undergoes the same changes as tyrosin.

When, as a result of bacterial putrefaction in the intestine (p. 329), the tryptophan molecule has had the propionic acid oxidised without the removal of the pyrrol ring, skatol and indol are formed. These are hydrated to skatoxyl or indoxyl,

and, in the liver, linked to sulphuric acid or potassium sulphate derived from the sulphur of the protein molecule, and thus excreted as *etheral sulphates*, the amount of which in the urine is a fair measure of the putrefaction changes in the intestine.

The remaining sulphur of the protein is chiefly oxidised to sulphuric acid, linked to bases and excreted as the *inorganic sulphates*.

A small part of the sulphur which in the protein exists as *cystin* may escape oxidation and appear in the urine. In some people this excretion of cystin is large, and cystin crystals appear in the urine (*neutral sulphur*).

The sulphates and the neutral sulphur are derived from the sulphur of the proteins, and the amount excreted in the urine is a measure of the amount of protein catabolised.

The **nucleo-proteins** are first split into the protein moiety, which is broken down as described above, and the nucleic acid moiety, which is broken down, possibly by an enzyme, a *nuclease*, and the phosphorus and purin parts then undergo changes and are excreted in the urine.

(a) The **purins** of nucleic acid, *e.g.* adenin, are amino-purins *i.e.* they have an amidogen molecule attached. This is split off, possibly by the action of an enzyme, and excreted as urea.

The deaminised purins, such as hypoxanthin, are then oxidised to uric acid and partly excreted in this form. In this process an enzyme may play a part. About one-half of the uric acid is split into two molecules of urea, probably by the action of another enzyme (*uricoclastase*) in the liver, while the connecting chain is oxidised to CO_2 .

(b) The **phosphorus** is oxidised to P_2O_5 and linked with monobasic sodium and potassium and dibasic calcium and magnesium.

2. Regulation of the H—OH ions of the Blood.—The phosphates play an important part in regulating the C_H of the tissues and in determining the reaction of the urine (Appendix III).

If the C_H of the blood is increased in acidosis (p. 481), the Na_2HPO_4 of the cells is changed to $(\text{NaH}_2\text{PO}_4)$ (p. 482) and is turned out into the plasma to be excreted in the urine and thus to carry off H ions.

If, on the other hand, a condition of alkalosis (p. 531) is produced, Na_2HPO_4 is excreted—OH ions being eliminated.

Under normal conditions the reaction of the urine varies between Na_2HPO_4 and NaH_2PO_4 .

The administration of acids does not materially increase the hydrogen ion concentration. They combine with the sodium of the bicarbonate of the plasma, turn out the CO_2 , increase the amount of dissolved CO_2 , and thus stimulate the respiratory centre to increase the ventilation of the lungs and then to eliminate the CO_2 and adjust the proportion of—

$$\frac{\text{H}_2\text{CO}_3}{\text{NaHCO}_3} = \frac{1}{20}$$

But when alkalis are given, or the citrates, malates, and tartrates of sodium or potassium which are oxidised to carbonates in the body, the kidneys then act in eliminating the increased OH ions and thus readjusting the balance of ions in the blood plasma.

II. Physical Characters.

The characters of the urine depend largely on the relative proportion of water and of solids which are excreted in it: at one time it may be very concentrated, while at another time it may be very dilute indeed. For this reason its **specific gravity**, which depends upon the percentage of solids in solution, varies within wide limits. But the average specific gravity in the horse is about 1036. It is possible from the specific gravity to form a rough idea of the amount of solids present, for by multiplying the last two figures by 2·22 the amount of solids per 1000 parts is given.

Since the percentage of pigments in the urine varies like that of the other constituents, the **colour** of the urine shows wide divergence in the normal condition. A concentrated urine has a dark amber colour, while a dilute urine may in some animals be almost colourless. Under average conditions the urine has a straw-yellow colour.

The **reaction** of urine is normally acid in dog and other carnivora.

In herbivora, when suckling or when fasting, the urine is acid, but when on their normal diet it is alkaline.

The alkalinity is due to the presence of alkaline carbonates formed from the citrates, malates, and tartrates of the vegetable foods, and also from the acetates, etc., produced by the decomposition of cellulose in the rumen and intestine.

Urine in carnivora is normally transparent; but when it has stood for a few hours, a cloud of a mucin-like substance is seen floating in it. In herbivora, as the urine cools, it rapidly becomes turbid and throws down a white precipitate composed chiefly of carbonate of lime.

The smell of urine is characteristic, and it may be modified by the ingestion of many different substances.

III. Composition.

The tests for the various constituents of the urine must be studied practically (Chemical Physiology).

Since the relative amounts of water and solids vary within such wide limits, the percentage amount of the later is of little moment. Under average conditions, the water constitutes about 96 per cent., and the solids about 4 per cent. Of these solids, rather more than half is organic, rather less than half is inorganic. Since water and solids are derived from the water and solids taken by the animal, the amounts excreted depend upon the amounts taken, and must be considered in connection with them. Thus, if a horse takes little fluid, it will pass little water in the urine. If it takes little food, a small quantity of solids will be excreted by the kidneys.

Since excretion and ingestion must be studied in relationship to one another, it is convenient to compare them during a definite period of time, and the natural division into days of twenty-four hours is generally adopted.

Under ordinary conditions, the amount of solid food taken per day does not vary very greatly, but the amount of fluid imbibed varies within much wider limits. For this reason, while the amount of water excreted in the urine per diem varies enormously, the amount of solids is more fixed.

In the horse, on an average diet, about 5 to 8 litres of water

are daily eliminated, while in the ox as much as 20 litres may be passed.

1. Nitrogenous Constituents.

The waste nitrogen of the body occurs in the urine in different substances, the origin of each of which has been considered.

A. Urea.—Urea is the most abundant constituent of the urine. Its chemistry and mode of formation have been discussed on p. 359. The *amount excreted depends upon the amount of protein taken in the food*, and for this reason, in man during fasting, the excretion may fall as low as 10 grms. per diem, while on a diet containing an average amount of proteins, about 36 grms. of urea—16·7 grms. of nitrogen—are excreted. On a normal diet about 90 per cent. in the dog and 80 per cent. in the horse of the waste nitrogen is excreted as urea, but, when the protein intake is decreased and non-nitrogenous food is substituted, the proportion of urea-nitrogen may fall as low as 60 per cent. of the whole (p. 562).

When urine is allowed to stand, micro-organisms are apt to gain access, and to cause a hydration of the urea, whereby it is changed into ammonium carbonate—

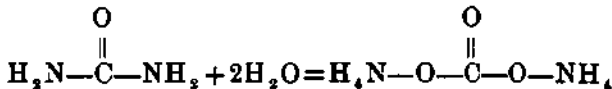

The urine is thus made alkaline, and the earthy phosphates are precipitated. The magnesium phosphate combines with the ammonia to form ammonium-magnesium-phosphate, $\text{NH}_4\text{MgPO}_4 + 6\text{H}_2\text{O}$ (triple phosphate), which crystallises in characteristic prism-like crystals (fig. 225).

B. Non-Urea Nitrogen.—Some 20 per cent. of nitrogen which, on an ordinary diet, is not excreted as urea is distributed in—

1. **Ammonium Salts.**—In herbivora a very small proportion of nitrogen is normally excreted as ammonium salts. But, under certain conditions, the proportion is increased (p. 554). Anything which tends to raise the C_2 of the blood, *e.g.* the formation of β -oxybutyric acid (p. 358), causes an increased excretion of ammonia—the ammonia being formed

from the proteins to neutralise the acids. In carnivorous and omnivorous animals the production of ammonia is a protective mechanism against acid intoxication. Herbivora have not the same power of forming ammonia to neutralise acids.

2. **Creatinin.**—Creatinin, like the creatin in muscle (p. 209), is characterised by containing the guanidin nucleus.

It may be readily formed from creatin by treatment with acids which remove a molecule of water.

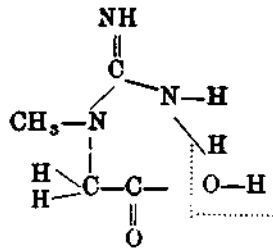

But, when creatin is administered by the mouth or injected subcutaneously, the creatinin of the urine is not proportionately increased; some of the creatin may appear in the urine, but much of it may not be recoverable, especially on a protein-free diet with abundance of carbohydrates. It seems to be retained or changed in the body, possibly being used in the resynthesis of the protein molecule. On the other hand, there is evidence that the creatinin in the urine may be taken as a rough measure of the muscular development and tone of the individual, and it is difficult to avoid the conclusion that it is derived either from the creatin of the muscle, or from some guanidin-containing precursor common to both. It is possible that every animal has a limited power of changing creatin to creatinin, and that this limit is readily overstepped—as the limit of sugar tolerance may be overstepped—and that under these conditions creatin is not converted to creatinin, but is excreted as creatin or changed in the body to some other substance not yet identified. In young children creatin is a normal constituent of the urine.

In the wasting of muscles which occurs in fasting, creatin appears in the urine along with creatinin. In birds it takes the place of creatinin in the urine and the excretion is increased when the muscles waste.

3. **Purin Bodies.**—A very small proportion of the nitrogen is found in these bodies. They consist of two unmodified or modified urea molecules, linked together by a nucleus of an acid radicle. In birds and reptiles the most important have as the linking part an oxy-acid with three carbons in series — **Uric Acid—Tri-oxy-purin** — an exceedingly insoluble substance which tends to crystallise in large polymorphic crystals.

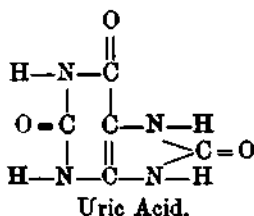

In these animals uric acid largely replaces urea as the substances in which nitrogen is eliminated, and they are formed in the liver from the various products of the decomposition of protein molecules. But in mammals the purins appear to be very largely derived from the decomposition of nucleic acid (p. 556). Even when all supplies of nucleins and purin bodies from without are cut off, a certain amount of these purins is daily eliminated. These have been called the “endogenous” purins, while those derived from the constituents of the food are termed the “exogenous” purins. A small amount is undoubtedly formed from the purins of muscle (p. 210).

In most mammals the chief purin is **Allantoin**. In this two urea molecules are linked by the radicle of glyoxylic acid.

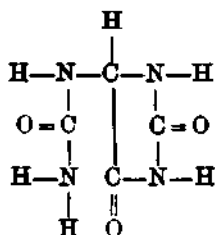

4. **Hippuric Acid.**—This is benzoyl-amino-acetic acid—

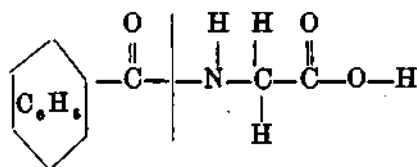

It is formed from benzoic acid taken in the food by linking it to glycin—amino-acetic acid. This synthesis appears to take place in the kidneys, for it has been found that hippuric acid is not formed when these organs are excised, and that, when blood containing benzoates is circulated through them, hippuric acid is produced. Its chief interest is in the fact that it is one of the first organic compounds which were demonstrated to be formed synthetically in the animal body. Normally it is present in human urine in very small quantities, but in the urine of herbivora the amount is considerable, from the presence of benzoic acid in the fodder, and is most abundant on a diet of grass or hay, less so upon one of oats. The acid itself is insoluble, and it occurs as the soluble sodium salt.

5. **Mon-amino Acids** are always present in traces in the urine, and any interference with the activity of the liver, the organ chiefly concerned in changing them to urea, leads to their appearance in increased amounts (p. 360).

6. **Undetermined Nitrogen.**—A small quantity of the nitrogen in the urine exists in substances the chemical nature of which has not been determined. The amount of these varies considerably.

The proportions of the total nitrogen of the urine in these various compounds varies with the kind of food taken. Folin gives the following table for the human subject, which shows this very clearly:—

	Per cent. of Total Nitrogen.	
	Protein-rich Diet.	Protein-poor Diet.
Total Nitrogen . . .	14.8 to 18.2 grms.	4.8 to 8.0 grms.
Urea	86.3 ,, 89.2 per cent.	62.0 ,, 80.4 per cent.
NH ₃	3.3 ,, 5.1 ,,	4.2 ,, 11.7 ,,
Creatinin Nitrogen . . .	3.2 ,, 4.5 ,,	5.5 ,, 11.1 ,,
Uric Acid Nitrogen . . .	0.5 ,, 1.0 ,,	1.2 ,, 2.4 ,,
Undetermined Nitrogen .	2.7 ,, 5.3 ,,	4.8 ,, 14.6 ,,

From these results he draws the conclusion that urea is largely the result of the metabolism of the proteins of the food, of "exogenous" protein metabolism, and that the creatinin and uric acid nitrogen and neutral sulphur (p. 564) are chiefly the result of "endogenous" protein metabolism.

2. Sulphur-containing Bodies.

The sulphur excreted in the urine is derived from the sulphur of the protein molecule, and the amount of sulphur excreted may be taken as a measure of the amount of protein decomposed.

A. Acid Sulphur.—The greater part of the sulphur is fully oxidised to sulphuric acid.

(a) *Preformed Sulphates.*—The greater part of this is linked with bases to form ordinary inorganic sulphates.

(b) *Ethereal Sulphates.*—Nearly all of the remaining sulphur is in organic combination, linked to benzene compounds, formed by oxidation of the indol, skatol, and phenol (see p. 330), which in carnivora are produced by the putrefaction of proteins in the bowel, and in herbivora from the aromatic compounds which occur chiefly in the roughage of the food.

Indol is oxidised into indoxyl thus—

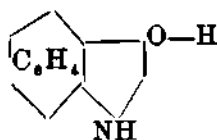

This, when linked to potassium sulphate, forms potassium indoxyl-sulphate or indican.

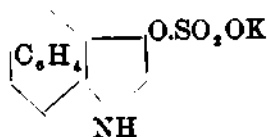

From skatol, which is methyl-indol, potassium skatoxyl-sulphate is formed in the same way.

These bodies are colourless, but when oxidised they yield pigments—indican yielding indigo blue, skatoxyl-sulphate of potassium yielding a rose colour.

Phenol—

is also linked with potassium sulphate, and excreted in the urine.

The amount of these ethereal sulphates depends upon the activity of putrefaction in the intestine, and is a good index of its extent.

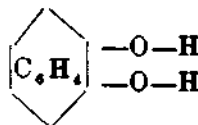
Dioxybenzene or Pyrocatechin—

is also linked to potassium sulphate and excreted. This compound is always present in the urine of the horse. When oxidised it yields a greenish-brown pigment when urine containing it is allowed to stand.

B. Neutral Sulphur.—A small quantity of sulphur is excreted in a less oxidised state, in the form of *neutral sulphur*. The most important compound of this kind is *cystin*, the disulphide of amino-propionic acid—two molecules of amino-propionic acid linked by sulphur—

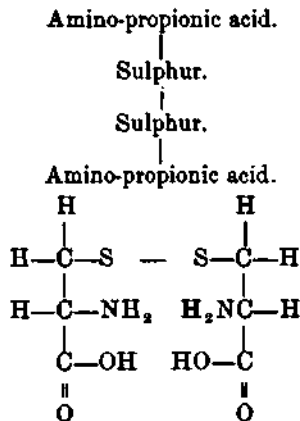

The condition of *cystinuria* has been already explained (p. 556), as has also the occurrence of *alkaptonuria* (p. 555).

3. Phosphorus-containing Bodies.

In herbivorous animals phosphates are practically absent from the urine. They are excreted from the mucous membrane of the bowel. Hence, in the horse, crystals of triple phosphates are found in the *fæces*, not in the urine.

In carnivores the phosphorus in the urine is derived partly from phosphates taken in the food, and partly from the nucleins of the food and tissues and from the bones.

(a) Normally the phosphorus is fully oxidised to P_2O_5 , which is linked to alkalies and earths, and excreted in the urine. The most important phosphate is the phosphate of soda, NaH_2PO_4 , which is the chief factor in causing the acidity of the urine. When the urine becomes ammoniacal, triple phosphate is formed (p. 559).

(b) It is probable that a small quantity of the phosphorus is excreted in organic compounds, such as glycerophosphates; but so far these have not been fully investigated.

4. Chlorine Compounds.

Sodium chloride is the chief salt of the urine. It is entirely derived from the salt taken in the food, and its amount varies with the amount ingested. From 10 to 15 grms. are usually excreted per diem in a person on a normal diet.

In starvation, to a certain extent, and very markedly in fever, the tissues of the body have a great power of holding on to the chlorine, and the chlorides may almost disappear from the urine.

5. Inorganic Bases of the Urine.

Sodium, potassium, calcium, and magnesium occur in the urine in amounts varying with the amounts taken in the food. On a flesh diet and in starvation potassium is in excess of the others. Calcium and magnesium are present in much smaller quantities. In herbivora potassium is the chief salt, and in the horse calcium is also abundant.

6. Pigments.

A brown hygroscopic substance, which gives no bands in the spectrum, may be extracted from urine. This has been termed **urochrome**. By reducing it, another pigment, **urobilin**, is produced, which gives definite bands, and which is frequently present in the urine. It is probably identical with the hydrobilirubin which has been prepared from the bile pigments, and it contains C, H, O, and N.

The pigment that gives the pink colour to urates has been called **uroerythrin**, and its chemical nature is unknown.

Hæmatoporphyrin (see p. 491) is normally present in traces in the urine, but in certain pathological states it is increased in amount and gives a brown colour to the urine.

7. Nucleo-Protein.

A mucin-like nucleo-protein, derived from the urinary passages, is always present in small amounts, and forms a cloud when the urine stands.

8. Carbonic Acids.

1. **Carbonic Acid**.—Small amounts of this are present in urine of carnivora.

In herbivora it is present in large amounts, combined with

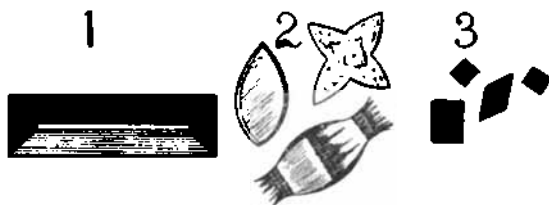
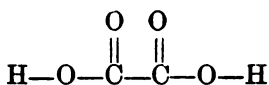

FIG. 225.—The Three most Common Urinary Crystals: 1, Triple phosphate; 2, uric acid; 3, calcium oxalate.

potassium, lime, and magnesia, and also free. The carbonate of lime readily crystallises out in large dumb-bell-like crystals which may be confused with crystals of oxalate of lime, but which are quickly soluble, with effervescence, on the addition of an acid.

9. Oxalic Acid



is a substance in a stage of oxidation just above that of carbonic acid. It is frequently present in the urine linked with lime, and the lime salt tends to crystallise out in characteristic octohedra, looking like small square envelopes under the microscope. Under certain conditions these crystals assume other shapes. The oxalic acid of the urine is chiefly derived from oxalates in vegetable foods, but it has been detected in the urine of animals on a purely flesh diet.

The differences between the urines of different herbivora are not important. The urine of the **ox** and **cow** is more abundant and more dilute than the urine of the **horse**, while the urine of the sheep is considerably more concentrated and contains a very high proportion of hippuric acid.

 II. FORMATION OF URINE.

No problem of physiology has proved more difficult than that of the mode of formation of urine in the kidneys.

This is largely due to the fact that theories were made by famous physiologists upon imperfect data, and that subsequent workers have tended to view their results in the light of one or other of these theories.

The purpose of the formation of urine, as already explained, is twofold—

1. To get rid of waste matter from the body.
2. To help to maintain the C_H of the blood plasma (p. 554).

The problem of how it is produced may best be approached by considering—

1st. The differences between the urine formed and the blood from which it is formed.

2nd. The apparatus which has to bring about these changes—the kidney.

RELATIONS OF THE DECOMPOSITION PRODUCTS

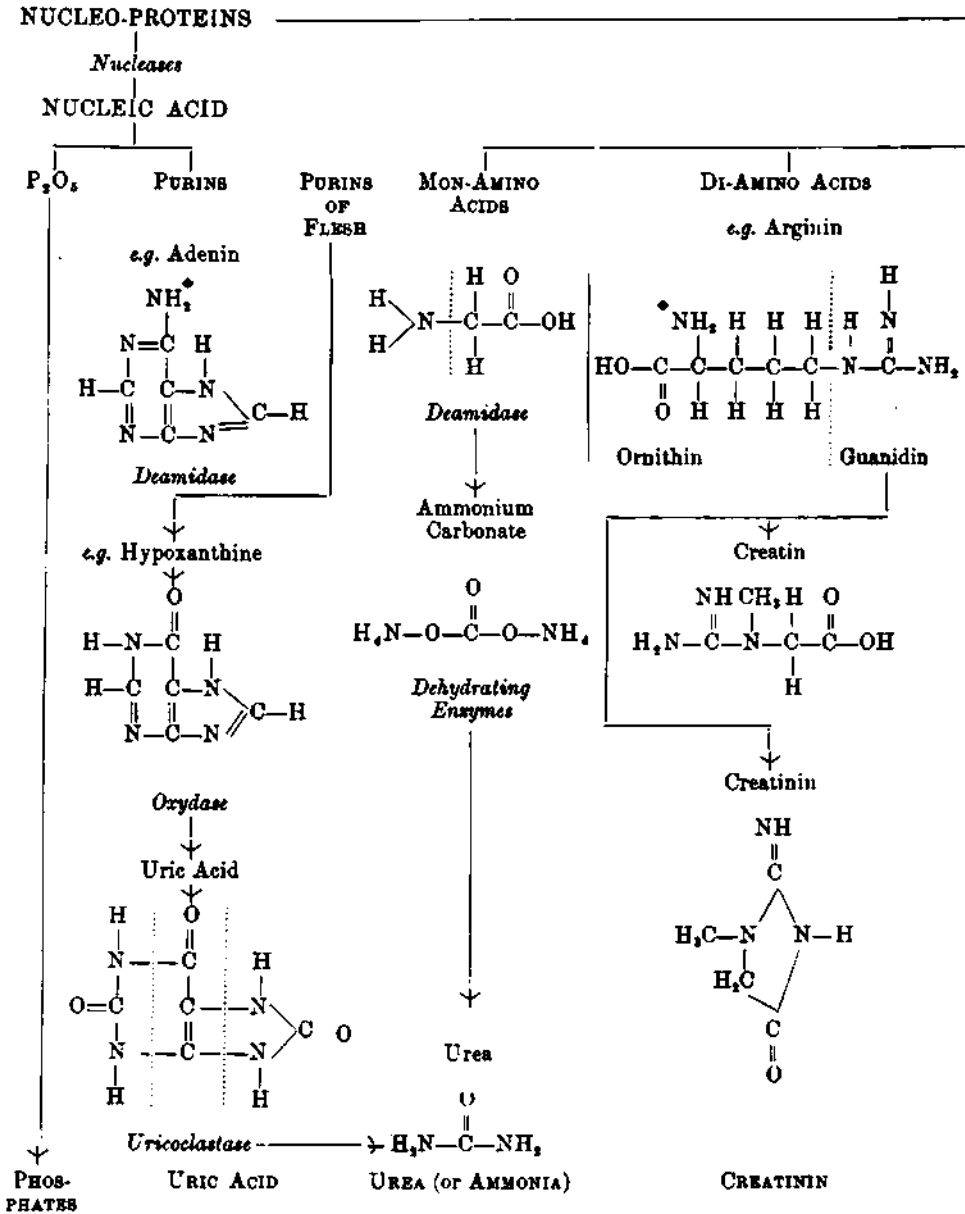

The NH₂ groups marked with * are changed to urea.

1st. The chief differences between the urine and the blood plasma.—1. The blood plasma contains some 7 to 8 per cent. of native proteins; in normal urine these are absent.

2. The blood plasma is almost neutral, *i.e.* it has a C_{25} of $10^{-7.4}$ or pH 7.4. The urine is generally markedly acid with a pH of about 6 (Appendix III).

3. The molecular concentration of the plasma, as determined by the reduction of the freezing-point, corresponds to about $\Delta 0.56^{\circ}$ C., corresponding with about 0.9 per cent. of NaCl. The urine has a molecular concentration of from $\Delta 1$ to 2.5 or even higher.

4. The urea in the plasma amounts to about 0.03 per cent. In the urine it is about 2 per cent., *i.e.* it is concentrated 60 times.

5. Uric acid is concentrated 25 times.

Ammonia	"	40	"
PO ₄	"	30	"
SO ₄	"	60	"

2nd. The apparatus which brings about these changes.—The kidney, the apparatus which has to effect this change, is a structure evolved from the nephridium of the annelid.

This nephridium consists of a tube, opening by a funnel-shaped end into the coelomic cavity and by a narrower orifice on the surface. The tube is lined by a syncytial secreting epithelium, in which may be seen the waste particles which occur in the coelomic fluid, or which have been injected into the coelome, *e.g.* Indian ink. It thus allows an escape of fluid from the coelome and passes out waste particles through the epithelium. In the vertebrate the coelomic orifice of each tubule is invaded by a tuft of capillary vessels, forming the glomerular tuft round which the remains of the funnel-shaped opening persists as the capsule of Bowman. The whole structure is often called a Malpighian body. The tubule in the vertebrate becomes enormously lengthened and differentiated into distinct segments. Myriads of these Malpighian bodies and tubules are massed together to form the kidney.

This may be briefly described as follows:—

I. Structure of the Kidney.

(This must be studied practically.)

Each kidney presents a depression or hilus on its inner aspect from which the ureter, the duct of the kidney passes, and by which the renal artery enters and the renal vein emerges. The nerves and lymphatics of the organ pass along with these. The whole organ is enclosed in a fibrous capsule, from which processes of fibrous tissue carrying small blood-vessels enter the organ.

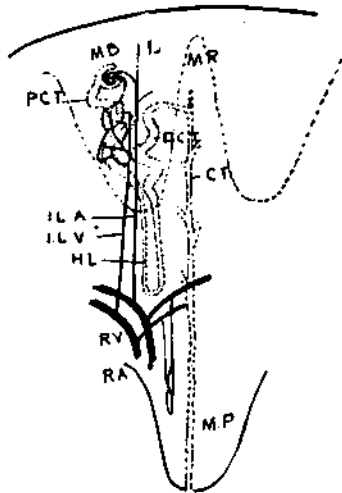

FIG. 226.—Diagram of the Structure of the Kidney. *M.P.*, Malpighian pyramid of the medulla; *M.R.*, medullary ray extending into cortex; *L.*, labyrinth of cortex; *M.B.*, a Malpighian body consisting of the glomerular tuft and Bowman's capsule; *P.C.T.*, a proximal convoluted tubule; *H.L.*, Henle's loop on the tubule; *D.C.T.*, distal convoluted tubule; *C.T.*, collecting tubule; *R.A.*, branch of renal artery, giving off *I.L.A.*, interlobular artery, to supply the glomeruli and the convoluted tubule; *I.L.B.*, interlobular artery bringing blood back from the cortex.

The ureter opens from the basin of the kidney, and into this the renal tissue projects as pyramidal processes.

This renal tissue is clearly divided into a thin outer cortex and an internal medulla. This latter is again subdivided into a paler pyramidal part, and a redder part between this and the cortex—the boundary zone. The medulla extends out into the cortex in a series of long medullary rays (fig. 226), so that the

cortex may be subdivided into these rays and the parts between the rays—the labyrinth of the cortex.

It is in this that the Malpighian bodies already described are situated.

Extending away from each of them is a *proximal convoluted tubule*, also in the labyrinth (*P.C.T.*), lined by pyramidal and granular epithelial cells. This dives into the boundary zone of the medulla, becomes constricted and lined by a transparent flattened epithelium, and is known as the *descending limb* of the looped tubule of Henle. Turning suddenly upwards and becoming lined by a cubical granular epithelium, it forms the *ascending limb*, and, reaching the labyrinth of the cortex, it expands into the *distal convoluted tubule* (*D.C.T.*), which resembles the proximal. It opens into a *collecting tubule*, running in a medullary ray, and (*C.T.*), lined by a low transparent epithelium, which conducts the urine to the pelvis of the kidney.

The *renal artery* breaks up and gives off a series of straight branches—the interlobular arteries (*I.L.A.*)—which, as they run towards the surface, give off short side branches which terminate in the glomeruli. The efferent vein passing from each glomerulus breaks up again into a series of capillaries between the convoluted tubules, and these pour their blood into the interlobular veins (*I.L.V.*). This arrangement helps to maintain a high pressure in the capillary loops of the glomerular tuft.

Nerves to the kidney in the dog pass in the splanchnic nerves from the anterior roots of the sixth to the thirteenth dorsal nerves, and from the vagus, chiefly through the semilunar ganglion, and the renal plexus upon the renal blood-vessels. The terminal fibres not only supply the arterioles, but may be traced into the secreting cells of the tubules.

Apparently the old differentiation of the nephridium with the arrangement for allowing the escape of coelomic fluid and for the excretion of waste material is preserved in the vertebrate kidney, but now the coelomic fluid is confined to blood-vessels which are related to both the coelomic expansions and the tubules.

II. Physiology of the Formation of Urine.

Bowman, from his investigations of the structure of the kidney, but without giving consideration to its phylogenetic

development, pointed out that two distinct mechanisms exist—

1st. In the Malpighian bodies, an arrangement manifestly suited to allow of filtration from the blood.

2nd. In the tubules, a series of secreting structures.

A. Malpighian Bodies.

1. It has been shown by injecting acid fuchsin, which is colourless in alkaline solution and red in acid solution, into the blood-vessels that the urine formed in these bodies is alkaline in reaction. It becomes acid as it passes down the convoluted tubules.

2. It is also known that these bodies are thrown out of action by lowering the pressure in the renal arterioles and by decreasing the flow of blood through the kidney.

The amount of blood in the kidneys may be measured by enclosing the organ in a closed vessel with rigid walls connected with a piston recorder—an *oncometer*—so that changes in the volume of the organ may be recorded, while the rate of flow may be estimated by measuring the amount of blood coming from the renal vein (p. 473). These two methods are frequently used in combination.

(a) Section of the splanchnic nerves to the kidney causes a dilatation of the renal arterioles, an expansion of the kidney, and an increased flow of urine. (b) Stimulation of these nerves has the opposite effect. Sometimes stimulation with slow induction shocks may cause a dilatation, but the action of these dilator fibres is generally masked by that of the constrictors. (c) A fall in the general arterial pressure, to about 50 mm. Hg in the dog, causes a decreased flow of blood through the kidney and practically stops the flow of urine, although the tubules, as will presently be shown, still act. (d) Conversely, a stoppage of the formation of urine may be brought about by raising the pressure in the ureter to about 50 mm. Hg.

3. In the frog the renal arteries supply the Malpighian bodies, while portal veins, from the posterior end of the animal, supply the convoluted tubules. Ligature of the renal arteries stops the flow of urine; but the flow may be again induced by injecting urea and other substances.

4. Even when this flow is induced dextrose, egg albumin

or peptone when injected into the blood are not excreted, although in the frog with the vessels unligatured they appear in the urine.

These observations seem to show that the Malpighian bodies have to do chiefly with the filtering off from the blood plasma of water and of solids held in true solution, and that their activity depends upon the rate of blood-flow through them, and upon the pressure in the glomerular capillaries. That such a purely physical process is involved seems to be indicated by the fact that a free flow of urine (*diuresis*) can be induced, without increasing the chemical changes in the kidneys, as indicated by

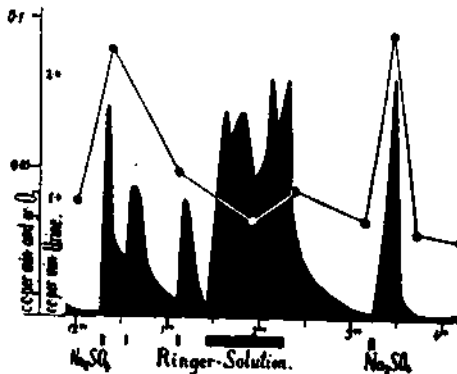

FIG. 227.—To show the relationship between the production of urine and the consumption of oxygen by the kidney under the influence of Ringer-Solution and of Sodium Sulphate. The black area indicates the amount of urine secreted, the thin line the consumption of oxygen. (BACROFT.)

the oxygen consumption, by injecting into the blood hypertonic solutions of various salines, such as NaCl, which dilute the blood and increase its volume (fig. 227).

The reason why the formation of urine stops when the arterial pressure falls to about 50 mm. Hg seems to be due to the fact that the filtration pressure must be well above the osmotic pressure of the colloids of the blood which are not filtered off. By determining the difference between the osmotic pressure of blood serum and of the filtrate from it through a semi-permeable membrane Starling concluded that the osmotic pressure of the blood proteins is about 30 mm. Hg, and that therefore the filtration pressure must be above this. When this osmotic

pressure, due to the colloids, is decreased formation of urine goes on at a lower pressure than 50 mm. Hg. He showed that the formation of urine is increased by injecting hypertonic solutions of glucose which caused a hydræmic plethora by producing an endosmosis from the tissues to the blood (p. 450), and he further proved that this is not simply the result of an increased pressure due to the increased volume of the blood by demonstrating that the injection of fluids of high colloidal content did not increase the flow of urine.

It is thus clear that filtration is the main factor in the formation of urine in the Malpighian bodies, and the membrane of cells through which this occurs must form a semi-permeable membrane which prevents the passage of the colloidal proteins of the blood.

On the other hand, that a selective action of the epithelium is involved seems to be suggested by the passage into the urine in Bowman's capsule of such large molecules as those of egg albumin and hæmoglobin and of various pigments such as carmine.

The point of practical importance is that *the secretion of water takes place chiefly through the Malpighian bodies, and that this is reduced or stopped by a fall in the general arterial pressure, such as occurs in failure of the heart.* The decreased excretion of water may lead to the development of dropsy.

B. The Tubules.

In the filtrate, the percentage of the various substances in solution cannot be higher than it is in the blood plasma.

But, as already stated, the concentration of most of the constituents of the plasma is generally enormously increased in the urine while the reaction is acid.

These changes must be effected in the tubules.

There are manifestly two ways in which they might be brought about.

1. By the secretion of solids by the epithelium from the blood to the urine (Bowman and Heidenhain).

2. By the absorption of some of the water filtered through the glomeruli back into the blood (Ludwig). Since the degree

of concentration of the various urinary constituents, compared with their amount in the blood, varies very greatly (p. 570), some of these substances would also have to be absorbed along with the water.

It is of course possible that both these processes are in operation.

In carrying out either process the epithelium has to do an equal amount of *work*.

This may be rendered clearer by the figure 228—

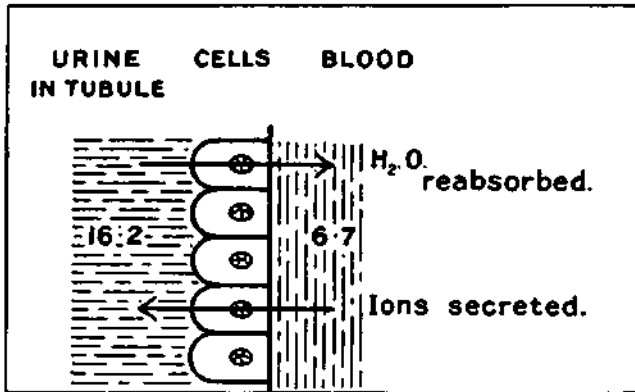

FIG. 228.—To illustrate the two views of the mode of action of the renal tubules. The figures 16.2 and 6.7 give the osmotic pressures of the urine and of the blood plasma respectively.

On the *secretion* theory, electrolytes have to be piled up from the point of low concentration in the blood to the point of high concentration in the urine; while on the *reabsorption* theory water has to be taken from a point of high osmotic pressure and passed to a point of low osmotic pressure.

It is well to understand what the reabsorption theory implies.

To produce the average 30 grms. of urea excreted per diem by a man from the plasma containing 0.03 per cent. would mean the filtration through the glomeruli of some 30,000 cc. But since only 1500 cc. of urine are generally secreted, this would mean the reabsorption of no less than 28,500 cc.—about 95 per cent. of what was filtered off! The work of filtering off some 30,000 cm. has superimposed upon it the work of reabsorb-

ing 28,500 cc. ! The process, on the face of it, seems somewhat wasteful.

But such evidence as has been procured must be examined on its merits, and the reabsorption theory cannot be rejected simply because it seems improbable.

1. Uric acid crystals are frequently found in the cells of the convoluted tubules of the kidney of birds. Further, uric acid is very soluble in piperazine, and when injected in solution of this substance into the veins of a mammal, the uric acid appears in the tubules and in the cells of the convoluted tubules, but not in the glomeruli or in the medulla.

2. Heidenhain, by injecting into the circulation of the rabbit a blue pigment—sulph-indigotate of soda—found that the cells of the convoluted tubules take it up and seem to pass it into the urine. In the normal rabbit the whole of the kidney and the urine became blue. But, if the formation of urine in the Malpighian bodies be stopped by cutting the spinal cord in the neck so as to lower the blood pressure, then the blue pigment is found in the cells of the convoluted tubules and of the ascending limb of Henle's tubule, since it is not washed out of these. The fact that later investigators have found after injection of aniline blue and Congo red, that these pigments appear first in the part of the cells next the lumen of the tubules seems of small significance. They might well accumulate there before being excreted.

The subcutaneous injection into rats of pyrrol blue leads to the appearance of the pigment in the cells of the convoluted tubules but not in the Malpighian bodies nor in the collecting tubules.

3. When the Malpighian bodies of the frog have been thrown out of action by ligaturing the renal arteries, the injection of urea still causes a flow of urine and the excretion of urea by the tubules. When the portal veins, which supply the tubules, are ligatured on one side, it is found that less urine is formed on the ligatured than on the unligatured side.

4. If the formation of urine in the Malpighian bodies of a dog be stopped by cutting the spinal cord in the neck, the administration of certain substances such as of caffeine, or Na_2SO_4 , causes an increased flow of urine, although the blood pressure in the kidneys is not raised. In this diuresis the

consumption of oxygen by the kidney is increased, indicating an increased metabolism (fig. 227). The renal cells are in fact doing work.

These last experiments seem to indicate that the cells of the convoluted tubules are capable of secreting water as well as solids.

Large doses of caffeine poison the cells, and in this condition a flow of urine without increased consumption of oxygen is produced. This supports the view that filtration from the glomeruli plays a part.

The stimulating action of such drugs as caffeine is taken advantage of in cases of heart-disease when the secretion of urine is almost arrested from low arterial pressure and when dropsy is rapidly advancing. The kidneys may be stimulated to get rid of water by means of such diuretics until compensation of the heart is established.

5. The fact that after drinking copious amounts of water a urine of a lower osmotic pressure than the plasma may be produced, can be equally well explained by an increased secretion of water by the tubules as by the reabsorption of solids by them.

6. The action of extracts of the hypophysis cerebri in increasing the flow of urine while actually lowering the arterial pressure (p. 594) seems to indicate a direct stimulation of the cells of the tubules.

7. When a mixture of NaCl and of Na_2SO_4 are injected, the proportion of the latter in the urine increases after some time, and the conclusion has been drawn that the NaCl is being reabsorbed to be returned to the blood. If this were the case the cells would do work and the O_2 consumption should be increased. But the injection of NaCl leads to a diuresis, as explained above, which is *not* accompanied by increased consumption of O_2 , while, on the other hand, the diuresis caused by Na_2SO_4 is accompanied by an increased metabolism of the kidney (fig. 227).

An increased secretion of Na_2SO_4 seems to explain the facts of the case just as well as a supposed increased absorption of NaCl. Similarly, the fact that when NaCl is withheld, it practically disappears from the urine, although it persists in the blood may just as well be explained on the theory of a

decreased elimination, possibly as the result of its more intimate association with the blood proteins retarding its filtration, as on the theory of an increased absorption.

At present it seems that no conclusive evidence of the theory that the concentration of the urine depends upon reabsorption has been adduced. Much of the evidence points to an active secretion, and the facts which do not directly point to this may be explained as well on the theory of secretion as on that of reabsorption. A verdict of not proven must be given, but since in the nephridial tubules of the annelid the epithelium is secretory, the onus of proving that the changes in the concentration and reaction of the urine are due to absorption lies upon the supporters of this theory.

The secretion theory does not raise the difficulty of explaining why a mechanism involving the filtration under pressure of such an enormous quantity of water with the sole purpose of having it again reabsorbed has been evolved, or of attempting to say at what stage of evolution the epithelium of the nephridial tubules reversed their function. It has been suggested that, when animals became terrestrial, the need of conserving water arose and the tubules took upon themselves this function. But the tubules of aquatic animals are as well developed as those of terrestrial animals.

Those who accept the reabsorption hypothesis claim that while such substances as urea are eliminated as fully as possible, other substances which are normally present in the blood in appreciable amounts are reabsorbed to the extent of maintaining that amount. The first set of substances they call "non-threshold substances," the second "threshold substances." But the differentiation between these is just as readily explained on a theory of secretion as on a theory of reabsorption.

While the evidence at present forthcoming does not directly point to the changes in the urine as it passes down the tubules being due to reabsorption, it by no means excludes the possibility that some reabsorption may take place.

The extraordinary differences in the structure of the epithelium in the convoluted tubules on the one hand, and of the looped tubules of Henle on the other, suggests the possibility that different processes may be carried on in these parts, that

possibly secretion may occur in the former and absorption in the latter.

The kidney responds readily to very small changes in the concentration or composition of the blood. Dilution, even to an amount insufficient to disturb the blood pressure, may lead to increased secretion of water, and the increase of various salts in the blood, and especially of anions, may bring about an increase of secretion. Thus an arrangement is secured by which the composition of the blood plasma is kept constant, and its carrying capacity for carbon dioxide is regulated. Hence renal disease may induce disturbance in the respirations (p. 527).

The Influence of the Nervous System on the Kidneys.

That renal secretion is fundamentally independent of the control of the central nervous system is shown by the facts (1) that it goes on after the nerves to the kidneys have been cut; (2) that it proceeds normally in a kidney which has been excised and transplanted.

As already indicated (p. 573), stimulation of the *splanchnic* nerves causes a constriction of the renal vessels and a stoppage of the formation of urine. Stimulation of the *vagus* by inhibiting the heart and lowering the arterial pressure causes a fall in the secretion of urine. Stimulation below the cardiac branch, or after its cardiac endings have been poisoned with atropine, seems to produce no definite result.

The action of the nervous system is therefore probably entirely through the vaso-motor mechanism. Vaso-constriction may be brought about—

1st. By direct stimulation of the vaso-constrictor centre as in asphyxia.

2nd. Reflexly by stimulation of many ingoing nerves, e.g. (a) by the application of cold to the skin; (b) by irritation of the bladder or urethra after the use of the catheter.

Vaso-dilator effects on the kidney are produced by stimulating the posterior roots of the lower dorsal nerves, which may explain the beneficial action of warm applications over the

loins in suppression of urine. There is some evidence that slight obstruction of a ureter may also cause a reflex vasodilatation with increased secretion of urine.

III. EXCRETION OF URINE.

1. **Passage from Kidney to Bladder.**—The pressure under which the urine is secreted is sufficient to drive it along the ureters to the bladder. If these are obstructed, the pressure behind the obstruction rises, and may distend the ureters and the pelvis of the kidney, and when it reaches about 50 mm. Hg in the dog, the secretion of urine is stopped. The muscular walls of the ureters show a rhythmic peristaltic contraction, which must also help the onward passage of the urine to the bladder.

2. **Micturition.**—As the urine accumulates in the urinary bladder, the viscus expands to accommodate it, the tone of the visceral muscular fibres being adapted to the degree of distension. The backward passage of the urine into the ureters is prevented by the way in which these tubes pass obliquely through the muscular coat of the bladder. When a certain distension is reached, rhythmic contractions are produced, which become more and more powerful. These are primarily dependent on the muscular fibres; but the wall of the bladder is richly supplied with peripherally placed neurons, and the possible action of these in controlling the contractions has not been excluded. Even after section of the nerves to the bladder, this peripheral mechanism is capable of controlling the act of micturition.

This involves not merely the contraction of the wall of the bladder, but also the relaxation of the visceral muscular fibres (the sphincter trigonalis) which surround the neck of the bladder, and of the striped fibres which surround the upper part of the urethra.

It is therefore an act requiring the co-ordinated contraction and relaxation of muscles, and it is presumably presided over by the nervous mechanism in the wall of the bladder.

Normally this is controlled by the *central nervous system*. The bladder is supplied by the *pelvic nerve*, in which white fibres run to the peripheral plexus, and by *sympathetic fibres* which have their cell stations in the inferior mesenteric ganglion, from which post-ganglionic fibres run to the bladder. In most animals the former are chiefly augmentor, and the latter inhibitory, but in some animals, *e.g.* the ferret, the reverse is the case. Adrenalin causes relaxation or contraction, according to whether the inhibitory or augmentor fibres run in the sympathetics.

The nerves are derived from a centre in the lumbar region of the spinal cord which normally controls the peripheral mechanism, and which may be reflexly excited by the passage of some urine from the bladder into the urethra or in other ways, *e.g.* in the dog by sponging the anus with warm water.

In some cases of inflammation of the spinal cord (*myelitis*), the increased activity of the centre may prevent the expulsion of urine, while later in the disease, when the nerve structures have been destroyed, the urine is not retained and dribbles away on account of the absence of the tonic contraction of the sphincter arrangement.

The expulsion of the last drops of urine is carried out by the rhythmic contraction of the bulbo-cavernous muscle; while the peristaltic contraction of the bladder wall is assisted by the various muscles which press upon the contents of the abdomen and the bladder. The horse micturates standing, but the ox can do so while walking.

In the young, micturition is a purely reflex act, and in the dog it is perfectly performed when the spinal cord is cut in the back. As age advances, the reflex mechanism comes to be more under the control of the higher centres, and the activity of the sphincters may be increased or abolished as circumstances indicate.

IV. Excretion by the Skin.

The skin is really a group of organs, and some of these have been already studied. (*The structure of the skin and its appendages must be studied practically.*)

- (1) The **Protective** functions of the horny layer of epidermis,

with its development in hair, and of the layer of subcutaneous fat, are manifest.

Hair.—The hairy coat of animals maintains a layer of air next the skin at a more equable temperature than that of the surrounding air, and so plays an important part in the regulation of temperature (p. 269).

The strong hairs developed about the muzzle and in the eyelashes are tactile organs (p. 102). Attached to each hair follicle is a band of non-striped muscle, the *arrector pili*, which can erect the hair by contracting. These muscles are under the control of the central nervous system, and the nerve fibres have been demonstrated in the cat to take much the same course as the vaso-constrictor fibres of somatic nerves. They belong to the true sympathetic set of nerves.

A hair after a time ceases to grow, and the lower part in the follicle is absorbed and the hair is readily detached. From the cells in the upper part of the follicle, a new down-growth occurs, a papilla forms and the hair is regenerated. In the horse this process occurs twice a year, and the thickness of the coat grown depends upon the degree of exposure to cold. The hair of the mane and tail and the tactile hairs are not shed with the rest of the coat.

(2) The **Sensory** functions have been studied under the Receptors (p. 99 *et seq.*).

(3) The **Respiratory** action of the skin in mammals is of little importance.

(4) **The Excretory Function of the Skin.**

Two sets of glands develop in the skin—sweat glands and sebaceous glands.

A. **Sweat Glands.**

1. **Structure.**—The sweat glands are simple tubular glands coiled up in the subcutaneous tissue with ducts opening on the surface of the skin. The secreting epithelium somewhat resembles that of the convoluted tubules of the kidney. Sweat glands are widely distributed over the skin of the horse. In oxen and sheep they are less abundant, being most developed on the muzzle. In the dog and cat they are found in the nose and in pads of the feet.

2. **Functions.**—From these glands, a considerable amount of sweat is poured out; but to form any estimate of the daily amount is no easy matter, since it varies so greatly under different conditions (p. 269). When poured out, sweat evaporates, and in doing so causes loss of heat. When large quantities are formed, or when, from coldness of the surface, or of the air, or from the large quantity of watery vapour already in the air, evaporation is prevented, it accumulates, and when it evaporates causes loss of heat. Hence the importance of grooming after exercise. In the horse the salts of evaporated sweat may accumulate on the coat if evaporation is allowed.

A free secretion of sweat is usually accompanied by a dilatation of the blood-vessels of the skin, but this may be absent, and it may occur without any sweat secretion, *e.g.* under the influence of atropine. The secretion of sweat and the condition of the blood vessels play an important part in regulating the temperature of the body (p. 269).

3. **Nervous Mechanism of Sweat Secretion.**—That the sweat glands are under the control of the central nervous system may be demonstrated in the cat. The sweat glands are chiefly in the pads of the feet, and, if a cat be put in a hot chamber, it sweats on the pads of all its feet. But if one sciatic nerve be cut the foot supplied remains dry. If the cat be placed in a warm place and the lower end of the cut sciatic stimulated, a secretion of sweat is produced. The secreting fibres for the sweat glands run in the true sympathetic system. They leave the cord by the anterior roots in the thoraco-abdominal region, pass to the sympathetic ganglia, where they have their cell stations. From these, non-medullated fibres pass back by the grey ramus into the somatic branch of the nerve and so onwards to plexuses round the sweat glands.

The centres presiding over these nerves are distributed down the medulla and cord. They are capable (*a*) of reflex stimulation, as when pepper is taken into the mouth; and (*b*) of direct stimulation (i.) by a venous condition of the blood, as in the impaired oxygenation of the blood which so frequently precedes death as the respirations fail, and (ii.) by a rise in the temperature of the blood supplied to them.

Even after the nerves of the sweat glands are cut, the glands may be stimulated by certain drugs, *e.g.* pilocarpine.

Adrenalin causes so powerful a contraction of the cutaneous vessels that any stimulating action it may have upon the sweat glands is masked. The action of heat seems also to be chiefly peripheral, setting up an unstable condition of the gland cells so that they respond more readily to stimulation.

4. **Chemistry of Sweat.**—Sweat from the horse is a sherry-coloured fluid, which, when pure, has a neutral or faintly alkaline reaction. Its specific gravity is about 1020 in the horse, and it contains about 5·5 per cent. of solids, of which 5 per cent. are inorganic and about 0·5 organic. When the sweat dries on the coat a white deposit is left. Potassium is the most abundant base. Chlorides are present in small amounts. The chief organic substances present are proteins—some globulin and some albumin. Fat is also present, probably derived from the sebaceous secretions, and it combines with the potassium to form a soap.

B. Sebaceous Glands.

The sebaceous glands are simple racemose glands which open into the hair follicles, and their function is to supply an oily material to lubricate the hairs. This secretion is produced by the shedding and breaking down of the cells formed in the follicles of the glands. Those lining the basement membrane are in a condition of active division, but the cells thrown off into the lumen of the follicle disintegrate and become converted into a semi-solid oily mass, which consists of free fatty acids and of neutral glycerol and cholesterol fats. These cholesterol fats are the *lanoline*, which differ from ordinary fats in being partly soluble in water. Free cholesterol is also present in the sebum.

Grooming.—This is of great importance in the horse. It removes salts of the sweat, shed epithelium, and loose hairs and dirt. It prevents the development of mange and of lice, and it acts as a form of massage to the skin and subjacent muscles.

SECTION VIII.

THE REGULATION OF GROWTH AND FUNCTION.

IN all the members of a species the course of the chemical changes in the various tissues and organs are fairly constant and depart but little from a normal course. Upon these changes depend not only the development and growth of each tissue and organ and of the animal as a whole, what might be called the *static adaptation* to surrounding conditions, but also the various responses to changes in external conditions, the *functional adaptation*. The development and the activities of each organ are co-related and co-ordinated with those of all the other organs, and in this co-relation three main factors play a part.

I. Heredity.

This is primarily the result of the chemical changes inherited from the parents. The principle of *Inertia*, that—“Every particle of matter in the universe remains in a state of rest or of uniform motion in a straight line, unless it is acted upon by external force,” is applicable to living as well as to dead matter.

Generation after generation a similar piece of protoplasm the ovum, undergoing the same molecular movements, is placed in the same external conditions, and hence must undergo the same course of development, under the influence of what may be called *Hereditary Inertia*. A proof of it is afforded by the development, both structural and functional, of embryonic tissues removed from the body and kept in the plasma of the animal blood. A fragment of the cell mass from which the heart develops undergoes the change into the muscular fibres of

the heart, and these manifest their characteristic regular rhythmic pulsation.

Scraps of some organs when removed and transplanted in other parts of the body may grow, and the cells may multiply and develop into those characteristic of the organ from which they were taken.

Hereditary inertia seems to be all-powerful in early embryonic life, and its influence extends on into the adult condition. Hooker found that, even after all that part of the central nervous system from which the nerves to the heart arise has been destroyed in the tadpole, the heart develops and beats in the usual way.

Its influence is dominant both in structural development and in the development of functional activity, not only in such simple actions as cardiac contraction, but in the most complex responses of the central nervous system upon which the conduct of the individual depends.

II. The Nervous System.

As development advances, the nervous system comes to play a part in the regulation of metabolism, and thus in the development of the static adaptations. Its effect is seen in the failure of regeneration after removal of structures in some invertebrates and in many amphibia if the nerves to the part are destroyed. It is also seen in infantile paralysis, a disease which follows destruction of the cells of the anterior horn of grey matter. The growth of the limb connected with that part of the spinal cord becomes arrested. The condition of herpes zoster, or shingles, a painful eruption of vesicles on the skin over a nerve, has already been considered (p. 91) as an example of the trophic influence of the nervous system.

The part played by the nervous system in regulating and co-ordinating the functional adaptations, *i.e.* the activities of one structure with those of others has been repeatedly indicated in the previous pages. The effect of a heightened arterial pressure in inhibiting the heart through the inferior cardiac branch of the vagus may be taken as an example; and that this

is fundamentally an alteration in the course of metabolism is indicated by Gaskell's observation that the vagus is an anabolic nerve (p. 421).

III. Chemical Regulation.

Yet another factor plays an important part. The products of the metabolism of one structure have an effect upon other structures, and so co-relate and regulate their reciprocal activity.

It has already been shown that the carbon dioxide produced in muscle stimulates the respiratory centre (p. 527). The slightest increase in the C_{m} of the blood increases the activity of the kidneys (p. 580). A product of the activity of the duodenum—secretin—has been shown to cause secretion by the pancreas (p. 322).

Chemical regulation plays a very important part in vertebrate animals, and special organs have been evolved which have as their function the elaboration of products which are passed into the blood, each to produce definite and specific actions in the body.

Such structures may be called glands with internal secretions, or **endocrinetes**. The name of hormones, from *ὄρμαινω* "I excite," has been suggested for the internal secretions, but, since they do not always increase functional activity, but may check it, the name is unsuitable.

Before deciding that any structure is a true endocrinete, it is necessary to prove that it produces a specific product or products with definite and specific actions.

The evidence required is of various kinds.

1. The effects of removal may be studied, and if these are definite—
2. The effects of transplanting a part of the structure in preventing the onset of the changes may be tried. If this is successful—
3. The effects of removing the graft may be observed.
4. The effects of administering extracts of the structure

either with or without its previous removal may be investigated.

This method has been largely used, but it must be employed with great care for the following reasons:—

i. The method of extraction may fail to remove the active product from the structure.

ii. The method of extraction may remove all sorts of constituents of the structure, and any result produced may be due to the combined action of many substances.

iii. Products of decomposition may be removed either alone or along with the active substance, and when administered may produce symptoms which may be ascribed to an active constituent which may not exist. The demonstration of the rapid development in decomposition of amines having a powerful physiological action shows that this is a real danger.

iv. When massive doses of the extracts produce an effect, there is a danger in concluding that a similar action is produced by the amount normally poured into the blood, but it has been shown that a massive dose may produce a totally different effect from a small dose.

v. It has been found that the action of these extracts may be materially altered by the functional condition of the structure to which they are applied; *e.g.* the uterus of the virgin guinea-pig may respond quite differently from that of the recently pregnant animal.

vi. The method of administration may modify the action. Thus, while the intravenous injection of the product of the medulla suprarenalis causes very marked symptoms, these may be entirely absent when it is injected under the skin or given by the mouth.

vii. Lastly, the danger of expectancy on the part of the observer must not be overlooked. This is of no small importance in the therapeutic administration of such extracts.

Classification of the Endocrinetes.—These endocrinetes are derived from different parts of the embryo, and they may be arranged according to their embryological source. Such a classification is more satisfactory than one based upon their anatomical position, for, in several cases, two of these organs, entirely separate in origin, structure, and function, have come

to lie in close juxtaposition and so to constitute a single organ according to anatomical nomenclature.

- | | |
|---|---|
| I. From the Nervous System. | |
| 1. Chromaffin Tissue (Medulla suprarenalis). | ← |
| 2. Hypophysis Cerebri. | ← |
| II. From the Buccal Cavity. | |
| 3. Thyreoid. | ← |
| 4. Pituitary. | ← |
| III. From the Intestine. | |
| 5. Pancreas. | |
| 6. Mucosa of Small Intestine. | |
| IV. From the Branchial Arches. | |
| 7. Parathyreoids. | ← |
| 8. Thymus. | |
| V. From the Mesothelium of the Genital Ridge. | |
| 9. Gonads. | |
| 10. Inter-renal Bodies (Cortex suprarenalis). | ← |

The pairs which occur in anatomical juxtaposition are indicated by joining lines.

I. *From the Nervous System.*

1. **Chromaffin Tissue.**

This in mammals is chiefly disposed as the medullary part of the suprarenal bodies. But smaller masses are found along the aorta and some of the large arteries. In fishes it lies entirely separate from the equivalent of the cortex suprarenalis—the inter-renal tissue.

1. **Development.**—It is developed from the emigrating cells which form the true sympathetic or visceral system of nerves (p. 54).

2. **Structure.**—It consists of rather large irregular cells containing granules which stain of a brown colour with chrome salts—hence the names of the tissue. These cells occupy spaces between large sinusoid capillary vessels.

3. **Physiology.**—(1) It is impossible to remove the chromaffin tissue in mammals without removing the inter-renal tissue of

the cortex with it. But recently Vincent has attempted completely to destroy the medulla in dogs by thermocautery, and he has found that the animals remain apparently normal.

(2) The discovery that the *injection* of extracts of the medulla suprarenalis gives rise to marked symptoms was the first step to the explanation of its functions. The demonstration that the active constituent is a definite chemical substance, **Adrenalin**, has enabled physiologists to carry out investigation with great precision. Adrenalin is—

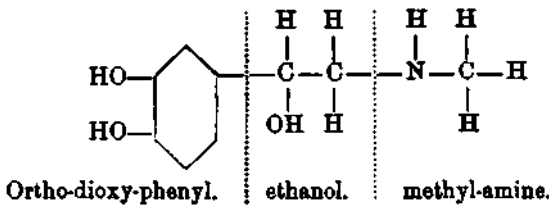

It has been prepared synthetically.

It may be recognised by its reaction with chrome salts, and by the ease with which it is oxidised, especially in alkaline solutions. On account of this it strikes a green colour with ferric chloride. With phosphotungstates along with phosphoric acid it gives a blue colour, and by this test 1 part in 3 million may be detected.

That it is a product of the chromaffin tissue is shown by the fact that the staining of the medulla is proportionate to its physiological activity, and by the great amount of adrenalin in the blood coming from the suprarenals. By pressing on the suprarenals its amount in the blood may be increased. Section of the branches of the splanchnic nerve going to the suprarenals checks its liberation, while stimulation increases it.

It acts—

(1) On the **Blood-vessels**. When injected into a vein or perfused in Ringer's Solution through the vessels, it causes constriction of the peripheral arterioles, and thus raises the arterial blood pressure (*Practical Physiology*). Its action is most powerful on the abdominal vessels, and hence blood is forced to the muscles of the limbs. The vessels of the skin, however, are contracted. On the pulmonary vessels, and on the intracranial vessels its action is slight, while it causes

dilatation of the coronary arteria. Hoskins finds that in very small doses it causes dilatation of all the arterioles. That it does not act directly on the muscle fibres is shown by the fact that, after the administration of apocodeine which poisons the endings of the abdomino-thoracic or true sympathetics, it no longer acts, although barium salts still cause a contraction, because they act directly on the muscle (p. 455). Ergotoxin poisons the endings of the augmentor fibres of the true sympathetic, and, after it has been administered, adrenalin may cause a dilatation of vessels because its action on the endings of the inhibitory fibres is thus unmasked.

In fact, the *action of adrenalin is absolutely specific, and consists in a stimulation of the endings of the true sympathetic nerves*. It thus produces on any organ the effect which is produced by stimulating these nerves.

(2) On the **Heart**. If the vagi are intact, it produces a slowing which is due to the raised arterial pressure (p. 420). When the vagi are cut it causes an acceleration and generally an increased amplitude of contraction by stimulating of the augmentor endings.

(3) On the **Allimentary Canal** it acts, as does stimulation of the splanchnic nerves, by inhibiting peristalsis and stimulating the sphincters (p. 333).

(4) On the **Bladder** its action varies in different animals according to whether motor or inhibitory fibres pass to the organs through the splanchnics by way of the inferior mesenteric ganglion and hypogastric nerves (p. 582). In the former case it causes contraction (ferret); in the latter case relaxation (cat).

(5) On the **Uterus** it generally causes contraction, but, in the virgin uterus, it may cause relaxation, showing that its action may be modified by the functional condition of the tissue.

(6) On the **Iris**, when applied to the excised eye of the frog, it has the same action as stimulation of the cervical sympathetic—it dilates the pupil. But in mammals this occurs only when (a) the superior cervical ganglion has been excised—a procedure which is supposed to make the nerve terminations more sensitive; and (b) in some cases of de-pancreatic diabetes (p. 357). Hence it has been concluded that an internal secretion

of the pancreas may inhibit the action of adrenalin on these terminations.

(7) It acts on the **sweat glands**, which are supplied by the true sympathetic nerves, but its action is masked by the constriction of the vessels which supply these glands.

(8) On the **kidney** its constricting action on the arterioles leads to a decreased production of urine.

(9) As already indicated (p. 356), injections of extracts of the suprarenal bodies profoundly modify the **metabolism**, leading to an increase of sugar in the blood and to its excretion in the urine. This is best marked when the animal is well fed and has a store of glycogen in its liver; but, since it occurs in fasting animals, after the stored carbohydrates have been markedly reduced by the administration of phloridzin (p. 357), it would appear to be due in part to an increased production of sugar from proteina. It has been suggested that the suprarenal secretion acts through the pancreas by preventing the formation of the internal secretion which checks carbohydrate metabolism in the liver (see p. 356). But the fact that it produces glycosuria in the bird after the pancreas has been excised negatives this view. The universality of the law that adrenalin acts on the terminations of true sympathetic nerves, and the fact that stimulation of these nerves to the liver causes a glycosuria, indicates that it probably acts on these nerve endings. This is supported by the fact that it does not cause glycosuria after the administration of ergotoxin.

4. **Nervous Control of the Chromaffin Tissue.**—The supply of adrenalin to the body from the chromaffin tissue is influenced by the nervous system through the splanchnic nerves, preganglionic medullated fibres of which go to the gland. Various injuries to the central nervous system may stimulate these nerves, and a glycosuria may be thus produced, as in Bernard's diabetic puncture (p. 356). Since this does not occur when the suprarenals are removed, it has been supposed that it is caused by the excessive supply of adrenalin to the blood. But the amount in the blood after Bernard's puncture is insufficient to cause a glycosuria. The adrenalin probably acts merely as an adjuvant to nerves.

5. **Significance of Adrenalin.**—The amount of adrenalin normally present in the blood is quite insufficient to exercise

any marked physiological effect or to account for the tone of the arterioles. An amount sufficient to act upon them causes marked paralysis of the gut. It is to be regarded as a reserve stimulant which is called upon when the true sympathetic system is powerfully stimulated, as it is in various disturbances of the central nervous system which are accompanied by such emotional conditions as fright or anger. The stimulation of the true sympathetics leads to the increased action of the heart and the contraction of the abdominal vessels with the increased flow of blood to the muscles, and to the other physical accompaniments of the emotions which are preparations for meeting the conditions producing them. If the stimulus is sufficiently powerful, the effect is augmented and sustained by an outpouring of adrenalin.

5. **Detection of Adrenalin in the Blood.**—The most delicate method for testing the amount of adrenalin is the inhibitory action upon a strip of intestine in oxygenated Ringer's solution at the body temperature. This action is manifested by as little as 1 in 400 million.

6. **Toxic Action.**—The administration of large doses of adrenalin may cause death from pulmonary congestion. Repeated doses result in degenerative changes in the liver, and in a thickening of the inner coat of the arteries.

2. Hypophysis Cerebri.

1. **Development.**—This is formed as a hollow downgrowth from the base of the third ventricle of the brain. In some animals the stalk remains open, but in man it is closed (fig. 230).

2. **Structure.**—It forms what is anatomically the posterior lobe of the pituitary body lying in the sella turcica. It is composed of neuroglia cells, but in it are frequently found little masses of colloid and cells resembling those of the intermediate part of the pituitary (p. 599) a structure which closely embraces the hypophysis.

3. **Physiology.**—(a) **Removal** produces no marked symptoms.

(b) **Extracts**, when injected into a vein cause—

(1) A rise of blood pressure from constriction of the arterioles. If the dose be repeated within half an hour, this

may be replaced by a dilatation and fall of pressure. In birds the *first* dose produces this dilator effect. In the renal arterioles it causes a dilatation, and in the coronary arteries a constriction, thus differing from adrenalin.

(2) On the **heart** it acts to increase the force of contraction, whether the *vagus* is intact or is cut. After section of the *vagus* it does not accelerate the heart as does adrenalin.

(3) Upon the **iris** it acts like adrenalin.

(4) On the **intestine, uterus, and bladder** it acts as an excitant, and it also increases the effect of stimulating the hypogastric nerves on the last two organs.

(5) It causes a great outpouring of **milk** from the mammary glands, probably by its action on the walls of the ducts, but it has no influence on milk *secretion*.

(6) It has a marked **diuretic action**, and, since this occurs even after a second dose when the arterial blood pressure falls, it has been ascribed to a specific stimulating action on the secreting cells of the kidney.

(7) Its action on **metabolism** requires further investigation. According to some investigators, it causes glycosuria.

So far the chemical nature of the active principles, which may be called **Hypophysin**, has not been ascertained, although active crystalline products have been prepared. Like adrenalin, it is not destroyed by heating. Whether it is a normal product, and whether it has any physiological significance, has yet to be proved. Herring's results seem to show that the passage of a colloidal material may be traced into the cerebro-spinal fluid. It is entirely formed in the hypophysis or in the *pars intermedia* of the pituitary. Some observations by Herring tend to show that the action on milk flow and on the uterus is more particularly due to a product of the latter.

II. *From the Buccal Cavity.*

3. **Thyroid Gland.**

1. **Development.**—This structure is formed as a hollow outgrowth from the anterior part of the alimentary canal, which breaks up into numerous branches.

¹ The gland was named after the shield-like cartilage of the larynx. Since *thyreos* is a shield, and *thuros* a door, it should be called thyreoid. The name thyroid given by British anatomists is manifestly erroneous.

2. **Structure.**—It early loses its connection with the alimentary canal, and becomes cut up by fibrous tissue into a number of small more or less rounded cysts or follicles, each lined with cubical epithelium and filled with a mucus-like colloid substance, with a marked affinity for acid stains (fig. 229). It is enormously vascular and has a rich supply of lymphatics.

3. **Chemistry.**—The colloid substance is characterised by containing iodine, but the amount varies in different animals and in the same animal according to the mode of feeding.

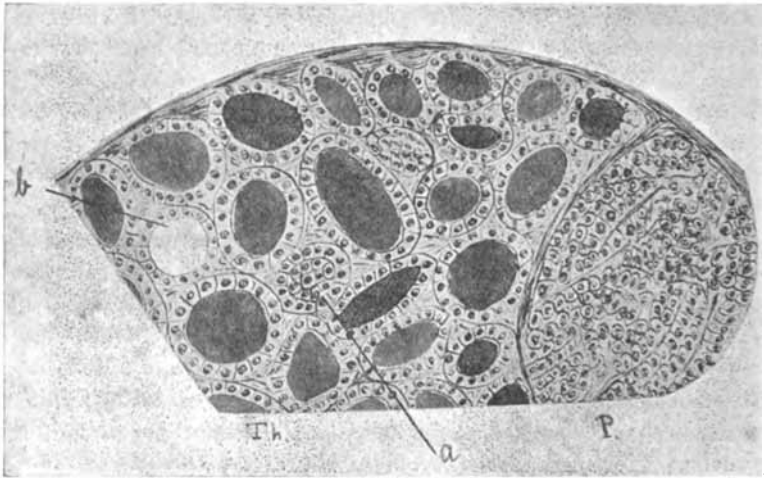

FIG. 229.—Section through Part of the Thyroid (*Th.*) and a Parathyroid (*P.*) of a Mammal.

A very stable organic compound of iodine, known as **iodothyrin**, may be prepared, but this is actually combined in a globulin-compound which is the active constituent of the organ, and is known as **iodothyreoglobulin**. Kendall has described a crystalline product of definite composition containing the indol nucleus (p. 330) with iodine attached to the benzene ring—a **thyreoxyindol**.

4. **Physiology.**—In 1873 Gull described a peculiar disease chiefly affecting women which has received the name of *myxœdema* (p. 597), and in 1877 Ord was able to show that it is associated with atrophy of the thyroid. Kocher and the

Reverdin in 1882 described a somewhat similar condition after removal of the thyroids in operations for goitre. In the last decade of the nineteenth century the experimental investigation of the effects of removal was taken up.

(1) **Removal.**—A difficulty is experienced in studying the effects of removal, inasmuch as the parathyroids lie embedded in the thyroid of most animals, and in close juxtaposition to it in others, and care is required to leave a sufficient amount of these to carry on their functions.

When proper precautions are taken, it is found that the effect of removal of the thyroid in *young animals* is to check the growth, and especially to check the growth of cartilage in developing bone (p. 46). This leads to marked shortening of the long bones, causing stunted growth. The basis cranii is also affected, and, since the intra-membranous bones continue to grow, the frontal bones tend to arch forward. The gonads do not develop, but remain infantile. The animal is generally dull—lethargic.

In *adults* the changes are less prominent. Muscular weakness and apathy are marked. The hair falls out, and the temperature is low. There is often a peculiar swelling of the skin, which does not pit on pressure. The rate of metabolism is markedly decreased. The mobilisation of carbohydrates is lowered and the carbohydrate tolerance is raised. Removal of the thyroid decreases the glycosuria produced by removal of the pancreas, and in this respect the influence of the thyroid co-operates with that of the chromaffin tissue in facilitating the mobilisation of carbohydrates, which is held in check by the pancreas. The functions of the sexual organs are disturbed. The condition is sometimes known as *cachexia strumipriva*.

(2) **Hypothyroidism (Decreased Functional Activity).**—(a) *In the Young.*—The thyroid may be congenitally imperfectly developed in man and animals, and all the conditions described under the effects of removal of the gland are in a very marked degree. (b) *In the adult human subject.*—When the thyroid atrophies, the disease *myxedema* is produced. The sufferer manifests the symptoms described above as *cachexia strumipriva*.

(3) **Transplantation.**—If, when the symptoms following re-

moval have developed, a small piece of the tissue of the thyroid is grafted in a suitable part of the body, blood-vessels may grow in, the tissue may survive and increase, and this may bring about a disappearance of symptoms. On removing the graft the symptoms recur.

(4) **Extracts**.—The administration of extracts of the thyroid subcutaneously, or by the mouth as was shown by Murray, frequently leads to the disappearance of the symptoms of removal or deficiency, and this line of treatment is now universally used in cases of cretinism and myxœdema in man. Iodothyreo-globulin or thyreo-oxyindol appears to be the active principle.

The way in which the thyroid acts upon the metabolism is demonstrated by the study of the effects of its administration to normal animals. When given in large doses over long periods, all the symptoms of hyperthyroidism may be produced.

Tadpoles fed on thyroid tissue undergo a very rapid development, and Hoskins and Herring have shown that in young white rats the continued administration of thyroid causes an extraordinary increase in the suprarenals, heart, kidneys, and pancreas with a decrease in the size of the pituitary in the female. The main effect is to increase metabolism.

A further effect is to activate the terminations of the true sympathetics and of the para-sympathetics of all the visceral nerve fibres. Hence both the augmentor and the inhibitory terminations in the heart are activated, and the heart responds more readily to stimulation of the vagus or of the augmentor. The same seems to be the case with the nerve terminations in the blood-vessels, *e.g.* the reflex response to the depressor nerve (p. 418). Since these thyroid preparations act upon the true sympathetic termination, they facilitate the action of adrenalin. Further, the suprarenals are supplied by the splanchnic nerves, and apparently the active principle of the thyroid facilitates the action of these, and so increases the output of adrenalin.

(5) **Hyperthyroidism**.—(*Increased Functional Activity*).—This condition in man is known as *Graves' Disease* or exophthalmic goitre. It is characterised by a condition of hyperexcitability and sleeplessness, rapid action of the heart, a

tendency to flushing from increased vaso-motor activity, sweating, increased secretion of urine, often prominence of the eyeballs and enlargement of the thyroid forming a soft goitre. The rate of metabolism is markedly accelerated, proteins are more rapidly broken down, and carbohydrates are too rapidly mobilised and hence sugar may appear in the urine. The symptoms may all be explained in terms of the action of thyroid extracts. The prominence of the eyeballs in man is probably due to stimulation of visceral muscular fibres in the eyelids by which they are unduly opened and the bulging of the eyeball allowed to take place. It may occur in lower animals.

In simple goitre the thyroid tissue undergoes a slow hypertrophy and no general symptoms are manifest.

(6) *Nervous Control*.—Taking as indices (a) the sensitising action of the internal secretion of the thyroid on the abdominal sympathetic nerve; and (b) the decrease in the amount of iodine in a lobe, it has been found that stimulation of the nerves supplying the gland leads to an increased output of the internal secretion.

The thyroid thus seems to produce an internal secretion rich in iodine which exercises a stimulating effect upon the metabolism.

Whether it does so by a direct action, or whether through the autonomic nervous system, upon which it undoubtedly acts, cannot at present be decided.

4. Pituitary.

The true pituitary is the anterior part of the pituitary of anatomists.

1. *Development*.—It is formed by a hollow outgrowth from the roof of the buccal cavity, and it lies in front of and embraces the hypophysis.

2. *Structure*.—It consists of (1) an *anterior part*, composed of dense columns of cells of two kinds—(a) the chief cells, which are large and do not stain readily; (b) the chromophil cells which contain granules, some staining with acid, some with basic stains. It is very vascular. (2) A *pars intermedia*, separated from the former by a cleft and applied closely to

the hypophysis, and consisting of cells with colloid material between them.

3. **Physiology.**—(a) **Removal** of the true pituitary is generally rapidly fatal; muscular tremors, slow pulse and respiration, and a fall of temperature preceding death. **Partial removal** in young animals is followed by decreased growth, persistence of the infantile characters, and arrested growth of the gonads. Often there is an accumulation of fat. The thyreoid is generally hypertrophied.

(b) *Acromegaly*, a disease in man characterised by greatly increased growth of the bones, and more especially of the intra-membranous bones, and with increased growth of the

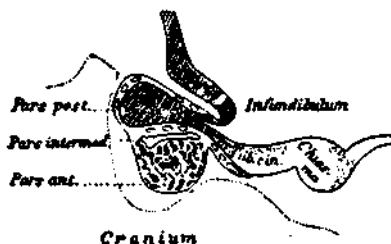

FIG. 230.—Longitudinal section through the Hypophysis and Pituitary. (EDINGER.)

subcutaneous fibrous tissue, has been associated with disease of the pituitary. According to Cushing, it shows two phases:—First, the irritative phase, in which there is an increased growth of bone and a premature development of the testis, and, second, the destructive stage, in which the testes atrophy and the sexual functions are in abeyance. Very probably the development of *giantism* is associated with increased activity of the pituitary, for, in most cases, an enlargement of the sella turcica has been described.

The fatal effects of removal may apparently be delayed for a time by the **transplantation** of a part of the gland, but the grafts do not persist. Administration of extracts of the pituitary has not given conclusive results. It has been claimed that a substance of definite composition which has been called *tethelin* may be prepared from it, which first decreases then increases the growth of young mice and causes a persistence of the soft coat of the young animal.

A **physiological hypertrophy** occurs in pregnancy, during which the ovarian functions are in abeyance, the chief cells being increased. In the male, removal of the testes leads to hypertrophy of the pituitary.

While the pituitary thus exercises a stimulating action on the growth of the connective tissues and of the gonads, the latter appear to have a checking action on the pituitary. More work upon this is required.

III. *From the Intestine.*

5. **Pancreas.**

The development and structure of the pancreas have been described (p. 300).

The effects of removal in producing the condition of diabetes have been considered (p. 357), and it has been shown that the organ produces an internal secretion which checks the mobilisation of sugar in the liver, and possibly facilitates its utilisation by the muscles. The transplantation of a piece of pancreas prevents the onset of these symptoms, but the administration of pancreas or of extracts of the pancreas does not do so.

The internal secretion of the pancreas acts in the opposite direction to that of the chromaffin tissue and the thyroid. The fact that, after removal of the pancreas, adrenalin causes dilatation of the pupil seems to indicate that its internal secretion inhibits the action of the termination of the true sympathetic in the iris, and therefore probably also in the liver.

It is probably the islets of Langerhans which yield the active principle. The true islets are developed early in foetal life from the epithelium of the ducts. A case has been described in which excision of a piece of pancreas, which had been left after partial removal of the organ, led to glycosuria, and in which the fragment was found to have degenerated and to be composed entirely of islet tissue.

6. **The Mucous Membrane of the Small Intestine.**

The production of **secretin** and its action on the pancreas have been dealt with on p. 321.

IV. *From the Branchial Arches.*7. **Thymus.**

1. **Development.**—The thymus is formed as epithelial outgrowths from the branchial arches—in mammals from the ventral side chiefly of the third and, to a lesser extent, from the fourth cleft.

2. **Position.**—In man and in most mammals it lies in the thorax just in front of the heart. Islets of thymus tissue are

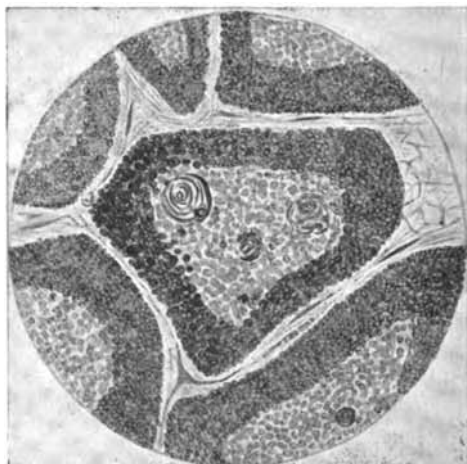

FIG. 231.—Section of the Lobules of the Thymus to show the Lobules, with Hassall's Corpuscles in the Central Part.

frequently found in and around the thyroid. In the guinea-pig it is entirely in the neck.

3. **Structure.**—It is composed of two lobes, each made up of a series of separate lobules surrounded by a fibrous capsule and showing a denser cortical and a less dense medullary part. It consists essentially of a network of epithelial cells, which, in the medullary part, are here and there massed together to form concentric agglomerations of cells, some in a state of degeneration—the *Hassall's Corpuscles*. In the meshes of the network are lymphocyte-like cells which are probably derived from outside the gland, but which, according to some observers, are formed from the epithelial cells (fig. 231).

4. **Life History.**—The thymus reaches its greatest size, in relationship to the weight of the body, about the time of birth; it continues to grow till puberty, when it begins to atrophy, being replaced by fatty tissue. In adult life, it is reduced to a mass of adipose tissue with only some islands of thymus substance. Conditions of malnutrition lead to a temporary atrophy of the gland.

5. **Physiology.**—(1) **Removal.**—In young guinea-pigs this produces no marked symptoms. In young dogs very different results have been recorded by different investigators; but the most recent series of experiments shows no observable difference between normal pups and those deprived of their thymus. Some investigators describe a peculiar sluggish condition with manifestations of muscular fatigue; others state that a condition of decreased calcification of the bones and the peculiar enlargement of their ends, characteristic of rickets, are produced; but rickets develops very readily in puppies, and just as readily in those with, as in those without, the thymus. A thymusless pup may escape rickets while other members of the litter may develop it.

(2) **Feeding tadpoles with thymus leads to continued growth and absence of development, while feeding with thyreoid leads to more rapid development.**

(3) **After castration of male animals, the thymus persists in adult life. If thymus and testes are both removed, the growth of the animal is delayed. It would thus seem as if the thymus and testes co-operate in stimulating growth, and that, if one of these structures is removed, a compensatory hypertrophy of the other occurs. As the testes increase in size, the thymus begins to atrophy and to play a less important part. Similar relations with the ovaries have not been established.**

8. Parathyroids.

1. **Development.**—These are formed as epithelial outgrowths from the dorsal aspect of the third and fourth branchial clefts on each side, there being thus two on each side.

2. **Position.**—The parathyroids formed from the third clefts, in most animals, lie close to the thyreoid lobes, but outside of them. Those from the fourth clefts are generally embedded in them. In man, both sets lie outside of the

thyreoid. Supplementary parathyroids are frequent, and in some animals, *e.g.* cats, they are embedded in the thymus. It is therefore impossible to be sure that, after removing the usual four parathyreoid bodies, a considerable amount of parathyreoid tissue is not left. This explains the negative results got by some experimenters.

3. **Structure.**—Each consists of columns of cells (*a*) the chief cells, large and not staining readily, (*b*) oxyphil cells, smaller than the last, and with granules staining with eosin. Masses of colloid material may occur, giving the structure somewhat the appearance of the thyreoid gland (fig. 229).

4. **Physiology.**—(1) **Removal.**—Since 1882 it has been known that, after removal of the thyreoid gland for goitre in the human subject, a peculiar condition of spasm of the muscles, and even of convulsions leading to death, may occur. This was first ascribed to removal of the thyreoid, but in 1896 Vassale and Generali definitely showed by experiments upon animals that it is due to removal of the parathyroids, and that, if a sufficient amount of their tissue is left, the symptoms do not develop.

The symptoms are (i) depression and emaciation; (ii) tonic contraction of various muscles, chiefly the extensors; (iii) tremors and jerkings of the muscles, which may go on to a general convulsion. Sometimes these disturbances of the neuro-muscular system are accompanied by disturbances of balancing. (iv) A peculiar increase in the excitability of the peripheral motor neurons, so that if a motor nerve is compressed or tapped a violent convulsive movement of the muscles supplied by it may be produced, while the response to galvanic stimulation is enormously heightened. (v) In the dog increased rate of the heart and of the respirations. The symptoms vary greatly from time to time, and may remain latent except for the increased excitability of the nerves which persists.

The spasticity and tremors are due to the implication of the motor neurons of the spinal cord and are arrested by cutting the nerve to the muscles. The increase in the response to the stimulation of peripheral nerves is due to an increased excitability of the nerve endings in the muscles. These two conditions are not necessarily proportional to one another.

All the symptoms are due to a poison developed in the

body and present in the blood. They are all temporarily removed by bleeding and transfusing with a 0.9 per cent. NaCl solution.

The evidence points to guanidin, $\text{NH}_2 - \overset{\text{NH}}{\underset{\text{NH CH}_3}{\parallel}} - \text{C} - \text{NH}_2$

or to methyl guanidin, $\text{NH}_2 - \overset{\text{NH}}{\underset{\text{H}}{\parallel}} - \text{C} - \text{N} - \text{H}$, as the toxic substance.

The administration of the salts of these reproduces all the symptoms following removal of the parathyroids, while the amount in the blood and in the urine is increased after parathyroidectomy.

The parathyroids thus seem to regulate the guanidin metabolism of the body and to prevent such an increase as will lead to symptoms. There is evidence that guanidin or methyl guanidin liberated in the body is linked to acetic acid to form the non-toxic creatin (p. 209).

In rats which have survived removal of the parathyroids lying beside the thyroid, but which presumably have some parathyroid tissue left, defective calcification of the teeth has been observed. This is probably associated with a decrease in the calcium of the blood. A decrease in the growth of the bones and changes resembling those of rickets have also been described.

(2) **Transplantation** of parathyroid tissue has been found to abolish the symptoms, and they recur when the graft is excised.

(3) **Extracts.**—Beebe has isolated a nucleo-protein which, according to some observers, suppresses or mitigates the symptoms of tetany.

V. From the Mesothelium of the Genital Ridges.

9. The Gonads, or Sex Glands.

1. **Development.**—These are formed by ingrowths of mesothelial cells over the genital ridge of the embryo.

A. **Testes.**—In the male, these cells, for the most part

become arranged in tubules, forming (a) the *spermatogonia*, from which the *spermatozoa* are produced (p. 620), and (b) certain larger cells, the supporting *cells of Sertoli*. (c) Some of the mesothelial cells remain outside and between the tubules, and form the *interstitial cells of Leydig*. These are large cells, and they contain a large amount of lipoids. Some observers maintain that they are really connective tissue cells.

B. Ovaries.—In the ovaries the ingrowing mesothelial cells form separate masses, the *Graafian follicles*. (a) One of the cells enlarges and becomes the ovum, the female gamete (p. 619); while (b) the others remain smaller and form the cells of the *zona granulosa*. (c) In many animals between the Graafian follicles a considerable number of the mesothelial cells remain as the *interstitial cells* of the ovary.

The interstitial cells of the testis and ovary resemble one another very closely and are both very similar to the cells of the inter-renal organ which forms the cortex suprarenalis. They are very rich in lipoids and especially in cholesterol compounds.

2. Physiology.—The part played by the gonads in the process of reproduction will be considered later (p. 618). At present their action as endocrinetes has to be dealt with.

A. Testes.

(1) **Removal.**—Removal of the testes in young boys and in young animals leads to a persistence of the infantile type of body, and to the absence of development of the secondary sexual structures, such as the prostate gland, the hair of the body and face in men, the horns of sheep and cattle, and the antlers of deer.

The temperament is generally phlegmatic, and hence a gelded horse is more easily managed. Castrated animals fatten more readily. The cartilaginous growth of bone tends to persist, and hence the bones tend to be longer and more slender than in the entire animal.

(2) **Precocious Development.**—In man this is accompanied by premature development of the secondary sexual organs, by abnormal growth of hair, premature union of the epiphyses of the long bones, and increased growth of the bones in thickness. These conditions have been observed in connection with tumour

growths of one testis, and removal of the tumour has been followed by their disappearance.

A similar condition is associated with hypertrophic changes in the cortex suprarenalis (p. 610), and with irritative changes in the pituitary (p. 600). Whether these act through the testes or directly is not known.

(3) **Transplantation.**—The first demonstration of the action the endocrinetes was afforded by Berthold, who showed that transplanting the testis into a capon leads to the development of the typical sexual characters of the cock. This has been fully confirmed by other observers in different species of animals.

(4) **Extracts.**—There is some evidence that in frogs the development of sexual character may be produced by the administration of testicular substance, but it is not quite satisfactory.

The testis thus exercises an important influence on the growth and development of the animal, and it does this by yielding an internal secretion. That the source of this is the *interstitial cells* is shown by the fact that ligature of the vas deferens causes atrophy of the spermatogonia, and also in course of time, of the cells of Sertoli, leaving only the interstitial cells, and yet there is no arrest of the development of the sexual characters. In the mole, these interstitial cells reach their greatest development before the beginning of the breeding season.

In man they are well developed at birth, but disappear in the course of the early weeks of life to reappear again at puberty and to persist throughout life.

B. Ovaries.

(1) **Removal** of the ovaries has the same effect on the female as removal of the testes has on the male. The development of the secondary sexual organs, the uterus, mammæ, etc., is arrested. But, after removal of the ovaries, there is frequently a tendency to develop the characters of the male. Thus, hinds with diseased ovaries may develop horns and hen pheasants and ducks may develop male plumage. The ovaries thus seem to check the development of male characters.

(2) **Transplantation** acts in the same way in the female as in the male in preventing the effects of removal. In most animals

it is the *interstitial cells* which are the active part; for, after complete degeneration of all the cells of the Graafian follicles, the graft of ovarian tissue still produces the development of the sexual characters.

The transplantation of ovaries into young castrated male rats and guinea-pigs has led to the development of female characters, such as excessive growth of the nipples, to the secretion of milk, and in rats to characteristic sexual reflexes.

The evidence is thus quite clear that the gonads exercise a direct influence upon the somal cells through an internal secretion.

But certain peculiar modifications in the development of the sexual characters have been recorded which appear inexplicable on any theory of the action of an internal secretion. Bond has described a pheasant with male plumage on one side and female plumage on the other, and a similar condition has been recorded in a bullfinch. In the pheasant an atrophic ovo-testis was present. It is, of course, inconceivable that an internal secretion could have had this bilateral action. In insects there is also evidence that the sexual characters develop after castration of the caterpillar.

In the female the ovaries not only act in the young in determining the development of the sexual characters, but in adult life they have an important influence on—

(1) **The Course of Pregnancy.**—In the bitch if the ovaries are removed early in pregnancy the ovum does not become embedded in the mucous membrane of the uterus. The cells of the *corpus luteum* exercise an influence on the uterus which brings this about. This structure is formed when the Graafian follicle ruptures and discharges its ovum. It is produced essentially by an enormously increased growth of the cells of the *zona granulosa*, which become loaded with lipoids. If the ovum is fertilised the *corpus luteum* grows to a large size; if the ovum is not fertilised it grows to a less extent. When the *corpus luteum* is formed, any irritation of the uterine mucosa may cause the development of the typical tissue for the embedding of the ovum.

Removal of the ovaries late in pregnancy produces no disturbances.

(2) **The Mammary Gland.**—When the ovaries are removed in early life the mammary gland does not grow. The growth of the gland in pregnancy seems to be associated with the development of the corpus luteum. It has been found that, in the rabbit, the injection of extracts of the foetus leads to a rapid growth and to a functional activity of the gland, and it has been deduced that a secretion from the foetus is the specific stimulus to the development of the gland and to milk formation. But milk secretion occurs *after* the expulsion of the foetus, and it is more probable that the retention in the mother of the material which was formerly passed to the foetus, and which is virtually foetal material, is the stimulus to milk secretion, rather than that this is caused by a reabsorption *from* the foetus. That an internal secretion from the foetus does not play an *essential* part is shown by the fact (i.) that milk secretion may occur in the young of both sexes; and (ii.) that it may be caused by stimulation through the nervous system, since it has been induced, even in the virgin animal, by continued stimulation of the nipple by sucking; (iii.) that milk may be produced in bitches some weeks after oestrus without impregnation. In such bitches development of the corpus luteum and of the uterus and mammary glands occurs and retrogressive changes do not appear till after thirty days. This may explain the secretion of milk which in these cases seems to follow atrophy of the corpus luteum, while increase of the mammary gland is associated with its growth.

10. Inter-renal Tissue.

In mammals, this is chiefly massed as the cortex *supra-renal*, but separate masses occur along the course of the aorta, in the epididymis testis and near the ovaries. In some animals, *e.g.* the rat, they are more abundant than in others. In fishes the *inter-renals* lie quite separately from the chromaffin tissue.

(1) **Development.**—The tissue is developed from ingrowths of the mesothelium of the genital ridge.

(2) **Structure.**—The cells are large, and the protoplasm contains an abundance of lipoids, with a high proportion of cholesterol. They closely resemble the interstitial cells of the

testes and ovaries and the cells of the corpus luteum. Brown granules are also often present in them.

The *cortex suprarenalis* is covered by a fibrous capsule which sends trabeculae inwards. Under the capsule, the cells are arranged in somewhat fan-like groups to form the *zona glomerulosa*. Deeper, they run in parallel rows at right angles to the surface, and constitute the *zona fasciculata*. In the deepest layer, the *zona reticularis*, their arrangement is in looser and less regular columns.

(3) **Physiology.**—(1) **Removal.**—Biedl has succeeded in removing the inter-renals in selachian fishes, and he finds that the animals die. In mammals it is impossible to remove this tissue without also removing the chromaffin tissue of the medulla suprarenalis (see p. 590).

(2) **Extracts** of this tissue are without the action of extracts of the medulla. Some experiments on continuous feeding in young rats indicate that the growth of the testis may be stimulated.

(3) **Relation to Gonads.**—The physiological significance of the inter-renals is obscure, but that they are probably of the same nature as the interstitial and other ancillary cells of the gonads is indicated by (i.) their common origin with the cells of the gonads; (ii.) their close resemblance to the interstitial cells; (iii.) the fact that pieces of inter-renal tissue are frequently found in close relationship to the gonads; (iv.) the fact that abnormalities of this tissue are frequently connected with abnormalities of the gonads. Hypertrophy seems to be associated with premature sexual development in the male and with the assumption of male characters by the female, such as the typical growth of hair and muscular development; and (v.) the observation that the cells of the cortex suprarenalis of the guinea-pig undergo marked changes in pregnancy.

It has been found that in infants born with the brain undeveloped, the cortex suprarenalis is also defective.

Addison's Disease.—Addison described in man a condition of great muscular weakness and emaciation with a curious bronzing of the skin which ends fatally, and he was able to associate this with destructive lesions of the suprarenals. The evidence at present forthcoming as to whether this condition is due to an implication of the inter-renal tissue of the cortex is inferential

and is based upon Biedl's experiments upon fish (p. 610), and Vincent's experiments on mammals (p. 591).

The Interaction of the Endocrinetes.

The endocrinetes, with their internal secretions, exercise a *balanced influence* on the metabolism.

This is very clearly shown by the reciprocal action on the mobilisation of sugar of the chromaffin tissue and thyreoid on the one hand, and of the pancreas on the other, the two former stimulating it, the latter checking it.

There is also evidence that they act upon one another. Thus, while thyreoidectomy has not been shown to have any influence upon the adrenalin content of the chromaffin tissue, feeding with thyreoid does increase it. The true pituitary and the thyreoid exercise an influence on the growth and on the functional activity of the gonads, and they in turn are acted upon by the gonads.

In some cases these structures seem to supplement one another. The thymus, testis, and anterior lobe of the pituitary all seem to combine in maintaining growth in the young.

Mode of Action of Internal Secretions.

The study of the action of these internal secretions involves the question of how far they act independently of or through the nervous system. The evidence that adrenalin acts through the nerve structures appears to be conclusive, and in all probability the products of the hypophysis, the thyreoid, and the pancreas act in the same way. On the other hand, in dominating the growth and development of the body in early life, it is very possible that the thymus and gonads, possibly the thyreoid and pituitary, act directly upon the tissues. If this be so, the internal secretions may act (1) as *primary chemical regulators* and (2) as *neuro-chemical regulators*.

The influence of the various factors dominating metabolism, growth, and development, might be represented in fig. 232, where the influence of hereditary inertia is shown as dominant in embryonic life; where the influence of the nervous system

is shown as gradually increasing in importance; where the primary chemical regulators are indicated as playing an important part towards the end of foetal and the beginning of extra-uterine life; and where the part played by the neuro-



FIG. 232.—To show the Relative Parts played during Embryonic and Post-embryonic Life in the Regulation of Metabolism by (a) hereditary inertia, (b) the primary chemical regulators, (c) the nervous system, and (d) the neuro-chemical regulators.

chemical regulators is shown as advancing with the increased importance of the nervous system.

Modifications of Metabolism for Protection against Toxic Agents.

The study of the production and modes of action of these internal secretions leads to the consideration of the protection of the organism against the action of various poisons of animal or bacterial origin.

This will be dealt with very briefly, since it must be studied fully in connection with Pathology.

The question may be most simply approached by considering first the probable mode of action of the toxin or poison of snake venom and of that produced by the diphtheria bacillus, and the way in which protection against these is established by the development of *antitoxins*.

1. Snake Venom and Diphtheria Toxin.—By injecting, under the skin of the horse, increasing doses of such toxins the animal is made quite resistant to the poison. A certain quantity of its serum can then neutralise a definite quantity of the toxin, so that, when the mixture of serum and toxin is injected into another animal, the latter is uninjured. Something has been

formed in the horse which seizes on the molecules of the toxin and makes them harmless, just as when soda is added to sulphuric acid a neutral salt is formed.

The two molecules have a definite chemical affinity for one another, so that the toxin or *antigen* is no longer free to seize upon the protoplasm of the animal's body. To explain this, Ehrlich has suggested that the protoplasm molecule (fig. 233) is made up of a central core with a number of side-chains or *receptors*, which play an important part in taking up nourishment of different kinds, special receptors being developed for each kind of material. He supposes that some of these side-chains fit the toxin molecule, and are thus capable of anchoring it to the cell and allowing it to exercise its toxic action. The production of antitoxin he explains by supposing that, as these side-chains get linked to the toxin and are thus, as it were, thrown out of action, others are produced to take their place, since they are necessary for the nourishment of the protoplasm. If the toxin is continually administered in small doses this production of side-chains may be so increased that they get thrown off into the blood, and in it they are capable of linking to the toxin and so preventing it from fixing itself to the cells. If, therefore, some of the blood be injected into an animal which afterwards receives a dose of the toxin, that toxin will not act, and the animal will be immune.

2. *Enteric Toxin*.—But immunity may also be established not merely against toxins separate from organisms, but against organisms which hold their toxin, as in the case of the bacillus of enteric fever. Here, repeated injections of increasing doses of the dead bacilli cause the production of a serum which has the power of destroying the organism when added to it even outside the body. This is not a simple combination; because, if the serum be heated to 55° C., it loses its power, but, if a few drops of the fresh serum even of an unimmunised animal be added, the power is restored. Obviously the anti-body which destroys the organism—the *bactericidal* or *bacteriolytic body*, often called the *amboceptor*—requires the co-operation of another body to enable it to act, and this body has been called the *complement* or *alexine*. This is readily destroyed at a comparatively low temperature. Ehrlich supposes that the immune body does link to the protoplasm of the organism, but that it must, in its turn, be linked

PART IV.

THE ANIMAL AS PART OF THE SPECIES.

A. REPRODUCTION.

So far the animal has been studied simply as an individual. But it has also to be regarded as part of a species, as an entity which has not only to lead its own life, but to transmit that life to offspring from generation to generation and thus to secure the survival of the species.

When a unicellular organism reaches such a size that the proportion of mass to surface begins to interfere with nutrition, the metabolism undergoes alterations which lead to the division of the cell (p. 28).

In certain cases conjugation between two cells may occur and this appears to precipitate the process of division.

In multicellular organisms the gametic cell or cells early throw off the somal cell or cells from which all the tissues of the body are developed. In *Ascaris* this occurs at the very first division.

The purpose of somal development, of the development of the body as a whole in all its marvellous complexity, is simply for the nutrition and protection of the gametic cells. These latter are eternal, going on from one generation to another and in each building up a body. The body is mortal, perishing with the death of the individual.

In all higher forms of animals conjugation of two gametic cells precedes division and development. In many invertebrates this is not always necessary and reproduction without conjugation—*parthenogenesis*—may occur.

In vertebrates and in a large number of invertebrates two sets of gametes are formed—one the *ovum* which is generally

large and which manifestly undergoes division, multiplication, and development to form the new individual, and one the sperm or *spermatozoon*, which is generally smaller and which conjugates with the former.

In vertebrates these are produced in separate individuals of the species which have the distinctive anatomical and physiological characters of the *female* and *male*.

The dependence upon the gonads of the development of these distinctive characters has been considered on p. 606 *et seq.*

I. Determination of Sex.

The problem of what determines in any ovum its development either into ova associated with the female type of body or into spermatozoa associated with the male type is a most difficult one. A consideration of importance is that, under normal conditions of sexual reproduction, the number of males and of females produced is approximately equal.

(1) In some animals the sex is determined before the ovum is impregnated. Among vertebrates this seems to be the case in birds. A hen with barred pattern of feathers transmits this character to male chicks only, unless the father is also barred. Hence it seems clear that there must be two kinds of ova—one to produce males and one to produce females.

(2) In other animals, and almost certainly in mammals, the sex seems probably to be determined by there being two types of spermatozoa. It is probable that certain special chromosomes, often called the X chromosomes, are the determining factors. When two of these are present, a female develops, when one is present, a male; and the gametic cells developed in each sex will be characterised by the possession of these numbers. When these cells undergo their reduction division (pp. 619 and 620), before forming ova and spermatozoa, each female cell is left with one X chromosome, while half the male cells contain an X chromosome and half do not contain one. When one of the former impregnates an ovum, that ovum has two X chromosomes and develops into a female; when one of the latter performs the impregnation, the ovum has only one X chromosome and develops into a male.

The existence of these two kinds of spermatozoa and the

fact that only those ova which have the paternal X chromosome will develop into females explains the transmission of certain paternal characters through the daughters. In the human subject this is seen in colour blindness and in hæmophilia, a disease characterised by excessive bleeding from slight wounds. These conditions are common in the male but very rare in the female. But since the female gamete alone contains the paternal chromosome, the abnormal conditions can pass only through the females to become manifest in the male progeny.

Such observations suggest that the determination of sex may be co-related with the Mendelian hypothesis.

(3) In some animals, *e.g.* the frog, the nutritional condition of the ovum may determine its sex. By varying the condition of the eggs before fertilisation the proportion of males to females may be modified.

It would appear that in some animals the course of development of the gamete is firmly established from the first, that in others it may be determined by the X chromosome in impregnation, while in a third group it may be modified by the nutrition of the cell either before impregnation or at the time of impregnation. How far this last factor acts in the case of mammals we do not at present know.

There is some evidence in invertebrates that the number of X chromosomes in a cell may be reduced under certain conditions, and thus a potential female cell changed into a male cell.

The problems of **Heredity** are fully dealt with in all text-books of **Biology**, and therefore they need not be considered here.

II. The Gonads.

(The structure of the organs of reproduction must be studied practically.)

The development of the true gametic cells of the gonads and of their ancillary cells has been already considered on p. 605.

While the individual is actively growing, the reproductive organs are quiescent; but, when *puberty* is reached, they begin to perform their functions—the testes to produce **spermatozoa**,

the ovaries to produce ova, and, as they become functionally active, the secondary sexual characters develop (p. 606).

A. Ovary.—The ovaries are oval structures lying in a fold of peritoneum—the broad ligament. The cells covering the genital ridge grow downwards as the oögonia. These become disposed (1) as a *covering layer* of columnar cells; (2) as *interstitial cells* (p. 608); (3) as clumps of cells forming the *Graafian follicles*. The central cell of each of these undergoes further growth, becomes larger than the surrounding cells and forms the *primary oöcyte*. This cell throws out the first polar body and becomes a *secondary oöcyte*. A second polar body is

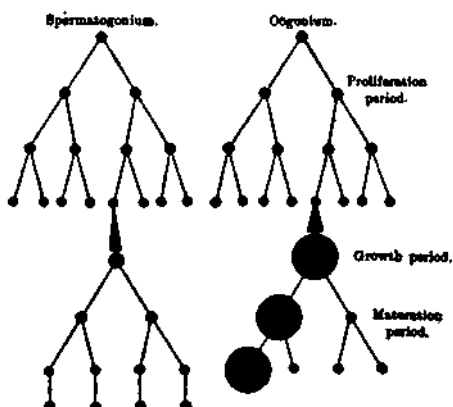

FIG. 235.—Scheme of Spermatogenesis and Oögenesis.

then thrown out, and half the chromosomes are thus eliminated and the mature ovum is formed (fig. 235). This becomes surrounded by a capsule, the *zona pellucida*. The surrounding cells forming the *zona granulosa* multiply, and a fluid, the *liquor folliculi*, appears among them, dividing them into a set attached to the capsule of the follicle and a set surrounding the ovum. When the follicle is ripe, it projects on the surface of the ovary, and finally bursts, setting free the ovum, which escapes into the peritoneal cavity and passes into the trumpet-shaped fimbriated upper end of the *Fallopian tube* through which it reaches the uterus. The ruptured Graafian follicle generally becomes filled with blood, and later with the

proliferated cells of the *zona granulosa* and forms the *corpus luteum*. If the ovum is fertilised and pregnancy occurs the corpus luteum goes on growing, attains a considerable size, and plays an important part in the course of gestation (p. 608).

B. Testis.—The testis is enclosed in a dense fibrous capsule—the *tunica albuginea*. Posteriorly this is thickened, and forms the *corpus Highmori*. Processes extend from this

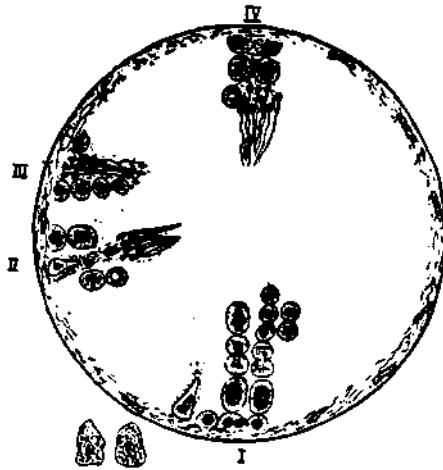

FIG. 236.—I, To show this development of spermatozoa from spermatogonia; II and III, heads of spermatozoa dipping into cells of Sertoli; IV, mature spermatozoa. Two interstitial cells shown below. (Morr.)

and form a supporting framework. In the spaces are situated the *seminiferous tubules*, which open into irregular spaces in the corpus Highmori—the *rete testis*. From these the efferent ducts, *vasa efferentia*, pass away and join together to form the *vas deferens*, which, after receiving the duct from a diverticulum of the *seminal vesicle*, opens into the urethra.

In the seminiferous tubules, the spermatozoa are produced. Some of the lining cells divide into two, forming a *supporting cell* next the membrane and a *spermatogonium*. The latter divides and subdivides till a group of cells, the *primary spermatocytes*, are formed. Each of these undergoes a division, in which the number of chromosomes in each cell formed is

reduced to one half, and thus *secondary spermatocytes* are produced. These again divide to form the *spermatids* (fig. 235). In each spermatid the nucleus elongates and passes to the attached extremity, the protoplasm decreases in amount, and a long cilium develops from the free end, and the *spermatozoon* is thus produced. As they develop they seem to bore into the cells of Sertoli (fig. 236), the lipoids of which probably act as nutrient material.

The interstitial cells of Leydig have been already described (p. 606). They are very rich in phospholipina.

III. The Secondary Sexual Organs.

A. In the Male.

1. **The Prostate** consists of a dense framework of fibrous tissue with visceral muscular fibres enclosing dense branching glands which secrete a fluid which undergoes coagulation. In some animals, *e.g.* the guinea-pig, it is ejaculated after the rest of the seminal emission and forms a plug in the vagina.

Semen.—When the testes have become active, the glands of the prostate increase and produce a fluid which, with the spermatozoa, forms the semen.

2. **The Penis.**—This consists of erectile tissue—a dense fibrous tissue filled with irregular blood spaces, into which arteries open. The penis of the bull is pointed, while that of the ram terminates in a filiform process. In these animals the semen is passed into the mouth of the uterus.

B. In the Female.

1. **The Fallopian Tubes.**—A tube, with a trumpet-like fimbriated upper end, lying close to the ovary on each side, leads to the uterus. It is lined by a mucous membrane raised into complex ridges and covered by a ciliated epithelium.

2. **The Uterus** is a hollow organ with a wall composed of visceral muscle fibres. In the sheep and cow and bitch it consists of two distinct cornua—in the mare of a central part. It is lined by a mucous membrane, which is covered by a ciliated epithelium, and in which are tubular glands that extend down

to the muscular coat. The nature of their secretion requires investigation. The nerve supply is considered on p. 633.

IV. The Œstrous Cycle.

The female of all species of mammals, and the male of some, pass through a cycle of sexual activity and sexual rest. This has been called the *œstrous cycle*.

In the *anœstrum* the ovaries, uterus, and other sexual organs are quiescent, and their blood-vessels more or less contracted. In the *proœstrum* one or more ova ripen, the blood-vessels dilate, hæmorrhages occur into the mucous membrane of the uterus, and blood may escape by the vagina. In the *œstrum* these conditions reach their maximum, and in the lower animals coitus is allowed.

In the mare, cow, pig, and sheep the *œstrum* may recur at short intervals at some special season of the year, while in carnivora, *e.g.* the dog, it occurs only once at a given sexual season.

In the mare the usual sexual season is early summer. Each *œstrum* may last 4 or 5 days.

In the cow the season varies, and in it *œstrum* may recur at intervals of about 20 days.

In the sheep the season is in autumn, and *œstrum* may recur repeatedly at intervals of about 12 days, lasting each time for only about a day or less.

In the sow *œstrum* may recur at intervals of about 20 days, and the whole cycle is generally repeated twice a year.

In the bitch an *œstrum* cycle recurs generally twice a year. *Œstrum* usually lasts for about a week. Even if not impregnated, the ovary, uterus, and mammary gland show the same changes as occur in pregnancy and which may be secreted.

In the *postœstrum* the organs return to their normal condition, and the corpus luteum or corpora lutea grow in the ovaries.

In some animals, *e.g.* the rabbit, rupture of the follicle occurs only if copulation takes place. If this does not occur the follicle atrophies.

V. Impregnation.

Impregnation is effected by the transmission of spermatozoa into the genital tract of the female. For this purpose erection of the penis is brought about reflexly through a centre in the

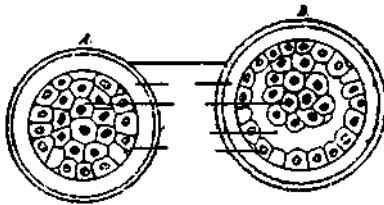

FIG. 237.—Ovum, after Segmentation, showing the Formation of the Ectoderm (A.) and Endoderm (B.). From the cells of the latter the Blastoderm is formed. (ELLEMBERGER.)

lumbar enlargement of the cord, the outgoing nerves being the nervi erigentes, or pelvic nerves which dilate the arterioles, and the internal pudics supplying the transversus perinei and bulbocavernosus muscles by which the veins of the penis are constricted.

The semen is ejected by a rhythmic contraction of the bulbo-

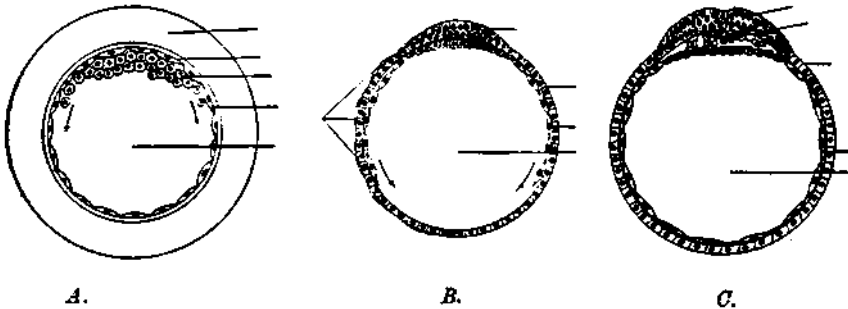

FIG. 238.—To show A., the Spreading out of the Endoderm Cells to Form the Blastoderm; B., the Formation of Epiblast and Hypoblast; and C., of Mesoblast. In B. and C. the ectoderm is not shown. (ELLEMBERGER.)

cavernosus and other perineal muscles, an action which is also presided over by a centre in the lumbar region of the cord (p. 89).

The spermatozoon meets the ovum in the Fallopian tube or upper part of the uterus.

B. DEVELOPMENT.

I. Early Stages.

As the ovum passes down the Fallopian tube it is surrounded by cells of the zona granulosa, and these probably serve as a source of nourishment and may prevent the ovum from becoming attached till it reaches the uterus and absorption of the cells is completed. Sometimes implantation occurs in the tube and a tubal pregnancy may ensue.

It is unnecessary here to describe the changes in the ovum before or immediately after its conjugation with the spermato-

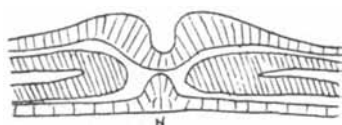

FIG. 239.—Transverse Section of more advanced Blastoderm, to show Epiblast, Mesoblast, and Hypoblast, formation of Neural Groove and splitting of the Mesoblast.

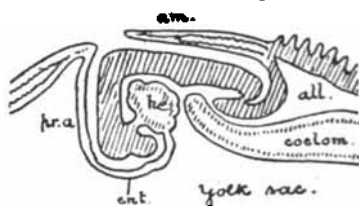

FIG. 240.—Longitudinal Section through Embryo to show it Sinking Down into Ovum and the Formation of the Amnion, *am.* In the Mesoblast round, *all.*, the allantois, the blood-vessels grow out to form the placenta.

zoon, since they are so fully dealt with in all works on Biology (p. 29).

The mammalian ovum is holoblastic, that is, undergoes complete segmentation, and forms a mulberry-like mass of cells (fig. 237, *A.*). The cells then get disposed in two sets, a layer of small surrounding cells and a set of large central cells (fig. 237, *B.*). The former constitute the Ectoderm and take part in forming the processes or *primitive villi* by which the ovum becomes attached to the maternal mucous membrane. The latter spread out at one pole to form the *blastoderm* (fig. 238, *A.*) and dispose themselves in three layers—the *epiblast*, *mesoblast*, and *hypoblast* (fig. 238, *B.* and *C.*). From these layers the various parts of the body are derived as follows:—

I. *Epiblast*.—Nervous system; epidermis and appendages; epithelium of the mouth, nose, naso-pharynx, and all cavities and glands opening into them, and the enamel of teeth.

II. *Hypoblast*.—Epithelia of (a) the alimentary canal from the back of the mouth to the anus and of all its glands; (b) of the Eustachian tube and tympanum; (c) of the trachea and lungs; (d) of the thyroid and thymus; and (e) of the urinary bladder and urethra.

III. *Mesoblast*.—All other structures.

By the formation of a vertical groove down the back of the blastoderm, a tube of epiblast cells (the *neural canal*) is enclosed, from which the nervous system develops by the conversion of

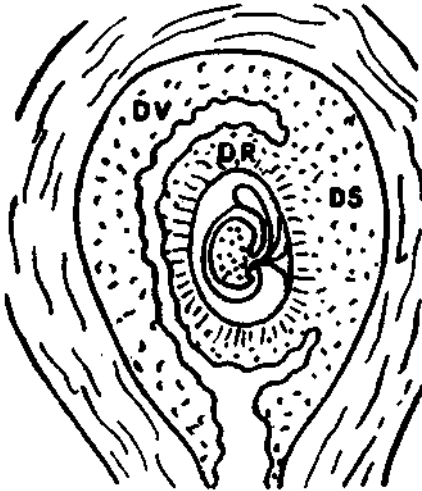

FIG. 241.—Longitudinal Section through the Human Uterus and Ovum at the Fifth Week of Pregnancy. *D.S.*, decidua serotina, which will become the placenta; *D.R.*, decidua reflexa; *D.V.*, the uterine mucous membrane called the decidua vera.

some of the cells into neurons, and others into neuroglia cells (fig. 239).

The mesoblast on each side of this splits, and the outer part, with the epiblast, goes to form the body-wall (*Somatopleur*), while the inner part with the hypoblast gets tucked in to produce the alimentary canal (*Splanchnopleur*) (fig. 239).

The developing embryo sinks into the blastocyst, and, as a result of this, the somatopleur folds over it and, uniting above, encloses it in a sac—the *amniotic sac* (fig. 240, *am.*), which becomes distended with fluid—the *amniotic fluid*, in which the embryo

floats during the latter stages of its development, and which acts as a most efficient protection against external violence. The source of this fluid has been much debated. In birds it is certainly of foetal origin. In mammals it has been contended that it is derived from the maternal circulation. But, since in herbivora it resembles urine more than a blood transudate and since the urethra of the foetus opens into the amniotic sac, it is probably chiefly derived from the foetal kidneys. In rabbits, when the foetus is killed *in utero*, no fluid is formed in the sac, although the maternal part of the placenta persists.

A very significant fact is that in herbivora it contains a sugar, lævulose, which is present in the foetal blood but not in the maternal blood.

II. Attachment to the Mother.

(1) By the action of its ectoderm cells the ovum burrows its way into the mucous membrane of the uterus which is hypertrophied and very vascular. These ectoderm cells grow outwards as syncytial masses of protoplasm forming the *trophoblast* layer. The burrowing action may be due to the development of some powerful proteolytic enzyme, although definite proof of its existence is not forthcoming.

Certainly, in some way the maternal tissues are killed and digested. When a maternal blood-vessel is opened into, the blood is hæmolyzed, thus probably rendering the iron of the hæmoglobin available for absorption by the embryo.

At this stage of development the embryo is a *parasite* upon the mother living upon her substance.

The important part played by the corpus luteum in determining the implantation of the ovum has been discussed on p. 608.

(2) Later, the mesoblast of the embryo extends out in a number of finger-like processes into the trophoblast layer, and soon afterwards blood-vessels shoot into these, and the *chorionic villi* are formed. These are at first covered by a definite layer of cubical cells, the layer of Langhans with outside it a syncytial trophoblast layer of protoplasm. Later the layer of Langhans disappears and the syncytium becomes extremely thin (fig. 242).

The origin of the first blood-vessels in the villi is not known, but ultimately they are derived from the **allantoic arteries** which pass out from near the posterior end of the hind gut.

As the villi grow, the blood-vessels of the maternal mucosa in the decidua serotina (fig. 241, *D.S.*) dilate, and the capillaries form large sinuses or blood spaces. Into these the chorionic villi pass, and thus the loops of foetal vessels hang free in the maternal blood, and an exchange of material is possible between the mother and foetus.

The distribution of these villi is different in different animals. In the horse they are diffusely scattered; in the cow and sheep they are arranged in circular patches, the cotyledons; in carnivora they are generally in a zone.

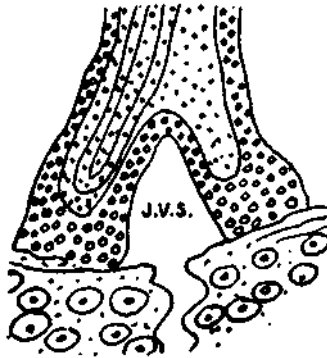

FIG. 242.—Longitudinal Section through the Tip of a Villus of the Placenta, covered by its trophoblast layer, and containing a loop of blood-vessels, and projecting into a large blood sinus, *J.V.S.*, in the maternal mucosa.

In the pig, horse, and in ruminants, the connection of the foetal blood-vessels with the maternal structures is not very intimate, and when the young are born the foetal part of the placenta separates from the maternal part, which is thus not shed. Hence such animals are called non-deciduata.

In rodents, insectivora, apes, man, and carnivora, the association is so intimate that at birth the maternal part of the placenta is shed along with the foetal. Hence these are called deciduata.

In the mesoblast, through which the allantoic arteries pass

out, a vesicle, filled with fluid, and at first communicating with the posterior gut, is developed (fig. 240, *all.*). This is the allantois. In man it never attains any size, but in most of the

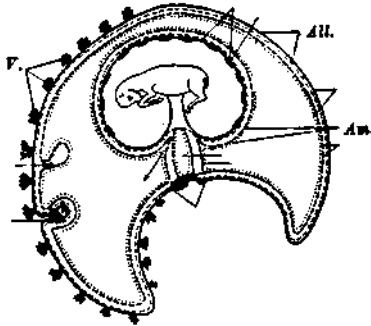

FIG. 243.—Schematic section through the pregnant uterus of the Mare to show the large allantoic sac, *All.*, filled with fluid surrounding the amniotic sac; *Am.*, the fluid in which the fetus floats.

lower animals it spreads all around and encloses the amnion, and is distended with a large quantity of fluid. This fluid has all the characters of urine, and when fluorescein is injected into

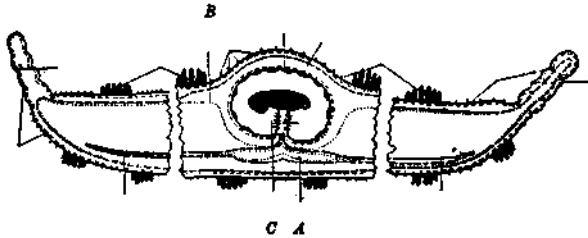

FIG. 244.—Schematic section of one cornu of the uterus of a ruminant at an early stage of gestation to show the elongated umbilical vesicle, *A*, and allantois, *B*, and the embryo in the amniotic sac, *C*.

the maternal circulation, it appears in the fetus before it shows in the allantoic fluid. It is almost certainly produced from the first by the foetal kidney.

III. The Nourishment of the Fœtus.

The **Placenta** is formed on the foetal side by these processes; on the maternal side by the increased growth and increased vascularity of the maternal mucosa.

In the deep layer of the mucosa under the placenta the connective tissue cells enlarge and form a thick mass of *decidual cells*. Possibly these are protective, preventing the enzymes or other products of foetal metabolism from invading the mother.

A new stage in the physiological relationship of the foetus to the mother is now established. It is no longer a parasite but rather a *guest* which shares with the mother the supply of nourishment in the maternal food. The placenta becomes (1) the foetal lung, giving the embryo the necessary oxygen and getting rid of the waste carbon dioxide. (2) The foetal alimentary canal supplying the necessary material for growth and development; and (3) the foetal kidney through which the waste nitrogenous constituents are thrown off.

When this stage of gestation is reached, it is generally found that the maternal body shows the same increased power of storing the constituents of the food as is seen during the period of growth. The pregnant animal stores material like the growing young, generally taking just what is required to satisfy the normal growth of the foetus, but frequently retaining more and storing it in its body. Hence the practice of having cows rendered pregnant in feeding them for market.

Carbohydrates are early stored as glycogen in the cells of the maternal placenta, and, since no glycogen is found in the foetus till much later, it must be taken up by the chorionic villi as sugar. Whether the diastase for this conversion is formed by the mother or by the foetus is not known.

Fats appear earlier in the chorionic villi than in the maternal placenta, and there is no evidence that fats stained with Sudan III are passed to the foetus. Probably the foetal fats are formed from carbohydrates.

Iron also appears earlier in the foetal placenta than in the maternal, and it is probably taken up from the hæmolyseid maternal blood (p. 626).

As regards the passage of proteins nothing is known with any certainty. It may be that the proteins of the maternal blood are passed to the foetus unchanged. Since amino-acids are found in the foetal blood it has been argued that the proteins may be digested to this condition before passing to the foetus. But it must be recognised that possibly these

amino-acids are the results of the protein metabolism of the foetus.

Chemical examination of the allantoic fluid of ungulates, which is foetal urine (p. 626), shows, in the early stage of development, a high proportion of nitrogen in amino-acids, peptides and allantoin. This seems to indicate a less complete catabolism of protein and a more active nuclear metabolism than in extra-uterine life.

The placenta manifests little power of regulating the materials which are passed to the foetus, and most drugs and toxic substances reach it. Even the micro-organisms which are the cause of various diseases may pass through the placenta. In this respect it seems to differ from the cells of the choroid plexus, which manifest a selective action on the materials which it passes to the cerebro-spinal fluid (p. 511).

IV. Growth of the Foetus.

The growth of the foetus is steady and slow, and the daily demands on the mother are comparatively small. At birth the human foetus is less than 8 per cent. of the weight of the mother, while in some animals, *e.g.* the dog, the litter may weigh 20 or 25 per cent. of the maternal weight.

Considering the fact that the power of fixing material in the body is increased during pregnancy, the amount of the food consumed which has to be transmitted to the foetus is comparatively trivial.

Only in the later period of intra-uterine life is the demand for proteins, and, more especially, for fats in any way considerable.

It may thus be said that under all conditions of normal nutrition it is the surplus of nourishment which is passed from the mother to the foetus, and, if in the later months of pregnancy her nourishment is limited, the size of the young may be reduced.

The maternal tissues part more readily with some substances than with others. Thus the demands of the foetus for calcium, when the supply to the mother is inadequate, may be met by removal of calcium from her bones, which may thus be softened. On the other hand, the maternal tissues do not become depleted of iron in the same way to meet the requirements of the young.

V. Metabolism in Pregnancy.

During pregnancy the increase in the metabolism is proportionate to the increase in the weight of the mother. This increase is due not only to the growth of the foetus, but also to the growth of the uterus and mammary glands and to the formation of the amniotic and allantoic fluids which are inert. Hence probably the metabolism of the foetal tissues is more active than that of the maternal. Experiments upon guinea-pigs support this conclusion.

It has been found by means of the respiratory calorimeter (p. 259) that the total metabolism of the mother just before delivery is practically the same as that of the mother and young after delivery.

VI. The Young Animal at Birth.

At birth the young animal is suddenly precipitated from its prolonged bath in the warm amniotic fluid where its temperature has been maintained, and where it has received a steady supply of oxygen and of food without any exertion on its part into the chill air of the outer world where it has to secure its oxygen by the efforts of breathing, to get its food by sucking and digesting and to maintain its temperature by its own metabolism. No wonder that this sudden change proves too much for the less robust, and that the mortality during the first week of life is high. The power of heat regulation is not at once developed, and the young animal at first tends to react to the temperature of its surroundings in the manner of a cold-blooded animal. In a day or two its power of adaptation improves and the rate of its chemical changes increases so that from this time onwards throughout the period of active growth they are in excess of those of the adult (p. 266).

VII. Foetal Circulation.

The performance of its functions by the placenta is associated with a course of circulation of the blood somewhat different to that in the post-natal state (fig. 245).

The blood coming from the placenta to the foetus is collected into a single umbilical vein, *u.v.*, which passes to the liver, *l.* This divides into the ductus venosus, *d.v.*, passing straight

through the organ, and into a series of capillaries among the cells. From these the blood flows away in the hepatic vein to the inferior vena cava, *p.v.c.*, and mixed blood passes to the right auricle. In this it is directed by a fold of endocardium,

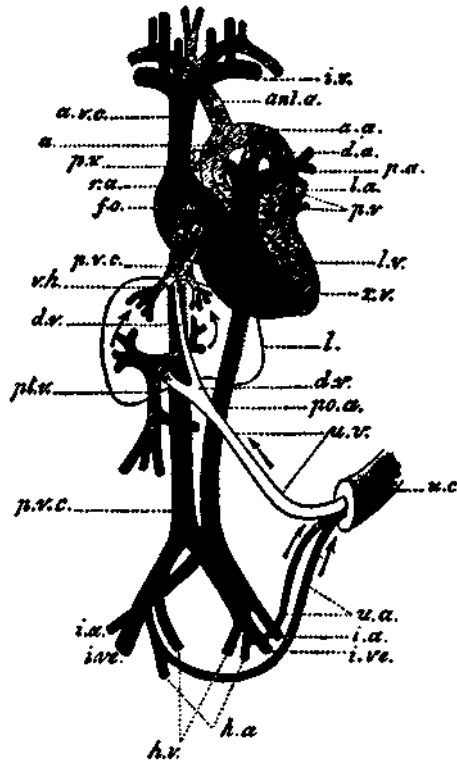

FIG. 245.—Scheme of Circulation in the Fœtus, *u.v.*, umbilical vein; *d.v.*, ductus venosus; *p.v.c.*, inferior vena cava pouring blood through the right auricle and through the foramen ovale, *f.o.*, into the left heart; *a.v.c.*, superior vena cava bringing blood from the head to pass through the right side of the heart, and through the ductus arteriosus, *d.a.*; *p.t.v.*, portal vein. The degree of impurity of the blood is indicated by the depth of shading.

through the foramen ovale, *f.o.*, a hole in the septum between the auricles, and it thus passes to the left auricle, and thence to the left ventricle, *l.v.*, which drives it into the aorta, *a.a.*, and chiefly up to the head, *ant.a.* From the head the blood returns to the superior vena cava, *a.v.c.*, and, passing through the right

auricle, enters the right ventricle, *r.v.*, which drives it into the pulmonary artery, *p.a.* Before birth this artery opens into the aorta by the *ductus arteriosus*, *d.a.*, while the branches to the lungs are still very small and unexpanded. In the aorta, this impure blood from the head mixes with the purer blood from the left ventricle, and the mixture is sent to the lower part of the body through the descending aorta, *p.o.a.* From each iliac artery, *i.a.*, an umbilical artery, *u.a.*, passes off, and these two vessels carry the blood in the umbilical cord, *u.c.*, to the placenta.

When the animal is born, the flow of blood between it and the mother is arrested. As a result of this, the respiratory centre is no longer supplied with pure blood, and is stimulated to action. The lungs are thus expanded and the blood flows through them. In the *ductus venosus* a clot forms and the vessel becomes obliterated. The *ductus arteriosus* also closes up, and the *foramen ovale* is occluded. The circulation now takes the normal course in post-natal life.

VIII. Gestation and Delivery.

The length of gestation is different in different animals—

Mare	11 months (330 to 340 days)
Cow	9 " (270 to 290 ")
Sheep	5 " (145 to 155 ")
Sow	4 " (115 to 120 ")
Dog	62 days
Cat	63 "

At the end of this period labour occurs, and the foetus and its membranes are expelled.

The mechanics of labour must be studied with obstetrics.

Nervous Control.—The uterus is supplied by fibres leaving the spinal cord by true sympathetic fibres from the splanchnics. These fibres pass to the inferior mesenteric ganglion and on in the hypogastric nerves to end in two large plexuses or ganglia, containing numerous nerve cells, one on each side of the cervix. From these, fibres pass to the uterus and to the vagina.

There is evidence that, in lower animals at least, the contents of the uterus may be expelled after complete separa-

tion of the organ from the central nervous system. The peripheral mechanism, like that of the intestine and bladder, is capable of independent action. But normally a centre in the lumbar enlargement of the spinal cord appears to be excited reflexly. This centre is further acted upon by the brain, and various disturbances, accompanied by emotional changes, may, for a time, arrest uterine contraction.

IX. Lactation.

1. **The Mammary Gland.**—The mammary glands consist essentially of a collection of specially developed sebaceous glands, the function of which has been modified to yield a nutritive secretion for the young. In some of the lower mammals (Monotremes) the secretion is provided by the enlarged skin glands which open direct on to the surface of the abdominal wall, and the young are nourished by licking the wall where aggregations of these occur. In the higher mammals the glands are more highly developed and more definitely collected into groups forming the mammary glands, with sinuses to act as reservoirs for the secreted fluid, and a teat for convenience of the young in sucking.

The number of glands present is roughly in proportion to the usual number of young born at a time. The mare, the sheep, and the goat have two glands. The pig has ten to fourteen, the dog eight to twelve. The udder of the cow is usually spoken of as having four "quarters." A fibrous septum in the median line divides the udder into two halves. There is no dividing line between the two quarters of the same side, though the sinuses of the same side do not communicate.

2. **Physiology—(1) Development.**—Rudimentary glands are present in both male and female animals. In the male, normally they remain undeveloped. In the female, as sexual maturity is reached, the gland increases in size, the increase consisting chiefly of fibrous tissue with a large amount of fat. In pregnancy, proliferation of the glandular tissue occurs. The tubules, which were solid blocks of cells, grow outward and alveoli develop. As the cells of the tubules and the alveoli divide, some remain attached to the

basement membrane, and some come to lie in the lumen of the tubules and the cavities of the alveoli. These latter undergo fatty degeneration and are shed with the first milk—colostrum. It is the cells left on the basement of the membrane of the alveoli that elaborate the constituents of the milk.

(2) **Regulation of Activity**—(a) **Chemical Stimulation**.—This subject is dealt with on page 609. (b) **Nerve Stimulation**.—The extent to which the secretion of milk is influenced by the nervous system has not been determined with certainty. After secretion of all the nerves passing to the gland, if the animal be lactating, secretion continues, though the amount may be diminished; if the animal be pregnant, glandular development proceeds, and at parturition normal secretion of milk occurs. On the other hand, pain or excitement reduces the quantity of milk. Whatever influence the nervous system does exert is probably produced through vasomotor nerves and intrinsic nerves of the gland. On the whole, it seems certain that control through the nerves is subsidiary to chemical control through the blood.

The flow of the milk can be influenced by the central nervous system. The walls of the ducts contain muscle fibres which can act by constricting the lumen and stopping the flow. In this way the cow is able to "hold up" its milk, as often occurs when milking is attempted by a person to whom the animal is unaccustomed, or when a cow that has been sucked by its calf is milked by hand. (c) **Mechanical Stimulation**.—The distension of the ducts with milk inhibits further secretion. The periodical emptying of the udder, therefore, by sucking or milking is necessary to maintain functional activity. The influence of the sucking is not entirely due to the relief of the distension. The mechanical stimulation probably induces secretion through a nervous reflex, as by this means a flow of milk may be produced in a virgin animal (p. 609).

3. **Composition of Milk**—(1) **Adaptation for Needs of Young Animal**.—Milk is produced to supply material and energy to a rapidly growing animal. The materials present, therefore, are in proportion to the requirements for growth. It

has already been shown (p. 372) that the percentage of proteins present varies with the rate of formation of new tissue. The relationship between the salts of the milk and those contained in the tissues of the growing animal is shown by the following table given by Bunge. The percentage composition of the chief inorganic constituents of the tissues of a young rabbit, of the milk it was receiving, and of the serum of the mother's blood are compared:—

	Rabbit 14 days old.	Rabbit's Milk.	Mother's Blood Serum.
Potash	10·8	10·1	3·2
Soda	6·0	7·9	54·7
Lime	35·0	35·7	1·4
Magnesia	2·2	2·2	0·6
Iron Oxide	0·23	0·08	0·
Phosphoric Acid . .	41·9	39·9	3·0
Chlorine	4·9	5·4	47·8

This close adaptation of the composition of the milk to the needs of growth affords an explanation for the difference in percentage composition of the milk of different species. It also accounts for the well-recognised fact that, after weaning, especially if this takes place too early, the rate of gain of weight per day suffers a marked decrease, since, in practice, no combination of food-stuffs can yield the perfect proportion of the necessary materials which is present in milk.

(2) **Constituents**—(i.) **Protein**.—The chief protein of milk is casein, a phospho-protein. It exists in milk in the form of a calcium salt. Casein contains all the amino-acids, except one, necessary for building up the various proteins of the young animal. The one absent—glycine—can be easily formed in the body from other amino-acids. The other proteins present are an albumin and a globulin, which closely resemble those found in the blood.

(ii.) **Fat**.—Milk fat consists of olein, palmitin, and stearin to the extent of nearly 90 per cent. The remaining 10 per cent. consists of fats of lower molecular weight. It is the latter that gives the characteristic flavour to butter. Lecithin and cholesterin are also present. The phospho-

lipins of the milk are much more abundant than those in the blood serum.

The fat occurs in the form of minute globules. Coalescence is prevented by the surface tension of the spheres, and by the adsorption of protein on the surface. It cannot be separated from milk by ether till the globules are broken down by an acid or an alkali.

The specific gravity of the fat is .93, while that of the milk free from fat is about 1.035. The globules of fat, therefore, tend to rise to the surface to form cream. The mechanical agitation in churning causes the globules to coalesce with the formation of butter.

(iii.) **Carbohydrates.**—The carbohydrate of the milk is lactose (p. 286). It only occurs in milk.

(4) **Ash.**—The ash of milk contains the same inorganic substances as are found in the tissues (p. 636). The substance present in greatest amounts are calcium and phosphorus. Iron is present only in traces.

3. The proportion in which constituents are present in the milk of some species is shown in the following table:—

(3) Percentage Composition.					
	Cow.	Goat.	Mare.	Sow.	Bitch.
Water . . .	86.3	85.7	91.6	84.0	75
Protein . . .	3.0	4.3	1.0	7.3	10
Fats . . .	3.5	4.8	1.3	4.5	11
Carbohydrates	4.5	4.4	5.7	3.1	3
Ash . . .	0.7	0.8	0.4	1.1	1

The cells of the mammary gland transfer to the milk many substances administered with the food, hence the taste of the milk may be altered and certain drugs given by mouth may appear in the milk.

(4) **Colostrum.**—The fluid drawn from the gland for the first two or three days after parturition differs from true milk. It is characterised by—

- (1) A large proportion of solids—25 to 30 per cent.
- (2) A high percentage of albumin and globulin.
- (3) The presence of multinuclear bodies, probably leucocytes and desquamated glandular cells.

The percentage of fat and carbohydrates are not markedly different from those of milk.

Colostrum is valuable to the newly born animal. Its food value is high, and it stimulates evacuation of the bowels.

(5) **Factors affecting Milk Production in Cows**—(1) **Breed**.—The amount and composition of the milk produced is partly dependent upon the breed of cows. Thus the milk of the Jersey is especially rich in fat, frequently containing over 5 per cent., while that of the Friesian Holstein and the Holderness has a comparatively low fat content. In general, the breeds noted for a large yield give milk with a low percentage of fat. The differences due to breeds are, however, comparatively small—less than what is often found between individuals of the same breed.

(2) **Milking**.—It has been definitely proved that in a cow with a large yield the cavities of the udder have not the capacity to contain all the milk that can be obtained at a milking. There must be rapid secretion during the time of milking. In the interval between the milkings secretion is most active when the udder is empty. As the cavities get filled the distension appears to inhibit secretion. The more frequent the emptying of the udder therefore up to the point where the prejudicial influence of over-action of the gland cells appears, the greater the quantity of milk obtained. It is estimated that three milkings per day may yield nearly 5 to 20 per cent. more milk than two, and two may yield nearly 50 per cent. more than one.

When the intervals between the milkings are of an unequal length, milk with a higher fat content is got after the shorter period. It has been suggested that this is due to the distension of the ducts, which occurs in the longer interval, preventing the extrusion of the fat globules from the secreting cells and consequently slowing the synthesis of fat.

Marked differences occur in the fat content of the milk drawn at different stages of milking. The first portion may contain less than 1 per cent., the last portion drawn, "the strippings," may contain over 10 per cent. The fat only is involved, the other constituents remain uniform throughout the period of milking.

The complete emptying of the udder at milking is necessary, not only to obtain the valuable fat in the last portion, but to maintain the full activity of the gland. In incomplete milking the amount secreted diminishes.

(3) **Food.**—(1) **The percentage composition** of the milk of any individual animal is within wide limits independent of the relative proportions of the constituents of the food. Only small deviations from the normal standard can be obtained by feeding excessive amounts of one constituent. So great is the tendency to secrete milk of normal composition that when one of the constituents is deficient in the food, the animal draws upon its own body for material, salts being supplied by the skeleton and protein and fat by the tissues. The amount secreted is however diminished. This prevents undue depletion of the body. The body possesses only a small reserve store of carbohydrate (p. 353). In an experiment in which the carbohydrate of the food was reduced, and the reserve store depleted by drawing off sugar through the kidneys by means of phloridzin, it was found that instead of milk deficient in sugar being secreted the quantity decreased.

Milk c.c.	Lactose per cent.	
230	3.9	
238	4.0	
238	3.9	} Sugar drawn off by phloridzin.
218	3.8	
170	3.8	

(2) **Nature of Fat.**—The composition of fat can be modified by the food. Abnormal fats fed may appear in the milk. Feeding stuffs rich in oils, such as linseed cake, produce butter which is deficient in the higher fatty acids and consequently soft at a low temperature.

(3) **Yield.**—So long as food is given to supply (1) the maintenance requirement of the animal and (2) sufficient material for milk formation, the yield depends upon the capacity of the animal as a milk producer much more than on the food. When, however, cows are put to graze on young pasture-grass increased flow almost invariably occurs, and in certain experiments, increasing the proportion of

protein in the diet increased the yield. Excess of carbohydrate or fat tends to fat formation and deposit in the animal's body.

The food requirements for milk cows are given on page 375.

(4) *Housing*.—It was formerly a custom to restrict ventilation for the purpose of maintaining heat in byres, the idea being that in warm byres the milk flow was increased. Spier and Hendrick have shown that cool byres and free ventilation do not reduce milk production. The following are results obtained at different temperatures :—

	Aver. temp. of byre.	Milk lbs. per cow.	Fat per cent.
Cool byres, free ventilation	41.2° F.	29.0	3.51
Warm byres, restricted ventilation	61.7° F.	28.9	3.48

The animals in the cool byres had better coats and were in better condition at the end of the winter.

It has been found however that a *marked* decrease in the temperature reduces milk secretion, and that animals exposed in winter eat more food than those comfortably housed.

The temperature below which more food is required, or at which the milk secretion begins to diminish, depends upon the critical temperature (p. 271) of the animal. Unfortunately comparatively little work has been done to determine the critical temperature of dairy cows. Owing to the stimulus to metabolism caused by the large amount of food eaten it is probably comparatively low. From the evidence available it would appear to be not higher than 7° to 8° C. To have animals housed in an atmosphere above the critical temperature should lead neither to a saving in food nor to an increased production of milk.

APPENDICES

I. SOME ELEMENTARY FACTS OF ORGANIC CHEMISTRY

THE following elementary facts may help the student who has neglected the study of the outlines of Organic Chemistry in understanding the chemical problems of physiology.

Organic compounds are built round the four-handed carbon atom



When each hand links to the one-handed hydrogen atom,

METHANE—

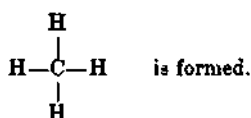

By taking away a hydrogen atom from two Methane molecules and linking the two molecules together

ETHANE—

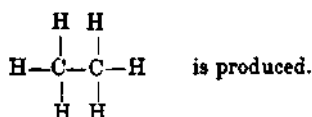

By further linking more and more of those molecules together, similar molecules containing three, four, five or more carbon atoms are produced.

When the carbons are arranged in a straight line the *normal* series is produced—

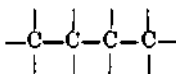

Where the line is branched the series is known as *iso*—

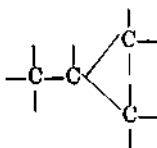

When each carbon has its due proportion of hydrogen atoms it is

saturated, but if two hydrogen atoms are let go, the unoccupied hands of the carbon may join and form an *unsaturated* molecule, thus:—



When one hydrogen atom is taken away, and the molecule has a hand ready to link with some other substance, a *radicle* is constituted, and these are known as **METHYL**, **ETHYL**, etc.

Alcohols.—If one of the hydrogen atoms of Methane is oxidised to hydroxyl (—OH), an alcohol is formed—

The hydroxyl group (—OH) is characteristic of alcohols.

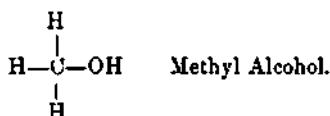

Similarly Ethane gives—

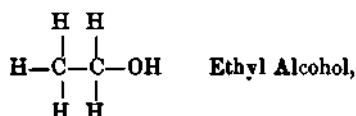

and so on for compounds having a longer carbon chain.

If only one —H is oxidised to —OH, the alcohol formed is termed *Monohydric*.

If two —H atoms are oxidised, the alcohol is *Dihydric*.

If more than two —OH groups are present, the alcohol is *Polyhydric*, e.g.

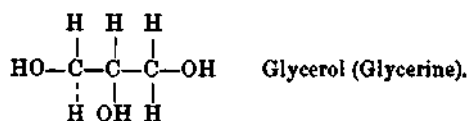

Propane C_3H_8 , and compounds having more than three carbon atoms, may form more than one monohydric alcohol, according to the C atom on which the —OH is placed.

Thus, there are two propyl, four butyl, and eight amyl alcohols.

Primary Alcohols are those in which a terminal carbon is oxidised.

Secondary Alcohols have one or more of the middle carbons oxidised.

Polyhydric alcohols may contain primary or secondary groups or both.

Aldehydes.—When, from a Primary Alcohol, two hydrogens are

removed, the vacant hand of the oxygen links to the vacant hand of the terminal carbon to form an Aldehyde—

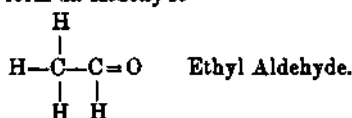

Ketones.—These are formed in the same way from the *Secondary Alcohols*, a carbon atom, which is not the terminal one, being involved, thus :—

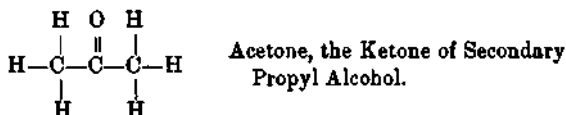

Acids.—If the hydrogen of the terminal carbon atom of the *Aldehyde* is replaced by hydroxyl —OH an acid is produced—

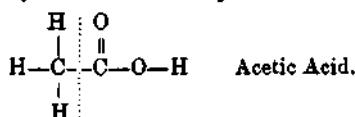

The *carboxyl* group (to the right of the dotted line) is characteristic of the acids.

The oxidation may be carried on at each end of the line ; *divalent acids* being thus produced—

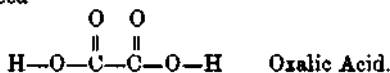

If, in the radicle of one of these acids, a hydrogen is replaced by hydroxyl —OH, an *oxy-acid* is formed, thus :—

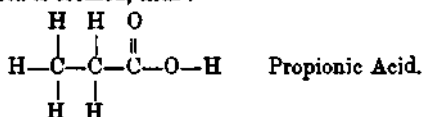

This may be converted to the two Lactic acids called respectively α and β hydroxy-propionic acid, according to the carbon which is oxidised.

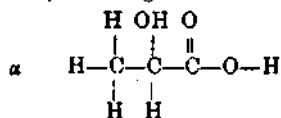

and

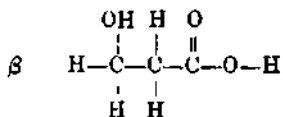

Similarly oxy-acids are formed from the divalent acids.

Ethers.—These are formed by the union of two alcohol molecules, with dehydration.

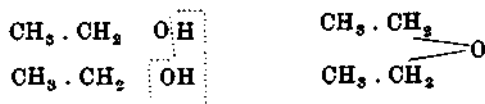

Esters.—These are formed by linking an alcohol and an acid molecule with dehydration.



Anhydrides.—These are formed by the union of two acid molecules with dehydration.

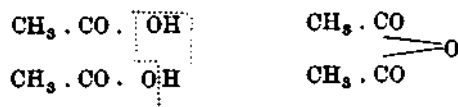

CYCLIC COMPOUNDS.

(1) An important series of carbon compounds contains a ring of six carbons, each with an unsatisfied affinity, thus:—

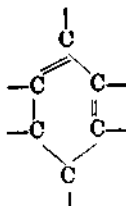

When each bond holds a hydrogen, **Benzene** is formed.

These hydrogens may be replaced by various molecules giving rise to a large series of different compounds.

(2) If a ring contains atoms of other elements besides carbon, it is called heterocyclic. One of the most important of these is **Pyrrrol**—

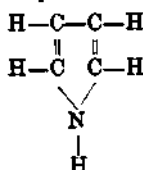

which occurs, linked to a benzene ring, in certain important constituents of the protein molecule.

NITROGEN-CONTAINING COMPOUNDS.

Ammonia.—The three-valent Nitrogen by linking with three hydrogens forms Ammonia,

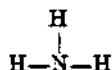

If one of these hydrogens is removed, Amidogen, $-\text{NH}_2$, which can link with other molecules, is produced.

Amino Acids.—If one of the hydrogen atoms directly joined to carbon in the radicle of an acid is replaced by amidogen, a *mon-amino acid* is formed, thus:—

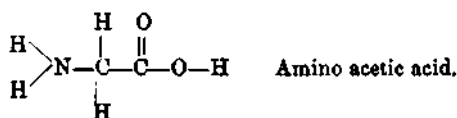

When two hydrogen atoms are thus replaced, a *di-amino acid* is produced—

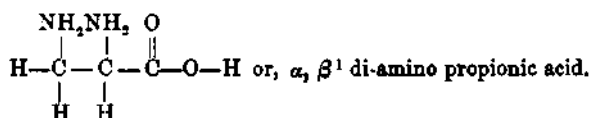

Amines.—In these, NH_2 takes the place of OH of an alcohol; or, looked at in another way, they are formed from NH_3 , by replacement of hydrogen atoms by alkyl groups.

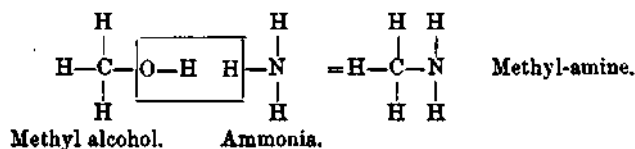

Di- and tri-amines may be formed thus—

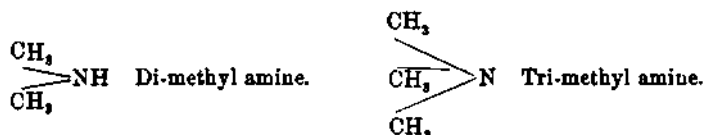

¹ The carbon atoms are named α , β , and γ from their position in relationship to the carboxyl group.

Amides.—If the amidogen molecule takes the place of the hydroxyl in the carboxyl of an acid, an amide results, thus :—

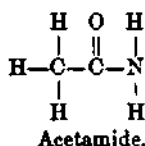
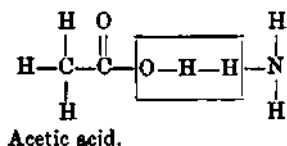

Compare *Methylamine*, CH_3NH_2 , with *Acetamide*, $\text{CH}_3\text{-CO-NH}_2$.

From the divalent carbonic acid—

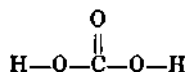

is formed—

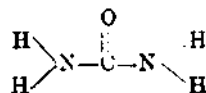

the important substance **Urea** or Carbonic Diamide.

Urea molecules may link together—

(a) By dropping NH_3 , when **Biuret** is produced—

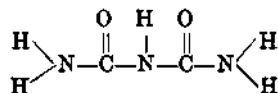

(b) By holding on to an intermediate radicle of an acid, e.g. an unsaturated three carbon acid. These are **Diureides**, or **Purins**, of which the most important is **Uric Acid**—

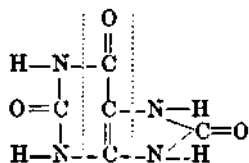

II. CLASSIFICATION OF THE PROTEINS.

I. Native Proteins.

A. UNCOMBINED.

1. *Poor in Di-amino Acids.*

- (i.) **Albumins.**—Coagulated on heating; soluble in water; not precipitated by half saturation with $(\text{NH}_4)_2\text{SO}_4$.
- (ii.) **Globulins.**—Coagulated on heating; insoluble in water; precipitated by half saturation with $(\text{NH}_4)_2\text{SO}_4$.

2. *Rich in Di-amino Acids.*

- (i.) **Protamines** from the heads of spermatozoa.
- (ii.) **Histones** from blood corpuscles, *e.g.* globin of hæmoglobin.

B. COMBINED.

- 1. **Phospho-proteins.**—Yield phosphoric acid on decomposition, but not purin bases, *e.g.* vitellin of yolk of egg and caseinogen of milk.
- 2. **Nucleo-proteins.**—Compounds of protein with nucleic acid. The nucleo-proteins with the largest amount of nucleic acid are called *nucleins*. Nucleic acid may be broken down into phosphoric acid, a carbohydrate, purin bases and pyrimidin bases.
- 3. **Glucoproteins**, *e.g.* mucin (p. 35).
- 4. **Chromoproteins**, *e.g.* hæmoglobin (p. 486).

II. Modified Proteins. The Sclero-proteins.

- 1. **Collagen** with its hydrate **gelatin** (p. 39).
- 2. **Elastin** (p. 39).
- 3. **Keratin** (p. 32).

III. Products of Digestion of the Proteins.

- 1. **Proteoses** (p. 16 *et seq.*).
- 2. **Peptones** (p. 16 *et seq.*).
- 3. **Polypeptides** (p. 19).

III. SOME ELEMENTARY FACTS OF PHYSICS.

DIFFUSION.

The molecules of a gas are in continual movement, and if two different gases be brought into contact the molecules of the two gases freely intermingle till a homogeneous mixture results. The molecules of a liquid are also in continual motion, the only difference from the gaseous state being that, owing to the greater concentration of the molecules, the paths are more restricted. When two miscible fluids, *e.g.* alcohol and water, are brought into contact, intermingling of molecules occurs as in the case of the gases with a resulting homogeneous mixture. This phenomenon whereby two gases or two miscible fluids in contact become uniformly mixed is known as **diffusion**. It may occur through a membrane permeable to the molecules.

In solids, molecules are also in motion, but the paths are so restricted and the mutual attraction of the molecules so great owing to their proximity to each other, that diffusion between solids in contact is extremely difficult, and only proceeds at a very slow rate. That it can occur, however, has been shown by the fact that if gold and lead be kept in contact for several years some gold is found to be deposited on the lead.

KINETIC ENERGY OF MOLECULES.

As molecules have a definite mass, their movement endows them with kinetic energy which is in proportion to their velocity. When the temperature of a substance is raised the velocity of the molecules is increased, and as a result their kinetic energy is increased. Consequently, when a gas is heated the molecules impinge on the containing vessel with greater force, tending to distend it. In other words, the pressure of the gas is increased.

When liquids are heated the kinetic energy of the molecules is increased so that they may break loose from the surface of the fluid and become free, forming gas, as occurs when water reaches 100° C. at ordinary atmospheric pressure. In the same way, under the influence of heat, the molecules of a solid may increase their movement and the solid become a liquid. Conversely, reducing the temperature decreases the kinetic energy and the velocity of the molecules, and consequently a gas may become a liquid, and, on still further cooling, a solid.

The heat of a substance is thus identical with its molecular energy. As heat is added the velocity and consequently the energy of the molecules are increased; as heat is withdrawn the velocity is decreased.

SOLUTIONS.

If a piece of solid cane sugar be put in water some of the molecules of the sugar break loose from the surface of the solid and move among the

molecules of the water. As in the case of two miscible fluids in contact a uniform mixture is produced. The sugar is said to go into solution in the water. The sugar is termed the **solute** and the water the **solvent**. The solvent is usually a liquid. The solute may be a solid, *e.g.* sugar in water, a liquid, *e.g.* alcohol in water, or a gas, *e.g.* CO₂ in water.

In their erratic flight some of the molecules of the sugar in solution impinge upon the solid sugar. When the free molecules of the solute have reached such a degree of concentration in the solvent that as many molecules are striking the solid as are leaving it, no higher concentration is possible, and the result is termed a **saturated solution**. If the solution be heated the kinetic energy of the molecules of the sugar both in solution and in the solid mass is increased and more break free from the solid, and consequently the degree of concentration is increased. This explains why, under the influence of heat, a substance dissolves more rapidly and a higher degree of concentration is obtained.

According to the foregoing description a solution can be regarded as a homogeneous mixture of two substances, the molecules of which are in free movement throughout the whole of the mixture.

COLLOIDS (see p. 12).

The essential character of the colloidal state consists, in the existence together in a physical combination, of two substances, one of which is in the form of ultra-microscopic particles dispersed in the other. The dispersed particles are separated from each other by the containing substance which forms a continuous film or medium surrounding the particles. Each particle has thus a surface of contact with the substance forming the continuous medium. At that surface the dispersed particle is internal and the continuous substance external. In this **colloid state**, therefore, matter is in two forms or "phases"—(1) *dispersed or internal*, and (2) *continuous or external*.

When the two substances are immiscible fluids the colloid complex forms an emulsion. In protoplasm, however, the condition is not simply a dispersion of one fluid in another immiscible fluid, since in it matter may exist in all degrees between the liquid and the solid condition. Protoplasm is termed an **Emulsoid**.

The main points of difference between a solution and a colloid may be noted:—

<i>Solution.</i>	<i>Colloid.</i>
Molecules small.	Molecules very large or molecules aggregated into particles.
Free movement of molecules of solute which possess kinetic energy.	Dispersed particles separated by continuous phase. Little or no movement, therefore little or no kinetic energy of particles.
No surface phenomena.	Large size of molecules introduces phenomena of surface tension and adsorption between the dispersed and continuous phases.

While there is such a marked difference between a true solution and the colloid state, there is no clear line of demarcation between the two conditions. As the size of the molecules or aggregates of molecules of the dispersed phase of a colloid becomes smaller, the colloid comes to take on the character of a solution, so that the particles or molecules of the colloid show movement, and therefore kinetic energy.

Substances that go into a true solution and pass through an animal membrane (*see* Osmosis) have been called crystalloids to distinguish them from colloids. There is, however, no fixed dividing line between crystalloids and colloids. Some colloids, *e.g.* hæmoglobin, can be obtained in the crystalloid form.

IONS.

When salts are dissolved in water they become "dissociated." Thus NaCl in a dilute solution becomes Na, carrying a positive charge of electricity usually indicated by the sign + or by a dot, *e.g.* Na⁺ or Na[.]; and Cl carrying a negative charge usually indicated by a dash, *e.g.* Cl⁻ or Cl[.]. Na does not exist as an atom of sodium nor Cl as an atom of chlorine. Each is combined with a definite quantity of electricity. A monovalent atom or group of atoms carries one unit charge, a divalent two and so on. Thus, if a phosphate be dissociated, the PO₄ part, being trivalent, carries three unit charges and is written PO₄^{'''}. In an ammonium salt the NH₄ is monovalent. It carries one unit charge and is written NH₄[.]. The atom or group of atoms thus dissociated and carrying a quantity of electricity is termed an **Ion**. It is the presence of ions that enables a salt solute to conduct electricity.

Substances that become dissociated into ions when in solution are called **Electrolytes**, to distinguish them from substances such as sugar that are not dissociated when dissolved. Nearly all salts, acids, and bases are electrolytes.

THE REACTION OF WATERY FLUIDS.

THE HYDROGEN ION CONCENTRATION.

Water between 22° and 23° C. is, to a slight extent, ionised. That is, some of the water molecules are dissociated into hydrogen and hydroxyl ions. According to the law of mass action, the ratio of the product of the ions to the undissociated water is a constant. This may be written—

$$\frac{[H] \times [OH]}{[H_2O]} = \text{a constant.}$$

This constant has been found experimentally for the temperature of 23° C. to be—

$$\frac{1}{100,000,000,000,000} \text{ or } 10^{-14}$$

It has also been found that in pure water at this temperature there is an equal number of H and OH ions, i.e. $[H]=[OH]$. Therefore the concentration of hydrogen ions

$$\text{or } C_H = \sqrt{10^{-14}} = 10^{-7}$$

$$\text{and } C_{OH} = C_H = 10^{-7}$$

For short, the H ion concentration is often denoted by the logarithmic exponent, i.e.

$$C_H \text{ of } 10^{-7} = \text{pH of } 7.$$

It has been found that all substances which make a solution acid do so by increasing the number of H ions, e.g.

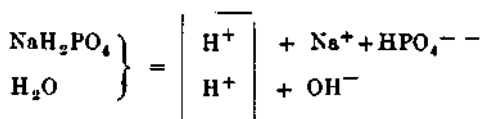
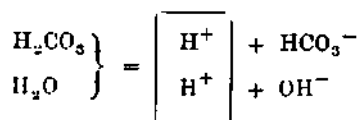
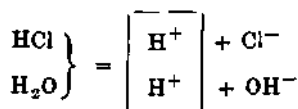

and as $[H] \times [OH]$ is a constant, $[OH]$ must be correspondingly decreased.

Similarly, alkalis and alkaline salts cause an increase in the number of free OH and a decrease in the free H ions.

Any increase in the concentration of the H ions will be denoted by a decrease in the denominator of the fraction expressing concentration.

At the neutral point

$$C_H = \frac{1}{10,000,000}, \text{ or } 10^{-7} \text{ or pH } 7.$$

Therefore, if the pH is denoted by a figure less than 7 the solution is acid, if by a figure greater than 7 the solution is alkaline.

A value lying between two whole numbers may be written in either of two ways. For example, water just slightly alkaline may have a concentration of hydrogen ions of 1 in 20 million = $\frac{0.5}{10,000,000}$. This may be written as $C_H = 0.5 \times 10^{-7}$ or the fraction may all be put as a power of 10 = $10^{-7.3}$ or pH = 7.3.

To convert one system of notation to the other is a simple matter of logarithms.

For example, to convert pH 7.6 to other notation—

$$\text{pH } 7.6 = 10^{-7.6} = 10^{-7} \times 10^{-0.6}$$

(the antilogarithm of -0.6 is 0.25). $\therefore = 0.25 \times 10^{-7}$.

$$\begin{aligned} \text{Conversely, } C_H \ 5 \times 10^{-6} &= \log 5 + \log 10^{-6} \\ &= 0.6990 + (-6.0000), \\ &= 5.3, \end{aligned}$$

$$\text{or } 5 \times 10^{-6} = 10^{0.699} \times 10^{-6} = 10^{-5.3} = \text{pH } 5.3.$$

(The student will remember that in dealing with logs, multiplication is done by addition division by subtraction, and squaring by multiplication by 2, etc.)

SEMIPERMEABLE MEMBRANE.

A membrane is simply a thin film of substance. It may be composed of almost any material, and therefore may have all degrees of permeability. When a membrane allows water to pass through, but prevents the passage of a substance in solution in the water, it is said to be semipermeable to the solution. Thus water passes through a membrane of copper-ferrocyanide, but cane sugar in solution is kept back. Copper-ferrocyanide is therefore said to be semipermeable to a solution of cane sugar in water.

OSMOSIS AND DIALYSIS.

The passage of water through a semipermeable membrane is termed **Osmosis**. The passage of substance in solution through such a membrane is termed **Dialysis**.

OSMOTIC PRESSURE.

If a solution of a substance in water be placed in a bag which is semipermeable to the solution, and the bag with its contents be immersed in pure water, the molecules of water will have free passage through the walls of the bag, but the molecules of the solute will be held back. No pressure will be exercised by the water, since it has free passage. The molecules of the solute, however, will impinge on the inside surface of the bag with a certain amount of force, which is not balanced by molecules of solute impinging on the outside. There will thus be a force exerted tending to distend the bag. This force is called **Osmotic Pressure**.

It has been found that the osmotic pressure of a solution is the same as the pressure exerted by a gas having the same number of molecules per unit of volume as the solute. The solute thus behaves as if it were a gas and the solvent absent. As in the case of a gas, the pressure is proportional to the temperature and to the concentration. This is easily understood,

since the greater the concentration the more molecules hit the containing membrane, and the higher the temperature the greater the velocity, and consequently the greater the force with which they impinge on the membrane.

The osmotic pressure may be very high. A 10 per cent. solution of cane sugar has an osmotic pressure of over ten atmospheres.

If a solution be separated by a semipermeable membrane from pure water or a less concentrated solution, water passes from the pure water to the solution or from the dilute to the more concentrated solution. Osmosis, therefore, always occurs towards the more concentrated solution. On the other hand, if the molecules of the solute are free to pass through the membrane the passage is from the concentrated to the dilute solution, the tendency being to establish a uniform mixture (*see* Diffusion). Dialysis, therefore, always occurs towards the more dilute solution.

SURFACE TENSION.

In the body of a fluid the molecules are equally attracted on all sides by other molecules, and the resultant is zero. At the surface, however, the attraction is one-sided—towards the liquid. The molecules are therefore subjected to unbalanced forces, and the surface is consequently in a state of tension. It is this tension that makes a drop spherical.

The same state of tension exists at the interface of two fluids. If the fluids are miscible a solution occurs and there is no interface. If, however, the fluids are immiscible an interface exists (*see* Colloids) and surface tension is present. In a colloidal state formed by two immiscible fluids, there is an enormous extent of surface (p. 13). Surface tension plays an extremely important part in many physiological processes.

The surface tension at the interface between immiscible fluids or between a solid and a fluid is lowered by the presence of substances in solution.

ADSORPTION.

According to the second law of thermo-dynamic, any process that diminishes free energy always tends to take place. Surface tension is diminished by substances in solution. These, therefore, tend to concentrate at the interfaces where the tension exists. This depositing of a solute at a surface of contact is termed **Adsorption**. In the colloidal state where there is a great extent of surface, adsorption is of great physiological importance. It facilitates chemical reaction between the substance composing the dispersed phase and those in solution in the continuous phase.

THERMOPILE.

In a circuit composed of two different metals, if one of the junctions of the metals be at a different temperature from the other junction, a current

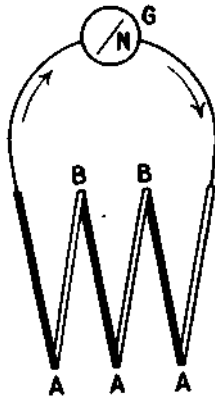

FIG. 246.
Diagram of Thermopile.

— = Iron.
 □ = German Silver.
 A, B = Junctions.
 G = Galvanometer.
 N = Needle of G.

ture of the junctions and strength of the resulting current.

of electricity is produced in the circuit. The strength of the current is in proportion to the difference of temperature of the junctions, and it can be measured by means of a galvanometer. By increasing the number of junctions the strength of the current produced by changes of temperature is proportionally increased.

In the figure, if the junctions B B be warmer than A A A, a current flows in the direction indicated and the needle is deflected, the degree of deflection being in proportion to the strength of the current.

The thermopile thus converts a heat change which is difficult to measure directly by a thermometer, into an electrical change which can be detected and measured with great accuracy by means of a sensitive galvanometer.

When the strength of the current is known, the amount of heat can be calculated, since for each thermopile there is a direct relationship between the degree of difference of the temperature of the junctions and strength of the resulting current.

INDEX

- ABDOMEN**, nerves of, 198
Abdominal breathing, 520
 muscles of respiration, 520
Abducens nerve, 201
Aberration, spherical, 147
 chromatic, 157
Abomasum, 294
Absorption, channels of, 348
 from the stomach, 318
 mode of, 348
 of carbohydrates, 347 *et seq.*
 of fats, 347
 of food, 347
 of proteins, 347
Accessory factors, 281
Accommodation, far point, 147
 near point, 146
 positive, 146
 range of, 149
Acetone, 358
Achroödextrin, 303
Acid sulphur in urine, 563
Acidosis, 481
Acids, divalent (*see* Appendix I.)
 organic (*see* Appendix)
Acinus of gland, 34
Acromegaly, 800
Action of limbs of horse, 237
Addison's disease, 610
Adenin, 556
Adipose tissue, 42, 351
Adrenalin, 591
 as vaso-constrictor, 591
 action of, 591
Adsorption, 14 (*see* Appendix III.)
Aerotonometer, 541
After-discharge in reflex arcs, 84
After-image, negative, 154
 positive, 154
Agglutinina, 614
Air breathed, influence of respiration on, 537
 complemental, 523
 interchange by diffusion, 523
 passages, structure of, 514
Air, residual, 523
 reserve, 523
 respired, amount of, 522
 tidal, 522
 vesicles in the lungs, 514
Alanin, 17
Albumin (*see* Appendix II.)
 " nucleo (*see* Appendix II.)
Alcapton, 555
Alcohols, chemistry of (*see* Appendix I.)
Aldehydes (*see* Appendix I.)
Aldoses (*see* Appendix I.)
Alexine, 613
Alimentary canal, 291 *et seq.*
 bacterial action in, 329
 nerve supply of, 300
 structure, 291
Alkaline reserve, 491
Alkalosis, 531
Allantoic arteries, 627
Allantoin, 561
Allantois, 628
Amble, 241
Amboceptor, 613
Amides, 17 (*see* Appendix I.)
Amines, 330 (*see* Appendix I.)
Amino-acetic acid (*see* Appendix I.)
Amitotic division, 30
Ammonio-magnesium phosphate, 559
Ammonium carbonate, 554
Ammonium salts in urine, 559
Amniotic fluid, 625
 sac, 625
Amœboid movement, 24, 484
Amount of respired air, 522
Amyolytic period of gastric digestion, 311
Anabolism, 9
Anacrotic pulse, 442
Anal canal, 296
Analysis of alveolar air, 540
Anelectrotonus, 63
Anhydrides (*see* Appendix I.)

- Animal products as food, 290
 Antipepsin, 313
 Antiperistalsis, 335, 345
 Antithrombin, 477
 Antitoxin, 612
 Aortic area, 407
 valve, 392
 Apnoea, 531
 Apocodeine and suprarenal extract,
 592
 Aqueous humour, 140
 Arc, cerebellar, 95
 cerebral, 95
 spinal, 82
 Areolar tissue, 40
 Arginin, 17, 555
 Armsby's standard, 378
 Arterial pressure, 449
 pulse, cause of, 435
 Arteries, 431
 factors controlling pressure, 435
 pressure in, 434
 Arterioles, nervous mechanism, 451
 normal state of, 453
 Artificial respiration, 549
 Arytenoid cartilages, 550
 Ash of food, 288
 Asparagine, 284
 Asphyxia, 548
 Astigmatism, 151
 Atmospheric pressure on respira-
 tion, 543
 Auditory centre, 173
 Auerbach's plexus, 301
 Augmentor nerve of heart, 421
 Auricle, 386
 Auricular flutter, 429
 Auriculo-ventricular rings, 385
 nodes, 385
 valves, 390
 Availability of food-stuffs, 363
 Axon, 56
 reflex, 93

BACTERIAL action in the alimentary
 canal, 329
 Balance sheet experiments, 369
 Barotaxis, 25
 Basal ganglion, 189
 metabolism, 264
 Bases of the urine, 565
 Basilar membrane, 170
 Basophil leucocytes, 484
 Bell's paralysis, 201
 Benzene compounds (*see* Appendix)
 Benzoates, 562

 Bi-amide of carbonic acid (*see* Urea)
 Bidder's ganglion, 389
 Bile, 323 *et seq.*
 flow of, 326
 flow, influence of nerves on, 326
 functions of, 327
 mode of secretion, 327
 pigments, 324
 salts of, 323
 Bilirubin, 324, 491
 Biliverdin, 324
 Binocular vision, 158
 Birth, young at, 631
 Biuret (*see* Appendix I.)
 Bladder, reflex, 93
 urinary, 681
 Blastoderm, 624
 Blind spot, 151
 Blood, 474 *et seq.*
 amount of, 501
 carbon dioxide, 495
 cells, 483
 changes in respiration, 538
 clotting, 475
 constituents, fate of, 503
 source of, 498
 corpuscles, 483
 defibrinated, 476
 distribution, 503
 erythrocytes, 485
 flow of, 464
 velocity of, 465
 flow through heart, 404, 411
 flow through different organs,
 473
 gases of, 492
 general characters, 474
 influence of respiration on, 538
 inorganic constituents, 480
 laked, 474
 leucocytes, 483
 mean pressure, 447
 methods of recording, 447
 opacity of, 474
 plasma, 479
 platelets, 484
 pressure, 432
 diastolic (*see* Diastolic
 pressure)
 general distribution, 432
 rhythmic variations, 434
 serum, 479
 sodium bicarbonate, 461
 specific gravity, 474
 Body, connections with brain stem,
 112

- Body receptors, 97
 Bone, 45 *et seq.*
 chemistry of, 49
 development, 45 *et seq.*
 diaphysis of, 49
 epiphysis of, 49
 Haversian system of, 48
 marrow, 500
 metabolism of, 50
 ossification, centre of, 45
 osteoblasts, 46
 osteoclasts, 46
 Bowman's capsule, 571
 Bradycardia, 429
 Brain (*see* Cerebrum, etc.)
 Breath sounds, 524
 Breathing shallow, 530
 Bronchial muscle, 515
 sound, 524
 Bronchioles, 515
 Brunner's glands, 295
 Bundle of His, 385

CACHERIA strumipriva, 597
 Cæcum, 296, 344
 Caffeine, 578
 Calcium in clotting, 477
 in food, 289
 Calories, definition of, 248
 Calorimeter, 256
 bomb, 256
 respiratory, 259
 Calorimetry, direct, 259
 indirect, 260
 Canaliculi, 46
 Canals, semi-circular, 117
 Cancellous tissue, 46
 Cane sugar, 286
 Canter, 242
 Capillaries, 431
 pulse in, 444
 pressure in, 460
 Carbohydrates, 20, 285
 absorption of, 347, 350
 determination of amount oxidised, 258
 in foods, 288
 storage of, 352
 tolerance, 355
 Carbon dioxide in blood, 481, 496
 hæmoglobin, 490
 in the urine, 566
 passage from tissues to blood, 546
 Carboxyhæmoglobin, 489
 Cardiac contraction, nature of, 427
 42
 Cardiac nerves, function of, 418
 propagation of, wave, 427
 starting mechanism, 424
 cycle, 393, 401
 impulse, 398
 muscle, 205
 branches of the vagus, 418
 Cardiac rhythm, control, 424
 Cardiogram, 398
 Cardiograph, 398
 Cardio-pneumatic movements, 536
 Cartilage, 43
 elastic fibro-, 45
 hyaline, 43
 white fibro-, 45
 Cartilages of the larynx, 550
 Casein, 636
 Castration, effect of, on thymus, 603
 effect of, on body, 606
 Catalytic action, 8
 Catelectrotonus, 63
 Cathode, 63
 Cells, 23 *et seq.*
 activity of, 24
 chalice, 34
 nucleus, 26
 oxyntic, 310
 peptic, 311
 reproduction of, 28
 Cellulose in food, 287
 Centre, auditory, 173
 for dilator pupillæ, 148
 for smell, 136
 for sphincter pupillæ, 148
 oculo-motor, 161
 of ossification, 45
 respiratory, 526
 taste, 132
 thermal sense, 116
 touch, 116
 vaso-constrictor, 457
 vaso-dilator, 460
 visual, 164
 Centrosome, 23
 Cerebellar arc, 95
 synapses, 117
 Cerebellum, structure, 125
 cells of Purkinje, 125
 connections of, 126
 functions of, 127
 removal, 128
 stimulation, 129
 Cerebral action, time of, 186
 Cerebral arc, 95
 cortex (*see* Cortex cerebri)

- Cerebral arc, discharging side, 189
 mechanism, fatigue of, 186
 time of action, 186
- Cerebrosides, 58
- Cerebro-spinal fluid, 511
- Cerebrum development, 181
 discharging mechanism of, 189
 evolution, 181
 fatigue, 186
 localisation of functions, 176
 removal of, 187
 storing mechanism, 185
- Chalice cells, 34
- Check ligaments, 237
- Chemical regulation of growth and
 function, 588 *et seq.*
- Chemiotaxis, 25
- Cheyne-Stokes respiration, 531
- Chlorine-containing bodies in urine,
 565
- Cholic acid, 323
- Cholesterol, 19, 58, 325
- Cholin, 20
- Chondro-mucoid, 44
- Chondroitin, 44
- Chondroitin-sulphuric acid, 44
- Chordæ tendinæ, 388
- Chorda tympani nerve, 304
- Chorionic villi, 626
- Choroid, 139
- Choroid plexus, 511
- Chromaffin tissue, 590
- Chromatic aberration, 157
- Chromatin, 27
- Chromo-proteins (*see* Appendix II.)
- Chromosomes, 617
- Chyle, 508
- Chyme, 319
- Cilia, 37
- Ciliary muscle, 139, 147
 processes, 139
- Ciliated epithelium, 37
- Circulation, the, 382 *et seq.*
 factors, extra-cardiac, in, 470
 fetal, 631
 "head down and up position,"
 471
 in bone-marrow, 470
 in cranium, 468
 influence on respiration, 536
 in heart wall, 469
 in kidney, 572
 in lungs, 468
 in spleen, 469
 in vessels, 431
 schema of, 383
- Circulation, time taken by, 472
- Classification of food-stuffs for
 herbivora, 290
- Coagulation of the blood, 475
- Cochlea, 170
 connections with central ner-
 vous system, 172
- Coefficient of oxidation, 254
- Cold spots, 104
- Collagen, 39
- Collecting tubules of kidney, 572
- Colloids, 12
- Colon, 296
- Colostrum, 637
- Colour-blindness, 157
- Columnæ carneæ, 387
- Columnar epithelium, 33
- Common path, 86
- Complemental air, 523
 pleura, 518
- Concentrates, 290
- "Conditioned" reflexes, 131
- Conducting paths (*see* Spinal cord,
etc.)
- Conduction of nerve impulse, 69
- Cones of retina (*see* Retina)
- Connective tissues, 37
- Consciousness, 185
 relations to cerebral action, 185
- Contraction of muscle, changes
 during, 219
- Convolved tubules of the kidney,
 572
- Cooking, effects of, on food, 366
- Co-operative antagonism of groups
 of muscles, 231
- Coprosterol, 332
- Cord, spinal (*see* Spinal cord)
- Cornea, 139
- Corona radiata (*see* Cerebrum)
- Coronary arteries, 406
- Corpus Arantii (*see* Valves of heart)
- Highmori, 620
 luteum, 606
 striatum, 189
 trapezoideum, 172
- Corpuscles, blood, 483 *et seq.*
 of Hassall, 602
 tactile, 102
- Cortex cerebri, synapses, 115
 discharging area, 189
 receiving areas (how localised),
 176
 fibres, 194
 functional development, 182
 storing and associating part, 185

- Cortex cerebri, structural development, 181
- Corti, organ of, 171
- Coughing, 522
- Cranial nerves, 200
nuclei of, 200
- Creatin, 209, 560
- Creatinin, 560
- Cricoid cartilage, 550
- Critical temperature, 271
- Crossed pyramidal tract, 194
- Crude fat, 285
fibre, 288
- Crystalline lens, 141
- Crystalloids, 20
- Curare experiment, 217
- Current of action, 213
injury, 212
- Cutaneous nerves, influence on respiration, 534
receptors, 99
- Cystin, 32, 564
- Cytase, 339
- Cytotoxins, 614
- DAIRY cows, food requirement, 375
- Death, 10
of muscle, 214
- Decerebration rigidity, 113
- Decidua reflexa, 625
- Defecation, 335
- Degeneration, Nissl's, 77
- Deiters' nucleus, 126
- Delivery, 633
- Dendrites, 53, 56
axon of, 56
- Dentate nucleus of the cerebellum, 125
- Depressor nerve (*see* Cardiac branches of vagus)
- Deutero-proteose, 312 (*see* Appendix II.)
- Development, 624
- Dextrose, 286
- Diabetes (*see* Glycosuria), 357
- Diacetic acid, 358
- Di-amino acids, 17
- Diapedesis, 468
- Diaphragm, 517
- Diaphysis, 49
- Diastase, 320
- Diastole of heart, 394
- Diastolic pressure, 449
- Dicrotic notch, 441
wave, 440
- Diets, influence of various, on gastric secretion, 313
- Diffusion of gases in lungs, 523
- Digestibility of food, 364
apparent, 364
- Digestion, 291 *et seq.*
experiments, 364
fate of the secretions of, 331
gastric, 308
in carnivora, 302
in herbivora, 336
in horse, 341
in mouth, 302
in ruminants, 337
intestinal, 319
of stomach wall, 313
- Digital torus, 233
- Dilator, pupillæ, 140
- Dioptric mechanism, 144
imperfections, 149
- Diphtheria bacillus, 612
toxin, 612
- Diploë of bone (*see* Bone)
- Diplopia, 162
- Disaccharida, 286
- Disc, optic, 141
- Dissociation of oxy-hæmoglobin, 494
- Diureides (*see* Appendix L.)
- Divalent acids (*see* Appendix I.)
- Dobie's line, 204
- Douglas bag, 261
- Dropsy, 462
- Ductus arteriosus, 633
venosus, 631
- Dynamometer, 225
- EAR, anatomy of, 167
annular ligament, 168
cochlea, connections with central nervous system, 173
external, 167
internal, 170
middle, 167
osseous labyrinth, 170
ossicles of, 167
- Eck's fistula, 360
- Effectors (*see* Muscle), 202
- Efferent nerves, 195
- Elastic-fibro cartilage, 45
- Elastin, 39
- Electrical changes in muscle, 212
- Electricity induced, action on muscle, 219
- Electrocardiogram, 428
- Electrotonus, 63

- Eleventh nerve (*see* Spinal accessory)
 Embryo, attachment to mother, 626
 Emmetropic eye, 146
 Empedocles, 1
 Emulsion, 13 (Appendix III.)
 Endocardium, 390
 Endocrinetes, 588 *et seq.*
 classification, 589
 interaction, 611
 Endogenous purins, 561
 Endolymph (*see* Ear)
 Endothelium, 40
 Energy requirements, 264 *et seq.*
 factors modifying, 266
 Energy value of carbohydrates, 257
 determination of, 256
 fats, 257
 proteins, 257
 Enteric fever, toxin of, 613
 Entero-hæmal circulation, 331
 Entero-hepatic circulation, 331
 Enterokinase, 321
 Enzymes, 7
 Eosinophils, 483
 Epiblast, 624
 parts developed from, 624
 Epiglottis, 307, 550
 Epiphysis, 49
 Epithelium, ciliated, 37
 columnar, 33
 excreting, 36
 glandular, 34
 mucin-secreting, 34
 secreting, 34
 simple squamous, 32
 stratified squamous, 32
 transitional, 33
 zymin-secreting, 36
 Equilibrium of body, 130
 Erection, 623
 Erepsin, 328
 Erythroblasts, 501
 Erythrocytes, 500, 505
 Erythro-dextrin, 303
 Esters (*see* Appendix I.)
 Ethane (*see* Appendix I.)
 Etheral sulphates in urine, 563
 Ether extract, 285
 Ethers (*see* Appendix I.)
 Ethylene (*see* Appendix I.)
 Euglobulin (*see* Blood serum), 480
 Eustachian tube, 167, 169
 Excito-motor nerves, 74
 reflex nerves, 74
 secretory nerves, 74
 Excreting epithelium, 36
 Excretion, by the lungs (*see* Respiration)
 by the skin, 583
 by the intestine, 363
 Exogenous purins, 561
 Exophthalmic goitre, 598
 Expiration, 521
 Expiration, forced, 521
 Expired air, 537
 Extensor thrust, crossed, 85
 Exteroceptive receptors, 96
 Eye, 139 *et seq.*
 anatomy of, 139
 astigmatic, 151
 blind spot, 151
 connection with central nervous system, 162
 dark adapted, 153
 emmetropic, 146
 fluids of, 140, 143
 hyaloid membrane of, 140
 hypermetropic, 149
 myopic, 150
 physiology, 143
 presbyopic, 149
 Eyeballs, glance movements of, 160
 movements of, 159
 muscles of, 159
 nervous mechanism of, 161
 FACIAL nerve, 201
 Faeces, 361
 composition of, 363
 Fainting, 472
 Fallopian tube, 621
 Faraday-Tyndall phenomenon, 13
 Faradic stimulation, 67
 Far point of accommodation, 147
 Fascia, 40
 dentata, 135
 Fasting, metabolism during, 272
 rate of waste during, 273
 Fat cells, 41
 in foods, 285
 storage of surplus, 351
 soluble A, 281
 Fat-splitting enzyme of pancreas (*see* Lipase)
 Fate of food absorbed, 350
 Fatigue of cerebral mechanism, 186
 nerve, 69
 of muscle, 225
 Fats, 19, 41, 285
 absorption of, 347, 350
 determination of amount oxidised, 258

- Fats, energy value of, 257
 regulation of supply, 358
- Fattening, 373
- Fatty acids, 29
 lower, 359
 tissue, 351
- Feeding, standards, 375
- Fenestra ovalis, 167
 rotunda, 167
- Fermentation in rumen, 340
 losses, 365
- Fetlock joint, 237
- Fibres, elastic, 39
 nerve, 56
 non-medullated nerve, 56
 splanchnic, 54
 somatic, 54
 white, 39
- Fibrillar twitching, 220
- Fibrillation of heart, 430
- Fibrin, 476
- Fibrinogen, 477, 480
- Fibroblasts, 38
- Fibro-cartilage, elastic, 45
 white, 45
- Fibrous tissue, 38
- Field of vision, 152, 158
- Fifth cranial nerve, 201
- Filiform papillæ (*see* Tongue)
- Flocculus of cerebellum, 125
- Flow of blood, 464
 to heart, 404
- Fluids, swallowing of, 308
- Fodder, green, 290
 dry, 290
- Fœtal circulation, 631
- Fœtus, growth of, 630
 nourishment of, 628
- Food, 283 *et seq.*
 absorption of, 347
 absorbed, fate of, 350
 availability of, 363
 effect of, on metabolism, 272
 not yielding energy, 288
 requirements, 368 *et seq.*
 methods of determining,
 369
 for fattening, 373
 for growth, 371
 for maintenance, 371
 for milk production, 374
 for meat production, 374
 for work, 375
 residues, 363
 storage of surplus, 351
 yielding energy, 283
- Food stuffs, classification of, for
 herbivora, 290
- Foot, horse's, 233 *et seq.*
- Foramen ovale, 632
 occlusion of, 633
- Formamide (*see* Appendix I.)
- Formic acid (*see* Appendix I.)
- Fourth cranial nerve, 201
- Fovea centralis (*see* Retina)
- Fraunhofer's lines, 487
- Frog of horse's foot, 233
- Frog's heart, 393
- GALACTOSE, 286
- Galactosides, 58
- Galen, 1
- Gall-bladder, 323
- Gallop, 241
- Galvanic current, stimulation by, 62
- Galvanometer, 212
 string, 214
- Galvanotaxis, 26
- Ganglia, nicotine on, 198
 terminal, 55
- Gas pump, 496
- Gases of the blood, 492
- Gastro-colic reflex, 335
- Gastric digestion, amyolytic period,
 311
 proteolytic period, 311
- Gastric glands, 295
- Gastric juice, 310
 action on gelatin, 312
 action on proteins, 311
 antiseptic action, 313
 influence of diet on, 313
 nervous mechanism of, 314
 source of constituents, 310
- Gastric movement, nervous mechanism of, 317
- Gelatin, 39
 action of trypsin on, 320
 value as a food, 276
- Gels, 13
- Gemmules, 56
- Generative organs (*see* Gonads)
- Gennari, layer of, 164
- Gestation, 633
- Giant cells, 501
- Giantism, 600
- Gills of aquatic animals, 513
- Glance movements of eyeballs, 160
- Glands, 34
- Glaucoma, 143
- Gliadins, 284
- Globin, 490

- Globulin (*see* Appendix II.)
 Glomerulus of kidney, 572
 Glossopharyngeal nerve, 201, 305
 Glucosamine, 35
 Glucose, 288
 Glutamine, 281
 Glutelins, 284
 Glycæmia, 355
 Glycerol, 41 (Appendix I.)
 Glycero-phosphates in urine, 565
 Glycin, 16
 Glycocholate of soda, 323
 Glycocholic acid, 323
 Glycogen, 287
 Glycogenic function of the liver, 354
 Glyco-proteins (*see* Appendix II.)
 Glycosuria, 355
 alimentary, 355
 experimental, 356, 357
 Glycuronic acid, 44
 Glycyl-glycin, 19
 Gmelin's test, 324
 Goitre, exophthalmic, 598
 Goitre, simple, 599
 Golgi, organs of, 105
 Gonads, 605
 Graafian follicle, 619
 Granules, in cells, 23
 Nissl's, 86
 Grass, 290
 Graves' disease, 598
 Gravity, influence on capillary pressure, 463
 Grey matter (*see* Cerebrum, etc.)
 Grooming, 585
 Growth, essentials for, 6
 rations for, 371
 regulation of, 586
 Guanidin, 209, 555
 methyl guanidin, 605

HÆMATIN, 490
 Hæmatoidin, 491
 Hæmatoporphyrin, 491, 566
 Hæmatalograph, 440
 Hæmin, 491
 Hæmocytometer, 485
 Hæmoglobin, 486
 decomposition of, 589
 derivatives, 489
 Hæmoglobinometer, Haldane's, 488
 Hæmolymp glands, 500
 Hæmolysin, 486
 Hæmolysis, 21, 486
 organs connected with, 504

 Hæmosiderin, 504
 Hair, 583
 Haller, 2
 Harvey, 2
 Hassall, corpuscles of (*see* Thymus)
 Haversian canals, spaces, etc., 48
 Hay, 290
 "Head down position," effect on blood pressure, 471
 Hearing, 166
 Heart action, influence on blood pressure, 451
 attachments and relations, 393
 auriculo-ventricular node, 385
 band of His, 385
 block, 429
 changes in shape, 397
 in position, 399
 in pressure, 399
 chordæ tendinæ, 388
 columnæ carnæ, 387
 compensation, 417
 connection with central nervous system, 418
 endocardium, 390
 failure, 462
 fibrillation, 430
 fibrous rings of, 385
 hypertrophy, 417
 influence of nerves upon, 418
 intra-cardiac nervous mechanism, 388
 intra-cardiac pressure, 399
 muscle, 205
 nerves of, 388, 418
 neurons, 388
 papillary muscle, 387
 pericardium, 389
 physiology of, 393 *et seq.*
 pulmonic, 383
 relations of, 393
 sino-auricular node, 385
 sounds of, 407
 structure, 384
 sympathetic fibres to, 421
 tone, 428
 valves (*see* Valves)
 work of, 410
 Heat elimination, 267, 271
 elimination from respiratory passages, 268
 elimination in urine and fæces, 268
 production, 268

- Heat production in glands, 268
 in muscle, 268
 regulation of, 269
 chemical, 269
 physical, 269
 units (*see* Calories)
- Hemispheres, cerebral (*see* Cerebrum)
- Henle's loop, 572
 sheath, 57
- Hepatic vein, 299
- Herbivora, digestion in, 336
- Hereditary inertia, 586
- Herpes zoster, 91
- Hexoses, 28
- Hiccough, 523
- High tension pulse, 443
- Highmori, corpus (*see* Corpus Highmori)
- Hippocampus, 136
- Hippocrates, 1
- Hippuric acid, 562
- Hirudin, action on blood, 478
- His, bundle of (*see* Bundle of His)
- Histamine, 451
- Histidin, 17, 555
- Histones (*see* Appendix II.)
- Holoblastic segmentation, 624
- Homogentisic acid, 555
- Hoof, horse's, 234 *et seq.*
- Hormones, 588
- Horse, action of limbs, 237 *et seq.*
 amble, 241
 cæcum, 297, 344
 canter, 242
 capacity for work, 252
 colon, 298, 344
 diet, maintenance, 371
 for work, 375
 digestion, 341
 efficiency as machine, 252
 foot, 237
 gallop, 241
 grooming, 585
 jump, 242
 legs, conformation of, 235
 lying, 239
 mastication, 293
 overwork, 253
 rising, 239
 standing, 237
 stomach, 295
 sweat, 585
 sweating, 267
 teeth, 292
 trot, 240
- Horse, vomiting, 346
 walk, 239
 watering, 367
 work, 375
- Hot spots, 104
- Humour, aqueous, 140
 vitreous, 140
- Hunger, 99
 contraction, 309
- Hyaline cartilage, 43
- Hyaloid membrane, 140
- Hydrocarbons, unsaturated (*see* Appendix I.)
 saturated (*see* Appendix I.)
- Hydrogen ion concentration (*see* Appendix III.)
- Hydroquinon, 555
- Hydrosols, 15
- Hydroxyl molecule (*see* Appendix III.)
- Hypermetropia, 149
- Hyperpnœa, 528, 531
- Hyperthyroidism, 598
- Hypnosis, 188
- Hypnotic drugs, 187
- Hypoblast, 625
 parts developed from, 625
- Hypoglossal nerve, 200
- Hypophysis, 595
- Hypophysis cerebri, 594
- Hypothyroidism, 597
- Hypoxanthin, 556
- ILEO-CÆCAL valve, 296, 334
- Impregnation, 623
- Impulse, nature of nervous, 74
- Incompetence (cardiac), 410
- Incus, 167
- Indican, 563
- Indol, 329
- Indoxyl, 563
- Induced electricity, stimulation, 62
- Inferior oblique muscle, 159
- Infundibula, pulmonary, 514
- Infundibular passages, 514
- Inhibitory action of vagus, 420
- Inorganic salts in food, 288
- Inosite, 209
- Insalivation, 302
- Inspiration, 516
 forced, 520
- Interchange of air in lungs, 537
- Intercostal muscles in respiration, 519
 external intercostals, 519
 internal intercostals, 521

- Intermittent muscular exercise, 470
 Internal respiration, 547
 secretions, mode of action, 611
 Interoceptive receptors, 96
 Interrenal tissue, 609
 Intestinal wall, enzymes of, 328
 mechanism of secretion, 328
 Intestine, 295
 absorption from, 348
 capacity, 301
 digestion in, 319 *et seq.*
 large, 296
 length, 301
 movements of, 332
 secretion, 328
 Intracardiac pressure, 399
 Inverted image rectified, 166
 Iodothyroglobulin, 596
 Iodothyryn, 596
 Iris, 140
 Islets of Langerhans, 300, 601
 Isometric contraction, 225
 Isotonic contraction, 225
- JACKSONIAN** epilepsy, 191
 Jacobson's nerve, 305
- KARYOPLASM**, 27
 Karyosomes, 27
 Kellner's standards, 376
 Keratin, 32
 Ketones (*see* Appendix I.)
 Kidney, 571 *et seq.*
 influence of nervous system,
 580
 nerves of, 572
 regulation of ions, 556
 structure, 571
 Kilogram-metre, 242
 Kinæsthetic sense (*see* Muscle-joint
 sense)
 Knee-jerks, 89
- LABYRINTH**, osseous, 117, 170
 connections with central nerv-
 ous system, 119
 physiology, 121
 Labyrintho-cerebellar mechanism,
 117
 physiology, 121
 Lactase, 328
 Lactation, 634
 Lactose, 286
 Lacuna, 46
 Lævulose, 286
 Lamellæ (*see* Bone)
- Laminitis, 253
 Langerhans, islets of, 300, 601
 Lanolina, 585
 Large intestine, 296, 334
 Laryngoscope, 552
 Larynx, cartilages of, 550
 centre, 552
 ligaments of, 550
 mucous membrane of, 551
 muscles of, 551
 nervous mechanism of, 552
 position in deglutition, 307
 structure of, 550
 Latent period of muscle, 216
 time of reflex action, 83
- Lateral fillet, 172
 Lecithin, 19
 Leg, horse's conformation of, 235
 Lens, capsule, 141
 crystalline, 141
 physiological, 145
 Lenticular nucleus (*see* Cerebrum)
 Leucin, 17
 Leucoblasts, 500
 Leucocytes, 483
 fate of, 503
 phagocytic action, 484
 source of, 499
 Leucocytosis digestion, 348
 Leuwenhoek, 2
 Levers, 231
 Leydig's cells, 606
 Lieberkühn's follicles, 295
 Life, 5
 Ligaments, 40
 Linin network, 27
 Lipase, 321, 328
 Lipoids, 19
 Liquor folliculi, 619
 sanguinis, 474
 Live weight test, 369
 Liver, 299
 circulation in, 353
 development of, 353
 formation of urea in, 359
 glycogenic function, 353
 regulator of supply to muscles,
 353
 relation to fats, 358
 relation to general metabolism,
 353 *et seq.*
 relation to proteins, 359
 storage of carbohydrates, 354
 Living matter, essentials of, 5
 Lobus pyriformis (*see* Smell)
 Loudness of sounds, 553

- Lungs, 514
 circulation in, 468
 interchange between air and blood in, 537
 physiology of, 515 *et seq.*
- Lymph, 507
 formation of, 508
 in disease, 508
- Lymphatic glands, 499
- Lymphatics, pressure in, 464
- Lymphocytes, 463
- Lysin, 17, 278
- MACULA lutea (*see* Retina)
- Maize as food, 276
- Malleus, 167
- Malpighi, 2
- Malpighian bodies of kidney, 573
 corpuscles of spleen, 504
- Maltose, 286
- Mammary glands, 609
- Manometer, papers, 400
- Maurial valves, 380
- Marchi's method of nerve-staining, 76
- Marey's muscle forceps, 226
- Mariotte's experiment, 151
- Mastication, 302, 337
 in horse, 293, 342
 in ruminant, 337
- Maternal attachment of ovum (*see* Placenta)
- Meat production, 374
- Meconium, 363
- Medulla of kidney (*see* Kidney)
- Medullary sheath (*see* Nerve)
- Meeh's formula, 265
- Megaloblasts, 500
- Meissner's plexus (*see* Intestine)
- Melanin, 43
- Melanoidins, 43
- Membrana nictitans, 140
 reticularis, 172
 tectoria, 172
 tympani, 167, 169
- Membranous labyrinth, 118, 171
- Memory, 180
- Mesoblast, 625
 parts developed from, 625
- Metabolism, basal, 264
 during fasting, 272
 effect of food on, 272
 factors modifying, 266
 general, 264
 method of investigating, 257
 of fats and carbohydrates, 257
- Metabolism of protoplasm, 9
 protein, 257
 regulation of, 586
 semi-starvation in, 274
- Metaphosphoric acid, 28
- Methæmoglobin, 489
- Methane (*see* Appendix I.)
- Methyl-guanidin, 209, 605
- Micro-organisms in rumen, 339
 in intestine, 329
- Micturition, 581
- Milk, 635
 composition of, 637
 enzyme causing curdling, 310
 fats, 636
 proteins of, 636
 production, 374
 secretion of, 635
 sugar of, 637
- Mitotic division, 29
- Mitral area, 408
 valve, 390
- Molecular layers of retina (*see* Retina)
- Mon-amino acids (*see* Appendix I.)
- Monaster stage of cell division, 30
- Monocular vision, 144
- Monosaccharide, 286
- Motor areas, 191
 nerves (*see* Nerves)
- Mountain sickness, 543
- Mouth, 291
- Mucin, 35
 secreting epithelium, 34
- Mucoid tissue, 37
- Mucus, 35
- Müller, 2
- Murmurs, cardiac, 409
 simulation of, by breath sounds, 537
- Muscarin, 20
- Muscle, 202 *et seq.*
 absolute force of, 224
 action, mode of, 231
 carbohydrates of, 208
 cardiac, 205
 changes in shape, 219
 chemical changes in, 254
 chemistry of, 207
 ciliary, 147
 colour of, 210
 contraction, 222
 contracture, 226
 corpuscles, 204
 course of contraction, 222
 death of, 214

- Muscle, degeneration of, 66**
 development, 202
 direct stimulation, 217
 Dobie's line, 204
 efficiency, 248, 250
 elasticity, 210
 electrical changes in, 212
 electrical condition of, 212
 electrotonus, 63
 extent of contraction, 223
 factors modifying contraction, 225
 fatigue, 226
 force of contraction, 223
 forceps, Marey's, 225
 galvanotonus, 62
 heart, 205
 heat production in, 212, 246
 in action, 215
 isometric tracings, 225
 isotonic tracings, 225
 latent period of contraction, 223
 lever arrangement of, 231
 metabolism, 254
 mode of action, 231
 optimum load, 244
 oxidation, 254
 material oxidised, 255
 mode of, 256
 paradoxical contraction, 72
 physical characters of, 210
 physiology of, 210
 polar excitation of, 62, 67, 219
 proteins of, 207
 red, 205
 sarcolemma of, 204
 sarcous substance, 204
 skeletal, 217
 spindles, 106
 stapedius, 167, 169
 stimulation by galvanic current, 219
 stimulation by induced electricity, 219
 stimulation, direct, 217
 stimulation, methods of, 218
 stimulation temperature, 219
 storage of food in, 352
 structure of, 202
 successive stimuli, 228
 tension developed, 224, 242, 248
 tensor tympani, 167, 169
 tetanus of, 229, 230
 tonus of, 211
 visceral, 203, 215
- Muscle, voluntary contraction, 230**
 white, 205
 work, 242
 work measurement, 245
 work production, relationship to heat production, 246, 248
- Muscles, and joint sense, 105**
 co-operative antagonism of, 231
 of eyeball, 159
 of larynx, 551
- Muscular sense, 105**
 work, effect on metabolism, 266
 work, effect on respiratory interchange, 258 *et seq.*
- Myelocytes, 484, 501**
 Myenteric plexus, 94
 Myocardium, 384
 Myoglobulin, 208
 Myohæmatin, 210
 Myoids, 202
 Myopia, 150
 Myosin, 207
 Myosinogen, 207
 Myostromin, 208
 Myxœdema, 596, 597
- NATIVE proteins (see Appendix II.)**
 Near point of accommodation, 146
 Necrobiosis, 10, 214
 Neopallium, 191
 Nephridium, 570
 Nerve, 58
 automatic action of, 75
 cells, 75
 centres (*see Centres*)
 changes in disease and injury in, 66
 chemistry of, 57
 conduction, 78
 corpuscles, 56
 degeneration of, 67
 development, 53
 electrical changes in, 60
 excitability, variations in, 68
 exposed, stimulation of, 62
 fibres, 56
 fibres, medullary sheaths of, 56
 fibres, non-medullated, 56
 grey, 56
 impulse, nature of, 74
 stimulous, relationship of, 68
 structure of, 55
 under skin, stimulation of, 64
- Nerves, afferent, 74**
 anterior roots, 107
 auditory, 172

- Nerves, augmentor, 73**
 cranial, 200
 degeneration of, 76
 efferent, 73, 195
 excito-motor, 74
 excito-reflex, 74
 excito-secretory, 74
 excito-vaso dilator, 74
 factors modifying conduction
 in, 71
 ingoing, 106
 inhibitory, 73
 mixed, 74
 motor, 73
 nature of impulse in, 74
 optic, 162
 posterior root, 107
 rate of conduction in, 70
 regeneration of, 76
 secretory, 73
 sensory, 74
 somatic, 54
 splanchnic, 54, 196
 thoracico-abdominal, 197
 vagus, 200
 vaso-constrictor, 456
 vaso-dilator, 456
 visceral, 195
- Nervous mechanism, intra-cardiac,**
 388
 extra-cardiac, 418
 gastric movement, 318
 regulation of metabolism, 587
 system, 53
 development of, 53
 structure of, 55
- Neural arcs, 78 et seq.**
 cerebellar, 81
 cerebral, 80
 general action of, 80
 spinal, 78
- Neurilemma, 56**
Neuroblast, 53
Neuro-keratin, 57
Neuromyal junction, 205
Neurons of heart, 388
Neurons, 53
 axon of, 56
 cell of, 55
 cell, Nissl granules in, 55
 classification of, 73
 conduction in, 69
 degeneration of, 77
 dendrites of, 56
 excitation of, 60
 function of cell, 76
- Neurons, gemmules of, 56**
 in series, 77
 manifestations of activity, 59
 means of stimulating, 61
 nature of impulse, 74
 neuro-myal junction, 205
 nutrition of, 76
 physiology, 58
 regeneration of, 77
 stimulation of, 61 *et seq.*
 structure, 55
 synapsis, 54
- Neutral sulphur in urine, 564**
Nicotine, effect of painting ganglia,
 198
- Ninth nerve, 201**
Nissl's degeneration, 77
 granules, 55
- Nitric oxide, 489**
Nitrogen in the urine, 559
 free extract, 286
 non-protein, 284
- Noxi-ceptive receptors (see Pain)**
Noxious stimuli, 100
Nodes of Ranvier, 57
Non-medullated nerve fibres, 56
Non-polarisable electrodes (see Elec-
trodes)
- Normoblasts, 601**
Nuclei of the cranial nerves, 200
Nucleic acid (see Appendix I.), 27
Nucleins (see Appendix I.), 27
Nucleolus, 27
Nucleo-proteins (see Appendix II.),
 556
 action of gastric juice on, 312
 action of trypsin on, 321
 of urine, 566
- Nucleus, 26 et seq.**
 accessorius, 172
 chemistry of, 27
 division of, 26
 functions of, 26
 membrane of, 26
 of Deiters', 126
 structure of, 26
- Nutritive ratio, 368**
- OATS, 366**
Oblique muscles of eye, 159
Oculomotor nerve, 161, 201
Oesophageal groove, 295
Oesophagus, 293
 peristaltic action of, 308
Oestrous cycle, 622
Oleic acid, 42

- Olein, 42
 Olfactory area, 134
 bulb and tracts, 134
 tubercle, 134
 Omasum, 294
 Oncometer, 452, 573
 Oocytes, 619
 Ophthalmoscope, 142
 Oponins, 615
 Optic axis, 159
 chiasma, 162
 disc, 141
 fibres, decussation of, 162
 nerve, 162
 thalamus, 112, 162
 tracts, 162
 Optimum stimulus, 227
 Ora serrata, 142
 Organ of Corti, 171
 Organic acids as salts in food, 340
 Organs of Golgi, 106
 Osmosis, 21 (*see* Appendix III.)
 Osseous labyrinth, 170
 Ossicles of ear, 167
 Ossification, process of, 45
 centre of, 45
 Osteoblasts, 46
 Osteoclasts, 46
 Osteomalacia, 50
 Otoliths, 118
 Ovary, 607, 619
 Ovum, 616, 618
 Oxalates on blood, 477
 Oxalic acid in urine, 566
 Oxidation coefficient, 254
 Oxy-acids (*see* Appendix I.)
 Oxybutyric acid, 358
 Oxygen, head of, 545
 in blood, 492
 Oxyhæmoglobin, 487
 Oxyntic cells, 310
 Oxyphil leucocytes, 483

 PACEMAKER of heart, 430
 Pacinian corpuscle, 97
 Pain, 100
 referred, 98
 sensation of, 100
 spots, 100
 Palmitic acid, 42
 Palmitin, 42
 Palpation of pulse, 442
 Pancreas, 300, 601
 islets of Langerhans (*see* Lan-
 gerhans)
 removal of, 357, 601

 Pancreatic secretion, 319
 action of, 320
 character of, 320
 enzymes of, 320
 nervous, control of, 322
 physiology of, 321
 Papillary muscles, 387
 Paradoxical contraction, 72
 Paralysis, 191
 crossed, 194
 Paramyosinogen, 208
 Parathyreoid, 603
 Parotid gland, 305
 Parthenogenesis, 616
 Partial pressure of oxygen and car-
 bon dioxide in blood, 541
 pressure of gases in air vesicle,
 539
 Passage of carbon dioxide from
 tissues to blood, 546
 of oxygen from blood to tissues,
 545
 Peas as food, 290
 Pectinate muscle, 386
 Peduncles of cerebrum (*see* Cerebrum)
 Pelvis, nerves of, 198
 Penis, 621
 erection, 623
 Pentosans, 287
 Pepsin, 310
 source of, 310
 Pepsinogen, 311
 Peptides, di-, tri-, 19
 Peptone (*see* Appendix II.)
 Perfusion method of studying action
 of drugs, 463
 Pericardium, 389
 Perichondrium, 46
 Perilymph, 170
 Perineurium, 57
 Peripheral resistance, 451
 Peristalsis, 333
 nervous mechanism of, 333
 of bladder wall, 581
 of intestine, 333 *et seq.*
 of wall of ureter, 581
 Peyer's patches, 296
 Pflüger's law, 72
 Phacocope, 147
 Phagocyte action, 484
 Pharynx, 307
 Phenol, 330, 563
 Phloridzin, injection of, 357
 Phosphatides, 19, 58
 Phospho-protein (*see* Appendix II.)
 Phosphorus in food, 289

- Phosphorus-containing bodies in the urine, 565
- Phototaxia, 26
- Phrenic nerves, 527
- Physiology, growth of, 1
study of, 3
- Pigment, blood (*see* Hæmoglobin) cells, 43
- Pigments of the bile, 324
of the urine, 566
- Pitch of sounds, 174, 553
- Pituitary, 699
- Placenta, 628
- Plantar cushion, 233
- Plasma, 479
- Plasmodia, 11
- Plasmolysis, 21
- Platelets, blood, 484
- Plethysmograph, 452
- Pleura, complemental, 518
- Pleural cavity, 615
- Plexus, Auerbach's (*see* Auerbach) Meissner's (*see* Meissner) terminal, 55
- Pneuma, 1
- Polar excitation, law of, 64
- Polycrotic pulse (*see* Pulse)
- Polymorpho-nuclear leucocytes, 463
- Polypeptides, 19
- Polysaccharids, 287
- Portal circulation, 353
- Positive accommodation, 147 *et seq.*
accommodation, varying power of, 149
- Posterior columns of spinal cord (*see* Spinal cord)
ganglion reflex, 93
grey commissure (*see* Spinal cord)
roots, ganglia of, 107
- Posture on circulation, 471
- Potassium in food-stuffs, 289
- Potatoes, composition, 290
- Precipitins, 614
- Predicrotic wave, 441
- Preformed sulphate in urine, 563
- Pregnancy, course of, 608
metabolism, 631
- Prepyloric sphincter, 295
- Presbyopia, 149
- Presphygmic period, 404
- Pressure, arterial, 447 *et seq.*
arterial, factors controlling, 450
blood, 432
in capillaries, 460
in lymphatics, 464
intracardiac, 399
- Pressure, variations in, due to
respiration, 446
venous, 463
- Primitive nerve sheath, 56
- Private path, 87
- Production of heat (in muscle), 268
- Propionic acid (*see* Appendix I.)
- Proprioceptive receptors, 96
- Prostate gland, 621
- Protamine, 17
- Proteates (*see* Appendix II.)
- Protein, absorption of, 347
chemistry of, 15
classification of (*see* Appendix II.)
conversion into fat, 352
determination of amount oxidised, 257
disintegration of, 16
energy value of, 257
in food, 263
metabolism of, 257 *et seq.*, 554
native (*see* Appendix II.)
physical characters, 14
products of, 15
regulation of supply, 359
- Protein, requirements, 370
storage of, 352
synthesis of, 18
vegetable, 284
- Proteins, 15 (*see* Appendix II.)
- Proteolytic period of gastric digestion, 311
- Proteoses, 311
- Prothrombin, 477
- Protoplasm, 5
chemistry of, 12
liberation of energy by, 7
metabolism of, 9
structure, 11
- Protoplasmic activity, 5, 21
- Proto-proteoses, 312
- Pseudoglobulin, 480
- Pseudopodia, 24
- Ptyalin, 302
- Puberty, 618
- Pulmonary area, 407
valve, 392
- Pulmonic heart (*see* Heart, pulmonic), 363
- Pulse, anacrotic, 442
arterial, 434
capillary, 444
characters of wave, 436
dicrotic, 440
form of wave, 438

- Pulse, height of wave, 437
 high tension, 443
 length of wave, 437
 palpation of, 442
 polycrotic, 442
 rate of, 442
 rhythm, 442
 tension, 443
 velocity of wave, 436
 venous, 444
 volume of, 442
- Pulsus celer, 443
 parvus, 442
 plenus, 442
 tardus, 443
- Pupil, 140
 dilatation, 148
 dilator of, 140
 drugs, action, 149
 sphincter of, 140, 147
- Purin bodies, 556, 561
- Purkinje's cells, 125
 images, 152
- Pyloric end of the stomach, 295
 sphincter, 316
- Pyramidal tracts (*see* Spinal cord),
 194
- Pyriform lobe, 134
- Pyrimidin bases, 28
- Pyrocatechin, 564
- Pyrrol derivatives (*see* Appendix I.)
- QUALITY** of sounds, 553
- RACEMOSE** glands, 34
- Radiation of heat from skin, 267
- Radicles, organic (*see* Appendix I.)
- Ranvier, nodes of, 57
- Reaction time, cerebral, 186
 of degeneration, 66
- Receptor spots, 306
- Receptors, 96
 connection with central
 nervous system, 106
 distance, 130
- Recti muscles (*see* Eye)
- Rectum, 296
- Recurrent laryngeal nerve (*see*
 Nerves of larynx)
- Red cells of blood (*see* Erythrocytes)
 marrow of bone, 501
 nuclei (*see* Cerebrum)
- Reduced alkaline hæmatin, 490
- Referred pain, 98
- Reflex action, 82 *et seq.*
 bladder, 93
- Reflex action, fatigue, 89
 posture, 86
- Reflexes, peripheral, 92
 visceral, 89
- Refraction of light, 144
- Refractive indices of media of eye,
 144
- Refractory period of muscle, 216
- Regeneration of nerve, 77
- Regulation of growth and function,
 586
- Rennet (*see* Rennin)
- Renuin, 312, 321
- Reproduction, 616 *et seq.*
- Requirements, food, 368 *et seq.*
 proteins, 370
- Reserve air, 523
- Residual air, 523
- Respiration, 513 *et seq.*
 artificial, 549
 at high altitudes, 543
 chemical regulation, 527
 Cheyne-Stokes, 531
 effect of, on air breathed, 537
 effect on the blood, 538
 external, 513
 influence of heart's action on,
 536
 influence on circulation, 535
 intermediate, 545
 internal, 547
 mechanism of, 513 *et seq.*
 movement of ribs in, 519 *et seq.*
 movements in, 516
 nervous mechanism of, 523
 number per minute, 525
 physiology of, 515
 reflex control of breathing, 532
 rhythm of, 525
 vagus, influence on, 532
- Respiratory calorimeter, 259
 centre, 526
 reflex regulation, 532
- Respiratory interchange, extent of,
 547; causes of, 539
 movements, special, 522
 passages, elimination of heat by,
 268
 quotient, 268
- Rete testis (*see* Testis)
- Reticulum, 294
- Retina, 140
 central spot, 153
 corresponding areas on the two
 sides, 158
 fatigue of, 154

- Retina, layers of, 141
 modes of stimulation, 153
 nature of changes in, 154
 rods and cones of, 142
 stimulation of, 153 *et seq.*
 Rhinencephalon, 135, 181
 Rhodopsin, 154
 Ribs, movements of, in respiration
 (*see* Respiration)
 Rickets, 50, 281
 Rigor mortis, 214
 Riva Rocci blood pressure apparatus,
 438
 Roaring, 553
 Rolandic area (*see* Motor areas)
 Roof nucleus of the cerebellum (*see*
 Cerebellum), 125
 Roots as food, 290
 Roots of the spinal nerves, 107
 Rubro-spinal fibres, 195
 Rumen, 294
 digestion in, 339
 Rumination, 337

SACCHAROMYCES cerevisæ, 5
 Saccule, 118
 Saliva, 302 *et seq.*
 character of, 302
 chemistry of, 302
 functions of, 303
 influence of chorda tympani in
 secretion of, 304
 physiology of, 303
 reflex stimulation of secretion,
 304
 stimulation of sympathetic
 effect on, 305
 Salivary centre, 305
 glands, 293
 glands, nerve supply, 303
 secretion, physiology of, 303
 Salts of the bile acids, 323
 Sanson's images, 147
 Sarcolactic acid, 206, 250
 Sarcolemma, 204
 Sarcostyle, 204
 Sarcous substance, 204
 Scala media, 171
 tympani, 170
 vestibula, 170
 Scheiner's experiment, 146
 Schwann, 2
 white sheath of (*see* Nerve)
 Sclero-proteins (*see* Appendix II.)
 Sclerotic, 139
 Scratch reflex, 87

 Sebaceous glands, 585
 Secretin, 321, 601
 Secreting epithelium, 34
 Secretions, internal, 588 *et seq.*
 Sectional area of circulatory system,
 383
 Semen, 621
 Semicircular canals, 117
 Semilunar valves, 391
 Semi-starvation, metabolism of, 274
 Seminiferous tubules, 620
 Sensation, colour, 155
 integration, 179
 of hunger (*see* Hunger)
 of pain (*see* Pain)
 of smell (*see* Smell)
 of taste (*see* Taste)
 of thirst (*see* Thirst)
 physiology of colour, 155
 Sensation, production of colour,
 156
 Sense of acceleration and retarda-
 tion of motion (*see* Labyrinth)
 of hearing, 166 *et seq.*
 joint and muscle, 105
 tactile, 101
 thermal, 103
 Sensibility, common, 98
 Sertolis cells, 606
 Serum, 479
 albumin, 476, 480
 globulin, 476, 480
 Sesamoid ligaments, 233
 Seventh cranial nerve, 199
 Sex, determination of, 617
 Sexual organs, 618
 organs, effect of removal of, 606
 Sheath of Schwann, white, 56
 Shingles, 91
 Side-chain theory, 614
 Sight, 136 *et seq.*
 Sino-auricular node, 385
 Sinus of Valsalva, 392
 Sixth nerve (*see* Abducens), 201
 Skatol, 330
 Skatoxyl-sulphate of potassium,
 563
 Skin, elimination of heat by, 267
 excretion by, 582
 receptors, 99
 Slaughter test, 369
 Sleep, 187
 Small intestine, 295, 332
 Smell, 133
 centre for, 134
 mechanism of, 133

- Smell, physiology of, 136
 Snake toxin, 612
 Sneezing, 522
 Sole, 13
 Soluble nitrogen in feeding stuffs, 284
 Somatic fibres, 54, 195
 Somatopleur, 625
 Sounds of the heart, 407
 Specific dynamic action of foods, 272
 nerve energy, 97, 138
 Spermatida, 621
 Spermatocytes, 621
 Spermatogonia, 620
 Spermatozoa, 618
 Spherical aberration, 147
 Sphincter ani, 296
 centre, 148
 ileo-cæcal, 334
 of stomach, 316
 pupillæ, 140, 147
 Sphygmograph, 439
 Sphygmomanometer (*see* Riva Rocci)
 Spinal accessory nerve, 200
 Spinal cord, 108 *et seq.*
 anterior columns, 111
 arc, 78, 82
 ascending degenerations, 102
 conducting paths in, 108, 194
 hemisection, 108
 lateral columns, 111
 nerves, 106
 posterior columns of, 111
 reflexes, 82 *et seq.*
 tracts of, 107, 194
 upgoing fibres, 107
 "Spinal dog," 82
 Spino-tectal synapsis, 113
 Spino-thalamic synapsis, 113
 Splanchnopleur, 625
 Spleen, 504
 circulation in, 469
 movements, 506
 Spot, blind (*see* Blind spot)
 cold (*see* Cold spot)
 hot (*see* Hot spot)
 Squamous epithelium, 32
 Squint, 182
 Stannius' experiment, 425
 Stapedius muscle, 167, 169
 Stapes, 167
 Starch, 237
 equivalent, 377
 value, 377
 Stearic acid, 42
 Stearin, 42
 Stenosis, valvular, 410
 Stercobilin, 332
 Stereoscopic vision, 158
 Stethograph, 525
 Stimulation, unilateral, 25
 nocuous, 85, 100
 of muscle direct, 217
 Stimuli, 10
 successive, on muscle, 228
 Stomach, 295
 absorption from, 318
 after feeding, 310
 digestion in, 308
 in horse, 342
 in ruminant, 340
 during fasting, 309
 movements of, 315, 318
 nervous mechanism of, 317
 rate of passage of food from, 317
 regurgitation, 318
 secretion of, 310
 structure of, 295
 Storage of surplus food, 351
 Storing mechanism (cerebral), 185
 Strain, muscular, 253, 471
 Stroma of red cells of blood (*see* Erythrocytes)
 Stromuhr, 466
 Sublingual gland, 293
 gland, nerve supply, 304
 Submaxillary gland, 293
 gland, nerve supply, 304
 Subminimal stimulus, 84
 Substrate, 8
 Succus entericus, 328
 Sulcus centralis, 190
 Sulphates, ethereal, 563
 inorganic, 556, 563
 performed (*see* Inorganic sulphates)
 Sulphur-containing bodies in the urine, 563
 Sulphur, neutral, 556, 564
 Superior cardiac branch of vagus, 418
 oblique muscle, 159
 Suprarenal bodies, 590
 cortex, 609
 medulla, 590
 metabolism after injection of, 593
 Surface tension, 13 (Appendix III.)
 Suspensory ligament of eye, 141
 Swallowing, 306
 time of, 308

- Sweat, chemistry of, 585
 evaporation, 267
 glands, 583
 secretion of, 584
- Sympathetic nerves, true, 198
 nerves, para, 199
- Synapsis, 53
- Systemic heart (*see* Heart), 382
- Systole of heart, 394
- Systolic blood-pressure, 449
- TACTILE** sense, 101
 corpuscles, 102
- Tapetum nigrum, 142
- Taste, 131
- Taurocholate of soda, 323
- Taurocholic acid, 323
- Tecto-spinal fibres, 195
- Tectum, 112, 127
- Teeth of horse, 292
 of ruminant, 292
- Temperature, 264 *et seq.*
 chemical regulation, 269
 physical regulation, 269
- Tendon sheaths, 40
- Tendons, 40
- Tensor tympani muscle, 167, 169
- Tenth nerve (*see* Vagus)
- Terminal ganglia, 55
- Testis, 606, 616
 interstitial cells, 606
- Tetanus, complete, 230
 incomplete, 229
- Tetany, 65
- Thermal sense, 103
- Thermo-electric method, 247
- Thermopiles, 247 (Appendix III.)
- Thermotaxis, 26
- Third nerve, 199
- Thirst, 99
- Thoracic breathing, 520
- Thoracico-abdominal sympathetic, 198
- Thorax, in respiration, 518
- Thrombin, 477
- Thromboplastin, 478
- Thymus, 602
 effect of castration on, 603
 removal of, 603
- Thyreoid, 596
 gland, administration of extracts of, 598
 gland removal of (thyroidectomy), 597
- Thyreo-oxy-indol, 596
- Tidal air, 522
- Tissues, 31
 adipose, 41
 areolar, 40
 cancellous, 46
 connective, 37
 fibrous, 38
 lymph, 499
 master, 51
 mucoid, 37
 vegetative, 31
- Tone, plastic, 212
- Tongue, 291
- Tonometer, 541
- Tonus, muscle, 211
- Touch, centre for, 115, 116
 spots, 100
- Tract, crossed pyramidal, 195
 direct cerebellar, 112
- Tracts of cord, 112, 194
- Transitional epithelium, 33
- Tricuspid valve, 390
- Trigeminal nerve, 201
- Triple-phosphata, 559
- Trochlearis nerve, 201
- Trophoblast, 626
- Trypsin, 320
- Trypsinogen, 321
- Tryptophan, 17, 320, 556
- Tuberculum acusticum, 172
- Tubers as food, 290
- Tubules, secretion in kidney, 575
- Tunica albuginea, 620
- Turnips as food, 290
- Twelfth nerve, 220
- Tympanic cavity, 167
- Tyrosin, 17, 33, 556
- UMBILICAL** veins, 631
- Unconsciousness, 185
- Unilateral stimulation, 25
- Uratea, 561
- Urea, 559, 559
 sources of, 360
- Ureter, 581
- Urethra, 582
- Uric acid, 556, 561
- Uricoclastase, 556
- Urinary bladder, 581
- Urine, 554
 composition, 558
 excretion of, 581
 formation of, 567
 method of estimating solids in, 557
 micro-organisms in, 559
 nitrogenous substances of, 559

- Urine, non-urea nitrogen in, 559
 pigments of, 566
 reaction, 567
- Urobilin, 566
- Urochrome, 566
- Uroerythrin, 566
- Uterus, 621
 nervous control, 633
- Utricle, 118
- VACCINES, 615
- Vagus, 200
- Valsalva sinus of (*see* Sinus of Valsalva)
- Valve action in reflexes, 84
 ileo-cæcal, 334
- Valves of the heart, 390, 402
 action of, 402
- Valvular incompetence, 410
- Vas deferens, 620
- Vasa efferentia, 620
- Vaso-constrictor centre, 457
 mechanism, 454
- Vaso-dilator centres, 460
 mechanism, 468
- Vegetable proteins, 284
- Veins, 432
 pressure in, 463
 umbilical, 631
- Velocity of blood, 465
- Vena cava, inferior (foetal), 632
 cava, superior (foetal), 632
- Venous pulse, 444
- Ventilation, 548
 positive and negative, 533
- Ventricles of the heart, 386
 left, 386
 muscular structure of, 387
 pressure in, 402
 right, 388
- Vermis, superior, of cerebellum, 125
- Vesicular sound, 525
- Vestibular root of the eighth nerve, 119
- Vestibule of the ear, 117, 170
- Villi, chorionic, 626
 of intestine, 295
 primitive, 624
- Visceral muscle, 203, 215
 receptor mechanism, 97
- Vision, 136
 binocular, 158
 colour, 155
 distant, 144
 double, 159
- Vision, field of, 152, 158
 glance, 160
 monocular, 144
- Visual centre, 164
 sensation, duration of, 165
 strength of, 165
 purple, 154
- Vital capacity of the thorax, 523
- Vitamines, 282
- Vitreous humour, 140
- Vocal cords, 550
- Voice, 552
 physiology, 552
- Volar aspect of hoof, 233
- Voluntary contraction, nature of, 230
- Vomiting, 318
 in horse, 346
- von Mohl, 3
- WALLERIAN degeneration, 76
- Waste, rate of (during fasting), 274
- Water in feeding stuffs, 289
 soluble B, 281
- Watering, 367
- Wave, characters of pulse (*see* Pulse)
- Weigert's method of nerve-staining, 76
- Weight estimation, 106
- White cells of blood, 483
 fate of, 503
 source of, 499
- White fibro-cartilage, 45
 line (hoof), 235
- Wolf-Lehmann standards, 376
- Work collector, 245
 done by muscle, 242
 muscular, effect on excreta, 262
- X-CHROMOSOMES, 617
- X-rays in the examination of the stomach, 315
 of the intestine, 333
- YAWNING, 522
- Yeast, 5
- ZEIN, 277
- Zona granulosa, 619
 pallucida, 619
- Zymin, 7 (*see also* Enzymes)
 secreting epithelium, 36
- Zymogen, 36

THIS BOOK IS DUE ON THE LAST DATE
STAMPED BELOW

AN INITIAL FINE OF 25 CENTS
WILL BE ASSESSED FOR FAILURE TO RETURN
THIS BOOK ON THE DATE DUE. THE PENALTY
WILL INCREASE TO 50 CENTS ON THE FOURTH
DAY AND TO \$1.00 ON THE SEVENTH DAY
OVERDUE.

BIOLOGY LIBRARY

JAN 4 1937

LD 31-100m-8,'84

87075
6.50

Paton, D.N.
Essentials of veteri-
nary physiology.

SF761
P3
1920
BIOLOGY
LIBRARY

MAY 17 1922

PHYSIOLOGY DEPT. 8/1927

MAY 7 1928

Michael MAY 7 1928

JAN 4 1937

DEC 21 1936

OCT 18 1935

Kerby NOV 21 1939

461269

SF761

P3

1920

BIOLOGY
LIBRARY
G

UNIVERSITY OF CALIFORNIA LIBRARY

