**Design of Rainwater
Storage Tanks for use
in Developing Countries**

Stephen Turner

EDAT Year Four

**Department of Engineering
University of Warwick**

27th April 2000

SUMMARY

This project is to investigate the problems associated with ferrocement water storage tanks in developing countries, with the aim of giving the engineer a series of practical tips that will help with tank construction in the field. Using the findings of the project a series of construction rules have been produced. The aim is to overcome the problems that are particular to constructing ferrocement water tanks in hot dry climates.

In rural areas of many developing countries, there is a scarcity of water. Traditionally, rainwater collection has provided valuable source household water. Therefore there is a need to provide simple, economical storage facilities that can be constructed with semi or unskilled labour. Approximately 80% of the cost of a ferrocement tank is the construction material. Due to the high cost the majority of water tanks are financed through donor funding. To enable self-sufficient production material costs need to be reduced. This project looks at efficient ways of reducing material inputs.

The first stage is to carry out structural analysis. For this thin shell theory has been used. Excel spreadsheets have been produced to allow the designer to vary the range of tank configurations and material characteristics. Initial findings from the analysis show that cylindrical tanks with curved walls can withstand greater loads than cylindrical tanks with vertical walls. Comparing a Thai jar (figure 2.7(b)) style water tank to standard cylindrical tank (figure 2.7(a)) of a similar volume material inputs can be reduced by approximately 30% (assuming the material is homogeneous).

Little is known about the mechanics of shrinkage, therefore this has been the focus of the experimental work carried out on ferrocement tanks. The author's new physical test shows how shrinkage can be reduced through the use of reinforcing. A range of reinforcing systems has been tested and results show that a thin-wire steel square mesh is the most effective of the three examined.

The report investigates how the environment in which the tank is constructed plays an important role in the degree of shrinkage and cracking. It is shown that tanks constructed in a hot and dry environment and tanks that are allowed to set at different rates are much more susceptible to cracking.

NOTATION

E	Youngs modulus
g	Gravity
h	Tank height
H_o	Edge loads consisting of shear forces at tank base
M_o	Edge loads consisting of bending moments at tank base
M_x	Bending moment
N_q	Hoop force in tank wall
N_f	Meridional force in tank
PR	Poisson's ratio (used in spreadsheet)
P_c	Portion of the load restrained by cantilever
P_r	Portion of the load restrained by hoop stresses and radial constraints
P_x	Total outward pressure load to be restrained
p_r	Pressure of fluid
Q_x	Shear force
r	Tank radius
r_1	Radius of curvature of the meridian in doubly curved tank
r_2	Radius of curvature of the second principal curve in doubly curved tank
S	Surface area of doubly curved tank
t	Tank wall thickness
ν	Poisson's ratio
V	Volume of tank
w	Radial deflection
x	Intermediate point on the tank wall
D_H	Horizontal deflection around the diameter of tank
e_f	Strain in plane of the meridional force
e_q	Strain in plane of the hoop force
g	Intermediate point on tank wall in the x direction
r	Fluid density
x	Intermediate point on tank wall in the y direction

1.0 INTRODUCTION

1.1 A Brief Introduction to Rainwater Harvesting

A good quality RainWater Harvesting (RWH) system provides people with access to an on-site water supply, either next to their homes or at local public buildings such as schools and health centres. Rainwater has been collected and used for drinking water throughout the centuries, but in recent years they have fallen out of favour as they are considered old-fashioned. Ideally, the RWH collection system should involve basic construction techniques, be inexpensive to maintain, and have a long functional life span (Pacey 1986). If the system is designed well, it should provide a good safe source of drinking water at a relatively low cost when compared to the mains supply.

The RWH system provides a good alternative water supply option, especially for rural areas, where the following characteristics apply:

- it operates independently, and therefore gives people access to drinking water without them being dependent on a grid supply which can be unreliable,
- alternate sources of water do not provide sufficient quantities of potable water,
- the available sources of water are of a poor quality, such that the construction and maintenance of expensive treatment plants would be prohibitive,
- the cost of supplying grid water is too high,
- rainwater catchment area i.e. roofs, tend to be larger per capita in rural areas compared to urban,
- pollution levels in rural areas tend to be lower when compared to the towns and cities, making the water more suitable for direct human consumption without treatment.

Other benefits of RWH include:

- it reduces soil erosion (especially in the hilly areas)

- it requires a reduced amount of valuable energy inputs compared to the grid supply,
- it localises the process of water collection, which results in a reduction of the amount of civil engineering works compared to grid connection.

There are many aspects to RWH, each of which must be studied and managed correctly, if the overall system is going to run efficiently. They may be classed as follows;

- water usage management,
- water quality and other health issues,
- water collection hardware (storage tanks),
- financial considerations.

In many ‘westernised’ countries the most common way of obtaining a rainwater storage tank is to purchase it ready-made from the factory. When looking at rainwater harvesting from the perspective of the rural poor, the factory made tanks are unlikely to be a realistic due to their high cost and transportation difficulties. The problem should be looked at from a self-help emphasis within the community. However, since tank construction is a skilled task, any self-help effort must involve specially trained individuals, even if the most basic tasks are left to the householders themselves.

Assistance should not only be in the form of technical skills, but also in the supply of raw materials and help in the method of payment. Several approaches to the development of necessary skills have been used in rainwater projects. Training may be offered to the village craftsmen, as in Kenya (Pacey and Cullis 1986), or to community workers or individuals chosen at village meetings who are given special training as ‘village technicians’ (Ichikawa 1995).

The design of the rainwater storage tank is not merely an abstract engineering problem, it is related to the type of assistance, the sort of materials and other resources that are locally available. In places where satisfactory rainwater storage jars or tanks are already available, assistance may come in other forms, such as, offering advice on what type of tank to buy, financial advice, health, or other hardware advice such as gutter construction.

Self-sustainability should be the ultimate aim of any RWH project, and where possible it should be independent of any external subsidy. Ideally the storage tank should be able to be constructed by local craftsmen, where possible using locally available materials, and funded by either the individual or community. Self-sustainability is not only the ability of individuals or communities to pay for and build their own tanks, but also to maintain them, so that the benefit the tank offers is permanent.

Once the tank is constructed, its performance should be monitored. Attention must be paid to deficiencies in maintenance, such as keeping gutters clean, as well as any other defect the tank may develop. As well as practical advice on tank construction and maintenance, other factors should be addressed such as water management and health issues regarding the stored water.

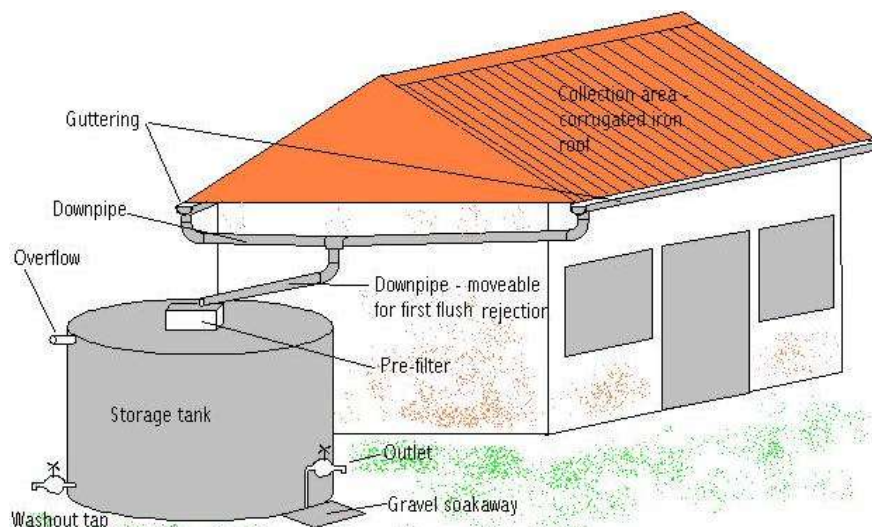

Fig. 1.0 Domestic rainwater harvesting system (DTU 1998).

From the engineering perspective, there are a number of RWH technologies that can be improved upon. These technologies, which involve the water collection and storage side of RWH, can be divided up into a number of key elements (see figure 1.0).

Tank sizes vary depending on ownership, domestic water storage tanks range from 1 to 10m³ see figure 1.1, community water tanks vary from 10 to over 100m³ (figure1.2). The main size limiting factor for domestic tanks is cost. For community tanks cost is a factor, but they are also size limited by catchment area and rainfall patterns. For typical ferrocement tanks constructed in Kenya costs vary from 50US\$/m³ for a 11m³ tank to 26US\$/m³ for a 46m³ tank (Gould 1999).



Fig. 1.1 A $8m^3$ domestic ferrocement storage tank in Sri Lanka



Fig. 1.2 A $46m^3$ community ferrocement storage tank in Uganda

As well as the above factors, ease of manufacture is an essential part of any good design. The majority of RWH projects are in rural areas, which may lack the resources and infrastructure that is available to the urban designer. Levels of construction skills may also be limited. This being so, ease of manufacture is a very important area, where possible the tank should be manufactured using a limited range of materials and tooling.

1.2 The Project

The project will investigate the problems associated with building water storage tanks in developing countries, with the final aim of giving the engineer a series of practical tips that will help with tank construction in the field.

The project will only investigate water storage tanks built above ground, where all the forces are carried by the tank walls. Water storage tanks can be constructed from a multitude of materials, but this project will concentrate on ferrocement. Ferrocement is a form of thin cement mortar reinforced with layers of continuous and relatively small diameter mesh. It is usually made from a mortar of Portland cement and sand applied to steel reinforcement which is often provided in the form of small aperture wire mesh, typically $15\text{mm} \times 15\text{mm}$, see figure 1.3. Ferrocement is a low-level technology and is labour intensive, it is therefore ideally suited for water tanks in rural areas of developing countries. Ferrocement is well suited for thin wall structures such as water tanks because the distribution and dispersion of reinforcement provides good cracking resistance, higher tensile strength-to-height ratio, ductility, and impact resistance.



Fig 1.3 Ferrocement tank under construction

The materials, which are usually imported into the area from nearby towns, can be relatively expensive. The cost of this material often puts water storage tanks out of reach

of many people in the rural sector. It is therefore important for the designer to investigate where and how construction materials can be reduced. To reduce material inputs it is important to know how large the forces are and where they act and also to know if it can be constructed from local available materials.

Section two of the project investigates how structural analysis can be carried out to establish the forces in the tank. To achieve this the theory of thin walled shells is used. Also, in section two, an Excel spreadsheet has been developed to allow the designer to study any range of tank shapes and construction materials.

A reduction in construction material through reduced wall and base thickness makes the tank more susceptible to additional problems which include shrinkage. Section three investigates the different types of shrinkage and how they effect cement based materials. It also looks into the degree to which shrinkage may be aggravated in less developed countries where the environment tends to be harsher. As well as dry weather, developing countries often suffer with a shortage of construction skills and poor quality raw materials. Different ways to reduce the additional stresses which shrinkage induces will be examined. This includes looking at tank design and education in the appropriate use of the raw materials.

Section four examines the mechanics and development of cracks in ferrocement and how they effect the durability of the tank. There is a limited amount of literature on the mechanical properties of ferrocement, so in section five a series of practical experiments are carried out to investigate some of these properties. It is essential to ascertain the tensile strength of the materials as well as looking into the effects of cracking caused by shrinkage, therefore three tests will be performed. They are,

- Tensile strength testing,
- Unrestrained (free) shrinkage,
- Restrained shrinkage.

Section six discusses the significance of the findings, section seven offers practical tips for tank construction and in section eight there are recommendations for future work.

2.0 STRUCTURAL ANALYSIS

The aim of this section is to study the theory of how stresses develop in structures and then to use the theory to write a spreadsheet to give 'real' results.

When analysing the loading on a water tank, it can be considered as a thin walled shell structure because the overall radius is large compared to the wall thickness, usually the ratio is greater than 10:1. These shell structures can be classified as shown in figures 2.0(a) and 2.0(b),



Fig 2.0(a) Singly curved shells

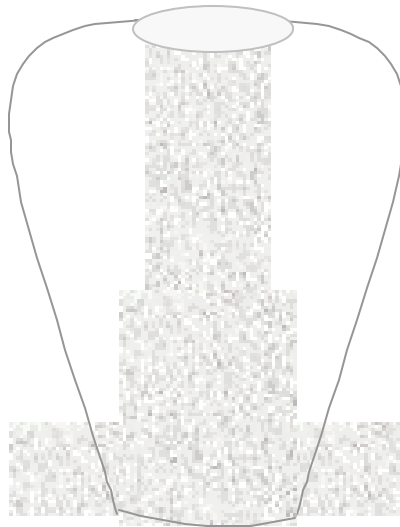

Fig 2.0(b) Doubly curved shells

The two main theories used when dealing with thin shells are,

- Membrane theory,
- Bending theory.

This project uses both membrane and bending theory. Initially the membrane theory will be used to calculate the stresses in the tank wall when there are no boundary conditions i.e. the tank walls are free to move, see figure 2.1(a).

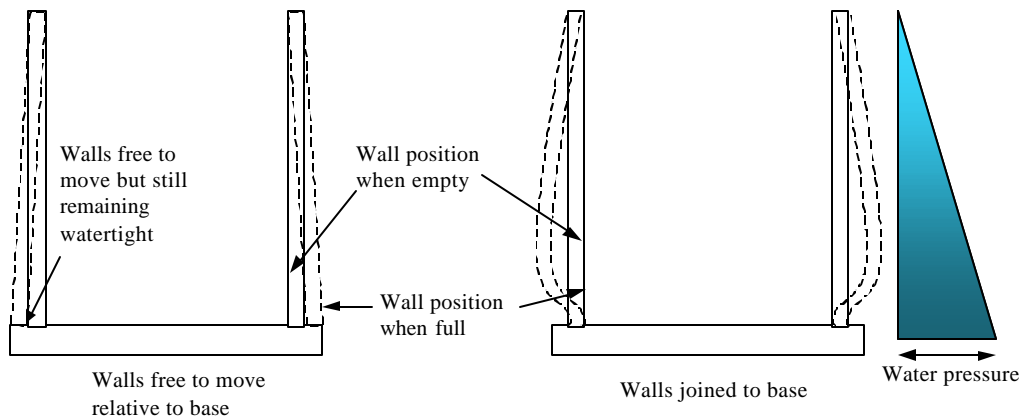

Fig. 2.1(a) Membrane theory

Fig. 2.1(b) Combined membrane and bending theory

In figure 2.1(b), the wall and base are monolithic i.e. the wall and base are continuous. As the wall is restrained bending stresses are set up in the wall. There now exists a complex combination of bending, shear and hoop stresses. Gray and Manning (1960) state that if the wall is not free to move at its base, then the loading caused by the water pressure is counteracted by a combination of hoop and cantilever resistance. It can be seen in figure 2.1(c) that as the base of the wall is restrained the hoop stress at the base is zero and the maximum hoop stress is now experienced higher up the wall. Bending theory is used to calculate this additional loading on the tank wall. The profile of the load distribution line is governed by the profile of the tank.

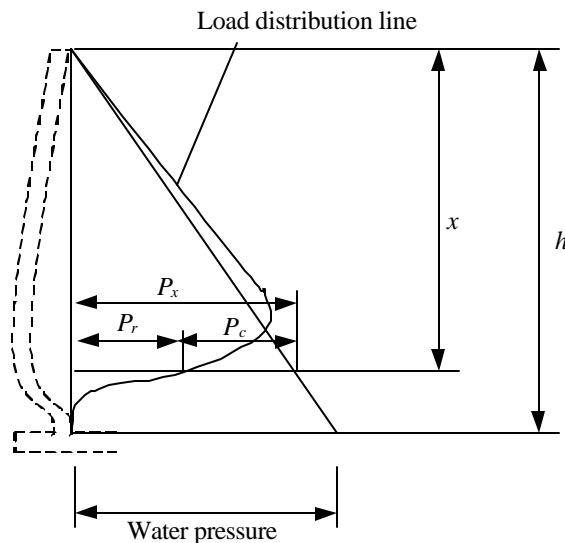

Fig 2.1(c) Typical load distribution for tank with a monolithic base (Gray and Manning 1960)

These theories are further simplified as only axisymmetric loading is considered. These loads are assumed to act at only the middle surface of the shell (wall), i.e. they pass through the centre of the structure. It is also assumed that the construction material is homogenous, isotropic, and linearly elastic, obeying Hooke's law.

2.1 Singly curved shells

Membrane theory

The governing equation for stress in singly curved shells, is;

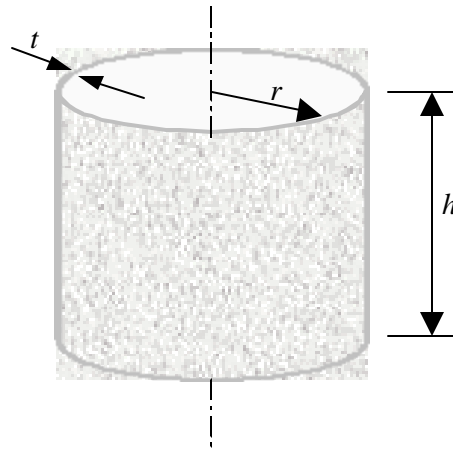

Fig. 2.2 Hoop force in singularly curved shell

$$N_q = p_r \cdot r \quad (1)$$

To find the hoop stress (\mathbf{s}), the hoop force is divided by the wall thickness (t) (Shigley 1983),

$$\mathbf{s}_q = \frac{p_r \cdot r}{t} \quad (2)$$

In this type of shell all the forces are resisted by the 'hoop' forces in one plane.

Tanks designed with singly curved shells, are probably the most common style of tank in current use as they are relatively easy to design and construct. Their main disadvantage is their weakness, they can only resist loads on one axis i.e. hoop forces.

Bending theory

As previously stated the membrane solution alone could not satisfy compatibility conditions at the boundaries. Bending theory can be further simplified by assuming that the base is solid and does not deflect. Using the spreadsheet it is possible to calculate the minimum depth which the base needs in order for it to be assumed to be solid and inflexible. The effects of edge loads have to be superimposed on the membrane solution. For both singly and doubly curved shells, these edge loads consist of shear forces (H_o) and bending moments (M_o).

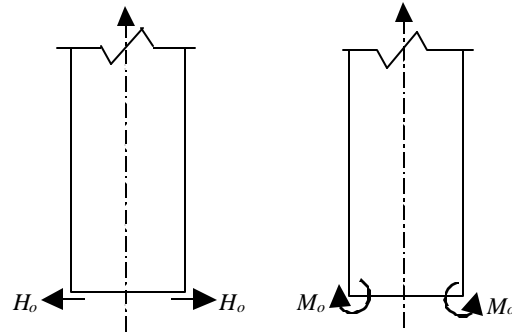

Fig. 2.3 Edge loads, H_o shear and M_o moments

These edge loads induce additional forces,

- M_x is the bending moment,
- Q_x is the shear force,
- N_q is the hoop force,
- w is the radial deflection.

these can be calculated from;

$$N_q = \mathbf{r}r \left[h - x - he^{-\mathbf{l}x/r} \cos \frac{\mathbf{l}x}{r} + \left(\frac{r}{\mathbf{l}} - h \right) e^{-\mathbf{l}x/r} \sin \frac{\mathbf{l}x}{r} \right] \quad (3)$$

$$M_x = -\frac{\mathbf{r}r\mathbf{l}}{\sqrt{12(1-\mathbf{n}^2)}} \left[\left(\frac{r}{\mathbf{l}} - h \right) e^{-\mathbf{l}x/r} \cos \frac{\mathbf{l}x}{r} + he^{-\mathbf{l}x/r} \sin \frac{\mathbf{l}x}{r} \right] \quad (4)$$

$$Q_x = \frac{\mathbf{r}t\mathbf{l}}{\sqrt{12(1-\mathbf{n}^2)}} \left[\left(\frac{r}{\mathbf{l}} - 2h \right) e^{-\mathbf{l}x/r} \cos \frac{\mathbf{l}x}{a} + \frac{r}{\mathbf{l}} e^{-\mathbf{l}x/r} \sin \frac{\mathbf{l}x}{r} \right] \quad (5)$$

$$w = \frac{r r^2}{Et} \left[h - x - h e^{-Ix/r} \cos \frac{Ix}{r} + \left(\frac{r}{I} - h \right) e^{-Ix/r} \sin \frac{Ix}{r} \right] \quad (6)$$

where;

$$I^4 = 3(1 - \nu^2) \left(\frac{r}{t} \right)^2$$

The effects of the additional loading forces are localised around the shell wall/base intersection. All the equations contain a multiplication term $e^{-Ix/r}$, which means the effect will decay exponentially with distance moved away from the base. For a full derivation of the formulae see Flügge (1967).

2.2 Doubly curved shells

The structural analysis for doubly curved shells is more complicated than that of the singly curved shell. These shells have curvature in two planes, figure 2.4. This allows them to resist loads by generation of forces in the two planes. They are generally more efficient than singly curved shells. The two main forces are,

- the meridional force (N_f),
- the hoop force (N_q).

And the two main radii of curvature are,

- radius of curvature of the meridian (r_1),
- radius of curvature of the second principal curve (r_2).

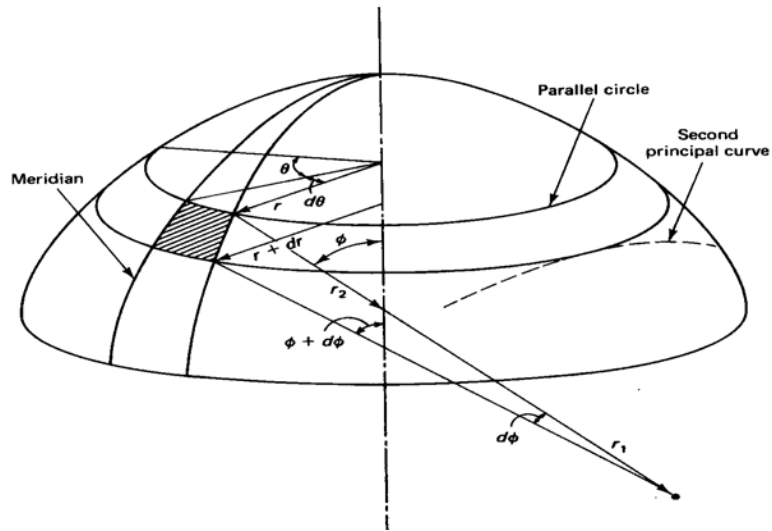

Fig. 2.4 Doubly curved shell, showing the parallel circle, principal curves, and shell element (Kelkar and Sewell 1987)

The main equation governing the forces in a doubly curved shell is;

$$\frac{N_f}{r_1} + \frac{N_q}{r_2} = p_r \quad (7)$$

Where p_r is the pressure at a particular point.

Equation (7) is rearranged to find the hoop force N_q ;

$$N_q = r_1 p_r - \frac{r_1}{r_2} N_f \quad (8)$$

After some mathematical manipulation the general solution for the meridional force N_f can be found as follows;

$$N_f = \frac{1}{r_2 \sin^2 \mathbf{f}} \left[\int (p_r \cos \mathbf{f} - p_f \sin \mathbf{f}) r_1 r_2 \sin \mathbf{f} d\mathbf{f} + k \right] \quad (9)$$

where k is a constant of integration to be obtained from an appropriate boundary condition.

The next step is to find the geometric parameters for the shell. The shell's profile can be described as a curve, where $y = f(x)$. The principal radius of curvature of the surface in the meridional plane, r_1 , and the second principal radius of curvature, r_2 , are given by;

$$r_1 = \frac{\{1+[f'(x)]^2\}^{3/2}}{f''(x)} \quad (10)$$

$$r_2 = \frac{x}{\sin \mathbf{f}} \quad (11)$$

where $f'(x)$ and $f''(x)$ denote first and second derivatives of $f(x)$ with respect to x . By sketching a right-angled triangle it can be seen that;

$$r_2 = \frac{x \{1+[f'(x)]^2\}^{1/2}}{f'(x)} \quad (12)$$

and angle \mathbf{f} is;

$$\sin \mathbf{f} = \frac{f'(x)}{\{1+[f'(x)]^2\}^{1/2}} \quad (13)$$

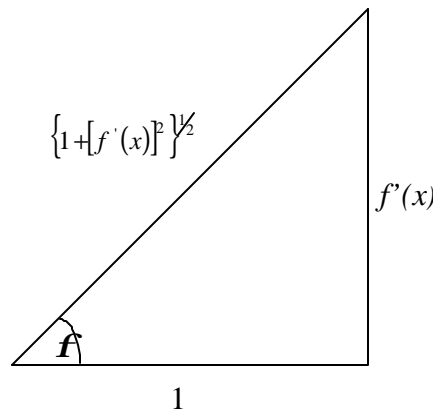

Fig. 2.5 Trigonometric interpretation of the equations

To calculate the stress resultants, figure 2.6 shows a shell of revolution generated by a rotation of a curve $y = f(x)$ about the y axis, filled with liquid of density \mathbf{r} ; to a depth $h = f(x_H)$. The pressure p_r acting in direction normal to the shell at height $\mathbf{g} = f(\mathbf{x})$ above the bottom of the tank is given by;

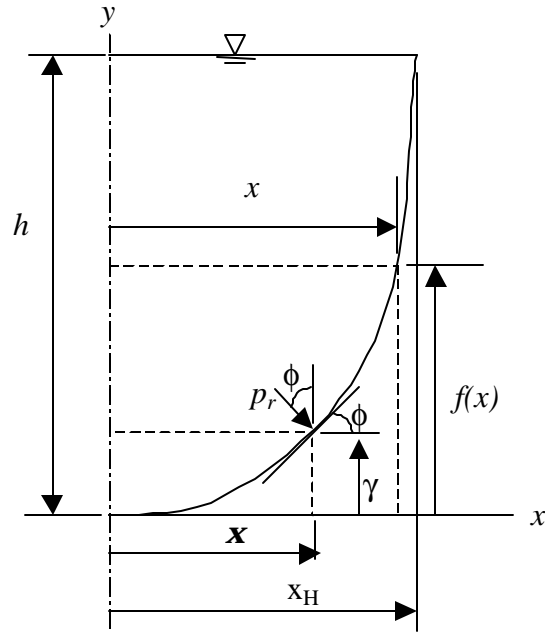

Fig 2.6 Liquid shell of revolution (Zingoni 1997)

$$p_r = \mathbf{r}g(h - \mathbf{g}) = \mathbf{r}g\{f(x_H) - f(\mathbf{x})\} \quad (14)$$

The net vertical resultant $W(x)$ of the pressure acting on the shell whose edges are defined by $(x, f(x))$ is obtained by integration, as follows;

$$W(x) = 2\mathbf{p} \mathbf{r}g \left\{ \frac{x^2}{2} f(x_H) - \int_0^x \mathbf{x} f(\mathbf{x}) d\mathbf{x} \right\} \quad (15)$$

The meridional stress N_f can be found by resolving forces in the vertical direction;

$$2\mathbf{p}x N_f \sin \mathbf{f} = W(x) \quad (16)$$

Form (16) and using the expression for $W(x)$ from (15), and the expression for $\sin \mathbf{f}$ given in (13), N_f is found as follows;

$$N_f = \mathbf{r}g \frac{\left\{ 1 + [f'(x)]^2 \right\}^{1/2}}{x f'(x)} \left\{ \frac{x^2}{2} f(x_H) - \int_0^x \mathbf{x} f(\mathbf{x}) d\mathbf{x} \right\} \quad (17)$$

As seen previously the hoop stress N_ϕ is given by (2).

The total volume V of the tank is obtained from (15), by dividing the total weight of the liquid, this is equal to $(W(x_H))$, by the unit weight $\mathbf{r}g$, thus;

$$V = 2\mathbf{p} \left\{ \frac{x^2}{2} f(x_H) - \int_0^{x_H} \mathbf{x} f(\mathbf{x}) d\mathbf{x} \right\} \quad (18)$$

The total surface area S of the (constant thickness) tank is obtained by rotating the curve $y=f(x)$ about the y axis².

$$S=2\mathbf{p}\int_0^{x_H}\left\{1+[f'(x)]^2\right\}^{1/2}dx \quad (19)$$

To find out how much the tank walls deflect under load the strain is required. Since both N_q and N_f have already been found using membrane theory, the following relationship can be used to find the strains;

$$\mathbf{e}_f = \frac{1}{Et}(N_f - \mathbf{n}N_q) \quad \& \quad \mathbf{e}_q = \frac{1}{Et}(N_q - \mathbf{n}N_f) \quad (20) \& (21)$$

Generally only the horizontal deflection D_H is required (Kelkar and Sewell 1987), i.e. the increase in size around the diameter of the tank;

$$\Delta_H = r\mathbf{e}_q = \frac{r}{Et}(N_q - \mathbf{n}N_f) \quad (22)$$

In the following section the formulae will be have been substituted into two Excel spreadsheets, one for singly curved shells and the other for doubly curved shells.

Due to the complexity of bending theory for shells of general revolution, it will not be incorporated. The solution given by the membrane theory gives good results for many practical problems, (Kelkar and Sewell 1987).

There are a number of good books that cover the full derivation of all these formulae, such as, 'Shell Structures' by Zingoni (1997) or 'Analysis and Design of Shell Structures' by Kelkar and Sewell (1987).

2.3 The Excel spreadsheets

The most common shape is the cylindrical tank, this style of tank resists all its applied loads in one plane. These loads vary linearly from a minimum at the top to a maximum at the base. Tanks are usually constructed with a constant wall thickness, which has to resist the maximum load at the bottom of the tank. This means that above this point the material is under utilised, and therefore wasted. To overcome this problem the tank shape may be varied, it could be made conical or tank thickness could be varied from top to bottom.

It is a well known fact that that certain shapes resist loads better than others, for example, if constructed of similar materials, a domed roof is stronger than a flat roof. Therefore it is important to investigate stresses in more unconventional tank shapes, such as the 'pumpkin' tank shown in figure 2.7(a) or the jar shaped in figure 2.7(b).

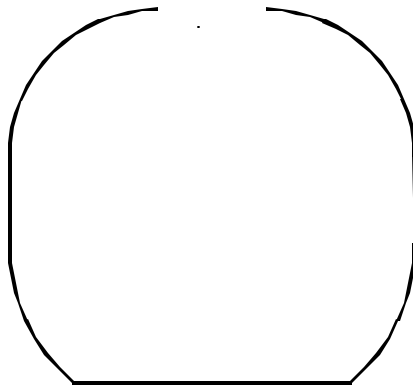

Fig 2.7(a) Pumpkin tank

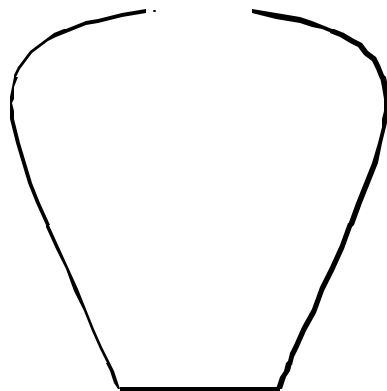

Fig. 2.7(b) 'Thai' Jar tank

The Excel spreadsheet lets the designer experiment with various shapes of tank and calculate where the maximum forces occur. These forces include shear, hoop and meridional force intensities, and bending moments, as well as tank wall deflection. The spreadsheet used to analyse the forces in the singly curved shells takes into account additional forces caused by the tank wall/base intersection (bending theory). The spreadsheet can be used to help with material optimisation as it can work out the ratio of construction material to water storage capacity.

The spreadsheet used to calculate forces in singly curved shells has already been used by the Development Technology Unit to aid in the design of a rammed earth water tank.

There are two spreadsheets, the first one analyses singly curved tanks and the second doubly curved tanks.

Singly Curved tanks

To start the operation a number of INPUTS are entered including material yield tensile strength, tank volume, base and lid thickness; and a suitable safety factor, see figure 2.8.

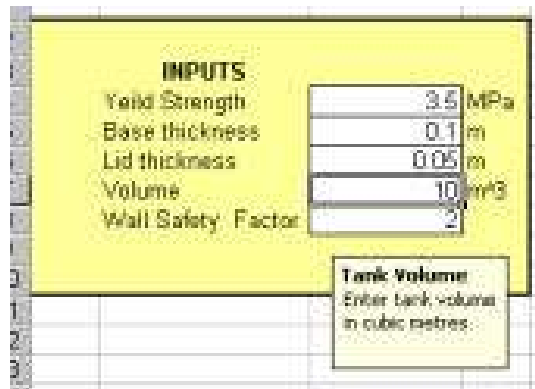

The image shows a spreadsheet-style input form with a yellow background. It is titled "INPUTS" and contains five rows of input fields. The first row is "Yield Strength" with a value of "3.5 MPa". The second row is "Base thickness" with a value of "0.1 m". The third row is "Lid thickness" with a value of "0.05 m". The fourth row is "Volume" with a value of "10 m³". The fifth row is "Wall Safety Factor" with a value of "2". Below the input fields is a small box titled "Tank Volume" with the text "Enter tank volume in cubic metres."

INPUTS	Value
Yield Strength	3.5 MPa
Base thickness	0.1 m
Lid thickness	0.05 m
Volume	10 m ³
Wall Safety Factor	2

Fig. 2.8 Input parameters

The yield strength of the material can be found from literature but if unconventional materials are being used, i.e. ferrocement, it may be necessary to carry out some form of mechanical strength testing. The material yield strength used in this example was found using experimental methods (see section 5.0). The results given by the numerical model are only as accurate as the material property data therefore it is vital at this stage to enter data that is as close as possible to realistic figures.

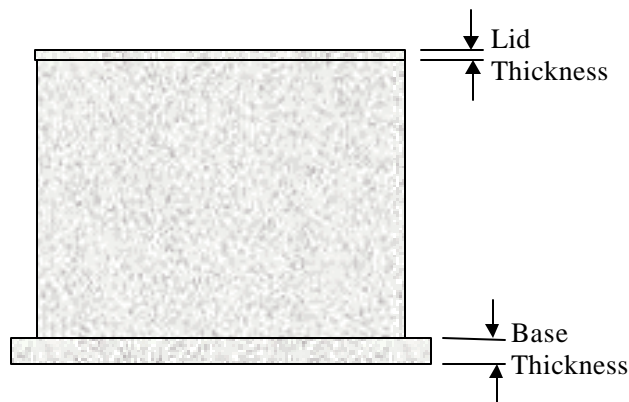

Fig. 2.9 Tank base and top geometry

The thickness of the base and lid (see figure 2.9) are used when calculating the amount of tank construction material needed to make the tank. The base thickness is also used in calculating the base rigidity (to be discussed later). The safety factor can be chosen by the designer, this may depend on a number of factors. Examples include uncertainty on the

quality of raw materials, climatic and geological conditions, as well as unusual loading such as wind.

For this example, the tank volume is $10m^3$ with the data given in figure 2.8, a range of tank sizes and amount of raw material required for construction is calculated, see figure 2.10.

Diameter	height	Wall thickness	Material	
0	#DIV/0!	#DIV/0!	m	#DIV/0!
0.2	318.31	0.178	m	67.53
0.4	79.58	0.089	m	10.93
0.6	35.37	0.059	m	4.40
0.8	19.89	0.045	m	2.43
1	12.73	0.036	m	1.60
1.2	8.84	0.030	m	1.19
1.4	6.50	0.025	m	0.97
1.6	4.97	0.022	m	0.87
1.8	3.93	0.020	m	0.83
2	3.18	0.018	m	0.83
2.2	2.63	0.016	m	0.87
2.4	2.21	0.015	m	0.93
2.6	1.88	0.014	m	1.01
2.8	1.62	0.013	m	1.11
3	1.41	0.012	m	1.22
3.2	1.24	0.011	m	1.35
3.4	1.10	0.010	m	1.49
3.6	0.98	0.010	m	1.64
3.8	0.88	0.009	m	1.80
4	0.80	0.009	m	1.97

Paste suitable figures into this table from above				
Diameter	height	Wall thickness	Material	
2.8	1.62	0.01275	m	1.107

Fig. 2.10 Range of tank sizes

The designer may choose any one of the tanks. The data for that particular tank including, the required diameter, height and wall thickness is entered into the next phase of the spreadsheet, see figure 2.11.

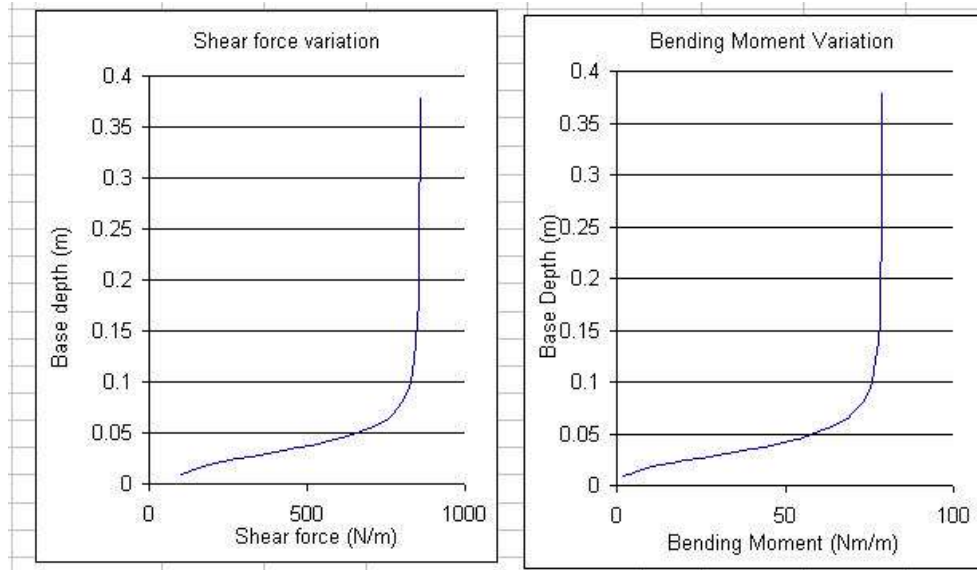

Fig. 2.12 Variation in shear force and bending moment

The spreadsheet calculates the maximum stresses, deflection and bending moment and at what point they are greatest, see figure 2.13. The ratio of construction material to water storage capacity is another deliverable. A full print out of the spreadsheet can be found in Appendix V

OUTPUT DATA			
Tank with fixed base			
Max deflection	0.055 mm	at	0.24 m
Max Shear Stress	0.63 MPa	at	0.24 m
Max hoop stres	1.50 MPa	at	0.24 m
Max BM	77.34 Nm/m	at	base
Max tensile Stress	2.86 MPa	at	base
Safety factor at base	0.23		
Tank with floating base			
Max hoop Stress	1.75 MPa	at	base
Max deflection	0.064 mm	at	base
Tank size		Raw Materials	
	1.62 m		1.11 m ³
	2.80 m		
	10.00 m ³		
Water storage to amount of raw material			9.04

Fig. 2.13 Output data

Figures 2.14(a-b) show the variation in deflection, hoop stress, bending moment and shear force up the tank wall, all acting uniformly over the stressed area.

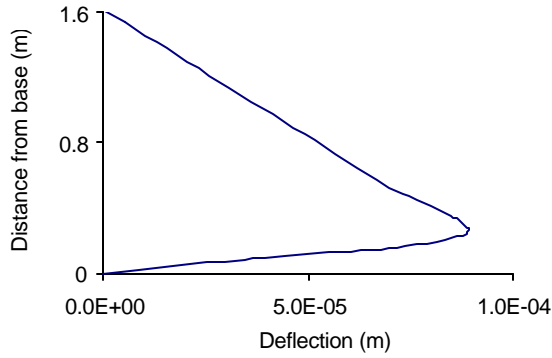

Figure 2.14(a) Variation in Deflection

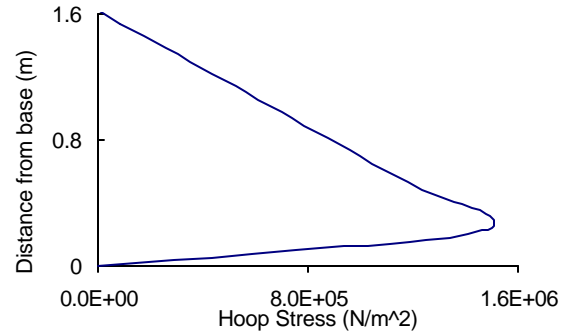

Figure 2.14(b) Variation in hoop stress

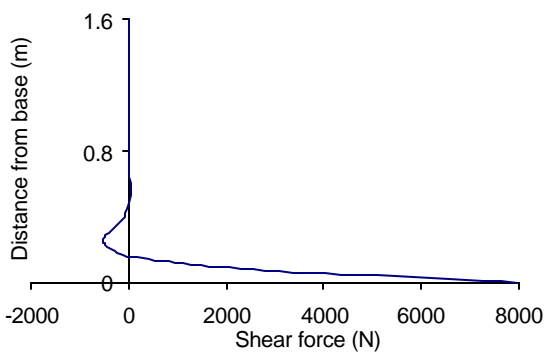

Figure 2.14(c) Variation in shear force

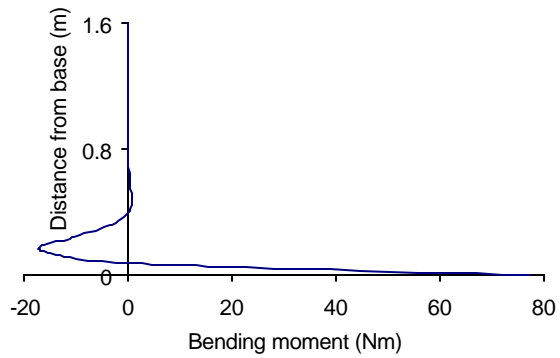

Figure 2.14(d) Variation in bending moment

The spreadsheet also allows the user to calculate the hoop stress in the tank wall if the wall is free to move, i.e. not connected to the base as shown in figure 2.1(a).

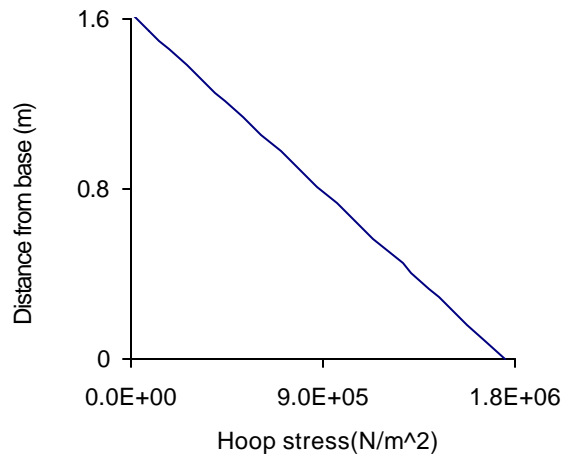

Fig. 2.15 Variation in hoop stress with floating base

Doubly curved shells

This spreadsheet is used to calculate the forces in the doubly curved shells. It is not as user friendly as the spreadsheet used for the singly curved format. As before, the material

characteristics including: Young's modulus, Poisson's ratio, volume fraction and wall thickness, are entered.

For the tank profile shown in figure 2.17, the following data has been entered.

Input				
E wall matrix	35	Gpa	PR wall matrix	0.1
E wall fibre	210	Gpa	PR wall fibre	0.3
fraction volume	0.01		fraction vol	0.01
E wall	36.75	Gpa	PR wall	0.102
thickness	100	mm		
tensile strength	3.4	MPa		

Fig. 2.16 Inputs for doubly curved tank

The tank profile is entered into the Excel format using x and y co-ordinates. Using the *trendline* function the formula for the curve can be found and hence the first and second derivatives. For this example the following profile will be used:

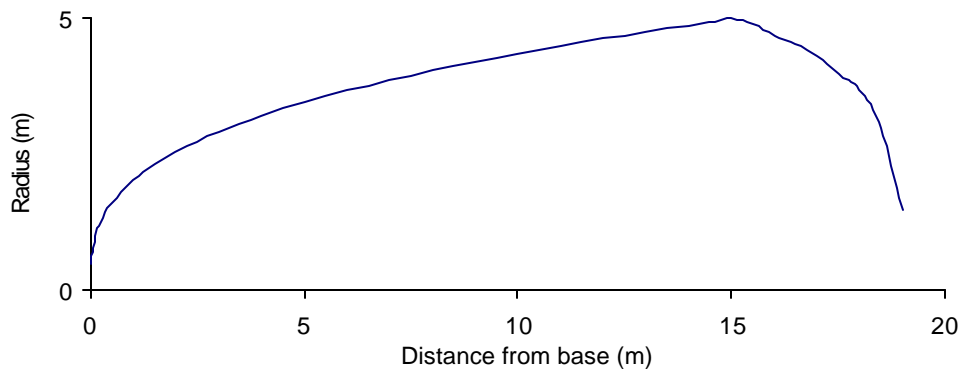

Fig. 2.17 Tank profile

The spreadsheet calculates the meridional and hoop stress, as well as the volume, surface area and ratio of construction material to volume. A full print out of the spreadsheet can be found in Appendix VI.

73				
74	Output			
75	Volume	505	m ²	
76	Surface area	314	m ³	
77	raw material	31	m ³	
78	ratio	16.07		
79	max deflection	4.71	mm	at 7.5 m
80	max hoop	5.07	MPa	at 4.5 m
81	max meridian	4.69	MPa	at 15 m
82				
83				
84				

Fig 2.18 Results for doubly curved tank

The spreadsheet calculates the maximum deflection, hoop stress, and meridional stress and at which point from the base of the tank they are the greatest. It also calculates the volume, surface area, the amount of raw materials required in construction and the ratio of raw materials to water storage capacity.

The variation in meridional and hoop stress is displayed in figure 2.19.

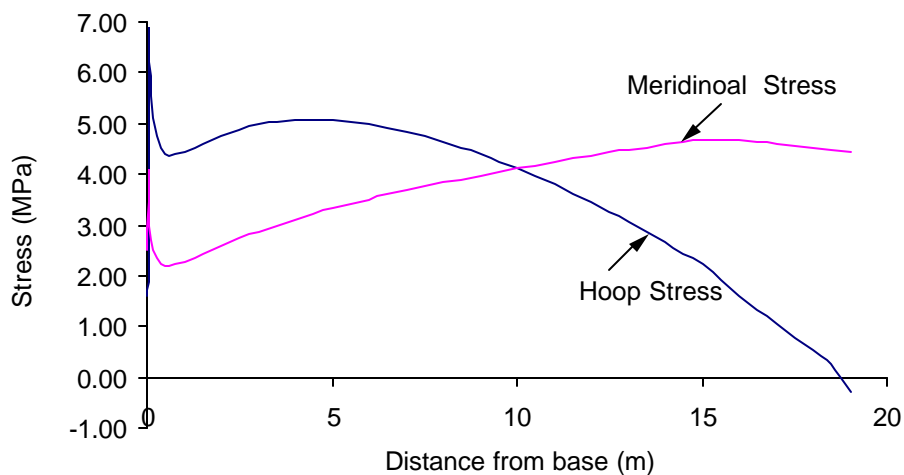

Fig 2.19 Variation in membrane stress

Variations in stress near the base of the tank can be ignored, this is due to the breakdown of the membrane hypothesis. The tank wall deflection, i.e. the increase in tank radius, can be seen in figure 2.20.

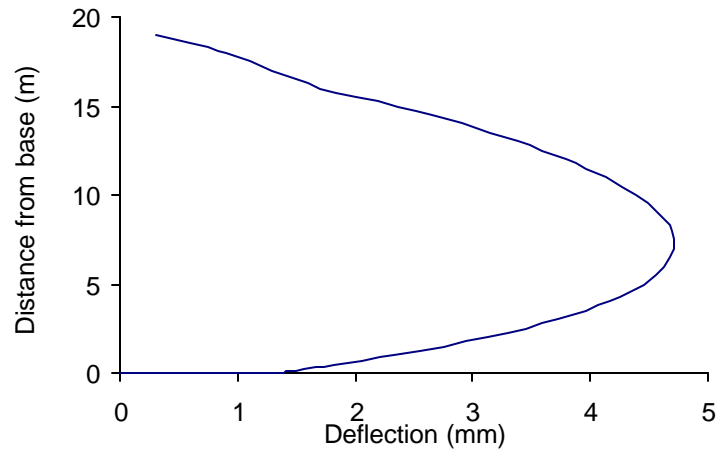

Fig. 2.19 Variation in Deflection

Discussion

The spreadsheets are to be used as tools to aid in the designing and construction of water storage tanks. They give the designer an opportunity to experiment with many shapes of tank, as well as material properties. The designer can enter any required tank specification, the spreadsheet is then run and the results are given. Changes to the tank specification can be made immediately. This process allows iterations to be made quickly and easily. The program results can be plotted out, this gives the designer a graphical representation of the forces. The visualisation of these forces will help with the design process.

From the results for the singly curved tank, figures 2.14a-c, it can be seen that the greatest load is near the base of the tank. In figure 2.15, for the tank whose wall is not attached to the base, the maximum force is at the bottom of the tank. For the doubly curved tank, see figure 2.19, the forces are more uniformly distributed over the whole tank wall. These results show the designer that if they require a tank of uniform wall thickness and hence a uniform wall strength, the doubly curved tank is the most suitable, as the forces are distributed evenly over the whole tank. It can also be seen that if a uniform wall is used to construct a singly curved tank, the construction material used in the upper part of the tank is not fully utilised and therefore wasted. Other factors have to be taken into consideration such as construction difficulties, a greater degree of skill is required to construct a doubly curved tank compared to a singly curved tank.

It is assumed that the designer is using a homogenous construction material which can withstand forces equally well in both a vertical and horizontal direction, a characteristic of ferrocement. The results and theory show that for singly curved tanks the majority of force is on the horizontal plane but for the doubly curved tanks, the force is on both vertical and horizontal planes. This means that the construction material is used to its full potential for the doubly curved tank.

It can be seen from figure 2.15, which if the wall is free to move relative to the base, the maximum stress and therefore wall deflection, is at the bottom of the tank wall. When the bottom of the wall is restricted from moving, as in figure 2.14(a-c), the maximum hoop force and wall deflection are a small distance from the base. This distance depends on the size of the tank and the characteristics of the construction materials used. Using these results the designer can decide where to position any extra reinforcing.

To overcome the problem of additional forces that are generated by the base wall interface it is possible to construct a tank so that the wall is free to expand. The Development Technology Unit is currently examining this construction technique at Warwick University. It is achieved by positioning two polythene strips between the wall and base, see figure 2.21. This reduces the sliding friction between the two surfaces, and therefore the wall is relatively free to expand, eliminating the additional forces.

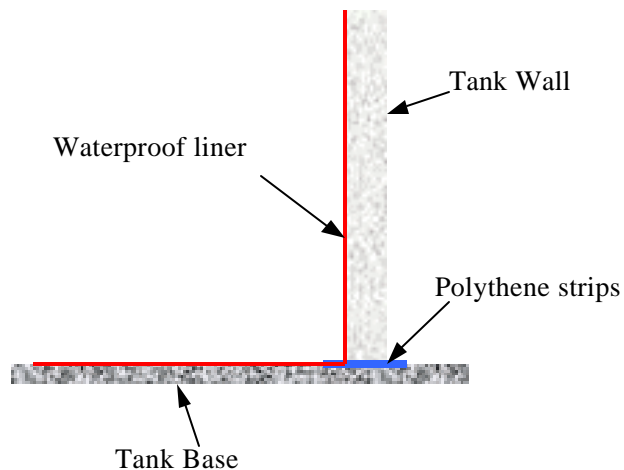

Fig 2.21 Experimental tank with sliding wall

The designer is also free to experiment with safety factors, these will vary according to raw material, climatic and ground conditions.

3.0 SHRINKAGE

This section of the project will concentrate of the effects shrinkage has on water tanks constructed from ferrocement. The mechanics of shrinkage in cement is a complicated subject and will not be fully explored in this report. Further information on the mechanics of shrinkage can be found in a number of books, including 'Proprieties of Concrete' by Neville (1995) and 'Concrete Technology' by White (1991).

3.1 Classes of Shrinkage

Shrinkage can be divided into three main categories. They are,

- Plastic,
- Autogenous,
- Drying.

Plastic Shrinkage

This takes place when the concrete is still in the plastic state. The volume change is small, in the order of 1% of the absolute volume of dry cement (American Concrete Institute). Although the mechanics of plastic shrinkage are not fully understood, it is known that it can lead to surface cracking. The amount of shrinkage is related to the rate of evaporation. One practical conclusion is that thin sections, such as tank walls, should not be cast under hot and dry conditions.

Autogenous Shrinkage

Autogenous shrinkage results in volume change without the loss of moisture. The magnitude of the strain induced is in the order of 40×10^{-6} at the age of one month and 100×10^{-6} after 5 years (Davis 1940). The contraction is relatively small and of significance only in large mass structures. This project only deals with thin walled structures therefore this type of shrinkage can be ignored as it very low compared to drying shrinkage.

Drying Shrinkage

As the cement sets it loses moisture, this loss of moisture causes shrinkage. This type of shrinkage has the greatest effect on the water tank. Shrinkage in the order of $2,000 \times 10^{-6}$ has been observed (Singh 1989). The finer the grain size in the mix the greater the shrinkage, cement for example will have a greater degree of shrinkage compared to concrete. The rate at which the shrinkage occurs depends on the speed of water loss, therefore in hot, dry and windy climates rates of shrinkage will be high.

3.2 Differential shrinkage

The problems that shrinkage creates are worsened by the effects of differential shrinkage. Differential shrinkage occurs if water loss from one area is greater than another, this is especially so in the early stages of curing. This type of shrinkage has a tendency to induce internal stresses in the structure and can lead to cracking. Differential shrinkage occurs in all cement-based products but to what extent depends greatly on the size and shape. It can be seen from figure 3.0 that the thinner the section the greater the shrinkage, this is because the moisture loss is faster. Therefore structures that have large surface areas compared to volume, a characteristic of water tanks, will have a tendency to display a high degree of shrinkage. For practical purposes shrinkage cannot be considered as purely an inherent property of the cement without reference to the geometry of the structure.

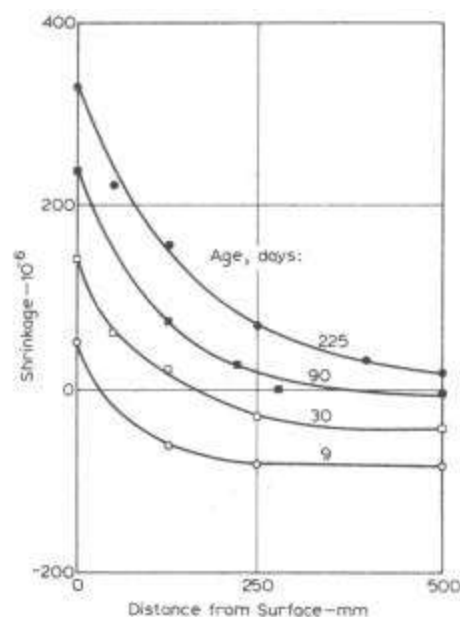

Fig.3.0 Effect of dimensions on shrinkage (Neville 1995)

There are a number of ways to help reduce the problems caused by differential shrinkage when building tanks in a hot climate;

- The wall thickness should be kept constant throughout the tank this will reduce the build up of internal stress.
- Ideally, the tank should be constructed in a shaded area, this will reduce water loss.
- The tank should be constructed in the coolest part of the day, ideally in the morning so the construction materials have had the opportunity to cool down overnight.
- The tank should not be constructed so it is half shaded, again this will cause internal stress to be built up.
- The application of cement mortar should be as continuous as possible. Rendering wet mortar onto dry should be avoided, as stresses will build up between the layers.
- A good curing regime is required, such as the use of wet hessian and plastic covers.

3.3 Restrained Shrinkage

The effects of shrinkage are only really a problem if the stresses they induce are not able to release themselves. If strains due to shrinkage cannot develop freely, large internal stresses are developed. If these tensile stresses are greater than the tensile strength of the material, cracking and sometimes total failure may occur. Shrinkage in any form weakens the structure as it acts as a preload this may lead to unexpected failure even under low loads. The effect of restrained shrinkage is shown in figure 3.1, the ends of the cement mortar specimen are held and as the cement shrinks, cracks start to form, usually at the weakest point.

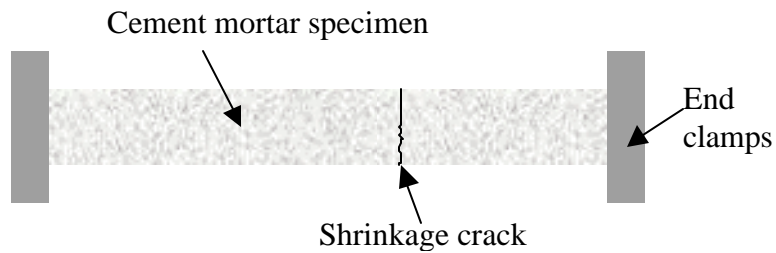

Fig. 3.1 Cracking caused by shrinkage

In the case of the water tank in figure 3.2, the bottom of the structure is usually cast earlier than the walls, consequently the shrinkage strains at the bottom ϵ_{base} and the walls ϵ_{wall} may be very different. Since the base of the wall cannot move freely additional bending moments and forces develop at the base/wall interface.

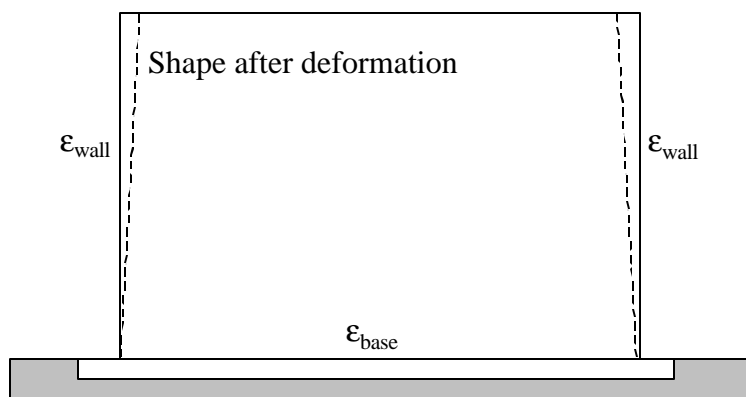

Fig. 3.2 Effect of shrinkage on the tank wall

3.4 Further factors that influence shrinkage

There are number of other factors that effect the degree and rate of shrinkage. They include,

- Water/cement ratio,
- Curing and storage conditions,
- Aggregate.

Water/cement ratio

In general, the higher the water/cement ratio the higher the degree of shrinkage. It has been demonstrated that shrinkage is directly proportional to the water/cement ratio between values of about 0.2 to 0.6 (Neville 1995). At higher water/cement ratios, the additional water is removed upon drying without resulting in shrinkage. A minimum water/cement ratio of 0.4 is required for the cement to reach its full strength, as the

water/cement ratio increases the strength is adversely effected. In practice, this value of 0.4 is rarely achieved because of difficulties in working of with such a dry mix.

Curing and storage conditions

Curing is the name given to the method used for promoting the hydration of cement. It consists of the control of temperature and of moisture movement from and into the cement mortar. The main object of curing is to keep the cement saturated or as near to saturation as possible. Prolonged moist curing delays the advent of shrinkage.

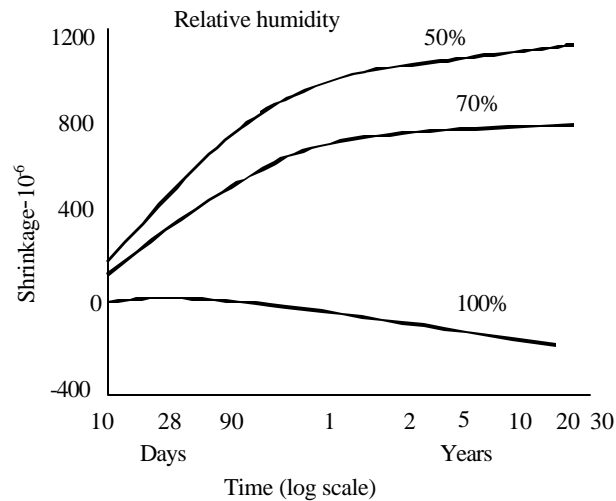

Fig. 3.3 Relationship between shrinkage and humidity (American Concrete Institute)

The ambient temperature has an important effect on the degree of shrinkage. Working with cement in hot weather, greater than 30°C (Neville 1995), can cause problems. Because of the high evaporation rate there is a loss of workability and increased shrinkage. The increased shrinkage can cause high internal stresses that may lead to cracking. It is therefore advantageous to cast cement in cooler conditions, less than 20°C , as the rate of water evaporation is less. This will reduce shrinkage rates as well as increasing strength.

The relative humidity of the surroundings also effects the degree of shrinkage. It can be seen in figure 3.3 that the drier the environment, the larger the degree of shrinkage. When the cement mortar is stored in 100% humidity (in water) it swells. Once removed from the water it will start to shrink. The above data is based on a mortar mix of 1:5, with a water cement ratio 0.59. The results are taken after 28 days of wet curing.

Aggregate

The size and grading of aggregate influence the magnitude of shrinkage. In general, coarser aggregate leads to lower rates of shrinkage because leaner mixes can be made. Ferrocement contains very fine aggregate in the form of sand so to make it workable relatively high water/cement ratios are required, typically in the range of 0.5 to 0.6. This makes ferrocement tanks very susceptible to shrinkage.

4.0 CRACKING

The development of cracks in any form of water retaining structure can have serious repercussions. This section looks at the how cracks develop in ferrocement and how their propagation can be reduced.

Cracks in ferrocement are mainly caused by:

- thermal and moisture movement incompatibilities between the phases of cement paste, sand and reinforcement,
- fatigue caused by repeated loading,
- induced stress caused by shrinkage.

This report will only deal with the later, stress cracks caused by shrinkage. Concerns regarding cracks in ferrocement, are expressed as follows:

- Aesthetic, from the aesthetic point of view a 0.3mm crack seen at a close distance is quite concerning, but viewed from a distance of 2 to 3 metres it is quite acceptable.
- Leakage, Nedwall and Swamy (1994) recommend an upper limit of 0.05mm for water-retaining structures.
- Durability, from the materials durability aspect, the stronger the construction material, the less likely it is to crack and the longer the tank life (assuming there is no mechanical damage).

In the case of the water tank one of the main concerns is leakage. This has two effects, loss of water and corrosion of the reinforcing material. Corrosion of the reinforcing mesh leads to spalling. Finely distributed reinforcement (wire mesh) combined with large mortar cover increases the resistance to corrosion. The permeability of the ferrocement depends greatly on the care taken in applying the mortar. The recommended minimum cover is only 2mm (Skinner 1995), assuming if the cement is applied well and cured in an appropriate manner. Because of variations of material and construction quality in less developed countries, Gould (1999) recommends a cover of 30mm, giving a wall thickness of 60mm. There are number of practical problems when it comes to applying very thin layers of cement mortar, the main one being the difficulties in ensuring an even cover over the wire mesh and that all the mesh is covered to the minimum thickness.

Development of cracks

Cracks with an applied tensile force in ferrocement develop in three stages. It can be seen in figure 4.0(a) that in the first stage of development both materials in the composite respond elastically, if the load is removed they will return to their unloaded state.

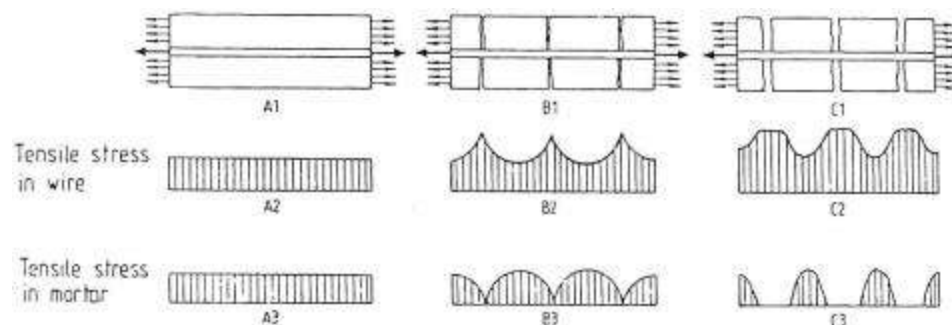

Fig 4.0(a) Stage one

Fig. 4.0(b) Stage two

Fig 4.0(c) Stage three

The ferrocement enters its second stage when micro cracks start to appear. During this stage, shown in figure 4.0(b), the number of cracks keeps increasing with the load though the width. Figure 4.0(c) show that the increase is only marginal. In the third stage, the number of cracks remain almost constant but their width increases with load. The mortar in the ferrocement no longer has any effect on its strength. Assuming that the steel reinforcement has not passed its yield point, if the load is removed the sample will contract leaving open cracks in the mortar.

The cracks develop in this way because the cement mortar is not as ductile as the steel reinforcement. It can be seen that as the cracks develop, the load on the reinforcing increases and finally when the cracks are fully developed (stage three) the reinforcing carries all the load. The practical result of this is that, if the quality of the mortar is not known and catastrophic failure is to be avoided, then the tank needs to be designed so that the reinforcing is capable of carrying the entire water load.

5.0 MATERIAL TESTING

This project looks into the practical effects of shrinkage on ferrocement water tanks. Shrinkage plays an important role in tank design as it induces forces that can cause tank failure. It is important to know the magnitude of these forces, and ways to reduce their detrimental effects need to be investigated. There is a limited amount of literature on the mechanical properties of ferrocement therefore three tests have been devised to help investigate these properties and their effect on shrinkage. They are:

- Tensile strength,
- Unrestricted shrinkage,
- Restricted shrinkage.

It is necessary to know the tensile strength of the material, as it is needed to produce realistic results in the spreadsheets. It is used in conjunction with the unrestricted shrinkage findings to calculate the theoretical crack propagation in the cement sample. The tensile strength is found by applying a direct tensile load, discussed further in section 6.2.

The unrestrained shrinkage test is needed to investigate the magnitude shrinkage. If the specimen's movement is not restricted, these results are used to help calculate the theoretical crack development of each sample. To measure the unrestrained shrinkage, blocks of each specimen are to be cast and then are allowed to set over a 28-day period, daily readings are taken and the shrinkage is calculated, discussed further in section 6.3.

The restrained shrinkage test is used to investigate the crack development in four different specimens. The test is aimed at mimicking the effect of cracking in the tank wall caused by the restriction in movement due to the base/wall junction (see figure 2.1). Two tests are used, the first looks at cracking in a reinforced specimen block and the second investigates cracking in a ring sample, both tests are discussed further in section 6.4.

There are numerous types of reinforcing materials used to enhance the mechanical properties of cement mortar. This project is aimed at tank construction in developing

countries therefore only reinforcing that is available in these countries is to be used. Three types of reinforcing material that are commonly available are:

- Chicken wire (volume fraction 1%),
- Square mesh (volume fraction 2%),
- Polypropylene fibres (volume fraction 1.5%).

As little is known about the effects of reinforcing is the experimental volume fraction for each reinforcing material (shown above) are to be used.

To ensure uniformity of results, it is important to use an appropriate research methodology.

5.1 Procedure

Materials

The chicken wire (figure 5.0(a)) and square mesh (figure 5.0(b)) are manufactured from galvanised mild steel. The polypropylene fibres are ‘home-made’ (figure 5.0(c)) and are approximately 10mm stands cut from a length of rope. The material’s mechanical properties are given in Appendix I.

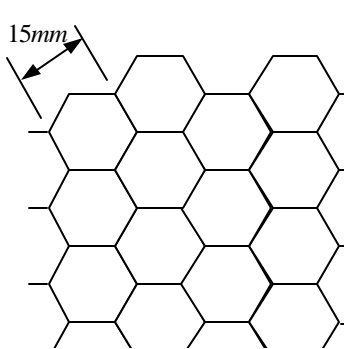

Mesh diameter = 0.5mm

Fig 5.0(a) Chicken wire

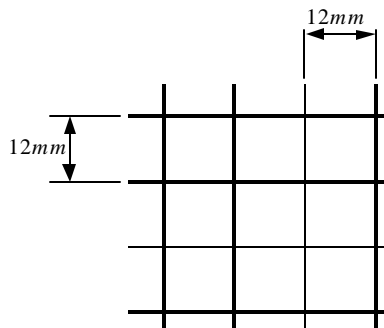

mesh diameter = 1.0mm

Fig 5.0(b) Square mesh

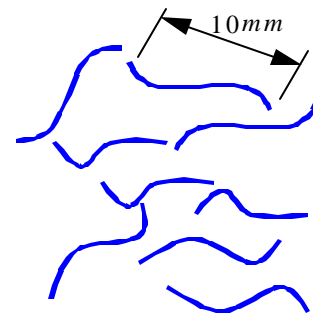

fibre diameter \cong 0.5mm

Fig 5.0(c) Polypropylene fibres

The cement used in all the mixes is Ordinary Portland Cement (OPC). This is mixed with standard building sand to a ratio of three parts sand to one part cement by weight, with a water cement ratio 0.6.

Mixing and making

When cement based products are made in developing countries they are usually hand mixed. Due to the problems caused by the high ambient temperature, such as rapid setting due to water loss and in turn reduced workability there is a tendency to make a relatively wet mix. There is also sometimes a lack of knowledge about the correct consistency of cement. As stated previously, for the optimum strength of the cement, a water cement ratio of 0.4 is required. To add authenticity to the results all the samples are made using a relatively high water cement ratio of 0.6 and they are all mixed by hand. With increased mixing time, the strength of the cement paste slightly increases and variations in strength decrease therefore for the sake of uniformity all the dry materials are mixed for approximately three minutes and then wet mixed for a further three minutes.

Curing and storage

It is usual practice to cure samples of this size in a water pond for 7 days but to try to get a level of authenticity to the results, a curing regime is used that is more likely to be found in most developing countries. All of the samples are cured under wet/damp hessian for 7 days, the hessian is moistened on a daily basis. It is acknowledged that the weather patterns of a tropical country cannot be easily modelled in the workshop. Whilst the experiments were carried out the samples were stored at 25°C, with a relative humidity of approximately 40%, this may be equivalent to an area such as Northern India in spring.

5.2 Tensile Strength

To help get a feel for the magnitude of tank wall thickness for various sizes of water tank. It is necessary to find out the tensile strength of the construction material. There is a great deal of documentation for the strength of concrete but little is known of the strength of ferrocement.

All the structural analysis is performed using thin shell theory. The assumption in this theory is that all the force is carried in tension through the centre of the material. There are three types of test for strength in tension: Flexural test, Splitting tension test, and Direct tension test. The first two tests are not suitable for the strength analysis used in the thin wall theory. In the Flexural test the reinforcing is at the outer edge of the sample.

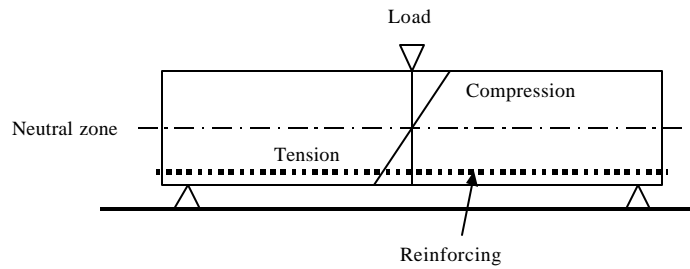

Fig 5.1 Modulus of rupture test

The indirect tensile test is used for testing the tensile strength of materials with a uniform constituency, such as concrete. This test is not suitable because the samples contain metal reinforcing.

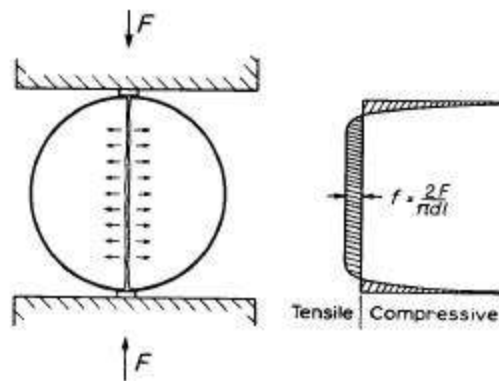

Fig. 5.2 Indirect tensile strength test (Kong and Evans 1985)

Therefore a more unconventional direct tension test has to be used to find the tensile strength. The direct tension test raises a number of problems, a direct application of a pure tension force, free from eccentricity, is very difficult. The test equipment used consisted of a square plate, into this a length of M10 threaded bar was screwed. On the other side of the plate four lengths of M6 threaded bar were attached.



Fig. 5.3 moulds used to cast samples

The cement sample was cast onto the 6mm bar. The samples were manufactured in batches of five, in a mould (see figure 5.3). They were mechanically vibrated, this was carried out to aid compaction as there was difficulty manually compacting due to restricted access. To avoid creating a weak point at the end of the M6 retaining bars, the bar lengths were varied from 35 to 50mm long, see figures 5.4 and 5.5.

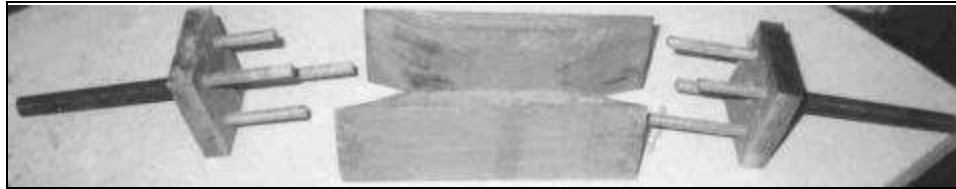

Fig 5.4 End plates and wooden inserts used in sample manufacture

The tensile load is applied through the 10mm bar by the tensile testing machine.

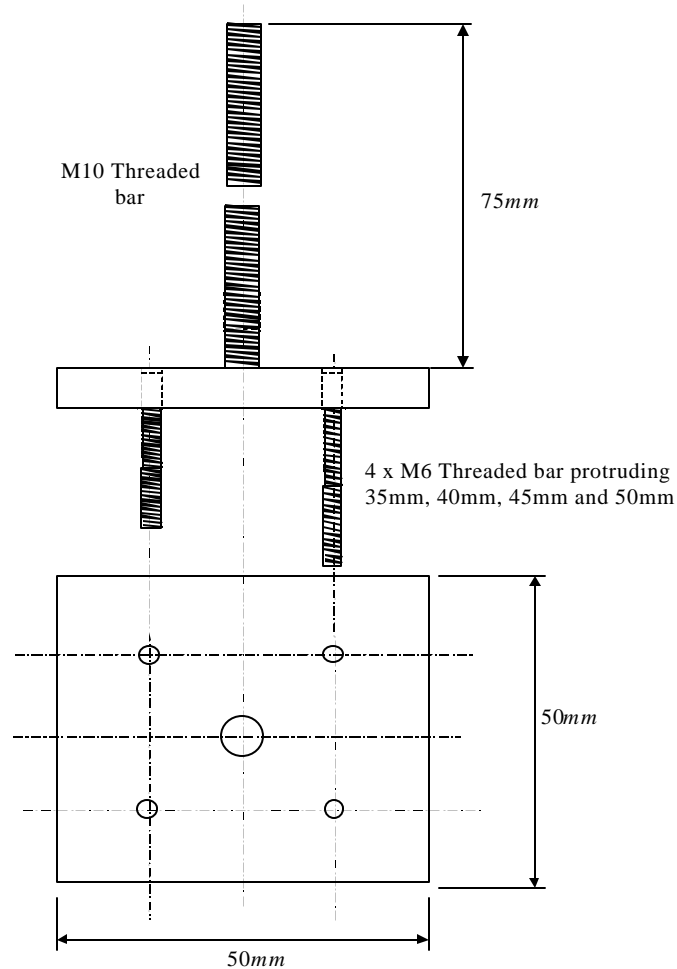

Fig. 5.5 Test plate assembly

The overall dimension of the specimen is shown in figure 5.6

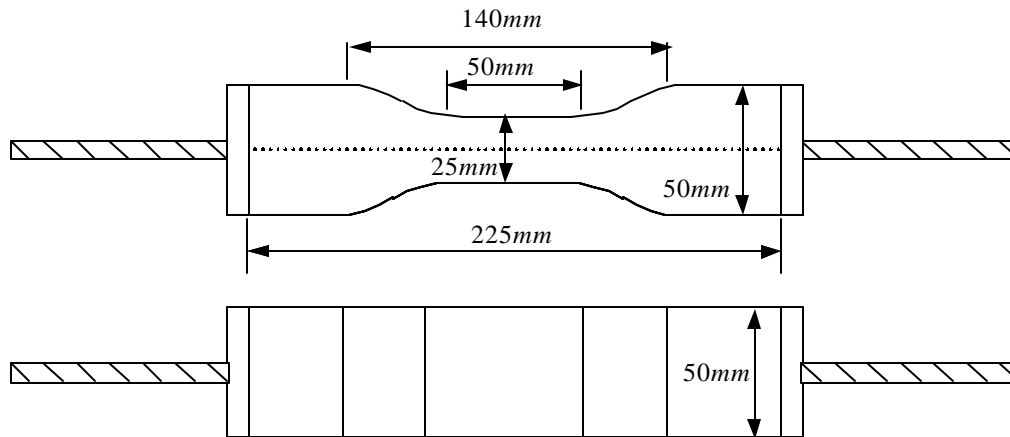

Fig 5.6 Specimen dimensions

To ensure the sample fails in the correct region the sample is necked using two wooden inserts, see figure 5.7.



Fig 5.7 Wooden inserts used to neck samples

A full set of drawings of the test equipment can be seen in appendix II.

Results

The samples were tested using a Testometric 100kN tensile testing machine. The results only show breaking loads. During the test, loads were applied at a strain rate of 0.07mm/min until the cement failed, at this point the load was removed. In the case of the chicken wire reinforced samples the mortar and mesh failed at the same time. With the square mesh the mortar failed first. To increase the accuracy of the results five of each sample were made and the mean strength was found. A full set of results is given in Appendix III.

Results for samples reinforced with one sheet of 13mm 19 gauge (1mm diameter) galvanised mild steel square mesh (4 strands) and one layer chicken wire also galvanised.

Sample	Average Strength (MPa)	Standard Deviation	Coefficient of variance
Plain mortar	1.60	0.57	0.24
Reinforced with chicken wire	1.90	0.45	0.15
Reinforced with square mesh	2.40	0.41	0.13

Table 5 tensile test results

Discussion

The results show that the reinforced samples are stronger. It can also be seen that there is less variation in strength in the reinforced samples compared to the non-reinforced. The reinforcing mesh acts in two ways, it provides tensile strength, but more importantly it restricts crack growth. It can be seen in figure 5.8 that if there is a flaw in the sample it acts as a stress concentrator where cracks can start to grow. In the plain mortar samples there is nothing to stop the propagation of the crack. In the reinforced sample crack propagation is stopped or restricted when it meets the mesh. The effect the mesh has on the cement is analogous to rip-stop nylon.

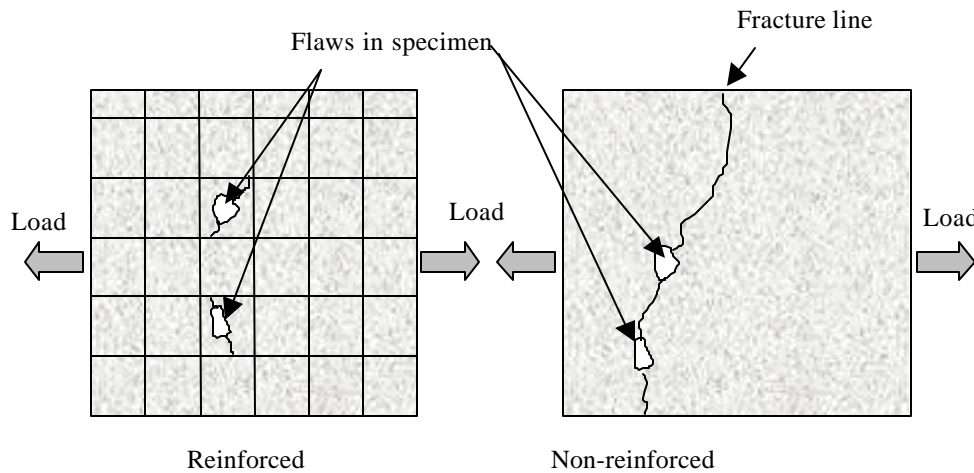

Fig. 5.8 Crack propagation in cement

Figure 5.8 shows one of the square mesh reinforced sample in the third stage of crack development (discussed in section 4.0). The sample was subjected to a tensile load, this load was increased until the cement mortar broke, then the load was removed. It can be seen that although the sample has failed it still retains its integrity, this implies that if the tank fails due to overloading, the failure will and will not be catastrophic but initially only lead to water leakage. If the cracks are small, e.g. less than 0.05mm, leakage will not occur. Cracks larger than 0.05mm will leak, this will cause water loss and corrosion on the reinforcement, which will also lead to spalling.

5.3 Unrestrained (free) shrinkage

The unrestrained shrinkage test is used to find the degree to which the specimen contracts if it is free from external clamping. These results are used to calculate the theoretical crack development of each sample. The unrestrained shrinkage tests were carried out on three samples, plain cement, chicken wire reinforced and square mesh reinforced. The reinforcement volume fraction and positioning was similar to that for the tensile testing (see figure 5.9). All of the samples are 225mm long and have a 50mm square cross section, see figure 5.9. The length of the sample over which the measurements were taken was 200mm. The unrestrained shrinkage test was not performed on any fibre reinforced samples as work in this area has already been carried out by Karagular & Shah (1990), see Appendix IV, and showed that the addition of fibres does not substantially alter the degree of free shrinkage.

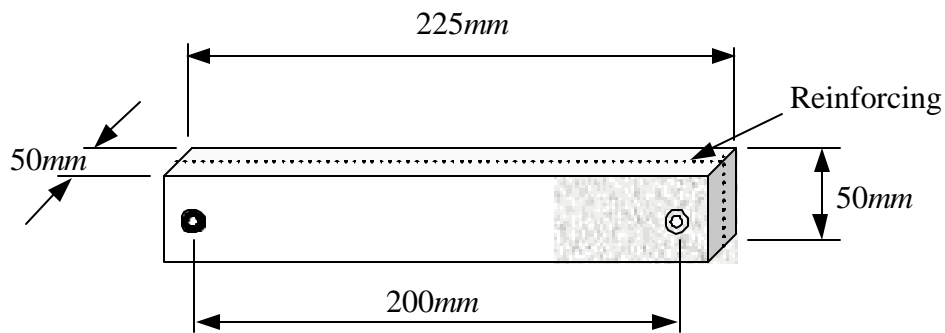

Fig. 5.9 Dimensions of unrestrained shrinkage sample

Daily readings were taken over a 28-day period using a demountable mechanical strain gauge (see Appendix II). To investigate any possible warping caused by differences in drying rates, measurements of shrinkage were taken two on sides of the sample, see figure 5.10.

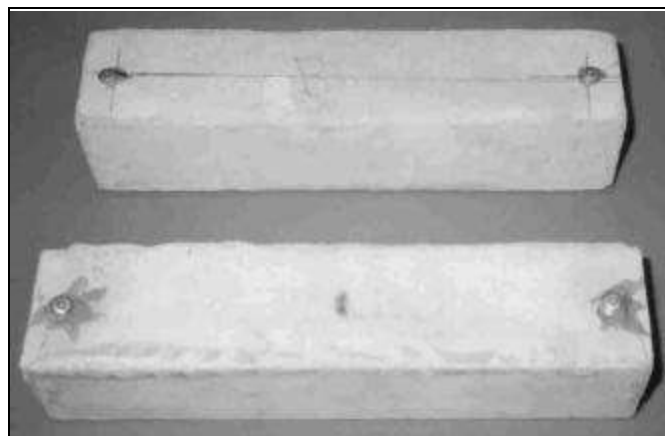

Fig 5.10 samples used for free shrinkage tests

Results

The results from this test compare favourably with the theory that was discussed in section 3.0 and Neville (1995). It can be seen in figure 5.11 that rates of shrinkage are relatively high, this is due to the high water/cement ratio (0.6), dry storage conditions (40% humidity), and an average temperature of 25⁰C. The initial swelling is due to curing in a damp environment (under hessian), once this is removed the samples began to shrink. All data points are given in Appendix III.

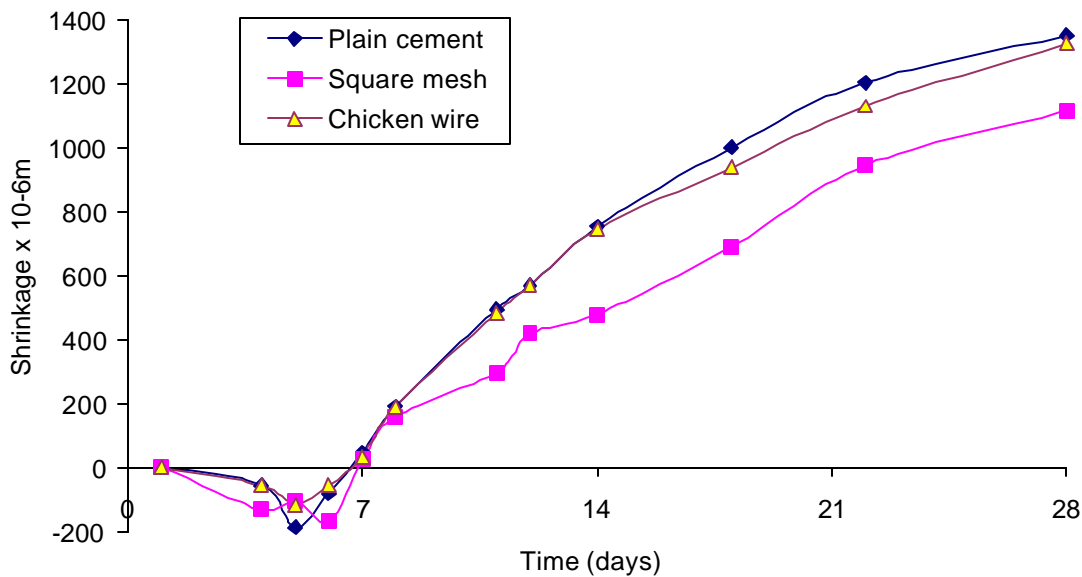

Fig. 5.11 Unrestrained Shrinkage results

Discussion

Cement swells when kept in moist conditions and shrinks in dry, the hotter and drier it is the faster the rate of shrinkage. As stated earlier, ferrocement tanks built in developing countries are very susceptible to rapid shrinkage because they have high wall area to volume, high water/cement ratios and they tend to be constructed in hot (and sometimes dry) climates. The results from the free shrinkage test show that there is initial swelling of the cement and as it dries it shrinks.

If the shrinkage is free to develop without any restriction, and it does not generate any extra stresses it should have little effect on the tanks performance. It can be seen that the use of chicken wire has little effect on the degree of shrinkage when compared to the plain sample. The ferrocement sample that contains square mesh has the greatest effect on the degree of shrinkage, this will induce additional internal stresses in the material.

The chicken wire does not perform as well as the square mesh when it comes to restricting shrinkage because it has a tendency to collapse under load, whereas the square mesh carries the load in same plane, see figure 5.1(a). There are two other reasons why the chicken wire may not perform as well:

- they are the wire is a smaller gauge,
- there is a lower volume fraction.

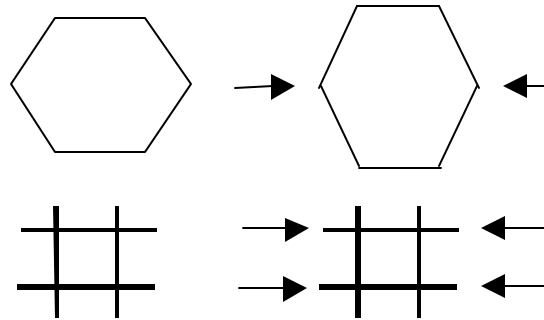

Fig. 5.11(a) Effects of compressive load on wire mesh

If the samples were restrained so that the strain caused by the shrinkage was not free to relieve itself, then the cracks would start to develop when the stress caused by the shrinkage exceeds the tensile strength of the material. Using the values for Youngs modulus in appendix I, i.e. 3.0GPa for cement and 210GPa steel, and knowing the volume fraction it is possible to calculate the overall Youngs modulus for each specimen. Using the results from the tensile testing (table 5), the theoretical time after which cracking will start to occur can be calculated, these are shown in table 5.1.

Sample	Tensile strength (σ) MPa	E (GPa)	$e = \frac{\sigma}{E}$ ($\mu\epsilon$)	No. of days before cracking starts (see figure 6.7)
Plain	1.6	3.50	373	9.5
Chicken wire	1.9	3.67	518	10.5
Square mesh	2.4	3.85	623	17

Table 5.1 Breaking strains

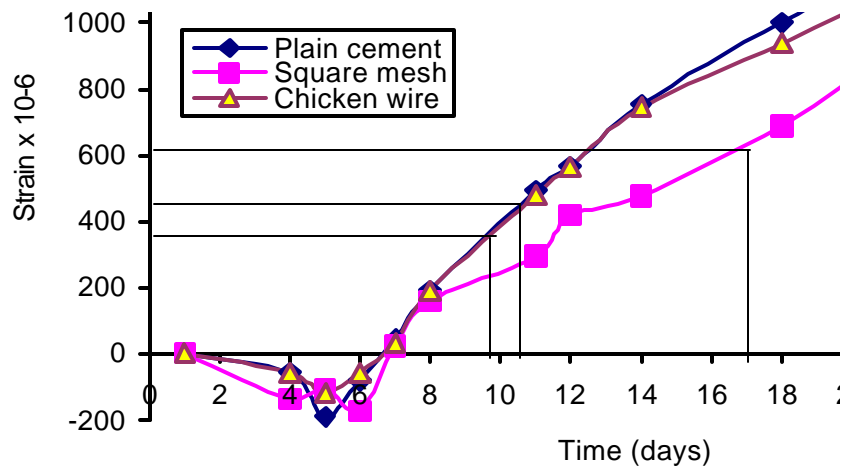

Fig 5.12 Breaking strain

It can be seen from figure 5.12 that the higher the tensile strength, the longer it will be before cracks start to develop. The practical implications are that to stop the tank cracking one or more of the following must be done:

- the amount of reinforcement needs to be increased, Skinner (1995) recommends a volume fraction of at least 5.1 to 6.3%,
- the tank needs to be kept in moist conditions so shrinkage is minimised (see section 3, figure 3.3),
- or the wall thickness needs to be increased so that the tensile strength is higher.

5.4 Restrained Shrinkage

The restrained shrinkage test is used to investigate how the cracks develop in a cement specimen. The test is aimed at mimicking the effect of cracking in the tank wall caused by the restriction in movement due to the base/wall junction (see figure 2.1). There is no British Standard test to assess cracking caused due to restrained shrinkage so a test had to be devised. The first test investigated cracking a reinforced specimen block, this test proves to be unsuccessful so a second test was used. The second test investigated cracking in a ring sample. The main failure in the first test was the effectiveness of the retaining pins, using a ring specimen this problem was overcome.

Test Method 1

An initial test was devised to examine when and where the specimen would crack if the shrinkage were restrained. To ensure that the test gave reliable results it was important to ensure that the two ends of the cement specimen were not free to move. A test rig was set up using a section of steel 'U' channel and two of the end plates from the tensile testing experiment, see figure 5.13. The 'U' channel had two purposes, it was a mould for the sample to be cast in to and it also ensured that the end plates did not move.

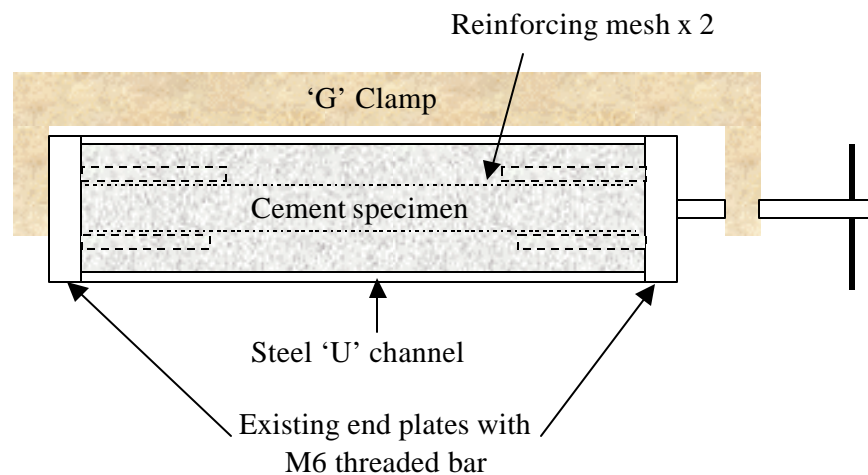

Fig. 5.13 Initial crack test

Results

This test gave inconclusive results, there was initial cracking, but these did not develop beyond micro cracks (less than 0.1mm), see figure 5.14.

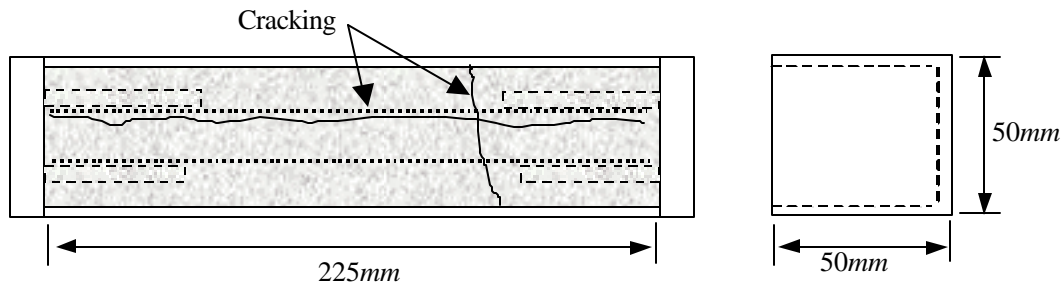

Fig. 5.14 Cracking caused by shrinkage

It can be seen from the specimen in figure 5.15 that even after 28-days the cracks were difficult to see without very close examination.



Figure 5.15 Micro crack development in restrained sample

The results from the unrestrained shrinkage tests showed that the amounts of shrinkage should have been much greater. These inconclusive results could have been due to a number of reasons such as that the specimen was cast in a steel 'U' channel therefore the cracks could only be viewed from surface also the moisture could only escape through one face. Another factor affecting the poor results was that the cement mortar might have pulled off the threaded retaining pins therefore leaving the mortar free to contract. All these factors lead to the test being discarded and a more reliable test being developed.

Test Method 2

Test method two overcomes the problem of holding the sample. A ring mould is used (see figure 5.16) and the cement is then rendered onto the outside of it. This test is likely to give more reliable results compared to the first test as it more resembles a 'real life' tank. In similar way to an actual tank, the ring mould gives greater surface area where moisture can escape therefore modelling real life conditions.

Due to time restrictions and uncertainties in the testing technique only one of each sample was made, one of each of the following:

- Reinforced with one layer of square mesh (see figure 5.17),

- Reinforced with one layer of chicken wire (see figure 5.17),
- Reinforced with 'home-made' polypropylene fibres,
- Plain mortar.

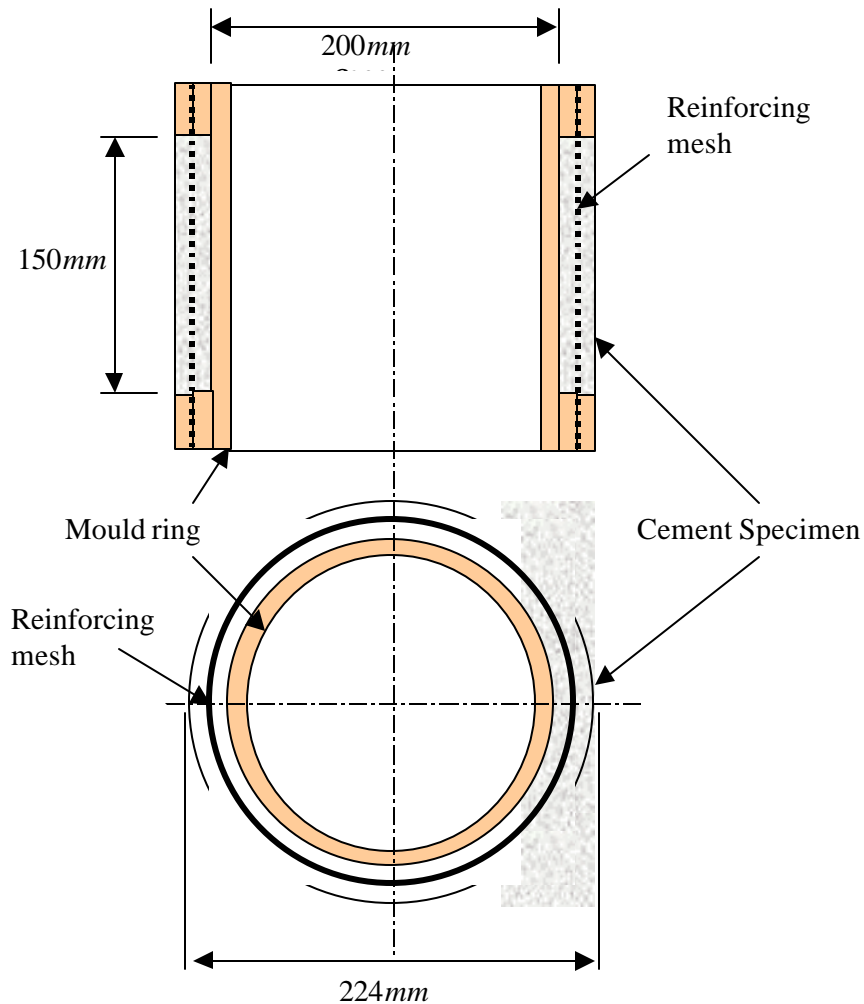

Fig. 5.16 Ring test used to investigate cracking

As with all the other samples, these were manufactured using the procedure described in 6.1, i.e. cured under wet/damp hessian for 7 days. Whilst the experiments were carried out the samples were stored at 25°C, with a relative humidity of approximately 40%. The cement used is OPC, which is mixed with standard building sand to a ratio of three parts sand to one part cement by weight, with a water/cement ratio of 0.6.

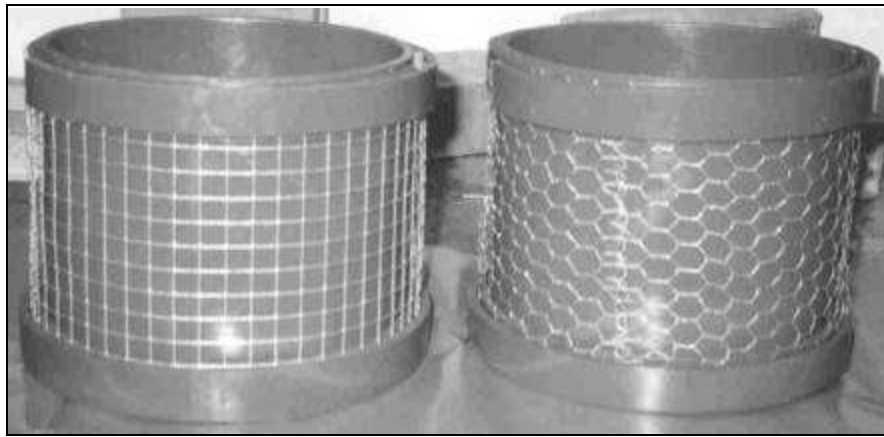

Fig 5.17 Reinforcing on test rings before mortar is rendered on.

As with both the tensile and unrestrained shrinkage, the restrained shrinkage tests were also carried out over a 28-day period.

Results

Plain mortar

The plain mortar specimen (figure 5.18) showed signs of cracking after five days. A single crack developed at a relatively linear rate, approximately 0.09mm/day. After 28 days the crack width was approximately 1.75mm.

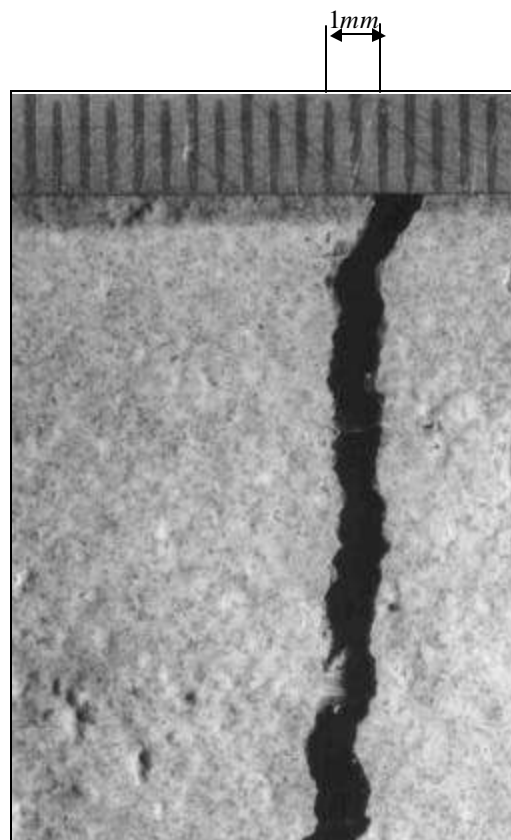

Fig. 5.18 Crack in plain mortar sample

Fibre reinforced

In this case two vertical cracks developed over the complete length of the specimen, they were approximately 180° apart. After 28 days the larger crack was slightly less than 0.5mm (figure 6.19(b)) and the smaller one approximately 0.1mm (figure 5.19(a)). The cracks started to develop after 6 days and developed at a relatively linear rate, the larger crack at approximately 0.02mm/day and the smaller at 0.005mm/day.

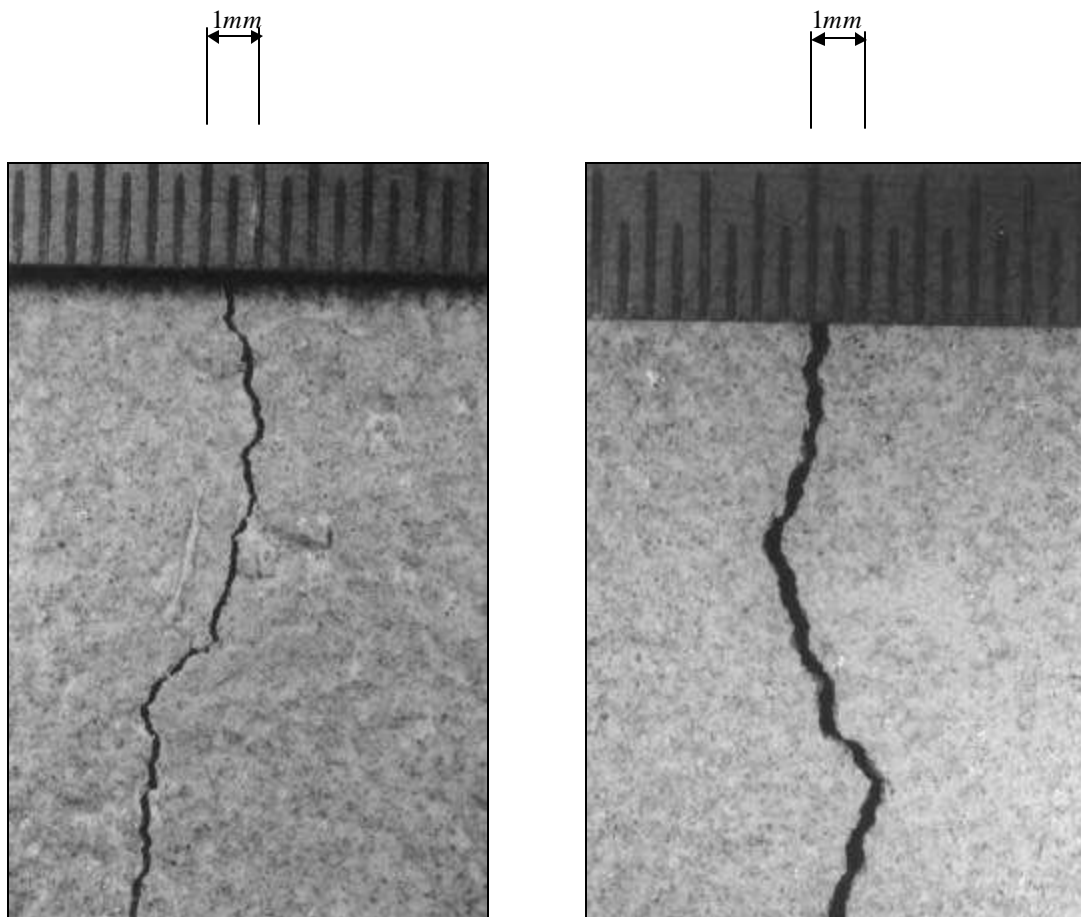

Fig. 5.19(a) Small crack in fibre reinforced sample Fig. 5.19(b) Large crack in fibre reinforced specimen

It cannot be clearly seen in the photographs but the fibre strands in the mix bridged the gaps between the cracks helping hold the sample together and therefore reducing shrinkage. This is illustrated in figure 5.20. The fibre also added to the tensile strength of the specimen, this also helped to reduce the shrinkage.

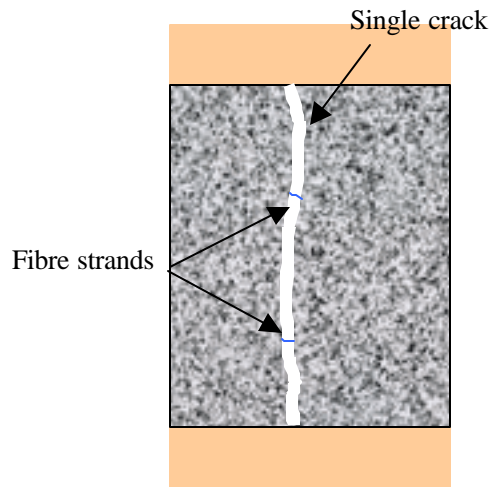

Fig. 5.20 Fibre reinforcing

Chicken wire reinforced

In the specimen containing chicken wire reinforcing the crack size was greatly reduced compared with the two previous samples. It can be seen from figure 5.21(a) that chicken wire reinforcing increased the number of cracks but reduced the size of individual cracks. Figure 5.21(b) shows a single larger crack with a width of approximately 0.2mm, due to the effects of the reinforcing. Towards the top of the specimen, the crack divides into two smaller cracks. Again in this case the cracks run vertically and are approximately 180° apart, the cracks started to develop after 7 days.

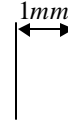
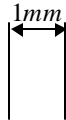



Fig. 5.21(a) Development of small cracks in chicken wire reinforced specimen



Fig. 5.21(b) Large cracks in chicken wire reinforced specimen

Square mesh reinforced

The specimen containing square mesh reinforcing showed the least amount of cracking. There were a number of minor hairline cracks propagating from the edge (figure 5.23). The specimen only had one major crack, see figure 5.22(a). Of all the minor cracks the greatest can be seen in figure 5.22(b). The cracks started to develop after 8 days, the rate of growth was relatively slow compared to the previous three and the rate decreased over time.

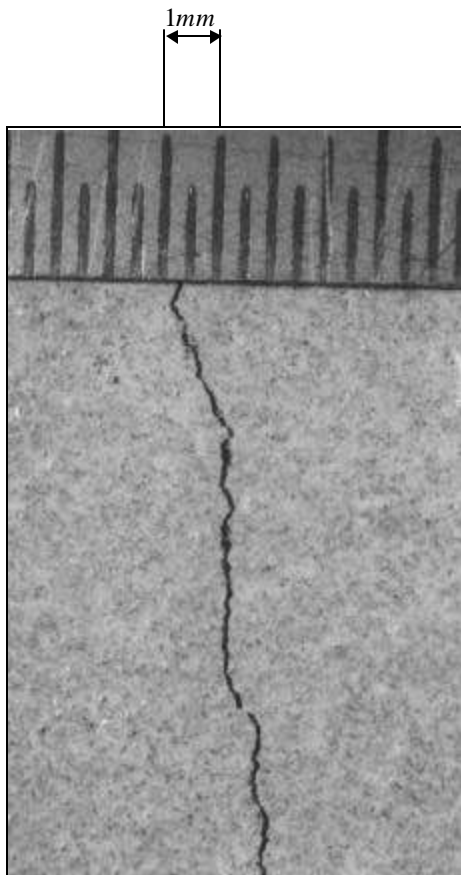

Fig. 5.22(a) Single cracks in square mesh reinforced specimen

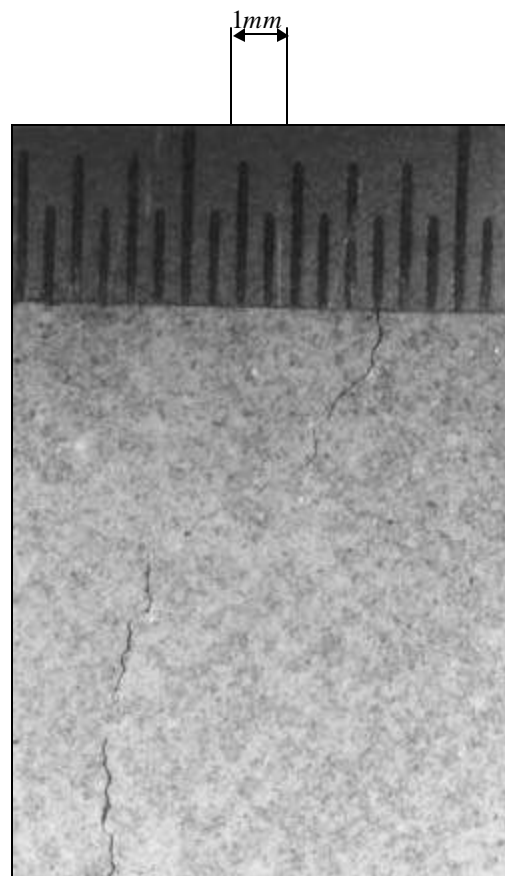

Fig. 5.22(b) Distributed cracks in square mesh reinforced specimen

Discussion

In all cases, the cracks started to develop at the edge of the specimens and propagated vertically towards the centre. In all the cases apart from the square mesh reinforced sample, the cracks were approximately 180° apart. The cracks started at the edge due to stress raisers caused by the rough surface finish of the cement mortar. This can be seen in figure 5.23. If the surface between the ring mould and the sample had a zero friction

factor then only one crack would develop, if the friction factor is greater than the force needed to start a crack, a new crack will develop. This is what happened in this case.

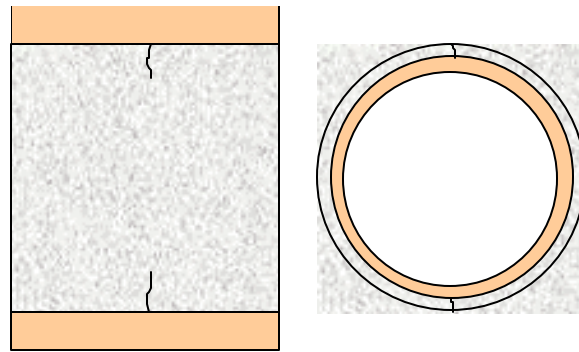

Figure 5.23 Crack development

One of the factors that affects the rate of shrinkage is the environment. In the early stages where rates of shrinkage are high, this has a very important role. The experimental results show that ferrocement cured and stored in a dry environment (40% relative humidity) is very susceptible to cracking (all samples started to crack after 5 to 7 days).

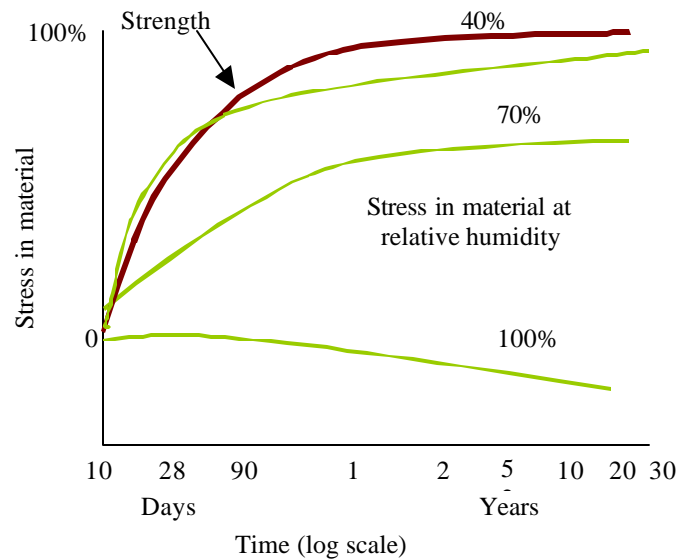

Fig. 5.24 Stress in material caused by shrinkage

To take full advantage of the composite strength it is important not to allow the cement to crack. This can be achieved by making the walls thicker as this slows down moisture loss and also increases overall strength. Another way of achieving this is to keep the cement in such an environment that shrinkage will not occur preferably in moist conditions.

Figure 5.24 shows the theoretical development of stress caused by restrained shrinkage against the development of stress in the cement as discussed in section 3.0. It can be seen that at a relative humidity of 40% the stress developed is greater than the strength of the

material, causing the material to crack or fail. If the cement is in an environment with a higher humidity the cracking will not occur. From the figure 5.24 it is seen that after about 40 days the composite has gained enough strength to withstand the internal stresses caused by shrinkage. These results have a practical application, if the water tank is constructed in humid conditions it will be less likely to crack due to shrinkage.



Fig 5.25(a) Polypropylene fibre reinforced

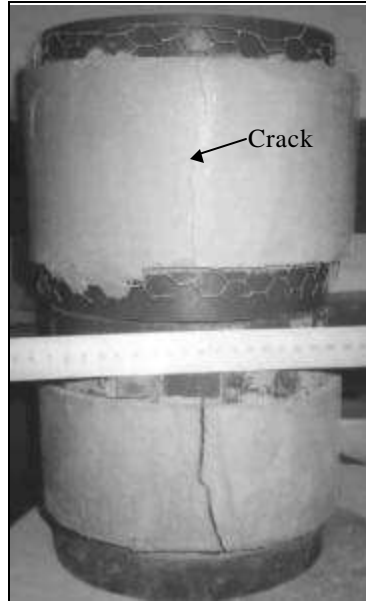

Fig 5.25(b) Chicken wire reinforced



Fig 5.25(c) Square mesh reinforced

Figures 6.25(a-c) show the relative crack size when the plain cement specimen (on the bottom) is compared to the three reinforced specimens. Compared to the crack development in the plain specimen, the specimen containing square mesh restricts the shrinkage cracking by approximately 95%, the specimen containing chicken wire by 80% and the fibre reinforced specimen by 52%. The mesh reinforcing disperses the cracks into a series of micro-cracks. In the specimen containing square mesh the majority of these micro-cracks are less than 0.05mm, according to Nedwall and Swany (1994) cracks of this size should not leak.

One of the reasons the fibre reinforcement does not restrict crack size when compared to the other two is because it has a lower tensile strength 29-38MPa compared to 215 MPa for steel mesh as well as having a higher ductility. Another reason is that there may be a tendency for the reinforcing to pull out of the mortar matrix.

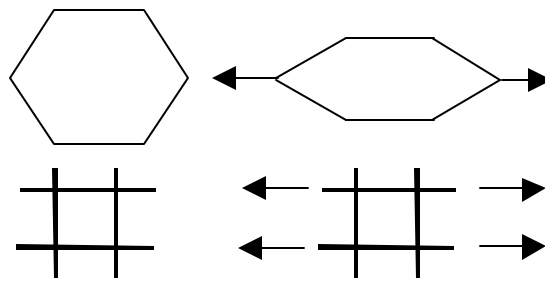

Fig. 5.26 Effects of tensile loads on wire mesh

The main reason why the specimen containing the square mesh restricted the cracking to a greater degree compared to the chicken wire can be seen in figure 5.26. When chicken wire is loaded there is a tendency for the mesh to ‘flatten’ out and expand in the plane of the load. In the case of the square mesh, the load is carried in the same plane therefore the only expansion is due to the wire mesh stretching. There are also a number of other factors which effect the degree to which a specimen shrinks such as volume fraction and the wire gauge. Generally, the larger the volume of steel reinforcing and the larger its gauge the lower the shrinkage will be.

6.0 DISCUSSION

Spreadsheet

In the current spreadsheets the designer is free to enter any safety factor they wish. It would be useful if the designer had some feel for what size of safety factor is required. For example, if the designer knows that the tank is going to be constructed by skilled masons, with high quality materials in a cool wet environment, a safety factor of 2 to 3 could be used. If a designer is not sure of the quality of the raw materials or skills of the masons but knows it will be constructed in a cool wet environment a safety factor of 4 to 5 could be used. If the designer has little knowledge of the environment or the quality of the materials a higher safety factor of 6 to 8 may be used.

Materials

For a typical ferrocement tank constructed in Kenya costs vary from 26US\$/m³ for a 46m³ tank to 50US\$/m³ for a 11m³ tank (Gould 1999). Approximately 80% of the cost is materials. If the tanks are going to be financed by the individual householder or community this cost will normally be out of their range. Any saving in the cost of raw

materials can be of great benefit, for example, the cost of cement in Uganda is equal to its cost in the UK, but the average income in Uganda is approximately 1/30th to that in the UK. Therefore the real cost of cement is equivalent to 30 times the cost in the UK, (£100-£150 per 50kg). One of the best ways of lowering these costs is to reduce the amount of expensive raw materials. This can be achieved through a number of ways, this report investigates tank design and improved construction methods.

The spreadsheet allows for experimentation with tank design. Results from the mechanical testing show that reinforcing square mesh inhibits shrinkage better than chicken wire. Reinforcing is used not only for strength but also to add uniformity to the structure. It also gives a base for the cement to be rendered onto. The reinforced samples have greater strength uniformity, this gives the designer greater confidence in predicting the strength of the materials thus allowing for reduced safety factors and therefore thinner walls which in turn reduce material inputs.

Construction techniques

One of the main problem areas in tank design is the wall/base interface. It was shown using the spreadsheet that the interface causes additional stresses, but more importantly the interface restricts the free shrinkage of the tank walls therefore generating additional forces at the tank base of the walls. There are two ways to overcome this problem, either strengthen the base/wall interface or construct the tank so the wall is not connected to the base and it is free to move. The first method increases material costs and second method adds to construction complexity. The final decision on what option to take is up to designer/builder, factors such as cost of additional materials and levels of available construction skills have to be taken into account.

7.0 GUIDE TO THE DESIGNER AND MANUFACTURER

The project has looked into many aspects of tank design and construction. This section summarises the findings into a set of useful guide rules that will help the designer and/or manufacturer. Some of these rules are already in use in the construction industry. Using theory and experimental results these rules have been made specific to overcome problems that are particular to constructing ferrocement water tanks in hot, dry climates.

One of the main problem areas is differential shrinkage; this can be reduced in a number of ways,

- The wall thickness should be kept to a minimum and where possible constant throughout the tank, this will reduce the build up of internal stress. For example, a wall thickness of *75mm* internal stresses caused by shrinkage can vary by 20%.
- The tank should not be constructed so it is half shaded, this will cause internal stress to be built up. Ideally, the tank should be constructed in a shaded area, this will reduce rapid water loss.
- If possible the application of cement mortar should be continuous. Rendering wet mortar onto dry should be avoided, as stresses will build up between the layers. The maximum recommended time between layers is 4 hours.

Hot dry weather has an adverse effect on tank strength.

- Where possible tanks should be made in the wet season or in the coolest part of the day, ideally in the morning so the construction materials have had the opportunity to cool down overnight.

It is important to incorporate good building practices and have an understanding of the properties of the construction materials.

- The water/cement ratio should be kept as low as possible as a low water/cement ratio will maximise strength and minimise shrinkage. Cement mortar having a water/cement ratio of 0.6 is 40% weaker than that with a water/cement ratio of 0.4.
- There is less variation in strength in reinforced cement compared to non-reinforced. In the tensile strength experiment, compared to plain mortar, variations were reduced by 40% and 45% for chicken wire and square mesh respectively. The lower the variation the lower safety factors that can be used.
- Increasing the amount of reinforcement can reduce cracking. Skinner (1995) recommends a volume fraction of at least 5 to 6%.

- Ensure that not only fine gauge mesh (chicken wire) is used, from experimental observations it was seen that when failure did occurred it was catastrophic.
- The finer the mesh size, the slower and more disperse the crack propagation. Using experimental results, compared to plain mortar the chicken wire reduced cracking by 80% and the square mesh by 95%.
- A good curing regime is required, i.e. the use of wet hessian and plastic covers. The tensile strength of a tank cured in water is approximately 300% greater than that cured in dry air. Appropriate early curing is very important as cement acquires 75% of its final strength within 14 days of casting.
- Shrinkage and cracking can be reduced if the tank is partly filled with water. This needs to be carried out as soon after construction as possible, the depth is not critical as long as the important wall/base junction is covered, e.g. 75 to 100mm.
- Use of safety factors, for example, 2-3 for a tank constructed by skilled labour, with high quality materials in a cool wet environment, 4-5 if the materials are of dubious quality but there are skilled labour, and 6-8 if there is little knowledge of environment, quality of the materials and labour.

For tanks of similar storage volume the material input for tanks with doubly curved walls are lower than that for tanks with singly curved walls. For example, a Thai jar uses approximately 30% less construction materials than a conventional cylindrical tank of similar volume.

8.0 FUTURE WORK

Spreadsheet

The spreadsheet that is used to calculate the force in doubly curved tanks needs to be made more user friendly. The effects of edge loads also need to be incorporated. The spreadsheets do not take into account the effect of shrinkage and cracking. At the moment their effects are covered by the use of safety factors. Ideally, it should possible to

enter a numerical correction factor, which has a similar effect as the safety factor, this may vary depending on construction materials and environmental conditions.

The current spreadsheets do not cater for tanks with non-uniform wall thickness, further work needs to be carried so that this facility is possible. Once this facility has been added it will be posted on the DTU's rainwater harvesting web site and available to the general public.

Construction materials

Future RWH work may concentrate on developing lower cost construction materials. Ideally these should be locally sourced. Work needs to be carried out on a replacement for OPC using rice ash husks, rice straw ash and peanut shell ash and future study needs to be carried out on how they reduce shrinkage and therefore cracking. The cost elements need to also be examined. Tank construction materials that could be investigated include bamboo-mud composites, especially in remote rural areas where access to conventional materials such as cement and steel reinforcing bar may be limited. In tropical areas one option is latex, this could be used in conjunction with jute or coir (coconut shell) sacking, as a waterproofing material. Flexible tanks could be made from this composite.

Construction techniques

The merits of shotcreting or the spraying of cement could be studied. Shotcreting is the spraying of concrete at high velocity, conventionally it is projected through a hose usually to a thickness of 50mm. The advantage of spraying concrete/cement is that the mix can be much drier (water/cement ratio 0.30 to 0.50), which in turn will reduce shrinkage and cracking. Spraying cement will give thin uniform cover over reinforcing mesh, as well as reducing application time.

9.0 CONCLUSIONS

Thin wall ferrocement tanks have many advantages and their use should be promoted. One of the main factors that reduce their widespread use is the cost of construction materials, in developing countries it is approximately 80% of the overall cost. The project

has looked at the problems that can occur when material inputs are reduced, these are mainly the problems caused by shrinkage induced cracking.

Due to the restricted sample size the accuracy of the results from the material testing may be limited. The purpose of testing was to get a ball park figure for tensile strength and investigate the mechanics of shrinkage of ferrocement. Three reinforcing regimes have been examined and their effects of tensile strength and shrinkage have been reported.

To help optimise material inputs two spreadsheets have been produced. These spreadsheets give the designer an opportunity to experiment with many shapes of tank, as well as material properties. The spreadsheets also have the added advantage of speed, allowing the designer to make changes to the tank specification and immediately seeing the consequences of their actions. This allows iterations to be made quickly and easily. For example comparing a Thai jar (figure 2.7(b)) style water tank to standard cylindrical tank (figure 2.7(a)) of a similar volume material inputs can be reduced by approximately 30% (assuming the material is homogeneous).

One of the main problems that can arise when material inputs are reduced is cracking that is caused by shrinkage. Various ways of reducing this and cracking has been investigated. They include,

- Reducing the effects of potentially damaging differential shrinkage,
- Incorporating good curing regimes,
- Studying the role reinforcing plays in reducing shrinkage and cracking.

The project has also sought to improve construction practices that will help with the manufacture of thin walled ferrocement tanks. A guide for the designer/manufacturer has been produced, this gives a list of some simple, practical and easy to follow rules that can be used in the ‘field’ to help overcome the problems that can occur when material inputs are reduced.

10.0 BIBLIOGRAPHY

- Calladine C.R. (1983), *Theory of Shells Structures*, Cambridge University Press.
- Cartwright A.J. ed. (1996), *Engineering Data Book*, University of Warwick, Coventry.
- Childers L.F. (1985), *Materials testing and mixing*, UNICEF, Nairobi, Kenya.
- Davis H. E. (1940), *Autogenous volume changes of concrete*, ASTM, USA.
- Flügge W. (1967), *Stresses in Shells*, Springer-Verlag, New York.
- Gould J & Nissen-Petersen E (1999), *Rainwater Catchment Systems for domestic supply*, Intermediate Technology Publications, UK.
- Gray W.S. (revised by Manning G.P.) (1960), *Reinforced Concrete Reservoirs and Tanks*, Concrete Publications Ltd., USA.
- Ichikawa R. (1995), *Rainwater and you: 100 ways to use rainwater*, Tokyo International Rainwater Utilisation Conference, Japan.
- Karagular M.E. & Shah S.P. (1990) *A test method to evaluate shrinkage cracking of concrete*, Proceedings of the material Engineering congress, American Society of Civil Engineers, USA.
- Kelkar.S. & Sewell R.T. (1987), *Fundamentals of the Analysis and Design of Shell Structures*, Prentice-Hall, New Jersey.
- Kong F.K. & Evans R.H. (1980), *Reinforced and Prestressed Concrete*, Pitman, Bath.
- Nedwall P.J. & Swamy R.N. ed. (1994), *Ferrocement*, Proceedings of the 5th International Symposium on Ferrocement (1994), Chapman & Hall, London.
- Neville A. M. (1971), *Hardened Concrete: Physical and Mechanical Aspects*, American Concrete Institute, Detroit, USA.
- Neville A.M. (1995), *Properties of Concrete*, Longman, England.
- Pacey A & Cullis A (1985), *Rainwater Harvesting*, Intermediate Technology publications, UK.
- Shigley J.E. (1983), *Mechanical Engineering Design*, McGraw-Hill, Singapore.
- Singh G. (1989), *Control of Cracking in Concrete Structures*, ACI Journal, Proceedings V69 No. 12, 1972, pp 717-753.
- Skinner B. (1995), *Ferrocement water storage tanks*, Sustainability of water and sanitation systems, 21st WEDC Conference, Kampala, Uganda.
- Smerda Z. & Kristek V. (1988), *Creep and shrinkage of concrete elements and structures*, Developments in civil engineering: 21, Elsevier, Amsterdam

Stulz R. (1998), *Appropriate Building Materials*, Intermediate Technology Publishing, UK.

Turner S. (1999), *Design of storage tanks for rainwater harvesting*, Indian Institute of Technology, Delhi, India.

White G.R. (1991), *Concrete Technology*, Delmar Publishers Inc, New York.

Zingoni A. (1997), *Shell Structures in Civil and Mechanical Engineering*, Thomas Telford, London.

APPENDIX I

Construction Materials

Construction Materials

Figures from the Engineering data book (Cartwright 1996)

	Material	Youngs modulus (GPa)	Ultimate Tensile Strength (MPa)	Yield Tensile Strength (MPa)
Chicken wire	Mild steel	210	430	280
Square mesh	Mild steel	210	430	280
Polypropylene fibres	Polypropylene	0.9-1.38	29-38	-
Cement mortar	OPC:Sand 3:1	3.5	1.60*	

*From experimental readings

Chicken wire

Chicken wire is hexagonal mild steel galvanised mesh approximately 0.5mm in diameter

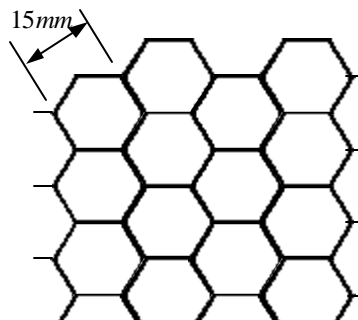

Square mesh

The 12mm square mesh wire is made from mild steel galvanised welded wire approximately 1mm in diameter

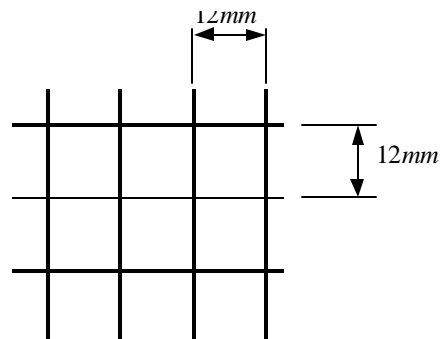

Polypropylene fibres

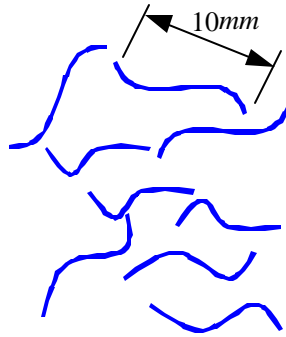

Home-made fibres made from polypropylene rope, individual fibres having a diameter of approximately 0.5mm .

APPENDIX II

Material testing equipment

Tensile testing equipment

See drawings of plate, plate assembly and insert overleaf.

Free shrinkage

The free shrinkage was measured using a *Demec gauge* as shown below



Demountable Mechanical Strain Gauge

APPENDIX III
Material Test Results

Tensile strength test results

Results for non-reinforced samples

	Load		Strength	
Sample 1	2.68	kN	2.14	MPa
Sample 2	2.44	kN	1.95	MPa
Sample 3	1.13	kN	0.90	MPa
Sample 4	1.67	kN	1.34	MPa
Average	1.38	kN	1.58	MPa
SD	0.71		0.57	
COV	0.38		0.24	

Results for chicken mesh reinforced samples

	Load		Strength	
Sample 1	2.78	kN	2.22	MPa
Sample 2	1.55	kN	1.24	MPa
Sample 3	2.65	kN	2.12	MPa
Sample 4	2.53	kN	2.03	MPa
Average	2.38	kN	1.90	MPa
SD	0.56		0.45	
COV	0.24		0.15	

Results for square mesh reinforced samples

	Load		Strength	
Sample 1	3.27	kN	2.62	MPa
Sample 2	2.34	kN	1.88	MPa
Sample 3	2.32	kN	2.34	MPa
Sample 4	3.54	kN	2.83	MPa
Average	3.02	kN	2.42	MPa
SD	0.51		0.41	
COV	0.20		0.13	

COV = Coefficient of Variance, SD= Standard deviation

Unrestrained shrinkage results

Square mesh

Day	Dummy reading	Side A	Side B	Strain A	Strain B	Average strain
1	648	648	648	0	0	0
2	648	663	666	-121.5	-145.8	-133.65
5	648	658	664	-81	-129.6	-105.3
6	648	667	671	-153.9	-186.3	-170.1
7	648	644	646	32.4	16.2	24.3
8	648	627	630	170.1	145.8	157.95
9	648	611	612	299.7	291.6	295.65
12	648	619	621	424.9	408.7	416.8
13	648	611	614	489.7	465.4	477.55
15	648	590	594	659.8	627.4	643.6
19	752	663	660	910.9	935.2	923.05
23	745	649	648	967.6	975.7	971.65
28	745	632	630	1105.3	1121.5	1113.4

Plain cement

Day	Dummy reading	Side A	Side B	Strain A	Strain B	Average strain
1	648	648	648	0	0	0
4	648	660	650	-97.2	-16.2	-56.7
5	648	670	673	-178.2	-202.5	-190.35
6	648	658	658	-81	-81	-81
7	648	643	642	40.5	48.6	44.55
8	648	624	625	194.4	186.3	190.35
11	648	586	588	502.2	486	494.1
12	648	576	580	583.2	550.8	567
14	648	555	555	753.3	753.3	753.3
18	648	625	632	1028.7	972	1000.35
22	752	595	598	1215	1190.7	1202.85
28	745	577	579	1360.8	1344.6	1352.70

Chicken wire

Day	Dummy reading	Side A	Side B	Strain A	Strain B	Average strain
1	648	648	648	0	0	0
4	648	658	652	-81	-32.4	-56.7
5	648	660	665	-97.2	-137.7	-117.45
6	648	658	652	-81	-32.4	-56.7
7	648	643	645	40.5	24.3	32.4
8	648	624	625	194.4	186.3	190.35
11	648	586	588	502.2	486	480
12	648	576	580	583.2	550.8	567
14	648	555	555	753.3	753.3	745
18	648	530	535	955.8	915.3	935.55
22	752	610	615	1150.2	1109.7	1129.95
28	745	582	580	1320.3	1336.5	1328.4

APPENDIX IV
Unrestrained shrinkage

Unrestrained Shrinkage

Base on free shrinkage test carried out by Karagular and Shah (1990) on concrete samples, cured in water for four hours and then after demoulding dried at 40% humidity.

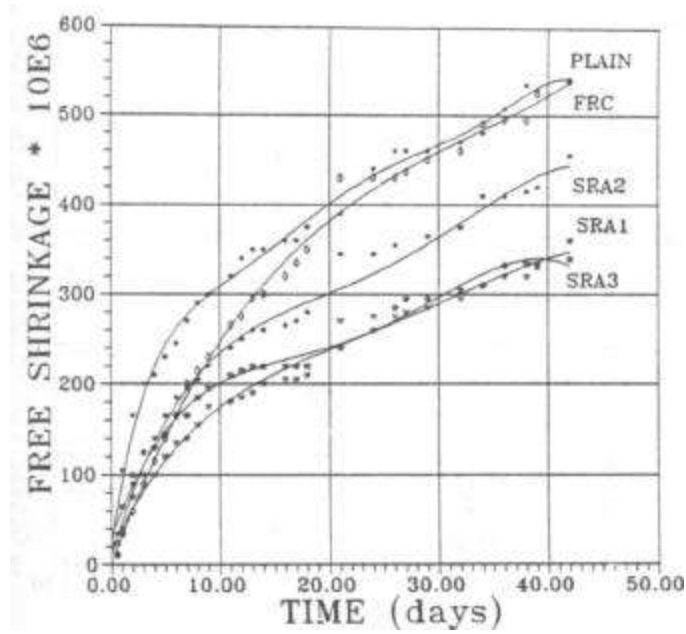

Fig A 4 free shrinkage test results (Karagular and Shah 1990)

Where;

- FRC is fibre reinforced
- SRA is shrinkage reducing agent

The plain concrete was reinforced with steel fibres, the amount being 0.5. Work was also carried out on the effects of shrinkage reducing agents, these agents were a commercially available material containing alkoxyated alcohol. The results for these agents can also be seen above.