



Slow Sand Filtration for Community Water Supply

By: J.T. Visscher, R. Paramasivan, A. Raman, and H.A. Heijnen

Published by: International Reference Centre for Community Water
Supply and Sanitation
P.O. Box 93190
2509 AD
The Hague
The Netherlands

Available from: International Reference Centre for Community Water
Supply and Sanitation
P.O. Box 93190
2509 AD
The Hague
The Netherlands

Reproduced with permission.

Reproduction of this microfiche document in any form is subject to the same restrictions as those of the original document.



IRC
International Reference Centre
for Community Water Supply
and Sanitation

WHO Collaborating Centre

The Hague, The Netherlands

June 1987

Slow Sand Filtration for Community Water Supply

planning, design, construction,
operation and maintenance

24

Technical Paper Series

INTERNATIONAL REFERENCE CENTRE FOR COMMUNITY WATER SUPPLY AND SANITATION

IRC is an internationally operating independent, non-profit organization dealing with information and technology support for water and sanitation improvement. With its partners in developing countries and with United Nations agencies, donor organizations, and non-governmental organizations, IRC assists in the generation, transfer and application of relevant knowledge. The focus of this co-operation is on the rural and urban fringe areas where the need for technical assistance is greatest.

Support is provided by means of publications, training and education, evaluation and advice, and development and demonstration. IRC's information-oriented programmes include: community participation including the role of women; hygiene education; human resources development; appropriate technology including operation and maintenance; programme evaluation; and community-based financial management.

Requests for information about IRC should be addressed to IRC, P.O. Box 93190, 2509 AD The Hague, The Netherlands.

SLOW SAND FILTRATION FOR COMMUNITY WATER SUPPLY

**Planning, design, construction,
operation and maintenance**

J.T. Visscher, R. Paramasivam, A. Raman
and H.A. Heijnen

Technical Paper No. 24

International Reference Centre for Community
Water Supply and Sanitation.
The Hague, The Netherlands

Slow sand filtration for community water supply: planning, design, construction, operation and maintenance/Visscher, J.T.; Paramasivan, R.; Raman, A.; Heijnen, H.A.

The Hague: International Reference Centre for Community Water Supply and Sanitation, 1987 x; 149 p.; 68 fig., 31 tab.

(Technical paper series; no. 24)

Includes selected bibliography

ISBN 90-6687-009-5

Abstract

Presents established information on slow sand filtration, as well as guidelines resulting from demonstration projects in developing countries.

In Chapter 2, the basic principles of community water supply and community participation are set out before entering into detailed discussion on the slow sand filtration process in Chapter 3. The overall system design is discussed in Chapter 4, and the cost of construction, operation and maintenance in Chapter 5. The information presented in these first chapters is illustrated in Chapter 6 with an example of planning and designing a slow sand filtration system for a hypothetical community. Chapter 7 provides detailed information on the structural design, which is further illustrated with design examples in Chapter 8. It should be understood, however, that these examples are based on specific local conditions and may not be directly applicable under other circumstances. In Chapter 9, construction guidelines are presented, because the quality of construction can be greatly improved in many cases. Finally, Chapter 10 outlines detailed operation and maintenance procedures and sets out the importance of proper training. The publication is concluded with a series of appendices.

Keywords: slow sand filtration/water treatment plants/guidelines/community participation/design/construction costs/operating costs/maintenance costs/construction/operation/maintenance/planning

Copyright © by the International Reference Centre for Community Water Supply and Sanitation (IRC).

IRC enjoys copyright under Protocol 2 of the Universal Copyright Convention. Nevertheless, permission is hereby granted for reproduction of this material, in whole or part, for educational, scientific, or development-related purposes except those involving commercial sale, provided that (a) full citation of the source is given and (b) notification is given in writing to IRC, P.O. Box 93190, 2509 AD The Hague, The Netherlands.

IRC Publications

The Technical Paper Series published by IRC provides expertise on selected topics on community water supply and sanitation in developing countries. Wherever possible in these publications, an integrated approach incorporating technical, economic, social and organizational aspects is developed to address present problems in this area.

These publications are produced jointly by consultant specialists and IRC staff. They are widely used in many countries by staff at all levels, by engineers and decision-makers at the national level to public health officials and technicians at the community level.

IRC also publishes the Bulletin Series comprising reports of international meetings organized by the Centre and also jointly with participating institutions in developing countries. The Occasional Paper Series, which is in photocopy format, presents ongoing work at IRC and related organizations. Many of these publications are available in French and can be obtained from IRC. Several of these are now available in Spanish and can be obtained from: CEPIS, Casilla 4537, Lima 100, Peru.

IRC titles of related interest

MANUAL FOR CARETAKERS OF SLOW SAND FILTRATION

Prepared by J. T. Vischer and S. Veenstra

TS 1 73 pages 1985

PARTICIPATION OF WOMEN IN WATER SUPPLY AND SANITATION

Role and results

Prepared by Christine van Wijk-Sijbesma

TP 23 191 pages 1983

RENEWABLE ENERGY SOURCES FOR RURAL WATER SUPPLY

Prepared by E. H. Hofkes and J. T. Vischer

TS 23 184 pages 1983

7. Structural Design Considerations	59
7.1 Design of filter box	59
7.2 Inlet structure	70
7.3 Outlet structure	72
7.4 System of underdrains	73
7.5 Filter control arrangements	76
7.6 Piping and pumping	79
7.7 Construction of the clear-water tank	80
8. Design Examples of Slow Sand Filters	81
9. Construction Guidelines	92
9.1 Preparation of a new filter	93
9.2 Building materials for slow sand filters	93
9.3 Selection of filter sand	97
10. Operation and Maintenance Procedures	101
10.1 The caretaker's role	101
10.2 Starting-up a new filter	104
10.3 Daily operation	107
10.4 Shutting down procedures	110
10.5 Cleaning a filter bed	111
10.6 Sand washing by hose	113
10.7 Re-sanding	115
10.8 Record keeping	117
10.9 Quality control	117
References	119
List of appendices	123
I Summary of WHO Guidelines for Drinking-Water Quality	123
II Design Considerations for Simple Pre-Treatment Systems	126
III Chlorination	134
IV Soil Investigation	136
V Flow Measurement in Slow Sand Filters	138
VI Water Quality Analysis	140

VII Participating Institutions in the Slow Sand Filtration Project and Documentation Centres	143
VIII Glossary	145

LIST OF TABLES

Table 2.1:	Importance of water-and-sanitation-related intervention for infectious disease control
Table 2.2:	Summary of considerations in slow sand filtration
Table 2.3:	Guideline for the selection of a water treatment system for surface water in rural areas
Table 2.4:	Community involvement in water supply projects
Table 3.1:	Performance of slow sand filters
Table 4.1:	Population growth factors
Table 4.2:	Average amount of water use for various types of rural water supplies
Table 4.3:	Example of estimate of water demand per capita for house connections in rural areas in India
Table 4.4:	General design criteria for slow sand filters in rural water supply
Table 5.1:	Estimate of average cost per m ² of filter bed area of floor, underdrains, gravel, filter sand and excavation for rural areas in India, 1983
Table 5.2:	Slow sand filters and total wall length for various design capacities with a filtration rate of 0.1 m/h
Table 5.3:	Estimated costs per m ² of rectangular slow sand filters in rural areas in India, 1983
Table 7.1:	Applicability of various types of constructions for slow sand filters
Table 7.2:	Criteria for dimensioning of underdrain system using perforated pipes
Table 9.1:	Summary of procedures in preparation of the sand filter
Table 9.2:	Recommended content of fines for normal and large aggregate concrete
Table 10.1:	Schedule of activities for caretaker
Table 10.2:	Procedures to start-up a new filter
Table 10.3:	Procedures in daily operation of the filters
Table 10.4:	Procedures to shut down a filter
Table 10.5:	Procedures to clean a filter bed
Table 10.6:	Procedures to wash filter sand and filter scrapings
Table 10.7:	Procedures to re-sand a filter

LIST OF FIGURES

Figure 1.1:	Slow sand filter plant, Borujwada, India, 1983
Figure 1.2:	Slow sand filter plant, Ban Bangloa, Thailand, 1982

- Figure 2.1: River bed filtration, collection well, Borujwada, India
- Figure 2.2: Horizontal flow-roughing filter under construction, Fau, Sudan
- Figure 2.3: Women are the main users of the village water supply
- Figure 2.4: Community support in digging trenches for the distribution network, Alto de los Idolos, Colombia
- Figure 3.1: Basic components of an outlet controlled slow sand filter
- Figure 3.2: Basic components of an inlet controlled slow sand filter
- Figure 3.3: Development of resistance in the filter bed
- Figure 3.4: Effect of sand size on removal of total coliform bacteria in slow sand filtration
- Figure 3.5: Slow sand filter pilot plant, Nagpur, India
- Figure 3.6: Slow sand filter pilot plant, Cali, Colombia
- Figure 3.7: Inlet controlled filter preceded by river bed filtration, Choro del Plata, Colombia
- Figure 3.8: Typical development of filtration rate in declining rate filtration
- Figure 5.1: Layout of a filter plant with (n) rectangular units
- Figure 5.2: Circular brick masonry filter, Gezira-Region, Sudan, 1979
- Figure 5.3: Slow sand filter plant, Santa Rosa, Colombia, 1985
- Figure 6.1: Daily pattern of water use in an adjacent community
- Figure 6.2: Components of the water supply system
- Figure 6.3: Accumulated water inflow and outflow in elevated raw-water balancing tank throughout a 24-hour period
- Figure 6.4: Accumulated water production and water use
- Figure 6.5: Possible layout of the water treatment plant
- Figure 7.1: Structural design of filter box
- Figure 7.2: Principle of universal compressive and tensile stresses
- Figure 7.3: Cross-section of filter wall constructed of masonry and ferrocement
- Figure 7.4: Cross-section of the wall of a ferrocement tank
- Figure 7.5: Construction of ferrocement tank using plastic pipe as the inside mould
- Figure 7.6: Pressure diagram for rectangular filters
- Figure 7.7: Pressure diagram for a wall of the filter box
- Figure 7.8: Drainage system underneath filter box
- Figure 7.9: Wall-floor connection in ferrocement and reinforced concrete
- Figure 7.10: Wall-floor connection in masonry and reinforced concrete
- Figure 7.11: Example of a reinforcement design for a wall-floor connection
- Figure 7.12: Various linings for sloping wall filters
- Figure 7.13: Inlet structure
- Figure 7.14: Outlet box of an outlet controlled filter
- Figure 7.15: Common systems of underdrains for slow sand filters
- Figure 7.16: Filter medium support
- Figure 7.17: Underdrain system made of corrugated PVC pipe
- Figure 7.18: Flow sheet for slow sand filtration installation (gravity flow)
- Figure 7.19: Gate valve for pipelines
- Figure 7.20: Gate valve in open conduit
- Figure 7.21: Hydraulic gradient line in a slow sand filtration plant (gravity flow)
- Figure 7.22: Head losses through friction in PVC pipes
- Figure 8.1: Design features of design example I
- Figure 8.2: Design features of design example II

- Figure 8.3:** Design features of design example III
- Figure 8.4:** Design features of design example IV
- Figure 8.5:** Design features of design example V
- Figure 9.1:** Relationship of water content, cement content and compression strength for cement with a characteristic strength of 42.5 N/mm^2
- Figure 9.2:** Example of grain size distribution of sand
- Figure 10.1:** Basic valves in an outlet controlled filter
- Figure 10.2:** Basic valves in an inlet controlled filter
- Figure 10.3:** Tools used for operation and maintenance
- Figure 10.4:** Float valve for constant water level
- Figure 10.5:** Operator checking rate of filtration at the flow indicator, Borujwada, India
- Figure 10.6:** Sand washing platform
- Figure 10.7:** Re-sanding a slow sand filter

Preface

This publication presents established information on slow sand filtration, as well as guidelines resulting from the International Research and Demonstration Project on Slow Sand Filtration sponsored by the Department of Research and Development of The Netherlands Ministry of Foreign Affairs. The project was initiated by institutions in Colombia, India, Jamaica, Kenya, Sudan and Thailand, in collaboration with the International Reference Centre for Community Water Supply and Sanitation (IRC).

These guidelines cover design, construction, as well as operation and maintenance procedures for water treatment plants using the slow sand filtration process. Since a properly designed plant will only produce safe water if its caretaker knows how to keep it fully operational, training of caretakers must receive full attention as early as the planning stage, and the plant design should facilitate operation and maintenance.

This publication is the result of collaboration between Mr R. Paramasivam and Mr A. Raman from the National Environmental Engineering Research Institute, Nagpur, India, Mr H. Heijnen, Community Water Supply and Sanitation Project, Pokhara, Nepal, and Mr J.T. Visscher, IRC, The Hague, The Netherlands. The earlier IRC Technical Paper No. 11: "Slow Sand Filtration for Community Water Supply in Developing Countries, a Design and Construction Manual", prepared by J.C. van Dijk and J.H.C.M. Oomen, was an important source of information.

A special thanks goes to Ms C. van Wijk for her advice on community participation and women's involvement, and to Mr T. Figeo who advised on the technical drawings and sections dealing with construction. All drawings have been prepared by Mr L. Huijg and final editing was done by Ms M. Simpson and Ms H. West.

Grateful mention is made of the following persons for reviewing the draft document: Dr R.C. Ballance, Mr L. Chainarong, Mr G. Galvis, Professor L. Huisman, Professor K.J. Ives, Mr G.E. Nepomuceno, Professor M.B. Pescod, Mr C.L.P.M. Pompe, Mr I.P. Toms, Mr J. Arboleda Valencia and Mr M. Wegelin.

1. Introduction

In many developing countries, treatment of water to make it fit for human consumption is still a major problem. Expensive and complex treatment plants have been built but many of these do not function satisfactorily because of inappropriate design, irregular power supply, and lack of fuel, chemicals, replacement parts and trained manpower. There is an obvious need for more reliable and simpler water treatment systems which can be maintained by local technicians without major contributions from external sources. Slow sand filtration has been identified as a method which can fulfil these requirements.

Institutions in Colombia, India, Jamaica, Kenya, Sudan and Thailand, have cooperated with IRC in an integrated research and demonstration project to field test the process of slow sand filtration, and to develop practical guidelines for its application in developing countries. This project started in 1976 with a research programme to establish the reliability of the process under tropical conditions. Subsequently, the collaborating institutions set up a number of demonstration projects to test the effectiveness of this process at community level. Water supply systems incorporating slow sand filters were built in selected villages by the agencies responsible for water supply in the participating countries (see Figure 1.1). These demonstration projects also provided an effective channel for the transfer of knowledge from the research institutions to the water agencies. To ensure that the communities would benefit fully from the provision of safe drinking water, a community participation and health education component was included in the project. Most participating communities were involved in the discussions and decision-making and contributed to the schemes by providing labour and materials. In many of the schemes, caretakers selected from the communities were responsible for operation and maintenance.

The demonstration programme has shown that slow sand filtration is a simple, economical and reliable treatment method. Often, it will be the only reliable and effective method to provide safe drinking water from surface water sources in developing countries. It was also found that it is essential to initiate the community education and participation process prior to the introduction of a water supply. It helps to ensure that the needs of the people are met satisfactorily, that local resources are mobilized, and that facilities are used and maintained properly. Furthermore, project findings showed that hygiene education is a key element in initiating discussion and change of community practices detrimental to hygiene and sanitation, without which the impact of a safe water supply is limited.

This publication is based on the results and practical experience gained from the Slow Sand Filtration Project, and on recent publications on the subject. It

particularly focuses on slow sand filtration plants for community water supply in small and medium sized communities. Wherever possible, simplified "rules of thumb", tables and graphs are given to eliminate the need for complicated calculations.

In Chapter 2, the basic principles of community water supply and community participation are set out before entering into detailed discussion on the slow sand filtration process in Chapter 3. The overall system design is discussed in Chapter 4, and the cost of construction, operation and maintenance in Chapter 5. The information presented in these first chapters is illustrated in Chapter 6 with an example of planning and designing a slow sand filtration system for a hypothetical community.

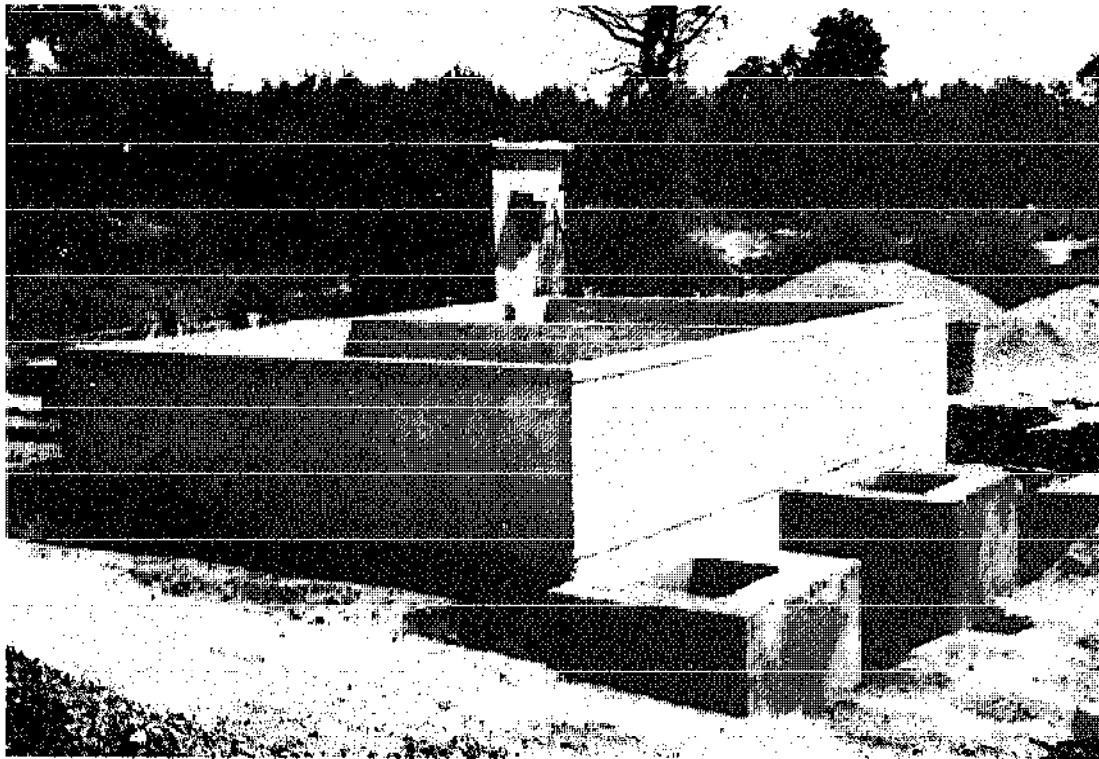

Figure 1.1: Slow sand filter plant, Borujwada, India, 1983

Chapter 7 provides detailed information on the structural design, which is further illustrated with design examples in Chapter 8. It should be understood, however, that these examples are based on specific local conditions and may not be directly applicable under other circumstances.

In Chapter 9, construction guidelines are presented, because the quality of construction can be greatly improved in many cases. Finally, Chapter 10 outlines detailed operation and maintenance procedures and sets out the importance of proper training.

The publication is concluded with a series of appendices which provide information on pre-treatment, water quality, soil investigation, flow measurement, chlorination and a listing of participating institutions in the Research and Demonstration Project on Slow Sand Filtration and documentation centres.

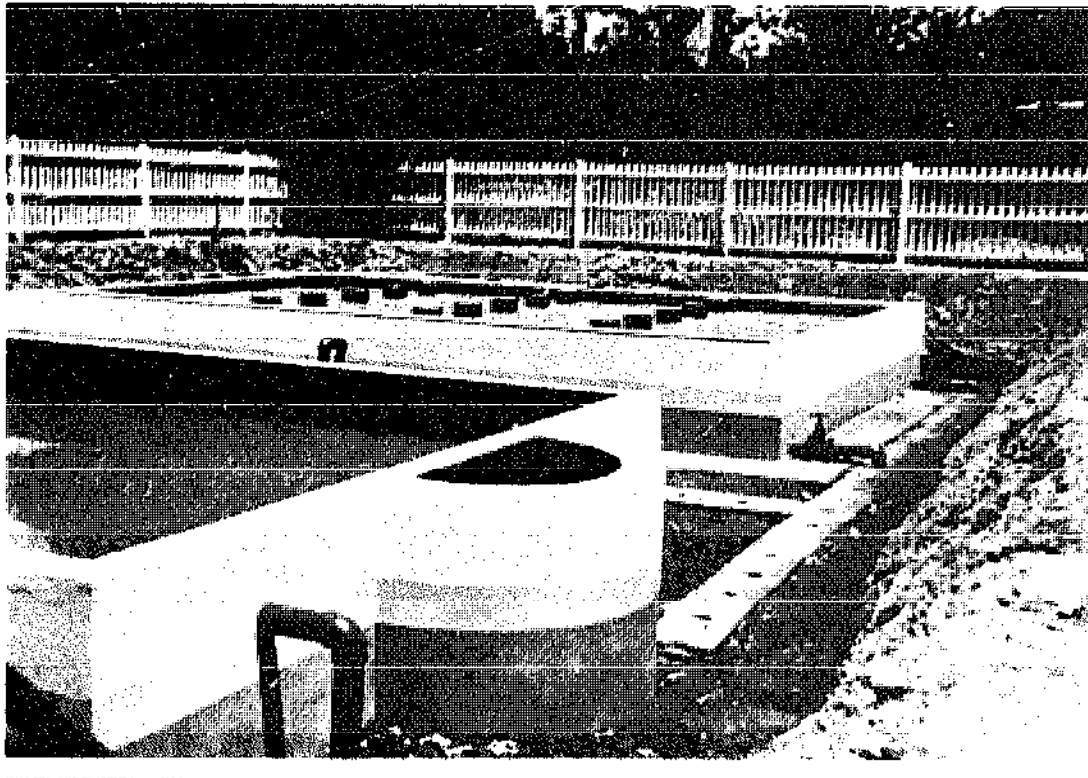

Figure 1.2: Slow sand filter plant, Ban Bangloa, Thailand, 1982

2. Community Water Supply and Sanitation

2.1 IMPORTANCE OF SAFE WATER SUPPLY

Water which is safe to drink must be free of pathogenic organisms, toxic substances and an excess of minerals and organic material. To be attractive to consumers, water should also be free from colour, turbidity, and odour, it should contain sufficient oxygen, be acceptable in taste, and preferably be "cool".

In 1985, the World Health Organization published the "WHO Guidelines for Drinking-water Quality", which advises on tolerable levels for bacteriological, physical and chemical constituents in drinking water (see Appendix I). With the aid of these guidelines, individual countries are expected to formulate their own national standards for water quality based on local conditions.

The provision of a nearby water supply sufficient for the daily needs of consumers will help greatly to decrease the incidence of skin and eye infections, and may also reduce diarrhoeal diseases and most worm infections, particularly if the water is of reasonable bacteriological quality. However, the provision of sufficient safe water will not lead to a major improvement in health conditions unless it is continuously and correctly used, and domestic hygiene practices and the method of human waste disposal are also improved. Ways to prevent the transmission of specific diseases related to water and sanitation are set out in Table 2.1.

2.2 WATER SOURCES

Groundwater, surface water and sometimes rain-water are used as sources for community water supply. Groundwater can be taken from springs or tapped from wells or boreholes; surface water from streams, rivers, canals, ponds or lakes; and rain-water collected from the roofs of houses or from surface runoff areas. Because the value of the source depends on the quantity and quality of the water to be abstracted, careful selection is essential and must be based on a sufficiently detailed survey to ensure that it is reliable and provides water of satisfactory quality.

COMMUNITY WATER SUPPLY AND SANITATION

Table 2.1: Importance of water-and-sanitation-related intervention for infectious disease control

Disease	Intervention*					
	Water quality	Water quantity/convenience	Personal and domestic hygiene	Waste-water disposal	Excreta disposal	Food sanitation
Diarrhoea						
Viral	++	+++	+++	o	++	++
Bacterial	+++	+++	+++	o	++	+++
Protozoal	+	+++	+++	o	++	++
Poliomyelitis and hepatitis A						
	+	+++	+++	o	++	++
Worm infections						
Ascaris, Trichuris	+	+	+	+	+++	++
Hookworm	+	+	+	o	+++	++
Pinworm, dwarf tapeworm	o	+++	+++	o	+++	+++
Other tapeworms	o	+	+	o	+++	+++
Schistosomiasis	+	+	o	+	+++	o
Guinea worm	+++	o	o	o	o	o
Other worms with aquatic hosts	o	o	o	o	++	+++
Skin infections						
	o	+++	+++	o	o	o
Eye infections						
	+	+++	+++	+	+	o
Insect-transmitted diseases						
Malaria	o	o	o	+	o	o
Urban yellow fever, dengue	o	o	+1)	++	o	o
Bancroftian filariasis	o	o	o	+++	+++	o
Onchocerciasis	o	o	o	o	o	o

* Degree of importance of intervention: +++ high ++ medium + low o negligible

** Vectors bred in water-storage containers

(after Ballance Source: 1984)

Groundwater

Groundwater is often the most appropriate source for drinking water, provided it does not have a high mineral content, which makes it unpleasant or even harmful to drink and, which makes treatment necessary. Deep groundwater is generally bacteriologically safe, but shallow groundwater may contain bacterial and viral pollution from nearby pit latrines, septic tanks or cattle ponds.

Surface water

Surface water generally needs to be treated to be made safe for human consumption unless the drainage area is uncultivated, unpopulated and well protected. Seasonal and even daily variation in the quality of surface water is common, for instance, turbidity may become very high in streams and rivers during rainy periods.

Rain-water

Usually, a community water supply system cannot rely on the collection of rain-water as its main source, because rainfall is often erratic. Reliability can be improved by the provision of storage facilities, although only water for drinking and cooking purposes can usually be stored because of the cost involved. Therefore, rain-water is only appropriate as a source of supply in areas where surface water or groundwater is scarce or of poor quality, for instance, in parts of the West Java Islands in Indonesia where groundwater is brackish.

Rain-water usually contains very few impurities, but when the surface from which it is collected is not clean, it will require treatment before it is safe to drink.

2.3 TREATMENT REQUIREMENTS

If water from the selected source cannot meet the quality requirements for drinking water, as indicated in national guidelines for the quality of drinking water or those of WHO (Appendix I), then it requires treatment. This will increase the cost and complicate operation and maintenance of the water supply system. For technical and economic reasons, treatment is usually only feasible for removal of turbidity, biological impurities, iron, manganese, colour and odour. Of the methods applied in community water supply, slow sand filtration has proven to be the most suitable and often cheapest treatment method in many cases.

COMMUNITY WATER SUPPLY AND SANITATION

General considerations for planning and designing water supply schemes in developing countries are:

- The quality of water supplied should not under any circumstances deteriorate below certain acceptable limits during the period of time for which the system has been designed.
- Sufficient water must be provided at all times, and at convenient locations. Where traditional sources remain competitive, their possible use will have to be discussed and any improvements will have to be arranged with the users.
- Construction, operation, maintenance, and preferably repair should be within the competence of local technical staff or the users. Prior to construction, an assessment should be made of available skills in the community and the water agency.
- A minimum of equipment should be used, and this should be sturdy, reliable and preferably available locally.
- Construction and operation costs should be reduced to a minimum, and limited or no use should be made of imported materials.
- The system design should minimize the need for chemicals and pumping, and allow for minimal operator's attendance, because wages are likely to be a heavy strain on budgets, especially in small communities.
- The system should be planned together with the community to enable adaptation to local needs and preferences, and to take full advantage of local skills and knowledge.
- Special steps should be taken to consult the women and to involve them in local management of the scheme, because they are the first users and have a direct interest in keeping it functioning.
- Appropriate systems should be included to monitor the performance of the treatment system.
- Provision should be made to prevent, or deal with, possible deterioration of the quality of raw water or breakdown of the treatment system.

2.4 WATER TREATMENT BY SLOW SAND FILTRATION

Slow sand filtration is one of the most effective, simplest, and least expensive water treatment processes and is therefore particularly suitable for rural areas in developing countries. Essentially, this process differs from rapid sand filtration because of its biological nature, its high efficiency, and its suitability for village level operation and maintenance.

The basic process of slow sand filtration is as follows. Water slowly passes through a bed of fine sand at a rate of 0.1-0.3 m³/m²/h, thus improving its quality considerably by removing turbidity and greatly reducing the number of micro-organisms (bacteria, viruses, cysts). Soon after the filtration process begins, a filter skin forms on the surface of the bed. This filter skin, or "Schmutzdecke", consists of retained organic and inorganic material and a wide variety of biologically active micro-organisms which break down organic matter. This biological activity and other treatment mechanisms extend through the upper layer of the sand bed, perhaps to a depth of about 0.4 m. Due to slow water movement and long retention time, slow sand filtration resembles the percolation of water through the subsoil, and the process effectively produces water comparable in quality to groundwater.

After the filter has been producing good quality water for several weeks, the filter skin gradually clogs and cleaning of the filter will be necessary. This is done by scraping off the top few centimetres of the filter bed and then restarting the filtration process.

From the considerations set out in Table 2.2, it is clear that the application of slow sand filtration should be carefully evaluated when designing a water supply scheme. When surface water is more readily available than groundwater, slow sand filtration will frequently prove to be the simplest, most economical and reliable method of preparing safe drinking water.

Pre-treatment of turbid surface water

Slow sand filters can only deal with water of low turbidity, for example, 20-30 NTU (nephelometric turbidity units). Raw water with a turbidity level greater than 50 NTU over periods of several weeks, or over 100 NTU for longer than a few days, causes rapid clogging of the slow sand filters. This would require frequent cleaning of the filters, which is not acceptable because of the increased work load and the reduction in production of treated water. The need to pre-treat the raw water to reduce initial turbidity therefore becomes paramount. Various simple methods are readily available and easily applicable on a smaller scale, including river bed filtration, horizontal flow-roughing filtration, vertical flow-roughing filtration and plain sedimentation.

COMMUNITY WATER SUPPLY AND SANITATION

Table 2.2: Summary of considerations in slow sand filtration

Consideration	Comments
Quality of treated water	Best single process to improve the physical, chemical and biological quality of surface water. In many rural areas, slow sand filtration may be the only feasible treatment.
Ease of construction	The relatively simple designs facilitate construction from local materials using local labour. Little or no special pipework or equipment is required.
Cost of construction	Construction from local materials using local labour reduces costs considerable. Imported materials and equipment are usually not required.
Ease of operation and maintenance	After a short period of training, local caretakers with little formal education can operate the system.
Cost of operation	Operation costs and energy requirements are lower than for other systems. No chemicals are required.
Reliability	The process is reliable and mechanical failures are minimal. Fluctuations in quality of raw water can be accommodated without disrupting the efficiency of the process.
Cleaning	The cleaning process is simple but somewhat labour-intensive. Although the cost may be low, in most developing countries, labour may not always be available at the required time.
Large surface area	A fairly large area is required for the filters: about 0.02-0.08 m ² per consumer. Because of the low cost of land in many rural areas, this may represent only 1-2% of total construction costs. However, this may be a constraint in areas where land is scarce.
Rapid clogging of the filters when turbidity is high	High turbidity of raw water may cause rapid clogging of the filters. This may often be overcome by simple pre-treatment.

Most information on pre-treatment is derived from laboratory testing, although some also results from the operation of full-scale plants. High turbidity removal efficiencies have been reported, for example, in Borujwada, India, where peak turbidity values of over 400 NTU have been reduced to a uniform value of less than 5 NTU by river bed filtration (see Figure 2.1). Horizontal flow-roughing filtration (see Figure 2.2) has been reported to remove over 70% of turbidity. A horizontal flow-roughing filter in Fau, Sudan, for example, has reduced peak turbidity values of approximately 1000 NTU to extremely low figures of 5-20 NTU (Wegelin, 1986). Satisfactory results are also being obtained with upflow-roughing filtration as shown by laboratory tests in 1986 in Cali, Colombia, where turbidity removal efficiencies of 70-85% and efficiencies for the removal of faecal coliform of 80-99% were recorded.

Information on the design and functioning of pre-treatment systems is still limited and further study is required to optimize these processes. For more information on pre-treatment, see Appendix II, which also includes preliminary guidelines for design and construction.



Figure 2.1: River bed filtration, collection well, Borujwada, India

Chlorination of the effluent

Slow sand filters are a very effective barrier against disease transmission by drinking water and in this regard, are much more effective than rapid sand filters. Nevertheless, it is advisable to adopt a multi-barrier system to prevent possible disease transmission, particularly if faecal contamination of some magnitude is present in the raw water. Pre-treatment provides a second barrier to some extent but if continuous chlorination of the slow sand filters' effluent can be ensured, as may be possible in some developing countries, this would establish a very effective multi-barrier system.

Information on chlorination is provided in Appendix III. If chlorination is not possible, sand of a finer grain size and a low rate of filtration may be adopted to ensure the best possible quality of the slow sand filter, as will be further explained in Chapter 3.



Figure 2.2: Horizontal flow-roughing filter under construction, Fau, Sudan
(photo IRCWD)

2.5 SELECTION OF TREATMENT SYSTEM

When surface water is not safe for human consumption and requires treatment, the guidelines given in Table 2.3 can be used to select a water treatment system, adopting slow sand filtration as the main process. The following parameters are used for selection:

- turbidity expressed in nephelometric turbidity units (NTU);
- faecal coliform count;
- presence of guinea worm or schistosomiasis.

In addition, if the oxygen content of the raw water is low, for example below 4 mg/l, aeration is required to prevent anaerobic conditions occurring in the slow sand filter. Schistosomiasis has been included because it can be transmitted through water contact, but not usually through water ingestion.

2.6 COMMUNITY INVOLVEMENT

Water supply systems have not only to be designed and constructed, but have to be used and maintained. Continuous and correct use can be achieved more easily when the community has been given an opportunity to express its needs and points of view, and has been actively involved in planning and implementing the scheme (White, 1982; van Wijk, 1986). This implies that all villagers, or at least representatives of all village sections (men and women, different ethnic and religious groups, rich and poor), are informed and consulted at an early stage of the project about the following:

- the benefits of a safe water supply;
- their preferences and the technical and financial consequences of their choice;
- the contributions expected of the community;
- the method used to carry out the project.

In practice, it is not always easy to reach all sections of the community, in particular the women. Women however, are most directly concerned with water and sanitation as users, domestic managers, educators of children and protectors of family health (see Figure 2.3), and thus should be actively involved in all aspects of the preparation, initiation, organization and maintenance of a safe water supply for their communities. Often, it will be possible to cooperate with female field workers in related departments or programmes, to request separate meetings with women in the communities, or to consult them informally at their work places (van Wijk, 1985).

Table 2.3: Guideline for the selection of a water treatment system for surface water in rural areas

Average raw water quality	Treatment required
Turbidity: 0-5 NTU Faecal coliform MPN*: 0 Guinea worm or schistosomiasis not endemic	- No treatment
Turbidity: 0-5 NTU Faecal coliform MPN*: 0 Guinea worm or schistosomiasis endemic	- Slow sand filtration
Turbidity: 0-20 NTU Faecal coliform MPN*: 1-500	- Slow sand filtration; - Chlorination, if possible
Turbidity: 20-30 NTU (30 NTU for a few days) Faecal coliform MPN*: 1-500	- Pre-treatment advantageous; - Slow sand filtration; - Chlorination, if possible
Turbidity: 20-30 NTU (30 NTU for several weeks) Faecal coliform MPN*: 1-500	- Pre-treatment advisable; - Slow sand filtration; - Chlorination, if possible
Turbidity: 30-150 NTU Faecal coliform MPN*: 500-5000	- Pre-treatment; - Slow sand filtration; - Chlorination, if possible
Turbidity: 30-150 NTU Faecal coliform MPN*: > 5000	- Pre-treatment; - Slow sand filtration; - Chlorination
Turbidity: > 150 NTU	- Detailed investigation and possible pilot plant study required

* Faecal coliform counts per 100 ml

Although the degree of community participation will vary greatly from country to country and from culture to culture, an attempt has been made to define major decisions on water supply in which the community should be actively involved (see Table 2.4).



Figure 2.3: Women are the main users of the village water supply

Table 2.4: Community involvement in water supply projects

Project phase	Community decisions and involvement
Planning	<ul style="list-style-type: none"> - Selection of type of system e.g. standposts or house connections, including siting of taps - Agreement on future contributions in cash or kind, and type of tariff system in view of multiple and productive water use - Site selection and preparation - Selection of reliable and motivated caretaker(s) - Establishment of local water committee for management
Construction	<ul style="list-style-type: none"> - Agreement on contributions in cash or kind - Timing of the construction period - Provision of labour
Operation	<ul style="list-style-type: none"> - Prevention of water wastage and pollution - Payment of water tariff
Maintenance	<ul style="list-style-type: none"> - Provision of labour support to the caretaker - Contributions in cash or kind for major repairs
Evaluation	<ul style="list-style-type: none"> - Occasional checks on user's satisfaction through informal discussions

Participation in planning

The importance of active involvement of the community in planning rural water supply projects is increasingly being recognized. If community water supply systems are to continue functioning and to be used by all, systems should be chosen which are acceptable and affordable for the community. This can be achieved by determining the expectations of the users and explaining to them the consequences, financially and otherwise, of possible options. In this way, well-reasoned decisions can be made on the type of technology and level of service, for example standposts, group or house connections, and their location. Also, a satisfactory agreement can be made on the obligations and rights of both the community and the water agency. Suitable arrangements will already have to be made at the planning stage for the possible involvement of the community in construction, future maintenance and revenue collection. For example, it may be arranged in consultation with the community that cattle owners pay for the water their cattle use, or a differential rate system may be agreed in which poorer community members who use less water pay a lower tariff.

The community, particularly the women, have valuable knowledge about the local situation and water sources which can be vital to the success of a water supply project. There are examples of treatment plants which cannot be used for part of the year because the water source dries up or the area is flooded. Such costly mistakes could have been prevented had the local community been consulted and the area adequately surveyed. Consultation with the local community may also prevent conflicts over water use and help to find appropriate solutions to particular local problems. For example, the manure of freely grazing cattle was polluting the water source of the village of Alto de los Idolos, Colombia. The water agency suggested fencing the intake, but the village water committee did not consider this feasible because of the cost and risk of the fence being stolen, and requiring people to confine their animals was not compatible with the local patterns of land use and labour. When the community understood the need to protect the water intake, they devised their own solution and organized voluntary labour from all user households to plant thorn bushes as a natural fence. This solution proved to be very effective in preventing the cattle grazing close to the intake.

Participation in construction

Well-organized community participation during construction (Figure 2.4) can reduce costs, and may also increase the skills of the community. This participation can be achieved more easily if the community benefits directly, for example, through a lower water tariff or the provision of house connections instead of public

standposts. To increase willingness to participate, construction work must be planned for periods when the daily work load of the community is low, for example, outside the planting and harvesting seasons. It is also preferable to contract paid labour from the community, including the future caretaker(s) of the plant, even when the community does not have to contribute to construction costs.



Figure 2.4: Community support in digging trenches for the distribution network, Alto de los Idolos, Colombia

Participation in operation and maintenance

After a short period of training, community members are able to operate and maintain slow sand filtration schemes, although daily routine tasks are best done by one or two caretakers selected from the community. Caretakers need adequate training and supervision and usually will need some form of compensation. In some cases, the provision of a tool kit and increased status may be a sufficient reward, or the donation of a plot of land near the treatment plant and supply of a limited quantity of raw water may be adequate compensation. However, when a caretaker receives monthly payment, preferably from the community, this offers the most effective control mechanism to ensure that operation and maintenance tasks are properly carried out.

Occasionally, the caretaker(s) may be assisted in labour intensive tasks by other members of the community, such as when cleaning and re-sanding the filters. Sometimes, this will be free labour but in other communities payment will be required. The community members may also contribute considerably by handling taps with care and reporting leaking taps and pipes immediately, thus avoiding loss of treated water.

A good relationship with the community is therefore essential and can be stimulated by informal discussions between caretakers and community members during regular inspection visits of the distribution network. During these visits, the caretaker can also assess whether users are satisfied with the supply.

Delegation of construction, management and administration tasks to the community or a community-based organization has many advantages, provided that it is officially authorized by the water agency or local government.

How to approach and involve the community

No blueprint can be given as to how the community can best be approached and involved. However, the first step will generally consist of contacting local authorities to inform them about the project, and to request organization of a general meeting to inform the people and seek their views. Where it is difficult for women or certain sections in the community to raise questions or express their views, they may be consulted separately and informally. Local leaders can also be asked to hold a separate meeting of all village women, organized through the local women's organization or women leaders (van Wijk, 1985). All meetings should be held at convenient times and places and active discussions should be encouraged. Early mornings and late afternoons, for example, may be inconvenient for a meeting, because women will be busy fetching water and preparing food. Daytime may be equally inconvenient during the planting and harvesting seasons.

After the concept of the programme has been introduced in the meeting, more detailed planning and discussions will be required, for example on design, community support in construction, financing of the operation, and maintenance. These discussions and consultations can often best be held with a smaller group of selected community members.

If a village committee already exists, it may be the most convenient partner in the discussions, provided that it represents the interests of all villagers and not just those of a specific group. Elsewhere, a special committee or sub-committee may be formed to make detailed arrangements for approval by the community. Thereafter, this committee may take responsibility for organizing community support and for administration of the water supply after construction is completed. In either case, the committee will usually need some special training for their tasks in management and financial administration.

Once the first contacts have been established, communities may become very enthusiastic and rapid follow-up action will be required. In other cases, a motivation campaign or a hygiene education programme may be required to convince certain or all community members of the new system's potential, and so persuade them to participate. It should always be remembered that sufficient time must be devoted to initiating this process of community participation, because it is often of paramount importance for the long-term functioning and use of the new facilities.

2.7 HYGIENE EDUCATION

Both community participation and the health impact of the new water supply can be increased considerably by a hygiene education programme, in which the relationship between hygiene and the prevention of disease is demonstrated clearly. This will stimulate the community to use only the safe water supply, and will also be an important step in demonstrating that provision of safe water alone does not prevent the transmission of disease.

Frequently, the potential health benefits of an adequate and accessible supply of clean water are not realized because infections continue to be transmitted by other routes. Improvements in sanitation and upgrading of the water supply system must be done simultaneously because both hygienic waste disposal and general hygiene improvements are essential to control the spread of disease.

A hygiene education programme needs to be planned in consultation with the community. Initially, it should aim to create awareness by discussing the relationships between disease, water, and sanitation. People are then in a better position to recognize aspects of their own behaviour and facilities which pose health

risks, and to take steps to change these practices (Boot, 1984).

The required changes in local practices are best discussed together with the technical improvements needed. When an atmosphere is created in which difficulties and constraints can be discussed openly, it becomes easier to find solutions that are feasible and acceptable for all concerned. One topic relevant for discussion is the ways in which safe water may become re-polluted. It should be made clear that water in the distribution system is safe and clean unless impurities enter this system through leaking or broken pipes. Damage must therefore be reported immediately to the caretaker as immediate repair is essential. Water may also become polluted during collection and storage in the home because:

- dirty containers are used to fetch water from the distribution point;
- water comes into contact with dirty hands of the person carrying it;
- water is stored in uncovered containers, thus allowing pollution by dust or dirt;
- water is drawn from storage containers with a dirty utensil, or dirty hands touch the water when taking it out of the container.

Hygiene education should not be restricted to water usage but should include sanitation and food hygiene. Food which is not hygienically prepared and stored is a very important source of disease. For further information, see the IRC Occasional Paper "Making the links: guidelines for hygiene education in community water supply and sanitation."

3. Principles of Slow Sand Filtration

3.1 THE COMPONENTS OF THE FILTER

Basically, a slow sand filter consists of a box containing:

- a supernatant layer of raw water;
- a bed of fine sand;
- a system of underdrains;
- an inlet and outlet structure;
- a set of filter regulation and control devices.

The water flow in a slow sand filter may be controlled at the outlet (Figure 3.1), or at the inlet of the filter (Figure 3.2), and the method chosen may slightly affect the structure, the control devices and the functioning, as will be explained in Section 3.4. These components are described briefly in this chapter, and in further detail in relation to the design of a slow filtration system in Chapter 7.

Filter box

The total height of the filter box, including the floor, may range from 2.5 to 3.0 m and can be constructed of reinforced concrete, ferrocement, stone or brickwork masonry. The filter box, effluent channel and clear-water storage reservoir should be watertight to prevent losses and to avoid contamination of the treated water by shallow groundwater or surface runoff.

Inlet structure

The inlet structure is intended to allow water to flow into the filter without damaging the filter skin on top of the sand bed. Usually, the inlet structure is a box which can also be used to drain the supernatant water quickly.

Supernatant water layer

The supernatant water layer provides a head of water which is sufficient to drive the raw water through the bed of filter medium, while creating a detention period of

PRINCIPLES OF SLOW SAND FILTRATION

several hours for the raw water. A range of 1.0-1.5 m is a suitable depth for the supernatant water layer. It is usual practice to maintain the supernatant water at a constant level, but an alternative mode of operation which results in a gradually increasing level may also be used. This will be discussed further in Section 3.4.

Scum outlet

An outlet is necessary for the removal of scum, which may be formed from leaves, algae and other material floating on the supernatant water. This outlet may also serve as an overflow for the supernatant water.

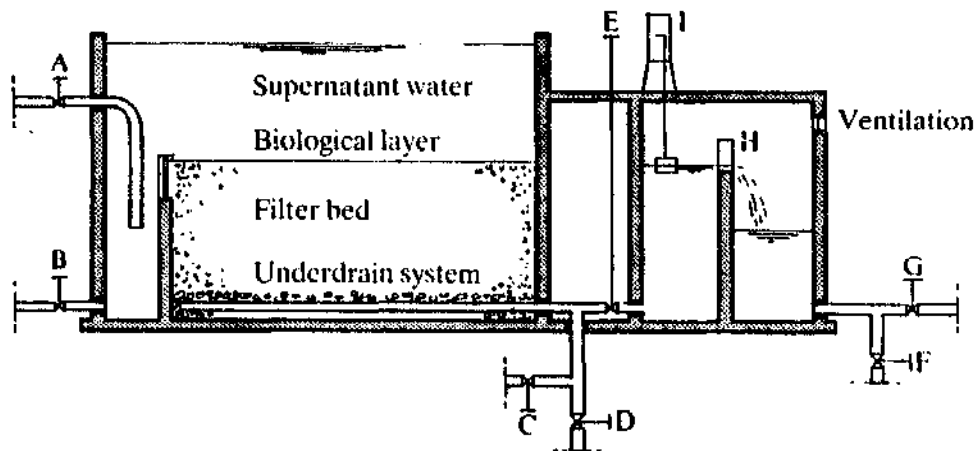

Figure 3.1: Basic components of an outlet controlled slow sand filter

- A: raw-water inlet valve
- B: valve for drainage of supernatant water layer
- C: valve for back-filling the filter bed with clean water
- D: valve for drainage of filter bed and outlet chamber
- E: valve for regulation of the filtration rate
- F: valve for delivery of treated water to waste
- G: valve for delivery of treated water to the clear-water reservoir
- H: outlet weir
- I: calibrated flow indicator

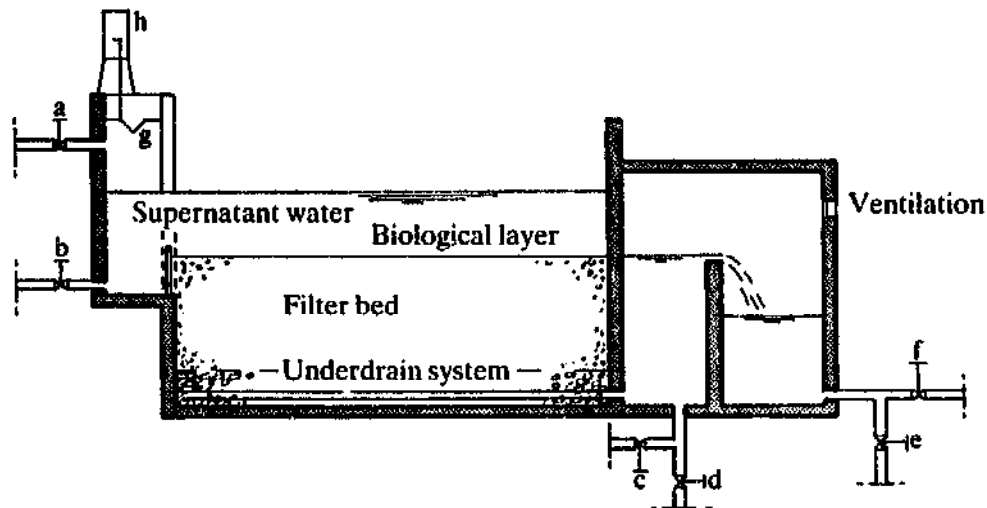

Figure 3.2: Basic components of an inlet controlled slow sand filter

- a: valve for raw-water inlet and regulation of filtration rate
- b: valve for drainage of supernatant water layer
- c: valve for back-filling the filter bed with clean water
- d: valve for drainage of filter bed and outlet chamber
- e: valve for delivery of treated water to waste
- f: valve for delivery of treated water to the clear-water reservoir
- g: inlet weir
- h: calibrated flow indicator

Filter bed

Although any inert, granular material can be used as the filter medium, sand is usually selected because it is cheap, inert, durable and widely available. When placed in the filter, the sand should be free from clay, soil and organic matter.

The filter medium is described in terms of its effective size and uniformity coefficient. The effective size (e_s , d_c or d_{10}) is the sieve opening which allows passage of 10% (by weight) of the grains. The uniformity coefficient is the ratio between the effective size and the sieve opening through which 60% (by weight) of the grains will pass (d_{60}); uniformity coefficient = d_{60}/d_{10} .



Sand used in slow sand filters should be relatively fine, have an effective size in the range of 0.15-0.30 mm, and a uniformity coefficient lower than 5 but preferably below 3. It is important that the effective grain size of the sand should not be finer than necessary, because sand which is too fine will add to the initial head loss (Ellis, 1985) although the quality of the effluent will be improved. If feasible, simple pilot-plant tests should be carried out to find the most suitable effective grain size.

The **minimum** thickness of the filter bed should be 0.5 m, but if slow sand filtration is the only treatment, and the effective grain size is in the higher range, an increase to 0.6 m would be advisable. To allow for periodic cleaning by removal of 1-2 cm from the top sand layer, 0.3 m is usually added to bring the **initial** thickness of the filter bed to 0.8 m (0.9 m). Successive cleanings of the filter, at intervals of approximately one to three months, will gradually reduce the thickness of the filter bed so that by the second or third year, the **minimum** thickness of the filter bed is reached. The filter bed then needs to be re-sanded, as will be discussed in Section 10.7.

Underdrain system

The underdrain system serves two purposes: firstly, it provides unobstructed passage of treated water and secondly, it supports the bed of filter medium. Usually, it consists of a main and lateral drain constructed from perforated pipes, or a false floor made of concrete blocks or bricks, and is covered with layers of graded gravel. These layers prevent the filter sand entering or blocking the underdrains and ensure uniform abstraction of the filtered water. The thickness of the underdrain system, including the gravel layers, may range from 0.3 to 0.5 m, although the depth of the underdrain system will be smaller if corrugated pipes are used (see Section 7.4).

Outlet chamber

The outlet chamber usually consists of two sections separated by a wall, on top of which a weir is placed with its overflow slightly above the top of the sand bed. This weir prevents the development of below-atmospheric pressure in the filter bed, which could lead to the formation of air bubbles underneath the biological layer. The weir also ensures that the filter operates independently of fluctuations in the level of the clear-water reservoir.

By allowing the free fall of water over the weir, the oxygen concentration in the filtered water is increased and the weir chamber should therefore be suitably ventilated to facilitate aeration.

3.2 TREATMENT PROCESS

In a slow sand filter impurities in the water are removed by a combination of processes: sedimentation, straining, adsorption, and chemical and bacteriological action. Purification begins in the supernatant water layer where large particles settle on the filter bed, and smaller particles agglomerate to settleable flocs as a result of physical, chemical, or biochemical interactions. Under the influence of sunlight, algae, which have entered the filter with the raw water, grow and influence the purification process.

During the first few days, water is purified mainly by mechanical and physical processes. The resulting accumulation of sediment and organic growth forms a thin layer on the sand surface, which remains permeable and retains particles even smaller than the spaces between the sand grains. As this layer (often referred to as the biological skin or "Schmutzdecke") develops, it becomes the "living quarters" of vast numbers of micro-organisms which break down organic material retained from the water, converting it into water, carbon dioxide and other oxides (PO_4 , NO_3). Nitrogenous organic material will initially be converted into ammonia, which is then oxidized by specific autotrophic bacteria to nitrite and ultimately to nitrate.

Most impurities, including bacteria and viruses, are removed from the raw water as it passes through the filter skin and the layer of filter bed sand just below. The removal of bacteria from the water is probably due primarily to the action of predators, such as protozoa. Those impurities carried deeper into the filter bed will come into contact with, and become attached to, sand grains so that the sand particles gradually become covered with a thin layer composed mainly of organic material and micro-organisms. These in turn adsorb the impurities by various attachment mechanisms. The purification mechanisms extend from the filter skin to approximately 0.3-0.4 m below the surface of the filter bed, gradually decreasing in activity at lower levels as the water becomes purified and contains less organic material and nutrients. More products of the biological processes are removed at even greater depths by physical processes (adsorption) and biochemical action (oxidation).

When the micro-organisms become well established, the filter will work efficiently and produce high quality effluent which is virtually free of disease-carrying organisms and biodegradable organic matter. The time taken for the filter to ripen depends on the quality of the raw water, but water temperature and oxygen levels are also important factors. Ripening of a new filter may generally take about three weeks, whereas a filter which has been cleaned in a single-day operation may take only one to two days. The absence of ammonia in the filtrate is an indication that the ripening process is completed.

The activity of the micro-organisms lessens considerably as the temperature decreases, or as the oxygen concentration of the water in the filter medium falls below 0.5 mg/l. A low oxygen concentration in the influent may even lead to anaerobic conditions in the filter, particularly when the temperature is high. This may result in the production of various obnoxious impurities and an unpalatable effluent so, if necessary, the raw water should be pre-treated to prevent anaerobic conditions in the filter bed.

Continuous sedimentation and straining of particles will gradually increase resistance in the filter skin (Figure 3.3), and after one to three months the resistance becomes too high for the filter to produce sufficient safe water. Filtration capacity can be restored by cleaning the filter, which is done by draining off the supernatant water and removing the top 1-2 cm of the sand bed, including the filter skin.

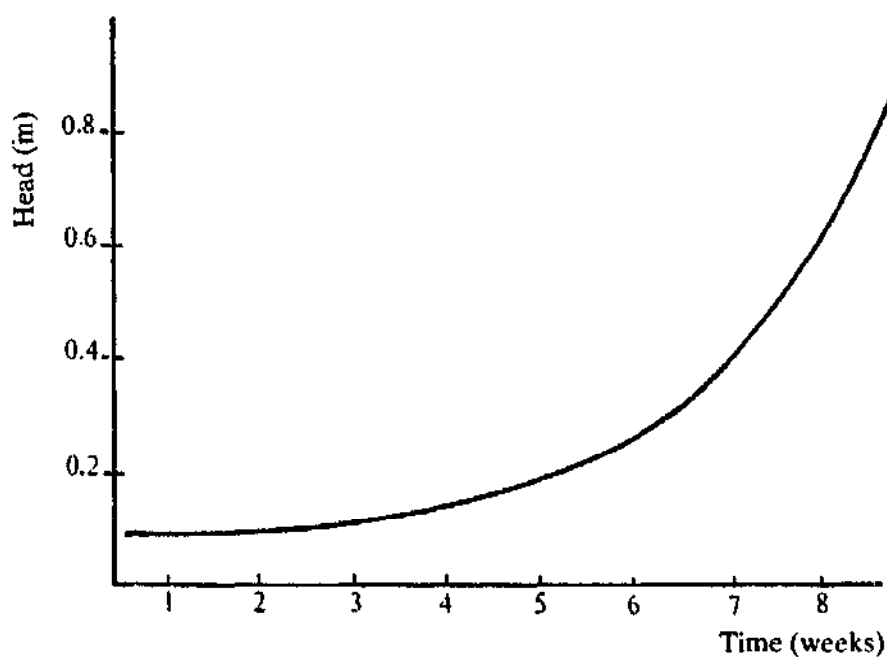

Figure 3.3: Development of resistance in the filter bed

Effect of algae

Algae develop in slow-moving or standing surface water as a result of the presence of nutrients, such as nitrates, phosphates and sunlight, and may enter the filter with

the raw water and then proliferate in the supernatant water. They will be beneficial to the treatment process if they are in moderate numbers, particularly when they form part of the filter skin.

However, algal blooms, that is excessive growth of algae, have created problems in many slow sand filters. In some cases, algal blooms of free-floating, filter-blocking varieties, have resulted in very short filter runs. In other cases, oxygen consumption at night by large numbers of algae has created anaerobic conditions in filters, leading to unpalatable effluents.

Certain types of algae form long filaments which attach to the surface of the sand in the filter, and in the hot season, entire filter beds can be covered with algae. During bright, warm conditions, oxygen bubbles produced by the algae may become attached in such quantities that large masses of algae float to the surface, pulling with them some of the sand and filter skin, and thus reducing the efficiency of the filter. Furthermore, masses of algae have to be removed when the bed is drained for cleaning so that it can be scraped properly.

Control of algae

Techniques to prevent or control troublesome algae growth in slow sand filters include pre-treatment, shading, chemical treatment, biological methods and manual removal.

Proper pre-treatment of the water by river bed filtration or horizontal roughing filtration may be very effective in removing the majority of algae from the raw water. This may lead to longer filter runs, particularly when combined with covering of the filters to prevent subsequent algae growth in the supernatant water. Covering of the filters alone will not be sufficient if algae blooms have already developed in the raw water. However, the shading principle can be used when building raw-water storage reservoirs, because construction of deep reservoirs will help to control the growth of algae.

Chlorination of the supernatant water to control algae growth has been tried, as well as the addition of copper sulphate, the latter being particularly widely used for the control of algal blooms in reservoirs. However, direct dosing into a slow sand filter involves a great risk of accidental overdosing and a subsequent negative effect on the biological life in the filter, leading to deterioration of the effluent.

Although no hard data are available, top-feeding fish, such as tilapia, may be of value in controlling algae growth in slow sand filters. Under no circumstances should bottom-feeders be introduced, such as carp, as they may damage the biological layer (Ellis, 1985). Finally, manual removal may be a suitable method of controlling the growth of filamentous algae.

3.3 RESULTS OF SLOW SAND FILTRATION

The improvement of water quality brought about by slow sand filtration will differ from place to place because the process depends on many factors, such as raw water quality, grain size, the rate of filtration, temperature, and the oxygen content of the water. An indication of the purification effect of a mature filter, that is a filter with a fully developed filter skin, is summarized in Table 3.1, based on the work of Ellis (1985) and the results of the IRC Slow Sand Filtration Project. The figures are from filters which are being operated under varying conditions, and the results therefore show a wide range.

Table 3.1: Performance of slow sand filters

Parameter of water quality	Purification effect of slow sand filtration
Colour	30-100% reduction
Turbidity	Turbidity is generally reduced to less than 1 NTU
Faecal coliforms	Between 95-100% and often 99-100% reduction in the level of faecal coliforms
Cercariae	Virtual removal of cercariae of schistosoma, cysts and ova
Viruses	Virtually complete removal
Organic matter	60-75% reduction in COD
Iron and manganese	Largely removed
Heavy metals	30-95% reduction

Grain size selection is a crucial factor in filter performance, as illustrated in Figure 3.4, which represents the results of 18 test runs with pilot filters at a filtration rate of 0.12 m/h (Bellamy, 1985). Selection of a fine effective grain size will improve the performance of the treatment process, although it will lead to an increase in initial head loss.

If there has been little experience with slow sand filters in a certain region or country, it is preferable to test their performance with the raw-water source in small pilot plants consisting, for example, of PVC pipes, oil drums or concrete sewer pipes (Figures 3.5 and 3.6).

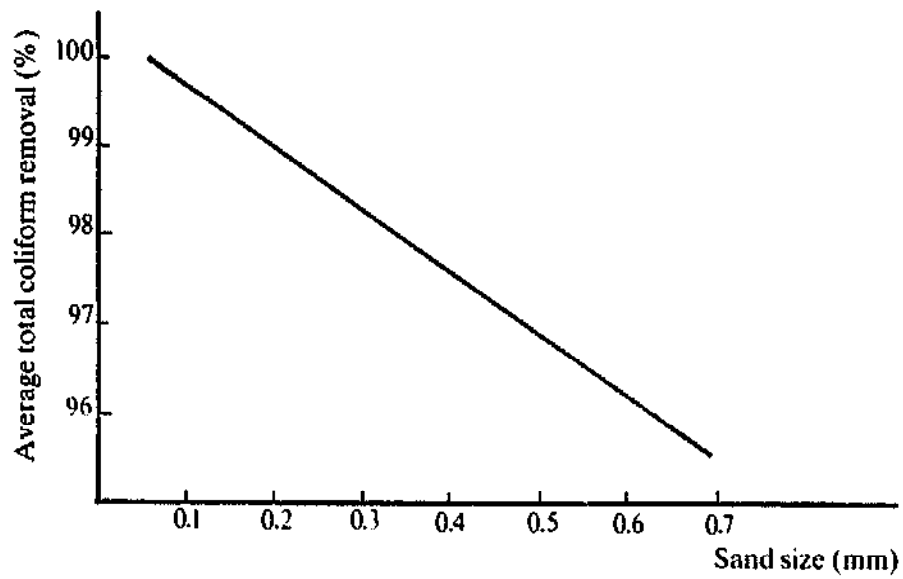

Figure 3.4: Effect of sand size on removal of total coliform bacteria in slow sand filtration (Bellamy, 1985)

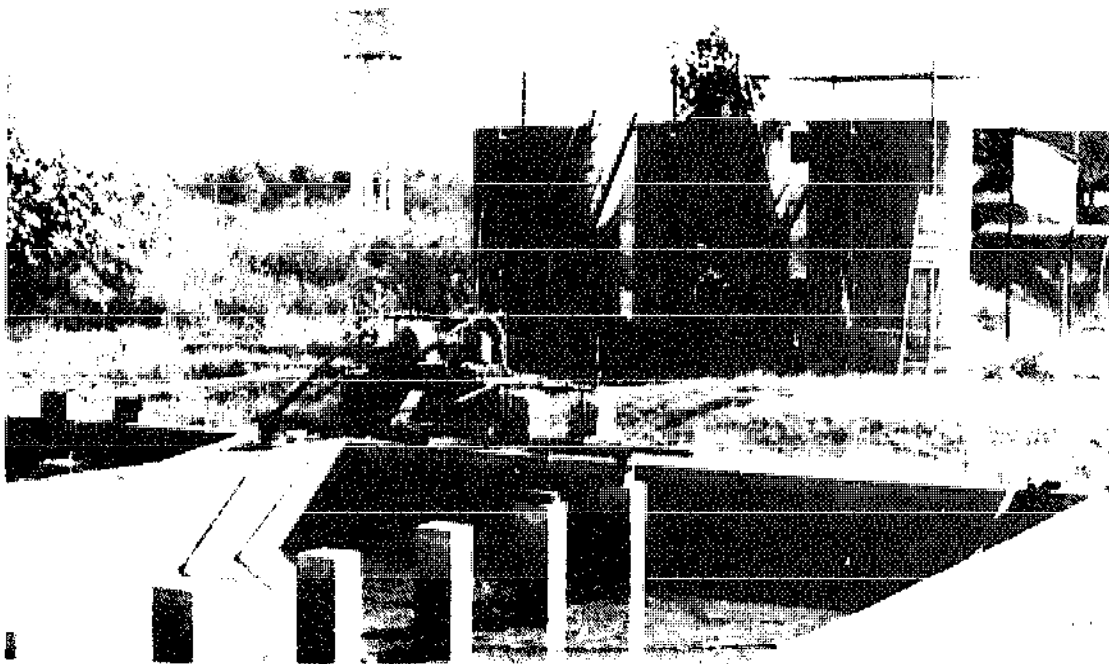

Figure 3.5: Slow sand filter pilot plant, Nagpur, India

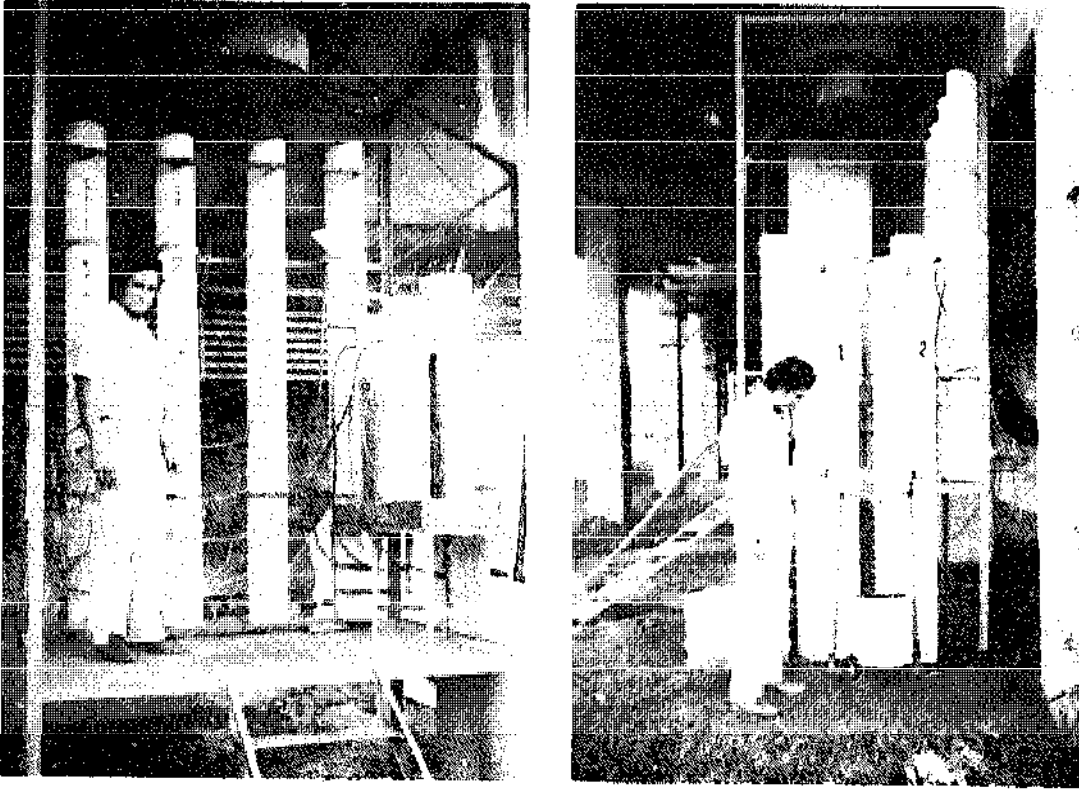

Figure 3.6: Slow sand filter pilot plant, Cali, Colombia

3.4 OPERATION AND CONTROL

The most attractive aspect of slow sand filtration is its simplicity of operation and control because, after a short training period, the operational procedures can be mastered by a local caretaker.

Controlling the rate of filtration is the key to adequate functioning of a slow sand filter. For surface water, operation at a rate between 0.1 and $0.2 \text{ m}^3/\text{m}^2/\text{h}$ is usually satisfactory, because the filter tends to clog within a shorter period of time using higher rates of filtration, as well as causing deterioration in the quality of filtered water. However, the rate may be increased to $0.3 \text{ m}^3/\text{m}^2/\text{h}$ for short periods of one or two days without undue harm, for example, while another filter is being cleaned. It is important to prevent rapid fluctuations in the filtration rate because bacterial flora in the filter bed require time to adjust to new situations.

Control of filtration rate of an outlet controlled filter

The rate of filtration can be regulated by the valve at the outlet of the filter (valve E in Figure 3.1). Resistance will increase with the course of time, particularly in the filter skin, and this valve will need to be opened further to maintain the original rate of filtration.

If the valve cannot be opened further, then cleaning of the filter bed is necessary to restore the filtration rate. As cleaning means that the filter will be out of service for at least one or two days, two or more units should be constructed so that the other(s) can be operated, at a higher rate if necessary, while one is being cleaned or re-sanded. For example, if the total water output of a two-unit plant is to remain the same, taking out one filter for cleaning means that the rate of filtration in the other unit has to be doubled. In a plant with three filter units, the rate in the two functioning units will have to be raised by 50%. Thus, a larger number of units has operational advantages, but will be somewhat more costly, as will be explained in Chapter 5.

Control of filtration rate of an inlet controlled filter

Another way to control the filtration rate is to set the raw-water inlet valve at the required rate of flow (valve a in Figure 3.2). Initially, the level of the supernatant water will be low, but with time it will gradually rise to compensate for the increase in filter resistance. The advantages of this method are that regular adjustment of the valves is not necessary and the rising water level is an obvious indication that the filter needs to be cleaned. On the other hand, removal of scum and algae becomes more complicated. It has not been determined whether the ripening process is influenced by the lower retention time resulting from the initial low supernatant water layer (see Figure 3.7). In areas where aquatic weeds can enter the filter and grow in the filter skin, this method of controlling the filtration rate can only be used in filters that are roofed.

Mode of operation

It is most effective to operate a slow sand filter continuously because good quality effluent is ensured, and the smallest filter area is used. Continuous operation of the filter is feasible where raw water can be fed into the filters by gravity flow, but in many cases the raw water has to be pumped. If continuous pumping cannot be guaranteed because of an intermittent power supply or lack of trained staff, continuous operation at a constant rate may be ensured by constructing a raw-water

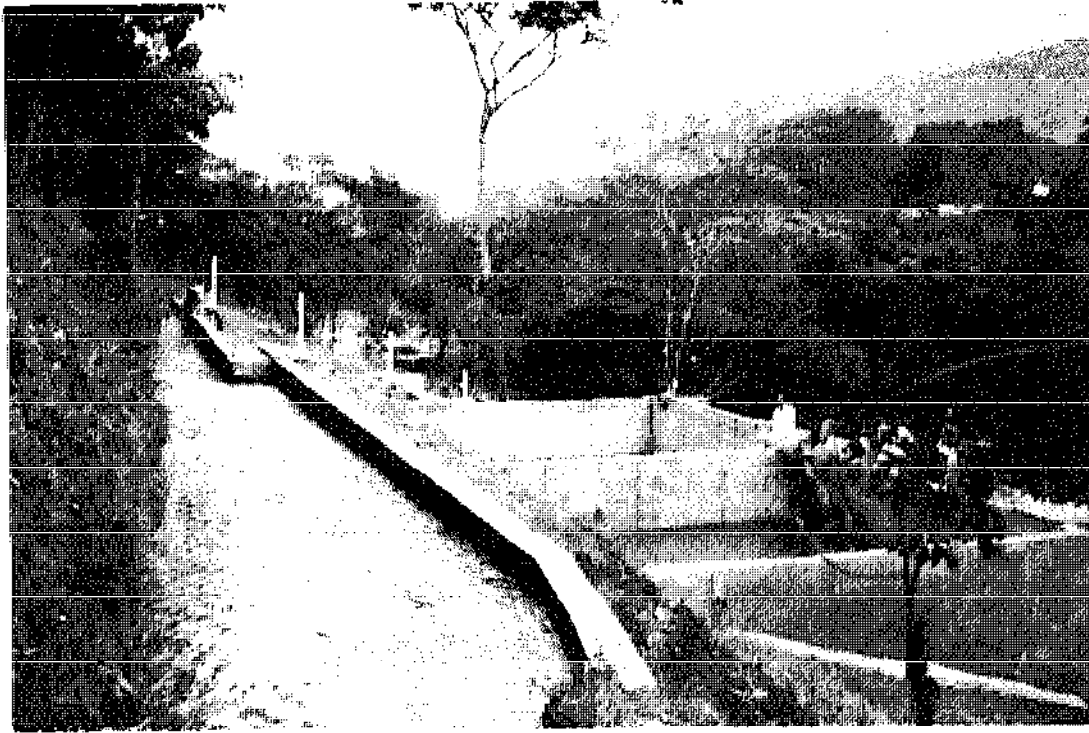

Figure 3.7: Inlet controlled filter preceded by river bed filtration, Choro del Plata, Colombia

balancing tank. Water is pumped into this tank at certain intervals, before being continuously fed into the filters by gravity flow. Covering of the tank may be required to prevent algal growth, particularly when it holds pre-treated water.

Alternatively, declining rate filtration can be applied in outlet controlled filters and this method operates as follows. When there is no power supply, water is not fed into the filters, but the outlet valve remains open. The level of the supernatant water will slowly drop and because it provides the head for filtration, the filtration rate will gradually decrease (Figure 3.8). When the power supply is restored, the pumps can be started and the level of supernatant water, and thus the filtration rate, will increase again. Declining rate filtration is often more costly, because a larger filter bed area is required to obtain the same water output as from continuously operated filters, but the effluent will still be of acceptable quality.

Declining rate filtration cannot be used in inlet controlled filters, however, because of the low height of the supernatant water in the first weeks of a filter run.

Unfortunately, it is common practice in some countries to close the outlet valve during periods when the raw-water pumps are not operating, which means that filtration is then intermittent because it stops completely during certain periods of the day. This **intermittent operation should not be permitted** because it has been shown conclusively that an unacceptable breakthrough of bacteriological pollutants occurs four to five hours after the filters recommence operation.

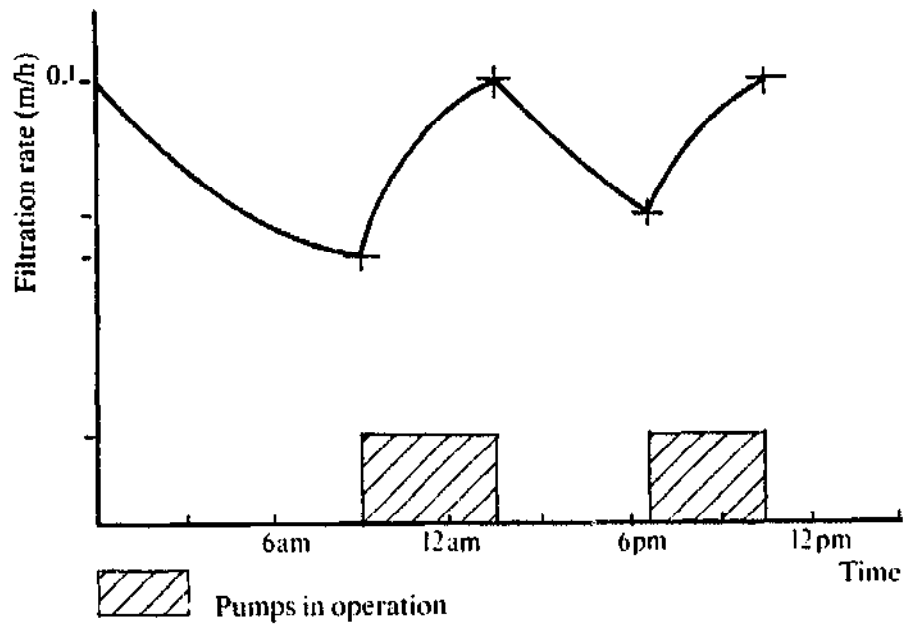

Figure 3.8: Typical development of filtration rate in declining rate filtration

4. Design Process

Two major stages can be identified when designing a slow sand filter for a particular location. In the first stage, decisions must be made about:

- system capacity;
- main components and sizing of the water supply system;
- estimated construction and operating costs.

The outcome of the first stage may be used as a basis for fund raising, planning and organizational purposes. The second stage is the preparation of the system's structural design and a specification of the equipment and materials involved. The structural design is dealt with in Chapters 7 and 8.

4.1 SYSTEM CAPACITY

The most important factor to be determined when designing a water supply system is the capacity of the plant, that is, the total quantity of water required per day, also referred to as the daily water demand. This is difficult to estimate and depends on the design period, the number of users the system is to serve, and the quantity of water to be provided per person per day.

Design period

The design period is the length of time for which the system is expected to provide a community with good quality water in sufficient quantities. This period should be neither too short, not less than ten years, nor too long because of economic reasons and the difficulty of predicting future water demand. A suitable design period for slow sand filters is usually between ten and fifteen years.

Design population

After the design period has been selected, the design population must be determined. The projected population growth during that time may be derived from available demographic data. Socio-economic factors should be taken into

account when estimating the rate of population growth, such as family planning, migration, changes in medical care and the level of economic prosperity. However, demographic data are not always reliable and should be checked against the actual population in the area to be served by the new system. If necessary, additional data should be collected.

It is essential that the water supply system is designed to meet the requirements of the population expected to be living in the community at the end of the design period by taking into account the design period and the annual growth rate. The design population can therefore be calculated by multiplying the present population with a population growth factor as follows:

$$P_d = P_p (1 + 0.01 a)^y.$$

where:

- P_d = design population
- P_p = present population
- a = annual growth rate (%)
- y = design period

For example, if the present population of a community is 1200, the annual growth rate 3%, and the design period 15 years, then the population growth factor will be $(1.03)^{15} = 1.56$. This means that during 15 years, the population is likely to increase to 1.56×1200 , that is, to 1872. As the new water supply system has to be designed to provide sufficient water for the community at the end of the design period, it should therefore be designed for 1872 people. The population growth factors for various combinations of annual growth rates and design periods are given in Table 4.1.

Table 4.1: Population growth factors

Design period (years)	Annual growth rate of population.		
	2%	3%	4%
10	1.22	1.34	1.48
15	1.35	1.56	1.80
20	1.49	1.81	2.19

Water demand per capita

The average amount of water fetched from water supply systems in developing countries ranges from 20 to 150 litres per person per day. However, this is influenced by many factors, such as quality and availability of the water, cost, cultural practices and climate (Table 4.2). The most important of these factors are the time that people can afford to collect the water, the convenience and accessibility of the water distribution points, and whether water is also used for watering livestock.

Table 4.2: Average amount of water use for various types of rural water supplies

Type of supply	Average daily water use (l/p/d)	Range of daily water use (l/p/d)
Point sources	15	5-25
Piped supplies with stand-pipes	30	10-50
Piped connection (single tap)	50	20-150

Based on Feachem et al (1977)

The data in Table 4.2 cannot be directly used to design a water supply system because they do not take into account that people are often unable to obtain the amount of water required due to intermittent operation of the supply system, or because of long waiting times at public standposts. The design of a water supply system must therefore be based on national, but preferably local, data on the amount of water to be supplied per person per day, taking into account the prevailing socio-economic conditions and preferences of the community. When national guidelines are not available, the water demand per capita can be estimated from the water requirements for particular uses (see Table 4.3).

Calculation of the design daily water demand

The design daily water demand, that is, the total quantity of water the water supply system has to provide per day, can be calculated by multiplying the design population by the quantity of water to be provided per person per day. However, if water losses and wastage are not included in the water demand figures, the design daily water demand should be increased by 20-30%.

Table 4.3: Estimate of water demand per capita for house connections in rural areas in India

Water usage	l/d
Drinking	5
Cooking and cleaning	18
Ablution	6
Flushing	8
Bathing	20
Washing clothes	20
Watering livestock	18
Total water usage	95

Based on NEERI (1982)

4.2 MAIN COMPONENTS AND SIZING OF THE WATER SUPPLY SYSTEM

When the required treatment and the design daily water demand are known, the main components and dimensions of the water treatment and distribution system can be determined.

In rural agricultural areas, water is usually fetched morning and evening, and the demand may be quite high at these times. It may therefore be useful, within reason, to design the system for these high demands. Although the cost of the system will be increased, insufficient water supply during peak hours leads to long queues and considerable wastage of time, and may also make community members return to traditional sources of water.

Preferably, the system design should ensure that the treatment system, particularly slow sand filters, can operate constantly with a daily capacity that equals demand. In this section, general design features of the main components are provided, which are illustrated with examples in Chapter 6.

Raw-water intake and pumps

In gravity water supply systems, the raw-water intake is designed for 24-hour operation. In pumped schemes, it will have to be based on the rate of discharge and the operating time of the raw-water pumps. In most rural water supply systems, these pumps operate 8-16 hours per day, depending on the size of the community and the availability of manpower, electricity and fuel.

Raw-water balancing tank

When raw-water pumps are not designed for continuous operation, a raw-water balancing tank will often be the best solution for ensuring continuous operation of the filters. Its capacity depends on the pump regime, which is explained in the example in Chapter 6.

Pre-treatment unit

This unit will preferably be operated 24 hours per day under gravity flow. In pumped systems, it is advisable to pre-treat the water before it is pumped, or to use a balancing tank to avoid discontinuous operation.

Slow sand filters

The design criteria for slow sand filters are indicated in Table 4.4. At a rate of filtration of 0.1 m/h, a continuously operated filter will produce 2.4 m³ of water per m² of filter bed surface area per day. Thus, the total surface area required can be determined by dividing the design daily water demand by 2.4. This total surface area will be provided in several units rather than a single unit, the number required depending on the following:

- At least two filters are required to ensure safe and continuous operation, and to allow one of the beds to be cleaned. In larger plants, the number of units can often be increased at little additional cost to ensure greater flexibility in operation and maintenance. An indication of a suitable number of rectangular units may be obtained with:

$$n = 0.5 \sqrt[3]{A}$$

where:

n = total number of rectangular units

A = total surface area

- The maximum size of the filter bed is generally 200 m² in rural areas, to ensure that cleaning can be carried out within a day.
- As a rule, the minimum size of a filter bed is 5 m², but experiments have shown that filters of less than 1 m² are equally efficient, provided raw water does not flow directly along the inside of the walls to the filter drains without being filtered. This is prevented if the walls have a rough surface.

Construction and operation costs differ from country to country, and from system to system. Experienced engineers responsible for water supply systems will be aware of approximate costs, or will be able to provide an estimation based on a bill of quantities of materials required for the various units and pipelines.

Table 4.4: General design criteria for slow sand filters in rural water supply

Design criteria	Recommended level
Design period	10-15 years
Period of operation	24 h/d
Filtration rate in the filters	0.1-0.2 m/h
Filter bed area	5-200 m ² per filter, minimum of 2 units
Height of filter bed:	
initial	0.8-0.9 m
minimum	0.5-0.6 m
Specification of sand:	
effective size	0.15-0.30 mm
uniformity coefficient	< 5, preferably below 3
Height of underdrains including gravel layer	0.3-0.5 m
Height of supernatant water	1 m

Clear-water storage and pumping

The treated water is collected in a clear-water tank or clear-water well, from which it can be directly distributed, or pumped to one or more higher level storage reservoirs. When supply by gravity is possible, the clear-water tank must have a sufficient storage capacity to balance the continuous outflow from the filters against fluctuating water demand. In other cases, the treated water will have to be pumped from the clear-water well to a central, overhead storage tank, or to decentralized tanks of sufficient capacity to enable continuous supply to consumers, even when the clear-water pumps are not operating.

Distribution system

The distribution system should, within reason, be designed to meet the maximum hourly water demand of the community. Decentralized storage within the distribution system may help to reduce the cost by enabling use of smaller diameter pipes.

4.3 ESTIMATION OF COST

The last step in the first design stage is to estimate the costs of construction, operation, and maintenance, and this is discussed further in Chapter 5. These figures are important for fund-raising, but especially to determine whether the consumers and the national government can meet the cost of the system. Although the maintenance costs of slow sand filters are low in comparison with other treatment systems, the total maintenance costs of the water supply system may nevertheless put a heavy burden on the budget of rural communities.

5. *Cost of Slow Sand Filters*

5.1 CONSTRUCTION COST

The construction cost of slow sand filters is mainly determined by the cost of materials such as cement, building sand, gravel, reinforcement steel, filter sand, pipes and valves. The cost of labour and land is usually of lesser importance. In rural areas of India for example, the cost of land rarely exceeds 1% of the total construction cost.

For a given filter bed area, the shape and number of filter units will have little effect on the cost per unit area of filter bed, but may influence the total wall length and the cost per unit length, and so affect the total construction cost.

To clarify this, the following equation to calculate the total construction costs of a filter, excluding the cost of pipes and valves, is given:

$$C_t = C_a \times A + C_l \times L_w$$

where:

- C_t = total construction cost, excluding pipes and valves
- C_a = combined costs per square metre of filter bed area of floor, underdrains, gravel, filter sand and excavation
- C_l = cost of the walls per running metre of wall length
- A = total surface area (m^2)
- L_w = total wall length (m)

Cost per square metre of filter bed area

An estimation of the cost per square metre of filter bed area in a particular country or region can be based on the cost of excavation work, concrete, underdrains and filter material (see Table 5.1).

COST OF SLOW SAND FILTERS

Table 5.1: Estimate of average cost per m² of filter bed area of floor, underdrains, gravel, filter sand and excavation for rural areas in India, 1983

Items	Depth (m)	Unit rate/m ³	Cost/m ² filter bed (in Indian Rp)*
Earthwork excavation	2.50	10	25
Foundation (concrete)	0.15	330	50
Floor (reinforced concrete)	0.15	885	135
Filter sand (1m) and gravel (0.3m)	1.30	200	260
Brick underdrain		280	30
Total cost per m ² of filter bed			Rp 500

* Exchange rate US\$ 1 = Rp 10

Cost per running metre of wall length

The thickness of the wall and the type of building materials used will affect the cost per unit wall length. Circular filters are only subject to tensile forces meaning that the wall thickness, and thus the cost per unit wall length, may be less, particularly for ferrocement filters. However, the advantage of a lower cost per unit wall length for larger circular units is usually offset by the simpler design and lower labour input required to construct rectangular units.

In the following example, using a concrete filter built in India in 1983, the average construction costs per running metre of wall length are calculated. The wall height of this particular slow sand filter was 2.7 m and the wall thickness was 0.23 m, therefore giving a wall volume per running metre of $0.23 \times 2.7 \times 1 = 0.62 \text{ m}^3$. In 1983, the average construction cost per volume of 1 m^3 of concrete wall for waterworks in India was Rp 1333 (US\$ 133), including labour and material. Thus, the cost per running metre of wall length in this example was Rp 1333 multiplied by 0.62, a total of Rp 830 (US\$ 83).

Total wall length

The size, shape, and number of filter units will determine the total wall length of the slow sand filter plant. The total wall length of a filter plant with circular units may be calculated as follows:

$$L_{wc} = 2 \sqrt{n \times \pi \times A}$$

where:

- L_{wc} = total wall length (m)
- n = number of filter units
- A = total surface area (m^2)

Rectangular filters have the advantage of common wall construction if the units are constructed next to each other (Figure 5.1).

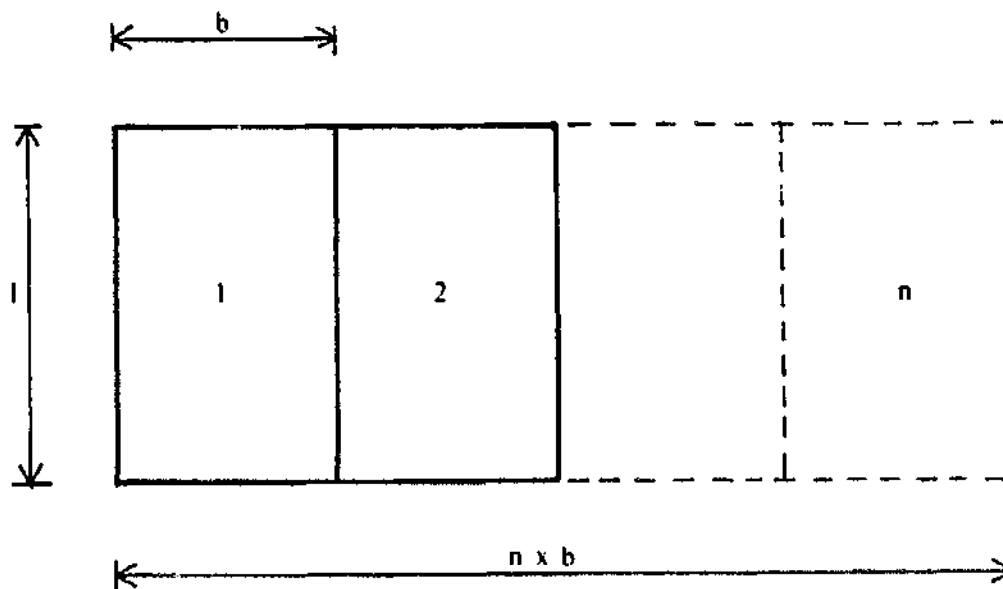

Figure 5.1: Layout of a filter plant with (n) rectangular units

COST OF SLOW SAND FILTERS

The total wall length of a filter plant with rectangular units may be calculated as follows:

$$L_{wr} = n \times b + l (n + 1)$$

where:

L_{wr} = total wall length (m)

n = number of units

b = breadth of unit (m)

l = wall length of unit (m)

For a given surface area and number of units having common walls, the total wall length will vary with different combinations of (b) and (l) and becomes smallest when:

$$l = \sqrt{\frac{2A}{n+1}} \text{ and } b = \frac{(n+1)l}{2n}$$

where:

l = wall length of unit (m)

A = total surface area (m^2)

n = number of units

b = breadth of unit (m)

For this value of (b), the equation for the minimum wall length for rectangular filters is:

$$L_{wmin} = 2l (n + 1) \\ = 2 \sqrt{2A (n + 1)}$$

where:

L_{wmin} = smallest total wall length (m)

l = wall length unit (m)

n = number of units

A = total surface area (m^2)

The dimensions and the total wall length of circular and rectangular filters are compared in Table 5.2. For smaller filter areas, circular filters (Figure 5.2) seem to

have an advantage, because although their total wall length is slightly bigger, this is normally compensated for by thinner walls. Rectangular units seem to be most appropriate for larger filter areas, greater than 100 m², divided between more units.

Table 5.2: Slow sand filters and total wall length for various design capacities with a filtration rate of 0.1 m/h

Surface area (m ²)	Circular filter units			Rectangular filter units		
	Diameter (m)	No. of units	Total wall length (m)	Width x length per unit (m)	No. of units	Total wall length (m)
24	3.9	2	24.5	3.0 x 4.0	2	24.0
50	5.7	2	35.4	4.3 x 5.8	2	34.6
100	8.0	2	50.1	6.1 x 8.2	2	49.0
100	6.5	3	61.3	4.7 x 7.1	3	56.0
200	9.3	3	86.8	6.7 x 10.0	3	80.0
500	14.6	3	137.3	10.6 x 15.8	3	126.8
500	11.2	4	158.5	8.8 x 14.1	4	141.0

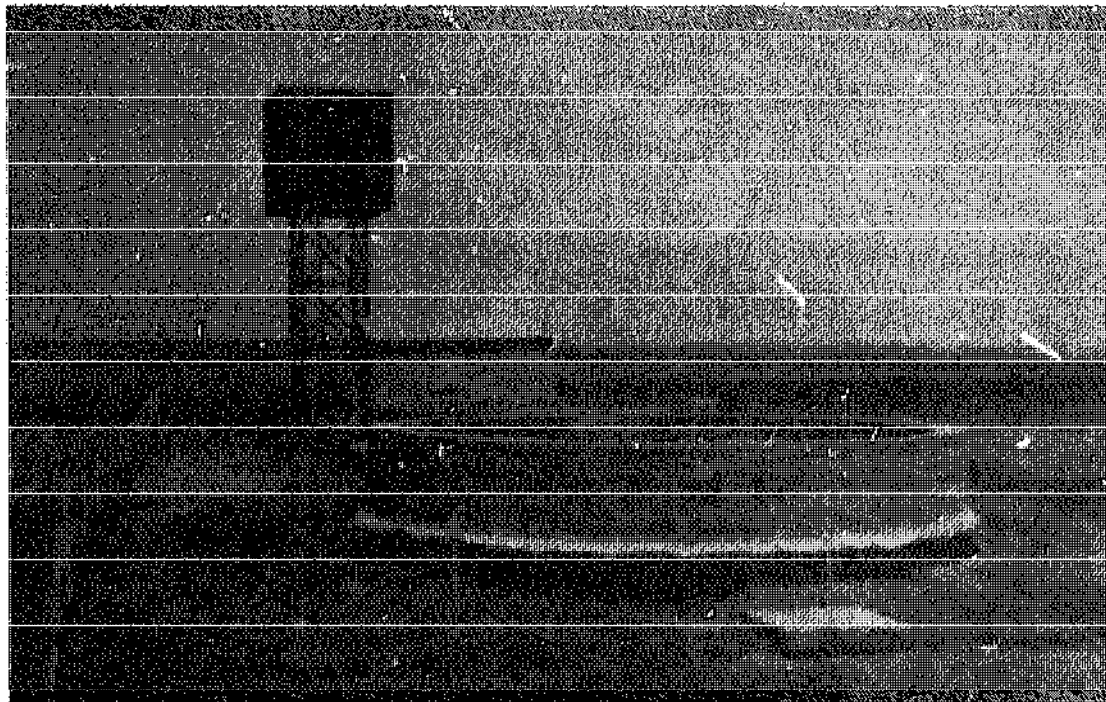

Figure 5.2: Circular brick masonry filter, Gezira-Region, Sudan, 1979

Minimum cost of filters

The cost of a filter plant is affected by the number of units. A larger number of units will require a greater wall length for the same total surface area.

When calculating the cost of rectangular filters, not only is the number of units an important factor, but also their layout because they may have common walls (Figure 5.3). The total cost of rectangular filters for the shortest wall length can be calculated as follows:

$$C_{tr} = C_a \cdot A + 2 C_1 \sqrt{2A (n + 1)}$$

where:

- C_{tr} = total cost of rectangular filters for shortest wall length, excluding appurtenances and land
- C_a = combined costs per square metre of filter bed area of floor, underdrains, gravel, filter sand and excavation
- C_1 = cost of the walls per running metre of wall length
- A = total surface area (m^2)
- n = number of units

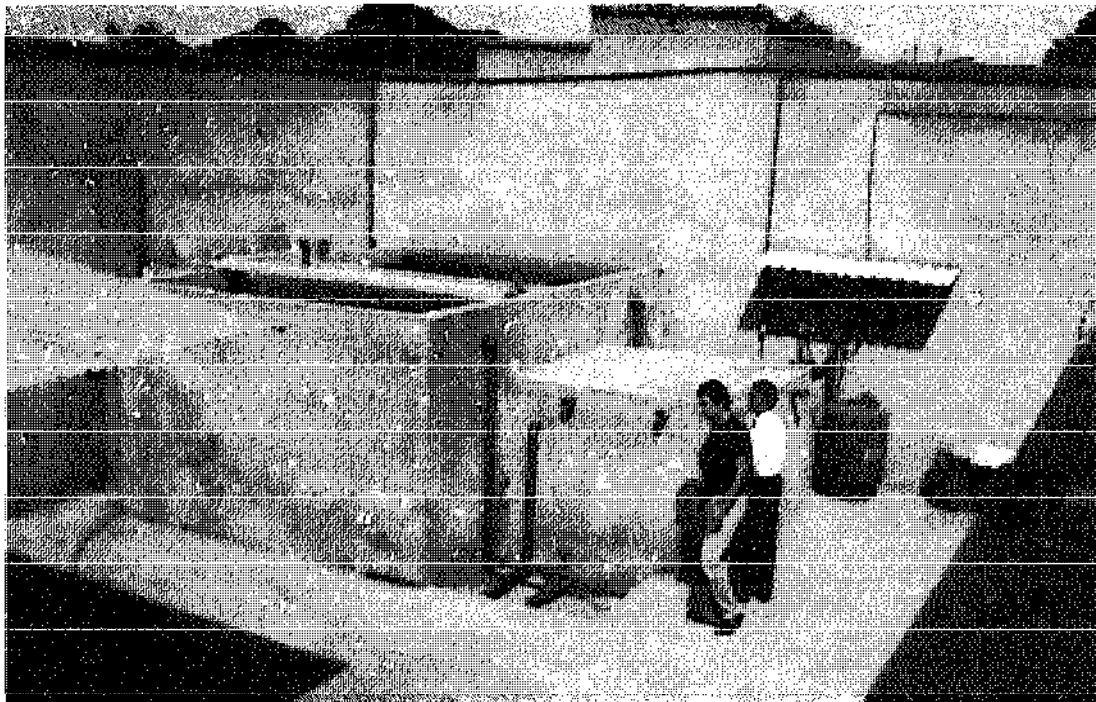

Figure 5.3: Slow sand filter plant, Santa Rosa, Colombia, 1985

The total cost of circular filters can be calculated as follows:

$$C_{tc} = C_a \cdot A + 2 C_1 \sqrt{n \times \pi \times A}$$

where:

- C_{tc} = total cost of circular filters, excluding appurtenances and land
- C_a = combined cost per m² of filter bed area of floor, underdrains, gravel, filter sand and excavation
- C_1 = cost of the wall per running metre of wall length
- A = total surface area (m²)
- n = number of units

The cost per unit area of the filter bed (C_a) and per unit length of wall (C_1) depends on local conditions, the price of construction materials and the cost of labour. On the basis of the estimated values of (C_a) and (C_1) for rural areas in India in 1983, that is, Rp 500 and Rp 830 respectively (see Table 5.1), the costs per square metre of rectangular slow sand filters with various capacities and numbers of units have been estimated (see Table 5.3). To obtain an estimate of the total construction cost, about 15-20% should be added to these figures to allow for pipes, valves, appurtenances and land.

Table 5.3: Estimated costs per m² of rectangular slow sand filters in rural areas in India, 1983

Total filter area (m ²)	Capacity* (m ³ /h)	Cost per m ² based on number of filter units (Rp 1000)**			
		2	3	4	5
50	5	1.07	1.16	1.24	1.31
100	10	0.91	0.97	1.02	1.07
200	20	0.79	0.83	0.87	0.91
300	30	0.73	0.77	0.80	0.83
500	50	0.68	0.71	0.73	0.76
1000	100	0.63	0.65	0.67	0.68

* Rate of filtration 0.1 m/h

** Exchange rate US\$ 1 = Rp 10

Economy of scale

The cost estimates given in Table 5.3 show that there is little economy of scale in the construction of slow sand filters, which means that there is little benefit in

constructing plants for a long period. For example, assuming a community in rural India would have a design demand of 20 m³/h in ten years and 30 m³/h in 20 years, constructing a plant for 30 m³/h (three units) would cost:

$$300 \times 0.77 \times 1000 = 231\,000 \text{ Rp.}$$

Constructing a plant for 20 m³/h (two units), and adding a unit of 10 m³/h after ten years, would require an initial investment of:

$$200 \times 0.79 \times 1000 = 158\,000 \text{ Rp.}$$

Assuming that the present value of the additional unit which will have to be constructed in ten years time is 91 000 Rp, the total cost could be approximately

$$158\,000 + 91\,000 = 249\,000 \text{ Rp.}$$

Thus, a design period of 10-15 years is adequate and will keep the initial investment low. Selecting a period of ten years, plus the option of constructing an extension thereafter, has the additional advantage that the estimation of future water demand will be less critical. Nevertheless, provisions for future extensions will be necessary.

Design flexibility

The cost estimates calculated in Table 5.3 also show that an increase in the number of units for the same area only increases the cost slightly. The division of a total filter area of 50 m² over two units would be 8% cheaper than over three units, and 16% cheaper than over four, while for a total filter area of 500 m², the figures would be 3.5% and 7% cheaper respectively. Taking into account that the required increase in the filtration rate when cleaning one unit is 100% for two units, 50% for three, and 33% for four, then the expenditure for a larger number of units over the same filter area may well be considered acceptable.

5.2 OPERATION AND MAINTENANCE COSTS

The operation cost of a slow sand filter depends on the costs of labour, and energy costs if pumping is required, but general figures cannot be given because of variation in local situations. For example, small gravity supply systems only require minimum attendance, and may not even need a watchman in remote areas. They require a larger labour input only when the filter needs to be cleaned. In contrast, large plants in pumped systems need continuous attendance by an operator and/or

watchman. When the pumps are operated 24 hours per day and the work is divided into three shifts, three operators, and possibly three watchmen, will therefore be required. Additional labourers may also be required to clean the filters when they become clogged.

Maintenance costs will include minor repairs to the filters, and replacement of sand washed out from the scrapings. Although the scrapings removed in the cleaning process can be washed, stored, and re-used, about 20% of the sand is washed out from the scrapings together with the silt. Other maintenance costs relate to the replacement of the filter's few moving parts, although these costs will also be higher in pumped schemes.

5.3 COST COMPARISON BETWEEN SLOW AND RAPID SAND FILTRATION

A cost comparison of slow and rapid sand filtration schemes was carried out in India during 1983. The capital cost of slow sand filtration systems was shown to be less than that of rapid sand filtration systems, up to a capacity of 3000 m³/day. When operation and maintenance costs were taken into account, the break-even point was 8000 m³/day.

Furthermore, the construction cost of a slow sand filter plant in Colombia, with a capacity of 1500 m³/day (design population 15 000 and a cost of US\$ 35 000), was compared with rapid sand filters. The cost for the rapid sand filters was approximately double that of the slow sand filters, merely because of the use of imported equipment.

Thus, slow sand filtration schemes often prove more economically attractive for communities in many developing countries where a protected water supply is needed.

6. Example of Planning and Designing a Slow Sand Filtration System

6.1 FEASIBILITY STUDY

This chapter details the planning and design procedures carried out when introducing a slow sand filtration system into a hypothetical village of 1200 inhabitants, who at present collect untreated water from a river. In the example, the community applies to the water supply authority for a safe, convenient water supply system because the river is some distance away and the untreated water is believed to be the source of much disease.

A preliminary survey team is sent to assess the technical and social feasibility of a new water supply system, as well as the possible economic and health benefits. The team collect demographic data, agree tentative locations for standposts with consumers, survey an appropriate location for the treatment plant and the service reservoir, investigate the availability of construction materials and suitable filter sand, and conclude that a water supply project is technically feasible and that the villagers are sufficiently interested to guarantee implementation. However, personal observations and discussions with the local health worker, indicate that most intestinal diseases, attributed by the community to the water, are in fact the result of poor hygiene, limited use of latrines, and unhygienic handling of food. The survey team advises that a hygiene education programme should be carried out simultaneously with the implementation of a new water supply system.

Health education must go hand-in-hand with technical provisions to achieve the maximum impact on health, but only the technical considerations in the design of a water supply system are discussed in this chapter.

6.2 DESIGN PROCEDURE

A number of steps have been identified in the design procedure for the new water supply system for the hypothetical village.

These 17 steps are presented in this section. Assumptions made in each step are based on the general design considerations presented in chapters 4 and 5. Figures and data used are derived from the feasibility study referred to in section 6.1. The

procedure outlined serves primarily as an illustration, but it also indicates the type of information required for the preparation of an adequate design. It does not indicate however how the water supply system can be introduced. For information on this aspect see chapter 2.

Step 1: Selection of design period

The design period is set at 15 years, which means that after a planning and construction period of 2-3 years, the plant capacity will be adequate for at least 12 or 13 years.

Step 2: Estimation of design population

The annual growth rate is estimated to be 3%. Thus, the present population of 1200 is likely to increase by a factor of 1.56 in 15 years (see Table 4.1) to 1872 people, and a design population of 1900 is therefore selected.

Step 3: Calculation of design daily water demand

A distribution system with standposts is selected in consultation with the community and the water consumption is estimated at 50 litres per capita per day. The water demand is estimated to be 60 litres per capita per day, including losses and wastage (estimated to be 20%). The design daily water demand is calculated as follows:

$$1900 \times 60 = 114\,000 \text{ l/d} = 114 \text{ m}^3/\text{d} (4.75 \text{ m}^3/\text{h}).$$

Step 4: Estimation of maximum hourly water demand

The daily pattern of water use in an adjacent community, which has a piped water supply, is known (Figure 6.1). The total water consumption in this community is $76 \text{ m}^3/\text{d}$ ($3.17 \text{ m}^3/\text{h}$) and the maximum hourly water consumption is $15 \text{ m}^3/\text{h}$. Thus, the peak factor, that is the ratio between maximum and average hourly water consumption, is $15/3.17 = 4.7 \text{ m}^3/\text{h}$.

Because conditions in the two villages are similar, the calculation is used to estimate the design hourly water demand for the new water supply system. This figure is required for the design of the clear-water tank and distribution system. The average hourly demand for the new system is thus $114/24 = 4.75 \text{ m}^3/\text{h}$, and the

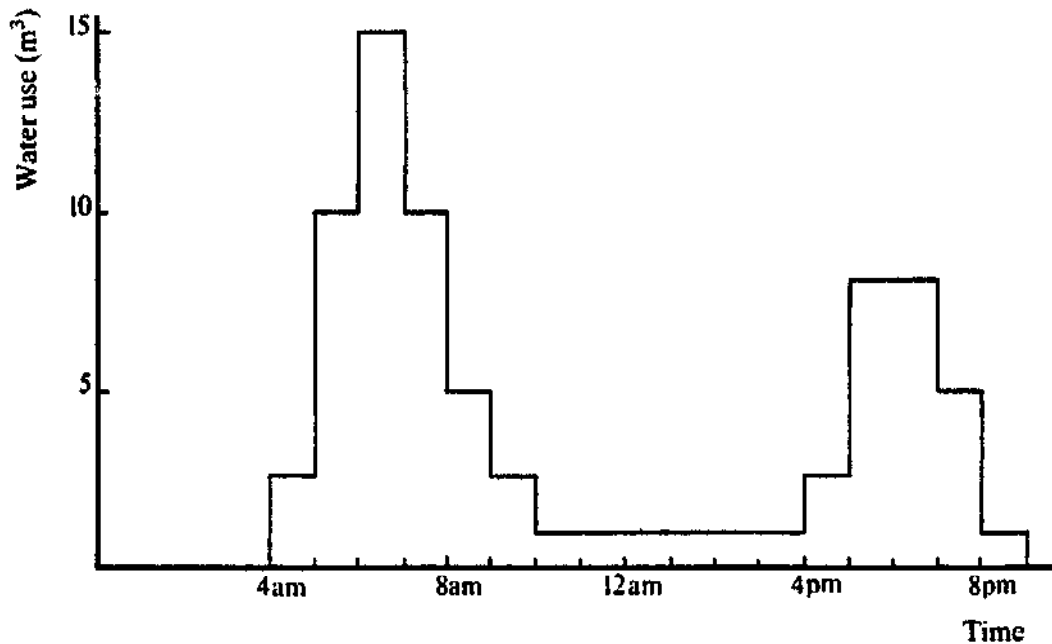

Figure 6.1: Daily pattern of water use in an adjacent community

design hourly water demand is $4.7 \times 4.75 = 22.3 \text{ m}^3/\text{h}$. In situations where the expected daily pattern of water use is not known, the peak factor should be estimated and although a peak factor of almost five is high, it is not unrealistic for rural water supply systems. However, if the withdrawal of water is likely to be more evenly distributed throughout the day, a lower peak factor should be applied.

Step 5: Selection of raw-water source

A raw-water source must be identified to supply the required water demand. From information on the geological characteristics of the subsoil and a few test boreholes made with a simple hand drill, groundwater is found to be unusable in this example and use of the nearby river is therefore investigated. Although hydrological readings are not available, it is estimated that minimal flow during the dry season will not drop below 140 l/sec. As the proposed drawoff of $114 \text{ m}^3/\text{d}$ will be less than 1% of the minimum flow, this is quite acceptable. The river is therefore selected as the raw-water source.

Step 6: Choice of treatment system

Information obtained from authorities upstream of the project indicate that most of the water quality parameters are within acceptable limits for human consumption, except for turbidity (5-100 NTU) and bacteriological parameters (faecal coliforms +100-1000/100 ml). A number of samples taken at the proposed site of the water intake (at least one at low flow and one at high flow) confirm these findings.

On the basis of the guidelines in Section 2.5, it is decided to treat the water by plain sedimentation in a storage basin, followed by slow sand filtration (see Figure 6.2). This treatment will reduce turbidity to less than one NTU, and will also bring the microbiological parameters within acceptable levels for drinking water.

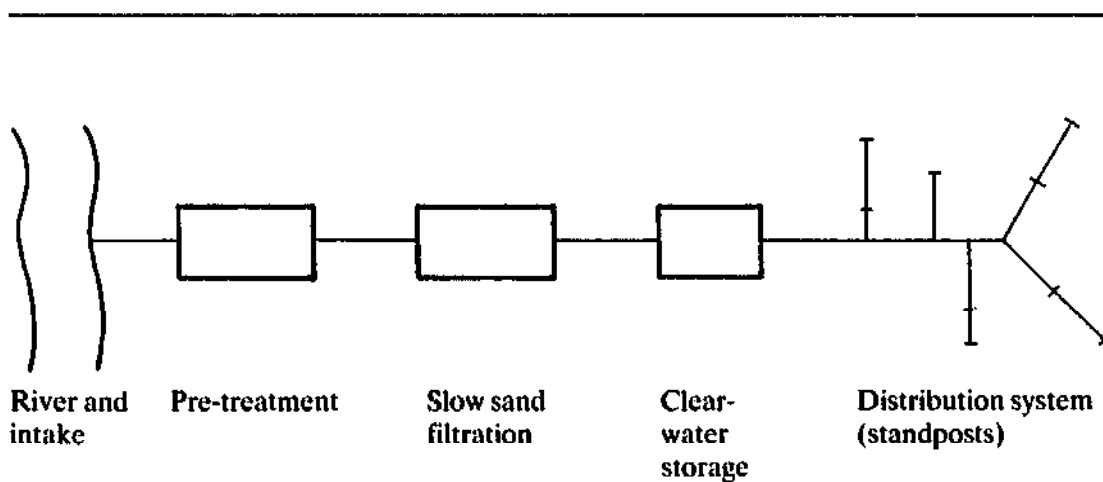

Figure 6.2: Components of the water supply system

Step 7: Location of raw-water intake

The location for the raw-water intake is determined taking into account fluctuations in water quality and stability of the river bank. A location inside a river bend is considered suitable. Flow velocities are low at this point and suspended particles will therefore settle, although the need for a sufficient water depth at all times may restrict the number of possible alternative intake locations. The intake is located upstream from the village to limit contamination of the river water by excreta.

Step 8: Location of treatment plant

Factors which influence the location of the treatment plant are:

- location of the water intake;
- availability of a suitable area;
- topography;
- soil properties;
- groundwater level;
- risk of flooding;
- location of water intake and length of distribution system.

The stability and bearing capacity of the soil determine the type of foundation, but piles and piers are to be avoided if possible. Simple soil investigation methods are given in Appendix IV.

A high water-table which is close to the soil surface means that drainage will be required during excavation and construction, and this adds to the complexity and cost of the project. Provisions must also be made to prevent the treated water becoming polluted by groundwater, and to prevent the construction being forced up by water pressure (see Chapter 7).

In the example being discussed, it is possible to find a suitable location for the treatment plant close to the water intake. This location has the added advantage that the caretaker can look after the treatment plant and water intake without travelling long distances between the two.

Step 9: Selection of mode of operation

Continuous operation for 24 hours per day is most appropriate for slow sand filters. The raw water should preferably be taken from a higher elevation and fed by gravity to the filters, even if the length of the raw-water main has to be increased, because the reliability of the plant is increased by eliminating the need for pumping. Although an entire gravity supply system is often not possible, a detailed survey to determine the potential of at least partial gravity flow is essential.

In the present example, the sedimentation pond is situated in such a way that gravity flow of river water to the pond is possible, although the water then has to be pumped to the filters because of an insufficient difference in levels. To permit continuous operation of the filters, it is decided that a raw-water storage tank should be constructed on a small elevation between the sedimentation pond and the filters. Water will be pumped from the sedimentation pond into the storage tank and will then be fed continuously to the filters by gravity.

Step 10: Dimensioning of the sedimentation pond

A large sedimentation pond is constructed by erecting a dam beside the river bank and the dimensions of such a storage basin can be determined on the basis of the design criteria described in Appendix II. A detention time of two months was chosen and a depth of 8 m selected so that assuming about 2 m of water is lost through the build-up of silt, an effective depth of 6 m remains, requiring an area of approximately 1150 m².

Step 11: Calculation of the raw-water pump capacity

Construction of an elevated raw-water storage tank increases the flexibility of the system, especially when considering the consequences of temporary power cuts, and reduces staff requirements. In addition, the provision of an elevated tank can be cost-effective when continuous pumping cannot be guaranteed, rather than increasing the area of the filter bed and applying declining rate filtration. The size of the tank is determined by the number of hours of operation and the capacity of the pumps. In this instance, it is assumed that the operator will work eight hours per day and operate the raw-water pumps in two shifts, from 6.0 a.m. to 10.0 a.m., and from 4.0 p.m. to 8.0 p.m. Local circumstances may dictate another pattern of attendance by the operator(s). The pumps are operated eight hours daily to pump the required 114 m³/d, and so need to have a capacity of $114/8 = 14.25$ m³/h (4 l/s).

Step 12: Dimensioning of the raw-water balancing tank

On the assumption that the elevated raw-water balancing tank is empty at 6.0 a.m., the variation in the quantity of water in the tank throughout the day is given in Figure 6.3. The balancing tank needs to have a capacity of 47.5 m³ and in order to cut costs, it is decided that a simple tank, 25 m² and 2.5 m deep, should be constructed from raised earthen embankments and lined with black polythene sheets.

Step 13: Selection of size of filters

In this example, a design filtration rate of 0.1 m/h is selected because the relatively high turbidity of the raw water would lead to rapid clogging of the filters at higher rates.

Because there is a continuous supply of raw water, the filter bed area can be calculated by dividing the average hourly water demand by the selected rate of filtration, that is, $4.75/0.1 = 47.5 \text{ m}^2$ (48 m^2).

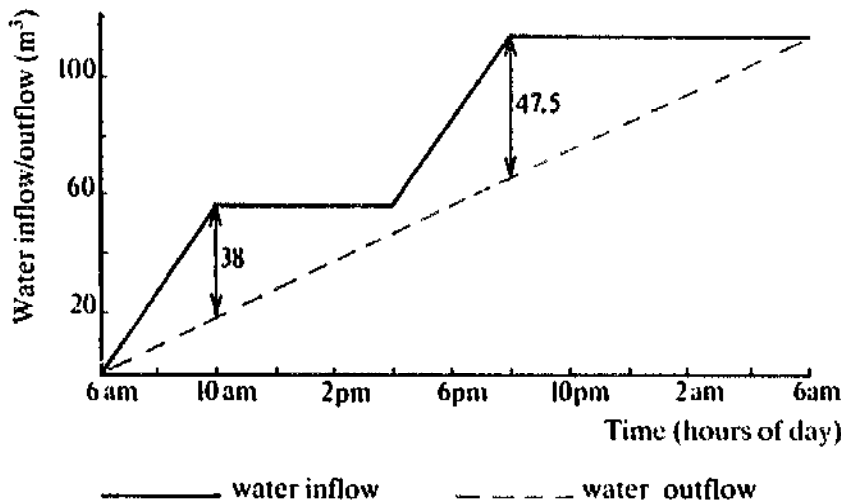

Figure 6.3: Accumulated water inflow and outflow in elevated raw-water balancing tank throughout a 24-hour period

The most appropriate size for a filter unit is determined by a combination of construction and operational factors. In this case, a satisfactory solution may be the use of two filters, each with a net area of 24 m^2 , although space should be reserved for a third unit to allow for possible expansion. During cleaning of one filter, the rate of filtration in the other would have to be increased to 0.2 m/h , but this will still give a good effluent quality.

Step 14: Dimensioning of the clear-water tank

Because the water can be supplied to consumers by gravity flow, the dimensions of the clear-water tank have to be determined using the daily pattern of water use and the water production by the filters. Assuming that the expected water use pattern is similar to that in the adjacent community (Figure 6.1), the accumulation curve of water demand and water production by the filter plant can be drawn as shown in Figure 6.4. The clear-water tank should provide a minimum storage capacity for the greatest difference between the accumulated water consumption and production

figures, which in this case is 39.25 m^3 . If data on the expected pattern of water consumption are not available, the volume of the storage tank for gravity supply may be assumed to be 40% of the daily water production of the plant.

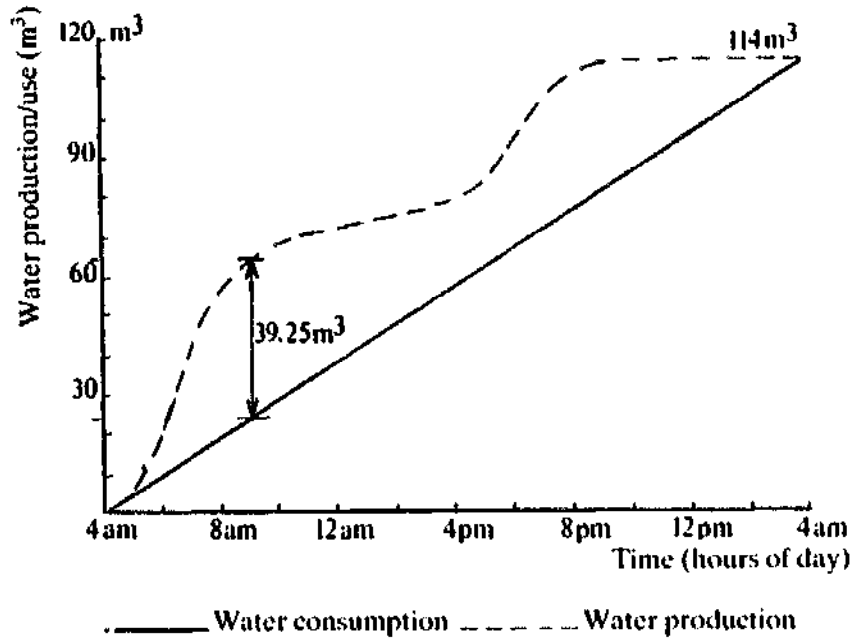

Figure 6.4: Accumulated water production and water use

Additional storage of 8.75 m^3 (two production hours) has been provided to cater for minor interruptions, by increasing the net storage capacity required to 48 m^3 . On the assumption that an acceptable variation in water level in the tank is 1.6 m , the net area will have to be 30 m^2 .

Step 15: Hydraulic design

The hydraulic design of the water supply system (raw-water pumps, clear-water distribution) depends on the head loss in the treatment units, piping arrangements,

and the topography of the area. Whenever possible, the system should be based on gravity supply as it is simpler, more reliable, and more cost-effective if pumps are not used. Even a partial gravity system, which may require a long pipeline, is preferable to a fully pumped system and, in fact, a cost comparison on the basis of capital and recurrent costs will usually favour a gravity supply. A pumped system has higher recurrent costs due to energy requirements and additional maintenance of the pumps.

Step 16: Design of the plant layout

The layout of the treatment plant is mainly determined by considerations for efficient operation and maintenance. An example of a layout is given in Figure 6.5, where an area is set aside for pre-treatment units, future extension, and basic services such as operators' workshop, storage and a site road.

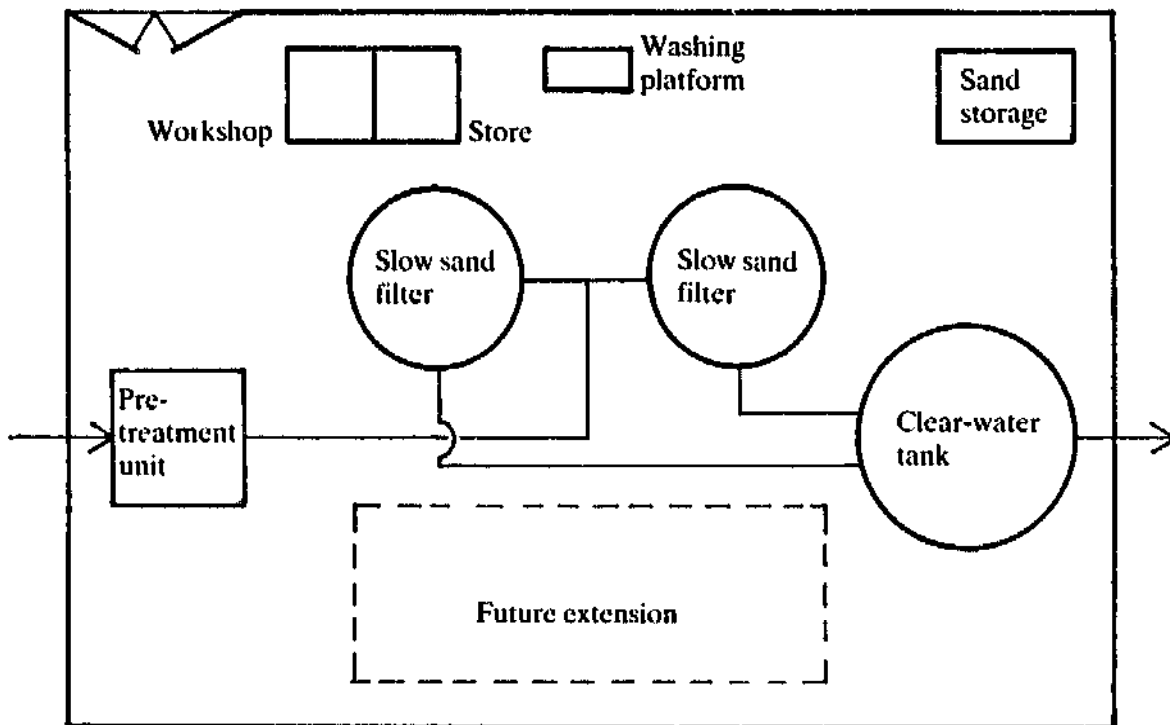

Figure 6.5: Possible layout of the water treatment plant

Step 17: Cost estimation

The estimation of costs for construction, operation, and maintenance of the system completes the preliminary design procedures, and can be calculated on the basis of average local cost figures for treatment plants and distribution systems. If these figures are not available, more detailed calculation based on the estimated quantity of building materials and labour levels for construction, operation and maintenance is required. The information generated can be used in discussions with the community, the appropriate authorities, and in fund raising.

6.3 SUMMARY OF DESIGN EXAMPLE

The example presented in this chapter can be summarized as follows:

Design period:	15years
Present population:	1200
Design population:	1900
Water demand:	50 l/p/d
Water losses:	20%
Design daily water demand:	114 m ³ /d (4.75 m ³ /h)
Design hourly demand:	22.3 m ³ /h
Raw-water intake:	river
Treatment:	sedimentation, slow sand filtration
Sedimentation pond:	
- size	1150 m ²
- depth of pond	8 m
Capacity of raw-water pumps:	4 l/s
Balancing tank for continuous operation of slow sand filtration:	
- size	25 m ²
- depth	2.5 m
Slow sand filter:	
- number	2
- size	24 m ²
- rate of filtration	0.1 m/h
Clear-water tank:	
- size	30 m ²
- depth	2.5 m

7. Structural Design and Design Considerations

This chapter deals with the structural design of slow sand filters and describes the design of the main components. Because the details of a design depend on local conditions, it is not possible to provide "standard" designs for the various components. Such designs could only be prepared if there is little variation in local conditions in a region or country, particularly with respect to the groundwater-table and the bearing capacity of the soil. Information on soil investigation is provided in Appendix IV to assist in making an appropriate design; general criteria for the design of pre-treatment units are given in Appendix II; and information on the design of chlorination equipment and adequate storage of chlorine components is given in Appendix III.

7.1 DESIGN OF FILTER BOX

Slow sand filters consist of either a stiff box made from reinforced concrete, mass concrete, masonry, brickwork or ferrocement, or an excavated structure with protected sloping walls. Filters with vertical walls may be circular or rectangular in shape, but those with protected sloping walls are usually rectangular (Figure 7.1).

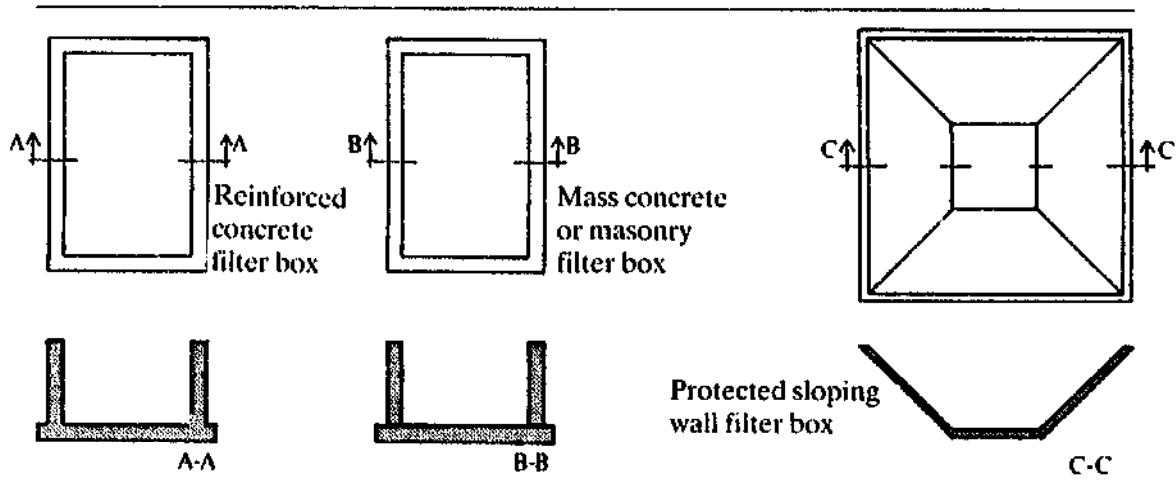

Figure 7.1: Structural design of filter box

Circular filters

Circular filters can be used to advantage in smaller plants, particularly in remote communities, and can be constructed of masonry (natural stone, quarry stones or bricks), ferrocement, or reinforced concrete. The latter material has the disadvantage of requiring complicated formwork. Circular filters have obvious structural advantages, such as uniform compressive or tensile stresses and limited bending moments in the wall, and these result in the economic use of materials (Figure 7.2).

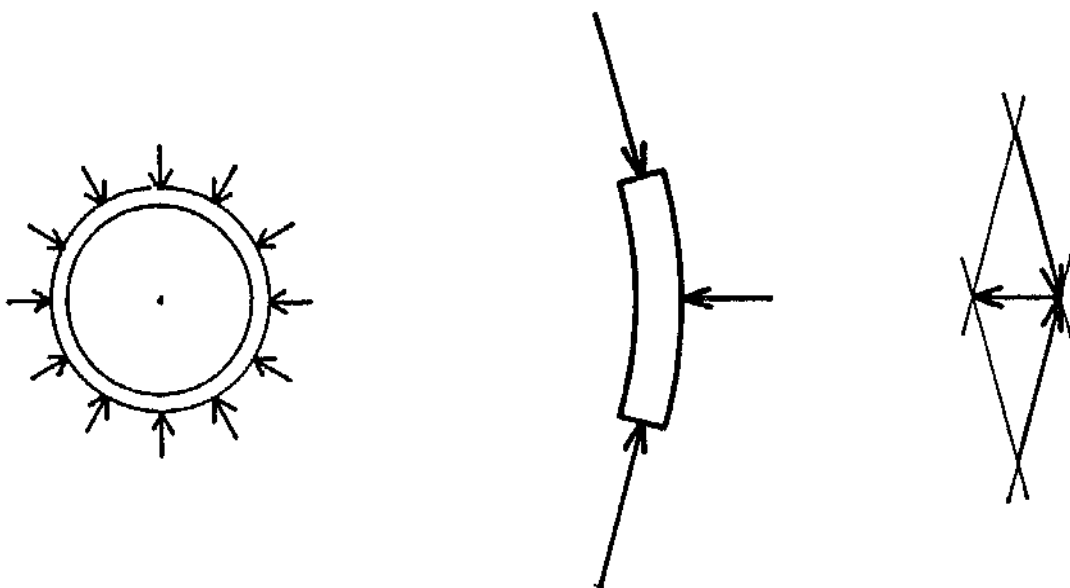

Figure 7.2: Principle of universal compressive and tensile stresses

In filters constructed largely below ground level, the resulting soil pressure produces compressive forces in the walls of the filter box. However, the pressure of sand and water in a filter box constructed above the ground will produce tensile forces in the filter walls and it is then preferable to use ferrocement, reinforced concrete, or a combination of masonry and ferrocement (Figure 7.3).

Circular filters made from ferrocement can be built above and below ground level, depending on the groundwater-level. Tanks of about 5 m diameter are common, but tanks of 10 m diameter have also been built.

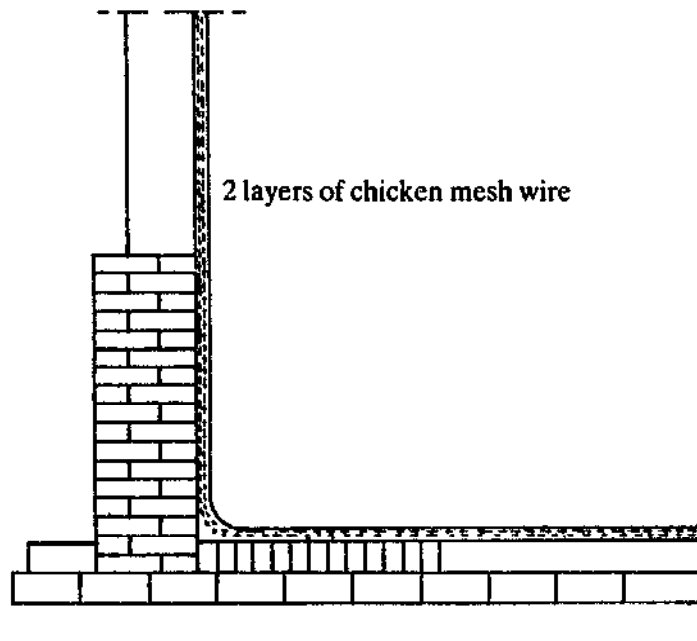

Figure 7.3: Cross-section of filter wall constructed of masonry and ferrocement

The tensile stresses in ferrocement are evenly distributed by a network of closely laid (10-15 cm) steel bars, of 4-5 mm diameter, and a layer of chicken wire on either side of the network (Figure 7.4). Thin membrane-like walls of 5-8 cm are sufficient.

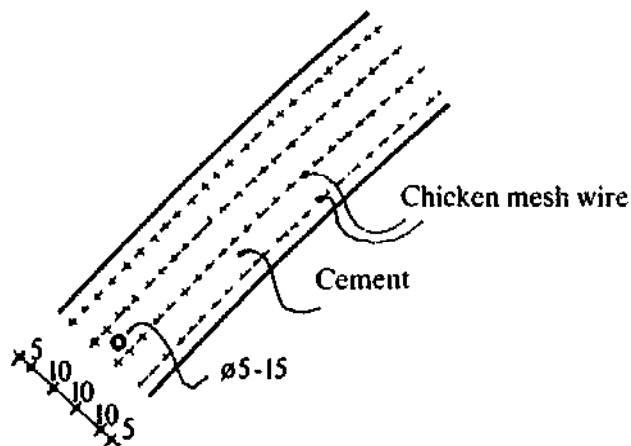

Figure 7.4: Cross-section of the wall of a ferrocement tank

especially if only tensile stresses are present, as in circular filter boxes. For calculation of ferrocement dimensions, see publications by Watt, Sharma, et al (1980), and those published by the International Ferrocement Information Centre (Appendix VII).

Although the construction of ferrocement tanks is new in many places, local artisans can learn the trade quickly. Furthermore, construction is quicker and the cost is appreciably lower than for certain other materials. For example, the construction cost of a ferrocement tank in Nepal was only 30-50% of that for a stone masonry tank. A team of one supervisor, two experienced masons/pipe fitters, and 5-10 semi-skilled labourers, can complete two tanks with a diameter of 4 m within four weeks. Thus, ferrocement work carried out by a small team of artisans may be quite efficient if adequate training is provided, particularly in curing the ferrocement.

A combination of brick masonry and ferrocement (Figure 7.3) is also worth considering. The brick wall is constructed first, serving as formwork for the thin layer of ferrocement, and construction is therefore quick. An additional advantage is that the ferrocement is protected by the brickwork.

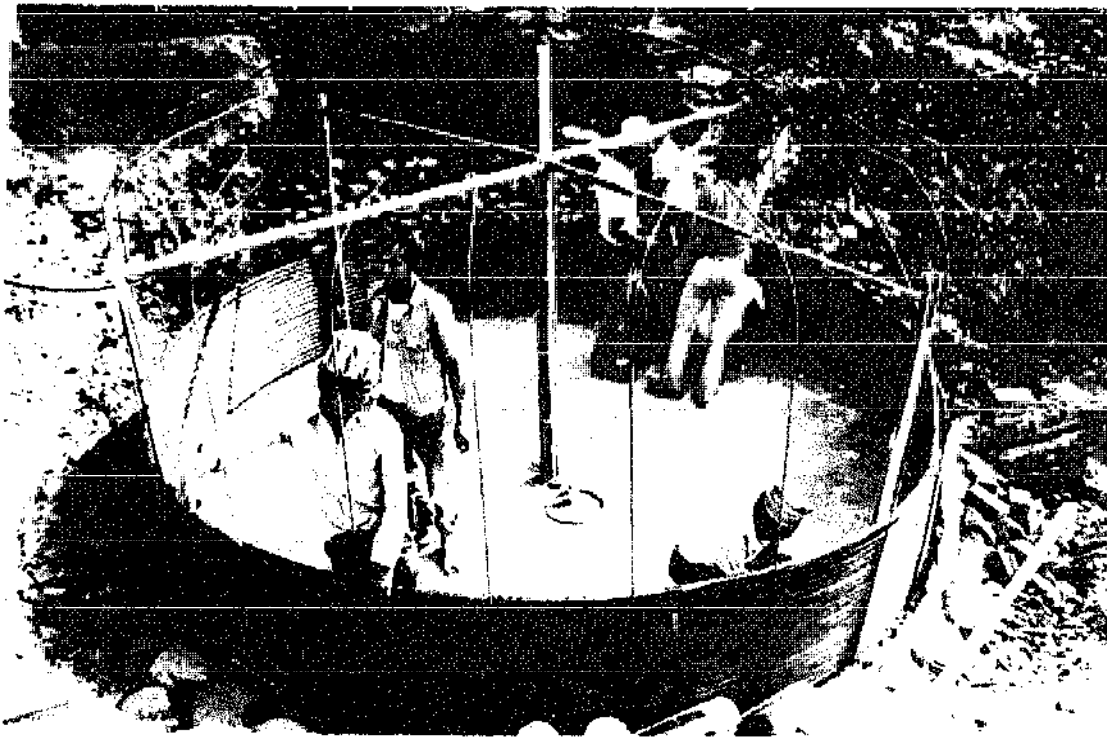

Figure 7.5: Construction of ferrocement tank using plastic pipe as the inside mould, Nepal, 1986 (photo Heynen)

Rectangular filters

Provided the necessary skills are available, rectangular filters are usually constructed of reinforced concrete, but smaller units may also be built in mass concrete or masonry. The amount of reinforcement depends on the dimensions of the filter box and the depth of the foundation. A pressure diagram for rectangular filters constructed above ground level is presented in Figure 7.6.

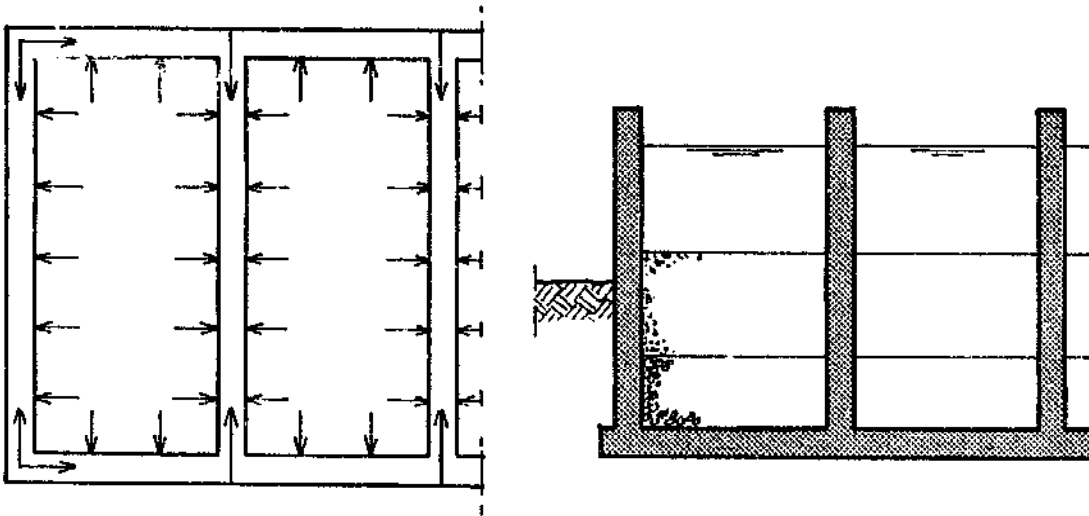

Figure 7.6: Pressure diagram for rectangular filters

The piping and valves in rectangular filters are easily accessible and future extensions can be incorporated easily. Both small and large boxes can be used, because experiments have shown that the quality of effluent from smaller units is equally good, provided short circuiting along the inside of the walls is prevented. This can be achieved by roughening the surface of the wall at the height of the sand bed, for example, by painting the walls with cement milk and covering it with a film of coarse sand.

Smaller units have the advantage of ensuring watertight construction, which is important where the filter box is mainly below ground level. Also, shrinkage of concrete and masonry, differential settlements, and temperature stresses which depend on the span of the walls, are less in smaller units. Other factors which may reduce shrinkage are a low water-cement ratio, and improvement of the compaction of the concrete mixture.

Foundation

The filter box may be constructed above, or partly below, ground level. The minimum depth of the foundation must be 0.3 m in areas where sub-zero temperatures do not occur, but when constructed below ground level, the wall should extend at least 0.5 m above the ground to prevent dust, animals, and even children entering the filter. A filter box placed largely below ground level has structural advantages because the load on the walls is smaller, due to the outside soil pressure compensating for the inside water pressure (Figure 7.7). However, the outside soil pressure should only be partly taken into account in calculations if sufficient compaction of the soil cannot be guaranteed after construction of the box. It should also be considered if adequate supervision of possible repairs, for example, of pipes and valves, cannot be guaranteed, because excavation of soil next to the box without draining the filter may result in serious cracks in the wall. The available head of the raw water may affect the possible excavated depth at which the filter box will be placed, but gravity flow through the entire treatment plant is generally preferable.

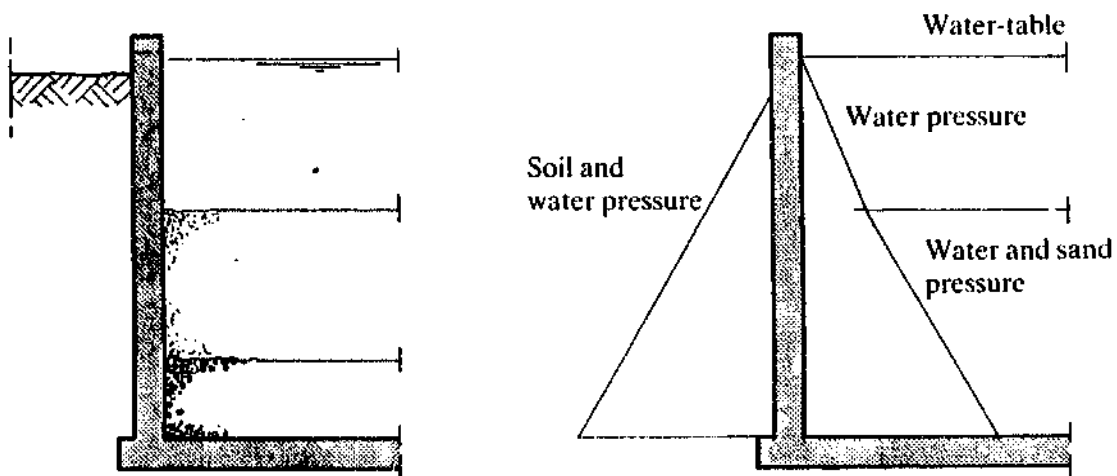

Figure 7.7: Pressure diagram for a wall of the filter box

Groundwater-table

In areas where the groundwater-table is high, the filter needs to be located above ground level, or watertightness of the filter box must be guaranteed to prevent re-contamination of the filtered water. Filter boxes made of reinforced concrete or ferrocement will generally be watertight, whereas those of either mass concrete or masonry are less suitable and require additional protection and careful design to guarantee watertightness.

Filter boxes constructed below ground level may be forced up by water pressure, as shown in the following example using the filter box indicated in Figure 7.8 and a groundwater-table 0.1 m below ground level. Assuming that the specific weight of concrete is 24 kN/m^3 , the total weight of the empty filter box can be calculated as follows:

$$\text{weight of walls} \quad 14 \times 0.2 \times 2.75 \times 24 = 184.8 \text{ kN}$$

$$\text{weight of floor} \quad 0.25 \times 3 \times 4 \times 24 = \underline{72.0 \text{ kN}}$$

$$\text{total weight of empty filter box} \quad 256.8 \text{ kN}$$

$$\text{outside water pressure (waterhead} \times \text{length} \times \text{width} \times \text{gravity)} = \\ 2.40 \times 3 \times 4 \times 9.8 = 292 \text{ kN.}$$

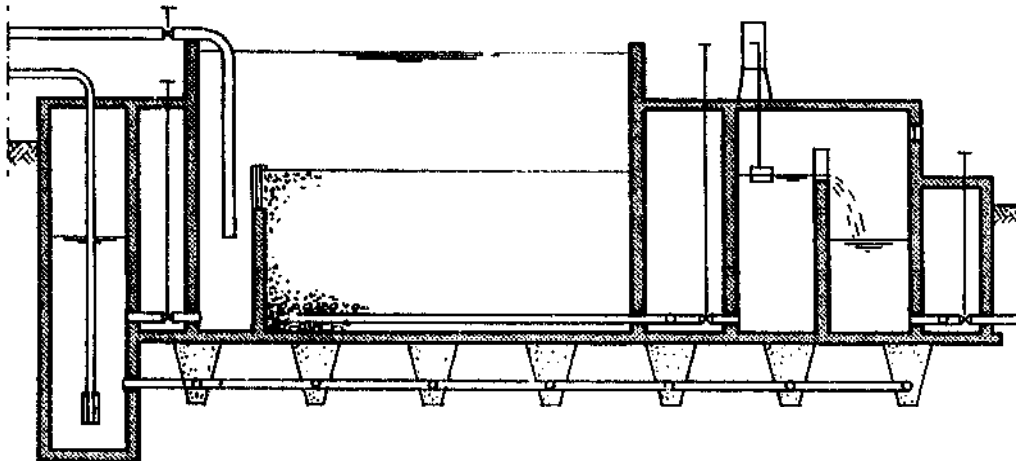

Figure 7.8: Drainage system underneath filter box

It can be seen from the calculation that the empty filter box will be forced up by the water pressure. However, under normal conditions, the box will remain once the gravel is in place as this adds about 187.8 kN ($0.4 \times 3 \times 4 \times 16$) to the weight of the construction. Thus, when the gravel is placed in the box, the filter box indicated in Figure 7.8 will not be forced up by the water pressure. Drainage therefore has to be provided during construction to lower the groundwater-table until the gravel is added, and this can be done by constructing a drainage system underneath the filters and the clear-water well. The groundwater-table can then be lowered by pumping during construction and repair work (Figure 7.8), but as this is obviously cumbersome, filter boxes are preferably constructed above the groundwater-table.

Wall and floor construction

If the filter walls are constructed of reinforced concrete, the floor must also be of reinforced concrete. The joints between floor and wall can be stiffened by extending the floor reinforcement into the lower part of the wall. This joint also needs to be stiff if the walls are constructed in ferrocement (Figure 7.9), but not if they are of mass concrete or masonry. These walls are placed on top of the floor after a layer of bitumen has been laid at the joint (Figure 7.10). Larger boxes with

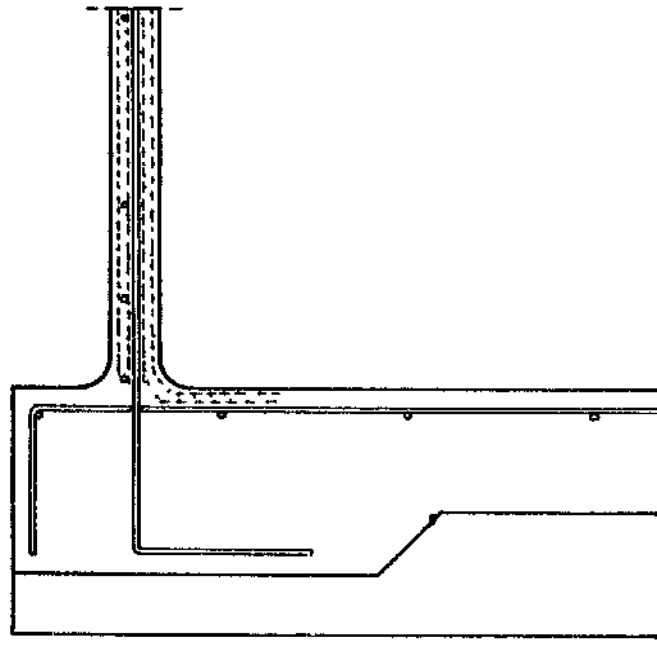

Figure 7.9: Wall-floor connection in ferrocement and reinforced concrete

mass concrete or masonry walls in particular will need a floor of reinforced concrete to ensure equal settlement. Small boxes, up to 5 m long and on solid ground, may have a floor of brickwork as well. If a layer of ferrocement is placed inside the box, larger boxes can also be completely constructed in brickwork.

Unequal loading of non-reinforced floors will result in the development of cracks. Minimum reinforcement can be provided which is sufficient to prevent the development of cracks, for example, by placing steel bars of 6 mm diameter at 150 mm intervals in both directions, and at both the top and bottom of the floor.

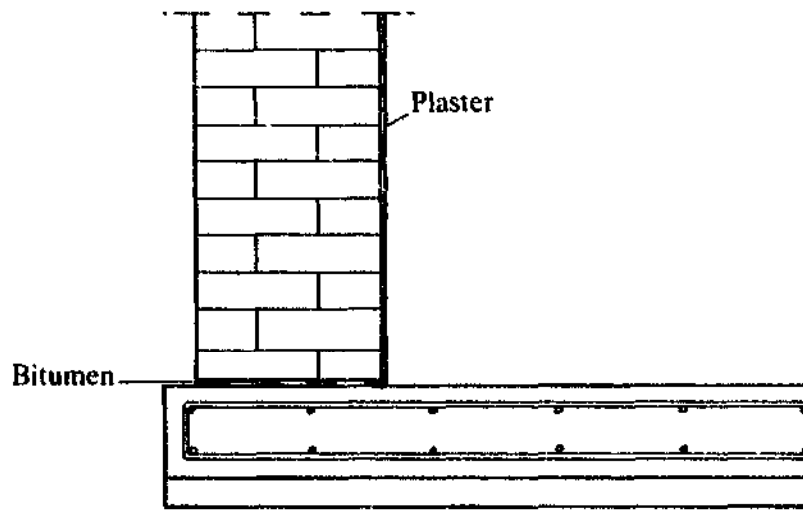

Figure 7.10: Wall-floor connection in masonry and reinforced concrete

Reinforcement of the wall and floor

The wall thickness and the required reinforcement of walls and floor depends on many factors, such as the dimensions and shape of the filter box, the bearing capability of the soil, and the load on the walls. Calculations for each possible situation are beyond the scope of this publication.

The quality of concrete and steel available in rural areas of developing countries may not be high and it is therefore advisable to use rather low values for the cube strength of concrete and the tensile strength of the steel, for example, 17.5 N/mm^2

and 220 N/mm^2 respectively. Placing a concrete cover measuring 25 mm over the reinforcement bars is advisable in rural areas. The minimum amount of reinforcement can be determined on the basis of a critical loading case, which is the situation leading to maximum bending moments, or maximum forces, and a maximum acceptable crack width of, for instance, 0.12 mm.

In addition to this minimal amount, further reinforcement may be required to reduce shrinkage. Walls and floor are generally cast separately, and shrinkage in the floor is therefore already in progress when the wall is poured. This will result in tensile stresses on the horizontal reinforcement which may then have to be stronger. The quantity of additional reinforcement will depend on the characteristic strength of the concrete and the reinforcement, and on the wall thickness. The reinforcement design should provide the best combination of the mechanical properties of both steel and concrete (see Figure 7.11).

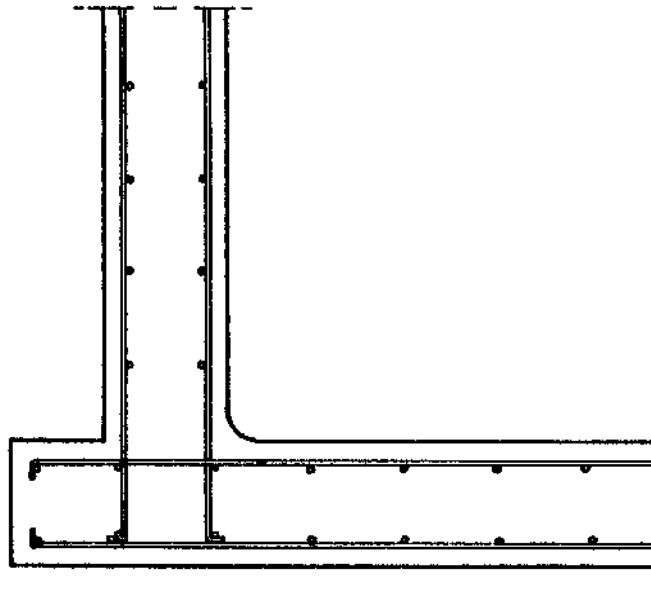

Figure 7.11: Example of a reinforcement design for a wall-floor connection

Protected sloping wall filters

A sloping wall filter is usually partly, or fully, excavated in the subsoil, the stability of which determines the slope of the walls, although a 1:2 slope is generally

satisfactory. Suitable materials for lining the walls are masonry, concrete tiles, or ferrocement (Figure 7.12). Ferrocement seems a very promising choice, but its low impact-resistance is a slight disadvantage and special constructions are required to make the filters accessible. The construction costs of sloping wall filters are relatively low, and unskilled labourers can be used.

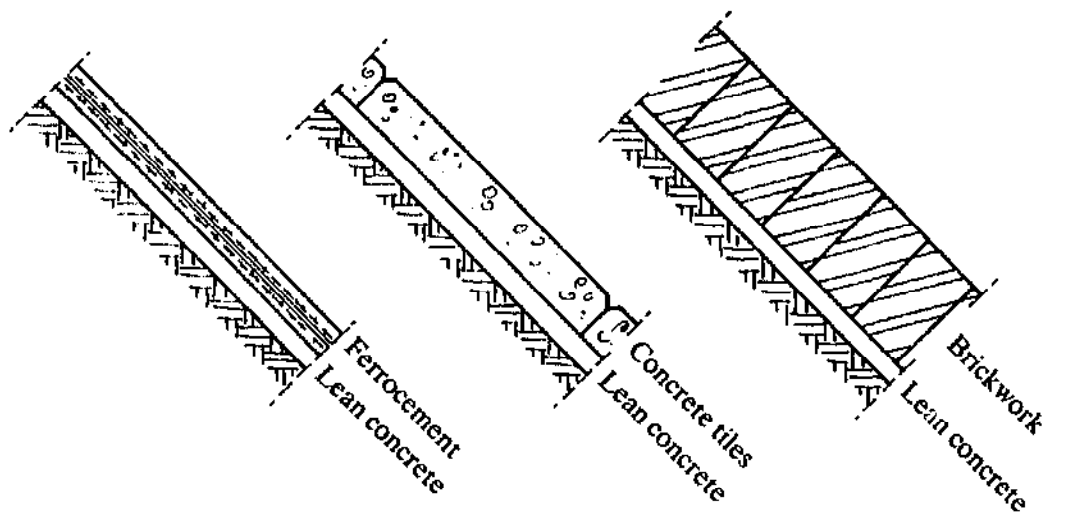

Figure 7.12: Various linings for sloping wall filters

Disadvantages of protected sloping wall filters include the following points:

- More land is required than for structures with vertical walls (the design area is the net filter bed area at the minimum filter bed depth).
- Piping and filter control facilities are less accessible.
- Watertightness of the construction is difficult to guarantee. Where the groundwater-table is low, this may not be important except for losses, but re-contamination of the filtered water may occur with a high groundwater-table.
- Fouling of the sloping walls may occur due to the growth of reeds and other vegetation.

A sloping wall filter may also be constructed in earthwork above ground level. This reduces the disadvantages, but also results in higher pressure in the upper layer of the soil, which may cause settlement and fissures. Various types of filter box constructions are summarized in Table 7.1.

Table 7.1: Applicability of various types of constructions for slow sand filters

Type of construction	Size range per unit (m ²)*	Thickness of lining or wall(m)	Comment
Protected sloping well	- rectangular 40-400	0.04-0.10	- Low cost - Minimum of skilled labour required for construction
Mass concrete or masonry	- circular or square 2-300	0.20-0.30	- Particularly suitable for small filters in low groundwater-table situations
Ferrocement	- circular 2-120	0.05-0.08	- Possible deformation of filter walls - Construction and curing of ferrocement require due attention
Reinforced concrete	- rectangular 4-400 - circular 4-400	0.20-0.25 0.15-0.20	- Skilled labour required for formwork and reinforcement

* For rural areas, the size per unit is best limited to a maximum of 200 m².

7.2 INLET STRUCTURE

The main functions of the inlet structure are as follows:

- It should reduce the energy of the incoming water to prevent the filter skin being damaged. This means that the inlet must be located immediately above the sand bed and the entrance velocity should be low, for example, about 0.1 m/s. As a rule of thumb, the length of the wooden or concrete planks in the inlet structure should be as wide in metres as the design flow (m³/h) divided by 20, with a minimum of 0.4 m and a maximum of 1 m (Figure 7.13). In this way, the height of the overflowing water will only be a few centimetres when the filter has just been started up, and thus a gentle flow is obtained.

STRUCTURAL DESIGN CONSIDERATIONS

- It should provide a means of adjusting the supernatant water level. This can be done by a float-controlled butterfly valve, a manually operated gate valve, or an adjustable overflow weir in the inlet channel or pipe. The diameter of the inlet pipe should be such, that the velocity of the water in the pipe is 0.3-0.5 m/s when the filters are operated at the designed rate of filtration.
- It should provide a means of shutting down the flow of raw water, generally by means of a hand-operated gate valve.
- In an inlet controlled filter, it should also provide the means to measure and control the flow through the filter bed.

Usually, the inlet structure is a box with an outlet pipe to drain the supernatant water quickly when the filter needs to be cleaned. Draining this water through the filter bed would take a considerable period of time because of the comparatively high resistance of the filter skin immediately before cleaning. Removable wooden planks measuring 0.05×0.10 m enable adjustment of the inlet structure when the level of the filter bed is reduced as a result of subsequent scrapings.

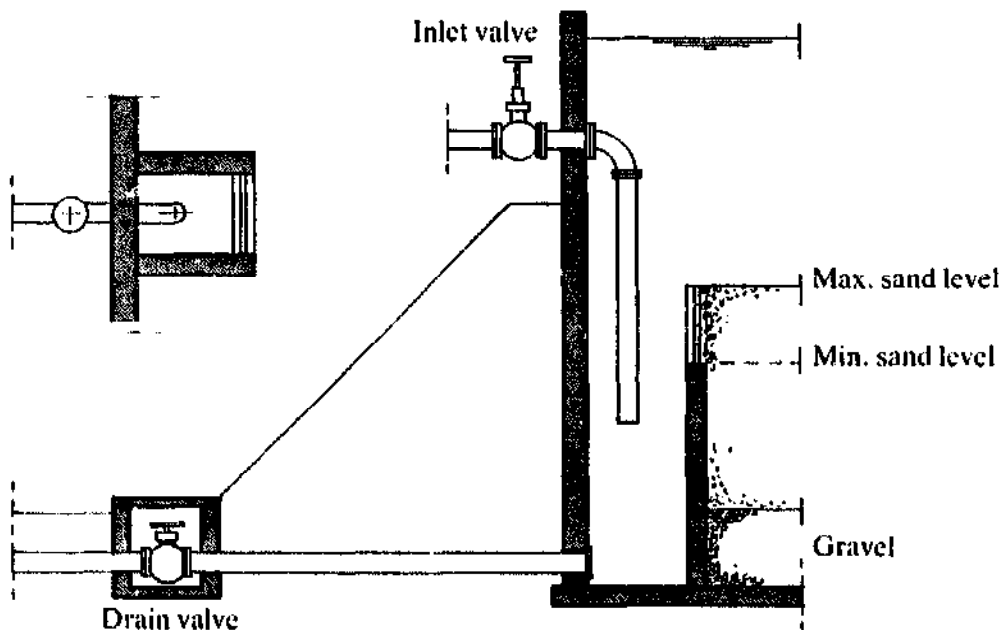

Figure 7.13: Inlet structure

7.3 OUTLET STRUCTURE

The main functions of the outlet structure are as follows:

- It should prevent the development of below-atmospheric pressure in the filter bed. Therefore, a simple overflow weir is often provided, with its crest slightly above the top of the sand bed.
- It should provide a means of draining the filter. A separate drain pipe is often included in the outlet structure to pass the water to waste.
- It should provide a means of refilling the filter with clean water after it has been scraped. This may be done through the system of underdrains.
- In an outlet controlled filter, it should be possible to measure the flow through the filter bed. The overflow weir, mentioned above, may also be used for this purpose by means of a calibrated flow indicator, combined with a V-notch weir. The relationship between the flow and height of water in a V-notch weir is explained in Appendix V.

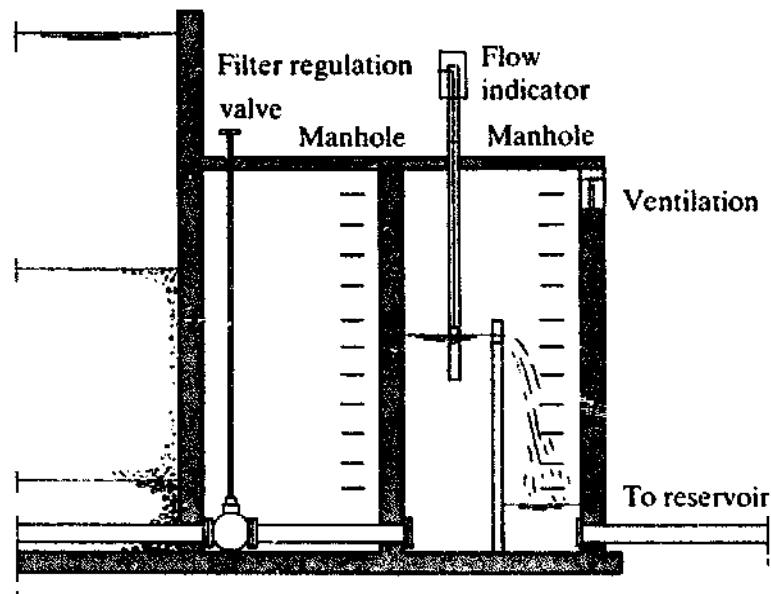

Figure 7.14: Outlet box of an outlet controlled filter

- ° In outlet controlled filters, it should provide a means of adjusting the filtration rate by shutting down the filter. The simplest method is manual adjustment of a valve or tap.

A suitable design for the filter outlet of an outlet controlled filter is presented in Figure 7.14. Installation of an overflow weir in the outlet box has the advantage that the filtered water is aerated, provided the box is adequately ventilated. The manhole is included to enable cleaning of the box and calibration of the flow indicator.

7.4 SYSTEM OF UNDERDRAINS

The system of underdrains has a two-fold function:

- to support the filter medium and prevent it being carried into the drainage system;
- to ensure uniform withdrawal of water over the entire filter area.

The drainage system should be carefully designed and constructed because it cannot be inspected, cleaned, or repaired without the complete removal of the filter bed material. Several types of underdrains can be used in slow sand filters and Figure 7.15 shows the more commonly used systems.

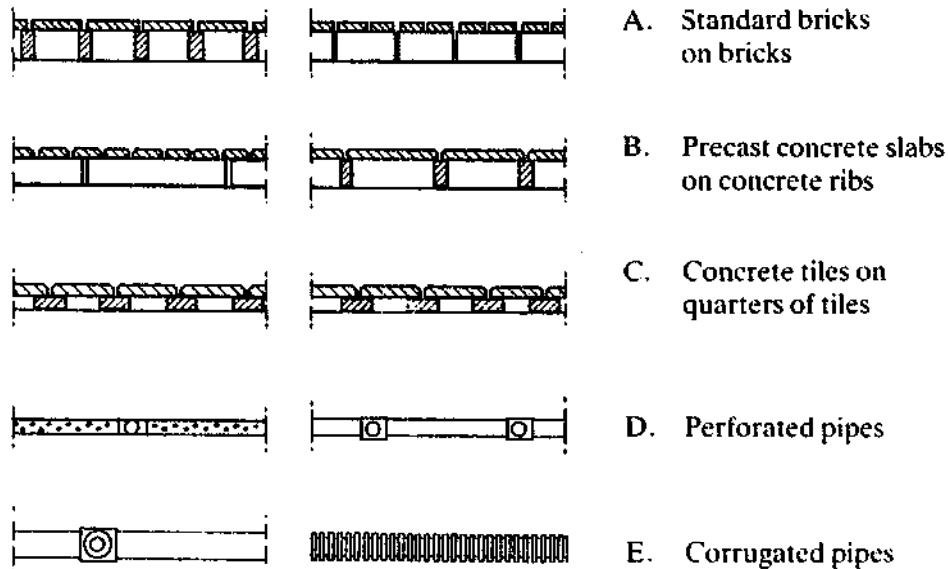

Figure 7.15: Common systems of underdrains for slow sand filters

To prevent loss of filter medium through the openings in the underdrain system, graded layers of gravel are placed between the filter sand and the underdrain system. Generally, three layers of gravel with grain sizes of 1.0-1.4 mm, 4.0-6.0 mm, and 16.0-23.0 mm respectively are used in conventional systems. Each of these layers should be about 100-150 mm thick (Figure 7.16). Recently, corrugated pipes have been introduced for slow sand filter underdrain systems, and often, these are only covered with one 100 mm thick layer of fine gravel.

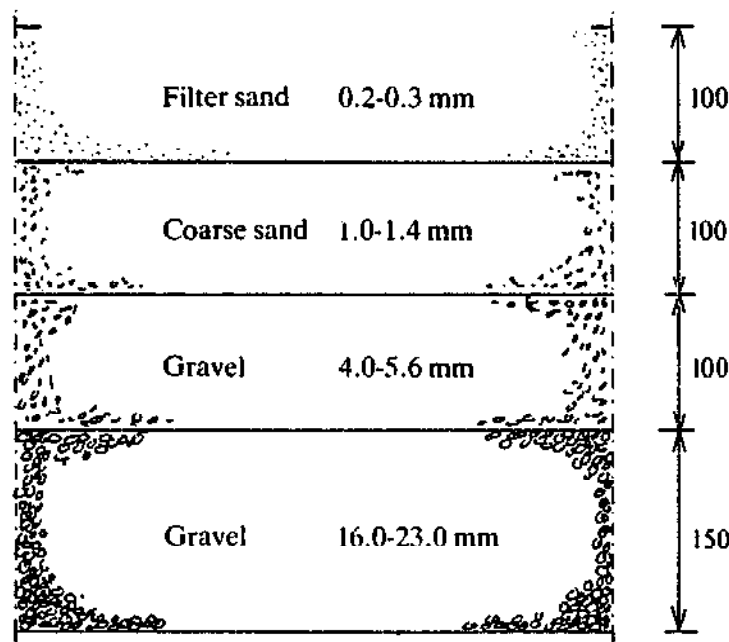

Figure 7.16: Filter medium support

Systems made from prefabricated concrete slabs, burned bricks or concrete tiles, have one feature in common, that is, water flows freely out of the sand bed over a relatively large area. These systems can therefore be relied upon without calculation of the hydraulic characteristics, whereas systems using perforated pipes must be designed more carefully (see Table 7.2).

Table 7.2: Criteria for dimensioning of underdrain system using perforated pipes

Dimensioning criteria	Values
Maximum velocity in manifold	0.5 m/s
Maximum velocity in laterals	0.5 m/s
Spacing of laterals	1-2 m
Size of holes in laterals	2-4 mm
Spacing of holes in laterals	0.1-0.3 m

For small filters of less than 20 m², a 15 cm layer of broken stones, measuring about 25-50 mm in size, can also be used as an underdrain system in combination with a filter support of gravel. An innovative underdrain system is being field tested in Colombia (Figure 7.17), where corrugated PVC pipes of 6 cm diameter are placed one metre apart, and covered with a 0.1 m layer of fine gravel. This development is interesting because it reduces the need for graded gravel, and also lessens the total height of the underdrain system compared to traditional systems so that the total height of the filter box is lower. Some pilot tests are also being carried out with corrugated pipes wrapped in a woven nylon or plastic fabric. This method might eliminate the need for gravel, provided the pipes are placed at a closer distance, for instance 0.6-0.7 m, and the fabric proves to be resistant to micro-biological clogging.

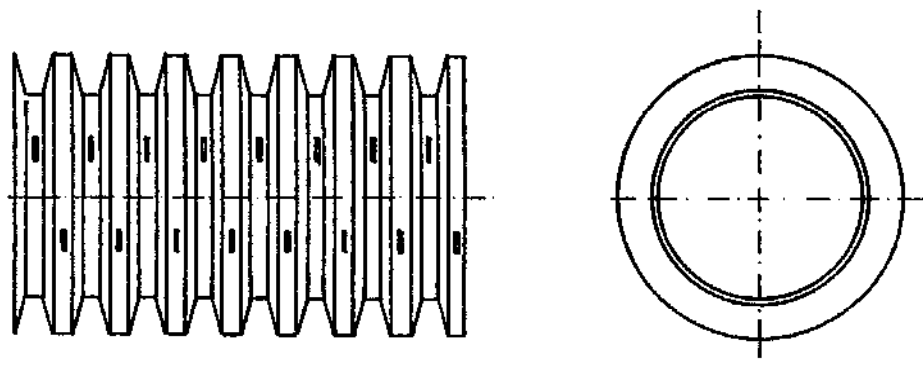

Figure 7.17: Underdrain system made of corrugated PVC pipe

7.5 FILTER CONTROL ARRANGEMENTS

The water flow in the filter and the treatment plant needs to be controlled, and this is done by regulatory valves placed at certain points, which can interrupt the water flow if required. These valves can be sited with the aid of a flow sheet, which is the diagram indicating the flow of water through the treatment plant. An example flow sheet is presented in Figure 7.18.

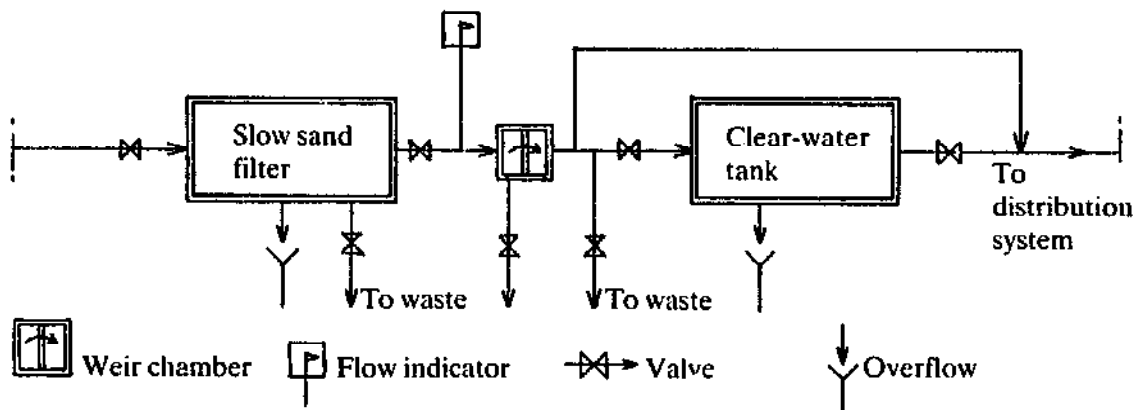

Figure 7.18: Flow sheet for slow sand filtration installation (gravity flow)

The simplest control device in a pipeline is a gate valve, or sluice valve (Figure 7.19), but this is not as accurate as other types of valves because the flow begins to decrease considerably only when the valve is closed more than 90%. Despite this, gate valves will be the most appropriate solution for rural areas in developing countries because of their simplicity. They are available in a size range of 5-35 cm diameter and simple versions can also be used in open conduits (Figure 7.20). Gate valves which are left shut for a long time tend to stick and will not open easily, and similarly, valves which have been left open for a long time may not close properly. Therefore, regular operation of the gate valves is required.

A more accurate flow control device in a pipeline is a butterfly valve because it is quick acting and allows better control of the flow rate. The minimum size of a butterfly valve is two inches.

Globe valves have a greater head loss than gate or butterfly valves, but are cheaper and have very good flow control. Sizes of up to two inches are quite suitable for rural water supply.

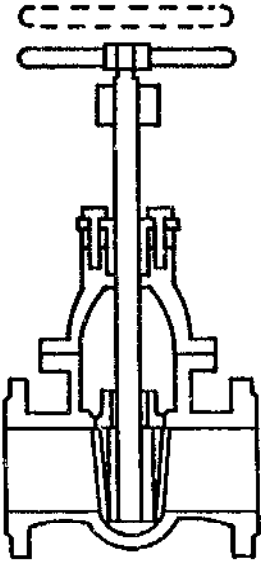

Figure 7.19: Gate valve for pipelines



Figure 7.20: Gate valve in open conduit

Hydraulic profile

An example of a hydraulic gradient line, that is, the line which indicates the head loss over the components of the plant, is set out in Figure 7.21. During operation, the head loss over the entire plant is kept constant by adjusting the control valves.

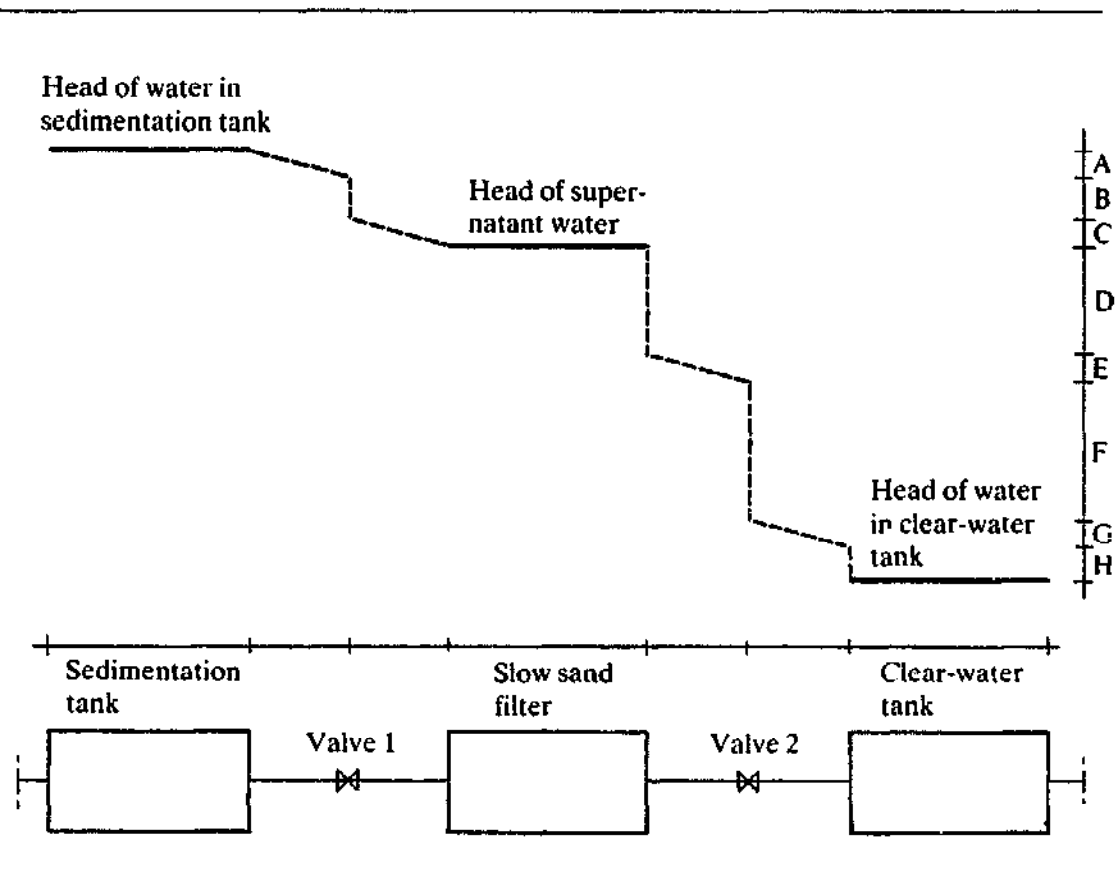

Figure 7.21: Hydraulic gradient line in a slow sand filtration plant (gravity flow)

- A = head loss in pipe between sedimentation tank and valve 1
- B = head loss over valve 1
- C = head loss in pipe between valve 1 and slow sand filter
- D = head loss over slow sand filter (increases during filter run)
- E = head loss in pipe between slow sand filter and valve 2
- F = head loss over filter-regulating valve 2 (decreases during filter run)
- G = head loss in pipe between valve 2 and clear-water tank
- H = head loss over effluent weir

7.6 PIPING AND PUMPING

In water supply engineering, it is good practice to “over-design” the major hydraulic elements of a treatment plant to at least 1.5 times the required capacity. This ensures that the treatment works can be extended without replacing pipes, valves and other appurtenances. Gate valves and filter control valves should be arranged in such a way that extensions can be connected and furthermore, vulnerable mechanical parts must be easily accessible for control and repair. The influent and drain-pipes should be quite separate from clear-water pipes.

Centrifugal pumps are used in many water treatment plants. When designing the pipelines and pumps, it is necessary to know the required flow, the head loss in the pipeline and the treatment units, and the required pressure head. The head loss in pipelines can be easily derived from graphs available for most pipe materials, and an example graph, for PVC pipes, is shown in Figure 7.22.

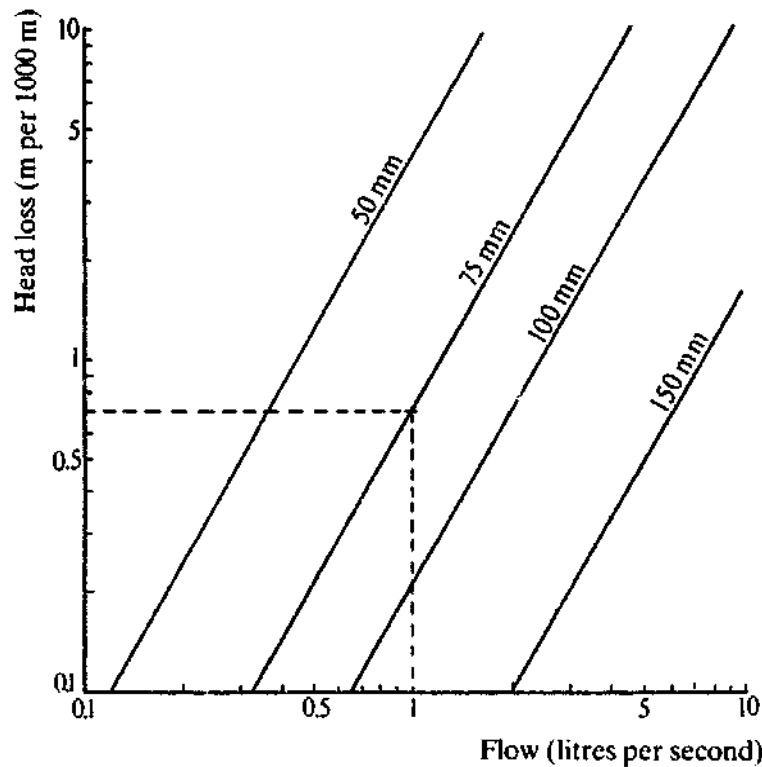

Figure 7.22: Head losses through friction in PVC pipes

From Figure 7.22, it can be seen that a flow of 1 l/s (3.6 m³/h) will cause a head loss of 0.7 m water column per 1000 m PVC pipe, for a pipeline of 75 mm diameter. Pipe fittings and bends will add further to this head loss. The head loss in the slow sand filters amounts to 1 m water column and in pre-sedimentation tanks, between 0.05 and 0.10 m water column.

7.7 CONSTRUCTION OF THE CLEAR-WATER TANK

The clear-water storage tank does not necessarily have to be located at the treatment plant. Location in the village in fact has the advantage of a more constant flow in the transport pipe between the treatment plant and village. Also, two or three smaller tanks can be built, with a total net volume that is equal to the calculated required storage volume. This may reduce the cost of transport pipes as smaller diameters can be used, and may increase the reliability of the water supply system because when one tank is out of order, the others can still supply water.

The foundation for the clear-water tanks will generally be deep, because the loss of head through the filter is 1 m (Figure 7.21), and some variation in the water level in the tank must be permitted to balance production and demand.

In small installations, the cover of the clear-water tank can be a simple structure of ferrocement or wood. For larger tanks, a cover of reinforced concrete or ferrocement is advisable. When the clear-water tank is covered with a reinforced concrete slab, the structural design differs from that of slow sand filters because side pressures are also transmitted to the cover. If the joints between cover and walls are strengthened with extended reinforcement bars, the strength of the structure increases, and it may therefore be possible to reduce the thickness of the walls. When calculating the dimensions of the floor and wall of the tank, the combination of an empty tank and a high groundwater-table are critical. Careful consideration should be given to whether the total weight of the construction should be increased, to prevent it being forced up by the water pressure.

The clear-water tank must be provided with ventilation pipes, a drain-pipe, an overflow, and a manhole for inspection. If the tank also serves as a chlorine contact chamber, then the clear-water outlet pipe should be located at such a height above floor level, that the minimum detention time is 30 minutes.

8. *Design Examples of Slow Sand Filters*

Five designs for slow sand filters of varying capacities and constructed in different materials are presented as examples (Figures 8.1 – 8.5). They are based on specific conditions and may not be suitable under other circumstances. When necessary, important local conditions are indicated, such as the height of the groundwater-table.

The first design is in brick masonry, because of the low water-table. Even if cracks should develop, they will only result in water losses but will not lead to a deterioration of the effluent by inflow of groundwater. An alternative is to build this filter in masonry and ferrocement, as shown in Figure 7.3. The circular masonry wall serves as an outside mould for the ferrocement and will take up pressure forces.

Thorough investigations of site conditions have taken place in the second design, which is a protected sloping wall filter with a ferrocement lining. Part of the soil has been excavated and used for the bunds. A 40° inclination of the slope could be selected because the bunds are made of clay.

The third design is in ferrocement, where the filters are placed above ground level because of the high groundwater-table. The clear-water well has a small storage capacity because another storage tank has been constructed in the supply area.

The fourth and largest design example is in reinforced concrete and consists of four units. This allows for flexible operation, with only a 30% increase in filtration rate required when one filter unit is out of operation. Provisions for chlorination of the effluent are included for this larger plant, which may provide water to a community of 5000-20 000 people. Allowances are therefore not made for discharging initially filtered water to waste.

The last design is a small concrete filter which differs widely from the others because it is an inlet controlled filter.

Provisions for pre-treatment of the raw water have not been included in any of the designs, which are therefore only applicable for relatively clear surface water, with an average turbidity level of less than 20 NTU. If turbidity of the raw water is higher, a pre-treatment unit must be incorporated, however. All designs allow for back-filling the filter units after cleaning, or re-sanding directly with the outflow from another unit. Initial filling through the underdrains may be achieved by making a temporary connection between the raw-water inlet and the outlet box. In each of the examples, an estimate of the building materials required for construction of the slow sand filter units is also provided. This estimate does not include construction materials for the clear-water well or other units.

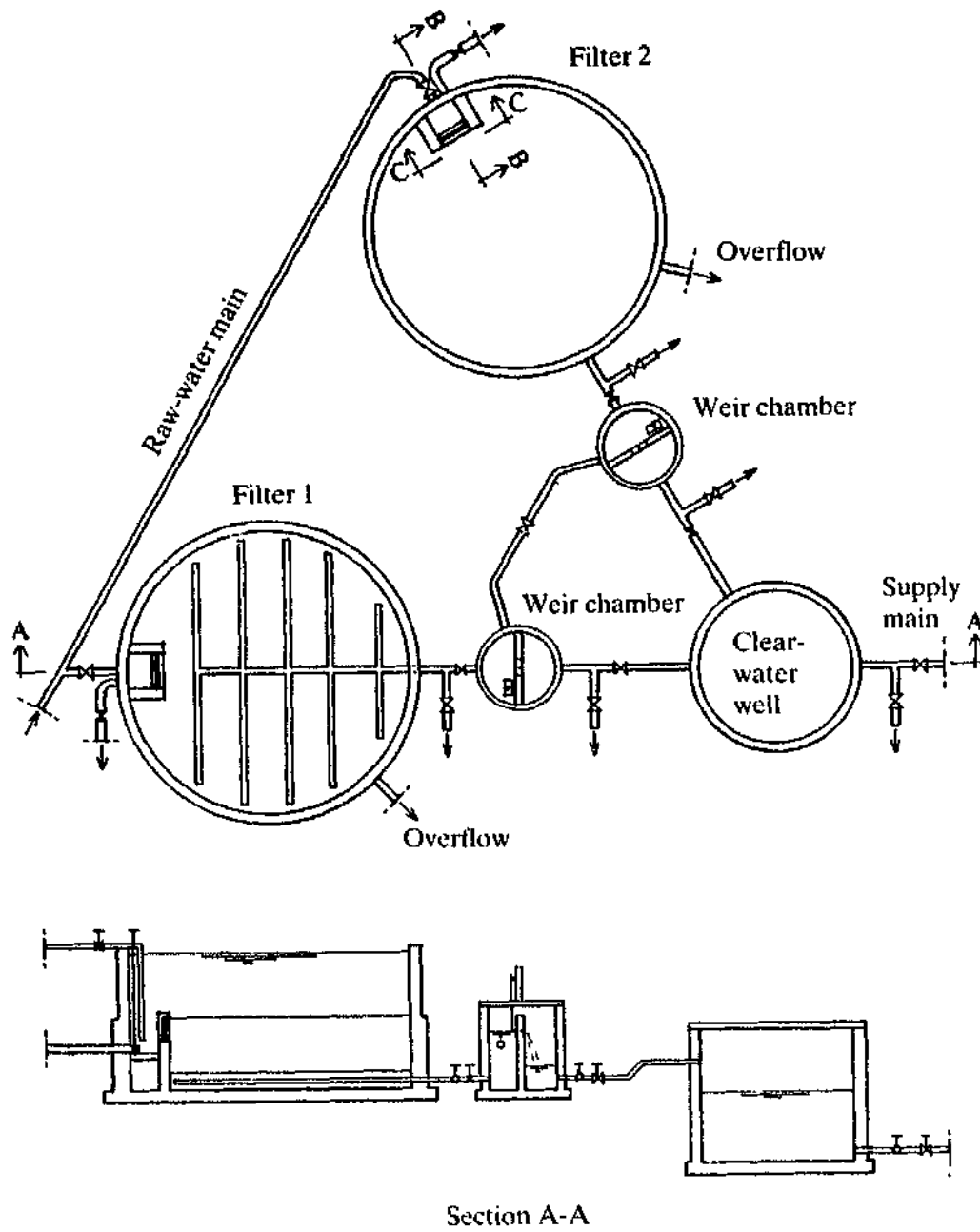
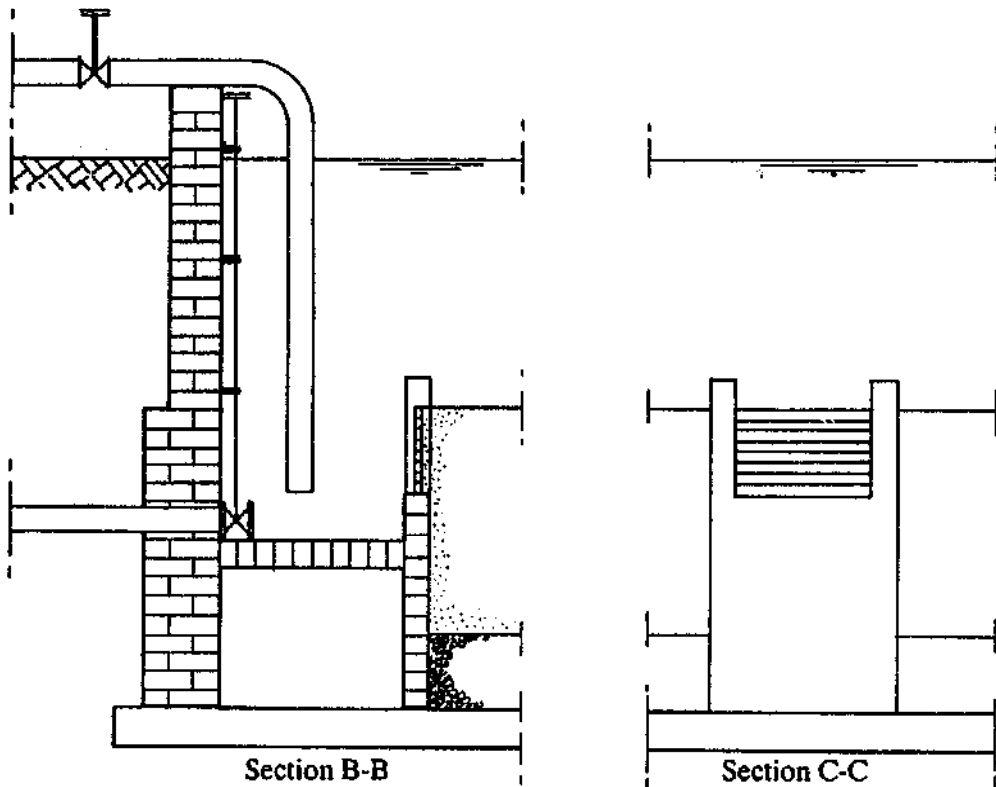

Figure 8.1: Design features of design example I



General:

Water-table 3 m below ground level
 Foundation stable soil

Slow sand filter:

Material brick masonry
 Design capacity 4.75 m³/h
 Design flow 0.1 m/h
 No. of units 2
 Size Ø 5.60 m
 Height of filter box 2.5 m
 Height of underdrain system 0.3 m
 Depth of sand bed 0.9 m

Clear-water tank in brick masonry:

Size Ø 3.10 m
 Height 2.00 m

Bill of quantities for filter units:

Steel 1200 kg
 Concrete (1:1½:2½) 15 m³
 Concrete (workfloor) (1:3:5) 5 m³
 Mortar (1:2) 4 m³
 Masonry 30 m³
 Filter sand 45 m³
 Filter gravel 15 m³
 Gate valves 9
 Butterfly valves 2

Outlet box:

Material brick masonry
 Size Ø 1.40 m
 Height 1.50 m

Figure 8.1: Design features of design example I

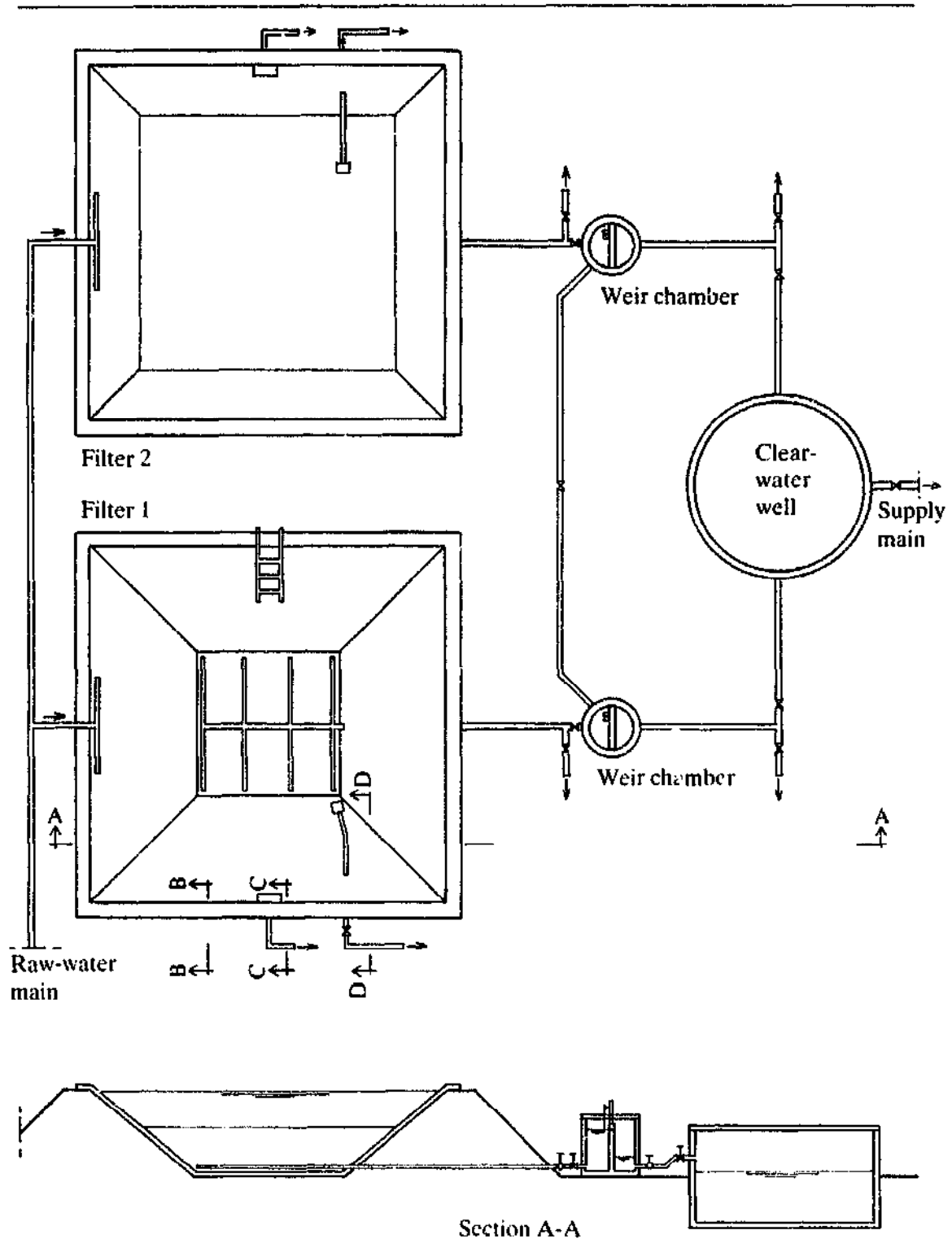
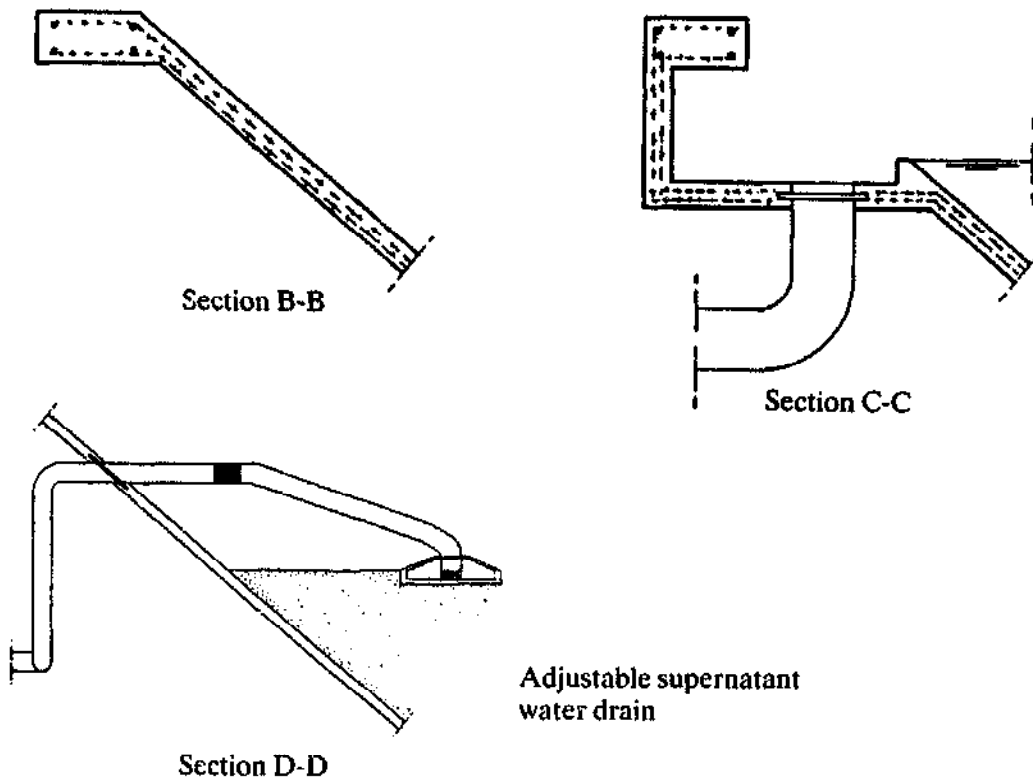

Figure 8.2: Design features of design example II



General:

Water-table 2 m below ground level
 Foundation stable, clayish soil

Outlet box:

Material ferrocement
 Size Ø 1.40 m
 Height 1.50 m

Slow sand filter:

Material ferrocement
 Inclination of slope 40°
 Design capacity 14.1 m³/h
 Design flow 0.15 m/h
 No. of units 2
 Net filter area*/unit 47 m²
 Unit size* 7 x 7 m
 Height of filter box 2.6 m
 Height of underdrain system 0.3 m
 Depth of sand bed 0.9 m

Clear-water tank:

Size Ø 5.00 m
 Height 2.00 m

Bill of quantities for filter units:

Concrete (1:3:5) 6 m³
 Ferrocement mortar (1:2) 6 m³
 Chicken wire mesh 560 m²
 Filter sand (0.15x0.35) 70 m³
 Filter gravel 18 m³
 Gate valves 9
 Butterfly valves 2

Figure 8.2: Design features of design example II

* at minimum sand level

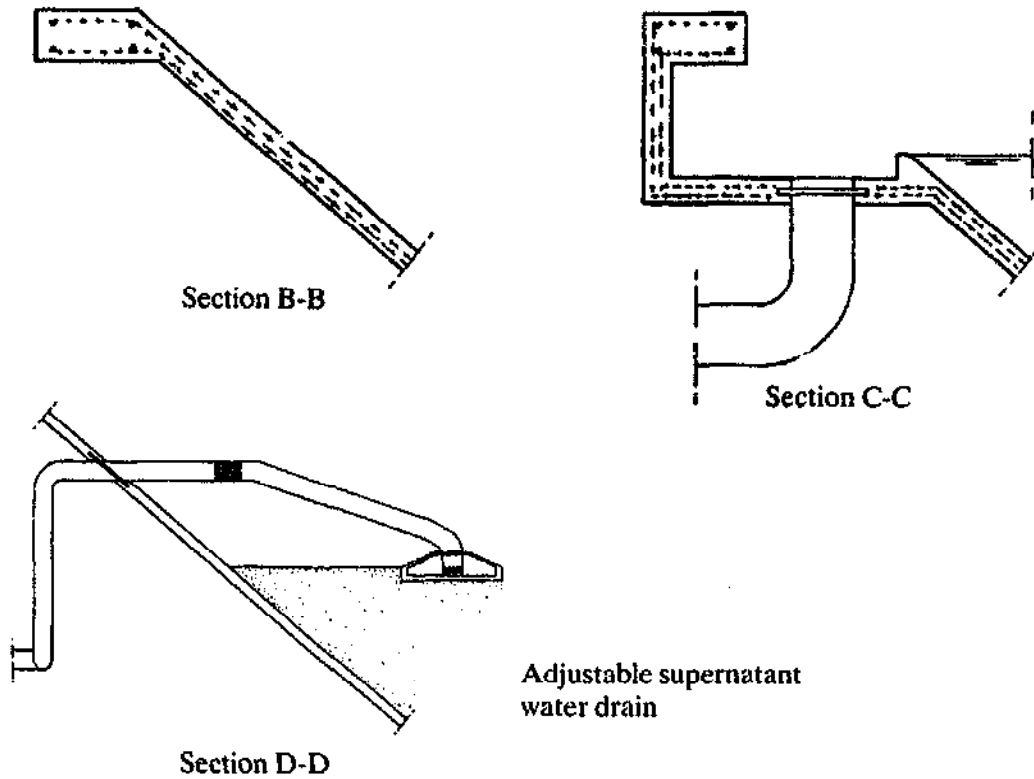

General:

Water-table 2 m below ground level
Foundation stable, clayish soil

Outlet box:

Material ferrocement
Size $\text{Ø } 1.40 \text{ m}$
Height 1.50 m

Slow sand filter:

Material ferrocement
Inclination of slope 40°
Design capacity $14.1 \text{ m}^3/\text{h}$
Design flow $0.15 \text{ m}/\text{h}$
No. of units 2
Net filter area*/unit 47 m^2
Unit size* $7 \times 7 \text{ m}$
Height of filter box 2.6 m
Height of underdrain system 0.3 m
Depth of sand bed 0.9 m

Clear-water tank:

Size $\text{Ø } 5.00 \text{ m}$
Height 2.00 m

Bill of quantities for filter units:

Concrete (1:3:5) 6 m^3
Ferrocement mortar (1:2) 6 m^3
Chicken wire mesh 560 m^2
Filter sand (0.15x0.35) 70 m^3
Filter gravel 18 m^3
Gate valves 9
Butterfly valves 2

Figure 8.2: Design features of design example II

* at minimum sand level

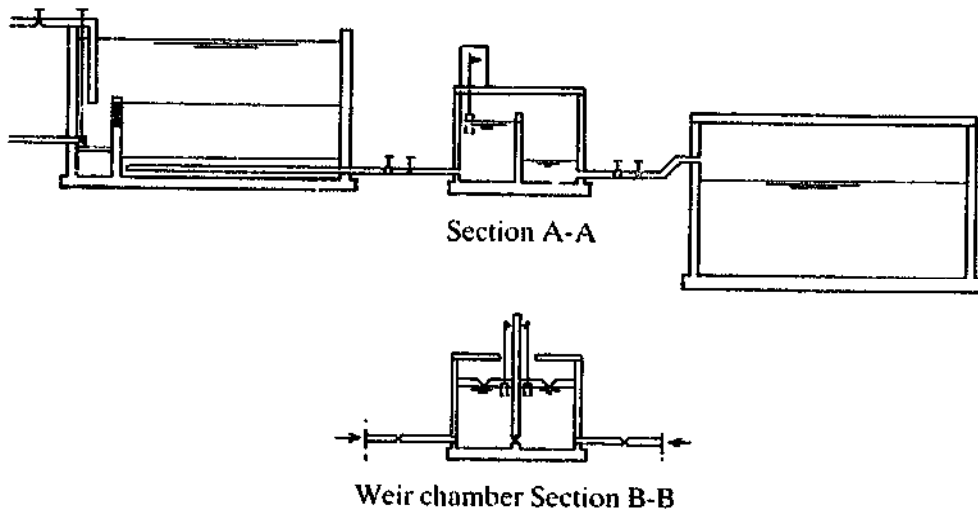
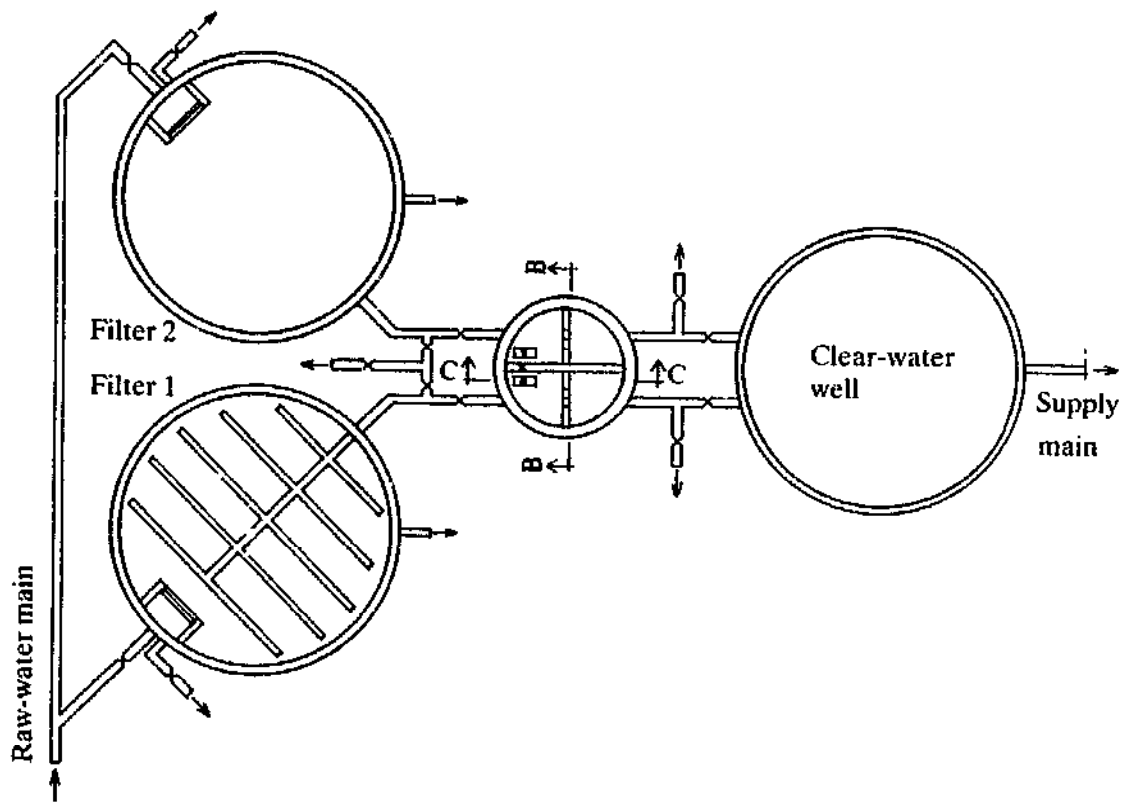
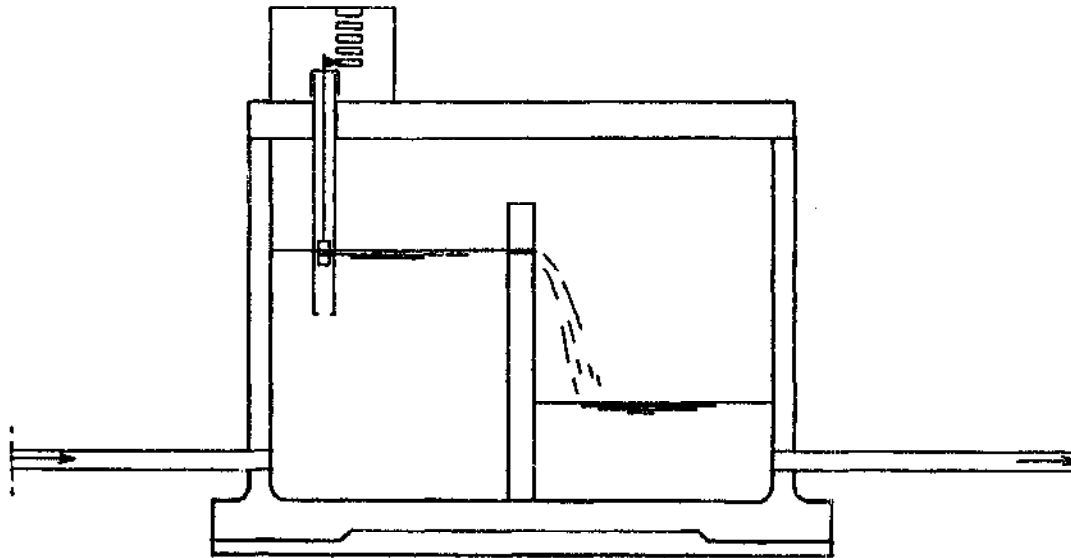

Figure 8.3: Design features of design example III



Section C-C

General:		Clear-water tank:	
Water-table	0.4 m below ground level	Material	ferrocement
Foundation	reasonably stable soil	Size	Ø 4.5 m
		Height	2.00 m
Slow sand filter:		Bill of quantities for filter units:	
Material	ferrocement	Concrete (1:1½:2½)	5 m ³
Design capacity	3.2 m ³ /h	Concrete (1:3:5)	2 m ³
Design flow	0.1 m/h	Steel	400 kg
No. of units	2	Ferrocement mortar (1:2)	5 m ³
Size	Ø 4.5 m	Chicken wire mesh	280 m ²
Height of filter box	2.5 m	Filter sand	29 m ³
Height of underdrain system	0.3 m	Filter gravel	10 m ³
Depth of sand bed	0.9 m	Gate valves	9
		Butterfly valves	2
Outlet box:			
Material	ferrocement		
Size	Ø 2.0 m		
Height	1.50 m		

Figure 8.3: Design features of design example III

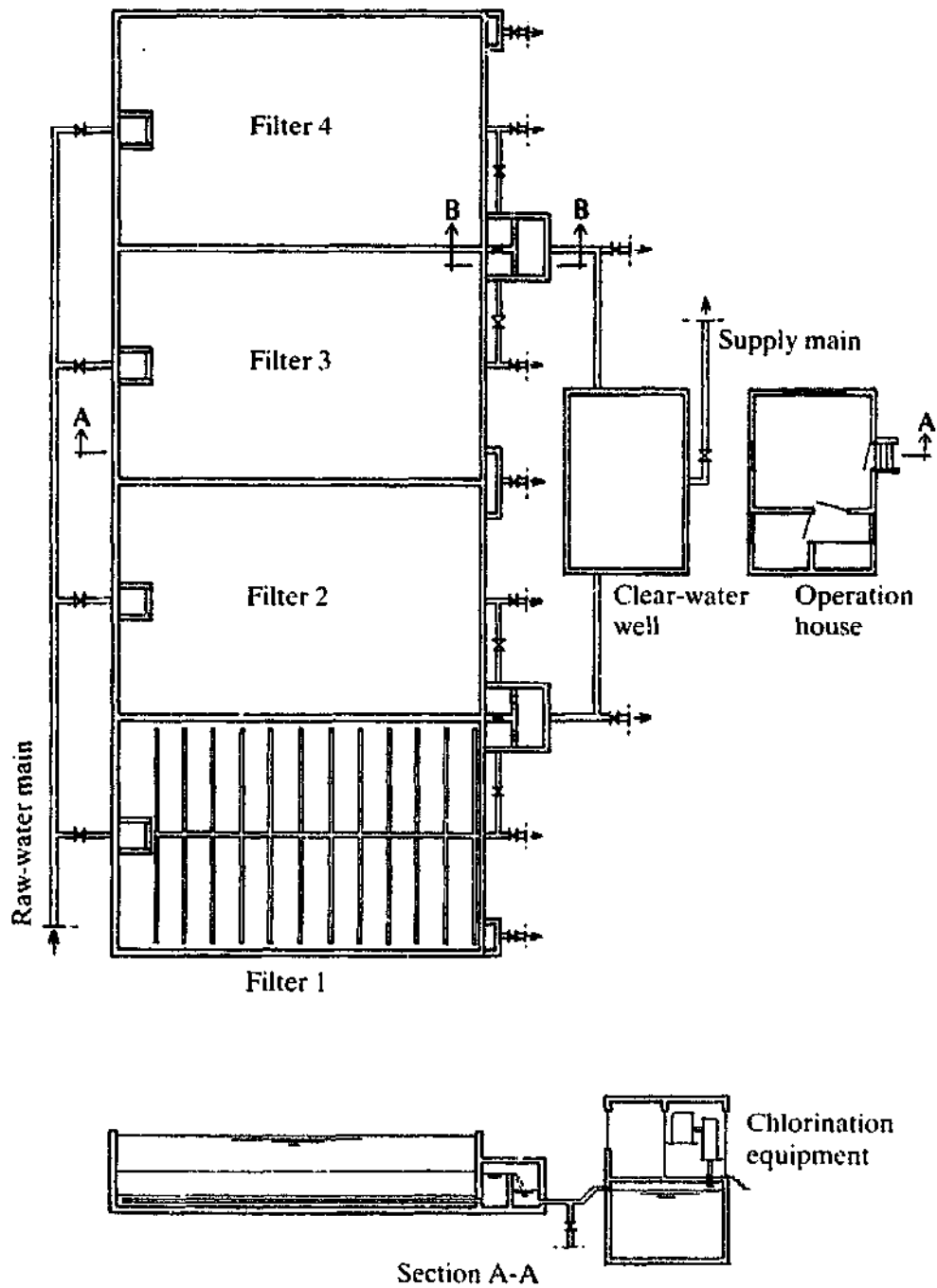

Figure 8.4: Design features of design example IV