

Wind turbine blade profiles,
Scale drawings
from
Hugh Piggott's
"Brakedrum Windmill Plans
Year 2000 edition"*

Slightly modified,
and drawn to scale

*Used by permission
See <http://homepages/enterprise.net/hughOpiggott/>

(c) 2001 Charles F Morrison
cmorrison@greeleynet.com
under the terms of the
GNU Free Documentation License
<http://www.fsf.org/copyleft/fdl.html>

Hugh Piggot's "Brakedrum Windmill Plans" is a must have for windmill generator enthusiasts everywhere. This publication is intended to supplement, not replace that work. It's main purpose is to help me further understand the plans and assist me in carving the blades. If it helps you so much the better, However I make no guarantees for the accuracy of these plans or their usefulness to you.

In the following pages you will find:

1. A short list of guidelines from the book.
2. Some issues I encountered and some possible solutions
3. Scale diagrams of the sections, as viewed from the tip end.

A few Design Guidelines:

1. Choice of wood:

Clear (no knots) Oregon Pine (UK) or Basswood.
Note: Sitka Spruce has been used for this with great results. Hugh suggests gluing 2 2x4s together to obtain the width required. One 2x6 is not quite wide enough, but could be used with a much smaller piece to glue on.

2. Relation of chord to thickness:

Near the root - 15% of the chord

At the tip - 12% of the chord

3. Location of the thickest part of the blade:

25% of the chord from the leading edge

Some issues and possible solutions

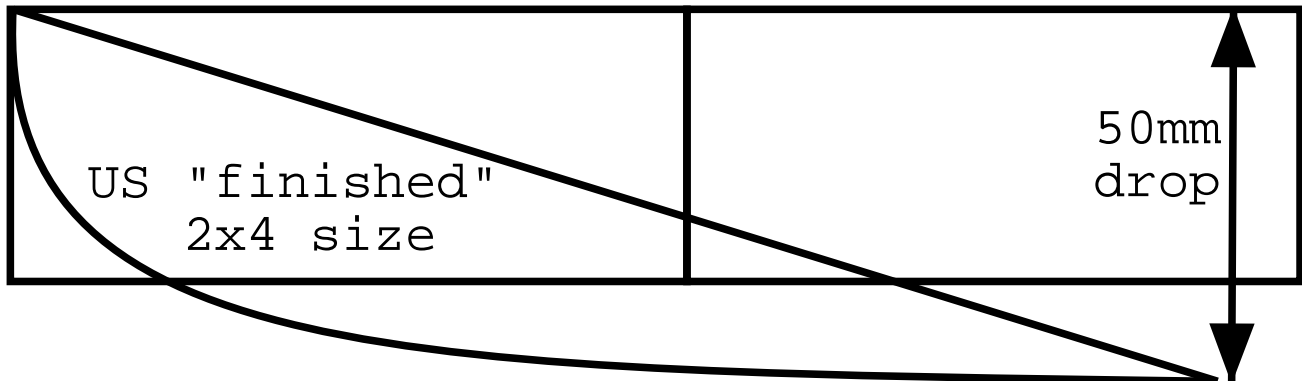

Issue: When using US 2x4 measurements for planed lumber, it is not possible to use the 50mm drop for the first station as recommended in the book since planed 2x4s are actually 1.5"x3.5" or 38mm x 89mm. This is indeed a rip off.

Solution 1: purchase lumber "in the rough" This is the best solution. It may require going further to obtain what you need, but should be worth it.

Solution 2: glue an additional block of wood to the area needing additional volume.

Solution 3: reduce the drop to 38mm and the thickness to 38mm. This will affect the drop on the other sections as well. I include a sample view of the 38mm drop on station 1 for illustrative purposes only.

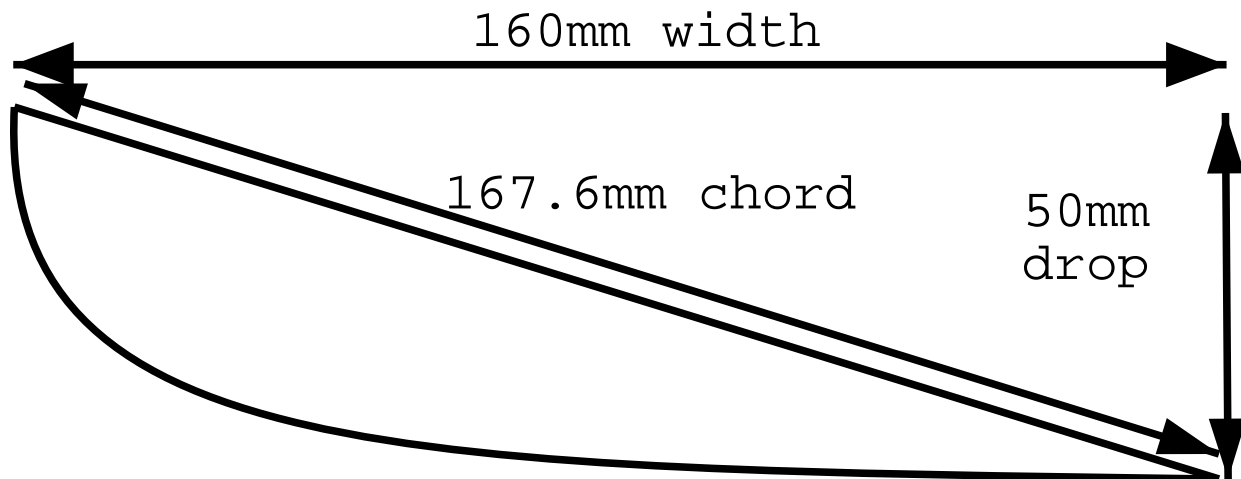

Issue: This is where I got confused. Due to the drop, the width of the cut is not the same as the chord of the airfoil. This is most noticeable at the inner sections.

Solution: The width is smaller than the chord, which is the widest point of the airfoil and the flat line on my templates. My templates are for checking the shape based on the chord of the airfoil. I've made calculations to get the chord based on the pythagorean theorem.

Issue: In the same way, the thickness is measured in the vertical, while the blade is at an angle. This results in a larger measurement than if the thickness is measured perpendicular to the flat surface.

Solution: The thicknesses are calculated as a percent of the cord. 1 - 15%, 2 - 14.5%, 3 - 14%, 4 - 13.5%, 5 - 13%, 6 - 12.5% and 7 - 12%.

Using finished 2x4s changes the angle of attack, but the energy loss is low.

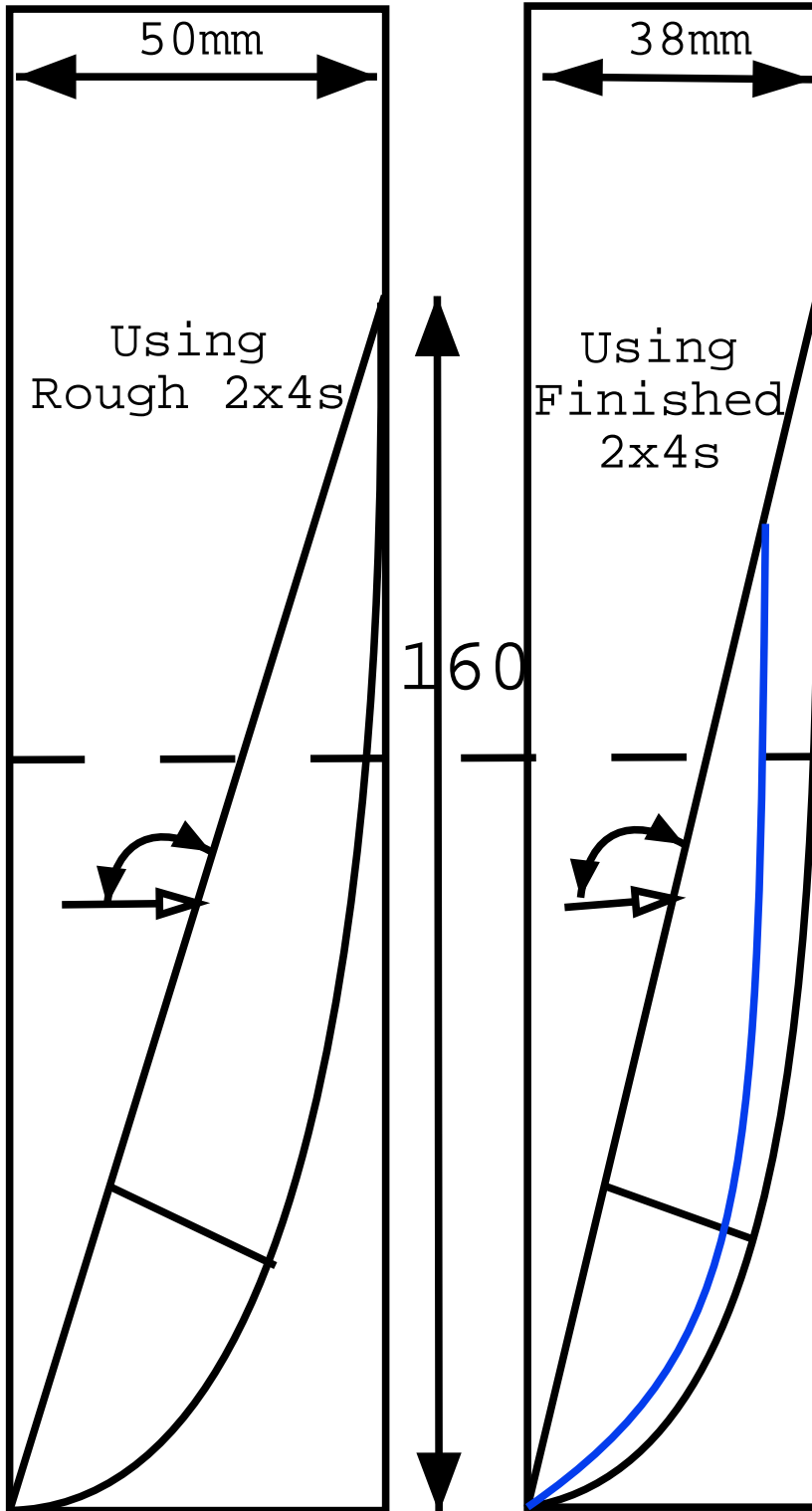

Station 1
160mm width
shown with
the specified
50 mm drop
and 38mm drop
for planed
lumber use.

Station 2
(in Blue)
140mm wide
shown at the
same angle.
The specified
drop is 40mm
which won't
fit this size
lumber.

A diagram of the measurements I'm using. The Width, Drop and Vth are all from the book. The Chord, Perp and Dist are all calculated.

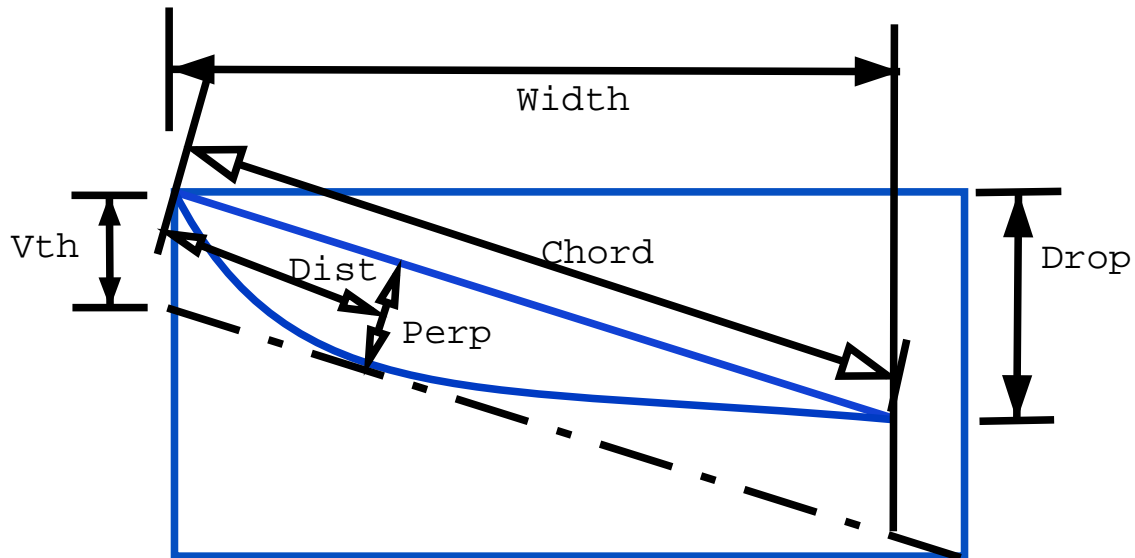

Sta.	Width	Drop	Vth	Chord	Perp	Dist
1.	160	50	50	167.6	25.1	41.9
2.	140	40	20	145.6	21.1	36.4
3.	122	27	18	125	17.5	31.2
4.	102	15	16	106.1	14.3	26.5
5.	90	9	14	90.4	11.8	22.6
6.	80	5	12	80.2	10	20.0
7.	70	3	9	70.1	8.4	17.5

Terms used above

Boxed numbers from the book, others are calculated.

Sta. - Station as shown in the book.

#7 is the tip, #1 is closest to the root

Width - The width of the blade as per the book

Drop - The distance from the top of the board to the trailing edge of the blade from the book.

Vth - The thickness given in the book (in fig 20)

Chord - the distance from the leading edge to the trailing edge of the blade

Perp - The thickness I calculated using 15 - 12% of the cord.

Dist - The distance from the leading edge to the thickest part of blade. 25% of the cord.

Station Templates

All stations are shown with the (windward) face up. This assumes the face has already been cut to the proper twist. When carving, the face will normally face down and the leading edge will be to the right.

Note: These templates use my calculated thickness values (perp) rather than those given in the book. This will be most apparent near the root, especially station 1. This modification may result in a weaker blade than that shown in the book.

Station 1 is a special case. The book shows it a much thicker than 15% of the Chord. This is because it is important to have extra strength near the root and the amount of power loss that close to the root is minimal.

I've included a second template which shows the first station at the book specified 50mm thickness along with the original (blue) and a compromise section in red. The dashed lines are the limits of the wood you have to work with. Thus the red line would be more in line with the book, although it isn't 50mm thick.

Also note that the airfoil I am using is flatter than most NACA designs. This is largely to make it easier to carve and measure. I include an additional set of rounder profiles at the end of this document.

Station 1

160mm wide on board (not shown)

50mm trailing edge drop (not shown)

145.6mm chord

25.1mm perpendicular at 41.9mm from leading edge

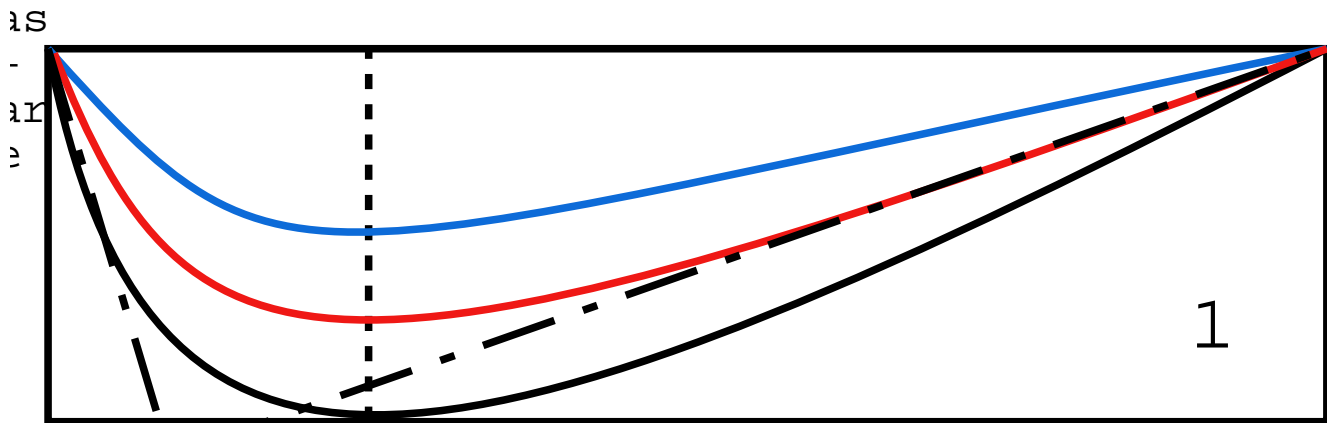
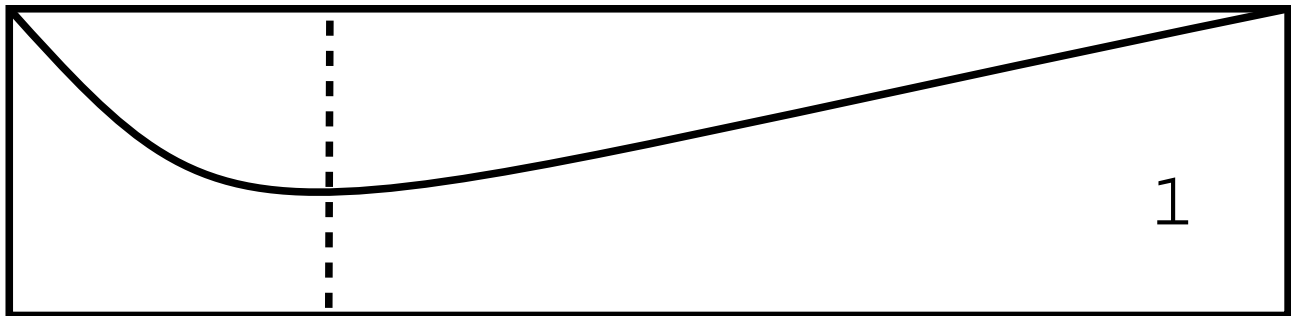

1
2
3
4
5
6
7
8
9
10
11
12
13
14
15
16
17
18
19
20
21
22
23
24
25
26
27
28
29
30
31
32
33
34
35
36
37
38
39
40
41
42
43
44
45
46
47
48
49
50
51
52
53
54
55
56
57
58
59
60
61
62
63
64
65
66
67
68
69
70
71
72
73
74
75
76
77
78
79
80
81
82
83
84
85
86
87
88
89
90
91
92
93
94
95
96
97
98
99
100

Station 2

140mm wide on board (not shown)

40mm trailing edge drop (not shown)

145.6mm chord

21.1mm thickness at 36.4mm from
leading edge

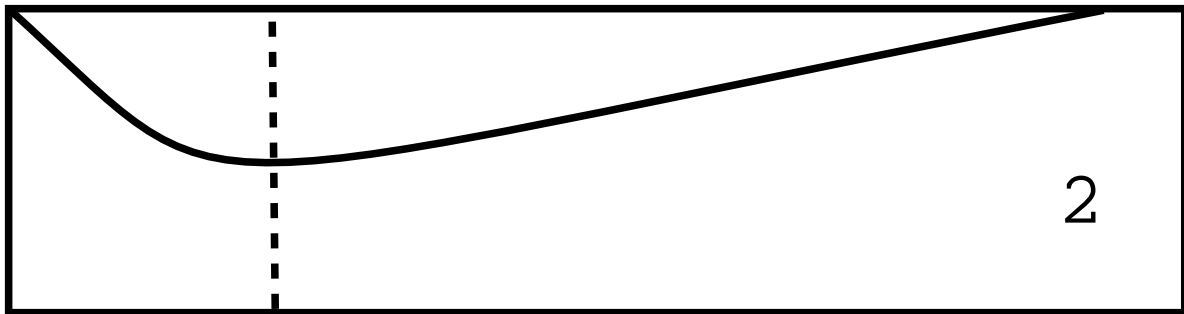

Station 3

122mm wide on board (not shown)

27mm trailing edge drop (not shown)

125mm chord

17.5mm thickness at 31.2mm from
leading edge

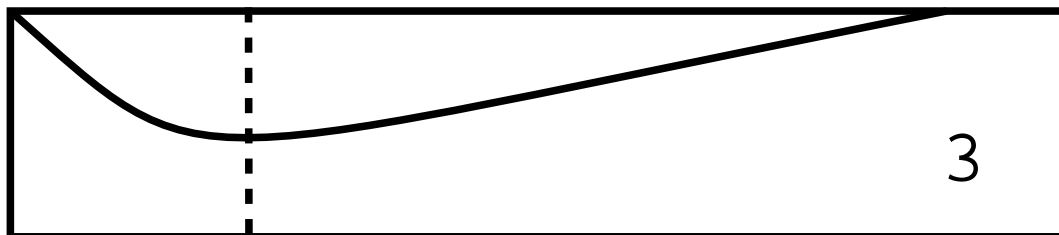

Station 4

102mm wide on board (not shown)

15mm trailing edge drop (not shown)

106.1mm chord

14.3mm thickness at 26.5mm from
leading edge

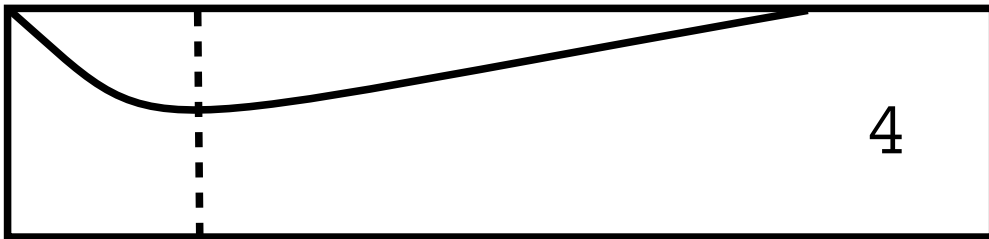

Station 5

90mm wide on board (not shown)

9mm trailing edge drop (not shown)

90.4mm chord

11.8mm thickness at 22.6mm from
leading edge

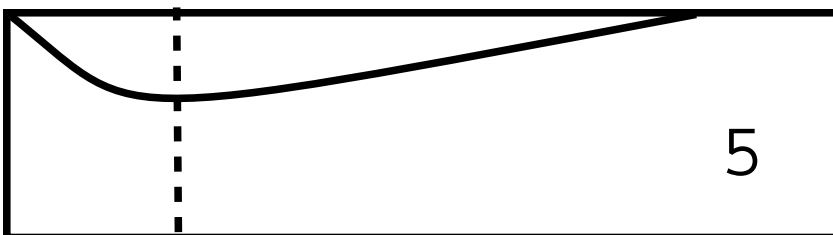

Station 6

80mm wide on board (not shown)

5mm trailing edge drop (not shown)

80.2mm chord

10mm thickness at 20mm from
leading edge

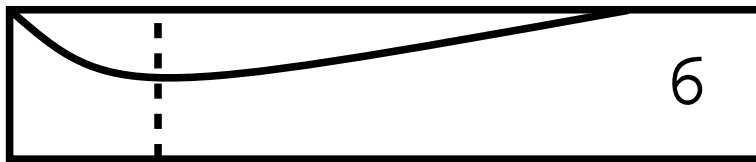

Station 7

70mm wide on board (not shown)

3mm trailing edge drop (not shown)

70.1mm chord

8.4mm thickness at 17.5mm from
leading edge



These are outside templates for checking the blade shape while carving them.

These will only be correct at the specified stations.

Once the blade face and width are cut, use these templates to verify thickness and shape at the stations. Use a straight edge and a good eye to verify the shape between the stations.

The airfoil sections are roughly to scale. The exact scale of printed copies may vary depending on the printer used and/or the program used to print it. All measurements are mm. Be sure to check the scale of printed copies before using. Note that the flat side faces the wind.

If you print this on transparency film, you should be able to cut out the shapes for actual size templates with a sharp knife or small sizzors. Or you can print on regular paper and glue it to masonite, thin plywood or acrylic for a more rigid tool.

Please let me know if you find these templates useful or if you find flaws that need to be fixed. Email me for a copy of the original DIA file or a postscript file if you wish to make changes to this document. These files should also be available at <http://www.greeley.net/~cmorrison>

Chuck Morrison
May 9, 2001

50x200 timber
viewed from
the tip end.

Wind
→

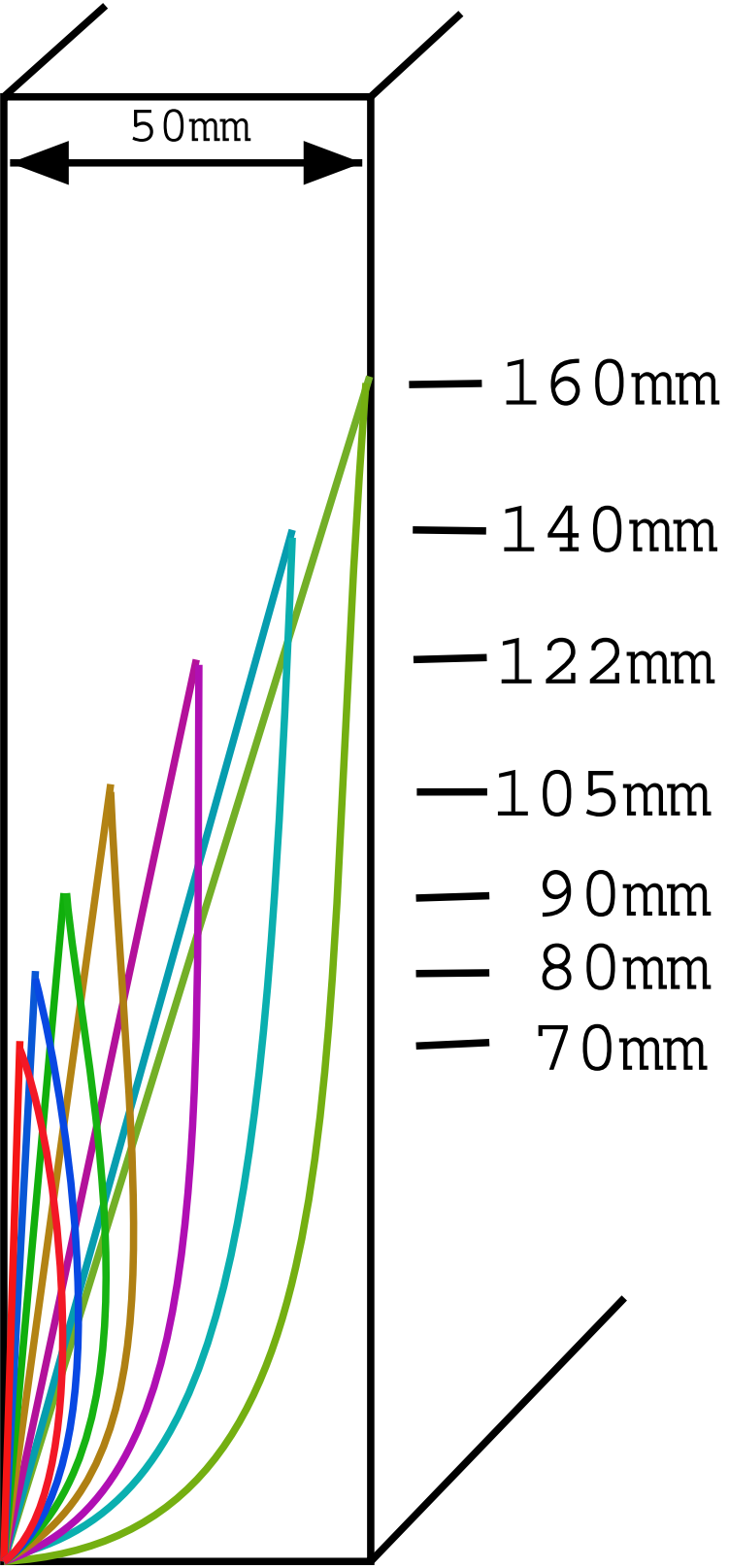

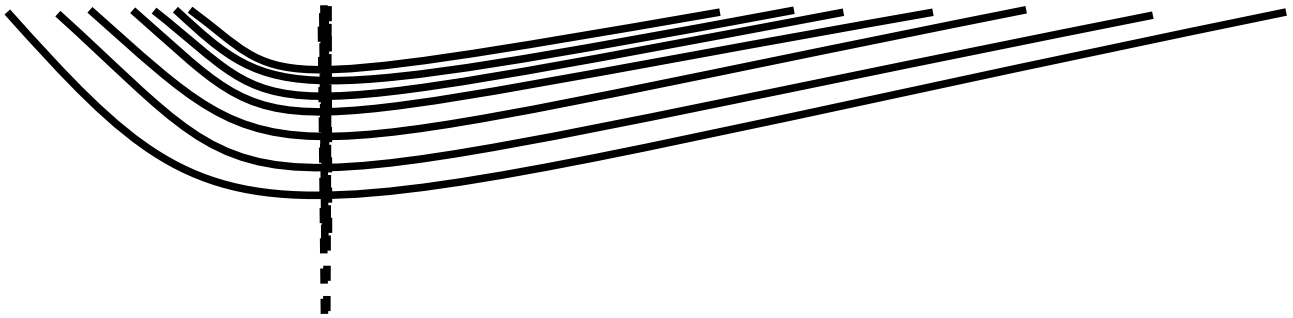

A View of all the sections lined up on the face and the line of the thickest point. This is not the way the blades are constructed, but shows the relative curves of the sections.

It should be noted that this is a very flat design for the airfoil. A more traditional design is shown below (in blue) in contrast to section 1 (in green). I have not tested this and have no idea of it's relative efficiency.

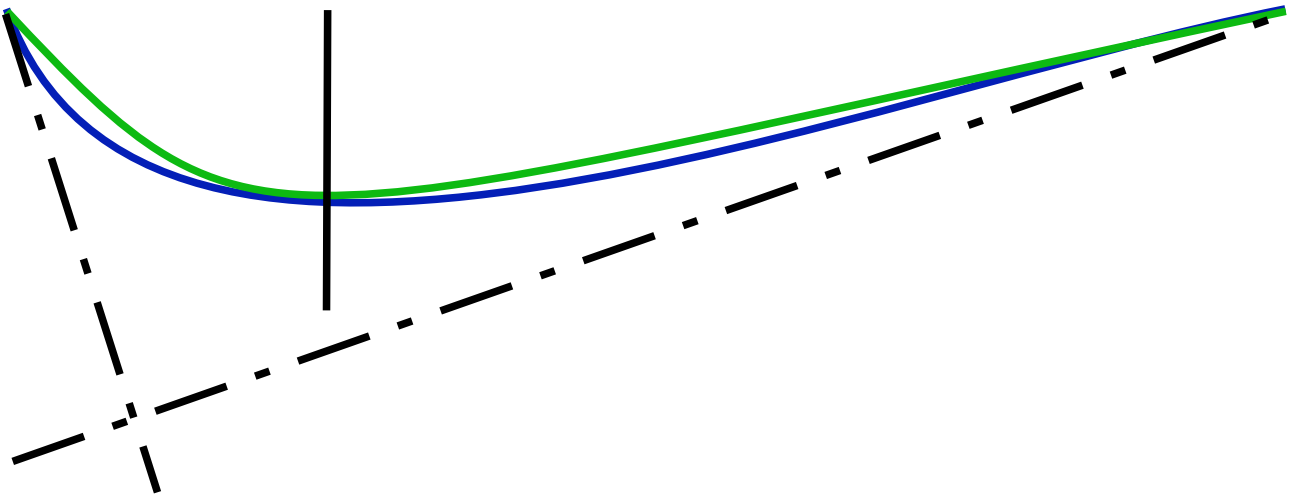

The following are templates of the stations with a more traditional rounded profile. These are more in line with what Hugh Piggot prefers than the previous templates.

Note that there are three profiles shown for station 1. The smallest is 15% of the chord. The largest is as thick as the materials allow. The middle is a compromise between the two. As before, the dashed lines are the limits of the wood.

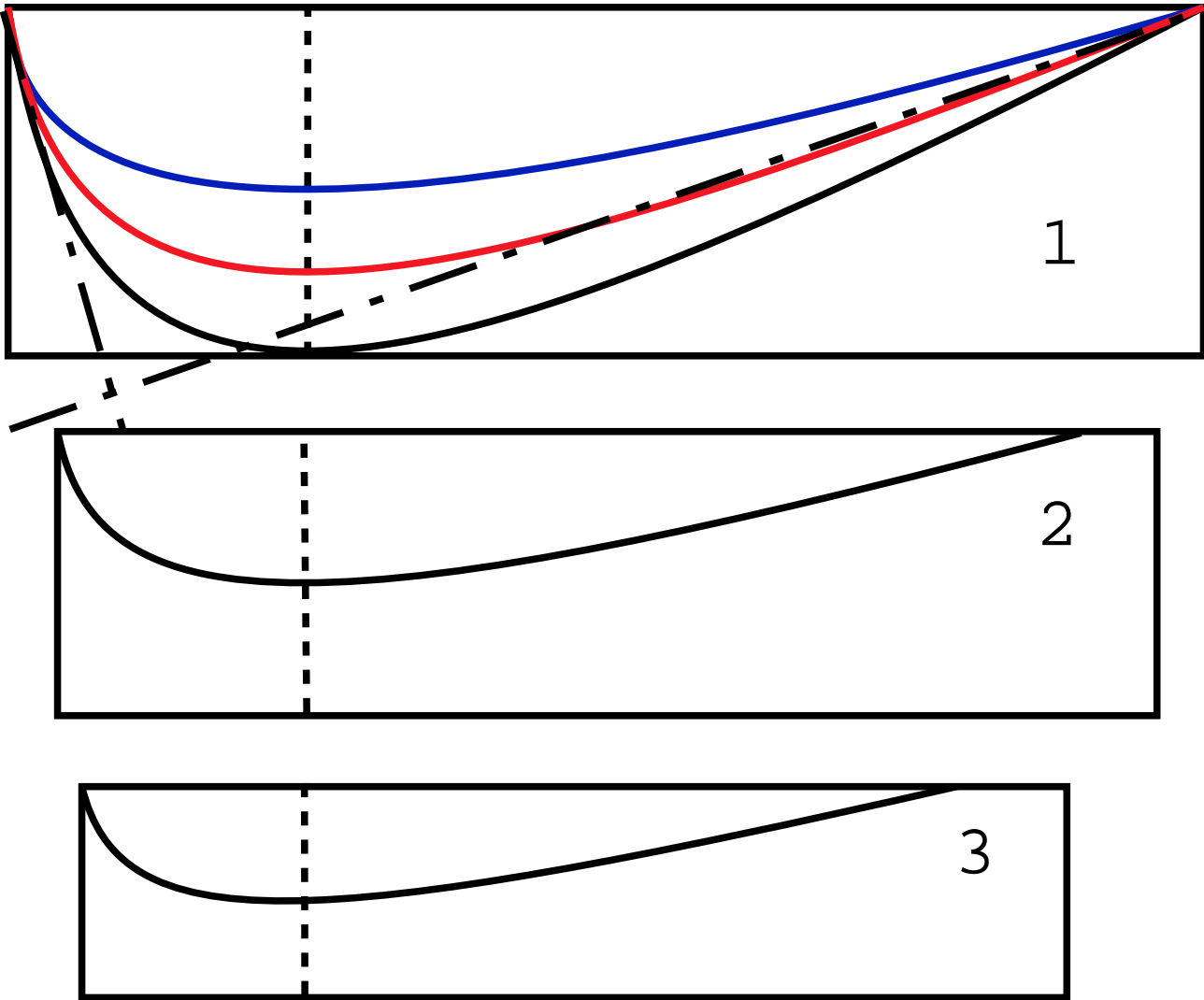

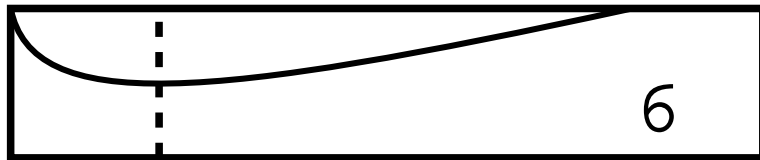
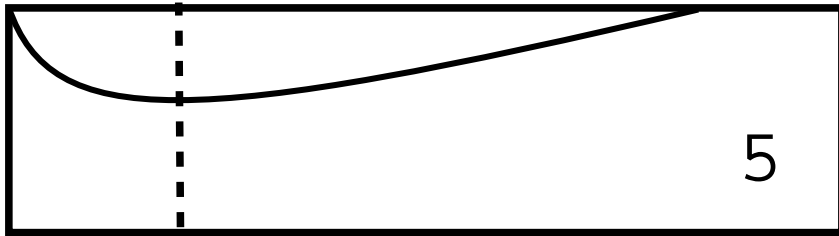
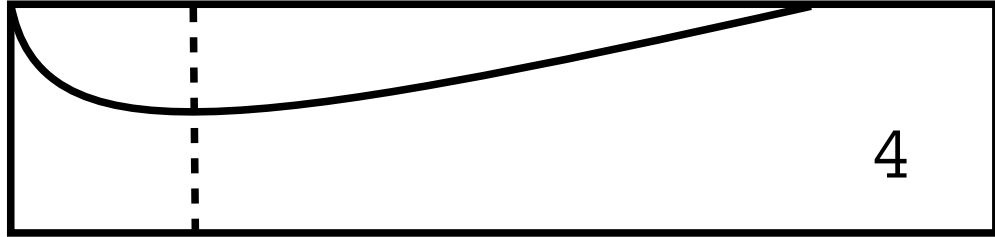

These templates were produced
with DIA.
<http://www.lysator.liu.se/~alla/dia>