



PicoTurbine Deluxe Windmill Plans

Instructions, Teacher's Guide, and Technical Notes

An easy to build project for adults and children grade 10 and above. Explains wind power generation concepts, including three phase alternators, rectification of three phase current, battery charging, and load regulation concepts.

BETA



WARNING:
CHOKING HAZARD - Small
parts, wire. Not for children under
4 years.

THESE PLANS ARE PRESENTED IN “AS IS” CONDITION. BY USING THESE PLANS YOU HOLD PICOTURBINE.COM, XIBOKK RESEARCH, AND ALL MEMBERS, INVESTORS, EMPLOYEES, AND OWNERS OF THOSE ORGANIZATIONS HARMLESS FROM ANY DAMAGES ARISING FROM THE USE OF THESE PLANS OR THE RESULTING MACHINES. IN NO CASE SHALL PICOTURBINE.COM OR XIBOKK RESEARCH BE LIABLE FOR ANY INCIDENTAL DAMAGES. THESE PLANS ARE NOT WARRENTEED FOR FITNESS FOR ANY PARTICULAR PURPOSE.

Revision 1.0A, October, 1999

www.picoturbine.com

Support PicoTurbine.com!

If you have purchased this document as a part of a PicoTurbine.com kit, we appreciate your support!

If you have downloaded this document as a free plan, we hope you enjoy it, and ask that you patronize PicoTurbine.com in the future so we can keep financing new projects. We have a complete line of Renewable Energy books, projects, and kits that are expanding every day. Use the “Voluntary Contribution” item on the order form if you believe you have received value from these plans. Or, stop by the web site and buy something! Tell your friends about us! Suggest our projects for youth groups, Scouting Groups, YMCA or similar organizations, classrooms and home schools. The proceeds will be used to support more fun renewable energy projects and kits at PicoTurbine.com. Thanks and have fun!

**Copyright © 1999 PicoTurbine.com. All rights reserved.
PicoTurbine.com is a wholly owned subsidiary of Xibokk Research.**

CONTENTS

PART 1: INSTRUCTIONS FOR BUILDING PICOTURBINE DELUXE.....	4
RELATED PLANS AND KITS.....	4
PICOTURBINE DELUXE MOTIVATION.....	4
PICOTURBINE DELUXE BUILDING TIME.....	4
BEFORE YOU BUILD PICOTURBINE DELUXE.....	5
<i>Step 1: Check Your Materials.....</i>	<i>5</i>
<i>Step 2: IMPORTANT: Review Safety Rules.....</i>	<i>6</i>
<i>Step 3: Building the Rotor.....</i>	<i>7</i>
<i>Step 4: Building the Stator.....</i>	<i>8</i>
<i>Step 5: Building the Frame.....</i>	<i>9</i>
<i>Step 6: Building the Blade Assembly.....</i>	<i>10</i>
<i>Step 7: Putting the Turbine Together.....</i>	<i>10</i>
<i>Step 8: Wiring for DC Output.....</i>	<i>11</i>
<i>Step 9: Wiring for Battery Charging.....</i>	<i>12</i>
PART 2: TEACHER'S GUIDE.....	13
KEY CONCEPTS.....	13
GROUP PROJECTS.....	13
MOUNTING.....	13
EXPERIMENTS.....	13
<i>Data Logging.....</i>	<i>13</i>
<i>Electric Brakes.....</i>	<i>14</i>
<i>Hybrid Systems.....</i>	<i>14</i>
PART 3: TECHNICAL NOTES.....	15
THREE PHASE ALTERNATOR WINDINGS.....	15
STAR AND DELTA WIRING.....	15
BATTERY VS. RESISTIVE LOADS AND EFFICIENCY.....	16
<i>Battery Load Formula.....</i>	<i>16</i>
<i>Resistive Load Formula.....</i>	<i>16</i>
<i>Comparison of Battery vs. Resistive Loads.....</i>	<i>16</i>
DUMP LOADS.....	17
ALTERNATIVE DESIGNS AND MATERIALS.....	17
<i>Double-disk Alternator.....</i>	<i>18</i>
<i>Woodless Construction.....</i>	<i>18</i>
<i>Alternative Blade Designs.....</i>	<i>18</i>
BETTER BEARINGS.....	19
TEMPLATES.....	21
COIL WINDING FORM TEMPLATE.....	21
ROTOR TEMPLATE.....	23
STATOR TEMPLATE.....	25

PART 1: Instructions for Building PicoTurbine Deluxe

RELATED PLANS AND KITS

This plan and the associated kit build on concepts explained in the following related kits from PicoTurbine.com. All plans are free for download and can be built with locally available parts. If you cannot obtain parts locally or just want the convenience of ordering a ready made kit, they are available for a nominal charge.

- **PicoTurbine Educational Windmill Kit**
This inexpensive kit is easy enough for children as young as fifth grade to build with some adult supervision. Using only cardboard, wooden dowels, magnets, and wire, a complete working windmill can be constructed in about 1 hour. The kit includes a bicolor LED that lights up from the electricity produced by the eight inch tall wind turbine. PicoTurbine.com has shipped this kit all over the world, and it is distributed by Paxton/Paterson throughout the United States to High Schools as part of their Alternative Energy course module.
- **PicoTurbine DC Experiments Kit**
This easy to use kit teaches AC to DC rectification concepts. It includes a solderless breadboard and electronic components such as diodes and capacitors to allow projects to be built without soldering, making it safe for a classroom environment. Building on the PicoTurbine windmill, it teaches four different circuits for use in rectifying AC current to direct current, explaining the concepts with interesting experiments.

For more information or to download free plans or order kits, visit <http://www.picoturbine.com> and visit the "Project List" page.

PICOTURBINE DELUXE MOTIVATION

The original PicoTurbine Educational Windmill kit is a great way to learn about renewable energy technology. It produces just enough power to light up a small lamp or LED (about 2 volts at 25 milliamps). While it makes for a very cost effective educational experiment, many people have asked for a larger version that is weatherproof and actually produces enough power to be useful.

PicoTurbine Deluxe is the answer to this request! While it only costs about three times as much as the little PicoTurbine kit, it is weatherproof and produces about 30 to 50 times as much power as the small version. In fact, the power produced is sufficient to charge NiCad batteries, or with alternative wiring could even provide a 12 volt battery bank a small trickle charge in a good stiff wind (see Alternative Designs section).

This project builds on the smaller PicoTurbine Windmill kit, which explained basic wind power theory. This kit goes several steps farther, and explains 3 phase wiring concepts as well as battery charging vs. resistive load concepts. Once this project is mastered, the student or adult hobbyist will understand a great deal of wind power and alternator construction theory, and if desired will be ready to try a full sized wind turbine such as the PicoTurbine-250.

PICOTURBINE DELUXE BUILDING TIME

The total build time will vary with your skill level, but generally speaking you should allow 6 to 8 hours of building time to complete this project, especially if you have not done similar types of projects in the past. This assumes you have all materials on hand and organized. Because of the need to paint certain parts and allow glue to dry, the actual build time must typically be spread over a 2 day period. Allow 3 to 4 hours for each day with an overnight period to wait for parts to dry and set. These times are approximate, of course, and it may take you more or less time than estimated here.

BEFORE YOU BUILD PICOTURBINE DELUXE

THESE PLANS ARE CONSIDERED BETA TEST LEVEL. This means they are not fully tested and are only for people who don't mind building an experimental project. In particular, there has not been enough testing to ensure the NiCad batteries used can withstand repeated charge/discharge cycles with the electronic components used, or whether the overcharge shunt circuit will protect it sufficiently in sustained high winds. We believe the main risk of this lack of testing is that the lifespan of the NiCad batteries could be shorter than normal, although there could be other problems that are unknown at this time.

Step 1: Check Your Materials

The following materials are supplied with your PicoTurbine Deluxe kit. If you did not purchase a kit but are using free downloaded plans, you must obtain these items from local supply houses:

- ◆ One steel disk, 14 gauge, 8" in diameter with a 3/8" hole in the center. You may need to contract with a local metal shop to have these made if you do not have tools to cut steel. You may be able to find steel "punch-outs" of the correct size at a scrap metal supplier and bore the center hole using a cobalt drill bit. A small variation in diameter is ok. Thicker metal is also ok.
- ◆ 16 ceramic grade 5 magnets, 1.875" by 0.75" by 0.375" thick, magnetized on the large faces.
- ◆ About 1.5 pounds of 20 AWG enamel coated magnet wire.
- ◆ 2 pieces of corrugated plastic, 24" long and 8" wide. Best is 2 millimeter, which is what ships with our kits. Most suppliers only carry 4 mm which is harder to work with but can be made to work by scoring one side half way through (see instructions below).
- ◆ A 3/8" inner diameter roller thrust washer. This is a small set of roller bearings about the size of a large washer.
- ◆ A small solderless breadboard.
- ◆ Six diodes rated 1 amp and 100 volts (1N5400 or similar).
- ◆ Two "AA" sized NiCad batteries plus holder.
- ◆ One small lamp, rated 3 volts and 100 milliamps.
- ◆ A zener diode, with a zener voltage of 2.4 volts and rated at 500 milliwatts.
- ◆ A power resistor rated at 2 watts and 10 ohms.
- ◆ A red LED.
- ◆ A plastic enclosure large enough to hold the battery pack and circuit board.
- ◆ A small SPST switch.
- ◆ A 3/4" wire nut.

The following items are not supplied with your kit in order to reduce shipping costs. They should be easy to obtain from a hardware store. All together these items cost in the neighborhood of \$20 to \$25. You may have some parts lying around in your basement such as scraps of wood or washers.

- ◆ One 3/8" threaded rod, 3 feet long.
- ◆ Twelve flat washers and eight nuts to fit the 3/8" rod. The washers should be 1" wide, of the "fender washer" variety. At least 2 of the nuts should be locking nuts, such as serrated locknuts or nylon insert lock nuts.
- ◆ One sheet of Plexiglas (or similar plastic sheet) 8" x 10" x 0.09" in thickness. The thickness is not critical. Some other materials that will work are polycarbonate (Lexan or similar), acrylic sheet, or any hard plastic material that can be drilled. Most large hardware stores have Plexiglas in this size because it is used for framing pictures. Try a glass store or picture frame store if your hardware store does not stock such a material.
- ◆ Three pieces of plywood 1 foot square, 1/2" thick (or thicker).
- ◆ A small scrap of 1/4" plywood, about 2" square or more.

- ◆ Four pieces of 2x2 wood 48” long. (Note for non-Americans: 2x2 wood is actually about 1.5” x 1.5”.)
- ◆ About two ounces any good waterproof glue such as silicone or hot glue gun, or epoxy resin. Be careful if using hot glue. If you use epoxy, be sure to wear impervious gloves as recommended by the manufacturer.
- ◆ A can of metal paint, such as “Rust-oleum” or similar. Only a cup or so will be needed.
- ◆ If desired, wood paint can be used to paint the wooden support structure. Alternatively, you can use pressure treated wood that is weather resistant. Painting is recommended to reduce swelling due to water absorption. Only a pint or so is needed.

You need the following tools:

- ◆ Screw driver.
- ◆ Electric drill plus 3/8” bit, 1/4” bit, and a small bit such as 1/8” for drilling pilot holes for screws.
- ◆ Shop scissors or a razor knife.
- ◆ Pliers or monkey wrench.
- ◆ Jigsaw, coping saw, or some other saw capable of cutting curves in wood.
- ◆ A few square inches of sand paper to strip wires.

It is also helpful to have the following tools, but not entirely necessary:

- ◆ A digital multimeter that can measure AC/DC millivolts is useful for displaying the exact voltage created and adjusting the alternator.
- ◆ If an oscilloscope is available, it is instructive to look at the waveforms output by the alternator before and after rectification. This is an expensive piece of equipment and not necessary unless one happens to be available.

Step 2: IMPORTANT: Review Safety Rules

PicoTurbine Deluxe is not a dangerous project to build, but as with any construction project certain safety rules must be followed. Most of these rules are just plain common sense. Be sure to review these rules with students if you are building this project as part of an educational curriculum.

- ◆ **Adult supervision is required for this project.**
- ◆ **This project is not recommended for children under 14 years old.**
- ◆ **Children must be supervised when working with scissors, saws, razor blades, power tools and sharp parts and tools to avoid cutting injuries.**
- ◆ **Children under 4 years old should never have access to wire or small parts because they represent strangulation and choking hazards. Keep the kit parts out of the reach of small children.**
- ◆ **PicoTurbine Deluxe generates low levels of electricity (under 10 volts) that are generally considered safe. But, to avoid shock hazard never work with electricity of any level when your hands or feet are wet.**
- ◆ **Persons wearing pacemakers should not handle strong magnets such as those found in the PicoTurbine alternator.**

- ◆ **Do not allow magnets to “snap” together, they may shatter and send pieces through the air that can lodge in eyes. The magnets supplied are grade 5 ceramic material and are powerful, if care is not taken they can snap together and pinch fingers or skin causing minor injuries.**
- ◆ **Use caution when working with power tools. Use extra caution when drilling through Plexiglas plastic. Secure the sheet of Plexiglas using a clamp between pieces of wood. Do not hold it with your bare hand when drilling, it is possible for the plastic to bind up with the drill bit and spin rapidly, slashing your hand.**
- ◆ **Follow all tool and material manufacturer recommendations. If the recommendations of this document conflict with those of the manufacturer, follow the manufacturer’s recommendations instead.**
- ◆ **Do not allow NiCad batteries to short circuit. NiCad batteries can be damaged or destroyed in a matter of seconds when short circuited. They can generate very large currents for brief periods of time under such conditions which can destroy electronic components like diodes very rapidly.**
- ◆ **This list does not purport to be a complete list of hazards. Use common sense, follow manufacturer recommendations for all tools and materials, and follow standard safety procedures such as the use of protective eyewear, gloves, and boots when using tools.**

Step 3: Building the Rotor

The rotor consists of a metal disk on which the magnets are attached. The templates section at the end of this booklet has an actual size template for the magnet layout. Make a copy of this page, cut out the disk diagram. Cut out the magnet shapes and the center hole using a razor knife. Hint: the corners of the magnets are very close on the inner diameter, leave some paper there so the template does not fall apart.

Obtain a steel disk, 8” in diameter with a 3/8” hole bored in the exact center. Line the template up on the steel disk using the center holes of the template and the disk to ensure a precise match. Use several pieces of tape to hold the template firmly to the disk. Using a marker or pencil, trace the outlines of the magnet shapes you cut out from the template. Be as precise as possible. Remove the template.

Arrange magnets by placing them in the marked spots on the steel disk. The magnets must alternate poles going around the stator disk. Your magnets are marked with a red dot on one side. To alternator poles, you should see first a magnet with a dot, then next to it a magnet with no dot (the dot is on the underside) etc. There should never be two dots showing next to each other, nor two magnets with dots face down next to each other. Now, remove the magnets one at a time, place some glue on the steel disk in the place you just removed the magnet, and replace the magnet. If you are using epoxy glue follow all manufacturer instructions carefully. If you are using hot glue be careful not to burn yourself. Repeat for each magnet, making sure you maintain the same alternating pole pattern (don’t turn the magnet over by accident).

Double check before the glue sets that all magnets are alternating poles going around the circumference of the disk.

Set aside the disk/magnet assembly and allow to set thoroughly. (For epoxy drying time varies, read the instructions. For hot glue setting time is typically only a few minutes.) If you used hot glue, it is a good idea to reinforce the magnets by squeezing some glue around the edges of each magnet, especially on the outer perimeter where centrifugal forces will tend to pull the magnets outward.

Step 4: Building the Stator

The stator holds 12 coils of wire that actually produce the electricity. PicoTurbine Deluxe uses a 3 phase winding instead of the single phase used in the smaller version. A 3 phase winding provides much smoother operation under load (more is explained in the section Technical Notes).

Step 4a: Winding the Coils

Start by constructing a coil winding tool. This is simply 3 pieces of plywood held together with a bolt. Two of the pieces should be 3" x 3", and the third should have the shape as shown in the template section titled "Coil Former Template". Affix that template to a piece of 1/4" thick plywood or cut out the template and trace around it on the plywood using a pencil. Cut out carefully with a coping saw, jigsaw, or similar saw capable of cutting curves. Drill a 1/4" hole in the centers of these 3 pieces of wood. Insert a 1/4" bolt through the pieces, with the smaller piece sandwiched in between the two larger pieces.

Wind 65 turns of #20 AWG magnet wire around the inner core of the winding tool, leaving a 6" long lead at the beginning. Do not cut the remaining wire when you are finished winding! When you are finished, remove the nut and carefully remove the outer side piece. Ready a piece of electrical tape before you remove the wire. Carefully work the wire off the winder without allowing it to uncoil much. As soon as you have it off, securely tape it as shown in the diagram below to prevent unwinding. Make sure it does not get any thicker than the 1/4" former it was wound on. Leave a 6" piece of wire and then wind three more coils like this, all as a single piece with about 6" of wire in between. When you are finished, cut the wire 6" beyond the third coil.

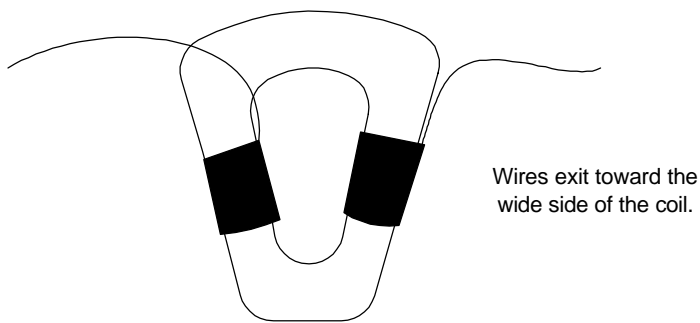

Use a piece of sandpaper or the edge of a knife to strip the ends of the leads approximately 1". You must strip the wire completely, removing all of the red enamel coating and leaving nothing but shiny copper. Fine grain sand paper is quite efficient at doing this.

Repeat this process to create three groups of four coils. Each of the 3 groups is made from a single piece of wire that is uncut. Each of these groups will be used to form a single phase of the alternator.

If you have a multimeter, it is useful to check the resistance of each coil group. All should be about the same (within 10 to 15%). The ones we wound in our test models were about 2.0 ohms. Your results will vary based on how tightly the coils are wound and other factors.

Step 4b: Positioning the Coils

Take the Stator template from the Templates section. Take a piece of 8" x 10" Plexiglas and carefully drill a 3/8" hole in its exact center. Find the center by drawing the two diagonal lines with ruler and pencil or marker. Also, drill 1/4" holes about 1 inch in from each corner.

CAUTION: When drilling Plexiglas you should never hold it with your bare hands. If the drill binds to the plastic material it can whip the piece around and slash your hand. Carefully clamp the piece between two pieces of wood or between wood and your work bench, or hold tightly with heavy leather gloves on. Stand back so if the piece does come loose and rotate it will not contact your body. Do not press too hard when drilling or you will crack the Plexiglas material. Also, use a high speed setting if you have a variable speed drill.

Place the Stator Template underneath this piece, aligning the center hole as marked on the template with the center hole you just drilled. Tape it in place so it does not move. You will be able to see the template through the Plexiglas (or similar clear plastic) and precisely position the coils.

Using hot glue or other glue, glue down a single phase of the coils as indicated on the template. The template marks each coil phase by a number, 1 to 3. Use the number 1 for the first phase coils, and so on. The coils must be oriented exactly as shown in the following figure, especially taking note of how the wires come off one coil and go to the next coil. You must not reverse the direction of the coils, they must all be facing the same direction (clockwise or anti-clockwise, it does not matter which as long as all are the same). Coils from a single phase are placed in every third position. There should be two empty spots between each coil.

The second and third phase are placed similarly. Place the second phase by putting coils after each of the coils in the first phase, then place the final phase by filling in the last set of empty spaces. In all cases, there must be two other coils between each coil of a given phase.

When finished, glue down the wires that connect coils down to the Plexiglas perimeter to keep them out of the way.

Place a flat piece of plywood or board on top of the coils affixed to the Plexiglas. Make sure all the coils are the same height. Place a large, heavy object on top or use clamps to press down the coils and make sure they are nice and flat at $\frac{1}{4}$ " in thickness. Use hot glue or epoxy to help hold down any coils that are too high if needed.

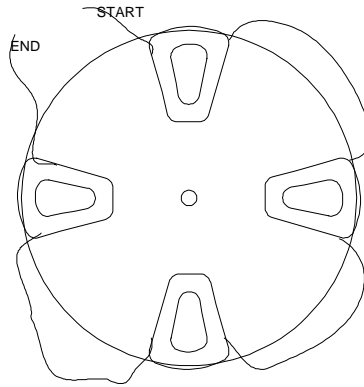

One phase of the alternator, note how all wires exit the coils in the same way, no coils have direction of the wire reversed.

Step 5: Building the Frame

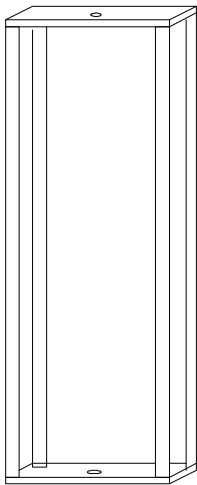

Cut 2 pieces of $\frac{1}{2}$ " thick plywood to 12" by 12". Drill a $\frac{3}{8}$ " hole in the exact center of each piece of plywood.

Cut 4 pieces of 4 foot long 2x2 wood to 34" in length, and keep the approximately 14" pieces you cut off. Affix each piece of 2x2 wood to a corner of one of the pieces of plywood by first drilling a $\frac{1}{16}$ " pilot hole then using 1 $\frac{1}{2}$ " wood screws. Drill pilot holes for the top piece of plywood but only insert one screw for now and keep it loose. The whole assembly is basically a "box" with two plywood pieces for a top and bottom and four posts at each corner, very simple.

Using the approximately 1 foot long pieces you cut off the 2x2 wood, create a square reinforcement frame on the underside of the bottom plywood base. Do this by cutting 2 pieces to exactly 12" long and attaching them to two opposite sides of the 12 x 12" plywood base, then cut the other two pieces so they fit in between as shown in the following diagram. Use wood screws from the top side of the plywood. It is recommended you drill pilot holes first. This frame is necessary for two reasons. First, it will allow the axle rod to extend below the bottom edge of the plywood which can be helpful for adjustments. Second, it will help to prevent the plywood base from warping, which could cause magnet/coil collisions in the alternator.

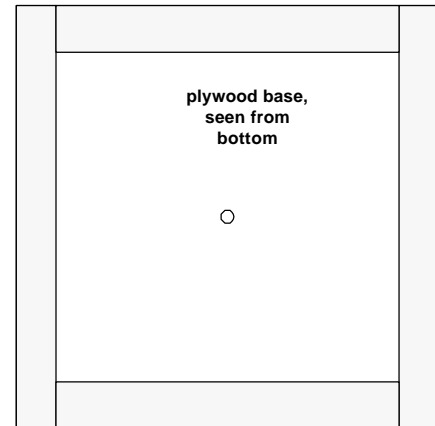

2x2 wood frame, screwed on from top side through pilot holes

Step 6: Building the Blade Assembly

Cut out the Blade Support Template from the templates section of this booklet. Trace it twice onto a piece of 1/2" plywood and cut out the pieces using a coping saw, jigsaw, or similar tool that can cut curves in wood. Drill a 3/8" hole as marked on the template.

Thread a nut about 6" from the bottom of a 3/8" threaded rod. Then place a washer under the nut and then one of the blade support pieces you just cut. Use another washer and nut to secure this support to the rod, tighten using a wrench. Do the same on the other side of the 3/8" threaded rod, but make sure the distance between the two blade supports is exactly 24" when measuring from the outer edges (in other words, it is 23" between the two when measuring from the inner edges of each piece of 1/2" plywood that the blade supports are made from). Also, make sure the two blade supports are positioned in the same way, do not position one upside-down. When viewed from above, the two shapes should overlap exactly and look the same. They should be rotated so they match up when viewed from above (looking down at the top surfaces of the blade supports. See the following diagram.

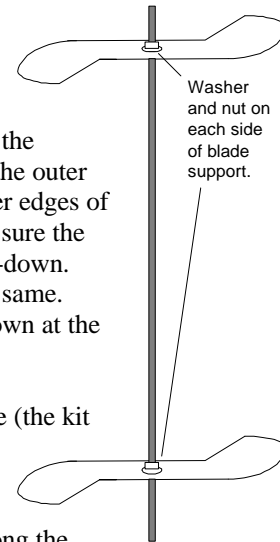

Take a piece of corrugated plastic and cut a piece exactly 24" long and 8" wide (the kit has these pre-cut for you). To make it easier to bend the plastic around the curved supports, it is suggested that you use a piece of scrap wood or a stiff yardstick to make 1" wide folds in it. Just press the ruler or wood strip against the plastic and fold over, forming a crease. These creases should be along the long edge of the plastic, i.e. in the same direction as the corrugations, not against them. About 3 such folds equally spaced is sufficient. The creased part will be attached to the bend as shown in the blade support template.

Drill 1/16" pilot holes as marked on the blade support template. Using small wood screws (1/2" long, thin) attach the plastic where indicated on the template, screwing into the side of the plywood blade support.

PicoTurbine Deluxe Rotor/Stator Assembly (side view)

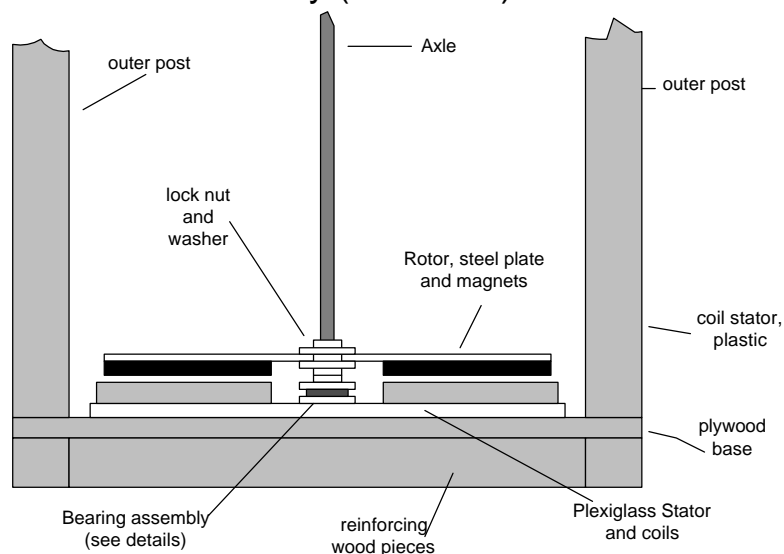

Step 7: Putting the Turbine Together

Place the stator on the bottom piece of plywood with the center holes of the two parts matching exactly. Use several wood screws around the outer edge to securely fasten down the bucket bottom stator.

Thread a nut about 3 inches down one side of the threaded rod, followed by a washer. Place the steel plate below this nut and washer, with the magnets facing down as shown in the following diagram. Place another washer and two more nuts below the steel plate. Then place another washer, the needle bearing, and yet another washer below the final nut, leaving about 1/2" of threaded rod exposed. Tighten the nuts to just light finger tightness so the steel disk remains fixed in place. Put this assembly through the center hole (keep the top piece of plywood swung out of the way for the moment).

Adjust this whole assembly so that the magnets float about 1/8" above the coils. You could use more washers if that makes things easier. Once it looks good, swing the other piece of plywood (the top) over and insert the top of the threaded rod into it. Screw it down lightly with only 2 screws on each diagonal. Spin the top of the threaded rod between thumb and forefinger, it should spin freely and there should be no collision with the coils (listen for a scraping sound). If there is a collision, adjust the nuts again or insert another washer at the bottom, but make sure it is not too far away, 1/8" is the most it should be. If you have built your coils very flat this should be possible. Once it looks good, tighten up the nuts using two wrenches and screw down the top piece of plywood tightly.

A few drops of oil on the bearing assembly and in the hole on the top plywood piece will help the assembly spin smoothly and with very little friction. If you take it outside even a very gentle breeze should start it up (about 2 to 3 miles per hour, even though you will not get much electricity from such a light wind).

Step 8: Wiring for DC Output

The PicoTurbine Deluxe alternator creates 3-phase AC power. For most applications this must be translated to DC (direct current). This is accomplished using a circuit called a rectifier that uses diodes to ensure current flows only in one direction.

If you have a digital multimeter, you can check the output from each phase before beginning. Connect the multimeter in AC volts mode, and give the turbine a good spin. From a single phase, you should get between 2 and 3 volts depending on how fast you spun the turbine and how well built it is (most critical is how small the air gap is between coils and magnets). Each phase should perform approximately the same.

You cannot simply connect the three groups of wires in series or parallel. This is because the waveforms of the voltage and current are out of phase between the three groups. If you simply connected them in series or parallel one phase would partially cancel out the other phases and power would be lost. Each phase must be rectified individually.

The wiring diagram to the right shows how the output wires from the alternator should be connected. Starting wire from each of the 3 phases are connected together, forming a "neutral" point. This point will be a reference of zero volts, and will not be used for rectification. It can be tied off with a wire nut. The other three wires are the "hot" wires that will be used in the rectifier circuit given in the next section.

After making this connection, you can connect your multimeter in DC volts mode to any two of the hot output leads. Give a good spin and you should see approximately 1.7 times as much voltage as you saw from a single phase. To test how much voltage

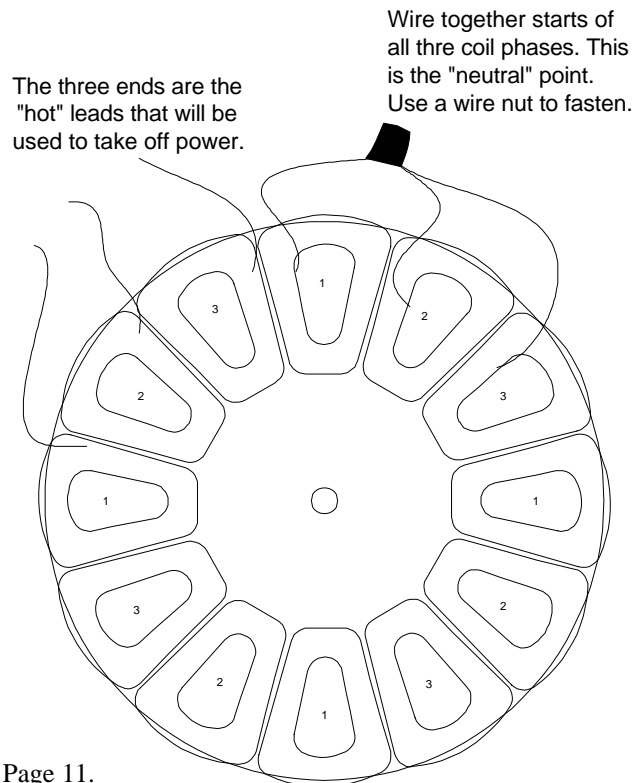

comes from a single phase, just measure from the neutral point to any of the three hot leads.

This type of wiring is called “star” configuration. When rectified, it sums the voltages of the three coil groups but leaves current the same as a single coil group. An alternative wiring is shown in the technical notes section, called “delta” wiring. It leaves voltage the same as a single coil group but multiplies the current by a factor of 3 on rectification.

Step 9: Wiring for Battery Charging

We can easily build a battery charging application from the rectified current produced by the circuit. Connect the battery as shown in the following diagram. **BE VERY CAREFUL.** You must connect the correct leads of the battery as shown. Shorting a NiCad battery can quickly destroy it and cause a surge of current that could destroy the diodes as well.

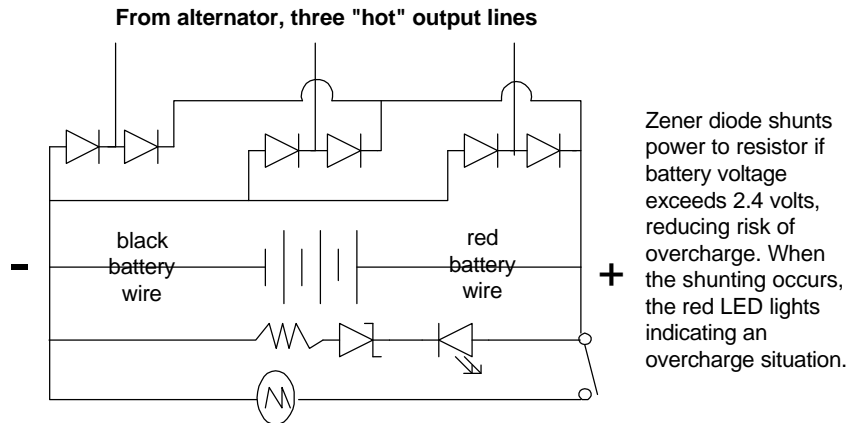

You can place these components into a waterproof box with a clear lid (supplied with kit) and create a small wind powered night light. Be sure to switch it off during the day and let the wind charge up the battery. At night you can turn on the switch and let the light be powered by wind and/or battery. By morning the battery will likely be discharged unless you had a lot of wind that night. The circuit shown also has a simple overvoltage feature.

A zener diode is used to shunt voltage to a power resistor if the battery exceeds a voltage of about 2.4 volts. Thus, power may be drained even if the switch is open, if the battery is full and the wind turbine is still charging it. This provides some protection for the battery, since overcharging can quickly limit its life. However, in a protracted strong wind this may not dissipate enough power to save the batteries, so caution should be used. During protracted windy periods it would be best to keep the light turned on to provide an additional load, or disconnect the battery entirely if you will not be in a position to monitor the situation from day to day.

PART 2: TEACHER'S GUIDE

Key Concepts

The key concepts taught by this project are:

- ◆ Three phase alternator wiring,
- ◆ Power rectification of three phase current,
- ◆ Battery charging issues such as dump loads,
- ◆ Resistive load issues such as cut-in.

As such, this project builds on the information found in the PicoTurbine Educational Windmill Kit and the PicoTurbine DC Experiments Kit. If those projects were not built first, you might want to review the technical information and teacher's guide for basic wind power information. The plans are available free for download.

The concepts in this project are obviously much more advanced than the small educational kit, and are appropriate for high school students or perhaps gifted children of a younger age who are interested in electronics and renewable energy.

Group Projects

In a classroom setting this is best built as a group project. If you do not have the capability to use power tools in the classroom, the wooden and plastic parts that need to be cut could be pre-cut in the school's wood shop or elsewhere. With all wooden parts cut and drilled to the proper dimensions, and the coil former constructed, no other power tools are needed. Simply a screw driver and pliers are sufficient to finish the project.

In a classroom environment a hot glue gun is probably not a good idea. The safest adhesive to use would be silicon glue, but it has a long drying time. If it is not necessary for the project to be used in severe weather you could substitute waterproof double-sided tape to hold the magnets to the rotor. The magnets tend to stick to the rotor anyway because of magnetic attraction, but if not taped or glued they could fly out of position at high RPM. If silicone glue is used, then final assembly would normally have to wait until the following day to allow 24 hours for full setting of the glue.

Mounting

The finished turbine could be mounted out of doors and monitored by the students over a period of time. It is best to mount the turbine at least four to five feet off the ground. This is to keep it clear of snow drifts (if you are in a temperate region) and also to get better wind. Near the ground the wind is usually much weaker. Mounting could be as simple as nailing the unit to a heavy base of some kind, such as a 4x4 beam, or perhaps by screwing the bottom of the unit to a flange screwed onto a 1" black pipe driven into the ground. It is necessary that the unit be held steady, or it will not be able to reach its maximum speed.

Experiments

Here are some experiments and project ideas that go beyond what is discussed in the building section.

Data Logging

A good long term project would be to measure output from the unit at the same time of day over a period of days or even weeks using a voltmeter. Another method would be to leave the light turned on for a certain number of hours each day and measure the state of charge of the battery periodically using the voltmeter. The measurements could be graphed and compared over time to note seasonal wind conditions and power production potential from a larger unit.

Electric Brakes

It is possible to implement a simple “electric brake” for this wind turbine. This is a very instructive experiment to perform on a windy day.

First, short circuit one of the three alternator hot leads to the neutral lead. This should slightly slow down the turbine, but it should be noticeable except in very strong winds. Remove the short and allow the turbine to speed up again, then try shorting two of the three hot leads with the neutral. This should slow the turbine down still further. Finally, short all three hot leads to the neutral lead. Unless the wind is very strong, this is likely to bring the rotor to a halt, or at the very least slow it down dramatically. This is because you are trying to take too much power off the alternator and this causes a magnetic drag effect.

You could build such a brake in a more permanent fashion using a single pole triple-throw (SP3T) switch. Connect the neutral point of the star to all 3 of the connections on one side, then connect one of each of the hot leads to each of the other switch terminals. Now, throwing the switch will connect each of the hot leads to the neutral lead, which should stop or at least greatly slow down the turbine. You could mount such a switch inside a waterproof enclosure with a lid, perhaps under the top section of plywood to help keep it dry.

Where is this power going? It is being dissipated as heat from the alternator coils. In this small turbine this is unlikely to ever cause a problem. In a larger, more efficient commercial turbine the heating could be very detrimental if the turbine fails to stop within a few seconds of applying the brake. The coils could literally melt from the heat generated.

Many small commercial systems use exactly this method to stop the turbine blades. It works as long as the wind power is not so strong that it can continue to turn the blades even on a short circuit. Because most commercial turbine alternators are built to be about 80% or more efficient, that means the wind would have to be so strong that it can keep turning the blades even though more than five times as much power is being drawn than normal.

Hybrid Systems

An excellent study would be to mount some solar photovoltaic (PV) cells on top of the unit (the plywood section on top has plenty of room for some cells) and produce a hybrid wind/PV system. We would suggest a PV cell that produces between 2 and 5 volts peak at 100 to 400 millivolts peak. Note how often the wind system compensates for the solar system and vice versa, providing an increase in reliability of the system. A blocking diode will be needed so the battery does not back-feed the PV at night. Connect the PV cell to the battery in parallel with the wind turbine output so that either or both can feed the battery. You should use a larger battery or have more load available (or both) to avoid overcharging on days that are both windy and sunny.

PART 3: Technical Notes

Three Phase Alternator Windings

The PicoTurbine Deluxe uses a three phase alternator. Each group of three coils is slightly out of phase with each other group. For example, when a magnet is directly over the center hole of the first magnet in phase 1, then the same pole of some other magnet is directly over the center hole of each other coil in that phase. Conversely, no other coil of any other phase has a magnet so positioned.

The effect of this is that waveforms for voltage and current overlap as shown in this figure:

There are several advantages to a three phase winding (as opposed to a single phase winding as used in the small PicoTurbine Educational Windmill kit):

- ◆ The turbine experiences much smoother operation because power is taken off more evenly. In a single phase winding the power is taken off of all coils at the same time (as magnets cut across the plane of the coil legs) and power goes to zero all at the same time (as magnets are between coil legs). This causes a “jerky” motion of the rotor assembly, resulting in wear and tear and noise.
- ◆ For similar reasons, rectified voltage and current are much smoother using three phase windings, even without the use of smoothing capacitors. Voltage and current remain more nearly in phase overall after rectification, meaning the “power factor” is better.

Star and Delta Wiring

You might think at first that six wires would be needed to take power off of a three phase winding. Actually, some wires can be shared, resulting in 3 wires emanating from the alternator. The two standard ways of achieving this are called “star” and “delta” wiring. In general, “star” configurations are used to attain a higher voltage, while “delta” is used to attain higher current. Power output from either is the same since power is voltage times current. In the text, a “star” winding is used to achieve high enough voltage to charge the two series NiCad batteries in low winds. “Delta” wiring is shown here and would result in lower voltage and higher current.

One interesting idea is to use a relay to switch between “star” and “delta” wiring configurations depending on wind speed. This is a simple form of voltage regulation, and could be used to optimize two different points on the power curve, for example for battery charging. More on this topic is discussed in the next section.

Another idea, used by some commercial turbines, is to wire two sets of three phases, and have one of these sets wired star and the other delta. The star wired set will cut in at a lower wind speed but provide less current, the delta set will cut in at a higher wind speed and provide more current. A third idea along these lines, used by Hugh Piggott of Scoraig wind electric, is to have each coil contain two separate sets of wires, one heavier gauge than the other with fewer turns and the other thinner with more turns.

The three black dots mark the "hot" leads that will be used to take off power. There is no "neutral" in delta wiring.

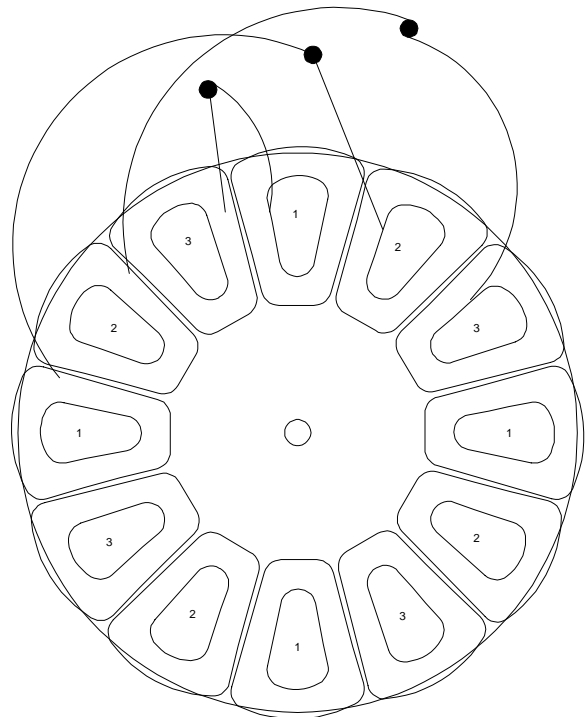

Again, one set of wires cuts in sooner but provides less current (for low winds) and the other provides higher current to take advantage of higher winds.

Battery vs. Resistive Loads and Efficiency

The circuit described in this booklet is a battery charging circuit. It is interesting to compare the mathematics of battery charging versus a resistive load such as a light bulb.

Battery Load Formula

The formula below shows the current flowing into the battery (IBAT) depending on the rectified voltage coming from the alternator (VALT) and the battery voltage (VBAT) as well as the coil resistance (RALT):

$$IBAT = (VALT - VBAT) / RALT$$

So, for example, if the battery is a NiCad and it currently holds a charge of 1.0 volts, and our alternator is currently outputting a rectified voltage of 2.0 volts and has an internal coil resistance of 5 ohms, then we would expect that $(2.0 - 1.0) / 5 = 200$ milliAmps to be flowing into the battery. The power being produced is this current times the battery voltage—in this example 200 milliAmps times 1.0 volts which is 200 milliWatts.

Resistive Load Formula

On the other hand, the mathematics of a resistive load are a bit different. A new variable must be added: the resistance of the load (RLOAD). The output power of the alternator is maximum when the load resistance is equal to the alternator's internal coil resistance. The current sent to the load would be:

$$ILOAD = (VALT * RLOAD) / (RLOAD + RALT)^2$$

For example, if as before our alternator is outputting 2.0 volts and has an internal resistance of 5 ohms, and we are driving a light bulb that has a resistance of 3 ohms, then the current flowing through the bulb would be $(2.0 * 3) / (5 + 3)^2 = 6/64 = 93$ milliAmps. If the bulb was 5 ohms, we achieve maximum current flowing to the bulb of 100 milliAmps. Load resistances of more or less than 5 ohms will result in less current making it to the load. Useful power is the alternator voltage times the load current. In the first example, 93 milliAmps times 2.0 volts, or 186 milliWatts.

Comparison of Battery vs. Resistive Loads

Let's compare how much useful power is generated in resistive vs. battery load conditions. The voltage coming off the alternator is proportional to its RPM. If you have built this project reasonably well, you might expect something like 1 volt for every 60 RPM (rectified, star wiring). Let's compare a 1.0 volt charge state NiCad battery vs. a 5 ohm light bulb at various speeds and note the amount of useful power being produced by the turbine:

RPM	Voltage (rectified)	Power to 1.0 Volt NiCad (watts)	Power to 5 ohm lamp (watts)
60	1.0	0	.05
120	2.0	.2	.2
180	3.0	.4	.45
240	4.0	.6	.8
300	5.0	.8	1.25
360	6.0	1.0	1.8
420	7.0	1.2	2.45

As you can see, the characteristics are quite different. The NiCad does not begin drawing current until the alternator voltage exceeds the battery voltage, and after that point the power increases linearly with increased RPM. On the other hand, the resistive load starts drawing power immediately, no matter how low

the voltage from the alternator is. It draws power at a much higher rate as RPM increases. In fact, power drawn increases with the square of the RPM—doubling the RPM increases power by a factor of four to a resistive load but only a factor of two to a battery.

This behavior brings both advantages and problems. If used for battery charging, a wind turbine that is directly connected will “cut in” as soon as its output voltage exceeds the battery voltage. This is good—it means the rotor can come up to speed with no load. In the resistive load case special controls are needed to prevent the load from cutting in before the rotor reaches a reasonable speed, in the battery case this happens automatically. If controls were not used with a resistive load then an efficient alternator might never allow the rotor to get started in the first place, and no power would be produced.

The disadvantage of a battery load is that without special controls the power take-off is linear and does not come near to matching the power curve of the wind (which is cubic). So, system efficiency degrades rapidly as wind speed increases. A resistive load matches wind power much better, being a quadratic curve (although it still lags the cubic nature of wind power).

One improvement to the battery charging curve matching problem would be to switch from “star” to “delta” at a certain RPM. This would have the effect of cutting VALT and also cutting RALT. This would increase the power take-off in a battery situation and help the power curves more closely match. In effect you could “bracket” two wind speeds that would have reasonably high efficiency instead of just one.

Commercial wind turbines often use sophisticated voltage regulation systems to help the power curve of the alternator match that of the wind. These systems typically use power transistors to regulate the voltage and current being delivered to the load.

Dump Loads

The building instructions include a simple circuit to provide a “dump load” if the battery is nearing an overcharge state. This is a common method of protecting batteries while at the same time maintaining a load on the rotor.

For the Savonius design used in this project, it is actually not very important to maintain a load on the rotor. This is because the Savonius design is relatively low speed and even in very strong winds the rotor is in little danger of overspeeding to the point of causing damage to the materials. This is not true of larger wind turbines based on either the usual horizontal axis design or other vertical axis designs such as the Darrius rotor. Those designs will rotate several times faster than the wind (the speed of the tip of the rotor will be up to 11 times the wind speed). A large Darrius or horizontal axis turbine might have a tip speed on the rotor near the speed of sound! Without a load the tip speed increases even further and the machine can literally tear itself apart from centrifugal force.

It is common for small wind turbines to depend on a load always being present to avoid this situation. Large power resistors are often used. An alternative that attempts to take advantage of this excess power would be to dump the extra power into a heating unit such as a hot water heater or space heater. Note that the lamp is not used as the dump load. It would be a bad design to depend on a lamp as a safety dump load: if the lamp burns out during a big windstorm then the dump load is gone!

In commercial systems, the simple zener diode shunt is not typically used. Typically power electronics are used to more precisely monitor voltage and allow for fine tuning of the shunt voltage. This zener based circuit was used in this educational kit because it is cheap and easy to wire and understand.

Alternative Designs and Materials

This section discusses some alternative designs and building materials you could use. We will not present detailed plans and diagrams, just discuss ideas. You should be able to make building adjustments yourself and experiment with these ideas.

Double-disk Alternator

It is possible to quadruple the power output of the alternator by placing a second magnet disk below the coils. To do this:

- Construct a second magnet disk identical to the first.
- Suspend the plexiglass stator above the plywood base several inches, perhaps using bolts or pieces of wood or brackets attached to the uprights.
- Thread the second disk below the plexiglass stator, about 1/8" away so it does not touch it when spinning. The second disk will strongly attract to the first disk so be careful when you assemble this that your fingers don't get slammed in between the two disks. The second disk will naturally align itself so that its North poles will align with the first disks South poles and vice versa. This is the right way for it to be aligned.
- Move the thrust washer assembly down to the wooden base, don't support it on the plexiglass which will not be strong enough. Allow the base to bear the weight.
- Use a six foot 3/8" threaded rod instead of a 3 foot rod. Construct blades that are 5 feet long instead of 2 feet long by using multiple sections of supports and plastic (3 sections each 1' 8" long). Make the blades 1 foot wide instead of 9 inches wide. You can use the same blade templates to cut the curves at the ends, just add three extra inches of wood in the center. You can rotate these three sections from each other 120 degrees to smooth out the torque and help startup in low winds from different angles.
- Increase the length of the side posts to accommodate the taller blades, and increase the size of the top and bottom plates to accommodate the increased blade width.

This design is harder to build and obviously costs more because of the use of the second set of magnets and disk and the extra blade material. It is harder to adjust the spacing for the magnets and coils to avoid collisions yet maintain a small air gap. However, all this trouble is worth it: this version can produce four times as much power as the standard version.

Woodless Construction

The weak point in this design is the use of wood. After a period of time, wood can warp, shrink, or absorb water and swell, which might cause a coil/magnet collision. This will cause the turbine to require adjustments periodically.

It is possible to build the project using no wooden pieces that affect the alternator. Substitute:

- Angle irons for the upright sections of wood,
- 1/4" plexiglass sheet for top and bottom supports, or alternatively any type of hard, stiff plastic material such as Lexan, acrylic, etc. Do not use metal (steel, aluminum, etc.) for the bottom plate! This will cause loss of efficiency because the alternator magnets will induce eddy currents in the metal, just like the "electric brakes" discussed previously.

Use angle brackets and bolts to connect the angle irons to the plexiglass. Be very careful when drilling plexiglass as mentioned above in the text. The thicker grade of plexiglass is required for stability. It is not necessary to replace the plywood used for the blade supports with any other kind of material because a little warping of that part will not affect the alternator.

The advantages of this design are that you should be able to reduce the gap between magnets and coils because you won't have to worry as much about structural warping, and also the plexiglass will provide a better, smoother bearing for the 3/8" threaded rod. You might expect to get some extra power out of the turbine because of these factors, and it will clearly last longer and require less maintenance.

Alternative Blade Designs

It is possible to use this same basic framework to test different blade designs. It might be instructive to attempt to build a Darrius style blade, which is aerodynamic instead of drag based. This could be built by

cutting out air foil cross sections from plywood, stringing them all together with threaded rods, then attaching a “skin” made from corrugated plastic. To find a suitable cross section simply do a patent search on the word “Darrius” on <http://www.patents.ibm.com>. It is legal to build patents for your own experimental purposes as long as you do not commercially profit from the design. Many patents are expired anyway. An “H-bar” Darrius will be the simplest to construct. Do some web searches and you will find a great deal of information about this design, which has been extensively researched.

Better Bearings

The bearings used in this small wind turbine are not optimal and are a source of friction and loss of efficiency. This is especially true of the top bearing, which is simply a hole in a piece of wood. The bottom bearing is a small needle point roller bearing and is reasonable, however the threaded rod still contacts the wooden frame and causes significant friction.

We have experimented with using a small scrap of plexiglas for the top bearing and have gotten better results. To do this, simply drill out the top plywood hole to a larger diameter (7/16” or 1/2”). Then drill a 3/8” hole in a piece of Plexiglas about 3” by 1”. Drill smaller, 1/8” holes near the edges to accommodate smaller screws to hold the Plexiglas in place. Position the Plexiglas bearing so that the threaded rod does not contact the wood. Put a drop or two of oil where the rod meets the Plexiglass hole.

It is of course also possible to use ball bearings or other more sophisticated methods of reducing friction. For a small project like this it is probably not worth the expense of purchasing such items, but if you build a larger machine then the efficiency gained can be worth the trouble.

TEMPLATES

The following templates are actual size. As described in the text, they can be used to easily mark parts for cutting or for gluing together. The back sides of these templates are purposely left blank so you can use them directly, but you may want to make a copy of them for safe keeping in case you want to build these projects again later.

Some of these templates are slightly too wide to print completely on the edges of standard paper. They are still quite useable even though a small amount of the edges are blank.

COIL WINDING FORM TEMPLATE

Approximate Coil size
and shape (actual size)

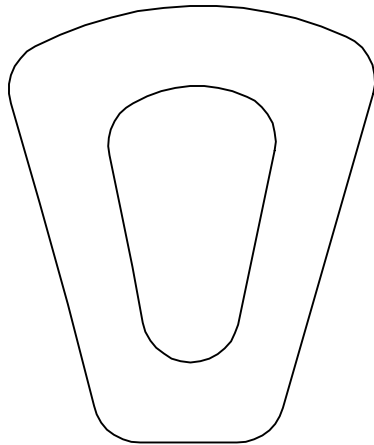

Former wood pattern
(actual size)
Former is 1/4" thick

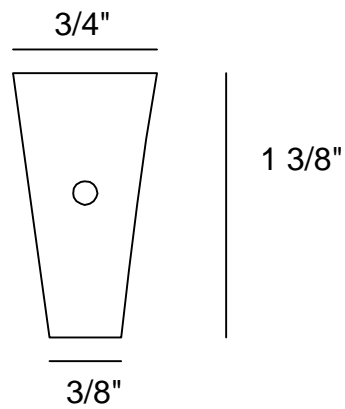

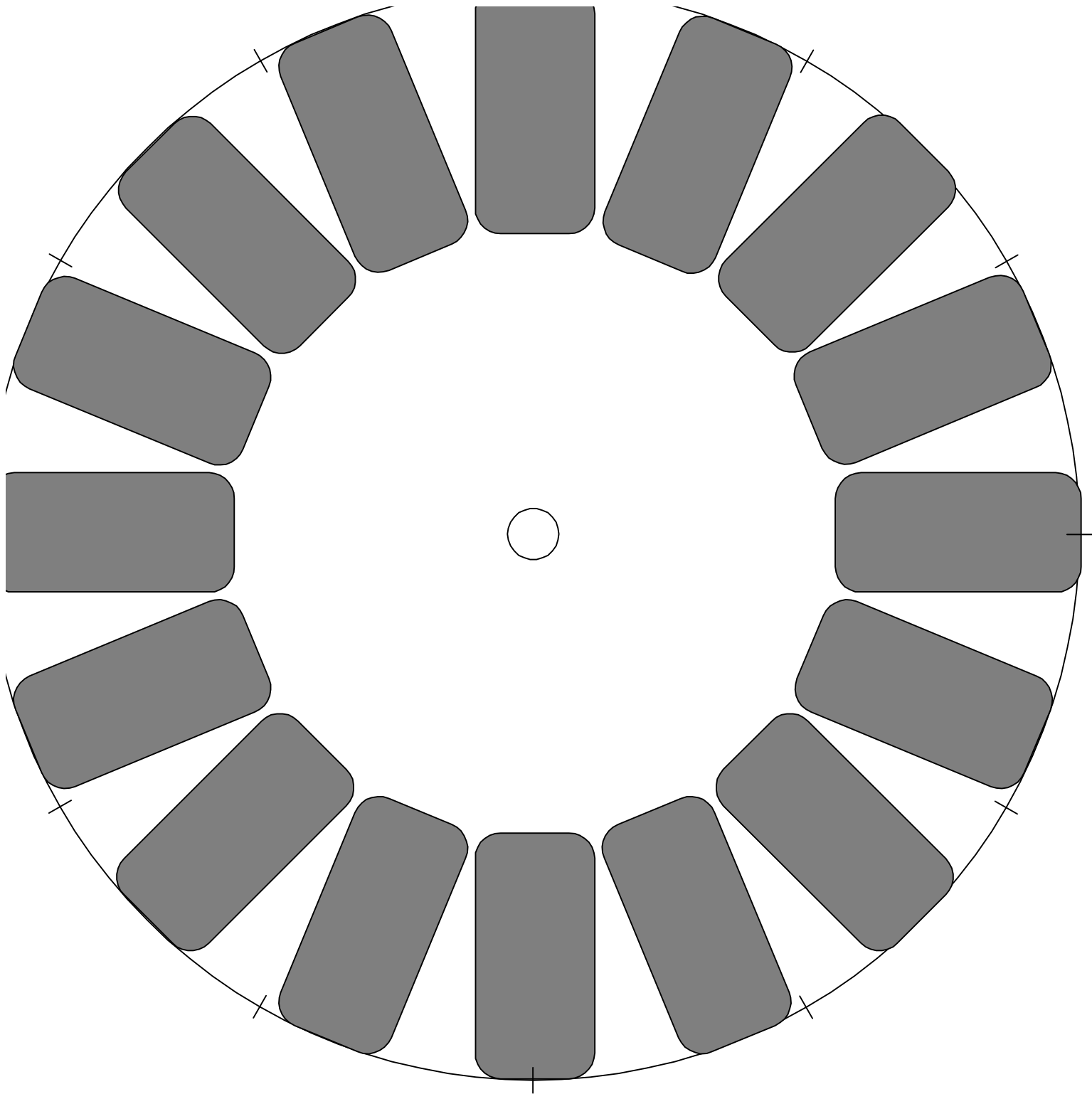

ROTOR TEMPLATE

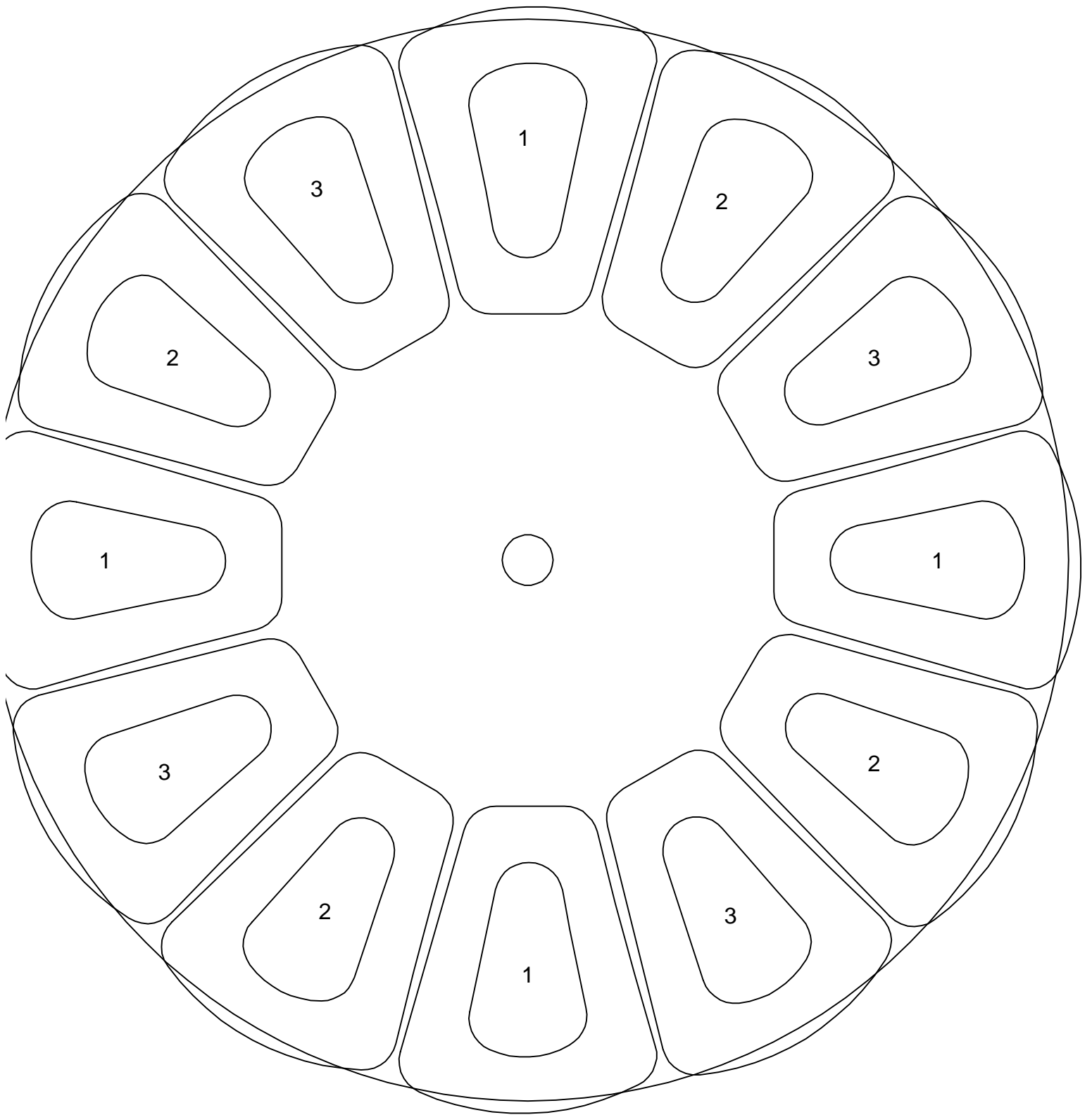

STATOR TEMPLATE

Blade Support Template (actual size)

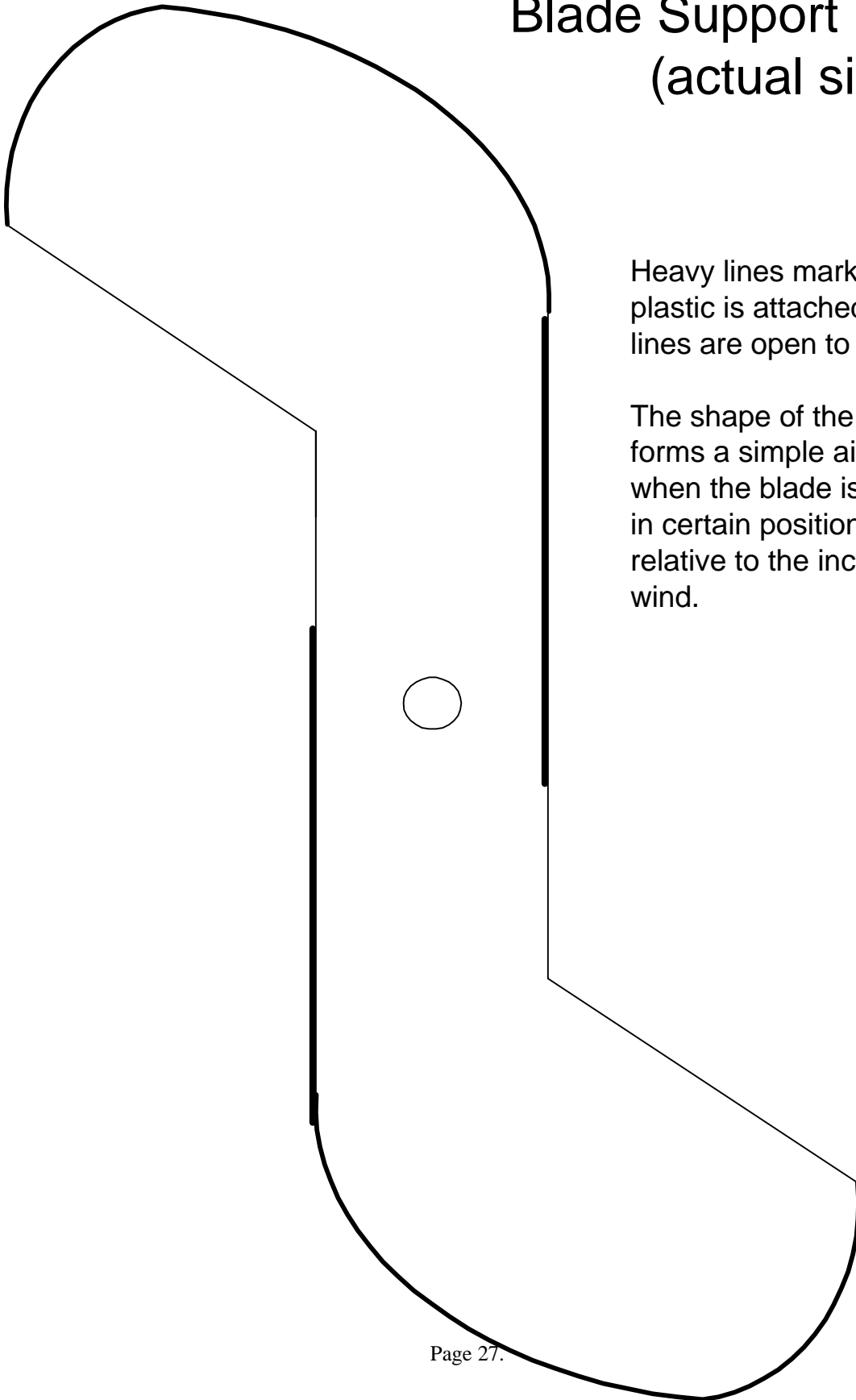

Heavy lines mark where plastic is attached. Light lines are open to the wind.

The shape of the blade forms a simple air foil when the blade is oriented in certain positions relative to the incoming wind.